

ACS800

Hardware Manual

ACS800-31 Drives (5.5 to 110 kW)

ACS800-U31 Drives (7.5 to 125 hp)



List of related manuals

Drive hardware manuals and guides	Code (English)
<i>ACS800-31/U31 Hardware Manual (5.5 to 110 kW, 7.5 to 125 hp)</i>	3AFE68599954
Drive firmware manuals and guides	
<i>ACS800 Standard Control Program Firmware Manual and Adaptive Program Application Guide</i>	3AFE64527592 3AFE64527274
<i>ACS800 IGBT Supply Control Program Firmware Manual</i>	3AFE68315735
<i>ACS800 System Control Program Firmware Manual and Adaptive Program Application Guide</i>	3AFE64670646 3AFE68420075
<i>ACS800 Permanent Magnet Synchronous Machine Control Program Supplement to Firmware Manual for System Control Program</i>	3AFE64492641
<i>ACS800 Permanent Magnet Synchronous Machine Drive Control Program Supplement to Firmware Manual for ACS800 Standard Control Program</i>	3AFE68437890
<i>ACS800 Crane Control Program Firmware Manual</i>	3AFE68775230
<i>ACS800 Master/Follower Application Guide</i>	3AFE64590430
<i>ACS800 Pump Control Application Program Firmware Manual</i>	3AFE68478952
<i>ACS800 Extruder Control Program Supplement</i>	3AFE64648543
<i>ACS800 Centrifuge Control Program Supplement</i>	3AFE64667246
<i>ACS800 Traverse Control Program Supplement</i>	3AFE64618334
<i>ACS800 Winch Control Program (+N698) Firmware Manual</i>	3AUA0000031177
<i>ACS800 Rod Pump Light Control Program Firmware Manual</i>	3AUA0000005304
etc.	

Option manuals and guides

<i>ACS800-01/04/11/31/104/104LC Safe torque off function (+Q967), Application guide</i>	3AUA0000063373
<i>RDCO-01/02/03 DDCS Communication Option Modules</i>	3AFE64492209
<i>AIMA-01 I/O Module Adapter User's Manual</i>	3AFE64661442
<i>NBRA-6xx Braking Choppers Installation and Start-up Guide</i>	3AFY58920541
<i>ACS800 Vibration Damper Installation Guide</i>	3AFE68295351
<i>Manuals and quick guides for I/O extension modules, fieldbus adapters, etc.</i>	

You can find manuals and other product documents in PDF format on the Internet. See section [Document library on the Internet](#) on the inside of the back cover. For manuals not available in the Document library, contact your local ABB representative.



[ACS800-31/U31 manuals](#)

ACS800-31 Drives
5.5 to 110 kW
ACS800-U31 Drives
7.5 to 125 hp

Hardware Manual

3AFE68599954 Rev B
EN
EFFECTIVE: 2013-03-04

Safety instructions

What this chapter contains

This chapter contains the safety instructions which you must follow when installing, operating and servicing the drive. If ignored, physical injury or death may follow, or damage may occur to the drive, motor or driven equipment. Read the safety instructions before you work on the unit.

Use of warnings and notes

There are two types of safety instructions throughout this manual: warnings and notes. Warnings caution you about conditions which can result in serious injury or death and/or damage to the equipment. They also tell you how to avoid the danger. Notes draw attention to a particular condition or fact, or give information on a subject. The warning symbols are used as follows:



Dangerous voltage warning warns of high voltage which can cause physical injury and/or damage to the equipment.



General warning warns about conditions, other than those caused by electricity, which can result in physical injury and/or damage to the equipment.



Electrostatic discharge warning warns of electrostatic discharge which can damage the equipment.

Installation and maintenance work

These warnings are intended for all who work on the drive, motor cable or motor.



WARNING! Ignoring the following instructions can cause physical injury or death, or damage to the equipment.

- **Only qualified electricians are allowed to install and maintain the drive.**
- Never work on the drive, motor cable or motor when main power is applied. After disconnecting the input power, always wait for 5 min to let the intermediate circuit capacitors discharge before you start working on the drive, motor or motor cable.

Always ensure by measuring with a multimeter (impedance at least 1 Mohm) that:

1. voltage between drive input phases U1, V1 and W1 and the frame is close to 0 V.
 2. voltage between terminals UDC+ and UDC- and the frame is close to 0 V.
- Do not work on the control cables when power is applied to the drive or to the external control circuits. Externally supplied control circuits may cause dangerous voltages inside the drive even when the main power on the drive is switched off.
 - Do not make any insulation or voltage withstand tests on the drive or drive modules.
 - When reconnecting the motor cable, always check that the phase order is correct.
 - After maintaining or modifying a drive safety circuit or changing circuit boards inside the module, retest the functioning of the safety circuit according to the start-up instructions.
 - Do not change the electrical installations of the drive except for the essential control and power connections. Changes may affect the safety performance or operation of the drive unexpectedly. All customer-made changes are on the customer's responsibility.

Note:

- The motor cable terminals on the drive are at a dangerously high voltage when the input power is on, regardless of whether the motor is running or not.
- The brake control terminals (UDC+, UDC-, R+ and R- terminals) carry a dangerous DC voltage (over 500 V).
- Depending on the external wiring, dangerous voltages (115 V, 220 V or 230 V) may be present on the terminals of relay outputs RO1 to RO3.

- At installation sites above 2000 m (6562 ft), the terminals of the RMIO board and optional modules attached to the board do not fulfil the Protective Extra Low Voltage (PELV) requirements stated in EN 50178 and EN 61800-5-1.
- The Prevention of unexpected start-up function (option +Q950) does not remove the voltage from the main and auxiliary circuits.
- The Safe torque off function (option +Q967) does not remove the voltage from the main and auxiliary circuits.

Grounding

These instructions are intended for all who are responsible for the grounding of the drive.



WARNING! Ignoring the following instructions can cause physical injury, death, increased electromagnetic interference and equipment malfunction.

- Ground the drive, motor and adjoining equipment to ensure personnel safety in all circumstances, and to reduce electromagnetic emission and pick-up.
- Make sure that grounding conductors are adequately sized as required by safety regulations.
- In a multiple-drive installation, connect each drive separately to protective earth (PE).
- ACS800-31: In European CE compliant installations and in other installations where EMC emissions must be minimized, make a 360° high frequency grounding of cable entries in order to suppress electromagnetic disturbances. In addition, connect the cable shields to protective earth (PE) in order to meet safety regulations.
- Drives with EMC filter option +E202 or +E200 are not suitable for use in an IT system (an ungrounded power system or a high-resistance-grounded [over 30 ohms] power system). Before connecting the drive to the power system, disconnect the EMC filter capacitors as described in section *IT (ungrounded) systems* on page 70.

Note:

- Power cable shields are suitable for equipment grounding conductors only when adequately sized to meet safety regulations.
- As the normal leakage current of the drive is higher than 3.5 mA AC or 10 mA DC (stated by EN 61800-5-1, 4.3.5.5.2), a fixed protective earth connection is required.

Mechanical installation and maintenance

These instructions are intended for all who install and service the drive.

WARNING! Ignoring the following instructions can cause physical injury or death, or damage to the equipment.



- Handle the unit carefully.
- The drive is heavy. Do not lift it alone. Do not lift the unit by the front cover. Place the unit only on its back.

Do not tilt!



- Beware of hot surfaces. Some parts, such as heatsinks of power semiconductors, remain hot for a while after disconnection of the electrical supply.
 - Make sure that dust from drilling does not enter the drive when installing. Electrically conductive dust inside the unit may cause damage or malfunctioning.
 - Ensure sufficient cooling.
 - Do not fasten the drive by riveting or welding.
-

Printed circuit boards



WARNING! Ignoring the following instructions can cause damage to the printed circuit boards.

- The printed circuit boards contain components sensitive to electrostatic discharge. Wear a grounding wrist band when handling the boards. Do not touch the boards unnecessarily.
-

Fibre optic cables



WARNING! Ignoring the following instructions can cause equipment malfunction and damage to the fibre optic cables.



- Handle the fibre optic cables with care. When unplugging optic cables, always grab the connector, not the cable itself. Do not touch the ends of the fibres with bare hands as the fibre is extremely sensitive to dirt. The minimum allowed bend radius is 35 mm (1.4 in.).
-

Operation

These warnings are intended for all who plan the operation of the drive or operate the drive.



WARNING! Ignoring the following instructions can cause physical injury or death, or damage to the equipment.

- Before adjusting the drive and putting it into service, make sure that the motor and all driven equipment are suitable for operation throughout the speed range provided by the drive. The drive can be adjusted to operate the motor at speeds above and below the speed provided by connecting the motor directly to the power line.
- Do not activate automatic fault reset functions of the Standard Control Program if dangerous situations can occur. When activated, these functions will reset the drive and resume operation after a fault.
- Do not control the motor with the disconnecting device (disconnecting means); instead, use the control panel keys  and , or commands via the I/O board of the drive. The maximum allowed number of charging cycles of the DC capacitors (i.e. power-ups by applying power) is five in ten minutes.
- The Safe torque off function (option +Q967) can be used for stopping the drive in emergency stop situations. In the normal operating mode, use the Stop command instead.

Note:

- If an external source for start command is selected and it is ON, the drive (with Standard Control Program) will start immediately after fault reset unless the drive is configured for 3-wire (a pulse) start/stop.
- When the control location is not set to Local (L not shown in the status row of the display), the stop key on the control panel will not stop the drive. To stop the drive using the control panel, press the LOC/REM key and then the stop key .

Permanent magnet motor

These are additional warnings concerning permanent magnet motor drives. Ignoring the instructions can cause physical injury or death, or damage to the equipment.

Note: Controlling a permanent magnet motor is only allowed using the ACS800 Permanent Magnet Synchronous Motor Drive Control Program.

Installation and maintenance work



WARNING! Do not work on the drive when the permanent magnet motor is rotating. Also, when the supply power is switched off and the drive is stopped, a rotating permanent magnet motor feeds power to the main circuit of the drive including the input power terminals.

Before installation and maintenance work on the drive:

- Stop the motor.
 - Ensure that the motor cannot rotate during work. Prevent the start-up of any drives in the same mechanical group by opening the Prevention of unexpected start-up switch (option +Q950) or the Safe torque off switch (option +Q967) and padlocking it. Make sure that no other system, like hydraulic crawling drives, are able to rotate the motor directly or through any mechanical connection like felt, nip, rope, etc.
 - Ensure that there is no voltage on the drive power terminals:
 - Alternative 1)* Disconnect the motor from the drive with a safety switch or by other means. Measure that there is no voltage present on the drive input, output or DC terminals (U1, V1, W1, U2, V2, W2, UDC+, UDC-).
 - Alternative 2)* Measure that there is no voltage present on the drive input, output or DC terminals (U1, V1, W1, U2, V2, W2, UDC+, UDC-). Ground the drive output terminals temporarily by connecting them together as well as to the PE.
 - Alternative 3)* If possible, both of the above.
-

Start-up and operation



WARNING! Do not run the motor over the rated speed. Motor overspeed leads to overvoltage which can damage the capacitors in the intermediate circuit of the drive.

Table of contents

List of related manuals	2
-------------------------------	---

Safety instructions

What this chapter contains	5
Use of warnings and notes	5
Installation and maintenance work	6
Grounding	7
Mechanical installation and maintenance	8
Printed circuit boards	9
Fibre optic cables	9
Operation	10
Permanent magnet motor	11
Installation and maintenance work	11
Start-up and operation	11

Table of contents

Introduction to this manual

What this chapter contains	21
Intended audience	21
Categorization according to the frame size	21
Categorization according to the plus code	21
Contents	22
Installation and commissioning flowchart	23
Terms and abbreviations	24

Operation principle and hardware description

What this chapter contains	27
Product overview	27
Terms	30
Operation principle	30
Line-side converter	30
Motor-side converter	30
AC voltage and current waveforms	31
Motor control	32
Printed circuit boards	32
DDCS communication modules	32
Main circuit and control interfaces diagram	33
Fieldbus control of the line-side converter	34
Control block diagram	34
Connection diagram of the RMIO board in the line-side converter	35
Type code	36

Mechanical installation

What this chapter contains	37
Unpacking the unit	37
Checking the delivery	38
Moving the unit	39
Before installation	40
Requirements for the installation site	40
Wall	40
Floor	40
Free space around the unit	41
Mounting the drive on the wall	41
Units without vibration dampers	41
Units with vibration dampers	41
Cabinet installation	42
Preventing cooling air recirculation	42
Unit above another	43
Installing cabinet duct plates (optional)	43
Installation kits	43
Before you start	44
Installation	44
Assembly drawing for cabinet duct plates	45

Planning the electrical installation

What this chapter contains	47
Motor selection and compatibility	47
Protecting the motor insulation and bearings	48
Requirements table	49
Permanent magnet motor	54
Supply connection	54
Disconnecting device (disconnecting means)	54
EU	54
US	54
Fuses	54
Thermal overload and short-circuit protection	54
Thermal overload protection	54
Short-circuit protection	55
Ground fault protection	56
Emergency stop devices	56
Prevention of unexpected start-up (option +Q950)	57
Safe torque off (option +Q967)	58
Safe torque off circuit diagram	59
Selecting the power cables	60
General rules	60
Alternative power cable types	61
Motor cable shield	61
Additional US requirements	62
Conduit	62
Armored cable / shielded power cable	62

Power factor compensation capacitors	63
Equipment connected to the motor cable	63
Installation of safety switches, contactors, connection boxes, etc.	63
Bypass connection	63
Using a contactor between the drive and the motor	64
Protecting the relay output contacts and attenuating disturbances in case of inductive loads.	65
Selecting the control cables	66
Relay cable	66
Control panel cable	66
Connection of a motor temperature sensor to the drive I/O	67
Installation sites above 2000 metres (6562 feet)	67
Routing the cables	67
Control cable ducts	68

Electrical installation

What this chapter contains	69
Checking the insulation of the installation	69
Drive	69
Supply cable	69
Motor and motor cable	70
IT (ungrounded) systems	70
Disconnecting the EMC filter capacitors	71
Units of frame size R5	71
Units of frame size R6	71
Connecting the power cables	72
Diagram	72
Conductor stripping lengths	73
Allowed wire sizes, tightening torques	73
Wall installed units (European version)	73
Power cable installation procedure	73
Wall installed units (US version)	76
Warning sticker	77
Cabinet installed units (IP00, UL type open)	77
Connecting the control cables	78
Terminals	78
360 degrees grounding	79
Connecting the shield wires	79
Cabling of I/O and fieldbus modules	80
Pulse encoder module cabling	80
Fastening the control cables and covers	81
Installation of optional modules and PC	81
Connecting a PC to the motor-side RMIO board	82

Installation of the AGPS board (Prevention of unexpected start-up, +Q950)

What this chapter contains	83
Prevention of unexpected start-up (+Q950)	83
Installation of the AGPS board	83
Circuit diagram	85

Start-up and validation	85
Use	86
Maintenance	86
Dimensional drawing	86

Installation of the ASTO board (Safe torque off, +Q967)

What this chapter contains	87
Safe torque off (+Q967)	87
Installation of the ASTO board	87
Circuit diagram	89
Validation and start-up	89
Dimensional drawing	89

Motor control and I/O board (RMIO)

What this chapter contains	91
Note on terminal labelling	91
Note on external power supply	91
Parameter settings	91
External control connections (non-US)	92
External control connections (US)	93
RMIO board specifications	94
Analogue inputs	94
Constant voltage output	94
Auxiliary power output	94
Analogue outputs	94
Digital inputs	94
Relay outputs	95
DDCS fibre optic link	95
24 VDC power input	95

Installation checklist

What this chapter contains	97
Installation checklist	97

Start-up and use

What this chapter contains	99
Start-up and use	99
Control panel	100
To control the line-side converter... ..	100
To control the motor-side converter... ..	101
Removing the control panel	101

Actual signals and parameters

What this chapter contains	103
----------------------------------	-----

Line-side converter actual signals and parameters in the motor-side converter control program .	103
Terms and abbreviations	103
Actual signals	104
09 ACTUAL SIGNALS	104
Parameters	104
95 HARDWARE SPECIF	104
ACS800-31/U31 specific parameters in the IGBT Supply Control Program	105
Terms and abbreviations	105
Parameters	105
16 SYSTEM CTR INPUTS	105
31 AUTOMATIC RESET	106
Fixed parameters with the ACS800-31 and ACS800-U31	107

Maintenance

What this chapter contains	109
Safety	109
Maintenance intervals	109
Heatsink	110
Main cooling fan	110
Fan replacement (R5, R6)	111
Additional fan	111
Replacement (R5)	111
Replacement (R6)	112
Capacitors	112
Reforming	112

Fault tracing

What this chapter contains	113
Faults and warnings displayed by the CDP 312R control panel	113
Conflicting ID numbers	113
LEDs	114

Technical data

What this chapter contains	115
IEC data	115
Ratings	115
Symbols	116
Sizing	116
Derating	116
Temperature derating	116
Altitude derating	116
Mains cable fuses	117
Cable types	119
Cable entries	119
Dimensions, weights and noise	119
NEMA data	120

Ratings	120
Symbols	120
Input cable fuses	121
Cable types	122
Cable Entries	122
Dimensions, weights and noise	122
Input power connection	123
Motor connection	124
Efficiency	124
Cooling	124
Degree of protection	124
AGPS-11C (option +Q950)	124
ASTO-11C (option +Q967)	125
Ambient conditions	125
Materials	126
Applicable standards	126
CE marking	127
Compliance with the European Low Voltage Directive	127
Compliance with the European EMC Directive	127
Compliance with the European Machinery Directive	127
Compliance with EN 61800-3:2004	127
Definitions	127
First environment (drive of category C2)	128
Second environment (drive of category C3)	128
Second environment (drive of category C4)	129
"C-tick" marking	129
UL/CSA markings	130
UL checklist	130

Dimensional drawings

Frame size R5 (IP21, UL type open, UL type 1)	132
Frame size R6 (IP21, UL type open, UL type 1)	133
Cabinet duct plates (optional), frame size R5	134
Cabinet duct plates (optional), frame size R6	135
Package (frame size R5)	136
Package (frame size R6)	136
AGPS board with enclosure (optional)	137
ASTO board with enclosure (optional)	138

Resistor braking

What this chapter contains	139
How to select the correct drive/chopper/resistor combination	139
External brake chopper and resistor(s) for the ACS800-31/U31	140
Brake chopper and resistor installation	141
Protection	141
Brake circuit commissioning	142

External +24 V power supply for the RMIO boards via terminal X34

What this chapter contains	143
Parameter settings	143
Connecting +24 V external power supply	144
RMIO board of the motor-side converter	144
RMIO board of the line-side converter	146
Frame size R5	146
Frame size R6	146

Further information

Product and service inquiries	149
Product training	149
Providing feedback on ABB Drives manuals	149
Document library on the Internet	149

Introduction to this manual

What this chapter contains

This chapter describes the intended audience and contents of this manual. It contains a flowchart of steps in checking the delivery, installing and commissioning the drive. The flowchart refers to chapters/sections in this manual and other manuals.

Intended audience

This manual is intended for people who plan the installation, install, commission, use and service the drive. Read the manual before working on the drive. The reader is expected to know the fundamentals of electricity, wiring, electrical components and electrical schematic symbols.

This manual is written for readers worldwide. Both SI and imperial units are shown. Special US instructions for installations within the United States that must be installed per the National Electrical Code and local codes are marked with (US).

Categorization according to the frame size

Some instructions, technical data and dimensional drawings which concern only certain frame sizes are marked with the symbol of the frame size R2, R3, ... or R8. The frame size is not marked on the drive designation label. To identify the frame size of your drive, see the rating tables in chapter [Technical data](#).

The ACS800-31/U31 is manufactured in frame sizes R5 and R6.

Categorization according to the plus code

The instructions, technical data and dimensional drawings which concern only certain optional selections are marked with plus codes, e.g. +E202. The options included in the drive can be identified from the plus codes visible on the type designation label of the drive. The plus code selections are listed in chapter [Operation principle and hardware description](#) under [Type code](#).

Contents

The chapters of this manual are briefly described below.

Safety instructions give safety instructions for the installation, commissioning, operation and maintenance of the drive.

Introduction to this manual lists the steps in checking the delivery and installing and commissioning the drive and refers to chapters/sections in this manual and other manuals for particular tasks.

Operation principle and hardware description describes the drive.

Mechanical installation instructs in how to place and mount the drive.

Planning the electrical installation instructs in the motor and cable selection, protections and cable routing.

Electrical installation shows how to wire the drive.

Installation of the AGPS board (Prevention of unexpected start-up, +Q950) describes the electrical installation of the optional Prevention of unexpected start-up function (+Q950).

Installation of the ASTO board (Safe torque off, +Q967) describes the electrical installation of the optional Safe torque off function (+Q967).

Motor control and I/O board (RMIO) shows the external control connections to the I/O board.

Installation checklist contains a list for checking the mechanical and electrical installation of the drive.

Start-up and use describes the start-up procedure and use of the drive.

Actual signals and parameters contains listings of parameters specific to the ACS800-31 and ACS800-U31.

Maintenance contains preventive maintenance instructions.

Fault tracing contains guidelines for fault tracing.

Technical data contains the technical specifications of the drive, e.g. the ratings, sizes and technical requirements and provisions for fulfilling the requirements for CE and other markings.

Dimensional drawings contains the dimensional drawings of the drive.

Resistor braking describes how to select, protect and wire external brake choppers and resistors for the drive. The chapter also contains installation instructions and the technical data.

External +24 V power supply for the RMIO boards via terminal X34 describes how to connect an external +24 V power supply for the RMIO board using terminal X34.

Installation and commissioning flowchart

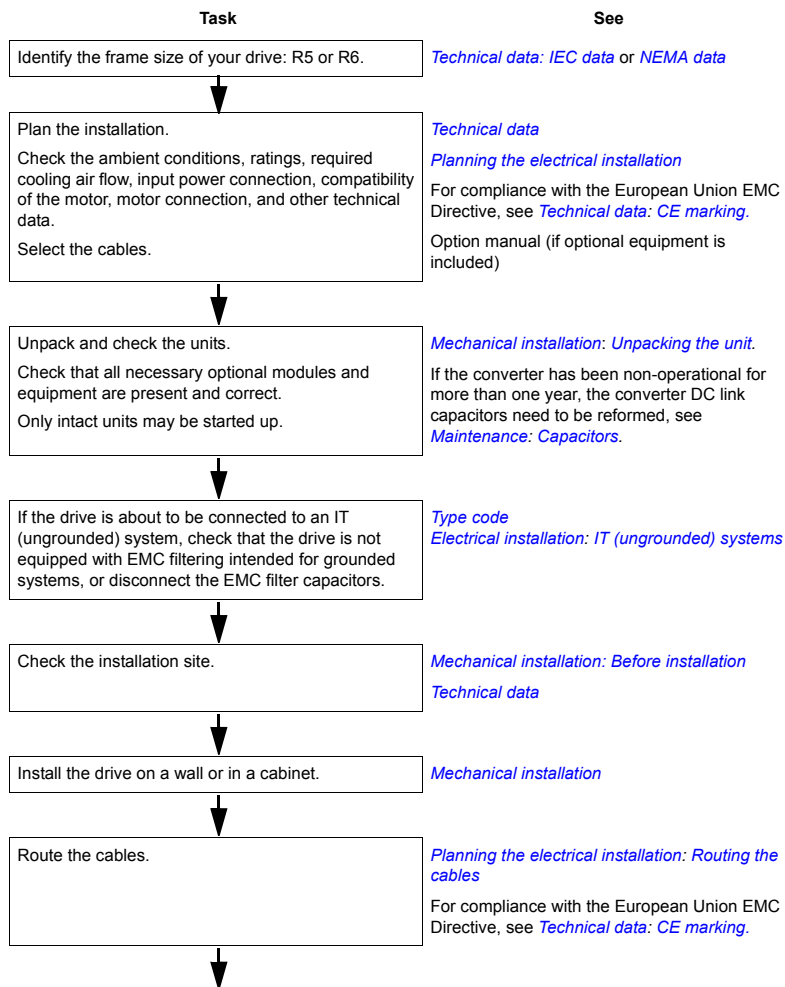

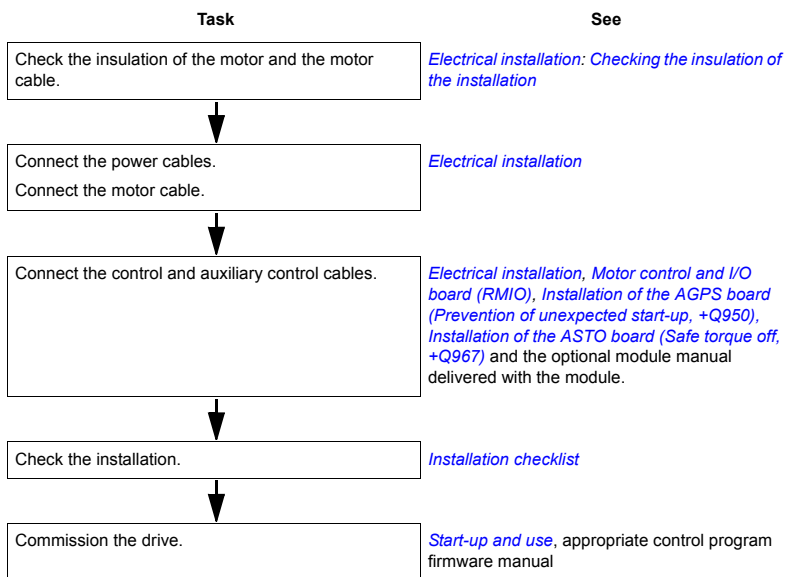

Terms and abbreviations

Term / Abbreviation	Description
AGPS	Power supply board for IGBT gate driver boards. Used in implementation of the optional Prevention of unexpected start-up function.
AIMA	I/O module adapter. An extension unit for mounting I/O extension modules outside the drive unit.
ASTO	Safe torque off board. An optional board used to implement the Safe torque off function.
CDP 312R	Control panel type
DDCS	Distributed drives communication system; a protocol used in optical fiber communication.
DTC	Direct torque control
EMC	Electromagnetic compatibility
GCUR	Current measurement board
GDIO	Charging diode board
GINT	Main circuit board
GRFC	Filter board
GRFCU	EMC filter unit
GVAR	Varistor board

IGBT	Insulated gate bipolar transistor
IT system	Type of supply network that has no (low-impedance) connection to ground/earth.
PCC	Point of common coupling
POUS	Prevention of unexpected start-up
RAIO	Analog I/O extension module
RCAN	CANopen adapter module
RCNA	ControlNet adapter module
RDCO	DDCS communication module
RDIO	Digital I/O extension module
RDNA	DeviceNet™ adapter module
RETA	Ethernet adapter module for Modbus/TCP and EtherNet/IP protocols
RFI	Radio-frequency interference
RIBA	InterBus-S adapter module
RLON	LONWORKS® adapter module
RMBA	Modbus adapter module
RMBP	Modbus plus adapter module
RMIO	Supply/motor control and I/O board
RPBA	PROFIBUS-DP adapter module
RRFC	RFI filter board (filter board for meeting the EMC requirements)
RRIA	Resolver adapter module
RTAC	Pulse encoder adapter module
STO	Safe torque off
THD	Total harmonic distortion
TN system	Type of supply network that provides a direct connection to ground (earth)

Operation principle and hardware description

What this chapter contains

This chapter describes the operating principle and construction of the drive in short.

Product overview

The ACS800-31/U31 is wall mountable, low-harmonic drive for controlling AC motors.

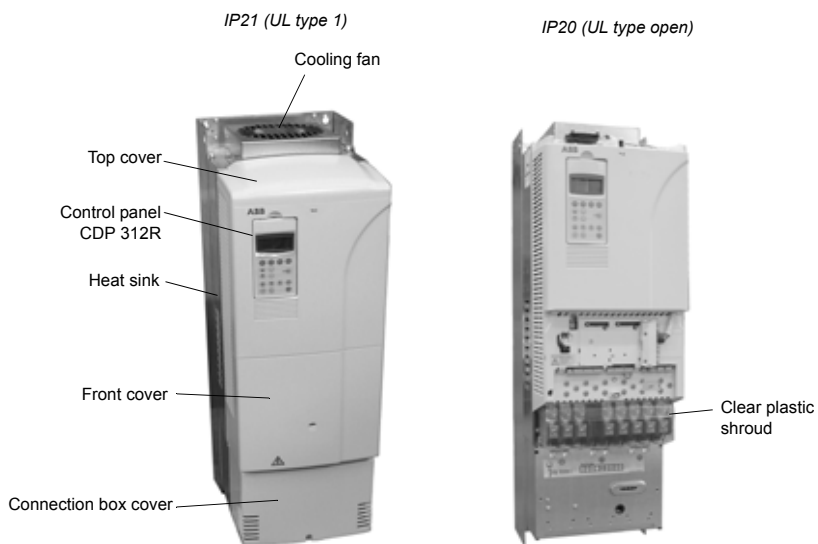

Frame size R6

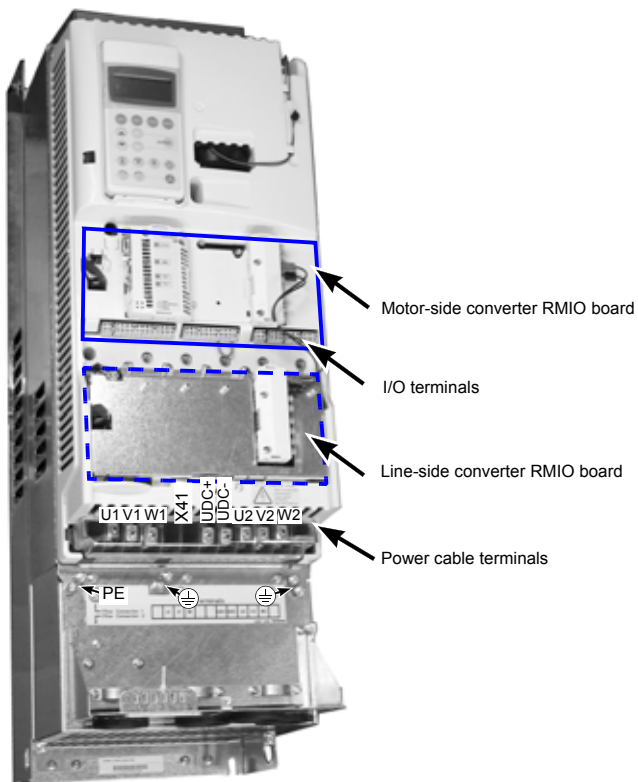

Frame size R5 without front and connection box covers

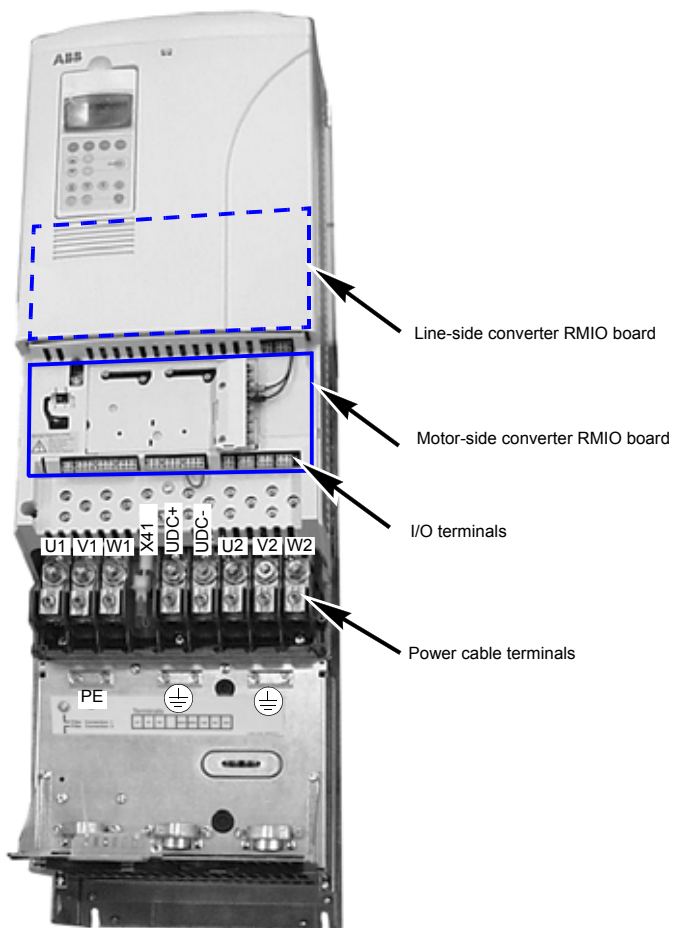

Frame size R6 without front and connection box covers

Terms

Line-side converter: A converter that is connected to the supply network and is capable of transferring energy from the network to the DC link.

Motor-side converter: A converter that is connected to the motor and controls the motor operation.

Operation principle

The line-side and motor-side converters consist of six insulated gate bipolar transistors (IGBT) with free wheeling diodes.

The converters have their own control programs. The parameters of both programs can be viewed and changed using one control panel. The control panel can be switched between the converters as described in section [Control panel](#) on page [100](#).

Line-side converter

The IGBT supply module rectifies three phase AC current to direct current for the intermediate DC link of the drive. The intermediate DC link is further supplying the motor-side converter that runs the motor. The line filter suppresses the AC voltage and current harmonics.

By default, the converter controls the DC link voltage to the peak value of the line-to-line voltage. The DC voltage reference can be set also higher by a parameter. The control of the IGBT power semiconductors is based on the Direct Torque Control (DTC) method also used in the motor control of the drive. Two line currents and the DC link voltage are measured and used for the control.

Motor-side converter

The motor control is based on the Direct Torque Control (DTC) method. Two phase currents and DC link voltage are measured and used for the control. The third phase current is measured for earth fault protection.

AC voltage and current waveforms

The AC line current of the drive is sinusoidal with power factor equal to 1. The IGBT supply unit does not generate characteristic current or voltage overtones like a traditional 6- or 12-pulse bridge does.

The Total Harmonic Distortion (THD) in current is given in chapter *Technical data / Input power connection*. The THD in voltage depends slightly on the Short Circuit Ratio in the Point of Common Coupling (PCC). The high frequency switching and high du/dt slightly distort the voltage waveform at the input of the converter.

Typical line current (i) and voltage (u) waveforms are shown below.

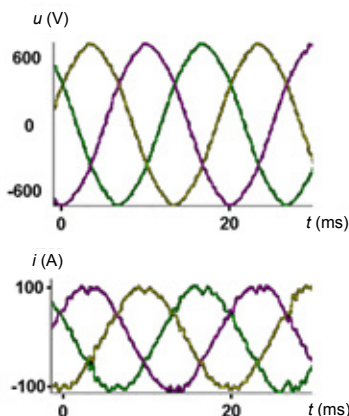

Example spectra of the current and voltage distortion at the output of the transformer are shown below. Each harmonic is presented as compared to fundamental voltage (reference value = 1). n denotes the ordinal number of the harmonic.

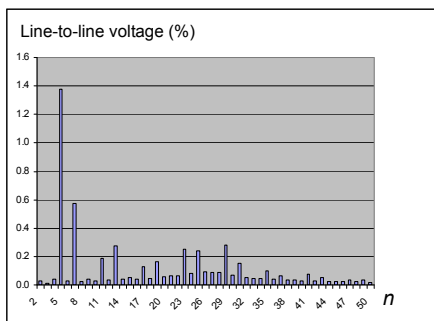
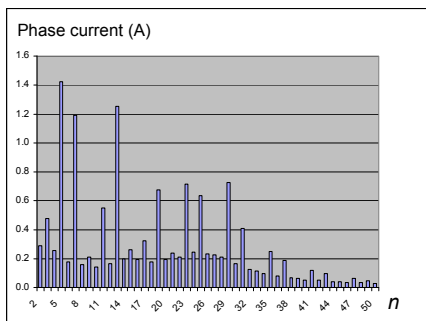

Motor control

The motor control is based on the Direct Torque Control (DTC) method. Two phase currents and DC link voltage are measured and used for the control. The third phase current is measured for earth fault protection.

Printed circuit boards

The drive contains the following printed circuit boards as standard:

- main circuit board (GINT)
- motor control and I/O board (RMIO), 2 pcs
- EMC filter unit (GRFCU) when EMC equipment is selected
- filter boards (GRFC or RRFC)
- varistor board (GVAR)
- control panel (CDP 312R)
- current measurement board (GCUR, in frame size R5 only)
- charging diode board (GDIO).

DDCS communication modules

The drive includes an RDCO-03 module in the line-side converter and another RDCO module in the motor-side converter.

Main circuit and control interfaces diagram

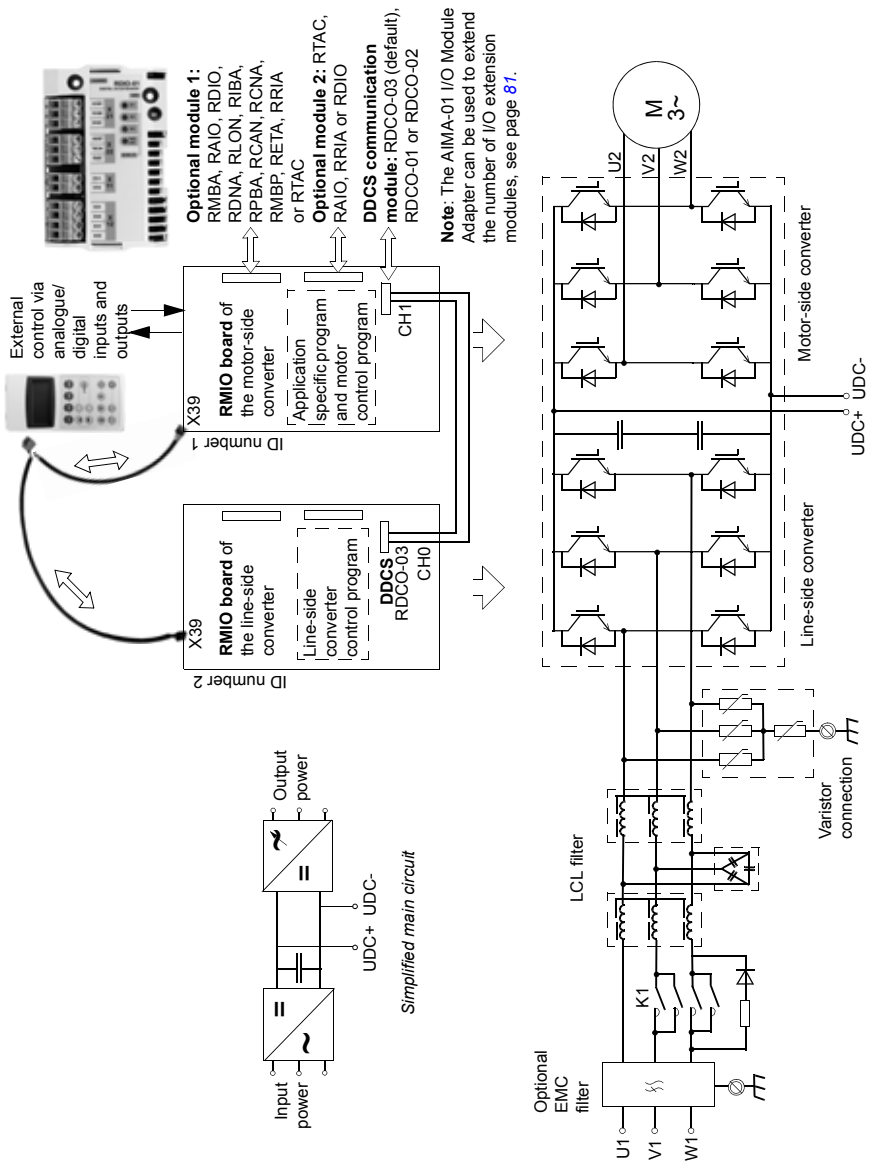

Fieldbus control of the line-side converter

Optional fieldbus modules cannot be inserted in the optional module slots of the RMIO board of the line-side converter. Fieldbus control of the line-side converter is performed via the motor-side converter RMIO board as shown in the block diagram below.

Control block diagram

The figure below shows the parameters for DC and reactive power reference selection of the line-side converter control program. The AMC table contains actual values and parameters of the line-side converter.

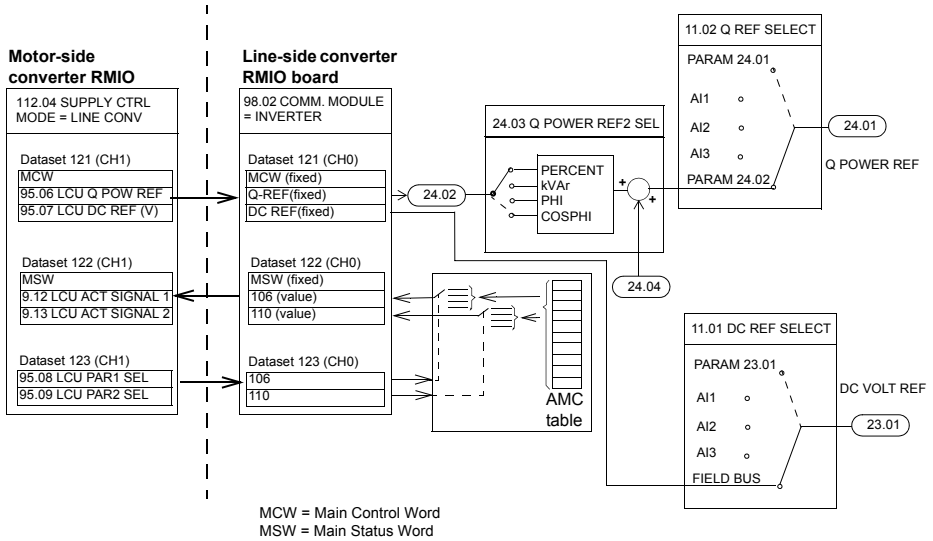

Connection diagram of the RMIO board in the line-side converter

Internal connections to the RMIO board for the ACS800 IGBT Supply Control Program are shown below. Do not change the connections.

Terminal block size:

cables 0.3 to 3.3 mm² (22 to 12 AWG)

Tightening torque:

0.2 to 0.4 N·m (0.2 to 0.3 lbf·ft)

¹⁾ non-programmable I/O

²⁾ External earth (ground) fault indication via digital input DI4: See parameter 30.04 EXT EARTH FAULT.

³⁾ External alarm/fault indication via digital input DI5: See parameter 30.05 EXT EVENT.

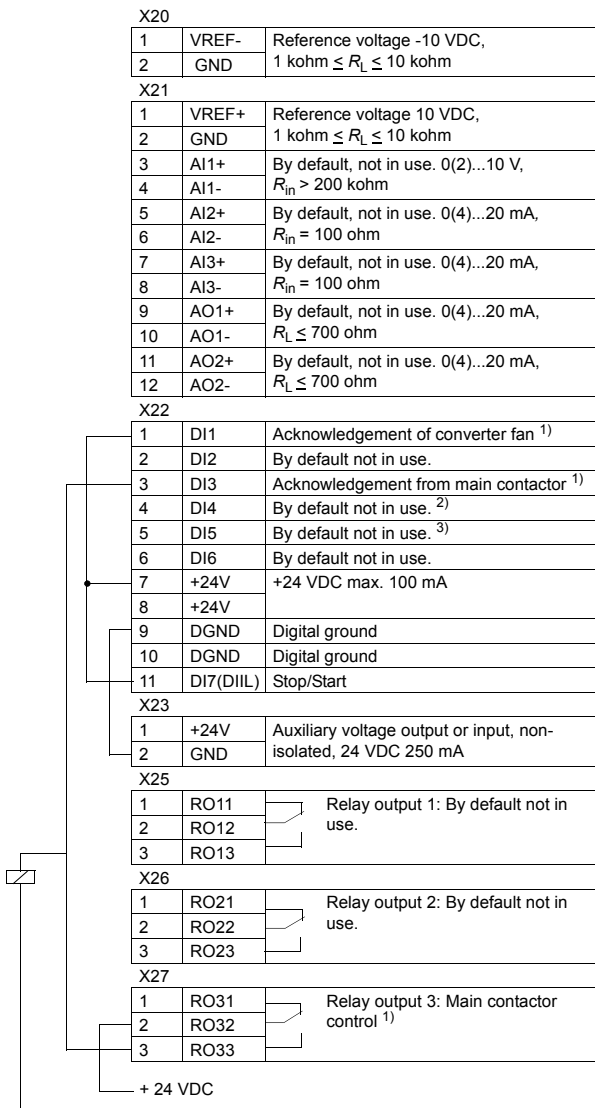

Type code

The type code contains information on the specifications and configuration of the drive. The first digits from left express the basic configuration (for example, ACS800-31-0025-3 or ACS800-U31-0025-3). The optional selections are given thereafter, separated by plus signs (for example, +E200 and +K454). The main selections are described below. Not all selections are available for all types. For more information, refer to *ACS800 Ordering Information* (EN code: 3AFY64556568, available on request).

Selection	Alternatives	
Product series	ACS800 product series	
Type	31	Wall mounted. When no options are selected: IP21, Control Panel CDP 312R, DDCS communication option module RDCO-03, no EMC filter, Standard Control Program, cable connection box (cabling from below), boards with coating, one set of English manuals.
	U31	Wall mounted (USA). When no options are selected: UL type 1, Control Panel CDP 312R, DDCS communication option module RDCO-03, no EMC filter, US version of the Standard Control Program (three-wire start/stop as default setting), US gland/conduit plate, boards with coating, one set of English manuals.
Size	Refer to Technical data: IEC data or NEMA data .	
Voltage range (nominal rating in bold)	2	208/220/ 230 /240 VAC
	3	380/ 400 /415 VAC
	5	380/400/415/440/460/480/ 500 VAC
	7	525/575/600/ 690 VAC
Option codes (+ codes)		
Degree of protection	B051	IP20 (UL type open)
Filter	E200	EMC/RFI filter for second environment TN (grounded) system, unrestricted distribution, drive category C3
	E202	EMC/RFI filter for first environment TN (grounded) system, restricted distribution, drive category C2
Cabling	H357	European lead-through plate for the ACS800-U31
	H358	US/UK gland/conduit plate for the ACS800-31
Control panel	0J400	No control panel
Fieldbus	K...	Refer to <i>ACS800 Ordering Information</i> (EN code: 3AFY64556568).
I/O	L...	
Control program	N...	
Manual language	R...	
Safety features	Q950	Prevention of unexpected start-up function
	Q967	Safe torque off (STO) function without safety relay
Specialities	P904	Extended warranty
		Duct plates for cabinet installation can be ordered with kit codes: frame size R5: 68654122 frame size R6: 68654131

Mechanical installation

What this chapter contains

This chapter contains unpacking instructions, the delivery checklist and the mechanical installation instructions of the drive.

Unpacking the unit

The drive is delivered in a box that also contains:

- plastic bag containing: screws (M3), clamps and cable lugs (2 mm², M3) for grounding the control cable screens
- residual voltage warning stickers
- hardware manual
- appropriate firmware manuals and guides
- optional module manuals
- delivery documents.

To unpack the package, cut the bands (A) and remove the outer box (B) and sleeve (C).

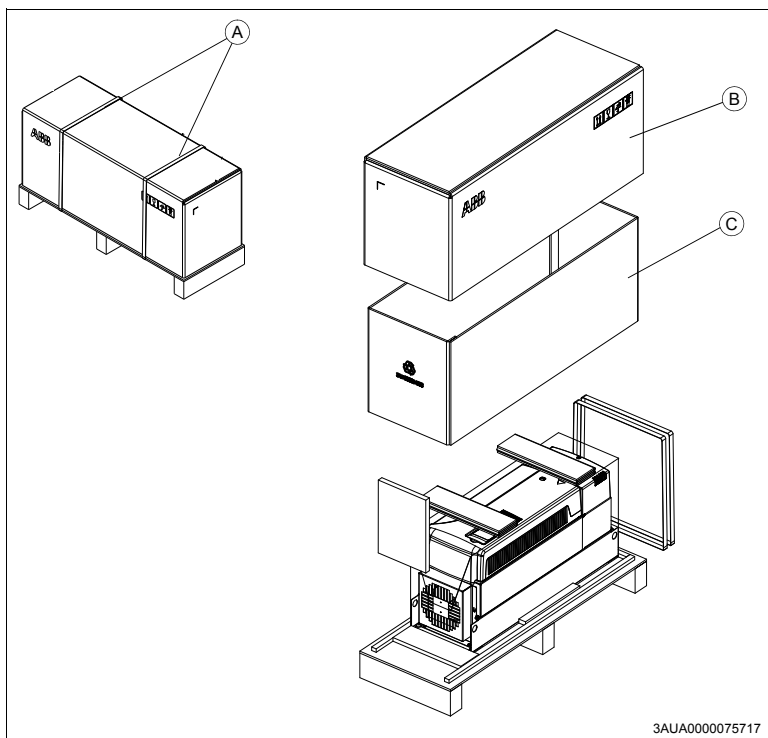

Checking the delivery

Check that all items listed in section [Unpacking the unit](#) are present.

Check that there are no signs of damage. Before attempting installation and operation, check the information on the type designation label of the drive to verify that the unit is of the correct type. The label includes an IEC and NEMA rating, C-UL, CSA and CE markings, a type code and a serial number, which allow individual recognition of each unit. The first digit of the serial number refers to the manufacturing plant. The next four digits refer to the unit's manufacturing year and week, respectively. The remaining digits complete the serial number so that there are no two units with the same serial number.

The type designation label is attached to the heat sink and the serial number label to the lower part of the back plate of the unit. Example labels are shown below.



Type designation label



Serial number label

Moving the unit

Lift the unit using the lifting holes at the top and bottom.



Lifting a unit of frame size R6

Before installation

The drive must be installed in an upright position with the cooling section facing a wall. Check the installation site according to the requirements below. Refer to chapter [Dimensional drawings](#) for frame details.



WARNING! Do not remove the protective film that covers the unit before the installation procedure is complete. It protects the unit from pieces of wire cuttings or other solid particles that can penetrate the unit during installation. Remove the film just before starting up the unit.



Requirements for the installation site

See chapter [Technical data](#) for the allowed operation conditions of the drive.

Wall

The wall should be as close to vertical as possible, of non-flammable material and strong enough to carry the weight of the unit. Check that there is nothing on the wall to inhibit the installation.

Floor

The floor/material below the installation should be non-flammable.

Free space around the unit

Required free space around the drive to enable cooling air flow, service and maintenance is shown below in millimetres and [inches].

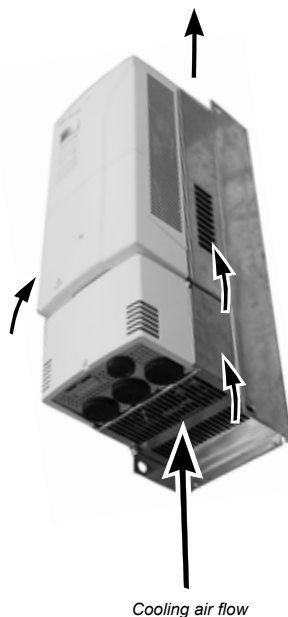
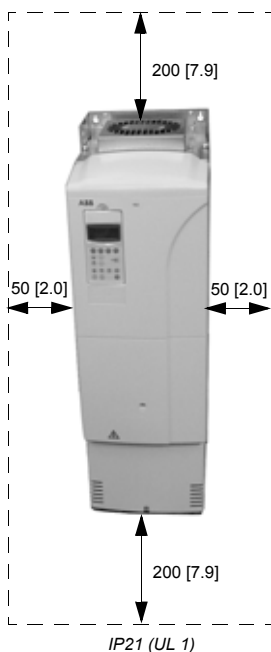

Mounting the drive on the wall

Units without vibration dampers

1. Mark the locations for the four holes. The mounting points are shown in chapter [Dimensional drawings](#).
2. Fix the screws or bolts to the marked locations.
3. Position the drive onto the screws on the wall. **Note:** Lift the drive by its lifting holes, not by its cover.
4. Tighten the screws in the wall securely.

Units with vibration dampers

In applications with considerable vibration in the frequency range of 50 Hz to 100 Hz, vibration dampers can be used. See [ACS800 Vibration Damper Installation Guide \[3AFE68295351 \(English\)\]](#).

Appropriate vibration dampers are GC3-50MS (kit code 68295581):

- for units of frame size R5, four dampers
- for units of frame size R6, six dampers

Note that the kit only includes four vibration dampers, but units of frame size R6 require six. Two dampers are installed in the middle.

Cabinet installation

The drive can be installed in a cabinet without the plastic front, top and connection box covers and without the lead-through plate. Vibration dampers are not needed.

The required minimum distance between parallel units is 50 millimetres (1.97 in.) in installations without the front cover. The cooling air entering the unit must not exceed +40 °C (+104 °F).

You can also use duct plates in the cabinet installation, see section [Installing cabinet duct plates \(optional\)](#) on page 43.

Preventing cooling air recirculation

Prevent air recirculation inside and outside the cabinet.

Example

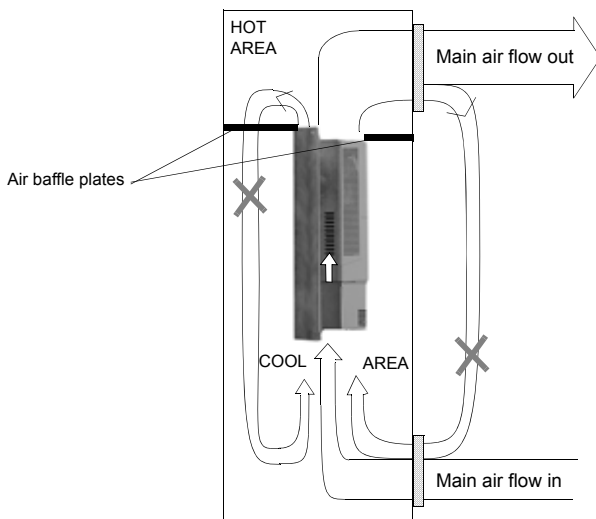

Unit above another

Lead the out-coming hot cooling air away from the air input of the drive above.

Example

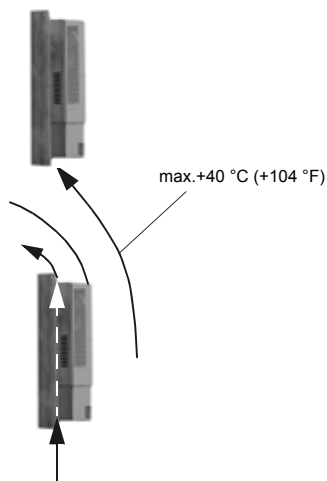

Installing cabinet duct plates (optional)

If the drive is installed in a cabinet that is inside a cooling air duct, duct plates can be used to lead the air flow.

With the cabinet duct plates, the IP protection class of the drive inside the cabinet is IP21 and IP20 outside the cabinet.

Installation kits

Separate installation kits for cabinet duct plates can be ordered with the following kit codes:

- frame size R5: 68654122
- frame size R6: 68654131.

The installation kit contains the following parts:

- left collar (A in the figure on page [45](#))
- right collar (B)
- top collar (C)
- bottom collar (D).

Screws are not included in the installation kit. The following screws are needed:

- frame size R5:
 - 18 pieces: M5X12, torque 3 N·m (2.2 lbf·ft)
 - 2 pieces: M4X16, torque 1.2 N·m (0.9 lbf·ft)
 - 2 pieces: M4X12, torque 1.2 N·m (0.9 lbf·ft)
- frame size R6:
 - 20 pieces: M5X12, torque 3 N·m (2.2 lbf·ft)
 - 2 pieces: M4X25, torque 1.2 N·m (0.9 lbf·ft)
 - 2 pieces: M4X12, torque 1.2 N·m (0.9 lbf·ft)

Before you start

Prepare the cabinet by following the requirements given in this manual and the dimensional drawings on pages [134](#) and [135](#).

The drive must always be fixed into the cabinet by using the original 4 fixing holes on the bottom plate, never by the collars only.

The cabinet supports (E) can be installed before or after installing the drive, but it may be easier to install the drive before the supports.

Installation

The following figure shows the installation procedure for a drive of frame size R5. In frame size R6, the design of the bottom collar (D) is slightly different.

1. After the drive and cabinet supports (E) have been installed, install the left (A) and right collars (B) by pushing them first in the grooves on both sides of the drive, and fasten them with 10 pcs of M5x12 screws (frame size R6: 12 pcs) in the cabinet supports.
2. Fix 4 pcs of M5x12 screws in the left (A) and right collars (B), and install the top collar (C) against the left and right collars through the screws.
3. Push down the top collar in the groove on the top of the drive and tighten the screws.
4. Fix 4 pcs of M5x12 screws in the left (A) and right collars (B), and install the bottom collar (D) against the left and right collars through the screws.
5. Push up the bottom collar in the groove on the bottom of the drive and tighten the screws.
6. Fix the bottom collar to the drive with 2 pcs of M4x16 screws (frame size R6: M4x25).
7. Secure the bottom collar to the drive with additional 2 pcs of M4x12 screws.

Note: If you install other parts in the cabinet, make sure that the top and bottom collars can be removed easily for maintenance purposes.

Assembly drawing for cabinet duct plates

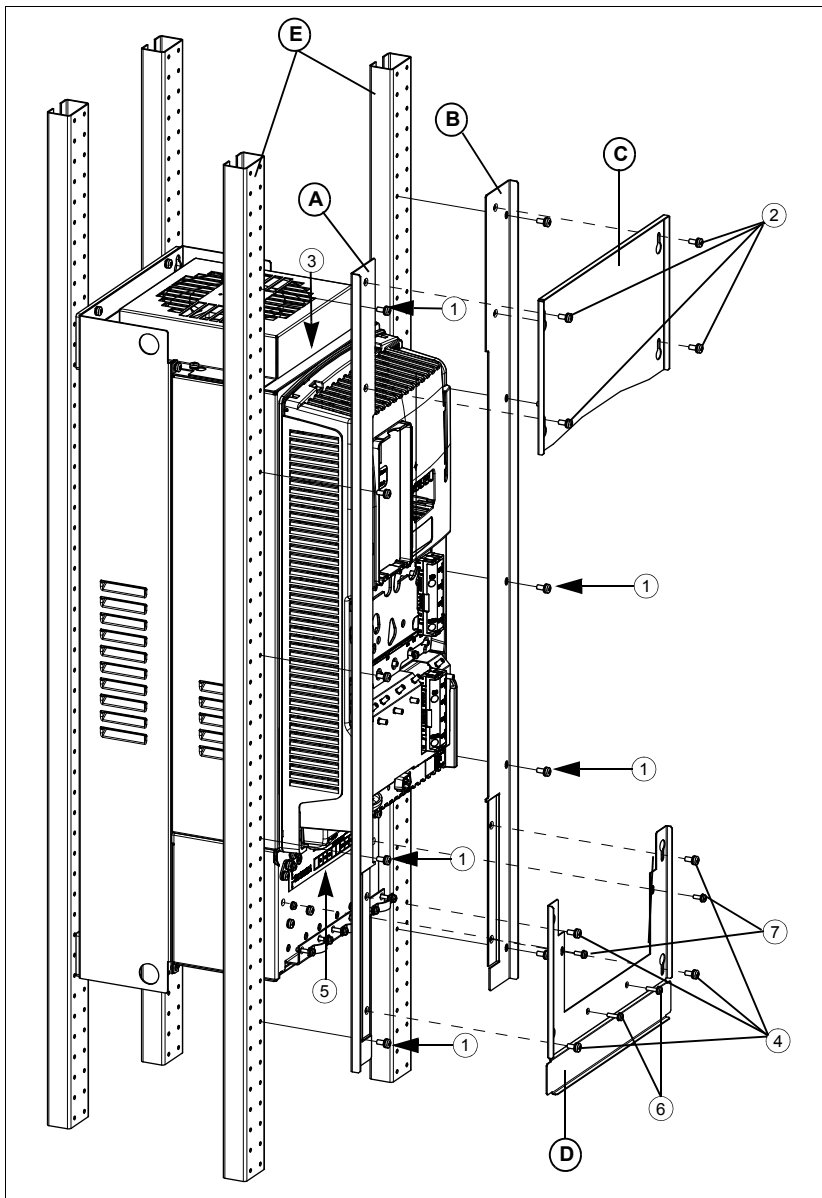

Planning the electrical installation

What this chapter contains

This chapter contains the instructions that you must follow when selecting the motor, cables, protections, cable routing and way of operation for the drive system.

Note: The installation must always be designed and made according to applicable local laws and regulations. ABB does not assume any liability whatsoever for any installation which breaches the local laws and/or other regulations. Furthermore, if the recommendations given by ABB are not followed, the drive may experience problems that the warranty does not cover.

Motor selection and compatibility

1. Select the motor according to the rating tables in chapter [Technical data](#). Use the DriveSize PC tool if the default load cycles are not applicable.
2. Check that the motor ratings lie within the allowed ranges of the drive control program:
 - motor nominal voltage is $1/2 \dots 2 \cdot U_N$ of the drive
 - motor nominal current is $1/6 \dots 2 \cdot I_{2hd}$ of the drive in DTC control and $0 \dots 2 \cdot I_{2hd}$ in scalar control. The control mode is selected by a drive parameter.
3. Check that the motor voltage rating meets the application requirements:

If the drive is equipped with and then the motor voltage rating should be ...
IGBT supply ACS800-31/U31	DC link voltage will not be increased from nominal (parameter setting)	U_N
	DC link voltage will be increased from nominal (parameter setting)	U_{ACeq2}

U_N = Rated input voltage of the drive

U_{ACeq2} = $U_{DC}/1.41$

U_{DC} = the maximum DC link voltage of the drive in VDC.

For resistor braking: $U_{DC} = 1.21 \times$ nominal DC link voltage.

For units with IGBT supply: See the parameter value.

Note: Nominal DC link voltage is (in VDC):

$U_N \times 1.35$ when the IGBT supply is stopped or

$U_N \times 1.41$ when the IGBT supply is on.

See notes 7 and 8 below the [Requirements table](#) on page 53.

4. Consult the motor manufacturer before using a motor in a drive system where the motor nominal voltage differs from the AC power source voltage.
5. Ensure that the motor insulation system withstands the maximum peak voltage in the motor terminals. See the [Requirements table](#) below for the required motor insulation system and drive filtering.

Example 1: When the supply voltage is 440 V and a drive with a diode supply is operating in motor mode only, the maximum peak voltage in the motor terminals can be approximated as follows: $440 \text{ V} \cdot 1.35 \cdot 2 = 1190 \text{ V}$. Check that the motor insulation system withstands this voltage.

Example 2: When the supply voltage is 440 V and the drive is equipped with an IGBT supply, the maximum peak voltage in the motor terminals can be approximated as follows: $440 \text{ V} \cdot 1.41 \cdot 2 = 1241 \text{ V}$. Check that the motor insulation system withstands this voltage.

Protecting the motor insulation and bearings

The output of the drive comprises – regardless of output frequency – pulses of approximately 1.35 times the equivalent mains network voltage with a very short rise time. This is the case with all drives employing modern IGBT inverter technology.

The voltage of the pulses can be almost double at the motor terminals, depending on the attenuation and reflection properties of the motor cable and the terminals. This in turn can cause additional stress on the motor and motor cable insulation.

Modern variable speed drives with their fast rising voltage pulses and high switching frequencies can generate current pulses that flow through the motor bearings, which can gradually erode the bearing races and rolling elements.

The stress on motor insulation can be avoided by using optional ABB du/dt filters. du/dt filters also reduce bearing currents.

To avoid damage to motor bearings, the cables must be selected and installed according to the instructions given in the hardware manual. In addition, insulated N-end (non-driven end) bearings and output filters from ABB must be used according to the following table. Two types of filters are used individually or in combinations:

- optional du/dt filter (protects motor insulation system and reduces bearing currents).
- common mode filter (mainly reduces bearing currents).

Requirements table

The following table shows how to select the motor insulation system and when an optional drive du/dt and common mode filters and insulated N-end (non-drive end) motor bearings are required. Ignoring the requirements or improper installation may shorten motor life or damage the motor bearings and voids the warranty.

Manufacturer	Motor type	Nominal mains voltage (AC line voltage)	Requirement for			
			Motor insulation system	ABB du/dt filter, insulated N-end bearing and ABB common mode filter		
				$P_N < 100$ kW and frame size < IEC 315	100 kW $\leq P_N < 350$ kW or frame size \geq IEC 315	$P_N \geq 350$ kW or frame size \geq IEC 400
			$P_N < 134$ hp and frame size < NEMA 500	134 hp $\leq P_N < 469$ hp or frame size \geq NEMA 500	$P_N \geq 469$ hp or frame size > NEMA 580	
A B B	Random-wound M2_, M3_ and M4_	$U_N \leq 500$ V	Standard	-	+ N	+ N + CMF
		500 V < $U_N \leq 600$ V	Standard	+ du/dt	+ du/dt + N	+ du/dt + N + CMF
			or	Reinforced	-	+ N
		600 V < $U_N \leq 690$ V (cable length ≤ 150 m)	Reinforced	+ du/dt	+ du/dt + N	+ du/dt + N + CMF
	600 V < $U_N \leq 690$ V (cable length > 150 m)	Reinforced	-	+ N	+ N + CMF	
	Form-wound HX_ and AM_	380 V < $U_N \leq 690$ V	Standard	n.a.	+ N + CMF	$P_N < 500$ kW: + N + CMF
						$P_N \geq 500$ kW: + N + CMF + du/dt
	Old* form-wound HX_ and modular	380 V < $U_N \leq 690$ V	Check with the motor manufacturer.	+ du/dt with voltages over 500 V + N + CMF		
Random-wound HX_ and AM_ **	0 V < $U_N \leq 500$ V	Enamelled wire with fibre glass taping	+ N + CMF			
	500 V < $U_N \leq 690$ V		+ du/dt + N + CMF			
HDP	Consult the motor manufacturer.					

Manufacturer	Motor type	Nominal mains voltage (AC line voltage)	Requirement for				
			Motor insulation system	ABB du/dt filter, insulated N-end bearing and ABB common mode filter			
				$P_N < 100$ kW and frame size < IEC 315	100 kW $\leq P_N < 350$ kW or frame size \geq IEC 315	$P_N \geq 350$ kW or frame size \geq IEC 400	
				$P_N < 134$ hp and frame size < NEMA 500	134 hp $\leq P_N < 469$ hp or frame size \geq NEMA 500	$P_N \geq 469$ hp or frame size > NEMA 580	
N O N - A B B	Random-wound and form-wound	$U_N \leq 420$ V	Standard: $\dot{U}_{LL} = 1300$ V	-	+ N or CMF	+ N + CMF	
		420 V < $U_N \leq 500$ V	Standard: $\dot{U}_{LL} = 1300$ V	+ du/dt	+ du/dt + N	+ du/dt + N + CMF	
					or		
					+ du/dt + CMF		
		or					
		500 V < $U_N \leq 600$ V	Reinforced: $\dot{U}_{LL} = 1600$ V, 0.2 microsecond rise time	-	+ du/dt	+ N or CMF	+ N + CMF
		500 V < $U_N \leq 600$ V	Reinforced: $\dot{U}_{LL} = 1600$ V	+ du/dt	-	+ du/dt + N	+ du/dt + N + CMF
						or	
+ du/dt + CMF							
or							
600 V < $U_N \leq 690$ V	Reinforced: $\dot{U}_{LL} = 1800$ V	-	+ du/dt	+ N or CMF	+ N + CMF		
600 V < $U_N \leq 690$ V	Reinforced: $\dot{U}_{LL} = 1800$ V	+ du/dt	-	+ du/dt + N	+ du/dt + N + CMF		
600 V < $U_N \leq 690$ V	Reinforced: $\dot{U}_{LL} = 2000$ V, 0.3 microsecond rise time ***	-	-	N + CMF	N + CMF		

* manufactured before 1.1.1998

** For motors manufactured before 1.1.1998, check for additional instructions with the motor manufacturer.

*** If the intermediate DC circuit voltage of the drive is increased from the nominal level by resistor braking or by the IGBT supply unit control program (parameter selectable function), check with the motor manufacturer if additional output filters are needed in the applied drive operation range.

Note 1: The abbreviations used in the table are defined below.

Abbreviation	Definition
U_N	nominal voltage of the supply network
\hat{U}_{LL}	peak line-to-line voltage at motor terminals which the motor insulation must withstand
P_N	motor nominal power
du/dt	du/dt filter at the output of the drive +E205
CMF	common mode filter +E208
N	N-end bearing: insulated motor non-driven end bearing
n.a.	Motors of this power range are not available as standard units. Consult the motor manufacturer.

Note 2: *Explosion-safe (EX) motors*

If you use an explosion-safe (EX) motor, follow the rules in the requirements table above. In addition, consult the motor manufacturer for any further requirements.

Note 3: *ABB high-output motors and IP23 motors*

The rated output power of high output motors is higher than what is stated for the particular frame size in EN 50347:2001. This table shows the requirements for ABB random-wound motor series (for example, M3AA, M3AP and M3BP).

Nominal AC supply voltage	Motor insulation system	Requirement for		
		ABB du/dt and common mode filters, insulated N-end motor bearings		
		$P_N < 100 \text{ kW}$ $P_N < 140 \text{ hp}$	$100 \text{ kW} \leq P_N < 200 \text{ kW}$ $140 \text{ hp} \leq P_N < 268 \text{ hp}$	$P_N \geq 200 \text{ kW}$ $P_N \geq 268 \text{ hp}$
$U_N \leq 500 \text{ V}$	Standard	-	+ N	+ N + CMF
$500 \text{ V} < U_N \leq 600 \text{ V}$	Standard	+ du/dt	+ N + du/dt	+ N + du/dt + CMF
	or			
$600 \text{ V} < U_N \leq 690 \text{ V}$	Reinforced	-	+ N	+ N + CMF
	Reinforced	+ du/dt	+ N + du/dt	+ N + du/dt + CMF

Note 4: Non-ABB high-output and IP23 motors

The rated output power of high output motors is higher than what is stated for the particular frame size in EN 50347:2001. The table below shows the requirements for random-wound and form-wound non-ABB motors with nominal power smaller than 350 kW. For bigger motors, consult the motor manufacturer.

Nominal AC supply voltage	Motor insulation system	Requirement for	
		ABB du/dt filter, insulated N-end bearing and ABB common mode filter	
		$P_N < 100 \text{ kW}$ or frame size $< \text{IEC 315}$	$100 \text{ kW} \leq P_N < 350 \text{ kW}$ or $\text{IEC 315} \leq \text{frame size} < \text{IEC 400}$
		$P_N < 134 \text{ hp}$ or frame size $< \text{NEMA 500}$	$134 \text{ hp} \leq P_N < 469 \text{ hp}$ or $\text{NEMA 500} \leq \text{frame size} \leq \text{NEMA 580}$
$U_N \leq 420 \text{ V}$	Standard: $\hat{U}_{LL} = 1300 \text{ V}$	+ N or CMF	+ N + CMF
$420 \text{ V} < U_N \leq 500 \text{ V}$	Standard: $\hat{U}_{LL} = 1300 \text{ V}$	+ du/dt + (N or CMF)	+ N + du/dt + CMF
	or Reinforced: $\hat{U}_{LL} = 1600 \text{ V}$, 0.2 microsecond rise time	+ N or CMF	+ N + CMF
$500 \text{ V} < U_N \leq 600 \text{ V}$	Reinforced: $\hat{U}_{LL} = 1600 \text{ V}$	+ du/dt + (N or CMF)	+ du/dt + N + CMF
	or Reinforced: $\hat{U}_{LL} = 1800 \text{ V}$	+ N or CMF	+ N + CMF
$600 \text{ V} < U_N \leq 690 \text{ V}$	Reinforced: $\hat{U}_{LL} = 1800 \text{ V}$	+ N + du/dt	+ N + du/dt + CMF
	Reinforced: $\hat{U}_{LL} = 2000 \text{ V}$, 0.3 microsecond rise time ***	N + CMF	N + CMF

*** If the intermediate DC circuit voltage of the drive is increased from the nominal level by resistor braking, check with the motor manufacturer if additional output filters are needed in the applied drive operation range.

Note 5: HXR and AMA motors

All AMA machines (manufactured in Helsinki) for drive systems have form-wound windings. All HXR machines manufactured in Helsinki starting 1.1.1998 have form-wound windings.

Note 6: ABB motors of types other than M2_, M3_, HX_ and AM_

Use the selection criteria given for non-ABB motors.

Note 7: Resistor braking of the drive

When the drive is in braking mode for a large part of its operation time, the intermediate circuit DC voltage of the drive increases, the effect being similar to increasing the supply voltage by up to 20 percent. The voltage increase should be taken into consideration when determining the motor insulation requirement.

Example: Motor insulation requirement for a 400 V application must be selected as if the drive were supplied with 480 V.

Note 8: Drives with an IGBT supply unit

If voltage is raised by the drive (this is a parameter selectable function), select the motor insulation system according to the increased intermediate circuit DC voltage level, especially in the 500 V supply voltage range.

Note 9: Calculating the rise time and the peak line-to-line voltage

The peak line-to-line voltage at the motor terminals generated by the drive as well as the voltage rise time depend on the cable length. The requirements for the motor insulation system given in the table are "worst case" requirements covering installations with 30 metre and longer cables. The rise time can be calculated as follows: $\Delta t = 0.8 \cdot \hat{U}_{LL} / (du/dt)$. Read \hat{U}_{LL} and du/dt from the diagrams below. **Multiply** the values of the graph by the supply voltage (U_N). In case of drives with an IGBT supply unit or resistor braking, the \hat{U}_{LL} and du/dt values are approximately 20 % higher.

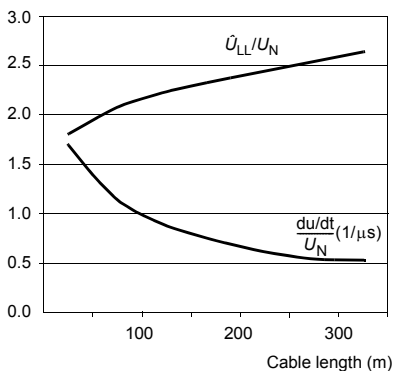

With du/dt Filter

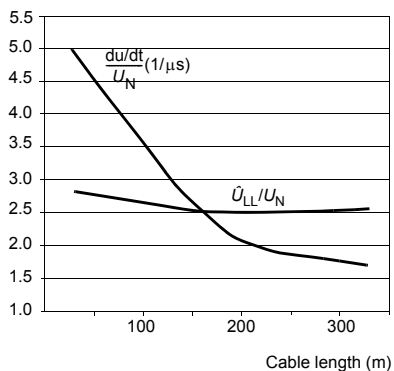

Without du/dt Filter

Note 10: Sine filters protect the motor insulation system. Therefore, du/dt filter can be replaced with a sine filter. The peak phase-to-phase voltage with the sine filter is approximately $1.5 \times U_N$.

Permanent magnet motor

Only one permanent magnet motor can be connected to the drive output.

It is recommended to install a safety switch between the permanent magnet motor and the drive output. The switch is needed to isolate the motor during any maintenance work on the drive.

Supply connection

Disconnecting device (disconnecting means)

Install a hand-operated input disconnecting device (disconnecting means) between the AC power source and the drive. The disconnecting device must be of a type that can be locked to the open position for installation and maintenance work.

EU

To meet the European Union Directives, according to standard EN 60204-1, Safety of Machinery, the disconnecting device must be one of the following types:

- switch-disconnector of utilization category AC-23B (EN 60947-3)
- disconnector that has an auxiliary contact that in all cases causes switching devices to break the load circuit before the opening of the main contacts of the disconnector (EN 60947-3)
- circuit breaker suitable for isolation in accordance with EN 60947-2.

US

The disconnecting means must conform to the applicable safety regulations.

Fuses

See section [Thermal overload and short-circuit protection](#).

Thermal overload and short-circuit protection

Thermal overload protection

The drive protects itself and the input and motor cables against thermal overload when the cables are dimensioned according to the nominal current of the drive. No additional thermal protection devices are needed.



WARNING! If the drive is connected to multiple motors, a separate thermal overload switch or a circuit breaker must be used for protecting each cable and motor. These devices may require a separate fuse to cut off the short-circuit current.

The drive protects the motor cable and motor in a short-circuit situation when the motor cable is dimensioned according to the nominal current of the drive.

Short-circuit protection

Protect the input cable and drive against short-circuit according to the following guide lines.

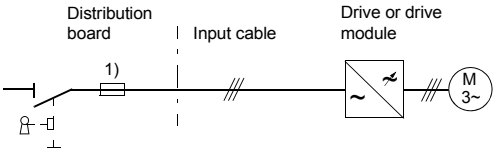
Circuit diagram	Drive type	Short-circuit protection
DRIVE IS NOT EQUIPPED WITH INPUT FUSES		
 <p>The diagram illustrates the electrical connection from a distribution board to a drive. On the left, a switch is shown in the closed position. A line leads to a fuse labeled '1)'. A vertical dashed line separates the 'Distribution board' from the 'Input cable'. The input cable is represented by a line with three parallel diagonal slashes. This cable connects to a square symbol representing the 'Drive or drive module', which contains a tilde symbol (~). To the right of the drive is another section of input cable (three parallel slashes) leading to a circle containing 'M' and '3~', representing a three-phase motor.</p>	ACS800-31 ACS800-U31	Protect the drive and input cable with fuses. See footnote 1).

- 1) Size the fuses according to local safety regulations, appropriate input voltage and the rated current of the drive. Only gG and aR fuses are allowed, see section [Mains cable fuses](#) on page 117.

Standard gG fuses (US: CC or T for ACS800-U31) will protect the input cable in short-circuit situations, restrict drive damage and prevent damage to adjoining equipment in case of a short-circuit inside the drive.

Check that the operating time of the fuse is below 0.1 seconds. The operating time depends on the fuse type (gG or aR), supply network impedance and the cross-sectional area, material and length of the supply cable. In case the 0.1 seconds operating time is exceeded with gG fuses (US: CC/T/L), ultrarapid (aR) fuses will in most cases reduce the operating time to an acceptable level. The US fuses must be of the "non-time delay" type.

For fuse ratings, see chapter [Technical data](#).

Note: Circuit breakers must not be used.

Ground fault protection

The drive is equipped with an internal ground fault protective function to protect the unit against ground faults in the motor and motor cable. This is not a personal safety or a fire protection feature. The ground fault protective function can be disabled with a parameter, refer to the appropriate *ACS800 Firmware Manual*.

The EMC filter of the drive includes capacitors connected between the main circuit and the frame. These capacitors and long motor cables increase the ground leakage current and may cause fault current circuit breakers to function.

Emergency stop devices

For safety reasons, install the emergency stop devices at each operator control station and at other operating stations where emergency stop may be needed.

Note: Pressing the stop key () on the control panel of the drive does not generate an emergency stop of the motor or separate the drive from dangerous potential.

Prevention of unexpected start-up (option +Q950)

The ACS800-31/U31 can be equipped with an optional Prevention of unexpected start-up function according to standards:

- IEC/EN 60204-1:1997,
- ISO/DIS 14118:2000,
- EN 1037:1996,
- EN ISO 12100:2003,
- EN 954-1:1996,
- EN ISO 13849-2:2003.

The Prevention of unexpected start-up (POUS) function disables the control voltage of the power semiconductors, thus preventing the drive from generating the AC voltage required to rotate the motor. By using this function, short-time operations (like cleaning) and/or maintenance work on non-electrical parts of the machinery can be performed without switching off the AC power supply to the drive.

The operator activates the Prevention of unexpected start-up function by opening a switch on a control desk. An indicating lamp on the control desk will light, signalling that the prevention is active. The switch can be locked out.

The user must install on a control desk near the machinery:

- switching/disconnecting device for the circuitry. “Means shall be provided to prevent inadvertent, and/or mistaken closure of the disconnecting device.” EN 60204-1:1997.
- indicating lamp; on = starting the drive is prevented, off = drive is operative.

For connections to the drive, see the circuit diagram delivered with the drive.



WARNING! The Prevention of unexpected start-up function does not disconnect the voltage of the main and auxiliary circuits from the drive. Therefore maintenance work on electrical parts of the drive or the motor can only be carried out after isolating the drive system from the main supply.

Note: The Prevention of unexpected start-up function is not intended for stopping the drive. If the Prevention of unexpected start-up function is activated when the drive is running, the control voltage of the inverter power semiconductors is cut off and the motor coasts to a stop.

For detailed instructions for installation, start-up, use and maintenance of the function, see chapter [Installation of the AGPS board \(Prevention of unexpected start-up, +Q950\)](#).

Safe torque off (option +Q967)

The drive supports the Safe torque off (STO) function according to standards:

- EN 61800-5-2:2007,
- EN ISO 13849-1:2008,
- IEC 61508,
- IEC 61511:2004,
- EN 62061:2005.

The function also corresponds to Prevention of unexpected start-up of EN 1037.

The STO may be used where power removal is required to prevent an unexpected start-up. The function disables the control voltage of the power semiconductors of the drive output stage, thus preventing the drive from generating the voltage required to rotate the motor (see diagram below). By using this function, short-time operations (like cleaning) and/or maintenance work on non-electrical parts of the machinery can be performed without switching off the power supply to the drive.



WARNING! The Safe torque off function does not disconnect the voltage of the main and auxiliary circuits from the drive. Therefore maintenance work on electrical parts of the drive or the motor can only be carried out after isolating the drive system from the main supply.

Note: The Safe torque off function can be used for stopping the drive in emergency stop situations. In the normal operating mode, use the Stop command instead. If a running drive is stopped by using the function, the drive will trip and stop by coasting. If this is not acceptable, e.g. causes danger, the drive and machinery must be stopped using the appropriate stopping mode before using this function.

Note concerning permanent magnet motor drives in case of a multiple IGBT power semiconductor failure: In spite of the activation of the Safe torque off function, the drive system can produce an alignment torque which maximally rotates the motor shaft by $180/p$ degrees. p denotes the pole pair number.

For more information on the installation of the Safe torque off function, see chapter [Installation of the ASTO board \(Safe torque off, +Q967\)](#).

For more information on the Safe torque off function and the relevant safety data, see [ACS800-01/04/11/31/104/104LC Safe torque off function \(+Q967\), Application guide \(3AUA0000063373 \[English\]\)](#).

An example circuit diagram is shown below.

Selecting the power cables

General rules

Dimension the mains (input power) and motor cables **according to local regulations**:

- The cable must be able to carry the drive load current. See chapter [Technical data](#) for the rated currents.
- The cable must be rated for at least 70 °C (158 °F) maximum permissible temperature of conductor in continuous use. For US, see [Additional US requirements](#).
- The inductance and impedance of the PE conductor/cable (grounding wire) must be rated according to permissible touch voltage appearing under fault conditions (so that the fault point voltage will not rise excessively when a ground fault occurs).
- 600 VAC cable is accepted for up to 500 VAC. 750 VAC cable is accepted for up to 600 VAC. For 690 VAC rated equipment, the rated voltage between the conductors of the cable should be at least 1 kV.

For drive frame size R5 and larger, or motors larger than 30 kW (40 hp), symmetrical shielded motor cable must be used (figure below). A four-conductor system can be used up to frame size R4 with up to 30 kW (40 hp) motors, but shielded symmetrical motor cable is recommended.



WARNING! Do not use unshielded single-core supply cables in IT (ungrounded) networks. A dangerous voltage can become present on the non-conductive outer sheath of the cable. This can cause injury or death.

Note: When continuous conduit is employed, shielded cable is not required.

A four-conductor system is allowed for input cabling, but shielded symmetrical cable is recommended. To operate as a protective conductor, the shield conductivity must be as follows when the protective conductor is made of the same metal as the phase conductors:

Cross-sectional area of the phase conductors S (mm ²)	Minimum cross-sectional area of the corresponding protective conductor S_p (mm ²)
$S \leq 16$	S
$16 < S \leq 35$	16
$35 < S$	$S/2$

Compared to a four-conductor system, the use of symmetrical shielded cable reduces electromagnetic emission of the whole drive system as well as motor bearing currents and wear.

The motor cable and its PE pigtail (twisted shield) should be kept as short as possible in order to reduce electromagnetic emission.

Alternative power cable types

Power cable types that can be used with the drive are represented below.

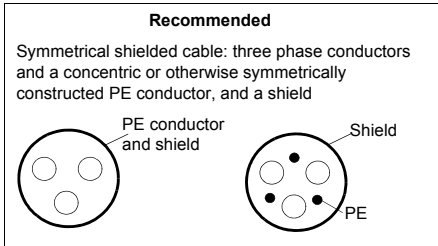

A separate PE conductor is required if the conductivity of the cable shield is $< 50\%$ of the conductivity of the phase conductor.

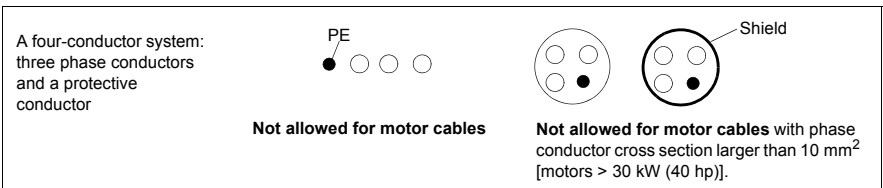
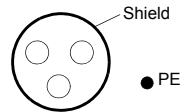

The following power cable type is not allowed.

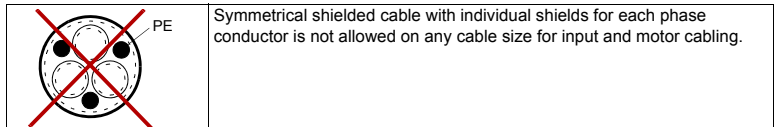

Motor cable shield

To effectively suppress radiated and conducted radio-frequency emissions, the shield conductivity must be at least $1/10$ of the phase conductor conductivity. The requirements are easily met with a copper or aluminium shield. The minimum requirement of the motor cable shield of the drive is shown below. It consists of a concentric layer of copper wires with an open helix of copper tape. The better and tighter the shield, the lower the emission level and bearing currents.

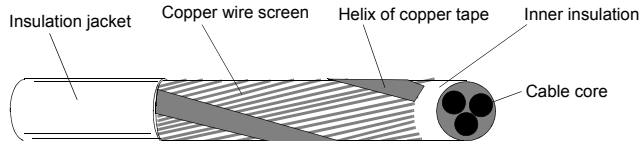

Additional US requirements

Type MC continuous corrugated aluminum armor cable with symmetrical grounds or shielded power cable must be used for the motor cables if metallic conduit is not used. For the North American market, 600 VAC cable is accepted for up to 500 VAC. 1000 VAC cable is required above 500 VAC (below 600 VAC). For drives rated over 100 amperes, the power cables must be rated for 75 °C (167 °F).

Conduit

Where conduits must be coupled together, bridge the joint with a ground conductor bonded to the conduit on each side of the joint. Bond the conduits also to the drive enclosure. Use separate conduits for input power, motor, brake resistor, and control wiring. When conduit is employed, type MC continuous corrugated aluminium armor cable or shielded cable is not required. A dedicated ground cable is always required.

Note: Do not run motor wiring from more than one drive in the same conduit.

Armored cable / shielded power cable

Six conductor (3 phases and 3 ground) type MC continuous corrugated aluminum armor cable with symmetrical grounds is available from the following suppliers (trade names in parentheses):

- Anixter Wire & Cable (Philsheath)
- BICC General Corp (Philsheath)
- Rockbestos Co. (Gardex)
- Oaknite (CLX).

Shielded power cables are available from Belden, LAPPKABEL (ÖLFLEX) and Pirelli.

Power factor compensation capacitors

Power factor compensation is not needed with AC drives. However, if a drive is to be connected in a system with compensation capacitors installed, note the following restrictions.



WARNING! Do not connect power factor compensation capacitors to the motor cables (between the drive and the motor). They are not meant to be used with AC drives and can cause permanent damage to the drive or themselves.

If there are power factor compensation capacitors in parallel with the three phase input of the drive:

1. Do not connect a high-power capacitor to the power line while the drive is connected. The connection will cause voltage transients that may trip or even damage the drive.
2. If capacitor load is increased/decreased step by step when the AC drive is connected to the power line: Ensure that the connection steps are low enough not to cause voltage transients that would trip the drive.
3. Check that the power factor compensation unit is suitable for use in systems with AC drives i.e. harmonic generating loads. In such systems, the compensation unit should typically be equipped with a blocking reactor or harmonic filter.

Equipment connected to the motor cable

Installation of safety switches, contactors, connection boxes, etc.

To minimize the emission level when safety switches, contactors, connection boxes or similar equipment are installed in the motor cable between the drive and the motor:

- EU: Install the equipment in a metal enclosure with 360 degrees grounding for the shields of both the incoming and outgoing cable, or connect the shields of the cables otherwise together.
- US: Install the equipment in a metal enclosure in a way that the conduit or motor cable shielding runs consistently without breaks from the drive to the motor.

Bypass connection



WARNING! Never connect the supply power to the drive output terminals U2, V2 and W2. If frequent bypassing is required, employ mechanically connected switches or contactors. Mains (line) voltage applied to the output can result in permanent damage to the unit.

Using a contactor between the drive and the motor

Implementing the control of the output contactor depends on how you select the drive to operate.

When you have selected to use DTC motor control mode, and motor ramp stop, open the contactor as follows:

1. Give a stop command to the drive.
2. Wait until the drive decelerates the motor to zero speed.
3. Open the contactor.

When you have selected to use DTC motor control mode, and motor coast stop, or scalar control mode, open the contactor as follows:

1. Give a stop command to the drive.
2. Open the contactor.



WARNING! When the DTC motor control mode is in use, never open the output contactor while the drive controls the motor. The DTC motor control operates extremely fast, much faster than it takes for the contactor to open its contacts. When the contactor starts opening while the drive controls the motor, the DTC control will try to maintain the load current by immediately increasing the drive output voltage to the maximum. This will damage, or even burn the contactor completely.

Protecting the relay output contacts and attenuating disturbances in case of inductive loads

Inductive loads (relays, contactors, motors) cause voltage transients when switched off.

The relay contacts on the RMIO board are protected with varistors (250 V) against overvoltage peaks. In spite of this, it is highly recommended to equip inductive loads with noise attenuating circuits [varistors, RC filters (AC) or diodes (DC)] in order to minimize the EMC emission at switch-off. If not suppressed, the disturbances may connect capacitively or inductively to other conductors in the control cable and form a risk of malfunction in other parts of the system.

Install the protective component as close to the inductive load as possible. Do not install protective components at the RMIO board terminal block.

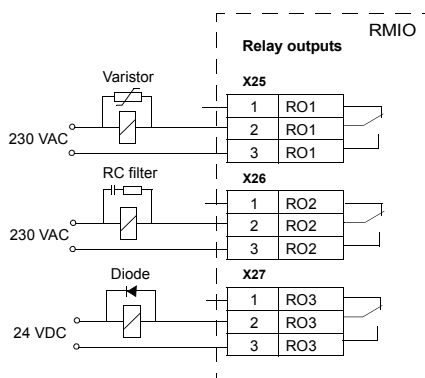

Selecting the control cables

All control cables must be shielded.

Use a double-shielded twisted pair cable (Figure a, e.g. JAMAK by NK Cables, Finland) for analogue signals. This type of cable is recommended for the pulse encoder signals also. Employ one individually shielded pair for each signal. Do not use common return for different analogue signals.

A double-shielded cable is the best alternative for low-voltage digital signals but single-shielded twisted pair cable (Figure b) is also usable.

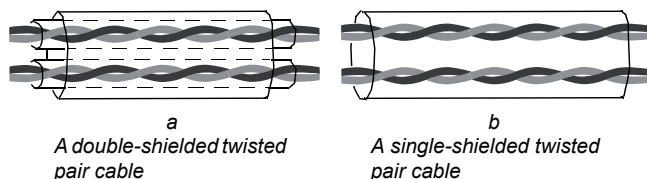

Run analogue and digital signals in separate, shielded cables.

Relay-controlled signals, providing their voltage does not exceed 48 V, can be run in the same cables as digital input signals. It is recommended that the relay-controlled signals be run as twisted pairs.

Never mix 24 VDC and 115/230 VAC signals in the same cable.

Relay cable

The cable type with braided metallic screen (e.g. ÖLFLEX by LAPPKABEL, Germany) has been tested and approved by ABB.

Control panel cable

In remote use, the cable connecting the control panel to the drive must not exceed 3 metres (10 ft). The cable type tested and approved by ABB is used in control panel option kits.

Connection of a motor temperature sensor to the drive I/O



WARNING! IEC 60664 requires double or reinforced insulation between live parts and the surface of accessible parts of electrical equipment which are either non-conductive or conductive but not connected to the protective earth.

To fulfil this requirement, the connection of a thermistor (and other similar components) to the digital inputs of the drive can be implemented in three alternate ways:

1. There is double or reinforced insulation between the thermistor and live parts of the motor.
 2. Circuits connected to all digital and analogue inputs of the drive are protected against contact and insulated with basic insulation (the same voltage level as the drive main circuit) from other low voltage circuits.
 3. An external thermistor relay is used. The insulation of the relay must be rated for the same voltage level as the main circuit of the drive. For connection, see *ACS800 Firmware Manual*.
-

Installation sites above 2000 metres (6562 feet)



WARNING! Protect against direct contact when installing, operating and servicing the RMIO board wiring and optional modules attached to the board. The Protective Extra Low Voltage (PELV) requirements stated in EN 50178 and IEC 61800-5-1 are not fulfilled at altitudes above 2000 m (6562 ft).

Routing the cables

Route the motor cable away from other cable routes. Motor cables of several drives can be run in parallel installed next to each other. It is recommended that the motor cable, input power cable and control cables be installed on separate trays. Avoid long parallel runs of motor cables with other cables in order to decrease electromagnetic interference caused by the rapid changes in the drive output voltage.

Where control cables must cross power cables make sure they are arranged at an angle as near to 90 degrees as possible. Do not run extra cables through the drive.

The cable trays must have good electrical bonding to each other and to the grounding electrodes. Aluminium tray systems can be used to improve local equalizing of potential.

A diagram of the cable routing is shown below.

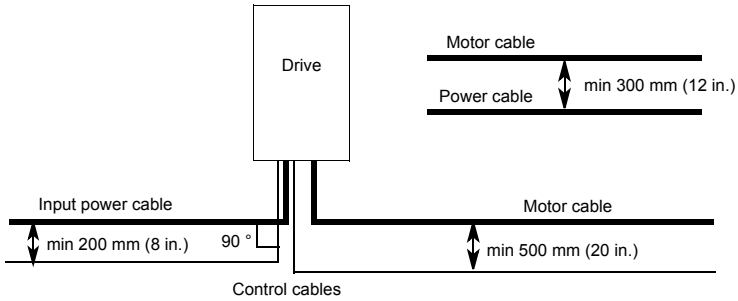

Control cable ducts

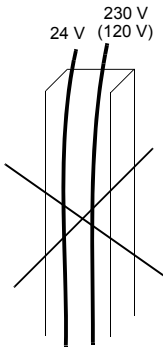

Not allowed unless the 24 V cable is insulated for 230 V (120 V) or insulated with an insulation sleeving for 230 V (120 V).

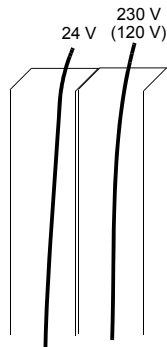

Lead 24 V and 230 V (120 V) control cables in separate ducts inside the cabinet.

Electrical installation

What this chapter contains

This chapter describes the electrical installation procedure of the drive.



WARNING! The work described in this chapter may only be carried out by a qualified electrician. Follow the [Safety instructions](#) on the first pages of this manual. Ignoring the safety instructions can cause injury or death.

Make sure that the drive is disconnected from the mains (input power) during the installation. If the drive is already connected to the mains, wait for 5 minutes after disconnecting mains power.

Checking the insulation of the installation

Drive

Do not make any voltage tolerance or insulation resistance tests on any part of the drive as testing can damage the drive. Every drive has been tested for insulation between the main circuit and the chassis at the factory. Also, there are voltage-limiting circuits inside the drive which cut down the testing voltage automatically.

Supply cable

Check the insulation of the supply (input) cable according to local regulations before connecting to the drive.

Motor and motor cable

Check the insulation of the motor and motor cable as follows:

1. Check that the motor cable is connected to the motor, and disconnected from the drive output terminals U2, V2 and W2.
2. Measure the insulation resistance between each phase conductor and the Protective Earth conductor using a measuring voltage of 1000 V DC. The insulation resistance of an ABB motor must exceed 100 Mohm (reference value at 25 °C or 77 °F). For the insulation resistance of other motors, please consult the manufacturer's instructions. **Note:** Moisture inside the motor casing will reduce the insulation resistance. If moisture is suspected, dry the motor and repeat the measurement.

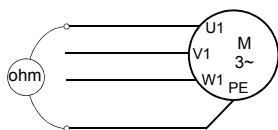

IT (ungrounded) systems

Drives with EMC filter option +E202 or +E200 are not suitable for use in an IT (ungrounded) system as such. Disconnect the EMC filter capacitors before connecting the drive to an ungrounded system as described below.



WARNING! If a drive with EMC filter selection +E202 or +E200 is installed on an IT system (an ungrounded power system or a high resistance-grounded [over 30 ohms] power system), the system will be connected to earth potential through the EMC filter capacitors of the drive. This may cause danger, or damage the unit.

Disconnecting the EMC filter capacitors

Units of frame size R5

Remove the two screws shown below. **Note:** Depending on the EMC filter type and the nominal voltage of the drive, there may be only one screw.

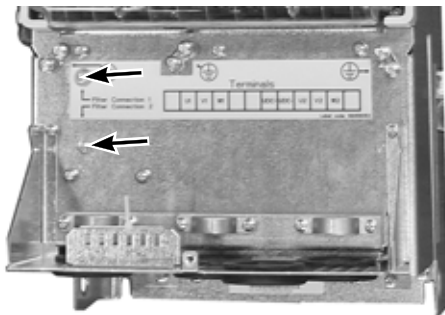

View of frame size R5

Note: When the capacitors of EMC filter +E202 or +E200 are disconnected, the EMC Directive requirements in the second environment will not be fulfilled. See chapter [Technical data: CE marking](#).

Units of frame size R6

Remove the two screws shown below. **Note:** Depending on the EMC filter type and the nominal voltage of the drive, there may be only one screw.

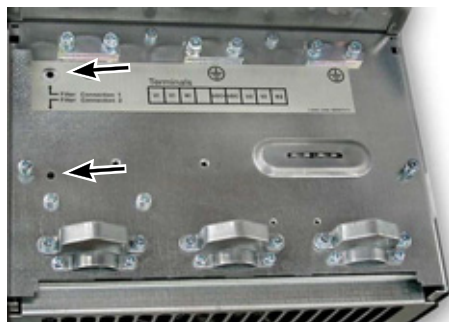

View of frame size R6

Note: When the capacitors of EMC filter +E202 are disconnected, the EMC Directive requirements may not be fulfilled in first environment, but are fulfilled in the second environment.

When the capacitors of EMC filter +E200 are disconnected, the EMC Directive requirements in the second environment are still fulfilled. See chapter [Technical data: CE marking](#).

Connecting the power cables

Diagram

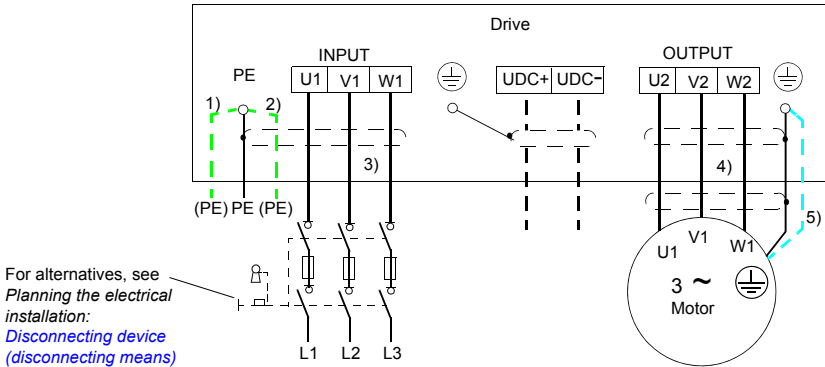

1), 2)

If shielded cable is used (not required but recommended), use a separate PE cable (1) or a cable with a grounding conductor (2) if the conductivity of the input cable shield is $< 50\%$ of the conductivity of the phase conductor.

Ground the other end of the input cable shield or PE conductor at the distribution board.

3) 360 degrees grounding recommended if shielded cable is used

4) 360 degrees grounding required

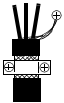

5) Use a separate grounding cable if the conductivity of the cable shield is $< 50\%$ of the conductivity of the phase conductor and there is no symmetrically constructed grounding conductor in the cable (see *Planning the electrical installation: Selecting the power cables*).

Note:

If there is a symmetrically constructed grounding conductor in the motor cable in addition to the conductive shield, connect the grounding conductor to the grounding terminal at the drive and motor ends.

Do not use an asymmetrically constructed motor cable for motors > 30 kW (40 hp). Connecting its fourth conductor at the motor end increases bearing currents and causes extra wear.

Grounding of the motor cable shield at the motor end

For minimum radio frequency interference:

- ground the cable shield 360 degrees at the lead-through of the motor terminal box

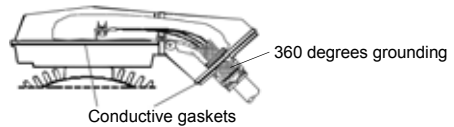

- or ground the cable by twisting the shield as follows: flattened width $\geq 1/5 \cdot \text{length}$.

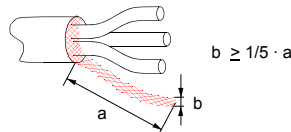

Conductor stripping lengths

Strip the conductor ends as follows to fit them inside the power cable connection terminals.

Frame size	Stripping length	
	mm	in.
R5	16	0.63
R6	28	1.10

Allowed wire sizes, tightening torques

See [Technical data: Cable entries](#).

Wall installed units (European version)

Power cable installation procedure

1. Remove the connection box cover.
2. Remove the front cover by releasing the retaining clip with a screw driver and lifting the cover from the bottom outwards.
3. Remove the clear plastic shroud of the phase conductor terminals.
4. Cut adequate holes into the rubber grommets and slide the grommets onto the cables. Slide the cables through the holes of the bottom plate.
5. Strip off the outer sheathing of the cables under the 360 degrees grounding clamps. Fasten the clamps onto the stripped parts of the cables.
6. Tighten the grounding clamps onto the twisted shields of the cables.
7. Connect the phase conductors of the mains cable to the U1, V1 and W1 terminals and the phase conductors of the motor cable to the U2, V2 and W2 terminals.
8. Cut holes to the clear plastic shroud for the conductors in frame size R5 and in cable lug installations of frame size R6.
9. Press the clear plastic shroud onto the phase conductor terminals.
10. Secure the cables outside the unit mechanically. Connect the control cables as described in section [Connecting the control cables](#) on page 78. Fasten the covers, see section [Fastening the control cables and covers](#) on page 81.

Views of frame size R5

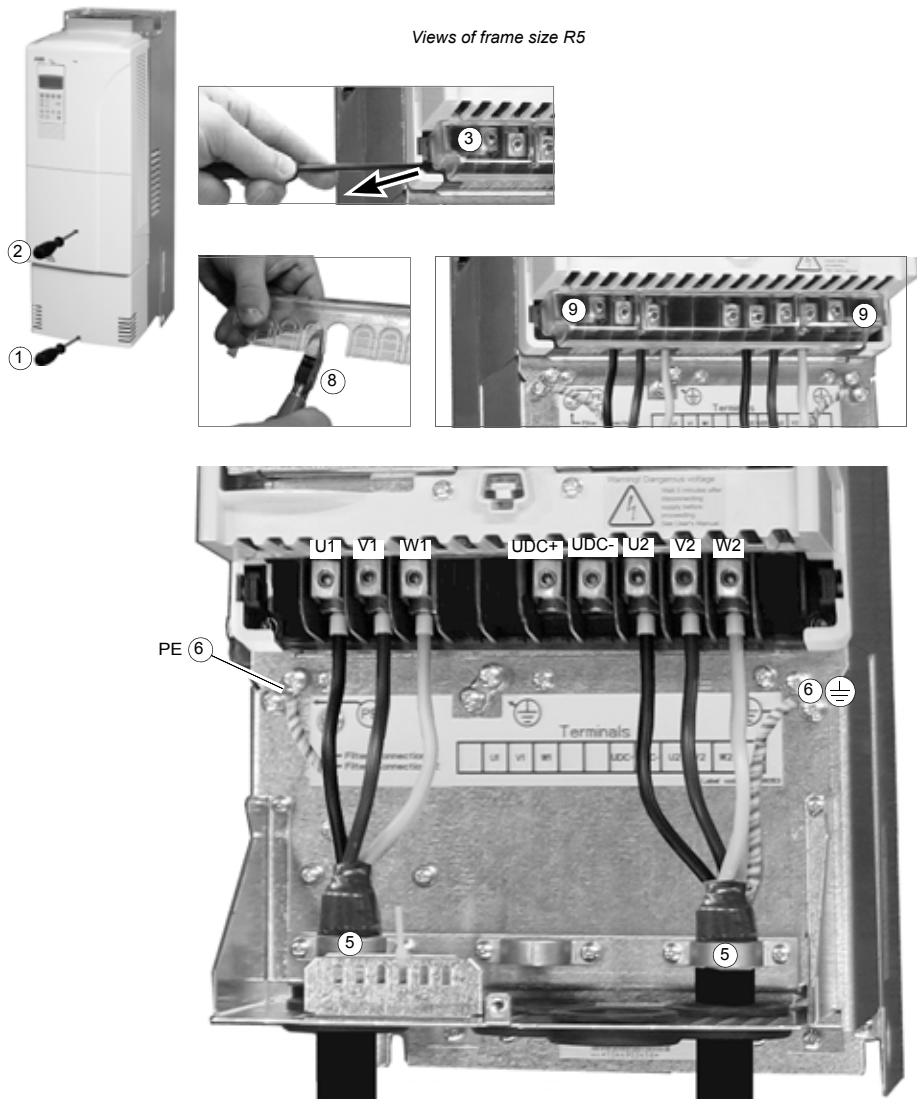

Frame sizes R6: Cable lug installation [16 to 70 mm² (6 to 2/0 AWG) cables]

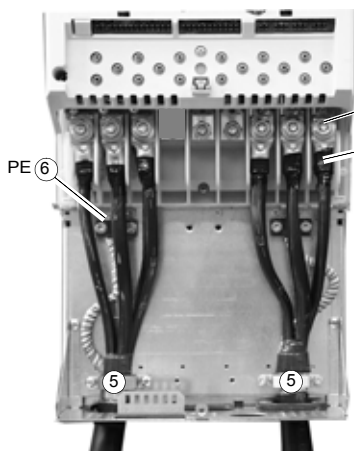

Remove the screw terminals. Fasten the cable lugs to the remaining bolts with M10 nuts.

Isolate the ends of the cable lugs with insulating tape or shrink tubing.

Shroud on the conductor terminals (screw terminal installation)



Frame size R6: Screw terminal installation [95 to 210 mm² (3/0 to 400 MCM) cables]

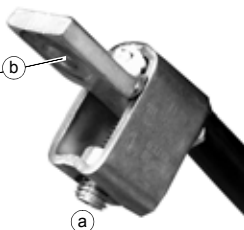
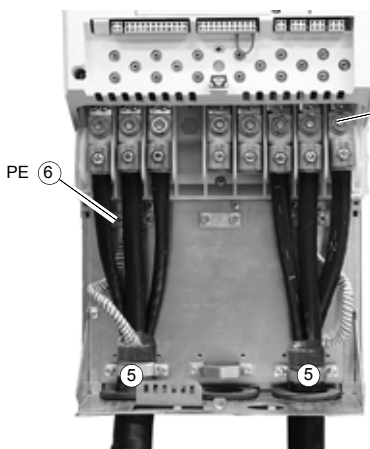

- a. Connect the cable to the terminal.
- b. Connect the terminal to the drive.



WARNING! If the wire size is less than 95 mm² (3/0 AWG), a cable lug must be used. A cable of wire size less than 95 mm² (3/0 AWG) connected to this terminal will loosen and may damage the drive.

Wall installed units (US version)

1. Remove the connection box cover.
2. Remove the front cover by releasing the retaining clip with a screw driver and lifting the cover from the bottom outwards.

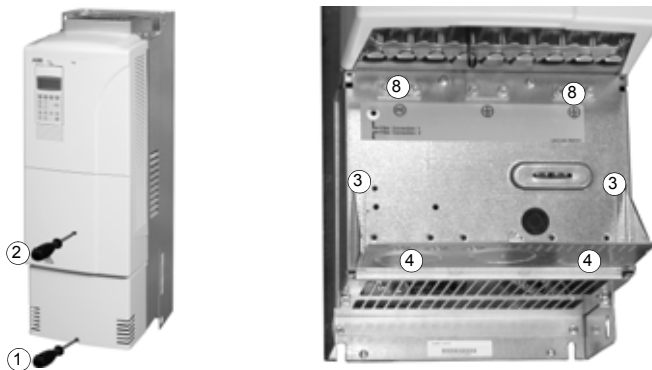

3. Remove the gland plate by undoing the fastening screws.
4. Make the cable entry holes in the gland plate by breaking off the suitable knock-out plates with a screw driver.
5. Fasten the cable glands to the opened holes of the gland plate.
6. Lead the cables through the glands.
7. Fasten the gland plate (3).
8. Connect the grounding conductors of the input and motor cables to the grounding clamps.
9. Remove the clear plastic shroud as shown in section [Power cable installation procedure](#) on page 73.
10. Connect the phase conductors of the input cable to the U1, V1 and W1 terminals and the phase conductors of the motor cable to the U2, V2 and W2 terminals.

See [Wall installed units \(European version\)](#) for cabling figures. In case of a cable lug installation, use UL listed cable lugs and tools given below or corresponding to meet UL requirements.

Wire size kcmil/AWG	Compression lug		Crimping tool		
	Manufacturer	Type	Manufacturer	Type	No. of crimps
4	Burndy	YA4C-L4BOX	Burndy	MY29-3	1
	IlSCO	CCL-4-38	IlSCO	MT-25	1
2	Burndy	YA2C-L4BOX	Burndy	MY29-3	2
	IlSCO	CRC-2	IlSCO	IDT-12	1
	IlSCO	CCL-2-38	IlSCO	MT-25	1
1	Burndy	YA1C-L4BOX	Burndy	MY29-3	2
	IlSCO	CRA-1-38	IlSCO	IDT-12	1
	IlSCO	CCL-1-38	IlSCO	MT-25	1
	Thomas & Betts	54148	Thomas & Betts	TBM-8	3
1/0	Burndy	YA25-L4BOX	Burndy	MY29-3	2
	IlSCO	CRB-0	IlSCO	IDT-12	1
	IlSCO	CCL-1/0-38	IlSCO	MT-25	1
	Thomas & Betts	54109	Thomas & Betts	TBM-8	3
2/0	Burndy	YAL26T38	Burndy	MY29-3	2
	IlSCO	CRA-2/0	IlSCO	IDT-12	1
	IlSCO	CCL-2/0-38	IlSCO	MT-25	1
	Thomas & Betts	54110	Thomas & Betts	TBM-8	3

11. Tighten the clamping nuts of the cable glands.

After connecting the control cables, fasten the clear plastic shroud and front covers.

Warning sticker



There are warning stickers in different languages inside the packing box of the drive. Attach a warning sticker in the language of your choice onto the plastic skeleton above the power cable terminals.

Cabinet installed units (IP00, UL type open)

The drive can be installed in a cabinet without the plastic front, top and connection box covers and without the lead-through plate.

It is recommended:

- to ground the cable shield 360 degrees at the cabinet entry. Grounding with the 360 degrees grounding clamps at the connection box back plate is then not needed.
- to lead the cable unstripped as close to the terminals as possible. Ground the twisted shields of the power cables under the PE and grounding clamps.

Secure the cables mechanically.

Protect the RMIO board terminals X25 to X27 against contact when input voltage exceeds 50 VAC.

Cover the power cable terminals with the clear plastic shroud as shown in section [Power cable installation procedure](#) on page 73.

Cabinet duct plates can also be used, see section [Installing cabinet duct plates \(optional\)](#) on page 43.

Connecting the control cables

Lead the cable through the control cable entry (1).

Connect the control cables as described below. Connect the conductors to the appropriate detachable terminals of the RMIO board [refer to chapter [Motor control and I/O board \(RMIO\)](#)]. Tighten the screws to secure the connection.

Terminals

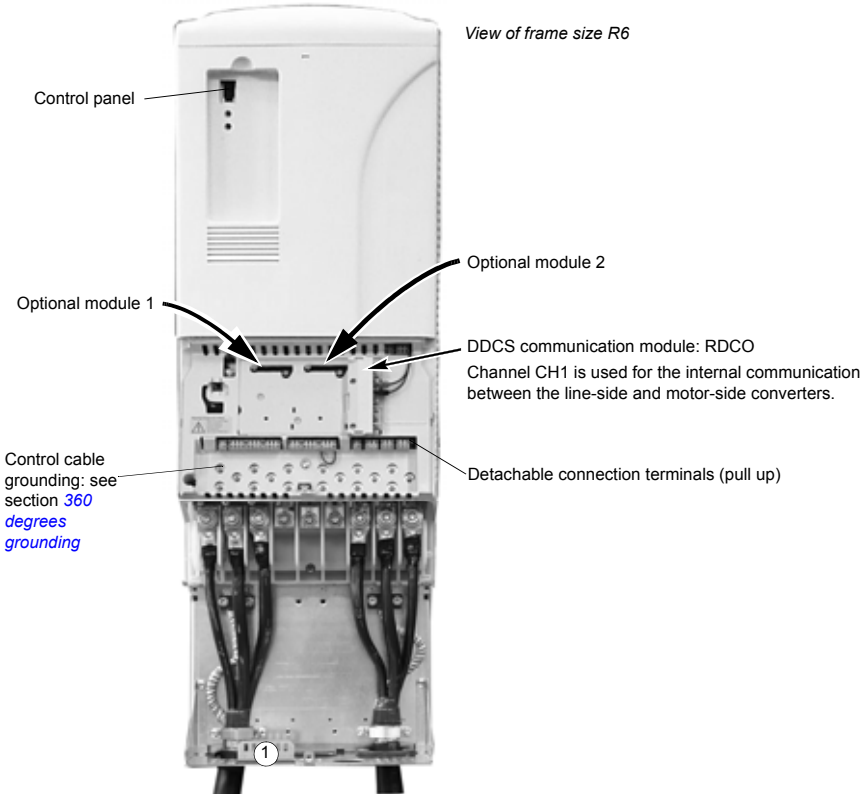

360 degrees grounding

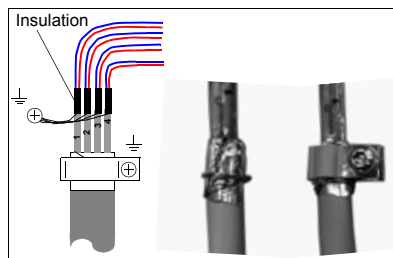

Double-shielded cable

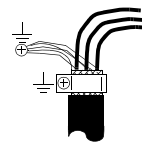

Single-shielded cable

When the outer surface of the shield is covered with non-conductive material:

- Strip the cable carefully (do not cut the grounding wire and the shield)
- Turn the shield inside out to expose the conductive surface.
- Wrap the grounding wire around the conductive surface.
- Slide a conductive clamp onto the conductive part.
- Fasten the clamp to the grounding plate with a screw as close as possible to the terminals where the wires are about to be connected.

Connecting the shield wires

Single-shielded cables: Twist the grounding wires of the outer shield and connect them through the shortest possible route to the nearest grounding hole with a cable lug and a screw. Double-shielded cables: Connect each pair cable shield (twisted grounding wires) with other pair cable shields of the same cable to the nearest grounding hole with a cable lug and a screw.

Do not connect shields of different cables to the same cable lug and grounding screw.

Leave the other end of the shield unconnected or ground it indirectly via a few nanofarads high-frequency capacitor (e.g. 3.3 nF / 630 V). The shield can also be grounded directly at both ends if they are *in the same ground line* with no significant voltage drop between the end points.

Keep the signal wire pairs twisted as close to the terminals as possible. Twisting the wire with its return wire reduces disturbances caused by inductive coupling.

Cabling of I/O and fieldbus modules

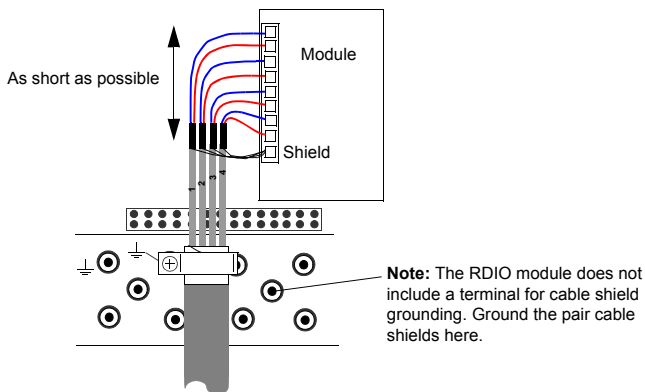

Pulse encoder module cabling

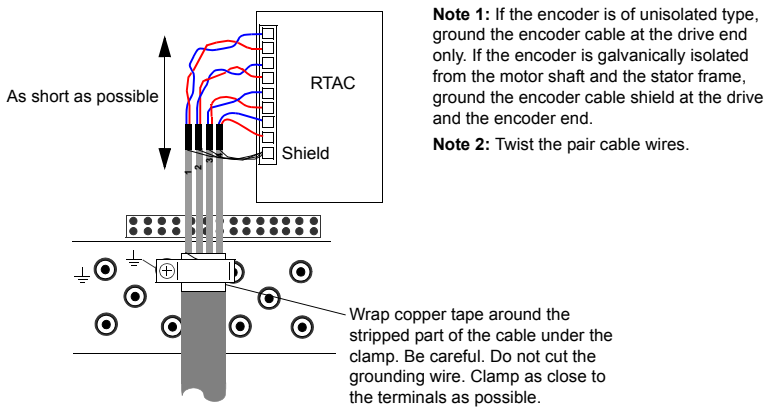

Fastening the control cables and covers

When all control cables are connected, fasten them together with cable ties. Units with a connection box: fasten the cables to the entry plate with cable ties. Units with a gland box: tighten the clamping nuts of the cable glands.



Fasten the connection box cover.



Replace the front cover.

Installation of optional modules and PC

Optional modules (such as fieldbus adapters, I/O extension modules and pulse encoder interface modules) are inserted in the optional module slots of the RMIO board (see section [Connecting the control cables](#)) and fixed with two screws. See the appropriate optional module manual for cable connections.

Note: Two RDCO modules are provided for the DDCS fibre optic link between the RMIO boards of the line-side and motor-side converters. Channel CH0 of the RDCO module in the line-side converter and channel CH1 of the RDCO module in the motor-side converter are used for the internal communication.

The number of optional modules connected to the motor-side RMIO board can be extended by using the AIMA-01 I/O module adapter. The AIMA-01 I/O module adapter is connected to the RMIO board using a fibre optic link. The line-side and motor-side RMIO boards of the drive are already connected to an internal DDCS ring, which must be customized to connect the AIMA-01 module adapter in the same ring.

In the example below, one AIMA-01 I/O module adapter is connected to the RMIO boards of the line-side and motor-side converters.

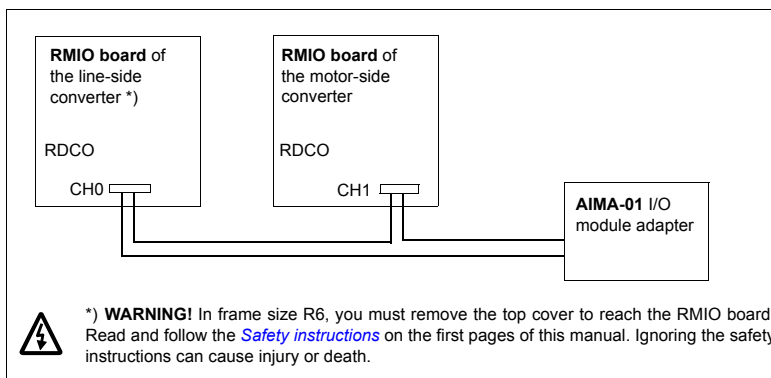

For more information, see *AIMA-01 I/O Module Adapter User's Manual* (3AFE68295351 [English]).

Connecting a PC to the motor-side RMIO board

Connect the PC to channel CH3 of the RDCO module in the motor-side converter using a fibre optic cable and a suitable adapter.

Make sure that you connect the PC to the correct RMIO board. For the locations of the RMIO boards on the drive, see section [Product overview](#) on page 30.

For more information on the RDCO module, see *RDCO-01/02/03 DDCS Communication Option Modules* (3AFE64492209 [English]).

Installation of the AGPS board (Prevention of unexpected start-up, +Q950)

What this chapter contains

This chapter describes the electrical installation of the optional Prevention of unexpected start-up function (+Q950) of the drive, and gives instructions for starting-up, validating and using the function.

Prevention of unexpected start-up (+Q950)

The optional Prevention of unexpected start-up function includes an AGPS board which is connected to the drive and an external power supply. See also section [Prevention of unexpected start-up \(option +Q950\)](#) on page 57.

Installation of the AGPS board



WARNING! Dangerous voltages can be present on the AGPS board even when the 115...230 V supply is switched off. Follow the [Safety instructions](#) on the first pages of this manual and the instruction in this chapter when working on the AGPS board.

Make sure that the drive is disconnected from the mains (input power) and the 115...230 V source for the AGPS board is switched off during installation and maintenance. If the drive is already connected to the mains, wait for 5 min after disconnecting mains power.



WARNING! The supply voltage for the AGPS board is 115...230 V AC. If the board is supplied with 24 V DC, the board is damaged and it needs to be replaced.

See

- page 28 for location of terminal block X41 of the drive
- page 85 for the circuit diagram
- page 86 for the dimensions of the AGPS board
- section [AGPS-11C \(option +Q950\)](#) in chapter [Technical data](#) for the technical data of the board.

Note: Maximum cable length between AGPS terminal block X2 and the drive terminal block is restricted to 10 metres (33 ft).

Connect the AGPS board as follows:

- Remove the enclosure cover by undoing the fixing screws (1).
- Ground the bottom plate of the enclosure or via terminal X1:1 of the AGPS board.
- Connect the cable delivered with the kit between terminal block X2 of the AGPS board (2) and drive terminal block X41.



WARNING! Use only the AGPS cable delivered with the kit. Using another cable or modifying the cable may cause a malfunction of the drive and the safety function.

- Connect a cable between connector X1 of the AGPS board (3) and the 115...230 V source.
- Fasten the enclosure cover back with screws.

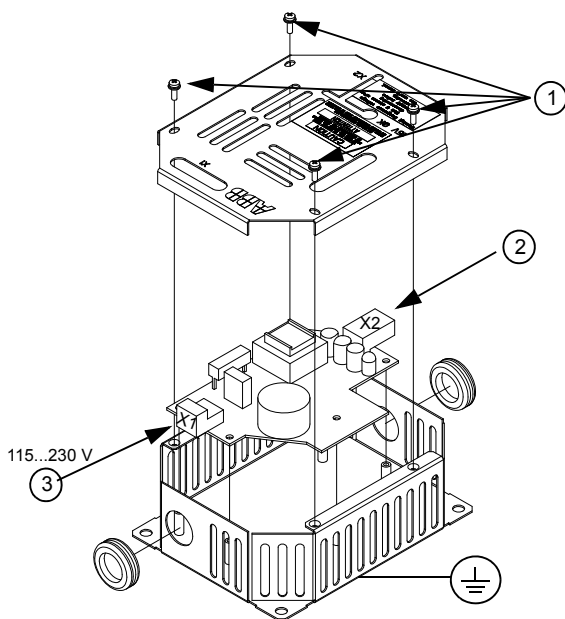

Circuit diagram

This circuit diagram shows how the AGPS-11 kit is installed.

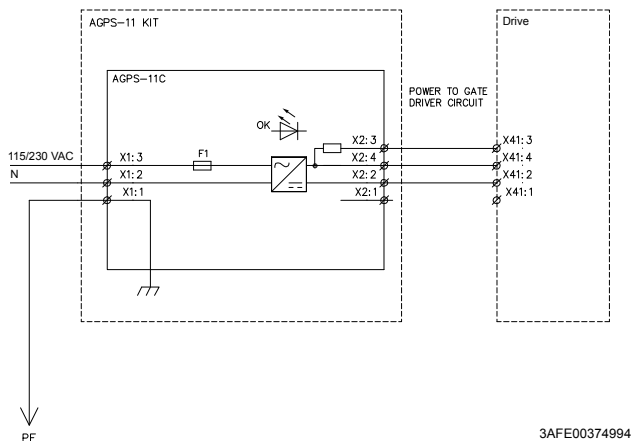

Start-up and validation

	Action
<input type="checkbox"/>	Follow the safety instructions, see section Safety instructions on page 5.
<input type="checkbox"/>	Ensure that the drive can be run and stopped freely during the start-up.
<input type="checkbox"/>	Stop the drive (if running), switch the input power off and isolate the drive from the power line by a disconnector.
<input type="checkbox"/>	Check the Prevention of unexpected start-up circuit connections against the circuit diagram.
<input type="checkbox"/>	Close the disconnector and switch the power on.
<input type="checkbox"/>	Test the operation of the Prevention of unexpected start-up function when the motor is stopped: <ul style="list-style-type: none"> • Give a stop command for the drive (if running) and wait until the motor shaft is at standstill. • Activate the Prevention of unexpected start-up function and give a start command for the drive. • Ensure that the drive does not start and the motor stays at standstill. • Deactivate the Prevention of unexpected start-up function.

Use

Activate the function as follows:

- Stop the drive. Use the stop key of the panel (local mode) or give the stop command through the I/O or fieldbus interface.
- Open the switch activating the Prevention of unexpected start-up function of the drive. -> The indication lamp (if installed) is lit.
- Lock the switch to the open position.
- Before starting the work on the machinery, ensure that the motor shaft is at standstill (not freely rotating).

Inactivate the function in reverse order.

Maintenance

After the operation of the circuit is validated at start-up, it does not need any maintenance. However, it is a good practice to check the operation of the function when other maintenance routines of the machinery are carried out.

Dimensional drawing

See page [137](#).

Installation of the ASTO board (Safe torque off, +Q967)

What this chapter contains

This chapter describes the electrical installation of the optional Safe torque off function (+Q967) of the drive and the specifications of the board.

Safe torque off (+Q967)

The optional Safe torque off function includes an ASTO board, which is connected to the drive and an external power supply.

For more information on the Safe torque off function, see section [Safe torque off \(option +Q967\)](#) on page 58 and ACS800-01/04/11/31/104/104LC *Safe torque off function (+Q967), Application guide* (3AUA0000063373 [English]).

Installation of the ASTO board



WARNING! Dangerous voltages can be present at the ASTO board even when the 24 V supply is switched off. Follow the *Safety instructions* on the first pages of this manual and the instruction in this chapter when working on the ASTO board.

Make sure that the drive is disconnected from the mains (input power) and the 24 V source for the ASTO board is switched off during installation and maintenance. If the drive is already connected to the mains, wait for 5 min after disconnecting mains power.



WARNING! The supply voltage for the ASTO-11C board is 24 V DC. If the board is supplied with 230 V AC, the board is damaged and it needs to be replaced.

See

- page 28 for location of terminal block X41 of the drive
- page 89 for the circuit diagram
- page 89 for the dimensions of the ASTO-11C board
- section *ASTO-11C (option +Q967)* in chapter *Technical data* for the technical data of the ASTO-11C board.

Note: Maximum cable length between ASTO terminal block X2 and the drive terminal block is restricted to 3 metres (9.8 ft).

Connect the ASTO board as follows:

- Remove the cover of the enclosed ASTO unit by undoing the fixing screws (1).
- Ground the ASTO unit via the bottom plate of the enclosure or via terminal X1:2 or X1:4 of the ASTO board.
- Connect the cable delivered with the kit between terminal block X2 of the ASTO board (2) and drive terminal block X41.



WARNING! Use only the ASTO cable delivered with the kit. Using another cable or modifying the cable may cause a malfunction of the drive and the safety function.

- Connect a cable between connector X1 of the ASTO board (3) and the 24 V source.
- Fasten the cover of the ASTO unit back with screws.

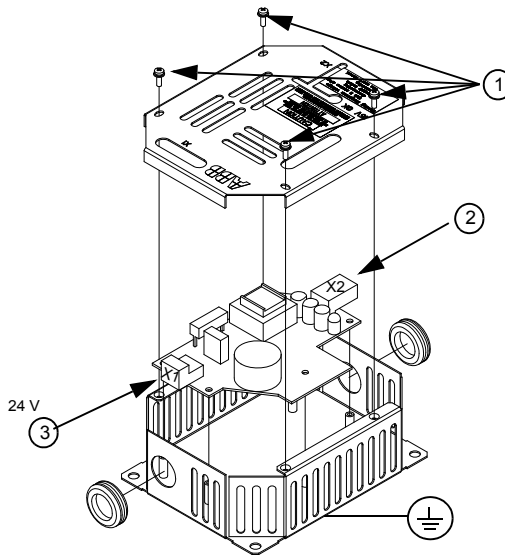

Circuit diagram

The diagram below shows the connection between the ASTO board and the drive when it is ready. For an example diagram of a complete Safe torque off circuit, see page 58.

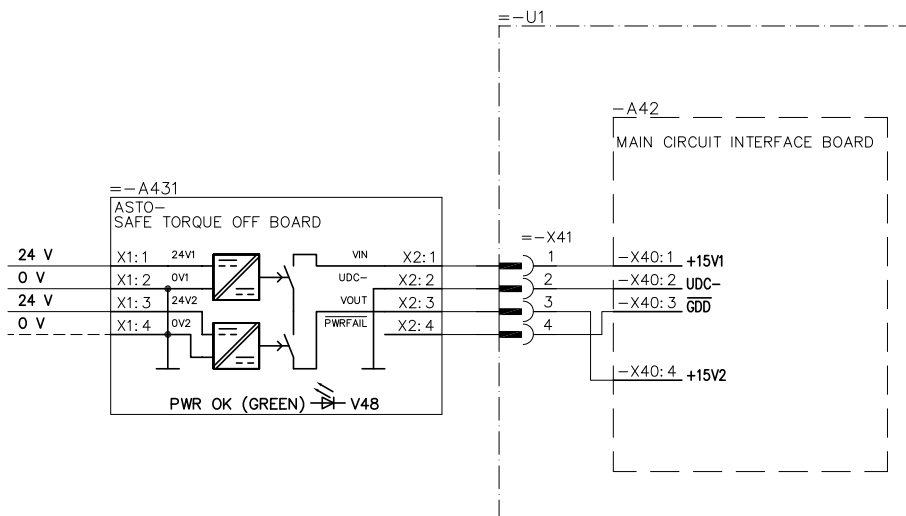

3AUA0000072542

Validation and start-up

Validate and start-up the function according to the instructions given in ACS800-01/04/11/31/104/104LC *Safe torque off function (+Q967)*, *Application guide* (3AUA0000063373 [English]).

Dimensional drawing

See page 138.

Motor control and I/O board (RMIO)

What this chapter contains

This chapter shows

- external control connections to the RMIO board for the ACS800 Standard Control Program (Factory Macro)
- specifications of the inputs and outputs of the board.

Note on terminal labelling

Optional modules (Rxxx) may have identical terminal designations with the RMIO board.

Note on external power supply

External +24 V power supply for the RMIO board is recommended if

- the application requires a fast start after connecting the input power supply
- fieldbus communication is required when the input power supply is disconnected.

The RMIO board can be supplied from an external power source via terminal X23 or X34 or via both X23 and X34. The internal power supply to terminal X34 can be left connected when using terminal X23.



WARNING! If the RMIO board is supplied from an external power source via terminal X34, the loose end of the cable removed from the RMIO board terminal must be secured mechanically to a location where it cannot come into contact with electrical parts. If the screw terminal plug of the cable is removed, the wire ends must be individually insulated.

Parameter settings

In Standard Control Program, set parameter 16.9 CTRL BOARD SUPPLY to EXTERNAL 24V if the RMIO board is powered from an external supply.

External control connections (non-US)

External control cable connections to the RMIO board for the ACS800 Standard Control Program (Factory Macro) are shown below. For external control connections of other application macros and programs, see the appropriate *Firmware Manual*.

RMIO

Terminal block size:

cables 0.3 to 3.3 mm² (22 to 12 AWG)

Tightening torque:

0.2 to 0.4 N·m
(0.2 to 0.3 lbf·ft)

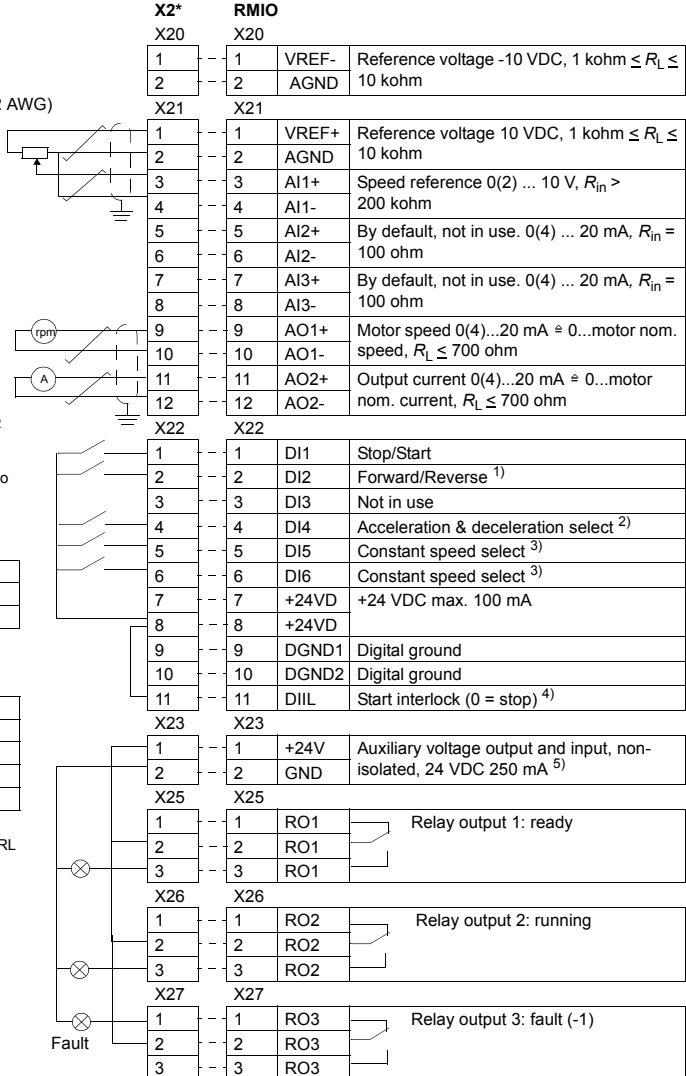

* optional terminal block in ACS800-02 and ACS800-07

¹⁾ Only effective if par. 10.03 is set to REQUEST by the user.

²⁾ 0 = open, 1 = closed

DI4	Ramp times according to
0	parameters 22.02 and 22.03
1	parameters 22.04 and 22.05

³⁾ See par. group 12 CONSTANT SPEEDS.

DI5	DI6	Operation
0	0	Set speed through AI1
1	0	Constant speed 1
0	1	Constant speed 2
1	1	Constant speed 3

⁴⁾ See parameter 21.09 START INTRL FUNC.

⁵⁾ Total maximum current shared between this output and optional modules installed on the board.

External control connections (US)

External control cable connections to the RMIO board for the ACS800 Standard Control Program (Factory Macro US version) are shown below. For external control connections of other application macros and programs, see the appropriate *Firmware Manual*.

RMIO

Terminal block size:

cables 0.3 to 3.3 mm² (22 to 12 AWG)

Tightening torque:

0.2 to 0.4 N·m
(0.2 to 0.3 lbf·ft)

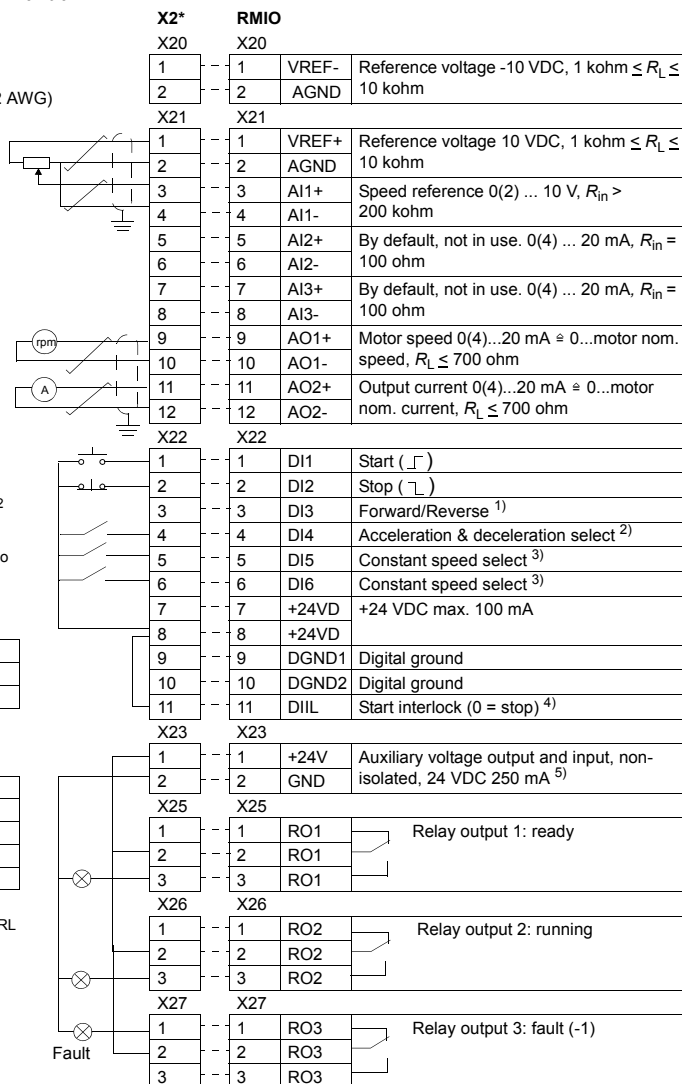

* optional terminal block in ACS800-U2 and ACS800-U7

¹⁾ Only effective if par. 10.03 is set to REQUEST by the user.

²⁾ 0 = open, 1 = closed

DI4	Ramp times according to
0	parameters 22.02 and 22.03
1	parameters 22.04 and 22.05

³⁾ See par. group 12 CONSTANT SPEEDS.

DI5	DI6	Operation
0	0	Set speed through AI1
1	0	Constant speed 1
0	1	Constant speed 2
1	1	Constant speed 3

⁴⁾ See parameter 21.09 START INTRL FUNC.

⁵⁾ Total maximum current shared between this output and optional modules installed on the board.

RMIO board specifications

Analogue inputs

	Two programmable differential current inputs (0 mA / 4 mA ... 20 mA, $R_{in} = 100 \text{ ohm}$) and one programmable differential voltage input (-10 V / 0 V / 2 V ... +10 V, $R_{in} > 200 \text{ kohm}$).
	The analogue inputs are galvanically isolated as a group.
Isolation test voltage	500 VAC, 1 min
Max. common mode voltage between the channels	$\pm 15 \text{ VDC}$
Common mode rejection ratio	$\geq 60 \text{ dB}$ at 50 Hz
Resolution	0.025% (12 bit) for the -10 V ... +10 V input. 0.5% (11 bit) for the 0 ... +10 V and 0 ... 20 mA inputs.
Inaccuracy	$\pm 0.5\%$ (Full Scale Range) at 25 °C (77 °F). Temperature coefficient: $\pm 100 \text{ ppm}/^\circ\text{C}$ ($\pm 56 \text{ ppm}/^\circ\text{F}$), max.

Constant voltage output

Voltage	+10 VDC, 0, -10 VDC $\pm 0.5\%$ (Full Scale Range) at 25 °C (77 °F). Temperature coefficient: $\pm 100 \text{ ppm}/^\circ\text{C}$ ($\pm 56 \text{ ppm}/^\circ\text{F}$) max.
Maximum load	10 mA
Applicable potentiometer	1 kohm to 10 kohm

Auxiliary power output

Voltage	24 VDC $\pm 10\%$, short circuit proof
Maximum current	250 mA (shared between this output and optional modules installed on the RMIO)

Analogue outputs

	Two programmable current outputs: 0 (4) to 20 mA, $R_L \leq 700 \text{ ohm}$
Resolution	0.1% (10 bit)
Inaccuracy	$\pm 1\%$ (Full Scale Range) at 25 °C (77 °F). Temperature coefficient: $\pm 200 \text{ ppm}/^\circ\text{C}$ ($\pm 111 \text{ ppm}/^\circ\text{F}$) max.

Digital inputs

	Six programmable digital inputs (common ground: 24 VDC, -15% to +20%) and a start interlock input. Group isolated, can be divided in two isolated groups (see Isolation and grounding diagram below).
	Thermistor input: 5 mA, $< 1.5 \text{ kohm} \hat{=} \text{"1"}$ (normal temperature), $> 4 \text{ kohm} \hat{=} \text{"0"}$ (high temperature), open circuit $\hat{=} \text{"0"}$ (high temperature).
	Internal supply for digital inputs (+24 VDC): short-circuit proof. An external 24 VDC supply can be used instead of the internal supply.
Isolation test voltage	500 VAC, 1 min
Logical thresholds	$< 8 \text{ VDC} \hat{=} \text{"0"}$, $> 12 \text{ VDC} \hat{=} \text{"1"}$
Input current	DI1 to DI 5: 10 mA, DI6: 5 mA
Filtering time constant	1 ms

Relay outputs

	Three programmable relay outputs
Switching capacity	8 A at 24 VDC or 250 VAC, 0.4 A at 120 VDC
Minimum continuous current	5 mA rms at 24 VDC
Maximum continuous current	2 A rms
Isolation test voltage	4 kVAC, 1 minute

DDCS fibre optic link

With optional communication adapter module RDCO. Protocol: DDCS (ABB Distributed Drives Communication System)

24 VDC power input

Voltage	24 VDC \pm 10%
Typical current consumption (without optional modules)	250 mA
Maximum current consumption	1200 mA (with optional modules inserted)

The terminals on the RMIO board as well as on the optional modules attachable to the board fulfil the Protective Extra Low Voltage (PELV) requirements stated in EN 50178 provided that the external circuits connected to the terminals also fulfil the requirements and the installation site is below 2000 m (6562 ft). Above 2000 m (6562 ft), see page [67](#).

Isolation and grounding diagram

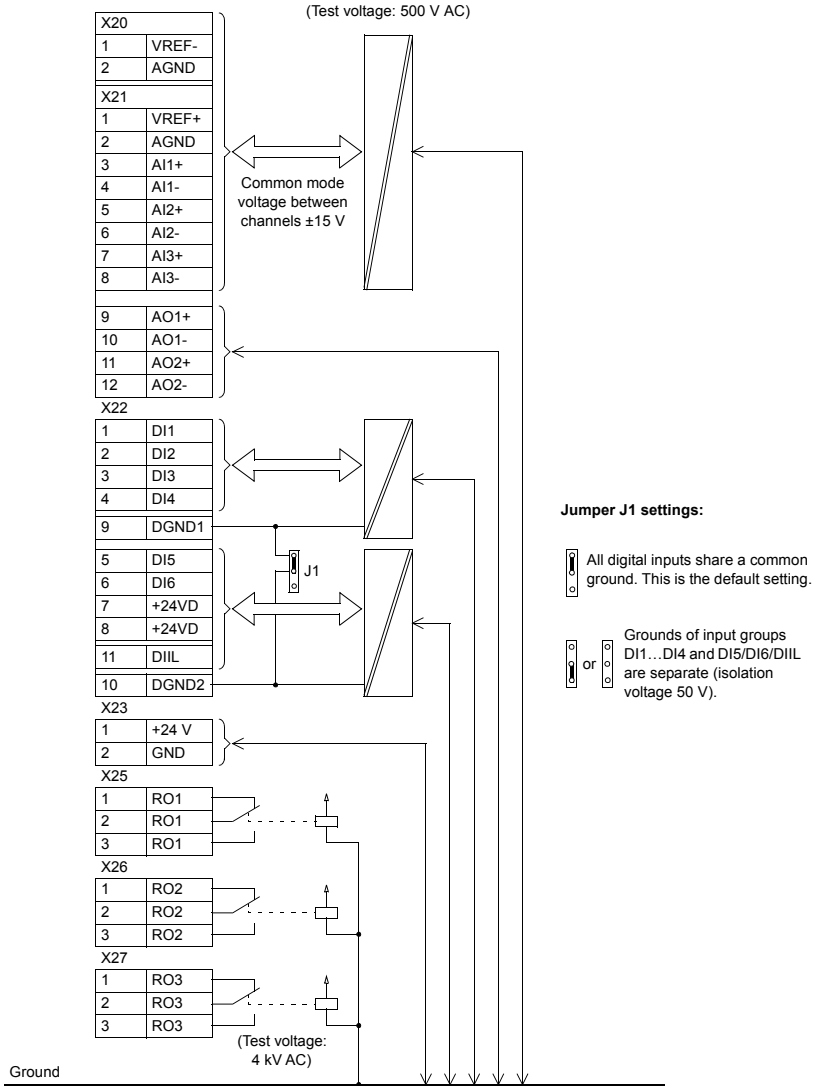

Installation checklist

What this chapter contains

This chapter contains an installation checklist.

Installation checklist

Check the mechanical and electrical installation of the drive before start-up. Go through the checklist below together with another person.



WARNING! Only qualified electricians are allowed to commission the drive. Read and follow the [Safety instructions](#) on the first pages of this manual. Ignoring the safety instructions can cause injury or death.

Check that...

MECHANICAL INSTALLATION

- The ambient operating conditions are allowed. (See [Mechanical installation, Technical data](#))
- The unit is fixed properly on a vertical non-flammable wall. (See [Mechanical installation.](#))
- The cooling air will flow freely.
- The motor and the driven equipment are ready for start. (See [Planning the electrical installation: Motor selection and compatibility, Technical data: Motor connection.](#))

ELECTRICAL INSTALLATION (See [Planning the electrical installation, Electrical installation.](#))

- The +E202 and +E200 EMC filter capacitors are disconnected if the drive is connected to an IT (ungrounded) system. (See [Electrical installation: IT \(ungrounded\) systems](#))
- The capacitors are reformed if stored over one year, refer to [Converter modules with electrolytic DC capacitors in the DC link, Capacitor reforming instructions](#) (3BFE64059629 [English]).
- The drive is grounded properly.
- The mains (input power) voltage matches the drive nominal input voltage.
- The mains (input power) connections at U1, V1 and W1 and their tightening torques are OK.
- Appropriate mains (input power) fuses and disconnector are installed.

Check that...

- The motor connections at U2, V2 and W2 and their tightening torques are OK.
- The motor cable is routed away from other cables.
- There are no power factor compensation capacitors in the motor cable.
- The external control connections inside the drive are OK.
- There are no tools, foreign objects or dust from drilling inside the drive.
- Mains (input power) voltage cannot be applied to the output of the drive (with bypass connection).
- Drive, motor connection box and other covers are in place.

Start-up and use

What this chapter contains

This chapter describes the start-up procedure and use of the drive, and the control panel control of the line-side and motor-side converters.

Start-up and use



WARNING! Only qualified electricians are allowed to commission the drive. Read and follow the [Safety instructions](#) on the first pages of this manual. Ignoring the safety instructions can cause injury or death.

Remove the protective film covering the unit.

Perform the start-up procedure as described in the appropriate control program firmware manual. **The parameters of the line-side converter control program need not be set in a normal start-up procedure or in normal use.** However, it is recommended to set parameter 16.15 START MODE to LEVEL:

- if the motor is started and stopped frequently. This prolongs the lifespan of the charging contactor.
- when starting the motor without start delay is required.
- if the drive is connected to other drives via a common DC bus. Otherwise, the charging resistor may be damaged.

For setting of parameter 16.15 START MODE, change the control panel to control the line-side converter as shown on page [100](#).

Note:

- By default, the control panel controls the RMIO board of the motor-side converter (ID number 1). If the control panel is set to control the RMIO board of the line-side converter (ID number 2), the drive does not stop by pressing the control panel Stop key in local control mode. Have the control panel control the RMIO board of the motor-side converter in normal use.
 - Do not change the ID numbers of the converters from the default settings. If the ID numbers of the line-side and motor side converters are set equal, the control panel stops communicating.
 - Keep parameter 20.05 OVERVOLTAGE CTRL set to ON (default) when no brake chopper and resistor are installed. The parameter index is valid for Standard Control Program. For other control programs, see the appropriate firmware manual. For parameter settings with a brake chopper and resistor, see chapter [Resistor braking](#).
-

Drives with option +Q950: Validate and perform the start-up procedure of the Prevention of unexpected start-up function according to instructions given in chapter [Installation of the AGPS board \(Prevention of unexpected start-up, +Q950\)](#).



Drives with option +Q967: Validate and perform the start-up procedure of the Safe torque off function according to instructions given in [ACS800-01/04/11/31/104/104LC Safe torque off function \(+Q967\), Application guide \(3AUA0000063373 \[English\]\)](#).

Control panel

The drive is equipped with a control panel (type CDP 312R). The CDP 312R is the user interface of the line-side converter and the motor-side converter of the drive, providing the essential controls such as Start/Stop/Direction/Reset/Reference, and the parameter settings for the control programs. More information on using the control panel can be found in the *Firmware Manual* delivered with the drive.

The control panel is wired to both the line-side converter and the motor-side converter using a Y-splitter. The converter that is currently being controlled is indicated by the converter name on the drive display; the suffix "MR" denotes motor-side converter, "LR" denotes line-side converter. The control is switched between the converters as follows:



To control the line-side converter...

Step	Action	Press key	Display (example)
1.	Enter the Drive Selection Mode. Note: In local control mode, the motor-side converter trips if parameter 30.02 PANEL LOSS is set to FAULT. Refer to the appropriate control program firmware manual.		ACS 800 0050_5MR ASXR7xxx ID-NUMBER 1
2.	Scroll to ID number 2.		ACS 800 0050_5LR IXXR7xxx ID-NUMBER 2
3.	Verify the change to the line-side converter and display the warning or fault text.		2 -> 380.0 V ACS 800 0050_5LR ** FAULT ** DC OVERVOLT (3210)



WARNING! The drive does not stop by pressing the control panel Stop key in local control mode.

To control the motor-side converter...

Step	Action	Press key	Display (example)
1.	Enter the Drive Selection Mode.		ACS 800 0050_5LR IXXR7xxx ID-NUMBER 2
2.	Scroll to ID number 1.		ACS 800 0050_5MR ACXR7xxx ID-NUMBER 1
3.	Verify the change to the motor-side converter.		1 L -> 0.0 rpm I FREQ 0.00 Hz CURRENT 0.00 A POWER 0.00 %

Removing the control panel

To remove the control panel from the panel holder, press down the locking clip and pull the panel out.

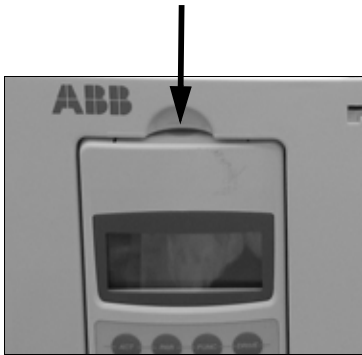

Actual signals and parameters

What this chapter contains

This chapter contains listings of parameters specific to the ACS800-31 and ACS800-U31.

Line-side converter actual signals and parameters in the motor-side converter control program

This section describes the actual signals and parameters of the line-side converter control program which are copied to the motor-side converter control program. The user can view two actual signals (by default, measured line current and intermediate circuit DC voltage) and change the values of the copied parameters without changing the control panel between two control boards and programs. In normal use, there is no need to set these or other parameters of the line-side converter control program. For more information on the parameters, refer to *ACS800 IGBT Supply Control Program Firmware Manual* [3AFE68315735 (English)].

Terms and abbreviations

Term	Definition
Actual signal	Signal measured or calculated by the drive. Can be monitored by the user. No user setting possible.
Def.	Default value
FbEq	Fieldbus equivalent: The scaling between the value shown on the control panel and the integer used in serial communication.
Parameter	A user-adjustable operation instruction of the drive.

Actual signals

No.	Name/Value	Description	FbEq	Def.
09 ACTUAL SIGNALS		Signals from the line converter.		
09.12	LCU ACT SIGNAL 1	Line converter signal selected by par. 95.08 LCU PAR1 SEL.	1 = 1	106
09.13	LCU ACT SIGNAL 2	Line converter signal selected by par. 95.09 LCU PAR2 SEL.	1 = 1	110

Parameters

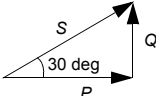
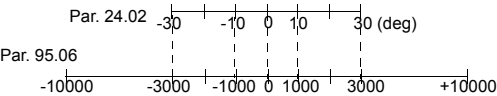
No.	Name/Value	Description	FbEq	Def.
95 HARDWARE SPECIF		Line converter references and actual signal selections.		
95.06	LCU Q POW REF	<p>Reactive power reference for the line converter i.e. the value for par. 24.02 Q POWER REF2 in the IGBT Supply Control Program.</p> <p><u>Scaling example 1:</u> 10000 equals to a value of 10000 of parameter 24.02 Q POWER REF2 and 100% of par. 24.01 Q POWER REF (i.e. 100% of the converter nominal power given in par. 04.06 CONV NOM POWER) when par. 24.03 Q POWER REF2 SEL is set to PERCENT.</p> <p><u>Scaling example 2:</u> Par. 24.03 Q POWER REF2 SEL is set to kVAr. A value of 1000 of par. 95.06 equals to 1000 kVAr of par. 24.02 Q POWER REF2. Value of par. 24.01 Q POWER REF is then $100 \cdot (1000 \text{ kVAr divided by converter nominal power in kVAr})\%$.</p> <p><u>Scaling example 3:</u> Par. 24.03 Q POWER REF2 SEL is set to PHI. A value of 10000 of par. 95.06 equals to a value of 100 deg of parameter 24.02 Q POWER REF2 which is limited to 30 deg. The value of par. 24.01 Q POWER REF will be determined approximately according to the following equation where P is read from actual signal 1.06 POWER:</p> <div style="text-align: center;">  </div> $\cos 30 = \frac{P}{S} = \frac{P}{\sqrt{P^2 + Q^2}}$ <p>Positive reference 30 deg denotes capacitive load. Negative reference 30 deg denotes inductive load.</p> <div style="text-align: center;">  </div>		0
	-10000 ... +10000	Setting range.	1 = 1	
95.07	LCU DC REF (V)	DC voltage reference for line converter i.e. the value for par. 23.01 DC VOLT REF.		0
	0 ... 1100	Setting range in volts.	1 = 1 V	
95.08	LCU PAR1 SEL	Selects the line-side converter address from which actual signal 09.12 LCU ACT SIGNAL 1 is read.		106
	0 ... 10000	Parameter index.	1 = 1	
95.09	LCU PAR2 SEL	Selects the line-side converter address from which actual signal 09.13 LCU ACT SIGNAL 2 is read.		110
	0 ... 10000	Parameter index.	1 = 1	

Actual signals and parameters

ACS800-31/U31 specific parameters in the IGBT Supply Control Program



The signals and parameters of the IGBT Supply Control Program which are specific to the ACS800-31 and ACS800-U31 are described in the tables below. These parameters need not be set in a normal start-up. For more information on parameters of the IGBT Supply Control Program, refer to *ACS800 IGBT Supply Control Program Firmware Manual* [3AFE68315735 (English)].

Terms and abbreviations

Term	Definition
B	Boolean data type
C	Character string data type
Def.	Default value data type
FbEq	Fieldbus equivalent: the scaling between the value shown on the control panel and the integer used in serial communication
I	Integer data type
R	Real data type
T.	Data type (see B, C, I, R)

Parameters

No.	Name/Value	Description	T./FbEq	Def.
16 SYSTEM CTR INPUTS		Parameter lock, parameter back-up etc.		
16.15	START MODE	Selects the start mode.	B	EDGE
	LEVEL	Starts converter by level of control command. Control command is selected by parameter 98.01 COMMAND SEL and 98.02 COMM. MODULE.  WARNING! After a fault reset, the converter will start if the start signal is on.	0	
	EDGE	Starts converter by EDGE of control command. Control command is selected by parameter 98.01 COMMAND SEL and 98.02 COMM. MODULE.	1	

No.	Name/Value	Description	T./FbEq	Def.
31	AUTOMATIC RESET	<p>Automatic fault reset.</p> <p>Automatic resets are possible only for certain fault types and when the automatic reset function is activated for that fault type.</p> <p>The automatic reset function is not operational if the drive is in local control (L visible on the first row of the control panel display).</p> <p> WARNING! If the start command is selected and it is ON, the line converter may restart immediately after automatic fault reset. Ensure that the use of this feature will not cause danger.</p> <p> WARNING! Do not use these parameters when the drive is connected to a common DC bus. The charging resistors may be damaged in an automatic reset.</p>		
31.01	NUMBER OF TRIALS	Defines the number of automatic fault resets the drive performs within the time defined by parameter 31.02 TRIAL TIME.	I	0
	0 ... 5	Number of the automatic resets	0	
31.02	TRIAL TIME	Defines the time for the automatic fault reset function. See parameter 31.01 NUMBER OF TRIALS.	R	30 s
	1.0 ... 180.0 s	Allowed resetting time	100 ... 18000	
31.03	DELAY TIME	Defines the time that the drive will wait after a fault before attempting an automatic reset. See parameter 31.01 NUMBER OF TRIALS.	R	0 s
	0.0 ... 3.0 s	Resetting delay	0 ... 300	
31.04	OVERCURRENT	Activates/deactivates the automatic reset for the line converter overcurrent fault.	B	NO
	NO	Inactive	0	
	YES	Active	65535	
31.05	OVERVOLTAGE	Activates/deactivates the automatic reset for the intermediate link overvoltage fault.	B	NO
	NO	Inactive	0	
	YES	Active	65535	
31.06	UNDERVOLTAGE	Activates/deactivates the automatic reset for the intermediate link undervoltage fault.	B	NO
	NO	Inactive	0	
	YES	Active	65535	

Fixed parameters with the ACS800-31 and ACS800-U31

When the IGBT Supply Control Program is loaded into the ACS800-31 or ACS800-U31, the following parameters are set to the default values given in the table below.

Parameter	Default value	If changed,
11.01 DC REF SELECT	FIELDBUS	the default values will be restored on the next power-up.
11.02 Q REF SELECT	PARAM 24.02	
98.01 COMMAND SEL	MCW. Note: If par. 16.15 START MODE is set to LEVEL, the default value is changed to I/O on the next RMIO board power-up.	
98.02 COMM. MODULE	INU COM LIM	
30.02 EARTH FAULT	FAULT. Note: The ACS800-31/U31 line converter is not equipped with internal earth fault supervision.	the default values will not be restored on the next power-up. Do not change. If the default values are changed, the drive will not operate.
70.01 CH0 NODE ADDR	120	
70.19 CH0 HW CONNECTION	RING	
70.20 CH3 HW CONNECTION	RING	
71.01 CH0 DRIVEBUS MODE	NO	

Maintenance

What this chapter contains

This chapter contains preventive maintenance instructions.

Safety



WARNING! Read the *Safety instructions* on the first pages of this manual before performing any maintenance on the equipment. Ignoring the safety instructions can cause injury or death.

Maintenance intervals

If installed in an appropriate environment, the drive requires very little maintenance. This table lists the routine maintenance intervals recommended by ABB.

Interval	Maintenance	Instruction
Every 6 to 12 months Depends on the dustiness of the environment.	Heatsink temperature check and cleaning	See <i>Heatsink</i> .
Every year when stored	Capacitor reforming	See <i>Reforming</i> .
Every 3 years	Change of additional cooling fan	See <i>Additional fan</i> .
Every 6 years	Main cooling fan change	See <i>Main cooling fan</i> .
Every 10 years	Capacitor change	See <i>Capacitors</i> .

Consult your local ABB Service representative for more details on the maintenance. On the Internet, go to <http://www.abb.com/driveservices>.

Heatsink

The heatsink fins pick up dust from the cooling air. The drive runs into overtemperature warnings and faults if the heatsink is not clean. In a “normal” environment (not dusty, not clean) the heatsink should be checked annually, in a dusty environment more often.

Clean the heatsink as follows (when necessary):

1. Remove the cooling fan (see section [Main cooling fan](#)).
2. Blow clean compressed air (not humid) from bottom to top and simultaneously use a vacuum cleaner at the air outlet to trap the dust. **Note:** If there is a risk of the dust entering adjoining equipment, perform the cleaning in another room.
3. Replace the cooling fan.

Main cooling fan

The lifespan of the cooling fan depends on the drive usage and ambient temperature. See the appropriate ACS800 firmware manual for an actual signal which indicates the hours of usage of the fan. For resetting the running time signal after a fan replacement, please contact ABB.

Fan failure can be predicted by the increasing noise from fan bearings and the gradual rise in the heatsink temperature in spite of heatsink cleaning. If the drive is operated in a critical part of a process, fan replacement is recommended once these symptoms start appearing. Replacement fans are available from ABB. Do not use other than ABB specified spare parts.

Fan replacement (R5, R6)

1. Loosen the fastening screws of the top plate.
2. Push the top plate backwards.
3. Lift the top plate up.
4. Disconnect the fan supply wires (detachable connector).
5. Lift the fan up.
6. Install the new fan in reverse order.

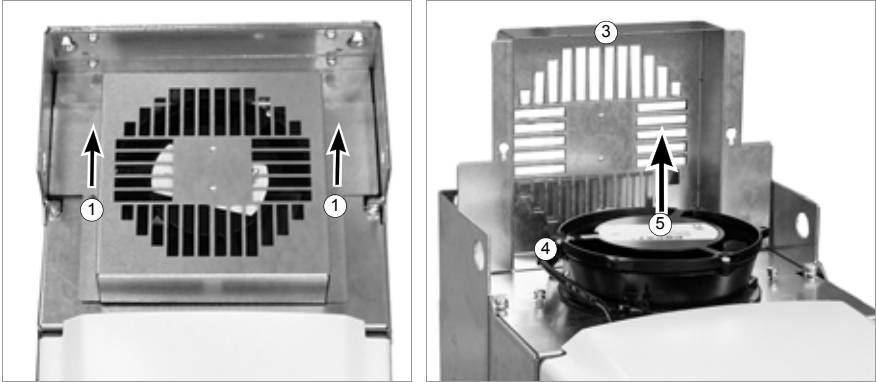

Additional fan

Replacement (R5)

Remove the front cover. The fan is located on the right-hand side of the control panel (R5). Lift the fan out and disconnect the cable. Install the new fan in reverse order.

Replacement (R6)

Remove the top cover by lifting it by the rear edge. To remove the fan, release the retaining clips by pulling the back edge (1) of the fan upwards. Disconnect the cable (2, detachable terminal). Install the new fan in reverse order.

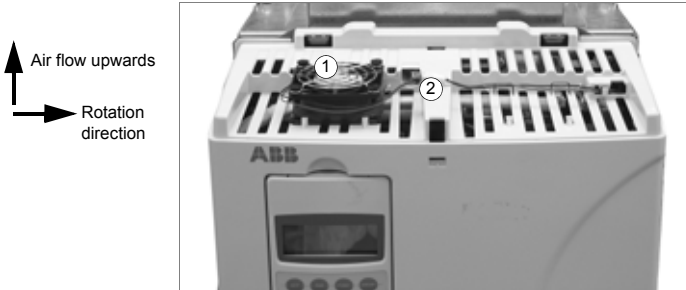

Capacitors

The drive intermediate circuit employs several electrolytic capacitors. The lifespan depends on drive loading and ambient temperature. Capacitor life can be prolonged by lowering the ambient temperature.

It is not possible to predict a capacitor failure. Capacitor failure is usually followed by a mains fuse failure or a fault trip. Contact ABB if capacitor failure is suspected. Replacements are available from ABB. Do not use other than ABB specified spare parts.

Reforming

Reform (re-age) spare part capacitors once a year according to *Converter modules with electrolytic DC capacitors in the DC link, Capacitor reforming instructions* (3BFE64059629 [English]).

Fault tracing

What this chapter contains

This chapter describes the fault and warning messages displayed on the control panel and the LEDs of the drive. For a detailed description of the fault and warning messages, see the appropriate firmware manual

Faults and warnings displayed by the CDP 312R control panel

The control panel displays the Warning and Fault messages of the unit (that is, line-side converter or motor-side converter) the panel is currently controlling.

In addition, the panel indicates the active warnings and faults in the unit that is not currently being controlled. The information between the units is delivered through a separate serial communication channel.

An active warning or fault state in the line-side converter (ID:2) is indicated by flashing messages WARNING, ID:2 or FAULT, ID:2 on the control panel display when the panel is controlling the line-side converter.

```

FAULT, ID:2
ACS 800 0490 3MR
*** FAULT ***
LINE CONV      (FF51)
  
```

To display the warning or fault identification text, switch the control panel to view the line-side converter as described in section [Control panel](#) on page 100.

Information on warnings and faults concerning the line-side converter are described in *ACS800 IGBT Supply Control Program Firmware Manual* [3AFE68315735 (English)].

The warnings and faults concerning the motor-side converter are described in the control program (e.g. Standard Control Program) *Firmware Manual*.

Conflicting ID numbers

If the ID numbers of the line-side and the motor-side converters are set equal, the control panel stops functioning. To clear the situation:

- Disconnect the panel cable from the RMIO board of the motor-side converter, and connect it to the RMIO board of the line-side converter.
- Set the ID number of the line-side converter RMIO board to 2. For the setting procedure, see the control program (e.g. Standard Control Program) *Firmware Manual*.
- Disconnect the panel cable from the line-side converter RMIO board, and reconnect it to the motor-side converter RMIO board.

- Reconnect the panel cable to the RMIO board of the motor-side converter again and set the ID number to 1.

LEDs

This table describes LEDs of the drive.

Where	LED	When the LED is lit
RMIO board *	Red	Drive in fault state
	Green	The power supply on the board is OK.
Control panel mounting platform	Red	Drive in fault state
	Green	The main +24 V power supply for the control panel and the RMIO board is OK.

* The LEDs are not visible

Technical data

What this chapter contains

This chapter contains the technical specifications of the drive, e.g. the ratings, sizes and technical requirements, provisions for fulfilling the requirements for CE and other markings and warranty policy.

IEC data

Ratings

The IEC ratings for the ACS800-31 with 50 Hz and 60 Hz supplies are given below. The symbols are described below the table.

ACS800-31 type	Nominal ratings		No-overload use	Light-overload use		Heavy-duty use		Frame size	Air flow m ³ /h	Heat dissipation W
	$I_{cont,max}$ A	I_{max} A	$P_{cont,max}$ kW	I_{2N} A	P_N kW	I_{2hd} A	P_{hd} kW			
Three-phase supply voltage 208 V, 220 V, 230 V or 240 V										
-0011-2	34	52	7.5	32	7.5	26	5.5	R5	350	505
-0016-2	47	68	11	45	11	38	7.5	R5	350	694
-0020-2	59	90	15	56	15	45	11	R5	350	910
-0025-2	75	118	22	69	18.5	59	15	R5	350	1099
-0030-2	88	137	22	83	22	72	18.5	R5	350	1315
-0040-2	120	168	37	114	30	84	22	R6	405	1585
-0050-2	150	234	45	143	45	117	30	R6	405	2125
-0060-2	169	264	45	157	45	132	37	R6	405	2530
Three-phase supply voltage 380 V, 400 V or 415 V										
-0016-3	34	52	15	32	15	26	11	R5	350	550
-0020-3	38	61	18.5	36	18.5	34	15	R5	350	655
-0025-3	47	68	22	45	22	38	18.5	R5	350	760
-0030-3	59	90	30	56	30	45	22	R5	350	1000
-0040-3	72	118	37	69	37	59	30	R5	350	1210
-0050-3	86	137	45	83	45	65	30	R5	350	1450
-0060-3	120	168	55	114	55	88	45	R6	405	1750
-0070-3	150	234	75	143	75	117	55	R6	405	2350
-0100-3	165	264	90	157	75	132	75	R6	405	2800
Three-phase supply voltage 380 V, 400 V, 415 V, 440 V, 460 V, 480 V or 500 V										
-0020-5	31	52	18.5	29	18.5	25	15	R5	350	655
-0025-5	36	61	22	34	22	30	18.5	R5	350	760
-0030-5	47	68	30	45	30	37	22	R5	350	1000
-0040-5	58	90	37	55	37	47	30	R5	350	1210
-0050-5	70	118	45	67	45	57	37	R5	350	1450
-0060-5	82	130	55	78	45	62	37	R5	350	1750
-0070-5	120	168	75	114	75	88	55	R6	405	2350
-0100-5	139	234	90	132	90	114	75	R6	405	2800
-0120-5	156	264	110	148	90	125	75	R6	405	3400
Three-phase supply voltage 525 V, 550 V, 575 V, 600 V, 660 V or 690 V										
-0060-7	57	86	55	54	45	43	37	R6	405	1750
-0070-7	79	120	75	75	55	60	55	R6	405	2350
-0100-7	93	142	90	88	75	71	55	R6	405	2800

00184674

Symbols

Nominal ratings

$I_{\text{cont.max}}$	continuous rms output current. No overload capability at 40 °C (104 °F).
I_{max}	maximum output current. Available for 10 s at start, otherwise as long as allowed by drive temperature.

Typical ratings:

No-overload use

$P_{\text{cont.max}}$	typical motor power. The power ratings apply to most IEC 60034 motors at the nominal voltage, 230 V, 400 V, 500 V or 690 V.
-----------------------	---

Light-overload use (10% overload capability)

I_{2N}	continuous rms current. 10% overload is allowed for one minute every 5 minutes.
P_N	typical motor power. The power ratings apply to most IEC 60034 motors at the nominal voltage, 230 V, 400 V, 500 V or 690 V.

Heavy-duty use (50% overload capability)

I_{2hd}	continuous rms current. 50% overload is allowed for one minute every 5 minutes.
P_{hd}	typical motor power. The power ratings apply to most IEC 60034 motors at the nominal voltage, 230 V, 400 V, 500 V or 690 V.

Sizing

The current ratings are the same regardless of the supply voltage within one voltage range. To achieve the rated motor power given in the table, the rated current of the drive must be higher than or equal to the rated motor current.

Note 1: The maximum allowed momentary motor shaft power is limited to approximately $1.3 \cdot P_{\text{cont.max}}$. If the limit is exceeded, motor torque and current are automatically restricted. The function protects the input bridge and LCL filter of the drive against overload.

Note 2: The ratings apply at an ambient temperature of 40 °C (104 °F). At lower temperatures the ratings are higher (except I_{max}).

Note 3: Use the DriveSize PC tool for a more accurate dimensioning if the ambient temperature is below 40 °C (104 °F) or the drive is loaded cyclically.

Derating

The load capacity (current and power) decreases if the installation site altitude exceeds 1000 metres (3300 ft), or if the ambient temperature exceeds 40 °C (104 °F).

Temperature derating

In the temperature range +40 °C (+104 °F) to +50 °C (+122 °F) the rated output current is decreased 1% for every additional 1 °C (1.8 °F). The output current is calculated by multiplying the current given in the rating table by the derating factor.

Example If the ambient temperature is 50 °C (+122 °F), the derating factor is $100\% - 1 \frac{\%}{^{\circ}\text{C}} \cdot 10^{\circ}\text{C} = 90\%$ or 0.90. The output current is then $0.90 \cdot I_{2N}$ or $0.90 \cdot I_{2hd}$.

Altitude derating

In altitudes from 1000 to 4000 m (3300 to 13123 ft) above sea level, the derating is 1% for every 100 m (328 ft). For a more accurate derating, use the DriveSize PC tool.

Mains cable fuses

Fuses for short-circuit protection of the mains cable are listed below. The fuses also protect the adjoining equipment of the drive in case of a short-circuit. **Check that the operating time of the fuse is below 0.1 seconds.** The operating time depends on the supply network impedance and the cross-sectional area and length of the supply cable. See also [Planning the electrical installation: Thermal overload and short-circuit protection](#). For UL recognized fuses, see [NEMA data](#).

Note 1: In multicable installations, install only one fuse per phase (not one fuse per conductor).

Note 2: Larger fuses must not be used.

Note 3: Fuses from other manufacturers can be used if they meet the ratings.

ACS800-31 type	Input current	gG fuses					
		A	A ² s *	V	Manufacturer	Type	IEC size
Three-phase supply voltage 208 V, 220 V, 230 V or 240 V							
-0011-2	32	40	9140	500	ABB Control	OFAF000H40	000
-0018-2	44	50	15400	500	ABB Control	OFAF000H50	000
-0020-2	55	63	21300	500	ABB Control	OFAF000H63	000
-0025-2	70	80	34500	500	ABB Control	OFAF000H80	000
-0030-2	82	100	63600	500	ABB Control	OFAF000H100	000
-0040-2	112	125	103000	500	ABB Control	OFAF000H125	00
-0050-2	140	160	200000	500	ABB Control	OFAF000H160	00
-0060-2	157	200	350000	500	ABB Control	OFAF1H200	1
Three-phase supply voltage 380 V, 400 V or 415 V							
-0016-3	32	40	9140	500	ABB Control	OFAF000H40	000
-0020-3	35	40	9140	500	ABB Control	OFAF000H40	000
-0025-3	44	50	15400	500	ABB Control	OFAF000H50	000
-0030-3	55	63	21300	500	ABB Control	OFAF000H63	000
-0040-3	67	80	34500	500	ABB Control	OFAF000H80	000
-0050-3	80	100	63600	500	ABB Control	OFAF000H100	000
-0060-3	112	125	103000	500	ABB Control	OFAF000H125	00
-0070-3	140	160	200000	500	ABB Control	OFAF000H160	00
-0100-3	153	200	350000	500	ABB Control	OFAF1H200	1
Three-phase supply voltage 380 V, 400 V, 415 V, 440 V, 460 V, 480 V or 500 V							
-0020-5	29	40	9140	500	ABB Control	OFAF000H40	000
-0025-5	33	40	9140	500	ABB Control	OFAF000H40	000
-0030-5	44	50	15400	500	ABB Control	OFAF000H50	000
-0040-5	54	63	21300	500	ABB Control	OFAF000H63	000
-0050-5	65	80	34500	500	ABB Control	OFAF000H80	000
-0060-5	76	100	63600	500	ABB Control	OFAF000H100	000
-0070-5	112	125	103000	500	ABB Control	OFAF000H125	00
-0100-5	129	160	200000	500	ABB Control	OFAF000H160	00
-0120-5	145	200	350000	500	ABB Control	OFAF1H200	1
Three-phase supply voltage 525 V, 550 V, 575 V, 600 V, 660 V or 690 V							
-0060-7	53	63	28600	690	ABB Control	OFAA0GG63	0
-0070-7	73	80	52200	690	ABB Control	OFAA0GG80	0
-0100-7	86	100	93000	690	ABB Control	OFAA1GG100	1

00184674

* maximum total I^2t value for 550 V

aR fuses							
ACS800-31 type	Input current	Fuse					
		A	A ² s (@660V)	V	Manufacturer	Fuse size	Type DIN 43620
Three-phase supply voltage 208 V, 220 V, 230 V or 240 V							
-0011-2	32	63	1450	690	Bussmann	000	170M1565
-0016-2	44	80	2550	690	Bussmann	000	170M1566
-0020-2	55	100	4650	690	Bussmann	000	170M1567
-0025-2	70	125	8500	690	Bussmann	000	170M1568
-0030-2	82	125	8500	690	Bussmann	000	170M1568
-0040-2	112	160	7500	690	Bussmann	1*	170M3814
-0050-2	140	200	15000	690	Bussmann	1*	170M3815
-0060-2	157	250	28500	690	Bussmann	1*	170M3816
Three-phase supply voltage 380 V, 400 V or 415 V							
-0016-3	32	63	1450	690	Bussmann	000	170M1565
-0020-3	35	80	2550	690	Bussmann	000	170M1566
-0025-3	44	80	2550	690	Bussmann	000	170M1566
-0030-3	55	100	4650	690	Bussmann	000	170M1567
-0040-3	67	125	8500	690	Bussmann	000	170M1568
-0050-3	80	125	8500	690	Bussmann	000	170M1568
-0060-3	112	160	7500	690	Bussmann	1*	170M3814
-0070-3	140	200	15000	690	Bussmann	1*	170M3815
-0100-3	153	250	28500	690	Bussmann	1*	170M3816
Three-phase supply voltage 380 V, 400 V, 415 V, 440 V, 460 V, 480 V or 500 V							
-0020-5	29	63	1450	690	Bussmann	000	170M1565
-0025-5	33	80	2550	690	Bussmann	000	170M1566
-0030-5	44	80	2550	690	Bussmann	000	170M1566
-0040-5	54	100	4650	690	Bussmann	000	170M1567
-0050-5	65	125	8500	690	Bussmann	000	170M1568
-0060-5	76	125	8500	690	Bussmann	000	170M1568
-0070-5	112	160	7500	690	Bussmann	1*	170M3814
-0100-5	129	200	15000	690	Bussmann	1*	170M3815
-0120-5	145	250	28500	690	Bussmann	1*	170M3816
Three-phase supply voltage 525 V, 550 V, 575 V, 600 V, 660 V or 690 V							
-0060-7	53	100	4650	690	Bussmann	000	170M1367
-0070-7	73	125	8500	690	Bussmann	000	170M1368
-0100-7	86	160	7500	690	Bussmann	1*	170M3164

00184674

Cable types

The table below gives copper and aluminium cable types for different load currents. Cable sizing is based on max. 9 cables laid on a cable ladder side by side, ambient temperature 30 °C (86 °F), PVC insulation, surface temperature 70 °C (158 °F) (EN 60204-1 and IEC 60364-5-2:2001). For other conditions, size the cables according to local safety regulations, appropriate input voltage and the load current of the drive.

Copper cables with concentric copper shield		Aluminium cables with concentric copper shield	
Max. load current A	Cable type mm ²	Max. load current A	Cable type mm ²
34	3x6	61	3x25
47	3x10	75	3x35
62	3x16	91	3x50
79	3x25	117	3x70
98	3x35	143	3x95
119	3x50	165	3x120
153	3x70	191	3x150
186	3x95	218	3x185
215	3x120		
249	3x150		
284	3x185		

00096931

Cable entries

Mains, DC link and motor cable terminal sizes (per phase), accepted cable diameters and tightening torques are given below.

Frame size	U1, V1, W1, U2, V2, W2, UDC+,UDC-			Earthing PE	
	Wire size	Max. cable Ø IP21	Tightening torque	Wire size	Tightening torque
	mm ²	mm	N·m	mm ²	N·m
R5	6...70	35	10	6...70	15
R6	95...210 *	53	20...40	16...95	8

* with cable lugs 16...70 mm², tightening torque 20...40 N·m

Dimensions, weights and noise

Frame size	IP21				Noise dB
	Height mm	Width mm	Depth mm	Weight kg	
Drive					
R5	816	265	390	65	70
R6	970	300	439	100	73
Package					
R5	1085	400	549	5	
R6	1145	400	585	4	

NEMA data

Ratings

The NEMA ratings for the ACS800-U31 and ACS800-31 with 60 Hz supplies are given below. The symbols are described below the table. For sizing, derating and 50 Hz supplies, see [IEC data](#) on page 115.

ACS800-U31 type ACS800-31 type	I_{max} A	Normal use		Heavy-duty use		Frame size	Air flow ft ³ /min	Heat dissipation BTU/Hr
		I_{2N} A	P_N hp	I_{2hd} A	P_{hd} hp			
Three-phase supply voltage 208 V, 220 V, 230 V or 240 V								
-0011-2	52	32	10	26	7.5	R5	206	1730
-0016-2	68	45	15	38	10	R5	206	2380
-0020-2	90	56	20	45	10	R5	206	3110
-0025-2	118	69	25	59	15	R5	206	3760
-0030-2	144	83	30	72	20	R5	206	4500
-0040-2	168	114	40	84	25	R6	238	5420
-0050-2	234	143	50	117	30	R6	238	7260
-0060-2	264	157	60	132	40	R6	238	8650
Three-phase supply voltage 380 V, 400 V, 415 V, 440 V, 460 V or 480 V								
-0020-5	52	29	20	25	15	R5	206	2240
-0025-5	61	34	25	30	20	R5	206	2600
-0030-5	68	45	30	37	25	R5	206	3420
-0040-5	90	55	40	47	30	R5	206	4140
-0050-5	118	67	50	57	40	R5	206	4960
-0060-5	144	78	60	62**	50**	R5	206	5980
-0070-5	168	114	75	88	60	R6	238	8030
-0100-5	234	132	100	114	75	R6	238	9570
-0120-5	264	148*	125*	125	100	R6	238	11620
Three-phase supply voltage 525 V, 575 V , 600 V								
-0060-7	86	54	50	43	40	R6	238	5980
-0070-7	120	75	60	60	50	R6	238	8030
-0100-7	142	88	75	71	60	R6	238	9570

00184674

* 156 A, motor power \leq 125 hp and a reactive power reference of 0 allowed with 460 V

** 65 A, motor power \leq 50 hp and a reactive power reference of 0 allowed with 460 V

Symbols

Nominal ratings

I_{max} maximum output current. Available for 10 s at start, otherwise as long as allowed by drive temperature.

Normal use (10% overload capability)

I_{2N} continuous rms current. 10% overload is typically allowed for one minute every 5 minutes.

P_N typical motor power. The power ratings apply to most 4-pole NEMA rated motors (230 V, 460 V or 575 V).

Heavy-duty use (50% overload capability)

I_{2hd} continuous rms current. 50% overload is typically allowed for one minute every 5 minutes.

P_{hd} typical motor power. The power ratings apply to most 4-pole NEMA rated motors (230 V, 460 V or 575 V).

Note 1: The ratings apply at an ambient temperature of 40 °C (104 °F). At lower temperatures the ratings are higher (except I_{max}).

Input cable fuses

The ratings of UL listed fuses for branch circuit protection are listed below. The fuses also prevent damage to the adjoining equipment of the drive in case of a short-circuit inside the drive. **Check that the operating time of the fuse is below 0.1 seconds.** The operating time depends on the supply network impedance and the cross-sectional area and length of the supply cable. The fuses must be of the “non-time delay” type. See also *Planning the electrical installation: [Thermal overload and short-circuit protection](#)*.

Note 1: In multicable installations, install only one fuse per phase (not one fuse per conductor).

Note 2: Larger fuses must not be used.

Note 3: Fuses from other manufacturers can be used if they meet the ratings.

ACS800-U31 type ACS800-31 type	Input current A	Fuse				
		A	V	Manufacturer	Type	UL class
Three-phase supply voltage 208 V, 220 V, 230 V or 240 V						
-0011-2	32	40	600	Bussmann	JJS-40	T
-0016-2	44	70	600	Bussmann	JJS-70	T
-0020-2	55	80	600	Bussmann	JJS-80	T
-0025-2	70	90	600	Bussmann	JJS-90	T
-0030-2	82	100	600	Bussmann	JJS-100	T
-0040-2	112	150	600	Bussmann	JJS-150	T
-0050-2	140	200	600	Bussmann	JJS-200	T
-0060-2	157	200	600	Bussmann	JJS-200	T
Three-phase supply voltage 380 V, 400 V, 415 V, 440 V, 460 V , 480 V or 500 V						
-0020-5	29	40	600	Bussmann	JJS-40	T
-0025-5	33	50	600	Bussmann	JJS-50	T
-0030-5	44	70	600	Bussmann	JJS-70	T
-0040-5	54	80	600	Bussmann	JJS-80	T
-0050-5	65	90	600	Bussmann	JJS-90	T
-0060-5	76	100	600	Bussmann	JJS-100	T
-0070-5	112	150	600	Bussmann	JJS-150	T
-0100-5	129	200	600	Bussmann	JJS-200	T
-0120-5	145	200	600	Bussmann	JJS-200	T
Three-phase supply voltage 525 V, 575 V , 600 V						
-0060-7	53	80	600	Bussmann	JJS-80	T
-0070-7	73	100	600	Bussmann	JJS-100	T
-0100-7	86	125	600	Bussmann	JJS-125	T

00184674

Cable types

Cable sizing is based on NEC Table 310-16 for copper wires, 75 °C (167 °F) wire insulation at 40 °C (104 °F) ambient temperature. Not more than three current-carrying conductors in raceway or cable or earth (directly buried). For other conditions, dimension the cables according to local safety regulations, appropriate input voltage and the load current of the drive.

Copper cables with concentric copper shield	
Max. load current A	Cable type AWG/kcmil
31	10
44	8
57	6
75	4
88	3
101	2
114	1
132	1/0
154	2/0
176	3/0
202	4/0
224	250 MCM or 2 x 1
251	300 MCM or 2 x 1/0
273	350 MCM or 2 x 2/0

00096931

Cable Entries

Input, DC link and motor cable (per phase) terminal sizes, accepted cable diameters and tightening torques are given below.

Frame size	U1, V1, W1, U2, V2, W2, UDC+, UDC-			Grounding PE	
	Wire size AWG	Wire Ø (UL type 1) in.	Tightening torque lbf-ft	Wire size AWG	Tightening torque lbf-ft
R5	10...2/0	1.39	11.1	10...2/0	11.1
R6	3/0 ... 350 MCM *	2.09	14.8...29.5	5...4/0	5.9

* with cable lugs 6...2/0 AWG, tightening torque 14.8...29.5 lbf-ft

Dimensions, weights and noise

Frame size	UL type 1				Noise dB
	Height in.	Width in.	Depth in.	Weight lb	
Drive					
R5	32.03	10.43	15.35	143	70
R6	38.19	11.81	17.28	220	73
Package					
R5	42.72	15.75	21.61	11	
R6	45.08	15.75	23.03	9	

Input power connection

Voltage (U_i)	208/220/230/240 VAC 3-phase $\pm 10\%$ for 230 VAC units 380/400/415 VAC 3-phase $\pm 10\%$ for 400 VAC units 380/400/415/440/460/480/500 VAC 3-phase $\pm 10\%$ for 500 VAC units 525/550/575/600/660/690 VAC 3-phase $\pm 10\%$ for 690 VAC units
Prospective short-circuit current (IEC 60439-1, UL 508C)	Maximum allowed prospective short-circuit current in the supply is 65 kA in a second providing that the mains cable of the drive is protected with appropriate fuses. US and Canada: The drive is suitable for use on a circuit capable of delivering not more than 65 kA rms symmetrical amperes at the drive nominal voltage when protected by T class fuses.
Frequency	48 to 63 Hz, maximum rate of change 17%/s
Imbalance	Max. $\pm 3\%$ of nominal phase to phase input voltage
Voltage dips	Max. 25%
Fundamental power factor (cos ϕ_1)	1.00 (fundamental at nominal load)
Harmonic distortion	Harmonics are below the limits defined in IEEE519 for all I_{sc}/I_L . Each individual harmonic current fulfils IEEE519 table 10-3 for $I_{sc}/I_L \geq 20$. Current THD and each individual current harmonic fulfill IEC 61000-3-4 table 5.2 for $R_{scc} \geq 66$. The values will be met if the supply network voltage is not distorted by other loads and when the drive operates at the nominal load.

R_{sc}	THD voltage (%)	THD current (%)
20	4	4
100	0.8	5

$$THD = \sqrt{\sum_{n=2}^{50} \left(\frac{I_n}{I_{1\text{contmax}}} \right)^2}$$

THD = Total Harmonic Distortion (THD). The voltage THD depends on the short-circuit ratio (R_{sc}). The spectrum of the distortion also contains interharmonics.

I_n = n^{th} harmonic component

$$R_{sc} = R_{scc} = I_{sc}/I_N$$

I_{sc} = short-circuit current at point of common coupling (PCC)

$I_{1\text{contmax}}$ = continuous maximum input current of the IGBT supply unit

I_L = maximum demand load current

Motor connection

Voltage (U_2)	0 to U_1 , 3-phase symmetrical, U_{\max} at the field weakening point
Frequency	DTC mode: 0 to $3.2 \cdot f_{\text{fwp}}$. Maximum frequency 300 Hz. $f_{\text{fwp}} = \frac{U_{\text{Nmains}}}{U_{\text{Nmotor}}} \cdot f_{\text{Nmotor}}$
	f_{fwp} : frequency at field weakening point; U_{Nmains} : mains (input power) voltage; U_{Nmotor} : rated motor voltage; f_{Nmotor} : rated motor frequency
Frequency resolution	0.01 Hz
Current	See section IEC data or NEMA data .
Power limit	Approximately $1.3 \cdot P_{\text{cont,max}}$
Field weakening point	8 to 300 Hz
Switching frequency	3 kHz (average)
Maximum motor cable length	300 m (984 ft). Additional restriction for units with EMC filtering (type code selections +E202 and +E200): max. motor cable length is 100 m (328 ft). With longer cables the EMC Directive requirements may not be fulfilled.

Efficiency

Approximately 97% at nominal power level

Cooling

Method	Internal fan, flow direction from bottom to top.
Free space around the unit	See chapter Mechanical installation .

Degree of protection

IP21 (UL type 1). IPXXD from above.

Without the front cover, the unit must be protected against contact according to IP2x, see chapter [Electrical installation: Cabinet installed units \(IP00, UL type open\)](#).

AGPS-11C (option +Q950)

Nominal input voltage	115...230 VAC \pm 10%
Nominal input current	0.1 A (230 V) / 0.2 A (115 V)
Nominal frequency	50/60 Hz
Max. external fuse	16 A
X1 terminal sizes	3 x 2.5 mm ²
Output voltage	15 VDC \pm 0.5 V
Nominal output current	0.4 A
X2 terminal block type	JST B4P-VH
Ambient temperature	0...50 °C (32...122 °F)
Relative humidity	Max. 90%, no condensation allowed
Dimensions (with enclosure)	167 x 128 x 52 mm (height x weight x depth)
Weight (with enclosure)	0.75 kg (1.65 lb)
Approvals	C-UL, US listed

ASTO-11C (option +Q967)

Supply voltage range	+24 V DC +/- 10%
Current consumption	40 mA (20mA per channel)
Supply cable	A single-shielded twisted pair
Maximum cable length	300 m
Conductor min. cross section	0.5 mm ² , 20 AWG
X1 terminal sizes	4 x 2.5 mm ²
Nominal output current	0.4 A
X2 terminal block type	JST B4P-VH
Ambient temperature	0...50 °C (32...122 °F)
Relative humidity	Max. 90%, no condensation allowed
Altitude in operation	0...2000 m (6562 ft)
Dimensions (with enclosure)	167 x 128 x 52 mm (height x weight x depth)
Weight (with enclosure)	0.75 kg (1.65 lb)

Ambient conditions

Environmental limits for the drive are given below. The drive is to be used in a heated, indoor, controlled environment.

	Operation installed for stationary use	Storage in the protective package	Transportation in the protective package
Installation site altitude	0 to 4000 m (13123 ft) above sea level [above 1000 m (3281 ft), see section Derating] Drives with option +Q967: 0 to 2000 (6562 ft)	-	-
Air temperature	-15 to +50 °C (5 to 122 °F). No frost allowed. See section Derating .	-40 to +70 °C (-40 to +158 °F)	-40 to +70 °C (-40 to +158 °F)
Relative humidity	5 to 95% No condensation allowed. Maximum allowed relative humidity is 60% in the presence of corrosive gases.	Max. 95%	Max. 95%
Contamination levels (IEC 60721-3-3, IEC 60721-3-2, IEC 60721-3-1)	No conductive dust allowed.		
	Boards with coating: Chemical gases: Class 3C2 Solid particles: Class 3S2	Boards with coating: Chemical gases: Class 1C2 Solid particles: Class 1S3	Boards with coating: Chemical gases: Class 2C2 Solid particles: Class 2S2
Atmospheric pressure	70 to 106 kPa 0.7 to 1.05 atmospheres	70 to 106 kPa 0.7 to 1.05 atmospheres	60 to 106 kPa 0.6 to 1.05 atmospheres
Vibration (IEC 60068-2)	Max. 1 mm (0.04 in.) (5 to 13.2 Hz). max. 7 m/s ² (23 ft/s ²) (13.2 to 100 Hz) sinusoidal	Max. 1 mm (0.04 in.) (5 to 13.2 Hz). max. 7 m/s ² (23 ft/s ²) (13.2 to 100 Hz) sinusoidal	Max. 3.5 mm (0.14 in.) (2 to 9 Hz). max. 15 m/s ² (49 ft/s ²) (9 to 200 Hz) sinusoidal
Shock (IEC 60068-2-27)	Not allowed	Max. 100 m/s ² (330 ft./s ²), 11 ms	Max. 100 m/s ² (330 ft./s ²), 11 ms
Free fall	Not allowed	250 mm (10 in.) for weight under 100 kg (220 lb) 100 mm (4 in.) for weight over 100 kg (220 lb)	250 mm (10 in.) for weight under 100 kg (220 lb) 100 mm (4 in.) for weight over 100 kg (220 lb)

Materials

Drive enclosure

- PC/ABS 2.5 mm, colour NCS 1502-Y (RAL 9002 / PMS 420 C)
- hot-dip zinc coated steel sheet 1.5 to 2 mm, thickness of coating 100 micrometres
- extruded aluminium AlSi

Package

Cardboard, plywood, PP bands (straps), PE plastic

Disposal

The drive contains raw materials that should be recycled to preserve energy and natural resources. The package materials are environmentally compatible and recyclable. All metal parts can be recycled. The plastic parts can either be recycled or burned under controlled circumstances, according to local regulations. Most recyclable parts are marked with recycling marks.

If recycling is not feasible, all parts excluding electrolytic capacitors and printed circuit boards can be landfilled. The DC capacitors (C1-1 to C1-x) contain electrolyte and the printed circuit boards contain lead, both of which are classified as hazardous waste within the EU. They must be removed and handled according to local regulations.

For further information on environmental aspects and more detailed recycling instructions, please contact your local ABB distributor.

Applicable standards

The drive complies with the following standards.

- EN 50178:1997 *Electronic equipment for use in power installations*
- EN 60204-1:2006 AC:2010 *Safety of machinery. Electrical equipment of machines. Part 1: General requirements.* Provisions for compliance: The final assembler of the machine is responsible for installing
 - an emergency-stop device
 - a supply disconnecting device.
- EN 60529:1991
+ corrigendum May 1993
+ A1:2000 *Degrees of protection provided by enclosures (IP code)*
- EN 60664-1:2007 *Insulation coordination for equipment within low-voltage systems. Part 1: Principles, requirements and tests.*
- EN 61800-3:2004 *Adjustable speed electrical power drive systems. Part 3: EMC requirements and specific test methods*
- EN 61800-5-1:2007 *Adjustable speed electrical power drive systems - Part 5-1: Safety requirements - Electrical, thermal and energy*
- UL 508C *UL Standard for Safety, Power Conversion Equipment, third edition*
- NEMA 250-2003 *Enclosures for Electrical Equipment (1000 Volts Maximum)*
- CSA C22.2 No. 14-05 *Industrial control equipment*

CE marking

A CE mark is attached to the drive to verify that the unit follows the provisions of the European Low Voltage and EMC Directives. The CE marking also verifies that the drive, in regard to its safety functions (such as Safe torque off), conforms with the Machinery Directive as a safety component.

Compliance with the European Low Voltage Directive

The compliance with the European Low Voltage Directive has been verified according to standards EN 60204-1 and EN 61800-5-1.

Compliance with the European EMC Directive

The EMC Directive defines the requirements for immunity and emissions of electrical equipment used within the European Union. The EMC product standard (EN 61800-3:2004) covers requirements stated for drives. See section [Compliance with EN 61800-3:2004](#) below.

Compliance with the European Machinery Directive

The drive is an electronic product which is covered by the European Low Voltage Directive. However, the drive can be equipped with the Safe torque off function and other safety functions for machinery which, as safety components, are in the scope of the Machinery Directive. These functions of the drive comply with European harmonized standards such as EN 61800-5-2. The declaration of conformity for each function is in the appropriate function-specific manual.

Compliance with EN 61800-3:2004

Definitions

EMC stands for **Electromagnetic Compatibility**. It is the ability of electrical/electronic equipment to operate without problems within an electromagnetic environment. Likewise, the equipment must not disturb or interfere with any other product or system within its locality.

First environment includes establishments connected to a low-voltage network which supplies buildings used for domestic purposes.

Second environment includes establishments connected to a network not supplying domestic premises.

Drive of category C2: drive of rated voltage less than 1000 V and intended to be installed and commissioned only by a professional when used in the first environment. **Note:** A professional is a person or organisation having necessary skills in installing and/or commissioning power drive systems, including their EMC aspects.

Drive of category C3: drive of rated voltage less than 1000 V and intended for use in the second environment and not intended for use in the first environment.

Drive of category C4: drive of rated voltage equal to or above 1000 V, or rated current equal to or above 400 A, or intended for use in complex systems in the second environment.

First environment (drive of category C2)

The drive complies with the standard with the following provisions:

1. The drive is equipped with EMC filter +E202.
2. The motor and control cables are selected as specified in the *Hardware Manual*.
3. The drive is installed according to the instructions given in the *Hardware Manual*.
- 4. The maximum cable length is 100 metres.**

WARNING! The drive may cause radio interference if used in a residential or domestic environment. The user is required to take measures to prevent interference, in addition to the requirements for CE compliance listed above, if necessary.

Note: It is not allowed to install a drive equipped with EMC filter +E202 on IT (unearthed) systems. The supply network becomes connected to earth potential through the EMC filter capacitors which may cause danger or damage the unit.

Second environment (drive of category C3)

The drive complies with the standard with the following provisions:

1. The drive is equipped with EMC filter +E200. See also page [70](#).
2. The motor and control cables are selected as specified in the *Hardware Manual*.
3. The drive is installed according to the instructions given in the *Hardware Manual*.
- 4. The maximum cable length is 100 metres.**

WARNING! A drive of category C3 is not intended to be used on a low-voltage public network which supplies domestic premises. Radio frequency interference is expected if the drive is used on such a network.

Second environment (drive of category C4)

If the provisions under [Second environment \(drive of category C3\)](#) cannot be met, e.g. the drive cannot be equipped with EMC filter +E200 when installed to an IT (unearthed) network, the requirements of the EMC Directive can be met as follows:

1. It is ensured that no excessive emission is propagated to neighbouring low-voltage networks. In some cases, the inherent suppression in transformers and cables is sufficient. If in doubt, a supply transformer with static screening between the primary and secondary windings can be used.

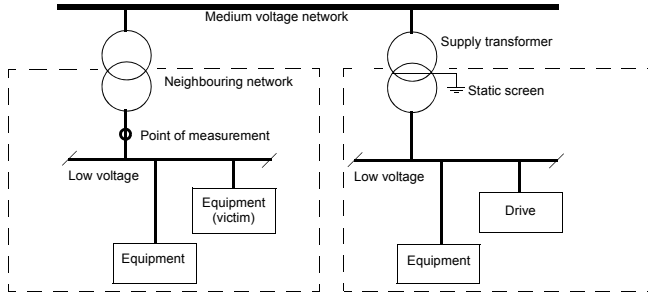

2. An EMC plan for preventing disturbances is drawn up for the installation. A template is available from the local ABB representative.
3. The motor and control cables are selected as specified in the *Hardware Manual*.
4. The drive is installed according to the instructions given in the *Hardware Manual*.

WARNING! A drive of category C4 is not intended to be used on a low-voltage public network which supplies domestic premises. Radio frequency interference is expected if the drive is used on such a network.

"C-tick" marking

A "C-tick" mark is attached to each drive in order to verify compliance with the EMC product standard (EN 61800-3:2004), required under the Trans-Tasman Electromagnetic Compatibility Scheme for levels 1, 2 and 3 in Australia and New Zealand. See section [Compliance with EN 61800-3:2004](#).

UL/CSA markings

The ACS800-U31 and ACS800-31 drives of UL type 1 are cULus listed and cCSAus certified.

UL checklist

- The drive is to be used in a heated, indoor controlled environment. The drive must be installed in clean air according to enclosure classification. Cooling air must be clean, free from corrosive materials and electrically conductive dust. See section [Ambient conditions](#) for specific limits.
- The maximum ambient air temperature is 40 °C (104 °F) at rated current. The current is derated for 40 to 50 °C (104 to 122 °F).
- The drive is suitable for use on a circuit capable of delivering not more than 65 kA rms symmetrical amperes at the drive nominal voltage (600 V maximum for 690 V units) when protected by T class fuses.
- The cables located within the motor circuit must be rated for at least 75 °C (167 °F) in UL-compliant installations.
- The input cable must be protected with fuses. Circuit breakers must not be used without fuses in the USA. Suitable IEC (class aR) fuses and UL (class T) fuses are listed in the hardware manual.
- For installation in the United States, branch circuit protection must be provided in accordance with the National Electrical Code (NEC) and any applicable local codes. To fulfil this requirement, use the UL classified fuses.
- For installation in Canada, branch circuit protection must be provided in accordance with the Canadian Electrical Code and any applicable provincial codes. To fulfil this requirement, use the UL classified fuses.
- The drive provides overload protection in accordance with the National Electrical Code (NEC). See *ACS800 Firmware Manual* for setting. Default setting is off, must be activated at start-up.

Dimensional drawings

The dimensions are given in millimetres and [inches].

Frame size R5 (IP21, UL type open, UL type 1)

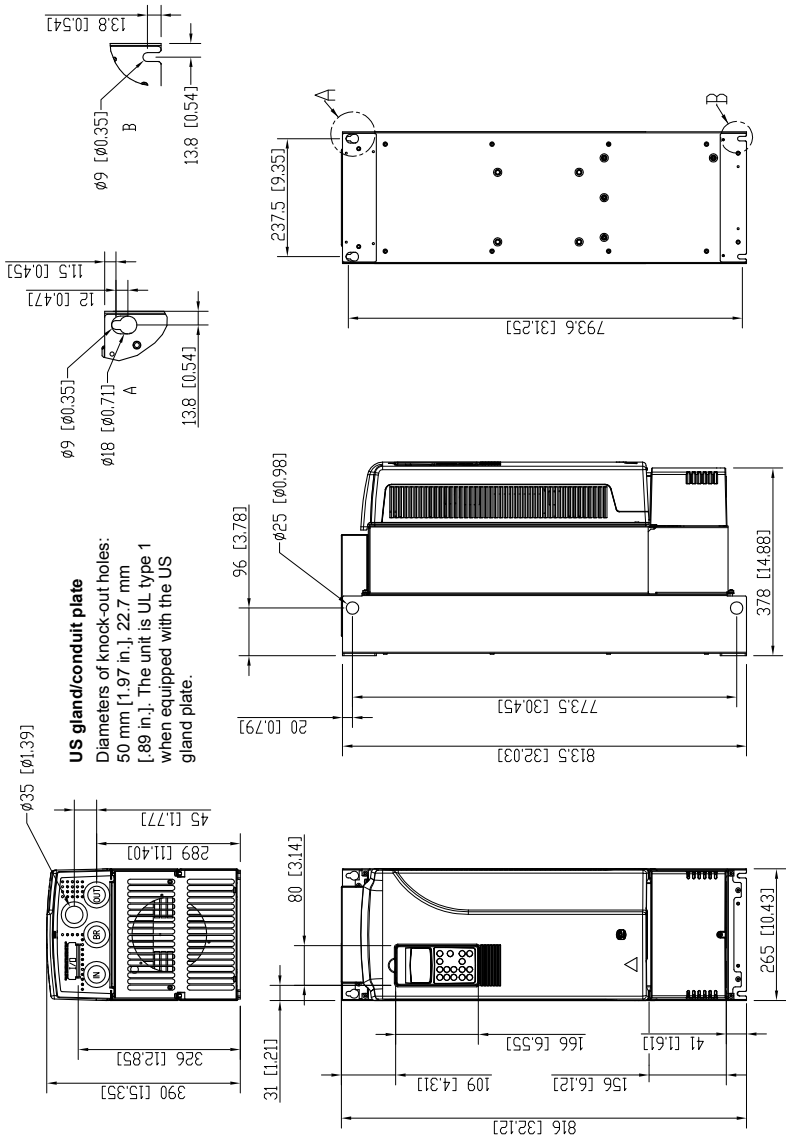

68-406200

Frame size R6 (IP21, UL type open, UL type 1)

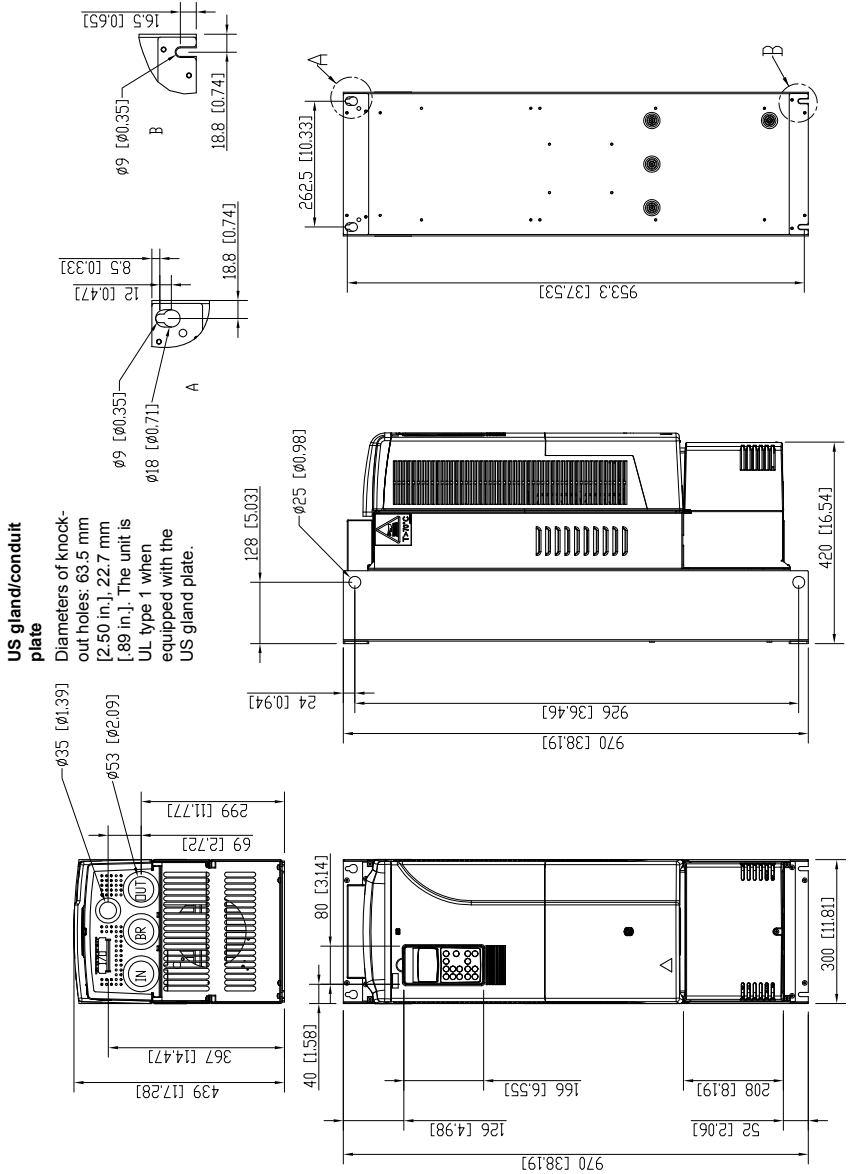

68-405726

Cabinet duct plates (optional), frame size R5

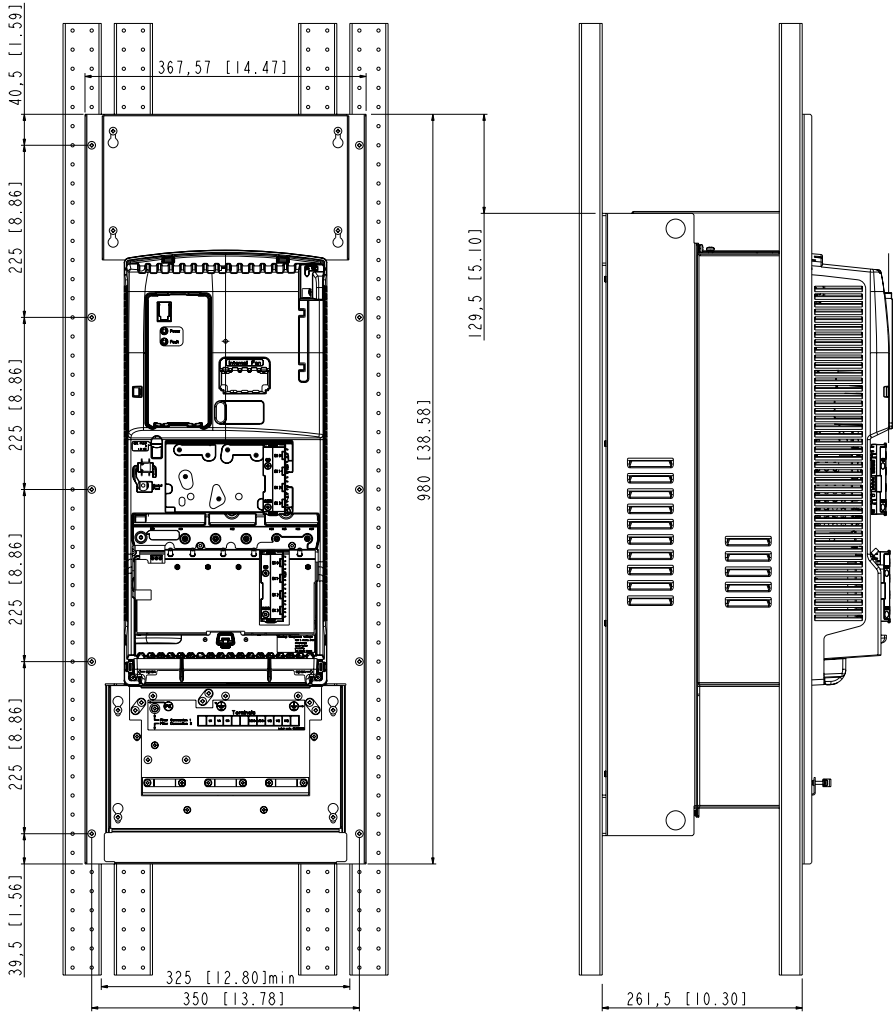

Package (frame size R5)

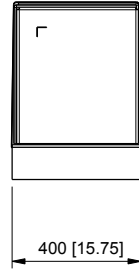
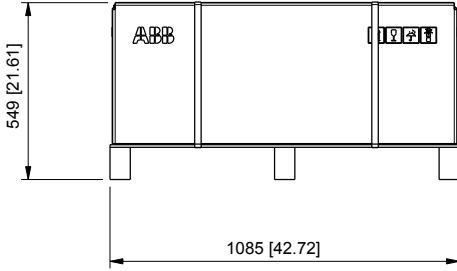

Package (frame size R6)

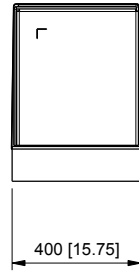
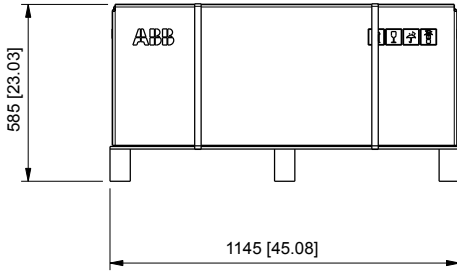

AGPS board with enclosure (optional)

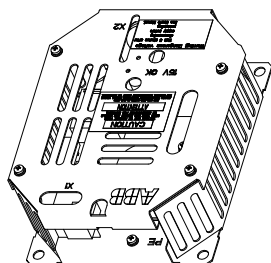

33:100

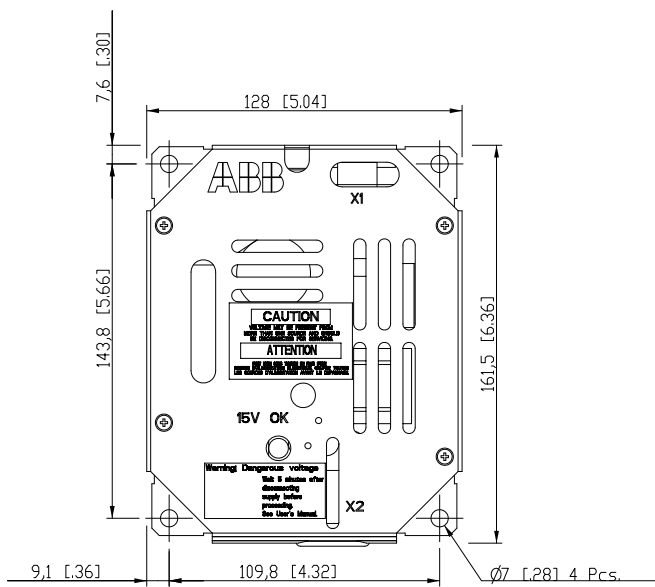
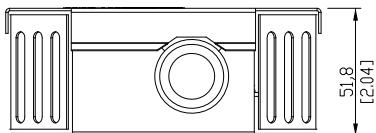

Input 230V

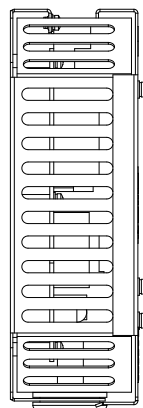

Output 15V

3AFE68293898

ASTO board with enclosure (optional)

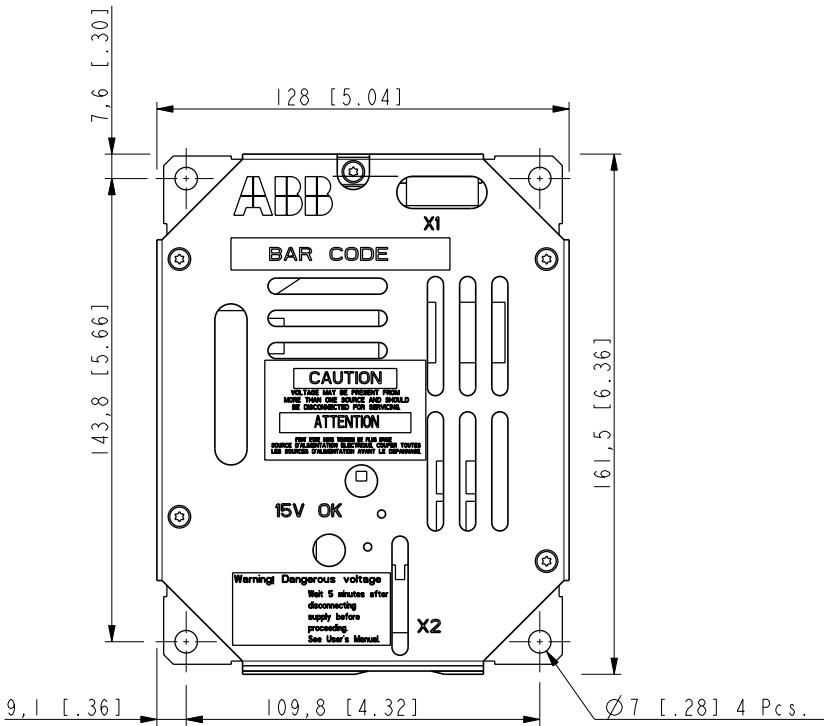
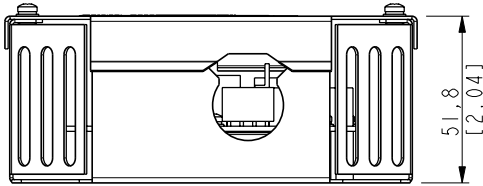

3AJA0000068698

Resistor braking

What this chapter contains

This chapter describes how to select, protect and wire external brake choppers and resistors for the drive. The chapter also contains installation instructions and the technical data.

How to select the correct drive/chopper/resistor combination

Refer to *NBRA-6xx Braking Choppers Installation and Start-up Guide* [3AFY58920541 (English)].



WARNING! Never use a brake resistor with a resistance below the value specified for the particular drive / brake chopper / resistor combination. The drive and the chopper are not able to handle the overcurrent caused by the low resistance.

External brake chopper and resistor(s) for the ACS800-31/U31

The nominal ratings for dimensioning the brake resistors for the ACS800-31 and ACS800-U31 are given below at an ambient temperature of 40 °C (104 °F).

ACS800-31 ACS800-U31 type	Chopper type	Brake resistor					Cable mm ²	P _{brmax} kW	Degree of protection	
		Type	R ohm	E _R kJ	P _{Rcont} kW	No. of elements			Chopper	Resistor
Three-phase supply voltage 380 V, 400 V or 415 V										
-0016-3	NBRA-653	SACE15RE22	22	420	2	4	3x6+6	14.4	IP54	IP21
-0020-3	NBRA-656	SACE15RE13	13	435	2	4	3x6+6	26.9	IP00	IP21
-0025-3	NBRA-656	SACE15RE13	13	435	2	4	3x6+6	26.9	IP00	IP21
-0030-3	NBRA-656	SAFUR90F575	8	1800	4.5	9	3x25+16	52.8	IP00	IP00
-0040-3	NBRA-656	SAFUR90F575	8	1800	4.5	9	3x25+16	52.8	IP00	IP00
-0050-3	NBRA-656	SAFUR90F575	8	1800	4.5	9	3x25+16	52.8	IP00	IP00
-0060-3	NBRA-656	SAFUR80F500	6	2400	6	12	3x35+16	65.6	IP00	IP00
-0070-3	NBRA-656	SAFUR125F500	4	3600	9	18	3x35+16	94.2	IP00	IP00
-0100-3	NBRA-657	SAFUR125F500	4	3600	9	18	3x70+35	94.2	IP00	IP00
Three-phase supply voltage 380 V, 400 V, 415 V, 440 V, 460 V, 480 V or 500 V										
-0020-5	NBRA-653	SACE15RE22	22	420	2	4	3x6+6	18.5	IP54	IP21
-0025-5	NBRA-656	SACE15RE13	13	435	2	4	3x6+6	31.4	IP00	IP21
-0030-5	NBRA-656	SACE15RE13	13	435	2	4	3x6+6	31.4	IP00	IP21
-0040-5	NBRA-656	SAFUR90F575	8	1800	4.5	9	3x25+16	62.6	IP00	IP00
-0050-5	NBRA-656	SAFUR90F575	8	1800	4.5	9	3x25+16	62.6	IP00	IP00
-0060-5	NBRA-656	SAFUR90F575	8	1800	4.5	9	3x25+16	62.6	IP00	IP00
-0070-5	NBRA-656	SAFUR80F500	6	2400	6	12	3x35+16	88.4	IP00	IP00
-0100-5	NBRA-656	SAFUR80F500	6	2400	6	12	3x35+16	88.4	IP00	IP00
-0120-5	NBRA-657	SAFUR125F500	4	3600	9	18	3x70+16	122.1	IP00	IP00

00184674

- R** Resistance value for the listed resistor assembly. **Note:** This is also the minimum allowed resistance for the brake resistor.
- E_R** Short energy pulse that the resistor assembly withstands every 400 seconds. This energy will heat the resistor element from 40 °C (104 °F) to the maximum allowable temperature.
- P_{Rcont}** Continuous power (heat) dissipation of the resistor when placed correctly. Energy E_R dissipates in 400 seconds.
- P_{brmax}** Maximum braking power of the drive equipped with the standard chopper and resistor. The drive and the chopper will withstand this braking power for one minute every ten minutes. **Note:** The braking energy transmitted to the resistor during any period shorter than 400 seconds may not exceed E_R.

All braking choppers and resistors must be installed outside the drive module. **Note:** The SACE and SAFUR resistors are not UL listed.

Brake chopper and resistor installation

The installation instructions for the chopper and resistor are given in *NBRA-6xx Braking Choppers Installation and Start-up Guide* [3AFY58920541 (English)]. All choppers and resistors must be installed outside the drive module in a place where they will cool.



WARNING! The materials near the brake resistor must be non-flammable. The surface temperature of the resistor is high. Air flowing from the resistor is hundreds of degrees Celsius. Protect the resistor against contact.

Use the cable type used for drive input cabling (refer to chapter *Technical data*) to ensure the input fuses will also protect the resistor cable. Alternatively, two-conductor shielded cable with the same cross-sectional area can be used. The maximum length of the resistor cable(s) is 10 m (33 ft).

Protection

It is highly recommended to equip the drive with a main contactor for safety reasons. Wire the contactor so that it opens in case the resistor overheats. This is essential for safety since the drive will not otherwise be able to interrupt the main supply if the chopper remains conductive in a fault situation.

Below is a simple example wiring diagram.

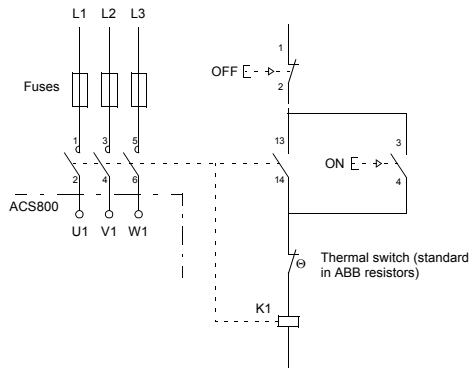

Brake circuit commissioning

For Standard Control Program:

- Switch off the overvoltage control of the drive (parameter 20.05).
- Frame size R6: Check the setting of parameter 21.09. If stop by coasting is required, select OFF2 STOP.

For the use of the brake resistor overload protection (parameters 27.02...27.05), consult an ABB representative.



WARNING! If the drive is equipped with a brake chopper but the chopper is not enabled by parameter setting, the brake resistor must be disconnected because the protection against resistor overheating is then not in use.



WARNING! Parameter 95.07 LCU DC REF (V) must be set to the minimum value (default) with brake resistors. Otherwise energy from the supply network can flow to the brake resistor causing overheating of the resistor and damage to the equipment.

For settings of other control programs, see the appropriate firmware manual.

Note: Some brake resistors are coated with oil film for protection. At the start-up, the coating burns off and produces a little bit of smoke. Ensure proper ventilation at the start-up.

External +24 V power supply for the RMIO boards via terminal X34

What this chapter contains

This chapter describes how to connect an external +24 V power supply for the RMIO boards of the motor-side and line-side converters via terminal X34. For current consumption of the RMIO board, see chapter [Motor control and I/O board \(RMIO\)](#).

Note: For the motor-side converter RMIO board, external power is easier to supply via terminal X23, see chapter [Motor control and I/O board \(RMIO\)](#).

Parameter settings

In Standard Control Program, set parameter 16.09 CTRL BOARD SUPPLY to EXTERNAL 24V if the RMIO board is powered from an external supply.

Connecting +24 V external power supply

RMIO board of the motor-side converter

1. Break off the tab covering the +24 VDC power input connector with pliers.
2. Pull the connector outwards.
3. Disconnect the wires from the connector (keep the connector for later use).
4. Isolate the ends of the wires individually with insulating tape.
5. Cover the isolated ends of the wires with insulating tape.
6. Push the wires into the inside of the skeleton.
7. Connect the wires of the +24 V external power supply to the disconnected connector:
if a two-way connector, + wire to terminal 1 and - wire to terminal 2
if a three-way connector, + wire to terminal 2 and - wire to terminal 3.
8. Plug the connector in.

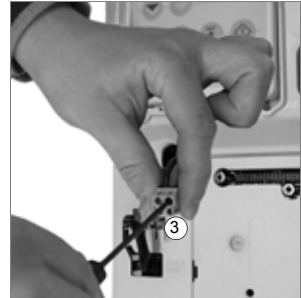
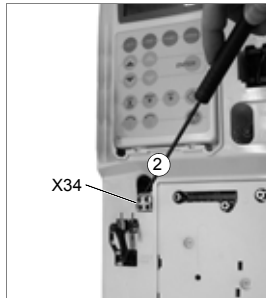

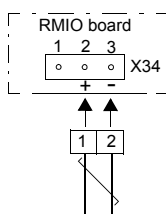
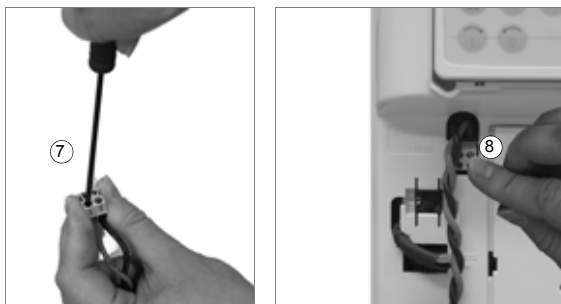

Connection of a two-way connector

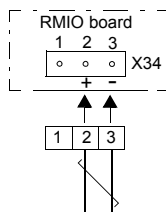

Connection of a three-way connector

RMIO board of the line-side converter

Frame size R5

The location of terminal X34 in the line-side converter is shown below. Connect the external +24 V supply to the board as described in steps 2 to 8 in section [RMIO board of the motor-side converter](#).

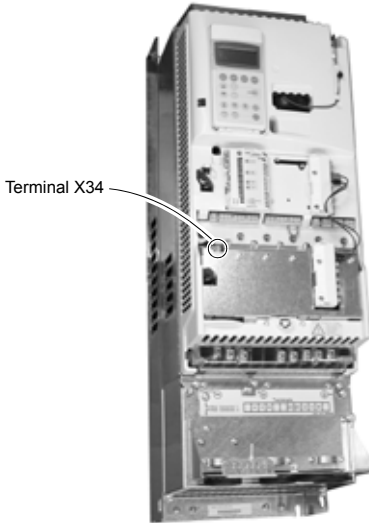

Frame size R6

1. Remove the top cover by releasing the retaining clip with a screw driver and lifting the cover upwards.
2. Disconnect the DDCS communication module by undoing the fastening screws and disconnecting the fibre optic cables. Disconnect other optional modules if present.
3. Disconnect the control panel cable.
4. Disconnect the additional fan cable (detachable terminal) and release the strain relief.
5. Remove the I/O terminal blocks.
6. Undo the fastening screws of the upper plastic cover.
7. Lift the cover carefully upwards by the lower sides.
8. Disconnect the control panel cable from the RMIO board.

9. Lift the upper plastic cover off.
10. Connect the external +24 V supply to the board as described in steps 2 to 5, 7 and 8 in section *RMIO board of the motor-side converter*.
11. Reconnect all disconnected cables and fasten the covers in reverse order.

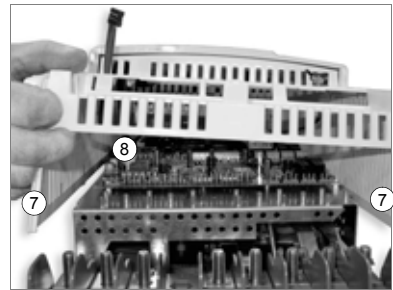
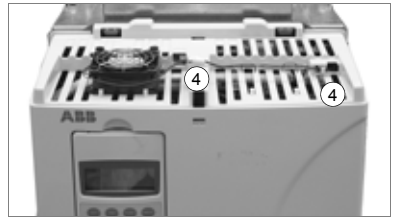
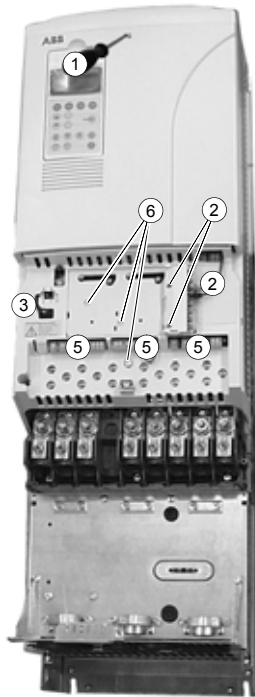

Further information

Product and service inquiries

Address any inquiries about the product to your local ABB representative, quoting the type designation and serial number of the unit in question. A listing of ABB sales, support and service contacts can be found by navigating to www.abb.com/drives and selecting *Sales, Support and Service network*.

Product training

For information on ABB product training, navigate to www.abb.com/drives and select *Training courses*.

Providing feedback on ABB Drives manuals

Your comments on our manuals are welcome. Go to www.abb.com/drives and select *Document Library – Manuals feedback form (LV AC drives)*.

Document library on the Internet

You can find manuals and other product documents in PDF format on the Internet. Go to www.abb.com/drives and select *Document Library*. You can browse the library or enter selection criteria, for example a document code, in the search field.

Contact us

www.abb.com/drives

www.abb.com/drivespartners

3AFE6859954 Rev B (EN) 2013-03-04

Power and productivity
for a better world™

