

---

ABB INDUSTRIAL DRIVES

# ACS880 crane control program (option +N5050)

Firmware manual





# ACS880 crane control program (option +N5050)

## Firmware manual

Table of contents



2. Quick start-up guide





# Table of contents

---

## 1 Introduction to the manual

What this chapter contains .....	19
Applicability .....	19
Licensing .....	20
Safety instructions .....	20
Target audience .....	21
Parameter access levels .....	21
Related manuals .....	21
Terms and abbreviations .....	22
Cybersecurity disclaimer .....	24

## 2 Quick start-up guide

Contents of this chapter .....	25
Before you start .....	25
Safety .....	25
Start-up .....	26
Crane control start-up .....	31
Control through I/O interface using a joystick .....	32
Control connections for hoist and trolley drives .....	34
Control through I/O interface using step reference logic .....	35
Control connections for hoist and trolley drives .....	37
Control through fieldbus interface using the fieldbus control word ....	38
Control connections for hoist and trolley drives .....	41
Control through fieldbus interface using the crane control word and a joystick .....	42
Control connections for hoist and trolley drives .....	45
Configuring Mechanical brake control .....	46
Configuring Slowdown inputs and limits .....	47
Configuring speed feedback using a HTL encoder .....	47
Configuring Lifetime monitor function .....	48
Configuring Lifetime monitor maintenance .....	49
Copying old values to new system .....	49
Resetting the load spectrum recorder .....	50

## 3 Crane program features

What this chapter contains .....	51
Overview of crane control program .....	51
Supported features Vs Crane motions .....	52

---



## 6 Table of contents

Start/stop control .....	53
Common crane control interface .....	54
Overview diagram of a crane drive and its control interfaces .....	54
Emergency control mode .....	55
Function block diagram .....	56
Settings and diagnostics .....	56
Start/stop interlocking .....	56
Joystick zero position interlocking .....	57
Joystick reference interlocking .....	57
Timing diagram .....	57
Pending start interlocking .....	58
Settings and diagnostics .....	58
Position counter initialization and scaling in crane application .....	59
Initialization .....	59
Scaling .....	59
Example 1: Calculating linear speed of rope .....	61
Example 2: Parameter settings .....	61
Settings and diagnostics .....	62
Master/follower communication in crane application .....	62
Master/follower communication types in crane application .....	62
M/F communication for drives with shafts running a common load .....	63
M/F communication for drives with separate drums and shaft synchro .....	64
D2D-link configuration in crane application .....	64
Master/follower communication .....	65
Antisway communication .....	66
D2D-link .....	66
Communication supervision .....	66
Example 1: Parameter settings for D2D-link configuration in a Speed-to-speed setup .....	66
Example 2: Parameter settings for D2D-link configuration in a Speed-to-torque setup .....	67
Example 3: Parameter settings for antisway communication from hoist to main trolley .....	68
Settings and diagnostics .....	69
Shaft synchro .....	70
Synchro control - basic function block diagram .....	70
Direct mode .....	71
Offset mode .....	71
Synchro control - full function block diagram .....	71
Example 1: Parameter settings for Synchro control (Speed-speed+position) setup .....	72
Example 2: Parameter settings for encoder mounted/ not mounted on motor shaft .....	74



Settings and diagnostics .....	78
Mechanical brake control .....	78
Inputs of the brake control logic .....	78
Outputs of the brake control logic .....	79
Brake control timing diagram .....	79
Wiring example .....	80
Brake system checks – overview .....	81
Timing diagram .....	84
Brake system checks – Torque proving .....	84
Brake system checks – Brake slip .....	85
Brake matching .....	85
Automatic restart of the crane .....	86
Brake matching modes .....	86
Controlling the crane .....	87
Brake matching timing diagram .....	88
Brake opening torque selection .....	89
Brake safe closure .....	90
Timing diagram .....	90
Extended run time .....	91
Settings and diagnostics .....	92
Speed reference handling .....	92
Possible control devices .....	92
Unipolar joysticks .....	93
Bipolar joysticks .....	93
Step reference selection .....	93
Speed reference priorities .....	93
Dead-band function .....	94
.....	95
Parabolic speed reference .....	95
Operation chart .....	95
Settings and diagnostics .....	96
Speed reference ramping .....	96
External speed limitation .....	97
Crane motor potentiometer .....	97
Timing diagram .....	97
Forward direction .....	98
Reverse direction .....	99
Direction change .....	100
Settings and diagnostics .....	100
Supervision and limit switch logic .....	100
End limits .....	100
Slowdown .....	101
Slowdown with direction .....	102
Slowdown without direction (safe zone) .....	102
Slowdown double bit .....	102



## 8 Table of contents

Slowdown position .....	102
Fast stop .....	103
Speed matching .....	103
Timing diagrams .....	104
Motor overspeed monitoring .....	105
Inverter overload detection .....	105
Inching control .....	106
Reverse plug .....	107
Slack rope .....	108
Watchdog .....	109
Watchdog test .....	109
Settings and diagnostics .....	110
Lifetime monitoring and maintenance .....	111
Maintenance work .....	111
Settings and diagnostics .....	112
Conical motor control .....	112
Timing diagram .....	114
Example parameter settings .....	114
Settings and diagnostics .....	115
Hoist speed optimization .....	115
Overview .....	115
HSO speed limitation defined manually .....	116
Operation chart .....	116
Example .....	117
Load margin calculation .....	118
Example .....	118
Auto calculation .....	119
Efficiency and inertia calculation .....	120
Tuning efficiency value .....	120
Tuning inertia value .....	120
Hoist speed limit testing .....	121
Settings and diagnostics .....	121
Smooth lifting .....	121
Settings and diagnostics .....	122
Antisway .....	122
Antisway functional description .....	122
Total pendulum arm length .....	124
Offset determination .....	124
External disturbances .....	125
Antisway function block diagram .....	125
Sway tracking .....	126
Automatic ON switching .....	127
Ramp times .....	127
Limit switches .....	127
Example .....	128





Antisway communication .....	128
Fieldbus communication .....	129
Antisway commissioning instructions .....	129
Preparations .....	129
Measuring and calculating a real pendulum arm with an empty hook .....	130
Determining pendulum arm offset .....	131
Power on acknowledgment .....	136
Function description .....	136
Timing diagram .....	136
Wiring example .....	137
Settings and diagnostics .....	137
Crane warning masking .....	137
Settings and diagnostics .....	138
Toggle bit .....	138
Function description .....	138
Function block diagram .....	139
Timing diagram .....	140
Example of Toggle bit function setup .....	140
Settings and diagnostics .....	141
Maintenance counters .....	141
Settings and diagnostics .....	142

#### **4 Using the control panel**

#### **5 Control locations and operating modes**

What this chapter contains .....	145
Local control vs. external control .....	145
Local control .....	146
External control .....	147
Using the control panel as an external control source .....	147
Operating modes of the drive .....	148
Speed control mode .....	148
Torque control mode .....	149

#### **6 Program features**

What this chapter contains .....	151
Drive configuration and programming .....	151
Programming via parameters .....	152
Adaptive programming .....	152
Inputs available to the adaptive program .....	153
Outputs available to the adaptive program .....	154
Settings and diagnostics .....	155
Application programming .....	156



- Control interfaces ..... 156
  - Programmable analog inputs ..... 156
    - Settings and diagnostics ..... 156
  - Programmable analog outputs ..... 156
    - Settings and diagnostics ..... 156
  - Programmable digital inputs and outputs ..... 156
    - Settings and diagnostics ..... 157
  - Programmable relay outputs ..... 157
    - Settings and diagnostics ..... 157
  - Programmable I/O extensions ..... 157
    - Settings and diagnostics ..... 158
- Fieldbus control ..... 158
  - Settings and diagnostics ..... 158
- Master/follower functionality ..... 159
  - General ..... 159
  - Load share function with a speed-controlled follower ..... 161
  - Communication ..... 161
  - Construction of the master/follower link ..... 163
  - Example parameter settings ..... 165
  - Specifications of the fiber optic master/follower link ..... 166
  - Settings and diagnostics ..... 166
- External controller interface ..... 167
  - General ..... 167
  - Topology ..... 167
  - Communication ..... 168
- Motor control ..... 169
  - Direct torque control (DTC) ..... 169
    - Settings and diagnostics ..... 169
  - Reference ramping ..... 170
    - Special acceleration/deceleration ramps ..... 170
    - Settings and diagnostics ..... 170
  - Constant speeds/frequencies ..... 170
    - Settings and diagnostics ..... 170
  - Critical speeds ..... 170
    - Example ..... 171
    - Settings and diagnostics ..... 171
  - Speed controller autotune ..... 171
    - Before activating the autotune routine ..... 172
    - Autotune modes ..... 173
    - Autotune results ..... 173
    - Warning indications ..... 174
    - Settings and diagnostics ..... 174
  - Oscillation damping ..... 174
    - Tuning procedure for oscillation damping ..... 175
    - Settings and diagnostics ..... 175



Resonance frequency elimination .....	175
Settings and diagnostics .....	176
Rush control .....	176
Settings and diagnostics .....	176
Encoder support .....	176
Encoder echo and emulation .....	177
Load and motor feedback .....	177
Position counter .....	178
Encoder error handling .....	179
Reading/writing position counter values through fieldbus .....	180
Configuration of HTL encoder motor feedback .....	180
Example 1: Using the same encoder for both load and motor feedback .....	181
Example 2: Using two encoders .....	181
Example 3: ACS 600 / ACS800 compatibility .....	182
Settings and diagnostics .....	183
Scalar motor control .....	183
IR compensation for scalar motor control .....	183
Settings and diagnostics .....	184
Autophasing .....	184
Autophasing modes .....	186
Settings and diagnostics .....	187
Flux braking .....	187
Settings and diagnostics .....	188
DC magnetization .....	188
Pre-heating .....	188
Pre-magnetization .....	188
DC hold .....	188
Post-magnetization .....	189
Continuous magnetization .....	189
Settings and diagnostics .....	190
Motor temperature estimation .....	190
Settings and diagnostics .....	190
Hexagonal motor flux pattern .....	190
Settings and diagnostics .....	191
DC voltage control .....	191
Overvoltage control .....	191
Undervoltage control (power loss ride-through) .....	191
Automatic restart .....	192
Settings and diagnostics .....	193
Voltage control and trip limits .....	194
Settings and diagnostics .....	194
Brake chopper .....	195
Settings and diagnostics .....	195



DC voltage boost .....	195
Description of the DC voltage boost function .....	195
Use case examples .....	196
Limits .....	197
Safety and protections .....	199
Emergency stop .....	199
Settings and diagnostics .....	199
Motor thermal protection .....	199
Motor thermal protection model .....	200
Temperature monitoring using PTC sensors .....	200
Temperature monitoring using Pt100 or Pt1000 sensors .....	202
Temperature monitoring using KTY84 sensors .....	202
Motor fan control logic (parameters <i>35.100...35.106</i> ) .....	203
Ex motor support (parameter <i>95.15</i> , bit 0) .....	203
Settings and diagnostics .....	203
Motor overload protection .....	204
Settings and diagnostics .....	204
Thermal protection of motor cable .....	205
Settings and diagnostics .....	205
User load curve .....	205
Settings and diagnostics .....	206
Automatic fault resets .....	206
Settings and diagnostics .....	207
Other programmable protection functions .....	207
External events (parameters <i>31.01...31.10</i> ) .....	207
Motor phase loss detection (parameter <i>31.19</i> ) .....	207
Earth (Ground) fault detection (parameter <i>31.20</i> ) .....	207
Safe torque off detection (parameter <i>31.22</i> ) .....	207
Swapped supply and motor cabling (parameter <i>31.23</i> ) .....	207
Stall protection (parameters <i>31.24...31.28</i> ) .....	208
Overspeed protection (parameter <i>31.30</i> ) .....	208
Ramp stop supervision (parameters <i>31.32, 31.33, 31.37</i> and <i>31.38</i> ) .....	208
Main cooling fan supervision (parameter <i>31.35</i> ) .....	208
Custom motor current fault limit (parameter <i>31.42</i> ) .....	208
Local control loss detection (parameter <i>49.05</i> ) .....	208
Diagnostics .....	208
Fault and warning messages, data logging .....	208
Signal supervision .....	208
Settings and diagnostics .....	209
Maintenance timers and counters .....	209
Settings and diagnostics .....	209
Load analyzer .....	209
Peak value logger .....	209
Amplitude loggers .....	210



Miscellaneous .....	210
User parameter sets .....	210
Settings and diagnostics .....	211
Parameter checksum calculation .....	211
Settings and diagnostics .....	212
User lock .....	213
Settings and diagnostics .....	213
Data storage parameters .....	214
Settings and diagnostics .....	214
Reduced run function .....	214
Activation of the reduced run function .....	215
du/dt filter support .....	216
Settings and diagnostics .....	216
Sine filter support .....	216
Settings and diagnostics .....	216
Router mode for BCU control unit .....	217
Settings and diagnostics .....	218

## 7 Default control connections

## 8 Parameters

What this chapter contains .....	221
Terms and abbreviations .....	221
Parameter group summary .....	223
Parameters list view .....	225
Parameter listing .....	226
1 Actual values .....	226



3 Input references ..... 231

4 Warnings and faults ..... 233

5 Diagnostics ..... 242

6 Control and status words ..... 244

7 System info ..... 257

9 Crane application signals ..... 261

10 Standard DI, RO ..... 269

11 Standard DIO, FI, FO ..... 276

12 Standard AI ..... 282

13 Standard AO ..... 288

14 I/O extension module 1 ..... 294

15 I/O extension module 2 ..... 322

16 I/O extension module 3 ..... 328

19 Operation mode ..... 334

20 Start/stop/direction ..... 337

21 Start/stop mode ..... 356

22 Speed reference selection ..... 365

23 Speed reference ramp ..... 378

24 Speed reference conditioning ..... 386

25 Speed control ..... 394

26 Torque reference chain ..... 405

29 Voltage reference chain ..... 414

30 Limits ..... 419

31 Fault functions ..... 430

32 Supervision ..... 444

33 Generic timer & counter ..... 451

35 Motor thermal protection ..... 460

36 Load analyzer ..... 475

37 User load curve ..... 480

43 Brake chopper ..... 483

44 Mechanical brake control ..... 486

46 Monitoring/scaling settings ..... 497

47 Data storage ..... 502

49 Panel port communication ..... 505

50 Fieldbus adapter (FBA) ..... 509

51 FBA A settings ..... 518

52 FBA A data in ..... 520

53 FBA A data out ..... 521

54 FBA B settings ..... 522

55 FBA B data in ..... 524

56 FBA B data out ..... 525

58 Embedded fieldbus ..... 526

60 DDCS communication ..... 535

61 D2D and DDCS transmit data ..... 555

62 D2D and DDCS receive data ..... 560



74 Speed matching .....	569
75 Hoist speed optimization .....	570
76 Conical motor control .....	579
77 Antisway .....	580
78 External sway control .....	594
82 Synchro control .....	600
83 Smooth lifting .....	604
85 ACC interface .....	606
90 Feedback selection .....	611
91 Encoder module settings .....	623
92 Encoder 1 configuration .....	627
93 Encoder 2 configuration .....	635
95 HW configuration .....	638
96 System .....	647
97 Motor control .....	659
98 User motor parameters .....	665
99 Motor data .....	668
200 Safety .....	677
206 I/O bus configuration .....	677
207 I/O bus service .....	678
208 I/O bus diagnostics .....	678
209 I/O bus fan identification .....	678

## 9 Fault tracing

What this chapter contains .....	679
Safety .....	679
Indications .....	679
Warnings and faults .....	679
Pure events .....	680
Editable messages .....	680
Warning/fault history and analysis .....	680
Event logs .....	680
Auxiliary codes .....	680
Factory data logger .....	681
Other data loggers .....	681
User data logger .....	681
PSL2 data logger .....	681
Parameters that contain warning/fault information .....	681
Event word (parameters <i>04.40...04.72</i> ) .....	682
QR Code generation for mobile service application .....	682
Warning, fault and pure event messages .....	683
Auxiliary codes for line-side converter warnings .....	731
Auxiliary codes for line-side converter faults .....	734



**10 Fieldbus control through the embedded fieldbus interface (EFB)**

What this chapter contains ..... 737

System overview ..... 738

Connecting the fieldbus to the drive ..... 738

Setting up the embedded fieldbus interface ..... 739

Setting the drive control parameters ..... 740

Basics of the embedded fieldbus interface ..... 742

    Control word and Status word ..... 743

    References ..... 744

    Actual values ..... 744

    Data input/outputs ..... 744

        Control of drive outputs through EFB ..... 744

    Register addressing ..... 745

About the control profiles ..... 745

The ABB Drives profile ..... 746

    Control Word ..... 746

    Status Word ..... 748

    State transition diagram ..... 749

    References ..... 751

    Actual values ..... 752

    Modbus holding register addresses ..... 753

The Transparent profile ..... 753

Modbus function codes ..... 754

Exception codes ..... 755

Coils (0xxxx reference set) ..... 756

Discrete inputs (1xxxx reference set) ..... 757

Error code registers (holding registers 400090...400100) ..... 758

**11 Fieldbus control through a fieldbus adapter**

What this chapter contains ..... 761

System overview ..... 761

Basics of the fieldbus control interface ..... 763

    Control word and Status word ..... 764

        Debugging the network words ..... 764

    References ..... 765

        Debugging the network words ..... 765

        Scaling of references ..... 765

    Actual values ..... 766

        Debugging the network words ..... 766

        Scaling of actual values ..... 766

    Contents of the fieldbus Control word (ABB Drives profile) ..... 767

    Contents of the fieldbus Status word (ABB Drives profile) ..... 769

    The state diagram (ABB Drives profile) ..... 770





Setting up the drive for fieldbus control .....	771
Parameter setting example: FPBA (PROFIBUS DP) .....	772

## 12 Drive-to-drive link

## 13 Control chain diagrams

What this chapter contains .....	777
Speed reference source selection I .....	778
Speed reference source selection II .....	779
Speed reference ramping and shaping .....	780
Crane speed reference .....	781
Motor feedback configuration .....	782
Load feedback and position counter configuration .....	783
Speed error calculation .....	784
Speed controller .....	785
Torque reference source selection and modification .....	786
Operating mode selection .....	787
Reference selection for torque controller .....	788
Torque limitation .....	789
Torque controller .....	790
Frequency reference selection .....	791
Frequency reference modification .....	792
Master/Follower communication I (Master) .....	793
Master/Follower communication II (Follower) .....	794

## 14 Example circuit diagrams

ACS880 crane control: Hoist .....	796
ACS880 crane control: Trolley .....	798
ACS880 crane control: Long travel .....	799

## Further information





# 1

## Introduction to the manual

---

### What this chapter contains

This chapter describes the contents of the manual. It also contains information on the compatibility, safety and intended audience.

### Applicability

This manual applies to the ACS880 crane control program (option +N5050), crane application version 4.30 (loading package ACRLX 4.30.0.0) or later, and primary control version 3.40.0.0 or later.

You can see firmware and loading package versions in parameters.

Example:

Parameter	Loading package version
7.4 Firmware name	AINFB or AINFC
7.5 Firmware version	3.40.x.x
7.6 Loading package name	ACRLB (BCON) or ACRLC (ZCON)
7.7 Loading package version	4.40.0.0

This crane application program is based on IEC standard 61131-3. It is an in-house application, therefore the application code is locked and cannot be modified by the user.

---

## Licensing

The crane control program (+N5050), version ACRLx v4.00.0.0 or later comes with a license key on the ZMU-02/-03 memory unit. The program activates only after recognizing the key and correspondingly registers itself with the crane software.

Device	License key
ZMU-02/-03 memory unit license key	N8015 MU Interlock key – Crane
Crane software (loading package)	N8016 Licensed appl Crane

You can see the license information in the Drive Composer PC tool or in the ACS-AP-I, -S, -W and ACH-AP-H, -W Assistant control panels from **System info** → **Licenses**.

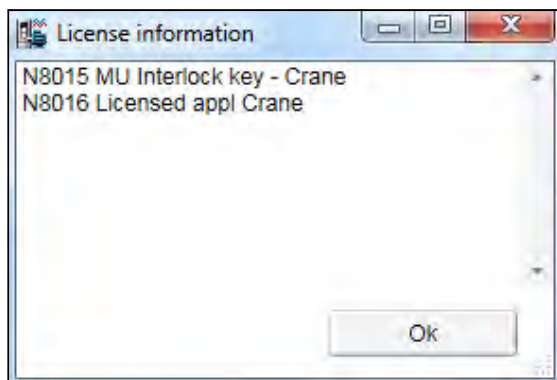

After the program is downloaded to the memory unit with the license key, the program remains there unless you overwrite it by downloading new program or program version. The license N8015 remains in the memory even if you overwrite the program. This makes it possible for you to upgrade the tower crane application later on a separate crane loading package.

If the program was loaded to the memory unit without the license key, then the drive indicates a fault **64A5 Licensing fault**. See the auxiliary fault code in the Event logger to know the plus code of the missing license, in this case N8015. For further assistance, contact your local ABB representative.

## Safety instructions

Follow all safety instructions delivered with the drive.

- Read the **complete safety instructions** before you install, commission, or use the drive. The complete safety instructions are delivered with the drive as either part of the *Hardware manual*, or, in the case of ACS880 multidrives, as a separate document.

- Read the **firmware function-specific warnings and notes** before changing parameter values. These warnings and notes are included in the parameter descriptions presented in chapter [Parameters](#).

## Target audience

This manual is intended for people who design, commission, or operate the drive system.

## Parameter access levels

Parameters in the control program are visible based on the following two access levels:

**Short menu (pass code 1)** – Most commonly used crane parameters. Parameters in this menu are visible only when you set parameter [96.2 Pass code](#) = 1.

**Long menu (pass code 584)** – Complete list of signals and parameters in the control program, for e.g. Smooth lifting. Parameters in this menu are visible only when you set parameter [96.2 Pass code](#) = 584.

**Note:** ABB recommends you to create a backup of complete parameters list using the long menu. However, you can also access the complete parameters list in the offline mode.

## Related manuals

**Note:** A quick start-up sequence for a speed control application is provided by *ACS880 drives with primary control program, Quick start-up guide* (3AUA0000098062), delivered with the drive.

Name	Code
<b>Lists of hyperlinks to product manuals <sup>1)</sup></b>	
ACS880-01 drives	<a href="#">9AKK105408A7004</a>
ACS880-04 drive modules (200 to 710 kW, 300 to 700 hp)	<a href="#">9AKK105713A4819</a>
ACS880-07 drives (45 to 710 kW, 50 to 700 hp)	<a href="#">9AKK105408A8149</a>
ACS880-07 drives (560 to 2800 kW)	<a href="#">9AKK105713A6663</a>
ACS880-11 drives	<a href="#">9AKK106930A9565</a>
ACS880-14 drive modules (132 to 400 kW, 200 to 450 hp)	<a href="#">9AKK107045A8023</a>
ACS880-17 drives (45 to 400 kW, 60 to 450 hp)	<a href="#">9AKK106930A3466</a>
ACS880-17 drives (160 to 3200 kW)	<a href="#">9AKK106354A1499</a>
ACS880-31 drives	<a href="#">9AKK106930A9564</a>
ACS880-34 drive modules (132 to 400 kW, 200 to 450 hp)	<a href="#">9AKK107045A8025</a>
ACS880-37 drives (45 to 400 kW, 60 to 450 hp)	<a href="#">9AKK106930A3467</a>
ACS880-37 drives (160 to 3200 kW)	<a href="#">9AKK106354A1500</a>

Name	Code
<b>Other drive hardware manuals</b>	
ACS880-04XT drive module packages (500 to 1200 kW) hardware manual	<a href="#">3AXD50000025169</a>
ACS880-04 single drive module packages hardware manual	<a href="#">3AUA0000138495</a>
ACS880-14 and -34 single drive packages hardware manual	<a href="#">3AXD50000022021</a>
ACS880-104 inverter modules hardware manual	<a href="#">3AUA0000104271</a>
ACS880-107 inverter units hardware manual	<a href="#">3AUA0000102519</a>
<b>Drive firmware manuals and guides</b>	
ACS880 primary control program firmware manual	<a href="#">3AUA0000085967</a>
ACS880 drives with primary control program, quick startup guide	<a href="#">3AUA0000098062</a>
Adaptive programming application guide	<a href="#">3AXD50000028574</a>
Drive application programming manual (IEC 61131-3)	<a href="#">3AUA0000127808</a>
ACS880 diode supply control program firmware manual	<a href="#">3AUA0000103295</a>
ACS880 IGBT supply control program firmware manual	<a href="#">3AUA0000131562</a>
CIO-01 I/O module for distributed I/O bus control user's manual	<a href="#">3AXD50000126880</a>
<b>Option manuals and guides</b>	
ACS-AP-I, -S, -W and ACH-AP-H, -W Assistant control panels user's manual	<a href="#">3AUA0000085685</a>
Drive Composer Start-up and maintenance PC tool user's manual	<a href="#">3AUA0000094606</a>
Manuals and quick guides for I/O extension modules, fieldbus adapters, encoder interfaces, etc.	

<sup>1)</sup> Available in the Document library.

You can find manuals and other product documents in PDF format on the Internet. See section *Document library on the Internet* on the inside of the back cover. For manuals not available in the Document library, contact your local ABB representative.

## Terms and abbreviations

Term	Description
AI	Analog input; an interface for analog input signals.
AO	Analog output; an interface for analog output signals.
BCU	Type of control unit
DC link	DC circuit between rectifier and inverter
DDCS	Distributed drives communication system protocol
DI	Digital input
DO	Digital output; an interface for digital output signals.
Drive	Frequency converter for controlling AC motors
DriveBus	A communication link used by, for example, ABB controllers. ACS6080 drives can be connected to the DriveBus link of the controller.
DTC	Direct torque control, a motor control method

<b>Term</b>	<b>Description</b>
EMC	Electromagnetic compatibility
EMI	Electromagnetic interference
FAIO-01	Analog I/O extension module
FBA	Fieldbus adapter
FCAN-01	Optional CANopen® adapter module
FCNA-01	Optional ControlNet™ adapter module
FDCO	Optical DDCS communication module
FDIO-01	Optional digital I/O extension module
FDNA-01	Optional DeviceNet™ adapter module
FEA-03	Optional I/O extension adapter
FECA-01	Optional EtherCAT® adapter module
FEN-01	Optional TTL incremental encoder interface module
FEN-11	Optional TTL absolute encoder interface module
FEN-21	Optional resolver interface module
FEN-31	Optional HTL incremental encoder interface module
FENA-11	Optional Ethernet adapter module for EtherNet/IP™, Modbus TCP and PROFINET IO protocols
FENA-21	Optional Ethernet adapter module for EtherNet/IP™, Modbus TCP and PROFINET IO protocols, 2-port
FEPL-02	Optional Ethernet POWERLINK adapter module
FIO-11	Optional analog I/O extension module
FPBA-01	Optional PROFIBUS DP® adapter module
FPTC-01	Optional thermistor protection module
FPTC-02	Optional ATEX-certified thermistor protection module for potentially explosive atmospheres
Frame, frame size	Physical size of the drive or power module
FSCA-01	Optional RS-485 (Modbus/RTU) adapter
FSO-12, FSO-21	Optional functional safety modules
HTL	High-threshold logic
ID run	Motor identification run. During the identification run, the drive will identify the characteristics of the motor for optimum motor control.
IGBT	Insulated gate bipolar transistor
INU	Inverter unit
Inverter unit	Inverter module(s) under control of one control unit, and related components. One inverter unit typically controls one motor.
ISU	IGBT supply unit
Line-side converter	In a drive module, the converter between the AC supply network and the DC link
ModuleBus	A communication link used by, for example, ABB controllers. ACS880 drives can be connected to the optical ModuleBus link of the controller.

Term	Description
Network control	With fieldbus protocols based on the Common Industrial Protocol (CIPTM), such as DeviceNet and Ethernet/IP, denotes the control of the drive using the Net Ctrl and Net Ref objects of the ODVA AC/DC Drive Profile. For more information, see <a href="http://www.odva.org">www.odva.org</a> .
Parameter	In the drive control program, user-adjustable operation instruction to the drive, or signal measured or calculated by the drive. In some (for example fieldbus) contexts, a value that can be accessed as an object. For example, variable, constant, or signal.
PID controller	Proportional–integral–derivative controller. Drive speed control is based on PID algorithm.
PLC	Programmable logic controller
Power module	(Frame sizes R1i...R7i) Contains the power electronics and power connections of the drive module. The control unit is connected to the power unit.
PSL2	Protocol used in communication inside ABB inverters
RDCO	Optical DDCS communication module
RO	Relay output
STO	Safe torque off (IEC/EN 61800-5-2)
Supply unit	Supply module(s) under control of one control unit, and related components.
TTL	Transistor-transistor logic
UPS	Uninterruptible power supply
ZCU	Type of control unit

## Cybersecurity disclaimer

This product can be connected to and communicate information and data via a network interface. The HTTP protocol, which is used between the commissioning tool (Drive Composer) and the product, is an unsecured protocol. For independent and continuous operation of product such connection via network to commissioning tool is not necessary. However it is Customer's sole responsibility to provide and continuously ensure a secure connection between the product and Customer network or any other network (as the case may be). Customer shall establish and maintain any appropriate measures (such as but not limited to the installation of firewalls, prevention of physical access, application of authentication measures, encryption of data, installation of anti-virus programs, etc.) to protect the product, the network, its system and the interface against any kind of security breaches, unauthorized access, interference, intrusion, leakage and/or theft of data or information.

Notwithstanding any other provision to the contrary and regardless of whether the contract is terminated or not, ABB and its affiliates are under no circumstances liable for damages and/or losses related to such security breaches, any unauthorized access, interference, intrusion, leakage and/or theft of data or information.



# 2

## Quick start-up guide

---

### Contents of this chapter

The chapter contains the basic start-up sequence of the drive and additional alternative checklists for starting up the drive with the control program. It also contains configuration setups for specific control program features.

See following sections:

- Start-up (page 26)
- Crane control start-up (page 31)

**Note:** In the start-up instructions, the drive is set up using the ACS-AP-I, -S, -W and ACH-AP-H, -W Assistant control panels. You can also set up the start-up sequence using the Drive composer PC tool.

### Before you start

Make sure that the drive is mechanically and electrically installed as described in the appropriate Quick installation guide and/or Hardware manual.

### Safety



**WARNING!** All electrical installation and maintenance work on the drive should be carried out by qualified electricians only.

Never work on the drive, the brake chopper circuit, the motor cable or the motor when power is applied to the drive. Always make sure by measuring that no voltage is actually present.

---







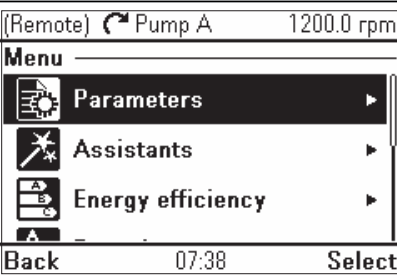

**WARNING!** Make sure that the machinery into which the drive with brake control function is integrated fulfills the personnel safety regulations. Note that the frequency converter (a Complete Drive Module or a Basic Drive Module, as defined in IEC 61800-2), is not considered as a safety device mentioned in the European Machinery Directive and related harmonized standards. Thus, the personnel safety of the complete machinery must not be based on a specific frequency converter feature (such as the brake control function), but it has to be implemented as defined in the application specific regulations.

## Start-up

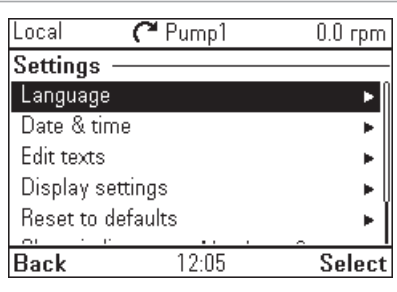
Safety	
	<p><b>WARNING!</b> The start-up may only be carried out by a qualified electrician. The safety instructions must be followed during the start-up procedure. See the safety instructions on the first pages of the appropriate <i>Hardware manual</i>.</p>
<input type="checkbox"/>	<p>Check the installation. See the installation checklist in the appropriate <i>Hardware manual</i>.</p>
<input type="checkbox"/>	<p>Check that the starting of the motor does not cause any danger. <b>De-couple the driven machine</b> if</p> <ul style="list-style-type: none"> <li>• there is a risk of damage in case of an incorrect direction of rotation, or</li> <li>• a <b>Normal</b> ID run is required during the drive start-up, when the load torque is higher than 20% or the machinery is not able to withstand the nominal torque transient during the ID run.</li> </ul>

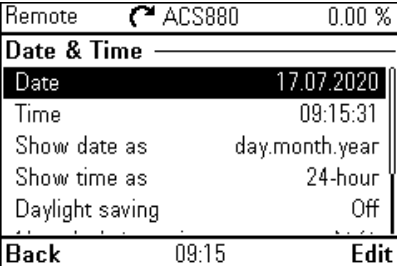
1 – Power-up, date and time settings											
<p><input type="checkbox"/> Power up the drive.</p> <p><b>Note:</b> It is normal that warning messages appear at various points along the start-up process. To hide a message and to resume the start-up process, press .</p> <p>Hide any warnings now to enter the <b>Home</b> view (shown on the right). The two commands at the bottom of the display (in this case, <b>Options</b> and <b>Menu</b>), show the functions of the two softkeys  and  located below the display. The commands assigned to the softkeys vary depending on the context.</p>	<table border="1" style="width: 100%; border-collapse: collapse;"> <tr> <td style="padding: 2px;">Local</td> <td style="text-align: right; padding: 2px;">↻ PumpA 1200.0 rpm</td> </tr> <tr> <td style="padding: 2px;">Motor speed used rpm</td> <td style="text-align: right; padding: 2px; font-size: 1.2em;">1200.07</td> </tr> <tr> <td style="padding: 2px;">Motor current A</td> <td style="text-align: right; padding: 2px; font-size: 1.2em;">0.83</td> </tr> <tr> <td style="padding: 2px;">Motor torque %</td> <td style="text-align: right; padding: 2px; font-size: 1.2em;">6.0</td> </tr> <tr> <td style="padding: 2px;"><b>Options</b></td> <td style="text-align: right; padding: 2px;">12:25 <b>Menu</b></td> </tr> </table>	Local	↻ PumpA 1200.0 rpm	Motor speed used rpm	1200.07	Motor current A	0.83	Motor torque %	6.0	<b>Options</b>	12:25 <b>Menu</b>
Local	↻ PumpA 1200.0 rpm										
Motor speed used rpm	1200.07										
Motor current A	0.83										
Motor torque %	6.0										
<b>Options</b>	12:25 <b>Menu</b>										

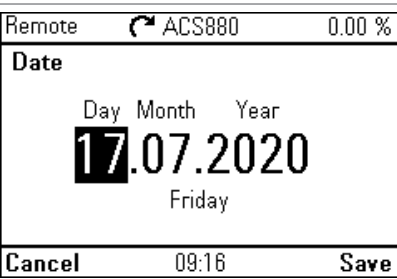
1 – Power-up, date and time settings	
<input type="checkbox"/> In the <b>Home</b> view, press  ( <b>Menu</b> ). The main <b>Menu</b> (right) appears.	
<input type="checkbox"/> Highlight <b>Settings</b> on the menu using  and  press ( <b>Select</b> ).	
<input type="checkbox"/> In the <b>Settings</b> menu, highlight <b>Date &amp; time</b> (if not already highlighted) and press  ( <b>Select</b> ).	
<input type="checkbox"/> In the <b>Date &amp; time</b> menu, highlight <b>Date</b> (if not already highlighted) and press  ( <b>Select</b> ).	

## 1 – Power-up, date and time settings

- Set the correct date:
- Use and to move the cursor left and right.
  - Use and to change the value.
  - Press (**Save**) to accept the new setting.
- Check/adjust all the remaining settings in the **Date & time** menu.
- The **Show clock** setting determines whether the time is shown at all times in the bottom pane of the display.
- After you have made the settings, press (**Back or Exit**) repeatedly until the **Home** view (right) reappears.

Local	PumpA	1200.0 rpm
Motor speed used	rpm	1200.07
Motor current	A	0.83
Motor torque	%	6.0
Options	12:25	Menu

## 2 – Supply voltage and motor data settings

- Switch to local control to ensure that external control is disabled by pressing the key. Local control is indicated by the text “Local” in the top pane.









Local	PumpA	1200.0 rpm
Motor speed used	rpm	1200.07
Motor current	A	0.83
Motor torque	%	6.0
Options	12:25	Menu

- Open the main **Menu** by pressing (**Menu**).

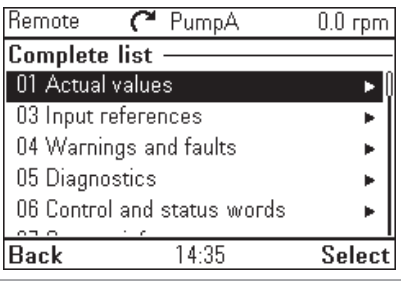
(Remote)	Pump A	1200.0 rpm
<b>Menu</b>		
	Parameters	
	Assistants	
	Energy efficiency	
Back	07:38	Select

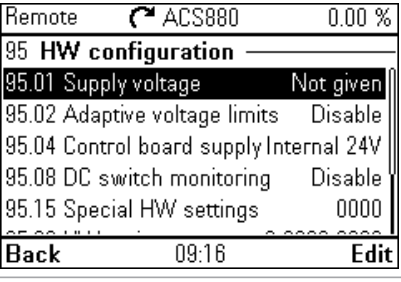
- Highlight **Parameters** and press (**Select**).

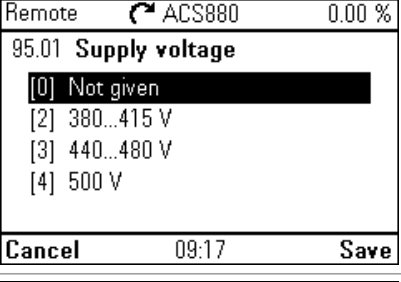
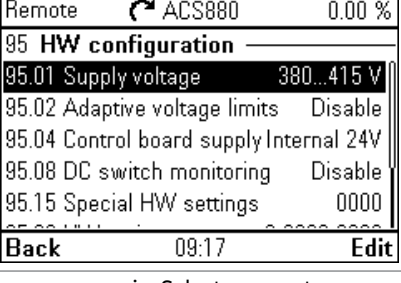
Remote	PumpA	0.0 rpm
<b>Parameters</b>		
	Complete list	
	By function	
	Favorites	
	Modified	
Back	14:30	Select

2 – Supply voltage and motor data settings	
<input type="checkbox"/> Highlight <b>Complete list</b> using  and  and press  ( <b>Select</b> ). A listing of parameter groups is displayed.	
<input type="checkbox"/> Highlight parameter group <b>95 HW configuration</b> and press  ( <b>Select</b> ). Note that the list wraps around in either direction between groups 99 and 01. In this case, it is quicker to use  to locate group 95 on the list. After selecting a group, a listing of parameters within the group is displayed.	
<input type="checkbox"/> Highlight parameter <b>95.01 Supply voltage</b> (if not already highlighted) and press  ( <b>Edit</b> ). The available parameter settings are listed.	
<input type="checkbox"/> Highlight the correct setting on the list and press <b>(Save)</b> .	
<input type="checkbox"/> Press  ( <b>Back</b> ) to display the list of parameter groups again. Select parameter group <b>99 Motor data</b> , and set parameter <b>99.03 Motor type</b> .	

**2 – Supply voltage and motor data settings**

- Set parameter **99.04 Motor ctrl mode**.  
**DTC** = Direct torque control; **Scalar**  
 DTC is suitable for most cases. Scalar mode is recommended if
  - the nominal current of the motor is less than 1/6 of the nominal current of the drive,
  - the drive is used for test purposes with no motor connected, or
  - the drive controls multiple motors and the number of motors connected is variable.

Refer to the motor nameplate for the following parameter settings. Whenever possible, enter the values exactly as shown on the motor nameplate.

- Example of a nameplate of an induction (asynchronous) motor:

ABB Motors		CE							
3 ~ motor		M2AA 200 MLA 4							
		IEC 200 M/L 55							
		No. Ins.cl. F IP 55							
V	Hz	kW	r/min	A	cos φ	η	IA/IN	IE/s	
690 Y	50	30	1475	32.5	0.83				
400 D	50	30	1475	56	0.83				
660 Y	50	30	1470	34	0.83				
380 D	50	30	1470	59	0.83				
415 D	50	30	1475	54	0.83				
440 D	60	35	1770	59	0.83				
Cat. no		3GAA 202 001 - ADA							
6312/C3		6210/C3		180		kg			
								IEC 34-1	



- Example of a nameplate of a permanent magnet motor:

ABB Motors		CE							
3 ~ motor		M2BJ 280SMB 10 B3							
		No. 3424622							
S1 SPEC INSUL		JK-21640-1							
		Ins.cl. F IP 55							
V	Hz	kW	r/min	A	cos φ	η	IA/IN	IE/s	
400 D	50	55	600	103	0.87				
Prod. code		2GBJ285220-ADA05445477							
6316/C3		6316/C3		630kg					
								IEC 34-1	

- 99.06 Motor nominal current**  
 The allowable range is
  - in DTC mode:  $1/6 \times I_{Hd} \dots 2 \times I_{Hd}$  of the drive
  - in Scalar mode:  $0 \dots 2 \times I_{Hd}$**Note:** With numerical parameter values:
  - Use  $\uparrow$  and  $\downarrow$  to change the value of a digit.
  - Use  $\leftarrow$  and  $\rightarrow$  to move the cursor left and right.
  - Press  $\text{Save}$  (Save) to enter the value.

Make the following parameter settings in the same manner.

- 99.07 Motor nominal voltage**  
 The allowable range is  $1/6 \times U_N \dots 2 \times U_N$  of the drive.  
 With permanent magnet motors, the nominal voltage is the BackEMF voltage at nominal speed. If the voltage is given in volt/rpm (eg. 60 V per 1000 rpm), the voltage at a nominal speed of 3000 rpm is  $3 \times 60 \text{ V} = 180 \text{ V}$ . Note that nominal voltage is not the same as equivalent DC motor voltage (EDCM) given by some manufacturers. The nominal voltage can be calculated by dividing the EDCM voltage by 1.7 (or square root of 3).
- 99.08 Motor nominal frequency**  
 With permanent magnet motors, if the nominal frequency is not shown on the nameplate, it can be calculated using the following formula:  
 $f = n \times p / 60$   
 where  $n$  = nominal motor speed,  $p$  = number of pole pairs.
- 99.09 Motor nominal speed**

2 – Supply voltage and motor data settings		
<input type="checkbox"/>	<b>99.10 Motor nominal power</b>	
<input type="checkbox"/>	<b>99.11 Motor nominal cosφ</b> <b>99.12 Motor nominal torque</b> These values are not required, but can be entered to improve control accuracy. If not known, leave at 0.	
<input type="checkbox"/>	<b>99.13 Identification run request</b> This parameter selects the mode of the identification run (DTC motor control mode only).   <b>WARNING!</b> The identification run modes marked thus * will run the motor in the forward direction (see below for details). Make sure it is safe to run the motor before choosing any of these modes.  * <b>Normal</b> mode should be selected whenever possible. The driven machinery must be decoupled from the motor if <ul style="list-style-type: none"> <li>• the load torque is higher than 20%, or</li> <li>• the machinery is not able to withstand the nominal torque transient during the identification run.</li> </ul> * <b>Reduced</b> mode should be selected if the mechanical losses are higher than 20%, ie. the load cannot be de-coupled, or full flux is required to keep the motor brake open (eg. with conical motors). The <b>Standstill</b> mode should be selected if neither the * <b>Normal</b> or * <b>Reduced</b> mode can be used.  <b>Note:</b> <ul style="list-style-type: none"> <li>• This mode cannot be used with a permanent magnet motor if the load torque is higher than 20% of nominal.</li> <li>• Mechanical brake is not opened by the logic for the identification run.</li> </ul>	
<input type="checkbox"/>	Ensure that the Safe torque off and emergency stop circuits (if present) are closed.	
<input type="checkbox"/>	Start the identification run by pressing the  (Start) button. <table border="1" style="float: right; margin-left: 20px;"> <tr> <td>A warning will indicate that the identification run is in progress.</td> </tr> </table>	A warning will indicate that the identification run is in progress.
A warning will indicate that the identification run is in progress.		
<input type="checkbox"/>	Check that the motor runs in the correct direction (forward direction shown below).   <p>The identification run has completed when the drive stops and the value of parameter <b>99.13</b> reverts to “No”.</p> <p>If the motor ran in the wrong direction, correct the motor cabling or adjust parameter <b>99.16 Phase order</b>.</p>	

## Crane control start-up

This section contains following alternative control schemes for starting up a drive in different crane motions with tower crane control program:

Crane motion	See topic
Hoist trolley	Control through I/O interface using a joystick (page 32)
	Control through I/O interface using step reference logic (page 35)
	Control through fieldbus interface using the fieldbus control word (page 38)
	Control through fieldbus interface using the crane control word and a joystick (page 42)

See also:

- Configuring Mechanical brake control (page 46)
- Configuring Slowdown inputs and limits (page 47)
- Configuring speed feedback using a HTL encoder (page 47)
- Configuring Lifetime monitor function (page 48)
- Configuring Lifetime monitor maintenance (page 49)



**Note:** Disable Torque proving and Brake open torque functions in the following modes:

- scalar motor control
- trolley motion
- long travel motion

### ■ Control through I/O interface using a joystick

This section describes how to set up hoist and trolley drives for control through I/O interface using a joystick. See [Control connections for hoist and trolley drives \(page 34\)](#).

<b>Safety</b>	
	<b>WARNING!</b> Obey all safety instructions for the drive. Only qualified electricians are allowed to start up the drive.
<b>Preliminary actions</b>	
<input type="checkbox"/>	Make sure that you have completed the basic start-up sequence of the drive. See <a href="#">Start-up (page 26)</a> .
<input type="checkbox"/>	Power up the drive and wait for 10 seconds. This is to make sure that all the boards are powered and the application is running
<input type="checkbox"/>	Switch to local control by pressing the <span style="border: 1px solid black; padding: 2px;">Loc/Rem</span> key, or alternatively, use the Drive composer PC tool.
<b>Brake circuit check</b>	







<input type="checkbox"/>	Make sure that you can safely do the brake circuit check. For example, make sure that the load is not hanging from a hook.
<input type="checkbox"/>	Make sure the brake circuit is working. 1. Open the brake temporarily by setting parameter 10.24 RO1 source = <i>Energized</i> . <b>Note:</b> Parameter 10.24 is locked for editing. To access, set parameter 96.2 Pass code = 584. 2. Set back par. 10.24 to its default value = P.44.210.0.
<b>Control signal settings</b>	
<input type="checkbox"/>	Select the signal sources for start and stop control. 20.1 Ext1 commands = In1 Start fwd; In2 Start rev 20.3 Ext1 in1 source = DI1 20.4 Ext1 in2 source = DI2
<input type="checkbox"/>	Select the signal source for speed reference 1. 22.11 Speed ref1 source = AI1 scaled
<input type="checkbox"/>	Define the analog input AI1 scales. 12.15 AI1 unit selection = V 12.17 AI1 min = 0 V 12.18 AI1 max = 10 V 12.19 AI1 scaled at AI1 min = The required maximum speed for reverse direction 12.20 AI1 scaled at AI1 max = The required maximum speed for forward direction
<input type="checkbox"/>	Set the required ramp times. 23.200 Crane ramp set selection 23.201 Crane acc time 1 23.202 Crane dec time 1 23.203 Crane acc time 2 23.204 Crane dec time 2
<input type="checkbox"/>	Set the speed limits. 30.11 Minimum speed = The same value as for 12.19 30.12 Maximum speed = The same value as for 12.20
<input type="checkbox"/>	Set the torque and current limits. 30.17 Maximum current = Nominal motor current [A] 30.19 Minimum torque 1 = Nominal motor torque (for example, -100%) 30.20 Maximum torque 1 = Nominal motor torque (for example, 100%) <b>Note:</b> After the trial run, you must set the above limits according to the application requirements.
<b>Brake and limit switches settings</b>	
<input type="checkbox"/>	Configure these functions: <ul style="list-style-type: none"> <li>• Mechanical brake control (page 78)</li> <li>• End limits (page 100) and Slowdown (page 101).</li> </ul>
<b>Trial run</b>	
<input type="checkbox"/>	Do a trial run with an empty hook.
<input type="checkbox"/>	Make sure that the brake and safety circuits are working.
<input type="checkbox"/>	Do a trial run with real load.

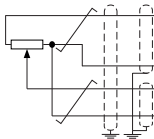
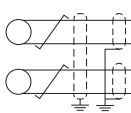

**Control connections for hoist and trolley drives**

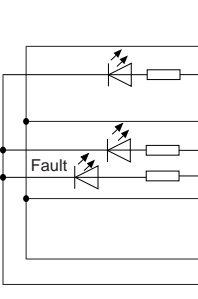

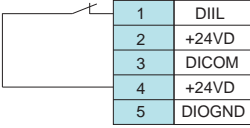
This figure shows Control through I/O interface using a joystick (page 32).

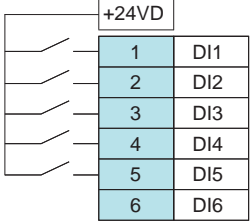
Connection	Term	Description
<b>XPOW External power input</b>		
	+24VI	24 V DC, 2 A
	GND	
<b>XAI Reference voltage and analog inputs</b>		
	+VREF	10 V DC, $R_L$ 1...10 kohm
	-VREF	-10 V DC, $R_L$ 1...10 kohm
	AGND	Ground
	AI1+	<b>Speed reference</b>
	AI1-	0(2)...10 V, $R_{in} > 200$ kohm
	AI2+	By default not in use.
	AI2-	0(4)...20 mA, $R_{in} = 100$ ohm
<b>XAO Analog outputs</b>		
	AO1	<b>Motor speed rpm</b>
	AGND	0...20 mA, $R_L < 500$ ohm
	AO2	<b>Motor current</b>
	AGND	0...20 mA, $R_L < 500$ ohm
<b>XD2D Drive-to-drive link</b>		
	B	Drive-to-drive link
	A	
	BGND	
<b>XRO1, XRO2, XRO3 Relay outputs</b>		
	NC	10.24 RO1 source = (Par. 44.210, b0)
	COM	250 V AC / 30 V DC
	NO	2 A
	NC	Watchdog ok (Par. 32.227, b0)
	COM	250 V AC / 30 V DC
	NO	2 A
	NC	10.24 RO1 source = <b>Fault (-1)</b>
	COM	250 V AC / 30 V DC
	NO	2 A
	+24VD	
	DIOGND	
	<b>XD24 Digital interlock</b>	

Connection	Term	Description
	1 DIIL	DIIL Power ackn. (par. 20.212) / Run enable (par. 20.12)
	2 +24VD	
	3 DICOM	+24VD +24 V DC 200 mA
	4 +24VD	DICOM Digital input ground
	5 DIOGND	+24VD +24 V DC 200 mA
		DIOGND Digital input/output ground
<b>XDIO Digital input/outputs</b>		
	DIO1	Open brake command
	DIO2	Output: Not in use.
<b>XDI Digital inputs</b>		
	DI1	Start forward (= positive speed = lifting load)
	DI2	Start reverse (= negative speed = lowering load)
	DI3	Fault reset
	DI4	Not in use.
	DI5	Not in use.
	DI6	Not in use.
XSTO	Safe torque off circuits must be closed for the drive to start. See <i>Hardware manual</i> of drive.	
X12	Safety options connection	
X13	Control panel connection	
X205	Memory unit connection	

## ■ Control through I/O interface using step reference logic

This section describes how to set up hoist and trolley drives for control through I/O interface using the step reference logic. See [Control connections for hoist and trolley drives](#) (page 37).

<b>Safety</b>	
	<b>WARNING!</b> Obey all safety instructions for the drive. Only qualified electricians are allowed to start up the drive.
<b>Preliminary actions</b>	
<input type="checkbox"/>	Make sure that you have completed the basic start-up sequence of the drive. See <a href="#">Start-up</a> (page 26).
<input type="checkbox"/>	Power up the drive and wait for 10 seconds. This is to make sure that all the boards are powered and the application is running.
<input type="checkbox"/>	Switch to local control by pressing the  key, or alternatively, use the Drive composer PC tool.

<b>Brake circuit check</b>	
<input type="checkbox"/>	Make sure that you can safely do the brake circuit check. For example, make sure that the load is not hanging from a hook.
<input type="checkbox"/>	Make sure the brake circuit is working. <ol style="list-style-type: none"> <li>1. Open the brake temporarily by setting parameter 10.24 RO1 source = <i>Energized</i>.  <b>Note:</b> Parameter 10.24 is locked for editing. To access, set parameter 96.2 Pass code = 584.</li> <li>2. Set back par. 10.24 to its default value = P.44.210.0.</li> </ol>
<b>Control signal settings</b>	
<input type="checkbox"/>	Select the signal sources for start and stop control. 20.1 Ext1 commands = In1 Start fwd; In2 Start rev 20.3 Ext1 in1 source = DI1 20.4 Ext1 in2 source = DI2
<input type="checkbox"/>	Define the Step reference logic. 22.203 Step reference mode = True 22.204 Step reference select 2 = Pointer xx.xx (DI4) 22.205 Step reference select 3 = Pointer xx.xx (DI5) 22.206 Step reference select 4 = Pointer xx.xx (DI6) 22.207 Step reference 1 = Reference 1 according to the application speed 22.208 Step reference 2 = Reference 2 according to the application speed 22.209 Step reference 3 = Reference 3 according to the application speed 22.210 Step reference 4 = Reference 4 according to the application speed
<input type="checkbox"/>	Set the required ramp times. 23.201 Crane acc time 1 23.202 Crane dec time 1 23.203 Crane acc time 2 23.204 Crane dec time 2
<input type="checkbox"/>	Set the speed limits so that they correspond to the step references 1...4. 30.11 Minimum speed 30.12 Maximum speed
<input type="checkbox"/>	Set the torque and current limits. 30.17 Maximum current = Nominal motor current [A] 30.19 Minimum torque 1 = Nominal motor torque (for example, -100%) 30.20 Maximum torque 1 = Nominal motor torque (for example, 100%)  <b>Note:</b> After the trial run, you must set the above limits according to the application requirements.
<b>Brake and limit switches settings</b>	
<input type="checkbox"/>	Configure these functions: <ul style="list-style-type: none"> <li>• Mechanical brake control (page 78)</li> <li>• End limits (page 100) and Slowdown (page 101).</li> </ul>
<b>Trial run</b>	
<input type="checkbox"/>	Do a trial run with an empty hook.
<input type="checkbox"/>	Make sure that the brake and safety circuits are working.
<input type="checkbox"/>	Do a trial run with real load.



## Control connections for hoist and trolley drives

This figure shows control connections for the step reference set-up described in section Control through I/O interface using step reference logic (page 35).

Connection	Term	Description
<b>XPOW External power input</b>		
	+24VI	24 V DC, 2 A
	GND	
<b>XAI Reference voltage and analog inputs</b>		
	+VREF	10 V DC, $R_L$ 1...10 kohm
	-VREF	-10 V DC, $R_L$ 1...10 kohm
	AGND	Ground
	AI1+	<b>Speed reference</b>
	AI1-	0(2)...10 V, $R_{in}$ > 200 kohm
	AI2+	By default not in use.
	AI2-	0(4)...20 mA, $R_{in}$ = 100 ohm
<b>XAO Analog outputs</b>		
	AO1	<b>Motor speed rpm</b>
	AGND	0...20 mA, $R_L$ < 500 ohm
	AO2	<b>Motor current</b>
	AGND	0...20 mA, $R_L$ < 500 ohm
<b>XD2D Drive-to-drive link</b>		
	B	Drive-to-drive link
	A	
	BGND	
<b>XRO1, XRO2, XRO3 Relay outputs</b>		
	NC	10.24 RO1 source = (Par. 44.210, b0) 250 V AC / 30 V DC
	COM	
	NO	Watchdog ok (Par. 32.227, b0) 250 V AC / 30 V DC 2 A
	NC	
	COM	10.24 RO1 source = <i>Fault (-1)</i> 250 V AC / 30 V DC 2 A
	NO	
	NC	
	COM	
	NO	
	+24VD	
	DIOGND	
	<b>XD24 Digital interlock</b>	

Connection		Term	Description												
<table border="1"> <tr><td>1</td><td>DIIL</td></tr> <tr><td>2</td><td>+24VD</td></tr> <tr><td>3</td><td>DICOM</td></tr> <tr><td>4</td><td>+24VD</td></tr> <tr><td>5</td><td>DIOGND</td></tr> </table>	1	DIIL	2	+24VD	3	DICOM	4	+24VD	5	DIOGND	DIIL	Power ackn. (par. 20.212) / Run enable (par. 20.12)			
	1	DIIL													
	2	+24VD													
	3	DICOM													
	4	+24VD													
5	DIOGND														
+24VD	+24 V DC 200 mA														
DICOM	Digital input ground														
+24VD	+24 V DC 200 mA														
DIOGND	Digital input/output ground														
<b>XDIO Digital input/outputs</b>															
<table border="1"> <tr><td>1</td><td>DIO1</td></tr> <tr><td>2</td><td>DIO2</td></tr> </table>	1	DIO1	2	DIO2	DIO1	Open brake command									
	1	DIO1													
2	DIO2														
DIO2	Output: Not in use														
<b>XDI Digital inputs</b>															
<table border="1"> <tr><td>+24VD</td></tr> <tr><td>1</td><td>DI1</td></tr> <tr><td>2</td><td>DI2</td></tr> <tr><td>3</td><td>DI3</td></tr> <tr><td>4</td><td>DI4</td></tr> <tr><td>5</td><td>DI5</td></tr> <tr><td>6</td><td>DI6</td></tr> </table>	+24VD	1	DI1	2	DI2	3	DI3	4	DI4	5	DI5	6	DI6	DI1	Start forward (= positive speed = lifting load)
	+24VD														
	1	DI1													
	2	DI2													
	3	DI3													
	4	DI4													
	5	DI5													
6	DI6														
DI2	Start reverse (= negative speed = lowering load)														
DI3	Fault reset														
DI4	Step reference 2 selection. See par. 22.204 Step reference select 2.														
DI5	Step reference 3 selection. See par. 22.205 Step reference select 3.														
DI6	Step reference 4 selection. See par. 22.206 Step reference select 4.														
XSTO	Safe torque off circuits must be closed for the drive to start. See <i>Hardware manual</i> of drive.														
X12	Safety options connection														
X13	Control panel connection														
X205	Memory unit connection														

■ **Control through fieldbus interface using the fieldbus control word**

This section describes how to set up hoist and trolley drives for control through fieldbus interface using the fieldbus control word. See *Control connections for hoist and trolley drives* (page 41).

Safety	
	<b>WARNING!</b> Obey all safety instructions for the drive. Only qualified electricians are allowed to start up the drive.
Preliminary actions	
<input type="checkbox"/>	Make sure that you have completed the basic start-up sequence of the drive. See <i>Start-up</i> (page 26).
<input type="checkbox"/>	Power up the drive and wait for 10 seconds. This is to make sure that all the boards are powered and the application is running.

<input type="checkbox"/>	Switch to local control by pressing the  key, or alternatively, use the Drive composer PC tool.
<b>Brake circuit check</b>	
<input type="checkbox"/>	Make sure that you can safely do the brake circuit check. For example, make sure that the load is not hanging from a hook.
<input type="checkbox"/>	<p>Make sure the brake circuit is working.</p> <ol style="list-style-type: none"> <li>Open the brake temporarily by setting parameter 10.24 RO1 source = <i>Energized</i>.</li> </ol> <p><b>Note:</b> Parameter 10.24 is locked for editing. To access, set parameter 96.2 Pass code = 584.</p> <ol style="list-style-type: none"> <li>Set back par. 10.24 to its default value = P.44.210.0.</li> </ol>
<b>Fieldbus communication settings</b>	
Start up the fieldbus adapter module. See the appropriate fieldbus adapter module user's manual. An example of the FPBA-01 start-up procedure is given below.	
<input type="checkbox"/>	<p>50.1 FBA A enable = Option slot x  50.2 FBA A comm loss func = Fault  50.3 FBA A comm loss t out = 1 s  50.4 FBA A ref1 type = Speed  46.1 Speed scaling = According to the maximum speed of the application</p>
<input type="checkbox"/>	Set the adapter module configuration parameters in group 51. At the minimum, set the required node address in parameter 51.02 Node address and the communication profile in 51.05 Profile.
<input type="checkbox"/>	<p>52.1 FBA A data in1 = SW 16bit  52.02 FBA A data in2 = 1.1 [16]  53.1 FBA data out1 = CW 16bit  53.02 FBA A data out2 = Ref1 16bit  53.03 FBA A data out3 = Ref2 16bit  46.1 Speed scaling = According to the maximum speed of the application</p>
<input type="checkbox"/>	Save the valid parameter values to the permanent memory. 96.7 Parameter save manually = Save
<input type="checkbox"/>	Validate the settings made in parameter groups 51, 52 and 53. 51.27 FBA A par refresh = Refresh
<input type="checkbox"/>	Switch power off and on.
<input type="checkbox"/>	Make sure that the settings in parameter group 51 are correct (type of the fieldbus adapter module, node address, and so on).
<input type="checkbox"/>	Define the start and stop control sources. 20.1 Ext1 commands = Fieldbus A
<input type="checkbox"/>	Select the source for the speed reference. 22.11 Speed ref1 source = FB A ref1
<input type="checkbox"/>	Set the required ramp times. 23.201 Crane acc time 1 23.202 Crane dec time 1 23.203 Crane acc time 2 23.204 Crane dec time 2
<input type="checkbox"/>	Set the speed limits. 30.11 Minimum speed 30.12 Maximum speed



## 40 Quick start-up guide



<input type="checkbox"/>	<b>Set the torque and current limits.</b> 30.17 Maximum current = Nominal motor current [A] 30.19 Minimum torque 1 = Nominal motor torque (for example, -100%) 30.20 Maximum torque 1 = Nominal motor torque (for example, 100%) <b>Note:</b> After the trial run, you must set the above limits according to the application requirements.
<b>Brake and limit switches settings</b>	
<input type="checkbox"/>	<b>Configure these functions:</b> <ul style="list-style-type: none"><li>• Mechanical brake control (page 78)</li><li>• End limits (page 100) and Slowdown (page 101).</li></ul>
<b>Trial run</b>	
<input type="checkbox"/>	Do a trial run with an empty hook.
<input type="checkbox"/>	Make sure that the brake and safety circuits are working before.
<input type="checkbox"/>	Do a trial run with real load.



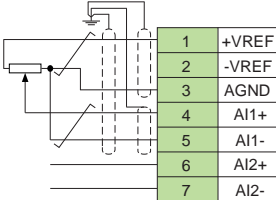
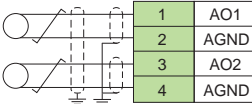

### Control connections for hoist and trolley drives

This figure shows control connections for fieldbus control word set-up described in section Control through fieldbus interface using the fieldbus control word.

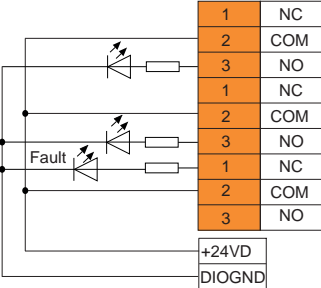
Connection	Term	Description
<b>XPOW External power input</b>		
	+24VI	24 V DC, 2 A
	GND	
<b>XAI Reference voltage and analog inputs</b>		
	+VREF	10 V DC, $R_L$ 1...10 kohm
	-VREF	-10 V DC, $R_L$ 1...10 kohm
	AGND	Ground
	AI1+	<b>Speed reference</b>
	AI1-	0(2)...10 V, $R_{in}$ > 200 kohm
	AI2+	By default not in use.
	AI2-	0(4)...20 mA, $R_{in}$ = 100 ohm
<b>XAO Analog outputs</b>		
	AO1	<b>Motor speed rpm</b>
	AGND	0...20 mA, $R_L$ < 500 ohm
	AO2	<b>Motor current</b>
	AGND	0...20 mA, $R_L$ < 500 ohm
<b>XD2D Drive-to-drive link</b>		
	B	Drive-to-drive link
	A	
	BGND	
<b>XRO1, XRO2, XRO3 Relay outputs</b>		
	NC	10.24 RO1 source = (Par. 44.210, b0) 250 V AC / 30 V DC
	COM	
	NO	Watchdog ok (Par. 32.227, b0) 250 V AC / 30 V DC 2 A
	NC	
	COM	
	NO	10.24 RO1 source = <i>Fault (-1)</i> 250 V AC / 30 V DC 2 A
	NC	
	COM	
	NO	
	+24VD	
	DIOGND	
	<b>XD24 Digital interlock</b>	



Connection	Term	Description												
<table border="1"> <tr><td>1</td><td>DIIL</td></tr> <tr><td>2</td><td>+24VD</td></tr> <tr><td>3</td><td>DICOM</td></tr> <tr><td>4</td><td>+24VD</td></tr> <tr><td>5</td><td>DIOGND</td></tr> </table>	1	DIIL	2	+24VD	3	DICOM	4	+24VD	5	DIOGND	DIIL	Power ackn. (par. 20.212) / Run enable (par. 20.12)		
	1	DIIL												
	2	+24VD												
	3	DICOM												
	4	+24VD												
5	DIOGND													
+24VD	+24 V DC 200 mA													
DICOM	Digital input ground													
+24VD	+24 V DC 200 mA													
DIOGND	Digital input/output ground													
<b>XDIO Digital input/outputs</b>														
<table border="1"> <tr><td>1</td><td>DIO1</td></tr> <tr><td>2</td><td>DIO2</td></tr> </table>	1	DIO1	2	DIO2	DIO1	Open brake command								
	1	DIO1												
2	DIO2													
DIO2	Output: Not in use													
<b>XDI Digital inputs</b>														
<table border="1"> <tr><td>1</td><td>DI1</td></tr> <tr><td>2</td><td>DI2</td></tr> <tr><td>3</td><td>DI3</td></tr> <tr><td>4</td><td>DI4</td></tr> <tr><td>5</td><td>DI5</td></tr> <tr><td>6</td><td>DI6</td></tr> </table>	1	DI1	2	DI2	3	DI3	4	DI4	5	DI5	6	DI6	DI1	
	1	DI1												
	2	DI2												
	3	DI3												
	4	DI4												
	5	DI5												
6	DI6													
DI2														
DI3	Fault reset													
DI4														
DI5														
DI6														
<b>XSTO</b>	Safe torque off circuits must be closed for the drive to start. See <i>Hardware manual</i> of drive.													
<b>X12</b>	Safety options connection													
<b>X13</b>	Control panel connection													
<b>X205</b>	Memory unit connection													

■ **Control through fieldbus interface using the crane control word and a joystick**

This section describes how to set up hoist and trolley drives for control through the fieldbus interface using the crane control word and a joystick. See *Control connections for hoist and trolley drives* (page 45).

<b>Safety</b>	
	<b>WARNING!</b> Obey all safety instructions for the drive. Only qualified electricians are allowed to start up the drive.
<b>Preliminary actions</b>	
<input type="checkbox"/>	Make sure that you have completed the basic start-up sequence of the drive. See <i>Start-up</i> (page 26).
<input type="checkbox"/>	Power up the drive and wait for 10 seconds. This is to make sure that all the boards are powered and the application is running.

<input type="checkbox"/>	Switch to local control by pressing the  key, or alternatively, use the Drive composer PC tool.
<b>Brake circuit check</b>	
<input type="checkbox"/>	Make sure that you can safely do the brake circuit check. For example, make sure that the load is not hanging from a hook.
<input type="checkbox"/>	<p>Make sure the brake circuit is working.</p> <ol style="list-style-type: none"> <li>Open the brake temporarily by setting parameter 10.24 RO1 source = <i>Energized</i>.</li> </ol> <p><b>Note:</b> Parameter 10.24 is locked for editing. To access, set parameter 96.2 Pass code = 584.</p> <ol style="list-style-type: none"> <li>Set back par. 10.24 to its default value = P.44.210.0.</li> </ol>
<b>Fieldbus communication settings</b>	
Start up the fieldbus adapter module. See the appropriate fieldbus adapter module user's manual. An example of the FPBA-01 start-up procedure is given below.	
<input type="checkbox"/>	<p>50.1 FBA A enable = Option slot x  50.2 FBA A comm loss func = Fault  50.3 FBA A comm loss t out = 1 s  50.4 FBA A ref1 type = Speed or Frequency  50.5 FBA A ref2 type = Speed or Frequency  46.1 Speed scaling = According to the maximum speed of the application</p>
<input type="checkbox"/>	Set the adapter module configuration parameters in group 51. At the minimum, set the required node address in parameter 51.02 Node address and the communication profile in 51.05 Profile.
<input type="checkbox"/>	<p>52.1 FBA A data in1 = SW 16bit  52.02 FBA A data in2 = 1.1 [16]  53.1 FBA data out1 = CW 16bit  53.02 FBA A data out2 = Ref1 16bit  53.03 FBA A data out3 = Other -&gt; 20.216  46.1 Speed scaling = According to the maximum speed of the application</p>
<input type="checkbox"/>	Save the valid parameter values to the permanent memory. 96.7 Parameter save manually = Save
<input type="checkbox"/>	Validate the settings made in parameter groups 51, 52 and 53. 51.27 FBA A par refresh = Refresh
<input type="checkbox"/>	Switch power off and on.
<input type="checkbox"/>	Make sure that the settings in parameter group 51 are correct (type of the fieldbus adapter module, node address, and so on).

<input type="checkbox"/>	<p><b>Define the start and stop control sources.</b>                  20.1 Ext1 commands = In1 Start fwd; In2 Start rev                  20.3 Ext1 in1 source = P.20.216.0                  20.4 Ext1 in2 source = P.20.216.1</p>	<p>Contents of par. 20.216 Crane control word 1:</p> <table border="1" data-bbox="453 188 919 639"> <thead> <tr> <th>Bit</th> <th>Name</th> <th>Value</th> </tr> </thead> <tbody> <tr><td>0</td><td>0 = Start forward</td><td>0</td></tr> <tr><td>1</td><td>1 = Start reverse</td><td>0</td></tr> <tr><td>2</td><td>2 = Fault reset</td><td>0</td></tr> <tr><td>3</td><td>3 = Step reference mode</td><td>0</td></tr> <tr><td>4</td><td>4 = Step reference select 2</td><td>0</td></tr> <tr><td>5</td><td>5 = Step reference select 3</td><td>0</td></tr> <tr><td>6</td><td>6 = Step reference select 4</td><td>0</td></tr> <tr><td>7</td><td>7 = Slowdown input 1</td><td>1</td></tr> <tr><td>8</td><td>8 = Slowdown input 2</td><td>1</td></tr> <tr><td>9</td><td>9 = Upper limit</td><td>1</td></tr> <tr><td>10</td><td>10 = Lower limit</td><td>1</td></tr> <tr><td>11</td><td>11 = Fast stop</td><td>1</td></tr> <tr><td>12</td><td>12 = Synchronizing mode</td><td>0</td></tr> <tr><td>13</td><td>13 = Homing select</td><td>0</td></tr> <tr><td>14</td><td>14 = Homing acknowledge</td><td>0</td></tr> <tr><td>15</td><td>15 = Position preset</td><td>0</td></tr> </tbody> </table>	Bit	Name	Value	0	0 = Start forward	0	1	1 = Start reverse	0	2	2 = Fault reset	0	3	3 = Step reference mode	0	4	4 = Step reference select 2	0	5	5 = Step reference select 3	0	6	6 = Step reference select 4	0	7	7 = Slowdown input 1	1	8	8 = Slowdown input 2	1	9	9 = Upper limit	1	10	10 = Lower limit	1	11	11 = Fast stop	1	12	12 = Synchronizing mode	0	13	13 = Homing select	0	14	14 = Homing acknowledge	0	15	15 = Position preset	0
Bit	Name	Value																																																			
0	0 = Start forward	0																																																			
1	1 = Start reverse	0																																																			
2	2 = Fault reset	0																																																			
3	3 = Step reference mode	0																																																			
4	4 = Step reference select 2	0																																																			
5	5 = Step reference select 3	0																																																			
6	6 = Step reference select 4	0																																																			
7	7 = Slowdown input 1	1																																																			
8	8 = Slowdown input 2	1																																																			
9	9 = Upper limit	1																																																			
10	10 = Lower limit	1																																																			
11	11 = Fast stop	1																																																			
12	12 = Synchronizing mode	0																																																			
13	13 = Homing select	0																																																			
14	14 = Homing acknowledge	0																																																			
15	15 = Position preset	0																																																			
<input type="checkbox"/>	<p><b>Select the source for the speed reference.</b>                  22.11 Speed ref1 source = FB A ref1</p>																																																				
<input type="checkbox"/>	<p><b>Set the required ramp times.</b>                  23.201 Crane acc time 1                  23.202 Crane dec time 1                  23.203 Crane acc time 2                  23.204 Crane dec time 2</p>																																																				
<input type="checkbox"/>	<p><b>Set the speed limits.</b>                  30.11 Minimum speed                  30.12 Maximum speed</p>																																																				
<input type="checkbox"/>	<p><b>Set the torque and current limits.</b>                  30.17 Maximum current = Nominal motor current [A]                  30.19 Minimum torque 1 = Nominal motor torque (for example, -100%)                  30.20 Maximum torque 1 = Nominal motor torque (for example, 100%)</p>																																																				
<p><b>Brake and limit switches settings</b></p>																																																					
<input type="checkbox"/>	<p><b>Configure these functions:</b></p> <ul style="list-style-type: none"> <li>• Mechanical brake control (page 78)</li> <li>• End limits (page 100) and Slowdown (page 101).</li> </ul>																																																				
<p><b>Trial run</b></p>																																																					
<input type="checkbox"/>	<p>Do a trial run with an empty hook.</p>																																																				
<input type="checkbox"/>	<p>Make sure that the brake and safety circuits are working.</p>																																																				
<input type="checkbox"/>	<p>Do a trial run with real load.</p>																																																				



### Control connections for hoist and trolley drives

This figure shows the control connections for the crane control word set-up described in section Control through fieldbus interface using the crane control word and a joystick (page 42).

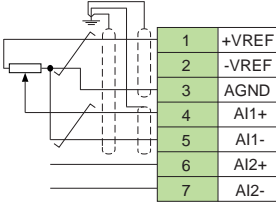
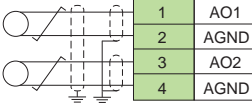
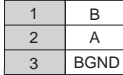
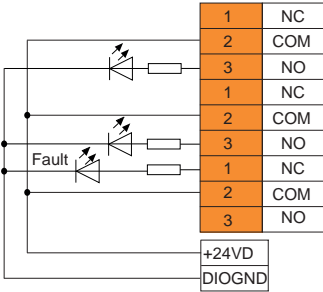
Connection	Term	Description
<b>XPOW External power input</b>		
	+24VI	24 V DC, 2 A
	GND	
<b>XAI Reference voltage and analog inputs</b>		
	+VREF	10 V DC, $R_L$ 1...10 kohm
	-VREF	-10 V DC, $R_L$ 1...10 kohm
	AGND	Ground
	AI1+	<b>Speed reference</b>
	AI1-	0(2)...10 V, $R_{in} > 200$ kohm
	AI2+	By default not in use.
	AI2-	0(4)...20 mA, $R_{in} = 100$ ohm
<b>XAO Analog outputs</b>		
	AO1	<b>Motor speed rpm</b>
	AGND	0...20 mA, $R_L < 500$ ohm
	AO2	<b>Motor current</b>
	AGND	0...20 mA, $R_L < 500$ ohm
<b>XD2D Drive-to-drive link</b>		
	B	Drive-to-drive link
	A	
	BGND	
<b>XRO1, XRO2, XRO3 Relay outputs</b>		
	NC	10.24 RO1 source = (Par. 44.210, b0)
	COM	250 V AC / 30 V DC
	NO	
	NC	Watchdog ok (Par. 32.227, b0)
	COM	250 V AC / 30 V DC
	NO	2 A
	NC	10.24 RO1 source = <b>Fault (-1)</b>
	COM	250 V AC / 30 V DC
	NO	2 A
	+24VD	
	DIOGND	
	<b>XD24 Digital interlock</b>	



Connection		Term	Description										
<table border="1"> <tr><td>1</td><td>DIIL</td></tr> <tr><td>2</td><td>+24VD</td></tr> <tr><td>3</td><td>DICOM</td></tr> <tr><td>4</td><td>+24VD</td></tr> <tr><td>5</td><td>DIOGND</td></tr> </table>	1	DIIL	2	+24VD	3	DICOM	4	+24VD	5	DIOGND		DIIL	Power ackn. (par. 20.212) / Run enable (par. 20.12)
	1	DIIL											
	2	+24VD											
	3	DICOM											
	4	+24VD											
5	DIOGND												
	+24VD	+24VD	+24 V DC 200 mA										
	DICOM	DICOM	Digital input ground										
	+24VD	+24VD	+24 V DC 200 mA										
	DIOGND	DIOGND	Digital input/output ground										
<b>XDIO Digital input/outputs</b>													
<table border="1"> <tr><td>1</td><td>DIO1</td></tr> <tr><td>2</td><td>DIO2</td></tr> </table>	1	DIO1	2	DIO2		DIO1	Open brake command						
	1	DIO1											
2	DIO2												
		DIO2	Output: Not in use										
<b>XDI Digital inputs</b>													
		DI1											
			DI2										
			DI3	Fault reset									
			DI4										
			DI5										
			DI6										
	XSTO	Safe torque off circuits must be closed for the drive to start. See <i>Hardware manual</i> of drive.											
	X12	Safety options connection											
	X13	Control panel connection											
	X205	Memory unit connection											

**■ Configuring Mechanical brake control**

This section describes how to configure mechanical brake control.

<b>Safety</b>	
	<b>WARNING!</b> Obey all safety instructions for the drive. Only qualified electricians are allowed to start up the drive.
<b>Parameter settings</b>	
<input type="checkbox"/>	Activate the brake control logic. 44.6 Brake control enable = Selected 10.24 RO1 source = 44.210.0
<input type="checkbox"/>	Define the brake opening and closing delays. 44.8 Brake open delay = 1 s. Too short time can cause wear of brake surface. 44.13 Brake close delay = 1 s. Too short time can cause small load drop.
<input type="checkbox"/>	Select the source for the brake acknowledge signal. 44.7 Brake acknowledge selection = According to the application requirements. For example, DI3 or No acknowledge.

<input type="checkbox"/>	<p>Select the source for the brake opening torque. At first, select the following:  44.9 Brake open torque source = Brake open torque  44.200 Brake open torque = 50%  After the trial run, select the brake opening torque source according to the application requirements.</p> <p><b>Note:</b> In scalar motor control or in trolley and long travel movements, disable Torque proving and Brake open torque. Select the following:  44.9 Brake open torque source = Zero  44.200 Brake open torque = 0%  44.202 Torque proving = Disable</p>
<input type="checkbox"/>	<p>If a pulse encoder does not exist in the system, activate the Brake safe closure function in parameter 44.207 Safety close select.</p>
<b>Trial run</b>	
<input type="checkbox"/>	<p>During final testing, and especially when you monitor the actual speed and torque, tune the brake control parameters.  The aim is to get the fastest possible response for the control commands without any jerk or roll-back in the actual speed while opening or closing the brake.</p>

## ■ Configuring Slowdown inputs and limits

This section describes how to configure inputs and limits of slowdown function.

<b>Safety</b>	
	<b>WARNING!</b> Obey all safety instructions for the drive. Only qualified electricians are allowed to start up the drive.
<b>Parameter settings</b>	
<input type="checkbox"/>	<p>Select the Slowdown inputs and reference.  20.200 Slowdown select = Either select one incoming signal in both directions, or two inputs, one input for each direction.  20.201 Slowdown input 1  20.202 Slowdown input 2 (If necessary)  22.200 Slowdown reference = According to the application requirements</p>
<input type="checkbox"/>	<p>Define the end limits.  20.205 End limit 1  20.206 End limit 2</p>
<b>Trial run</b>	
<input type="checkbox"/>	<p>Test the connected inputs and outputs in the local control mode before the final trial run.</p>

## ■ Configuring speed feedback using a HTL encoder

This section describes how to configure speed feedback using a HTL encoder.

<b>Safety</b>
---------------



**WARNING!** Obey all safety instructions for the drive. Only qualified electricians are allowed to start up the drive.

**Parameter settings**

- Specify the type of the encoder interface module (parameter 91.11 Module 1 type = FEN-31) and the slot the module is installed into (91.12 Module 1 location).
- Specify the type of the encoder (92.1 Encoder 1 type = HTL). The parameter listing will be re-read from the drive after the value is changed.
- Specify the interface module that the encoder is connected to (92.2 Encoder 1 source = *Module 1*).
- Set the number of pulses according to encoder nameplate (92.10 Pulses/revolution).
- If the encoder rotates at a different speed to the motor (ie. is not mounted directly on the motor shaft), enter the gear ratio in 90.43 Motor gear numerator and 90.44 Motor gear denominator.
- Set parameter 91.10 Encoder parameter refresh to Refresh to apply the new parameter settings. The parameter will automatically revert to Done.
- Check that 91.2 Module 1 status is showing the correct interface module type (FEN-31). Also check the status of the module; both LEDs should be glowing green.
- Start the motor with a reference of, for example, 400 rpm.
- Compare the estimated speed (1.2 Motor speed estimated) with the measured speed (01.04 Encoder 1 speed filtered). If the values are the same, set the encoder as the feedback source (90.41 Motor feedback selection = *Encoder 1*).
- Specify the action taken in case the feedback signal is lost (90.45 Motor feedback fault).



■ **Configuring Lifetime monitor function**

This section describes how to configure the lifetime monitor function.

**Safety**



**WARNING!** Obey all safety instructions for the drive. Only qualified electricians are allowed to start up the drive.

**Preliminary actions**

- Make sure that you have made the Lifetime monitor parameters visible using the user lock pass code 584 in parameter 96.2 Pass code.
- Configure parameters as in Parameter settings, but set parameter 75.70 Start lifetime monitor = Off.

**Parameter settings**

-  **WARNING!** Incorrect values can cause wrong results of lifetime calculation, that can further lead to accidents and injuries.  
  
The functionality should be verified by a commissioning engineer together with the customer.



<input type="checkbox"/>	<b>Define the hoist nominal values:</b> 75.3 Motor base speed 75.31 Hoist nominal load 75.32 Hoist nominal speed 75.33 Hoist maximum speed
<input type="checkbox"/>	<b>Tune the hoist lost weight calculation as per the instructions.</b>
<input type="checkbox"/>	<b>Set the lifetime monitor parameters:</b> 75.71 Crane lifetime 75.74 Lifetime speed scaling
<input type="checkbox"/>	<b>Start the Lifetime monitor function:</b> 75.70 Start lifetime monitor = On
<input type="checkbox"/>	<b>After setting the parameters, hide the Lifetime monitor function parameters with 96.2 Pass code = 1.</b>
<input type="checkbox"/>	<b>Monitor the values in the signals:</b> 9.10 Lifetime left 9.11 Lifetime left in percent 9.12 Load spectrum factor 9.13 Lifetime sw 75.80 Lifetime used Warnings or maintenance indicators can be taken from 9.13 Lifetime sw, bit 1. When the bit is set to 1, the drive generates the warning D216 Lifetime left less 10%, for example to the relay output ROxx.

## ■ Configuring Lifetime monitor maintenance

This section describes how to configure the lifetime monitor maintenance function.

The following maintenance tasks can be done if any changes are recorded in the load spectrum of the crane system.

- Copying old values to new system (page 49)
- Resetting the load spectrum recorder (page 50)

### Copying old values to new system

If you replaced a control board or a complete drive, copy the old values to the new system (e.g. from the parameter file). Follow the instructions below:

<b>Safety</b>	
	<b>WARNING!</b> Obey all safety instructions for the drive. Only qualified electricians are allowed to start up the drive.
<b>Preliminary actions</b>	
<input type="checkbox"/>	Make sure that you have made the Lifetime monitor parameters visible using the user lock pass code 584 in parameter 96.2 Pass code.
<input type="checkbox"/>	Configure parameters as in Parameter settings, but set parameter 75.70 Start lifetime monitor = Off.
<b>Parameter settings</b>	

<input type="checkbox"/>	Crane operating hours (run with open brake): <ol style="list-style-type: none"> <li>Copy the value from parameter 9.20 Crane operation hours into parameter 33.201 Crane operation hrs init value.</li> <li>Activate the set command with parameter 33.200 Set crane operation hours.</li> </ol>
<input type="checkbox"/>	Lifetime monitor actual values: <ol style="list-style-type: none"> <li>Copy the value from parameter 9.12 Load spectrum factor into parameter 75.73 Preset value of load spectrum.</li> <li>Activate 75.72 Reset load spectrum = Reset.</li> </ol>
<input type="checkbox"/>	Re-start the Lifetime monitor function: 75.70 Start lifetime monitor = On
<input type="checkbox"/>	After setting the parameters, hide the Lifetime monitor function parameters with 96.2 Pass code = 1.

**Resetting the load spectrum recorder**

If you did some maintenance work on a hoist unit, reset the load spectrum recorder to its starting values. Follow the instructions below:

<b>Safety</b>	
	<b>WARNING!</b> Obey all safety instructions for the drive. Only qualified electricians are allowed to start up the drive.
<b>Preliminary actions</b>	
<input type="checkbox"/>	Make sure that you have made the Lifetime monitor parameters visible using the user lock pass code 584 in parameter 96.2 Pass code.
<input type="checkbox"/>	Configure parameters as in Parameter settings, but set parameter 75.70 Start lifetime monitor = Off.
<b>Parameter settings</b>	
<input type="checkbox"/>	Crane operating hours (run with open brake): <ol style="list-style-type: none"> <li>Set parameter 33.201 Crane operation hrs init value = 0.</li> <li>Activate the set command with parameter 33.200 Set crane operation hours.</li> </ol>
<input type="checkbox"/>	Lifetime monitor actual values: <ol style="list-style-type: none"> <li>Set parameter 75.73 Preset value of load spectrum = 0.</li> <li>Activate 75.72 Reset load spectrum = Reset.</li> </ol>
<input type="checkbox"/>	Re-start the Lifetime monitor function: 75.70 Start lifetime monitor = On.
<input type="checkbox"/>	After setting the parameters, hide the Lifetime monitor function parameters with 96.2 Pass code = 1.



# 3

## Crane program features

---

### What this chapter contains

The control program contains all of the parameters including actual signals. This chapter describes some of the more important functions of the control program, how to use them and how to program them to operate.

---



#### **WARNING!**

Make sure that the machinery into which the drive is integrated fulfils the personnel safety regulations. Note that the frequency converter (a Complete Drive Module or a Basic Drive Module, as defined in IEC 61800-2), is not considered as a safety device mentioned in the European Machinery Directive and related harmonized standards. Thus, the personnel safety of the complete machinery must not be based on a specific frequency converter feature, but it has to be implemented as defined in the application specific regulations.

---

### Overview of crane control program

ABB industrial drive modules with crane control program can be used in indoor electric overhead traveling (EOT) cranes and in outdoor tower cranes that require independent movements, i.e., hoist, trolley and slew.

---

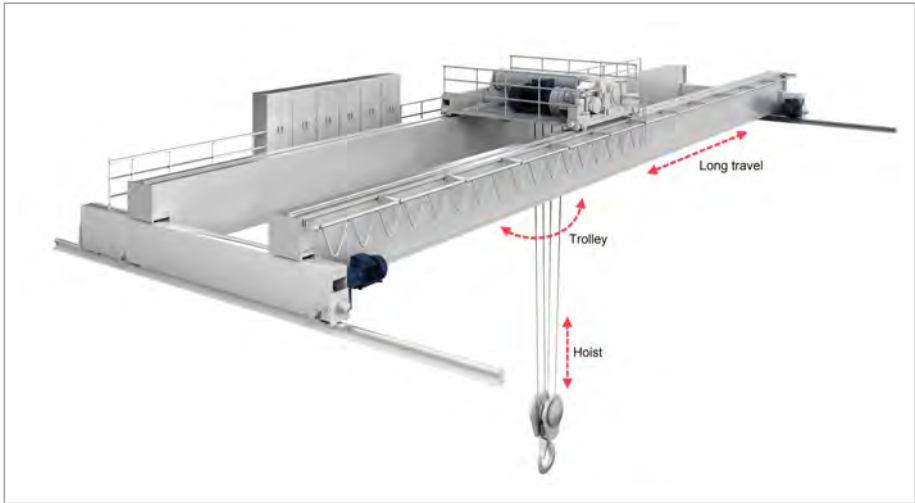

1	Hoist	lifts and lowers the load safely without any jerk on the ropes
2	Trolley	positions the hook precisely along the jib
3	Long travel	moves the load smoothly in horizontal movement in forward or backward direction

The Crane control program contains various functions to control the hoist, trolley and long travel motions of the crane. See sections below.

■ **Supported features Vs Crane motions**

The table below lists the different program features Vs the crane motions in the tower crane control program.” x” indicates feature is applicable.

Program features	Hoist	Trolley	Long travel
Emergency control mode (page 55)	x	x	x
Joystick supervision (see Start/stop interlocking (page 56))	x	x	x
Inverter overload detection (page 105)	x	x	x
Overspeed detection (see Motor overspeed monitoring (page 105))	x	x	x
Extended run time (page 91)	x	x	x
Position counter initialization and scaling in crane application (page 59)	x	x	x
Watchdog (page 109)	x	x	x

<b>Program features</b>	<b>Hoist</b>	<b>Trolley</b>	<b>Long travel</b>
<b>Brake acknowledge delay</b> (see Power on acknowledgment (page 136))	×	×	×
Mechanical brake control (page 78)	×	×	×
Conical motor control (page 112)	×	×	×
Power on acknowledgment (page 136)	×	×	×
Toggle bit (page 138)	×	×	×
Maintenance counters (page 141)	×	×	×
Brake opening torque selection (page 89)	×		
Brake matching (page 85)	×		
<b>Torque proving</b> (see Brake system checks – Torque proving (page 84))	×		
Smooth lifting (page 121)	×		
Hoist speed optimization (page 115)	×	×	
Speed matching (page 103)	×	×	
Slowdown (page 101)	×	×	
End limits (page 100)	×	×	
Fast stop (page 103)	×	×	
Slack rope (page 108)	×	×	
Inching control (page 106)	×	×	
Reverse plug (page 107)	×	×	
Master/follower communication in crane application (page 62)	×	×	

### ■ **Start/stop control**

The start, stop and control signals can be analog, digital or fieldbus-based from a programmable logic controller (PLC). See a typical crane control interface in section [Common crane control interface \(page 54\)](#).

The control program includes four different user parameter sets for customizing the parameter settings. Each set includes two different control locations and an overriding emergency control location. For more information, see section [User parameter sets \(page 210\)](#).

ABB product offering for cranes highlights the safety and performance. With a crane drive, every component that increases safety must be used. For example, in hoist drives, closed loop control (encoder or external supervision) must be used for safe speed supervision.

## Common crane control interface

The control program includes external control locations EXT1 and EXT2 for normal operation. For temporary overriding control, the control program includes an emergency control mode. For more information on the external control locations, see section [Local control vs. external control](#) (page 145).

### ■ Overview diagram of a crane drive and its control interfaces

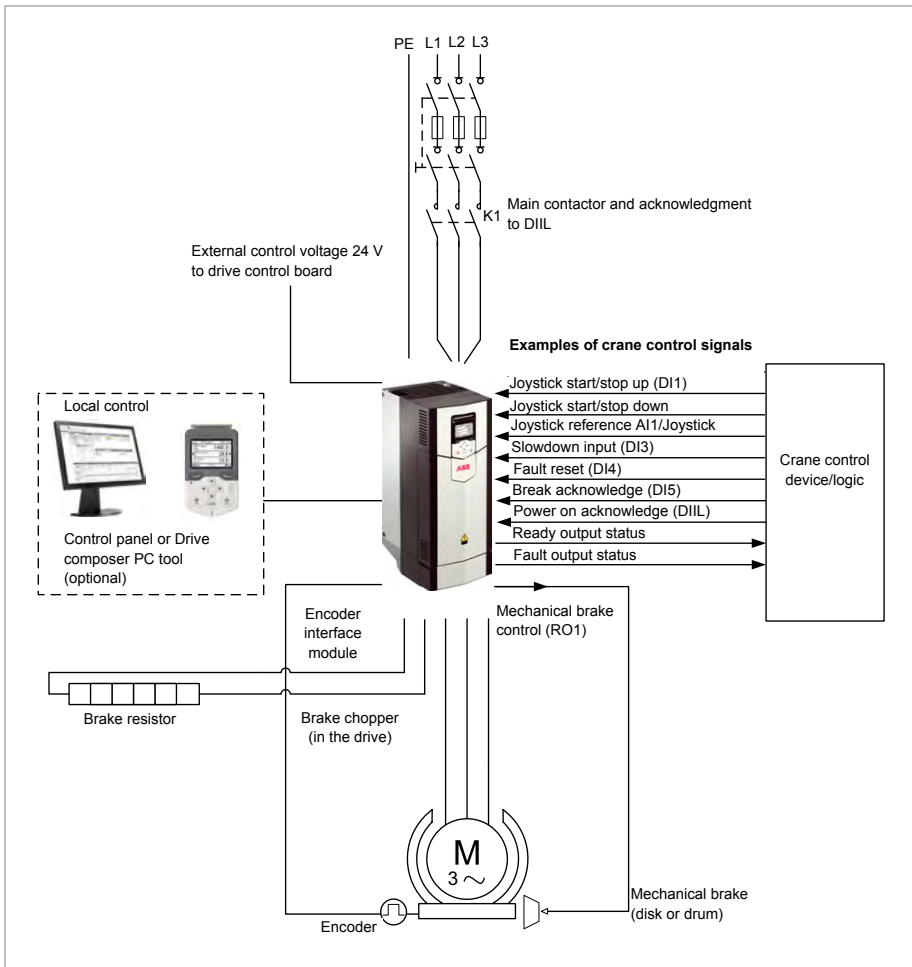

## ■ Emergency control mode

The Emergency control mode overrides control locations EXT1 and EXT2 when the drive is in external control.

The end-user can use the Emergency control mode as the last control possibility to safely operate the crane, for example, if control locations EXT1 and EXT2 are not working. The Emergency control mode is not meant to be used in normal operation.

When the drive operates in the Emergency control mode, it uses the emergency control speed reference (22.202) and the active acceleration and deceleration times.

### **Note:**

- In case of emergency control with slew motion, whatever control mode is selected, torque or speed, the control mode is forced to use speed (rpm) as reference.
- If you have, for example, a control panel in local control, the Emergency control mode does not override it.
- When emergency control mode is enabled, parameters 20.1 Ext1 commands and 20.6 Ext2 commands are automatically set as *Not selected*. This setting prevents, for example, fieldbus communication fault, that stops the drive from starting.
- When emergency control is disabled, the last set values are restored into parameters 20.1 Ext1 commands and 20.6 Ext2 commands.

See the below Function block diagram (page 56). See also section Speed reference priorities (page 93).

---

■ **Function block diagram**

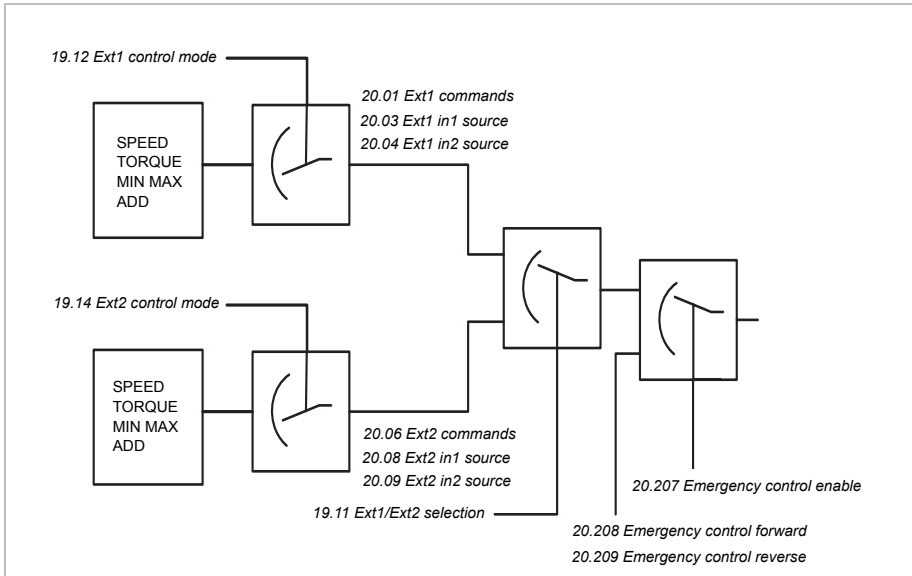

■ **Settings and diagnostics**

Parameters:

- 20.207 Emergency control enable, 20.208 Emergency control forward, 20.209 Emergency control reverse, 22.202 Emergency control reference,
- 23.23 Emergency stop time

Signals: 9.2 Crane SW2

Events: -

**Start/stop interlocking**

The Start/stop interlocking function of the control program lets the end-user start the crane only when the drive is ready to operate.

The function includes the following features:

- Joystick zero position interlocking (page 57)
- Joystick reference interlocking (page 57)
- Pending start interlocking (page 58).



## ■ Joystick zero position interlocking

This function supervises the zero position of the joystick while the drive is running and a stop command is given, or if the drive trips on a fault. A falling edge of the zero position input (20.214 Joystick zero position) must occur before the end-user can give a new start command after stopping or tripping. If the drive logic does not detect a falling edge (that is, the signal remains high) before a new start command is given, the drive generates a warning (D209 Joystick zero position).

This figure shows how the joystick works with NO (normally open) contact elements for start/stop in the forward and reverse directions and one NC (normally closed) contact element for the zero position.

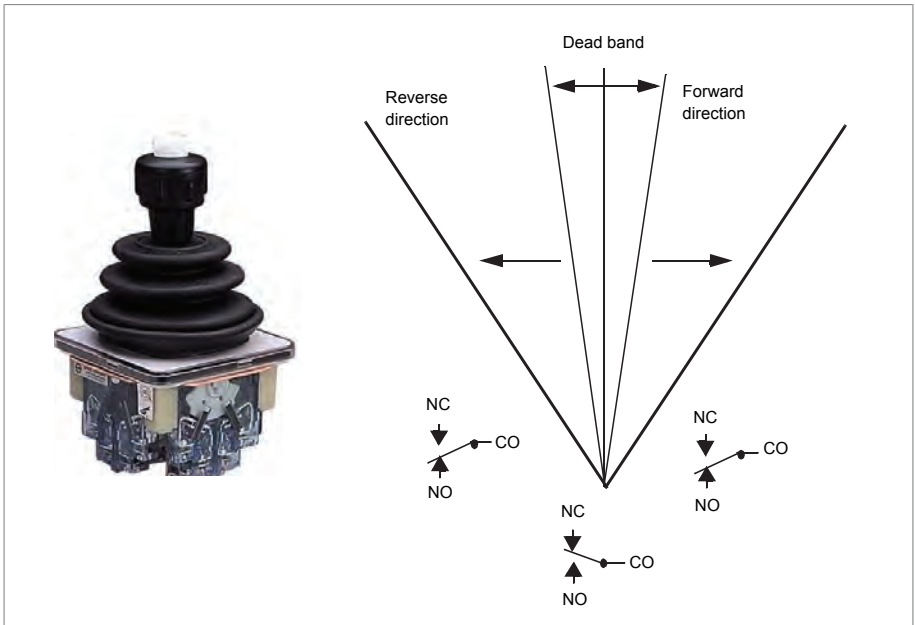

## ■ Joystick reference interlocking

This function can be used for checking the analog reference coming from the joystick. If the joystick zero position input (20.214 Joystick zero position) is active and the speed reference or torque reference is greater than  $\pm 10\%$  of the minimum or maximum scaled value of the used reference, the drive generates a warning (D208) after a time delay (20.215 Joystick warning delay).

### Timing diagram

The diagram shows the operation of the warning D208 Joystick reference check.

## 58 Crane program features

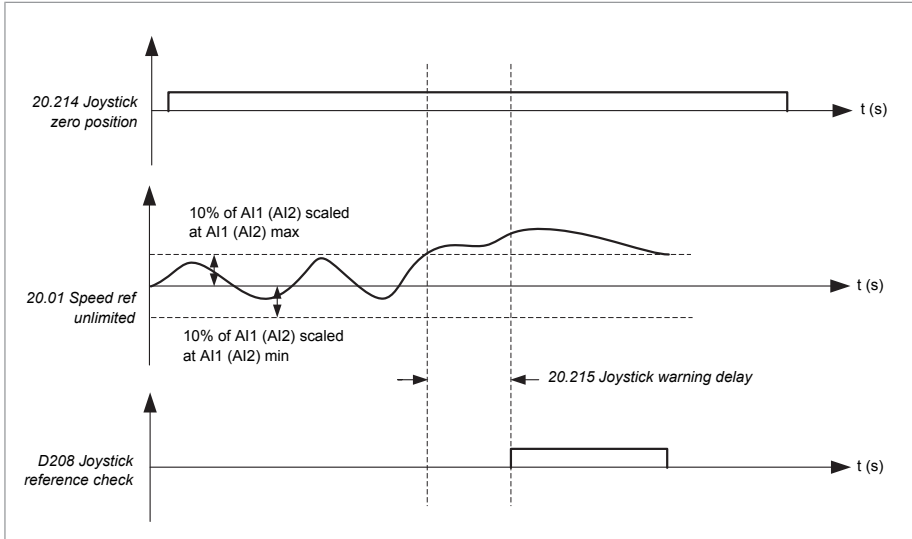

### ■ Pending start interlocking

When the joystick zero position input (20.214 Joystick zero position) is not used for Joystick zero position interlocking (page 57), the drive generates a warning (D207 Wrong start sequence) when it trips on a fault or stops in some condition, and the start request remains active.

### ■ Settings and diagnostics

Parameters: 20.214 Joystick zero position, 20.215 Joystick warning delay

Signals: 9.1 Crane SW1

Events: D207 Wrong start sequence, D208 Joystick reference check, D209 Joystick zero position

## Position counter initialization and scaling in crane application

In addition to the standard [Position counter \(page 178\)](#) feature, the crane control program contains additional parameters to initialize (reset/preset) the counter value.

### ■ Initialization

The initialization method (parameter [90.201 Position counter init method](#)) can be selected based on the reset condition that is rising or falling edge of the reset source input while the drive is in modulating or in standby mode. You can also manually trigger the position initialization command by setting the parameter [90.200 Position counter init source](#) = True.

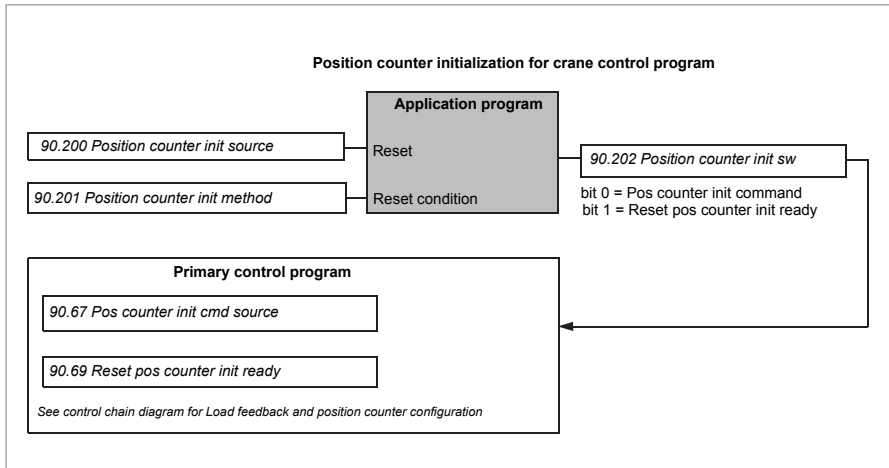

Parameter [90.202 Position counter init sw](#) shows the status of the position counter initialization function. Bit 0 is connected as default into parameter [90.67 Pos counter init cmd source](#) and Bit 1 is connected as default into parameter [90.69 Reset pos counter init ready](#).

If only the position counter of primary control program is needed, then set their corresponding parameters. See description of [Position counter \(page 178\)](#).

### ■ Scaling

The crane control program uses this function to calculate the actual position of the hook.

## 60 Crane program features

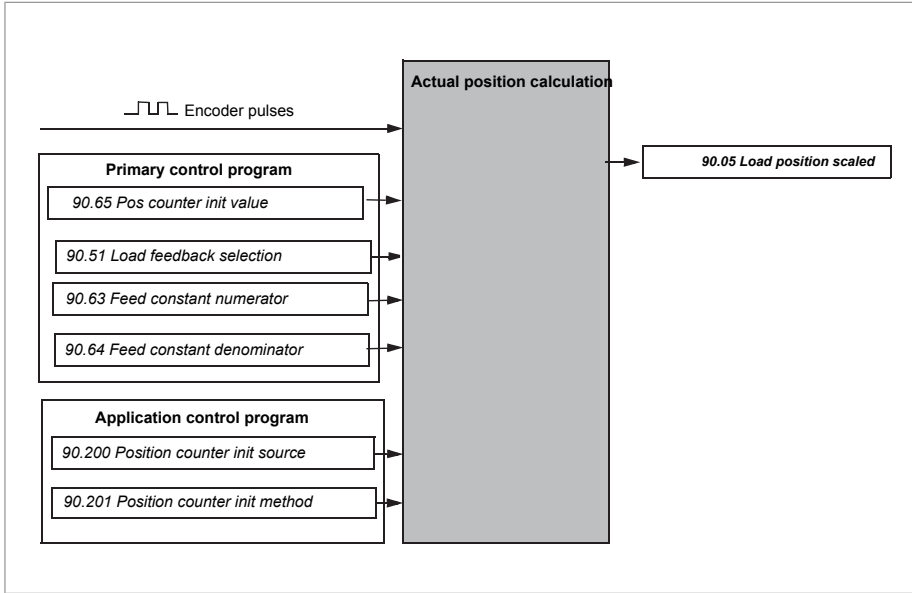

The position is determined based on the encoder located on the motor shaft. You can enable the position calculation, by defining the factor that scales the encoder pulse to the actual position units. See the example below.

**Note:** The value of parameter 90.5 Load position scaled remains over power failure.

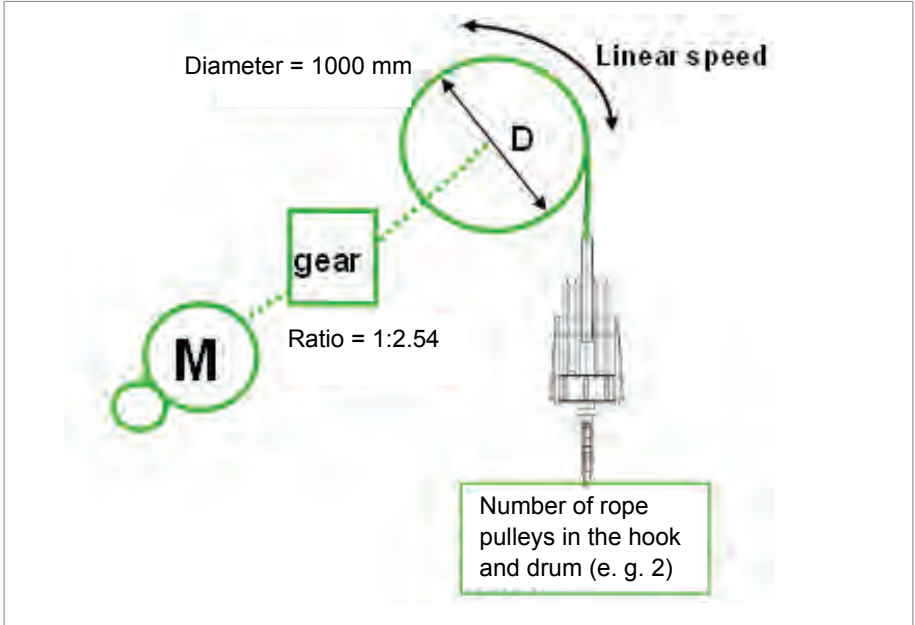
**Example 1: Calculating linear speed of rope**

$$\text{Scaling} = \frac{\pi \cdot D(\text{mm})}{\text{Gear Ratio} \cdot \text{Number Of Rope Pulleys}} = \frac{P90.63}{P90.64}$$

$$\text{Example1} = \frac{\pi \cdot 1000(\text{mm})}{2.54 \cdot 2} = \frac{3141.59}{5.08} \rightarrow \frac{P90.63}{P90.64} = \frac{314159}{508}$$

$$\text{Example2} = \frac{\pi \cdot 1000(\text{mm})}{2.54 \cdot 2} = 618.424 \rightarrow \frac{P90.63}{P90.64} = \frac{618}{1}$$

**Example 2: Parameter settings**

The following configuration can be used for position counter initialization and scaling:

- 90.5 Load position scaled
- 90.51 Load feedback selection = Encoder 1
- 90.60 Pos counter error and boot action = Continue from previous value (this value remains even after a power failure)
- 90.63 Feed constant numerator = 618
- 90.64 Feed constant denominator = 1
- 90.65 Pos counter init value = 0.000 (Preset value for the counter)

## 62 Crane program features

- 90.66 Pos counter init value source = Pos counter init value (90.65 Pos counter init value)
- 90.200 Position counter init source = P.10.1.4 (DI5, End limit 1 switch)
- 90.201 Position counter init method = Rising edge running (when you start lowering from end limit 1 switch (upper limit), the switch closes and the rising edge presets the counter automatically (rising edge when running))

### ■ Settings and diagnostics

Parameters: 90.200 Position counter init source, 90.201 Position counter init method

Signals: 90.202 Position counter init sw

Events: -

## Master/follower communication in crane application

### Note:

- This section applies only for hoist and trolley drives. Master/follower communication is not applicable for slew motion.
- When multiple drives are connected on the same D2D link, all drives must use exactly same version of the control software.

The master/follower function in the crane control program uses D2D-communication link instead of the standard optical link, because it contains additional interlock signals. See the detailed diagram of D2D-link configuration in crane application (page 64).

### ■ Master/follower communication types in crane application

The following master/follower connections are possible in the crane application:

- When the motor shafts are coupled to each other for running a common load, the master drive is speed controlled and transmits the torque reference to the follower drives. The follower drive is in torque control mode, for example, a hoist with two drives and motors running a common drum. See figure below.

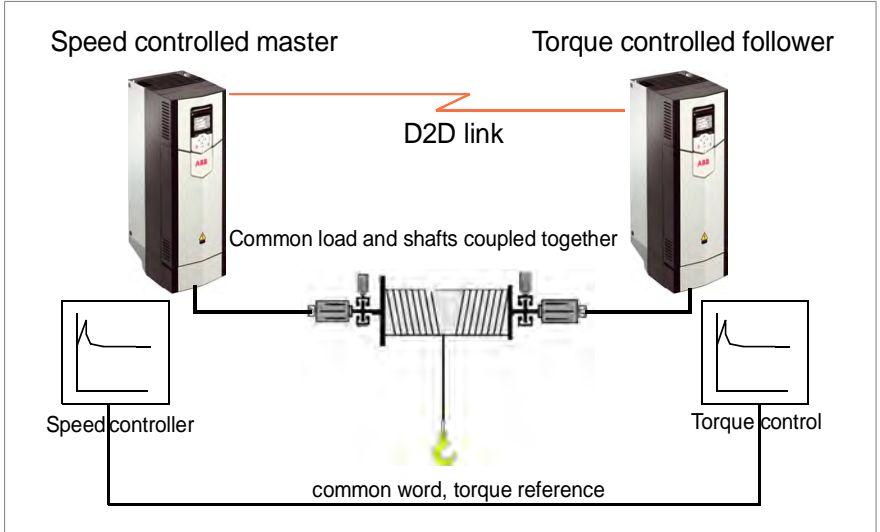
**M/F communication for drives with shafts running a common load**

- When the motor shafts are not coupled to each other, the speed reference of the master drive is transmitted to the follower drives. In this case, the follower drive is speed controlled, for example, two trolleys in a common bridge. See figure below.

**M/F communication for drives with separate drums and shaft synchro**

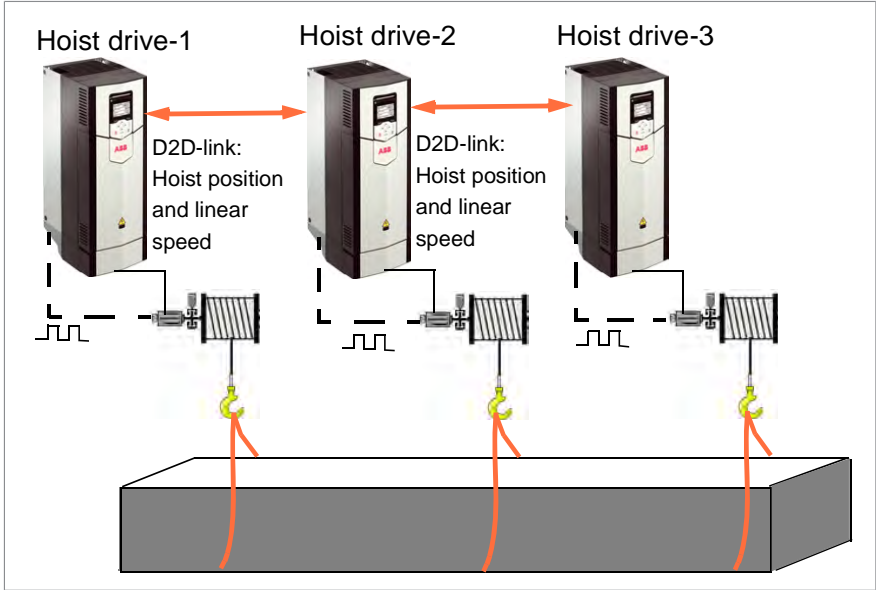

**Note:** In trolley and long travel drives, speed control is achieved with speed correction ( $\pm$ ) from the synchro controls function. See description in section *Shaft synchro* (page 70).

- In a synchro control (electrical shaft), the speed reference and position of the master drive are transmitted to the follower drives. The follower drives are in speed control mode with speed correction, where the position of the follower drives is compared with the position of the master drive and the required speed correction is added to its own speed reference chain. For more information, see section *Shaft synchro* (page 70).

■ **D2D-link configuration in crane application**

The figure below shows the D2D-link configuration.



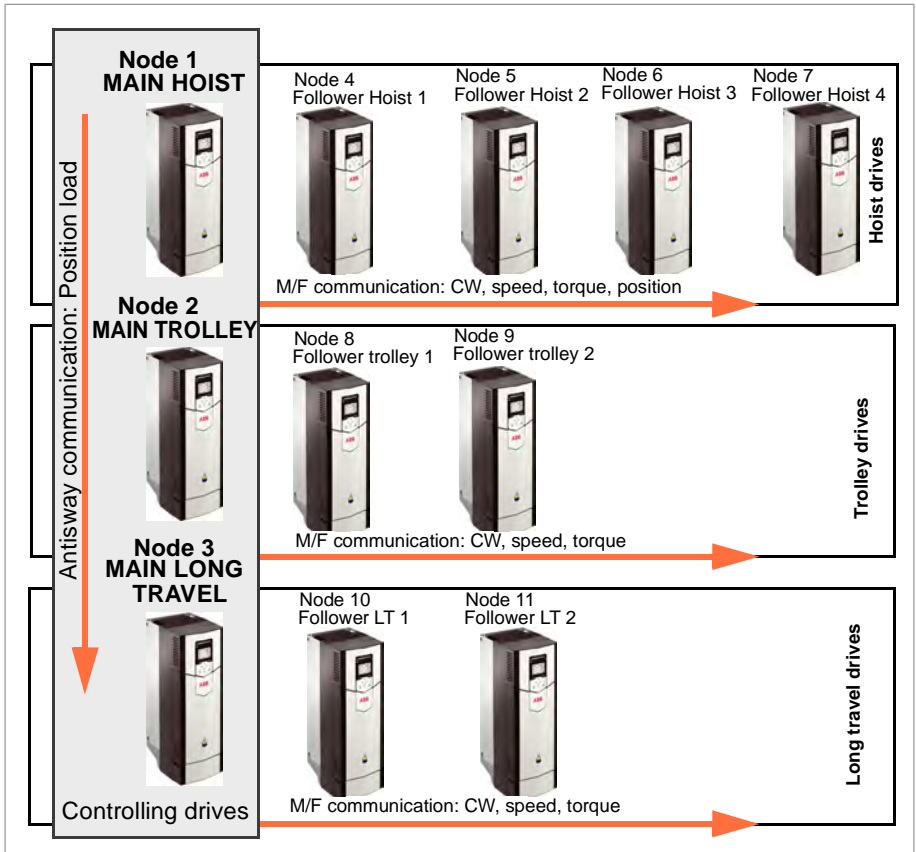

The drives in the crane master-follower/D2D-link can be main hoist and 4 followers, main trolley and 2 followers or main long travel and 2 followers. The main hoist is the master of the complete communication network and must always exist in the system.

### Master/follower communication

The main drive (main hoist and main trolley, main long travel) communicates to the follower drives through commands and status words, interlocks and references. This communication works only when both the master and the follower(s) drives are in external control location EXT2. If the drives are in wrong control locations, the warning D20E M/F control location mismatch appears. See figure below.

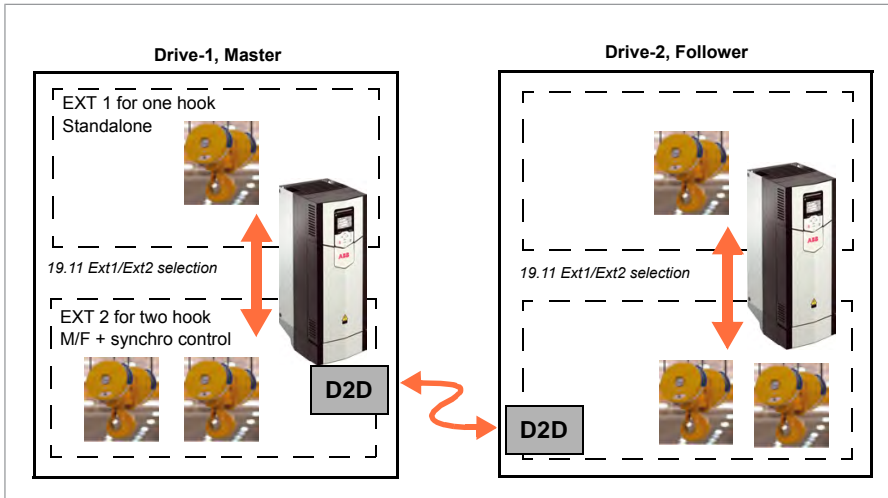

**Antisway communication**

The main hoist drive transmits antisway data, for example, position and load to the main trolley and long travel drives. This communication works also in control location EXT1.

**D2D-link**

In each drive, master/follower communication or antisway communication through the D2D-link is activated with parameter 60.200 Crane drive type (main hoist, main trolley, etc.) by selecting the appropriate drive type. The application then sets all the needed parameters through the D2D-link. **User should not set any** of these parameters manually in the parameter groups 60 DDCS communication, 61 D2D and DDCS transmit data and 62 D2D and DDCS receive data.

**Communication supervision**

Supervision is activated with parameter 60.201 Crane drives structure in the main drives. Each of the main drives supervises its respective followers. Setting in the main hoist can be par. 60.201 Crane drives structure = 0000000001111000, bits 3, 4, 5 and 6 are set, follower hoist 1...4 are supervised.

**Example 1: Parameter settings for D2D-link configuration in a Speed-to-speed setup**

The table below shows the master-follower settings for speed-to-speed setup.

**Note:** Do not change any other parameters in group 60 than listed here. The selections in parameter 60.200 Crane drive type automatically changes the rest of communication parameters.

Parameter	Master	Follower	Notes
<b>Selecting the control location</b>			
19.11 Ext1/Ext2 selection	DI6	DI6	Or another source
19.14 Ext2 control mode	Speed	Speed	-
<b>Setting D2D communication parameters</b>			
60.200 Crane drive type	Main hoist	Follower hoist 1	<ul style="list-style-type: none"> <li>Main hoist is D2D master.</li> <li>D2D communication can be established only if the main hoist drive exists.</li> </ul>
60.201 Crane drives structure	<ul style="list-style-type: none"> <li>bit 3 = Follower hoist 1 = 1</li> <li>Rest of the bits = 0</li> </ul>	Not needed	Setup the bits of used drives in the master drive.
<b>Setting reference signals parameters</b>			
22.12 Speed ref2 source	AI1 scaled	Not needed	If reference comes from AI1.
22.14 Speed ref1/2 selection	Follow Ext1/Ext2	Follow Ext1/Ext2	-
<b>Setting Start/Stop/Direction parameters</b>			
20.6 Ext2 commands	In1 Start fwd; In2 Start rev	Not selected	The Follower drive must be set to <i>Not selected</i> .
Edge	Level	Not needed	Default value
20.8 Ext2 in1 source	DI1	Not selected	Start command fwd
20.9 Ext2 in2 source	DI2	Not selected	Start command rev

### Example 2: Parameter settings for D2D-link configuration in a Speed-to-torque setup

The below table shows the master-follower settings for speed-to-torque setup.

**Note:** Do not change any other parameters in group 60 than listed here. The selections in parameter 60.200 Crane drive type automatically changes the rest of communication parameters.

Parameter	Master	Follower	Notes
<b>Selecting the control location</b>			
19.11 Ext1/Ext2 selection	DI6	DI6	Or another source

## 68 Crane program features

Parameter	Master	Follower	Notes
19.14 Ext2 control mode	Speed	Torque	-
<b>Setting D2D communication parameters</b>			
60.200 Crane drive type	Main hoist	Follower hoist 1	<ul style="list-style-type: none"> <li>Main hoist is D2D master.</li> <li>D2D communication can be established only if the main hoist drive exists.</li> </ul>
60.201 Crane drives structure	<ul style="list-style-type: none"> <li>bit 3 = Follower hoist 1 = 1</li> <li>Rest of the bits = 0</li> </ul>	Not needed	Setup the bits of used drives in the master drive.
<b>Setting reference signals parameters</b>			
22.12 Speed ref2 source	AI1 scaled	Not needed	If reference comes from AI1.
22.14 Speed ref1/2 selection	Follow Ext1/Ext2	Not needed	-
26.14 Torque ref1/2 selection	Not needed	Torque reference 2	EXT2, then torque reference 2
<b>Setting Start/Stop/Direction parameters</b>			
20.6 Ext2 commands	In1 Start fwd; In2 Start rev	Not selected	The Follower drive must be set to <i>Not selected</i> .
Edge	Level	Not needed	Default value
20.8 Ext2 in1 source	DI1	Not selected	Start command fwd
20.9 Ext2 in2 source	DI2	Not selected	Start command rev

### Example 3: Parameter settings for antisway communication from hoist to main trolley

The below table shows the master-follower settings for antisway communication from hoist to main trolley.

**Note:** Do not change any other parameters in group 60 than listed here. The selections in parameter 60.200 Crane drive type automatically changes the rest of communication parameters.

Parameter	Master (hoist)	Antisway drive (trolley)	Notes
<b>Selecting the control location</b>			

Parameter	Master (hoist)	Antisway drive (trolley)	Notes
The control location in both drives is selected according to the control circuit diagram and application requirements.			The hoist and antisway drives work independently from each other.
<b>Setting D2D communication parameters</b>			
60.200 Crane drive type	Main hoist	Follower hoist 1	<ul style="list-style-type: none"> <li>Main hoist is D2D master.</li> <li>D2D communication can be established only if the main hoist drive exists.</li> </ul>
60.201 Crane drives structure	<ul style="list-style-type: none"> <li>bit 1 = Main trolley = 1</li> <li>Rest of the bits = 0</li> </ul>	Not needed	If it is needed to supervise D2D communication, setup the bits of used drives in the D2D master drive.
77.20 Pendulum length source 1	Par 90.5 Load position scaled	D2D	In the hoist drive, configure settings for scaling and position counter.
77.30 Load signal source	Not needed	D2D	In the antisway drive, configure settings if load information is needed. For example, offset steps.
77.80 Load to antiway selection	Internal = 77.81 Hoist load from torque act, Other = 75.40 Relative hoist load	Not needed	In hoist drive, configure settings if load signal is needed in the antisway drive. If 75.40 Relative hoist load is used, configure required settings in group 75 Hoist speed optimization.

**Note:** Similar settings are used for long travel drive. See (trolley) column. Set parameter 60.200 Crane drive type = *Main long travel*.

## ■ Settings and diagnostics

Parameter groups: 60 DDCS communication, 61 D2D and DDCS transmit data, 62 D2D and DDCS receive data, , 75 Hoist speed optimization, 77 Antisway.

Parameters: 19.11 Ext1/Ext2 selection, 19.14 Ext2 control mode, 20.6 Ext2 commands...20.9, 22.12 Speed ref2 source, 22.14 Speed ref1/2 selection, 26.14 Torque ref1/2 selection, 60.200 Crane drive type, 60.201 Crane drives structure, 77.20 Pendulum length source 1, 77.30 Load signal source, 77.80 Load to antiway selection, 77.81 Hoist load from torque act, 75.40 Relative hoist load

Events: Warning D20E M/F control location mismatch

## Shaft synchro

The Shaft synchro function synchronises the master and follower drives when the drives are in the master/follower mode (see [Master/follower communication types in crane application](#) (page 62)). However, synchronisation is used only when the drives are set to speed control mode and have control location EXT2 active. The master drive position is transferred to the follower through the D2D-link. The follower uses the difference between the positions as the speed correction factor in the speed control loop of the follower drive. Therefore, in both master and follower drives, you must define position counter with scalings and runtime initializations.

### ■ Synchro control - basic function block diagram

The diagram shows the basic functionality of the synchro control function. For full functionality, see the [Synchro control - full function block diagram](#) (page 71).

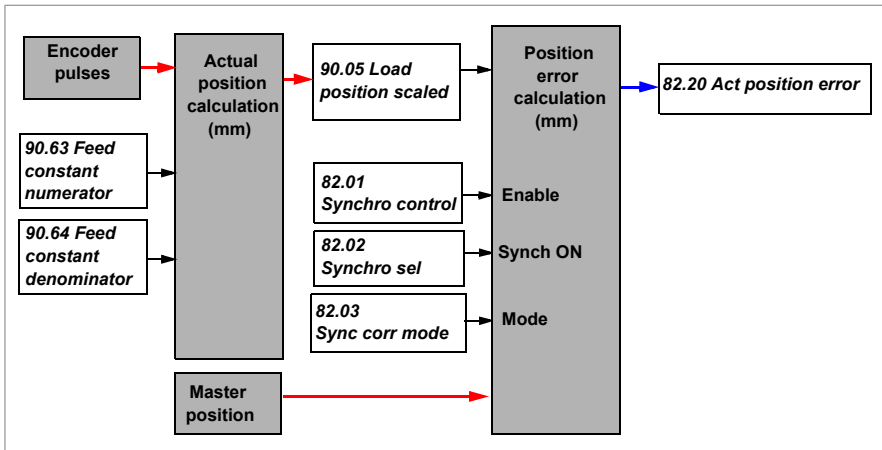

The parameter [82.1 Synchro control](#) = *On* activates the execution of the Shaft synchro function in the master and follower drives. The master sends linear rope speed instead of motor rotation speed reference. In both, master and follower position calculation must be set to corresponding real linear speed, see [Power on acknowledgment](#) (page 136).

With parameter [82.2 Synchro sel](#) the source is defined to activate position error calculation and speed correction to reference chain in follower drive.

Normally both the hoist drives are driven in standalone mode (EXT1) to the right position separately. Then switchover to EXT 2 happens and master/follower communication is activated between the drives. Finally with parameter [82.2 Synchro sel](#) position calculation and corrections are activated according to the selected correction mode. Correction modes are defined with parameter [82.3 Sync corr mode](#).

### Direct mode

In this mode, the follower runs at the same position as the master drive (master position = follower position). See figure below.

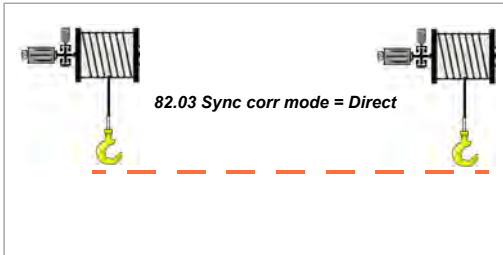

### Offset mode

In this mode, the position difference (offset) between the master and follower drives at the time of activating 82.2 Synchro sel is the controlled manner. See figure below.

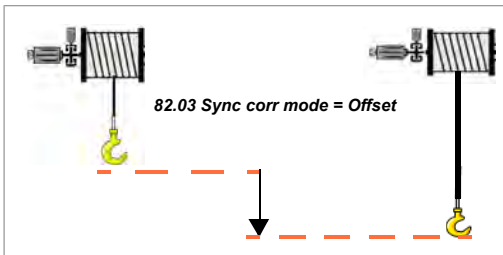

### ■ Synchro control - full function block diagram

The full functionality of synchro control is a combination of the basic function and the synchro correction. See the elongated block diagram below.

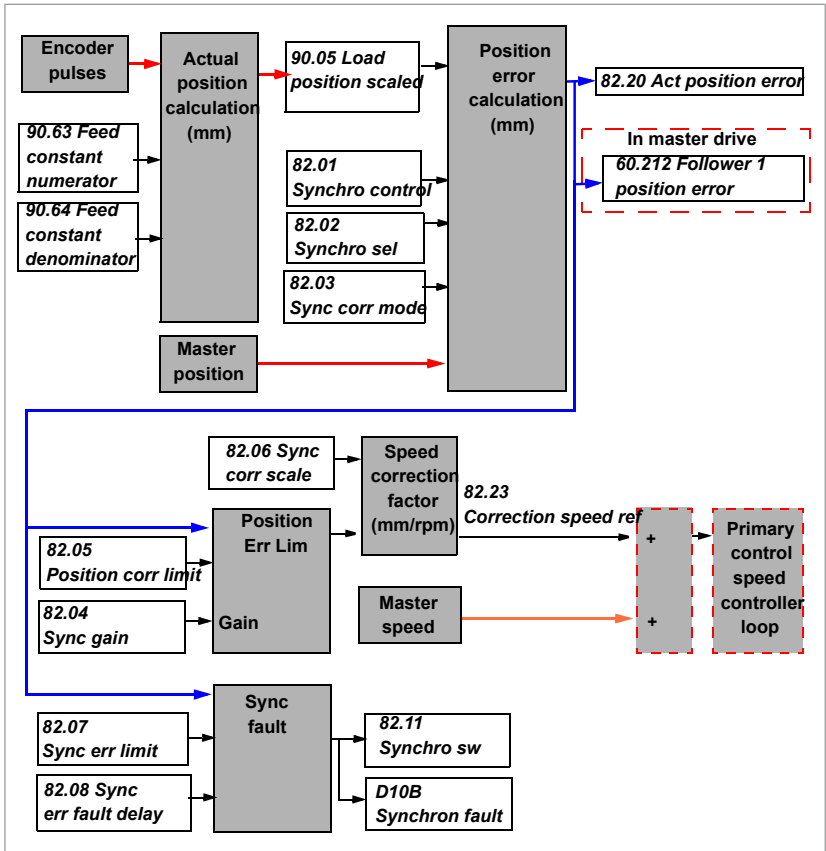

The first part of the synchro control function is the basic function described in Synchro control - basic function block diagram (page 70). The second part of the synchro control function is the synchro correction. Parameter 82.5 Position corr limit is used for limiting the speed correction in millimeters. If the detected error exceeds this parameter, the speed correction is limited to these parameter values.

When detected absolute error is greater than the value defined in 82.7 Sync err limit for a period longer than 82.8 Sync err fault delay, the drive trips on D10B Synchron fault and 82.11 Synchro sw, bit 3 is set.

To reset the fault, deactivate 82.2 Synchro sel (example, D1x).

**Example 1: Parameter settings for Synchro control (Speed-speed+position) setup**

The example below shows the parameter settings of the system with main hoist and follower hoist1 (linear speed - linear speed + position).

In general, Master drive’s speed limits (external speed limits, slowdown limits, and HSO curve) are taken for the whole system. But when Synchro control and HSO is



activated in Followers, then limit conditions from those drives (external speed limits, slowdown limits, and HSO curve) are applied to the whole system.

**Note:** Do not change any other parameters in group 60 than listed here. The selection in parameter 60.200 Crane drive type automatically changes the rest of communication parameters.

Parameter	Master	Follower	Notes
<b>Selecting the control location</b>			
19.11 Ext1/Ext2 selection	DI6	DI6	Or another source
19.14 Ext2 control mode	Speed	Speed	-
<b>Setting D2D communication parameters</b>			
60.200 Crane drive type	Main hoist	Follower hoist 1	<ul style="list-style-type: none"> <li>Main hoist is D2D master.</li> <li>D2D communication can be established only if the main hoist drive exists.</li> </ul>
60.201 Crane drives structure	<ul style="list-style-type: none"> <li>bit 3 = Follower hoist 1 = 1</li> <li>Rest of the bits = 0</li> </ul>	Not needed	Setup the bits of used drives in the master drive.
<b>Setting reference signals parameters</b>			
22.11 Speed ref1 source	AI1 scaled	AI1 scaled	If reference comes from AI1.
22.12 Speed ref2 source	AI1 scaled	Not needed	If reference comes from AI1.
22.14 Speed ref1/2 selection	Follow Ext1/Ext2	Not needed	-
<b>Setting Start/Stop/Direction parameters</b>			
20.1 Ext1 commands	In1 Start fwd; In2 Start rev	In1 Start fwd; In2 Start rev	Default value
20.2 Ext1 start trigger type	Level	Level	Default value
20.3 Ext1 in1 source	DI1	DI1	Start command fwd
20.4 Ext1 in2 source	DI2	DI2	Start command rev
20.6 Ext2 commands	In1 Start fwd; In2 Start rev	Not selected	The Follower drive must be set to <i>Not selected</i> .

## 74 Crane program features

Parameter	Master	Follower	Notes
20.7 Ext2 start trigger type	Level	Not needed	Default value
20.8 Ext2 in1 source	DI1	Not selected	Start command fwd
20.9 Ext2 in2 source	DI2	Not selected	Start command rev
<b>Setting the Synchro control function parameters</b>			
82.1 Synchro control	ON	ON	Or pointer to DI
82.2 Synchro sel	Select	Select	Or pointer to DI
82.3 Sync corr mode	Offset	Offset	Or Direct
82.4 Sync gain	Not needed	2	P controller tuning
82.5 Position corr limit	Not needed	100	Maximum position error value that is used by P-controller.
82.6 Sync corr scale	Not needed	3 rpm/mm	Position to speed coefficient that is used by P-controller.
82.7 Sync err limit	Not needed	50 mm	Allowed position error difference that triggers the fault delay timer.
82.8 Sync err fault delay	Not needed	5 s	Delay time before the detected Sync error appears.
82.9 Position hysteresis	Not needed	10 mm	Allowed position difference between the master and follower drives.
<b>Setting the position feedback source and position scaling parameters. See also Position counter initialization and scaling in crane application (page 59).</b>			
90.51 Load feedback selection	Encoder 1	Encoder 1	-
90.63 Feed constant numerator	1 (scale: gear ratio, diameter)	1	Rev to mm scaling parameter
90.64 Feed constant denominator	1 (scale: gear ratio, diameter)	1	Rev to mm scaling parameter

### Example 2: Parameter settings for encoder mounted/ not mounted on motor shaft

The basic parameters settings of position counter, for example, resetting and scaling, are described in the section [Position counter initialization and scaling in crane application \(page 59\)](#). This example describes the parameter settings for scaling of position counter in such cases where,

- the encoder is not mounted on the motor

and/or

- the crane mechanics is not same in the master and follower drive systems.

The Shaft synchro function uses the same set of parameters for speed reference scaling and position scaling. Due to this, additional parameter settings are needed when the encoder is not mounted on a motor shaft. The settings are based on the following conditions of the crane mechanics.

- If the crane mechanics are same in the master and follower drive systems and when the encoder is mounted/not mounted on the motor shaft, you can use the [Settings for identical mechanics \(page 75\)](#).
- If the crane mechanics are not same in the master and follower drive systems and when the encoder is mounted/not mounted on a motor shaft, you can use the [Settings for non-identical mechanics \(page 76\)](#)

Settings for identical mechanics

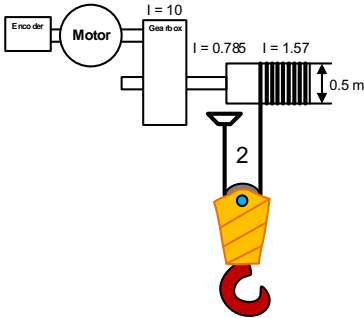
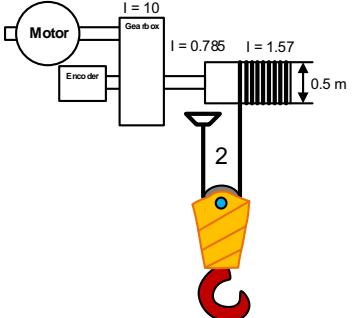
Encoder mounted on motor shaft	Encoder not mounted on motor shaft (is on the drum shaft)
<b>Common for both conditions</b>	
<p>Used speed reference = 1000 rpm                      Drum diameter: 500 mm = 0.5 m                      One turn of the drum causes the rope to shift by: <math>3.14 \times \text{Drum diameter} = 3.14 \times 0.5 \text{ m} = 1.57 \text{ m}</math>                      Polyspast number 2 (two ropes), then one turn of the drum shifts the hook by: <math>1.57 \text{ m} / 2 = 0.785 \text{ m}</math>                      Gearbox (motor to drum), <math>i = 10</math>, then one turn of the motor causes: <math>0.785 \text{ m} / 10 = 0.0785 \text{ m}</math></p>	
	
<b>Master drive settings</b>	

76 Crane program features

Encoder mounted on motor shaft	Encoder not mounted on motor shaft (is on the drum shaft)
<p>Set the following parameters for the Synchro control function, to scale the rotation of the motor to linear speed of the hook:                      90.63 Feed constant numerator = 785                      90.64 Feed constant denominator = 10000  <u>Position calculation:</u>                      Scaling = 0.0785                      Speed of the motor = 1000 rpm                      Speed of the encoder = 1000 rpm                      Position = 0.0785 meter/motor revolution                      Linear speed reference to follower = <math>1000 \times 0.0785 = 78.5</math> mpm (meter/minute)</p>	<p>Set the following parameters for the Synchro control function, to scale the rotation of the encoder shaft to linear speed of the hook:                      90.63 Feed constant numerator = 785                      90.64 Feed constant denominator = 1000  <u>Position calculation:</u>                      Scaling = 0.785                      Speed of the motor = 1000 rpm                      Speed of the encoder = <math>1000/10 = 100</math> rpm                      Position = <math>0.785/10</math> meter/motor revolution                      Linear speed reference to follower = <math>1000 \times 0.785 = 785</math> mpm (meter/minute)</p> <p><b>Note:</b> Linear speed is calculated in relation to encoder (if encoder speed reference was 1000 rpm).</p>

**Follower drive settings**

<p>In follower drive, set the following parameters for Synchro control function, to convert linear speed of the master drive to rotational speed reference for the follower motor:                      90.63 Feed constant numerator = 785                      90.64 Feed constant denominator = 10000                      Linear speed of master = 78.5 mpm                      Speed reference for motor = <math>78.5 / 0.0785 = 1000</math> rpm                      Position = 0.0785 meter/motor revolution</p>	<p>In follower drive, set the following parameters for Synchro control function, to convert linear speed of master drive to rotational speed reference for the follower motor:                      90.63 Feed constant numerator = 785                      90.64 Feed constant denominator = 1000                      Linear speed of master = 785 mpm                      Speed reference of motor = <math>785 / 0.785 = 1000</math> rpm                      Position = <math>0.785/10</math> meter/motor revolution</p>
--	--

Settings for non-identical mechanics

Encoder mounted on motor shaft	Encoder not mounted on motor shaft (is on the drum shaft)
<p><b>Common for both conditions</b></p>	
<p>Used speed reference = 1000 rpm                      Drum diameter: 500 mm = 0.5 m                      One turn of the drum causes the rope to shift by: <math>3.14 \times \text{Drum diameter} = 3.14 \times 0.5 \text{ m} = 1.57 \text{ m}</math>                      Polyspast number 2 (two ropes), then one turn of the drum shifts the hook by: <math>1.57 \text{ m} / 2 = 0.785 \text{ m}</math>                      Gearbox (motor to drum), <math>I = 10</math>, then one turn of the motor causes: <math>0.785 \text{ m} / 10 = 0.0785 \text{ m}</math></p>	

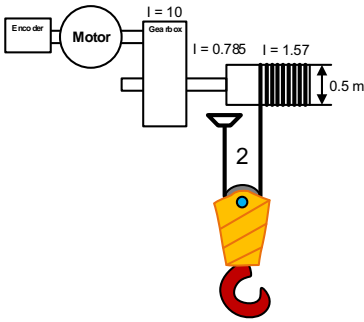
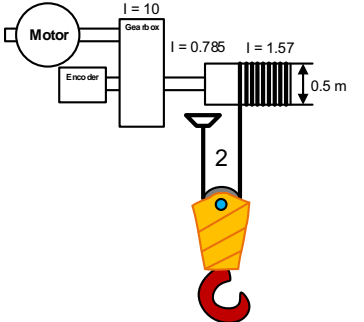
Encoder mounted on motor shaft	Encoder not mounted on motor shaft (is on the drum shaft)
	
<p><b>Master/Follower drive settings</b></p>	
<p>Set the following parameters for the Synchro control function, to scale the rotation of the motor to linear speed of the hook:            90.63 Feed constant numerator = 785            90.64 Feed constant denominator = 10000            Set the following parameters to compensate the difference in rotation between the encoder shaft and motor shaft:</p> <p><b>Note:</b> When the encoder is mounted on motor shaft, value in parameters 90.53 Load gear numerator and 90.54 Load gear denominator is 1.</p> <p>90.53 Load gear numerator = 1            90.54 Load gear denominator = 1</p> <p><u>Position calculation:</u>            Position = Encoder revolutions * (90.63/90.64) * (90.53/90.54)            Scaling = 0.0785            Speed of the motor = 1000 rpm            Speed of the encoder = 1000 rpm            Position = 0.0785 meter/motor revolution            Position = 0.0785 m/encoder revolution</p>	<p>Set the following parameters for the Synchro control function, to scale the rotation of the encoder shaft to linear speed of the hook:            90.63 Feed constant numerator = 785            90.64 Feed constant denominator = 10000            Set the following parameters to compensate the difference in rotation between the encoder shaft and motor shaft:            90.53 Load gear numerator = 10            90.54 Load gear denominator = 1</p> <p><u>Position calculation:</u>            Position = Encoder revolutions * (90.63/90.64) * (90.53/90.54)            Position scaling = 0.0785 * 10 = 0.785            Speed of motor = 1000 rpm            Speed of encoder = 1000/10 = 100 rpm            Position = 0.0785 m/motor revolution            Position = 0.785 m/encoder revolution</p>
<p><b>Master drive results</b></p>	
<p>Linear speed reference to follower = Used speed reference * (90.63/90.64)            Linear speed reference to follower = 1000 * 0.0785 = 78.5 m/min</p>	<p>Linear speed reference to follower = Used speed reference * (90.63/90.64)            Linear speed reference to follower = 1000 * 0.0785 = 78.5 m/min</p>
<p><b>Follower drive results</b></p>	

Encoder mounted on motor shaft	Encoder not mounted on motor shaft (is on the drum shaft)
Speed reference for motor = Linear speed reference from master/(90.63/90.64) Speed reference for motor = 78.5/0.0785 = 1000 rpm	Speed reference for motor = Linear speed reference from master/(90.63/90.64) Speed reference for motor = 78.5/0.0785 = 1000 rpm

■ **Settings and diagnostics**

**Parameters:** 82.1 Synchro control, 82.2 Synchro sel, 82.3 Sync corr mode, 82.4 Sync gain, 82.5 Position corr limit, 82.6 Sync corr scale, 82.7 Sync err limit, 82.8 Sync err fault delay, 82.9 Position hysteresis, 90.53 Load gear numerator, 90.54 Load gear denominator, 90.63 Feed constant numerator, 90.64 Feed constant denominator.

**Signals:** 82.11 Synchro sw, 82.20 Act position error, 82.21 Master position, 82.22 Offset value, 82.23 Correction speed ref, 82.24 Master linear speed ref.

**Warnings:** D20E M/F control location mismatch

**Faults:** D10B Synchron fault, D10C M/F comm loss

**Mechanical brake control**

A mechanical brake can be used for holding the motor and driven machinery at zero speed when the drive is stopped, or not powered. The brake control logic observes the settings in parameter group 44 Mechanical brake control as well as several external signals. The Brake control timing diagram (page 79) shows an example of a close-open-close sequence.

The brake is controlled through relay output RO1 (parameter 10.24 RO1 source = P.44.210.0).

■ **Inputs of the brake control logic**

Signals that affect the state of the control logic are

- brake status acknowledgment (optional, defined by 44.7 Brake acknowledge selection),
- bit 2 of 6.11 Main status word (indicates whether the drive is ready to follow the given reference or not),
- bit 6 of 6.16 Drive status word 1 (indicates whether the drive is modulating or not),
- optional FSO-xx safety functions module.

The brake control is, by default, enabled without supervision (44.7 Brake acknowledge selection = No acknowledge).

## ■ Outputs of the brake control logic

The mechanical brake is controlled by bit 0 of parameter 44.210 Crane brake status. This bit is selected by default as the source of the relay output RO1 and digital input/output DIO1. See the wiring example in section Brake control timing diagram (page 79).

The brake control logic, in various states, requests the drive control logic to hold the motor, increase the torque, or ramp down the speed. These requests are visible in parameter 44.210 Crane brake status.

## ■ Brake control timing diagram

The simplified timing diagram below illustrates the operation of the brake control function.

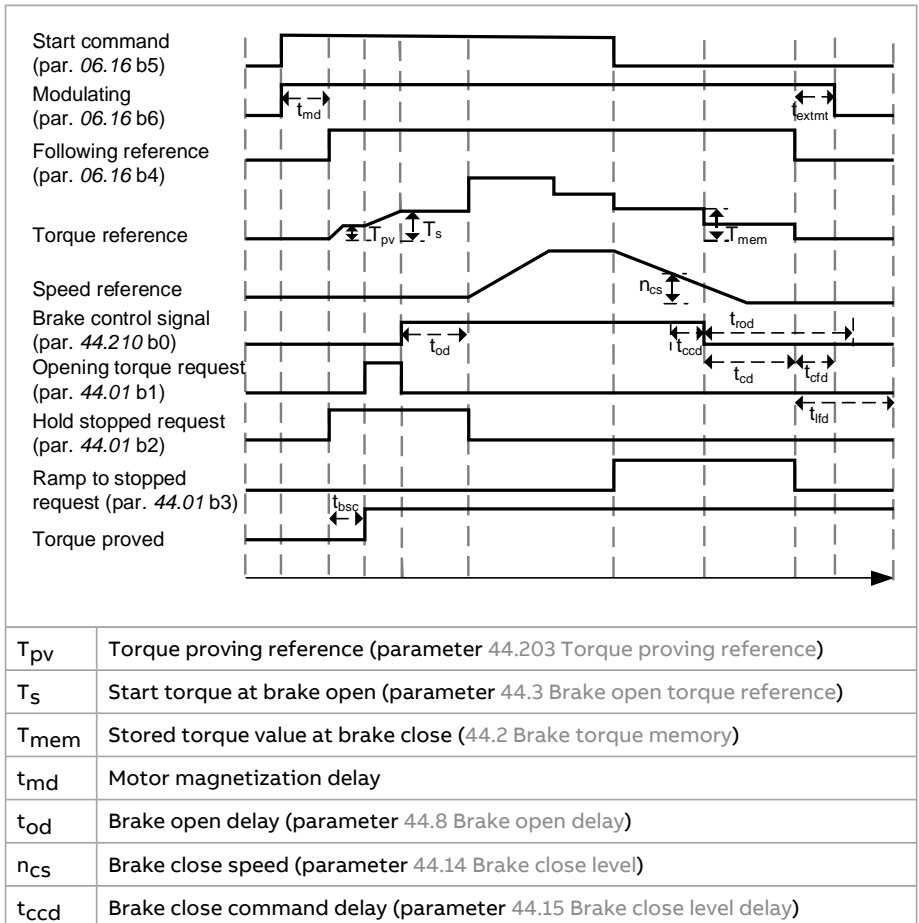

t <sub>cd</sub>	Brake close delay (parameter 44.13 Brake close delay)
t <sub>cf</sub>	Brake close fault delay (parameter 44.18 Brake fault delay)
t <sub>rod</sub>	Brake reopen delay (parameter 44.16 Brake reopen delay)
t <sub>b</sub> sc	Brake system check time (parameter 44.204 Brake system check time)
t <sub>ext</sub> mt	Extended run time (parameter 44.211 Extended runtime)
t <sub>l</sub> fd	Brake long fall delay (parameter 44.213 Brake long fall delay)

**Note:**

- In the event of a fault, the brake will close immediately. The brake control uses relay output RO1 as default.

■ **Wiring example**

The figure below shows a brake control wiring example. The brake control hardware and wiring must be acquired and installed by the customer.

---

 **WARNING!** The drive (a Complete Drive Module or a Basic Drive Module, as defined in IEC 61800-2), is not considered a safety device mentioned in the European Machinery Directive and related harmonized standards. Thus, the personnel safety of the complete machinery must not be based on a specific drive feature (such as the brake control function), but it has to be implemented as defined in the application-specific regulations.

---

---

 **WARNING!** Make sure that the machinery into which the drive with brake control function is integrated fulfills the personnel safety regulations. Use relay output RO1 for brake control in the crane control program. Make sure that parameter 10.24 RO1 source = P.44.210.0.

---

The brake is controlled by bit 0 of parameter 44.210 Crane brake status. The source of brake acknowledge (status supervision) is selected by parameter 44.7 Brake acknowledge selection. In this example,

- parameter 10.24 RO1 source is set to bit 0 of 44.210 Crane brake status, and
  - parameter 44.7 Brake acknowledge selection is set to DI5.
-



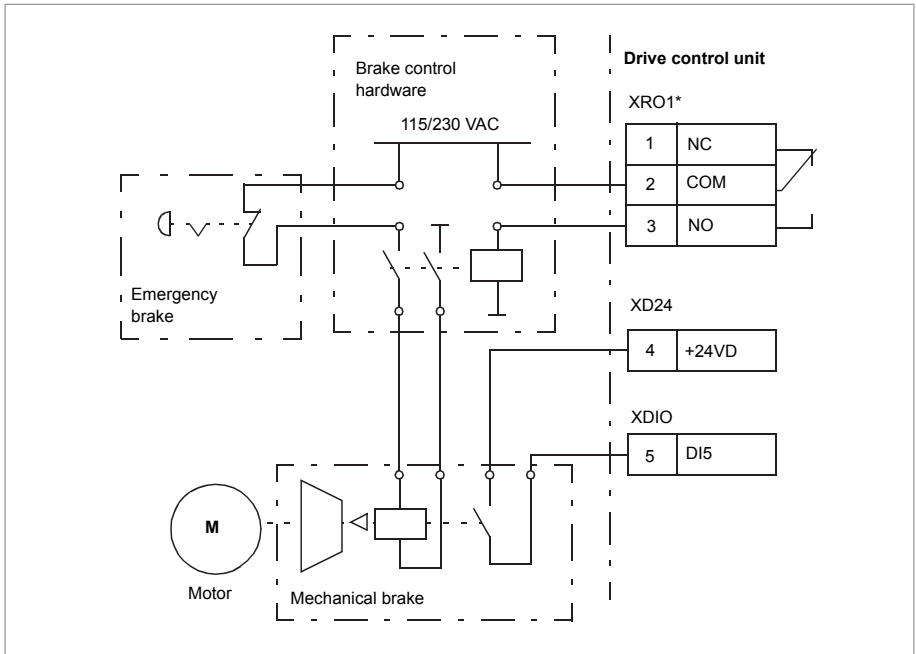

**Note:** Parameter 10.24 RO1 source must be set to bit 0 of par. 44.210 Crane brake status.

### ■ Brake system checks – overview

The brake system checks consist of electrical and mechanical tests.

- The electrical test makes sure that the drive can produce torque before it releases the brake and starts the crane operation. That is, electrical components like the drive, motor cable and motor itself are ready to start.
- The mechanical test makes sure that motor brake is not slipping.

Both tests are done in parallel (at the same time) during a check time (par. 44.204 Brake system check time). If both tests are performed successfully during the check time, the drive opens the brake, and starts crane hoist motion.

For more detailed information on the tests, see sections:

- Brake system checks – Torque proving (page 84)
- Brake system checks – Brake slip (page 85).

**Note:**

- Disable torque proving and brake open torque functions in the following controls:
    - Scalar motor control
    - Trolley motion
    - Long travel
- To disable, set following values:
- 44.9 Brake open torque source = Zero
  - 44.200 Brake open torque = 0%
  - 44.202 Torque proving = Disable

This flowchart shows the brake system check sequence.

---

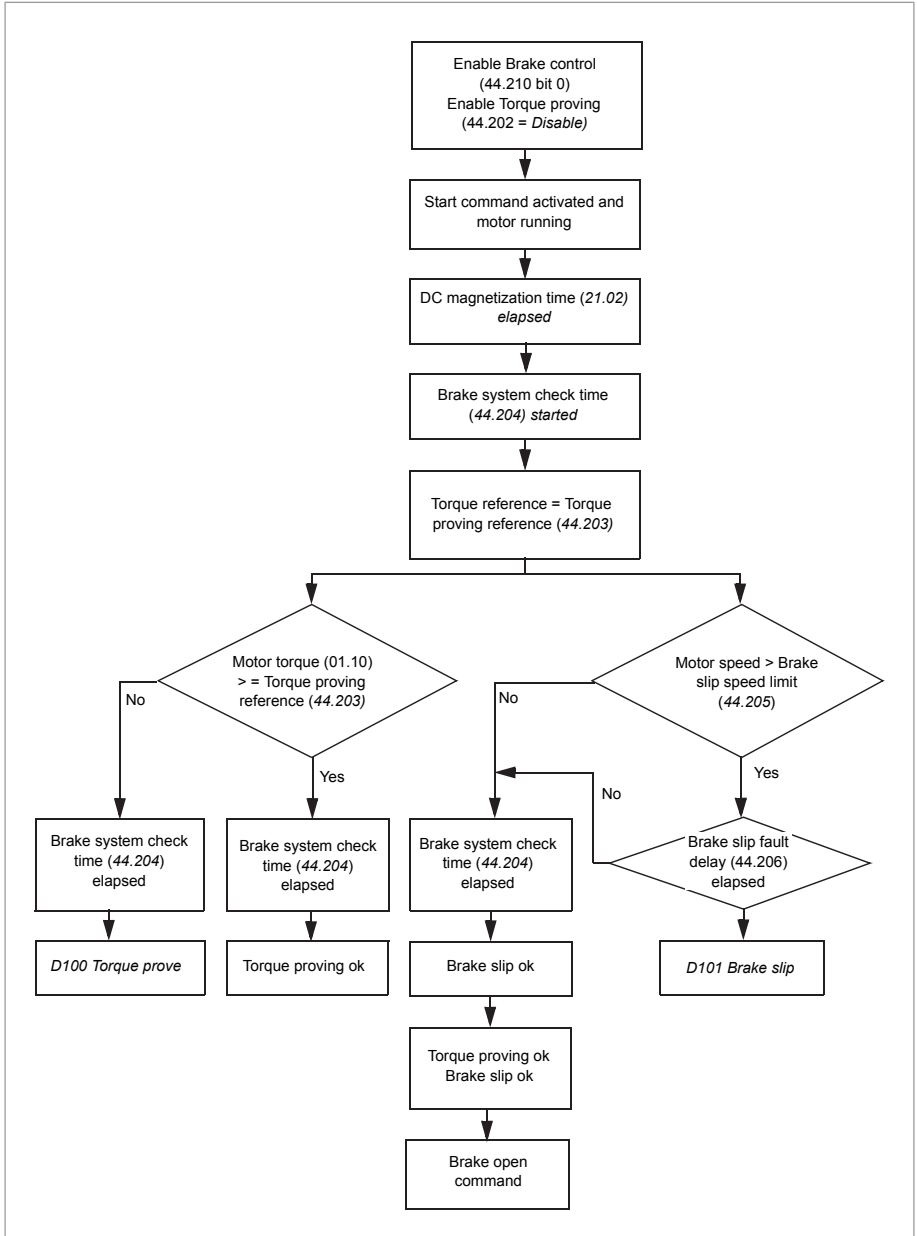

### Timing diagram

This timing diagram shows the operation of the Torque proving and Brake system check functions.

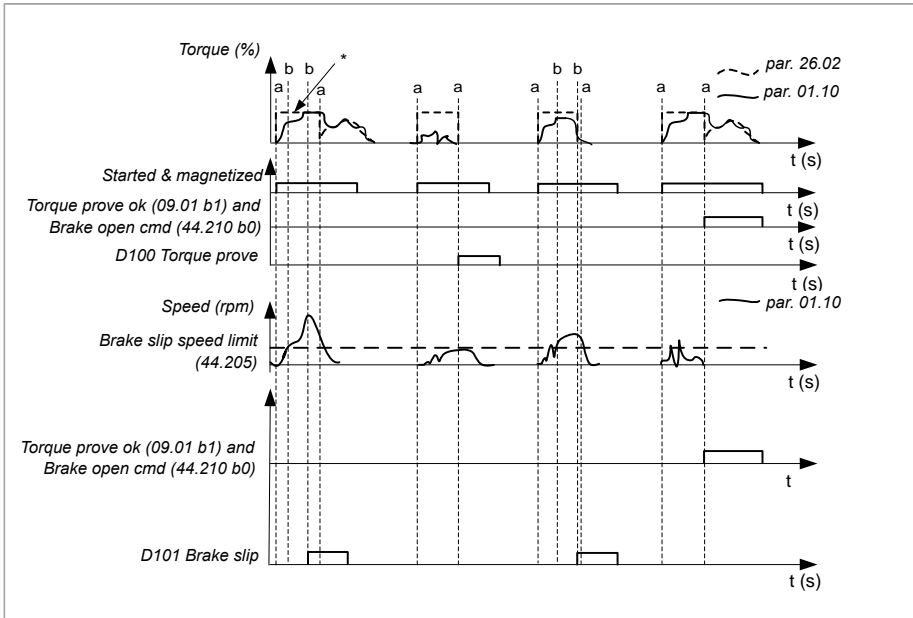

a	Brake system check time (44.204)
b	Brake slip fault delay (44.206 Brake slip fault delay)
* Torque proving reference is held for the brake system check time even though the torque has been proved.	

### ■ Brake system checks – Torque proving

Torque proving makes sure that the drive can produce torque before it releases the brake and starts the crane operation. The function is mainly intended for hoist drives, but you can also activate it in drives that control other crane motions if the drives have encoder feedback in use.

Torque proving gives a positive or negative torque reference against a closed mechanical brake. If torque proving is successful, in other words, the actual torque of the drive reaches the reference level (44.203), the drive lets the brake open and starts the next step in the starting sequence.

You can select the direction of the torque proving with parameter (44.201). By default, the setting is False, which means that the torque is applied in the hoisting direction.

A time delay (par. 44.204) defines the time during which the torque reference (par. 44.203) is active and the electrical and mechanical tests of the crane system are completed. Unsuccessful torque proving trips the drive (fault code D100 Torque prove).

See also Timing diagram (page 84).

### ■ Brake system checks – Brake slip

**Note:** Brake slip is not applicable (must be disabled) for slew motion. The Brake slip function examines the system for brake slips while the control program is performing Torque proving with the brake closed. If the motor actual speed exceeds a speed limit (44.205 Brake slip speed limit) during a check time (44.204), and stays there for longer than a time delay (44.206 Brake slip fault delay), the drive trips on a fault (D101 Brake slip).

See also Timing diagram (page 84).

#### **Note:**

- Disable torque proving and brake open torque functions in the following controls:
  - Scalar motor control
  - Trolley motion
  - Long travel

To disable, set following values:

- 44.9 Brake open torque source = Zero
- 44.200 Brake open torque = 0%
- 44.202 Torque proving = Disable

### ■ Brake matching

**Note:** Brake matching function is not applicable for trolley and slew motions.

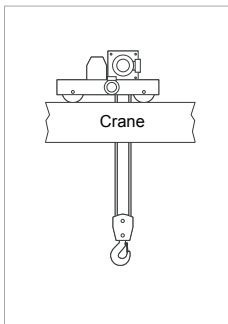

The Brake matching function detects mechanical brake slips and downward movement of the load during the following conditions:

- when mechanical brake control is in use
- when the operator has given a stop command and
- when the target is to close the brake.

The function can be used for automatic restart of the crane or for warning (alarm) indication.

#### **Note:**

- Slip detection is based on the motor encoder position signal. The function works only if an encoder is used.
- Brake matching function is not enabled as default.



**WARNING!**

- This function does not replace any local safety regulations and devices.
- The function is meant only to support in case of a brake failure. Check the functionality at the time of commissioning.

The figure below shows an electrical hoist motor connected to a gear box with an electro-hydraulic mechanical drum brake and a rope drum. This is a typical application where Brake matching can be used to improve safety.

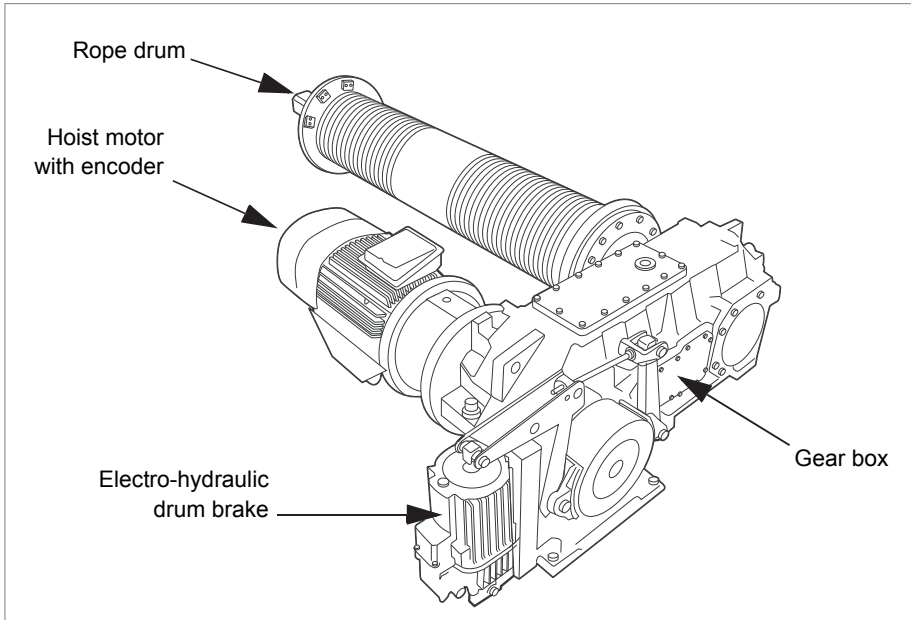

**Automatic restart of the crane**

Brake matching function can be used to restart the crane automatically. Restarting the crane with fixed zero speed reference means holding the crane and the load electrically due to a mechanical brake malfunction.

**Note:** The automatic restart is possible only after performing manual start at least once after power-up.

**Brake matching modes**

The Brake matching modes can be selected with parameter 44.220 Brake match mode.

### Warning mode

The warning **D20F Brake match** is generated when the drive is stopped or brake slippage is detected during extended run time or later when the drive is not modulating. The crane is not restarted, but a warning is generated for further external action (a signal horn or an alarm lamp).

### Restart mode

The crane restarts automatically with fixed zero speed reference if brake slippage is detected in these two conditions,

- after the brake was closed during extended run time and
- during the time period defined in parameter **44.222 Brake match timeout** after modulation is stopped.

If brake slippage is detected after the timeout is elapsed, the crane is not restarted, but the warning **D20F Brake match** is generated.

If you used the Brake matching function to restart the crane (with Restart mode), then the drive runs with fixed zero speed reference until you take over the crane control and bring the load electrically to the floor or to a safe place. Additionally, in the Restart mode, the function checks that parameter **44.211 Extended runtime** is set to at least three seconds. If the value is below three seconds, the function sets the value to be exactly three seconds. This setting allows the drive to restart quickly while it is still modulating and brake slippage is detected.

You can take over the control of the crane using the control switch connected to a digital input configured with parameter **44.223 Brake match ref enable**. See instructions for **Controlling the crane** (page 87) below.

### **Controlling the crane**

1. Take over the control of the crane when the digital input value changes from 0 to 1.
2. Bring the load down to a safe place on the floor with a normal joystick operation.

#### **Note:**

- When using joystick, the standard user start command is required to control the drive, to open the brake and to release the reference.
  - If the drive is controlled from fieldbus, the operation is enabled when the digital input configured with parameter **44.223 Brake match ref enable** changes from 0 to 1. After the reference becomes higher than the brake close speed, the drive starts following the reference.
-

## 88 Crane program features

3. When the load is in a safe place, switch off the crane and disable the control of the crane with the control switch by changing the digital input value from 1 to 0.
4. After the input value is False (0), the drive is switched off and the relay output for the mechanical brake is closed.

See also Brake matching timing diagram (page 88).

### Example parameter settings

The following is a typical setting of a brake match when hook position is not required (90.63 Feed constant numerator and 90.64 Feed constant denominator are set to 1).

- 44.220 Brake match mode = Restart
- 44.221 Brake match position limit = 0.010
- 44.222 Brake match timeout = 10 s
- 44.223 Brake match ref enable = any digital input/status bit. For example DI2 (during lowering, releases joystick reference control).

In this scenario, if motor axle moves 3.6 degrees ( $0.01 * 360$ ), brake match gets activated.

### **Brake matching timing diagram**

The Brake matching function is triggered based on signals from the motor encoder. The actual load position signal (parameter 90.5 Load position scaled) is used to detect brake slippage. If the slippage exceeds the limit defined in parameter 44.221 Brake match position limit, the warning D20F Brake match is generated and the drive is started if the necessary conditions defined in the Restart mode is fulfilled. When the motor is started, it holds the load at zero speed and mechanical brake is still closed.

---



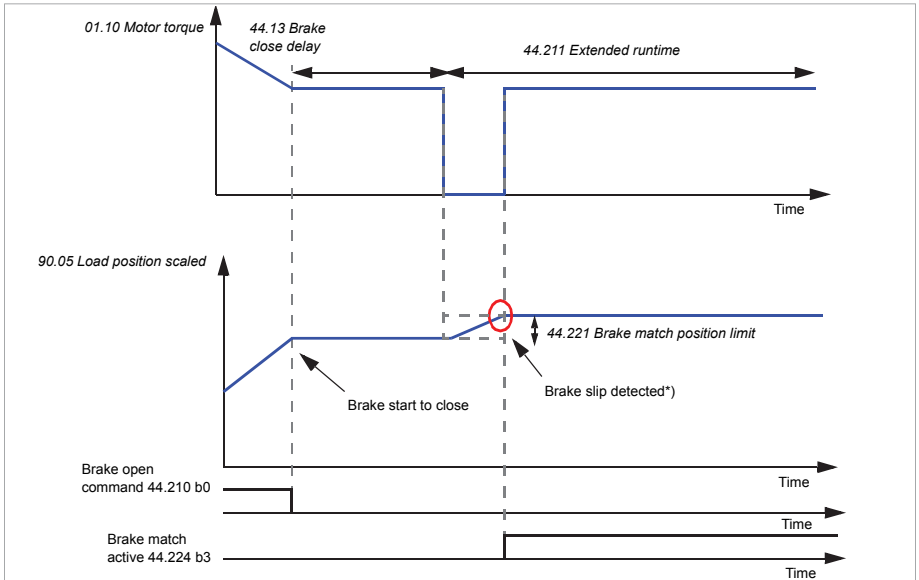

\*) Brake slip is detected if the change in the actual encoder position signal 90.5 Load position scaled exceeds the limit defined in parameter 44.221 Brake match position limit. The increasing value of the actual load position signal 90.5 Load position scaled indicates that the mechanical brake slips while the brake is closed. The brake slip detection comparison is started when delay time in parameter 44.13 Brake close delay elapses.

**Note:** For correct brake matching function, configure parameter group 90 Feedback selection according to the actual crane setup.

## ■ Brake opening torque selection

The Brake opening torque selection function makes sure that the right starting torque level is reached after brake opening. This enables the function to prevent the load from rolling back. The function is in operation when torque proving is complete and the brake open command is given.

The following alternative sources can be used for brake opening torque reference:

- Brake open torque: is a fixed value defined in parameter 44.200 Brake open torque
- Brake torque memory: is a torque value used when the brake is closed
- Torque reference: is defined by analog input or fieldbus references.

You can select the direction of brake opening torque with parameter 44.201 Torque proving sign. The default value is False, which means that torque is applied in the hoisting direction.

**Note:**

- Disable torque proving and brake open torque functions in the following controls:
    - Scalar motor control
    - Trolley motion
    - Long travel motion
- To disable, set following values:
- 44.9 Brake open torque source = Zero
  - 44.200 Brake open torque = 0%
  - 44.202 Torque proving = Disable

■ **Brake safe closure**

The Brake safe closure function performs a forced closure of the brake and prevents the user from operating the drive at very low speeds. ABB recommends to use this function especially in hoist drives which, for some reason, has no pulse encoder. (As a safety measure, a speed feedback device is highly recommended in hoist drives.)

The function monitors the estimated motor speed when the drive is running. When both the estimated motor speed (par. 1.1) and the ramped and shaped speed references (par. 23.2) are less than the user-defined speed limit (par. 44.208 Safety close speed) and higher than the user-defined delay time (par. 44.209 Safety close delay), the drive trips on a fault (D102 Brake safe closure) and closes the motor brake.

**Timing diagram**

The diagram below shows the operation of the D102 Brake safe closure fault.

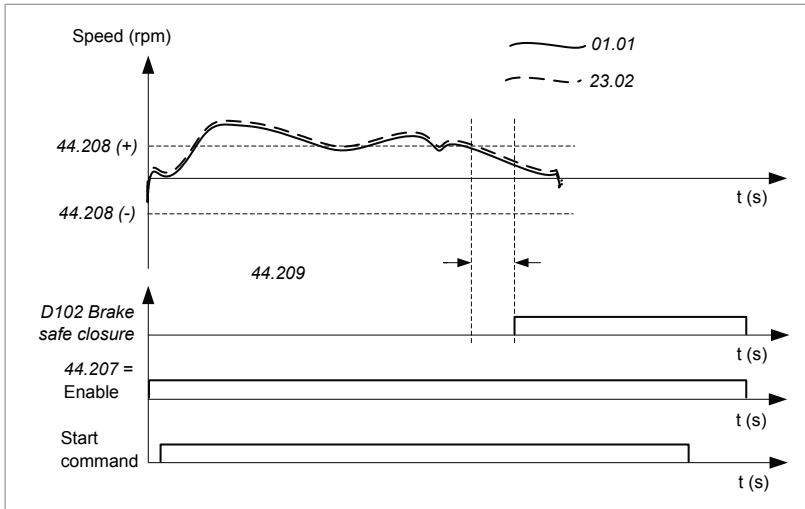

## ■ Extended run time

The Extended run time function minimizes the delay between consecutive start commands. The function keeps the motor magnetized for a defined time period after the brake is closed and the brake close delay time is elapsed. During the delay period, the motor is kept magnetized (modulating), to be ready for immediate restart. Because of this action, the next start can be considerably faster by skipping certain start sequence steps, such as DC magnetization (page 188) and Brake system checks – Torque proving (page 84).

The function works based on timer off module using the inverted signal BRAKE CLOSED state as input (parameter 44.1 Brake control status, bit 5). When this input signal goes low, the Extended run time operation (parameter 44.212, bit 1) is activated and connects to parameter 21.12 Continuous magnetization command, which keeps the drive modulating for the time defined in parameter 44.211 Extended runtime after the brake is closed.

If the drive trips during the extended run time operation, the function timer resets.

See the operation of the function in the Brake control timing diagram (page 79).

**Note:** The Extended run time function is available only in DTC motor control mode when the drive is in Remote mode and only when parameter 21.03 Stop mode is set as Ramp. See Operating modes of the drive (page 148).



### WARNING!

Make sure the motor is capable of absorbing or dissipating the thermal energy generated by continuous magnetization, for example by forced ventilation.

## ■ Settings and diagnostics

Parameter groups: 44 Mechanical brake control

Parameters:

- **I/O brake control logic:** 10.24 RO1 source, 44.7 Brake acknowledge selection, 44.210 Crane brake status,
- **Torque proving:** 44.201 Torque proving sign, 44.202 Torque proving, 44.203 Torque proving reference, 44.204 Brake system check time
- **Brake slip:** 44.204 Brake system check time, 44.205 Brake slip speed limit, 44.206 Brake slip fault delay
- **Brake matching:** 44.220 Brake match mode, 44.221 Brake match position limit, 44.222 Brake match timeout, 44.223 Brake match ref enable
- **Brake opening torque selection:** 44.9 Brake open torque source, 44.200 Brake open torque, 44.201 Torque proving sign
- **Brake safe closure:** 44.207 Safety close select, 44.208 Safety close speed, 44.209 Safety close delay
- **Extended runtime:** 44.211 Extended runtime, 21.12 Continuous magnetization command

Signals: 6.11 Main status word, 6.16 Drive status word 1, 9.1 Crane SW1, 9.2 Crane SW2 (bit 11), 9.3 Crane FW1, 90.5 Load position scaled, 44.224 Brake Match SW, 44.6 Brake control enable, 44.212 Extended runtime sw

Events:

- **Warnings:** D20E M/F control location mismatch, D20F Brake match, D218 Brake match config
- **Faults:** D100 Torque prove, D101 Brake slip, D102 Brake safe closure

## Speed reference handling

### ■ Possible control devices

The user can give speed reference through any of the following:

- control panel
  - PC tool (Drive composer)
  - joystick connected to an analog input
  - control device connected to the fieldbus interface
  - control device connected to digital inputs or the step references.
-

## Unipolar joysticks

Unipolar joysticks give the speed reference value with analog signal 0...10 V. The direction commands are specified with two digital inputs. One option is to use the zero position signal for the joystick (that is, the neutral position of the joystick).

## Bipolar joysticks

Bipolar joysticks give the speed reference value with analog signal -10...10 V. The direction commands are specified with polarity of the analog signal, + or -. One digital input is needed for starting the crane.

To use a bipolar joystick, set parameter 20.1 Ext1 commands to *In1 Start*.

### ■ Step reference selection

You can select between four step reference speeds. The polarity of the references depends on the direction in which the end-user gives the start command using digital inputs (20.3 Ext1 in1 source and 20.4 Ext1 in2 source).

The table below shows the default settings. The control program determines which step reference speed is used. Any other parameter value combination selects the step reference speed 1 (22.207 Step reference 1).

22.203 Step reference mode	22.204 Step reference select 2	22.205 Step reference select 3	22.206 Step reference select 4	Used reference
1	0	0	0	22.207 Step reference 1
1	1	0	0	22.208 Step reference 2
1	1	1	0	22.209 Step reference 3
1	1	1	1	22.210 Step reference 4

See also section Speed reference priorities (page 93).

### ■ Speed reference priorities

The speed references of the control program have the following priorities. The lowest priority is the first one and the highest priority is the last one on the list.

- The primary speed reference is the one selected in parameters 22.11 Speed ref1 source, 22.12 Speed ref2 source and 22.14 Speed ref1/2 selection.
- If the speed reference source is an analog signal, the speed reference is scaled based on the dead-band forward and reverse settings (30.203 Deadband forward, 30.204 Deadband reverse).

## 94 Crane program features

- If the Constant speed function is selected, the drive uses the constant speeds (22.21 Constant speed function...22.32 Constant speed 7) as the speed reference.
- If the Step reference mode is enabled (22.203) and the drive is not in local control, the drive uses the step reference (22.207...22.210) as the speed reference.
- If the Emergency control mode is active (20.207), the drive uses the emergency control reference (22.202) as the speed reference with the polarity based on parameters 20.208 Emergency control forward and 20.209 Emergency control reverse.

The speed reference selected according to the previous principle is limited as follows:

- If the External speed limitation command is active (30.200 External speed limits), the drive limits the speed reference to a predefined value (30.201 External min speed limit or 30.202 External max speed limit).
- If the Hoist speed optimization function is active (75.1), the drive limits the speed reference to the value calculated by the function (9.5 Load speed limit).
- If the Slowdown function is active (20.200 Slowdown select), the drive limits the speed reference to the slowdown reference (22.202).

The value that results is the final speed reference used by the crane system (9.6).

For more information on the speed references and related parameters, see below sections.

- Dead-band function (page 94)
- Constant speeds/frequencies (page 170)
- Step reference selection (page 93)
- Emergency control mode (page 55)
- External speed limitation (page 97)
- Hoist speed optimization (page 115)
- Slowdown (page 101)

### ■ Dead-band function

The accuracy of an analog input signal near zero is poor. With the Dead-band function, you can freeze the speed reference for a defined band area (that is, dead band) or ignore a low speed reference caused by possible crane vibrations on the joystick.

The function re-scales the analog signal based on the dead-band settings, and then calculates a new speed reference.

---

See also section [Speed reference priorities](#) (page 93).

In the example:

- Analog input reference (AI1) comes from the joystick:
  - Par. 12.18 AI1 max = 10 V
  - Par. 12.17 AI1 min = 0 V
  - Par. 12.20 AI1 scaled at AI1 max = 1500
- 0...5 V gives the reverse speed reference.
- 5 V is the joystick zero position.
- 5...10 V gives the forward speed reference.

When parameter 30.203 [Deadband forward](#) is set to 2%, it means that there is a deadband area of 30 rpm (2% of par. 12.20 AI1 scaled at AI1 max = 1500 rpm) in the forward direction. Inside this deadband area, the resulting speed reference is zero. Actual signal 9.6 [Crane speed reference](#) shows the final speed reference used, and when the speed reference is outside this dead-band area. In this case, actual signal 9.6 starts to show a positive reference starting from the point where the scaled value of analog input AI1 (12.12 [AI1 scaled value](#)) exceeds 30 rpm.

### ■ Parabolic speed reference

Normally, joystick movements cause a linear change to the speed reference, that is, a 50% change in position gives a 50% speed reference. Quite often accurate load handling is needed in lower speed areas, for example, when the end-user needs to position the load manually, or when the lack of space causes limitations. In such situations, the end-user can control joystick movements more accurately with a parabolic speed reference instead of a linear reference.

The Parabolic speed reference function (par. 22.211 [Speed reference shape](#)) changes the interrelationship of the incoming signal (that is, the joystick movement) and the speed reference according to a mathematical function. The mathematical functions available are  $X^2$  (= *Parabolic 1*),  $X^3$  (= *Parabolic 2*) and linear interrelationship (= *Linear*). The joystick has parameters for setting the deadband in the forward (par. 30.203 [Deadband forward](#)) and reverse (par. 30.204) directions.

Besides the joystick, the source of a parabolic speed reference can also be an analog signal from an external device

### Operation chart

This graph shows the parabolic reference curves compared to the linear speed reference curve.

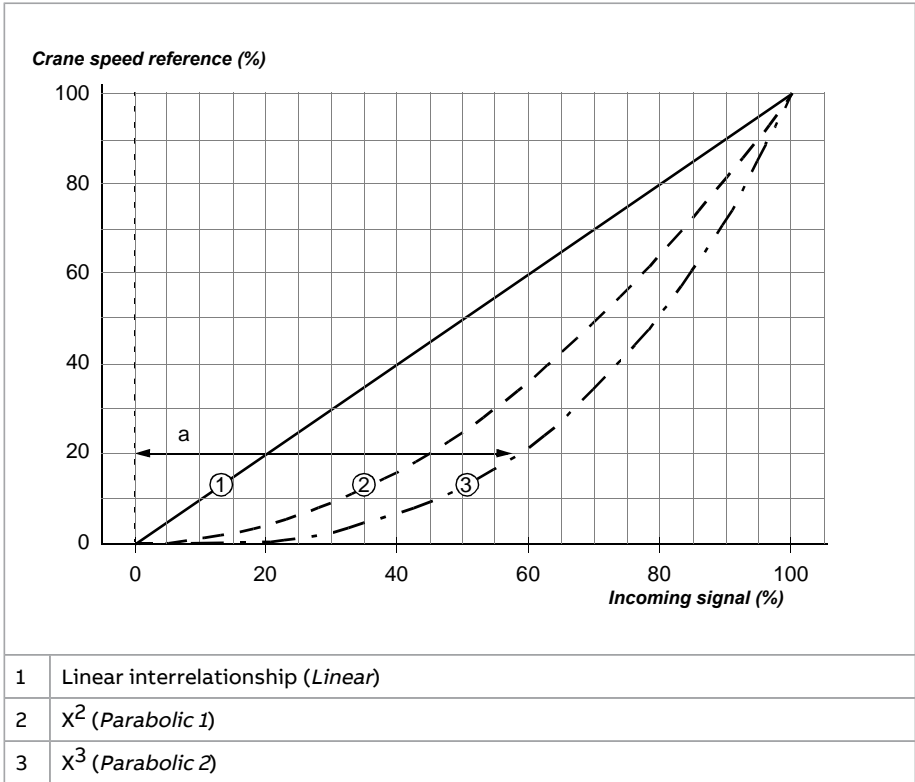

■ **Settings and diagnostics**

Parameters:

- Step reference selection: 22.203 Step reference mode, 22.204 Step reference select 2... 22.206 Step reference select 4, 22.207 Step reference 1 ... 22.210 Step reference 4
- Dead-band function: 30.203 Deadband forward, 30.204
- Parabolic speed reference: 22.211 Speed reference shape

Signals: 9.6 Crane speed reference

Events: -

**Speed reference ramping**

The control program has two user-selectable acceleration and deceleration ramps. You can adjust the acceleration/deceleration times and the ramp shape, and control switching between the two ramps via a digital input.



Based on the ramp set selection (par. 23.200) different ramp times are used:

- Acc/Dec 1 means acceleration time 1 (par. 23.201) and deceleration time 1 (par. 23.202) are used.
- Acc/Dec 2 means acceleration time 2 (par. 23.203) and deceleration time 2 (par. 23.204) are used.
- Acc/Dec Direction means acceleration time 1 (par. 23.201) and deceleration time 1 (par. 23.202) are used when motor is running in the forward direction, and acceleration time 2 (par. 23.203) and deceleration time 2 (par. 23.204) are used when motor is running in the reverse direction.

### ■ External speed limitation

The External speed limitation function limits the speed reference to a predefined value while the External speed limitation command (par. 30.200) is active. The source of the command can be a digital input, a PLC digital input using fieldbus communication, or any other signal bit.

If the External speed limitation command is activated when the motor is running in the forward direction, the drive limits the speed reference to the maximum limit (par. 30.202). If the command is activated when the motor is running in the reverse direction, the drive limits the speed reference to the minimum limit (par. 30.201).

See also section [Speed reference priorities](#) (page 93).

### ■ Crane motor potentiometer

The crane motor potentiometer function can be used in retrofit cases with older controllers. The function is used instead of the normal motor potentiometer which contains separate incoming signals for increasing and decreasing the reference.

These signals are not effective when the drive is stopped. The function can be enabled with parameter 22.220 [Crane motpot enable](#).

**Note:** If you prefer to use the normal motor potentiometer, open the user lock by entering your pass code into parameter 96.2 [Pass code](#). When the user lock is open, the motor potentiometer parameters 22.71 [Motor potentiometer function...22.80](#) are visible and you can configure the normal motor potentiometer. For more information, see [Parameter access levels](#) (page 21).

### Timing diagram

The following example shows the behavior of the motor potentiometer value:

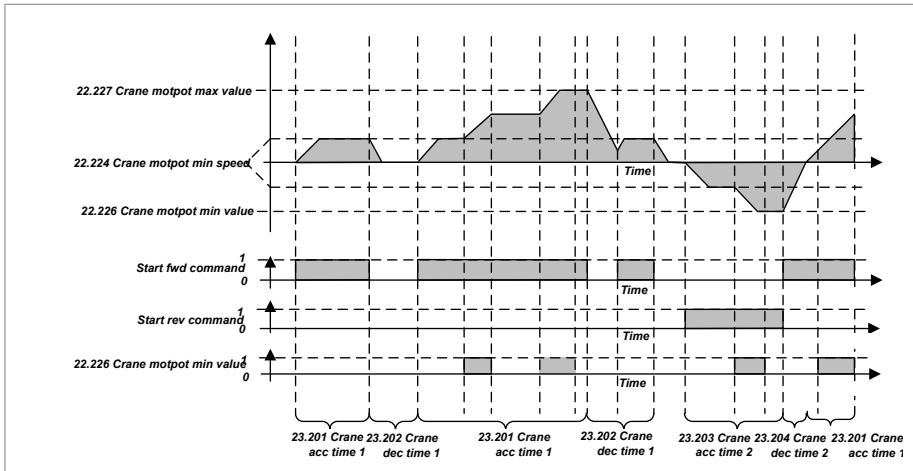

The function uses three signals, start forward, start reverse, and accelerate as shown in the above diagram.

**Forward direction**

You can increase the motor potentiometer reference (parameter 22.80 Motor potentiometer ref act) with any of these two methods:

- When forward command is activated, motor potentiometer reference (par. 22.80 Motor potentiometer ref act) increases to the crane motor potentiometer minimum speed (parameter 22.224 Crane motpot min speed).

or

- When crane motor potentiometer acceleration command (parameter 22.223 Crane motpot accel sel) is activated together with the forward command, then motor potentiometer reference (par. 22.80 Motor potentiometer ref act) increases.

**Note:** When you release the acceleration command (par. 22.223 Crane motpot accel sel), the motor potentiometer reference (par. 22.80 Motor potentiometer ref act) will remain in the last reached level. If the existing motor potentiometer reference (par. 22.80 Motor potentiometer ref act) is less than the reference maximum value (parameter 22.227 Crane motpot max value), further acceleration is possible only when acceleration command (parameter 22.223 Crane motpot accel sel) is activated again.

If a forward command appears,

- When actual speed reference (par. 22.80 Motor potentiometer ref act) is less than the crane motor potentiometer minimum speed (par. 22.224 Crane motpot min speed), the crane will accelerate to the minimum speed (par. 22.224 Crane motpot min speed).

- When actual speed reference (par. 22.80 Motor potentiometer ref act) is higher than the crane motor potentiometer minimum speed (par. 22.224 Crane motpot min speed), and if it is in the same direction, then the speed reference will remain at the last speed before the forward command was given. If it is in the reverse direction, the crane will decelerate to zero speed, change direction and accelerate to the crane motor potentiometer minimum speed (par. 22.224 Crane motpot min speed).

The motor potentiometer reference (par. 22.80 Motor potentiometer ref act) uses the following ramp time:

- When 22.80 Motor potentiometer ref act is more than 0, it uses the ramp time in parameters 23.201 Crane acc time 1 and 23.202 Crane dec time 1.
- When 22.80 Motor potentiometer ref act is less than 0, it uses the ramp time in parameters 23.203 Crane acc time 2 and 23.206 Fast stop deceleration time.

### Reverse direction

You can decrease the motor potentiometer reference (parameter 22.80 Motor potentiometer ref act) with either of the two methods:

- Activating the reverse command, decreases the motor potentiometer reference (22.80 Motor potentiometer ref act) to the negative value of the crane motor potentiometer minimum speed (parameter 22.224 Crane motpot min speed).

or

- Activating the crane motor potentiometer acceleration command (parameter 22.223 Crane motpot accel sel) together with reverse command, decreases the motor potentiometer reference (22.80 Motor potentiometer ref act).

**Note:** when you release the acceleration command (par. 22.223 Crane motpot accel sel), the motor potentiometer reference (par. 22.80 Motor potentiometer ref act) remains in the last reached level. If the existing motor potentiometer reference (par. 22.80 Motor potentiometer ref act) is more than the reference maximum value (parameter 22.226 Crane motpot min value), further acceleration is possible by activating the acceleration command (par. 22.223 Crane motpot accel sel) again.

If a reverse command appears,

- When actual speed reference (par. 22.80 Motor potentiometer ref act) is less than the crane motor potentiometer minimum speed (par. 22.224 Crane motpot min speed), the crane will accelerate to the minimum speed (par. 22.224 Crane motpot min speed).
- When actual speed reference (par. 22.80 Motor potentiometer ref act) is higher than the crane motor potentiometer minimum speed (par. 22.224 Crane motpot min speed), and if it is in the same direction, then the speed reference will remain at the last speed before the reverse command was given. If it is in the forward direction, the crane will decelerate to zero speed, change direction

and accelerate to crane motor potentiometer minimum speed (par. 22.224 Crane motpot min speed).

The motor potentiometer reference (par. 22.80 Motor potentiometer ref act) uses the following ramp time:

- When 22.80 Motor potentiometer ref act is more than 0, it uses the ramp time in parameters 23.201 Crane acc time 1 and 23.202 Crane dec time 1.
- When 22.80 Motor potentiometer ref act is less than 0, it uses the ramp time in parameters 23.203 Crane acc time 2 and 23.204 Crane dec time 2.

### Direction change

- If the actual motor potentiometer reference (par. 22.80 Motor potentiometer ref act) is negative, then activating the forward command starts increasing until it reaches 0 using the ramp time defined in parameter 23.204 Crane dec time 2 and after 0 it uses the ramp time defined in parameter 23.201 Crane acc time 1.

If the actual motor potentiometer reference (par. 22.80 Motor potentiometer ref act) is positive, then activating the reverse command starts decreasing until it reaches 0 using the ramp time defined in parameter 23.202 Crane dec time 1 and after 0 it uses the ramp time defined in parameter 23.203 Crane acc time 2.

### ■ Settings and diagnostics

Parameters: 22.220 Crane motpot enable, 22.223 Crane motpot accel sel, 22.224 Crane motpot min speed, 22.226 Crane motpot min value, 22.227 Crane motpot max value, 23.201, 23.202, 23.203, 23.204

Signals: 22.80 Motor potentiometer ref act, 22.225 Crane motpot sw

Events: -

## Supervision and limit switch logic

### ■ End limits

The End limits 1 and 2 of the control program enable you to connect sensors directly to the drive to make the crane stop safely when it reaches the end position of its travel. If one of the two limits is active, the function activates an emergency stop command. The two limits are independent of each other.

End limit 1 (par. 20.205) – for forward lifting (positive) direction. Make sure the input is wired to the forward (positive) limit switch.

End limit 2 (par. 20.206) – for reverse lowering (negative) direction. Make sure the input is wired to the reverse (negative) limit switch.

The below active and inactive conditions are applicable for both limits 1 and 2:

---

- the limits are active when the limit input to the drive is False, in other words, when the normally-closed limit switch is off (0)
- the limits are inactive when the limit input to the drive is True, in other words, the normally-closed limit switch is on (1). This condition is applicable for the normal operation of the crane.

The following steps describe the End limit 1 operation in the forward lifting (positive) direction. The same can be applied for End limit 2 in the reverse lowering (negative) direction:

1. When End limit 1 is activated while the drive is running in the forward lifting (positive) direction, the function activates an emergency stop command (Em stop off3). The drive then decelerates according to the defined emergency stop time (par. 23.23).
2. The limit input must be set back to inactive before the end-user can start the drive in the forward lifting (positive) direction. However, the end-user can run the drive in the reverse lowering (negative) direction even when the End limit 1 is active.
3. When the End limit 1 command is activated, the drive also generates a warning D205 End limit 1.

### ■ Slowdown

The Slowdown function limits the speed reference when the crane is operating in the slowdown area.

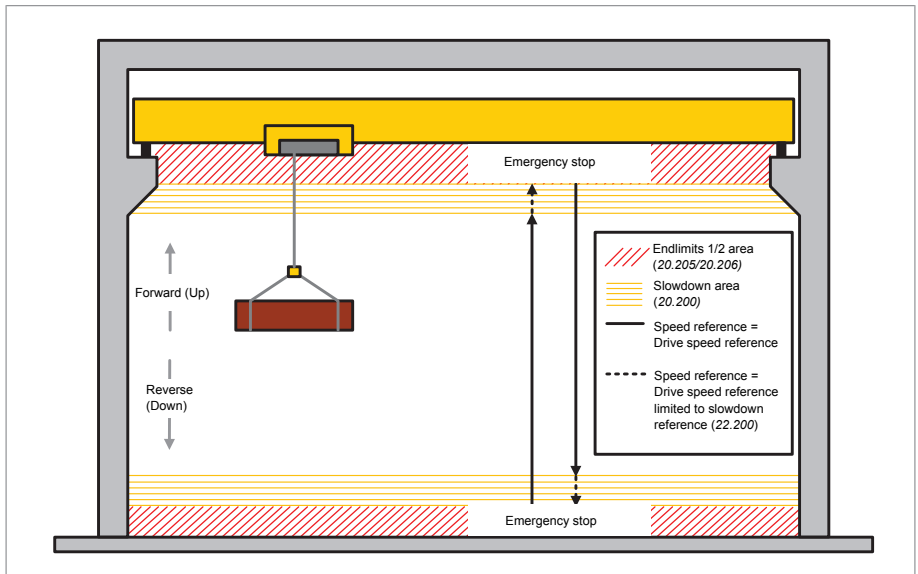

The Slowdown function has four modes:

- *Slowdown with direction*
- *Slowdown without direction (safe zone)*
- *Slowdown double bit*
- *Slowdown position.*

See also section [Speed reference priorities](#) (page 93).

### **Slowdown with direction**

This mode is activated when Slowdown input 1 (par. 20.201) changes from 1 (True) to 0 (False). The function then limits the speed reference to the slowdown reference limit (par. 22.200) in the direction of motion at the time of the activation. As long as the supply voltage is not switched off, the drive remembers the direction of motion and allows full speed in the opposite direction.

If the Slowdown command is activated after the drive has stopped, the function allows only slow speed in both directions. The function also limits the speed reference in both directions if the Slowdown command is activated when the drive is powered up.

### **Slowdown without direction (safe zone)**

Unlike the *Slowdown with direction* mode, the Slowdown without direction mode is activated by Slowdown input 1 (par. 20.201), but the speed reference is limited in both forward and reverse directions instead of just one direction. You can use this mode to create a safe zone, for example, for trolley movement.

### **Slowdown double bit**

In this mode, two switches are used through two inputs. Slowdown input 1 (par. 20.201) is used for the slowdown command in forward direction, while Slowdown input 2 (par. 20.202) is used for the slowdown command in reverse direction. When the slowdown command is activated (par. 20.201 or 20.202 = 0), the function limits the speed reference to the slowdown reference limit (par. 22.200).

### **Slowdown position**

In this mode, the following two position limits (parameter 20.203 Slowdown pos 1 or 20.204 Slowdown pos 2) are used:

- Slowdown up position limit (par. 20.203 Slowdown pos 1): used for the slowdown command in forward direction
- Slowdown down position limit (par. 20.204 Slowdown pos 2): used for the slowdown command in reverse direction.

The function activates the slowdown command and limits the speed reference to the slowdown reference limit defined in parameter 22.200 Slowdown reference, when parameter 90.5 Load position scaled is:

---

- greater than the slowdown up position limit (par. 20.203 Slowdown pos 1) in forward direction

or

- lesser than the slowdown down position limit (par. 20.204 Slowdown pos 2) in reverse direction.

### ■ Fast stop

The Fast stop function stops the drive extremely fast from high speed. The function can be used, for example, to stop the swift downward movement of a bucket crane before the ropes unwind and pile up on top of the crane. Note that the function is not an emergency stop function.

When the function is activated, the drive generates a warning D20A Fast stop.

The function has three modes:

Mode	Description
Ramping and mechanical braking	In this mode the drive decelerates to zero speed according to a defined ramp time. The mechanical brake closes when the drive reaches the brake close speed.
Torque limit and mechanical braking	In this mode the drive decelerates to zero speed against the drive torque limits. The mechanical brake closes when the drive reaches the brake close speed.
Mechanical braking only	In this mode the function forces the mechanical brake to close.

### ■ Speed matching

The Speed matching function compares the crane speed reference continuously to the actual motor speed to detect any differences. The function makes sure that the motor follows the speed reference when stopped, during acceleration or deceleration, and when running at the constant speed. The function also makes sure that the brake does not slip when the drive has stopped with the brake closed.

The function has two deviation levels:

- one level checks the speed deviation during a ramping state, that is, acceleration and deceleration (par. 74.3 Motor speed ramp deviation level)
- another level checks the speed deviation during a constant speed (par. 74.2 Motor speed steady deviation level).

The drive trips on a fault D105 Speed match when the drive is operating in the following conditions:

- the motor is running in a steady state, and the difference between the motor actual speed (par. 1.1 Motor speed used) and the ramped and shaped speed reference (par. 23.2 Speed ref ramp output) is greater than the steady state

## 104 Crane program features

deviation level for longer than a delay defined in parameter 74.4 Speed match fault delay.

or

- the motor is accelerating or decelerating, and the difference between the motor actual speed (par. 1.1 Motor speed used) and the ramped and shaped speed reference (par. 23.2 Speed ref ramp output) is greater than the ramping state deviation level for longer than a delay (par. 74.4 Speed match fault delay).

The drive generates a warning (D200 Brake slip at standstill) if the drive is stopped, and

- the difference between the motor actual speed and the speed reference is greater than the steady state deviation level for longer than a delay defined in parameter 74.4 Speed match fault delay

and

- the brake control is active and the brake is closed.

### Timing diagrams

#### Operation of the Speed match fault

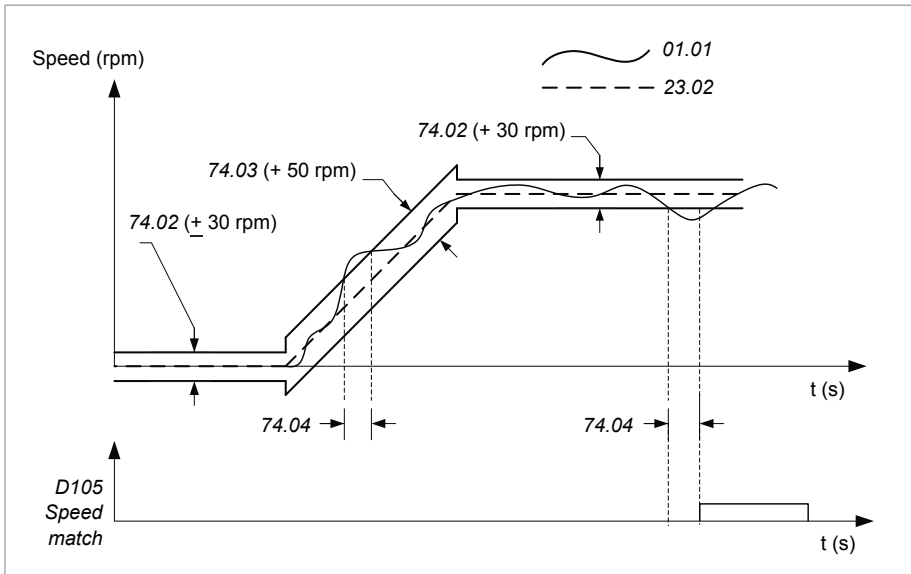

#### Operation of the Brake slip at standstill warning



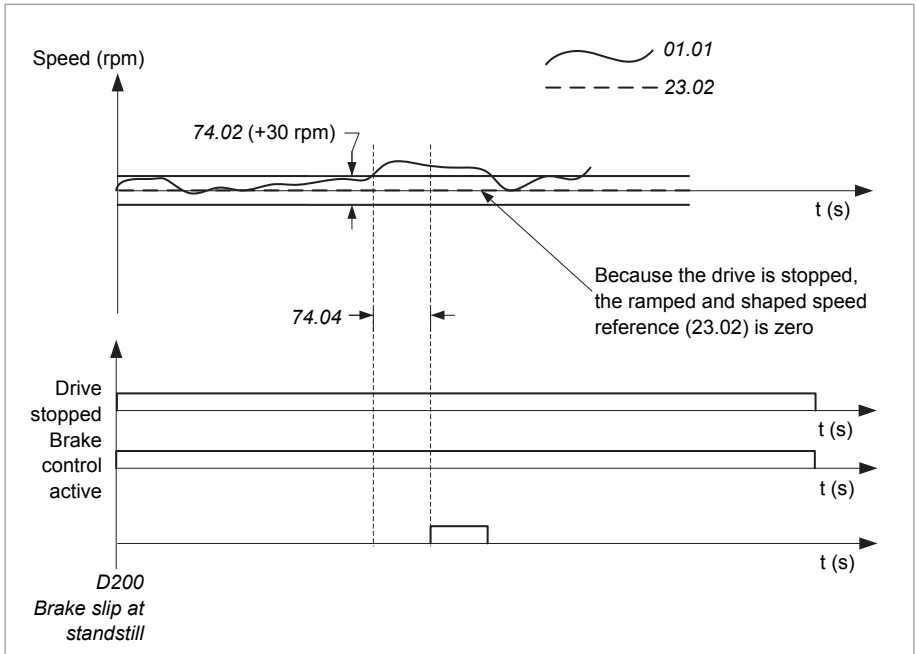

### ■ Motor overspeed monitoring

The Motor overspeed monitoring function is an internal protection function that supervises the motor speed and trips the drive at motor overspeed.

If the motor speed exceeds the defined level (par. 31.200 *Motor overspeed level*), and a time delay (par. 31.201 *Motor overspeed level delay*) elapses, the drive trips on a fault (D104 *Over speed*), stops and closes the brake.

### ■ Inverter overload detection

The Inverter overload detection function makes sure that the inverter is capable of providing sufficient current and torque and that the drive is operating within the defined inverter current and torque limits. The function is mainly used in hoist motion.

The function is in operation while the motor is in the generating mode and generating more than 10% of the motor nominal power and running at an actual speed greater than 5% of the motor synchronous speed. If the limits are exceeded in this condition, and a time delay (par. 31.204 *Inverter overload delay*) elapses, the drive trips on a fault (D106 *Inverter overload*) and closes the brake for safety reasons.

The function monitors the following inverter current and torque limit status bits in parameter 30.2 Torque limit status, to make sure that the inverter current and torque limits are within limits:

- Bit 2 Minimum torque
- Bit 3 Maximum torque
- Bit 4 Internal current
- Bit 5 Load angle
- Bit 6 Motor pullout.

To activate the status bit monitoring, you must select the above-mentioned bits with the corresponding bits of parameter 31.202 Inverter overload selection. You can also select to monitor an additional bit of your own selection (Par. 31.203 User limit bit selection).

### ■ Inching control

The Inching control function positions the load precisely by providing movements with defined reference and duration. Parameters 20.221 Inching run time and 20.222 Inching wait time define the running duration and waiting time. Parameters 20.221 Inching run time and 20.223 Inching speed ref can be used to adjust the movement distance.

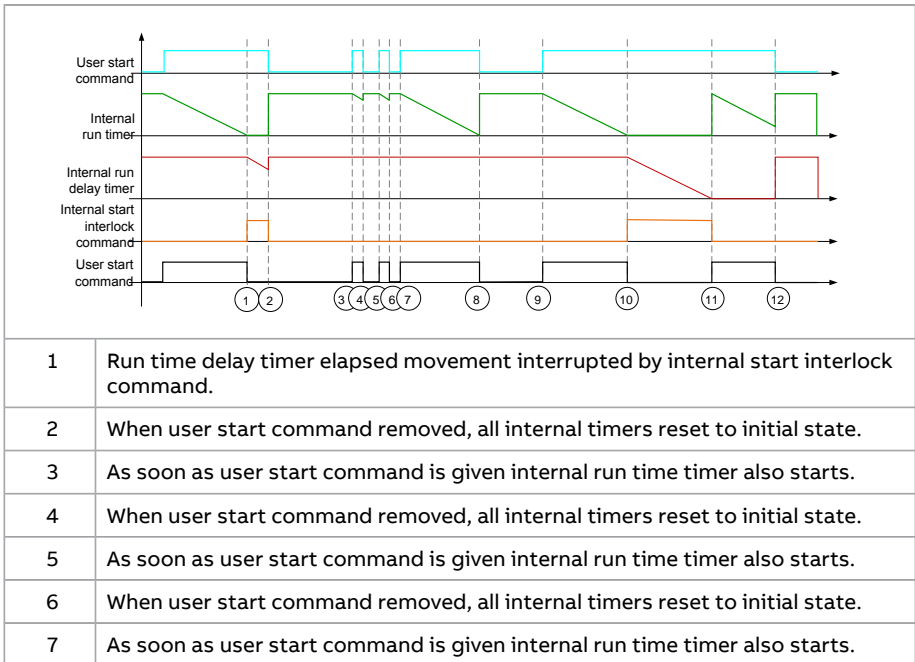

8	When user start command removed, all internal timers reset to initial state.
9	As soon as user start command is given internal run time timer also starts.
10	As soon as run time delay timer elapsed movement interrupted by internal start interlock command and run delay timer activated.
11	As soon as run delay timer elapsed internal start interlock condition removed, and movement continue.
12	When user start command removed, all internal timers reset to initial state.

**Note:** To avoid frequent mechanical brake operation, parameter 44.15 Brake close level delay can be set longer than 20.222 Inching wait time.

### ■ Reverse plug

The reverse plug function activates the alternate deceleration and acceleration ramp times when the direction command changes. The alternate deceleration and acceleration ramp times are set with parameters 23.211...23.214 and follow the 23.200 Crane ramp set selection logic.

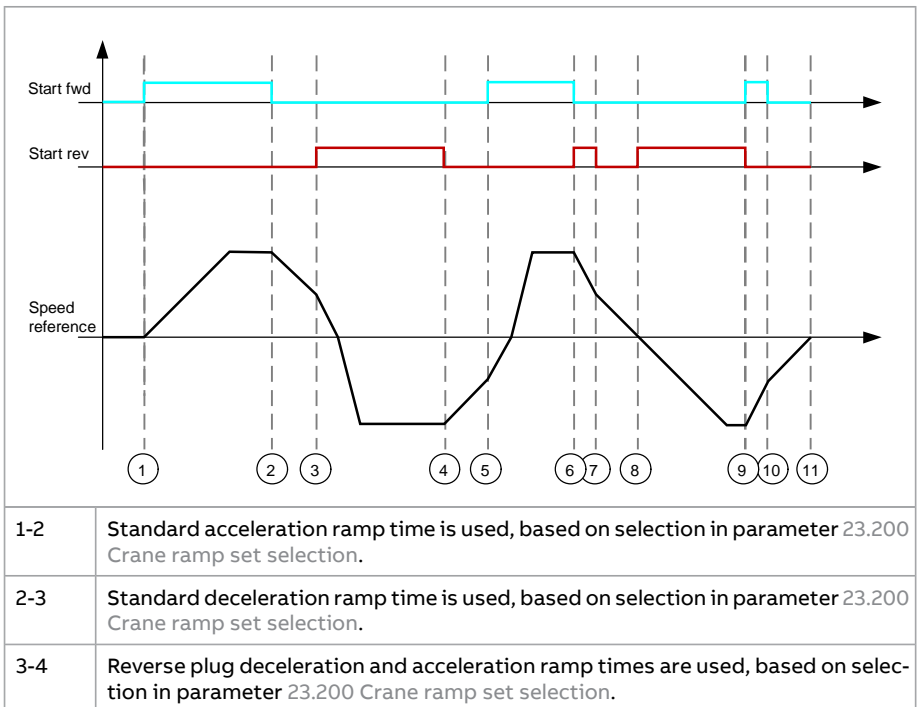

## 108 Crane program features

4-5	Standard deceleration ramp time is used, based on selection in parameter 23.200 Crane ramp set selection.
5-6	Reverse plug deceleration and acceleration ramp times are used, based on selection in parameter 23.200 Crane ramp set selection.
6-7	Reverse plug deceleration time is used, based on selection in parameter 23.200 Crane ramp set selection.
7-8-9	Standard deceleration and acceleration ramp times are used, based on selection in parameter 23.200 Crane ramp set selection.
9-10	Reverse plug deceleration time is used, based on selection in parameter 23.200 Crane ramp set selection.
10-11	Standard deceleration ramp time is used, based on selection in parameter 23.200 Crane ramp set selection.

### ■ Slack rope

The Slack rope function provides warnings against any slackness in the rope which may result when the boom is thrust upwards by heavy and strong wind in outdoor cranes or when the hook jams in a mechanical structure in indoor industrial cranes.

#### *Slack rope function block diagram*

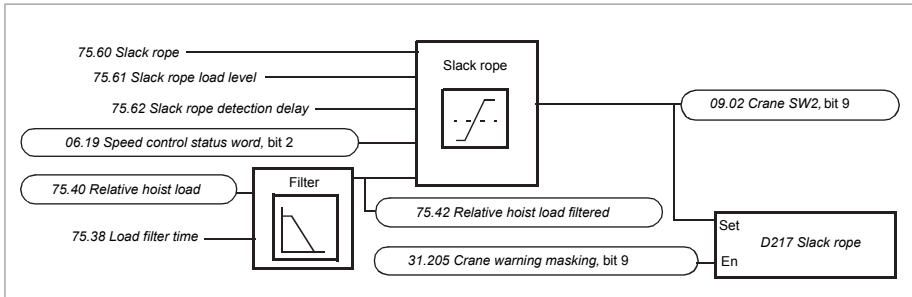

The function can be enabled with parameter 75.60 Slack rope and by setting the slack rope load level with parameter 75.61 Slack rope load level to different than -400%.

The function detects a slack rope condition at the time of lowering the crane, if the value in parameter 75.42 Relative hoist load filtered is less than slack rope load level (par. 75.61 Slack rope load level) during the delay time defined in parameter 75.62 Slack rope detection delay. Parameter 9.2 Crane SW2, bit 9, shows the slack rope detected status.

When a slack rope condition is detected, drive generates the warning D217 Slack rope or a Fast stop according to the selection defined in parameter 75.60 Slack rope. The warning can be masked by setting parameter 31.205 Crane warning masking, bit 9 to 0.

## ■ Watchdog

The Watchdog function monitors the drive critical warnings (alarm)s and opens the relay output RO2 (default settings) of the drive, when any of the monitored warnings or when the watchdog user bit in parameter 32.225 Watchdog user bit is active. The watchdog signal (parameter 32.227 Watchdog sw) can be used for safety, emergency interlocks or controlling the main contactor.

The critical warnings can be selected with parameter 32.226 Watchdog mask. When a selected warning in the list is activated, the drive opens the relay output RO2 (default settings) of the drive. Unselected warnings are ignored.

Bit	Warning	Warning code
0	Fb A comm	A7C1 FBA A communication (page 715)
1	Fb B comm	A7C2 FBA B communication (page 715)
2	M/F comm	A7CB M/F comm loss (page 715)
3	Braking resistor failure	A791 Brake resistor (page 710)
4	Braking resistor temp	A793 BR excess temperature (page 710)
5	Braking chopper failure	A79B BC short circuit (page 713)
6	Brake chopper temp	A79C BC IGBT excess temperature (page 713)
7	Brake closing failure	A7A1 Mechanical brake closing failed (page 713)
15	User bit 1	-

**Note:** The Watchdog function requires an external 24 V connection to the drive control board.

### Watchdog test

The Watchdog test function performs periodical tests to check the condition of the watchdog circuit. The circuit consists of one digital input for Power on acknowledgment signal (par. 20.212) and watchdog relay output RO2 (par. 32.227 Watchdog sw, bit 1). The function can be enabled with parameter 32.221 Watchdog test.

The testing of watchdog circuit starts after the main contactor was closed, as indicated by the Power on acknowledgment signal (par. 20.212) and the delay time defined in parameter 32.222 Watchdog test delay is elapsed.

After the test is completed, the watchdog relay output RO2 opens for a fixed time of 0.5 s and closes again. If the Power on acknowledgment signal (par. 20.212) does not deactivate and reactivate within the time defined in parameter 32.224 Watchdog fault delay, then the fault D10D Watchdog test fault occurs.

If the crane is powered up frequently, parameter 32.223 Watchdog re test delay can be used to prevent the test from starting every time the main contractor is

closed. The next watchdog test sequence executes only after the re-test delay time is elapsed.

**Note:** The Watchdog test function can be used only when the drive is powered using an external power supply. Otherwise, the drive will perform the watchdog test every time the drive is powered up without considering the value of parameter 32.223 Watchdog re test delay.

### ■ Settings and diagnostics

Parameters:

- **End limits:** 20.205 End limit 1, 20.206 End limit 2
- **Slowdown:** 20.200 Slowdown select, 20.201 Slowdown input 1, 20.202 Slowdown input 2, 20.203 Slowdown pos 1, 20.204 Slowdown pos 2, 22.200 Slowdown reference
- **Fast stop:** 20.210 Fast stop input, 20.211 Fast stop mode, 23.206 Fast stop deceleration time
- **Speed matching: parameter group 74** Speed matching (page 569)
- **Motor overspeed monitoring:** 31.200 Motor overspeed level, 31.201 Motor overspeed level delay
- **Inverter overload detection:** 31.202 Inverter overload selection, 31.203 User limit bit selection, 31.204 Inverter overload delay
- **Inching control:** 20.221 Inching run time, 20.222 Inching wait time and 20.223 Inching speed ref.
- **Reverse plug:** 23.210 Reverse plug sel, 23.211 Reverse plug acc time 1, 23.212 Reverse plug dec time 1, 23.213 Reverse plug acc time 2, 23.214 Reverse plug dec time 2 and 23.200 Crane ramp set selection.
- **Slack rope:** 75.60 Slack rope, 75.61 Slack rope load level, 75.62 Slack rope detection delay, 75.42 Relative hoist load filtered, 75.38 Load filter time, 75.40 Relative hoist load
- **Watchdog test:** 32.221 Watchdog test, 32.222 Watchdog test delay, 32.223 Watchdog re test delay, 32.224 Watchdog fault delay, 32.225 Watchdog user bit

**Signals:** 9.1 Crane SW1, 9.2 Crane SW2, 9.3 Crane FW1, 20.212 Power on acknowledge, 30.2 Torque limit status, 31.205 Crane warning masking, 32.226 Watchdog mask, 32.227 Watchdog sw

Events:

- **Warnings:** D205 End limit 1, D206 End limit 2, D201 Slowdown 1, D201 Slowdown 1, D20C Slowdown safe zone, D20A Fast stop, D200 Brake slip at standstill, D215 Watchdog warning, D217 Slack rope
-

- **Faults:** D104 Over speed, D105 Speed match, D106 Inverter overload, D108 End limits I/O error, D10D Watchdog test fault

## Lifetime monitoring and maintenance

The Lifetime of the lifting equipment in the crane system can be monitored to determine the maintenance needs. One possible way is using the built-in functionality of the drive. The drive monitors the working cycles of the hoist considering the operating time, the lifting and lowering speeds and the load. All these values are known signals in the inverter or from the sizing of the hoist.

The function can be activated with the parameter 75.70 Start lifetime monitor and the lifetime hours can be defined in parameter 75.71 Crane lifetime. See also instructions for [Configuring Lifetime monitor function \(page 48\)](#).

The function indicates the remaining mechanical lifetime of the crane hoist. See signals [9.10 Lifetime left](#) and [9.11 Lifetime left in percent](#). There are other signals supporting the function:

- Total operating time or brake open time of the drive ([9.20 Crane operation hours](#))
- Continuously calculated actual hoist load ([75.43 Absolute hoist load filtered](#))
- Load spectrum factor Km for function of load and time ([9.12 Load spectrum factor](#))

The correct load signal can be achieved by defining the weight calculation according to the [Efficiency and inertia calculation \(page 120\)](#), which is part of the commissioning the hoist speed optimization procedure.

During the lifetime of the crane installation, you must record the changes to the load spectrum as a consequence of drive replacement or any maintenance work on the hoist unit. A set of protected (hidden) parameters in the control program can be used to record these changes.



**WARNING!** Parameters used for maintenance records are protected with password to prevent the operation and manipulation by any unauthorized personnel.

Only authorized personnel shall work on these protected parameters.

---

### ■ Maintenance work

- If you replaced a control board or a complete drive, then copy the old values to the new system, for example, from the parameter file. See instructions for [Copying old values to new system \(page 49\)](#).
  - If you did some maintenance work on a hoist unit, reset the load spectrum recorder to its starting values. See instructions for [Resetting the load spectrum recorder \(page 50\)](#).
-

## ■ Settings and diagnostics

**Parameters:** 75.70 Start lifetime monitor, 75.71 Crane lifetime, 75.72 Reset load spectrum, 75.73 Preset value of load spectrum, 75.74 Lifetime speed scaling, 75.75 Lifetime factor

**Signals:** 9.10 Lifetime left, 9.11 Lifetime left in percent, 9.12 Load spectrum factor, 9.13 Lifetime sw, 9.20 Crane operation hours, 75.43 Absolute hoist load filtered

**Events:**

- Warnings: D216 Lifetime left less 10%
- Faults: -

## Conical motor control

The Conical motor control function handles the brake control for conical motors, which do not have an external mechanical brake. A conical motor has an internal brake, which opens or closes according to the motor flux level. The brake opens when the motor flux level is higher than the normal flux level and closes when the flux is below the normal flux level. You can find the opening and closing flux levels on the motor rating plate or ask the motor manufacturer for the levels. The opening flux level has to be kept active for a certain period of time. The time depends on the motor.

When a conical motor is switched on, axial force is created as a result of the electromagnetic field (flux) and the air gap between the cone-shaped rotor and stator. This axial force overcomes the return force of the brake spring and moves the rotor shaft and brake disc in an axial direction. The brake is then released, allowing the motor to start up. After the motor is switched off or if the voltage fails, the magnetic force collapses, and the motor mechanically brakes to a standstill by the return force of the brake spring.

---



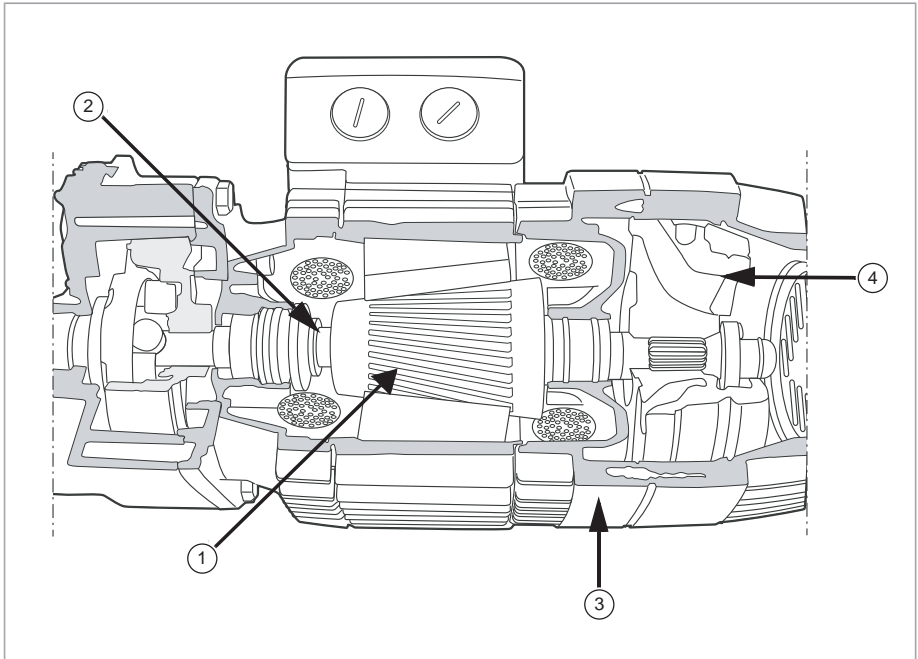

1	Conical rotor
2	Brake rotor spring
3	Motor housing
4	Internal brake

**Note:**

- Mechanical brake control (par. 44.6) must not be selected when Conical motor control function is used. If mechanical brake control is not active, the drive trips on a fault (D10A Brake control selected).
- Brake close delay (par. 44.13) must be greater than 0 seconds.

When the function is enabled and the start command is given, the motor flux ramps up over the normal level (100%) to the start flux level (par. 76.2) during a flux ramp up time (par. 76.5). The ramp-up time makes sure that the brake opens faster and there is minimal roll-back that can cause a load dip. The start flux level is kept as the reference for a hold time (par. 76.4) to make sure that there is enough time for the brake to open.

After the start flux hold time is over, the normal flux level (100%) is activated for normal running. The flux ramps down from the start flux level to the normal level (100%) during a flux ramp-down time (par. 76.6).

When the stop command is given, the drive decelerates the motor. When the motor speed (par. 1.1) decreases below the zero speed limit (par. 21.6), the motor starts to use the stop flux level (par. 76.3) as the flux reference. The flux ramps down from the normal level (100%) to the stop flux level during the ramp-down time. When the actual motor flux reaches the stop flux level, the brake closes. See also section *Speed reference priorities* (page 93).

■ **Timing diagram**

The diagram below shows brake opening and closing as well as the normal running flux levels.

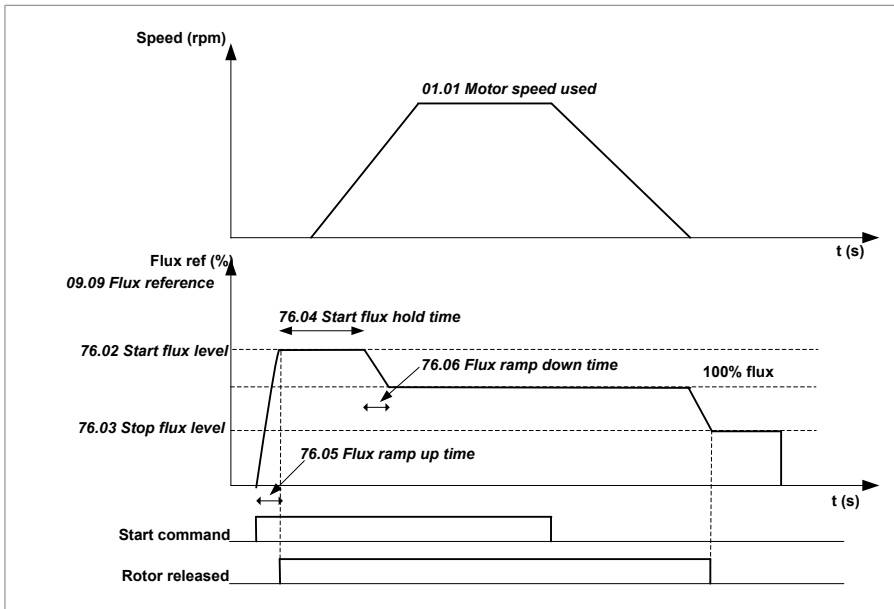

■ **Example parameter settings**

The following is an example for conical motor control parameter settings.

- 76.1 Conical motor control = *Enable*
- 76.2 Start flux level = 125%
- 76.3 Stop flux level = 65%
- 76.4 Start flux hold time = 2000 ms
- 76.5 Flux ramp up time = 1000 ms
- 76.6 Flux ramp down time = 1000 ms

If required, when you stop the conical motors, tune the zero speed delay:

21.7 Zero speed delay = 1000...1500 ms

## ■ Settings and diagnostics

Parameters: 76 Conical motor control

Signals: 9.1 Crane SW1, 9.9 Flux reference

Events:

- Warnings: -
- Faults: D10A Brake control selected

## Hoist speed optimization

### ■ Overview

If a hoist drive needs to run above its nominal speed (in the field weakening range), you need to enable its Hoist speed optimization (HSO) function. You also need to define the necessary variables for the function, such as the actual load values Vs. the corresponding speed limit values. On the basis of the given data, the function automatically defines the allowed maximum speed depending on the actual load that the hoist is currently moving.

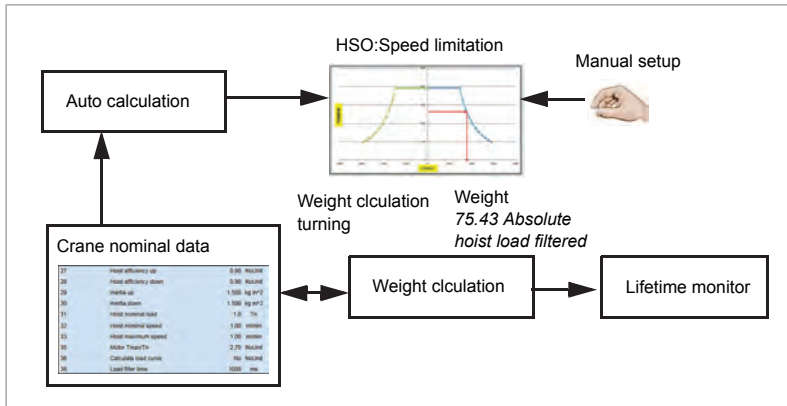

The diagram shows the relationship between different functions in the hoist speed optimization.

- **HSO:** Speed limitation, load Vs speed points for both direction can be either manually defined or can be calculated and set automatically. When function is activated the speed reference is limited within safe limits.
- **Auto calculation** needs crane nominal data. If values are known, you can directly enter the values into parameters 75.3 Motor base speed and 75.27 Hoist efficiency up...75.35 Motor T<sub>max</sub>/T<sub>n</sub>. If it is needed to verify the crane nominal data, then the weight calculation function can be used by comparing the

measured weight and test weight. The efficiency and inertia parameters can be tuned to find the correct reading from weight calculation. These parameters are finally used for auto calculation. See [Efficiency and inertia calculation \(page 120\)](#).

- **Weight calculation** is used for Lifetime monitor function. Note that this calculation is not meant for overload protection.
- **Lifetime monitor** function monitors all working cycles of the hoist, considering the operating time, the lifting and lowering speed and the load. All these values are known signals for the inverter or from the sizing of the hoist.

### **HSO speed limitation defined manually**

For manual parameterization of HSO speed limitation, you need to define these variables for the function:

- motor base speed (at which point the actual load is defined and above which the function is in use)
- actual load values vs. corresponding speed limit values for both forward and reverse directions.

**Note:** The function operates assuming that the load remains constant after the motor exceeds the motor base speed once until the drive stops and receives a new start command.

### **■ Operation chart**

The below chart shows the operating principle of the Hoist speed optimization function. The function controls the maximum speed limit according to the active load.

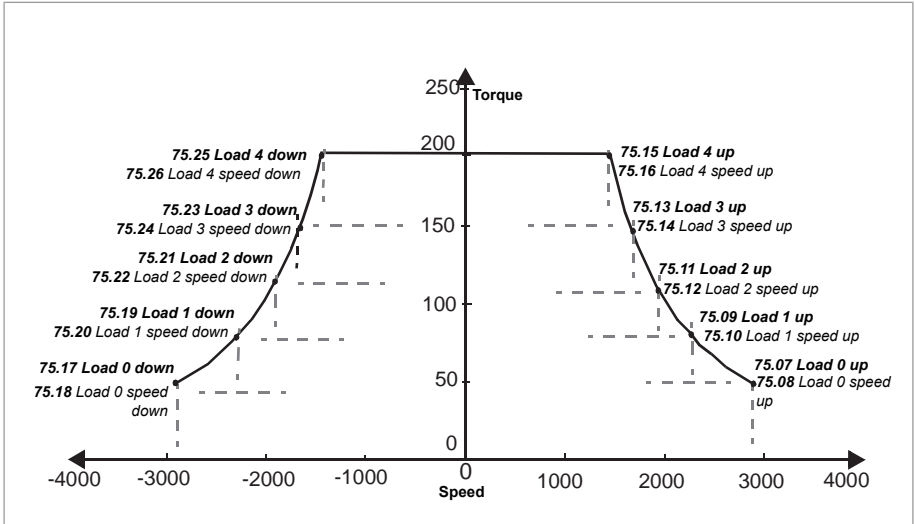

The right side of the chart shows the actual load values Vs. the corresponding speed limit values for the forward direction. The left side shows the actual load values Vs. the corresponding speed limit values for the reverse direction.

#### Note:

- Give the actual load values in increasing order and the speed limit values in decreasing order. Otherwise the function will limit the speed to the base speed and generates a warning.
- Set all points in correct order. See example below.

#### Example

The example below shows how to set the load and speed values shown in the *operation chart*.

**Note:** The values in this example only shows the sequence and the setting method. You need to set the actual parameter values according to the actual motor details and the load.

In the example, motor nominal torque is equal to 100% that corresponds to motor base speed value 1500 rpm (par. 75.03).

Enable the Hoist speed optimization function and define its attributes as follows:

- 75.3 Motor base speed = 1500 rpm
- 75.7 Load 0 up = 60%
- 75.8 Load 0 speed up = 2000 rpm

## 118 Crane program features

- 75.9 Load 1 up = 70%
- 75.10 Load 1 speed up = 1800 rpm
- 75.11 Load 2 up = 80%
- 75.12 Load 2 speed up = 1700 rpm
- 75.13 Load 3 up = 90%
- 75.14 Load 3 speed up = 1600 rpm
- 75.15 Load 4 up = 100%
- 75.16 Load 4 speed up = 1500 rpm

You must set the parameters for the reverse direction in the same order. Otherwise, the function limits the speed to the motor base speed (par. 75.3 Motor base speed).

### ■ Load margin calculation

The Hoist speed optimization function applies a load margin (par. 75.4 Load margin) to the detected base speed torque (par. 75.3 Motor base speed).

The below formulas show how to calculate the load margin:

$$X(\%) = Y \cdot \frac{\text{Loadmargin}(\%)}{100}$$

$$Z = Y - X$$

where:

X = Torque or load offset

Y = Torque at base speed

Z = Base speed torque after the load margin has been deducted

You can use the value of Z with a set of torque (%) and speed (rpm) parameters to calculate the load speed limit in the forward and reverse directions.

See Operation chart (page 116).

### Example

In this example:

- 75.4 Load margin = 10%
- 1.10 Motor torque (monitored by the function during the base speed crossover) = 60%

The Hoist speed optimization function calculates the new maximum torque based on the load margin. See below calculations:

$$X(\%) = Y \cdot \frac{\text{Loadmargin}(\%)}{100}$$

$$Z = Y - X$$

---

$$X(\%) = 60\% \cdot \frac{10\%}{100} = 6\%$$

$$Z = 60\% - 6\% = 54\%$$

The function uses the torque value 54% instead of the actual torque value (60%).

**Note:** If you do not want the function to use the load margin (par. 75.4 Load margin), set the value to zero.

### ■ Auto calculation

The control program can automatically calculate the speed Vs torque curve with the data defined in the following parameters:

- 75.3 Motor base speed= 1500 rpm (corresponds to parameter 75.32 Hoist nominal speed)
- 75.27 Hoist efficiency up
- 75.28 Hoist efficiency down
- 75.29 Inertia up
- 75.30 Inertia down
- 75.31 Hoist nominal load
- 75.32 Hoist nominal speed
- 75.33 Hoist maximum speed
- 75.35 Motor Tmax/Tn

After settings these parameters, activate auto calculation with parameter 75.36 Calculate load curve= *Calculate*. The control program sets the load curve parameters for one time. After this operation, you can manually change the load curve parameters.

The auto calculated hoist load values are shown in parameters 75.40 Relative hoist load and 75.41 Absolute hoist load.

### **Note:**

- Auto calculation can be activated only when the drive is in standby state.
- If you changed acceleration/deceleration time after activating auto calculation, then you must again execute auto calculation.

You can also test the hoist speed optimization without running the motor. For more information, see section Hoist speed limit testing (page 121).

---

## ■ Efficiency and inertia calculation

When the efficiency and inertia values are not available, you can perform a trial run and determine required values using the following parameters:

- 75.3 Motor base speed
- 75.31 Hoist nominal load
- 75.32 Hoist nominal speed
- 75.33 Hoist maximum speed
- 75.35 Motor T<sub>max</sub>/T<sub>n</sub>

### Tuning efficiency value

1. Lift a known load with constant speed and adjust the value in parameter 75.27 Hoist efficiency up to the correct load value shown in signal 75.43 Absolute hoist load filtered. If value in signal 75.43 is
  - less than the weight of the known load, increase the value in parameter 75.27 Hoist efficiency up.
  - more than the weight of the known load, decrease value in parameter 75.27 Hoist efficiency up.
2. Reduce the known load with constant speed and adjust the value in parameter 75.28 Hoist efficiency down to the correct load value shown in signal 75.43 Absolute hoist load filtered. If value in signal 75.43 is
  - more than the weight of the known load, increase the value in parameter 75.28 Hoist efficiency down.
  - less than the weight of the known load, decrease value in parameter 75.28 Hoist efficiency down.

### Tuning inertia value

Inertia of the hoist system is calculated with an empty hook for lifting operation only. You can activate inertia calculation with parameter 75.45 Inertia calculation. Make sure that there is enough gap between the empty hook and the upper end limit so that inertia calculation can be performed at 80% of the maximum speed for 10 seconds. The drive runs the hoist system at different speed, torque and acceleration time to determine the inertia value.

**Note:** Inertia calculation works only on lifting operation.

To calculate the inertia, set the parameter 75.45 Inertia calculation = *At next start* and wait until the parameter selection changes (takes approximately nine seconds) to Done. To stop the calculation, you can manually set the parameter to Done.

Note

**Note:** If you stop the drive during calculation, the calculation starts from the beginning during the next start.

---



After calculation is completed, the values are sent to parameters 75.29 Inertia up and 75.30 Inertia down automatically. ABB recommends to perform the calculation at least more than two times to determine the average value.

### ■ Hoist speed limit testing

The hoist speed limit testing function enables to calculate the crane load speed limit without running the motor. The test values (torque %) can be set with parameter 75.5 Load speed limit test. The function performs an internal calculation and the parameter 9.5 Load speed limit displays the calculated value.

**Note:** Set positive value for the forward direction and a negative value for the reverse direction.

### ■ Settings and diagnostics

Parameters group: 75 Hoist speed optimization

Signals: 9.1 Crane SW1, 9.5 Load speed limit, 9.7 Load speed error status, 75.43 Absolute hoist load filtered

Events:

- Warnings: D203 Hoist speed up limit, D204 Hoist speed down limit
- Faults: D103 Hoist speed opt settings

## Smooth lifting

The Smooth lifting function can be used to decrease the mechanical stress in crane construction that occurs mainly during load lifting. The function monitors the load on the hoist after each lowering operation and ramps down the speed when a load is detected. After each triggering of the function, the load must be lowered for it to be ready for the next trigger. The function releases control only after the load is lifted. See the timing diagram below:

---

## 122 Crane program features

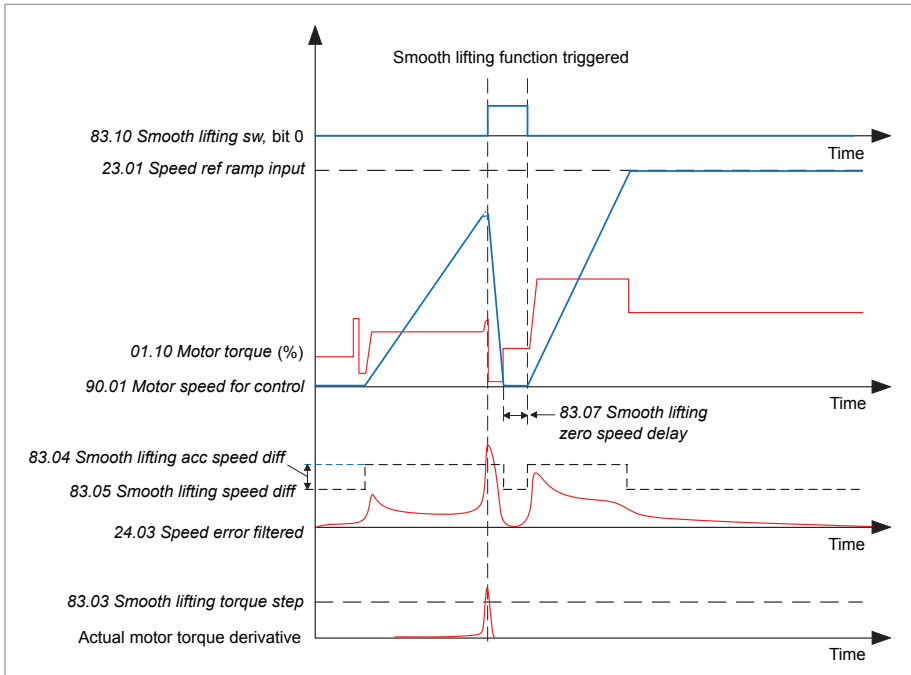

The function can be enabled with parameter 83.1 Smooth lifting and following characteristics can be configured:

- Sensitivity (parameters 83.3 Smooth lifting torque step, 83.4 Smooth lifting acc speed diff, 83.5 Smooth lifting speed diff)
- Triggering margins (parameters 83.2 Smooth lifting delay, 83.6 Smooth lifting torq lim, 83.7 Smooth lifting zero speed delay)
- Speed of reaction (parameter 83.8 Smooth lifting dec time multiplier)

### ■ Settings and diagnostics

Parameters group: 83 Smooth lifting

Signals: 83.10 Smooth lifting sw

Events: -

## Antisway

### ■ Antisway functional description

The Antisway function is designed for indoor cranes to prevent unnecessary swaying of the load. The function eliminates load sway by adjusting the operator given speed reference. It gives the crane operator a better control of the crane,

cutting the time movements by higher speed and shorter acceleration and deceleration times.

The function works without any additional antisway sensors (open-loop). The function needs to know the total pendulum arm length to define the time constant of swaying ( $\tau$ ) that can control trolley and long travel accelerations and decelerations. See the acceleration and deceleration movements in the figure below.

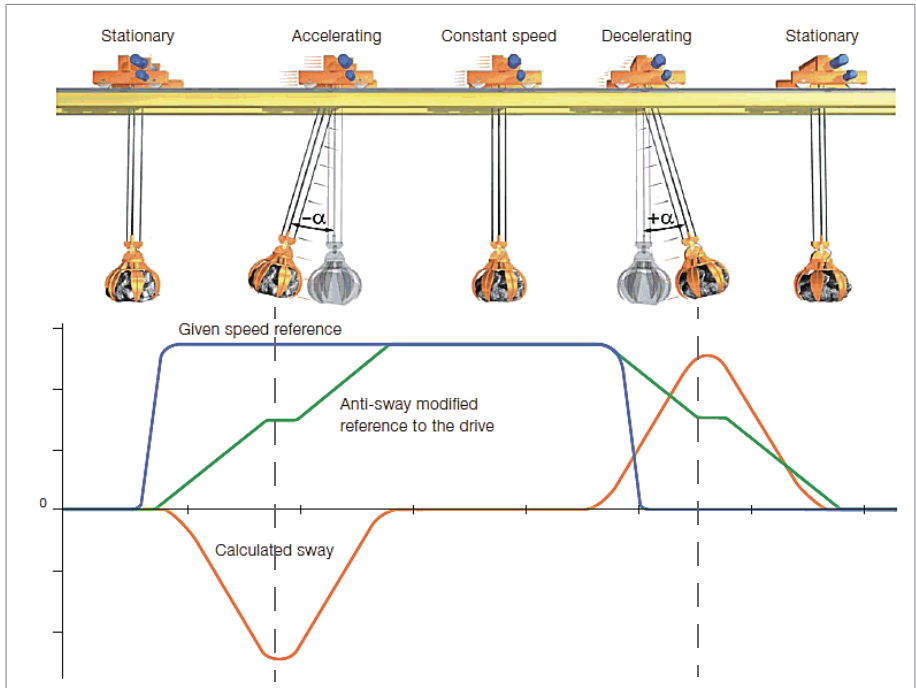

Total pendulum arm length is the sum of rope length and offset. See the below figure on page 124.

- **Rope length/hook position** is measured, calculated and transmitted either from a hoist drive or from a PLC.
- **Offset** or pendulum arm offset is the distance between hook and gravity point of the lifted object. It can vary for different load types. See Total pendulum arm length on page 124.

**Note:** The accuracy of antisway control is as good as the known real pendulum arm length.

### Total pendulum arm length

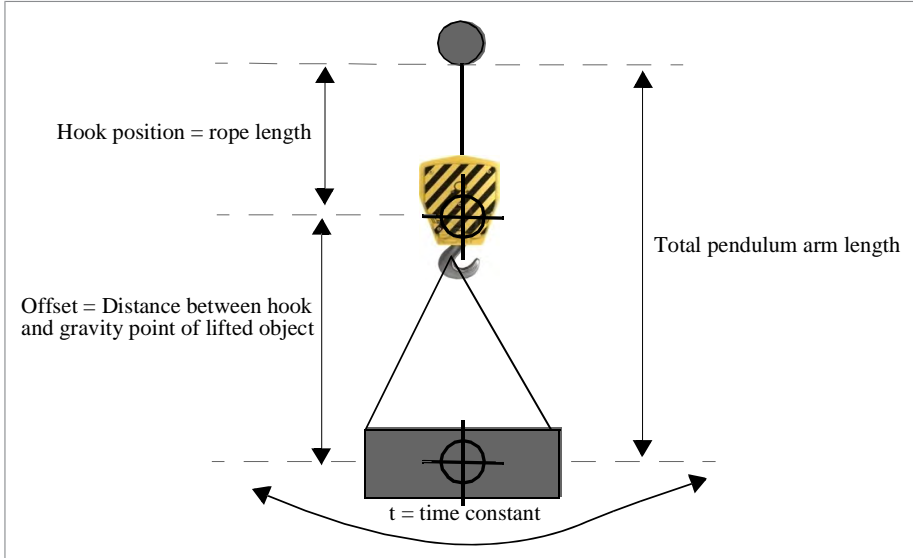

### Offset determination

Pendulum arm offset determination is needed if the shape of lifted load varies. The determination is based on one of the following methods. The final offset is added to the pendulum arm length (from the hoist drive) and this result is used by the antisway core.

**Step offset:** Uses the step logic and consists of three offset values that are selected by either digital inputs Dix, PTR, or hoist load. For more information, see [Step offset](#) (page 132).

**Linear offset:** Used when the weight of the lifted load (hoist load) correlates with the shape of lifted load. The values are set in this parameter combination: Min load-Min offset and Max load-Max offset. See [Linear offset/weight sensitive offset](#) (page 132).

**Direct offset:** The value comes directly from the fieldbus, analog inputs or PTR. See [Direct offset](#) (page 134).

**Auto offset:** Used when the load is every time lifted from the same floor level.

Offset = maximum length - actual hook position. See [Auto offset](#) (page 135).

**Note:** In some cases, a separate offset is not needed because the hook may consist of a fixed lifting device like the grab device (for waste handling) or a magnetic disc (for waste metal handling). These lifting devices are fixed permanently to the hook.

## External disturbances

Because there is no feedback signal for the real load sway, Antisway function cannot compensate the effect of external disturbances (see figure below) such as wind or undirect lifting, or wrong antisway settings configured during start-up.

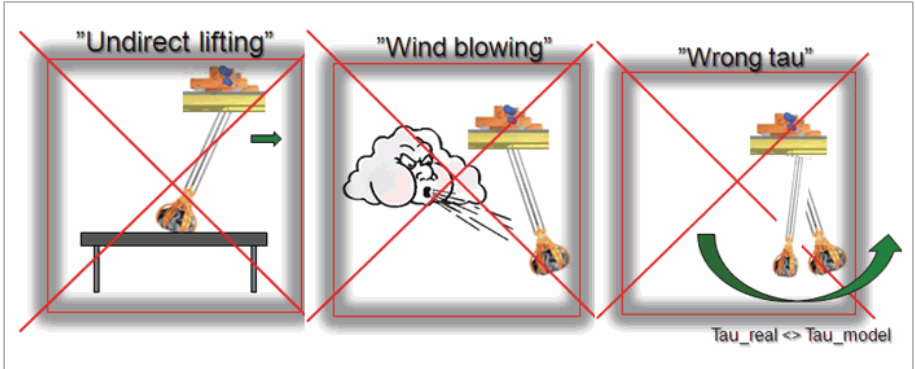

For successful operation, the function should have the following actual values from the hoist drive:

- **Load/torque.** If the hoist and antisway drives have D2D communication, then Antisway drives get load value from the hoist drive (torque/load). Load value is only needed if offset selection logic is based on lifted load. For example, higher load means bigger offset.
- **Hook position/rope length.** This is mandatory for the antisway. This value is available either through D2D link or PLC/fieldbus.

## ■ Antisway function block diagram

The main parts of the Antisway function are shown in the block diagram below.

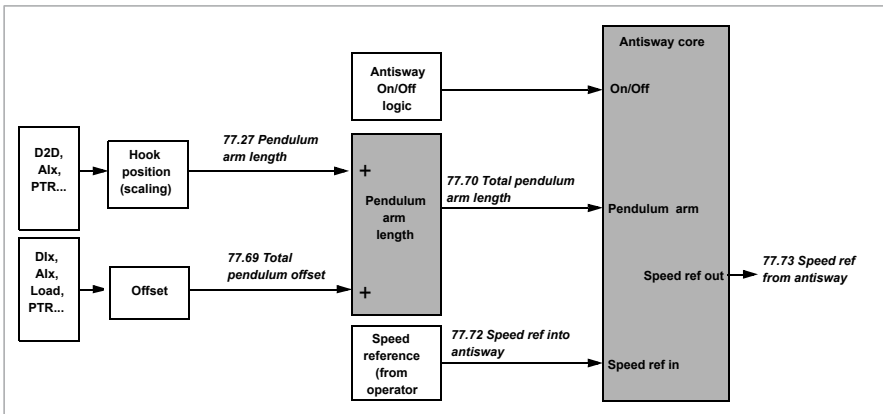

**Antisway On/Off** is activated with parameter 77.1 Antisway enable. When antisway is enabled, for example, with digital inputs DIx, then it is possible to switch Off/On antisway automatically if parameter 77.2 Enable auto on function is enabled with following parameters:

- minimum speed logic (parameter 77.5 Antisway enable minimum speed)
- pendulum arm minimum/maximum length (parameters 77.3 Auto on at maximum pendulum and 77.4 Auto on at minimum pendulum).

See also Automatic ON switching (page 127).

**Pendulum arm length** is the sum of hook position and offset. See Total pendulum arm length (page 124).

- The value of hook position is transferred from the hoist drive. The signal source for hoist position can be selected with parameter 77.20 Pendulum length source 1.
- Offset can be determined by step reference logic with actual hoist load (see parameters 77.33...77.54).
- Offset can also be automatically determined using the Auto offset mode (parameter 77.56). This method is used if the load is lifted up from the same floor level and when different load types and loading devices are used.

**Antisway core** modifies the speed reference ramp with the known pendulum arm length (parameters 77.72 and 77.73) to eliminate load swaying. You can check the status of the Antisway function in parameter 77.71 Antisway status.

## ■ Sway tracking

The Sway tracking function allows the drive to compensate the sway caused by movements before switching on the Antisway function.

The pendulum state calculation is activated whenever the speed reference changes. This allows the load swing compensation even if the Antisway function is enabled after the crane movement is already started.

- If sway tracking is enabled (parameter 77.7 Sway tracking enable) and the antisway function is disabled (parameters 77.1 Antisway enable and 77.2 Enable auto on function), the control program tracks the sway movement caused by the given speed reference.

**Note:** If Antisway function is enabled during acceleration, the control program compensates the existing (calculated) sway.

- If sway tracking is disabled (parameter 77.7) and the Antisway function is disabled (parameters 77.1 and 77.2), the control program does not track the sway movement. This gives the possibility for the crane operator during start (during hoisting) to compensate manually the initial sway before enabling the Antisway function.
-

You can check the status of the Sway tracking function in parameter 77.71 Antisway status, bit 2.

### ■ Automatic ON switching

Switching the Antisway function ON and OFF can be automated based on the hoist position for the following occurrences:

- speed reference is above the set minimum speed (parameter 77.5 Antisway enable minimum speed). This is useful when trolley or bridge need final positioning accuracy without antisway effects.
- pendulum arm length is between the set minimum and maximum length (parameters 77.3 Auto on at maximum pendulum and 77.4 Auto on at minimum pendulum)
- time has not elapsed for Antisway function to end calculations (parameter 77.11 Antisway timeout)

If it is frequently needed to correct the initial sway during hoisting of the load (example, trolley movement of waste-handling grab cranes), it is possible to define a certain lifting range where the Antisway function is always ON. Outside that range, it is always OFF. The AUTO ON function operates only when the Antisway function is switched ON and auto on function is enabled with parameter 77.2 Enable auto on function. If the Antisway function is disabled, then the AUTO ON function has no effect.

You can check the status of the auto ON for antisway function in parameter 77.71 Antisway status, bit 11, 13, 14 and 15.

**Note:** Sway tracking must be enabled whenever Automatic ON switching is activated.

### ■ Ramp times

The control program takes the ramp time based on the activation of Antisway function.

- If parameter 77.1 Antisway enable = *Enable*, ramp time is taken from parameter 77.8 Antisway ramp time.
- If parameter 77.1 Antisway enable = *Disable*, ramp time is taken from parameters 23.201 Crane acc time 1 and 23.204 Crane dec time 2.

In many cases, a higher acceleration rate can be utilized when driving the crane with the Antisway function.

### ■ Limit switches

The distance to stop the crane from full speed can be estimated using the following formula (units are SI units):

## 128 Crane program features

$$s = \frac{v}{4}(\tau + t_{acc}), t_{acc} = \text{deceleration time}$$

Here,

$\tau$   
is the longest possible pendulum time constant. It can be estimated from the hoisting height

$$\tau = 2\sqrt{h}$$

(approximation from

$$\tau = \sqrt{\frac{4h\pi^2}{g}}$$

, where

$g$   
= gravity and

$h$   
= length of pendulum arm)

### Example

The hoisting height is 16 m, crane full speed is 30 m/min (0.5 m/s), normal deceleration time for manual driving is 5 sec (parameter 23.202 Crane dec time 1). For a linear ramp (antisway OFF), the slowdown distance of the crane would be

$$s = \frac{1}{2}v \times t_{acc} = \frac{1}{2} \times 0,5 \frac{m}{s} \times 5_s = 1,25m$$

With Antisway function enabled the basic ramp time can be set shorter, for example 4 seconds (parameter 77.8 Antisway ramp time). In this case, the slowdown distance of the load is:

$$\tau = 2 \times \sqrt{16} = 8_s$$
$$s = \frac{0,5ms}{4} \times (8_s + 4_s) = 1,5m$$

**Note:** Stopping the load without antisway control (with linear ramp) in this example can cause overshoot of the load (swaying) which can make the real stopping distance of the load longer than the calculated distance (1.25 m).

With antisway (1.5 m), there is no overshoot problem and the load travels perpendicular to the trolley (because the load stops at equilibrium).

### ■ Antisway communication

Antisway communication can be used for delivering signals from the hoist drive to the Antisway function like hoist position and hoist torque. Antisway drives (trolley and long travel) form a chain. **D2D** communication must be used.

See Example 3: Parameter settings for antisway communication from hoist to main trolley (page 68).

---



## ■ Fieldbus communication

In case of fieldbus controlled antisway drive (trolley/long travel), to get a faster response to the start and stop commands, use parameter 20.216 Crane control word 1. Do the following parameter settings:

- 20.1 Ext1 commands = *In1 Start fwd; In2 Start rev*
- 20.3 Ext1 in1 source = Par. 20.216 Crane control word 1, bit 0
- 20.4 Ext1 in2 source = Par. 20.216 Crane control word 1, bit 1,

instead of fieldbus control word (20.1 Ext1 commands = *Fieldbus A*).

## ■ Antisway commissioning instructions

### Preparations

The general parameter settings for Antisway function are in group 77 Antisway. For best results it is essential to define the pendulum arm calculation parameters as accurately as possible. The mathematical length of pendulum arm can be different for bridge and trolley directions, so these settings should be done separately for both movements.

Before proceeding with parameter settings for Antisway function, the following checks are done:

Preliminary actions	
Trial run the crane drives (hoist, trolley and long travel) to confirm the crane works as planned without the Antisway function.	<input type="checkbox"/>
Check the position counter settings and function (rope length measurement) in the hoist drive or in an overriding system (PLC). The output of the position counter can be read in parameter 90.5 Load position scaled.	<input type="checkbox"/>
In the hoist drive, set parameter 90.5 Load position scaled into D2D-link communication with parameter 77.20 Pendulum length source 1 = par. 90.5 Load position scaled.	<input type="checkbox"/>
Build and configure Antisway communication between the drives according to the master/follower communication setup instructions. See Example 3: Parameter settings for antisway communication from hoist to main trolley.	<input type="checkbox"/>
Check that actual length in parameter 77.21 Active length from source follows the value sent by the hoist drive.	<input type="checkbox"/>
Check that actual load is as shown in parameter 77.31 Active load (when driving hoist up and down). The transmitted load value is set in the hoist drive with parameter 77.80 Load to antisway selection (Internal = 77.81 Hoist load from torque act, Other...(75.40 Relative hoist load, but in this case hoist speed optimization needs real crane data)	<input type="checkbox"/>

### Measuring and calculating a real pendulum arm with an empty hook

When measuring and calculating the real pendulum arm length, note that the real pendulum arm length is not same as the rope length/hook position. The following procedure sets the two values (rope length/hook position and real pendulum arm length) to coincide with each other.

**Note:** This operation is done with an empty hook and Antisway function disabled.

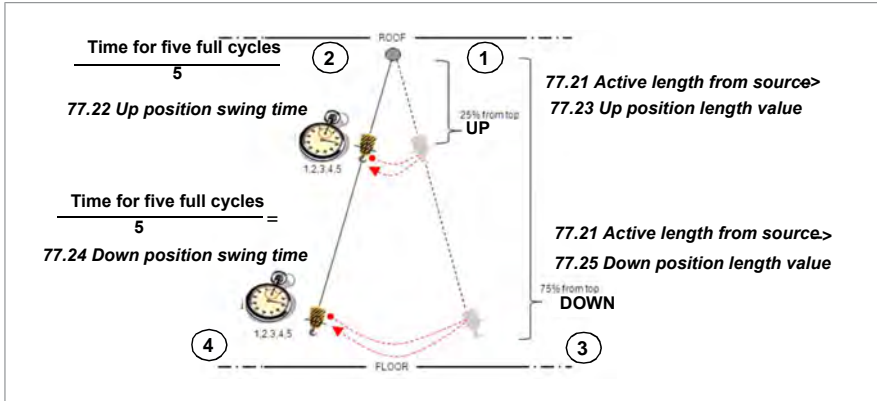

#### Hook in UP position

Step	Action
1	Set parameter 77.1 Antisway enable = <i>Disable</i> . The mathematical length of pendulum arm can be different for bridge and trolley directions, so these settings must be done for both movements. See the above picture.
2	Move the hook to UP position, for example, 25% from top position (UP).
3	In the trolley drive, read the signal in parameter 77.21 Active length from source and enter it to parameter 77.23 Up position length value. See (1) in above figure.
4	In the trolley drive, initiate load swing, for example, stop the trolley using emergency stop.
5	Measure the time for five full oscillations. Divide the measured time by the number of full oscillations (5). Set the calculated time in the parameter 77.22 Up position swing time. See (2) in above figure.
6	While the hook is in the same UP position, repeat steps 3 to 5 with the long travel drive.

Hook in DOWN position

Step	Action
1	Make sure that parameter 77.1 Antisway enable = <i>Disable</i> . The mathematical length of pendulum arm can be different for bridge and trolley directions, so these settings must be done for both movements. See the above picture.
2	Lower the hook to DOWN to the floor level, for example, 75% from top position (UP).
3	In the trolley drive, read the signal in parameter 77.21 Active length from source and enter it to parameter 77.25 Down position length value. See (3) in above figure.
4	In the trolley drive, initiate load swing, for example, stop the trolley by using emergency stop/fast stop.
5	Measure the time for five full oscillations. Divide the measured time by the number of full oscillations (5). Set the calculated time in the parameter 77.24 Down position swing time. See (4) in above figure.
6	While the hook is in the same DOWN position, repeat steps 3 to 5 with the long travel drive.

Test with an empty hook

Step	Action
1	Set parameters 77.1 Antisway enable = <i>Enable</i> and 77.2 Enable auto on function = <i>Disable</i>
2	Execute the test with an empty hook. Test the trolley and long travel movements.
3	If swinging still exists, switch OFF antisway temporarily and swing the hook. Now measure/calculate the time for full cycle time and calculate the real pendulum length using the below formula. Compare the results with parameter 77.27 Pendulum arm length. $\text{Pendulum arm length} = 0.25 \times \text{One full cycle time}^2 = \frac{1}{4}T^2$
4	If the values are different, make sure the values are correct in parameters 77.22...77.25 and the actual position shown in parameter 77.21 Active length from source is updated from the hoist drive or from the PLC.

**Determining pendulum arm offset**

The pendulum arm offset is determined using one of the following methods.

- Step offset (page 132)
  - Linear offset/weight sensitive offset (page 132)
  - Direct offset (page 134)
  - Auto offset (page 135)
-

The final offset is added to the pendulum arm length (from the hoist drive) and this result is used by the antisway core. For more information, see Total pendulum arm length (page 124).

**Step offset**

When the lifted load varies in shape, size and weight, the step offset method can be used. The control can be taken from Load or from digital I/O (example, crane operator or PLC). The load step is selected with parameter selection is made with parameters 77.36...77.38. The figure below illustrates the load based offset control.

*Offset steps controlled by the actual load of the hoist*

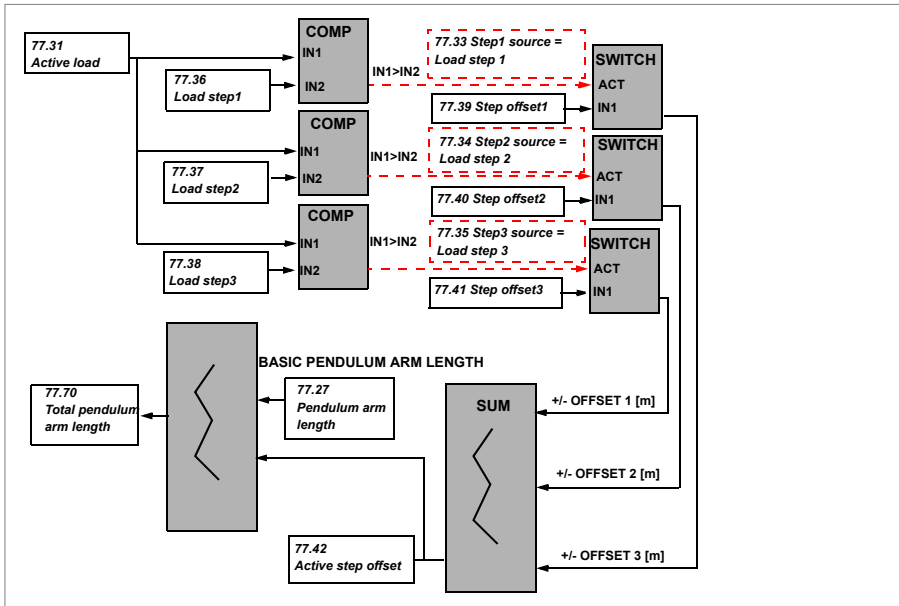

**Linear offset/weight sensitive offset**

The below procedure describes the configurations when offset is directly proportional (linear) to the weight of the lifted load. See Example: Linear load configuration (page 134) and Linear load curve (page 134).

Step	Action
1	Read the empty hook or the lowest possible load from parameter 77.31 Active load (when moving UP).
2	Enter the value into parameter 77.52 Load min. Above this load, the linear effect to pendulum arm is calculated.

Step	Action
3	<p>Measure the pendulum time and calculate the corresponding total pendulum arm length  <math>(\frac{\text{five full cycles}}{5} = \tau[s], \text{length}[m] = 0.25 \times \tau)m</math></p> <p>Make sure that Antisway function is disabled.</p>
4	<p>Calculate the difference between the result of step 3 and value in parameter 77.27 Pendulum arm length. Set this value into parameter 77.50 Load offset min.</p>
5	<p>Connect the highest possible load to the hook and read the load value from parameter 77.31 Active load (when moving UP).</p>
6	<p>Enter the value read in step 5 into parameter 77.53 Load max.</p>
7	<p>Measure the pendulum time and calculate the corresponding total pendulum arm length  <math>(\frac{\text{five full cycles}}{5} = \tau[s], \text{length}[m] = 0.25 \times \tau)m</math></p> <p>Make sure that Antisway function is disabled.</p>
8	<p>Calculate the difference between the result of step 7 and value in parameter 77.27 Pendulum arm length. Set this value into parameter 77.51 Load offset max.</p>
9	<p>Trial run with different load. If swaying still exist, then calculate the real pendulum arm length and compare with value in parameter 77.70 Total pendulum arm length and tune points of linear offset.</p>

**Note:** The accuracy remains same for any measurement unit other than millimeters, for example, centimeters.

*Example: Linear load configuration*

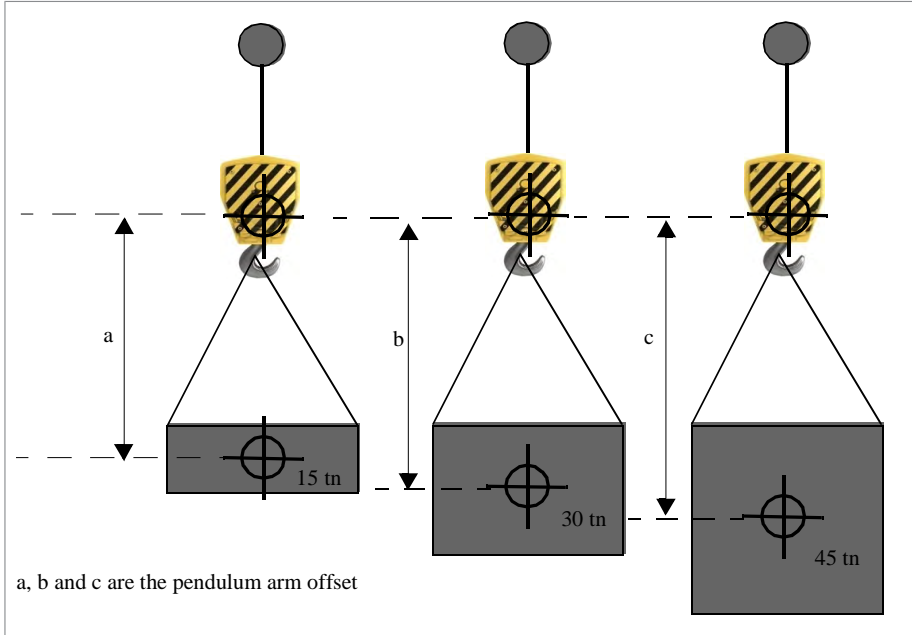

*Linear load curve*

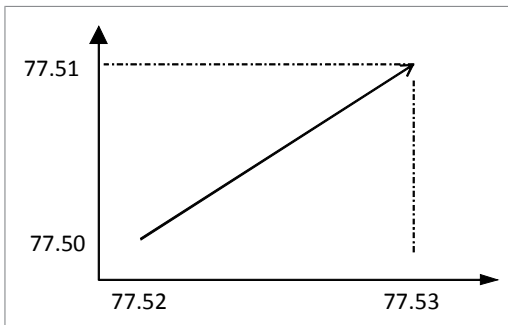

*Direct offset*

When the pendulum arm offset is determined in a PLC program the value of the offset can be directly written into the antisway drive. The value can be first written into, for example, parameter 47.21 DataStorage 1 int16 and picked up using pointer selection in parameter 77.65 Direct offset source (=Parameter 47.21).

The source for direct offset can also be from analog inputs AI.

### Auto offset

The Auto offset mode (parameter 77.56 Auto offset enable) can be used only when the load is always lifted up from the same (approximately) floor level and it is especially useful when several different load types and loading devices (lifting straps) are in use.

In Auto offset mode, parameter 77.56 Auto offset enable is considered as full pendulum arm length, meaning the load is just/almost touching the floor level.

The below procedure describes the configurations to use in the Auto offset mode.

Step	Action
1	Measure and calculate the real pendulum arm length with an empty hook. See page 130.
2	Pick-up the lightest load to be lifted during normal operation.
3	Enter a suitable load value between the empty condition (point 1) and small load condition into parameter 77.58 Load minimum in auto mode (this is the decision level between a load and no-load condition).
4	Put the empty hook swaying when close to the floor level and calculate the pendulum arm. Enter the result into parameter 77.57 Full pendulum arm. Five cycles/5 = ___ s, length = $0.25 \times \tau =$ ___ m
5	Put the load on the floor and lift it up and measure/calculate again. Compare that value to the actual calculated pendulum arm in the signal 77.70 Total pendulum arm length. If the values differ from each other considerably, change the setting of the parameter 77.57 Full pendulum arm respectively and repeat the measurement. The actual signal 77.60 Active auto offset shows the active offset.

### Lifting different kind of objects from the same level

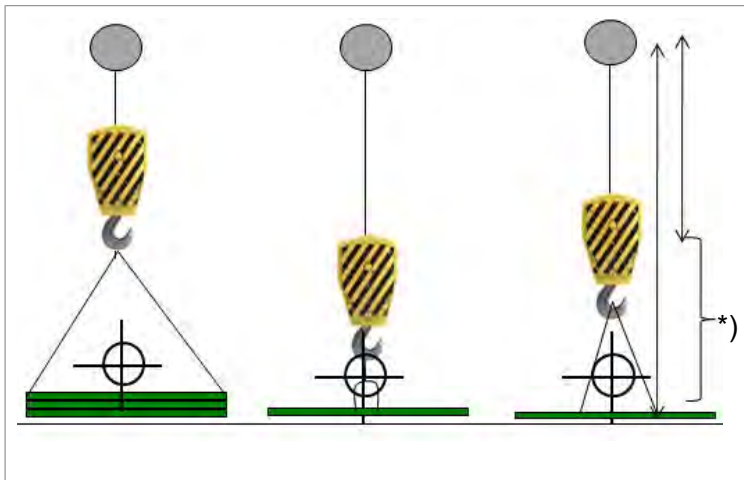

\*) New offset is calculated every time the load is lifted from the floor. Eg. Offset = Parameter 77.57 Full pendulum arm - hook position Parameter 77.60 Active auto offset = 77.57 Full pendulum arm - 77.27 Pendulum arm length

## Power on acknowledgment

### ■ Function description

The Power on acknowledgment function checks that the main power is connected and the drive is ready for operation. You can use this function, for example, to automatically reset faults that are generated when the drive is in standby.

The control board (BCU-xx or ZCU-xx) consists of an external +24 V power supply that can be selected with parameter 95.4 Control board supply.

The source to Power on acknowledgment signal (par. 20.212) can be from either of the following sources:

- typically from the auxiliary contact of the main contactor. By default, the signal is connected to the DIIL input of the drive control unit. This is the default connection.
- from the Safe torque off (STO), parameter 6.18 Start inhibit status word, bit 7 inverted.

If the drive trips on a fault, and the Power on acknowledgment signal is activated (a rising edge), the drive generates an internal fault reset after a time delay (20.213).

Meanwhile the Power on acknowledgment circuit is open (par. 20.212 = False) and the drive shows the warning D20B Power on acknowledge.

### ■ Timing diagram

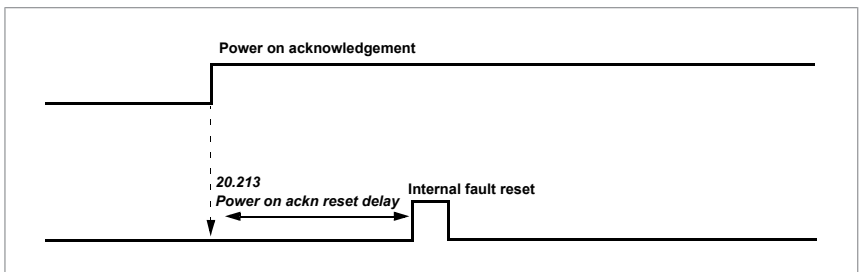



**Note:** The same input [DIIL or STO status (P.6.18.7)] for Power on acknowledge (par. 20.212) is also used for RUN ENABLE (par. 20.12 Run enable 1 source).

### ■ Wiring example

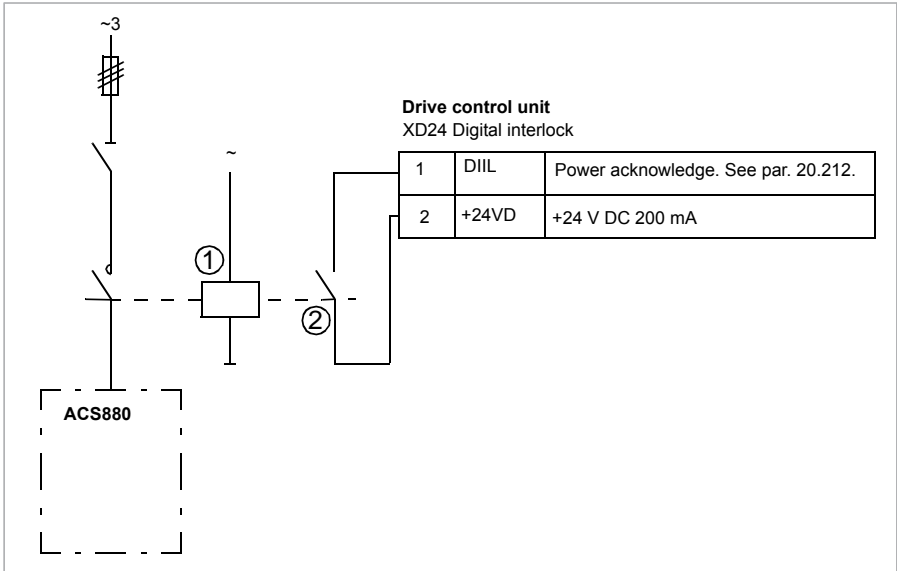

1. Main contactor
2. Auxiliary contact

**Note:** By default, the input DIIL is also used in par. 20.12 Run enable 1 source.

### ■ Settings and diagnostics

Parameters group: 20.212 Power on acknowledge, 20.213 Power on ackn reset delay

Signals: 9.1 Crane SW1

Events:

- Warnings: D20B Power on acknowledge

## Crane warning masking

The Crane warning masking function masks the predefined crane control warnings. The warnings are defined with the two 16-bit word parameters 31.40 Disable warning messages and 31.205 Crane warning masking. Each bit corresponds to a warning. The table below lists the warnings and describes the bit conditions for masking a warning.

Bit	Parameter 31.40 Disable warning messages 0 = corresponding warning appears in the event logger or control panel. 1 = corresponding warning is masked. The warning can be read only from parameters 30.2 Torque limit status and 6.19 Speed control status word	Parameter 31.205 Crane warning masking 0 = corresponding warning is masked. The warning can be read only from parameters 9.1 Crane SW1 and 9.2 Crane SW2. 1 = corresponding warning appears in the event logger or control panel.
0	Overvoltage (A3A1 DC link overvoltage)	D200 Brake slip at standstill
1	-	D201 Slowdown 1, D202 Slowdown 2
2	Encoder 1 error (A7E1 Encoder)	D20C Slowdown safe zone
3	Encoder 2 error (A7E1 Encoder)	D203 Hoist speed up limit, D204 Hoist speed down limit
4	-	D205 End limit 1, D206 End limit 2
5	-	D20D External speed limit
6	-	D208 Joystick reference check
7	-	D209 Joystick zero position
8	-	D20B Power on acknowledge
9	-	D217 Slack rope
10	-	D20A Fast stop
11	-	D221 Follower 1 Faulted, D222 Follower 2 Faulted, D223 Follower 3 Faulted, D224 Follower 4 Faulted

■ **Settings and diagnostics**

Parameters: 31.40 Disable warning messages, 31.205 Crane warning masking

Signals: 6.19 Speed control status word, 9.1 Crane SW1, 9.2 Crane SW2, 30.2 Torque limit status

Events: -

**Toggle bit**

■ **Function description**

The Toggle bit function can be used as an additional communication supervision between the overriding system, e.g. a PLC and the drive. The function can be activated with parameter 31.211 Toggle bit enable. The value of parameter 31.215 Toggle bit statusword, bit 0 is transferred into the overriding system through fieldbus. Once the return bit (from the input defined with 31.214 Toggle bit source)

is equal to the value of parameter 31.215 Toggle bit statusword, bit 0, the value of the latter is inverted and the timer is reset. In the event of a communication loss, the return bit is not updated during the defined delay and the function triggers a warning/fault. See the below timing diagram.

■ **Function block diagram**

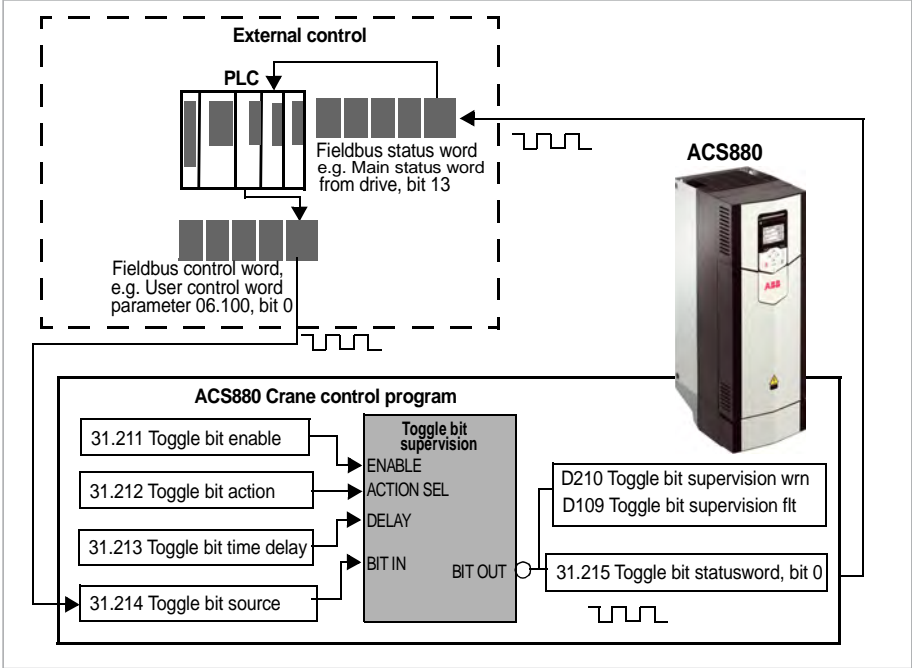

**Note:** External control is intended to work like a repeater and **does not modify the signal in any way.**

■ **Timing diagram**

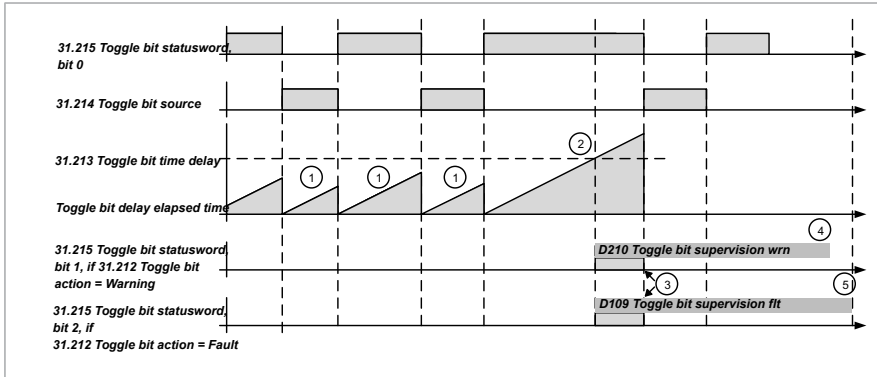

- As soon as the input configured by 31.214 Toggle bit source = 31.215 Toggle bit statusword, the value of the latter is inverted and the toggle bit timer is reset.
- If in the time defined with 31.213 Toggle bit time delay, the return bit (31.214 Toggle bit source) is not equal to the output toggle bit (31.215 Toggle bit statusword), then the drive generates a warning or a fault depending on the setting in 31.212 Toggle bit action.
- Internal warning/fault flags are reset once the return bit is equal to the output toggle bit.
- Warning D210 Toggle bit supervision wrn is active according to firmware instruction.
- Fault D109 Toggle bit supervision flt remains active until a reset command is received.

■ **Example of Toggle bit function setup**

The example below shows the parameter settings to configure the toggle bit function. The software in the overriding system, such as the PLC, receives the bit from the drive in data in1 (Main status word containing the toggle bit output) and redirects the bit without any modifications back to the drive over fieldbus (in this example, PLC uses data out 6 to send the return bit).

Step	Parameter	Value	Remarks
1	Set the Toggle bit main settings		
	31.212 Toggle bit action	Enable	-
	31.212 Toggle bit action	Fault	-
	31.213 Toggle bit time delay	500 ms	Depends on communication speed and software in the overriding system.
	31.214 Toggle bit source	P.47.21.0	P.6.100.0 User control word 1 can also be used.
2	Set bit 13 of the Main status word to transmit the Toggle bit out bit		
	6.32 MSW bit 13 sel	P.31.215.0	The toggle bit output bit is added to the main status word.
3	Set the overriding system to receive the status word containing the Toggle bit output bit as data in1.		
	52.01 FBA A data in1	SW 16bit	-
4	Set data storage parameter 47.21 to receive the Toggle bit return bit redirected from the overriding system.		
	53.06 FBA data out 6	P.47.21[16]	P.6.100.0 User control word 1 can also be used.

## ■ Settings and diagnostics

Parameters: 31.211 Toggle bit enable, 31.212 Toggle bit action, 31.213 Toggle bit time delay, 31.214 Toggle bit source.

Signals: 31.215 Toggle bit statusword

Events:

- Warnings: D210 Toggle bit supervision wrn
- Faults: D109 Toggle bit supervision flt

## Maintenance counters

In addition to the Supervision function (group 32 Supervision), the crane control program contains the following three maintenance counters.

The values of these maintenance counters can be set/reset after some maintenance actions or drive unit replacements. All these counters have warning limits. Parameter 9.2 Crane SW2 shows the actual status of these counter.

Counters	Description
<i>Crane operating hours counter</i>	This counter supervises the crane operating hours, for example, number of hours the hoist was running with open brake.
<i>Brake operated counts</i>	This counter supervises the number of times mechanical brake was opened.
<i>Number of power on counts.</i>	This counter supervises the number of times the main power was connected to the drive. It counts the number of power acknowledgments (parameter 20.212 Power on acknowledge). See also Power on acknowledgment (page 136).

■ **Settings and diagnostics**

Parameters:

- **Crane operating hours counter:** 9.20 Crane operation hours, 33.200 Set crane operation hours, 33.201 Crane operation hrs init value, and 33.202 Crane operation hrs warning limit.
- **Brake operated counts:** 9.21 Brake operated counts, 33.210 Set brake oper counts, 33.211 Brake oper counts init value, and 33.212 Brake oper counts warning limit.
- **Number of power on counts:** 9.22 Number of pwr on, 33.220 Set number of power on, 33.221 Number of pwr on init value, and 33.222 Number of pwr on warning limit.

Signals: 9.2 Crane SW2

Events:

- **Warnings:** D212 Crane operating hours, D213 Brake oper counts, D214 Number of power on
- **Faults:** -



# Using the control panel

---

Refer to *ACS-AP-I, -S, -W and ACH-AP-H, -W Assistant control panels user's manual* ([3AUA0000085685](#) [English]).





## 5

# Control locations and operating modes

## What this chapter contains

This chapter describes the control locations and operating modes supported by the control program.

## Local control vs. external control

The ACS880 has two main control locations: external and local. The control location is selected with the Loc/Rem key on the control panel or in the PC tool.

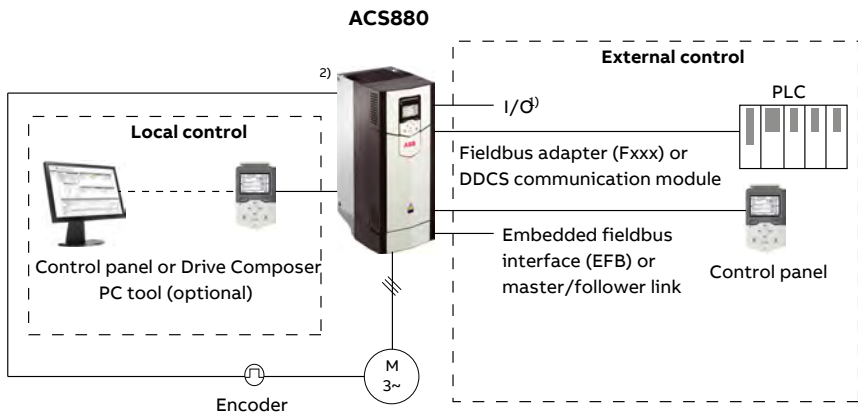

- 1) Extra inputs/outputs can be added by installing optional I/O extension modules (FIO-xx) in drive slots.
- 2) Encoder or resolver interface module(s) (FEN-xx) installed in drive slots.

### ■ Local control

The control commands are given from the control panel keypad or from a PC equipped with Drive Composer when the drive is set to local control. Speed and torque control modes are available for local control; frequency mode is available when scalar motor control mode is used (see parameter 19.16).

Local control is mainly used during commissioning and maintenance. The control panel always overrides the external control signal sources when used in local control. Changing the control location to local can be prevented by parameter 19.17.

The user can select by a parameter (49.5) how the drive reacts to a control panel or PC tool communication break. (The parameter has no effect in external control.)

---

## ■ External control

When the drive is in external control, control commands are given through

- the I/O terminals (digital and analog inputs), or optional I/O extension modules
- the embedded fieldbus interface or an optional fieldbus adapter module
- the external (DDCS) controller interface
- the master/follower link, and/or
- the control panel.

Two external control locations, EXT1 and EXT2, are available. The user can select the sources of the start and stop commands separately for each location by parameters 20.1...20.10. The operating mode can be selected separately for each location (in parameter group 19) which enables quick switching between different operating modes, for example speed and torque control. Selection between EXT1 and EXT2 is done via any binary source such as a digital input or fieldbus control word (see parameter 19.11). The source of reference is selectable for each operating mode separately.

The control location selection is checked on a 2 ms time level.

### Using the control panel as an external control source

The control panel can also be used as a source of start/stop commands and/or reference in external control. Selections for the control panel are available in the start/stop command source and reference source selection parameters.

Reference source selection parameters (except PID setpoint selectors) have two selections for the control panel. The difference between the two selections is in the initial reference value after the reference source switches to the control panel.

The panel reference is saved whenever another reference source is selected. If the reference source selection parameter is set to Control panel (ref saved), the saved value is used as the initial reference when control switches back to the panel. Note that only one type of reference can be saved at a time: for example, attempting to use the same saved reference with different operating modes (speed, torque, etc.) causes the drive to trip on 7083. The panel reference can be separately limited by parameters in group 49.

With the reference source selection parameter set to Control panel (ref copied), the initial panel reference value depends on whether the operating mode changes with the reference source. If the source switches to the panel and the operating mode does not change, the last reference from the previous source is adopted. If the operating mode changes, the drive actual value corresponding to the new mode is adopted as the initial value.

## Operating modes of the drive

The drive can operate in several operating modes with different types of reference. The mode is selectable for each control location (Local, EXT1 and EXT2) in parameter group 19.

The following is a general representation of the reference types and control chains.

For detailed diagrams, see chapter [Control chain diagrams](#).

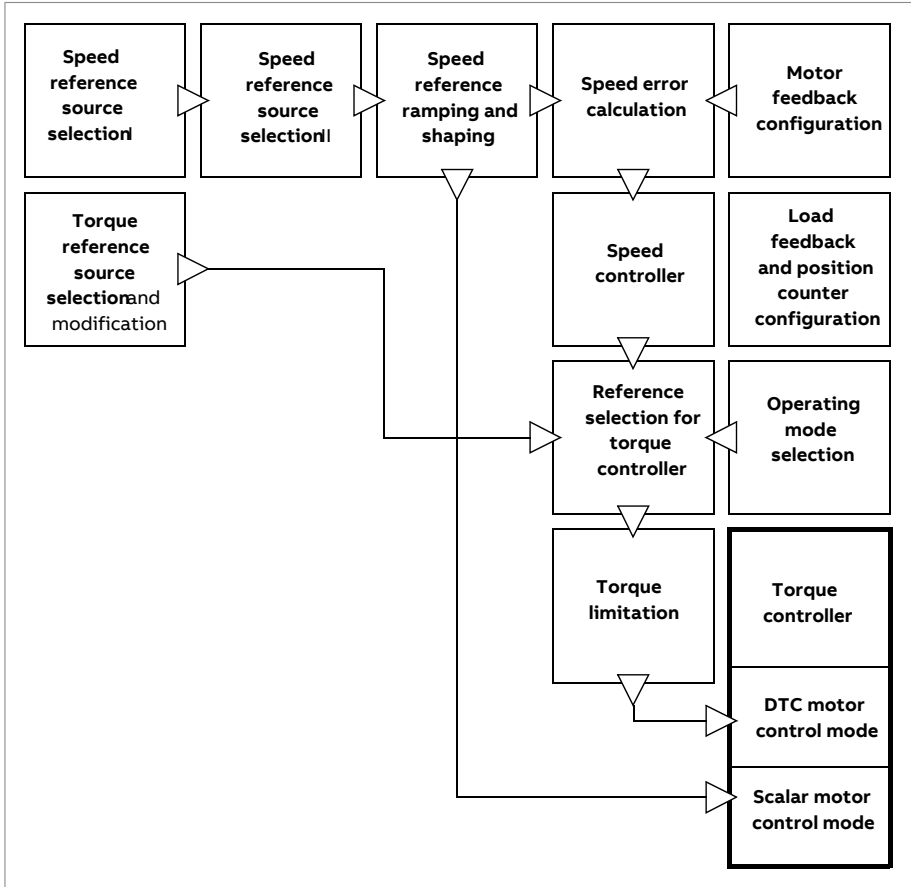

### ■ Speed control mode

The motor follows a speed reference given to the drive. This mode can be used either with estimated speed as feedback, or with an encoder or resolver for better speed control accuracy.

Speed control mode is available in both local and external control. It is also available both in DTC (Direct Torque Control) and scalar motor control modes.

■ **Torque control mode**

Motor torque follows a torque reference given to the drive. Torque control is possible without feedback, but is much more dynamic and accurate when used in conjunction with a feedback device such as an encoder or a resolver. It is recommended that a feedback device is used in crane, winch or lift control situations.

Torque control mode is available in DTC motor control mode for both local and external control locations.



6

# Program features

---

## What this chapter contains

The control program contains all of the parameters including actual signals. This chapter describes some of the more important functions of the control program, how to use them and how to program them to operate.

---

**WARNING!**

Make sure that the machinery into which the drive is integrated fulfils the personnel safety regulations. Note that the frequency converter (a Complete Drive Module or a Basic Drive Module, as defined in IEC 61800-2), is not considered as a safety device mentioned in the European Machinery Directive and related harmonized standards. Thus, the personnel safety of the complete machinery must not be based on a specific frequency converter feature, but it has to be implemented as defined in the application specific regulations.

---

## Drive configuration and programming

The drive control program is divided into two parts:

- firmware program
  - application program
-

**Crane control program**

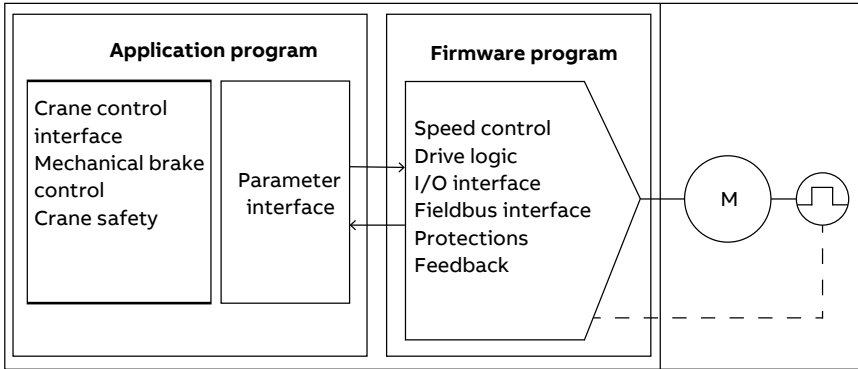

The firmware program performs the main control functions, including speed and torque control, drive logic (start/stop), I/O, feedback, communication and protection functions. Firmware functions are configured and programmed with parameters, and can be extended by application programming.

■ **Programming via parameters**

Parameters configure all of the standard drive operations and can be set through

- the control panel, as described in chapter [Using the control panel](#)
- the Drive Composer PC tool, as described in *Drive Composer start-up and maintenance PC tool user's manual* (3AUA0000094606 [English]), or
- the fieldbus interface, as described in chapters [Fieldbus control through the embedded fieldbus interface \(EFB\)](#) and [Fieldbus control through a fieldbus adapter](#).

All parameter settings are stored automatically to the permanent memory of the drive. However, if an external +24 V DC power supply is used for the drive control unit, it is highly recommended to force a save by using parameter 96.7 before powering down the control unit after any parameter changes have been made.

If necessary, the default parameter values can be restored by parameter 96.6.

■ **Adaptive programming**

Conventionally, the user can control the operation of the drive by parameters. However, the standard parameters have a fixed set of choices or a setting range. To further customize the operation of the drive, an adaptive program can be constructed out of a set of function blocks.

The Drive composer PC tool has an Adaptive programming feature with a graphical user interface for building the custom program. The function blocks include the



usual arithmetic and logical functions, as well as eg. selection, comparison and timer blocks. The program can contain a maximum of 30 blocks. The adaptive program is executed on a 10 ms time level.

For selecting input to the program, the user interface has pre-selections for the physical inputs, common actual values, and other status information of the drive. Parameter values as well as constants can also be defined as inputs. The output of the program can be used eg. as a start signal, external event or reference, or connected to the drive outputs. Note that connecting the output of the adaptive program to a selection parameter will write-protect the parameter.

The status of the adaptive program is shown by parameter 7.30. The adaptive program can be disabled by 96.70.

**Note:** Sequential programming is not supported.

For more information, see the *Adaptive programming application guide* (3AXD50000028574 [English]).

### Inputs available to the adaptive program

Input	Source
<b>I/O</b>	
DI1	10.2 DI delayed status, bit 0
DI2	10.2 DI delayed status, bit 1
DI3	10.2 DI delayed status, bit 2
DI4	10.2 DI delayed status, bit 3
DI5	10.2 DI delayed status, bit 4
DI6	10.2 DI delayed status, bit 5
DIIL	10.2 DI delayed status, bit 15
AI1	12.11 AI1 actual value
AI2	12.21 AI2 actual value
DIO1	11.2 DIO delayed status, bit 0
DIO2	11.2 DIO delayed status, bit 1
<b>Actual signals</b>	
Motor speed	1.1 Motor speed used
Output frequency	1.6 Output frequency
Motor current	1.7 Motor current
Motor torque	1.10 Motor torque

## 154 Program features

<b>Input</b>	<b>Source</b>
Motor shaft power	1.17 Motor shaft power
<b>Status</b>	
Enabled	6.16 Drive status word 1, bit 0
Inhibited	6.16 Drive status word 1, bit 1
Ready to start	6.16 Drive status word 1, bit 3
Tripped	6.11 Main status word, bit 3
At setpoint	6.11 Main status word, bit 8
Limiting	6.16 Drive status word 1, bit 7
Ext1 active	6.16 Drive status word 1, bit 10
Ext2 active	6.16 Drive status word 1, bit 11
<b>Data storage</b>	
Data storage 1 real32	47.1 DataStorage 1 real32
Data storage 2 real32	47.12 DataStorage 2 int32
Data storage 3 real32	47.13 DataStorage 3 int32
Data storage 4 real32	47.14 DataStorage 4 int32
Data storage 5 real32	47.15 DataStorage 5 int32
Data storage 6 real32	47.16 DataStorage 6 int32
Data storage 7 real32	47.7 DataStorage 7 real32
Data storage 8 real32	47.8 DataStorage 8 real32

### Outputs available to the adaptive program

<b>Output</b>	<b>Target</b>
<b>I/O</b>	
RO3	10.30 RO3 source
AO1	13.12 AO1 source
AO2	13.22 AO2 source
DIO1	11.6 DIO1 output source
DIO2	11.10 DIO2 output source
<b>Start control</b>	
Ext1/Ext2 selection	19.11 Ext1/Ext2 selection

<b>Output</b>	<b>Target</b>
Ext1 in1 cmd	20.3 Ext1 in1 source
Ext1 in2 cmd	20.4 Ext1 in2 source
Ext1 in3 cmd	20.5 Ext1 in3 source
Ext2 in1 cmd	20.8 Ext2 in1 source
Ext2 in2 cmd	20.9 Ext2 in2 source
Ext2 in3 cmd	20.10 Ext2 in3 source
Fault reset	30.1 Limit word 1
<b>Speed control</b>	
Speed ref1	22.11 Speed ref1 source
Speed ref2	22.12 Speed ref2 source
Speed additive 1	22.15 Speed additive 1 source
Speed controller proportional gain	25.2 Speed proportional gain
Speed controller integration time	25.3 Speed integration time
<b>Limit function</b>	
Minimum torque 2	30.21 Minimum torque 2 source
Maximum torque 2	30.24 Maximum torque 2
<b>Events</b>	
External event 1	31.1 External event 1 source
External event 2	31.3 External event 2 source
External event 3	31.5 External event 3 source
External event 4	31.7 External event 4 source
External event 5	31.9 External event 5 source
<b>Data storage</b>	
Data storage 1 real 32	47.1 DataStorage 1 real32
...	...
Data storage 8 real 32	47.8 DataStorage 8 real32

### Settings and diagnostics

Parameters: 7.30 Adaptive program status (page 259) and 96.70 Disable adaptive program (page 656).

Events: 64A6 Adaptive program (page 693).

### ■ Application programming

The crane application program is based on the IEC 61131-3 standard. The program is an in-house application and is locked to the user to avoid any changes to the program.

## Control interfaces

### ■ Programmable analog inputs

The control unit has two programmable analog inputs. Each of the inputs can be independently set as a voltage (0/2...10 V or -10...10 V) or current (0/4...20 mA) input by a jumper or switch on the control unit. Each input can be filtered, inverted and scaled. The analog inputs on the control unit are read on a 0.5 ms time level.

The number of analog inputs can be increased by installing FIO-11 or FAIO-01 I/O extensions (see *Programmable I/O extensions* below). The analog inputs on extension modules are read on a 2 ms time level.

The drive can be set to perform an action (for example, to generate a warning or fault) if the value of an analog input moves out of a predefined range.

### Settings and diagnostics

Parameter group: 12 Standard AI (page 282).

Events: 80A0 AI Supervision (page 700) and A8A0 AI Supervised Warning (page 718).

### ■ Programmable analog outputs

The control unit has two current (0...20 mA) analog outputs. Each output can be filtered, inverted and scaled. The analog outputs on the control unit are updated on a 0.5 ms time level.

The number of analog outputs can be increased by installing FIO-11 or FAIO-01 I/O extensions (see *Programmable I/O extensions* below). The analog outputs on extension modules are updated on a 2 ms time level.

### Settings and diagnostics

Parameter group: 13 Standard AO (page 288).

### ■ Programmable digital inputs and outputs

The control unit has six digital inputs, a digital start interlock input, and two digital input/outputs (I/O that can be set as either an input or an output). The digital inputs on the control unit are read on a 0.5 ms time level.

---

One digital input (DI6) doubles as a PTC thermistor input. See section [Motor thermal protection](#) (page 199).

Digital input/output DIO1 can be used as a frequency input, DIO2 as a frequency output.

The number of digital inputs/outputs can be increased by installing FIO-01, FIO-11 or FDIO-01 I/O extensions (see [Programmable I/O extensions](#) below). The digital inputs on extension modules are read on a 2 ms time level.

### Settings and diagnostics

Parameter groups: 10 Standard DI, RO (page 269) and 11 Standard DIO, FI, FO (page 276).

#### ■ Programmable relay outputs

The control unit has three relay outputs. The signal to be indicated by the outputs can be selected by parameters. The relay outputs on the control unit are updated on a 0.5 ms time level.

Relay outputs can be added by installing FIO-01 or FDIO-01 I/O extensions. The relay outputs on extension modules are updated on a 2 ms time level.

#### Note:

- By default, relay output RO1 is used for the brake control command (10.24 RO1 source = 44.210, b0). The default value must not be changed.
- By default relay output RO2 is used for the watchdog output (10.27 RO2 source = 32.227, b1). The default value must not be changed.

### Settings and diagnostics

Parameter groups: 10 Standard DI, RO (page 269).

#### ■ Programmable I/O extensions

Inputs and outputs can be added by using I/O extension modules. One to three modules can be mounted on the slots of the control unit. Slots can be added by connecting an FEA-03 I/O extension adapter.

The table below shows the number of I/O on the control unit as well as optional I/O extension modules.

Location	Digital inputs (DI)	Digital I/Os (DIO)	Analog inputs (AI)	Analog outputs (AO)	Relay outputs (RO)
Control unit	6 + DIIL	2	2	2	3
FIO-01	-	4	-	-	2
FIO-11	-	2	3	1	-
FAIO-01	-	-	2	2	-

Location	Digital inputs (DI)	Digital I/Os (DIO)	Analog inputs (AI)	Analog outputs (AO)	Relay outputs (RO)
FDIO-01	3	-	-	-	2

Three I/O extension modules can be activated and configured using parameter groups 14...16.

**Note:** Each configuration parameter group contains parameters that display the values of the inputs on that particular extension module. These parameters are the only way of utilizing the inputs on I/O extension modules as signal sources. To connect to an input, choose the setting *Other* in the source selector parameter, then specify the appropriate value parameter (and bit, for digital signals) in group 14, 15 or 16.

**Settings and diagnostics**

Parameter groups: 14 I/O extension module 1 (page 294), 15 I/O extension module 2 (page 322) and 16 I/O extension module 3 (page 328).

Parameter: 60.41 Extension adapter com port (page 546)

Events: 7082 Ext I/O comm loss (page 696) and A799 ExtIO comm loss (page 712).

■ **Fieldbus control**

The drive can be connected to several different automation systems through its fieldbus interfaces. See chapter Fieldbus control through the embedded fieldbus interface (EFB) (page 737) and Fieldbus control through a fieldbus adapter (page 761).

**Settings and diagnostics**

Parameter groups: 50 Fieldbus adapter (FBA) (page 509), 51 FBA A settings (page 518), 52 FBA A data in (page 520), 53 FBA A data out (page 521), 54 FBA B settings (page 522), 55 FBA B data in (page 524), 56 FBA B data out (page 525) and 58 Embedded fieldbus (page 526).

Events: 7510 FBA A communication (page 699), 7520 FBA B communication (page 699), A7C1 FBA A communication (page 715), A7C2 FBA B communication (page 715) and A7CE EFB comm loss (page 715).

## ■ Master/follower functionality

### General

**Note:** The crane control program uses its own master/follower communication with D2D-link and ready made crane application interlocks. See section [Master/follower communication in crane application](#) (page 62). However, the Master/Follower functionality can be implemented as described in this section, but then you must separately build the crane application based interlocking.

The master/follower functionality can be used to link several drives together so that the load can be evenly distributed between the drives. This is ideal in applications where the motors are coupled to each other via gearing, chain, belt, etc.

The external control signals are typically connected to one drive only which acts as the master. The master controls up to 10 followers by sending broadcast messages over an electrical cable or fiber optic link. The master can read feedback signals from up to 3 selected followers.

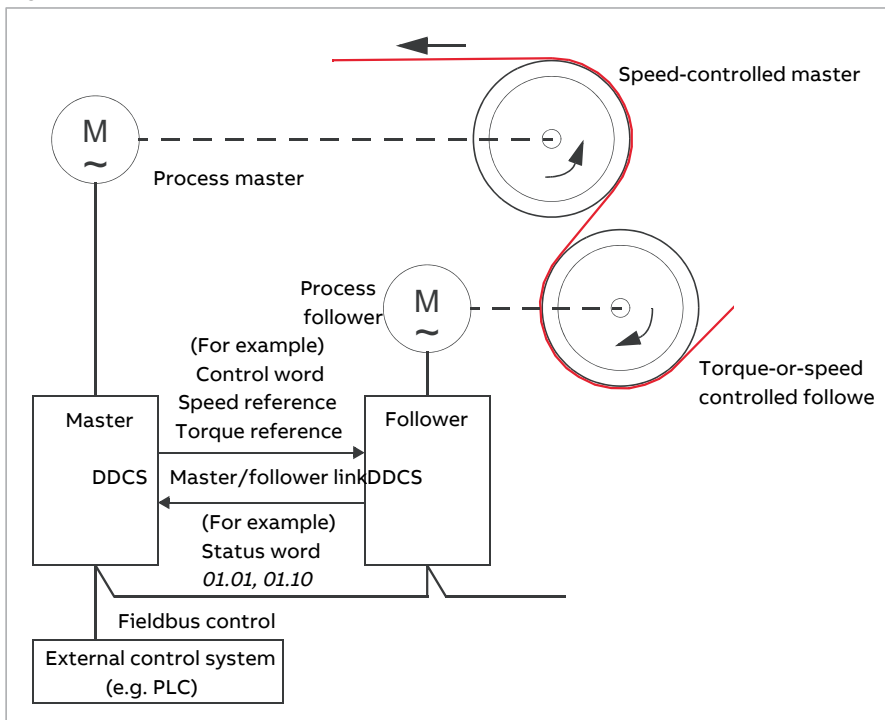

The master drive is typically speed-controlled and the other drives follow its torque or speed reference. In general, a follower should be

## 160 Program features

- torque-controlled when the motor shafts of the master and the follower are rigidly coupled by gearing, chain etc. so that no speed difference between the drives is possible.
- speed-controlled when the motor shafts of the master and the follower are flexibly coupled so that a slight speed difference is possible. When both the master and the follower are speed-controlled, drooping is also typically used (see parameter 25.8). The distribution of load between the master and follower can alternatively be adjusted as described under Load share function with a speed-controlled follower below.

**Note:** With a speed-controlled follower (without load sharing), pay attention to the acceleration and deceleration ramp times of the follower. If the ramp times are set longer than in the master, the follower will follow its own acceleration/deceleration ramp times rather than those from the master. In general, it is recommended to set identical ramp times in both the master and the follower(s). Any ramp shape settings (see parameters 23.16...23.19) should only be applied in the master.

In some applications, both speed control and torque control of the follower are required. In those cases, the operating mode can be switched by parameter (19.12 or 19.14). Another method is to set one external control location to speed control mode, the other to torque control mode. Then, a digital input of the follower can be used to switch between the control locations. See chapter *Control locations and operating modes* (page 145).

With torque control, follower parameter 26.15 can be used to scale the incoming torque reference for optimal load sharing between the master and the follower. Some torque-controlled follower applications, eg. where the torque is very low, or very low speed operation is required, may require encoder feedback.

If a drive needs to quickly switch between master and follower statuses, one user parameter set (see page 210) can be saved with the master settings, another with the follower settings. The suitable settings can then be activated using for example, digital inputs.

**Note:** In the crane application, the master/follower functionality is implemented in the application program instead of the primary control program, because it contains more number of nodes and interlock signals. The function uses the D2D-link for communication between the hoist and trolley drives.

In case of limited followers, you can use the primary control based Master/follower function having speed-torque or speed-speed combination with limited interlocking.

For more information of the crane control master/follower function, see *Master/follower communication in crane application* (page 62).

---



## Load share function with a speed-controlled follower

Load sharing between the master and a speed-controlled follower can be used in various applications. The load share function is implemented by fine-tuning the follower speed reference with an additional trim signal based on a torque reference. The torque reference is selected by parameter 23.42 (by default, reference 2 received from the master). Load share is adjusted by parameter 26.15 and activated by the source selected by 23.40. Parameter 23.41 provides a gain adjustment for the speed correction. The final correction signal added to the speed reference is shown by 23.39. See the block diagram on page 784.

### Note:

- The function can be enabled only when the drive is a speed-controlled follower in remote control mode.
- Drooping (25.8) is ignored when the load share function is active.
- The master and follower should have the same speed control tuning values.
- The speed correction term is limited by the speed error window parameters 24.44 and 24.43. An active limitation is indicated by 6.19.

## Communication

A master/follower link can be built by connecting the drives together with fiber optic cables (may require additional equipment depending on existing drive hardware), or by wiring together the XD2D connectors of the drives. The medium is selected by parameter 60.1.

Parameter 60.3 defines whether the drive is the master or a follower on the communication link. Typically, the speed-controlled process master drive is also configured as the master in the communication.

The communication on the master/follower link is based on the DDCS protocol, which employs data sets (specifically, data set 41). One data set contains three 16-bit words. The contents of the data set are freely configurable using parameters 61.1...61.3. The data set broadcast by the master typically contains the control word, speed reference and torque reference, while the followers return a status word with two actual values.

The default setting of parameter 61.1 is *Follower CW*. With this setting in the master, a word consisting of bits 0...11 of 6.1 and four bits selected by parameters 6.45...6.48 is broadcast to the followers. However, bit 3 of the follower control word is modified so that it remains on as long as the master is modulating, and its switching to 0 causes the follower to coast to a stop. This is to synchronize the stopping of both master and follower.

**Note:** When the master is ramping down to a stop, the follower observes the decreasing reference but receives no stop command until the master stops modulating and clears bit 3 of the follower control word. Because of this, the maximum and minimum speed limits on the follower drive should not have the same sign – otherwise the follower would be pushing against the limit until the master finally stops.

Three words of additional data can optionally be read from each follower. The followers from which data is read are selected by parameter 60.14 in the master. In each follower drive, the data to be sent is selected by parameters 61.1...61.3. The data is transferred in integer format over the link, and displayed by parameters 62.28...62.36 in the master. The data can then be forwarded to other parameters using 62.4...62.12.

To indicate faults in the followers, each follower must be configured to transmit its status word as one of the above-mentioned data words. In the master, the corresponding target parameter must be set to *Follower SW*. The action to be taken when a follower is faulted is selected by parameter 60.17. External events (see parameter group 31 *Fault functions*) can be used to indicate the status of other bits of the status word.

For block diagrams of the master/follower communication are presented on pages 793 and 794.

---

### Construction of the master/follower link

The master/follower link is formed by connecting the drives together using either

- shielded twisted-pair cable between the XD2D terminals of the drives\*, or
- fiber optic cables. Drives with a ZCU control unit require an additional FDCO DDCS communication module; drives with a BCU control unit require an RDCO module.

\*This connection cannot co-exist with, and is not to be confused with, drive-to-drive (D2D) communication implemented by application programming (detailed in *Drive application programming manual (IEC 61131-3)*, 3AUA0000127808 [English]).

Connection examples are shown below. Note that a star configuration using fiber optic cables requires an NDBU-95C DDCS branching unit.

#### Master/follower wiring with electrical cable

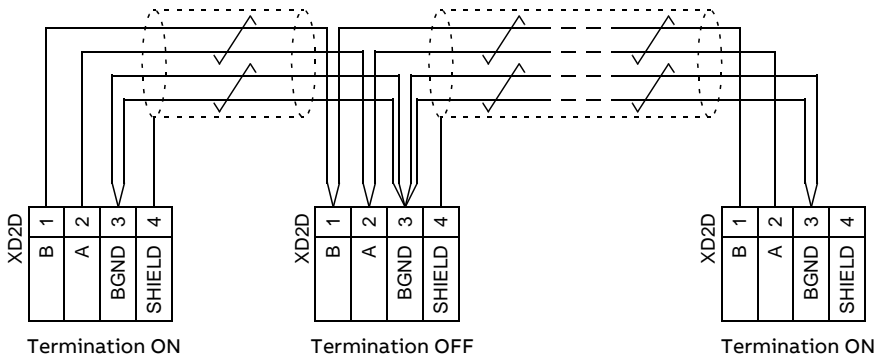

See the hardware manual of the drive for wiring and termination details.

#### Ring configuration with fiber optic cables

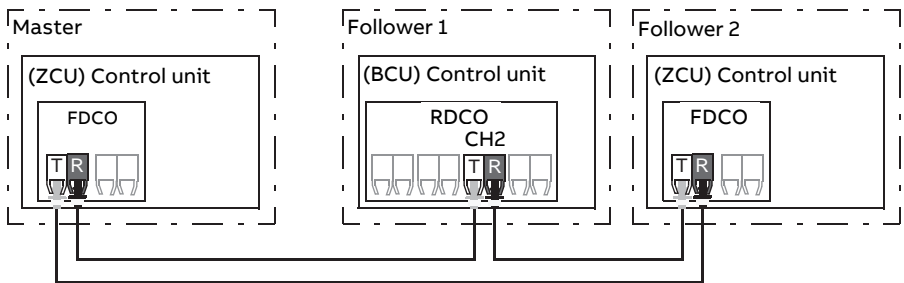

Where, T = Transmitter; R = Receiver

Star configuration with fiber optic cables (1)

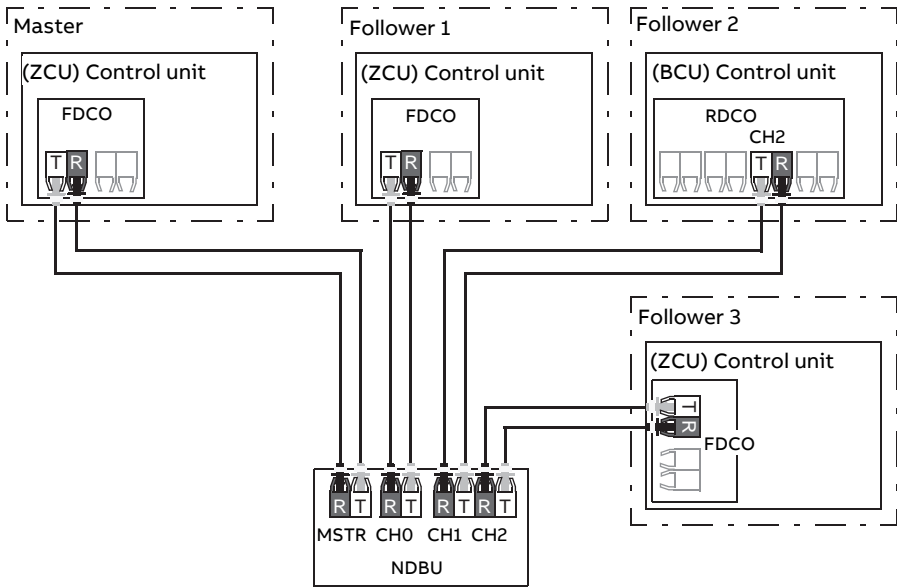

Where, T = Transmitter; R = Receiver

## Star configuration with fiber optic cables (2)

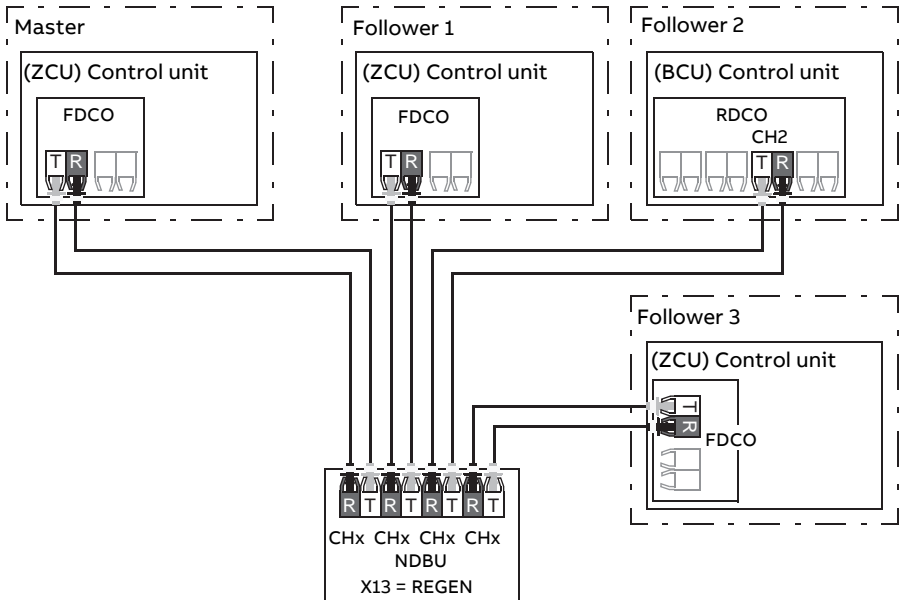

Where, T = Transmitter; R = Receiver

### Example parameter settings

The following is a checklist of parameters that need to be set when configuring the master/follower link. In this example, the master broadcasts the Follower control word, a speed reference and a torque reference. The follower returns a status word and two actual values (this is not compulsory but is shown for clarity).

#### Master settings

- **Master/follower link activation**
  - 60.1 M/F communication port (fiber optic channel or XD2D selection)
  - (60.2 M/F node address = 1)
  - 60.3 M/F mode = DDCS master (for both fiber optic and wire connection)
  - 60.5 M/F HW connection (Ring or Star for fiber optic, Star for wire)
- **Data to be broadcast to the followers**
  - 61.1 M/F data 1 selection = Follower CW (Follower control word)
  - 61.2 M/F data 2 selection = Used speed reference
  - 61.3 M/F data 3 selection = Torque reference act 5
- **Data to be read from the followers (optional)**
  - 60.14 M/F follower selection (selection of followers that data is read from)

## 166 Program features

- 62.4 Follower node 2 data 1 sel ... 62.12 Follower node 4 data 3 sel (mapping of data received from followers)

### Follower settings

- **Master/follower link activation**
  - 60.1 M/F communication port (fiber optic channel or XD2D selection)
  - 60.2 M/F node address = 2...60
  - 60.3 M/F mode = DDCCS follower (for both fiber optic and wire connection)
  - 60.5 M/F HW connection (Ring or Star for fiber optic, Star for wire)
- **Mapping of data received from master**
  - 62.1 M/F data 1 selection = CW 16bit
  - 62.2 M/F data 2 selection = Ref1 16bit
  - 62.3 M/F data 3 selection = Ref2 16bit
- **Selection of operating mode and control location**
  - 19.12 Ext1 control mode = Speed or Torque
  - 20.1 Ext1 commands = M/F link
  - 20.2 Ext1 start trigger type = Level
- **Selection of reference sources**
  - 22.11 Speed ref1 source = M/F reference 1
  - 26.11 Torque ref1 source = M/F reference 2
- **Selection of data to be sent to master (optional)**
  - 61.1 M/F data 1 selection = SW 16bit
  - 61.2 M/F data 2 selection = Act1 16bit
  - 61.3 M/F data 3 selection = Act2 16bit

### **Specifications of the fiber optic master/follower link**

- Maximum fiber optic cable length:
  - FDCO-01/02 or RDCO-04 with POF (Plastic Optic Fiber): 30 m
  - For distances up to 1000 m, use two NOCR-01 optical converter/repeaters with glass optic cable (GOF, 62.5 micrometers, Multi-Mode)
- Maximum shielded twisted-pair cable length: 50 m
- Transmission rate: 4 Mbit/s
- Total performance of the link: < 5 ms to transfer references between the master and followers.
- Protocol: DDCCS (Distributed Drives Communication System)

### **Settings and diagnostics**

Parameter groups: 60 DDCCS communication (page 535), 61 D2D and DDCCS transmit data (page 555) and 62 D2D and DDCCS receive data (page 560).

Events: 7582 M/F comm loss (page 700) and A7CB M/F comm loss (page 715).

---

## ■ External controller interface

### General

The drive can be connected to an external controller (such as the ABB AC 800M) using either fiber optic or twisted-pair cable. The ACS880 is compatible with both the ModuleBus and DriveBus connections. Note that some features of DriveBus (such as BusManager) are not supported.

### Topology

An example connection with either a ZCU-based or BCU-based drive using fiber optic cables is shown below.

Drives with a ZCU control unit require an additional FDCO DDCS communication module; drives with a BCU control unit require an RDCO or FDCO module. The BCU has a dedicated slot for the RDCO – an FDCO module can also be used with a BCU control unit but it will reserve one of the three universal option module slots. Ring and star configurations are also possible much in the same way as with the master/follower link (see section [Master/follower functionality \(page 159\)](#)); the notable difference is that the external controller connects to channel CH0 on the RDCO module instead of CH2. The channel on the FDCO communication module can be freely selected.

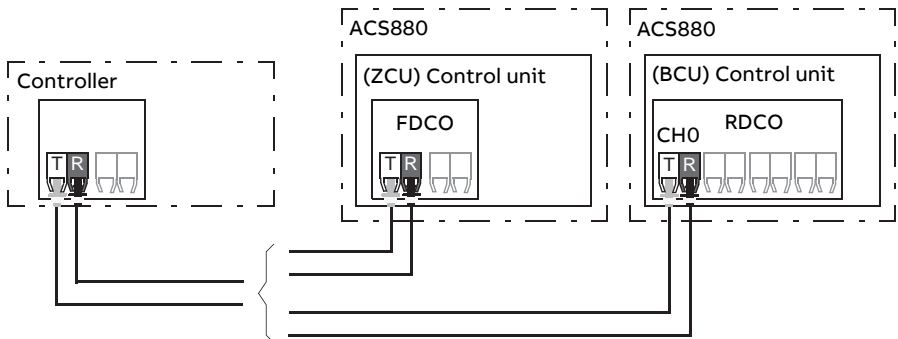

T = Transmitter, R = Receiver

The external controller can also be wired to the D2D (RS-485) connector using shielded, twisted-pair cable. The selection of the connection is made by parameter 60.51.

The transfer rate can be selected by parameter 60.56.

### Communication

The communication between the controller and the drive consists of data sets of three 16-bit words each. The controller sends a data set to the drive, which returns the next data set to the controller.

The communication uses data sets 10...33. The contents of the data sets are freely configurable, but data set 10 typically contains the control word and one or two references, while data set 11 returns the status word and selected actual values. For ModuleBus communication, the ACS880 can be set up as a “standard drive” or an “engineered drive” by parameter 60.50. ModuleBus communication uses data sets 1...4 with a “standard drive” and data sets 10...33 with an “engineered drive”.

The word that is defined as the control word is internally connected to the drive logic; the coding of the bits is as presented in section Contents of the fieldbus Control word (ABB Drives profile) (page 767). Likewise, the coding of the status word is as shown in section Contents of the fieldbus Status word (ABB Drives profile) (page 769).

By default, data sets 32 and 33 are dedicated for the mailbox service, which enables the setting or inquiry of parameter values as follows:

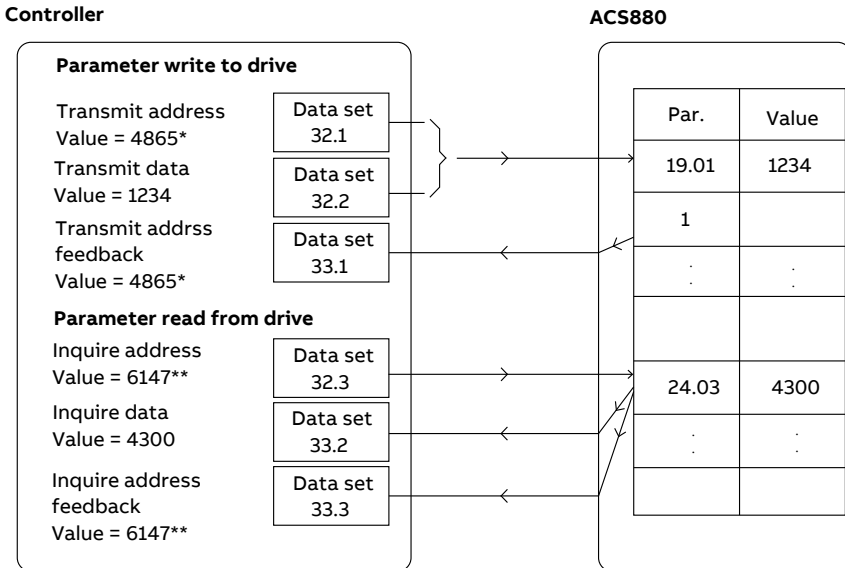

\*19.01 → 13h.01h → 1301h = 4865

\*\*24.03 → 18h.03h → 1803h = 6147



By parameter 60.64, data sets 24 and 25 can be selected instead of data sets 32 and 33.

The update intervals of the data sets are as follows:

- Data sets 10...11: 2 ms
- Data sets 12...13: 4 ms
- Data sets 14...17: 10 ms
- Data sets 18...25, 32, 33: 100 ms.

### Settings and diagnostics

**Parameter groups:** 60 DDCS communication (page 535), 61 D2D and DDCS transmit data (page 555) and 62 D2D and DDCS receive data (page 560).

**Events:** 7581 DDCS controller comm loss (page 699) and A7CA DDCS controller comm loss (page 715).

## Motor control

### ■ Direct torque control (DTC)

The motor control of the ACS880 is based on direct torque control (DTC), the ABB premium motor control platform. The switching of the output semiconductors is controlled to achieve the required stator flux and motor torque. The reference value for the torque controller comes from the speed controller, DC voltage controller or directly from an external torque reference source.

Motor control requires measurement of the DC voltage and two motor phase currents. Stator flux is calculated by integrating the motor voltage in vector space. Motor torque is calculated as a cross product of the stator flux and the rotor current. By utilizing the identified motor model, the stator flux estimate is improved. Actual motor shaft speed is not needed for the motor control.

The main difference between traditional control and DTC is that torque control operates on the same time level as the power switch control. There is no separate voltage and frequency controlled PWM modulator; the output stage switching is wholly based on the electromagnetic state of the motor.

The best motor control accuracy is achieved by activating a separate motor identification run (ID run).

See also section *Scalar motor control* (page 183).

### Settings and diagnostics

**Parameters:** 99.4 Motor control mode (page 668) and 99.13 ID run requested (page 672).

---

## ■ Reference ramping

Acceleration and deceleration ramping times can be set individually for speed, frequency and torque reference.

With a speed or frequency reference, the ramps are defined as the time it takes for the drive to accelerate or decelerate between zero speed or frequency and the value defined by parameter 46.1 or 46.2. The user can switch between two preset ramp sets using a binary source such as a digital input. For speed reference, also the shape of the ramp can be controlled.

With a torque reference, the ramps are defined as the time it takes for the reference to change between zero and nominal motor torque (parameter 1.30).

### Special acceleration/deceleration ramps

The change rate of the motor potentiometer function (page 170) is adjustable. The same rate applies in both directions.

A deceleration ramp can be defined for emergency stop (“Off3” mode).

### Settings and diagnostics

Parameters:

- Speed reference ramping: 23.19 Shape time dec 2 and 46.1 Speed scaling (page 497).
- Motor potentiometer: 22.75 Motor potentiometer ramp time...22.227.

## ■ Constant speeds/frequencies

Constant speeds and frequencies are predefined references that can be quickly activated, for example, through digital inputs. It is possible to define up to 7 constant speeds for speed control and 7 constant frequencies for frequency control.



### **WARNING!**

Constant speeds and frequencies override the normal reference irrespective of where the reference is coming from.

---

The constant speeds/frequencies function operates on a 2 ms time level.

### Settings and diagnostics

Parameter groups: 22 Speed reference selection (page 365).

## ■ Critical speeds

Critical speeds (sometimes called “skip speeds”) can be predefined for applications where it is necessary to avoid certain motor speeds or speed ranges because of, for example, mechanical resonance problems.

---

The critical speeds function prevents the reference from dwelling within a critical band for extended times. When a changing reference (22.87) enters a critical range, the output of the function (22.1) freezes until the reference exits the range. Any instant change in the output is smoothed out by the ramping function further in the reference chain.

### Example

A fan has vibrations in the range of 540 to 690 rpm and 1380 to 1560 rpm. To make the drive avoid these speed ranges,

- enable the critical speeds function by turning on bit 0 of parameter 22.51, and
- set the critical speed ranges as in the figure below.

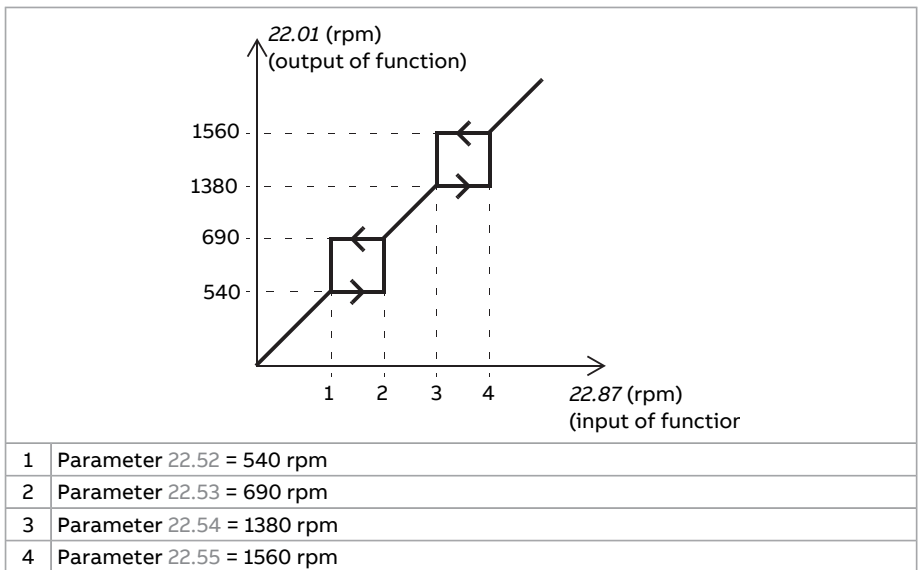

### Settings and diagnostics

Parameters: 22.51 Critical speed function...22.57 Critical speed 3 high (page 371).

#### ■ Speed controller autotune

The speed controller of the drive can be automatically adjusted using the autotune function. Autotuning is based on an estimation of the mechanical time constant (inertia) of the motor and machine.

The autotune routine will run the motor through a series of acceleration/deceleration cycles, the number of which can be adjusted by parameter 25.40. Higher values will produce more accurate results, especially if the difference between initial and maximum speeds is small.

The maximum torque reference used during autotuning will be the initial torque (ie. torque when the routine is activated) plus 25.38, unless limited by the maximum torque limit (parameter group 30 Limits) or the nominal motor torque (parameter group 99 Motor data). The calculated maximum speed during the routine is the initial speed (ie. speed when the routine is activated) + 25.39, unless limited by parameter 30.12 or 99.9.

The diagram below shows the behavior of speed and torque during the autotune routine. In this example, 25.40 is set to 2.

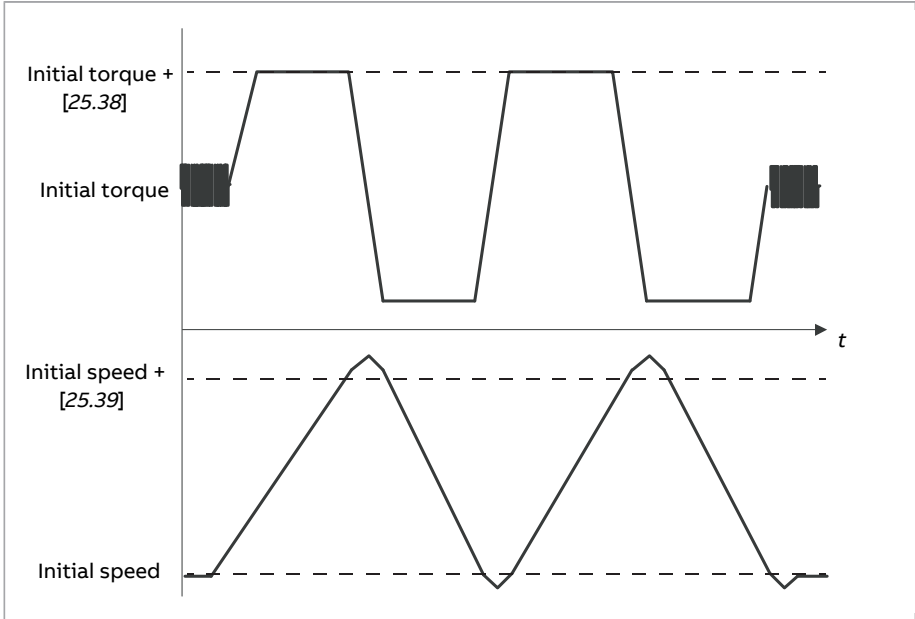

**Note:**

- If the drive cannot produce the requested braking power during the routine, the results will be based on the acceleration stages only, and not as accurate as with full braking power.
- The motor will exceed the calculated maximum speed slightly at the end of each acceleration stage.

**Before activating the autotune routine**

The prerequisites for performing the autotune routine are:

- The motor identification run (ID run) has been successfully completed
- Speed and torque limits (parameter group 30 Limits) have been set

- The speed feedback has been monitored for noise, vibrations and other disturbances caused by the mechanics of the system, and
  - speed feedback filtering (parameter group 90 Feedback selection)
  - speed error filtering (parameter group 24 Speed reference conditioning) and
  - zero speed (parameters 21.6 and 21.7) have been set to eliminate these disturbances.
- The drive has been started and is running in speed control mode.

After these conditions have been fulfilled, autotuning can be activated by parameter 25.33 (or the signal source selected by it).

### Autotune modes

Autotuning can be performed in three different ways depending on the setting of parameter 25.34. The selections *Smooth*, *Normal* and *Tight* define how the drive torque reference should react to a speed reference step after tuning. The selection *Smooth* will produce a slow but robust response; *Tight* will produce a fast response but possibly too high gain values for some applications. The figure below shows speed responses at a speed reference step (typically 1...20%).

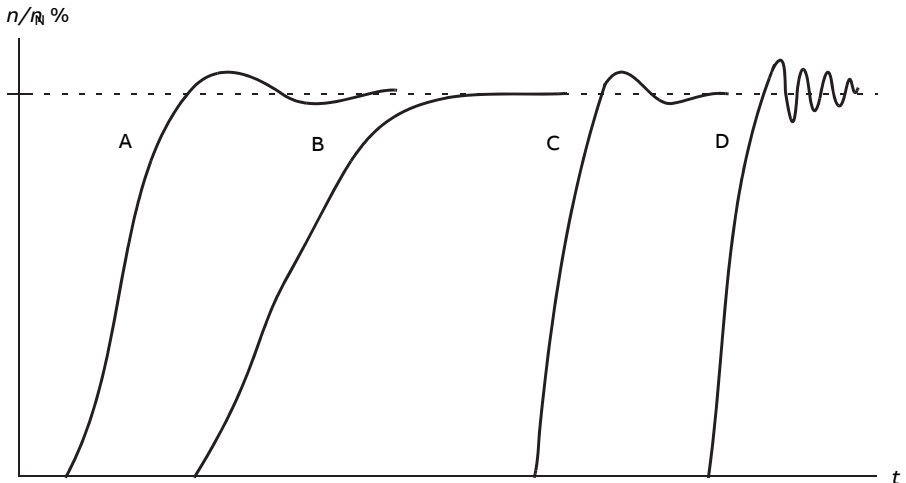

- A Undercompensated
- B Normally tuned (autotuning)
- C Normally tuned (manually). Better dynamic performance than with B
- D Overcompensated speed controller

### Autotune results

At the end of a successful autotune routine, its results are automatically transferred into parameters

- 25.2 (proportional gain of the speed controller)
- 25.3 (integration time of the speed controller)
- 25.37 (mechanical time constant of the motor and machine).

Nevertheless, it is still possible to manually adjust the controller gain, integration time and derivation time.

The figure below is a simplified block diagram of the speed controller. The controller output is the reference for the torque controller.

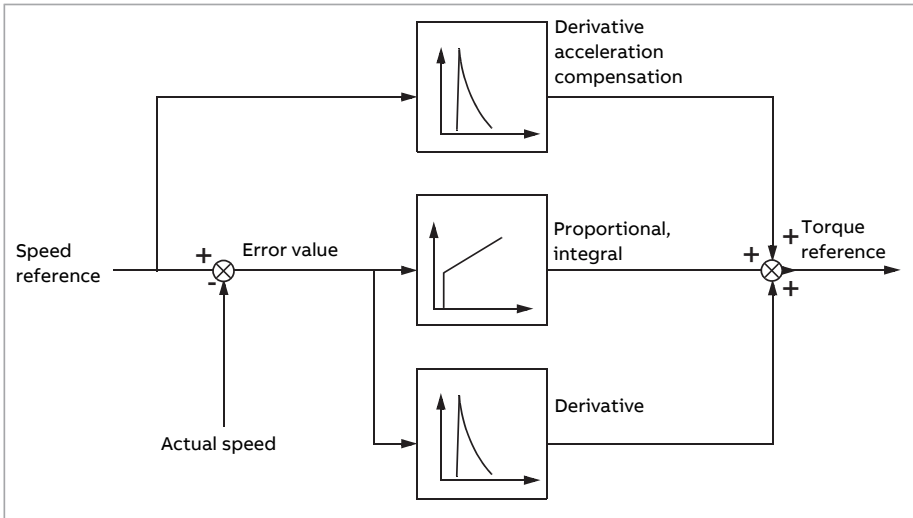

### Warning indications

A warning message, AF90 will be generated if the autotune routine does not complete successfully.

For further information, see chapter [Fault tracing](#) (page 679).

### Settings and diagnostics

Parameters: [25.33 Speed controller autotune...](#)[25.40 Autotune repeat times](#) (page 403).

Events: [AF90 Speed controller autotuning](#) (page 720).

### ■ Oscillation damping

The oscillation damping function can be used to cancel out oscillations caused by mechanics or an oscillating DC voltage. The input – a signal reflecting the oscillation – is selected by parameter [26.53](#). The oscillation damping function outputs a sine

wave (26.58) which can be summed with the torque reference with a suitable gain (26.57) and phase shift (26.56).

The oscillation damping algorithm can be activated without connecting the output to the reference chain, which makes it possible to compare the input and output of the function and make further adjustments before applying the result.

### Tuning procedure for oscillation damping

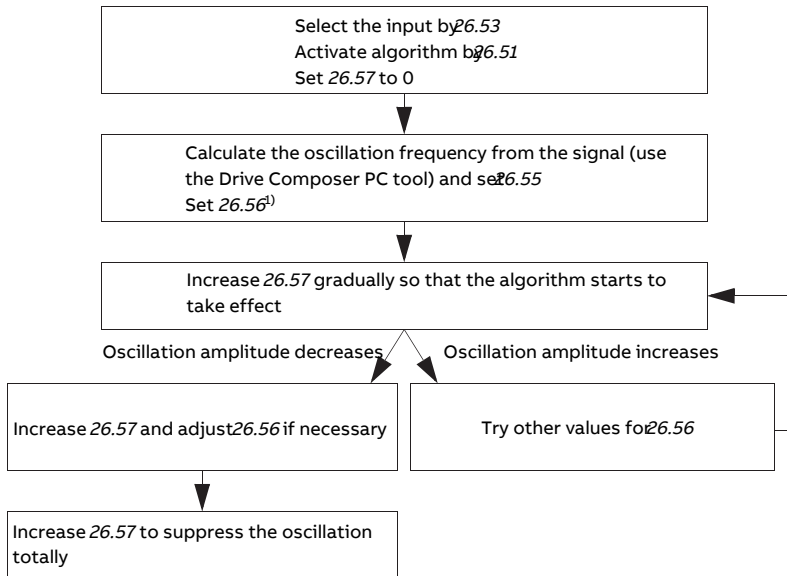

<sup>1)</sup>If the phasing of a DC oscillation cannot be determined by measuring, the value of 0 degrees is usually a suitable initial value.

**Note:** Changing the speed error low-pass filter time constant or the integration time of the speed controller can affect the tuning of the oscillation damping algorithm. It is recommended to tune the speed controller before the oscillation damping algorithm. (The speed controller gain can be adjusted after the tuning of this algorithm.)

### Settings and diagnostics

Parameters: 26.51 Oscillation damping...26.58 Oscillation damping output (page 412).

#### ■ Resonance frequency elimination

The control program contains a notch filter function for removing the resonance frequencies from the speed error signal.

### Settings and diagnostics

Parameters: 24.13 RFE speed filter...24.17 Damping of pole (page 389).

#### ■ Rush control

In torque control, the motor could potentially rush if the load were suddenly lost. The control program has a rush control function that decreases the torque reference whenever the motor speed (90.1) exceeds parameter 30.11 or 30.12.

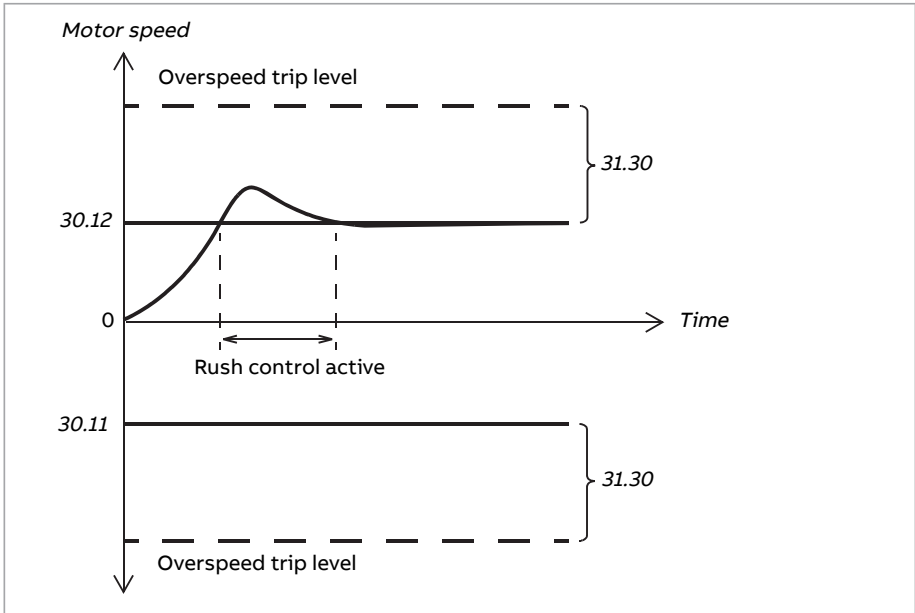

The function is based on a PI controller. The proportional gain and integration time can be defined by parameters. Setting these to zero disables rush control.

### Settings and diagnostics

Parameter groups: 30 Limits (page 419), 31 Fault functions (page 430) and 90 Feedback selection (page 611).

Parameters: 26.81 Rush control gain (page 413) and 26.82 Rush control integration time (page 413).

#### ■ Encoder support

The program supports two single-turn or multturn encoders (or resolvers). The following optional interface modules are available:

- TTL encoder interface FEN-01: two TTL inputs, TTL output (for encoder emulation and echo) and two digital inputs



- Absolute encoder interface FEN-11: absolute encoder input, TTL input, TTL output (for encoder emulation and echo) and two digital inputs
- Resolver interface FEN-21: resolver input, TTL input, TTL output (for encoder emulation and echo) and two digital inputs
- HTL encoder interface FEN-31: HTL encoder input, TTL output (for encoder emulation and echo) and two digital inputs
- HTL/TTL encoder interface FSE-31 (for use with an FSO-xx safety functions module): Two HTL/TTL encoder inputs (one HTL input supported at the time of publication).

The interface module is to be installed onto one of the option slots on the drive control unit. The module (except the FSE-31) can also be installed onto an FEA-03 extension adapter.

### **Encoder echo and emulation**

Both encoder echo and emulation are supported by the above-mentioned FEN-xx interfaces.

Encoder echo is available with TTL, TTL+ and HTL encoders. The signal received from the encoder is relayed to the TTL output unchanged. This enables the connection of one encoder to several drives.

Encoder emulation also relays the encoder signal to the output, but the signal is either scaled, or position data converted to pulses. Emulation can be used when absolute encoder or resolver position needs to be converted to TTL pulses, or when the signal must be converted to a different pulse number than the original.

### **Load and motor feedback**

Three different sources can be used as speed and position feedback: encoder 1, encoder 2, or motor position estimate. Any of these can be used for load position calculation or motor control. The load position calculation makes it possible, for example, to determine the position of a conveyor belt or the height of the load on a crane. The feedback sources are selected by parameters 90.41 and 90.51.

For detailed parameter connections of the motor and load feedback functions, see the block diagrams on pages 782 and 783. For more information on load position calculation, see section [Position counter](#) (page 178).

Any mechanical gear ratios between the components (motor, motor encoder, load, load encoder) are specified using the gear parameters shown in the diagram below.

---

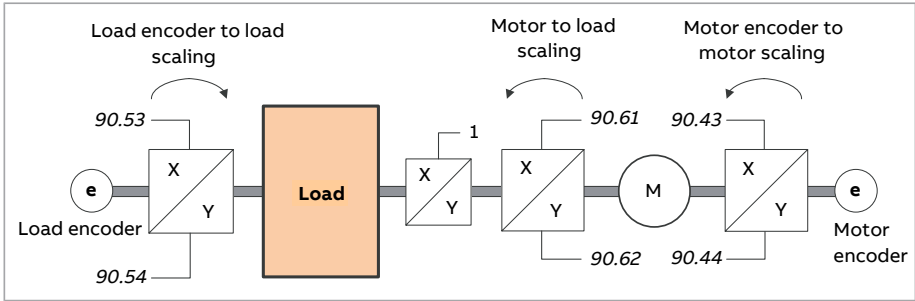

Any gear ratio between the load encoder and the load is defined by 90.53 and 90.54. Similarly, any gear ratio between the motor encoder and the motor is defined by 90.43 and 90.44. In case the internal estimated position is chosen as load feedback, the gear ratio between the motor and load can be defined by 90.61 and 90.62. By default, all of the ratios mentioned above are 1:1. The ratios can only be changed with the drive stopped; new settings require validation by 91.10.

**Position counter**

**Note:** The crane control program uses its own interface to the position counter. The difference is a reset/preset logic. See Power on acknowledgment on page xx. The user can build a position counter for crane application without using any ready-made logic.

The control program contains a position counter feature that can be used to indicate the position of the load. The output of the counter function, parameter 90.7, indicates the scaled number of revolutions read from the selected source (see section Load and motor feedback).

The relation between revolutions of the motor shaft and the translatory movement of the load (in any given unit of distance) is defined by parameters 90.63 and 90.64. This gear function can be changed without the need of a parameter refresh or position counter reinitialization – however, the counter output is only updated after new position input data is received.

For detailed parameter connections of the load feedback function, see the block diagram on page 783.

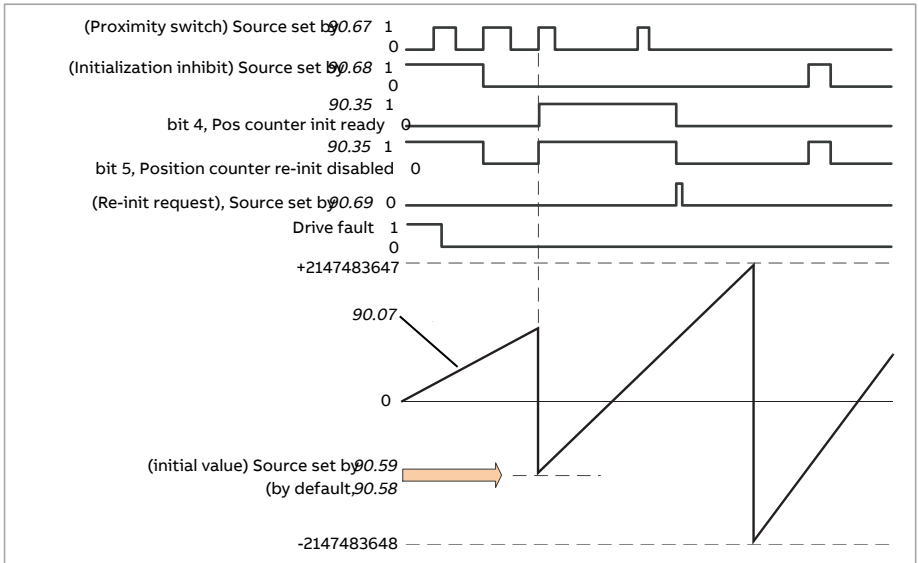

The position counter is initialized by setting a known physical position of the load into the control program. The initial position (for example, the home/zero position, or the distance from it) can be entered manually in a parameter (90.58), or taken from another parameter. This position is set as the value of the position counter (90.7) when the source selected by 90.67, such as a proximity switch connected to a digital input, is activated. A successful initialization is indicated by bit 4 of 90.35.

Any subsequent initialization of the counter must first be enabled by 90.69. To define a time window for initializations, 90.68 can be used to inhibit the signal from the proximity switch. An active fault in the drive will also prevent counter initialization.

### Encoder error handling

When an encoder is used for load feedback, the action taken in case of an encoder error is specified by 90.55. If the parameter is set to *Warning*, the calculation will continue smoothly using estimated motor position. If the encoder recovers from the error, the calculation will smoothly switch back to encoder feedback. The load position signals (90.4, 90.5 and 90.7) will continue to be updated all the time, but bit 6 of 90.35 will be set to indicate potentially inaccurate position data. In addition, bit 4 of 90.35 will be cleared upon the next stop as a recommendation to reinitialize the position counter.

Parameter 90.60 defines whether position calculation resumes from the previous value over an encoder error or control unit reboot. By default, bit 4 of 90.35 is cleared after an error, indicating that reinitialization is needed. With 90.60 set to

Continue from previous value, the position values are retained over an error or reboot; bit 6 of 90.35 is set however to indicate that an error occurred.

**Note:** With a multturn absolute encoder, bit 6 of 90.35 is cleared at the next stop of the drive if the encoder has recovered from the error; bit 4 is not cleared. The status of the position counter is retained over a control unit reboot, after which position calculation resumes from the absolute position given by the encoder, taking into account the initial position specified by 90.58.



### **WARNING!**

If the drive is in stopped state when an encoder error occurs, or if the drive is not powered, parameters 90.4, 90.5, 90.7 and 90.35 are not updated because no movement of the load can be detected. When using previous position values (90.60 is set to Continue from previous value), be aware that the position data is unreliable if the load is able to move.

---

### **Reading/writing position counter values through fieldbus**

The parameters of the position counter function, such as 90.7 and 90.58, can be accessed from an upper-level control system in the following formats:

- 16-bit integer (if 16 bits are sufficient for the application)
- 32-bit integer (can be accessed as two consequent 16-bit words).

For example, to read parameter 90.7 through fieldbus, set the selection parameter of the desired dataset (in group 52) to Other – 90.7, and select the format. If you select a 32-bit format, the subsequent data word is also automatically reserved.

### **Configuration of HTL encoder motor feedback**

1. Specify the type of the encoder interface module (parameter 91.11 = FEN-31) and the slot the module is installed into (91.12).
  2. Specify the type of the encoder (92.1 = HTL). The parameter listing will be re-read from the drive after the value is changed.
  3. Specify the interface module that the encoder is connected to (92.2 = Module 1).
  4. Set the number of pulses according to encoder nameplate (92.10).
  5. If the encoder rotates at a different speed to the motor (ie. is not mounted directly on the motor shaft), enter the gear ratio in 90.43 and 90.44.
  6. Set parameter 91.10 to Refresh to apply the new parameter settings. The parameter will automatically revert to Done.
  7. Check that 91.2 is showing the correct interface module type (FEN-31). Also check the status of the module; both LEDs should be glowing green.
  8. Start the motor with a reference of eg. 400 rpm.
-

9. Compare the estimated speed (1.2) with the measured speed (1.4). If the values are the same, set the encoder as the feedback source (90.41 = Encoder 1).
10. Specify the action taken in case the feedback signal is lost (90.45).

### Example 1: Using the same encoder for both load and motor feedback

The drive controls a motor used for lifting a load in a crane. An encoder attached to the motor shaft is used as feedback for motor control. The same encoder is also used for calculating the height of the load in the desired unit. A gear exists between the motor shaft and the cable drum. The encoder is configured as Encoder 1 as shown in [Configuration of HTL encoder motor feedback](#) above. In addition, the following settings are made:

- 90.43 = 1
- 90.44 = 1  
(No gear is needed as the encoder is mounted directly on the motor shaft.)
- 90.51 = Encoder 1
- 90.53 = 1
- 90.54 = 50  
The cable drum turns one revolution per 50 revolutions of the motor shaft.
- 90.61 = 1
- 90.62 = 1  
(These parameters need not be changed as position estimate is not being used for feedback.)
- 90.63 = 7
- 90.64 = 10  
The load moves 70 centimeters, ie. 7/10 of a meter, per one revolution of the cable drum.

The load height in meters can be read from 90.7, while 90.3 displays the rotational speed of the cable drum.

### Example 2: Using two encoders

One encoder (encoder 1) is used for motor feedback. The encoder is connected to the motor shaft through a gear. Another encoder (encoder 2) measures the line speed elsewhere in the machine. Each encoder is configured as shown in [Configuration of HTL encoder motor feedback](#) above. In addition, the following settings are made:

- 90.41 = Encoder 1
  - 90.43 = 1
  - 90.44 = 3
-

The encoder turns three revolutions per one revolution of the motor shaft.

- 90.51 = Encoder 2

The line speed measured by encoder 2 can be read from 90.3. This value is given in rpm which can be converted into another unit by using 90.53 and 90.54. Note that the feed constant gear cannot be used in this conversion because it does not affect 90.3.

### Example 3: ACS 600 / ACS800 compatibility

With ACS 600 and ACS800 drives, both the rising and falling edges from encoder channels A and B are typically counted to achieve best possible accuracy. Thus the received pulse number per revolution equals four times the nominal pulse number of the encoder.

In this example, an HTL-type 2048-pulse encoder is fitted directly on the motor shaft. The desired initial position to correspond the proximity switch is 66770.

In the ACS880, the following settings are made:

- 92.1 = HTL
- 92.2 = Module 1
- 92.10 = 2048
- 92.13 = Enable
- 90.51 = Encoder 1
- 90.63 = 8192 (ie.  $4 \times$  value of 92.10, as the received number of pulses is 4 times nominal. See also parameter 92.12)
- The desired “data out” parameter is set to Other – 90.58 (32-bit format). Only the high word needs to be specified – the subsequent data word is reserved for the low word automatically.
- The desired sources (such as digital inputs or user bits of the control word) are selected in 90.67 and 90.69.

In the PLC, if the initial value is set in 32-bit format using low and high words (corresponding to ACS800 parameters POS COUNT INIT LO and POS COUNT INIT HI), enter the value 66770 into these words as follows:

- **Eg. PROFIBUS:**
  - FBA data out  $x$  = POS COUNT INIT HI = 1 (as bit 16 equals 65536)
  - FBA data out  $(x + 1)$  = POS COUNT INIT LO = 1234.
- ABB Automation using DDCS communication, eg.:
  - Data set 12.1 = POS COUNT INIT HI
  - Data set 12.2 = POS COUNT INIT LO

To test the configuration of the PLC, initialize the position counter with the encoder connected. The initial value sent from the PLC should immediately be reflected by

---

90.7 in the drive. The same value should then appear in the PLC after having been read from the drive.

### Settings and diagnostics

Parameter groups 90 Feedback selection (page 611), 91 Encoder module settings (page 623), 92 Encoder 1 configuration (page 627) and 93 Encoder 2 configuration (page 635).

#### ■ Scalar motor control

It is possible to select scalar control as the motor control method instead of DTC (Direct Torque Control). In scalar control mode, the drive is controlled with a speed or frequency reference. However, the outstanding performance of DTC is not achieved in scalar control.

It is recommended to activate scalar motor control mode

- if the nominal current of the motor is less than 1/6 of the nominal output current of the drive
- if the drive is used without a motor connected (for example, for test purposes)
- if the drive runs a medium-voltage motor through a step-up transformer, or
- in multimotor drives, if
  - the load is not equally shared between the motors,
  - the motors are of different sizes, or
  - the motors are going to be changed after motor identification (ID run)

In scalar control, some standard features are not available.

#### Note:

- Scalar motor control is not applicable for hoist motion drives.
- Disable torque proving and brake open torque functions in following controls:
  - Scalar motor control
  - Trolley motion
 To disable, set following values:
  - 44.9 Brake open torque source = Zero
  - 44.200 Brake open torque = 0%
  - 44.202 Torque proving = Disable

See also section Operating modes of the drive (page 148).

#### IR compensation for scalar motor control

IR compensation (also known as voltage boost) is available only when the motor control mode is scalar. When IR compensation is activated, the drive gives an extra voltage boost to the motor at low speeds. IR compensation is useful in applications that require a high breakaway torque. In step-up applications, voltage cannot be

---

fed through the transformer at 0 Hz, so an additional breakpoint is available for defining the compensation near zero frequency.

In Direct Torque Control (DTC), no IR compensation is possible or needed as it is applied automatically.

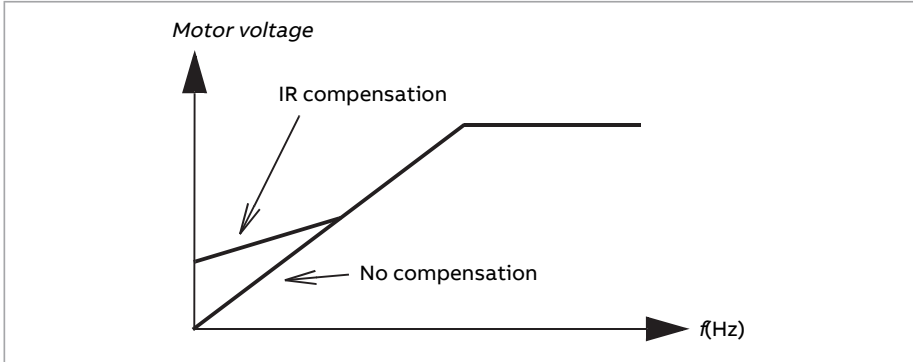

### Settings and diagnostics

Parameters: 97.12 IR comp step-up frequency (page 662), 97.13 IR compensation (page 662) and 99.4 Motor control mode (page 668).

#### ■ Autophasing

Autophasing is an automatic measurement routine to determine the angular position of the magnetic flux of a permanent magnet synchronous motor or the magnetic axis of a synchronous reluctance motor. The motor control requires the absolute position of the rotor flux in order to control motor torque accurately.

Sensors like absolute encoders and resolvers indicate the rotor position at all times after the offset between the zero angle of rotor and that of the sensor has been established. On the other hand, a standard pulse encoder determines the rotor position when it rotates but the initial position is not known. However, a pulse encoder can be used as an absolute encoder if it is equipped with Hall sensors, albeit with coarse initial position accuracy. Hall sensors generate so-called commutation pulses that change their state six times during one revolution, so it is only known within which 60° sector of a complete revolution the initial position is.

Many encoders give a zero pulse (also called Z-pulse) once during each rotation. The position of the zero pulse is fixed. If this position is known with respect to zero position used by motor control, the rotor position at the instant of the zero pulse is also known.

Using the zero pulse improves the robustness of the rotor position measurement. The rotor position must be determined during starting because the initial value given by the encoder is zero. The autophasing routine determines the position,



but there is a risk of some position error. If the zero pulse position is known in advance, the position found by autophasing can be corrected as soon as the zero pulse is detected for the first time after starting.

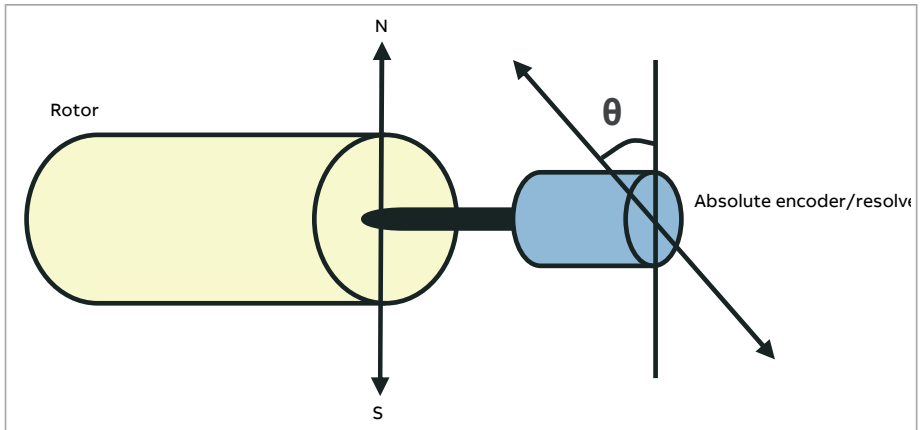

The autophasing routine is performed with permanent magnet synchronous motors and synchronous reluctance motors in the following cases:

1. One-time measurement of the rotor and encoder position difference when an absolute encoder, a resolver, or an encoder with commutation signals is used
2. At every power-up when an incremental encoder is used
3. With open-loop motor control, repetitive measurement of the rotor position at every start
4. When the position of the zero pulse must be measured before the first start after power-up.

**Note:** In closed-loop control, autophasing is performed automatically after the motor identification run (ID run). Autophasing is also performed automatically before starting when necessary.

In open-loop control, the zero angle of the rotor is determined before starting. In closed-loop control, the actual angle of the rotor is determined with autophasing when the sensor indicates zero angle. The offset of the angle must be determined because the actual zero angles of the sensor and the rotor do not usually match. The autophasing mode determines how this operation is done both in open-loop and closed-loop control.

The rotor position offset used in motor control can also be given by the user – see parameter 98.15. Note that the autophasing routine also writes its result into this parameter. The results are updated even if user settings are not enabled by 98.1.

**Note:** In open-loop control, the motor always turns when it is started as the shaft is turned towards the remanence flux.

Bit 4 of 6.21 indicates if the rotor position has already been determined

### Autophasing modes

Several autophasing modes are available (see parameter 21.13).

The turning mode (**Turning**) is recommended especially with case 1 (see the list above) as it is the most robust and accurate method. In turning mode, the motor shaft is turned back and forward ( $\pm 360/\text{polepairs}$ )° in order to determine the rotor position. In case 3 (open-loop control), the shaft is turned only in one direction and the angle is smaller.

Another turning mode, **Turning with Z-pulse**, can be used if there is difficulty using the normal turning mode, for example, because of significant friction. With this mode, the rotor is turned slowly until a zero pulse is detected from the encoder. When the zero pulse is detected for the first time, its position is stored into parameter 98.15, which can be edited for fine-tuning. Note that it is not mandatory to use this mode with a zero pulse encoder. In open-loop control, the two turning modes are identical.

The standstill modes (**Standstill 1**, **Standstill 2**) can be used if the motor cannot be turned (for example, when the load is connected). As the characteristics of motors and loads differ, testing must be done to find out the most suitable standstill mode.

The drive is capable of determining the rotor position when started into a running motor in open-loop or closed-loop control. In this situation, the setting of 21.13 has no effect.

The autophasing routine can fail and therefore it is recommended to perform the routine several times and check the value of parameter 98.15.

An autophasing fault (3385) can occur with a running motor if the estimated angle of the motor differs too much from the measured angle. This could be caused by, for example, the following:

- The encoder is slipping on the motor shaft
  - An incorrect value has been entered into 98.15
  - The motor is already turning before the autophasing routine is started
  - **Turning** mode is selected in 21.13 but the motor shaft is locked
  - **Turning with Z-pulse** mode is selected in 21.13 but no zero pulse is detected within a revolution of the motor
  - The wrong motor type is selected in 99.3
  - Motor ID run has failed.
-

## Settings and diagnostics

Parameters: 6.21 Drive status word 3 (page 249), 21.13 Autophasing mode (page 360), 98.15 Position offset user (page 667) and 99.13 ID run requested (page 672).

### ■ Flux braking



#### WARNING!

The motor needs to be rated to absorb the thermal energy generated by flux braking.

The drive can provide greater deceleration by raising the level of magnetization in the motor. By increasing the motor flux, the energy generated by the motor during braking can be converted to motor thermal energy.

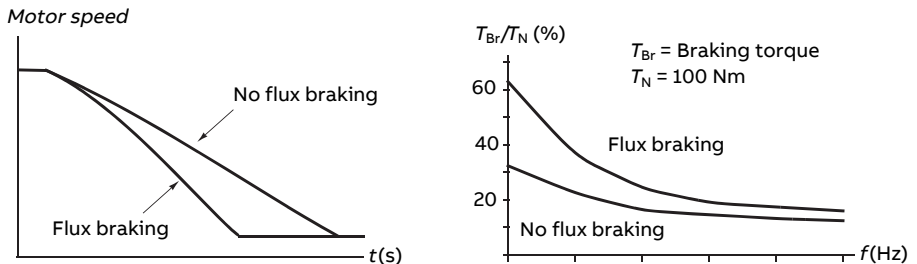

The drive monitors the motor status continuously, also during flux braking. Therefore, flux braking can be used both for stopping the motor and for changing the speed. The other benefits of flux braking are:

- The braking starts immediately after a stop command is given. The function does not need to wait for the flux reduction before it can start the braking.
- The cooling of the induction motor is efficient. The stator current of the motor increases during flux braking, not the rotor current. The stator cools much more efficiently than the rotor.
- Flux braking can be used with induction motors and permanent magnet synchronous motors.

Two braking power levels are available:

- Moderate braking provides faster deceleration compared to a situation where flux braking is disabled. The flux level of the motor is limited to prevent excessive heating of the motor.
- Full braking exploits almost all available current to convert the mechanical braking energy to motor thermal energy. Braking time is shorter compared to moderate braking. In cyclic use, motor heating may be significant.

## Settings and diagnostics

Parameter: 97.5 Flux braking (page 660).

### ■ DC magnetization

DC magnetization can be applied to the motor to

- heat the motor to remove or prevent condensation, or
- to lock the rotor at, or near, zero speed.

### Pre-heating

A motor pre-heating function is available to prevent condensation in a stopped motor, or to remove condensation from the motor before start. Pre-heating involves feeding a DC current into the motor to heat up the windings.

Pre-heating is deactivated at start, or when one of the other DC magnetization functions is activated. With the drive stopped, pre-heating is disabled by the safe torque off function, a drive fault state, or the process PID sleep function.

Pre-heating can only start after one minute has elapsed from stopping the drive.

A digital source to control pre-heating is selected by parameter 21.14. The heating current is set by 21.16.

### Pre-magnetization

Pre-magnetization refers to DC magnetization of the motor before start. Depending on the selected start mode (21.1 or 21.19), premagnetization can be applied to guarantee the highest possible breakaway torque, up to 200% of the nominal torque of the motor. By adjusting the pre-magnetization time (21.2), it is possible to synchronize the motor start and, for example, the release of a mechanical brake.

### DC hold

The function makes it possible to lock the rotor at (near) zero speed in the middle of normal operation. DC hold is activated by parameter 21.8. When both the reference and motor speed drop below a certain level (parameter 21.9), the drive will stop generating sinusoidal current and start to inject DC into the motor. The current is set by parameter 21.10. When the reference exceeds parameter 21.9, normal drive operation continues.

---

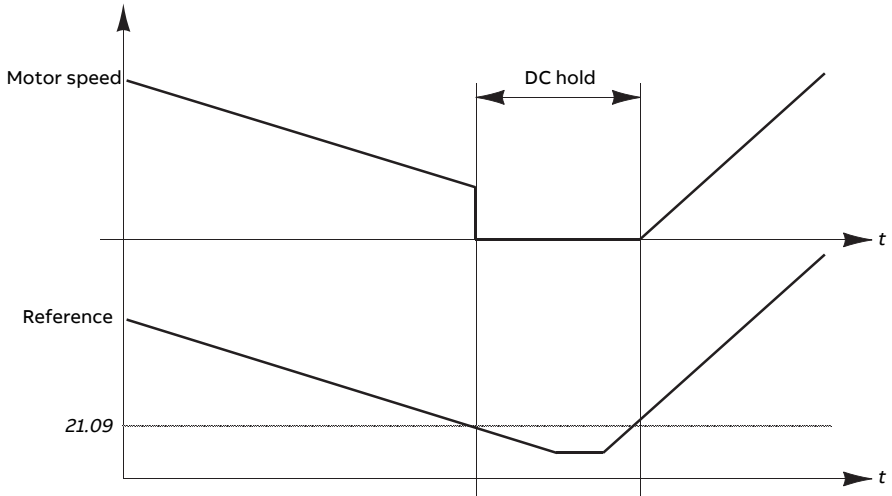
**Note:**

- DC hold is only available in speed control in DTC motor control mode (see page 148).
- The function applies the DC current to one phase only, depending on the position of the rotor. The return current will be shared between the other phases.

**Post-magnetization**

This feature keeps the motor magnetized for a certain period (parameter 21.11) after stopping. This is to prevent the machinery from moving under load, for example before a mechanical brake can be applied. Postmagnetization is activated by parameter 21.8. The magnetization current and time are set by parameters 21.10 and 21.11.

**Continuous magnetization**

A digital signal, such as a user bit in the fieldbus control word, can be selected to activate continuous magnetization. This can be especially useful in processes requiring motors to be stopped (for example, to stand by until new material is processed), then quickly started without magnetizing them first.

**Note:**

- Continuous magnetization is only available in DTC motor control mode (see page 148). If parameter 21.12 is on, the motor will be kept magnetized after a ramp stop. To enable continuous magnetization after a coast stop, the command (21.12) must be cycled (on, off, on). Furthermore, if the Run enable signal has been off, a new rising edge is required before continuous magnetization starts.
- Continuous magnetization should not be enabled while the motor is rotating.



**WARNING!**

The motor must be designed to absorb or dissipate the thermal energy generated by continuous magnetization, for example by forced ventilation.

---

**Settings and diagnostics**

Parameters: 6.21 Drive status word 3 (page 249), 21.1 Start mode (page 356), 21.2 Magnetization time (page 357), 21.8 DC current control...21.12 Continuous magnetization command (page 360), 21.14 Pre-heating input source (page 361) and 21.16 Pre-heating current (page 361).

■ **Motor temperature estimation**

The Motor temperature estimation function identifies the stator resistance and estimates the initial temperature of the motor. The estimated temperature of the motor can be used when the ambient temperature drops below zero celsius.

The temperature is estimated by feeding a DC current (25% of the motor nominal current) into the motor for a time period of 4 seconds (default). The function uses the resistance value at room temperature obtained during an ID run. For better results, set correct temperature value in parameter 35.50 during ID run.

The function can be activated with parameter 21.37. The estimation time can be defined with parameter 21.38. The function can be activated using either of the two ways: With Drive start command or at Drive power-up (after control board boot).

**Settings and diagnostics**

Parameters: 21.37 Motor temperature estimation (page 363), 21.38 Motor temperature estimation time (page 364) and 35.50 Motor ambient temperature (page 468).

■ **Hexagonal motor flux pattern**

**Note:** This feature is only available in scalar motor control mode (see page 148).

---

Typically, the drive controls the motor flux so that the rotating flux vector follows a circular pattern. This is ideal for most applications. However, when operating above the field weakening point (FWP), it is not possible to reach 100% of the output voltage. This reduces the peak load capacity of the drive.

Using a hexagonal motor flux vector pattern, the maximum output voltage can be reached above the field weakening point. This increases the peak load capacity compared to the circular pattern, but the continuous load capacity in the range of FWP ...  $1.6 \times$  FWP is reduced because of increasing losses. With hexagonal motor flux active, the pattern changes from circular to hexagonal gradually as the frequency rises from 100% to 120% of the FWP.

### Settings and diagnostics

Parameters: 97.18 Hexagonal field weakening (page 663) and 97.19 Hexagonal field weakening point (page 663).

## DC voltage control

### ■ Overvoltage control

Overvoltage control of the intermediate DC link is typically needed when the motor is in generating mode. The motor can generate when it decelerates or when the load overhauls the motor shaft, causing the shaft to turn faster than the applied speed or frequency. To prevent the DC voltage from exceeding the overvoltage control limit, the overvoltage controller automatically decreases the generating torque when the limit is reached. The overvoltage controller also increases any programmed deceleration times if the limit is reached; to achieve shorter deceleration times, a brake chopper and resistor may be required.

### ■ Undervoltage control (power loss ride-through)

If the incoming supply voltage is cut off, the drive will continue to operate by utilizing the kinetic energy of the rotating motor. The drive will be fully operational as long as the motor rotates and generates energy to the drive. The drive can continue operation after the break if the main contactor (if present) remained closed.

**Note:** Units equipped with a main contactor must be equipped with a hold circuit (e.g. UPS) to keep the contactor control circuit closed during a short supply break.

---

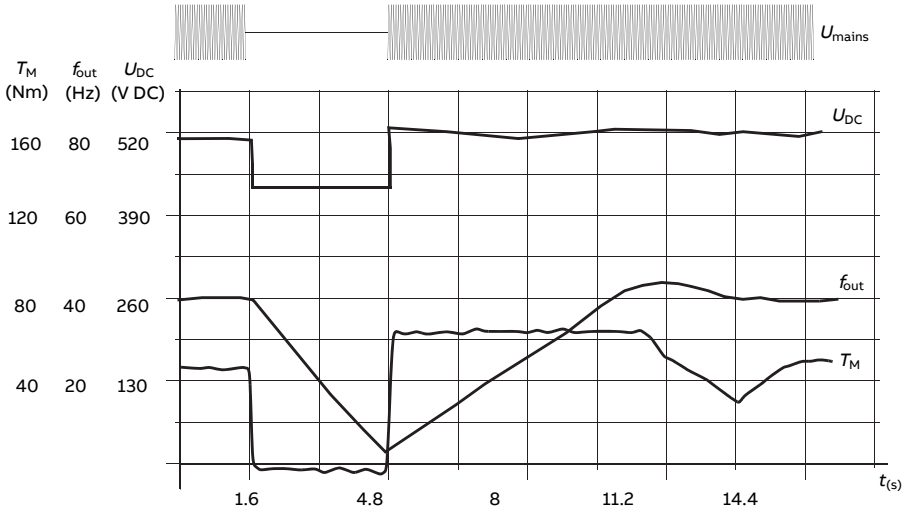

$U_{DC}$  = intermediate circuit voltage of the drive,  $f_{out}$  = output frequency of the drive,  $T_M$  = motor torque Loss of supply voltage at nominal load ( $f_{out} = 40$  Hz). The intermediate circuit DC voltage drops to the minimum limit. The controller keeps the voltage steady as long as the mains is switched off. The drive runs the motor in generator mode. The motor speed falls but the drive is operational as long as the motor has enough kinetic energy.

**Automatic restart**



**WARNING!**

Before you activate the function, make sure that no dangerous situations can occur. The function restarts the drive automatically and continues operation after a supply break.

It is possible to restart the drive automatically after a short power supply failure by using the Automatic restart function provided that the drive is allowed to run for a time defined by parameter 21.18 to restart time without the cooling fans operating.

When enabled, the function takes the following actions upon a supply failure to enable a successful restart:

- The undervoltage fault is suppressed (but a warning is generated)
- Modulation and cooling is stopped to conserve any remaining energy
- DC circuit pre-charging is enabled.



If the DC voltage is restored before the expiration of the period defined by parameter 21.18 and the start signal is still on, normal operation will continue. However, if the DC voltage remains too low at that point, the drive trips on a fault, 3280.

**Settings and diagnostics**

Parameter: 21.18 Auto restart time (page 362).

Event: 3280 Standby timeout (page 686).

---

■ **Voltage control and trip limits**

The control and trip limits of the intermediate DC voltage regulator are relative to the supply voltage as well as drive/inverter type. The DC voltage is approximately 1.35 times the line-to-line supply voltage, and is displayed by parameter 1.11.

All levels are relative to the supply voltage range selected in parameter 95.1. The following table shows the values of selected DC voltage levels in volts and in percent of  $U_{DCmax}$  (the DC voltage at the upper bound of the supply voltage range).

	<b>Supply voltage range [V AC] (see 95.1)</b>					
<b>Level [V DC (% of <math>U_{DCmax}</math>)]</b>	<b>208...240</b>	<b>380...415</b>	<b>440...480</b>	<b>500</b>	<b>525...600</b>	<b>660...690</b>
Overvoltage fault limit	489/440 <sup>1)</sup>	800	878	880	1113	1218
Overvoltage control limit	405 (125)	700 (125)	810 (125)	810 (120)	1013 (125)	1167 (125)
Internal brake chopper at 100% pulse width	403 (124)	697 (124)	806 (124)	806 (119)	1008 (124)	1159 (124)
Internal brake chopper at 0% pulse width	375 (116)	648 (116)	749 (116)	780 (116)	936 (116)	1077 (116)
Overvoltage warning limit	373 (115)	644 (115)	745 (115)	776 (115)	932 (115)	1071 (115)
$U_{DCmax}$ = DC voltage at upper bound of supply voltage range	324 (100)	560 (100)	648 (100)	675 (100)	810 (100)	932 (100)
DC voltage at lower bound of supply voltage range	281	513	594	675	709	891
Undervoltage control and warning limit	239 (85)	436 (85)	505 (85)	574 (85)	602 (85)	757 (85)
Charging activation/standby limit	225 (80)	410 (80)	475 (80)	540 (80)	567 (80)	713 (80)
Undervoltage fault limit	168 (60)	308 (60)	356 (60)	405 (60)	425 (60)	535 (60)

1) 489 V with frames R1...R3, 440 V with frames R4...R8.

**Settings and diagnostics**

**Parameters:** 1.11 DC voltage (page 227), 30.30 Overvoltage control (page 426), 30.31 Undervoltage control (page 427), 95.1 Supply voltage (page 638), and 95.2 Adaptive voltage limits (page 638).

## ■ Brake chopper

A brake chopper can be used to handle the energy generated by a decelerating motor. When the DC voltage rises high enough, the chopper connects the DC circuit to an external brake resistor. The chopper operates on the pulse width modulation principle.

The brake chopper (43.6) can be enabled with the overvoltage controller (30.30) still active. In such case, make sure the overvoltage controller limits are set high enough not to limit before the full braking power is reached. This function in certain applications avoids unnecessary overvoltage trip and implements a simpler control logic if the resistor cannot absorb enough energy or when the resistor breaks during braking.

Some ACS880 drives have an internal brake chopper as standard, some have a brake chopper available as an internal or external option. See the appropriate hardware manual or sales catalog.

The internal brake choppers of ACS880 drives start conducting when the DC link voltage reaches  $1.156 \times U_{DCmax}$ . 100% pulse width is reached at approximately  $1.2 \times U_{DCmax}$ , depending on supply voltage range – see table under [Voltage control and trip limits](#) above. ( $U_{DCmax}$  is the DC voltage corresponding to the maximum of the AC supply voltage range.) For information on external brake choppers, refer to their documentation.

**Note:** For runtime braking, overvoltage control (parameter 30.30) needs to be disabled for the chopper to operate.

## Settings and diagnostics

Parameters: [1.11 DC voltage](#) (page 227) and [30.30 Overvoltage control](#) (page 426).

Parameter group: [43 Brake chopper](#) (page 483).

## ■ DC voltage boost

This section describes the use of the DC voltage boost function for the drives which has separate IGBT supply unit control.

The DC voltage boost require drive derating. See hardware manual of the drive for derating factors.

### Description of the DC voltage boost function

The regenerative and ultra low harmonic drives can boost their DC link voltage. In other words, they can increase the operating voltage of the DC link from its default value.

The user can take the DC voltage boost function in use by:

1. Adjusting the user-defined DC voltage reference value and

2. Selecting the user-defined reference as the source for the drive DC voltage reference.

Benefits of the DC voltage boost function are:

- Possibility to supply nominal voltage to the motor even when the supply voltage of the drive is below the motor nominal voltage. Example: A drive that is connected to 415 V can supply 460 V to a 460 V motor.
- Compensation of a voltage drop due to an output filter, motor cable or input supply cables.
- Increased motor torque in the field weakening area (that is, when the drive operates the motor in the speed range above the motor nominal speed).

### Use case examples

#### Example 1: Full motor voltage regardless of supply voltage fluctuations

Supply voltage is 380 V, motor nominal voltage is 400 V. To get motor nominal voltage at nominal speed regardless of the supply voltage fluctuations:

1. Calculate the required user DC voltage reference:  $400 \text{ V} \times \sqrt{2} = 567 \text{ V DC}$ .
2. Set the value of parameter *94.22* to 567 V.
3. Make sure that the value of parameter *99.7* is set to 400 V.

#### Example 2: Sine filter at the output of the drive

The drive is equipped with a sine filter at the output. Motor cable length is 300 m (984 ft). Estimated voltage loss across the filter and cable is 40 V. Motor nominal voltage is 400 V.

To compensate for the 40 V voltage loss at the nominal speed:

1. Calculate the required voltage at the drive output before the sine filter to compensate for the voltage drop:  $400 \text{ V} + 40 \text{ V} = 440 \text{ V}$ .
2. Calculate the required user DC voltage reference:  $440 \text{ V} \times \sqrt{2} = 622 \text{ V}$ .
3. Set the value of parameter *94.22* to 622 V.

If the drive is configured to operate in DTC motor control mode and the ID run is performed with the output filter and motor cable connected, no other configuration is needed. The DTC motor control will take care of the estimated losses and boost drive output voltage without getting limited by parameter *99.7*.

If the drive is configured to operate in the scalar motor control mode, change the value of parameter *99.7* to 440 V to allow the motor control to go up to 440 V at the drive output at nominal speed.

---

**Note:** In scalar motor control mode, the output voltage can alternatively be increased by adjusting the  $U/f$  curve: by setting parameter 97.7. The value of 97.7, can be calculated as the ratio of the desired voltage and the nominal voltage. In this example, the ratio is  $440 \text{ V} / 400 \text{ V} = 110\%$ . Set the value of 97.7 to 110% and leave motor nominal voltage as 400 V.

### Limits

There are two types of limitations that you must take into account when you use the DC voltage boost function: limitations to the DC voltage reference and the limitation to the drive output voltage.

The drive calculates the minimum and maximum limits for the User DC voltage reference. The calculation is based on the actual supply voltage and the upper limit of the largest supply voltage range selection available for the drive (95.1). Limits are:

1. Minimum limit: Internal DC voltage reference ( $U_{dc,int}$ ).
2. Maximum limit: Maximum DC voltage reference ( $U_{dc,max}$ ).

For more information, see the table below and sections [Internal DC voltage reference \( \$U\_{dc,int}\$ \)](#) and [Maximum DC voltage reference \( \$U\_{dc,max}\$ \)](#).

This table summarizes the limits to the user-defined DC voltage reference and to the drive output voltage.

Drive type	95.1 selection	Internal DC voltage reference ( $U_{dc,int}$ ) <sup>1)</sup>	Maximum DC voltage reference ( $U_{dc,max}$ )	Maximum drive output voltage with parameter 97.4 default value
xxxA-3	380...415 V	553 V	663 V	479 V
xxxA-5	380...415 V	553 V	799 V	576 V
	440...480 V	641 V		
	500 V	728 V		
xxxA-7	525...600 V	764 V	1102 V	795 V
	660...690 V	981 V		

<sup>1)</sup> See section [Internal DC voltage reference \( \$U\_{dc,int}\$ \)](#).

#### Internal DC voltage reference ( $U_{dc,int}$ )

$$U_{dc,int} = U_{ac,rms} \times \sqrt{2} \times 1.03$$

where

$$U_{dc,int} \text{ Internal DC voltage reference}$$

$U_{ac,rms}$  Actual input supply voltage.

If the user-defined reference is less than the internal reference value ( $U_{dc,int}$ ), the control program uses the internal reference as the drive DC voltage reference.

Maximum DC voltage reference ( $U_{dc,max}$ )

$$U_{dc,max} = U_{cat,hi} \times \sqrt{2} \times 1.13$$

where

$U_{dc,max}$  Maximum DC voltage reference

$U_{cat,hi}$  Upper limit of the largest supply voltage range selection available for the drive (95.1)

If the user-defined reference is more than the maximum DC voltage reference ( $U_{dc,max}$ ), the control program uses the maximum value as the drive DC voltage reference.

Maximum drive output voltage

$$U_{ac,out} = (U_{dc} / \sqrt{2}) \times (1 - U_{res})$$

where

$U_{ac,out}$  Maximum output voltage of the drive

$U_{dc}$  Actual DC voltage

$U_{res}$  Value of parameter 97.4

The voltage reserve setting (97.4) limits the maximum drive output voltage.

Limit calculation examples

Example 1: Calculating the internal DC voltage reference and maximum DC voltage reference

The voltage category is 380 ... 415 V and the power line voltage is 400 V.

Internal DC voltage reference  $U_{dc,int} = 400 \text{ V} \times \sqrt{2} \times 1.03 = 583 \text{ V}$ .

Maximum DC voltage reference  $U_{dc,max} = 415 \text{ V} \times \sqrt{2} \times 1.13 = 663 \text{ V}$ .

Example 2: Calculating the maximum output voltage of the drive

DC voltage is 650 V DC, and the voltage reserve setting (97.04) is -2%.

The maximum output voltage of the drive is  $U_{ac,out} = (650 / \sqrt{2}) \times (1 + 0.02) = 469 \text{ V}$ .

**Settings and diagnostics**

---

Parameters: 97.7 User flux reference, and 99.7 Motor nominal voltage.

## Safety and protections

### ■ Emergency stop

The emergency stop function is used by the control program. An emergency stop can be generated through fieldbus (parameter 6.1, bits 0...2).

The mode of the emergency stop from the control program is always Off3: Stop by the emergency stop ramp, defined by parameter 23.23 Emergency stop time.

The ramp-down of the motor speed can be supervised by parameters 31.32 and 31.33.

#### **Note:**

- For SIL 3 / PL e-level emergency stop functions, the drive can be fitted with a TÜV-certified FSO-xx safety options module. The module can then be incorporated into certified safety systems.
- The installer of the equipment is responsible for installing the emergency stop devices and all additional devices needed for the emergency stop function to fulfill the required emergency stop categories. For more information, contact your local ABB representative.
- After an emergency stop signal is detected, the emergency stop function cannot be canceled even though the signal is canceled.
- If the minimum (or maximum) torque limit is set to 0%, the emergency stop function may not be able to stop the drive.
- Speed and torque reference additives (parameters 22.15, 22.17, 26.16, 26.25 and 26.41) and reference ramp shapes (23.16...23.19) are ignored in case of emergency ramp stops.

**Note:** In the crane control program, the crane movement can be stopped using the Fast stop function. See section Fast stop (page 103).

### Settings and diagnostics

Parameters: 6.17 Drive status word 2 (page 246), 6.18 Start inhibit status word (page 247), 23.23 Emergency stop time (page 380), 31.32 Emergency ramp supervision (page 438) and 31.33 Emergency ramp supervision delay (page 438).

### ■ Motor thermal protection

The control program features two separate motor temperature monitoring functions. The temperature data sources and warning/trip limits can be set up independently for each function.

The motor temperature can be monitored using

- the motor thermal protection model (estimated temperature derived internally inside the drive), or
- sensors installed in the windings. This will result in a more accurate motor model.



**WARNING!** Double or reinforced insulation is required between the live parts of the motor and the drive control unit. See the hardware manual for more information.

---

In addition to temperature monitoring, a protection function is available for ‘Ex’ motors installed in a potentially explosive atmosphere.

### Motor thermal protection model

The drive calculates the temperature of the motor on the basis of the following assumptions:

1. When power is applied to the drive for the first time, the motor is assumed to be at ambient temperature (defined by parameter 35.50). After this, when power is applied to the drive, the motor is assumed to be at the estimated temperature.
2. Motor temperature is calculated using the user-adjustable motor thermal time and motor load curve. The load curve should be adjusted in case the ambient temperature exceeds 30 °C.

The motor thermal protection model fulfills standard IEC/EN 61800-5-1 ed. 2.1 requirements for thermal memory retention and speed sensitivity. The estimated temperature is retained over power down. Speed dependency is set by parameters 35.51, 35.52 and 35.53.

**Note:** The motor thermal model can be used when only one motor is connected to the drive.

### Temperature monitoring using PTC sensors

One PTC sensor can be connected to digital input DI6.

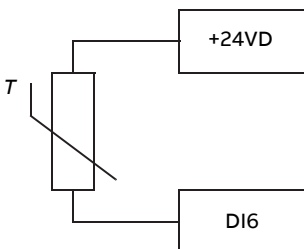



The resistance of the PTC sensor increases when its temperature rises. The increasing resistance of the sensor decreases the voltage at the input, and eventually its state switches from 1 to 0, indicating overtemperature.

1...3 PTC sensors can also be connected in series to an analog input and an analog output. The analog output feeds a constant excitation current of 1.6 mA through the sensor. The sensor resistance increases as the motor temperature rises, as does the voltage over the sensor. The temperature measurement function calculates the resistance of the sensor and generates an indication if overtemperature is detected.

For wiring of the sensor, refer to the *Hardware Manual* of the drive.

The figure below shows typical PTC sensor resistance values as a function of temperature.

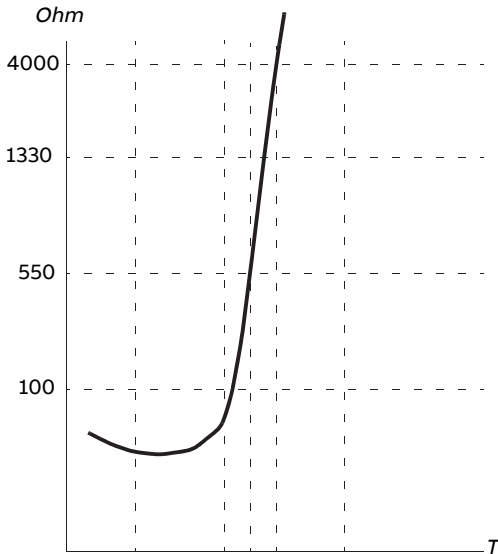

In addition to the above, optional FEN-xx encoder interfaces, and FPTC-xx modules have connections for PTC sensors. Refer to the module-specific documentation for more information.

### **Temperature monitoring using Pt100 or Pt1000 sensors**

1...3 Pt100 or Pt1000 sensors can be connected in series to an analog input and an analog output.

The analog output feeds a constant excitation current of 9.1 mA (Pt100) or 1 mA (Pt1000) through the sensor. The sensor resistance increases as the motor temperature rises, as does the voltage over the sensor. The temperature measurement function reads the voltage through the analog input and converts it into degrees Celsius.

The warning and fault limits can be adjusted by parameters.

For the wiring of the sensor, refer to the *Hardware Manual* of the drive.

**Note:** If excitation current is too high for the sensor, use some other means to measure the temperature.

### **Temperature monitoring using KTY84 sensors**

One KTY84 sensor can be connected to an analog input and an analog output on the control unit.

The analog output feeds a constant excitation current of 2.0 mA through the sensor. The sensor resistance increases as the motor temperature rises, as does the voltage over the sensor. The temperature measurement function reads the voltage through the analog input and converts it into degrees Celsius.

FEN-xx encoder interfaces (optional) also have a connection for one KTY84 sensor.

The figure and table below show typical KTY84 sensor resistance values as a function of the motor operating temperature.

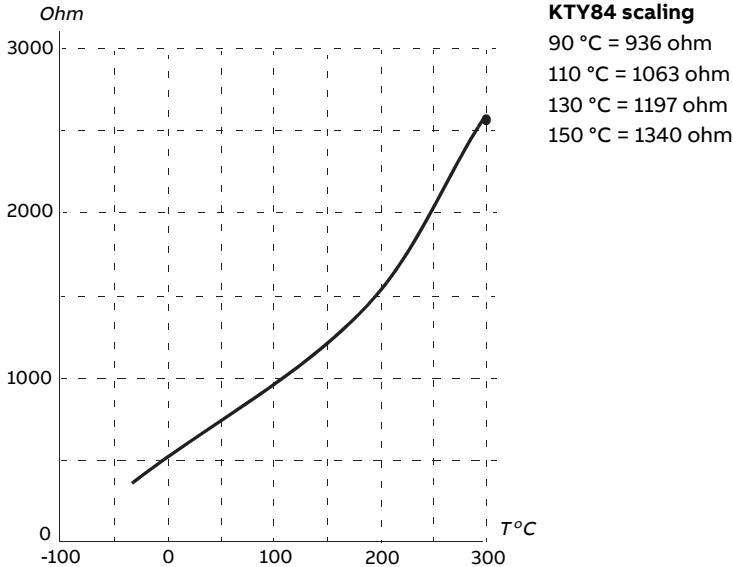

The warning and fault limits can be adjusted by parameters.

For the wiring of the sensor, refer to the *Hardware Manual* of the drive.

### Motor fan control logic (parameters 35.100...35.106)

If the motor has an external cooling fan, it is possible to use a drive signal (for example, running/stopped) to control the starter of the fan via a relay or digital output. A digital input can be selected for fan feedback. A loss of the feedback signal will optionally cause a warning or a fault.

Start and stop delays can be defined for the fan. In addition, a feedback delay can be set to define the time within which feedback must be received after the fan starts.

### Ex motor support (parameter 95.15, bit 0)

The control program has a temperature protection function for Ex motors located in a potentially explosive atmosphere. The protection is enabled by setting bit 0 of parameter 95.15.

### Settings and diagnostics

Parameter groups: 35 Motor thermal protection (page 460) and 91 Encoder module settings (page 623).

Parameter: 95.15 Special HW settings (page 642).

### ■ Motor overload protection

This section describes motor overload protection without using motor thermal protection model, either with estimated or measured temperature. For protection with the motor thermal protection model, see section [Motor thermal protection \(page 199\)](#).

Motor overload protection is required and specified by multiple standards including the US National Electric Code (NEC), UL 508C and the common UL\IEC 61800-5-1 standard in conjunction with IEC 60947-4-1. The standards allow for motor overload protection without external temperature sensors.

The Motor overload protection fulfills standard IEC/EN 61800-5-1 ed. 2.1 requirements for thermal memory retention and speed sensitivity. The estimated temperature is retained over power down. Speed dependency is set by parameters.

The protection feature allows the user to specify the class of operation in the same manner as the overload relays are specified in standards IEC 60947-4-1 and NEMA ICS 2.

Motor overload protection requires that you specify a motor current tripping level. This is defined by a curve using parameters [35.51](#), [35.52](#) and [35.53](#). The tripping level is the motor current at which the overload protection will ultimately trip if the motor current remains at this level continuously.

The motor overload class (class of operation), parameter [35.57](#), is given as the time required for the overload relay to trip when operating at 7.2 times the tripping level in the case of IEC 60947-4-1 and 6 times the tripping level in the case of NEMA ICS 2. The standards also specify the time to trip for current levels between the tripping level and the 6 times tripping level. The drive satisfies the IEC standard and NEMA standard trip times.

Using class 20 satisfies the UL 508C requirements.

The motor overload algorithm monitors the squared ratio (motor current / tripping level)<sup>2</sup> and accumulates this over time. This is sometimes referred to as  $I^2t$  protection. The accumulated value is shown in parameter [35.5](#).

You can define with parameter [35.56](#) that when [35.5](#) reaches 88%, a motor overload warning will be generated, and when it reaches 100%, the drive will trip on the motor overload fault. The rate at which this internal value is increased depends on the actual current, tripping level current and overload class selected.

Parameters [35.51](#), [35.52](#) and [35.53](#) serve a dual purpose. They determine the load curve for temperature estimate as well as specify the overload tripping level.

### Settings and diagnostics

Parameters common to motor thermal protection and motor overload protection: [35.51](#) Motor load curve ... [35.53](#) Break point (page 469).

---

Parameters specific to motor overload protection: 35.5 Motor overload level (page 461), 35.56 Motor overload action ... 35.57 Motor overload class (page 471).

### ■ Thermal protection of motor cable

The control program contains a thermal protection function for the motor cable. This function should be used, for example, when the nominal current of the drive exceeds the current-carrying capacity of the motor cable.

The program calculates the temperature of the cable on the basis of the following data:

- Measured output current (parameter 1.7)
- Nominal continuous current rating of the cable, specified by 35.61, and
- Thermal time constant of the cable, specified by 35.62.

When the calculated temperature of the cable reaches 102% of the rated maximum, a warning (A480) is given. The drive trips on a fault (4000) when 106% is reached.

### Settings and diagnostics

Parameters: 35.60 Cable temperature...35.62 Cable thermal rise time (page 472).

Events: A480 Motor cable overload (page 702) and 4000 Motor cable overload (page 687).

### ■ User load curve

The user load curve provides a function that monitors an input signal (eg. motor torque or motor current) as a function of drive output speed or frequency. The function includes both high limit (overload) and low limit (underload) monitoring. Overload monitoring can, for example, be used to detect a pump becoming clogged or a saw blade hitting a knot. Underload monitoring can detect the load being lost, for example because of the snapping of a transmission belt.

The monitoring is effective within a motor speed and/or frequency range. The frequency range is used with a frequency reference in scalar motor control mode; otherwise, the speed range is used. The range is defined by five speed (parameters 37.11...37.15) or frequency (37.16...37.20) values. The values are positive, but the monitoring is symmetrically active in the negative direction as the sign of the monitored signal is ignored. Outside the speed/frequency range, the monitoring is disabled.

An underload (37.21...37.25) and overload (37.31...37.35) limit is set for each of the five speed or frequency points. Between these points, the limits are interpolated linearly to form overload and underload curves.

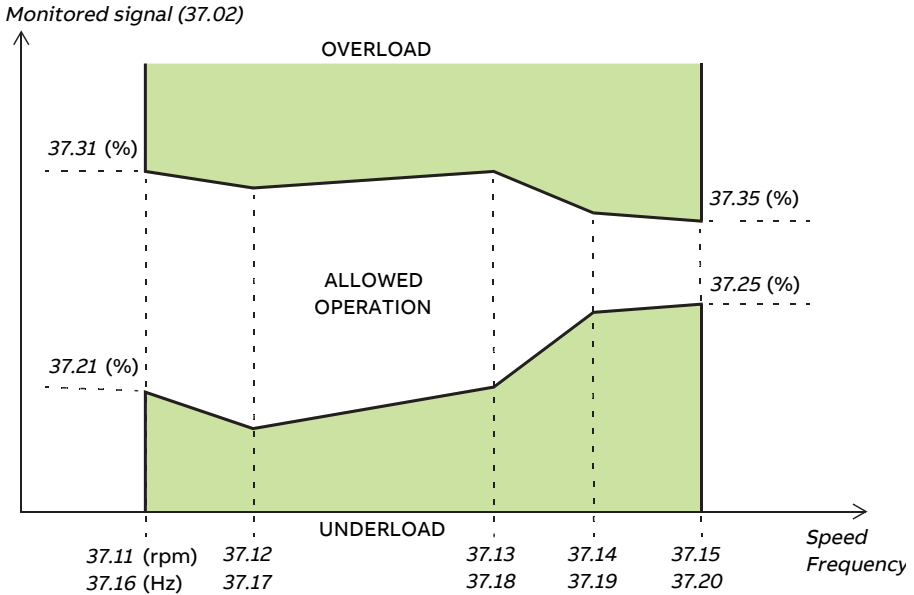

The action (none, warning or fault) taken when the signal exits the allowed operation area can be selected separately for overload and underload conditions (parameters 37.3 and 37.4 respectively). Each condition also has an optional timer to delay the selected action (37.41 and 37.42).

**Settings and diagnostics**

Parameter group: 37 User load curve (page 480).

Events: A6E6 ULC configuration (page 709), A8BE ULC overload (page 719), A8BF ULC underload (page 719), 8001 ULC underload (page 700) and 8002 ULC overload (page 700).

■ **Automatic fault resets**



**WARNING!**

Before you activate the function, make sure that no dangerous situations can occur. The function resets the drive automatically and continues operation after a fault.

The drive can automatically reset itself after overcurrent, overvoltage, undervoltage and external faults. The user can also specify a fault (excluding Safe torque off related faults) to be reset automatically.

By default, automatic resets are off and must be specifically activated by the user.

## Settings and diagnostics

Parameters: 31.12 Autoreset selection...31.16 Delay time (page 433).

### ■ Other programmable protection functions

#### External events (parameters 31.01...31.10)

Five different event signals from the process can be connected to selectable inputs to generate trips and warnings for the driven equipment. When the signal is lost, an external event (fault, warning, or a mere log entry) is generated. The contents of the messages can be edited on the control panel by selecting **Menu - Settings - Edit texts**.

#### Motor phase loss detection (parameter 31.19)

The parameter selects how the drive reacts whenever a motor phase loss is detected.

#### Earth (Ground) fault detection (parameter 31.20)

The earth fault detection function is based on sum current measurement. Note that

- an earth fault in the supply cable does not activate the protection
- in a grounded supply, the protection activates within 2 milliseconds
- in an ungrounded supply, the supply capacitance must be 1 microfarad or more
- the capacitive currents caused by shielded motor cables up to 300 meters will not activate the protection
- the protection is deactivated when the drive is stopped.

#### Safe torque off detection (parameter 31.22)

The drive monitors the status of the Safe torque off input, and this parameter selects which indications are given when the signals are lost. (The parameter does not affect the operation of the Safe torque off function itself). For more information on the Safe torque off function, see the *Hardware manual*.

#### Swapped supply and motor cabling (parameter 31.23)

The drive can detect if the supply and motor cables have accidentally been swapped (for example, if the supply is connected to the motor connection of the drive). The parameter selects if a fault is generated or not. Note that the protection should be disabled in drive/inverter hardware supplied from a common DC bus.

---

### **Stall protection (parameters 31.24...31.28)**

The drive protects the motor in a stall situation. It is possible to adjust the supervision limits (current, frequency and time) and choose how the drive reacts to a motor stall condition.

### **Overspeed protection (parameter 31.30)**

The user can set overspeed limits by specifying a margin that is added to the currently-used maximum and minimum speed limits.

### **Ramp stop supervision (parameters 31.32, 31.33, 31.37 and 31.38)**

The control program has a supervision function for both the normal and emergency stop ramps. The user can either define a maximum time for stopping, or a maximum deviation from the expected deceleration rate. If the drive fails to stop in the expected manner, a fault is generated and the drive coasts to a stop.

### **Main cooling fan supervision (parameter 31.35)**

The parameter selects how the drive reacts to a loss of the main cooling fan.

With an inverter unit consisting of frame R8i inverter modules, it may be possible to continue operation even if a cooling fan of an inverter module stops. See the description of the parameter.

### **Custom motor current fault limit (parameter 31.42)**

The control program sets a motor current limit based on drive hardware. In most cases, the default value is appropriate. However, a lower limit can be manually set by the user, for example, to protect a permanent magnet motor from demagnetization.

### **Local control loss detection (parameter 49.05)**

The parameter selects how the drive reacts to a control panel or PC tool communication break.

## **Diagnostics**

### ■ **Fault and warning messages, data logging**

See chapter [Fault tracing \(page 679\)](#).

### ■ **Signal supervision**

Three signals can be selected to be supervised by this function. Whenever a supervised signal exceeds or falls below predefined limits, a bit in 32.1 is activated, and a warning or fault generated. The contents of the message can be edited on the control panel by selecting **Menu - Settings - Edit texts**.

---



The supervised signal is low-pass filtered. The supervision operates on a 2 ms time level. The configuration parameters are scanned for changes on a 10 ms time level.

### Settings and diagnostics

Parameter group: 32 Supervision (page 444).

Events: A8B0 Signal supervision (page 718), A8B1 Signal supervision 2 (page 718), A8B2 Signal supervision 3 (page 718), 80B0 Signal supervision (page 700), 80B1 Signal supervision 2 (page 700) and 80B2 Signal supervision 3 (page 700).

#### ■ Maintenance timers and counters

The program has six different maintenance timers or counters that can be configured to generate a warning when a pre-defined limit is reached. The contents of the message can be edited on the control panel by selecting **Menu - Settings - Edit texts**.

The timer/counter can be set to monitor any parameter. This feature is especially useful as a service reminder.

There are three types of counters:

- On-time timers. Measures the time a binary source (for example, a bit in a status word) is on.
- Signal edge counters. The counter is incremented whenever the monitored binary source changes state.
- Value counters. The counter measures, by integration, the monitored parameter. A warning is given when the calculated area below the signal peak exceeds a user-defined limit.

### Settings and diagnostics

Parameter group: 33 Generic timer & counter (page 451).

#### ■ Load analyzer

##### Peak value logger

The user can select a signal to be monitored by a peak value logger. The logger records the peak value of the signal along with the time the peak occurred, as well as motor current, DC voltage and motor speed at the time of the peak. The peak value is sampled at 2 ms intervals.

---

### Amplitude loggers

The control program has two amplitude loggers. Depending on the setting of parameter 36.8, the loggers are active continuously or only when the drive is modulating.

For amplitude logger 2, the user can select a signal to be sampled at 200 ms intervals, and specify a value that corresponds to 100%. The collected samples are sorted into 10 read-only parameters according to their amplitude. Each parameter represents an amplitude range 10 percentage points wide, and displays the percentage of the collected samples that have fallen within that range. Note that the lowest range also contains the negative values (if any), while the highest range also contains the values above 100%.

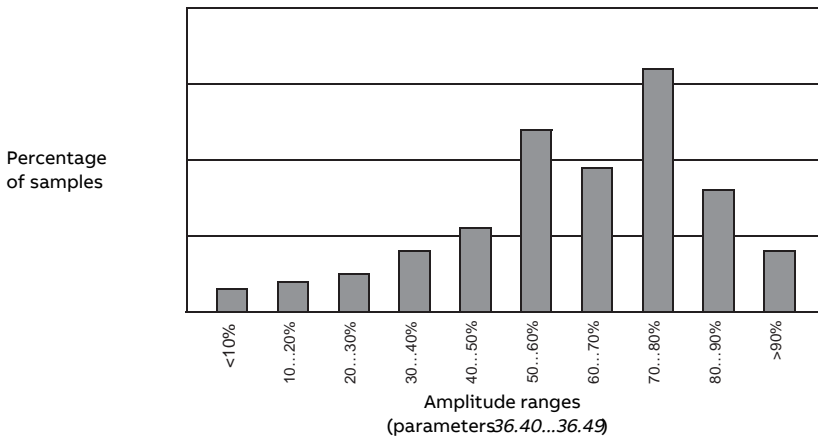

Amplitude logger 1 is fixed to monitor motor current, and cannot be reset. With amplitude logger 1, 100% corresponds to the maximum output current of the drive ( $I_{max}$ , as given in the hardware manual). The distribution of collected samples is shown by parameters 36.20...36.29.

### Settings and diagnostics

Parameter group: 36 Load analyzer (page 475).

### Miscellaneous

#### ■ User parameter sets

The drive supports four user parameter sets that can be saved to the permanent memory and recalled using drive parameters. It is also possible to use digital inputs to switch between user parameter sets.

A user parameter set contains all editable values in parameter groups 10...99 except

- forced I/O values such as parameters 10.3 and 10.4
- I/O extension module settings (groups 14...16)
- fieldbus communication enable parameters (50.1 and 50.31)
- other fieldbus communication settings (groups 51...56 and 58)
- encoder configuration settings (groups 92...93),
- some hardware settings in parameter group 95, and
- user set selection parameters 96.11...96.13

As the motor settings are included in the user parameter sets, make sure the settings correspond to the motor used in the application before recalling a user set. In an application where different motors are used with the drive, the motor ID run needs to be performed with each motor and the results saved to different user sets. The appropriate set can then be recalled when the motor is switched.

If no parameter sets have been saved, attempting to load a set will create all sets from the currently active parameter settings.

Switching between user parameter sets is only possible with the drive stopped.

### Settings and diagnostics

Parameters: 10.3 DI force selection (page 269), 10.4 DI force data (page 269), 50.1 FBA A enable (page 509), 50.31 FBA B enable (page 513), and 96.10 User set status (page 650)...96.13 User set I/O mode in2 (page 652).

Parameter group: 95 HW configuration (page 638).

Events: 64B2 User set fault (page 694).

#### ■ Parameter checksum calculation

A parameter checksum can be calculated from a user-definable set of parameters to monitor changes in the drive configuration. The calculated checksum is compared to 1...4 reference checksums; in case of a mismatch, an event (a pure event, warning or fault) is generated.

By default, the set of parameters included in the calculation contain most parameters with the exception of

- actual signals
  - parameter group 47
  - parameters that are activated to validate new settings (such as 51.27 and 96.7)
  - parameters that are not saved to the flash memory (such as 96.24...96.26)
  - parameters that are internally calculated from others (such as 98.9...98.14).
  - dynamic parameters (eg. parameters that vary according to hardware), and
-

## 212 Program features

- application program parameters.

The default set can be edited using the Drive customizer PC tool.

### **Settings and diagnostics**

**Parameters:** 96.53 Actual checksum (page 654)...96.59 Approved checksum 4 (page 655).

**Events:** 6200 Checksum mismatch (page 692) and A686 Checksum mismatch (page 707).

---

## ■ User lock

---



### **WARNING!**

ABB will not be liable for damages or losses caused by the failure to activate the user lock using a new pass code. See [Cybersecurity disclaimer \(page 24\)](#).

---

For improved cybersecurity, it is highly recommended that you set a master pass code to prevent, for example, the changing of parameter values and/or the loading of firmware and other files.

With several drives, set a unique pass code for each drive.

To activate the user lock for the first time,

- Enter the default pass code, 10000000, into 96.2. This will make parameters 96.100...96.102 visible.
  - Enter a new pass code into 96.100. Always use eight digits; if using Drive Composer, finish with Enter.
  - Confirm the new pass code in 96.101.
- 



### **WARNING!**

Store the pass code in a safe place – the user lock cannot be opened even by ABB if the pass code is lost.

---

- In 96.102, define the actions that you want to prevent (we recommend you select all the actions unless otherwise required by the application).
- Enter an invalid (random) pass code into 96.2.
- Activate 96.8, or cycle the power to the control unit.
- Check that parameters 96.100...96.102 are hidden. If they are not, enter another random pass code into 96.2.

To reopen the lock, enter your pass code into 96.2. This will again make parameters 96.100...96.102 visible.

## **Settings and diagnostics**

Parameters: 96.2 Pass code (page 648) and 96.100 Change user pass code...96.102 User lock functionality (page 657).

Events: A6B0 User lock open (page 708).

---

### ■ Data storage parameters

Twenty-four (sixteen 32-bit, eight 16-bit) parameters are reserved for data storage. These parameters are unconnected by default and can be used for eg. linking, testing and commissioning purposes. They can be written to and read from using other parameters' source or target selections.

Note that only 32-bit floating point (type *real32*) parameters can be selected as the source of another parameter value. In other words, parameters 47.1...47.8 can be used as value sources of other parameters while 47.11...47.28 cannot.

To use a 16-bit integer (received in DDCS data sets) as the source of another parameter, write the value into one of the *real32* type storage parameters (47.1...47.8). Select the storage parameter as the source, and define a suitable scaling method between the 16-bit and 32-bit values in parameters 47.31...47.38.

### Settings and diagnostics

Parameter group: 47 Data storage (page 502).

### ■ Reduced run function

A "reduced run" function is available for inverter units consisting of parallel-connected inverter modules. The function makes it possible to continue operation with limited current even if one (or more) module is out of service, for example, because of maintenance work. In principle, reduced run is possible with only one module, but the physical requirements of operating the motor still apply; for example, the modules remaining in use must be able to provide the motor with enough magnetizing current.

The reduced run mask can be used instead of the reduced run mode in case there is no need to remove the power module physically from the system. Masking a module or several modules stops BCU from sending control commands to selected PSL2 channel or channels.

#### Note:

- STO circuit must remain as it has been.
  - Do not use mask to bypass STO circuit faults.
  - Do not remove fiber optic cables from the system.
  - Module must be disconnected from AC side to avoid current flow through the freewheeling diodes.
-

## Activation of the reduced run function

**Note:** For cabinet-built drives, the wiring accessories and the air baffle needed during the procedure are available from ABB, and are included in the delivery.



### **WARNING!**

Follow the safety instructions provided for the drive or inverter unit in question.

---

1. Disconnect the supply voltage and all auxiliary voltages from the drive/inverter unit.
2. If the inverter control unit is powered from the faulty module, install an extension to the wiring and connect it to one of the remaining modules.
3. Remove the module to be serviced from its bay. See the appropriate hardware manual for instructions.
4. If the Safe torque off (STO) function is in use, install jumpering in the STO wiring in place of the missing module (unless the module was the last on the chain).
5. Install an air baffle to the top module guide to block the airflow through the empty module bay.
6. In case the inverter unit has a DC switch with a charging circuit, disable the appropriate channel on the xSFC-xx charging controller.
7. Switch on the power to the drive/inverter unit.
8. Enter the number of inverter modules present into parameter 95.13.
9. Reset all faults and start the drive/inverter unit. The maximum current is now automatically limited according to the new inverter configuration. A mismatch between the number of detected modules (95.14) and the value set in 95.13 will generate a fault.

After all modules have been reinstalled, parameter 95.13 must be reset to 0 to disable the reduced run function. In case the inverter is equipped with a charging circuit, the charging monitoring must be reactivated for all modules. If the Safe torque off (STO) function is in use, an acceptance test must be performed (see the hardware manual of the drive/inverter unit for instructions).

## Settings and diagnostics

**Parameters:** 6.17 Drive status word 2 (page 246) and 95.13 Reduced run mode...95.14 Connected modules (page 642).

**Events:** 5695 Reduced run (page 691).

---

### ■ du/dt filter support

With an external du/dt filter connected to the output of the drive, bit 13 of 95.20 must be switched on. The setting limits the output switching frequency. With frame size R5i...R7i inverter modules, the setting also forces the drive/inverter module fan to full speed. Note that the setting is not to be activated with inverter modules with internal du/dt filters.

#### Settings and diagnostics

Parameter: 95.20 HW options word 1 (page 644).

### ■ Sine filter support

The control program has a setting that enables the use of sine filters (available separately from ABB and others).

With an ABB sine filter connected to the output of the drive, bit 1 of 95.15 must be switched on. The setting limits the switching and output frequencies to

- prevent the drive from operating at filter resonance frequencies, and
- protect the filter from overheating.

With a custom sine filter, bit 3 of 95.15 must be switched on. (The setting does not limit the output frequency.) Additional parameters must be set according to the properties of the filter as listed below.

#### Settings and diagnostics

Parameters: 95.15 Special HW settings (page 642), 97.1 Switching frequency reference (page 659), 97.2 Minimum switching frequency (page 659), 99.18 Sine filter inductance (page 676) and 99.19 Sine filter capacitance (page 677).

---



■ **Router mode for BCU control unit**

The BCU control unit of an inverter unit can be set to a “router mode” to allow the control of locally-connected power units (for example, inverter modules) by another BCU. Using the router mode and some hardware switching, it is possible to have the same modules alternate between inverter and, for example, IGBT supply use.

The router mode involves connecting the two BCUs together by their PSL2 channels. When router mode is active, the channels coming from the other BCU are forwarded to the local modules.

The diagrams below show how the control of four converter modules can be switched between two BCUs.

**Note:** For an example of how to switch converter modules between inverter and IGBT supply use, see the *ACS880 IGBT supply control program firmware manual* (3AUA0000131562 [English]).

*BCU 1 controlling all modules, BCU 2 in router mode*

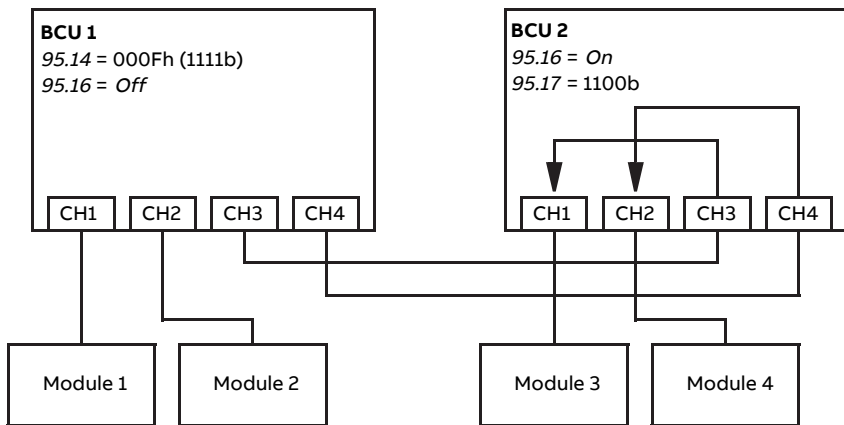

*BCU 2 controlling all modules, BCU 1 in router mode*

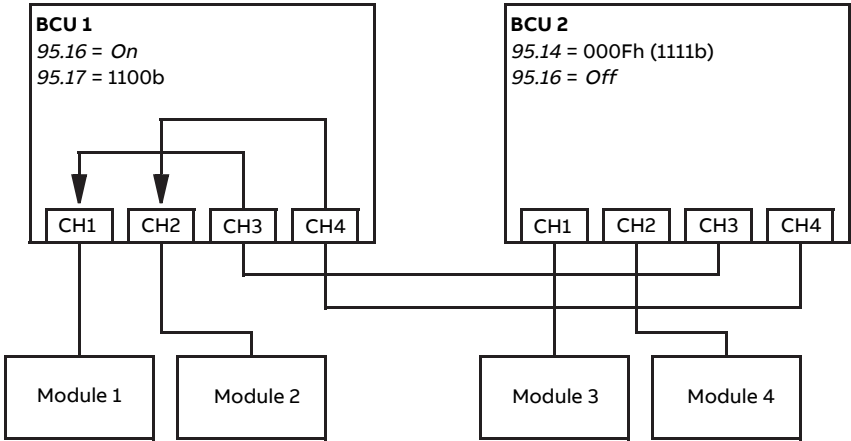

**Note:**

- The local modules must be connected to successive channels starting from CH1. The immediately following channels are connected to the other BCU and routed to the local modules. There must be at least as many local modules as there are routed channels.
- In PLC control, any switch-overs must be done in stopped state, and so that at least one BCU is in router mode at any given time.
- Additional rules or restrictions may apply when using the router mode with other control programs. See the appropriate firmware manual.

**Settings and diagnostics**

Parameters: 95.16 Router mode (page 643) and 95.17 Router channel config (page 643).



# Default control connections

---

The default I/O connections of the control program are shown in section [Control through I/O interface using a joystick](#).



## 8

# Parameters

---

## What this chapter contains

The chapter describes the parameters, including actual signals, of the control program.

## Terms and abbreviations

Term	Definition
Actual signal	Type of parameter that is the result of a measurement or calculation by the drive, or contains status information. Most actual signals are read-only, but some (especially counter-type actual signals) can be reset.
Def	(In the following table, shown on the same row as the parameter name) The default value of a parameter when used in the Factory macro. For information on other macro-specific parameter values, see chapter Application macros.  <b>Note:</b> Certain configurations or optional equipment may require specific default values.  These are labelled as follows: (95.20 bx) = Default changed or write-protected by parameter 95.20, bit x.
FbEq 16b / 32b	(In the following table, shown on the same row as the parameter range, or for each selection) The scaling between the integer used in communication and the value shown on the panel when a 16-bit value is selected for transmission to an external system. The scaling is indicated for both 16-bit and 32-bit values. A dash (-) indicates that the parameter is not accessible in that format.

---

222 Parameters

Term	Definition
Other	<p>The value is taken from another parameter. Choosing “Other” displays a parameter list in which the user can specify the source parameter.</p> <p><b>Note:</b> The source parameter must be of the real32 (32-bit floating point) type. To use a 16-bit integer (for example, received from an external device in data sets) as the source, data storage parameters 47.1 ... 47.8 can be used.</p>
Other [bit]	<p>The value is taken from a specific bit in another parameter. Choosing “Other” displays a parameter list in which the user can specify the source parameter and bit.</p>
Parameter	Either a user-adjustable operating instruction for the drive, or an actual signal.
p.u.	Per unit
[parameter number in square brackets]	The value of the parameter.

## Parameter group summary

Group	Contents	Page
<i>1 Actual values</i>	Basic signals for monitoring the drive.	226
<i>3 Input references</i>	Values of references received from various sources.	231
<i>4 Warnings and faults</i>	Information on warnings and faults that occurred last.	233
<i>5 Diagnostics</i>	Various run-time-type counters and measurements related to drive maintenance.	242
<i>6 Control and status words</i>	Drive control and status words.	244
<i>7 System info</i>	Information on drive hardware, firmware and application program.	257
<i>9 Crane application signals</i>	Crane application signals.	261
<i>10 Standard DI, RO</i>	Configuration of digital inputs and relay outputs.	269
<i>11 Standard DIO, FI, FO</i>	Configuration of digital input/outputs and frequency inputs/outputs.	276
<i>12 Standard AI</i>	Configuration of standard analog inputs.	282
<i>13 Standard AO</i>	Configuration of standard analog outputs.	288
<i>14 I/O extension module 1</i>	Configuration of I/O extension module 1.	294
<i>15 I/O extension module 2</i>	Configuration of I/O extension module 2.	322
<i>16 I/O extension module 3</i>	Configuration of I/O extension module 3.	328
<i>19 Operation mode</i>	Selection of local and external control location sources and operating modes.	334
<i>20 Start/stop/direction</i>	Start/stop/direction and run/start/jog enable signal source selection; positive/negative reference enable signal source selection.	337
<i>21 Start/stop mode</i>	Start and stop modes; emergency stop mode and signal source selection; DC magnetization settings; autophasing mode selection.	356
<i>22 Speed reference selection</i>	Speed reference selection; motor potentiometer settings.	365
<i>23 Speed reference ramp</i>	Speed reference ramp settings (programming of the acceleration and deceleration rates for the drive).	378
<i>24 Speed reference conditioning</i>	Speed error calculation; speed error window control configuration; speed error step.	386
<i>25 Speed control</i>	Speed controller settings.	394
<i>26 Torque reference chain</i>	Settings for the frequency reference chain.	405
<i>29 Voltage reference chain</i>	Settings for the DC voltage reference chain.	414
<i>30 Limits</i>	Drive operation limits.	419
<i>31 Fault functions</i>	Configuration of external events; selection of behavior of the drive upon fault situations.	430
<i>32 Supervision</i>	Configuration of signal supervision functions 1...3.	444
<i>33 Generic timer &amp; counter</i>	Configuration of maintenance timers/counters.	451
<i>35 Motor thermal protection</i>	Motor thermal protection settings such as temperature measurement configuration, load curve definition and motor fan control configuration.	460
<i>36 Load analyzer</i>	Peak value and amplitude logger settings.	475

## 224 Parameters

<b>Group</b>	<b>Contents</b>	<b>Page</b>
<i>37 User load curve</i>	Settings for user load curve.	480
<i>43 Brake chopper</i>	Settings for the internal brake chopper.	483
<i>44 Mechanical brake control</i>	Configuration of mechanical brake control.	486
<i>46 Monitoring/scaling settings</i>	Speed supervision settings; actual signal filtering; general scaling settings.	497
<i>47 Data storage</i>	Data storage parameters that can be written to and read from using other parameters' source and target settings.	502
<i>49 Panel port communication</i>	Communication settings for the control panel port on the drive.	505
<i>50 Fieldbus adapter (FBA)</i>	Fieldbus communication configuration.	509
<i>51 FBA A settings</i>	Fieldbus adapter A configuration.	518
<i>52 FBA A data in</i>	Selection of data to be transferred from drive to fieldbus controller through fieldbus adapter A.	520
<i>53 FBA A data out</i>	Selection of data to be transferred from fieldbus controller to drive through fieldbus adapter A.	521
<i>54 FBA B settings</i>	Fieldbus adapter B configuration.	522
<i>55 FBA B data in</i>	Selection of data to be transferred from drive to fieldbus controller through fieldbus adapter B.	524
<i>56 FBA B data out</i>	Selection of data to be transferred from fieldbus controller to drive through fieldbus adapter B.	525
<i>58 Embedded fieldbus</i>	Configuration of the embedded fieldbus (EFB) interface.	526
<i>60 DDCS communication</i>	DDCS communication configuration.	535
<i>61 D2D and DDCS transmit data</i>	Defines the data sent to the DDCS link.	555
<i>62 D2D and DDCS receive data</i>	Mapping of data received through the DDCS link.	560
<i>74 Speed matching</i>	Settings for Speed matching.	569
<i>75 Hoist speed optimization</i>	Settings for Hoist speed optimization.	570
<i>76 Conical motor control</i>	Settings for Conical motor control.	579
<i>77 Antisway</i>	Settings for Antisway control.	580
<i>78 External sway control</i>	This is the block, where writer shortly describes what is the purpose of the parameter in the group.	594
<i>82 Synchro control</i>	Synchro control configuration.	600
<i>83 Smooth lifting</i>	Smooth lifting configuration.	604
<i>85 ACC interface</i>	ACC interface configuration.	606
<i>90 Feedback selection</i>	Motor and load feedback configuration.	611
<i>91 Encoder module settings</i>	Configuration of encoder interface modules.	623
<i>92 Encoder 1 configuration</i>	Settings for encoder 1.	627
<i>93 Encoder 2 configuration</i>	Settings for encoder 2.	635
<i>95 HW configuration</i>	Various hardware-related settings.	638



<b>Group</b>	<b>Contents</b>	<b>Page</b>
<i>96 System</i>	Language selection; access levels; macro selection; parameter save and restore; control unit reboot; user parameter sets; unit selection; data logger triggering; parameter checksum calculation; user lock.	<i>647</i>
<i>97 Motor control</i>	Motor model settings.	<i>659</i>
<i>98 User motor parameters</i>	Motor values supplied by the user that are used in the motor model.	<i>665</i>
<i>99 Motor data</i>	Motor configuration settings.	<i>668</i>
<i>200 Safety</i>	FSO-xx settings.	<i>677</i>
<i>206 I/O bus configuration</i>	Distributed I/O bus settings.	<i>677</i>
<i>207 I/O bus service</i>	Distributed I/O bus settings.	<i>678</i>
<i>208 I/O bus diagnostics</i>	Distributed I/O bus settings.	<i>678</i>
<i>209 I/O bus fan identification</i>	Distributed I/O bus settings.	<i>678</i>

## Parameters list view

Parameters are visible based on access levels. See the description of [Parameter access levels](#) (page 21).

In the below parameters table, index of those parameters that are not visible in the short menu (pass code 1) are shaded grey.

## Parameter listing

No.	Name / Range / Selection	Description	Def / Type FbEq 16b / 32b
<b>1</b>	<b>Actual values</b>	Basic signals for monitoring the drive. All parameters in this group are read-only unless otherwise noted.	
1.1	Motor speed used	Measured or estimated motor speed depending on which type of feedback is used (see parameter 90.41 <i>Motor feedback selection</i> ). A filter time constant for this signal can be defined by parameter 46.11 <i>Filter time motor speed</i> .	- / real32
	-30000.00 ... 30000.00 rpm	Measured or estimated motor speed. For scaling, see parameter 46.1.	- / -
1.2	Motor speed estimated	Estimated motor speed in rpm. A filter time constant for signal can be defined by parameter 46.11 <i>Filter time motor speed</i> .	- / real32
	-30000.00 ... 30000.00 rpm	Estimated motor speed. For scaling, see parameter 46.1.	- / -
1.3	Motor speed %	Shows the value of 1.1 <i>Motor speed used</i> in percent of the synchronous speed of the motor.	- / real32
	-1000.00 ... 1000.00 %	Measured or estimated motor speed. For scaling, see parameter 46.1.	- / -
1.4	Encoder 1 speed filtered	Speed of encoder 1 in rpm. A filter time constant for this signal can be defined by parameter 46.11 <i>Filter time motor speed</i> .	- / real32
	-30000.00 ... 30000.00 rpm	Encoder 1 speed. For scaling, see parameter 46.1.	- / -
1.5	Encoder 2 speed filtered	Speed of encoder 2 in rpm. A filter time constant for this signal can be defined by parameter 46.11 <i>Filter time motor speed</i> .	- / real32
	-30000.00 ... 30000.00 rpm	Encoder 2 speed. For scaling, see parameter 46.1.	- / -
1.6	Output frequency	Estimated drive output frequency in Hz. A filter time constant for this signal can be defined by parameter 46.12 <i>Filter time output frequency</i> .	- / real32
	-600.00 ... 600.00 Hz	Estimated output frequency. For scaling, see parameter 46.2.	- / -
1.7	Motor current	Measured (absolute) motor current in A.	- / real32
	0.00 ... 30000.00 A	Motor current. For scaling, see parameter 46.5.	- / -
1.8	Motor current % of motor nom	Motor current (drive output current) in percent of the nominal motor current.	- / real32
	0.0 ... 1000.0 %	Motor current.	1 = 1 % / 10 = 1 %
1.10	Motor torque	Motor torque in percent of the nominal motor torque. See also parameter 1.30 <i>Nominal torque scale</i> . A filter time constant for this signal can be defined by parameter 46.13 <i>Filter time motor torque</i> .	- / real32
	-1600.0 ... 1600.0 %	Motor torque. For scaling, see parameter 46.3.	- / -

No.	Name / Range / Selection	Description	Def / Type FbEq 16b / 32b
1.11	DC voltage	Measured DC link voltage.	- / real32
	0.00 ... 2000.00 V	DC link voltage.	10 = 1 V / 100 = 1 V
1.13	Output voltage	Calculated motor voltage in V AC.	- / real32
	0...2000 V	Motor voltage.	1 = 1 V / 1 = 1 V
1.14	Output power	Drive output power. The unit is selected by parameter 96.16 Unit selection. A filter time constant for this signal can be defined by parameter 46.14 Filter time power out.	- / real32
	-32768.00 ... 32767.00 kW	Output power. For scaling, see parameter 46.4.	- / -
1.15	Output power % of motor nom	Shows the value of 1.14 Output power in percent of the nominal power of the motor.	- / real32
	-300.00 ... 300.00 %	Output power.	10 = 1 % / 100 = 1 %
1.17	Motor shaft power	Estimated mechanical power at motor shaft. The unit is selected by parameter 96.16 Unit selection. A filter time constant for this signal can be defined by parameter 46.14 Filter time power out.	- / real32
	-32768.00 ... 32767.00 kW or hp	Motor shaft power.	1 = 1 kW or hp / 100 = 1 kW or hp
1.18	Inverter GWh motoring	Amount of energy that has passed through the drive (towards the motor) in full gigawatt-hours. The minimum value is zero.	- / int16
	0...32767 GWh	Motoring energy in GWh.	1 = 1 GWh / 1 = 1 GWh
1.19	Inverter MWh motoring	Amount of energy that has passed through the drive (towards the motor) in full megawatt-hours. Whenever the counter rolls over, 1.18 Inverter GWh motoring is incremented. The minimum value is zero.	- / int16
	0...1000 MWh	Motoring energy in MWh.	1 = 1 MWh / 1 = 1 MWh
1.20	Inverter kWh motoring	Amount of energy that has passed through the drive (towards the motor) in full kilowatt-hours. Whenever the counter rolls over, 1.19 Inverter MWh motoring is incremented. The minimum value is zero.	- / real32
	0...1000 kWh	Motoring energy in kWh.	10 = 1 kWh / 1 = 1 kWh
1.21	U-phase current	Measured U-phase current.	- / real32
	-30000.00 ... 30000.00 A	U-phase current. For scaling, see parameter 46.5.	- / -
1.22	V-phase current	Measured V-phase current.	- / real32
	-30000.00 ... 30000.00 A	V-phase current. For scaling, see parameter 46.5.	- / -
1.23	W-phase current	Measured W-phase current.	- / real32
	-30000.00 ... 30000.00 A	W-phase current. For scaling, see parameter 46.5.	- / -
1.24	Flux actual %	Used flux reference in percent of nominal flux of motor.	- / real32
	0...200 %	Flux reference.	1 = 1 % / 1 = 1 %

## 228 Parameters

No.	Name / Range / Selection	Description	Def / Type FbEq 16b / 32b
1.25	INU momentary cos $\phi$	Momentary cosphi of the drive.	0.00 / real32
	-1.00 ... 1.00	Cosphi.	100 = 1 / 100 = 1
1.29	Speed change rate	Rate of actual speed change. Positive values indicate acceleration, negative values indicate deceleration. See also parameters 31.32 Emergency ramp supervision, 31.33 Emergency ramp supervision delay, 31.37 Ramp stop supervision and 31.38 Ramp stop supervision delay.	- / real32
	-15000...15000 rpm/s	Rate of speed change.	1 = 1 rpm/s / 1 = 1 rpm/s
1.30	Nominal torque scale	Torque that corresponds to 100% of nominal motor torque. The unit is selected by parameter 96.16 Unit selection.  <b>Note:</b> This value is copied from parameter 99.12 Motor nominal torque if entered. Otherwise the value is calculated from other motor data.	0.000 Nm or lb-ft / uint32
	0.000 ... 4000000.000 Nm or lb-ft	Nominal torque.	1 = 1 Nm or lb-ft / 1000 = 1 Nm or lb-ft
1.31	Ambient temperature	Measured temperature of incoming cooling air. The unit (°C or °F) is selected by parameter 96.16 Unit selection.	- / real32
	-40.0 ... 200.0 °	Cooling air temperature.	1 = 1 ° / 10 = 1 °
1.32	Inverter GWh regenerating	Amount of energy that has passed through the drive (towards the supply) in full gigawatt-hours. The minimum value is zero.	- / int16
	0...32767 GWh	Regenerative energy in GWh.	1 = 1 GWh / 1 = 1 GWh
1.33	Inverter MWh regenerating	Amount of energy that has passed through the drive (towards the supply) in full megawatt-hours. Whenever the counter rolls over, 1.32 Inverter GWh regenerating is incremented. The minimum value is zero.	- / int16
	0...1000 MWh	Regenerative energy in MWh.	1 = 1 MWh / 1 = 1 MWh
1.34	Inverter kWh regenerating	Amount of energy that has passed through the drive (towards the supply) in full kilowatt-hours. Whenever the counter rolls over, 1.33 Inverter MWh regenerating is incremented. The minimum value is zero.	- / real32
	0...1000 kWh	Regenerative energy in kWh.	10 = 1 kWh / 1 = 1 kWh
1.35	Mot - regen energy GWh (resettable)	Amount of net energy (motoring energy - regenerating energy) that has passed through the drive in full gigawatt hours. You can reset the value by setting it to zero. Resetting any of the parameters 1.35 to 1.37 resets all.	0 GWh / int16
	-32768...32767 GWh	Energy balance in GWh.	1 = 1 GWh / 1 = 1 GWh

No.	Name / Range / Selection	Description	Def / Type FbEq 16b / 32b
1.36	Mot - regen energy MWh (resettable)	Amount of net energy (motoring energy - regenerating energy) that has passed through the drive in full megawatt hours. Whenever the counter rolls over, 1.35 Mot - regen energy GWh (resettable) is incremented or decremented. You can reset the value by setting it to zero. Resetting any of the parameters 1.35 to 1.37 resets all.	0 MWh / int16
	-1000...1000 MWh	Energy balance in MWh.	1 = 1 MWh / 1 = 1 MWh
1.37	Mot - regen energy kWh (resettable)	Amount of energy (motoring energy - regenerating energy) that has passed through the drive in full kilowatt-hours. Whenever the counter rolls over, 1.36 Mot - regen energy MWh (resettable) is incremented or decremented. You can reset the value by setting it to zero. Resetting any of the parameters 1.35 to 1.37 resets all.	0 kWh / real32
	-1000...1000 kWh	Energy balance in kWh.	10 = 1 kWh / 1 = 1 kWh
1.61	Abs motor speed used	Absolute value of 1.1 Motor speed used.	- / real32
	0.00 ... 30000.00 rpm	Measured or estimated motor speed. For scaling, see parameter 46.1.	- / -
1.62	Abs motor speed %	Absolute value of 1.3 Motor speed %.	- / real32
	0.00 ... 1000.00 %	Measured or estimated motor speed.	10 = 1 % / 100 = 1 %
1.63	Abs output frequency	Absolute value of 1.6 Output frequency.	- / real32
	0.00 ... 600.00 Hz	Estimated output frequency. For scaling, see parameter 46.2.	- / -
1.64	Abs motor torque	Absolute value of 1.10 Motor torque.	- / real32
	0.0 ... 1600.0 %	Motor torque. For scaling, see parameter 46.3	- / -
1.65	Abs output power	Absolute value of 1.14 Output power.	- / real32
	0.00 ... 32767.00 kW or hp	Output power.	1 = 1 kW or hp / 100 = 1 kW or hp
1.66	Abs output power %	Absolute value of 1.15 Output power % of motor nom.	- / real32
	0.00 ... 300.00 %	Output power.	10 = 1 % / 100 = 1 %
1.68	Abs motor shaft power	Absolute value of 1.17 Motor shaft power.	- / real32
	0.00 ... 32767.00 kW or hp	Motor shaft power.	1 = 1 kW or hp / 100 = 1 kW or hp
1.70	Ambient temperature %	Measured temperature of incoming cooling air. The amplitude range of 0...100 % corresponds to 0...60 °C or 32...140 °F. See also 1.31 Ambient temperature.	0.00 % / real32
	-200.00 ... 200.00 %	Cooling air temperature.	1 = 1 % / 100 = 1 %

## 230 Parameters

No.	Name / Range / Selection	Description	Def / Type FbEq 16b / 32b
1.71	Step-up motor current	Estimated motor current in A when a step-up transformer is in use. The value is calculated from parameter 1.7 using the step-up transformer ratio (95.40) and sine filter values 99.18 and 99.19.	- / real32
	0.00 ... 30000.00 A	Estimated motor current. For scaling, see parameter 46.5.	- / -
1.72	U-phase RMS current	U-phase rms current.	- / real32
	0.00 ... 30000.00 A	U-phase rms current. For scaling, see parameter 46.5.	- / -
1.73	V-phase RMS current	V-phase rms current.	- / real32
	0.00 ... 30000.00 A	V-phase rms current. For scaling, see parameter 46.5.	- / -
1.74	W-phase RMS current	W-phase rms current.	- / real32
	0.00 ... 30000.00 A	W-phase rms current. For scaling, see parameter 46.5.	- / -

No.	Name / Range / Selection	Description	Def / Type FbEq 16b / 32b
<b>3</b>	<b>Input references</b>	Values of references received from various sources. All parameters in this group are read-only unless otherwise noted.	
3.1	Panel reference	Local reference given from the control panel or PC tool.	0.00 / real32
	-100000.00 ... 100000.00	Local control panel or PC tool reference.	1 = 10 / 100 = 1
3.2	Panel reference 2	Remote reference given from the control panel or PC tool.	- / real32
	-30000.00 ... 30000.00	Remote control panel or PC tool reference.	1 = 10 / 100 = 1
3.5	FB A reference 1	Reference 1 received through fieldbus adapter A. See also chapter <a href="#">Fieldbus control through a fieldbus adapter (page 761)</a> .	0.00 / real32
	-100000.00 ... 100000.00	Reference 1 from fieldbus adapter A.	1 = 10 / 100 = 1
3.6	FB A reference 2	Reference 2 received through fieldbus adapter A.	0.00 / real32
	-100000.00 ... 100000.00	Reference 2 from fieldbus adapter A.	1 = 10 / 100 = 1
3.7	FB B reference 1	Reference 1 received through fieldbus adapter B.	0.00 / real32
	-100000.00 ... 100000.00	Reference 1 from fieldbus adapter B.	1 = 10 / 100 = 1
3.8	FB B reference 2	Reference 2 received through fieldbus adapter B.	0.00 / real32
	-100000.00 ... 100000.00	Reference 2 from fieldbus adapter B.	1 = 10 / 100 = 1
3.9	EFB reference 1	Scaled reference 1 received through the embedded fieldbus interface. The scaling is defined by <a href="#">58.26 EFB ref1 type</a> .	- / real32
	-30000.00 ... 30000.00	Reference 1 received through the embedded fieldbus interface.	1 = 10 / 100 = 1
3.10	EFB reference 2	Scaled reference 2 received through the embedded fieldbus interface. The scaling is defined by <a href="#">58.27 EFB ref2 type</a> .	- / real32
	-30000.00 ... 30000.00	Reference 2 received through the embedded fieldbus interface.	1 = 10 / 100 = 1
3.11	DDCS controller ref 1	Reference 1 received from the external (DDCS) controller. The value has been scaled according to parameter <a href="#">60.60 DDCS controller ref1 type</a> . See also section <a href="#">External controller interface (page 167)</a> .	- / real32
	-30000.00 ... 30000.00	Scaled reference 1 received from external controller.	1 = 10 / 100 = 1
3.12	DDCS controller ref 2	Reference 2 received from the external (DDCS) controller. The value has been scaled according to parameter <a href="#">60.61 DDCS controller ref2 type</a> .	- / real32

## 232 Parameters

No.	Name / Range / Selection	Description	Def / Type FbEq 16b / 32b
	-30000.00 ... 30000.00	Scaled reference 2 received from external controller.	1 = 10 / 100 = 1
3.13	M/F or D2D ref1	Master/follower reference 1 received from the master. The value has been scaled according to parameter 60.10 M/F ref1 type. See also section Master/follower functionality (page 159).	- / real32
	-30000.00 ... 30000.00	Scaled reference 1 received from master.	1 = 10 / 100 = 1
3.14	M/F or D2D ref2	Master/follower reference 2 received from the master. The value has been scaled according to parameter 60.11 M/F ref2 type.	- / real32
	-30000.00 ... 30000.00	Scaled reference 2 received from master.	1 = 10 / 100 = 1
3.30	FB A reference 1 int32	Reference 1 received through fieldbus adapter A as a 32-bit integer.	- / int32
	-2147483648..2147483647	Reference 1 from fieldbus adapter A.	- / -
3.31	FB A reference 2 int32	Reference 2 received through fieldbus adapter A as a 32-bit integer.	- / int32
	-2147483648..2147483647	Reference 2 from fieldbus adapter A.	- / -
3.51	IEC application panel reference	Panel reference defined in the application program.	0 / real32
	-100000...100000	Panel reference in the application program.	1 = 1 / 1 = 1



No.	Name / Range / Selection	Description	Def / Type FbEq 16b / 32b
<b>4</b>	<b>Warnings and faults</b>	Information on warnings and faults that occurred last. For explanations of individual warning and fault codes, see chapter <a href="#">Fault tracing (page 679)</a> . All parameters in this group are read-only unless otherwise noted.	
4.1	Tripping fault	Code of the 1st active fault (the fault that caused the current trip).	0 / uint16
	0000...FFFFh	1st active fault.	1 = 1
4.2	Active fault 2	Code of the 2nd active fault.	0 / uint16
	0000...FFFFh	2nd active fault.	1 = 1
4.3	Active fault 3	Code of the 3rd active fault.	0 / uint16
	0000...FFFFh	3rd active fault.	1 = 1
4.4	Active fault 4	Code of the 4th active fault.	0 / uint16
	0000...FFFFh	4th active fault.	1 = 1
4.5	Active fault 5	Code of the 5th active fault.	0 / uint16
	0000...FFFFh	5th active fault.	1 = 1
4.6	Active warning 1	Code of the 1st active warning.	0 / uint16
	0000...FFFFh	1st active warning.	1 = 1
4.7	Active warning 2	Code of the 2nd active warning.	0 / uint16
	0000...FFFFh	2nd active warning.	1 = 1
4.8	Active warning 3	Code of the 3rd active warning.	0 / uint16
	0000...FFFFh	3rd active warning.	1 = 1
4.9	Active warning 4	Code of the 4th active warning.	0 / uint16
	0000...FFFFh	4th active warning.	1 = 1
4.10	Active warning 5	Code of the 5th active warning.	0 / uint16
	0000...FFFFh	5th active warning.	1 = 1
4.11	Latest fault	Code of the 1st stored (non-active) fault.	0 / uint16
	0000...FFFFh	1st stored fault.	1 = 1
4.12	2nd latest fault	Code of the 2nd stored (non-active) fault.	0 / uint16
	0000...FFFFh	2nd stored fault.	1 = 1
4.13	3rd latest fault	Code of the 3rd stored (non-active) fault.	0 / uint16
	0000...FFFFh	3rd stored fault.	1 = 1
4.14	4th latest fault	Code of the 4th stored (non-active) fault.	0 / uint16
	0000...FFFFh	4th stored fault.	1 = 1
4.15	5th latest fault	Code of the 5th stored (non-active) fault.	0 / uint16
	0000...FFFFh	5th stored fault.	1 = 1
4.16	Latest warning	Code of the 1st stored (non-active) warning.	0 / uint16
	0000...FFFFh	1st stored warning.	1 = 1

234 Parameters

No.	Name / Range / Selection	Description	Def / Type FbEq 16b / 32b
4.17	2nd latest warning	Code of the 2nd stored (non-active) warning.	0 / uint16
	0000...FFFFh	2nd stored warning.	1 = 1
4.18	3rd latest warning	Code of the 3rd stored (non-active) warning.	0 / uint16
	0000...FFFFh	3rd stored warning.	1 = 1
4.19	4th latest warning	Code of the 4th stored (non-active) warning.	0 / uint16
	0000...FFFFh	4th stored warning.	1 = 1
4.20	5th latest warning	Code of the 5th stored (non-active) warning.	0 / uint16
	0000...FFFFh	5th stored warning.	1 = 1

No.	Name / Range / Selection	Description	Def / Type FbEq 16b / 32b
4.21	Fault word 1	ACS800-compatible fault word 1. The bit assignments of this word correspond to <b>FAULT WORD 1</b> in the ACS800. Parameter 4.120 Fault/Warning word compatibility determines whether the bit assignments are according to the ACS800 Standard or ACS800 System control program. Each bit can indicate several ACS880 events as listed below. This parameter is read-only.	- / uint16

Bit	ACS880 fault name		ACS880 events indicated by this bit (see Fault tracing (page 679)).
	(4.120 = ACS800 Standard ctrl program)	(4.120 = ACS800 System ctrl program)	
0	SHORT CIRC	SHORT CIRC	2340
1	OVERCURRENT	OVERCURRENT	2310
2	DC OVERVOLT	DC OVERVOLT	3210
3	ACS800 TEMP	ACS800 TEMP	2381, 4210, 4290, 42F1, 4310, 4380
4	EARTH FAULT	EARTH FAULT	2330, 2392, 3181
5	THERMISTOR	MOTOR TEMP M	4981, 4991, 4992, 4993
6	MOTOR TEMP	MOTOR TEMP	4982
7	SYS-TEM_FAULT	SYS-TEM_FAULT	6481, 6487, 64A1, 64A2, 64A3, 64B1, 64E1, 6881, 6882, 6883, 6885
8	UNDERLOAD	UNDERLOAD	-
9	OVERFREQ	OVERFREQ	7310
10	Reserved	MPROT SWITCH	9081
11	Reserved	CH2 COMM LOSS	7582
12	Reserved	SC (INU1)	2340 (XXYY YY01)
13	Reserved	SC (INU2)	2340 (XXYY YY02)
14	Reserved	SC (INU3)	2340 (XXYY YY03)
15	Reserved	SC (INU4)	2340 (XXYY YY04)

236 Parameters

No.	Name / Range / Selection	Description	Def / Type FbEq 16b / 32b
-----	--------------------------	-------------	------------------------------

4.22    Fault word 2    ACS800-compatible fault word 2.  
 The bit assignments of this word correspond to **FAULT WORD 2** in the ACS800. Parameter 4.120 *Fault/Warning word compatibility* determines whether the bit assignments are according to the ACS800 Standard or ACS800 System control program.  
 Each bit can indicate several ACS880 events as listed below.  
 This parameter is read-only.

Bit	ACS880 fault name		ACS880 events indicated by this bit (see Fault tracing (page 679).
	(4.120 = ACS800 Standard ctrl program)	(4.120 = ACS800 System ctrl program)	
0	SUPPLY PHASE	SUPPLY PHASE	3130
1	NO MOT DATA	NO MOTOR DATA	-
2	DC UNDER-VOLT	DC UNDER-VOLT	3220
3	Reserved	CABLE TEMP	4000
4	RUN ENABLE	RUN DISABLE	AFEb
5	ENCODERERR	ENCODERERR	7301, 7380, 7381, 73A0, 73A1
6	I/O COMM	IO COMM ERR	7080, 7082
7	CTRL B TEMP	CTRL B TEMP	-
8	EXTERNAL FLT	SELECTABLE	9082
9	OVER SW-FREQ	OVER SW-FREQ	-
10	AI < MIN FUNC	AI < MIN FUNC	80A0
11	PPCC LINK	PPCC LINK	5681, 5682, 5690, 5691, 5692, 5693, 5694, 5695
12	COMM MODULE	COMM MODULE	6681, 7510, 7520, 7581
13	PANEL LOSS	PANEL LOSS	7081
14	MOTORSTALL	MOTORSTALL	7121
15	MOTOR PHASE	MOTOR PHASE	3381

4.25    Faulted modules    *(Only visible with a BCU control unit)*  
 Indicates which parallel-connected modules have faulted.  
 The bits of this word are cleared when all faults have been reset.  
 This parameter is read-only.

b0	1 = Module 1 faulted
b1	1 = Module 2 faulted
b2	1 = Module 3 faulted.

No.	Name / Range / Selection	Description	Def / Type FbEq 16b / 32b
b3		1 = Module 4 faulted.	
b4		1 = Module 5 faulted.	
b5		1 = Module 6 faulted.	
b6		1 = Module 7 faulted.	
b7		1 = Module 8 faulted.	
b8		1 = Module 9 faulted.	
b9		1 = Module 10 faulted.	
b10		1 = Module 11 faulted.	
b11		1 = Module 12 faulted.	
b12...15 Reserved			
	0000h...FFFh		1 = 1

238 Parameters

No.	Name / Range / Selection	Description	Def / Type FbEq 16b / 32b
-----	--------------------------	-------------	------------------------------

4.31 Warning word 1 ACS800-compatible warning (alarm) word 1. The bit assignments of this word correspond to ALARM WORD 1 in the ACS800. Parameter 4.120 Fault/Warning word compatibility determines whether the assignments are according to the ACS800 Standard or ACS800 System control program. Each may indicate several ACS880 warnings as listed below. This parameter is read-only.

- / uint16

Bit	ACS800 alarm name		ACS880 events indicated by this bit (see Fault tracing (page 679).
	(4.120 = ACS800 Standard ctrl program)	(4.120 = ACS800 System ctrl program)	
0	START INHIBIT	START INHIBIT	A5A0
1	Reserved	EM STOP	AFE1, AFE2
2	THERMISTOR	MOTOR TEMP M	A491, A497, A498, A499
3	MOTOR TEMP	MOTOR TEMP	A492
4	ACS800 TEMP	ACS800 TEMP	A2BA, A4A9, A4B0, A4B1, A4F6
5	ENCODERERR	ENCODERERR	A797, A7B0, A7B1, A7E1
6	T MEAS ALM	T MEAS CIRC	A490, A5EA, A782, A8A0
7	Reserved	DIGITAL IO	-
8	Reserved	ANALOG IO	-
9	Reserved	EXT DIGITAL IO	-
10	Reserved	EXT ANALOG IO	A6E5, A7AA, A7AB
11	Reserved	CH2 COMM LOSS	A7CB, AF80
12	COMM MODULE	MPROT SWITCH	A981
13	Reserved	EM STOP DEC	-
14	EARTH FAULT	EARTH FAULT	A2B3
15	Reserved	SAFETY SWITC	A983

No.	Name / Range / Selection	Description	Def / Type FbEq 16b / 32b																																																																						
4.32	Warning word 2	<p>ACS800-compatible warning (alarm) word 2. The bit assignments of this word correspond to ALARM WORD 2 in the ACS800. Parameter 4.120 Fault/Warning word compatibility determines whether the bit assignments are according to the ACS800 Standard or ACS800 System control program. Each may indicate several ACS880 warnings as listed below. This parameter is read-only.</p> <table border="1"> <thead> <tr> <th rowspan="2">Bit</th> <th colspan="2">ACS800 alarm name</th> <th rowspan="2">ACS880 events indicated by this bit (see Fault tracing (page 679)).</th> </tr> <tr> <th>(4.120 = ACS800 Standard ctrl program)</th> <th>(4.120 = ACS800 System ctrl program)</th> </tr> </thead> <tbody> <tr> <td>0</td> <td>Reserved</td> <td>MOTOR FAN</td> <td>A781</td> </tr> <tr> <td>1</td> <td>UNDERLOAD</td> <td>UNDERLOAD</td> <td>-</td> </tr> <tr> <td>2</td> <td>Reserved</td> <td>INV OVERLOAD</td> <td>-</td> </tr> <tr> <td>3</td> <td>Reserved</td> <td>CABLE TEMP</td> <td>A480</td> </tr> <tr> <td>4</td> <td>ENCODER</td> <td>ENCODER A&lt;&gt;B</td> <td>-</td> </tr> <tr> <td>5</td> <td>Reserved</td> <td>FAN OVERTEMP</td> <td>A984</td> </tr> <tr> <td>6</td> <td>Reserved</td> <td>Reserved</td> <td>-</td> </tr> <tr> <td>7</td> <td>POWFAIL FILE</td> <td>POWFAIL FILE</td> <td>-</td> </tr> <tr> <td>8</td> <td>ALM (OS_17)</td> <td>POWDOWN FILE</td> <td>-</td> </tr> <tr> <td>9</td> <td>MOTORSTALL</td> <td>MOTORSTALL</td> <td>A780</td> </tr> <tr> <td>10</td> <td>AI &lt; MIN FUNC</td> <td>AI&lt;MIN FUNC</td> <td>A8A0</td> </tr> <tr> <td>11</td> <td>Reserved</td> <td>COMM MODULE</td> <td>A6D1, A6D2, A7C1, A7C2, A7CA, A7CE</td> </tr> <tr> <td>12</td> <td>Reserved</td> <td>BATT FAILURE</td> <td>-</td> </tr> <tr> <td>13</td> <td>PANEL LOSS</td> <td>PANEL LOSS</td> <td>A7EE</td> </tr> <tr> <td>14</td> <td>Reserved</td> <td>DC UNDERVOLT</td> <td>A3A2</td> </tr> <tr> <td>15</td> <td>Reserved</td> <td>RESTARTED</td> <td>-</td> </tr> </tbody> </table>	Bit	ACS800 alarm name		ACS880 events indicated by this bit (see Fault tracing (page 679)).	(4.120 = ACS800 Standard ctrl program)	(4.120 = ACS800 System ctrl program)	0	Reserved	MOTOR FAN	A781	1	UNDERLOAD	UNDERLOAD	-	2	Reserved	INV OVERLOAD	-	3	Reserved	CABLE TEMP	A480	4	ENCODER	ENCODER A<>B	-	5	Reserved	FAN OVERTEMP	A984	6	Reserved	Reserved	-	7	POWFAIL FILE	POWFAIL FILE	-	8	ALM (OS_17)	POWDOWN FILE	-	9	MOTORSTALL	MOTORSTALL	A780	10	AI < MIN FUNC	AI<MIN FUNC	A8A0	11	Reserved	COMM MODULE	A6D1, A6D2, A7C1, A7C2, A7CA, A7CE	12	Reserved	BATT FAILURE	-	13	PANEL LOSS	PANEL LOSS	A7EE	14	Reserved	DC UNDERVOLT	A3A2	15	Reserved	RESTARTED	-	- / uint16
Bit	ACS800 alarm name			ACS880 events indicated by this bit (see Fault tracing (page 679)).																																																																					
	(4.120 = ACS800 Standard ctrl program)	(4.120 = ACS800 System ctrl program)																																																																							
0	Reserved	MOTOR FAN	A781																																																																						
1	UNDERLOAD	UNDERLOAD	-																																																																						
2	Reserved	INV OVERLOAD	-																																																																						
3	Reserved	CABLE TEMP	A480																																																																						
4	ENCODER	ENCODER A<>B	-																																																																						
5	Reserved	FAN OVERTEMP	A984																																																																						
6	Reserved	Reserved	-																																																																						
7	POWFAIL FILE	POWFAIL FILE	-																																																																						
8	ALM (OS_17)	POWDOWN FILE	-																																																																						
9	MOTORSTALL	MOTORSTALL	A780																																																																						
10	AI < MIN FUNC	AI<MIN FUNC	A8A0																																																																						
11	Reserved	COMM MODULE	A6D1, A6D2, A7C1, A7C2, A7CA, A7CE																																																																						
12	Reserved	BATT FAILURE	-																																																																						
13	PANEL LOSS	PANEL LOSS	A7EE																																																																						
14	Reserved	DC UNDERVOLT	A3A2																																																																						
15	Reserved	RESTARTED	-																																																																						
4.40	Event word 1	<p>User-defined event word. This word collects the status of the events (warnings, faults or pure events) selected by parameters 4.41...4.72. For each event, an auxiliary code can optionally be specified for filtering. This parameter is read-only.</p>	- / uint16																																																																						
	b0 User bit 0	1 = Event selected by parameters 4.41 Event word 1 bit 0 code (and 4.42 Event word 1 bit 0 aux code) is active																																																																							
	b1 User bit 1	1 = Event selected by parameters 4.43 Event word 1 bit 1 code (and 4.44 Event word 1 bit 1 aux code) is active																																																																							
	b15 User bit 15	1 = Event selected by parameters 4.71 (and 4.72) is active																																																																							
	0000h...FFFFh		1 = 1																																																																						

240 Parameters

No.	Name / Range / Selection	Description	Def / Type FbEq 16b / 32b
4.41	Event word 1 bit 0 code	Selects the hexadecimal code of an event (warning, fault or pure event) whose status is shown as bit 0 of 4.40 Event word 1. The event codes are listed in chapter Fault tracing (page 679).	0 / uint16
	0000...FFFFh	Code of event.	1 = 1
4.42	Event word 1 bit 0 aux code	Specifies an auxiliary code for the event selected by the previous parameter. The selected event is indicated by the event word only if its auxiliary code matches the value of this parameter. With a value of 0000 0000h, the event word will indicate the event regardless of the auxiliary code.	0 / uint32
	0000...FFFFh	Code of warning, fault or pure event.	1 = 1
4.43	Event word 1 bit 1 code	Selects the hexadecimal code of an event (warning, fault or pure event) whose status is shown as bit 1 of 4.40 Event word 1. The event codes are listed in chapter Fault tracing (page 679).	0 / uint16
	0000...FFFFh	Code of event.	1 = 1
4.44	Event word 1 bit 1 aux code	Specifies an auxiliary code for the event selected by the previous parameter. The selected event is indicated by the event word only if its auxiliary code matches the value of this parameter. With a value of 0000 0000h, the event word will indicate the event regardless of the auxiliary code.	0 / uint32
	0000...FFFFh	Code of warning, fault or pure event.	1 = 1
...	...	...	...
4.55	Event word 1 bit 7 code		0 / uint16
	0000...FFFFh	This is the block, where writer describes in more details how the values of parameters should be interpreted.	1 = 1
4.56	Event word 1 bit 7 aux code		0 / uint32
	0000...FFFFh	This is the block, where writer describes in more details how the values of parameters should be interpreted.	1 = 1
4.71	Event word 1 bit 15 code	Selects the hexadecimal code of an event (warning, fault or pure event) whose status is shown as bit 15 of 4.40 Event word 1. The event codes are listed in chapter Fault tracing (page 679).	0000h / uint16
	0000...FFFFh	Code of event.	1 = 1
4.72	Event word 1 bit 15 aux code	Specifies an auxiliary code for the event selected by the previous parameter. The selected event is indicated by the event word only if its auxiliary code matches the value of this parameter. With a value of 0000 0000h, the event word will indicate the event regardless of the auxiliary code.	0000 0000h / uint32



No.	Name / Range / Selection	Description	Def / Type FbEq 16b / 32b
	0000 0000h...FFFF FFFFh	Code of warning, fault or pure event.	1 = 1
4.120	Fault/Warning word compatibility	Selects whether the bit assignments of parameters 4.21...4.32 correspond to the ACS800 Standard control program or the ACS800 System control program.	ACS800 Standard ctrl program / uint16
	ACS800 Standard ctrl program	<p>The bit assignments of parameters 4.21...4.32 correspond to the ACS800 Standard control program as follows:</p> <ul style="list-style-type: none"> <li>• 4.21: 03.05 FAULT WORD 1</li> <li>• 4.22: 03.06 FAULT WORD 2</li> <li>• 4.31: 03.08 ALARM WORD 1</li> <li>• 4.32: 03.09 ALARM WORD 2</li> </ul>	0
	ACS800 System ctrl program	<p>The bit assignments of parameters 4.21...4.32 correspond to the ACS800 System control program as follows:</p> <ul style="list-style-type: none"> <li>• 4.21: 09.01 FAULT WORD 1</li> <li>• 4.22: 09.02 FAULT WORD 2</li> <li>• 4.31: 09.04 ALARM WORD 1</li> <li>• 4.32: 09.04 ALARM WORD 2</li> </ul>	1

## 242 Parameters

No.	Name / Range / Selection	Description	Def / Type FbEq 16b / 32b
<b>5</b>	<b>Diagnostics</b>	Various run-time-type counters and measurements related to drive maintenance. All parameters in this group are read-only unless otherwise noted.	
5.1	On-time counter	On-time counter. The counter runs when the drive is powered.	0 d / uint16
	0...65535 d	On-time counter.	1 = 1 d / 1 = 1 d
5.2	Run-time counter	Motor run-time counter. The counter runs when the inverter modulates.	0 d / uint16
	0...65535 d	Motor run-time counter.	1 = 1 d / 1 = 1 d
5.4	Main fan on-time counter	Running time of the drive cooling fan. Can be reset from the control panel by keeping Reset depressed for over 3 seconds.	0 d / uint16
	0...65535 d	Cooling fan run-time counter.	1 = 1 d / 1 = 1 d
5.9	Time from power-up	500-microsecond ticks elapsed since the last boot of the control unit.	- / uint32
	0...4294967295	500-microsecond ticks since last boot.	1 = 1 / 1 = 1
5.11	Inverter temperature	Estimated drive temperature in percent of fault limit. The actual trip temperature varies according to the type of the drive. 0.0 % = 0 °C (32 °F) 94 % approx. = Warning limit 100.0 % = Fault limit	- / real32
	-40.0 ... 160.0 %	Drive temperature in percent.	1 = 1 % / 10 = 1 %
5.22	Diagnostic word 3	Diagnostic word 3.	- / uint16
	b0...10	Reserved	
	b11 Fan command	1 = Drive fan is rotating above idle speed	
	b12 Fan service counter	1 = Drive fan service counter has reached its limit	
	b13...15	Reserved	
	0000h...FFFFh		1 = 1
5.41	Main fan service counter	Displays the age of the main cooling fan as a percentage of its estimated lifetime. The estimate is based on the duty, operating conditions and other operating parameters of the fan. When the counter reaches 100%, a warning (A8CO Fan service counter) is generated. Can be reset from the control panel by keeping Reset depressed for over 3 seconds.	0 % / real32
	0...150 %	Main cooling fan age.	1 = 1 % / 1 = 1 %

No.	Name / Range / Selection	Description	Def / Type FbEq 16b / 32b
5.42	Aux. fan service counter	Displays the age of the auxiliary cooling fan as a percentage of its estimated lifetime. The estimate is based on the duty, operating conditions and other operating parameters of the fan. When the counter reaches 100%, a warning (A8C0 Fan service counter) is generated. Can be reset from the control panel by keeping Reset depressed for over 3 seconds.	0 % / real32
	0...150 %	Auxiliary cooling fan age.	1 = 1 % / 1 = 1 %

## 244 Parameters

No.	Name / Range / Selection	Description	Def / Type FbEq 16b / 32b
<b>6</b>	<b>Control and status words</b>	Drive control and status words.	
6.1	Main control word	<p>The main control word of the drive. This parameter shows the control signals as received from the selected sources (such as digital inputs, the fieldbus interfaces and the application program). The bit assignments of the word are as described on page 767. The related status word and state diagram are presented on pages 769 and 770 respectively.</p> <p><b>Note:</b> This parameter is read-only.</p> <ul style="list-style-type: none"> <li>Bits 12...15 can be used to carry additional control data, and used as a signal source by any binary-source selector parameter. Bit 10 must be active for bits 12...15 to update.</li> <li>In fieldbus control, this parameter value is not exactly the same as the control word that the drive receives from the PLC. See parameter 50.12 FBA A debug mode.</li> </ul>	- / uint16
6.2	Application control word	<p>The drive control word received from the application program (if any). The bit assignments are described on page 767. This parameter is read-only.</p>	- / uint16
6.3	FBA A transparent control word	<p>Displays the unaltered control word received from the PLC through fieldbus adapter A when a transparent communication profile is selected eg. by parameter group 51 FBA A settings. See section Control word and Status word (page 764). This parameter is read-only.</p>	0 / uint32
	00000000...FFFFFFFh	Control word received through fieldbus adapter A.	1 = 1
6.4	FBA B transparent control word	<p>Displays the unaltered control word received from the PLC through fieldbus adapter B when a transparent communication profile is selected eg. by parameter group 54 FBA B settings. See section Control word and Status word (page 764). This parameter is read-only.</p>	0 / uint32
	00000000...FFFFFFFh	Control word received through fieldbus adapter B.	1 = 1
6.5	EFB transparent control word	<p>Displays the unaltered control word received from the PLC through the embedded fieldbus interface when a transparent communication profile is selected in parameter 58.25 Control profile. See section The Transparent profile (page 753). This parameter is read-only.</p>	0 / uint32
	00000000...FFFFFFFh	Control word received through the embedded fieldbus interface.	1 = 1

No.	Name / Range / Selection	Description	Def / Type FbEq 16b / 32b
6.11	Main status word	<p>Main status word of the drive. The bit assignments are described on page 769. The related control word and state diagram are presented on pages 767 and 770.</p> <p><b>Note:</b> In fieldbus control, this parameter value is not exactly the same as the status word that the drive sends to the PLC. See parameter 50.12 FBA A debug mode.</p> <p>This parameter is read-only.</p>	- / uint16
6.16	Drive status word 1	<p>Drive status word 1. This parameter is read-only.</p>	- / uint16
	b0 Enabled	<p>1 = Both run enable (see par. 20.12) and start enable (20.19) signals are present, and Safe torque off has not been activated.</p> <p><b>Note:</b></p> <ul style="list-style-type: none"> <li>In I/O or local control, clearing this bit makes the drive enter the SWITCH-ON INHIBITED state. For further information, see 769.</li> <li>This bit is not affected by the presence of a fault.</li> </ul>	
	b1 Inhibited	1 = Start inhibited. See parameters 6.18 and 6.25 for the source of the inhibiting signal.	
	b2 DC charged	<p>1 = DC circuit has been charged. If present, the DC switch is closed, and charging switch is open. 0 = Charging not complete. If the inverter unit is not equipped with a DC switch (option +F286), check setting of 95.9.</p>	
	b3 Ready to start	1 = Drive is ready to receive a start command	
	b4 Following reference	1 = Drive is ready to follow given reference	
	b5 Started	1 = Drive has been started	
	b6 Modulating	1 = Drive is modulating (output stage is being controlled)	
	b7 Limiting	1 = Any operating limit (speed, torque, etc.) is active	
	b8 Local control	1 = Drive is in local control	
	b9 Network control	1 = Drive is in network control. See Terms and abbreviations (page 22).	
	b10 Ext1 active	1 = Control location EXT1 active	
	b11 Ext2 active	1 = Control location EXT2 active	
	b12 Reserved		
	b13 Start request	<p>1 = Start requested</p> <p><b>Note:</b> At the time of publishing, a start request from the control panel does not activate this bit if any start-inhibiting condition (see bit 1) is present.</p>	
	b14...15 Reserved		

## 246 Parameters

No.	Name / Range / Selection	Description	Def / Type FbEq 16b / 32b
	0000h...FFFFh		1 = 1
6.17	Drive status word 2	Drive status word 2. This parameter is read-only.	- / uint16
	b0 Identification run done	1 = Motor identification (ID) run has been performed	
	b1 Magnetized	1 = The motor has been magnetized	
	b2 Torque control	1 = Torque control mode active	
	b3 Speed control	1 = Speed control mode active	
	b4 Voltage control	Reserved	
	b5 Safe reference active	1 = A "safe" reference is being applied by functions such as parameters 49.5 and 50.2.	
	b6 Last speed active	1 = A "last speed" reference is being applied by functions such as parameters 49.5 and 50.2.	
	b7 Loss of reference	1 = Reference signal lost	
	b8 Emergency stop failed	1 = Emergency stop failed (see parameters 31.32 and 31.33).	
	b9 Jogging active	1 = Jogging enable signal is on	
	b10 Above limit	1 = Actual speed, frequency or torque equals or exceeds limit (defined by parameters 46.31...46.33). Valid in both directions of rotation.	
	b11 Emergency stop active	1 = An emergency stop command signal is active, or the drive is stopping after receiving an emergency stop command.	
	b12 Reduced run	1 = Reduced run active (see section <a href="#">Reduced run function</a> (page 214)).	
	b13 Reserved		
	b14 Stop failed	1 = Stopping failed (see parameters 31.37 and 31.38)	
	b15 Reserved		
	0000h...FFFFh		1 = 1

No.	Name / Range / Selection	Description	Def / Type FbEq 16b / 32b
6.18	Start inhibit status word	<p>Start inhibit status word. This word specifies the source of the inhibiting condition that is preventing the drive from starting.</p> <p>After the condition is removed, the start command must be cycled. See bit-specific notes.</p> <p>See also parameter 6.25 Drive inhibit status word 2, and 6.16 Drive status word 1, bit 1.</p> <p>This parameter is read-only.</p> <p><b>Note:</b></p> <ul style="list-style-type: none"> <li>• If bit 1 of 6.16 Drive status word 1 is still set after the removal of the inhibiting condition, and edge triggering is selected for the active external control location, a fresh rising-edge start signal is required. See parameters 20.2, 20.7 and 20.19.</li> <li>• If bit 1 of 6.16 Drive status word 1 is still set after the removal of the inhibiting condition, a fresh rising-edge start signal is required.</li> <li>• Informative bit. The inhibiting condition need not be removed by the user.</li> </ul>	- / uint16
	b0 Not ready run	1 = DC voltage is missing or drive has not been parametrized correctly. Check the parameters in groups 95 and 99.	
	b1 Ctrl location changed	1 = Control location has changed	
	b2 SSW inhibit	1 = Control program is keeping itself in inhibited state	
	b3 Fault	1 = A fault is active	
	b4 Lost start enable	1 = Start enable signal missing	
	b5 Lost run enable	1 = Run enable signal missing	
	b6 FSO inhibit	1 = Operation prevented by FSO-xx safety functions module	
	b7 STO	1 = Safe torque off active	
	b8 Current calibration ended	1 = Current calibration routine has finished	
	b9 ID run ended	1 = Motor identification run has finished	
	b10 Auto phase ended	1 = Autophasing routine has finished	
	b11 Off1	1 = Emergency stop signal (mode Off1)	
	b12 Em Off2	1 = Emergency stop signal (mode Off2)	
	b13 Em Off3	1 = Emergency stop signal (mode Off3)	
	b14 Auto reset inhibit	1 = The autoreset function is inhibiting operation	
	b15 Jogging active	1 = The jogging enable signal is inhibiting operation	
	0000h...FFFFh		1 = 1
6.19	Speed control status word	<p>Speed control status word.</p> <p>This parameter is read-only.</p>	- / uint16

## 248 Parameters

No.	Name / Range / Selection	Description	Def / Type FbEq 16b / 32b
b0	Zero speed	1 = Drive is running at zero speed, ie. the absolute value of par. 90.1 Motor speed for control has remained below 21.6 Zero speed limit for longer than 21.7 Zero speed delay.  <b>Note:</b> <ul style="list-style-type: none"> <li>This bit is not updated when mechanical brake control is enabled by par. 44.6 and the drive is modulating.</li> <li>During a ramp stop when the drive is running forward, the delay count runs whenever <math>[90.1] &lt; [21.6]</math>. From the reverse direction, the delay count runs whenever <math>90.1 &gt; -[21.6]</math>.</li> </ul>	
b1	Forward	1 = Drive is running in forward direction above zero speed limit, ie. $[90.1] > +[21.6]$ .	
b2	Reverse	1 = Drive is running in reverse direction above zero speed limit, ie. $[90.1] < -[21.6]$ .	
b3	Out of window	1 = Speed error window control active (see par. 24.41)	
b4	Internal speed feedback	1 = Estimated speed feedback used in motor control, ie. estimated speed is selected by par. 90.41 or 90.46, or selected encoder has faulted (par. 90.45) 0 = Encoder 1 or 2 used for speed feedback	
b5	Encoder 1 feedback	1 = Encoder 1 used for speed feedback in motor control 0 = Encoder 1 faulted or not selected as source of speed feedback (see par. 90.41 and 90.46)	
b6	Encoder 2 feedback	1 = Encoder 2 used for speed feedback in motor control 0 = Encoder 2 faulted or not selected as source of speed feedback (see par. 90.41 and 90.46)	
b7	Constant speed req	1 = A constant speed or frequency has been selected; see par. 6.20.	
b8	MF speed corr min	1 = Minimum limit of speed correction (in a speed-controlled follower) has been reached (see par. 23.39...23.41).	
b9	MF speed corr max	1 = Maximum limit of speed correction (in a speed-controlled follower) has been reached (see par. 23.39...23.41).	
b10...15	Reserved		
	0000h...FFFFh		1 = 1
6.20	Constant speed status word	Constant speed/frequency status word. Indicates which constant speed or frequency is active (if any). See also parameter 6.19 Speed control status word, bit 7, and section Constant speeds/frequencies. This parameter is read-only.	- / uint16
b0	Constant speed 1	1 = Constant speed or frequency 1 selected	
b1	Constant speed 2	1 = Constant speed or frequency 2 selected	



No.	Name / Range / Selection	Description	Def / Type FbEq 16b / 32b
	b2 Constant speed 3	1 = Constant speed or frequency 3 selected	
	b3 Constant speed 4	1 = Constant speed or frequency 4 selected	
	b4 Constant speed 5	1 = Constant speed or frequency 5 selected	
	b5 Constant speed 6	1 = Constant speed or frequency 6 selected	
	b6 Constant speed 7	1 = Constant speed or frequency 7 selected	
	b7...15 Reserved		
	0000h...FFFFh		1 = 1
6.21	Drive status word 3	Drive status word 3. This parameter is read-only.	- / uint16
	b0 DC hold active	1 = DC hold is active (see par. 21.8)	
	b1 Post-magnetizing active	1 = Post-magnetizing is active (see par. 21.8)	
	b2 Motor pre-heating active	1 = Motor pre-heating is active (see par. 21.14)	
	b3 Smooth start active	Reserved	
	b4 Rotor position known	1 = Rotor position has been determined (autophasing not needed). See section <i>Autophasing</i> (page 184).	
	b5 Brake chopper active	Brake chopper active. See section <i>Brake chopper</i> (page 195).	
	b6 Motor temperature estimation active		
	b7...15 Reserved		
	0000h...FFFFh		1 = 1
6.25	Drive inhibit status word 2	Drive inhibit status word 2. This word specifies the source of the inhibiting condition that is preventing the drive from starting. After the condition is removed, the start command must be cycled. See bit-specific notes. See also parameter 6.18 <i>Start inhibit status word</i> , and 6.16 <i>Drive status word 1, bit 1</i> . This parameter is read-only.	- / uint16
		<b>Note:</b>	
		<ul style="list-style-type: none"> <li>If bit 1 of 6.16 <i>Drive status word 1</i> is still set after the removal of the inhibiting condition, and edge triggering is selected for the active external control location, a fresh rising-edge start signal is required. See parameters 20.2, 20.7 and 20.19.</li> <li>If bit 1 of 6.16 <i>Drive status word 1</i> is still set after the removal of the inhibiting condition, a fresh rising-edge start signal is required.</li> </ul>	
	b0 Follower drive	1 = A follower is preventing the master from starting.	
	b1 Application	1 = The application program is preventing the drive from starting.	

## 250 Parameters

No.	Name / Range / Selection	Description	Def / Type FbEq 16b / 32b
	b2	Reserved	
	b3	Encoder feedback	1 = The encoder feedback configuration is preventing the drive from starting.
	b4	Ref source parametrization	1 = A reference source parametrization conflict is preventing the drive from starting. See warning A6DA Reference source parametrization.
	b5...15	Reserved	
	0000h...FFFFh		1 = 1
6.29	MSW bit 10 sel	Selects a binary source whose status is transmitted as bit 10 of 6.11 Main status word.	Above limit / uint32
	False	0	0
	True	1	1
	Above limit	Bit 10 of 6.17 Drive status word 2 (page 246).	2
	Other [bit]	See Terms and abbreviations (page 221).	
6.30	MSW bit 11 sel	Selects a binary source whose status is transmitted as bit 11 of 6.11 Main status word.	Ext ctrl loc / uint32
	False	0	0
	True	1	1
	Ext ctrl loc	Bit 11 of 6.1 Main control word (page 244).	2
	Other [bit]	See Terms and abbreviations (page 221).	
6.31	MSW bit 12 sel	Selects a binary source whose status is transmitted as bit 12 of 6.11 Main status word.	Ext run enable / uint32
	False	0	0
	True	1	1
	Ext run enable	Inverted bit 5 of 6.18 Start inhibit status word (page 247).	2
	Other [bit]	See Terms and abbreviations (page 221).	
6.32	MSW bit 13 sel	Selects a binary source whose status is transmitted as bit 13 of 6.11 Main status word.	False / uint32
	False	0	0
	True	1	1
	Other [bit]	See Terms and abbreviations (page 221).	
6.33	MSW bit 14 sel	Selects a binary source whose status is transmitted as bit 14 of 6.11 Main status word.	False / uint32
	False	0	0
	True	1	1
	Other [bit]	See Terms and abbreviations (page 221).	

No.	Name / Range / Selection	Description	Def / Type FbEq 16b / 32b
6.45	Follower CW user bit 0 selection	Selects a binary source whose status is transmitted as bit 12 of the Follower control word to follower drives. (Bits 0...11 of the Follower control word are taken from 6.1 Main control word.) See also section Master/follower functionality (page 159).	MCW user bit 0 / uint32
	FALSE	0	0
	TRUE	1	1
	MCW user bit 0	Bit 12 of 6.1 Main control word (page 244).	2
	MCW user bit 1	Bit 13 of 6.1 Main control word (page 244).	3
	MCW user bit 2	Bit 14 of 6.1 Main control word (page 244).	4
	MCW user bit 3	Bit 15 of 6.1 Main control word (page 244).	5
	Other [bit]	See Terms and abbreviations (page 221).	
6.46	Follower CW user bit 1 selection	Selects a binary source whose status is transmitted as bit 13 of the Follower control word to follower drives. (Bits 0...11 of the Follower control word are taken from 6.1 Main control word.)	MCW user bit 1 / uint32
	FALSE	0	0
	TRUE	1	1
	MCW user bit 0	Bit 12 of 6.1 Main control word (page 244).	2
	MCW user bit 1	Bit 13 of 6.1 Main control word (page 244).	3
	MCW user bit 2	Bit 14 of 6.1 Main control word (page 244).	4
	MCW user bit 3	Bit 15 of 6.1 Main control word (page 244).	5
	Other [bit]	See Terms and abbreviations (page 221).	
6.47	Follower CW user bit 2 selection	Selects a binary source whose status is transmitted as bit 14 of the Follower control word to follower drives. (Bits 0...11 of the Follower control word are taken from 6.1 Main control word.)	MCW user bit 2 / uint32
	FALSE	0	0
	TRUE	1	1
	MCW user bit 0	Bit 12 of 6.1 Main control word (page 244).	2
	MCW user bit 1	Bit 13 of 6.1 Main control word (page 244).	3
	MCW user bit 2	Bit 14 of 6.1 Main control word (page 244).	4
	MCW user bit 3	Bit 15 of 6.1 Main control word (page 244).	5
	Other [bit]	See Terms and abbreviations (page 221).	
6.48	Follower CW user bit 3 selection	Selects a binary source whose status is transmitted as bit 15 of the Follower control word to follower drives. (Bits 0...11 of the Follower control word are taken from 6.1 Main control word.)	MCW user bit 3 / uint32
	FALSE	0	0
	TRUE	1	1
	MCW user bit 0	Bit 12 of 6.1 Main control word (page 244).	2

## 252 Parameters

No.	Name / Range / Selection	Description	Def / Type FbEq 16b / 32b
	MCW user bit 1	Bit 13 of 6.1 Main control word (page 244).	3
	MCW user bit 2	Bit 14 of 6.1 Main control word (page 244).	4
	MCW user bit 3	Bit 15 of 6.1 Main control word (page 244).	5
	Other [bit]	See Terms and abbreviations (page 221).	
6.50	User status word 1	User-defined status word. This word shows the status of the binary sources selected by parameters 6.60...6.75. This parameter is read-only.	- / uint16
	b0 User status bit 0	Status of source selected by parameter 6.60.	
	b1 User status bit 1	Status of source selected by parameter 6.61.	
	b2 User status bit 2	Status of source selected by parameter 6.62.	
	b3 User status bit 3	Status of source selected by parameter 6.63.	
	b4 User status bit 4	Status of source selected by parameter 6.64.	
	b5 User status bit 5	Status of source selected by parameter 6.65.	
	b6 User status bit 6	Status of source selected by parameter 6.66.	
	b7 User status bit 7	Status of source selected by parameter 6.67.	
	b8 User status bit 8	Status of source selected by parameter 6.68.	
	b9 User status bit 9	Status of source selected by parameter 6.69.	
	b10 User status bit 10	Status of source selected by parameter 6.70.	
	b11 User status bit 11	Status of source selected by parameter 6.71.	
	b12 User status bit 12	Status of source selected by parameter 6.72.	
	b13 User status bit 13	Status of source selected by parameter 6.73.	
	b14 User status bit 14	Status of source selected by parameter 6.74.	
	b15 User status bit 15	Status of source selected by parameter 6.75.	
	0000h...FFFFh		1 = 1
6.60	User status word 1 bit 0 sel	Selects a binary source whose status is shown as bit 0 of 6.50 User status word 1.	FALSE / uint32
	FALSE	0	0
	TRUE	1	1
	Other [bit]	See Terms and abbreviations (page 221).	
6.61	User status word 1 bit 1 sel	Selects a binary source whose status is shown as bit 1 of 6.50 User status word 1.	Out of window / uint32
	False	0	0
	True	1	1
	Out of window	Bit 3 of 6.19 Speed control status word (page 247).	2
	Other [bit]	See Terms and abbreviations (page 221).	
6.62	User status word 1 bit 2 sel	Selects a binary source whose status is shown as bit 2 of 6.50 User status word 1.	Emergency stop failed / uint32
	False	0	0

No.	Name / Range / Selection	Description	Def / Type FbEq 16b / 32b
	True	1	1
	Emergency stop failed	Bit 8 of 6.17 Drive status word 2 (page 246).	2
	Other [bit]	See Terms and abbreviations (page 221).	
6.63	User status word 1 bit 3 sel	Selects a binary source whose status is shown as bit 3 of 6.50 User status word 1.	Magnetized / uint32
	False	0	0
	True	1	1
	Magnetized	Bit 1 of 6.17 Drive status word 2 (page 246).	2
	Other [bit]	See Terms and abbreviations (page 221).	
6.64	User status word 1 bit 4 sel	Selects a binary source whose status is shown as bit 4 of 6.50 User status word 1.	Run disable / uint32
	False	0	0
	True	1	1
	Run disable	Bit 5 of 6.18 Start inhibit status word.	2
	Other [bit]	See Terms and abbreviations (page 221).	
6.65	User status word 1 bit 5 sel	Selects a binary source whose status is shown as bit 5 of 6.50 User status word 1.	FALSE / uint32
	FALSE	0	0
	TRUE	1	1
	Other [bit]	See Terms and abbreviations (page 221).	
6.66	User status word 1 bit 6 sel	Selects a binary source whose status is shown as bit 6 of 6.50 User status word 1.	FALSE / uint32
	FALSE	0	0
	TRUE	1	1
	Other [bit]	See Terms and abbreviations (page 221).	
6.67	User status word 1 bit 7 sel	Selects a binary source whose status is shown as bit 7 of 6.50 User status word 1.	Identification run done / uint32
	False	0	0
	True	1	1
	Identification run done	Bit 0 of 6.17 Drive status word 2 (page 246).	2
	Other [bit]	See Terms and abbreviations (page 221).	
6.68	User status word 1 bit 8 sel	Selects a binary source whose status is shown as bit 8 of 6.50 User status word 1.	Start inhibition / uint32
	False	0	0
	True	1.	1
	Start inhibition	Bit 7 of 6.18 Start inhibit status word (page 247).	2
	Other [bit]	See Terms and abbreviations (page 221).	

## 254 Parameters

No.	Name / Range / Selection	Description	Def / Type FbEq 16b / 32b
6.69	User status word 1 bit 9 sel	Selects a binary source whose status is shown as bit 9 of 6.50 User status word 1.	Limiting / uint32
	False	0	0
	True	1	1
	Limiting	Bit 7 of 6.16 Drive status word 1 (page 245).	2
	Other [bit]	See Terms and abbreviations (page 221).	
6.70	User status word 1 bit 10 sel	Selects a binary source whose status is shown as bit 10 of 6.50 User status word 1.	Torque control / uint32
	False	0	0
	True	1	1
	Torque control	Bit 2 of 6.17 Drive status word 2 (page 246).	2
	Other [bit]	See Terms and abbreviations (page 221).	
6.71	User status word 1 bit 11 sel	Selects a binary source whose status is shown as bit 11 of 6.50 User status word 1.	Zero speed / uint32
	False	0	0
	True	1	1
	Zero speed	Bit 0 of 6.19 Speed control status word (page 247).	2
	Other [bit]	See Terms and abbreviations (page 221).	
6.72	User status word 1 bit 12 sel	Selects a binary source whose status is shown as bit 12 of 6.50 User status word 1.	Internal speed feedback / uint32
	False	0	0
	True	1	1
	Internal speed feedback	Bit 4 of 6.19 Speed control status word (page 247).	2
	Other [bit]	See Terms and abbreviations (page 221).	
6.73	User status word 1 bit 13 sel	Selects a binary source whose status is shown as bit 13 of 6.50 User status word 1.	FALSE / uint32
	FALSE	0	0
	TRUE	1	1
	Other [bit]	See Terms and abbreviations (page 221).	
	6.74	User status word 1 bit 14 sel	Selects a binary source whose status is shown as bit 14 of 6.50 User status word 1.
FALSE		0	0
TRUE		1	1
Other [bit]		See Terms and abbreviations (page 221).	
6.75		User status word 1 bit 15 sel	Selects a binary source whose status is shown as bit 15 of 6.50 User status word 1.
	FALSE	0	0
	TRUE	1	1
	Other [bit]	See Terms and abbreviations (page 221).	

No.	Name / Range / Selection	Description	Def / Type FbEq 16b / 32b
6.100	User control word 1	User-defined control word 1.	- / uint16
	b0	User control word 1 bit 0 sel	
	b1	User control word 1 bit 1 sel	
	b2	User control word 1 bit 2 sel	
	b3	User control word 1 bit 3 sel	
	b4	User control word 1 bit 4 sel	
	b5	User control word 1 bit 5 sel	
	b6	User control word 1 bit 6 sel	
	b7	User control word 1 bit 7 sel	
	b8	User control word 1 bit 8 sel	
	b9	User control word 1 bit 9 sel	
	b10	User control word 1 bit 10 sel	
	b11	User control word 1 bit 11 sel	
	b12	User control word 1 bit 12 sel	
	b13	User control word 1 bit 13 sel	
	b14	User control word 1 bit 14 sel	
	b15	User control word 1 bit 15 sel	
	0000h...FFFFh		1 = 1
6.101	User control word 2	User-defined control word 2.	- / uint16
	b0	User control word 2 bit 0 sel	
	b1	User control word 2 bit 1 sel	
	b2	User control word 2 bit 2 sel	
	b3	User control word 2 bit 3 sel	

## 256 Parameters

No.	Name / Range / Selection	Description	Def / Type FbEq 16b / 32b
	b4	User control word 2 bit 4 sel	User-defined bit.
	b5	User control word 2 bit 5 sel	User-defined bit.
	b6	User control word 2 bit 6 sel	User-defined bit.
	b7	User control word 2 bit 7 sel	User-defined bit.
	b8	User control word 2 bit 8 sel	User-defined bit.
	b9	User control word 2 bit 9 sel	User-defined bit.
	b10	User control word 2 bit 10 sel	User-defined bit.
	b11	User control word 2 bit 11 sel	User-defined bit.
	b12	User control word 2 bit 12 sel	User-defined bit.
	b13	User control word 2 bit 13 sel	User-defined bit.
	b14	User control word 2 bit 14 sel	User-defined bit.
	b15	User control word 2 bit 15 sel	User-defined bit.
	0000h...FFFFh		1 = 1



No.	Name / Range / Selection	Description	Def / Type FbEq 16b / 32b
<b>7</b>	<b>System info</b>	Information on drive hardware, firmware and application program. All parameters in this group are read-only.	
7.3	Drive rating id	Type of the drive/inverter unit.	- / uint16
7.4	Firmware name	Firmware identification. The format is AINFX, where X denotes the control unit type (2 or B = BCU-x2, 6 or C = ZCU-12/14).	0 / uint32
7.5	Firmware version	Version number of the firmware. The format is A.BB.C.D, where A = major version, B = minor version, C = patch (ie. firmware variant code), D = 0.	0 / uint32
7.6	Loading package name	Name of the firmware loading package. The format is AINLX, where X denotes the control unit type (2 or B = BCU-x2, 6 or C = ZCU-12/14).	0 / uint32
7.7	Loading package version	Version number of the firmware loading package. See parameter 7.5.	0 / uint32
7.8	Bootloader version	Version number of the firmware bootloader.	0 / uint32
7.11	Cpu usage	Microprocessor load in percent.	- / uint32
	0...100 %	Microprocessor load.	1 = 1 % / 1 = 1 %
7.13	PU logic version number	Version number of the power unit logic. The value of FFFF indicates that the version numbers of parallel-connected power units are different. See the drive information on the control panel.	- / uint16
7.14	FPGA logic version name	Version name of the FPGA logic of the control unit.	- / uint32
7.15	FPGA logic version number	Version number of the FPGA logic of the control unit.	- / uint16
7.21	Application environment status 1	<i>(Only visible with option +N8010 [application programmability])</i> Shows which tasks of the application program are running. See the <i>Drive (IEC 61131-3) application programming manual (3AUA0000127808 [English])</i> .	- / uint16
	b0 Pre task	1 = Pre-task running.	
	b1 Appl task1	1 = Task 1 running.	
	b2 Appl task2	1 = Task 2 running.	
	b3 Appl task3	1 = Task 3 running.	
	b4...14 Reserved		
	b15 Task monitoring	1 = Task monitoring enabled.	
	0000h...FFFFh		1 = 1

## 258 Parameters

No.	Name / Range / Selection	Description	Def / Type FbEq 16b / 32b
7.22	Application environment status 2	<i>(Only visible with option +N8010 [application programmability])</i> Shows the status of the openings in the application program. See the <i>Drive (IEC 61131-3) application programming manual (3AUA0000127808 [English])</i> .	- / uint16
	b0 Opening1	Status of opening 1 in the application program.	
	b1 Opening2	Status of opening 2 in the application program.	
	b2 Opening3	Status of opening 3 in the application program.	
	b3 Opening4	Status of opening 4 in the application program.	
	b4 Opening5	Status of opening 5 in the application program.	
	b5 Opening6	Status of opening 6 in the application program.	
	b6 Opening7	Status of opening 7 in the application program.	
	b7 Opening8	Status of opening 8 in the application program.	
	b8 Opening9	Status of opening 9 in the application program.	
	b9 Opening10	Status of opening 10 in the application program.	
	b10 Opening11	Status of opening 11 in the application program.	
	b11 Opening12	Status of opening 12 in the application program.	
	b12 Opening13	Status of opening 13 in the application program.	
	b13 Opening14	Status of opening 14 in the application program.	
	b14 Opening15	Status of opening 15 in the application program.	
	b15 Opening16	Status of opening 16 in the application program.	
	0000h...FFFFh		1 = 1
7.23	Application name	<i>(Only visible with option +N8010 [application programmability])</i> First five ASCII letters of the name given to the application program in the programming tool. The full name is visible under System info on the control panel or the Drive Composer PC tool. _N/A_ = None.	0 / uint32
7.24	Application version	<i>(Only visible with option +N8010 [application programmability])</i> Application program version number given to the application program in the programming tool. Also visible under System info on the control panel or the Drive Composer PC tool.	0 / uint32
7.25	Customization package name	First five ASCII letters of the name given to the customization package. The full name is visible under System info on the control panel or the Drive Composer PC tool. _N/A_ = None.	0 / uint32
7.26	Customization package version	Customization package version number. Also visible under System info on the control panel or the Drive Composer PC tool.	0 / uint32

No.	Name / Range / Selection	Description	Def / Type FbEq 16b / 32b
7.30	Adaptive program status	Shows the status of the adaptive program. See section <i>Adaptive programming</i> (page 152).	- / uint16
	b0 Initialized	1 = Adaptive program initialized	
	b1 Editing	1 = Adaptive program is being edited	
	b2 Edit done	1 = Editing of adaptive program finished	
	b3 Running	1 = Adaptive program running	
	b4...13 Reserved		
	b14 State changing	Reserved	
	b15 Faulted	1 = Error in adaptive program	
	0000h...FFFFh		1 = 1
7.40	IEC application Cpu usage peak	<i>(Only visible with option +N8010 [application programmability])</i> Displays the peak loading of the microprocessor caused by the application program. This parameter can, for example, be used to check the effect of a given application program functionality on the CPU load. The value is in percent of an internal quota. Can be reset from the control panel by keeping Reset depressed for over 3 seconds.	- / real32
	0.0 ... 100.0 %	Peak microprocessor loading caused by application program.	10 = 1 % / 10 = 1 %
7.41	IEC application Cpu load average	<i>(Only visible with option +N8010 [application programmability])</i> Displays the average loading of the microprocessor caused by the application program. The value is in percent of an internal quota.	- / real32
	0.0 ... 100.0 %	Average microprocessor loading caused by application program.	10 = 1 % / 10 = 1 %
7.51	Slot 1 option module	Displays the type of module detected in slot 1 of the drive control unit.	- / uint16
		No module detected.	0
		Type of module detected.	1
7.52	Slot 2 option module	Displays the type of module detected in slot 2 of the drive control unit.	- / uint16
		No module detected.	0
		Type of module detected.	1
7.53	Slot 3 option module	Displays the type of module detected in slot 3 of the drive control unit.	- / uint16
		No module detected.	0
		Type of module detected.	1

## 260 Parameters

No.	Name / Range / Selection	Description	Def / Type FbEq 16b / 32b
7.54	Slot 1 module logic version	Displays the FPGA logic version of module detected in slot 1 of the drive control unit. The logic version is detected for DDCS option modules, for example, FEN encoder modules (FEN-01, FEN-11, FEN-21, FEN-31) and I/O modules (FIO-11, FDIO-01, FAIO-01).	0 / uint16
	0000...FFFFh	Logic version of module detected in slot 1.	1 = 1
7.55	Slot 1 module software version	Displays the software version of module detected in slot 1 of the drive control unit.	- / uint16
7.56	Slot 2 module logic version	Displays the FPGA logic version of module detected in slot 2 of the drive control unit. The logic version is detected for DDCS option modules, for example, FEN encoder modules (FEN-01, FEN-11, FEN-21, FEN-31) and I/O modules (FIO-11, FDIO-01, FAIO-01).	0 / uint16
	0000...FFFFh	Logic version of module detected in slot 2.	1 = 1
7.57	Slot 2 module software version	Displays the software version of module detected in slot 2 of the drive control unit.	- / uint16
7.58	Slot 3 module logic version	Displays the FPGA logic version of module detected in slot 3 of the drive control unit. The logic version is detected for DDCS option modules, for example, FEN encoder modules (FEN-01, FEN-11, FEN-21, FEN-31) and I/O modules (FIO-11, FDIO-01, FAIO-01).	0 / uint16
	0000...FFFFh	Logic version of module detected in slot 3.	1 = 1
7.59	Slot 3 module software version	Displays the software version of module detected in slot 3 of the drive control unit.	- / uint16

No.	Name / Range / Selection	Description	Def / Type FbEq 16b / 32b
<b>9</b>	<b>Crane application signals</b>	Crane application signals.	
9.1	Crane SW1	Crane control program status word 1.	- / uint16
	b0 Brake slip at standstill	1 = Speed matching function detected a brake slip when the motor was not running.	
	b1 Slowdown activated	1 = Slowdown command is active either in the forward or reverse direction.	
	b2 Slowdown 1	1 = Slowdown 1 command is inactive in the forward direction.	
	b3 Slowdown 2	1 = Slowdown 2 command is inactive in the reverse direction.	
	b4 Load speed enabled	1 = Load speed is active.	
	b5 Load speed up limit	1 = Load speed up limit is active.	
	b6 Load speed down limit	1 = Load speed down limit is active.	
	b7 End limit 1	1 = End limit 1 command is inactive.	
	b8 End limit 2	1 = End limit 2 command is inactive.	
	b9 Wrong start sequence	1 = Drive does not accept a start command because of a wrong start sequence.	
	b10 Joystick reference check	1 = Reference is greater than +/- 10% of the minimum or maximum scaled value of the used joystick reference, and the joystick zero position input is active.	
	b11 Joystick zero position	1 = Drive does not accept a start command because of a wrong state of the joystick zero position input.	
	b12 Brake control selected	1 = Mechanical brake control is selected.	
	b13 Torque prove ok	1 = Torque proving has been successfully performed or Torque proving has been disabled.	
	b14 Fast stop	1 = Fast stop command is active.	
	b15 Power on acknowledge warning	1 = Power on acknowledgment circuit is open, main contactor is open, warning D20B Power on acknowledge. 0 = Power on acknowledgment circuit is closed, main contactor is closed. See parameter 20.212 Power on acknowledge and section Power on acknowledgment (page 136).	
	0000h...FFFFh		1 = 1
9.2	Crane SW2	Crane control program status word 2.	- / uint16
	b0 External speed limit	1 = External speed limit1 is active.	
	b1 Emergency control activated	1 = Emergency control mode is active.	
	b2 User set 1 has been loaded	1 = User set 1 is loaded.	

## 262 Parameters

No.	Name / Range / Selection	Description	Def / Type FbEq 16b / 32b
	b3	User set 2 has been loaded	1 = User set 2 is loaded.
	b4	User set 3 has been loaded	1 = User set 3 is loaded.
	b5	User set 4 has been loaded	1 = User set 4 is loaded.
	b6	Crane operating hours warning	1 = Warning D212 Crane operating hours (page 725) activated.
	b7	Brake oper counts warning	1 = Warning D213 Brake oper counts (page 725) activated.
	b8	Number of power on warning	1 = Warning D214 Number of power on activated.
	b9	Slack rope detected	1 = Warning D217 Slack rope activated.
	b10	Hso high speed active	1 = Hoist speed optimization high speed limit is active, i.e. speed can go above the limit defined in parameter 75.3 Motor base speed.
	b11	Brake match	1 = Brake slip detected when brake is closed.
	b12...15	Reserved	
		0000h...FFFFh	1 = 1
9.3	Crane FW1	Crane fault status word 1 with fault bits.	- / uint16
	b0	Inverter overload	1 = D106 Inverter overload
	b1	Speed match	1 = D105 Speed match (page 723)
	b2	Over speed	1 = D104 Over speed (page 723)
	b3	ID run and remote	1 = D107 ID run and remote (page 723)
	b4	End limits IO error	1 = D108 End limits I/O error (page 723)
	b5	Hoist speed optimization settings	1 = D103 Hoist speed opt settings (page 722)
	b6	Torque prove	1 = D100 Torque prove (page 722)
	b7	Brake slip	1 = D101 Brake slip (page 722)
	b8	Brake safe closure	1 = D102 Brake safe closure (page 722)
	b9	Reserved1	
	b10	Reserved2	
	b11...15	Reserved	
		0000h...FFFFh	1 = 1
9.5	Load speed limit	Shows the speed limit calculated by the Hoist speed optimization function.	0.00 rpm / real32
		0.00 ... 30000.00 rpm	Speed limit calculated by the Hoist speed optimization function. 1 = 1 rpm / 1 = 1 rpm
9.6	Crane speed reference	Shows the final speed reference calculated by the control program.	0.00 rpm / real32

No.	Name / Range / Selection	Description	Def / Type FbEq 16b / 32b
	0.00 ... 30000.00 rpm	Final speed reference calculated by the control program.	1 = 1 rpm / 1 = 1 rpm
9.7	Load speed error status	Load speed limit error status word (Hoist speed optimization)	- / uint16
b0...1 Reserved			
	b2 Order value error	1 = Parameters for load values are not set in increasing order, or parameters for speed limit values are not set in decreasing order.	
b3...15 Reserved			
	0000h...FFFFh		1 = 1
9.9	Flux reference	Shows the crane flux reference in percent of the nominal flux of the motor.	0% / real32
	0...200%	Crane flux reference.	1 = 1% / 1 = 1%
9.10	Lifetime left	Shows the remaining lifetime hours from the defined lifetime hours in parameter 75.71 Crane lifetime.	0 hour / uint32
	0...10000 hour	Left lifetime hours.	1 = 1 hour / 1 = 1 hour
9.11	Lifetime left in percent	Shows the percent of remaining lifetime from the defined lifetime hours in parameter 75.71 Crane lifetime.	0.00% / real32
	0.00 ... 100.00%	Left lifetime in percent.	100 = 1% / 1 = 1%
9.12	Load spectrum factor	Shows the load spectrum factor.	0.00 / real32
	0.00 ... 10.00	Load spectrum factor.	100 = 1 / 1 = 1
9.13	Lifetime sw	Lifetime status word.	- / uint16
	b0 Lifetime monitor active	1 = Lifetime monitor function is activated.	
	b1 Warning: less 10% lifetime left	1 = Warning D216 Lifetime left less 10% (page 726)	
b2...15 Reserved			
	0000h...FFFFh		1 = 1
9.20	Crane operation hours	Shows the number of hours the crane was operating with open brake. The counter can be initialized/preset with parameters 33.200...33.202.	0 hour / uint32
	0...1100000 hour	Crane operation hours.	1 = 1 hour / 1 = 1 hour
9.21	Brake operated counts	Shows the number of times the mechanical brake was opened. The counter can be initialized/preset with parameters 33.210...33.212	0 / uint32
	0...2147483647	Mechanical brake open counts	1 = 1 / 1 = 1
9.22	Number of pwr on	Shows the number of times the crane system was powered on. The counter counts the number of power acknowledges. The source is set with parameter 20.212 Power on acknowledge (page 352). The counter can be initialized/preset with parameters 33.220...33.222.	0 / uint16
	0...65535	Power on counts	1 = 1 / 1 = 1

## 264 Parameters

No.	Name / Range / Selection	Description	Def / Type FbEq 16b / 32b
9.31	Motor load	Shows the motor torque in percent of nominal motor torque. Negative sign indicates generating side of motor. Positive sign indicates motor side.	0.0% / real32
	-1600.0 ... 1600.0%	Motor load in percent	10 = 1% / 1 = 1%
9.40	ACC Crane fieldbus SW	<i>(Only visible after entering access level pass code 584. See parameter 96.2 Pass code.)</i> ACC interface crane control program fieldbus status word. This parameter is read-only.	- / uint16
	b0 RDY FOR ON	Ready for on	
	b1 POWER ON ACKN	Power on acknowledgment	
	b2 RDY FOR RUN	Ready for run (magnetized)	
	b3 RUNNING	Running (producing torque)	
	b4 ZERO SPEED	At zero speed	
	b5 REM LOC	Remote/ Local (1 = Remote)	
	b6 TORQ PROV OK	Torque proving is Ok	
	b7 USER 1 OR 2	User macro 1 or 2 is active	
	b8 FAULT	Fault is active	
	b9 WARNING	Warning is active	
	b10 LIMIT	Drive is in torque limit	
	b11 SYNC	Synchronisation input (e.g. DI3) status	
	b12 SYNC RDY	Synchronisation ready	
	b13 BRAKE LONG FTIME	Brake long falling time indication	
	b14 COMTEST TRA	Communication test transmit bit	
	b15 SNAG LOAD	Snag load	
	0000h...FFFFh		1 = 1
9.41	ACC Crane fault word 1	<i>(Only visible after entering access level pass code 584. See parameter 96.2 Pass code.)</i> ACC interface crane control program fault status word 1. This parameter is read-only.	- / uint16
	b0 MOT OVERSP	Motor overspeed fault	
	b1 TORQ FLT	Torque fault	
	b2 BRAKE FLT	Mechanical brake fault	
	b3 ELECTR SHAFT	Electrical shaft control fault	
	b4 TORQ PR FLT	Torque proving fault	
	b5 MAS OSC FLT	Fieldbus "oscillator" (toggle) bit fault	
	b6 CHOPPER FLT	Braking chopper fault	
	b7 INV OVERLOD	Inverter overload	
	b8 EXTERNAL FLT	External fault	



No.	Name / Range / Selection	Description	Def / Type FbEq 16b / 32b
	b9 MF COMM ERR	Master/follower bus communication fault	
	b10 PANEL LOSS	Panel communication fault	
	b11 I/O COMM	I/O board communication fault	
	b12 AMBIENT TEMP	Drive ambient over temperature	
	b13 THERMISTOR	Thermistor fault (DI6)	
	b14 MF RUN FLT	Master/follower running fault	
	b15 COMM MODULE	Communication fault in Comm module	
	0000h...FFFFh		1 = 1
9.42	ACC Crane fault word 2	<i>(Only visible after entering access level pass code 584. See parameter 96.2 Pass code.)</i> ACC interface crane control program fault status word 2. This parameter is read-only.	- / uint16
	b0 DC OVERVOLT	DC link overvoltage	
	b1 DC UNDERVOLT	DC link undervoltage	
	b2 OVERCURRENT	Overcurrent fault	
	b3 EARTH FAULT	Earth fault	
	b4 MOTOR PHASE	Motor phase loss fault	
	b5 USER MACRO	User macro requested in not saved, or shared motion change fault	
	b6 ACS880 TEMP	Over temperature in IGBT power plate	
	b7 MOTOR TEMP	Motor over temperature (calculated)	
	b8 OVERFREQ	Over frequency fault	
	b9 START INHIBIT	Start inhibit fault ("Prevention of unexpected start" is active)	
	b10 SHORT CIRCUIT	Short circuit at output	
	b11 PPCC LINK	Power plate communication link fault (INT board)	
	b12 SUPPLY PHASE	Supply phase is missing (DC ripple)	
	b13 ENCODER ERR	Encoder module/ speed deviation fault	
b14...15	Reserved		
	0000h...FFFFh		1 = 1
9.43	ACC Crane alarm word 1	<i>(Only visible after entering access level pass code 584. See parameter 96.2 Pass code.)</i> ACC interface crane control program alarm status word 1. This parameter is read-only.	- / uint16
	b0 MOTOR TEMP	Motor high (95%) temperature (calculated)	
	b1 COMM MODULE	Comm module communication alarm	
	b2 ID RUN FAIL	ID run failed	
	b3 ACS880 TEMP	High temperature in IGBT power plate	

## 266 Parameters

No.	Name / Range / Selection	Description	Def / Type FbEq 16b / 32b
	b4 ENCODER ERR	Encoder module speed deviation alarm	
	b5 JOYSTICK	Joystick supervision alarm (standalone)	
	b6 START INHIBIT	Start inhibit alarm ("Prevention of unexpected start" is active)	
	b7 Reserved		
	b8 THERMISTOR	Thermistor alarm (DI6)	
	b9 NO MOT DATA	No motor data or too low nominal current entered	
	b10 LIFETIME>90%	Crane hoist machinery lifetime exceeded 90% of total lifetime set in parameter 75.71 Crane lifetime.	
	b11...15 Reserved		
	0000h...FFFFh		1 = 1
9.44	ACC Crane auxiliary SW	<i>(Only visible after entering access level pass code 584. See parameter 96.2 Pass code.)</i> ACC interface crane control program auxiliary status word. This parameter is read-only.	- / uint16
	b0 DIR A	Standalone direction A order	
	b1 DIR B	Standalone direction B order	
	b2 ZERO POS	Standalone zero position order	
	b3 SLOWDOWN DIR A	Standalone slowdown direction A	
	b4 SLOWDOWN DIR B	Standalone slowdown direction B	
	b5 ELSHAFT ON ACKN	Electric shaft control on acknowledge	
	b6 BRAKE LIFT	Brake lift order	
	b7 FOLL SEP ACKN	Follower separate acknowledge	
	b8 LOGG DATA READY	Drive datalogger data is ready (triggered)	
	b9 AI3 LIMIT ACTIVE	Analog input AI3 speed limit is active (AI3 < 10 mA)	
	b10 SLACK ROPE	Slack rope is detected	
	b11 COMTEST MF	Master/follower communication test	
	b12 FAST STOP	Fast stop is active	
	b13 MOTOR1	Motor 1 or user macro 1 is activated	
	b14 MOTOR2	Motor 2 or user macro 2 is activated	
	b15 Reserved		
	0000h...FFFFh		1 = 1
9.45	ACC Crane fieldbus CW	<i>(Only visible after entering access level pass code 584. See parameter 96.2 Pass code.)</i> ACC interface crane control program fieldbus control word.	- / uint16
	b0 COMTEST REC	Communication test receive bit	
	b1 DRIVE ON	Drive On (magnetize) from PLC in fieldbus mode	
	b2 HIGH SPEED	High speed selected (power optimization)	

No.	Name / Range / Selection	Description	Def / Type FbEq 16b / 32b
	b3 START OVR	Start order from PLC in fieldbus mode	
	b4 RAMP HOLD	Speed ramp hold signal	
	b5 SEPARATE	Separate control select signal (only in master/follower control)	
	b6 TORQ CTRL SEL	Torque control selected (Torque ref = DS1.3)	
	b7 LOAD MES SEL	Load measurement selected (enable LOAD MEAS REF)	
	b8 RESET OVR	Reset fault from overriding control (PLC)	
	b9 FAST STOP 1	Fast stop type 1 selected (torque limit stop)	
	b10 FAST STOP 11	Fast stop type 11 selected	
	b11 PGM SYNC	Program synchronisation of position measurement	
	b12 HW SYNC INHIBIT	Hardware (DI) synchronisation of position measurement is blocked	
	b13 RESET SYNC READY	Reset synchronisation is ready	
	b14 USER MACRO CHANGE	User macro 1 or 2 change request	
	b15 ENABLE FB CTRL	Enable fieldbus control in stand alone Joystick mode (not FB Joystick mode). Used by Sway control.	
	0000h...FFFFh		1 = 1
9.46	ACC Crane auxiliary CW	<i>(Only visible after entering access level pass code 584. See parameter 96.2 Pass code.)</i> ACC interface crane control program auxiliary control word.	- / uint16
	b0 FB ZERO POS	Fieldbus transmitted zero position signal from Joystick	
	b1 FB START DIR A	Fieldbus transmitted Start Dir A signal from Joystick	
	b2 FB START DIR B	Fieldbus transmitted Start Dir B signal from Joystick	
	b3 FB JOYST TQREF SEL	Fieldbus Joystick mode torque control is selected	
	b4 FB ELSHAFT ON	Fieldbus electric shaft control is on (enabled) for master or slave drive	
	b5 RESTART DLOG	Restart the drive data loggers	
	b6 TRIGG LOGGER	Forced trigger (stop) of the drive data loggers	
	b7 DISABLE SLACKROPE	Disable the slack rope makes a fast stop (stop on torque limit)	
	b8 User ctrl bit 8	A bit of your own selection.	
	b9 User ctrl bit 9	A bit of your own selection.	
	b10 User ctrl bit 10	A bit of your own selection.	
	b11 User ctrl bit 11	A bit of your own selection.	
	b12 User ctrl bit 12	A bit of your own selection.	
	b13 User ctrl bit 13	A bit of your own selection.	
	b14 User ctrl bit 14	A bit of your own selection.	

## 268 Parameters

No.	Name / Range / Selection	Description	Def / Type FbEq 16b / 32b
	b15 User ctrl bit 15	A bit of your own selection.	
	0000h...FFFFh		1 = 1
9.47	ACC DC voltage	<i>(Only visible after entering access level pass code 584. See parameter 96.2 Pass code.)</i> Shows the DC voltage for ACC interface. This parameter is read-only.	0 / uint16
	0...2000	ACC interface DC voltage	1 = 1 / 1 = 1
9.48	ACC Shaft power	<i>(Only visible after entering access level pass code 584. See parameter 96.2 Pass code.)</i> Shows the shaft power for ACC interface. This parameter is read-only.	0 / int16
	-300...300	ACC interface shaft power	1 = 1 / 1 = 1
9.49	ACC Measured load	<i>(Only visible after entering access level pass code 584. See parameter 96.2 Pass code.)</i> Shows the measured load for ACC interface. This parameter is read-only.	0.00% / real32
	-300.00 ... 300.00%	Percent of ACC interface measured load	100 = 1% / 1 = 1%
9.50	Crane speed reference cor	<i>(Only visible after entering access level pass code 584. See parameter 96.2 Pass code.)</i> Shows the crane speed reference correction value. This parameter is read-only.	0.00 rpm / real32
	-30000.00 ... 30000.00 rpm	Speed correction	1 = 1 rpm / 1 = 1 rpm

No.	Name / Range / Selection	Description	Def / Type FbEq 16b / 32b
<b>10</b>	<b>Standard DI, RO</b>	Configuration of digital inputs and relay outputs.	
10.1	DI status	Displays the electrical status of digital inputs DIIL and DI6...DI1. The activation/deactivation delays of the inputs (if any are specified) are ignored. A filtering time can be defined by parameter 10.51 DI filter time. Bits 0...5 reflect the status of DI1...DI6; bit 15 reflects the status of the DIIL input. <b>Example:</b> 1000000000010011b = DIIL, DI5, DI2 and DI1 are on, DI3, DI4 and DI6 are off. This parameter is read-only.	- / uint16
10.2	DI delayed status	Displays the status of digital inputs DIIL and DI6...DI1. This word is updated only after activation/deactivation delays (if any are specified). A filtering time can be defined by parameter 10.51 DI filter time. Bits 0...5 reflect the delayed status of DI1...DI6; bit 15 reflects the delayed status of the DIIL input. This parameter is read-only.	- / uint16
10.3	DI force selection	The electrical statuses of the digital inputs can be overridden for eg. testing purposes. A bit in parameter 10.4 DI force data is provided for each digital input, and its value is applied whenever the corresponding bit in this parameter is 1.	- / uint16
	b0 DI1	1 = Force DI1 to value of bit 0 of parameter 10.4 DI force data.	
	b1 DI2	1 = Force DI2 to value of bit 1 of parameter 10.4 DI force data.	
	b2 DI3	1 = Force DI3 to value of bit 2 of parameter 10.4 DI force data.	
	b3 DI4	1 = Force DI4 to value of bit 3 of parameter 10.4 DI force data.	
	b4 DI5	1 = Force DI5 to value of bit 4 of parameter 10.4 DI force data.	
	b5 DI6	1 = Force DI6 to value of bit 5 of parameter 10.4 DI force data.	
	b6...14 Reserved		
	b15 DIIL	1 = Force DIIL to value of bit 15 of parameter 10.4 DI force data.	
	0000h...FFFFh		1 = 1
10.4	DI force data	Contains the values that the digital inputs are forced to when selected by 10.3 DI force selection. Bit 0 is the forced value for DI1; bit 15 is the forced value for the DIIL input.	- / uint16

270 Parameters

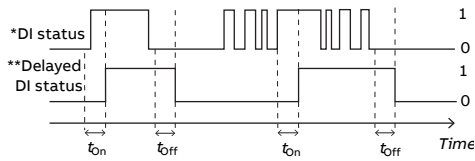
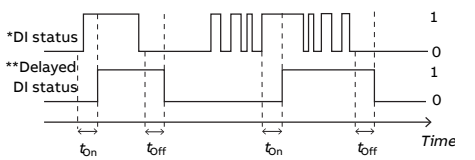
No.	Name / Range / Selection	Description	Def / Type FbEq 16b / 32b
10.5	DI1 ON delay	Defines the activation delay for digital input DI1.	0.0 s / uint32
 <p data-bbox="337 419 812 528"> <math>t_{On} = 10.5</math> DI1 ON delay  <math>t_{Off} = 10.6</math> DI1 OFF delay                      *Electrical status of digital input. Indicated by 10.1 DI status.                      **Indicated by 10.2 DI delayed status.                 </p>			
0.0 ... 3000.0 s		Activation delay for DI1.	10 = 1 s / 10 = 1 s
10.6	DI1 OFF delay	Defines the deactivation delay for digital input DI1. See parameter 10.5 DI1 ON delay.	0.0 s / uint32
0.0 ... 3000.0 s		Deactivation delay for DI1.	10 = 1 s / 10 = 1 s
10.7	DI2 ON delay	Defines the activation delay for digital input DI2.	0.0 s / uint32
 <p data-bbox="337 892 812 1000"> <math>t_{On} = 10.7</math> DI2 ON delay  <math>t_{Off} = 10.8</math> DI2 OFF delay                      *Electrical status of digital input. Indicated by 10.1 DI status.                      **Indicated by 10.2 DI delayed status.                 </p>			
0.0 ... 3000.0 s		Activation delay for DI2.	10 = 1 s / 10 = 1 s
10.8	DI2 OFF delay	Defines the deactivation delay for digital input DI2. See parameter 10.7 DI2 ON delay.	0.0 s / uint32
0.0 ... 3000.0 s		Deactivation delay for DI2.	10 = 1 s / 10 = 1 s

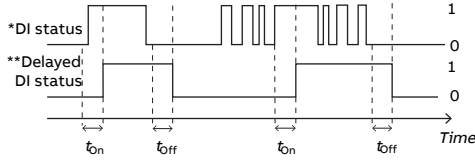
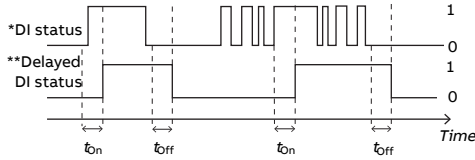
No.	Name / Range / Selection	Description	Def / Type FbEq 16b / 32b
10.9	DI3 ON delay	Defines the activation delay for digital input DI3.	0.0 s / uint32
 <p data-bbox="385 424 860 533"> <math>t_{On}</math> = 10.9 DI3 ON delay  <math>t_{Off}</math> = 10.10 DI3 OFF delay            *Electrical status of digital input. Indicated by 10.1 DI status.            **Indicated by 10.2 DI delayed status.         </p>			
0.0 ... 3000.0 s		Activation delay for DI3.	10 = 1 s / 10 = 1 s
10.10	DI3 OFF delay	Defines the deactivation delay for digital input DI3. See parameter 10.9 DI3 ON delay.	0.0 s / uint32
0.0 ... 3000.0 s		Deactivation delay for DI3.	10 = 1 s / 10 = 1 s
10.11	DI4 ON delay	Defines the activation delay for digital input DI4.	0.0 s / uint32
 <p data-bbox="385 903 860 1011"> <math>t_{On}</math> = 10.11 DI4 ON delay  <math>t_{Off}</math> = 10.12 DI4 OFF delay            *Electrical status of digital input. Indicated by 10.1 DI status.            **Indicated by 10.2 DI delayed status.         </p>			
0.0 ... 3000.0 s		Activation delay for DI4.	10 = 1 s / 10 = 1 s
10.12	DI4 OFF delay	Defines the deactivation delay for digital input DI4. See parameter 10.11 DI4 ON delay.	0.0 s / uint32
0.0 ... 3000.0 s		Deactivation delay for DI4.	10 = 1 s / 10 = 1 s

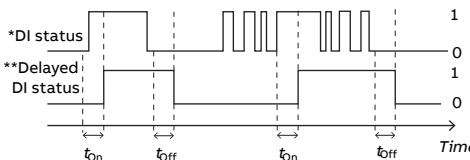
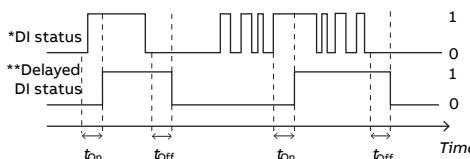
No.	Name / Range / Selection	Description	Def / Type FbEq 16b / 32b
10.13	DI5 ON delay	Defines the activation delay for digital input DI5.	0.0 s / uint32
		 <p> <math>t_{On}</math> = 10.13 DI5 ON delay  <math>t_{Off}</math> = 10.14 DI5 OFF delay                      *Electrical status of digital input. Indicated by 10.1 DI status.                      **Indicated by 10.2 DI delayed status.                 </p>	
	0.0 ... 3000.0 s	Activation delay for DI5.	10 = 1 s / 10 = 1 s
10.14	DI5 OFF delay	Defines the deactivation delay for digital input DI5. See parameter 10.13 DI5 ON delay.	0.0 s / uint32
	0.0 ... 3000.0 s	Deactivation delay for DI5.	10 = 1 s / 10 = 1 s
10.15	DI6 ON delay	Defines the activation delay for digital input DI6.	0.0 s / uint32
		 <p> <math>t_{On}</math> = 10.15 DI6 ON delay  <math>t_{Off}</math> = 10.16 DI6 OFF delay                      *Electrical status of digital input. Indicated by 10.1 DI status.                      **Indicated by 10.2 DI delayed status.                 </p>	
	0.0 ... 3000.0 s	Activation delay for DI6.	10 = 1 s / 10 = 1 s
10.16	DI6 OFF delay	Defines the deactivation delay for digital input DI6. See parameter 10.15 DI6 ON delay.	0.0 s / uint32
	0.0 ... 3000.0 s	Deactivation delay for DI6.	10 = 1 s / 10 = 1 s
10.21	RO status	Status of relay outputs RO8...RO1. <b>Example:</b> 00000001b = RO1 is energized, RO2...RO8 are de-energized.	- / uint16
10.24	RO1 source	Selects a drive signal to be connected to relay output RO1.  <b>Note:</b> Default value is 44.210 Crane brake status, bit 0. Value must not be changed. RO1 is only used for mechanical brake control.	Ready run; 10.01 b3 (-1) (95.20 b2); 35.105 b1 (95.20 b6); 06.16 b6 (95.20 b9) / uint32
	Not energized	Output is not energized.	0
	Energized	Output is energized.	1
	Ready run	Bit 1 of 6.11 Main status word (page 245).	2



No.	Name / Range / Selection	Description	Def / Type FbEq 16b / 32b
	Enabled	Bit 0 of 6.16 Drive status word 1 (page 245).	4
	Started	Bit 5 of 6.16 Drive status word 1 (page 245).	5
	Magnetized	Bit 1 of 6.17 Drive status word 2 (page 246).	6
	Running	Bit 6 of 6.16 Drive status word 1 (page 245).	7
	Ready ref	Bit 2 of 6.11 Main status word (page 245).	8
	At setpoint	Bit 8 of 6.11 Main status word (page 245).	9
	Reverse	Bit 2 of 6.19 Speed control status word (page 247).	10
	Zero speed	Bit 0 of 6.19 Speed control status word (page 247).	11
	Above limit	Bit 10 of 6.17 Drive status word 2 (page 246).	12
	Warning	Bit 7 of 6.11 Main status word (page 245).	13
	Fault	Bit 3 of 6.11 Main status word (page 245).	14
	Fault (-1)	Inverted bit 3 of 6.11 Main status word (page 245).	15
	Start request	Bit 13 of 6.16 Drive status word 1 (page 245).	16
	Open brake command	Do not use this selection.  <b>Note:</b> The default value of this parameter is 44.210 Crane brake status, bit 0. The default value must not be changed.	22
	Ext2 active	Bit 11 of 6.16 Drive status word 1 (page 245).	23
	Remote control	Bit 9 of 6.11 Main status word (page 245).	24
	Supervision 1	Bit 0 of 32.1 Supervision status (page 444).	33
	Supervision 2	Bit 1 of 32.1 Supervision status (page 444).	34
	Supervision 3	Bit 2 of 32.1 Supervision status (page 444).	35
	RO/DIO control word bit0	Bit 0 of 10.99 RO/DIO control word (page 275).	40
	RO/DIO control word bit1	Bit 1 of 10.99 RO/DIO control word (page 275).	41
	RO/DIO control word bit2	Bit 2 of 10.99 RO/DIO control word (page 275).	42
	RO/DIO control word bit8	Bit 8 of 10.99 RO/DIO control word (page 275).	43
	RO/DIO control word bit9	Bit 9 of 10.99 RO/DIO control word (page 275).	44
	Other [bit]	See Terms and abbreviations (page 221).	

274 Parameters

No.	Name / Range / Selection	Description	Def / Type FbEq 16b / 32b
10.25	RO1 ON delay	Defines the activation delay for relay output RO1.	0.0 s / uint32
		<p> <math>t_{On} = 10.25</math> RO1 ON delay  <math>t_{Off} = 10.26</math> RO1 OFF delay                 </p>	
	0.0 ... 3000.0 s	Activation delay for RO1.	10 = 1 s / 10 = 1 s
10.26	RO1 OFF delay	Defines the deactivation delay for relay output RO1. See parameter 10.25 RO1 ON delay.	0.0 s / uint32
	0.0 ... 3000.0 s	Deactivation delay for RO1.	10 = 1 s / 10 = 1 s
10.27	RO2 source	Selects a drive signal to be connected to relay output RO2. For the available selections, see parameter 10.24 RO1 source. By default this source is parameter 32.227, b1 Watchdog relay control.	Running (95.20 b3) / uint32
10.28	RO2 ON delay	Defines the activation delay for relay output RO2.	0.0 (95.20 b3) s / uint32
		<p> <math>t_{On} = 10.28</math> RO2 ON delay  <math>t_{Off} = 10.29</math> RO2 OFF delay                 </p>	
	0.0 ... 3000.0 s	Activation delay for RO2.	10 = 1 s / 10 = 1 s
10.29	RO2 OFF delay	Defines the deactivation delay for relay output RO2. See parameter 10.28 RO2 ON delay.	0.0 (95.20 b3) s / uint32
	0.0 ... 3000.0 s	Deactivation delay for RO2.	10 = 1 s / 10 = 1 s
10.30	RO3 source	Selects a drive signal to be connected to relay output RO3. For the available selections, see parameter 10.24 RO1 source.	Fault (-1) / uint32

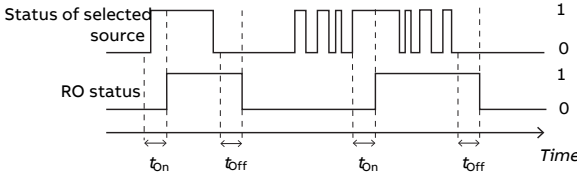
No.	Name / Range / Selection	Description	Def / Type FbEq 16b / 32b
10.31	RO3 ON delay	Defines the activation delay for relay output RO3.	0.0 s / uint32
		 <p> <math>t_{On} = 10.31</math> RO3 ON delay  <math>t_{Off} = 10.32</math> RO3 OFF delay </p>	
	0.0 ... 3000.0 s	Activation delay for RO3.	10 = 1 s / 10 = 1 s
10.32	RO3 OFF delay	Defines the deactivation delay for relay output RO3. See parameter 10.31 RO3 ON delay.	0.0 s / uint32
	0.0 ... 3000.0 s	Deactivation delay for RO3.	10 = 1 s / 10 = 1 s
10.51	DI filter time	Defines a filtering time for parameters 10.1 DI status and 10.2 DI delayed status.	10.0 ms / uint32
	0.3 ... 100.0 ms	Filtering time for 10.1 and 10.2.	10 = 1 ms / 10 = 1 ms
10.99	RO/DIO control word	Storage parameter for controlling the relay outputs and digital input/outputs eg. through the embedded fieldbus interface. To control the relay outputs (RO) and the digital input/outputs (DIO) of the drive, send a control word with the bit assignments shown below as Modbus I/O data. Set the target selection parameter of that particular data (58.101...58.124) to RO/DIO control word. In the source selection parameter of the desired output, select the appropriate bit of this word.	- / uint16
	b0 RO1	Source bit for relay output RO1. See parameter 10.24.	
	b1 RO2	Source bit for relay output RO2. See parameter 10.27.	
	b2 RO3	Source bit for relay output RO3. See parameter 10.30.	
	b3...7 Reserved		
	b8 DIO1	Source bit for digital input/output DIO1 (see parameter 11.6.	
	b9 DIO2	Source bit for digital input/output DIO2 (see parameter 11.10.	
	b10...15 Reserved		
	0000h...FFFFh		1 = 1

## 276 Parameters

No.	Name / Range / Selection	Description	Def / Type FbEq 16b / 32b
<b>11</b>	<b>Standard DIO, FI, FO</b>	Configuration of digital input/outputs and frequency inputs/outputs.	
11.1	DIO status	Displays the status of digital input/outputs DIO2 and DIO1. The activation/deactivation delays (if any are specified) are ignored. A filtering time (for input mode) can be defined by parameter 11.81 DIO filter time. <b>Example:</b> 0010 = DIO2 is on, DIO1 is off. This parameter is read-only.	- / uint16
11.2	DIO delayed status	Displays the delayed status of digital input/outputs DIO2 and DIO1. This word is updated only after activation/deactivation delays (if any are specified). A filtering time (for input mode) can be defined by parameter 11.81 DIO filter time. <b>Example:</b> 0010 = DIO2 is on, DIO1 is off. This parameter is read-only.	- / uint16
11.5	DIO1 function	Selects whether DIO1 is used as a digital output or input, or a frequency input.	Output / uint16
	Output	DIO1 is used as a digital output.	0
	Input	DIO1 is used as a digital input.	1
	Frequency	DIO1 is used as a frequency input.	2
11.6	DIO1 output source	Selects a drive signal to be connected to digital input/output DIO1 when parameter 11.5 DIO1 function is set to Output.	Ready run / uint32
	Not energized	Output is not energized.	0
	Energized	Output is energized.	1
	Ready run	Bit 1 of 6.11 Main status word (page 245).	2
	Enabled	Bit 0 of 6.16 Drive status word 1 (page 245).	4
	Started	Bit 5 of 6.16 Drive status word 1 (page 245).	5
	Magnetized	Bit 1 of 6.17 Drive status word 2 (page 246).	6
	Running	Bit 6 of 6.16 Drive status word 1 (page 245).	7
	Ready ref	Bit 2 of 6.11 Main status word (page 245).	8
	At setpoint	Bit 8 of 6.11 Main status word (page 245).	9
	Reverse	Bit 2 of 6.19 Speed control status word (page 247).	10
	Zero speed	Bit 0 of 6.19 Speed control status word (page 247).	11
	Above limit	Bit 10 of 6.17 Drive status word 2 (page 246).	12
	Warning	Bit 7 of 6.11 Main status word (page 245).	13
	Fault	Bit 3 of 6.11 Main status word (page 245).	14
	Fault (-1)	Inverted bit 3 of 6.11 Main status word (page 245).	15
	Start request	Bit 13 of 6.16 Drive status word 1 (page 245).	16
	Open brake command	Bit 0 of 44.1 Brake control status (page 486).	22
	Ext2 active	Bit 11 of 6.16 Drive status word 1 (page 245).	23

No.	Name / Range / Selection	Description	Def / Type FbEq 16b / 32b
	Remote control	Bit 9 of 6.11 Main status word (page 245).	24
	Supervision 1	Bit 0 of 32.1 Supervision status (page 444).	33
	Supervision 2	Bit 1 of 32.1 Supervision status (page 444).	34
	Supervision 3	Bit 2 of 32.1 Supervision status (page 444).	35
	RO/DIO control word bit0	Bit 0 of 10.99 RO/DIO control word (page 275).	40
	RO/DIO control word bit1	Bit 1 of 10.99 RO/DIO control word (page 275).	41
	RO/DIO control word bit2	Bit 2 of 10.99 RO/DIO control word (page 275).	42
	RO/DIO control word bit8	Bit 8 of 10.99 RO/DIO control word (page 275).	43
	RO/DIO control word bit9	Bit 9 of 10.99 RO/DIO control word (page 275).	44
	Other [bit]	See Terms and abbreviations (page 221).	
11.7	DIO1 ON delay	Defines the activation delay for digital input/output DIO1 (when used as a digital output or digital input).	0.0 s / uint32
		<p> <math>t_{on}</math> = 11.7 DIO1 ON delay  <math>t_{off}</math> = 11.8 DIO1 OFF delay            *Electrical status of DIO (in input mode) or status of selected source (in output mode). Indicated by 11.1 DIO status.            **Indicated by 11.2 DIO delayed status.         </p>	
	0.0 ... 3000.0 s	Activation delay for DIO1.	10 = 1 s / 10 = 1 s
11.8	DIO1 OFF delay	Defines the deactivation delay for digital input/output DIO1 (when used as a digital output or digital input). See parameter 11.7 DIO1 ON delay.	0.0 s / uint32
	0.0 ... 3000.0 s	Deactivation delay for DIO1.	10 = 1 s / 10 = 1 s
11.9	DIO2 function	Selects whether DIO2 is used as a digital output or input, or a frequency output.	Output / uint16
	Output	DIO2 is used as a digital output.	0
	Input	DIO2 is used as a digital input.	1
	Frequency	DIO2 is used as a frequency output.	2
11.10	DIO2 output source	Selects a drive signal to be connected to digital input/output DIO2 when parameter 11.9 DIO2 function is set to Output. For the available selections, see parameter 11.6 DIO1 output source.	Running / uint32

## 278 Parameters

No.	Name / Range / Selection	Description	Def / Type FbEq 16b / 32b
11.11	DIO2 ON delay	Defines the activation delay for digital input/output DIO2 (when used as a digital output or digital input).	0.0 s / uint32
<p style="text-align: center;"> <math>t_{on}</math>   <math>t_{off}</math>   <math>t_{on}</math>   <math>t_{off}</math> </p>			
<p> <math>t_{on}</math> = 11.11 DIO2 ON delay  <math>t_{off}</math> = 11.12 DIO2 OFF delay                      *Electrical status of DIO (in input mode) or status of selected source (in output mode). Indicated by 11.1 DIO status.                      **Indicated by 11.2 DIO delayed status.                 </p>			
	0.0 ... 3000.0 s	Activation delay for DIO2.	10 = 1 s / 10 = 1 s
11.12	DIO2 OFF delay	Defines the deactivation delay for digital input/output DIO2 (when used as a digital output or digital input). See parameter 11.11 DIO2 ON delay.	0.0 s / uint32
	0.0 ... 3000.0 s	Deactivation delay for DIO2.	10 = 1 s / 10 = 1 s
11.38	Freq in 1 actual value	Displays the value of frequency input 1 (via DIO1 when it is used as a frequency input) before scaling. See parameter 11.42 Freq in 1 min. This parameter is read-only.	- / real32
	0...16000 Hz	Unscaled value of frequency input 1.	1 = 1 Hz / 1 = 1 Hz
11.39	Freq in 1 scaled	Displays the value of frequency input 1 (via DIO1 when it is used as a frequency input) after scaling. See parameter 11.42 Freq in 1 min. This parameter is read-only.	- / real32
	-32768.000 ... 32767.000	Scaled value of frequency input 1.	1 = 1 / 1000 = 1

No.	Name / Range / Selection	Description	Def / Type FbEq 16b / 32b
11.42	Freq in 1 min	<p>Defines the minimum for the frequency actually arriving at frequency input 1 (DIO1 when it is used as a frequency input).</p> <p>The incoming frequency signal (11.38 Freq in 1 actual value) is scaled into an internal signal (11.39 Freq in 1 scaled) by parameters 11.42...11.45 as follows:</p>	0 Hz / real32
	0...16000 Hz	Minimum frequency of frequency input 1 (DIO1).	1 = 1 Hz / 1 = 1 Hz
11.43	Freq in 1 max	<p>Defines the maximum for the frequency actually arriving at frequency input 1 (DIO1 when it is used as a frequency input).</p> <p>See parameter 11.42 Freq in 1 min.</p>	16000 Hz / real32
	0...16000 Hz	Maximum frequency for frequency input 1 (DIO1).	1 = 1 Hz / 1 = 1 Hz
11.44	Freq in 1 at scaled min	Defines the value that is required to correspond internally to the minimum input frequency defined by parameter 11.42 Freq in 1 min. See diagram at parameter 11.42 Freq in 1 min.	0.000 / real32
	-32768.000 ... 32767.000	Value corresponding to minimum of frequency input 1.	1 = 1 / 1000 = 1
11.45	Freq in 1 at scaled max	Defines the value that is required to correspond internally to the maximum input frequency defined by parameter 11.43 Freq in 1 max. See diagram at parameter 11.42 Freq in 1 min.	1500.000; 1800.000 (95.20 b0) / real32
	-32768.000 ... 32767.000	Value corresponding to maximum of frequency input 1.	1 = 1 / 1000 = 1
11.54	Freq out 1 actual value	<p>Displays the value of frequency output 1 after scaling.</p> <p>See parameter 11.58 Freq out 1 src min.</p> <p>This parameter is read-only.</p>	- / real32
	0...16000 Hz	Value of frequency output 1.	1 = 1 Hz / 1 = 1 Hz
11.55	Freq out 1 source	Selects a signal to be connected to frequency output 1.	Motor speed used / uint32
	Zero	None	0
	Motor speed used	1.1 Motor speed used (page 226).	1
	Output frequency	1.6 Output frequency (page 226).	3
	Motor current	1.7 Motor current (page 226).	4

280 Parameters

No.	Name / Range / Selection	Description	Def / Type FbEq 16b / 32b
	Motor torque	1.10 Motor torque (page 226).	6
	DC voltage	1.11 DC voltage (page 227).	7
	Power inu out	1.14 Output power (page 227).	8
	Speed ref ramp in	23.1 Speed ref ramp input (page 378).	10
	Speed ref ramp out	23.2 Speed ref ramp output (page 378).	11
	Speed ref used	24.1 Used speed reference (page 386).	12
	Torq ref used	26.2 Torque reference used (page 405).	13
	Freq ref used	Not in use.	14
	Process PID out	Not in use.	16
	Process PID fbk	Not in use.	17
	Process PID act	Not in use.	18
	Process PID dev	Not in use.	19
	Other [value]	See Terms and abbreviations (page 221).	

**11.58** Freq out 1 src min Defines the real value of the signal (selected by parameter 11.55 Freq out 1 source and shown by parameter 11.54 Freq out 1 actual value) that corresponds to the minimum value of frequency output 1 (defined by parameter 11.60 Freq out 1 at src min).

0.000 / real32

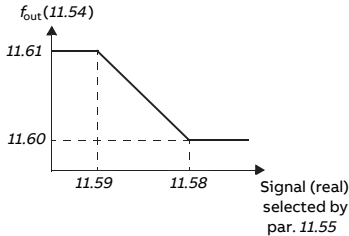
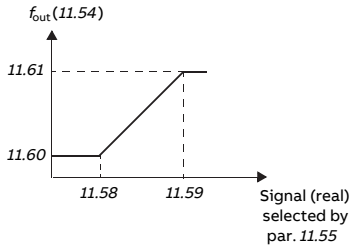

-32768.000 ...  
32767.000

Real signal value corresponding to minimum value of frequency output 1.



1 = 1 / 1000 = 1



No.	Name / Range / Selection	Description	Def / Type FbEq 16b / 32b
11.59	Freq out 1 src max	Defines the real value of the signal (selected by parameter 11.55 Freq out 1 source and shown by parameter 11.54 Freq out 1 actual value) that corresponds to the maximum value of frequency output 1 (defined by parameter 11.61 Freq out 1 at src max). See parameter 11.58 Freq out 1 src min.	1500.000; 1800.000 (95.20 b0) / real32
	-32768.000 ... 32767.000	Real signal value corresponding to maximum value of frequency output 1.	1 = 1 / 1000 = 1
11.60	Freq out 1 at src min	Defines the minimum value of frequency output 1. See diagrams at parameter 11.58 Freq out 1 src min.	0 Hz / real32
	0...16000 Hz	Minimum value of frequency output 1.	1 = 1 Hz / 1 = 1 Hz
11.61	Freq out 1 at src max	Defines the maximum value of frequency output 1. See diagrams at parameter 11.58 Freq out 1 src min.	16000 Hz / real32
	0...16000 Hz	Maximum value of frequency output 1.	1 = 1 Hz / 1 = 1 Hz
11.81	DIO filter time	Defines a filtering time for parameter 11.1 DIO status and 11.2 DIO delayed status. The filtering time will only affect the DIOs that are in input mode.	10.0 ms / uint32
	0.3 ... 100.0 ms	Filtering time for 11.1.	10 = 1 ms / 10 = 1 ms

## 282 Parameters

No.	Name / Range / Selection	Description	Def / Type FbEq 16b / 32b
<b>12</b>	<b>Standard AI</b>	Configuration of standard analog inputs.	
12.1	AI tune	Triggers the analog input tuning function. Connect the signal to the input and select the appropriate tuning function.	No action / uint16
	No action	AI tune is not activated.	0
	AI1 min tune	Current analog input AI1 signal value is set as minimum value of AI1 into parameter 12.17 AI1 min. The value reverts back to No action automatically.	1
	AI1 max tune	Current analog input AI1 signal value is set as maximum value of AI1 into parameter 12.18 AI1 max. The value reverts back to No action automatically.	2
	AI2 min tune	Current analog input AI2 signal value is set as minimum value of AI2 into parameter 12.27 AI2 min. The value reverts back to No action automatically.	3
	AI2 max tune	Current analog input AI2 signal value is set as maximum value of AI2 into parameter 12.28 AI2 max. The value reverts back to No action automatically.	4
12.3	AI supervision function	<p>Selects how the drive reacts when an analog input signal moves out of the minimum and/or maximum limits specified for the input.</p> <p>The supervision applies a margin of 0.5 V or 1.0 mA to the limits. For example, if the maximum limit for the input is 7.000 V, the maximum limit supervision activates at 7.500 V.</p> <p>The inputs and the limits to be observed are selected by parameter 12.4 AI supervision selection.</p> <p><b>Note:</b> Analog input signal supervision is only active when</p> <ul style="list-style-type: none"> <li>the analog input is set as the source (using the AI1 scaled or AI2 scaled selection) in parameter 22.11, 22.12, 22.15, 22.17, 23.42, 26.11, 26.12, 26.16, 26.25, 30.21, 30.22, or 44.9, and is being used as the active source, or</li> <li>supervision is forced using parameter 12.5 AI supervision force.</li> </ul>	No action / uint16
	No action	No action taken.	0
	Fault	Drive trips on 80A0 AI Supervision.	1
	Warning	Drive generates an A8A0 AI Supervised Warning warning.	2

No.	Name / Range / Selection	Description	Def / Type FbEq 16b / 32b
	Last speed	Drive generates a warning (A8A0 AI Supervised Warning) and freezes the speed (or frequency) to the level the drive was operating at. The speed/frequency is determined on the basis of actual speed using 850 ms low-pass filtering.	3
		 <b>WARNING!</b> Make sure that it is safe to continue operation in case of a communication break.	
	Speed ref safe	Drive generates a warning (A8A0 AI Supervised Warning) and sets the speed to the speed defined by parameter 22.41 Speed ref safe.	4
		 <b>WARNING!</b> Make sure that it is safe to continue operation in case of a communication break.	
12.4	AI supervision selection	Specifies the analog input limits to be supervised. See parameter 12.3 AI supervision function.	- / uint16
	b0 AI1 < MIN	1 = Minimum limit supervision of AI1 active.	
	b1 AI1 > MAX	1 = Maximum limit supervision of AI1 active.	
	b2 AI2 < MIN	1 = Minimum limit supervision of AI2 active.	
	b3 AI2 > MAX	1 = Maximum limit supervision of AI2 active.	
	b4...15 Reserved		
	0000h...FFFFh		1 = 1
12.5	AI supervision force	Activates analog input supervision separately for each control location (see section Local control vs. external control (page 145)). The parameter is primarily intended for analog input supervision when the input is connected to the application program and not selected as a control source by drive parameters.	- / uint16
	b0 AI1 Ext 1	1 = AI1 supervision active when EXT1 is being used.	
	b1 AI1 Ext 2	1 = AI1 supervision active when EXT2 is being used.	
	b2 AI1 Local	1 = AI1 supervision active when local control is being used.	
	b3 Reserved		
	b4 AI2 Ext 1	1 = AI2 supervision active when EXT1 is being used.	
	b5 AI2 Ext 2	1 = AI2 supervision active when EXT2 is being used.	
	b6 AI2 Local	1 = AI2 supervision active when local control is being used.	
	b7...15 Reserved		
	0000 0000b...0111 0111b		1 = 1

284 Parameters

No.	Name / Range / Selection	Description	Def / Type FbEq 16b / 32b
12.11	AI1 actual value	Displays the value of analog input AI1 in mA or V (depending on whether the input is set to current or voltage by a hardware setting). This parameter is read-only.	- / real32
	-22.000 ... 22.000 mA or V	Value of analog input AI1.	1000 = 1 mA or V / 1000 = 1 mA or V
12.12	AI1 scaled value	Displays the value of analog input AI1 after scaling. See parameters 12.19 AI1 scaled at AI1 min and 12.20 AI1 scaled at AI1 max. This parameter is read-only.	- / real32
	-32768.000 ... 32767.000	Scaled value of analog input AI1.	1 = 1 / 1000 = 1
12.15	AI1 unit selection	Selects the unit for readings and settings related to analog input AI1.  <b>Note:</b> This setting must match the corresponding hardware setting on the drive control unit (see the hardware manual of the drive). Control board reboot (either by cycling the power or through parameter 96.8 Control board boot) is required to validate any changes in the hardware settings.	V / uint16
	V	Volts.	2
	mA	Milliamperes.	10
12.16	AI1 filter time	Defines the filter time constant for analog input AI1.	0.100 s / real32

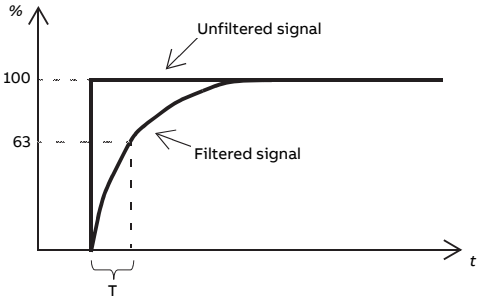

$O = I \times (1 - e^{-t/T})$   
 I = filter input (step)  
 O = filter output  
 t = time  
 T = filter time constant

**Note:** The signal is also filtered due to the signal interface hardware (approximately 0.25 ms time constant). This cannot be changed by any parameter.

0.000 ... 30.000 s	Filter time constant.	1000 = 1 s / 1000 = 1 s
--------------------	-----------------------	-------------------------

No.	Name / Range / Selection	Description	Def / Type FbEq 16b / 32b
12.17	AI1 min	Defines the minimum site value for analog input AI1. Set the value actually sent to the drive when the analog signal from plant is wound to its minimum setting. See also parameter 12.1 AI tune.	0.000 mA or V / real32
	-22.000 ... 22.000 mA or V	Minimum value of AI1.	1000 = 1 mA or V / 1000 = 1 mA or V
12.18	AI1 max	Defines the maximum site value for analog input AI1. Set the value actually sent to the drive when the analog signal from plant is wound to its maximum setting. See also parameter 12.1 AI tune.	20.000 mA or V / real32
	-22.000 ... 22.000 mA or V	Maximum value of AI1.	1000 = 1 mA or V / 1000 = 1 mA or V
12.19	AI1 scaled at AI1 min	Defines the real internal value that corresponds to the minimum analog input AI1 value defined by parameter 12.17 AI1 min. (Changing the polarity settings of 12.19 and 12.20 can effectively invert the analog input.)	0.000 / real32
	-32768.000 ... 32767.000	Real value corresponding to minimum AI1 value.	1 = 1 / 1000 = 1
12.20	AI1 scaled at AI1 max	Defines the real internal value that corresponds to the maximum analog input AI1 value defined by parameter 12.18 AI1 max. See the drawing at parameter 12.19 AI1 scaled at AI1 min.	1500.000; 1800.000 (95.20 b0) / real32
	-32768.000 ... 32767.000	Real value corresponding to maximum AI1 value.	1 = 1 / 1000 = 1
12.21	AI2 actual value	Displays the value of analog input AI2 in mA or V (depending on whether the input is set to current or voltage by a hardware setting). This parameter is read-only	- / real32
	-22.000 ... 22.000 mA or V	Value of analog input AI2.	1000 = 1 mA or V / 1000 = 1 mA or V

## 286 Parameters

No.	Name / Range / Selection	Description	Def / Type FbEq 16b / 32b
12.22	AI2 scaled value	Displays the value of analog input AI2 after scaling. See parameters 12.29 AI2 scaled at AI2 min and 12.30 AI2 scaled at AI2 max. This parameter is read-only.	- / real32
	-32768.000 ... 32767.000	Scaled value of analog input AI2.	1 = 1 / 1000 = 1
12.25	AI2 unit selection	Selects the unit for readings and settings related to analog input AI2.  <b>Note:</b> This setting must match the corresponding hardware setting on the drive control unit (see the hardware manual of the drive). Control board reboot (either by cycling the power or through parameter 96.8 Control board boot) is required to validate any changes in the hardware settings.	mA / uint16
	V	Volts.	2
	mA	Milliamperes.	10
12.26	AI2 filter time	Defines the filter time constant for analog input AI2. See parameter 12.16 AI1 filter time.	0.100 s / real32
	0.000 ... 30.000 s	Filter time constant.	1000 = 1 s / 1000 = 1 s
12.27	AI2 min	Defines the minimum site value for analog input AI2. Set the value actually sent to the drive when the analog signal from plant is wound to its minimum setting. See also parameter 12.1 AI tune.	0.000 mA or V / real32
	-22.000 ... 22.000 mA or V	Minimum value of AI2.	1000 = 1 mA or V / 1000 = 1 mA or V
12.28	AI2 max	Defines the maximum site value for analog input AI2. Set the value actually sent to the drive when the analog signal from plant is wound to its maximum setting. See also parameter 12.1 AI tune.	20.000 mA or V / real32
	-22.000 ... 22.000 mA or V	Maximum value of AI2.	1000 = 1 mA or V / 1000 = 1 mA or V

No.	Name / Range / Selection	Description	Def / Type FbEq 16b / 32b
12.29	AI2 scaled at AI2 min	Defines the real value that corresponds to the minimum analog input AI2 value defined by parameter 12.27 AI2 min. (Changing the polarity settings of 12.29 and 12.30 can effectively invert the analog input.)	0.000 / real32
	-32768.000 ... 32767.000	Real value corresponding to minimum AI2 value.	1 = 1 / 1000 = 1
12.30	AI2 scaled at AI2 max	Defines the real value that corresponds to the maximum analog input AI2 value defined by parameter 12.28 AI2 max. See the drawing at parameter 12.29 AI2 scaled at AI2 min.	100.000 / real32
	-32768.000 ... 32767.000	Real value corresponding to maximum AI2 value.	1 = 1 / 1000 = 1

## 288 Parameters

No.	Name / Range / Selection	Description	Def / Type FbEq 16b / 32b
<b>13</b>	<b>Standard AO</b>	Configuration of standard analog outputs.	
13.11	AO1 actual value	Displays the value of AO1 in mA. This parameter is read-only.	- / real32
	0.000 ... 22.000 mA	Value of AO1.	1000 = 1 mA / 1000 = 1 mA
13.12	AO1 source	Selects a signal to be connected to analog output AO1. Alternatively, sets the output to excitation mode to feed a constant current to a temperature sensor.	Motor speed used / uint32
	Zero	None	0
	Motor speed used	1.1 Motor speed used (page 226).	1
	Output frequency	1.6 Output frequency (page 226).	3
	Motor current	1.7 Motor current (page 226).	4
	Motor torque	1.10 Motor torque (page 226).	6
	DC voltage	1.11 DC voltage (page 227).	7
	Power inu out	1.14 Output power (page 227).	8
	Speed ref ramp in	23.1 Speed ref ramp input (page 378).	10
	Speed ref ramp out	23.2 Speed ref ramp output (page 378).	11
	Speed ref used	24.1 Used speed reference (page 386).	12
	Torq ref used	26.2 Torque reference used (page 405).	13
	Freq ref used	Not in use.	14
	Process PID out	Not in use.	16
	Process PID fbk	Not in use.	17
	Process PID act	Not in use.	18
	Process PID dev	Not in use.	19
	Other [value]	See Terms and abbreviations (page 221).	
	Force Pt100 excitation	The output is used to feed an excitation current to 1...3 Pt100 sensors. See section Motor thermal protection (page 199).	20
	Force KTY84 excitation	The output is used to feed an excitation current to a KTY84 sensor. See section Motor thermal protection (page 199).	21
	Force PTC excitation	The output is used to feed an excitation current to 1...3 PTC sensors. See section Motor thermal protection (page 199).	22
	Force Pt1000 excitation	The output is used to feed an excitation current to 1...3 Pt1000 sensors. See section Motor thermal protection (page 199).	23
	AO1 data storage	13.91 AO1 data storage (page 293).	37
	AO2 data storage	13.92 AO2 data storage (page 293).	38



No.	Name / Range / Selection	Description	Def / Type FbEq 16b / 32b
13.16	AO1 filter time	Defines the filtering time constant for analog output AO1.	0.100 s / real32

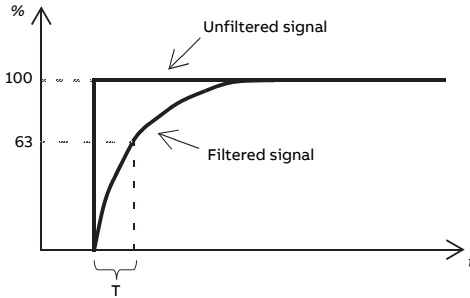

$$O = I \times (1 - e^{-t/T})$$

I = filter input (step)

O = filter output

t = time

T = filter time constant

0.000 ... 30.000 s

Filter time constant.

1000 = 1 s / 1000 = 1  
s

290 Parameters

No.	Name / Range / Selection	Description	Def / Type FbEq 16b / 32b
13.17	AO1 source min	Defines the real minimum value of the signal (selected by parameter 13.12 AO1 source) that corresponds to the minimum required AO1 output value (defined by parameter 13.19 AO1 out at AO1 src min).	0.0 / real32

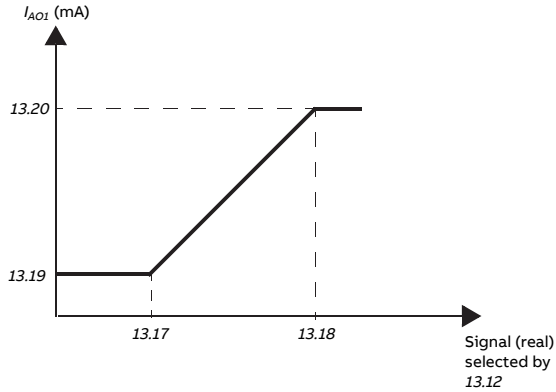

Programming 13.17 as the maximum value and 13.18 as the minimum value inverts the output.

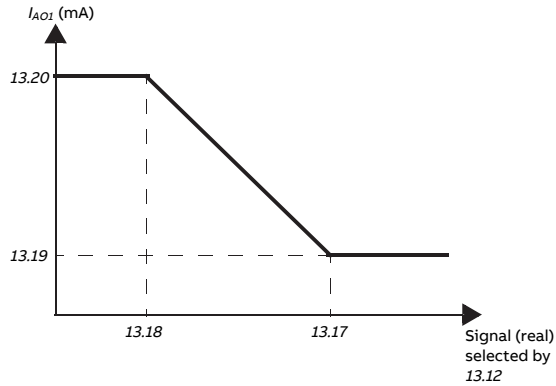

-32768.0 ... 32767.0	Real signal value corresponding to minimum AO1 output value.	1 = 1 / 10 = 1	
13.18	AO1 source max	Defines the real maximum value of the signal (selected by parameter 13.12 AO1 source) that corresponds to the maximum required AO1 output value (defined by parameter 13.20 AO1 out at AO1 src max). See parameter 13.17 AO1 source min.	1500.000; 1800.000 (95.20 b0) / real32
-32768.0 ... 32767.0	Real signal value corresponding to maximum AO1 output value.	1 = 1 / 10 = 1	

No.	Name / Range / Selection	Description	Def / Type FbEq 16b / 32b
13.19	AO1 out at AO1 src min	Defines the minimum output value for analog output AO1. See also drawing at parameter 13.17 AO1 source min.	0.000 mA / real32
	0.000 ... 22.000 mA	Minimum AO1 output value.	1000 = 1 mA / 1000 = 1 mA
13.20	AO1 out at AO1 src max	Defines the maximum output value for analog output AO1. See also drawing at parameter 13.17 AO1 source min.	20.000 mA / real32
	0.000 ... 22.000 mA	Maximum AO1 output value.	1000 = 1 mA / 1000 = 1 mA
13.21	AO2 actual value	Displays the value of AO2 in mA. This parameter is read-only.	- / real32
	0.000 ... 22.000 mA	Value of AO2.	1000 = 1 mA / 1000 = 1 mA
13.22	AO2 source	Selects a signal to be connected to analog output AO2. Alternatively, sets the output to excitation mode to feed a constant current to a temperature sensor. For the selections, see parameter 13.12 AO1 source.	Motor current / uint32
13.26	AO2 filter time	Defines the filtering time constant for analog output AO2. See parameter 13.16 AO1 filter time.	0.100 s / real32
	0.000 ... 30.000 s	Filter time constant.	1000 = 1 s / 1000 = 1 s

## 292 Parameters

No.	Name / Range / Selection	Description	Def / Type FbEq 16b / 32b
13.27	AO2 source min	Defines the real minimum value of the signal (selected by parameter 13.22 AO2 source) that corresponds to the minimum required AO2 output value (defined by parameter 13.29 AO2 out at AO2 src min).	0.0 / real32

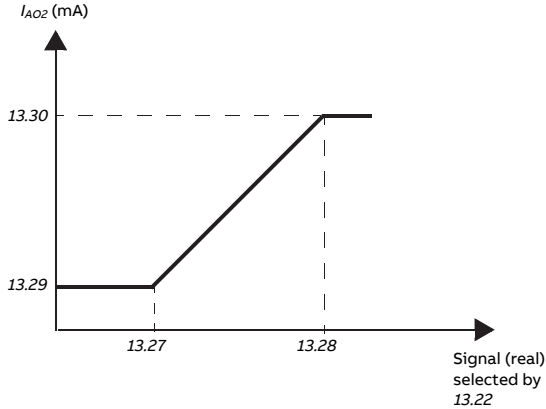

Programming 13.27 as the maximum value and 13.28 as the minimum value inverts the output.

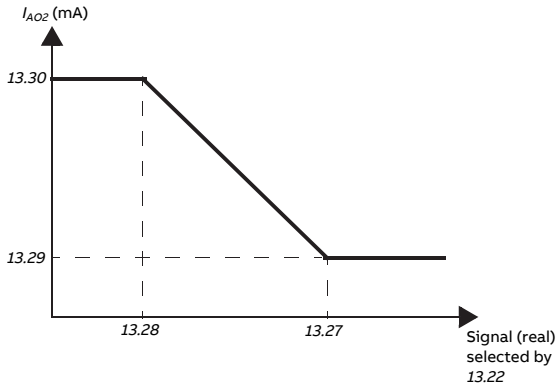

-32768.0 ... 32767.0	Real signal value corresponding to minimum AO2 output value.	1 = 1 / 10 = 1	
13.28	AO2 source max	Defines the real maximum value of the signal (selected by parameter 13.22 AO2 source) that corresponds to the maximum required AO2 output value (defined by parameter 13.30 AO2 out at AO2 src max). See parameter 13.27 AO2 source min.	100.0 / real32
-32768.0 ... 32767.0	Real signal value corresponding to maximum AO2 output value.	1 = 1 / 10 = 1	

No.	Name / Range / Selection	Description	Def / Type FbEq 16b / 32b
13.29	AO2 out at AO2 src min	Defines the minimum output value for analog output AO2. See also drawing at parameter 13.27 AO2 source min.	0.000 mA / real32
	0.000 ... 22.000 mA	Minimum AO2 output value.	1000 = 1 mA / 1000 = 1 mA
13.30	AO2 out at AO2 src max	Defines the maximum output value for analog output AO2. See also drawing at parameter 13.27 AO2 source min.	20.000 mA / real32
	0.000 ... 22.000 mA	Maximum AO2 output value.	1000 = 1 mA / 1000 = 1 mA
13.91	AO1 data storage	Storage parameter for controlling analog output AO1 eg. through fieldbus. In 13.12 AO1 source, select AO1 data storage. Then set this parameter as the target of the incoming value data. With the embedded fieldbus interface, simply set the target selection parameter of that particular data (58.101...58.124) to AO1 data storage.	0.00 / real32
	-327.68 ... 327.67	Storage parameter for AO1.	100 = 1 / 100 = 1
13.92	AO2 data storage	Storage parameter for controlling analog output AO2 eg. through fieldbus. In 13.22 AO2 source, select AO2 data storage. Then set this parameter as the target of the incoming value data. With the embedded fieldbus interface, simply set the target selection parameter of that particular data (58.101...58.124) to AO2 data storage.	0.00 / real32
	-327.68 ... 327.67	Storage parameter for AO2.	100 = 1 / 100 = 1

## 294 Parameters

No.	Name / Range / Selection	Description	Def / Type FbEq 16b / 32b
14	<b>I/O extension module 1</b>	Configuration of I/O extension module 1. See also section <a href="#">Programmable I/O extensions (page 157)</a> .  <b>Note:</b> The contents of the parameter group vary according to the selected I/O extension module type.	
14.1	Module 1 type	Activates (and specifies the type of) I/O extension module 1.  <b>Note:</b> This parameter cannot be changed while the drive is running.	None / uint16
	None	Inactive.	0
	FIO-01	FIO-01.	1
	FIO-11	FIO-11.	2
	FAIO-01	FAIO-01.	4
	FDIO-01	FDIO-01.	3
14.2	Module 1 location	Specifies the slot (1...3) on the control unit of the drive into which the I/O extension module is installed. Alternatively, specifies the node ID of the slot on an FEA-03 extension adapter.  <b>Note:</b> This parameter cannot be changed while the drive is running.	1 / uint16
	1...254	Slot 1 = 1; Slot 2 = 2; Slot 3 = 3. 4...254: Node ID of the slot on the FEA-03 extension adapter.	1 = 1 / 1 = 1
14.3	Module 1 status	Displays the status of I/O extension module 1.	No option / uint16
	No option	No module detected in the specified slot.	0
		A module has been detected but cannot be communicated with.	1
		The module type is unknown.	2
	FIO-01	An FIO-01 module has been detected and is active.	15
	FIO-11	An FIO-11 module has been detected and is active.	20
	FAIO-01	An FAIO-01 module has been detected and is active.	24
14.5	DI status	(Visible when <a href="#">14.1 Module 1 type</a> = FDIO-01) Displays the status of the digital inputs on the extension module. The activation/deactivation delays (if any are specified) are ignored. A filtering time (for input mode) can be defined by parameter <a href="#">14.8 DI filter time</a> . Bit 0 indicates the status of DI1.  <b>Note:</b> The number of active bits in this parameter depends on the number of digital input/outputs on the extension module.  <b>Example:</b> 0101b = DI1 and DI3 are on, remainder are off. This parameter is read-only.	- / uint16

No.	Name / Range / Selection	Description	Def / Type FbEq 16b / 32b
14.5	DIO status	<p>(Visible when 14.1 Module 1 type = FIO-11)</p> <p>Displays the status of the digital input/outputs on the extension module. The activation/deactivation delays (if any are specified) are ignored. A filtering time (for input mode) can be defined by parameter 14.8 DIO filter time.</p> <p>Bit 0 indicates the status of DIO1.</p> <p><b>Note:</b> The number of active bits in this parameter depends on the number of digital input/outputs on the extension module.</p> <p><b>Example:</b> 1001b = DIO1 and DIO4 are on, remainder are off.</p> <p>This parameter is read-only.</p>	- / uint16
14.5	DIO status	<p>(Visible when 14.1 Module 1 type = FIO-01)</p> <p>Displays the status of the digital input/outputs on the extension module. The activation/deactivation delays (if any are specified) are ignored. A filtering time (for input mode) can be defined by parameter 14.8 DIO filter time.</p> <p>Bit 0 indicates the status of DIO1.</p> <p><b>Note:</b> The number of active bits in this parameter depends on the number of digital input/outputs on the extension module.</p> <p><b>Example:</b> 1001b = DIO1 and DIO4 are on, remainder are off.</p> <p>This parameter is read-only.</p>	- / uint16
14.6	DI delayed status	<p>(Visible when 14.1 Module 1 type = FDIO-01)</p> <p>Displays the delayed status of the digital inputs on the extension module. The word is updated only after activation/deactivation delays (if any are specified). Bit 0 indicates the status of DI1.</p> <p><b>Note:</b> The number of active bits in this parameter depends on the number of digital inputs on the extension module.</p> <p><b>Example:</b> 0101b = DI1 and DI3 are on, remainder are off.</p> <p>This parameter is read-only.</p>	- / uint16
14.6	DIO delayed status	<p>(Visible when 14.1 Module 1 type = FIO-11)</p> <p>Displays the delayed status of the digital input/outputs on the extension module. This word is updated only after activation/deactivation delays (if any are specified).</p> <p>Bit 0 indicates the status of DIO1.</p> <p><b>Note:</b> The number of active bits in this parameter depends on the number of digital input/outputs on the extension module.</p> <p><b>Example:</b> 1001b = DIO1 and DIO4 are on, remainder are off.</p> <p>This parameter is read-only.</p>	- / uint16

## 296 Parameters

No.	Name / Range / Selection	Description	Def / Type FbEq 16b / 32b
14.6	DIO delayed status	(Visible when 14.1 Module 1 type = FIO-01) Displays the delayed status of the digital input/outputs on the extension module. This word is updated only after activation/deactivation delays (if any are specified). Bit 0 indicates the status of DIO1.  <b>Note:</b> The number of active bits in this parameter depends on the number of digital input/outputs on the extension module.  <b>Example:</b> 1001b = DIO1 and DIO4 are on, remainder are off. This parameter is read-only.	- / uint16
14.8	DI filter time	(Visible when 14.1 Module 1 type = FDIO-01) Defines a filtering time for parameters 14.5 DI status and 14.6 DI delayed status.	10.0 ms / real32
	0.8 ... 100.0 ms	Filtering time for DI status parameters.	10 = 1 ms / 10 = 1 ms
14.8	DIO filter time	(Visible when 14.1 Module 1 type = FIO-11) Defines a filtering time for parameters 14.5 DIO status and 14.6 DIO delayed status. The filtering time will only affect the DIOs that are in input mode.	10.0 ms / real32
	0.8 ... 100.0 ms	Filtering time for DIO status parameters.	10 = 1 ms / 10 = 1 ms
14.8	DIO filter time	(Visible when 14.1 Module 1 type = FIO-01) Defines a filtering time for parameters 14.5 DIO status and 14.6 DIO delayed status. The filtering time will only affect the DIOs that are in input mode.	10.0 ms / real32
	0.8 ... 100.0 ms	Filtering time for DIO status parameters.	10 = 1 ms / 10 = 1 ms
14.9	DIO1 function	(Visible when 14.1 Module 1 type = FIO-11) Selects whether DIO1 of the extension module is used as a digital input or output.	Input / uint16
	Output	DIO1 is used as a digital output.	0
	Input	DIO1 is used as a digital input.	1
14.9	DIO1 function	(Visible when 14.1 Module 1 type = FIO-01) Selects whether DIO1 of the extension module is used as a digital input or output.	Input / uint16
	Output	DIO1 is used as a digital output.	0
	Input	DIO1 is used as a digital input.	1
14.11	DIO1 output source	(Visible when 14.1 Module 1 type = FIO-11) Selects a drive signal to be connected to digital input/output DIO1 of the extension module when parameter 14.9 DIO1 function is set to Output.	Not energized / uint32
	Not energized	Output is not energized.	0
	Energized	Output is energized.	1
	Ready run	Bit 1 of 6.11 Main status word (page 245).	2
	Enabled	Bit 0 of 6.16 Drive status word 1 (page 245).	4
	Started	Bit 5 of 6.16 Drive status word 1 (page 245).	5



No.	Name / Range / Selection	Description	Def / Type FbEq 16b / 32b
	Magnetized	Bit 1 of 6.17 Drive status word 2 (page 246).	6
	Running	Bit 6 of 6.16 Drive status word 1 (page 245).	7
	Ready ref	Bit 2 of 6.11 Main status word (page 245).	8
	At setpoint	Bit 8 of 6.11 Main status word (page 245).	9
	Reverse	Bit 2 of 6.19 Speed control status word (page 247).	10
	Zero speed	Bit 0 of 6.19 Speed control status word (page 247).	11
	Above limit	Bit 10 of 6.17 Drive status word 2 (page 246).	12
	Warning	Bit 7 of 6.11 Main status word (page 245).	13
	Fault	Bit 3 of 6.11 Main status word (page 245).	14
	Fault (-1)	Inverted bit 3 of 6.11 Main status word (page 245).	15
	Start request	Bit 13 of 6.16 Drive status word 1 (page 245).	16
	Open brake command	Do not use this selection. <b>Note:</b> The default value of this parameter is 44.210 Crane brake status, bit 0. The default value must not be changed.	22
	Ext2 active	Bit 11 of 6.16 Drive status word 1 (page 245).	23
	Remote control	Bit 9 of 6.11 Main status word (page 245).	24
	Supervision 1	Bit 0 of 32.1 Supervision status (page 444).	33
	Supervision 2	Bit 1 of 32.1 Supervision status (page 444).	34
	Supervision 3	Bit 2 of 32.1 Supervision status (page 444).	35
	RO/DIO control word bit0	Bit 0 of 10.99 RO/DIO control word (page 275).	40
	RO/DIO control word bit1	Bit 1 of 10.99 RO/DIO control word (page 275).	41
	RO/DIO control word bit2	Bit 2 of 10.99 RO/DIO control word (page 275).	42
	RO/DIO control word bit8	Bit 8 of 10.99 RO/DIO control word (page 275).	43
	RO/DIO control word bit9	Bit 9 of 10.99 RO/DIO control word (page 275).	44
	Other [bit]	See Terms and abbreviations (page 221).	
14.11	DIO1 output source	(Visible when 14.1 Module 1 type = FIO-01) Selects a drive signal to be connected to digital input/output DIO1 of the extension module when parameter 14.9 DIO1 function is set to Output.	Not energized / uint32
	Not energized	Output is not energized.	0
	Energized	Output is energized.	1
	Ready run	Bit 1 of 6.11 Main status word (page 245).	2
	Enabled	Bit 0 of 6.16 Drive status word 1 (page 245).	4
	Started	Bit 5 of 6.16 Drive status word 1 (page 245).	5



## 298 Parameters

No.	Name / Range / Selection	Description	Def / Type FbEq 16b / 32b
	Magnetized	Bit 1 of 6.17 Drive status word 2 (page 246).	6
	Running	Bit 6 of 6.16 Drive status word 1 (page 245).	7
	Ready ref	Bit 2 of 6.11 Main status word (page 245).	8
	At setpoint	Bit 8 of 6.11 Main status word (page 245).	9
	Reverse	Bit 2 of 6.19 Speed control status word (page 247).	10
	Zero speed	Bit 0 of 6.19 Speed control status word (page 247).	11
	Above limit	Bit 10 of 6.17 Drive status word 2 (page 246).	12
	Warning	Bit 7 of 6.11 Main status word (page 245).	13
	Fault	Bit 3 of 6.11 Main status word (page 245).	14
	Fault (-1)	Inverted bit 3 of 6.11 Main status word (page 245).	15
	Start request	Bit 13 of 6.16 Drive status word 1 (page 245).	16
	Open brake command	Do not use this selection. <b>Note:</b> The default value of this parameter is 44.210 Crane brake status, bit 0. The default value must not be changed.	22
	Ext2 active	Bit 11 of 6.16 Drive status word 1 (page 245).	23
	Remote control	Bit 9 of 6.11 Main status word (page 245).	24
	Supervision 1	Bit 0 of 32.1 Supervision status (page 444).	33
	Supervision 2	Bit 1 of 32.1 Supervision status (page 444).	34
	Supervision 3	Bit 2 of 32.1 Supervision status (page 444).	35
	RO/DIO control word bit0	Bit 0 of 10.99 RO/DIO control word (page 275).	40
	RO/DIO control word bit1	Bit 1 of 10.99 RO/DIO control word (page 275).	41
	RO/DIO control word bit2	Bit 2 of 10.99 RO/DIO control word (page 275).	42
	RO/DIO control word bit8	Bit 8 of 10.99 RO/DIO control word (page 275).	43
	RO/DIO control word bit9	Bit 9 of 10.99 RO/DIO control word (page 275).	44
	Other [bit]	See Terms and abbreviations (page 221).	

No.	Name / Range / Selection	Description	Def / Type FbEq 16b / 32b
14.12	DI1 ON delay	(Visible when 14.1 Module 1 type = FDIO-01) Defines the activation delay for digital input DI1.	0.00 s / real32
$t_{On} = 14.12$ DI1 ON delay $t_{Off} = 14.13$ DI1 OFF delay *Electrical status of DI or status of selected source (in output mode). Indicated by 14.5 DI status. **Indicated by 14.6 DI delayed status.			
0.00 ... 3000.00 s			10 = 1 s / 100 = 1 s
14.12	DIO1 ON delay	(Visible when 14.1 Module 1 type = FIO-11) Defines the activation delay for digital input/output DIO1.	0.00 s / real32
$t_{On} = 14.12$ DIO1 ON delay $t_{Off} = 14.13$ DIO1 OFF delay *Electrical status of DIO (in input mode) or status of selected source (in output mode). Indicated by 14.5 DIO status. **Indicated by 14.6 DIO delayed status.			
0.00 ... 3000.00 s			10 = 1 s / 100 = 1 s
14.12	DIO1 ON delay	(Visible when 14.1 Module 1 type = FIO-01) Defines the activation delay for digital input/output DIO1.	0.00 s / real32
$t_{On} = 14.12$ DIO1 ON delay $t_{Off} = 14.13$ DIO1 OFF delay *Electrical status of DIO (in input mode) or status of selected source (in output mode). Indicated by 14.5 DIO status. **Indicated by 14.6 DIO delayed status.			

## 300 Parameters

No.	Name / Range / Selection	Description	Def / Type FbEq 16b / 32b
	0.00 ... 3000.00 s	Activation delay for DIO1.	10 = 1 s / 100 = 1 s
14.13	DI1 OFF delay	(Visible when 14.1 Module 1 type = FDIO-01) Defines the deactivation delay for digital input DI1. See parameter 14.12 DI1 ON delay.	0.00 s / real32
	0.00 ... 3000.00 s	Deactivation delay for DI1.	10 = 1 s / 100 = 1 s
14.13	DIO1 OFF delay	(Visible when 14.1 Module 1 type = FIO-11) Defines the deactivation delay for digital input/output DIO1. See parameter 14.12 DIO1 ON delay.	0.00 s / real32
	0.00 ... 3000.00 s	Deactivation delay for DIO1.	10 = 1 s / 100 = 1 s
14.13	DIO1 OFF delay	(Visible when 14.1 Module 1 type = FIO-01) Defines the deactivation delay for digital input/output DIO1. See parameter 14.12 DIO1 ON delay.	0.00 s / real32
	0.00 ... 3000.00 s	Deactivation delay for DIO1.	10 = 1 s / 100 = 1 s
14.14	DIO2 function	(Visible when 14.1 Module 1 type = FIO-11) Selects whether DIO2 of the extension module is used as a digital input or output.	Input / uint16
	Output	DIO2 is used as a digital output.	0
	Input	DIO2 is used as a digital input.	1
14.14	DIO2 function	(Visible when 14.1 Module 1 type = FIO-01) Selects whether DIO2 of the extension module is used as a digital input or output.	Input / uint16
	Output	DIO2 is used as a digital output.	0
	Input	DIO2 is used as a digital input.	1
14.16	DIO2 output source	(Visible when 14.1 Module 1 type = FIO-11) Selects a drive signal to be connected to digital input/output DIO2 when parameter 14.14 DIO2 function is set to Output. For the available selections, see parameter 14.11 DIO1 output source.	Not energized / uint32
14.16	DIO2 output source	(Visible when 14.1 Module 1 type = FIO-01) Selects a drive signal to be connected to digital input/output DIO2 when parameter 14.14 DIO2 function is set to Output. For the available selections, see parameter 14.11 DIO1 output source.	Not energized / uint32
14.17	DI2 ON delay	(Visible when 14.1 Module 1 type = FDIO-01) Defines the activation delay for digital input DI2. See parameter 14.12 DI1 ON delay.	0.00 s / real32
	0.00 ... 3000.00 s	Activation delay for DI2.	10 = 1 s / 100 = 1 s
14.17	DIO2 ON delay	(Visible when 14.1 Module 1 type = FIO-11) Defines the activation delay for digital input/output DIO2. See parameter 14.12 DIO1 ON delay.	0.00 s / real32
	0.00 ... 3000.00 s	Activation delay for DIO2.	10 = 1 s / 100 = 1 s

No.	Name / Range / Selection	Description	Def / Type FbEq 16b / 32b
14.17	DIO2 ON delay	(Visible when 14.1 Module 1 type = FIO-01) Defines the activation delay for digital input/output DIO2. See parameter 14.12 DIO1 ON delay.	0.00 s / real32
	0.00 ... 3000.00 s	Activation delay for DIO2.	10 = 1 s / 100 = 1 s
14.18	DI2 OFF delay	(Visible when 14.1 Module 1 type = FDIO-01) Defines the deactivation delay for digital input DI2. See parameter 14.12 DI1 ON delay.	0.00 s / real32
	0.00 ... 3000.00 s	Deactivation delay for DI2.	10 = 1 s / 100 = 1 s
14.18	DIO2 OFF delay	(Visible when 14.1 Module 1 type = FIO-11) Defines the deactivation delay for digital input/output DIO2. See parameter 14.12 DIO1 ON delay.	0.00 s / real32
	0.00 ... 3000.00 s	Deactivation delay for DIO2.	10 = 1 s / 100 = 1 s
14.18	DIO2 OFF delay	(Visible when 14.1 Module 1 type = FIO-01) Defines the deactivation delay for digital input/output DIO2. See parameter 14.12 DIO1 ON delay.	0.00 s / real32
	0.00 ... 3000.00 s	Deactivation delay for DIO2.	10 = 1 s / 100 = 1 s
14.19	AI supervision function	(Visible when 14.1 Module 1 type = FAIO-01) Selects how the drive reacts when an analog input signal moves out of the minimum and/or maximum limits specified for the input. The inputs and the limits to be observed are selected by parameter 12.4 AI supervision selection.	No action / uint16
	No action	No action taken.	0
	Fault	Drive trips on 80A0 AI Supervision.	1
	Warning	Drive generates an A8A0 AI Supervised Warning warning.	2
	Last speed	Drive generates a warning (A8A0 AI Supervised Warning) and freezes the speed (or frequency) to the level the drive was operating at. The speed/frequency is determined on the basis of actual speed using 850 ms low-pass filtering.	3
		 <b>WARNING!</b> Make sure that it is safe to continue operation in case of a communication break.	
	Speed ref safe	Drive generates a warning (A8A0 AI Supervised Warning) and sets the speed to the speed defined by parameter 22.41 Speed ref safe .	4
		 <b>WARNING!</b> Make sure that it is safe to continue operation in case of a communication break.	
14.19	DIO3 function	(Visible when 14.1 Module 1 type = FIO-01) Selects whether DIO3 of the extension module is used as a digital input or output.	Input / uint16

## 302 Parameters

No.	Name / Range / Selection	Description	Def / Type FbEq 16b / 32b
	Output	DIO3 is used as a digital output.	0
	Input	DIO3 is used as a digital input.	1
14.20	AI supervision selection	(Visible when 14.1 Module 1 type = FAIO-01) Specifies the analog input limits to be supervised. See parameter 14.19 AI supervision function.  <b>Note:</b> The number of active bits in this parameter depends on the number of inputs on the extension module.	- / uint16
	b0 AI1 < MIN	1 = Minimum limit supervision of AI1 active.	
	b1 AI1 > MAX	1 = Maximum limit supervision of AI1 active.	
	b2 AI2 < MIN	1 = Minimum limit supervision of AI2 active.	
	b3 AI2 > MAX	1 = Maximum limit supervision of AI2 active.	
	b4...15 Reserved		
	0000h...FFFFh		1 = 1
14.20	AI supervision selection	(Visible when 14.1 Module 1 type = FIO-11) Specifies the analog input limits to be supervised. See parameter 14.19 AI supervision function.	- / uint16
	b0 AI1 < MIN	1 = Minimum limit supervision of AI1 active.	
	b1 AI1 > MAX	1 = Maximum limit supervision of AI1 active.	
	b2 AI2 < MIN	1 = Minimum limit supervision of AI2 active.	
	b3 AI2 > MAX	1 = Maximum limit supervision of AI2 active.	
	b4 AI3 < MIN	1 = Minimum limit supervision of AI3 active.	
	b5 AI3 > MAX	1 = Maximum limit supervision of AI3 active.	
	b6...15 Reserved		
	0000h...FFFFh		1 = 1
14.21	AI tune	(Visible when 14.1 Module 1 type = FAIO-01) Triggers the analog input tuning function, which enables the use of actual measurements as the minimum and maximum input values instead of potentially inaccurate estimates. Apply the minimum or maximum signal to the input and select the appropriate tuning function. See also the drawing at parameter 14.35 AI1 scaled at AI1 min.	No action / uint16
	No action	Tuning action completed or no action has been requested. The parameter automatically reverts to this value after any tuning action.	0
	AI1 min tune	The measured value of AI1 is set as the minimum value of AI1 into parameter 14.33 AI1 min.	1
	AI1 max tune	The measured value of AI1 is set as the maximum value of AI1 into parameter 14.34 AI1 max.	2

No.	Name / Range / Selection	Description	Def / Type FbEq 16b / 32b
	AI2 min tune	The measured value of AI2 is set as the minimum value of AI2 into parameter 14.48 AI2 min.	3
	AI2 max tune	The measured value of AI2 is set as the maximum value of AI2 into parameter 14.49 AI2 max.	4
14.21	AI tune	(Visible when 14.1 Module 1 type = FIO-11) Triggers the analog input tuning function, which enables the use of actual measurements as the minimum and maximum input values instead of potentially inaccurate estimates. Apply the minimum or maximum signal to the input and select the appropriate tuning function. See also the drawing at parameter 14.35 AI1 scaled at AI1 min.	No action / uint16
	No action	Tuning action completed or no action has been requested. The parameter automatically reverts to this value after any tuning action.	0
	AI1 min tune	The measured value of AI1 is set as the minimum value of AI1 into parameter 14.33 AI1 min.	1
	AI1 max tune	The measured value of AI1 is set as the maximum value of AI1 into parameter 14.34 AI1 max.	2
	AI2 min tune	The measured value of AI2 is set as the minimum value of AI2 into parameter 14.48 AI2 min.	3
	AI2 max tune	The measured value of AI2 is set as the maximum value of AI2 into parameter 14.49 AI2 max.	4
	AI3 min tune	The measured value of AI3 is set as the minimum value of AI3 into parameter 14.63 AI3 min.	5
	AI3 max tune	The measured value of AI3 is set as the maximum value of AI3 into parameter 14.64 AI3 max.	6
14.21	DIO3 output source	(Visible when 14.1 Module 1 type = FIO-01) Selects a drive signal to be connected to digital input/output DIO3 when parameter 14.19 DIO3 function is set to Output. For the available selections, see parameter 14.11 DIO1 output source.	Not energized / uint32
14.22	AI force selection	(Visible when 14.1 Module 1 type = FAIO-01) The true readings of the analog inputs can be overridden for eg. testing purposes. A forced value parameter is provided for each analog input, and its value is applied whenever the corresponding bit in this parameter is 1.	- / uint16
	b0 AI1	1 = Force mode: Force AI1 to value of parameter 14.28 AI1 force data.	
	b1 AI2	1 = Force mode: Force AI2 to value of parameter 14.43 AI2 force data.	
	b2...15 Reserved		
	0000h...FFFFh		1 = 1

## 304 Parameters

No.	Name / Range / Selection	Description	Def / Type FbEq 16b / 32b
14.22	DI3 ON delay	(Visible when 14.1 Module 1 type = FDIO-01) Defines the activation delay for digital input DI3. See parameter 14.12 DI1 ON delay.	0.00 s / real32
	0.00 ... 3000.00 s	Activation delay for DI3.	10 = 1 s / 100 = 1 s
14.22	AI force selection	(Visible when 14.1 Module 1 type = FIO-11) The true readings of the analog inputs can be overridden for eg. testing purposes. A forced value parameter is provided for each analog input, and its value is applied whenever the corresponding bit in this parameter is 1.	- / uint16
	b0 AI1	1 = Force mode: Force AI1 to value of parameter 14.28 AI1 force data.	
	b1 AI2	1 = Force mode: Force AI2 to value of parameter 14.43 AI2 force data.	
	b2 AI3	1 = Force mode: Force AI3 to value of parameter 14.58 AI3 force data (FIO-11 only).	
	b3...15 Reserved		
	0000h...FFFFh		1 = 1
14.22	DIO3 ON delay	(Visible when 14.1 Module 1 type = FIO-01) Defines the activation delay for digital input/output DIO3. See parameter 14.12 DIO1 ON delay.	0.00 s / real32
	0.00 ... 3000.00 s	Activation delay for DIO3.	10 = 1 s / 100 = 1 s
14.23	DI3 OFF delay	(Visible when 14.1 Module 1 type = FDIO-01) Defines the deactivation delay for digital input DI3. See parameter 14.12 DI1 ON delay.	0.00 s / real32
	0.00 ... 3000.00 s	Deactivation delay for DI3.	10 = 1 s / 100 = 1 s
14.23	DIO3 OFF delay	(Visible when 14.1 Module 1 type = FIO-01) Defines the deactivation delay for digital input/output DIO3. See parameter 14.12 DIO1 ON delay.	0.00 s / real32
	0.00 ... 3000.00 s	Deactivation delay for DIO3.	10 = 1 s / 100 = 1 s
14.24	DIO4 function	(Visible when 14.1 Module 1 type = FIO-01) Selects whether DIO4 of the extension module is used as a digital input or output.	Input / uint16
	Output	DIO4 is used as a digital output.	0
	Input	DIO4 is used as a digital input.	1
14.26	AI1 actual value	(Visible when 14.1 Module 1 type = FAIO-01) Displays the value of analog input AI1 in mA or V (depending on whether the input is set to current or voltage). This parameter is read-only.	- / real32
	-22.000 ... 22.000 mA or V	Value of analog input AI1.	1000 = 1 mA or V / 1000 = 1 mA or V



No.	Name / Range / Selection	Description	Def / Type FbEq 16b / 32b
14.26	DIO4 output source	(Visible when 14.1 Module 1 type = FIO-01) Selects a drive signal to be connected to digital input/output DIO4 when parameter 14.24 DIO4 function is set to Output. For the available selections, see parameter 14.11 DIO1 output source.	Not energized / uint32
14.27	AI1 scaled value	(Visible when 14.1 Module 1 type = FAIO-01) Displays the value of analog input AI1 after scaling. See parameter 14.35 AI1 scaled at AI1 min. This parameter is read-only.	- / real32
	-32768.000 ... 32767.000	Scaled value of analog input AI1.	1 = 1 / 1000 = 1
14.27	DIO4 ON delay	(Visible when 14.1 Module 1 type = FIO-01) Defines the activation delay for digital input/output DIO4. See parameter 14.12 DIO1 ON delay.	0.00 s / real32
	0.00 ... 3000.00 s	Activation delay for DIO4.	10 = 1 s / 100 = 1 s
14.28	AI1 force data	(Visible when 14.1 Module 1 type = FAIO-01) Forced value that can be used instead of the true reading of the input. See parameter 14.22 AI force selection.	- / real32
	-22.000 ... 22.000 mA or V	Forced value of analog input AI1.	1000 = 1 mA or V / 1000 = 1 mA or V
14.28	DIO4 OFF delay	(Visible when 14.1 Module 1 type = FIO-01) Defines the deactivation delay for digital input/output DIO4. See parameter 14.12 DIO1 ON delay.	0.00 s / real32
	0.00 ... 3000.00 s	Deactivation delay for DIO4.	10 = 1 s / 100 = 1 s
14.29	AI1 HW switch position	(Visible when 14.1 Module 1 type = FAIO-01) Shows the position of the hardware current/voltage selector on the I/O extension module.  <b>Note:</b> The setting of the current/voltage selector must match the unit selection made in parameter 14.30 AI1 unit selection. I/O module reboot either by cycling the power or through parameter 96.8 Control board boot is required to validate any changes in the hardware settings.	- / uint16
	mA	Milliamperes.	10
	V	Volts.	2
14.30	AI1 unit selection	(Visible when 14.1 Module 1 type = FAIO-01) Selects the unit for readings and settings related to analog input AI1.  <b>Note:</b> This setting must match the corresponding hardware setting on the I/O extension module (see the manual of the I/O extension module). The hardware setting is shown by parameter 14.29 AI1 HW switch position. I/O module reboot either by cycling the power or through parameter 96.8 Control board boot is required to validate any changes in the hardware settings.	mA / uint16

### 306 Parameters

No.	Name / Range / Selection	Description	Def / Type FbEq 16b / 32b
	mA	Milliamperes.	10
	V	Volts.	2
14.31	RO status	(Visible when 14.1 Module 1 type = FDIO-01) Status of relay outputs on the I/O extension module. <b>Example:</b> 0001b = RO1 is energized, RO2 is de-energized.	- / uint16
14.31	AI1 filter gain	(Visible when 14.1 Module 1 type = FAIO-01) Selects a hardware filtering time for AI1. See also parameter 14.32 AI1 filter time.	1 ms / uint16
	No filtering	No filtering.	0
	125 us	125 microseconds.	1
	250 us	250 microseconds.	2
	500 us	500 microseconds.	3
	1 ms	1 millisecond.	4
	2 ms	2 milliseconds.	5
	4 ms	4 milliseconds.	6
	7.9375 ms	7.9375 milliseconds.	7
14.31	RO status	(Visible when 14.1 Module 1 type = FIO-01) Status of relay outputs on the I/O extension module. <b>Example:</b> 0001b = RO1 is energized, RO2 is de-energized.	- / uint16
14.32	AI1 filter time	(Visible when 14.1 Module 1 type = FAIO-01) Defines the filter time constant for analog input AI1.	0.100 s / real32

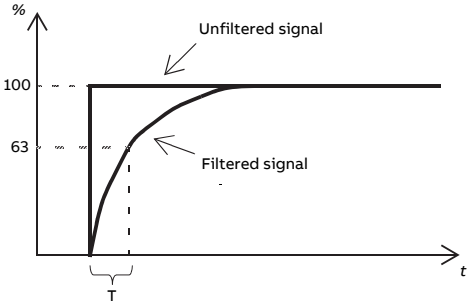

$O = I \times (1 - e^{-t/T})$   
 $I =$  filter input (step)  
 $O =$  filter output  
 $t =$  time  
 $T =$  filter time constant

**Note:** The signal is also filtered due to the signal interface hardware. See parameter 14.31 AI1 filter gain.

0.000 ... 30.000 s	Filter time constant.	1000 = 1 s / 1000 = 1 s
--------------------	-----------------------	-------------------------

No.	Name / Range / Selection	Description	Def / Type FbEq 16b / 32b
14.33	AI1 min	(Visible when 14.1 Module 1 type = FAIO-01) Defines the minimum value for analog input AI1. See also parameter 14.21 AI tune.	0.000 mA or V / real32
	-22.000 ... 22.000 mA or V	Minimum value of AI1.	1000 = 1 mA or V / 1000 = 1 mA or V
14.34	RO1 source	(Visible when 14.1 Module 1 type = FDIO-01) Selects a drive signal to be connected to relay output RO1. For the available selections, see parameter 14.11 DIO1 output source.	Not energized / uint32
14.34	AI1 max	(Visible when 14.1 Module 1 type = FAIO-01) Defines the maximum value for analog input AI1. See also parameter 14.21 AI tune.	10.000 mA or V / real32
	-22.000 ... 22.000 mA or V	Maximum value of AI1.	1000 = 1 mA or V / 1000 = 1 mA or V
14.34	RO1 source	(Visible when 14.1 Module 1 type = FIO-01) Selects a drive signal to be connected to relay output RO1. For the available selections, see parameter 14.11 DIO1 output source.	Not energized / uint32
14.35	RO1 ON delay	(Visible when 14.1 Module 1 type = FDIO-01) Defines the activation delay for relay output RO1.	0.00 s / real32
		<p> <math>t_{On}</math> = 14.35 RO1 ON delay  <math>t_{Off}</math> = 14.36 RO1 OFF delay </p>	
	0.00 ... 3000.00 s	Activation delay for RO1.	10 = 1 s / 100 = 1 s

### 308 Parameters

No.	Name / Range / Selection	Description	Def / Type FbEq 16b / 32b
14.35	AI1 scaled at AI1 min	(Visible when 14.1 Module 1 type = FAIO-01) Defines the real value that corresponds to the minimum analog input AI1 value defined by parameter 14.33 AI1 min.	0.000 / real32
	-32768.000 ... 32767.000	Real value corresponding to minimum AI1 value.	1 = 1 / 1000 = 1
14.35	RO1 ON delay	(Visible when 14.1 Module 1 type = FIO-01) Defines the activation delay for relay output RO1.	0.00 s / real32
$t_{On} = 14.35$ RO1 ON delay $t_{Off} = 14.36$ RO1 OFF delay			
	0.00 ... 3000.00 s	Activation delay for RO1.	10 = 1 s / 100 = 1 s
14.36	RO1 OFF delay	(Visible when 14.1 Module 1 type = FDIO-01) Defines the deactivation delay for relay output RO1. See parameter 14.35 RO1 ON delay.	0.00 s / real32
	0.00 ... 3000.00 s	Deactivation delay for RO1.	10 = 1 s / 100 = 1 s
14.36	AI1 scaled at AI1 max	(Visible when 14.1 Module 1 type = FAIO-01) Defines the real value that corresponds to the maximum analog input AI1 value defined by parameter 14.34 AI1 max. See the drawing at parameter 14.35 AI1 scaled at AI1 min.	100.000 / real32
	-32768.000 ... 32767.000	Real value corresponding to maximum AI1 value.	1 = 1 / 1000 = 1

No.	Name / Range / Selection	Description	Def / Type FbEq 16b / 32b
14.36	RO1 OFF delay	(Visible when 14.1 Module 1 type = FIO-01) Defines the deactivation delay for relay output RO1. See parameter 14.35 RO1 ON delay.	0.00 s / real32
	0.00 ... 3000.00 s	Deactivation delay for RO1.	10 = 1 s / 100 = 1 s
14.37	RO2 source	(Visible when 14.1 Module 1 type = FDIO-01) Selects a drive signal to be connected to relay output RO2. For the available selections, see parameter 14.11 DIO1 output source.	Not energized / uint32
14.37	RO2 source	(Visible when 14.1 Module 1 type = FIO-01) Selects a drive signal to be connected to relay output RO2. For the available selections, see parameter 14.11 DIO1 output source.	Not energized / uint32
14.38	RO2 ON delay	(Visible when 14.1 Module 1 type = FDIO-01) Defines the activation delay for relay output RO2. See parameter 14.35 RO1 ON delay.	0.00 s / real32
	0.00 ... 3000.00 s	Activation delay for RO2.	10 = 1 s / 100 = 1 s
14.38	RO2 ON delay	(Visible when 14.1 Module 1 type = FIO-01) Defines the activation delay for relay output RO2. See parameter 14.35 RO1 ON delay.	0.00 s / real32
	0.00 ... 3000.00 s	Activation delay for RO2.	10 = 1 s / 100 = 1 s
14.39	RO2 OFF delay	(Visible when 14.1 Module 1 type = FDIO-01) Defines the deactivation delay for relay output RO2. See parameter 14.35 RO1 ON delay.	0.00 s / real32
	0.00 ... 3000.00 s	Deactivation delay for RO2.	10 = 1 s / 100 = 1 s
14.39	RO2 OFF delay	(Visible when 14.1 Module 1 type = FIO-01) Defines the deactivation delay for relay output RO2. See parameter 14.35 RO1 ON delay.	0.00 s / real32
	0.00 ... 3000.00 s	Deactivation delay for RO2.	10 = 1 s / 100 = 1 s
14.41	AI2 actual value	(Visible when 14.1 Module 1 type = FAIO-01) Displays the value of analog input AI2 in mA or V (depending on whether the input is set to current or voltage). This parameter is read-only.	- / real32
	-22.000 ... 22.000 mA or V	Value of analog input AI2.	1000 = 1 mA or V / 1000 = 1 mA or V
14.42	AI2 scaled value	(Visible when 14.1 Module 1 type = FAIO-01) Displays the value of analog input AI2 after scaling. See parameter 14.50 AI2 scaled at AI2 min. This parameter is read-only.	- / real32
	-32768.000 ... 32767.000	Scaled value of analog input AI2.	1 = 1 / 1000 = 1
14.43	AI2 force data	(Visible when 14.1 Module 1 type = FAIO-01) Forced value that can be used instead of the true reading of the input. See parameter 14.22 AI force selection.	- / real32

## 310 Parameters

No.	Name / Range / Selection	Description	Def / Type FbEq 16b / 32b
	-22.000 ... 22.000 mA or V	Forced value of analog input AI2.	1000 = 1 mA or V / 1000 = 1 mA or V
14.44	AI2 HW switch position	(Visible when 14.1 Module 1 type = FAIO-01) Shows the position of the hardware current/voltage selector on the I/O extension module.  <b>Note:</b> The setting of the current/voltage selector must match the unit selection made in parameter 14.45 AI2 unit selection. I/O module reboot either by cycling the power or through parameter 96.8 Control board boot is required to validate any changes in the hardware settings.	- / uint16
	mA	Milliamperes.	10
	V	Volts.	2
14.45	AI2 unit selection	(Visible when 14.1 Module 1 type = FAIO-01) Selects the unit for readings and settings related to analog input AI2.  <b>Note:</b> This setting must match the corresponding hardware setting on the I/O extension module (see the manual of the I/O extension module). The hardware setting is shown by parameter 14.44 AI2 HW switch position. I/O module reboot either by cycling the power or through parameter 96.8 Control board boot is required to validate any changes in the hardware settings.	mA / uint16
	mA	Milliamperes.	10
	V	Volts.	2
14.46	AI2 filter gain	(Visible when 14.1 Module 1 type = FAIO-01) Selects a hardware filtering time for AI2. See also parameter 14.47 AI2 filter time.	1 ms / uint16
	No filtering	No filtering.	0
	125 us	125 microseconds.	1
	250 us	250 microseconds.	2
	500 us	500 microseconds.	3
	1 ms	1 millisecond.	4
	2 ms	2 milliseconds.	5
	4 ms	4 milliseconds.	6
	7.9375 ms	7.9375 milliseconds.	7

No.	Name / Range / Selection	Description	Def / Type FbEq 16b / 32b
14.47	AI2 filter time	(Visible when 14.1 Module 1 type = FAIO-01) Defines the filter time constant for analog input AI2.	0.100 s / real32

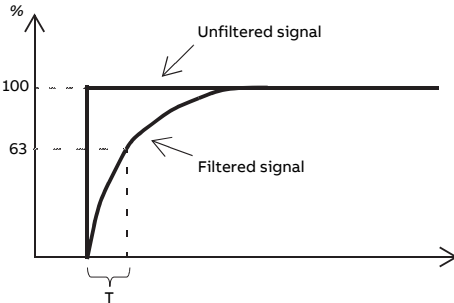

$$O = I \times (1 - e^{-t/T})$$

I = filter input (step)

O = filter output

t = time

T = filter time constant

**Note:** The signal is also filtered due to the signal interface hardware. See parameter 14.46 AI2 filter gain.

	0.000 ... 30.000 s	Filter time constant.	1000 = 1 s / 1000 = 1 s
14.48	AI2 min	(Visible when 14.1 Module 1 type = FAIO-01) Defines the minimum value for analog input AI2. See also parameter 14.21 AI tune.	0.000 mA or V / real32
	-22.000 ... 22.000 mA or V	Minimum value of AI2.	1000 = 1 mA or V / 1000 = 1 mA or V
14.49	AI2 max	(Visible when 14.1 Module 1 type = FAIO-01) Defines the maximum value for analog input AI2. See also parameter 14.21 AI tune.	10.000 mA or V / real32
	-22.000 ... 22.000 mA or V	Maximum value of AI2.	1000 = 1 mA or V / 1000 = 1 mA or V

### 312 Parameters

No.	Name / Range / Selection	Description	Def / Type FbEq 16b / 32b
14.50	AI2 scaled at AI2 min	(Visible when 14.1 Module 1 type = FAIO-01) Defines the real value that corresponds to the minimum analog input AI2 value defined by parameter 14.48 AI2 min.	0.000 / real32
	-32768.000 ... 32767.000	Real value corresponding to minimum AI2 value.	1 = 1 / 1000 = 1
14.51	AI2 scaled at AI2 max	(Visible when 14.1 Module 1 type = FAIO-01) Defines the real value that corresponds to the maximum analog input AI2 value defined by parameter 14.49 AI2 max. See the drawing at parameter 14.50 AI2 scaled at AI2 min.	100.000 / real32
	-32768.000 ... 32767.000	Real value corresponding to maximum AI2 value.	1 = 1 / 1000 = 1
14.56	AI3 actual value	(Visible when 14.1 Module 1 type = FIO-11) Displays the value of analog input AI3 in mA or V (depending on whether the input is set to current or voltage). This parameter is read-only.	- / real32
	-22.000 ... 22.000 mA or V	Value of analog input AI3.	1000 = 1 mA or V / 1000 = 1 mA or V
14.57	AI3 scaled value	(Visible when 14.1 Module 1 type = FIO-11) Displays the value of analog input AI3 after scaling. See parameter 14.65 AI3 scaled at AI3 min. This parameter is read-only.	- / real32
	-32768.000 ... 32767.000	Scaled value of analog input AI3.	1 = 1 / 1000 = 1
14.58	AI3 force data	(Visible when 14.1 Module 1 type = FIO-11) Forced value that can be used instead of the true reading of the input. See parameter 14.22 AI force selection.	- / real32
	-22.000 ... 22.000 mA or V	Forced value of analog input AI3.	1000 = 1 mA or V / 1000 = 1 mA or V



No.	Name / Range / Selection	Description	Def / Type FbEq 16b / 32b
14.59	AI3 HW switch position	(Visible when 14.1 Module 1 type = FIO-11) Shows the position of the hardware current/voltage selector on the I/O extension module.  <b>Note:</b> The setting of the current/voltage selector must match the unit selection made in parameter 14.60 AI3 unit selection. I/O module reboot either by cycling the power or through parameter 96.8 Control board boot is required to validate any changes in the hardware settings.	- / uint16
	mA	Milliamperes.	10
	V	Volts.	2
14.60	AI3 unit selection	(Visible when 14.1 Module 1 type = FIO-11) Selects the unit for readings and settings related to analog input AI3.  <b>Note:</b> This setting must match the corresponding hardware setting on the I/O extension module (see the manual of the I/O extension module). The hardware setting is shown by parameter 14.59 AI3 HW switch position. I/O module reboot either by cycling the power or through parameter 96.8 Control board boot is required to validate any changes in the hardware settings.	mA / uint16
	mA	Milliamperes.	10
	V	Volts.	2
14.61	AI3 filter gain	(Visible when 14.1 Module 1 type = FIO-11) Selects a hardware filtering time for AI3. See also parameter 14.62 AI3 filter time.	1 ms / uint16
	No filtering	No filtering.	0
	125 us	125 microseconds.	1
	250 us	250 microseconds.	2
	500 us	500 microseconds.	3
	1 ms	1 millisecond.	4
	2 ms	2 milliseconds.	5
	4 ms	4 milliseconds.	6
	7.9375 ms	7.9375 milliseconds.	7

### 314 Parameters

No.	Name / Range / Selection	Description	Def / Type FbEq 16b / 32b
14.62	AI3 filter time	(Visible when 14.1 Module 1 type = FIO-11) Defines the filter time constant for analog input AI3.	0.100 s / real32
<p> <math>O = I \times (1 - e^{-t/T})</math>  <math>I</math> = filter input (step)  <math>O</math> = filter output  <math>t</math> = time  <math>T</math> = filter time constant         </p> <p><b>Note:</b> The signal is also filtered due to the signal interface hardware. See parameter 14.61 AI3 filter gain.</p>			
	0.000 ... 30.000 s	Filter time constant.	1000 = 1 s / 1000 = 1 s
14.63	AI3 min	(Visible when 14.1 Module 1 type = FIO-11) Defines the minimum value for analog input AI3. See also parameter 14.21 AI tune.	0.000 mA or V / real32
	-22.000 ... 22.000 mA or V	Minimum value of AI3.	1000 = 1 mA or V / 1000 = 1 mA or V
14.64	AI3 max	(Visible when 14.1 Module 1 type = FIO-11) Defines the maximum value for analog input AI3. See also parameter 14.21 AI tune.	10.000 mA or V / real32
	-22.000 ... 22.000 mA or V	Maximum value of AI3.	1000 = 1 mA or V / 1000 = 1 mA or V

No.	Name / Range / Selection	Description	Def / Type FbEq 16b / 32b
14.65	AI3 scaled at AI3 min	(Visible when 14.1 Module 1 type = FIO-11) Defines the real value that corresponds to the minimum analog input AI3 value defined by parameter 14.63 AI3 min.	0.000 / real32
	-32768.000 ... 32767.000	Real value corresponding to minimum AI3 value.	1 = 1 / 1000 = 1
14.66	AI3 scaled at AI3 max	(Visible when 14.1 Module 1 type = FIO-11) Defines the real value that corresponds to the maximum analog input AI3 value defined by parameter 14.64 AI3 max. See the drawing at parameter 14.65 AI3 scaled at AI3 min.	100.000 / real32
	-32768.000 ... 32767.000	Real value corresponding to maximum AI3 value.	1 = 1 / 1000 = 1
14.71	AO force selection	(Visible when 14.1 Module 1 type = FAIO-01) The value of the analog output can be overridden for eg. testing purposes. A forced value parameter (14.78 AO1 force data) is provided for the analog output, and its value is applied whenever the corresponding bit in this parameter is 1.	- / uint16
	b0 AO1	1 = Force mode: Force AO1 to value of parameter 14.78 AO1 force data.	
	b1 AO2	1 = Force mode: Force AO2 to value of parameter 14.88 AO2 force data (FAIO-01 only).	
	b2...15 Reserved		
	0000h...FFFFh		1 = 1
14.71	AO force selection	(Visible when 14.1 Module 1 type = FIO-11) The value of the analog output can be overridden for eg. testing purposes. A forced value parameter (14.78 AO1 force data) is provided for the analog output, and its value is applied whenever the corresponding bit in this parameter is 1.	- / uint16

## 316 Parameters

No.	Name / Range / Selection	Description	Def / Type FbEq 16b / 32b
b0	AO1	1 = Force mode: Force AO1 to value of parameter 14.78 AO1 force data.	
b1...15 Reserved			
	0000h...FFFFh		1 = 1
14.76	AO1 actual value	(Visible when 14.1 Module 1 type = FAIO-01) Displays the value of AO1 in mA. This parameter is read-only.	- / real32
	0.000 ... 22.000 mA	Value of AO1.	1000 = 1 mA / 1000 = 1 mA
14.77	AO1 source	(Visible when 14.1 Module 1 type = FAIO-01) Selects a signal to be connected to analog output AO1. Alternatively, sets the output to excitation mode to feed a constant current to a temperature sensor.	Zero / uint32
	Zero	None	0
	Motor speed used	1.1 Motor speed used (page 226).	1
	Output frequency	1.6 Output frequency (page 226).	3
	Motor current	1.7 Motor current (page 226).	4
	Motor torque	1.10 Motor torque (page 226).	6
	DC voltage	1.11 DC voltage (page 227).	7
	Power inu out	1.14 Output power (page 227).	8
	Speed ref ramp in	23.1 Speed ref ramp input (page 378).	10
	Speed ref ramp out	23.2 Speed ref ramp output (page 378).	11
	Speed ref used	24.1 Used speed reference (page 386).	12
	Torq ref used	26.2 Torque reference used (page 405).	13
	Freq ref used	Not in use.	14
	Process PID out	Not in use.	16
	Process PID fbk	Not in use.	17
	Process PID act	Not in use.	18
	Process PID dev	Not in use.	19
	Other [value]	See Terms and abbreviations (page 221).	
	Force Pt100 excitation	The output is used to feed an excitation current to 1...3 Pt100 sensors. See section Motor thermal protection (page 199).	20
	Force KTY84 excitation	The output is used to feed an excitation current to a KTY84 sensor. See section Motor thermal protection (page 199).	21
	Force PTC excitation	The output is used to feed an excitation current to 1...3 PTC sensors. See section Motor thermal protection (page 199).	22
	Force Pt1000 excitation	The output is used to feed an excitation current to 1...3 Pt1000 sensors. See section Motor thermal protection (page 199).	23

No.	Name / Range / Selection	Description	Def / Type FbEq 16b / 32b
	AO1 data storage	13.91 AO1 data storage.	37
	AO2 data storage	13.92 AO2 data storage.	38
14.78	AO1 force data	(Visible when 14.1 Module 1 type = FIO-11) Forced value that can be used instead of the selected output signal. See parameter 14.71 AO force selection.	- / real32
	0.000 ... 22.000 mA	Forced value of analog output AO1.	1000 = 1 mA / 1000 = 1 mA
14.78	AO1 force data	(Visible when 14.1 Module 1 type = FAIO-01) Forced value that can be used instead of the selected output signal. See parameter 14.71 AO force selection.	0.000 mA / real32
	0.000 ... 20.000 mA	Forced value of analog output AO1.	1000 = 1 mA / 1000 = 1 mA
14.79	AO1 filter time	(Visible when 14.1 Module 1 type = FAIO-01) Defines the filtering time constant for analog output AO1.	0.100 s / real32

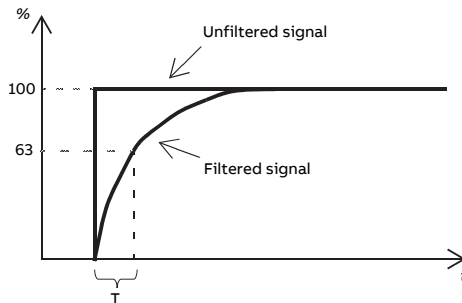

$$O = I \times (1 - e^{-t/T})$$

$I$  = filter input (step)  
 $O$  = filter output  
 $t$  = time  
 $T$  = filter time constant

0.000 ... 30.000 s	Filter time constant.	1000 = 1 s / 1000 = 1 s
--------------------	-----------------------	-------------------------

### 318 Parameters

No.	Name / Range / Selection	Description	Def / Type FbEq 16b / 32b
14.80	AO1 source min	(Visible when 14.1 Module 1 type = FAIO-01) Defines the real value of the signal (selected by parameter 14.77 AO1 source) that corresponds to the minimum AO1 output value (defined by parameter 14.82 AO1 out at AO1 src min).	0.0 / real32
-32768.0 ... 32767.0	Real signal value corresponding to minimum AO1 output value.	1 = 1 / 10 = 1	
14.81	AO1 source max	(Visible when 14.1 Module 1 type = FAIO-01) Defines the real value of the signal (selected by parameter 14.77 AO1 source) that corresponds to the maximum AO1 output value (defined by parameter 14.83 AO1 out at AO1 src max). See parameter 14.80 AO1 source min.	100.0 / real32
-32768.0 ... 32767.0	Real signal value corresponding to maximum AO1 output value.	1 = 1 / 10 = 1	
14.82	AO1 out at AO1 src min	(Visible when 14.1 Module 1 type = FIO-11) Defines the minimum output value for analog output AO1. See also drawing at parameter 14.80 AO1 source min.	0.000 mA / real32
0.000 ... 22.000 mA	Minimum AO1 output value.	1000 = 1 mA / 1000 = 1 mA	

No.	Name / Range / Selection	Description	Def / Type FbEq 16b / 32b
14.82	AO1 out at AO1 src min	(Visible when 14.1 Module 1 type = FAIO-01) Defines the minimum output value for analog output AO1. See also drawing at parameter 14.80 AO1 source min.	0.000 mA / real32
	0.000 ... 20.000 mA	Minimum AO1 output value.	1000 = 1 mA / 1000 = 1 mA
14.83	AO1 out at AO1 src max	(Visible when 14.1 Module 1 type = FIO-11) Defines the maximum output value for analog output AO1. See also drawing at parameter 14.80 AO1 source min.	10.000 mA / real32
	0.000 ... 22.000 mA	Maximum AO1 output value.	1000 = 1 mA / 1000 = 1 mA
14.83	AO1 out at AO1 src max	(Visible when 14.1 Module 1 type = FAIO-01) Defines the maximum output value for analog output AO1. See also drawing at parameter 14.80 AO1 source min.	10.000 mA / real32
	0.000 ... 20.000 mA	Maximum AO1 output value.	1000 = 1 mA / 1000 = 1 mA
14.86	AO2 actual value	(Visible when 14.1 Module 1 type = FAIO-01) Displays the value of AO2 in mA. This parameter is read-only.	- / real32
	0.000 ... 22.000 mA	Value of AO2.	1000 = 1 mA / 1000 = 1 mA
14.87	AO2 source	(Visible when 14.1 Module 1 type = FAIO-01) Selects a signal to be connected to analog output AO2. Alternatively, sets the output to excitation mode to feed a constant current to a temperature sensor. For the selections, see parameter 14.77 AO1 source.	Zero / uint32
14.88	AO2 force data	(Visible when 14.1 Module 1 type = FAIO-01) Forced value that can be used instead of the selected output signal. See parameter 14.71 AO force selection.	0.000 mA / real32
	0.000 ... 20.000 mA	Forced value of analog output AO2.	1000 = 1 mA / 1000 = 1 mA
14.89	AO2 filter time	(Visible when 14.1 Module 1 type = FAIO-01) Defines the filtering time constant for analog output AO2. See parameter 14.79 AO1 filter time.	0.100 s / real32
	0.000 ... 30.000 s	Filter time constant.	1000 = 1 s / 1000 = 1 s

## 320 Parameters

No.	Name / Range / Selection	Description	Def / Type FbEq 16b / 32b
14.90	AO2 source min	(Visible when 14.1 Module 1 type = FAIO-01) Defines the real value of the signal (selected by parameter 14.87 AO2 source) that corresponds to the minimum AO2 output value (defined by parameter 14.92 AO2 out at AO2 src min).	0.0 / real32
	-32768.0 ... 32767.0	Real signal value corresponding to minimum AO2 output value.	1 = 1 / 10 = 1
14.91	AO2 source max	(Visible when 14.1 Module 1 type = FAIO-01) Defines the real value of the signal (selected by parameter 14.87 AO2 source) that corresponds to the maximum AO2 output value (defined by parameter 14.93 AO2 out at AO2 src max). See parameter 14.90 AO2 source min.	100.0 / real32
	-32768.0 ... 32767.0	Real signal value corresponding to maximum AO2 output value.	1 = 1 / 10 = 1
14.92	AO2 out at AO2 src min	(Visible when 14.1 Module 1 type = FAIO-01) Defines the minimum output value for analog output AO2. See also drawing at parameter 14.90 AO2 source min.	0.000 mA / real32
	0.000 ... 20.000 mA	Minimum AO2 output value.	1000 = 1 mA / 1000 = 1 mA



No.	Name / Range / Selection	Description	Def / Type FbEq 16b / 32b
14.93	AO2 out at AO2 src max	(Visible when 14.1 Module 1 type = FAIO-01) Defines the maximum output value for analog output AO2. See also drawing at parameter 14.90 AO2 source min.	10.000 mA / real32
	0.000 ... 20.000 mA	Maximum AO2 output value.	1000 = 1 mA / 1000 = 1 mA

## 322 Parameters

No.	Name / Range / Selection	Description	Def / Type FbEq 16b / 32b
<b>15</b>	<b>I/O extension module 2</b>	Configuration of I/O extension module 2. See also section Programmable I/O extensions (page 157).  <b>Note:</b> The contents of the parameter group vary according to the selected I/O extension module type.	
15.1	Module 2 type	See parameter 14.1 Module 1 type.	None / uint16
15.2	Module 2 location	See parameter 14.2 Module 1 location.	Slot 1 / uint16
15.3	Module 2 status	See parameter 14.3 Module 1 status.	No option / uint16
15.5	DI status	(Visible when 15.1 Module 2 type = FDIO-01) See parameter 14.5 DI status.	- / uint16
15.5	DIO status	(Visible when 15.1 Module 2 type = FIO-11) See parameter 14.5 DIO status.	- / uint16
15.5	DIO status	(Visible when 15.1 Module 2 type = FIO-01) See parameter 14.5 DIO status.	- / uint16
15.6	DI delayed status	(Visible when 15.1 Module 2 type = FDIO-01) See parameter 14.6 DI delayed status.	- / uint16
15.6	DIO delayed status	(Visible when 15.1 Module 2 type = FIO-11) See parameter 14.6 DIO delayed status.	- / uint16
15.6	DIO delayed status	(Visible when 15.1 Module 2 type = FIO-01) See parameter 14.6 DIO delayed status.	- / uint16
15.8	DI filter time	(Visible when 15.1 Module 2 type = FDIO-01) See parameter 14.8 DI filter time.	- / real32
15.8	DIO filter time	(Visible when 15.1 Module 2 type = FIO-11) See parameter 14.8 DIO filter time.	10.0 ms / real32
15.8	DIO filter time	(Visible when 15.1 Module 2 type = FIO-01) See parameter 14.8 DIO filter time.	10.0 ms / real32
15.9	DIO1 function	(Visible when 15.1 Module 2 type = FIO-11) See parameter 14.9 DIO1 function.	Input / uint16
15.9	DIO1 function	(Visible when 15.1 Module 2 type = FIO-01) See parameter 14.9 DIO1 function.	Input / uint16
15.11	DIO1 output source	(Visible when 15.1 Module 2 type = FIO-11) See parameter 14.11 DIO1 output source.	Not energized / uint32
15.11	DIO1 output source	(Visible when 15.1 Module 2 type = FIO-01) See parameter 14.11 DIO1 output source.	Not energized / uint32
15.12	DI1 ON delay	(Visible when 15.1 Module 2 type = FDIO-01) See parameter 14.12 DI1 ON delay.	- / real32
15.12	DIO1 ON delay	(Visible when 15.1 Module 2 type = FIO-11) See parameter 14.12 DIO1 ON delay.	0.00 s / real32
15.12	DIO1 ON delay	(Visible when 15.1 Module 2 type = FIO-01) See parameter 14.12 DIO1 ON delay.	0.00 s / real32
15.13	DI1 OFF delay	(Visible when 15.1 Module 2 type = FDIO-01) See parameter 14.13 DI1 OFF delay.	0.00 s / real32
15.13	DIO1 OFF delay	(Visible when 15.1 Module 2 type = FIO-11) See parameter 14.13 DIO1 OFF delay.	0.00 s / real32

No.	Name / Range / Selection	Description	Def / Type FbEq 16b / 32b
15.13	DIO1 OFF delay	(Visible when 15.1 Module 2 type = FIO-01) See parameter 14.13 DIO1 OFF delay.	0.00 s / real32
15.14	DIO2 function	(Visible when 15.1 Module 2 type = FIO-11) See parameter 14.14 DIO2 function.	Input / uint16
15.14	DIO2 function	(Visible when 15.1 Module 2 type = FIO-01) See parameter 14.14 DIO2 function.	Input / uint16
15.16	DIO2 output source	(Visible when 15.1 Module 2 type = FIO-11) See parameter 14.16 DIO2 output source.	Not energized / uint32
15.16	DIO2 output source	(Visible when 15.1 Module 2 type = FIO-01) See parameter 14.16 DIO2 output source.	Not energized / uint32
15.17	DI2 ON delay	(Visible when 15.1 Module 2 type = FDIO-01) See parameter 14.17 DI2 ON delay.	0.00 s / real32
15.17	DIO2 ON delay	(Visible when 15.1 Module 2 type = FIO-11) See parameter 14.17 DIO2 ON delay.	0.00 s / real32
15.17	DIO2 ON delay	(Visible when 15.1 Module 2 type = FIO-01) See parameter 14.17 DIO2 ON delay.	0.00 s / real32
15.18	DI2 OFF delay	(Visible when 15.1 Module 2 type = FDIO-01) See parameter 14.18 DI2 OFF delay.	0.00 s / real32
15.18	DIO2 OFF delay	(Visible when 15.1 Module 2 type = FIO-11) See parameter 14.18 DIO2 OFF delay.	0.00 s / real32
15.18	DIO2 OFF delay	(Visible when 15.1 Module 2 type = FIO-01) See parameter 14.18 DIO2 OFF delay.	0.00 s / real32
15.19	DIO3 function	(Visible when 15.1 Module 2 type = FIO-01) See parameter 14.19 DIO3 function.	Input / uint16
15.19	AI supervision function	(Visible when 15.1 Module 2 type = FAIO-01) See parameter 14.19 AI supervision function.	No action / uint16
15.20	AI supervision selection	(Visible when 15.1 Module 2 type = FAIO-01) See parameter 14.20 AI supervision selection.	- / uint16
15.20	AI supervision selection	(Visible when 15.1 Module 2 type = FIO-11) See parameter 14.20 AI supervision selection.	- / uint16
15.21	DIO3 output source	(Visible when 15.1 Module 2 type = FIO-01) See parameter 14.21 DIO3 output source.	Not energized / uint32
15.21	AI tune	(Visible when 15.1 Module 2 type = FAIO-01) See parameter 14.21 AI tune.	No action / uint16
15.21	AI tune	(Visible when 15.1 Module 2 type = FIO-11) See parameter 14.21 AI tune.	No action / uint16
15.22	DI3 ON delay	(Visible when 15.1 Module 2 type = FDIO-01) See parameter 14.22 DI3 ON delay.	0.00 s / real32
15.22	DIO3 ON delay	(Visible when 15.1 Module 2 type = FIO-01) See parameter 14.22 DIO3 ON delay.	0.00 s / real32
15.22	AI force selection	(Visible when 15.1 Module 2 type = FAIO-01) See parameter 14.22 AI force selection.	- / uint16
15.22	AI force selection	(Visible when 15.1 Module 2 type = FIO-11) See parameter 14.22 AI force selection.	- / uint16

## 324 Parameters

No.	Name / Range / Selection	Description	Def / Type FbEq 16b / 32b
15.23	DI3 OFF delay	(Visible when 15.1 Module 2 type = FDIO-01) See parameter 14.23 DI3 OFF delay.	0.00 s / real32
15.23	DIO3 OFF delay	(Visible when 15.1 Module 2 type = FIO-01) See parameter 14.23 DIO3 OFF delay.	0.00 s / real32
15.24	DIO4 function	(Visible when 15.1 Module 2 type = FIO-01) See parameter 14.24 DIO4 function.	Input / uint16
15.26	DIO4 output source	(Visible when 15.1 Module 2 type = FIO-01) See parameter 14.26 DIO4 output source.	Not energized / uint32
15.26	AI1 actual value	(Visible when 15.1 Module 2 type = FAIO-01) See parameter 14.26 AI1 actual value.	- / real32
15.27	DIO4 ON delay	(Visible when 15.1 Module 2 type = FIO-01) See parameter 14.27 DIO4 ON delay.	0.00 s / real32
15.27	AI1 scaled value	(Visible when 15.1 Module 2 type = FAIO-01) See parameter 14.27 AI1 scaled value.	- / real32
15.28	DIO4 OFF delay	(Visible when 15.1 Module 2 type = FIO-01) See parameter 14.28 DIO4 OFF delay.	0.00 s / real32
15.28	AI1 force data	(Visible when 15.1 Module 2 type = FAIO-01) See parameter 14.28 AI1 force data.	- / real32
15.29	AI1 HW switch position	(Visible when 15.1 Module 2 type = FAIO-01) See parameter 14.29 AI1 HW switch position.	- / uint16
15.30	AI1 unit selection	(Visible when 15.1 Module 2 type = FAIO-01) See parameter 14.30 AI1 unit selection.	mA / uint16
15.31	RO status	(Visible when 15.1 Module 2 type = FDIO-01) See parameter 14.31 RO status.	- / uint16
15.31	RO status	(Visible when 15.1 Module 2 type = FIO-01) See parameter 14.31 RO status.	- / uint16
15.31	AI1 filter gain	(Visible when 15.1 Module 2 type = FAIO-01) See parameter 14.31 AI1 filter gain.	1 ms / uint16
15.32	AI1 filter time	(Visible when 15.1 Module 2 type = FAIO-01) See parameter 14.32 AI1 filter time.	0.100 s / real32
15.33	AI1 min	(Visible when 15.1 Module 2 type = FAIO-01) See parameter 14.33 AI1 min.	0.000 mA or V / real32
15.34	RO1 source	(Visible when 15.1 Module 2 type = FDIO-01) See parameter 14.34 RO1 source.	Not energized / uint32
15.34	RO1 source	(Visible when 15.1 Module 2 type = FIO-01) See parameter 14.34 RO1 source.	Not energized / uint32
15.34	AI1 max	(Visible when 15.1 Module 2 type = FAIO-01) See parameter 14.34 AI1 max.	10.000 mA or V / real32
15.35	RO1 ON delay	(Visible when 15.1 Module 2 type = FDIO-01) See parameter 14.35 RO1 ON delay.	0.00 s / real32
15.35	RO1 ON delay	(Visible when 15.1 Module 2 type = FIO-01) See parameter 14.35 RO1 ON delay.	0.00 s / real32
15.35	AI1 scaled at AI1 min	(Visible when 15.1 Module 2 type = FAIO-01) See parameter 14.35 AI1 scaled at AI1 min.	0.000 / real32

No.	Name / Range / Selection	Description	Def / Type FbEq 16b / 32b
15.36	RO1 OFF delay	(Visible when 15.1 Module 2 type = FDIO-01) See parameter 14.36 RO1 OFF delay.	0.00 s / real32
15.36	RO1 OFF delay	(Visible when 15.1 Module 2 type = FIO-01) See parameter 14.36 RO1 OFF delay.	0.00 s / real32
15.36	AI1 scaled at AI1 max	(Visible when 15.1 Module 2 type = FAIO-01) See parameter 14.36 AI1 scaled at AI1 max.	100.000 / real32
15.37	RO2 source	(Visible when 15.1 Module 2 type = FDIO-01) See parameter 14.37 RO2 source.	Not energized / uint32
15.37	RO2 source	(Visible when 15.1 Module 2 type = FIO-01) See parameter 14.37 RO2 source.	Not energized / uint32
15.38	RO2 ON delay	(Visible when 15.1 Module 2 type = FDIO-01) See parameter 14.38 RO2 ON delay.	0.00 s / real32
15.38	RO2 ON delay	(Visible when 15.1 Module 2 type = FIO-01) See parameter 14.38 RO2 ON delay.	0.00 s / real32
15.39	RO2 OFF delay	(Visible when 15.1 Module 2 type = FDIO-01) See parameter 14.39 RO2 OFF delay.	0.00 s / real32
15.39	RO2 OFF delay	(Visible when 15.1 Module 2 type = FIO-01) See parameter 14.39 RO2 OFF delay.	0.00 s / real32
15.41	AI2 actual value	(Visible when 15.1 Module 2 type = FAIO-01) See parameter 14.41 AI2 actual value.	- / real32
15.42	AI2 scaled value	(Visible when 15.1 Module 2 type = FAIO-01) See parameter 14.42 AI2 scaled value.	- / real32
15.43	AI2 force data	(Visible when 15.1 Module 2 type = FAIO-01) See parameter 14.43 AI2 force data.	- / real32
15.44	AI2 HW switch position	(Visible when 15.1 Module 2 type = FAIO-01) See parameter 14.44 AI2 HW switch position.	- / uint16
15.45	AI2 unit selection	(Visible when 15.1 Module 2 type = FAIO-01) See parameter 14.45 AI2 unit selection.	mA / uint16
15.46	AI2 filter gain	(Visible when 15.1 Module 2 type = FAIO-01) See parameter 14.46 AI2 filter gain.	1 ms / uint16
15.47	AI2 filter time	(Visible when 15.1 Module 2 type = FAIO-01) See parameter 14.47 AI2 filter time.	0.100 s / real32
15.48	AI2 min	(Visible when 15.1 Module 2 type = FAIO-01) See parameter 14.48 AI2 min.	0.000 mA or V / real32
15.49	AI2 max	(Visible when 15.1 Module 2 type = FAIO-01) See parameter 14.49 AI2 max.	10.000 mA or V / real32
15.50	AI2 scaled at AI2 min	(Visible when 15.1 Module 2 type = FAIO-01) See parameter 14.50 AI2 scaled at AI2 min.	0.000 / real32
15.51	AI2 scaled at AI2 max	(Visible when 15.1 Module 2 type = FAIO-01) See parameter 14.51 AI2 scaled at AI2 max.	100.000 / real32
15.56	AI3 actual value	(Visible when 15.1 Module 2 type = FIO-11) See parameter 14.56 AI3 actual value.	- / real32
15.57	AI3 scaled value	(Visible when 15.1 Module 2 type = FIO-11) See parameter 14.57 AI3 scaled value.	- / real32

## 326 Parameters

No.	Name / Range / Selection	Description	Def / Type FbEq 16b / 32b
15.58	AI3 force data	(Visible when 15.1 Module 2 type = FIO-11) See parameter 14.58 AI3 force data.	- / real32
15.59	AI3 HW switch position	(Visible when 15.1 Module 2 type = FIO-11) See parameter 14.59 AI3 HW switch position.	- / uint16
15.60	AI3 unit selection	(Visible when 15.1 Module 2 type = FIO-11) See parameter 14.60 AI3 unit selection.	mA / uint16
15.61	AI3 filter gain	(Visible when 15.1 Module 2 type = FIO-11) See parameter 14.61 AI3 filter gain.	1 ms / uint16
15.62	AI3 filter time	(Visible when 15.1 Module 2 type = FIO-11) See parameter 14.62 AI3 filter time.	0.100 s / real32
15.63	AI3 min	(Visible when 15.1 Module 2 type = FIO-11) See parameter 14.63 AI3 min.	0.000 mA or V / real32
15.64	AI3 max	(Visible when 15.1 Module 2 type = FIO-11) See parameter 14.64 AI3 max.	10.000 mA or V / real32
15.65	AI3 scaled at AI3 min	(Visible when 15.1 Module 2 type = FIO-11) See parameter 14.65 AI3 scaled at AI3 min.	0.000 / real32
15.66	AI3 scaled at AI3 max	(Visible when 15.1 Module 2 type = FIO-11) See parameter 14.66 AI3 scaled at AI3 max.	100.000 / real32
15.71	AO force selection	(Visible when 15.1 Module 2 type = FAIO-01) See parameter 14.71 AO force selection.	- / uint16
15.71	AO force selection	(Visible when 15.1 Module 2 type = FIO-11) See parameter 14.71 AO force selection.	- / uint16
15.76	AO1 actual value	(Visible when 15.1 Module 2 type = FAIO-01) See parameter 14.76 AO1 actual value.	- / real32
15.77	AO1 source	(Visible when 15.1 Module 2 type = FAIO-01) See parameter 14.77 AO1 source.	Zero / uint32
15.78	AO1 force data	(Visible when 15.1 Module 2 type = FIO-11) See parameter 14.78 AO1 force data.	- / real32
15.78	AO1 force data	(Visible when 15.1 Module 2 type = FAIO-01) See parameter 14.78 AO1 force data.	0.000 mA / real32
15.79	AO1 filter time	(Visible when 15.1 Module 2 type = FAIO-01) See parameter 14.79 AO1 filter time.	0.100 s / real32
15.80	AO1 source min	(Visible when 15.1 Module 2 type = FAIO-01) See parameter 14.80 AO1 source min.	0.0 / real32
15.81	AO1 source max	(Visible when 15.1 Module 2 type = FAIO-01) See parameter 14.81 AO1 source max.	100.0 / real32
15.82	AO1 out at AO1 src min	(Visible when 15.1 Module 2 type = FIO-11) See parameter 14.82 AO1 out at AO1 src min.	0.000 mA / real32
15.82	AO1 out at AO1 src min	(Visible when 15.1 Module 2 type = FAIO-01) See parameter 14.82 AO1 out at AO1 src min.	0.000 mA / real32
15.83	AO1 out at AO1 src max	(Visible when 15.1 Module 2 type = FIO-11) See parameter 14.83 AO1 out at AO1 src max.	10.000 mA / real32
15.83	AO1 out at AO1 src max	(Visible when 15.1 Module 2 type = FAIO-01) See parameter 14.83 AO1 out at AO1 src max.	10.000 mA / real32

<b>No.</b>	<b>Name / Range / Selection</b>	<b>Description</b>	<b>Def / Type FbEq 16b / 32b</b>
15.86	AO2 actual value	(Visible when 15.1 Module 2 type = FAIO-01) See parameter 14.86 AO2 actual value.	- / real32
15.87	AO2 source	(Visible when 15.1 Module 2 type = FAIO-01) See parameter 14.87 AO2 source.	Zero / uint32
15.88	AO2 force data	(Visible when 15.1 Module 2 type = FAIO-01) See parameter 14.88 AO2 force data.	0.000 mA / real32
15.89	AO2 filter time	(Visible when 15.1 Module 2 type = FAIO-01) See parameter 14.89 AO2 filter time.	0.100 s / real32
15.90	AO2 source min	(Visible when 15.1 Module 2 type = FAIO-01) See parameter 14.90 AO2 source min.	0.0 / real32
15.91	AO2 source max	(Visible when 15.1 Module 2 type = FAIO-01) See parameter 14.91 AO2 source max.	100.0 / real32
15.92	AO2 out at AO2 src min	(Visible when 15.1 Module 2 type = FAIO-01) See parameter 14.92 AO2 out at AO2 src min.	0.000 mA / real32
15.93	AO2 out at AO2 src max	(Visible when 15.1 Module 2 type = FAIO-01) See parameter 14.93 AO2 out at AO2 src max.	10.000 mA / real32

## 328 Parameters

No.	Name / Range / Selection	Description	Def / Type FbEq 16b / 32b
<b>16</b>	<b>I/O extension module 3</b>	Configuration of I/O extension module 3. See also section Programmable I/O extensions (page 157).  <b>Note:</b> The contents of the parameter group vary according to the selected I/O extension module type.	
16.1	Module 3 type	See parameter 14.1 Module 1 type.	None / uint16
16.2	Module 3 location	See parameter 14.2 Module 1 location.	Slot 1 / uint16
16.3	Module 3 status	See parameter 14.3 Module 1 status.	No option / uint16
16.5	DI status	(Visible when 16.1 Module 3 type = FDIO-01) See parameter 14.5 DI status.	- / uint16
16.5	DIO status	(Visible when 16.1 Module 3 type = FIO-11) See parameter 14.5 DIO status.	- / uint16
16.5	DIO status	(Visible when 16.1 Module 3 type = FIO-01) See parameter 14.5 DIO status.	- / uint16
16.6	DI delayed status	(Visible when 16.1 Module 3 type = FDIO-01) See parameter 14.6 DI delayed status.	- / uint16
16.6	DIO delayed status	(Visible when 16.1 Module 3 type = FIO-11) See parameter 14.6 DIO delayed status.	- / uint16
16.6	DIO delayed status	(Visible when 16.1 Module 3 type = FIO-01) See parameter 14.6 DIO delayed status.	- / uint16
16.8	DI filter time	(Visible when 16.1 Module 3 type = FDIO-01) See parameter 14.8 DI filter time.	10.0 ms / real32
16.8	DIO filter time	(Visible when 16.1 Module 3 type = FIO-11) See parameter 14.8 DIO filter time.	10.0 ms / real32
16.8	DIO filter time	(Visible when 16.1 Module 3 type = FIO-01) See parameter 14.8 DIO filter time.	10.0 ms / real32
16.9	DIO1 function	(Visible when 16.1 Module 3 type = FIO-11) See parameter 14.9 DIO1 function.	Input / uint16
16.9	DIO1 function	(Visible when 16.1 Module 3 type = FIO-01) See parameter 14.9 DIO1 function.	Input / uint16
16.11	DIO1 output source	(Visible when 16.1 Module 3 type = FIO-11) See parameter 14.11 DIO1 output source.	Not energized / uint32
16.11	DIO1 output source	(Visible when 16.1 Module 3 type = FIO-01) See parameter 14.11 DIO1 output source.	Not energized / uint32
16.12	DI1 ON delay	(Visible when 16.1 Module 3 type = FDIO-01) See parameter 14.12 DI1 ON delay.	0.00 s / real32
16.12	DIO1 ON delay	(Visible when 16.1 Module 3 type = FIO-11) See parameter 14.12 DIO1 ON delay.	0.00 s / real32
16.12	DIO1 ON delay	(Visible when 16.1 Module 3 type = FIO-01) See parameter 14.12 DIO1 ON delay.	0.00 s / real32
16.13	DI1 OFF delay	(Visible when 16.1 Module 3 type = FDIO-01) See parameter 14.13 DI1 OFF delay.	0.00 s / real32
16.13	DIO1 OFF delay	(Visible when 16.1 Module 3 type = FIO-11) See parameter 14.13 DIO1 OFF delay.	0.00 s / real32



<b>No.</b>	<b>Name / Range / Selection</b>	<b>Description</b>	<b>Def / Type FbEq 16b / 32b</b>
16.13	DIO1 OFF delay	(Visible when 16.1 Module 3 type = FIO-01) See parameter 14.13 DIO1 OFF delay.	0.00 s / real32
16.14	DIO2 function	(Visible when 16.1 Module 3 type = FIO-11) See parameter 14.14 DIO2 function.	Input / uint16
16.14	DIO2 function	(Visible when 16.1 Module 3 type = FIO-01) See parameter 14.14 DIO2 function.	Input / uint16
16.16	DIO2 output source	(Visible when 16.1 Module 3 type = FIO-11) See parameter 14.16 DIO2 output source.	Not energized / uint32
16.16	DIO2 output source	(Visible when 16.1 Module 3 type = FIO-01) See parameter 14.16 DIO2 output source.	Not energized / uint32
16.17	DI2 ON delay	(Visible when 16.1 Module 3 type = FDIO-01) See parameter 14.17 DI2 ON delay.	0.00 s / real32
16.17	DIO2 ON delay	(Visible when 16.1 Module 3 type = FIO-11) See parameter 14.17 DIO2 ON delay.	0.00 s / real32
16.17	DIO2 ON delay	(Visible when 16.1 Module 3 type = FIO-01) See parameter 14.17 DIO2 ON delay.	0.00 s / real32
16.18	DI2 OFF delay	(Visible when 16.1 Module 3 type = FDIO-01) See parameter 14.18 DI2 OFF delay.	0.00 s / real32
16.18	DIO2 OFF delay	(Visible when 16.1 Module 3 type = FIO-11) See parameter 14.18 DIO2 OFF delay.	0.00 s / real32
16.18	DIO2 OFF delay	(Visible when 16.1 Module 3 type = FIO-01) See parameter 14.18 DIO2 OFF delay.	0.00 s / real32
16.19	AI supervision function	(Visible when 16.1 Module 3 type = FAIO-01) See parameter 14.19 AI supervision function.	No action / uint16
16.19	DIO3 function	(Visible when 16.1 Module 3 type = FIO-01) See parameter 14.19 DIO3 function.	Input / uint16
16.20	AI supervision selection	(Visible when 16.1 Module 3 type = FAIO-01) See parameter 14.20 AI supervision selection.	- / uint16
16.20	AI supervision selection	(Visible when 16.1 Module 3 type = FIO-11) See parameter 14.20 AI supervision selection.	- / uint16
16.21	AI tune	(Visible when 16.1 Module 3 type = FAIO-01) See parameter 14.21 AI tune.	No action / uint16
16.21	AI tune	(Visible when 16.1 Module 3 type = FIO-11) See parameter 14.21 AI tune.	No action / uint16
16.21	DIO3 output source	(Visible when 16.1 Module 3 type = FIO-01) See parameter 14.21 DIO3 output source.	Not energized / uint32
16.22	AI force selection	(Visible when 16.1 Module 3 type = FAIO-01) See parameter 14.22 AI force selection.	- / uint16
16.22	AI force selection	(Visible when 16.1 Module 3 type = FIO-11) See parameter 14.22 AI force selection.	- / uint16
16.22	DI3 ON delay	(Visible when 16.1 Module 3 type = FDIO-01) See parameter 14.22 DI3 ON delay.	0.00 s / real32
16.22	DIO3 ON delay	(Visible when 16.1 Module 3 type = FIO-01) See parameter 14.22 DIO3 ON delay.	0.00 s / real32

## 330 Parameters

No.	Name / Range / Selection	Description	Def / Type FbEq 16b / 32b
16.23	DI3 OFF delay	(Visible when 16.1 Module 3 type = FDIO-01) See parameter 14.23 DI3 OFF delay.	0.00 s / real32
16.23	DIO3 OFF delay	(Visible when 16.1 Module 3 type = FIO-01) See parameter 14.23 DIO3 OFF delay.	0.00 s / real32
16.24	DIO4 function	(Visible when 16.1 Module 3 type = FIO-01) See parameter 14.24 DIO4 function.	Input / uint16
16.26	AI1 actual value	(Visible when 16.1 Module 3 type = FAIO-01) See parameter 14.26 AI1 actual value.	- / real32
16.26	DIO4 output source	(Visible when 16.1 Module 3 type = FIO-01) See parameter 14.26 DIO4 output source.	Not energized / uint32
16.27	AI1 scaled value	(Visible when 16.1 Module 3 type = FAIO-01) See parameter 14.27 AI1 scaled value.	- / real32
16.27	DIO4 ON delay	(Visible when 16.1 Module 3 type = FIO-01) See parameter 14.27 DIO4 ON delay.	0.00 s / real32
16.28	AI1 force data	(Visible when 16.1 Module 3 type = FAIO-01) See parameter 14.28 AI1 force data.	- / real32
16.28	DIO4 OFF delay	(Visible when 16.1 Module 3 type = FIO-01) See parameter 14.28 DIO4 OFF delay.	0.00 s / real32
16.29	AI1 HW switch position	(Visible when 16.1 Module 3 type = FAIO-01) See parameter 14.29 AI1 HW switch position.	- / uint16
16.30	AI1 unit selection	(Visible when 16.1 Module 3 type = FAIO-01) See parameter 14.30 AI1 unit selection.	mA / uint16
16.31	RO status	(Visible when 16.1 Module 3 type = FDIO-01) See parameter 14.31 RO status.	- / uint16
16.31	RO status	(Visible when 16.1 Module 3 type = FIO-01) See parameter 14.31 RO status.	- / uint16
16.31	AI1 filter gain	(Visible when 16.1 Module 3 type = FAIO-01) See parameter 14.31 AI1 filter gain.	1 ms / uint16
16.32	AI1 filter time	(Visible when 16.1 Module 3 type = FAIO-01) See parameter 14.32 AI1 filter time.	0.100 s / real32
16.33	AI1 min	(Visible when 16.1 Module 3 type = FAIO-01) See parameter 14.33 AI1 min.	0.000 mA or V / real32
16.34	RO1 source	(Visible when 16.1 Module 3 type = FDIO-01) See parameter 14.34 RO1 source.	Not energized / uint32
16.34	RO1 source	(Visible when 16.1 Module 3 type = FIO-01) See parameter 14.34 RO1 source.	Not energized / uint32
16.34	AI1 max	(Visible when 16.1 Module 3 type = FAIO-01) See parameter 14.34 AI1 max.	10.000 mA or V / real32
16.35	RO1 ON delay	(Visible when 16.1 Module 3 type = FDIO-01) See parameter 14.35 RO1 ON delay.	0.00 s / real32
16.35	RO1 ON delay	(Visible when 16.1 Module 3 type = FIO-01) See parameter 14.35 RO1 ON delay.	0.00 s / real32
16.35	AI1 scaled at AI1 min	(Visible when 16.1 Module 3 type = FAIO-01) See parameter 14.35 AI1 scaled at AI1 min.	0.000 / real32

No.	Name / Range / Selection	Description	Def / Type FbEq 16b / 32b
16.36	RO1 OFF delay	(Visible when 16.1 Module 3 type = FDIO-01) See parameter 14.36 RO1 OFF delay.	0.00 s / real32
16.36	RO1 OFF delay	(Visible when 16.1 Module 3 type = FIO-01) See parameter 14.36 RO1 OFF delay.	0.00 s / real32
16.36	AI1 scaled at AI1 max	(Visible when 16.1 Module 3 type = FAIO-01) See parameter 14.36 AI1 scaled at AI1 max.	100.000 / real32
16.37	RO2 source	(Visible when 16.1 Module 3 type = FDIO-01) See parameter 14.37 RO2 source.	Not energized / uint32
16.37	RO2 source	(Visible when 16.1 Module 3 type = FIO-01) See parameter 14.37 RO2 source.	Not energized / uint32
16.38	RO2 ON delay	(Visible when 16.1 Module 3 type = FDIO-01) See parameter 14.38 RO2 ON delay.	0.00 s / real32
16.38	RO2 ON delay	(Visible when 16.1 Module 3 type = FIO-01) See parameter 14.38 RO2 ON delay.	0.00 s / real32
16.39	RO2 OFF delay	(Visible when 16.1 Module 3 type = FDIO-01) See parameter 14.39 RO2 OFF delay.	0.00 s / real32
16.39	RO2 OFF delay	(Visible when 16.1 Module 3 type = FIO-01) See parameter 14.39 RO2 OFF delay.	0.00 s / real32
16.41	AI2 actual value	(Visible when 16.1 Module 3 type = FAIO-01) See parameter 14.41 AI2 actual value.	- / real32
16.42	AI2 scaled value	(Visible when 16.1 Module 3 type = FAIO-01) See parameter 14.42 AI2 scaled value.	- / real32
16.43	AI2 force data	(Visible when 16.1 Module 3 type = FAIO-01) See parameter 14.43 AI2 force data.	- / real32
16.44	AI2 HW switch position	(Visible when 16.1 Module 3 type = FAIO-01) See parameter 14.44 AI2 HW switch position.	- / uint16
16.45	AI2 unit selection	(Visible when 16.1 Module 3 type = FAIO-01) See parameter 14.45 AI2 unit selection.	mA / uint16
16.46	AI2 filter gain	(Visible when 16.1 Module 3 type = FAIO-01) See parameter 14.46 AI2 filter gain.	1 ms / uint16
16.47	AI2 filter time	(Visible when 16.1 Module 3 type = FAIO-01) See parameter 14.47 AI2 filter time.	0.100 s / real32
16.48	AI2 min	(Visible when 16.1 Module 3 type = FAIO-01) See parameter 14.48 AI2 min.	0.000 mA or V / real32
16.49	AI2 max	(Visible when 16.1 Module 3 type = FAIO-01) See parameter 14.49 AI2 max.	10.000 mA or V / real32
16.50	AI2 scaled at AI2 min	(Visible when 16.1 Module 3 type = FAIO-01) See parameter 14.50 AI2 scaled at AI2 min.	0.000 / real32
16.51	AI2 scaled at AI2 max	(Visible when 16.1 Module 3 type = FAIO-01) See parameter 14.51 AI2 scaled at AI2 max.	100.000 / real32
16.56	AI3 actual value	(Visible when 16.1 Module 3 type = FIO-11) See parameter 14.56 AI3 actual value.	- / real32
16.57	AI3 scaled value	(Visible when 16.1 Module 3 type = FIO-11) See parameter 14.57 AI3 scaled value.	- / real32

### 332 Parameters

No.	Name / Range / Selection	Description	Def / Type FbEq 16b / 32b
16.58	AI3 force data	(Visible when 16.1 Module 3 type = FIO-11) See parameter 14.58 AI3 force data.	- / real32
16.59	AI3 HW switch position	(Visible when 16.1 Module 3 type = FIO-11) See parameter 14.59 AI3 HW switch position.	- / uint16
16.60	AI3 unit selection	(Visible when 16.1 Module 3 type = FIO-11) See parameter 14.60 AI3 unit selection.	mA / uint16
16.61	AI3 filter gain	(Visible when 16.1 Module 3 type = FIO-11) See parameter 14.61 AI3 filter gain.	1 ms / uint16
16.62	AI3 filter time	(Visible when 16.1 Module 3 type = FIO-11) See parameter 14.62 AI3 filter time.	0.100 s / real32
16.63	AI3 min	(Visible when 16.1 Module 3 type = FIO-11) See parameter 14.63 AI3 min.	0.000 mA or V / real32
16.64	AI3 max	(Visible when 16.1 Module 3 type = FIO-11) See parameter 14.64 AI3 max.	10.000 mA or V / real32
16.65	AI3 scaled at AI3 min	(Visible when 16.1 Module 3 type = FIO-11) See parameter 14.65 AI3 scaled at AI3 min.	0.000 / real32
16.66	AI3 scaled at AI3 max	(Visible when 16.1 Module 3 type = FIO-11) See parameter 14.66 AI3 scaled at AI3 max.	100.000 / real32
16.71	AO force selection	(Visible when 16.1 Module 3 type = FAIO-01) See parameter 14.71 AO force selection.	- / uint16
16.71	AO force selection	(Visible when 16.1 Module 3 type = FIO-11) See parameter 14.71 AO force selection.	- / uint16
16.76	AO1 actual value	(Visible when 16.1 Module 3 type = FAIO-01) See parameter 14.76 AO1 actual value.	- / real32
16.77	AO1 source	(Visible when 16.1 Module 3 type = FAIO-01) See parameter 14.77 AO1 source.	Zero / uint32
16.78	AO1 force data	(Visible when 16.1 Module 3 type = FIO-11) See parameter 14.78 AO1 force data.	- / real32
16.78	AO1 force data	(Visible when 16.1 Module 3 type = FAIO-01) See parameter 14.78 AO1 force data.	0.000 mA / real32
16.79	AO1 filter time	(Visible when 16.1 Module 3 type = FAIO-01) See parameter 14.79 AO1 filter time.	0.100 s / real32
16.80	AO1 source min	(Visible when 16.1 Module 3 type = FAIO-01) See parameter 14.80 AO1 source min.	0.0 / real32
16.81	AO1 source max	(Visible when 16.1 Module 3 type = FAIO-01) See parameter 14.81 AO1 source max.	100.0 / real32
16.82	AO1 out at AO1 src min	(Visible when 16.1 Module 3 type = FIO-11) See parameter 14.82 AO1 out at AO1 src min.	0.000 mA / real32
16.82	AO1 out at AO1 src min	(Visible when 16.1 Module 3 type = FAIO-01) See parameter 14.82 AO1 out at AO1 src min.	0.000 mA / real32
		0.000 ... 20.000 mA	1000 = 1 mA / 1000 = 1 mA
16.83	AO1 out at AO1 src max	(Visible when 16.1 Module 3 type = FIO-11) See parameter 14.83 AO1 out at AO1 src max.	10.000 mA / real32

<b>No.</b>	<b>Name / Range / Selection</b>	<b>Description</b>	<b>Def / Type FbEq 16b / 32b</b>
16.83	AO1 out at AO1 src max	(Visible when 16.1 Module 3 type = FAIO-01) See parameter 14.83 AO1 out at AO1 src max.	10.000 mA / real32
16.86	AO2 actual value	(Visible when 16.1 Module 3 type = FAIO-01) See parameter 14.86 AO2 actual value.	- / real32
16.87	AO2 source	(Visible when 16.1 Module 3 type = FAIO-01) See parameter 14.87 AO2 source.	Zero / uint32
16.88	AO2 force data	(Visible when 16.1 Module 3 type = FAIO-01) See parameter 14.88 AO2 force data.	0.000 mA / real32
16.89	AO2 filter time	(Visible when 16.1 Module 3 type = FAIO-01) See parameter 14.89 AO2 filter time.	0.100 s / real32
16.90	AO2 source min	(Visible when 16.1 Module 3 type = FAIO-01) See parameter 14.90 AO2 source min.	0.0 / real32
16.91	AO2 source max	(Visible when 16.1 Module 3 type = FAIO-01) See parameter 14.91 AO2 source max.	100.0 / real32
16.92	AO2 out at AO2 src min	(Visible when 16.1 Module 3 type = FAIO-01) See parameter 14.92 AO2 out at AO2 src min.	0.000 mA / real32
16.93	AO2 out at AO2 src max	(Visible when 16.1 Module 3 type = FAIO-01) See parameter 14.93 AO2 out at AO2 src max.	10.000 mA / real32

### 334 Parameters

No.	Name / Range / Selection	Description	Def / Type FbEq 16b / 32b
<b>19</b>	<b>Operation mode</b>	Selection of local and external control location sources and operating modes. See also section <i>Operating modes of the drive</i> (page 148).	
19.1	Actual operation mode	Displays the operating mode currently used. See parameters 19.11...19.14. This parameter is read-only.	- / uint16
	Zero	None.	1
	Speed	Speed control (in DTC motor control mode).	2
	Torque	Torque control (in DTC motor control mode).	3
	Min	The torque selector is comparing the output of the speed controller (25.1 Torque reference speed control) and torque reference (26.74 Torque ref ramp out) and the smaller of the two is used.	4
	Max	The torque selector is comparing the output of the speed controller (25.1 Torque reference speed control) and torque reference (26.74 Torque ref ramp out) and the greater of the two is used.	5
	Add	The speed controller output is added to the torque reference.	6
		DC voltage control.	7
	Scalar (Hz)	Frequency control in scalar motor control mode.	10
	Scalar (rpm)	Speed control in scalar motor control mode.	11
	Forced magn.	Motor is in magnetizing mode.	20
19.11	Ext1/Ext2 selection	Selects the source for external control location EXT1/EXT2 selection. 0 = EXT1 1 = EXT2	EXT1 / uint32
	EXT1	EXT1 (permanently selected).	0
	EXT2	EXT2 (permanently selected).	1
	FBA A MCW bit 11	Control word bit 11 received through fieldbus interface A.	2
	DI1	Digital input DI1 (10.2 DI delayed status, bit 0).	3
	DI2	Digital input DI2 (10.2 DI delayed status, bit 1).	4
	DI3	Digital input DI3 (10.2 DI delayed status, bit 2).	5
	DI4	Digital input DI4 (10.2 DI delayed status, bit 3).	6
	DI5	Digital input DI5 (10.2 DI delayed status, bit 4).	7
	DI6	Digital input DI6 (10.2 DI delayed status, bit 5).	8
	DIO1	Digital input/output DIO1 (11.2 DIO delayed status, bit 0).	11
	DIO2	Digital input/output DIO2 (11.2 DIO delayed status, bit 1).	12

No.	Name / Range / Selection	Description	Def / Type FbEq 16b / 32b
	EFB MCW bit 11	Control word bit 11 received through the embedded fieldbus interface.	32
	Other [bit]	See <a href="#">Terms and abbreviations (page 221)</a> .	
19.12	Ext1 control mode	Selects the operating mode for external control location EXT1.	Speed / uint16
	Zero	None.	1
	Speed	Speed control. The torque reference used is <a href="#">25.1 Torque reference speed control</a> (output of the speed reference chain).	2
	Torque	Torque control. The torque reference used is <a href="#">26.74 Torque ref ramp out</a> (output of the torque reference chain).	3
	Minimum	Combination of selections <a href="#">Speed</a> and <a href="#">Torque</a> : the torque selector compares the speed controller output ( <a href="#">25.1 Torque reference speed control</a> ) and the torque reference ( <a href="#">26.74 Torque ref ramp out</a> ) and selects the smaller of the two. If speed error becomes negative, the drive follows the speed controller output until speed error becomes positive again. This prevents the drive from accelerating uncontrollably if the load is lost in torque control.	4
	Maximum	Combination of selections <a href="#">Speed</a> and <a href="#">Torque</a> : the torque selector compares the speed controller output ( <a href="#">25.1 Torque reference speed control</a> ) and the torque reference ( <a href="#">26.74 Torque ref ramp out</a> ) and selects the greater of the two. If speed error becomes positive, the drive follows the speed controller output until speed error becomes negative again. This prevents the drive from accelerating uncontrollably if the load is lost in torque control.	5
	Add	Combination of selections <a href="#">Speed</a> and <a href="#">Torque</a> : Torque selector adds the speed reference chain output to the torque reference chain output.	6
	Voltage	(Type BCU control units only) DC voltage control. The torque reference used is <a href="#">29.1 Torque ref DC voltage control</a> (output of the DC voltage reference chain).	7
19.14	Ext2 control mode	Selects the operating mode for external control location EXT2. For the selections, see parameter <a href="#">19.12 Ext1 control mode</a> .	Speed / uint16
19.16	Local control mode	Selects the operating mode for local control.	Speed / uint16
	Speed	Speed control. The torque reference used is <a href="#">25.1 Torque reference speed control</a> (output of the speed reference chain).	0
	Torque	Torque control. The torque reference used is <a href="#">26.74 Torque ref ramp out</a> (output of the torque reference chain).	1

# 336 Parameters

No.	Name / Range / Selection	Description	Def / Type FbEq 16b / 32b
19.17	Local control disable	Enables/disables local control (start and stop buttons on the control panel, and the local controls on the PC tool).	No / uint16
<hr/>  <b>WARNING!</b> Before disabling local control, ensure that the control panel is not needed for stopping the drive. <hr/>			
No		Local control enabled.	0
Yes		Local control disabled.	1



No.	Name / Range / Selection	Description	Def / Type FbEq 16b / 32b															
20	<b>Start/stop/direction</b>	Start/stop/direction and run/start/jog enable signal source selection; positive/negative reference enable signal source selection. For information on control locations, see section <i>Local control vs. external control</i> (page 145).																
20.1	Ext1 commands	Selects the source of start, stop and direction commands for external control location 1 (EXT1). See also parameters 20.2...20.5.	In1 Start; In2 Dir / uint16															
	Not selected	No start or stop command sources selected.	0															
	In1 Start	The source of the start and stop commands is selected by parameter 20.3 <i>Ext1 in1 source</i> . The state transitions of the source bits are interpreted as follows:	1															
		<table border="1"> <thead> <tr> <th>State of source 1 (20.3)</th> <th>Command</th> </tr> </thead> <tbody> <tr> <td>0?1 (20.2 = Edge) 1 (20.2 = Level)</td> <td>Start</td> </tr> <tr> <td>0</td> <td>Stop</td> </tr> </tbody> </table>	State of source 1 (20.3)	Command	0?1 (20.2 = Edge) 1 (20.2 = Level)	Start	0	Stop										
State of source 1 (20.3)	Command																	
0?1 (20.2 = Edge) 1 (20.2 = Level)	Start																	
0	Stop																	
	In1 Start; In2 Dir	The source selected by 20.3 <i>Ext1 in1 source</i> is the start signal; the source selected by 20.4 <i>Ext1 in2 source</i> determines the direction. The state transitions of the source bits are interpreted as follows:	2															
		<table border="1"> <thead> <tr> <th>State of source 1 (20.3)</th> <th>State of source 2 (20.4)</th> <th>Command</th> </tr> </thead> <tbody> <tr> <td>0</td> <td>Any</td> <td>Stop</td> </tr> <tr> <td>0?1 (20.2 = Edge) 1 (20.2 = Level)</td> <td>0</td> <td>Start forward</td> </tr> <tr> <td></td> <td>1</td> <td>Start reverse</td> </tr> </tbody> </table>	State of source 1 (20.3)	State of source 2 (20.4)	Command	0	Any	Stop	0?1 (20.2 = Edge) 1 (20.2 = Level)	0	Start forward		1	Start reverse				
State of source 1 (20.3)	State of source 2 (20.4)	Command																
0	Any	Stop																
0?1 (20.2 = Edge) 1 (20.2 = Level)	0	Start forward																
	1	Start reverse																
	In1 Start fwd; In2 Start rev	The source selected by 20.3 <i>Ext1 in1 source</i> is the forward start signal; the source selected by 20.4 <i>Ext1 in2 source</i> is the reverse start signal. The state transitions of the source bits are interpreted as follows:	3															
		<table border="1"> <thead> <tr> <th>State of source 1 (20.3)</th> <th>State of source 2 (20.4)</th> <th>Command</th> </tr> </thead> <tbody> <tr> <td>0</td> <td>0</td> <td>Stop</td> </tr> <tr> <td>0?1 (20.2 = Edge) 1 (20.2 = Level)</td> <td>0</td> <td>Start forward</td> </tr> <tr> <td>0</td> <td>0?1 (20.2 = Edge) 1 (20.2 = Level)</td> <td>Start reverse</td> </tr> <tr> <td>1</td> <td>1</td> <td>Stop</td> </tr> </tbody> </table>	State of source 1 (20.3)	State of source 2 (20.4)	Command	0	0	Stop	0?1 (20.2 = Edge) 1 (20.2 = Level)	0	Start forward	0	0?1 (20.2 = Edge) 1 (20.2 = Level)	Start reverse	1	1	Stop	
State of source 1 (20.3)	State of source 2 (20.4)	Command																
0	0	Stop																
0?1 (20.2 = Edge) 1 (20.2 = Level)	0	Start forward																
0	0?1 (20.2 = Edge) 1 (20.2 = Level)	Start reverse																
1	1	Stop																

### 338 Parameters

No.	Name / Range / Selection	Description	Def / Type FbEq 16b / 32b																
	In1P Start; In2 Stop	<p>The sources of the start and stop commands are selected by parameters 20.3 Ext1 in1 source and 20.4 Ext1 in2 source.</p> <p>The state transitions of the source bits are interpreted as follows:</p> <table border="1"> <thead> <tr> <th>State of source 1 (20.3)</th> <th>State of source 2 (20.4)</th> <th>Command</th> </tr> </thead> <tbody> <tr> <td>0?1</td> <td>1</td> <td>Start</td> </tr> <tr> <td>Any</td> <td>0</td> <td>Stop</td> </tr> </tbody> </table> <p><b>Note:</b> The start signal is always edge-triggered with this setting regardless of parameter 20.2 Ext1 start trigger type.</p>	State of source 1 (20.3)	State of source 2 (20.4)	Command	0?1	1	Start	Any	0	Stop	4							
State of source 1 (20.3)	State of source 2 (20.4)	Command																	
0?1	1	Start																	
Any	0	Stop																	
	In1P Start; In2 Stop; In3 Dir	<p>The sources of the start and stop commands are selected by parameters 20.3 Ext1 in1 source and 20.4 Ext1 in2 source.</p> <p>The source selected by 20.5 Ext1 in3 source determines the direction. The state transitions of the source bits are interpreted as follows:</p> <table border="1"> <thead> <tr> <th>State of source 1 (20.3)</th> <th>State of source 2 (20.4)</th> <th>State of source 3 (20.5)</th> <th>Command</th> </tr> </thead> <tbody> <tr> <td>0?1</td> <td>1</td> <td>0</td> <td>Start forward</td> </tr> <tr> <td>0?1</td> <td>1</td> <td>1</td> <td>Start reverse</td> </tr> <tr> <td>Any</td> <td>0</td> <td>Any</td> <td>Stop</td> </tr> </tbody> </table> <p><b>Note:</b> The start signal is always edge-triggered with this setting regardless of parameter 20.2 Ext1 start trigger type.</p>	State of source 1 (20.3)	State of source 2 (20.4)	State of source 3 (20.5)	Command	0?1	1	0	Start forward	0?1	1	1	Start reverse	Any	0	Any	Stop	5
State of source 1 (20.3)	State of source 2 (20.4)	State of source 3 (20.5)	Command																
0?1	1	0	Start forward																
0?1	1	1	Start reverse																
Any	0	Any	Stop																
	In1P Start fwd; In2P Start rev; In3 Stop	<p>The sources of the start and stop commands are selected by parameters 20.3 Ext1 in1 source, 20.4 Ext1 in2 source and 20.5 Ext1 in3 source. The state transitions of the source bits are interpreted as follows:</p> <table border="1"> <thead> <tr> <th>State of source 1 (20.3)</th> <th>State of source 2 (20.4)</th> <th>State of source 3 (20.5)</th> <th>Command</th> </tr> </thead> <tbody> <tr> <td>0?1</td> <td>Any</td> <td>1</td> <td>Start forward</td> </tr> <tr> <td>Any</td> <td>0?1</td> <td>1</td> <td>Start reverse</td> </tr> <tr> <td>Any</td> <td>Any</td> <td>0</td> <td>Stop</td> </tr> </tbody> </table> <p><b>Note:</b> The start signal is always edge-triggered with this setting regardless of parameter 20.2 Ext1 start trigger type.</p>	State of source 1 (20.3)	State of source 2 (20.4)	State of source 3 (20.5)	Command	0?1	Any	1	Start forward	Any	0?1	1	Start reverse	Any	Any	0	Stop	6
State of source 1 (20.3)	State of source 2 (20.4)	State of source 3 (20.5)	Command																
0?1	Any	1	Start forward																
Any	0?1	1	Start reverse																
Any	Any	0	Stop																
	Control panel	<p>The start and stop commands are taken from the control panel.</p>	11																

No.	Name / Range / Selection	Description	Def / Type FbEq 16b / 32b
	Fieldbus A	The start and stop commands are taken from fieldbus adapter A.  <b>Note:</b> The start signal is always level-triggered with this setting regardless of parameter 20.2 Ext1 start trigger type.	12
	Embedded fieldbus	The start and stop commands are taken from the embedded fieldbus interface.  <b>Note:</b> The start signal is always level-triggered with this setting regardless of parameter 20.2 Ext1 start trigger type.	14
	M/F link	The start and stop commands are taken from another drive through the master/follower link.  <b>Note:</b> The start signal is always level-triggered with this setting regardless of parameter 20.2 Ext1 start trigger type.	15
	Application Program	The start and stop commands are taken from the application program control word (parameter 6.2 Application control word).  <b>Note:</b> The start signal is always level-triggered with this setting regardless of parameter 20.2 Ext1 start trigger type.	21
	ATF	Reserved.	22
	DDCS controller	The start and stop commands are taken from an external (DDCS) controller.  <b>Note:</b> The start signal is always level-triggered with this setting regardless of parameter 20.2 Ext1 start trigger type.	16
20.2	Ext1 start trigger type	Defines whether the start signal for external control location EXT1 is edge-triggered or level-triggered.  <b>Note:</b> This parameter is only effective when parameter 20.1 Ext1 commands is set to In1 Start, In1 Start; In2 Dir, In1 Start fwd; In2 Start rev, or Control panel.	Edge / uint16
	Edge	The start signal is edge-triggered.	0
	Level	The start signal is level-triggered.	1
20.3	Ext1 in1 source	Selects source 1 for parameter 20.1 Ext1 commands.	DI1 / uint32
	Not selected	0 (always off).	0
	Selected	1 (always on).	1
	DI1	Digital input DI1 (10.2 DI delayed status, bit 0).	2
	DI2	Digital input DI2 (10.2 DI delayed status, bit 1).	3
	DI3	Digital input DI3 (10.2 DI delayed status, bit 2).	4
	DI4	Digital input DI4 (10.2 DI delayed status, bit 3).	5

## 340 Parameters

No.	Name / Range / Selection	Description	Def / Type FbEq 16b / 32b															
	DI5	Digital input DI5 (10.2 DI delayed status, bit 4).	6															
	DI6	Digital input DI6 (10.2 DI delayed status, bit 5).	7															
	DIO1	Digital input/output DIO1 (11.2 DIO delayed status, bit 0).	10															
	DIO2	Digital input/output DIO2 (11.2 DIO delayed status, bit 1).	11															
	Other [bit]	See Terms and abbreviations (page 221).																
20.4	Ext1 in2 source	Selects source 2 for parameter 20.1 Ext1 commands. For the available selections, see parameter 20.3 Ext1 in1 source.	DI2 / uint32															
20.5	Ext1 in3 source	Selects source 3 for parameter 20.1 Ext1 commands. For the available selections, see parameter 20.3 Ext1 in1 source.	Not selected / uint32															
20.6	Ext2 commands	Selects the source of start, stop and direction commands for external control location 2 (EXT2). See also parameters 20.7...20.10.	Not selected / uint16															
	Not selected	No start or stop command sources selected.	0															
	In1 Start	The source of the start and stop commands is selected by parameter 20.8 Ext2 in1 source. The state transitions of the source bits are interpreted as follows:	1															
		<table border="1"> <thead> <tr> <th>State of source 1 (20.8)</th> <th>Command</th> </tr> </thead> <tbody> <tr> <td>0?1 (20.7 = Edge) 1 (20.7 = Level)</td> <td>Start</td> </tr> <tr> <td>0</td> <td>Stop</td> </tr> </tbody> </table>	State of source 1 (20.8)	Command	0?1 (20.7 = Edge) 1 (20.7 = Level)	Start	0	Stop										
State of source 1 (20.8)	Command																	
0?1 (20.7 = Edge) 1 (20.7 = Level)	Start																	
0	Stop																	
	In1 Start; In2 Dir	The source selected by 20.8 Ext2 in1 source is the start signal; the source selected by 20.9 Ext2 in2 source determines the direction. The state transitions of the source bits are interpreted as follows:	2															
		<table border="1"> <thead> <tr> <th>State of source 1 (20.8)</th> <th>State of source 2 (20.9)</th> <th>Command</th> </tr> </thead> <tbody> <tr> <td>0</td> <td>Any</td> <td>Stop</td> </tr> <tr> <td>0?1 (20.7 = Edge) 1 (20.7 = Level)</td> <td>0</td> <td>Start forward</td> </tr> <tr> <td></td> <td>1</td> <td>Start reverse</td> </tr> </tbody> </table>	State of source 1 (20.8)	State of source 2 (20.9)	Command	0	Any	Stop	0?1 (20.7 = Edge) 1 (20.7 = Level)	0	Start forward		1	Start reverse				
State of source 1 (20.8)	State of source 2 (20.9)	Command																
0	Any	Stop																
0?1 (20.7 = Edge) 1 (20.7 = Level)	0	Start forward																
	1	Start reverse																
	In1 Start fwd; In2 Start rev	The source selected by 20.8 Ext2 in1 source is the forward start signal; the source selected by 20.9 Ext2 in2 source is the reverse start signal. The state transitions of the source bits are interpreted as follows:	3															
		<table border="1"> <thead> <tr> <th>State of source 1 (20.8)</th> <th>State of source 2 (20.9)</th> <th>Command</th> </tr> </thead> <tbody> <tr> <td>0</td> <td>0</td> <td>Stop</td> </tr> <tr> <td>0?1 (20.7 = Edge) 1 (20.7 = Level)</td> <td>0</td> <td>Start forward</td> </tr> <tr> <td>0</td> <td>0?1 (20.7 = Edge) 1 (20.7 = Level)</td> <td>Start reverse</td> </tr> <tr> <td>1</td> <td>1</td> <td>Stop</td> </tr> </tbody> </table>	State of source 1 (20.8)	State of source 2 (20.9)	Command	0	0	Stop	0?1 (20.7 = Edge) 1 (20.7 = Level)	0	Start forward	0	0?1 (20.7 = Edge) 1 (20.7 = Level)	Start reverse	1	1	Stop	
State of source 1 (20.8)	State of source 2 (20.9)	Command																
0	0	Stop																
0?1 (20.7 = Edge) 1 (20.7 = Level)	0	Start forward																
0	0?1 (20.7 = Edge) 1 (20.7 = Level)	Start reverse																
1	1	Stop																

No.	Name / Range / Selection	Description	Def / Type FbEq 16b / 32b															
In1P Start; In2 Stop	<p>The sources of the start and stop commands are selected by parameters 20.8 Ext2 in1 source and 20.9 Ext2 in2 source.</p> <p>The state transitions of the source bits are interpreted as follows:</p>	4																
<table border="1"> <thead> <tr> <th data-bbox="396 320 535 363">State of source 1 (20.8)</th> <th data-bbox="549 320 688 363">State of source 2 (20.9)</th> <th data-bbox="736 320 818 343">Command</th> </tr> </thead> <tbody> <tr> <td data-bbox="437 363 493 386">0?1</td> <td data-bbox="613 363 624 386">1</td> <td data-bbox="759 363 796 386">Start</td> </tr> <tr> <td data-bbox="437 386 474 408">Any</td> <td data-bbox="613 386 624 408">0</td> <td data-bbox="759 386 796 408">Stop</td> </tr> </tbody> </table>			State of source 1 (20.8)	State of source 2 (20.9)	Command	0?1	1	Start	Any	0	Stop							
State of source 1 (20.8)	State of source 2 (20.9)	Command																
0?1	1	Start																
Any	0	Stop																
<p><b>Note:</b> The start signal is always edge-triggered with this setting regardless of parameter 20.7 Ext2 start trigger type.</p>																		
In1P Start; In2 Stop; In3 Dir	<p>The sources of the start and stop commands are selected by parameters 20.8 Ext2 in1 source and 20.9 Ext2 in2 source.</p> <p>The source selected by 20.10 Ext2 in3 source determines the direction. The state transitions of the source bits are interpreted as follows:</p>	5																
<table border="1"> <thead> <tr> <th data-bbox="396 683 482 726">State of source 1 (20.8)</th> <th data-bbox="527 683 613 726">State of source 2 (20.9)</th> <th data-bbox="639 683 725 726">State of source 3 (20.10)</th> <th data-bbox="740 683 826 705">Command</th> </tr> </thead> <tbody> <tr> <td data-bbox="437 726 493 748">0?1</td> <td data-bbox="549 726 561 748">1</td> <td data-bbox="661 726 673 748">0</td> <td data-bbox="740 726 848 748">Start forward</td> </tr> <tr> <td data-bbox="437 748 493 770">0?1</td> <td data-bbox="549 748 561 770">1</td> <td data-bbox="661 748 673 770">1</td> <td data-bbox="740 748 848 770">Start reverse</td> </tr> <tr> <td data-bbox="437 770 474 793">Any</td> <td data-bbox="549 770 561 793">0</td> <td data-bbox="661 770 698 793">Any</td> <td data-bbox="740 770 777 793">Stop</td> </tr> </tbody> </table>			State of source 1 (20.8)	State of source 2 (20.9)	State of source 3 (20.10)	Command	0?1	1	0	Start forward	0?1	1	1	Start reverse	Any	0	Any	Stop
State of source 1 (20.8)	State of source 2 (20.9)	State of source 3 (20.10)	Command															
0?1	1	0	Start forward															
0?1	1	1	Start reverse															
Any	0	Any	Stop															
<p><b>Note:</b> The start signal is always edge-triggered with this setting regardless of parameter 20.7 Ext2 start trigger type.</p>																		
In1P Start fwd; In2P Start rev; In3 Stop	<p>The sources of the start and stop commands are selected by parameters 20.8 Ext2 in1 source, 20.9 Ext2 in2 source and 20.10 Ext2 in3 source. The state transitions of the source bits are interpreted as follows:</p>	6																
<table border="1"> <thead> <tr> <th data-bbox="396 1045 482 1088">State of source 1 (20.8)</th> <th data-bbox="527 1045 613 1088">State of source 2 (20.9)</th> <th data-bbox="639 1045 725 1088">State of source 3 (20.10)</th> <th data-bbox="740 1045 826 1067">Command</th> </tr> </thead> <tbody> <tr> <td data-bbox="437 1088 493 1110">0?1</td> <td data-bbox="549 1088 586 1110">Any</td> <td data-bbox="661 1088 673 1110">1</td> <td data-bbox="740 1088 848 1110">Start forward</td> </tr> <tr> <td data-bbox="437 1110 474 1133">Any</td> <td data-bbox="549 1110 586 1133">0?1</td> <td data-bbox="661 1110 673 1133">1</td> <td data-bbox="740 1110 848 1133">Start reverse</td> </tr> <tr> <td data-bbox="437 1133 474 1155">Any</td> <td data-bbox="549 1133 586 1155">Any</td> <td data-bbox="661 1133 673 1155">0</td> <td data-bbox="740 1133 777 1155">Stop</td> </tr> </tbody> </table>			State of source 1 (20.8)	State of source 2 (20.9)	State of source 3 (20.10)	Command	0?1	Any	1	Start forward	Any	0?1	1	Start reverse	Any	Any	0	Stop
State of source 1 (20.8)	State of source 2 (20.9)	State of source 3 (20.10)	Command															
0?1	Any	1	Start forward															
Any	0?1	1	Start reverse															
Any	Any	0	Stop															
<p><b>Note:</b> The start signal is always edge-triggered with this setting regardless of parameter 20.7 Ext2 start trigger type.</p>																		
Control panel	The start and stop commands are taken from the control panel.	11																

## 342 Parameters

No.	Name / Range / Selection	Description	Def / Type FbEq 16b / 32b
	Fieldbus A	The start and stop commands are taken from fieldbus adapter A.  <b>Note:</b> The start signal is always edge-triggered with this setting regardless of parameter 20.7 Ext2 start trigger type.	12
	Embedded fieldbus	The start and stop commands are taken from the embedded fieldbus interface.  <b>Note:</b> The start signal is always edge-triggered with this setting regardless of parameter 20.7 Ext2 start trigger type.	14
	M/F link	The start and stop commands are taken from another drive through the master/follower link.  <b>Note:</b> The start signal is always edge-triggered with this setting regardless of parameter 20.7 Ext2 start trigger type.	15
	Application Program	The start and stop commands are taken from the application program control word (parameter 6.2 Application control word).  <b>Note:</b> The start signal is always edge-triggered with this setting regardless of parameter 20.7 Ext2 start trigger type.	21
	ATF	Reserved.	22
	DDCS controller	The start and stop commands are taken from an external (DDCS) controller.  <b>Note:</b> The start signal is always edge-triggered with this setting regardless of parameter 20.7 Ext2 start trigger type.	16
20.7	Ext2 start trigger type	Defines whether the start signal for external control location EXT2 is edge-triggered or level-triggered.  <b>Note:</b> This parameter is only effective when parameter 20.6 Ext2 commands is set to In1 Start, In1 Start; In2 Dir, In1 Start fwd; In2 Start rev, or Control panel.	Edge / uint16
	Edge	The start signal is edge-triggered.	0
	Level	The start signal is level-triggered.	1
20.8	Ext2 in1 source	Selects source 1 for parameter 20.6 Ext2 commands. For the available selections, see parameter 20.3 Ext1 in1 source.	Not selected / uint32
20.9	Ext2 in2 source	Selects source 2 for parameter 20.6 Ext2 commands. For the available selections, see parameter 20.3 Ext1 in1 source.	Not selected / uint32
20.10	Ext2 in3 source	Selects source 3 for parameter 20.6 Ext2 commands. For the available selections, see parameter 20.3 Ext1 in1 source.	Not selected / uint32

No.	Name / Range / Selection	Description	Def / Type FbEq 16b / 32b
20.11	Run enable stop mode	Selects the way the motor is stopped when the run enable signal switches off. The source of the run enable signal is selected by parameter 20.12 Run enable 1 source.	Coast (95.20 b10) / uint16
	Coast	Stop by switching off the output semiconductors of the drive. The motor coasts to a stop.	0
		 <b>WARNING!</b> If a mechanical brake is used, ensure it is safe to stop the drive by coasting.	
	Ramp	Stop along the active deceleration ramp. See parameter group 23 Speed reference ramp (page 378).	1
	Torque limit	Stop according to torque limits (parameters 30.19 and 30.20).	2
20.12	Run enable 1 source	Selects the source of the external run enable signal. If the run enable signal is switched off, the drive will not start. If already running, the drive will stop according to the setting of parameter 20.11 Run enable stop mode. 1 = Run enable signal on.  <b>Note:</b> The warning that indicates a missing signal can be suppressed using parameter 20.30 Enable signals warning function. See also parameter 20.19 Enable start command.	DIIL (95.20 b10); Selected (95.20 b5); DI5 (95.20 b9) / uint32
	Not selected		0
	Selected		1
	DI1	Digital input DI1 (10.2 DI delayed status, bit 0).	2
	DI2	Digital input DI2 (10.2 DI delayed status, bit 1).	3
	DI3	Digital input DI3 (10.2 DI delayed status, bit 2).	4
	DI4	Digital input DI4 (10.2 DI delayed status, bit 3).	5
	DI5	Digital input DI5 (10.2 DI delayed status, bit 4).	6
	DI6	Digital input DI6 (10.2 DI delayed status, bit 5).	7
	DIO1	Digital input/output DIO1 (11.2 DIO delayed status, bit 0).	10
	DIO2	Digital input/output DIO2 (11.2 DIO delayed status, bit 1).	11
	FBA A MCW bit 3	Control word bit 3 received through fieldbus interface A.	30
	EFB MCW bit 3	Control word bit 3 received through the embedded fieldbus interface.	32
	DIIL	DIIL input (10.2 DI delayed status, bit 15).	33

## 344 Parameters

No.	Name / Range / Selection	Description	Def / Type FbEq 16b / 32b
	Active control source MCW bit 3	Control word bit 3 received from the active control source.  <b>Note:</b> <ul style="list-style-type: none"> <li>If the drive is running in fieldbus control, switching bit 3 off effectively removes both the start and run enable signals.</li> <li>In this case, the stop mode is determined by 20.11 Run enable stop mode. The order of stop modes from highest to lowest priority is Coast – Torque limit – Ramp. In case the active source is the control panel, PC tool or drive I/O, the run enable signal is always on.</li> </ul>	34
	Other [bit]	See Terms and abbreviations (page 221).	
20.19	Enable start command	Selects the source for the start enable signal. 1 = Start enable. With the signal switched off, any drive start command is inhibited. (Switching the signal off while the drive is running will not stop the drive.)  <b>Note:</b> <ul style="list-style-type: none"> <li>If a level-triggered start command is on when the start enable signal switches on, the drive will start. (An edgetriggered start signal must be cycled for the drive to start.) See parameters 20.2 Ext1 start trigger type, 20.7 Ext2 start trigger type and 20.29 Local start trigger type.</li> <li>The warning that indicates a missing signal can be suppressed using parameter 20.30 Enable signals warning function.</li> </ul> <p>See also parameter 20.12 Run enable 1 source.</p>	Selected / uint32
	Not selected	0	0
	Selected	1	1
	DI1	Digital input DI1 (10.2 DI delayed status, bit 0).	2
	DI2	Digital input DI2 (10.2 DI delayed status, bit 1).	3
	DI3	Digital input DI3 (10.2 DI delayed status, bit 2).	4
	DI4	Digital input DI4 (10.2 DI delayed status, bit 3).	5
	DI5	Digital input DI5 (10.2 DI delayed status, bit 4).	6
	DI6	Digital input DI6 (10.2 DI delayed status, bit 5).	7
	DIO1	Digital input/output DIO1 (11.2 DIO delayed status, bit 0).	10
	DIO2	Digital input/output DIO1 (11.2 DIO delayed status, bit 1).	11
	DIIL	DIIL input (10.2 DI delayed status, bit 15).	30



No.	Name / Range / Selection	Description	Def / Type FbEq 16b / 32b
	Other [bit]	See Terms and abbreviations (page 221).	
20.23	Positive speed enable	<p>Selects the source of the positive speed enable command.</p> <p>1 = Positive speed enabled.</p> <p>0 = Positive speed interpreted as zero speed reference.</p> <p>In the figure below, 23.1 Speed ref ramp input is set to zero after the positive speed enable signal has cleared.</p> <p>Actions in different control modes:</p> <p>Speed control: Speed reference is set to zero and the motor ramps down along the currently active deceleration ramp. The drive keeps modulating. The rush controller prevents additional torque terms from running the motor in the positive direction.</p> <p>Torque control: The rush controller monitors the rotation direction of the motor.</p>	Selected / uint32
	Not selected	0	0
	Selected	1	1
	DI1	Digital input DI1 (10.2 DI delayed status, bit 0).	2
	DI2	Digital input DI2 (10.2 DI delayed status, bit 1).	3
	DI3	Digital input DI3 (10.2 DI delayed status, bit 2).	4
	DI4	Digital input DI4 (10.2 DI delayed status, bit 3).	5
	DI5	Digital input DI5 (10.2 DI delayed status, bit 4).	6
	DI6	Digital input DI6 (10.2 DI delayed status, bit 5).	7
	DIO1	Digital input/output DIO1 (11.2 DIO delayed status, bit 0).	10
	DIO2	Digital input/output DIO2 (11.2 DIO delayed status, bit 1).	11
	Other [bit]	See Terms and abbreviations (page 221).	
20.24	Negative speed enable	Selects the source of the negative speed reference enable command. See parameter 20.23 Positive speed enable.	Selected / uint32
20.29	Local start trigger type	Defines whether the start signal for local control (for example, control panel or PC tool) is edge-triggered or level-triggered.	Edge / uint16

## 346 Parameters

No.	Name / Range / Selection	Description	Def / Type FbEq 16b / 32b
	Edge	The start signal is edge-triggered.	0
	Level	The start signal is level-triggered.	1
20.30	Enable signals warning function	Selects enable signal (eg. run enable, start enable) warnings to be suppressed. This parameter can be used to prevent these warnings from flooding the event log. Whenever a bit of this parameter is set to 1, the corresponding warning is suppressed, ie. no warning is generated even if the signal is switched off. The bits of this binary number correspond to the following warnings:	- / uint16
	b0 Enable Start	AFEA Enable start signal missing	
	b1 Run enable 1	AFEB Run enable missing	
	b2...15 Reserved		
	0000h...FFFFh		1 = 1
20.200	Slowdown select	Selects the mode of the Slowdown function. For more information on the function, see section Slowdown	Single bit with direction / int16
	Single bit with direction	Slowdown uses two switches through one input. Either of the switches triggers the Slowdown command, but it is not known which one. Parameter 20.201 Slowdown input 1 selects the input to which the switches are connected for activating the Slowdown command. The drive remembers the direction from which the slowdown switch was hit.	1
	Single bit without direction	Slowdown uses two switches through one input. Either of the switches triggers the Slowdown command, but it is not known which one. Parameter 20.201 Slowdown input 1 selects the input to which the switches are connected for activating the Slowdown command. The Slowdown command is active both in forward and reverse directions. A safe zone can be created using this selection.	2
	Double bit	Slowdown uses two switches through two inputs. Either of the switches triggers the Slowdown command. Parameter 20.201 Slowdown input 1 is only used in the forward direction and parameter 20.202 Slowdown input 2 in the reverse direction.	3
	Position	Slowdown uses two positions defined in parameters 20.203 Slowdown pos 1 and 20.204 Slowdown pos 2. Either of the positions reached triggers the Slowdown command. See also description of 20.203 Slowdown pos 1 and 20.204 Slowdown pos 2.	4

No.	Name / Range / Selection	Description	Def / Type FbEq 16b / 32b
20.201	Slowdown input 1	<p>Selects the source for activating the Slowdown command</p> <ul style="list-style-type: none"> <li>in the forward direction when the Double bit mode is active</li> <li>both in forward and reverse directions when the Single bit with direction or Single bit without direction mode is active.</li> </ul> <p>0 = Slowdown command is active. 1 = Slowdown command is inactive. When the command is active, the drive limits the speed reference to the value of parameter 22.200 Slowdown reference.</p>	Inactive (true) / int32
	Active (false)	0	0
	Inactive (true)	1	1
	DI1	Digital input DI1 (10.2 DI delayed status, bit 0).	2
	DI2	Digital input DI2 (10.2 DI delayed status, bit 1).	3
	DI3	Digital input DI3 (10.2 DI delayed status, bit 2).	4
	DI4	Digital input DI4 (10.2 DI delayed status, bit 3).	5
	DI5	Digital input DI5 (10.2 DI delayed status, bit 4).	6
	DI6	Digital input DI6 (10.2 DI delayed status, bit 5).	7
	DIO1	Digital input/output DIO1 (11.2 DIO delayed status, bit 0).	8
	DIO2	Digital input/output DIO2 (11.2 DIO delayed status, bit 1).	9
	Other [bit]	See Terms and abbreviations (page 221).	
20.202	Slowdown input 2	<p>Selects the source for activating the Slowdown command in the reverse direction when the Double bit mode is active.</p> <p>0 = Slowdown command is active. 1 = Slowdown command is inactive. When the command is active, the drive limits the speed reference to the value of parameter 22.200 Slowdown reference.</p>	Inactive (true) / int32
	Active (false)	0	0
	Inactive (true)	1	1
	DI1	Digital input DI1 (10.2 DI delayed status, bit 0).	2
	DI2	Digital input DI2 (10.2 DI delayed status, bit 1).	3
	DI3	Digital input DI3 (10.2 DI delayed status, bit 2).	4
	DI4	Digital input DI4 (10.2 DI delayed status, bit 3).	5
	DI5	Digital input DI5 (10.2 DI delayed status, bit 4).	6
	DI6	Digital input DI6 (10.2 DI delayed status, bit 5).	7
	DIO1	Digital input/output DIO1 (11.2 DIO delayed status, bit 0).	8

## 348 Parameters

No.	Name / Range / Selection	Description	Def / Type FbEq 16b / 32b
	DIO2	Digital input/output DIO2 (11.2 DIO delayed status, bit 1).	9
	Other [bit]	See Terms and abbreviations (page 221).	
20.203	Slowdown pos 1	Defines the Up position limit for Slowdown function in the forward direction. When the actual position of crane (signal 90.5 Load position scaled) is greater than this value, the slowdown command in the forward direction is activated. When the command is active, the drive limits the speed reference to the value of parameter 22.200 Slowdown reference.	0.000 / real32
	-32000.000 ... 32000.000	Up position limit.	1 = 1 / 1 = 1
20.204	Slowdown pos 2	Defines the Down position limit for Slowdown function in the reverse direction. When the actual position of crane (signal 90.5 Load position scaled) is less than this value, the slowdown command in the reverse direction is activated. When the command is active, the drive limits the speed reference to the negative value of parameter 22.200 Slowdown reference.	0.000 / real32
	-32000.000 ... 32000.000	Down position limit.	1 = 1 / 1 = 1
20.205	End limit 1	Selects the source for activating the End limit 1 command. When this command is active, the End limit function activates an emergency stop command in the forward direction (i.e. positive speed reference) and drive will stop within the time defined in parameter 23.23 Emergency stop time. The action for the end limit command is selected with parameter 20.218 End limit action. See also description of End limits.	Inactive (true) / int32
	Active (false)	0	0
	Inactive (true)	1	1
	DI1	Digital input DI1 (10.2 DI delayed status, bit 0).	2
	DI2	Digital input DI2 (10.2 DI delayed status, bit 1).	3
	DI3	Digital input DI3 (10.2 DI delayed status, bit 2).	4
	DI4	Digital input DI4 (10.2 DI delayed status, bit 3).	5
	DI5	Digital input DI5 (10.2 DI delayed status, bit 4).	6
	DI6	Digital input DI6 (10.2 DI delayed status, bit 5).	7
	DIO1	Digital input/output DIO1 (11.2 DIO delayed status, bit 0).	8
	DIO2	Digital input/output DIO2 (11.2 DIO delayed status, bit 1).	9
	Other [bit]	See Terms and abbreviations (page 221).	

No.	Name / Range / Selection	Description	Def / Type FbEq 16b / 32b
20.206	End limit 2	<p>Selects the source for activating the End limit 2 command.</p> <p>When this command is active, the End limit function activates an emergency stop command in the reverse direction (i.e. negative speed reference) and drive will stop within the time defined in parameter 23.23 Emergency stop time. The action for the end limit command is selected with parameter 20.218 End limit action.</p> <p>See also description of End limits.</p>	Inactive (true) / int32
	Active (false)	0	0
	Inactive (true)	1	1
	DI1	Digital input DI1 (10.2 DI delayed status, bit 0).	2
	DI2	Digital input DI2 (10.2 DI delayed status, bit 1).	3
	DI3	Digital input DI3 (10.2 DI delayed status, bit 2).	4
	DI4	Digital input DI4 (10.2 DI delayed status, bit 3).	5
	DI5	Digital input DI5 (10.2 DI delayed status, bit 4).	6
	DI6	Digital input DI6 (10.2 DI delayed status, bit 5).	7
	DIO1	Digital input/output DIO1 (11.2 DIO delayed status, bit 0).	8
	DIO2	Digital input/output DIO2 (11.2 DIO delayed status, bit 1).	9
	Other [bit]	See Terms and abbreviations (page 221).	
20.207	Emergency control enable	<p>Selects the source for activating the Emergency control mode.</p> <p>0 = Emergency control mode is inactive (normal operation).</p> <p>1 = Emergency control mode is active.</p> <p>Parameters 20.208 Emergency control forward and 20.209 Emergency control reverse are applicable only when the Emergency control mode is active. For more information on the function, see section Emergency control mode.</p> <p><b>Note:</b></p> <ul style="list-style-type: none"> <li>When emergency control mode is enabled, parameters 20.1 Ext1 commands and 20.6 Ext2 commands are automatically set as Not selected. This setting prevents, for example, fieldbus communication fault, that stops the drive from starting.</li> <li>When emergency control is disabled, the last set values are restored into parameters 20.1 Ext1 commands and 20.6 Ext2 commands.</li> </ul>	Disable / int32
	Disable	0	0
	Enable	1	1
	DI1	Digital input DI1 (10.2 DI delayed status, bit 0).	2

## 350 Parameters

No.	Name / Range / Selection	Description	Def / Type FbEq 16b / 32b
	DI2	Digital input DI2 (10.2 DI delayed status, bit 1).	3
	DI3	Digital input DI3 (10.2 DI delayed status, bit 2).	4
	DI4	Digital input DI4 (10.2 DI delayed status, bit 3).	5
	DI5	Digital input DI5 (10.2 DI delayed status, bit 4).	6
	DI6	Digital input DI6 (10.2 DI delayed status, bit 5).	7
	DIO1	Digital input/output DIO1 (11.2 DIO delayed status, bit 0).	8
	DIO2	Digital input/output DIO2 (11.2 DIO delayed status, bit 1).	9
	Other [bit]	See Terms and abbreviations (page 221).	
20.208	Emergency control forward	<p>Selects the source for activating the Emergency control start command in the forward direction. This parameter is applicable only when the Emergency control mode is enabled using parameter 20.207 Emergency control enable.</p> <p>0 = Emergency control start command is inactive. 1 = Emergency control start command is active. When the command is active, the drive uses the speed reference defined in parameter 22.202 Emergency control reference with positive polarity as the reference.</p>	False / int32
	False	0	0
	True	1	1
	DI1	Digital input DI1 (10.2 DI delayed status, bit 0).	2
	DI2	Digital input DI2 (10.2 DI delayed status, bit 1).	3
	DI3	Digital input DI3 (10.2 DI delayed status, bit 2).	4
	DI4	Digital input DI4 (10.2 DI delayed status, bit 3).	5
	DI5	Digital input DI5 (10.2 DI delayed status, bit 4).	6
	DI6	Digital input DI6 (10.2 DI delayed status, bit 5).	7
	DIO1	Digital input/output DIO1 (11.2 DIO delayed status, bit 0).	8
	DIO2	Digital input/output DIO2 (11.2 DIO delayed status, bit 1).	9
	Other [bit]	See Terms and abbreviations (page 221).	
20.209	Emergency control reverse	<p>Selects the source for activating the Emergency control start command in the reverse direction. This parameter is applicable only when the Emergency control mode is enabled using parameter 20.207 Emergency control enable.</p> <p>0 = Emergency control start command is inactive. 1 = Emergency control start command is active. When the command is active, the drive uses the speed reference defined in parameter 22.202 Emergency control reference with negative polarity as the reference.</p>	False / int32
	False	0	0

No.	Name / Range / Selection	Description	Def / Type FbEq 16b / 32b
	True	1	1
	DI1	Digital input DI1 (10.2 DI delayed status, bit 0).	2
	DI2	Digital input DI2 (10.2 DI delayed status, bit 1).	3
	DI3	Digital input DI3 (10.2 DI delayed status, bit 2).	4
	DI4	Digital input DI4 (10.2 DI delayed status, bit 3).	5
	DI5	Digital input DI5 (10.2 DI delayed status, bit 4).	6
	DI6	Digital input DI6 (10.2 DI delayed status, bit 5).	7
	DIO1	Digital input/output DIO1 (11.2 DIO delayed status, bit 0).	8
	DIO2	Digital input/output DIO2 (11.2 DIO delayed status, bit 1).	9
	Other [bit]	See Terms and abbreviations (page 221).	
20.210	Fast stop input	Selects the source for activating the Fast stop command. 0 = Fast stop command is active. 1 = Fast stop command is inactive (normal operation). When the command is active, the drive decelerates according to the value in parameter 23.206 Fast stop deceleration time.	Inactive (true) / int32
	Active (false)	0	0
	Inactive (true)	1	1
	DI1	Digital input DI1 (10.2 DI delayed status, bit 0).	2
	DI2	Digital input DI2 (10.2 DI delayed status, bit 1).	3
	DI3	Digital input DI3 (10.2 DI delayed status, bit 2).	4
	DI4	Digital input DI4 (10.2 DI delayed status, bit 3).	5
	DI5	Digital input DI5 (10.2 DI delayed status, bit 4).	6
	DI6	Digital input DI6 (10.2 DI delayed status, bit 5).	7
	DIO1	Digital input/output DIO1 (11.2 DIO delayed status, bit 0).	8
	DIO2	Digital input/output DIO2 (11.2 DIO delayed status, bit 1).	9
	Other [bit]	See Terms and abbreviations (page 221).	
20.211	Fast stop mode	Selects the mode of the Fast stop function.	Level: Ramp / uint16
	Edge: Ramp	The drive decelerates to zero speed according to a defined ramp time. The mechanical brake closes when the drive reaches the brake close speed.	1
	Edge: Torque limit	The drive decelerates to zero speed against the drive torque limits. The mechanical brake closes when the drive reaches the brake close speed.	2
	Edge: Mechanical brake	The function forces the mechanical brake to close.	3

## 352 Parameters

No.	Name / Range / Selection	Description	Def / Type FbEq 16b / 32b
	Level: Ramp	The drive decelerates to zero speed according to a defined ramp time. The mechanical brake closes when the drive reaches the brake close speed.	4
	Level: torque limit	The drive decelerates to zero speed against the drive torque limits. The mechanical brake closes when the drive reaches the brake close speed.	5
	Level: mechanical brake	The function forces the mechanical brake to close.	6
20.212	Power on acknowledge	Selects the source for activating the Power on acknowledgment signal. 1 = Power on acknowledgment circuit is closed, main contactor is closed. 0 = Power on acknowledgment circuit is open, main contactor is open, warning D20B Power on acknowledge generated. For more information on the function, see section Power on acknowledgment (page 136).	DIIL / int32
	False	0	0
	True	1	1
	DIIL	DIIL input (10.2 DI delayed status, bit 15).	2
	DI1	Digital input DI1 (10.2 DI delayed status, bit 0).	3
	DI2	Digital input DI2 (10.2 DI delayed status, bit 1).	4
	DI3	Digital input DI3 (10.2 DI delayed status, bit 2).	5
	DI4	Digital input DI4 (10.2 DI delayed status, bit 3).	6
	DI5	Digital input DI5 (10.2 DI delayed status, bit 4).	7
	DI6	Digital input DI6 (10.2 DI delayed status, bit 5).	8
	DIO1	Digital input/output DIO1 (11.2 DIO delayed status, bit 0).	9
	DIO2	Digital input/output DIO2 (11.2 DIO delayed status, bit 1).	10
	Other [bit]	See Terms and abbreviations (page 221).	
20.213	Power on ackn reset delay	Defines the time delay for a fault reset after the Power on acknowledgment signal is activated.	1000 ms / real32
	0...30000 ms	Time delay	1 = 1 ms / 1 = 1 ms
20.214	Joystick zero position	Selects the source for activating the joystick zero position input. 0 = Joystick is not at zero position. 1 = Joystick is at zero position. For more information, see section Start/stop interlocking (page 56).	Disable / int32
	Disable	0	0
	Enable	1	1
	DI1	Digital input DI1 (10.2 DI delayed status, bit 0).	2
	DI2	Digital input DI2 (10.2 DI delayed status, bit 1).	3



No.	Name / Range / Selection	Description	Def / Type FbEq 16b / 32b
	DI3	Digital input DI3 (10.2 DI delayed status, bit 2).	4
	DI4	Digital input DI4 (10.2 DI delayed status, bit 3).	5
	DI5	Digital input DI5 (10.2 DI delayed status, bit 4).	6
	DI6	Digital input DI6 (10.2 DI delayed status, bit 5).	7
	DIO1	Digital input/output DIO1 (11.2 DIO delayed status, bit 0).	8
	DIO2	Digital input/output DIO2 (11.2 DIO delayed status, bit 1).	9
	Other [bit]	See Terms and abbreviations (page 221).	
20.215	Joystick warning delay	Defines the time delay for generating warning D208 Joystick reference check. The warning is generated if 20.214 Joystick zero position is active and the speed reference is greater than +/- 10% of the minimum or maximum scaled value of the joystick reference used.	1000 ms / real32
	0...30000 ms	Time delay	1 = 1 ms / 1 = 1 ms
20.216	Crane control word 1	Crane control program control word 1. Can be updated from the fieldbus using parameter group 53 FBA A data out (page 521) or 56 FBA B data out (page 525).	- / uint16
		<b>Note:</b>	
		<ul style="list-style-type: none"> <li>These bits are not connected to any function by default. Bit names are existing, for which you need to make connections separately. For example, parameter 20.3 Ext1 in1 source = 20.216, bit 0 and 20.4 Ext1 in2 source = 20.216, bit 1.</li> <li>When using bits 0 and 1, for the start command in forward and reverse direction, the speed reference must be an absolute value because the directions are defined by these bits.</li> </ul>	
	b0 Start forward	1 = Start command in the forward direction.	
	b1 Start reverse	1 = Start command in the reverse direction.	
	b2 Fault reset	1 = Fault reset activated.	
	b3 Step reference mode 1	1 = Step reference mode enabled.	
	b4 Step reference select 2	1 = Step reference selection pointer 2 enabled.	
	b5 Step reference select 3	1 = Step reference selection pointer 3 enabled.	
	b6 Step reference select 4	1 = Step reference selection pointer 4 enabled.	
	b7 Slowdown input 1	1 = Slowdown command in the forward direction is deactivated.	
	b8 Slowdown input 2	1 = Slowdown command in the reverse direction is deactivated.	

## 354 Parameters

No.	Name / Range / Selection	Description	Def / Type FbEq 16b / 32b
	b9 End limit 1	1 = End limit 1 command deactivated.	
	b10 End limit 2	1 = End limit 2 command deactivated.	
	b11 Fast stop	1 = Fast stop command activated.	
	b12 Crane ramp set select	1 = Acceleration/deceleration ramp set 2 selected. 0 = Acceleration/deceleration ramp set 1 selected.	
	b13 External speed limits	1 = External speed limit activated.	
	b14 Torque proving sign	1 = Torque proving and brake open torque directions inverted.	
	b15 Hoist speed optimization sel	1 = Hoist speed optimization function enabled.	
	0000h...FFFFh		1 = 1
20.218	End limit action	<p>Selects the action that can be used if the end limit command is active.</p> <p><b>Note:</b> ABB recommends that you do not change the end limit action to other than the default selection, unless it is really needed to fulfill the specific requirements.</p>	Emergency stop / uint16
		 <p><b>WARNING!</b> Do not use Coast stop for hoist drives to avoid load dropping.</p>	
	Normal stop	Normal ramp is used when end limit command is active.	0
	Emergency stop	Emergency stop ramp is used when end limit command is active.	1
	Fast stop	Fast stop ramp is used when end limit command is active.	2
	Coast stop	Coast stop is initiated when end limit command is active.	3
20.219	End limit fault	Enables fault action when end limit command is active.	Enable / uint32
	Disable	End limit fault action is inactive.	0
	Enable	End limit fault is active.	1
20.220	Inching sel	Selects the source for activating inching function. See also section <i>Inching control</i> (page 106).	No / int32
	No	Inching function is not active.	0
	Select	Inching function is activated.	1
	DI1	Digital input DI1 (10.2 DI delayed status, bit 0).	2
	DI2	Digital input DI2 (10.2 DI delayed status, bit 1).	3
	DI3	Digital input DI3 (10.2 DI delayed status, bit 2).	4
	DI4	Digital input DI4 (10.2 DI delayed status, bit 3).	5
	DI5	Digital input DI5 (10.2 DI delayed status, bit 4).	6
	DI6	Digital input DI6 (10.2 DI delayed status, bit 5).	7

No.	Name / Range / Selection	Description	Def / Type FbEq 16b / 32b
	DIO1	Digital input/output DIO1 (11.2 DIO delayed status, bit 0).	8
	DIO2	Digital input/output DIO2 (11.2 DIO delayed status, bit 1).	9
	Other [bit]	See Terms and abbreviations (page 221).	
20.221	Inching run time	Defines the duration of inching start command.	0.50 s / real32
	0.00 ... 1800.00 s	Run time	10 = 1 s / 1 = 1 s
20.222	Inching wait time	Defines the duration of stop command before new inching start.	1.00 s / real32
	0.00 ... 1800.00 s	Waiting time	10 = 1 s / 1 = 1 s
20.223	Inching speed ref	Defines the maximum speed reference for inching routine.	300.00 rpm / real32
	0.00 ... 30000.00 rpm	Speed reference	1 = 1 rpm / 1 = 1 rpm

## 356 Parameters

No.	Name / Range / Selection	Description	Def / Type FbEq 16b / 32b
21	<b>Start/stop mode</b>	Start and stop modes; emergency stop mode and signal source selection; DC magnetization settings; autophasing mode selection.	
21.1	Start mode	Selects the motor start function for the DTC motor control mode, ie. when 99.4 Motor control mode is set to DTC.	Automatic / uint16
		<p><b>Note:</b></p> <ul style="list-style-type: none"> <li>• The start function for the scalar motor control mode is selected by parameter 21.19 Scalar start mode.</li> <li>• Starting into a rotating motor is not possible when DC magnetizing is selected (Fast or Constant time).</li> <li>• With permanent magnet motors and synchronous reluctance motors, Automatic start mode must be used.</li> <li>• This parameter cannot be changed while the drive is running.</li> </ul> <p>See also section DC magnetization (page 188).</p>	
	Fast	The drive pre-magnetizes the motor before start. The premagnetizing time is determined automatically, being typically 200 ms to 2 s depending on motor size. This mode should be selected if a high break-away torque is required.	0
	Constant time	The drive pre-magnetizes the motor before start. The premagnetizing time is defined by parameter 21.2 Magnetization time. This mode should be selected if constant pre-magnetizing time is required (e.g. if the motor start must be synchronized with the release of a mechanical brake). This setting also guarantees the highest possible break-away torque when the pre-magnetizing time is set long enough.	1
		<p> <b>WARNING!</b> The drive will start after the set magnetizing time has passed even if motor magnetization is not completed. In applications where a full break-away torque is essential, ensure that the constant magnetizing time is long enough to allow generation of full magnetization and torque.</p>	

No.	Name / Range / Selection	Description	Def / Type FbEq 16b / 32b										
	Automatic	Automatic start guarantees optimal motor start in most cases. It includes the flying start function (starting into a rotating motor) and the automatic restart function (a stopped motor can be restarted immediately without waiting the motor flux to die away). The drive motor control program identifies the flux as well as the mechanical state of the motor and starts the motor instantly under all conditions.	2										
	Flying start	This method is intended for asynchronous motors only, and is optimized for applications where the drive must be started into a rotating motor at high frequencies (above 150 Hz).	3										
21.2	Magnetization time	<p>Defines the pre-magnetization time when</p> <ul style="list-style-type: none"> <li>parameter 21.1 Start mode is set to Constant time (in DTC motor control mode), or</li> <li>parameter 21.19 Scalar start mode is set to Constant time (in scalar motor control mode).</li> </ul> <p>After the start command, the drive automatically premagnetizes the motor for the set time. To ensure full magnetizing, set this parameter to the same value as, or higher than, the rotor time constant. If not known, use the rule-of-thumb value given in the table below:</p> <table border="1"> <thead> <tr> <th>Motor rated power</th> <th>Constant magnetizing time</th> </tr> </thead> <tbody> <tr> <td>&lt; 1 kW</td> <td>≥ 50 to 100 ms</td> </tr> <tr> <td>1 to 10 kW</td> <td>≥ 100 to 200 ms</td> </tr> <tr> <td>10 to 200 kW</td> <td>≥ 200 to 1000 ms</td> </tr> <tr> <td>200 to 1000 kW</td> <td>≥ 1000 to 2000 ms</td> </tr> </tbody> </table> <p><b>Note:</b> This parameter cannot be changed while the drive is running.</p>	Motor rated power	Constant magnetizing time	< 1 kW	≥ 50 to 100 ms	1 to 10 kW	≥ 100 to 200 ms	10 to 200 kW	≥ 200 to 1000 ms	200 to 1000 kW	≥ 1000 to 2000 ms	500 ms / uint16
Motor rated power	Constant magnetizing time												
< 1 kW	≥ 50 to 100 ms												
1 to 10 kW	≥ 100 to 200 ms												
10 to 200 kW	≥ 200 to 1000 ms												
200 to 1000 kW	≥ 1000 to 2000 ms												
	0...10000 ms	Constant DC magnetizing time.	1 = 1 ms / 1 = 1 ms										
21.6	Zero speed limit	<p>Defines the zero speed limit. The motor is stopped along a speed ramp (when ramped stop is selected) until the defined zero speed limit is reached. After the zero speed delay, the motor coasts to a stop.</p> <p><b>Note:</b> If you use a value below the default, make sure the drive is able to stop.</p>	30.00 rpm / real32										
	0.00 ... 30000.00 rpm	Zero speed limit. For scaling, see parameter 46.1.	- / -										

# 358 Parameters

No.	Name / Range / Selection	Description	Def / Type FbEq 16b / 32b
-----	--------------------------	-------------	------------------------------

21.7 Zero speed delay

Defines the delay for the zero speed delay function. The function is useful in applications where a smooth and quick restarting is essential. During the delay, the drive knows the rotor position accurately.

Without zero speed delay:  
The drive receives a stop command and decelerates along a ramp. When actual motor speed falls below the value of parameter 21.6 Zero speed limit, inverter modulation is stopped and the motor coasts to a standstill.

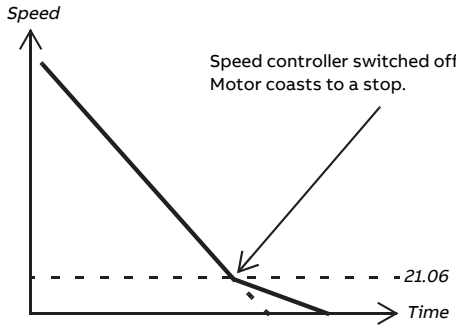

With zero speed delay:  
The drive receives a stop command and decelerates along a ramp. When actual motor speed falls below the value of parameter 21.6 Zero speed limit, the zero speed delay function activates. During the delay the function keeps the speed controller live: the inverter modulates, motor is magnetized and the drive is ready for a quick restart. Zero speed delay can be used e.g. with the jogging function.

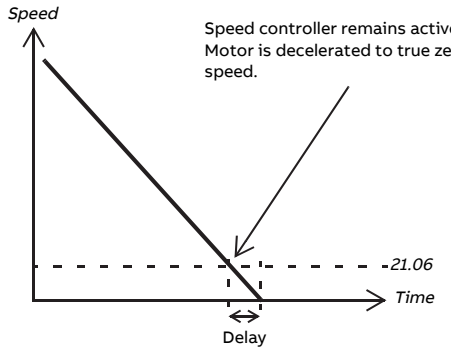

0...30000 ms	Zero speed delay.	1 = 1 ms / 1 = 1 ms
--------------	-------------------	---------------------

No.	Name / Range / Selection	Description	Def / Type FbEq 16b / 32b
21.8	DC current control	Activates/deactivates the DC hold and post-magnetization functions. See section DC magnetization (page 188).  <b>Note:</b> <ul style="list-style-type: none"> <li>DC hold is only available with speed control in DTC motor control mode (see page 148).</li> <li>DC magnetization causes the motor to heat up. In applications where long DC magnetization times are required, externally ventilated motors should be used. If the DC magnetization period is long, DC magnetization cannot prevent the motor shaft from rotating if a constant load is applied to the motor.</li> </ul>	- / uint16
	b0 DC hold	1 = Enable DC hold. See section DC hold (page 188).  <b>Note:</b> The DC hold function has no effect if the start signal is switched off.	
	b1 Post magnetization	1 = Enable post-magnetization. See section Post-magnetization (page 189).	
	b2...15 Reserved		
	0000h...FFFFh		1 = 1
21.9	DC hold speed	Defines the DC hold speed. See parameter 21.8 DC current control, and section DC hold (page 188).	5.00 rpm / real32
	0.00 ... 1000.00 rpm	DC hold speed. For scaling, see parameter 46.1.	- / -
21.10	DC current reference	Defines the DC hold current in percent of the motor nominal current. See parameter 21.8 DC current control, and section DC magnetization (page 188).	30.0 % / real32
	0.0 ... 100.0 %	DC hold current.	1 = 1 % / 10 = 1 %
21.11	Post magnetization time	Defines the length of time for which post-magnetization is active after stopping the motor. The magnetization current is defined by parameter 21.10 DC current reference. See parameter 21.8 DC current control.	0 s / uint32
	0...3000 s	Post-magnetization time.	1 = 1 s / 1 = 1 s



## 360 Parameters

No.	Name / Range / Selection	Description	Def / Type FbEq 16b / 32b
21.12	Continuous magnetization command	<p>Activates/deactivates (or selects a source that activates/deactivates) continuous magnetization. See section <a href="#">Continuous magnetization (page 189)</a>. The magnetization current is calculated on the basis of flux reference (see parameter group <a href="#">97 Motor control</a>).</p> <p><b>Note:</b></p> <ul style="list-style-type: none"> <li>This function is only available in DTC motor control mode.</li> <li>Continuous magnetization causes the motor to heat up. In applications where long magnetization times are required, externally ventilated motors should be used.</li> <li>Continuous magnetization may not be able to prevent the motor shaft from rotating during a long period if a constant load is applied to the motor.</li> </ul> <p>0 = Normal operation 1 = Magnetization active</p>	Off / uint32
	Off	0.	0
	On	1.	1
	Other [bit]	See <a href="#">Terms and abbreviations (page 221)</a> .	
21.13	Autophasing mode	<p>Selects the way autophasing is performed. See section <a href="#">Autophasing (page 184)</a>.</p> <p><b>Note:</b> This parameter cannot be changed while the drive is running.</p>	Turning / uint16
	Turning	<p>This mode gives the most accurate autophasing result. This mode can be used, and is recommended, if the motor is allowed to rotate and the start-up is not time-critical.</p> <p><b>Note:</b> This mode will cause the motor to rotate. The load torque must be less than 5%.</p>	0
	Standstill 1	Faster than the <a href="#">Turning</a> mode, but not as accurate. The motor will not rotate.	1
	Standstill 2	An alternative standstill autophasing mode that can be used if the <a href="#">Turning</a> mode cannot be used, and the <a href="#">Standstill 1</a> mode gives erratic results. However, this mode is considerably slower than <a href="#">Standstill 1</a> .	2
	Turning with Z-pulse	This mode should be used if the zero pulse signal of the pulse encoder is to be observed, and other modes do not give a result. The motor will turn until a zero pulse is detected.	3



No.	Name / Range / Selection	Description	Def / Type FbEq 16b / 32b
21.14	Pre-heating input source	<p>Selects the source of the motor pre-heat on/off command. See section <a href="#">Pre-heating (page 188)</a>.</p> <p><b>Note:</b> The pre-heating function will not activate if</p> <ul style="list-style-type: none"> <li>the Safe torque off function is active,</li> <li>a fault is active,</li> <li>less than one minute has elapsed after stopping, or</li> <li>PID sleep function is active.</li> </ul> <p>Pre-heating is deactivated when the drive is started, and overridden by pre-magnetization, post-magnetization or continuous magnetization. 0 = Pre-heating inactive 1 = Pre-heating active</p>	Inactive (false) / uint32
	Inactive (false)	0. Pre-heating is always deactivated.	0
	Active (true)	1. Pre-heating is always activated when the drive is stopped (apart from conditions stated above).	1
	DI1	Digital input DI1 (10.2 DI delayed status, bit 0).	2
	DI2	Digital input DI2 (10.2 DI delayed status, bit 1).	3
	DI3	Digital input DI3 (10.2 DI delayed status, bit 2).	4
	DI4	Digital input DI4 (10.2 DI delayed status, bit 3).	5
	DI5	Digital input DI5 (10.2 DI delayed status, bit 4).	6
	DI6	Digital input DI6 (10.2 DI delayed status, bit 5).	7
	Supervision 1	Supervision 1 active (32.1 Supervision status, bit 0).	8
	Supervision 2	Supervision 2 active (32.1 Supervision status, bit 1).	9
Supervision 3	Supervision 3 active (32.1 Supervision status, bit 2).	10	
Other [bit]	See <a href="#">Terms and abbreviations (page 221)</a> .		
21.15	Pre-heating time delay	Defines the delay time for the pre-heating function.	60 s / real32
	10...3000 s	Pre-heating time delay.	1 = 1 s / 1 = 1 s
21.16	Pre-heating current	<p>Defines the motor pre-heating current that is fed into the motor when the source selected by <a href="#">21.14</a> Pre-heating input source is on. The value is in percent of the nominal motor current.</p>	0.0 % / real32
	0.0 ... 30.0 %	Pre-heating current.	1 = 1 % / 10 = 1 %

## 362 Parameters

No.	Name / Range / Selection	Description	Def / Type FbEq 16b / 32b
21.18	Auto restart time	<p>The motor can be automatically started after a short supply power failure using the automatic restart function. See section <a href="#">Automatic restart</a> (page 192). When this parameter is set to 0.0 seconds, automatic restarting is disabled. Otherwise, the parameter defines the maximum duration of the power failure after which restarting is attempted. Note that this time also includes the DC precharging delay.</p> <hr/> <p> <b>WARNING!</b> The function restarts the drive automatically and continues operation after a supply break. Make sure that no dangerous situations can occur.</p> <hr/>	5.0 s / real32
	0.0 ... 10.0 s	0.0 s = Automatic restarting disabled. 0.1 ... 5.0 s = Maximum power failure duration.	1 = 1 s / 10 = 1 s
21.19	Scalar start mode	<p>Selects the motor start function for the scalar motor control mode, ie. when <a href="#">99.4 Motor control mode</a> is set to <i>Scalar</i>.</p> <p><b>Note:</b></p> <ul style="list-style-type: none"> <li>The start function for the DTC motor control mode is selected by parameter <a href="#">21.1 Start mode</a>.</li> <li>With permanent magnet motors, <i>Automatic start mode</i> must be used.</li> </ul> <p>See also section <a href="#">DC magnetization</a> (page 188).</p> <hr/>	Normal / uint16
	Normal	Immediate start from zero speed.	0
	Const time	<p>The drive pre-magnetizes the motor before start. The premagnetizing time is defined by parameter <a href="#">21.2 Magnetization time</a>. This mode should be selected if constant pre-magnetizing time is required (e.g. if the motor start must be synchronized with the release of a mechanical brake). This setting also guarantees the highest possible break-away torque when the pre-magnetizing time is set long enough.</p> <p><b>Note:</b> This mode cannot be used to start into a rotating motor.</p> <hr/> <p> <b>WARNING!</b> The drive will start after the set magnetizing time has passed even if motor magnetization is not completed. In applications where a full break-away torque is essential, ensure that the constant magnetizing time is long enough to allow generation of full magnetization and torque.</p> <hr/>	1

No.	Name / Range / Selection	Description	Def / Type FbEq 16b / 32b
	Automatic	This setting should be used <ul style="list-style-type: none"> <li>in applications where flying starts (ie. starting into a rotating motor) are required, and</li> <li>with permanent magnet motors.</li> </ul>	2
21.20	Follower force ramp stop	In a torque-controlled follower drive, forces (or selects a source that forces) the drive to switch to speed control upon a ramp stop (Off1 or Off3) command. This is required for an independent ramp stop of the follower. See also section Master/follower functionality (page 159). 1 = Ramp stop forces speed control	Not selected / uint32
	Not selected	0.	0
	Selected	1.	1
	DIIL	DIIL input (10.2 DI delayed status, bit 15).	2
	DI1	Digital input DI1 (10.2 DI delayed status, bit 0).	3
	DI2	Digital input DI2 (10.2 DI delayed status, bit 1).	4
	DI3	Digital input DI3 (10.2 DI delayed status, bit 2).	5
	DI4	Digital input DI4 (10.2 DI delayed status, bit 3).	6
	DI5	Digital input DI5 (10.2 DI delayed status, bit 4).	7
	DI6	Digital input DI6 (10.2 DI delayed status, bit 5).	8
	DIO1	Digital input/output DIO1 (11.2 DIO delayed status, bit 0).	11
	DIO2	Digital input/output DIO2 (11.2 DIO delayed status, bit 1).	12
	Other [bit]	See Terms and abbreviations (page 221).	
21.37	Motor temperature estimation	Selects the source of the motor temperature estimation on/off command. See section Motor temperature estimation (page 190).  <b>Note:</b> The motor temperature estimation function requires that <ul style="list-style-type: none"> <li>ID run is performed</li> <li>ID run request is not active</li> <li>a fault is not active, and</li> <li>drive is in stopped state and ready to run.</li> </ul>	Inactive (false) / uint32
		 <b>WARNING!</b> The drive starts modulation when the above conditions are fulfilled and the selection is active. Take extra care when rebooting the drive.	
	Inactive (false)	0	0

## 364 Parameters

No.	Name / Range / Selection	Description	Def / Type FbEq 16b / 32b
	Active (true)	1	1
	DI1	Digital input DI1 (10.2 DI delayed status, bit 0).	2
	DI2	Digital input DI2 (10.2 DI delayed status, bit 1).	3
	DI3	Digital input DI3 (10.2 DI delayed status, bit 2).	4
	DI4	Digital input DI4 (10.2 DI delayed status, bit 3).	5
	DI5	Digital input DI5 (10.2 DI delayed status, bit 4).	6
	DI6	Digital input DI6 (10.2 DI delayed status, bit 5).	7
	Supervision 1	Supervision 1 active (32.1 Supervision status, bit 0).	8
	Supervision 2	Supervision 2 active (32.1 Supervision status, bit 1).	9
	Supervision 3	Supervision 3 active (32.1 Supervision status, bit 2).	10
	Drive start command	Motor temperature estimation is performed always with drive start command.	11
	Drive power-up	Motor temperature estimation is performed once after drive power-up (control board boot).	12
21.38	Motor temperature estimation time	Defines the motor temperature estimation time. Motor temperature estimation is activated with parameter 21.37 Motor temperature estimation.	4.0 s / real32
	0.5 ... 20.0 s	Motor temperature estimation time in seconds.	10 = 1 s / 10 = 1 s

No.	Name / Range / Selection	Description	Def / Type FbEq 16b / 32b
<b>22</b>	<b>Speed reference selection</b>	Speed reference selection; motor potentiometer settings. See the control chain diagrams on pages 778...780.	
22.1	Speed ref unlimited	Displays the output of the speed reference selection block. See the control chain diagram on page 779. This parameter is read-only.	- / real32
		-30000.00 ... 30000.00 rpm	Value of the selected speed reference. For scaling, see parameter 46.1.
22.11	Speed ref1 source	Selects speed reference source 1. Two signal sources can be defined by this parameter and 22.12 Speed ref2 source. A digital source selected by 22.14 Speed ref1/2 selection can be used to switch between the two sources, or a mathematical function (22.13 Speed ref1 function) applied to the two signals to create the reference.	AI1 scaled / uint32

Zero	None.	0
AI1 scaled	12.12 AI1 scaled value (page 284).	1
AI2 scaled	12.22 AI2 scaled value (page 286).	2
FB A ref1	3.5 FB A reference 1 (page 231).	4
FB A ref2	3.6 FB A reference 2 (page 231).	5
EFB ref1	3.9 EFB reference 1 (page 231).	8
EFB ref2	3.10 EFB reference 2 (page 231).	9
DDCS ctrl ref1	3.11 DDCS controller ref 1 (page 231).	10
DDCS ctrl ref2	3.12 DDCS controller ref 2 (page 231).	11
M/F reference 1	3.13 M/F or D2D ref1 (page 232).	12
M/F reference 2	3.14 M/F or D2D ref2 (page 232).	13
Motor potentiometer	22.80 Motor potentiometer ref act (output of the motor potentiometer).	15
PID	40.01 Process PID output actual (output of the process PID controller).	16

## 366 Parameters

No.	Name / Range / Selection	Description	Def / Type FbEq 16b / 32b
	Control panel (ref saved)	Control panel reference, with initial value from last-used panel reference. See section <a href="#">Using the control panel as an external control source</a> (page 147).	18
	Control panel (ref copied)	Control panel reference, with initial value from previous source or actual value. See section <a href="#">Using the control panel as an external control source</a> (page 147).	19
	Other [value]	See <a href="#">Terms and abbreviations</a> (page 221).	
22.12	Speed ref2 source	Selects speed reference source 2. For the selections, and a diagram of reference source selection, see parameter <a href="#">22.11 Speed ref1 source</a> .	Zero / uint32
22.13	Speed ref1 function	Selects a mathematical function between the reference sources selected by parameters <a href="#">22.11 Speed ref1 source</a> and <a href="#">22.12 Speed ref2 source</a> . See diagram at <a href="#">22.11 Speed ref1 source</a> .	Ref1 / uint16
	Ref1	Signal selected by <a href="#">22.11 Speed ref1 source</a> is used as speed reference 1 as such (no function applied).	0
	Add (ref1 + ref2)	The sum of the reference sources is used as speed reference 1.	1
	Sub (ref1 - ref2)	The subtraction ( $[\text{22.11 Speed ref1 source}] - [\text{22.12 Speed ref2 source}]$ ) of the reference sources is used as speed reference 1.	2
	Mul (ref1 x ref2)	The multiplication of the reference sources is used as speed reference 1.	3
	Min (ref1, ref2)	The smaller of the reference sources is used as speed reference 1.	4
	Max (ref1, ref2)	The greater of the reference sources is used as speed reference 1.	5
22.14	Speed ref1/2 selection	Configures the selection between speed references 1 and 2. See diagram at <a href="#">22.11 Speed ref1 source</a> . 0 = Speed reference 1 1 = Speed reference 2	Follow Ext1/Ext2 selection / uint32
	Speed reference 1	0.	0
	Speed reference 2	1.	1
	Follow Ext1/Ext2 selection	Speed reference 1 is used when external control location EXT1 is active. Speed reference 2 is used when external control location EXT2 is active. See also parameter <a href="#">19.11 Ext1/Ext2 selection</a> .	2
	DI1	Digital input DI1 (10.2 DI delayed status, bit 0).	3
	DI2	Digital input DI2 (10.2 DI delayed status, bit 1).	4
	DI3	Digital input DI3 (10.2 DI delayed status, bit 2).	5
	DI4	Digital input DI4 (10.2 DI delayed status, bit 3).	6
	DI5	Digital input DI5 (10.2 DI delayed status, bit 4).	7
	DI6	Digital input DI6 (10.2 DI delayed status, bit 5).	8

No.	Name / Range / Selection	Description	Def / Type FbEq 16b / 32b
	DIO1	Digital input/output DIO1 (11.2 DIO delayed status, bit 0).	11
	DIO2	Digital input/output DIO2 (11.2 DIO delayed status, bit 1).	12
	Other [bit]	See <a href="#">Terms and abbreviations</a> (page 221).	
22.15	Speed additive 1 source	Defines a reference to be added to the speed reference after reference selection (see page 778). For the selections, see parameter 22.11 Speed ref1 source.  <b>Note:</b> For safety reasons, the additive is not applied when any of the stop functions are active.	Zero / uint32
22.16	Speed share	Defines a scaling factor for the selected speed referencec (speed reference 1 or 2, multiplied by the defined value). Speed reference 1 or 2 is selected by parameter 22.14 Speed ref1/2 selection.	1.000 / real32
	-8.000 ... 8.000	Speed reference scaling factor.	1000 = 1 / 1000 = 1
22.17	Speed additive 2 source	Defines a reference to be added to the speed reference after the speed share function (see page 778). For the selections, see parameter 22.11 Speed ref1 source.  <b>Note:</b> For safety reasons, the additive is not applied when any of the stop functions are active.	Zero / uint32
22.21	Constant speed function	Determines how constant speeds are selected, and whether the rotation direction signal is considered or not when applying a constant speed.	- / uint16
	b0 Constant speed mode	1 = Packed: 7 constant speeds are selectable using the three sources defined by parameters 22.22, 22.23 and 22.24. 0 = Separate: Constant speeds 1, 2 and 3 are separately activated by the sources defined by parameters 22.22, 22.23 and 22.24 respectively. In case of conflict, the constant speed with the smaller number takes priority.	
	b1 Direction enable	1 = Start dir: To determine running direction for a constant speed, the sign of the constant speed setting (parameters 22.26...22.32) is multiplied by the direction signal (forward: +1, reverse: -1). This effectively allows the drive to have 14 (7 forward, 7 reverse) constant speeds if all values in 22.26...22.32 are positive.   <b>WARNING!</b> If the direction signal is reverse and the active constant speed is negative, the drive will run in the forward direction.  0 = Accord Par: The running direction for the constant speed is determined by the sign of the constant speed setting (parameters 22.26...22.32).	

# 368 Parameters

No.	Name / Range / Selection	Description	Def / Type FbEq 16b / 32b																																				
b2...15 Reserved																																							
	0000h...FFFFh		1 = 1																																				
22.22	Constant speed sel1	<p>When bit 0 of parameter 22.21 Constant speed function is 0 (Separate), selects a source that activates constant speed 1.</p> <p>When bit 0 of parameter 22.21 Constant speed function is 1 (Packed), this parameter and parameters 22.23 Constant speed sel2 and 22.24 Constant speed sel3 select three sources whose states activate constant speeds as follows:</p> <table border="1" style="margin-left: 40px;"> <thead> <tr> <th>Source defined by par. 22.22</th> <th>Source defined by par. 22.23</th> <th>Source defined by par. 22.24</th> <th>Constant speed active</th> </tr> </thead> <tbody> <tr><td>0</td><td>0</td><td>0</td><td>None</td></tr> <tr><td>1</td><td>0</td><td>0</td><td>Constant speed 1</td></tr> <tr><td>0</td><td>1</td><td>0</td><td>Constant speed 2</td></tr> <tr><td>1</td><td>1</td><td>0</td><td>Constant speed 3</td></tr> <tr><td>0</td><td>0</td><td>1</td><td>Constant speed 4</td></tr> <tr><td>1</td><td>0</td><td>1</td><td>Constant speed 5</td></tr> <tr><td>0</td><td>1</td><td>1</td><td>Constant speed 6</td></tr> <tr><td>1</td><td>1</td><td>1</td><td>Constant speed 7</td></tr> </tbody> </table>	Source defined by par. 22.22	Source defined by par. 22.23	Source defined by par. 22.24	Constant speed active	0	0	0	None	1	0	0	Constant speed 1	0	1	0	Constant speed 2	1	1	0	Constant speed 3	0	0	1	Constant speed 4	1	0	1	Constant speed 5	0	1	1	Constant speed 6	1	1	1	Constant speed 7	DI5 / uint32
Source defined by par. 22.22	Source defined by par. 22.23	Source defined by par. 22.24	Constant speed active																																				
0	0	0	None																																				
1	0	0	Constant speed 1																																				
0	1	0	Constant speed 2																																				
1	1	0	Constant speed 3																																				
0	0	1	Constant speed 4																																				
1	0	1	Constant speed 5																																				
0	1	1	Constant speed 6																																				
1	1	1	Constant speed 7																																				
	Not selected	0	0																																				
	Selected	1	1																																				
	DI1	Digital input DI1 (10.2 DI delayed status, bit 0).	2																																				
	DI2	Digital input DI2 (10.2 DI delayed status, bit 1).	3																																				
	DI3	Digital input DI3 (10.2 DI delayed status, bit 2).	4																																				
	DI4	Digital input DI4 (10.2 DI delayed status, bit 3).	5																																				
	DI5	Digital input DI5 (10.2 DI delayed status, bit 4).	6																																				
	DI6	Digital input DI6 (10.2 DI delayed status, bit 5).	7																																				
	DIO1	Digital input/output DIO1 (11.2 DIO delayed status, bit 0).	10																																				
	DIO2	Digital input/output DIO2 (11.2 DIO delayed status, bit 1).	11																																				
	Other [bit]	See Terms and abbreviations (page 221).																																					



No.	Name / Range / Selection	Description	Def / Type FbEq 16b / 32b
22.23	Constant speed sel2	When bit 0 of parameter 22.21 Constant speed function is 0 (Separate), selects a source that activates constant speed 2. When bit 0 of parameter 22.21 Constant speed function is 1 (Packed), this parameter and parameters 22.22 Constant speed sel1 and 22.24 Constant speed sel3 select three sources that are used to activate constant speeds. See table at parameter 22.22 Constant speed sel1. For the selections, see parameter 22.22 Constant speed sel1.	Not selected / uint32
22.24	Constant speed sel3	When bit 0 of parameter 22.21 Constant speed function is 0 (Separate), selects a source that activates constant speed 3. When bit 0 of parameter 22.21 Constant speed function is 1 (Packed), this parameter and parameters 22.22 Constant speed sel1 and 22.23 Constant speed sel2 select three sources that are used to activate constant speeds. See table at parameter 22.22 Constant speed sel1. For the selections, see parameter 22.22 Constant speed sel1.	Not selected / uint32
22.26	Constant speed 1	Defines constant speed 1 (the speed the motor will turn when constant speed 1 is selected).	300.00 rpm / real32
	-30000.00 ... 30000.00 rpm	Constant speed 1. For scaling, see parameter 46.1.	- / -
22.27	Constant speed 2	Defines constant speed 2.	0.00 rpm / real32
	-30000.00 ... 30000.00 rpm	Constant speed 2. For scaling, see parameter 46.1.	- / -
22.28	Constant speed 3	Defines constant speed 3.	0.00 rpm / real32
	-30000.00 ... 30000.00 rpm	Constant speed 3. For scaling, see parameter 46.1.	- / -
22.29	Constant speed 4	Defines constant speed 4.	0.00 rpm / real32
	-30000.00 ... 30000.00 rpm	Constant speed 4. For scaling, see parameter 46.1.	- / -
22.30	Constant speed 5	Defines constant speed 5.	0.00 rpm / real32
	-30000.00 ... 30000.00 rpm	Constant speed 5. For scaling, see parameter 46.1.	- / -
22.31	Constant speed 6	Defines constant speed 6.	0.00 rpm / real32
	-30000.00 ... 30000.00 rpm	Constant speed 6. For scaling, see parameter 46.1.	- / -
22.32	Constant speed 7	Defines constant speed 7.	0.00 rpm / real32
	-30000.00 ... 30000.00 rpm	Constant speed 7. For scaling, see parameter 46.1.	- / -

# 370 Parameters

No.	Name / Range / Selection	Description	Def / Type FbEq 16b / 32b
22.41	Speed ref safe	<p>Defines a safe speed reference value that is used with supervision functions such as</p> <ul style="list-style-type: none"> <li>12.3 AI supervision function</li> <li>49.5 Communication loss action</li> <li>50.2 FBA A comm loss func</li> <li>50.32 FBA B comm loss func</li> <li>58.14 Communication loss action.</li> </ul>	- / real32
	-30000.00 ... 30000.00 rpm	Safe speed reference. For scaling, see parameter 46.1.	- / -
22.51	Critical speed function	<p>Enables/disables the critical speeds function. Also determines whether the specified ranges are effective in both rotating directions or not. See also section <i>Critical speeds</i> (page 170).</p>	- / uint16
	b0 Enable	<p>1 = Enable: Critical speeds enabled. 0 = Disable: Critical speeds disabled.</p>	
	b1 Sign mode	<p>1 = Signed: The signs of parameters 22.52...22.57 are taken into account. 0 = Absolute: Parameters 22.52...22.57 are handled as absolute values. Each range is effective in both directions of rotation.</p>	
	b2...15 Reserved		
	0000h...FFFFh		1 = 1
22.52	Critical speed 1 low	<p>Defines the low limit for critical speed range 1.</p> <p><b>Note:</b> This value must be less than or equal to the value of 22.53 Critical speed 1 high.</p>	0.00 rpm / real32
	-30000.00 ... 30000.00 rpm	Low limit for critical speed 1. For scaling, see parameter 46.1.	- / -
22.53	Critical speed 1 high	<p>Defines the high limit for critical speed range 1.</p> <p><b>Note:</b> This value must be greater than or equal to the value of 22.52 Critical speed 1 low.</p>	0.00 rpm / real32
	-30000.00 ... 30000.00 rpm	High limit for critical speed 1. For scaling, see parameter 46.1.	- / -
22.54	Critical speed 2 low	<p>Defines the low limit for critical speed range 2.</p> <p><b>Note:</b> This value must be less than or equal to the value of 22.55 Critical speed 2 high.</p>	0.00 rpm / real32
	-30000.00 ... 30000.00 rpm	Low limit for critical speed 2. For scaling, see parameter 46.1.	- / -
22.55	Critical speed 2 high	<p>Defines the high limit for critical speed range 2.</p> <p><b>Note:</b> This value must be greater than or equal to the value of 22.54 Critical speed 2 low.</p>	0.00 rpm / real32

No.	Name / Range / Selection	Description	Def / Type FbEq 16b / 32b
	-30000.00 ... 30000.00 rpm	High limit for critical speed 2. For scaling, see parameter 46.1.	- / -
22.56	Critical speed 3 low	Defines the low limit for critical speed range 3.  <b>Note:</b> This value must be less than or equal to the value of 22.57 Critical speed 3 high.	0.00 rpm / real32
	-30000.00 ... 30000.00 rpm	Low limit for critical speed 3. For scaling, see parameter 46.1.	- / -
22.57	Critical speed 3 high	Defines the high limit for critical speed range 3.  <b>Note:</b> This value must be greater than or equal to the value of 22.56 Critical speed 3 low.	0.00 rpm / real32
	-30000.00 ... 30000.00 rpm	High limit for critical speed 3. For scaling, see parameter 46.1.	- / -
22.71	Motor potentiometer function	Activates and selects the mode of the motor potentiometer. See section Speed reference ramping (page 96).	Disabled / uint16
	Disabled	Motor potentiometer is disabled and its value set to 0.	0
	Enabled (init at stop/power-up)	When enabled, the motor potentiometer first adopts the value defined by parameter 22.72 Motor potentiometer initial value. When the drive is running, the value can be adjusted from the up and down sources defined by parameters 22.73 Motor potentiometer up source and 22.74 Motor potentiometer down source. A stop or a power cycle will reset the motor potentiometer to the initial value (22.72).	1
	Enabled (resume always)	As Enabled (init at stop/power-up), but the motor potentiometer value is retained over a stop or a power cycle.	2
22.72	Motor potentiometer initial value	Defines an initial value (starting point) for the motor potentiometer. See the selections of parameter 22.71 Motor potentiometer function.	0.00 / real32
	-32768.00 ... 32767.00	Initial value for motor potentiometer.	1 = 1 / 100 = 1
22.73	Motor potentiometer up source	Selects the source of motor potentiometer up signal. 0 = No change 1 = Increase motor potentiometer value. (If both the up and down sources are on, the potentiometer value will not change.)	Not selected / uint32
	Not selected	0	0
	Selected	1	1
	DI1	Digital input DI1 (10.2 DI delayed status, bit 0).	2
	DI2	Digital input DI2 (10.2 DI delayed status, bit 1).	3
	DI3	Digital input DI3 (10.2 DI delayed status, bit 2).	4
	DI4	Digital input DI4 (10.2 DI delayed status, bit 3).	5
	DI5	Digital input DI5 (10.2 DI delayed status, bit 4).	6

## 372 Parameters

No.	Name / Range / Selection	Description	Def / Type FbEq 16b / 32b
	DI6	Digital input DI6 (10.2 DI delayed status, bit 5).	7
	DIO1	Digital input/output DIO1 (11.2 DIO delayed status, bit 0).	10
	DIO2	Digital input/output DIO2 (11.2 DIO delayed status, bit 1).	11
	Other [bit]	See Terms and abbreviations (page 221).	
22.74	Motor potentiometer down source	Selects the source of motor potentiometer down signal. 0 = No change 1 = Decrease motor potentiometer value. (If both the up and down sources are on, the potentiometer value will not change.) For the selections, see parameter 22.73 Motor potentiometer up source.	Not selected / uint32
22.75	Motor potentiometer ramp time	Defines the change rate of the motor potentiometer. This parameter specifies the time required for the motor potentiometer to change from minimum (22.76) to maximum (22.77). The same change rate applies in both directions.	60.0 s / real32
	0.0 ... 3600.0 s	Motor potentiometer change time.	10 = 1 s / 10 = 1 s
22.76	Motor potentiometer min value	Defines the minimum value of the motor potentiometer.	-1500.00 / real32
	-32768.00 ... 32767.00	Motor potentiometer minimum.	1 = 1 / 100 = 1
22.77	Motor potentiometer max value	Defines the maximum value of the motor potentiometer.	1500.00 / real32
	-32768.00 ... 32767.00	Motor potentiometer maximum.	1 = 1 / 100 = 1
22.80	Motor potentiometer ref act	Displays the output of the motor potentiometer function. (The motor potentiometer is configured using parameters 22.71...22.74.) This parameter is read-only.	- / real32
	-32768.00 ... 32767.00	Value of motor potentiometer.	1 = 1 / 100 = 1
22.81	Speed reference act 1	Displays the value of speed reference source 1 (selected by parameter 22.11 Speed ref1 source). See the control chain diagram on page 778. This parameter is read-only.	- / real32
	-30000.00 ... 30000.00 rpm	Value of reference source 1. For scaling, see parameter 46.1.	- / -
22.82	Speed reference act 2	Displays the value of speed reference source 2 (selected by parameter 22.12 Speed ref2 source). See the control chain diagram on page 778. This parameter is read-only.	- / real32
	-30000.00 ... 30000.00 rpm	Value of reference source 2. For scaling, see parameter 46.1.	- / -

No.	Name / Range / Selection	Description	Def / Type FbEq 16b / 32b
22.83	Speed reference act 3	Displays the value of speed reference after the mathematical function applied by parameter 22.13 Speed ref1 function and reference 1/2 selection (22.14 Speed ref1/2 selection). See the control chain diagram on page 778. This parameter is read-only.	- / real32
	-30000.00 ... 30000.00 rpm	Speed reference after source selection. For scaling, see parameter 46.1.	- / -
22.84	Speed reference act 4	Displays the value of speed reference after application of 1st speed additive (22.15 Speed additive 1 source). See the control chain diagram on page 778. This parameter is read-only.	- / real32
	-30000.00 ... 30000.00 rpm	Speed reference after additive 1. For scaling, see parameter 46.1.	- / -
22.85	Speed reference act 5	Displays the value of speed reference after the application of the speed share scaling factor (22.16 Speed share). See the control chain diagram on page 778. This parameter is read-only.	- / real32
	-30000.00 ... 30000.00 rpm	Speed reference after speed share scaling. For scaling, see parameter 46.1.	- / -
22.86	Speed reference act 6	Displays the value of speed reference after application of 2nd speed additive (22.17 Speed additive 2 source). See the control chain diagram on page 778. This parameter is read-only.	- / real32
	-30000.00 ... 30000.00 rpm	Speed reference after additive 2. For scaling, see parameter 46.1.	- / -
22.87	Speed reference act 7	Displays the value of speed reference before application of critical speeds. See the control chain diagram on page 779. The value is received from 22.86 Speed reference act 6 unless overridden by <ul style="list-style-type: none"> <li>• any constant speed</li> <li>• a jogging reference</li> <li>• network control reference (see Terms and abbreviations (page 22))</li> <li>• control panel reference</li> <li>• safe speed reference.</li> </ul> This parameter is read-only.	- / real32
	-30000.00 ... 30000.00 rpm	Speed reference before application of critical speeds. For scaling, see parameter 46.1.	- / -
22.200	Slowdown reference	Defines the speed reference limit used while the Slowdown function is active (20.200 Slowdown select). This reference is an absolute value, and its polarity is based on the motor direction.	150.00 rpm / real32
	0.00 ... 30000.00 rpm	Slowdown reference limit.	1 = 1 rpm / 1 = 1 rpm

## 374 Parameters

No.	Name / Range / Selection	Description	Def / Type FbEq 16b / 32b
22.202	Emergency control reference	Defines the speed reference limit used while the Emergency control mode is active (20.207 Emergency control enable). This reference is an absolute value, and its polarity is defined by the start commands 20.208 Emergency control forward and 20.209 Emergency control reverse.	375.00 rpm / real32
	0.00 ... 30000.00 rpm	Emergency control reference limit.	1 = 1 rpm / 1 = 1 rpm
22.203	Step reference mode	Selects the source for activating the Step reference mode. 0 = Step reference mode is inactive. 1 = Step reference mode is active. The combination of parameter values 22.204 Step reference select 2 ... 22.206 Step reference select 4 determines which step reference speed is used. For the parameter value combinations, see section Step reference selection (page 93).	False / int32
	False	0.	0
	True	1.	1
	DI1	Digital input DI1 (10.2 DI delayed status, bit 0).	2
	DI2	Digital input DI2 (10.2 DI delayed status, bit 1).	3
	DI3	Digital input DI3 (10.2 DI delayed status, bit 2).	4
	DI4	Digital input DI4 (10.2 DI delayed status, bit 3).	5
	DI5	Digital input DI5 (10.2 DI delayed status, bit 4).	6
	DI6	Digital input DI6 (10.2 DI delayed status, bit 5).	7
	DIO1	Digital input/output DIO1 (11.2 DIO delayed status, bit 0).	8
	DIO2	Digital input/output DIO2 (11.2 DIO delayed status, bit 1).	9
Other [bit]	See Terms and abbreviations (page 221).		
22.204	Step reference select 2	Defines source bit 2 for selecting the step reference. 0 = Source bit 2 is disabled. 1 = Source bit 2 is enabled. See also parameter 22.203 Step reference mode.	False / int32
	False	0.	0
	True	1.	1
	DI1	Digital input DI1 (10.2 DI delayed status, bit 0).	2
	DI2	Digital input DI2 (10.2 DI delayed status, bit 1).	3
	DI3	Digital input DI3 (10.2 DI delayed status, bit 2).	4
	DI4	Digital input DI4 (10.2 DI delayed status, bit 3).	5
	DI5	Digital input DI5 (10.2 DI delayed status, bit 4).	6
	DI6	Digital input DI6 (10.2 DI delayed status, bit 5).	7
DIO1	Digital input/output DIO1 (11.2 DIO delayed status, bit 0).	8	

No.	Name / Range / Selection	Description	Def / Type FbEq 16b / 32b
	DIO2	Digital input/output DIO2 (11.2 DIO delayed status, bit 1).	9
	Other [bit]	See Terms and abbreviations (page 221).	
22.205	Step reference select 3	Defines source bit 3 for selecting the step reference. 0 = Source bit 3 is disabled. 1 = Source bit 3 is enabled. See also parameter 22.203 Step reference mode.	False / int32
	False	0.	0
	True	1.	1
	DI1	Digital input DI1 (10.2 DI delayed status, bit 0).	2
	DI2	Digital input DI2 (10.2 DI delayed status, bit 1).	3
	DI3	Digital input DI3 (10.2 DI delayed status, bit 2).	4
	DI4	Digital input DI4 (10.2 DI delayed status, bit 3).	5
	DI5	Digital input DI5 (10.2 DI delayed status, bit 4).	6
	DI6	Digital input DI6 (10.2 DI delayed status, bit 5).	7
	DIO1	Digital input/output DIO1 (11.2 DIO delayed status, bit 0).	8
	DIO2	Digital input/output DIO2 (11.2 DIO delayed status, bit 1).	9
	Other [bit]	See Terms and abbreviations (page 221).	
22.206	Step reference select 4	Defines source bit 4 for selecting the step reference. 0 = Source bit 4 is disabled. 1 = Source bit 4 is enabled. See also parameter 22.203 Step reference mode.	False / int32
	False	0.	0
	True	1.	1
	DI1	Digital input DI1 (10.2 DI delayed status, bit 0).	2
	DI2	Digital input DI2 (10.2 DI delayed status, bit 1).	3
	DI3	Digital input DI3 (10.2 DI delayed status, bit 2).	4
	DI4	Digital input DI4 (10.2 DI delayed status, bit 3).	5
	DI5	Digital input DI5 (10.2 DI delayed status, bit 4).	6
	DI6	Digital input DI6 (10.2 DI delayed status, bit 5).	7
	DIO1	Digital input/output DIO1 (11.2 DIO delayed status, bit 0).	8
	DIO2	Digital input/output DIO2 (11.2 DIO delayed status, bit 1).	9
	Other [bit]	See Terms and abbreviations (page 221).	
22.207	Step reference 1	Step reference speed 1.	500.00 rpm / real32
	0.00 ... 30000.00 rpm	Step reference speed 1.	1 = 1 rpm / 1 = 1 rpm
22.208	Step reference 2	Defines step reference speed 2.	600.00 rpm / real32

## 376 Parameters

No.	Name / Range / Selection	Description	Def / Type FbEq 16b / 32b
	0.00 ... 30000.00 rpm	Step reference speed 2.	1 = 1 rpm / 1 = 1 rpm
22.209	Step reference 3	Defines step reference speed 3.	700.00 rpm / real32
	0.00 ... 30000.00 rpm	Step reference speed 3.	1 = 1 rpm / 1 = 1 rpm
22.210	Step reference 4	Defines step reference speed 4.	1000.00 rpm / real32
	0.00 ... 30000.00 rpm	Step reference speed 4.	1 = 1 rpm / 1 = 1 rpm
22.211	Speed reference shape	Defines the speed reference shape. See also section Parabolic speed reference (page 95).	Linear / uint16
	Linear	Linear speed reference.	0
	Parabolic 1	X <sub>2</sub> speed reference.	1
	Parabolic 2	X <sub>3</sub> speed reference.	2
22.220	Crane motpot enable	Enables or selects the source to activate the Crane motor potentiometer function. See section Crane motor potentiometer (page 97).	Disable / int32
	Disable	0.	0
	Enable	1.	1
	DI1	Digital input DI1 (10.2 DI delayed status, bit 0).	2
	DI2	Digital input DI2 (10.2 DI delayed status, bit 1).	3
	DI3	Digital input DI3 (10.2 DI delayed status, bit 2).	4
	DI4	Digital input DI4 (10.2 DI delayed status, bit 3).	5
	DI5	Digital input DI5 (10.2 DI delayed status, bit 4).	6
	DI6	Digital input DI6 (10.2 DI delayed status, bit 5).	7
	DIO1	Digital input/output DIO1 (11.2 DIO delayed status, bit 0).	8
	DIO2	Digital input/output DIO2 (11.2 DIO delayed status, bit 1).	9
	Other [bit]	See Terms and abbreviations (page 221).	
22.223	Crane motpot accel sel	Selects the source of Crane motor potentiometer accelerate signal. See section Crane motor potentiometer (page 97).	False / int32
	False	No change.	0
	True	Increases the motor potentiometer value depending on the selected direction. The possible effect can be seen in parameter 22.225 Crane motpot sw, bits 3 and 4.	1
	DI1	Digital input DI1 (10.2 DI delayed status, bit 0).	2
	DI2	Digital input DI2 (10.2 DI delayed status, bit 1).	3
	DI3	Digital input DI3 (10.2 DI delayed status, bit 2).	4
	DI4	Digital input DI4 (10.2 DI delayed status, bit 3).	5



No.	Name / Range / Selection	Description	Def / Type FbEq 16b / 32b
	DI5	Digital input DI5 (10.2 DI delayed status, bit 4).	6
	DI6	Digital input DI6 (10.2 DI delayed status, bit 5).	7
	DIO1	Digital input/output DIO1 (11.2 DIO delayed status, bit 0).	8
	DIO2	Digital input/output DIO2 (11.2 DIO delayed status, bit 1).	9
	Other [bit]	See Terms and abbreviations (page 221).	
22.224	Crane motpot min speed	Defines an initial value (starting point) for the motor potentiometer at start. See section Crane motor potentiometer (page 97).	0.00 rpm / real32
	0.00 ... 32000.00 rpm	Minimum speed.	1 = 1 rpm / 1 = 1 rpm
22.225	Crane motpot sw	Crane motor potentiometer status word.	- / uint16
	b0 Motpot enabled	Status of the Crane motor potentiometer function. 1 = Crane motor potentiometer enabled. 0 = Crane motor potentiometer disabled.	
	b1 Reserved		
	b2 Reserved_		
	b3 Motpot up source	Used as source for four inputs of the motor potentiometer to increase the output value. 1 = Crane motor potentiometer with increased output reference. 0 = Crane motor potentiometer without increased output reference.	
	b4 Motpot dn source	Used as source for four inputs of the motor potentiometer to decrease the output value. 1 = Crane motor potentiometer with decreased output reference. 0 = Crane motor potentiometer without decreased output reference	
	b5...15 Reserved		
	0000h...FFFFh		1 = 1
22.226	Crane motpot min value	Defines an minimum value of the Crane motor potentiometer.	-1500.00 rpm / real32
	-32768.00 ... 32767.00 rpm	Minimum value.	1 = 1 rpm / 1 = 1 rpm
22.227	Crane motpot max value	Defines the maximum value of Crane motor potentiometer.	1500.00 rpm / real32
	-32768.00 ... 32767.00 rpm	Maximum value.	1 = 1 rpm / 1 = 1 rpm

### 378 Parameters

No.	Name / Range / Selection	Description	Def / Type FbEq 16b / 32b
23	<b>Speed reference ramp</b>	Speed reference ramp settings (programming of the acceleration and deceleration rates for the drive). See the control chain diagram on page 780.	
23.1	Speed ref ramp input	Displays the used speed reference (in rpm) before it enters the ramping and shaping functions. See the control chain diagram on page 780. This parameter is read-only.	- / real32
	-30000.00 ... 30000.00 rpm	Speed reference before ramping and shaping. For scaling, see parameter 46.1.	- / -
23.2	Speed ref ramp output	Displays the ramped and shaped speed reference in rpm. See the control chain diagram on page 780. This parameter is read-only.	- / real32
	-30000.00 ... 30000.00 rpm	Speed reference after ramping and shaping. For scaling, see parameter 46.1.	- / -

No.	Name / Range / Selection	Description	Def / Type FbEq 16b / 32b
-----	--------------------------	-------------	------------------------------

23.16	Shape time acc 1	<p>Defines the shape of the acceleration ramp at the beginning of the acceleration.</p> <p>0.000 s: Linear ramp. Suitable for steady acceleration or deceleration and for slow ramps.</p> <p>0.001...1000.000 s: S-curve ramp. S-curve ramps are ideal for lifting applications. The S-curve consists of symmetrical curves at both ends of the ramp and a linear part in between.</p>	- / real32
-------	------------------	--	------------

**Note:** For safety reasons, shape times are not applied to emergency stop ramps.

**Acceleration:**

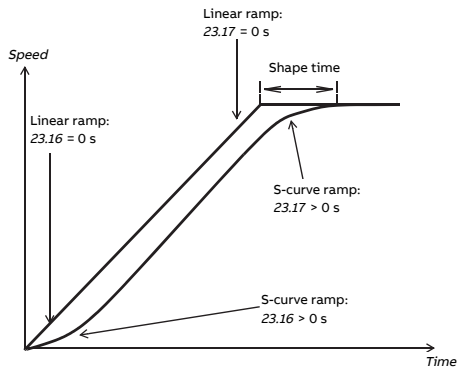

**Deceleration:**

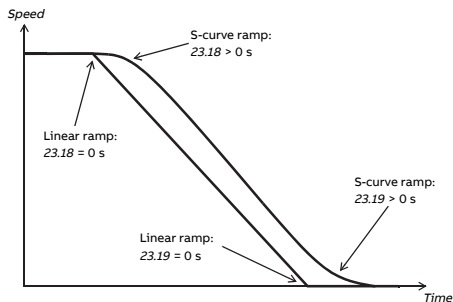

0.000 ... 1800.000 s	Ramp shape at start of acceleration.	10 = 1 s / 1000 = 1 s
23.17	Shape time acc 2	0.000 s / real32
0.000 ... 1800.000 s	Ramp shape at end of acceleration.	10 = 1 s / 1000 = 1 s

## 380 Parameters

No.	Name / Range / Selection	Description	Def / Type FbEq 16b / 32b
23.18	Shape time dec 1	Defines the shape of the deceleration ramp at the beginning of the deceleration. See parameter 23.16 Shape time acc 1.	0.000 s / real32
	0.000 ... 1800.000 s	Ramp shape at start of deceleration.	10 = 1 s / 1000 = 1 s
23.19	Shape time dec 2	Defines the shape of the deceleration ramp at the end of the deceleration. See parameter 23.16 Shape time acc 1.	0.000 s / real32
	0.000 ... 1800.000 s	Ramp shape at end of deceleration.	10 = 1 s / 1000 = 1 s
23.23	Emergency stop time	In speed control mode, this parameter defines the deceleration rate for emergency stop Off3 as the time it would take for the speed to decrease from the value of parameter 46.1 Speed scaling. This also applies to torque control because the drive switches to speed control on receiving an emergency stop Off3 command.	3.000 s / real32
	0.000 ... 1800.000 s	Emergency stop Off3 deceleration time.	10 = 1 s / 1000 = 1 s
23.24	Speed ramp in zero source	Selects a source that forces the speed reference to zero just before it enters the ramp function. 0 = Force speed reference to zero before the ramp function 1 = Speed reference continues towards the ramp function as normal	Inactive / uint32
	Active	0.	0
	Inactive	1.	1
	DI1	Digital input DI1 (10.2 DI delayed status, bit 0).	2
	DI2	Digital input DI2 (10.2 DI delayed status, bit 1).	3
	DI3	Digital input DI3 (10.2 DI delayed status, bit 2).	4
	DI4	Digital input DI4 (10.2 DI delayed status, bit 3).	5
	DI5	Digital input DI5 (10.2 DI delayed status, bit 4).	6
	DI6	Digital input DI6 (10.2 DI delayed status, bit 5).	7
	DIO1	Digital input/output DIO1 (11.2 DIO delayed status, bit 0).	10
	DIO2	Digital input/output DIO2 (11.2 DIO delayed status, bit 1).	11
Other [bit]	See Terms and abbreviations (page 221).		
23.26	Ramp out balancing enable	Selects the source for enabling/disabling speed reference ramp balancing. This function is used to generate a smooth transfer from a torque- or tension-controlled motor back to being speed-controlled. The balancing output would be tracking the present "line" speed of the application and when transfer is required, the speed reference can then be quickly "seeded" to the correct line speed. See also parameter 23.27 Ramp out balancing ref. 0 = Disabled 1 = Enabled	Not selected / uint32
	Not selected	0	0

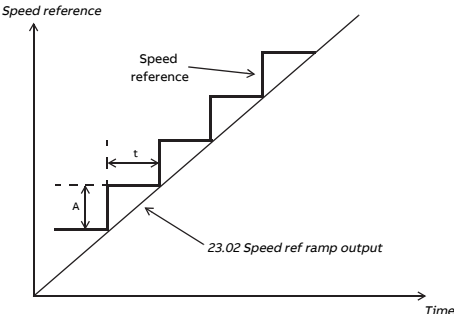
No.	Name / Range / Selection	Description	Def / Type FbEq 16b / 32b
	Selected	1	1
	DI1	Digital input DI1 (10.2 DI delayed status, bit 0).	2
	DI2	Digital input DI2 (10.2 DI delayed status, bit 1).	3
	DI3	Digital input DI3 (10.2 DI delayed status, bit 2).	4
	DI4	Digital input DI4 (10.2 DI delayed status, bit 3).	5
	DI5	Digital input DI5 (10.2 DI delayed status, bit 4).	6
	DI6	Digital input DI6 (10.2 DI delayed status, bit 5).	7
	DIO1	Digital input/output DIO1 (11.2 DIO delayed status, bit 0).	10
	DIO2	Digital input/output DIO2 (11.2 DIO delayed status, bit 1).	11
	Other [bit]	See Terms and abbreviations (page 221).	
23.27	Ramp out balancing ref	Defines the reference for speed ramp balancing. The output of the ramp generator is forced to this value when balancing is enabled by parameter 23.26 Ramp out balancing enable.	- / real32
	-30000.00 ... 30000.00 rpm	Speed ramp balancing reference. For scaling, see parameter 46.1.	- / -
23.28	Variable slope enable	<p>Activates the variable slope function, which controls the slope of the speed ramp during a speed reference change. This allows for a constantly variable ramp rate to be generated, instead of just the standard two ramps normally available.</p> <p>If the update interval of the signal from an external control system and the variable slope rate (23.29 Variable slope rate) are equal, the resulting speed reference (23.2 Speed ref ramp output) is a straight line.</p>  <p><math>t</math> = update interval of signal from external control system  <math>A</math> = speed reference change during <math>t</math>  This function is only active in remote control.</p>	Off / uint32
	Off	Variable slope disabled.	0

## 382 Parameters

No.	Name / Range / Selection	Description	Def / Type FbEq 16b / 32b
	On	Variable slope enabled (not available in local control).	1
	Other [bit]	See <a href="#">Terms and abbreviations (page 221)</a> .	
23.29	Variable slope rate	Defines the rate of the speed reference change when variable slope is enabled by parameter 23.28 Variable slope enable. For the best result, enter the reference update interval into this parameter.	50 ms / real32
	2...30000 ms	Variable slope rate.	1 = 1 ms / 1 = 1 ms
23.39	Follower speed correction out	Displays the speed correction term for the load share function with a speed-controlled follower drive. See section <a href="#">Load share function with a speed-controlled follower (page 161)</a> . This parameter is read-only.	- / real32
	-30000.00 ... 30000.00 rpm	Speed correction term. For scaling, see parameter 46.1.	- / -
23.40	Follower speed correction enable	With a speed-controlled follower, selects the source for enabling/disabling the load share function. See section <a href="#">Load share function with a speed-controlled follower (page 161)</a> . 0 = Disabled 1 = Enabled	Not selected / uint32
	Not selected	0	0
	Selected	1	1
	DI1	Digital input DI1 (10.2 DI delayed status, bit 0).	2
	DI2	Digital input DI2 (10.2 DI delayed status, bit 1).	3
	DI3	Digital input DI3 (10.2 DI delayed status, bit 2).	4
	DI4	Digital input DI4 (10.2 DI delayed status, bit 3).	5
	DI5	Digital input DI5 (10.2 DI delayed status, bit 4).	6
	DI6	Digital input DI6 (10.2 DI delayed status, bit 5).	7
	DIO1	Digital input/output DIO1 (11.2 DIO delayed status, bit 0).	10
	DIO2	Digital input/output DIO2 (11.2 DIO delayed status, bit 1).	11
	Other [bit]	See <a href="#">Terms and abbreviations (page 221)</a> .	
23.41	Follower speed correction gain	Adjusts the gain of the speed correction term in a speed-controlled follower. In effect, defines how accurately the follower follows the master torque. A greater value results in a more accurate performance. See section <a href="#">Load share function with a speed-controlled follower (page 161)</a> .	1.00 % / real32
	0.00 ... 100.00 %	Speed correction term adjustment.	1 = 1 % / 100 = 1 %
23.42	Follower speed corr torq source	Selects the source of the torque reference for the load share function. See section <a href="#">Load share function with a speed-controlled follower (page 161)</a> .	MF ref 2 / uint32
	NULL	None.	0

No.	Name / Range / Selection	Description	Def / Type FbEq 16b / 32b
	MF ref 2	3.14 M/F or D2D ref2 (page 232).	1
	Other [value]	See Terms and abbreviations (page 221).	
23.200	Crane ramp set selection	Selects the source that switches between the two sets of acceleration/deceleration times defined by parameters 23.201 Crane acc time 1...23.204 Crane dec time 2.	Acc/Dec 1 / int32
	Acc/Dec 1	Acceleration time 1 and deceleration time 1 are in force.	0
	Acc/Dec 2	Acceleration time 2 and deceleration time 2 are in force.	1
	Acc/Dec Direction	Acceleration time 1 and deceleration time 1 are in force in the forward direction, and acceleration time 2 and deceleration time 2 are in force in the reverse direction.	2
	DI1	Digital input DI1 (10.2 DI delayed status, bit 0).	3
	DI2	Digital input DI2 (10.2 DI delayed status, bit 1).	4
	DI3	Digital input DI3 (10.2 DI delayed status, bit 2).	5
	DI4	Digital input DI4 (10.2 DI delayed status, bit 3).	6
	DI5	Digital input DI5 (10.2 DI delayed status, bit 4).	7
	DI6	Digital input DI6 (10.2 DI delayed status, bit 5).	8
	DIO1	Digital input/output DIO1 (11.2 DIO delayed status, bit 0).	9
	DIO2	Digital input/output DIO2 (11.2 DIO delayed status, bit 1).	10
	Other [bit]	See Terms and abbreviations (page 221).	
23.201	Crane acc time 1	Defines acceleration time 1 as the time required for the speed to change from zero to the speed defined by parameter 46.1 Speed scaling (not to parameter 30.12 Maximum speed). The following actions happen according to the changes in the speed reference or related parameters: <ul style="list-style-type: none"> <li>• If the speed reference increases faster than the set acceleration rate, acceleration rate, the motor speed follows the</li> <li>• If the speed reference increases slower than the set acceleration rate, the motor speed follows the reference.</li> <li>• If the acceleration time is set too short, the drive automatically prolongs the acceleration not to exceed the drive torque limits.</li> </ul>	3.00 s / real32
	0.00 ... 1800.00 s	Acceleration time 1.	10 = 1 s / 1 = 1 s

## 384 Parameters

No.	Name / Range / Selection	Description	Def / Type FbEq 16b / 32b
23.202	Crane dec time 1	<p>Defines deceleration time 1 as the time required for the speed to change from the speed defined by parameter 46.1 <i>Speed scaling</i> (not from parameter 30.12 <i>Maximum speed</i>) to zero. The following actions happen according to the changes in the speed reference or related parameters:</p> <ul style="list-style-type: none"> <li>• If the speed reference decreases slower than the set deceleration rate, the motor speed follows the reference.</li> <li>• If the reference changes faster than the set deceleration rate, the motor speed follows the deceleration rate.</li> <li>• If the deceleration rate is set too short, the drive automatically prolongs the deceleration not to exceed the drive torque limits. To confirm that deceleration rate is not too short, make sure that DC overvoltage control is enabled with parameter 30.30 <i>Overvoltage control</i>.</li> </ul>	3.00 s / real32
	0.00 ... 1800.00 s	Deceleration time 1.	10 = 1 s / 1 = 1 s
23.203	Crane acc time 2	Defines acceleration time 2. See parameter 23.201 <i>Crane acc time 1</i> (page 383).	3.00 s / real32
	0.00 ... 1800.00 s	Acceleration time 2.	10 = 1 s / 1 = 1 s
23.204	Crane dec time 2	Defines deceleration time 1. See parameter 23.202 <i>Crane dec time 1</i> (page 384).	3.00 s / real32
	0.00 ... 1800.00 s	Deceleration time 2.	10 = 1 s / 1 = 1 s
23.206	Fast stop deceleration time	Defines the time within which the drive stops if the drive receives a Fast stop command (20.210 <i>Fast stop input</i> ).	0.50 s / real32
	0.00 ... 3000.00 s	Fast stop deceleration time.	10 = 1 s / 1 = 1 s
23.210	Reverse plug sel	<p>Selects the source for activating the reverse plug function.</p> <p>See also description in section <i>Reverse plug</i> (page 107).</p>	No / int32
	No	Reverse plug function is not activated.	0
	Select	Reverse plug function is activated.	1
	DI1	Digital input DI1 (10.2 <i>DI delayed status</i> , bit 0).	2
	DI2	Digital input DI2 (10.2 <i>DI delayed status</i> , bit 1).	3
	DI3	Digital input DI3 (10.2 <i>DI delayed status</i> , bit 2).	4
	DI4	Digital input DI4 (10.2 <i>DI delayed status</i> , bit 3).	5
	DI5	Digital input DI5 (10.2 <i>DI delayed status</i> , bit 4).	6
	DI6	Digital input DI6 (10.2 <i>DI delayed status</i> , bit 5).	7
	DIO1	Digital input/output DIO1 (11.2 <i>DIO delayed status</i> , bit 0).	8
	DIO2	Digital input/output DIO2 (11.2 <i>DIO delayed status</i> , bit 1).	9



<b>No.</b>	<b>Name / Range / Selection</b>	<b>Description</b>	<b>Def / Type FbEq 16b / 32b</b>
	Other [bit]	See Terms and abbreviations (page 221).	
23.211	Reverse plug acc time 1	Defines acceleration time 1 during reverse plug. See 23.200 Crane ramp set selection parameter settings.	3.00 s / real32
	0.00 ... 1800.00 s	Acceleration time 1.	10 = 1 s / 1 = 1 s
23.212	Reverse plug dec time 1	Defines deceleration time 1 during reverse plug. See 23.200 Crane ramp set selection parameter settings.	3.00 s / real32
	0.00 ... 1800.00 s	Deceleration time 1.	10 = 1 s / 1 = 1 s
23.213	Reverse plug acc time 2	Defines acceleration time 2 during reverse plug. See 23.200 Crane ramp set selection parameter settings.	3.00 s / real32
	0.00 ... 1800.00 s	Acceleration time 2.	10 = 1 s / 1 = 1 s
23.214	Reverse plug dec time 2	Defines deceleration time 1 during reverse plug. See 23.200 Crane ramp set selection parameter settings.	3.00 s / real32
	0.00 ... 1800.00 s	Reverse plug deceleration time 2.	10 = 1 s / 1 = 1 s

## 386 Parameters

No.	Name / Range / Selection	Description	Def / Type FbEq 16b / 32b
<b>24</b>	<b>Speed reference conditioning</b>	Speed error calculation; speed error window control configuration; speed error step. See the control chain diagrams on pages 784 and 785.	
24.1	Used speed reference	Displays the ramped and corrected speed reference (before speed error calculation). See the control chain diagram on page 784. This parameter is read-only.	- / real32
	-30000.00 ... 30000.00 rpm	Speed reference used for speed error calculation. For scaling, see parameter 46.1.	- / -
24.2	Used speed feedback	Displays the speed feedback used for speed error calculation. See the control chain diagram on page 784. This parameter is read-only.	- / real32
	-30000.00 ... 30000.00 rpm	Speed feedback used for speed error calculation. For scaling, see parameter 46.1.	- / -
24.3	Speed error filtered	Displays the filtered speed error. See the control chain diagram on page 784. This parameter is read-only.	0.00 rpm / real32
	-30000.00 ... 30000.00 rpm	Filtered speed error. For scaling, see parameter 46.1.	- / -
24.4	Speed error inverted	Displays the inverted (unfiltered) speed error. See the control chain diagram on page 784. This parameter is read-only	0.00 rpm / real32
	-30000.00 ... 30000.00 rpm	Inverted speed error. For scaling, see parameter 46.1.	- / -
24.12	Speed error filter time	Defines the time constant of the speed error low-pass filter. If the used speed reference changes rapidly, the possible interferences in the speed measurement can be filtered with the speed error filter. Reducing the ripple with this filter may cause speed controller tuning problems. A long filter time constant and fast acceleration time contradict one another. A very long filter time results in unstable control.	0 ms / real32
	0...10000 ms	Speed error filtering time constant. 0 = filtering disabled.	1 = 1 ms / 1 = 1 ms

No.	Name / Range / Selection	Description	Def / Type FbEq 16b / 32b
24.13	RFE speed filter	<p>Enables/disables resonance frequency filtering. The filtering is configured by parameters 24.13...24.17. The speed error value coming to the speed controller is filtered by a common 2nd order band-elimination filter to eliminate the amplification of mechanical resonance frequencies.</p> <p><b>Note:</b> Tuning the resonance frequency filter requires a basic understanding of frequency filters. Incorrect tuning can amplify mechanical oscillations and damage the drive hardware. To ensure the stability of the speed controller, stop the drive or disable the filtering before changing the parameter settings.</p> <p>0 = Resonance frequency filtering disabled. 1 = Resonance frequency filtering enabled.</p>	Off / uint16
	On	1.	1
	Off	0.	0
24.14	Frequency of zero	<p>Defines the zero frequency of the resonance frequency filter.</p> <p>The value must be set near the resonance frequency, which is filtered out before the speed controller. The drawing shows the frequency response.</p>	45.00 Hz / real32
	0.50 ... 500.00 Hz	Zero frequency.	1 = 1 Hz / 100 = 1 Hz

# 388 Parameters

No.	Name / Range / Selection	Description	Def / Type FbEq 16b / 32b
24.15	Damping of zero	Defines the damping coefficient for parameter 24.14. The value of 0 corresponds to the maximum elimination of the resonance frequency.	0.000 / real32

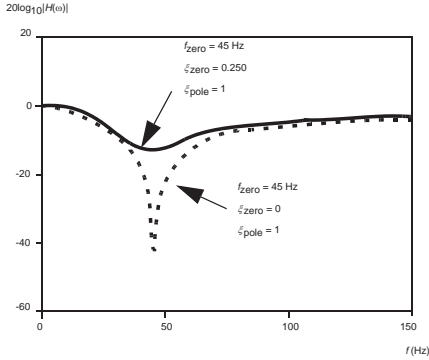

**Note:** To ensure that the resonance frequency band is filtered (rather than amplified), the value of 24.15 must be smaller than 24.17.

-1.000 ... 1.000	Damping coefficient.	100 = 1 / 1000 = 1	
24.16	Frequency of pole	Defines the frequency of pole of the resonance frequency filter.	40.00 Hz / real32

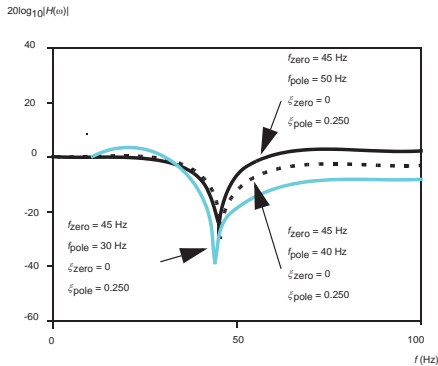

**Note:** If this value is very different from the value of 24.14, the frequencies near the frequency of pole are amplified, which can damage the driven machine.

0.50 ... 500.00 Hz	Frequency of pole.	1 = 1 Hz / 100 = 1 Hz
--------------------	--------------------	-----------------------

No.	Name / Range / Selection	Description	Def / Type
24.17	Damping of pole	Defines the damping coefficient for parameter 24.16. The coefficient shapes the frequency response of the resonance frequency filter. A narrower bandwidth results in better dynamic properties. By setting this parameter to 1, the effect of the pole is eliminated.	0.250 / real32

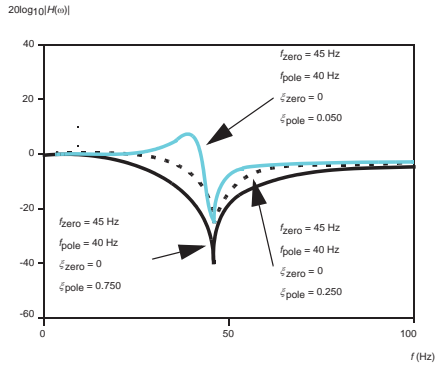

**Note:** To ensure that the resonance frequency band is filtered (rather than amplified), the value of 24.15 must be smaller than 24.17.

-1.000 ... 1.000	Damping coefficient.	100 = 1 / 1000 = 1
------------------	----------------------	--------------------

## 390 Parameters

---

<b>No.</b>	<b>Name / Range / Selection</b>	<b>Description</b>	<b>Def / Type FbEq 16b / 32b</b>
24.41	Speed error window control enable		Disable / uint32

---

No.	Name / Range / Selection	Description	Def / Type FbEq 16b / 32b
		<p>Enables/disables (or selects a source that enables/disables) speed error window control, sometimes also referred to as deadband control or strip break protection. It forms a speed supervision function for a torque-controlled drive, preventing the motor from running away if the material that is being held under tension breaks.</p> <p><b>Note:</b> Speed error window control is only effective when the <b>Add</b> operating mode is active (see parameters 19.12 and 19.14), or when the drive is a speed-controlled follower (see page 161).</p> <p>In normal operation, window control keeps the speed controller input at zero so the drive stays in torque control.</p> <p>If the motor load is lost, then the motor speed will rise as the torque controller tries to maintain torque. The speed error (speed reference - actual speed) will increase until it exits the speed error window. When this is detected, the exceeding part of the error value is connected to the speed controller. The speed controller produces a reference term relative to the input and gain (25.2 Speed proportional gain) which the torque selector adds to the torque reference. The result is used as the internal torque reference for the drive.</p> <p>The activation of speed error window control is indicated by bit 3 of 6.19 Speed control status word. The window boundaries are defined by 24.43 Speed error window high and 24.44 Speed error window low as follows:</p>	

No.	Name / Range / Selection	Description	Def / Type FbEq 16b / 32b
-----	--------------------------	-------------	------------------------------

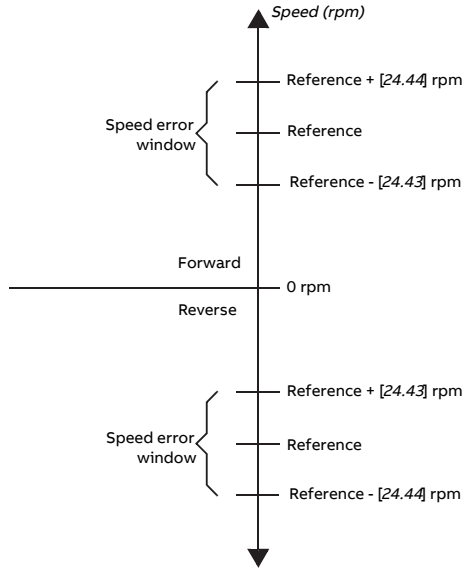

Note that it is parameter 24.44 (rather than 24.43) that defines the overspeed limit in both directions of rotation. This is because the function monitors speed error (which is negative in case of overspeed, positive in case of underspeed).





**WARNING!**

In a speed-controlled follower, the speed error window must not exceed 21.6 Zero speed limit for a reliable ramp stop. Make sure both 24.43 and 24.44 are smaller than 21.6 (or speed error window control disabled) when a ramp stop is required.

0 = Speed error window control disabled  
 1 = Speed error window control enabled

	Disable	0.	0
	Enable	1.	1
	Other [bit]	See Terms and abbreviations (page 221).	
24.42	Speed window control mode	When speed error window control (see parameter 24.41 Speed error window control enable) is enabled, this parameter determines whether the speed controller only observes the proportional term instead of all three (P, I and D) terms.	Normal speed control / uint16



No.	Name / Range / Selection	Description	Def / Type FbEq 16b / 32b
	Normal speed control	All three terms (parameters 25.2, 25.3 and 25.4) are observed by the speed controller.	0
	P-control	Only the proportional term (25.2) is observed by the speed controller. The integral and derivative terms are internally forced to zero.	1
24.43	Speed error window high	Defines the upper boundary of the speed error window. See parameter 24.41 Speed error window control enable.	0.00 rpm / real32
	0.00 ... 3000.00 rpm	Upper boundary of speed error window. For scaling, see parameter 46.1.	- / -
24.44	Speed error window low	Defines the lower boundary of the speed error window. See parameter 24.41 Speed error window control enable.	0.00 rpm / real32
	0.00 ... 3000.00 rpm	Lower boundary of speed error window. For scaling, see parameter 46.1.	- / -
24.46	Speed error step	Defines an additional speed error step given to the input of the speed controller (and added to the speed error value). This can be used in large drive systems for dynamic speed normalizing.	0.00 rpm / real32
		 <b>WARNING!</b> Make sure the error step value is removed when a stop command is given.	
	-3000.00 ... 3000.00 rpm	Speed error step. For scaling, see parameter 46.1.	- / -
24.200	Speed correction	<i>(Visible only after entering access level pass code 584. See parameter 96.2 Pass code.)</i> Defines a speed reference correction, i.e. a value added to the existing reference between ramping and limitation. This is useful to trim the speed if necessary, for example to adjust draw between sections of a paper machine.  <b>Note:</b> For safety reasons, the correction is not applied when an emergency stop is active.	0.00 rpm / real32
		 <b>WARNING!</b> If the speed reference correction exceeds 21.6 Zero speed limit, a ramp stop may be impossible. Make sure the correction is reduced or removed when a ramp stop is required.	
	-30000.00 ... 30000.00 rpm	Speed reference correction.	1 = 1 rpm / 1 = 1 rpm

## 394 Parameters

No.	Name / Range / Selection	Description	Def / Type FbEq 16b / 32b
25	<b>Speed control</b>	Speed controller settings. See the control chain diagrams on pages 784 and 785.	
25.1	Torque reference speed control	Displays the speed controller output that is transferred to the torque controller. See the control chain diagram on page 785. This parameter is read-only.	- / real32
		-1600.0 ... 1600.0 % Limited speed controller output torque. For scaling, see parameter 46.3.	- / -
25.2	Speed proportional gain	Defines the proportional gain ( $K_p$ ) of the speed controller. Too high a gain may cause speed oscillation. The figure below shows the speed controller output after an error step when the error remains constant.	10.00; 5.00 (95.21 b1/b2) / real32

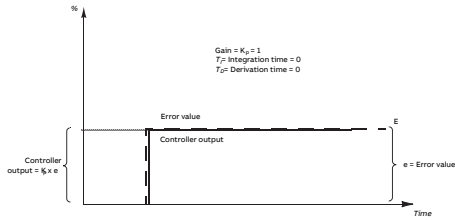

If gain is set to 1.00, a 10% error (reference - actual value) in the motor synchronous speed produces a proportional term of 10%.

**Note:** This parameter is automatically set by the speed controller autotune function. See section [Speed controller autotune](#) (page 171).

0.00 ... 250.00

Proportional gain for speed controller.

100 = 1 / 100 = 1

No.	Name / Range / Selection	Description	Def / Type FbEq 16b / 32b
25.3	Speed integration time	<p>Defines the integration time of the speed controller. The integration time defines the rate at which the controller output changes when the error value is constant and the proportional gain of the speed controller is 1. The shorter the integration time, the faster the continuous error value is corrected. Setting the integration time to zero disables the I-part of the controller. This is useful to do when tuning the proportional gain; adjust the proportional gain first, then return the integration time.</p> <p>The integrator has anti-windup control for operation at a torque or current limit.</p> <p>The figure below shows the speed controller output after an error step when the error remains constant.</p>	2.50; 5.00 s (95.21 b1/b2) s / real32

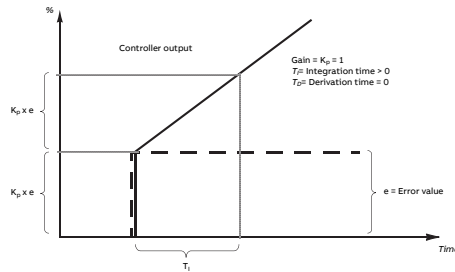

**Note:** This parameter is automatically set by the speed controller autotune function. See section [Speed controller autotune](#) (page 171).

0.00 ... 1000.00 s	Integration time for speed controller.	10 = 1 s / 100 = 1 s
--------------------	--	----------------------

### 396 Parameters

No.	Name / Range / Selection	Description	Def / Type FbEq 16b / 32b
25.4	Speed derivation time	<p>Defines the derivation time of the speed controller. Derivative action boosts the controller output if the error value changes.</p> <p>The longer the derivation time, the more the speed controller output is boosted during the change. If the derivation time is set to zero, the controller works as a PI controller, otherwise as a PID controller. The derivation makes the control more responsive for disturbances. For simple applications (especially those without an encoder), derivative time is not normally required and should be left at zero.</p> <p>The figure below shows the speed controller output after an error step when the error remains constant. The speed error derivative must be filtered with a low pass filter to eliminate external disturbances.</p>	0.000 s / real32
<p>Gain = <math>K_p = 1</math>  <math>T_i</math> = Integration time &gt; 0  <math>T_D</math> = Derivation time &gt; 0  <math>T_s</math> = Sample time period = 500 <math>\mu</math>s  <math>\Delta e</math> = Error value change between two samples</p>			
0.000 ... 10.000 s	Derivation time for speed controller.	1000 = 1 s / 1000 = 1 s	
25.5	Derivation filter time	Defines the derivation filter time constant. See parameter 25.4 Speed derivation time.	8 ms / real32
0...10000 ms	Derivation filter time constant.	1 = 1 ms / 1 = 1 ms	

No.	Name / Range / Selection	Description	Def / Type FbEq 16b / 32b
-----	--------------------------	-------------	------------------------------

25.6	Acc comp derivation time	Defines the derivation time for acceleration(/deceleration) compensation. In order to compensate for a high inertia load during acceleration, a derivative of the reference is added to the output of the speed controller. The principle of a derivative action is described under parameter 25.4 Speed derivation time.	- / real32
------	--------------------------	---	------------

**Note:** As a general rule, set this parameter to the value between 50 and 100% of the sum of the mechanical time constants of the motor and the driven machine.

The figure below shows the speed responses when a high inertia load is accelerated along a ramp.

**No acceleration compensation:**

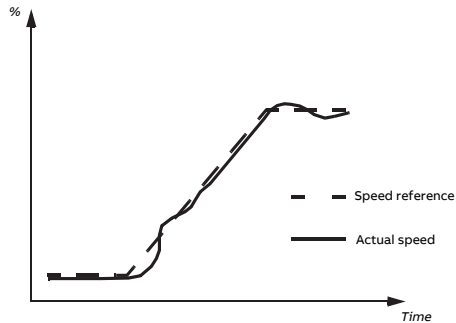

**Acceleration compensation:**

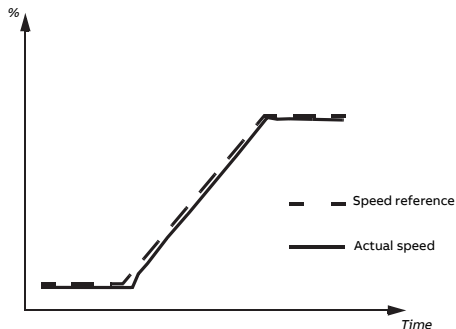

	0.00 ... 1000.00 s	Acceleration compensation derivation time.	10 = 1 s / 100 = 1 s
25.7	Acc comp filter time	Defines the acceleration (or deceleration) compensation filter time constant. See parameters 25.4 Speed derivation time and 25.6 Acc comp derivation time.	8.0 ms / real32
	0.0 ... 1000.0 ms	Acceleration/deceleration compensation filter time.	1 = 1 ms / 10 = 1 ms

398 Parameters

No.	Name / Range / Selection	Description	Def / Type FbEq 16b / 32b
25.8	Drooping rate	<p>Defines the droop rate in percent of the nominal motor speed.</p> <p>Drooping decreases the drive speed slightly as the drive load increases. The actual speed decrease at a certain operating point depends on the droop rate setting and the drive load (= torque reference / speed controller output). At 100 % speed controller output, drooping is at its nominal level, i.e. equal to the value of this parameter. The drooping effect decreases linearly to zero along with the decreasing load.</p> <p>The droop rate can be used e.g. to adjust the load sharing in a Master/Follower application run by several drives. In a Master/Follower application the motor shafts are coupled to each other.</p> <p>The correct droop rate for a process must be found out case by case in practice.</p> <p><b>Speed decrease</b> = Speed controller output × Drooping × Nominal speed</p> <p><b>Example:</b> Speed controller output is 50 %, droop rate is 1 %, nominal speed of the drive is 1500 rpm. Speed decrease = 0.50 × 0.01 × 1500 rpm = 7.5 rpm.</p>	- / real32
	0.00 ... 100.00 %	Droop rate.	100 = 1 % / 100 = 1 %
25.11	Speed control min torque	<p>Defines the minimum speed controller output torque.</p> <p>-1600.0 ... 0.0 %</p> <p>Minimum speed controller output torque. For scaling, see parameter 46.3.</p>	-300.0 % / real32
25.12	Speed control max torque	<p>Defines the maximum speed controller output torque.</p> <p>0.0 ... 1600.0 %</p> <p>Maximum speed controller output torque. For scaling, see parameter 46.3.</p>	300.0 % / real32
25.13	Min torq sp ctrl em stop	<p>Defines the minimum speed controller output torque during a ramped emergency stop (Off1 or Off3).</p> <p>-1600.0 ... 0.0 %</p> <p>Minimum speed controller output torque for ramped emergency stop. For scaling, see parameter 46.3.</p>	-400.0 % / real32
25.14	Max torq sp ctrl em stop	<p>Defines the maximum speed controller output torque during a ramped emergency stop (Off1 or Off3).</p> <p>0.0 ... 1600.0 %</p> <p>Maximum speed controller output torque for ramped emergency stop. For scaling, see parameter 46.3.</p>	400.0 % / real32

No.	Name / Range / Selection	Description	Def / Type FbEq 16b / 32b
25.15	Proportional gain em stop	Defines the proportional gain for the speed controller when an emergency stop is active. See parameter 25.2 Speed proportional gain.	10.00; 5.00 (95.21 b1/b2) / real32
	1.00 ... 250.00	Proportional gain upon an emergency stop.	- / -
25.18	Speed adapt min limit	<p>Minimum actual speed for speed controller adaptation. Speed controller gain and integration time can be adapted according to actual speed (90.1 Motor speed for control).</p> <p>This is done by multiplying the gain (25.2 Speed proportional gain) and integration time (25.3 Speed integration time) by coefficients at certain speeds. The coefficients are defined individually for both gain and integration time.</p> <p>When actual speed is below or equal to 25.18 Speed adapt min limit, the gain is multiplied by 25.21 Kp adapt coef at min speed, and the integration time divided by 25.22 Ti adapt coef at min speed.</p> <p>When actual speed is equal to or above 25.19 Speed adapt max limit, no adaptation takes place (the coefficient is 1).</p> <p>When actual speed is between 25.18 Speed adapt min limit and 25.19 Speed adapt max limit, the coefficients for the gain and integration time are calculated linearly on the basis of the breakpoints.</p> <p>See also the block diagram on page 785.</p>	- / real32
	0...30000 rpm	Minimum actual speed for speed controller adaptation.	1 = 1 rpm / 1 = 1 rpm
25.19	Speed adapt max limit	Maximum actual speed for speed controller adaptation. See parameter 25.18 Speed adapt min limit.	- / real32
	0...30000 rpm	Maximum actual speed for speed controller adaptation.	1 = 1 rpm / 1 = 1 rpm
25.21	Kp adapt coef at min speed	Proportional gain coefficient at minimum actual speed. See parameter 25.18 Speed adapt min limit.	1.000 / real32
	0.000 ... 10.000	Proportional gain coefficient at minimum actual speed.	1000 = 1 / 1000 = 1
25.22	Ti adapt coef at min speed	Integration time coefficient at minimum actual speed. See parameter 25.18 Speed adapt min limit.	1.000 / real32
	0.000 ... 10.000	Integration time coefficient at minimum actual speed.	1000 = 1 / 1000 = 1

# 400 Parameters

No.	Name / Range / Selection	Description	Def / Type FbEq 16b / 32b
25.25	Torque adapt max limit	<p>Maximum torque reference for speed controller adaptation.</p> <p>Speed controller gain can be adapted according to the final unlimited torque reference (26.1 Torque reference to TC).</p> <p>This can be used to smooth out disturbances caused by a small load and backlashes.</p> <p>The functionality involves multiplying the gain (25.2 Speed proportional gain) by a coefficient within a certain torque range.</p> <p>When the torque reference is 0%, the gain is multiplied by the value of parameter 25.27 Kp adapt coef at min torque.</p> <p>When the torque reference is equal to or above 25.25 Torque adapt max limit, no adaptation takes place (the coefficient is 1).</p> <p>Between 0% and 25.25 Torque adapt max limit, the coefficient for the gain is calculated linearly on the basis of the breakpoints.</p> <p>Filtering can be applied on the torque reference using parameter 25.26 Torque adapt filt time.</p> <p>See also the block diagram on page 785.</p> <div data-bbox="342 715 792 983" data-label="Figure"> <p>The graph plots the 'Coefficient for k (proportional gain)' on the y-axis against the 'Final torque referenc (26.02) (rpm)' on the x-axis. The y-axis has tick marks at 25.27 and 1.000. The x-axis has tick marks at 0 and 25.25. A line starts at (0, 25.27) and rises linearly to (25.25, 1.000). From x = 25.25 onwards, the line is horizontal at y = 1.000.</p> </div>	- / real32
	0.0 ... 1600.0 %	Maximum torque reference for speed controller adaptation. For scaling, see parameter 46.3.	- / -
25.26	Torque adapt filt time	<p>Defines a filter time constant for the adaptation, in effect adjusting the rate of change of the gain.</p> <p>See parameter 25.25 Torque adapt max limit.</p>	0.000 s / real32
	0.000 ... 100.000 s	Filter time for adaptation.	100 = 1 s / 1000 = 1 s
25.27	Kp adapt coef at min torque	<p>Proportional gain coefficient at 0% torque reference.</p> <p>See parameter 25.25 Torque adapt max limit.</p>	1.000 / real32
	0.000 ... 10.000	Proportional gain coefficient at 0% torque reference.	1000 = 1 / 1000 = 1



No.	Name / Range / Selection	Description	Def / Type
25.30	Flux adaptation enable	<p>Enables/disables speed controller adaptation based on motor flux reference (1.24 Flux actual %).</p> <p>The proportional gain of the speed controller is multiplied by a coefficient of 0...1 between 0...100% flux reference respectively.</p> <p>See also the block diagram on page 785.</p> <div data-bbox="396 357 841 616" data-label="Figure"> <p>The graph plots the 'Coefficient for k (proportional gain)' on the y-axis against 'Flux reference (01.24) (%)' on the x-axis. The y-axis has tick marks at 0.000 and 1.000. The x-axis has tick marks at 0 and 100. A line starts at the origin (0, 0.000) and rises linearly to the point (100, 1.000). From x=100, the line continues horizontally at y=1.000.</p> </div>	Enable / uint16
	Disable	Speed controller adaptation based on flux reference disabled	0
	Enable	Speed controller adaptation based on flux reference enabled.	1

## 402 Parameters

No.	Name / Range / Selection	Description	Def / Type FbEq 16b / 32b
25.33	Speed controller autotune	<p>Activates (or selects a source that activates) the speed controller autotune function. See section <a href="#">Speed controller autotune (page 171)</a>.</p> <p>The autotune will automatically set parameters <a href="#">25.2 Speed proportional gain</a>, <a href="#">25.3 Speed integration time</a> and <a href="#">25.37 Mechanical time constant</a>.</p> <p>The prerequisites for performing the autotune routine are:</p> <ul style="list-style-type: none"> <li>the motor identification run (ID run) has been successfully completed</li> <li>the speed and torque limits (parameter group <a href="#">30 Limits</a>) have been set</li> <li>speed feedback filtering (parameter group <a href="#">90 Feedback selection</a>), speed error filtering (<a href="#">24 Speed reference conditioning</a>) and zero speed (<a href="#">21 Start/stop mode</a>) have been set, and</li> <li>the drive has been started and is running in speed control mode.</li> </ul>	Off / uint32
		<p> <b>WARNING!</b> The motor and machinery will run against the torque and speed limits during the autotune routine. MAKE SURE IT IS SAFE TO ACTIVATE THE AUTOTUNE FUNCTION!</p>	
		<p>The autotune routine can be aborted by stopping the drive.</p> <p>0→1 = Activate speed controller autotune</p> <p><b>Note:</b> The value does not revert to 0 automatically.</p>	
		<p>Off 0.</p> <p>On 1.</p> <p>Other [bit] See <a href="#">Terms and abbreviations (page 221)</a>.</p>	
25.34	Speed controller autotune mode	Defines a control preset for the speed controller autotune function. The setting affects the way the torque reference will respond to a speed reference step.	Normal / uint16
	Smooth	Slow but robust response.	0
	Normal	Medium setting.	1
	Tight	Fast response. May produce too high a gain value for some applications.	2
25.37	Mechanical time constant	Mechanical time constant of the drive and the machinery as determined by the speed controller autotune function. The value can be adjusted manually.	0.00 s / real32
	0.00 ... 1000.00 s	Mechanical time constant.	10 = 1 s / 100 = 1 s

No.	Name / Range / Selection	Description	Def / Type FbEq 16b / 32b
25.38	Autotune torque step	Defines an added torque value used by the autotune function. This value is scaled to motor nominal torque. Note that the torque used by the autotune function can also be limited by the torque limits (in parameter group 30 Limits) and nominal motor torque.	10.00 % / real32
	0.00 ... 100.00 %	Autotune torque step.	100 = 1 % / 100 = 1 %
25.39	Autotune speed step	Defines a speed value added to the initial speed for the autotune routine. The initial speed (speed used when autotune is activated) plus the value of this parameter is the calculated maximum speed used by the autotune routine. The maximum speed can also be limited by the speed limits (in parameter group 30 Limits) and nominal motor speed. The value is scaled to motor nominal speed. <b>Note:</b> The motor will exceed the calculated maximum speed slightly at the end of each acceleration stage.	10.00 % / real32
	0.00 ... 100.00 %	Autotune speed step.	100 = 1 % / 100 = 1 %
25.40	Autotune repeat times	Determines how many acceleration/deceleration cycles are performed during the autotune routine. Increasing the value will improve the accuracy of the autotune function, and allow the use of smaller torque or speed step values.	10 / uint16
	1...10	Number of cycles during autotune routine.	1 = 1 / 1 = 1
25.41	Torque reference Autotune2	Reserved	- / real32
25.42	Integral term enable	Selects a source that enables/disables the integral (I) part of the speed controller. 0 = I-part disabled 1 = I-part enabled	Selected / uint32
	Not selected	0	0
	Selected	1	1
	DI1	Digital input DI1 (10.2 DI delayed status, bit 0).	2
	DI2	Digital input DI2 (10.2 DI delayed status, bit 1).	3
	DI3	Digital input DI3 (10.2 DI delayed status, bit 2).	4
	DI4	Digital input DI4 (10.2 DI delayed status, bit 3).	5
	DI5	Digital input DI5 (10.2 DI delayed status, bit 4).	6
	DI6	Digital input DI6 (10.2 DI delayed status, bit 5).	7
	DIO1	Digital input/output DIO1 (11.2 DIO delayed status, bit 0).	10
	DIO2	Digital input/output DIO2 (11.2 DIO delayed status, bit 1).	11
	Other [bit]	See Terms and abbreviations (page 221).	

## 404 Parameters

No.	Name / Range / Selection	Description	Def / Type FbEq 16b / 32b
25.53	Torque prop reference	Displays the output of the proportional (P) part of the speed controller. See the control chain diagram on page 785. This parameter is read-only.	- / real32
	-30000.0 ... 30000.0 %	P-part output of speed controller. For scaling, see parameter 46.3.	- / -
25.54	Torque integral reference	Displays the output of the integral (I) part of the speed controller. See the control chain diagram on page 785. This parameter is read-only.	- / real32
	-30000.0 ... 30000.0 %	I-part output of speed controller. For scaling, see parameter 46.3.	- / -
25.55	Torque deriv reference	Displays the output of the derivative (D) part of the speed controller. See the control chain diagram on page 785. This parameter is read-only.	- / real32
	-30000.0 ... 30000.0 %	D-part output of speed controller. For scaling, see parameter 46.3.	- / -
25.56	Torque acc compensation	Displays the output of the acceleration compensation function on page 785. See the control chain diagram. This parameter is read-only.	- / real32
	-30000.0 ... 30000.0 %	Output of acceleration compensation function. For scaling, see parameter 46.3.	- / -
25.57	Torque reference unbalanced	Displays the acceleration-compensated output of the speed controller. See the control chain diagram on page 785. This parameter is read-only.	- / real32
	-30000.0 ... 30000.0 %	Acceleration-compensated output of speed controller. For scaling, see parameter 46.3.	- / -

No.	Name / Range / Selection	Description	Def / Type FbEq 16b / 32b
26	<b>Torque reference chain</b>	Settings for the torque reference chain. See the control chain diagrams on pages 786 and 788.	
26.1	Torque reference to TC	Displays the final torque reference given to the torque controller in percent. This reference is then acted upon by various final limiters, like power, torque, load etc. See the control chain diagrams on pages 788 and 789. This parameter is read-only.	- / real32
	-1600.0 ... 1600.0 %	Torque reference for torque control. For scaling, see parameter 46.3.	- / -
26.2	Torque reference used	Displays the final torque reference (in percent of motor nominal torque) given to the DTC core, and comes after frequency, voltage and torque limitation. See the control chain diagram on page 789. This parameter is read-only.	- / real32
	-1600.0 ... 1600.0 %	Torque reference for torque control. For scaling, see parameter 46.3.	- / -
26.8	Minimum torque ref	Defines the minimum torque reference. Allows for local limiting of the torque reference before it is passed on to the torque ramp controller. For absolute torque limiting, refer to parameter 30.19 Minimum torque 1.	-300.0 % / real32
	-1000.0 ... 0.0 %	Minimum torque reference. For scaling, see parameter 46.3.	- / -
26.9	Maximum torque ref	Defines the maximum torque reference. Allows for local limiting of the torque reference before it is passed on to the torque ramp controller. For absolute torque limiting, refer to parameter 30.20 Maximum torque 1.	300.0 % / real32
	0.0 ... 1000.0 %	Maximum torque reference. For scaling, see parameter 46.3.	- / -
26.11	Torque ref1 source	Selects torque reference source 1. Two signal sources can be defined by this parameter and 26.12 Torque ref2 source. A digital source selected by 26.14 Torque ref1/2 selection can be used to switch between the two sources, or a mathematical function (26.13 Torque ref1 function) applied to the two signals to create the reference.	Zero / uint32
	Zero	None.	0
	AI1 scaled	12.12 AI1 scaled value (page 284).	1

## 406 Parameters

No.	Name / Range / Selection	Description	Def / Type FbEq 16b / 32b
	AI2 scaled	12.22 AI2 scaled value (page 286).	2
	FB A ref1	3.5 FB A reference 1 (page 231).	4
	FB A ref2	3.6 FB A reference 2 (page 231).	5
	EFB ref1	3.9 EFB reference 1 (page 231).	8
	EFB ref2	3.10 EFB reference 2 (page 231).	9
	DDCS ctrl ref1	3.11 DDCS controller ref 1 (page 231).	10
	DDCS ctrl ref2	3.12 DDCS controller ref 2 (page 231).	11
	M/F reference 1	3.13 M/F or D2D ref1 (page 232).	12
	M/F reference 2	3.14 M/F or D2D ref2 (page 232).	13
	Motor potentiometer		15
	PID	Not in use.	16
	Control panel (ref saved)	Control panel reference, with initial value from last-used panel reference. See section <i>Using the control panel as an external control source</i> (page 147).	18
	Control panel (ref copied)	Control panel reference, with initial value from previous source or actual value. See section <i>Using the control panel as an external control source</i> (page 147).	19
	Other [value]	See <i>Terms and abbreviations</i> (page 221).	
26.12	Torque ref2 source	Selects torque reference source 2. For the selections, and a diagram of reference source selection, see parameter 26.11 <i>Torque ref1 source</i> .	Zero / uint32
26.13	Torque ref1 function	Selects a mathematical function between the reference sources selected by parameters 26.11 <i>Torque ref1 source</i> and 26.12 <i>Torque ref2 source</i> . See diagram at 26.11 <i>Torque ref1 source</i> .	Ref1 / uint16
	Ref1	Signal selected by 26.11 <i>Torque ref1 source</i> is used as torque reference 1 as such (no function applied).	0
	Add (ref1 + ref2)	The sum of the reference sources is used as torque reference 1.	1
	Sub (ref1 - ref2)	The subtraction ( $[\text{26.11 Torque ref1 source}] - [\text{26.12 Torque ref2 source}]$ ) of the reference sources is used as torque reference 1.	2
	Mul (ref1 x ref2)	The multiplication of the reference sources is used as torque reference 1.	3
	Min (ref1, ref2)	The smaller of the reference sources is used as torque reference 1.	4
	Max (ref1, ref2)	The greater of the reference sources is used as torque reference 1.	5
26.14	Torque ref1/2 selection	Configures the selection between torque references 1 and 2. See diagram at 26.11 <i>Torque ref1 source</i> . 0 = Torque reference 1 1 = Torque reference 2	Torque reference 1 / uint32

No.	Name / Range / Selection	Description	Def / Type FbEq 16b / 32b
	Torque reference 1	0.	0
	Torque reference 2	1.	1
	Follow Ext1/Ext2 selection	Torque reference 1 is used when external control location EXT1 is active. Torque reference 2 is used when external control location EXT2 is active. See also parameter 19.11 Ext1/Ext2 selection.	2
	DI1	Digital input DI1 (10.2 DI delayed status, bit 0).	3
	DI2	Digital input DI2 (10.2 DI delayed status, bit 1).	4
	DI3	Digital input DI3 (10.2 DI delayed status, bit 2).	5
	DI4	Digital input DI4 (10.2 DI delayed status, bit 3).	6
	DI5	Digital input DI5 (10.2 DI delayed status, bit 4).	7
	DI6	Digital input DI6 (10.2 DI delayed status, bit 5).	8
	Other [bit]	See Terms and abbreviations (page 221).	
26.15	Load share	Defines the scaling factor for the torque reference (the torque reference is multiplied by the value). This allows drives sharing the load between two motors on the same mechanical plant to be tailored to share the correct amount each, yet use the same master torque reference.	1.000 / real32
	-8.000 ... 8.000	Torque reference scaling factor.	1000 = 1 / 1000 = 1
26.16	Torque additive 1 source	Selects the source of torque reference additive 1. <b>Note:</b> For safety reasons, the additive is not applied when an emergency stop is active. See the control chain diagram on page 786. For the selections, see parameter 26.11 Torque ref1 source.	Zero / uint32
26.17	Torque ref filter time	Defines a low-pass filter time constant for the torque reference.	0.000 s / real32
	0.000 ... 30.000 s	Filter time constant for torque reference.	1000 = 1 s / 1000 = 1 s
26.18	Torque ramp up time	Defines the torque reference ramp-up time, ie. the time for the reference to increase from zero to nominal motor torque.	0.000 s / real32
	0.000 ... 60.000 s	Torque reference ramp-up time.	100 = 1 s / 1000 = 1 s
26.19	Torque ramp down time	Defines the torque reference ramp-down time, ie. the time for the reference to decrease from nominal motor torque to zero.	0.000 s / real32
	0.000 ... 60.000 s	Torque reference ramp-down time.	100 = 1 s / 1000 = 1 s

## 408 Parameters

No.	Name / Range / Selection	Description	Def / Type FbEq 16b / 32b
26.25	Torque additive 2 source	<p>Selects the source of torque reference additive 2. The value received from the selected source is added to the torque reference after operating mode selection. Because of this, the additive can be used in speed and torque modes.</p> <p><b>Note:</b> For safety reasons, the additive is not applied when an emergency stop is active.</p> <hr/> <p> <b>WARNING!</b> If the additive exceeds the limits set by parameters 25.11 Speed control min torque and 25.12 Speed control max torque, a ramp stop may be impossible. Make sure the additive is reduced or removed when a ramp stop is required eg. by using parameter 26.26 Force torque ref add 2 zero.</p> <hr/> <p>See the control chain diagram on page 788. For the selections, see parameter 26.11 Torque ref1 source.</p>	Zero / uint32
26.26	Force torque ref add 2 zero	<p>Selects a source that forces torque reference additive 2 (see parameter 26.25 Torque additive 2 source) to zero.</p> <p>0 = Normal operation 1 = Force torque reference additive 2 to zero.</p>	Not selected / uint32
	Not selected	0	0
	Selected	1	1
	DI1	Digital input DI1 (10.2 DI delayed status, bit 0).	2
	DI2	Digital input DI2 (10.2 DI delayed status, bit 1).	3
	DI3	Digital input DI3 (10.2 DI delayed status, bit 2).	4
	DI4	Digital input DI4 (10.2 DI delayed status, bit 3).	5
	DI5	Digital input DI5 (10.2 DI delayed status, bit 4).	6
	DI6	Digital input DI6 (10.2 DI delayed status, bit 5).	7
	DIO1	Digital input/output DIO1 (11.2 DIO delayed status, bit 0).	10
	DIO2	Digital input/output DIO2 (11.2 DIO delayed status, bit 1).	11
	Other [bit]	See Terms and abbreviations (page 221).	
26.27	Torque limit filter time	<p>Defines the filtering time of the torque limit. This parameter is used to smooth the step when changing the limit if the drive is running on torque limit.</p>	100 ms / real32
	0...100 ms	Torque limit filter time.	1 = 1 ms / 1 = 1 ms



No.	Name / Range / Selection	Description	Def / Type FbEq 16b / 32b
26.41	Torque step	<p>When enabled by parameter 26.42 Torque step enable, adds an additional step to the torque reference. A second torque step can be added using pointer parameters 26.43 Torque step pointer enable and 26.44 Torque step source.</p> <p>The two torque steps work independently of each other, and are summed up to calculate the total torque step.</p> <p><b>Note:</b> For safety reasons, the torque steps are not applied when an emergency stop is active.</p> <hr/> <p> <b>WARNING!</b> If the total torque step exceeds the limits set by parameters 25.11 Speed control min torque and 25.12 Speed control max torque, a ramp stop may be impossible. Make sure the torque step is reduced or disabled when a ramp stop is required.</p> <hr/>	0.0 % / real32
	-300.0 ... 300.0 %	Torque step. For scaling, see parameter 46.3.	- / -
26.42	Torque step enable	Enables/disables the torque step defined by parameter 26.41 Torque step.	Disable / uint32
	Disable	Torque step disabled.	0
	Enable	Torque step enabled.	1
26.43	Torque step pointer enable	Selects a source that enables/disables the torque step defined by parameter 26.44 Torque step source. See also parameter 26.41 Torque step. 1 = Torque step enabled.	Selected / uint32
	Not selected	0	0
	Selected	1	1
	DI1	Digital input DI1 (10.2 DI delayed status, bit 0).	2
	DI2	Digital input DI2 (10.2 DI delayed status, bit 1).	3
	DI3	Digital input DI3 (10.2 DI delayed status, bit 2).	4
	DI4	Digital input DI4 (10.2 DI delayed status, bit 3).	5
	DI5	Digital input DI5 (10.2 DI delayed status, bit 4).	6
	DI6	Digital input DI6 (10.2 DI delayed status, bit 5).	7
	DIO1	Digital input/output DIO1 (11.2 DIO delayed status, bit 0).	10
	DIO2	Digital input/output DIO2 (11.2 DIO delayed status, bit 1).	11
	Other [bit]	See Terms and abbreviations (page 221).	
26.44	Torque step source	Selects the source of the torque step enabled by 26.43 Torque step pointer enable.	Zero / uint32
	Zero	None.	0
	AI1 scaled	12.12 AI1 scaled value (page 284).	1
	AI2 scaled	12.22 AI2 scaled value (page 286).	2

## 410 Parameters

No.	Name / Range / Selection	Description	Def / Type FbEq 16b / 32b
	FB A ref1	3.5 FB A reference 1 (page 231).	4
	FB A ref2	3.6 FB A reference 2 (page 231).	5
	EFB ref1	3.9 EFB reference 1 (page 231).	8
	EFB ref2	3.10 EFB reference 2 (page 231).	9
	DDCS ctrl ref1	3.11 DDCS controller ref 1 (page 231).	10
	DDCS ctrl ref2	3.12 DDCS controller ref 2 (page 231).	11
	M/F reference 1	3.13 M/F or D2D ref1 (page 232).	12
	M/F reference 2	3.14 M/F or D2D ref2 (page 232).	13
	Motor potentiometer		15
	PID	Not in use.	16
	Control panel (ref saved)	Control panel reference, with initial value from last-used panel reference. See section <a href="#">Using the control panel as an external control source (page 147)</a> .	18
	Control panel (ref copied)	Control panel reference, with initial value from previous source or actual value. See section <a href="#">Using the control panel as an external control source (page 147)</a> .	19
	Other [value]	See <a href="#">Terms and abbreviations (page 221)</a> .	
26.51	Oscillation damping	Parameters 26.51...26.58 configure the oscillation damping function. See section <a href="#">Oscillation damping (page 174)</a> , and the block diagram on <a href="#">page 788</a> . This parameter enables (or selects a source that enables) the oscillation damping algorithm. 1 = Oscillation damping algorithm enabled	Not selected / uint32
	Not selected	0	0
	Selected	1	1
	DI1	Digital input DI1 (10.2 DI delayed status, bit 0).	2
	DI2	Digital input DI2 (10.2 DI delayed status, bit 1).	3
	DI3	Digital input DI3 (10.2 DI delayed status, bit 2).	4
	DI4	Digital input DI4 (10.2 DI delayed status, bit 3).	5
	DI5	Digital input DI5 (10.2 DI delayed status, bit 4).	6
	DI6	Digital input DI6 (10.2 DI delayed status, bit 5).	7
	DIO1	Digital input/output DIO1 (11.2 DIO delayed status, bit 0).	10
	DIO2	Digital input/output DIO2 (11.2 DIO delayed status, bit 1).	11
	Other [bit]	See <a href="#">Terms and abbreviations (page 221)</a> .	

No.	Name / Range / Selection	Description	Def / Type FbEq 16b / 32b
26.52	Oscillation damping out enable	Determines (or selects a source that determines) whether the output of the oscillation damping function is applied to the torque reference or not.  <b>Note:</b> Before enabling the oscillation damping output, adjust parameters 26.53...26.57. Then monitor the input signal (selected by 26.53) and the output (26.58) to make sure that the correction is safe to apply.  1 = Apply oscillation damping output to torque reference	Not selected / uint32
	Not selected	0	0
	Selected	1	1
	DI1	Digital input DI1 (10.2 DI delayed status, bit 0).	2
	DI2	Digital input DI2 (10.2 DI delayed status, bit 1).	3
	DI3	Digital input DI3 (10.2 DI delayed status, bit 2).	4
	DI4	Digital input DI4 (10.2 DI delayed status, bit 3).	5
	DI5	Digital input DI5 (10.2 DI delayed status, bit 4).	6
	DI6	Digital input DI6 (10.2 DI delayed status, bit 5).	7
	DIO1	Digital input/output DIO1 (11.2 DIO delayed status, bit 0).	10
	DIO2	Digital input/output DIO2 (11.2 DIO delayed status, bit 1).	11
Other [bit]	See Terms and abbreviations (page 221).		
26.53	Oscillation compensation input	Selects the input signal for the oscillation damping function.  <b>Note:</b> Before changing this parameter run-time, disable the oscillation damping output using parameter 26.52. Monitor the behavior of 26.58 before re-enabling the output.	Speed error / uint32
	Speed error	24.1 Used speed reference - unfiltered motor speed.  <b>Note:</b> This setting is not supported in scalar motor control mode.	0
	DC voltage	1.11 DC voltage. (The value is internally filtered.)	1
26.55	Oscillation damping frequency	Defines the center frequency of the oscillation damping filter.  Set the value according to the number of oscillation peaks in the monitored signal (selected by 26.53) per second.  <b>Note:</b> Before changing this parameter run-time, disable the oscillation damping output using parameter 26.52. Monitor the behavior of 26.58 before re-enabling the output.	31.0 Hz / real32
	0.1 ... 60.0 Hz	Center frequency for oscillation damping.	10 = 1 Hz / 10 = 1 Hz

## 412 Parameters

No.	Name / Range / Selection	Description	Def / Type FbEq 16b / 32b
26.56	Oscillation damping phase	Defines a phase shift for the output of the filter.  <b>Note:</b> Before changing this parameter run-time, disable the oscillation damping output using parameter 26.52. Monitor the behavior of 26.58 before re-enabling the output.	180 deg / real32
	0..360 deg	Phase shift for oscillation damping function output.	10 = 1 deg / 1 = 1 deg
26.57	Oscillation damping gain	Defines a gain for the output of the oscillation damping function, ie. how much the output of the filter is amplified before it is added to the torque reference. Oscillation gain is scaled according to the speed controller gain so that changing the gain will not disturb oscillation damping.  <b>Note:</b> Before changing this parameter run-time, disable the oscillation damping output using parameter 26.52. Monitor the behavior of 26.58 before re-enabling the output.	1.0 % / real32
	0.0 ... 100.0 %	Gain setting for oscillation damping output.	10 = 1 % / 10 = 1 %
26.58	Oscillation damping output	Displays the output of the oscillation damping function. This value is added to the torque reference (as allowed by parameter 26.52 Oscillation damping out enable). This parameter is read-only.	- / real32
	-1600.000 ... 1600.000 %	Output of the oscillation damping function.	10 = 1 % / 1000 = 1 %
26.70	Torque reference act 1	Displays the value of torque reference source 1 (selected by parameter 26.11 Torque ref1 source). See the control chain diagram on page 786. This parameter is read-only.	- / real32
	-1600.0 ... 1600.0 %	Value of torque reference source 1. For scaling, see parameter 46.3.	- / -
26.71	Torque reference act 2	Displays the value of torque reference source 2 (selected by parameter 26.12 Torque ref2 source). See the control chain diagram on page 786. This parameter is read-only.	- / real32
	-1600.0 ... 1600.0 %	Value of torque reference source 2. For scaling, see parameter 46.3.	- / -
26.72	Torque reference act 3	Displays the torque reference after the function applied by parameter 26.13 Torque ref1 function (if any), and after selection (26.14 Torque ref1/2 selection). See the control chain diagram on page 786. This parameter is read-only.	- / real32
	-1600.0 ... 1600.0 %	Torque reference after selection. For scaling, see parameter 46.3.	- / -
26.73	Torque reference act 4	Displays the torque reference after application of reference additive 1. See the control chain diagram on page 786. This parameter is read-only.	- / real32

No.	Name / Range / Selection	Description	Def / Type FbEq 16b / 32b
	-1600.0 ... 1600.0 %	Torque reference after application of reference additive 1. For scaling, see parameter 46.3.	- / -
26.74	Torque ref ramp out	Displays the torque reference after limiting and ramping. See the control chain diagram on page 786. This parameter is read-only.	- / real32
	-1600.0 ... 1600.0 %	Torque reference after limiting and ramping. For scaling, see parameter 46.3.	- / -
26.75	Torque reference act 5	Displays the torque reference after control mode selection. See the control chain diagram on page 788. This parameter is read-only.	- / real32
	-1600.0 ... 1600.0 %	Torque reference after control mode selection. For scaling, see parameter 46.3.	- / -
26.76	Torque reference act 6	Displays the torque reference after application of reference additive 2. See the control chain diagram on page 788. This parameter is read-only.	- / real32
	-1600.0 ... 1600.0 %	Torque reference after application of reference additive 2. For scaling, see parameter 46.3.	- / -
26.77	Torque ref add A actual	Displays the value of the source of torque reference additive 2. See the control chain diagram on page 788. This parameter is read-only.	- / real32
	-1600.0 ... 1600.0 %	Torque reference additive 2. For scaling, see parameter 46.3.	- / -
26.78	Torque ref add B actual	Displays the value of torque reference additive 2 before it is added to torque reference. See the control chain diagram on page 788. This parameter is read-only.	- / real32
	-1600.0 ... 1600.0 %	Torque reference additive 2. For scaling, see parameter 46.3.	- / -
26.81	Rush control gain	Rush controller gain term. See section Rush control (page 176).	10.0 / real32
	0.0 ... 10000.0	Rush controller gain (0.0 = disabled).	1 = 1 / 10 = 1
26.82	Rush control integration time	Rush controller integration time term.	2.0 s / real32
	0.0 ... 10.0 s	Rush controller integration time (0.0 = disabled).	1 = 1 s / 10 = 1 s

## 414 Parameters

No.	Name / Range / Selection	Description	Def / Type FbEq 16b / 32b
<b>29</b>	<b>Voltage reference chain</b>	Settings for the DC voltage reference chain. This group is only visible with a BCU control unit.	
29.1	Torque ref DC voltage control	Displays the DC voltage controller output that is transferred to the torque controller. This parameter is read-only.	- / real32
	-1600.0 ... 1600.0 %	Final DC voltage reference.	100 = 1 % / 10 = 1 %
29.2	DC voltage ref	Displays the DC voltage reference after the function applied by parameter 29.13 DC voltage ref1 function (if any), and after selection (29.14 DC voltage ref1/2 selection). See the diagram at parameter 29.11 DC voltage ref1 source.	- / real32
	0...2000 V	DC voltage reference after selection.	10 = 1 V / 1 = 1 V
29.3	DC voltage ref used	Displays the DC voltage reference between minimum/maximum limitation and ramping.	- / real32
	0..2000 V	DC voltage reference before ramping.	10 = 1 V / 1 = 1 V
29.4	DC voltage ref ramped	Displays the DC voltage reference after ramping.	- / real32
	0...2000 V	DC voltage reference after ramping.	10 = 1 V / 1 = 1 V
29.5	Filtered DC voltage	Displays the measured DC voltage after filtering.	- / real32
	0...2000 V	Measured and filtered DC voltage.	10 = 1 V / 1 = 1 V
29.6	DC voltage error	Displays the difference between the ramped voltage reference (29.4) and measured, filtered DC voltage (29.5).	- / real32
	-2000...2000 V	Measured and filtered DC voltage.	10 = 1 V / 1 = 1 V
29.7	Power reference	Displays the output of the PI controller, ie. the DC voltage reference before it is converted to a torque reference.	- / real32
	-300.00 ... 300.00 %	Output of the PI controller.	10 = 1 % / 100 = 1 %
29.9	Minimum DC voltage reference	Defines a minimum limit for the DC voltage reference before it is ramped.	0 V / real32
	0...2000 V	Minimum DC voltage reference.	1 = 1 V / 1 = 1 V
29.10	Maximum DC voltage reference	Defines a maximum limit for the DC voltage reference before it is ramped.	2000 V / real32
	0...2000 V	Maximum DC voltage reference.	1 = 1 V / 1 = 1 V

No.	Name / Range / Selection	Description	Def / Type FbEq 16b / 32b
29.11	DC voltage ref1 source	<p>Selects DC voltage reference source 1.</p> <p>Two signal sources can be defined by this parameter and 29.12 DC voltage ref2 source. A digital source selected by 29.14 DC voltage ref1/2 selection can be used to switch between the two sources, or a mathematical function (29.13 DC voltage ref1 function) applied to the two signals to create the reference.</p>	Zero / uint32
		<p>The diagram illustrates the logic for selecting the DC voltage reference source. It shows two input sources, 29.11 and 29.12, each with inputs for 0, AI, FB, and Other. These sources feed into a central block labeled 29.13, which contains a 'Ref1' section with five mathematical function options: ADD, SUB, MUL, MIN, and MAX. The output of block 29.13 is connected to a switch labeled 29.14. This switch is controlled by parameter 29.02, which can be set to 0 or 1. The output of the switch is labeled 29.02.</p>	
	Zero	None.	0
	AI1 scaled	12.12 AI1 scaled value (page 284).	1
	AI2 scaled	12.22 AI2 scaled value (page 286).	2
	FB A ref1	3.5 FB A reference 1 (page 231).	4
	FB A ref2	3.6 FB A reference 2 (page 231).	5
	EFB ref1	3.9 EFB reference 1 (page 231).	8
	EFB ref2	3.10 EFB reference 2 (page 231).	9
	DDCS ctrl ref1	3.11 DDCS controller ref 1 (page 231).	10
	DDCS ctrl ref2	3.12 DDCS controller ref 2 (page 231).	11
	M/F reference 1	3.13 M/F or D2D ref1 (page 232).	12
	M/F reference 2	3.14 M/F or D2D ref2 (page 232).	13
	Motor potentiometer		15
	PID	Not in use.	16
	Control panel (ref saved)	Control panel reference, with initial value from last-used panel reference. See section Using the control panel as an external control source (page 147).	18
	Control panel (ref copied)	Control panel reference, with initial value from previous source or actual value. See section Using the control panel as an external control source (page 147).	19
	Other [value]	See Terms and abbreviations (page 221).	
29.12	DC voltage ref2 source	<p>Selects DC voltage reference source 2.</p> <p>For the selections, and a diagram of reference source selection, see parameter 29.11 DC voltage ref1 source.</p>	Zero / uint32

## 416 Parameters

No.	Name / Range / Selection	Description	Def / Type FbEq 16b / 32b
29.13	DC voltage ref1 function	Selects a mathematical function between the reference sources selected by parameters 29.11 DC voltage ref1 source and 29.12 DC voltage ref2 source. See diagram at 29.11 DC voltage ref1 source.	Ref1 / uint16
	Ref1	Signal selected by 29.11 DC voltage ref1 source is used as DC voltage reference 1 as such (no function applied).	0
	Add (ref1 + ref2)	The sum of the reference sources is used as DC voltage reference 1.	1
	Sub (ref1 - ref2)	The subtraction ([29.11 DC voltage ref1 source] - [29.12 DC voltage ref2 source]) of the reference sources is used as DC voltage reference 1.	2
	Mul (ref1 x ref2)	The multiplication of the reference sources is used as DC voltage reference 1.	3
	Min (ref1, ref2)	The smaller of the reference sources is used as DC voltage reference 1.	4
	Max (ref1, ref2)	The greater of the reference sources is used as DC voltage reference 1.	5
29.14	DC voltage ref1/2 selection	Configures the selection between DC voltage references 1 and 2. See diagram at 29.11 DC voltage ref1 source. 0 = DC voltage reference 1 1 = DC voltage reference 2	Follow Ext1/Ext2 selection / uint32
	DC voltage reference 0. 1		0
	DC voltage reference 1. 2		1
	Follow Ext1/Ext2 selection	DC voltage reference 1 is used when external control location EXT1 is active. DC voltage reference 2 is used when external control location EXT2 is active. See also parameter 19.11 Ext1/Ext2 selection.	2
	DI1	Digital input DI1 (10.2 DI delayed status, bit 0).	3
	DI2	Digital input DI2 (10.2 DI delayed status, bit 1).	4
	DI3	Digital input DI3 (10.2 DI delayed status, bit 2).	5
	DI4	Digital input DI4 (10.2 DI delayed status, bit 3).	6
	DI5	Digital input DI5 (10.2 DI delayed status, bit 4).	7
	DI6	Digital input DI6 (10.2 DI delayed status, bit 5).	8
	Other [bit]	See Terms and abbreviations (page 221).	
29.17	DC voltage filter time	Defines a filtering time for measured DC voltage.	- / real32
	0...10000 ms	Filtering time for DC voltage measurement.	1 = 1 ms / 1 = 1 ms
29.18	DC voltage ramp down speed	Defines the maximum decrease rate for the DC voltage reference.	10 V/s / real32
	0...30000 V/s	DC voltage reference decrease rate.	1 = 1 V/s / 1 = 1 V/s
29.19	DC voltage ramp up speed	Defines the maximum increase rate for the DC voltage reference.	10 V/s / real32



No.	Name / Range / Selection	Description	Def / Type FbEq 16b / 32b
	0...30000 V/s	DC voltage reference increase rate.	1 = 1 V/s / 1 = 1 V/s
29.20	DC voltage proportional gain	Defines the proportional gain for the DC voltage reference PI controller.	54.66 V/s / real32
	0.00 ... 1000.00 V/s	Proportional gain.	100 = 1 V/s / 100 = 1 V/s
29.21	DC voltage integration time	Defines the integration time for the DC voltage reference PI controller. Setting the integration time to zero disables the I-part of the controller.	0.1646 s / real32
	0.0000 ... 60.0000 s	Integration time.	10000 = 1 s / 10000 = 1 s
29.25	DC capacitance source	Selects the source of the total DC circuit capacitance value. The value is used in DC voltage reference calculation.  <b>Note:</b> This parameter cannot be changed while the drive is running.	Copy from database / uint16
	Copy from database	DC capacitance value is taken from an internal database according to drive type.	0
	User value	The DC capacitance value is read from parameter 29.26 Used DC capacitance.	1
29.26	Used DC capacitance	Defines the DC circuit capacitance when parameter 29.25 DC capacitance source is set to User value.  <b>Note:</b> This parameter cannot be changed while the drive is running.	0.000 mF / real32
	0.000 ... 1000.000 mF	User-specified DC capacitance.	100 = 1 mF / 1000 = 1 mF
29.70	Speed data point 1	Parameters 29.70...29.79 define a maximum torque limitation curve as a function of speed. The limit is applied before the reference is forwarded to the torque controller.  This parameter defines the speed at the first point of the curve. The curve is linear between 0 rpm and this speed.	400.00 rpm / real32
	0.00 ... 30000.00 rpm	Speed at 1st point of curve.	1 = 1 rpm / 100 = 1 rpm
29.71	Torque data point 1	Defines the maximum torque at the first point of the limitation curve.	300.0 % / real32

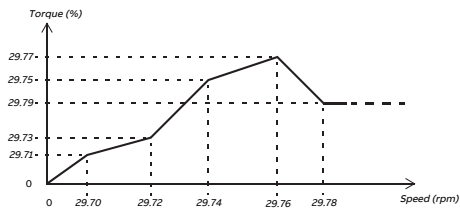







## 418 Parameters

No.	Name / Range / Selection	Description	Def / Type FbEq 16b / 32b
	0.0 ... 1600.0 %	Maximum torque at 1st point of curve.	1 = 1 % / 10 = 1 %
29.72	Speed data point 2	Defines the speed at the second point of the curve.	800.00 rpm / real32
	0.00 ... 30000.00 rpm	Speed at 2nd point of curve.	1 = 1 rpm / 100 = 1 rpm
29.73	Torque data point 2	Defines the maximum torque at the second point of the limitation curve.	300.0 % / real32
	0.0 ... 1600.0 %	Maximum torque at 2nd point of curve.	1 = 1 % / 10 = 1 %
29.74	Speed data point 3	Defines the speed at the third point of the curve.	1200.00 rpm / real32
	0.00 ... 30000.00 rpm	Speed at 3rd point of curve.	1 = 1 rpm / 100 = 1 rpm
29.75	Torque data point 3	Defines the maximum torque at the third point of the limitation curve.	300.0 % / real32
	0.0 ... 1600.0 %	Maximum torque at 3rd point of curve.	1 = 1 % / 10 = 1 %
29.76	Speed data point 4	Defines the speed at the fourth point of the curve.	1600.00 rpm / real32
	0.00 ... 30000.00 rpm	Speed at 4th point of curve.	1 = 1 rpm / 100 = 1 rpm
29.77	Torque data point 4	Defines the maximum torque at the fourth point of the limitation curve.	300.0 % / real32
	0.0 ... 1600.0 %	Maximum torque at 4th point of curve.	1 = 1 % / 10 = 1 %
29.78	Speed data point 5	Defines the speed at the fifth point of the curve.	2000.00 rpm / real32
	0.00 ... 30000.00 rpm	Speed at 5th point of curve.	1 = 1 rpm / 100 = 1 rpm
29.79	Torque data point 5	Defines the maximum torque at the fifth point of the limitation curve.	300.0 % / real32
	0.0 ... 1600.0 %	Maximum torque at 5th point of curve.	1 = 1 % / 10 = 1 %





No.	Name / Range / Selection	Description	Def / Type FbEq 16b / 32b
<b>30</b>	<b>Limits</b>	Drive operation limits.	
30.1	Limit word 1	Displays limit word 1. This parameter is read-only.	- / uint16
	b0 Torq lim	1 = Drive torque is being limited by the motor control (undervoltage control, current control, load angle control or pull-out control), or by the torque limits defined by parameters.	
	b1 Spd ctl tlim min	1 = Speed controller output is being limited by 25.11 Speed control min torque	
	b2 Spd ctl tlim max	1 = Speed controller output is being limited by 25.12 Speed control max torque	
	b3 Torq ref max	1 = Torque reference ramp input is being limited by 26.9 Maximum torque ref, source of 30.25 Maximum torque sel, 30.26 Power motoring limit or 30.27 Power generating limit. See diagram on page 789.	
	b4 Torq ref min	1 = Torque reference ramp input is being limited by 26.8 Minimum torque ref, source of 30.18 Minimum torque sel, 30.26 Power motoring limit or 30.27 Power generating limit. See diagram on page 789.	
	b5 Tlim max speed	1 = Torque reference is being limited by the rush control because of maximum speed limit (30.12 Maximum speed)	
	b6 Tlim min speed	1 = Torque reference is being limited by the rush control because of minimum speed limit (30.11 Minimum speed)	
	b7 Max speed ref lim	1 = Speed reference is being limited by 30.12 Maximum speed, or by maximum permanent magnet motor speed limit based on DC voltage	
	b8 Min speed ref lim	1 = Speed reference is being limited by 30.11 Minimum speed, or by maximum permanent magnet motor speed limit based on DC voltage	
	b9 Max freq ref lim	1 = Frequency reference is being limited by 30.14 Maximum frequency	
	b10 Min freq ref lim	1 = Frequency reference is being limited by 30.13 Minimum frequency	
	b11 Reserved		
	b12 Sw freq ref lim	1 = Requested output frequency cannot be reached because of switching frequency limitation (because of eg. output filtering or ATEXrelated protections)	
	b13 Load angle lim	(With permanent magnet motors and synchronous reluctance motors, and externally-excited synchronous motors in steady state) 1 = Maximum load angle is being limited, ie. the motor cannot produce any more torque (With externally-excited synchronous motors in dynamic situations) 1 = Torque is being limited	
	b14...15 Reserved		

## 420 Parameters

No.	Name / Range / Selection	Description	Def / Type FbEq 16b / 32b
	0000h...FFFFh		1 = 1
30.2	Torque limit status	Displays the torque controller limitation status word. This parameter is read-only. *Only one out of bits 0...3, and one out of bits 9...13 can be on simultaneously. The bit typically indicates the limit that is exceeded first.	- / uint16
	b0 Undervoltage	*1 = Intermediate DC circuit undervoltage	
	b1 Overvoltage	*1 = Intermediate DC circuit overvoltage	
	b2 Minimum torque	*1 = Torque is being limited by 30.26 Power motoring limit, 30.27 Power generating limit or the source of 30.18 Minimum torque sel. See diagram on page 789.	
	b3 Maximum torque	*1 = Torque is being limited by 30.26 Power motoring limit, 30.27 Power generating limit or the source of 30.25 Maximum torque sel. See diagram on page 789.	
	b4 Internal current	1 = An inverter current limit (identified by bits 8...11) is active	
	b5 Maximum load angle	(With permanent magnet motors, synchronous reluctance motors, and externally-excited synchronous motors only) 1 = Maximum load angle limit is active, ie. the motor is producing as much torque as possible	
	b6 Motor pullout	(With asynchronous motors only) 1 = Motor pull-out limit is active, ie. the motor cannot produce any more torque	
	b7 Reserved		
	b8 Thermal	1 = Input current is being limited by the main circuit thermal limit	
	b9 Max current	*1 = Maximum output current ( $I_{MAX}$ ) is being limited	
	b10 User current	*1 = Output current is being limited by 30.17 Maximum current	
	b11 Thermal IGBT	*1 = Output current is being limited by a calculated thermal current value	
	b12 IGBT overtemperature	*1 = Output current is being limited because of estimated IGBT temperature	
	b13 IGBT overload	*1 = Output current is being limited because of IGBT junction to case temperature	
b14...15	Reserved		
	0000h...FFFFh		1 = 1

No.	Name / Range / Selection	Description	Def / Type FbEq 16b / 32b
30.11	Minimum speed	Defines the minimum allowed speed.	-1500.00; -1800.00 (95.20 b0) rpm / real32
		 <b>WARNING!</b> This value must not be higher than 30.12 Maximum speed.	
		 <b>WARNING!</b> In frequency control mode, this limit is not effective. Make sure the frequency limits (30.13 and 30.14) are set appropriately if frequency control is used.	
		 <b>WARNING!</b> In a master/follower configuration, do not set maximum and minimum speed limits with the same sign on a follower drive. See section Master/follower functionality (page 159).	
		-30000.00 ... 30000.00 rpm	Minimum allowed speed. For scaling, see parameter 46.1. - / -
30.12	Maximum speed	Defines the maximum allowed speed.	1500.00; 1800.00 (95.20 b0) rpm / real32
		 <b>WARNING!</b> This value must not be lower than 30.11 Minimum speed.	
		 <b>WARNING!</b> In frequency control mode, this limit is not effective. Make sure the frequency limits (30.13 and 30.14) are set appropriately if frequency control is used.	
		 <b>WARNING!</b> In a master/follower configuration, do not set maximum and minimum speed limits with the same sign on a follower drive. See section Master/follower functionality (page 159).	
		-30000.00 ... 30000.00 rpm	Maximum speed. For scaling, see parameter 46.1. - / -

## 422 Parameters

No.	Name / Range / Selection	Description	Def / Type FbEq 16b / 32b
30.13	Minimum frequency	Defines the minimum allowed frequency.	-50.00; -60.00 (95.20 b0) Hz / real32
		 <b>WARNING!</b> This value must not be higher than 30.14 Maximum frequency.	
		 <b>WARNING!</b> This limit is effective in frequency control mode only.	
		-598.00 ... 598.00 Hz Minimum frequency. For scaling, see parameter 46.2.	- / -
30.14	Maximum frequency	Defines the maximum allowed frequency.	50.00; 60.00 (95.20 b0) Hz / real32
		 <b>WARNING!</b> This value must not be lower than 30.13 Minimum frequency.	
		 <b>WARNING!</b> This limit is effective in frequency control mode only.	
		-598.00 ... 598.00 Hz Maximum frequency. For scaling, see parameter 46.2.	- / -
30.15	Maximum start current enable	<p>A temporary motor current limit specifically for starting can be defined by this parameter and 30.16 Maximum start current.</p> <p>When this parameter is set to Enable, the drive observes the start current limit defined by 30.16 Maximum start current. The limit is in force for 2 seconds after initial magnetization (of an asynchronous induction motor) or autophasing (of a permanent magnet motor), but not more often than once in every 7 seconds. Otherwise, the limit defined by 30.17 Maximum current is in force.</p> <p><b>Note:</b> The availability of a start current higher than the general limit depends on drive hardware. See the rating data in the hardware manual of the drive.</p>	Disable / uint16
	Disable	Start current limit disabled.	0
	Enable	Start current limit enabled.	1
30.16	Maximum start current	Defines a maximum start current when enabled by parameter 30.15 Maximum start current enable.	0.00 A / real32
	0.00 ... 30000.00 A	Maximum start current.	1 = 1 A / 100 = 1 A
30.17	Maximum current	Defines the maximum allowed motor current.	0.00 A / real32
	0.00 ... 30000.00 A	Maximum motor current.	1 = 1 A / 100 = 1 A

No.	Name / Range / Selection	Description	Def / Type FbEq 16b / 32b
30.18	Minimum torque sel	<p>Selects a source that switches between two different predefined minimum torque limits.</p> <p>0 = Minimum torque limit defined by 30.19 is active 1 = Minimum torque limit selected by 30.21 is active</p> <p>The user can define two sets of torque limits, and switch between the sets using a binary source such as a digital input.</p> <p>The minimum limit selection (30.18) is independent of the maximum limit selection (30.25).</p> <p>The first set of limits is defined by parameters 30.19 and 30.20. The second set has selector parameters for both the minimum (30.21) and maximum (30.22) limits that allows the use of a selectable analog source (such as an analog input).</p>	Minimum torque 1 / uint32

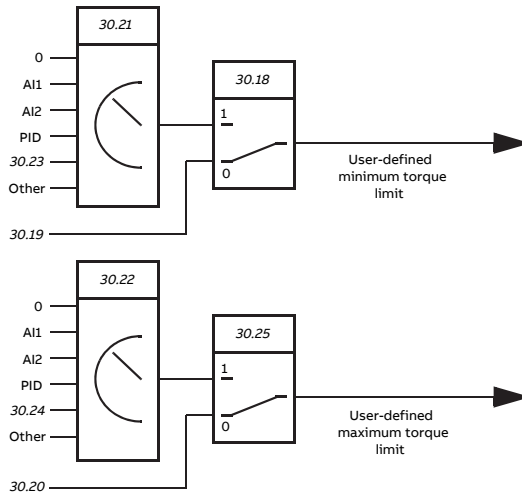

The limit selection parameters are updated on a 10 ms time level.

**Note:** In addition to the user-defined limits, torque may be limited for other reasons (such as power limitation). Refer to the block diagram on page 789.

Minimum torque 1	0 (minimum torque limit defined by 30.19 is active).	0
Minimum torque 2 source	1 (minimum torque limit selected by 30.21 is active).	1
DI1	Digital input DI1 (10.2 DI delayed status, bit 0).	2
DI2	Digital input DI2 (10.2 DI delayed status, bit 1).	3
DI3	Digital input DI3 (10.2 DI delayed status, bit 2).	4
DI4	Digital input DI4 (10.2 DI delayed status, bit 3).	5

## 424 Parameters

No.	Name / Range / Selection	Description	Def / Type FbEq 16b / 32b
	DI5	Digital input DI5 (10.2 DI delayed status, bit 4).	6
	DI6	Digital input DI6 (10.2 DI delayed status, bit 5).	7
	DIO1	Digital input/output DIO1 (11.2 DIO delayed status, bit 0).	10
	DIO2	Digital input/output DIO2 (11.2 DIO delayed status, bit 1).	11
	Other [bit]	See Terms and abbreviations (page 221).	
30.19	Minimum torque 1	<p>Defines a minimum torque limit for the drive (in percent of nominal motor torque). See diagram at parameter 30.18 Minimum torque sel.</p> <p>The limit is effective when</p> <ul style="list-style-type: none"> <li>the source selected by 30.18 Minimum torque sel is 0, or</li> <li>30.18 is set to Minimum torque 1.</li> </ul> <p><b>Note:</b> Do not set this parameter to 0% in an attempt to prevent reverse rotation. In an open-loop application, that is likely to prevent the motor from stopping altogether. To prevent reverse rotation, use the speed/frequency limits in this parameter group, or parameters 20.23/20.24.</p>	-300.0 % / real32
	-1600.0 ... 0.0 %	Minimum torque limit 1. For scaling, see parameter 46.3.	- / -
30.20	Maximum torque 1	<p>Defines a maximum torque limit for the drive (in percent of nominal motor torque). See diagram at parameter 30.18 Minimum torque sel.</p> <p>The limit is effective when</p> <ul style="list-style-type: none"> <li>the source selected by 30.25 Maximum torque sel is 0, or</li> <li>30.25 is set to Maximum torque 1.</li> </ul>	300.0 % / real32
	0.0 ... 1600.0 %	Maximum torque 1. For scaling, see parameter 46.3.	- / -
30.21	Minimum torque 2 source	<p>Defines the source of the minimum torque limit for the drive (in percent of nominal motor torque) when</p> <ul style="list-style-type: none"> <li>the source selected by parameter 30.18 Minimum torque sel is 1, or</li> <li>30.18 is set to Minimum torque 2 source</li> </ul> <p>See diagram at 30.18 Minimum torque sel.</p> <p><b>Note:</b> Any positive values received from the selected source are inverted.</p>	Minimum torque 2 / uint32
	Zero	None.	0
	AI1 scaled	12.12 AI1 scaled value (see page ?).	1
	AI2 scaled	12.22 AI2 scaled value (see page ?).	2
	PID	Not in use.	5



No.	Name / Range / Selection	Description	Def / Type FbEq 16b / 32b
	Minimum torque 2	30.23 Minimum torque 2.	6
	Other [value]	See Terms and abbreviations (page 221).	
30.22	Maximum torque 2 source	<p>Defines the source of the maximum torque limit for the drive (in percent of nominal motor torque) when</p> <ul style="list-style-type: none"> <li>the source selected by parameter 30.25 Maximum torque sel is 1, or</li> <li>30.25 is set to Maximum torque 2 source.</li> </ul> <p>See diagram at 30.18 Minimum torque sel.</p> <p><b>Note:</b> Any negative values received from the selected source are inverted.</p>	Maximum torque 2 / uint32
	Zero	None.	0
	AI1 scaled	12.12 AI1 scaled value (see page ?).	1
	AI2 scaled	12.22 AI2 scaled value (see page ?).	2
	PID	Not in use.	5
	Maximum torque 2	30.24 Maximum torque 2.	6
	Other [value]	See Terms and abbreviations (page 221).	
30.23	Minimum torque 2	<p>Defines the minimum torque limit for the drive (in percent of nominal motor torque) when</p> <ul style="list-style-type: none"> <li>the source selected by parameter 30.18 Minimum torque sel is 1, and</li> <li>30.21 is set to PID.</li> </ul> <p><b>Note:</b> Do not set this parameter to 0% in an attempt to prevent reverse rotation. In an open-loop application, that is likely to prevent the motor from stopping altogether. To prevent reverse rotation, use the speed/frequency limits in this parameter group, or parameters 20.23/20.24. See diagram at 30.18 Minimum torque sel.</p>	-300.0 % / real32
	-1600.0 ... 0.0 %	Minimum torque limit 2. For scaling, see parameter 46.3.	- / -
30.24	Maximum torque 2	<p>Defines the maximum torque limit for the drive (in percent of nominal motor torque) when</p> <ul style="list-style-type: none"> <li>the source selected by parameter 30.25 Maximum torque sel is 1, and</li> <li>30.22 is set to Maximum torque 2.</li> </ul> <p>See diagram at 30.18 Minimum torque sel.</p>	300.0 % / real32
	0.0 ... 1600.0 %	Maximum torque limit 2. For scaling, see parameter 46.3.	- / -

## 426 Parameters

No.	Name / Range / Selection	Description	Def / Type FbEq 16b / 32b
30.25	Maximum torque sel	Selects a source that switches between two different maximum torque limits. 0 = Maximum torque limit 1 defined by 30.20 is active 1 = Maximum torque limit selected by 30.22 is active See also parameter 30.18 Minimum torque sel.	Maximum torque 1 / uint32
	Maximum torque 1	0.	0
	Maximum torque 2 source	1.	1
	DI1	Digital input DI1 (10.2 DI delayed status, bit 0).	2
	DI2	Digital input DI2 (10.2 DI delayed status, bit 1).	3
	DI3	Digital input DI3 (10.2 DI delayed status, bit 2).	4
	DI4	Digital input DI4 (10.2 DI delayed status, bit 3).	5
	DI5	Digital input DI5 (10.2 DI delayed status, bit 4).	6
	DI6	Digital input DI6 (10.2 DI delayed status, bit 5).	7
	DIO1	Digital input/output DIO1 (11.2 DIO delayed status, bit 0).	10
	DIO2	Digital input/output DIO2 (11.2 DIO delayed status, bit 1).	11
	Other [value]	See Terms and abbreviations (page 221).	
30.26	Power motoring limit	Defines the maximum shaft power in motoring mode, ie. when power is being transferred from the motor to the machinery. The value is given in percent of nominal motor power.	300.00 % / real32
	0.00 ... 600.00 %	Maximum shaft power in motoring mode.	1 = 1 % / 100 = 1 %
30.27	Power generating limit	Defines the maximum shaft power in generating mode, ie. when power is being transferred from the machinery to the motor. The value is given in percent of nominal motor power.  <b>Note:</b> Do not set this parameter to 0% in an attempt to prevent reverse rotation. In an open-loop application, that is likely to prevent the motor from stopping altogether. To prevent reverse rotation, use the speed/frequency limits in this parameter group, or parameters 20.23/20.24.	-300.00 % / real32
	-600.00 ... 0.00 %	Maximum shaft power in generating mode.	1 = 1 % / 100 = 1 %
30.30	Overvoltage control	Enables the overvoltage control of the intermediate DC link. Fast braking of a high inertia load causes the voltage to rise to the overvoltage control limit. To prevent the DC voltage from exceeding the limit, the overvoltage controller automatically decreases the braking torque.  <b>Note:</b> With internal brake chopper, drive increases its internal overvoltage control limit to enable higher reliability in breaking.	Enable / uint16
	Disable	Overvoltage control disabled.	0

No.	Name / Range / Selection	Description	Def / Type FbEq 16b / 32b
	Enable	Overvoltage control enabled.	1
30.31	Undervoltage control	Enables the undervoltage control of the intermediate DC link. If the DC voltage drops due to input power cut off, the undervoltage controller will automatically decrease the motor torque in order to keep the voltage above the lower limit. By decreasing the motor torque, the inertia of the load will cause regeneration back to the drive, keeping the DC link charged and preventing an undervoltage trip until the motor coasts to a stop. This will act as a power-loss ride-through functionality in systems with high inertia, such as a centrifuge or a fan.	Enable / uint16
	Disable	Undervoltage control disabled.	0
	Enable	Undervoltage control enabled.	1
30.35	Thermal current limitation	Enables/disables temperature-based output current limitation. The limitation should only be disabled if required by the application.	Enable / uint16
	Disable	Thermal current limitation disabled.	0
	Enable	Thermal current limitation enabled.	1
30.200	External speed limits	Selects the source for activating the External speed limitation command. 0 = External speed limitation command is inactive. 1 = External speed limitation command is active. When the command is active, the drive speed reference is limited to the value defined with parameter 30.201 External min speed limit or 30.202 External max speed limit, depending on the motor direction. For more information on the function, see section External speed limitation (page 97).	Disable / int32
	Disable	0.	0
	Enable	1.	1
	DI1	Digital input DI1 (10.2 DI delayed status, bit 0).	2
	DI2	Digital input DI2 (10.2 DI delayed status, bit 1).	3
	DI3	Digital input DI3 (10.2 DI delayed status, bit 2).	4
	DI4	Digital input DI4 (10.2 DI delayed status, bit 3).	5
	DI5	Digital input DI5 (10.2 DI delayed status, bit 4).	6
	DI6	Digital input DI6 (10.2 DI delayed status, bit 5).	7
	DIO1	Digital input/output DIO1 (11.2 DIO delayed status, bit 0).	8
	DIO2	Digital input/output DIO2 (11.2 DIO delayed status, bit 1).	9
	Other [bit]	See Terms and abbreviations (page 221).	
30.201	External min speed limit	Defines the speed reference limit used in the reverse direction when the External speed limit command (30.200 External speed limits) is active.	-300.00 rpm / real32

## 428 Parameters

No.	Name / Range / Selection	Description	Def / Type FbEq 16b / 32b
	-30000.00 ... 0.00 rpm	External minimum speed limit.	1 = 1 rpm / 1 = 1 rpm
30.202	External max speed limit	Defines the speed reference limit used in the forward direction when the External speed limit command (30.200 External speed limits) is active.	300.00 rpm / real32
	0.00 ... 30000.00 rpm	External maximum speed limit.	1 = 1 rpm / 1 = 1 rpm
30.203	Deadband forward	<p>Defines the dead-band area for the positive speed reference when the speed reference is taken from an analog input.</p> <p>The analog speed reference is blocked for the dead-band area, and the speed reference is scaled from the dead-band forward value (30.203) to 100% instead of 0 to 100% of the analog input.</p> <p>This diagram shows the effect of the dead-band forward (30.203) and dead-band reverse (30.204) values when analog input 1 is the source of the speed reference.</p>	2.00% / real32
<p>For more information, see section <a href="#">Dead-band function</a> (page 94).</p>			
	0.00 ... 100.00%	Dead-band forward setting in percent of the analog input signal (12.11 AI1 actual value).	1 = 1% / 1 = 1%

No.	Name / Range / Selection	Description	Def / Type FbEq 16b / 32b
30.204	Deadband reverse	<p>Defines the dead-band area for the negative speed reference when the speed reference is taken from an analog</p> <p>The analog speed reference is blocked for the dead-band area, and the speed reference is scaled from the dead-band reverse value (30.204) to 100% instead of 0 to 100% of the analog input.</p> <p>See the diagram in parameter 30.203 <i>Deadband forward</i> for the effect of the dead-band reverse value in the reference scaling.</p>	2.00% / real32
	0.00 ... 100.00%	Dead-band reverse setting in percent of the analog input signal (12.11 AI1 actual value).	1 = 1% / 1 = 1%

## 430 Parameters

No.	Name / Range / Selection	Description	Def / Type FbEq 16b / 32b
<b>31</b>	<b>Fault functions</b>	Configuration of external events; selection of behavior of the drive upon fault situations.	
31.1	External event 1 source	Defines the source of external event 1. See also parameter 31.2 External event 1 type. 0 = Trigger event 1 = Normal operation	Inactive (true); DI6 (95.20 b8) / uint32
	Active (false)	0.	0
	Inactive (true)	1.	1
	DIIL	DIIL input (10.2 DI delayed status, bit 15).	2
	DI1	Digital input DI1 (10.2 DI delayed status, bit 0).	3
	DI2	Digital input DI2 (10.2 DI delayed status, bit 1).	4
	DI3	Digital input DI3 (10.2 DI delayed status, bit 2).	5
	DI4	Digital input DI4 (10.2 DI delayed status, bit 3).	6
	DI5	Digital input DI5 (10.2 DI delayed status, bit 4).	7
	DI6	Digital input DI6 (10.2 DI delayed status, bit 5).	8
	DIO1	Digital input/output DIO1 (11.2 DIO delayed status, bit 0).	11
	DIO2	Digital input/output DIO2 (11.2 DIO delayed status, bit 1).	12
	Other [value]	See Terms and abbreviations (page 221).	
31.2	External event 1 type	Selects the type of external event 1.	Fault (95.20 b8) / uint16
	Fault	The external event generates a fault.	0
	Warning	The external event generates a warning.	1
	Warning/Fault	If the drive is modulating, the external event generates a fault. Otherwise, the event generates a warning.	3
31.3	External event 2 source	Defines the source of external event 2. See also parameter 31.4 External event 2 type. For the selections, see parameter 31.1 External event 1 source.	Inactive (true); DIIL (95.20 b5) / uint32
31.4	External event 2 type	Selects the type of external event 2.	Fault / uint16
	Fault	The external event generates a fault.	0
	Warning	The external event generates a warning.	1
	Warning/Fault	If the drive is modulating, the external event generates a fault. Otherwise, the event generates a warning.	3
31.5	External event 3 source	Defines the source of external event 3. See also parameter 31.6 External event 3 type. For the selections, see parameter 31.1 External event 1 source.	Inactive (true) / uint32
31.6	External event 3 type	Selects the type of external event 3.	- / uint16
	Fault	The external event generates a fault.	0

No.	Name / Range / Selection	Description	Def / Type FbEq 16b / 32b
	Warning	The external event generates a warning.	1
	Warning/Fault	If the drive is modulating, the external event generates a fault. Otherwise, the event generates a warning.	3
31.7	External event 4 source	Defines the source of external event 4. See also parameter 31.8 External event 4 type. For the selections, see parameter 31.1 External event 1 source.	Inactive (true) / uint32
31.8	External event 4 type	Selects the type of external event 4.	- / uint16
	Fault	The external event generates a fault.	0
	Warning	The external event generates a warning.	1
	Warning/Fault	If the drive is modulating, the external event generates a fault. Otherwise, the event generates a warning.	3
31.9	External event 5 source	Defines the source of external event 5. See also parameter 31.10 External event 5 type. For the selections, see parameter 31.1 External event 1 source.	Inactive (true) / uint32
31.10	External event 5 type	Selects the type of external event 5.	- / uint16
	Fault	The external event generates a fault.	0
	Warning	The external event generates a warning.	1
	Warning/Fault	If the drive is modulating, the external event generates a fault. Otherwise, the event generates a warning.	3
31.11	Fault reset selection	Selects the source of an external fault reset signal. This signal will be observed even if it is not the active source in the current control location (EXT1/EXT2/Local). (A reset from the active source will be observed regardless of this parameter.) 0 → 1 = Reset	DI3 / uint32
	Not selected	0	0
	Selected	1	1
	DI1	Digital input DI1 (10.2 DI delayed status, bit 0).	2
	DI2	Digital input DI2 (10.2 DI delayed status, bit 1).	3
	DI3	Digital input DI3 (10.2 DI delayed status, bit 2).	4
	DI4	Digital input DI4 (10.2 DI delayed status, bit 3).	5
	DI5	Digital input DI5 (10.2 DI delayed status, bit 4).	6
	DI6	Digital input DI6 (10.2 DI delayed status, bit 5).	7
	DIO1	Digital input/output DIO1 (11.2 DIO delayed status, bit 0).	10
	DIO2	Digital input/output DIO2 (11.2 DIO delayed status, bit 1).	11

## 432 Parameters

No.	Name / Range / Selection	Description	Def / Type FbEq 16b / 32b
	FBA A MCW bit 7	Control word bit 7 received through fieldbus interface A.	30
	EFB MCW bit 7	Control word bit 7 received through the embedded fieldbus interface.	32
	Other [bit]	See <a href="#">Terms and abbreviations (page 221)</a> .	
31.12	Autoreset selection	<p>Selects faults that are automatically reset. The parameter is a 16-bit word with each bit corresponding to a fault type. Whenever a bit is set to 1, the corresponding fault is automatically reset. The number and interval of reset attempts are defined by parameters 31.14...31.16.</p> <p><b>WARNING!</b>   Before you activate the function, make sure that no dangerous situations can occur. The function resets the drive automatically and continues operation after a fault.</p> <p><b>Note:</b></p> <ul style="list-style-type: none"> <li>The autoreset function is only available in external control; see section <a href="#">Local control vs. external control (page 145)</a>.</li> <li>Faults related to the Safe torque off (STO) function cannot be automatically reset.</li> </ul> <p>The bits of this binary number correspond to the following faults:</p>	- / uint16
	b0	Overcurrent	
	b1	Overvoltage	
	b2	Undervoltage	
	b3	AI supervision fault	
	b4	Supply unit	
	b5...7	Reserved	
	b8	Application fault 1	Defined in the application program
	b9	Application fault 2	Defined in the application program
	b10	Selectable fault	See parameter 31.13 <a href="#">User selectable fault</a>
	b11	External fault 1	From source selected by parameter 31.1 <a href="#">External event 1 source</a>
	b12	External fault 2	From source selected by parameter 31.3 <a href="#">External event 2 source</a>
	b13	External fault 3	From source selected by parameter 31.5 <a href="#">External event 3 source</a>
	b14	External fault 4	From source selected by parameter 31.7 <a href="#">External event 4 source</a>



No.	Name / Range / Selection	Description	Def / Type FbEq 16b / 32b
	b15 External fault 5	From source selected by parameter 31.9 External event 5 source	
	0000h...FFFFh		1 = 1
31.13	User selectable fault	Defines the fault that can be automatically reset using parameter 31.12 Autoreset selection, bit 10. The faults are listed in chapter Fault tracing (page 679).	0 / uint32
	0000...FFFFh	Fault code.	1 = 1
31.14	Number of trials	Defines the maximum number of automatic resets that the drive is allowed to attempt within the time specified by 31.15 Total trials time. If the fault persists, subsequent reset attempts will be made at intervals defined by 31.16 Delay time. The faults to be automatically reset are defined by 31.12 Autoreset selection.	0 / uint32
	0...5	Number of automatic resets.	1 = 1 / 1 = 1
31.15	Total trials time	Defines a time window for automatic fault resets. The maximum number of attempts made during any period of this length is defined by 31.14 Number of trials.  <b>Note:</b> If the fault condition remains and cannot be reset, each reset attempt will generate an event and start a new time window. In practice, if the specified number of resets (31.14) at specified intervals (31.16) take longer than the value of 31.15, the drive will continue to attempt resetting the fault until the cause is eventually removed.	30.0 s / real32
	1.0 ... 600.0 s	Time for automatic resets.	10 = 1 s / 10 = 1 s
31.16	Delay time	Defines the time that the drive will wait after a fault (or a previous reset attempt) before attempting an automatic reset. See parameter 31.12 Autoreset selection.	0.0 s / real32
	0.0 ... 120.0 s	Autoreset delay.	10 = 1 s / 10 = 1 s
31.19	Motor phase loss	Selects how the drive reacts when a motor phase loss is detected.  <b>Note:</b> The drive may not be able to reliably detect a phase loss in a multimotor application: a separate protection method (eg. a motor protection switch) should be installed for each motor.	Fault / uint16
	No action	No action taken.	0
	Fault	The drive trips on fault 3381 Output phase loss.	1
31.20	Earth fault	Selects how the drive reacts when an earth fault or current unbalance is detected in the motor or the motor cable. See also section Earth (Ground) fault detection (parameter 31.20) (page 207).	Fault / uint16
	No action	No action taken.	0
	Warning	The drive generates an A2B3 Earth leakage warning.	1

## 434 Parameters

No.	Name / Range / Selection	Description	Def / Type FbEq 16b / 32b
	Fault	The drive trips on fault 2330 Earth leakage.	2

31.22	STO indication run/stop	<p>Selects which indications are given when both Safe torque off (STO) signals are switched off or lost. The indications also depend on whether the drive is running or stopped when this occurs.</p> <p>The tables at each selection below show the indications generated with that particular setting.</p>	Fault/Fault / uint16
-------	-------------------------	--	----------------------

**Note:**

- This parameter does not affect the operation of the STO function itself. The STO function will operate regardless of the setting of this parameter: a running drive will stop upon removal of one or both STO signals, and will not start until both STO signals are restored and all faults reset.
- The loss of only one STO signal always generates a fault as it is interpreted as a malfunction.
- This parameter cannot be changed while the drive is running.

For more information on the STO, see the Hardware manual of the drive.

Fault/Fault

Inputs		Indication (running or stopped)
IN1	IN2	
0	0	Fault 5091 Safe torque off
0	1	Faults 5091 Safe torque off and FA81 Safe torque off 1 loss
1	0	Faults 5091 Safe torque off and FA82 Safe torque off 2 loss
1	1	(Normal operation)

0

No.	Name / Range / Selection	Description	Def / Type FbEq 16b / 32b																									
	Fault/Warning		1																									
		<table border="1"> <thead> <tr> <th colspan="2">Inputs</th> <th colspan="2">Indication</th> </tr> <tr> <th>IN1</th> <th>IN2</th> <th>Running</th> <th>Stopped</th> </tr> </thead> <tbody> <tr> <td>0</td> <td>0</td> <td>Fault 5091 Safe torque off 5091 Safe torque off</td> <td>Warning A5A0 Safe torque off</td> </tr> <tr> <td>0</td> <td>1</td> <td>Faults 5091 Safe torque off and FA81 Safe torque off 1 loss</td> <td>Warning A5A0 Safe torque off and fault FA81 Safe torque off 1 loss</td> </tr> <tr> <td>1</td> <td>0</td> <td>Faults 5091 Safe torque off and FA82 Safe torque off 2 loss</td> <td>Warning A5A0 Safe torque off and fault FA82 Safe torque off 2 loss</td> </tr> <tr> <td>1</td> <td>1</td> <td colspan="2">(Normal operation)</td> </tr> </tbody> </table>	Inputs		Indication		IN1	IN2	Running	Stopped	0	0	Fault 5091 Safe torque off 5091 Safe torque off	Warning A5A0 Safe torque off	0	1	Faults 5091 Safe torque off and FA81 Safe torque off 1 loss	Warning A5A0 Safe torque off and fault FA81 Safe torque off 1 loss	1	0	Faults 5091 Safe torque off and FA82 Safe torque off 2 loss	Warning A5A0 Safe torque off and fault FA82 Safe torque off 2 loss	1	1	(Normal operation)			
Inputs		Indication																										
IN1	IN2	Running	Stopped																									
0	0	Fault 5091 Safe torque off 5091 Safe torque off	Warning A5A0 Safe torque off																									
0	1	Faults 5091 Safe torque off and FA81 Safe torque off 1 loss	Warning A5A0 Safe torque off and fault FA81 Safe torque off 1 loss																									
1	0	Faults 5091 Safe torque off and FA82 Safe torque off 2 loss	Warning A5A0 Safe torque off and fault FA82 Safe torque off 2 loss																									
1	1	(Normal operation)																										
	Fault/Event		2																									
		<table border="1"> <thead> <tr> <th colspan="2">Inputs</th> <th colspan="2">Indication</th> </tr> <tr> <th>IN1</th> <th>IN2</th> <th>Running</th> <th>Stopped</th> </tr> </thead> <tbody> <tr> <td>0</td> <td>0</td> <td>Fault 5091 Safe torque off</td> <td>Event B5A0 STO event</td> </tr> <tr> <td>0</td> <td>1</td> <td>Faults 5091 Safe torque off and FA81 Safe torque off 1 loss</td> <td>Event B5A0 STO event and fault FA81 Safe torque off 1 loss</td> </tr> <tr> <td>1</td> <td>0</td> <td>Faults 5091 Safe torque off and FA82 Safe torque off 2 loss</td> <td>Event B5A0 STO event and fault FA82 Safe torque off 2 loss</td> </tr> <tr> <td>1</td> <td>1</td> <td colspan="2">(Normal operation)</td> </tr> </tbody> </table>	Inputs		Indication		IN1	IN2	Running	Stopped	0	0	Fault 5091 Safe torque off	Event B5A0 STO event	0	1	Faults 5091 Safe torque off and FA81 Safe torque off 1 loss	Event B5A0 STO event and fault FA81 Safe torque off 1 loss	1	0	Faults 5091 Safe torque off and FA82 Safe torque off 2 loss	Event B5A0 STO event and fault FA82 Safe torque off 2 loss	1	1	(Normal operation)			
Inputs		Indication																										
IN1	IN2	Running	Stopped																									
0	0	Fault 5091 Safe torque off	Event B5A0 STO event																									
0	1	Faults 5091 Safe torque off and FA81 Safe torque off 1 loss	Event B5A0 STO event and fault FA81 Safe torque off 1 loss																									
1	0	Faults 5091 Safe torque off and FA82 Safe torque off 2 loss	Event B5A0 STO event and fault FA82 Safe torque off 2 loss																									
1	1	(Normal operation)																										
	Warning/Warning		3																									
		<table border="1"> <thead> <tr> <th colspan="2">Inputs</th> <th rowspan="2">Indication (running or stopped)</th> </tr> <tr> <th>IN1</th> <th>IN2</th> </tr> </thead> <tbody> <tr> <td>0</td> <td>0</td> <td>Warning A5A0 Safe torque off</td> </tr> <tr> <td>0</td> <td>1</td> <td>Warning A5A0 Safe torque off and fault FA81 Safe torque off 1 loss</td> </tr> <tr> <td>1</td> <td>0</td> <td>Warning A5A0 Safe torque off and fault FA82 Safe torque off 2 loss</td> </tr> <tr> <td>1</td> <td>1</td> <td>(Normal operation)</td> </tr> </tbody> </table>	Inputs		Indication (running or stopped)	IN1	IN2	0	0	Warning A5A0 Safe torque off	0	1	Warning A5A0 Safe torque off and fault FA81 Safe torque off 1 loss	1	0	Warning A5A0 Safe torque off and fault FA82 Safe torque off 2 loss	1	1	(Normal operation)									
Inputs		Indication (running or stopped)																										
IN1	IN2																											
0	0	Warning A5A0 Safe torque off																										
0	1	Warning A5A0 Safe torque off and fault FA81 Safe torque off 1 loss																										
1	0	Warning A5A0 Safe torque off and fault FA82 Safe torque off 2 loss																										
1	1	(Normal operation)																										

# 436 Parameters

No.	Name / Range / Selection	Description	Def / Type FbEq 16b / 32b																	
	Event/Event	<table border="1"> <thead> <tr> <th colspan="2">Inputs</th> <th rowspan="2">Indication (running or stopped)</th> </tr> <tr> <th>IN1</th> <th>IN2</th> </tr> </thead> <tbody> <tr> <td>0</td> <td>0</td> <td>Event B5A0 STO event</td> </tr> <tr> <td>0</td> <td>1</td> <td>Event B5A0 STO event and fault FA81 Safe torque off 1 loss</td> </tr> <tr> <td>1</td> <td>0</td> <td>Event B5A0 STO event and fault FA82 Safe torque off 2 loss</td> </tr> <tr> <td>1</td> <td>1</td> <td>(Normal operation)</td> </tr> </tbody> </table>	Inputs		Indication (running or stopped)	IN1	IN2	0	0	Event B5A0 STO event	0	1	Event B5A0 STO event and fault FA81 Safe torque off 1 loss	1	0	Event B5A0 STO event and fault FA82 Safe torque off 2 loss	1	1	(Normal operation)	4
Inputs		Indication (running or stopped)																		
IN1	IN2																			
0	0	Event B5A0 STO event																		
0	1	Event B5A0 STO event and fault FA81 Safe torque off 1 loss																		
1	0	Event B5A0 STO event and fault FA82 Safe torque off 2 loss																		
1	1	(Normal operation)																		
	No indication/No indication	<table border="1"> <thead> <tr> <th colspan="2">Inputs</th> <th rowspan="2">Indication (running or stopped)</th> </tr> <tr> <th>IN1</th> <th>IN2</th> </tr> </thead> <tbody> <tr> <td>0</td> <td>0</td> <td>None</td> </tr> <tr> <td>0</td> <td>1</td> <td>Fault FA81 Safe torque off 1 loss</td> </tr> <tr> <td>1</td> <td>0</td> <td>Fault FA82 Safe torque off 2 loss</td> </tr> <tr> <td>1</td> <td>1</td> <td>(Normal operation)</td> </tr> </tbody> </table>	Inputs		Indication (running or stopped)	IN1	IN2	0	0	None	0	1	Fault FA81 Safe torque off 1 loss	1	0	Fault FA82 Safe torque off 2 loss	1	1	(Normal operation)	5
Inputs		Indication (running or stopped)																		
IN1	IN2																			
0	0	None																		
0	1	Fault FA81 Safe torque off 1 loss																		
1	0	Fault FA82 Safe torque off 2 loss																		
1	1	(Normal operation)																		
31.23	Wiring or earth fault	<p>Selects how the drive reacts to incorrect input power and motor cable connection (i.e. input power cable is connected to drive motor connection).</p> <p><b>Note:</b> The protection must be disabled with drive/inverter hardware supplied from a common DC bus.</p>	Fault; No action (95.20 b15) / uint16																	
	No action	No action taken (protection disabled).	0																	
	Fault	The drive trips on fault 3181 Wiring or earth fault.	1																	
31.24	Stall function	<p>Selects how the drive reacts to a motor stall condition. A stall condition is defined as follows:</p> <ul style="list-style-type: none"> <li>The drive exceeds the stall current limit (31.25 Stall current limit), and</li> <li>the output frequency is below the level set by parameter 31.27 Stall frequency limit or the motor speed is below the level set by parameter 31.26 Stall speed limit, and</li> <li>the conditions above have been true longer than the time set by parameter 31.28 Stall time.</li> </ul>	Fault / uint16																	
	No action	None (stall supervision disabled).	0																	
	Warning	The drive generates an A780 Motor stall.	1																	
	Fault	The drive trips on fault 7121 Motor stall.	2																	
31.25	Stall current limit	Stall current limit in percent of the nominal current of the motor. See parameter 31.24 Stall function.	200.0 % / real32																	
	0.0 ... 1600.0 %	Stall current limit.	10 = 1 % / 10 = 1 %																	

No.	Name / Range / Selection	Description	Def / Type FbEq 16b / 32b
31.26	Stall speed limit	Stall speed limit in rpm. See parameter 31.24 Stall function.	150.00; 180.00 rpm (95.20 b0) rpm / real32
	0.00 ... 10000.00 rpm	Stall speed limit. For scaling, see parameter 46.1.	- / -
31.27	Stall frequency limit	Stall frequency limit. See parameter 31.24 Stall function.  <b>Note:</b> Setting the limit below 10 Hz is not recommended.	15.00; 18.00 Hz (95.20 b0) Hz / real32
	0.00 ... 500.00 Hz	Stall frequency limit. For scaling, see parameter 46.2.	- / -
31.28	Stall time	Stall time. See parameter 31.24 Stall function.	20 s / real32
	0...3600 s	Stall time.	1 = 1 s / 1 = 1 s
31.30	Overspeed trip margin	Defines, together with 30.11 Minimum speed and 30.12 Maximum speed, the maximum allowed speed of the motor (overspeed protection). If 90.1 Motor speed for control or the estimated speed exceeds the speed limit defined by parameter 30.11 or 30.12 by more than the value of this parameter, the drive trips on the 7310 Overspeed.  <b>Example:</b> If the maximum speed is 1420 rpm and speed trip margin is 300 rpm, the drive trips at 1720 rpm.	500.00 rpm / real32
	0.00 ... 10000.00 rpm	Overspeed trip margin. For scaling, see parameter 46.1.	- / -

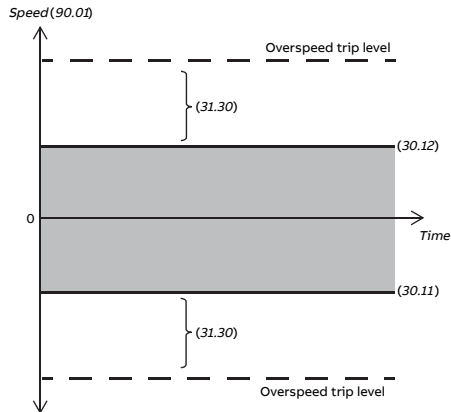

## 438 Parameters

No.	Name / Range / Selection	Description	Def / Type FbEq 16b / 32b
31.32	Emergency ramp supervision	<p>Parameters 31.32 Emergency ramp supervision and 31.33 Emergency ramp supervision delay, together with 1.29 Speed change rate, provide a supervision function for emergency stop modes Off1 and Off3. The supervision is based on either</p> <ul style="list-style-type: none"> <li>• observing the time within which the motor stops, or</li> <li>• comparing the actual and expected deceleration rates.</li> </ul> <p>If this parameter is set to 0%, the maximum stop time is directly set in parameter 31.33. Otherwise, 31.32 defines the maximum allowed deviation from the expected deceleration rate, which is calculated from parameter 23.23 Emergency stop time (Off3). If the actual deceleration rate (1.29) deviates too much from the expected rate, the drive trips on 73B0 Emergency ramp failed, sets bit 8 of 6.17 Drive status word 2, and coasts to a stop.</p> <p>If 31.32 is set to 0% and 31.33 is set to 0 s, the emergency stop ramp supervision is disabled.</p>	- / real32
	0...300 %	Maximum deviation from expected deceleration rate.	1 = 1 % / 0 = 1 %
31.33	Emergency ramp supervision delay	<p>If parameter 31.32 Emergency ramp supervision is set to 0%, this parameter defines the maximum time an emergency stop (mode Off1 or Off3) is allowed to take. If the motor has not stopped when the time elapses, the drive trips on 73B0 Emergency ramp failed, sets bit 8 of 6.17 Drive status word 2, and coasts to a stop.</p> <p>If 31.32 is set to a value other than 0%, this parameter defines a delay between the receipt of the emergency stop command and the activation of the supervision. It is recommended to specify a short delay to allow the speed change rate to stabilize.</p>	- / real32
	0...32767 s	Maximum ramp-down time, or supervision activation delay.	1 = 1 s / 1 = 1 s

No.	Name / Range / Selection	Description	Def / Type FbEq 16b / 32b
31.35	Main fan fault function	<p>Selects how the drive reacts when a main cooling fan fault is detected.</p> <p><b>Note:</b> With an inverter unit consisting of one or more frame R8i inverter modules with speed-controlled fans, it may be possible to continue operation even if one main fan of a module stops. When fan failure is detected, the control program will automatically</p> <ul style="list-style-type: none"> <li>• set the other fan of the module to full speed</li> <li>• set the fans of the other modules (if any) to full speed</li> <li>• decrease the switching frequency to a minimum, and</li> <li>• disable the supervision of temperature difference between the modules.</li> </ul> <p>If this parameter is set to <b>Fault</b>, the inverter unit will trip (but still carry out the actions listed above). Otherwise, the inverter will attempt to continue operation.</p>	Warning / uint16
	Fault	The drive trips on fault 5080 Fan.	0
	Warning	The drive generates an A581 Fan.	1
	No action	No action taken.	2
31.37	Ramp stop supervision	<p>Parameters 31.37 Ramp stop supervision and 31.38 Ramp stop supervision delay, together with 1.29 Speed change rate, provide a supervision function for normal (ie. nonemergency) ramp stopping. The supervision is based on either</p> <ul style="list-style-type: none"> <li>• observing the time within which the motor stops, or</li> <li>• comparing the actual and expected deceleration rates.</li> </ul> <p>If this parameter is set to 0%, the maximum stop time is directly set in parameter 31.38. Otherwise, 31.37 defines the maximum allowed deviation from the expected deceleration rate, which is calculated from parameters 23.11...23.19. If the actual deceleration rate (1.29) deviates too much from the expected rate, the drive trips on 73B1 Stop failed, sets bit 14 of 6.17 Drive status word 2, and coasts to a stop.</p> <p>If 31.37 is set to 0% and 31.38 is set to 0 s, the ramp stop supervision is disabled.</p>	- / real32
	0...300 %	Maximum deviation from expected deceleration rate.	1 = 1% / 0 = 1%

## 440 Parameters

No.	Name / Range / Selection	Description	Def / Type FbEq 16b / 32b
31.38	Ramp stop supervision delay	<p>If parameter 31.37 Ramp stop supervision is set to 0%, this parameter defines the maximum time a ramp stop is allowed to take. If the motor has not stopped when the time elapses, the drive trips on 73B1 Stop failed, sets bit 14 of 6.17 Drive status word 2, and coasts to a stop.</p> <p>If 31.37 is set to a value other than 0%, this parameter defines a delay between the receipt of the stop command and the activation of the supervision. It is recommended to specify a short delay to allow the speed change rate to stabilize.</p>	0 s / real32
	0...32767 s	Maximum ramp-down time, or supervision activation delay.	1 = 1 s / 1 = 1 s
31.40	Disable warning messages	<p>Selects warnings to be suppressed. The parameter is a 16-bit word with each bit corresponding to a warning. Whenever a bit is set to 1, the corresponding warning is suppressed.</p> <p>The bits of this binary number correspond to the following warnings:</p>	- / uint16
	b0 Overvoltage	A3A1 DC link overvoltage	
	b1 Reserved		
	b2 Encoder 1	A7E1 Encoder (for encoder 1)	
	b3 Encoder 2	A7E1 Encoder (for encoder 2)	
	b4 CU Battery	A5F4 Control unit battery	
	b5 EmergencyStop Off2	AFE1 Emergency stop (off2)	
	b6 EmergencyStop Off1 Off3	AFE2 Emergency stop (off1 or off3)	
	b7...15 Reserved		
	0000h...FFFFh		1 = 1
31.42	Overcurrent fault limit	<p>Sets a custom motor current fault limit. The drive automatically sets an internal motor current limit according to the drive hardware. The internal limit is appropriate in most cases, but this parameter can be used to set a lower current limit, for example, to protect a permanent magnet motor from demagnetization.</p> <p><b>Note:</b> The limit defines the maximum peak current of one phase.</p> <p>With this parameter at 0.0 A, only the internal limit is in force.</p>	0.00 A / real32
	0.00 ... 30000.00 A	Custom motor current fault limit. For scaling, see parameter 46.5.	- / -
31.54	Fault action	Selects the stop mode when a non-critical fault occurs.	Coast / uint16
	Coast	The drive coasts to a stop.	0
	Emergency ramp	The drive follows the ramp specified for an emergency stop in parameter 23.23 Emergency stop time.	1



No.	Name / Range / Selection	Description	Def / Type FbEq 16b / 32b
31.55	Ext I/O comm loss event	Selects how the drive reacts when the communication to an I/O extension module fails.	Fault / uint16
	No action	No action taken.	0
	Warning	The drive generates a warning, A799 ExtIO comm loss.	1
	Fault	The drive trips on a fault, 7082 Ext I/O comm loss.	2
31.200	Motor overspeed level	Defines the motor overspeed level. The parameter value is applicable in both forward and reverse directions. For more information on the function, see section <i>Motor overspeed monitoring</i> (page 105).	2000.00 rpm / real32
	0.00 ... 30000.00 rpm	Motor overspeed level.	1 = 1 rpm / 1 = 1 rpm
31.201	Motor overspeed level delay	Defines the time delay for generating fault D104 Over speed after the motor speed has exceeded the level defined with parameter 31.200 Motor overspeed level.	1000 ms / real32
	0...30000 ms	Time delay.	1 = 1 ms / 1 = 1 ms
31.202	Inverter overload selection	Selects the bits to be monitored by the Inverter overload detection function. When a bit value = 1, the corresponding bits in parameter 30.2 Torque limit status are used for generating fault D106 Inverter overload. You can also select to monitor a bit of your own selection. For more information on the function, see section <i>Inverter overload detection</i> (page 105).	- / uint16
	b0 Minimum torque	See parameter 30.2 Torque limit status.	
	b1 Maximum torque	See parameter 30.2 Torque limit status.	
	b2 Internal current	See parameter 30.2 Torque limit status.	
	b3 Load angle	See parameter 30.2 Torque limit status.	
	b4 Motor pullout	See parameter 30.2 Torque limit status.	
	b5 User bit	A bit of your own selection.	
	b6...15 Reserved		
	0000h...FFFFh		1 = 1
31.203	User limit bit selection	Selects the source for disabling or enabling the user selectable limit bit for the Inverter overload function. 0 = User-selectable limit bit is disabled. 1 = User-selectable limit bit is enabled.	False / int32
	False	0	0
	True	1	1
	DI1	Digital input DI1 (10.2 DI delayed status, bit 0).	2
	DI2	Digital input DI2 (10.2 DI delayed status, bit 1).	3
	DI3	Digital input DI3 (10.2 DI delayed status, bit 2).	4
	DI4	Digital input DI4 (10.2 DI delayed status, bit 3).	5
	DI5	Digital input DI5 (10.2 DI delayed status, bit 4).	6
	DI6	Digital input DI6 (10.2 DI delayed status, bit 5).	7

## 442 Parameters

No.	Name / Range / Selection	Description	Def / Type FbEq 16b / 32b
	DIO1	Digital input/output DIO1 (11.2 DIO delayed status, bit 0).	8
	DIO2	Digital input/output DIO2 (11.2 DIO delayed status, bit 1).	9
	Other [bit]	See Terms and abbreviations (page 221).	
31.204	Inverter overload delay	Defines the time delay for generating fault D106 Inverter overload after the drive has exceeded any of the inverter current and torque limits defined with parameter 31.202 Inverter overload selection.	3000 ms / real32
	0...30000 ms	Time delay.	1 = 1 ms / 1 = 1 ms
31.205	Crane warning masking	Selects which crane control warnings trigger events to the drive. Whenever a bit of this parameter is set to 1, the corresponding warning can trigger an event. If a bit is set to 0, the warning does not appear in the event logger or control panel, and the warning can be read only from parameters 9.1 Crane SW1 and 9.2 Crane SW2. The bits of this binary number correspond to the following warnings:	- / uint16
	b0 Brake slip at standstill	D200 Brake slip at standstill	
	b1 Slowdown 1/2	D201 Slowdown 1, D202 Slowdown 2	
	b2 Slowdown safe zone	D20C Slowdown safe zone	
	b3 Hoist speed up / down limit	D203 Hoist speed up limit, D204 Hoist speed down limit	
	b4 End limit 1/2	D205 End limit 1, D206 End limit 2	
	b5 External speed limit	D20D External speed limit	
	b6 Joystick reference check	D208 Joystick reference check	
	b7 Joystick zero position	D209 Joystick zero position	
	b8 Power on acknowledge	D20B Power on acknowledge	
	b9 Slack rope	D217 Slack rope	
	b10 Fast stop	D20A Fast stop	
	b11 Follower drive faulted	D221 Follower 1 Faulted, D222 Follower 2 Faulted, D223 Follower 3 Faulted, D224 Follower 4 Faulted	
b12...15	Reserved		
	0000h...FFFFh		1 = 1
31.211	Toggle bit enable	Selects the source for enabling the Toggle bit function.	Disable / int32
	Disable	Toggle bit function is disabled.	0
	Enable	Toggle bit function is enabled.	1
	DI1	Digital input DI1 (10.2 DI delayed status, bit 0).	2

No.	Name / Range / Selection	Description	Def / Type FbEq 16b / 32b
	DI2	Digital input DI2 (10.2 DI delayed status, bit 1).	3
	DI3	Digital input DI3 (10.2 DI delayed status, bit 2).	4
	DI4	Digital input DI4 (10.2 DI delayed status, bit 3).	5
	DI5	Digital input DI5 (10.2 DI delayed status, bit 4).	6
	DI6	Digital input DI6 (10.2 DI delayed status, bit 5).	7
	DIO1	Digital input/output DIO1 (11.2 DIO delayed status, bit 0).	8
	DIO2	Digital input/output DIO2 (11.2 DIO delayed status, bit 1).	9
	Other [bit]	See Terms and abbreviations (page 221).	
31.212	Toggle bit action	Selects how the drive reacts when there is communication loss between the overriding system and the drive in both directions.	Warning / uint32
	Warning	The drive generates a warning (D210 Toggle bit supervision wrn).	0
	Fault	Drive trips on D109 Toggle bit supervision flt.	1
31.213	Toggle bit time delay	Defines the delay time for activating warning/fault.	300 ms / int32
	0...10000 ms	Delay time.	1 = 1 ms / 1 = 1 ms
31.214	Toggle bit source	Selects the source signal from the fieldbus control word to the Toggle bit function. The signal comes, for example, from an overriding system (PLC) through a fieldbus. The function transfers the output from parameter 31.215 Toggle bit statusword, bit 0, into the overriding system through the fieldbus.	False / int32
	False	0.	0
	True	1.	1
	Other [bit]	See Terms and abbreviations (page 221).	
31.215	Toggle bit statusword	Status word for Toggle bit function.	- / uint16
	b0 Toggle bit out (pulse out)	This bit should be connected to the status word that is transferred to the overriding system. See 31.214 Toggle bit source.	
	b1 Warning active	1 = Warning D210 Toggle bit supervision wrn is active.	
	b2 Fault active	1 = Fault D109 Toggle bit supervision flt is active.	
	b3 Enabled	1 = Toggle bit function is enabled	
	b4...15 Reserved		
	0000h...FFFFh		1 = 1
31.216	Toggle bit max response time	Shows the toggle bit maximum response time.	0 ms / uint32
	0...2147483647 ms	Response time.	1 = 1 ms / 1 = 1 ms

## 444 Parameters

No.	Name / Range / Selection	Description	Def / Type FbEq 16b / 32b
<b>32</b>	<b>Supervision</b>	Configuration of signal supervision functions 1...3. Three values can be chosen to be monitored; a warning or fault is generated whenever predefined limits are exceeded. See also section <a href="#">Signal supervision (page 208)</a> .	
32.1	Supervision status	Signal supervision status word. Indicates whether the values monitored by the signal supervision functions are within or outside their respective limits.  <b>Note:</b> This word is independent of the drive actions defined by parameters 32.6, 32.16 and 32.26.	- / uint16
b0 Supervision 1 active 1 = Signal selected by 32.7 is outside its limits.			
b1 Supervision 2 active 1 = Signal selected by 32.17 is outside its limits.			
b2 Supervision 3 active 1 = Signal selected by 32.27 is outside its limits.			
b3...15 Reserved			
	0000h...FFFFh		1 = 1
32.5	Supervision 1 function	Selects the mode of signal supervision function 1. Determines how the monitored signal (see parameter 32.7) is compared to its lower and upper limits (32.9 and 32.10 respectively). The action to be taken when the condition is fulfilled is selected by 32.6.	Disabled / uint16
	Disabled	Signal supervision 1 not in use.	0
	Low	Action is taken whenever the signal falls below its lower limit.	1
	High	Action is taken whenever the signal rises above its upper limit.	2
	Abs low	Action is taken whenever the absolute value of the signal falls below its (absolute) lower limit.	3
	Abs high	Action is taken whenever the absolute value of the signal rises above its (absolute) upper limit.	4
	Both	Action is taken whenever the signal falls below its low limit or rises above its high limit.	5
	Abs both	Action is taken whenever the absolute value of the signal falls below its (absolute) low limit or rises above its (absolute) high limit.	6
32.6	Supervision 1 action	Selects the action the drive takes when the value monitored by signal supervision 1 exceeds its limits.  <b>Note:</b> This parameter does not affect the status indicated by 32.1 <a href="#">Supervision status</a> .	No action / uint16
	No action	No action taken.	0
	Warning	A warning (A8B0 <a href="#">Signal supervision</a> ) is generated.	1
	Fault	The drive trips on 80B0 <a href="#">Signal supervision</a> .	2
	Fault if running	If running, the drive trips on 80B0 <a href="#">Signal supervision</a> .	3

No.	Name / Range / Selection	Description	Def / Type FbEq 16b / 32b
32.7	Supervision 1 signal	Selects the signal to be monitored by signal supervision function 1.	Zero / uint32
	Zero	None.	0
	Speed	1.1 Motor speed used.	1
	Frequency	1.6 Output frequency.	3
	Current	1.7 Motor current.	4
	Torque	1.10 Motor torque.	6
	DC voltage	1.11 DC voltage.	7
	Output power	1.14 Output power.	8
	AI1	12.11 AI1 actual value.	9
	AI2	12.21 AI2 actual value (page 285).	10
	Speed ref ramp in	23.1 Speed ref ramp input (page 378).	18
	Speed ref ramp out	23.2 Speed ref ramp output (page 378).	19
	Speed ref used	24.1 Used speed reference (page 386).	20
	Torque ref used	26.2 Torque reference used (page 405).	21
	Freq ref used	Not in use.	22
	Process PID Output	Not in use.	24
	Process PID feedback	Not in use.	25
	Other [value]	See Terms and abbreviations (page 221).	
32.8	Supervision 1 filter time	Defines a filter time constant for the signal monitored by signal supervision 1.	0.000 s / real32
	0.000 ... 30.000 s	Signal filter time.	1000 = 1 s / 1000 = 1 s
32.9	Supervision 1 low	Defines the lower limit for signal supervision 1.	0.00 / real32
	-21474830.00 ... 21474830.00	Low limit.	- / -
32.10	Supervision 1 high	Defines the upper limit for signal supervision 1.	0.00 / real32
	-21474830.00 ... 21474830.00	Upper limit.	- / -
32.15	Supervision 2 function	Selects the mode of signal supervision function 2. Determines how the monitored signal (see parameter 32.17) is compared to its lower and upper limits (32.19 and 32.20 respectively). The action to be taken when the condition is fulfilled is selected by 32.16.	Disabled / uint16
	Disabled	Signal supervision 2 not in use.	0
	Low	Action is taken whenever the signal falls below its lower limit.	1
	High	Action is taken whenever the signal rises above its upper limit.	2

## 446 Parameters

No.	Name / Range / Selection	Description	Def / Type FbEq 16b / 32b
	Abs low	Action is taken whenever the absolute value of the signal falls below its (absolute) lower limit.	3
	Abs high	Action is taken whenever the absolute value of the signal rises above its (absolute) upper limit.	4
	Both	Action is taken whenever the signal falls below its low limit or rises above its high limit.	5
	Abs both	Action is taken whenever the absolute value of the signal falls below its (absolute) low limit or rises above its (absolute) high limit.	6
32.16	Supervision 2 action	Selects the action the drive takes when the value monitored by signal supervision 2 exceeds its limits.  <b>Note:</b> This parameter does not affect the status indicated by 32.1 Supervision status.	No action / uint16
	No action	No action taken.	0
	Warning	A warning (A8B1 Signal supervision 2) is generated.	1
	Fault	The drive trips on 80B1 Signal supervision 2.	2
	Fault if running	If running, the drive trips on 80B1 Signal supervision 2.	3
32.17	Supervision 2 signal	Selects the signal to be monitored by signal supervision function 2. For the available selections, see parameter 32.7 Supervision 1 signal.	Zero / uint32
32.18	Supervision 2 filter time	Defines a filter time constant for the signal monitored by signal supervision 2.	0.000 s / real32
	0.000 ... 30.000 s	Signal filter time.	1000 = 1 s / 1000 = 1 s
32.19	Supervision 2 low	Defines the lower limit for signal supervision 2.	0.00 / real32
	-21474830.00 ... 21474830.00	Low limit.	- / -
32.20	Supervision 2 high	Defines the upper limit for signal supervision 2.	0.00 / real32
	-21474830.00 ... 21474830.00	Upper limit.	- / -
32.25	Supervision 3 function	Selects the mode of signal supervision function 3. Determines how the monitored signal (see parameter 32.27) is compared to its lower and upper limits (32.29 and 32.30 respectively). The action to be taken when the condition is fulfilled is selected by 32.26.	Disabled / uint16
	Disabled	Signal supervision 3 not in use.	0
	Low	Action is taken whenever the signal falls below its lower limit.	1
	High	Action is taken whenever the signal rises above its upper limit.	2
	Abs low	Action is taken whenever the absolute value of the signal falls below its (absolute) lower limit.	3

No.	Name / Range / Selection	Description	Def / Type FbEq 16b / 32b
	Abs high	Action is taken whenever the absolute value of the signal rises above its (absolute) upper limit.	4
	Both	Action is taken whenever the signal falls below its low limit or rises above its high limit.	5
	Abs both	Action is taken whenever the absolute value of the signal falls below its (absolute) low limit or rises above its (absolute) high limit.	6
32.26	Supervision 3 action	Selects the action the drive takes when the value monitored by signal supervision 3 exceeds its limits.  <b>Note:</b> This parameter does not affect the status indicated by 32.1 Supervision status.	No action / uint16
	No action	No action taken.	0
	Warning	A warning (A8B2 Signal supervision 3) is generated.	1
	Fault	The drive trips on 80B2 Signal supervision 3.	2
	Fault if running	If running, the drive trips on 80B2 Signal supervision 3.	3
32.27	Supervision 3 signal	Selects the signal to be monitored by signal supervision function 3. For the available selections, see parameter 32.7 Supervision 1 signal.	Zero / uint32
32.28	Supervision 3 filter time	Defines a filter time constant for the signal monitored by signal supervision 3.	0.000 s / real32
	0.000 ... 30.000 s	Signal filter time.	1000 = 1 s / 1000 = 1 s
32.29	Supervision 3 low	Defines the lower limit for signal supervision 3.	0.00 / real32
	-21474830.00 ... 21474830.00	Low limit.	- / -
32.30	Supervision 3 high	Defines the upper limit for signal supervision 3.	0.00 / real32
	-21474830.00 ... 21474830.00	Upper limit.	- / -
32.221	Watchdog test	<i>(Visible only when user lock is open with pass code 584. See parameter 96.2 Pass code.)</i> Enables the Watchdog test function. During power-up, the function performs a check-in of the watchdog circuit. See also Watchdog (page 109).	Disable / int32
	Disable	Watchdog test function disabled.	0
	Enable	Watchdog test function enabled.	1
	Other [bit]	See Terms and abbreviations (page 221).	
32.222	Watchdog test delay	<i>(Visible only when user lock is open with pass code 584. See parameter 96.2 Pass code.)</i> Defines the delay time for performing the watchdog test after the Power on acknowledgment signal (parameter 20.212 Power on acknowledgment) is activated.	2.0 s / real32
	0.0 ... 10.0 s	Delay time	10 = 1 s / 1 = 1 s

## 448 Parameters

No.	Name / Range / Selection	Description	Def / Type FbEq 16b / 32b
32.223	Watchdog re test delay	<p>(Visible only when user lock is open with pass code 584. See parameter 96.2 Pass code.)</p> <p>Defines the delay time to prevent repeating the watchdog tests upon a power-up, after the test has been performed once.</p> <p>With this delay time, you can,</p> <ul style="list-style-type: none"> <li>prevent the next watchdog test</li> <li>make sure that the test is not performed every time the drive is powered up.</li> </ul> <p><b>Note:</b> The Watchdog function is applicable only when the drive is using an external power supply. Otherwise, the drive performs the watchdog test every time the drive is powered up without considering this parameter.</p>	1800.0 s / real32
	0.0 ... 1800.0 s	Re-test delay time	10 = 1 s / 1 = 1 s
32.224	Watchdog fault delay	<p>(Visible only when user lock is open with pass code 584. See parameter 96.2 Pass code.)</p> <p>Defines the delay time for generating the D10D Watchdog test fault, when watchdog test fails.</p>	2.0 s / real32
	0.0 ... 10.0 s	Fault delay time	10 = 1 s / 1 = 1 s
32.225	Watchdog user bit	<p>(Visible only when user lock is open with pass code 584. See parameter 96.2 Pass code.)</p> <p>Selects the source for the watchdog signal bit used with predefined critical warning (alarm) bits for generating the D10D Watchdog test fault. When this bit is activated, the drive trips on the fault immediately.</p>	Disable / int32
	Disable	Watchdog user bit function disabled.	0
	Enable	Watchdog user bit function enabled.	1
	Other [bit]	See Terms and abbreviations (page 221).	
32.226	Watchdog mask	<p>(Visible only when user lock is open with pass code 584. See parameter 96.2 Pass code.)</p> <p>Allows to select the warnings that can be monitored by Watchdog function.</p> <p><b>Note:</b> The Brake closing failure (bit 7) warning is active only when the delay time defined with parameter 44.213 Brake long fall delay elapsed after the brake close command and brake acknowledge is not received.</p> <p>The parameter is a 16-bit word with each bit corresponding to a warning. Whenever a bit is set to 1, the corresponding warning is generated. This eliminates the possibility of drive tripping to fault. The bits of this binary number correspond to the following warnings:</p>	- / uint16
	b0 Fb A comm	<p>Warning: A7C1 FBA A communication</p> <p>1 = Parameter 50.2 FBA A comm loss func is forced to Warning, if previous selection was Fault or Fault always.</p>	



No.	Name / Range / Selection	Description	Def / Type FbEq 16b / 32b
b1	Fb B comm	Warning: A7C2 FBA B communication 1 = Parameter 50.32 FBA B comm loss func is forced to <i>Warning</i> , if previous selection was <i>Fault</i> or <i>Fault always</i> .	
b2	M/F comm	Warning: A7CB M/F comm loss 1 = Parameter 60.9 M/F comm loss function and 60.59 DDCS controller comm loss function is forced to <i>Warning</i> , if previous selection was <i>Fault</i> or <i>Fault always</i> .	
b3	Braking resistor failure	Warning: A791 Brake resistor Fault reaction cannot be prevented.	
b4	Braking resistor temp	Warning: A793 BR excess temperature Fault reaction cannot be prevented.	
b5	Braking chopper failure	Warning: A79B BC short circuit Fault reaction cannot be prevented.	
b6	Braking chopper temp	Warning: A79C BC IGBT excess temperature Fault reaction cannot be prevented.	
b7	Brake closing failure	Warning: A7A1 Mechanical brake closing failed 1 = Parameter 44.17 Brake fault function is forced to <i>Open fault</i> , if previous selection was <i>Fault</i> .	
b8	Cpu health	CPU health to do: new	
b9...14	Reserved		
b15	User bit 1	1 = Allows the Watchdog function to monitor the status of the bit selected by pointer parameter 32.225 Watchdog user bit.	
	0000h...FFFFh		1 = 1
32.227	Watchdog sw	Displays the status of Watchdog function. The word can be used as the source for e.g., control relay. This parameter is read-only.	- / uint16
b0	Watchdog fault active	1 = Watchdog test failed. D10D Watchdog test fault has been detected.	
b1	Watchdog relay control bit	0 = Watchdog is Ok 1 = Watchdog tripped  <b>Note:</b> By default, this bit is connected to relay output RO2 (10.27 RO2 source).	
b2	Watchdog test done	0 = Watchdog test is executing 1 = Watchdog test is done	
b3...15	Reserved		
	0000h...FFFFh		1 = 1
32.228	Watchdog trip sw	Displays the warnings that trip the Watchdog function. The parameter is a 16-bit word with each bit corresponding to a warning or fault. Whenever a bit is set to 1, the corresponding warning or fault is generated. The bits of this binary number correspond to the following warnings and faults:	- / uint16
b0	A7C1 FBA A comm	-	

## 450 Parameters

No.	Name / Range / Selection	Description	Def / Type FbEq 16b / 32b
	b1 A7C2 FBA B comm	-	
	b2 A7CB M/F comm loss	-	
	b3 D10C M/F comm loss	-	
	b4 A791 Brake resistor	-	
	b5 A793 Brake resistor temp	-	
	b6 A79B Br chop short circuit	-	
	b7 A79C Brake igbt temp	-	
	b8 A7A1 Brake closing fail	-	
	b9 Cpu health	-	
b10...14	Reserved		
	b15 User bit 1	-	
	0000h...FFFFh		1 = 1

No.	Name / Range / Selection	Description	Def / Type FbEq 16b / 32b
<b>33</b>	<b>Generic timer &amp; counter</b>	Configuration of maintenance timers/counters. See also section <a href="#">Maintenance timers and counters (page 209)</a> .	
33.1	Counter status	Displays the maintenance timer/counter status word, - / uint16 indicating which maintenance timers/counters have exceeded their limits. This parameter is read-only.	
	b0 On-time 1	1 = On-time timer 1 has reached its preset limit.	
	b1 On-time 2	1 = On-time timer 2 has reached its preset limit.	
	b2 Edge 1	1 = Signal edge counter 1 has reached its preset limit.	
	b3 Edge 2	1 = Signal edge counter 2 has reached its preset limit.	
	b4 Value 1	1 = Value counter 1 has reached its preset limit.	
	b5 Value 2	1 = Value counter 2 has reached its preset limit.	
	b6...15 Reserved		
	0000h...FFFFh		1 = 1
33.10	On-time 1 actual	Displays the actual present value of on-time timer 1. The timer runs whenever the signal selected by parameter 33.13 On-time 1 source is on. When the timer exceeds the limit set by 33.11 On-time 1 warn limit, bit 0 of 33.1 Counter status is set to 1. The warning specified by 33.14 On-time 1 warn message is also given if enabled by 33.12 On-time 1 function. The timer can be reset from the Drive Composer PC tool, or from the control panel by keeping Reset depressed for over 3 seconds.	- / uint32
	0...4294967295 s	Actual present value of on-time timer 1.	- / -
33.11	On-time 1 warn limit	Sets the warning limit for on-time timer 1.	- / uint32
	0...4294967295 s	Warning limit for on-time timer 1.	- / -
33.12	On-time 1 function	Configures on-time timer 1.	- / uint16
	b0 Counter mode	0 = Loop: When the limit is reached, the counter is reset. The counter status (bit 0 of 33.1) switches to 1 for one second. The warning (if enabled) stays active for at least 10 seconds. 1 = Saturate: When the limit is reached, the counter status (bit 0 of 33.1) switches to 1, and remains so until 33.10 is reset. The warning (if enabled) also stays active until 33.10 is reset.	
	b1 Warning enable	0 = Disable: No warning is given when the limit is reached 1 = Enable: A warning (see 33.14) is given when the limit is reached	
	b2...15 Reserved		
	0000h...FFFFh		1 = 1
33.13	On-time 1 source	Selects the signal to be monitored by on-time timer 1.	False / uint32
	False	Constant 0 (timer disabled).	0

## 452 Parameters

No.	Name / Range / Selection	Description	Def / Type FbEq 16b / 32b
	True	Constant 1.	1
	RO1	Bit 0 of 10.21 RO status (page 272).	2
	Other [bit]	See Terms and abbreviations (page 221).	
33.14	On-time 1 warn message	Selects the optional warning message for on-time timer 1.	On-time 1 exceeded / uint32
	On-time 1 exceeded	A886 On-Time 1. The message text can be edited on the control panel by choosing Menu – Settings – Edit texts.	0
	Clean device	A88C Device clean.	6
	Maintain additional cooling fan	A890 Additional cooling fan.	7
	Maintain cabinet fan	A88E Cabinet fan.	8
	Maintain DC capacitors	A88D DC capacitor.	9
	Maintain motor bearing	A880 Motor bearing.	10
33.20	On-time 2 actual	Displays the actual present value of on-time timer 2. The timer runs whenever the signal selected by parameter 33.23 On-time 2 source is on. When the timer exceeds the limit set by 33.21 On-time 2 warn limit, bit 1 of 33.1 Counter status is set to 1. The warning specified by 33.24 On-time 2 warn message is also given if enabled by 33.22 On-time 2 function. The timer can be reset from the Drive Composer PC tool, or from the control panel by keeping Reset depressed for over 3 seconds.	- / uint32
	0...4294967295 s	Actual present value of on-time timer 2.	- / -
33.21	On-time 2 warn limit	Sets the warning limit for on-time timer 2.	- / uint32
	0...4294967295 s	Warning limit for on-time timer 2.	- / -
33.22	On-time 2 function	Configures on-time timer 2.	- / uint16
	b0 Counter mode	0 = Loop: When the limit is reached, the counter is reset. The counter status (bit 1 of 33.1) switches to 1 for one second. The warning (if enabled) stays active for at least 10 seconds. 1 = Saturate: When the limit is reached, the counter status (bit 1 of 33.1) switches to 1, and remains so until 33.20 is reset. The warning (if enabled) also stays active until 33.20 is reset.	
	b1 Warning enable	0 = Disable: No warning is given when the limit is reached 1 = Enable: A warning (see 33.24) is given when the limit is reached	
	b2...15 Reserved		
	0000h...FFFFh		1 = 1
33.23	On-time 2 source	Selects the signal to be monitored by on-time timer 2.	False / uint32
	False	Constant 0 (timer disabled).	0

No.	Name / Range / Selection	Description	Def / Type FbEq 16b / 32b
	True	Constant 1.	1
	RO1	Bit 0 of 10.21 RO status (page 272).	2
	Other [bit]	See Terms and abbreviations (page 221).	
33.24	On-time 2 warn message	Selects the optional warning message for on-time timer 2.	On-time 2 exceeded / uint32
	On-time 2 exceeded	A887 On-Time 2. The message text can be edited on the control panel by choosing Menu – Settings – Edit texts.	1
	Clean device	A88C Device clean.	6
	Maintain additional cooling fan	A890 Additional cooling fan.	7
	Maintain cabinet fan	A88E Cabinet fan.	8
	Maintain DC capacitors	A88D DC capacitor.	9
	Maintain motor bearing	A880 Motor bearing.	10
33.30	Edge counter 1 actual	Actual present value of signal edge counter 1. The counter is incremented every time the signal selected by parameter 33.33 Edge counter 1 source switches on or off (or either, depending on the setting of 33.32 Edge counter 1 function). A divisor may be applied to the count (see 33.34 Edge counter 1 divider). When the counter exceeds the limit set by 33.31 Edge counter 1 warn limit, bit 2 of 33.1 Counter status is set to 1. The warning specified by 33.35 Edge counter 1 warn message is also given if enabled by 33.32 Edge counter 1 function. The counter can be reset from the Drive Composer PC tool, or from the control panel by keeping Reset depressed for over 3 seconds.	- / uint32
	0...4294967295	Actual present value of signal edge counter 1.	- / -
33.31	Edge counter 1 warn limit	Sets the warning limit for signal edge counter 1.	- / uint32
	0...4294967295	Warning limit for signal edge counter 1.	- / -
33.32	Edge counter 1 function	Configures signal edge counter 1.	- / uint16
	b0 Counter mode	0 = Loop: When the limit is reached, the counter is reset. The counter status (bit 2 of 33.1) switches to 1 and remains so until the counter is again incremented. The warning (if enabled) stays active for at least 10 seconds. 1 = Saturate: When the limit is reached, the counter status (bit 2 of 33.1) switches to 1, and remains so until 33.30 is reset. The warning (if enabled) also stays active until 33.30 is reset.	
	b1 Warning enable	0 = Disable: No warning is given when the limit is reached 1 = Enable: A warning (see 33.35) is given when the limit is reached	

## 454 Parameters

No.	Name / Range / Selection	Description	Def / Type FbEq 16b / 32b
	b2 Count rising edges	Count rising edges 0 = Disable: Rising edges are not counted 1 = Enable: Rising edges are counted	
	b3 Count falling edges	Count falling edges 0 = Disable: Falling edges are not counted 1 = Enable: Falling edges are counted	
	b4...15 Reserved		
	0000h...FFFFh		1 = 1
33.33	Edge counter 1 source	Selects the signal to be monitored by signal edge counter 1.	False / uint32
	False	Constant 0.	0
	True	Constant 1.	1
	RO1	Bit 0 of 10.21 RO status (page 272).	2
	Other [bit]	See Terms and abbreviations (page 221).	
33.34	Edge counter 1 divider	Defines a divisor for signal edge counter 1. Determines how many signal edges increment the counter by 1.	1 / uint32
	1...2147483647	Divisor for signal edge counter 1.	- / -
33.35	Edge counter 1 warn message	Selects the optional warning message for signal edge counter 1.	Edge counter 1 exceeded / uint32
	Edge counter 1 exceeded	A888 Edge counter 1. The message text can be edited on the control panel by choosing Menu – Settings – Edit texts.	2
	Counted main contactor	A884 Main contactor.	11
	Counted output relay	A881 Output relay.	12
	Counted motor starts	A882 Motor starts.	13
	Counted power ups	A883 Power ups.	14
	Counted DC charges	A885 DC charge.	15
33.40	Edge counter 2 actual	Displays the actual present value of signal edge counter 2. The counter is incremented every time the signal selected by parameter 33.43 Edge counter 2 source switches on or off (or either, depending on the setting of 33.42 Edge counter 2 function). A divisor may be applied to the count (see 33.44 Edge counter 2 divider). When the counter exceeds the limit set by 33.41 Edge counter 2 warn limit, bit 3 of 33.1 Counter status is set to 1. The warning specified by 33.45 Edge counter 2 warn message is also given if enabled by 33.42 Edge counter 2 function. The counter can be reset from the Drive Composer PC tool, or from the control panel by keeping Reset depressed for over 3 seconds.	- / uint32
	0...4294967295	Actual present value of signal edge counter 2.	- / -

No.	Name / Range / Selection	Description	Def / Type FbEq 16b / 32b
33.41	Edge counter 2 warn limit	Sets the warning limit for signal edge counter 2.	- / uint32
	0...4294967295	Warning limit for signal edge counter 2.	- / -
33.42	Edge counter 2 function	Configures signal edge counter 2.	- / uint16
	b0 Counter mode	0 = Loop: When the limit is reached, the counter is reset. The counter status (bit 3 of 33.1) remains 1 until the counter is again incremented. The warning (if enabled) stays active for at least 10 seconds. 1 = Saturate: After the limit is reached, the counter status (bit 3 of 33.1) remains 1 until 33.40 is reset. The warning (if enabled) also stays active until 33.40 is reset.	
	b1 Warning enable	Warning enable 0 = Disable: No warning is given when the limit is reached 1 = Enable: A warning (see 33.45) is given when the limit is reached	
	b2 Count rising edges	Count rising edges 0 = Disable: Rising edges are not counted 1 = Enable: Rising edges are counted	
	b3 Count falling edges	Count falling edges 0 = Disable: Falling edges are not counted 1 = Enable: Falling edges are counted	
	b4...15 Reserved		
	0000h...FFFFh		1 = 1
33.43	Edge counter 2 source	Selects the signal to be monitored by signal edge counter 2.	False / uint32
	False	0.	0
	True	1.	1
	RO1	Bit 0 of 10.21 RO status (page 272).	2
	Other [bit]	See Terms and abbreviations (page 221).	
33.44	Edge counter 2 divider	Defines a divisor for signal edge counter 2. Determines how many signal edges increment the counter by 1.	1 / uint32
	1...4294967295	Divisor for signal edge counter 2.	- / -
33.45	Edge counter 2 warn message	Selects the optional warning message for signal edge counter 2.	Edge counter 2 exceeded / uint32
	Edge counter 2 exceeded	A889 Edge counter 2. The message text can be edited on the control panel by choosing Menu – Settings – Edit texts.	3
	Counted main contactor	A884 Main contactor.	11
	Counted output relay	A881 Output relay.	12
	Counted motor starts	A882 Motor starts.	13

## 456 Parameters

No.	Name / Range / Selection	Description	Def / Type FbEq 16b / 32b
	Counted power ups	A883 Power ups.	14
	Counted DC charges	A885 DC charge.	15
33.50	Value counter 1 actual	<p>Displays the actual present value of value counter 1. The value of the source selected by parameter 33.53 Value counter 1 source is read at one-second intervals and added to the counter. A divisor can be applied to the count (see 33.54 Value counter 1 divider).</p> <p>When the counter exceeds the limit set by 33.51 Value counter 1 warn limit, bit 4 of 33.1 Counter status is set to 1.</p> <p>The warning specified by 33.55 Value counter 1 warn message is also given if enabled by 33.52 Value counter 1 function.</p> <p>The counter can be reset from the Drive Composer PC tool, or from the control panel by keeping Reset depressed for over 3 seconds.</p>	0 / real32
	-2147483000..2147483000	Actual present value of value counter 1.	- / -
33.51	Value counter 1 warn limit	<p>Sets the limit for value counter 1.</p> <p>With a positive limit, bit 4 of 33.1 Counter status is set to 1 (and a warning optionally generated) when the counter is equal or greater than the limit.</p> <p>With a negative limit, bit 4 of 33.1 Counter status is set to 1 (and a warning optionally generated) when the counter is equal or smaller than the limit.</p> <p>0 = Counter disabled.</p>	- / real32
	-2147483000..2147483000	Limit for value counter 1.	- / -
33.52	Value counter 1 function	Configures value counter 1.	- / uint16
	b0 Counter mode	<p>0 = Loop: When the limit is reached, the counter is reset. The counter status (bit 4 of 33.1) switches to 1 for one second. The warning (if enabled) stays active for at least 10 seconds.</p> <p>1 = Saturate: When the limit is reached, the counter status (bit 4 of 33.1) switches to 1, and remains so until 33.50 is reset. The warning (if enabled) also stays active until 33.50 is reset.</p>	
	b1 Warning enable	<p>0 = Disable: No warning is given when the limit is reached</p> <p>1 = Enable: A warning (see 33.55) is given when the limit is reached</p>	
	b2...15 Reserved		
	0000h...FFFFh		1 = 1
33.53	Value counter 1 source	Selects the signal to be monitored by value counter 1.	Not selected / uint32
	Not selected	None (counter disabled).	0
	Motor speed	1.1 Motor speed used.	1
	Other [bit]	See Terms and abbreviations (page 221).	



No.	Name / Range / Selection	Description	Def / Type FbEq 16b / 32b
33.54	Value counter 1 divider	Defines a divisor for value counter 1. The value of the monitored signal is divided by this value before integration.	1.000 / real32
	0.001 ... 2147483.000	Divisor for value counter 1.	- / -
33.55	Value counter 1 warn message	Selects the optional warning message for value counter 1.	Value counter 1 exceeded / uint32
	Value counter 1 exceeded	A88A Value counter 1. The message text can be edited on the control panel by choosing Menu – Settings – Edit texts.	4
	Maintain motor bearing	A880 Motor bearing.	10
33.60	Value counter 2 actual	Displays the actual present value of value counter 2. The value of the source selected by parameter 33.63 Value counter 2 source is read at one-second intervals and added to the counter. A divisor can be applied to the count (see 33.64 Value counter 2 divider). When the counter exceeds the limit set by 33.61 Value counter 2 warn limit, bit 5 of 33.1 Counter status is set to 1. The warning specified by 33.65 Value counter 2 warn message is also given if enabled by 33.62 Value counter 2 function. The counter can be reset from the Drive Composer PC tool, or from the control panel by keeping Reset depressed for over 3 seconds.	0 / real32
	-2147483008_2147483008	Actual present value of value counter 2.	- / -
33.61	Value counter 2 warn limit	Sets the limit for value counter 2. With a positive limit, bit 5 of 33.1 Counter status is set to 1 (and a warning optionally generated) when the counter is equal or greater than the limit. With a negative limit, bit 5 of 33.1 Counter status is set to 1 (and a warning optionally generated) when the counter is equal or smaller than the limit. 0 = Counter disabled.	- / real32
	-2147483008_2147483008	Limit for value counter 2.	- / -
33.62	Value counter 2 function	Configures value counter 2.	- / uint16
	b0 Counter mode	0 = Loop: When the limit is reached, the counter is reset. The counter status (bit 5 of 33.1) switches to 1 for one second. The warning (if enabled) stays active for at least 10 seconds. 1 = Saturate: When the limit is reached, the counter status (bit 5 of 33.1) switches to 1, and remains so until 33.60 is reset. The warning (if enabled) also stays active until 33.60 is reset.	
	b1 Warning enable	Warning enable 0 = Disable: No warning is given when the limit is reached 1 = Enable: A warning (see 33.65) is given when the limit is reached	

## 458 Parameters

No.	Name / Range / Selection	Description	Def / Type FbEq 16b / 32b
b2...15	Reserved		
	0000h...FFFFh		1 = 1
33.63	Value counter 2 source	Selects the signal to be monitored by value counter 2.	Not selected / uint32
	Not selected	None (counter disabled).	0
	Motor speed	1.1 Motor speed used.	1
	Other [value]	See Terms and abbreviations (page 221).	
33.64	Value counter 2 divider	Defines a divisor for value counter 2. The value of the monitored signal is divided by this value before integration.	1.000 / real32
	0.001...2147483.000	Divisor for value counter 2.	- / -
33.65	Value counter 2 warn message	Selects the optional warning message for value counter 2.	Value counter 2 exceeded / uint32
	Value counter 2 exceeded	A88B Value counter 2. The message text can be edited on the control panel by choosing Menu – Settings – Edit texts.	5
	Maintain motor bearing	A880 Motor bearing.	10
33.200	Set crane operation hours	<i>(Visible when user lock is open with pass code 584. See parameter 96.2 Pass code.)</i> Selects the command to initialize current crane operation time to the value specified with parameter 33.201 Crane operation hrs init value. Actual value can be read from parameter 9.20 Crane operation hours.	Done / int32
	Done	Reset done.	0
	Set	Resets the time counter.	1
	Other [value]	See Terms and abbreviations (page 221).	
33.201	Crane operation hrs init value	<i>(Visible when user lock is open with pass code 584. See parameter 96.2 Pass code.)</i> Defines the value to which current crane operation time is reset upon activation of corresponding command. This parameter can be used to initialize the crane operation counter to the previous value after replacing the control board or after doing a firmware upgrade.	0 hour / uint32
	0...1100000 hour	Crane operation time	1 = 1 hour / 1 = 1 hour
33.202	Crane operation hrs warning limit	<i>(Visible when user lock is open with pass code 584. See parameter 96.2 Pass code.)</i> Defines the operation time limit at which a corresponding maintenance warning (D212 Crane operating hours) is activated.	0 hour / uint32
	0...1100000 hour	Crane operation time limit	1 = 1 hour / 1 = 1 hour

No.	Name / Range / Selection	Description	Def / Type FbEq 16b / 32b
33.210	Set brake oper counts	<i>(Visible when user lock is open with pass code 584. See parameter 96.2 Pass code.)</i> Selects the command to initialize the current value of brake open counter to the value specified with parameter 33.211 Brake oper counts init value. Actual value can be read from parameter 9.21 Brake operated counts.	Done / int32
	Done	Reset done.	0
	Set	Resets the brake operating counter.	1
	Other [value]	See Terms and abbreviations (page 221).	
33.211	Brake oper counts init value	<i>(Visible when user lock is open with pass code 584. See parameter 96.2 Pass code.)</i> Defines the value to which the brake operation counter is reset upon activation of corresponding command. Using this parameter after replacing the control board or upgrading firmware will initialize the brake operation counter to the previous value.	0 / uint32
	0...2147483647	Brake operation time	1 = 1 / 1 = 1
33.212	Brake oper counts warning limit	<i>(Visible when user lock is open with pass code 584. See parameter 96.2 Pass code.)</i> Defines the operation time limit at which a corresponding maintenance warning (D213 Brake oper counts) is activated.	0 / uint32
	0...2147483647	Brake operation time limit for activating warning.	1 = 1 / 1 = 1
33.220	Set number of power on	<i>(Visible when user lock is open with pass code 584. See parameter 96.2 Pass code.)</i> Selects the command to initialize the current value of power on counter to the value specified with parameter 33.221 Number of pwr on init value. Actual value can be read from parameter 9.22 Number of pwr on.	Done / int32
	Done	Reset done.	0
	Set	Resets the power on counter.	1
	Other [value]	See Terms and abbreviations (page 221).	
33.221	Number of pwr on init value	<i>(Visible when user lock is open with pass code 584. See parameter 96.2 Pass code.)</i> Defines the value to which the power on counter is reset upon activation of corresponding command. Using this parameter after replacing the control board or after upgrading firmware will initialize the power on counter to the previous value.	0 / uint16
	0..65535	Counts	1 = 1 / 1 = 1
33.222	Number of pwr on warning limit	<i>(Visible when user lock is open with pass code 584. See parameter 96.2 Pass code.)</i> Defines the counter limit at which a corresponding maintenance warning (D214 Number of power on) is activated.	0 / uint16
	0..65535	Counts	1 = 1 / 1 = 1

## 460 Parameters

No.	Name / Range / Selection	Description	Def / Type FbEq 16b / 32b
35	<b>Motor thermal protection</b>	Motor thermal protection settings such as temperature measurement configuration, load curve definition and motor fan control configuration. See also section <a href="#">Motor thermal protection (page 199)</a> .	
35.1	Motor estimated temperature	Displays the motor temperature as estimated by the internal motor thermal protection model (see parameters 35.50...35.55). The unit (°C or °F) is selected by parameter 96.16 Unit selection. This parameter is read-only.	- / real32
	-60.0 ... 1000.0 °	Estimated motor temperature.	1 = 1° / 1 = 1°
35.2	Measured temperature 1	Displays the temperature received through the source defined by parameter 35.11 Temperature 1 source. The unit is selected by parameter 96.16 Unit selection. <b>Note:</b> With °F, the range is -76...1832. With a PTC sensor, the range is 0...5000 ohms. This parameter is read-only.	- / real32
	-60...1000 °	Measured temperature 1.	1 = 1° / 1 = 1°
35.3	Measured temperature 2	Displays the temperature received through the source defined by parameter 35.21 Temperature 2 source. The unit is selected by parameter 96.16 Unit selection. <b>Note:</b> With °F, the range is -76...1832. With a PTC sensor, the range is 0...5000 ohms. This parameter is read-only.	- / real32
	-60...1000 °	Measured temperature 2.	1 = 1° / 1 = 1°
35.4	FPTC status word	Displays the status of optional FPTC-xx thermistor protection modules. The word can be used as the source of eg. external events. <b>Note:</b> The “module found” bits are updated regardless of whether the corresponding module is activated. However, the “fault active” and “warning active” bits are not updated if the module is not activated. Modules are activated by parameter 35.30 FPTC configuration word. This parameter is read-only.	- / uint16
	b0 Module found in slot 1	1 = Yes: An FPTC-xx module has been detected in slot 1.	
	b1 Fault active in slot 1	1 = Yes: The module in slot 1 has an active fault (4991 Safe motor temperature 1).	
	b2 Warning active in slot 1	1 = Yes: The module in slot 1 has an active warning (A497 Motor temperature 1).	
	b3 Module found in slot 2	1 = Yes: An FPTC-xx module has been detected in slot 2.	
	b4 Fault active in slot 2	1 = Yes: The module in slot 2 has an active fault (4992 Safe motor temperature 2).	
	b5 Warning active in slot 2	1 = Yes: The module in slot 2 has an active warning (A498 Motor temperature 2).	

No.	Name / Range / Selection	Description	Def / Type FbEq 16b / 32b
b6	Module found in slot 3	1 = Yes: An FPTC-xx module has been detected in slot 3.	
b7	Fault active in slot 3	1 = Yes: The module in slot 3 has an active fault (4993 Safe motor temperature 3).	
b8	Warning active in slot 3	1 = Yes: The module in slot 3 has an active warning (A499 Motor temperature 3).	
b9...15	Reserved		
	0000h...FFFFh		1 = 1
35.5	Motor overload level	Displays the motor overload level as a percent of the motor overload fault limit. See parameter 35.56 Motor overload action and section Motor overload protection (page 204).	- / real32
	0.0 ... 300.0 %	Motor overload level. 0.0% No motor overloading. 88.0% Motor overloaded to warning level. 100.0% Motor overloaded to fault level.	10 = 1 % / 10 = 1 %
35.9	Temperature Calibration status word	Shows temperature calibration status word.	- / uint16
b0	Temperature 1 calibration done	Calibration status of temperature 1. See parameter 35.17 Temperature 1 calibration.	
b1	Temperature 2 calibration done	Calibration status of temperature 2. See parameter 35.27 Temperature 2 calibration.	
b2...15	Reserved		
	0000h...FFFFh		1 = 1
35.11	Temperature 1 source	Selects the source from which measured temperature 1 is read. For wiring examples, see the hardware manual of the drive. Usually this source is from a sensor connected to the motor controlled by the drive, but it could be used to measure and monitor a temperature from other parts of the process as long as a suitable sensor is used as per the selection list.	Disabled / uint16
	Disabled	None. Temperature monitoring function 1 is disabled.	0
	Estimated temperature	Estimated motor temperature (see parameter 35.1 Motor estimated temperature). The temperature is estimated from an internal drive calculation. It is important to set up the ambient temperature of the motor in 35.50 Motor ambient temperature.	1

## 462 Parameters

No.	Name / Range / Selection	Description	Def / Type FbEq 16b / 32b
KTY84 analog I/O	<p>KTY84 sensor connected to the analog input selected by parameter 35.14 Temperature 1 AI source and an analog output. The input and output can be on the drive control unit or on an extension module. The following settings are required:</p> <ul style="list-style-type: none"> <li>• Set the hardware jumper or switch related to the analog input to <b>U</b> (voltage). Any change must be validated by a control unit reboot.</li> <li>• Set the unit selection parameter of the input to volt.</li> <li>• Set the source selection parameter of the analog output to “Force KTY84 excitation”.</li> <li>• Select the analog input in parameter 35.14. In case the input is located on an I/O extension module, use selection <b>Other</b> (see <i>Terms and abbreviations (page 22)</i>) to point at the actual input value parameter (for example, 14.26 AI1 actual value).</li> </ul> <p>The analog output feeds a constant current through the sensor. As the resistance of the sensor changes along with its temperature, the voltage over the sensor changes. The voltage is read by the analog input and converted into degrees.</p>	2	
KTY84 encoder module 1	<p>KTY84 sensor connected to encoder interface 1. See also parameters 91.21 Module 1 temp sensor type and 91.22 Module 1 temp filter time.</p>	3	
KTY84 encoder module 2	<p>KTY84 sensor connected to encoder interface 2. See also parameters 91.24 Module 2 temp sensor type and 91.25 Module 2 temp filter time.</p>	4	
1 x Pt100 analog I/O	<p>Pt100 sensor connected to a standard analog input selected by parameter 35.14 Temperature 1 AI source and an analog output. The input and output can be on the drive control unit or on an extension module. The required settings are the same as with selection KTY84 analog I/O, except that the source selection parameter of the analog output must be set to Force Pt100 excitation.</p>	5	
2 x Pt100 analog I/O	<p>As selection 1 x Pt100 analog I/O, but with two sensors connected in series. Using multiple sensors improves measurement accuracy significantly.</p>	6	
3 x Pt100 analog I/O	<p>As selection 1 x Pt100 analog I/O, but with three sensors connected in series. Using multiple sensors improves measurement accuracy significantly.</p>	7	

No.	Name / Range / Selection	Description	Def / Type FbEq 16b / 32b
PTC DI6	<p>PTC sensor connected to digital input DI6 (see the connection diagram on page 200).</p> <p><b>Note:</b> Either 0 ohm (normal temperature) or 4000 ohm (excessive temperature) will be shown by 35.2 Measured temperature 1. By default, an excessive temperature will generate a warning as per parameter 35.13 Temperature 1 warning limit. If you want a fault instead, set 35.12 Temperature 1 fault limit to 4000 ohm.</p>	8	
PTC analog I/O	<p>PTC sensor connected to a standard analog input selected by parameter 35.14 Temperature 1 AI source and an analog output. The input and output can be on the drive control unit or on an extension module. The required settings are the same as with selection KTY84 analog I/O, except that the source selection parameter of the analog output must be set to Force PTC excitation.</p>	20	
PTC encoder module 1	<p>PTC sensor connected to encoder interface 1. See also parameters 91.21 Module 1 temp sensor type and 91.22 Module 1 temp filter time.</p>	9	
PTC encoder module 2	<p>PTC sensor connected to encoder interface 2. See also parameters 91.24 Module 2 temp sensor type and 91.25 Module 2 temp filter time.</p>	10	
Direct temperature	<p>The temperature is taken from the source selected by parameter 35.14 Temperature 1 AI source. The value of the source is assumed to be in the unit of temperature specified by 96.16 Unit selection.</p>	11	
1 x Pt1000 analog I/O	<p>Pt1000 sensor connected to a standard analog input selected by parameter 35.14 Temperature 1 AI source and an analog output. The input and output can be on the drive control unit or on an extension module. The required settings are the same as with selection KTY84 analog I/O, except that the source selection parameter of the analog output must be set to Force Pt1000 excitation.</p>	13	
2 x Pt1000 analog I/O	<p>As selection 1 x Pt1000 analog I/O, but with two sensors connected in series. Using multiple sensors improves measurement accuracy significantly.</p>	14	
3 x Pt1000 analog I/O	<p>As selection 1 x Pt1000 analog I/O, but with three sensors connected in series. Using multiple sensors improves measurement accuracy significantly.</p>	15	
Pt1000 encoder module 1	<p>Pt1000 sensor connected to encoder interface 1. See parameters 91.21 Module 1 temp sensor type and 91.22 Module 1 temp filter time.</p> <p><b>Note:</b> Pt1000 sensor supports FEN-11 and FEN-31 encoder modules only.</p>	16	

## 464 Parameters

No.	Name / Range / Selection	Description	Def / Type FbEq 16b / 32b
	Pt1000 encoder module 2	Pt1000 sensor connected to encoder interface 2. See parameters 91.24 Module 2 temp sensor type and 91.25 Module 2 temp filter time.  <b>Note:</b> Pt1000 sensor supports FEN-11 and FEN-31 encoder modules only.	17
35.12	Temperature 1 fault limit	Defines the fault limit for temperature monitoring function 1. When measured temperature 1 exceeds the limit, the drive trips on fault 4981 External temperature 1. The unit is selected by parameter 96.16 Unit selection.  <b>Note:</b> With °F, the range is -76...1832. With a PTC sensor, the range is 0...5000 ohms.	130 ° / real32
	-60...1000 °	Fault limit for temperature monitoring function 1.	1 = 1 ° / 1 = 1 °
35.13	Temperature 1 warning limit	Defines the warning limit for temperature monitoring function 1. When measured temperature 1 exceeds this limit, a warning (A491 External temperature 1) is generated. The unit is selected by parameter 96.16 Unit selection.  <b>Note:</b> With °F, the range is -76...1832. With a PTC sensor, the range is 0...5000 ohms.	110 ° / real32
	-60...1000 °	Warning limit for temperature monitoring function 1.	1 = 1 ° / 1 = 1 °
35.14	Temperature 1 AI source	Specifies the analog input when the setting of 35.11 Temperature 1 source requires measurement through an analog input.  <b>Note:</b> If the input is located on an I/O extension module, use the selection <i>Other</i> to point to the AI actual value in group 14, 15 or 16, eg. 14.26 AI1 actual value.	Not selected / uint32
	Not selected	None.	0
	AI1 actual value	Analog input AI1 on the control unit.	1
	AI2 actual value	Analog input AI2 on the control unit.	2
	Other [value]	See <i>Terms and abbreviations</i> (page 221).	
35.17	Temperature 1 calibration	Defines the calibration of temperature 1. Calibration can be used to fine-tune the motor temperature measurement. Once the motor has cooled down, measure its ambient temperature and set this value accordingly. This parameter affects only if Pt100 or Pt1000 measurement is using AI and AO of the control unit or I/O extension modules.	0 ° / real32
	-30...1000 °	Calibration of temperature 1 in celsius.	1 = 1 ° / 1 = 1 °



No.	Name / Range / Selection	Description	Def / Type FbEq 16b / 32b
35.21	Temperature 2 source	<p>Selects the source from which measured temperature 2 is read.</p> <p>For wiring examples, see the hardware manual of the drive.</p> <p>Usually this source is from a sensor connected to the motor controlled by the drive, but it could be used to measure and monitor a temperature from other parts of the process as long as a suitable sensor is used as per the selection list.</p>	Disabled / uint16
	Disabled	None. Temperature monitoring function 2 is disabled.	0
	Estimated temperature	<p>Estimated motor temperature (see parameter 35.1 Motor estimated temperature).</p> <p>The temperature is estimated from an internal drive calculation. It is important to set up the ambient temperature of the motor in 35.50 Motor ambient temperature.</p>	1
	KTY84 analog I/O	<p>KTY84 sensor connected to the analog input selected by parameter 35.24 Temperature 2 AI source and an analog output. The input and output can be on the drive control unit or on an extension module.</p> <p>The following settings are required:</p> <ul style="list-style-type: none"> <li>• Set the hardware jumper or switch related to the analog input to U (voltage). Any change must be validated by a control unit reboot.</li> <li>• Set the unit selection parameter of the input to volt.</li> <li>• Set the source selection parameter of the analog output to “Force KTY84 excitation”.</li> <li>• Select the analog input in parameter 35.24. In case the input is located on an I/O extension module, use the selection Other (see Terms and abbreviations (page 22)) to point at the actual input value parameter (for example, 14.26 AI1 actual value).</li> </ul> <p>The analog output feeds a constant current through the sensor. As the resistance of the sensor changes along with its temperature, the voltage over the sensor changes. The voltage is read by the analog input and converted into degrees.</p>	2
	KTY84 encoder module 1	<p>KTY84 sensor connected to encoder interface 1.</p> <p>See also parameters 91.21 Module 1 temp sensor type and 91.22 Module 1 temp filter time.</p>	3
	KTY84 encoder module 2	<p>KTY84 sensor connected to encoder interface 2.</p> <p>See also parameters 91.24 Module 2 temp sensor type and 91.25 Module 2 temp filter time.</p>	4

## 466 Parameters

No.	Name / Range / Selection	Description	Def / Type FbEq 16b / 32b
1 x Pt100 analog I/O	Pt100 sensor connected to a standard analog input selected by parameter 35.24 Temperature 2 AI source and an analog output. The input and output can be on the drive control unit or on an extension module. The required settings are the same as with selection KTY84 analog I/O, except that the source selection parameter of the analog output must be set to Force Pt100 excitation.	5	
2 x Pt100 analog I/O	As selection 1 x Pt100 analog I/O, but with two sensors connected in series. Using multiple sensors improves measurement accuracy significantly.	6	
3 x Pt100 analog I/O	As selection 1 x Pt100 analog I/O, but with three sensors connected in series. Using multiple sensors improves measurement accuracy significantly.	7	
PTC DI6	PTC sensor connected to digital input DI6 (see the connection diagram on page 200).  <b>Note:</b> Either 0 ohm (normal temperature) or 4000 ohm (excessive temperature) will be shown by 35.3 Measured temperature 2. By default, an excessive temperature will generate a warning as per parameter 35.23 Temperature 2 warning limit. If you want a fault instead, set 35.22 Temperature 2 fault limit to 4000 ohm.	8	
PTC analog I/O	PTC sensor connected to a standard analog input selected by parameter 35.24 Temperature 2 AI source and an analog output. The input and output can be on the drive control unit or on an extension module. The required settings are the same as with selection KTY84 analog I/O, except that the source selection parameter of the analog output must be set to Force Pt100 excitation.	20	
PTC encoder module 1	PTC sensor connected to encoder interface 1. See also parameters 91.21 Module 1 temp sensor type and 91.22 Module 1 temp filter time.	9	
PTC encoder module 2	PTC sensor connected to encoder interface 2. See also parameters 91.24 Module 2 temp sensor type and 91.25 Module 2 temp filter time.	10	
Direct temperature	The temperature is taken from the source selected by parameter 35.24 Temperature 2 AI source. The value of the source is assumed to be in the unit of temperature specified by 96.16 Unit selection.	11	
1 x Pt1000 analog I/O	Pt1000 sensor connected to a standard analog input selected by parameter 35.24 Temperature 2 AI source and an analog output. The input and output can be on the drive control unit or on an extension module. The required settings are the same as with selection KTY84 analog I/O, except that the source selection parameter of the analog output must be set to Force Pt100 excitation.	13	

No.	Name / Range / Selection	Description	Def / Type FbEq 16b / 32b
	2 x Pt1000 analog I/O	As selection 1 x Pt1000 analog I/O, but with two sensors connected in series. Using multiple sensors improves measurement accuracy significantly.	14
	3 x Pt1000 analog I/O	As selection 1 x Pt1000 analog I/O, but with three sensors connected in series. Using multiple sensors improves measurement accuracy significantly.	15
	Pt1000 encoder module 1	Pt1000 sensor connected to encoder interface 1. See parameters 91.21 Module 1 temp sensor type and 91.22 Module 1 temp filter time.  <b>Note:</b> Pt1000 sensor is supported with FEN-11 and FEN-31 encoder modules only.	16
	Pt1000 encoder module 2	Pt1000 sensor connected to encoder interface 2. See parameters 91.24 Module 2 temp sensor type and 91.25 Module 2 temp filter time.  <b>Note:</b> Pt1000 sensor is supported with FEN-11 and FEN-31 encoder modules only.	17
35.22	Temperature 2 fault limit	Defines the fault limit for temperature monitoring function 2. When measured temperature 2 exceeds the limit, the drive trips on fault 4982 External temperature 2. The unit is selected by parameter 96.16 Unit selection.  <b>Note:</b> With °F, the range is -76...1832. With a PTC sensor, the range is 0...5000 ohms.	130 ° / real32
	-60...1000 °	Fault limit for temperature monitoring function 2.	1 = 1 ° / 1 = 1 °
35.23	Temperature 2 warning limit	Defines the warning limit for temperature monitoring function 2. When measured temperature 2 exceeds the limit, a warning (A492 External temperature 2) is generated. The unit is selected by parameter 96.16 Unit selection.  <b>Note:</b> With °F, the range is -76...1832. With a PTC sensor, the range is 0...5000 ohms.	110 ° / real32
	-60...1000 °	Warning limit for temperature monitoring function 2.	1 = 1 ° / 1 = 1 °
35.24	Temperature 2 AI source	Selects the input for parameter 35.21 Temperature 2 source, selections KTY84 analog I/O, 1 x Pt100 analog I/O, 2 x Pt100 analog I/O, 3 x Pt100 analog I/O and Direct temperature.	Not selected / uint32
	Not selected	None.	0
	AI1 actual value	Analog input AI1 on the control unit.	1
	AI2 actual value	Analog input AI2 on the control unit.	2
	Other [value]	See Terms and abbreviations (page 221).	
35.27	Temperature 2 calibration	Defines the calibration of temperature 2. See parameter 35.17 Temperature 1 calibration.	0 °C / real32
	-30...1000 °C	Calibration of temperature 2 in celsius.	1 = 1 °C / 1 = 1 °C

## 468 Parameters

No.	Name / Range / Selection	Description	Def / Type FbEq 16b / 32b
35.30	FPTC configuration word	Activates FPTC-xx thermistor protection modules installed on the control unit of the drive. Using this word, it is also possible to suppress the warnings (but not faults) from each module.	- / uint16
	b0 Module in slot 1	1 = Yes: Module installed in slot 1.	
	b1 Disable slot 1 warning	1 = Yes: Warnings from the module in slot 1 suppressed.	
	b2 Module in slot 2	1 = Yes: Module installed in slot 2.	
	b3 Disable slot 2 warning	1 = Yes: Warnings from the module in slot 2 suppressed.	
	b4 Module in slot 3	1 = Yes: Module installed in slot 3.	
	b5 Disable slot 3 warning	1 = Yes: Warnings from the module in slot 3 suppressed.	
	b6...15 Reserved		
	0000h...FFFFh		1 = 1
35.50	Motor ambient temperature	<p>Defines the ambient temperature of the motor for the motor thermal protection model. The unit (°C or °F) is selected by parameter 96.16 <i>Unit selection</i>. The motor thermal protection model estimates the motor temperature on the basis of parameters 35.50...35.55. The motor temperature increases if it operates in the region above the load curve, and decreases if it operates in the region below the load curve.</p> <hr/> <p> <b>WARNING!</b> The model cannot protect the motor if the motor does not cool properly because of dust, dirt, etc.</p> <hr/>	20 ° / real32
	-60...100 °	Ambient temperature.	1 = 1 ° / 1 = 1 °

No.	Name / Range / Selection	Description	Def / Type FbEq 16b / 32b
35.51	Motor load curve	<p>Defines the motor load curve together with parameters 35.52 Zero speed load and 35.53 Break point. The load curve is used by the motor thermal protection model to estimate the motor temperature.</p> <p>When the parameter is set to 100%, the maximum load is taken as the value of parameter 99.6 Motor nominal current (higher loads heat up the motor). The load curve level should be adjusted if the ambient temperature differs from the nominal value set in 35.50 Motor ambient temperature.</p>	100 % / uint16
<p>The graph plots the ratio of motor current to nominal motor current, <math>I/I_N</math> (%), on the y-axis against the drive output frequency on the x-axis. The y-axis has markings at 50, 100, and 150. The x-axis has markings at 35.52 and 35.53. A horizontal dashed line is drawn at <math>I/I_N = 100</math>. The curve starts at a point labeled 35.52 on the y-axis (representing zero speed load). It rises linearly to a point labeled 35.51 on the x-axis (representing the break point frequency) where it reaches the 100% level. From this point, the curve continues horizontally at 100% for higher frequencies. A legend indicates <math>I</math> = Motor current and <math>I_N</math> = Nominal motor current.</p>			
	50...150 %	Maximum load for the motor load curve.	1 = 1 % / 1 = 1 %
35.52	Zero speed load	<p>Defines the motor load curve together with parameters 35.51 Motor load curve and 35.53 Break point. Defines the maximum motor load at zero speed of the load curve. A higher value can be used if the motor has an external motor fan to boost the cooling. See the motor manufacturer's recommendations.</p> <p>See parameter 35.51 Motor load curve.</p>	70 % / uint16
	25...150 %	Zero speed load for the motor load curve.	1 = 1 % / 1 = 1 %
35.53	Break point	<p>Defines the motor load curve together with parameters 35.51 Motor load curve and 35.52 Zero speed load. Defines the break point frequency of the load curve i.e. the point at which the motor load curve begins to decrease from the value of parameter 35.51 Motor load curve towards the value of parameter 35.52 Zero speed load.</p> <p>See parameter 35.51 Motor load curve.</p>	45.00 Hz / uint16
	1.00 ... 500.00 Hz	Break point for the motor load curve. For scaling, see parameter 46.2.	- / -

470 Parameters

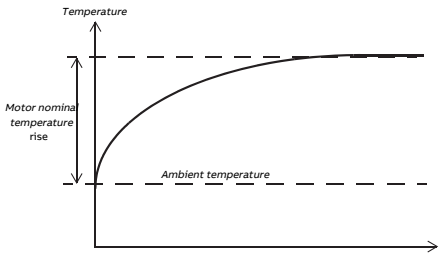
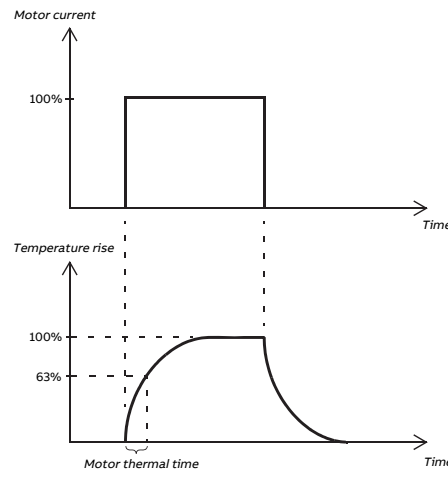
No.	Name / Range / Selection	Description	Def / Type FbEq 16b / 32b
35.54	Motor nominal temperature rise	<p>Defines the temperature rise of the motor above ambient when the motor is loaded with nominal current. See the motor manufacturer's recommendations.</p> <p>The unit (°C or °F) is selected by parameter 96.16 Unit selection.</p> 	80 ° / real32
	0...300 °	Temperature rise.	1 = 1 ° / 1 = 1 °
35.55	Motor thermal time constant	<p>Defines the thermal time constant for use with the motor thermal protection model, defined as the time to reach 63% of the nominal motor temperature. See the motor manufacturer's recommendations.</p> 	256 s / uint16
	100...10000 s	Motor thermal time constant.	1 = 1 s / 1 = 1 s
35.56	Motor overload action	<p>Selects the action taken when motor overload is detected.</p> <p>See section <a href="#">Motor overload protection (page 204)</a>.</p>	No action / uint16
	No action	No action taken.	0

No.	Name / Range / Selection	Description	Def / Type FbEq 16b / 32b
	Warning only	Drive generates warning A783 Motor overload when the motor is overloaded to the warning level, that is, parameter 35.5 Motor overload level reaches value 88.0%.	1
	Warning and fault	Drive generates warning A783 Motor overload when the motor is overloaded to the warning level, that is, parameter 35.5 Motor overload level reaches value 88.0%. Drive trips on fault 7122 Motor overload when the motor is overloaded to the fault level, that is, parameter 35.5 Motor overload level reaches value 100.0%.	2
35.57	Motor overload class	Defines the motor overload class to be used. The class of protection is specified by the user as the time for tripping at 7.2 times (IEC 60947-4-1) or 6 times (NEMA ICS) the tripping level current. See section Motor overload protection (page 204).	Class 20 / uint16
	Class 5	Motor overload class 5.	0
	Class 10	Motor overload class 10.	1
	Class 20	Motor overload class 20.	2
	Class 30	Motor overload class 30.	3
	Class 40	Motor overload class 40.	4
35.60	Cable temperature	Shows the calculated temperature of the motor cable. See section Thermal protection of motor cable (page 205). 102% = overtemperature warning (A480 Motor cable overload) 106% = overtemperature fault (4000 Motor cable overload) This parameter is read-only.	0.0 % / real32
	0.0 ... 200.0 %	Calculated temperature of motor cable.	1 = 1 % / 10 = 1 %
35.61	Cable nominal current	Specifies the continuous current of the motor cable for the thermal protection function in the control program.   <b>WARNING!</b> The value entered in this parameter must be limited according to all factors affecting the loadability of the cable, such as ambient temperature, cabling arrangement, and shrouding. Refer to the technical data from the cable manufacturer.	10000.00 A / real32
	0.00 ... 10000.00 A	Continuous current-carrying capacity of motor cable.	1 = 1 A / 100 = 1 A

472 Parameters

No.	Name / Range / Selection	Description	Def / Type FbEq 16b / 32b
35.62	Cable thermal rise time	<p>Specifies the thermal time of the motor cable for the thermal protection function in the control program. This value is defined as the time to reach 63% of the nominal cable temperature when the cable is loaded with nominal current (parameter 35.61 Cable nominal current).</p> <p>0 s = Thermal protection of motor cable disabled. Refer to the technical data from the cable manufacturer.</p>	1 s / uint16
0...50000 s		0 s → Thermal protection of motor cable disabled. 1...50000 s → Motor cable thermal time constant.	1 = 1 s / 1 = 1 s
35.100	DOL starter control source	<p>Parameters 35.100...35.106 configure a monitored start/stop control logic for external equipment such as a contactor controlled motor cooling fan. This parameter selects the signal that starts and stops the fan.</p> <p>0 = Stop 1 = Start</p> <p>The output controlling the fan contactor is to be connected to parameter 35.105, bit 1. On and off delays can be set for the fan by 35.101 and 35.102 respectively. A feedback signal from the fan can be connected to an input selected by 35.103; the loss of the feedback will optionally trigger a warning or fault (see 35.104 and 35.106).</p>	Off, 06.16 b6 (95.20 b6) / uint32
Off		0 (function disabled).	0
On		1.	1
Running		Bit 6 of 6.16 Drive status word 1 (page 245).	2
Other [bit]		See Terms and abbreviations (page 221).	



No.	Name / Range / Selection	Description	Def / Type FbEq 16b / 32b
35.101	DOL starter on delay	Defines a start delay for the motor fan. The delay timer starts when the control source selected by parameter 35.100 switches on. After the delay, bit 1 of 35.105 switches on.	- / uint32
	0...42949673 s	Motor fan start delay.	1 = 1 s / 100 = 1 s
35.102	DOL starter off delay	Defines a stop delay for the motor fan. The delay timer starts when the control source selected by parameter 35.100 switches off. After the delay, bit 1 of 35.105 switches off.	20 min / uint32
	0...715828 min	Motor fan stop delay.	1 = 1 min / 1 = 1 min
35.103	DOL starter feedback source	Selects the input for motor fan feedback signal. 0 = Stopped 1 = Running After the fan is started (bit 1 of 35.105 switches on), feedback is expected within the time set by 35.104.	Not selected; DI5 (95.20 b6) / uint32
	Not selected	0	0
	Selected	1	1
	DI1	Digital input DI1 (10.2 DI delayed status, bit 0).	2
	DI2	Digital input DI2 (10.2 DI delayed status, bit 1).	3
	DI3	Digital input DI3 (10.2 DI delayed status, bit 2).	4
	DI4	Digital input DI4 (10.2 DI delayed status, bit 3).	5
	DI5	Digital input DI5 (10.2 DI delayed status, bit 4).	6
	DI6	Digital input DI6 (10.2 DI delayed status, bit 5).	7
	DIO1	Digital input/output DIO1 (11.2 DIO delayed status, bit 0).	10
	DIO2	Digital input/output DIO2 (11.2 DIO delayed status, bit 1).	11
	Other [bit]	See Terms and abbreviations (page 221).	
35.104	DOL starter feedback delay	Defines a feedback delay for the motor fan. The delay timer starts when bit 1 of 35.105 switches on. If no feedback is received from the fan until the delay elapses, the action selected by 35.106 is taken.  <b>Note:</b> This delay is only applied at start. If the feedback signal is lost during run, the action selected by 35.106 is taken immediately.	0; 5 (95.20 b6) s / uint32
	0...42949673 s	Motor fan start delay.	1 = 1 s / 1 = 1 s
35.105	DOL starter status word	Status of the motor fan control logic. Bit 1 is the control output for the fan, to be selected as the source of, for example, a digital or relay output. The other bits indicate the statuses of the selected control and feedback sources, and the fault status. This parameter is read-only.	- / uint16
	b0 Start command:	Status of fan control source selected by 35.100. 0 = Stop requested 1 = Start requested	

## 474 Parameters

No.	Name / Range / Selection	Description	Def / Type FbEq 16b / 32b
b1	Delayed start command:	Fan control bit (delays observed). Select this bit as the source of the output controlling the fan. 0 = Stopped 1 = Started	
b2	DOL feedback:	Status of fan feedback (source selected by 35.103). 0 = Stopped 1 = Running	
b3	DOL fault (-1):	Fault status. 0 = Fault (fan feedback missing). The action taken is selected by 35.106. 1 = No fault	
b4...15 Reserved			
	0000h...FFFFh		1 = 1
35.106	DOL starter event type	Selects the action taken when missing fan feedback is detected by the motor fan control logic.	Fault / uint16
	No action	No action taken.	0
	Warning	The drive generates a warning (A781 Motor fan).	1
	Fault	Drive trips on 71B1 Motor fan.	2

No.	Name / Range / Selection	Description	Def / Type FbEq 16b / 32b
<b>36</b>	<b>Load analyzer</b>	Peak value and amplitude logger settings. See also section <a href="#">Load analyzer (page 209)</a> .	
36.1	PVL signal source	Selects the signal to be monitored by the peak value logger. The signal is filtered using the filtering time specified by parameter 36.2 PVL filter time. The peak value is stored, along with other pre-selected signals at the time, into parameters 36.12...36.15. The peak value logger can be reset using parameter 36.9 Reset loggers. The logger is also reset whenever the signal source is changed. The date and time of the last reset are stored into parameters 36.16 and 36.17 respectively.	Power inu out / uint32
	Zero	None	0
	Motor speed used	1.1 Motor speed used (page 226).	1
	Output frequency	1.6 Output frequency (page 226).	3
	Motor current	1.7 Motor current (page 226).	4
	Motor torque	1.10 Motor torque (page 226).	6
	DC voltage	1.11 DC voltage (page 227).	7
	Power inu out	1.14 Output power (page 227).	8
	Speed ref ramp in	23.1 Speed ref ramp input (page 378).	10
	Speed ref ramp out	23.2 Speed ref ramp output (page 378).	11
	Speed ref used	24.1 Used speed reference (page 386).	12
	Torq ref used	26.2 Torque reference used (page 405).	13
	Freq ref used	Not in use.	14
	Process PID out	Not in use.	16
	Process PID fbk	Not in use.	17
	Process PID act	Not in use.	18
	Process PID dev	Not in use.	19
	Other [value]	See <a href="#">Terms and abbreviations (page 221)</a> .	
36.2	PVL filter time	Defines a filtering time for the peak value logger. See parameter 36.1 PVL signal source.	2.00 s / real32
	0.00 ... 120.00 s	Peak value logger filtering time.	100 = 1 s / 100 = 1 s
36.6	AL2 signal source	Selects the signal to be monitored by amplitude logger 2. The signal is sampled at 200 ms intervals, and can be scaled using parameter 36.7 AL2 signal scaling. The results are displayed by parameters 36.40...36.49. Each parameter represents an amplitude range, and shows what portion of the samples fall within that range. Amplitude logger 2 can be reset using parameter 36.9 Reset loggers. The logger is also reset whenever the signal source or scaling is changed. The date and time of the last reset are stored into parameters 36.50 and 36.51 respectively.	Ambient temperature / uint32

# 476 Parameters

No.	Name / Range / Selection	Description	Def / Type FbEq 16b / 32b
	Zero	None	0
	Motor speed used	1.1 Motor speed used (page 226).	1
	Output frequency	1.6 Output frequency (page 226).	3
	Motor current	1.7 Motor current (page 226).	4
	Motor torque	1.10 Motor torque (page 226).	6
	DC voltage	1.11 DC voltage (page 227).	7
	Power inu out	1.14 Output power (page 227).	8
	Speed ref ramp in	23.1 Speed ref ramp input (page 378).	10
	Speed ref ramp out	23.2 Speed ref ramp output (page 378).	11
	Speed ref used	24.1 Used speed reference (page 386).	12
	Torq ref used	26.2 Torque reference used (page 405).	13
	Freq ref used	Not in use.	14
	Process PID out	Not in use.	16
	Process PID fbk	Not in use.	17
	Process PID act	Not in use.	18
	Process PID dev	Not in use.	19
	Other [value]	See Terms and abbreviations (page 221).	
	Ambient temperature	1.70 Ambient temperature % (page 229). The amplitude range of 0...100% corresponds to 0...60 °C or 32...140 °F.	20
36.7	AL2 signal scaling	Defines the signal value that corresponds to 100% amplitude.	100.00 / real32
	0.00 ... 32767.00	Signal value corresponding to 100%.	1 = 1 / 100 = 1
36.8	Logger function	Determines whether amplitude loggers 1 and 2 are active continuously or only when the drive is modulating.	- / uint16
	b0 AL1	0 = Amplitude logger 1 active continuously 1 = Amplitude logger 1 active only when the drive is modulating	
	b1 AL2	0 = Amplitude logger 2 active continuously 1 = Amplitude logger 2 active only when the drive is modulating	
	b2...15 Reserved		
	0000h...FFFFh		1 = 1
36.9	Reset loggers	Resets the peak value logger and/or amplitude logger 2. (Amplitude logger 1 cannot be reset.)	Done / uint16
	Done	Reset completed or not requested (normal operation).	0
	All	Reset both the peak value logger and amplitude logger 2.	1
	PVL	Reset the peak value logger.	2

No.	Name / Range / Selection	Description	Def / Type FbEq 16b / 32b
	AL2	Reset amplitude logger 2.	3
36.10	PVL peak value	Displays the peak value recorded by the peak value logger.	- / real32
	-32768.00 ... 32767.00	Peak value.	$1 = 1 / 100 = 1$
36.11	PVL peak date	Displays the date on which the peak value was recorded.	0 / uint16
36.12	PVL peak time	Displays the time at which the peak value was recorded.	0 / uint32
	00:00:00...23:59:59	Peak occurrence time.	$1 = 1$
36.13	PVL current at peak	Displays the motor current at the moment the peak value was recorded.	- / real32
	-32768.00 ... 32767.00 A	Motor current at peak.	$1 = 1 \text{ A} / 100 = 1 \text{ A}$
36.14	PVL DC voltage at peak	Displays the voltage in the intermediate DC circuit of the drive at the moment the peak value was recorded.	- / real32
	0.00 ... 2000.00 V	DC voltage at peak.	$10 = 1 \text{ V} / 100 = 1 \text{ V}$
36.15	PVL speed at peak	Displays the motor speed at the moment the peak value was recorded.	- / real32
	-32768.00 ... 32767.00 rpm	Motor speed at peak. For scaling, see parameter 46.1.	- / -
36.16	PVL reset date	Displays the date on which the peak value logger was last reset.	0 / uint16
36.17	PVL reset time	Displays the time at which the peak value logger was last reset.	0 / uint32
	00:00:00...23:59:59	Last reset time of the peak value logger.	$1 = 1$
36.20	AL1 below 10%	Displays the percentage of samples recorded by amplitude logger 1 that were below 10%. Note that this percentage also includes the samples that had a negative value.	- / real32
	0.00 ... 100.00 %	Amplitude logger 1 samples below 10%.	$1 = 1 \% / 100 = 1 \%$
36.21	AL1 10 to 20%	Displays the percentage of samples recorded by amplitude logger 1 that fall between 10 and 20 %.	- / real32
	0.00 ... 100.00 %	Amplitude logger 1 samples between 10 and 20 %.	$1 = 1 \% / 100 = 1 \%$
36.22	AL1 20 to 30%	Displays the percentage of samples recorded by amplitude logger 1 that fall between 20 and 30 %.	- / real32
	0.00 ... 100.00 %	Amplitude logger 1 samples between 20 and 30 %.	$1 = 1 \% / 100 = 1 \%$
36.23	AL1 30 to 40%	Displays the percentage of samples recorded by amplitude logger 1 that fall between 30 and 40 %.	- / real32
	0.00 ... 100.00 %	Amplitude logger 1 samples between 30 and 40 %.	$1 = 1 \% / 100 = 1 \%$
36.24	AL1 40 to 50%	Displays the percentage of samples recorded by amplitude logger 1 that fall between 40 and 50 %.	- / real32
	0.00 ... 100.00 %	Amplitude logger 1 samples between 40 and 50 %.	$1 = 1 \% / 100 = 1 \%$

## 478 Parameters

No.	Name / Range / Selection	Description	Def / Type FbEq 16b / 32b
36.25	AL1 50 to 60%	Displays the percentage of samples recorded by amplitude logger 1 that fall between 50 and 60 %.	- / real32
	0.00 ... 100.00 %	Amplitude logger 1 samples between 50 and 60 %.	1 = 1 % / 100 = 1 %
36.26	AL1 60 to 70%	Displays the percentage of samples recorded by amplitude logger 1 that fall between 60 and 70 %.	- / real32
	0.00 ... 100.00 %	Amplitude logger 1 samples between 60 and 70 %.	1 = 1 % / 100 = 1 %
36.27	AL1 70 to 80%	Displays the percentage of samples recorded by amplitude logger 1 that fall between 70 and 80 %.	- / real32
	0.00 ... 100.00 %	Amplitude logger 1 samples between 70 and 80 %.	1 = 1 % / 100 = 1 %
36.28	AL1 80 to 90%	Displays the percentage of samples recorded by amplitude logger 1 that fall between 80 and 90 %.	- / real32
	0.00 ... 100.00 %	Amplitude logger 1 samples between 80 and 90 %.	1 = 1 % / 100 = 1 %
36.29	AL1 over 90%	Displays the percentage of samples recorded by amplitude logger 1 that exceed 90 %.	- / real32
	0.00 ... 100.00 %	Amplitude logger 1 samples over 90 %.	1 = 1 % / 100 = 1 %
36.40	AL2 below 10%	Displays the percentage of samples recorded by amplitude logger 2 that were below 10 %. Note that this percentage also includes the samples that had a negative value.	- / real32
	0.00 ... 100.00 %	Amplitude logger 2 samples below 10 %.	1 = 1 % / 100 = 1 %
36.41	AL2 10 to 20%	Displays the percentage of samples recorded by amplitude logger 2 that fall between 10 and 20 %.	- / real32
	0.00 ... 100.00 %	Amplitude logger 2 samples between 10 and 20 %.	1 = 1 % / 100 = 1 %
36.42	AL2 20 to 30%	Displays the percentage of samples recorded by amplitude logger 2 that fall between 20 and 30 %.	- / real32
	0.00 ... 100.00 %	Amplitude logger 2 samples between 20 and 30 %.	1 = 1 % / 100 = 1 %
36.43	AL2 30 to 40%	Displays the percentage of samples recorded by amplitude logger 2 that fall between 30 and 40 %.	- / real32
	0.00 ... 100.00 %	Amplitude logger 2 samples between 30 and 40 %.	1 = 1 % / 100 = 1 %
36.44	AL2 40 to 50%	Displays the percentage of samples recorded by amplitude logger 2 that fall between 40 and 50 %.	- / real32
	0.00 ... 100.00 %	Amplitude logger 2 samples between 40 and 50 %.	1 = 1 % / 100 = 1 %
36.45	AL2 50 to 60%	Displays the percentage of samples recorded by amplitude logger 2 that fall between 50 and 60 %.	- / real32
	0.00 ... 100.00 %	Amplitude logger 2 samples between 50 and 60 %.	1 = 1 % / 100 = 1 %
36.46	AL2 60 to 70%	Displays the percentage of samples recorded by amplitude logger 2 that fall between 60 and 70 %.	- / real32
	0.00 ... 100.00 %	Amplitude logger 2 samples between 60 and 70 %.	1 = 1 % / 100 = 1 %
36.47	AL2 70 to 80%	Displays the percentage of samples recorded by amplitude logger 2 that fall between 70 and 80 %.	- / real32
	0.00 ... 100.00 %	Amplitude logger 2 samples between 70 and 80 %.	1 = 1 % / 100 = 1 %

<b>No.</b>	<b>Name / Range / Selection</b>	<b>Description</b>	<b>Def / Type FbEq 16b / 32b</b>
36.48	AL2 80 to 90%	Displays the percentage of samples recorded by amplitude logger 2 that fall between 80 and 90 %.	- / real32
	0.00 ... 100.00 %	Amplitude logger 2 samples between 80 and 90 %.	1 = 1 % / 100 = 1 %
36.49	AL2 over 90%	Displays the percentage of samples recorded by amplitude logger 2 that exceed 90 %.	- / real32
	0.00 ... 100.00 %	Amplitude logger 2 samples over 90 %.	1 = 1 % / 100 = 1 %
36.50	AL2 reset date	Displays the date on which amplitude logger 2 was last reset.	0 / uint16
36.51	AL2 reset time	Displays the time at which amplitude logger 2 was last reset.	0 / uint32
	00:00:00...23:59:59	Last reset time of amplitude logger 2.	1 = 1

## 480 Parameters

No.	Name / Range / Selection	Description	Def / Type FbEq 16b / 32b
<b>37</b>	<b>User load curve</b>	Settings for user load curve. See also section <a href="#">User load curve</a> .	
<b>37.1</b>	<b>ULC output status word</b>	Displays the status of the monitored signal. (The status word is independent of the actions and delays selected by parameters <a href="#">37.3</a> , <a href="#">37.4</a> , <a href="#">37.41</a> and <a href="#">37.42</a> .) This parameter is read-only.	- / uint16
	b0 Under load limit	1 = Monitored signal is below the underload curve	
	b1 Reserved		
	b2 Over load limit	1 = Monitored signal is above the overload curve	
	b3...15 Reserved		
	0000h...FFFFh		1 = 1
<b>37.2</b>	<b>ULC supervision signal</b>	Selects the signal to be monitored. The function compares the absolute value of the signal against the load curve.	Not selected / uint32
	Not selected	No signal selected (monitoring disabled).	0
	Motor current %	1.7 Motor current (page 226).	2
	Motor torque %	1.10 Motor torque (page 226).	3
	Output power % of motor nominal	1.15 Output power % of motor nom (page 227).	4
	Other [value]	See <a href="#">Terms and abbreviations</a> (page 221).	
<b>37.3</b>	<b>ULC overload actions</b>	Selects how the drive reacts if the absolute value of the monitored signal stays above the overload curve for longer than the value of <a href="#">37.41</a> ULC overload timer.	Disabled / uint16
	Disabled	No action taken.	0
	Warning	The drive generates a warning (A8BE ULC overload).	1
	Fault	Drive trips on 8002 ULC overload.	2
	Warning/Fault	The drive generates a warning (A8BE ULC overload) if the signal stays continuously above the overload curve for half of the time defined by <a href="#">37.41</a> ULC overload timer. The drive trips on 8002 ULC overload if the signal stays continuously above the overload curve for the time defined by <a href="#">37.41</a> ULC overload timer.	3
<b>37.4</b>	<b>ULC underload actions</b>	Selects how the drive reacts if the absolute value of the monitored signal stays below the underload curve for longer than the value of <a href="#">37.42</a> ULC underload timer.	Disabled / uint16
	Disabled	No action taken.	0
	Warning	The drive generates a warning (A8BF ULC underload).	1
	Fault	Drive trips on 8001 ULC underload.	2
	Warning/Fault	The drive generates a warning (A8BF ULC underload) if the signal stays continuously below the underload curve for half of the time defined by <a href="#">37.42</a> ULC underload timer. The drive trips on 8001 ULC underload if the signal stays continuously below the underload curve for the time defined by <a href="#">37.42</a> ULC underload timer.	3



No.	Name / Range / Selection	Description	Def / Type FbEq 16b / 32b
37.11	ULC speed table point 1	Defines the 1st speed point on the X-axis of the user load curve. The speed points are used in DTC motor control mode, and in scalar motor control mode when speed control is being used. The five points must be in order from lowest to highest. The points are defined as positive values, but the range is symmetrically effective also in the negative direction. The monitoring is not active outside these two areas.	150.0 rpm / real32
	0.0 ... 30000.0 rpm	Speed.	1 = 1 rpm / 10 = 1 rpm
37.12	ULC speed table point 2	Defines the 2nd speed point on the X-axis of the user load curve.	750.0 rpm / real32
	0.0 ... 30000.0 rpm	Speed.	1 = 1 rpm / 10 = 1 rpm
37.13	ULC speed table point 3	Defines the 3rd speed point on the X-axis of the user load curve.	1290.0 rpm / real32
	0.0 ... 30000.0 rpm	Speed.	1 = 1 rpm / 10 = 1 rpm
37.14	ULC speed table point 4	Defines the 4th speed point on the X-axis of the user load curve.	1500.0 rpm / real32
	0.0 ... 30000.0 rpm	Speed.	1 = 1 rpm / 10 = 1 rpm
37.15	ULC speed table point 5	Defines the 5th speed point on the X-axis of the user load curve.	1800.0 rpm / real32
	0.0 ... 30000.0 rpm	Speed.	1 = 1 rpm / 10 = 1 rpm
37.16	ULC frequency table point 1	Defines the 1st frequency point on the X-axis of the user load curve. The frequency points are used in scalar motor control mode when frequency control is being used. The five points must be in order from lowest to highest. The points are defined as positive values, but the range is symmetrically effective also in the negative direction. The monitoring is not active outside these two areas.	5.0 Hz / real32
	0.0 ... 598.0 Hz	Frequency.	1 = 1 Hz / 10 = 1 Hz
37.17	ULC frequency table point 2	Defines the 2nd frequency point on the X-axis of the user load curve.	25.0 Hz / real32
	0.0 ... 598.0 Hz	Frequency.	1 = 1 Hz / 10 = 1 Hz
37.18	ULC frequency table point 3	Defines the 3rd frequency point on the X-axis of the user load curve.	43.0 Hz / real32
	0.0 ... 598.0 Hz	Frequency.	1 = 1 Hz / 10 = 1 Hz
37.19	ULC frequency table point 4	Defines the 4th frequency point on the X-axis of the user load curve.	50.0 Hz / real32
	0.0 ... 598.0 Hz	Frequency.	1 = 1 Hz / 10 = 1 Hz
37.20	ULC frequency table point 5	Defines the 5th frequency point on the X-axis of the user load curve.	60.0 Hz / real32
	0.0 ... 598.0 Hz	Frequency.	1 = 1 Hz / 10 = 1 Hz
37.21	ULC underload point 1	Defines the 1st point of the underload curve. Each point of the underload curve must have a lower value than the corresponding overload point.	10.0 % / real32

## 482 Parameters

No.	Name / Range / Selection	Description	Def / Type FbEq 16b / 32b
	0.0 ... 1600.0 %	Underload point.	1 = 1 % / 10 = 1 %
37.22	ULC underload point 2	Defines the 2nd point of the underload curve.	15.0 % / real32
	0.0 ... 1600.0 %	Underload point.	1 = 1 % / 10 = 1 %
37.23	ULC underload point 3	Defines the 3rd point of the underload curve.	25.0 % / real32
	0.0 ... 1600.0 %	Underload point.	1 = 1 % / 10 = 1 %
37.24	ULC underload point 4	Defines the 4th point of the underload curve.	30.0 % / real32
	0.0 ... 1600.0 %	Underload point.	1 = 1 % / 10 = 1 %
37.25	ULC underload point 5	Defines the 5th point of the underload curve.	30.0 % / real32
	0.0 ... 1600.0 %	Underload point.	1 = 1 % / 10 = 1 %
37.31	ULC overload point 1	Defines the 1st point of the overload curve. Each point of the overload curve must have a higher value than the corresponding underload point.	300.0 % / real32
	0.0 ... 1600.0 %	Overload point.	1 = 1 % / 10 = 1 %
37.32	ULC overload point 2	Defines the 2nd point of the overload curve.	300.0 % / real32
	0.0 ... 1600.0 %	Overload point.	1 = 1 % / 10 = 1 %
37.33	ULC overload point 3	Defines the 3rd point of the overload curve.	300.0 % / real32
	0.0 ... 1600.0 %	Overload point.	1 = 1 % / 10 = 1 %
37.34	ULC overload point 4	Defines the 4th point of the overload curve.	300.0 % / real32
	0.0 ... 1600.0 %	Overload point.	1 = 1 % / 10 = 1 %
37.35	ULC overload point 5	Defines the 5th point of the overload curve.	300.0 % / real32
	0.0 ... 1600.0 %	Overload point.	1 = 1 % / 10 = 1 %
37.41	ULC overload timer	Defines the time for which the monitored signal must continuously stay above the overload curve before the drive takes the action selected by 37.3 ULC overload actions.	20.0 s / real32
	0.0 ... 10000.0 s	Overload timer.	1 = 1 s / 10 = 1 s
37.42	ULC underload timer	Defines the time for which the monitored signal must continuously stay below the underload curve before the drive takes the action selected by 37.4 ULC underload actions.	20.0 s / real32
	0.0 ... 10000.0 s	Underload timer.	1 = 1 s / 10 = 1 s

No.	Name / Range / Selection	Description	Def / Type FbEq 16b / 32b
<b>43</b>	<b>Brake chopper</b>	Settings for the internal brake chopper. See also section <a href="#">DC voltage control (page 191)</a> .	
43.1	Brake resistor temperature	Displays the estimated temperature of the brake resistor, or how close the brake resistor is to being too hot. The value is given in percent where 100% is the eventual temperature the resistor would reach when loaded long enough with its rated maximum load capacity (43.9 Brake resistor max cont power). The temperature calculation is based on the values of parameters 43.08, 43.09 and 43.10, and on the assumption that the resistor is installed as instructed by the manufacturer (ie. it cools down as expected). This parameter is read-only.	- / real32
	0.0 ... 120.0 %	Estimated brake resistor temperature.	1 = 1 % / 1000 = 1 %
43.6	Brake chopper function	Enables brake chopper control and selects the brake resistor overload protection method (calculation or measurement).  <b>Note:</b> Before enabling brake chopper control, ensure that <ul style="list-style-type: none"> <li>• A brake resistor is connected,</li> <li>• Overvoltage control is switched off (parameter 30.30 <a href="#">Overvoltage control</a>), and</li> <li>• The supply voltage range (parameter 95.1 <a href="#">Supply voltage</a>) has been selected correctly.</li> </ul>	Disabled / uint16
	Disabled	Brake chopper control disabled.	0
	Enabled with thermal model	Brake chopper control enabled with resistor overload protection based on a thermal model. If you select this, you must also specify the values needed by the model, ie. parameters 43.08...43.12. See the resistor data sheet.	1
	Enabled without thermal model	Brake chopper control enabled without resistor overload protection based on a thermal model. This setting can be used, for example, if the resistor is equipped with a thermal circuit breaker that is wired to stop the drive if the resistor overheats. Before using this setting, ensure that overvoltage control is switched off (parameter 30.30 <a href="#">Overvoltage control</a> )	2

## 484 Parameters

No.	Name / Range / Selection	Description	Def / Type FbEq 16b / 32b
	Overvoltage peak protection	<p>Brake chopper starts to conduct at 100% pulse width whenever</p> <ul style="list-style-type: none"> <li>The DC voltage exceeds the overvoltage fault limit (a hysteresis applies), and</li> <li>The drive is not modulating (for example, during a coast stop).</li> </ul> <p>The thermal model-based resistor overload protection is not active. This setting is intended for situations where</p> <ul style="list-style-type: none"> <li>The braking chopper is not needed for runtime operation, ie. to dissipate the inertial energy of the motor,</li> <li>The motor is able to store a considerable amount of magnetic energy in its windings, and</li> <li>The motor might, deliberately or inadvertently, be stopped by coasting.</li> </ul> <p>In such a situation, the motor would potentially discharge enough magnetic energy towards the drive to cause damage. To protect the drive, the brake chopper can be used with a small resistor dimensioned merely to handle the magnetic energy (not the inertial energy) of the motor.</p>	3
43.7	Brake chopper run enable	<p>Selects the source for quick brake chopper on/off control. 0 = Brake chopper IGBT pulses are cut off 1 = Normal brake chopper IGBT modulation allowed. This parameter can be used to enable chopper operation only when the supply is missing from a drive with a regenerative supply unit.</p>	On / uint32
	Off	0.	0
	On	1.	1
	Other [bit]	See <a href="#">Terms and abbreviations (page 221)</a> .	
43.8	Brake resistor thermal tc	<p>Defines the thermal time constant for the brake resistor thermal model.</p>	0 s / real32
	0...10000 s	Brake resistor thermal time constant, ie. the rated time to achieve 63% temperature.	1 = 1 s / 1 = 1 s
43.9	Brake resistor max cont power	<p>Defines the maximum continuous load of the brake resistor which will eventually raise the resistor temperature to the maximum allowed value (= continuous heat dissipation capacity of the resistor in kW) but not above it. The value is used in the resistor overload protection based on the thermal model. See parameter <a href="#">43.6 Brake chopper function</a>, and the brake resistor data sheet.</p>	0.00 kW / real32
	0.00 ... 10000.00 kW	Maximum continuous load of the brake resistor.	1 = 1 kW / 1 = 1 kW

No.	Name / Range / Selection	Description	Def / Type FbEq 16b / 32b
43.10	Brake resistance	Defines the resistance value of the brake resistor. The value is used for the brake chopper protection based on the thermal model. See parameter 43.6 Brake chopper function.	0.0 Ohm / real32
	0.0 ... 1000.0 Ohm	Brake resistor resistance value.	1 = 1 Ohm / 1 = 1 Ohm
43.11	Brake resistor fault limit	Selects the fault limit for the brake resistor protection based on the thermal model. See parameter 43.6 Brake chopper function. When the limit is exceeded, the drive trips on fault 7183 BR excess temperature. The value is given in percent of the temperature the resistor reaches when loaded with the power defined by parameter 43.9 Brake resistor max cont power.	105 % / real32
	0...150 %	Brake resistor temperature fault limit.	1 = 1 % / 1 = 1 %
43.12	Brake resistor warning limit	Selects the warning limit for the brake resistor protection based on the thermal model. See parameter 43.6 Brake chopper function. When the limit is exceeded, the drive generates a A793 BR excess temperature warning. The value is given in percent of the temperature the resistor reaches when loaded with the power defined by parameter 43.9 Brake resistor max cont power.	95 % / real32
	0...150 %	Brake resistor temperature warning limit.	1 = 1 % / 1 = 1 %

## 486 Parameters

No.	Name / Range / Selection	Description	Def / Type FbEq 16b / 32b
<b>44</b>	<b>Mechanical brake control</b>	Configuration of mechanical brake control. See also section <a href="#">Mechanical brake control (page 78)</a> .	
44.1	Brake control status	Displays the mechanical brake control status word. This parameter is read-only.	- / uint16
	b0 Open command	Close/open command to brake actuator (0 = close, 1 = open).  <b>Note:</b> Parameter 44.210 Crane brake status, bit 0 is used for controlling crane mechanical brake. By default 44.210.b0 is connected into a relay output 1 (par. 10.24).	
	b1 Opening torque request	1 = Opening torque requested from drive logic	
	b2 Hold stopped request	1 = Hold requested from drive logic	
	b3 Ramp to stopped	1 = Ramping down to zero speed requested from drive logic	
	b4 Enabled	1 = Brake control is enabled	
	b5 Closed	1 = Brake control logic in <i>BRAKE CLOSED</i> state.	
	b6 Opening	1 = Brake control logic in <i>BRAKE OPENING</i> state.	
	b7 Open	1 = Brake control logic in <i>BRAKE OPEN</i> state.	
	b8 Closing	1 = Brake control logic in <i>BRAKE CLOSING</i> state.	
	b9...15 Reserved		
	0000h...FFFFh		1 = 1
44.2	Brake torque memory	Displays the torque (in percent) at the instant of the previous brake close command. This value can be used as a reference for the brake open torque. See parameters 44.9 Brake open torque source and 44.200 Brake open torque. A filtering time for this value can be defined using 44.21 Filter time brake torque memory.	- / real32
	-1600.0 ... 1600.0 %	Torque at brake closure. For scaling, see parameter 46.3.	- / -
44.3	Brake open torque reference	Displays the currently active brake open torque. See parameters 44.9 Brake open torque source and 44.200 Brake open torque. This parameter is read-only.	- / real32
	-1600.0 ... 1600.0 %	Currently active brake open torque. For scaling, see parameter 46.3.	- / -
44.6	Brake control enable	Activates/deactivates (or selects a source that activates/deactivates) the mechanical brake control logic. 0 = Brake control inactive 1 = Brake control active  <b>Note:</b> This parameter cannot be changed while the drive is running.	Not selected / uint32
	Not selected	0	0

No.	Name / Range / Selection	Description	Def / Type FbEq 16b / 32b
	Selected	1	1
	DI1	Digital input DI1 (10.2 DI delayed status, bit 0).	2
	DI2	Digital input DI2 (10.2 DI delayed status, bit 1).	3
	DI3	Digital input DI3 (10.2 DI delayed status, bit 2).	4
	DI4	Digital input DI4 (10.2 DI delayed status, bit 3).	5
	DI5	Digital input DI5 (10.2 DI delayed status, bit 4).	6
	DI6	Digital input DI6 (10.2 DI delayed status, bit 5).	7
	DIO1	Digital input/output DIO1 (11.2 DIO delayed status, bit 0).	10
	DIO2	Digital input/output DIO2 (11.2 DIO delayed status, bit 1).	11
	Other [bit]	See Terms and abbreviations (page 221).	
44.7	Brake acknowledge selection	Activates/deactivates (and selects the source for) brake open/close status (acknowledgement) supervision. When a brake control error (unexpected state of the acknowledgement signal) is detected, the drive reacts as defined by parameter 44.17 Brake fault function. 0 = Brake closed 1 = Brake open	No acknowledge / uint32
	Off	0.	0
	On	1.	1
	No acknowledge	Brake open/closed supervision disabled.	2
	DI1	Digital input DI1 (10.2 DI delayed status, bit 0).	3
	DI2	Digital input DI2 (10.2 DI delayed status, bit 1).	4
	DI3	Digital input DI3 (10.2 DI delayed status, bit 2).	5
	DI4	Digital input DI4 (10.2 DI delayed status, bit 3).	6
	DI5	Digital input DI5 (10.2 DI delayed status, bit 4).	7
	DI6	Digital input DI6 (10.2 DI delayed status, bit 5).	8
	DIO1	Digital input/output DIO1 (11.2 DIO delayed status, bit 0).	11
	DIO2	Digital input/output DIO2 (11.2 DIO delayed status, bit 1).	12
	Other [bit]	See Terms and abbreviations (page 221).	
44.8	Brake open delay	Defines the brake open delay, ie. the delay between the internal open brake command and the release of motor speed control. The delay timer starts when the drive has magnetized the motor and increased the motor torque to the level required for brake release (parameter 44.3 Brake open torque reference). Simultaneously with the timer start, the brake control logic energizes the brake control output and the brake starts to open. Set this parameter to the value of mechanical opening delay specified by the brake manufacturer.	0.00 s / real32

## 488 Parameters

No.	Name / Range / Selection	Description	Def / Type FbEq 16b / 32b
	0.00 ... 5.00 s	Brake open delay.	100 = 1 s / 100 = 1 s
44.9	Brake open torque source	<p>Defines a source that is used as a brake opening torque reference if</p> <ul style="list-style-type: none"> <li>its absolute value is greater than the setting of parameter 44.200 Brake open torque, and</li> <li>its sign is the same as the setting of 44.200 Brake open torque.</li> </ul> <p>See parameter 44.200 Brake open torque.</p> <p><b>Note:</b> For scalar control, disable Torque proving and Brake open torque. Select the following:            44.9 Brake open torque source = <i>Zero</i>            44.200 Brake open torque = <i>0%</i>            44.202 Torque proving = <i>Disable</i></p>	Brake open torque / uint32
	Zero	Zero.	0
	AI1 scaled	12.12 AI1 scaled value (page 284).	1
	AI2 scaled	12.22 AI2 scaled value (page 286).	2
	FBA ref1	3.5 FB A reference 1 (page 231).	3
	FBA ref2	3.6 FB A reference 2 (page 231).	4
	Brake torque memory	Parameter 44.2 Brake torque memory.	7
	Brake open torque	Parameter 44.200 Brake open torque.	8
	Other [value]	See Terms and abbreviations (page 221).	
44.11	Keep brake closed	<p>Selects a source that prevents the brake from opening.</p> <p>0 = Normal brake operation            1 = Keep brake closed</p> <p><b>Note:</b> This parameter cannot be changed while the drive is running.</p>	Not selected / uint32
	Not selected	0	0
	Selected	1	1
	DI1	Digital input DI1 (10.2 DI delayed status, bit 0).	2
	DI2	Digital input DI2 (10.2 DI delayed status, bit 1).	3
	DI3	Digital input DI3 (10.2 DI delayed status, bit 2).	4
	DI4	Digital input DI4 (10.2 DI delayed status, bit 3).	5
	DI5	Digital input DI5 (10.2 DI delayed status, bit 4).	6
	DI6	Digital input DI6 (10.2 DI delayed status, bit 5).	7
	DIO1	Digital input/output DIO1 (11.2 DIO delayed status, bit 0).	10
	DIO2	Digital input/output DIO2 (11.2 DIO delayed status, bit 1).	11
	Other [bit]	See Terms and abbreviations (page 221).	



No.	Name / Range / Selection	Description	Def / Type FbEq 16b / 32b
44.13	Brake close delay	Defines a delay between a close command (that is, when the brake control output is de-energized) and when the drive stops modulating. This is to keep the motor live and under control until the brake actually closes. Set this parameter equal to the value specified by the brake manufacturer as the mechanical make-up time of the brake.	0.00 s / real32
	0.00 ... 60.00 s	Brake close delay.	100 = 1 s / 100 = 1 s
44.14	Brake close level	Defines the brake close speed as an absolute value. After motor speed remains below this level for the duration of the brake close level delay (44.15 Brake close level delay), a close command is given.	10.00 rpm / real32
	0.00 ... 1000.00 rpm	Brake close speed. For scaling, see parameter 46.1.	- / -
44.15	Brake close level delay	Defines a brake close level delay. See parameter 44.14 Brake close level.	0.00 s / real32
	0.00 ... 10.00 s	Brake close level delay.	100 = 1 s / 100 = 1 s
44.16	Brake reopen delay	Defines a minimum time between brake closure and a subsequent open command.	0.00 s / real32
	0.00 ... 10.00 s	Brake reopen delay.	100 = 1 s / 100 = 1 s
44.17	Brake fault function	Determines how the drive reacts upon a mechanical brake control error.  <b>Note:</b> If parameter 44.7 Brake acknowledge selection is set to No acknowledge, acknowledgement status supervision is disabled altogether and will generate no warnings or faults. However, the brake open conditions are always supervised.	Fault / uint16
	Fault	The drive trips on a 71A2 Mech brake closing failed / 71A3 Mech brake opening failed fault if the status of the acknowledgement does not match the status presumed by the brake control logic. The drive trips on a 71A5 Mech brk opening not allowed fault if the brake open conditions cannot be fulfilled (for example, the required motor starting torque is not achieved).	0
	Warning	The drive generates a A7A1 Mechanical brake closing failed / A7A2 Mechanical brake opening failed warning if the status of the acknowledgement does not match the status presumed by the brake control logic. The drive generates a A7A5 Mechanical brake opening not allowed warning if the brake open conditions cannot be fulfilled (for example, the required motor starting torque is not achieved).	1

## 490 Parameters

No.	Name / Range / Selection	Description	Def / Type FbEq 16b / 32b
	Open fault	<p>Upon closing the brake, the drive generates a <b>A7A1 Mechanical brake closing failed</b> warning if the status of the acknowledgement does not match the status presumed by the brake control logic.</p> <p>Upon opening the brake, the drive trips on a <b>71A3 Mech brake opening failed</b> fault if the status of the acknowledgement does not match the status presumed by the brake control logic.</p> <p>The drive trips on a <b>71A5 Mech brk opening not allowed</b> fault if the brake open conditions cannot be fulfilled (for example, the required motor starting torque is not achieved).</p>	2
44.18	Brake fault delay	Defines a close fault delay, ie. time between brake closure and brake close fault trip.	0.00 s / real32
	0.00 ... 60.00 s	Brake close fault delay.	100 = 1 s / 100 = 1 s
44.21	Filter time brake torque memory	Defines a filtering time for parameter <b>44.2 Brake torque memory</b> (actual torque value used as open torque reference).	100 ms / real32
	0...100 ms	Filtering time.	100 = 1 ms / 1 = 1 ms
44.200	Brake open torque	<p>Defines the minimum absolute value of the brake open torque (motor torque requested at brake release in percent of motor nominal torque).</p> <p>The value of the source selected by parameter <b>44.9 Brake open torque source</b> is used as the brake open torque only if it has the same sign as this parameter and has a greater absolute value.</p> <p><b>Note:</b> For scalar control, disable Torque proving and Brake open torque. Select the following:  <b>44.9 Brake open torque source = Zero</b>  <b>44.200 Brake open torque = 0%</b>  <b>44.202 Torque proving = Disable</b></p>	30.0% / real32
	0.0 ... 1000.0%	Minimum torque at brake release.	1 = 1% / 1 = 1%
44.201	Torque proving sign	<p>Selects the source for the signal which inverts the torque proving and brake open torque values.</p> <p>0 = Not inverted. Torque is applied in the hoisting direction.</p> <p>1 = Inverted. Torque is applied in the reverse direction.</p>	False / int32
	False	0	0
	True	1	1
	DI1	Digital input DI1 (10.2 DI delayed status, bit 0).	2
	DI2	Digital input DI2 (10.2 DI delayed status, bit 1).	3
	DI3	Digital input DI3 (10.2 DI delayed status, bit 2).	4
	DI4	Digital input DI4 (10.2 DI delayed status, bit 3).	5
	DI5	Digital input DI5 (10.2 DI delayed status, bit 4).	6
	DI6	Digital input DI6 (10.2 DI delayed status, bit 5).	7
	DIO1	Digital input/output DIO1 (11.2 DIO delayed status, bit 0).	8

No.	Name / Range / Selection	Description	Def / Type FbEq 16b / 32b
	DIO2	Digital input/output DIO2 (11.2 DIO delayed status, bit 1).	9
	Other [bit]	See Terms and abbreviations (page 221).	
44.202	Torque proving	<p>Selects whether Torque proving (electrical test) is active or not. For more information on the function, see section Brake system checks – Torque proving (page 84).</p> <p><b>Note:</b> For scalar control, disable Torque proving and Brake open torque. Select the following:  44.9 Brake open torque source = <i>Zero</i>  44.200 Brake open torque = <i>0%</i>  44.202 Torque proving = <i>Disable</i></p>	Enable / int32
	Disable	0	0
	Enable	1	1
	DI1	Digital input DI1 (10.2 DI delayed status, bit 0).	2
	DI2	Digital input DI2 (10.2 DI delayed status, bit 1).	3
	DI3	Digital input DI3 (10.2 DI delayed status, bit 2).	4
	DI4	Digital input DI4 (10.2 DI delayed status, bit 3).	5
	DI5	Digital input DI5 (10.2 DI delayed status, bit 4).	6
	DI6	Digital input DI6 (10.2 DI delayed status, bit 5).	7
	DIO1	Digital input/output DIO1 (11.2 DIO delayed status, bit 0).	8
	DIO2	Digital input/output DIO2 (11.2 DIO delayed status, bit 1).	9
	Other [bit]	See Terms and abbreviations (page 221).	
44.203	Torque proving reference	Defines the Torque proving (electrical test) reference to be used when the Torque proving function is enabled.	25.00% / real32
	0.00 ... 300.00%	Torque proving (electrical test) reference in percentage of the motor nominal torque (1.10 Motor torque).	1 = 1% / 1 = 1%
44.204	Brake system check time	Defines the time delay during which Torque proving is active and the electrical and mechanical tests of the crane system are done against a closed brake. If the actual torque cannot be reached during this check time, the drive trips on fault D100 Torque prove.	300 ms / real32
	100...30000 ms	Time delay.	1 = 1 ms / 1 = 1 ms
44.205	Brake slip speed limit	Defines the speed limit used for examining the system for brake slips during Torque proving (mechanical test). For more information on the function, see section Brake system checks – Brake slip (page 85).	30.0 rpm / real32
	0.0 ... 30000.0 rpm	Brake slip speed limit.	1 = 1 rpm / 1 = 1 rpm

## 492 Parameters

No.	Name / Range / Selection	Description	Def / Type FbEq 16b / 32b
44.206	Brake slip fault delay	Defines the time delay before the drive trips on fault D101 Brake slip during Torque proving (mechanical test). If a brake slip is detected during the system check time (44.204 Brake system check time), the fault is generated immediately, even if the check time had not yet elapsed.	300 ms / real32
	0...30000 ms	Time delay.	1 = 1 ms / 1 = 1 ms
44.207	Safety close select	Selects whether the Brake safe closure function is active or not. For more information on the function, see section Brake safe closure (page 90).	Disable / int32
	Disable	0	0
	Enable	1	1
	DI1	Digital input DI1 (10.2 DI delayed status, bit 0).	2
	DI2	Digital input DI2 (10.2 DI delayed status, bit 1).	3
	DI3	Digital input DI3 (10.2 DI delayed status, bit 2).	4
	DI4	Digital input DI4 (10.2 DI delayed status, bit 3).	5
	DI5	Digital input DI5 (10.2 DI delayed status, bit 4).	6
	DI6	Digital input DI6 (10.2 DI delayed status, bit 5).	7
	DIO1	Digital input/output DIO1 (11.2 DIO delayed status, bit 0).	8
	DIO2	Digital input/output DIO2 (11.2 DIO delayed status, bit 1).	9
	Other [bit]	See Terms and abbreviations (page 221).	
44.208	Safety close speed	Defines the speed limit for the Brake safe closure function.	50.00 rpm / real32
	0.00 ... 30000.00 rpm	Brake safe closure speed.	1 = 1 rpm / 1 = 1 rpm
44.209	Safety close delay	Defines the time delay before the drive trips on fault D102 Brake safe closure.	2000 ms / real32
	0...30000 ms	Time delay.	1 = 1 ms / 1 = 1 ms
44.210	Crane brake status	Shows the status of the brake.  <b>Note:</b> By default 44.210.b0 is connected into a relay output 1 (par. 10.24). This signal must be used with the crane application.	- / uint16
	b0 Crane open brake command	Close/open command to brake actuator (0 = close, 1 = open).	
	b1 Brake acknowledge with delay	Brake open/close acknowledgement. 0 = Brake closed, 1 = Brake is open.	
	b2...15 Reserved		
	0000h...FFFFh		1 = 1

No.	Name / Range / Selection	Description	Def / Type FbEq 16b / 32b
44.211	Extended runtime	<p>Defines the time period during which drive keeps the motor magnetized after the brake is closed. The Extended run time function is enabled if this value is less than 3600 seconds or greater than 0 seconds. See also, section <a href="#">Extended run time</a> (page 91).</p> <p><b>Note:</b> The extended run time function is active only when all these conditions are satisfied:</p> <ul style="list-style-type: none"> <li>the drive is set to DTC motor control mode, see <a href="#">Operating modes of the drive</a> (page 148)</li> <li>the drive is in Remote control</li> </ul>	0.0 s / real32
 <p><b>WARNING!</b> Extended runtime causes the motor to heat up. In cases where long magnetization time is required, make sure to use motors with external ventilation.</p>			
	0.0 ... 3600.0 s	Time period.	1 = 1 s / 1 = 1 s
44.212	Extended runtime sw	<p>Shows the status of the Extended runtime function. Bit 0 is connected as default into parameter <a href="#">21.12</a> Continuous magnetization command command. This parameter is read-only.</p>	- / uint16
	b0 Extended run in operation	Extended run time in operation (0 = active, 1 = not active).	
	b1 Extended run enabled	Extended runtime function is enabled. 0 = Disabled, 1 = Enabled.	
	b2...15 Reserved		
	0000h...FFFFh		1 = 1
44.213	Brake long fall delay	<p>Defines the additional delay time (after <a href="#">44.13</a> Brake close delay) to close the brake before the Watchdog function opens the relay output RO2 (default setting) of the drive.</p> <p><b>Note:</b> This setting is effective only when the Brake closing failure (bit 7) warning of the parameter <a href="#">32.226</a> Watchdog mask is set to 1.</p>	0.0 s / real32
	0.0 ... 60.0 s	Delay time.	10 = 1 s / 1 = 1 s
44.220	Brake match mode	Selects the Brake matching mode. See also <a href="#">Brake matching</a> (page 85).	Disabled / uint16
	Disabled	Brake matching function is disabled.	0
	Warning	<p>Brake matching Warning mode is enabled. The warning <a href="#">D20F</a> Brake match is generated when the drive is stopped or when brake slippage is detected during extended run time or later when the drive is not modulating. The crane is not restarted, but the warning is generated for further external action (a signal horn or an alarm lamp).</p>	1

## 494 Parameters

No.	Name / Range / Selection	Description	Def / Type FbEq 16b / 32b
	Restart	<p>Brake matching Restart mode is enabled. The crane restarts automatically with fixed zero speed reference if brake slippage is detected in these two conditions,</p> <ul style="list-style-type: none"> <li>• after the brake was closed during extended run time and</li> <li>• during the time period defined with parameter 44.222 Brake match timeout after modulation is stopped.</li> </ul> <p>If brake slippage is detected after the timeout is elapsed, the crane is not restarted, but the warning D2OF Brake match is generated. The drive runs with fixed zero speed reference until you take over the crane control and bring the load electrically to the floor or to a safe place. See also Brake matching modes (page 86).</p>	2
44.221	Brake match position limit	Defines the brake matching position limit. ABB recommends to start with a value of 0.01.	0.000 / real32
	0.000 ... 500.000	Brake matching position limit in meters.	100 = 1 / 1 = 1
44.222	Brake match timeout	<p>Defines the maximum timeout within which the crane can be restarted if brake matching Mode 3 is selected with parameter 44.220 Brake match mode. The timer starts when the drive stops modulating.</p> <p><b>Note:</b> If value is set as 32767, timeout is disabled.</p>	0 s / uint16
	0...32767 s	Time.	1 = 1 s / 1 = 1 s
44.223	Brake match ref enable	<p>Selects the source for the operator to take over the control after brake slippage was detected (that is, releases joystick reference control). Brake matching Mode 2 and Mode 3 restarts the drive and runs with fixed zero speed reference until you take over the crane and bring the load electrically to the floor or to a safe place.</p>	Disable / int32
	Disable	Brake match reference input is inactive.	0
	Enable	Brake match reference input is active.	1
	DI1	Digital input DI1 (10.2 DI delayed status, bit 0).	2
	DI2	Digital input DI2 (10.2 DI delayed status, bit 1).	3
	DI3	Digital input DI3 (10.2 DI delayed status, bit 2).	4
	DI4	Digital input DI4 (10.2 DI delayed status, bit 3).	5
	DI5	Digital input DI5 (10.2 DI delayed status, bit 4).	6
	DI6	Digital input DI6 (10.2 DI delayed status, bit 5).	7
	DIO1	Digital input/output DIO1 (11.2 DIO delayed status, bit 0).	8
	DIO2	Digital input/output DIO2 (11.2 DIO delayed status, bit 1).	9
	Other [bit]	See Terms and abbreviations (page 221).	

No.	Name / Range / Selection	Description	Def / Type FbEq 16b / 32b
44.224	Brake Match SW	Brake match function status word. This parameter is read-only.	- / uint16
	b0 Enabled	Brake match function is enabled and all configurations are correct.	
	b1 Start command	Brake match function is forcing start command when brake slipping is detected.	
	b2 Reference release	Reference release command is activated when brake match function restarted the drive.	
	b3 Brake match active	Brake match active warning is active. After brake slipping is detected, the warning is active until next normal start command is given.	
	b4 Configuration error	Not all drive parameters are configured to enable the use of brake match function.	
	b5 Hold zero speed	Hold zero speed command is active.	
	b6 Timeout timer running	Timeout timer is running after the drive stopped modulation.	
	b7 Brake slipping	Brake slipping is detected after the brake was closed.	
	b8...15 Reserved		
	0000h...FFFFh		1 = 1
44.230	Brake acknowledge selection	(Visible only when user lock is open with pass code 584. See parameter 96.2 Pass code.) Activates or selects the source for brake open (acknowledgment) supervision.  <b>Note:</b> Parameter 44.7 Brake acknowledge selection must be set in parameter 44.210 Crane brake status, bit 1 (Brake acknowledge with delay).	No acknowledge / int32
	Off	0	0
	On	1	1
	No acknowledge	Brake open/closed supervision is disabled.	2
	DI1	Digital input DI1 (10.2 DI delayed status, bit 0).	3
	DI2	Digital input DI2 (10.2 DI delayed status, bit 1).	4
	DI3	Digital input DI3 (10.2 DI delayed status, bit 2).	5
	DI4	Digital input DI4 (10.2 DI delayed status, bit 3).	6
	DI5	Digital input DI5 (10.2 DI delayed status, bit 4).	7
	DI6	Digital input DI6 (10.2 DI delayed status, bit 5).	8
	DIO1	Digital input/output DIO1 (11.2 DIO delayed status, bit 0).	9
	DIO2	Digital input/output DIO2 (11.2 DIO delayed status, bit 1).	10
	Other [bit]	See Terms and abbreviations (page 221).	

# 496 Parameters

No.	Name / Range / Selection	Description	Def / Type FbEq 16b / 32b
44.231	Brake acknowledge delay	<p><i>(Visible only when user lock is open with pass code 584. See parameter 96.2 Pass code.)</i></p> <p>Defines the delay time for brake open supervision, i.e. the delay between the internal open brake command and the brake acknowledge signal (parameter 44.230 Brake acknowledge selection).</p> <p>When a brake control error (unexpected state of the acknowledgment signal) is detected after delay time is elapsed, the drive reacts as defined in parameter 44.17 Brake fault function.</p> <p>0 = Brake closed 1 = Brake open</p> <p><b>Note:</b> Parameter 44.7 Brake acknowledge selection must be set in parameter 44.210 Crane brake status, bit 1 (Brake acknowledge with delay).</p>	0.500 s / real32
	0.000 ... 5.000 s	Brake acknowledge delay.	1000 = 1 s / 1 = 1 s



No.	Name / Range / Selection	Description	Def / Type FbEq 16b / 32b
46	<b>Monitoring/scaling settings</b>	Speed supervision settings; actual signal filtering; general scaling settings.  <b>Note:</b> The 16-bit scalings apply when parameter values are read or written directly. With protocol- and profile-specific read/write commands (eg. communication objects), the scaling depends on the protocol or profile. See the documentation of the adapter module.	
46.1	Speed scaling	Defines the maximum speed value used to define the acceleration ramp rate and the initial speed value used to define the deceleration ramp rate (see parameter group 23 <i>Speed reference ramp</i> ). The speed acceleration and deceleration ramp times are therefore related to this value (not to parameter 30.12 <i>Maximum speed</i> ). Also defines the 16-bit scaling of speed-related parameters. The value of this parameter corresponds to 20000 in fieldbus, master/follower etc. communication.	1500.00;1800.00 rpm (95,20 b0) rpm / real32
	0.10 ... 30000.00 rpm	Acceleration/deceleration terminal/initial speed.	1 = 1 rpm / 100 = 1 rpm
46.2	Frequency scaling	Defines the maximum frequency value used to define the acceleration ramp rate and the initial frequency value used to define deceleration ramp rate. The frequency acceleration and deceleration ramp times are therefore related to this value (not to parameter 30.14 <i>Maximum frequency</i> ). Also defines the 16-bit scaling of frequency-related parameters. The value of this parameter corresponds to 20000 in fieldbus, master/follower etc. communication.	50.00 Hz; 60.00 Hz (95,20 b0) Hz / real32
	0.10 ... 1000.00 Hz	Acceleration/deceleration terminal/initial frequency.	10 = 1 Hz / 100 = 1 Hz
46.3	Torque scaling	Defines the 16-bit scaling of torque parameters. The value of this parameter (in percent of nominal motor torque) corresponds to 10000 in fieldbus, master/follower etc. communication. See also parameter 46.42 <i>Torque decimals</i> .	100.0 % / real32
	0.1 ... 1000.0 %	Torque corresponding to 10000 on fieldbus.	10 = 1 % / 10 = 1 %
46.4	Power scaling	Defines the output power value that corresponds to 10000 in fieldbus, master/follower etc. communication. The unit is selected by parameter 96.16 <i>Unit selection</i> .	1000.00 kW or hp / real32
	0.10 ... 30000.00 kW or hp	Power corresponding to 10000 on fieldbus.	1 = 1 kW or hp / 100 = 1 kW or hp
46.5	Current scaling	Defines the 16-bit scaling of current parameters. The value of this parameter corresponds to 10000 in fieldbus, master/follower etc. communication.	10000 A / real32
	0...30000 A	Current corresponding to 10000 on fieldbus.	1 = 1 A / 1 = 1 A

## 498 Parameters

No.	Name / Range / Selection	Description	Def / Type FbEq 16b / 32b
46.6	Speed ref zero scaling	Defines a speed corresponding to a zero reference received from fieldbus (either the embedded fieldbus interface, or interface FBA A or FBA B). For example, with a setting of 500, the fieldbus reference range of 0...20000 would correspond to a speed of 500...[46.1] rpm.  <b>Note:</b> This parameter is effective only with the ABB Drives communication profile.	0.00 rpm / real32
	0.00 ... 30000.00 rpm	Speed corresponding to minimum fieldbus reference.	1 = 1 rpm / 100 = 1 rpm
46.7	Frequency ref zero scaling	Defines a frequency corresponding to a zero reference received from fieldbus (either the embedded fieldbus interface, or interface FBA A or FBA B). For example, with a setting of 30, the fieldbus reference range of 0...20000 would correspond to a speed of 30...[46.2] Hz.  <b>Note:</b> This parameter is effective only with the ABB Drives communication profile.	0.00 Hz / real32
	0.00 ... 1000.00 Hz	Frequency corresponding to minimum fieldbus reference.	10 = 1 Hz / 100 = 1 Hz
46.11	Filter time motor speed	Defines a filter time for signals 1.1 Motor speed used, 1.2 Motor speed estimated, 1.4 Encoder 1 speed filtered and 1.5 Encoder 2 speed filtered.	500 ms / real32
	0...20000 ms	Motor speed signal filter time.	1 = 1 ms / 1 = 1 ms
46.12	Filter time output frequency	Defines a filter time for signal 1.6 Output frequency.	500 ms / real32
	0...20000 ms	Output frequency signal filter time.	1 = 1 ms / 1 = 1 ms
46.13	Filter time motor torque	Defines a filter time for signal 1.10 Motor torque.	100 ms / real32
	0...20000 ms	Motor torque signal filter time.	1 = 1 ms / 1 = 1 ms
46.14	Filter time power out	Defines a filter time for signal 1.14 Output power.	100 ms / real32
	0...20000 ms	Output power signal filter time.	1 = 1 ms / 1 = 1 ms

No.	Name / Range / Selection	Description	Def / Type FbEq 16b / 32b
46.21	At speed hysteresis	<p>Defines the “at setpoint” limits for speed control of the drive.</p> <p>When the absolute difference between reference (22.87 Speed reference act 7) and actual speed (90.1 Motor speed for control) becomes smaller than half the value of 46.21 At speed hysteresis, the drive is considered to be “at setpoint”.</p> <p>This is indicated by bit 8 of 6.11 Main status word.</p> <p>The bit switches off when the absolute difference between reference and actual speed exceeds the value of 46.21 At speed hysteresis.</p>	100.00 rpm / real32

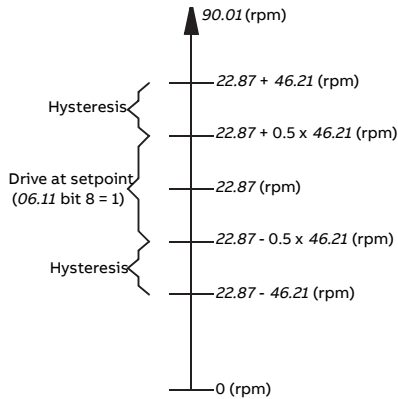

0.00 ... 30000.00 rpm	Limit for “at setpoint” indication in speed control. For - / - scaling, see parameter 46.1.
-----------------------	---

500 Parameters

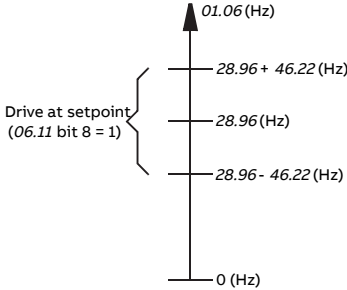
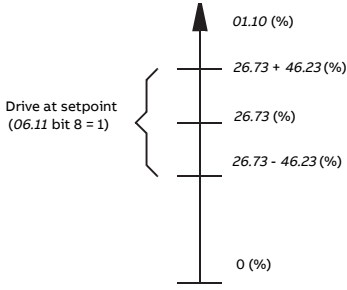
No.	Name / Range / Selection	Description	Def / Type FbEq 16b / 32b
46.22	At frequency hysteresis	<p>Defines the “at setpoint” limits for frequency control of the drive. When the absolute difference between reference and actual frequency (1.6 Output frequency) is smaller than 46.22 At frequency hysteresis, the drive is considered to be “at setpoint”. This is indicated by bit 8 of 6.11 Main status word.</p> 	10.00 Hz / real32
0.00 ... 1000.00 Hz	<p>Limit for “at setpoint” indication in frequency control. For scaling, see parameter 46.2.</p>	- / -	
46.23	At torque hysteresis	<p>Defines the “at setpoint” limits for torque control of the drive. When the absolute difference between reference (26.73 Torque reference act 4) and actual torque (1.10 Motor torque) is smaller than 46.23 At torque hysteresis, the drive is considered to be “at setpoint”. This is indicated by bit 8 of 6.11 Main status word.</p> 	10.0 % / real32
0.0 ... 300.0 %	<p>Limit for “at setpoint” indication in torque control. For scaling, see parameter 46.3.</p>	- / -	
46.31	Above speed limit	<p>Defines the trigger level for “above limit” indication in speed control. When actual speed exceeds the limit, bit 10 of 6.17 Drive status word 2 is set.</p>	1500.00 rpm / real32
0.00 ... 30000.00 rpm	<p>“Above limit” indication trigger level for speed control. For scaling, see parameter 46.1.</p>	- / -	

No.	Name / Range / Selection	Description	Def / Type FbEq 16b / 32b
46.32	Above frequency limit	Defines the trigger level for “above limit” indication in frequency control. When actual frequency exceeds the limit, bit 10 of 6.17 Drive status word 2 is set.	50.00 Hz / real32
	0.00 ... 1000.00 Hz	“Above limit” indication trigger level for frequency control. For scaling, see parameter 46.2.	- / -
46.33	Above torque limit	Defines the trigger level for “above limit” indication in torque control. When actual torque exceeds the limit, bit 10 of 6.17 Drive status word 2 is set.	300.0 % / real32
	0.0 ... 1600.0 %	“Above limit” indication trigger level for torque control. For scaling, see parameter 46.3.	- / -
46.42	Torque decimals	Defines the number of decimal places of torque-related parameters.	1 / uint16
	0...2	Number of decimal places of torque parameters.	1 = 1 / 1 = 1

## 502 Parameters

No.	Name / Range / Selection	Description	Def / Type FbEq 16b / 32b
<b>47</b>	<b>Data storage</b>	Data storage parameters that can be written to and read from using other parameters' source and target settings. Note that there are different storage parameters for different data types. Integer-type storage parameters cannot be used as the source of other parameters. See also section <a href="#">Data storage parameters (page 214)</a> .	
47.1	DataStorage 1 real32	Data storage parameter 1. Parameters 47.1...47.8 are real 32-bit numbers that can be used as source values of other parameters. Storage parameters 47.1...47.8 can be used as the target of received 16-bit data (parameter group 62 D2D and DDCS receive data) or the source of transmitted 16-bit data (parameter group 61 D2D and DDCS transmit data). The scaling and range are defined by parameters 47.31...47.38.	- / real32
	-32768.000 ... 32767.000	32-bit real (floating point) number. For scaling, see parameter 47.31.	- / -
47.2	DataStorage 2 real32	Data storage parameter 2. See also parameter 47.1 DataStorage 1 real32.	- / real32
	-32768.000 ... 32767.000	32-bit real (floating point) number. For scaling, see parameter 47.32.	- / -
47.3	DataStorage 3 real32	Data storage parameter 3. See also parameter 47.1 DataStorage 1 real32.	- / real32
	-32768.000 ... 32767.000	32-bit real (floating point) number. For scaling, see parameter 47.33.	- / -
47.4	DataStorage 4 real32	Data storage parameter 4. See also parameter 47.1 DataStorage 1 real32.	- / real32
	-32768.000 ... 32767.000	32-bit real (floating point) number. For scaling, see parameter 47.34.	- / -
47.5	DataStorage 5 real32	Data storage parameter 5. See also parameter 47.1 DataStorage 1 real32.	- / real32
	-32768.000 ... 32767.000	32-bit real (floating point) number. For scaling, see parameter 47.35.	- / -
47.6	DataStorage 6 real32	Data storage parameter 6. See also parameter 47.1 DataStorage 1 real32.	- / real32
	-32768.000 ... 32767.000	32-bit real (floating point) number. For scaling, see parameter 47.36.	- / -
47.7	DataStorage 7 real32	Data storage parameter 7. See also parameter 47.1 DataStorage 1 real32.	- / real32
	-32768.000 ... 32767.000	32-bit real (floating point) number. For scaling, see parameter 47.37.	- / -
47.8	DataStorage 8 real32	Data storage parameter 8. See also parameter 47.1 DataStorage 1 real32.	- / real32
	-32768.000 ... 32767.000	32-bit real (floating point) number. For scaling, see parameter 47.38.	- / -
47.11	DataStorage 1 int32	Data storage parameter 9.	- / int32

No.	Name / Range / Selection	Description	Def / Type FbEq 16b / 32b
	-2147483648..2147483647	32-bit integer.	- / -
47.12	DataStorage 2	int32 Data storage parameter 10.	- / int32
	-2147483648..2147483647	32-bit integer.	- / -
47.13	DataStorage 3	int32 Data storage parameter 11.	- / int32
	-2147483648..2147483647	32-bit integer.	- / -
47.14	DataStorage 4	int32 Data storage parameter 12.	- / int32
	-2147483648..2147483647	32-bit integer.	- / -
47.15	DataStorage 5	int32 Data storage parameter 13.	- / int32
	-2147483648..2147483647	32-bit integer.	- / -
47.16	DataStorage 6	int32 Data storage parameter 14.	- / int32
	-2147483648..2147483647	32-bit integer	- / -
47.17	DataStorage 7	int32 Data storage parameter 15.	- / int32
	-2147483648..2147483647	32-bit integer.	- / -
47.18	DataStorage 8	int32 Data storage parameter 16.	- / int32
	-2147483648..2147483647	32-bit integer.	- / -
47.21	DataStorage 1	int16 Data storage parameter 17.	- / int16
	-32768...32767	16-bit integer.	1 = 1 / 1 = 1
47.22	DataStorage 2	int16 Data storage parameter 18.	- / int16
	-32768...32767	16-bit integer.	1 = 1 / 1 = 1
47.23	DataStorage 3	int16 Data storage parameter 19.	- / int16
	-32768...32767	16-bit integer.	1 = 1 / 1 = 1
47.24	DataStorage 4	int16 Data storage parameter 20.	- / int16
	-32768...32767	16-bit integer.	1 = 1 / 1 = 1
47.25	DataStorage 5	int16 Data storage parameter 21.	- / int16
	-32768...32767	16-bit integer.	1 = 1 / 1 = 1
47.26	DataStorage 6	int16 Data storage parameter 22.	- / int16
	-32768...32767	16-bit integer.	1 = 1 / 1 = 1
47.27	DataStorage 7	int16 Data storage parameter 23.	- / int16
	-32768...32767	16-bit integer.	1 = 1 / 1 = 1
47.28	DataStorage 8	int16 Data storage parameter 24.	- / int16
	-32768...32767	16-bit integer.	1 = 1 / 1 = 1



## 504 Parameters

No.	Name / Range / Selection	Description	Def / Type FbEq 16b / 32b
47.31	DataStorage 1 real32 type	Defines the scaling of parameter 47.1 DataStorage 1 real32 to and from 16-bit integer format. This scaling is used when the data storage parameter is the target of received 16-bit data (defined in parameter group 62 D2D and DDCS receive data), or when the data storage parameter is the source of transmitted 16-bit data (defined in parameter group 61 D2D and DDCS transmit data). The setting also defines the visible range of the storage parameter.	Unscaled / uint16
	Unscaled	Data storage only. Range: -2147483.264 ... 2147473.264.	0
	Transparent	Scaling: 1 = 1. Range: -32768 ... 32767.	1
	General	Scaling: 1 = 100. Range: -327.68 ... 327.67.	2
	Torque	The scaling is defined by parameter 46.3 Torque scaling. Range: -1600.0 ... 1600.0.	3
	Speed	The scaling is defined by parameter 46.1 Speed scaling. Range: -30000.00 ... 30000.00.	4
	Frequency	The scaling is defined by parameter 46.2 Frequency scaling. Range: -600.00 ... 600.00.	5
47.32	DataStorage 2 real32 type	Defines the 16-bit scaling of parameter 47.2 DataStorage 2 real32. See parameter 47.31 DataStorage 1 real32 type.	Unscaled / uint16
47.33	DataStorage 3 real32 type	Defines the 16-bit scaling of parameter 47.3 DataStorage 3 real32. See parameter 47.31 DataStorage 1 real32 type.	Unscaled / uint16
47.34	DataStorage 4 real32 type	Defines the 16-bit scaling of parameter 47.4 DataStorage 4 real32. See parameter 47.31 DataStorage 1 real32 type.	Unscaled / uint16
47.35	DataStorage 5 real32 type	Defines the 16-bit scaling of parameter 47.5 DataStorage 5 real32. See parameter 47.31 DataStorage 1 real32 type.	Unscaled / uint16
47.36	DataStorage 6 real32 type	Defines the 16-bit scaling of parameter 47.6 DataStorage 6 real32. See parameter 47.31 DataStorage 1 real32 type.	Unscaled / uint16
47.37	DataStorage 7 real32 type	Defines the 16-bit scaling of parameter 47.7 DataStorage 7 real32. See parameter 47.31 DataStorage 1 real32 type.	Unscaled / uint16
47.38	DataStorage 8 real32 type	Defines the 16-bit scaling of parameter 47.8 DataStorage 8 real32. See parameter 47.31 DataStorage 1 real32 type.	Unscaled / uint16



No.	Name / Range / Selection	Description	Def / Type FbEq 16b / 32b
<b>49</b>	<b>Panel port communication</b>	Communication settings for the control panel port on the drive.	
49.1	Node ID number	Defines the node ID of the drive. All devices connected to the network must have a unique node ID.  <b>Note:</b> For networked drives, it is advisable to reserve ID 1 for spare/replacement drives.	1 / uint32
	1...32	Node ID.	1 = 1 / 1 = 1
49.3	Baud rate	Defines the transfer rate of the link.	230.4 kbps / uint32
	38.4 kbps	38.4 kbit/s.	1
	57.6 kbps	57.6 kbit/s.	2
	86.4 kbps	86.4 kbit/s.	3
	115.2 kbps	115.2 kbit/s.	4
	230.4 kbps	230.4 kbit/s.	5
49.4	Communication loss time	Sets a timeout for control panel (or PC tool) communication. If a communication break lasts longer than the timeout, the action specified by parameter 49.5 <i>Communication loss action</i> is taken.	10.0 s / uint32
	0.3 ... 3000.0 s	Panel/PC tool communication timeout.	10 = 1 s / 1000 = 1 s
49.5	Communication loss action	Selects how the drive reacts to a control panel (or PC tool) communication break. Changes to this parameter take effect after the control unit is rebooted or the new settings validated by parameter 49.6 <i>Refresh settings</i> . See also parameters 49.7 <i>Panel comm supervision force</i> and 49.8 <i>Secondary comm. loss action</i> .	Fault / uint16
	No action	No action taken.	0
	Fault	Drive trips on 7081 <i>Control panel loss</i> . This only occurs if control is expected from the control panel (it is selected as source of start/stop/reference in the currently active control location), or if supervision is forced using parameter 49.7 <i>Panel comm supervision force</i> .	1
	Last speed	Drive generates an A7EE <i>Control panel loss warning</i> and freezes the speed to the level the drive was operating at. This only occurs if control is expected from the control panel, or if supervision is forced using parameter 49.7 <i>Panel comm supervision force</i> . The speed is determined on the basis of actual speed using 850 ms low-pass filtering.	2
 <b>WARNING!</b> Make sure that it is safe to continue operation in case of a communication break.			

## 506 Parameters

No.	Name / Range / Selection	Description	Def / Type FbEq 16b / 32b
	Speed ref safe	Drive generates an A7EE Control panel loss warning and sets the speed to the speed defined by parameter 22.41 Speed ref safe. This only occurs if control is expected from the control panel, or if supervision is forced using parameter 49.7 Panel comm supervision force.	3
		 <b>WARNING!</b> Make sure that it is safe to continue operation in case of a communication break.	
	Warning	Drive generates an A7EE Control panel loss warning. This only occurs if control is expected from the control panel, or if supervision is forced using parameter 49.7 Panel comm supervision force.	5
		 <b>WARNING!</b> Make sure that it is safe to continue operation in case of a communication break.	
49.6	Refresh settings	Applies the settings of parameters 49.1 Node ID number...49.5.	Done / uint16
	Done	Refresh done or not requested.	0
	Refresh	Refresh parameters 49.1 Node ID number...49.5. The value reverts automatically to Done.	1
49.7	Panel comm supervision force	Activates control panel communication monitoring separately for each control location (see section Local control vs. external control (page 145)). The parameter is primarily intended for monitoring the communication with the panel when it is connected to the application program and not selected as a control source by drive parameters.	- / uint16
	b0 Ext 1	1 = Communication monitoring active when Ext 1 is being used.	
	b1 Ext 2	1 = Communication monitoring active when Ext 2 is being used.	
	b2 Local	1 = Communication monitoring active when local control is being used.	
	b3...15 Reserved		
	0000h...FFFFh		1 = 1



No.	Name / Range / Selection	Description	Def / Type FbEq 16b / 32b
49.8	Secondary comm. loss action	<p>Selects how the drive reacts to a control panel (or PC tool) communication break. This action is taken when</p> <ul style="list-style-type: none"> <li>the panel is parametrized as an alternative control or reference source but is not currently the active source, and</li> <li>communication supervision for the active control location is not forced by parameter 49.7 Panel comm supervision force.</li> </ul>	No action / uint16
	No action	No action taken.	0
	Warning	<p>Drive generates an A7EE Control panel loss warning.</p> <div style="text-align: center;">  <p><b>WARNING!</b> Make sure that it is safe to continue operation in case of a communication break.</p> </div>	5
49.14	Panel speed reference unit	Defines the unit for speed reference when given from the control panel.	rpm / uint16
	rpm	rpm.	0
	%	Percent of parameter 46.1 Speed scaling.	1
49.15	Minimum ext speed ref panel	<p>Defines a minimum limit for control panel speed reference in external control. In local control, the limits in parameter group 30 Limits are in force. See section Local control vs. external control (page 145).</p>	-30000.00 rpm / real32
	-30000.00 ... 30000.00 rpm	Minimum speed reference. For scaling, see parameter 46.1.	- / -
49.16	Maximum ext speed ref panel	<p>Defines a maximum limit for control panel speed reference in external control. In local control, the limits in parameter group 30 Limits are in force. See section Local control vs. external control (page 145).</p>	30000.00 rpm / real32
	-30000.00 ... 30000.00 rpm	Maximum speed reference. For scaling, see parameter 46.1.	- / -
49.17	Minimum ext frequency ref panel	<p>Defines a minimum limit for control panel frequency reference in external control. In local control, the limits in parameter group 30 Limits are in force. See section Local control vs. external control (page 145).</p>	-500.00 Hz / real32
	-598.00 ... 598.00 Hz	Minimum frequency reference. For scaling, see parameter 46.2.	- / -
49.18	Maximum ext frequency ref panel	<p>Defines a maximum limit for control panel frequency reference in external control. In local control, the limits in parameter group 30 Limits are in force. See section Local control vs. external control (page 145).</p>	500.00 Hz / real32
	-598.00 ... 598.00 Hz	Maximum frequency reference. For scaling, see parameter 46.2.	- / -

## 508 Parameters

No.	Name / Range / Selection	Description	Def / Type FbEq 16b / 32b
49.24	Panel actual source	Selects an actual value to be displayed in the top right corner of the control panel. This parameter is only effective when the control panel is not an active reference source.	Automatic / uint32
	Automatic	The active reference is displayed.	0
	Process PID setpoint actual	Not in use.	1
	Other [value]	See Terms and abbreviations (page 221).	

No.	Name / Range / Selection	Description	Def / Type FbEq 16b / 32b
50	<b>Fieldbus adapter (FBA)</b>	Fieldbus communication configuration. See also chapter <a href="#">Fieldbus control through a fieldbus adapter</a> (page 761).	
50.1	FBA A enable	Enables/disables communication between the drive and fieldbus adapter A, and specifies the slot the adapter is installed into.  <b>Note:</b> This parameter cannot be changed while the drive is running.	Disable / uint16
	Disable	Communication between drive and fieldbus adapter A disabled.	0
	Option slot 1	Communication between drive and fieldbus adapter A enabled. The adapter is in slot 1.	1
	Option slot 2	Communication between drive and fieldbus adapter A enabled. The adapter is in slot 2.	2
	Option slot 3	Communication between drive and fieldbus adapter A enabled. The adapter is in slot 3.	3
50.2	FBA A comm loss func	Selects how the drive reacts upon a fieldbus communication break. A time delay for the action can be defined by parameter <a href="#">50.3 FBA A comm loss t out</a> . See also parameter <a href="#">50.26 FBA A comm supervision force</a> .	No action / uint16
	No action	No action taken.	0
	Fault	Drive trips on <a href="#">7510 FBA A communication</a> . This only occurs if control is expected from the FBA A interface (FBA A selected as source of start/stop/reference in the currently active control location), or if supervision is forced using parameter <a href="#">50.26 FBA A comm supervision force</a> .	1
	Last speed	Drive generates an <a href="#">A7C1 FBA A communication warning</a> and freezes the speed to the level the drive was operating at. This only occurs if control is expected from the FBA A interface, or if supervision is forced using parameter <a href="#">50.26 FBA A comm supervision force</a> . The speed is determined on the basis of actual speed using 850 ms low-pass filtering.	2
 <b>WARNING!</b> Make sure that it is safe to continue operation in case of a communication break.			

# 510 Parameters

No.	Name / Range / Selection	Description	Def / Type FbEq 16b / 32b
	Speed ref safe	<p>Drive generates an <a href="#">A7C1 FBA A communication warning</a> and sets the speed to the value defined by parameter <a href="#">22.41 Speed ref safe</a> (when speed reference is being used). This only occurs if control is expected from the FBA A interface, or if supervision is forced using parameter <a href="#">50.26 FBA A comm supervision force</a>.</p> <hr/> <p> <b>WARNING!</b> Make sure that it is safe to continue operation in case of a communication break.</p> <hr/>	3
	Fault always	<p>Drive trips on <a href="#">7510 FBA A communication</a>. This occurs even though no control is expected from the FBA A interface.</p>	4
	Warning	<p>Drive generates an <a href="#">A7C1 FBA A communication warning</a>. This only occurs if control is expected from the FBA A interface, or if supervision is forced using parameter <a href="#">50.26 FBA A comm supervision force</a>.</p> <hr/> <p> <b>WARNING!</b> Make sure that it is safe to continue operation in case of a communication break.</p> <hr/>	5
50.3	FBA A comm loss t out	<p>Defines the time delay before the action defined by parameter <a href="#">50.2 FBA A comm loss func</a> is taken. Time count starts when the communication link fails to update the message. As a rule of thumb, this parameter should be set to at least 3 times the transmit interval of the master.</p> <p><b>Note:</b> There is a 60-second boot-up delay immediately after power-up. During the delay, the communication break monitoring is disabled (but communication itself can be active).</p>	0.3 s / uint16
	0.1 ... 6553.5 s	Time delay.	10 = 1 s / 10 = 1 s
50.4	FBA A ref1 type	<p>Selects the type and scaling of reference 1 received from fieldbus adapter A.</p> <p><b>Note:</b> Fieldbus-specific communication profiles may use different scalings. For more information, see the manual of the fieldbus adapter.</p>	Auto / uint16
	Auto	Type and scaling are chosen automatically according to which reference chain (see settings <a href="#">Torque</a> , <a href="#">Speed</a> , <a href="#">Frequency</a> ) the incoming reference is connected to. If the reference is not connected to any chain, no scaling is applied (as with setting <a href="#">Transparent</a> ).	0
	Transparent	No scaling is applied (the 16-bit scaling is 1 = 1 unit).	1
	General	Generic reference with a 16-bit scaling of 100 = 1 (ie. integer and two decimals).	2
	Torque	The scaling is defined by parameter <a href="#">46.3 Torque scaling</a> .	3

No.	Name / Range / Selection	Description	Def / Type FbEq 16b / 32b
	Speed	The scaling is defined by parameter 46.1 Speed scaling.	4
	Frequency	The scaling is defined by parameter 46.2 Frequency scaling.	5
50.5	FBA A ref2 type	Selects the type and scaling of reference 2 received from fieldbus adapter A. See parameter 50.4 FBA A ref1 type.	Auto / uint16
50.7	FBA A actual 1 type	Selects the type/source and scaling of actual value 1 transmitted to the fieldbus network through fieldbus adapter A.  <b>Note:</b> Fieldbus-specific communication profiles may use different scalings. For more information, see the manual of the fieldbus adapter.	Auto / uint16
	Auto	Type/source and scaling follow the type of reference 1 selected by parameter 50.4 FBA A ref1 type. See the individual settings below for the sources and scalings.	0
	Transparent	The value selected by parameter 50.10 FBA A act1 transparent source is sent as actual value 1. No scaling is applied (the 16-bit scaling is 1 = 1 unit).	1
	General	The value selected by parameter 50.10 FBA A act1 transparent source is sent as actual value 1 with a 16-bit scaling of 100 = 1 unit (ie. integer and two decimals).	2
	Torque	1.10 Motor torque is sent as actual value 1. The scaling is defined by parameter 46.3 Torque scaling.	3
	Speed	1.1 Motor speed used is sent as actual value 1. The scaling is defined by parameter 46.1 Speed scaling.	4
	Frequency	1.6 Output frequency is sent as actual value 1. The scaling is defined by parameter 46.2 Frequency scaling.	5
	Position	Motor position is sent as actual value 1. See parameter 90.6 Motor position scaled.	6
50.8	FBA A actual 2 type	Selects the type/source and scaling of actual value 2 transmitted to the fieldbus network through fieldbus adapter A. See parameter 50.7 FBA A actual 1 type.	Auto / uint16
50.9	FBA A SW transparent source	Selects the source of the fieldbus status word when the fieldbus adapter is set to a transparent communication profile eg. by its configuration parameters (group 51 FBA A settings).	Not selected / uint32
	Not selected	No source selected.	0
	Other [value]	See Terms and abbreviations (page 221).	
50.10	FBA A act1 transparent source	When parameter 50.7 FBA A actual 1 type is set to Transparent or General, this parameter selects the source of actual value 1 transmitted to the fieldbus network through fieldbus adapter A.	Not selected / uint32
	Not selected	No source selected.	0
	Other [value]	See Terms and abbreviations (page 221).	



## 512 Parameters

No.	Name / Range / Selection	Description	Def / Type FbEq 16b / 32b
50.11	FBA A act2 transparent source	When parameter 50.8 FBA A actual 2 type is set to <i>Transparent</i> or <i>General</i> , this parameter selects the source of actual value 2 transmitted to the fieldbus network through fieldbus adapter A.	Not selected / uint32
	Not selected	No source selected.	0
	Other [value]	See <i>Terms and abbreviations (page 221)</i> .	
50.12	FBA A debug mode	Enables the display of raw (unmodified) data received from and sent to fieldbus adapter A in parameters 50.13...50.18. This functionality should only be used for debugging.  <b>Note:</b> This parameter cannot be changed while the drive is running.	Disable / uint16
	Disable	Display of raw data from fieldbus adapter A disabled.	0
	Fast	Display of raw data from fieldbus adapter A enabled.	1
50.13	FBA A control word	Displays the raw (unmodified) control word sent by the master (PLC) to fieldbus adapter A if debugging is enabled by parameter 50.12 FBA A debug mode. This parameter is read-only.	0 / uint32
	00000000...FFFFFFFh	Control word sent by master to fieldbus adapter A.	1 = 1
50.14	FBA A reference 1	Displays raw (unmodified) reference REF1 sent by the master (PLC) to fieldbus adapter A if debugging is enabled by parameter 50.12 FBA A debug mode. This parameter is read-only.	- / int32
50.15	FBA A reference 2	Displays raw (unmodified) reference REF2 sent by the master (PLC) to fieldbus adapter A if debugging is enabled by parameter 50.12 FBA A debug mode. This parameter is read-only.	- / int32
50.16	FBA A status word	Displays the raw (unmodified) status word sent by fieldbus adapter A to the master (PLC) if debugging is enabled by parameter 50.12 FBA A debug mode. This parameter is read-only.	0 / uint32
	00000000...FFFFFFFh	Status word sent by fieldbus adapter A to master.	1 = 1
50.17	FBA A actual value 1	Displays raw (unmodified) actual value ACT1 sent by fieldbus adapter A to the master (PLC) if debugging is enabled by parameter 50.12 FBA A debug mode. This parameter is read-only.	- / int32
50.18	FBA A actual value 2	Displays raw (unmodified) actual value ACT2 sent by fieldbus adapter A to the master (PLC) if debugging is enabled by parameter 50.12 FBA A debug mode. This parameter is read-only.	- / int32



No.	Name / Range / Selection	Description	Def / Type FbEq 16b / 32b															
50.21	FBA A timelevel sel	<p>Selects the communication time levels. In general, lower time levels of read/write services reduce CPU load. The table below shows the time levels of the read/write services for cyclic high and cyclic low data with each parameter setting.</p> <table border="1"> <thead> <tr> <th>Selection</th> <th>Cyclic high *</th> <th>Cyclic low **</th> </tr> </thead> <tbody> <tr> <td>Monitoring</td> <td>10 ms</td> <td>2 ms</td> </tr> <tr> <td>Normal</td> <td>2 ms</td> <td>10 ms</td> </tr> <tr> <td>Fast</td> <td>500 µs</td> <td>2 ms</td> </tr> <tr> <td>Very fast</td> <td>250 µs</td> <td>2 ms</td> </tr> </tbody> </table> <p>* Cyclic high data consists of fieldbus Status word, Act1 and Act2.  ** Cyclic low data consists of the parameter data mapped to parameter groups 52 FBA A data in and 53 FBA A data out, and acyclic data.  Control word, Ref1 and Ref2 are handled as interrupts generated on receipt of cyclic high messages.</p> <p><b>Note:</b> This parameter cannot be changed while the drive is running.</p>	Selection	Cyclic high *	Cyclic low **	Monitoring	10 ms	2 ms	Normal	2 ms	10 ms	Fast	500 µs	2 ms	Very fast	250 µs	2 ms	Normal / uint16
Selection	Cyclic high *	Cyclic low **																
Monitoring	10 ms	2 ms																
Normal	2 ms	10 ms																
Fast	500 µs	2 ms																
Very fast	250 µs	2 ms																
	Normal	Normal speed.	0															
	Fast	Fast speed.	1															
	Very fast	Very fast speed.	2															
	Monitoring	Low speed. Optimized for PC tool communication and monitoring usage.	3															
50.26	FBA A comm supervision force	<p>Activates fieldbus communication monitoring separately for each control location (see section <i>Local control vs. external control</i> (page 145)). The parameter is primarily intended for monitoring the communication with FBA A when it is connected to the application program and not selected as a control source by drive parameters.</p>	- / uint16															
	b0 Ext 1	1 = Communication monitoring active when Ext 1 is being used.																
	b1 Ext 2	1 = Communication monitoring active when Ext 2 is being used.																
	b2 Local	1 = Communication monitoring active when local control is being used.																
	b3...15 Reserved																	
	0000h...FFFFh		1 = 1															
50.31	FBA B enable	<p>Enables/disables communication between the drive and fieldbus adapter B, and specifies the slot the adapter is installed into.</p> <p><b>Note:</b> This parameter cannot be changed while the drive is running.</p>	Disable / uint16															
	Disable	Communication between drive and fieldbus adapter B disabled.	0															

## 514 Parameters

No.	Name / Range / Selection	Description	Def / Type FbEq 16b / 32b
	Option slot 1	Communication between drive and fieldbus adapter B enabled. The adapter is in slot 1.	1
	Option slot 2	Communication between drive and fieldbus adapter B enabled. The adapter is in slot 2.	2
	Option slot 3	Communication between drive and fieldbus adapter B enabled. The adapter is in slot 3.	3
50.32	FBA B comm loss func	Selects how the drive reacts upon a fieldbus communication break. A time delay for the action can be defined by parameter 50.33 FBA B comm loss timeout. See also parameter 50.56 FBA B comm supervision force.	No action / uint16
	No action	No action taken.	0
	Fault	Drive trips on 7520 FBA B communication. This only occurs if control is expected from the FBA B interface (FBA B selected as source of start/stop/reference in the currently active control location), or if supervision is forced using parameter 50.56 FBA B comm supervision force.	1
	Last speed	Drive generates an A7C2 FBA B communication warning and freezes the speed to the level the drive was operating at. This only occurs if control is expected from the FBA B interface, or if supervision is forced using parameter 50.56 FBA B comm supervision force. The speed is determined on the basis of actual speed using 850 ms low-pass filtering.	2
		 <b>WARNING!</b> Make sure that it is safe to continue operation in case of a communication break.	
	Speed ref safe	Drive generates an A7C2 FBA B communication warning and sets the speed to the value defined by parameter 22.41 Speed ref safe (when speed reference is being used). This only occurs if control is expected from the FBA B interface, or if supervision is forced using parameter 50.56 FBA B comm supervision force.	3
		 <b>WARNING!</b> Make sure that it is safe to continue operation in case of a communication break.	
	Fault always	Drive trips on 7520 FBA B communication. This occurs even though no control is expected from the FBA B interface.	4

No.	Name / Range / Selection	Description	Def / Type FbEq 16b / 32b
	Warning	Drive generates an A7C2 FBA B communication warning. This only occurs if control is expected from the FBA B interface, or if supervision is forced using parameter 50.56 FBA B comm supervision force.	5
		 <b>WARNING!</b> Make sure that it is safe to continue operation in case of a communication break.	
50.33	FBA B comm loss timeout	Defines the time delay before the action defined by parameter 50.32 FBA B comm loss func is taken. Time count starts when the communication link fails to update the message. As a rule of thumb, this parameter should be set to at least 3 times the transmit interval of the master.  <b>Note:</b> There is a 60-second boot-up delay immediately after power-up. During the delay, the communication break monitoring is disabled (but communication itself can be active).	0.3 s / uint16
	0.1 ... 6553.5 s	Time delay.	10 = 1 s / 10 = 1 s
50.34	FBA B ref1 type	Selects the type and scaling of reference 1 received from fieldbus adapter B. See parameter 50.4 FBA A ref1 type.	Auto / uint16
50.35	FBA B ref2 type	Selects the type and scaling of reference 2 received from fieldbus adapter B. See parameter 50.4 FBA A ref1 type.	Auto / uint16
50.37	FBA B actual 1 type	Selects the type/source and scaling of actual value 1 transmitted to the fieldbus network through fieldbus adapter B. See parameter 50.7 FBA A actual 1 type.	Auto / uint16
50.38	FBA B actual 2 type	Selects the type/source and scaling of actual value 2 transmitted to the fieldbus network through fieldbus adapter B. See parameter 50.8 FBA A actual 2 type.	Auto / uint16
50.39	FBA B SW transparent source	Selects the source of the fieldbus status word when the fieldbus adapter is set to a transparent communication profile eg. by its configuration parameters (group 54 FBA B settings).	Not selected / uint32
	Not selected	No source selected.	0
	Other [value]	See Terms and abbreviations (page 221).	
50.40	FBA B act1 transparent source	When parameter 50.37 FBA B actual 1 type is set to Transparent or General, this parameter selects the source of actual value 1 transmitted to the fieldbus network through fieldbus adapter B.	Not selected / uint32
	Not selected	No source selected.	0
	Other [value]	See Terms and abbreviations (page 221).	

## 516 Parameters

No.	Name / Range / Selection	Description	Def / Type FbEq 16b / 32b
50.41	FBA B act2 transparent source	When parameter 50.38 FBA B actual 2 type is set to Transparent or General, this parameter selects the source of actual value 2 transmitted to the fieldbus network through fieldbus adapter B.	Not selected / uint32
	Not selected	No source selected.	0
	Other [value]	See Terms and abbreviations (page 221).	
50.42	FBA B debug mode	Enables the display of raw (unmodified) data received from and sent to fieldbus adapter B in parameters 50.43...50.48. This functionality should only be used for debugging.  <b>Note:</b> This parameter cannot be changed while the drive is running.	Disable / uint16
	Disable	Display of raw data from fieldbus adapter B disabled.	0
	Fast	Display of raw data from fieldbus adapter B enabled.	1
50.43	FBA B control word	Displays the raw (unmodified) control word sent by the master (PLC) to fieldbus adapter B if debugging is enabled by parameter 50.42 FBA B debug mode. This parameter is read-only.	0 / uint32
	00000000...FFFFFFFh	Control word sent by master to fieldbus adapter B.	1 = 1
50.44	FBA B reference 1	Displays raw (unmodified) reference REF1 sent by the master (PLC) to fieldbus adapter B if debugging is enabled by parameter 50.42 FBA B debug mode. This parameter is read-only.	- / int32
50.45	FBA B reference 2	Displays raw (unmodified) reference REF2 sent by the master (PLC) to fieldbus adapter B if debugging is enabled by parameter 50.42 FBA B debug mode. This parameter is read-only.	- / int32
50.46	FBA B status word	Displays the raw (unmodified) status word sent by fieldbus adapter B to the master (PLC) if debugging is enabled by parameter 50.42 FBA B debug mode. This parameter is read-only.	0 / uint32
	00000000...FFFFFFFh	Status word sent by fieldbus adapter B to master.	1 = 1
50.47	FBA B actual value 1	Displays raw (unmodified) actual value ACT1 sent by fieldbus adapter B to the master (PLC) if debugging is enabled by parameter 50.42 FBA B debug mode. This parameter is read-only.	- / int32
50.48	FBA B actual value 2	Displays raw (unmodified) actual value ACT2 sent by fieldbus adapter B to the master (PLC) if debugging is enabled by parameter 50.42 FBA B debug mode. This parameter is read-only.	- / int32

No.	Name / Range / Selection	Description	Def / Type FbEq 16b / 32b															
50.51	FBA B timelevel sel	<p>Selects the communication time levels. In general, lower time levels of read/write services reduce CPU load. The table below shows the time levels of the read/write services for cyclic high and cyclic low data with each parameter setting.</p> <table border="1"> <thead> <tr> <th>Selection</th> <th>Cyclic high *</th> <th>Cyclic low **</th> </tr> </thead> <tbody> <tr> <td>Monitoring</td> <td>10 ms</td> <td>2 ms</td> </tr> <tr> <td>Normal</td> <td>2 ms</td> <td>10 ms</td> </tr> <tr> <td>Fast</td> <td>500 µs</td> <td>2 ms</td> </tr> <tr> <td>Very fast</td> <td>250 µs</td> <td>2 ms</td> </tr> </tbody> </table> <p>* Cyclic high data consists of fieldbus Status word, Act1 and Act2.  ** Cyclic low data consists of the parameter data mapped to parameter groups 55 FBA B data in and 56 FBA B data out, and acyclic data.  Control word, Ref1 and Ref2 are handled as interrupts generated on receipt of cyclic high messages.</p> <p><b>Note:</b> This parameter cannot be changed while the drive is running.</p>	Selection	Cyclic high *	Cyclic low **	Monitoring	10 ms	2 ms	Normal	2 ms	10 ms	Fast	500 µs	2 ms	Very fast	250 µs	2 ms	Normal / uint16
Selection	Cyclic high *	Cyclic low **																
Monitoring	10 ms	2 ms																
Normal	2 ms	10 ms																
Fast	500 µs	2 ms																
Very fast	250 µs	2 ms																
	Normal	Normal speed.	0															
	Fast	Fast speed.	1															
	Very fast	Very fast speed.	2															
	Monitoring	Low speed. Optimized for PC tool communication and monitoring usage.	3															
50.56	FBA B comm supervision force	<p>Activates fieldbus communication monitoring separately for each control location (see section <i>Local control vs. external control</i> (page 145)). The parameter is primarily intended for monitoring the communication with FBA B when it is connected to the application program and not selected as a control source by drive parameters.</p>	- / uint16															
	b0 Ext 1	1 = Communication monitoring active when Ext 1 is being used.																
	b1 Ext 2	1 = Communication monitoring active when Ext 2 is being used.																
	b2 Local	1 = Communication monitoring active when local control is being used.																
	b3...15 Reserved																	
	0000h...FFFFh		1 = 1															
50.99	FBA automatic detection	<p>Enables/disables the FBA automatic detection.</p> <p><b>Note:</b> FBA automatic detection works with one fieldbus adapter only.</p>	Enable / uint16															
	Disable	FBA automatic detection is disabled.	0															
	Enable	FBA automatic detection is enabled.	1															

## 518 Parameters

No.	Name / Range / Selection	Description	Def / Type FbEq 16b / 32b
<b>51</b>	<b>FBA A settings</b>	Fieldbus adapter A configuration.	
51.1	FBA A type	Displays the type of the connected fieldbus adapter module. <b>0</b> = Module is not found or is not properly connected, or is disabled by parameter <b>50.1 FBA A enable</b> ; <b>1</b> = FPBA; <b>32</b> = FCAN; <b>37</b> = FDNA; <b>101</b> = FCNA, <b>128</b> = FENA-11/21; <b>135</b> = FECA; <b>136</b> = FEPL; <b>485</b> = FSCA. This parameter is read-only.	- / uint16
51.2	FBA A Par2	Parameters <b>51.02...51.26</b> are adapter module-specific. For more information, see the documentation of the fieldbus adapter module. Note that not all of these parameters are necessarily in use.	- / uint16
	0...65535	Fieldbus adapter configuration parameter.	1 = 1 / 1 = 1
...	...	...	...
51.26	FBA A Par26	See parameter <b>51.2 FBA A Par2</b> .	- / uint16
	0...65535	Fieldbus adapter configuration parameter.	1 = 1 / 1 = 1
51.27	FBA A par refresh	Validates any changed fieldbus adapter module configuration settings. After refreshing, the value reverts automatically to <b>Done</b> .  <b>Note:</b> This parameter cannot be changed while the drive is running.	Done / uint16
	Done	Refreshing done.	0
	Refresh	Refreshing.	1
51.28	FBA A par table ver	Displays the parameter table revision of the fieldbus adapter module mapping file (stored in the memory of the drive). In format axyz, where ax = major table revision number; yz = minor table revision number. This parameter is read-only.	0 / uint16
	0000...FFFFh	Parameter table revision of adapter module.	1 = 1
51.29	FBA A drive type code	Displays the drive type code in the fieldbus adapter module mapping file (stored in the memory of the drive). This parameter is read-only.	- / uint16
51.30	FBA A mapping file ver	Displays the fieldbus adapter module mapping file revision stored in the memory of the drive in decimal format. This parameter is read-only.	- / uint16
51.31	D2FBA A comm status	Displays the status of the fieldbus adapter module communication.	- / uint16
	Not configured	Adapter is not configured.	0
	Initializing	Adapter is initializing.	1
	Time out	A timeout has occurred in the communication between the adapter and the drive.	2

No.	Name / Range / Selection	Description	Def / Type FbEq 16b / 32b
	Configuration error	Adapter configuration error: mapping file not found in the file system of the drive, or mapping file upload has failed more than three times.	3
	Off-line	Fieldbus communication is off-line.	4
	On-line	Fieldbus communication is on-line, or fieldbus adapter has been configured not to detect a communication break. For more information, see the documentation of the fieldbus adapter.	5
	Reset	Adapter is performing a hardware reset.	6
51.32	FBA A comm SW ver	Displays the patch and build versions of the adapter module firmware in format xxyy, where xx = patch version number, yy = build version number. Example: C802 = 200.02 (patch version 200, build version 2).	0 / uint16
	0000...FFFFh	Patch and build versions of adapter module firmware.	1 = 1
51.33	FBA A appl SW ver	Displays the major and minor versions of the adapter module firmware in format xyy, where x = major revision number, yy = minor revision number. Example: 300 = 3.00 (major version 3, minor version 00).	0 / uint16
	0000...FFFFh	Major and minor versions of adapter module firmware.	1 = 1

## 520 Parameters

No.	Name / Range / Selection	Description	Def / Type FbEq 16b / 32b
<b>52</b>	<b>FBA A data in</b>	Selection of data to be transferred from drive to fieldbus controller through fieldbus adapter A.  <b>Note:</b> 32-bit values require two consecutive parameters. Whenever a 32-bit value is selected in a data parameter, the next parameter is automatically reserved.	
52.1	FBA A data in1	Parameters 52.01...52.12 select data to be transferred from the drive to the fieldbus controller through fieldbus adapter A.	None / uint32
	None	None.	0
	CW 16bit	Control Word (16 bits)	1
	Ref1 16bit	Reference REF1 (16 bits)	2
	Ref2 16bit	Reference REF2 (16 bits)	3
	SW 16bit	Status Word (16 bits)	4
	Act1 16bit	Actual value ACT1 (16 bits)	5
	Act2 16bit	Actual value ACT2 (16 bits)	6
	CW 32bit	Control Word (32 bits)	11
	Ref1 32bit	Reference REF1 (32 bits)	12
	Ref2 32bit	Reference REF2 (32 bits)	13
	SW 32bit	Status Word (32 bits)	14
	Act1 32bit	Actual value ACT1 (32 bits)	15
	Act2 32bit	Actual value ACT2 (32 bits)	16
	SW2 16bit	Status Word 2 (16 bits)	24
	Other [value]	See Terms and abbreviations (page 221).	
...	...	...	...
52.12	FBA A data in12	See parameter 52.1 FBA A data in1.	None / uint32



No.	Name / Range / Selection	Description	Def / Type FbEq 16b / 32b
53	<b>FBA A data out</b>	Selection of data to be transferred from fieldbus controller to drive through fieldbus adapter A.  <b>Note:</b> 32-bit values require two consecutive parameters. Whenever a 32-bit value is selected in a data parameter, the next parameter is automatically reserved.	
53.1	FBA data out1	Parameters 53.01...53.12 select data to be transferred from the fieldbus controller to the drive through fieldbus adapter A.	None / uint32
	None	None.	0
	CW 16bit	Control Word (16 bits)	1
	Ref1 16bit	Reference REF1 (16 bits)	2
	Ref2 16bit	Reference REF2 (16 bits)	3
	CW 32bit	Control Word (32 bits)	11
	Ref1 32bit	Reference REF1 (32 bits)	12
	Ref2 32bit	Reference REF2 (32 bits)	13
	CW2 16bit	Control Word 2 (16 bits)	21
	Other [value]	See <a href="#">Terms and abbreviations (page 221)</a> .	
...	...	...	...
53.12	FBA data out12	See parameter 53.1 FBA data out1.	None / uint32

## 522 Parameters

No.	Name / Range / Selection	Description	Def / Type FbEq 16b / 32b
<b>54</b>	<b>FBA B settings</b>	Fieldbus adapter B configuration.	
54.1	FBA B type	Displays the type of the connected fieldbus adapter module. <b>0</b> = Module is not found or is not properly connected, or is disabled by parameter 50.31 FBA B enable; <b>1</b> = FPBA; <b>32</b> = FCAN; <b>37</b> = FDNA; <b>101</b> = FCNA, <b>128</b> = FENA-11/21; <b>135</b> = FECA; <b>136</b> = FEPL; <b>485</b> = FSCA. This parameter is read-only.	- / uint16
54.2	FBA B Par2	Parameters 54.02...54.26 are adapter module-specific. For more information, see the documentation of the fieldbus adapter module. Note that not all of these parameters are necessarily in use.	- / uint16
	0.0 ... 65535.0	Fieldbus adapter configuration parameter.	1 = 1 / 1 = 1
...	...	...	...
54.26	FBA B Par26	See parameter 54.2 FBA B Par2.	- / uint16
	0.0 ... 65535.0	Fieldbus adapter configuration parameter.	1 = 1 / 1 = 1
54.27	FBA B par refresh	Validates any changed fieldbus adapter module configuration settings. After refreshing, the value reverts automatically to <i>Done</i> .  <b>Note:</b> This parameter cannot be changed while the drive is running.	Done / uint16
	Done	Refreshing done.	0
	Refresh	Refreshing.	1
54.28	FBA B par table ver	Displays the parameter table revision of the fieldbus adapter module mapping file (stored in the memory of the drive). In format axyz, where ax = major table revision number; yz = minor table revision number. This parameter is read-only.	0 / uint16
	0000...FFFFh	Parameter table revision of adapter module.	1 = 1
54.29	FBA B drive type code	Displays the drive type code in the fieldbus adapter module mapping file (stored in the memory of the drive). This parameter is read-only.	- / uint16
	0...65535	Drive type code stored in the mapping file.	1 = 1 / 1 = 1
54.30	FBA B mapping file ver	Displays the fieldbus adapter module mapping file revision stored in the memory of the drive in decimal format. This parameter is read-only.	- / uint16
	0...65535	Mapping file revision.	1 = 1 / 1 = 1
54.31	D2FBA B comm status	Displays the status of the fieldbus adapter module communication.	- / uint16
	Not configured	Adapter is not configured.	0
	Initializing	Adapter is initializing.	1
	Time out	A timeout has occurred in the communication between the adapter and the drive.	2

No.	Name / Range / Selection	Description	Def / Type FbEq 16b / 32b
	Configuration error	Adapter configuration error: mapping file not found in the file system of the drive, or mapping file upload has failed more than three times.	3
	Off-line	Fieldbus communication is off-line.	4
	On-line	Fieldbus communication is on-line, or fieldbus adapter has been configured not to detect a communication break. For more information, see the documentation of the fieldbus adapter.	5
	Reset	Adapter is performing a hardware reset.	6
54.32	FBA B comm SW ver	Displays the patch and build versions of the adapter module firmware in format xxyy, where xx = patch version number, yy = build version number. Example: C802 = 200.02 (patch version 200, build version 2).	0 / uint16
	0000...FFFFh	Patch and build versions of adapter module firmware.	1 = 1
54.33	FBA B appl SW ver	Displays the major and minor versions of the adapter module firmware in format xyy, where x = major revision number, yy = minor revision number. Example: 300 = 3.00 (major version 3, minor version 00).	0 / uint16
	0000...FFFFh	Major and minor versions of adapter module firmware.	1 = 1

## 524 Parameters

No.	Name / Range / Selection	Description	Def / Type FbEq 16b / 32b
<b>55</b>	<b>FBA B data in</b>	Selection of data to be transferred from drive to fieldbus controller through fieldbus adapter B.	
55.1	FBA B data in1	Parameters 55.01...55.12 select data to be transferred from the drive to the fieldbus controller through fieldbus adapter B.	None / uint32
	None	None.	0
	CW 16bit	Control Word (16 bits)	1
	Ref1 16bit	Reference REF1 (16 bits)	2
	Ref2 16bit	Reference REF2 (16 bits)	3
	SW 16bit	Status Word (16 bits)	4
	Act1 16bit	Actual value ACT1 (16 bits)	5
	Act2 16bit	Actual value ACT2 (16 bits)	6
	CW 32bit	Control Word (32 bits)	11
	Ref1 32bit	Reference REF1 (32 bits)	12
	Ref2 32bit	Reference REF2 (32 bits)	13
	SW 32bit	Status Word (32 bits)	14
	Act1 32bit	Actual value ACT1 (32 bits)	15
	Act2 32bit	Actual value ACT2 (32 bits)	16
	SW2 16bit	Status Word 2 (16 bits)	24
	Other [value]	See Terms and abbreviations (page 221).	
...	...	...	...
55.12	FBA B data in12	See parameter 55.1 FBA B data in1.	None / uint32

No.	Name / Range / Selection	Description	Def / Type FbEq 16b / 32b
<b>56</b>	<b>FBA B data out</b>	Selection of data to be transferred from fieldbus controller to drive through fieldbus adapter B.	
56.1	FBA B data out1	Parameters 56.01...56.12 select data to be transferred from the fieldbus controller to the drive through fieldbus adapter B.	None / uint32
	None	None.	0
	CW 16bit	Control Word (16 bits)	1
	Ref1 16bit	Reference REF1 (16 bits)	2
	Ref2 16bit	Reference REF2 (16 bits)	3
	CW 32bit	Control Word (32 bits)	11
	Ref1 32bit	Reference REF1 (32 bits)	12
	Ref2 32bit	Reference REF2 (32 bits)	13
	CW2 16bit	Control Word 2 (16 bits)	21
	Other [value]	See Terms and abbreviations (page 221).	
...	...	...	...
56.12	FBA B data out12	See parameter 56.1 FBA B data out1.	None / uint32

## 526 Parameters

No.	Name / Range / Selection	Description	Def / Type FbEq 16b / 32b
<b>58</b>	<b>Embedded fieldbus</b>	Configuration of the embedded fieldbus (EFB) interface. See also chapter <i>Fieldbus control through the embedded fieldbus interface (EFB) (page 737)</i> .	
58.1	Protocol enable	Enables/disables the embedded fieldbus interface and selects the protocol to use.  <b>Note:</b> <ul style="list-style-type: none"> <li>When the embedded fieldbus interface is enabled, the drive-to-drive link functionality is automatically disabled.</li> <li>This parameter cannot be changed while the drive is running.</li> </ul>	None / uint16
	None	None (communication disabled).	0
	Modbus RTU	Embedded fieldbus interface is enabled and uses the Modbus RTU protocol.	1
58.2	Protocol ID	Displays the protocol ID and revision. This parameter is read-only.	0 / uint16
	0000...FFFFh	Protocol ID and revision.	1 = 1
58.3	Node address	Defines the node address of the drive on the fieldbus link. Values 1...247 are allowable. Two devices with the same address are not allowed on-line. Changes to this parameter take effect after the control unit is rebooted or the new settings validated by parameter 58.6 <i>Communication control</i> .	1 / uint16
	0...255	Node address (values 1...247 are allowable).	1 = 1 / 1 = 1
58.4	Baud rate	Selects the transfer rate of the fieldbus link. Changes to this parameter take effect after the control unit is rebooted or the new settings validated by parameter 58.6 <i>Communication control</i> .	19.2 kbps / uint16
	4.8 kbps	4.8 kbit/s.	1
	9.6 kbps	9.6 kbit/s.	2
	19.2 kbps	19.2 kbit/s.	3
	38.4 kbps	38.4 kbit/s.	4
	57.6 kbps	57.6 kbit/s.	5
	76.8 kbps	76.8 kbit/s.	6
	115.2 kbps	115.2 kbit/s.	7
58.5	Parity	Selects the type of parity bit and the number of stop bits. Changes to this parameter take effect after the control unit is rebooted or the new settings validated by parameter 58.6 <i>Communication control</i> .	8 EVEN 1 / uint16
	8 NONE 1	Eight data bits, no parity bit, one stop bit.	0
	8 NONE 2	Eight data bits, no parity bit, two stop bits.	1

No.	Name / Range / Selection	Description	Def / Type FbEq 16b / 32b
	8 EVEN 1	Eight data bits, even parity bit, one stop bit.	2
	8 ODD 1	Eight data bits, odd parity bit, one stop bit.	3
58.6	Communication control	Validates any changes in the EFB settings, or activates silent mode.	Enabled / uint16
	Enabled	Normal operation.	0
	Refresh settings	Validates any changed EFB configuration settings. Reverts automatically to <i>Enabled</i> .	1
	Silent mode	Activates silent mode (no messages are transmitted). Silent mode can be terminated by activating the <i>Refresh settings</i> selection of this parameter.	2
58.7	Communication diagnostics	Displays the status of the EFB communication. This parameter is read-only.	- / uint16
	b0 Init failed	1 = EFB initialization failed	
	b1 Addr config err	1 = Node address not allowed by protocol	
	b2 Silent mode	1 = Drive not allowed to transmit 0 = Drive allowed to transmit	
	b3 Autobauding	Reserved	
	b4 Wiring error	1 = Errors detected (A/B wires possibly swapped)	
	b5 Parity error	1 = Error detected: check parameters 58.04 and 58.05	
	b6 Baud rate error	1 = Error detected: check parameters 58.05 and 58.04	
	b7 No bus activity	1 = 0 bytes received during last 5 seconds	
	b8 No packets	1 = 0 packets (addressed to any device) detected during last 5 seconds	
	b9 Noise or addressing error	1 = Errors detected (interference, or another device with the same address on line)	
	b10 Comm loss	1 = 0 packets addressed to the drive received within timeout (58.16)	
	b11 CW/Ref loss	1 = No control word or references received within timeout (58.16)	
	b12 Not active	Reserved	
	b13 Protocol 1	1 = Protocol-dependent status information	
	b14 Protocol 2	1 = Protocol-dependent status information	
	b15 Internal error	1 = Problem with calls to drive control program	
	0000h...FFFFh		1 = 1
58.8	Received packets	Displays a count of valid packets addressed to the drive. During normal operation, this number increases constantly. Can be reset from the control panel by keeping Reset depressed for over 3 seconds.	0 / uint32
	0..4294967295	Number of received packets addressed to the drive.	1 = 1 / 1 = 1

## 528 Parameters



No.	Name / Range / Selection	Description	Def / Type FbEq 16b / 32b
58.9	Transmitted packets	Displays a count of valid packets transmitted by the drive. During normal operation, this number increases constantly. Can be reset from the control panel by keeping Reset depressed for over 3 seconds.	0 / uint32
	0...4294967295	Number of transmitted packets.	1 = 1 / 1 = 1
58.10	All packets	Displays a count of valid packets addressed to any device on the bus. During normal operation, this number increases constantly. Can be reset from the control panel by keeping Reset depressed for over 3 seconds.	0 / uint32
	0...4294967295	Number of all received packets.	1 = 1 / 1 = 1
58.11	UART errors	Displays a count of character errors received by the drive. An increasing count indicates a configuration problem on the bus. Can be reset from the control panel by keeping Reset depressed for over 3 seconds.	0 / uint32
	0...4294967295	Number of UART errors.	1 = 1 / 1 = 1
58.12	CRC errors	Displays a count of packets with a CRC error received by the drive. An increasing count indicates interference on the bus. Can be reset from the control panel by keeping Reset depressed for over 3 seconds.	0 / uint32
	0...4294967295	Number of CRC errors.	1 = 1 / 1 = 1
58.14	Communication loss action	Selects how the drive reacts to an EFB communication break. Changes to this parameter take effect after the control unit is rebooted or the new settings validated by parameter 58.6 Communication control. See also parameters 58.15 Communication loss mode and 58.16 Communication loss time.	Fault / uint16
	No	No action taken (monitoring disabled).	0
	Fault	Drive trips on 6681 EFB communication loss. This only occurs if control is expected from the EFB (EFB selected as source of start/stop/reference in the currently active control location), or if supervision is forced using parameter 58.36 EFB comm supervision force.	1
	Last speed	Drive generates an A7CE EFB comm loss warning and freezes the speed to the level the drive was operating at. This only occurs if control is expected from the EFB, or if supervision is forced using parameter 58.36 EFB comm supervision force. The speed is determined on the basis of actual speed using 850 ms low-pass filtering.	2



### WARNING!

Make sure that it is safe to continue operation in case of a communication break.



No.	Name / Range / Selection	Description	Def / Type FbEq 16b / 32b
	Speed ref safe	Drive generates an A7CE EFB comm loss warning and sets the speed to the speed defined by parameter 22.41 Speed ref safe. This only occurs if control is expected from the EFB, or if supervision is forced using parameter 58.36 EFB comm supervision force.	3
		 <b>WARNING!</b> Make sure that it is safe to continue operation in case of a communication break.	
	Fault always	Drive trips on 6681 EFB communication loss. This occurs even though no control is expected from the EFB.	4
	Warning	Drive generates an A7CE EFB comm loss warning. This only occurs if control is expected from the EFB, or if supervision is forced using parameter 58.36 EFB comm supervision force.	5
		 <b>WARNING!</b> Make sure that it is safe to continue operation in case of a communication break.	
58.15	Communication loss mode	Defines which message types reset the timeout counter for detecting an EFB communication loss. Changes to this parameter take effect after the control unit is rebooted or the new settings validated by parameter 58.6 Communication control. See also parameters 58.14 Communication loss action and 58.16 Communication loss time.	Cw / Ref1 / Ref2 / uint16
	Any message	Any message addressed to the drive resets the timeout.	1
	Cw / Ref1 / Ref2	A write of the control word or a reference from the fieldbus resets the timeout.	2
58.16	Communication loss time	Sets a timeout for EFB communication. If a communication break lasts longer than the timeout, the action specified by parameter 58.14 Communication loss action is taken. Changes to this parameter take effect after the control unit is rebooted or the new settings validated by parameter 58.6 Communication control. <b>Note:</b> There is a 30-second boot-up delay immediately after power-up. During the delay, the communication break monitoring is disabled (but communication itself can be active). See also parameter 58.15 Communication loss mode.	3.0 s / uint16
	0.0 ... 6000.0 s	EFB communication timeout.	1 = 1 s / 10 = 1 s
58.17	Transmit delay	Defines a minimum response delay in addition to any fixed delay imposed by the protocol. Changes to this parameter take effect after the control unit is rebooted or the new settings validated by parameter 58.6 Communication control.	0 ms / uint16

## 530 Parameters

No.	Name / Range / Selection	Description	Def / Type FbEq 16b / 32b
	0...65535 ms	Minimum response delay.	1 = 1 ms / 1 = 1 ms
58.18	EFB control word	Displays the raw (unmodified) control word sent by the Modbus controller to the drive. For debugging purposes. This parameter is read-only.	0 / uint32
	00000000...FFFFFFFFh	Control word sent by Modbus controller to the drive.	1 = 1
58.19	EFB status word	Displays the raw (unmodified) status word sent by the drive to the Modbus controller. For debugging purposes. This parameter is read-only.	0 / uint32
	00000000...FFFFFFFFh	Status word sent by the drive to the Modbus controller.	1 = 1
58.25	Control profile	Defines the control profile used by the protocol.	ABB Drives / uint16
	ABB Drives	ABB Drives profile (with a 16-bit control word) with registers in the classic format for backward compatibility.	0
	Transparent	Transparent profile (16-bit or 32-bit control word) with registers in the classic format.	2
58.26	EFB ref1 type	Selects the type and scaling of reference 1 received through the embedded fieldbus interface. The scaled reference is displayed by 3.9 EFB reference 1.	Auto / uint16
	Auto	Type and scaling are chosen automatically according to which reference chain (see settings <a href="#">Torque</a> , <a href="#">Speed</a> , <a href="#">Frequency</a> ) the incoming reference is connected to. If the reference is not connected to any chain, no scaling is applied (as with setting <a href="#">Transparent</a> ).	0
	Transparent	No scaling is applied.	1
	General	Generic reference with a scaling of 100 = 1 (ie. integer and two decimals).	2
	Torque	The scaling is defined by parameter <a href="#">46.3 Torque scaling</a> .	3
	Speed	The scaling is defined by parameter <a href="#">46.1 Speed scaling</a> .	4
	Frequency	The scaling is defined by parameter <a href="#">46.2 Frequency scaling</a> .	5
58.27	EFB ref2 type	Selects the type and scaling of reference 2 received through the embedded fieldbus interface. The scaled reference is displayed by 3.10 EFB reference 2. For the selections, see parameter <a href="#">58.26 EFB ref1 type</a> .	Torque / uint16
58.28	EFB act1 type	Selects the type/source and scaling of actual value 1 transmitted to the fieldbus network through the embedded fieldbus interface.	Auto / uint16
	Auto	Type/source and scaling follow the type of reference 1 selected by parameter <a href="#">58.26 EFB ref1 type</a> . See the individual settings below for the sources and scalings.	0
	Transparent	The value selected by parameter <a href="#">58.31 EFB act1 transparent source</a> is sent as actual value 1. No scaling is applied (the 16-bit scaling is 1 = 1 unit).	1

No.	Name / Range / Selection	Description	Def / Type FbEq 16b / 32b
	General	The value selected by parameter 58.31 EFB act1 transparent source is sent as actual value 1 with a 16-bit scaling of 100 = 1 unit (ie. integer and two decimals).	2
	Torque	1.10 Motor torque is sent as actual value 1. The scaling is defined by parameter 46.3 Torque scaling.	3
	Speed	1.1 Motor speed used is sent as actual value 1. The scaling is defined by parameter 46.1 Speed scaling.	4
	Frequency	1.6 Output frequency is sent as actual value 1. The scaling is defined by parameter 46.2 Frequency scaling.	5
	Position	Motor position is sent as actual value 1. See parameter 90.6 Motor position scaled.	6
58.29	EFB act2 type	Selects the type/source and scaling of actual value 2 transmitted to the fieldbus network through the embedded fieldbus interface.	Torque / uint16
	Auto	Type/source and scaling follow the type of reference 2 selected by parameter 58.27 EFB ref2 type. See the individual settings below for the sources and scalings.	0
	Transparent	The value selected by parameter 58.32 EFB act2 transparent source is sent as actual value 2. No scaling is applied (the 16- bit scaling is 1 = 1 unit).	1
	General	The value selected by parameter 58.32 EFB act2 transparent source is sent as actual value 2 with a 16-bit scaling of 100 = 1 unit (ie. integer and two decimals).	2
	Torque	1.10 Motor torque is sent as actual value 2. The scaling is defined by parameter 46.3 Torque scaling.	3
	Speed	1.1 Motor speed used is sent as actual value 2. The scaling is defined by parameter 46.1 Speed scaling.	4
	Frequency	1.6 Output frequency is sent as actual value 2. The scaling is defined by parameter 46.2 Frequency scaling.	5
	Position	Motor position is sent as actual value 1. See parameter 90.6 Motor position scaled.	6
58.30	EFB status word transparent source	Selects the source of the status word when 58.25 Control profile is set to Transparent.	Not selected / uint32
	Not selected	None.	0
	Other [value]	See Terms and abbreviations (page 221).	
58.31	EFB act1 transparent source	Selects the source of actual value 1 when 58.28 EFB act1 type is set to Transparent or General.	Not selected / uint32
	Not selected	None.	0
	Other [value]	See Terms and abbreviations (page 221).	
58.32	EFB act2 transparent source	Selects the source of actual value 1 when 58.29 EFB act2 type is set to Transparent or General.	Not selected / uint32
	Not selected	None.	0
	Other [value]	See Terms and abbreviations (page 221).	

## 532 Parameters

No.	Name / Range / Selection	Description	Def / Type FbEq 16b / 32b
58.33	Addressing mode	Defines the mapping between parameters and holding registers in the 400101...465535 Modbus register range. Changes to this parameter take effect after the control unit is rebooted or the new settings validated by parameter 58.6 Communication control.	Mode 0 / uint16
	Mode 0	<u>16-bit values (groups 1...99, indexes 1...99):</u> Register address = 400000 + 100 × parameter group + parameter index. For example, parameter 22.80 would be mapped to register 400000 + 2200 + 80 = 402280. <u>32-bit values (groups 1...99, indexes 1...99):</u> Register address = 420000 + 200 × parameter group + 2 × parameter index. For example, parameter 22.80 would be mapped to register 420000 + 4400 + 160 = 424560.	0
	Mode 1	<u>16-bit values (groups 1...255, indexes 1...255):</u> Register address = 400000 + 256 × parameter group + parameter index. For example, parameter 22.80 would be mapped to register 400000 + 5632 + 80 = 405712.	1
	Mode 2	<u>32-bit values (groups 1...127, indexes 1...255):</u> Register address = 400000 + 512 × parameter group + 2 × parameter index. For example, parameter 22.80 would be mapped to register 400000 + 11264 + 160 = 411424.	2
58.34	Word order	Selects in which order 16-bit registers of 32-bit parameters are transferred. For each register, the first byte contains the high order byte and the second byte contains the low order byte. Changes to this parameter take effect after the control unit is rebooted or the new settings validated by parameter 58.6 Communication control.	LO-HI / uint16
	HI-LO	The first register contains the high order word, the second contains the low order word.	0
	LO-HI	The first register contains the low order word, the second contains the high order word.	1
58.36	EFB comm supervision force	Activates fieldbus communication monitoring separately for each control location (see section Local control vs. external control (page 145)). The parameter is primarily intended for monitoring the communication with EFB when it is connected to the application program and not selected as a control source by drive parameters.	- / uint16
	b0 Ext 1	1 = Communication monitoring active when Ext 1 is being used.	
	b1 Ext 2	1 = Communication monitoring active when Ext 2 is being used.	
	b2 Local	1 = Communication monitoring active when local control is being used.	
	b3...15 Reserved		
	0000h...FFFFh		1 = 1

No.	Name / Range / Selection	Description	Def / Type FbEq 16b / 32b
58.101	Data I/O 1	Defines the address in the drive which the Modbus master accesses when it reads from or writes to register address 400001. The master defines the type of the data (input or output). The value is transmitted in a Modbus frame consisting of two 16-bit words. If the value is 16-bit, it is transmitted in the LSW (least significant word). If the value is 32-bit, the subsequent parameter is also reserved for it and must be set to <i>None</i> .	CW 16bit / uint32
	None	None.	0
	CW 16bit	Control Word (16 bits).	1
	Ref1 16bit	Reference REF1 (16 bits).	2
	Ref2 16bit	Reference REF2 (16 bits).	3
	SW 16bit	Status Word (16 bits).	4
	Act1 16bit	Actual value ACT1 (16 bits).	5
	Act2 16bit	Actual value ACT2 (16 bits).	6
	CW 32bit	Control Word (32 bits).	11
	Ref1 32bit	Reference REF1 (32 bits).	12
	Ref2 32bit	Reference REF2 (32 bits).	13
	SW 32bit	Status Word (32 bits).	14
	Act1 32bit	Actual value ACT1 (32 bits).	15
	Act2 32bit	Actual value ACT2 (32 bits).	16
	CW2 16bit	Control Word 2 (16 bits). When a 32-bit control word is used, this setting means the most-significant 16 bits.	21
	SW2 16bit	Status Word 2 (16 bits). When a 32-bit control word is used, this setting means the most-significant 16 bits.	24
	RO/DIO control word	Parameter 10.99 RO/DIO control word.	31
	AO1 data storage	Parameter 13.91 AO1 data storage.	32
	AO2 data storage	Parameter 13.92 AO2 data storage.	33
	Other [value]	See <i>Terms and abbreviations</i> (page 221).	
58.102	Data I/O 2	Defines the address in the drive which the Modbus master accesses when it reads from or writes to register address 400002. For the selections, see parameter 58.101 Data I/O 1.	Ref1 16bit / uint32
58.103	Data I/O 3	Defines the address in the drive which the Modbus master accesses when it reads from or writes to register address 400003. For the selections, see parameter 58.101 Data I/O 1.	Ref2 16bit / uint32
58.104	Data I/O 4	Defines the address in the drive which the Modbus master accesses when it reads from or writes to register address 400004. For the selections, see parameter 58.101 Data I/O 1.	SW 16bit / uint32

## 534 Parameters

No.	Name / Range / Selection	Description	Def / Type FbEq 16b / 32b
58.105	Data I/O 5	Defines the address in the drive which the Modbus master accesses when it reads from or writes to register address 400005. For the selections, see parameter 58.101 Data I/O 1.	Act1 16bit / uint32
58.106	Data I/O 6	Defines the address in the drive which the Modbus master accesses when it reads from or writes to register address 400006. For the selections, see parameter 58.101 Data I/O 1.	Act2 16bit / uint32
58.107	Data I/O 7	Parameter selector for Modbus register address 400007. For the selections, see parameter 58.101 Data I/O 1.	None / uint32
...	...	...	...
58.124	Data I/O 24	Parameter selector for Modbus register address 400024. For the selections, see parameter 58.101 Data I/O 1.	None / uint32

No.	Name / Range / Selection	Description	Def / Type FbEq 16b / 32b
60	<b>DDCS communication</b>	<p>DDCS communication configuration. The DDCS protocol is used in the communication between</p> <ul style="list-style-type: none"> <li>• drives in a master/follower configuration (see page 159),</li> <li>• the drive and an external controller such as the AC 800M (see page 167), or</li> <li>• the drive (or more precisely, an inverter unit) and the supply unit of the drive system.</li> </ul> <p>All of the above utilize a fiber optic link which also requires an FDCO module (typically with ZCU control units) or an RDCO module (with BCU control units). Master/follower and external controller communication can also be implemented through shielded twisted-pair cable connected to the XD2D connector of the drive. This group also contains parameters for drive-to-drive (D2D) communication supervision.</p>	
60.1	M/F communication port	Selects the connection used by the master/follower functionality.	Not in use / uint16
	Not in use	None (communication disabled).	0
	Slot 1A	Channel A on FDCO module in slot 1 (with ZCU control unit only).	1
	Slot 2A	Channel A on FDCO module in slot 2 (with ZCU control unit only).	2
	Slot 3A	Channel A on FDCO module in slot 3 (with ZCU control unit only).	3
	Slot 1B	Channel B on FDCO module in slot 1 (with ZCU control unit only).	4
	Slot 2B	Channel B on FDCO module in slot 2 (with ZCU control unit only).	5
	Slot 3B	Channel B on FDCO module in slot 3 (with ZCU control unit only).	6
	XD2D	Connector XD2D.	7
		<p><b>Note:</b> This connection cannot co-exist, and is not to be confused with, drive-to-drive (D2D) communication implemented by application programming (detailed in <i>Drive application programming manual (IEC 61131-3)</i>, 3AUA0000127808 [English]).</p>	
60.2	M/F node address	Selects the node address of the drive for master/follower communication. No two nodes on-line may have the same address.	1 / uint16
		<p><b>Note:</b> The allowable addresses for the master are 0 and 1. The allowable addresses for followers are 2...60.</p>	
	1...254	Node address.	- / -

## 536 Parameters

No.	Name / Range / Selection	Description	Def / Type FbEq 16b / 32b
60.3	M/F mode	Defines the role of the drive on the master/follower or drive-to-drive link.	Not in use / uint16
	Not in use	Master/follower functionality not active.	0
	DDCS master	The drive is the master on the master/follower (DDCS) link.	1
	DDCS follower	The drive is a follower on the master/follower (DDCS) link.	2
	D2D master	The drive is the master on the master/follower (D2D) link.  <b>Note:</b> This setting is only to be used with D2D communication implemented by application programming. If you are using the master/follower functionality (see page 159) through the XD2D connector, select <i>DDCS master</i> instead.	3
	D2D follower	The drive is a follower on the master/follower (D2D) link.  <b>Note:</b> This setting is only to be used with D2D communication implemented by application programming. If you are using the master/follower functionality (see page 159) through the XD2D connector, select <i>DDCS follower</i> instead.	4
	DDCS forcing	The role of the drive on the master/follower (DDCS) link is defined by parameters 60.15 <i>Force master</i> and 60.16 <i>Force follower</i> .	5
60.5	D2D forcing	The role of the drive on the master/follower (D2D) link is defined by parameters 60.15 <i>Force master</i> and 60.16 <i>Force follower</i> .  <b>Note:</b> This setting is only to be used with D2D communication implemented by application programming. If you are using the master/follower functionality (see page 159) through the XD2D connector, select <i>DDCS forcing</i> instead.	6
	M/F HW connection	Selects the topology of the master/follower link.  <b>Note:</b> Use the setting <i>Star</i> if using the master/follower functionality (see page 159) through the XD2D connector (as opposed to a fiber optic link).	Ring / uint16
	Ring	The devices are connected in a ring topology. Forwarding of messages is enabled.	0
	Star	The devices are connected in a star topology (for example, through a branching unit). Forwarding of messages is disabled.	1



No.	Name / Range / Selection	Description	Def / Type FbEq 16b / 32b
60.7	M/F link control	Defines the light intensity of the transmission LED of RDCO module channel CH2. (This parameter is effective only when parameter 60.1 M/F communication port is set to RDCO CH 2. FDCO modules have a hardware transmitter current selector.) In general, use higher values with longer fiber optic cables. The maximum setting is applicable to the maximum length of the fiber optic link. See Master/follower functionality (page 159).	10 / uint16
	1...15	Light intensity.	- / -
60.8	M/F comm loss timeout	Sets a timeout for master/follower (DDCS) communication. If a communication break lasts longer than the timeout, the action specified by parameter 60.9 M/F comm loss function is taken. As a rule of thumb, this parameter should be set to at least 3 times the transmit interval of the master.	100 ms / uint16
	0...65535 ms	Master/follower communication timeout.	- / -
60.9	M/F comm loss function	Selects how the drive reacts to a master/follower communication break.	Fault / uint16
	NoAction	No action taken.	0
	Warning	The drive generates an A7CB M/F comm loss warning. This only occurs if control is expected from the master/follower link, or if supervision is forced using parameter 60.32 M/F comm supervision force.	1
	 <b>WARNING!</b> Make sure that it is safe to continue operation in case of a communication break.		
Fault	Drive trips on 7582 M/F comm loss. This only occurs if control is expected from the master/follower link, or if supervision is forced using parameter 60.32 M/F comm supervision force.	2	
	Fault always	Drive trips on 7582 M/F comm loss. This occurs even though no control is expected from the master/follower link.	3
60.10	M/F ref1 type	Selects the type and scaling of reference 1 received from the master/follower link. The resulting value is shown by 3.13 M/F or D2D ref1.	Auto / uint16
	Auto	Type and scaling are chosen automatically according to which reference chain (see settings Torque, Speed, Frequency) the incoming reference is connected to. If the reference is not connected to any chain, no scaling is applied (as with setting Transparent).	0
		No scaling is applied.	1
		Generic reference with a scaling of 100 = 1 (ie. integer and two decimals).	2
	Torque	The scaling is defined by parameter 46.3 Torque scaling.	3

## 538 Parameters

No.	Name / Range / Selection	Description	Def / Type FbEq 16b / 32b
	Speed	The scaling is defined by parameter 46.1 Speed scaling.	4
	Frequency	The scaling is defined by parameter 46.2 Frequency scaling.	5
60.11	M/F ref2 type	Selects the type and scaling of reference 2 received from the master/follower link. The resulting value is shown by 3.14 M/F or D2D ref2. For the selections, see parameter 60.10 M/F ref1 type.	Torque / uint16
60.12	M/F act1 type	Selects the type/source and scaling of actual value ACT1 transmitted to the master/follower link.	Auto / uint16
	Auto	Type/source and scaling follow the type of reference 1 selected by parameter 60.10 M/F ref1 type. See the individual settings below for the sources and scalings.	0
		Reserved	1
		Reserved	2
	Torque	1.10 Motor torque is sent as actual value 1. The scaling is defined by parameter 46.3 Torque scaling.	3
	Speed	1.1 Motor speed used is sent as actual value 1. The scaling is defined by parameter 46.1 Speed scaling.	4
	Frequency	1.6 Output frequency is sent as actual value 1. The scaling is defined by parameter 46.2 Frequency scaling.	5
60.13	M/F act2 type	Selects the type/source and scaling of actual value ACT2 transmitted to the master/follower link.	Auto / uint16
	Auto	Type/source and scaling follow the type of reference 2 selected by parameter 60.11 M/F ref2 type. See the individual settings below for the sources and scalings.	0
		Reserved	1
		Reserved	2
	Torque	1.10 Motor torque is sent as actual value 2. The scaling is defined by parameter 46.3 Torque scaling.	3
	Speed	1.1 Motor speed used is sent as actual value 2. The scaling is defined by parameter 46.1 Speed scaling.	4
	Frequency	1.6 Output frequency is sent as actual value 2. The scaling is defined by parameter 46.2 Frequency scaling.	5
60.14	M/F follower selection	(Effective in the master only.) Defines the followers from which data is read. See also parameters 62.28...62.33.	None / uint32
	Follower node 2	Data is read from the follower with node address 2.	2
	Follower node 3	Data is read from the follower with node address 3.	4
	Follower node 4	Data is read from the follower with node address 4.	8
	Follower nodes 2+3	Data is read from the followers with node addresses 2 and 3.	6
	Follower nodes 2+4	Data is read from the followers with node addresses 2 and 4.	10

No.	Name / Range / Selection	Description	Def / Type FbEq 16b / 32b
	Follower nodes 3+4	Data is read from the followers with node addresses 3 and 4.	12
	Follower nodes 2+3+4	Data is read from the followers with node addresses 2, 3 and 4.	14
	None	None.	0
60.15	Force master	When parameter 60.3 M/F mode is set to DDCS forcing or D2D forcing, this parameter selects a source that forces the drive to be the master on the master/follower link. 1 = Drive is master on the master/follower link	FALSE / uint32
	FALSE	0.	0
	TRUE	1.	1
	Other [bit]	See Terms and abbreviations (page 221).	
60.16	Force follower	When parameter 60.3 M/F mode is set to DDCS forcing or D2D forcing, this parameter selects a source that forces the drive to be a follower on the master/follower link. 1 = Drive is follower on the master/follower link	FALSE / uint32
	FALSE	0.	0
	TRUE	1.	1
	Other [bit]	See Terms and abbreviations (page 221).	
60.17	Follower fault action	(Effective in the master only.) Selects how the drive reacts to a fault in a follower. See also parameter 60.23 M/F status supervision sel 1.  <b>Note:</b> Each follower must be configured to transmit its status word as one of the three data words in parameters 60.1...60.3. In the master, the corresponding target parameter (62.4...62.12) must be set to Follower SW.	Fault / uint16
	No action	No action taken. Unaffected drives on the master/follower link will continue running.	0
	Warning	The drive generates a warning (AFE7 Follower).	1
	Fault	Drive trips on FF7E Follower. All followers will be stopped.	2
60.18	Follower enable	Interlocks the starting of the master to the status of the followers. See also parameter 60.23 M/F status supervision sel 1.  <b>Note:</b> Each follower must be configured to transmit its status word as one of the three data words in parameters 60.1...60.3. In the master, the corresponding target parameter (62.4...62.12) must be set to Follower SW.	Always / uint16
	MSW bit 0	The master can only be started if all followers are ready to switch on (bit 0 of 6.11 Main status word in each follower is on).	0

## 540 Parameters

No.	Name / Range / Selection	Description	Def / Type FbEq 16b / 32b
	MSW bit 1	The master can only be started if all followers are ready to operate (bit 1 of 6.11 Main status word in each follower is on).	1
	MSW bits 0 + 1	The master can only be started if all followers are ready to switch on and ready to operate (bits 0 and 1 of 6.11 Main status word in each follower are on).	2
	Always	The starting of the master is not interlocked to the status of the followers.	3
	MSW bit 12	The master can only be started if user-definable bit 12 of 6.11 Main status word in each follower is on. See parameter 6.31 MSW bit 12 sel.	4
	MSW bits 0 + 12	The master can only be started if both bit 0 and bit 12 of 6.11 Main status word in each follower are on.	5
	MSW bits 1 + 12	The master can only be started if both bit 1 and bit 12 of 6.11 Main status word in each follower are on.	6
60.19	M/F comm supervision sel 1	Parameters 60.19...60.28 are only effective when the drive is the master on a D2D (drive-to-drive) link, implemented by application programming. See parameters 60.1 M/F communication port and 60.3 M/F mode, and <i>Drive (IEC 61131-3) application programming manual (3AUA0000127808 [English])</i> . In the master, parameters 60.19 M/F comm supervision sel 1 and 60.20 M/F comm supervision sel 2 specify the followers that are monitored for loss of communication. This parameter selects which followers (out of followers 1...16) are monitored. Each of the selected followers is polled by the master. If no reply is received, the action specified in 60.9 M/F comm loss function is taken. The status of communication is shown by 62.37 M/F communication status 1 and 62.38 M/F communication status 2.	- / uint16
	b0 Follower 1	1 = Follower 1 is polled by the master.	
	b1 Follower 2	1 = Follower 2 is polled by the master.	
	b2 Follower 3	1 = Follower 3 is polled by the master.	
	b3 Follower 4	1 = Follower 4 is polled by the master.	
	b4 Follower 5	1 = Follower 5 is polled by the master.	
	b5 Follower 6	1 = Follower 6 is polled by the master.	
	b6 Follower 7	1 = Follower 7 is polled by the master.	
	b7 Follower 8	1 = Follower 8 is polled by the master.	
	b8 Follower 9	1 = Follower 9 is polled by the master.	
	b9 Follower 10	1 = Follower 10 is polled by the master.	
	b10 Follower 11	1 = Follower 11 is polled by the master.	
	b11 Follower 12	1 = Follower 12 is polled by the master.	
	b12 Follower 13	1 = Follower 13 is polled by the master.	
	b13 Follower 14	1 = Follower 14 is polled by the master.	

No.	Name / Range / Selection	Description	Def / Type FbEq 16b / 32b
b14	Follower 15	1 = Follower 15 is polled by the master.	
b15	Follower 16	1 = Follower 16 is polled by the master.	
	0000h...FFFFh		1 = 1
60.20	M/F comm supervision sel 2	Selects which followers (out of followers 17...32) are monitored for loss of communication. See parameter 60.19 M/F comm supervision sel 1.	- / uint16
b0	Follower 17	1 = Follower 17 is polled by the master.	
b1	Follower 18	1 = Follower 18 is polled by the master.	
b2	Follower 19	1 = Follower 19 is polled by the master.	
b3	Follower 20	1 = Follower 20 is polled by the master.	
b4	Follower 21	1 = Follower 21 is polled by the master.	
b5	Follower 22	1 = Follower 22 is polled by the master.	
b6	Follower 23	1 = Follower 23 is polled by the master.	
b7	Follower 24	1 = Follower 24 is polled by the master.	
b8	Follower 25	1 = Follower 25 is polled by the master.	
b9	Follower 26	1 = Follower 26 is polled by the master.	
b10	Follower 27	1 = Follower 27 is polled by the master.	
b11	Follower 28	1 = Follower 28 is polled by the master.	
b12	Follower 29	1 = Follower 29 is polled by the master.	
b13	Follower 30	1 = Follower 30 is polled by the master.	
b14	Follower 31	1 = Follower 31 is polled by the master.	
b15	Follower 32	1 = Follower 32 is polled by the master.	
	0000h...FFFFh		1 = 1

## 542 Parameters

No.	Name / Range / Selection	Description	Def / Type FbEq 16b / 32b
60.23	M/F status supervision sel 1	<p>(This parameter is only effective when the drive is the master on a D2D link. See parameters 60.1 M/F communication port and 60.3 M/F mode.)</p> <p>In the master, parameters 60.23 M/F status supervision sel 1 and 60.24 M/F status supervision sel 2 specify the followers whose status word is monitored by the master.</p> <p>This parameter selects the followers (out of followers 1...16) whose status words are monitored by the master.</p> <p>If a follower reports a fault (bit 3 of the status word is on), the action specified in 60.17 Follower fault action is taken. Bits 0 and 1 of the status word (ready states) are handled as defined by 60.18 Follower enable.</p> <p>Using 60.27 M/F status supv mode sel 1 and 60.28 M/F status supv mode sel 2, it is possible to define whether any given follower is only monitored when it is stopped.</p> <p><b>Note:</b> Also activate communication supervision for the same followers in parameter 60.19 M/F comm supervision sel 1.</p> <p>The status of communication is shown by 62.37 M/F communication status 1 and 62.38 M/F communication status 2.</p>	- / uint16
	b0 Follower 1	Status of follower 1 is monitored.	
	b1 Follower 2	Status of follower 2 is monitored.	
	b2 Follower 3	Status of follower 3 is monitored.	
	b3 Follower 4	Status of follower 4 is monitored.	
	b4 Follower 5	Status of follower 5 is monitored.	
	b5 Follower 6	Status of follower 6 is monitored.	
	b6 Follower 7	Status of follower 7 is monitored.	
	b7 Follower 8	Status of follower 8 is monitored.	
	b8 Follower 9	Status of follower 9 is monitored.	
	b9 Follower 10	Status of follower 10 is monitored.	
	b10 Follower 11	Status of follower 11 is monitored.	
	b11 Follower 12	Status of follower 12 is monitored.	
	b12 Follower 13	Status of follower 13 is monitored.	
	b13 Follower 14	Status of follower 14 is monitored.	
	b14 Follower 15	Status of follower 15 is monitored.	
	b15 Follower 16	Status of follower 16 is monitored.	
	0000h...FFFFh		1 = 1

No.	Name / Range / Selection	Description	Def / Type FbEq 16b / 32b
60.24	M/F status supervision sel 2	<p>Selects the followers (out of followers 17...32) whose status words are monitored by the D2D master.</p> <p><b>Note:</b> Also activate communication supervision for the same followers in parameter 60.20 M/F comm supervision sel 2.</p> <p>See parameter 60.23 M/F status supervision sel 1.</p>	- / uint16
	b0 Follower 17	1 = Status of follower 17 is monitored.	
	b1 Follower 18	1 = Status of follower 18 is monitored.	
	b2 Follower 19	1 = Status of follower 19 is monitored.	
	b3 Follower 20	1 = Status of follower 20 is monitored.	
	b4 Follower 21	1 = Status of follower 21 is monitored.	
	b5 Follower 22	1 = Status of follower 22 is monitored.	
	b6 Follower 23	1 = Status of follower 23 is monitored.	
	b7 Follower 24	1 = Status of follower 24 is monitored.	
	b8 Follower 25	1 = Status of follower 25 is monitored.	
	b9 Follower 26	1 = Status of follower 26 is monitored.	
	b10 Follower 27	1 = Status of follower 27 is monitored.	
	b11 Follower 28	1 = Status of follower 28 is monitored.	
	b12 Follower 29	1 = Status of follower 29 is monitored.	
	b13 Follower 30	1 = Status of follower 30 is monitored.	
	b14 Follower 31	1 = Status of follower 31 is monitored.	
	b15 Follower 32	1 = Status of follower 32 is monitored.	
	0000h...FFFFh		1 = 1
60.27	M/F status supv mode sel 1	<p>In the D2D master, parameters 60.27 M/F status supv mode sel 1 and 60.28 M/F status supv mode sel 2 specify the mode of follower status word monitoring. Each follower can individually be set to be monitored continuously, or only when it is in stopped state. This parameter selects the mode of status word monitoring of followers 1...16.</p>	- / uint16
	b0 Follower 1	<p>0 = Status of follower 1 is monitored continuously. 1 = Status of follower 1 is monitored only when it is in stopped state.</p>	
	b1 Follower 2	<p>0 = Status of follower 2 is monitored continuously. 1 = Status of follower 2 is monitored only when it is in stopped state.</p>	
	b2 Follower 3	<p>0 = Status of follower 3 is monitored continuously. 1 = Status of follower 3 is monitored only when it is in stopped state.</p>	
	b3 Follower 4	<p>0 = Status of follower 4 is monitored continuously. 1 = Status of follower 4 is monitored only when it is in stopped state.</p>	

## 544 Parameters

No.	Name / Range / Selection	Description	Def / Type FbEq 16b / 32b
b4	Follower 5	0 = Status of follower 5 is monitored continuously. 1 = Status of follower 5 is monitored only when it is in stopped state.	
b5	Follower 6	0 = Status of follower 6 is monitored continuously. 1 = Status of follower 6 is monitored only when it is in stopped state.	
b6	Follower 7	0 = Status of follower 7 is monitored continuously. 1 = Status of follower 7 is monitored only when it is in stopped state.	
b7	Follower 8	0 = Status of follower 8 is monitored continuously. 1 = Status of follower 8 is monitored only when it is in stopped state.	
b8	Follower 9	0 = Status of follower 9 is monitored continuously. 1 = Status of follower 9 is monitored only when it is in stopped state.	
b9	Follower 10	0 = Status of follower 10 is monitored continuously. 1 = Status of follower 10 is monitored only when it is in stopped state.	
b10	Follower 11	0 = Status of follower 11 is monitored continuously. 1 = Status of follower 11 is monitored only when it is in stopped state.	
b11	Follower 12	0 = Status of follower 12 is monitored continuously. 1 = Status of follower 12 is monitored only when it is in stopped state.	
b12	Follower 13	0 = Status of follower 13 is monitored continuously. 1 = Status of follower 13 is monitored only when it is in stopped state.	
b13	Follower 14	0 = Status of follower 14 is monitored continuously. 1 = Status of follower 14 is monitored only when it is in stopped state.	
b14	Follower 15	0 = Status of follower 15 is monitored continuously. 1 = Status of follower 15 is monitored only when it is in stopped state.	
b15	Follower 16	0 = Status of follower 16 is monitored continuously. 1 = Status of follower 16 is monitored only when it is in stopped state.	
	0000h...FFFFh		1 = 1
60.28	M/F status supv mode sel 2	Selects the mode of status word monitoring of followers 17...32.	- / uint16
b0	Follower 17	0 = Status of follower 17 is monitored continuously. 1 = Status of follower 17 is monitored only when it is in stopped state.	
b1	Follower 18	0 = Status of follower 18 is monitored continuously. 1 = Status of follower 18 is monitored only when it is in stopped state.	
b2	Follower 19	0 = Status of follower 19 is monitored continuously. 1 = Status of follower 19 is monitored only when it is in stopped state.	



No.	Name / Range / Selection	Description	Def / Type FbEq 16b / 32b
	b3 Follower 20	0 = Status of follower 20 is monitored continuously. 1 = Status of follower 20 is monitored only when it is in stopped state.	
	b4 Follower 21	0 = Status of follower 21 is monitored continuously. 1 = Status of follower 21 is monitored only when it is in stopped state.	
	b5 Follower 22	0 = Status of follower 22 is monitored continuously. 1 = Status of follower 22 is monitored only when it is in stopped state.	
	b6 Follower 23	0 = Status of follower 23 is monitored continuously. 1 = Status of follower 23 is monitored only when it is in stopped state.	
	b7 Follower 24	0 = Status of follower 24 is monitored continuously. 1 = Status of follower 24 is monitored only when it is in stopped state.	
	b8 Follower 25	0 = Status of follower 25 is monitored continuously. 1 = Status of follower 25 is monitored only when it is in stopped state.	
	b9 Follower 26	0 = Status of follower 26 is monitored continuously. 1 = Status of follower 26 is monitored only when it is in stopped state.	
	b10 Follower 27	0 = Status of follower 27 is monitored continuously. 1 = Status of follower 27 is monitored only when it is in stopped state.	
	b11 Follower 28	0 = Status of follower 28 is monitored continuously. 1 = Status of follower 28 is monitored only when it is in stopped state.	
	b12 Follower 29	0 = Status of follower 29 is monitored continuously. 1 = Status of follower 29 is monitored only when it is in stopped state.	
	b13 Follower 30	0 = Status of follower 30 is monitored continuously. 1 = Status of follower 30 is monitored only when it is in stopped state.	
	b14 Follower 31	0 = Status of follower 31 is monitored continuously. 1 = Status of follower 31 is monitored only when it is in stopped state.	
	b15 Follower 32	0 = Status of follower 32 is monitored continuously. 1 = Status of follower 32 is monitored only when it is in stopped state.	
	0000h...FFFFh		1 = 1
60.31	M/F wake up delay	Defines a wake-up delay during which no master/follower communication faults or warnings are generated. This is to allow all drives on the master/follower link to power up. The master cannot be started until the delay elapses or all monitored followers are found to be ready.	60.0 s / uint16
	0.0 ... 180.0 s	Master/follower wake-up delay.	10 = 1 s / 10 = 1 s



## 546 Parameters

No.	Name / Range / Selection	Description	Def / Type FbEq 16b / 32b
60.32	M/F comm supervision force	Activates master/follower communication monitoring separately for each control location (see section <a href="#">Local control vs. external control (page 145)</a> ). The parameter is primarily intended for monitoring the communication with master or follower when it is connected to the application program and not selected as a control source by drive parameters.	- / uint16
	b0 Ext 1	1 = Communication monitoring active when Ext 1 is being used.	
	b1 Ext 2	1 = Communication monitoring active when Ext 2 is being used.	
	b2 Local	1 = Communication monitoring active when local control is being used.	
b3...15 Reserved			
	0000h...FFFFh		1 = 1
60.41	Extension adapter com port	Selects the channel used for connecting an optional FEA-xx extension adapter.	Not in use / uint16
	Not in use	None (communication disabled).	0
	Slot 1A	Channel A on FDCO module in slot 1.	1
	Slot 2A	Channel A on FDCO module in slot 2.	2
	Slot 3A	Channel A on FDCO module in slot 3.	3
	Slot 1B	Channel B on FDCO module in slot 1.	4
	Slot 2B	Channel B on FDCO module in slot 2.	5
	Slot 3B	Channel B on FDCO module in slot 3.	6
		Channel CH 3 on RDCO module (with BCU control unit only).	13
60.50	DDCS controller drive type	In ModuleBus communication, defines whether the drive is of the "engineered" or "standard" type.  <b>Note:</b> This parameter cannot be changed while the drive is running.	ABB engineered drive / uint16
	ABB engineered drive	The drive is an "engineered drive" (data sets 10...25 are used).	0
	ABB standard drive	The drive is a "standard drive" (data sets 1...4 are used).	1
60.51	DDCS controller comm port	Selects the DDCS channel used for connecting an external controller (such as an AC 800M).	Not in use / uint16
	Not in use	None (communication disabled).	0
	Slot 1A	Channel A on FDCO module in slot 1.	1
	Slot 2A	Channel A on FDCO module in slot 2.	2
	Slot 3A	Channel A on FDCO module in slot 3.	3
	Slot 1B	Channel B on FDCO module in slot 1.	4
	Slot 2B	Channel B on FDCO module in slot 2.	5
Slot 3B	Channel B on FDCO module in slot 3.	6	

No.	Name / Range / Selection	Description	Def / Type FbEq 16b / 32b
		Channel 0 on RDCO module (with BCU control unit only).	10
	XD2D	Connector XD2D.	7
60.52	DDCS controller node address	<p>Selects the node address of the drive for communication with the external controller. No two nodes on-line may have the same address.</p> <p>With an AC 800M (CI858) DriveBus connection, drives must be addressed 1...24; with an AC 80 DriveBus connection, drives must be addressed 1...12. Note that the BusManager function must be disabled in the DriveBus controller.</p> <p>With optical ModuleBus, the drive address is set according to the position value as follows:</p> <ol style="list-style-type: none"> <li>1. Multiply the hundreds of the position value by 16.</li> <li>2. Add the tens and ones of the position value to the result.</li> </ol> <p>For example, if the position value is 101, this parameter must be set to <math>1 \times 16 + 1 = 17</math>.</p>	1 / uint16
	1...254	Node address.	- / -
60.55	DDCS controller HW connection	Selects the topology of the fiber optic link with an external controller.	Star / uint16
	Ring	The devices are connected in a ring topology. Forwarding of messages is enabled.	0
	Star	The devices are connected in a star topology (for example, through a branching unit). Forwarding of messages is disabled.	1
60.56	DDCS controller baud rate	Selects the communication speed of the channel selected by parameter 60.51 DDCS controller comm port.	4 mbps / uint16
	1 mbps	1 megabit/second.	1
	2 mbps	2 megabit/second.	2
	4 mbps	4 megabit/second.	4
	8 mbps	8 megabit/second.	8
60.57	DDCS controller link control	<p>Defines the light intensity of the transmission LED of RDCO module channel CH0. (This parameter is effective only when parameter 60.51 DDCS controller comm port is set to RDCO CH 0. FDCO modules have a hardware transmitter current selector.)</p> <p>In general, use higher values with longer fiber optic cables.</p> <p>The maximum setting is applicable to the maximum length of the fiber optic link. See <i>Master/follower functionality</i> (page 159).</p>	10 / uint16
	1...15	Light intensity.	- / -

## 548 Parameters

No.	Name / Range / Selection	Description	Def / Type FbEq 16b / 32b
60.58	DDCS controller comm loss time	<p>Sets a timeout for communication with the external controller.</p> <p>If a communication break lasts longer than the timeout, the action specified by parameter <a href="#">60.59 DDCS controller comm loss function</a> is taken.</p> <p>As a rule of thumb, this parameter should be set to at least 3 times the transmit interval of the controller.</p> <p><b>Note:</b></p> <ul style="list-style-type: none"> <li>There is a 60-second boot-up delay immediately after power-up. During the delay, the communication break monitoring is disabled (but communication itself can be active).</li> <li>With an AC 800M controller, the controller detects a communication break immediately but re-establishing the communication is done at 9-second idle intervals. Also note that the sending interval of a data set is not the same as the execution interval of the application task. On ModuleBus, the sending interval is defined by controller parameter Scan Cycle Time (by default, 100 ms).</li> </ul>	100 ms / uint16
	0..60000 ms	Timeout for communication with external controller.	- / -
60.59	DDCS controller comm loss function	Selects how the drive reacts to a communication break between the drive and the external controller.	Fault / uint16
	No action	No action taken (monitoring disabled).	0
	Fault	Drive trips on <a href="#">7581 DDCS controller comm loss</a> . This only occurs if control is expected from the external controller, or if supervision is forced using parameter <a href="#">60.65 DDCS controller comm supervision force</a> .	1
	Last speed	<p>Drive generates an <a href="#">A7CA DDCS controller comm loss</a> warning and freezes the speed to the level the drive was operating at. This only occurs if control is expected from the external controller, or if supervision is forced using parameter <a href="#">60.65 DDCS controller comm supervision force</a>.</p> <p>The speed is determined on the basis of actual speed using 850 ms low-pass filtering.</p>	2
<p> <b>WARNING!</b> Make sure that it is safe to continue operation in case of a communication break.</p>			

No.	Name / Range / Selection	Description	Def / Type FbEq 16b / 32b
	Speed ref safe	Drive generates an A7CA DDCS controller comm loss warning and sets the speed to the speed defined by parameter 22.41 Speed ref safe. This only occurs if control is expected from the external controller, or if supervision is forced using parameter 60.65 DDCS controller comm supervision force.	3
		 <b>WARNING!</b> Make sure that it is safe to continue operation in case of a communication break.	
	Fault always	Drive trips on 7581 DDCS controller comm loss. This occurs even though no control is expected from the external controller.	4
	Warning	Drive generates an A7CA DDCS controller comm loss warning. This only occurs if control is expected from the external controller, or if supervision is forced using parameter 60.65 DDCS controller comm supervision force.	5
		 <b>WARNING!</b> Make sure that it is safe to continue operation in case of a communication break.	
60.60	DDCS controller ref1 type	Selects the type and scaling of reference 1 received from the external controller. The resulting value is shown by 3.11 DDCS controller ref 1.	Auto / uint16
	Auto	Type and scaling are chosen automatically according to which reference chain (see settings Torque, Speed, Frequency) the incoming reference is connected to. If the reference is not connected to any chain, no scaling is applied (as with setting Transparent).	0
		No scaling is applied.	1
		Generic reference with a scaling of 100 = 1 (ie. integer and two decimals).	2
	Torque	The scaling is defined by parameter 46.3 Torque scaling.	3
	Speed	The scaling is defined by parameter 46.1 Speed scaling.	4
	Frequency	The scaling is defined by parameter 46.2 Frequency scaling.	5
60.61	DDCS controller ref2 type	Selects the type and scaling of reference 2 received from the external controller. The resulting value is shown by 3.12 DDCS controller ref 2. For the selections, see parameter 60.60 DDCS controller ref1 type.	Auto / uint16
60.62	DDCS controller act1 type	Selects the type/source and scaling of actual value ACT1 transmitted to the external controller.	Auto / uint16
	Auto	Type/source and scaling follow the type of reference 1 selected by parameter 60.60 DDCS controller ref1 type. See the individual settings below for the sources and scalings.	0

## 550 Parameters

No.	Name / Range / Selection	Description	Def / Type FbEq 16b / 32b
		Reserved.	1
		Reserved.	2
	Torque	1.10 Motor torque is sent as actual value 1. The scaling is defined by parameter 46.3 Torque scaling.	3
	Speed	1.1 Motor speed used is sent as actual value 1. The scaling is defined by parameter 46.1 Speed scaling.	4
	Frequency	1.6 Output frequency is sent as actual value 1. The scaling is defined by parameter 46.2 Frequency scaling.	5
60.63	DDCS controller act2 type	Selects the type/source and scaling of actual value ACT2 transmitted to the external controller.	Auto / uint16
	Auto	Type/source and scaling follow the type of reference 2 selected by parameter 60.61 DDCS controller ref2 type. See the individual settings below for the sources and scalings.	0
		Reserved.	1
		Reserved.	2
	Torque	1.10 Motor torque is sent as actual value 2. The scaling is defined by parameter 46.3 Torque scaling.	3
	Speed	1.1 Motor speed used is sent as actual value 2. The scaling is defined by parameter 46.1 Speed scaling.	4
	Frequency	1.6 Output frequency is sent as actual value 2. The scaling is defined by parameter 46.2 Frequency scaling.	5
60.64	Mailbox dataset selection	Selects the pair of data sets used by the mailbox service in the drive/controller communication. See section External controller interface (page 167).	0 / uint16
	0...1	Data sets 32 and 33.	1 = 1 / 1 = 1
60.65	DDCS controller comm supervision force	Activates DDCS controller communication monitoring separately for each control location (see section Local control vs. external control (page 145). The parameter is primarily intended for monitoring the communication with the controller when it is connected to the application program and not selected as a control source by drive parameters.	- / uint16
	b0 Ext 1	1 = Communication monitoring active when Ext 1 is being used.	
	b1 Ext 2	1 = Communication monitoring active when Ext 2 is being used.	
	b2 Local	1 = Communication monitoring active when local control is being used.	
	b3...15 Reserved		
	0000h...FFFFh		1 = 1

No.	Name / Range / Selection	Description	Def / Type FbEq 16b / 32b
60.200	Crane drive type	<p>Selects the crane drive type for M/F communication in the D2D-link.</p> <p>All drives in the link must have individual value of this parameter. After setting this parameter, the application will automatically set D2D-link communication parameters. For example, parameters 60.1 M/F communication port...60.3. These parameters are not allowed to change manually.</p> <p><b>Note:</b> Reboot the drive after setting parameters 60.200 Crane drive type and 60.201 Crane drives structure. See Master/follower communication in crane application.</p>	Not selected / uint16
	Not selected	Crane drive type is not selected.	0
	Main hoist (D2D master)	Main hoist (D2D master)	1
	Main trolley	Main trolley	2
	Main long travel	Main long travel	3
	Follower hoist 1	Follower hoist 1	4
	Follower hoist 2	Follower hoist 2	5
	Follower hoist 3	Follower hoist 3	6
	Follower hoist 4	Follower hoist 4	7
	Follower trolley 1	Follower trolley 1	8
	Follower trolley 2	Follower trolley 2	9
	Follower long travel 1	Follower long travel 1	10
	Follower long travel 2	Follower long travel 2	11
60.201	Crane drives structure	<p>Sets the crane M/F communication supervision in the D2Dlink.</p> <p>Setting the bit from 0 to 1 activates supervision. For example, in the main hoist drive setting bits 3,4,5,6 activates supervision between main hoist and its followers. Similarly, in the main trolley drive setting bits 7 and 8 activates supervision.</p> <p><b>Note:</b></p> <ul style="list-style-type: none"> <li>• ABB recommends you not to activate all the bits in the main hoist drive, because a communication problem between the main trolley and its follower can trip the main hoist.</li> <li>• Reboot the drive after setting parameters 60.200 Crane drive type and 60.201 Crane drives structure.</li> </ul>	- / uint16
	b0 Reserved		
	b1 Main Trolley	Main trolley	
	b2 Main Long travel	Main long travel	

## 552 Parameters

No.	Name / Range / Selection	Description	Def / Type FbEq 16b / 32b
	b3 Follower Hoist 1	Follower hoist 1	
	b4 Follower Hoist 2	Follower hoist 2	
	b5 Follower Hoist 3	Follower hoist 3	
	b6 Follower Hoist 4	Follower hoist 4	
	b7 Follower Trolley 1	Follower trolley 1	
	b8 Follower Trolley 2	Follower trolley 2	
	b9 Follower Long travel 1	Follower long travel 1	
	b10 Follower Long travel 2	Follower long travel 2	
b11...15 Reserved			
	0000h...FFFFh		1 = 1
60.202	CW1	Control word 1 generated by current drive.	0 / uint16
	0...65535	Control word 1	1 = 1 / 1 = 1
60.203	CW2	Control word 2 generated by current drive.	0 / uint16
	0...65535	Control word 2	1 = 1 / 1 = 1
60.204	Ref1	Reference 1. Shows the speed reference type for Synchro control. The value depends on the Synchro On/Off (par. 82.1) different data transferred	0 / real32
	-30000...30000	Reference 1.	1 = 1 / 1 = 1
60.205	Ref2	Reference 2. Shows the torque/ load position reference type for Synchro control. The value depends on Synchro On or Off (par. 82.1) different data transferred.	0 / real32
	-30000...30000	Reference 2	1 = 1 / 1 = 1
60.206	Master SW1	Master drive application status word 1.	0 / uint16
	0...65535	Status word 1	1 = 1 / 1 = 1
60.207	Master SW2	Master drive application status word 2. Used by application internally for D2D supervision.	0 / uint16
	0...65535	Status word 2	1 = 1 / 1 = 1
60.208	Master position error	Master position error. to do: new	0 / real32
	-2147483...2147483	Master position error.	1 = 1 / 1 = 1
60.209	Master ACT2	Master ACT2. to do: new	0 / real32
	-30000...30000	Master ACT2	1 = 1 / 1 = 1
60.210	Follower 1 SW1	Follower x drive application status word 1.	0 / uint16
	0...65535	Follower x drive application status word 1.	1 = 1 / 1 = 1
60.211	Follower 1 SW2	Follower x drive application status word 2. Used by application internally for D2D supervision.	0 / uint16
	0...65535	Status word 2	1 = 1 / 1 = 1



No.	Name / Range / Selection	Description	Def / Type FbEq 16b / 32b
60.212	Follower 1 position error	Shows the follower x drive position difference compared with the master drive. This parameter is visible only in master drive.	0 / real32
	-2147483...2147483	Follower 1 position error	1 = 1 / 1 = 1
60.213	Follower 1 position actual	Shows the actual position of the follower x drive. This parameter is visible only in master drive.	0 / real32
	-2147483...2147483	Actual position	1 = 1 / 1 = 1
60.214	Follower 2 SW1	Follower x drive application status word 1.	0 / uint16
	0...65535	Status word 1.	1 = 1 / 1 = 1
60.215	Follower 2 SW2	Follower x drive application status word 2. Used by application internally for D2D supervision.	0 / uint16
	0...65535	Status word 2	1 = 1 / 1 = 1
60.216	Follower 2 position error	Shows the follower x drive position difference compared with the master drive. This parameter is visible only in master drive.	0 / real32
	-2147483...2147483	Position error	1 = 1 / 1 = 1
60.217	Follower 2 position actual	Shows the actual position of the follower x drive. This parameter is visible only in master drive.	0 / real32
	-2147483...2147483	Actual position	1 = 1 / 1 = 1
60.218	Follower 3 SW1	Follower x drive application status word 1.	0 / uint16
	0...65535	Status word 1	1 = 1 / 1 = 1
60.219	Follower 3 SW2	Follower x drive application status word 2. Used by application internally for D2D supervision.	0 / uint16
	0...65535	Status word 2	1 = 1 / 1 = 1
60.220	Follower 3 position error	Shows the follower x drive position difference compared with the master drive. This parameter is visible only in master drive.	0 / real32
	-2147483...2147483	Position error	1 = 1 / 1 = 1
60.221	Follower 3 position actual	Shows the actual position of the follower x drive. This parameter is visible only in master drive.	0 / real32
	-2147483...2147483	Actual position	1 = 1 / 1 = 1
60.222	Follower 4 SW1	Follower x drive application status word 1.	0 / uint16
	0...65535	Status word 1	1 = 1 / 1 = 1
60.223	Follower 4 SW2	Follower x drive application status word 2. Used by application internally for D2D supervision.	0 / uint16
	0...65535	Status word 2	1 = 1 / 1 = 1
60.224	Follower 4 position error	Shows the follower x drive position difference compared with the master drive. This parameter is visible only in master drive.	0 / real32
	-2147483...2147483	Position error	1 = 1 / 1 = 1
60.225	Follower 4 position actual	Shows the actual position of the follower x drive. This parameter is visible only in master drive.	0 / real32

## 554 Parameters

No.	Name / Range / Selection	Description	Def / Type FbEq 16b / 32b
	-2147483...2147483	Actual position	1 = 1 / 1 = 1
60.226	Hoist position	Shows the value of hoist position transferred from the main hoist drive through D2D link to all drives. See parameter 77.20 Pendulum length source 1.	0 / real32
	-32768...32767	Hoist position	1 = 1 / 1 = 1
60.227	Hoist position 2	Shows the hoist position signal source 2 for pendulum calculation. See parameter 77.28 Pendulum length source 2.	0 / real32
	-32768...32767	Hoist position 2	1 = 1 / 1 = 1
60.228	Hoist load	Shows the hoist load value transferred from the main hoist drive through D2D link to all drives. See parameter 77.80 Load to antisway selection.	0.0% / real32
	0.0 ... 6553.5%	Hoist load	1 = 1% / 1 = 1%

No.	Name / Range / Selection	Description	Def / Type FbEq 16b / 32b
61	<b>D2D and DDCS transmit data</b>	Defines the data sent to the DDCS link. See also parameter group <a href="#">60 DDCS communication</a> .	
61.1	M/F data 1 selection	Preselects the data to be sent as word 1 onto the master/follower link. See also parameter <a href="#">61.25 M/F data 1 value</a> , and section <a href="#">General (page 159)</a> .	Follower CW / uint32
	None	None.	0
	CW 16bit	Control Word (16 bits)	1
	SW 16bit	Status Word (16 bits)	4
	Act1 16bit	Actual value ACT1 (16 bits)	5
		<b>Note:</b> Using this setting to send a reference to the follower is not recommended as the source signal is filtered. Use the “reference” selections instead.	
	Act2 16bit	Actual value ACT2 (16 bits)	6
		<b>Note:</b> Using this setting to send a reference to the follower is not recommended as the source signal is filtered. Use the “reference” selections instead.	
	Follower CW	A word consisting of bits 0...11 of <a href="#">6.1 Main control word</a> and the bits selected by parameters <a href="#">06.45...06.48</a> .	27
		<b>Note:</b> Bit 3 of the follower control word is kept on as long as the master is modulating, and when it switches to 0, the follower coasts to a stop.	
	Used speed reference	<a href="#">24.1 Used speed reference (page 386)</a> .	6145
	Torque reference act 5	<a href="#">26.75 Torque reference act 5 (page 413)</a> .	6731
	Torque reference used	<a href="#">26.2 Torque reference used (page 405)</a> .	6658
	ACS800 System ctrl SW	A follower status word compatible with an ACS800 (System Control Program) master. With this setting, status word bit 0 is cleared whenever the run enable signal is missing.	28
	Follower CW B6 high	Otherwise identical to selection <a href="#">Follower CW</a> , but bit 6 of the follower control word is also kept on as long as the master is modulating. This will allow the follower to stop along the stop ramp of the master.	29
	Follower CW B6 high	Virtual address for Control word for the follower units, bit 6 high as long as the drive modulates	809013
		<b>Note:</b> This setting cannot be used in <a href="#">61.03 M/F data 3 selection</a> because the 32-bit value requires two consecutive words.	

## 556 Parameters

No.	Name / Range / Selection	Description	Def / Type FbEq 16b / 32b
	Follower CW B6 high	Scaled velocity value as displayed by 88.54 D2D velocity send.  <b>Note:</b> Occasionally, below data are also sent to the follower: <ul style="list-style-type: none"> <li>32768-Position initialization or position send type changed.</li> <li>32767-Latch 1 triggered in master.</li> </ul>	22582
	Other [value]	See <a href="#">Terms and abbreviations (page 221)</a> .	
61.2	M/F data 2 selection	Preselects the data to be sent as word 2 onto the master/follower link. See also parameter <a href="#">61.26 M/F data 2 value</a> . For the selections, see parameter <a href="#">61.1 M/F data 1 selection</a> .	Used speed reference / uint32
	None	This is the block, where writer describes in more details how the selection value should be interpreted.	0
	CW 16bit	This is the block, where writer describes in more details how the selection value should be interpreted.	1
	SW 16bit	This is the block, where writer describes in more details how the selection value should be interpreted.	4
	Act1 16bit	This is the block, where writer describes in more details how the selection value should be interpreted.	5
	Act2 16bit	This is the block, where writer describes in more details how the selection value should be interpreted.	6
	Follower CW	This is the block, where writer describes in more details how the selection value should be interpreted.	27
	Used speed reference	This is the block, where writer describes in more details how the selection value should be interpreted.	6145
	Torque reference act 5	This is the block, where writer describes in more details how the selection value should be interpreted.	6731
	Torque reference used	This is the block, where writer describes in more details how the selection value should be interpreted.	6658
	ACS800 System ctrl SW	This is the block, where writer describes in more details how the selection value should be interpreted.	28
	Follower CW B6 high	This is the block, where writer describes in more details how the selection value should be interpreted.	29
61.3	M/F data 3 selection	Preselects the data to be sent as word 3 onto the master/follower link. See also parameter <a href="#">61.27 M/F data 3 value</a> . For the selections, see parameter <a href="#">61.1 M/F data 1 selection</a> .	Torque reference act 5 / uint32
61.25	M/F data 1 value	Displays the data to be sent onto the master/follower link as word 1 as an integer. If no data has been preselected by <a href="#">61.1 M/F data 1 selection</a> , the value to be sent can be written directly into this parameter.	- / uint16

No.	Name / Range / Selection	Description	Def / Type FbEq 16b / 32b
	0...65535	Data to be sent as word 1 in master/follower communication.	- / -
61.26	M/F data 2 value	Displays the data to be sent onto the master/follower link as word 2 as an integer. If no data has been preselected by 61.2 M/F data 2 selection, the value to be sent can be written directly into this parameter.	- / uint16
	0...65535	Data to be sent as word 2 in master/follower communication.	- / -
61.27	M/F data 3 value	Displays the data to be sent onto the master/follower link as word 3 as an integer. If no data has been preselected by 61.3 M/F data 3 selection, the value to be sent can be written directly into this parameter.	- / uint16
	0...65535	Data to be sent as word 3 in master/follower communication.	- / -
61.45	Data set 2 data 1 selection	Parameters 61.45...61.50 preselect data to be sent in data sets 2 and 4 to the external controller. These data sets are used in ModuleBus communication with a "standard drive" (60.50 DDCS controller drive type = ABB standard drive). Parameters 61.95...61.100 display the data to be sent to the external controller. If no data has been preselected, the value to be sent can be written directly into these parameters. For example, this parameter preselects the data for word 1 of data set 2. Parameter 61.95 Data set 2 data 1 value displays the selected data in integer format. If no data is preselected, the value to be sent can be written directly into parameter 61.95.	None / uint32
	None	None.	0
	CW 16bit	Control Word (16 bits)	1
	SW 16bit	Status Word (16 bits)	4
	Act1 16bit	Actual value ACT1 (16 bits)	5
	Act2 16bit	Actual value ACT2 (16 bits)	6
	Other [value]	See Terms and abbreviations (page 221).	
61.46	Data set 2 data 2 selection	Preselects the data to be sent as word 2 of data set 2 to the external controller. See also parameter 61.96 Data set 2 data 2 value. For the selections, see parameter 61.45 Data set 2 data 1 selection.	None / uint32
61.47	Data set 2 data 3 selection	See parameter 61.45 Data set 2 data 1 selection.	None / uint32
...	...	...	...
61.50	Data set 4 data 3 selection	See parameter 61.45 Data set 2 data 1 selection.	None / uint32

## 558 Parameters

No.	Name / Range / Selection	Description	Def / Type FbEq 16b / 32b
61.51	Data set 11 data 1 selection	<p>Parameters 61.51...61.74 preselect data to be sent in data sets 11, 13, 15, 17, 19, 21, 23 and 25 to the external controller.</p> <p>Parameters 61.101...61.124 display the data to be sent to the external controller. If no data has been preselected, the value to be sent can be written directly into these parameters.</p> <p>For example, this parameter preselects the data for word 1 of data set 11. Parameter 61.101 Data set 11 data 1 value displays the selected data in integer format. If no data is preselected, the value to be sent can be written directly into parameter 61.101.</p>	None / uint32
	None	None.	0
	CW 16bit	Control Word (16 bits)	1
	SW 16bit	Status Word (16 bits)	4
	Act1 16bit	Actual value ACT1 (16 bits)	5
	Act2 16bit	Actual value ACT2 (16 bits)	6
	Other [value]	See Terms and abbreviations (page 221).	
61.52	Data set 11 data 2 selection	<p>Preselects the data to be sent as word 2 of data set 11 to the external controller.</p> <p>See also parameter 61.102 Data set 11 data 2 value.</p> <p>For the selections, see parameter 61.51 Data set 11 data 1 selection.</p>	None / uint32
61.53	Data set 11 data 3 selection	<p>Preselects the data to be sent as word 3 of data set 11 to the external controller.</p> <p>See also parameter 61.103 Data set 11 data 3 value.</p> <p>For the selections, see parameter 61.51 Data set 11 data 1 selection.</p>	None / uint32
61.54	Data set 13 data 1 selection	See parameter 61.51 Data set 11 data 1 selection.	None / uint32
...	...	...	...
61.74	Data set 25 data 3 selection	See parameter 61.51 Data set 11 data 1 selection.	None / uint32
61.95	Data set 2 data 1 value	<p>Displays (in integer format) the data to be sent to the external controller as word 1 of data set 2.</p> <p>If no data has been preselected by 61.45 Data set 2 data 1 selection, the value to be sent can be written directly into this parameter.</p>	0 / uint16
	0...65535	Data to be sent as word 1 of data set 2.	- / -
61.96	Data set 2 data 2 value	<p>Displays (in integer format) the data to be sent to the external controller as word 2 of data set 2.</p> <p>If no data has been preselected by 61.46 Data set 2 data 2 selection, the value to be sent can be written directly into this parameter.</p>	0 / uint16
	0...65535	Data to be sent as word 2 of data set 2.	- / -

No.	Name / Range / Selection	Description	Def / Type FbEq 16b / 32b
61.97	Data set 2 data 3 value	Displays (in integer format) the data to be sent to the external controller as word 3 of data set 2. If no data has been preselected by 61.47 Data set 2 data 3 selection, the value to be sent can be written directly into this parameter.	0 / uint16
	0...65535	Data to be sent as word 3 of data set 2.	- / -
...	...	...	...
61.100	Data set 4 data 3 value	Displays (in integer format) the data to be sent to the external controller as word 3 of data set 4. If no data has been selected by 61.50 Data set 4 data 3 selection, the value to be sent can be written directly into this parameter.	0 / uint16
	0...65535	Data to be sent as word 3 of data set 4.	- / -
61.101	Data set 11 data 1 value	Displays (in integer format) the data to be sent to the external controller as word 1 of data set 11. If no data has been preselected by 61.51 Data set 11 data 1 selection, the value to be sent can be written directly into this parameter.	- / uint16
	0...65535	Data to be sent as word 1 of data set 11.	- / -
61.102	Data set 11 data 2 value	Displays (in integer format) the data to be sent to the external controller as word 2 of data set 11. If no data has been preselected by 61.52 Data set 11 data 2 selection, the value to be sent can be written directly into this parameter.	- / uint16
	0...65535	Data to be sent as word 2 of data set 11.	- / -
61.103	Data set 11 data 3 value	Displays (in integer format) the data to be sent to the external controller as word 3 of data set 11. If no data has been selected by 61.53 Data set 11 data 3 selection, the value to be sent can be written directly into this parameter.	- / uint16
	0...65535	Data to be sent as word 3 of data set 11.	- / -
61.104	Data set 13 data 1 value	Displays (in integer format) the data to be sent to the external controller as word 1 of data set 13. If no data has been selected by 61.54 Data set 13 data 1 selection, the value to be sent can be written directly into this parameter.	- / uint16
	0...65535	Data to be sent as word 1 of data set 13.	- / -
...	...	...	...
61.124	Data set 25 data 3 value	Displays (in integer format) the data to be sent to the external controller as word 3 of data set 25. If no data has been selected by 61.74 Data set 25 data 3 selection, the value to be sent can be written directly into this parameter.	- / uint16
	0...65535	Data to be sent as word 3 of data set 25.	- / -

## 560 Parameters

No.	Name / Range / Selection	Description	Def / Type FbEq 16b / 32b
62	<b>D2D and DDCS receive data</b>	Mapping of data received through the DDCS link. See also parameter group 60 DDCS communication.	
62.1	M/F data 1 selection	(Follower only) Defines a target for the data received as word 1 from the master through the master/follower link. See also parameter 62.25 M/F data 1 value.	None / uint32
	None	None.	0
	CW 16bit	Control Word (16 bits)	1
	Ref1 16bit	Reference REF1 (16 bits)	2
	Ref2 16bit	Reference REF2 (16 bits)	3
	Ref2 16bit	Scaled velocity value.	4
		<b>Note:</b> This selection should be chosen for the same data word as was set to D2D velocity in the master.	
	Ref2 16bit	32-bit position value.	30
		<b>Note:</b> This selection should be chosen for the same data word as was set to D2D position in the master. (The setting will automatically reserve two consecutive data words.)	
	Other [value]	See Terms and abbreviations (page 221).	
62.2	M/F data 2 selection	(Follower only) Defines a target for the data received as word 2 from the master through the master/follower link. See also parameter 62.26 M/F data 2 value. For the selections, see parameter 62.1 M/F data 1 selection.	None / uint32
62.3	M/F data 3 selection	(Follower only) Defines a target for the data received as word 3 from the master through the master/follower link. See also parameter 62.27 M/F data 3 value. For the selections, see parameter 62.1 M/F data 1 selection.	None / uint32
62.4	Follower node 2 data 1 sel	Defines a target for the data received as word 1 from the first follower (ie. the follower with node address 2) through the master/follower link. See also parameter 62.28 Follower node 2 data 1 value.	Follower SW / uint32
	None	None.	0
	Follower SW	Status word of the follower. See also parameter 60.18 Follower enable.	26
	Other [value]	See Terms and abbreviations (page 221).	
62.5	Follower node 2 data 2 sel	Defines a target for the data received as word 2 from the first follower (ie. the follower with node address 2) through the master/follower link. See also parameter 62.29 Follower node 2 data 2 value. For the selections, see parameter 62.4 Follower node 2 data 1 sel.	None / uint32



No.	Name / Range / Selection	Description	Def / Type FbEq 16b / 32b
62.6	Follower node 2 data 3 sel	Defines a target for the data received as word 3 from the first follower (ie. the follower with node address 2) through the master/follower link. See also parameter 62.30 Follower node 2 data 3 value. For the selections, see parameter 62.4 Follower node 2 data 1 sel.	None / uint32
62.7	Follower node 3 data 1 sel	Defines a target for the data received as word 1 from the second follower (ie. the follower with node address 3) through the master/follower link. See also parameter 62.31 Follower node 3 data 1 value. For the selections, see parameter 62.4 Follower node 2 data 1 sel.	Follower SW / uint32
62.8	Follower node 3 data 2 sel	Defines a target for the data received as word 2 from the second follower (ie. the follower with node address 3) through the master/follower link. See also parameter 62.32 Follower node 3 data 2 value. For the selections, see parameter 62.4 Follower node 2 data 1 sel.	None / uint32
62.9	Follower node 3 data 3 sel	Defines a target for the data received as word 3 from the second follower (ie. the follower with node address 3) through the master/follower link. See also parameter 62.33 Follower node 3 data 3 value. For the selections, see parameter 62.4 Follower node 2 data 1 sel.	None / uint32
62.10	Follower node 4 data 1 sel	Defines a target for the data received as word 1 from the third follower (ie. the follower with node address 4) through the master/follower link. See also parameter 62.34 Follower node 4 data 1 value. For the selections, see parameter 62.4 Follower node 2 data 1 sel.	Follower SW / uint32
62.11	Follower node 4 data 2 sel	Defines a target for the data received as word 2 from the third follower (ie. the follower with node address 4) through the master/follower link. See also parameter 62.35 Follower node 4 data 2 value. For the selections, see parameter 62.4 Follower node 2 data 1 sel.	None / uint32
62.12	Follower node 4 data 3 sel	Defines a target for the data received as word 3 from the third follower (ie. the follower with node address 4) through the master/follower link. See also parameter 62.36 Follower node 4 data 3 value. For the selections, see parameter 62.4 Follower node 2 data 1 sel.	None / uint32
62.25	M/F data 1 value	(Follower only) Displays, in integer format, the data received from the master as word 1. Parameter 62.1 M/F data 1 selection can be used to select a target for the received data. This parameter can also be used as a signal source by other parameters.	- / uint16
0...65535	Data received as word 1 in master/follower communication.	- / -	

## 562 Parameters

No.	Name / Range / Selection	Description	Def / Type FbEq 16b / 32b
62.26	M/F data 2 value	(Follower only) Displays, in integer format, the data received from the master as word 2. Parameter 62.2 M/F data 2 selection can be used to select a target for the received data. This parameter can also be used as a signal source by other parameters.	- / uint16
	0...65535	Data received as word 2 in master/follower communication.	- / -
62.27	M/F data 3 value	(Follower only) Displays, in integer format, the data received from the master as word 3. Parameter 62.3 M/F data 3 selection can be used to select a target for the received data. This parameter can also be used as a signal source by other parameters.	- / uint16
	0...65535	Data received as word 3 in master/follower communication.	- / -
62.28	Follower node 2 data 1 value	Displays, in integer format, the data received from the first follower (ie. follower with node address 2) as word 1. Parameter 62.4 Follower node 2 data 1 sel can be used to select a target for the received data. This parameter can also be used as a signal source by other parameters.	- / uint16
	0...65535	Data received as word 1 from follower with node address 2.	- / -
62.29	Follower node 2 data 2 value	Displays, in integer format, the data received from the first follower (ie. follower with node address 2) as word 2. Parameter 62.5 Follower node 2 data 2 sel can be used to select a target for the received data. This parameter can also be used as a signal source by other parameters.	- / uint16
	0...65535	Data received as word 2 from follower with node address 2.	- / -
62.30	Follower node 2 data 3 value	Displays, in integer format, the data received from the first follower (ie. follower with node address 2) as word 3. Parameter 62.6 Follower node 2 data 3 sel can be used to select a target for the received data. This parameter can also be used as a signal source by other parameters.	- / uint16
	0...65535	Data received as word 3 from follower with node address 2.	- / -
62.31	Follower node 3 data 1 value	Displays, in integer format, the data received from the second follower (ie. follower with node address 3) as word 1. Parameter 62.7 Follower node 3 data 1 sel can be used to select a target for the received data. This parameter can also be used as a signal source by other parameters.	- / uint16

No.	Name / Range / Selection	Description	Def / Type FbEq 16b / 32b
	0...65535	Data received as word 1 from follower with node address 3.	- / -
62.32	Follower node 3 data 2 value	Displays, in integer format, the data received from the second follower (ie. follower with node address 3) as word 2. Parameter 62.8 Follower node 3 data 2 sel can be used to select a target for the received data. This parameter can also be used as a signal source by other parameters.	- / uint16
	0...65535	Data received as word 2 from follower with node address 3.	- / -
62.33	Follower node 3 data 3 value	Displays, in integer format, the data received from the second follower (ie. follower with node address 3) as word 3. Parameter 62.9 Follower node 3 data 3 sel can be used to select a target for the received data. This parameter can also be used as a signal source by other parameters.	- / uint16
	0...65535	Data received as word 3 from follower with node address 3.	- / -
62.34	Follower node 4 data 1 value	Displays, in integer format, the data received from the third follower (ie. follower with node address 4) as word 1. Parameter 62.10 Follower node 4 data 1 sel can be used to select a target for the received data. This parameter can also be used as a signal source by other parameters.	- / uint16
	0...65535	Data received as word 1 from follower with node address 4.	- / -
62.35	Follower node 4 data 2 value	Displays, in integer format, the data received from the third follower (ie. follower with node address 4) as word 2. Parameter 62.11 Follower node 4 data 2 sel can be used to select a target for the received data. This parameter can also be used as a signal source by other parameters.	- / uint16
	0...65535	Data received as word 2 from follower with node address 4.	- / -
62.36	Follower node 4 data 3 value	Displays, in integer format, the data received from the third follower (ie. follower with node address 4) as word 3. Parameter 62.12 Follower node 4 data 3 sel can be used to select a target for the received data. This parameter can also be used as a signal source by other parameters.	- / uint16
	0...65535	Data received as word 3 from follower with node address 4.	- / -

## 564 Parameters

No.	Name / Range / Selection	Description	Def / Type FbEq 16b / 32b
62.37	M/F communication status 1	In the master, displays the status of the communication with followers specified by parameter 60.19 M/F comm supervision sel 1. In a follower, bit 0 indicates the status of the communication with the master.	- / uint16
	b0 Follower 1 / Foll	1 (in the master) = Communication with follower 1 OK. 1 (in a follower) = Communication with master OK.	
	b1 Follower 2	1 = Communication with follower 2 OK.	
	b2 Follower 3	1 = Communication with follower 3 OK.	
	b3 Follower 4	1 = Communication with follower 4 OK.	
	b4 Follower 5	1 = Communication with follower 5 OK.	
	b5 Follower 6	1 = Communication with follower 6 OK.	
	b6 Follower 7	1 = Communication with follower 7 OK.	
	b7 Follower 8	1 = Communication with follower 8 OK.	
	b8 Follower 9	1 = Communication with follower 9 OK.	
	b9 Follower 10	1 = Communication with follower 10 OK.	
	b10 Follower 11	1 = Communication with follower 11 OK.	
	b11 Follower 12	1 = Communication with follower 12 OK.	
	b12 Follower 13	1 = Communication with follower 13 OK.	
	b13 Follower 14	1 = Communication with follower 14 OK.	
	b14 Follower 15	1 = Communication with follower 15 OK.	
	b15 Follower 16	1 = Communication with follower 16 OK.	
	0000h...FFFFh		1 = 1
62.38	M/F communication status 2	In the master, displays the status of the communication with followers specified by parameter 60.20 M/F comm supervision sel 2.	- / uint16
	b0 Follower 17	1 = Communication with follower 17 OK.	
	b1 Follower 18	1 = Communication with follower 18 OK.	
	b2 Follower 19	1 = Communication with follower 19 OK.	
	b3 Follower 20	1 = Communication with follower 20 OK.	
	b4 Follower 21	1 = Communication with follower 21 OK.	
	b5 Follower 22	1 = Communication with follower 22 OK.	
	b6 Follower 23	1 = Communication with follower 23 OK.	
	b7 Follower 24	1 = Communication with follower 24 OK.	
	b8 Follower 25	1 = Communication with follower 25 OK.	
	b9 Follower 26	1 = Communication with follower 26 OK.	
	b10 Follower 27	1 = Communication with follower 27 OK.	
	b11 Follower 28	1 = Communication with follower 28 OK.	
	b12 Follower 29	1 = Communication with follower 29 OK.	

No.	Name / Range / Selection	Description	Def / Type FbEq 16b / 32b
	b13 Follower 30	1 = Communication with follower 30 OK.	
	b14 Follower 31	1 = Communication with follower 31 OK.	
	b15 Follower 32	1 = Communication with follower 32 OK.	
	0000h...FFFFh		1 = 1
62.41	M/F follower ready status 1	In the master, displays the ready status of the communication with followers specified by parameter 60.23 M/F status supervision sel 1.	- / uint16
	b0 Follower 1	1 = Follower 1 ready.	
	b1 Follower 2	1 = Follower 2 ready.	
	b2 Follower 3	1 = Follower 3 ready.	
	b3 Follower 4	1 = Follower 4 ready.	
	b4 Follower 5	1 = Follower 5 ready.	
	b5 Follower 6	1 = Follower 6 ready.	
	b6 Follower 7	1 = Follower 7 ready.	
	b7 Follower 8	1 = Follower 8 ready.	
	b8 Follower 9	1 = Follower 9 ready.	
	b9 Follower 10	1 = Follower 10 ready.	
	b10 Follower 11	1 = Follower 11 ready.	
	b11 Follower 12	1 = Follower 12 ready.	
	b12 Follower 13	1 = Follower 13 ready.	
	b13 Follower 14	1 = Follower 14 ready.	
	b14 Follower 15	1 = Follower 15 ready.	
	b15 Follower 16	1 = Follower 16 ready.	
	0000h...FFFFh		1 = 1
62.42	M/F follower ready status 2	In the master, displays the ready status of the communication with followers specified by parameter 60.24 M/F status supervision sel 2.	- / uint16
	b0 Follower 17	1 = Follower 17 ready.	
	b1 Follower 18	1 = Follower 18 ready.	
	b2 Follower 19	1 = Follower 19 ready.	
	b3 Follower 20	1 = Follower 20 ready.	
	b4 Follower 21	1 = Follower 21 ready.	
	b5 Follower 22	1 = Follower 22 ready.	
	b6 Follower 23	1 = Follower 23 ready.	
	b7 Follower 24	1 = Follower 24 ready.	
	b8 Follower 25	1 = Follower 25 ready.	
	b9 Follower 26	1 = Follower 26 ready.	
	b10 Follower 27	1 = Follower 27 ready.	

## 566 Parameters

No.	Name / Range / Selection	Description	Def / Type FbEq 16b / 32b
	b11 Follower 28	1 = Follower 28 ready.	
	b12 Follower 29	1 = Follower 29 ready.	
	b13 Follower 30	1 = Follower 30 ready.	
	b14 Follower 31	1 = Follower 31 ready.	
	b15 Follower 32	1 = Follower 32 ready.	
	0000h...FFFFh		1 = 1
62.45	Data set 1 data 1 selection	Parameters 62.45...62.50 define a target for the data received in data sets 1 and 3 from the external controller. These data sets are used in ModuleBus communication with a "standard drive" (60.50 DDCS controller drive type = ABB standard drive). Parameters 62.95...62.100 display the data received from the external controller in integer format, and can be used as sources by other parameters. For example, this parameter selects a target for word 1 of data set 1. Parameter 62.95 Data set 1 data 1 value displays the received data in integer format, and can also be used as a source by other parameters.	None / uint32
	None	None.	0
	CW 16bit	Control Word (16 bits)	1
	Ref1 16bit	Reference REF1 (16 bits)	2
	Ref2 16bit	Reference REF2 (16 bits)	3
	Other [value]	See Terms and abbreviations (page 221).	
62.46	Data set 1 data 2 selection	Defines a target for the data received as word 2 of data set 1. See also parameter 62.96 Data set 1 data 2 value. For the selections, see parameter 62.45 Data set 1 data 1 selection.	None / uint32
62.47	Data set 1 data 3 selection	See parameter 62.45 Data set 1 data 1 selection.	None / uint32
...	...	...	...
62.50	Data set 3 data 3 selection	See parameter 62.45 Data set 1 data 1 selection.	None / uint32
62.51	Data set 10 data 1 selection	Parameters 62.51...62.74 define a target for the data received in data sets 10, 12, 14, 16, 18, 20, 22 and 24 from the external controller. Parameters 62.101...62.124 display the data received from the external controller in integer format, and can be used as sources by other parameters. For example, this parameter selects a target for word 1 of data set 10. Parameter 62.101 Data set 10 data 1 value displays the received data in integer format, and can also be used as a source by other parameters.	None / uint32
	None	None.	0
	CW 16bit	Control Word (16 bits)	1
	Ref1 16bit	Reference REF1 (16 bits)	2

No.	Name / Range / Selection	Description	Def / Type FbEq 16b / 32b
	Ref2 16bit	Reference REF2 (16 bits)	3
	Other [value]	See <a href="#">Terms and abbreviations (page 221)</a> .	
62.52	Data set 10 data 2 selection	Defines a target for the data received as word 2 of data set 10. See also parameter <a href="#">62.102 Data set 10 data 2 value</a> . For the selections, see parameter <a href="#">62.51 Data set 10 data 1 selection</a> .	None / uint32
62.53	Data set 10 data 3 selection	Defines a target for the data received as word 3 of data set 10. See also parameter <a href="#">62.103 Data set 10 data 3 value</a> . For the selections, see parameter <a href="#">62.51 Data set 10 data 1 selection</a> .	None / uint32
62.54	Data set 12 data 1 selection	See parameter <a href="#">62.51 Data set 10 data 1 selection</a> .	None / uint32
...	...	...	...
62.74	Data set 24 data 3 selection	See parameter <a href="#">62.51 Data set 10 data 1 selection</a> .	None / uint32
62.95	Data set 1 data 1 value	Displays (in integer format) the data received from the external controller as word 1 of data set 1. A target for this data can be selected by parameter <a href="#">62.45 Data set 1 data 1 selection</a> . The value can also be used as a source by another parameter.	0 / uint16
	0..65535	Data received as word 1 of data set 1.	- / -
62.96	Data set 1 data 2 value	Displays (in integer format) the data received from the external controller as word 2 of data set 1. A target for this data can be selected by parameter <a href="#">62.46 Data set 1 data 2 selection</a> . The value can also be used as a source by another parameter.	0 / uint16
	0..65535	Data received as word 2 of data set 1.	- / -
62.97	Data set 1 data 3 value	Displays (in integer format) the data received from the external controller as word 3 of data set 1. A target for this data can be selected by parameter <a href="#">62.47 Data set 1 data 3 selection</a> . The value can also be used as a source by another parameter.	0 / uint16
	0..65535	Data received as word 3 of data set 1.	- / -
...	...	...	...
62.100	Data set 3 data 3 value	Displays (in integer format) the data received from the external controller as word 3 of data set 3. A target for this data can be selected by parameter <a href="#">62.50 Data set 3 data 3 selection</a> . The value can also be used as a source by another parameter.	0 / uint16
	0..65535	Data received as word 3 of data set 3.	- / -
62.101	Data set 10 data 1 value	Displays (in integer format) the data received from the external controller as word 1 of data set 10. A target for this data can be selected by parameter <a href="#">62.51 Data set 10 data 1 selection</a> . The value can also be used as a source by another parameter.	- / uint16

## 568 Parameters

No.	Name / Range / Selection	Description	Def / Type FbEq 16b / 32b
	0...65535	Data received as word 1 of data set 10.	- / -
62.102	Data set 10 data 2 value	Displays (in integer format) the data received from the external controller as word 2 of data set 10. A target for this data can be selected by parameter 62.52 Data set 10 data 2 selection. The value can also be used as a source by another parameter.	- / uint16
	0...65535	Data received as word 2 of data set 10.	- / -
62.103	Data set 10 data 3 value	Displays (in integer format) the data received from the external controller as word 3 of data set 10. A target for this data can be selected by parameter 62.53 Data set 10 data 3 selection. The value can also be used as a source by another parameter.	- / uint16
	0...65535	Data received as word 3 of data set 10.	- / -
62.104	Data set 12 data 1 value	Displays (in integer format) the data received from the external controller as word 1 of data set 12. A target for this data can be selected by parameter 62.54 Data set 12 data 1 selection. The value can also be used as a source by another parameter.	- / uint16
	0...65535	Data received as word 1 of data set 12.	- / -
...	...	...	...
62.124	Data set 24 data 3 value	Displays (in integer format) the data received from the external controller as word 3 of data set 24. A target for this data can be selected by parameter 62.74 Data set 24 data 3 selection. The value can also be used as a source by another parameter.	- / uint16
	0...65535	Data received as word 3 of data set 24.	- / -



No.	Name / Range / Selection	Description	Def / Type FbEq 16b / 32b
74	<b>Speed matching</b>	Settings for Speed matching. See also section <a href="#">Speed matching (page 103)</a> .	
74.1	Motor speed match	Enables the Speed matching function.	Enable / int32
	Disable	Speed matching disabled.	0
	Enable	Speed matching enabled.	1
	DI1	Digital input DI1 (10.2 DI delayed status, bit 0).	2
	DI2	Digital input DI2 (10.2 DI delayed status, bit 1).	3
	DI3	Digital input DI3 (10.2 DI delayed status, bit 2).	4
	DI4	Digital input DI4 (10.2 DI delayed status, bit 3).	5
	DI5	Digital input DI5 (10.2 DI delayed status, bit 4).	6
	DI6	Digital input DI6 (10.2 DI delayed status, bit 5).	7
	DIO1	Digital input/output DIO1 (11.2 DIO delayed status, bit 0).	8
	DIO2	Digital input/output DIO2 (11.2 DIO delayed status, bit 1).	9
	Other [bit]	See <a href="#">Terms and abbreviations (page 221)</a> .	
74.2	Motor speed steady deviation level	Defines the absolute motor speed deviation level for the steady state.  <b>Note:</b> ABB recommend you to define this value as minimum settings that is double the nominal slip speed of the motor.	30.00 rpm / real32
	0.00 ... 30000.00 rpm	Speed deviation level for the steady state.	1 = 1 rpm / 1 = 1 rpm
74.3	Motor speed ramp deviation level	Defines the absolute motor speed deviation level for the ramping state (acceleration/deceleration).	70.00 rpm / real32
	0.00 ... 30000.00 rpm	Speed deviation level for the ramping state.	1 = 1 rpm / 1 = 1 rpm
74.4	Speed match fault delay	Defines the time delay for generating fault D105 Speed match and warning D200 Brake slip at standstill.	1000 ms / real32
	0...30000 ms	Time delay.	1 = 1 ms / 1 = 1 ms
74.5	Speed change rate limit	to do: new, check if it is applicable	50 rpm / real32
	0...500 rpm	to do	1 = 1 rpm / 1 = 1 rpm

## 570 Parameters

No.	Name / Range / Selection	Description	Def / Type FbEq 16b / 32b
<b>75</b>	<b>Hoist speed optimization</b>	Settings for Hoist speed optimization. See also section <a href="#">Hoist speed optimization (page 115)</a> .	
75.1	Hoist speed optimization sel	Enables the Hoist speed optimization function.	Disable / int32
	Disable	Hoist speed optimization is disabled.	0
	Enable	Hoist speed optimization is enabled.	1
	DI1	Digital input DI1 (10.2 DI delayed status, bit 0).	2
	DI2	Digital input DI2 (10.2 DI delayed status, bit 1).	3
	DI3	Digital input DI3 (10.2 DI delayed status, bit 2).	4
	DI4	Digital input DI4 (10.2 DI delayed status, bit 3).	5
	DI5	Digital input DI5 (10.2 DI delayed status, bit 4).	6
	DI6	Digital input DI6 (10.2 DI delayed status, bit 5).	7
	DIO1	Digital input/output DIO1 (11.2 DIO delayed status, bit 0).	8
	DIO2	Digital input/output DIO2 (11.2 DIO delayed status, bit 1).	9
	Other [bit]	See Terms and abbreviations (page 221).	
75.2	High speed	Enables to use speed above the limit defined in parameter 75.3 Motor base speed, when Hoist speed optimization function is enabled.  <b>Note:</b> This parameter is not effective when Hoist speed optimization function is disabled. See parameter 75.1 Hoist speed optimization sel.	Disable / int32
	Disable	Hoist speed optimization is disabled.	0
	Enable	Hoist speed optimization is enabled.	1
	DI1	Digital input DI1 (10.2 DI delayed status, bit 0).	2
	DI2	Digital input DI2 (10.2 DI delayed status, bit 1).	3
	DI3	Digital input DI3 (10.2 DI delayed status, bit 2).	4
	DI4	Digital input DI4 (10.2 DI delayed status, bit 3).	5
	DI5	Digital input DI5 (10.2 DI delayed status, bit 4).	6
	DI6	Digital input DI6 (10.2 DI delayed status, bit 5).	7
	DIO1	Digital input/output DIO1 (11.2 DIO delayed status, bit 0).	8
	DIO2	Digital input/output DIO2 (11.2 DIO delayed status, bit 1).	9
	Other [bit]	See Terms and abbreviations (page 221).	

No.	Name / Range / Selection	Description	Def / Type FbEq 16b / 32b
75.3	Motor base speed	<p>Defines the motor base speed.</p> <p>When the actual motor speed exceeds this value either in the forward or reverse direction, the Hoist speed optimization function uses this value to check for the actual motor torque after the period of time defined in parameter 75.6 Hold ramp.</p> <p>This motor torque is further used with parameters 75.7...75.25 to calculate the speed limit in the forward and reverse directions.</p> <p>If you do not set parameters 75.7...75.25 in the correct order, the speed is always limited to this base speed.</p>	1500.0 rpm / real32
	0.0 ... 30000.0 rpm	Motor base speed.	1 = 1 rpm / 1 = 1 rpm
75.4	Load margin	<p>Defines a torque margin for the set load values. The Hoist speed optimization function applies this margin to the detected base speed torque. The margin can be used for reserving tolerance for motor actual current because of voltage drops.</p>	0.0% / real32
	0.0 ... 100.0%	Torque margin as percentage of the monitored current.	1 = 1% / 1 = 1%
75.5	Load speed limit test	<p>Defines a test value (torque) for calculating the load speed limit when the drive is not running.</p>	0.00% / real32
	-30000.00 ... 30000.00%	Test value (torque).	1 = 1% / 1 = 1%
75.6	Hold ramp	<p>Defines the time period for holding speed reference at the motor base speed before the function checks for actual motor torque.</p> <p>This motor torque is considered by the Hoist speed optimization function as the base speed torque for the particular load used.</p>	200 ms / real32
	0...10000 ms	Hold ramp time.	1 = 1 ms / 1 = 1 ms
75.7	Load 0 up	<p>Defines the torque value (X1) in the forward direction for the load speed graph.</p> <p>If the Hoist speed optimization function detects this value as the base speed torque in the forward direction, the load speed limit calculated is the speed defined in parameter 75.7 Load 0 up.</p>	0.0% / real32
<b>Note:</b>			
<ul style="list-style-type: none"> <li>You must define two load and speed parameters at the minimum.</li> <li>If you set a load parameter to zero, all the parameters above this parameter must be set to zero.</li> <li>The load parameters must be in increasing order and the speed parameters in decreasing order.</li> </ul> <p>If any of the above conditions is not met, the speed is limited to the motor base speed.</p>			
	0.0 ... 300.0%	Torque value (X1) in the forward direction.	1 = 1% / 1 = 1%

## 572 Parameters

No.	Name / Range / Selection	Description	Def / Type FbEq 16b / 32b
75.8	Load 0 speed up	Defines the speed limit value (Y1) in the forward direction based on 75.7 Load 0 up (X1). This value can be the maximum allowed speed with an empty hook in the forward direction. See the notes in 75.7 Load 0 up.	0.0 rpm / real32
	0.0 ... 30000.0 rpm	Speed limit value (Y1) in the forward direction.	1 = 1 rpm / 1 = 1 rpm
75.9	Load 1 up	Defines the torque value at load1 (X2) in the forward direction for the load speed graph. See the notes in 75.7 Load 0 up.	0.0% / real32
	0.0 ... 300.0%	Torque value (X2) in the forward direction.	1 = 1% / 1 = 1%
75.10	Load 1 speed up	Defines the speed limit value (Y2) in the forward direction based on 75.9 Load 1 up.	0.0 rpm / real32
	0.0 ... 30000.0 rpm	Speed limit value (Y2) in the forward direction.	1 = 1 rpm / 1 = 1 rpm
75.11	Load 2 up	Defines the torque value at load2 (X3) in the forward direction for the load speed graph. See the notes in 75.7 Load 0 up.	0.0% / real32
	0.0 ... 300.0%	Torque value (X3) in the forward direction.	1 = 1% / 1 = 1%
75.12	Load 2 speed up	Defines the speed limit value (Y3) in the forward direction based on 75.11 Load 2 up.	0.0 rpm / real32
	0.0 ... 30000.0 rpm	Speed limit value (Y3) in the forward direction.	1 = 1 rpm / 1 = 1 rpm
75.13	Load 3 up	Defines the torque value at load3 (X4) in the forward direction for the load speed graph. See the notes in 75.7 Load 0 up.	0.0% / real32
	0.0 ... 300.0%	Torque value (X4) in the forward direction.	1 = 1% / 1 = 1%
75.14	Load 3 speed up	Defines the speed limit value (Y4) in the forward direction based on 75.13 Load 3 up.	0.0 rpm / real32
	0.0 ... 30000.0 rpm	Speed limit value (Y4) in the forward direction.	1 = 1 rpm / 1 = 1 rpm
75.15	Load 4 up	Defines the torque value at load4 (X5) in the forward direction for the load speed graph. This torque can be the torque at the base speed with maximum load when the motor is running in the forward direction.	0.0% / real32
	0.0 ... 300.0%	Torque value (X5) in the forward direction.	1 = 1% / 1 = 1%
75.16	Load 4 speed up	Defines the speed limit value (Y5) in the forward direction based on 75.15 Load 4 up. See the notes in 75.7 Load 0 up.	0.0 rpm / real32
	0.0 ... 30000.0 rpm	Speed limit value (Y5) in the forward direction.	1 = 1 rpm / 1 = 1 rpm
75.17	Load 0 down	Defines the torque value X1 in the reverse direction for the hoist speed optimization graph. If the Hoist speed optimization function detects this value as the base speed torque in the reverse direction, the load speed limit calculated is the speed defined in parameter 75.17 Load 0 down. See the notes in 75.7 Load 0 up.	0.0% / real32
	0.0 ... 300.0%	Torque value (X1) in the reverse direction.	1 = 1% / 1 = 1%

No.	Name / Range / Selection	Description	Def / Type FbEq 16b / 32b
75.18	Load 0 speed down	Defines the speed limit value (Y1) in the reverse direction based on 75.17 Load 0 down. This value can be the maximum allowed speed with an empty hook in the reverse direction.	0.0 rpm / real32
	0.0 ... 30000.0 rpm	Speed limit value (Y1) in the reverse direction.	1 = 1 rpm / 1 = 1 rpm
75.19	Load 1 down	Defines the torque value at load1 (X2) in the reverse direction for the load speed graph. See the notes in 75.7 Load 0 up.	0.0% / real32
	0.0 ... 300.0%	Torque value (X2) in the reverse direction.	1 = 1% / 1 = 1%
75.20	Load 1 speed down	Defines the speed limit value (Y2) in the reverse direction based on 75.19 Load 1 down.	0.0 rpm / real32
	0.0 ... 30000.0 rpm	Speed limit value (Y2) in the reverse direction.	1 = 1 rpm / 1 = 1 rpm
75.21	Load 2 down	Defines the torque value at load2 (X3) in the reverse direction for the load speed graph. See the notes in 75.7 Load 0 up.	0.0% / real32
	0.0 ... 300.0%	Torque value (X3) in the reverse direction.	1 = 1% / 1 = 1%
75.22	Load 2 speed down	Defines the speed limit value (Y3) in the reverse direction based on 75.21 Load 2 down.	0.0 rpm / real32
	0.0 ... 30000.0 rpm	Speed limit value (Y3) in the reverse direction.	1 = 1 rpm / 1 = 1 rpm
75.23	Load 3 down	Defines the torque value at load3 (X4) in the reverse direction for the load speed graph. See the notes in 75.7 Load 0 up.	0.0% / real32
	0.0 ... 300.0%	Torque value (X4) in the reverse direction.	1 = 1% / 1 = 1%
75.24	Load 3 speed down	Defines the speed limit value (Y4) in the reverse direction based on 75.23 Load 3 down.	0.0 rpm / real32
	0.0 ... 30000.0 rpm	Speed limit value (Y4) in the reverse direction.	1 = 1 rpm / 1 = 1 rpm
75.25	Load 4 down	Defines the torque value at load4 (X5) in the reverse direction for the load speed graph. This torque can be the torque at the base speed with the maximum load when the motor is running in the reverse direction. See the notes in 75.7 Load 0 up.	0.0% / real32
	0.0 ... 300.0%	Torque value (X5) in the reverse direction.	1 = 1% / 1 = 1%
75.26	Load 4 speed down	Defines the speed limit value (Y5) in the reverse direction based on 75.25 Load 4 down.	0.0 rpm / real32
	0.0 ... 30000.0 rpm	Speed limit value (Y5) in the reverse direction.	1 = 1 rpm / 1 = 1 rpm
75.27	Hoist efficiency up	Allows the user to define the mechanical efficiency of the system.	0.90 / real32
	0.00 ... 2.00	Efficiency	100 = 1 / 1 = 1
75.28	Hoist efficiency down	Allows the user to define the mechanical efficiency of the system.	0.90 / real32
	0.00 ... 2.00	Efficiency	100 = 1 / 1 = 1
75.29	Inertia up	Allows the user to define the motor maximum overload ability (estimated pull out torque at base speed).	1.500 kg m <sup>2</sup> / real32

## 574 Parameters

No.	Name / Range / Selection	Description	Def / Type FbEq 16b / 32b
	-100.000 ... 100.000 kg m <sup>2</sup>	Overload ability.	1000 = 1 kg m <sup>2</sup> / 1 = 1 kg m <sup>2</sup>
75.30	Inertia down	Allows the user to define the motor maximum overload ability (estimated pull out torque at base speed).	1.500 kg m <sup>2</sup> / real32
	-100.000 ... 100.000 kg m <sup>2</sup>	Overload ability.	1000 = 1 kg m <sup>2</sup> / 1 = 1 kg m <sup>2</sup>
75.31	Hoist nominal load	Defines the hoist load for hoist speed optimization.	1.0 t / real32
	0.0 ... 3200.0 t	Load in Tons.	10 = 1 t / 1 = 1 t
75.32	Hoist nominal speed	Defines the nominal speed of the hoist drive.	1.00 m/min / real32
	0.00 ... 1000.00 m/min	Speed	100 = 1 m/min / 1 = 1 m/min
75.33	Hoist maximum speed	Defines the maximum speed limit of the hoist drive. This value is used to plot equal divisions on the load curve.	1.00 m/min / real32
	0.00 ... 1000.00 m/min	Speed limit.	100 = 1 m/min / 1 = 1 m/min
75.35	Motor Tmax/Tn	Allows the user to define the motor pull-out torque (from motor catalogue or rating plate).	2.70 / real32
	0.00 ... 200.00	Torque value	100 = 1 / 1 = 1
75.36	Calculate load curve	Enables load curve calculation.	No / uint32
	No	Load curve calculation is disabled.	0
	Calculate	Load curve calculation is enabled.	1
75.38	Load filter time	Defines the time constant of the absolute hoist load and relative hoist load low pass filter.	1000 ms / real32
	0...30000 ms	Load filter time.	1 = 1 ms / 1 = 1 ms
75.39	Load reset speed level	(Visible only after entering access level pass code 584. See parameter 96.2 Pass code.) Defines the speed level depending on motor base speed (parameter 75.3 Motor base speed) to initiate Hold ramp function (parameter 75.6 Hold ramp), that monitors the actual motor torque at the motor base speed. Based on this value the Hoist speed optimization function defines the allowed maximum speed. When actual speed goes below the defined load reset speed level, a new motor torque value is calculated again when actual speed gets to the point of motor base speed. See also parameter 75.3 Motor base speed.	95.0% / real32
	0.0 ... 100.0%	Percent of motor base speed.	10 = 1% / 1 = 1%
75.40	Relative hoist load	Shows the calculated relative hoist load value from load curve calculation. At 100%, value is equal to hoist nominal load (par. 75.31). To get correct value, set parameters 75.31...75.36. This parameter is read only.	0.00% / real32
	0.00 ... 300.00%	Relative hoist load	100 = 1% / 1 = 1%

No.	Name / Range / Selection	Description	Def / Type FbEq 16b / 32b
75.41	Absolute hoist load	Shows the calculated absolute hoist load value from load curve calculation. This signal can be used for fine tuning hoist speed optimization (by comparing actual value with reading on the external system, if exists). To get correct value of this signal, see settings in par. 75.40. This parameter is read only.	0.0 t / real32
	0.0 ... 3200.0 t	Absolute hoist load	10 = 1 t / 1 = 1 t
75.42	Relative hoist load filtered	Shows the filtered value of the parameter 75.40 Relative hoist load for the filter time constant defined with parameter 75.38 Load filter time. This parameter is read only.	0.00% / real32
	0.00 ... 300.00%	Percent of filtered relative hoist load.	100 = 1% / 1 = 1%
75.43	Absolute hoist load filtered	Shows the filtered value of the parameter 75.41 Absolute hoist load for the filter time constant defined with parameter 75.38 Load filter time. This parameter is read only.	0.0 t / real32
	0.0 ... 3200.0 t	Filtered absolute hoist load.	10 = 1 t / 1 = 1 t
75.45	Inertia calculation	Performs special ID run and automatically calculates the inertia of the hoist system. For more information, see section Efficiency and inertia calculation.  <b>Note:</b> <ul style="list-style-type: none"> <li>If you stop the drive during ID run, inertia calculation starts from the beginning during the next start.</li> <li>Direction of the motor will be always in positive direction irrespective of the start command direction.</li> </ul>	Done / uint32
	Done	Inertia calculation completed.	0
	At next start	Inertia calculation ready to begin at the next start.	1
75.46	Inertia calculation status	Inertia calculation status to do: new	- / uint16
	b0 Busy	Inertia calculation is in progress	
	b1 Done	Inertia calculation completed	
	b2 Error	Inertia calculation error detected	
	b3 Error during last run	Inertia calculation error during last run	
	b4 Low speed never reached	Low speed never reached	
	b5 High speed never reached	High speed never reached	
	b6 Too much oscillation	Too much oscillation on the acceleration signal on the acceleration signal	

## 576 Parameters

No.	Name / Range / Selection	Description	Def / Type FbEq 16b / 32b
b7	Too much oscillation on the speed signal	Too much oscillation on the speed signal	
b8	Start cmd released before the end	Start command released before the end	
b9	Motor speed scaling or acceleration time too small	Motor speed scaling or acceleration time too small	
b10...15	Reserved		
	0000h...FFFFh		1 = 1
75.47	Inertia calculation speed tolerance	<i>(This parameter is visible only when user lock is open with pass code 584)</i> Defines the tolerance limit for the actual speed against the reference value. If the actual speed is within +/- tolerance, the speed is accepted for inertia calculation.	2.0 rpm / real32
	0.0 ... 1000.0 rpm	Actual speed tolerance limit.	10 = 1 rpm / 1 = 1 rpm
75.48	Inertia calculation acc tolerance	<i>(This parameter is visible only when user lock is open with pass code 584)</i> Defines the tolerance limit for the actual speed against the reference value. If the actual speed is within +/- tolerance, the speed is accepted for inertia calculation.	10.0 rpm/s / real32
	0.0 ... 1000.0 rpm/s	Acceleration tolerance limit.	10 = 1 rpm/s / 1 = 1 rpm/s
75.56	Required hoist power up	Defines the relation between required motor power and existing motor power for lifting load if an oversized motor is used. Example: If Required power = 45 kW and Existing motor power = 55 kW, then parameter settings = $45/55 * 100 = 81.82\%$	100.00% / real32
	0.01 ... 200.00%	Percent of required hoist power up.	100 = 1% / 1 = 1%
75.57	Required hoist power down	Defines the relation between required motor power and existing motor power for lowering load if an oversized motor is used. See also parameter 75.56 Required hoist power up.	100.00% / real32
	0.01 ... 200.00%	Percent of required hoist power down.	100 = 1% / 1 = 1%
75.60	Slack rope	Enables the Slack rope function and selects how the drive should react when a slack rope condition is detected. See also <a href="#">Slack rope (page 108)</a> .	Disabled / uint32
	Disabled	Slack rope function is disabled.	0
	Warning	When a slack rope condition is detected, the warning D217 Slack rope is generated.	1
	Fast stop	When a slack rope condition is detected, the warning D20A Fast stop is generated and a Fast stop is triggered. The warning D217 Slack rope is also generated if it is not masked. See also <a href="#">Fast stop (page 103)</a> .	2



No.	Name / Range / Selection	Description	Def / Type FbEq 16b / 32b
75.61	Slack rope load level	Defines the slack rope load level. A slack rope condition is detected at the time of lowering the crane, if value in parameter 75.42 Relative hoist load filtered is less than this value during the delay time defined in parameter 75.62 Slack rope detection delay.	-400.00% / real32
	-400.00 ... 400.00%	Load level	100 = 1% / 1 = 1%
75.62	Slack rope detection delay	Defines the delay time for detecting a slack rope condition when parameter 75.42 Relative hoist load filtered is less than the slack rope load level defined in parameter 75.61 Slack rope load level at the time of lowering the crane.	1.0 s / real32
	0.0 ... 60.0 s	Slack rope detection delay time.	10 = 1 s / 1 = 1 s
75.70	Start lifetime monitor	(Visible only after entering access level pass code 584. See parameter 96.2 Pass code.) Activates the lifetime function.	Off / int32
	Off	Lifetime monitor function is Off.	0
	On	Lifetime monitor function is On.	1
75.71	Crane lifetime	(Visible only after entering access level pass code 584. See parameter 96.2 Pass code.) Defines the user defined lifetime for the mechanics of the crane.	0 hour / real32
	0...32768 hour	Lifetime hours	1 = 1 hour / 1 = 1 hour
75.72	Reset load spectrum	(Visible only after entering access level pass code 584. See parameter 96.2 Pass code.) Allows to reset the load spectrum to the value defined in parameter 75.73 Preset value of load spectrum. See also Configuring Lifetime monitor maintenance (page 49).	Done / uint32
	Done	Reset done.	0
	Reset	Reset activated.	1
75.73	Preset value of load spectrum	(Visible only after entering access level pass code 584. See parameter 96.2 Pass code.) Defines the preset value that is accounted when parameter 75.72 Reset load spectrum is set to Reset. See also Configuring Lifetime monitor maintenance (page 49).	1.00 / real32
	0.00 ... 10.00	Preset value	100 = 1 / 1 = 1
75.74	Lifetime speed scaling	(Visible only after entering access level pass code 584. See parameter 96.2 Pass code.) Defines the relation between required hoist speed to the motor nominal speed. For example: At 2 m/min, nominal hoist speed = 2000 rpm Base speed of the motor = 1380 rpm Speed scaling = 2000/1380 = 145%	100.00% / real32
	0.00 ... 200.00%	Percent of nominal motor speed to reach the hoist nominal speed.	100 = 1% / 1 = 1%

## 578 Parameters

No.	Name / Range / Selection	Description	Def / Type FbEq 16b / 32b
75.75	Lifetime factor	(Visible only after entering access level pass code 584. See parameter 96.2 Pass code.) Defines the scaling factor for the lifetime monitor function.	1.00 / real32
	0.00 ... 2.00	Scaling factor	100 = 1 / 1 = 1
75.80	Lifetime used	(Visible only after entering access level pass code 584. See parameter 96.2 Pass code.) Shows the used lifetime hours. This parameter is used as memory cell (at power failure).	0.000 hour / real32
	0.000 ... 10000.000 hour	Lifetime hours	1000 = 1 hour / 1 = 1 hour
75.81	Load at stop	Shows the load value when drive stops.	Off / int32
	Off	When drive stops load value resets to 0.	0
	On	When drive stops the last known value of the load remains visible.	1

No.	Name / Range / Selection	Description	Def / Type FbEq 16b / 32b
<b>76</b>	<b>Conical motor control</b>	Settings for Conical motor control. See also section <a href="#">Conical motor control (page 112)</a> .	
76.1	Conical motor control	Enables the Conical motor control function.  <b>Note:</b> Mechanical brake control must be enabled when the Conical motor control function is used. See parameter <a href="#">44.6 Brake control enable</a> .	Disable / uint16
	Disable	Conical motor control function is disabled.	0
	Enable	Conical motor control function is enabled.	1
76.2	Start flux level	Defines the start flux level, that is, the flux level for opening the brake. The drive uses this value as the flux reference when the Conical motor function is activated and the drive is started. See also parameter <a href="#">76.4 Start flux hold time</a> .	125% / real32
	0...150%	Start flux level in percentage of the motor nominal flux.	1 = 1% / 1 = 1%
76.3	Stop flux level	Defines the stop flux level, that is, the flux level for closing the brake. The drive uses this value as the flux reference when the stop command is given and the motor actual speed is below <a href="#">21.6 Zero speed limit</a> .	75% / real32
	0...100%	Stop flux level in percentage of the motor nominal flux.	1 = 1% / 1 = 1%
76.4	Start flux hold time	Defines the hold time for the start flux level as the flux reference. This hold time makes sure that the start flux level is active for the time required for the brake to open.	2000 ms / real32
	0...10000 ms	Start flux hold time.	1 = 1 ms / 1 = 1 ms
76.5	Flux ramp up time	Defines the time for the flux reference to ramp up from the normal flux level (100%) to the start flux level, and from the stop flux level to the normal level (100%).	2000 ms / real32
	0...10000 ms	Flux ramp-up time.	1 = 1 ms / 1 = 1 ms
76.6	Flux ramp down time	Defines the time for the flux reference to ramp down from the normal flux level (100%) to the stop flux level, and from the start flux level to the normal level (100%).	2000 ms / real32
	0...10000 ms	Flux ramp-down time.	1 = 1 ms / 1 = 1 ms

## 580 Parameters

No.	Name / Range / Selection	Description	Def / Type FbEq 16b / 32b
<b>77</b>	<b>Antisway</b>	Settings for Antisway control.	
77.1	Antisway enable	Enables the Antisway function.  <b>Note:</b> Mechanical brake control must be enabled when the Conical motor control function is used. See parameter 44.6 Brake control enable.	Disable / int32
	Disable	Antisway function is disabled.	0
	Enable	Antisway function is enabled.	1
	DI1	Digital input DI1 (10.2 DI delayed status, bit 0).	2
	DI2	Digital input DI2 (10.2 DI delayed status, bit 1).	3
	DI3	Digital input DI3 (10.2 DI delayed status, bit 2).	4
	DI4	Digital input DI4 (10.2 DI delayed status, bit 3).	5
	DI5	Digital input DI5 (10.2 DI delayed status, bit 4).	6
	DI6	Digital input DI6 (10.2 DI delayed status, bit 5).	7
	DIO1	Digital input/output DIO1 (11.2 DIO delayed status, bit 0).	8
	DIO2	Digital input/output DIO2 (11.2 DIO delayed status, bit 1).	9
	Other [bit]	See Terms and abbreviations (page 221).	
77.2	Enable auto on function	Enables some Antisway auto On/Off functions. See parameters 77.3, 77.4 and 77.5.  <b>Note:</b> <ul style="list-style-type: none"> <li>This parameter is effective only if the Antisway function is enabled (parameter 77.1).</li> <li>Sway tracking parameter (77.7) must be enabled whenever Antisway auto On/Off function is activated.</li> </ul>	Enable / int32
	Disable	Antisway control function is disabled.	0
	Enable	Antisway control function is enabled.	1
	DI1	Digital input DI1 (10.2 DI delayed status, bit 0).	2
	DI2	Digital input DI2 (10.2 DI delayed status, bit 1).	3
	DI3	Digital input DI3 (10.2 DI delayed status, bit 2).	4
	DI4	Digital input DI4 (10.2 DI delayed status, bit 3).	5
	DI5	Digital input DI5 (10.2 DI delayed status, bit 4).	6
	DI6	Digital input DI6 (10.2 DI delayed status, bit 5).	7
	DIO1	Digital input/output DIO1 (11.2 DIO delayed status, bit 0).	8
	DIO2	Digital input/output DIO2 (11.2 DIO delayed status, bit 1).	9
	Other [bit]	See Terms and abbreviations (page 221).	

No.	Name / Range / Selection	Description	Def / Type FbEq 16b / 32b
77.3	Auto on at maximum pendulum	<p>Defines the maximum limit for pendulum arm length. If the pendulum arm length (parameter 77.27 Pendulum arm length) is less than this value, Antisway function is automatically On.</p> <p><b>Note:</b> This parameter is effective only if both Antisway functions are enabled with parameter 77.1 Antisway enable and Auto On function (parameter 77.2 Enable auto on function).</p>	100.00 m / real32
	0.00 ... 100.00 m	Maximum pendulum arm length.	100 = 1 m / 1 = 1 m
77.4	Auto on at minimum pendulum	<p>Defines the minimum limit for pendulum arm length. If the pendulum arm length (parameter 77.27 Pendulum arm length) is more than this value, Antisway function is automatically On.</p> <p><b>Note:</b> This parameter is effective only if both Antisway functions are enabled with parameter 77.1 Antisway enable and Auto On function (parameter 77.2 Enable auto on function).</p>	0.00 m / real32
	0.00 ... 100.00 m	Maximum pendulum arm length.	100 = 1 m / 1 = 1 m
77.5	Antisway enable minimum speed	<p>Defines the minimum speed limit to enable Antisway function in trolley/long travel drives.</p> <ul style="list-style-type: none"> <li>If actual speed (parameter 90.1 Motor speed for control) is less than this value, Antisway function is deactivated.</li> <li>If actual speed (parameter 90.1 Motor speed for control) is more than this value, Antisway function is activated.</li> </ul> <p><b>Note:</b> This parameter is not effective at zero speed.</p>	0.00 rpm / real32
	0.00 ... 32000.00 rpm	Minimum speed.	1 = 1 rpm / 1 = 1 rpm
77.6	Antisway enable in slowdown	Enables Antisway function during drive slowdown.	Normal ramp / uint32
	Normal ramp	Normal ramp time without Antisway	0
	Antisway	Antisway is active during slowdown	1
77.7	Sway tracking enable	<p>Enables the Sway tracking function that allows the drive to compensate the sway caused by movements before switching on Antisway function.</p> <p><b>Note:</b> Sway tracking must be enabled when 77.2 Enable auto on function is activated.</p>	Enable / int32
	Disable	Sway function is disabled.	0
	Enable	Sway function is enabled.	1
	DI1	Digital input DI1 (10.2 DI delayed status, bit 0).	2
	DI2	Digital input DI2 (10.2 DI delayed status, bit 1).	3
	DI3	Digital input DI3 (10.2 DI delayed status, bit 2).	4

## 582 Parameters

No.	Name / Range / Selection	Description	Def / Type FbEq 16b / 32b
	DI4	Digital input DI4 (10.2 DI delayed status, bit 3).	5
	DI5	Digital input DI5 (10.2 DI delayed status, bit 4).	6
	DI6	Digital input DI6 (10.2 DI delayed status, bit 5).	7
	DIO1	Digital input/output DIO1 (11.2 DIO delayed status, bit 0).	8
	DIO2	Digital input/output DIO2 (11.2 DIO delayed status, bit 1).	9
	Other [bit]	See Terms and abbreviations (page 221).	
77.8	Antisway ramp time	Defines ramp time for Antisway function.	3.00 s / real32
		<p><b>Note:</b></p> <ul style="list-style-type: none"> <li>When Antisway function is disabled, ramp time is taken from parameters 23.201 Crane acc time 1...23.204 Crane dec time 2.</li> <li>ABB recommends you to set this value less than the normal ramp time.</li> </ul>	
	0.00 ... 1800.00 s	Antisway ramp time.	10 = 1 s / 1 = 1 s
77.9	Antisway gain	<p>Defines Antisway gain factor.</p> <p>The acceleration rate increases with gain when speed reference is changed in smaller steps.</p> <p>Example: If gain is 5, then acceleration rate (parameter 22.1 Speed ref unlimited) is applied with 20% difference between the speed reference and actual speed. In this case the program produces maximum acceleration at 20% speed reference change and the crane is more dynamic. If gain is 1, then acceleration is applied with 100% difference between the speed reference and actual speed. With smaller speed steps acceleration rate is limited proportionally to the difference between speed reference and actual speed.</p> <p><b>Note:</b> When changing the gain value it is recommended to start from 1 and check the behavior of the crane when increasing it.</p>	1.00 / real32
	0.00 ... 5.00	Gain factor.	100 = 1 / 1 = 1

No.	Name / Range / Selection	Description	Def / Type FbEq 16b / 32b
77.10	Short rope mode enable	<p>Enables the short rope mode (SR mode).</p> <ul style="list-style-type: none"> <li>The SR mode keeps the sway angle constant during acceleration rather than allowing several oscillations in the acceleration pattern.</li> <li>With this mode the time to execute the acceleration pattern is longer (up to 1.33 times) than in the normal mode. The difference may be 5.3 s against 4.9 s (+8%).</li> <li>In a open loop system, this mode improves the antisway performance by reducing the cumulative error in sway calculation.</li> </ul> <p>The difference between normal mode and SR mode is illustrated below.</p>	Disable / int32
	Disable	SR mode is disabled.	0
	Enable	SR mode is enabled.	1
	Other [bit]	See <a href="#">Terms and abbreviations (page 221)</a> .	
77.11	Antisway timeout	<p>Allows to define the time at which Antisway function can end all calculations.</p> <p>The timeout counter starts as soon as speed reference is 0. With this parameter the antisway drive can control oscillations and force the antisway output to zero after this timeout value.</p> <p><b>Note:</b> You must define a timeout longer than the time constant, so that antisway output is not forced to 0 before the sway is compensated. If this value is set to 0, the timeout feature is deactivated.</p>	0 s / real32
	0...32000 s	Timeout value	1 = 1 s / 1 = 1 s
77.15	Lock antisway in hoist	<p>Locks/unlocks Antisway function in hoist drives.</p> <p><b>Note:</b> This functionality is used when the hoist drive (master of the complete D2D-link) is placed as master trolley or master long travel. The trolley or long travel may have more than two followers.</p>	Lock / int32

## 584 Parameters

No.	Name / Range / Selection	Description	Def / Type FbEq 16b / 32b
	Unlock	Antisway function is unlocked and can be used in hoist drives. For example, when the system does not have hoist drive, but this motion is used as trolley or long travel motion.	0
	Lock	Antisway function is disabled in hoist drives.	1
77.16	Antisway ref speed diff	Defines the difference of Antisway reference speed. To do: new	10.00 rpm / real32
	0.00 ... 32000.00 rpm	Antisway reference speed difference	1 = 1 rpm / 1 = 1 rpm
77.20	Pendulum length source 1	Selects the hoist position signal source 1 for pendulum calculation. In the hoist drive, this parameter defines the source signal transmitted to the antisway drive when the D2D-link is used. In the antisway drive, this parameter selects the hoist position signal source for pendulum calculation (par. 77.20 = par. 90.5).	D2D / uint32
	NULL	None.	0
	D2D	Value comes through the D2D link from the main hoist.	1
	AI1	12.12 AI1 scaled value	2
	AI2	12.22 AI2 scaled value	3
	Load pos	Value comes from parameter 90.5 Load position scaled. Encoder settings and scaling are done in group 90 Feedback selection (page 611).	4
	Hoist length from 77.91	Value comes from parameter 77.91 Hoist pos fba int. Hoist position signal is in INT16 format from fieldbus.	5
	Other [bit]	See Terms and abbreviations (page 221).	
77.21	Active length from source	Shows the active length from the selected source (parameter 77.20). Scaling of pendulum arm length is done with parameters 77.22...77.25. This parameter is read-only.	0.00 / real32
	0.00 ... 2147483.00	Active length from source	1 = 1 / 1 = 1
77.22	Up position swing time	Defines the time constant of one full swaying cycle when hook is at UP position. For accurate results, we recommend to take five full swaying cycle time and divide the total by 5. The calculated result is stored in this parameter. For more details, see section Hook in UP position.	4.00 s / real32
	1.00 ... 20.00 s	Sway cycle time in UP position.	100 = 1 s / 1 = 1 s
77.23	Up position length value	Defines the measurement point when hook is at UP position during the swaying test. The scaled value is shown in parameter 77.21 Active length from source.	20000.00 / real32
	-32768.00 ... 32768.00	Scaled pendulum arm length.	1 = 1 / 1 = 1



No.	Name / Range / Selection	Description	Def / Type FbEq 16b / 32b
77.24	Down position swing time	Defines the time constant of one full swaying cycle when hook is at DOWN position. For accurate results, we recommend to take five full swaying cycle time and divide the total by 5. The calculated result is stored in this parameter. For more details, see section Hook in DOWN position.	4.00 s / real32
	1.00 ... 20.00 s	Sway cycle time in DOWN position.	100 = 1 s / 1 = 1 s
77.25	Down position length value	Defines the measurement point when the hook is at DOWN position during the swaying test. The scaled value is shown in parameter 77.21 Active length from source.	20000.00 / real32
	-32768.00 ... 32768.00	Scaled pendulum arm length.	1 = 1 / 1 = 1
77.26	Maximum pendulum length	Defines the maximum pendulum arm length. It limits the maximum pendulum arm length in the selected source.	100.00 m / real32
	1.00 ... 100.00 m	Pendulum arm length.	100 = 1 m / 1 = 1 m
77.27	Pendulum arm length	Shows the actual pendulum arm length. This parameter is read-only.	0.00 m / real32
	0.00 ... 2147483.00 m	Actual pendulum arm length.	1 = 1 m / 1 = 1 m
77.28	Pendulum length source 2	Selects the hoist position signal source 2 for pendulum calculation.	Not selected / uint32
	Not selected	0.	0
	Hoist follower 1	Hoist follower 1 activated.	1
	Hoist follower 2	Hoist follower 2 activated.	2
	Hoist follower 3	Hoist follower 3 activated.	3
	Hoist follower 4	Hoist follower 4 activated.	4
77.29	Pendulum length source sel	Selects the hoist position signal source 1 or 2 for pendulum calculation.	Source 1 / int32
	Source 1	Hoist position signal source 1 activated. See parameter 77.20 Pendulum length source 1.	0
	Source 2	Hoist position signal source 2 activated. See parameter 77.28 Pendulum length source 2.	1
	Other [bit]	See Terms and abbreviations (page 221).	
77.30	Load signal source	Selects the load signal source for pendulum arm offset calculation.	AI1 / uint32
	NULL	0.	0
	D2D	Value comes through the D2D link from the main hoist.	1
	AI1	12.12 AI1 scaled value	2
	AI2	12.22 AI2 scaled value	3
	Hoist load from 77.92	Value comes from parameter 77.92 Hoist load fba int. Hoist load signal is in INT16 format from fieldbus.	4

## 586 Parameters

No.	Name / Range / Selection	Description	Def / Type FbEq 16b / 32b
77.31	Active load	Shows the active load signal. This parameter is read-only.	0.00% / real32
	0.00 ... 300.00%	Load signal	100 = 1% / 1 = 1%
77.33	Step 1 source	Selects the source to activate offset step 1. The offset value is defined with parameter 77.39 Step offset 1.	False / int32
	False	Step 1 source is not activated.	0
	True	Step 1 source is activated.	1
	DI1	Digital input DI1 (10.2 DI delayed status, bit 0).	2
	DI2	Digital input DI2 (10.2 DI delayed status, bit 1).	3
	DI3	Digital input DI3 (10.2 DI delayed status, bit 2).	4
	DI4	Digital input DI4 (10.2 DI delayed status, bit 3).	5
	DI5	Digital input DI5 (10.2 DI delayed status, bit 4).	6
	DI6	Digital input DI6 (10.2 DI delayed status, bit 5).	7
	Load step 1	When hoist load is greater than 77.36 Load step 1, then 77.39 Step offset 1 is added to the final pendulum arm length.	8
Other [bit]	See Terms and abbreviations (page 221).		
77.34	Step 2 source	Selects the source to activate offset step 2. The offset value is defined with parameter 77.41 Step offset 3.	False / int32
	False	Step 2 source is not activated.	0
	True	Step 2 source is activated.	1
	DI1	Digital input DI1 (10.2 DI delayed status, bit 0).	2
	DI2	Digital input DI2 (10.2 DI delayed status, bit 1).	3
	DI3	Digital input DI3 (10.2 DI delayed status, bit 2).	4
	DI4	Digital input DI4 (10.2 DI delayed status, bit 3).	5
	DI5	Digital input DI5 (10.2 DI delayed status, bit 4).	6
	DI6	Digital input DI6 (10.2 DI delayed status, bit 5).	7
	Load step 2	When hoist load is greater than 77.37 Load step 2, then 77.40 Step offset 2 is added to the final pendulum arm length.	8
Other [bit]	See Terms and abbreviations (page 221).		
77.35	Step 3 source	Selects the source to activate offset step 3. The offset value is defined with parameter 77.41 Step offset 3.	False / int32
	False	Step 3 source is not activated.	0
	True	Step 3 source is activated.	1
	DI1	Digital input DI1 (10.2 DI delayed status, bit 0).	2
	DI2	Digital input DI2 (10.2 DI delayed status, bit 1).	3
	DI3	Digital input DI3 (10.2 DI delayed status, bit 2).	4
	DI5	Digital input DI5 (10.2 DI delayed status, bit 4).	6

No.	Name / Range / Selection	Description	Def / Type FbEq 16b / 32b
	DI6	Digital input DI6 (10.2 DI delayed status, bit 5).	7
	Load step 3	When hoist load is greater than 77.38 Load step 3, then 77.41 Step offset 3 is added to the final pendulum arm length.	8
	Step 1 and 2	When step1 and step2 are active at the same time, then 77.41 Step offset 3 is added to the final pendulum arm length.	9
	Other [bit]	See Terms and abbreviations (page 221).	
77.36	Load step 1	Defines the step1 load weight above which the offset 1 (par. 77.39) is added to the pendulum arm length. See parameter 77.33 Step 1 source.	0.00% / real32
	0.00 ... 300.00%	Percent of step1 load weight.	100 = 1% / 1 = 1%
77.37	Load step 2	Defines the step2 load weight above which the offset 2 (par. 77.40) is added to the pendulum arm length. See parameter 77.34 Step 2 source.	0.00% / real32
	0.00 ... 300.00%	Percent of step2 load weight.	100 = 1% / 1 = 1%
77.38	Load step 3	Defines the step3 load weight above which the offset 3 (par. 77.41) is added to the pendulum arm length. See parameter 77.35 Step 3 source.	0.00% / real32
	0.00 ... 300.00%	Percent of step3 load weight.	100 = 1% / 1 = 1%
77.39	Step offset 1	Defines the step1 offset that adds to the final pendulum arm length.	0.00 m / real32
	0.00 ... 300.00 m	Offset 1.	100 = 1 m / 1 = 1 m
77.40	Step offset 2	Defines the step2 offset that adds to the final pendulum arm length.	0.00 m / real32
	0.00 ... 300.00 m	Offset 2.	100 = 1 m / 1 = 1 m
77.41	Step offset 3	Defines the step3 offset that adds to the final pendulum arm length.	0.00 m / real32
	0.00 ... 300.00 m	Offset 3.	100 = 1 m / 1 = 1 m
77.42	Active step offset	Shows the active step offset. This parameter is read-only.	0.00 m / real32
	0.00 ... 300.00 m	Active step offset.	100 = 1 m / 1 = 1 m
77.50	Load offset min	Defines the offset for minimum load (parameter 77.52 Load min) on the linear curve.	0.00 m / real32
	0.00 ... 300.00 m	Load offset minimum value.	100 = 1 m / 1 = 1 m
77.51	Load offset max	Defines offset for maximum load (parameter 77.53 Load max) on the linear curve.	0.00 m / real32
	0.00 ... 300.00 m	Load offset maximum value.	100 = 1 m / 1 = 1 m
77.52	Load min	Defines minimum load on the linear curve. The offset in parameter 77.50 Load offset min is added to this value.	0.00% / real32
	0.00 ... 300.00%	Minimum load.	100 = 1% / 1 = 1%

## 588 Parameters

No.	Name / Range / Selection	Description	Def / Type FbEq 16b / 32b
77.53	Load max	Defines maximum load on the linear curve. The offset in parameter 77.51 Load offset max is added to this value.	100.00% / real32
	0.00 ... 300.00%	Maximum load.	100 = 1% / 1 = 1%
77.54	Active linear offset	Shows the active linear offset. This parameter is read-only.	0.00 m / real32
	0.00 ... 300.00 m	Active linear offset.	100 = 1 m / 1 = 1 m
77.56	Auto offset enable	Enables auto offset mode. When the lifted load is greater than the minimum load (parameter 77.58 Load minimum in auto mode), the difference between total arm length (parameter 77.57 Full pendulum arm) and actual hook position (parameter 77.27 Pendulum arm length) is calculated and result is shown in 77.60 Active auto offset.  <b>Note:</b> This setting is used only when the load is lifted up from the same floor level, and when different load types and loading devices (lifting straps) are used.	Disable / int32
	Disable	Auto offset mode is disabled.	0
	Enable	Auto offset mode is enabled.	1
77.57	Full pendulum arm	Defines the total length from hoist drum to the floor level (lifting basement). See parameter 77.56 Auto offset enable.	0.00 m / real32
	0.00 ... 300.00 m	Total pendulum arm length.	100 = 1 m / 1 = 1 m
77.58	Load minimum in auto mode	Defines the minimum load at which auto offset value is calculated. If lifted load is greater than this value, auto offset is calculated as 77.57 Full pendulum arm - 77.27 Pendulum arm length.	0.00% / real32
	0.00 ... 300.00%	Minimum load.	100 = 1% / 1 = 1%
77.60	Active auto offset	Shows the active auto offset value if 77.56 Auto offset enable is set. This parameter is read-only.	0.00 m / real32
	0.00 ... 300.00 m	Active auto offset value.	100 = 1 m / 1 = 1 m
77.65	Direct offset source	Selects the source for direct offset. Parameter 77.67 Active direct offset shows the actual value.	No / uint32
	No	Direct offset is not active.	0
	AI1	12.12 AI1 scaled value	1
	AI2	12.22 AI2 scaled value	2
	Other [bit]	See Terms and abbreviations (page 221).	
77.67	Active direct offset	Shows the active direct offset. This parameter is read-only.	0.00 m / real32
	0.00 ... 300.00 m	Active direct offset value.	100 = 1 m / 1 = 1 m
77.69	Total pendulum offset	Shows the total pendulum offset. This parameter is read-only.	0.00 m / real32
	0.00 ... 300.00 m	Total pendulum offset.	100 = 1 m / 1 = 1 m

No.	Name / Range / Selection	Description	Def / Type FbEq 16b / 32b
77.70	Total pendulum arm length	Shows the total pendulum arm length (sum of 77.27 Pendulum arm length + 77.69 Total pendulum offset limited with 77.26 Maximum pendulum length). This parameter is read-only.	0.00 m / real32
	0.00 ... 2147483.00 m	Total pendulum arm length.	1 = 1 m / 1 = 1 m
77.71	Antisway status	Shows the active status of antisway control. This parameter is read-only.	- / uint16
	b0 Antisway control is on	1 = Antisway logic activated and allows changing the speed reference.	
	b1 Antisway pattern is on	1 = Antisway logic is calculating new reference.	
	b2 Sway tracking is on	1 = Antisway logic provides sway tracking.	
	b3 Brake is on	0 = Brake closed 1 = Brake open	
	b4 Offset 1 is selected	1 = Offset 1 selected. See parameter 77.39 Step offset 1.	
	b5 Offset 2 is selected	1 = Offset 2 selected. See parameter 77.40 Step offset 2.	
	b6 Offset 3 is selected	1 = Offset 3 selected. See parameter 77.41 Step offset 3.	
	b7 Offset 1 and 2 are selected	1 = Offset 1 and 2 (parameters 77.39 and 77.40) values are added to pendulum.	
	b8 Offset load 1 level reached	1 = Load level 1 reached. See parameter 77.36 Load step 1.	
	b9 Offset load 2 level reached	1 = Load level 2 reached. See parameter 77.37 Load step 2.	
	b10 Offset load 3 level reached	1 = Load level 3 reached. See parameter 77.38 Load step 3.	
	b11 Auto mode load level reached	1 = Load level defined for auto offset activation is reached.	
	b12 Reserved		
	b13 Above minimum speed	1 = Condition to enable Antisway function: actual speed is greater than defined minimum speed. See parameter 77.5 Antisway enable minimum speed.	
	b14 Minimum pendulum	1 = Condition to enable Antisway function: Pendulum arm length is higher than the defined limit. See parameter 77.4 Auto on at minimum pendulum	
	b15 Maximum pendulum	1 = Condition to enable Antisway function: Pendulum arm length is higher than the defined limit. See parameter 77.3 Auto on at maximum pendulum	
	0000h...FFFFh		1 = 1
77.72	Speed ref into antisway	Shows the speed reference into the antisway core. This parameter is read-only.	0.00 rpm / real32

## 590 Parameters

No.	Name / Range / Selection	Description	Def / Type FbEq 16b / 32b
	-30000.00 ... 30000.00 rpm	Speed reference	1 = 1 rpm / 1 = 1 rpm
77.73	Speed ref from antisway	Shows the speed reference from antisway control. This is connected to the speed reference chain. This parameter is read-only.	0.00 rpm / real32
	-30000.00 ... 30000.00 rpm	Speed reference	1 = 1 rpm / 1 = 1 rpm
77.75	Pendulum angle	Shows the sway angle of pendulum arm. This parameter is read-only.	0.00 / real32
	-1000.00 ... 1000.00	Pendulum angle	100 = 1 / 1 = 1
77.76	Pendulum time constant	<i>(Visible only when parameter 60.200 Crane drive type = Main trolley or Main long travel)</i> Shows the calculated internal time constant. This parameter is read-only.	0.00 / real32
	0.00 ... 32767.00	Time constant.	100 = 1 / 1 = 1
77.78	Gear scaling	Defines gear relation between motor revolution to its linear movement. To find the correct scaling value: <ol style="list-style-type: none"> <li>Detect the starting motor position from signals. Starting motor position [rev] = par. 90.26 Motor revolution extension + par. 90.2 Motor position</li> <li>Provide short linear movement of the system (Trolley or Long travel) in meters. Linear movement = distance [meters] the system moves for every revolution of motor</li> <li>Measure the linear movement with available tool = Shift[m].</li> <li>Detect the new motor position from signals. New motor position [rev] = par. 90.26 Motor revolution extension + par. 90.2 Motor position</li> </ol> Gear scaling [m/rev] = Shift [m]/Absolute value (starting motor position [rev] - new motor position [rev])	0.000 m/rev / real32
	0.000 ... 65536.000 m/rev	Gear scaling	1000 = 1 m/rev / 1 = 1 m/rev
77.79	Stop distance	Shows estimated distance in meters required to stop the antisway profile. This parameter is read-only.  <b>Note:</b> To provide correct scaling of motor revolutions to linear distance, use par. 77.78 Gear scaling.	0.000 m / real32
	0.000 ... 65000.000 m	Stopping distance	1000 = 1 m / 1 = 1 m
77.80	Load to antisway selection	Selects the signal type to transmit the load signal from hoist drive to antisway drives (trolley and long travel).	NULL / uint32
	NULL	None.	0

No.	Name / Range / Selection	Description	Def / Type FbEq 16b / 32b
	Internal	Internally calculated load value from actual torque. Active value can be seen in parameter 77.81 Hoist load from torque act.	1
		See Terms and abbreviations (page 221). For example, parameter 75.40 Relative hoist load, if hoist speed optimization was set.	
77.81	Hoist load from torque act	Shows the calculated load value from actual torque. This parameter is read-only.	0.00% / real32
	0.00 ... 1000.00%	Load value.	100 = 1% / 1 = 1%
77.82	Hoist load to antisway	Shows the load value transmitted from hoist drive to antisway drive based on the signal selected with parameter 77.80 Load to antisway selection. This parameter is read-only.	0.00% / real32
	0.00 ... 1000.00%	Load value from hoist drive.	100 = 1% / 1 = 1%
77.91	Hoist pos fba int	Defines the hoist position signal in INT16 format from fieldbus.	0 / int16
	-32768...32767	Hoist position.	1 = 1 / 1 = 1
77.92	Hoist load fba int	Defines the hoist load signal in INT16 format from fieldbus.	0 / int16
	-32768...32767	Hoist load.	1 = 1 / 1 = 1
77.93	Hoist pos int as real	Shows the hoist position INT16 format as Real format from fieldbus. to do: new	0 / real32
	-32767...32767	Hoist position int as real	1 = 1 / 1 = 1
77.94	Hoist load int as real	Shows the hoist load INT16 format as Real format from fieldbus. to do: new	0 / real32
	-32767...32767	Hoist load int as real	1 = 1 / 1 = 1
77.122	Up position swing time 1	<i>(Visible only when user lock is open with pass code 584. See parameter 96.2 Pass code.)</i> Defines the UP position swing time used when parameter 77.29 Pendulum length source sel = Source 1. See also description in parameter 77.22 Up position swing time and description in section Hook in UP position.	4.00 s / real32
	1.00 ... 20.00 s	Source 1 sway cycle time in UP position.	100 = 1 s / 1 = 1 s
77.123	Up position length value 1	<i>(Visible only when user lock is open with pass code 584. See parameter 96.2 Pass code.)</i> Defines the UP position length used when parameter 77.29 Pendulum length source sel = Source 1. See also description in parameter 77.23 Up position length value.	20000.00 / real32
	-32768.00 ... 32768.00	Source 1 scaled pendulum arm length in UP position.	1 = 1 / 1 = 1

## 592 Parameters

No.	Name / Range / Selection	Description	Def / Type FbEq 16b / 32b
77.124	Down position swing time 1	<i>(Visible only when user lock is open with pass code 584. See parameter 96.2 Pass code.)</i> Defines the DOWN position swing time used when parameter 77.29 Pendulum length source sel = Source 2. See also description in parameter 77.24 Down position swing time and description in section Hook in DOWN position.	4.00 s / real32
	1.00 ... 20.00 s	Source 1 sway cycle time in DOWN position.	100 = 1 s / 1 = 1 s
77.125	Down position length value 1	<i>(Visible only when user lock is open with pass code 584. See parameter 96.2 Pass code.)</i> Defines the DOWN position length used when parameter 77.29 Pendulum length source sel = Source 1. See also description in parameter 77.25 Down position length value.	20000.00 / real32
	-32768.00 ... 32768.00	Source 1 scaled pendulum arm length in DOWN position.	1 = 1 / 1 = 1
77.126	Maximum pendulum length 1	<i>(Visible only when user lock is open with pass code 584. See parameter 96.2 Pass code.)</i> Limits the maximum pendulum arm length when parameter 77.29 Pendulum length source sel = Source 1.	100.000 m / real32
	1.000 ... 100.000 m	Source 1 pendulum arm length.	100 = 1 m / 1 = 1 m
77.132	Up position swing time 2	<i>(Visible only when user lock is open with pass code 584. See parameter 96.2 Pass code.)</i> Defines the UP position swing time used when parameter 77.29 Pendulum length source sel = Source 2. See also description in parameter 77.22 Up position swing time and description in section Hook in UP position.	4.00 s / real32
	1.00 ... 20.00 s	Source 2 sway cycle time in UP position.	100 = 1 s / 1 = 1 s
77.133	Up position length value 2	<i>(Visible only when user lock is open with pass code 584. See parameter 96.2 Pass code.)</i> Defines the UP position length used when parameter 77.29 Pendulum length source sel = Source 2. See also description in parameter 77.23 Up position length value.	20000.00 / real32
	-32768.00 ... 32768.00	Source 2 scaled pendulum arm length in UP position.	1 = 1 / 1 = 1
77.134	Down position swing time 2	<i>(Visible only when user lock is open with pass code 584. See parameter 96.2 Pass code.)</i> Defines the DOWN position swing time used when parameter 77.29 Pendulum length source sel = Source 2. See also description in parameter 77.24 Down position swing time and description in section Hook in DOWN position.	4.00 s / real32
	1.00 ... 20.00 s	Source 1 sway cycle time in DOWN position.	100 = 1 s / 1 = 1 s



No.	Name / Range / Selection	Description	Def / Type FbEq 16b / 32b
77.135	Down position length value 2	<i>(Visible only when user lock is open with pass code 584. See parameter 96.2 Pass code.)</i> Defines the DOWN position length used when parameter 77.29 Pendulum length source sel = Source 2. See also description in parameter 77.25 Down position length value.	20000.00 / real32
	-32768.00 ... 32768.00	Source 1 scaled pendulum arm length in DOWN position.	1 = 1 / 1 = 1
77.136	Maximum pendulum length 2	<i>(Visible only when user lock is open with pass code 584. See parameter 96.2 Pass code.)</i> Limits the maximum pendulum arm length when parameter 77.29 Pendulum length source sel = Source 2.	100.000 m / real32
	1.000 ... 100.000 m	Source 2 pendulum arm length.	100 = 1 m / 1 = 1 m

## 594 Parameters

No.	Name / Range / Selection	Description	Def / Type FbEq 16b / 32b
<b>78</b>	<b>External sway control</b>	This is the block, where writer describes in more details what is the purpose of the parameter in the group.	
78.1	Enable ext sway control	This is the block, where writer describes in more details what is the purpose of the parameter.	Disable / int32
	Disable	This is the block, where writer describes in more details how the selection value should be interpreted.	0
	Enable	This is the block, where writer describes in more details how the selection value should be interpreted.	1
	DI1	This is the block, where writer describes in more details how the selection value should be interpreted.	2
	DI2	This is the block, where writer describes in more details how the selection value should be interpreted.	3
	DI3	This is the block, where writer describes in more details how the selection value should be interpreted.	4
	DI4	This is the block, where writer describes in more details how the selection value should be interpreted.	5
	DI5	This is the block, where writer describes in more details how the selection value should be interpreted.	6
	DI6	This is the block, where writer describes in more details how the selection value should be interpreted.	7
	DIO1	This is the block, where writer describes in more details how the selection value should be interpreted.	8
	DIO2	This is the block, where writer describes in more details how the selection value should be interpreted.	9
78.2	Ext speed corr to drive src	This is the block, where writer describes in more details what is the purpose of the parameter.	Par 47.01 / uint32
	NULL	This is the block, where writer describes in more details how the selection value should be interpreted.	0
	Par 47.01	This is the block, where writer describes in more details how the selection value should be interpreted.	1
78.3	Direct lift enable	This is the block, where writer describes in more details what is the purpose of the parameter.	False / int32
	False	This is the block, where writer describes in more details how the selection value should be interpreted.	0
	True	This is the block, where writer describes in more details how the selection value should be interpreted.	1
78.5	Actual speed unscaled	This is the block, where writer describes in more details what is the purpose of the parameter.	0 rpm / real32
	-32000...32000 rpm	This is the block, where writer describes in more details how the values of parameters should be interpreted.	1 = 1 rpm / 1 = 1 rpm
78.20	User status word 1	This is the block, where writer describes in more details what is the purpose of the parameter.	- / uint16
	b0 Enabled	This is the block, where writer describes in more details how the bit value should be interpreted.	

No.	Name / Range / Selection	Description	Def / Type FbEq 16b / 32b
b1	Toggle bit	This is the block, where writer describes in more details how the bit value should be interpreted.	
b2	Start active	This is the block, where writer describes in more details how the bit value should be interpreted.	
b3	Started (Following_ref)	This is the block, where writer describes in more details how the bit value should be interpreted.	
b4	Reference is limited	This is the block, where writer describes in more details how the bit value should be interpreted.	
b5	Stopped	This is the block, where writer describes in more details how the bit value should be interpreted.	
b6	Direct lift command	This is the block, where writer describes in more details how the bit value should be interpreted.	
b7...15	Reserved		
	0000h...FFFFh		1 = 1
78.30	User status word 1 bit 0	This is the block, where writer describes in more details what is the purpose of the parameter.	False / int32
	False	This is the block, where writer describes in more details how the selection value should be interpreted.	0
	True	This is the block, where writer describes in more details how the selection value should be interpreted.	1
78.31	User status word 1 bit 1	This is the block, where writer describes in more details what is the purpose of the parameter.	False / int32
	False	This is the block, where writer describes in more details how the selection value should be interpreted.	0
	True	This is the block, where writer describes in more details how the selection value should be interpreted.	1
78.32	User status word 1 bit 2	This is the block, where writer describes in more details what is the purpose of the parameter.	False / int32
	False	This is the block, where writer describes in more details how the selection value should be interpreted.	0
	True	This is the block, where writer describes in more details how the selection value should be interpreted.	1
78.33	User status word 1 bit 3	This is the block, where writer describes in more details what is the purpose of the parameter.	False / int32
	False	This is the block, where writer describes in more details how the selection value should be interpreted.	0
	True	This is the block, where writer describes in more details how the selection value should be interpreted.	1
78.34	User status word 1 bit 4	This is the block, where writer describes in more details what is the purpose of the parameter.	False / int32
	False	This is the block, where writer describes in more details how the selection value should be interpreted.	0
	True	This is the block, where writer describes in more details how the selection value should be interpreted.	1

## 596 Parameters

No.	Name / Range / Selection	Description	Def / Type FbEq 16b / 32b
78.35	User status word 1 bit 5	This is the block, where writer describes in more details what is the purpose of the parameter.	False / int32
	False	This is the block, where writer describes in more details how the selection value should be interpreted.	0
	True	This is the block, where writer describes in more details how the selection value should be interpreted.	1
78.50	Ext sway control word 1	This is the block, where writer describes in more details what is the purpose of the parameter.	- / uint16
	b0 Toggle bit reply	This is the block, where writer describes in more details how the bit value should be interpreted.	
	b1 Keep brake closed	This is the block, where writer describes in more details how the bit value should be interpreted.	
	b2 Keep start active	This is the block, where writer describes in more details how the bit value should be interpreted.	
	b3 Force ref to zero	This is the block, where writer describes in more details how the bit value should be interpreted.	
	b4 Direct lift is done	This is the block, where writer describes in more details how the bit value should be interpreted.	
	b5...15 Reserved		
	0000h...FFFFh		1 = 1
78.51	Timeout delay	This is the block, where writer describes in more details what is the purpose of the parameter.	10 s / uint32
	0...60 s	This is the block, where writer describes in more details how the values of parameters should be interpreted.	1 = 1 s / 1 = 1 s
78.60	Ext sway configuration word 1	This is the block, where writer describes in more details what is the purpose of the parameter.	- / uint16
	b0 Enable at start	This is the block, where writer describes in more details how the bit value should be interpreted.	
	b1 Enable at stop	This is the block, where writer describes in more details how the bit value should be interpreted.	
	b2 Enable measure mode	This is the block, where writer describes in more details how the bit value should be interpreted.	
	b3 Direct lift start signal	This is the block, where writer describes in more details how the bit value should be interpreted.	
	b4 Direct lift start to this drive	This is the block, where writer describes in more details how the bit value should be interpreted.	
	b5 Disable signal filtering	This is the block, where writer describes in more details how the bit value should be interpreted.	
	b6...15 Reserved		
	0000h...FFFFh		1 = 1
78.61	Ext sway configuration word 2	This is the block, where writer describes in more details what is the purpose of the parameter.	- / uint16

No.	Name / Range / Selection	Description	Def / Type FbEq 16b / 32b
	b0 Inverse sensor polarity	This is the block, where writer describes in more details how the bit value should be interpreted.	
	b1 Automatic zero angle calibration	This is the block, where writer describes in more details how the bit value should be interpreted.	
	b2 Trigger zero angle calibration	This is the block, where writer describes in more details how the bit value should be interpreted.	
	b3 NS100 control board reboot	This is the block, where writer describes in more details how the bit value should be interpreted.	
	b4...15 Reserved		
	0000h...FFFFh		1 = 1
78.62	Minimum speed for correction	This is the block, where writer describes in more details what is the purpose of the parameter.	250 rpm / int16
	-16000...16000 rpm	This is the block, where writer describes in more details how the values of parameters should be interpreted.	1 = 1 rpm / 1 = 1 rpm
78.63	P value for NS correction PID	This is the block, where writer describes in more details what is the purpose of the parameter.	100 / int16
	0...32000	This is the block, where writer describes in more details how the values of parameters should be interpreted.	1 = 1 / 1 = 1
78.64	D value for NS correction PID	This is the block, where writer describes in more details what is the purpose of the parameter.	0 / int16
	0...32000	This is the block, where writer describes in more details how the values of parameters should be interpreted.	1 = 1 / 1 = 1
78.65	Direct lift speed	This is the block, where writer describes in more details what is the purpose of the parameter.	500 rpm / int16
	0...32000 rpm	This is the block, where writer describes in more details how the values of parameters should be interpreted.	1 = 1 rpm / 1 = 1 rpm
78.66	Status_alarm_word_1	This is the block, where writer describes in more details what is the purpose of the parameter.	- / uint16
	b0 NS ready for operation	This is the block, where writer describes in more details how the bit value should be interpreted.	
	b1 NS active	This is the block, where writer describes in more details how the bit value should be interpreted.	
	b2 Direct lifting function active	This is the block, where writer describes in more details how the bit value should be interpreted.	
	b3 Measur mode active	This is the block, where writer describes in more details how the bit value should be interpreted.	
	b4 Reserved		
	b5 Measured angle problem	This is the block, where writer describes in more details how the bit value should be interpreted.	
	b6 Reserved_	This is the block, where writer describes in more details how the bit value should be interpreted.	
	b7 Sensor failure	This is the block, where writer describes in more details how the bit value should be interpreted.	
	b8...15 Reserved		

## 598 Parameters

No.	Name / Range / Selection	Description	Def / Type FbEq 16b / 32b
	0000h...FFFFh		1 = 1
78.67	Ext sway measured value 1	This is the block, where writer describes in more details what is the purpose of the parameter.	0 / int16
	-16000...16000	This is the block, where writer describes in more details how the values of parameters should be interpreted.	1 = 1 / 1 = 1
78.68	Ext sway measured value 2	This is the block, where writer describes in more details what is the purpose of the parameter.	0 / int16
	-16000...16000	This is the block, where writer describes in more details how the values of parameters should be interpreted.	1 = 1 / 1 = 1
78.69	Ext sway measured value 3	This is the block, where writer describes in more details what is the purpose of the parameter.	0 / int16
	-16000...16000	This is the block, where writer describes in more details how the values of parameters should be interpreted.	1 = 1 / 1 = 1
78.70	Ext sway measured value 4	This is the block, where writer describes in more details what is the purpose of the parameter.	0 / int16
	-16000...16000	This is the block, where writer describes in more details how the values of parameters should be interpreted.	1 = 1 / 1 = 1
78.71	Ext sway measured value 5	This is the block, where writer describes in more details what is the purpose of the parameter.	0 / int16
	-16000...16000	This is the block, where writer describes in more details how the values of parameters should be interpreted.	1 = 1 / 1 = 1
78.72	Ext sway measured value 6	This is the block, where writer describes in more details what is the purpose of the parameter.	0 / int16
	-32000...32000	This is the block, where writer describes in more details how the values of parameters should be interpreted.	1 = 1 / 1 = 1
78.73	Fixed correction span	This is the block, where writer describes in more details what is the purpose of the parameter.	0 rpm / int16
	-32768...32000 rpm	This is the block, where writer describes in more details how the values of parameters should be interpreted.	1 = 1 rpm / 1 = 1 rpm
78.74	Keep alive speed	This is the block, where writer describes in more details what is the purpose of the parameter.	0 rpm / int16
	0...32767 rpm	This is the block, where writer describes in more details how the values of parameters should be interpreted.	1 = 1 rpm / 1 = 1 rpm
78.75	Configuration word sp 1	This is the block, where writer describes in more details what is the purpose of the parameter.	0 / int16
	-32768...32767	This is the block, where writer describes in more details how the values of parameters should be interpreted.	1 = 1 / 1 = 1
78.76	Configuration word sp 2	This is the block, where writer describes in more details what is the purpose of the parameter.	0 / int16
	-32768...32767	This is the block, where writer describes in more details how the values of parameters should be interpreted.	1 = 1 / 1 = 1
78.77	Configuration word sp 3	This is the block, where writer describes in more details what is the purpose of the parameter.	0 / int16

No.	Name / Range / Selection	Description	Def / Type FbEq 16b / 32b
	-32768...32767	This is the block, where writer describes in more details how the values of parameters should be interpreted.	1 = 1 / 1 = 1
78.78	Hardware revision	This is the block, where writer describes in more details what is the purpose of the parameter.	0 / int16
	-32768...32767	This is the block, where writer describes in more details how the values of parameters should be interpreted.	1 = 1 / 1 = 1
78.79	Software version	This is the block, where writer describes in more details what is the purpose of the parameter.	0 / int16
	-32768...32767	This is the block, where writer describes in more details how the values of parameters should be interpreted.	1 = 1 / 1 = 1

## 600 Parameters

No.	Name / Range / Selection	Description	Def / Type FbEq 16b / 32b
<b>82</b>	<b>Synchro control</b>	Synchro control configuration. See description in section Shaft Synchro.	
82.1	Synchro control	<i>(Visible only when user lock is open with pass code 584. See parameter 96.2 Pass code.)</i> Enables the Synchro control function.	Off / int32
	Off	Synchro control function is disabled.	0
	On	Synchro control function is enabled.	1
	Other [bit]	See Terms and abbreviations (page 221).	
82.2	Synchro sel	<i>(Visible only when user lock is open with pass code 584. See parameter 96.2 Pass code.)</i> Activates Synchro control and defines the input for the Synchro command. When this command is active and the drive is in Master/Follower mode, the shaft synchronisation is enabled. This parameter is active only when the Synchro control function is enabled with parameter 82.1 Synchro control.	No / int32
	No	Synchro command is not active.	0
	Select	Synchro command is always active.	1
	DI1	Digital input DI1 (10.2 DI delayed status, bit 0).	2
	DI2	Digital input DI2 (10.2 DI delayed status, bit 1).	3
	DI3	Digital input DI3 (10.2 DI delayed status, bit 2).	4
	DI4	Digital input DI4 (10.2 DI delayed status, bit 3).	5
	DI5	Digital input DI5 (10.2 DI delayed status, bit 4).	6
	DI6	Digital input DI6 (10.2 DI delayed status, bit 5).	7
	DIO1	Digital input/output DIO1 (11.2 DIO delayed status, bit 0).	8
	DIO2	Digital input/output DIO2 (11.2 DIO delayed status, bit 1).	9
	Other [bit]	See Terms and abbreviations (page 221).	
82.3	Sync corr mode	<i>(Visible only when user lock is open with pass code 584. See parameter 96.2 Pass code.)</i> Defines the synchronisation correction mode used in Synchro command activation with parameter 82.2 Synchro sel.	Direct / int32
	Direct	Direct mode of synchronization correction. In this mode, the difference between the Master position and the Follower position at the time of Synchro command activation is taken as position error. No permanent offset is calculated in this mode.	0
	Offset	Offset mode of synchronization correction. In this mode, the difference between the Master position and the Follower position at the time of Synchro command activation is taken as an offset and is not considered as position error.	1



No.	Name / Range / Selection	Description	Def / Type FbEq 16b / 32b
82.4	Sync gain	<i>(Visible only when user lock is open with pass code 584. See parameter 96.02 Pass code.)</i> Defines the gain for Synchro control (P-controller) in Follower drives.	1.00 / real32
	0.00 ... 100.00	Gain	100 = 1 / 1 = 1
82.5	Position corr limit	<i>(Visible only when user lock is open with pass code 584. See parameter 96.02 Pass code.)</i> Defines the maximum/minimum limit for position correction value. The difference between the Master and Follower position in unit (mm) is limited to this value before it is given as speed correction factor to the Follower speed loop.	1.00 mm / real32
	0.00 ... 100.00 mm	Gain	100 = 1 mm / 1 = 1 mm
82.6	Sync corr scale	<i>(Visible only when user lock is open with pass code 584. See parameter 96.02 Pass code.)</i> Defines the scaling factor for final speed correction reference in slave speed loop. The scaling value corresponds to a correction of speed in rpm for a position error of 1 mm.	1.00 rpm/mm / real32
	0.00 ... 100.00 rpm/mm	Gain	100 = 1 rpm/mm / 1 = 1 rpm/mm
82.7	Sync err limit	<i>(Visible only when user lock is open with pass code 584. See parameter 96.02 Pass code.)</i> Defines the synchronization error limit in the Follower drive for the fault supervision of synchronization error. The fault delay timer is activated immediately when the actual position is greater or equal to this limit and is reset.	1.00 mm / real32
	0.00 ... 100.00 mm	Synchronization error limit.	100 = 1 mm / 1 = 1 mm
82.8	Sync err fault delay	<i>(Visible only when user lock is open with pass code 584. See parameter 96.2 Pass code.)</i> Defines the time delay in generating the fault due to synchronization error. The fault is generated when the synchronization error limit (par. 82.7 Sync err limit) is active and the corresponding delay time has elapsed.	2 s / real32
	0...100 s	Synchronization error limit.	1 = 1 s / 1 = 1 s
82.9	Position hysteresis	<i>(Visible only when user lock is open with pass code 584. See parameter 96.02 Pass code.)</i> Defines the position hysteresis for stop sequence in synchronization mode. The drive stops only when the absolute synchronization position error is in this range.  <b>Note:</b> This parameter is applicable only for Follower drives in the synchronization mode.	5.00 mm / real32
	1.00 ... 50.00 mm	Synchronization error limit.	100 = 1 mm / 1 = 1 mm

## 602 Parameters

No.	Name / Range / Selection	Description	Def / Type FbEq 16b / 32b
82.11	Synchro sw	(Visible only when user lock is open with pass code 584. See parameter 96.2 Pass code.) Displays the status of Synchro control function. This parameter is read-only.	- / uint16
	b0 Synchro on	Synchro control function is On.	
	b1 Synchro selected	Synchro control function is selected and Position correction logic modifies the speed reference.	
	b2 Synchro Fault	Fault condition tripped and still presented due to position difference going beyond limits defined in parameter 82.07 Sync err limit.	
	b3...15 Reserved		
	0000h...FFFFh		1 = 1
82.20	Act position error	(Visible only when user lock is open with pass code 584. See parameter 96.2 Pass code.) Shows the actual position error. This parameter is read-only.	0.00 mm / real32
	-32767.00 ... 32767.00 mm	Position error	100 = 1 mm / 1 = 1 mm
82.21	Master position	(Visible only when user lock is open with pass code 584. See parameter 96.2 Pass code.) Shows the Synchro control position in Master drive. If the Synchro control function is Off, this signal is set to 0, because when Synchro control is Off, different signals can be transferred. This parameter is read-only.	0.00 mm / real32
	-32767.00 ... 32767.00 mm	Synchro control position.	1 = 1 mm / 1 = 1 mm
82.22	Offset value	(Visible only when user lock is open with pass code 584. See parameter 96.2 Pass code.) Shows the offset value. This parameter is read-only.	0.00 mm / real32
	-32767.00 ... 32767.00 mm	Offset value.	1 = 1 mm / 1 = 1 mm
82.23	Correction speed ref	(Visible only when user lock is open with pass code 584. See parameter 96.2 Pass code.) Shows the speed reference correction. This parameter is read-only.	0.00 rpm / real32
	-30000.00 ... 30000.00 rpm	Offset value.	1 = 1 rpm / 1 = 1 rpm
82.24	Master linear speed ref	(Visible only when user lock is open with pass code 584. See parameter 96.2 Pass code.) Shows the linear speed reference correction in Master drive. This parameter is read-only.	0.00 mm/min / real32
	-32767.00 ... 32767.00 mm/min	Offset value.	1 = 1 mm/min / 1 = 1 mm/min

No.	Name / Range / Selection	Description	Def / Type FbEq 16b / 32b
82.25	Actual linear speed ref	<i>(Visible only when user lock is open with pass code 584. See parameter 96.2 Pass code.)</i> Shows the actual speed reference of the drive. This parameter is read-only.	0.00 mm/min / real32
	-32767.00 ... 32767.00 mm/min	Offset value.	1 = 1 mm/min / 1 = 1 mm/min

## 604 Parameters

No.	Name / Range / Selection	Description	Def / Type FbEq 16b / 32b
<b>83</b>	<b>Smooth lifting</b>	Smooth lifting configuration. See description of <a href="#">Smooth lifting (page 121)</a> .	
83.1	Smooth lifting	(Visible only after entering access level pass code 584. See parameter <a href="#">96.2 Pass code</a> .) Enables the Smooth lifting function.	Disable / int32
	Disable	Smooth lifting function is disabled.	0
	Enable	Smooth lifting function is enabled.	1
83.2	Smooth lifting delay	(Visible only after entering access level pass code 584. See parameter <a href="#">96.2 Pass code</a> .) Defines the delay time to apply the reference before the smooth lifting function starts monitoring the torque. This delay time also prevents from triggering the smooth lifting function after the brake is opened.	10 ms / int32
	0...1000 ms	Delay time	1 = 1 ms / 1 = 1 ms
83.3	Smooth lifting torque step	(Visible only after entering access level pass code 584. See parameter <a href="#">96.2 Pass code</a> .) Defines the rising limit of torque at intervals of 2 ms. This condition indicates that peak torque condition.	1.0% / real32
	0.0 ... 1600.0%	Torque rising limit.	10 = 1% / 1 = 1%
83.4	Smooth lifting acc speed diff	(Visible only after entering access level pass code 584. See parameter <a href="#">96.2 Pass code</a> .) Defines the difference between reference speed and actual speed during acceleration. When the difference is more or equal (i.e., <a href="#">83.4 Smooth lifting acc speed diff</a> + <a href="#">83.5 Smooth lifting speed diff</a> ), then one of the conditions for smooth lifting is satisfied.	0.0 rpm / real32
	0.0 ... 30000.0 rpm	Speed difference.	10 = 1 rpm / 1 = 1 rpm
83.5	Smooth lifting speed diff	(Visible only after entering access level pass code 584. See parameter <a href="#">96.2 Pass code</a> .) Defines the difference between reference speed and actual speed. When a sudden speed difference appears one of the condition for smooth lifting is satisfied. If value is smaller, the function is more sensitive.	7.0 rpm / real32
	0.0 ... 30000.0 rpm	Speed difference.	10 = 1 rpm / 1 = 1 rpm
83.6	Smooth lifting torq lim	(Visible only after entering access level pass code 584. See parameter <a href="#">96.2 Pass code</a> .) Defines the torque limit above which the smooth lifting function cannot execute. It is recommended to set this value gradually higher than the torque required to lift an empty hook.	50% / real32
	0...1600%	Percent of torque limit.	1 = 1% / 1 = 1%
83.7	Smooth lifting zero speed delay	(Visible only after entering access level pass code 584. See parameter <a href="#">96.2 Pass code</a> .) Defines the time during which drive reference is kept at 0 rpm after the smooth lifting function was triggered and motor speed reached 0 rpm.	0.0 s / real32
	0.0 ... 32767.0 s	Smooth lifting zero speed delay time in seconds.	10 = 1 s / 1 = 1 s

No.	Name / Range / Selection	Description	Def / Type FbEq 16b / 32b
83.8	Smooth lifting dec time multiplier	(Visible only after entering access level pass code 584. See parameter 96.2 Pass code.) Defines the ramp multiplier applied to the deceleration time when the smooth lifting function is executed. Deceleration time = Deceleration time defined in parameter 23.202 Crane dec time 1 or 23.204 Crane dec time 2 (whichever is used) * this value.	0.50 / real32
	0.00 ... 10.00	Ramp multiplier.	100 = 1 / 1 = 1
83.10	Smooth lifting sw	(Visible only after entering access level pass code 584. See parameter 96.2 Pass code.) Shows the status of smooth lifting function. The status of first 7 bits must be 1 to activate the smooth lifting function during constant speed driving and first 8 bits must be 1 when the drive is accelerating.  <b>Note:</b> PC tool sampling interval causes change in bit indications. For example, transitions such as 0 → 1 → 0 can be missed if the sampling interval time is too long.	- / uint16
	b0 Function executed	1 = Function executed now.  <b>Note:</b> This bit must be connected to parameter 23.24 Speed ramp in zero source (inverted).	
	b1 Direction lifting	1 = Current direction is lifting.	
	b2 Speed drop detected	1 = Difference between reference speed and actual speed is more than the defined speed. 83.5 + 83.4 * 83.10, bit 8	
	b3 Torque rise detected	1 = Torque difference is more than the value defined in parameter 83.3.	
	b4 Delay time elapsed	1 = Delay time defined in parameter 83.2 is elapsed.	
	b5 Ready to trigger	1 = Smooth lifting function is ready to be executed.  <b>Note:</b> <ul style="list-style-type: none"> <li>• After execution, this bit resets to 0.</li> <li>• After each triggering of the function, the load must be lowered for it to be ready for next trigger.</li> </ul>	
	b6 Torque below limit	1 = Actual torque is below the value defined in parameter 83.6.	
	b7 Ready to execute	1 = Drive successfully finished torque proving and shock load is ready to execute.	
	b8 Acc speed error in use	1 = Drive is accelerating and function is less sensitive.	
	b9...15 Reserved		
	0000h...FFFFh		1 = 1

## 606 Parameters

No.	Name / Range / Selection	Description	Def / Type FbEq 16b / 32b
85	<b>ACC interface</b>	ACC interface configuration.  <b>Note:</b> These parameters are used only when you replace the ACC600/ACS800 Crane drive control (ACC600 or ACS800/+N652).  For the complete description and instructions on how to use the ACC interface, contact ABB.	
85.1	ACC interface enable	(Visible only after entering access level pass code 584. See parameter 96.2 Pass code.) Enables ACC interface.	Disable / int32
	Disable	ACC interface is disabled.	0
	Enable	ACC interface is enabled.	1
85.2	ACC Ena EXT2 ctrl mode selection	(Visible only after entering access level pass code 584. See parameter 96.2 Pass code.) Enables external control location EXT2 for ACC interface.	False / int32
	False	EXT2 is disabled.	0
	True	EXT2 is enabled.	1
85.3	ACC EXT2 control mode sel	(Visible only after entering access level pass code 584. See parameter 96.2 Pass code.) Selects the EXT2 control mode type for ACC interface.	ACC FB CW.TORQ CTRL SEL / int32
	Speed	Speed is used as the EXT2 control mode for ACC interface.	0
	Torque	Torque is used as the EXT2 control mode for ACC interface.	1
	ACC FB CW.TORQ CTRL SEL	Torque control is selected as the ACC fieldbus interface. See parameter 9.45 ACC Crane fieldbus CW, bit 6.	2
85.4	ACC Ramp Rate 1	(Visible only after entering access level pass code 584. See parameter 96.2 Pass code.) Enables ramp rate for ACC interface.	False / uint16
	False	0	0
	True	1	1
85.5	ACC FB ramp rate	(Visible only after entering access level pass code 584. See parameter 96.2 Pass code.) Defines the ramp rate for ACC fieldbus interface.	1000 / int16
	0...5000	ACC fieldbus ramp rate.	1 = 1 / 1 = 1
85.6	ACC Second ramp sel	(Visible only after entering access level pass code 584. See parameter 96.2 Pass code.) Selects the source for ACC second ramp.	Normal ramp / int32
	Normal ramp	Normal ramp is disabled.	0
	Second ramp	Second ramp is enabled.	1
	DI1	Digital input DI1 (10.2 DI delayed status, bit 0).	2
	DI2	Digital input DI2 (10.2 DI delayed status, bit 1).	3
	DI3	Digital input DI3 (10.2 DI delayed status, bit 2).	4

No.	Name / Range / Selection	Description	Def / Type FbEq 16b / 32b
	DI4	Digital input DI4 (10.2 DI delayed status, bit 3).	5
	DI5	Digital input DI5 (10.2 DI delayed status, bit 4).	6
	DI6	Digital input DI6 (10.2 DI delayed status, bit 5).	7
	DIO1	Digital input/output DIO1 (11.2 DIO delayed status, bit 0).	8
	DIO2	Digital input/output DIO2 (11.2 DIO delayed status, bit 1).	9
	Other [bit]	See Terms and abbreviations (page 221).	
85.7	ACC Second ramp scale	(Visible only after entering access level pass code 584. See parameter 96.2 Pass code.) Defines the scaling of second ramp for ACC interface.	1.00 / real32
	0.00 ... 5.00	Scaled value of second ramp.	1 = 1 / 1 = 1
85.9	Drive on	(Visible only after entering access level pass code 584. See parameter 96.2 Pass code.) Enables start command to magnetize the motor.	Off / int32
		<b>Note:</b>	
		<ul style="list-style-type: none"> <li>Provide the start command in the time period defined in parameter 44.211 Extended runtime. If drive does not receive the start command, drive stops until it receives a new rising edge of signal.</li> <li>If parameter 44.211 Extended runtime = 0, the drive keeps the motor magnetized until it receives the start command.</li> </ul>	
	Off	Stop (magnetize) motor.	0
	On	Start (magnetize) motor.	1
	D2D	Command provided via the D2D link from the master drive (follower drives only).	2
	Other [bit]	See Terms and abbreviations (page 221).	
85.10	Fast stop 1	(Visible only after entering access level pass code 584. See parameter 96.2 Pass code.) Selects the source to activate the fast stop mode. When this command is active, drive stops with Torque limit stop.	Direct: Active (false) / int32
	Active (false)	Fast stop 1 activated.	0
	Inactive (true)	Fast stop 1 disabled.	1
	Direct: Active (false)	Par. 9.45 ACC Crane fieldbus CW, bit 9 direct activation logic. Fast stop 1 is activated if 9.45 bit 9 = False.	2
	Inverted: Active (true)	Par. 9.45 ACC Crane fieldbus CW, bit 9 inverted activation logic. Fast stop 1 is activated if 9.45 bit 9 = True.	3
	Other [bit]	See Terms and abbreviations (page 221).	

## 608 Parameters

No.	Name / Range / Selection	Description	Def / Type FbEq 16b / 32b
85.15	Snag load	<i>(Visible only after entering access level pass code 584. See parameter 96.2 Pass code.)</i> Enables snag load indication	Disable / int32
	Disable	Snag load indication disabled.	0
	Enable	Snag load indication enabled.	1
	Other [bit]	See Terms and abbreviations (page 221).	
85.16	Snag load trig	Selects the source to trigger snag load indication.	Inactive (true) / int32
	Active (false)	Snag load trigger condition activated.	0
	Inactive (true)	Snag load trigger condition deactivated.	1
	DI1	Digital input DI1 (10.2 DI delayed status, bit 0).	2
	DI2	Digital input DI2 (10.2 DI delayed status, bit 1).	3
	DI3	Digital input DI3 (10.2 DI delayed status, bit 2).	4
	DI4	Digital input DI4 (10.2 DI delayed status, bit 3).	5
	DI5	Digital input DI5 (10.2 DI delayed status, bit 4).	6
	DI6	Digital input DI6 (10.2 DI delayed status, bit 5).	7
	DIO1	Digital input/output DIO1 (11.2 DIO delayed status, bit 0).	8
DIO2	Digital input/output DIO2 (11.2 DIO delayed status, bit 1).	9	
Other [bit]	See Terms and abbreviations (page 221).		
85.20	ACC Data set 5 data 1 selection	<i>(Visible only after entering access level pass code 584. See parameter 96.2 Pass code.)</i> Parameters 85.20...85.36 preselects the data to be sent in data sets 5 and 7 to the external controller for ACC interface. These data sets are used in ModuleBus communication with a "Standard drive". Parameters 85.40...85.45 shows the data to be sent to the external controller for ACC interface. If no data is preselected, the value to be sent can be written directly into these parameter.	0 / uint32
	Unknown data parameter format	ACC Data set 5 data 1 selection	1 = 1
85.36	ACC Data set 7 data 3 selection	<i>(Visible only after entering access level pass code 584. See parameter 96.2 Pass code.)</i> Preselects the ACC data to be sent as word 3 of data set 7 to the external controller.	0 / uint32
	Unknown data parameter format	ACC Data set 7 data 3 selection	1 = 1
85.40	ACC Data set 5 data 1 value	<i>(Visible only after entering access level pass code 584. See parameter 96.2 Pass code.)</i> Parameters 85.40...85.45 show (in integer format) the data to be sent to the external controller as word (1...3) of data sets 5 and 7. If no data is preselected in parameters 85.20...85.36, the value to be sent can be written directly into this parameter.	0 / int16



No.	Name / Range / Selection	Description	Def / Type FbEq 16b / 32b
	-32767...32767	Data to be sent as word (1...3) of data sets 5 and 7.	1 = 1 / 1 = 1
85.45	ACC Data set 7 data 3 value	(Visible only after entering access level pass code 584. See parameter 96.2 Pass code.) Shows (in integer format) the data to be sent to the external controller as word 3 of data set 7. If no data is preselected by 85.36 ACC Data set 7 data 3 selection, the value to be sent can be written directly into this parameter.	0 / int16
	-32767...32767	Data to be sent as word 3 of data set 7.	1 = 1 / 1 = 1
85.50	ACC Data set 6 data 1 selection	(Visible only after entering access level pass code 584. See parameter 96.2 Pass code.) Parameters 85.50...85.76 preselects the data to be sent in data sets 6, 8, and 12 to the external controller for ACC interface. These data sets are used in ModuleBus communication with a "Standard drive". Parameters 85.80...85.88 shows the data to be sent to the external controller for ACC interface. If no data is preselected, the value to be sent can be written directly into these parameter.	2345 / uint32
	Unknown data parameter format	ACC Data set 6 data 1 selection	1 = 1
85.70	ACC Data set 12 data 1 selection	This is the block, where writer describes in more details what is the purpose of the parameter.	2348 / uint32
	Unknown data parameter format	This is the block, where writer describes in more details how the values of parameters should be interpreted.	1 = 1
	Unknown data parameter format	This is the block, where writer describes in more details what is the purpose of the parameter.	3084 / NA1
	Unknown data parameter format	This is the block, where writer describes in more details how the values of parameters should be interpreted.	1 = 1
85.76	ACC Data set 12 data 3 selection	(Visible only after entering access level pass code 584. See parameter 96.2 Pass code.) Preselects the ACC data to be sent as word 3 of data set 12 to the external controller.	0 / uint32
	Unknown data parameter format	ACC Data set 12 data 3 selection	1 = 1
85.80	ACC Data set 6 data 1 value	(Visible only after entering access level pass code 584. See parameter 96.2 Pass code.) Parameters 85.80...85.88 show (in integer format) the data to be sent to the external controller as word (1...3) of data sets 6, 8 and 12. If no data is preselected in parameters 85.50...85.76, the value to be sent can be written directly into this parameter.	0 / int16
	-32767...32767	Data to be sent as word (1...3) of data sets 6, 8 and 12.	1 = 1 / 1 = 1

## 610 Parameters

No.	Name / Range / Selection	Description	Def / Type FbEq 16b / 32b
85.88	ACC Data set 12 data 3 value	(Visible only after entering access level pass code 584. See parameter 96.2 Pass code.) Shows (in integer format) the data to be sent to the external controller as word 3 of data set 12. If no data is preselected by 85.88 ACC Data set 12 data 3 value, the value to be sent can be written directly into this parameter.	0 / int16
	-32767...32767	Data to be sent as word 3 of data set 12.	1 = 1 / 1 = 1

No.	Name / Range / Selection	Description	Def / Type FbEq 16b / 32b
90	<b>Feedback selection</b>	Motor and load feedback configuration. See also section Encoder support (page 176), and the diagram on page 782.	
90.1	Motor speed for control	Displays the estimated or measured motor speed that is used for speed control, ie. final motor speed feedback selected by parameter 90.41 Motor feedback selection and filtered by 90.42 Motor speed filter time. In case measured feedback is selected, it is also scaled by the motor gear function (90.43 Motor gear numerator and 90.44 Motor gear denominator). Estimated speed is always used in scalar control.  <b>Note:</b> This parameter is read-only.	- / real32
	-32768.00 ... 32767.00 rpm	Motor speed used for control. For scaling, see parameter 46.1.	- / -
90.2	Motor position	Displays the motor position (within one revolution) received from the source selected by parameter 90.41 Motor feedback selection. In case measured feedback is selected, it is also scaled by the motor gear function (90.43 Motor gear numerator and 90.44 Motor gear denominator).  <b>Note:</b> This parameter is read-only.	- / real32
	0.00000000 ... 1.00000000 rev	Motor position.	32767 = 1 rev / 100000000 = 1 rev
90.3	Load speed	Displays the estimated or measured load speed that is used for motor control, ie. final load speed feedback selected by parameter 90.51 Load feedback selection and filtered by 90.52 Load speed filter time. In case measured feedback is selected, it is also scaled by the load gear function (90.53 Load gear numerator and 90.54 Load gear denominator). In case motor feedback or estimated feedback is used, it is inversely scaled by 90.61 Gear numerator and 90.62 Gear denominator (ie. 90.62 divided by 90.61).  <b>Note:</b> This parameter is read-only.	- / real32
	-32768.00 ... 32767.00 rpm	Load speed. For scaling, see parameter 46.1.	- / -
90.4	Load position	Displays the load position received from the source selected by parameter 90.51 Load feedback selection. The value is multiplied as specified by parameter 90.57 Load position resolution. In case measured feedback is selected, it is also scaled by the load gear function (90.53 Load gear numerator and 90.54 Load gear denominator). In case motor feedback or estimated feedback is used, it is inversely scaled by 90.61 Gear numerator and 90.62 Gear denominator (ie. 90.62 divided by 90.61). An offset can be defined by 90.56 Load position offset.  <b>Note:</b> This parameter is read-only.	- / int32

## 612 Parameters

No.	Name / Range / Selection	Description	Def / Type FbEq 16b / 32b
	-2147483648..2147483647	Load position.	- / -
90.5	Load position scaled	<p>Displays the scaled load position in decimal format. The position is relative to the initial position set by parameters 90.65 and 90.66. The number of decimal places is defined by parameter 90.38 Pos counter decimals.</p> <p><b>Note:</b> This is a floating point parameter, and the accuracy is compromised near the ends of the range. Consider using parameter 90.7 Load position scaled int instead of this parameter.</p> <p><b>Note:</b> This parameter is read-only.</p>	- / real32
	-2147483.648 ... 2147483.647	Scaled load position in decimal format.	- / -
90.6	Motor position scaled	<p>Displays the calculated motor position. The axis mode (linear or rollover) and resolution are defined by parameters 90.48 Motor position axis mode and 90.49 Motor position resolution respectively.</p> <p><b>Note:</b> The position value can be sent on a fast time level to the fieldbus controller by selecting Position in either 50.7 FBA A actual 1 type, 50.8 FBA A actual 2 type, 50.37 FBA B actual 1 type or 50.38 FBA B actual 2 type.</p> <p><b>Note:</b> This parameter is read-only.</p>	- / int32
	-2147483.648 ... 2147483.647	Motor position.	1 = 1 / 1000 = 1
90.7	Load position scaled int	<p>Displays the output of the position counter function as an integer, enabling backwards compatibility with ACS 600 and ACS800 drives. The position is relative to the initial position set by parameters 90.58 and 90.59. See section Position counter (page 178), and the block diagram on page 783.</p> <p><b>Note:</b> This parameter is read-only.</p>	- / int32
	-2147483648..2147483647	Scaled load position in integer format.	- / -
90.10	Encoder 1 speed	<p>Displays encoder 1 speed in rpm.</p> <p><b>Note:</b> This parameter is read-only.</p>	- / real32
	-32768.00 ... 32767.00 rpm	Encoder 1 speed. For scaling, see parameter 46.1.	- / -
90.11	Encoder 1 position	<p>Displays the actual position of encoder 1 within one revolution.</p> <p><b>Note:</b> This parameter is read-only.</p>	- / real32
	0.00000000 ... 1.00000000 rev	Encoder 1 position within one revolution.	32767 = 1 rev / 100000000 = 1 rev

No.	Name / Range / Selection	Description	Def / Type FbEq 16b / 32b
90.12	Encoder 1 multiturn revolutions	Displays the revolutions of (multiturn) encoder 1 within its value range (see parameter 92.14 Revolution data width).  <b>Note:</b> This parameter is read-only.	- / uint32
	0...16777215	Encoder 1 revolutions.	- / -
90.13	Encoder 1 revolution extension	Displays the revolution count extension for encoder 1. With a single-turn encoder, the counter is incremented when encoder position (parameter 90.11) wraps around in the positive direction, and decremented in the negative direction. With a multiturn encoder, the counter is incremented when the revolutions count (parameter 90.12) exceeds the value range in the positive direction, and decremented in the negative direction.  <b>Note:</b> This parameter is read-only.	- / int32
	<del>2147483648</del> <del>2147483647</del>	Encoder 1 revolution count extension.	1 = 1 / 1 = 1
90.14	Encoder 1 position raw	Displays the raw measurement data of encoder 1 position (within one revolution) as a 24-bit unsigned integer received from the encoder interface.  <b>Note:</b> This parameter is read-only.	- / uint32
	0...16777215	Raw encoder 1 position within one revolution.	- / -
90.15	Encoder 1 revolutions raw	Displays the revolutions of (multiturn) encoder 1 within its value range (see parameter 92.14 Revolution data width) as a raw measurement.  <b>Note:</b> This parameter is read-only.	- / uint32
	0...16777215	Raw encoder 1 revolution count.	- / -
90.20	Encoder 2 speed	Displays encoder 2 speed in rpm.  <b>Note:</b> This parameter is read-only.	- / real32
	-32768.00 ... 32767.00 rpm	Encoder 2 speed. For scaling, see parameter 46.1.	- / -
90.21	Encoder 2 position	Displays the actual position of encoder 2 within one revolution.  <b>Note:</b> This parameter is read-only.	- / real32
	0.00000000 ... 1.00000000 rev	Encoder 2 position within one revolution.	- / -
90.22	Encoder 2 multiturn revolutions	Displays the revolutions of (multiturn) encoder 2 within its value range (see parameter 93.14 Revolution data width).  <b>Note:</b> This parameter is read-only.	- / uint32
	0...16777215	Encoder 2 revolutions.	- / -

## 614 Parameters

No.	Name / Range / Selection	Description	Def / Type FbEq 16b / 32b
90.23	Encoder 2 revolution extension	Displays the revolution count extension for encoder 2. With a single-turn encoder, the counter is incremented when encoder position (parameter 90.21) wraps around in the positive direction, and decremented in the negative direction. With a multiturn encoder, the counter is incremented when the revolutions count (parameter 90.22) exceeds the value range in the positive direction, and decremented in the negative direction.  <b>Note:</b> This parameter is read-only.	- / int32
	<del>2147483648</del> . <del>2147483647</del>	Encoder 2 revolution count extension.	- / -
90.24	Encoder 2 position raw	Displays the raw measurement data of encoder 2 position (within one revolution) as a 24-bit unsigned integer received from the encoder interface.  <b>Note:</b> This parameter is read-only.	- / uint32
	0...16777215	Raw encoder 2 position within one revolution.	- / -
90.25	Encoder 2 revolutions raw	Displays the revolutions of (multiturn) encoder 2 within its value range (see parameter 93.14 Revolution data width) as a raw measurement.  <b>Note:</b> This parameter is read-only.	- / uint32
	0...16777215	Raw encoder 2 revolution count.	- / -
90.26	Motor revolution extension	Displays the motor revolution count extension. The counter is incremented when the position selected by 90.41 Motor feedback selection wraps around in the positive direction, and decremented in the negative direction.  <b>Note:</b> This parameter is read-only.	- / int32
	<del>2147483648</del> . <del>2147483647</del>	Motor revolution count extension.	- / -
90.27	Load revolution extension	Displays the load revolution count extension. The counter is incremented when the position selected by 90.51 Load feedback selection wraps around in the positive direction, and decremented in the negative direction.  <b>Note:</b> This parameter is read-only.	- / int32
	<del>2147483648</del> . <del>2147483647</del>	Load revolution count extension.	- / -
90.35	Pos counter status	Status information related to the position counter function. See section Position counter (page 178).  <b>Note:</b> This parameter is read-only.	- / uint16
	b0 Encoder 1 feedback	1 = Encoder 1 selected as load feedback source	
	b1 Encoder 2 feedback	1 = Encoder 2 selected as load feedback source	
	b2 Internal position feedback	1 = Internal load position estimate selected as load feedback source	

No.	Name / Range / Selection	Description	Def / Type FbEq 16b / 32b
	b3 Motor feedback	1 = Motor feedback selected as load feedback source	
	b4 Pos counter init ready	0 = Position counter not initialized, or encoder feedback was lost. Fresh counter initialization recommended. 1 = Position counter successfully initialized	
	b5 Position counter re-init disabled	1 = Position counter initialization is being prevented by par. 90.68	
	b6 Position data inaccurate	1 = Encoder feedback intermittent or lost. (If the drive is running, estimated position is used whenever encoder feedback is unavailable. If the drive is in stopped state, position counting will continue based on encoder data after the connection is restored.)	
	b7...15 Reserved		
	0000h...FFFFh		1 = 1
90.38	Pos counter decimals	Scales the values of parameters 90.5 Load position scaled and 90.65 Pos counter init value when accessed from an external source (eg. fieldbus). The setting corresponds to the number of decimal places. For example, with the setting of 3, an integer value of 66770 written into 90.65 Pos counter init value is divided by 1000, so the final value applied will be 66.770. Likewise, the value of 90.5 Load position scaled is multiplied by 1000 when read.	3 / uint16
	0...9	Number of position counter decimal places.	1 = 1 / 1 = 1
90.41	Motor feedback selection	Selects the motor speed feedback value used during motor control.  <b>Note:</b> With a permanent magnet motor, make sure an autophasing routine (see page 184) is performed using the selected encoder. If necessary, set parameter 99.13 ID run requested to Autophasing to request a fresh autophasing routine.	Estimate / uint16
	Estimate	A calculated speed estimate generated from the DTC core is used.	0
	Encoder 1	Actual speed measured by encoder 1. The encoder is set up by the parameters in group 92 Encoder 1 configuration.	1
	Encoder 2	Actual speed measured by encoder 2. The encoder is set up by the parameters in group 93 Encoder 2 configuration.	2
90.42	Motor speed filter time	Defines a filter time for motor speed feedback used for speed control (90.1 Motor speed for control).	3 ms / real32
	0...10000 ms	Motor speed filter time.	1 = 1 ms / 1 = 1 ms

## 616 Parameters

No.	Name / Range / Selection	Description	Def / Type FbEq 16b / 32b
90.43	Motor gear numerator	<p>Parameters 90.43 and 90.44 define a gear function between the motor speed feedback and motor control. The gear is used to correct a difference between the motor and encoder speeds for example if the encoder is not mounted directly on the motor shaft.</p> $\frac{90.43}{90.44} = \frac{\text{Motor speed}}{\text{Encoder speed}}$ <p>See also section Load and motor feedback (page 177).</p> <p><b>Note:</b> This parameter cannot be changed while the drive is running.</p>	1 / int32
	-2147483648..2147483647	Motor gear numerator.	- / -
90.44	Motor gear denominator	<p>See parameter 90.43 Motor gear numerator.</p> <p><b>Note:</b> This parameter cannot be changed while the drive is running.</p>	1 / int32
	-2147483648..2147483647	Motor gear denominator.	- / -
90.45	Motor feedback fault	Selects how the drive reacts to loss of measured motor feedback.	Fault / uint16
	Fault	Drive trips on a 7301 Motor speed feedback or 7381 Encoder fault.	0
	Warning	<p>Drive generates an A798 Encoder option comm loss, A7B0 Motor speed feedback or A7E1 Encoder warning and continues operation using estimated feedbacks.</p> <p><b>Note:</b> Before using this setting, test the stability of the speed control loop with estimated feedback by running the drive on estimated feedback (see 90.41 Motor feedback selection).</p>	1
90.46	Force open loop	<p>Forces the DTC motor model to use estimated motor speed as feedback. This parameter can be activated when the encoder data is obviously unreliable because of slippage, for example.</p> <p><b>Note:</b> This parameter only affects the selection of feedback for the motor model, not for the speed controller.</p>	No / uint16
	No	The motor model uses the feedback selected by 90.41 Motor feedback selection.	0
	Yes	The motor model uses the calculated speed estimate (regardless of the setting of 90.41 Motor feedback selection, which in case only selects the source of feedback for the speed controller).	1
90.48	Motor position axis mode	Selects the axis type for motor position measurement.	Rollover / uint16
	Linear	Linear.	0
	Rollover	The value is between 0 and 1 revolutions, and rolls over at 360 degrees.	1



No.	Name / Range / Selection	Description	Def / Type FbEq 16b / 32b
90.49	Motor position resolution	Defines how many bits are used for motor position count within one revolution. For example, with the setting of 24, the position value is multiplied by 16777216 for display in parameter 90.6 Motor position scaled (or for fieldbus).	24 / uint16
	0...31	Motor position resolution.	- / -
90.51	Load feedback selection	Selects the source of load speed and position feedbacks used in control.	None / uint16
	None	No load feedback selected.	0
	Encoder 1	Load feedbacks are updated based on the speed and position values read from encoder 1. The values are scaled by the load gear function (90.53 Load gear numerator and 90.54 Load gear denominator). The encoder is set up by the parameters in group 92 Encoder 1 configuration.	1
	Encoder 2	Load feedbacks are updated based on the speed and position values read from encoder 2. The values are scaled by the load gear function (90.53 Load gear numerator and 90.54 Load gear denominator). The encoder is set up by the parameters in group 93 Encoder 2 configuration.	2
	Estimate	Calculated speed and position estimates are used. The values are scaled from the motor side to the load side using the inverted ratio between 90.61 Gear numerator and 90.62 Gear denominator (ie. 90.62 divided by 90.61).	3
	Motor feedback	The source selected by parameter 90.41 Motor feedback selection for motor feedback is also used for load feedback. Any difference between the motor and load speeds (and positions) can be compensated by using the inverted ratio between 90.61 Gear numerator and 90.62 Gear denominator (ie. 90.62 divided by 90.61).	4
90.52	Load speed filter time	Defines a filter time for load speed feedback (90.3 Load speed).	4 ms / real32
	0...10000 ms	Load speed filter time.	- / -
90.53	Load gear numerator	Parameters 90.53 and 90.54 define a gear function between the load (ie. driven equipment) speed and the encoder feedback selected by parameter 90.51 Load feedback selection. The gear can be used to correct a difference between the load and encoder speeds for example if the encoder is not mounted directly on the rotated machinery. $\frac{90.53}{90.54} = \frac{\text{Load speed}}{\text{Encoder speed}}$ See also section Load and motor feedback (page 177). <b>Note:</b> This parameter cannot be changed while the drive is running.	1 / int32

## 618 Parameters

No.	Name / Range / Selection	Description	Def / Type FbEq 16b / 32b
	-2147483648..2147483647	Load gear numerator.	- / -
90.54	Load gear denominator	See parameter 90.53 Load gear numerator. <b>Note:</b> This parameter cannot be changed while the drive is running.	1 / int32
	-2147483648..2147483647	Load gear denominator.	- / -
90.55	Load feedback fault	Selects how the drive reacts to loss of load feedback.	Fault / uint16
	Fault	Drive trips on a 73A1 Load position feedback fault.	0
	Warning	Drive generates an A798 Encoder option comm loss or A7B1 Load speed feedback warning and continues operation using estimated feedbacks.	1
90.56	Load position offset	Defines a load-side position offset. The resolution is determined by parameter 90.57 Load position resolution.	- / int32
	-2147483648..2147483647 rev	Load-side position offset.	- / -
90.57	Load position resolution	Defines how many bits are used for load position count within one revolution. For example, with the setting of 18, the position value is multiplied by 65536 for display in parameter 90.4 Load position.	16 / uint16
	0...31	Load position resolution.	- / -
90.58	Pos counter init value int	Defines an initial position (or distance) for the position counter (as an integer value) when parameter 90.59 Pos counter init value int source is set to Pos counter init value int. See also section Position counter (page 178).	- / int32
	-2147483648..2147483647	Initial integer value for position counter.	- / -
90.59	Pos counter init value int source	Selects the source of the initial position integer value. When the source selected by 90.67 Pos counter init cmd source activates, the value selected in this parameter is assumed to be the position of the load.	Pos counter init value int / uint32
	Zero	0.	0
	Pos counter init value int	Parameter 90.58 Pos counter init value int.	1
	Other [value]	See Terms and abbreviations (page 221).	
90.60	Pos counter error and boot action	Selects how the position counter reacts to loss of load feedback.	Request re-initialization / uint16
	Request re-initialization	Bit 4 of 90.35 Pos counter status is cleared. Reinitialization of position counter is recommended.	0

No.	Name / Range / Selection	Description	Def / Type FbEq 16b / 32b
	Continue from previous value	Position counting resumes from the previous value over a loss of load feedback or control unit reboot. Bit 4 of 90.35 Pos counter status is not cleared, but bit 6 is set to indicate that an error has occurred.  <b>Note:</b> If load feedback is lost when the drive is in stopped state or not powered, the counter is not updated even if the load moves.	1
90.61	Gear numerator	Parameter 90.61 and 90.62 define a gear function between the motor and load speeds. $\frac{90.61}{90.62} = \frac{\text{Motor speed}}{\text{Load speed}}$ See also section Load and motor feedback (page 177).	1 / int32
	-2147483648..2147483647	Gear numerator (motor-side).	- / -
90.62	Gear denominator	See parameter 90.61 Gear numerator.	1 / int32
	-2147483648..2147483647	Gear denominator (load-side).	- / -
90.63	Feed constant numerator	Parameters 90.63 and 90.64 define the feed constant for the position calculation: $\frac{90.63}{90.64}$ The feed constant converts rotational motion into translatory motion. The feed constant is the distance the load moves during one turn of the motor shaft. The translatory load position is shown by parameter 90.7 Load position scaled int. Note that the load position is only updated after new position input data is received.	1 / int32
	-2147483648..2147483647	Feed constant numerator.	- / -
90.64	Feed constant denominator	See parameter 90.63 Feed constant numerator.	1 / int32
	-2147483648..2147483647	Feed constant denominator.	- / -
90.65	Pos counter init value	Defines an initial position (or distance) for the position counter (as a decimal number) when parameter 90.66 Pos counter init value source is set to Pos counter init value. The number of decimal places is defined by parameter 90.38 Pos counter decimals.	0.000 / real32
	-2147483.648 ... 2147483.647	Initial value for position counter.	- / -
90.66	Pos counter init value source	Selects the source of the initial position value. When the source selected by 90.67 Pos counter init cmd source activates, the value selected in this parameter is assumed to be the position of the load (in decimal format).	Pos counter init value / uint32
	Zero	0.	0
	Pos counter init value	Parameter 90.65 Pos counter init value.	1
	Other [value]	See Terms and abbreviations (page 221).	

## 620 Parameters

No.	Name / Range / Selection	Description	Def / Type FbEq 16b / 32b
90.67	Pos counter init cmd source	<p>Selects a digital source (for example, a limit switch connected to a digital input) that initializes the position counter. When the digital source activates, the value selected by 90.66 Pos counter init value source is assumed to be the position of the load.</p> <p><b>Note:</b> Position counter initialization can be prevented by parameter 90.68 Disable pos counter initialization.</p>	Not selected / uint32
	Not selected	0	0
	Selected	1	1
	DI1	Digital input DI1 (10.2 DI delayed status, bit 0).	2
	DI2	Digital input DI2 (10.2 DI delayed status, bit 1).	3
	DI3	Digital input DI3 (10.2 DI delayed status, bit 2).	4
	DI4	Digital input DI4 (10.2 DI delayed status, bit 3).	5
	DI5	Digital input DI5 (10.2 DI delayed status, bit 4).	6
	DI6	Digital input DI6 (10.2 DI delayed status, bit 5).	7
	DIO1	Digital input/output DIO1 (11.2 DIO delayed status, bit 0).	10
	DIO2	Digital input/output DIO2 (11.2 DIO delayed status, bit 1).	11
	Other [bit]	See Terms and abbreviations (page 221).	
90.68	Disable pos counter initialization	Selects a source that prevents the initialization of the position counter.	Not selected / uint32
	Not selected	0	0
	Selected	1	1
	DI1	Digital input DI1 (10.2 DI delayed status, bit 0).	2
	DI2	Digital input DI2 (10.2 DI delayed status, bit 1).	3
	DI3	Digital input DI3 (10.2 DI delayed status, bit 2).	4
	DI4	Digital input DI4 (10.2 DI delayed status, bit 3).	5
	DI5	Digital input DI5 (10.2 DI delayed status, bit 4).	6
	DI6	Digital input DI6 (10.2 DI delayed status, bit 5).	7
	DIO1	Digital input/output DIO1 (11.2 DIO delayed status, bit 0).	10
	DIO2	Digital input/output DIO2 (11.2 DIO delayed status, bit 1).	11
	Other [bit]	See Terms and abbreviations (page 221).	
90.69	Reset pos counter init ready	Selects a source that enables a new initialization of the position counter, ie. resets bit 4 of 90.35 Pos counter status.	Not selected / uint32
	Not selected	0	0
	Selected	1	1
	DI1	Digital input DI1 (10.2 DI delayed status, bit 0).	2

No.	Name / Range / Selection	Description	Def / Type FbEq 16b / 32b
	DI2	Digital input DI2 (10.2 DI delayed status, bit 1).	3
	DI3	Digital input DI3 (10.2 DI delayed status, bit 2).	4
	DI4	Digital input DI4 (10.2 DI delayed status, bit 3).	5
	DI5	Digital input DI5 (10.2 DI delayed status, bit 4).	6
	DI6	Digital input DI6 (10.2 DI delayed status, bit 5).	7
	DIO1	Digital input/output DIO1 (11.2 DIO delayed status, bit 0).	10
	DIO2	Digital input/output DIO2 (11.2 DIO delayed status, bit 1).	11
	Other [bit]	See <i>Terms and abbreviations</i> (page 221).	
90.200	Position counter init source	Selects the source for position counter initialization reset command or allows to manually reset the position counter initialization.  <b>Note:</b> This parameter is applicable only for Crane application program.	False / int32
	False	Position counter initialization reset command.	0
	True	Allows manual resetting of position counter initialization.	1
	Other [bit]	See <i>Terms and abbreviations</i> (page 221).	
90.201	Position counter init method	Selects the method of resetting the position counter initialization.  <b>Note:</b> This parameter is applicable only for Crane application program.	Rising edge standby / uint16
	Rising edge running	Rising edge of signal when drive is running.	0
	Rising edge standby	Rising edge of signal when drive is in standby.	1
	Rising edge	Rising edge of signal when drive is running or is in standby.	2
	Falling edge running	Falling edge of signal when drive is running.	3
	Falling edge standby	Falling edge of signal when drive is in standby.	4
	Falling edge	Falling edge of signal when drive is running or is in standby.	5
90.202	Position counter init sw	Status information related to the position counter initialization function. This is used together with standard position counter. Status word bits with default connection. See section <i>Power on acknowledgment</i> (page 136). This parameter is read-only.  <b>Note:</b> This parameter is applicable only for Crane application program.	- / uint16
	b0 Pos counter init command	This bit is connected as default into parameter 90.67 Pos counter init cmd source.	

## 622 Parameters

No.	Name / Range / Selection	Description	Def / Type FbEq 16b / 32b
b1	Reset pos counter init ready	This bit is connected as default into a parameter 90.69 Reset pos counter init ready.	
b2...15	Reserved		
	0000h...FFFFh		1 = 1

No.	Name / Range / Selection	Description	Def / Type FbEq 16b / 32b
<b>91</b>	<b>Encoder module settings</b>	Configuration of encoder interface modules.	
91.1	FEN DI status	Displays the status of the digital inputs of FEN-xx encoder interface modules.  <b>Note:</b> This parameter is read-only.	- / uint16
	b0 DI1 /module 1	DI1 of interface module 1 (see parameters 91.11 and 91.12)	
	b1 DI2 /module 1	DI2 of interface module 1 (see parameters 91.11 and 91.12)	
	b2...3 Reserved		
	b4 DI1 /module 2	DI1 of interface module 2 (see parameters 91.13 and 91.14)	
	b5 DI2 /module 2	DI2 of interface module 2 (see parameters 91.13 and 91.14)	
	b6...15 Reserved		
	0000h...FFFFh		1 = 1
91.2	Module 1 status	Displays the type of the interface module found in the location specified by parameter 91.12 Module 1 location.  <b>Note:</b> This parameter is read-only.	- / uint16
	No option	No module detected in the specified slot.	0
		A module has been detected but cannot be communicated with.	1
		The module type is unknown.	2
	FEN-01	An FEN-01 module has been detected and is active.	16
	FEN-11	An FEN-11 module has been detected and is active.	17
	FEN-21	An FEN-21 module has been detected and is active.	18
	FEN-31	An FEN-31 module has been detected and is active.	21
	FSE-31	An FSE-31 module has been detected and is active.	25
91.3	Module 2 status	Displays the type of the interface module found in the location specified by parameter 91.14 Module 2 location. For the indications, see parameter 91.2 Module 1 status.  <b>Note:</b> This parameter is read-only.	- / uint16
91.4	Module 1 temperature	Displays the temperature measured through the sensor input of interface module 1. The unit (°C or °F) is selected by parameter 96.16 Unit selection.  <b>Note:</b> With a PTC sensor, the unit is ohms.  <b>Note:</b> This parameter is read-only.	- / real32
	0.0 ... 1000.0 °C	Temperature measured through interface module 1.	- / -

## 624 Parameters

No.	Name / Range / Selection	Description	Def / Type FbEq 16b / 32b
91.6	Module 2 temperature	Displays the temperature measured through the sensor input of interface module 2. The unit (°C or °F) is selected by parameter 96.16 Unit selection.  <b>Note:</b> With a PTC sensor, the unit is ohms.  <b>Note:</b> This parameter is read-only.	- / real32
	0.0 ... 1000.0 °	Temperature measured through interface module 2.	- / -
91.10	Encoder parameter refresh	Validates any changed encoder interface module parameters. This is needed for any parameter changes in groups 90...93 to take effect. After refreshing, the value reverts automatically to Done.  <ul style="list-style-type: none"> <li>Permanent magnet motors only: The drive will perform a fresh autophasing routine (see page 184) at next start if the motor feedback encoder settings have been changed.</li> <li>The parameter cannot be changed while the drive is running.</li> </ul>	Done / uint16
	Done	Refreshing done.	0
	Refresh	Refreshing.	1
91.11	Module 1 type	Defines the type of the module used as interface module 1.	None / uint16
	None	None (communication disabled).	0
	FEN-01	FEN-01.	1
	FEN-11	FEN-11.	2
	FEN-21	FEN-21.	3
	FEN-31	FEN-31.	4
	FSE-31	FSE-31.	5
91.12	Module 1 location	Specifies the slot (1...3) on the control unit of the drive into which the interface module is installed. Alternatively, specifies the node ID of the slot on an FEA-03 extension adapter.	2 / uint16
	1...254	Slot 1 = 1; Slot 2 = 2; Slot 3 = 3 4...254: Node ID of the slot on the FEA-03 extension adapter	1 = 1 / 1 = 1
91.13	Module 2 type	Defines the type of the module used as interface module 2.	None / uint16
	None	None (communication disabled).	0
	FEN-01	FEN-01.	1
	FEN-11	FEN-11.	2
	FEN-21	FEN-21.	3
	FEN-31	FEN-31.	4
	FSE-31	FSE-31.	5



No.	Name / Range / Selection	Description	Def / Type FbEq 16b / 32b
91.14	Module 2 location	Specifies the slot (1...3) on the control unit of the drive into which the interface module is installed. Alternatively, specifies the node ID of the slot on an FEA-03 extension adapter.	3 / uint16
	1...254	Slot 1 = 1; Slot 2 = 2; Slot 3 = 3 4...254: Node ID of the slot on the FEA-03 extension adapter	1 = 1 / 1 = 1
91.21	Module 1 temp sensor type	Specifies the type of temperature sensor connected to interface module 1. Note that the module must also be activated by parameters 91.11 ... 91.12.	None / uint16
	None	None.	0
	PTC	PTC. (The unit is ohms.)	1
	KTY-84	KTY84. (The unit is selected by parameter 96.16 Unit selection.)	2
	Pt1000	Pt1000 (The unit is selected by parameter 96.16 Unit selection).  <b>Note:</b> Pt1000 sensor supports FEN-11 and FEN-31 encoder modules only.	3
91.22	Module 1 temp filter time	Defines a filtering time for the temperature measurement through interface module 1.	1500 ms / real32
	0...10000 ms	Filtering time for temperature measurement.	- / -
91.24	Module 2 temp sensor type	Specifies the type of temperature sensor connected to interface module 2. Note that the module must also be activated by parameters 91.13 ... 91.14.	None / uint16
	None	None.	0
	PTC	PTC. (The unit is ohms.)	1
	KTY-84	KTY84. (The unit is selected by parameter 96.16 Unit selection.)	2
	Pt1000	Pt1000 (The unit is selected by parameter 96.16 Unit selection).  <b>Note:</b> Pt1000 sensor supports FEN-11 and FEN-31 encoder modules only.	3
91.25	Module 2 temp filter time	Defines a filtering time for the temperature measurement through interface 2.	1500 ms / real32
	0...10000 ms	Filtering time for temperature measurement.	- / -
91.31	Module 1 TTL output source	Selects the encoder input on interface module 1 whose signal is echoed by or emulated to the TTL output. See also section <a href="#">Encoder support</a> (page 176).	Not selected / uint16
	Not selected	TTL output not in use.	0
	Module input 1	Input 1 is echoed by or emulated to the TTL output.	1
	Module input 2	Input 2 is echoed by or emulated to the TTL output.	2
91.32	Module 1 emulation pulses/rev	Defines the number of TTL pulses per revolution for encoder emulation output of interface module 1.	- / uint16

## 626 Parameters

No.	Name / Range / Selection	Description	Def / Type FbEq 16b / 32b
	0...65535	Number of TTL pulses for emulation.	1 = 1 / 1 = 1
91.33	Module 1 emulated Z-pulse offset	With interface module 1, defines when zero pulses are emulated in relation to zero position received from the encoder. For example, with a value of 0.50000, a zero pulse is emulated whenever the encoder position passes 0.5 revolutions. With a value of 0.00000, a zero pulse is emulated whenever the encoder position passes zero position.	- / real32
	0.00000 ... 1.00000 rev	Position of emulated zero pulses.	32767 = 1 rev / 100000 = 1 rev
91.41	Module 2 TTL output source	Selects the encoder input on interface module 2 whose signal is echoed by or emulated to the TTL output. See also section <a href="#">Encoder support (page 176)</a> .	Not selected / uint16
	Not selected	TTL output not in use.	0
	Module input 1	Input 1 is echoed by or emulated to the TTL output.	1
	Module input 2	Input 2 is echoed by or emulated to the TTL output.	2
91.42	Module 2 emulation pulses/rev	Defines the number of TTL pulses per revolution for encoder emulation output of interface module 2.	- / uint16
	0...65535	Number of TTL pulses for emulation.	1 = 1 / 1 = 1
91.43	Module 2 emulated Z-pulse offset	With interface module 2, defines when zero pulses are emulated in relation to zero position received from the encoder. For example, with a value of 0.50000, a zero pulse is emulated whenever the encoder position passes 0.5 revolutions. With a value of 0.00000, a zero pulse is emulated whenever the encoder position passes zero position.	- / real32
	0.00000 ... 1.00000 rev	Position of emulated zero pulses.	32767 = 1 rev / 100000 = 1 rev

No.	Name / Range / Selection	Description	Def / Type FbEq 16b / 32b
92	<b>Encoder 1 configuration</b>	<p>Settings for encoder 1.</p> <p><b>Note:</b> The contents of this parameter group vary according to the selected encoder type.</p> <p><b>Note:</b> It is recommended that encoder connection 1 (this group) is used whenever possible since the data received through that interface is fresher than the data received through connection 2 (group <a href="#">93 Encoder 2 configuration</a>).</p>	
92.1	Encoder 1 type	Selects the type of encoder/resolver 1.	None configured / uint16
	None configured	None.	0
	TTL	TTL. Module type (input): FEN-01 (X31), FEN-11 (X41) or FEN-21 (X51).	1
	TTL+	TTL+. Module type (input): FEN-01 (X32).	2
	Absolute encoder	Absolute encoder. Module type (input): FEN-11 (X42).	3
	Resolver	Resolver. Module type (input): FEN-21 (X52).	4
	HTL	HTL. Module type (input): FEN-31 (X82).	5
	HTL 1	HTL. Module type (input): FSE-31 (X31).	6
	HTL 2	HTL. Module type (input): FSE-31 (X32). Not supported at the time of publication.	7
92.2	Encoder 1 source	Selects the interface module that the encoder is connected to. (The physical locations and types of encoder interface modules are defined in parameter group <a href="#">91 Encoder module settings</a> .)	Module 1 / uint16
	Module 1	Interface module 1.	0
	Module 2	Interface module 2.	1
92.10	Excitation signal frequency	(Visible when <a href="#">92.1 Encoder 1 type</a> = Resolver) Defines the frequency of the excitation signal.  <b>Note:</b> With an EnDat or HIPERFACE encoder and FEN-11 FPGA version VIE12200 or later, this parameter is automatically set upon validation of encoder settings ( <a href="#">91.10 Encoder parameter refresh</a> ).	1 kHz / uint16
	1...20 kHz	Excitation signal frequency.	1 = 1 kHz / 1 = 1 kHz
92.10	Sine/cosine number	(Visible when <a href="#">92.1 Encoder 1 type</a> = Absolute encoder) Defines the number of sine/cosine wave cycles within one revolution.  <b>Note:</b> This parameter need not be set when an EnDat or SSI encoder is used in continuous mode. See parameter <a href="#">92.30 Serial link mode</a> .	0 / uint16
	0..65535	Number of sine/cosine wave cycles within one revolution.	- / -

## 628 Parameters

No.	Name / Range / Selection	Description	Def / Type FbEq 16b / 32b
92.10	Pulses/revolution	(Visible when 92.1 Encoder 1 type = HTL 1) Defines the pulse number per revolution.	2048 / uint16
	0...65535	Number of pulses.	- / -
92.11	Excitation signal amplitude	(Visible when 92.1 Encoder 1 type = Resolver) Defines the rms amplitude of the excitation signal.	4.0 V / uint16
	4.0 ... 12.0 V	Excitation signal amplitude.	10 = 1 V / 100 = 1 V
92.11	Absolute position source	(Visible when 92.1 Encoder 1 type = Absolute encoder) Selects the source of the absolute position information.	None / uint16
	None	Not selected.	0
	Commut. signals	Commutation signals.	1
	EnDat	Serial interface: EnDat encoder.	2
	Hiperface	Serial interface: HIPERFACE encoder.	3
	SSI	Serial interface: SSI encoder.	4
	Tamagawa	Serial interface: Tamagawa 17/33-bit encoder.	5
92.11	Pulse encoder type	(Visible when 92.1 Encoder 1 type = HTL 1) Selects the type of encoder.	Quadrature / uint16
	Quadrature	Quadrature encoder (with two channels, A and B).	0
	Single track	Single-track encoder (with one channel, A).  <b>Note:</b> With this setting, the measured speed value is always positive regardless of direction of rotation.	1
92.12	Resolver polepairs	(Visible when 92.1 Encoder 1 type = Resolver) Defines the number of pole pairs of the resolver.	1 / uint16
	1...32	Number of resolver pole pairs.	1 = 1 / 1 = 1
92.12	Zero pulse enable	(Visible when 92.1 Encoder 1 type = Absolute encoder) Enables the encoder zero pulse for the absolute encoder input (X42) of the FEN-11 interface module.  <b>Note:</b> No zero pulse exists with serial interfaces, ie. when parameter 92.11 Absolute position source is set to EnDat, Hiperface, SSI or Tamagawa.	Disable / uint16
	Disable	Zero pulse disabled.	0
	Enable	Zero pulse enabled.	1
92.12	Speed calculation mode	(Visible when 92.1 Encoder 1 type = HTL 1) Selects the speed calculation mode. *With a single-track encoder (parameter 92.11 Pulse encoder type is set to Single track), the speed is always positive.	Auto rising / uint16
	A&B all	Channels A and B: Rising and falling edges are used for speed calculation. *Channel B: Defines the direction of rotation.  <b>Note:</b> With a single-track encoder (parameter 92.11 Pulse encoder type, this setting acts like setting A all.	0

No.	Name / Range / Selection	Description	Def / Type FbEq 16b / 32b								
	A all	Channel A: Rising and falling edges are used for speed calculation. *Channel B: Defines the direction of rotation.	1								
	A rising	Channel A: Rising edges are used for speed calculation. *Channel B: Defines the direction of rotation.	2								
	A falling	Channel A: Falling edges are used for speed calculation. *Channel B: Defines the direction of rotation.	3								
	Auto rising	One of the above modes is selected automatically depending on the pulse frequency as follows:	4								
		<table border="1"> <thead> <tr> <th>Pulse frequency of the channel(s)</th> <th>Used mode</th> </tr> </thead> <tbody> <tr> <td>&lt; 2442 Hz</td> <td>A&amp;B all</td> </tr> <tr> <td>2442...4884 Hz</td> <td>A all</td> </tr> <tr> <td>&gt; 4884 Hz</td> <td>A rising</td> </tr> </tbody> </table>	Pulse frequency of the channel(s)	Used mode	< 2442 Hz	A&B all	2442...4884 Hz	A all	> 4884 Hz	A rising	
Pulse frequency of the channel(s)	Used mode										
< 2442 Hz	A&B all										
2442...4884 Hz	A all										
> 4884 Hz	A rising										
	Auto falling	One of the above modes is selected automatically depending on the pulse frequency as follows:	5								
		<table border="1"> <thead> <tr> <th>Pulse frequency of the channel(s)</th> <th>Used mode</th> </tr> </thead> <tbody> <tr> <td>&lt; 2442 Hz</td> <td>A&amp;B all</td> </tr> <tr> <td>2442...4884 Hz</td> <td>A all</td> </tr> <tr> <td>&gt; 4884 Hz</td> <td>A falling</td> </tr> </tbody> </table>	Pulse frequency of the channel(s)	Used mode	< 2442 Hz	A&B all	2442...4884 Hz	A all	> 4884 Hz	A falling	
Pulse frequency of the channel(s)	Used mode										
< 2442 Hz	A&B all										
2442...4884 Hz	A all										
> 4884 Hz	A falling										
92.13	Position data width	(Visible when 92.1 Encoder 1 type = Absolute encoder) Defines the number of bits used to indicate position within one revolution. For example, a setting of 15 bits corresponds to 32768 positions per revolution. The value is used when parameter 92.11 Absolute position source is set to EnDat, Hiperface or SSI. When parameter 92.11 Absolute position source is set to Tamagawa, this parameter is internally set to 17.  <b>Note:</b> With an EnDat or HIPERFACE encoder and FEN-11 FPGA version VIE12200 or later, this parameter is automatically set upon validation of encoder settings (91.10 Encoder parameter refresh).	0 / uint16								
	0...32	Number of bits used in position indication within one revolution.	1 = 1 / 1 = 1								
92.13	Position estimation enable	(Visible when 92.1 Encoder 1 type = HTL 1) Selects whether position estimation is used with encoder 1 to increase position data resolution or not.	Enable / uint16								
	Disable	Measured position used. (The resolution is 4 × pulses per revolution for quadrature encoders, 2 × pulses per revolution for single-track encoders.)	0								

## 630 Parameters

No.	Name / Range / Selection	Description	Def / Type FbEq 16b / 32b
	Enable	Estimated position used. (Uses position interpolation; extrapolated at the time of data request.)	1
92.14	Revolution data width	(Visible when 92.1 Encoder 1 type = Absolute encoder) Defines the number of bits used in revolution counting with a multturn encoder. For example, a setting of 12 bits would support counting up to 4096 revolutions. The value is used when parameter 92.11 Absolute position source is set to EnDat, Hiperface or SSI. When parameter 92.11 Absolute position source is set to Tamagawa, setting this parameter to a non-zero value activates multturn data requesting.  <b>Note:</b> With an EnDat or HIPERFACE encoder and FEN-11 FPGA version VIE12200 or later, this parameter is automatically set upon validation of encoder settings (91.10 Encoder parameter refresh).	0 / uint16
	0...32	Number of bits used in revolution count.	1 = 1 / 1 = 1
92.14	Speed estimation enable	(Visible when 92.1 Encoder 1 type = HTL 1) Selects whether calculated or estimated speed is used. Estimation increases the speed ripple in steady state operation, but improves the dynamics.  <b>Note:</b> This parameter is not effective with FEN-xx modules with FPGA version VIEx 2000 or later.	Disable / uint16
	Disable	Last calculated speed used. (The calculation interval is 62.5 microseconds to 4 milliseconds.)	0
	Enable	Estimated speed (estimated at the time of data request) is used.	1
92.15	Transient filter	(Visible when 92.1 Encoder 1 type = HTL 1) Activates transient filtering for the encoder (changes in direction of rotation are ignored above the selected pulse frequency).	4880Hz / uint16
	4880Hz	Change in direction of rotation allowed below 4880 Hz.	0
	2440Hz	Change in direction of rotation allowed below 2440 Hz.	1
	1220Hz	Change in direction of rotation allowed below 1220 Hz.	2
	Disabled	Change in direction of rotation allowed at any pulse frequency.	3
92.17	Accepted pulse freq of encoder 1	(Visible when 92.1 Encoder 1 type = HTL 1) Defines the maximum pulse frequency of encoder 1.	0 kHz / uint16
	0...300 kHz	Pulse frequency.	1 = 1 kHz / 1 = 1 kHz
92.21	Encoder cable fault mode	(Visible when 92.1 Encoder 1 type = HTL 1) Selects which encoder cable channels and wires are monitored for wiring faults.	A, B / uint16
	A+, A-, B+, B-, Z+, Z-	A and B.	0
	A, B, Z	A, B and Z.	1
	A+, A-, B+, B-	A+, A-, B+ and B-.	2
	A+, A-, B+, B-, Z+, Z-	A+, A-, B+, B-, Z+ and Z-.	3

No.	Name / Range / Selection	Description	Def / Type FbEq 16b / 32b
92.23	Maximum pulse waiting time	<p>(Visible when 92.1 Encoder 1 type = TTL+)</p> <p>Determines a pulse waiting time used in speed calculation for the encoder interface. If no pulse edges are detected within this time, the measured speed is zeroed by the interface.</p> <p>Increasing the setting can improve measuring performance especially at low, near zero speeds.</p> <p><b>Note:</b> The parameter is only supported by FEN-xx modules with FPGA version VIEx 2000 or later. On older modules, the pulse waiting time is fixed to 4 ms.</p> <p><b>Note:</b> The parameter only affects speed measurement. Position is updated whenever a new pulse edge is detected. When the measured speed from the interface is zero, the drive updates its speed data based on position changes.</p>	4 ms / real32
	1...200 ms	Maximum pulse waiting time.	1 = 1 ms / 1 = 1 ms
92.23	Maximum pulse waiting time	<p>(Visible when 92.1 Encoder 1 type = HTL 1)</p> <p>Determines a pulse waiting time used in speed calculation for the encoder interface. If no pulse edges are detected within this time, the measured speed is zeroed by the interface.</p> <p>Increasing the setting can improve measuring performance especially at low, near zero speeds.</p> <p><b>Note:</b> The parameter is only supported by FEN-xx modules with FPGA version VIEx 2000 or later. On older modules, the pulse waiting time is fixed to 4 ms.</p> <p><b>Note:</b> The parameter only affects speed measurement. Position is updated whenever a new pulse edge is detected. When the measured speed from the interface is zero, the drive updates its speed data based on position changes.</p>	4 ms / real32
	1...200 ms	Maximum pulse waiting time.	1 = 1 ms / 1 = 1 ms
92.24	Pulse edge filtering	<p>(Visible when 92.1 Encoder 1 type = HTL)</p> <p>Enables pulse edge filtering. Pulse edge filtering can improve the reliability of measurements especially from encoders with a single-ended connection.</p> <p><b>Note:</b> Pulse edge filtering is only supported by FEN-31 modules with FPGA version VIE3 2200 or later.</p> <p><b>Note:</b> Pulse edge filtering decreases the maximum pulse frequency. With 2 <math>\mu</math>s filtering time, the maximum pulse frequency is 200 kHz.</p>	No filtering / uint16
	No filtering	Filtering disabled.	0
	1 $\mu$ s	Filtering time: 1 microsecond.	1
	2 $\mu$ s	Filtering time: 2 microseconds.	2

## 632 Parameters

No.	Name / Range / Selection	Description	Def / Type FbEq 16b / 32b
92.25	Pulse overfrequency function	(Visible when 92.1 Encoder 1 type = HTL) Selects how the drive reacts when the encoder interface detects a pulse overfrequency condition.  <b>Note:</b> This parameter is effective only with FEN-xx module FPGA version VIEx 2200 or later.	Fault / uint16
	Warning	The drive generates a warning, 7381 Encoder. The FEN-xx module will continue to update speed and position data.	0
	Fault	The drive trips on fault A7E1 Encoder.	1
92.30	Serial link mode	(Visible when 92.1 Encoder 1 type = Absolute encoder) Selects the serial link mode with an EnDat or SSI encoder.	Initial position / uint16
	Initial position	Single position transfer mode (initial position).	0
	Continuous	Continuous position data transfer mode.	1
	Continuous speed and position	Continuous speed and position data transfer mode. This setting is intended for EnDat 2.2 encoders without sin/cos signals.  <b>Note:</b> This setting requires an FEN-11 interface revision H or later.	2
	EnDat max calculation time	(Visible when 92.1 Encoder 1 type = Absolute encoder) Selects the maximum encoder calculation time for an EnDat encoder.  <b>Note:</b> This parameter needs to be set only when an EnDat encoder is used in continuous mode, ie. without incremental sin/cos signals (supported only as encoder 1). See also parameter 92.30 Serial link mode.	50 ms / uint16
92.31	10 us	10 microseconds.	0
	100 us	100 microseconds.	1
	1 ms	1 millisecond.	2
	50 ms	50 milliseconds.	3
	92.32	SSI cycle time	(Visible when 92.1 Encoder 1 type = Absolute encoder) Selects the transmission cycle for an SSI encoder.  <b>Note:</b> This parameter needs to be set only when an SSI encoder is used in continuous mode, ie. without incremental sin/cos signals (supported only as encoder 1). See also parameter 92.30 Serial link mode.
50 us		50 microseconds.	0
100 us		100 microseconds.	1
200 us		200 microseconds.	2
500 us		500 microseconds.	3
1 ms		1 millisecond.	4
2 ms		2 milliseconds.	5



No.	Name / Range / Selection	Description	Def / Type FbEq 16b / 32b
92.33	SSI clock cycles	(Visible when 92.1 Encoder 1 type = Absolute encoder) Defines the length of an SSI message. The length is defined as the number of clock cycles. The number of cycles can be calculated by adding 1 to the number of bits in an SSI message frame.	2 / uint16
	2...127	SSI message length.	- / -
92.34	SSI position msb	(Visible when 92.1 Encoder 1 type = Absolute encoder) With an SSI encoder, defines the location of the MSB (most significant bit) of the position data within an SSI message.	1 / uint16
	1...126	Position data MSB location (bit number).	- / -
92.35	SSI revolution msb	(Visible when 92.1 Encoder 1 type = Absolute encoder) With an SSI encoder, defines the location of the MSB (most significant bit) of the revolution count within an SSI message.	1 / uint16
	1...126	Revolution count MSB location (bit number).	- / -
92.36	SSI data format	(Visible when 92.1 Encoder 1 type = Absolute encoder) Selects the data format for an SSI encoder.	Binary / uint16
	Binary	Binary code.	0
	Gray	Gray code.	1
92.37	SSI baud rate	(Visible when 92.1 Encoder 1 type = Absolute encoder) Selects the baud rate for an SSI encoder.	100 kBit/s / uint16
	10 kBit/s	10 kbit/s.	0
	50 kBit/s	50 kbit/s.	1
	100 kBit/s	100 kbit/s.	2
	200 kBit/s	200 kbit/s.	3
	500 kBit/s	500 kbit/s.	4
	1000 kBit/s	1000 kbit/s.	5
92.40	SSI zero phase	(Visible when 92.1 Encoder 1 type = Absolute encoder) Defines the phase angle within one sine/cosine signal period that corresponds to the value of zero on the SSI serial link data. The parameter is used to adjust the synchronization of the SSI position data and the position based on sine/cosine incremental signals. Incorrect synchronization may cause an error of $\pm 1$ incremental period.  <b>Note:</b> This parameter needs to be set only when an SSI encoder is used in initial position mode (see parameter 92.30 Serial link mode).	315-45 deg / uint16
	315-45 deg	315-45 degrees.	0
	45-135 deg	45-135 degrees.	1
	135-225 deg	135-225 degrees.	2
	225-315 deg	225-315 degrees.	3

## 634 Parameters

No.	Name / Range / Selection	Description	Def / Type FbEq 16b / 32b
92.45	Hiperface parity	(Visible when 92.1 Encoder 1 type = Absolute encoder) Defines the use of parity and stop bits with a HIPERFACE encoder. Typically this parameter need not be set.	Odd / uint16
	Odd	Odd parity indication bit, one stop bit.	0
	Even	Even parity indication bit, one stop bit.	1
92.46	Hiperface baud rate	(Visible when 92.1 Encoder 1 type = Absolute encoder) Defines the transfer rate of the link with a HIPERFACE encoder. Typically this parameter need not be set.	4800 bits/s / uint16
	4800 bits/s	4800 bit/s.	0
	9600 bits/s	9600 bit/s.	1
	19200 bits/s	19200 bit/s.	2
	38400 bits/s	38400 bit/s.	3
92.47	Hiperface node address	(Visible when 92.1 Encoder 1 type = Absolute encoder) Defines the node address for a HIPERFACE encoder. Typically this parameter need not be set.	64 / uint16
	0...255	HIPERFACE encoder node address.	- / -

No.	Name / Range / Selection	Description	Def / Type FbEq 16b / 32b
93	<b>Encoder 2 configuration</b>	<p>Settings for encoder 2.</p> <p><b>Note:</b> The contents of the parameter group vary according to the selected encoder type.</p> <p><b>Note:</b> It is recommended that encoder connection 1 (group 92 Encoder 1 configuration) is used whenever possible since the data received through that interface is fresher than the data received through connection 2 (this group).</p>	
93.1	Encoder 2 type	Selects the type of encoder/resolver 2.	None configured / uint16
	None configured	None.	0
	TTL	TTL. Module type (input): FEN-01 (X31), FEN-11 (X41) or FEN-21 (X51).	1
	TTL+	TTL+. Module type (input): FEN-01 (X32).	2
	Absolute encoder	Absolute encoder. Module type (input): FEN-11 (X42).	3
	Resolver	Resolver. Module type (input): FEN-21 (X52).	4
	HTL	HTL. Module type (input): FEN-31 (X82).	5
	HTL 1	HTL. Module type (input): FSE-31 (X31).	6
	HTL 2	HTL. Module type (input): FSE-31 (X32). Not supported at the time of publication.	7
93.2	Encoder 2 source	Selects the interface module that the encoder is connected to. (The physical locations and types of encoder interface modules are defined in parameter group 91 Encoder module settings.)	Module 1 / uint16
	Module 1	Interface module 1.	1
	Module 2	Interface module 2.	2
93.10	Excitation signal frequency	(Visible when 93.1 Encoder 2 type = Resolver) See parameter 92.10 Excitation signal frequency.	1 kHz / uint16
93.10	Sine/cosine number	(Visible when 93.1 Encoder 2 type = Absolute encoder) See parameter 92.10 Sine/cosine number.	0 / uint16
93.10	Pulses/revolution	(Visible when 93.1 Encoder 2 type = HTL 1) See parameter 92.10 Pulses/revolution.	2048 / uint16
93.11	Excitation signal amplitude	(Visible when 93.1 Encoder 2 type = Resolver) See parameter 92.11 Excitation signal amplitude.	4.0 V / uint16
93.11	Absolute position source	(Visible when 93.1 Encoder 2 type = Absolute encoder) See parameter 92.11 Absolute position source.	None / uint16
93.11	Pulse encoder type	(Visible when 93.1 Encoder 2 type = HTL 1) See parameter 92.11 Pulse encoder type.	Quadrature / uint16
93.12	Resolver polepairs	(Visible when 93.1 Encoder 2 type = Resolver) See parameter 92.12 Resolver polepairs.	1 / uint16
93.12	Zero pulse enable	(Visible when 93.1 Encoder 2 type = Absolute encoder) See parameter 92.12 Zero pulse enable.	Disable / uint16

## 636 Parameters

No.	Name / Range / Selection	Description	Def / Type FbEq 16b / 32b
93.12	Speed calculation mode	(Visible when 93.1 Encoder 2 type = HTL 1) See parameter 92.12 Speed calculation mode.	Auto rising / uint16
93.13	Position data width	(Visible when 93.1 Encoder 2 type = Absolute encoder) See parameter 92.13 Position data width.	0 / uint16
93.13	Position estimation enable	(Visible when 93.1 Encoder 2 type = HTL 1) See parameter 92.13 Position estimation enable.	Enable / uint16
93.14	Revolution data width	(Visible when 93.1 Encoder 2 type = Absolute encoder) See parameter 92.14 Revolution data width.	0 / uint16
93.14	Speed estimation enable	(Visible when 93.1 Encoder 2 type = HTL 1) See parameter 92.14 Speed estimation enable.	Disable / uint16
93.15	Transient filter	(Visible when 93.1 Encoder 2 type = HTL 1) See parameter 92.15 Transient filter.	4880Hz / uint16
93.17	Accepted pulse freq of encoder 2	(Visible when 93.1 Encoder 2 type = HTL 1) See parameter 92.17 Accepted pulse freq of encoder 1.	- / uint16
93.21	Encoder cable fault mode	(Visible when 93.1 Encoder 2 type = HTL 1) See parameter 92.21 Encoder cable fault mode.	A, B / uint16
93.23	Maximum pulse waiting time	(Visible when 93.1 Encoder 2 type = HTL 1) See parameter 92.23 Maximum pulse waiting time.	4 ms / real32
93.24	Pulse edge filtering	(Visible when 93.1 Encoder 2 type = HTL) See parameter 92.24 Pulse edge filtering.	No filtering / uint16
93.25	Pulse overfrequency function	(Visible when 93.1 Encoder 2 type = HTL) See parameter 92.25 Pulse overfrequency function.	Fault / uint16
93.30	Serial link mode	(Visible when 93.1 Encoder 2 type = Absolute encoder) See parameter 92.30 Serial link mode.	Initial position / uint16
93.31	EnDat calc time	(Visible when 93.1 Encoder 2 type = Absolute encoder) See parameter 92.31 EnDat max calculation time.	50 ms / uint16
93.32	SSI cycle time	(Visible when 93.1 Encoder 2 type = Absolute encoder) See parameter 92.32 SSI cycle time.	100 us / uint16
93.33	SSI clock cycles	(Visible when 93.1 Encoder 2 type = Absolute encoder) See parameter 92.33 SSI clock cycles.	2 / uint16
93.34	SSI position msb	(Visible when 93.1 Encoder 2 type = Absolute encoder) See parameter 92.34 SSI position msb.	1 / uint16
93.35	SSI revolution msb	(Visible when 93.1 Encoder 2 type = Absolute encoder) See parameter 92.35 SSI revolution msb.	1 / uint16
93.36	SSI data format	(Visible when 93.1 Encoder 2 type = Absolute encoder) See parameter 92.36 SSI data format.	Binary / uint16
93.37	SSI baud rate	(Visible when 93.1 Encoder 2 type = Absolute encoder) See parameter 92.37 SSI baud rate.	100 kBit/s / uint16
93.40	SSI zero phase	(Visible when 93.1 Encoder 2 type = Absolute encoder) See parameter 92.40 SSI zero phase.	315-45 deg / uint16
93.45	Hiperface parity	(Visible when 93.1 Encoder 2 type = Absolute encoder) See parameter 92.45 Hiperface parity.	Odd / uint16
93.46	Hiperface baud rate	(Visible when 93.1 Encoder 2 type = Absolute encoder) See parameter 92.46 Hiperface baud rate.	4800 bits/s / uint16

---

<b>No.</b>	<b>Name / Range / Selection</b>	<b>Description</b>	<b>Def / Type FbEq 16b / 32b</b>
93.47	Hiperface node address	(Visible when 93.1 Encoder 2 type = Absolute encoder) See parameter 92.47 Hiperface node address.	64 / uint16

---

---

## 638 Parameters

No.	Name / Range / Selection	Description	Def / Type FbEq 16b / 32b
<b>95</b>	<b>HW configuration</b>	Various hardware-related settings.	
95.1	Supply voltage	Selects the supply voltage range. This parameter is used by the drive to determine the nominal voltage of the supply network. The parameter also affects the current ratings and the DC voltage control functions (trip and brake chopper activation limits) of the drive.	- / uint16
		 <b>WARNING!</b> An incorrect setting may cause the motor to rush uncontrollably, or the brake chopper or resistor to overload.	
		<p><b>Note:</b> The selections shown depend on the hardware of the drive. If only one voltage range is valid for the drive in question, it is selected by default.</p> <p><b>Note:</b> This parameter cannot be changed while the drive is running.</p>	
	Not given	No voltage range selected. The drive will not start modulating before a range is selected.	0
	208...240 V	208...240 V	1
	380...415 V	380...415 V	2
	440...480 V	440...480 V	3
	500 V	500 V	4
	525...600 V	525...600 V	5
	660...690 V	660...690 V	6
95.2	Adaptive voltage limits	<p>Enables adaptive voltage limits. Adaptive voltage limits can be used if, for example, an IGBT supply unit is used to raise the DC voltage level. If the communication between the inverter and the IGBT supply unit is active (95.20 HW options word 1), the voltage limits are related to the DC voltage reference transmitted to the supply unit (94.20 DC voltage reference) assuming that the reference is high enough. Otherwise, the limits are calculated based on the measured DC voltage at the end of the pre-charging sequence.</p> <p>This function is also useful if the AC supply voltage to the drive is high, as the warning levels are raised accordingly.</p> <p>*Affected by 95.20 HW options word 1, bit 15.</p>	Disable; Enable (95.20 b15) / uint16
	Disable	Adaptive voltage limits disabled.	0
	Enable	Adaptive voltage limits enabled.	1
95.4	Control board supply	<p>Specifies how the control unit of the drive is powered.</p> <p>*The default value depends on the type of control unit and the setting of parameter 95.20 HW options word 1, bit 4.</p>	Internal 24V (ZCU); External 24V (BCU; 95.20 b4) / uint16

No.	Name / Range / Selection	Description	Def / Type FbEq 16b / 32b
Internal 24V	<p>The drive control unit is powered from the drive power unit it is connected to.</p> <p><b>Note:</b> If reduced run (see section <a href="#">Reduced run function (page 214)</a>) is required, select <a href="#">External 24V</a> or <a href="#">Redundant external 24V</a> instead.</p>	0	
External 24V	<p>The drive control unit is powered from an external power supply. The drive power unit and power unit link faults are masked when the drive is in stopped state, so the main circuit can be powered down without faults while the control unit is powered.</p>	1	
	<p><i>(Type BCU control units only)</i></p> <p>The drive control unit is powered from two redundant external power supplies. The loss of one of the supplies generates a warning (<a href="#">AFEC External power signal missing</a>). The drive power unit and power unit link faults are masked when the drive is in stopped state, so the main circuit can be powered down without faults while the control unit is powered.</p>	2	

## 640 Parameters

No.	Name / Range / Selection	Description	Def / Type FbEq 16b / 32b
95.8	DC switch monitoring	<p><i>(Only visible with a ZCU control unit)</i></p> <p>Enables/disables DC switch monitoring via the DIIL input. This setting is intended for use with inverter modules with an internal charging circuit that are connected to the DC bus through a DC switch. An auxiliary contact of the DC switch must be wired to the DIIL input so that the input switches off when the DC switch is opened.</p>	Disable; Enable (95.20 b5) / uint16

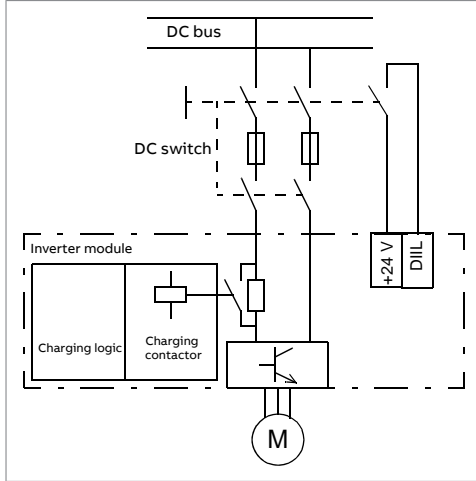

If the DC switch is opened with the inverter running, the inverter is given a coast-to-stop command, and its charging circuit activated. Starting the inverter is prevented until the DC switch is closed and the DC circuit in the inverter unit recharged.

**Note:** By default, DIIL is the input for the Run enable signal. Adjust 20.12 Run enable 1 source if necessary.

**Note:** An internal charging circuit is standard on some inverter module types but optional on others; check with your local ABB representative.

Disable	DC switch monitoring through the DIIL input disabled. 0
Enable	DC switch monitoring through the DIIL input enabled. 1



No.	Name / Range / Selection	Description	Def / Type FbEq 16b / 32b
95.9	Switch fuse controller	<p><i>(Only visible with a BCU control unit)</i>            Activates communication to a BSFC charging controller. This setting is intended for use with inverter modules that are connected to a DC bus through a DC switch/charging circuit controlled by a charging controller. On units without a DC switch, this parameter should be set to <i>Disable</i>.            The charging controller monitors the charging of the inverter unit, and sends an enable command when the charging has finished (ie. DC switch is closed after the 'charging OK' lamp lights, and charging switch opened). For more information, see BSFC documentation.</p>	Enable / uint16
		Communication with BSFC disabled.	0
		Communication with BSFC enabled.	1
95.12	Reduced run mask	<p><i>(Only visible with BCU control unit)</i>            Specifies which converter modules have been removed from the converter configuration. A value other than 0 activates the reduced run function.            See section <i>Reduced run function</i> (page 214).</p>	- / uint16
	b0 Module 1 removed	Module 1 has been removed.	
	b1 Module 2 removed	Module 2 has been removed.	
	b2 Module 3 removed	Module 3 has been removed.	
	b3 Module 4 removed	Module 4 has been removed.	
	b4 Module 5 removed	Module 5 has been removed.	
	b5 Module 6 removed	Module 6 has been removed.	
	b6 Module 7 removed	Module 7 has been removed.	
	b7 Module 8 removed	Module 8 has been removed.	
	b8 Module 9 removed	Module 9 has been removed.	
	b9 Module 10 removed	Module 10 has been removed.	
	b10 Module 11 removed	Module 11 has been removed.	
	b11 Module 12 removed	Module 12 has been removed.	
b12...15	Reserved		
	0000h...FFFFh		1 = 1
95.13	Reduced run mode	<p><i>(Only visible with a BCU control unit)</i>            Specifies the number of inverter modules available. This parameter must be set if reduced run is required. A value other than 0 activates the reduced run function. If the control program cannot detect the number of modules specified by this parameter, a fault (5695 <i>Reduced run</i>) is generated.            See section <i>Reduced run function</i> (page 214).            0 = Reduced run disabled            1...12 = Number of modules available</p> <p><b>Note:</b> This parameter cannot be changed while the drive is running.</p>	- / uint16

## 642 Parameters

No.	Name / Range / Selection	Description	Def / Type FbEq 16b / 32b
	0...65535	Number of inverter modules available.	- / -
95.14	Connected modules	<i>(Only visible with a BCU control unit)</i> Shows which of the parallel-connected inverter modules have been detected by the control program.  <b>Note:</b> This parameter is read-only.	- / uint16
	b0	Module 1 has been detected.	
	b1	Module 2 has been detected.	
	b2	Module 3 has been detected.	
	b3	Module 4 has been detected.	
	b4	Module 5 has been detected.	
	b5	Module 6 has been detected.	
	b6	Module 7 has been detected.	
	b7	Module 8 has been detected.	
	b8	Module 9 has been detected.	
	b9	Module 10 has been detected.	
	b10	Module 11 has been detected.	
	b11	Module 12 has been detected.	
	b12...15	Reserved	
	0000h...FFFFh		1 = 1
95.15	Special HW settings	Contains hardware-related settings that can be enabled and disabled by toggling the specific bits.  <b>Note:</b> The installation of the hardware specified by this parameter may require derating of drive output, or impose other limitations. Refer to the hardware manual of the drive.  <b>Note:</b> This parameter cannot be changed while the drive is running.	- / uint16
	b0 EX motor	1 = The driven motor is an Ex motor provided by ABB for potentially explosive atmospheres. This sets the required minimum switching frequency for ABB Ex motors.  <b>Note:</b> For non-ABB Ex motors, contact your local ABB representative.	
	b1 ABB sine filter	1 = An ABB sine filter is connected to the output of the drive/inverter.	
	b2 High speed mode	1 = Minimum switching frequency limit adaptation to output frequency active. This setting improves control performance at high output frequencies (typically above 120 Hz).	

No.	Name / Range / Selection	Description	Def / Type FbEq 16b / 32b
b3	Custom sine filter	1 = A custom sine filter is connected to the output of the drive/inverter. See also parameters 97.1, 97.2, 99.18, 99.19.	
b4...15	Reserved		
	0000h...FFFFh		1 = 1
95.16	Router mode	<p><i>(Only visible with a BCU control unit)</i>            Enables/disables router mode of the BCU control unit. When router mode is active, the PSL2 channels connected to another BCU (ie. those selected by 95.17 Router channel config) are routed to the power units (converter modules) connected to this BCU.            See section Router mode for BCU control unit (page 217).</p> <p><b>Note:</b> This parameter cannot be changed while the drive is running.</p>	Off / uint32
	Off	Router mode inactive.	0
	On	Router mode active.	1
	Other [bit]	See Terms and abbreviations (page 221).	
95.17	Router channel config	<p><i>(Only visible with a BCU control unit)</i>            Selects which PSL2 channels on the BCU control unit are connected to another BCU and routed to a local power unit.</p> <p><b>Note:</b> The local power units are to be connected to successive channels starting from CH1. The other BCU is then connected to one or more successive channels starting from the first free channel.</p> <p><b>Note:</b> The lowest channel selected in this parameter is routed to the local power unit with the lowest number, etc.</p> <p><b>Note:</b> There must be at least as many local power modules as there are routed channels.</p> <p><b>Note:</b> This parameter cannot be changed while the drive is running.            See section Router mode for BCU control unit (page 217).</p>	- / uint16
	b0	0	
	b1	1 = Channel CH2 is routed to the local power unit (which is connected to CH1)	
	b2	1 = Channel CH3 is routed to the local power unit (which is connected to CH1)	
	b3	1 = Channel CH4 is routed to a local power unit	
	b4	1 = Channel CH5 is routed to a local power unit	
	b5	1 = Channel CH6 is routed to a local power unit	
	b6	1 = Channel CH7 is routed to a local power unit	
	b7	1 = Channel CH8 is routed to a local power unit	

## 644 Parameters

No.	Name / Range / Selection	Description	Def / Type FbEq 16b / 32b
	b8	1 = Channel CH9 is routed to a local power unit	
	b9	1 = Channel CH10 is routed to a local power unit	
	b10	1 = Channel CH11 is routed to a local power unit	
	b11	1 = Channel CH12 is routed to a local power unit	
	b12...15 Reserved		
	0000h...FFFFh		1 = 1
95.20	HW options word 1	Specifies hardware-related options that require differentiated parameter defaults. Activating a bit in this parameter makes the necessary changes in other parameters. For example, activating an emergency stop option reserves a digital input. In many cases, the differentiated parameters will also be write-protected. This parameter, as well as the changes in other parameters implemented by it, are not affected by a parameter restore.	- / uint16
 <b>WARNING!</b> After switching any bits in this word, recheck the values of the affected parameters.			
<b>Note:</b> This parameter cannot be changed while the drive is running.			
	b0 Supply frequency 60 Hz	0 = 50 Hz; 1 = 60 Hz. Affects 11.45, 11.59, 12.20, 13.18, 30.11, 30.12, 30.13, 30.14, 31.26, 31.27, 46.1, 46.2.	
	b1 Emergency stop Cat 0	1 = Emergency stop, Category 0, without FSO module. Affects 21.04, 21.05, 23.11.	
	b2 Emergency stop Cat 1	1 = Emergency stop, Category 1, without FSO module. Affects 10.24, 21.04, 21.05, 23.11.	
	b3 RO2 for -07 cabinet cooling fan	1 = Control of cabinet cooling fan (used only with specific ACS880-07 hardware). Affects 10.27, 10.28, 10.29.	
	b4 Externally powered control unit	1 = Control unit powered externally. Affects 95.4. <i>(Only visible with a ZCU control unit)</i>	
	b5 DC supply switch	1 = DC switch monitoring active. Affects 20.12, 31.3, 95.8. <i>(Only visible with a ZCU control unit)</i>	
	b6 DOL motor switch	1 = Motor fan control active. Affects 10.24, 35.100, 35.103, 35.104.	
	b7 Service switch or PTC/Pt100 relay	1 = xSFC charging controller used. Affects 95.9. <i>(Only visible with a BCU control unit)</i>	
	b8 Service switch or PTC/Pt100 relay	1 = Service switch or PTC/Pt100 relay connected. Affects 31.1, 31.2.	
	b9 Output contactor	1 = Output contactor present. Affects 10.24, 20.12.	
	b10 Brake resistor, sine filter, IP54 fan	1 = Status (eg. thermal) switches connected to DIIL input. Affects 20.11, 20.12.	

No.	Name / Range / Selection	Description	Def / Type FbEq 16b / 32b
b11	Brake resistor, sine filter, IP54 fan	*1 = Diode supply unit control by inverter unit active. Makes several parameters visible in groups 6, 60, 61, 62 and 94. <i>(Only visible with a BCU control unit)</i>	
b12	Reserved		
b13	du/dt filter activation	1 = Active: An external du/dt filter is connected to the drive output. The setting will limit the output switching frequency. With inverter module frame sizes R5i to R7i, the fan of the module will be forced to full speed.  <b>Note:</b> This bit is to be left at 0 if the drive/inverter module is equipped with internal du/dt filtering (eg. frame R8i inverter modules with option +E205).	
b14	DOL fan activation	1 = The inverter unit consists of frame R8i modules with direct-on-line cooling fans (option +C188). Disables fan feedback monitoring and changes fan control to ON/OFF type.	
b15	INU-ISU communication	*1 = IGBT supply unit control by inverter unit active. Affects 31.23 and 95.2. Makes several parameters visible in groups 1, 5, 6, 7, 30, 31, 60, 61, 62, 94 <i>LSU control</i> and 96.	
	0000h...FFFFh		1 = 1
95.21	HW options word 2	Specifies more hardware-related options that require differentiated parameter defaults. See parameter 95.20 HW options word 1.   <b>WARNING!</b> After switching any bits in this word, recheck the values of the affected parameters.  <b>Note:</b> This parameter cannot be changed while the drive is running.	- / uint16
b0	Dual use	1 = Dual use active. For drives with option +N8200. (Allows higher output speeds/frequencies and speed/frequency reference limits.)	
b1	SynRM	1 = Synchronous reluctance motor used. Affects 25.2, 25.3, 25.15, 99.3.	
b2	Salient PM	1 = Salient-pole permanent magnet motor used. Affects 25.2, 25.3, 25.15, 99.3.	
b3	LV Synchro	1 = Externally-excited synchronous motor used. Requires a license. Contact your local ABB representative for more information.	
b4	Aux fan 1 supervision	1 = Auxiliary fan 1 installed and supervised.	
b5	Aux fan 2 supervision	1 = Auxiliary fan 2 installed and supervised.	
b6...15	Reserved		
	0000h...FFFFh		1 = 1

## 646 Parameters

No.	Name / Range / Selection	Description	Def / Type FbEq 16b / 32b
95.30	Parallel type list filter	<p><i>(Only visible with a BCU control unit)</i> Filters the list of drive/inverter types listed by parameter 95.31 Parallel type configuration.</p> <p><b>Note:</b> This parameter cannot be changed while the drive is running.</p>	No filter / uint16
	No filter	All types listed.	1
	400 V	-3 (380...415 V) types listed.	2
	500 V	-5 (380...500 V) types listed.	3
	690 V	-7 (525...690 V) types listed.	4
	-7 LC (525-690V)	Liquid-cooled -7 (525...690 V) types listed.	5
95.31	Parallel type configuration	<p><i>(Visible when 95.30 Parallel type list filter = No filter)</i> <i>(Only visible with a BCU control unit)</i> Defines the drive/inverter type if it consists of parallel-connected modules. If the drive/inverter consists of a single module, leave the value at <i>Not selected</i>.</p> <p><b>Note:</b> This parameter cannot be changed while the drive is running.</p>	Not selected / uint16
	Not selected	The drive/inverter does not consist of parallel-connected modules, or type not selected.	0
	-	Drive/inverter type consisting of parallel-connected modules.	-
95.40	Transformation ratio	Defines the ratio of the step-up transformer.	0.000 / real32
	0.000 ... 100.000	Step-up transformer ratio.	1000 = 1 / 1000 = 1

No.	Name / Range / Selection	Description	Def / Type FbEq 16b / 32b
96	<b>System</b>	Language selection; access levels; macro selection; parameter save and restore; control unit reboot; user parameter sets; unit selection; data logger triggering; parameter checksum calculation; user lock.	
96.1	Language	Selects the language of the parameter interface and other displayed information when viewed on the control panel.  <b>Note:</b> Not all languages listed below are necessarily supported.  <b>Note:</b> This parameter does not affect the languages visible in the Drive Composer PC tool. (Those are specified under View – Settings.)	- / uint16
	Deutsch	German.	1031
	Italiano	Italian.	1040
	Español	Spanish.	3082
	Português	Portuguese.	2070
	Nederlands	Dutch.	1043
	Français	French.	1036
	Dansk	Danish.	1030
	Suomi	Finnish.	1035
	Svenska	Swedish.	1053
	Русский	Russian.	1049
	Not selected	None.	0
	Polski	Polish.	1045
	Česky	Czech.	1029
	Chinese (Simplified, Simplified Chinese. PRC)		2052
	Türkçe	Turkish.	1055
	Japanese	Japanese.	1041
	English	English.	1033

## 648 Parameters

No.	Name / Range / Selection	Description	Def / Type FbEq 16b / 32b
96.2	Pass code	<p>Pass codes can be entered into this parameter to activate further access levels (see parameter 96.3 <i>Access levels active</i>) or to configure the user lock. Entering "358" toggles the parameter lock, which prevents the changing of all other parameters through the control panel or the Drive Composer PC tool. Entering the user pass code (by default, "10000000") enables parameters 96.100 ... 96.102, which can be used to define a new user pass code and to select the actions that are to be prevented. Entering an invalid pass code will close the user lock if open, i.e. hide parameters 96.100 ... 96.102. After entering the code, check that the parameters are in fact hidden. If they are not, enter another (random) pass code. Entering several invalid pass codes introduces a delay before a new attempt can be made. Entering further invalid codes will progressively lengthen the delay.</p> <p><b>Note:</b> You must change the default user pass code to maintain a high level of cybersecurity. <u>Store the code in a safe place – the protection cannot be disabled even by ABB if the code is lost.</u></p> <p>See also section <i>User lock</i> (page 213).</p>	0 / uint32
	0...99999999	Pass code.	1 = 1
96.3	Access levels active	<p>Shows which access levels have been activated by pass codes entered into parameter 96.2 <i>Pass code</i>.</p> <p><b>Note:</b> This parameter is read-only.</p>	- / uint16
	b0 End user	End user.	
	b1 Service	Service.	
	b2 Advanced programmer	Advanced programmer.	
	b3...10 .		
	b11 OEM access level 1	OEM access level 1.	
	b12 OEM access level 2	OEM access level 2.	
	b13 OEM access level 3	OEM access level 3.	
	b14 Parameter lock	Parameter lock.	
	b15 .		
	0000h...FFFFh		1 = 1
96.6	Parameter restore	<p>Restores the original settings of the control program, i.e. parameter default values.</p> <p><b>Note:</b> This parameter cannot be changed while the drive is running.</p>	Done / uint16
	Done	Restoring is completed.	0



No.	Name / Range / Selection	Description	Def / Type FbEq 16b / 32b
Restore defaults	<p>All editable parameter values are restored to default values, except</p> <ul style="list-style-type: none"> <li>• motor data and ID run results</li> <li>• parameter 31.42 Overcurrent fault limit</li> <li>• control panel/PC communication settings</li> <li>• I/O extension module settings</li> <li>• fieldbus adapter settings</li> <li>• encoder configuration data</li> <li>• application macro selection and the parameter defaults implemented by it</li> <li>• parameter 95.21 HW options word 2</li> <li>• parameter 95.9 Switch fuse controller</li> <li>• differentiated defaults implemented by parameters 95.20 HW options word 1 and 95.21 HW options word 2</li> <li>• user lock configuration parameters 96.100 ... 96.102.</li> </ul>	8	
Clear all	<p>All editable parameter values are restored to default values, except</p> <ul style="list-style-type: none"> <li>• control panel/PC communication settings</li> <li>• application macro selection and the parameter defaults implemented by it</li> <li>• parameter 95.1 Supply voltage</li> <li>• parameter 95.9 Switch fuse controller</li> <li>• differentiated defaults implemented by parameters 95.20 HW options word 1 and 95.21 HW options word 2</li> <li>• user lock configuration parameters 96.100 ... 96.102.</li> </ul> <p>PC tool communication is interrupted during the restoring.</p> <p><b>Note:</b> Activating this selection will restore the default settings of the fieldbus adapter if one is connected, potentially including settings that cannot be accessed through drive parameters.</p>	62	
Reset all fieldbus settings	<p>Fieldbus adapter and embedded fieldbus interface settings (parameter groups 50...58) are restored to default values. This will also restore the default settings of the fieldbus adapter if one is connected, potentially including settings that cannot be accessed through drive parameters.</p>	32	

## 650 Parameters

No.	Name / Range / Selection	Description	Def / Type FbEq 16b / 32b
96.7	Parameter save manually	<p>Saves the valid parameter values to permanent memory. This parameter should be used to store values sent from a fieldbus, or when using an external power supply to the control board as the supply might have a very short hold-up time when powered off.</p> <p><b>Note:</b> A new parameter value is saved automatically when changed from the PC tool or control panel but not when altered through a fieldbus adapter connection.</p>	Done / uint16
	Done	Save completed.	0
	Save	Start save, or save in progress.	1
96.8	Control board boot	<p>Changing the value of this parameter to 1 reboots the control unit (without requiring a power off/on cycle of the complete drive module). The value reverts to 0 automatically.</p> <p><b>Note:</b> This parameter cannot be changed while the drive is running.</p>	- / uint16
	0...1	1 = Reboot the control unit.	1 = 1 / 1 = 1
96.9	FSO reboot	<p>Changing the value of (or the source selected by) this parameter from 0 to 1 reboots the optional FSO-xx safety functions module.</p> <p><b>Note:</b> The value does not revert to 0 automatically.</p>	False / uint32
	False	0.	0
	True	1.	1
	Other [bit]	See <a href="#">Terms and abbreviations (page 221)</a> .	
96.10	User set status	<p>Shows the status of the user parameter sets.</p> <p><b>Note:</b> This parameter is read-only. See also section <a href="#">User parameter sets (page 210)</a>.</p>	- / uint16
	n/a	No user parameter sets have been saved.	0
	Loading	A user set is being loaded.	1
	Saving	A user set is being saved.	2
	Faulted	Invalid parameter set.	3
	User set 1	User set 1 has been loaded.	4
	User set 2	User set 2 has been loaded.	5
	User set 3	User set 3 has been loaded.	6
	User set 4	User set 4 has been loaded.	7

No.	Name / Range / Selection	Description	Def / Type FbEq 16b / 32b															
96.11	User set save/load	<p>Enables the saving and restoring of up to four custom sets of parameter settings. See section <a href="#">User parameter sets (page 210)</a>.</p> <p>The set that was in use before powering down the drive is in use after the next power-up.</p> <p><b>Note:</b> Hardware configuration settings such as I/O extension module, fieldbus and encoder configuration parameters (groups 14...16, 51...56, 58 and 92...93, and parameters 50.1 and 50.31), and forced input/output values (such as 10.3 and 10.4) are not included in user parameter sets.</p> <p><b>Note:</b> Parameter changes made after loading a set are not automatically stored – they must be saved using this parameter.</p> <p><b>Note:</b> If no sets have been saved, attempting to load a set will create all sets from the currently active parameter settings.</p> <p><b>Note:</b> Switching between sets is only possible with the drive stopped.</p>	No action / uint16															
	No action	Load or save operation complete; normal operation.	0															
	User set I/O mode	Load user parameter set using parameters 96.12 and 96.13.	1															
	Load set 1	Load user parameter set 1.	2															
	Load set 2	Load user parameter set 2.	3															
	Load set 3	Load user parameter set 3.	4															
	Load set 4	Load user parameter set 4.	5															
	Save to set 1	Save user parameter set 1.	18															
	Save to set 2	Save user parameter set 2.	19															
	Save to set 3	Save user parameter set 3.	20															
	Save to set 4	Save user parameter set 4.	21															
96.12	User set I/O mode in1	When parameter 96.11 is set to <a href="#">User set I/O mode</a> , selects the user parameter set together with parameter 96.13 as follows:	Not selected / uint32															
		<table border="1"> <thead> <tr> <th>Status of source defined by 96.12</th> <th>Status of source defined by 96.13</th> <th>User parameter set selected</th> </tr> </thead> <tbody> <tr> <td>0</td> <td>0</td> <td>Set 1</td> </tr> <tr> <td>1</td> <td>0</td> <td>Set 2</td> </tr> <tr> <td>0</td> <td>1</td> <td>Set 3</td> </tr> <tr> <td>1</td> <td>1</td> <td>Set 4</td> </tr> </tbody> </table>	Status of source defined by 96.12	Status of source defined by 96.13	User parameter set selected	0	0	Set 1	1	0	Set 2	0	1	Set 3	1	1	Set 4	
Status of source defined by 96.12	Status of source defined by 96.13	User parameter set selected																
0	0	Set 1																
1	0	Set 2																
0	1	Set 3																
1	1	Set 4																

## 652 Parameters

No.	Name / Range / Selection	Description	Def / Type FbEq 16b / 32b
	Not selected	0	0
	Selected	1	1
	DI1	Digital input DI1 (10.2 DI delayed status, bit 0).	2
	DI2	Digital input DI2 (10.2 DI delayed status, bit 1).	3
	DI3	Digital input DI3 (10.2 DI delayed status, bit 2).	4
	DI4	Digital input DI4 (10.2 DI delayed status, bit 3).	5
	DI5	Digital input DI5 (10.2 DI delayed status, bit 4).	6
	DI6	Digital input DI6 (10.2 DI delayed status, bit 5).	7
	DIO1	Digital input/output DIO1 (11.2 DIO delayed status, bit 0).	10
	DIO2	Digital input/output DIO2 (11.2 DIO delayed status, bit 1).	11
	Other [bit]	See Terms and abbreviations (page 221).	
96.13	User set I/O mode in2	See parameter 96.12 User set I/O mode in1.	Not selected / uint32
96.16	Unit selection	Selects the unit of parameters indicating power, temperature and torque.	- / uint16
	b0 Power unit	0 = kW 1 = hp	
	b1 Reserved		
	b2 Temperature unit	0 = C (°C) 1 = F (°F)	
	b3 Reserved		
	b4 Torque unit	0 = Nm (N·m) 1 = lbft (lb·ft)	
	b5...15 Reserved		
	0000h...FFFFh		1 = 1
96.20	Time sync primary source	Defines the 1st priority external source for synchronization of the drive's time and date. The date and time can also be directly set into 96.24 ... 96.26 in which case this parameter is ignored.	DDCS Controller / uint16
	Internal	No external source selected.	0
	DDCS Controller	External controller.	1
	Fieldbus A or B	Fieldbus interface A or B.	2
	Fieldbus A	Fieldbus interface A.	3
	Fieldbus B	Fieldbus interface B.	4
	D2D or M/F	The master station on a master/follower or drive-to-drive link.	5
	Embedded FB	Embedded fieldbus interface.	6
	Panel link	Control panel, or Drive Composer PC tool connected to the control panel.	8

No.	Name / Range / Selection	Description	Def / Type FbEq 16b / 32b
	Ethernet tool link	Drive Composer PC tool through an FENA module.	9
96.23	M/F and D2D clock synchronization	In the master drive, activates clock synchronization for master/follower and drive-to-drive communication.	Inactive / uint16
	Inactive	Clock synchronization not active.	0
	Active	Clock synchronization active.	1
96.24	Full days since 1st Jan 1980	Number of full days passed since beginning of the year 1980. This parameter, together with 96.25 Time in minutes within 24 h and 96.26 Time in ms within one minute makes it possible to set the date and time in the drive via the parameter interface from a fieldbus or application program. This may be necessary if the fieldbus protocol does not support time synchronization.	- / uint16
	1...59999 days	Days count. 1 = 1st January 1980.	1 = 1 days / 1 = 1 days
96.25	Time in minutes within 24 h	Number of full minutes passed since midnight. For example, the value 860 corresponds to 2:20 pm. See parameter 96.24 Full days since 1st Jan 1980.	0 min / uint16
	0...1439 min	Minutes since midnight.	1 = 1 min / 1 = 1 min
96.26	Time in ms within one minute	Number of milliseconds passed since last minute. See parameter 96.24 Full days since 1st Jan 1980.	0 ms / uint16
	0...59999 ms	Number of milliseconds since last minute.	1 = 1 ms / 1 = 1 ms
96.29	Time sync source status	Time source status word. <b>Note:</b> This parameter is read-only.	- / uint16
	b0 Time tick received	1 = 1st priority tick received: Tick has been received from 1st priority source (or from 96.24 ... 96.26).	
	b1 Aux Time tick received	1 = 2nd priority tick received: Tick has been received from 2nd priority source.	
	b2 Tick interval is too long	1 = Yes: Tick interval too long (accuracy compromised).	
	b3 DDCS controller	1 = Tick received: Tick has been received from an external controller.	
	b4 Master/Follower	1 = Tick received: Tick has been received through the master/follower link.	
	b5 Reserved		
	b6 D2D	1 = Tick received: Tick has been received through the drive-to-drive link.	
	b7 FbusA	1 = Tick received: Tick has been received through fieldbus interface A.	
	b8 FbusB	1 = Tick received: Tick has been received through fieldbus interface B.	
	b9 EFB	1 = Tick received: Tick has been received through the embedded fieldbus interface.	
	b10 Reserved		

654 Parameters

No.	Name / Range / Selection	Description	Def / Type FbEq 16b / 32b
b11	Panel link	1 = Tick received: Tick has been received from the control panel, or Drive Composer PC tool connected to the control panel.	
b12	Ethernet tool link	1 = Tick received: Tick has been received from Drive Composer PC tool through an FENA module.	
b13	Parameter setting	1 = Tick received: Tick has been set by parameters 96.24 ... 96.26.	
b14	RTC	1 = RTC time in use: Time and date have been read from the real-time clock.	
b15	Drive On-Time	1 = Drive on-time in use: Time and date are displaying drive on-time.	
	0000h...FFFFh		1 = 1
96.31	Drive ID number	Specifies an ID number for the drive. The ID can be read by an external controller through DDCCS, for example, for comparison with an ID contained by the controller's application.	0 / uint16
	0...32767	ID number.	1 = 1 / 1 = 1
96.53	Actual checksum	Displays the actual parameter configuration checksum. The checksum is generated and updated whenever an action is selected in 96.54 Checksum action. The parameters included in the calculation have been pre-selected, but the selection can be edited using the Drive customizer PC tool. See also section Parameter checksum calculation (page 211).	0 / uint32
	00000000...FFFFFFFFh	Actual checksum.	1 = 1
96.54	Checksum action	Selects how the drive reacts if the parameter checksum (96.53 Actual checksum) does not match any of the active approved checksums (96.56 ... 96.59). The active checksums are selected by 96.55 Checksum control word.	No action / uint16
	No action	No action taken. (The checksum feature is not in use.)	0
	Pure event	The drive generates an event log entry (B686 Checksum mismatch).	1
	Warning	The drive generates a warning (A686 Checksum mismatch).	2
	Warning and prevent start	The drive generates a warning (A686 Checksum mismatch). Starting the drive is prevented.	3
	Fault	The drive trips on 6200 Checksum mismatch.	4
96.55	Checksum control word	Bits 0...3 select to which approved checksums (out of 96.56 ... 96.59) the actual checksum (96.53) is compared. Bits 4...7 select an approved (reference) checksum parameter (96.56 ... 96.59) into which the actual checksum from parameter 96.53 is copied.	- / uint16
	b0 Approved checksum	1 = Enabled: Checksum 1 (96.56) is observed.	
	1		

No.	Name / Range / Selection	Description	Def / Type FbEq 16b / 32b
	b1	Approved checksum 1 = Enabled: Checksum 2 (96.57) is observed. 2	
	b2	Approved checksum 1 = Enabled: Checksum 3 (96.58) is observed. 3	
	b3	Approved checksum 1 = Enabled: Checksum 4 (96.59) is observed. 4	
	b4	Set approved checksum 1 1 = Set: Copy value of 96.53 into 96.56.	
	b5	Set approved checksum 2 1 = Set: Copy value of 96.53 into 96.57.	
	b6	Set approved checksum 3 1 = Set: Copy value of 96.53 into 96.58.	
	b7	Set approved checksum 4 1 = Set: Copy value of 96.53 into 96.59.	
	b8...15 Reserved		
	0000h...FFFFh		1 = 1
96.56	Approved checksum 1	Approved (reference) checksum 1. 00000000...FFFFFFFFh Approved checksum 1.	0 / uint32 1 = 1
96.57	Approved checksum 2	Approved (reference) checksum 2. 00000000...FFFFFFFFh Approved checksum 2.	0 / uint32 1 = 1
96.58	Approved checksum 3	Approved (reference) checksum 3. 00000000...FFFFFFFFh Approved checksum 3.	0 / uint32 1 = 1
96.59	Approved checksum 4	Approved (reference) checksum 4. 00000000...FFFFFFFFh Approved checksum 4.	0 / uint32 1 = 1
96.61	User data logger status word	Provides status information on the user data logger. See section <i>Warning/fault history and analysis</i> (page 680). <b>Note:</b> This parameter is read-only.	- / uint16
	b0	Running 1 = The user data logger is running. The bit is cleared after the post-trigger time has passed.	
	b1	Triggered 1 = The user data logger has been triggered. The bit is cleared when the logger is restarted.	
	b2	Data available 1 = The user data logger contains data that can be read. Note that the bit is not cleared because the data is saved to the memory unit.	
	b3	Configured 1 = The user data logger has been configured. Note that the bit is not cleared because the configuration data is saved to the memory unit.	
	b4...15 Reserved		

## 656 Parameters

No.	Name / Range / Selection	Description	Def / Type FbEq 16b / 32b
	0000h...FFFFh		1 = 1
96.63	User data logger trigger	Triggers, or selects a source that triggers, the user data logger.	Off / uint32
	Off	0.	0
	On	1.	1
	Other [bit]	See Terms and abbreviations (page 221).	
96.64	User data logger start	Starts, or selects a source that starts, the user data logger.	Off / uint32
	Off	0.	0
	On	1.	1
	Other [bit]	See Terms and abbreviations (page 221).	
96.65	Factory data logger time level	Selects the sampling interval for the factory data logger. See section Warning/fault history and analysis (page 680).	500us / uint16
	500us	500 microseconds.	500
	2ms	2 milliseconds.	2000
	10ms	10 milliseconds.	10000
96.70	Disable adaptive program	Disables/enables the adaptive program (if present). See also section Adaptive programming (page 152).  <b>Note:</b> This parameter cannot be changed while the drive is running.	No / uint16
	No	Adaptive program enabled.	0
	Yes	Adaptive program disabled.	1
96.100	Change user pass code	<i>(Visible when user lock is open)</i> To change the current user pass code, enter a new code into this parameter as well as 96.101 Confirm user pass code. A warning will be active until the new pass code is confirmed. To cancel changing the pass code, close the user lock without confirming. To close the lock, enter an invalid pass code in parameter 96.2 Pass code, activate parameter 96.8 Control board boot, or cycle the power. See also section User lock (page 213).	10000000 / uint32
	10000000...99999999	New user pass code.	1 = 1
96.101	Confirm user pass code	<i>(Visible when user lock is open)</i> Confirms the new user pass code entered in 96.100 Change user pass code (page 656).	- / uint32
	10000000...99999999	Confirmation of new user pass code.	1 = 1



No.	Name / Range / Selection	Description	Def / Type FbEq 16b / 32b
96.102	User lock functionality	<i>(Visible when user lock is open)</i> Selects the actions or functionalities to be prevented by the user lock. Note that the changes made take effect only when the user lock is closed. See parameter 96.2 Pass code.  <b>Note:</b> We recommend you select all the actions and functionalities unless otherwise required by the application.	- / uint16
	b0 Disable ABB access levels	1 = ABB access levels (service, advanced programmer, etc. [see 96.3]) disabled	
	b1 Freeze parameter lock state	1 = Changing the parameter lock state prevented, ie. pass code 358 has no effect	
	b2 Disable file download	1 = Loading of files to drive prevented. This applies to <ul style="list-style-type: none"> <li>• firmware upgrades</li> <li>• safety functions module (FSO-xx) configuration</li> <li>• parameter restore</li> <li>• loading an adaptive program</li> <li>• loading and debugging an application program</li> <li>• changing home view of control panel</li> <li>• editing drive texts</li> <li>• editing the favorite parameters list on control panel</li> <li>• configuration settings made through control panel such as time/date formats and enabling/disabling clock display.</li> </ul>	
	b3 Disable FB write to hidden	1 = Access to parameters on disabled access levels from fieldbus prevented	
	b4...5 Reserved		
	b6 Protect AP	1 = Creating a backup and restoring from a backup prevented	
	b7 Disable panel bluetooth	1 = Bluetooth disabled on ACS-AP-W control panel. If the drive is part of a panel bus, Bluetooth is disabled on all panels.	
	b8...10 Reserved		
	b11 Disable OEM access level 1	1 = OEM access level 1 disabled	
	b12 Disable OEM access level 2	1 = OEM access level 2 disabled	
	b13 Disable OEM access level 3	1 = OEM access level 3 disabled	
	b14...15 Reserved		
	0000h...FFFFh		1 = 1

## 658 Parameters

<b>No.</b>	<b>Name / Range / Selection</b>	<b>Description</b>	<b>Def / Type FbEq 16b / 32b</b>
96.200	Parameter dynamic hide	Enables/disables to hide or show parameters.	Enabled / uint16
	Disabled	Parameter hiding disabled.	0
	Enabled	Parameter hiding enabled.	1

No.	Name / Range / Selection	Description	Def / Type FbEq 16b / 32b
97	<b>Motor control</b>	Motor model settings.	
97.1	Switching frequency reference	When parameter 97.9 <i>Switching freq mode</i> is set to <i>Custom</i> , defines the switching frequency when it is not otherwise being internally limited.  <b>Note:</b> This is an expert level parameter and should not be adjusted without appropriate skill.	4.500 kHz / real32
	0.000 ... 24.000 kHz	Switching frequency reference.	1000 = 1 kHz / 1000 = 1 kHz
97.2	Minimum switching frequency	When parameter 97.9 <i>Switching freq mode</i> is set to <i>Custom</i> , defines a minimum switching frequency reference. The actual switching frequency will not fall below this limit under any circumstances.  <b>Note:</b> This is an expert level parameter and should not be adjusted without appropriate skill.  <b>Note:</b> The drive has internal switching frequency limits that may override the value entered here.	1.500 kHz / real32
	0.000 ... 24.000 kHz	Minimum switching frequency.	1000 = 1 kHz / 1000 = 1 kHz
97.3	Slip gain	Defines the slip gain which is used to improve the estimated motor slip. 100% means full slip gain; 0% means no slip gain. The default value is 100%. Other values can be used if a static speed error is detected despite having the setting at full slip gain. <b>Example</b> (with nominal load and nominal slip of 40 rpm): A 1000 rpm constant speed reference is given to the drive. Despite having full slip gain (= 100%), a manual tachometer measurement from the motor axis gives a speed value of 998 rpm. The static speed error is 1000 rpm - 998 rpm = 2 rpm. To compensate the error, the slip gain should be increased to 105% (2 rpm / 40 rpm = 5%).	100 % / real32
	0...200 %	Slip gain.	1 = 1 % / 100 = 1 %
97.4	Voltage reserve	Defines the minimum allowed voltage reserve. When the voltage reserve has decreased to the set value, the drive enters the field weakening area.  <b>Note:</b> This is an expert level parameter and should not be adjusted without appropriate skill.  If the intermediate circuit DC voltage $U_{dc} = 550$ V and the voltage reserve is 5%, the rms value of the maximum output voltage in steady-state operation is $0.95 \times 550$ V / $\sqrt{2}$ = 369 V The dynamic performance of the motor control in the field weakening area can be improved by increasing the voltage reserve value, but the drive enters the field weakening area earlier.	-2 % / real32
	-5...50 %	Voltage reserve.	1 = 1 % / 100 = 1 %

## 660 Parameters

No.	Name / Range / Selection	Description	Def / Type FbEq 16b / 32b
97.5	Flux braking	Defines the level of flux braking power. (Other stopping and braking modes can be configured in parameter group 21 Start/stop mode). See section Flux braking (page 187).  <b>Note:</b> This is an expert level parameter and should not be adjusted without appropriate skill.	Disabled / uint16
	Disabled	Flux braking is disabled.	0
	Moderate	Flux level is limited during the braking. Deceleration time is longer compared to full braking.	1
	Full	Maximum braking power. Almost all available current is used to convert the mechanical braking energy to thermal energy in the motor.	2
97.6	Flux reference select	Defines the source of flux reference.  <b>Note:</b> This is an expert level parameter and should not be adjusted without appropriate skill.	User flux reference / uint32
	Zero	None.	0
	User flux reference	Parameter 97.7 User flux reference.	1
	Other [value]	See Terms and abbreviations (page 221).	
97.7	User flux reference	Defines the flux reference when parameter 97.6 Flux reference select is set to User flux reference.	100.00 % / real32
	0.00 ... 200.00 %	User-defined flux reference.	100 = 1 % / 100 = 1 %
97.8	Optimizer minimum torque	This parameter can be used to improve the control dynamics of a synchronous reluctance motor or a salient permanent magnet synchronous motor. As a rule of thumb, define a level to which the output torque must rise with minimum delay. This will increase the motor current and improve the torque response at low speeds.	0.0 % / real32
	0.0 ... 1600.0 %	Optimizer torque limit.	10 = 1 % / 10 = 1 %
97.9	Switching freq mode	An optimization setting for balancing between control performance and motor noise level.  <b>Note:</b> This is an expert level parameter and should not be adjusted without appropriate skill.  <b>Note:</b> Other settings than Normal may require derating. Refer to the rating data in the hardware manual of the drive.  <b>Note:</b> To improve the control performance, the switching frequency reference is automatically increased with ABB sine filter if the motor/drive current ratio is less than 0.55.	Normal / uint16
	Normal	Control performance optimized for long motor cables.	0
	Low noise	Minimizes motor noise.	1

No.	Name / Range / Selection	Description	Def / Type FbEq 16b / 32b
	Cyclic	Control performance optimized for cyclic load applications.	2
	Custom	This setting is to be used by ABB-authorized service personnel only.	3
97.10	Signal injection	<p>Enables signal injection. A high-frequency alternating signal is injected into the motor at low speeds to improve the stability of torque control. Signal injection can be enabled with different amplitude levels.</p> <p><b>Note:</b> This is an expert level parameter and should not be adjusted without appropriate skill.</p> <p><b>Note:</b> Use as low a level as possible that gives satisfactory performance.</p> <p><b>Note:</b> Signal injection cannot be applied to asynchronous motors.</p>	Disabled / uint16
	Disabled	Signal injection disabled.	0
	Enabled (5 %)	Signal injection enabled with an amplitude level of 5%.	1
	Enabled (10 %)	Signal injection enabled with an amplitude level of 10%.	2
	Enabled (15 %)	Signal injection enabled with an amplitude level of 15%.	3
	Enabled (20 %)	Signal injection enabled with an amplitude level of 20%.	4
97.11	TR tuning	<p>Rotor time constant tuning.</p> <p>This parameter can be used to improve torque accuracy in closed-loop control of an induction motor. Normally, the motor identification run provides sufficient torque accuracy, but manual fine-tuning can be applied in exceptionally demanding applications to achieve optimal performance.</p> <p><b>Note:</b> This is an expert level parameter and should not be adjusted without appropriate skill.</p>	100 % / real32
	25...400 %	Rotor time constant tuning.	1 = 1 % / 100 = 1 %

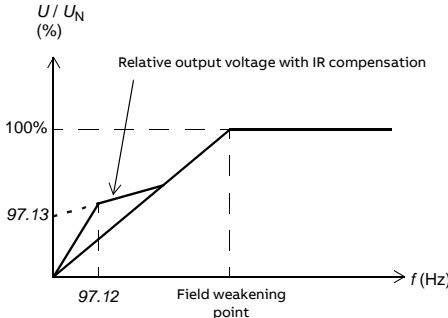
No.	Name / Range / Selection	Description	Def / Type FbEq 16b / 32b
97.12	IR comp step-up frequency	<p>IR compensation (i.e. output voltage boost) can be used in step-up applications to compensate for resistive losses in the step-up transformer, cabling and motor. As voltage cannot be fed through a step-up transformer at 0 %, a specific type of IR compensation should be used.</p> <p>This parameter adds a frequency breakpoint for parameter 97.13 IR compensation as shown.</p>  <p>0.0 Hz = Breakpoint disabled.</p> <p><b>Note:</b> This parameter cannot be changed while the drive is running.</p>	0.0 Hz / real32

0.0 ... 50.0 Hz      IR compensation breakpoint for step-up applications.      1 = 1 Hz / 10 = 1 Hz

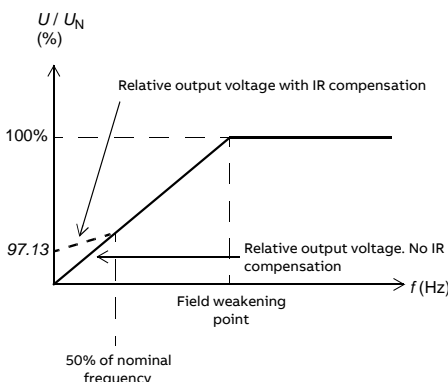
97.13	IR compensation	<p>Defines the relative output voltage boost at zero speed (IR compensation). The function is useful in applications with a high break-away torque where direct torque control (DTC mode) cannot be applied.</p>  <p>See also section IR compensation for scalar motor control (page 183).</p>	0.00 % / real32
-------	-----------------	--	-----------------

No.	Name / Range / Selection	Description	Def / Type FbEq 16b / 32b
	0.00 ... 50.00 %	Voltage boost at zero speed in percent of nominal motor voltage.	1 = 1 % / 10000 = 1 %
97.15	Motor model temperature adaptation	Selects whether the temperature-dependent parameters (such as stator or rotor resistance) of the motor model adapt to actual (measured or estimated) temperature or not. See parameter group 35 Motor thermal protection for selection of temperature measurement sources.	Disabled / uint16
	Disabled	Temperature adaptation of motor model disabled.	0
	Estimated temperature	Estimated temperature (35.1 Motor estimated temperature) used for adaptation of motor model.	1
	Measured temperature 1	Measured temperature 1 (35.2 Measured temperature 1) used for adaptation of motor model.	2
	Measured temperature 2	Measured temperature 2 (35.3 Measured temperature 2) used for adaptation of motor model.	3
97.18	Hexagonal field weakening	Activates hexagonal motor flux pattern in the field weakening area, i.e. above the limit defined by parameter 97.19 Hexagonal field weakening point.  <b>Note:</b> This parameter is only effective in scalar motor control mode.  See also section Hexagonal motor flux pattern (page 190).	Off / uint16
	Off	The rotating flux vector follows a circular pattern.	0
	On	The flux vector follows a circular pattern below, and a hexagonal pattern above, the hexagonal field weakening point (97.19).	1
97.19	Hexagonal field weakening point	Defines the activation limit for hexagonal field weakening (in percent of the field weakening point, i.e. the frequency at which maximum output voltage is reached). See parameter 97.18 Hexagonal field weakening.  <b>Note:</b> This parameter is only effective in scalar motor control mode.	120.0 % / real32
	0.0 ... 500.0 %	Activation limit for hexagonal field weakening.	1 = 1 % / 1000 = 1 %
97.32	Motor torque unfiltered	Unfiltered motor torque in percent of the nominal motor torque.  <b>Note:</b> This parameter is read-only.	0.0 % / real32
	-1600.0 ... 1600.0 %	Unfiltered motor torque. For scaling, see parameter 46.3.	- / -
97.33	Speed estimate filter time	Defines a filtering time for estimated speed See the diagram on page 782.	5.00 ms / real32
	0.00 ... 100.00 ms	Filtering time for estimated speed.	1 = 1 ms / 100 = 1 ms

## 664 Parameters

No.	Name / Range / Selection	Description	Def / Type FbEq 16b / 32b
97.78	Maximum flux reference assistance	Defines the maximum allowed stator flux assistance reference for boosting the flux when needed. Stator flux assistance improves the efficiency of the drive in high load conditions with externally-excited synchronous motors. The function is activated when a non-zero value is set to parameter 97.78. The flux is boosted between parameters 97.7 and 97.7 + 97.78, when needed.	0.00 % / real32
	0.00 ... 200.00 %	Maximum flux reference assistance.	1 = 1 % / 100 = 1 %



No.	Name / Range / Selection	Description	Def / Type FbEq 16b / 32b
98	<b>User motor parameters</b>	Motor values supplied by the user that are used in the motor model. These parameters are useful for non-standard motors, or to just get more accurate motor control of the motor on site. A better motor model always improves the shaft performance.	
98.1	User motor model mode	Activates the motor model parameters 98.2 ... 98.14 and the rotor angle offset parameter 98.15.  <b>Note:</b> Parameter value is automatically set to zero when ID run is selected by parameter 99.13 ID run requested. The values of parameters 98.2 ... 98.15 are then updated according to the motor characteristics identified during the ID run.  <b>Note:</b> Measurements made directly from the motor terminals during the ID run are likely to produce slightly different values than those on a datasheet from a motor manufacturer.  <b>Note:</b> This parameter cannot be changed while the drive is running.	Not selected / uint16
	Not selected	The values detected during the ID run are being used.	0
	Motor parameters	The values of parameters 98.2 ... 98.14 are used in the motor model.	1
	Position offset	The value of parameter 98.15 is used as the rotor angle offset. Parameters 98.2 ... 98.14 are inactive.	2
	Motor parameters & position offset	The values of parameters 98.2 ... 98.14 are used in the motor model, and the value of parameter 98.15 is used as the rotor angle offset.	3
98.2	Rs user	Defines the stator resistance $R_S$ of the motor model. With a star-connected motor, $R_S$ is the resistance of one winding. With a delta-connected motor, $R_S$ is one-third of the resistance of one winding. Resistance value is given at 20 °C (68 °F).	0.00000 pu / real32
	0.00000 ... 0.50000 pu	Stator resistance in per unit.	- / -
98.3	Rr user	Defines the rotor resistance $R_R$ of the motor model. Resistance value is given at 20 °C (68 °F).  <b>Note:</b> This parameter is valid only for asynchronous motors.	0.00000 pu / real32
	0.00000 ... 0.50000 pu	Rotor resistance in per unit.	- / -
98.4	Lm user	Defines the main inductance $L_M$ of the motor model.  <b>Note:</b> This parameter is valid only for asynchronous motors.	0.00000 pu / real32
	0.00000 ... 10.00000 pu	Main inductance in per unit.	- / -

## 666 Parameters

No.	Name / Range / Selection	Description	Def / Type FbEq 16b / 32b
98.5	SigmaL user	Defines the leakage inductance $\sigma L_s$ .  <b>Note:</b> This parameter is valid only for asynchronous motors.	0.00000 pu / real32
	0.00000 ... 1.00000 pu	Leakage inductance in per unit.	- / -
98.6	Ld user	Defines the direct axis (synchronous) inductance.  <b>Note:</b> This parameter is valid only for permanent magnet motors and SynRM. With SynRM the value can be used to tune the saturation curve.	0.00000 pu / real32
	0.00000 ... 10.00000 pu	Direct axis inductance in per unit.	- / -
98.7	Lq user	Defines the quadrature axis (synchronous) inductance.  <b>Note:</b> This parameter is valid only for permanent magnet motors and SynRM. With SynRM the value can be used to tune the saturation curve.	0.00000 pu / real32
	0.00000 ... 10.00000 pu	Quadrature axis inductance in per unit.	- / -
98.8	PM flux user	Defines the permanent magnet flux.  <b>Note:</b> This parameter is valid only for permanent magnet motors.	0.00000 pu / real32
	0.00000 ... 2.00000 pu	Permanent magnet flux in per unit.	- / -
98.9	Rs user SI	Defines the stator resistance $R_s$ of the motor model. Resistance value is given at 20 °C (68 °F).	0.00000 Ohm / real32
	0.00000 ... 100.00000 Ohm	Stator resistance.	- / -
98.10	Rr user SI	Defines the rotor resistance $R_r$ of the motor model. Resistance value is given at 20 °C (68 °F).  <b>Note:</b> This parameter is valid only for asynchronous motors.	0.00000 Ohm / real32
	0.00000 ... 100.00000 Ohm	Rotor resistance.	100 = 1 Ohm / 100000 = 1 Ohm
98.11	Lm user SI	Defines the main inductance $L_M$ of the motor model.  <b>Note:</b> This parameter is valid only for asynchronous motors.	0.00 mH / real32
	0.00 ... 100000.00 mH	Main inductance.	10 = 1 mH / 100 = 1 mH
98.12	SigmaL user SI	Defines the leakage inductance $\sigma L_s$ .  <b>Note:</b> This parameter is valid only for asynchronous motors.	0.00 mH / real32

No.	Name / Range / Selection	Description	Def / Type FbEq 16b / 32b
	0.00 ... 100000.00 mH	Leakage inductance.	10 = 1 mH / 100 = 1 mH
98.13	Ld user SI	Defines the direct axis (synchronous) inductance.  <b>Note:</b> This parameter is valid only for permanent magnet motors.	0.00 mH / real32
	0.00 ... 100000.00 mH	Direct axis inductance.	10 = 1 mH / 100 = 1 mH
98.14	Lq user SI	Defines the quadrature axis (synchronous) inductance.  <b>Note:</b> This parameter is valid only for permanent magnet motors.	0.00 mH / real32
	0.00 ... 100000.00 mH	Quadrature axis inductance.	10 = 1 mH / 100 = 1 mH
98.15	Position offset user	Defines an angle offset between the zero position of the synchronous motor and the zero position of the position sensor. This value is initially set by the autophasing routine when an absolute encoder or an incremental encoder with Z-pulse is used. The value can be fine-tuned by setting 98.1 User motor model mode to Position offset or Motor parameters & position offset.  <b>Note:</b> The value is in electrical degrees. The electrical angle equals the mechanical angle multiplied by the number of motor pole pairs.  <b>Note:</b> This parameter is valid only for permanent magnet motors.	0.0 deg / real32
	0.0 ... 360.0 deg	Angle offset.	1 = 1 deg / 1 = 1 deg

## 668 Parameters

No.	Name / Range / Selection	Description	Def / Type FbEq 16b / 32b
<b>99</b>	<b>Motor data</b>	Motor configuration settings.	
99.3	Motor type	Selects the motor type.  <b>Note:</b> This parameter cannot be changed while the drive is running.	Asynchronous motor; SynRM (95.21 b1); Permanent magnet motor (95.21 b2) / uint16
	Asynchronous motor	Standard squirrel cage AC induction motor (asynchronous induction motor).	0
	Permanent magnet motor	Permanent magnet motor. Three-phase AC synchronous motor with permanent magnet motor and sinusoidal BackEMF voltage.	1
	SynRM	Synchronous reluctance motor. Three-phase AC synchronous motor with salient pole rotor without permanent magnets.	2
99.4	Motor control mode	Selects the motor control mode.  <b>Note:</b> This parameter cannot be changed while the drive is running.	DTC / uint16
	DTC	Direct torque control. This mode is suitable for most applications.  <b>Note:</b> Instead of direct torque control, scalar control is also available, and should be used in the following situations: <ul style="list-style-type: none"> <li>• with multimotor applications <ol style="list-style-type: none"> <li>1. if the load is not equally shared between the motors,</li> <li>2. if the motors are of different sizes, or</li> <li>3. if the motors are going to be changed after the motor identification (ID) run</li> </ol> </li> <li>• if the nominal current of the motor is less than 1/6 of the nominal output current of the drive</li> <li>• if the drive is used with no motor connected (for example, for test purposes).</li> </ul> <p>See also section <a href="#">Operating modes of the drive (page 148)</a>.</p>	0

No.	Name / Range / Selection	Description	Def / Type FbEq 16b / 32b
Scalar		<p>Scalar control. The outstanding motor control accuracy of DTC cannot be achieved in scalar control. Refer to the selection DTC above for a list of applications where scalar control should definitely be used.</p> <p><b>Note:</b></p> <ul style="list-style-type: none"> <li>• Correct motor operation requires that the magnetizing current of the motor does not exceed 90% of the nominal current of the inverter.</li> <li>• Some standard features are disabled in scalar control mode.</li> </ul> <p>See also section <a href="#">Scalar motor control (page 183)</a> and section <a href="#">Operating modes of the drive (page 148)</a>.</p>	1
99.6	Motor nominal current	<p>Defines the nominal motor current. This setting must match the value on the rating plate of the motor. If multiple motors are connected to the drive, enter the total current of the motor.</p> <p><b>Note:</b> Correct motor operation requires that the magnetizing current of the motor does not exceed 90% of the nominal current of the drive.</p> <p><b>Note:</b> This parameter cannot be changed while the drive is running.</p>	0.0 A / real32
0.0 ... 6400.0 A		<p>Nominal current of the motor. The allowable range is <math>1/6 \dots 2 \times I_N</math> (nominal current) of the drive (<math>0 \dots 2 \times I_N</math> with scalar control mode).</p>	1 = 1 A / 10 = 1 A
99.7	Motor nominal voltage	<p>Defines the nominal motor voltage supplied to the motor. This setting must match the value on the rating plate of the motor.</p> <p><b>Note:</b> With permanent magnet motors, the nominal voltage is the BackEMF voltage at nominal speed of the motor. If the voltage is given as voltage per rpm, e.g. 60 V per 1000 rpm, the voltage for a nominal speed of 3000 rpm is <math>3 \times 60 \text{ V} = 180 \text{ V}</math>. Note that nominal voltage is not the same as equivalent DC motor voltage (EDCM) given by some manufacturers. The nominal voltage can be calculated by dividing the EDCM voltage by 1.7 (or square root of 3).</p> <p><b>Note:</b> The stress on the motor insulation is always dependent on the drive supply voltage. This also applies to the case where the motor voltage rating is lower than that of the drive and the supply.</p> <p><b>Note:</b> This parameter cannot be changed while the drive is running.</p>	0.0 V / real32

## 670 Parameters

No.	Name / Range / Selection	Description	Def / Type FbEq 16b / 32b
	0.0 ... 800.0 V	Nominal voltage of the motor. The allowable range is $1/6 \dots 2 \times U_N$ (nominal voltage) of the drive. $U_N$ equals the upper bound of the supply voltage range selected by parameter 95.1 Supply voltage.	10 = 1 V / 10 = 1 V
99.8	Motor nominal frequency	Defines the nominal motor frequency. This setting must match the value on the rating plate of the motor.  <b>Note:</b> This parameter cannot be changed while the drive is running.	50.00 Hz / real32
	0.00 ... 1000.00 Hz	Nominal frequency of the motor.	10 = 1 Hz / 100 = 1 Hz
99.9	Motor nominal speed	Defines the nominal motor speed. The setting must match the value on the rating plate of the motor.  <b>Note:</b> This parameter cannot be changed while the drive is running.  <b>Note:</b> (Asynchronous generator) Nominal speed needs to be adjusted as running the generator as a motor.	0 rpm / real32
	0...30000 rpm	Nominal speed of the motor.	1 = 1 rpm / 1 = 1 rpm
99.10	Motor nominal power	Defines the nominal motor power. The setting must match the value on the rating plate of the motor. If nominal power is not shown on the rating plate, nominal torque can be entered instead in parameter 99.12. If multiple motors are connected to the drive, enter the total power of the motors. The unit is selected by parameter 96.16 Unit selection.  <b>Note:</b> This parameter cannot be changed while the drive is running.	- / real32
	0.00 ... 10000.00 kW or hp	Nominal power of the motor.	1 = 1 kW or hp / 100 = 1 kW or hp
99.11	Motor nominal cos $\phi$	Defines the cosphi of the motor for a more accurate motor model. The value is not obligatory, but is useful with an asynchronous motor, especially when performing a standstill identification run. With a permanent magnet or synchronous reluctance motor, this value is not needed.  <b>Note:</b> Do not enter an estimated value. If you do not know the exact value, leave the parameter at zero.  <b>Note:</b> This parameter cannot be changed while the drive is running.	0.00 / real32
	0.00 ... 1.00	Cosphi of the motor.	100 = 1 / 100 = 1

No.	Name / Range / Selection	Description	Def / Type FbEq 16b / 32b
99.12	Motor nominal torque	<p>Defines the nominal motor shaft torque. This value can be given instead of nominal power (99.10) if shown on the rating plate of the motor.</p> <p>The unit is selected by parameter 96.16 Unit selection.</p> <p><b>Note:</b> This setting is an alternative to the nominal power value (99.10). If both are entered, 99.12 takes priority.</p> <p><b>Note:</b> This parameter cannot be changed while the drive is running.</p>	0.000 Nm or lb-ft / uint32
	0.000 ... 4000000.000 Nm or lb-ft	Nominal motor torque.	1 = 1 Nm or lb-ft / 1000 = 1 Nm or lb-ft

## 672 Parameters

No.	Name / Range / Selection	Description	Def / Type FbEq 16b / 32b
99.13	ID run requested	<p>Selects the type of the motor identification routine (ID run) performed at the next start of the drive. During the ID run, the drive will identify the characteristics of the motor for optimum motor control.</p> <p>If no ID run has been performed yet (or if default parameter values have been restored using parameter 96.6 <i>Parameter restore</i>), this parameter is automatically set to <i>Standstill</i>, signifying that an ID run must be performed.</p> <p>After the ID run, the drive stops and this parameter is automatically set to <i>None</i>.</p> <p><b>Note:</b> For the <i>Advanced ID run</i>, the machinery must always be de-coupled from the motor.</p> <p><b>Note:</b> Before activating the ID run, configure motor temperature measurement (if used) in parameter group 35 <i>Motor thermal protection</i>, and in parameter 97.15.</p> <p><b>Note:</b> If a sine filter is installed, set the appropriate bit in parameter 95.15 <i>Special HW settings</i> before activating the ID run. With a non-ABB (custom) filter, set also 99.18 and 99.19.</p> <p><b>Note:</b> With scalar control mode (99.4 <i>Motor control mode = Scalar</i>), the ID run is not requested automatically. However, an ID run can be performed for more accurate torque estimation.</p> <p><b>Note:</b> Once the ID run is activated, it can be canceled by stopping the drive.</p> <p><b>Note:</b> The ID run must be performed every time any of the motor parameters (99.4, 99.6 ... 99.12) have been changed.</p> <p><b>Note:</b> Make sure that the Safe torque off and emergency stop circuits (if any) are closed during the ID run.</p> <p><b>Note:</b> Mechanical brake (if present) is not opened by the logic for the ID run.</p> <p><b>Note:</b> For the permanent magnet and SynRM, the Reduced, Normal, and Advanced ID runs are the same. In addition, the Standstill and Advanced Standstill ID runs are identical.</p> <p><b>Note:</b> This parameter cannot be changed while the drive is running.</p>	None; Standstill (95.21 b1/b2) / uint16
	None	No motor ID run is requested. This mode can be selected only if the ID run ( <i>Normal, Reduced, Standstill, Advanced, Advanced Standstill</i> ) has already been performed once.	0



No.	Name / Range / Selection	Description	Def / Type FbEq 16b / 32b
Normal	<p data-bbox="385 196 857 260">Normal ID run. Guarantees good control accuracy for all cases. This mode should be selected whenever it is possible.</p> <p data-bbox="385 280 857 432"><b>Note:</b> If the load torque will be higher than 20% of motor nominal torque, or if the machinery is not able to withstand the nominal torque transient during the ID run, then the driven machinery must be de-coupled from the motor during a Normal ID run. With the permanent magnet or SynRM motors the transient torque value can be up to two times the nominal torque.</p> <p data-bbox="385 464 857 528"><b>Note:</b> Check the direction of rotation of the motor before starting the ID run. During the run, the motor will rotate in the forward direction.</p>	1	
Reduced	<p data-bbox="385 711 857 751">Reduced ID run. This mode should be selected instead of the Normal or Advanced ID run if</p> <ul data-bbox="385 772 857 916" style="list-style-type: none"> <li data-bbox="385 772 857 836">• mechanical losses are higher than 20% (i.e. the motor cannot be de-coupled from the driven equipment), or if</li> <li data-bbox="385 857 857 916">• flux reduction is not allowed while the motor is running (i.e. in case of a motor with an integrated brake supplied from the motor terminals).</li> </ul> <p data-bbox="385 932 857 1038">With this ID run mode, the resultant motor control in the field weakening area or at high torques is not necessarily as accurate as motor control following a Normal ID run. Reduced ID run is completed faster than the Normal ID run (&lt; 90 seconds).</p> <p data-bbox="385 1059 857 1121"><b>Note:</b> Check the direction of rotation of the motor before starting the ID run. During the run, the motor will rotate in the forward direction.</p>	2	
	<p data-bbox="385 1158 857 1265"> <b>WARNING!</b> The motor will run at up to approximately 50...100% of the nominal speed during the ID run. MAKE SURE THAT IT IS SAFE TO RUN THE MOTOR BEFORE PERFORMING THE ID RUN!</p>		

## 674 Parameters

No.	Name / Range / Selection	Description	Def / Type FbEq 16b / 32b
Standstill	<p>Standstill ID run. The motor is injected with DC current. With an AC induction (asynchronous) motor, the motor shaft is not rotated. With a permanent magnet motor or synchronous reluctance motor, the shaft can rotate up to half a revolution.</p> <p><b>Note:</b> A standstill ID run should be selected only if the Normal, Reduced or Advanced ID run is not possible because of the restrictions caused by the connected mechanics (e.g. with lift or crane applications).</p> <p>See also selection <a href="#">Advanced Standstill</a>.</p>	3	
Autophasing	<p>The autophasing routine determines the start angle of a permanent magnet or synchronous reluctance motor (see section <a href="#">Autophasing (page 184)</a>). Autophasing does not update the other motor model values. Autophasing is automatically performed as part of the Normal, Reduced, Standstill, Advanced or Advanced Standstill ID runs. Using this setting, it is possible to perform autophasing alone. This is useful after changes in the feedback configuration, such as the replacement or addition of an absolute encoder, resolver, or pulse encoder with commutation signals.</p> <p><b>Note:</b> This setting can only be used after a Normal, Reduced, Standstill, Advanced or Advanced Standstill ID run has already been performed.</p> <p><b>Note:</b> Depending on the selected autophasing mode, the shaft can rotate during autophasing. See parameter <a href="#">21.13 Autophasing mode</a>.</p>	4	
Current measurement calibration	<p>Requests current measurement calibration, i.e. identification of current measurement offset and gain errors.</p> <p>The calibration will be performed at next start.</p>	5	

No.	Name / Range / Selection	Description	Def / Type FbEq 16b / 32b
	Advanced	<p>Advanced ID run. Guarantees the best possible control accuracy. The ID run can take a couple of minutes. This mode should be selected when top performance is needed across the whole operating area.</p> <p><b>Note:</b> If the load torque is higher than 20% of motor nominal torque, or if the machinery is not able to withstand the nominal torque transient during the ID run, then the driven machinery must be de-coupled from the motor during a Advanced ID run.</p> <p><b>Note:</b> Check the direction of rotation of the motor before starting the ID run. During the run, the motor will rotate in the forward direction.</p> <hr/> <p> <b>WARNING!</b> The motor will run at up to approximately 50...100% of the nominal speed during the ID run. Several accelerations and decelerations are done. <b>MAKE SURE THAT IT IS SAFE TO RUN THE MOTOR BEFORE PERFORMING THE ID RUN!</b></p>	6
	Advanced Standstill	<p>Advanced Standstill ID run.</p> <p>This selection is recommended with AC induction motors up to 75 kW instead of the Standstill ID run if</p> <ul style="list-style-type: none"> <li>the exact nominal ratings of the motor are not known, or</li> <li>the control performance of the motor is not satisfactory after a Standstill ID run.</li> </ul> <p><b>Note:</b> The time it takes for the Advanced Standstill ID run to complete varies according to motor size. With a small motor, the ID run typically completes within 5 minutes; with a large motor, the ID run may take up to an hour.</p>	7
99.14	Last ID run performed	<p>Displays the type of ID run that was performed last.</p> <p>For more information about the different modes, see the selections of parameter 99.13 ID run requested.</p>	None / uint16
	None	No ID run has been performed.	0
	Normal	Normal ID run.	1
	Reduced	Reduced ID run.	2
	Standstill	Standstill ID run.	3
	Autophasing	Autophasing.	4
	Current measurement calibration	Current measurement calibration.	5
	Advanced	Advanced ID run.	6
	Advanced Standstill	Advanced Standstill ID run.	7

## 676 Parameters

No.	Name / Range / Selection	Description	Def / Type FbEq 16b / 32b
99.15	Motor polepairs calculated	Calculated number of pole pairs in the motor. This parameter is read-only.	0 / uint16
	0...1000	Number of pole pairs.	1 = 1 / 1 = 1
99.16	Motor phase order	Switches the rotation direction of the motor. This parameter can be used if the motor turns in the wrong direction (for example, because of the wrong phase order in the motor cable), and correcting the cabling is considered impractical.  <b>Note:</b> Changing this parameter does not affect speed reference polarities, so positive speed reference will rotate the motor forward. The phase order selection just ensures that "forward" is in fact the correct direction.  <b>Note:</b> After changing this parameter, the sign of encoder feedback (if any) must be checked. This can be done by setting parameter 90.41 Motor feedback selection to Estimate, and comparing the sign of 90.1 Motor speed for control to 90.10 Encoder 1 speed (or 90.20 Encoder 2 speed). If the sign of the measurement is incorrect, the encoder wiring must be corrected or the sign of 90.43 Motor gear numerator reversed.  <b>Note:</b> This parameter cannot be changed while the drive is running.	U V W / uint16
	U V W	Normal.	0
	U W V	Reversed rotation direction.	1
99.18	Sine filter inductance	Defines the inductance of a custom sine filter, i.e. when parameter 95.15 Special HW settings bit 3 is activated.  <b>Note:</b> For an ABB sine filter (95.15 Special HW settings bit 1), this parameter is set automatically and should not be adjusted.	0.000 mH / real32
	0.000 ... 100000.000 mH	Inductance of custom sine filter.	1000 = 1 mH / 1000 = 1 mH

No.	Name / Range / Selection	Description	Def / Type FbEq 16b / 32b
-----	--------------------------	-------------	------------------------------

99.19	Sine filter capacitance	Defines the capacitance of a custom sine filter, i.e. when parameter 95.15 <i>Special HW settings</i> bit 3 is activated. If the capacitors are star/wye-connected, enter the capacitance of <u>one leg</u> into the parameter.	0.00 uF / real32
-------	-------------------------	---	------------------

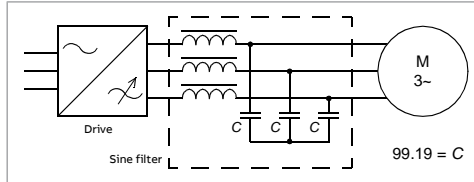

If the capacitors are delta-connected, multiply the capacitance of one leg by 3 and enter the result into the parameter.

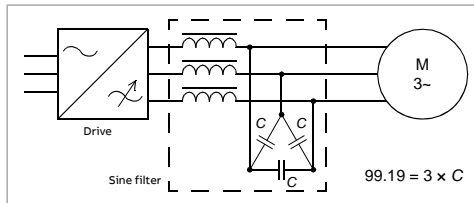

**Note:** For an ABB sine filter (95.15 *Special HW settings* bit 1), this parameter is set automatically and should not be adjusted.

0.00 ... 100000.00 uF Capacitance of custom sine filter.

100 = 1 uF / 100 = 1 uF

No.	Name / Range / Selection	Description	Def / Type FbEq 16b / 32b
-----	--------------------------	-------------	------------------------------

200	Safety	FSO-xx settings. This group contains parameters related to the optional FSO-xx safety functions module. For details, refer to the documentation of the FSO-xx module.	
-----	--------	--	--

No.	Name / Range / Selection	Description	Def / Type FbEq 16b / 32b
-----	--------------------------	-------------	------------------------------

206	I/O bus configuration	Distributed I/O bus settings. This group is only visible with a BCU control unit. This group contain parameters related to the distributed I/O bus, which is used with some drives for monitoring the cooling fans of the cabinet system. For details, refer to <i>CIO-01 I/O module for distributed I/O bus control user's manual</i> (3AXD50000126880 [English]).	
-----	-----------------------	---	--

## 678 Parameters

No.	Name / Range / Selection	Description	Def / Type FbEq 16b / 32b
207	<b>I/O bus service</b>	Distributed I/O bus settings. This group is only visible with a BCU control unit. This group contain parameters related to the distributed I/O bus, which is used with some drives for monitoring the cooling fans of the cabinet system. For details, refer to <i>CIO-01 I/O module for distributed I/O bus control user's manual</i> (3AXD50000126880 [English]).	

No.	Name / Range / Selection	Description	Def / Type FbEq 16b / 32b
208	<b>I/O bus diagnostics</b>	Distributed I/O bus settings. This group is only visible with a BCU control unit. This group contain parameters related to the distributed I/O bus, which is used with some drives for monitoring the cooling fans of the cabinet system. For details, refer to <i>CIO-01 I/O module for distributed I/O bus control user's manual</i> (3AXD50000126880 [English]).	

No.	Name / Range / Selection	Description	Def / Type FbEq 16b / 32b
209	<b>I/O bus fan identification</b>	Distributed I/O bus settings. This group is only visible with a BCU control unit. This group contain parameters related to the distributed I/O bus, which is used with some drives for monitoring the cooling fans of the cabinet system. For details, refer to <i>CIO-01 I/O module for distributed I/O bus control user's manual</i> (3AXD50000126880 [English]).	

## 9

# Fault tracing

---

## What this chapter contains

The chapter lists the warning and fault messages including possible causes and corrective actions. The causes of most warnings and faults can be identified and corrected using the information in this chapter. If not, contact an ABB service representative. If you have the possibility to use the *Drive Composer* PC software, send the Support package created by the Drive Composer tool to the ABB service representative.

Warnings and faults are listed below in separate tables. Each table is sorted by warning/fault code.

## Safety

---

**WARNING!**

Only qualified electricians are allowed to service the drive. Read the instructions in the *Safety instructions* chapter of the *Hardware manual* of the drive before working on the drive.

---

## Indications

### ■ Warnings and faults

Warnings and faults indicate an abnormal drive status. The codes and names of active warnings/faults are displayed on the control panel of the drive as well as the *Drive Composer* PC tool. Only the codes of warnings/faults are available over fieldbus.

---

Warnings do not need to be reset; they stop showing when the cause of the warning ceases. Warnings do not latch and the drive will continue to operate the motor.

Faults do latch inside the drive and cause the drive to trip, and the motor stops. After the cause of a fault has been removed, the fault can be reset from a selectable source (parameter [31.11 Fault reset selection](#)), such as the control panel, the *Drive Composer* PC tool, the digital inputs of the drive, or fieldbus. After the fault is reset, the drive can be restarted.

Note that some faults require a reboot of the control unit either by switching the power off and on, or using parameter [96.8 Control board boot](#) – this is mentioned in the fault listing wherever appropriate.

Warning and fault indications can be directed to a relay output or a digital input/output by selecting Warning, Fault or Fault (-1) in the source selection parameter. See the following sections:

- Programmable digital inputs and outputs (page 156)
- Programmable relay outputs (page 157), and
- Programmable I/O extensions (page 157).

### ■ Pure events

In addition to warnings and faults, there are pure events that are only recorded in the event logs of the drive. The codes of these events are included in the [Warning, fault and pure event messages table](#).

### ■ Editable messages

For some warnings and faults, the message text can be edited and instructions and contact information added. To edit these messages, choose **Menu - Settings - Edit texts** on the control panel, or use the Localization editor in Drive Composer pro.

## Warning/fault history and analysis

### ■ Event logs

The drive has two event logs. One log contains faults and fault resets; the other contains warnings, pure events, and clearing entries. Each log contains the 64 most recent events with a time stamp and other information.

The logs can be accessed separately from the main Menu on the control panel. The logs are displayed as a single list when viewed using the Drive Composer PC tool.

### Auxiliary codes

Some events generate an auxiliary code that often helps in pinpointing the problem. The auxiliary code is displayed on the control panel together with the message. It

---



is also stored in the event log details. In the Drive Composer PC tool, the auxiliary code (if any) is shown in the event listing.

### **Factory data logger**

The drive has a data logger that samples preselected drive values at 500-microsecond (default; see parameter 96.65 *Factory data logger time level*) intervals.

By default, approximately 700 samples recorded immediately before and after a fault are saved to the memory unit of the drive. The fault data of the last five faults is accessible in the event log when viewed in the Drive Composer pro PC tool. (The fault data is not accessible through the control panel.)

The values that are recorded in the factory data log are 1.7 Motor current, 1.10 Motor torque, 1.11 DC voltage, 1.24 Flux actual %, 6.1 Main control word, 6.11 Main status word, 24.1 Used speed reference, 30.1 Limit word 1, 30.2 Torque limit status and 90.1 Motor speed for control. The selection of parameters cannot be changed by the user.

### ■ **Other data loggers**

#### **User data logger**

A custom data logger can be configured using the Drive Composer pro PC tool. This functionality enables the free selection of up to eight drive parameters to be sampled at selectable intervals. The triggering conditions and the length of the monitoring period can also be defined by the user within the limit of approximately 8000 samples. In addition to the PC tool, the status of the logger is shown by drive parameter 96.61 *User data logger status word*. The triggering sources can be selected by parameters 96.63 *User data logger trigger* and 96.64 *User data logger start*. The configuration, status and collected data is saved to the memory unit for later analysis.

#### **PSL2 data logger**

The BCU control unit used with certain drive types (especially those with parallel-connected inverter modules) contains a data logger that collects data from the inverter modules to help fault tracing and analysis. The data is saved onto the SD card attached to the BCU, and can be analyzed by ABB service personnel.

### ■ **Parameters that contain warning/fault information**

The drive is able to store a list of the active faults actually causing the drive to trip at the present time. The faults are displayed in parameter group 4 *Warnings and faults* (page 233). The parameter group also displays a list of faults and warnings that have previously occurred.

---

### **Event word (parameters 04.40...04.72)**

Parameter 4.40 Event word 1 can be configured by the user to indicate the status of 16 selectable events (ie. faults, warnings or pure events). It is possible to specify an auxiliary code for each event to filter out other auxiliary codes.

### **QR Code generation for mobile service application**

A QR Code (or a series of QR Codes) can be generated by the drive for display on the control panel. The QR Code contains drive identification data, information on the latest events, and values of status and counter parameters. The code can be read with a mobile device containing the ABB service application, which then sends the data to ABB for analysis. For more information on the application, contact your local ABB service representative.

The QR Code can be generated by choosing **Menu - Assistants - QR code** on the control panel.

---

## Warning, fault and pure event messages

Code (hex)	Event name / Aux. code	Cause	What to do
2281	Calibration	Measured offset of output phase current measurement or difference between output phase U2 and W2 current measurement is too great (the values are updated during current calibration).	Try performing the current calibration again (select <b>Current measurement calibration</b> at parameter 99.13). If the fault persists, contact your local ABB representative.
2310	Overcurrent	Output current has exceeded internal fault limit.	<p>Check motor load.</p> <p>If the control unit is externally powered, check the setting of parameter 95.04 <b>Control board supply</b>. Check acceleration times in parameter group 23 <b>Speed reference ramp (speed control)</b>, 26 <b>Torque reference chain (torque control)</b>. Also check parameters 46.1 <b>Speed scaling</b>, 46.2 <b>Frequency scaling</b> and 46.3 <b>Torque scaling</b>.</p> <p>Check motor and motor cable (including phasing and delta/star connection).</p> <p>Check there are no contactors opening and closing in motor cable.</p> <p>Check that the start-up data in parameter group 99 corresponds to the motor rating plate.</p> <p>Check that there are no power factor correction capacitors or surge absorbers in motor cable.</p> <p>Check encoder cable (including phasing).</p> <p>Check the auxiliary code (format XXXY YYZZ). With parallel-connected inverter modules, "YY" specifies through which BCU control unit channel the fault was received. "ZZ" indicates the phase that triggered the fault (<b>0</b>: No detailed information available, <b>1</b>: U-phase, <b>2</b>: Vphase, <b>4</b>: W-phase, <b>3/5/6/7</b>: multiple phases).</p>
2330	Earth leakage	Drive has detected load unbalance typically due to earth fault in motor or motor cable.	<p>If the control unit is externally powered, check the setting of parameter 95.4 <b>Control board supply</b>.</p> <p>Check there are no power factor correction capacitors or surge absorbers in motor cable.</p> <p>Check for an earth fault in motor or motor cables by measuring the insulation resistances of motor and motor cable.</p> <p>Try running the motor in scalar control mode if allowed. (See parameter 99.4 <b>Motor control mode</b>.)</p>

## 684 Fault tracing

Code (hex)	Event name / Aux. code	Cause	What to do
			<p>With parallel-connected modules, check the auxiliary code (format XXXY YYZZ).            “Y YY” specifies through which BCU control unit channel the fault was received.            If no earth fault can be detected, contact your local ABB representative.</p>
2340	Short circuit	Short-circuit in motor cable(s) or motor.	<p>Check motor and motor cable for cabling errors.            If the control unit is externally powered, check the setting of parameter 95.4 Control board supply. Check that parameter 99.10 Motor nominal power has been set correctly. Check there are no power factor correction capacitors or surge absorbers in motor cable.            Check the auxiliary code (format XXXY YYZZ). With parallel-connected inverter modules, “Y YY” specifies through which BCU control unit channel the fault was received. “ZZ” indicates the location of the short circuit (<b>0</b>: No detailed information available, <b>1</b>: Upper branch of U-phase, <b>2</b>: Lower branch of U-phase, <b>4</b>: Upper branch of V-phase, <b>8</b>: Lower branch of V-phase, <b>10</b>: Upper branch of W-phase, <b>20</b>: Lower branch of W-phase, <b>other</b>: combinations of the above).            Check auxiliary code 40h = DC capacitor short circuit.            After correcting the cause of the fault, reboot the control unit (using parameter 96.8 Control board boot) or by cycling power.</p>
2381	IGBT overload	Excessive IGBT junction to case temperature. This fault protects the IGBT(s) and can be activated by a short circuit in the motor cable.	<p>Check motor cable.            Check ambient conditions.            Check air flow and fan operation.            Check heatsink fins for dust pick-up.            Check motor power against drive power.</p>
2391	BU current difference	AC phase current difference between parallel-connected inverter modules is excessive.	<p>Check motor cabling.            Check there are no power factor correction capacitors or surge absorbers in motor cable.            Check the auxiliary code (format XXXY YYZZ). “XXX” specifies the source of the first error (see “YYY”). “YYY” specifies the module through which BCU control unit channel the fault was received (<b>1</b>: Channel 1, <b>2</b>: Channel 2, <b>4</b>: Channel 3, <b>8</b>: Channel 4, ..., <b>800</b>: Channel 12, <b>other</b>: combinations of the</p>

Code (hex)	Event name / Aux. code	Cause	What to do
			above). "ZZ" indicates the phase (1: U, 2: V, 3: W).
2392	BU earth leakage	Total earth leakage of inverter modules is excessive.	Check there are no power factor correction capacitors or surge absorbers in motor cable. Measure insulation resistances of motor cables and motor. Contact your local ABB representative.
2E01	Earth leakage	IGBT supply unit has detected an earth fault.	Check AC fuses. Check for earth leakages. Check supply cabling. Check power modules. Check there are no power factor correction capacitors or surge absorbers in supply cable. If no earth fault can be detected, contact your local ABB representative.
3000	Invalid voltage chain datapoints	Parametrization of the speed/torque limitation curve (in the DC voltage reference chain) are inconsistent.	Check that the speed points of the curve (defined by 29.70...29.79) are in increasing order.
3130	Supply phase loss	Intermediate circuit DC voltage is oscillating due to missing input power line phase or blown fuse.	Check input power line fuses. Check for loose power cable connections. Check for input power supply imbalance.
3180	Charge relay lost	No acknowledgement received from charge relay.	Contact your local ABB representative.
3181	Wiring or earth fault	<ol style="list-style-type: none"> <li>1. The drive hardware is supplied from a common DC bus.</li> <li>2. Incorrect input power and motor cable connection (i.e. input power cable is connected to the motor connection).</li> <li>3. Drive has detected load unbalance typically due to earth fault in motor or motor cable.</li> </ol>	<ol style="list-style-type: none"> <li>1. Switch off the protection in parameter 31.23.</li> <li>2. Check the power connections. Check the input fuses.</li> <li>3. Check there are no power factor correction capacitors or surge absorbers in motor cable. Check for an earth fault in motor or motor cables by measuring the insulation resistances of motor and motor cable. Try running the motor in scalar control mode if allowed. (See parameter 99.4 Motor control mode.)</li> </ol>
3210	DC link overvoltage	Excessive intermediate circuit DC voltage.	Check that overvoltage control is on (parameter 30.30 Overvoltage control). Check that the supply voltage matches the nominal input voltage of the drive. Check the supply line for static or transient overvoltage. Check brake chopper and resistor (if present).

## 686 Fault tracing

Code (hex)	Event name / Aux. code	Cause	What to do
			<p>Check deceleration time.            Use coast-to-stop function (if applicable).            Retrofit drive with brake chopper and brake resistor.            With parallel-connected modules, check the auxiliary code (format XXXY YYZZ).            "YY" specifies through which BCU control unit channel the fault was received.</p>
3220	DC link undervoltage	Intermediate circuit DC voltage is not sufficient because of a missing supply phase, blown fuse or fault in the rectifier bridge.	<p>Check supply cabling, fuses and switchgear.            With parallel-connected modules, check the auxiliary code (format XXXY YYZZ).            "YY" specifies through which BCU control unit channel the fault was received.</p>
3280	Standby timeout	Automatic restart failed (see section Automatic restart (page 192)).	Check the condition of the supply (voltage, cabling, fuses, switchgear).
3291	DC voltage difference	Difference in DC voltages between parallel-connected inverter modules.	<p>Check the auxiliary code (format XXXY YYZZ). "XXX" specifies the source of the first error (see "YYY"). "YYY" specifies the module through which BCU control unit channel the fault was received (<b>1</b>: Channel 1, <b>2</b>: Channel 2, <b>4</b>: Channel 3, <b>8</b>: Channel 4, ..., <b>800</b>: Channel 12).</p>
3381	Output phase loss	Motor circuit fault due to missing motor connection (all three phases are not connected).	Connect motor cable.
3385	Autophasing	Autophasing routine (see section Autophasing (page 184)) has failed.	<p>For more information, check the auxiliary code.            Check that the motor ID run has been successfully completed.            Clear parameter 98.15 Position offset user.            Check the setting of parameter 99.3 Motor type.</p>
0001		Estimated and measured positions have opposite signs.	<p>Check the signs of measured and estimated speeds.            Reverse encoder cable phasing or edit parameter 99.16.            Check that the load torque is not too high for the Turning mode (must be less than 5%).</p>
0002		Motor is rotating during autophasing.	Check that the motor is not already rotating when the autophasing routine starts.
0003		Too much difference between measured and estimated positions.	Check that encoder is not slipping.

Code (hex)	Event name / Aux. code	Cause	What to do
			Check parameter 98.15 several times to verify that the autophasing routine gives consistent results. Check the motor model parameters.
0004		Rotor did not rotate as expected between zero pulses.	Check that the zero pulses are given correctly.
0005		Position estimate did not stabilize.	Check that the selected mode (parameter 21.13) is appropriate for the motor.
0006		Measured position status information changed.	Check that parameter 90.41 is not changed to Estimate during the routine.
0007		General autophasing failure.	Contact your local ABB representative.
0008		Selected mode not supported.	Check that the selected mode (parameter 21.13) is supported by the motor type.
0009		(LV-Synchro) Standstill failure.	Contact your local ABB representative.
3E00	Input phase loss	Input phase loss detected by the IGBT bridge.	Check the auxiliary code. Check the source of the fault corresponding to the code: 1: Phase A 2: Phase B 4: Phase C 8: Phase cannot be detected Check the AC fuses. Check for input power supply imbalance.
4000	Motor cable overload	Calculated motor cable temperature has exceeded warning limit.	Check the settings of parameters 35.61 and 35.62. Check the dimensioning of the motor cable in regard to required load.
4100	Ambient temperature	Drive module temperature is excessive.	Check ambient temperature. If it exceeds 40 °C (104 °F), ensure that load current does not exceed derated load capacity of drive. See appropriate <i>Hardware manual</i> . Check drive module cooling air flow and fan operation. Check inside of cabinet and heatsink of drive module for dust pick-up. Clean whenever necessary.
4110	Control board temperature	Control board temperature is too high.	Check proper cooling of the drive. Check the auxiliary cooling fan.
4210	IGBT overtemperature	Estimated drive IGBT temperature is excessive.	Check ambient conditions. Check air flow and fan operation. Check heatsink fins for dust pick-up. Check motor power against drive power.

## 688 Fault tracing

Code (hex)	Event name / Aux. code	Cause	What to do
4290	Cooling	Drive module temperature is excessive.	Check ambient temperature. If it exceeds 40 °C (104 °F), ensure that load current does not exceed derated load capacity of drive. See appropriate <i>Hardware manual</i> . Check drive module cooling air flow and fan operation. Check inside of cabinet and heatsink of drive module for dust pick-up. Clean whenever necessary.
42F1	IGBT temperature	Drive IGBT temperature is excessive.	Check ambient conditions. Check air flow and fan operation. Check heatsink fins for dust pick-up. Check motor power against drive power.
4310	Excess temperature	Power unit module temperature is excessive.	See A4B0 Excess temperature.
4380	Excess temp difference	High temperature difference between the IGBTs of different phases.	See A4B1 Excess temperature difference (page 704).
4981	External temperature 1	Measured temperature 1 has exceeded fault limit.	Check the value of parameter 35.2 Measured temperature 1. Check the cooling of the motor (or other equipment whose temperature is being measured). Check the value of parameter 35.12 Temperature 1 fault limit.
4982	External temperature 2	Measured temperature 2 has exceeded fault limit.	Check the value of parameter 35.3 Measured temperature 2. Check the cooling of the motor (or other equipment whose temperature is being measured). Check the value of parameter 35.22 Temperature 2 fault limit.
4990	FPTC not found	A thermistor protection module has been activated by parameter 35.30 but cannot be detected.	Power down the control unit and make sure that the module is properly inserted in the correct slot. The last digit of the auxiliary code identifies the slot.
4991	Safe motor temperature 1	The thermistor protection module installed in slot 1 indicates overtemperature.	Check the cooling of the motor. Check the motor load and drive ratings. Check the wiring of the temperature sensor. Repair wiring if faulty. Measure the resistance of the sensor. Replace sensor if faulty.
4992	Safe motor temperature 2	The thermistor protection module installed in slot 2 indicates overtemperature.	Check the cooling of the motor. Check the motor load and drive ratings. Check the wiring of the temperature sensor. Repair wiring if faulty. Measure the resistance of the sensor. Replace sensor if faulty.



Code (hex)	Event name / Aux. code	Cause	What to do
4993	Safe motor temperature 3	The thermistor protection module installed in slot 3 indicates overtemperature.	Check the cooling of the motor. Check the motor load and drive ratings. Check the wiring of the temperature sensor. Repair wiring if faulty. Measure the resistance of the sensor. Replace sensor if faulty.
5080	Fan	Cooling fan feedback missing.	See A581 Fan.
5081	Auxiliary fan not running	An auxiliary cooling fan (connected to the fan connectors on the control unit) is stuck or disconnected.	See A582 Auxiliary fan not running.
5090	STO hardware failure	Safe torque off hardware failure.	Contact your local ABB representative, quoting the auxiliary code. The code contains location information, especially with parallel-connected inverter modules. When converted into a 32-bit binary number, the bits of the code indicate the following: 31...28: Number of faulty inverter module (0...11 decimal). 1111: STO_ACT states of control unit and inverter modules in conflict 27: STO_ACT state of inverter modules 26: STO_ACT state of control unit 25: STO1 of control unit 24: STO2 of control unit 23...12: STO1 of inverter modules 12...1 (Bits of non-existing modules set to 1) 11...0: STO2 of inverter modules 12...1 (Bits of non-existing modules set to 1)
5091	Safe torque off	Safe torque off function is active, i.e. safety circuit signal(s) connected to connector XSTO is broken during start or run.	Check safe torque off circuit connections. For more information, see appropriate drive hardware manual and description of parameter 31.22 STO indication run/stop (page 434).
5092	PU logic error	Power unit memory has cleared.	Cycle the power to the drive. If the control unit is externally powered, also reboot the control unit (using parameter 96.8 Control board boot) or by cycling its power. If the problem persists, contact your local ABB representative.
5093	Rating ID mismatch	The hardware of the drive does not match the information stored in the memory unit. This may occur eg. after a firmware update or memory unit replacement.	Cycle the power to the drive. Check the auxiliary code (format 0X0Y). "X" indicates the first faulty PU channel in hexadecimal (1...C) (With a ZCU control unit, "X" can be 1 or 2 but this is irrelevant to the fault).

## 690 Fault tracing

Code (hex)	Event name / Aux. code	Cause	What to do
5094	Measurement circuit temperature	Problem with internal temperature measurement of the drive.	<p>“Y” indicates the auxiliary code category.            The auxiliary code categories are as follows:            1 = PU and CU ratings not the same.            Rating ID has changed.            2 = Parallel connection rating ID has changed.            3 = PU types not the same in all power units.            4 = Parallel connection rating ID is active in a single power unit setup.            5 = It is not possible to implement the selected rating with the current PUs.            6 = PU rating ID is 0.            7 = Reading PU rating ID or PU type failed on PU connection.            8 = PU not supported (illegal rating ID).            9 = Incompatible module current rating (unit contains a module with too low a current rating).  <b>A</b> - Selected parallel rating ID not found from database.            With parallel connection faults (BCU control unit), the format of the auxiliary code is OXOY.</p>
5681	PU communication	The way the control unit is powered does not correspond to parameter setting. Communication errors detected between the drive control unit and the power unit.	<p>Check setting of 95.4 Control board supply.            Check the connection between the control unit and the power unit.            Check the auxiliary code (format XXXY YYZZ). With parallel-connected modules, “Y YY” specifies the affected BCU control unit channel (<b>0</b>: broadcast). “ZZ” specifies the error source (<b>1</b>: Transmitter side [link error], <b>2</b>: Transmitter side [no communication], <b>3</b>: Receiver side [link error], <b>4</b>: Receiver side [no communication], <b>5</b>: Transmitter FIFO error [see “XXX”], <b>6</b>: Module [xINT board] not found, <b>7</b>: BAMU board not found).            “XXX” specifies the transmitter FIFO error code (<b>1</b>: Internal error [invalid call parameter], <b>2</b>: Internal error [configuration not supported], <b>3</b>: Transmission buffer full).</p>
5682	Power unit lost	Connection between the drive control unit and the power unit is lost.	Check the connection between the control unit and the power unit.

Code (hex)	Event name / Aux. code	Cause	What to do
5690	PU communication internal	Internal communication error.	Contact your local ABB representative.
5691	Measurement circuit ADC	Measurement circuit fault.	If the control unit is externally powered, check the setting of parameter 95.4 Control board supply. If the problem persists, contact your local ABB representative, quoting the auxiliary code.
5692	PU board powerfail	Power unit power supply failure.	Check the auxiliary code (format ZZZY YYXX). "YY Y" specifies the affected inverter module (0...C, always 0 for ZCU control units). "XX" specifies the affected power supply (1: Power supply 1, 2: Power supply 2, 3: both supplies).
5693	Measurement circuit DFF	Measurement circuit fault.	Contact your local ABB representative, quoting the auxiliary code.
5694	PU communication conf	Number of connected power modules differs from expected.	Check setting of 95.31 Parallel type configuration. Cycle the power to the drive. If the control unit is externally powered, also reboot the control unit (using parameter 96.8 Control board boot) or by cycling its power. If the problem persists, contact your local ABB representative.
5695	Reduced run	Number of inverter modules detected does not match the value of parameter 95.13 Reduced run mode.	Check that the value of 95.13 Reduced run mode corresponds to the number of inverter modules present. Check that the modules present are powered from the DC bus and connected by fiber optic cables to the BCU control unit. If all modules of the inverter unit are in fact available (eg. maintenance work has been completed), check that parameter 95.13 Reduced run mode is set to 0 (reduced run function disabled).
5696	PU state feedback	State feedback from output phases does not match control signals.	Contact your local ABB representative, quoting the auxiliary code.
5697	Charging feedback	<ul style="list-style-type: none"> <li>• Incorrect parameter setting.</li> <li>• The charging switch and DC switch were operated out of sequence, or a start command was issued before the unit was ready.</li> <li>• Charging circuit fault.</li> </ul>	<ul style="list-style-type: none"> <li>• Check the setting of 95.9 Switch fuse controller. The parameter should be enabled only if an xSFC charging controller is installed.</li> <li>• The normal power-up sequence is: <ol style="list-style-type: none"> <li>1. Close charging switch.</li> </ol> </li> </ul>

## 692 Fault tracing

Code (hex)	Event name / Aux. code	Cause	What to do
		<ul style="list-style-type: none"> <li>Brake circuit fault.</li> </ul>	<ol style="list-style-type: none"> <li>After charging finishes (charging OK lamp lights), close DC switch.</li> <li>Open charging switch.</li> </ol> <ul style="list-style-type: none"> <li>Check the charging circuit. With a frame R6i/R7i inverter module, the auxiliary code “FA” indicates that the charging contactor status feedback does not match the control signal. With parallel-connected frame R8i modules, the auxiliary code (format XX00), “XX” specifies the affected BCU control unit channel.</li> <li>Check the wiring and condition of brake resistor.</li> </ul>
5698	Unknown PU fault	Unidentified power unit logic fault.	Check power unit logic and firmware compatibility. Contact your local ABB representative.
6000	Internal SW error	Internal error.	Contact your local ABB representative, quoting the auxiliary code.
6181	FPGA version incompatible	<ul style="list-style-type: none"> <li>Firmware and FPGA file version in the power unit are incompatible.</li> <li>Update of power unit logic failed.</li> </ul>	<ul style="list-style-type: none"> <li>Reboot the control unit (using parameter 96.8 Control board boot) or by cycling power. If the problem persists, contact your local ABB representative.</li> <li>Retry.</li> <li>Check the auxiliary code to identify FPGA version compatibility (format: XYZZZ). “XX” (8: cannot recognize power unit logic, FPGA logic not compatible, 9 = power unit FPGA logic is old, update FPGA logic, 10 = software is not compatible with power unit FPGA logic, update software (or downgrade power unit FPGA)). YY = BCU control unit channel (first channel = 0)</li> </ul>
6200	Checksum mismatch	The calculated parameter checksum does not match any enabled reference checksum.	See A686 Checksum mismatch.
6306	FBA A mapping file	Fieldbus adapter A mapping file read error.	Contact your local ABB representative.
6307	FBA B mapping file	Fieldbus adapter B mapping file read error.	Contact your local ABB representative.

Code (hex)	Event name / Aux. code	Cause	What to do
6481	Task overload	Internal fault.	Reboot the control unit (using parameter 96.8 Control board boot) or by cycling power. If the problem persists, contact your local ABB representative.
6487	Stack overflow	Internal fault.	Reboot the control unit (using parameter 96.8 Control board boot) or by cycling power. If the problem persists, contact your local ABB representative.
64A1	Internal file load	File read error.	Reboot the control unit (using parameter 96.8 Control board boot) or by cycling power. If the problem persists, contact your local ABB representative.
64A2	Internal record load	Internal record load error.	Contact your local ABB representative.
64A3	Application loading	Application file incompatible or corrupted.	Check the auxiliary code. See actions for each code below.
	8006	Not enough memory for the application.	Reduce the size of the application. Reduce the number of parameter mappings. See the drive-specific log generated by Automation Builder.
	8007	The application contains the wrong system library version.	Update the system library or reinstall Automation Builder. See the drive-specific log generated by Automation Builder.
	8008	The application is empty.	In Automation Builder, give a "Clean" command and reload the application.
	8009	The application contains invalid tasks.	In Automation Builder, check application task configuration, give a "Clean all" command, and reload the application.
	800A	The application contains an unknown target (system) library function.	Update the system library or reinstall Automation Builder. See the drive-specific log generated by Automation Builder.
64A5	Licensing fault	Running the control program is prevented either because a restrictive license exists, or because a required license is missing.	Record the auxiliary codes of all active licensing faults and contact your product vendor for further instructions.
64A6	Adaptive program	Error running the adaptive program.	Check the auxiliary code (format XXXX YYYY). "XXXX" specifies the number of the function block (0000 = generic error). "YYYY" indicates the problem (see actions for each code below).
	000A	Program corrupted or block non-existent.	Restore the template program or download the program to the drive.
	000C	Required block input missing.	Check the inputs of the block.

## 694 Fault tracing

Code (hex)	Event name / Aux. code	Cause	What to do
	000E	Program corrupted or block non-existent.	Restore the template program or download the program to the drive.
	0011	Program too large.	Remove blocks until the error stops.
	0012	Program is empty.	Correct the program and download it to the drive.
	001C	A nonexisting parameter or block is used in the program.	Edit the program to correct the parameter reference, or to use an existing block.
	001D	Parameter type invalid for selected pin.	Edit the program to correct the parameter reference.
	001E	Output to parameter failed because the parameter was write-protected.	Check the parameter reference in the program. Check for other sources affecting the target parameter.
	0023, 0024	Program file incompatible with current firmware version.	Adapt the program to current block library and firmware version.
	002A	Too many blocks.	Edit the program to reduce the number of blocks.
64B0	Memory unit detached	The memory unit was detached when the control unit was powered.	Switch off the power to the control unit and reinstall the memory unit. In case the memory unit was not actually removed when the fault occurred, check that the memory unit is properly inserted into its connector and its mounting screw is tight. Reboot the control unit (using parameter 96.8 Control board boot) or by cycling power. If the problem persists, contact your local ABB representative.
64B1	Internal SSW fault	Internal fault.	Reboot the control unit (using parameter 96.8 Control board boot) or by cycling power. If the problem persists, contact your local ABB representative.
64B2	User set fault	Loading of user parameter set failed because <ul style="list-style-type: none"> <li>• set is not compatible with control program</li> <li>• drive was switched off during loading.</li> </ul>	Ensure that a valid user parameter set exists. Reload if uncertain.
64E1	Kernel overload	Operating system error.	Reboot the control unit (using parameter 96.8 Control board boot) or by cycling power. If the problem persists, contact your local ABB representative.
64FF	Fault reset	Informative fault.	An active fault has been reset.
6581	Parameter system	Parameter load or save failed.	Try forcing a save using parameter 96.7 Parameter save manually. Retry.

Code (hex)	Event name / Aux. code	Cause	What to do
6591	Backup/Restore Timeout	Parameter load or save timeout caused by communication break between drive and control panel, or control panel and PC tool.	Check the communication between drive and control panel or PC. Retry.
65A1	FBA A parameter conflict	The drive does not have a functionality requested by PLC, or requested functionality has not been activated.	Check PLC programming. Check settings of parameter groups 50 Fieldbus adapter (FBA) and 51 FBA A settings.
65A2	FBA B parameter conflict	The drive does not have a functionality requested by PLC, or requested functionality has not been activated.	Check PLC programming. Check settings of parameter groups 50 Fieldbus adapter (FBA) and 54 FBA B settings.
65B1	Reference source parametrization	A reference source is simultaneously connected to multiple parameters with different units.	See A6DA Reference source parametrization (page 709).
6681	EFB communication loss	Communication break in embedded fieldbus (EFB) communication.	Check the status of the fieldbus master (online/offline/error etc.). Check cable connections to the XD2D connector on the control unit.
6682	EFB configuration file	Embedded fieldbus (EFB) configuration file could not be read.	Contact your local ABB representative.
6683	EFB invalid parameterization	Embedded fieldbus (EFB) parameter settings inconsistent or not compatible with selected protocol.	Check the settings in parameter group 58 Embedded fieldbus.
6684	EFB load fault	<ul style="list-style-type: none"> <li>• Embedded fieldbus (EFB) protocol firmware could not be loaded.</li> <li>• Version mismatch between EFB protocol firmware and drive firmware.</li> </ul>	Contact your local ABB representative.
6881	Text data overflow	Internal fault.	Reset the fault. Contact your local ABB representative if the fault persists.
6882	Text 32-bit table overflow	Internal fault.	Reset the fault. Contact your local ABB representative if the fault persists.
6883	Text 64-bit table overflow	Internal fault.	Reset the fault. Contact your local ABB representative if the fault persists.
6885	Text file overflow	Internal fault.	Reset the fault. Contact your local ABB representative if the fault persists.
7080	Option module comm loss	Communication between drive and an option module is lost.	See A798 Encoder option comm loss (page 711).
7081	Control panel loss	Control panel (or PC tool) has stopped communicating.	Check PC tool or control panel connection. Check control panel connector. Disconnect and reconnect the control panel.

## 696 Fault tracing

Code (hex)	Event name / Aux. code	Cause	What to do
			Check the auxiliary code. The code specifies the I/O port used as follows: <b>0:</b> Panel, <b>1:</b> Fieldbus interface A, <b>2:</b> Fieldbus interface B, <b>3:</b> Ethernet, <b>4:</b> D2D/EFB port).
7082	Ext I/O comm loss	The I/O extension module types specified by parameters do not match the detected configuration.	See A799 ExtIO comm loss (page 712).
7083	Panel reference conflict	Use of saved control panel reference in multiple control modes attempted.	The control panel reference can only be saved for one reference type at a time. Consider the possibility of using a copied reference instead of saved reference (see the reference selection parameter).
7084	Panel/PC tool version conflict	The current version of the control panel and/or PC tool does not support a function. (For example, older panel versions cannot be used as a source of external reference.)	Update control panel and/or PC tool. Contact your local ABB representative if necessary.
7085	Incompatible option module	Option module not supported. (For example, type Fxxx-xx-M fieldbus adapter modules are not supported.)	Check the auxiliary code. The code specifies the interface to which the unsupported module is connected: <b>1:</b> Fieldbus interface A, <b>2:</b> Fieldbus interface B. Replace the module with a supported type. <b>A</b> - FSO-xx module is not supported by the control board. Remove FSO-xx module to clear the fault. Connect FSO-xx module to the supported control board.
7121	Motor stall	Motor is operating in stall region because of e.g. excessive load or insufficient motor power.	Check motor load and drive ratings. Check fault function parameters.
7122	Motor overload	Motor current is too high.	Check for overloaded motor. Adjust the parameters used for the motor overload function 35.51...35.53) and 35.55...35.56.
7181	Brake resistor	DC overvoltage detected during braking.	Check that a brake resistor has been connected. Check the condition of the brake resistor. Check the dimensioning of the brake chopper and resistor.
7183	BR excess temperature	Brake resistor temperature has exceeded fault limit defined by parameter 43.11 Brake resistor fault limit.	Stop drive. Let resistor cool down. Check resistor overload protection function settings (parameter group 43 Brake chopper). Check fault limit setting, parameter 43.11 Brake resistor fault limit.



Code (hex)	Event name / Aux. code	Cause	What to do
			Check that braking cycle meets allowed limits.
7184	Brake resistor wiring	Brake resistor short circuit or brake chopper control fault.	Check brake chopper and brake resistor connection. Ensure brake resistor is not damaged. After correcting the cause of the fault, reboot the control unit (using parameter 96.8 Control board boot) or by cycling power.
7191	BC short circuit	Short circuit in brake chopper IGBT.	Ensure brake resistor is connected and not damaged. Check the electrical specifications of the brake resistor against the <i>Hardware manual</i> . Replace brake chopper (if replaceable). After correcting the cause of the fault, reboot the control unit (using parameter 96.8 Control board boot) or by cycling power.
7192	BC IGBT excess temperature	Brake chopper IGBT temperature has exceeded internal fault limit.	Let chopper cool down. Check for excessive ambient temperature. Check for cooling fan failure. Check for obstructions in the air flow. Check the dimensioning and cooling of the cabinet. Check resistor overload protection function settings (parameter group 43 Brake chopper). Check that braking cycle meets allowed limits. Check that drive supply AC voltage is not excessive.
71A2	Mech brake closing failed	Mechanical brake control fault. Activated eg. if brake acknowledgement is not as expected during brake closing.	Check mechanical brake connection. Check mechanical brake settings in parameter group 44 Mechanical brake control. Check that acknowledgement signal matches actual status of brake.
71A3	Mech brake opening failed	Mechanical brake control fault. Activated eg. if brake acknowledgement is not as expected during brake opening.	Check mechanical brake connection. Check mechanical brake settings in parameter group 44 Mechanical brake control. Check that acknowledgement signal matches actual status of brake.
71A5	Mech brk opening not allowed	Open conditions of mechanical brake cannot be fulfilled (for example, brake has been prevented from opening by parameter 44.11 Keep brake closed). In an encoderless application, the brake is kept closed by a brake close request against a modulating drive for longer than 5 seconds.	Check mechanical brake settings in parameter group 44 Mechanical brake control (especially 44.11 Keep brake closed). Check that acknowledgement signal (if used) matches actual status of brake.

## 698 Fault tracing

Code (hex)	Event name / Aux. code	Cause	What to do
			Check the safety circuits connected to the FSO-xx safety functions module.
71B1	Motor fan	No feedback received from external fan.	Check external fan (or other equipment controlled) by the logic. Check settings of parameters 35.100...35.106.
7301	Motor speed feedback	No motor speed feedback received.	See A7B0 Motor speed feedback (page 714).
7310	Overspeed	<ul style="list-style-type: none"> <li>Motor is turning faster than highest allowed speed due to incorrectly set minimum/maximum speed, insufficient braking torque or changes in load when using torque reference.</li> <li>Incorrect estimated speed.</li> </ul>	<ul style="list-style-type: none"> <li>Check minimum/maximum speed settings, parameters 30.11 Minimum speed, 30.12 Maximum speed and 31.30 Overspeed trip margin. Check adequacy of motor braking torque. Check applicability of torque control. Check need for brake chopper and resistor(s).</li> <li>Check the status of motor current measurement. Perform a Normal, Advanced or Advanced Standstill ID run instead of, for example, a Reduced or Standstill. See parameter 99.13 ID run requested (page 672).</li> </ul>
7380	Encoder internal	Internal fault.	Contact your local ABB representative.
7381	Encoder	Encoder feedback fault.	See A7E1 Encoder (page 715).
73A0	Speed fbk configuration	Speed feedback configuration incorrect.	See A797 Speed feedback configuration (page 711).
73A1	Load position feedback	No load position feedback received.	Check the auxiliary code (format XXYY ZZZZ). "XX" specifies the number of the encoder interface module ( <b>01</b> : 91.11/91.12, <b>02</b> : 91.13/91.14), "YY" specifies the encoder ( <b>01</b> : 92 Encoder 1 configuration, <b>02</b> : 93 Encoder 2 configuration). "ZZZZ" indicates the problem (see actions for each code below).
	0001	Encoder stopped working.	Check encoder status.
	0002	Feed constant definition invalid or outside limits.	Check feed constant settings (90.63 and 90.64).
	0003	Motor/load gear definition invalid or outside limits.	Check motor/load gear settings (90.61 and 90.62).
	0004	Encoder not configured.	Check encoder settings (92 Encoder 1 configuration or 93 Encoder 2 configuration).

Code (hex)	Event name / Aux. code	Cause	What to do
	0005	Encoder stopped working.	Use parameter 91.10 Encoder parameter refresh) to validate any changes in the settings. Check encoder status.
73B0	Emergency ramp failed	Emergency stop did not finish within expected time.	Check the settings of parameters 31.32 Emergency ramp supervision and 31.33 Emergency ramp supervision delay. Check the predefined ramp times (23.19 for mode Off1, 23.23 for mode Off3).
73B1	Stop failed	Ramp stop did not finish within expected time.	Check the settings of parameters 31.37 Ramp stop supervision and 31.38 Ramp stop supervision delay. Check the predefined ramp times in parameter group 23 Speed reference ramp.
73F0	Overfrequency	Maximum allowed output frequency exceeded.	Without a dual-use license, the fault limit is 598 Hz. Contact your local ABB representative for dual-use licensing information.
7510	FBA A communication	Cyclical communication between drive and fieldbus adapter module A or between PLC and fieldbus adapter module A is lost.	Check status of fieldbus communication. See user documentation of fieldbus interface. Check settings of parameter groups 50 Fieldbus adapter (FBA), 51 FBA A settings, 52 FBA A data in and 53 FBA A data out. Check cable connections. Check if communication master is able to communicate.
7520	FBA B communication	Cyclical communication between drive and fieldbus adapter module B or between PLC and fieldbus adapter module B is lost.	Check status of fieldbus communication. See user documentation of fieldbus interface. Check settings of parameter group 50 Fieldbus adapter (FBA). Check cable connections. Check if communication master is able to communicate.
7580	INU-LSU comm loss	DDCS (fiber optic) communication between converters (for example, the inverter unit and the supply unit) is lost.	Check status of other converter (parameter group 6 Control and status words). Check settings of parameter group 60 DDCS communication. Check the corresponding settings in the control program of the other converter. Check cable connections. If necessary, replace cables.
7581	DDCS controller comm loss	DDCS (fiber optic) communication between drive and external controller is lost.	Check status of controller. See user documentation of controller.

## 700 Fault tracing

Code (hex)	Event name / Aux. code	Cause	What to do
			Check settings of parameter group 60 DDCS communication. Check cable connections. If necessary, replace cables.
7582	M/F comm loss	Master/follower communication is lost.	See A7CB M/F comm loss (page 715).
7583	Line side unit faulted	The supply unit (or other converter) connected to the inverter unit has generated a fault.	The auxiliary code specifies the original fault code in the supply unit control program. See section Auxiliary codes for line-side converter faults (page 734).
7584	LSU charge failed	The supply unit was not ready (ie. the main contactor/breaker could not be closed) within expected time.	Check that communication to the supply unit has been activated by 95.20 HW options word 1. Check that the supply unit is enabled, allowed to start, and can be controlled by the inverter unit (eg. not in local control mode).
8001	ULC underload	Selected signal has fallen below the user underload curve.	See A8BF ULC underload (page 719).
8002	ULC overload	Selected signal has exceeded the user overload curve.	See A8BE ULC overload (page 719).
80A0	AI Supervision	An analog signal is outside the limits specified for the analog input.	Check the auxiliary code (format XXXX XYZZ). "Y" specifies the location of the input ( <b>0</b> : Control unit, <b>1</b> : I/O extension module 1, <b>2</b> : I/O extension module 2, <b>3</b> : I/O extension module 3). "ZZ" specifies the limit ( <b>01</b> : AI1 under minimum, <b>02</b> : AI1 above maximum, <b>03</b> : AI2 under minimum, <b>04</b> : AI2 above maximum). Check signal level at the analog input. Check the wiring connected to the input. Check the minimum and maximum limits of the input in parameter group 12 Standard AI.
80B0	Signal supervision	Fault generated by the signal supervision 1 function.	Check the source of the fault (parameter 32.7 Supervision 1 signal).
80B1	Signal supervision 2	Fault generated by the signal supervision 2 function.	Check the source of the fault (parameter 32.17 Supervision 2 signal).
80B2	Signal supervision 3	Fault generated by the signal supervision 3 function.	Check the source of the fault (parameter 32.27 Supervision 3 signal).
8E12	Fan speed	Fan speed is under limit (parameter 206.07).	Check fan feedback. See parameters 206.30...206.33 for individual failing fans.
8E13	I/O module version mismatch	Communication services of the CIO-01 module are incompatible with the firmware version on the control unit.	See the auxiliary code for incompatible CIO-01 module. Auxiliary code is a bit word where bit 0 indicates CIO-01 module assigned to node ID 1.

Code (hex)	Event name / Aux. code	Cause	What to do
			Replace the incompatible CIO-01 module.
8E14	CIO MCB monitoring	Fault related to miniature circuit breaker. Some of the bits of the MCB status word are 0.	Check miniature circuit breaker and digital input DI5.
8E15	CIO fuse monitoring	Fault related to fuses. Some of the bits of the fuse status word are 0.	Check fuses and digital input DI6.
8E17	CIO DI8 monitoring	Fault related to digital input DI8.	Check digital input DI8.
9081	External fault 1	Fault in external device 1.	Check the external device. Check setting of parameter 31.1 External event 1 source.
9082	External fault 2	Fault in external device 2.	Check the external device. Check setting of parameter 31.3 External event 2 source.
9083	External fault 3	Fault in external device 3.	Check the external device. Check setting of parameter 31.5 External event 3 source.
9084	External fault 4	Fault in external device 4.	Check the external device. Check setting of parameter 31.7 External event 4 source.
9085	External fault 5	Fault in external device 5.	Check the external device. Check setting of parameter 31.9 External event 5 source.
A2A1	Current calibration	Current offset and gain measurement calibration will occur at next start.	Informative warning. (See parameter 99.13 ID run requested.)
A2B3	Earth leakage	Drive has detected load unbalance typically due to earth fault in motor or motor cable.	Check there are no power factor correction capacitors or surge absorbers in motor cable. Check for an earth fault in motor or motor cables by measuring the insulation resistances of motor and motor cable. Try running the motor in scalar control mode if allowed. (See parameter 99.4 Motor control mode.) If no earth fault can be detected, contact your local ABB representative.
A2B4	Short circuit	Short-circuit in motor cable(s) or motor.	Check motor and motor cable for cabling errors. Check there are no power factor correction capacitors or surge absorbers in motor cable.
A2BA	IGBT overload	Excessive IGBT junction to case temperature. This warning protects the IGBT(s) and can be activated by a short circuit in the motor cable.	Check motor cable. Check ambient conditions. Check air flow and fan operation. Check heatsink fins for dust pick-up. Check motor power against drive power.

## 702 Fault tracing

Code (hex)	Event name / Aux. code	Cause	What to do
A3A1	DC link overvoltage	Intermediate circuit DC voltage too high (when the drive is stopped).	Check the supply voltage setting (parameter 95.1 Supply voltage). Note that the wrong setting of the parameter may cause the motor to rush uncontrollably, or may overload the brake chopper or resistor. Check the supply voltage. If the problem persists, contact your local ABB representative.
A3A2	DC link undervoltage	Intermediate circuit DC voltage too low (when the drive is stopped).	Check the supply voltage setting (parameter 95.1 Supply voltage). Note that the wrong setting of the parameter may cause the motor to rush uncontrollably, or may overload the brake chopper or resistor. Check the supply voltage. If the problem persists, contact your local ABB representative.
A3AA	DC not charged	The voltage of the intermediate DC circuit has not yet risen to operating level.	Check the supply voltage setting (parameter 95.1 Supply voltage). Note that the wrong setting of the parameter may cause the motor to rush uncontrollably, or may overload the brake chopper or resistor. Check the supply voltage. If the problem persists, contact your local ABB representative.
A480	Motor cable overload	Calculated motor cable temperature has exceeded warning limit.	Check the settings of parameters 35.61 and 35.62. Check the dimensioning of the motor cable in regard to required load.
A490	Incorrect temperature sensor setup	Problem with motor temperature measurement.	Check the auxiliary code (format OXY ZZZZ). "X" identifies the affected temperature monitoring function (1 = parameter 35.11, 2 = parameter 35.21). "YY" indicates the selected temperature source, ie. the setting of the selection parameter in hexadecimal. "ZZZZ" indicates the problem (see actions for each code below).
0001		Sensor type mismatch.	Check parameters 35.11/35.21 against 91.21/91.24.
0002		Temperature under limit.	Check parameters 35.11...35.14/35.21...35.24 (and 91.21/91.24 if sensor is connected to an encoder interface). Check the sensor and its wiring.
0003		Short circuit.	Check parameters 35.11...35.14/35.21...35.24 (and 91.21/91.24 if sensor is connected to an encoder interface). Check the sensor and its wiring.

Code (hex)	Event name / Aux. code	Cause	What to do
	0004	Open circuit.	Check parameters 35.11...35.14/35.21...35.24 (and 91.21/91.24 if sensor is connected to an encoder interface). Check the sensor and its wiring.
A491	External temperature 1	Measured temperature 1 has exceeded warning limit.	Check the value of parameter 35.2 Measured temperature 1. Check the cooling of the motor (or other equipment whose temperature is being measured). Check the value of 35.13 Temperature 1 warning limit.
A492	External temperature 2	Measured temperature 2 has exceeded warning limit.	Check the value of parameter 35.3 Measured temperature 2. Check the cooling of the motor (or other equipment whose temperature is being measured). Check the value of 35.23 Temperature 2 warning limit.
A497	Motor temperature 1	The thermistor protection module installed in slot 1 indicates overtemperature.	Check the cooling of the motor. Check the motor load and drive ratings. Check the wiring of the temperature sensor. Repair wiring if faulty. Measure the resistance of the sensor. Replace sensor if faulty.
A498	Motor temperature 2	The thermistor protection module installed in slot 2 indicates overtemperature.	Check the cooling of the motor. Check the motor load and drive ratings. Check the wiring of the temperature sensor. Repair wiring if faulty. Measure the resistance of the sensor. Replace sensor if faulty.
A499	Motor temperature 3	The thermistor protection module installed in slot 3 indicates overtemperature.	Check the cooling of the motor. Check the motor load and drive ratings. Check the wiring of the temperature sensor. Repair wiring if faulty. Measure the resistance of the sensor. Replace sensor if faulty.
A4A0	Control board temperature	Control unit temperature is excessive.	Check the auxiliary code. See actions for each code below.
	-	Temperature above warning limit.	Check ambient conditions. Check air flow and fan operation. Check heatsink fins for dust pick-up.
	1	Thermistor broken.	Contact an ABB service representative for control unit replacement.
A4A9	Cooling	Drive module temperature is excessive.	Check ambient temperature. If it exceeds 40 °C (104 °F), ensure that load current does not exceed derated

## 704 Fault tracing

Code (hex)	Event name / Aux. code	Cause	What to do
			load capacity of drive. See appropriate Hardware manual. Check drive module cooling air flow and fan operation. Check inside of cabinet and heatsink of drive module for dust pick-up. Clean whenever necessary.
A4B0	Excess temperature	Power unit temperature is excessive.	Check ambient conditions. Check air flow and fan operation. Check heatsink fins for dust pick-up. Check motor power against drive power. See A5EA Measurement circuit temperature (page 705).
A4B1	Excess temperature difference	High temperature difference between the IGBTs of different phases.	Check the motor cabling. Check cooling of drive module(s). Check the auxiliary code (format XXXY YYZZ). "XXX" indicates the source of difference ( <b>0</b> : Single module, difference between phase IGBTs, <b>1</b> : parallel-connected modules, minimum-maximum difference between all IGBTs of all modules, <b>2</b> : parallel-connected modules, minimum-maximum difference between auxiliary power supply boards). With parallel-connected modules, "Y YY" specifies through which BCU control unit channel the highest temperature was measured. "ZZ" specifies the phase ( <b>0</b> : single module, <b>1</b> : U-phase [parallel connection], <b>2</b> : V-phase [parallel connection], <b>3</b> : W-phase [parallel connection]).
A4F6	IGBT temperature	Drive IGBT temperature is excessive.	Check ambient conditions. Check air flow and fan operation. Check heatsink fins for dust pick-up. Check motor power against drive power.
A580	PU communication	Communication errors detected between the drive control unit and the power unit.	Check the connections between the drive control unit and the power unit. Check the auxiliary code (format XXXY YYZZ). With parallel-connected modules, "Y YY" specifies the affected BCU control unit channel ( <b>0</b> : broadcast). "ZZ" specifies the error source ( <b>8</b> : Transmission errors in PSL link [see "XXX"], <b>9</b> : Transmitter FIFO warning limit hit). "XXX" specifies the transmission error direction and detailed warning code ( <b>0</b> : Rx/communication error, <b>1</b> : Tx/Reed-Solomon symbol error, <b>2</b> :



Code (hex)	Event name / Aux. code	Cause	What to do
			<p>Tx/no synchronization error, <b>3</b>: Tx/Reed-Solomon decoder failures, <b>4</b>: Tx/Manchester coding errors).  Read the PSL2 data log. In Drive Composer pro, check the time stamp of the A580 fault. Load the log with the same date and time. When the file opens, click "Show fault log".  Check the power unit hardware.</p>
A581	Fan	Cooling fan feedback missing.	<p>Check the setting of parameter <b>95.20 HW options word 1, bit 14</b>.  Check the auxiliary code to identify the fan. Code <b>0</b> denotes main fan 1. Other codes (format XYZ): "<b>X</b>" specifies state code (<b>1</b>: ID run, <b>2</b>: normal). "<b>Y</b>" specifies the index of the inverter module connected to BCU (<b>0...n</b>, always <b>0</b> for ZCU control units). "<b>Z</b>" specifies the index of the fan (<b>1</b>: Main fan 1, <b>2</b>: Main fan 2, <b>3</b>: Main fan 3).  Note that modules are coded starting from 0. For example, the code <b>101</b> means that Main fan 1 of module <b>1</b> (connected to BCU channel V1T/V1R) has faulted during its ID run.  Check fan operation and connection.  Replace fan if faulty.</p>
A582	Auxiliary fan not running	An auxiliary cooling fan (connected to the fan connectors on the control unit) is stuck or disconnected.	<p>The auxiliary code identifies the fan (<b>1</b>: Auxiliary fan 1, <b>2</b>: Auxiliary fan 2).  Check that the auxiliary fan supervision selection in parameter <b>95.21 HW options word 2</b> matches the hardware.  Make sure the front cover of the drive module is in place and tightened.  Check auxiliary fan(s) and connection(s).  Replace faulty fan.</p>
A5A0	Safe torque off	Safe torque off function is active, i.e. safety circuit signal(s) connected to connector XSTO is lost.	<p>Check safety circuit connections. For more information, see appropriate drive hardware manual and description of parameter <b>31.22 STO indication run/stop</b> (page 434).</p>
A5EA	Measurement circuit temperature	Problem with internal temperature measurement of the drive.	<p>Check the auxiliary code (format XXXY YYZZ). "<b>Y YY</b>" specifies through which BCU control unit channel the fault was received ("<b>0 00</b>" with a ZCU control unit).  "<b>ZZ</b>" specifies the location:  <u>With control program version 2.8x and later</u>: <b>1</b>: U-phase IGBT, <b>2</b>: V-phase IGBT, <b>3</b>: W-phase IGBT, <b>4</b>: Power supply board, <b>5</b>: Power unit xINT board, <b>6</b>:</p>

# 706 Fault tracing

Code (hex)	Event name / Aux. code	Cause	What to do
			<p>Brake chopper, <b>7</b>: Air inlet (TEMP3, X10), <b>8</b>: du/dt filter (TEMP2, X7), <b>9</b>: TEMP1 (X6).</p> <p><u>With control program version up to and including 2.7x</u>: <b>1</b>: U-phase IGBT, <b>2</b>: V-phase IGBT, <b>3</b>: W-phase IGBT, <b>4</b>: Power unit INT board, <b>5</b>: Brake chopper, <b>6</b>: Air inlet, <b>7</b>: Power supply board, <b>8</b>: du/dt filter, <b>FAh</b>: Air in temp.</p>
A5EB	PU board powerfail	Power unit power supply failure.	Contact your local ABB representative.
A5EC	PU communication internal	Communication errors detected between the drive control unit and the power unit.	Check the connections between the drive control unit and the power unit.
A5ED	Measurement circuit ADC	Problem with measurement circuit of power unit (analog to digital converter).	Contact your local ABB representative.
A5EE	Measurement circuit DFF	Problem with current or voltage measurement of power unit.	Contact your local ABB representative.
A5EF	PU state feedback	State feedback from output phases does not match control signals.	Contact your local ABB representative.
A5F0	Charging feedback	Charging in progress.	Informative warning. Wait until charging finishes before starting the inverter unit.
A5F3	Switching frequency below requested	Adequate motor control at requested output frequency cannot be reached because of limited switching frequency (eg. by parameter 95.15).	Informative warning.
A5F4	Control unit battery	The battery of the control unit is low.	Replace control unit battery. This warning can be suppressed using parameter 31.40.
A682	Flash erase speed exceeded	The flash memory (in the memory unit) has been erased too frequently, compromising the lifetime of the memory.	<p>Avoid forcing unnecessary parameter saves by parameter 96.7 or cyclic parameter writes (such as user logger triggering through parameters). Check the auxiliary code (format XYYY YZZZ). "X" specifies the source of warning (1: generic flash erase supervision). "ZZZ" specifies the flash subsector number that generated the warning.</p>
A683	Data saving to power unit	An error in saving data to the power unit.	Check the auxiliary code. See actions for each code below.
	0, 1	An error is preventing saving from initializing.	Cycle the power to the drive. If the control unit is externally powered, also reboot the control unit (using parameter 96.8 Control board boot) or by cycling its power. If the problem persists, contact your local ABB representative.

Code (hex)	Event name / Aux. code	Cause	What to do
	2	Write error.	Cycle the power to the drive. If the control unit is externally powered, also reboot the control unit (using parameter 96.8 Control board boot) or by cycling its power. If the problem persists, contact your local ABB representative.
A684	SD card	Error related to SD card used to store data (BCU control unit only).	Check the auxiliary code. See actions for each code below.
	0	No SD card.	Insert a compatible, writable SD card into the SD CARD slot of the BCU control unit.
	1	SD card write-protected.	Insert a compatible, writable SD card into the SD CARD slot of the BCU control unit.
	2	SD card unreadable.	Insert a compatible, writable SD card into the SD CARD slot of the BCU control unit.
A685	Power fail saving	Power fail saving is requested too frequently. Because of the limited saving interval, some of the requests do not trigger the saving and power fail data may be lost. This may be caused by DC voltage oscillation.	Check the supply voltage.
A686	Checksum mismatch	The calculated parameter checksum does not match any enabled reference checksum.	Check that all necessary approved (reference) checksums (96.56...96.59) are enabled in 96.55 Checksum control word. Check the parameter configuration. Using 96.55 Checksum control word, enable a checksum parameter and copy the actual checksum into that parameter.
A687	Checksum configuration	An action has been defined for a parameter checksum mismatch but the feature has not been configured.	Contact your local ABB representative for configuring the feature, or disable the feature in 96.54 Checksum action.
A688	Parameter map configuration	Too much data in parameter mapping table created in Drive customizer.	See the <i>Drive customizer PC tool user's manual</i> (3AUA0000104167 [English]).
A689	Mapped parameter value cut	Parameter value saturated eg. by the scaling specified in parameter mapping table (created in Drive customizer).	Check parameter scaling and format in parameter mapping table. See the <i>Drive customizer PC tool user's manual</i> (3AUA0000104167 [English]).
A6A4	Motor nominal value	The motor parameters are set incorrectly. The drive is not dimensioned correctly.	Check the auxiliary code. See actions for each code below.
	1	Slip frequency is too small.	Check the settings of the motor configuration parameters in groups 98 and 99. Check that the drive is sized correctly for the motor.

## 708 Fault tracing

Code (hex)	Event name / Aux. code	Cause	What to do
	2	Synchronous and nominal speeds differ too much.	Check the settings of the motor configuration parameters in groups 98 and 99. Check that the drive is sized correctly for the motor.
	3	Nominal speed is higher than synchronous speed with 1 pole pair.	Check the settings of the motor configuration parameters in groups 98 and 99. Check that the drive is sized correctly for the motor.
	4	Nominal current is outside limits.	Check the settings of the motor configuration parameters in groups 98 and 99. Check that the drive is sized correctly for the motor.
	5	Nominal voltage is outside limits.	Check the settings of the motor configuration parameters in groups 98 and 99. Check that the drive is sized correctly for the motor.
	6	Mechanical nominal power is higher than electrical active power.	Check the settings of the motor configuration parameters in groups 98 and 99. Check that the drive is sized correctly for the motor.
	7	Nominal power not consistent with nominal speed and torque.	Check the settings of the motor configuration parameters in groups 98 and 99. Check that the drive is sized correctly for the motor.
A6A5	No motor data	Parameters in group 99 have not been set.	Check that all the required parameters in group 99 have been set.  <b>Note:</b> It is normal for this warning to appear during the start-up and continue until the motor data is entered.
A6A6	Supply voltage unselected	The supply voltage has not been defined.	Set supply voltage in parameter 95.1 Supply voltage.
A6B0	User lock open	The user lock is open, ie. user lock configuration parameters 96.100...96.102 are visible.	Close the user lock by entering an invalid pass code in parameter 96.2 Pass code. See section User lock (page 213).
A6B1	User pass code not confirmed	A new user pass code has been entered in parameter 96.100 but not confirmed in 96.101.	Confirm the new pass code by entering the same code in 96.101. To cancel, close the user lock without confirming the new code. See section User lock (page 213).
A6D1	FBA A parameter conflict	The drive does not have a functionality requested by a PLC, or requested functionality has not been activated.	Check PLC programming.

Code (hex)	Event name / Aux. code	Cause	What to do
			Check settings of parameter groups 50 Fieldbus adapter (FBA) and 51 FBA A settings.
A6D2	FBA B Parameter conflict	The drive does not have a functionality requested by a PLC, or requested functionality has not been activated.	Check PLC programming. Check settings of parameter groups 50 Fieldbus adapter (FBA) and 54 FBA B settings.
A6DA	Reference source parametrization	A reference source is simultaneously connected to multiple parameters with different units.	Check the reference source selection parameters. Check the auxiliary code (format XYY 00ZZ). "XX" and "YY" specify the two sets of parameters where the source was connected to (01 = speed reference chain [22.11, 22.12, 22.15, 22.17], 03 = torque reference chain [26.11, 26.12, 26.16], 04 = other torque-related parameters [26.25, 30.21, 30.22, 44.9]. "ZZ" indicates the conflicting reference source (01...0E = index in parameter group 3, 33 = process PID control, 3D = motor potentiometer, 65 = AI1, 66 = AI2, 6F = frequency input).
A6E5	AI parametrization	The current/voltage hardware setting of an analog input does not correspond to parameter settings.	Check the auxiliary code. The code identifies the analog input whose settings are in conflict. Adjust either the hardware setting (on the drive control unit) or parameter 12.15/12.25.  <b>Note:</b> Control board reboot (either by cycling the power or through parameter 96.8 Control board boot) is required to validate any changes in the hardware settings.
A6E6	ULC configuration	User load curve configuration error.	Check the auxiliary code (format XXXX ZZZZ). "ZZZZ" indicates the problem (see actions for each code below).
	0000	Speed points inconsistent.	Check that each speed point (parameters 37.11...37.15) has a higher value than the previous point.
	0001	Frequency points inconsistent.	Check that each frequency point (37.16...37.20) has a higher value than the previous point.
	0002	Underload point above overload point.	Check that each overload point (37.31...37.35) has a higher value than the corresponding underload point (37.21...37.25).
	0003	Overload point below underload point.	Check that each overload point (37.31...37.35) has a higher value than the corresponding underload point (37.21...37.25).

# 710 Fault tracing

Code (hex)	Event name / Aux. code	Cause	What to do
A780	Motor stall	Motor is operating in stall region because of e.g. excessive load or insufficient motor power.	Check motor load and drive ratings. Check fault function parameters.
A781	Motor fan	No feedback received from external fan.	Check external fan (or other equipment controlled) by the logic. Check settings of parameters 35.100...35.106.
A782	FEN temperature	<ul style="list-style-type: none"> <li>Error in temperature measurement when temperature sensor (KTY or PTC) connected to encoder interface FEN-xx is used.</li> <li>Error in temperature measurement when KTY sensor connected to encoder interface FEN-01 is used.</li> </ul>	<ul style="list-style-type: none"> <li>Check that parameter 35.11 Temperature 1 source / 35.21 Temperature 2 source setting corresponds to actual encoder interface installation. Check the settings of parameters 91.21 and 91.24. Check that the corresponding module is activated in parameters 91.11...91.14. Use parameter 91.10 Encoder parameter refresh to validate any changes in the settings.</li> <li>FEN-01 does not support temperature measurement with KTY sensor. Use PTC sensor or other encoder interface module.</li> </ul>
A783	Motor overload	Motor current is too high.	Check for overloaded motor. Adjust the parameters used for the motor overload function (35.51...35.53) and 35.55...35.56.
A791	Brake resistor	Brake resistor broken or not connected.	Check that a brake resistor has been connected. Check the condition of the brake resistor.
A793	BR excess temperature	Brake resistor temperature has exceeded warning limit defined by parameter 43.12 Brake resistor warning limit.	Stop drive. Let resistor cool down. Check resistor overload protection function settings (parameter group 43 Brake chopper). Check warning limit setting, parameter 43.12 Brake resistor warning limit. Check that the resistor has been dimensioned correctly. Check that braking cycle meets allowed limits.
A794	BR data	Brake resistor data has not been given.	One or more of the resistor data settings (parameters 43.8...43.10) is incorrect. The parameter is specified by the auxiliary code.
	0000 0001	Resistance value too low.	Check value of 43.10.
	0000 0002	Thermal time constant not given.	Check value of 43.8.

Code (hex)	Event name / Aux. code	Cause	What to do
	0000 0003	Maximum continuous power not given.	Check value of 43.9.
A797	Speed feedback configuration	Speed feedback configuration has changed.	Check the auxiliary code (format XYY ZZZZ). "XX" specifies the number of the encoder interface module ( <b>01</b> : 91.11/91.12, <b>02</b> : 91.13/91.14, "YY" specifies the encoder ( <b>01</b> : 92 Encoder 1 configuration, <b>02</b> : 93 Encoder 2 configuration). "ZZZZ" indicates the problem (see actions for each code below).
	0001	Adapter not found in specified slot.	Check module location (91.12 or 91.14).
	0002	Detected type of interface module does not match parameter setting.	Check the module type (91.11 or 91.13) against status (91.2 or 91.3).
	0003	Logic version too old.	Contact your local ABB representative.
	0004	Software version too old.	Contact your local ABB representative.
	0006	Encoder type incompatible with interface module type.	Check module type (91.11 or 91.13) against encoder type (92.1 or 93.1).
	0007	Adapter not configured.	Check module location (91.12 or 91.14).
	0008	Speed feedback configuration has changed.	Use parameter 91.10 Encoder parameter refresh to validate any changes in the settings.
	0009	No encoders configured to encoder module.	Configure the encoder in group 92 Encoder 1 configuration or 93 Encoder 2 configuration.
	000A	Non-existing emulation input.	Check input selection (91.31 or 91.41).
	000B	Echo not supported by selected input (for example, resolver or absolute encoder).	Check input selection (91.31 or 91.41), interface module type, and encoder type.
	000C	Emulation in continuous mode not supported.	Check input selection (91.31 or 91.41) and serial link mode (92.30 or 93.30) settings.
A798	Encoder option comm loss	Encoder feedback not used as actual feedback, or measured motor feedback lost (and parameter 90.45/90.55 is set to Warning).	Check that the encoder is selected as feedback source in parameter 90.41 or 90.51. Check that the encoder interface module is properly seated in its slot. Check that the encoder interface module or slot connectors are not damaged. To pinpoint the problem, try installing the module into a different slot. If the module is installed on an FEA-03 extension adapter, check the fiber optic connections.

## 712 Fault tracing

Code (hex)	Event name / Aux. code	Cause	What to do
			Check the auxiliary code (format XXXX YYYY). "YYYY" indicates the problem (see actions for each code below).
	0001	Failed answer to encoder configuration message.	Contact your local ABB representative.
	0002	Failed answer to adapter watchdog disable message.	Contact your local ABB representative.
	0003	Failed answer to adapter watchdog enable message.	Contact your local ABB representative.
	0004	Failed answer to adapter configuration message.	Contact your local ABB representative.
	0005	Too many failed answers inline to speed and position messages.	Contact your local ABB representative.
	0006	DDCS driver failed.	Contact your local ABB representative.
A799	Ext I/O comm loss	The I/O extension module types specified by parameters do not match the detected configuration.	Check the auxiliary code (format XXYY YYYY). "XX" specifies the number of the I/O extension module (01: parameter group 14 I/O extension module 1, 02: 15 I/O extension module 2, 03: 16 I/O extension module 3). "YY YYYY" indicates the problem (see actions for each code below).
	00 0001	Communication with module failed.	Check that the module is properly seated in its slot. Check that the module and the slot connector is not damaged. Try installing the module into another slot.
	00 0002	Module not found.	Check the type and location settings of the modules (parameters 14.1/14.2, 15.1/15.2 or 16.1/16.2). Check that the module is properly seated in its slot. Check that the module and the slot connector is not damaged. Try installing the module into another slot.
	00 0003	Configuration of module failed.	Check the type and location settings of the modules (parameters 14.1/14.2, 15.1/15.2 or 16.1/16.2). Check that the module is properly seated in its slot. Check that the module and the slot connector is not damaged. Try installing the module into another slot.
	00 0004	Configuration of module failed.	Check the type and location settings of the modules (parameters 14.1/14.2, 15.1/15.2 or 16.1/16.2). Check that the module is properly seated in its slot.



Code (hex)	Event name / Aux. code	Cause	What to do
			Check that the module and the slot connector is not damaged. Try installing the module into another slot.
A79B	BC short circuit	Short circuit in brake chopper IGBT.	Replace brake chopper if external. Drives with internal choppers will need to be returned to ABB. Ensure brake resistor is connected and not damaged.
A79C	BC IGBT excess temperature	Brake chopper IGBT temperature has exceeded internal warning limit.	Let chopper cool down. Check for excessive ambient temperature. Check for cooling fan failure. Check for obstructions in the air flow. Check the dimensioning and cooling of the cabinet. Check resistor overload protection function settings (parameters 43.6...43.10). Check minimum allowed resistor value for the chopper being used. Check that braking cycle meets allowed limits. Check that drive supply AC voltage is not excessive.
A7A1	Mechanical brake closing failed	Status of mechanical brake acknowledgement is not as expected during brake close.	Check mechanical brake connection. Check mechanical brake settings in parameter group 44 Mechanical brake control. Check that acknowledgement signal matches actual status of brake.
A7A2	Mechanical brake opening failed	Status of mechanical brake acknowledgement is not as expected during brake open.	Check mechanical brake connection. Check mechanical brake settings in parameter group 44 Mechanical brake control. Check that acknowledgement signal matches actual status of brake.
A7A5	Mechanical brake opening not allowed	Open conditions of mechanical brake cannot be fulfilled (for example, brake has been prevented from opening by parameter 44.11 Keep brake closed).	Check mechanical brake settings in parameter group 44 Mechanical brake control (especially 44.11 Keep brake closed). Check that acknowledgement signal (if used) matches actual status of brake.
A7AA	Extension AI parameterization	The hardware current/voltage setting of an analog input (on an I/O extension module) does not correspond to parameter settings.	Check the auxiliary code (format XX00 00YY). "XX" specifies the number of the I/O extension module ( <b>01</b> : parameter group 14 I/O extension module 1, <b>02</b> : 15 I/O extension module 2, <b>03</b> : 16 I/O extension module 3). "YY" specifies the analog input on the module.

## 714 Fault tracing

Code (hex)	Event name / Aux. code	Cause	What to do
			<p>For example, in case of I/O extension module 1, analog input AI1 (auxiliary code 0000 0101), the hardware current/voltage setting on the module is shown by parameter 14.29. The corresponding parameter setting is 14.30. Adjust either the hardware setting on the module or the parameter to solve the mismatch.</p> <p><b>Note:</b> Control board reboot (either by cycling the power or through parameter 96.8 Control board boot) is required to validate any changes in the hardware settings.</p>
A7AB	Extension I/O configuration failure	The I/O extension module types and locations specified by parameters do not match the detected configuration.	<p>Check the type and location settings of the modules (parameters 14.1, 14.2, 15.1, 15.2, 16.1 and 16.2).</p> <p>Check that the modules are properly installed.</p> <p>Check the auxiliary code. See <i>Drive application programming manual (IEC 61131-3)</i>(3AUA0000127808[English]).</p>
A7B0	Motor speed feedback	No motor speed feedback is received.	<p>Check the auxiliary code (format XXYY ZZZZ). "XX" specifies the number of the encoder interface module (<b>01:</b> 91.11/91.12, <b>02:</b> 91.13/91.14), "YY" specifies the encoder (<b>01:</b> 92 Encoder 1 configuration, <b>02:</b> 93 Encoder 2 configuration). "ZZZZ" indicates the problem (see actions for each code below).</p>
	0001	Motor gear definition invalid or outside limits.	<p>Check motor gear settings (90.43 and 90.44).</p>
	0002	Encoder not configured.	<p>Check encoder settings (92 Encoder 1 configuration or 93 Encoder 2 configuration).</p> <p>Use parameter 91.10 Encoder parameter refresh) to validate any changes in the settings.</p>
	0003	Encoder stopped working.	<p>Check encoder status.</p>
	0004	Encoder drift detected.	<p>Check for slippage between encoder and motor.</p>
A7B1	Load speed feedback	No load speed feedback is received.	<p>Check the auxiliary code (format XXYY ZZZZ). "XX" specifies the number of the encoder interface module (<b>01:</b> 91.11/91.12, <b>02:</b> 91.13/91.14), "YY" specifies the encoder (<b>01:</b> 92 Encoder 1 configuration, <b>02:</b> 93 Encoder 2 configuration). "ZZZZ" indicates the problem (see actions for each code below).</p>

Code (hex)	Event name / Aux. code	Cause	What to do
	0001	Load gear definition invalid or outside limits.	Check load gear settings (90.53 and 90.54).
	0002	Feed constant definition invalid or outside limits.	Check feed constant settings (90.63 and 90.64).
	0003	Encoder stopped working.	Check encoder status.
	0004	Encoder drift detected.	Check for slippage between encoder and motor.
A7C1	FBA A communication	Cyclical communication between drive and fieldbus adapter module A or between PLC and fieldbus adapter module A is lost.	Check status of fieldbus communication. See user documentation of fieldbus interface. Check settings of parameter groups 50 Fieldbus adapter (FBA), 51 FBA A settings, 52 FBA A data in and 53 FBA A data out. Check cable connections. Check if communication master is able to communicate.
A7C2	FBA B communication	Cyclical communication between drive and fieldbus adapter module B or between PLC and fieldbus adapter module B is lost.	Check status of fieldbus communication. See user documentation of fieldbus interface. Check settings of parameter group 50 Fieldbus adapter (FBA). Check cable connections. Check if communication master is able to communicate.
A7CA	DDCS controller comm loss	DDCS (fiber optic) communication between drive and external controller is lost.	Check status of controller. See user documentation of controller. Check settings of parameter group 60 DDCS communication. Check cable connections. If necessary, replace cables.
A7CB	M/F comm loss	Master/follower communication is lost.	Check the auxiliary code. The code indicates which node address (defined by parameter 60.2 in each drive) on the master/follower link is affected. Check settings of parameter group 60 DDCS communication. On the FDCO module (if present), check that the DDCS link switch is not set to 0 (OFF). Check cable connections. If necessary, replace cables.
A7CE	EFB comm loss	Communication break in embedded fieldbus (EFB) communication.	Check the status of the fieldbus master (online/offline/error etc.). Check cable connections to the XD2D connector on the control unit.
A7E1	Encoder	Encoder error.	Check the auxiliary code (format XXYY ZZZZ). "XX" specifies the number of the encoder interface module (01: 91.11/91.12, 02: 91.13/91.14), "YY"

# 716 Fault tracing

Code (hex)	Event name / Aux. code	Cause	What to do
			specifies the encoder ( <b>01</b> : 92 Encoder 1 configuration, <b>02</b> : 93 Encoder 2 configuration). "ZZZZ" indicates the problem (see actions for each code below).
0001		Cable fault.	Check the conductor order at both ends of the encoder cable. Check the groundings of the encoder cable. If the encoder was working previously, check the encoder, encoder cable and encoder interface module for damage. See also parameter 92.21 Encoder cable fault mode.
0002		No encoder signal.	Check the condition of the encoder.
0003		Overspeed.	Contact your local ABB representative.
0004		Overfrequency.	Contact your local ABB representative.
0005		Resolver ID run failed.	Contact your local ABB representative.
0006		Resolver overcurrent fault.	Contact your local ABB representative.
0007		Speed scaling error.	Contact your local ABB representative.
0008		Absolute encoder communication error.	Contact your local ABB representative.
0009		Absolute encoder initialization error.	Contact your local ABB representative.
000A		Absolute SSI encoder configuration error.	Contact your local ABB representative.
000B		Encoder reported an internal error.	See the documentation of the encoder.
000C		Encoder reported a battery error.	See the documentation of the encoder.
000D		Encoder reported overspeed or decreased resolution due to overspeed.	See the documentation of the encoder.
000E		Encoder reported a position counter error.	See the documentation of the encoder.
000F		Encoder reported an internal error.	See the documentation of the encoder.
A7EE	Control panel loss	Control panel (or PC tool) has stopped communicating.	Check PC tool or control panel connection. Check control panel connector. Check mounting platform if being used. Disconnect and reconnect the control panel.

Code (hex)	Event name / Aux. code	Cause	What to do
A880	Motor bearing	Warning generated by an ontime timer or a value counter.	Check the auxiliary code. Check the source of the warning corresponding to the code: 0: 33.13 On-time 1 source 1: 33.23 On-time 2 source 4: 33.53 Value counter 1 source 5: 33.63 Value counter 2 source.
A881	Output relay	Warning generated by an edge counter. Programmable warnings: 33.35 Edge counter 1 warn message 33.45 Edge counter 2 warn message	Check the auxiliary code. Check the source of the warning corresponding to the code: 2: 33.33 Edge counter 1 source 3: 33.43 Edge counter 2 source.
A882	Motor starts	Warning generated by an edge counter. Programmable warnings: 33.35 Edge counter 1 warn message 33.45 Edge counter 2 warn message	Check the auxiliary code. Check the source of the warning corresponding to the code: 2: 33.33 Edge counter 1 source 3: 33.43 Edge counter 2 source.
A883	Power ups	Warning generated by an edge counter. Programmable warnings: 33.35 Edge counter 1 warn message 33.45 Edge counter 2 warn message	Check the auxiliary code. Check the source of the warning corresponding to the code: 2: 33.33 Edge counter 1 source 3: 33.43 Edge counter 2 source.
A884	Main contactor	Warning generated by an edge counter. Programmable warnings: 33.35 Edge counter 1 warn message 33.45 Edge counter 2 warn message	Check the auxiliary code. Check the source of the warning corresponding to the code: 2: 33.33 Edge counter 1 source 3: 33.43 Edge counter 2 source.
A885	DC charge	Warning generated by an edge counter. Programmable warnings: 33.35 Edge counter 1 warn message 33.45 Edge counter 2 warn message	Check the auxiliary code. Check the source of the warning corresponding to the code: 2: 33.33 Edge counter 1 source 3: 33.43 Edge counter 2 source.
A886	On-Time 1	Warning generated by on-time timer 1.	Check the source of the warning (parameter 33.13 On-time 1 source).
A887	On-Time 2	Warning generated by on-time timer 2.	Check the source of the warning (parameter 33.23 On-time 2 source).
A888	Edge counter 1	Warning generated by edge counter 1.	Check the source of the warning (parameter 33.33 Edge counter 1 source).
A889	Edge counter 2	Warning generated by edge counter 2.	Check the source of the warning (parameter 33.43 Edge counter 2 source).
A88A	Value counter 1	Warning generated by value counter 1.	Check the source of the warning (parameter 33.53 Value counter 1 source).
A88B	Value counter 2	Warning generated by value counter 2.	Check the source of the warning (parameter 33.63 Value counter 2 source).

## 718 Fault tracing

Code (hex)	Event name / Aux. code	Cause	What to do
A88C	Device clean	Warning generated by an ontime timer. Programmable warnings: 33.14 On-time 1 warn message 33.24 On-time 2 warn message	Check the auxiliary code. Check the source of the warning corresponding to the code: 0: 33.13 On-time 1 source 1: 33.23 On-time 2 source 10: 5.4 Main fan on-time counter.
A88D	DC capacitor	Warning generated by an ontime timer. Programmable warnings: 33.14 On-time 1 warn message 33.24 On-time 2 warn message	Check the auxiliary code. Check the source of the warning corresponding to the code: 0: 33.13 On-time 1 source 1: 33.23 On-time 2 source 10: 5.4 Main fan on-time counter.
A88E	Cabinet fan	Warning generated by an ontime timer. Programmable warnings: 33.14 On-time 1 warn message 33.24 On-time 2 warn message	Check the auxiliary code. Check the source of the warning corresponding to the code: 0: 33.13 On-time 1 source 1: 33.23 On-time 2 source 10: 5.4 Main fan on-time counter.
A88F	Cooling fan	Warning generated by an ontime timer. Programmable warnings: 33.14 On-time 1 warn message 33.24 On-time 2 warn message	Check the auxiliary code. Check the source of the warning corresponding to the code: 0: 33.13 On-time 1 source 1: 33.23 On-time 2 source 10: 5.4 Main fan on-time counter.
A890	Additional cooling fan	Warning generated by an ontime timer. Programmable warnings: 33.14 On-time 1 warn message 33.24 On-time 2 warn message	Check the auxiliary code. Check the source of the warning corresponding to the code: 0: 33.13 On-time 1 source 1: 33.23 On-time 2 source 10: 5.4 Main fan on-time counter.
A8A0	AI Supervised Warning	An analog signal is outside the limits specified for the analog input.	Check the auxiliary code (format XYY). "X" specifies the location of the input (0: AI on control unit; 1: I/O extension module 1, etc.), "YY" specifies the input and limit (01: AI1 under minimum, 02: AI1 over maximum, 03: AI2 under minimum, 04: AI2 over maximum). Check signal level at the analog input. Check the wiring connected to the input. Check the minimum and maximum limits of the input in parameter group 12 Standard AI, 14 I/O extension module 1, 15 I/O extension module 2 or 16 I/O extension module 3.
A8B0	Signal supervision	Warning generated by the signal supervision 1 function.	Check the source of the warning (parameter 32.7 Supervision 1 signal).
A8B1	Signal supervision 2	Warning generated by the signal supervision 2 function.	Check the source of the warning (parameter 32.17 Supervision 2 signal).
A8B2	Signal supervision 3	Warning generated by the signal supervision 3 function.	Check the source of the warning (parameter 32.27 Supervision 3 signal).

Code (hex)	Event name / Aux. code	Cause	What to do
A8BE	ULC overload	Selected signal has exceeded the user overload curve.	Check for any operating conditions increasing the monitored signal (for example, the loading of the motor if the torque or current is being monitored). Check the definition of the load curve (parameter group 37 User load curve).
A8BF	ULC underload	Selected signal has fallen below the user underload curve.	Check for any operating conditions decreasing the monitored signal (for example, loss of load if the torque or current is being monitored). Check the definition of the load curve (parameter group 37 User load curve).
A8C0	Fan service counter	A cooling fan has reached the end of its estimated lifetime. See parameters 5.41 and 5.42.	Check the auxiliary code. The code indicates which fan is to be replaced. 0: Main cooling fan 1: Auxiliary cooling fan 2: Auxiliary cooling fan 2 3: Cabinet cooling fan 4: PCB compartment fan Refer to the hardware manual of the drive for fan replacement instructions.
A981	External warning 1	Fault in external device 1.	Check the external device. Check setting of parameter 31.1 External event 1 source.
A982	External warning 2	Fault in external device 2.	Check the external device. Check setting of parameter 31.3 External event 2 source.
A983	External warning 3	Fault in external device 3.	Check the external device. Check setting of parameter 31.5 External event 3 source.
A984	External warning 4	Fault in external device 4.	Check the external device. Check setting of parameter 31.7 External event 4 source.
A985	External warning 5	Fault in external device 5.	Check the external device. Check setting of parameter 31.9 External event 5 source.
AE90	I/O bus communication	Communication break noticed on I/O bus.	Check I/O bus wiring, powering of the nodes and node number settings on the CIO-01 module. Parameters of parameter group 208 I/O bus diagnostics can be used to identify the nodes that are timing out.
AE91	Fan lifetime exceeded	Warning limit for fan lifetime (parameter 206.08) has been exceeded.	See the auxiliary code for indication of module IDs that contain fans that have exceeded their lifespan. Auxiliary code is a bit word where bit 0 indicates CIO-01 module assigned to node ID 1. Replace the failing fan and reset the fan data via parameter group 207 I/O bus service.

## 720 Fault tracing

Code (hex)	Event name / Aux. code	Cause	What to do
AE92	Fan speed	Fan speed is under limit (parameter 206.06).	Check fan feedback. See parameters 206.30...206.33 for individual failing fans.
AE93	Fan speed feedback error	Error in fan speed feedback.	See the auxiliary code for node(s) giving faulty feedback indication for fan(s). Auxiliary code is a bit word where bit 0 indicates CIO-01 module assigned to node ID 1. Check fan feedback. Verify the identification run results against the tachometer pulse count of the fan feedback.
AE94	CIO MCB monitoring	Warning related to miniature circuit breaker. Some of the bits of the MCB status word are 0.	Check miniature circuit breaker and digital input DI5.
AE95	CIO fuse monitoring	Warning related to fuses. Some of the bits of the fuse status word are 0.	Check fuses and digital input DI6.
AE97	CIO DI8 monitoring	Warning related to digital input DI8.	Check digital input DI8.
AF80	INU-LSU comm loss	DDCS (fiber optic) communication between converters (for example, the inverter unit and the supply unit) is lost. Note that the inverter unit will continue operating based on the status information that was last received from the other converter.	Check status of other converter (parameters 06.36 and 06.39). Check settings of parameter group 60 DDCS communication. Check the corresponding settings in the control program of the other converter. Check cable connections. If necessary, replace cables.
AF85	Line side unit warning	The supply unit (or other converter) has generated a warning.	The auxiliary code specifies the original warning code in the supply unit control program. See section Auxiliary codes for line-side converter warnings (page 731).
AF8C	Process PID sleep mode	The drive is entering sleep mode.	Informative warning.
AF90	Speed controller autotuning	The speed controller autotune routine did not complete successfully.	Check the auxiliary code (format XXXX YYYY). "YYYY" indicates the problem (see actions for each code below).
	0000	The drive was stopped before the autotune routine finished.	Repeat autotune until successful.
	0001	The drive was started but was not ready to follow the autotune command.	Make sure the prerequisites of the autotune run are fulfilled. See section Speed controller autotune (page 171).
	0002	Required torque reference could not be reached before the drive reached maximum speed.	Decrease torque step (parameter 25.38) or increase speed step (25.39).
	0003	Motor could not accelerate/decelerate to maximum/minimum speed.	Increase torque step (parameter 25.38) or decrease speed step (25.39).



Code (hex)	Event name / Aux. code	Cause	What to do
	0005	Motor could not decelerate with full autotune torque.	Decrease torque step (parameter 25.38) or speed step (25.39).
AFAA	Autoreset	A fault is about to be autoreset.	Informative warning. See the settings in parameter group 31 Fault functions.
AFE1	Emergency stop (off2)	<ul style="list-style-type: none"> <li>Drive has received an emergency stop (mode selection off2) command.</li> <li>(Follower drive in a master/follower configuration) Drive has received a stop command from the master.</li> </ul>	<ul style="list-style-type: none"> <li>Check that it is safe to continue operation. Reset the source of the emergency stop signal (such as an emergency stop push button). Restart drive. If the emergency stop was unintentional, check the source of the stop signal (for example, control word received from an external control system).</li> <li>Informative warning. After stopping on a ramp stop (Off1 or Off3) command, the master sends a short, 10-millisecond coast stop (Off2) command to the follower(s). The Off2 stop is stored in the event log of the follower.</li> </ul>
AFE2	Emergency stop (off1 or off3)	Drive has received an emergency stop (mode selection Off1 or Off3) command.	Check that it is safe to continue operation. Reset the source of the emergency stop signal (such as an emergency stop push button). Restart drive. If the emergency stop was unintentional, check the source of the stop signal (for example, control word received from an external control system).
AFE7	Follower	A follower drive has tripped.	Check the auxiliary code. Add 2 to the code to find out the node address of the faulted drive. Correct the fault in the follower drive.
AFEA	Enable start signal missing	No enable start signal received.	Check the setting of (and the source selected by) parameter 20.19 Enable start command.
AFEB	Run enable missing	No run enable signal is received.	Check setting of parameter 20.12 Run enable 1 source. Switch signal on (e.g. in the fieldbus Control Word) or check wiring of selected source.
AFEC	External power signal missing	95.4 Control board supply is set to External 24V but no voltage is connected to the XPOW connector of the control unit.	Check the external 24 V DC power supply to the control unit, or change the setting of parameter 95.4.
AFF6	Identification run selected	Motor ID run will occur at next start, or is in progress.	Informative warning.
AFF7	Autophasing	Autophasing will occur at next start.	Informative warning.

## 722 Fault tracing

Code (hex)	Event name / Aux. code	Cause	What to do
B5A0	STO event	Safe torque off function is active, i.e. safety circuit signal(s) connected to connector XSTO is lost.	Check safety circuit connections. For more information, see appropriate drive hardware manual and description of parameter 31.22 STO indication run/stop.
B5A2	Power up	The drive has been powered up.	Informative event.
B5A4	SW internal diagnostics	Control unit rebooted unexpectedly.	Informative event.
B5F6	ID run done	ID run completed.	Informative event. The auxiliary code specifies the type of ID run. 0: None 1: Normal 2: Reduced 3: Standstill 4: Autophasing 5: Current measurement calibration 6: Advanced 7: Advanced standstill
B680	SW internal diagnostics	SW internal malfunction.	Contact your local ABB representative, quoting the auxiliary code. If the Drive Composer tool is available, also create and send a 'support package' (see Drive composer manual for instructions).
B686	Checksum mismatch	The calculated parameter checksum does not match any enabled reference checksum.	See A686 Checksum mismatch (page 707).
D100	Torque prove	Drive was not able to provide sufficient torque during Torque proving. The pre-magnetizing time mode is wrong or too short.	Check the motor and motor cables. Check that the parameter settings are as follows: <ul style="list-style-type: none"> <li>21.1 Start mode = Const time</li> <li>21.2 Magnetization time = Setting is not fixed. Enter an appropriate value.</li> </ul>
D101	Brake slip	Brake slipped during Torque proving.	Check the brake. Check whether the brake is slipping when it is in the closed state.
D102	Brake safe closure	Start command is active, the actual speed is below the limit defined with parameter 44.208 Safety close speed, and the delay defined with parameter 44.209 Safety close delay has elapsed.	Check whether it is necessary to drive the application at a low speed. If it is not, change the values of parameters 44.208 Safety close speed and 44.209 Safety close delay to correspond to the application. In trolley movement, disable the Brake safe closure function with parameter 44.207 Safety close select.
D103	Hoist speed opt settings	Parameters settings for Hoist speed optimization are incorrect.	Check the parameter settings in group 75 Hoist speed optimization (page 570).

Code (hex)	Event name / Aux. code	Cause	What to do
D104	Over speed	Motor speed has exceeded the motor overspeed level (31.200 Motor overspeed level), and the delay defined with parameter 31.201 Motor overspeed level delay has elapsed.	Check the torque and current limit settings. Check the motor and motor cables. Check pulse encoder connections, if used.
D105	Speed match	Motor speed has exceeded the steady state deviation level (par. 74.2) or the ramping state deviation level (par. 74.3), and the delay defined with parameter 74.4 Speed match fault delay has elapsed.	Check the torque and current limit settings. If an encoder is used, check the encoder settings.
D106	Inverter overload	Drive has exceeded the inverter current or torque limits, and the delay defined with parameter 31.204 Inverter overload delay has elapsed. The fault condition is checked only when the generating power is more than 10% of the motor nominal power and the actual speed is greater than 5% of the motor synchronous speed.	Check the speed controller torque settings. Check the torque, speed and power limit settings.
D107	ID run and remote	Motor ID run was requested when the drive was in external control.	Switch the drive to local control to perform the motor ID run.
D108	End limits I/O error	Both End limits 1 and 2 inputs are active simultaneously.	Check the wiring of End limits 1 and 2.
D109	Toggle bit supervision flt	Communication loss occurred between the overriding system and the drive. Time between two consecutive toggle bit rising edges from overriding system is longer than the time set in parameter 31.213 Toggle bit time delay.	Check communication between overriding system and drive.
D10A	Brake control selected	Mechanical brake control was inactive when the Conical motor control function was enabled.	Activate mechanical brake control with parameter 44.6 Brake control enable.
D10B	Synchron fault	Difference in actual position of Master drive and drive. For example, value in parameter 82.20 Act position error is more than the limit defined in parameter 82.7 Sync err limit and the condition prevails for more than the delay time set in parameter 82.08 Sync err fault delay.	Check the limit set for position difference in parameter 82.7 Sync err limit. Check the delay time set in parameter 82.08 Sync err fault delay. Check the position correction parameters: 82.4 Sync gain, 82.5 Position corr limit, and 82.6 Sync corr scale.
D10C	M/F comm loss	Master/follower communication is lost in trolley drive.	Check the D2D link connections in trolley drive. Check the master drive settings in parameter 60.201 Crane drives structure of trolley drive.
D10D	Watchdog test fault	Watchdog test routine fails: welded contacts in main contactor.	Check the wiring and drive parameterization (e.g., wrong relay used).

## 724 Fault tracing

Code (hex)	Event name / Aux. code	Cause	What to do
			Check the mechanical condition of the watchdog relay and main contactor.
D200	Brake slip at standstill	Brake is slipping when the motor is not running.	Check the mechanical brake. Check the parameter settings in group 74 Speed matching (page 569).
D201	Slowdown 1	Slowdown command is active in the forward (up) direction based on the selection in parameter 20.200 Slowdown select.	Run the motor in the opposite direction and deactivate the Slowdown command, or let the drive run with the limited speed reference.
D202	Slowdown 2	Slowdown command is active in the reverse (down) direction based on the selection in parameter 20.200 Slowdown select.	Run the motor in the opposite direction and deactivate the Slowdown command, or let the drive run with the limited speed reference.
D203	Hoist speed up limit	Hoist speed optimization function is limiting the speed reference in the forward direction.	Check the parameter settings in group 75 Hoist speed optimization (page 570). Check the physical load condition and the motor current settings.
D204	Hoist speed down limit	Hoist speed optimization function is limiting the speed reference in the forward direction.	Check the parameter settings in group 75 Hoist speed optimization (page 570). Check the physical load condition and the motor current settings.
D205	End limit 1	End limit 1 command is active based on the selection in parameter 20.205 End limit 1.	Check the wiring of the End limit 1 connection. Run the motor in the opposite direction and deactivate the End limit 1 command.
D206	End limit 2	End limit 2 command is active based on the selection in parameter 20.206 End limit 2.	Check the wiring of the End limit 2 connection. Run the motor in the opposite direction and deactivate the End limit 2 command.
D207	Wrong start sequence	Drive does not accept a start command because the drive is not ready for the following reasons: <ul style="list-style-type: none"> <li>The main power is switched off.</li> <li>Fieldbus control bits are used in the wrong order.</li> <li>The upper or lower limit is active.</li> </ul>	Check and correct the possible causes for the warning, and then give the start command again.
D208	Joystick reference check	Speed reference is greater than +/- 10% of the minimum or maximum scaled value of the used joystick reference, the joystick zero position input (20.214 Joystick zero position) is active, and the delay defined with parameter 20.215 Joystick warning delay has elapsed.	Check the wiring of the joystick zero position input. Check the wiring of the analog input reference signal of the joystick.

Code (hex)	Event name / Aux. code	Cause	What to do
D209	Joystick zero position	Drive does not accept a start command because of a wrong state of the joystick zero position input (20.214 Joystick zero position).	Check the wiring of the joystick zero position input.
D20A	Fast stop	Fast stop command (20.210 Fast stop input) is activated.	Deactivate the Fast stop command.
D20B	Power on acknowledge	Power on acknowledge circuit is open.	Check the wiring and the setting of parameter 20.212 Power on acknowledge.
D20C	Slowdown safe zone	Crane is operating within the safe zone limit. Slowdown function mode in parameter 20.200 Slowdown select is set as Single bit without direction.	Check the source for activating the Slowdown command in parameter 20.201 Slowdown input 1. Check the external circuit. See also section Slowdown (page 101). Check parameter 31.205 Crane warning masking, b2 for masking warning.
D20D	External speed limit	External speed limits are active instead of the internal speed limits.	Check the source from parameter 30.200 External speed limits. Check the external circuit. See also section External speed limitation (page 97). Check parameter 31.205 Crane warning masking, b5 for masking warnings.
D20E	M/F control location mismatch	Master and follower are not in the same control location.	Check that the master and the follower are both in control location EXT2.
D20F	Brake match	Brake slippage is detected when the brake is assumed to be closed i.e., delay time in parameter 44.13 Brake close delay elapses and if the change in actual load position (parameter 90.5 Load position scaled) exceeded the limit in 44.221 Brake match position limit.	The drive may be restarted automatically based on the selected brake matching mode. See Brake matching modes (page 86). Check parameter 44.13 Brake close delay.
D210	Toggle bit supervision wrn	Communication loss occurred between the overriding system and the drive. Time between two consecutive toggle bit rising edges from overriding system is longer than the time set in parameter 31.213 Toggle bit time delay.	Check communication between overriding system and drive.
D211	Synchro sel mismatch	Parameter (82.1 Synchro control) settings are different in Master and Follower drives.	Check settings in parameter 82.1 Synchro control. The settings should be same.
D212	Crane operating hours	Crane actual operating time (when brake was open) limit is more than the limit defined in parameter 33.202 Crane operation hrs warning limit.	Do the required maintenance task. Reset the time counter with parameter 33.200 Set crane operation hours.
D213	Brake oper counts	Number of times mechanical brake was open is more than the limit	Do the required maintenance task.

## 726 Fault tracing

Code (hex)	Event name / Aux. code	Cause	What to do
		defined in parameter 33.212 Brake oper counts warning limit.	Reset the brake operating counter with parameter 33.210 Set brake oper counts.
D214	Number of power on	Number of times the drive was powered on is more than the limit defined in parameter 33.222 Number of pwr on warning limit.	Do the required maintenance task. Reset the power on counter with parameter 33.220 Set number of power on.
D215	Watchdog warning	Monitored condition detected and watchdog relay is activated.	Check parameter 32.228 Watchdog trip sw.
D216	Lifetime left less 10%	System lifetime is less than 10%.	Do the required maintenance task. Reset the maintenance counters.
D217	Slack rope	Slack rope condition detected.	Check parameter settings 75.70 Start lifetime monitor.
D218	Brake match config	Not all drive parameter settings are configured to enable the use of the brake match function. For example, A Brake match mode is selected with parameter 44.220 Brake match mode, when the encoder or mechanical brake control is not in use.	-
D219	Inertia calculation running	Inertia calculation (75.45 Inertia calculation) is activated.	Warning disappears automatically after the inertia calculation. You can set the parameter to Done and remove the warning. This stops the inertia calculation.
D221	Follower 1 Faulted	Follower drive 1 has tripped on a fault. This fault message is displayed in the master drive only.	See the follower drive 1 for more detailed fault description.
D222	Follower 2 Faulted	Follower drive 2 has tripped on a fault. This fault message is displayed in the master drive only.	See the follower drive 2 for more detailed fault description.
D223	Follower 3 Faulted	Follower drive 3 has tripped on a fault. This fault message is displayed in the master drive only.	See the follower drive 3 for more detailed fault description.
D224	Follower 4 Faulted	Follower drive 4 has tripped on a fault. This fault message is displayed in the master drive only.	See the follower drive 4 for more detailed fault description.
FA81	Safe torque off 1 loss	Safe torque off function is active, ie. STO circuit 1 is broken.	Check safety circuit connections. For more information, see appropriate drive hardware manual and description of parameter 31.22 STO indication run/stop (page 434). Check the auxiliary code, The code contains location information, especially with parallel-connected inverter modules. When converted into a 32-bit binary number, the bits of the code indicate the following: 31...28: Number of faulty inverter module (0...11 decimal). 1111: STO_ACT

Code (hex)	Event name / Aux. code	Cause	What to do
			<p>states of control unit and inverter modules in conflict</p> <p>27: STO_ACT state of inverter modules</p> <p>26: STO_ACT state of control unit</p> <p>25: STO1 of control unit</p> <p>24: STO2 of control unit</p> <p>23...12: STO1 of inverter modules 12...1 (Bits of non-existing modules set to 1)</p> <p>11...0: STO2 of inverter modules 12...1 (Bits of non-existing modules set to 1)</p>
FA82	Safe torque off 2 loss	Safe torque off function is active, ie. STO circuit 2 is broken.	<p>Check safety circuit connections. For more information, see appropriate drive hardware manual and description of parameter 31.22 STO indication run/stop (page 434).</p> <p>Check the auxiliary code, The code contains location information, especially with parallel-connected inverter modules.</p> <p>When converted into a 32-bit binary number, the bits of the code indicate the following:</p> <p>31...28: Number of faulty inverter module (0...11 decimal). 1111: STO_ACT states of control unit and inverter modules in conflict</p> <p>27: STO_ACT state of inverter modules</p> <p>26: STO_ACT state of control unit</p> <p>25: STO1 of control unit</p> <p>24: STO2 of control unit</p> <p>23...12: STO1 of inverter modules 12...1 (Bits of non-existing modules set to 1)</p> <p>11...0: STO2 of inverter modules 12...1 (Bits of non-existing modules set to 1)</p>
FA90	STO diagnostics failure	SW internal malfunction.	Contact your local ABB representative.
FB11	Memory unit missing	<ul style="list-style-type: none"> <li>No memory unit is attached to the control unit.</li> <li>The memory unit attached to the control unit is empty.</li> </ul>	<ul style="list-style-type: none"> <li>Power down the control unit. Check that the memory unit is properly inserted into the control unit.</li> <li>Power down the control unit. Attach a memory unit (with the appropriate firmware) to the control unit.</li> </ul>
FB12	Memory unit incompatible	The memory unit attached to the control unit is incompatible.	Power down the control unit. Attach a compatible memory unit.

## 728 Fault tracing

Code (hex)	Event name / Aux. code	Cause	What to do
FB13	Memory unit FW incompatible	The firmware on the attached memory unit is incompatible with the drive.	Power down the control unit. Attach a memory unit with compatible firmware.
FB14	Memory unit FW load failed	The memory unit is empty, or contains incompatible or corrupted firmware.	Recycle the power to the control unit. Check the sticker on the memory unit to confirm that the firmware is compatible with the control unit (ZCU-1x/BCU-x2). Connect Drive Composer PC tool (version 2.3 or later) to the drive. Select Tools - Recover drive. If the problem persists, replace the memory unit.
FF61	ID run	Motor ID run was not completed successfully.	Check the nominal motor values in parameter group 99 Motor data. Check that no external control system is connected to the drive. Cycle the power to the drive (and its control unit, if powered separately). Check that the motor shaft is not locked. Check the auxiliary code. The second number of the code indicates the problem (see actions for each code below).
0001		Maximum current limit too low.	Check settings of parameters 99.6 Motor nominal current and 30.17 Maximum current. Make sure that 30.17 Maximum current > 99.6 Motor nominal current. Check that the drive is dimensioned correctly according to the motor.
0002		Maximum speed limit or calculated field weakening point too low.	Check that SLS function is not active. Check settings of parameters <ul style="list-style-type: none"> <li>• 30.11 Minimum speed</li> <li>• 30.12 Maximum speed</li> <li>• 99.7 Motor nominal voltage</li> <li>• 99.8 Motor nominal frequency</li> <li>• 99.9 Motor nominal speed.</li> </ul> Make sure that <ul style="list-style-type: none"> <li>• 30.12 Maximum speed &gt; (0.55 × 99.9 Motor nominal speed) &gt; (0.50 × synchronous speed)</li> <li>• 30.11 Minimum speed &lt; 0, and</li> <li>• supply voltage &gt; (0.66 × 99.7 Motor nominal voltage).</li> </ul>



Code (hex)	Event name / Aux. code	Cause	What to do
0003		Maximum torque limit too low.	Check settings of parameter 99.12 <i>Motor nominal torque</i> , and the torque limits in group 30 <i>Limits</i> . Make sure that the maximum torque limit in force is greater than 100%.
0004		Current measurement calibration did not finish within reasonable time.	Contact your local ABB representative.
0005...0008		Internal error.	Contact your local ABB representative.
0009		(Asynchronous motors only) Acceleration did not finish within reasonable time.	Contact your local ABB representative.
000A		(Asynchronous motors only) Deceleration did not finish within reasonable time.	Contact your local ABB representative.
000B		(Asynchronous motors only) Speed dropped to zero during ID run.	Contact your local ABB representative.
000C		(Permanent magnet motors only) First acceleration did not finish within reasonable time.	Contact your local ABB representative.
000D		(Permanent magnet motors only) Second acceleration did not finish within reasonable time.	Contact your local ABB representative.
000E...0010		Internal error.	Contact your local ABB representative.
0011		(SynRM only) Rotor orientation not correct during the pulse test.	Try to perform ID run again. Contact your local ABB representative.
0012		Not possible to perform Advanced Standstill ID run.	Check that nominal power is as advised in Advanced Standstill ID run description. Contact your local ABB representative.
0013		(Asynchronous motors only) Error in motor data.	Check name plate data. Contact your local ABB representative.
0014		Acceleration did not finish within reasonable time during Autophasing ID run.	Contact your local ABB representative.
0015		Advanced standstill failure.	Contact your local ABB representative.
FF7E	Follower	A follower drive has tripped.	Check the auxiliary code. Add 2 to the code to find out the node address of the faulted drive. Correct the fault in the follower drive.
FF81	FB A force trip	A fault trip command has been received through fieldbus adapter A.	Check the fault information provided by the PLC.
FF82	FB B force trip	A fault trip command has been received through fieldbus adapter B.	Check the fault information provided by the PLC.

## 730 Fault tracing

---

<b>Code (hex)</b>	<b>Event name / Aux. code</b>	<b>Cause</b>	<b>What to do</b>
FF8E	EFB force trip	A fault trip command has been received through the embedded fieldbus interface.	Check the fault information provided by the Modbus controller.

---

## Auxiliary codes for line-side converter warnings

The table below lists the auxiliary codes of AF85 Line side unit warning. For advanced troubleshooting, see the firmware manual of the line converter.

Code (hex)	Event name / Aux. code	Cause	What to do
AE01	Overcurrent	Output current has exceeded internal fault limit.	Check supply voltage. Check that there are no power factor correction capacitors or surge absorbers in supply cable. Check motor load and acceleration times. Check power semiconductors (IGBTs) and current transducers.
AE02	Earth leakage	IGBT supply has detected load unbalance.	Check AC fuses. Check for earth leakages. Check supply cabling. Check power modules. Check there are no power factor correction capacitors or surge absorbers in supply cable.
AE04	IGBT overload	Excessive IGBT junction to case temperature.	Check supply cable.
AE05	BU current difference	Current difference detected by the branching unit (BU).	Check converter fuses. Check converter(s). Check inverter(s). Check LCL filter.
AE06	BU earth leakage	Earth leakage detected by the branching unit: sum of all currents exceeds the level.	Check AC fuses. Check for earth leakages. Check supply cabling. Check power modules. Check there are no power factor correction capacitors or surge absorbers in supply cable.
AE09	DC link overvoltage	Excessive intermediate circuit DC voltage.  <b>Note:</b> This warning can be shown only when the IGBT supply unit is not modulating.	Check that parameter 95.1 Supply voltage is set according to the supply voltage in use.
AE0A	DC link undervoltage	Intermediate circuit DC voltage is not sufficient due to missing phase in supply voltage, blown fuse or rectifier bridge internal fault.  <b>Note:</b> This warning can be shown only when the IGBT supply unit is not modulating.	Check supply and fuses. Check that parameter 95.1 Supply voltage is set according to the supply voltage in use.

## 732 Fault tracing

Code (hex)	Event name / Aux. code	Cause	What to do
AE0B	DC not charged	The voltage of the intermediate DC circuit has not yet risen to operating level.  <b>Note:</b> This warning can be shown only when the IGBT supply unit is not modulating.	Check the input voltage setting in parameter 95.1 Supply voltage. Check the input voltage. If the problem persists, contact your local ABB representative.
AE0C	BU DC link difference	DC link voltage difference detected by the branching unit.	Check DC fuses. Check converter module connections to DC link.
AE0D	BU voltage difference	Main voltage difference detected by the branching unit.	Check AC fuses. Check supply cable.
AE14	Excess temperature	Power unit module temperature is excessive.	Check ambient conditions. Check air flow and fan operation. Check heatsink fins for dust pick-up. Check motor power against IGBT supply unit power.
AE15	Excess temperature difference	High temperature difference between the IGBTs of different phases.	Check the cabling. Check cooling of power module(s).
AE16	IGBT temperature	IGBT temperature is excessive.	Check ambient conditions. Check air flow and fan operation. Check heatsink fins for dust pick-up. Check motor power against IGBT supply unit power.
AE24	Voltage category unselected	The supply voltage range has not been defined.	Define the supply voltage range (parameter 95.1 Supply voltage).
AE58	Emergency stop (OFF2)	Supply unit has received an emergency stop (mode selection off2) command.	Check that it is safe to continue operation. Return emergency stop push button to normal position. Restart the drive.
AE5F	Temperature Warning	Supply module temperature is excessive due to eg, module overload or fan failure.	Check module cooling air flow and fan operation. Check ambient temperature. If it exceeds 40 °C (104 °F), ensure that load current does not exceed derated load capacity. See appropriate hardware manual. Check inside of cabinet and heatsink of supply module for dust pick-up. Clean whenever necessary.
AE73	Fan	Cooling fan is stuck or disconnected.	Check the auxiliary code in the line-side converter program to identify the fan. Check fan operation and connection. Replace fan if faulty.
AE78	Net lost	Net lost is detected.	Resynchronize the IGBT supply unit to the grid after net lost.

---

<b>Code (hex)</b>	<b>Event name / Aux. code</b>	<b>Cause</b>	<b>What to do</b>
AE85	Charging count	There are too many DC link charging attempts.	Two attempts in five minutes is allowed to prevent charging circuit overheating.

---

## Auxiliary codes for line-side converter faults

The table below lists the auxiliary codes of 7583 Line side unit faulted. For advanced troubleshooting, see the firmware manual of the line converter.

Code (hex)	Event name / Aux. code	Cause	What to do
2E00	Overcurrent	Output current has exceeded internal fault limit.	<p>Check supply voltage.</p> <p>Check that there are no power factor correction capacitors or surge absorbers in supply cable.</p> <p>Check motor load and acceleration times.</p> <p>Check power semiconductors (IGBTs) and current transducers.</p>
2E01	Earth leakage	IGBT supply unit has detected an earth fault.	<p>Check AC fuses.</p> <p>Check for earth leakages.</p> <p>Check supply cabling.</p> <p>Check power modules.</p> <p>Check there are no power factor correction capacitors or surge absorbers in supply cable.</p> <p>If no earth fault can be detected, contact your local ABB representative.</p>
2E02	Short circuit	IGBT supply unit has detected short circuit.	<p>Check supply cable.</p> <p>Check there are no power factor correction capacitors or surge absorbers in supply cable.</p> <p>After correcting the cause of the fault, reboot the control unit (using parameter 96.8 Control board boot or by cycling power.</p>
2E04	IGBT overload	Excessive IGBT junction to case temperature.	Check the load.
2E05	BU current difference	Current difference detected by the branching unit (BU).	<p>Check converter fuses.</p> <p>Check converter(s).</p> <p>Check inverter(s).</p> <p>Check LCL filter.</p> <p>Power off all boards.</p> <p>If the fault persists, contact your local ABB representative.</p>
2E06	BU earth leakage	Earth leakage detected by the branching unit: sum of all currents exceeds the level.	<p>Check AC fuses.</p> <p>Check for earth leakages.</p> <p>Check supply cabling.</p> <p>Check power modules.</p> <p>Check there are no power factor correction capacitors or surge absorbers in supply cable.</p> <p>If no earth fault can be detected, contact your local ABB representative.</p>

Code (hex)	Event name / Aux. code	Cause	What to do
3E00	Input phase loss	Input phase loss detected by the IGBT bridge.	Check the auxiliary code. Check the source of the fault corresponding to the code: 1: Phase A 2: Phase B 4: Phase C 8: Phase cannot be detected Check the AC fuses. Check for input power supply imbalance.
3E04	DC link overvoltage	Excessive intermediate circuit DC voltage.	Check that parameter <b>95.1 Supply voltage</b> is set according to the supply voltage in use.
3E05	DC link undervoltage	Intermediate circuit DC voltage is not sufficient because of a missing supply phase or blown fuse.	Check supply cabling, fuses and switchgear. Check that parameter <b>95.1 Supply voltage</b> is set according to the supply voltage in use.
3E06	BU DC link difference	Difference in DC voltages between parallel-connected supply modules.	Check the DC fuses. Check the connection to the DC bus. If the problem persists, contact your local ABB representative.
3E07	BU voltage difference	Difference in main voltages between parallel-connected supply modules.	Check the supply network connections. Check the AC fuses. If the problem persists, contact your local ABB representative.
3E08	LSU charging	DC link voltage is not high enough after charging.	Check parameter <b>95.1 Supply voltage</b> . Check supply voltage and fuses. Check the connection from the relay output to the charging contactor. Check that the DC voltage measuring circuit is working correctly.
4E01	Cooling	Power module temperature is excessive.	Check ambient temperature. If it exceeds 40 °C (104 °F), ensure that load current does not exceed derated load capacity. See appropriate hardware manual. Check power module cooling air flow and fan operation. Check inside of cabinet and heatsink of power module for dust pick-up. Clean whenever necessary.
4E02	IGBT temperature	IGBT temperature is excessive.	Check ambient conditions. Check air flow and fan operation. Check heatsink fins for dust pick-up. Check motor power against IGBT supply unit power.
4E03	Excess temperature	Power unit module temperature is excessive.	See <b>AE14 Excess temperature</b> (page 732).

## 736 Fault tracing

Code (hex)	Event name / Aux. code	Cause	What to do
4E04	Excess temperature difference	High temperature difference between the IGBTs of different phases. The amount of available temperatures depends on the frame size.	See AE15 Excess temperature difference.
4E06	Cabinet or LCL overtemperature	Overtemperature detected either in cabinet, LCL filter or auxiliary transformer.	Check the cooling of the cabinet, LCL filter and auxiliary transformer.
5E01	Auxiliary fan broken	An auxiliary cooling fan is stuck or disconnected.	Check the fan operation and connection. Replace the fan if faulty.
5E05	Rating ID mismatch	The hardware of the supply unit does not match the information stored in the memory unit. This may occur eg, after a firmware update or memory unit replacement.	Cycle the power to the supply unit. If the control unit is externally powered, reboot the control unit or by cycling its power. If the problem persists, contact your local ABB representative.
5E06	Main contactor Fault	Control program does not receive main contactor on (1) acknowledgement through digital input even control program has closed the contactor control circuit with relay output. Main contactor / main breaker is not functioning properly, or there is a loose / bad connection.	Check main contactor / main breaker control circuit wiring. Check the status of other switches connected to contactor control circuit. See the delivery-specific circuit diagrams. Check main contactor operating voltage level (should be 230 V). Check digital input DI3 connections.
6E19	Synchronization fault	Synchronization to supply network has failed.	Monitor possible network transients.
6E1A	Rating ID fault	Rating ID load error.	Contact your local ABB representative.
6E1F	Licensing fault	There are two types of licenses being used in ACS880 drives: licenses that need to be found from the unit which allow the firmware to be executed, and licenses that prevent the firmware from running. The license is indicated by the value of the auxiliary code field. The license is Nxxxx, where xxxx is indicated by the 4-digit value of the auxiliary code field. 8201: A restrictive license is found from the unit. The firmware on this inverter unit cannot be executed because a Low harmonic license is found from the unit. This unit is meant to be used with IGBT supply control program (2Q) only.	Check the line-converter control program. Record the auxiliary codes of all active licensing faults and contact your product vendor for further instructions. This fault requires a reboot of the control unit either by switching the power off and on. 8201: Contact your product vendor for further instructions.
7E01	Panel loss	Control panel or PC tool selected as active control location has ceased communicating.	Check PC tool or control panel connection. Check control panel connector. Replace control panel in mounting platform.
8E07	Net lost	Net lost is detected. Duration of net lost is too long.	Resynchronize the IGBT supply unit to the grid after net lost.



# 10

## **Fieldbus control through the embedded fieldbus interface (EFB)**

---

### **What this chapter contains**

The chapter describes how the drive can be controlled by external devices over a communication network (fieldbus) using the embedded fieldbus interface.

---

## System overview

The drive can be connected to an external control system through a communication link using either a fieldbus adapter or the embedded fieldbus interface.

The embedded fieldbus interface supports the Modbus RTU protocol. The drive control program can handle 10 Modbus registers in a 10-millisecond time level. For example, if the drive receives a request to read 20 registers, it will start its response within 22 ms of receiving the request – 20 ms for processing the request and 2 ms overhead for handling the bus. The actual response time depends on other factors as well, such as the baud rate (a parameter setting in the drive).

The drive can be set to receive all of its control information through the fieldbus interface, or the control can be distributed between the embedded fieldbus interface and other available sources, for example, digital and analog inputs.

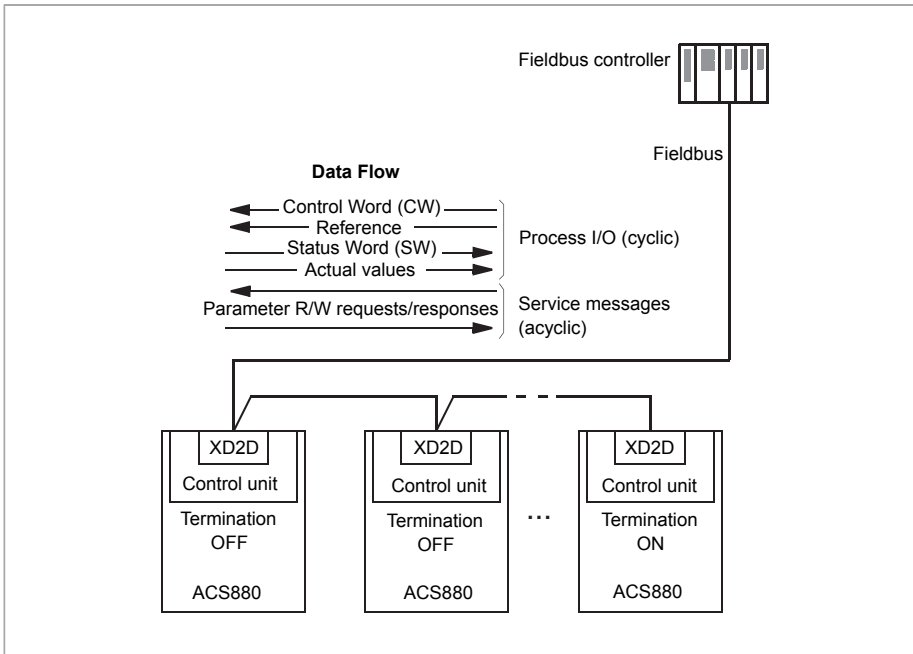

## Connecting the fieldbus to the drive

Connect the fieldbus to terminal XD2D on the control unit of the drive. See the appropriate *Hardware Manual* for more information on the connection, chaining and termination of the link.

**Note:** If the XD2D connector is reserved by the embedded fieldbus interface (parameter 58.1 Protocol enable is set to Modbus RTU), the drive-to-drive link functionality is automatically disabled.

## Setting up the embedded fieldbus interface

Set the drive up for the embedded fieldbus communication with the parameters shown in the table below. The **Setting for fieldbus control** column gives either the value to use or the default value. The **Function/Information column** gives a description of the parameter.

Parameter	Setting for fieldbus control	Function/Information
<b>COMMUNICATION INITIALIZATION</b>		
58.1 Protocol enable	Modbus RTU	Initializes embedded fieldbus communication. Drive-to-drive link operation is automatically disabled.
<b>EMBEDDED MODBUS CONFIGURATION</b>		
58.3 Node address	1 (default)	Node address. There must be no two nodes with the same node address online.
58.4 Baud rate	19.2 kbps (default)	Defines the communication speed of the link. Use the same setting as in the master station
58.5 Parity	8 EVEN 1 (default)	Selects the parity and stop bit setting. Use the same setting as in the master station.
58.14 Communication loss action	Fault (default)	Defines the action taken when a communication loss is detected.
58.15 Communication loss mode	Cw / Ref1 / Ref2 (default)	Enables/disables communication loss monitoring and defines the means for resetting the counter of the communication loss delay.
58.16 Communication loss time	3.0 s (default)	Defines the time-out limit for the communication monitoring.
58.17 Transmit delay	0 ms (default)	Defines a response delay for the drive.
58.25 Control profile	ABB Drives (default), Transparent	Selects the control profile used by the drive. See section Basics of the embedded fieldbus interface (page 742).

## 740 Fieldbus control through the embedded fieldbus interface (EFB)

Parameter	Setting for fieldbus control	Function/Information
58.26 EFB ref1 type ... .. 58.29 EFB act2 type	Auto, Transparent, General, Torque, Speed, Frequency	Selects the reference and actual value types. With the <b>Auto</b> setting, the type is selected automatically according to the currently active drive control mode.
58.30 EFB status word transparent source	<b>Other</b> (see Terms and abbreviations)	Defines the source of status word when 58.25 Control profile = Transparent.
58.31 EFB act1 transparent source	<b>Other</b> (see Terms and abbreviations)	Defines the source of actual value 1 when 58.28 EFB act1 type = Transparent or General.
58.32 EFB act2 transparent source	<b>Other</b> (see Terms and abbreviations)	Defines the source of actual value 2 when 58.29 EFB act2 type = Transparent or General.
58.33 Addressing mode	eg. Mode 0 (default)	Defines the mapping between parameters and holding registers in the 40001...46536 (100...65535) Modbus register range.
58.34 Word order	LO-HI (default)	Defines the order of the data words in the Modbus message frame.
58.101 Data I/O 1 ... 58.124 Data I/O 24	For example, the default settings (I/Os 1...6 contain the control word, the status word, two references and two actual values)	Define the address of the drive parameter which the Modbus master accesses when it reads from or writes to the register address corresponding to Modbus In/Out parameters. Select the parameters that you want to read or write through the Modbus I/O words.
	RO/DIO control word, AO1 data storage, AO2 data storage	These settings write the incoming data into storage parameters 10.99 RO/DIO control word, 13.91 AO1 data storage, 13.92 AO2 data storage.
58.6 Communication control	Refresh settings	Validates the settings of the configuration parameters.

The new settings will take effect when the drive is powered up the next time, or when they are validated by parameter 58.6 Communication control.

### Setting the drive control parameters

After the embedded fieldbus interface has been set up, check and adjust the drive control parameters listed in the table below. The **Setting for fieldbus control** column gives the value or values to use when the embedded fieldbus signal is the

desired source or destination for that particular drive control signal. The **Function/Information** column gives a description of the parameter.

Parameter	Setting for fieldbus control	Function/Information
<b>CONTROL COMMAND SOURCE SELECTION</b>		
20.1 Ext1 commands	Embedded fieldbus	Selects fieldbus as the source for the start and stop commands when EXT1 is selected as the active control location.
20.2 Ext1 start trigger type	Embedded fieldbus	Selects fieldbus as the source for the start and stop commands when EXT2 is selected as the active control location.
<b>SPEED REFERENCE SELECTION</b>		
22.11 Speed ref1 source	EFB ref1 or EFB ref2	Selects a reference received through the embedded fieldbus interface as speed reference 1.
22.12 Speed ref2 source	EFB ref1 or EFB ref2	Selects a reference received through the embedded fieldbus interface as speed reference 2.
<b>TORQUE REFERENCE SELECTION</b>		
26.11 Torque ref1 source	EFB ref1 or EFB ref2	Selects a reference received through the embedded fieldbus interface as torque reference 1.
26.12 Torque ref2 source	EFB ref1 or EFB ref2	Selects a reference received through the embedded fieldbus interface as torque reference 2.
<b>FREQUENCY REFERENCE SELECTION</b>		
28.11 Frequency ref1 source	EFB ref1 or EFB ref2	Selects a reference received through the embedded fieldbus interface as frequency reference 1.
28.12 Frequency ref2 source	EFB ref1 or EFB ref2	Selects a reference received through the embedded fieldbus interface as frequency reference 2.
<b>OTHER SELECTIONS</b>		
EFB references can be selected as the source at virtually any signal selector parameter by selecting Other (see Terms and abbreviations), then either 3.9 EFB reference 1 or 3.10 EFB reference 2.		
<b>CONTROL OF RELAY OUTPUTS, ANALOG OUTPUTS AND DIGITAL INPUT/OUTPUTS</b>		
10.24 RO1 source	RO/DIO control word bit0	Connects bit 0 of storage parameter 10.99 RO/DIO control word to relay output RO1.
10.27 RO2 source	RO/DIO control word bit1	Connects bit 1 of storage parameter 10.99 RO/DIO control word to relay output RO2.
10.30 RO3 source	RO/DIO control word bit2	Connects bit 2 of storage parameter 10.99 RO/DIO control word to relay output RO3.

742 Fieldbus control through the embedded fieldbus interface (EFB)

Parameter	Setting for fieldbus control	Function/Information
11.5 DIO1 function 11.9 DIO2 function	Output (default)	Sets the digital input/output to output mode.
11.6 DIO1 output source	RO/DIO control word bit8	Connects bit 8 of storage parameter 10.99 RO/DIO control word to digital input/output DIO1.
11.10 DIO2 output source	RO/DIO control word bit9	Connects bit 9 of storage parameter 10.99 RO/DIO control word to digital input/output DIO2.
13.12 AO1 source	AO1 data storage	Connects storage parameter 13.91 AO1 data storage to analog output AO1.
13.22 AO2 source	AO2 data storage	Connects storage parameter 13.92 AO2 data storage to analog output AO2.
<b>PROCESS PID FEEDBACK AND SETPOINT</b>		
40.08 Set 1 feedback 1 source	Feedback data storage	Connect the bits of the storage parameter (10.99 RO/DIO control word) to the digital input/outputs of the drive.
40.16 Set 1 setpoint 1 source	Setpoint data storage	
<b>SYSTEM CONTROL INPUTS</b>		
96.7 Parameter save manually	Save (reverts to Done)	Saves parameter value changes (including those made through fieldbus control) to permanent memory.

## Basics of the embedded fieldbus interface

The cyclic communication between a fieldbus system and the drive consists of 16-bit data words or 32-bit data words (with the transparent control profiles).

The diagram below illustrates the operation of the embedded fieldbus interface. The signals transferred in the cyclic communication are explained further below the diagram.

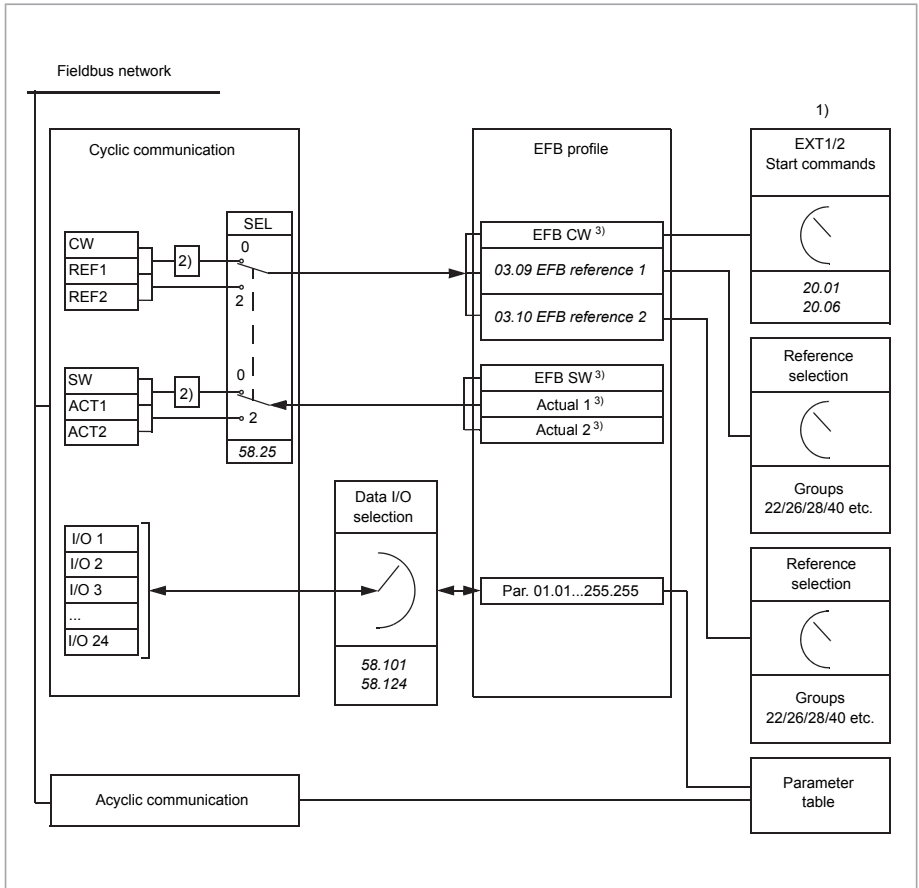

1	See also other parameters which can be controlled through fieldbus.
2	Data conversion if parameter 58.25 Control profile is set to ABB Drives. See section About the control profiles (page 745).
3	<p>If parameter 58.25 Control profile is set to Transparent,</p> <ul style="list-style-type: none"> <li>The sources of the status word and actual values are selected by parameters 58.30...58.32 (otherwise, actual values 1 and 2 are automatically selected according to reference type), and</li> <li>The control word is displayed by 6.5 EFB transparent control word.</li> </ul>

### ■ Control word and Status word

The Control Word (CW) is a 16-bit or 32-bit packed boolean word. It is the principal means of controlling the drive from a fieldbus system. The CW is sent by the fieldbus controller to the drive. By drive parameters, the user selects the EFB CW as the source of drive control commands (such as start/stop, emergency stop,

selection between external control locations 1/2, or fault reset). The drive switches between its states according to the bit-coded instructions of the CW.

The fieldbus CW is either written to the drive as it is (see parameter 6.5 EFB transparent control word), or the data is converted. See section [About the control profiles](#) (page 745).

The fieldbus Status Word (SW) is a 16-bit or 32-bit packed boolean word. It contains status information from the drive to the fieldbus controller. The drive SW is either written to the fieldbus SW as it is or the data is converted. See section [About the control profiles](#) (page 745).

### ■ References

EFB references 1 and 2 are 16-bit or 32-bit signed integers. The contents of each reference word can be used as the source of virtually any signal, such as the speed, frequency, torque or process reference. In embedded fieldbus communication, references 1 and 2 are displayed by 3.9 EFB reference 1 and 3.10 EFB reference 2 respectively. Whether the references are scaled or not depends on the settings of 58.26 EFB ref1 type and 58.27 EFB ref2 type. See section [About the control profiles](#) (page 745).

### ■ Actual values

Fieldbus actual signals (ACT1 and ACT2) are 16-bit or 32-bit signed integers. They convey selected drive parameter values from the drive to the master. Whether the actual values are scaled or not depends on the settings of 58.28 EFB act1 type and 58.29 EFB act2 type. See section [About the control profiles](#) (page 745).

### ■ Data input/outputs

Data input/outputs are 16-bit or 32-bit words containing selected drive parameter values. Parameters 58.101 Data I/O 1 ... 58.124 Data I/O 24 define the addresses from which the master either reads data (input) or to which it writes data (output).

### **Control of drive outputs through EFB**

The address selection parameters of the data input/outputs have a setting with which the data can be written into a storage parameter in the drive. These storage parameters are readily selectable as signal sources of the drive outputs.

The desired values of the relay outputs (RO) and digital input/outputs (DIO) can be written in a 16-bit word into 10.99 RO/DIO control word, which is then selected as the source of those outputs. Each of the analog outputs (AO) of the drive have a dedicated storage parameter (13.91 AO1 data storage and 13.92 AO2 data storage), which are available in the source selection parameters 13.12 AO1 source and 13.22 AO2 source.

---



## ■ Register addressing

The address field of Modbus requests for accessing holding registers is 16 bits. This allows the Modbus protocol to support addressing of 65536 holding registers.

Historically, Modbus master devices used 5-digit decimal addresses from 40001 to 49999 to represent holding register addresses. The 5-digit decimal addressing limited to 9999 the number of holding registers that could be addressed.

Modern Modbus master devices typically provide a means to access the full range of 65536 Modbus holding registers. One of these methods is to use 6-digit decimal addresses from 400001 to 465536. This manual uses 6-digit decimal addressing to represent Modbus holding register addresses.

Modbus master devices that are limited to the 5-digit decimal addressing may still access registers 400001 to 409999 by using 5-digit decimal addresses 40001 to 49999. Registers 410000 to 465536 are inaccessible to these masters.

**Note:** Register addresses of 32-bit parameters cannot be accessed by using 5-digit register numbers.

## About the control profiles

A control profile defines the rules for data transfer between the drive and the fieldbus master, for example:

- if packed boolean words are converted and how
- how drive register addresses are mapped for the fieldbus master.

You can configure the drive to receive and send messages according to the ABB Drives profile or the Transparent profile. With the ABB Drives profile, the embedded fieldbus interface of the drive converts the control word and status word to and from the native data used in the drive. The Transparent profile involves no data conversion. The figure below illustrates the effect of the profile selection.

---

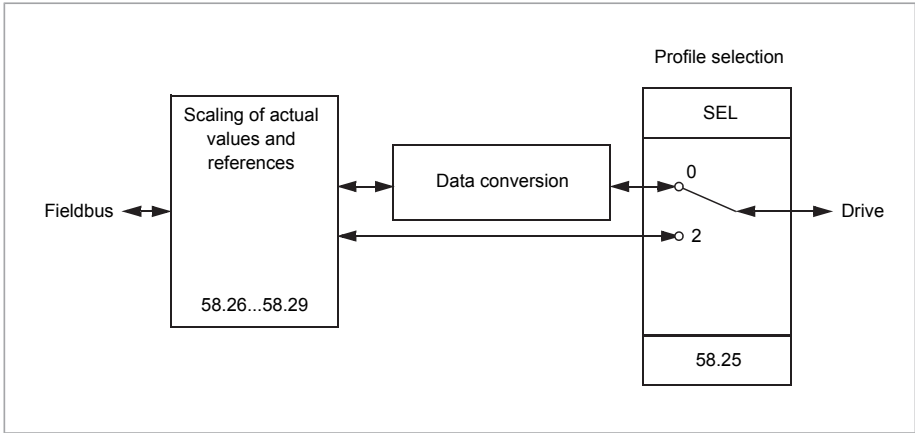

Control profile selection with parameter 58.25 Control profile:

- (0) ABB Drives
- (2) Transparent

Note that scaling of references and actual values can be selected independent of the profile selection by parameters 58.26...58.29.

## The ABB Drives profile

### ■ Control Word

The table below shows the contents of the fieldbus Control Word for the ABB Drives control profile. The embedded fieldbus interface converts this word to the form in which it is used in the drive. The upper case boldface text refers to the states shown in State transition diagram (page 749).

Bit	Name	Value	STATE/Description
0	OFF1_CONTROL	1	Proceed to <b>READY TO OPERATE</b> .
		0	Stop along currently active deceleration ramp. Proceed to <b>OFF1 ACTIVE</b> ; proceed to <b>READY TO SWITCH ON</b> unless other interlocks ( <b>OFF2</b> , <b>OFF3</b> ) are active.
1	OFF2_CONTROL	1	Continue operation ( <b>OFF2</b> inactive).
		0	Emergency OFF, coast to stop. Proceed to <b>OFF2 ACTIVE</b> , proceed to <b>SWITCH-ON INHIBITED</b> .

Bit	Name	Value	STATE/Description
2	OFF3_CONTROL	1	Continue operation (OFF3 inactive).
		0	Emergency stop, stop within time defined by drive parameter. Proceed to OFF3 ACTIVE; proceed to SWITCH-ON INHIBITED.   <b>WARNING!</b> Ensure that the motor and driven machine can be stopped using this stop mode.
3	INHIBIT_OPERATION	1	Proceed to <b>OPERATION ENABLED</b> .  <b>Note:</b> Run enable signal must be active; see the drive documentation. If the drive is set to receive the Run enable signal from the fieldbus, this bit activates the signal.
		0	Inhibit operation. Proceed to <b>OPERATION INHIBITED</b> .
4	RAMP_OUT_ZERO	1	Normal operation. Proceed to <b>RAMP FUNCTION GENERATOR: OUTPUT ENABLED</b> .
		0	Force Ramp Function Generator output to zero. Drive ramps to stop (current and DC voltage limits in force).
5	RAMP_HOLD	1	Enable ramp function. Proceed to <b>RAMP FUNCTION GENERATOR: ACCELERATOR ENABLED</b> .
		0	Halt ramping (Ramp Function Generator output held).
6	RAMP_IN_ZERO	1	Normal operation. Proceed to <b>OPERATING</b> .  <b>Note:</b> This bit is effective only if the fieldbus interface is set as the source for this signal by drive parameters.
		0	Force Ramp Function Generator input to zero.
7	RESET	0=>1	Fault reset if an active fault exists. Proceed to <b>SWITCH-ON INHIBITED</b> .  <b>Note:</b> This bit is effective only if the fieldbus interface is set as the source for this signal by drive parameters.
		0	Continue normal operation.
8	JOGGING_1	1	Accelerate to jogging 1 reference.
		0	Jogging 1 disabled.
9	JOGGING_2	1	Accelerate to jogging 2 reference. See notes at bit 8.
		0	Jogging 2 disabled.

748 Fieldbus control through the embedded fieldbus interface (EFB)

Bit	Name	Value	STATE/Description
10	REMOTE_CMD	1	Fieldbus control enabled.
		0	Control word and reference will not get through to the drive, except for CW bits OFF1, OFF2 and OFF3.
11	EXT_CTRL_LOC	1	Select External Control Location EXT2. Effective if the control location is parameterized to be selected from the fieldbus.
		0	Select External Control Location EXT1. Effective if the control location is parameterized to be selected from the fieldbus.
12...15	Reserved		

■ **Status Word**

The table below shows the fieldbus Status Word for the ABB Drives control profile. The embedded fieldbus interface converts the drive Status Word into this form for the fieldbus. The upper case boldface text refers to the states shown in State transition diagram (page 749).

Bit	Name	Value	STATE/Description
0	RDY_ON	1	READY TO SWITCH ON.
		0	NOT READY TO SWITCH ON.
1	RDY_RUN	1	READY TO OPERATE.
		0	OFF1 ACTIVE.
2	RDY_REF	1	OPERATION ENABLED.
		0	OPERATION INHIBITED.
3	TRIPPED	1	FAULT.
		0	No fault.
4	OFF_2_STA	1	OFF2 inactive.
		0	OFF2 ACTIVE.
5	OFF_3_STA	1	OFF3 inactive.
		0	OFF3 ACTIVE.
6	SWC_ON_INHIB	1	SWITCH-ON INHIBITED.
		0	-
7	ALARM	1	Warning/Alarm.
		0	No warning/alarm.
8	AT_SETPOINT	1	OPERATING. Actual value equals Reference = is within tolerance limits, i.e. in speed control, speed error is 10% max. of nominal motor speed.
		0	Actual value differs from Reference = is outside tolerance limits.

Bit	Name	Value	STATE/Description
9	REMOTE	1	Drive control location: REMOTE (EXT1 or EXT2).
		0	Drive control location: LOCAL.
10	ABOVE_LIMIT	1	Actual frequency or speed equals or exceeds supervision limit (set by drive parameter). Valid in both directions of rotation.
		0	Actual frequency or speed within supervision limit.
11	USER_0		S
12	EXT_RUN_ENABLE	1	External Run enable signal received.
		0	No external Run enable signal received.
13...15	Reserved		

### ■ State transition diagram

The diagram below shows the state transitions in the drive when the drive is using the ABB Drives profile, and configured to follow the commands of the control word from the embedded fieldbus interface. The upper case texts refer to the states which are used in the tables representing the fieldbus Control and Status words. See sections [Control Word \(page 746\)](#) and [Status Word \(page 748\)](#).

# 750 Fieldbus control through the embedded fieldbus interface (EFB)

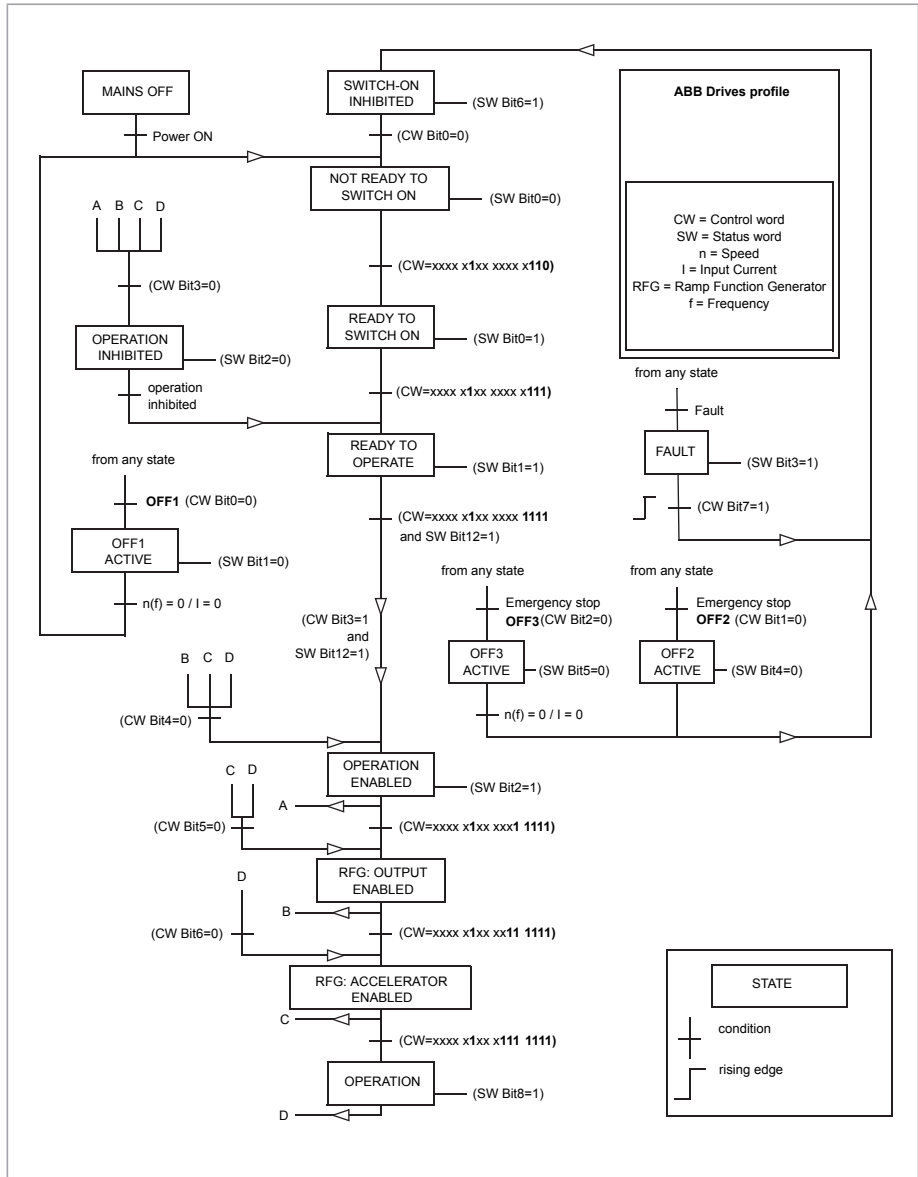

## ■ References

The ABB drives profile supports the use of two references, EFB reference 1 and EFB reference 2. The references are 16-bit words each containing a sign bit and a 15-bit integer. A negative reference is formed by calculating the two's complement from the corresponding positive reference.

The references are scaled as defined by parameters 46.01...46.07; which scaling is in use depends on the setting of 58.26 EFB ref1 type and 58.27 EFB ref2 type (page 530).

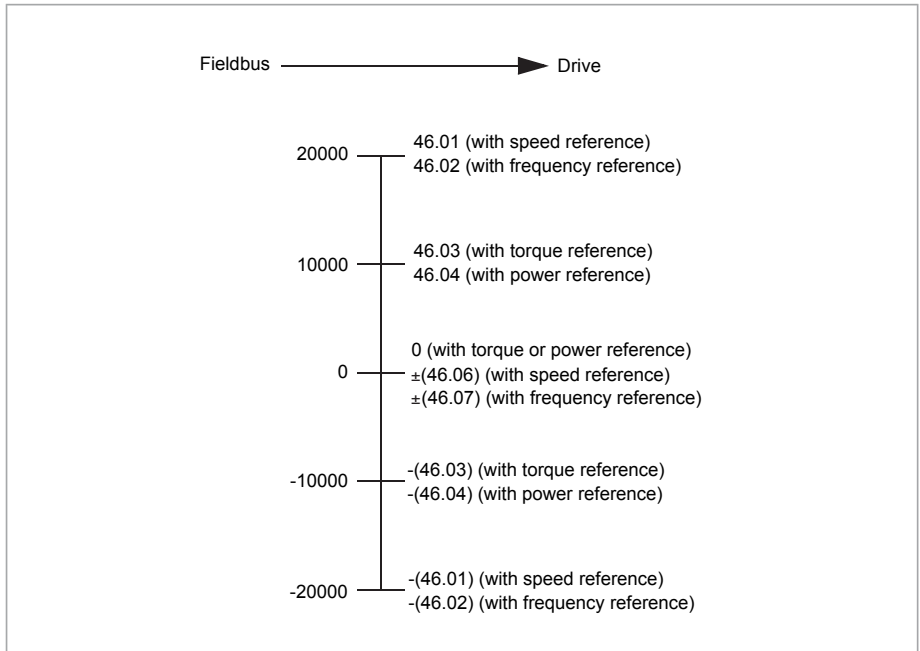

The scaled references are shown by parameters 3.9 EFB reference 1 and 3.10 EFB reference 2.

■ **Actual values**

The ABB Drives profile supports the use of two fieldbus actual values, ACT1 and ACT2. The actual values are 16-bit words each containing a sign bit and a 15-bit integer. A negative value is formed by calculating the two's complement from the corresponding positive value.

The actual values are scaled as defined by parameters 46.01...46.04; which scaling is in use depends on the setting of parameters 58.28 EFB act1 type and 58.29 EFB act2 type (page 531).

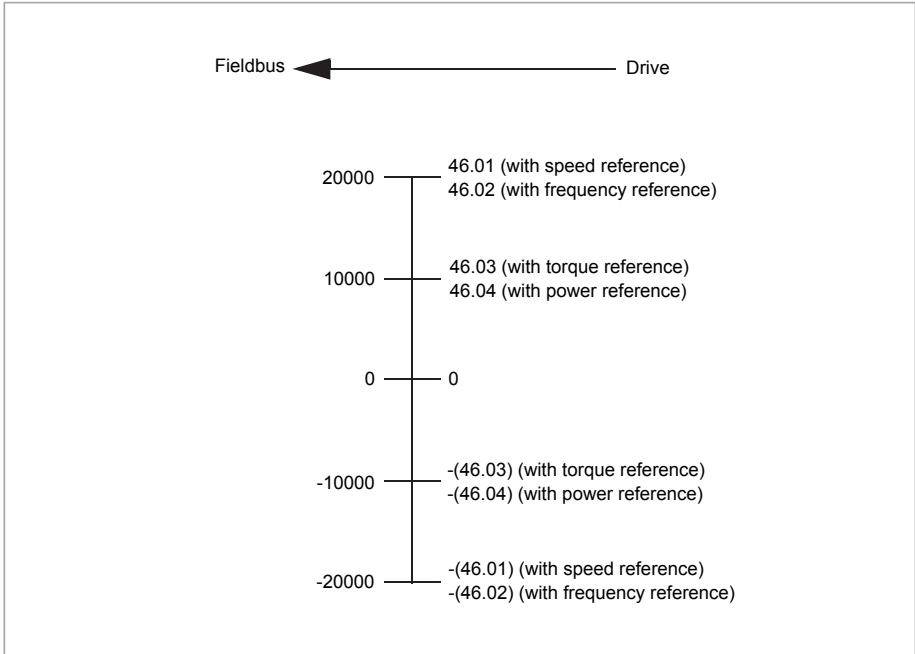



## ■ Modbus holding register addresses

The table below shows the default Modbus holding register addresses for drive data.

This profile provides a converted 16-bit access to the data.

Register address	Register data (16-bit words)
400001	Control word. See section <a href="#">Control Word (page 746)</a> . The selection can be changed using parameter <a href="#">58.101 Data I/O 1</a> .
400002	Reference 1 (REF1). The selection can be changed using parameter <a href="#">58.102 Data I/O 2</a> .
400003	Reference 2 (REF2). The selection can be changed using parameter <a href="#">58.103 Data I/O 3</a> .
400004	Status Word (SW). See section <a href="#">Status Word (page 748)</a> . The selection can be changed using parameter <a href="#">58.104 Data I/O 4</a> .
400005	Actual value 1 (ACT1). The selection can be changed using parameter <a href="#">58.105 Data I/O 5</a> .
400006	Actual value 2 (ACT2). The selection can be changed using parameter <a href="#">58.106 Data I/O 6</a> .
400007...400024	Data in/out 7...24. Selected by parameters <a href="#">58.107 Data I/O 7 ... 58.124 Data I/O 24</a> .
400025...400089	Unused
400090...400100	Error code access. See section <a href="#">Error code registers (holding registers 400090...400100) (page 758)</a> .
400101...465536	Parameter read/write. Parameters are mapped to register addresses according to parameter <a href="#">58.33 Addressing mode</a> .

## The Transparent profile

The Transparent profile enables a customizable access to the drive.

The contents of the control word are user-definable. The control word received from the fieldbus is visible in parameter [6.5 EFB transparent control word](#), and can be used to control the drive using pointer parameters and/or application programming.

The status word to be sent to the fieldbus controller is selected by parameter [58.30 EFB status word transparent source](#). This can be, for example, the user-configurable status word in [6.50 User status word 1](#).

The Transparent profile involves no data conversion of the control or status word. Whether references or actual values are scaled depends on the setting of parameters [58.26...58.29](#). The references received from the fieldbus are visible in parameters [3.9 EFB reference 1](#) and [3.10 EFB reference 2](#).

The Modbus holding register addresses for the Transparent profile are as with the ABB Drives profile (see page 559).

## Modbus function codes

The table below shows the Modbus function codes supported by the embedded fieldbus interface.

Code	Function name	Description
01h	Read Coils	Reads the 0/1 status of coils (0X references).
02h	Read Discrete Inputs	Reads the 0/1 status of discrete inputs (1X references).
03h	Read Holding Registers	Reads the binary contents of holding registers (4X references).
05h	Write Single Coil	Forces a single coil (0X reference) to 0 or 1.
06h	Write Single Register	Writes a single holding register (4X reference).
08h	Diagnostics	Provides a series of tests for checking the communication, or for checking various internal error conditions. Supported subcodes: <ul style="list-style-type: none"> <li>• 00h Return Query Data: Echo/loopback test.</li> <li>• 01h Restart Comm Option: Restarts and initializes the EFB, clears communications event counters.</li> <li>• 04h Force Listen Only Mode</li> <li>• 0Ah Clear Counters and Diagnostic Register</li> <li>• 0Bh Return Bus Message Count</li> <li>• 0Ch Return Bus Comm. Error Count</li> <li>• 0Dh Return Bus Exception Error Count</li> <li>• 0Eh Return Slave Message Count</li> <li>• 0Fh Return Slave No Response Count</li> <li>• 10h Return Slave NAK (negative acknowledgement) Count</li> <li>• 11h Return Slave Busy Count</li> <li>• 12h Return Bus Character Overrun Count</li> <li>• 14h Clear Overrun Counter and Flag</li> </ul>
0Bh	Get Comm Event Counter	Returns a status word and an event count.
0Fh	Write Multiple Coils	Forces a sequence of coils (0X references) to 0 or 1.
10h	Write Multiple Registers	Writes the contents of a contiguous block of holding registers (4X references).
16h	Mask Write Register	Modifies the contents of a 4X register using a combination of an AND mask, an OR mask, and the register's current contents.

Code	Function name	Description
17h	Read/Write Multiple Registers	Writes the contents of a contiguous block of 4X registers, then reads the contents of another group of registers (the same or different than those written) in a server device.
2Bh/0Eh	Encapsulated Interface Transport	Supported subcodes: <ul style="list-style-type: none"> <li>• 0Eh Read Device Identification: Allows reading the identification and other information.</li> </ul> Supported ID codes (access type): <ul style="list-style-type: none"> <li>• 00h: Request to get the basic device identification (stream access)</li> <li>• 04h: Request to get one specific identification object (individual access)</li> </ul> Supported Object IDs: <ul style="list-style-type: none"> <li>• 00h: Vendor Name (“ABB”)</li> <li>• 01h: Product Code (for example, “AINFX”)</li> <li>• 02h: Major Minor Revision (combination of contents of parameters 7.5 Firmware version and 58.2 Protocol ID).</li> <li>• 03h: Vendor URL (“<a href="http://www.abb.com">www.abb.com</a>”)</li> <li>• 04h: Product name (for example, “ACS880”)</li> </ul>

## Exception codes

The table below shows the Modbus exception codes supported by the embedded fieldbus interface.

Code	Name	Description
01h	ILLEGAL FUNCTION	The function code received in the query is not an allowable action for the server.
02h	ILLEGAL DATA ADDRESS	The data address received in the query is not an allowable address for the server.
03h	ILLEGAL DATA VALUE	The requested Quantity of Registers is larger than the drive can handle.  <b>Note:</b> This error does not mean that a value written to a drive parameter is outside the valid range.
04h	SLAVE DEVICE FAILURE	The value written to a drive parameter is outside the valid range. See section <a href="#">Error code registers (holding registers 400090...400100)</a> (page 758).
06h	SLAVE DEVICE BUSY	The server is engaged in processing a long-duration program command.

## Coils (0xxxx reference set)

Coils are 1-bit read/write values. Control Word bits are exposed with this data type. The table below summarizes the Modbus coils (0xxxx reference set).

Reference	ABB drives profile	Transparent profile
00001	OFF1_CONTROL	Control Word bit 0
00002	OFF2_CONTROL	Control Word bit 1
00003	OFF3_CONTROL	Control Word bit 2
00004	INHIBIT_OPERATION	Control Word bit 3
00005	RAMP_OUT_ZERO	Control Word bit 4
00006	RAMP_HOLD	Control Word bit 5
00007	RAMP_IN_ZERO	Control Word bit 6
00008	RESET	Control Word bit 7
00009	JOGGING_1	Control Word bit 8
00010	JOGGING_2	Control Word bit 9
00011	REMOTE_CMD	Control Word bit 10
00012	EXT_CTRL_LOC	Control Word bit 11
00013	User-defined (0)	Control Word bit 12
00014	User-defined (1)	Control Word bit 13
00015	User-defined (2)	Control Word bit 14
00016	User-defined (3)	Control Word bit 15
00017	Reserved	Control Word bit 16
00018	Reserved	Control Word bit 17
00019	Reserved	Control Word bit 18
00020	Reserved	Control Word bit 19
00021	Reserved	Control Word bit 20
00022	Reserved	Control Word bit 21
00023	Reserved	Control Word bit 22
00024	Reserved	Control Word bit 23
00025	Reserved	Control Word bit 24
00026	Reserved	Control Word bit 25
00027	Reserved	Control Word bit 26
00028	Reserved	Control Word bit 27
00029	Reserved	Control Word bit 28
00030	Reserved	Control Word bit 29
00031	Reserved	Control Word bit 30
00032	Reserved	Control Word bit 31
00033	Reserved	10.99 RO/DIO control word, bit 0
00034	Reserved	10.99 RO/DIO control word, bit 1
00035	Reserved	10.99 RO/DIO control word, bit 2
00036	Reserved	10.99 RO/DIO control word, bit 3

Reference	ABB drives profile	Transparent profile
00037	Reserved	10.99 RO/DIO control word, bit 4
00038	Reserved	10.99 RO/DIO control word, bit 5
00039	Reserved	10.99 RO/DIO control word, bit 6
00040	Reserved	10.99 RO/DIO control word, bit 7
00041	Reserved	10.99 RO/DIO control word, bit 8
00042	Reserved	10.99 RO/DIO control word, bit 9

## Discrete inputs (1xxxx reference set)

Discrete inputs are 1-bit read-only values. Status Word bits are exposed with this data type. The table below summarizes the Modbus discrete inputs (1xxxx reference set).

Reference	ABB drives profile	Transparent profile
10001	RDY_ON	Status Word bit 0
10002	RDY_RUN	Status Word bit 1
10003	RDY_REF	Status Word bit 2
10004	TRIPPED	Status Word bit 3
10005	OFF_2_STA	Status Word bit 4
10006	OFF_3_STA	Status Word bit 5
10007	SWC_ON_INHIB	Status Word bit 6
10008	ALARM	Status Word bit 7
10009	AT_SETPOINT	Status Word bit 8
10010	REMOTE	Status Word bit 9
10011	ABOVE_LIMIT	Status Word bit 10
10012	User-defined (0)	Status Word bit 11
10013	User-defined (1)	Status Word bit 12
10014	User-defined (2)	Status Word bit 13
10015	User-defined (3)	Status Word bit 14
10016	Reserved	Status Word bit 15
10017	Reserved	Status Word bit 16
10018	Reserved	Status Word bit 17
10019	Reserved	Status Word bit 18
10020	Reserved	Status Word bit 19
10021	Reserved	Status Word bit 20
10022	Reserved	Status Word bit 21
10023	Reserved	Status Word bit 22
10024	Reserved	Status Word bit 23
10025	Reserved	Status Word bit 24
10026	Reserved	Status Word bit 25
10027	Reserved	Status Word bit 26

758 Fieldbus control through the embedded fieldbus interface (EFB)

Reference	ABB drives profile	Transparent profile
10028	Reserved	Status Word bit 27
10029	Reserved	Status Word bit 28
10030	Reserved	Status Word bit 29
10031	Reserved	Status Word bit 30
10032	Reserved	Status Word bit 31
10033	Reserved	10.2 DI delayed status, bit 0
10034	Reserved	10.2 DI delayed status, bit 1
10035	Reserved	10.2 DI delayed status, bit 2
10036	Reserved	10.2 DI delayed status, bit 3
10037	Reserved	10.2 DI delayed status, bit 4
10038	Reserved	10.2 DI delayed status, bit 5
10039	Reserved	10.2 DI delayed status, bit 6
10040	Reserved	10.2 DI delayed status, bit 7
10041	Reserved	10.2 DI delayed status, bit 8
10042	Reserved	10.2 DI delayed status, bit 9
10043	Reserved	10.2 DI delayed status, bit 10
10044	Reserved	10.2 DI delayed status, bit 11
10045	Reserved	10.2 DI delayed status, bit 12
10046	Reserved	10.2 DI delayed status, bit 13
10047	Reserved	10.2 DI delayed status, bit 14
10048	Reserved	10.2 DI delayed status, bit 15

**Error code registers (holding registers 400090...400100)**

These registers contain information about the last query. The error register is cleared when a query has finished successfully.

Reference	Name	Description
90	Reset Error Registers	1 = Reset internal error registers (91...95).
91	Error Function Code	Function code of the failed query.
92	Error Code	Set when exception code 04h is generated (see table above). <ul style="list-style-type: none"> <li>• 00h No error</li> <li>• 02h Low/High limit exceeded</li> <li>• 03h Faulty Index: Unavailable index of an array parameter</li> <li>• 05h Incorrect Data Type: Value does not match the data type of the parameter</li> <li>• 65h General Error: Undefined error when handling query</li> </ul>
93	Failed Register	The last register (discrete input, coil, or holding register) that failed to be read or written.

<b>Reference</b>	<b>Name</b>	<b>Description</b>
94	Last Register Written Successfully	The last register that was written successfully.
95	Last Register Read Successfully	The last register that was read successfully.





# 11

## Fieldbus control through a fieldbus adapter

---

### What this chapter contains

This chapter describes how the drive can be controlled by external devices over a communication network (fieldbus) through an optional fieldbus adapter module.

The fieldbus control interface of the drive is described first, followed by a configuration example.

### System overview

The drive can be connected to an external control system through an optional fieldbus adapter mounted onto the control unit of the drive. The drive actually has two independent interfaces for fieldbus connection, called “fieldbus adapter A” (FBA A) and “fieldbus adapter B” (FBA B). The drive can be configured to receive all of its control information through the fieldbus interface(s), or the control can be distributed between the fieldbus interface(s) and other available sources such as digital and analog inputs, depending on how control locations EXT1 and EXT2 are configured.

**Note:** The text and examples in this chapter describe the configuration of one fieldbus adapter (FBA A) by parameters 50.01...50.21 and parameter groups 51...53. The second adapter (FBA B), if present, is configured in a similar fashion by parameters 50.31...50.51 and parameter groups 54...56. It is recommended that the FBA B interface is only used for monitoring.

Fieldbus adapters are available for various communication systems and protocols, for example

---

## 762 Fieldbus control through a fieldbus adapter

- CANopen (FCAN-01 adapter)
- ControlNet (FCNA-01 adapter)
- DeviceNet (FDNA-01 adapter)
- EtherCAT® (FECA-01 adapter)
- EtherNet/IP™ (FENA-11 or FENA-21 adapter)
- Modbus/RTU (FSCA-01 adapter)
- Modbus/TCP (FENA-11 or FENA-21 adapter)
- POWERLINK (FEPL-02 adapter)
- PROFIBUS DP (FPBA-01 adapter)
- PROFINET IO (FENA-11 or FENA-21 adapter).

**Note:** Fieldbus adapters with the suffix “M” (eg. FPBA-01-M) are not supported.

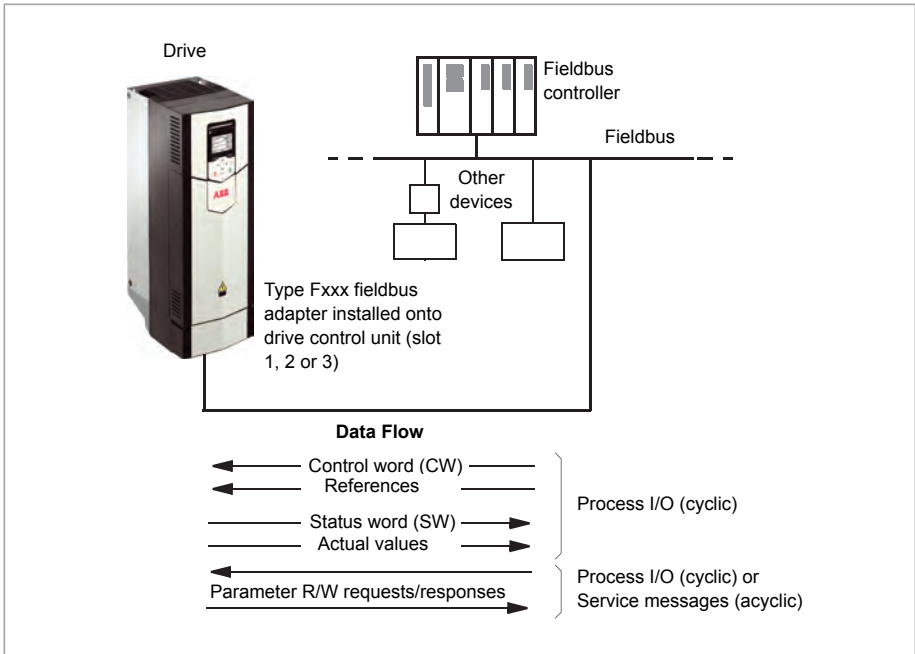

## Basics of the fieldbus control interface

The cyclic communication between a fieldbus system and the drive consists of 16- or 32-bit input and output data words. The drive is able to support a maximum of 12 data words (16 bits) in each direction.

Data transmitted from the drive to the fieldbus controller is defined by parameters 52.1 FBA A data in1 ... 52.12 FBA A data in12. The data transmitted from the fieldbus controller to the drive is defined by parameters 53.1 FBA data out1 ... 53.12 FBA data out12.

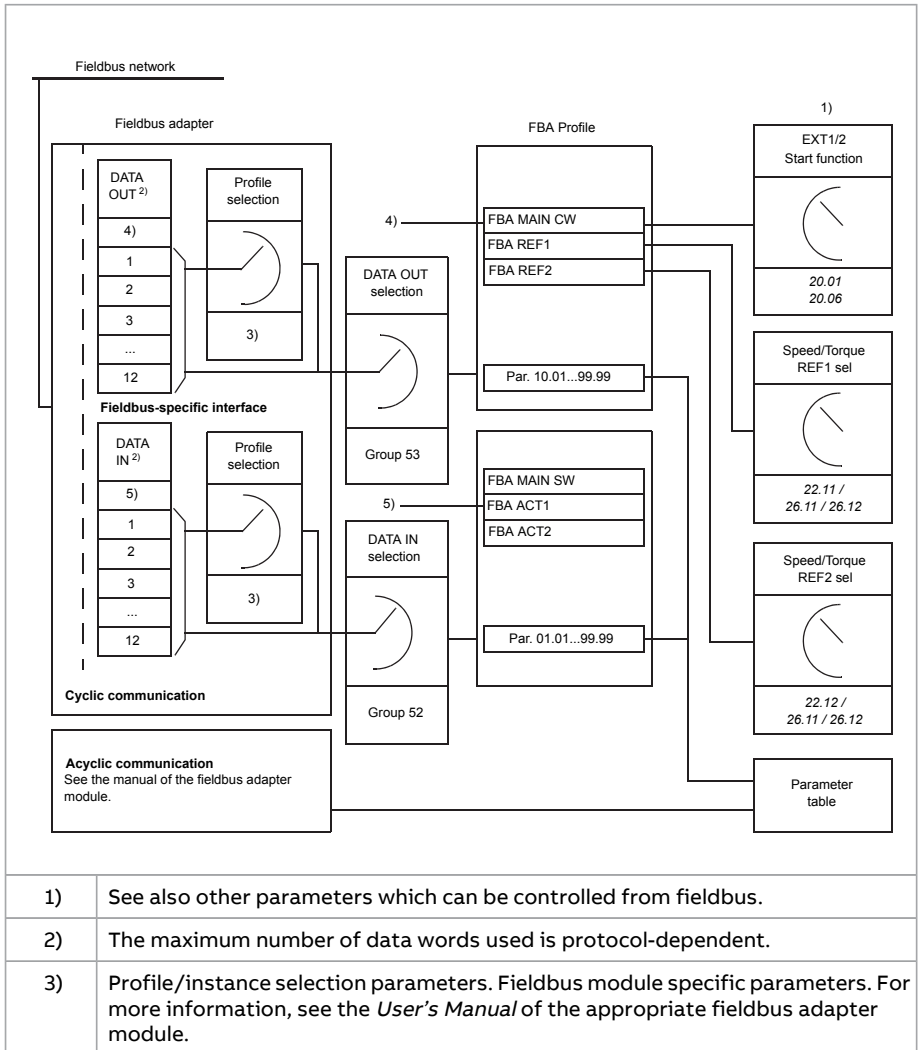

4)	With DeviceNet, the control part is transmitted directly.
5)	With DeviceNet, the actual value part is transmitted directly.

### ■ Control word and Status word

The Control word is the principal means for controlling the drive from a fieldbus system. It is sent by the fieldbus master station to the drive through the adapter module. The drive switches between its states according to the bit-coded instructions in the Control word, and returns status information to the master in the Status word.

For the ABB Drives communication profile, the contents of the Control word and the Status word are detailed on pages 573 and 574 respectively. The drive states are presented in the state diagram (page 575).

When a transparent communication profile is selected eg. by parameter group 51 FBA A settings, the control word received from the PLC is available in 6.3 FBA A transparent control word. The individual bits of the word can then be used for drive control through bit pointer parameters. The source of the status word, for example 6.50 User status word 1, can be selected in 50.9 FBA A SW transparent source.

### Debugging the network words

If parameter 50.12 FBA A debug mode is set to Fast, the Control word received from the fieldbus is shown by parameter 50.13 FBA A control word, and the Status word transmitted to the fieldbus network by 50.16 FBA A status word. This “raw” data is very useful to determine if the fieldbus master is transmitting the correct data before handing control to the fieldbus network.

---

## ■ References

References are 16-bit words containing a sign bit and a 15-bit integer. A negative reference (indicating reversed direction of rotation) is formed by calculating the two's complement from the corresponding positive reference.

ABB drives can receive control information from multiple sources including analog and digital inputs, the drive control panel and a fieldbus adapter module. In order to have the drive controlled through the fieldbus, the module must be defined as the source for control information such as reference. This is done using the source selection parameters in groups 22 Speed reference selection, and 26 Torque reference chain.

### Debugging the network words

If parameter 50.12 FBA A debug mode is set to Fast, the references received from the fieldbus are displayed by 50.14 FBA A reference 1 and 50.15 FBA A reference 2.

### Scaling of references

**Note:** The scalings described below are for the ABB Drives communication profile. Fieldbus-specific communication profiles may use different scalings. For more information, see the manual of the fieldbus adapter

The references are scaled as defined by parameters 46.01...46.07; which scaling is in use depends on the setting of 50.4 FBA A ref1 type and 50.5 FBA A ref2 type.

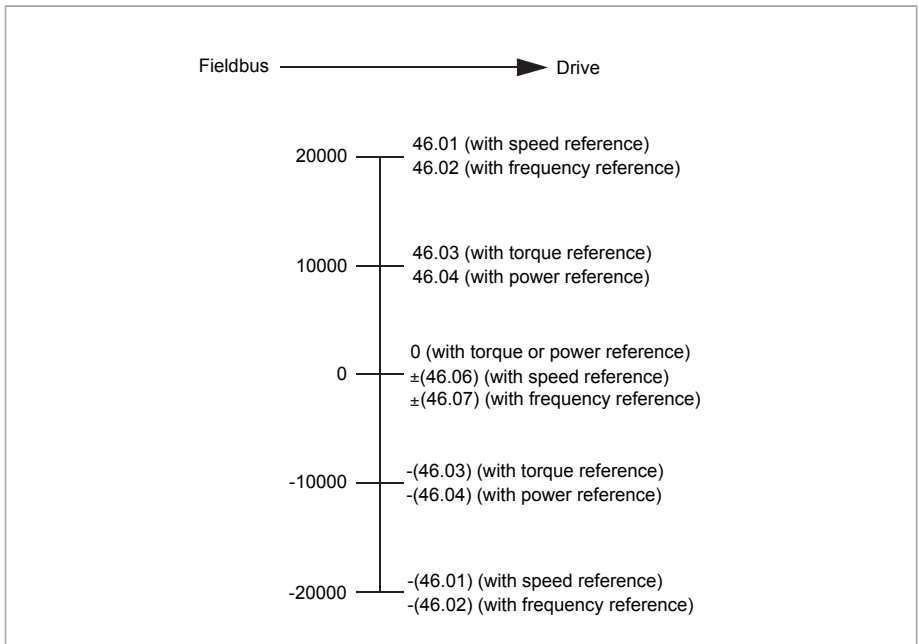

## 766 Fieldbus control through a fieldbus adapter

The scaled references are shown by parameters 3.5 FB A reference 1 and 3.6 FB A reference 2.

### ■ Actual values

Actual values are 16-bit words containing information on the operation of the drive. The types of the monitored signals are selected by parameters 50.7 FBA A actual 1 type and 50.8 FBA A actual 2 type.

### Debugging the network words

If parameter 50.12 FBA A debug mode is set to Fast, the actual values sent to the fieldbus are displayed by 50.17 FBA A actual value 1 and 50.18 FBA A actual value 2.

### Scaling of actual values

**Note:** The scalings described below are for the ABB Drives communication profile. Fieldbus-specific communication profiles may use different scalings. For more information, see the manual of the fieldbus adapter.

The actual values are scaled as defined by parameters 46.01...46.04; which scaling is in use depends on the setting of parameters 50.7 FBA A actual 1 type and 50.8 FBA A actual 2 type.

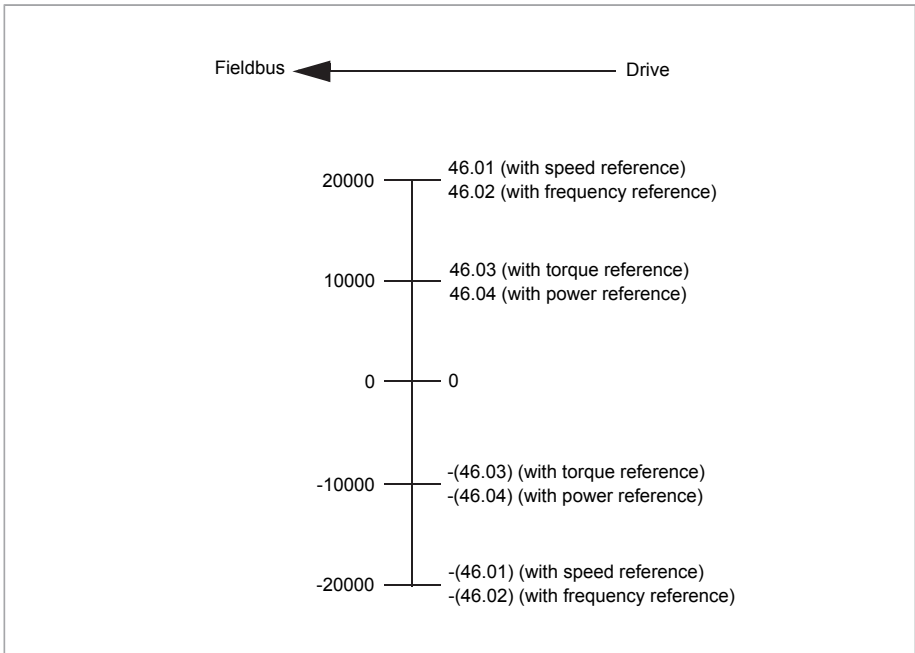

## ■ Contents of the fieldbus Control word (ABB Drives profile)

The upper case boldface text refers to the states shown in the state diagram (page 575).

Bit	Name	Value	STATE/Description
0	Off1 control	1	Proceed to <b>READY TO OPERATE</b> .
		0	Stop along currently active deceleration ramp. Proceed to <b>OFF1 ACTIVE</b> ; proceed to <b>READY TO SWITCH ON</b> unless other interlocks (OFF2, OFF3) are active.
1	Off2 control	1	Continue operation (OFF2 inactive).
		0	Emergency OFF, coast to a stop. Proceed to <b>OFF2 ACTIVE</b> , proceed to <b>SWITCH-ON INHIBITED</b> .
2	Off3 control	1	Continue operation (OFF3 inactive).
		0	Emergency stop, stop within time defined by drive parameter. Proceed to <b>OFF3 ACTIVE</b> ; proceed to <b>SWITCH-ON INHIBITED</b> .   <b>WARNING!</b> Ensure motor and driven machine can be stopped using this stop mode.
3	Run	1	Proceed to <b>OPERATION ENABLED</b> .  <b>Note:</b> Run enable signal must be active. If the drive is set to receive the Run enable signal from the fieldbus, this bit activates the signal. See also parameters 6.18 Start inhibit status word and 6.25 Drive inhibit status word 2.
		0	Inhibit operation. Proceed to <b>OPERATION INHIBITED</b> .
4	Ramp out zero	1	Normal operation. Proceed to <b>RAMP FUNCTION GENERATOR: OUTPUT ENABLED</b> .
		0	Force Ramp function generator output to zero. The drive will immediately decelerate to zero speed (observing the torque limits).
5	Ramp hold	1	Enable ramp function. Proceed to <b>RAMP FUNCTION GENERATOR: ACCELERATOR ENABLED</b> .
		0	Halt ramping (Ramp Function Generator output held).
6	Ramp in zero	1	Normal operation. Proceed to <b>OPERATING</b> .  <b>Note:</b> This bit is effective only if the fieldbus interface is set as the source for this signal by drive parameters.
		0	Force Ramp function generator input to zero.

## 768 Fieldbus control through a fieldbus adapter

Bit	Name	Value	STATE/Description
7	Reset	0=>1	Fault reset if an active fault exists. Proceed to <b>SWITCH-ON INHIBITED</b> .  <b>Note:</b> This bit is effective only if the fieldbus interface is set as the source of the reset signal by drive parameters.
		0	Continue normal operation.
8	Inching 1	1	Accelerate to inching (jogging) setpoint 1.  <b>Note:</b> • Bits 4...6 must be 0.
		0	Inching (jogging) 1 disabled.
9	Inching 2	1	Accelerate to inching (jogging) setpoint 2. See notes at bit 8.
		0	Inching (jogging) 2 disabled.
10	Remote cmd	1	Fieldbus control enabled.
		0	Control word and reference not getting through to the drive, except for bits 0...2.
11	Ext ctrl loc	1	Select External Control Location EXT2. Effective if control location is parameterized to be selected from fieldbus.
		0	Select External Control Location EXT1. Effective if control location is parameterized to be selected from fieldbus.
12 to 15	Reserved.		



## ■ Contents of the fieldbus Status word (ABB Drives profile)

The upper case boldface text refers to the states shown in the state diagram (page 575).

Bit	Name	Value	STATE/Description
0	Ready to switch ON	1	<b>READY TO SWITCH ON.</b>
		0	<b>NOT READY TO SWITCH ON.</b>
1	Ready run	1	<b>READY TO OPERATE.</b>
		0	<b>OFF1 ACTIVE.</b>
2	Ready ref	1	<b>OPERATION ENABLED.</b>
		0	<b>OPERATION INHIBITED.</b> See parameters 6.18 Start inhibit status word and 6.25 Drive inhibit status word 2 for the inhibiting condition.
3	Tripped	1	<b>FAULT.</b>
		0	No fault.
4	Off 2 inactive	1	OFF2 inactive.
		0	<b>OFF2 ACTIVE.</b>
5	Off 3 inactive	1	OFF3 inactive.
		0	<b>OFF3 ACTIVE.</b>
6	Switch-on inhibited	1	<b>SWITCH-ON INHIBITED.</b>
		0	–
7	Warning	1	Warning active.
		0	No warning active.
8	At setpoint	1	<b>OPERATING.</b> Actual value equals reference = is within tolerance limits (see parameters 46.21...46.23).
		0	Actual value differs from reference = is outside tolerance limits.
9	Remote	1	Drive control location: <b>REMOTE</b> (EXT1 or EXT2).
		0	Drive control location: <b>LOCAL.</b>
10	Above limit	-	See parameter 6.29 MSW bit 10 sel.
11	User bit 0	-	See parameter 6.30 MSW bit 11 sel.
12	User bit 1	-	See parameter 6.31 MSW bit 12 sel.
13	User bit 2	-	See parameter 6.32 MSW bit 13 sel.
14	User bit 3	-	See parameter 6.33 MSW bit 14 sel.
15	Reserved.		



## Setting up the drive for fieldbus control

1. Install the fieldbus adapter module mechanically and electrically according to the instructions given in the *User's manual* of the module.
2. Power up the drive.
3. Enable the communication between the drive and the fieldbus adapter module with parameter 50.1 FBA A enable.
4. With 50.2 FBA A comm loss func, select how the drive should react to a fieldbus communication break.

**Note:** This function monitors both the communication between the fieldbus master and the adapter module and the communication between the adapter module and the drive.

5. With 50.3 FBA A comm loss t out, define the time between communication break detection and the selected action.
6. Select application-specific values for the rest of the parameters in group 50 Fieldbus adapter (FBA), starting from 50.04. Examples of appropriate values are shown in the tables below.
7. Set the fieldbus adapter module configuration parameters in group 51 FBA A settings. As a minimum, set the required node address and the control profile.
8. Define the process data transferred to and from the drive in parameter groups 52 FBA A data in and 53 FBA A data out.

**Note:** Depending on the communication protocol and profile being used, the Control word and Status word may already be configured to be sent/received by the communication system.

9. Save the valid parameter values to permanent memory by setting parameter 96.7 Parameter save manually to Save.
  10. Validate the settings made in parameter groups 51, 52 and 53 by setting parameter 51.27 FBA A par refresh to Refresh.
  11. Configure control locations EXT1 and EXT2 to allow control and reference signals to come from the fieldbus. Examples of appropriate values are shown in the tables below.
-

■ **Parameter setting example: FPBA (PROFIBUS DP)**

This example shows how to configure a basic speed control application that uses the PROFIdrive communication profile with PPO Type 2. The start/stop commands and reference are according to the PROFIdrive profile, speed control mode.

The reference values sent over the fieldbus have to be scaled within the drive so they have the desired effect. The reference value ±16384 (4000h) corresponds to the range of speed set in parameter 46.1 Speed scaling (both forward and reverse directions). For example, if 46.01 is set to 480 rpm, then 4000h sent over fieldbus will request 480 rpm.

Direction	PZD1	PZD2	PZD3	PZD4	PZD5	PZD6
Out	Control word	Speed reference	Acc time 1		Dec time 1	
In	Status word	Speed actual value	Motor current		DC voltage	

The table below gives the recommended drive parameter settings.

Drive parameter	Setting for ACS880 drives	Description
50.1 FBA A enable	<b>1...3</b> = [slot number]	Enables communication between the drive and the fieldbus adapter module.
50.4 FBA A ref1 type	<b>4</b> = Speed	Selects the fieldbus A reference 1 type and scaling.
50.7 FBA A actual 1 type	<b>0</b> = Auto	Selects the actual value type/source and scaling according to the currently active control mode (as displayed by parameter 19.01).
51.1 FBA A type	<b>1</b> = FPBA <sup>1)</sup>	Displays the type of the fieldbus adapter module.
51.02 Node address	<b>3</b> <sup>2)</sup>	Defines the PROFIBUS node address of the fieldbus adapter module.
51.03 Baud rate	<b>12000</b> <sup>1)</sup>	Displays the current baud rate on the PROFIBUS network in kbit/s.
51.04 MSG type	<b>1</b> = PPO1 <sup>1)</sup>	Displays the telegram type selected by the PLC configuration tool.
51.05 Profile	<b>0</b> = PROFIdrive	Selects the Control word according to the PROFIdrive profile (speed control mode).
51.07 RPBA mode	<b>0</b> = Disabled	Disables the RPBA emulation mode.
52.01 FBA data in1	<b>4</b> = SW 16bit <sup>1)</sup>	Status word
52.02 FBA data in2	<b>5</b> = Act1 16bit	Actual value 1
52.03 FBA data in3	<b>01.07</b> <sup>2)</sup>	Motor current
52.05 FBA data in5	<b>01.11</b> <sup>2)</sup>	DC voltage
53.01 FBA data out1	<b>1</b> = CW 16bit <sup>1)</sup>	Control word
53.02 FBA data out2	<b>2</b> = Ref1 16bit	Reference 1 (speed)

Drive parameter	Setting for ACS880 drives	Description
53.03 FBA data out3	23.12 <sup>2)</sup>	Acceleration time 1
53.05 FBA data out5	23.13 <sup>2)</sup>	Deceleration time 1
51.27 FBA A par refresh	<b>1</b> = Refresh	Validates the configuration parameter settings.
19.12 Ext1 control mode	<b>2</b> = Speed	Selects speed control as the control mode 1 for external control location EXT1.
20.1 Ext1 commands	<b>12</b> = Fieldbus A	Selects fieldbus adapter A as the source of the start and stop commands for external control location EXT1.
20.2 Ext1 start trigger type	<b>1</b> = Level	Selects a level-triggered start signal for external control location EXT1.
22.11 Speed ref1 source	<b>4</b> = FB A ref1	Selects fieldbus A reference 1 as the source for speed reference 1.

1) Read-only or automatically detected/set

2) Example

The start sequence for the parameter example above is given below.

Control word

- after power-on, fault or emergency stop:
  - 476h (1142 decimal) → NOT READY TO SWITCH ON
- in normal operation:
  - 477h (1143 decimal) → READY TO SWITCH ON (stopped)
  - 47Fh (1151 decimal) → OPERATING (running)





## Drive-to-drive link

---

The firmware supports the use of the drive-to drive (D2D) link through application programming (IEC 61131-3) only. In crane application this is used to create Master/Follower and Antisway communication, therefore any additional drive-to-drive (D2D) link modifications are locked and cannot be modified by the user.

---





# 13

## Control chain diagrams

---

### What this chapter contains

The chapter presents the reference chains of the drive. The control chain diagrams can be used to trace how parameters interact and where parameters have an effect within the drive parameter system.

For a more general diagram, see section [Operating modes of the drive](#) (page 148).

# Speed reference source selection I

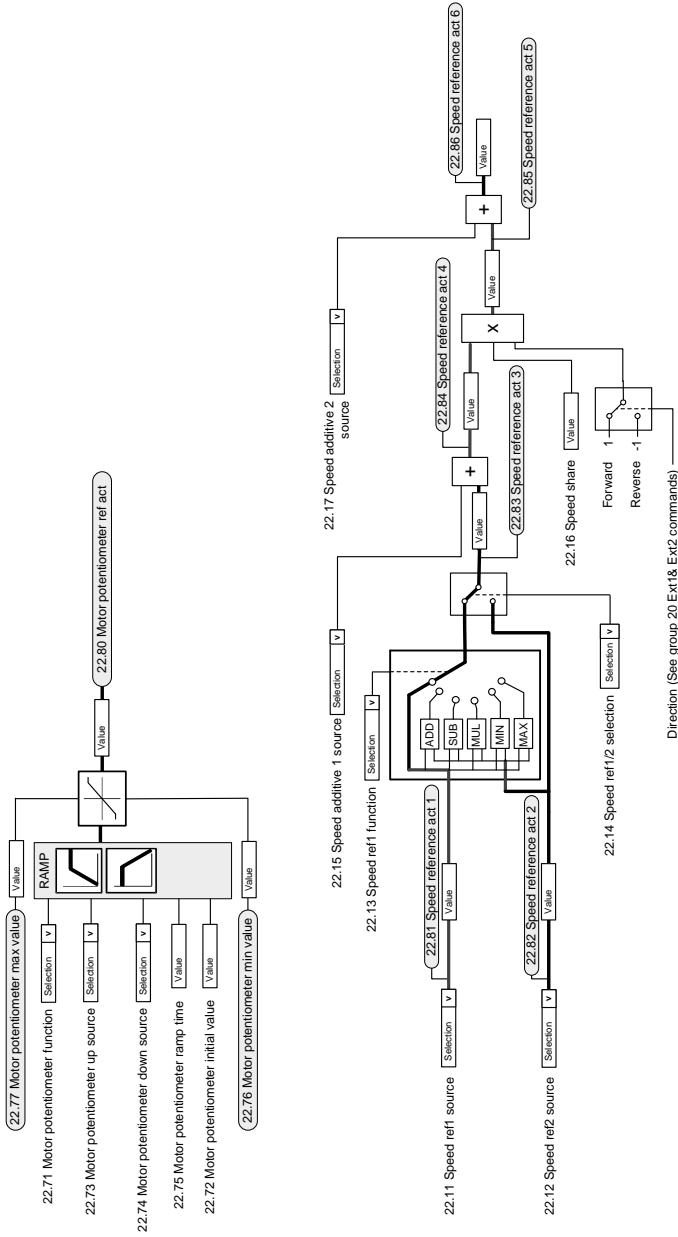

# Speed reference source selection II

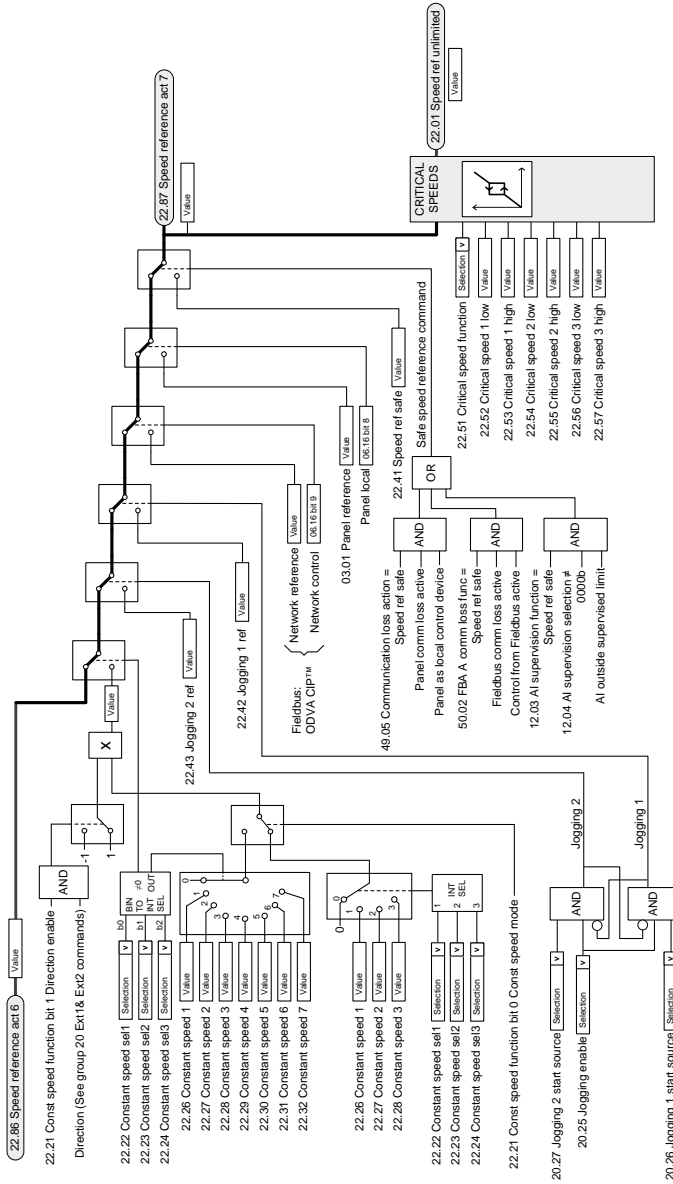

# Speed reference ramping and shaping

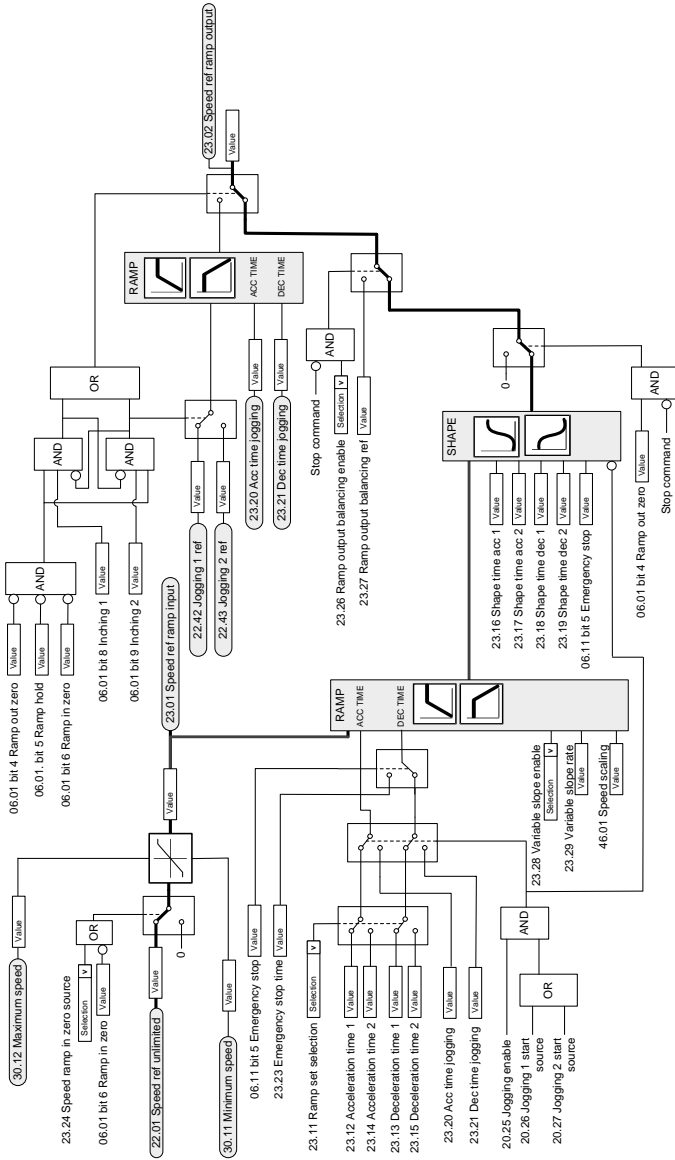

# Crane speed reference

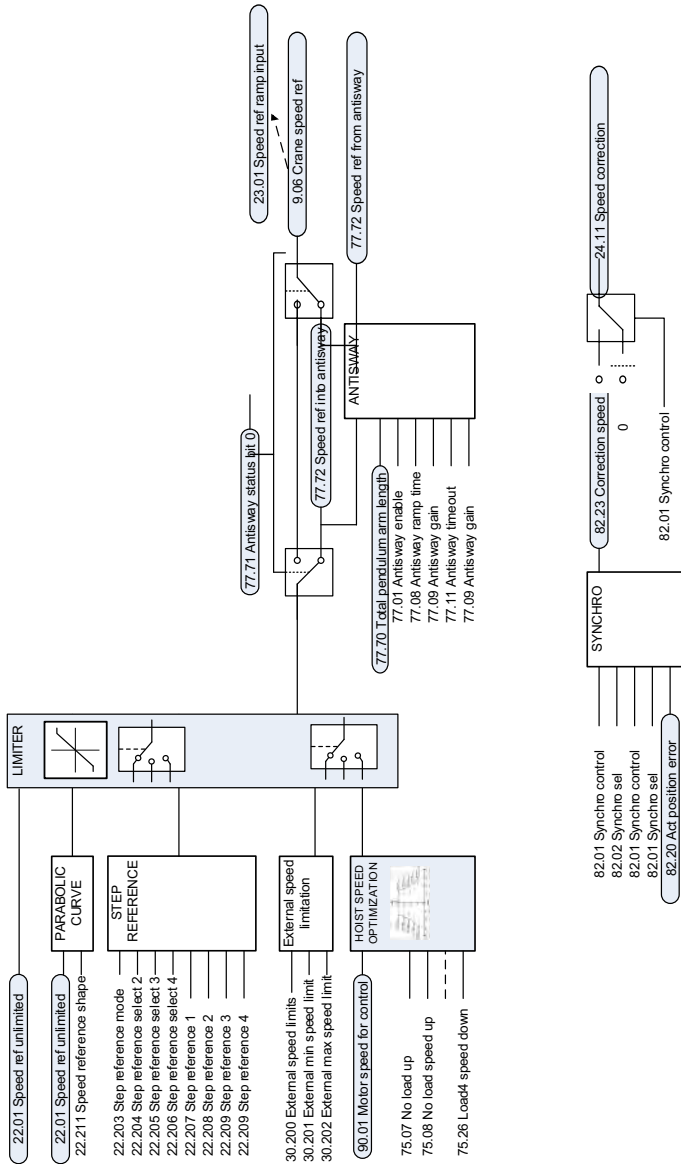

# Motor feedback configuration

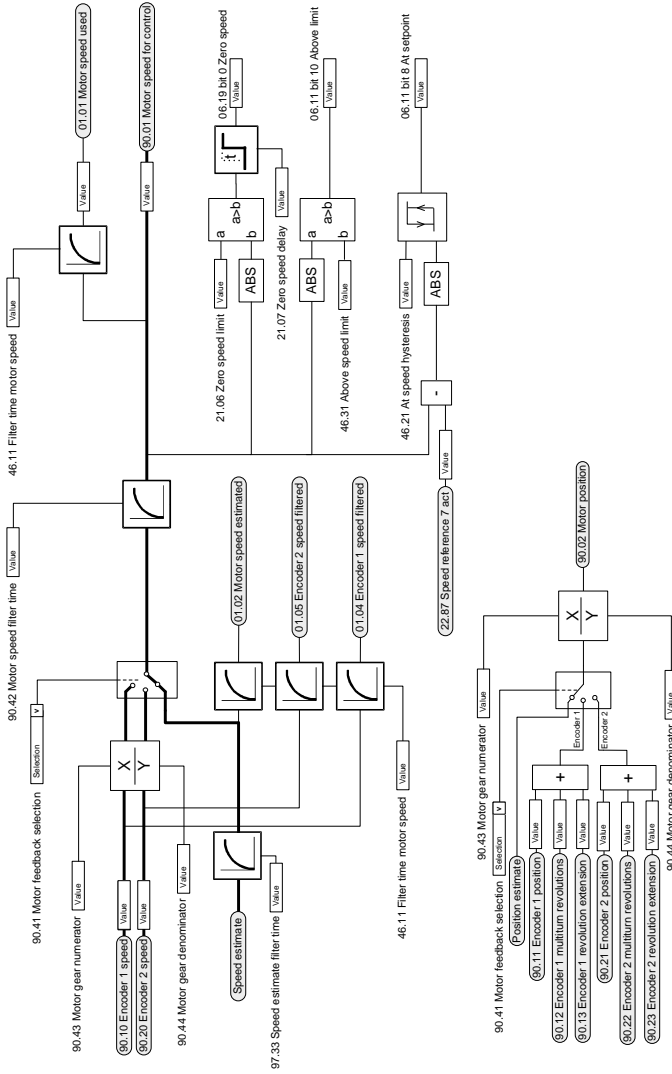

## Load feedback and position counter configuration

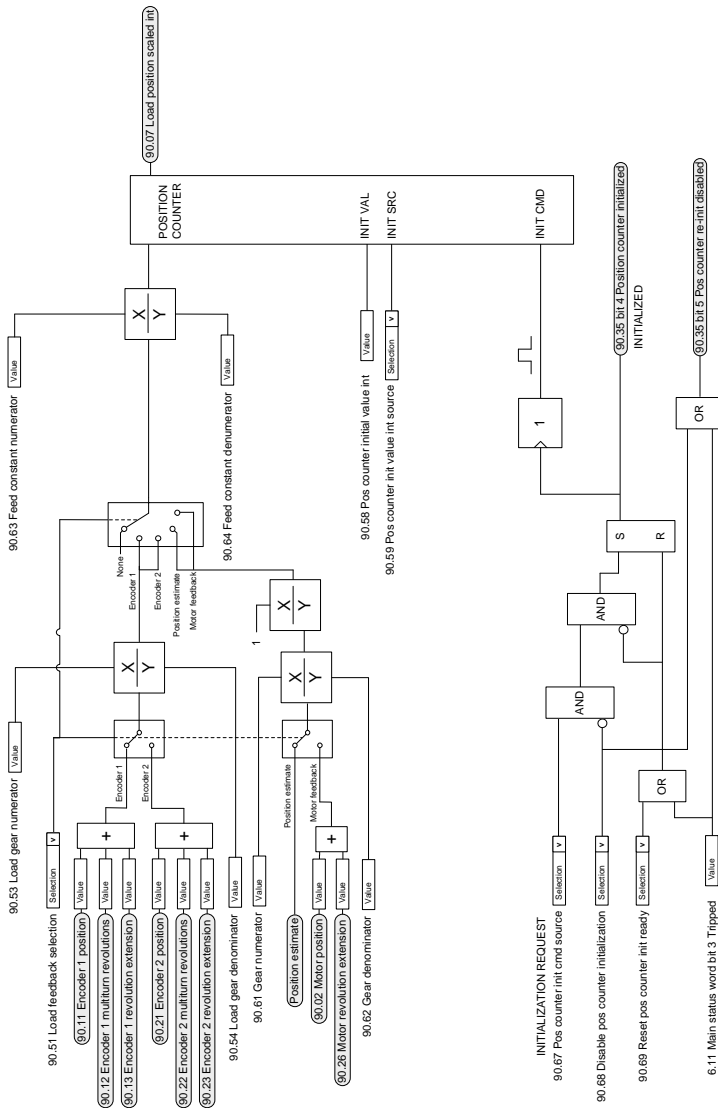





# Speed controller

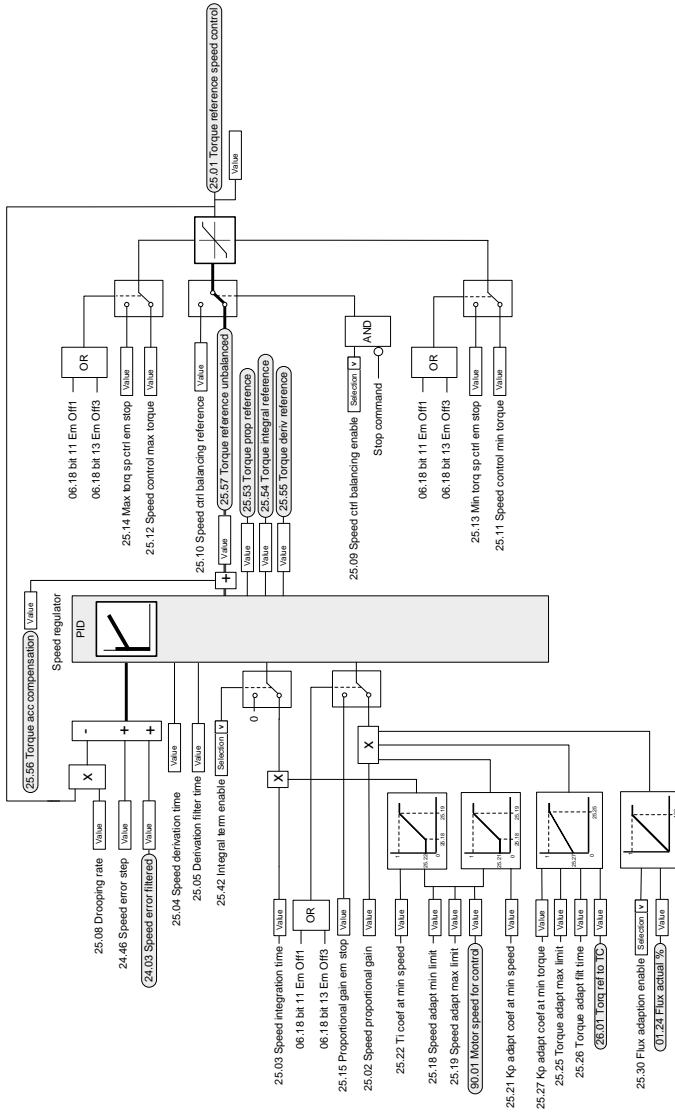

# Torque reference source selection and modification

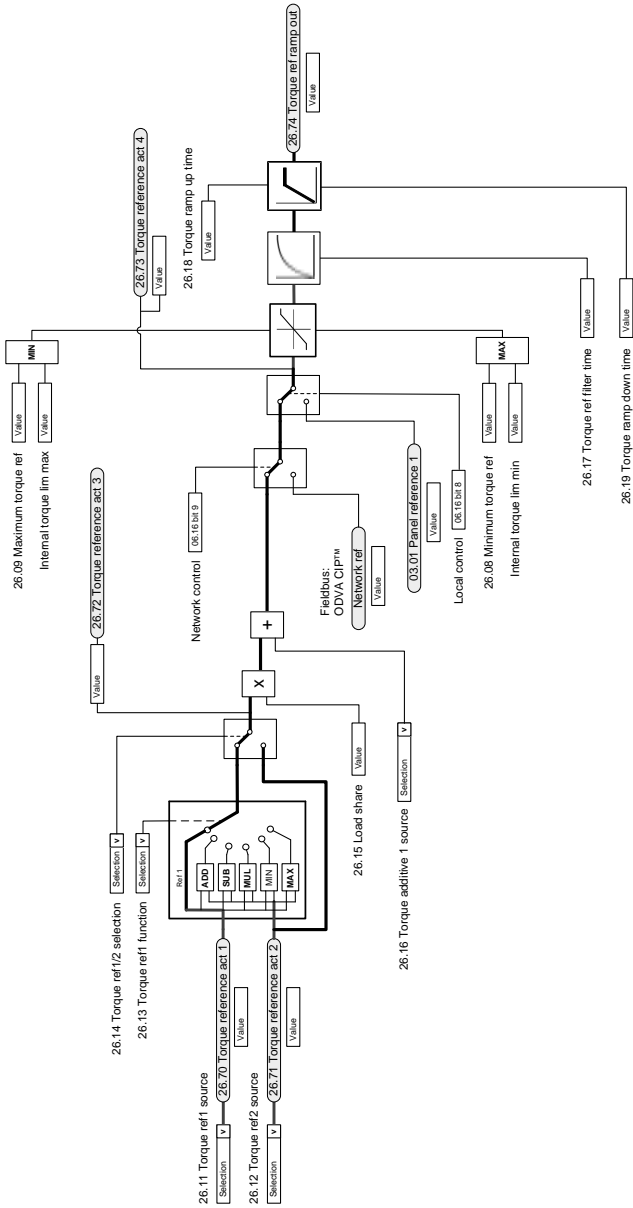

# Operating mode selection

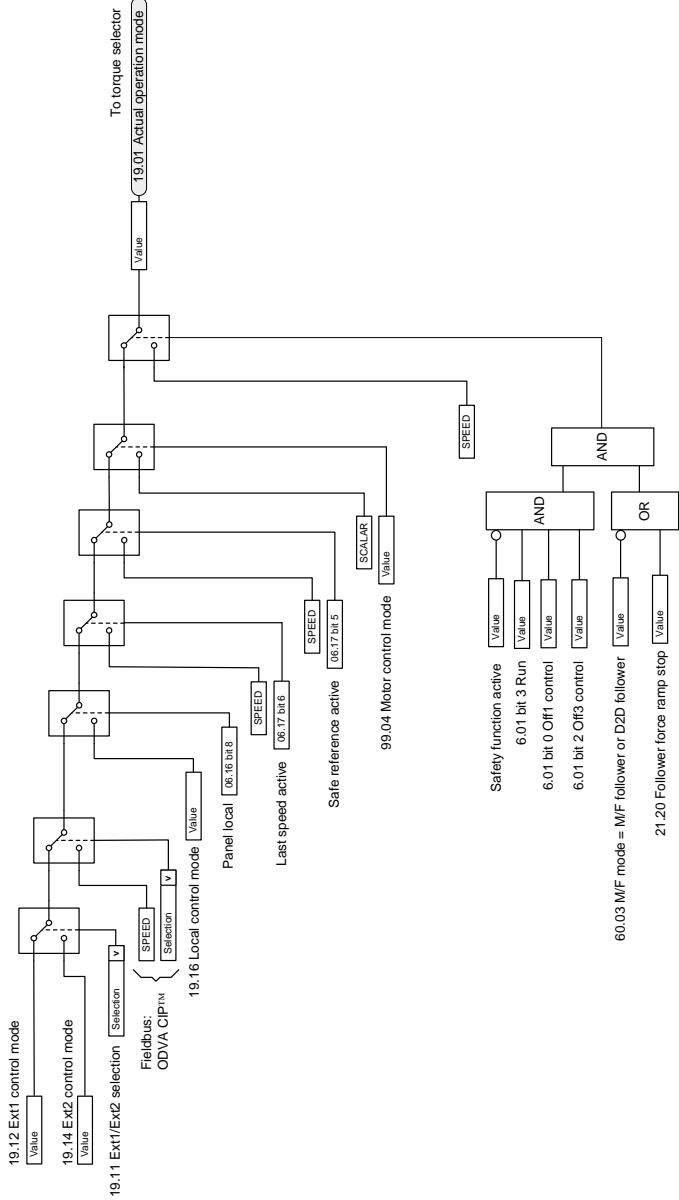

# Reference selection for torque controller

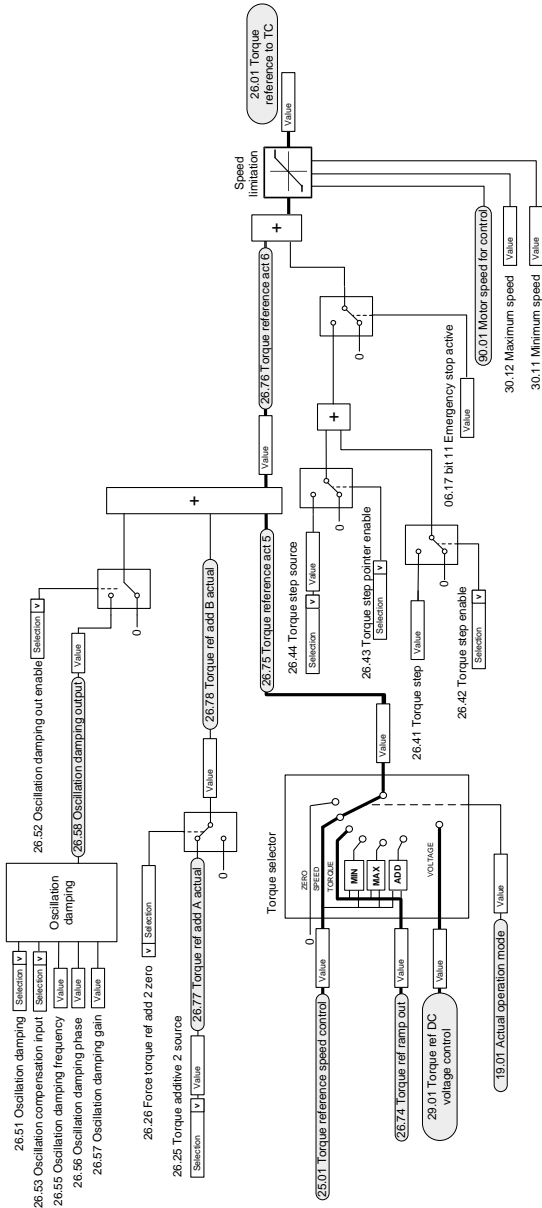

# Torque limitation

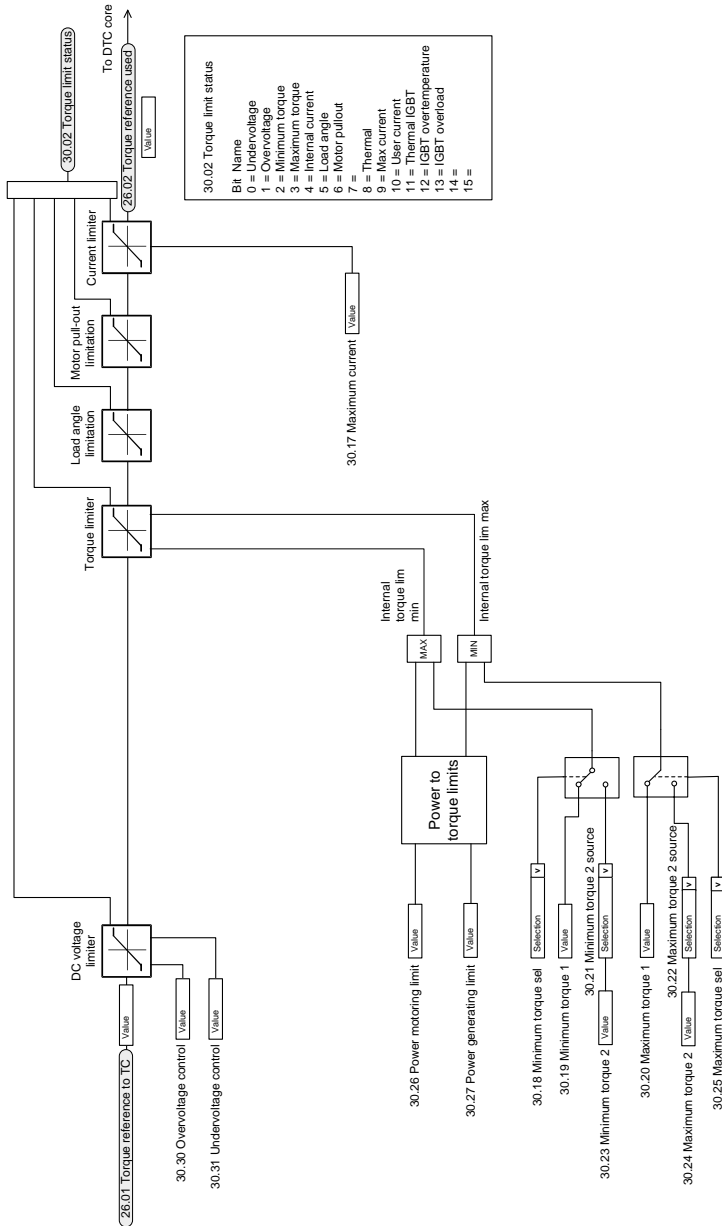

30.02 Torque limit status  
 Bit Name  
 0 = Undervoltage  
 1 = Overvoltage  
 2 = Minimum torque  
 3 = Maximum torque  
 4 = Internal current  
 5 = Load angle  
 6 = Motor pullout  
 7 = Thermal  
 8 = Max current  
 9 = User current  
 10 = Thermal IGBT  
 11 = Thermal IGBT  
 12 = IGBT overtemperature  
 13 = IGBT overload  
 14 =  
 15 =

# Torque controller

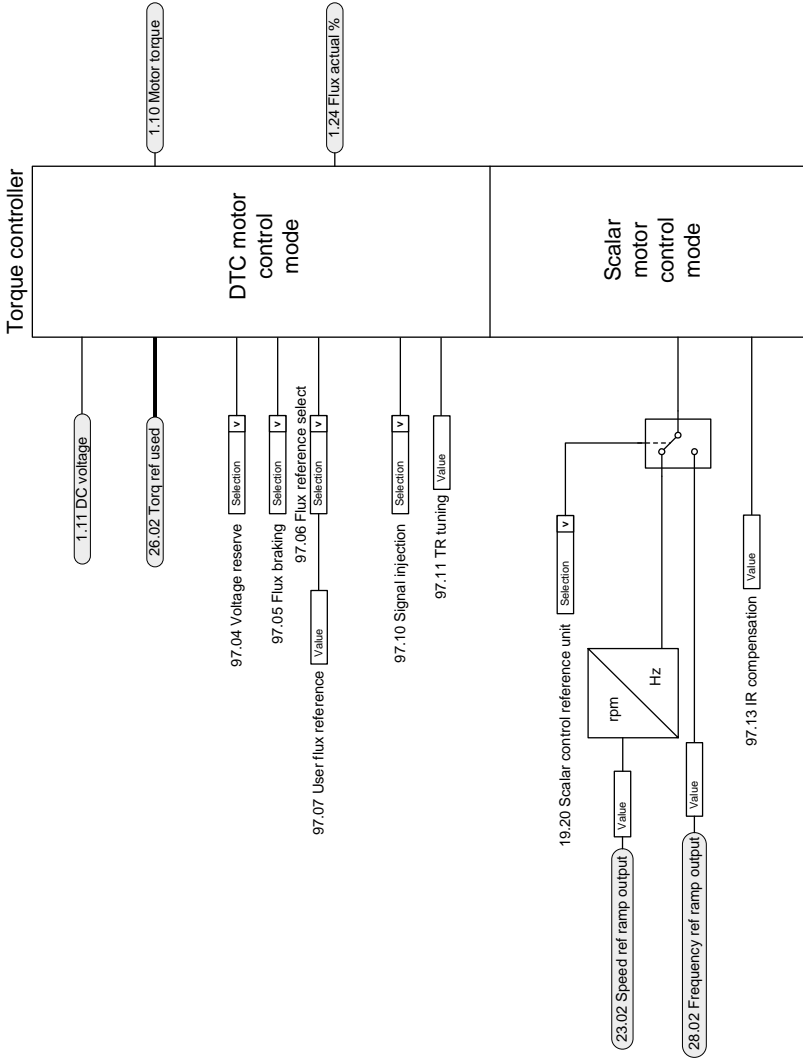

# Frequency reference selection

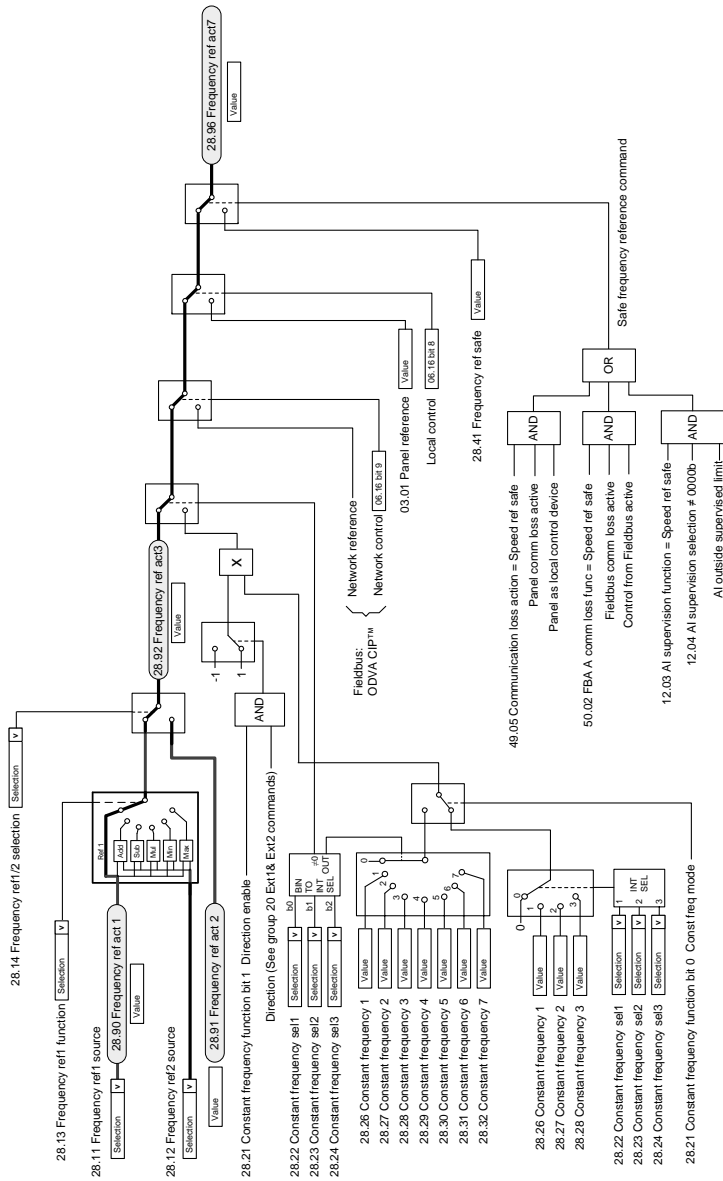





# Master/Follower communication I (Master)

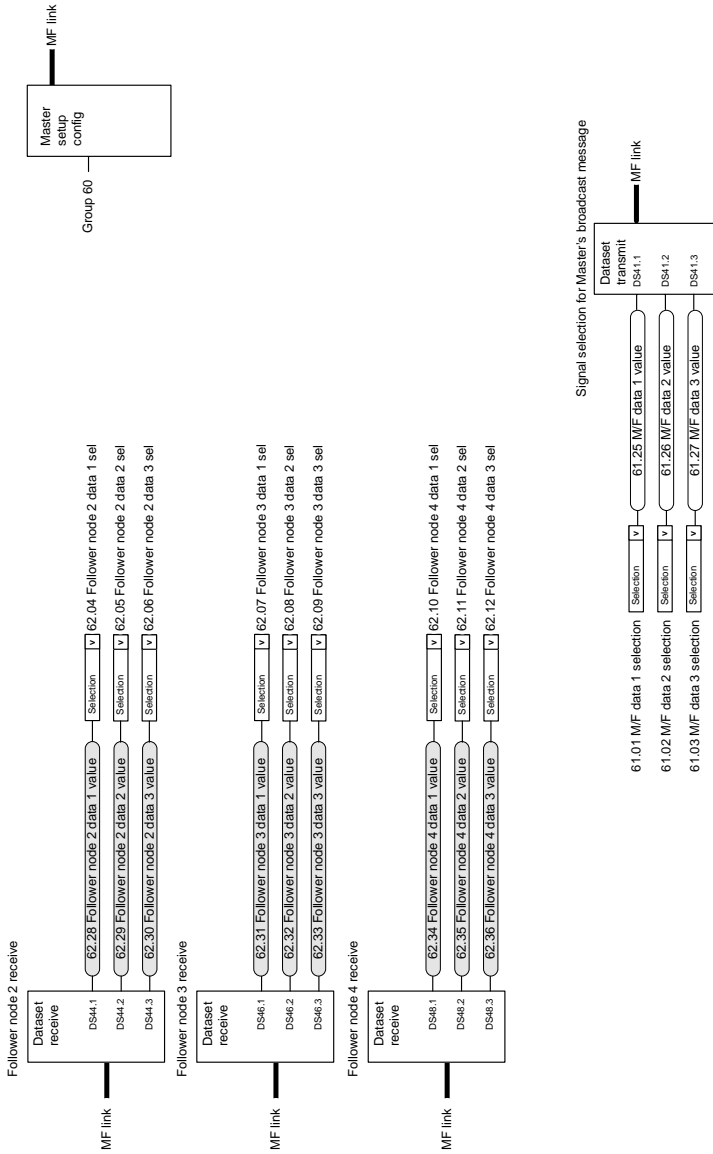

# Master/Follower communication II (Follower)

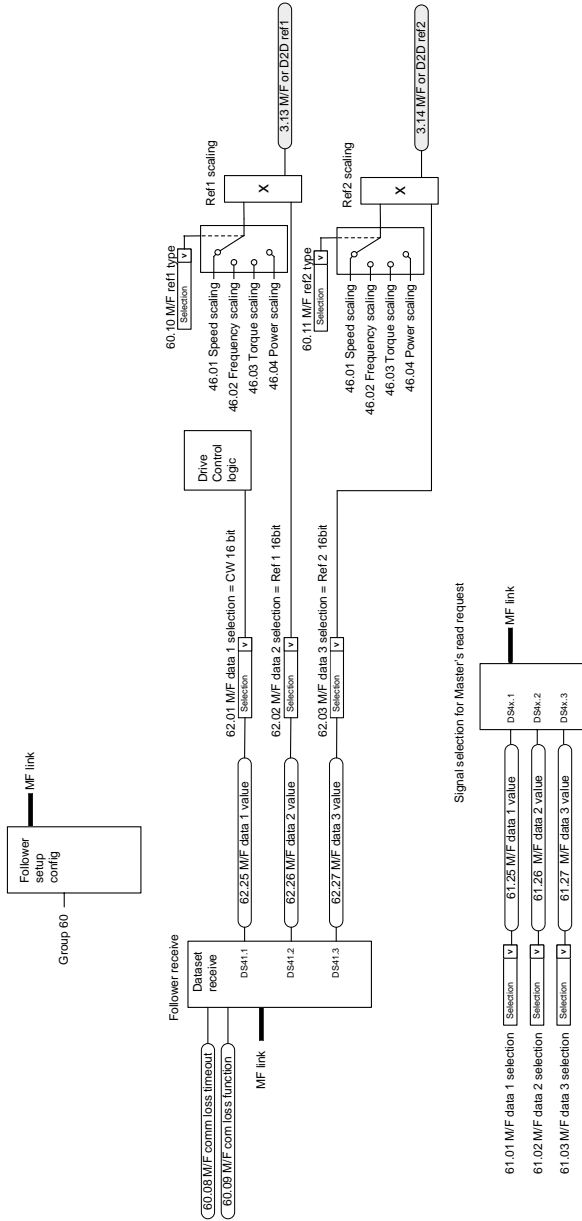



# Example circuit diagrams

---

**ACS880 crane control: Hoist**

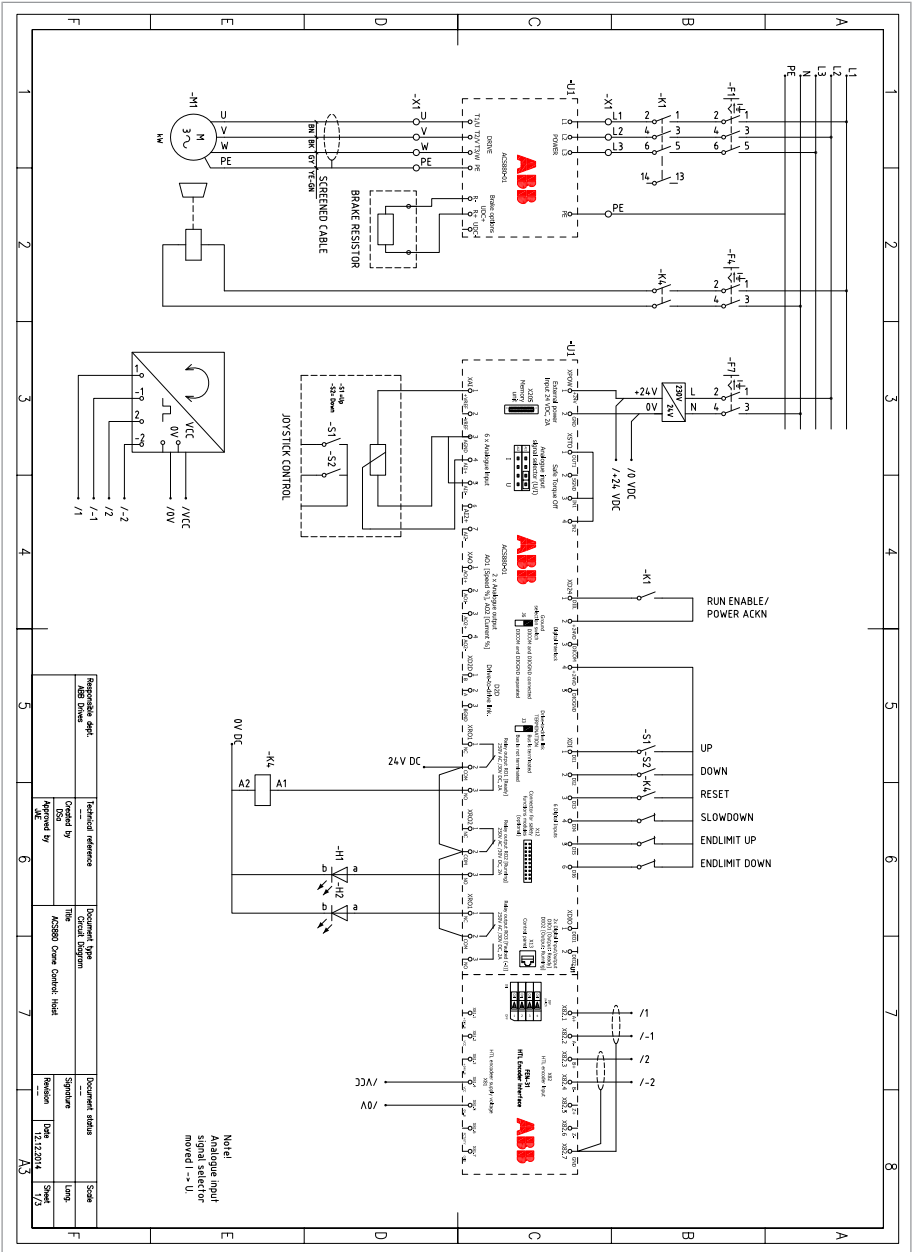

# ACS880 crane control: Trolley

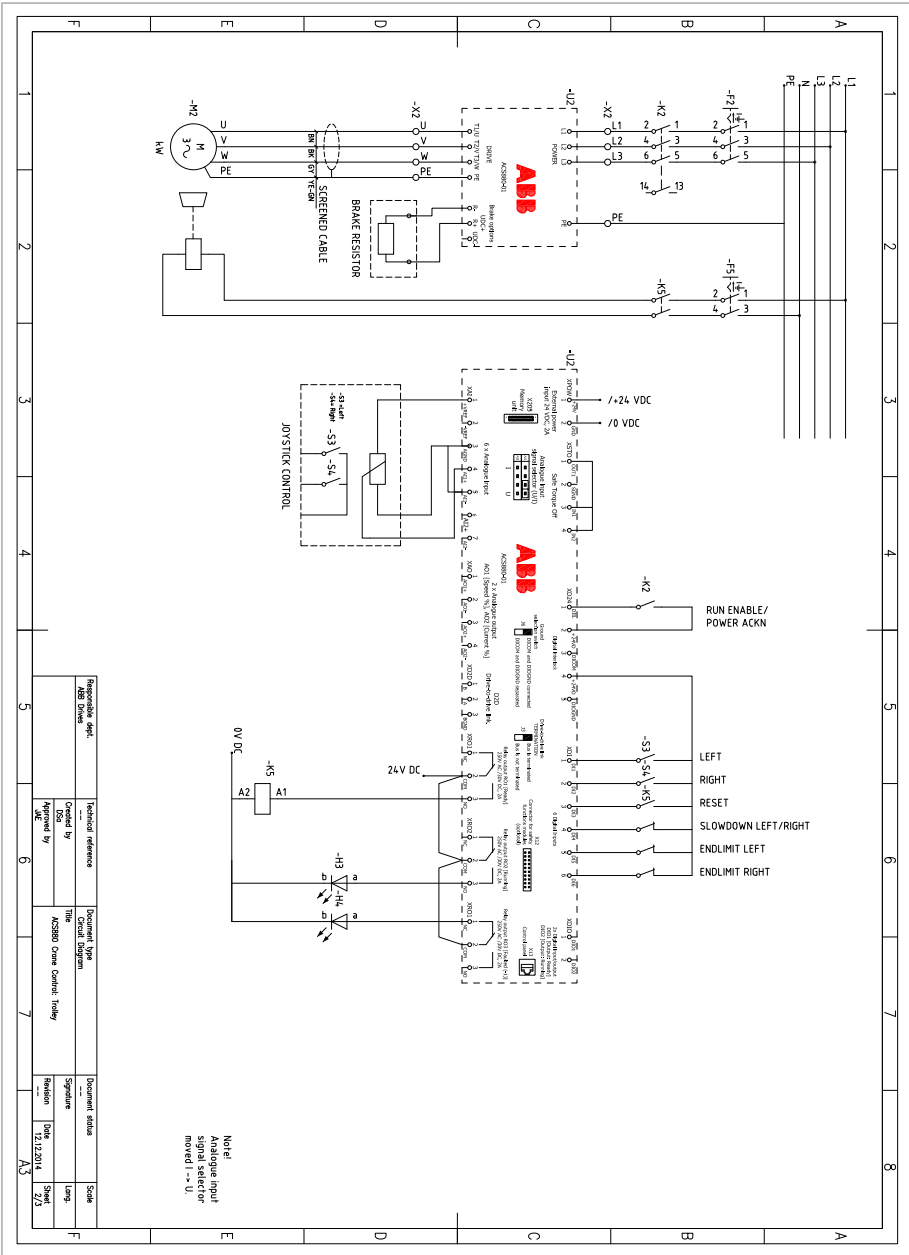

# ACS880 crane control: Long travel

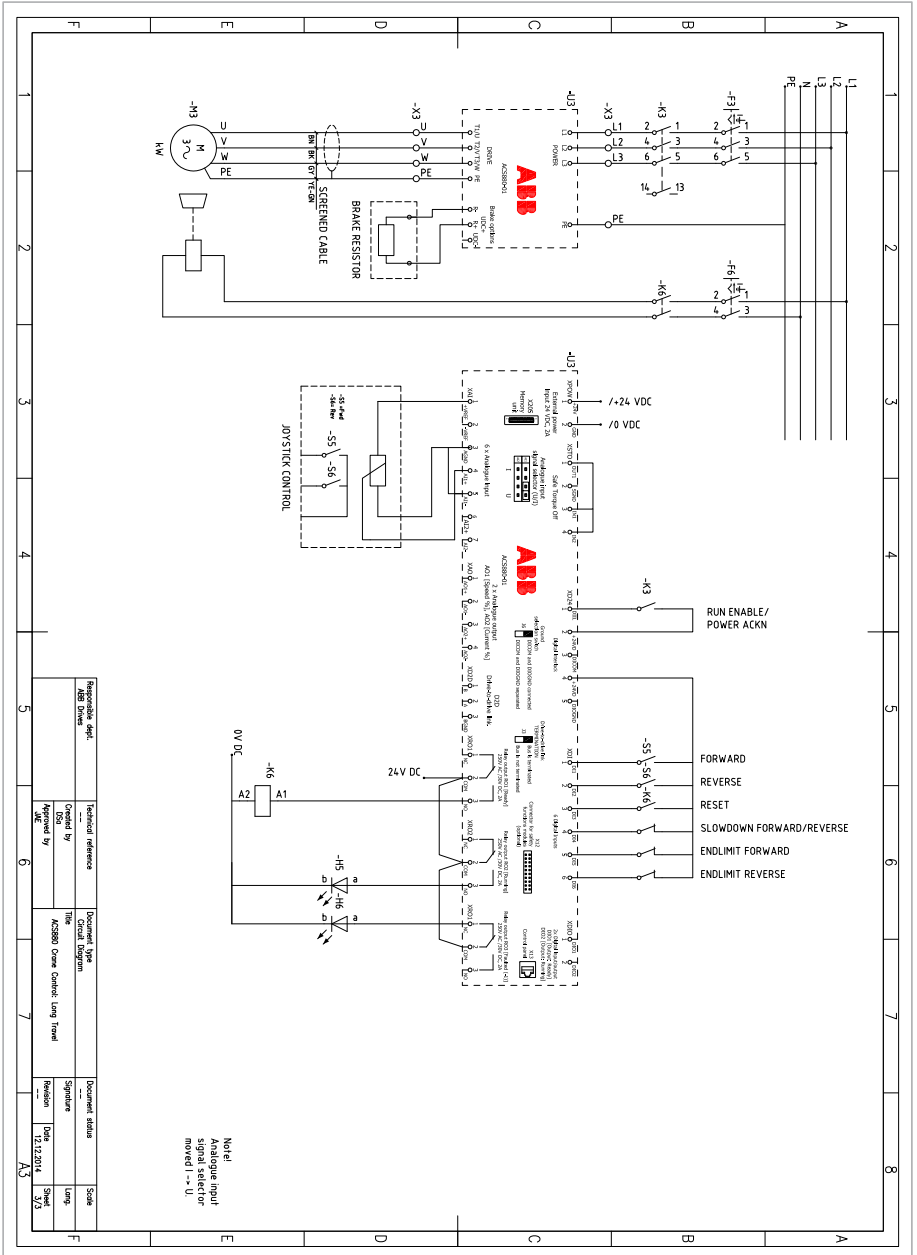





---

## Further information

### Product and service inquiries

Address any inquiries about the product to your local ABB representative, quoting the type designation and serial number of the unit in question. A listing of ABB sales, support and service contacts can be found by navigating to [www.abb.com/searchchannels](http://www.abb.com/searchchannels).

### Product training

For information on ABB product training, navigate to [new.abb.com/service/training](http://new.abb.com/service/training).

### Providing feedback on ABB manuals

Your comments on our manuals are welcome. Navigate to [new.abb.com/drives/manuals-feedback-form](http://new.abb.com/drives/manuals-feedback-form).

### Document library on the Internet

You can find manuals and other product documents in PDF format on the Internet at [www.abb.com/drives/documents](http://www.abb.com/drives/documents).



[www.abb.com/drives](http://www.abb.com/drives)



3AXD50000027678F