

Hardware Specifications

MONITOUCH S8



Preface

Thank you for selecting the S8 series.

For correct set-up of the S8 series, you are requested to read through this manual to understand more about the product.

The manuals shown below are related manuals for the S8 series. Refer to them as necessary.

Manual Name	Contents	Reference No.
S8 Series Reference Manual	The functions and instructions of the S8 series are explained.	1201NE
S8 Series Connection Manual	The connection and communication parameters for the S8 series and controllers are explained in detail.	2202NE
V Series Macro Reference	An overview of macros as well as macro editor operations and macro command descriptions are explained in detail.	1056NE
V8 Series Operation Manual	The information related to the operations of V-SFT version 5, such as software composition, editing procedure or limitations, is explained in detail.	1058NE

For further details about controllers (PLCs, temperature controllers, etc.), refer to the manual issued by each controller manufacturer.

Notes:

1. This manual may not, in whole or in part, be printed or reproduced without the prior written consent of Hakko Electronics Co., Ltd.
2. The information in this manual is subject to change without prior notice.
3. Windows and Excel are registered trademarks of Microsoft Corporation in the United States and other countries.
4. All other company names or product names are trademarks or registered trademarks of their respective holders.
5. If the specifications of the software do not correspond with the contents of this manual, the software specifications have priority.

Notes on Safe Usage of MONITOUCH

In this manual, you will find various notes categorized under the following levels with the signal words "DANGER," and "CAUTION."



DANGER

Indicates an imminently hazardous situation which, if not avoided, will result in death or serious injury.



CAUTION

Indicates a potentially hazardous situation which, if not avoided, may result in minor or moderate injury and could cause property damage.

Note that there is a possibility that the item listed with  **CAUTION** may have serious ramifications.



DANGER

- Never use the output signal of MONITOUCH for operations that may threaten human life or damage the system, such as signals used in case of emergency. Please design the system so that it can cope with the malfunctions of a touch switch. A malfunction of a touch switch will result in machine accident or damage.
- Turn off the power supply when you set up the unit, connect new cables or perform maintenance or inspections. Otherwise, electrical shock or damage may occur.
- Never touch any terminals while the power is on. Otherwise, electric shock may occur.
- You must put a cover on the terminals on the unit when you turn the power on and operate the unit. Otherwise, electric shock may occur.
- The liquid crystal in the LCD panel is a hazardous substance. If the LCD panel is damaged, do not ingest the leaked liquid crystal. If the liquid crystal spills on skin or clothing, use soap and wash off thoroughly.
- Never disassemble, recharge, deform by pressure, short-circuit, reverse the polarity of the lithium battery, nor dispose of the lithium battery in fire. Failure to follow these conditions will lead to explosion or ignition.
- Never use a lithium battery that is deformed, leaks, or shows any other signs of abnormality. Failure to follow these conditions will lead to explosion or ignition.

CAUTION

- Check the appearance of the unit when it is unpacked. Do not use the unit if any damage or deformation is found. Failure to do so may lead to fire, damage or malfunction.
- For use in a facility or for a system related to nuclear energy, aerospace, medical, traffic equipment, or mobile installations, please consult your local distributor.
- Operate (or store) MONITOUCH under the conditions indicated in this manual and related manuals. Failure to do so could cause fire, malfunction, physical damage or deterioration.
- Understand the following environmental limits for use and storage of MONITOUCH. Otherwise, fire or damage to the unit may result.
 - Avoid locations where there is a possibility that water, corrosive gas, flammable gas, solvents, grinding fluids or cutting oil can come into contact with the unit.
 - Avoid high temperature, high humidity, and outside weather conditions, such as wind, rain or direct sunlight.
 - Avoid locations where excessive dust, salt, and metallic particles are present.
 - Avoid installing the unit in a location where vibration or physical shock may be transmitted.
- Equipment must be correctly mounted so that the main terminal of MONITOUCH will not be touched inadvertently. Otherwise, an accident or electric shock may occur.
- Check periodically that terminal screws on the power supply terminal block and fixtures are firmly tightened. Loosened screws may result in fire or malfunction.
- Tighten terminal screws on the power supply terminal block equally to the specified torque. Improper tightening of screws may result in fire, malfunction, or other serious trouble.
- Tighten mounting screws on MONITOUCH equally to the specified torque. Excessive tightening may distort the panel surface. Loose tightening may cause MONITOUCH to come off, malfunction or be short-circuited.
- MONITOUCH has a glass screen. Do not drop or give physical shock to the unit. Otherwise, the screen may be damaged.
- Connect the cables correctly to the terminals of MONITOUCH in accordance with the specified voltage and wattage. Over-voltage, over-wattage, or incorrect cable connection could cause fire, malfunction or damage to the unit.
- Be sure to establish a ground of MONITOUCH. The FG terminal must be used exclusively for the unit with the level of grounding resistance less than 100Ω . Otherwise, electric shock or a fire may occur.
- Prevent any conductive particles from entering into MONITOUCH. Failure to do so may lead to fire, damage, or malfunction.
- Do not attempt to repair MONITOUCH at your site. Ask Hakko Electronics or the designated contractor for repair.
- Do not repair, disassemble or modify MONITOUCH. Hakko Electronics Co., Ltd. is not responsible for any damages resulting from repair, disassembly or modification of MONITOUCH that was performed by an unauthorized person.
- Do not use a sharp-pointed tool when pressing a touch switch. Doing so may damage the screen. Doing so may damage the screen.
- Only experts are authorized to set up the unit, connect the cables or perform maintenance and inspection.
- Lithium batteries contain combustible material such as lithium or organic solvent. Mishandling may cause heat, explosion or ignition resulting in fire or injury. Read related manuals carefully and handle the lithium battery correctly as instructed.
- Do not press two or more positions on the screen at the same time. If two or more positions are pressed at the same time, the switch located between the pressed positions will be activated.
- Take safety precautions during such operations as setting change during running, forced output, start, and stop. Any misoperation may cause unexpected machine motions, resulting in machine accident or damage.
- In facilities where a failure of MONITOUCH could lead to accident threatening human life or other serious damage, be sure that the facilities are equipped with adequate safeguards.
- At the time of disposal, MONITOUCH must be treated as industrial waste.
- Before touching MONITOUCH, discharge static electricity from your body by touching grounded metal. Excessive static electricity may cause malfunction or trouble.

[General Notes]

- Never bundle control cables nor input/output cables with high-voltage and large-current carrying cables such as power supply cables. Keep these cables at least 200 mm away from the high-voltage and large-current carrying cables. Otherwise, malfunction may occur due to noise.
- When using MONITOUCH in an environment where a source of high-frequency noise is present, it is recommended that the FG shielded cable (communication cable) be grounded at its ends. However, the cable may be grounded only at one end if this is necessary due to unstable communication conditions or for any other reason.
- Plug connectors or sockets of MONITOUCH in the correct orientation. Failure to do so may lead to damage or malfunction.
- Do not use thinners for cleaning because they may discolor MONITOUCH surface. Use alcohol or benzine commercially available.
- If a data receive error occurs when MONITOUCH and the counterpart (PLC, temperature controller, etc.) are started at the same time, read the manual for the counterpart unit and remove the error correctly.
- Avoid discharging static electricity on the mounting panel of MONITOUCH. Static charges can damage the unit and cause malfunctions. Otherwise, malfunction may occur due to noise.
- Avoid prolonged display of any fixed pattern. Due to the characteristics of the liquid crystal display, an afterimage may occur. If a prolonged display of a fixed pattern is expected, use the auto OFF function of the backlight.

[Notes on LCD]

Note that the following conditions may occur under normal circumstances.

- The response time, brightness and colors of MONITOUCH may be affected by the ambient temperature.
- Tiny spots (dark or luminescent) may appear on the display due to the liquid crystal characteristics.
- There are variations in brightness and colors on each unit.
- For S808, cold cathode tubes are incorporated into the LCD display for backlights. Optical properties (brightness, irregular colors, etc.) may change in a low-temperature environment or over time of operation.

Contents

Preface

Notes on Safe Usage of MONITOUCH

Chapter 1 Product Outline

1. Features.....	1-1
2. Models and Peripheral Equipment.....	1-2
MONITOUCH Models	1-2
Peripheral Equipment.....	1-3
3. System Composition.....	1-4

Chapter 2 Specifications

1. Specifications.....	2-1
General Specifications	2-1
Installation Specifications.....	2-3
Display Specifications	2-3
Touch Switch Specifications	2-3
Interface Specifications	2-4
Clock and Backup Memory Specifications (S808C / S806C / S806M20)	2-4
Drawing Environment.....	2-5
Display Function Specifications	2-5
Function Performance Specifications.....	2-6
2. Dimensions and Panel Cut-out	2-7
External Dimensions and Panel Cut-out Dimensions for S808.....	2-7
External Dimensions and Panel Cut-out Dimensions for S806.....	2-8
3. Names and Functions of Components.....	2-9
4. Serial Connector	2-11
COM1: RS-422/485 Communication Connector.....	2-11
COM2: RS-232C Communication Connector	2-12
5. USB Connector.....	2-13
USB-B (Slave Port)	2-13

Chapter 3 Installation

1. Mounting Procedure.....	3-1
Mounting Procedure.....	3-1
Mounting Angle	3-1
2. Power Supply Cable Connection	3-2
Power Supply Cable Connection	3-2
Grounding	3-2

Chapter 4 Instructions

1. Coin-type Lithium Battery (S808C/S806C/S806M20)	4-1
Battery Usage	4-1
Battery Voltage Drop Detection	4-1
Battery Replacement	4-1
Notes on Battery: EU Directive 2006/66/EC	4-5
2. DIP Switches (S808C/S806C/S806M20)	4-6
DIP Switch (DIPSW) Setting	4-6

Chapter 5 MONITOUCH Operations

1. Before Operation	5-1
Procedure before Operation	5-1
Transferring Screen Data to MONITOUCH for the First Time	5-2
2. Main Menu Screen	5-3
Displaying the Main Menu Screen	5-3
Main Menu Screen	5-4
[Main Menu] Switch	5-5
Main Menu Screen Composition	5-5
1. RUN	5-6
2. Language Selection	5-6
3. Communication Parameter	5-7
4. SRAM/Clock (S808C/S806C/S806M20)	5-8
4-1. Date and Time Adjustment	5-9
4-2. Formatting SRAM	5-9
5. Extension Program Information	5-10
6. Contrast Adjustment (S806 Series)	5-11
7. I/O Test	5-12
7-1. Self-loop Test	5-13
7-2. Print Test	5-16
7-3. Touch Switch Test	5-17
8. Extended Function Setting	5-19
8-1. Setting Local Port Number	5-20
3. System Menu	5-21
Types of the System Menu Switches	5-21
Functions of the System Menu Switches	5-21

Chapter 6 Error Handling

1. Error Messages	6-1
1. Communication Error	6-1
2. Data Loading	6-3
3. Warning	6-3
4. SYSTEM ERROR	6-4
5. Touch Switch Is Active	6-4

2.	Troubleshooting	6-5
	In the Event of an Error	6-5
	Probable Symptoms	6-5

Chapter 7 Inspection and Maintenance

1.	Inspection and Maintenance	7-1
	Daily Inspection	7-1
	Periodical Inspection	7-1
2.	Warranty Policy	7-2
	Inquiries about Failure	7-2
	Warranty Period	7-2
	Free-of-charge Repair	7-2
	Chargeable Repair	7-2
	Inquiry Form	7-3

1 Product Outline

1. Features
2. Models and Peripheral Equipment
3. System Composition

1. Features

The S8 series inherits and heightens the features of the V606e series as described below:

1. Low-cost standard model

The S8 series is a low-cost model adapted to provide the minimum necessary functions. This compact model with a simple interface is ideal for cost reduction.

This model is equipped with the analog-type touch panel, on which a display in 256 colors (without blinking) or 128 colors (with 16-color blinking)* is possible.

* 8 grayscales with the S806M

2. 2-way communication

The S8 series is equipped with two communication ports of RS-232C and RS-422/485, which enable communications with two types of devices at one time and exchange of data between these devices.

Connection example: serial two ports

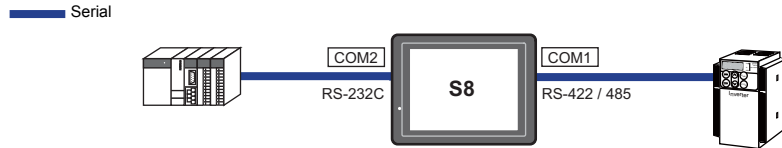

3. USB-B (USB-B slave port) provided as standard

The USB-B port can be used for transferring screen data or connecting a PictBridge-compatible printer.

High-speed data transfer and simple printing is possible using a USB cable.

4. Process for screen data creation is reduced with the use of "component parts".

A "component part" is a part which consists of multiple components having different functions or different macro programs.

Screen data with advanced functions can be created quickly and easily.

5. Built-in battery and 128-kbyte SRAM*

Both can be used for purposes, such as the built-in clock function, logging data backup, and nonvolatile memory \$L.

* Only for the S808CD, S806CD and S806M20D

2. Models and Peripheral Equipment

MONITOUCH Models

The model name consists of the following information.

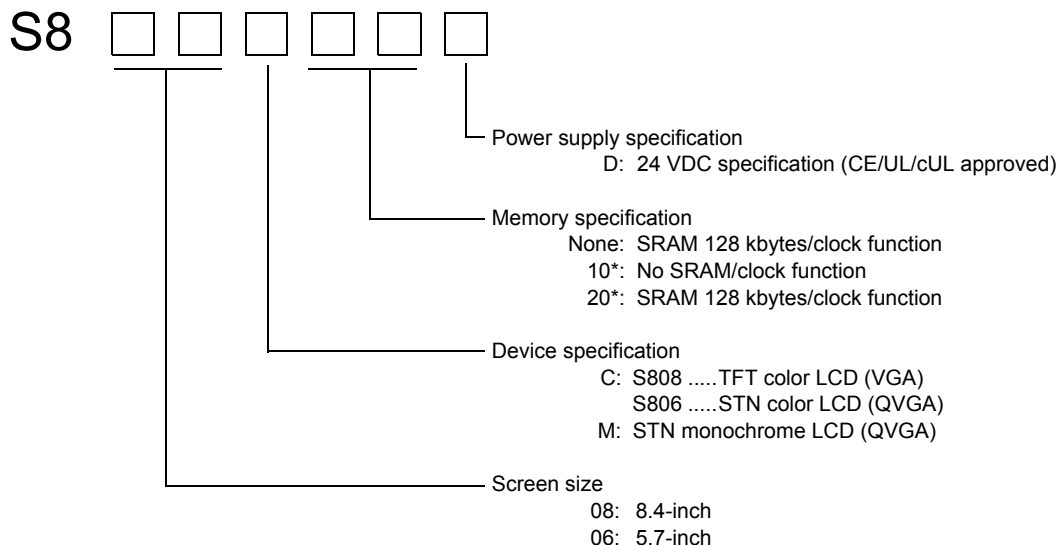

* S806M only

The following models are available.

Analog resistance film type

Series	Model	Specifications	Remarks
S808 8-inch	S808CD	TFT color, 640 × 480 dots, SRAM/clock function, DC power supply	CE/UL/cUL approved
S806 series 6-inch	S806CD	STN color, 320 × 240 dots, SRAM/clock function, DC power supply	
	S806M10D	STN monochrome, 320 × 240 dots, DC power supply	
	S806M20D	STN monochrome, 320 × 240 dots, SRAM/clock function, DC power supply	

Peripheral Equipment

The following devices are available as options for the S8 series.

Drawing Tool

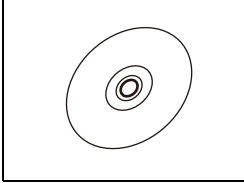

V-SFT-5 (configuration software: English version)
Application software for editing screen data for MONITOUCH.
(Windows 98SE/NT4.0/Me/2000/XP/XP 64 Edition/Vista 32-bit compatible)

Cable

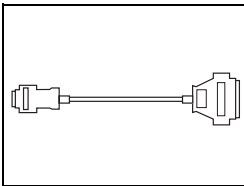

D9-D25 (D-sub 9-pin-to-25-pin conversion cable) 0.1 m
Conversion cable used for connecting the communication cable for the CN1 (D-sub 25-pin) in the V6/V7 series to the COM1 (D-sub 9-pin) in the S8 series.

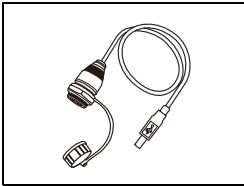

UB-FR (for USB-B port) 1 m
Cable used for USB-B (slave), which allows connection from the front of the control cabinet.

Protective Sheet

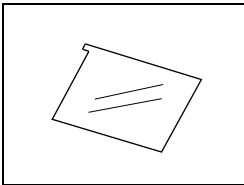

V8xx-GS
Used for protecting the operation panel surface (5 pcs./set).
V808-GS → S808C
V806-GS → S806 series

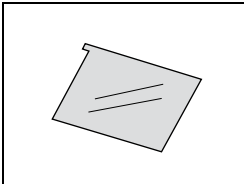

V8xx-GSN10
Used for protecting the operation panel surface (5 pcs./set, anti-glare treated).
The sheet is colored in light gray and has graininess on its surface to avoid light reflection.
V808-GSN10 → S808C
V806-GSN10 → S806 series

Other Options

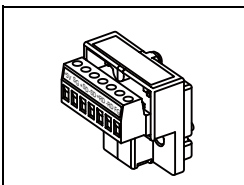

TC-D9 (terminal converter)
Used for connection between COM1 (D-sub 9-pin) of the S8 series and a controller at the RS-422/485 terminal block.

3. System Composition

The following illustration shows possible system configurations using the S8 series.

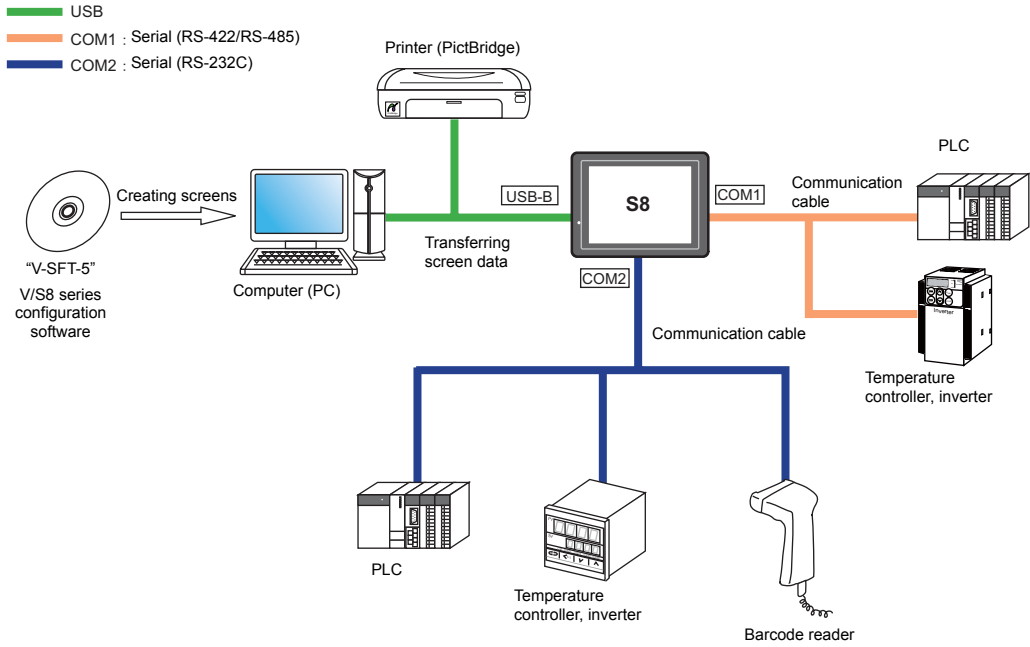

2 Specifications

1. Specifications
2. Dimensions and Panel Cut-out
3. Names and Functions of Components
4. Serial Connector
5. USB Connector

1. Specifications

General Specifications

Item		S808	S806	
			S806C	S806M
Standards	CE Marking	EN61000-6-2 EN61000-6-4		
	UL/cUL	UL60950-1	UL508	
Power Supply	Permissible Range of Voltage	24 VDC \pm 10% *1		
	Permissible Momentary Power Failure	For 24 VDC: Within 1 ms		
	Current Consumption	0.35 A or less	0.25 A or less	0.20 A or less
	Power Consumption (Maximum Rating)	9.0 W or less	6.5 W or less	4.5 W or less
	Rush Current	For 24 VDC: 18 A, 1 ms or less		For 24 VDC: 10 A, 1 ms or less
	Withstand Voltage	DC external terminals to FG: 500 VAC, 1 minute		
Insulation Resistance		500 VDC, 10 M Ω or above		
Physical Environment	Operational Ambient Temperature	0°C to +50°C *2		
	Storage Ambient Temperature	-10°C to +60°C *2		
	Operational Ambient Humidity	85% RH or less (without dew condensation) *2		
	Storage Ambient Temperature	85% RH or less (without dew condensation) *2		
	Altitude	2000 m or less		
	Atmosphere	No corrosive gas, no excessive dust, and no conductive dust		
	Contamination Level *3	Contamination level: 2		
Mechanical Working Conditions	Vibration Resistance	Vibration frequency: 10 to 150 Hz, acceleration: 9.8 m/s ² (1.0 G), half-amplitude: 0.075 mm, X, Y, Z: 3 directions for one hour		
	Shock Resistance	Pulse shape: sine half wave, peak acceleration: 147 m/s ² (15 G), X, Y, Z: 3 directions six times each		
Electrical Working Conditions	Noise Resistance	Noise voltage: 1000 Vp-p, pulse width: 1 μ s, rising time: 1 ns (Measured by using a noise simulator)		
	Static Electricity Discharge Resistance	Compliant with IEC61000-4-2, contact: 6 kV, air: 8 kV		
Mounting Conditions	Weight	Approx. 1.1 kg	Approx. 0.6 kg	
	Dimensions W \times H \times D	233.0 \times 178.0 \times 59.8 mm	182.5 \times 138.8 \times 44.8 mm	
	Panel Cut-out Dimensions	220.5 ^{+0.5} _{-0.5} \times 165.5 ^{+0.5} _{-0.5} mm	174.0 ^{+0.5} _{-0.5} \times 131.0 ^{+0.5} _{-0.5} mm	
Case Color		Black		
Material		PC / PS		

*1 Use the Class 2 power supply for the 24-VDC power unit.

*2 Use MONITOUCH in the environment whose wet-bulb temperature is 39°C or less. Otherwise, MONITOUCH may be damaged.

*3 This is an index that expresses the degree of conductive contamination in the environment where MONITOUCH is used.

"Contamination level 2" indicates the condition where only non-conductive contamination occurs. However, due to condensation, temporary conductive contamination may occur.

UL/cUL Approval

The S8 series is the UL/cUL-approved product.

For S808:

S808 conforms to the following two standards. (File No.: E185413 (UL60950-1))

- UL60950-1 Information Technology Equipment - Safety - Part 1: General Requirements
- CSA-C22.2 No. 60950-1 Information Technology Equipment - Safety - Part 1: General Requirements

For S806:

S806 conforms to the following two standards. (File No.: E313548 (UL508))

- UL508 Industrial Control Equipment
- CSA-C22.2 No. 142-M1987 Process Control Equipment

UL Listing Application for a System Equipped with the S8 Series

- The back panel of the S8 series is not approved as an enclosure. For UL listing application, build the S8 series in the system, and configure an enclosure so that the entire system will be UL-approved.
- Use the S8 series indoors only.
- Mount it on a flat surface so that it will comply with the enclosure type 1.
- Use a bare cable for wiring the power supply.

Terminal Screw		Power Cable
Screw Size	Tightening Torque	
M3.5	0.8 N•m	AWG14 - 16

- Use the Class 2 power supply for the 24-VDC power unit.

CE Marking

- The S8 series complies with following EMC Directives: EN61000-6-2, EN61000-6-4
- The S8 series is identified as a class-A product in industrial environments. In the case of use in a domestic environment, the S8 series is likely to cause electromagnetic interference. Preventive measures should thereby be taken as appropriate.

Installation Specifications

Item		Specifications
Grounding		Less than 100 Ω , FG/SG separated
Protection Structure	Front Panel *1	Compliant with IP65 (when using waterproof gasket) *2
	Rear Case	Compliant with IP20
Cooling System		Cooling naturally
Structure		Inserted in a mounting panel
Appropriate Mounting Panel Thickness		1.5 to 5 mm

*1 Protection structure for the front when the S8 series is mounted on the mounting panel

*2 You are recommended to use the mounting panel whose thickness (steel, stainless) is 3.0 mm or more to keep the unit compliant with IP65. The strength differs depending on the material of the mounting panel. Check the environment where the S8 series is used.

Display Specifications

Item	S808C	S806C	S806M
Display Device	TFT color	STN color	STN monochrome
Display Size	8.4-inch	5.7-inch	
Colors	256 colors (without blinking) 128 colors (16-color blinking)		8 grayscales (with blinking)
Display Resolution (W × H)	640 × 480 dots	320 × 240 dots	
Dot Pitch (W × H)	0.267 × 0.267 mm	0.12 × 0.36 mm	0.36 × 0.36 mm
Backlight	Cold cathode tube	LED	
Backlight Life (average life of backlight only)	Approx. 50,000 hours (at the normal temperature 25°C)	Approx. 40,000 hours (at the normal temperature 25°C)	Approx. 50,000 hours (at the normal temperature 25°C)
Backlight Auto OFF Function	Always ON, random setting		
Brightness Adjustment	Not provided		
Contrast Adjustment	Not provided	Contrast adjustment screen: 155 levels Macro: 155 levels	
Surface Sheet Material	PET, 188 μ m		
POWER Lamp	ON when the power is supplied		

Touch Switch Specifications

Item	Specifications
Method	Analog resistance film type
Number of Switches	1024 × 1024
Mechanical Life	One million activations or more
Surface Treatment	Hard-coated, anti-glare treatment 5%

Interface Specifications

Item		Specifications	
D-sub 9-pin (COM1/2)	COM1	Applicable Standards	RS-422/485
		Synchronization	Asynchronous type
		Data Length	7- or 8-bit
		Parity	None, odd, even
		Stop Bit	1- or 2-bit
		Baud Rate	4800, 9600, 19200, 38400, 57600, 76800, 115 kbps (187500 bps for MPI connection *)
		Applications	PLC, temperature controller, etc.
	COM2	Applicable Standards	RS-232C
		Synchronization	Asynchronous type
		Data Length	7- or 8-bit
		Parity	None, odd, even
		Stop Bit	1- or 2-bit
		Baud Rate	4800, 9600, 19200, 38400, 57600, 76800, 115 kbps
		Applications	PLC, temperature controller, barcode reader, etc.
USB Connector (USB-B)	USB-B	Applicable Standards	Compliant with USB version 1.1
		Baud Rate	Low speed: 1.5 Mbps, full speed: 12 Mbps
		Applications	Screen data transfer, PictBridge-compatible printer

* Only for the S808C, S806C and S806M20. For more information, refer to the S8 Series Connection Manual.

Clock and Backup Memory Specifications (S808C / S806C / S806M20)

Item	Specifications
Battery Specification	Coin-type lithium primary cell
Backup Memory	SRAM 128 kbytes
Backup Period	5 years from the date of manufacturing (ambient temperature at 25°C)
Battery Voltage Drop Detection	Provided (internal memory of 167 allocated)
Calendar Accuracy	Monthly deviation ± 90 sec (ambient temperature at 25°C)*

* Time loss is approximately 90 seconds a month in an ambient temperature of 25°C in the non-energized state (backup with battery). Depending on the ambient temperature, the calendar may lose 356 seconds or advance 189 seconds in a month at the maximum. Correct the clock periodically.

Drawing Environment

Item	Specifications
Drawing Method	Exclusive configuration software
Drawing Tool	Name of exclusive configuration software: V-SFT-5 Personal computer: Pentium III 800 MHz or above (Pentium IV 2.0 GHz or above recommended) OS: Windows 98SE/NT4.0/Me/2000/XP/XP 64 Edition/ Vista 32-bit compatible) Memory: 512 Mbytes or more Capacity of hard disk required: Free space of approx. 850 Mbytes or more Display: Resolution 1024 × 800 or above Screen color: 16 bits or more

Display Function Specifications

Item		Specifications				
Interface Language *1		Japanese	English/Western Europe	Chinese (Traditional)	Chinese (Simplified)	Korean
Characters	1/4-size, 1-byte	ANK code	Latin 1	ASCII code	ASCII code	ASCII code
	2-byte 16-dot	JIS #1, 2 levels	–	Chinese (traditional)	Chinese (simplified)	Hangul (without Kanji)
	2-byte 32-dot	JIS #1 level	–	–	–	–
Font		Bitmap font Windows font				
Character Size	1/4-size	8 × 8 dots				
	1-byte	8 × 16 dots				
	2-byte	16 × 16 dots or 32 × 32 dots				
	Enlargement Factor	X: 1 to 8 times, Y: 1 to 8 times Point *2: 8, 9, 10, 11, 12, 14, 16, 18, 20, 22, 24, 26, 28, 36, 48, 72				
Number of Displayable Characters	Display Resolution	640 × 480			320 × 240	
	1/4-size	80 characters × 60 lines			40 characters × 30 lines	
	1-byte	80 characters × 30 lines			40 characters × 15 lines	
	2-byte	40 characters × 30 lines			20 characters × 15 lines	
Character Properties	Display Properties	Normal, reverse, blink, bold, shadow, transparent				
	Colors	S808C, S806C: 256 colors (without blinking), 128 colors (with 16-color blinking) S806M: 8 grayscales (with blinking)				
Graphics	Lines	Line, continuous line, box, parallelogram, polygon				
	Circles	Circle, arc, sector, ellipse, elliptical arc				
	Others	Tile patterns				
Graphic Properties	Line Types	6 types (thin, thick, dot, chain, broken, two-dot chain)				
	Tile Patterns	16 types (including user-definable 8 patterns)				
	Display Properties	Normal, reverse, blink				
	Colors	S808C, S806C: 256 colors (without blinking), 128 colors (with 16-color blinking) S806M: 8 grayscales (with blinking)				
	Color Selection	Foreground, background, boundary (line)				

*1 In addition, the following fonts are available.
 Gothic, English/Western Europe HK Gothic, English/Western Europe HK Times, Central Europe, Cyrillic, Greek, Turkish

For more information, refer to the S8 Series Reference Manual.

*2 Applicable when Gothic font or Windows font is used.

Function Performance Specifications

Item		Specifications	
		S808	S806
Screens		Max. 4000	
Screen Memory		Flash memory: Approx. 2.25 Mbytes (not including fonts)	
Switch		1024 per screen	192 per screen
Switch Actions		Set, reset, momentary, alternate, to light	
Lamp		Reverse, blink, exchange of graphics 1024 per screen	Reverse, blink, exchange of graphics 192 per screen
Graph		Pie, bar, panel meter and closed area graph: No limitation ^{*1} Statistics and trend graphs: Max. 256 per layer ^{*2}	
Data Setting	Numerical Data Display	No limitation ^{*1}	
	Character Display	No limitation ^{*1}	
	Message Display	Display resolution: 640 × 480: Max. 80 characters 320 × 240: Max. 40 characters No limitation ^{*1}	
Sampling		Sampling display of buffer data (Constant sampling, bit synchronization, alarm logging, time order alarming, alarm function)	
Graphic Library		Max. 2560	
Overlap Library		Max. 1024	
Data Blocks		Max. 1024	
Messages		Max. 32768 lines	
Patterns		Max. 1024	
Macro Blocks		Max. 1024	
Page Blocks		Max. 1024	
Direct Blocks		Max. 1024	
Screen Blocks		Max. 1024	
Data Sheets		Max. 1024	
Screen Library		Max. 1024	
Comments		Max. 32767	
Device Memory Map		Max. 32 × 2 (PLC1, 2)	
Time Display		Provided	
Hard Copy		Provided	
Buzzer		Provided, 2 sounds (short beep, long beep)	
Auto OFF Function		Always ON, random setting	
Self-diagnostic Function		Switch self-test function Communication parameter setting check function Communication check function	

*1 The number of setting memory locations varies depending on the model. It is limited to 1024 per screen for the S808, and 256 per screen for the S806.

*2 Layer: 4 per screen (base + 3 overlap displays)

2. Dimensions and Panel Cut-out

External Dimensions and Panel Cut-out Dimensions for S808

- Front View

(Unit: mm)

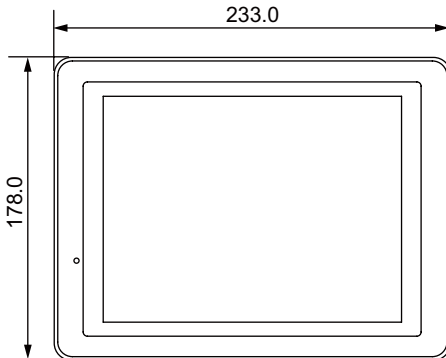

- Rear View

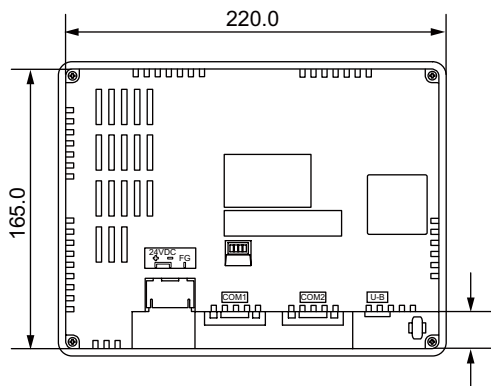

- Side View

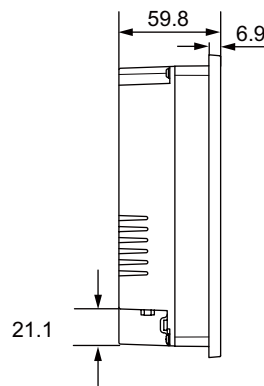

- Bottom View

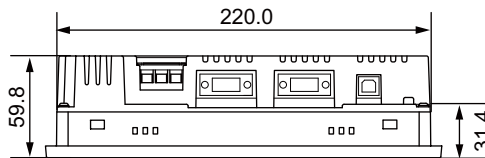

- Panel Cut-out Dimensions

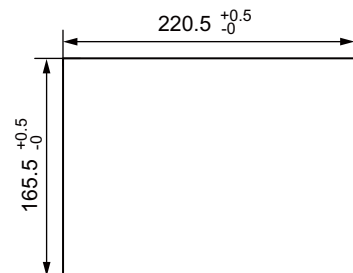

External Dimensions and Panel Cut-out Dimensions for S806

- Front View

(Unit: mm)

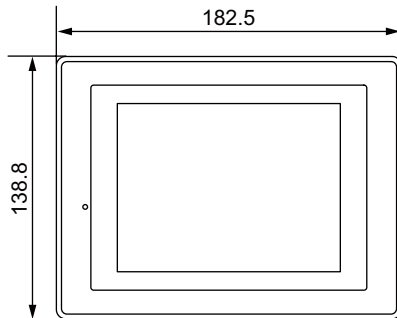

- Rear View

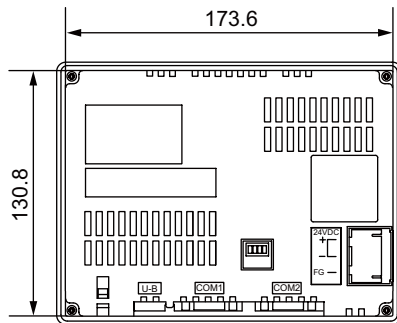

- Side View

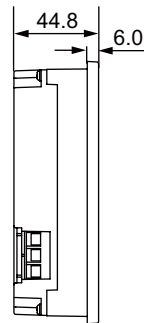

- Bottom View

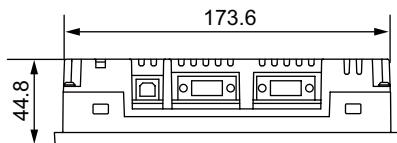

- Panel Cut-out Dimensions

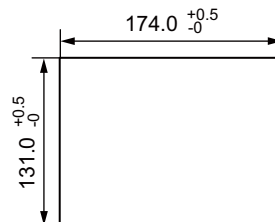

3. Names and Functions of Components

S808

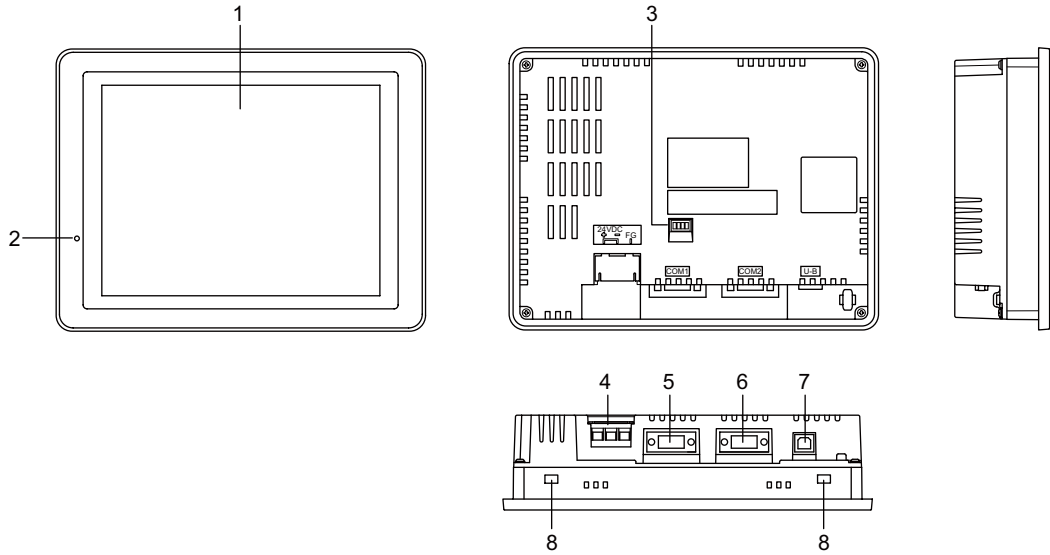

S806

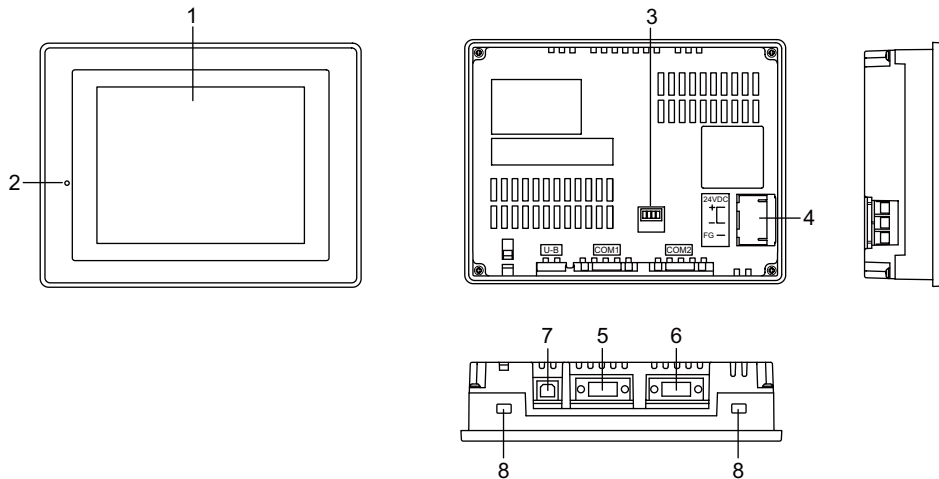

1. Display
This is the display unit.
2. Power lamp (POWER)
Illuminates in green when the power is supplied to the S8 series.
3. DIP switch S808C/S806C/S806M20
Used for setting the terminating resistance of the RS-422/485 signal line of COM1.
4. Power supply terminal block
Supplies the power (24 VDC) to the S8 series.

5. RS-422/RS-485 communication connector (COM1)
Used for connecting a controller (PLC, temperature controller, inverter, etc.) via RS-422/RS-485.
6. RS-232C communication connector (COM2)
Used for connecting a controller (PLC, temperature controller, inverter, etc.) or a barcode reader via RS-232C.
7. USB-B (slave port)
Used for transferring screen data or connecting a PictBridge-compatible printer.
8. Mounting holes
Used for inserting fixtures when securing the S8 series to the mounting panel.

4. Serial Connector

COM1: RS-422/485 Communication Connector

This connector is used for communication with a controller via RS-422/RS-485.

- S808

Bottom View

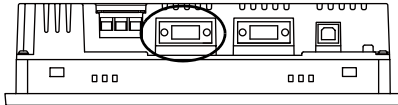

- S806

Bottom View

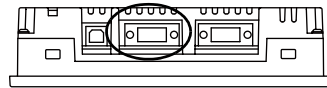

The serial connector pins (COM1) correspond to signals as given below.

COM1 (D-sub 9-pin, female)	Pin No.	Signal	Contents
	1	+RD	Receive data (+)
	2	-RD	Receive data (-)
	3	-SD	Send data (-)
	4	+SD	Send data (+)
	5	SG	Signal ground
	6	NC	Not used
	7		
	8		
	9	+5V/+3.3V	Use prohibited ^{*1}

*1 +5 V (S808) or +3.3 V (S806) is output from pin No. 9.
It is used as the power supply for the external terminating resistance. It cannot be used as an external power supply.

Recommended Connector

The following connector is recommended for a self-made cable.

Recommended connector	DDK's 17JE-23090-02(D8C)-CG	D-sub 9-pin / male / inch screw thread (#4-40UNC) type / with hood / lead- and cadmium-free
-----------------------	-----------------------------	---

Unavailable Models

The following models cannot be connected at COM1.

Connected Device	Manufacturer	Model
PLC	MITSUBISHI ELECTRIC	A series CPU
		QnA series CPU
		FX series CPU (FX1, FX2)
	KEYENCE	KZ-A500 CPU

Connection with PLC/Temperature Controller

The PLC or temperature controller can be connected.

For details on available models or settings on the V-SFT-5, refer to the S8 Series Connection Manual.

COM2: RS-232C Communication Connector

This connector is used for communication with a controller or a barcode reader via RS-232C.

- S808

Bottom View

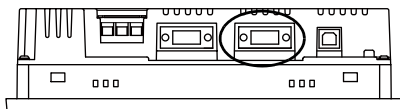

- S806

Bottom View

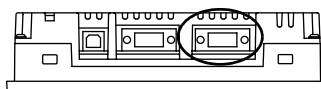

The serial connector pins (COM2) correspond to signals as given below.

COM2 (D-sub 9-pin, male)	Pin No.	Signal	Contents
	1	NC	Not used
	2	RD	Receive data
	3	SD	Send data
	4	NC	Not used
	5	SG	Signal ground
	6	NC	Not used
	7	RTS	Request to send
	8	CTS	Clear to send
	9	NC	Not used

Recommended Connector

The following connector is recommended for a self-made cable.

Recommended connector	DDK's 17JE-13090-02(D8C)-CG	D-sub 9-pin / female / inch screw thread (#4-40UNC) type / with hood / lead- and cadmium-free
-----------------------	-----------------------------	---

Connection with PLC/Temperature Controller

The PLC or temperature controller can be connected.

For details on available models or settings on the V-SFT-5, refer to the S8 Series Connection Manual.

Connection with Barcode Reader

The barcode reader can be connected to read barcode data.

For details on settings on the V-SFT-5, refer to the S8 Series Connection Manual.

5. USB Connector

USB-B (Slave Port)

This connector is used for screen data transfer or connection with a PictBridge-compatible printer.

- S808

Bottom View

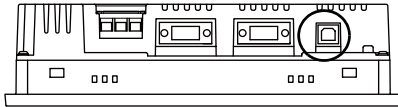

- S806

Bottom View

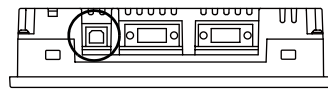

Enlarged View



Printer (PictBridge)

Screen hard copy, historical data or data sheet can be printed out from the PictBridge-compatible printer.

Connection Example

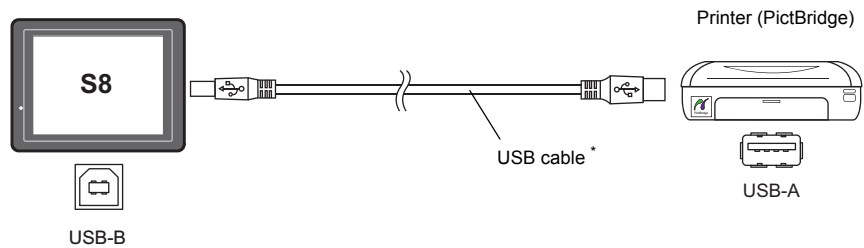

* Use a commercially available USB cable. You are recommended to use a shielded twist-pair USB cable of 5 m in length.

Available Printer

Any PictBridge-compatible printer can be connected.

V-SFT-5 Setting

Select [System Setting] → [Device Connection Setting] → [Others] → [Printer], and select "PictBridge" for [Type] in the [Printer] tab window.

Transferring Screen Data

Screen data can be transferred via USB-B (USB slave port).

Be sure to install the dedicated USB driver for the S8 series on the computer. For the installation procedure, refer to "Installation Procedure of the Driver for Screen Data Transfer" on (page 2-14).

Connection Example

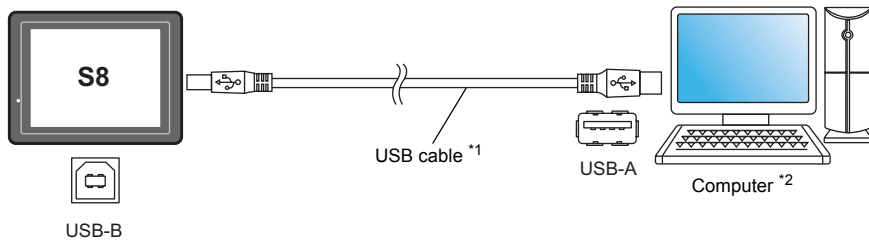

*1 Use a commercially available USB cable. You are recommended to use a shielded twist-pair USB cable of 5 m in length.

*2 When using the USB port on Windows 98, Windows 98 Second Edition or later is required.

Installation Procedure of the Driver for Screen Data Transfer

The installation procedure on Windows XP is described as an example below.

1. Connect the USB-B port of the S8 series (with power on) to the computer (with power on) using a USB cable.
2. The message "Found New Hardware" and then the driver installation wizard appear on the computer.
Select [No, not this time] and click the [Next] button.

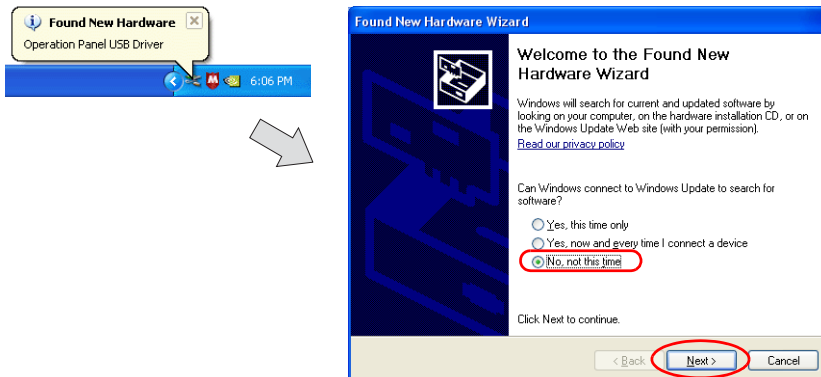

- The dialog below is displayed. Select [Install from a list or specific location], and click the [Next] button.

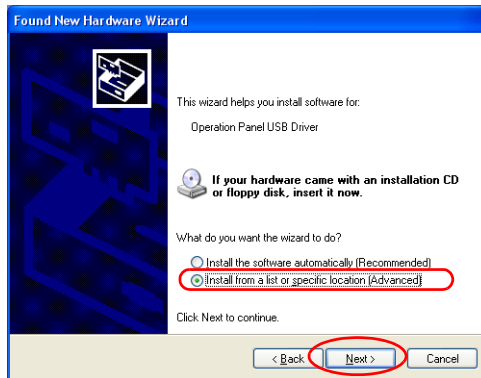

- The dialog below is displayed. Select [Don't search. I will choose the driver to install.] and click the [Next] button.

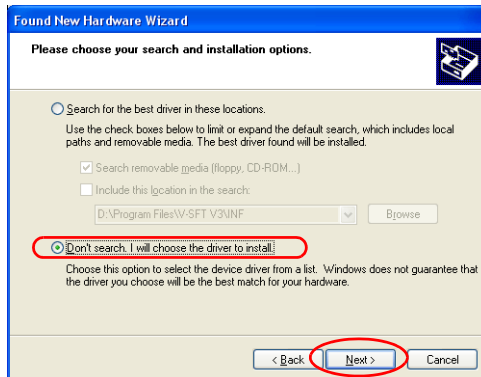

- The dialog below is displayed. Click the [Next] button.

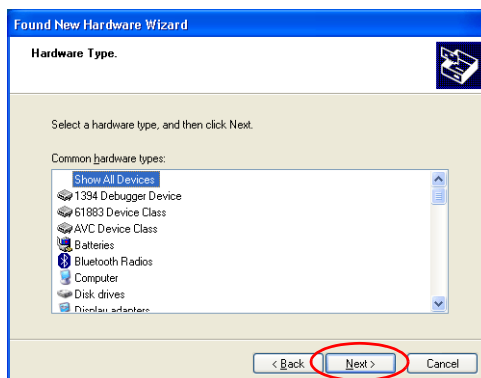

6. The dialog below is displayed. Click the [Have Disk] button.

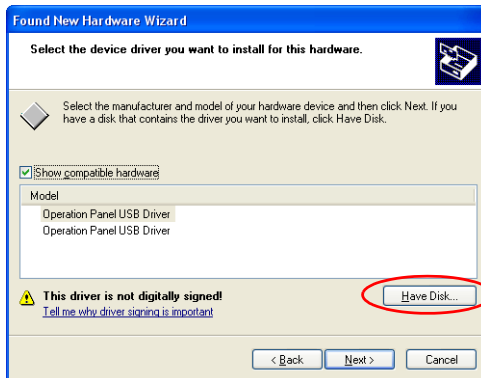

7. The [Install From Disk] dialog is displayed. Click the [Browse] button.

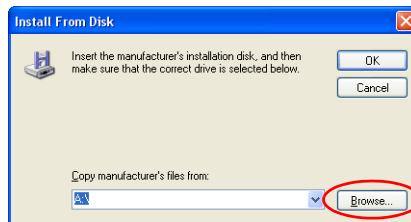

8. The USB driver "OP-U.inf" is stored in the "INF" folder within the V-SFT-5 editor installation folder ("V-SFT V5" for example).



The USB driver to be installed varies depending on the OS installed on your computer. Make sure that the driver is correct.

Select the "OP-U.inf" file that is compatible with the OS and click the [Open] button.

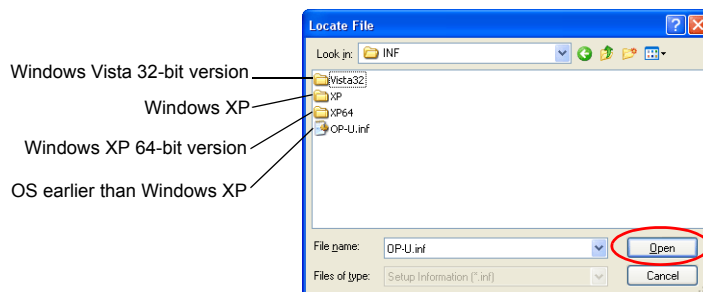

9. The previous dialog is displayed again. Check the path shown under [Copy manufacturer's files from:] and click the [OK] button.

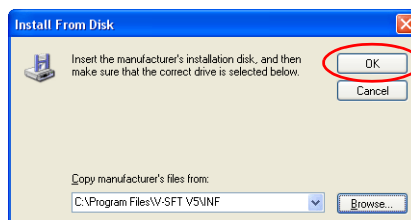

10. The dialog below is displayed. Check that [Operation Panel USB Driver] is shown under [Model]. Click the [Next] button.

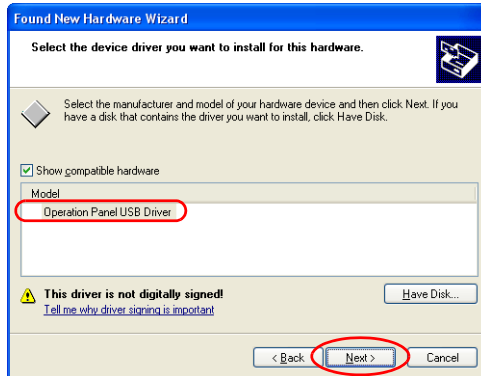

11. The driver installation starts.



12. The dialog below is displayed on completion of installation. Click the [Finish] button.



Recognition of USB Driver

When the driver has been installed successfully, the [Device Manager] window shows “Operation Panel - Operation Panel USB Driver”.

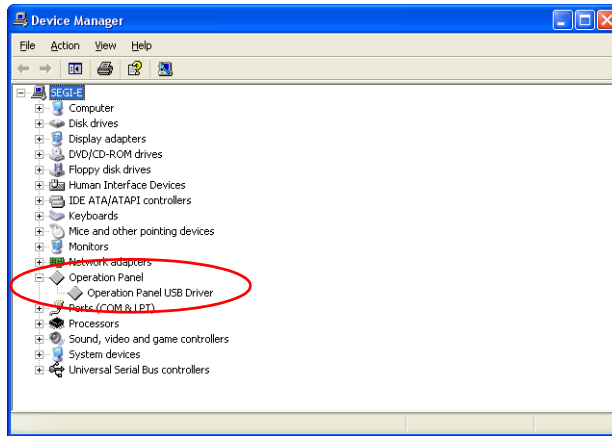

This will disappear when MONITOUCH and computer are disconnected.

If [Other Device] or [?] is shown even while their connection via USB is maintained, the USB driver is not recognized. If this happens, uninstall the USB driver and reinstall it.

3 Installation

1. Mounting Procedure
2. Power Supply Cable Connection

1. Mounting Procedure

Mounting Procedure

1. Insert the S8 unit into the mounting panel (max. thick: 5 mm).

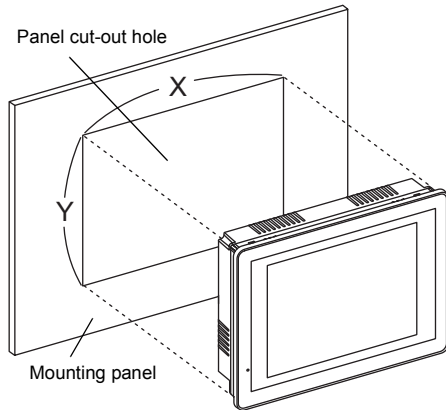

Panel cut-out dimensions		Unit: mm
Model	X	Y
S808	220.5 ^{+0.5} ₋₀	165.5 ^{+0.5} ₋₀
S806	174.0 ^{+0.5} ₋₀	131.0 ^{+0.5} ₋₀

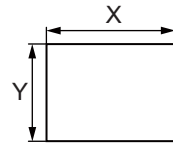

2. Insert four fixtures attached to the S8 series into the mounting holes, and tighten them with the tightening screws.
Tightening torque: 0.5 to 0.7 N·m

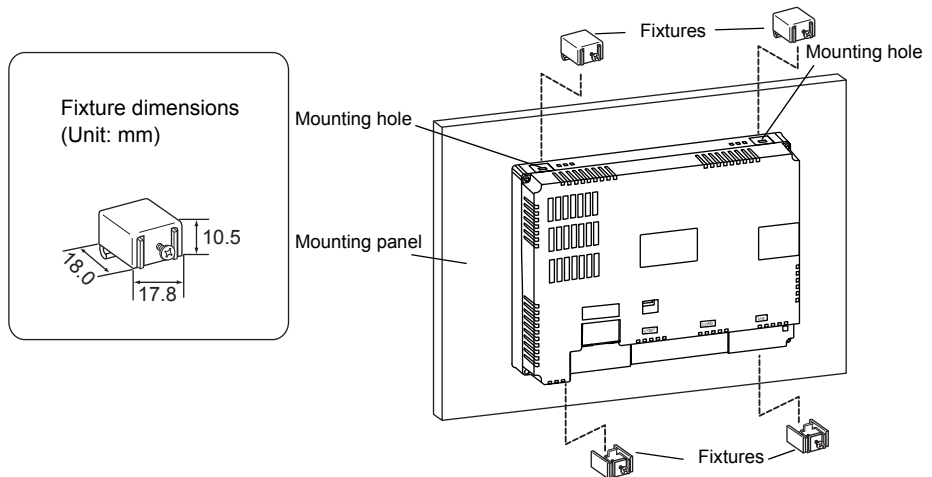

3. Mount the gasket so that it will be sandwiched securely between the S8 unit and the mounting panel.

Mounting Angle

Install the unit within the angle of 0° to 135° as shown below.

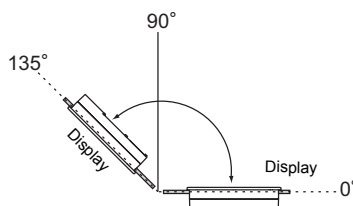

2. Power Supply Cable Connection



DANGER

Electric shock hazard
Shut the power off before connecting the power supply cable.

Power Supply Cable Connection

Connect the power supply cable to the terminal on the backside of the unit.

- S808

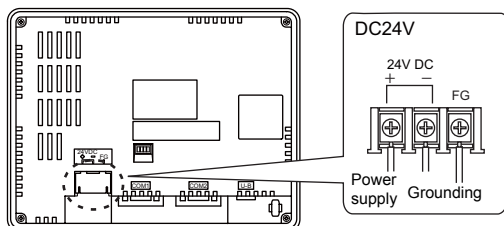

- S806

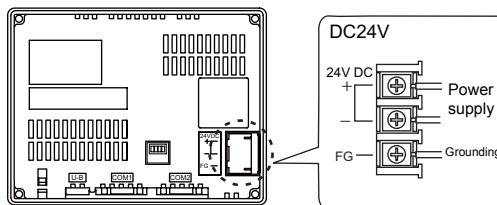

Power Supply Cable Specifications

For information on specifications of the power supply cable and the tightening torque of the screws on the power supply terminal block, refer to the following table.

Screw Size	Tightening Torque	Power Supply Cable
M3.5	0.8 N•m	AWG14 - 16

Notes on the Power Supply:

- Power supply must be within allowable voltage fluctuations.
- Use power supply with low noise between the cables or between the ground and the cable.
- Use as thick a power supply cable as possible to minimize drop in voltage.
- Keep power supply cables away from high-voltage, large-current carrying cables.

Grounding



CAUTION

Be sure to establish a ground for the S8 series.
(The level of grounding resistance should be less than 100Ω.)

- An independent grounding must be used for MONITOUCH.
- Use a cable which has a nominal cross section of more than 2 mm² for grounding.
- Set the grounding point near MONITOUCH to shorten the distance of grounding cables.

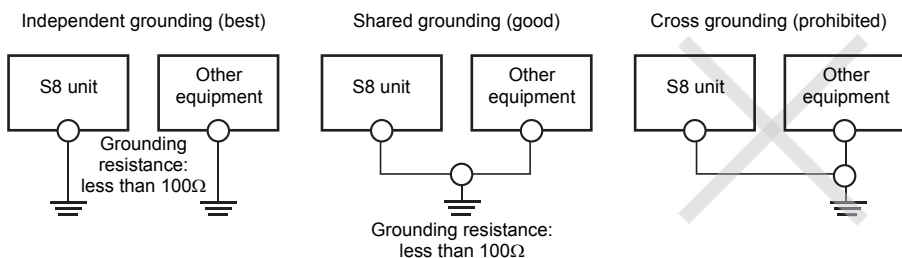

4 Instructions

1. Coin-type Lithium Battery (S808C/S806C/S806M20)
2. DIP Switches (S808C/S806C/S806M20)

1. Coin-type Lithium Battery (S808C/S806C/S806M20)



CAUTION

The battery is inserted upon delivery.

Battery Usage

The battery is used for the user memory area (non-volatile memory \$L and \$LD, storing sampling data, etc.) in SRAM, or backup battery for the built-in clock.

Battery Voltage Drop Detection

The battery status is output to the internal memory \$s167 of the S8 series.

When the battery voltage is lowered, the message "Replace a battery after saving SRAM." is displayed at the bottom center of the Main Menu screen. If the battery voltage drops (4th bit is set) before five years has elapsed, replace the battery immediately.

\$s167	MSB															LSB	
	15	14	13	12	11	10	09	08	07	06	05	04	03	02	01	00	
	0	0	0	0	0	0	0	0	0	0	0	0	0	0	0	0	

System reserved (setting: 0)

0: Battery OK.

1: Battery voltage drop, no battery

Battery Replacement

Recommended Battery

It is recommended that one of the following batteries be used for replacement.

Recommended Manufacturer	Model	
Mitsubishi Electric Home Appliance	CR2032	Coin-type lithium primary cell
Hitachi Maxell		
Panasonic Corporation		
FDK Energy	CR2032v	

Safety Instructions on Handling the Battery

Lithium batteries contain combustible material such as lithium or organic solvent. Mishandling may cause heat, explosion or ignition resulting in fire or injury. To prevent accidents, pay attention to the following cautions when handling the lithium battery.



CAUTION

- Be sure to discharge static electricity from your body before battery replacement.
- Use the recommended battery for replacement.
- Rough handling of the battery may cause fire or chemical burn hazard.
- Do not disassemble, incinerate or heat the battery.
- Observe local and governmental regulations when disposing of waste batteries.
- Keep batteries out of reach of children. (If swallowed, immediately consult a doctor.)
- Never re-charge the battery.
- When the battery leaks or smells, the leaking battery electrolyte is flammable. Keep from heat or flame.

SRAM Area Backup Procedure

Before replacing the battery, be sure to make a backup copy of data stored in SRAM using the V-SFT-5 editor.

- 1) Connecting a USB cable
Connect the S8 unit and the computer with a USB cable.
 - 2) Starting the V-SFT-5 editor
Start the V-SFT-5 editor on the computer.
 - 3) Displaying the [Transfer] dialog
Click the [Transfer] icon. The [Transfer] dialog is displayed.
 - 4) Selecting data to be transferred
Select [Display] for [Transfer Device], and [SRAM Data] for [Transfer Data].
Do not check [Use Simulator].
 - 5) Starting SRAM data transfer
Click the [PC <-] button under [Transfer]. Data transfer from the SRAM is started.
 - 6) Saving the SRAM data
When the SRAM data has been transferred, the [Save As] dialog is displayed on the computer. Save the data as a backup copy. The extension is "*.RAM".
- * To transfer the "*.RAM" data, which is saved as a backup copy, to the S8, click the [PC ->] button under [Transfer] in step 5).

Battery Replacement Procedure



Electric shock hazard

Steps 3 to 10 must be performed when the power to the S8 series is turned off.

1. Make a backup copy of data stored in the SRAM area.
For information on the backup procedure, refer to "SRAM Area Backup Procedure" (page 4-2).
2. Turn the S8 unit on.
3. Disconnect the power cable, communication cable and USB cable.
4. Put the display panel face down and remove the four screws from each corner.



Put a cloth under the panel to avoid scratches.

• S808

• S806

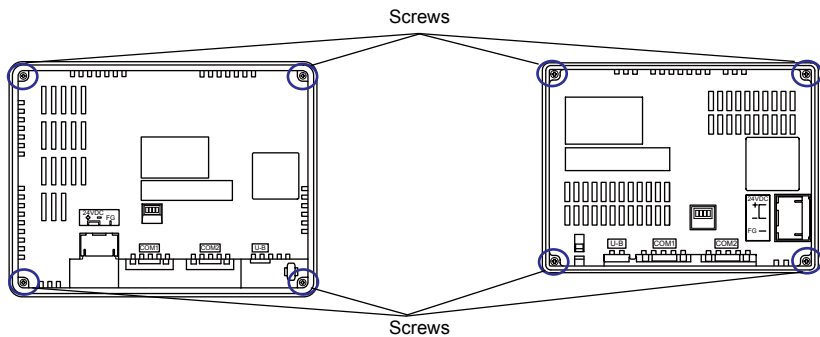

5. Remove the rear case.
The battery fit in the socket comes into view.

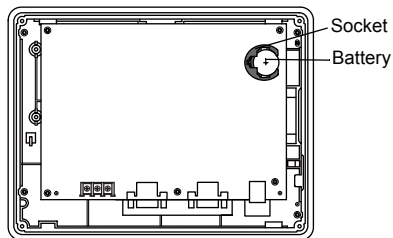

Notes on Battery: EU Directive 2006/66/EC

According to the EU directive 2006/66/EC effective in EU countries, the battery supplied with the S8 series as well as the package box of the S8 series have the marking shown below:



CAUTION

- The marking shown above is effective only in EU countries.
- The details on the marking is designated in Article 20 "Information for end-users" and ANNEX II in EU directive 2006/66/EC.
- The marking indicates that the battery should be disposed of separately from general household waste.
- If element symbols are indicated below the marking, it means that the battery contains the specified heavy metal at a concentration exceeding the control value. The control values of concentration are given below.
Hg: mercury (0.0005%), Cd: cadmium (0.002%), Pb: lead (0.004%)
- The EU has determined the separating program for used batteries.
Dispose of used batteries properly at your local waste-disposal/recycling center.

2. DIP Switches (S808C/S806C/S806M20)

DIP Switch (DIPSW) Setting

The S8 series is equipped with four (1 to 4) DIP switches. When setting the DIP switches, turn the power off. Upon delivery, all the DIP switches are set to OFF.

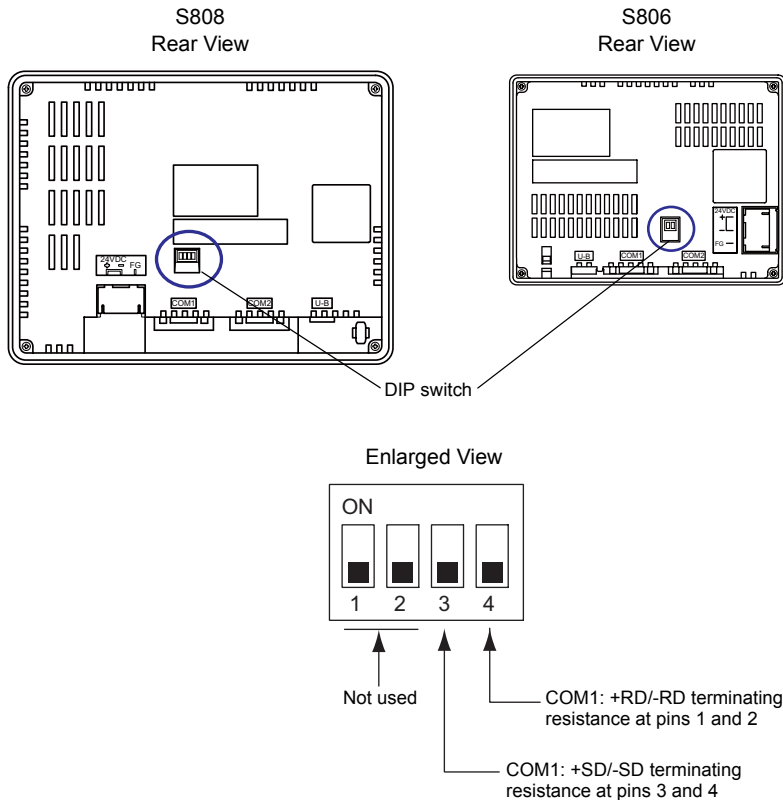

DIPSW1, 2 (Not Used)

Set the DIPSW1 and 2 to the OFF positions.

DIPSW3, 4 (Terminating Resistance Setting)

- When connecting a controller at COM1 via RS-422/485 (2-wire connection), set the DIPSW4 to the ON position.
- When connecting a controller at COM1 via RS-422/485 (4-wire connection), set the DIPSW3 and 4 to the ON positions.

Terminating resistance at S806M10D

S806M10D is not equipped with DIP switches. Therefore, the terminating resistance for COM1 is always ON.

Note that there are some restrictions on the configuration including S806M10D when multiple units of S8 and V8 are connected via multi-link, multi-link 2, V-Link, and Modbus slave. For more information, refer to the S8 Series Connection Manual.

5 MONITOUCH Operations

1. Before Operation
2. Main Menu Screen
3. System Menu

1. Before Operation

Procedure before Operation

1. Mount the S8 series on the mounting panel, install it and carry out wiring.
For more information, refer to “Chapter 3”.
2. Install peripheral devices, such as PLCs or temperature controllers, and carry out wiring.
For information on precautions, refer to the Connection Manual separately provided.
3. Turn the S8 series on.

When turning the power on for the first time:

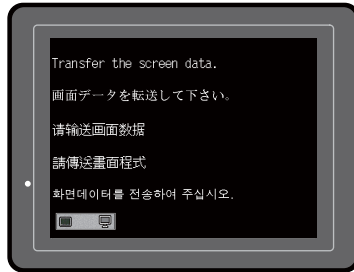

Other cases:



4. Transfer the created screen data.
 - When transferring screen data for the first time:
For details, refer to “Transferring Screen Data to MONITOUCH for the First Time” (page 5-2).
 - Other cases:
For information on the procedure to change screen data with another, refer to the Operation Manual.

5. Start MONITOUCH operation. To change to the RUN mode, refer to “Main Menu Screen” (page 5-3).

When the connection with controllers has been established, the RUN screen is displayed.

* If MONITOUCH does not operate normally and shows an error message, eliminate the cause by referring to Chapter 6 or the S8 Series Reference Manual.

Transferring Screen Data to MONITOUCH for the First Time

The procedure for transferring screen data for the first time is explained below:

Initial screen displayed when the power is turned on for the first time

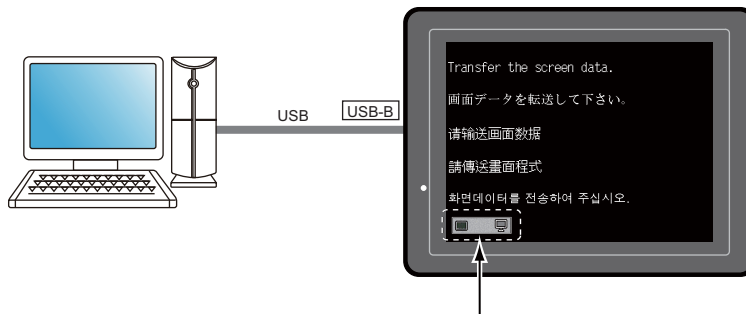

Displays communication status between the S8 and the computer.

Transfer via USB:

Connect the USB cable to the USB slave port (USB-B) on the S8 series, and transfer screen data from the computer.

- * Before transferring screen data via USB for the first time, install the USB driver.
For information on the installation procedure, refer to "Installation Procedure of the Driver for Screen Data Transfer" (page 2-14).

When the screen data has been transferred, the following screen is brought up. For details, refer to "Main Menu Screen" (page 5-3).

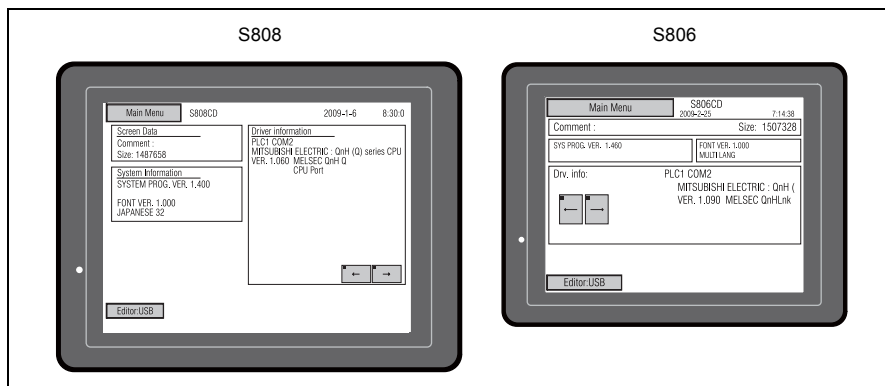

2. Main Menu Screen

Displaying the Main Menu Screen

To bring up the Main Menu screen in the RUN mode, press the corners on the S8 series unit and the [MODE] switch on the System Menu*.

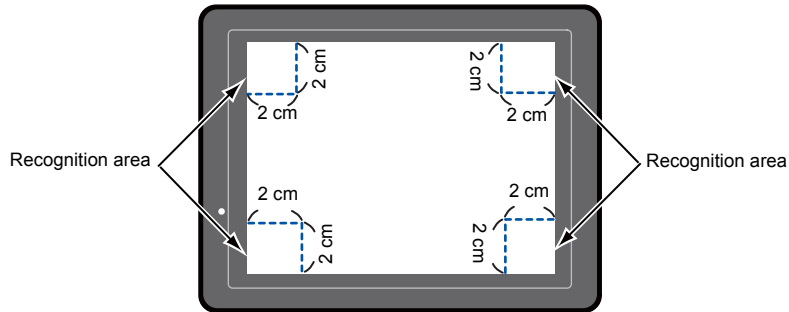

* For the details on the System Menu, refer to "System Menu" (page 5-21).

1. Hold down any corner for two seconds or longer, and remove your finger.

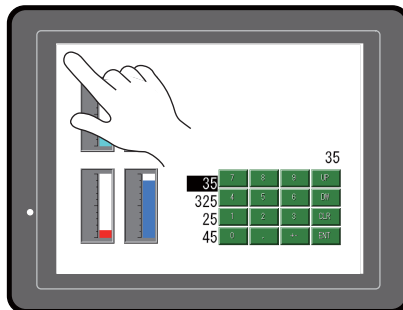

Hold down the upper left corner for two second or longer.

2. Hold down one of the other three corners for two seconds or longer. Then the System Menu is displayed.

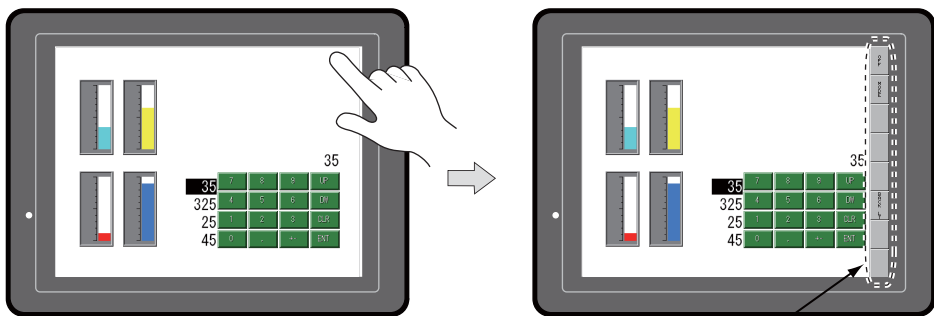

Hold down one of the other three corners for two second or longer.

System Menu

* When an item, such as a switch, data display part with switch, display area, slider switch, scroll bar, or table data display part, is placed on the position you press, the switch in the recognition area becomes invalid. Press a corner where none of the items described above is placed. If the items are placed on all of the corners, change the screen to another and display the Main Menu screen by following the procedure described above.

- Press the [MODE] switch while the System Menu is displayed. Then the Main Menu screen is displayed.

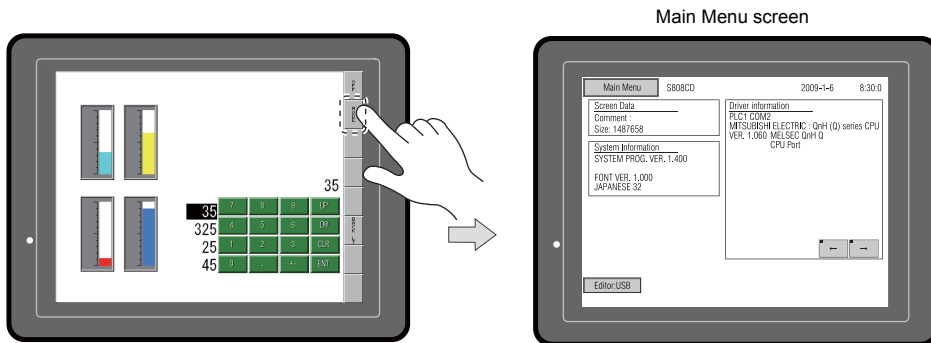

Main Menu Screen

The Main Menu screen indicates the S8 series model, system information, and screen data information.

Also, it works as the system screen when the screen data is transferred between a computer and the S8 series.

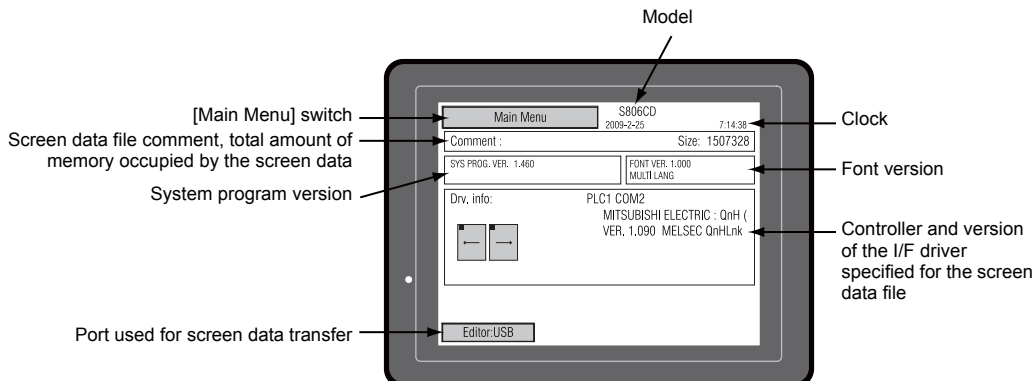
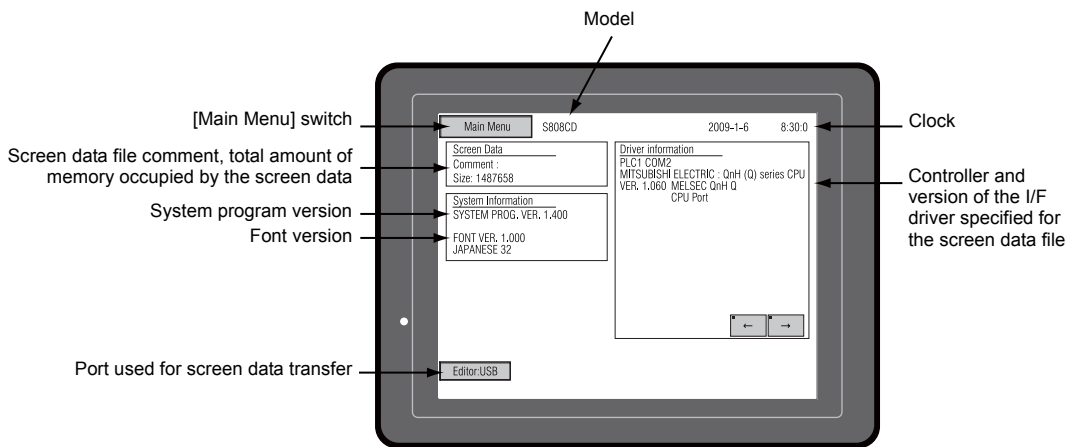

[Main Menu] Switch

Pressing the [Main Menu] switch brings up the following drop-down window.

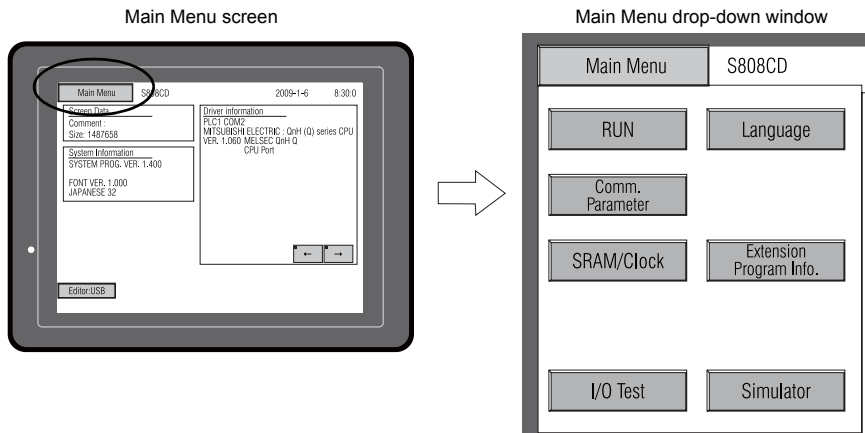

Main Menu Screen Composition

The Main Menu screen is configured as shown below:

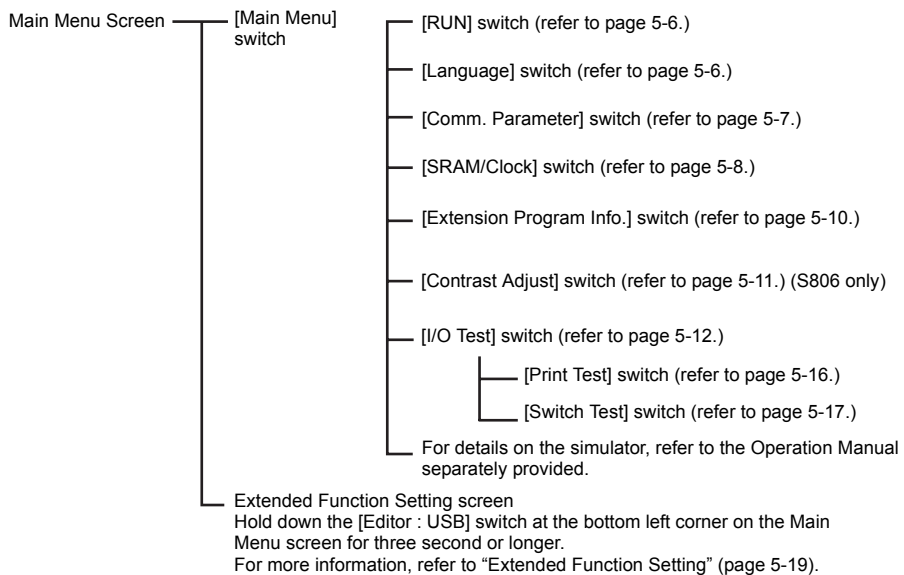

1. RUN

Pressing the [RUN] switch on the Main Menu drop-down window switches the screen to the RUN mode.

Main Menu drop-down window

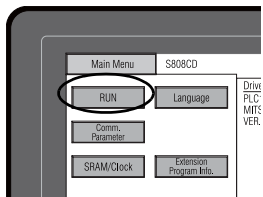

RUN screen



2. Language Selection

Pressing the [Language] switch on the Main Menu drop-down window brings up the Language Selection screen.

Languages* selected in the [Font Setting] dialog of the V-SFT-5 editor are displayed on the Language Selection screen that is used for selecting an interface language for the Main Menu screen.

Main Menu drop-down window

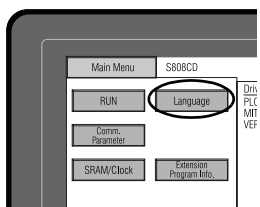

Language Selection screen

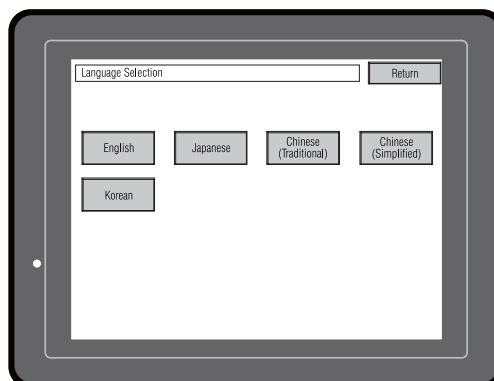

* The interface language for the Main Menu screen can be selected from English, Japanese, Chinese (Simplified), Chinese (Traditional) or Korean. English is always displayed.

3. Communication Parameter

Pressing the [Comm. Parameter] switch on the Main Menu drop-down window brings up the Comm. Param. screen.

Communication parameters of PLC1 and PLC2 that are set on the V-SFT-5 editor can be checked on this screen.

Main Menu drop-down window

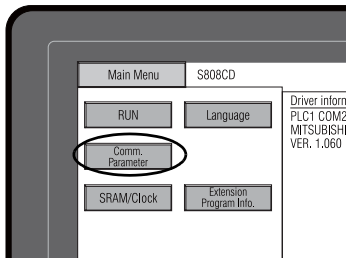

Comm. Param. screen

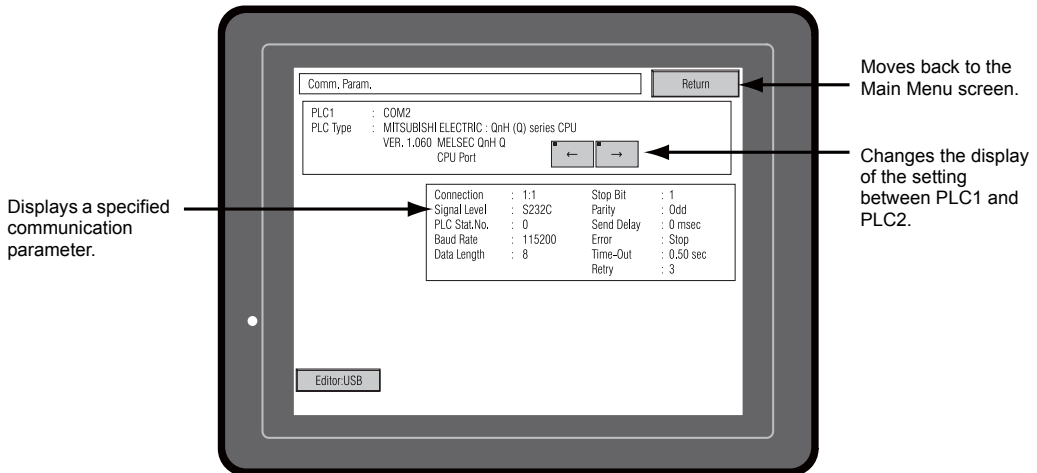

4. SRAM/Clock (S808C/S806C/S806M20)

Pressing the [SRAM/Clock] switch on the Main Menu drop-down window brings up the SRAM/Clock screen.

This screen is used for correcting the built-in calendar (date and time) and for formatting the SRAM area.

Main Menu drop-down window

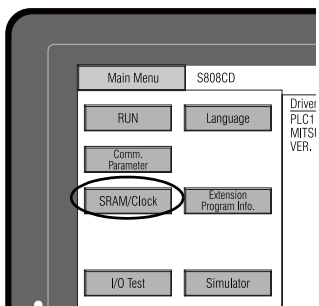

SRAM/Clock screen

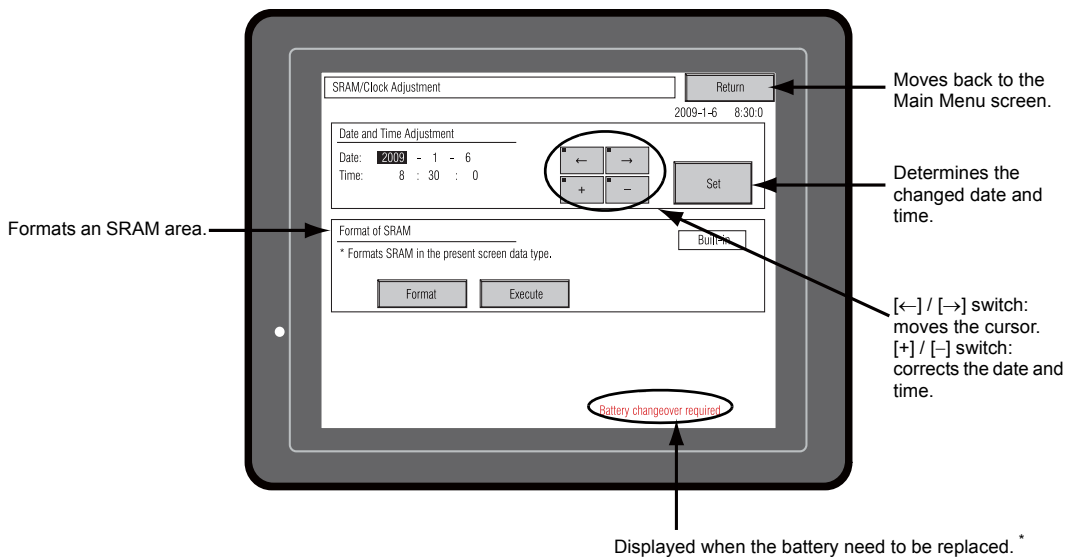

* Be sure to set the battery. Without the battery, the contents in the SRAM or clock data will not be retained.

4-1. Date and Time Adjustment

This screen is used for correcting the built-in clock of the S8 series.

To use the built-in clock of the S8 series, check [Use Built-in Clock] in the [SRAM/Clock Setting] dialog that is displayed by selecting [System Setting] → [Unit Setting] → [SRAM/Clock] on the V-SFT-5 editor.

1. Move the cursor using the [←] and [→] switches. Correct the date and time using the [+] and [-] switches.
2. Press the [Set] switch to determine the setting. The clock displayed on the upper right is modified.

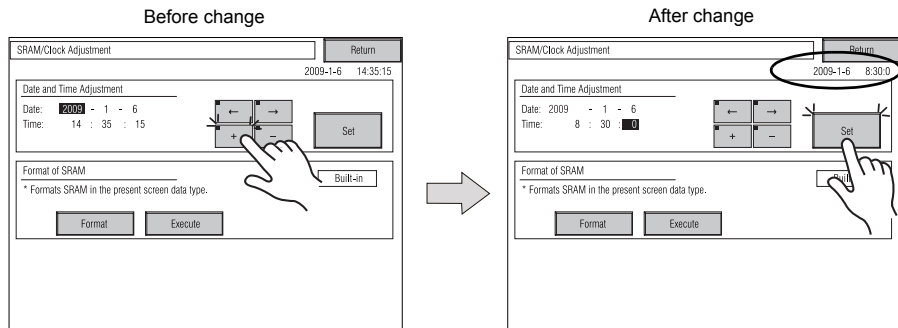

3. Pressing the [Return] switch displays the Main Menu screen again.

4-2. Formatting SRAM

An SRAM area can be formatted.

When the SRAM area is formatted, the contained data (historical data saved in SRAM, internal memory \$L, etc.) is cleared. Double-check before formatting the SRAM.

1. Press the [Format] switch and the [Execute] switch.
The SRAM area is formatted in the current screen data format. When formatting has been completed, the message ****Format Completed**** is displayed.

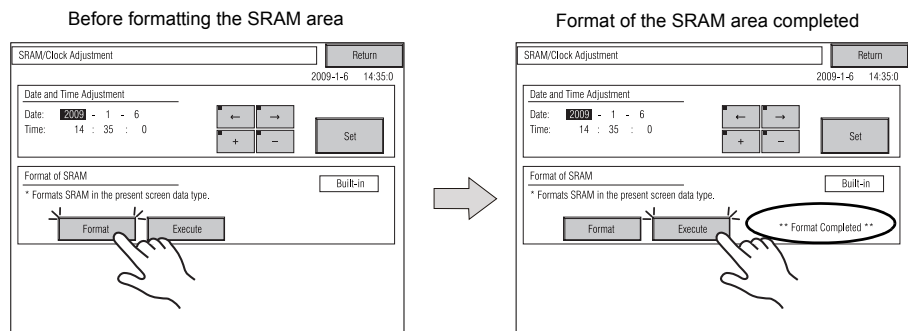

2. Pressing the [Return] switch displays the Main Menu screen again.

5. Extension Program Information

Pressing the [Extension Program Info.] switch on the Main Menu drop-down window brings up the Extension Program Info. screen. This screen is used for checking program versions of the ladder transfer function, simulator, etc.

Main Menu drop-down window

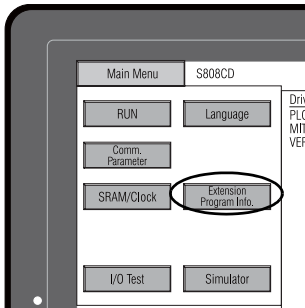

Extension Program Info. screen

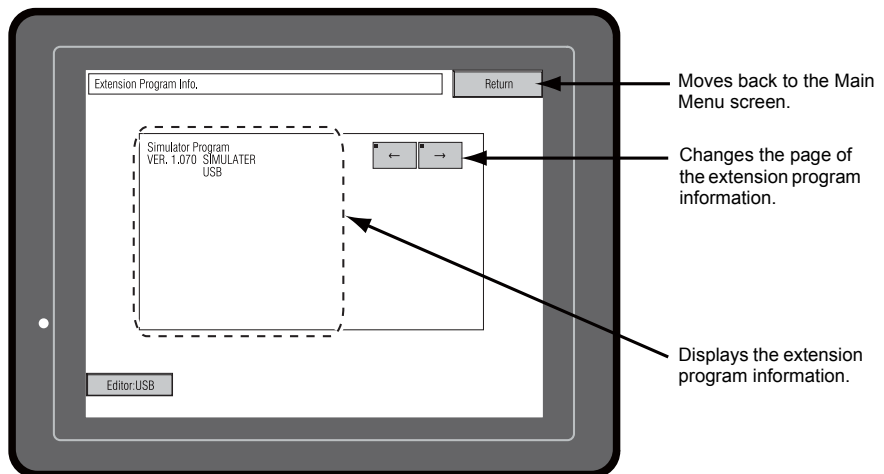

6. Contrast Adjustment (S806 Series)

Pressing the [Contrast Adjust] switch on the Main Menu drop-down window brings up the Contrast Adjustment screen. This screen is used for adjusting the contrast of the S806 series.

Main Menu drop-down window

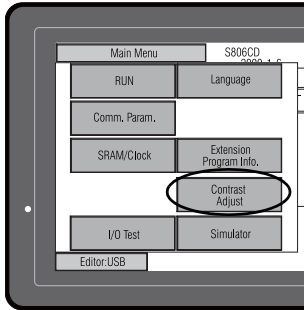

Contrast Adjustment screen

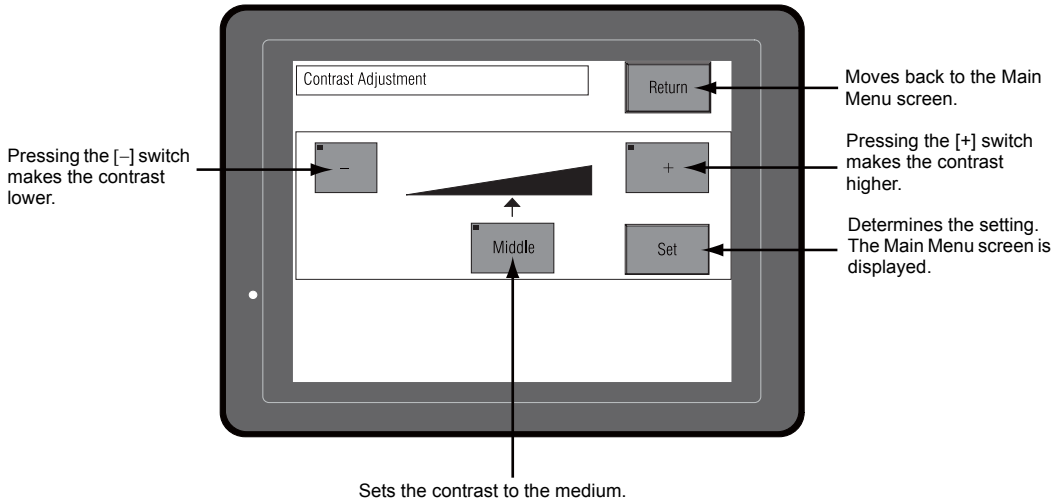

7. I/O Test

Pressing the [I/O Test] switch on the Main Menu drop-down window brings up the I/O Test screen. This screen is used to check that there is no problem with the S8 interfaces and touch switch operation.

Main Menu drop-down window

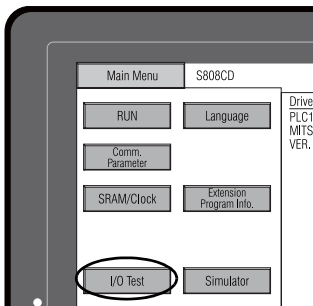

S808 I/O Test screen

Moves to the touch switch test screen. (page 5-17)

Moves back to the Main Menu screen. (page 5-3)

Performs a COM1/COM2 interface test. (page 5-13)

Moves to the Print Test screen. (page 5-16)

S806 I/O Test screen

Moves to the Print Test screen. (page 5-16)

Moves to the touch switch test screen. (page 5-17)

Performs a COM1/COM2 interface test. (page 5-13)

7-1. Self-loop Test

This is a signal test for communications through the COM1 or COM2 connector. Perform this test if the communication is not successfully established when connecting a controller (PLC, temperature controller, etc.) using COM1 or COM2.

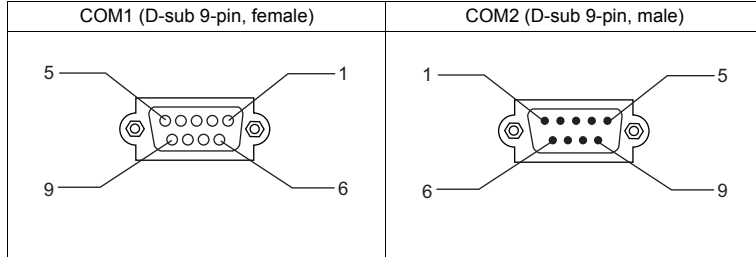

COM1: RS-485 Signal Test

Press the [COM1] switch for "Communication Port". The [RS485] lamp turns on.

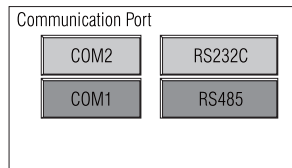

SD/RD Test

Check the signals [SD] and [RD].

1. Install a jumper between pins 1 and 4, and between pins 2 and 3 of COM1 on the S8 series.

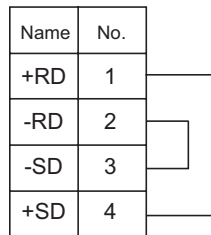

2. Press the [Self-Loop Test] switch. When the [OK] lamp lights up, the test is successfully completed.

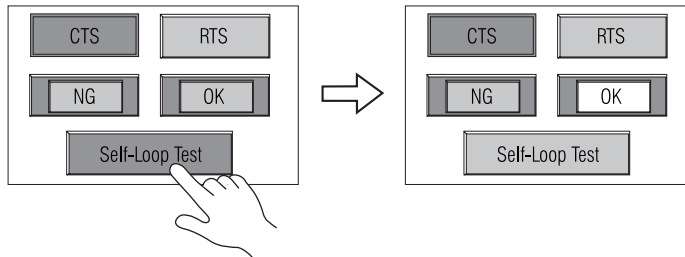

* If the [NG] lamp lights up, a pin may be faulty. Contact your local distributor.

COM2: RS-232C Signal Test

Press the [COM2] switch for "Communication Port". The [RS232C] lamp turns on.

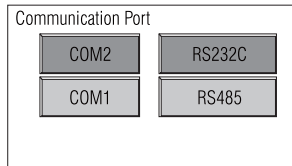

SD/RD Test

Check the signals [SD] and [RD].

1. Install a jumper between pins 2 and 3 of COM2 on the S8 series.

Name	No.
RD	2
SD	3

2. Press the [Self-Loop Test] switch. When the [OK] lamp lights up, the test is successfully completed.

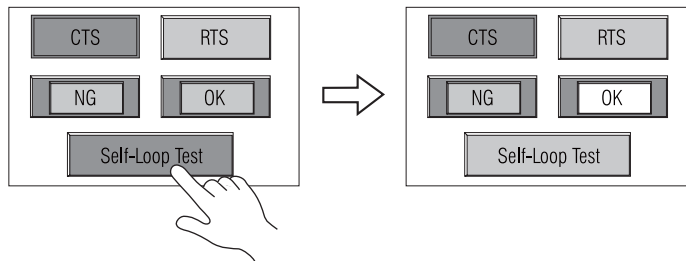

* If the [NG] lamp lights up, pin 2 or 3 may be faulty. Contact your local distributor.

CTS/RTS Test

Check the signals [CTS] and [RTS].

1. Install a jumper between pins 7 (RTS) and 8 (CTS) of COM2 on the S8 series.

Name	No.
RTS	7
CTS	8



2. Press the [RTS] switch and check that both [RTS] and [CTS] lamps light up at the same time. Press the [RTS] switch again and check that both [RTS] and [CTS] lamps go off at the same time.

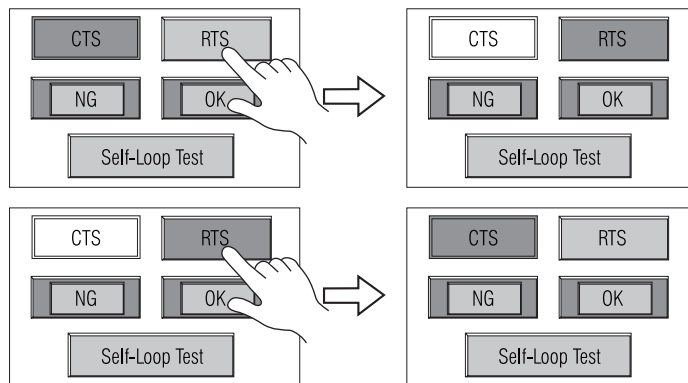

7-3. Touch Switch Test

If a touch switch does not activate at all or if an operation is performed without pressing any touch switch, check if the touch switches on the S8 panel are working properly.

1. Touch switch test screen:
Press the [Switch Test] switch. Grids appear on the screen as shown below.

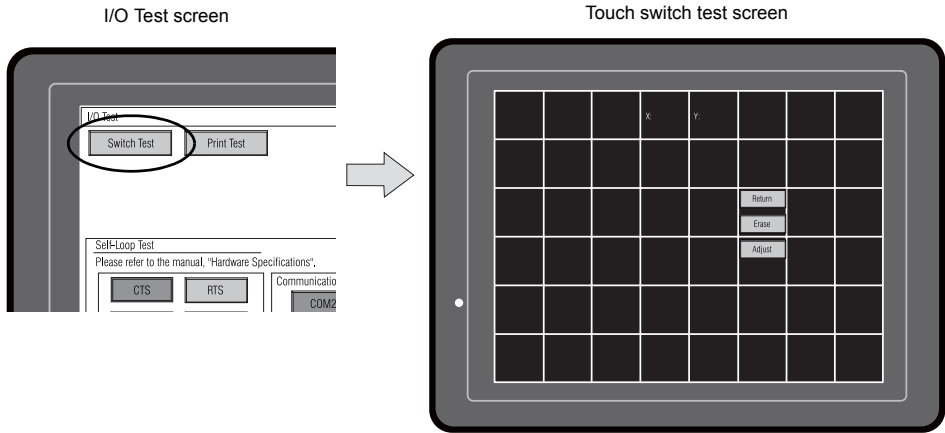

2. Checking the switch output state:
Press a position on the panel, and check if the pressed position turns white. When the pressed position turns white, the switch is activated normally. To move back to the I/O Test screen, press the [Return] switch. To delete white dots, press the [Erase] switch.

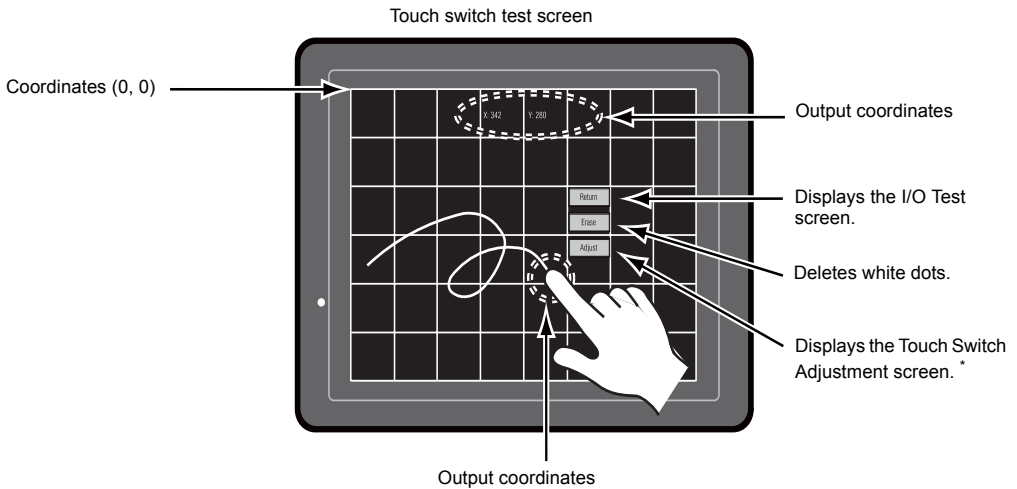

* If a position different from the pressed position turns white, refer to "Touch Switch Adjustment" on the next page and adjust the touch switch position.

Touch Switch Adjustment

If a position different from the pressed position turns white on the touch switch test screen, follow the steps described below to adjust the touch switch position.

1. Press the [Adjust] switch on the touch switch test screen. The Touch Switch Adjustment screen appears.

Touch switch test screen

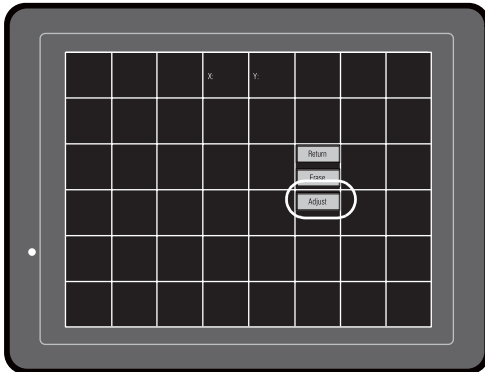

Touch Switch Adjustment screen

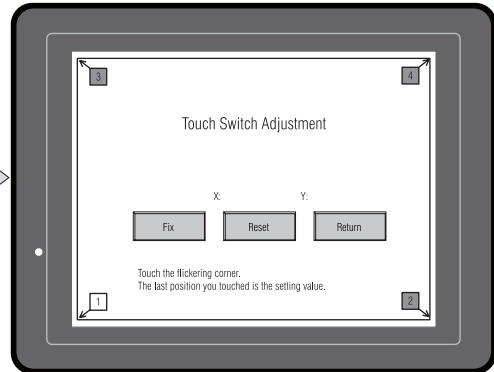

2. Press on "1" that is flashing at the corner. When the finger is released, a beep sounds and the position is set. "2" flashes.
3. Press on "2" that is flashing at the corner. When the finger is released, a beep sounds and the position is set. "3" flashes.
4. Press on "3" that is flashing at the corner. When the finger is released, a beep sounds and the position is set. "4" flashes.
5. Press on "4" that is flashing at the corner. When the finger is released, a beep sounds and the position is set.
6. To re-set the positions, press the [Reset] switch and follow step 2 and later.
7. To cancel the setting, press the [Return] switch. The touch switch test screen is displayed again.
8. To determine the setting, press the [Fix] switch. A long beep sounds and the positions are determined. The touch switch test screen is displayed again.

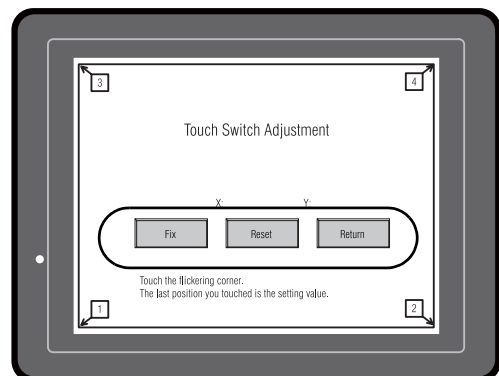
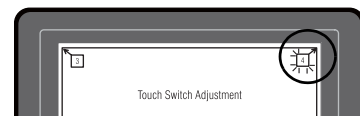
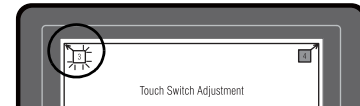
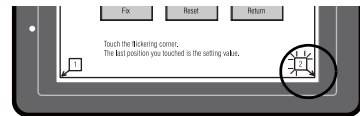
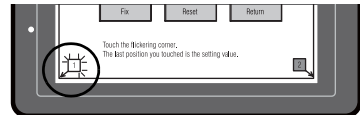

8. Extended Function Setting

Holding down the [Editor: USB] switch for three seconds on the Main Menu screen displays the Extended Function Setting screen. This screen is used to set the local port number for V-Link, Modbus slave or multi-link communication.

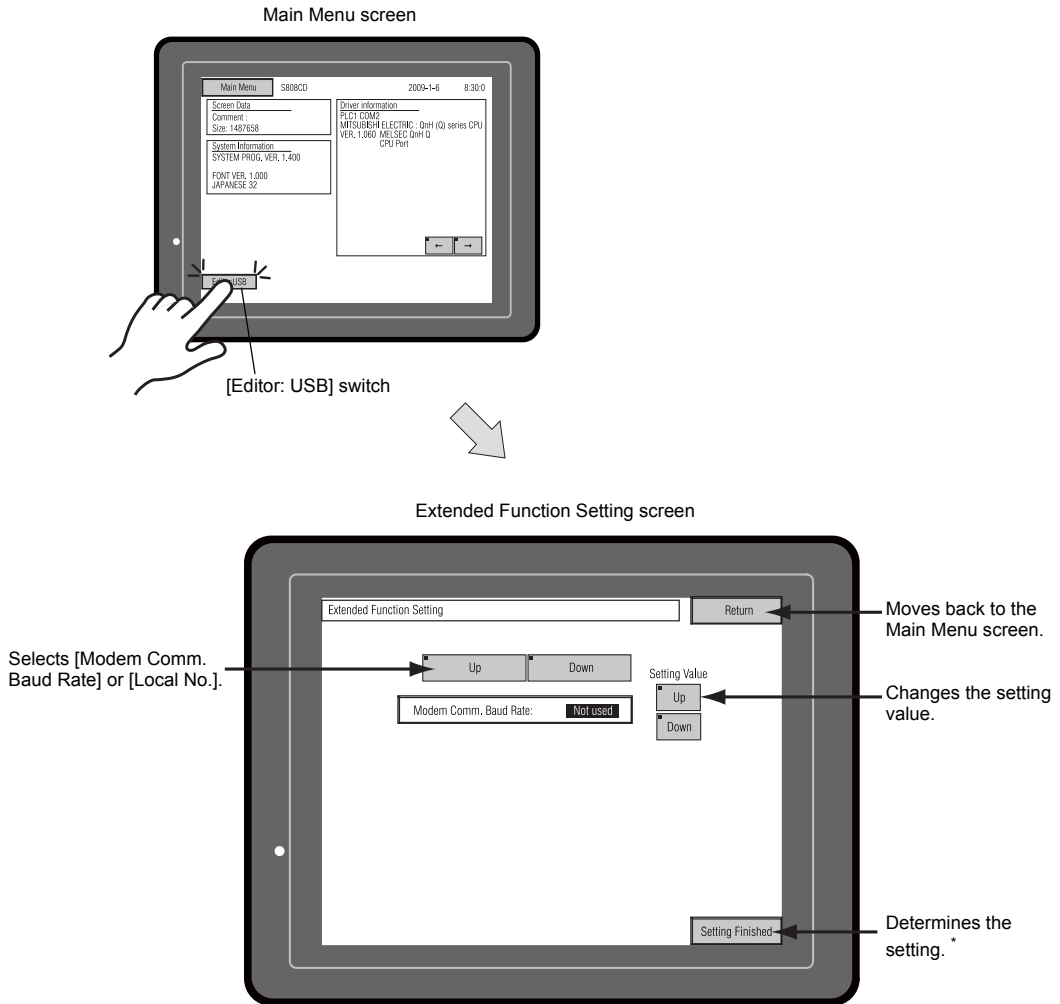

* The switches on the Main Menu screen are not valid for 15 seconds after the [Setting Finished] switch is pressed.

8-1. Setting Local Port Number

For V-Link, Modbus slave or multi-link communication, set the local port number from the Main Menu screen.

(The local port number can be set when [Set Local Port No. in Main Menu] is checked with [PLC2: V-Link] or [PLC2: Modbus Slave (RTU)] selected in the [Device Communication Setting] dialog ([System Setting] → [Device Connection Setting]) or with [Connection Mode: Multi-link] selected in the [Communication Setting] tab window ([System Setting] → [Device Connection Setting] → [Communication Setting]) on the V-SFT-5 editor.

1. Displaying the [Local No.] field:
Press the [Down] switch to display the [Local No.] field.
2. Setting the local port number:
Select a local port number using the [+] or [-] switch. The local port number can be selected from 1 to 254.
Press the [Setting Finished] switch to complete the setting.

Local port number setting screen

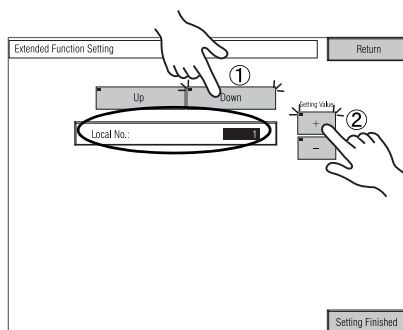

Setting completed

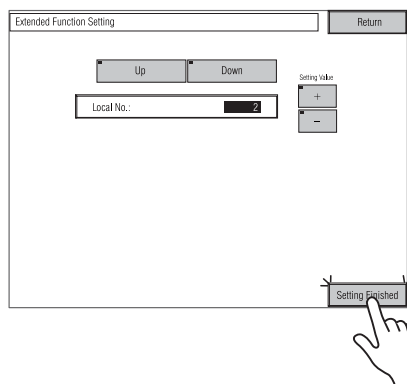

3. The Main Menu screen is automatically displayed again.

3. System Menu

Types of the System Menu Switches

There are three system menu switches; [OFF], [MODE], and [BACK LT]. For the way to display the System Menu, refer to "Displaying the Main Menu Screen" on page 5-3.

Functions of the System Menu Switches

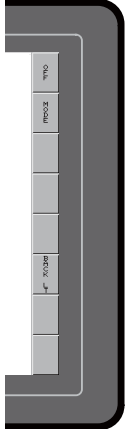
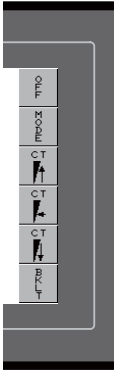
	Function	Specifications	S808	S806
OFF	System Menu hiding	Hides the System Menu.		
MODE	Mode selection	Switches the screen from the RUN mode to the System Menu.		
CT ↑	Contrast adjustment *1	Makes the contrast higher each time the switch is pressed.		
CT ←		Resets the contrast to the medium.		
CT ↓		Makes the contrast lower each time the switch is pressed.		
BACK LT *2	Backlight control	Always ON	-	
		Auto 1 Auto 2 Auto 3	<ul style="list-style-type: none"> The [BACK LT] *2 switch turns the backlight off. This is available when the backlight control bit (bit 11) in the read area "n+1" in the system memory is reset (OFF: 0). 	
		Manual	The [BACK LT] *2 switch turns the backlight off. To turn the backlight on, press somewhere on the screen.	

*1 Available only with S806.

*2 "BKLT" displayed on S806.

MEMO

Please use this page freely.

6 Error Handling

1. Error Messages
2. Troubleshooting

1. Error Messages

There are five kinds of error messages displayed on the S8 series:

1. Communication Error
2. Data Loading
3. Warning
4. SYSTEM ERROR
5. Touch switch is active.

1. Communication Error

When communication is not established between the S8 series and a controller, or any abnormality (noise etc.) is detected, the following messages are displayed on the S8 series.

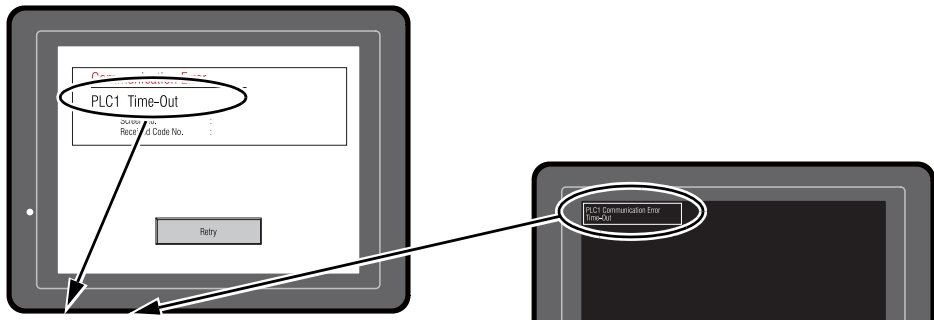

Error Messages	Contents	Solution	Remarks
Time-Out	Although a request to send is given to a controller, no answer is returned within the specified time.	1. Check settings in the [Communication Setting] tab window of the [Device Connection Setting] dialog. 2. Check the cable connection.	1
		3. Data may be disrupted because of noise. Fix noise.	2
Parity	An error occurred in parity check.	1. Check the cable connection.	1
		2. Data may be disrupted because of noise. Fix noise.	2
Framing	Although the stop bit must be [1], it is detected as [0].	1. Check settings in the [Communication Setting] tab window of the [Device Connection Setting] dialog. 2. Check the cables and wiring.	1
		3. Data may be disrupted because of noise. Fix noise.	2
Overrun	After one character is received, the next character is received before internal processing is completed.	1. Check settings in the [Communication Setting] tab window of the [Device Connection Setting] dialog.	1
		2. Data may be disrupted because of noise. Fix noise.	2
Check code error	The check code in the controller response was not correct.	1. Check settings in the [Communication Setting] tab window of the [Device Connection Setting] dialog.	1
		2. Data may be disrupted because of noise. Fix noise.	2

* If the above error messages are displayed on the S8 series without establishing communication between S8 and PLC, test the solution of remark "1". If the error occurs suddenly in communication, test the solution of remark "2".

Error Messages	Contents	Solution
Error code received	An error code was sent by a controller. (NAK)	Examine the controller error code and solve the problem.
Break	The controller's SD remains at the low level.	Examine the connection between the controller's SD and the S8's RD.
Invalid memory (Mitsubishi CPU)	You specified an address that exceeds the memory range of the PLC that you are linked to.	Check the type and range of memory that you set.
Format	The code of the received data is invalid.	<ol style="list-style-type: none"> 1. Confirm link unit settings. (After making settings, cut power to the controller.) 2. On the V-SFT-5 editor, select [System Setting] → [Device Connection Setting] and check the settings. 3. If errors only occur from time to time, a noise-based communication error may be present.
Compare (HIDIC S10)	Transmission data and received data are different.	
NAK	A NAK code is received.	
Transaction Error (Allen-Bradley PLC)	Transmitted transaction data and received transaction data are not in agreement.	
Communication Error	An unclear communication error is detected.	
Count error (Mitsubishi CPU and Q link unit)	The expected data amount is different from the count value.	
Command error (Mitsubishi CPU and Q link unit)	The response code differs from the expected code.	

2. Data Loading

If an error is detected on the screen data in the RUN mode, the following messages are displayed on the S8 series.

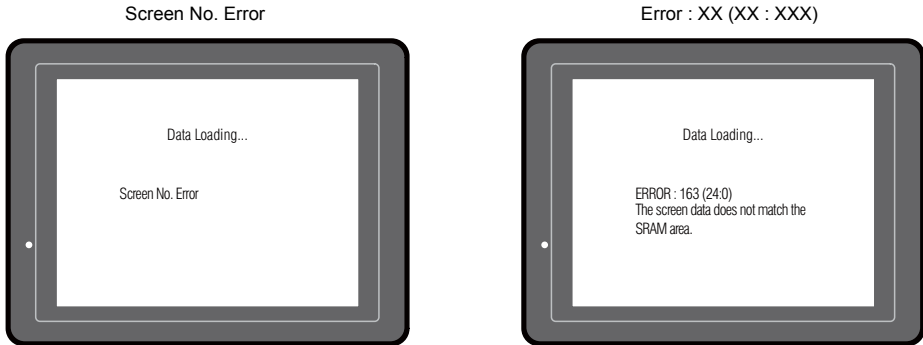

Error Messages	Contents	Solution
Screen No. Error	There is no setting for the received screen.	At the start of communications, the S8 series regards the value in the read area "n + 2" as the screen number. Check that this value is an existing screen number on the controller.
Error : XX (XX : XXX)	There is an error in the created screen data.	<p>According to the item number and the sub-item number displayed on the S8 series, find the edited screen where the error occurs. Check the contents of the error (error number) and remove the error.</p> <p>Error : XX (XX : XXX)</p> <p>Sub-item No. Item No. Error No.</p> <p>For details on the item number and sub-item number, refer to the S8 Series Reference Manual.</p>

3. Warning

A message may be displayed on the Main Menu screen. This is a warning message. For the warning details and solutions, refer to the S8 Series Reference Manual and correct screen data.

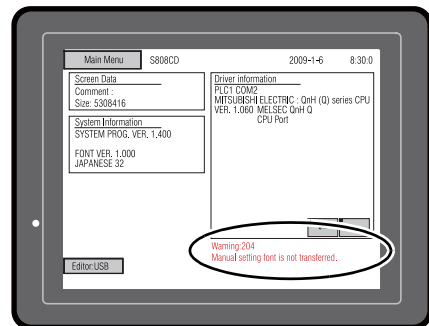

4. SYSTEM ERROR

When a system error is detected, the following error screen is displayed on the S8 series.

System Error screen

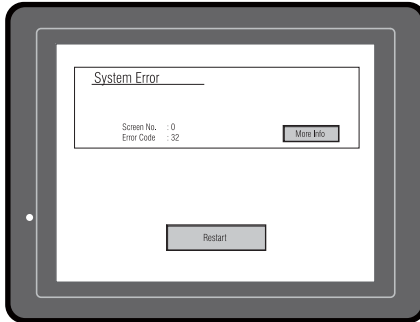

Error Code: XX

- 1: Watchdog timer error
- 11: Switch table error
- 30: Request for displaying full error
- 31: Memory allocation system error
- 32: General exceptions/MMU address system error
- 33: RTOS system error
- 34: Memory error
- 35: Inaccurate memory error

The source of the error could be one of the following three problems.

- 1) Program crash due to noise
- 2) Hardware problem
- 3) Bad program

If any of these errors occurs, contact your local distributor.

5. Touch Switch Is Active

If the power is turned off while a touch switch is activated, the error screen shown on the right is displayed. Remove your finger from the screen. If the error screen remains displayed, contact your local distributor.





2. Troubleshooting

In the Event of an Error

Perform the steps below:

1. If the current error matches a symptom in the following table, correct it by following the instructions provided.
2. If the error does not match the symptoms in the table, contact your local distributor. Please provide the distributor with the information on the MONITOUCH model, serial number, symptom of the error, error message, etc.

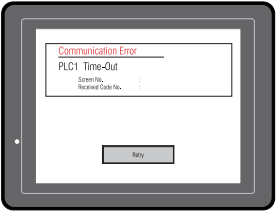
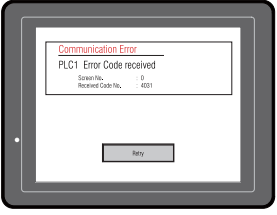
Probable Symptoms

Symptom	Cause	Solution
<p>MONITOUCH is connected to controllers; however, communication fails. "Communication Error: Time-Out" appears on the screen.</p> 	<p>Probable causes are:</p> <ol style="list-style-type: none"> 1) Cables are not connected correctly or any cable is disconnected. 2) Parameter settings in the controller are not correct or disagree with the S8-series settings. 3) The MONITOUCH is faulty. 	<p>Solutions are:</p> <ol style="list-style-type: none"> 1) Check the cable connection. 2) Recheck the parameter settings in the controller. 3) Perform a self-loop test on the I/O Test screen (page 5-13). If the test is not successful, please return MONITOUCH to your local distributor immediately.
<p>Communications have been successful. However, opening a certain page always causes a "Communication Error: Error Code received" error.</p> 	<p>The error code denotes a controller error (NAK).</p> <ol style="list-style-type: none"> 1) When the error code appears only on a certain screen, a memory address that does not exist on the controller may be set on the S8-series screen. 2) When the error code appears at power-on, the memory address set for buffering area or initial macro or in the [Read/Write Area] tab window ([System Setting] → [Device Connection Setting]) may not exist in the controller. 	<ol style="list-style-type: none"> 1) Check if any address outside the allowable range for controller memory is set on the screen. 2) Check if the address set for buffering area or initial macro or in the [Read/Write Area] tab window ([System Setting] → [Device Connection Setting]) is outside the allowable range for the controller memory.
<p>Communications have been successful. However, "Communication Error: Parity" or "Communication Error: Framing" suddenly occurs.</p> 	<p>Noise may cause the error.</p>	<p>Check if appropriate measures are taken against noise.</p> <p>Example: Check if communication and power cables are bundled together. Try to attach a ferrite core to the communication cable. Try to attach a noise filter to the power supply, etc.</p>

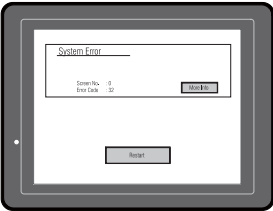
Symptom	Cause	Solution
<p>"SYSTEM ERROR: xx" occurs.</p> 	<p>The following causes are probable, depending on the symptoms.</p> <ol style="list-style-type: none"> 1) Turning the power off and back on corrects the error. ↓ Communication failed because of improper timing. 2) Turning the power off and back on does not correct the error. ↓ A certain condition always causes the error. Or MONITOUCH is faulty. <p>If none of the above matches your error, contact your local distributor.</p>	<ol style="list-style-type: none"> 1) If communication is stable after turning the power on again, continue and observe operation. 2) Make a note of the information on error number, etc. displayed on the screen and contact your local distributor.
Switches do not work.	<ol style="list-style-type: none"> 1) Switches do not work in the RUN mode. A beep sounds. ↓ Is the switch interlock enabled? 2) Switch activation position is wrong. On the I/O Test screen displayed from the Main Menu screen, press the [Switch Test] switch. On the touch switch test screen, a position different from the pressed position is activated. ↓ The switch activation position may be misaligned. 3) Switches do not work even in the STOP mode. On the I/O Test screen displayed from the Main Menu screen, press the [Switch Test] switch. When the touch switch test screen is pressed, nowhere is activated. ↓ MONITOUCH switches may be faulty. 	<ol style="list-style-type: none"> 1) Check the settings of switch functions, etc. on the V-SFT-5 editor. 2) Perform a touch switch adjustment (page 5-18). 3) Return MONITOUCH to your local distributor.
The screen becomes dark or black.	<ol style="list-style-type: none"> 1) Touching the screen restores it to the previous illuminated state. ↓ The backlight operates automatically as preset. 2) Touching the screen does not restore it. However, the POWER lamp is lit. ↓ The backlight may be at the end of its life. Or MONITOUCH may be faulty. 	<ol style="list-style-type: none"> 1) The time for turning off the backlight can be changed on the V-SFT-5 editor. 2) Return MONITOUCH to your local distributor.
Screen data cannot be transferred.	<ol style="list-style-type: none"> 1) An error is displayed on the computer when screen data is transferred. ↓ There may be errors in the USB settings. 	<ol style="list-style-type: none"> 1) Is the USB driver recognized? Has the driver been installed successfully (page 2-14)? If the problem persists, contact your local distributor.

7 Inspection and Maintenance

1. Inspection and Maintenance
2. Warranty Policy

1. Inspection and Maintenance

**DANGER**

Be sure to turn off the power before conducting inspection or maintenance. Failure to do so could cause an electric shock or damage to the unit.

Daily Inspection

- Check that the screws on the S8 series are tightened firmly.
- Check that the connectors and terminal screws used for connection with other devices are tightened firmly.
- If the display surface or frame is dirty, wipe it with a soft cloth soaked in alcohol (commercially available).
- Conduct periodical inspection once or twice a year. The number of inspections may be increased as necessary if facilities are relocated or modified, or the environment is hot, humid, or dusty.

Periodical Inspection

Inspect the following points periodically.

- Are the ambient temperature and humidity appropriate?
0 to +50°C, 85%RH or less
- Are the environmental conditions appropriate?
No excessive dust, and no conductive dust
- Does the atmosphere contain no corrosive gas?
- Is the source voltage in the allowable range?
With DC power supply: 24 VDC \pm 10%
- Are the S8-series mounting screws tightened firmly?
- Are the connectors and terminal screws used for connection with other devices tightened firmly?
- Is the lithium primary battery within the expiry date?
About 5 years from the date of your purchase

2. Warranty Policy

Inquiries about Failure

Please direct inquiries about failure or repair to your local distributor. Your information on the MONITOUCH model, serial number, symptom of the failure, error message (if shown), etc. will be appreciated.

- * An inquiry form is provided on the final page (page 7-3) of this chapter. The form may be used for your inquiry.

Warranty Period

The product is under warranty for one year after the date of purchase or delivery to the specified place. On the assumption that the maximum stock period of the product after manufacture is 6 months, the warranty period is limited to 18 months (checked by the serial number) after manufacture. When a warranty period is specified in the contract, however, the period in the contract takes precedence.

Free-of-charge Repair

If the product fails before the expiry of the warranty, it will be repaired free of charge. However, repair of any failure resulting from the causes below will be chargeable even within the warranty period.

- Breakage of or damage to the appearance (case or surface sheet), touch switches, LCD, or other components due to dropping, impact, or mishandling
- LCD or backlight at the end of life
- Fusion of a printed circuit board pattern associated with connection to external devices, or fusion of a pattern in the terminal block or connector section of a printed circuit board caused by short-circuiting of external load circuit
- Overvoltage or different voltage applied due to wiring mistake (power supply terminal, external communication terminal, or other terminal blocks)
- Failure caused by lightning surge
- Failure due to the entry of conductive substances, water, solvent, particles, etc. under inappropriate environmental conditions
- Failure due to inappropriate environmental conditions (e.g. corrosive gas or high humidity)
- Failure due to vibration or impact exceeding the specified level
- Disassembly and modification by the customer or failure obviously resulting from improper handling by the customer

Chargeable Repair

Any failure that occurs after the expiry of the warranty or does not satisfy the requirements for the free-of-charge repair will be repaired on a chargeable basis.

Inquiry Form

Your name			
Company name			
Contact	Phone		Fax
	E-mail		
Model code(*1)			Ser. No. (*1)
MONITOUCH version (*2)	SYS. PROG. Ver. :		I/F DRV. Ver. :
Purchased from: (Distributor)			
Person in charge		Date of purchase	
Symptom			
(Please describe the symptom of the failure and also include the error message if any is displayed.)			

*1 See the label on the back of MONITOUCH for the model code and serial number (seven digits plus one letter of the alphabet).

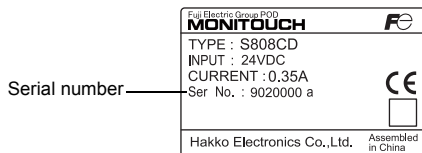

*2 Enter the version if it can be checked. The version is displayed on the Main Menu screen (page 5-3).

MEMO

Please use this page freely.

Hakko Electronics Co., Ltd.
www.monitouch.com

Sales 890-1, Kamikashiwano-machi, Hakusan-shi,
Ishikawa, 924-0035 Japan
TEL +81-76-274-2144 FAX +81-76-274-5208