



## AC700 Series Intelligent Machine Controller User Guide



Industrial  
Automation



Intelligent  
Elevator



New Energy  
Vehicle



Industrial  
Robot



Rail  
Transit



Data code PS00004465 A00

# Preface

## About This Manual

The AC700 series intelligent machine controller features outstanding motion control performance and diverse network interfaces to meet different expansion requirements. The controller can control equipment in a variety of industries, such as packaging, printing, die cutting, mobile phone manufacturing, silicon wafer manufacturing, logistics, and pharmacy.

This guide provides the installation, wiring, and operation instructions of the product.

## More Documents

Document Name	Document Code	Description
Medium-Sized PLC Programming Software User Guide	19010980	Describes the basic functions, quick start, network settings, and programming basics of medium-sized PLC programming software.

## Revision History

Date	Version	Change Description
January 2022	A00	Initial release

## How to Obtain

This guide is not delivered with the controller, but an electronic PDF version is available. To obtain it, visit [www.inovance.com](http://www.inovance.com), click Downloads, search the keyword, and download the guide.

# Safety Precautions

## Safety Disclaimer

- This chapter presents essential safety instructions for proper use of the controller. Before using the product, please read the guide and make sure you understand the safety instructions correctly. Failure to comply with the safety instructions may result in damage to equipment, serious injury, or even death.
- "CAUTION", "WARNING", and "DANGER" items in the guide are just supplementary and do not cover all safety instructions.
- Use this product in an environment that complies with the design specifications. Malfunction or component damage caused by improper usage is not covered by warranty.
- Inovance shall take no responsibility for any physical injuries or property loss caused by noncompliance with this guide or improper use of this product.

## Safety Levels and Definitions



indicates that failure to comply with the notice will result in serious injury or even death.



indicates that failure to comply with the notice may result in serious injury or even death.



indicates that failure to comply with the notice may result in minor physical injury or damage to the equipment.

## Safety Precautions

- Some drawings in this guide show the product without covers or protective guards to display more details. When using this product, be sure to install the covers or protective guards according to the regulations, and operate in accordance with the guide.
- The product drawings in this guide are for reference only and may be slightly different from the product you ordered.

Unpacking and Acceptance	
	<ul style="list-style-type: none"><li>• Do not install the product if any damage, rust, or sign of use is found on the product and accessories.</li><li>• Do not install the product in case of water seepage in the product, part missing or part damage.</li><li>• Do not install the product if you find the packing list does not conform to the product you received.</li></ul>
	<ul style="list-style-type: none"><li>• Before unpacking, check whether the packing is intact and without damage, water seepage, damp, and deformation.</li><li>• Unpack the package in sequence. Do not strike the package with force.</li><li>• Check the surface of the equipment and accessories for any damage or rust.</li><li>• Check the equipment, accessories, and materials in the package against the packing list to ensure that no item is missing.</li></ul>
Storage and Transportation	



- Use professional hoisting equipment operated by qualified professionals to move large-scale or heavy products. Failure to comply may result in physical injury or product damage.
- Before hoisting the product, confirm that the front cover, terminal block, and other parts of the product are firmly fixed with screws. Failure to comply may cause the parts to fall off and result in physical injury or product damage.
- Never stand or stay below the product that is lifted by hoisting equipment.
- Lift the product with a steel rope steadily at a constant speed to protect the product against vibration, impact, or turnover. Do not keep the product lifted for a long time. Failure to comply may result in physical injury or product damage.



- Handle the product with care and mind your steps. Failure to comply may result in physical injury or product damage.
- When carrying the product with bare hands, hold the product casing firmly with care to prevent parts from falling. Failure to comply may result in physical injury or product damage.
- Store and transport the product as required. Failure to comply may result in product damage.
- Avoid storage and transportation in environments subject to water splash, rain, direct sunlight, strong electric field, strong magnetic field, and strong vibration.
- Avoid storing the product for more than 3 months. Long-term storage shall require stricter protection and necessary inspections.
- Pack the product strictly before transportation. Use a sealed box for long-distance transportation.
- Never transport this product with equipment or materials that may damage or have negative impacts on this product.





### Installation











- Only professional personnel with electrical expertise can operate this product. Operations by non-professionals are strictly prohibited.



- Read through the user guide and safety precautions before installation.
- Do not install this product in places subject to strong electric field or strong electromagnetic wave interference.
- Before installation, make sure that the installation position is mechanically strong enough to bear the weight of the equipment. Failure to comply may result in mechanical hazards.
- Do not wear loose clothes or accessories during installation. Failure to comply may result in an electric shock.
- When installing the product in a closed environment (such as a cabinet or a chassis), cool the environment with a fan or an air conditioner to prevent overheat or fire.
- Do not modify this product.
- Do not fiddle with the bolts used to fix equipment components or the bolts marked in red.
- To install the product in a cabinet or terminal equipment, make sure that the enclosure of the cabinet or terminal equipment provides adequate fire prevention, electrical protection, and mechanical protection conforming to relevant IEC standards and local laws and regulations.
- Before installing equipment with strong electromagnetic interference, such as a transformer, install an electromagnetic shielding device to prevent malfunctions of this product.
- Install the product on incombustible objects such as metal and keep it away from combustible materials. Failure to comply may result in a fire.

<p> CAUTION</p> <ul style="list-style-type: none"><li>• Cover the top of the product with cloth or paper during installation to prevent unwanted objects such as metal chippings, oil, and water from falling into the equipment and causing faults. After installation, remove the cloth or paper to prevent overtemperature caused by poor ventilation due to blocked ventilation holes.</li><li>• Resonance may occur when the equipment operating at a constant speed executes variable speed operations. In this case, install the anti-vibration rubber under the motor frame or use the vibration suppression function to reduce the resonance.</li></ul>
<b>Wiring</b>
<p> DANGER</p> <ul style="list-style-type: none"><li>• Do not allow non-professionals to perform equipment installation, wiring, maintenance, inspection, or parts replacement.</li><li>• Cut off all power supplies before wiring. Wait for at least the time specified on the product warning label after power-off so that residual voltage can discharge safely. Measure the DC voltage on the main circuit to ensure that it is within the safe voltage range. Failure to comply may result in an electric shock.</li><li>• Do not perform wiring, remove the product cover, or touch the circuit board with power ON. Failure to comply may result in an electric shock.</li><li>• Ensure that the product is well grounded. Failure to comply may result in an electric shock.</li></ul>
<p> WARNING</p> <ul style="list-style-type: none"><li>• Never connect the power cable to an output terminal. Failure to comply may result in product damage or even fire.</li><li>• When connecting a drive with the motor, ensure that the phase sequences of the drive and motor are consistent to prevent motor reverse rotation.</li><li>• Ensure that the diameter and shield of the cables used meet corresponding requirements, and that the shield of the shielded cables is grounded reliably at one end.</li><li>• Tighten terminal screws with tightening torque specified in this guide. Failure to comply may result in overheat and damage to the connection parts or even fire.</li><li>• After wiring, check that each cable is connected properly, no screws or gaskets fall into the product, and no cables are exposed. Failure to comply may result in an electric shock or product damage.</li></ul>
<p> CAUTION</p> <ul style="list-style-type: none"><li>• Follow the proper electrostatic discharge (ESD) procedures, and wear an anti-static wrist strap during wiring. Failure to comply may result in damage to the product or the circuit of the product.</li><li>• Use shielded twisted pair cables for the control circuit. Connect the shield to the product grounding terminal. Failure to comply may result in product malfunction.</li></ul>
<b>Power-on</b>
<p> DANGER</p> <ul style="list-style-type: none"><li>• Before power-on, ensure that the product is properly installed, all cables are securely connected, and the motor can be restarted.</li><li>• Before power-on, ensure that the power supply meets requirements. Failure to comply may result in product damage or even fire.</li><li>• Do not open the cabinet or protective cover, touch any terminal, or dismantle any device or component when the product is powered on. Failure to comply may result in an electric shock.</li></ul>

 <b>WARNING</b>
<ul style="list-style-type: none"><li>• After wiring and parameter setting, perform a trial run to check whether the device can run properly. Failure to comply may result in physical injury or device damage.</li><li>• Before power-on, check that the rated voltage of the product is consistent with that of the power supply. Failure to comply may result in fire.</li><li>• Before power-on, check that no one is near the equipment, motor, or machine. Failure to comply may result in physical injury or even death.</li></ul>
<b>Operation</b>
 <b>DANGER</b>
<ul style="list-style-type: none"><li>• Do not allow non-professionals to operate the product. Failure to comply may result in physical injury or even death.</li><li>• Do not touch any wiring terminals or disassemble any unit or component of the equipment during operation. Failure to comply may result in an electric shock.</li></ul>
 <b>WARNING</b>
<ul style="list-style-type: none"><li>• Never touch the product shell, fan, or resistor to check the temperature. Failure to comply may result in burn.</li><li>• Prevent metal or other objects from falling into the product during operation. Failure to comply may result in product damage or fire.</li></ul>
<b>Maintenance</b>
 <b>DANGER</b>
<ul style="list-style-type: none"><li>• Do not allow non-professionals to perform equipment installation, wiring, maintenance, inspection, or parts replacement.</li><li>• Never perform maintenance during power-on. Failure to comply may result in an electric shock.</li><li>• Before maintenance, cut off all equipment power supplies and wait for at least the time specified on the product warning label.</li><li>• In case of a permanent magnet motor, do not touch the motor terminals immediately after power-off because the motor terminals can generate induced voltage during rotation even after the equipment power supply is off. Failure to comply may result in an electric shock.</li></ul>
 <b>WARNING</b>
<ul style="list-style-type: none"><li>• Perform daily and periodic inspection and maintenance on the equipment according to maintenance requirements and keep a maintenance record.</li></ul>
<b>Repair</b>
 <b>DANGER</b>
<ul style="list-style-type: none"><li>• Do not allow non-professionals to perform equipment installation, wiring, maintenance, inspection, or parts replacement.</li><li>• Never perform any inspection or maintenance operations during power-on. Failure to comply may result in an electric shock.</li><li>• Before inspection or maintenance, cut off all equipment power supplies and wait for at least the time specified on the product warning label.</li></ul>

 WARNING
<ul style="list-style-type: none"> <li>• Require repair services according to the product warranty agreement.</li> <li>• When the fuse is blown or the circuit breaker or earth leakage current breaker (ELCB) trips, wait for at least the time specified on the product warning label before power-on or further operations. Failure to comply may result in equipment damage, physical injury, or even death.</li> <li>• When the equipment fails or is damaged, designate qualified technicians to troubleshoot and repair the equipment in accordance with the maintenance instructions and keep a maintenance record.</li> <li>• Replace quick-wear parts of the equipment according to the replacement guide.</li> <li>• Do not use a damaged machine. Failure to comply may result in worse damages, physical injury, or even death.</li> <li>• Make sure to re-check the wiring and parameter setting after device replacement.</li> </ul>
<b>Disposal</b>
 WARNING
<ul style="list-style-type: none"> <li>• Scrap the equipment or product in accordance with relevant national regulations and standards. Failure to comply may result in property damage, physical injury, or even death.</li> <li>• Recycle retired equipment by observing industry waste disposal standards to avoid environmental pollution.</li> </ul>

## Safety Signs

For safety operations, follow the safety signs on the equipment. Do not stain or remove the safety signs. The safety signs are described as follows:

Safety Sign	Description
	<ul style="list-style-type: none"> <li>• Read through the safety instructions before operating the equipment. Failure to comply may result in equipment damage, physical injury, or even death.</li> <li>• Do not touch terminals or remove the cover during power-on or within 10 minutes after power-off. Failure to comply may result in an electric shock.</li> </ul>

# 1 Product Information

## 1.1 Nameplate and Model Number

### Nameplate

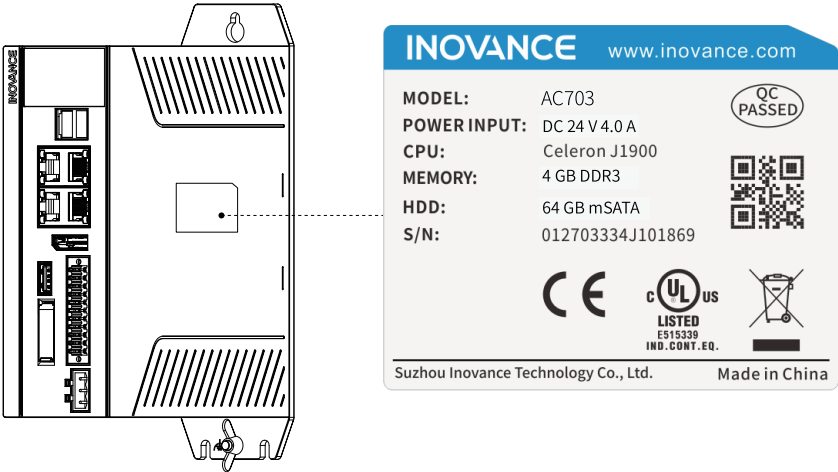

### Model number

A
C
7
03
-
 

①
②
③
④
⑤

<p>1. <b>Product Name</b> A: controller</p>	<p>3. <b>Serial No. (First Digit)</b> 7: 7 series</p>	<p>5. <b>Operating System</b> W: Windows L: Linux</p>
<p>2. <b>Structure Type</b> C: booksize type</p>	<p>4. <b>Hardware Configuration Code</b> XX: two digits, which are defined based on functions and performance</p>	



## 1.2 Components

### 1.2.1 Appearance



The AC700 series includes the following models:

Type	Description	Model	Serial No.
Booksize controller	Intel J1900; 4 GB memory; 64 GB hard drive; three USB 2.0 ports; three network ports; DP; with display; 16 axes	AC702	01440300
Booksize controller	Intel J1900; 4 GB memory; 64 GB hard drive; three USB 2.0 ports; three network ports; DP; with display; 32 axes	AC703	01440354

### 1.2.2 Ports

The following figure shows the external ports of the AC700:

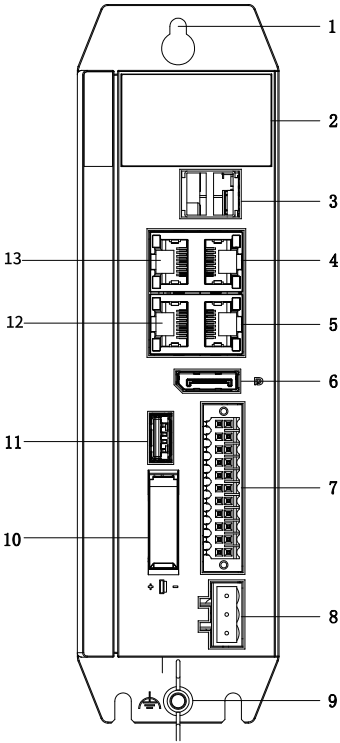

No.	Port	Description
1	Rear earhook	Standard component
2	Display	For specific functions and operations, see <a href="#">"5.3 Display" on page 37.</a>
3/11	USB port	Three USB 2.0 ports
4	LAN port	Not supported
5	LAN C port	EtherCAT port
6	DP	Display Port (DP)
7	I/O communication port	Eight DIs/four DOs; RS485/RS232. For details on the pins, see section 4.3.
8	Power terminal	24 V power input
9	Grounding terminal	Controller grounding
10	Battery cover	Open the battery cover to replace the battery.
12	LAN B port	Ethernet port
13	LAN A port	Ethernet port

## 2 Product Specifications

### 2.1 Basic Specifications

The AC700 series includes two controller models: AC702 and AC703. The following table provides basic specifications of the two models.

Item	AC702	AC703
Power supply	24 VDC (-15% to +20%)	24 VDC (-15% to +20%)
CPU model	Intel J1900, 2 GHz	Intel J1900, 2 GHz
Memory	4 GB	4 GB
Memory type	DDR3 SO-DIMM	DDR3 SO-DIMM
Hard drive capacity	64 GB	64 GB
Hard drive type	mSATA SSD	mSATA SSD
SPI FLASH	64 Mbit	64 Mbit
Programming mode	IEC 61131-3-compliant programming language (LD, ST, SFC, CFC)	IEC 61131-3-compliant programming language (LD, ST, SFC, CFC)
Program execution mode	Compile and run	Compile and run
Number of EtherCAT axes	16 axes	32 axes
User program storage space	128 MB	128 MB
User data storage space	128 MB	128 MB
EtherCAT communication	1 (each supports up to 128 slaves)	1 (each supports up to 128 slaves)
Modbus TCP communication	2 (supporting up to 63 slaves)	2 (supporting up to 63 slaves)
Modbus (serial port) communication	2 (each supports up to 31 slaves)	2 (each supports up to 31 slaves)
Ethernet/IP	1 (supporting connection with up to 64 clients and 32 servers)	1 (supporting connection with up to 64 clients and 32 servers)
Retain memory at power failure	5 MB	5 MB
Dimensions (mm)	160 (H) x 55 (W) x 147 (D)	160 (H) x 55 (W) x 147 (D)
Weight (kg)	< 1.3 kg	< 1.3 kg
Heat-dissipating method	Natural cooling	Natural cooling

## 2.2 Environmental Specifications

	Item	Working	Transportation	Storage	
Environment parameters (IEC60721-3)	Class	IE33	IE22	IE12	
	Temperature	-5°C to +55°C	-40°C to +70°C	-25°C to +70°C	
	Humidity	10% to 95%, no-condensation			
	Vibration	Frequency	5 Hz to 150 Hz	2M2	1M2
		Displacement	3.5 mm (direct installation) (< 9 Hz)		
		Acceleration	1 g (direct installation) (> 9 Hz)		
		Direction	3 axial directions		
	Impact (collision)	15 g, 11 ms, half sine wave, 3 axial directions			
Altitude/air pressure	0 m to 2000 m	0 m to 3000 m (> 70 kPa)			

## 2.3 EMC Specifications

The following table provides EMC specifications of the AC700 series controller.

No.	Item	Standard	Description
1	Conducted emission Power terminals	IEC61131-2:2017 IEC 61000-6-4:2018	Class A
2	Radiated emission Controller	IEC61131-2:2017 IEC 61000-6-4:2018	Class A
3	ESD	IEC61131-2:2017 IEC 61000-4-2:2008	±6 kV (contact discharge) ±8 kV (air discharge)
4	Radiated susceptibility (RS)	IEC61131-2:2017 IEC 61000-4-3:2006 +A1:2007+A2:2010	80 MHz to 1000 MHz 10 V/m, 1.4 GHz to 6 GHz 10 V/m
5	EFT/Burst, DC power terminal	IEC61131-2:2017 IEC 61000-4-4:2012	±2 kV, direct injection (5/50 ns, 5/100 kHz)
6	EFT/Burst, Communication and signal ports	IEC61131-2:2017 IEC 61000-4-4:2012	±2 kV, capacitive coupling clamp (5/50 ns, 5/100 kHz)
7	Conducted susceptibility (CS) DC power terminal	IEC61131-2:2017 IEC 61000-4-6:2013	0.15 MHz to 230 MHz, (1 kHz, AM 80%) 10 V, CDN
8	Conducted susceptibility (CS) Communication and signal ports	IEC61131-2:2017 IEC 61000-4-6:2013	0.15 MHz to 230 MHz, (1 kHz, AM 80%) 10 V, electromagnetic clamp
9	Surge DC power terminal	IEC61131-2:2017 IEC 61000-4-5:2014+ A1:2017	±1 kV (line to ground) ±0.5 kV (line to line)

## Product Specifications

---

No.	Item	Standard	Description
10	Surge Communication and signal ports	IEC61131-2:2017 IEC 61000-4-5:2014+ A1:2017	± 1 kV (line to ground)
11	Voltage dip and short interruption	IEC 61000-4-29:2000	Voltage dip: 40% U <sup>T</sup> and 70% U <sup>T</sup> ; duration: 0.01s, 0.03s, 0.1s, 0.3s, 1s Duration for short interruption: 0.001s, 0.003s, 0.01s, 0.03s, 0.1s, 0.3s, 1s
12	Power frequency magnetic field immunity	IEC 61000-4-8:2009	30 A/m

## 3 Installation

### 3.1 Installation Requirements

#### 3.1.1 Installation Precautions

Observe the following precautions when installing the controller:

- Before installation, ensure that the controller is powered off.
- To avoid damage to the controller, do not drop or shock the controller's housing, terminal block, or connector.
- Do not disassemble the controller; otherwise the controller may be damaged.
- To avoid damage to the terminal and controller, do not overtighten the fasteners.
- The left panel of the controller is an aluminum plate for heat dissipation. Exercise caution to avoid burns.

#### 3.1.2 Installation Environment

When installing the controller on the guide rail, take the operability, maintainability, and environment adaptation into account. Do not install the controller in a location with:

- An ambient temperature exceeding the range of  $-5^{\circ}\text{C}$  to  $+55^{\circ}\text{C}$
- Ambient humidity exceeding the range of 5% to 95% RH
- Drastic temperature changes and condensation
- Corrosive and flammable gas
- Conductive powders (such as dust and iron powder), oil mist, salt, and organic solvents
- Direct sunlight
- Strong electric and magnetic fields
- Vibration or shocks

#### 3.1.3 Installation Space

To facilitate ventilation and module replacement, reserve enough space between the module and its surroundings.

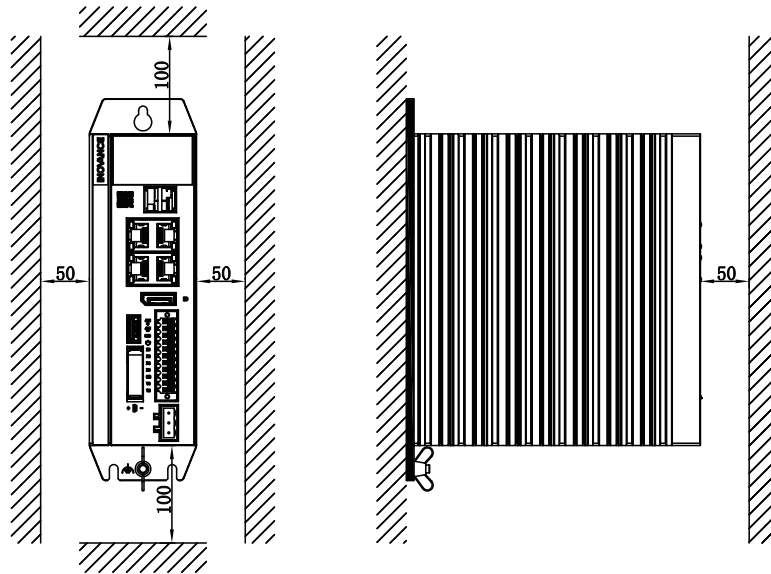

## 3.2 Installation Instructions

### 3.2.1 Installation Dimensions

The following figure shows the installation dimensions of the controller.

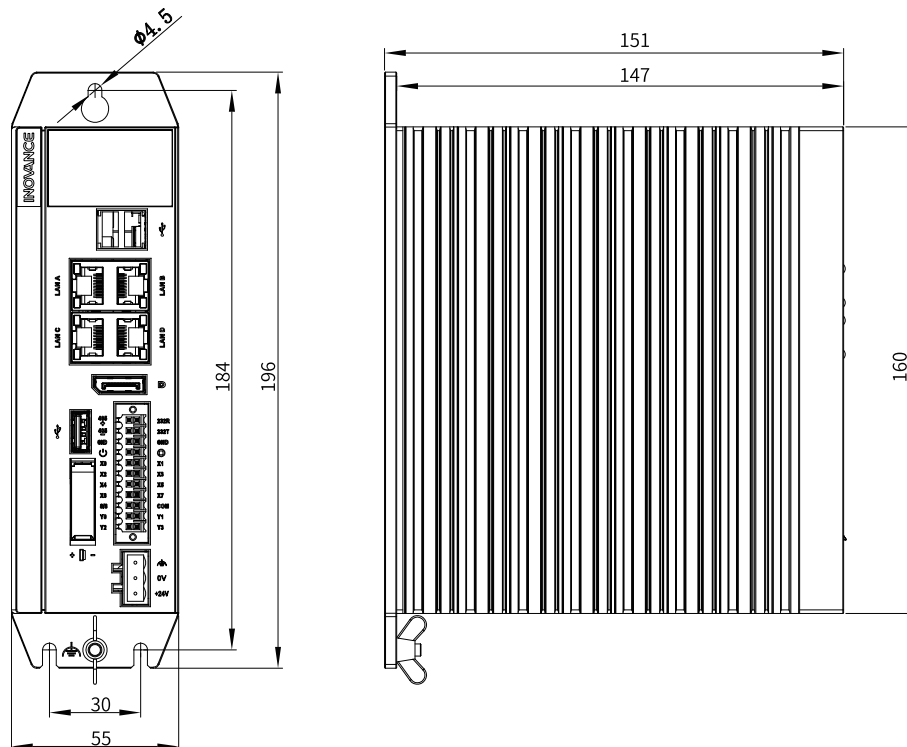

### 3.2.2 Installation Method

Install and secure the AC700 with three screws at the torque of 1.2 N m through the rear earhook and the bottom stand.

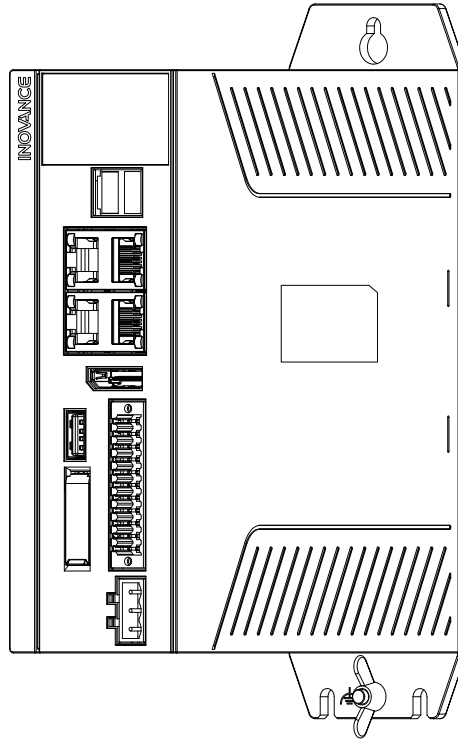

Figure 3-1 Installing the controller through the rear earhook



## 4 Wiring

### 4.1 Cabling Suggestions

#### 4.1.1 Grounding Requirements

A grounding point (⏏) is set on the power terminal of the controller and the rear earhook each. Choose one of the grounding points as needed, but the grounding point on the rear earhook is recommended. Ground the controller using a grounding wire that is as thick and short (less than 30 cm) as possible.

Use a wing nut for grounding, with a tightening torque of 0.55 N.m to 0.8 N.m, as shown below:

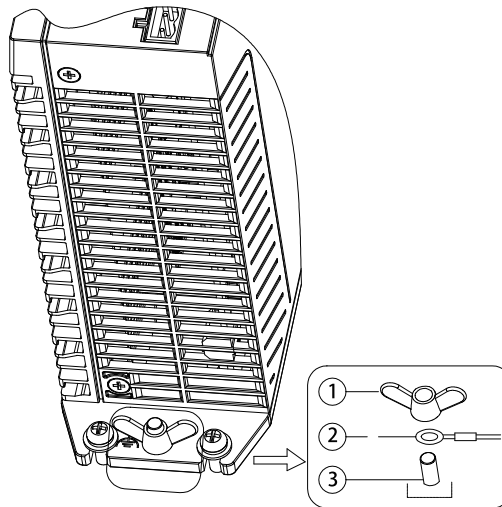

1-Wing nut; 2-Grounding cable; 3-Grounding screw

Figure 4-1 Grounding

#### Grounding of shielded cables

Communication cables must be shielded cables. Ground the shielded cable as close to the controller as possible so that the cable is not interfered with by electromagnetic induction. The exposed shielded cable must touch the grounding point as much as possible to ensure good contact.

Do not solder a PVC wire to the shielded cable for grounding because this will increase the high frequency impedance and attenuate the shielding effect. The communication cable must be grounded at both ends.

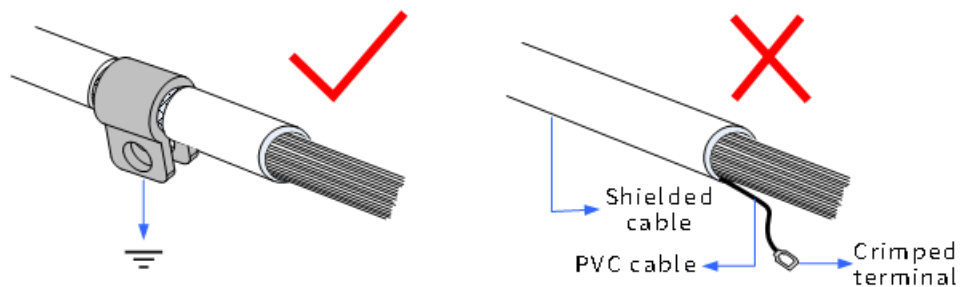

Figure 4-2 Grounding a shielded cable

## 4.1.2 Cabling Requirements

Low-voltage cables (< 1 kV) are generally divided into four types. Only cables of the same type can be bundled together. Cables of different types must be separated without intersection or overlap. If intersection cannot be avoided, route cables in a right-angle crossover manner.

No.	Type	Application
1	I	Ethernet port and EtherCAT port
2	II	Low-speed digital communication signals (RS232 and RS485) and DI/DO signals
3	III	Low-voltage AC power distribution cables or DC power cables (such as a 24 VDC power supply)
4	IV	Input and output cables, welding machine cables, and power converter power cables

Keep a proper distance between different types of cables. For cables shorter than 30 m, the minimum distance allowed is shown in the figure below.

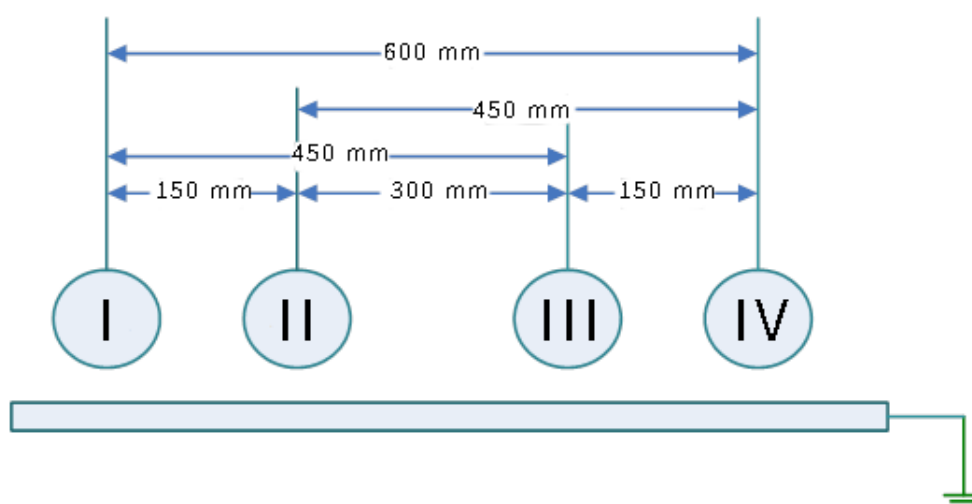

Figure 4-3 Required distances between different types of cables

### Note

- If two cables run parallel for an extended length, increase the distance between the two cables accordingly.
- You can also install spliced shielding plates between different types of cables. To reduce cross interference, route all cables as closely as possible to the grounded structural components of the cabinet, such as the cabinet's mounting plate or rack components.

## 4.1.3 Installation of the Filter

If the controller is subject to a strong interference source (such as an AC drive), it is recommended that you add a noise filter to suppress the interference.

Install the filter as close as possible to the power supply of the controller. Fix the filter to the conductive backplane through screws. Protect the area around the screws with paint and ensure reliable grounding. The outgoing and incoming cables of the filter should be routed separately to avoid noise coupling on the cables.

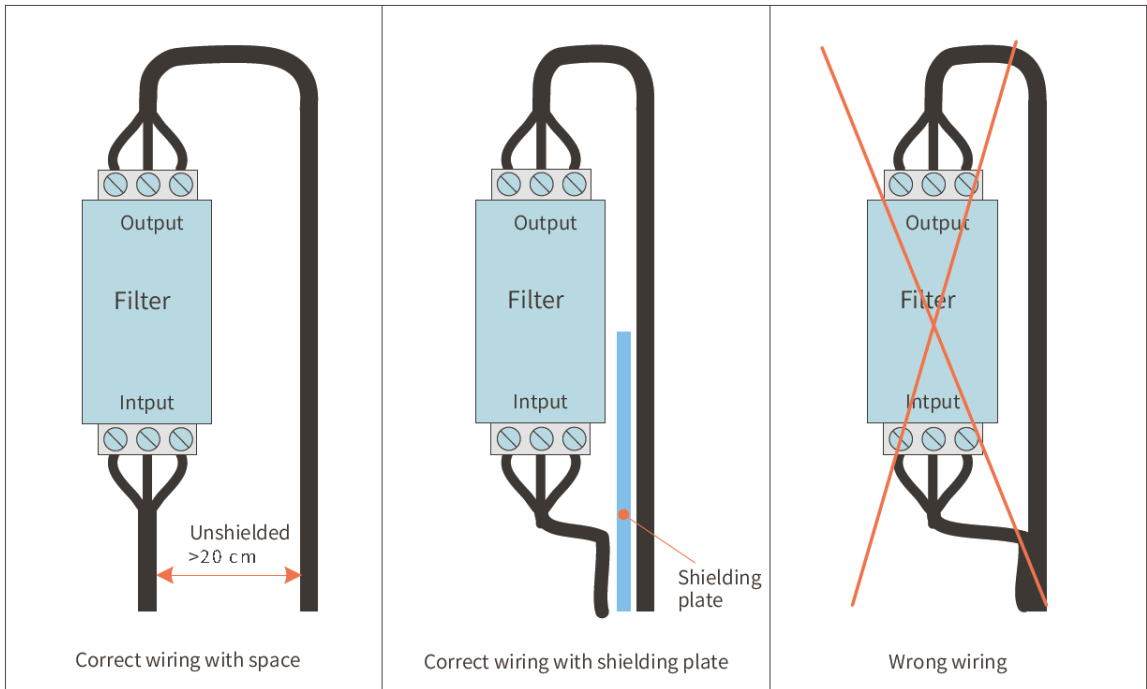

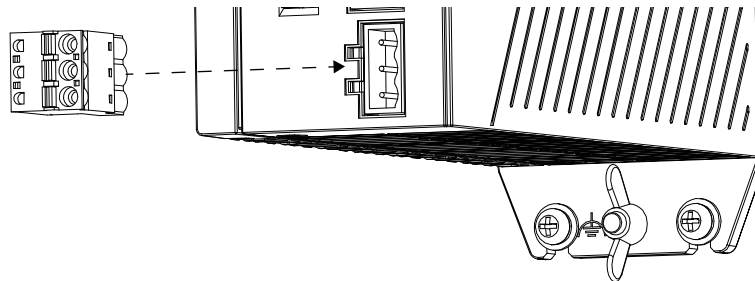

## 4.2 Wiring of the Power Input Port

The power input terminal includes three pluggable pins spaced at 5.08 mm. You can use a spring to crimp the wire onto the terminal, thus facilitating wiring, replacement, and maintenance on site. The following figure shows how to insert the power cable connector into the power input port:

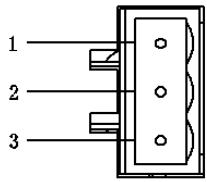

### Definition of the power input terminals

Terminal	No.	Name	Type	Function
	1		Grounding	Enclosure PE
	2	0 V	Input	Negative DC input terminal
	3	+24 V	Input	Positive DC input terminal

### Specifications of the input power supply

No.	Item	Specifications
1	Input voltage	24 VDC (-15% to +20%)
2	Input current	4 A
3	Brown-out detection threshold	18 V

No.	Item	Specifications
4	Hold-up time	150 ms
5	Foolproof	Yes
6	Short circuit protection	Yes

Note: The power input is equipped with a fuse.

## Power cable preparation requirements

The power input cable uses a pin-type terminal. For preparation requirements, see [“4.7.2 Cable Preparation Requirements” on page 32](#)

## 4.3 Wiring of the I/O Communication Port



### 4.3.1 Port Definition

#### Introduction to the I/O Communication Port

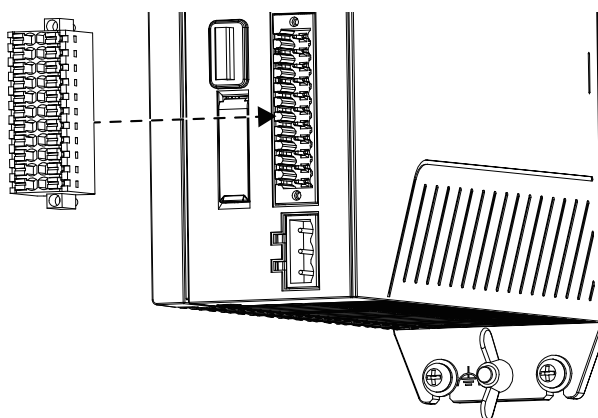
The I/O communication port includes 22 pins (terminals) arranged in dual rows (11 pins per row) and spaced at 3.5 mm. It is used to transfer the DI signal, DO signal, RS232 signal, RS485 signal, power-on signal, and PLC program start/stop control signal. The terminal is a screw-fixed pluggable terminal. You can use a spring to crimp the wire onto the terminal, thus facilitating wiring, replacement, and maintenance on site. The following figure shows how to insert the I/O connector into the I/O communication port.

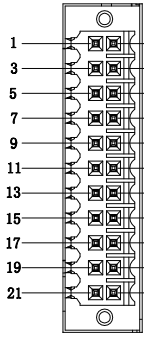

## Definition of the I/O communication port

Type	Function	Terminal	No.	I/O communication port	No.	Terminal	Function	Type
RS485	RS485+	485+	1		2	232R	RS232 receiving	RS232
	RS485-	485-	3		4	232T	RS232 transmitting	
	Serial port ground	GND	5		6	GND	Serial port ground	
DI	Power-on signal		7		8		RUN/STOP	DI
DI	High-speed input 0	X0	9		10	X1	High-speed input 1	DI
DI	High-speed input 2	X2	11		12	X3	High-speed input 3	DI
DI	High-speed input 4	X4	13		14	X5	High-speed input 5	DI
DI	High-speed input 6	X6	15		16	X7	High-speed input 7	DI
DI	Input common terminal	S/S	17		18	COM	Output common terminal	DO
DO	High-speed output 0	Y0	19		20	Y1	High-speed output 1	DO
DO	High-speed output 2	Y2	21		22	Y3	High-speed output 3	DO

### Note

When the PLC crashes, you can forcibly stop and restart the PLC program through the RUN/STOP port.

To do so, you need to connect the RUN/STOP port to 24 V and the S/S port to 0 V. Then, the startup icon on the display turns off, indicating that the PLC is forcibly stopped.

## 4.3.2 Port Specifications

### High-speed digital input specifications (pins 9/10/11/12/13/14/15/16)

Item	Specifications
Number of channels	8
Input type	DC digital input
Input mode	SINK/SOURCE
Max. input frequency	200 kHz
Frequency detection error	±1 pulse
Input impedance	4.3 kΩ
Input voltage/current class	Detection voltage: 24 V (Max.: 30 V. When all inputs are ON, the input voltage does not exceed 26.4 V.) ON: Voltage ≥ 15 V; Input current > 5 mA OFF: Voltage ≤ 5 V; Input current < 1.5 mA

## High-Speed digital output specifications (pins 19/20/21/22)

Item		Specifications
Number of channels		4
Output type		DC digital output, transistor
Output mode		SINK
Maximum output frequency		200 kHz (To reach 200 kHz, connect an external load equivalent to 12 mA or above.)
Voltage of the control circuit		5 VDC to 24 VDC
Min. load		5 mA
Max. output current	Resistive load	Max. output current
	Inductive load	7.2 W/24 VDC
Max. voltage drop at ON		0.2 V (typical value)
Leakage current at OFF		< 0.1 mA
ON response time		1 $\mu$ s
OFF response time		1 $\mu$ s
Isolation method		Optocoupler isolation
Short circuit-proof output		Yes

## RS485 communication specifications

Item		Specifications
Number of channels		1
Baud rate (bps)		4.8 kbps, 9.6 kbps, 19.2 kbps, 38.4 kbps, 57.6 kbps, 115.2 kbps
Max. number of stations		31
Supported protocol		Modbus and free protocol
Isolation method		Optocoupler isolation

## RS232 communication specifications

Item		Specifications
Number of channels		1
Baud rate (bps)		4.8 kbps, 9.6 kbps, 19.2 kbps, 38.4 kbps, 57.6 kbps, 115.2 kbps
Supported protocol		Modbus and free protocol
Isolation method		Optocoupler isolation

### 4.3.3 Wiring of User Terminals

#### Wiring of power-on signal and run/stop signal terminals

##### Wiring of the external circuit

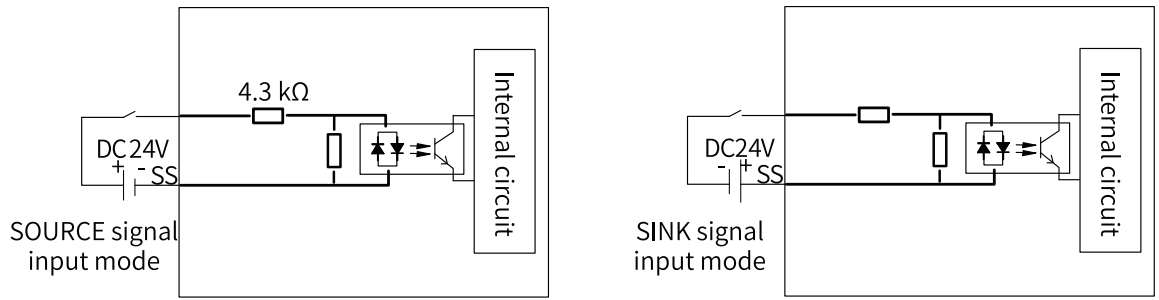

Internal structure

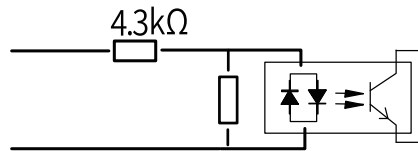

### Wiring of 8 high-speed DI and 4 high-speed DO terminals

Wiring of the external circuit

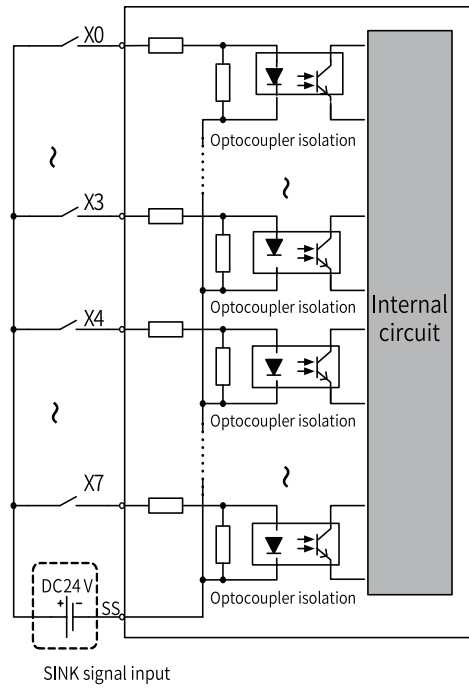

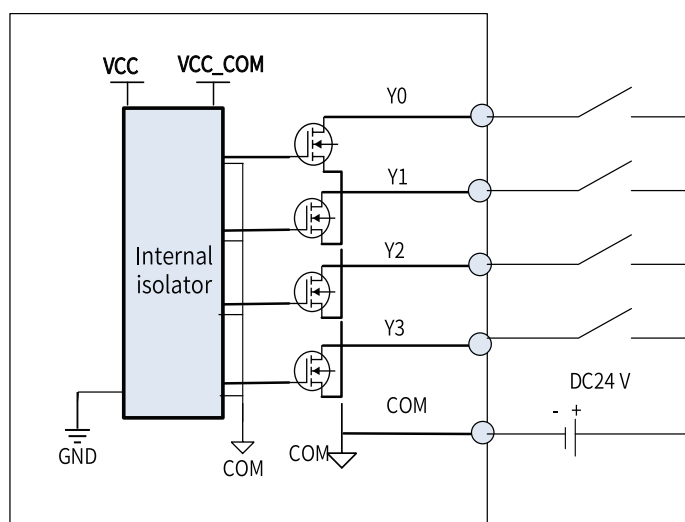

Internal structure

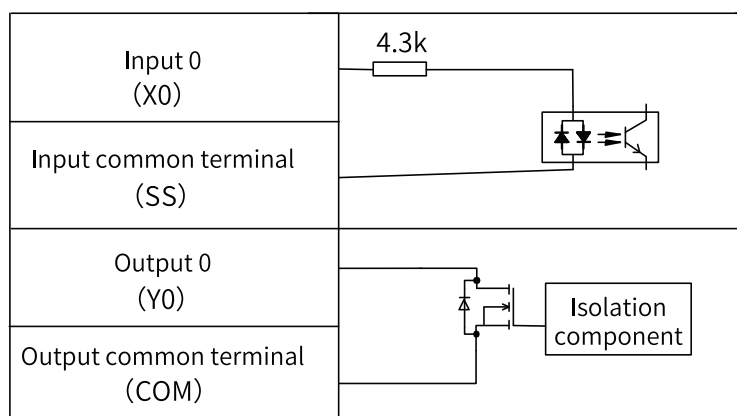

#### 4.3.4 RS485 Bus Wiring Instructions

- Do not bundle the extension cable together with power cables (high voltage, large current) which produce strong interference signals. Separate it from other cables and avoid cabling in parallel.
- Select recommended cables and pinboards for connection. It is recommended that shielded cables be used as extension cables to enhance capacity of resisting interference.

The figure below shows the RS485 bus topology. It is recommended that you use the shielded twisted pair as the RS485 bus. The 485+ and 485- wires form a twisted pair. A 120  $\Omega$  termination resistor is attached to each end of the bus to prevent signal reflection. All RS485 reference grounds are connected together. Up to 128 nodes can be connected and the length of each cable connecting a node and the bus must be less than 3 m.

- **RS485 topology**

The figure below shows the RS485 bus topology. It is recommended that you use the shielded twisted pair as the RS485 bus. The 485+ and 485- wires form a twisted pair. A 120  $\Omega$  termination resistor is attached to each end of the bus to prevent signal reflection. All RS485 reference grounds are connected together. Up to 128 nodes can be connected and the length of each cable connecting a node and the bus must be less than 3 m.



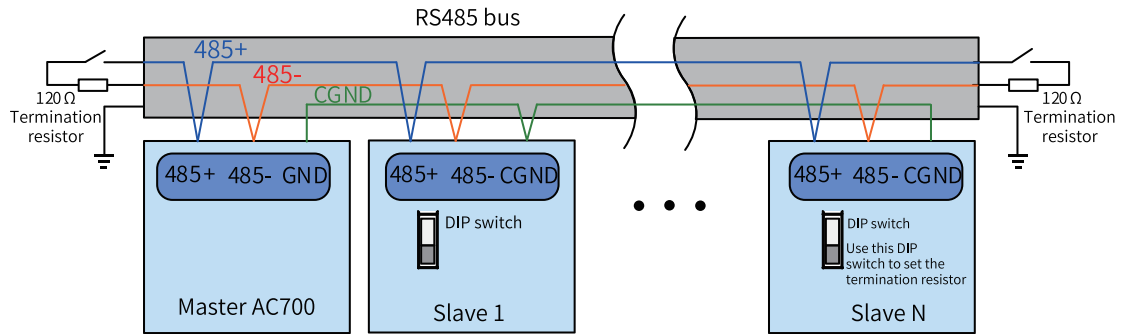
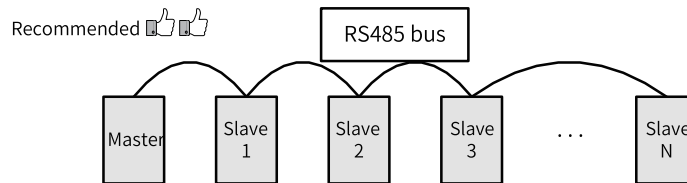

Figure 4-4 Wiring of the RS485 bus

- **Multi-node topology**

To connect a large number of nodes, use the daisy chain topology for the RS485 bus. If a branch cable is needed, keep its length shorter than 3 m and as short as possible. Star connection is strictly prohibited. The following figure shows the commonly-used bus topologies.

- Daisy chain



- Branch line

**Note**

It is recommended that the distance between the bus and the node do not exceed 3 m.

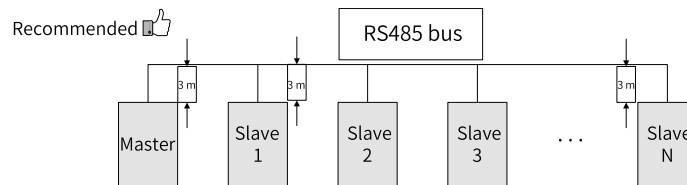

- Star connection (prohibited)

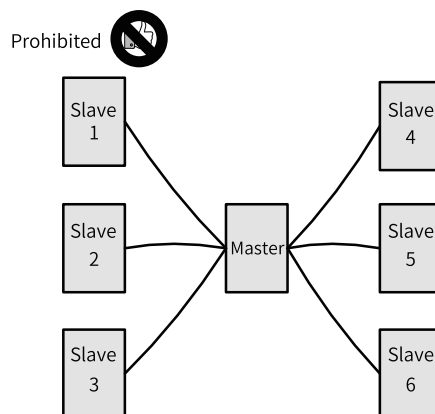

### Terminal wiring

The AC700 series controller provides three terminals (485+, 485— and GND) for RS485 communication. Ensure that the RS485 bus contains three cables, and the terminals are connected correctly. For the shielded cables, the shield must be connected to the GND terminal, rather than any other location (including housings and equipment ground terminals).

Due to the attenuation effect of the cable, it is recommended that you use AGW26 or thicker cables for a connection length longer than 3 m. It is always recommended that you connect the 485+ and 485— terminals to twisted pair cables.

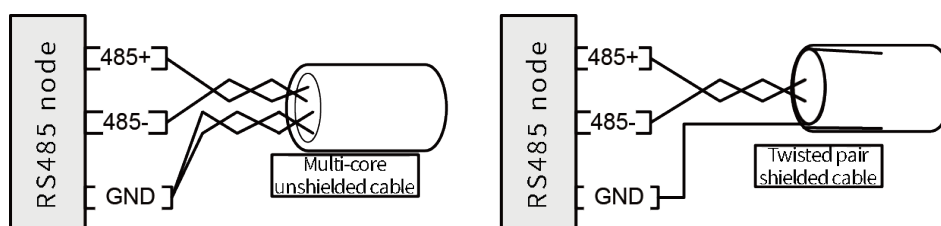

1. Recommended cable 1: Unshielded twisted pair cable with multiple conductors. Connect one twisted pair to the 485+ and 485— terminals, and twist other wires together and connect them to the GND terminal.
2. Recommended cable 2: Shielded twisted pair cable. Connect the twisted pair cable to the 485+ and 485— terminals, and connect the shield to the CGND terminal. The shield must only be connected to the GND terminal, not to the field ground.

## 4.3.5 RS232 Bus Wiring Instructions

When you use an RS232 to RS485 converter, it is recommended that you use an external power supply to power the converter. If the external power supply is unavailable, the baud rate should not exceed 9.6 kbps.

## 4.4 Wiring of Network Ports

### 4.4.1 Network Port Specifications

The AC700 series controller provides four Gigabit network ports, which are described as follows:

Model	No.	Network ports	Function
AC702	1	LAN A	Programming port (used for downloading and monitoring)
	2	LAN B	Modbus/TCP communication port (which does not support communication with InoProshop)
	3	LAN C	EtherCAT master port
AC703	1	LAN A	Programming port (used for downloading and monitoring)
	2	LAN B	Modbus/TCP communication port (which does not support communication with InoProshop)
	3	LAN C	EtherCAT master port

### 4.4.2 Ethernet Connection

With the Ethernet port, the controller can be connected point-to-point with devices such as a computer and HMI through an Ethernet cable, as shown in the following figure.

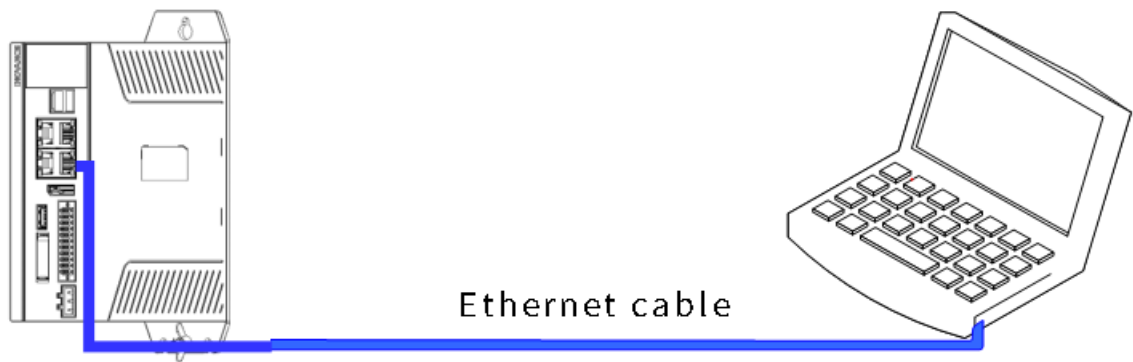

Figure 4-5 Connection between the controller and PC

The controller can also be connected to a hub or switch, which is further connected with other network devices, through an Ethernet cable to achieve multi-point connection.

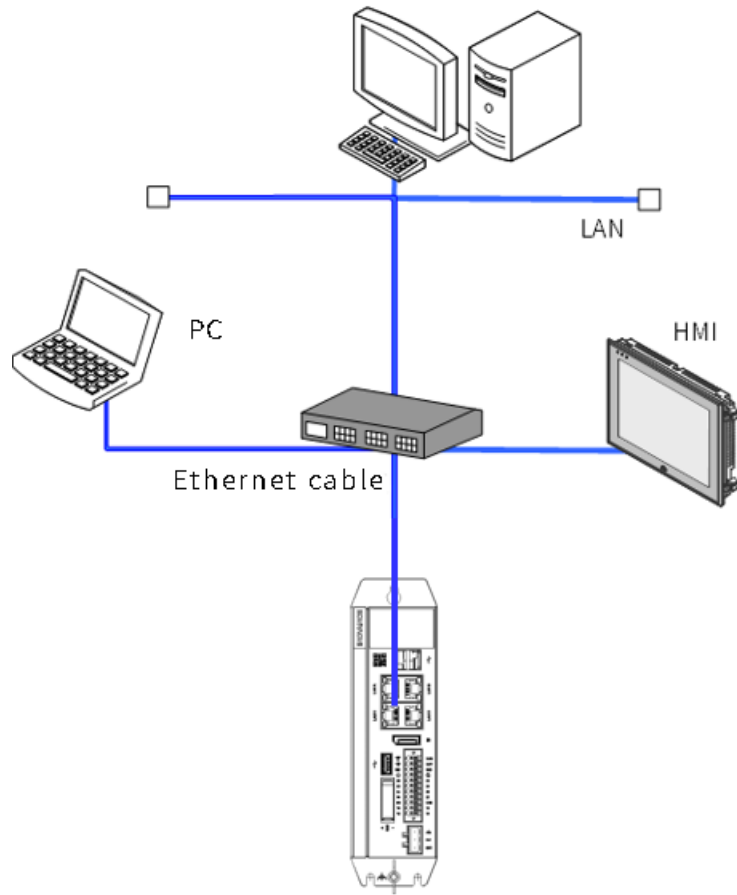

Figure 4-6 Connection between the PLC and other devices through a hub

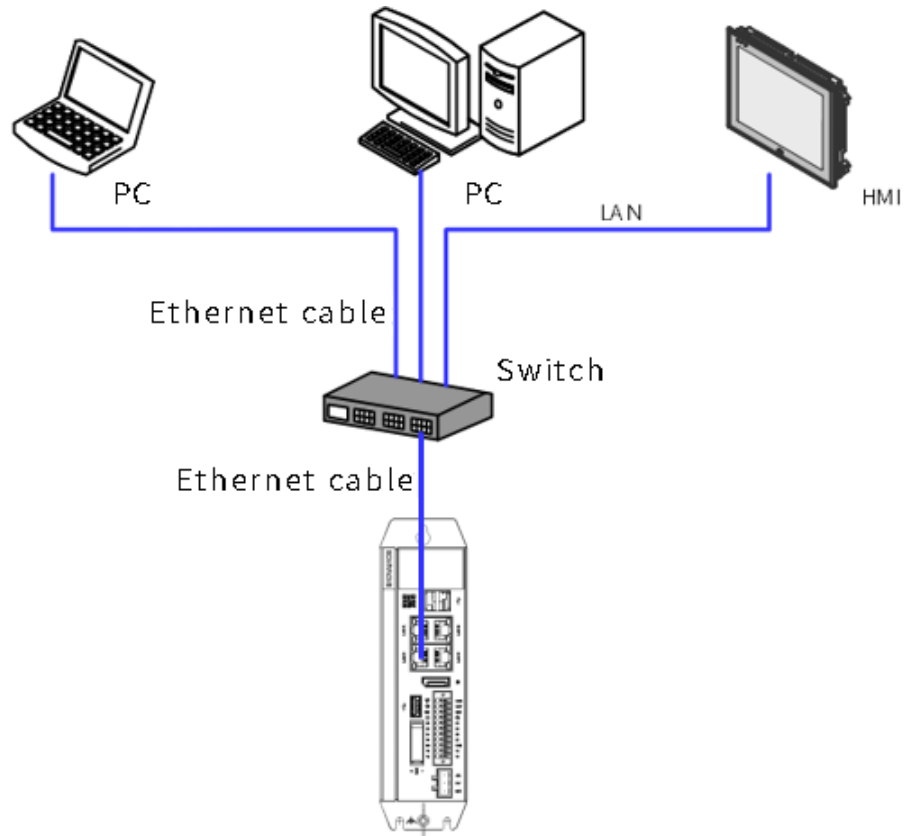

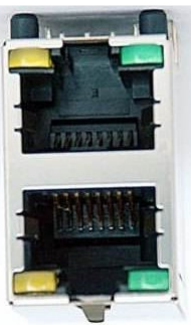





Figure 4-7 Connection between the PLC and other devices through a switch

### 4.4.3 Ethernet Wiring Instructions

#### Ethernet specifications

Communication rate (bps): 10M/100M/1000M adaptive

#### Network port indicators

Indicator	Function	Color	State	Description
	A: Link/Act	Yellow		Steady off: Disconnected
				Blinking: Sending and receiving data
				Steady on: Connected
	B: Speed	Green		Steady off: Disconnected
				Steady on: Connected at 100/1000 Mbps

## 4.4.4 EtherCAT Wiring Instructions

### EtherCAT specifications

Item	Specifications
Number of channels	2
Communication protocol	EtherCAT
Service supported	FoE, EoE, CoE (PDO and SDO)
Min. synchronization period of 8 axes with cam (32 axes without cam)	1 ms (typical value)
Maximum number of axes	32
Synchronization mode	DC-distributed clock for servo drives, and input/output synchronization for I/O modules
Physical layer	100BASE-TX
Baud rate	100 Mbit/s (100Base-TX)
Duplex mode	Full duplex
Topology	Line topology
Transmission medium	Network cable (For details, see the following technical specifications of cables.)
Transmission distance	Less than 100 m between two nodes
Number of slaves	128 slaves per EtherCAT bus
EtherCAT frame length	44 bytes to 1,498 bytes
Process data	Maximum 1,486 bytes per Ethernet frame
Update time	The update time is specified only in the EtherCAT bus design. For the update time, see the manual or specifications of the slave station module.
Ring network	Not supported
Automatic scanning	Supported

### Network port indicators

For details, see “[Network port indicators](#)” on page 28.

## 4.4.5 Wiring Requirements of Communication Cables

### Connection of the RJ45 network cable

Connection: Insert the cable connector into the RJ45 port of the communication module until you hear a click sound.

Removal: Press the release tab of the connector to pull out the connector from the module horizontally.

---

### Note

To avoid the influence on the communication cable due to other stresses and ensure the stability of communication, secure the cable near the equipment before EtherCAT communication.

---

## Cable specifications

Use the shielded twisted pair (STP) of Cat 5e or above for EtherCAT communication. The requirements are as follows.

### 1. Cable requirements

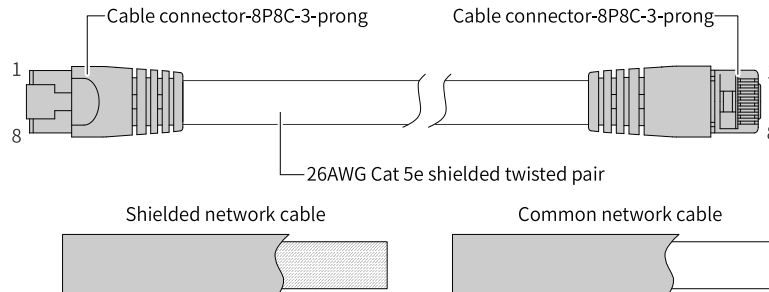

### 2. Length requirements

According to FastEthernet technology, when an EtherCAT bus is used, the length of the cable between the devices must not exceed 100 meters. Otherwise, the signal will be attenuated and the communication will be affected.

### 3. Technical requirements

100% continuity test, no short circuit, open circuit, misalignment and poor contact

Use a shielded cable as the EtherCAT bus for network data transmission, with the following recommended specifications:

Item	Specifications
Cable type	Flexible crossover cable, S-FTP, Cat 5e
Complied standards	EIA/TIA568A, EN50173, ISO/IEC11801 EIA/TIA bulletin TSB, EIA/TIA SB40-A&TSB36
Conductor cross section	AWG26
Conductor type	Twisted pair
Number of pairs	4

The following table describes the relationship between the number of EtherCAT bus nodes, cable impedance, and transmission distance:

Max. Number of Nodes	Cable Impedance	16	32	64
Transmission Distance	88 Ω/km	215 m	200 m	170 m
	93 Ω/km	205 m	185 m	160 m
	157 Ω/km	120 m	110 m	95 m

### 4. Signal pins

Pin	Signal (Ethernet 1000 Mbps)	Signal Direction	Description
1	TD+	Output	Data transmission+
2	TD-	Output	Data transmission-
3	RD+	Input	Data reception+
4	- (DC+*)	- (Bidirectional)	Not used (data C+)
5	- (DC-)	- (Bidirectional)	Not used (data C+)
6	RD-	Input	Data reception-

Pin	Signal (Ethernet 1000 Mbps)	Signal Direction	Description
7	- (DD+)	- (Bidirectional)	Not used (data D+)
8	- (DD-)	- (Bidirectional)	Not used (data D-)

The definitions of pins 4, 5, 7, and 8 under the Ethernet baud rate of 1000 Mbps differ from those under 100 Mbps.

## 4.5 Display Port

The controller provides a standard display port (DP). The specifications of this port are as follows:

Item	Specifications
Signal type	Digital DP
Max. resolution	1920 x 1200 @60 Hz
Hot swapping	Supported

Pins of the DP port are defined as follows:

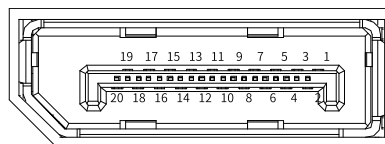

No.	Description	Function
1	ML_Lane 0 (p)	Lane 0 of the main link: Differential signal
2	GND	
3	ML_Lane 0 (n)	Lane 0 of the main link: Differential signal
4	ML_Lane 1 (p)	Lane 1 of the main link: Differential signal
5	GND	
6	ML_Lane 1 (n)	Lane 1 of the main link: Differential signal
7	ML_Lane 2 (p)	Lane 2 of the main link: Differential signal
8	GND	
9	ML_Lane 2 (n)	Lane 2 of the main link: Differential signal
10	ML_Lane 3 (p)	Lane 3 of the main link: Differential signal
11	GND	
12	ML_Lane 3 (n)	Lane 3 of the main link: Differential signal
13	GND	
14	GND	
15	AUX_CH (p)	Auxiliary channel: Differential signal
16	GND	
17	AUX_CH (n)	Auxiliary channel: Differential signal
18	Hot Plug	Hot swapping detection
19	DP_PWR Return	DP power return signal
20	DP_PWR	Power supply: +3.3 V



## 4.6 USB Port

The controller provides three USB 2.0 ports, as shown in the following figure.

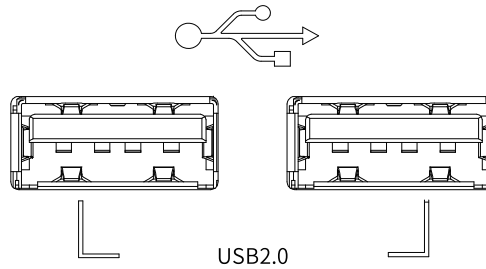

USB port specifications:

Item	USB 2.0
Max. communication rate	480 Mbps
Max. output current at 5 V	500 mA
Max. communication distance	5 m
Isolated?	No

## 4.7 Cable Selection and Preparation

### 4.7.1 Cable Selection

Cable Type	Supporting Material	Cable Diameter	
		Chinese Standard (mm <sup>2</sup> )	AWG
Power signal cable	Pin terminal	0.8 to 2.5	18 to 12
User signal cable	Pin terminal	0.2 to 1.5	24 to 16
Grounding cable	Tubular lug	≥ 2	14 to 15
Ethernet cable	-	-	-

### 4.7.2 Cable Preparation Requirements

#### Cable with the pin terminal

Preparation procedure:

1. Strip the insulation layer to expose 6 mm of the conductor.
2. Pass the cable through a cable marking sleeve.
3. Insert the exposed conductor into the terminal, and then crimp the terminal with a crimping tool recommended by the terminal manufacturer.
4. Sleeve the copper tube of the terminal with a 20 mm heat-shrink tube (Φ3) and then perform heat shrink.
5. Insert the terminal into the screw terminal block.

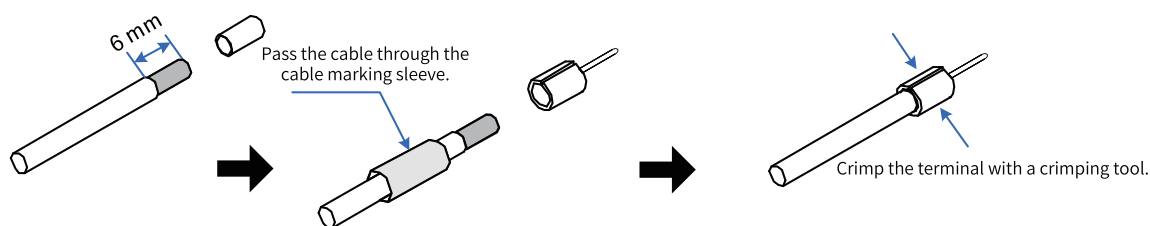

## Cable with the cord end terminal

Preparation procedure:

1. Strip the insulation layer to expose 6 mm of the conductor. Pass the cable through a cable marking sleeve.
2. Insert the exposed conductor into the terminal, and then crimp the terminal with a crimping tool recommended by the terminal manufacturer.
3. Insert the terminal into the terminal block and fix it with a screwdriver to a tightening torque not larger than 0.45 N.m.

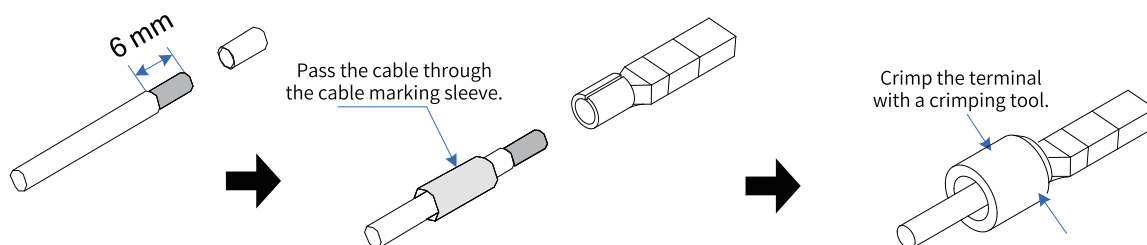

For the 2\*11-pin dual-row connector used for I/O communication, the terminal requirements are as follows:

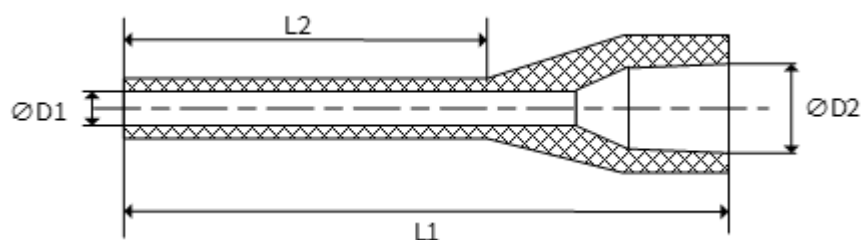

Category	Terminal Size	Length of Metal Part (L2)	Stripping Length
Cord end with sheath (max. conductor OD: 2.6 mm)	1.00 mm <sup>2</sup> [H1.0/18D]	12 mm	15 mm
	0.75 mm <sup>2</sup> [H0.75/18D]	12 mm	14 mm
	0.50 mm <sup>2</sup> [H0.5/16D]	10 mm	12 mm
	0.34 mm <sup>2</sup> [H0.34/12D]	8 mm	10 mm
	0.25 mm <sup>2</sup> [H0.25/12D]	8 mm	10 mm
	0.14 mm <sup>2</sup> [H0.14/12D]	8 mm	10 mm
Naked end	1.50 mm <sup>2</sup> [H1.5/10D]	10 mm	10 mm

Wiring

---

Category	Terminal Size	Length of Metal Part (L2)	Stripping Length
Cord end with sheath (crimping two wires)	2 x 0.20 mm <sup>2</sup> [H0.5/16D]	10 mm	12 mm
	2 x 0.34 mm <sup>2</sup> [H0.5/16D]	12 mm	15 mm

## 5 Operation Instructions

### 5.1 Power-on

#### 5.1.1 Power-on Safety Precautions

After power-on, it takes about 15s to 25s or 70s to 80s for the PLC to enter the operating mode. During this period, the output remains OFF or at a value corresponding to module/slave settings, and the controller cannot communicate with external devices. To avoid malfunction of external devices, construct a fail-safe circuit using the operating output of the power supply unit.

#### 5.1.2 PLC Startup

The PLC becomes operable after the following time since power-on.

Before the PLC enters the operating state, the RUN LED indicator is off.

- If the programming port (enp1s0) is set to a static IP address, it takes about 15 to 25 seconds for the PLC to enter the operating mode.
- If the programming port (enp1s0) is set to a DHCP-assigned address, but no DHCP server or network connection is available, it takes about 70 to 80 seconds for the PLC to enter the operating mode.

---

#### **Note**

- Some EtherCAT slaves allow you to set the maximum waiting time (1s to 200s), but the PLC only becomes operable when the EtherCAT master function module starts operation, regardless of the waiting time.
  - If a slave has not been activated within the maximum waiting time, the EtherCAT master function module determines that the slave encounters an error.
- 

#### 5.1.3 PLC Operations

If there is an app when the PLC becomes operable, the PLC enters the operating state immediately based on the default setting. You can also change the default setting to enable the PLC to enter the stop state instead.

If the operation mode of the user program (app) is "NO-APP" when the power is on, the PLC enters the stop state.

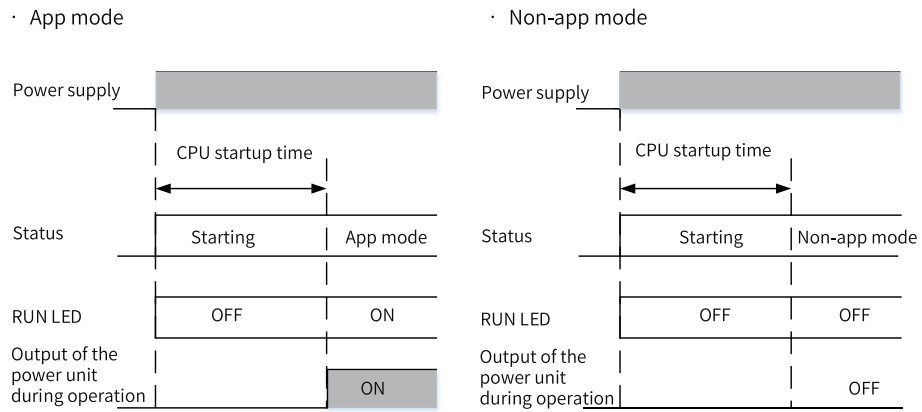

## 5.2 Power-off

### 5.2.1 Power-off Safety Precautions

Safety precautions

**Warning**

- The AC700 series controller will continue to operate normally for a certain period of time when an instantaneous power failure occurs. Therefore, it may receive error signals from external devices affected by the instantaneous power failure.
- Take fail-safe measures externally and monitor the power supply voltage on the external device side as necessary. In addition, take safety measures in the user program.

### 5.2.2 Operations at Power-off

When a power failure occurs because the following power-off judgment time expires, the user program is terminated.

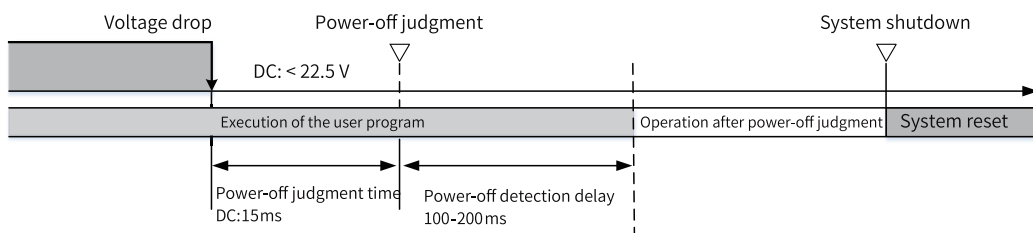

After the power-off judgment time, even if the voltage is reset, the PLC still stops running, as shown in the following figure.

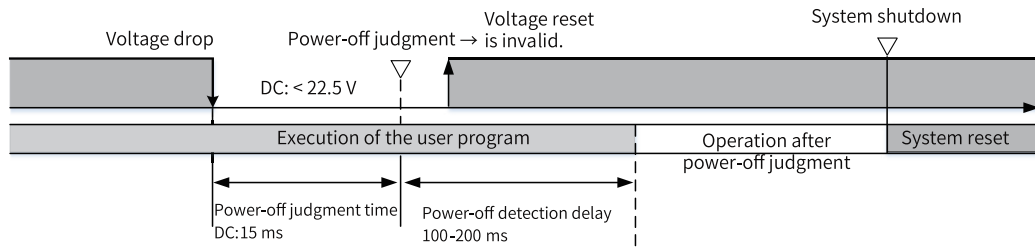

### 5.2.3 Operations at Instantaneous Power-off

The following figure shows the operations at instantaneous power-off.

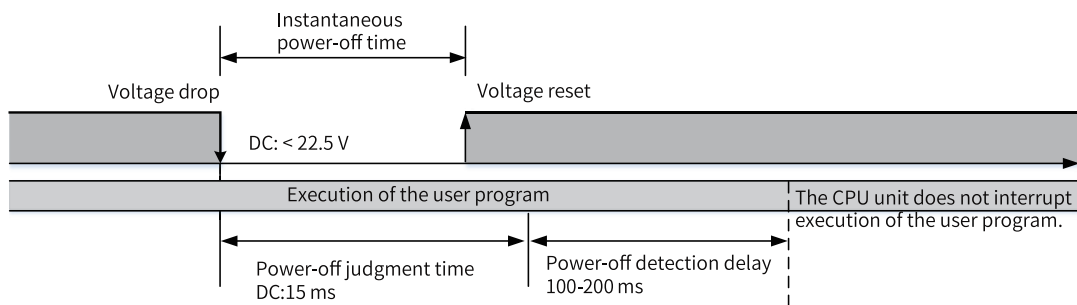

### 5.2.4 Operations After Power-off Judgment

The following table lists the operations performed after power-off judgment.







	Item	Content
Processing	Transferring the user program (including online editing)	Interrupt. The controller will be in NO-APP mode at the next power-on, waiting for the user program to be downloaded.
	Executing the user program	Instruction execution is interrupted, and the data is saved in the hard drive.

## 5.3 Display

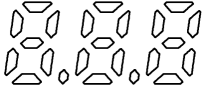
The following figure shows the display.



The following table describes the content displayed.

Content	Function	Remarks
	DI/DO status	ON: Green OFF: Not displayed
	Error code	White: The error code is displayed in white.
	SSD indicator	The indicator blinks when data is being read or written.
	Warning	ON (Yellow): App/system operation warning
	Error indicator (ERR)	ON (Red): App/system error
	Running status indicator (RUN)	Blinking: The device is being identified. ON (Green): The app is running.
	System identification indicator	Blinking: The PLC is identified.
	CPU usage	0 < CPU usage ≤ 10: One LED indicator is on. 10 < CPU usage ≤ 30: Two LED indicators are on. 30 < CPU usage ≤ 60: Three LED indicators are on. 60 < CPU usage ≤ 90: Four LED indicators are on. CPU usage > 90: Five LED indicators are on.

## 6 Programming Tool and Download

### 6.1 Acquisition of the Programming Tool

You can obtain the user programming software InoProShop and documents related to the controller in the following ways:

- Obtain a CD copy of the installation files from any Inovance distributor.
- Download the software installation package for free on the Service and Support > Downloads page at [www.inovance.com](http://www.inovance.com).
- Download the software installation package for free on the Inovance page at [www.gongkong.com](http://www.gongkong.com).

Inovance is continuously improving its products and documents. Therefore, it is recommended that you timely update the software and search for the latest documents to help you with the application design.

### 6.2 Programming Environment and Software Installation

#### 6.2.1 Environmental Requirements

Prepare a desktop or portable PC meeting the following requirements:

1. OS: Windows 7 or 10, 64-bit is recommended
2. Memory: 4 GB or above
3. Hard drive: free space of 5 GB or above

Connect the PC and AC700 controller in the following way:

Connection Method	Port and Cable	Remarks
Using the LAN network cable (recommended)	An available LAN network port in the local network and a network cable	Long distance connection between the PC and controller is supported. For example, you can program a controller which is operating in the workshop in your office, and the communication rate is faster.

#### 6.2.2 Uninstallation of InoProShop

On the PC running the Windows operating system, you can uninstall InoProShop directly from the Control Panel as follows:

1. Quit InoProShop and ensure that Gateway is closed. If the CoDeSys icon exists on the task bar, right-click the icon and choose Exit to close Gateway.
2. Choose Start > Settings > Control Panel.
3. Double-click Add or Remove Programs.
4. Select InoProShop in the list.
5. Click Remove.



## 6.2.3 Installation Procedure

### Before installation

- If you install InoProShop for the first time, ensure that there is at least 5 GB free space on the target drive.
- If you are upgrading InoProShop, backup your files, uninstall the old version of InoProShop, and restart the computer.

### Installing InoProShop

Go to the Windows System Resource Manager, open the directory where the installation files are located, and double-click the InoProShop (V\*.\*.\*).exe file (V\*.\*.\* is the version of InoProShop. Make sure you have the latest version).

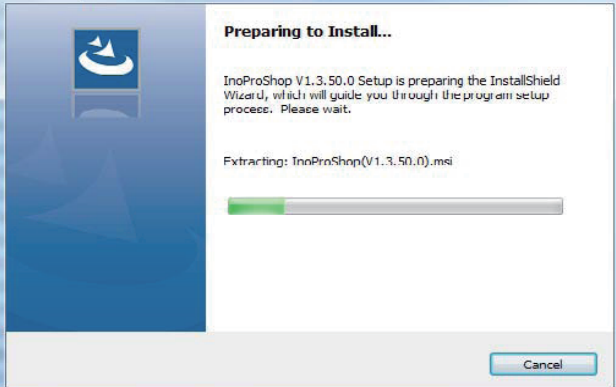
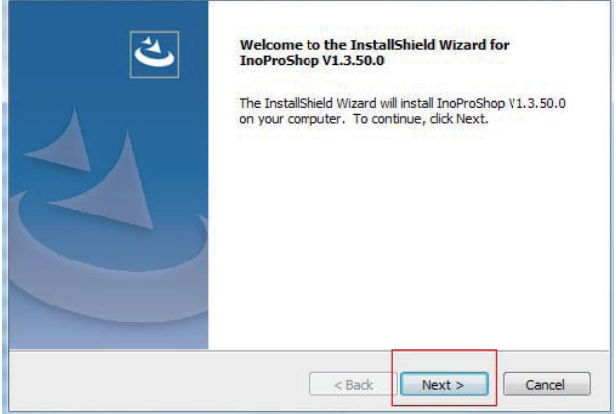
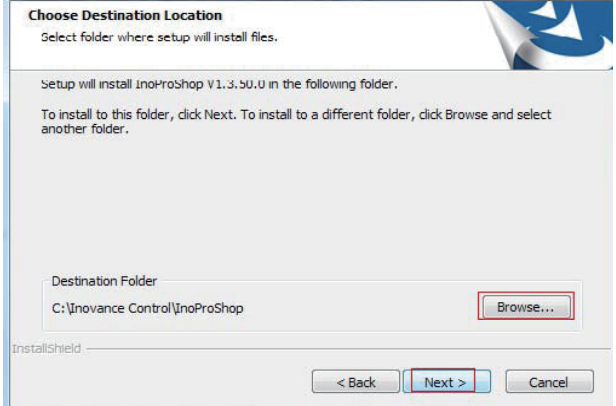
Step	Description	Screen
1	The installation wizard appears and prepares for the installation.	
2	Click Next to start the installation.	
3	Select the installation path and click Next.	

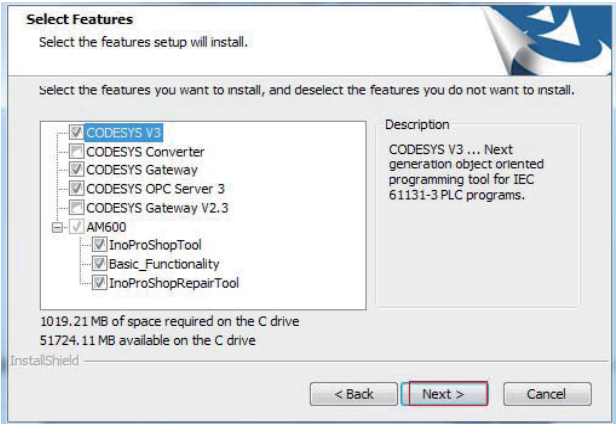
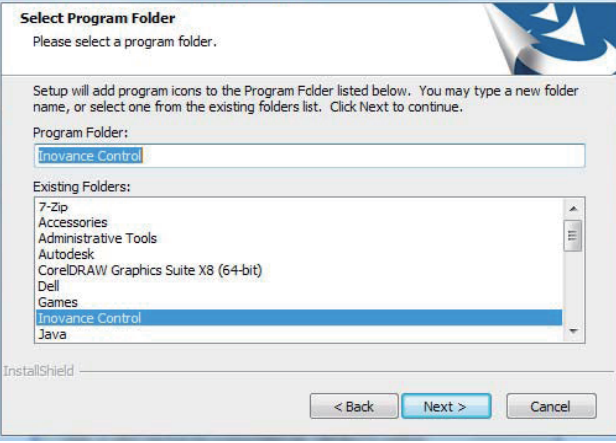
Step	Description	Screen
4	Select components that you want to install and click Next.	
5	Click Next.	

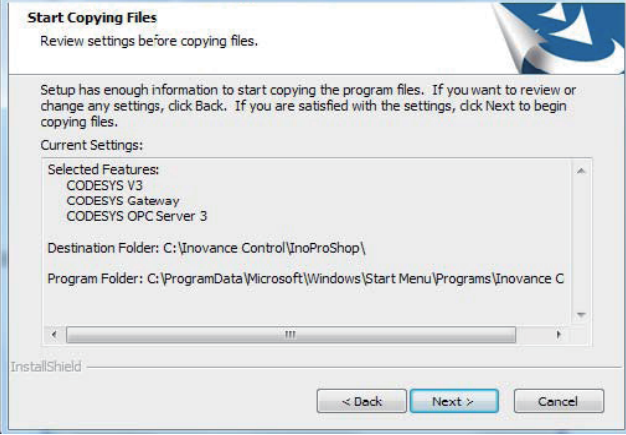
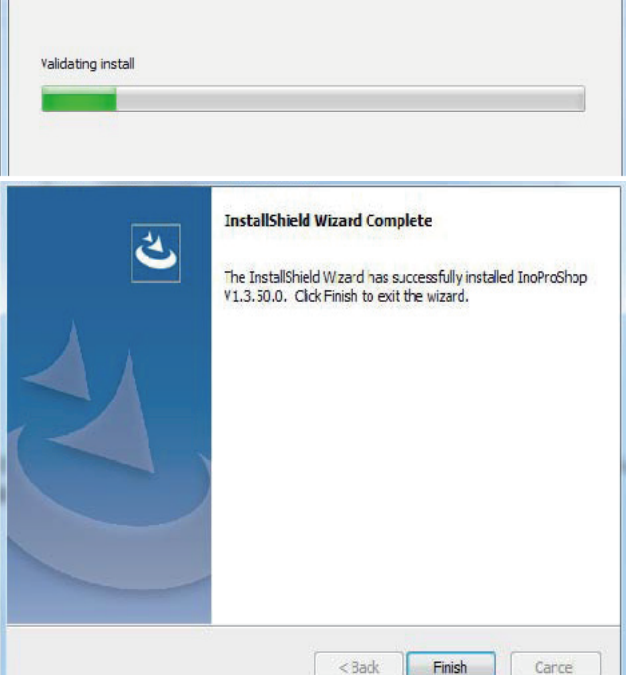
Step	Description	Screen
6	Click Next.	
7	Wait until the Installation Wizard Complete window appears, and click Finish to complete the installation.	

### Setting the language

The default interface language of InoProShop is Simplified Chinese. If you need to change the language, choose Tools > Options > International Settings on the main page of the software to select the desired language.

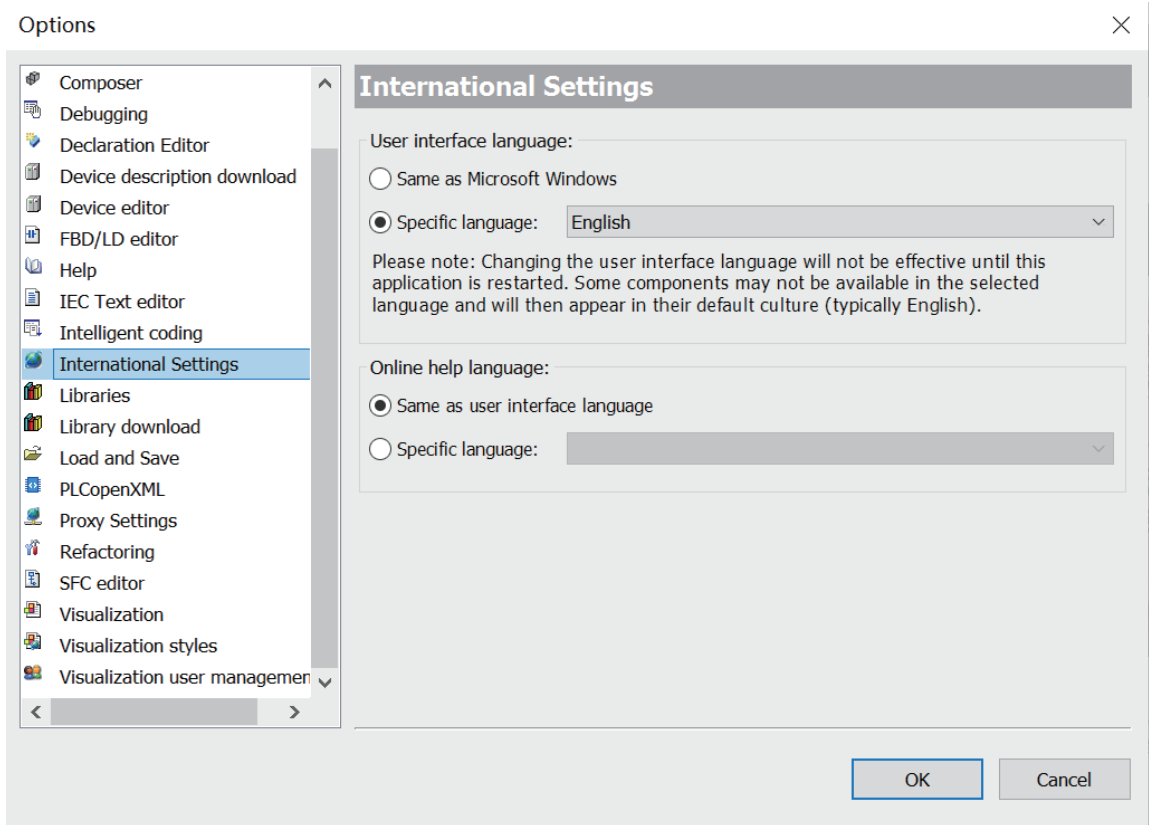

## 7 Maintenance and Troubleshooting

### 7.1 Periodical Maintenance and Inspection

Periodical inspection is required because the parts of the controller may deteriorate due to environmental conditions. The interval is recommended to be 6 to 12 months, and can be shortened according to the environment conditions. Take measures if any item fails the inspection.

No.	Item	Description	Criteria	Measure
1	Power supply	Measure the power terminal block and check that the voltage change is within the allowed range.	24 VDC (–15% to +20%)	Use a multimeter to measure the terminals, and control the supply voltage within the allowable range.
2	Environment	Check that the ambient temperature is suitable (when the controller is in a cabinet, the temperature in the cabinet is the ambient temperature).	–5°C to 55°C	Use a thermometer to measure the ambient temperature and control the ambient temperature within 0°C to 55°C.
		Check that the ambient humidity is suitable (when the controller is in a cabinet, the humidity in the cabinet is the ambient humidity).	10% to 90% RH (no condensation)	Use a hygrometer to measure the ambient humidity control the ambient humidity within 10% to 90% RH. The temperature changes drastically, so check for condensation.
		Direct sunlight	Not allowed	Provide a shelter.
		Dust, dirt, salt, and iron filings	Not allowed	Remove them and provide a shelter.
		Droplets of water, oil, and chemicals	Not allowed	Remove them and provide a shelter.
		Corrosive gas or flammable gas	Not allowed	Use an odor or gas sensor for detection.
		Vibration or shock to the controller	The vibration and shock resistance should meet relevant requirements.	Install cushioning materials for vibration and shock resistance.
Interference sources	Not allowed	Keep the controller away from any interference sources or take shielding measures.		

No.	Item	Description	Criteria	Measure
3	Installation and wiring	Check that cable connectors are fully inserted and locked.	Looseness is not allowed.	Fully insert the connector and lock it with screws.
		Check that external wiring screws are securely fastened.	Looseness is not allowed.	Use a Phillips screwdriver to tighten the screws.
		Check that external wiring terminals are properly distanced.	Ensure a proper distance between terminals.	Check the distance visually and correct any improper distance.
		Check for broken external cables.	Broken external cables are not allowed.	Check cables visually and replace broken cables (if any).
4	Real-time clock battery (button battery)	Check that the shelf life or service life does not expire.	No "battery voltage low" alarm is displayed on the controller.	The shelf life of the battery at 25°C is 5 years, and its service life is generally 0.75 to 5 years, depending on the model and ambient temperature. If the service life expires, replace the battery whether it can run normally or not. For the replacement method, see <a href="#">"7.2 Installation and Removal of the Battery" on page 45</a>

## 7.2 Installation and Removal of the Battery

### Precautions

- After replacing the battery, you need to manually start the controller.
- Before installing or removing the battery, power off the controller. Live working is prohibited.
- When installing the battery, check the label at the bottom of the battery to identify the battery's positive and negative poles. Make sure that the battery is located on the right of the battery handle to facilitate the next removal.
- After replacing the battery, power on the controller and check if the controller reports a battery error. If such an error is reported, check whether the battery is installed correctly.
- If the controller is powered on without reporting any error, recalibrate the system clock.
- Dispose of the replaced battery properly to avoid environmental pollution and physical injury.

### Installation and removal of the battery

1. Open the battery cover clockwise.
2. Pull the battery handle outward, and slowly pull out the battery in the direction perpendicular to the controller.

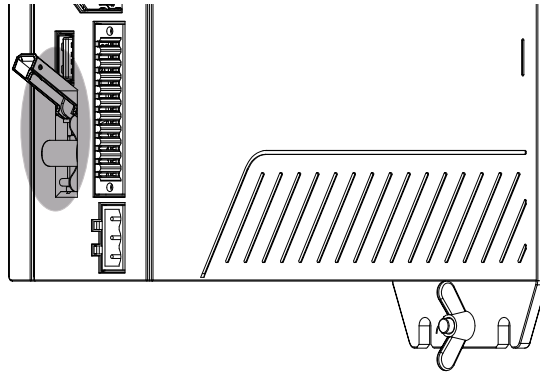

3. Insert the new battery into the battery slot, flip the battery handle, and install the battery cover.

### 7.3 Battery Maintenance

#### Purpose of battery installation

A battery is required for the RTC timing of the clock in the controller and for keeping the CMOS data when the power is off. If the battery is not installed or the battery is being discharged, the clock will stop timing, and the CMOS data will be lost when the power is off.

#### Battery life and replacement interval

The actual service life of the battery is related to the application scenario of the controller. The curve below shows the longest service life and is for reference only.

When the controller prompts that the battery is abnormal, replace the battery in time to ensure that the clock function of the controller is normal.

When a time deviation is found, check the battery voltage and replace the battery in time.

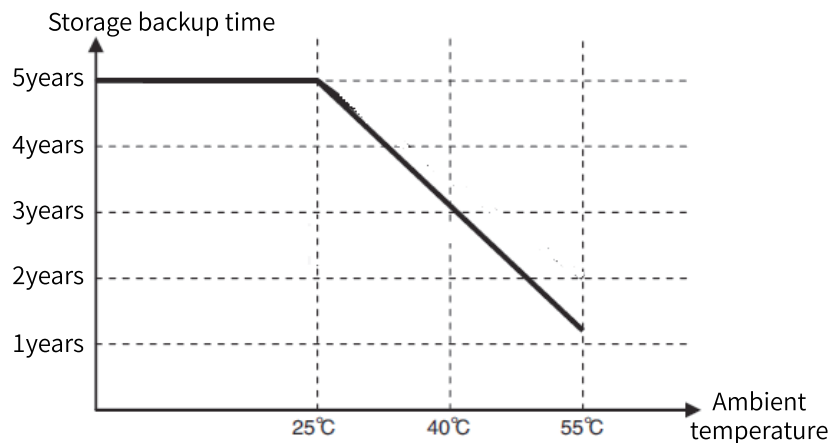

\* The storage backup time in the figure is for reference.

## 7.4 Instructions for Using the USB Flash Disk for Upgrade

### Upgrading the PLC firmware

Operation procedure:

1. Obtain the PLC firmware upgrade package from Inovance.
2. Copy this package to the root directory of the USB flash disk, insert the USB flash disk to the USB port of the PLC, and wait until the automatic upgrade is completed.

#### Precautions

- Do not modify the name of the PLC firmware upgrade package.
- Place the PLC firmware upgrade package only under the root directory of the USB flash disk.
- Before the upgrade is completed, do not remove the USB flash disk. Remove the USB flash disk only after the automatic restart following the update.
- If you remove the USB flash disk before countdown, the upgrade does not start. The firmware upgrade starts after countdown. At this time, if you remove the USB flash disk, the upgrade result is unpredictable. That is, the upgrade may succeed or fail.
- Do not power off the controller during the firmware upgrade.

### Upgrading the user program

Operation procedure:

1. Choose Compile > Pack User Program to generate a user program package.

The screenshot shows a dialog box titled "User program packager". It contains the following fields and values:

- PLC Type: AC712
- Runtime Version: 3.5.11.50
- Project: AC700 Project.prc
- Application: Application
- Company: (empty)
- Author: (empty)
- Version: (empty)
- Init On Upgrade: No
- Remarks: (empty text area)

Buttons at the bottom: Pack, Close.

PLC type: Retain the default value.

Runtime: Retain the default value.

App name: Retain the default value.

Initialize after upgrade: If you select Yes, the data saved upon power-off will be initialized. If you select No, the data saved upon power-off will not be initialized.



2. Place the user program package under the root directory of the USB flash disk, insert the USB flash disk to the USB port of the PLC, and wait until the automatic upgrade is completed.

**Precautions**

- Place the user program package only under the root directory of the USB flash disk.
- Before the upgrade is completed, do not remove the USB flash disk.
- Do not power off the controller during the user program upgrade.

## 7.5 Operation Instructions of the USB Flash Disk

---

**Note**

The PLC takes effect only under normal operation.

---

### Restoring the default IP address

If the IP address of the controller is unknown, you can perform the following steps to restore the default IP address. The default IP address of LAN A port is 192.168.1.88, and that of LAN B port is 192.168.2.88.

1. Format the USB flash disk to FAT32 or NTFS, and create an empty file "network.default" in the root directory of the USB flash disk.
2. Insert the USB flash disk into the controller, and wait for about 1 to 2 minutes. Then, the default IP address of the controller is restored.
3. After the default IP address is restored, you can use InoProShop to scan and modify the IP address by connecting the PC to the LAN A port of the controller.

### Obtaining the IP address of the controller

If the IP address of the controller is unknown, you can perform the following steps to obtain the IP address:

1. Format the USB flash disk to FAT32 or NTFS, and create an empty file "network.info" in the root directory of the USB flash disk.
2. Insert the USB flash disk into the controller, and wait for about 1 to 2 minutes. Then, the IP address of the controller is exported to the file "network.info". Read this file to obtain the IP address.

## 8 Appendices

### 8.1 Appendix 1 Process Codes and Error Codes During BIOS Startup

Note: BIOS process coding and error coding are independent of other error coding of the controller.

1. The following figure illustrates display of a BIOS process code:

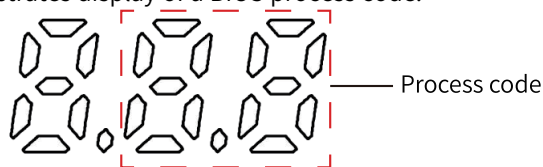

2. The following figure illustrates display of a BIOS error code:

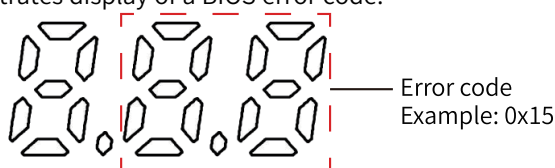

BIOS Code	Description
Process Code	
0x15	Pre-memory North Bridge initialization is started
0x19	Pre-memory South Bridge initialization is started
0x32	CPU post-memory initialization is started
0x3B	Post-Memory South Bridge initialization is started
0x4F	DXE IPL is started
0x60	DXE Core is started
0x61	NVRAM initialization
0x62	Installation of the South Bridge Runtime Services
0x69	North Bridge DXE initialization is started
0x70	South Bridge DXE initialization is started
0x72	South Bridge devices initialization
0x78	ACPI module initialization
0x79	CSM initialization
0x90	Boot Device Selection (BDS) phase is started
0x91	Driver connecting is started
0x92	PCI Bus initialization is started
0x93	PCI Bus Hot Plug Controller Initialization
0x94	PCI Bus Enumeration
0x95	PCI Bus Request Resources
0x96	PCI Bus Assign Resources
0x97	Console Output devices connect
0x98	Console input devices connect
0x99	Super IO Initialization
0x9A	USB initialization is started
0x9C	USB Detect
0x9D	USB Enable
0xA0	IDE initialization is started

BIOS Code	Description
0xA2	IDE Detect
0xAD	Ready To Boot event
0xAE	Legacy Boot event
0xB2	Legacy Option ROM Initialization
0xB4	USB hot plug
Error code (When a BIOS error occurs, contact the manufacturer.)	
0x0E	Microcode not found
0x0F	Microcode not loaded
0x50	Memory initialization error. Invalid memory type or incompatible memory speed
0x51	Memory initialization error. SPD reading has failed
0x52	Memory initialization error. Invalid memory size or memory modules do not match
0x2C	PEI_MEMORY_PRESENCE_DETECT
	Note: If the buzzer beeps consistently during startup, the memory is not installed properly or is not installed. Contact the manufacturer for a solution.
0x54	Unspecified memory initialization error
0x55	Memory not installed
0x56	Invalid CPU type or Speed
0x57	CPU mismatch
0x58	CPU self test failed or possible CPU cache error
0x59	CPU micro-code is not found or micro-code update is failed
0x5A	Internal CPU error
0x5B	reset PPI is not available
0x5C	PEI phase BMC self-test failure
0xAB	Setup Input Wait
0xD0	CPU initialization error
0xD1	North Bridge initialization error
0xD2	South Bridge initialization error
0xD3	Some of the Architectural Protocols are not available
0xD4	PCI resource allocation error. Out of Resources
0xD5	No Space for Legacy Option ROM
0xD6	No Console Output Devices are found
0xD7	No Console Input Devices are found
0xD8	Invalid password
0xD9	Error loading Boot Option (LoadImage returned error)
0xDA	Boot Option is failed (StartImage returned error)
0xDB	Flash update is failed
0xDC	Reset protocol is not available
0xDD	DXE phase BMC self-test failure
0xE8	S3 Resume Failed
0xE9	S3 Resume PPI not Found
0xEA	S3 Resume Boot Script Error
0xEB	S3 OS Wake Error
0xF8	Recovery PPI is not available
0xF9	Recovery capsule is not found
0xFA	Invalid recovery capsule
0xA1	Failed to switch BIOS to OS
0XA2	No BIOS data was received

## 8.2 Appendix 2 Controller Related Error Codes

### FPGA error code

dE1: Regular monitoring watchdog register timeout

### Runtime error codes

Runtime error codes for the AC700 series controller are the same as those for the AC800 series controller, and only the last two digits of the error code is displayed.

Error Code	Description
0x70	Modbus RTU0:Slave address setting error
0x71	Modbus RTU0:Frame length error
0x72	Modbus RTU0:Illegal data address
0x73	Modbus RTU0:CRC check failed
0x74	Modbus RTU0:Illegal function
0x75	Modbus RTU0:Communication time out
0x76	Modbus RTU0:Illegal data value
0x77	Modbus RTU0:Buffer overflow
0x78	Modbus RTU0:Server device failure
0x79	Modbus RTU0:Serial port setting error
0x80	Modbus RTU1:Slave address setting error
0x81	Modbus RTU1:Frame length error
0x82	Modbus RTU1:Illegal data address
0x83	Modbus RTU1:CRC check failed
0x84	Modbus RTU1:Illegal function
0x85	Modbus RTU1:Communication time out
0x86	Modbus RTU1:Illegal data value
0x87	Modbus RTU1:Buffer overflow
0x88	Modbus RTU1:Server device failure
0x89	Modbus RTU1:Serial port setting error
<b>Ethernet (Modbus TCP)</b>	
0x90	Modbus TCP:Slave address setting error
0x91	Modbus TCP:Frame length error
0x92	Modbus TCP:Illegal data address
0x93	Modbus TCP:CRC check failed
0x94	Modbus TCP:Illegal function
0x95	Modbus TCP:Communication time out
0x96	Modbus TCP:Illegal data value
0x97	Modbus TCP:Buffer overflow
0x98	Modbus TCP:Server device failure
0x9A	Modbus TCP: Destination XX is unreachable
0x9B	Modbus TCP: Protocol identifier error
<b>CPU errors</b>	
0x21	System:Runtime crashed
<b>Permission error</b>	
0x23	Authentication failed, please contact the supplier!

### 8.3 Appendix 3 EtherCAT Related Error Codes

EtherCAT error coding is independent of other error coding of the controller. All the EtherCAT error codes start with "E".

Error Code	Description
E01	Error:communication lost ! check the cables !
E02	Working counter for sync unit group is wrong! Warning: number of slaves has changed or is different to the configuration!
E03	Distributed clock is always same value! Change in and out connector of slave
E04	1.Networkadapter could not be opened 2.Networkadapter could not be found
E05	1.Second Networkadapter could not be found 2.Second Networkadapter could not be opened
E06	Second Networkadapter uses the MAC-ID as first network adapter
E07	Init slaves error: possibly slave missing or no communication at all
E08	1.Address: <addr> VendorID does not match -> All stopped . 2.Address: <addr> VendorID does not match -> try to continue. 3.Address: <addr> Revision Number does not match -> All stopped. 4.Address: <addr> Revision Number does not match -> try to continue
E09	1.Address: <addr> ProductID does not match -> All stopped. 2.Address: <addr> ProductID ProductID does not match ->try to continue.
E0A	Read of product or vendor ID not successful, more slaves in config as real?
E0B	SDO write error
E0C	SDO timeout
E0D	Emergency from device:<> Error code: <> Error register: <> Error field: <>
E0E	IDN write error
E0F	IDN timeout
E10	1.watchdog for opmode expired. Address: 2.Some devices not operational.
E65	AL Status read from slave address <> status <> Unspecified error
E66	No memory
E6A	Firmware and EEPROM does not match
E6B	Firmware update not successful
E75	Invalid requested state change
E76	Unknown requested state
E77	Bootstrap not supported
E78	No valid firmware
E79	Invalid mailbox configuration
E7A	Invalid mailbox configuration
E7B	Invalid sync manager configuration
E7C	No valid inputs available
E7D	No valid outputs
E7E	Synchronization error
E7F	Sync manager watchdog
E80	Invalid Sync Manager Types
E81	Invalid Output Configuration
E82	Invalid Input Configuration
E83	Invalid Watchdog Configuration
E84	Slave needs cold start
E85	Slave needs INIT
E86	Slave needs PREOP

Error Code	Description
E87	Slave needs SAFEOP
E88	Invalid input mapping
E89	Invalid output mapping
E8A	Inconsistent settings
E8B	Free-Run not supported
E8C	Synchronization not supported
E8D	Free-Run needs 3 buffer mode
E8E	Background watchdog
E8F	No valid inputs and outputs
E90	Fatal Sync error
E91	No Sync error
E92	Cycle Time too small
E94	Invalid DC SYNCH Configuration
E95	Invalid DC Latch Configuration
E96	PLL Error
E97	Invalid DC IO Error
E98	Invalid DC Timeout Error
E99	DC invalid Sync Cycle Time
E9A	DC Sync0 Cycle Time
E9B	DC Sync1 Cycle Time
EA5	MBX_AOE
EA6	MBX_EOE
EA7	MBX_COE
EA8	MBX_FOE
EA9	MBX_SOE
EB3	MBX_VOE
EB4	EEPROM no access
EB5	EEPROM error
EB6	External hardware not ready
ED4	Detected Module and Configured does not match
ED5	Slave alias address duplicate error! Alias address
ED6	In/out connection error between slaves -> All stopped!



PS00004465A00

---

Copyright © Shenzhen Inovance Technology Co., Ltd.

---

**Shenzhen Inovance Technology Co., Ltd.**

[www.inovance.com](http://www.inovance.com)

---

**Suzhou Inovance Technology Co., Ltd.**

[www.inovance.com](http://www.inovance.com)

---

**Add.:** Inovance Headquarters Tower, High-tech Industrial Park,  
Guanlan Street, Longhua New District, Shenzhen

**Tel:** (0755) 2979 9595      **Fax:** (0755) 2961 9897

**Customer service:** 4000-300124

---

**Add.:** No. 16 Youxiang Road, Yuexi Town,  
Wuzhong District, Suzhou 215104, P.R. China

**Tel:** (0512) 6637 6666      **Fax:** (0512) 6285 6720

**Customer service:** 4000-300124