

Easy Series PLC

High performance, compact, EtherCAT-enabled PLC



- Compact footprint
- A complete product range – from the simplest to the most complex motion control capable PLC
- PLCopen compliant axis control
- Simulation mode for offline debugging
- Real-time fieldbus



Easy series PLC: a comprehensive product range

Easy300



Ultra compact CPU
Easy301
RS232 + RS485

General CPU
Easy302
RS232 + RS485

CPU with Ethernet
Easy320
Dual Ethernet + RS485

Easy500

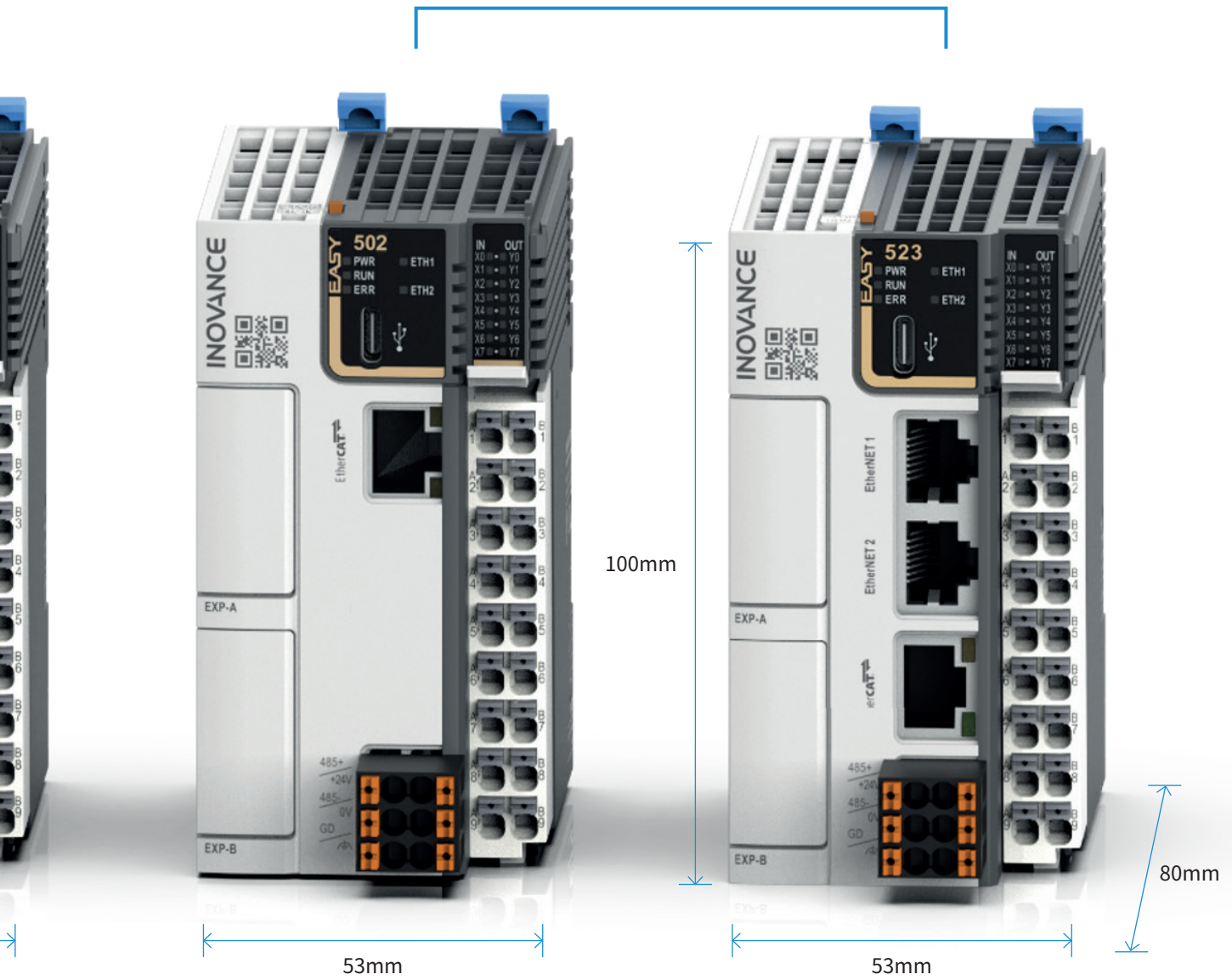

Motion control CPU
Easy502
EtherCAT + RS485

Motion control CPU with Ethernet
Easy523 Dual Ethernet
+ EtherCAT + RS485

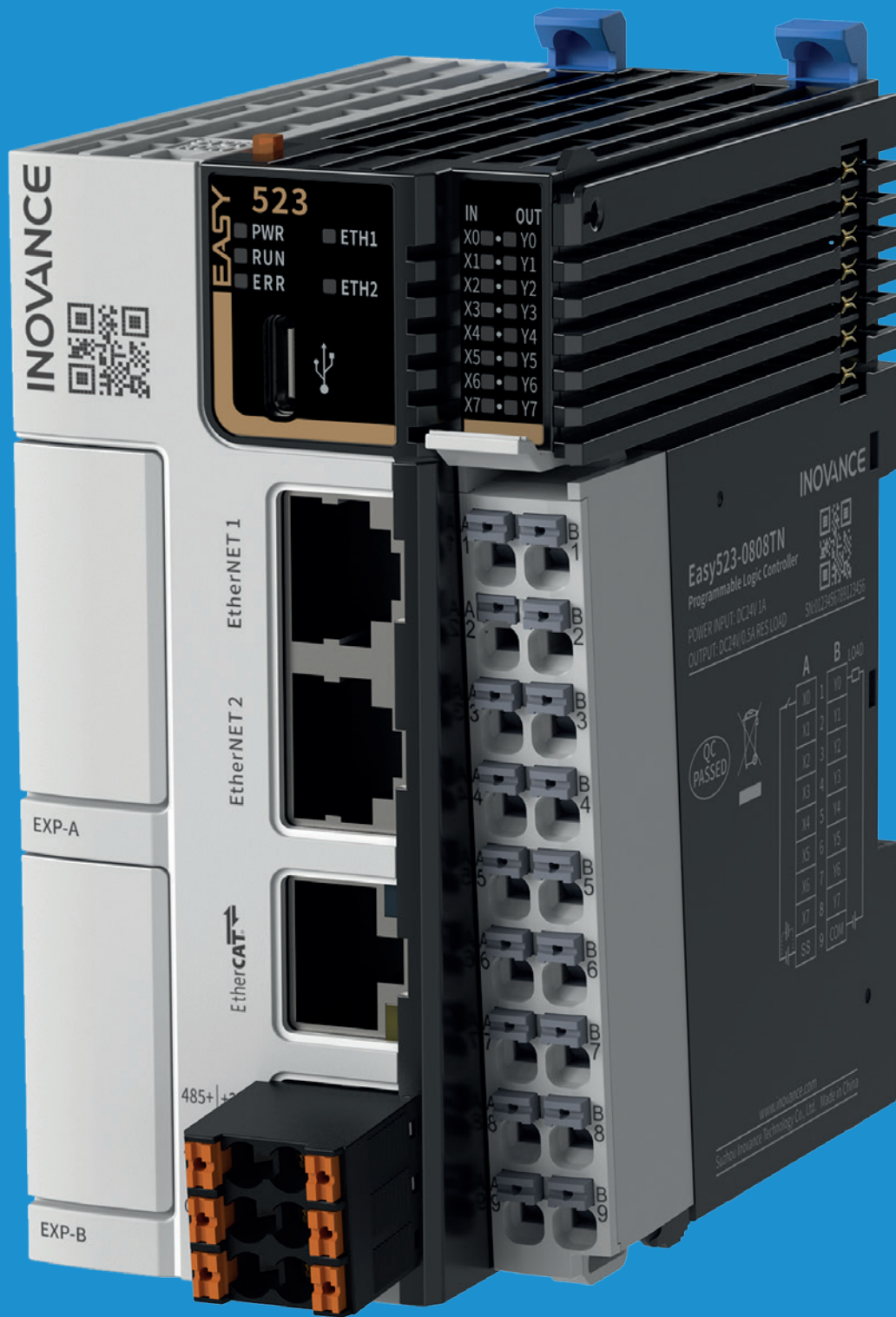

EASY programming

Customized FB/FC - self defined variable programming assistant



EASY assembly & wiring

Easy to add and/or replace modules. Plug in wires directly with spring clamp terminals

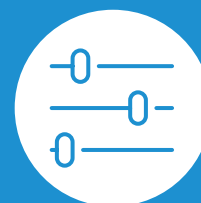

EASY commissioning

Auto device scanning, easy configuration, servo debug without programming, offline simulation



The type-C port works as a programming port allowing support programs, uploading/downloading and debugging.

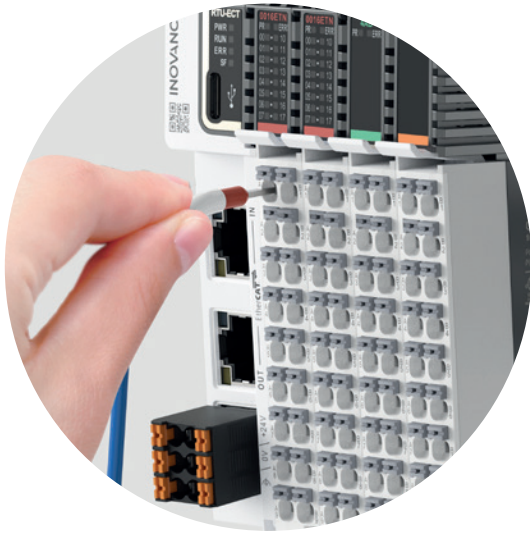

Easy wiring with spring clamp terminals.



Slim and compact I/O expansion modules (GL20). Easy to plug in and remove for fast replacement.

Scalable system architecture

Multiple configurations

Easy301

Cost effective architecture using Modbus RTU communication and/or pulses to control the drives.

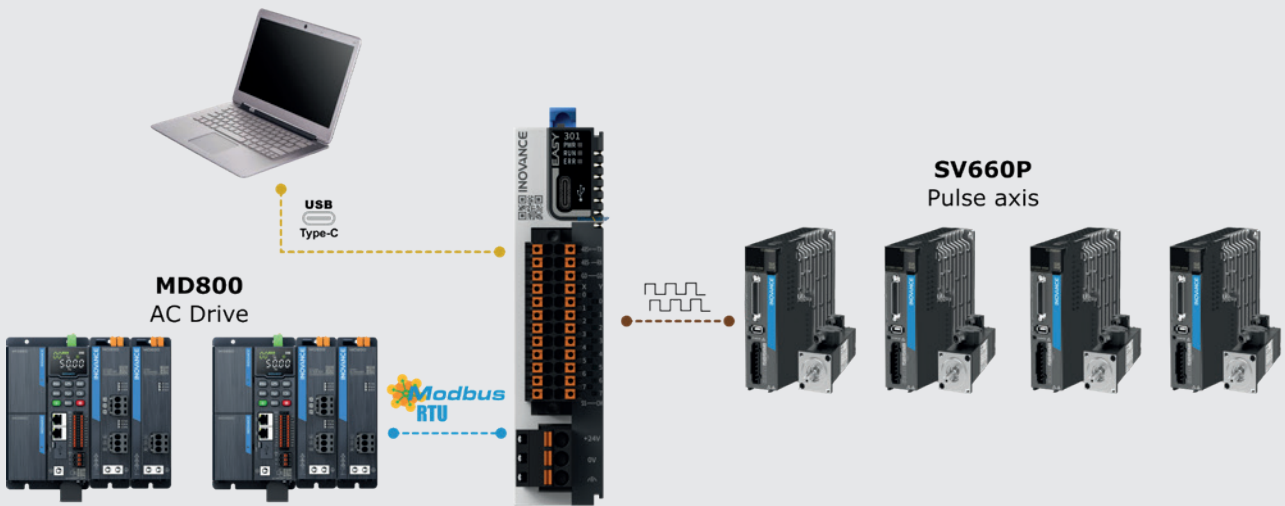

Easy302

Flexible architecture using CANopen communication and/or pulses to control the drives.

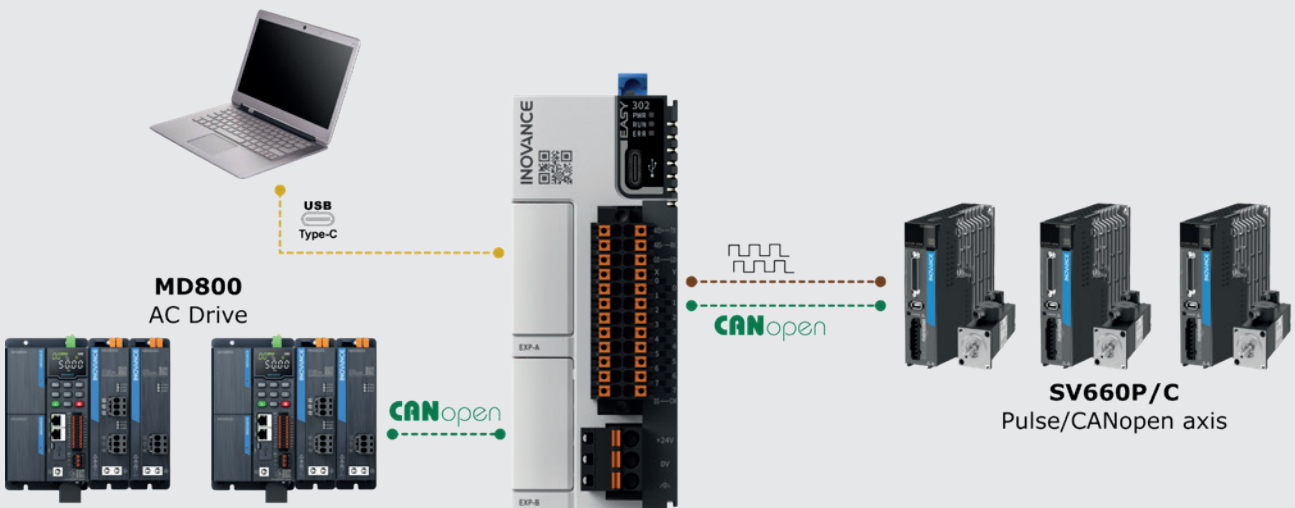

The Easy PLC series can cover anything from the simplest pulse control architecture to the most complex motion control applications using EtherCAT and Ethernet/IP

Easy320

Multiprotocol architecture using Ethernet/IP, CANopen communication and/or pulses to control the drives, and Modbus TCP with the HMI touchpanel

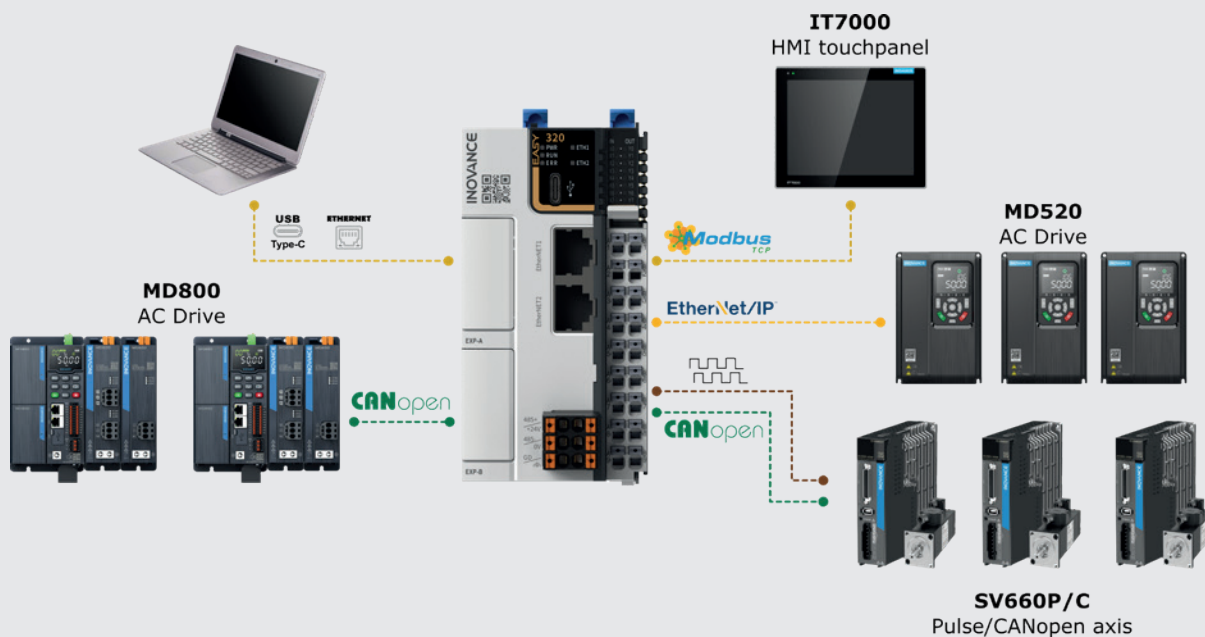

Easy523

Powerful motion control architecture using realtime EtherCAT communication and Ethernet/IP to control the drives, and Modbus TCP with the HMI touchpanel

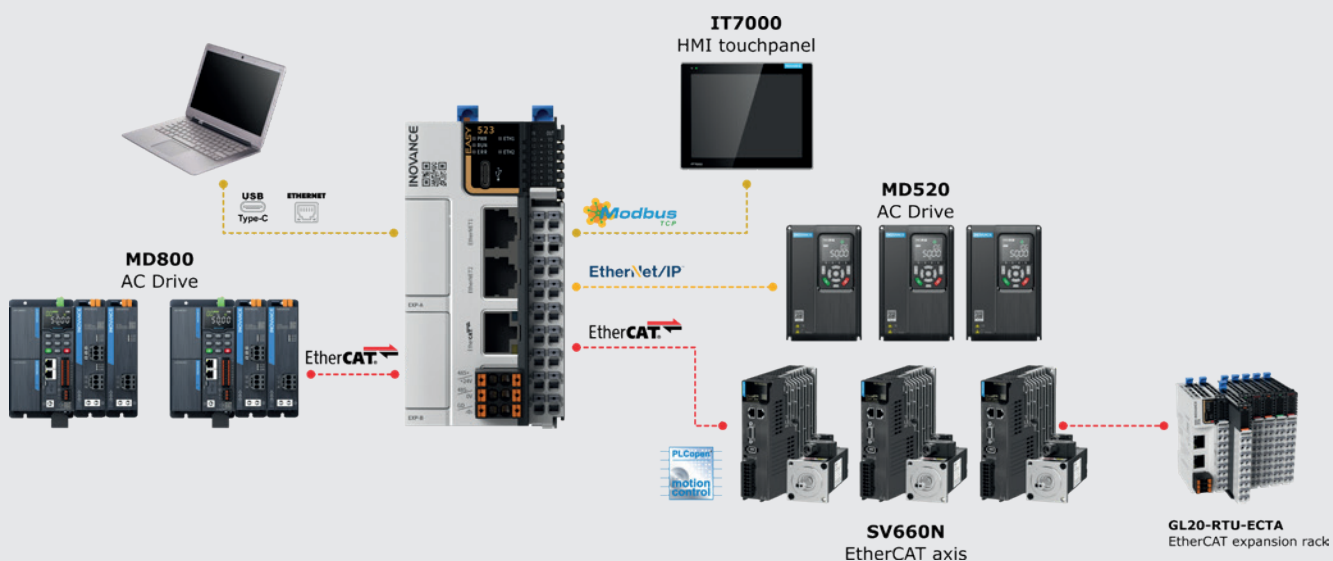

Specifications

Basic specifications of easy series controller

Item	Easy300		
	Easy301-0808TN	Easy302-0808TN	Easy320-0808TN
Part number	01440323	01440324	01440325
Motion axis	4 pulse control axes	5 pulse control axes	5 pulse control axes
Expansion modules (GL20)	8	16	
Expansion slots (GE20)	–	2 (support communication/digital IO/analog IO/TF card/R)	
Ethernet	–	2 Modbus TCP up to 32 slaves Ethernet/IP scanner/adap	
EtherCAT	–		
Serial communication	1 x RS232 1 x RS485 Support free protocol, Modbus RTU/ASC up to 16 slaves	1 x RS232, 1 x RS485 Support 1 x RS232/485 expansion and 1 x CAN expansion Support free protocol, Modbus RTU/ASC 16 slaves (recommended)	1 x RS485 Support 2 x RS232 /485 expansion and 1 x CAN expansion Support free protocol, Modbus RTU/ASC 16 slaves (recommended)
CAN communication	–	1 (requires expansion card), supports CANlink/CANopen m	
Program storage	128 K step		
Data storage	1 Mbyte (128 KB non-volatile) 150 KB soft element, non-volatile after No.1000		
Instruction execution time	20 K step / 2 ms		
Dimensions (WxHxD: mm)	24x100x83	40x100x83	53x100x80
Other interfaces	Type C	Type C, TF card (requires TF card expansion module)	
CAM and interpolation	–	Supports CAM and interpolation motion	
Encoder axis	4 channel encoder axis (8 x high speed inputs, up to 200 KHz)		
Built in I/Os	8 inputs (selectable sink/source) and 8 outputs (sink type - available, source type - con		
Programming languages	LD, SFC, ST, FB/FC (supports encryption functionality)		
Power supply	DC24V		

¹Synchronised axes

²EtherCAT slaves include I/Os and synchronised and non-synchronised axes

Easy500	
Easy502-0808TN	Easy523-0808TN
01440336	01440326
A total of 16 synchronised axes are possible. This can be a max. of 16 EtherCAT axes ¹ , or a combination that includes a max. of five pulse control axes	A total of 32 synchronised axes are possible. This can be a max. of 32 EtherCAT axes ¹ , or a combination that includes a max. of five pulse control axes
TC)	
es ter	–
	2
	Modbus TCP up to 32 slaves Ethernet/IP scanner/adapter
Support up to 72 EtherCAT slaves ² (including synchronised axes)	
1 x RS485 Support 2 x RS232/485 expansion and 1 x CAN expansion Support free protocol, Modbus RTU/ASC 16 slaves (recommended)	1 x RS485 Support 2 x RS232/485 expansion Support free protocol, Modbus RTU/ASC 16 slaves (recommended)
master/slave (up to 62 slaves)	
200 k step	
2 Mbyte (128 KB non-volatile)	
20 K step / 1.6 ms	
ning soon)	

Autoshop

A powerful PC tool is provided as standard

PLCopen FB

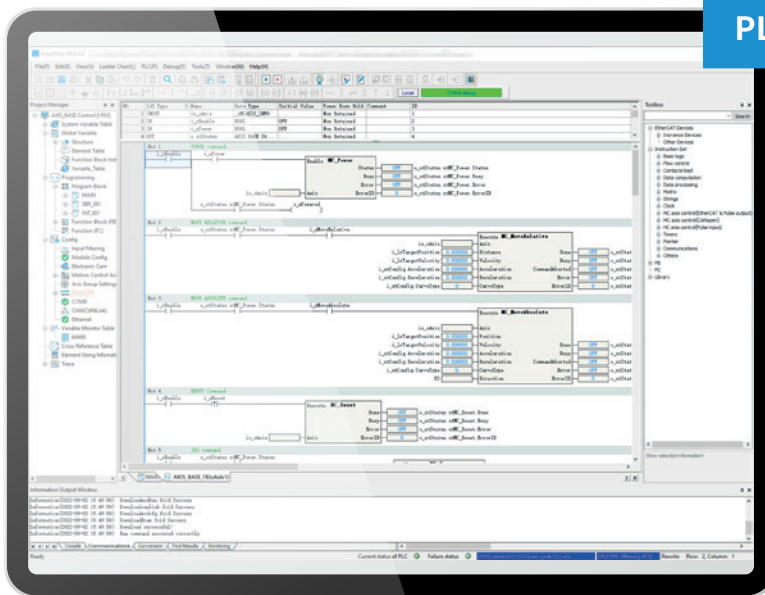

Hardware simulation

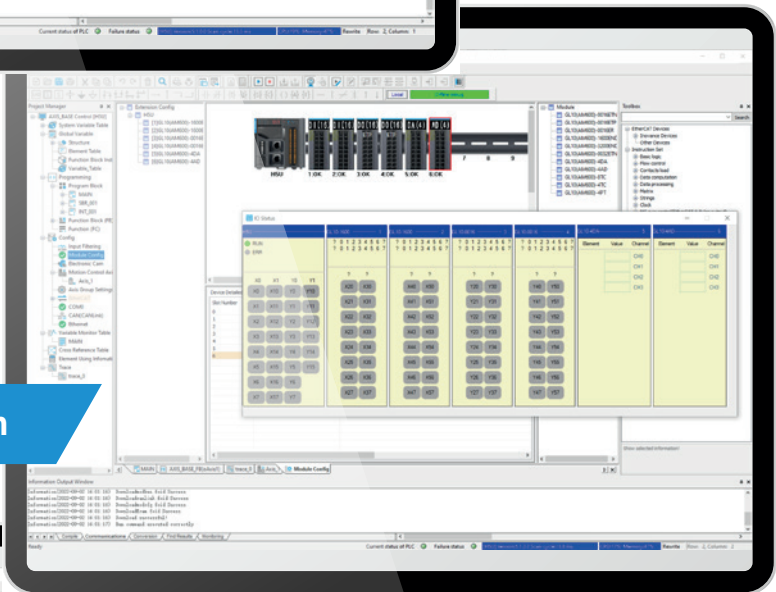

Easy hardware configuration

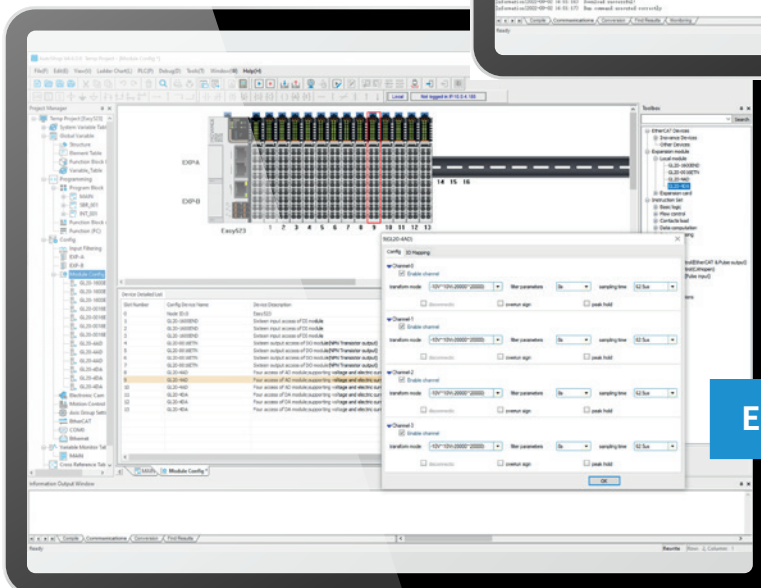

ST programming

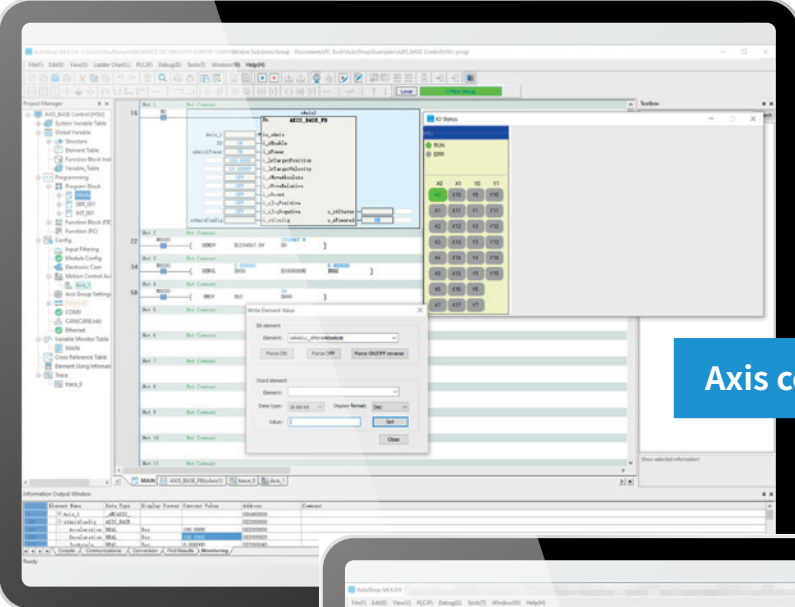
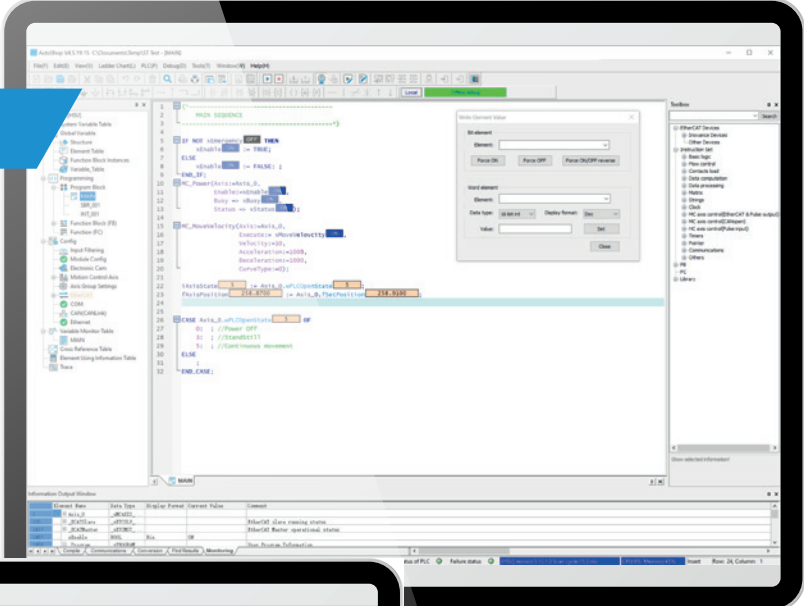

Axis commissioning tool

Trace

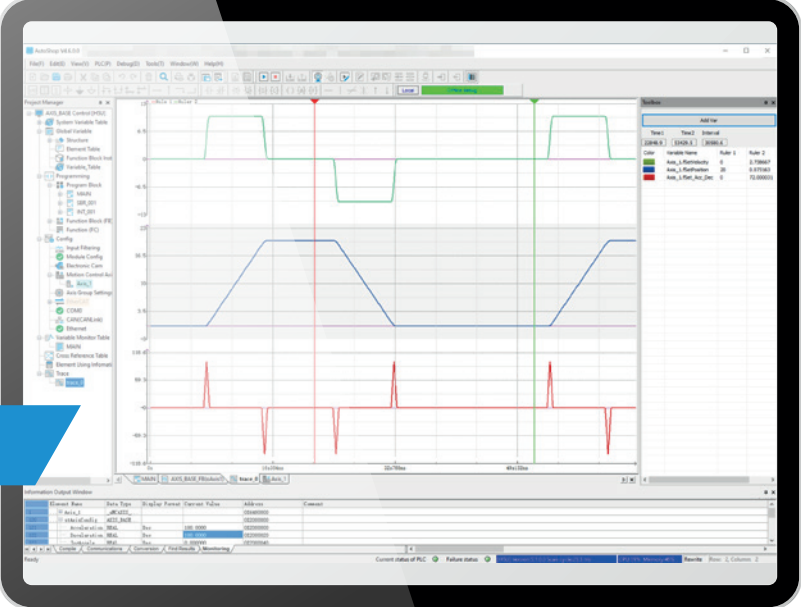

Expansion capability

GE20 Expansion cards

Expansion slot A

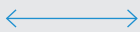

Expansion slot B

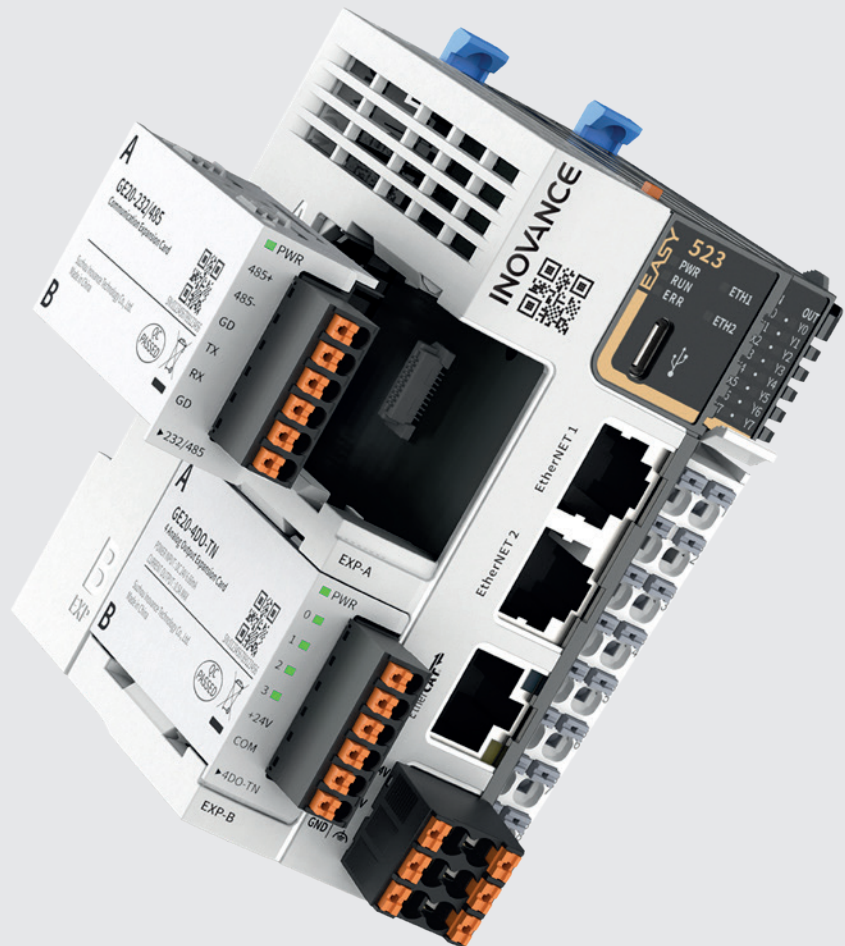

Communications capabilities

- RS485 connection - up to 31 slaves
- CANopen - up to 62 slaves
- CANlink - up to 62 slaves
- Modbus TCP - up to 32 slaves (working as client/master)
- Modbus TCP - up to 16 masters (working as server/slave)
- Up to 3 serial ports (RS232/485) - 1 onboard and 2 GE20 expansion cards

Please note: GE20 expansion cards are not applicable to Easy301 CPU.

Product appearance	Expansion card	Product code	Description	Slot A	Slot B
	GE20-4DO-TN	01480033	4 channel sink outputs	✓	✓
	GE20-4DI	01480032	4 channel source/sink inputs	✓	✓
	GE20-2AD1DA-I	01480027	2 analog inputs and 1 analog current output	✓	✓
	GE20-2AD1DA-V	01480028	2 analog inputs and 1 analog voltage output	✓	✓
	GE20-232/485-RTC	01480035	RS232/485 expansion card with RTC		✓
	GE20-232/485	01480029	RS232/485 expansion card	✓	✓
	GE20-CAN-485	01480034	CAN/RS485 expansion card with RJ45 interface	✓	
	GE20-RTC	01480031	RTC expansion card		✓
	GE20-TF	01480030	TF expansion card		✓

Expansion card size: 54*30*1.2 (mm)

Expansion capability

GE20 Expansion cards

Digital expansion card

Material code	01480033	Material code	01480032
Appearance		Appearance	
Model	GE20-4DO-TN	Model	GE20-4DI
Description	4 channel output module	Description	4 channel input module
Slot	A/B	Slot	A/B
IP level	IP20	IP level	IP20
Operational temperature	-20 °C ~ 55 °C	Operational temperature	-20 °C ~ 55 °C
Output type	Digital transistor	Input type	Digital transistor
Source/sink (PNP/NPN)	Sink (NPN)	Source/sink (PNP/NPN)	Source/sink
Channels	4	Channels	4
Output voltage	24 V DC (20.4 V DC ~ 26.4 V DC)	Input voltage	24 V DC \pm 10% (21.6 V DC ~ 26.4 V DC)
Output (resistance load)	0.5 A/point, 1 A/common point	Input resistance	5.6 k Ω
Output (inductance load)	6 w/24 V DC (in total)	ON current	>3.5 mA
Output (lamp load)	1 w/24 V DC (in total)	OFF current	<1.5 mA
Hardware ON/OFF response	Within 100 us	Input response	\approx 15 ms (hardware RC filter)
Leakage current (ON->OFF)	10 uA below	ON voltage	\geq 15 V DC
Frequency	Resistance load: 100 Hz, inductance load: 0.5 Hz, lamp load: 10 Hz	OFF voltage	\leq 5 V DC
Isolation	Opto-isolation	Software filter	NOT support
Protection function	Surge suppression	Isolation	Opto-isolation

Analog expansion card



Material code	01480028		
Appearance			
Model	GE20-2AD1DA-V		
Description	2 channel analog inputs plus 1 channel analog input, voltage type		
Slot	A/B		
IP level	IP20		
Operational temperature	-20 °C~55 °C		
Input type	Analog input	Output type	Analog output
Input mode	Current/voltage	Output mode	Voltage
Input channels	2	Output channel	1
Resolution	12 bit	Resolution	12 bit
Conversion time	6 ms/channel	Conversion time	1 ms/channel
Input range	0 ~ 10 v/0 mA ~ 20 mA	Output range	0 ~ 10 v
Current input resistance	250 Ω	Voltage output resistance	>2 KΩ
Input accuracy (25 °C)	Voltage ±1%, Current ±1% (full range)	Output accuracy (25 °C)	±1% (full range)
Input accuracy (-20 °C ~ 55 °C)	Voltage ±3%, Current ±3% (full range)	Output accuracy (-20 °C ~ 55 °C)	±5% (full range)
Digital input range	0 ~ 20,000	Digital output range	0 ~ 20,000

Material code	01480027		
Appearance			
Model	GE20-2AD1DA-I		
Description	2 channel analog inputs plus 1 channel analog input, current type		
Slot	A/B		
IP level	IP20		
Operational temperature	-20 °C ~ 55 °C		
Input type	Analog input	Output type	Analog output
Input mode	Current/ voltage	Output mode	Current
Input channels	2	Output channel	1
Resolution	12 bit	Resolution	12 bit
Conversion time	6ms/ channel	Conversion time	1 ms/channel
Input range	0 ~ 10 v/ 0 mA ~ 20 mA	Output range	0 mA ~ 20 mA
Current input resistance	250 Ω	Current output resistance	0 Ω ~ 500 Ω
Input accuracy (25 °C)	Voltage ±1%, Current ±1% (full range)	Output accuracy (25 °C)	±1% (full range)
Input accuracy (-20 °C ~ 55 °C)	Voltage ±3%, Current ±3% (full range)	Output accuracy (-20 °C ~ 55 °C)	±5% (full range)
Digital input range	0 ~ 20,000	Digital output range	0 ~ 20,000

Expansion capability

GE20 Expansion cards

Communication expansion card

Material code	01480035	01480029	01480034
Appearance			
Model	GE20-232/485-RTC	GE20-232/485	GE20-CAN-485
Description	RS232/RS485 communications card with RTC	RS232/ RS485 communications card	CAN/RS485 communications card
Slot	B	A/B	A
IP level	IP20	IP20	IP20
Operational temperature	-20 °C ~ 55 °C	-20 °C ~ 55 °C	-20 °C ~ 55 °C
RS485/RS232	1	1	1
Terminal resistor	Set via DIP switch	Set via DIP switch	NO terminal resistor for RS485 Built-in terminal resistor for CAN
Communications ability	Up to 31 slaves Distance between adjacent slaves not over 3m	Up to 31 slaves Distance between adjacent slaves not over 3 m	Up to 31 slaves(RS485) Distance between adjacent slaves not over 3 m Up to 63 slaves (CAN)
Baud rate of RS485/RS232	9600/19200/38400/ 57600/115200 bit/s	9600/19200/38400/ 57600/115200 bit/s	9600/19200/38400/ 57600/115200 bit/s
Baud rate of CAN	/	/	1 Mbit/s: distance < 20 m 500 kbit/s: distance < 80 m 250 kbit/s: distance < 150 m 125 kbit/s: distance < 300 m 100 kbit/s: distance < 500 m 50 kbit/s: distance < 1,000 m
RTC accuracy	120 sec/ month	/	/
RTC format	YYYY/MM/DD/HH/MM/SS	/	/
In-built lithium battery	CR2302, 3 year life cycle, removable	/	/

RTC expansion card

Material code	01480031
Appearance	
Model	GE20-RTC
Description	RTC extension card
Slot	B
IP level	IP20
Operational temperature	-20 °C ~ 55 °C
RTC accuracy	120 sec/month
RTC format	YYYY/MM/DD/HH/MM/SS
In-built lithium battery	CR2302, 3 year life cycle, removable

TF card expansion card

Material code	01480030
Appearance	
Model	GE20-TF
Description	TF card extension card
Slot	B
IP level	IP20
Operational temperature	-20 °C ~ 55 °C
SD card capacity	NOT over 32 G
SD card type	TransFlash (Micro SD)

Expansion capability

GL20 expansion modules



Great performance with ultra fast response

Microsecond level response | Synchronous control



Compact size and wiring without tools

Compact size | Fast installation | Fast replacement



Stable and reliable design

Stable connection | Gold plating process | Safety and



Many variants to suit different systems

Multiple protocols | Many variants

Applicable to either bus coupler or CPU

se

NEW generation distributed I/O system



d reliability

GL20 slim and compact I/O modules



Expansion capability

GL20 expansion modules



Compact Size

Saves 2/3 of the space in the cabinet compared to the previous generation product – GL10

GL20 Series

Designed for compact cabinets

Thickness reduced to **12mm**

2/3 cabinet space saved

Space utilisation maximised

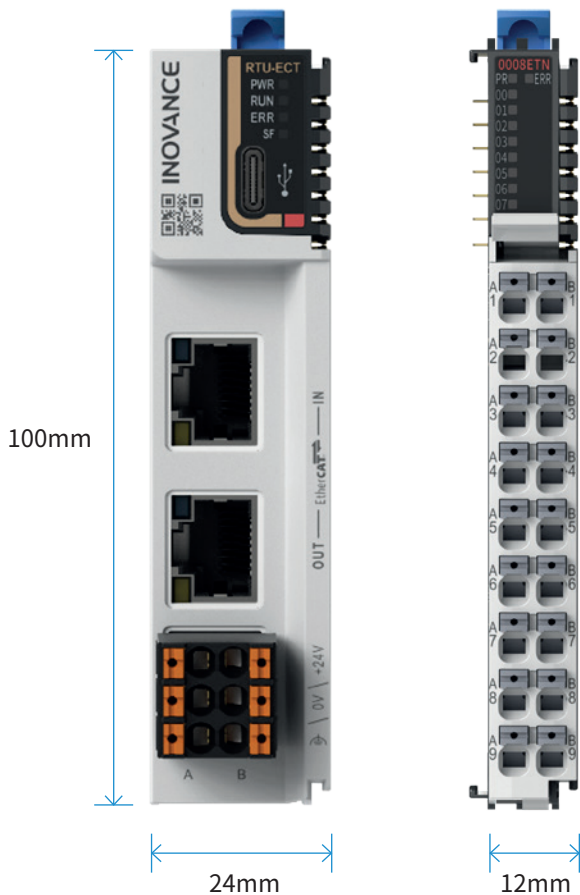
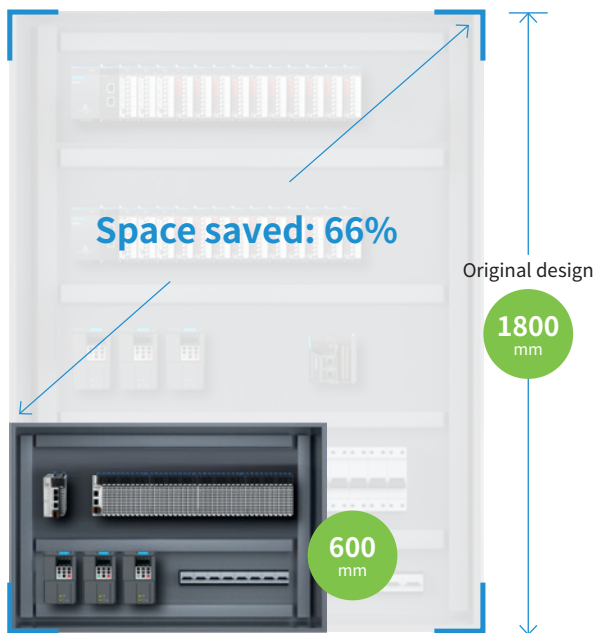

Compact design and tool-free wiring



Simple lever system allows easy removal of individual modules from the DIN rail



Easy wiring with spring-type terminals, with large 1.5mm² apertures



Easy module removal

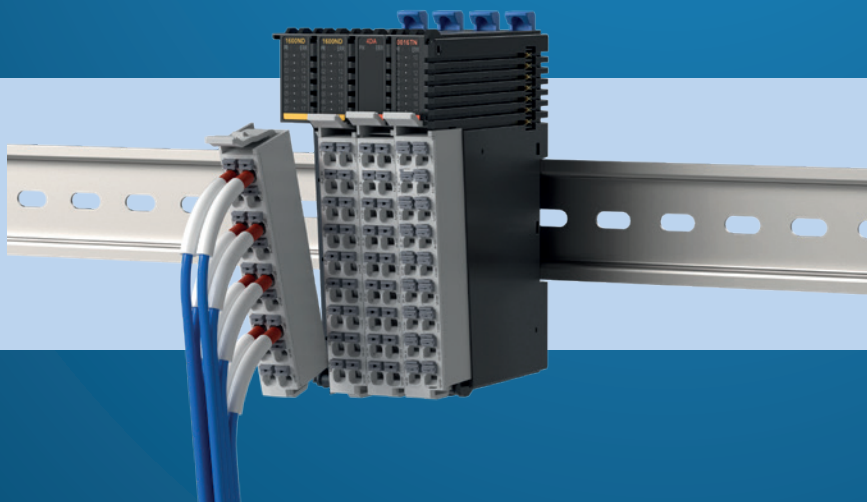

Removable terminals minimizes installation errors

Expansion capability

GL20 modules – EtherCAT bus coupler



EtherCAT®

- ✓ Min. cycle time of 125 microseconds
- ✓ Allows EtherCAT alias configuration
- ✓ USB-C port for firmware upgrade

Specification	Description
Dimensions (WxHxD:mm)	24×100×83
Max. number of expansion modules	16
Protection	Over current/ reverse connection protection
Operating ambient temperature	-20~55°C
Operating ambient humidity	Less than 95% and no condensation
IP rating	IP20
Power supply	+24 VDC
Process data	Up to 1,024 input bytes and 1,024 output bytes
Mailbox size	Up to 256 input bytes and 256 output bytes
Alias	It admits the configuration of EtherCAT aliases through the master. Expansion modules connected behind ECT do not support alias access and configuration. Range: 1~65535
EtherCAT cycle	Min. cycle time of 125 microseconds
EtherCAT port	2 x RJ45
Communication rate	100 M, full duplex
Transmission distance	100 meters
Firmware update port	USB-C port for firmware upgrade

Expansion capability

GL20 expansion modules

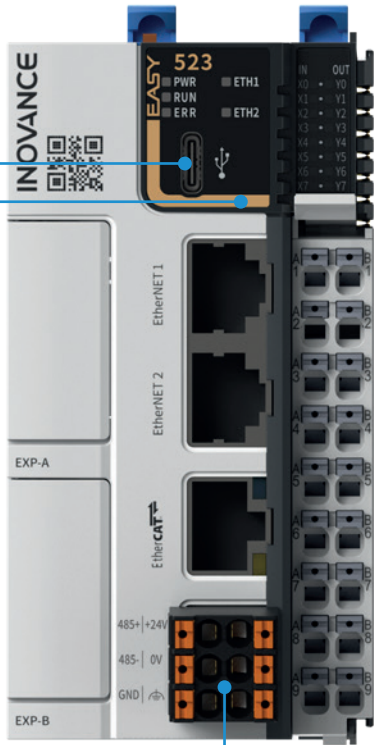

Main CPU

EtherCAT coupler

24VDC power supply
2 channels (A&B)

Wiring diagram

Type C port for firmware upgrade



I/O LED indicator

Label for each
connection
terminal

Digital outputs module

Analog outputs module

Digital inputs module

Analog inputs module

Communication module

Others



Please note: the colour codes
specify the module type

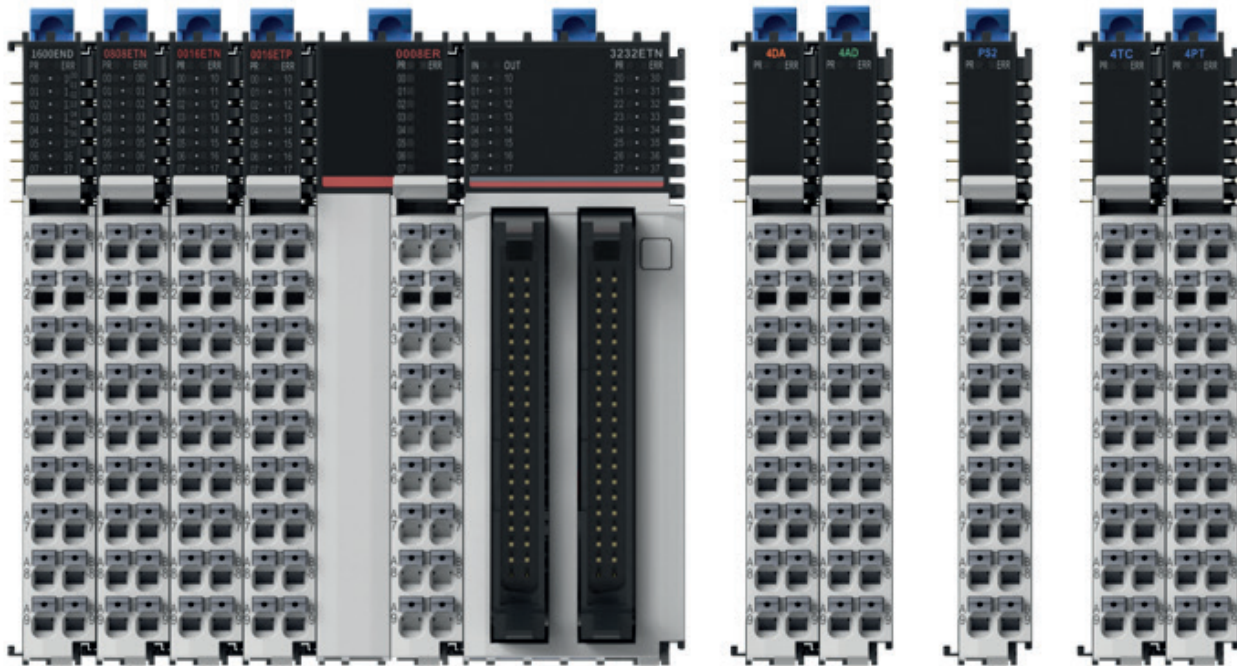

Type of module	Model	Product code	Description
Bus coupler	GL20-RTU-ECT	1440286	EtherCAT slave bus coupler. Up to 16 expansion modules can be added
	GL20-RTU-PN	1440289	PROFINET slave bus coupler. Up to 16 expansion modules can be added
Digital inputs	GL20-1600END	1440291	16 x source (PNP)/sink (NPN) digital inputs module. Input filter from 0.25 ms to 32 ms
	GL20-0800END	1440381	8 x source (PNP)/sink (NPN) digital inputs module. Input filter from 0.25 ms to 32 ms
	GL20-3200END-M	1440378	32 x source (PNP)/sink (NPN) digital inputs module. Input filter from 0.25 ms to 32 ms
Digital outputs	GL20-0008ETP	1440380	8 x source (PNP) transistor outputs module. Response time 100 μ s
	GL20-0008ETN	1440379	8 x sink (NPN) transistor outputs module. Response time 100 μ s
	GL20-0016ETP	1440292	16 x source (PNP) transistor outputs module. Response time 100 μ s
	GL20-0016ETN	1440293	16 x sink (NPN) transistor outputs module. Response time 100 μ s
	GL20-0032ETN-M	1440377	32 x sink (NPN) transistor outputs module. Response time 100 μ s
Relay outputs	GL20-0008ER	1440334	8 x relay outputs module. Response time 15 ms
Digital I/Os	GL20-0808ETN	1440339	8 x source (PNP)/sink (NPN) digital inputs and 8 x sink (NPN) transistor outputs module. Response time 100 μ s. Input filter from 0.25 ms to 32 ms
	GL20-3232ETN-M	1440290	32 x source (PNP)/sink (NPN) digital inputs and 32 x sink (NPN) transistor outputs module. Response time 100 μ s. Input filter from 0.25 ms to 32 ms
Analog inputs	GL20-4AD	1440288	4 x analog inputs module (resolution 16 bits, sampling time 250 μ s)
Analog outputs	GL20-4DA	1440287	4 x analog outputs module (resolution 16 bits, sampling time 250 μ s)
Temperature detection	GL20-4PT	1440337	4 x channel thermal resistance inputs temperature detection module (Pt100, Pt500, Pt1000, Cu100, KTY84, NTC5K, NTC10K)
	GL20-4TC	1440338	4 x channel thermocouple inputs temperature detection module (thermocouple type: B,E,N,J,K,R,S,T)
Accessories	XA3210A-40-L0.5M-01	15310167	I/O extension cable - 0.5 m length with 2 FCN connectors (required for GL20-3200END/GL20-0032ETN-M/GL20-3232ETN)
	XA3210A-40-L2M-01	15310166	I/O extension cable - 2 m length with 2 FCN connectors (required for GL20-3200END/GL20-0032ETN-M/GL20-3232ETN)
	T024-K	15020452	40PIN MIL screw terminal block (Required for GL20-3200END/GL20-0032ETN-M/GL20-3232ETN)

Dimensions

Easy301

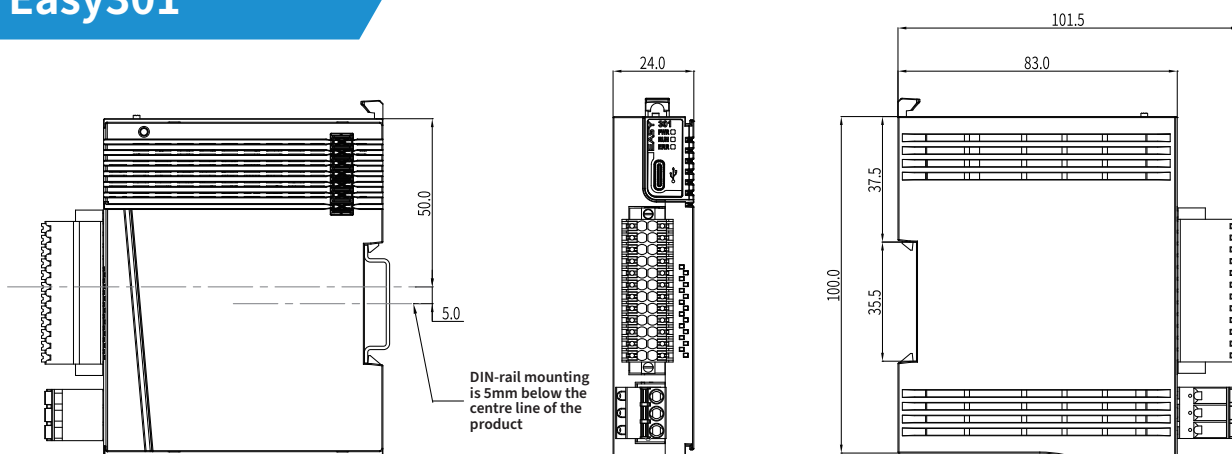

Easy302

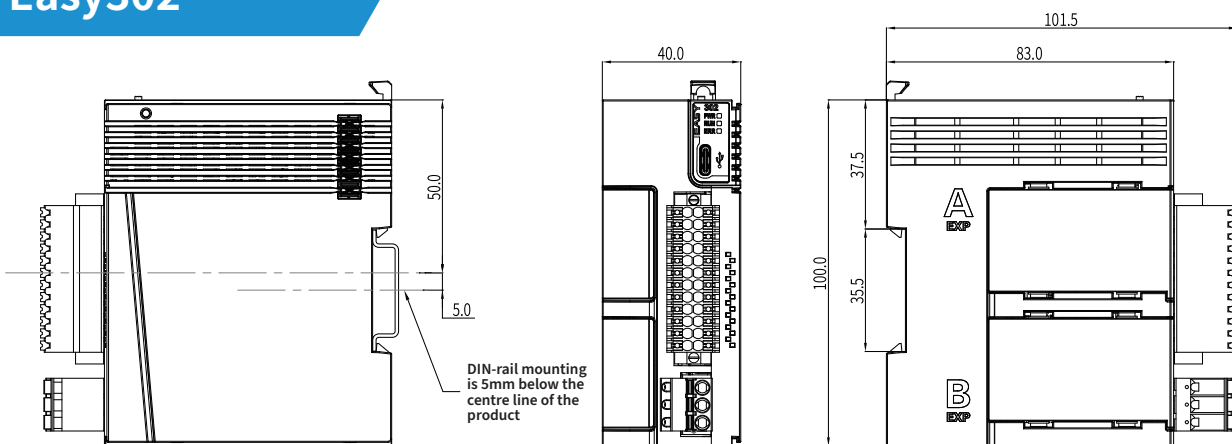

GL20-RTU-ECT

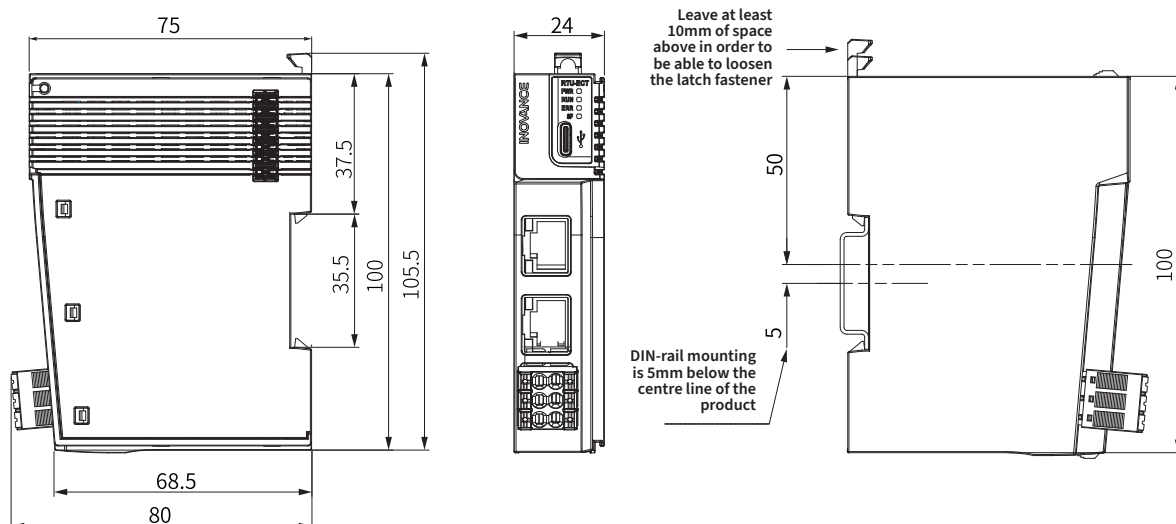

Easy320

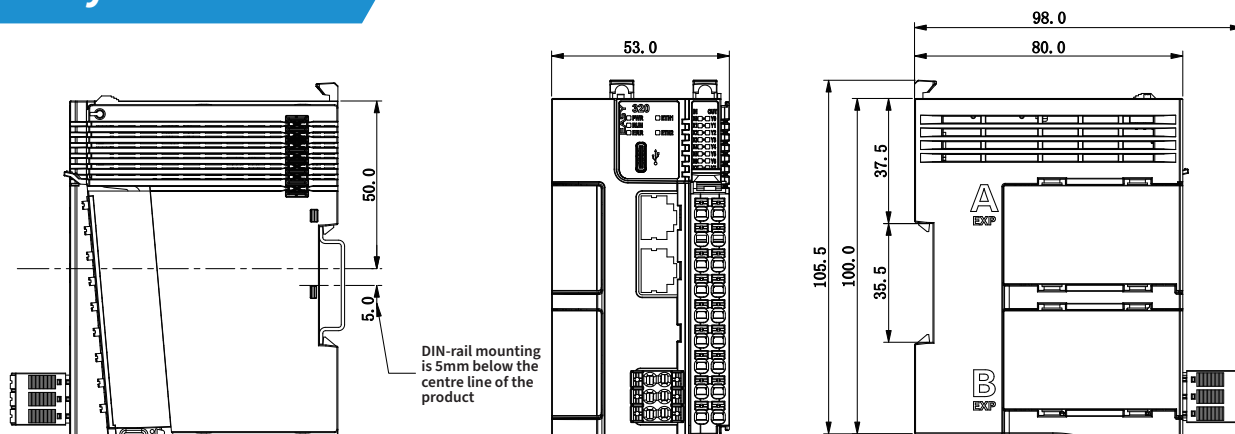

Easy502 & 523

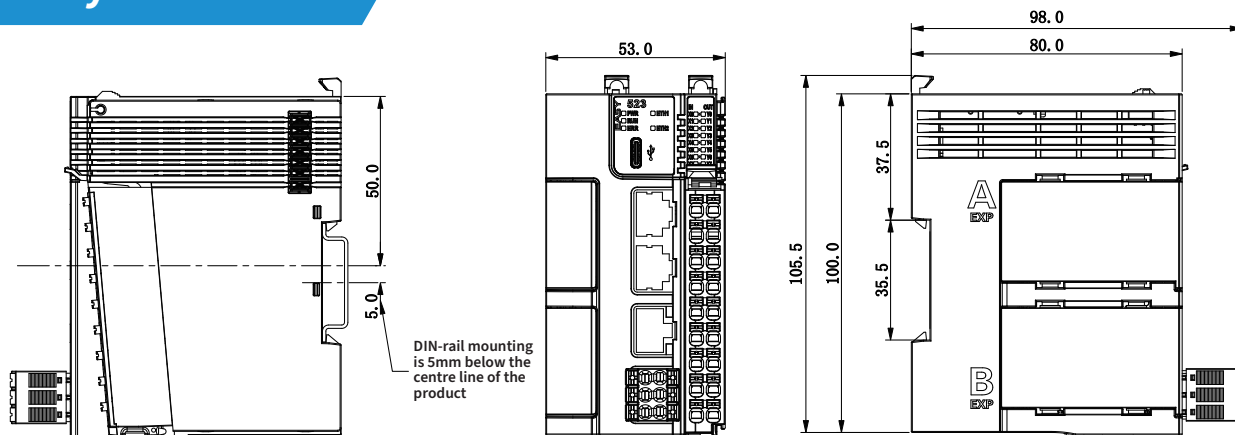

GL20-1600END, GL20-0800END, GL20-0008ETP, GL20-0016ETP, GL20-0016ETN, GL20-0808ETN, GL20-4AD, GL20-4DA, GL20-4PT, GL20-4TC

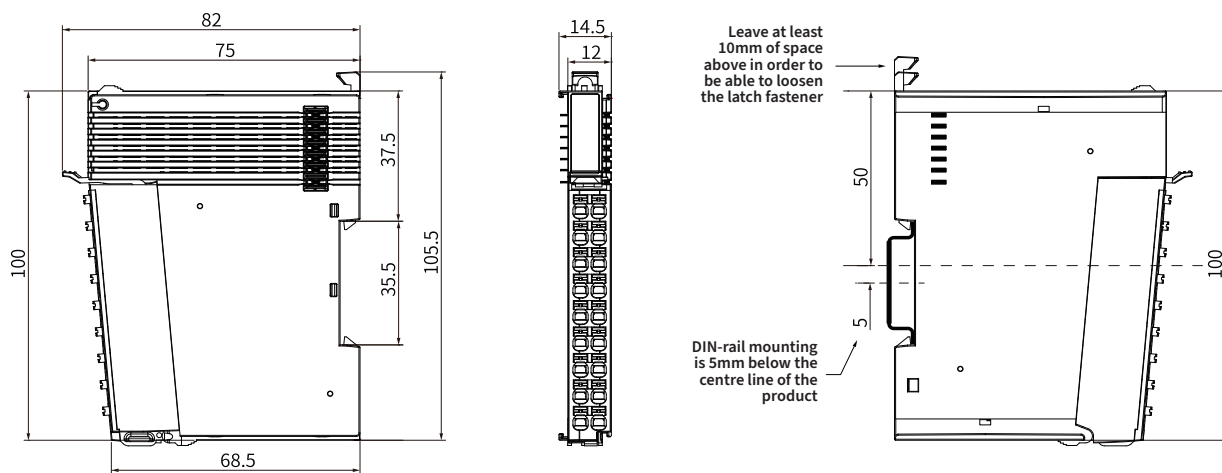

Please note: GL20-008ER, GL20-3200END, GL20-0032ETN-M, GL20-3232ETN are a larger size. Details are available in the separate GL20 brochure.

Driven by technology

AC drives



AC MultiDrives



MV drives



Single-Axis servos



Multi-Axis servos



Robotics & motion controllers



PLCs & HMIs



CNC machine tool solutions



Electric vehicle inverters

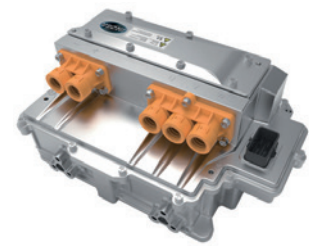

For more information, please contact our local offices.

International Offices

Germany-Stuttgart
Tel: +49 (0) 7144 8990
sales.de@inovance.eu

Spain-Barcelona
Tel: +34 93 504 94 48
sales.es@inovance.eu

India
Head Office Chennai Tel: +91 (0) 44 4380 0201
Ahmedabad Tel: +91 (0) 79 4003 4274

Hong Kong SAR
International export office
Tel: +852 2751 6080
info@inovance.eu

Italy-Milano
Tel: +39 (0) 2268 22318
sales.it@inovance.eu

Turkey-Istanbul
Tel: +90 (216) 706 17 89
sales.tr@inovance.eu

Mumbai Tel: +91 (0) 22 4971 5883
New Delhi Tel: +91 (0) 11 4165 4524

For other country distributors,
contact the Hong Kong office.

Inovance Technology Companies
Shenzhen Inovance Technology Co. Ltd.
Suzhou Inovance Technology Co. Ltd.

France-Bordeaux
Tel: +33 (0) 5594 01050
sales.fr@inovance.eu

South Korea-Seoul
Tel: +82 2 3489 8850
sales.kr@inovance.eu

Sales Network in Kolkata, Bengaluru, Pune,
Coimbatore, Hyderabad, Vadodara, Jaipur
info@inovance.ind.in

INOVANCE
www.inovance.eu