

MD380L Series

Open loop AC elevator drive



Open loop AC elevator drive

Application Features

- Smooth ride performance
- Integrated brake control
- UPS/ARD (sine & quasi square type) rescue light load direction sensing
- 5 independent S-Ramps
- Easy setup with default factory setting, gets you started quickly
- Programmable DC injection braking

Enhanced reliability with conformal coating, protects against humidity and dust pollution

Operation in high ambient temperatures  45°C_{avg}

Wide operating voltage range 323 to 528 Vac

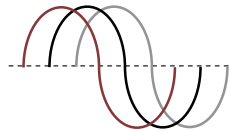

Cooling fan removable for easy maintenance



Optional: hot pluggable remote keypad



With/without memory

*1 PC-Tools software offers simplified start up & backup

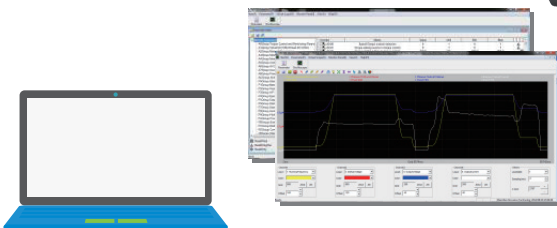

*1 Compatible with Windows 7



3.7 kW~15 kW

Drive Key Features

- Automatic torque boost
- Slip compensation
- Flexible programmable I/O's
- Onboard Modbus-RTU
- Comprehensive trip diagnostics
- Built-in dynamic braking unit
- Output frequency 0.00~100.00 Hz



General Specifications

Drive Model		MD380L-T3.7GB	MD380L-T5.5GB	MD380L-T7.5GB	MD380L-T11GB	MD380L-T15GB	
Dimensions	Height [mm]	248			322		
	Width [mm]	160			208		
	Depth [mm]	183			192		
Drive Input	Rated Input Voltage	3-phase 380 to 480 Vac, -15% to +10% (323 to 528 Vac)					
	Rated Input Current [A]	10.5	14.6	20.5	26	35	
	Rated Input Frequency	50/60 Hz, ±5% (47.5 to 63 Hz)					
Drive Output	Applicable Motor	[kW]	3.7	5.5	7.5	11	15
		[HP]	5	7.5	10	15	20
	Output Current [A]*2	9	13	17	25	32	
	Power Capacity [kVA]	5.9	8.9	11	17	21	
	Overload Capacity	150% for 60 Sec & 180% for 3 Sec					
	Max. Output Voltage	3-phase 380 to 480 Vac (Proportional to input voltage)					
	Max. Output Frequency	100.00 Hz					
Braking Resistor	Recommended Power [W]	750	1,200	1,500	2,500	3,000	
	Recommended Resistance [Ω]	≥ 130	≥ 90	≥ 65	≥ 43	≥ 32	
Enclosure		IP20					

*2 Carrier switching frequency 4 kHz at rated output current
Please note: all units are fan cooled

General Connection Diagram

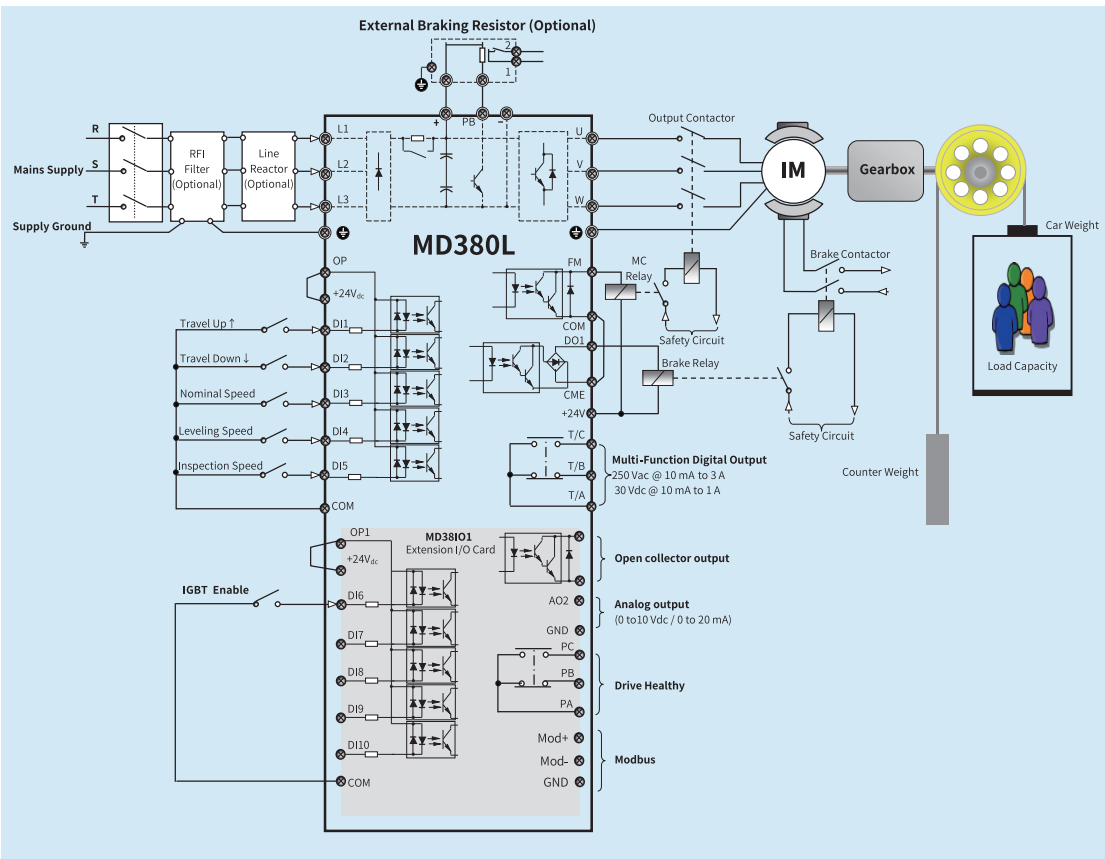

We Pioneered NICE Integrated Solutions for Elevators



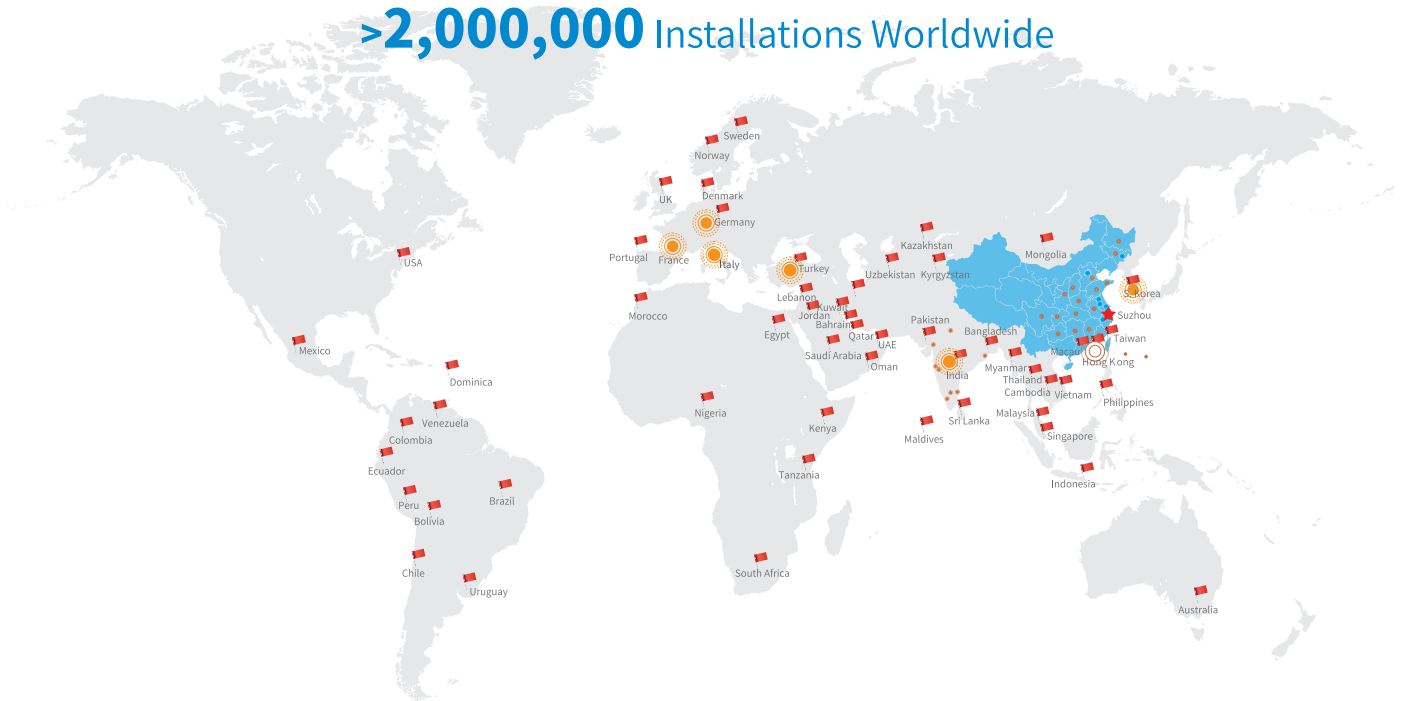

>2,000,000 Installations Worldwide



INOVANCE

www.inovance.eu

International Offices

-  **Germany-Stuttgart**
Tel: +49 (0) 7144 8990 | sales.de@inovance.eu
-  **Italy-Milano**
Tel: +39 (0) 2268 22318 | sales.it@inovance.eu
-  **France-Bordeaux**
Tel: +33 (0) 5594 01050 | sales.fr@inovance.eu
-  **Turkey-Istanbul**
Tel: +90 (216) 706 17 89 | info@inovance.eu
-  **South Korea-Seoul**
Tel: +82 (0) 10 7428 5732 | info@inovance.eu

Hong Kong SAR
International Export Office
Tel: +852 2751 6080 | info@inovance.eu

-  **India**
Head Office Chennai | Tel: +91 (0) 44 4380 0201
Ahmedabad | Tel: +91 794003 4272
Mumbai | Tel: +91 22 4971 5883
New Delhi | Tel: +91 11 4165 4524
Sales Network in Kolkata, Bengaluru, Pune, Coimbatore, Hyderabad, Vadodara, Jaipur
Email: info@inovance.ind.in

For other country distributors, contact the Hong Kong office.

Inovance Technology Companies
Shenzhen Inovance Technology Co. Ltd.
Suzhou Inovance Technology Co. Ltd.