

# SV660N Series Servo Drive Commissioning Guide



# Preface

## Overview

The SV660N series high-performance AC servo drive covers a power range from 50 W to 7.5 kW. It supports EtherCAT communication protocol and carries Ethernet communication interfaces to work with the host controller for a networked operation of multiple servo drives.

The SV660N series servo drive supports stiffness level setting, inertia auto-tuning and vibration suppression to simplify the operation process. It allows a quiet and stable operation together with an MS1 series servo motor with low or medium inertia and a 23-bit single-turn or multi-turn absolute encoder.

The SV660N series servo drive aims to implement fast and accurate control in automation equipment such as semi-conductor manufacturing equipment, chip mounters, PCB punching machines, handling machineries, food processing machineries, machine tools, and transmission machineries.

This guide presents commissioning process, parameters, and solutions to faults and warnings, including the keypad, and software tool, and commissioning procedure.

## More Documents

| Name  | Data Code |
|---|-----------|
| SV660N Series Servo Drive Selection Guide     | 19011431  |
| SV660N Series Servo Drive Hardware Guide      | 19011432  |
| SV660N Series Servo Drive Communication Guide | 19011435  |
| SV660N series servo drive function guide      | 19011434  |

## Revision History

| Date of Revision | Version | Revision          |
|------------------|---------|-------------------|
| October 2020     | A00     | First release     |
| January 2021     | A01     | Minor corrections |
| January 2021     | A02     | Minor corrections |

## Document Acquisition

This guide is not delivered along with the product. To download the PDF version, visit <http://en.inovance.cn/support/download.html>.

# Table of Contents

|   |     |
|---|-----|
| Preface .....                                       | 1   |
| Fundamental Safety Instructions .....               | 3   |
| 1 Commissioning Tool .....                          | 9   |
| 1.1 Keypad .....                                    | 9   |
| 1.1.1 Introduction to the Keypad .....              | 9   |
| 1.1.2 Display Modes .....                           | 10  |
| 1.1.3 Parameter Settings .....                      | 16  |
| 1.2 Software Tool .....                             | 17  |
| 2 Commissioning and Operation .....                 | 19  |
| 2.1 Commissioning Flowchart .....                   | 19  |
| 2.2 Commissioning Procedure .....                   | 20  |
| 2.2.1 Inspection Before Operation .....             | 20  |
| 2.2.2 Power-on .....                                | 20  |
| 2.2.3 Jogging .....                                 | 21  |
| 2.2.4 Parameter Settings .....                      | 23  |
| 2.2.5 Servo ON .....                                | 43  |
| 2.2.6 Servo OFF .....                               | 52  |
| 3 Troubleshooting .....                             | 60  |
| 3.1 Fault and Warning Levels .....                  | 60  |
| 3.2 List of Fault and Warning Codes .....           | 62  |
| 3.3 Solutions to Faults .....                       | 67  |
| 3.4 Solutions to Warnings .....                     | 109 |
| 3.5 Solutions to Communication Faults .....         | 120 |
| 4 List of Parameters .....                          | 124 |
| 4.1 Parameter Groups .....                          | 124 |
| 4.2 Parameter Group 1000h .....                     | 124 |
| 4.3 Parameter Group 2000h .....                     | 134 |
| 4.4 Parameter Group 6000h .....                     | 172 |
| 5 Appendix A Display of Monitoring Parameters ..... | 182 |

# Fundamental Safety Instructions

## Safety Precautions

1. This chapter presents essential safety instructions for a proper use of the equipment. Before operating the equipment, read through the guide and comprehend all the safety instructions. Failure to comply with the safety instructions may result in death, severe personal injuries, or equipment damage.
2. "CAUTION", "WARNING", and "DANGER" items in the guide only indicate some of the precautions that need to be followed; they just supplement the safety precautions.
3. Use this equipment according to the designated environment requirements. Damage caused by improper use is not covered by warranty.
4. Inovance shall take no responsibility for any personal injuries or property damage caused by improper use.

## Safety Levels and Definitions



**DANGER**

Indicates that failure to comply with the notice will result in death or severe personal injuries.



**WARNING**

Indicates that failure to comply with the notice may result in death or severe personal injuries.



**CAUTION**

Indicates that failure to comply with the notice may result in minor or moderate personal injuries or equipment damage.

## General Safety Instructions

- Drawings in the guide are sometimes shown without covers or protective guards. Remember to install the covers or protective guards as specified first, and then perform operations in accordance with the instructions.
- The drawings in the guide are shown for illustration only and may be different from the product you purchased.

### Unpacking



**WARNING**

- Do not install the equipment if you find damage, rust, or signs of use on the equipment or accessories upon unpacking.
- Do not install the equipment if you find water seepage or missing or damaged components upon unpacking.
- Do not install the equipment if you find the packing list does not conform to the equipment you received.



**CAUTION**

- Check whether the packing is intact and whether there is damage, water seepage, dampness, and deformation before unpacking.
- Unpack the package by following the unpacking sequence. Do not strike the package violently.
- Check whether there is damage, rust, or injuries on the surface of the equipment and equipment accessories before unpacking.
- Check whether the package contents are consistent with the packing list before unpacking.

**Storage and Transportation**



**WARNING**

- Large-scale or heavy equipment must be transported by qualified professionals using specialized hoisting equipment. Failure to comply may result in personal injuries or equipment damage.
- Before hoisting the equipment, ensure the equipment components such as the front cover and terminal blocks are secured firmly with screws. Loosely-connected components may fall off and result in personal injuries or equipment damage.
- Never stand or stay below the equipment when the equipment is being hoisted by the hoisting equipment.
- When hoisting the equipment with a steel rope, ensure the equipment is hoisted at a constant speed without suffering from vibration or shock. Do not turn the equipment over or let the equipment stay hanging in the air. Failure to comply may result in personal injuries or equipment damage.



**CAUTION**

- Handle the equipment with care during transportation and mind your steps to prevent personal injuries or equipment damage.
- When carrying the equipment with bare hands, hold the equipment casing firmly with care to prevent parts from falling. Failure to comply may result in personal injuries.
- Store and transport the equipment based on the storage and transportation requirements. Failure to comply will result in equipment damage.
- Avoid storing or transporting the equipment in environments with water splash, rain, direct sunlight, strong electric field, strong magnetic field, and strong vibration.
- Avoid storing the equipment for more than three months. Long-term storage requires stricter protection and necessary inspections.
- Pack the equipment strictly before transportation. Use a sealed box for long-distance transportation.
- Never transport the equipment with other equipment or materials that may harm or have negative impacts on this equipment.

**Installation**



**DANGER**

- The equipment must be operated only by professionals with electrical knowledge.

 **WARNING**

- Read through the guide and safety instructions before installation.
- Do not install this equipment in places with strong electric or magnetic fields.
- Before installation, check that the mechanical strength of the installation site can bear the weight of the equipment. Failure to comply will result in mechanical hazards.
- Do not wear loose clothes or accessories during installation. Failure to comply may result in an electric shock.
- When installing the equipment in a closed environment (such as a cabinet or casing), use a cooling device (such as a fan or air conditioner) to cool the environment down to the required temperature. Failure to comply may result in equipment over-temperature or a fire.
- Do not retrofit the equipment.
- Do not fiddle with the bolts used to fix equipment components or the bolts marked in red.
- When the equipment is installed in a cabinet or final assembly, a fireproof enclosure providing both electrical and mechanical protections must be provided. The IP rating must meet IEC standards and local laws and regulations.
- Before installing devices with strong electromagnetic interference, such as a transformer, install a shielding device for the equipment to prevent malfunction.
- Install the equipment onto an incombustible object such as a metal. Keep the equipment away from combustible objects. Failure to comply will result in a fire.

 **CAUTION**

- Cover the top of the equipment with a piece of cloth or paper during installation. This is to prevent unwanted objects such as metal chippings, oil, and water from falling into the equipment and causing faults. After installation, remove the cloth or paper on the top of the equipment to prevent over-temperature caused by poor ventilation due to blocked ventilation holes.
- Resonance may occur when the equipment operating at a constant speed executes variable speed operations. In this case, install the vibration-proof rubber under the motor frame or use the vibration suppression function to reduce resonance.

**Wiring** **DANGER**

- Equipment installation, wiring, maintenance, inspection, or parts replacement must be performed only by professionals.
- Before wiring, cut off all the power supplies of the equipment, and wait for at least the time designated on the equipment warning label before further operations because residual voltage still exists after power-off. After waiting for the designated time, measure the DC voltage in the main circuit to ensure the DC voltage is within the safe voltage range. Failure to comply will result in an electric shock.
- Do not perform wiring, remove the equipment cover, or touch the circuit board with power ON. Failure to comply will result in an electric shock.
- Check that the equipment is grounded properly. Failure to comply will result in an electric shock.

 **WARNING**

- Do not connect the input power supply to the output end of the equipment. Failure to comply will result in equipment damage or even a fire.
- When connecting a drive to the motor, check that the phase sequences of the drive and motor terminals are consistent to prevent reverse motor rotation.
- Cables used for wiring must meet cross sectional area and shielding requirements. The shield of the cable must be reliably grounded at one end.
- Fix the terminal screws with the tightening torque specified in the user guide. Improper tightening torque may overheat or damage the connecting part, resulting in a fire.
- After wiring is done, check that all cables are connected properly and no screws, washers or exposed cables are left inside the equipment. Failure to comply may result in an electric shock or equipment damage.

 **CAUTION**

- During wiring, follow the proper electrostatic discharge (ESD) procedure, and wear an antistatic wrist strap. Failure to comply will damage the equipment or the internal circuits of the equipment.
- Use shielded twisted pairs for the control circuit. Connect the shield to the grounding terminal of the equipment for grounding purpose. Failure to comply will result in equipment malfunction.

**Power-on**

 **DANGER**

- Before power-on, check that the equipment is installed properly with reliable wiring and the motor can be restarted.
- Check that the power supply meets equipment requirements before power-on to prevent equipment damage or a fire.
- After power-on, do not open the cabinet door or protective cover of the equipment, touch any terminal, or disassemble any unit or component of the equipment. Failure to comply will result in an electric shock.

 **WARNING**

- Perform a trial run after wiring and parameter setting to ensure the equipment operates safely. Failure to comply may result in personal injuries or equipment damage.
- Before power-on, check that the rated voltage of the equipment is consistent with that of the power supply. Failure to comply may result in a fire.
- Before power-on, check that no one is near the equipment, motor, or machine. Failure to comply may result in death or personal injuries.

**Operation**

 **DANGER**

- The equipment must be operated only by professionals. Failure to comply will result in death or personal injuries.
- Do not touch any connecting terminals or disassemble any unit or component of the equipment during operation. Failure to comply will result in an electric shock.

 **WARNING**

- Do not touch the equipment casing, fan, or resistor with bare hands to feel the temperature. Failure to comply may result in personal injuries.
- Prevent metal or other objects from falling into the equipment during operation. Failure to comply may result in a fire or equipment damage.

**Maintenance** **DANGER**

- Equipment installation, wiring, maintenance, inspection, or parts replacement must be performed only by professionals.
- Do not maintain the equipment with power ON. Failure to comply will result in an electric shock.
- Before maintenance, cut off all the power supplies of the equipment and wait for at least the time designated on the equipment warning label.
- In case of a permanent magnet motor, do not touch the motor terminals immediately after power-off because the motor terminals will generate induced voltage during rotation even after the equipment power supply is off. Failure to comply will result in an electric shock.



 **WARNING**

- Perform routine and periodic inspection and maintenance on the equipment according to maintenance requirements and keep a maintenance record.

**Repair** **DANGER**

- Equipment installation, wiring, maintenance, inspection, or parts replacement must be performed only by professionals.
- Do not repair the equipment with power ON. Failure to comply will result in an electric shock.
- Before inspection and repair, cut off all the power supplies of the equipment and wait for at least the time designated on the equipment warning label.



|   |
|---|
|  <b>WARNING</b>  |
| <ul style="list-style-type: none"> <li>• When the fuse is blown or the circuit breaker or earth leakage current breaker (ELCB) trips, wait for at least the time designated on the equipment warning label before power-on or further operations. Failure to comply may result in death, personal injuries or equipment damage.</li> <li>• When the equipment is faulty or damaged, the troubleshooting and repair work must be performed by professionals that follow the repair instructions, with repair records kept properly.</li> <li>• Replace quick-wear parts of the equipment according to the replacement instructions.</li> <li>• Do not use damaged equipment. Failure to comply may result in death, personal injuries, or severe equipment damage.</li> <li>• After the equipment is replaced, check the wiring and set parameters again.</li> </ul> |
| <b>Disposal</b>   |
|  <b>WARNING</b>  |
| <ul style="list-style-type: none"> <li>• Dispose of retired equipment in accordance with local regulations and standards. Failure to comply may result in property damage, personal injuries, or even death.</li> <li>• Recycle retired equipment by observing industry waste disposal standards to avoid environmental pollution.</li> </ul>   |

### Safety Labels

For safe equipment operation and maintenance, comply with the safety labels on the equipment. Do not damage or remove the safety labels. See the following table for descriptions of the safety labels.

| Safety Label   | Description   |
|--|---|
|  | <ul style="list-style-type: none"> <li>• Read through the safety instructions before operating the equipment. Failure to comply may result in death, personal injuries, or equipment damage.</li> <li>• Do not touch the terminals or remove the cover with power ON or within 10 min after power-off. Failure to comply will result in an electric shock.</li> </ul> |

# 1 Commissioning Tool

## 1.1 Keypad

### 1.1.1 Introduction to the Keypad

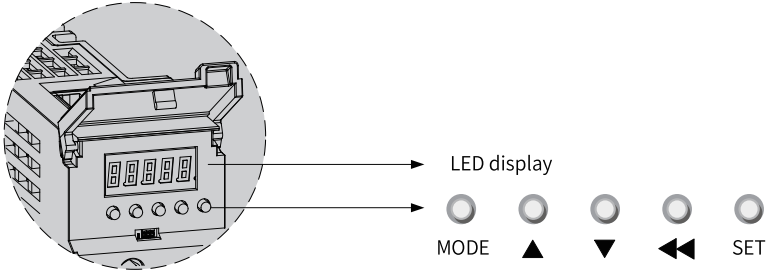







Figure 1-1 Magnified view of the keypad

The keypad on the SV660N servo drive consists of five LEDs and five keys. The keypad is used for value display, parameter settings, user password settings and general function executions. The following table takes parameter setting as an example to describe the general functions of the keys.

Table 1-1 Descriptions of keys

| Name | Symbol  | Description   |
|------|---|---|
| MODE |   | Used to switch among different modes and return to the previous menu. |
| UP   |  | Used to increase the value of the blinking bit.                       |
| DOWN |  | Used to decrease the value of the blinking bit.                       |

| Name  | Symbol  | Description   |
|-------|---|---|
| SHIFT |  | Used to shift the blinking bit and view the high bits of a number consisting of more than 5 bits. |
| SET   |  | Used to enter the next menu and execute commands such as saving parameter setpoints.              |

### 1.1.2 Display Modes

The keypad can be used to display the servo drive status, parameters, faults, and monitored values.

- Status display: Display current servo drive status, such as servo ready or servo running.
- Parameter display: Display parameters and their setpoints.
- Fault display: Display fault and warnings that occur on the servo drive.
- Monitored value display: Display values of monitoring parameters.

#### Mapping relation between keypad display and object dictionary

The mapping relation between the parameter displayed on the keypad (in decimal) and the object dictionary operated by the host controller (in hexadecimal, "Index" and "Sub-index") is as follows.

Object dictionary index = 0x2000 + Parameter group No.

Object dictionary sub-index = Hexadecimal offset within the parameter group + 1

Example:

| Display | Object Dictionary Operated by the Host Controller |
|---------|---|
| H00-00  | 2000-01h  |
| H00-01  | 2000-02h  |
| ...     | ...   |
| H01-09  | 2001-0Ah  |
| H01-10  | 2001-0Bh  |
| ...     | ...   |
| H02-15  | 2002-10h  |

---

### Note

The following section only describes the display and parameter settings on the keypad side (in decimal), which are different from those displayed in the software tool (in hexadecimal). Make necessary value conversions during use.

---

## Display mode switchover

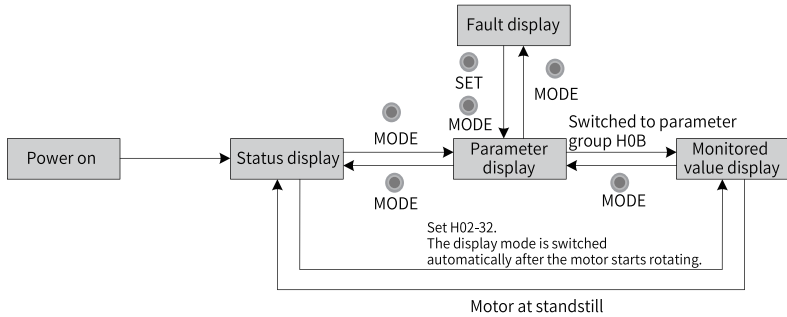







Figure 1-2 Switchover among different display modes

- The keypad enters status display immediately upon power-on.
- Press MODE to switch among different display modes based on the conditions shown in "Figure 1-2" on page 11.
- In status display, set H02-32 to select the parameter to be monitored. When the motor rotates, the keypad automatically switches to monitored value display. After the motor stops, the keypad automatically reverts to status display.
- In parameter display, after you select the parameter to be monitored in group H0B, the keypad switches to monitored value display.
- Once a fault occurs, the keypad switches to fault display immediately, with all the five LEDs blinking. Press SET to stop the LEDs from blinking, and then press MODE to switch to parameter display.

## Status display

| Display | Name                          | Applicable Occasion                            | Meaning  |
|---------|-------------------------------|--|--|
|         | reset<br>(Servo initializing) | At the moment upon power on                    | The servo drive is in the initialization or reset status. After initialization or reset is done, the servo drive automatically switches to other status. |
|         | nr<br>(Servo not ready)       | Initialization done, but servo drive not ready | The servo drive is not ready to run because the main circuit is not powered on. For details, see Chapter "Troubleshooting".                              |
|         | ry<br>(Servo ready)           | Servo drive ready                              | The servo drive is ready to run and waits for the S-ON signal.   |

| Display  | Name                         | Applicable Occasion                                     | Meaning   |
|--|------------------------------|---|---|
|   | rn<br>(Servo running)        | Servo ON (S-ON) signal active (S-ON signal switched on) | The servo drive is running.   |
|   | 1-A:<br>Control modes        | -   | Displays present operation mode of the servo drive in hexadecimal digits.<br>1: Profile position control<br>3: Profile velocity mode<br>4: Profile torque mode<br>6: Homing mode<br>8: Cyclic synchronous position mode<br>9: Cyclic synchronous velocity mode<br>A: Cyclic synchronous torque mode |
|   | 1-8:<br>Communication status | -   | Displays the status of the slave EtherCAT state machine in characters.<br>1: Initialization<br>2: Pre-operational<br>4: Safe-operational<br>8: Operational  |
|   | - CN4 connection indication  | EtherCAT output connected successfully                  | Solid OFF: No communication connection is detected in the physical layer.   |
|  | - CN3 connection indication  | EtherCAT input connected successfully                   | Solid ON: Communication connection is detected in the physical layer.   |

### Parameter display

Parameters are divided into 14 groups based on their functions. A parameter can be located quickly based on the parameter group it belongs to. See ["4.3 Parameter Group 2000h" on page 134](#) for list of parameters.

- Display of parameter groups

| Display | Name            | Description  |
|---------|-----------------|--|
| HXX.YY  | Parameter group | XX: Parameter group No. (decimal)<br>YY: Offset within the parameter group (hexadecimal) |

For example, "H02-00" is displayed as follows.

| Display   | Name   | Description  |
|---|--------|--|
|  | H02-00 | 02: Parameter group No.<br>00: Offset within the parameter group |

- Display of negative numbers and numbers with different lengths
  - Signed number with 4 digits and below or unsigned number with 5 digits and below  
Such numbers are displayed in a single page (five digits). For signed numbers, the highest bit "-" represents the negative symbol.

For example, "-9999" is displayed as follows.



"65535" is displayed as follows.



- Signed number with more than 4 digits or unsigned number with more than 5 digits  
Such numbers are displayed from low to high bits in several pages (5 digits per page): current page + values on current page, as shown in the following figure. Hold down SHIFT for more than 2s to switch to the next page.

For example, "-1073741824" is displayed as follows.

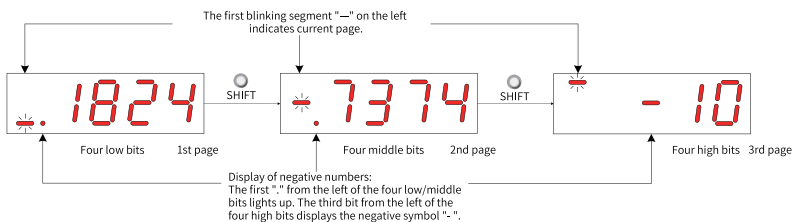

Figure 1-3 Display of "-1073741824"

"1073741824" is displayed as follows:

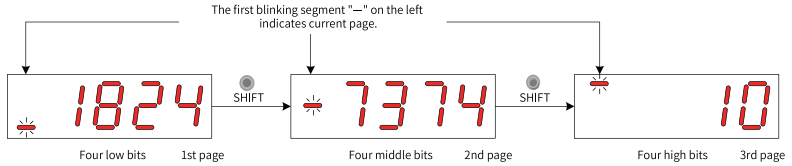

Figure 1-4 Display of "1073741824"

- Display of the decimal point  
The segment "." of the ones indicates the decimal point, which does not blink.

| Display | Name          | Description |
|---------|---------------|-------------|
|         | Decimal point | 100.0       |

- Display of parameter setting status

| Display | Name                          | Applicable Occasion  | Meaning  |
|---------|-------------------------------|--|--|
|         | Done (parameter setting done) | The parameter is set successfully.   | The parameter is set and saved to the servo drive (Done). The servo drive can execute other operations.                          |
|         | F.InIt (restored to default)  | Parameter initialization is in progress (H02-31 = 1).                      | The servo drive is in the process of parameter initialization. Switch on the control circuit again after initialization is done. |
|         | Error (wrong password)        | The user password (H02-30) is activated and the password entered is wrong. | A wrong password is entered. You need to enter the password again.   |
|         | TunE                          | Auto-tuning with one-key enabled   | The function of auto-tuning with one-key is in progress.   |
|         | FAIL                          | Auto-tuning with one-key failed  | The function of auto-tuning with one-key fails.  |

### Fault display

- The keypad can be used to display present or previous faults and warnings. For analysis and solutions to the faults and warnings, see Chapter "Troubleshooting".

- When a fault or warning occurs, the keypad displays the corresponding fault or warning code immediately. When multiple faults or warnings occur, the keypad displays the fault code of the highest fault level.
- You can select the previous fault/warning to be viewed through H0B-33 and view the code of the selected fault/warning in H0B-34.
- You can clear the latest 10 faults or warnings saved in the servo drive by setting H02-31 to 2.



For example, "E941.0" is displayed as follows.

| Display   | Name                           | Description   |
|---|--------------------------------|---|
|  | E941.0<br>Present warning code | E: A fault or warning occurs on the servo drive.<br>941.0: Warning code |

### Monitored value display

- Group H0B: Displays parameters used to monitor the operating state of the servo drive.
- Set H02-32 (Default keypad display) properly. After the servo motor operates normally, the keypad switches from status display to parameter display. The parameter group No. is H0B and the offset within the group is the setpoint of H02-32.
- For example, if H02-32 is set to 00 and the motor speed is not 0 RPM, the keypad displays the value of H0B-00.

See the following table for descriptions of H0B-00.

| Para. No. | Name                     | Unit | Meaning  | Example of Display  |
|-----------|--------------------------|------|--|---|
| H0B-00    | Motor speed actual value | RPM  | Displays the actual motor speed after round-off, which can be accurate to 1 RPM. | Display of 3000 RPM:<br><br>Display of -3000 RPM:<br> |

### Note

For details of parameter group H0B, see "[Appendix A Display of Monitoring Parameters](#)" on [page 182](#).



### 1.1.3 Parameter Settings

#### Example of parameter settings

You can set parameters through the keypad. For details on parameters, see Chapter "List of Parameters". The following figure shows how to switch from position control mode to speed control mode using the keypad after power-on.

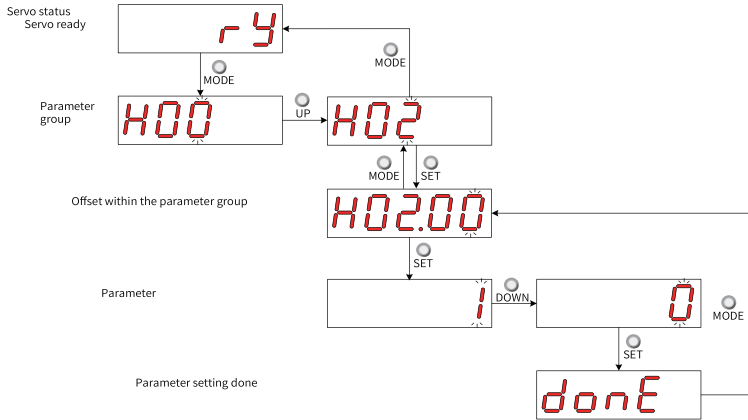

Figure 1-5 Example of parameter setting

- **MODE:** Used to switch the keypad display mode and return to the previous interface.
- **UP/DOWN:** Used to increase or decrease the value of the blinking bit.
- **SHIFT:** Used to shift the blinking bit.
- **SET:** Used to save the present setpoint or switch to the next interface.

After parameter setting is done, that is, "done" is displayed on the keypad, press **MODE** to return to the parameter group interface (interface of "H02.00").

#### User password

After the user password (H02-30) is activated, only authorized operators can set parameters.

- **Setting the user password**  
The following figure shows how to set the user password to "00001".

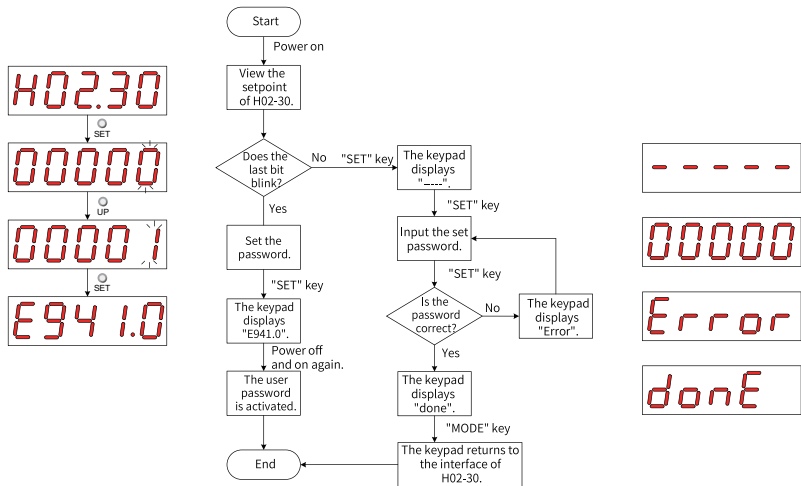

Figure 1-6 Procedure for setting the user password

To change the user password, input current password first to authorize the access to parameter setting. Next, enter H02-30 again to set a new password based on the procedure shown in the preceding figure.

## Note

If the last bit does not blink, the access to parameters is password protected. If the last bit blinks, password is not needed or the password entered is correct.

- Canceling the user password  
Input the user password, and set H02-30 to "00000" to cancel the user password.

## 1.2 Software Tool

The software tool InoDriverShop can be downloaded from the official website of Inovance. Connect the PC communication cable (S6-L-T00-3.0) provided by Inovance or a customized communication cable to the servo drive for communication purpose. For how to connect the customized communication cable, see SV660N Series Servo Drive Hardware Guide.

InoDriverShop features the following functions:

- Oscilloscope: Detects and saves instantaneous data during operation.
- Parameter management: Reads and downloads parameters in batches.
- Database: Identifies parameters of customized software.
- Inertia auto-tuning: Obtains the load inertia ratio through a series of actions.

- Mechanical characteristic analysis: Analyzes the resonance frequency of the mechanical system.
- Motion JOG: Generates position references to make the motor reciprocate.
- Gain tuning: Adjusts the stiffness level and monitors the motion data.

InoDriverShop supports 32-bit/64-bit Windows 7 and 64-bit Windows 10 operating systems. For details on how to use InoDriverShop, see the help file of InoDriverShop.

You can use the SV660N commissioning wizard in InoDriverShop to facilitate commissioning on site.

## 2 Commissioning and Operation

### 2.1 Commissioning Flowchart

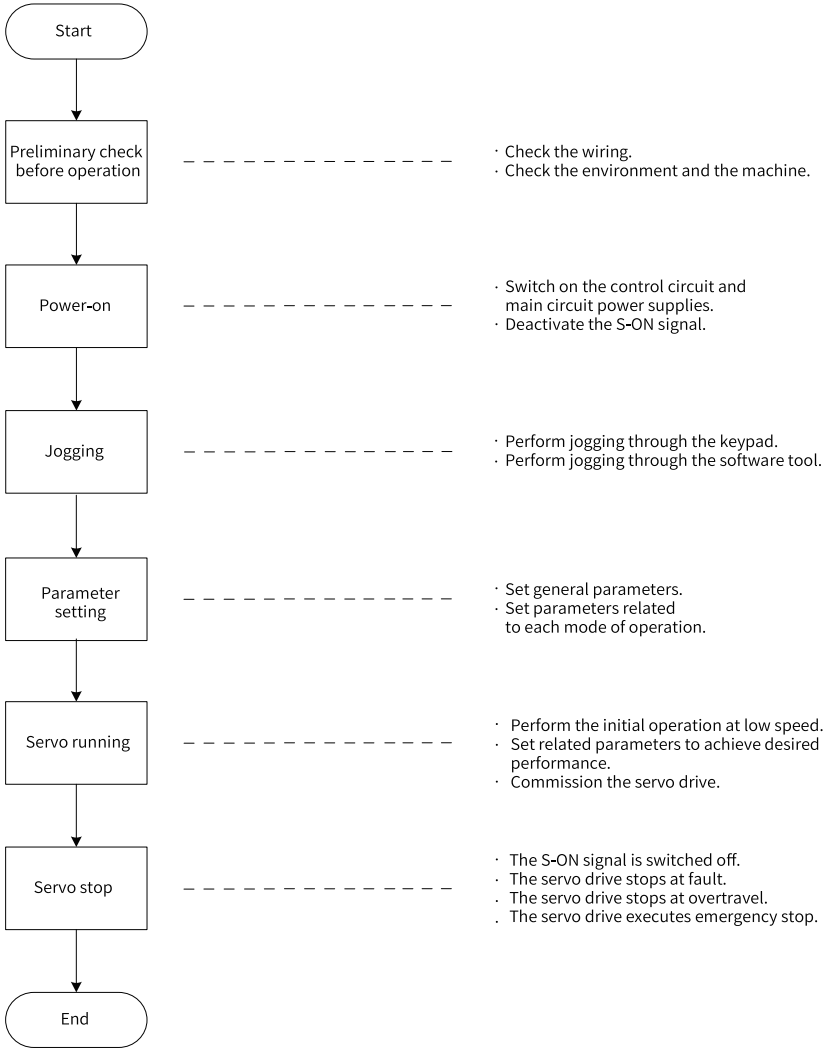

## 2.2 Commissioning Procedure

### 2.2.1 Inspection Before Operation

Check the following items before operating the servo drive and the servo motor.

Table 2-1 Checklist before operation

| Record                                       | No. | Description   |
|--|-----|---|
| <b>Wiring</b>                                |     |   |
| <input type="checkbox"/>                     | 1   | The power input terminals (L1, L2/L1, L2, L3/L1C, L2C/R, S, T) of the servo drive are connected properly.                                       |
| <input type="checkbox"/>                     | 2   | The main circuit cables (U, V, W) of the servo motor are connected in the correct phase sequence.   |
| <input type="checkbox"/>                     | 3   | No short circuit exists in the power input terminals (L1, L2/L1, L2, L3/R, S, T) or main circuit output terminals (U, V, W) of the servo drive. |
| <input type="checkbox"/>                     | 4   | The control signal cables, such as the brake signal cable and overtravel protection signal cable, are connected properly.                       |
| <input type="checkbox"/>                     | 5   | The servo drive and servo motor are grounded properly.  |
| <input type="checkbox"/>                     | 6   | The cable tension is within the specified range.  |
| <input type="checkbox"/>                     | 7   | All the wiring terminals are insulated.   |
| <b>Environment and Mechanical Conditions</b> |     |   |
| <input type="checkbox"/>                     | 1   | No unwanted objects (such as cable terminals and metal chippings) that may cause short circuit are present inside or outside the servo drive.   |
| <input type="checkbox"/>                     | 2   | The servo drive and the external regenerative resistor are placed on incombustible objects.   |
| <input type="checkbox"/>                     | 3   | The servo motor is installed properly. The motor shaft is connected to the machine securely.  |
| <input type="checkbox"/>                     | 4   | The servo motor and the machine it is connected to are in good condition and ready to run.  |

### 2.2.2 Power-on

#### 1. Switching on the input power supply

- The power input terminals for a single-phase 220 V power supply are L1 and L2.
- The power input terminals for a three-phase 220 V power supply are L1/L2/L3 (main circuit power input terminals) and L1C/L2C (control circuit power input terminals).
- The power input terminals for a three-phase 380 V power supply are R/S/T (Main circuit power input terminals) and L1C/L2C (control circuit power input terminals).

After the power supply is switched on, if the bus voltage indicator is in the normal state and the keypad displays "reset"→"ry" in sequence, the servo drive is ready to run and waits for the S-ON signal.

---

## **Note**

- If the keypad keeps displaying "nr", rectify the fault according to Chapter "Troubleshooting".
  - If the keypad displays other faults, rectify the fault according to Chapter "Troubleshooting".
- 

### 2. Switching off the S-ON signal

Deactivate the S-ON signal sent from the host controller when switching the servo status.

## **2.2.3 Jogging**

---



To use the jog function, deactivate the S-ON signal first.

---

Start jogging through the keypad (speed control mode or position control mode) or the software tool (speed control mode) to check whether the motor rotates properly without unexpected vibration or noise.

---

## **Note**

The acceleration and deceleration time constants of speed and position references can be set through H06-12 (2006-0Dh) during jogging.

---

### **Using the keypad (speed control mode)**

- Commissioning procedure

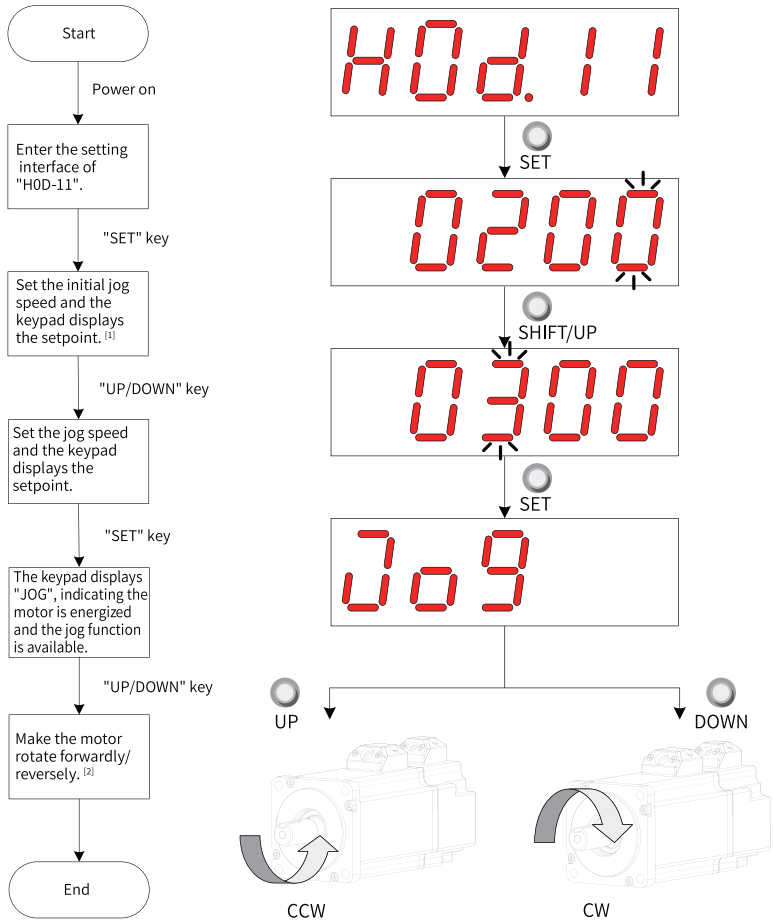

Figure 2-1 Procedure for setting the jog function

**Note**

- [1]: Press the UP or DOWN key to increase or decrease the jog speed. After exiting from the jog mode, the motor reverts to the initial speed.
- [2]: Press the UP or DOWN key to make the motor rotate forwardly or reversely. After you release the key, the motor stops immediately.

• Procedure:

1. Enter the jog mode by setting H0D-11 through the keypad.

The keypad displays the default jog speed at this moment.

2. Adjust the jog speed through the UP/DOWN key and press the SET key to enter the jog state.

The keypad displays "JOG" at this moment, and the motor is energized.

3. Hold the UP/DOWN key down to make the motor jog forwardly or reversely.
4. Press the MODE key to exit from jogging and return to the previous menu.

### Using the software tool (speed control mode)

Procedure:

1. Open the Speed JOG interface in the software tool.
2. Set the jog speed.
3. After switching the servo status to ON, press the forward/reverse arrow displayed on the interface to switch between forward and reverse jog.

### Using the keypad (position control mode)

Procedure:

1. Enter the jog mode by setting H0D-08 through the keypad.  
The keypad displays the default jog speed at this moment.
2. Adjust the jog speed through the UP/DOWN key and press the SET key to enter the jog state. The keypad displays "JOG-P" at this moment, and the motor is energized.
3. Hold the UP/DOWN key down to make the motor jog forwardly or reversely.  
Press the MODE key to exit from jogging and return to the previous menu.

☆ Related parameter:

| H06-12  | Name   | Acceleration ramp time of jog speed |         |     | Setting Condition & Effective Time | Any condition & Immediately | Data Structure | -            | Data Type | Unit |
|---|--------|-------------------------------------|---------|-----|------------------------------------|-----------------------------|----------------|--------------|-----------|------|
| 2006-0Dh  | Access | RW                                  | Mapping | Yes | Related Mode                       | All                         | Data Range     | 0-65535 (ms) | Default   | 10   |
| Defines the time constant for the servo motor to accelerate from 0 RPM to 1000 RPM. |        |                                     |         |     |                                    |                             |                |              |           |      |

## 2.2.4 Parameter Settings

### Forced DI/DO signals

There are five DI signals and three DO signals on CN1 of SV660N. You can assign DI/DO functions and logic to parameters in group H03/H04 using the keypad (or host controller), so that the host controller can control corresponding servo functions through DIs or use DO signals output by the servo drive.



The servo drive also provides forced DI/DO functions. The forced DIs can be used to test the DI functions of the servo drive, and the forced DOs can be used to check the DO signal connection between the host controller and the servo drive.

Table 2-2 DI/DO function assignment

| Function No.   | Name          | Function              | Description  | Remarks   |
|--|---------------|-----------------------|--|---|
| Consisting of two digits which indicate the function No. |               |                       |  |   |
| Description of DI signals                                |               |                       |  |   |
| 01   | S-ON          | Servo ON              | Inactive - Servo motor disabled in local mode<br>Active - Servo motor enabled in local mode                      | The S-ON function is only active in non-bus control mode.<br>The corresponding terminal logic must be level-triggered.                        |
| 02   | ALM-RST       | Fault reset           | Active - Fault reset executed in local mode<br>Inactive - Fault reset not executed in local mode                 | The ALM-RST function is only active in non-bus control mode.<br>The corresponding terminal logic is recommended to be level-triggered.        |
| 14   | P-OT          | Positive limit switch | Active - Forward drive inhibited<br>Inactive - Forward drive permitted   | Overtravel prevention applies when the load moves beyond the limit.<br>The corresponding terminal logic is recommended to be level-triggered. |
| 15   | N-OT          | Negative limit switch | Active - Reverse drive inhibited<br>Inactive - Reverse drive permitted   | Overtravel prevention applies when the load moves beyond the limit.<br>The corresponding terminal logic is recommended to be level-triggered. |
| 31   | HomeSwitch    | Home switch           | Inactive - Mechanical load beyond the home switch range<br>Active - Mechanical load within the home switch range | The corresponding terminal logic must be level-triggered.   |
| 34   | EmergencyStop | Emergency stop        | Active: Position lock applied after stop at zero speed<br>Inactive: Current operating state unaffected           | The corresponding terminal logic is recommended to be level-triggered.  |
| 38   | TouchProbe1   | Touch probe 1         | Inactive - Touch probe not triggered<br>Active - Touch probe triggerable   | The touch probe logic is only related to the touch probe function (60B8h).  |
| 39   | TouchProbe2   | Touch probe 2         | Inactive - Touch probe not triggered<br>Active - Touch probe triggerable   | The touch probe logic is only related to the touch probe function (60B8h).  |
| Description of DO signals                                |               |                       |  |   |
| 01   | S-RDY         | Servo ready           | Active - Servo ready<br>Inactive - Servo not ready   | The servo drive is ready to run.  |

| Function No. | Name   | Function            | Description  | Remarks   |
|--------------|--|---------------------|--|---|
| 02           | TGON   | Motor rotation      | Inactive - Absolute value of filtered motor speed lower than the setpoint of H06-16<br>Active - Absolute value of filtered motor speed reaching the setpoint of H06-16 | -   |
| 09           | BK   | Brake output        | Active - Brake signal outputted<br>Inactive - Brake signal not outputted   | -   |
| 10           | WARN   | Warning             | Active - Warning occurred on the servo drive<br>Inactive - No warning occurred on the servo drive or the warning has been reset  | -   |
| 11           | ALM  | Fault               | Active - Fault occurred on the servo drive<br>Inactive - No fault occurred on the servo drive or the fault has been reset  | -   |
| 25           | CMP  | Position comparison | Active: Servo drive passing the target position comparison point<br>Inactive: Servo drive not passing the target position comparison point                             | -   |
| 32           | EDM  | Safe state          | Active - STO function triggered<br>Inactive - STO function not triggered   | The EDM outputs active signals only when the 24 V input voltages for STO1 and STO2 are disconnected simultaneously. |
| H04-23       | EtherCAT forced DO in non-operational status |                     | See "Table 2-3 " on page 25 for details.   |   |

Table 2-3 Description for EtherCAT forced DO in the non-operational status

| Setpoint | Description  |
|----------|--|
| 0        | Status of DO1, DO2, and DO3 unchanged in the non-operational status                |
| 1        | No output in DO1 and status of DO2 and DO3 unchanged in the non-operational status |
| 2        | No output in DO2 and status of DO1 and DO3 unchanged in the non-operational status |
| 3        | No output in DO1 or DO2 and status of DO3 unchanged in the non-operational status  |
| 4        | No output in DO3 and status of DO1 and DO2 unchanged in the non-operational status |
| 5        | No output in DO1 or DO3 and status of DO2 unchanged in the non-operational status  |
| 6        | No output in DO2 or DO3 and status of DO1 unchanged in the non-operational status  |
| 7        | No output in DO1, DO2, or DO3  |

- Forced DI function

When this function is enabled, all DI signal levels are controlled only by H0D-18 (Forced DI value), regardless of external DI signal status.

- Operating process:

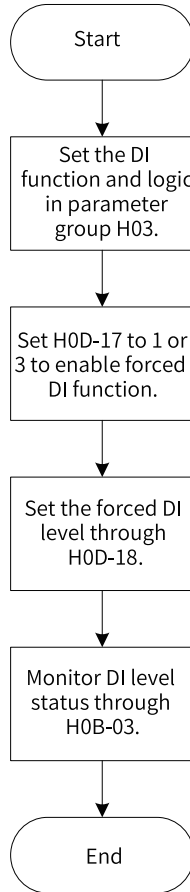

Figure 2-2 Procedure for setting forced DI function

Related parameter:

| Para. No.   |                    | Name                   | Value Range   | Description                           | Setting Condition | Effective Time | Default |
|-------------|--------------------|------------------------|---|---------------------------------------|-------------------|----------------|---------|
| Keypad Side | Software Tool Side |                        |   |                                       |                   |                |         |
| H0D-17      | 200D-12h           | Forced DI/DO selection | 0: No operation<br>1: Forced DI enabled, forced DO disabled<br>2: Forced DO enabled, forced DI disabled<br>3: Forced DI and DO enabled<br>4: EtherCAT-forced DO enabled | Used to enable forced DI/DO function. | During running    | At once        | 0       |

H0D-18 is used to set the forced DI level. The keypad displays the value in hexadecimal. After the hexadecimal value is converted to a binary value, the value "1" indicates high level and "0" indicates low level.

The DI logic is defined by parameters in group H03. H0B-03 is used to monitor the DI level status. The keypad displays the level, and the value of H0B-03 (Monitored DI signal) read in the software tool is a hexadecimal.

- Example:  
To activate the function assigned to DI1 and deactivate functions assigned to DI2...DI5, set as follows (logic of DI1 to DI5 are "active low"):

As the value "1" indicates high level and the value "0" indicates low level, the corresponding binary value and hexadecimal value are "11110" and "1E" respectively. Therefore, set H0D-18 to "1E" through the keypad.

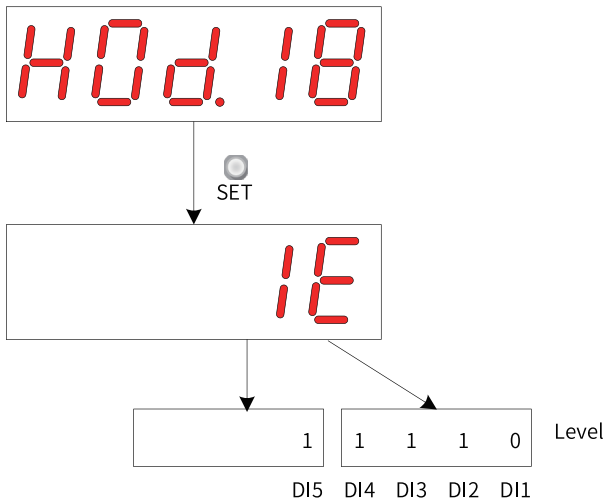

Figure 2-3 Description of H0D-18

Monitor the DI level status through H0B-03:

If the DI function is normal, the display value of H0B-03 is always the same as that of H0D-18.

In this case, DI1 is displayed as low level and DI2 to DI5 are displayed as high level on the keypad, and the value of H0B-03 read by the software tool is 1E (hexadecimal).

The keypad displays as follows:

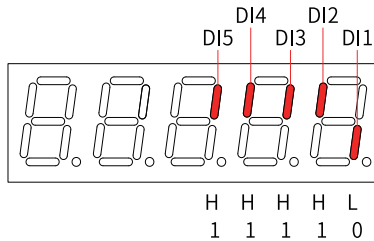

Figure 2-4 DI level status corresponding to H0B-03

- Exit  
The forced DI function is not retentive upon power-off. Normal DIs apply after restart, or you can set H0D-17 (200D-12h) to 0 to revert to the normal DI mode.
- Forced DO function  
After this function is enabled, all DO signal levels are controlled by H0D-19 (Forced DO value), regardless of the internal DO status of the servo drive.



If the motor is used in vertical motion, the load may fall when the brake is released upon an active brake (BK) output signal (FunOUT.9: BK). Take protective measures on the machine to prevent the risk of falling.

- Operating process

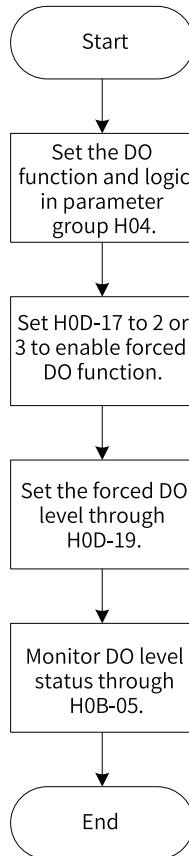

Figure 2-5 Procedure for setting forced DO function

H0D-19 (Forced DO value) is used to set whether the DO function is active. The keypad displays the value in hexadecimal. After the hexadecimal value is converted to a binary value, the value "1" indicates the DO function is active and "0" indicates the DO function is inactive.

The DO logic is defined by parameters in group H04. The DO level status is monitored by H0B-05 and displayed on the keypad. The value of H0B-05 (Monitored DO signal) read in the software tool is a hexadecimal.

- Example:  
To activate the DO function assigned to DO1 and deactivate DO functions assigned to DO2 and DO3, set as follows:

As the value "1" indicates the DO function is active and "0" indicates the DO function is inactive, the binary value is "110", which corresponds to the hexadecimal value "6". Therefore, set H0D-19 (Forced DO value) to 6 through the keypad.

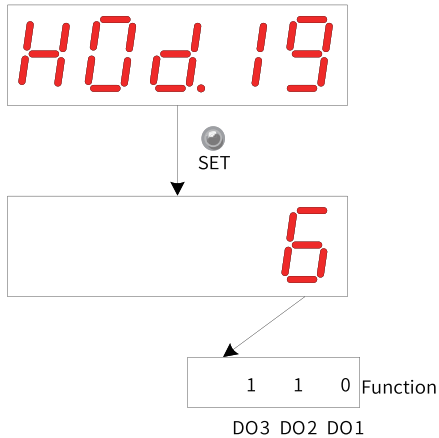

Figure 2-6 Description of H0D-19

Monitoring the DO level status through H0B-05

If DO1...DO3 are "active low", then DO1 is high level and DO2/DO3 is low level. In this case, the corresponding binary number is "001", and the value of H0B-05 (Monitored DO signal) read in the software tool is 1 (in decimal). The keypad displays as follows:

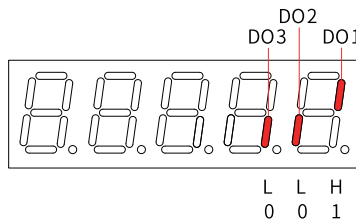

Figure 2-7 Display of H0B-05 when all DOs are "active low"

If DO1...DO3 are "active high", then DO1 is low level and DO2/DO3 is high level. In this case, the corresponding binary number is "110", and the value of H0B-05 (Monitored DO signal) read in the software tool is "6" (in decimal). The keypad displays as follows:

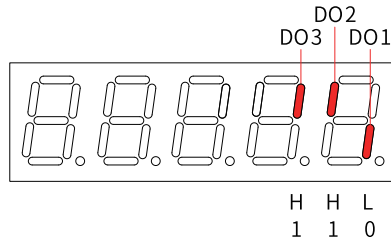

Figure 2-8 Display of H0B-05 when all DOs are active high

- Exit

The forced DO function is not retentive upon power-off. Normal DOs apply after restart, or you can set H0D-17 (200D-12h) to 0 to revert to the normal DO mode.

- EtherCAT-forced DO function

After this function is enabled, all DO signal levels are controlled only by 60FE-01h (Physical output), regardless of the internal DO status of the servo drive.

If the motor is used in vertical motion, the load may fall when the brake is released upon an active brake (BK) output signal (FunOUT.9: BK). Take protective measures on the machine to prevent the risk of falling.

- Operating process



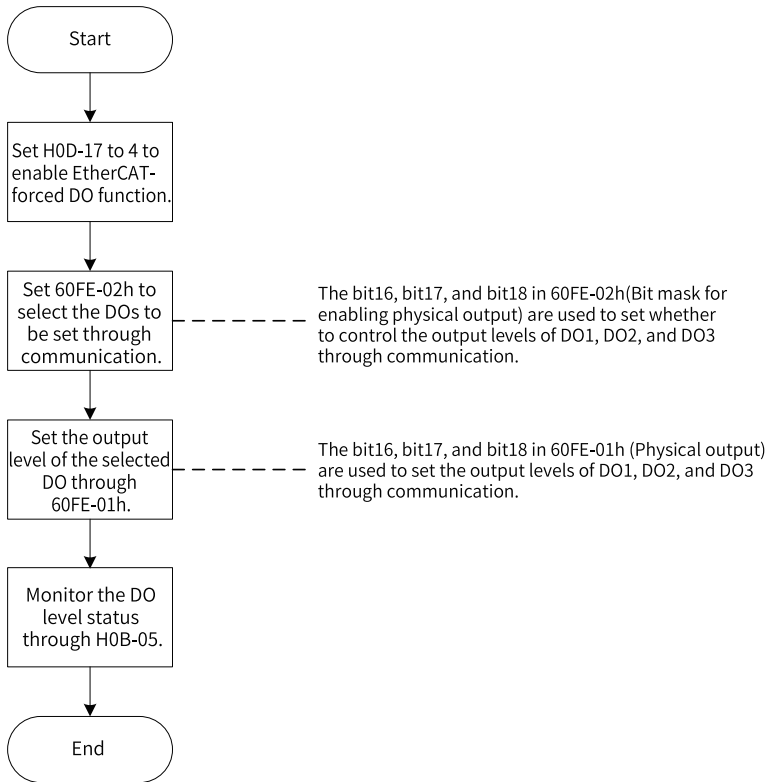

Figure 2-9 Procedure for setting EtherCAT-forced DO function

When 200D-12h is set to 4, 60FE (Digital output) can be used to set the DO level through the bus, regardless of the internal DO status of the servo drive.

| Bit | Related DO | Physical Output Enable: 60FE-02h | Physical Output: 60FE-01h         |
|-----|------------|----------------------------------|-----------------------------------|
| 16  | DO1        | 1: DO1 forced output enabled     | DO1 forced output (0: OFF, 1: ON) |
| 17  | DO2        | 1: DO2 forced output enabled     | DO2 forced output (0: OFF, 1: ON) |
| 18  | DO3        | 1: DO3 forced output enabled     | DO3 forced output (0: OFF, 1: ON) |

When 200D-12h is set to 4 and any bit among bit16...bit18 of 60FE-02h is set to 1, the corresponding forced DO is OFF.

The DO level status is monitored through H0B-05 and displayed on the keypad. The value of H0B-05 (Monitored DO signal) read in the software tool is a hexadecimal.

Example: To make the output levels of DO1...DO3 be forcibly set by the bus, in which DO1 outputs low level and DO2 to DO3 output high level, set as follows:

Set 200D-12h to 4, 60FE-02h to 0x00070000, and 60FE-01 to 0x00060000.  
 Monitor the DO level status through H0B-05 (Monitored DO signal). The keypad displays as follows.

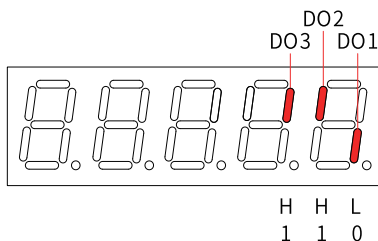

Figure 2-10 Display of H0B-05 when DO signals are controlled by the bus

- Exit  
 The EtherCAT-forced DO function is not retentive upon power-off. Normal DOs apply after restart, or you can set H0D-17 (200D-12h) to 0 to revert to the normal DO mode.

### Direction of rotation

Set H02-02 (2002-03h) (Direction of rotation) to change the motor direction of rotation without changing the polarity of the input reference.

☆Related parameter

|   |        |   |         |   |   |                         |                |        |           |        |
|---|--------|---|---------|---|---|-------------------------|----------------|--------|-----------|--------|
| H02-02  | Name   | Direction of rotation                       |         |   | Setting Condition & Effective Time  | At stop & Next power-on | Data Structure | -      | Data Type | Uint16 |
| 2002-03h  | Access | RW  | Mapping | - | Related Mode  | All                     | Data Range     | 0 to 1 | Default   | 0      |
| Defines the forward direction of the motor when viewed from the motor shaft side. |        |   |         |   |   |                         |                |        |           |        |
| Setpoint  |        | Direction of rotation                       |         |   | Remarks   |                         |                |        |           |        |
| 0   |        | Counterclockwise (CCW) as forward direction |         |   | Defines the CCW direction as the forward direction when a forward run command is received, indicating the motor rotates in the CCW direction when viewed from the motor shaft side. |                         |                |        |           |        |
| 1   |        | Clockwise (CW) as forward direction         |         |   | Defines the CW direction as the forward direction when a forward run command is received, indicating the motor rotates in the CW direction when viewed from motor shaft side.       |                         |                |        |           |        |

Changes in the setpoint of H02-02 (2002-03h) do not affect the pulse output form or the positive/negative attribute of monitoring parameter values.

The direction of "forward drive" in the function of overtravel prevention is the same as the setting in H02-02 (2002-03h).

## Brake settings

The brake is used to lock the motor position when the servo drive is in the non-operational status, preventing the mechanical load from moving under the influence of gravity or external force.



- Use the built-in brake for position-lock purpose only. Do not use this brake for any other purposes (such as braking) other than position-lock in the stop state.
- The brake coil has no polarity.
- Switch off the S-ON signal after the motor stops.
- When the motor with brake runs, the brake may generate a click sound, which does not affect its function.
- When brake coils are energized (the brake is released), flux leakage may occur on the shaft end. Pay special attention when using magnetic sensors around the motor.

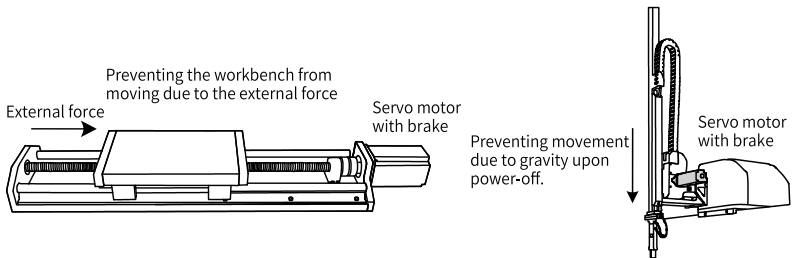

Figure 2-11 Application of the brake

Table 2-4 Brake specifications

| Motor Model                | Holding Torque (N·m) | Supply Voltage (VDC) ±10% | Coil Resistance ( $\Omega$ ) ±7% | Exciting Current (A) | Release Time (ms) | Apply Time (ms) | Backlash (°) |
|----------------------------|----------------------|---------------------------|----------------------------------|----------------------|-------------------|-----------------|--------------|
| MS1H1-05B/10B              | 0.32                 | 24                        | 94.4                             | 0.25                 | ≤ 20              | ≤ 40            | ≤ 1.5        |
| MS1H1-20B/40B<br>MS1H4-40B | 1.5                  |                           | 75.79                            | 0.32                 | ≤ 20              | ≤ 60            | ≤ 1.5        |
| MS1H1-75B/MS1H4-75B        | 3.2                  |                           | 57.6                             | 0.42                 | ≤ 40              | ≤ 60            | ≤ 1          |
| MS1H2-10C/15C/<br>20C/25C  | 8                    |                           | 25                               | 0.96                 | ≤ 30              | ≤ 85            | ≤ 0.5        |
| MS1H2-30C/40C/<br>50C      | 16                   |                           | 21.3                             | 1.13                 | ≤ 60              | ≤ 100           | ≤ 0.5        |
| MS1H3-85B/13C/<br>18C      | 12                   |                           | 29.7                             | 0.81                 | ≤ 60              | ≤ 120           | ≤ 0.5        |
| MS1H3-29C/44C/<br>55C/75C  | 50                   |                           | 14.4                             | 1.67                 | ≤ 100             | ≤ 200           | ≤ 0.5        |

- Brake software setting

For the motor with brake, assign FunOUT.9 (BK, brake output) to DO3 (default DO terminal) and set the active logic of DO3.

☆Related function No.

| Function No. | Name | Function     | Description  |
|--------------|------|--------------|--|
| FunOUT.9     | BK   | Brake output | Inactive: The brake power supply is switched off and the brake applies. In this case, the motor is locked.<br>Active: The brake power supply is switched on and the brake is released. In this case, the motor can rotate. |

The operating sequences of the brake are different in normal state and fault state.

- Brake sequence in normal state

The brake sequence in normal state is further divided into the following two types:

- Standstill: The actual motor speed is lower than 20 RPM.
- Rotating: The actual motor speed is higher than or equal to 20 RPM.

- Brake sequence for motor at standstill

Applicable to cases where the motor speed is lower than 20 RPM upon switch-off of the S-ON signal

 **Caution**

- After the brake (BK) output signal changes from OFF to ON, do not input a position/speed/torque reference within the time defined by H02-09 (2002-0Ah). Otherwise, reference loss or an operation error may occur.
- When the motor is used to drive a vertical axis, the motion part may move slightly under the influence of gravity or external force. If the S-ON signal is switched off when the motor is at a standstill, the brake output (BK) is set to "OFF" immediately. However, within the time defined by H02-10 (2002-0Bh), the motor is still energized, preventing the motion part from moving under the influence of gravity or external force.

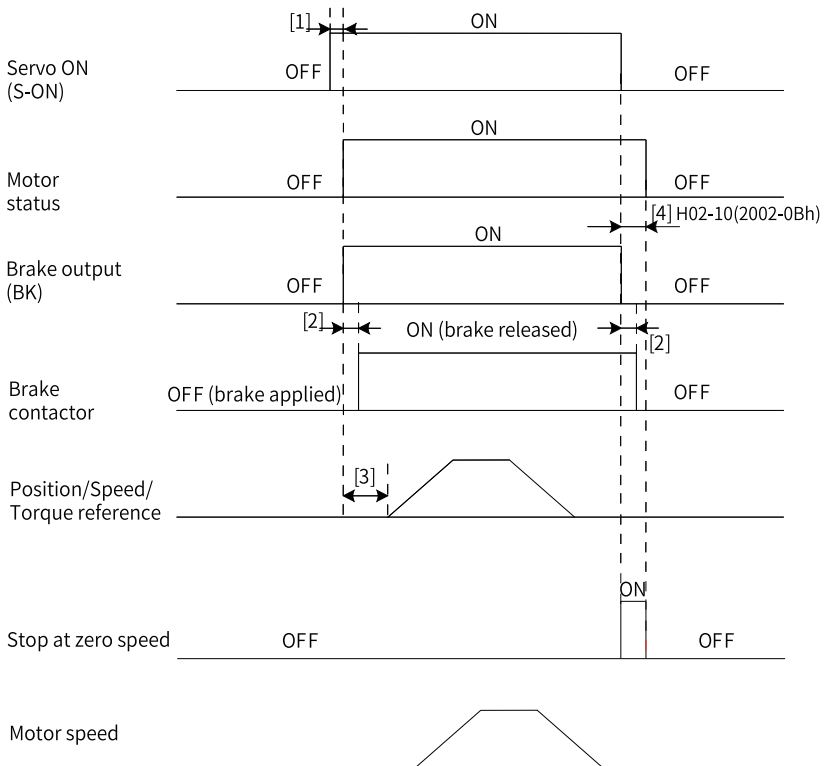

Figure 2-12 Brake sequence for motor at standstill

## Note

- [1] When the S-ON signal is switched on, the brake (BK) output signal is set to "ON" at a delay of about 100 ms, and the motor is energized at the same time.
- [2] For delay of brake contactor actions, see "[Table 2-4](#)" on page 35.
- [3] The time interval from the moment when brake (BK) output is set to "ON" to the moment when the command is input must be longer than the time defined by H02-09 (2002-0Ah).
- [4] If the S-ON signal is switched off when the motor is at a standstill (motor speed lower than 20 RPM), the brake output (BK) will be set to "OFF" at the same time. You can set in H02-10 (2002-0Bh) the delay of the motor in entering the de-energized state after brake output (BK) is off.

### ☆Related parameters

| H02-09   | Name   | Delay from brake (BK) output ON to command received |         |   | Setting Condition & Effective Time | Any condition & At once | Data Structure | -        | Data Type | Uint16 |
|--|--------|---|---------|---|------------------------------------|-------------------------|----------------|----------|-----------|--------|
| 2002-0Ah   | Access | RW  | Mapping | - | Related Mode                       | All                     | Data Range     | 0 to 500 | Default   | 250    |
| Defines the delay from the moment the brake (BK) output signal is ON to the moment the servo drive starts to receive commands after power-on.<br>Within the time defined by 2002-0Ah, the servo drive does not receive position/speed/torque references. |        |   |         |   |                                    |                         |                |          |           |        |

| H02-10  | Name   | Delay from brake (BK) output OFF to motor de-energized |         |   | Setting Condition & Effective Time | Any condition & At once | Data Structure | -          | Data Type | Uint16 |
|---|--------|--|---------|---|------------------------------------|-------------------------|----------------|------------|-----------|--------|
| 2002-0Bh  | Access | RW   | Mapping | - | Related Mode                       | All                     | Data Range     | 50-1000 ms | Default   | 150    |
| Defines the delay from the moment the brake (BK) output signal is OFF to the moment the motor enters de-energized status. |        |  |         |   |                                    |                         |                |            |           |        |

- Brake sequence for a rotating motor  
 Applicable to cases where the motor speed is higher than or equal to 20 RPM upon switch-off of the S-ON signal

 **Caution**

- When the S-ON signal changes from OFF to ON, do not input a position/speed/torque reference within the time defined by H02-09 (2002-0Ah). Otherwise, reference loss or an operation error may occur.
- If the S-ON signal is switched off when the motor is still rotating, the motor ramps to stop as defined by 6085h, but the brake (BK) output can be set to "OFF" only when one of the following conditions is met:
  - The motor has decelerated to the value defined by H02-11 (2002-0Ch) but the time defined by H02-12 (2002-0Dh) is not reached.
  - The motor speed is higher than the value defined by H02-11 (2002-0Ch) though the time defined by H02-12 (2002-0Dh) is reached.
- After the brake (BK) output signal changes from ON to OFF, the motor remains energized within the time defined by H02-10 (2002-0B), preventing the motion part from moving under the influence of gravity or external force.

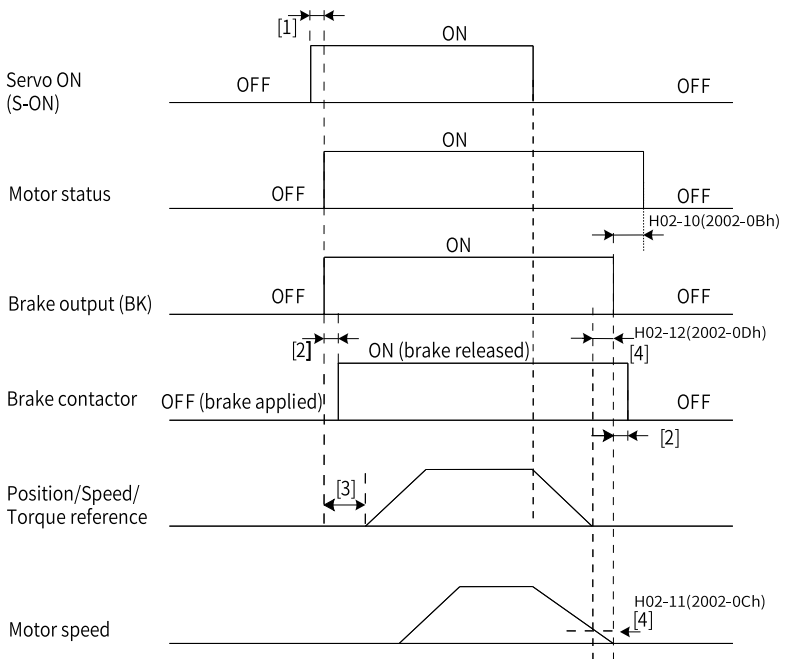

Figure 2-13 Brake sequence for a rotating motor

## Note

- [1]: When the S-ON signal is switched on, the brake (BK) output signal is set to "ON" at a delay of about 100 ms, and the motor is energized at the same time.
- [2] For delay of brake contactor actions, see "[Table 2-4](#)" on page 35.
- [3] The time interval from the moment when brake (BK) output is set to "ON" to the moment when the command is input must be longer than the time defined by H02-09 (2002-0Ah).
- [4] You can set in H02-11 (2002-0Ch) and H02-12 (2002-0Dh) the delay in setting the brake (BK) output to "OFF" when the S-ON signal is switched off during motor rotation. The motor will be de-energized at a delay defined by H02-10 (2002-0Bh) after the brake (BK) output is OFF.

### ☆Related parameters

|  |        |  |         |   |                                    |                         |                |             |           |        |
|--|--------|--|---------|---|------------------------------------|-------------------------|----------------|-------------|-----------|--------|
| H02-11   | Name   | Motor speed threshold at brake (BK) output OFF in the rotation state |         |   | Setting Condition & Effective Time | Any condition & At once | Data Structure | -           | Data Type | Uint16 |
| 2002-0Ch   | Access | RW   | Mapping | - | Related Mode                       | All                     | Data Range     | 20–3000 RPM | Default   | 30     |
| Defines the motor speed threshold when brake (BK) output is OFF in the rotation state. |        |  |         |   |                                    |                         |                |             |           |        |

|   |        |  |         |   |                                    |                         |                |           |           |        |
|---|--------|--|---------|---|------------------------------------|-------------------------|----------------|-----------|-----------|--------|
| H02-12  | Name   | Delay from S-ON OFF to brake (BK) output OFF in the rotation state |         |   | Setting Condition & Effective Time | Any condition & At once | Data Structure | -         | Data Type | Uint16 |
| 2002-0Dh  | Access | RW   | Mapping | - | Related Mode                       | All                     | Data Range     | 1–1000 ms | Default   | 500    |
| Defines the delay from the moment the S-ON signal is OFF to the moment the brake (BK) output signal is OFF in the rotation state. |        |  |         |   |                                    |                         |                |           |           |        |

- Brake sequence in quick stop  
The status after quick stop can be divided into de-energized or position-lock depending on the stop mode. For the de-energized status (605Ah < 4), the brake (BK) output condition is the same as that in the brake sequence for a rotating motor.
- Brake sequence in fault state  
Servo drive faults can be classified into No. 1 faults and No. 2 faults based on the stop mode, see Chapter "Troubleshooting" for details. The brake sequences in the fault state are further divided into the following two types:
  - For No. 1 faults:  
When a No. 1 fault occurs and the brake is used, the stop mode is forcibly set to "Dynamic braking stop, keeping dynamic braking status", but the brake (BK)



output condition is the same as that in the brake sequence for a rotating motor.

- For No. 2 faults:  
When a No. 2 fault occurs and the brake is used, the stop mode is forcibly set to "Ramp to stop as defined by 6085h, keeping dynamic braking status", but the brake (BK) output condition is the same as that in the brake sequence for a rotating motor.

## Note

Recommended setpoint: When the brake is used, the setpoint of 6085h (Stop deceleration) must meet the following requirement:

Deceleration time < 2002-0Dh

If the preceding requirement is not fulfilled, the deceleration command will be generated based on H02-12 (2002-0Dh).

## Braking settings

When the motor torque direction is opposite to the direction of rotation, the energy is fed back to the servo drive from the motor side, leading to bus voltage rise. Once the bus voltage rises to the braking threshold, the surplus energy must be consumed by a regenerative resistor. Otherwise, the servo drive will be damaged. The regenerative resistor can be a built-in or an external one. However, a built-in regenerative resistor cannot be used together with an external one. Specifications of the regenerative resistor are as follows.

Table 2-5 Specifications of the regenerative resistor

| Servo Drive Model | Specifications of Built-in Regenerative Resistor |                |                           | Min. Permissible Resistance of External Regenerative Resistor (Ω) (H02-21) |
|-------------------|--|----------------|---------------------------|--|
|                   | Resistance (Ω)                                   | Power (Pr) (W) | Processing Power (Pa) (W) |  |
| SV660NS1R6I       | -  | -              | -                         | 50   |
| SV660NS2R8I       | -  | -              | -                         | 45   |
| SV660NS5R5I       | 50   | 50             | 25                        | 40   |
| SV660NS7R6I       | 25   | 80             | 40                        | 20   |
| SV660NS012I       |  |                |                           | 15   |
| SV660NT3R5I       | 100  | 80             | 40                        | 80   |
| SV660NT5R4I       | 100  | 80             | 40                        | 60   |
| SV660NT8R4I       | 50   | 80             | 40                        | 45   |
| SV660NT012I       |  |                |                           | 40   |
| SV660NT017I       | 35   | 100            | 50                        | 35   |
| SV660NT021I       |  |                |                           | 25   |
| SV660NT026I       |  |                |                           |  |

**Note**

The built-in regenerative resistor is not available in S1R6 or S2R8 models. For these models, you can install an external regenerative resistor as needed.

- Without external load torque  
 The kinetic energy generated upon braking of a reciprocating motor is converted into electric energy that fed back to the bus capacitor. When the bus voltage rises above the braking voltage threshold, the regenerative resistor starts consuming the excessive energy. The following figure shows the motor speed curve in a no-load operation from 3000 RPM to a standstill.

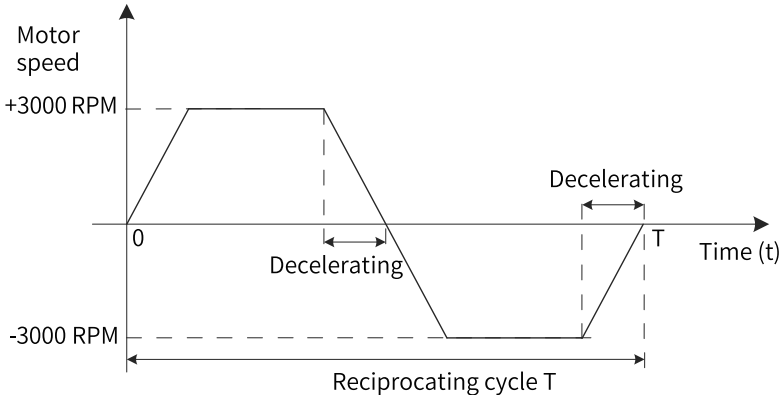

Figure 2-14 Example of motor speed curve (without external load torque)

- Energy calculation  
 The built-in regenerative resistor is not available in SV660PS1R6I or SV660PS2R8I models. The energy that can be absorbed by a capacitor is described in section "Wiring and Setting of the Regenerative Resistor" in SV660N Series Servo Drive Hardware Guide. An external regenerative resistor is needed when the rotational energy of the motor and the load exceeds the values listed in the following table.

| Servo Drive Model | Regenerative Energy That Can Be Absorbed (J) | Remarks  |
|-------------------|--|--|
| SV660NS1R6I       | 13.15  | The input voltage of the main circuit power supply is 220 VAC. |
| SV660NS2R8I       | 26.29  |  |

- The following table shows the energy generated by a 220 V motor in decelerating from the rated speed to a standstill during no-load operation.

| Capacity (W) | Servo Motor Model<br>MS1H*-*****_*****     |                     | Rotor Inertia<br>J(10 <sup>-4</sup> kgm <sup>2</sup> ) | Braking Energy E <sub>O</sub><br>(J) Generated During Operation | Max. Braking Energy Absorbed by the Capacitor E <sub>C</sub> (J) |
|--------------|--|---------------------|--|---|--|
| 750 W        | MS1H1<br>(low inertia, small capacity)     | MS1H1-75B30CB-*331Z | 1.38   | 6.8   | 22.4   |
|              |  | MS1H1-75B30CB-*334Z | 1.43   | 7.1   |  |
| 1000 W       | MS1H2<br>(low inertia, medium capacity)    | MS1H2-10C30CB-*331Z | 1.87   | 9.2   | 26.7   |
|              |  | MS1H2-10C30CB-*334Z |  |   |  |
| 1500 W       |  | MS1H2-15C30CB-*331Z | 2.46   | 12.2  | 26.7   |
|              |  | MS1H2-15C30CB-*334Z |  |   | 47.7   |
| 850 W        | MS1H3<br>(medium inertia, medium capacity) | MS1H3-85B15CB-*331Z | 13.3   | 65.8  | 22.4   |
|              |  | MS1H3-85B15CB-*334Z | 14   | 69.2  |  |
| 1300 W       |  | MS1H3-13C15CB-*331Z | 17.8   | 88  | 22.4   |
|              |  | MS1H3-13C15CB-*334Z | 18.5   | 91.5  |  |
| 750 W        | MS1H4<br>(medium inertia, small capacity)  | MS1H4-75B30CB-*331Z | 2  | 9.9   | 22.4   |
|              |  | MS1H4-75B30CB-*334Z | 2.012  | 9.9   |  |

- The following table shows the energy generated by a 380V motor in decelerating from the rated speed to a standstill during no-load operation.

| Capacity (W) | Servo Motor Model<br>MS1H*-*****_*****  |                     | Rotor Inertia<br>J(10 <sup>-4</sup> kgm <sup>2</sup> ) | Braking Energy E <sub>O</sub><br>(J) Generated During Operation | Max. Braking Energy Absorbed by the Capacitor E <sub>C</sub> (J) |
|--------------|---|---------------------|--|---|--|
| 1000 W       | MS1H2<br>(low inertia, medium capacity) | MS1H2-10C30CD-*331Z | 1.87   | 9.2   | 34.3   |
|              |   | MS1H2-10C30CD-*334Z |  |   |  |
| 1500 W       |   | MS1H2-15C30CD-*331Z | 2.46   | 12.2  | 34.3   |
|              |   | MS1H2-15C30CD-*334Z |  |   |  |
| 2000W        |   | MS1H2-20C30CD-*331Z | 3.06   | 15.1  | 50.4   |
| 2500 W       |   | MS1H2-25C30CD-*331Z | 3.65   | 18  | 50.4   |
| 3000 W       | MS1H2-30C30CD-*331Z                     | 7.72                | 38.2   | 50.4  |  |
| 4000 W       | MS1H2<br>(low inertia, medium capacity) | MS1H2-40C30CD-*331Z | 12.1   | 59.8  | 82.7   |
| 5000 W       |   | MS1H2-50C30CD-*331Z | 15.4   | 76.2  | 82.7   |

| Capacity (W) | Servo Motor Model<br>MS1H*-*****_*****        | Rotor Inertia<br>J(10 <sup>-4</sup> kgm <sup>2</sup> ) | Braking Energy E <sub>O</sub><br>(J) Generated During<br>Operation | Max. Braking Energy<br>Absorbed by the<br>Capacitor<br>E <sub>C</sub> (J) |       |
|--------------|---|--|--|---|-------|
| 850 W        | MS1H3<br>(medium inertia,<br>medium capacity) | MS1H3-85B15CD-*331Z                                    | 13.3   | 65.8  | 28.2  |
|              |   | MS1H3-85B15CD-*334Z                                    | 14   | 69.2  | 34.3  |
| 1300 W       |   | MS1H3-13C15CD-*331Z                                    | 17.8   | 88  | 34.3  |
|              |   | MS1H3-13C15CD-*334Z                                    | 18.5   | 91.5  | 34.3  |
| 1800 W       |   | MS1H3-18C15CD-*331Z                                    | 25   | 123.6   | 50.4  |
|              |   | MS1H3-18C15CD-*334Z                                    | 25.7   | 127.1   | 50.4  |
| 2900 W       |   | MS1H3-29C15CD-*331Z                                    | 55   | 271.98  | 50.4  |
|              |   | MS1H3-29C15CD-*334Z                                    | 55   | 271.98  | 50.4  |
| 4400 W       |   | MS1H3-44C15CD-*331Z                                    | 88.9   | 439.6   | 82.7  |
|              |   | MS1H3-44C15CD-*334Z                                    | 88.9   | 439.6   | 82.7  |
| 5500 W       |   | MS1H3-55C15CD-*331Z                                    | 107  | 529.1   | 100.8 |
|              |   | MS1H3-55C15CD-*334Z                                    | 107  | 529.1   | 100.8 |
| 7500 W       |   | MS1H3-75C15CD-*331Z                                    | 141  | 697.3   | 100.8 |
|              |   | MS1H3-75C15CD-*334Z                                    | 141  | 697.3   | 100.8 |

## Note

If the total braking time T is known, you can determine whether an external regenerative resistor is needed and the power required using the formula described in section "Wiring and Setting of Regenerative Resistor" in SV660N Series Servo Drive Hardware Guide.

## 2.2.5 Servo ON

Set the S-ON signal to "ON".

When the S-ON signal is switched on, the keypad displays "rn", but if there is no command input at this moment, the servo motor does not rotate and stays locked. After a command is input, the servo motor starts rotating.

Table 2-6 Operation of the servo drive

| Record                   | No. | Description  |
|--------------------------|-----|--|
| <input type="checkbox"/> | 1   | During initial operation, set a proper command to make the motor run at low speed and check whether the motor rotates properly.  |
| <input type="checkbox"/> | 2   | Observe whether the motor rotates in the correct direction. If the direction of rotation is opposite to the expected direction, check the reference signal input and the reference direction setting signal. |

| Record                   | No. | Description  |
|--------------------------|-----|--|
| <input type="checkbox"/> | 3   | If the direction of rotation is correct, observe the actual motor speed in H0B-00 (200B-01h) and average load rate in H0B-12 (200B-0Dh) through the keypad or software tool. |
| <input type="checkbox"/> | 4   | After checking the preceding conditions, adjust related parameters to make the motor operate as desired.   |
| <input type="checkbox"/> | 5   | Perform gain auto-tuning according to Chapter "Adjustment" in SV660N Series Servo Drive Function Guide.  |

**Power-on sequence diagram**

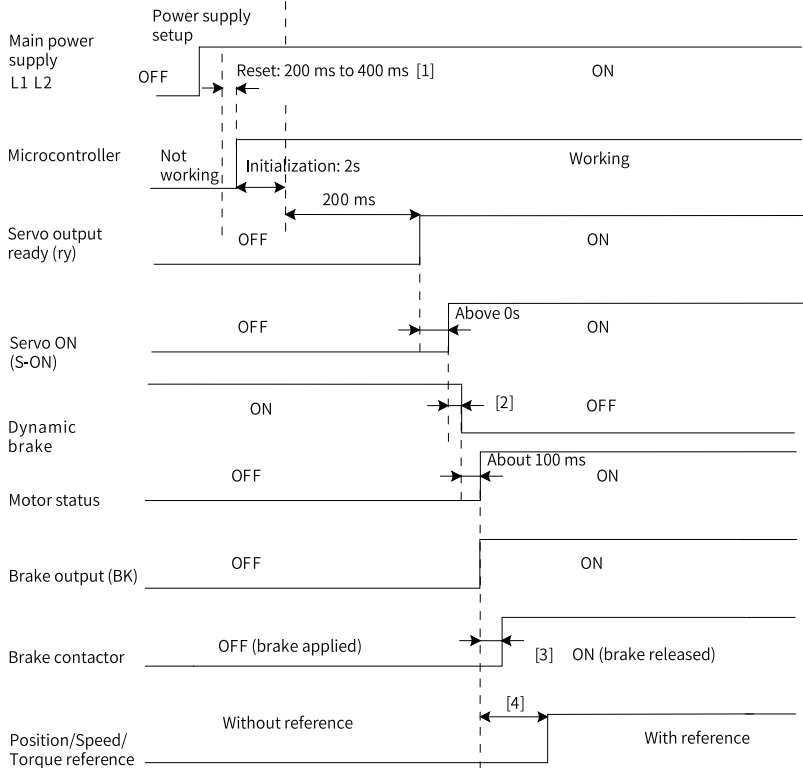

Figure 2-15 Power-on sequence

## Note

- [1] The reset time is determined by the setup time of the +5V power supply of the microprocessor.
- [2] The dynamic brake is included in the standard configuration.
- [3] For delay of brake contactor actions, see "[Table 2-4](#)" on page 35.
- [4] When the brake function is not used, the command delay time is invalid. When the brake function is used, the time interval from the moment the brake (BK) output is set to "ON" to the moment the command is input must be longer than the time defined by H02-09 (2002-0Ah).

### Sequence diagram upon stop at warning or fault

- No. 1 fault: Coast to stop, keeping de-energized status

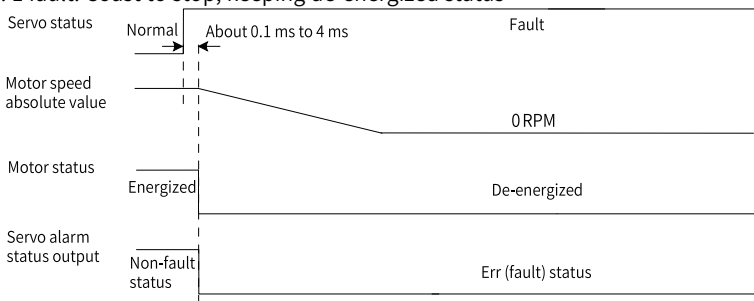

Figure 2-16 Sequence of "Coast to stop, keeping de-energized status" at No. 1 fault

- No. 1 fault (without brake): Dynamic braking stop, keeping de-energized status

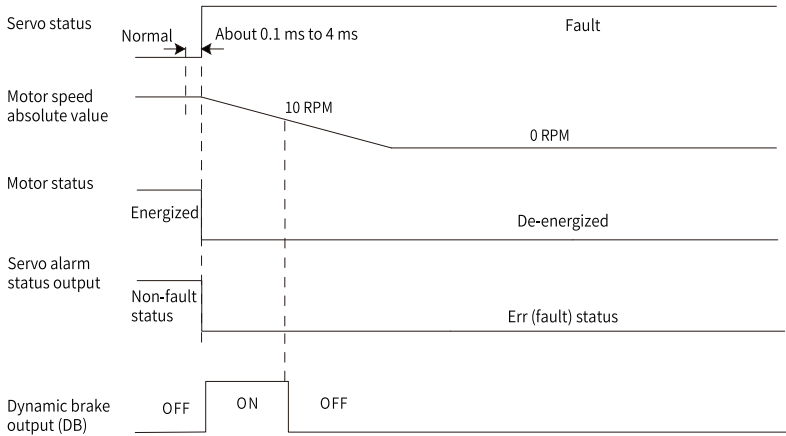

Figure 2-17 Sequence of "Dynamic braking stop, keeping de-energized status" at No. 1 fault

- No. 1 fault (with brake): Dynamic braking stop, keeping dynamic braking status

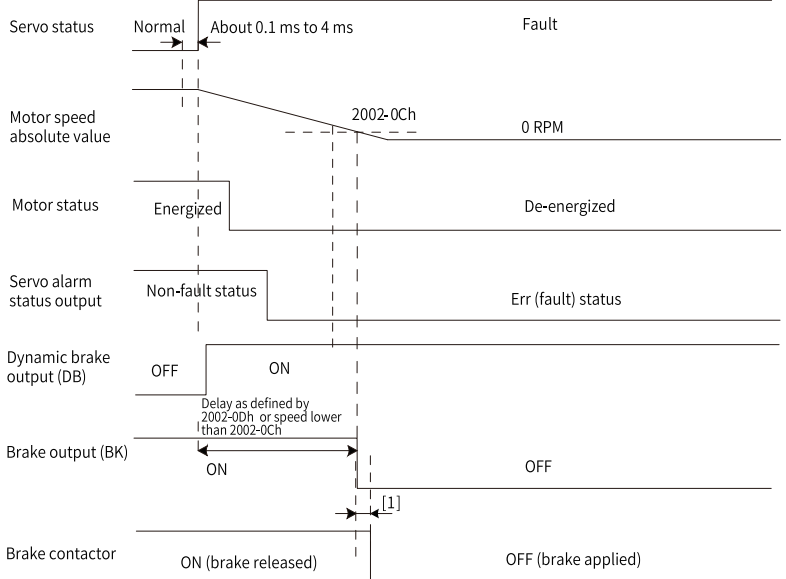

Figure 2-18 Sequence of "Dynamic braking stop, keeping dynamic braking status" at No. 1 fault

## Note

[1] For delay of brake contactor actions, see ["Table 2-4" on page 35](#).

- No. 1 fault (without brake): Dynamic braking stop, keeping dynamic braking status

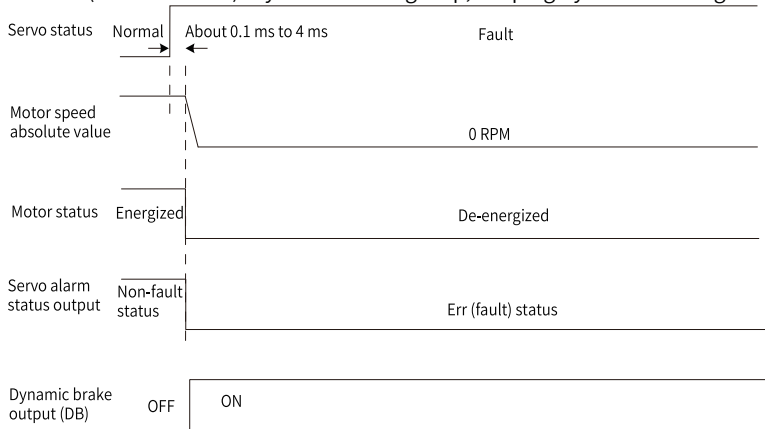

Figure 2-19 Sequence of "Dynamic braking stop, keeping dynamic braking status" at No. 1 fault

- No. 2 fault (without brake): Coast to stop, keeping de-energized status (same as "Coast to stop at No. 1 fault", see ["Figure 2-16 Sequence of "Coast to stop, keeping de-energized status" at No. 1 fault" on page 45](#))
- No. 2 fault: Dynamic braking stop, keeping dynamic braking status<sup>[1]</sup>



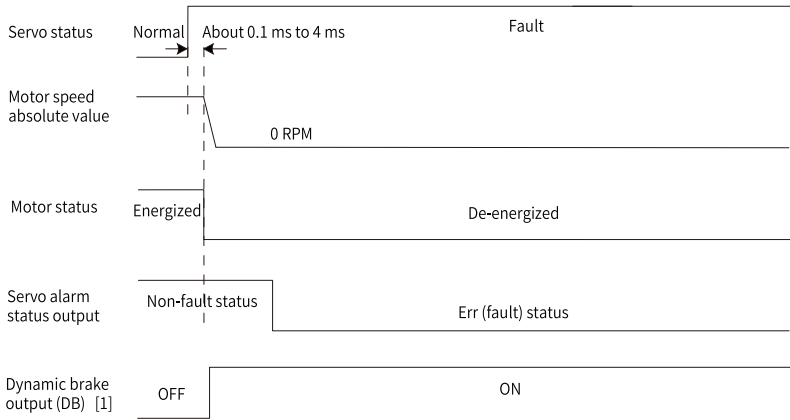

Figure 2-20 Sequence of "Dynamic braking stop, keeping dynamic braking status" at No. 2 fault

**Note**

[1]: After DB is enabled

- No. 2 fault: Ramp to stop/Stop at emergency-stop torque, keeping de-energized/dynamic braking status<sup>[1]</sup>

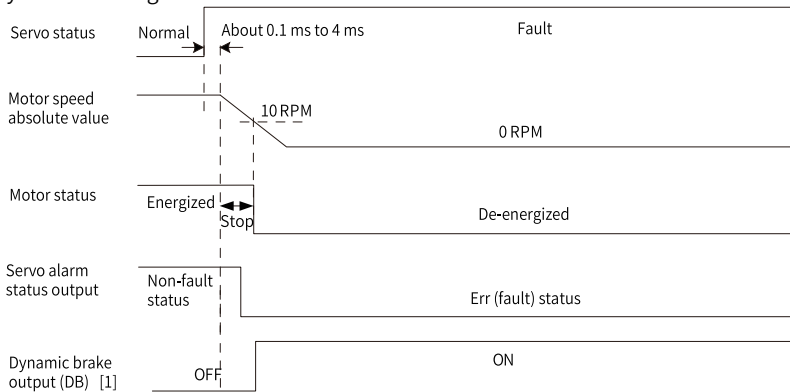

Figure 2-21 Sequence of "Ramp to stop or stop at emergency-stop torque, keeping de-energized/dynamic braking status" at No. 2 fault (without brake)

## Note

[1]: After DB is enabled

- No. 2 fault (with brake): Ramp to stop, keeping dynamic braking status

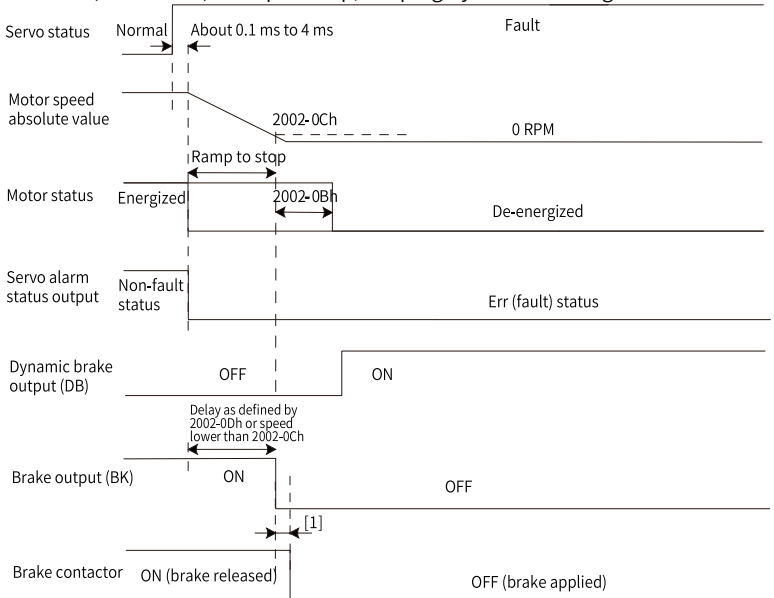

Figure 2-22 Sequence of "Ramp to stop, keeping dynamic braking status" at No. 2 fault (with brake)

## Note

[1] For delay of brake contactor actions, see ["Table 2-4" on page 35](#).

- When a No. 3 warning occurs, such as E950.0 (Forward overtravel warning) and E952.0 (Reverse overtravel warning), the servo drive stops based on the sequence shown in the following figure.

- Overtravel warning:

When the brake function is enabled, the motor ramps to stop as defined by 6085h, keeping position lock status.

When the brake function is not enabled, the motor stops at zero speed by default, keeping position lock status.

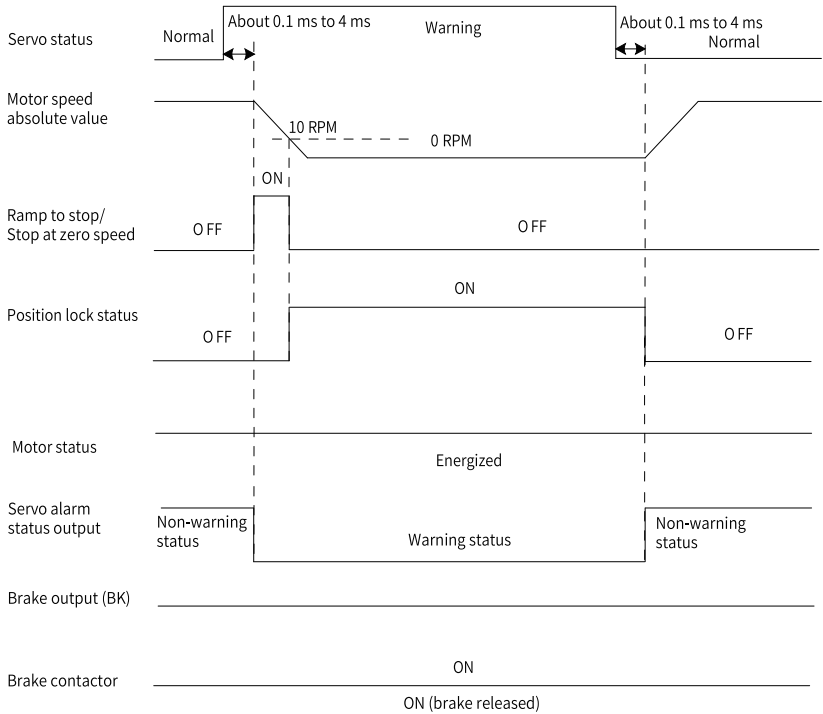

Figure 2-23 Sequence for warnings that cause stop

**Note**

The other warnings do not affect the operating state of the servo drive. The sequence diagram for these warnings is as follows.

- Warnings that do not cause stop

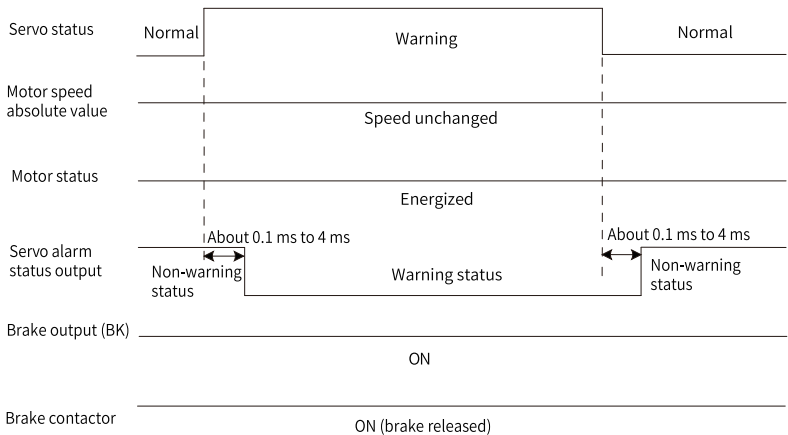

Figure 2-24 Sequence for warnings that do not cause stop

- Fault reset

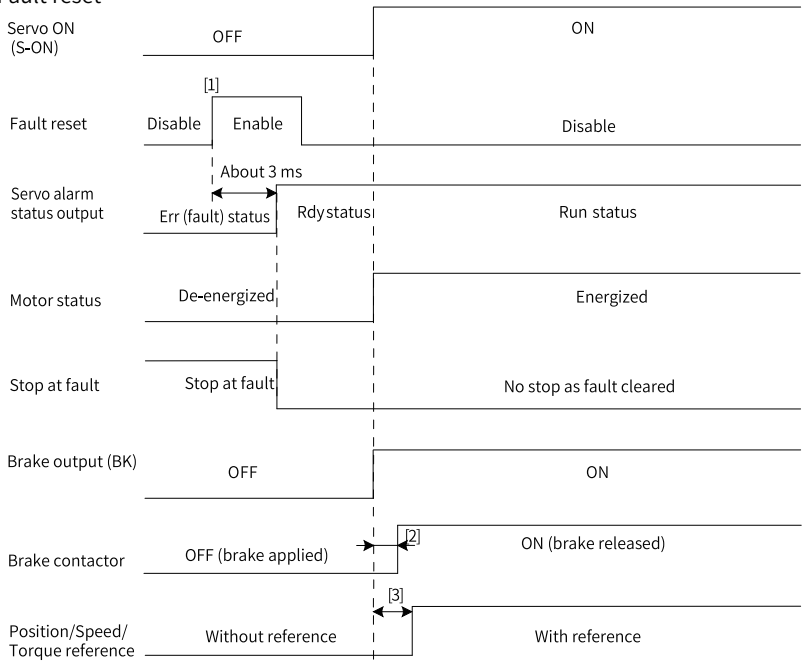

Figure 2-25 Sequence for fault reset

## Note

- [1] The fault reset signal is edge-triggered.
- [2] For delay of brake contactor actions, see "[Table 2-4](#)" on page 35.
- [3] The command delay is invalid when the brake function is not enabled.

### 2.2.6 Servo OFF

A total of three type of stop modes are available for the servo drive: coast to stop, stop at zero speed, and dynamic braking stop, along with three kinds of stop status: de-energized, dynamic braking, and position lock. See the following table for details.

Table 2-7 Comparison of the stop modes

| Stop Mode                             | Description   | Feature   |
|---------------------------------------|---|---|
| Mode 1: Coast to stop                 | The motor is de-energized and coasts to 0 RPM. The deceleration time is affected by the mechanical inertia and mechanical friction. | Mode 1 features a smooth and slow deceleration process with a small mechanical shock. |
| Mode 2: Stop at zero speed            | The motor takes 0 RPM as the target speed and decelerates immediately to 0 RPM and stops.   | Mode 2 features a quick deceleration process with an obvious mechanical shock.        |
| Mode 3: Ramp to stop                  | The motor smoothly decelerates to 0 RPM upon position/speed/torque reference.   | Mode 3 features smooth and controllable deceleration with a small mechanical impact.  |
| Mode 4: Stop at emergency-stop torque | The servo drive outputs a reverse braking torque to stop the motor.   | Mode 4 features a quick deceleration process with an obvious mechanical shock.        |
| Mode 5: Dynamic braking               | The servo motor is in the dynamic braking status.   | Mode 5 features a quick deceleration process with an obvious mechanical shock.        |

Table 2-8 Comparison of the stop status

| Stop Status     | Description   |
|-----------------|---|
| De-energized    | The motor is de-energized and the motor shaft can be rotated freely after the motor stops rotating. |
| Position lock   | The motor shaft is locked and cannot be rotated freely after the motor stops rotating.              |
| Dynamic braking | The motor is not energized after it stops rotating, and the motor shaft cannot be rotated freely.   |

The stop events can be divided into the following types: stop at S-ON OFF, stop at fault, stop at overtravel, stop at emergency, quick stop, halt, and ramp to stop. See the following descriptions for details.

### Stop at S-ON OFF

Switch off the S-ON signal through communication, and the servo drive stops accordingly.

☆Related parameters

|          |        |                       |         |    |                                    |                         |                |          |           |       |
|----------|--------|-----------------------|---------|----|------------------------------------|-------------------------|----------------|----------|-----------|-------|
| H02-05   | Name   | Stop mode at S-ON OFF |         |    | Setting Condition & Effective Time | Any condition & At stop | Data Structure | -        | Data Type | int16 |
| 2002-06h | Access | RW                    | Mapping | No | Related Mode                       | All                     | Data Range     | -3 to +1 | Default   | 0     |

Defines the deceleration mode of the motor for stopping rotating upon S-ON OFF and the motor status after stop.

| Setpoint | Stop Mode  |
|----------|--|
| -3       | Stop at zero speed, keeping dynamic braking status                     |
| -2       | Ramp to stop as defined by 6084h/609Ah, keeping dynamic braking status |
| -1       | Dynamic braking stop, keeping dynamic braking status                   |
| 0        | Coast to stop, keeping de-energized state                              |
| 1        | Ramp to stop as defined by 6084h/609Ah, keeping de-energized status    |

Set a proper stop mode according to the mechanical status and operation requirements.

After the brake (BK) output function is enabled, the stop mode upon S-ON OFF is forcibly set to "Ramp to stop as defined by 6085h, keeping dynamic braking status".

|       |        |                               |         |    |                                    |                         |                |          |           |       |
|-------|--------|-------------------------------|---------|----|------------------------------------|-------------------------|----------------|----------|-----------|-------|
| 605Ch | Name   | Disable operation option code |         |    | Setting Condition & Effective Time | Any condition & At stop | Data Structure | -        | Data Type | int16 |
|       | Access | RW                            | Mapping | No | Related Mode                       | All                     | Data Range     | -4 to +1 | Default   | 0     |

Defines the deceleration mode of the motor for stopping rotating upon S-ON OFF and the motor status after stop.

| Setpoint | Stop Mode  |
|----------|--|
| -4       | Ramp to stop as defined by 6085h, keeping dynamic braking status |
| -3       | Stop at zero speed, keeping dynamic braking status               |
| -2       | Ramp to stop under all modes, keeping dynamic braking status     |
| -1       | Dynamic braking stop, keeping dynamic braking status             |
| 0        | Coast to stop, keeping de-energized state                        |
| 1        | Ramp to stop under all modes, keeping de-energized status        |

Set a proper stop mode according to the mechanical status and operation requirements.

After the brake output (BK) function is enabled, the stop mode upon S-ON OFF is forcibly set to "Ramp to stop as defined by 6085h, keeping dynamic braking status".

## Note

The stop mode can be set in H02-05 (2002-06h) and 605Ch. If the value of H02-06 (2002-06h) or 605Ch changes, the value of 605Ch or H02-06 (2002-06h) also changes.

### Stop at fault

The stop mode varies with the fault type. For fault classification, see ["3.1 Fault and Warning Levels" on page 60](#).

☆Related parameters

| H02-08  | Name   | Stop mode at No. 1 fault |         |      | Setting Condition & Effective Time | At stop & At once | Data Structure | -      | Data Type | Uint16 |          |           |   |   |   |   |   |  |
|---|--|--------------------------|---------|------|------------------------------------|-------------------|----------------|--------|-----------|--------|----------|-----------|---|---|---|---|---|--|
| 2002-09h  | Access   | RW                       | Mapping | RPDO | Related Mode                       | All               | Data Range     | 0 to 2 | Default   | 2      |          |           |   |   |   |   |   |  |
| <p>Defines the deceleration mode of the motor for stopping rotating upon occurrence of a No. 1 fault and the motor status after stop.</p> <table border="1"> <thead> <tr> <th>Setpoint</th> <th>Stop Mode</th> </tr> </thead> <tbody> <tr> <td>0</td> <td>Coast to stop, keeping de-energized state</td> </tr> <tr> <td>1</td> <td>Dynamic braking stop, keeping de-energized status</td> </tr> <tr> <td>2</td> <td>Dynamic braking stop, keeping dynamic braking status</td> </tr> </tbody> </table> <p>After the brake (BK) output function is enabled, the stop mode at No. 1 fault is forcibly set to "Dynamic braking stop, keeping dynamic braking status".</p> |  |                          |         |      |                                    |                   |                |        |           |        | Setpoint | Stop Mode | 0 | Coast to stop, keeping de-energized state | 1 | Dynamic braking stop, keeping de-energized status | 2 | Dynamic braking stop, keeping dynamic braking status |
| Setpoint  | Stop Mode  |                          |         |      |                                    |                   |                |        |           |        |          |           |   |   |   |   |   |  |
| 0   | Coast to stop, keeping de-energized state            |                          |         |      |                                    |                   |                |        |           |        |          |           |   |   |   |   |   |  |
| 1   | Dynamic braking stop, keeping de-energized status    |                          |         |      |                                    |                   |                |        |           |        |          |           |   |   |   |   |   |  |
| 2   | Dynamic braking stop, keeping dynamic braking status |                          |         |      |                                    |                   |                |        |           |        |          |           |   |   |   |   |   |  |

|          |        |                          |         |    |                                    |                         |                |          |           |       |
|----------|--------|--------------------------|---------|----|------------------------------------|-------------------------|----------------|----------|-----------|-------|
| H02-06   | Name   | Stop mode at No. 2 fault |         |    | Setting Condition & Effective Time | Any condition & At stop | Data Structure | -        | Data Type | int16 |
| 2002-07h | Access | RW                       | Mapping | No | Related Mode                       | All                     | Data Range     | -5 to +3 | Default   | 0     |

Defines the deceleration mode of the motor for stopping rotating upon occurrence of a No. 2 fault and the motor status after stop.

| Setpoint | Stop Mode  |
|----------|--|
| -5       | Stop at zero speed, keeping dynamic braking status                     |
| -4       | Stop at emergency-stop torque, keeping dynamic braking status          |
| -3       | Ramp to stop as defined by 6085h, keeping dynamic braking status       |
| -2       | Ramp to stop as defined by 6084h/609Ah, keeping dynamic braking status |
| -1       | Dynamic braking stop, keeping dynamic braking status                   |
| 0        | Coast to stop, keeping de-energized state                              |
| 1        | Ramp to stop as defined by 6084h/609Ah, keeping de-energized status    |
| 2        | Ramp to stop as defined by 6085h, keeping de-energized status          |
| 3        | Stop at emergency-stop torque, keeping de-energized status             |

After the brake (BK) output function is enabled, the stop mode at No. 2 fault is forcibly set to "Ramp to stop as defined by 6085h, keeping dynamic braking status".

|       |        |                            |         |    |                                    |                         |                |          |           |       |
|-------|--------|----------------------------|---------|----|------------------------------------|-------------------------|----------------|----------|-----------|-------|
| 605Eh | Name   | Fault reaction option code |         |    | Setting Condition & Effective Time | Any condition & At stop | Data Structure | -        | Data Type | int16 |
|       | Access | RW                         | Mapping | No | Related Mode                       | All                     | Data Range     | -5 to +3 | Default   | 0     |

Defines the deceleration mode of the motor for stopping rotating upon occurrence of a No. 2 fault and the motor status after stop.

| Setpoint | Stop Mode  |
|----------|--|
| -5       | Stop at zero speed, keeping dynamic braking status                     |
| -4       | Stop at emergency-stop torque, keeping dynamic braking status          |
| -3       | Ramp to stop as defined by 6085h, keeping dynamic braking status       |
| -2       | Ramp to stop as defined by 6084h/609Ah, keeping dynamic braking status |
| -1       | Dynamic braking stop, keeping dynamic braking status                   |
| 0        | Coast to stop, keeping de-energized state                              |
| 1        | Ramp to stop as defined by 6084h/609Ah, keeping de-energized status    |
| 2        | Ramp to stop as defined by 6085h, keeping de-energized status          |
| 3        | Stop at emergency-stop torque, keeping de-energized status             |

After the brake (BK) output function is enabled, the stop mode at No. 2 fault is forcibly set to "Ramp to stop as defined by 6085h, keeping dynamic braking status".



## Note

The "Stop mode at No. 2 fault " can be set in H02-06 (2002-07h) or 605Eh. If the value of H02-06 (2002-07h) or 605Eh changes, the value of 605Eh or H02-06 (2002-07h) also changes.

### Stop at overtravel

★Definitions of terms:

- "Overtravel": The distance of the mechanical movement exceeds the designed range of safe movement.
- "Stop at overtravel": When a motion part moves beyond the range of safe movement, the limit switch outputs a level change to force the motor to stop.

☆Related parameter

|          |        |                         |         |   |                                    |                   |                |        |           |        |
|----------|--------|-------------------------|---------|---|------------------------------------|-------------------|----------------|--------|-----------|--------|
| H02-07   | Name   | Stop mode at overtravel |         |   | Setting Condition & Effective Time | At stop & At once | Data Structure | -      | Data Type | Uint16 |
| 2002-08h | Access | RW                      | Mapping | - | Related Mode                       | All               | Data Range     | 0 to 7 | Default   | 1      |

Defines the deceleration mode of the motor for stopping rotating upon overtravel and the motor status after stop.

| Setpoint | Stop Mode  |
|----------|--|
| 0        | Coast to stop, keeping de-energized status                     |
| 1        | Stop at zero speed, keeping position lock status               |
| 2        | Stop at zero speed, keeping de-energized status                |
| 3        | Ramp to stop as defined by 6085h, keeping de-energized status  |
| 4        | Ramp to stop as defined by 6085h, keeping position lock status |
| 5        | Dynamic braking stop, keeping de-energized status              |
| 6        | Dynamic braking stop, keeping dynamic braking status           |
| 7        | Not responding to overtravel                                   |

When the servo motor drives a vertical axis, for the sake of safety, set H02-07 (2002-08h) to 1 to lock the motor shaft after overtravel occurs.

After the brake (BK) output function is enabled, the stop mode at overtravel is forcibly set to "Ramp to stop as defined by 6085h, keeping position lock status".

If the motor enters overtravel status when driving a vertical axis, the workpiece may fall. To prevent the risk of falling, set H02-07 (2002-08h) to 1. When the workpiece moves linearly, install limit switches to prevent potential mechanical damage. When overtravel occurs, input a reverse running command to make the motor (workpiece) run in the opposite direction.

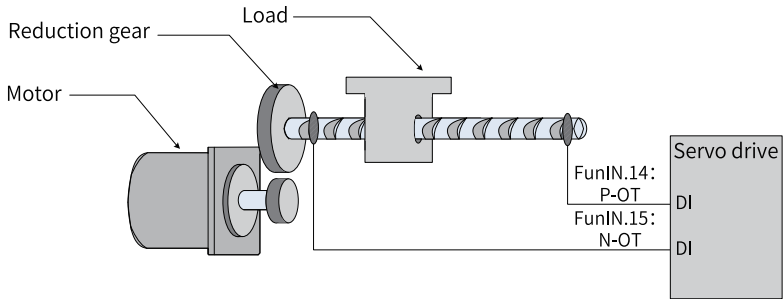

Figure 2-26 Installation of limit switches

To use the limit switch, assign FunIN.14 (P-OT, positive limit switch) and FunIN.15 (N-OT, negative limit switch) to two DIs of the servo drive and set the active logic of these DIs. This is to enable the servo drive to receive the level signals input from the limit switches. The servo drive enables or cancels the stop-at-overtravel status based on the DI level status.

☆Related function No.

| Function No. | Name | Function              | Description  |
|--------------|------|-----------------------|--|
| FunIN.14     | P-OT | Positive limit switch | When the mechanical movement exceeds the specified range, overtravel prevention will be activated.<br>Inactive: Forward drive permitted<br>Active: Forward drive inhibited |
| FunIN.15     | N-OT | Negative limit switch | When the mechanical movement exceeds the specified range, overtravel prevention will be activated.<br>Inactive: Reverse drive permitted<br>Active: Reverse drive inhibited |

## Emergency stop

There are two ways to enable emergency stop, as shown below:

- Using DI function 34: FunIN.34 (EmergencyStop)
- Using the auxiliary emergency stop function in H0D-05 (200D-06h)

☆Related function No.

| Function No. | Name           | Function | Description  |
|--------------|----------------|----------|--|
| FunIN.34     | Emergency Stop | Braking  | Inactive: The current operating state is unaffected.<br>Active: The servo drive stops according to the stop mode defined by 605Ah. |

☆Related parameter

|          |        |                |         |   |                                    |                   |                |        |           |        |
|----------|--------|----------------|---------|---|------------------------------------|-------------------|----------------|--------|-----------|--------|
| H0D-05   | Name   | Emergency stop |         |   | Setting Condition & Effective Time | At stop & At once | Data Structure | -      | Data Type | uint16 |
| 200D-06h | Access | RW             | Mapping | - | Related Mode                       | -                 | Data Range     | 0 to 1 | Default   | 0      |

Defines whether to enable emergency stop.

| Setpoint | Function               |
|----------|------------------------|
| 0        | No operation           |
| 1        | Emergency stop enabled |

When H0D-05 is enabled, the servo drive stops in the stop mode defined by 605Ch regardless of the operating status.

**Quick stop**

Quick stop applies when bit2 (Quick stop) in the control word 6040h is set to 0 (Valid). The quick stop mode is defined by 605Ah.

☆Related parameter

|       |        |                        |         |    |                                    |                         |                |        |           |       |
|-------|--------|------------------------|---------|----|------------------------------------|-------------------------|----------------|--------|-----------|-------|
| 605Ah | Name   | Quick stop option code |         |    | Setting Condition & Effective Time | Any condition & At stop | Data Structure | VAR    | Data Type | int16 |
|       | Access | RW                     | Mapping | No | Related Mode                       | All                     | Data Range     | 0 to 7 | Default   | 2     |

Defines the deceleration mode of the motor for stopping rotating upon quick stop and the motor status after stop.

| Setpoint | Stop Mode   |
|----------|---|
| 0        | Coast to stop, keeping de-energized status                                |
| 1        | Ramp to stop as defined by 6084h/609Ah (HM), keeping de-energized status  |
| 2        | Ramp to stop as defined by 6085h, keeping de-energized status             |
| 3        | Stop at emergency-stop torque, keeping de-energized status                |
| 4        | N/A   |
| 5        | Ramp to stop as defined by 6084h/609Ah (HM), keeping position lock status |
| 6        | Ramp to stop as defined by 6085h, keeping position lock status            |
| 7        | Stop at emergency-stop torque, keeping position lock status               |

When the brake function is enabled and the value of 605Ah is lower than 4, the stop mode is forcibly set to "Ramp to stop as defined by 6085h, keeping de-energized status".

**Halt**

The halt function applies when bit8 in the control word 6040h is set to 1 (Valid). The halt mode is defined by 605Dh.

## ☆Related parameter

| 605Dh   | Name   | Halt option code  |         |    | Setting Condition & Effective Time | Any condition & At stop | Data Structure | -      | Data Type | int16 |
|---|--------|---|---------|----|------------------------------------|-------------------------|----------------|--------|-----------|-------|
|   | Access | RW  | Mapping | No | Related Mode                       | All                     | Data Range     | 1 to 3 | Default   | 1     |
| Defines the deceleration mode of the motor for stopping rotating upon halt and the motor status after stop.<br>PP/PV/HM mode: |        |   |         |    |                                    |                         |                |        |           |       |
| Setpoint  |        | Stop Mode   |         |    |                                    |                         |                |        |           |       |
| 1   |        | Ramp to stop as defined by 6084h/609Ah (HM), keeping position lock status |         |    |                                    |                         |                |        |           |       |
| 2   |        | Ramp to stop as defined by 6085h, keeping position lock status            |         |    |                                    |                         |                |        |           |       |
| 3   |        | Stop at emergency-stop torque, keeping position lock status               |         |    |                                    |                         |                |        |           |       |
| PT mode   |        |   |         |    |                                    |                         |                |        |           |       |
| Setpoint  |        | Stop Mode   |         |    |                                    |                         |                |        |           |       |
| 1/2/3   |        | Ramp to stop as defined by 6087h, keeping position lock status            |         |    |                                    |                         |                |        |           |       |

**Caution**

Do not set the acceleration/deceleration time to an excessively low value. An excessively low value will lead to a long stop distance, incurring the risk of collision.

**Ramp to stop**

When the stop mode is set to "Ramp to stop as defined by 6084h/609Ah (HM)" or "Ramp to stop as defined by 6085h", set the maximum time for ramp-to-stop through H0A-72 (200A-49h) to prevent a long stop distance caused by an excessively small deceleration setpoint. When 6084h/609Ah (HM) or 6085h is set to an excessively small value, the stop deceleration is restricted to the deceleration rate corresponding to H0A-72 (200A-49h).

## ☆Related parameter

| H0A-72   | Name   | Maximum time of ramp-to-stop |         |   | Setting Condition & Effective Time | At stop & At once | Data Structure | -               | Data Type | uint16 |
|--|--------|------------------------------|---------|---|------------------------------------|-------------------|----------------|-----------------|-----------|--------|
| 200A-49h   | Access | RW                           | Mapping | - | Related Mode                       | All               | Data Range     | 0 to 65535 (ms) | Default   | 10000  |
| Defines the maximum time taken by the motor in decelerating from 6000 RPM to 0 RPM when the stop mode is set to "Ramp to stop as defined by 6084h/609Ah (HM)" or "Ramp to stop as defined by 6085h". |        |                              |         |   |                                    |                   |                |                 |           |        |

## 3 Troubleshooting

### 3.1 Fault and Warning Levels

Faults and warnings of the servo drive are divided into three levels based on severity: No. 1 > No. 2 > No. 3, as shown below.

- No. 1 non-resettable fault
- No. 1 resettable fault
- No. 2 resettable fault
- No. 3 resettable warning

---

#### Note

"Resettable" means the keypad stops displaying the fault/warning once a "Reset signal" is input.

---

To reset a fault/warning, use one of the following two methods:

- Set H0D-01 (200D-02h) to 1 (Fault reset).
- Set the rising edge of bit7 of the control word 0x6040 through the host controller.

To reset No. 1 and No. 2 faults, switch off the S-ON signal first and then send the fault reset signal.

For No.3 warnings, the servo drive resets the warning automatically after the warning source is cleared.

☆Related parameter

| Para. No. | Name        | Value Range                  | Description   | Setting Condition | Effective Time | Default |
|-----------|-------------|------------------------------|---|-------------------|----------------|---------|
| 200Dh-02h | Fault reset | 0: No operation<br>1: Enable | Used to stop the keypad from displaying the fault/warning when a resettable fault/warning occurs.<br>200Dh-02h is set to 0 immediately after reset. | At stop           | Immediately    | 0       |

Troubleshooting during startup:

| Start Process  | Fault Symptom                                | Cause   | Confirming Method   |
|--|--|---|---|
| Switching on the control circuit power supply (L1C, L2C) and main power supply (L1, L2, L3). | The LED neither lights up nor displays "ry". | 1. The voltage of the control circuit power supply is abnormal.   | Check whether the value of H0B-63 is 1.<br>Measure the AC voltage between L1C and L2C.  |
|  |  | 2: Phase loss occurs on the input power supply.   | Check whether the value of H0B-63 is 2.<br>Voltage must be present in all the phases of a three-phase 380 V power supply.   |
|  |  | 3. The voltage of the main circuit power supply is abnormal.  | Check whether the value of H0B-63 is 3.<br><ul style="list-style-type: none"> <li>For single-phase 220 V models, measure the AC voltage between L1 and L2. When the DC bus voltage amplitude (voltage between P⊕ and N⊖) is lower than 200 V, the keypad displays "nr".</li> <li>For three-phase 220 V/380 V models, measure the AC voltage among L1, L2, L3/R, S, T. When the DC bus voltage amplitude (voltage between P⊕ and N⊖) is lower than 200 V/460 V, the keypad displays "nr".</li> </ul> |
|  |  | 4. The servo drive is faulty.   | -   |
|  | The keypad displays "Exxx.x".                | Rectify the fault according to <a href="#">"3.3 Solutions to Faults" on page 67</a> , <a href="#">"3.4 Solutions to Warnings" on page 109</a> , and <a href="#">"3.5 Solutions to Communication Faults" on page 120</a> . |   |
| The keypad displays "ry" after preceding faults are cleared.                                 |  |   |   |

## 3.2 List of Fault and Warning Codes

### List of fault codes

| Fault Code | Display | Fault Name   | Fault Type | Resettable | Fault Range       | Error Code (603Fh) | Aux. Code (203Fh) |
|------------|---------|--|------------|------------|-------------------|--------------------|-------------------|
| E101       | E101.0  | System parameter error   | No. 1      | No         | Servo drive fault | 0x6320             | 0x01010101        |
|            | E101.1  | Parameter error in group 2000h/2001h                                 | No. 1      | No         | Servo drive fault | 0x6320             | 0x11010101        |
|            | E101.2  | Address error in read/write after total number of parameters changes | No. 1      | No         | Servo drive fault | 0x6320             | 0x21010101        |
| E102       | E102.0  | Logic configuration fault  | No. 1      | No         | Servo drive fault | 0x7500             | 0x01020102        |
|            | E102.8  | Software version mismatch  | No. 1      | No         | Servo drive fault | 0x7500             | 0x81020102        |
| E104       | E104.1  | MCU operation timeout  | No. 1      | No         | Servo drive fault | 0x7500             | 0x11040104        |
|            | E104.2  | Current loop operation timeout                                       | No. 1      | No         | Servo drive fault | 0x7500             | 0x21040104        |
|            | E104.4  | Command update timeout   | No. 1      | No         | Servo drive fault | 0x7500             | 0x41040104        |
| E108       | E108.0  | Parameter write error  | No. 2      | Yes        | Servo drive fault | 0x5530             | 0x01080108        |
|            | E108.1  | Parameter read error   | No. 2      | Yes        | Servo drive fault | 0x5530             | 0x11080108        |
|            | E108.2  | Invalid check on data written in EEPROM                              | No. 2      | Yes        | Servo drive fault | 0x5530             | 0x21080108        |
|            | E108.3  | Invalid check on data read in EEPROM                                 | No. 2      | Yes        | Servo drive fault | 0x5530             | 0x31080108        |
| E120       | E120.0  | Unknown encoder type   | No. 1      | No         | Axis fault        | 0x7122             | 0x01200120        |
|            | E120.1  | Unknown motor model  | No. 1      | No         | Axis fault        | 0x7122             | 0x11200120        |
|            | E120.2  | Unknown drive model  | No. 1      | No         | Axis fault        | 0x7122             | 0x21200120        |
|            | E120.5  | Motor and drive current mismatch                                     | No. 1      | No         | Axis fault        | 0x7122             | 0x51200120        |
|            | E120.6  | FPGA and motor model mismatch  | No. 1      | No         | Axis fault        | 0x7122             | 0x61200120        |

| Fault Code | Display | Fault Name                                    | Fault Type | Resettable | Fault Range       | Error Code (603Fh) | Aux. Code (203Fh) |
|------------|---------|---|------------|------------|-------------------|--------------------|-------------------|
| E122       | E122.0  | Multi-turn absolute encoder setting error     | No. 2      | Yes        | Axis fault        | 0x6320             | 0x01220122        |
|            | E122.1  | Different DIs assigned with the same function | No. 2      | Yes        | Axis fault        | 0x6320             | 0x11220122        |
|            | E122.2  | Different DOs assigned with the same function | No. 2      | Yes        | Servo drive fault | 0x6320             | 0x21220122        |
|            | E122.3  | Upper limit in the rotation mode invalid      | No. 2      | Yes        | Axis fault        | 0x6320             | 0x31220122        |
| E136       | E136.0  | Encoder parameter error                       | No. 1      | No         | Axis fault        | 0x7305             | 0x01360136        |
|            | E136.1  | Encoder communication error                   | No. 1      | No         | Axis fault        | 0x7305             | 0x11360136        |
| E140       | E140.0  | Encryption chip check fault                   | No. 1      | No         | Servo drive fault | 0x0140             | 0x01400140        |
|            | E140.1  | Encryption chip check failure                 | No. 1      | No         | Servo drive fault | -                  | -                 |
| E150       | E150.0  | STO signal input protection                   | No. 1      | Yes        | Servo drive fault | 0x0150             | 0x01500150        |
|            | E150.1  | STO signal input error                        | No. 1      | Yes        | Servo drive fault | 0x0150             | 0x11500150        |
|            | E150.2  | Buffer 5 V supply voltage error               | No. 1      | Yes        | Servo drive fault | 0x0150             | 0x21500150        |
|            | E150.3  | STO upstream optocoupler detection failure    | No. 1      | Yes        | Servo drive fault | 0x0150             | 0x31500150        |
|            | E150.4  | PWM Buffer detection failure                  | No. 1      | Yes        | Servo drive fault | 0x0150             | 0x41500150        |
| E201       | E201.0  | Phase-P overcurrent                           | No. 1      | No         | Servo drive fault | 0x2312             | 0x02010201        |
|            | E201.1  | Phase-U overcurrent                           | No. 1      | No         | Axis fault        | 0x2312             | 0x12010201        |
|            | E201.2  | Phase-V overcurrent                           | No. 1      | No         | Axis fault        | 0x2312             | 0x22010201        |
|            | E201.4  | Phase-N overcurrent                           | No. 1      | No         | Servo drive fault | 0x2312             | 0x42010201        |



| Fault Code | Display | Fault Name   | Fault Type | Resettable | Fault Range       | Error Code (603Fh) | Aux. Code (203Fh) |
|------------|---------|--|------------|------------|-------------------|--------------------|-------------------|
| E208       | E208.0  | MCU position reference updated frequently                | No. 1      | Yes        | Axis fault        | 0x0208             | 0x02080208        |
|            | E208.2  | Encoder communication timeout                            | No. 1      | Yes        | Axis fault        | 0x0208             | 0x22080208        |
|            | E208.3  | Current sampling fault                                   | No. 1      | Yes        | Axis fault        | 0x0208             | 0x32080208        |
|            | E208.4  | FPGA current loop operation timeout                      | No. 1      | Yes        | Axis fault        | 0x0208             | 0x42080208        |
| E210       | E210.0  | Output short-circuited to ground                         | No. 1      | No         | Axis fault        | 0x2330             | 0x02100210        |
| E234       | E234.0  | Runaway protection                                       | No. 1      | No         | Axis fault        | 0x0234             | 0x02340234        |
| E400       | E400.0  | Main circuit overvoltage                                 | No. 1      | Yes        | Servo drive fault | 0x3210             | 0x04000400        |
| E410       | E410.0  | Main circuit undervoltage                                | No. 1      | Yes        | Servo drive fault | 0x3220             | 0x04100410        |
| E420       | E420.0  | Phase loss   | No. 2      | Yes        | Servo drive fault | 0x3130             | 0x04200420        |
| E430       | E430.0  | Control power supply undervoltage                        | No. 2      | Yes        | Servo drive fault | 0x3120             | 0x04300430        |
| E500       | E500.0  | Motor overspeed  | No. 1      | Yes        | Axis fault        | 0x8400             | 0x05000500        |
|            | E500.1  | Speed feedback overflow                                  | No. 1      | Yes        | Axis fault        | 0x8400             | 0x15000500        |
|            | E500.2  | FPGA position feedback pulse overspeed                   | No. 1      | Yes        | Axis fault        | -                  | 0x25000500        |
| E602       | E602.0  | Angle auto-tuning error                                  | No. 1      | Yes        | Axis fault        | 0x0602             | 0x06020602        |
|            | E602.2  | Wrong U/V/W phase sequence detected in angle auto-tuning | No. 1      | Yes        | Axis fault        | 0x0602             | 0x26020602        |
| E605       | E605.0  | Motor speed upon S-ON too high                           | No. 1      | Yes        | Axis fault        | 0x8400             | 0x06050605        |
| E620       | E620.0  | Motor overload   | No. 1      | Yes        | Axis fault        | 0x3230             | 0x06200620        |
| E630       | E630.0  | Motor stalled  | No. 1      | Yes        | Axis fault        | 0x7121             | 0x06300630        |
| E640       | E640.0  | IGBT over-temperature                                    | No. 1      | Yes        | Axis fault        | 0x4210             | 0x06400640        |
|            | E640.1  | Flywheel diode over-temperature                          | No. 1      | Yes        | Axis fault        | -                  | 0x06050605        |
| E650       | E650.0  | Heatsink over-temperature                                | No. 1      | Yes        | Axis fault        | 0x4210             | 0x06500650        |
| E660       | E660.0  | Air-cooled motor over-temperature                        | No. 1      | Yes        | Axis fault        | 0x4210             | 0x06600660        |

| Fault Code | Display | Fault Name  | Fault Type | Resettable | Fault Range | Error Code (603Fh) | Aux. Code (203Fh) |
|------------|---------|---|------------|------------|-------------|--------------------|-------------------|
| E661       | E661.0  | Auto-tuned gains too low                            | No. 2      | Yes        | Axis fault  | 0x4210             | 0x06610661        |
| E731       | E731.0  | Encoder battery failure                             | No. 2      | Yes        | Axis fault  | 0x0661             | 0x07310731        |
| E733       | E733.0  | Encoder multi-turn counting error                   | No. 2      | Yes        | Axis fault  | 0x7305             | 0x07330733        |
| E735       | E735.0  | Encoder multi-turn counting overflow                | No. 2      | Yes        | Axis fault  | 0x7305             | 0x07350735        |
| E740       | E740.2  | Absolute encoder error                              | No. 1      | No         | Axis fault  | 0x7305             | 0x27400740        |
|            | E740.3  | Absolute encoder single-turn calculation error      | No. 1      | No         | Axis fault  | 0x7305             | 0x37400740        |
|            | E740.6  | Encoder write error                                 | No. 1      | No         | Axis fault  | 0x7305             | 0x67400740        |
| E755       | E755.0  | Nikon encoder communication fault                   | No. 1      | No         | Axis fault  | -                  | 0x07550755        |
| E765       | E765.0  | Nikon encoder out of limit                          | No. 1      | No         | Axis fault  | -                  | 0x07650765        |
| E760       | E760.0  | Encoder over-temperature                            | No. 2      | Yes        | Axis fault  | 0x4210             | 0x07600760        |
| EA33       | EA33.0  | Encoder read/write check error                      | No. 1      | No         | Axis fault  | 0x7305             | 0x0A330A33        |
| EB00       | EB00.0  | Position deviation too large                        | No. 2      | Yes        | Axis fault  | 0x8611             | 0x0B000B00        |
|            | EB00.1  | Position deviation overflow                         | No. 2      | Yes        | Axis fault  | 0x8611             | 0x1B000B00        |
| EB01       | EB01.1  | Individual position reference increment too large   | No. 2      | Yes        | Axis fault  | 0x6320             | 0x1B010B01        |
|            | EB01.2  | Position reference increment too large continuously | No. 2      | Yes        | Axis fault  | 0x6320             | 0x2B010B01        |
|            | EB01.3  | Command overflow                                    | No. 2      | Yes        | Axis fault  | 0x6320             | 0x3B010B01        |
|            | EB01.4  | Target position beyond upper/lower limit            | No. 2      | Yes        | Axis fault  | 0x6320             | 0x4B010B01        |

| Fault Code | Display | Fault Name                            | Fault Type | Resettable | Fault Range       | Error Code (603Fh) | Aux. Code (203Fh) |
|------------|---------|---------------------------------------|------------|------------|-------------------|--------------------|-------------------|
| EE08       | EE08.0  | Synchronization (SYNC) signal loss    | No. 2      | Yes        | Axis fault        | 0x0FFF             | 0x0E080E08        |
|            | EE08.1  | Status switchover error               | No. 2      | Yes        | Axis fault        | 0x0FFF             | 0x1E080E08        |
|            | EE08.2  | IRQ loss                              | No. 2      | Yes        | Axis fault        | 0x0FFF             | 0x2E080E08        |
|            | EE08.3  | Network cable connected improperly    | No. 2      | Yes        | Axis fault        | 0x0FFF             | 0x3E080E08        |
|            | EE08.4  | Data frame loss protection error      | No. 2      | Yes        | Axis fault        | 0x0FFF             | 0x4E080E08        |
|            | EE08.5  | Data frame transfer error             | No. 2      | Yes        | Axis fault        | 0x0FFF             | 0x5E080E08        |
|            | EE08.6  | Data update timeout                   | No. 2      | Yes        | Axis fault        | 0x0FFF             | 0x6E080E08        |
| EE09       | EE09.0  | Software position limit setting error | No. 2      | Yes        | Axis fault        | 0x6320             | 0x0E090E09        |
|            | EE09.1  | Home setting error                    | No. 2      | Yes        | Axis fault        | 0x6320             | 0x1E090E09        |
|            | EE09.2  | Gear ratio beyond the limit           | No. 2      | Yes        | Axis fault        | 0x6320             | 0x2E090E09        |
|            | EE09.3  | No synchronization signal             | No. 2      | Yes        | Axis fault        | 0x6320             | 0x3E090E09        |
|            | EE09.5  | PDO mapping beyond the limit          | No. 2      | Yes        | Axis fault        | 0x6320             | 0x5E090E09        |
| EE11       | EE11.0  | ESI check error                       | No. 2      | Yes        | Servo drive fault | 0x5530             | 0x0E110E11        |
|            | EE11.1  | EEPROM read error                     | No. 2      | Yes        | Servo drive fault | 0x5530             | 0x1E110E11        |
|            | EE11.2  | EEPROM update failure                 | No. 2      | Yes        | Servo drive fault | 0x5530             | 0x2E110E11        |
| EE12       | EE12.0  | EtherCAT external device error        | No. 1      | No         | Servo drive fault | 0x0E12             | 0x0E120E12        |
| EE13       | EE13.0  | Synchronization cycle setting error   | No. 2      | Yes        | Servo drive fault | 0x6320             | 0x0E130E13        |
| EE15       | EE15.0  | Synchronization cycle error too large | No. 2      | Yes        | Servo drive fault | 0x0E15             | 0x0E150E15        |

### List of warning codes

| Warning Code | Display | Name                        | Fault Type | Resettable | Fault Range | Error Code (603Fh) | Aux. Code (203Fh) |
|--------------|---------|-----------------------------|------------|------------|-------------|--------------------|-------------------|
| E121         | E121.0  | S-ON command invalid        | No. 3      | Yes        | Warning     | 0x0121             | 0x01210121        |
| E600         | E600.0  | Inertia auto-tuning failure | No. 3      | Yes        | Warning     | 0x0600             | 0x06000600        |

| Warning Code | Display | Name   | Fault Type | Resettable | Fault Range | Error Code (603Fh) | Aux. Code (203Fh) |
|--------------|---------|--|------------|------------|-------------|--------------------|-------------------|
| E601         | E601.0  | Homing warning   | No. 3      | Yes        | Warning     | 0x0601             | 0x06010601        |
|              | E601.1  | Homing switch error                                    | No. 3      | Yes        | Warning     | 0x0601             | 0x16010601        |
|              | E601.2  | Homing method setting error                            | No. 3      | Yes        | Warning     | 0x6320             | 0x2601E602        |
| E730         | E730.0  | Encoder battery warning                                | No. 3      | Yes        | Warning     | 0x7305             | 0x07300730        |
| E900         | E900.0  | Emergency stop   | No. 3      | Yes        | Warning     | 0x0900             | 0x09000900        |
| E902         | E902.0  | DI setting invalid                                     | No. 3      | Yes        | Warning     | 0x6320             | 0x09020902        |
|              | E902.1  | DO setting invalid                                     | No. 3      | Yes        | Warning     | 0x0902             | 0x19020902        |
|              | E902.2  | Invalid setting for torque reach                       | No. 3      | Yes        | Warning     | 0x0902             | 0x29020902        |
| E908         | E908.0  | Model identification failure                           | No. 3      | Yes        | Warning     | 0x0908             | 0x09080908        |
| E909         | E909.0  | Motor overload   | No. 3      | Yes        | Warning     | 0x3230             | 0x09090909        |
| E920         | E920.0  | Regenerative resistor overload                         | No. 3      | Yes        | Warning     | 0x3210             | 0x09200920        |
| E922         | E922.0  | Resistance of external regenerative resistor too small | No. 3      | Yes        | Warning     | 0x6320             | 0x09220922        |
| E924         | E924.0  | Regenerative transistor over-temperature               | No. 3      | Yes        | Warning     | 0x3230             | 0x09240924        |
| E941         | E941.0  | Parameter modifications activated at next power-on     | No. 3      | Yes        | Warning     | 0x6320             | 0x09410941        |
| E942         | E942.0  | Parameters saved frequently                            | No. 3      | Yes        | Warning     | 0x7600             | 0x09420942        |
| E950         | E950.0  | Forward overtravel                                     | No. 3      | Yes        | Warning     | 0x5443             | 0x09500950        |
| E952         | E952.0  | Reverse overtravel                                     | No. 3      | Yes        | Warning     | 0x5444             | 0x09520952        |
| EA41         | EA41.0  | Torque fluctuation compensation failure                | No. 3      | Yes        | Warning     | 0x0A41             | 0x0A410A41        |
| E902         | E902.3  | Homing method setting error                            | No. 3      | Yes        | Warning     | 0x6320             | 0x4E090E09        |

### 3.3 Solutions to Faults

- E101.0: System parameter error  
Cause:

The total number of parameters changes, which generally occurs after software update.

Values of parameters in groups 2002h and above exceed the limit, which generally occurs after software update.

| Cause  | Confirming Method  | Solution  |
|--|--|---|
| 1. The voltage of the control circuit power supply drops instantaneously.            | 1. Check whether the control circuit (L1C, L2C) is in the process of power-off or instantaneous power failure occurs.  | Restore system parameters to default values (2002-20h (H02-31) = 1) and write parameters again.   |
|  | 2. Measure whether the input voltage of the control circuit cable on the non-drive side is within the following range:<br>220 V servo drive:<br>Effective value: 220 V to 240 V<br>Allowable deviation: -10% to +10% (198 V to 264 V)<br>380 V servo drive:<br>Effective value: 380 V to 440 V<br>Allowable deviation: -10% to +10% (342 V to 484 V) | Enlarge the capacity of the power supply or replace with a power supply of higher capacity. Restore system parameters to default values (2002-20h (H02-31) = 1) and write parameters again. |
| 2. Instantaneous power failure occurs when saving parameters.                        | Check whether instantaneous power failure occurs when saving parameters.   | Power on the servo drive again, restore system parameters to default values (2002-20h (H02-31) = 1) and write parameters again.   |
| 3. The number of write operations within a certain period of time exceeds the limit. | Check whether parameters are updated frequently through the host controller.   | 1. If the servo drive is faulty, replace the servo drive.<br>2. Change the write mode and write parameters again.   |
| 4. The software is updated.  | Check whether the software is updated.   | Reset the servo drive model and the motor model, and restore system parameters to default values (2002-20h (H02-31) = 1).   |
| 5. The servo drive is faulty.  | If the fault persists though parameters are restored to default settings and the servo drive is powered off and on several times, the servo drive is faulty.   | Replace the servo drive.  |

- E101.1: Parameter error in group 2000h/2001h

Cause:

The total number of parameters changes, which generally occurs after software update.

Values of parameters in groups 2000 or 2001 exceed the limit, which generally occurs after software update.

| Cause  | Confirming Method  | Solution   |
|--|--|--|
| 1. Instantaneous power failure occurs when saving parameters.                      | Check whether instantaneous power failure occurs when saving parameters.   | Set the servo drive model (2001-0Bh (H01-10)) to a wrong value first and perform a power cycle, and then set the servo drive model to the correct value and perform a power cycle. |
| 2. Instantaneous power failure occurs during writing serial-type motor parameters. | Check whether instantaneous power failure occurs during writing serial-type motor parameters.  | Write the serial-type motor parameters again using the software tool.  |
| 3. The software is updated.  | Check whether the software is updated.   | Set the servo drive model (2001-0Bh (H01-10)) to a wrong value first and perform a power cycle, and then set the servo drive model to the correct value and perform a power cycle. |
| 4. The servo drive is faulty.  | If the fault persists even though the servo drive is powered off and on several times and steps 1 and 2 are executed repeatedly, it indicates the servo drive is faulty. | Replace the servo drive.   |

- E101.2: Address error in read/write after total number of parameters changes

| Cause  | Confirming Method   | Solution                  |
|--|---|---------------------------|
| The total number of parameters changes after software update, leading to address error in read/write operations. | Check whether the parameter access address exceeds the limit. | Restore default settings. |

- E102.0: Logic configuration fault

Cause:

The FPGA- or MCU-related hardware is damaged, leading to communication failure between MCU and FPGA.

| Cause  | Confirming Method   | Solution   |
|--|---|--|
| 1. The FPGA is faulty.<br>2. The communication between MCU and FPGA fails. | The fault persists after the servo drive is powered off and on several times. | Check whether FPGA has been upgraded. If yes, make sure FPGA is programmed successfully.<br>Replace the servo drive. |

- E102.8: Software version mismatch

Cause:

The software version of MCU or FPGA is wrong.

| Cause   | Confirming Method   | Solution  |
|---|---|---|
| The software version of MCU or FPGA is wrong. | 1. Check whether the MCU version (H01-00) is 9xx.x (the fourth digit displayed on the keypad is 9).<br>2. Check whether the FPGA version (H01-01) is 9xx.x (the fourth digit displayed on the keypad is 9). | Contact Inovance for technical support. Update the FPGA or MCU software to make them match. |

- E104.1: MCU operation timeout

Cause:

The access to MCU times out.

| Cause   | Confirming Method   | Solution                 |
|---|---|--------------------------|
| 1. The FPGA is faulty.<br>2. The communication handshake between FPGA and HOST is abnormal.<br>3. Access timeout occurs between HOST and the coprocessor. | The fault persists after the servo drive is powered off and on several times. | Replace the servo drive. |

- E104.2: Current loop operation timeout

Cause:

The MCU torque interrupt scheduling time is detected to be abnormal. This fault is reported only in the commissioning stage.

| Cause   | Confirming Method   | Solution                 |
|---|---|--------------------------|
| The time interval of MCU torque interrupt scheduling is abnormal. | The fault persists after the servo drive is powered off and on several times. | Replace the servo drive. |

- E104.4: Command update timeout

Take the moment of entering the interrupt as the starting time, if the time when commands are written to MCU is larger than the time when position and speed regulators are started by FPGA, a warning will be reported.

| Cause   | Confirming Method   | Solution  |
|---|---|---|
| The system reports that the encoder communication time is set improperly or the command calculation time is too long. | The fault persists after the servo drive is powered off and on several times. | 1. Hide unnecessary functions.<br>2. Replace the servo drive. |

- E108.0: Parameter write error

Cause:

Parameter values cannot be written to EEPROM.

| Cause                                    | Confirming Method   | Solution  |
|--|---|---|
| An error occurs when writing parameters. | Modify a certain parameter, power off and on the servo drive again and check whether the modification is saved. | If the modification is not saved and the fault persists after the servo drive is powered off and on several times, replace the servo drive. |

- E108.1: Parameter read error

Cause:

Parameter values cannot be read in EEPROM.

| Cause                                    | Confirming Method   | Solution  |
|--|---|---|
| An error occurs when reading parameters. | Modify a certain parameter, power off and on the servo drive again and check whether the modification is saved. | If the modification is not saved and the fault persists after the servo drive is powered off and on several times, replace the servo drive. |

- E108.2: Invalid check on data written in EEPROM

Cause:

The check on the data written in EEPROM fails.

| Cause  | Confirming Method   | Solution  |
|--|---|---|
| The check on the data written in EEPROM fails. | Modify a certain parameter, power off and on the servo drive again and check whether the modification is saved. | If the modification is not saved and the fault persists after the servo drive is powered off and on several times, replace the servo drive. |

- E108.3: Invalid check on data read in EEPROM

Cause:



The check on the data read in EEPROM fails.

| Cause                                       | Confirming Method   | Solution  |
|---|---|---|
| The check on the data read in EEPROM fails. | Modify a certain parameter, power off and on the servo drive again and check whether the modification is saved. | If the modification is not saved and the fault persists after the servo drive is powered off and on several times, replace the servo drive. |

- E120.0: Unknown encoder type

Cause:

The servo drive detects the encoder type during initialization upon power-on. If the encoder type does not comply with the requirement, E120.0 occurs.

| Cause   | Confirming Method                                  | Solution             |
|---|--|----------------------|
| 1. The encoder model does not match.                    | Check whether the encoder model is correct.        | Replace the encoder. |
| 2. An ISMH1 series motor and a 20-bit encoder are used. | Check whether H00-00 (Motor code) is set properly. | Set H00-00 to 14000. |

- E120.1: Unknown motor model

Cause:

The servo drive detects the motor model defined by H00-00 during initialization upon power-on. If the motor model does not exist, E120.1 occurs.

| Cause                              | Confirming Method                                  | Solution             |
|------------------------------------|--|----------------------|
| The motor model is set improperly. | Check whether H00-00 (Motor code) is set properly. | Set H00-00 properly. |

- E120.2: Unknown drive model

Cause:

The servo drive detects the servo drive model defined by H01-10 during initialization upon power-on. If the servo drive model does not exist, E120.2 occurs.

| Cause                                    | Confirming Method   | Solution             |
|--|---|----------------------|
| The servo drive model is set improperly. | Check whether H01-10 (Servo drive model) is set properly. | Set H01-10 properly. |

- E120.5: Motor and drive current mismatch

Cause:

The rated output of the servo drive is far higher than the rated current of the motor. Replace with a servo drive of lower rated output or a motor with higher rated current.

| Cause                                   | Confirming Method  | Solution                 |
|---|--|--------------------------|
| The internal scaling value is abnormal. | Check whether the servo drive model is correct. If the set current sampling coefficient is too large, calculation overflow will occur. | Replace the servo drive. |

- E120.6: FPGA and motor model mismatch

Cause:

- The motor model is set improperly, causing mismatch and malfunction of the servo drive.
- The motor model is set properly, but the motor encoder is not supported by the servo drive.

| Cause                                       | Confirming Method  | Solution                                 |
|---|--|--|
| The motor encoder is not supported by FPGA. | Check whether the motor encoder is supported by the FPGA version (H01-01). | Update the program or replace the motor. |

- E122.0: Multi-turn absolute encoder setting error

Cause:

The motor does not match in the absolute position mode or the motor code is set improperly.

| Cause  | Confirming Method   | Solution   |
|--|---|--|
| The motor does not match in the absolute position mode or the motor code is set incorrectly. | <ol style="list-style-type: none"> <li>1. Check the motor nameplate to see whether the motor is configured with a multi-turn absolute encoder.</li> <li>2. Check whether the motor code is set correctly in 2000-01h (H00-00).</li> </ol> | Reset 2000-01h (H00-00) according to the motor nameplate or replace with a matching motor. |

- E122.1: Different DIs assigned with the same function

Cause:

The same function is assigned to different DIs.

The DI function No. exceeds the maximum setting number allowed for DI functions.

| Cause  | Confirming Method   | Solution   |
|--|---|--|
| 1. Different DIs are assigned with the same function.      | View 2003-03h (H03-02)/2003-05h (H03-04)...2003-15h (H03-20) and 2017-01h (H17-00)/2017-03h (H17-02)...2017-1Fh(H17-30) to check whether they are assigned with the same DI function No.. | Assign different DI functions to parameters that have been assigned with the same DI function in groups 2003h and 2017h. To enable such assignments, restart the control circuit power supply or switch off the S-ON signal and send a "RESET" signal. |
| 2. The DI function No. exceeds the number of DI functions. | Check whether the MCU program is updated.   | Restore system parameters to default values (2002-20h (H02-31) = 1) and power on the servo drive again.  |

- E122.2: Different DOs assigned with the same function

| Cause  | Confirming Method  | Solution                         |
|--|--|----------------------------------|
| The DO function No. exceeds the maximum setting number allowed for DO functions. | Check whether DO function numbers defined by 2004-01h (H04-00), 2004-03h (H04-02), and 2004-05h (H04-04) are improper. | Set the correct DO function No.. |

- E122.3: Upper limit in the rotation mode invalid  
Cause:

The upper limit (reference range) of the mechanical single-turn position exceeds  $2^{31}$  in the absolute position rotation mode.

| Cause   | Confirming Method   | Solution  |
|---|---|---|
| The upper limit of the mechanical single-turn position exceeds $2^{31}$ in the absolute position rotation mode. | Check the set mechanical gear ratio, upper limit of the mechanical single-turn position and electronic gear ratio in the absolute position rotation mode (H02-01 (2002-02h) = 2). | Reset the mechanical gear ratio, the upper limit of mechanical single-turn position and the electronic gear ratio to ensure the upper limit of the mechanical single-turn position (reference range) does not exceed $2^{31}$ . |

- E136.0: Encoder parameter error  
Cause:

When the servo drive reads parameters in the encoder ROM, no parameters are saved there or parameter values are inconsistent with the parameter setpoints.

| Cause  | Confirming Method  | Solution  |
|--|--|---|
| 1. The motor model does not match the servo drive model.   | View the servo drive and servo motor nameplates to check whether they are Inovance SV660N series servo drive and servo motor.  | Replace with the mutually-matching servo drive and servo motor.   |
| 2. A parameter check error occurs or no parameter is saved in the ROM of the serial incremental encoder. | <ol style="list-style-type: none"> <li>1. Check whether the encoder cable provided by Inovance is used. For cable specifications, see SV660N Series Servo Drive Selection Guide. The cable must be connected securely without scratching, breaking or poor contact.</li> <li>2. Measure signals PS+, PS-, +5V and GND on both ends of the encoder cable and observe whether signals at both ends are consistent. For signal assignment, see Chapter "Wiring" in SV660N Series Servo Drive Hardware Guide.</li> </ol> | <ol style="list-style-type: none"> <li>1. Use the encoder cable provided by Inovance. Ensure motor terminals and servo drive screws are connected securely. Use a new encoder cable if necessary.</li> <li>2. Route encoder cables and power cables (R/S/T, U/V/W) through different routes.</li> </ol> |
| 3. The servo drive is faulty.  | The fault persists after the servo drive is restarted.   | Replace the servo drive.  |

- E136.1: Encoder communication error

Cause:

- The encoder cable is disconnected.
- A communication error occurs on the encoder due to interference.

| Cause   | Confirming Method                                       | Solution  |
|---|---|---|
| A fault occurs on the communication between FPGA and the encoder during initialization upon power-on. | Observe the value of H0B-28 to see whether it is not 0. | <ol style="list-style-type: none"> <li>1. Check whether encoder cables are connected properly.</li> <li>2. Check whether the motor model is set properly.</li> <li>3. Check whether H01-00 (MCU software version) and H01-01 (FPGA software version) are set properly.</li> </ol> |

- E140.1: Encryption chip check failure

| Cause  | Confirming Method   | Solution   |
|--|---|--|
| The key of the encryption chip is incorrect, causing failure in decrypting the Renesas chip. | <ol style="list-style-type: none"> <li>1. Check the software version. Check whether the encryption program is programmed in the servo drive.</li> <li>2. Check whether the encryption chip works properly.</li> </ol> | Power off and on the servo drive again, if the fault persists, contact Inovance for maintenance. |

- E150.0: STO signal input protection

Cause:

The STO input protection applies (safety state).

| Cause                       | Confirming Method   | Solution   |
|-----------------------------|---|--|
| The STO function is active. | 1. Check whether the STO function is activated.             | There is no need to take any corrective actions. After the STO terminal is back to normal, clear the fault using the fault reset function. |
|                             | 2. Check whether the STO power supply is normal.            | Check whether the 24 V power supply for the STO is stable. Tighten the cables that are loose or disconnected.                              |
|                             | 3. The fault persists after preceding causes are rectified. | Replace the servo drive.   |

- E150.1: STO signal input error

Cause:

The single-channel input of STO is invalid.

| Cause                                  | Confirming Method  | Solution  |
|--|--|---|
| 1. The STO power supply is abnormal.   | Check whether the STO power supply is normal.  | Check whether the 24 V power supply for the STO is stable. Tighten the cables that are loose or disconnected. |
| 2. The STO input resistor is abnormal. | After STO is triggered, only one STO signal is sent to MCU after the 24 V power supply is cut off due to input resistor drift. | Replace the servo drive.  |
| 3: The STO function fails.             | The fault persists after preceding causes are rectified.   | Replace the servo drive.  |

- E150.2: Buffer 5 V supply voltage error

Cause:

The MCU monitors the 5 V power supply of the PWM Buffer to detect whether overvoltage or undervoltage occurs. If the voltage is abnormal, E150.2 occurs.

| Cause   | Confirming Method           | Solution                 |
|---|-----------------------------|--------------------------|
| The 5 V power supply of the Buffer is abnormal. | Check the 5 V power supply. | Replace the servo drive. |

- E150.3: STO upstream optocoupler detection failure

Cause:

Short circuit occurs on the optocoupler of the upstream hardware circuit of STO.

| Cause   | Confirming Method  | Solution                 |
|---|--|--------------------------|
| Short circuit occurs on the upstream optocoupler of STO1 or STO2. | Switch off the 24 V power supply and power on the servo drive again, E150.0 is not reported. | Replace the servo drive. |

- E150.4: PWM Buffer detection failure

Cause:

An error occurs on the PWM Buffer integrated circuit during initialization detection upon power-on (the PWM signal cannot be blocked).

| Cause                                    | Confirming Method  | Solution                 |
|--|--|--------------------------|
| The Buffer fails to block the PWM waves. | This fault persists after the servo drive is powered off and on several times. | Replace the servo drive. |

- E201.0: Phase-P overcurrent

Cause:

An excessively high current flows through the positive pole of the DC-AC circuit.

| Cause   | Confirming Method   | Solution   |
|---|---|--|
| <p>1. Gains are set improperly, leading to motor oscillation.</p>       | <p>Check whether vibration or sharp noise occurs during start and operation of the motor, or view "Current feedback" in the software tool.</p>  | <ol style="list-style-type: none"> <li>1. Motor parameters are set improperly, modify motor parameter values.</li> <li>2. Current loop parameters are set improperly, modify current loop parameter values.</li> <li>3. Speed loop parameters are set improperly, leading to motor oscillation.</li> <li>4. If the servo drive operates improperly, replace it.</li> </ol> |
| <p>2. The encoder is wired improperly, aging, or connected loosely.</p> | <p>Check whether the encoder cable provided by Inovance is used and whether the cable is aging, corroded, or connected loosely.</p>   | <p>Re-solder, tighten or replace the encoder cable.</p>  |
| <p>3. The servo drive is faulty.</p>                                    | <ol style="list-style-type: none"> <li>1. Switch off the S-ON signal, rotate the motor shaft manually, and check whether the value of 200B-12h (H0B-17) changes as the motor shaft rotates.</li> <li>2. Disconnect the motor cable but the fault persists after the servo drive is powered off and on again.</li> <li>3. Check whether resistance of the external regenerative resistor is too small or the regenerative resistor is short-circuited (between terminals P⊕ and C).</li> </ol> | <ol style="list-style-type: none"> <li>1. Replace with a regenerative resistor with matching resistance and model and perform wiring again.</li> <li>2. Replace the servo drive.</li> </ol>  |

- E201.1: Phase-U overcurrent Cause:

A current higher than the threshold is collected in the phase-U current.

| Cause  | Confirming Method   | Solution  |
|--|---|---|
| <ol style="list-style-type: none"> <li>1. Motor cables are in poor contact.</li> <li>2. Motor cables are grounded.</li> <li>3. U/V/W cables of the motor are short-circuited.</li> </ol> | <ol style="list-style-type: none"> <li>1. Check whether the servo drive power cables and motor cables on the U, V, and W side of the servo drive are loose.</li> <li>2. After confirming the servo drive power cables and motor cables are connected properly, measure whether the insulation resistance between the servo drive U/V/W side and the PE cable is at MΩ level.</li> </ol> | <ol style="list-style-type: none"> <li>1. Tighten the cables that are loose or disconnected.</li> <li>2. Replace the motor in case of poor insulation.</li> </ol> |
| <ol style="list-style-type: none"> <li>4. The motor is damaged due to over-temperature.</li> </ol>   | <ol style="list-style-type: none"> <li>1. Disconnect motor cables and check whether short circuit occurs among motor U/V/W cables and whether burrs exist in the wiring.</li> <li>2. Disconnect the motor cables and measure whether the resistance among U, V, and W phases of motor cables is balanced.</li> </ol>  | <ol style="list-style-type: none"> <li>1. Connect the motor cables correctly.</li> <li>2. Replace the motor if the resistance is unbalanced.</li> </ol>           |

- E201.2: Phase-V overcurrent

Cause:

A current higher than the threshold is collected in the phase-V current.



| Cause   | Confirming Method   | Solution  |
|---|---|---|
| <ol style="list-style-type: none"> <li>Motor cables are in poor contact.</li> <li>Motor cables are grounded.</li> <li>U/V/W cables of the motor are short-circuited.</li> </ol> | <ol style="list-style-type: none"> <li>Check whether the servo drive power cables and motor cables on the U, V, and W side of the servo drive are loose.</li> <li>After confirming the servo drive power cables and motor cables are connected properly, measure whether the insulation resistance between the servo drive U/V/W side and the PE cable is at MΩ level.</li> </ol> | <ol style="list-style-type: none"> <li>Tighten the cables that are loose or disconnected.</li> <li>Replace the motor in case of poor insulation.</li> </ol> |
| <ol style="list-style-type: none"> <li>The motor is damaged due to over-temperature.</li> </ol>   | <ol style="list-style-type: none"> <li>Disconnect the motor cables and check whether short circuit occurs among U, V, and W phases and whether burrs exist in the wiring.</li> <li>Disconnect the motor cables and measure whether the resistance among U, V, and W phases of motor cables is balanced.</li> </ol>  | <ol style="list-style-type: none"> <li>Connect the motor cables correctly.</li> <li>Replace the motor if the resistance is unbalanced.</li> </ol>           |

● E201.4: Phase-N overcurrent

Cause:

An excessively high current flows through the negative pole of the DC-AC circuit.

| Cause   | Confirming Method  | Solution  |
|---|--|---|
| <ol style="list-style-type: none"> <li>Gains are set improperly, leading to motor oscillation.</li> </ol>       | <p>Check whether vibration or sharp noise occurs during start and operation of the motor, or view "Current feedback" in the software tool.</p> | <p>Adjust the gains.</p>                                |
| <ol style="list-style-type: none"> <li>The encoder is wired improperly, aging, or connected loosely.</li> </ol> | <p>Check whether the encoder cable provided by Inovance is used and whether the cable is aging, corroded, or connected loosely.</p>            | <p>Re-solder, tighten or replace the encoder cable.</p> |

| Cause   | Confirming Method   | Solution  |
|---|---|---|
| 3. Overcurrent occurs on the regenerative resistor. | Check whether resistance of the external regenerative resistor is too small or the regenerative resistor is short-circuited (between terminals P⊕ and C).   | Replace with a regenerative resistor of matching resistance and model.<br>Perform wiring again. |
| 4. The servo drive is faulty.                       | Switch off the S-ON signal, rotate the motor shaft manually, and check whether the value of 200B-12h (H0B-17) changes as the motor shaft rotates. Disconnect the motor cable and power on the servo drive again, but the fault persist. | Replace the servo drive.  |

- E208.0: MCU position reference updated frequently  
Cause: Locate the fault cause through the internal fault code (200B-2Eh).

| Cause                            | Confirming Method  | Solution                 |
|----------------------------------|--|--------------------------|
| 1. MCU communication times out.  | Internal fault code 200B-2Eh (H0B-45) = 1208:<br>The internal integrated circuit is damaged. | Replace the servo drive. |
| 2. The FPGA operation times out. | Internal fault code 200B-2Eh (H0B-45) = 0208:<br>Figure out the cause based on cause 1.      |                          |

- E208.2: Encoder communication timeout  
Cause:  
The servo drive fails to receive the data fed back by the encoder in three consecutive cycles.

| Cause  | Confirming Method   | Solution  |
|--|---|---|
| The servo drive fails to receive the data fed back by the encoder in three consecutive cycles. | <ol style="list-style-type: none"> <li>1. Check bit12 of H0B-30.</li> <li>2. The encoder cable is connected improperly.</li> <li>3. The encoder cable is connected loosely.</li> <li>4. The encoder cable is too long.</li> <li>5. The encoder communication suffers from interference.</li> <li>6. The encoder is faulty.</li> </ol> | <ol style="list-style-type: none"> <li>1. Check whether the motor model is correct.</li> <li>2. Check whether the encoder cable is proper.</li> <li>3. Check whether the encoder version (H00-04) is set properly.</li> <li>4. If servo drive operates improperly, replace it.</li> </ol> |

- E208.3: Current sampling fault

Cause:

Phase-U and phase-V current sampling is abnormal.

| Cause   | Confirming Method  | Solution   |
|---|--|--|
| Phase-U and phase-V current sampling is abnormal. | <ol style="list-style-type: none"> <li>1. Check whether ambient devices are generating disturbance and whether multiple disturbance sources such as variable-frequency devices are inside the cabinet.</li> <li>2. The internal current sampling integrated circuit is damaged.</li> </ol> | <ol style="list-style-type: none"> <li>1. Check whether the servo drive and motor are grounded and shielded properly.</li> <li>2. Install magnetic ring on the motor power cables and encoder cable.</li> <li>3. Replace the servo drive.</li> </ol> |

- E208.4: FPGA current loop operation timeout

Cause:

The operating time of the current loop exceeds the interval threshold.

| Cause                         | Confirming Method  | Solution   |
|-------------------------------|--|--|
| The FPGA operation times out. | Internal fault code 200B-2Eh (H0B-45) = 4208: Current loop operation timeout | Disable some unnecessary functions to reduce the operating load of the current loop. |

- E210.0: Output short-circuited to ground

Cause:

An abnormal motor phase current or bus voltage is detected during auto-inspection upon power-on.

| Cause  | Confirming Method  | Solution  |
|--|--|---|
| 1. The servo drive power cables (U/V/W) are short-circuited to ground. | Disconnect the motor cables and measure whether the servo drive power cables (U/V/W) are short-circuited to ground (PE).   | Re-connect or replace the servo drive power cables. |
| 2. The motor is short-circuited to ground.                             | After confirming the servo drive power cables and motor cables are connected properly, measure whether the insulation resistance between the servo drive U/V/W side and the PE cable is at MΩ level. | Replace the motor.                                  |
| 3. The servo drive is faulty.  | Disconnect the power cables from the servo drive, but the fault persists after the servo drive is powered off and on several times.  | Replace the servo drive.                            |

- E234.0: Runaway Protection

Cause:

The torque reference direction is opposite to the speed feedback direction in the torque control mode.

The speed feedback direction is opposite to the speed reference direction in the position or speed control mode.

| Cause   | Confirming Method  | Solution   |
|---|--|--|
| 1. The U/V/W cables are connected in the wrong phase sequence.  | Check whether the U/V/W phase sequence on the drive side is consistent with that on the motor side.  | Connect the U/V/W cables in the correct phase sequence.  |
| 2. An error occurs on the initial phase detection of the motor rotor due to disturbing signals upon power-on. | The U/V/W phase sequence is correct. But E234.0 occurs when the servo drive is enabled.  | Power off and on the servo drive again.  |
| 3. The encoder model is wrong or the wiring is incorrect.   | View the servo drive and servo motor nameplates to check whether they are Inovance SV660N series servo drive and servo motor equipped with a 20-bit encoder. | Replace with the mutually-matching servo drive and servo motor. If you use Inovance SV660N series servo drive and servo motor equipped with a 20-bit encoder, ensure 2000-01h (H00-00) is set to 14000. Check the motor model, encoder type, and encoder cable connection again. |

| Cause  | Confirming Method   | Solution  |
|--|---|---|
| 4. The encoder is wired improperly, aging, or connected loosely. | <ol style="list-style-type: none"> <li>1. Check whether the encoder cable provided by Inovance is used and whether the cable is aging, corroded, or connected loosely.</li> <li>2. Switch off the S-ON signal, rotate the motor shaft manually, and check whether the value of 200B-0Bh (H0B-10) changes as the motor shaft rotates.</li> </ol> | Re-solder, tighten or replace the encoder cable.  |
| 5. The gravity load in vertical axis applications is too large.  | Check whether the load of the vertical axis is too large. Adjust brake parameters 2002-0Ah (H02-09)...2002-0Dh (H02-12) to check whether the fault can be cleared.  | Reduce the load of the vertical axis, increase the stiffness level, or hide this fault without affecting the safety performance and normal use. |
| 6. Improper parameter settings lead to excessive vibration.      | The stiffness level is set to an excessively high value, leading to excessive vibration.  | Set a proper stiffness level to avoid excessive vibration.  |

- E400.0: Main circuit overvoltage

Cause:

The DC bus voltage between P $\oplus$  and N $\ominus$  exceeds the overvoltage threshold.

220 V servo drive: Normal value: 310 V; Overvoltage threshold: 420 V

380 V servo drive: Normal value: 540 V; Overvoltage threshold: 760 V

| Cause   | Confirming Method   | Solution  |
|---|---|---|
| 1. The voltage input to the main circuit is too high.     | Check the power input specifications of the servo drive and measure whether the voltage input to main circuit cables (R/S/T) on the drive side is within the following range:<br>220 V servo drive:<br>Effective value: 220 V to 240 V<br>Allowable deviation: -10% to +10% (198 V to 264 V)<br>380 V servo drive:<br>Effective value: 380 V to 440 V<br>Allowable deviation: -10% to +10% (342 V to 484 V) | Replace or adjust the power supply according to the specified range.  |
| 2. The power supply is unstable or affected by lightning. | Check whether the power supply is unstable, affected by lightning, or complies with the preceding range.  | Connect a surge protection device and then switch on the main circuit and control circuit power supplies again. If the fault persists, replace the servo drive. |

| Cause                                      | Confirming Method  | Solution   |
|--|--|--|
| <p>3. The regenerative resistor fails.</p> | <p>If the built-in regenerative resistor is used (2002-1Ah (H02-25) = 0), check whether P⊕ and D are jumpered properly. If yes, measure the resistance between terminals C and D. If an external regenerative resistor is used (2002-1Ah (H02-25) = 1 or 2), measure the resistance between P⊕ and C. For details, See section "Specifications of the regenerative resistor" in SV660P Series Servo Drive Commissioning Guide.</p> | <ol style="list-style-type: none"> <li>1. If the resistance is "∞" (infinite), the regenerative resistor is disconnected internally.</li> <li>2. If the built-in regenerative resistor is used, turn to using an external regenerative resistor (2002-1Ah (H02-25) = 1 or 2) instead of the built-in one, and remove the jumper between P⊕ and D. Note that the external regenerative resistor used must carry the same resistance and equal or higher power than the built-in one.</li> <li>3. If an external regenerative resistor is used, replace with a new one and connect it between P⊕ and C.</li> <li>4. Set 2002-1Bh (H02-26) (Power of external regenerative resistor) and 2002-1Ch (H02-27) (Resistance of external regenerative resistor) properly according to the specifications of the external regenerative resistor used.</li> </ol> |

| Cause  | Confirming Method  | Solution   |
|--|--|--|
| <p>4. The resistance of the external regenerative resistor is too large, resulting in insufficient energy absorption during braking.</p> | <p>Measure the resistance of the external regenerative resistor connected between terminals P⊕ and C, and compare the measured value with the recommended value.</p>   | <p>1. Replace with a new external regenerative resistor that carries the recommended resistance, and connect it between P⊕ and C.<br/>2. Set 2002-1Bh (H02-26) (Power of external regenerative resistor) and 2002-1Ch (H02-27) (Resistance of external regenerative resistor) properly according to the specifications of the external regenerative resistor used.</p> |
| <p>5. The motor is in abrupt acceleration/ deceleration status and the maximum braking energy exceeds the energy absorption value.</p>   | <p>Confirm the acceleration/ deceleration time during operation and measure whether the DC bus voltage between P⊕ and N⊖ exceeds the overvoltage threshold during deceleration.</p>  | <p>After confirming the input voltage of the main circuit is within the specified range, increase the acceleration/deceleration time if the operating conditions allow.</p>  |
| <p>6. The bus voltage sampling value deviates greatly from the measured value.</p>   | <p>Check whether the bus voltage 200B-1Bh (H0B-26) detected is within the following range:<br/>220 V servo drive: 200B-1Bh (H0B-26) &gt; 420 V<br/>380 V servo drive: 200B-1Bh (H0B-26) &gt; 760 V<br/>Measure whether the DC bus voltage detected between P⊕ and N⊖ is close to the value displayed in 200B-1Bh (H0B-26).</p> | <p>Contact Inovance for technical support.</p>   |
| <p>7. The servo drive is faulty.</p>   | <p>The fault persists after the main circuit is powered off and on several times.</p>  | <p>Replace the servo drive.</p>  |

- E410.0: Main circuit undervoltage

Cause:

The DC bus voltage between P⊕ and N⊖ is lower than the undervoltage threshold.

220 V servo drive: Normal value: 310 V; Undervoltage threshold: 200 V (180 V for S5R5 models)

380 V servo drive: Normal value: 540 V; Undervoltage threshold: 380 V



| Cause  | Confirming Method   | Solution  |
|--|---|---|
| 1. The power supply of the main circuit is unstable or power failure occurs.                     | Check the specifications of the power supply. Measure whether the input voltages of the main circuit on the power supply side and the drive side (L1, L2) are within the following range:<br>220 V servo drive:<br>Effective value: 220 V to 240 V<br>Allowable deviation: -10% to +10% (198 V to 264 V)<br>Measure the voltages of all the three phases. | Increase the capacity of the power supply.  |
| 2. Instantaneous power failure occurs.   |   |   |
| 3. The power supply voltage drops during operation.  |   |   |
| 4. A three-phase servo drive is connected to a single-phase power supply, leading to phase loss. | Check whether the main circuit is wired properly and whether the phase loss detection (200A-01h (H0A-00)) is disabled.  | Replace the cables and connect the main circuit cables correctly.<br>Three-phase: R, S, T |
| 5. The servo drive is faulty.  | Check whether the bus voltage 200B-1Bh (H0B-26) detected is within the following range:<br>220 V servo drive: 200B-1Bh (H0B-26) < 200 V<br>380 V servo drive: 200B-1Bh (H0B-26) < 380 V<br>The fault persists after the main circuit (L1, L2) is powered off and on several times.  | Replace the servo drive.  |

- E420.0: Phase loss

Cause:

Phase loss occurs on the three-phase servo drive.

| Cause  | Confirming Method  | Solution  |
|--|--|---|
| 1. The three-phase input cables are connected improperly.                                      | Check whether the cables between the power supply side and R/S/T terminals of the servo drive are connected properly.  | Replace the cables and connect the main circuit cables correctly.   |
| 2. A single-phase power supply is used for a three-phase servo drive.                          | Check the specifications of power supply and measure whether the voltage input to the main circuit is within the following range:<br>220 V servo drive:<br>Effective value:<br>220 V to 240 V<br>Allowable deviation: -10% to +10% (198 V to 264 V)<br>380 V servo drive:<br>Effective value:<br>380 V to 440 V<br>Allowable deviation: -10% to +10% (342 V to 484 V)<br>Measure the voltages of all the three phases. | A three-phase servo drive of 0.75 kW (2001-03h (H01-02) = 5) is allowed to run under a single-phase power supply. If the input voltage is within specified range, set 200A-01h (H0A-00) to 2 (Inhibit phase loss fault and warning). If the input voltage is outside the specified range, replace or adjust the power supply. |
| 3. The three-phase power supply is unbalanced or the voltages of the three phases are too low. |  |   |
| 4. The servo drive is faulty.  | The fault persists after the main circuit (R/S/T) is powered off and on several times.   | Replace the servo drive.  |

- E430.0: Control circuit power supply undervoltage

Cause:

220 V servo drive: Normal value 310 V; Undervoltage threshold 190 V

380 V servo drive: Normal value 540 V; Undervoltage threshold 350 V

| Cause  | Confirming Method  | Solution   |
|--|--|--|
| 1. The control circuit power supply is unstable or power failure occurs. | Check whether the control circuit (L1C, L2C) is in the process of power-off or instantaneous power failure occurs.   | Power off and on the servo drive again. If unexpected power failure occurs, ensure the power supply is stable. |
|  | Check whether the input voltage of the control circuit cables on the drive side is within the following range:<br>220 V servo drive:<br>Effective value: 220 V to 240 V<br>Allowable deviation: -10% to +10% (198 V to 264 V)<br>380 V servo drive:<br>Effective value: 380 V to 440 V<br>Allowable deviation: -10% to +10% (342 V to 484 V) | Increase the power supply capacity.  |
| 2. The control circuit cables are in poor contact.                       | Check whether control cables are well connected and whether the voltage of control circuit cables (L1C, L2C) is within the specified range.  | Re-connect or replace the cables.  |

- E500.0: Motor overspeed

Cause: The actual speed of the motor exceeds the overspeed threshold.

| Cause   | Confirming Method  | Solution  |
|---|--|---|
| 1. The U/V/W phase sequence of motor cables is wrong. | Check whether U/V/W phase sequence on the drive side is consistent with that on the motor side.  | Connect the U/V/W cables in the correct phase sequence.                 |
| 2. Parameter 200A-09h (H0A-08) is set improperly.     | Check whether the overspeed threshold is lower than the maximum speed needed:<br>Overspeed threshold = 1.2 x Maximum motor speed (when 200A-09h (H0A-08) = 0).<br>Overspeed threshold = H0A-08 (when H0A-08 ≠ 0, and H0A-08 < 1.2 x Maximum motor speed) | Reset the overspeed threshold according to the mechanical requirements. |

| Cause  | Confirming Method  | Solution  |
|--|--|---|
| <p>3. The input reference exceeds the overspeed threshold.</p> | <p>Check whether the motor speed corresponding to the input reference exceeds the overspeed threshold.</p> <ul style="list-style-type: none"> <li>• Position control mode: In CSP mode, view the gear ratio 6091-01h/6091-02h to determine the position reference increment for an individual synchronization cycle and convert it to the speed information. In PP mode, view the gear ratio 6091-01h/6091-02h and determine the value of 6081h (Profile velocity). In HM mode, view the gear ratio 6091-01h/6091-02h and determine the value of 6099-01h and 6099-02h.</li> <li>• Speed control mode: View the values of 6091h (Gear ratio), 60FFh (Target velocity), H06-06...H06-09, and 607Fh (Max. profile velocity).</li> <li>• Torque control mode: View the speed limits defined by H07-19 and H07-20 and check the corresponding speed limits.</li> </ul> | <ul style="list-style-type: none"> <li>• Position control mode: In CSP mode, decrease the position reference increment for an individual synchronization cycle. The host controller should handle the position ramp when generating references. In PP mode, decrease the value of 6081h or increase the acceleration/deceleration ramp (6083h, 6084h). In HM mode, decrease the values of 6099-01h and 6099-02h or increase the acceleration/deceleration ramp (609Ah). Decrease the gear ratio according to actual conditions.</li> <li>• Speed control mode: Decrease the target speed, speed limit, and gear ratio. In PV mode, increase the speed ramp (6083h, 6084h). In CSV mode, the host controller should handle the speed ramp.</li> <li>• Torque control mode: Set the speed limit to a value lower than the overspeed threshold.</li> </ul> |
| <p>4. The motor speed overshoots.</p>                          | <p>Check in the software tool whether the speed feedback exceeds the overspeed threshold.</p>  | <p>Adjust the gains or mechanical operating conditions.</p>   |
| <p>5. The servo drive is faulty.</p>                           | <p>The fault persists after the servo drive is powered off and on again.</p>   | <p>Replace the servo drive.</p>   |

- E500.1: Speed feedback overflow

Cause:

The FPGA speed measurement overflows.

| Cause                                   | Confirming Method                  | Solution   |
|---|------------------------------------|--|
| The FPGA speed measurement is abnormal. | Check whether bit9 of H0B-30 is 1. | <ol style="list-style-type: none"> <li>1. The speed feedback is abnormal, check whether the encoder version (H00-04) is proper.</li> <li>2. The encoder cable is abnormal, replace the encoder cable.</li> <li>3. The encoder cable is being disturbed. Re-connect the grounding cable and the shielded cable or install a magnetic ring.</li> </ol> |

- E500.2: FPGA position feedback pulse overspeed

| Cause   | Confirming Method  | Solution  |
|---|--|---|
| The MCU detects excessive pulse increment fed back by FPGA. | <ol style="list-style-type: none"> <li>1. Check whether the value of H0B-17 changes abruptly.</li> <li>2. Check whether the communication between the servo drive and the encoder is being disturbed.</li> </ol> | Modify the value of H0A-70 (Overspeed threshold). The default value of H0A-70 is 0. Take the maximum speed of the motor as the threshold for excessive pulse increment. |

- E602.0: Angle auto-tuning error  
Cause:

Unusual jitter occurs on the encoder feedback during angle auto-tuning.

| Cause   | Confirming Method                                      | Solution                         |
|---|--|----------------------------------|
| The data fed back by the encoder is abnormal. | Check if the encoder communication is being disturbed. | Check the wiring of the encoder. |

- E602.2: Wrong U/V/W phase sequence detected in angle auto-tuning  
Cause:

A wrong U/V/W phase sequence is detected in angle auto-tuning.

| Cause   | Confirming Method                               | Solution   |
|---|---|--|
| U/V/W cables are connected reversely, which is detected during angle auto-tuning. | Check whether U/V/W phases are wired correctly. | Exchange cables of any two phases among U/V/W and perform auto-tuning again. |

- E605.0: Motor speed too high upon S-ON

Cause:

The motor speed exceeds the rated speed when the servo drive in size A/B is switched on.

| Cause  | Confirming Method   | Solution  |
|--|---|---|
| The motor speed exceeds the rated speed when the servo drive is switched on. | Check whether the motor is in the power generating state when the servo drive is switched on. | Reduce the motor speed before switching on the servo drive. |

- E620.0: Motor overload

Cause:

The accumulative heat of the motor reaches the fault threshold.

| Cause  | Confirming Method  | Solution   |
|--|--|--|
| 1. The motor and encoder cables are connected improperly or in poor contact.                               | Check the wiring among the servo drive, motor and encoder according to the correct wiring diagram.   | Connect cables according to the correct wiring diagram. It is recommended to use the cables provided by Inovance. When customized cables are used, prepare and connect the customized cables according to the wiring instructions. |
| 2. The load is so heavy that the effective torque outputted by the motor keeps exceeding the rated torque. | Confirm the overload characteristics of the servo drive or motor. Check whether the average load rate (200B-0DH (H0B-12)) of the servo drive keeps exceeding 100.0%.                                     | Replace with a servo drive of higher capacity and a matching servo motor. Reduce the load and increase the acceleration/ deceleration time.  |
| 3. Acceleration/deceleration is too frequent or the load inertia is too large.                             | Calculate the mechanical inertia ratio or perform inertia auto-tuning, and view the inertia ratio in 2008-10h (H08-00). Confirm the individual operation cycle when the servo motor operates cyclically. | Increase the acceleration/ deceleration time in an individual operation cycle.   |
| 4. The gains are improper or the stiffness level is too high.  | Check whether the motor vibrates and generates unusual noise during operation.   | Adjust the gains again.  |

| Cause  | Confirming Method  | Solution  |
|--|--|---|
| 5. The model of the servo drive or motor is set incorrectly.                               | View the servo drive model (2001-0Bh (H01-10)) and motor model (2000-06h (H0D-05)) saved in the serial encoder.  | Read the servo drive nameplate and set the servo drive model (2001-0Bh (H01-10)) and motor model properly according to section "Servo Drive Model and Nameplate" in SV660N Series Servo Drive Hardware Guide. |
| 6. The motor is stalled due to mechanical factors, resulting in overload during operation. | <p>Check the reference and the motor speed (200B-01h (H0B-00)) through the software tool or keypad.</p> <ul style="list-style-type: none"> <li>● References in the position control mode: 200B-0Eh (H0B-13) (Input position reference counter)</li> <li>● References in the speed control mode: 200B-02h (H0B-01) (Speed reference)</li> <li>● References in the torque control mode: 200B-03h (H0B-02) (Internal torque reference)</li> </ul> <p>Check whether the reference value is not 0 but the motor speed is 0 RPM in the corresponding mode.</p> | Eliminate the mechanical factors.   |
| 7. The servo drive is faulty.  | The fault persists after the servo drive is powered off and on again.  | Replace the servo drive.  |

## Note

When this fault occurs, stop for at least 30s before further operations.

- E630.0: Motor stalled  
Cause:

The actual motor speed is lower than 10 RPM but the torque reference reaches the limit, and such status persists for the time defined by 200A-21h (H0A-32).

| Cause  | Confirming Method  | Solution   |
|--|--|--|
| 1. U/V/W output phase loss or incorrect phase sequence occurs on the servo drive.  | Perform motor trial run without load and check cable connections and the phase sequence.   | Connect cables again according to the correct wiring diagram or replace the cables.                      |
| 2. The motor parameters (especially the number of pole pairs) are set improperly and motor angle auto-tuning is not performed. | Read parameters in group H00 to check whether the number of pole pairs are set properly.<br>Perform several angle auto-tunings on the motor and check whether the value of H00-28 is consistent upon each angle auto-tuning.   | Modify the motor parameter values.   |
| 3. The communication commands are being disturbed.   | Check whether jitter occurs on the commands sent from the host controller and whether EtherCAT communication is being disturbed.   | Check whether the communication line between the host controller and the servo drive is being disturbed. |
| 4. The motor is stalled due to mechanical factors.   | Check the reference and the motor speed (H0B-00) through the software tool or keypad.<br><ul style="list-style-type: none"> <li>• References in the position control mode: H0B-13 (Input position reference counter)</li> <li>• References in the speed control mode: H0B-01 (Speed reference)</li> <li>• References in the torque control mode: H0B-02 (Internal torque reference)</li> </ul> Check whether the reference value is not 0 but the motor speed is 0 RPM in the corresponding mode.<br>Check the current feedback (torque reference) waveform. | Check whether any mechanical part gets stuck or eccentric.   |

## Note

When this fault occurs, stop for at least 30s before further operations.

- E640.0: IGBT over-temperature



Cause: The IGBT temperature reaches the fault threshold defined by H0A-18.

| Cause  | Confirming Method   | Solution   |
|--|---|--|
| <p>1. The ambient temperature is too high.</p> <p>2. The servo drive is restarted several times to reset the overload fault.</p> | <p>Measure the ambient temperature, view the fault records (set 200B-22h (H0B-33) and 200B-23h (H0B-34)) to check whether an overload fault or warning (E620, E630, E650, E909, E920, E922) occurs.</p> | <ul style="list-style-type: none"> <li>• Improve the cooling conditions of the servo drive to lower down the ambient temperature.</li> <li>• Change the fault reset method. After overload occurs, wait for 30s before reset. Increase the capacities of the servo drive and servo motor. Increase the acceleration/ deceleration time and reduce the load.</li> </ul> |
| <p>3. The fan is damaged.</p>  | <p>Check whether the fan works properly during operation.</p>   | <p>Replace the servo drive.</p>  |
| <p>4. The servo drive is installed in a wrong direction and the clearance between servo drives is improper.</p>                  | <p>Check whether the servo drive is installed properly.</p>   | <p>Install the servo drive according to the installation requirements.</p>   |
| <p>5. The servo drive is faulty.</p>   | <p>The fault persists even though the servo drive is restarted five minutes after power-off.</p>  | <p>Replace the servo drive.</p>  |

## Note

When this fault occurs, stop for at least 30s before further operations.

- E640.1: Flywheel diode over-temperature

Cause:

The temperature of the flywheel diode reaches the fault threshold defined by H0A-18.

| Cause   | Confirming Method  | Solution   |
|---|--|--|
| 1. The ambient temperature is too high.<br>2. The servo drive is restarted several times to reset the overload fault. | Measure the ambient temperature, view the fault records (set 200B-22h (H0B-33) and 200B-23h (H0B-34)) to check whether an overload fault or warning (E620, E630, E650, E909, E920, E922) occurs. | <ul style="list-style-type: none"> <li>● Improve the cooling conditions of the servo drive to lower down the ambient temperature.</li> <li>● Change the fault reset method. After overload occurs, wait for 30s before reset. Increase the capacities of the servo drive and servo motor. Increase the acceleration/ deceleration time and reduce the load.</li> </ul> |
| 3. The fan is damaged.  | Check whether the fan works properly during operation.   | Replace the servo drive.   |
| 4. The servo drive is installed in a wrong direction and the clearance between servo drives is improper.              | Check whether the servo drive is installed properly.   | Install the servo drive according to the installation requirements.  |
| 5. The servo drive is faulty.   | The fault persists even though the servo drive is restarted five minutes after power-off.  | Replace the servo drive.   |

## Note

When this fault occurs, stop for at least 30s before further operations.

- E650.0: Heatsink over-temperature

Cause:

The temperature of the servo drive power module is higher than the over-temperature threshold.

| Cause  | Confirming Method   | Solution   |
|--|---|--|
| 1. The ambient temperature is too high.  | Measure the ambient temperature.  | Improve the cooling conditions of the servo drive to lower down the ambient temperature.   |
| 2. The servo drive is restarted several times to reset the overload fault.                               | View the fault records (set 200B-22h (H0B-33) and 200B-23h (H0B-34)) to check whether an overload fault or warning (E620.0, E630.0, E650.5, E909.0, E920.0, E922.0) occurs. | Change the fault reset method. After overload occurs, wait for 30s before reset. Increase the capacities of the servo drive and servo motor. Increase the acceleration/ deceleration time and reduce the load. |
| 3. The fan is damaged.   | Check whether the fan works properly during operation.  | Replace the servo drive.   |
| 4. The servo drive is installed in a wrong direction and the clearance between servo drives is improper. | Check whether the servo drive is installed properly.  | Install the servo drive according to the installation requirements.  |
| 5. The servo drive is faulty.  | The fault persists even though the servo drive is restarted five minutes after power-off.   | Replace the servo drive.   |

## Note

When this fault occurs, stop for at least 30s before further operations.

- E660.0: Air-cooled motor over-temperature

Cause:

The temperature of the air-cooled motor is too high.

| Cause  | Confirming Method  | Solution             |
|--|--|----------------------|
| The temperature of the air-cooled motor is too high. | Measure whether the temperature of the air-cooled motor is too high. | Cool the motor down. |

- E661.0: Auto-tuned gains too low

| Cause   | Confirming Method   | Solution   |
|---|---|--|
| <ol style="list-style-type: none"> <li>1. The auto-tuned gain values are wrong.</li> <li>2. The internal gains reach the lower limit (5 for position loop and 10 for speed loop).</li> <li>3. Excessive overshoot occurs during positioning.</li> </ol> | <ul style="list-style-type: none"> <li>• Check whether the machine suffers from periodic fluctuation.</li> <li>• Check whether the positioning threshold is too low.</li> </ul> | <ol style="list-style-type: none"> <li>1. Set the notch manually when vibration cannot be suppressed automatically.</li> <li>2. Check whether the positioning threshold is too low. Increase the reference acceleration/ deceleration time.</li> <li>3. Modify the electronic gear ratio to improve the reference resolution, or increase the reference filter time constant in the Parameter configuration interface. Check whether the machine suffers from periodic vibration.</li> </ol> |

- E731.0: Encoder battery failure

Cause:

The voltage of the absolute encoder battery is lower than 2.8 V.

| Cause  | Confirming Method  | Solution                                       |
|--|--|--|
| The battery is not connected during power-off. | Check whether the battery is connected during power-off. | Set 200D-15h (H0D-20) to 1 to clear the fault. |
| The encoder battery voltage is too low.        | Measure the battery voltage.                             | Use a new battery with the matching voltage.   |

- E733.0: Encoder multi-turn counting error

Cause:

An encoder multi-turn counting error occurs.

| Cause                  | Confirming Method   | Solution           |
|------------------------|---|--------------------|
| The encoder is faulty. | Set 200D-15h (H0D-20) to 2 to clear the fault. E733.0 persists after the servo drive is powered on again. | Replace the motor. |

- E735.0: Encoder multi-turn counting overflow

Cause:

A multi-turn counting overflow occurs on the absolute encoder.

| Cause   | Confirming Method   | Solution   |
|---|---|--|
| The number of forward revolutions exceeds 32767 or the number of reverse revolutions exceeds 32768. | Check whether the value of H0B-70 is 32767 or 32768 when the servo drive works in the absolute position linear mode (H02-01 = 1). | Set H0D-20 to 2 and power on again. Perform homing if necessary. |

- E740.2: Absolute encoder error

Cause:

Communication timeout occurs on the absolute encoder.

| Cause  | Confirming Method                           | Solution   |
|--|---|--|
| The communication between the servo drive and the encoder is abnormal. | Check whether the value of H0B-28 is not 0. | <ol style="list-style-type: none"> <li>1. Check whether H00-00 (Motor code) is set properly.</li> <li>2. Check whether the encoder cable is connected properly.</li> <li>3. Check whether the servo drive and motor are grounded properly. You can install a magnetic ring on the encoder cable to reduce interference.</li> </ol> |

- E740.3: Absolute encoder single-turn calculation error

Cause:

An encoder fault occurs.

| Cause                    | Confirming Method                  | Solution   |
|--------------------------|------------------------------------|--|
| An encoder fault occurs. | Check whether bit7 of H0B-28 is 1. | <ol style="list-style-type: none"> <li>1. Check whether the encoder version (H00-04) is proper.</li> <li>2. Check whether the encoder cable is proper.</li> <li>3. Replace the motor.</li> </ol> |

- E740.6: Encoder data write error

Cause:

The attempt to write the encoder data fails.

| Cause   | Confirming Method  | Solution   |
|---|--|--|
| An error occurs when writing the position offset after angle auto-tuning. | Replace with a new encoder cable. If the fault no longer occurs after cable replacement, it indicates the original encoder cable is damaged.<br>Keep the motor in a fixed place, power on the servo drive several times and check the electrical angle changes in 200B-12h (H0B-17). The electrical angle change should be within $\pm 30^\circ$ . | Replace with a new encoder cable. If the fault persists after the encoder cable is replaced, the encoder may be faulty. In this case, replace the servo motor. |

- E755.0: Nikon encoder communication fault

| Cause  | Confirming Method  | Solution  |
|--|--|---|
| <ol style="list-style-type: none"> <li>1. An encoder communication error or encoder fault is detected after servo drive initialization is done upon power-on.</li> <li>2. E755.0 will be reported when a Nikon encoder that has been idled for a long time is powered on again.</li> </ol> | <ol style="list-style-type: none"> <li>1. Check whether the encoder cable is connected properly.</li> <li>2. Check whether strong interference sources are present and whether connectors are loose or cables are broken.</li> </ol> | <ol style="list-style-type: none"> <li>1. Ensure the encoder cable is connected properly.</li> <li>2. Take proper shielding measures in case of strong interference sources.</li> </ol> |

- E765.0: Nikon encoder out of limit

| Cause   | Confirming Method  | Solution                            |
|---|--|-------------------------------------|
| Over-temperature, overspeed, or EEPROM access error is detected in the encoder. | The error is detected by the Nikon encoder. The servo drive only displays the error. | Set H0D-21 to 1 to clear the fault. |

- E902.2: Torque reach setting invalid

| Cause  | Confirming Method   | Solution  |
|--|---|---|
| The DO parameters set for torque reach in the torque control mode are invalid. | Check whether the value of 2007-17h (H07-22) is equal to or less than the setpoint (unit: 0.1%) of 2007-18h (H07-23). | Set 2007-17h (H07-22) to a value higher than 2007-18h (H07-23). |

- EA33.0: Encoder read/write check error

Cause:

Encoder parameters are abnormal.

| Cause  | Confirming Method   | Solution   |
|--|---|--|
| 1. The serial incremental encoder cable is disconnected or loose.                  | Check the wiring.   | Check for wrong connection, disconnection and poor contact of the encoder cable. Route the motor cable and encoder cable through different routes. |
| 2. An error occurs when reading/writing the serial incremental encoder parameters. | If the fault persists after the servo drive is powered off and on several times, the encoder is faulty. | Replace the servo motor.   |

- EB00.0: Position deviation too large

Cause:

The position deviation is larger than the setpoint of 6065h in the position control mode.

| Cause   | Confirming Method  | Solution  |
|---|--|---|
| 1. U/V/W output phase loss or incorrect phase sequence occurs on the servo drive. | Perform a no-load trial run on the motor and check the wiring. | Connect cables again according to the correct wiring diagram or replace the cables.   |
| 2. The servo drive U/V/W cables or the encoder cable is disconnected.             | Check the wiring.  | Connect the cables again. The U/V/W phase sequence on the drive side must be consistent with that on the motor side. Replace with new cables if necessary and ensure cables are connected properly. |

| Cause   | Confirming Method  | Solution  |
|---|--|---|
| <p>3. The motor is stalled due to mechanical factors.</p> | <p>Check the reference and the motor speed (200B-01h (H0B-00)) through the software tool or keypad.</p> <ul style="list-style-type: none"> <li>● References in the position control mode: 200B-0Eh (H0B-13) (Input position reference counter)</li> <li>● References in the speed control mode: 200B-02h (H0B-01) (Speed reference)</li> <li>● References in the torque control mode: 200B-03h (H0B-02) (Internal torque reference)</li> </ul> <p>Check whether the reference value is not 0 but the motor speed is 0 RPM in the corresponding mode.</p> | <p>Eliminate the mechanical factors.</p>  |
| <p>4. The gain values are too low.</p>                    | <p>Check the position loop gain and speed loop gain of the servo drive.</p> <p>1st gain set: H08-00...H08-02<br/>2nd gain set: H08-03...H08-05</p>   | <p>Adjust the gain values manually or perform gain auto-tuning.</p>   |
| <p>5. The position reference increment is too large.</p>  | <p>Position control mode:</p> <ul style="list-style-type: none"> <li>● In CSP mode, view the gear ratio 6091-01h/6091-02h and determine the position reference increment for an individual synchronization cycle and convert it to the speed information.</li> <li>● In PP mode, view the gear ratio 6091-01h/6091-02h and determine the value of 6081h (Profile velocity).</li> <li>● In HM mode, view the gear ratio 6091-01h/6091-02h and determine the value of 6099-01h and 6099-02h.</li> </ul>  | <ul style="list-style-type: none"> <li>● CSP: Decrease the position reference increment for an individual synchronization cycle. The host controller should handle the position ramp when generating references.</li> <li>● PP: Decrease the value of 6081h or increase the acceleration/deceleration ramp (6083h, 6084h).</li> <li>● HM: Decrease the value of 6099-01h and 6099-02h or increase the acceleration/deceleration ramp (609Ah).</li> <li>● Decrease the gear ratio according to actual conditions.</li> </ul> |



| Cause   | Confirming Method   | Solution  |
|---|---|---|
| 6. Given the operating condition, the value of 6065h (Following error window) is too low. | Check whether the setpoint of 6065h is too low.   | Increase the setpoint of 6065h.   |
| 7. The servo drive/motor is faulty.   | Monitor the operating waveforms using the oscilloscope function in the software tool:<br>position reference, position feedback, speed reference, torque reference | If the position reference is not 0 but the position feedback is always 0, replace the servo drive or motor. |

● EB00.1: Position deviation overflow

Cause:

The position deviation is too large.

| Cause   | Confirming Method  | Solution  |
|---|--|---|
| 1. U/V/W output phase loss or incorrect phase sequence occurs on the servo drive. | Perform a no-load trial run on the motor and check the wiring.   | Connect cables again according to the correct wiring diagram or replace the cables.   |
| 2. The servo drive U/V/W cables or the encoder cable is disconnected.             | Check the wiring.  | Connect the cables again. The U/V/W phase sequence on the drive side must be consistent with that on the motor side. Replace with new cables if necessary and ensure cables are connected properly. |
| 3. The motor is stalled due to mechanical factors.                                | Check the reference and motor speed (H0B-00) through the software tool or keypad.<br><ul style="list-style-type: none"> <li>● References in the position control mode: H0B-13(Input position reference counter)</li> <li>● References in the speed control mode: H0B-01(Speed reference)</li> <li>● References in the torque control mode: H0B-02(Internal torque reference)</li> </ul> Check whether the reference value is not 0 but the motor speed is 0 RPM in the corresponding mode. | Eliminate the mechanical factors.   |

| Cause   | Confirming Method  | Solution   |
|---|--|--|
| 4. The gain values are too low.   | Check the position loop gain and speed loop gain of the servo drive. <ul style="list-style-type: none"> <li>● 1st gain set: H08-00...H08-02</li> <li>● 2nd gain set: H08-03...H08-05</li> </ul>  | Adjust the gain values manually or perform gain auto-tuning.   |
| 5. The position reference increment is too large.   | Position control mode: <ul style="list-style-type: none"> <li>● In CSP mode, view the gear ratio 6091-01h/6091-02h and determine the position reference increment for an individual synchronization cycle and convert it to the speed information.</li> <li>● In PP mode, view the gear ratio 6091-01h/6091-02h and determine the value of 6081h (Profile velocity).</li> <li>● In HM mode, view the gear ratio 6091-01h/6091-02h and determine the value of 6099-01h and 6099-02h.</li> </ul> | <ul style="list-style-type: none"> <li>● CSP: Decrease the position reference increment for an individual synchronization cycle. The host controller should handle the position ramp when generating references.</li> <li>● PP: Decrease the value of 6081h or increase the acceleration/deceleration ramp (6083h, 6084h).</li> <li>● HM: Decrease the value of 6099-01h and 6099-02h or increase the acceleration/deceleration ramp (609Ah).</li> </ul> Decrease the gear ratio according to actual conditions. |
| 6. Given the operating condition, the value of 6065h (Following error window) is too low. | Check whether the setpoint of 6065h is too low.  | Increase the setpoint of 6065h.  |
| 7. The servo drive/motor is faulty.   | Monitor the operating waveforms using the oscilloscope function in the software tool: position reference, position feedback, speed reference, torque reference   | If the position reference is not 0 but the position feedback is always 0, replace the servo drive or motor.  |

- EB01.1: Individual position reference increment too large

Cause:

The target position increment is too large.

| Cause                                       | Confirming Method  | Solution   |
|---|--|--|
| The target position increment is too large. | Check the variation between two adjacent target positions using the software tool. | <ol style="list-style-type: none"> <li>1. Check whether the maximum speed of the motor fulfills the application requirement. If yes, reduce the target position reference increment, which is to lower the profile reference speed. If not, replace the servo motor.</li> <li>2. Before switching the mode or enabling the servo drive, check whether the target position is aligned with current position feedback.</li> <li>3. The communication sequence of the host controller is abnormal, leading to slave data error. Check the communication sequence of the host controller.</li> </ol> |

- EB01.2: Position reference increment too large continuously

Cause:

The target position increment exceeds the limit value N times consecutively.

| Cause                                       | Confirming Method  | Solution   |
|---|--|--|
| The target position increment is too large. | Check the variation between two adjacent target positions using the software tool. | <ol style="list-style-type: none"> <li>1. Check whether the maximum speed of the motor fulfills the application requirement. If yes, reduce the target position reference increment, which is to lower the profile reference speed. If not, replace the servo motor.</li> <li>2. Before switching the mode or enabling the servo drive, check whether the target position is aligned with current position feedback.</li> <li>3. The communication sequence of the host controller is abnormal, leading to slave data error. Check the communication sequence of the host controller.</li> </ol> |

- EB01.3: Command overflow

Cause:

The target position is still in the process of transmission when the servo limit or software position limit signal is activated and the 32-bit upper/lower limit is reached.

| Cause  | Confirming Method   | Solution  |
|--|---|---|
| The target position is still in the process of transmission when the servo limit or software position limit signal is activated and the 32-bit upper/lower limit is reached. | Check whether the host controller continues sending commands after overtravel warning is reported by the servo drive. | <ol style="list-style-type: none"> <li>1. Detect the servo limit signal (bit0 and bit1 of 60FD recommended) through the host controller.</li> <li>2. Stop sending limit direction commands when an active servo limit signal is detected by the host controller.</li> </ol> |

- EB01.4: Target position beyond upper/lower limit

Cause:

The target position exceeds the upper/lower limit of the unit position in the single-turn absolute mode.

| Cause  | Confirming Method  | Solution   |
|--|--|--|
| The target position exceeds the upper/lower limit of the unit position in the single-turn absolute mode. | Check whether the set target position is within the single-turn upper/lower limit. | Set the target position to a value within the upper/lower limit. |

- EE09.0: Software position limit setting error

Cause:

The lower limit of the software position limit is equal to or higher than the upper limit.

| Cause  | Confirming Method                          | Solution                                     |
|--|--|--|
| The lower limit of the software position limit is equal to or larger than the upper limit. | Check the values of 607D-01h and 607D-02h. | Set 607D-01h to a value lower than 607D-02h. |

- EE09.1: Home setting error

Cause:

The home offset exceeds the upper/lower limit.

| Cause  | Confirming Method   | Solution  |
|--|---|---|
| 1. The home offset is outside the software position limit.               | The home offset is outside the software position limit when the encoder works in the incremental mode, absolute linear mode, and single-turn absolute mode. | Set the home offset to a value within the software position limit.                  |
| 2. The home offset is beyond the upper/lower limit in the rotation mode. | The home offset is outside the mechanical single-turn upper/lower limit when the encoder works in the rotation mode.  | Set the home offset to a value within the mechanical single-turn upper/lower limit. |

- EE09.2: Gear ratio beyond the limit

Cause:

The electronic gear ratio exceeds the limit: (0.001, 4000 x Encoder resolution/ 10000).

| Cause  | Confirming Method  | Solution   |
|--|--|--|
| The set electronic gear ratio exceeds the preceding range. | Check whether the ratio of 6091-01h to 6091-02h exceeds the preceding range. | Set the gear ratio according to the preceding range. |

- EE09.3: No synchronization signal

Cause:

The MCU does not receive the synchronization signal when the servo communication is switched to OP status.

| Cause  | Confirming Method   | Solution  |
|--|---|---|
| 1. The communication synchronization clock is configured improperly. | Replace with another master (such as Beckhoff or Omron PLC) and perform tests to compare between different masters. | Rectify improper configurations.                      |
| 2. The IN/OUT port of EtherCAT communication is connected reversely. | Check whether the IN/OUT port is connected reversely.   | Connect the IN and OUT ports in the correct sequence. |

| Cause  | Confirming Method  | Solution  |
|--|--|---|
| 3. The slave controller integrated circuit is damaged. | If the fault persists after the master is replaced, measure the synchronization signal generated by the slave controller integrated circuit with an oscilloscope. If there is no signal, the slave controller integrated circuit is damaged. | Contact Inovance for replacing the slave controller integrated circuit. |
| 4. The MCU pins are damaged.                           | Test the synchronization signal generated by the slave controller integrated circuit with an oscilloscope. If there is a signal, the pins of the MCU integrated circuit are damaged.   | Contact Inovance for replacing the MCU integrated circuit.              |

- EE09.5: PDO mapping beyond the limit

Cause:

The number of the mapping objects in TPDO or RPDO exceeds 10.

| Cause   | Confirming Method  | Solution  |
|---|--|---|
| The number of mapping objects in TPDO or RPDO exceeds 10. | Check the number of self-indexes configured in 1600h or 1A00h. | The number of mapping objects in TPDO or RPDO cannot exceed 10. |

### 3.4 Solutions to Warnings

- E121.0: S-ON command invalid

Cause:

The S-ON signal is set repeatedly.

| Cause  | Confirming Method  | Solution  |
|--|--|---|
| 1. The servo drive is enabled internally at the same time when the S-ON signal is activated through communication. | Check whether an S-ON signal is sent from the host controller when auxiliary functions (200D-03h (H0D-02), 200D-04h (H0D-03), and 200D-0Ch (H0D-11)) are used. | Switch off the S-ON signal sent from the host controller. |
| 2. The S-ON signal is sent from the DI and the software tool simultaneously.                                       | Check whether the S-ON signal is sent from the DI and the software tool simultaneously.  | Switch off the redundant S-ON signal.                     |

- E600.0: Inertia auto-tuning failure

Cause:

- The vibration cannot be suppressed. Enable vibration suppression manually to dampen the vibration.
- The auto-tuned values fluctuate dramatically. Increase the maximum operating speed, reduce the acceleration/deceleration time, and shorten the stroke of the lead screw during ETune operation.
- Mechanical couplings of the load are loose or eccentric. Rectify the mechanical faults.
- A warning occurs during auto-tuning and causes interruption. Rectify the fault causes and perform inertia auto-tuning again.
- The vibration cannot be suppressed if the load carries a large inertia. In this case, increase the acceleration/deceleration time first to ensure the motor current is unsaturated.

| Cause   | Confirming Method   | Solution   |
|---|---|--|
| <ol style="list-style-type: none"> <li>1. Continuous vibration occurs during auto-tuning.</li> <li>2. The auto-tuned values fluctuate dramatically.</li> <li>3. Mechanical couplings of the load are loose or the mechanism is eccentric.</li> <li>4. A warning occurs during auto-tuning and causes interruption.</li> <li>5. The vibration cannot be suppressed if the load carries large inertia. In this case, increase the acceleration/deceleration time to ensure the motor current is unsaturated.</li> </ol> | <p>Perform internal inspection to check whether the torque jitters upon stop (not FFT).</p> | <ol style="list-style-type: none"> <li>1. Rectify the fault and perform inertia auto-tuning again.</li> <li>2. For vibration that cannot be suppressed, enable vibration suppression function.</li> <li>3. Ensure mechanical couplings are connected securely.</li> <li>4. Increase the maximum operating speed, reduce the acceleration/ deceleration time, and shorten the stroke of the lead screw during ETune operation.</li> </ol> |

- E601.0: Homing warning

Cause:

When using the homing function, the home is not found within the time defined by 2005-24h.

| Cause   | Confirming Method   | Solution  |
|---|---|---|
| 1. The home switch is faulty.   | There is only high-speed searching but no low-speed searching during homing. After high-speed searching, low-speed searching in the reverse direction applies .           | <ul style="list-style-type: none"> <li>• If Z signal is used as the home signal, a hardware DI is used as the deceleration point, check whether DI functions (FunIN.14 for positive position limit; FunIN.15 for negative position limit; FunIN.31 for home switch) are set properly in group 2003h and then check the wiring of the DI. Change the DI logic manually and observe the value of 200B-04h (H0B-03) to see whether the servo drive receives the corresponding DI level change. If not, the DI is wired improperly. If yes, a fault occurs during homing. Perform the homing operation correctly.</li> <li>• The preceding process also applies when the home switch is used as the home signal.</li> </ul> |
| 2. The time limit for homing is too short.                                  | Check whether the value of 2005-24h (H05-35) is too small.  | Increase the value of 2005-24h (H05-35).  |
| 3. The speed in high-speed searching for the home switch signal is too low. | Check the distance between the initial position of homing and the home switch. Then check whether the value of 6099-01h is too small, resulting in a long homing process. | Increase the value of 6099-01h.   |

● E601.1: Homing switch error

Cause:

The homing switch is set improperly.

| Cause                              | Confirming Method   | Solution                                   |
|------------------------------------|---|--|
| The home switch is set improperly. | Check whether the limit signals at both sides are both activated.<br>Check whether the limit signal and the deceleration point signal/home signal are both activated. | Set the hardware switch position properly. |

● E601.2: Homing method setting error

Cause:

The homing method (0x6098h) is set improperly.



| Cause  | Confirming Method             | Solution  |
|--|-------------------------------|---|
| The homing method (0x6098) is set to a value outside [-2 to +14] when the absolute position single-turn mode is used (H02-01 = 4).           | Check the setpoint of 0x6098. | Set 0x6098 to a value within the specified range. |
| The homing method (0x6098) is set to a value outside [-2, 14], [17, 30], and [33,35] in modes other than absolute position single-turn mode. | Check the setpoint of 0x6098. | Set 0x6098 to a value within the specified range. |

- E730.0: Encoder battery warning

Cause:

The voltage of the absolute encoder battery is lower than 3.0 V.

| Cause  | Confirming Method            | Solution                                     |
|--|------------------------------|--|
| The voltage of the absolute encoder battery is lower than 3.0 V. | Measure the battery voltage. | Use a new battery with the matching voltage. |

- E900.0: Emergency stop

Cause:

The logic of the DI (hardware DI or virtual DI) assigned with FunIN.34 (EmergencyStop) is active.

| Cause                                  | Confirming Method   | Solution  |
|--|---|---|
| FunIN.34 (EmergencyStop) is triggered. | Check whether the logic of the DI assigned with FunIN.34 (EmergencyStop) is active. | Check the operating mode and clear the active DI braking signal without affecting the safety performance. |

- E902.0: DI setting invalid

Cause:

DI function parameters are set to invalid values.

| Cause   | Confirming Method   | Solution                                    |
|---|---|---|
| DI (DI1...DI5) function parameters are set to invalid values. | Check whether H03-02, H03-04, H03-06, H03-08, and H03-10 are set to invalid values. | Set DI function parameters to valid values. |

- E902.1: DO setting invalid

Cause:

DO function parameters are set to invalid values.

| Cause   | Confirming Method   | Solution                                    |
|---|---|---|
| DO (DO1...DO3) function parameters are set to invalid values. | Check whether H04-00, H04-02, and H04-04 are set to invalid values. | Set DO function parameters to valid values. |

- E902.2: Invalid setting for torque reach

Cause:

The DO parameters set for torque reach in the torque control mode are invalid.

| Cause  | Confirming Method   | Solution  |
|--|---|---|
| The DO parameters set for torque reach in the torque control mode are invalid. | Check whether the value of H07-22 is lower than or equal to the value of H07-23 (unit: 0.1%). | Set H07-22 to a value higher than that of H07-23. |

- E908.0: Model identification failure

Cause:

The first two check bytes of model identification are incorrect, indicating the attempt to read model identification parameter fails.

| Cause  | Confirming Method                   | Solution  |
|--|-------------------------------------|---|
| 1. The model identification parameter is not written.<br>2. The check bytes of model identification are incorrect. | The warning persists after restart. | 1. Write the model identification parameter again.<br>2. Set H01-72 to 1 to hide the model identification function. |

- E909.0: Motor overload warning

Cause:

The accumulative heat of the motor reaches the warning threshold (90% of the maximum allowable heat).

| Cause  | Confirming Method  | Solution   |
|--|--|--|
| 1. The motor cables and encoder cable are connected improperly or in poor contact.                         | Check the wiring among the servo drive, servo motor and the encoder according to the correct wiring diagram.   | Connect cables according to the correct wiring diagram.<br>It is recommended to use the cables provided by Inovance.<br>When customized cables are used, prepare and connect the customized cables according to the wiring instructions. |
| 2. The load is so heavy that the effective torque outputted by the motor keeps exceeding the rated torque. | Confirm the overload characteristics of the servo drive or motor.<br>Check whether the average load rate (H0B-12) keeps exceeding 100.0%.  | Replace with a servo drive of higher capacity and a matching servo motor.<br>Reduce the load and increase the acceleration/ deceleration time.   |
| 3. Acceleration/ Deceleration is too frequent or the load inertia is too large.                            | Check the mechanical inertia ratio or perform inertia auto-tuning. View the value of H08-15 (Load moment of inertia ratio). Confirm the individual operation cycle when the servo motor operates cyclically. | Increase the acceleration/ deceleration time.  |
| 4. The gain values are improper or the stiffness level is too high.  | Check whether the motor vibrates and generates unusual noise during operation.   | Adjust the gains again.  |
| 5. The model of the servo drive or motor is set improperly.  | View the serial-type motor model in H00-05 and the servo drive model in H01-10.  | Read the servo drive nameplate and set the servo drive model (H01-10) and motor model properly.  |

| Cause  | Confirming Method   | Solution   |
|--|---|--|
| 6. The motor is stalled due to mechanical factors, resulting in overload during operation. | <p>Check the reference and the motor speed (HOB-00) through the software tool or the keypad.</p> <ul style="list-style-type: none"> <li>References in the position control mode: HOB-13 (Input position reference counter)</li> <li>References in the speed control mode: HOB-01 (Speed reference)</li> <li>References in the torque control mode: HOB-02 (Internal torque reference)</li> </ul> <p>Check whether the reference value is not 0 or is very large but the motor speed is 0 RPM in the corresponding mode.</p> | Eliminate the mechanical factors.  |
| 7. The servo drive is faulty.  | Power off and on the servo drive again.   | Replace the servo drive if the fault persists after the servo drive is powered off and on again. |

- E920.0: Regenerative resistor overload

Cause:

The accumulative heat of the regenerative resistor is too high and reaches the warning threshold (90% of the maximum allowable heat).

| Cause  | Confirming Method  | Solution   |
|--|--|--|
| 1. The cable connected to the external regenerative resistor is in poor contact, disconnected or broken.                     | Remove the external regenerative resistor and measure whether its resistance is " $\infty$ " (infinite). Measure whether the resistance between terminals P $\oplus$ and C is " $\infty$ " (infinite). | Replace with a new external regenerative resistor. After confirming the resistance measured is the same as the nominal value, connect it between terminals P $\oplus$ and C. |
|  |  | Connect the external regenerative resistor between terminals P $\oplus$ and C with a proper cable.   |
| 2. The jumper between terminals P $\oplus$ and D is shorted or disconnected when the built-in regenerative resistor is used. | Measure whether the resistance between terminals P $\oplus$ and D is " $\infty$ " (infinite).  | Ensure terminals P $\oplus$ and D are jumpered.  |

| Cause  | Confirming Method  | Solution  |
|--|--|---|
| 3. 2002-1Ah (H02-25) is set improperly when an external regenerative resistor is used.   | <ul style="list-style-type: none"> <li>● View the setpoint of H02-25.</li> <li>● Measure the resistance of the external regenerative resistor connected between P⊕ and C. Check whether the resistance measured is too large by comparing it with the value listed in Table "Specifications of the regenerative resistor".</li> <li>● Check whether the value of H02-27 is larger than the resistance of the external regenerative resistor connected between terminals P⊕ and C.</li> </ul> | Set H02-25 (Regenerative resistor type) based on section "Wiring and Setting of the Regenerative Resistor" in SV660N Series Servo Drive Hardware Guide.<br>H02-25 = 1 (external, naturally ventilated)<br>H02-25 = 2 (external, forced-air cooling) |
| 4. The resistance of the external regenerative resistor is too large.  |  | Select a proper regenerative resistor according to Table "Specifications of the Regenerative Resistor" in SV660N Series Servo Drive Commissioning Guide.  |
| 5. The value of 2002-1Ch (H02-27) (Resistance of external regenerative resistor) is larger than the resistance of the external regenerative resistor used. |  | Set H02-27 according to the resistance of the external regenerative resistor used.  |
| 6. The input voltage of the main circuit is beyond the specified range.  | <p>Check whether the input voltage of the main circuit cable on the drive side is within the following range:</p> <ul style="list-style-type: none"> <li>● 220 V servo drive:<br/>Effective value: 220 V to 240 V<br/>Allowable deviation: -10% to +10% (198 V to 264 V)</li> <li>● 380 V servo drive:<br/>Effective value: 380 V to 440 V<br/>Allowable deviation: -10% to +10% (342 V to 484 V)</li> </ul>   | Replace or adjust the power supply according to the specified range.  |

| Cause  | Confirming Method   | Solution   |
|--|---|--|
| 7. The load moment of inertia ratio is too large.  | Perform moment of inertia auto-tuning according to section "Inertia auto-tuning" in SV660N Series Servo Drive Function Guide or calculate the total mechanical inertia based on mechanical parameters.<br>Check whether the actual load inertia ratio exceeds 30. | <ul style="list-style-type: none"> <li>• Select an external regenerative resistor with large capacity and set H02-26 (Power of the external regenerative resistor) to a value consistent with the actual power.</li> </ul> |
| 8. The motor speed is excessively high and deceleration is not done within the set time. The motor is in the continuous deceleration status during cyclic operation. | View the motor speed curve during cyclic operation and check whether the motor is in the deceleration status continuously.  | <ul style="list-style-type: none"> <li>• Select a servo drive with large capacity.</li> <li>• Reduce the load if allowed.</li> <li>• Increase the acceleration/ deceleration time if allowed.</li> </ul>                   |
| 9. The capacity of the servo drive or the regenerative resistor is insufficient.   | View the motor speed curve in an individual cycle and calculate whether the maximum braking energy can be absorbed completely.  | <ul style="list-style-type: none"> <li>• Increase the motor operation cycle if allowed.</li> </ul>   |
| 10. The servo drive is faulty.   | -   | Replace with a new servo drive.  |

- E922.0: Resistance of the external regenerative resistor too small

Cause:

The value of 2002-1Ch (H02-27) (Resistance of external regenerative resistor) is smaller than the value of 2002-16h (H02-21) (Permissible minimum resistance of regenerative resistor).

| Cause   | Confirming Method  | Solution   |
|---|--|--|
| When an external regenerative resistor (2002-1Ah (H02-25) = 1 or 2) is used, the resistance of the external regenerative resistor is lower than the minimum permissible resistance. | Measure the resistance of the external regenerative resistor between P⊕ and C and check whether it is lower than the value of 2002-16h (H02-21). | <ul style="list-style-type: none"> <li>• If yes, replace with an external regenerative resistor that matches the servo drive, then set 2002-1Ch (H02-27) according to the resistance of the resistor used. Finally, connect the new resistor between P⊕ and C.</li> <li>• If not, set 2002-1Ch (H02-27) according to the resistance of the external regenerative resistor used.</li> </ul> |

- E924.0: Regenerative transistor over-temperature

Cause:

The estimated temperature of the regenerative transistor is higher than H0A-49 (Regenerative transistor over-temperature threshold).

| Cause   | Confirming Method  | Solution   |
|---|--|--|
| 1. The temperature of the regenerative transistor is too high. 2. The regenerative transistor will be turned off automatically after overload occurs. | The regenerative transistor temperature exceeds the threshold defined by H0A-49. | Control the usage of the regenerative transistor based on actual conditions. |

- E941.0: Parameter modifications activated at next power-on

Cause:

The parameters modified are those whose "Effective time" is "Next power-on".

| Cause  | Confirming Method  | Solution                                |
|--|--|---|
| The parameters modified are those whose "Effective time" is "Next power-on". | Check whether parameters you modified are those whose "Effective Time" is "Next power-on". | Power off and on the servo drive again. |

- E942.0: Parameter saved frequently

Cause:

The number of parameters modified at a time exceeds 200.

| Cause   | Confirming Method   | Solution   |
|---|---|--|
| A large number of parameters are modified and saved frequently to EEPROM (200E-02h = 1 or 3). | Check whether the host controller executes parameter modifications at a brief interval. | Check the operation mode. For parameters that need not be saved in EEPROM, set 200E-02h (H0E-01) to 0. |

- E950.0: Forward overtravel warning

Cause:

The logic of DI assigned with FunIN.14 (P-OT, positive limit switch) is active.

| Cause  | Confirming Method   | Solution  |
|--|---|---|
| 1. The logic of the DI assigned with FunIN.14 (P-OT, positive limit switch) is active. | <ul style="list-style-type: none"> <li>• Check whether a DI in group 2003h is assigned with FunIN.14.</li> <li>• Check whether the DI logic of the corresponding bit of 200E-04h (H0E-03) (Monitored DI status) is active.</li> </ul> | Check the operation mode and on the prerequisite of ensuring safety, send a reverse run command or rotate the motor to deactivate the logic of the DI assigned with FunIN.14. |
| 2. The servo drive position feedback reaches the positive software position limit.     | Check whether the position feedback (0x6064) is close to the value of 0x607D-02.  | Ensure the servo drive references are proper, allowing the load travel range to be within the software position limit.  |

- E952.0: Reverse overtravel warning

Cause:

The logic of the DI assigned with FunIN.15 (N-OT, negative limit switch) is active.

| Cause  | Confirming Method   | Solution   |
|--|---|--|
| 1. The logic of the DI assigned with FunIN.15 (N-OT, negative limit switch) is active. | <ul style="list-style-type: none"> <li>• Check whether a DI in group 2003h is assigned with FunIN.15.</li> <li>• Check whether the DI logic of the corresponding bit of 200E-04h (H0E-03) (Monitored DI status) is active.</li> </ul> | Check the operation mode. On the prerequisite of ensuring safety, send a forward run command or rotate the motor to deactivate the logic of DI assigned with FunIN.15. |
| 2. The servo drive position feedback reaches the negative software position limit      | Check whether the position feedback (0x6064) is close to the value of 0x607D-02.  | Ensure the servo drive references are proper, allowing the load travel range to be within the software position limit.   |

- EA41.0 Torque fluctuation compensation failure

Cause:

The attempt to write torque fluctuation compensation parameter to the encoder fails.

| Cause   | Confirming Method                | Solution  |
|---|----------------------------------|---|
| The attempt to write torque fluctuation compensation parameter to the encoder fails. An encoder data read/write error occurs. | Check the wiring of the encoder. | If the fault persists after several attempts, contact Inovance for technical support. |



### 3.5 Solutions to Communication Faults

This section describes solutions to communication faults. For solutions to the servo drive faults, see the preceding sections.

- EE08.0: Synchronization (SYNC) signal loss

Cause:

The SYNC signal is turned off when the EtherCAT network is in the OP state.

| Cause  | Confirming Method   | Solution   |
|--|---|--|
| The SYNC signal is not generated due to hardware errors. | Check whether the SYNC signal cycle is 0 using the oscilloscope in the software tool. | Replace the servo drive. Contact Inovance for maintenance. |

- EE08.1: Network status switchover error

Cause:

When the servo drive is enabled, the EtherCAT network status switches from OP to other status.

| Cause  | Confirming Method   | Solution  |
|--|---|---|
| This fault is caused by mal-operation of the master or the operator. | Check whether the master switches the network status when the servo drive is enabled. | Check the network status switchover program of the host controller. |

- EE08.2: IRQ loss

Cause:

- For servo drives with H01-00 (MCU software version) = 902.0 or earlier, causes for IRQ loss include all the causes for EE08.0...EE08.6 without differentiation.
- For servo drives with H01-00 (MCU software version) = 902.1 or later, causes for IRQ loss are further differentiated and categorized into different faults, which means EE08.2 will no longer be reported.

- EE08.3: Network cable connected improperly

Cause:

The network cable of the servo drive is connected improperly. (The low 16 bits of H0E-29 represent the number of IN port loss events. The high 16 bits of H0E-29 represent the number of OUT port loss events.)

| Cause   | Confirming Method   | Solution   |
|---|---|--|
| The physical connection of the data link is unstable or the process data is lost due to plug-in/ plug-out of the network cable. | Check: 1) whether the network cable of the servo drive is connected securely. 2) whether strong vibration occurs on site. 3) whether the network cable is plugged in or out. 4) whether the network cable provided by Inovance is used. | Check the connection of the network port through the value change of H0E-29. Replace with a new network cable. |

- EE08.4 Data frame loss protection error

Cause:

The PDO data is corrupted due to EMC interference or inferior network cable.

| Cause   | Confirming Method  | Solution   |
|---|--|--|
| The data is lost due to EMC interference, poor quality of the network cable or improper connection. | Check whether the high 16 bits of H0E-25 have values that are increased. | <ul style="list-style-type: none"> <li>● Check whether the servo drive is grounded properly and rectify the EMC problem.</li> <li>● Check whether the network cable used is the one designated by Inovance.</li> <li>● Check whether the network cable is connected properly.</li> </ul> |

- EE08.5: Data frame transfer error

Cause:

As error data frames are generated from the upstream slave, the downstream slave receives invalid data frames.

| Cause  | Confirming Method   | Solution  |
|--|---|---|
| The upstream slave detects that the data frame has been corrupted and marked, which is then transferred to the downstream slave, leading to a warning event. | Check whether a processing unit error occurs due to transfer error (H0E-27) or invalid frames (H0E-28) upon occurrence of the fault, and check whether no counting is performed in RX-ERR of Port0. | Check the upstream slave to locate the fault cause. |

- EE08.6: Data update timeout

Cause:

The slave is in the OP status and does not receive the data frame in a long time.

| Cause  | Confirming Method  | Solution   |
|--|--|--|
| The data frame is lost or aborted in the upstream slave or the master performance is not up to standard. | Check through the software tool whether the phase difference between SYNC and IRQ exceeds the value of H0E-22 multiplied by the communication cycle. | <ul style="list-style-type: none"> <li>Check whether the operating load of the master CPU is excessive. Increase the communication time or set H0E-22 to a high value.</li> <li>Check whether link loss occurs on the upstream slave.</li> </ul> |

- EE11.0: ESI check error

Cause:

The attempt to load the XML file fails during EtherCAT communication.

| Cause   | Confirming Method  | Solution              |
|---|--|-----------------------|
| <ol style="list-style-type: none"> <li>The XML file is programmed in the EEPROM.</li> <li>The XML file in the EEPROM is modified unexpectedly.</li> </ol> | Check whether the XML version displayed in H0E-96 is normal. | Program the XML file. |

- EE11.1: EEPROM read failure

Cause:

The EEPROM communication of external EtherCAT devices fails.

| Cause  | Confirming Method  | Solution                 |
|--|--|--------------------------|
| The EtherCAT data in the EEPROM cannot be read | This fault persists after the servo drive is powered off and on several times. | Replace the servo drive. |

- EE11.2: EEPROM update failure

Cause:

The communication is normal but the message in the EEPROM is wrong or lost.

| Cause  | Confirming Method  | Solution                 |
|--|--|--------------------------|
| The EtherCAT data in the EEPROM cannot be updated. | This fault persists after the servo drive is powered off and on several times. | Replace the servo drive. |

- EE12.0: EtherCAT external device error

Cause:

The EtherCAT network cannot be initialized.

| Cause                                   | Confirming Method                 | Solution                   |
|---|-----------------------------------|----------------------------|
| 1. The FPGA firmware is not programmed. | Check whether 2001-02h is 09xx.Y. | Program the FPGA firmware. |
| 2. The servo drive is faulty.           | The servo drive is faulty.        | Replace the servo drive.   |

- EE13.0: Synchronization cycle setting error

Cause:

The synchronization cycle is not an integer multiple of 125 μs or 250 μs after the network switches to the OP mode.

| Cause   | Confirming Method   | Solution  |
|---|---|---|
| The synchronization cycle is not an integer multiple of 125 μs or 250 μs. | Check the setting of the synchronization cycle in the controller. | Set the synchronization cycle to an integer multiple of 125 μs or 250 μs. |

- EE15.0: Synchronization cycle error too large

Cause:

The synchronization cycle error exceeds the threshold.

| Cause   | Confirming Method   | Solution                        |
|---|---|---------------------------------|
| The synchronization cycle error of the controller is too large. | <ul style="list-style-type: none"> <li>● Measure the synchronization cycle of the controller using a digital oscilloscope or the oscilloscope tool in the software tool.</li> </ul> | Increase the value of 200E-21h. |

## 4 List of Parameters

### 4.1 Parameter Groups

Parameter access address: index+subindex, both of which are in hexadecimal.

The CiA402 protocol establishes the following restrictions on the parameter address:

| Index (Hex) | Description                  |
|-------------|------------------------------|
| 0001h–0FFFh | Data type description        |
| 1000h–1FFFh | CoE communication object     |
| 2000h–5FFFh | Manufacturer-specific object |
| 6000h–9FFFh | Profile object               |
| A000h–FFFFh | Reserved                     |

### 4.2 Parameter Group 1000h

| Index (HEX) | Sub-index (HEX) | Name                          | Access | PDO Mapping | Data Type | Unit | Data Range | Default                    |
|-------------|-----------------|-------------------------------|--------|-------------|-----------|------|------------|----------------------------|
| 1000        | 0               | Device type                   | RO     | No          | Uint32    | -    | -          | 0x00020192                 |
| 1008        | 0               | Manufacturer device name      | RO     | No          | -         | -    | -          | SV660N-ECAT                |
| 1009        | 0               | Manufacturer hardware version | RO     | No          | -         | -    | -          | Software version dependent |
| 100A        | 0               | Manufacturer software version | RO     | No          | -         | -    | -          | Hardware version dependent |
| 1018        | Identity object |                               |        |             |           |      |            |                            |
|             | 0               | Number of entries             | RO     | No          | Uint8     | -    | -          | 0x04                       |
|             | 1               | Vendor ID                     | RO     | No          | Uint32    | -    | -          | 0x00100000                 |
|             | 2               | Product code                  | RO     | No          | Uint32    | -    | -          | 0x000C010D                 |
|             | 3               | Revision number               | RO     | No          | Uint32    | -    | -          | 0x00010001                 |
|             | 4               | Serial number                 | RO     | No          | Uint32    | -    | -          | 0x00000000                 |

| Index (HEX) | Sub-index (HEX)                 | Name                              | Access | PDO Mapping | Data Type | Unit            | Data Range      | Default    |
|-------------|---------------------------------|-----------------------------------|--------|-------------|-----------|-----------------|-----------------|------------|
| 1C00        | Sync Manager communication type |                                   |        |             |           |                 |                 |            |
|             | 0                               | Number of SYNC Manager channels   | RO     | No          | Uint8     | -               | -               | 0x04       |
|             | 1                               | SM0 communication type            | RO     | No          | Uint8     | -               | -               | 0x01       |
|             | 2                               | SM1 communication type            | RO     | No          | Uint8     | -               | -               | 0x02       |
|             | 3                               | SM2 communication type            | RO     | No          | Uint8     | -               | -               | 0x03       |
|             | 4                               | SM3 communication type            | RO     | No          | Uint8     | -               | -               | 0x04       |
| 1600        | 1st Receive PDO mapping         |                                   |        |             |           |                 |                 |            |
|             | 0                               | Number of mapped objects in RPDO1 | RW     | No          | Uint8     | -               | 0 to 0x0A       | 0x03       |
|             | 1                               | 1st mapped object                 | RW     | No          | Uint32    | -               | 0 to 0xFFFFFFFF | 0x60400010 |
|             | 2                               | 2nd mapped object                 | RW     | No          | Uint32    | -               | 0 to 0xFFFFFFFF | 0x60600008 |
|             | 3                               | 3rd mapped object                 | RW     | No          | Uint32    | -               | 0 to 0xFFFFFFFF | 0x60B80010 |
|             | 4                               | 4th mapped object                 | RW     | No          | Uint32    | -               | 0 to 0xFFFFFFFF | -          |
|             | 5                               | 5th mapped object                 | RW     | No          | Uint32    | -               | 0 to 0xFFFFFFFF | -          |
|             | 6                               | 6th mapped object                 | RW     | No          | Uint32    | -               | 0 to 0xFFFFFFFF | -          |
|             | 7                               | 7th mapped object                 | RW     | No          | Uint32    | -               | 0 to 0xFFFFFFFF | -          |
|             | 8                               | 8th mapped object                 | RW     | No          | Uint32    | -               | 0 to 0xFFFFFFFF | -          |
|             | 9                               | 9th mapped object                 | RW     | No          | Uint32    | -               | 0 to 0xFFFFFFFF | -          |
| 0A          | 10th mapped object              | RW                                | No     | Uint32      | -         | 0 to 0xFFFFFFFF | -               |            |

List of Parameters

| Index (HEX) | Sub-index (HEX)           | Name                                | Access | PDO Mapping | Data Type | Unit | Data Range | Default    |
|-------------|---------------------------|-------------------------------------|--------|-------------|-----------|------|------------|------------|
| 1701        | 258th Receive PDO mapping |                                     |        |             |           |      |            |            |
|             | 0                         | Number of mapped objects in RPDO258 | RO     | No          | Uint8     | -    | -          | 0x04       |
|             | 1                         | 1st mapped object                   | RO     | No          | Uint32    | -    | -          | 0x60400010 |
|             | 2                         | 2nd mapped object                   | RO     | No          | Uint32    | -    | -          | 0x607A0020 |
|             | 3                         | 3rd mapped object                   | RO     | No          | Uint32    | -    | -          | 0x60B80010 |
|             | 4                         | 4th mapped object                   | RO     | No          | Uint32    | -    | -          | 0x60FE0120 |
| 1702        | 259th Receive PDO mapping |                                     |        |             |           |      |            |            |
|             | 0                         | Number of mapped objects in RPDO259 | RO     | No          | Uint8     | -    | -          | 0x07       |
|             | 1                         | 1st mapped object                   | RO     | No          | Uint32    | -    | -          | 0x60400010 |
|             | 2                         | 2nd mapped object                   | RO     | No          | Uint32    | -    | -          | 0x607A0020 |
|             | 3                         | 3rd mapped object                   | RO     | No          | Uint32    | -    | -          | 0x60FF0020 |
|             | 4                         | 4th mapped object                   | RO     | No          | Uint32    | -    | -          | 0x60710010 |
|             | 5                         | 5th mapped object                   | RO     | No          | Uint32    | -    | -          | 0x60600008 |
|             | 6                         | 6th mapped object                   | RO     | No          | Uint32    | -    | -          | 0x60B80010 |
| 7           | 7th mapped object         | RO                                  | No     | Uint32      | -         | -    | 0x607F0020 |            |

| Index (HEX) | Sub-index (HEX)           | Name                                | Access | PDO Mapping | Data Type | Unit | Data Range | Default    |
|-------------|---------------------------|-------------------------------------|--------|-------------|-----------|------|------------|------------|
| 1703        | 260th Receive PDO mapping |                                     |        |             |           |      |            |            |
|             | 0                         | Number of mapped objects in RPDO260 | RO     | No          | Uint8     | -    | -          | 0x07       |
|             | 1                         | 1st mapped object                   | RO     | No          | Uint32    | -    | -          | 0x60400010 |
|             | 2                         | 2nd mapped object                   | RO     | No          | Uint32    | -    | -          | 0x607A0020 |
|             | 3                         | 3rd mapped object                   | RO     | No          | Uint32    | -    | -          | 0x60FF0020 |
|             | 4                         | 4th mapped object                   | RO     | No          | Uint32    | -    | -          | 0x60600008 |
|             | 5                         | 5th mapped object                   | RO     | No          | Uint32    | -    | -          | 0x60B80010 |
|             | 6                         | 6th mapped object                   | RO     | No          | Uint32    | -    | -          | 0x60E00010 |
|             | 7                         | 7th mapped object                   | RO     | No          | Uint32    | -    | -          | 0x60E10010 |
| 1704        | 261st Receive PDO mapping |                                     |        |             |           |      |            |            |
|             | 0                         | Number of mapped objects in RPDO261 | RO     | No          | Uint8     | -    | -          | 0x09       |
|             | 1                         | 1st mapped object                   | RO     | No          | Uint32    | -    | -          | 0x60400010 |
|             | 2                         | 2nd mapped object                   | RO     | No          | Uint32    | -    | -          | 0x607A0020 |
|             | 3                         | 3rd mapped object                   | RO     | No          | Uint32    | -    | -          | 0x60FF0020 |
|             | 4                         | 4th mapped object                   | RO     | No          | Uint32    | -    | -          | 0x60710010 |
|             | 5                         | 5th mapped object                   | RO     | No          | Uint32    | -    | -          | 0x60600008 |
|             | 6                         | 6th mapped object                   | RO     | No          | Uint32    | -    | -          | 0x60B80010 |
|             | 7                         | 7th mapped object                   | RO     | No          | Uint32    | -    | -          | 0x607F0020 |
|             | 8                         | 8th mapped object                   | RO     | No          | Uint32    | -    | -          | 0x60E00010 |
|             | 9                         | 9th mapped object                   | RO     | No          | Uint32    | -    | -          | 0x60E10010 |



List of Parameters

| Index (HEX) | Sub-index (HEX)           | Name                                | Access | PDO Mapping | Data Type | Unit | Data Range | Default    |
|-------------|---------------------------|-------------------------------------|--------|-------------|-----------|------|------------|------------|
| 1705        | 262nd Receive PDO mapping |                                     |        |             |           |      |            |            |
|             | 0                         | Number of mapped objects in RPDO262 | RW     | No          | Uint8     | -    | -          | 0x08       |
|             | 1                         | 1st mapped object                   | RW     | No          | Uint32    | -    | -          | 0x60400010 |
|             | 2                         | 2nd mapped object                   | RW     | No          | Uint32    | -    | -          | 0x607A0020 |
|             | 3                         | 3rd mapped object                   | RW     | No          | Uint32    | -    | -          | 0x60FF0020 |
|             | 4                         | 4th mapped object                   | RW     | No          | Uint32    | -    | -          | 0x60600008 |
|             | 5                         | 5th mapped object                   | RW     | No          | Uint32    | -    | -          | 0x60B80010 |
|             | 6                         | 6th mapped object                   | RW     | No          | Uint32    | -    | -          | 0x60E00010 |
|             | 7                         | 7th mapped object                   | RW     | No          | Uint32    | -    | -          | 0x60E10010 |
| 8           | 8th mapped object         | RW                                  | No     | Uint32      | -         | -    | 0x60B20010 |            |

| Index (HEX) | Sub-index (HEX)          | Name                              | Access | PDO Mapping | Data Type | Unit | Data Range      | Default    |
|-------------|--------------------------|-----------------------------------|--------|-------------|-----------|------|-----------------|------------|
| 1A00        | 1st Transmit PDO mapping |                                   |        |             |           |      |                 |            |
|             | 0                        | Number of mapped objects in TPDO1 | RW     | No          | Uint8     | -    | 0 to 0x0A       | 0x07       |
|             | 1                        | 1st mapped object                 | RW     | No          | Uint32    | -    | 0 to 0xFFFFFFFF | 0x60410010 |
|             | 2                        | 2nd mapped object                 | RW     | No          | Uint32    | -    | 0 to 0xFFFFFFFF | 0x60640020 |
|             | 3                        | 3rd mapped object                 | RW     | No          | Uint32    | -    | 0 to 0xFFFFFFFF | 0x60B90010 |
|             | 4                        | 4th mapped object                 | RW     | No          | Uint32    | -    | 0 to 0xFFFFFFFF | 0x60BA0020 |
|             | 5                        | 5th mapped object                 | RW     | No          | Uint32    | -    | 0 to 0xFFFFFFFF | 0x60BC0020 |
|             | 6                        | 6th mapped object                 | RW     | No          | Uint32    | -    | 0 to 0xFFFFFFFF | 0x603F0010 |
|             | 7                        | 7th mapped object                 | RW     | No          | Uint32    | -    | 0 to 0xFFFFFFFF | 0x60FD0010 |
|             | 8                        | 8th mapped object                 | RW     | No          | Uint32    | -    | 0 to 0xFFFFFFFF | -          |
|             | 9                        | 9th mapped object                 | RW     | No          | Uint32    | -    | 0 to 0xFFFFFFFF | -          |
|             | 0A                       | 10th mapped object                | RW     | No          | Uint32    | -    | 0 to 0xFFFFFFFF | -          |

List of Parameters

| Index (HEX) | Sub-index (HEX)            | Name                                | Access | PDO Mapping | Data Type | Unit | Data Range | Default    |
|-------------|----------------------------|-------------------------------------|--------|-------------|-----------|------|------------|------------|
| 1B01        | 258th Transmit PDO mapping |                                     |        |             |           |      |            |            |
|             | 0                          | Number of mapped objects in TPDO258 | RO     | No          | Uint8     | -    | -          | 0x09       |
|             | 1                          | 1st mapped object                   | RO     | No          | Uint32    | -    | -          | 0x603F0010 |
|             | 2                          | 2nd mapped object                   | RO     | No          | Uint32    | -    | -          | 0x60410010 |
|             | 3                          | 3rd mapped object                   | RO     | No          | Uint32    | -    | -          | 0x60640020 |
|             | 4                          | 4th mapped object                   | RO     | No          | Uint32    | -    | -          | 0x60770010 |
|             | 5                          | 5th mapped object                   | RO     | No          | Uint32    | -    | -          | 0x60F40020 |
|             | 6                          | 6th mapped object                   | RO     | No          | Uint32    | -    | -          | 0x60B90010 |
|             | 7                          | 7th mapped object                   | RO     | No          | Uint32    | -    | -          | 0x60BA0020 |
|             | 8                          | 8th mapped object                   | RO     | No          | Uint32    | -    | -          | 0x60BC0020 |
| 9           | 9th mapped object          | RO                                  | No     | Uint32      | -         | -    | 0x60FD0010 |            |

| Index (HEX) | Sub-index (HEX)            | Name                                | Access | PDO Mapping | Data Type | Unit | Data Range | Default    |
|-------------|----------------------------|-------------------------------------|--------|-------------|-----------|------|------------|------------|
| 1B02        | 259th Transmit PDO mapping |                                     |        |             |           |      |            |            |
|             | 0                          | Number of mapped objects in TPDO259 | RO     | No          | Uint8     | -    | -          | 0x09       |
|             | 1                          | 1st mapped object                   | RO     | No          | Uint32    | -    | -          | 0x603F0010 |
|             | 2                          | 2nd mapped object                   | RO     | No          | Uint32    | -    | -          | 0x60410010 |
|             | 3                          | 3rd mapped object                   | RO     | No          | Uint32    | -    | -          | 0x60640020 |
|             | 4                          | 4th mapped object                   | RO     | No          | Uint32    | -    | -          | 0x60770010 |
|             | 5                          | 5th mapped object                   | RO     | No          | Uint32    | -    | -          | 0x60610008 |
|             | 6                          | 6th mapped object                   | RO     | No          | Uint32    | -    | -          | 0x60B90010 |
|             | 7                          | 7th mapped object                   | RO     | No          | Uint32    | -    | -          | 0x60BA0020 |
|             | 8                          | 8th mapped object                   | RO     | No          | Uint32    | -    | -          | 0x60BC0020 |
| 9           | 9th mapped object          | RO                                  | No     | Uint32      | -         | -    | 0x60FD0010 |            |

List of Parameters

| Index (HEX) | Sub-index (HEX)            | Name                                | Access | PDO Mapping | Data Type | Unit | Data Range | Default    |
|-------------|----------------------------|-------------------------------------|--------|-------------|-----------|------|------------|------------|
| 1B03        | 260th Transmit PDO mapping |                                     |        |             |           |      |            |            |
|             | 0                          | Number of mapped objects in TPDO260 | RO     | No          | Uint8     | -    | -          | 0x0A       |
|             | 1                          | 1st mapped object                   | RO     | No          | Uint32    | -    | -          | 0x603F0010 |
|             | 2                          | 2nd mapped object                   | RO     | No          | Uint32    | -    | -          | 0x60410010 |
|             | 3                          | 3rd mapped object                   | RO     | No          | Uint32    | -    | -          | 0x60640020 |
|             | 4                          | 4th mapped object                   | RO     | No          | Uint32    | -    | -          | 0x60770010 |
|             | 5                          | 5th mapped object                   | RO     | No          | Uint32    | -    | -          | 0x60F40020 |
|             | 6                          | 6th mapped object                   | RO     | No          | Uint32    | -    | -          | 0x60610008 |
|             | 7                          | 7th mapped object                   | RO     | No          | Uint32    | -    | -          | 0x60B90010 |
|             | 8                          | 8th mapped object                   | RO     | No          | Uint32    | -    | -          | 0x60BA0020 |
|             | 9                          | 9th mapped object                   | RO     | No          | Uint32    | -    | -          | 0x60BC0020 |
|             | 0A                         | 10th mapped object                  | RO     | No          | Uint32    | -    | -          | 0x60FD0010 |

| Index (HEX) | Sub-index (HEX)                | Name                                | Access | PDO Mapping | Data Type | Unit | Data Range  | Default    |
|-------------|--------------------------------|-------------------------------------|--------|-------------|-----------|------|-------------|------------|
| 1B04        | 261st Transmit PDO mapping     |                                     |        |             |           |      |             |            |
|             | 0                              | Number of mapped objects in TPDO261 | RO     | No          | Uint8     | -    | -           | 0x0A       |
|             | 1                              | 1st mapped object                   | RO     | No          | Uint32    | -    | -           | 0x603F0010 |
|             | 2                              | 2nd mapped object                   | RO     | No          | Uint32    | -    | -           | 0x60410010 |
|             | 3                              | 3rd mapped object                   | RO     | No          | Uint32    | -    | -           | 0x60640020 |
|             | 4                              | 4th mapped object                   | RO     | No          | Uint32    | -    | -           | 0x60770010 |
|             | 5                              | 5th mapped object                   | RO     | No          | Uint32    | -    | -           | 0x60610008 |
|             | 6                              | 6th mapped object                   | RO     | No          | Uint32    | -    | -           | 0x60F40020 |
|             | 7                              | 7th mapped object                   | RO     | No          | Uint32    | -    | -           | 0x60B90010 |
|             | 8                              | 8th mapped object                   | RO     | No          | Uint32    | -    | -           | 0x60BA0020 |
|             | 9                              | 9th mapped object                   | RO     | No          | Uint32    | -    | -           | 0x60BC0020 |
|             | 0A                             | 10th mapped object                  | RO     | No          | Uint32    | -    | -           | 0x60CC0020 |
| 1C12        | Sync Manager 2_RPDO assignment |                                     |        |             |           |      |             |            |
|             | 0                              | Number of assigned RPDOs            | RW     | No          | Uint8     | -    | 0 to 0x1    | 0x01       |
|             | 1                              | Index of assigned RPDO              | RW     | Yes         | Uint16    | -    | 0 to 0xFFFF | 0x1701     |
| 1C13        | Sync Manager 2_TPDO assignment |                                     |        |             |           |      |             |            |
|             | 0                              | Number of assigned TPDOs            | RW     | No          | Uint8     | -    | 0 to 0x1    | 0x01       |
|             | 1                              | Index of assigned TPDO              | RW     | Yes         | Uint16    | -    | 0 to 0xFFFF | 0x1B01     |

| Index (HEX)                      | Sub-index (HEX) | Name                                 | Access | PDO Mapping | Data Type | Unit | Data Range | Default        |
|----------------------------------|-----------------|--------------------------------------|--------|-------------|-----------|------|------------|----------------|
| Sync Manager 2 output parameters |                 |                                      |        |             |           |      |            |                |
| 1C32                             | 0               | Number of synchronization parameters | RO     | No          | Uint8     | -    | -          | 0x20           |
|                                  | 1               | Synchronization type                 | RO     | No          | Uint16    | -    | -          | 0x0002         |
|                                  | 2               | Cycle time                           | RO     | No          | Uint32    | ns   | -          | 0              |
|                                  | 4               | Synchronization types supported      | RO     | No          | Uint16    | -    | -          | 0x0004         |
|                                  | 5               | Minimum cycle time                   | RO     | No          | Uint32    | ns   | -          | 0x0003<br>D090 |
|                                  | 6               | Calc and copy time                   | RO     | No          | Uint32    | ns   | -          | -              |
|                                  | 9               | Delay time                           | RO     | No          | Uint32    | ns   | -          | -              |
|                                  | 20              | Sync error                           | RO     | No          | BOOL      | -    | -          | -              |
| Sync Manager 2 input parameters  |                 |                                      |        |             |           |      |            |                |
| 1C33                             | 0               | Number of synchronization parameters | RO     | No          | Uint8     | -    | -          | 0x20           |
|                                  | 1               | Synchronization type                 | RO     | No          | Uint16    | -    | -          | 0x0002         |
|                                  | 2               | Cycle time                           | RO     | No          | Uint32    | ns   | -          | 0              |
|                                  | 4               | Synchronization types supported      | RO     | No          | Uint16    | -    | -          | 0x0004         |
|                                  | 5               | Minimum cycle time                   | RO     | No          | Uint32    | ns   | -          | 0x0003<br>D090 |
|                                  | 6               | Calc and copy time                   | RO     | No          | Uint32    | ns   | -          | -              |
|                                  | 9               | Delay time                           | RO     | No          | Uint32    | ns   | -          | -              |
|                                  | 20              | Sync error                           | RO     | No          | BOOL      | -    | -          | -              |

### 4.3 Parameter Group 2000h

| Para. Group                       |        | Name       | Description | Value Range | Default | Unit | Data Type | Change Condition | Effective Time |
|-----------------------------------|--------|------------|-------------|-------------|---------|------|-----------|------------------|----------------|
| HEX                               | DEC    |            |             |             |         |      |           |                  |                |
| Index                             | Para.  |            |             |             |         |      |           |                  |                |
| 2000h/H00: Servo motor parameters |        |            |             |             |         |      |           |                  |                |
| 01h                               | H00-00 | Motor code | -           | 0 to 65535  | 14101   | -    | 16 bits   | At stop          | Next power-on  |

| Para. Group                       |        | Name                                    | Description  | Value Range         | Default | Unit | Data Type | Change Condition | Effective Time |
|-----------------------------------|--------|---|--|---------------------|---------|------|-----------|------------------|----------------|
| HEX                               | DEC    |   |  |                     |         |      |           |                  |                |
| Index                             | Para.  |   |  |                     |         |      |           |                  |                |
| 03h                               | H00-02 | Customized no.                          | -  | 0 to $(2^{32} - 1)$ | 0       | -    | 32 bits   | -                | -              |
| 05h                               | H00-04 | Encoder version                         | -  | 0 to 6553.5         | 0       | -    | 16 bits   | -                | -              |
| 06h                               | H00-05 | Serial-type motor code                  | -  | 0 to 65535          | 0       | -    | 16 bits   | -                | -              |
| 07h                               | H00-06 | FPGA customized No.                     | -  | 0 to 655.35         | 0       | -    | 16 bits   | -                | -              |
| 08h                               | H00-07 | STO version                             | -  | 0 to 655.35         | 0       | -    | 16 bits   | -                | -              |
| 09h                               | H00-08 | Serial encoder type                     | -  | 0 to 65535          | 0       | -    | 16 bits   | -                | -              |
| 2001h/H01: Servo drive parameters |        |   |  |                     |         |      |           |                  |                |
| 01h                               | H01-00 | MCU software version                    | -  | 0 to 6553.5         | 0       | -    | 16 bits   | -                | -              |
| 02h                               | H01-01 | FPGA software version                   | -  | 0 to 6553.5         | 0       | -    | 16 bits   | -                | -              |
| 0Bh                               | H01-10 | Servo drive model                       | 2: 1R6<br>3: S2R8<br>5: S5R5<br>60005: S6R6<br>6: S7R6<br>7: S012<br>10001: T3R5<br>10002: T5R4<br>10003: T8R4<br>10004: T012<br>10005: T017<br>10006: T021<br>10007: T026 | 0 to 65535          | 3       | -    | 16 bits   | At stop          | Next power-on  |
| 0Ch                               | H01-11 | DC-AC voltage class                     | -  | 0 to 65535          | 220     | V    | 16 bits   | -                | -              |
| 0Dh                               | H01-12 | Rated power of the servo drive          | -  | 0 to 1073741824     | 0.4     | kW   | 32 bits   | -                | -              |
| 0Fh                               | H01-14 | Max. output power of the servo drive    | -  | 0 to 1073741824     | 0.4     | kW   | 32 bits   | -                | -              |
| 11h                               | H01-16 | Rated output current of the servo drive | -  | 0 to 1073741824     | 2.8     | A    | 32 bits   | -                | -              |
| 13h                               | H01-18 | Max. output current of the servo drive  | -  | 0 to 1073741824     | 10.1    | A    | 32 bits   | -                | -              |



List of Parameters

| Para. Group                         |        | Name                                    | Description   | Value Range | Default | Unit | Data Type | Change Condition | Effective Time |
|-------------------------------------|--------|---|---|-------------|---------|------|-----------|------------------|----------------|
| HEX                                 | DEC    |   |   |             |         |      |           |                  |                |
| Index                               | Para.  |   |   |             |         |      |           |                  |                |
| 29h                                 | H01-40 | DC bus overvoltage protection threshold | -   | 0 to 2000   | 420     | V    | 16 bits   | -                | -              |
| 2002h/H02: Basic control parameters |        |   |   |             |         |      |           |                  |                |
| 01h                                 | H02-00 | Control mode                            | 0: Speed control mode<br>1: Position control mode<br>2: Torque control mode<br>9: EtherCAT mode   | 0 to 9      | 9       | -    | 16 bits   | At stop          | At once        |
| 02h                                 | H02-01 | Absolute system selection               | 0: Incremental mode<br>1: Absolute position linear mode<br>2: Absolute position rotation mode<br>3: Absolute position linear mode (encoder overflow not detected)<br>4: Absolute position single-turn mode  | 0 to 4      | 0       | -    | 16 bits   | At stop          | Next power-on  |
| 03h                                 | H02-02 | Direction of rotation                   | 0: CCW as the forward direction<br>1: CW as the forward direction   | 0 to 1      | 0       | -    | 16 bits   | At stop          | Next power-on  |
| 06h                                 | H02-05 | Stop mode at S-ON OFF                   | -3: Stop at zero speed, keeping dynamic braking status<br>-2: Ramp to stop as defined by 6084h/609Ah, keeping dynamic braking status<br>-1: Dynamic braking stop, keeping dynamic braking status<br>0: Coast to stop, keeping de-energized status<br>1: Ramp to stop as defined by 6084h/609Ah, keeping de-energized status | -3 to +1    | 0       | -    | 16 bits   | At stop          | At once        |

| Para. Group |        | Name                     | Description   | Value Range | Default | Unit | Data Type | Change Condition | Effective Time |
|-------------|--------|--------------------------|---|-------------|---------|------|-----------|------------------|----------------|
| HEX         | DEC    |                          |   |             |         |      |           |                  |                |
| Index       | Para.  |                          |   |             |         |      |           |                  |                |
| 07h         | H02-06 | Stop mode at No. 2 fault | -5: Stop at zero speed, keeping dynamic braking status<br>-4: Stop at the emergency-stop torque, keeping dynamic braking status<br>-3: Ramp to stop as defined by 6085h, keeping dynamic braking status<br>-2: Ramp to stop as defined by 6084h/609Ah, keeping dynamic braking status<br>-1: Dynamic braking stop, keeping dynamic braking status<br>0: Coast to stop, keeping de-energized status<br>1: Ramp to stop as defined by 6084h/609Ah, keeping de-energized status<br>2: Ramp to stop as defined by 6085h, keeping de-energized status<br>3: Stop at emergency-stop torque, keeping de-energized status | -5 to +3    | 2       | -    | 16 bits   | At stop          | At once        |

List of Parameters

| Para. Group |        | Name  | Description   | Value Range | Default | Unit | Data Type | Change Condition | Effective Time |
|-------------|--------|---|---|-------------|---------|------|-----------|------------------|----------------|
| HEX         | DEC    |   |   |             |         |      |           |                  |                |
| Index       | Para.  |   |   |             |         |      |           |                  |                |
| 08h         | H02-07 | Stop mode at overtravel                             | 0: Coast to stop, keeping de-energized state<br>1: Stop at zero speed, keeping position lock state<br>2: Stop at zero speed, keeping de-energized status<br>3: Ramp to stop as defined by 6085h, keeping de-energized status<br>4: Ramp to stop as defined by 6085h, keeping position lock status<br>5: Dynamic braking stop, keeping de-energized status<br>6: Dynamic braking stop, keeping dynamic braking status<br>7: Not responding to overtravel (with warning displayed only) | 0 to 7      | 1       | -    | 16 bits   | At stop          | At once        |
| 09h         | H02-08 | Stop mode at No. 1 fault                            | 0: Coast to stop, keeping de-energized state<br>1: Dynamic braking stop, keeping de-energized status<br>2: Dynamic braking stop, keeping dynamic braking status   | 0 to 2      | 2       | -    | 16 bits   | At stop          | At once        |
| 0Ah         | H02-09 | Delay from brake (BK) output ON to command received | -   | 0 to 500    | 250     | ms   | 16 bits   | During running   | At once        |

| Para. Group |        | Name   | Description  | Value Range | Default | Unit | Data Type | Change Condition | Effective Time |
|-------------|--------|--|--|-------------|---------|------|-----------|------------------|----------------|
| HEX         | DEC    |  |  |             |         |      |           |                  |                |
| Index       | Para.  |  |  |             |         |      |           |                  |                |
| 0Bh         | H02-10 | Delay from brake (BK) output OFF to motor de-energized             | -  | 50 to 1000  | 150     | ms   | 16 bits   | During running   | At once        |
| 0Ch         | H02-11 | Speed threshold at brake (BK) output OFF in the rotation state     | -  | 20 to 3000  | 30      | RPM  | 16 bits   | During running   | At once        |
| 0Dh         | H02-12 | Delay from S-ON OFF to brake (BK) output OFF in the rotation state | -  | 1 to 1000   | 500     | ms   | 16 bits   | During running   | At once        |
| 10h         | H02-15 | Warning display on the keypad                                      | 0: Warning information outputted immediately<br>1: Warning information not outputted | 0 to 1      | 0       | -    | 16 bits   | During running   | At once        |
| 11h         | H02-16 | Brake enable switch  | 0: Disable<br>1: Enable  | 0 to 1      | 1       | -    | 16 bits   | During running   | At once        |
| 15h         | H02-20 | Dynamic brake relay coil ON delay                                  | -  | 30 to 30000 | 30      | ms   | 16 bits   | During running   | At once        |
| 16h         | H02-21 | Permissible minimum resistance of the regenerative resistor        | -  | 1 to 1000   | 40      | Ω    | 16 bits   | -                | -              |
| 17h         | H02-22 | Power of built-in regenerative resistor                            | -  | 0 to 65535  | 0       | W    | 16 bits   | -                | -              |
| 18h         | H02-23 | Resistance of built-in regenerative resistor                       | -  | 0 to 65535  | 0       | Ω    | 16 bits   | -                | -              |
| 19h         | H02-24 | Resistor heat dissipation coefficient                              | -  | 10 to 100   | 30      | %    | 16 bits   | During running   | At once        |

List of Parameters

| Para. Group                          |        | Name   | Description  | Value Range | Default | Unit | Data Type | Change Condition | Effective Time |
|--------------------------------------|--------|--|--|-------------|---------|------|-----------|------------------|----------------|
| HEX                                  | DEC    |  |  |             |         |      |           |                  |                |
| Index                                | Para.  |  |  |             |         |      |           |                  |                |
| 1Ah                                  | H02-25 | Regenerative resistor type                   | 0: Built-in<br>1: External, natural cooling<br>2: External, forced air cooling<br>3: No resistor needed, braking energy absorbed by the capacitor  | 0 to 3      | 3       | -    | 16 bits   | During running   | At once        |
| 1Bh                                  | H02-26 | Power of external regenerative resistor      | -  | 1 to 65535  | 40      | W    | 16 bits   | During running   | At once        |
| 1Ch                                  | H02-27 | Resistance of external regenerative resistor | -  | 15 to 1000  | 50      | Ω    | 16 bits   | During running   | At once        |
| 1Fh                                  | H02-30 | User password                                | -  | 0 to 65535  | 0       | -    | 16 bits   | During running   | At once        |
| 20h                                  | H02-31 | System parameter initialization              | 0: No operation<br>1: Restore default settings<br>2: Clear fault log   | 0 to 2      | 0       | -    | 16 bits   | At stop          | At once        |
| 21h                                  | H02-32 | Selection of parameters in group H0B         | -  | 0 to 99     | 50      | -    | 16 bits   | During running   | At once        |
| 24h                                  | H02-35 | Keypad data update frequency                 | -  | 0 to 20     | 0       | Hz   | 16 bits   | During running   | At once        |
| 2Ah                                  | H02-41 | Factory password                             | -  | 0 to 65535  | 0       | -    | 16 bits   | During running   | At once        |
| 2003h/H03: Terminal input parameters |        |  |  |             |         |      |           |                  |                |
| 03h                                  | H03-02 | DI1 function                                 | 0: No assignment<br>1: Servo ON<br>2: Fault reset<br>14: Positive limit switch<br>15: Negative limit switch<br>31: Home switch<br>34: Emergency stop<br>38: Touch probe 1<br>39: Touch probe 2 | 0 to 40     | 14      | -    | 16 bits   | During running   | At once        |
| 04h                                  | H03-03 | DI1 logic                                    | 0: NO<br>1: NC   | 0 to 1      | 0       | -    | 16 bits   | During running   | At once        |

| Para. Group                           |        | Name            | Description   | Value Range | Default | Unit | Data Type | Change Condition | Effective Time |
|---------------------------------------|--------|-----------------|---|-------------|---------|------|-----------|------------------|----------------|
| HEX                                   | DEC    |                 |   |             |         |      |           |                  |                |
| Index                                 | Para.  |                 |   |             |         |      |           |                  |                |
| 05h                                   | H03-04 | DI2 function    | 0 to 39<br>See the description of H03-02 for details. | 0 to 40     | 15      | -    | 16 bits   | During running   | At once        |
| 06h                                   | H03-05 | DI2 logic       | 0 to 1<br>See the description of H03-03 for details.  | 0 to 1      | 0       | -    | 16 bits   | During running   | At once        |
| 07h                                   | H03-06 | DI3 function    | 0 to 39<br>See the description of H03-02 for details. | 0 to 40     | 31      | -    | 16 bits   | During running   | At once        |
| 08h                                   | H03-07 | DI3 logic       | 0 to 1<br>See the description of H03-03 for details.  | 0 to 1      | 0       | -    | 16 bits   | During running   | At once        |
| 09h                                   | H03-08 | DI4 function    | 0 to 39<br>See the description of H03-02 for details. | 0 to 40     | 39      | -    | 16 bits   | During running   | At once        |
| 0Ah                                   | H03-09 | DI4 logic       | 0 to 1<br>See the description of H03-03 for details.  | 0 to 1      | 0       | -    | 16 bits   | During running   | At once        |
| 0Bh                                   | H03-10 | DI5 function    | 0 to 39<br>See the description of H03-02 for details. | 0 to 40     | 38      | -    | 16 bits   | During running   | At once        |
| 0Ch                                   | H03-11 | DI5 logic       | 0 to 1<br>See the description of H03-03 for details.  | 0 to 1      | 0       | -    | 16 bits   | During running   | At once        |
| 3Dh                                   | H03-60 | DI1 filter time |   | 0 to 500    | 0.5     | ms   | 16 bits   | During running   | At once        |
| 3Eh                                   | H03-61 | DI2 filter time |   | 0 to 500    | 0.5     | ms   | 16 bits   | During running   | At once        |
| 3Fh                                   | H03-62 | DI3 filter time |   | 0 to 500    | 0.5     | ms   | 16 bits   | During running   | At once        |
| 40h                                   | H03-63 | DI4 filter time |   | 0 to 500    | 0.5     | ms   | 16 bits   | During running   | At once        |
| 41h                                   | H03-64 | DI5 filter time |   | 0 to 500    | 0.5     | ms   | 16 bits   | During running   | At once        |
| 2004h/H04: Terminal output parameters |        |                 |   |             |         |      |           |                  |                |

List of Parameters

| Para. Group |        | Name         | Description  | Value Range | Default | Unit | Data Type | Change Condition | Effective Time |
|-------------|--------|--------------|--|-------------|---------|------|-----------|------------------|----------------|
| HEX         | DEC    |              |  |             |         |      |           |                  |                |
| Index       | Para.  |              |  |             |         |      |           |                  |                |
| 01h         | H04-00 | DO1 function | 0: No assignment<br>1: Servo ready<br>2: Motor rotating<br>9: Brake (BK) output<br>10: Warning<br>11: Fault<br>25: Comparison output<br>31: EtherCAT forced output<br>32: EDM safety state | 0 to 32     | 1       | -    | 16 bits   | During running   | At once        |
| 02h         | H04-01 | DO1 logic    | 0: NO<br>1: NC   | 0 to 1      | 0       | -    | 16 bits   | During running   | At once        |
| 03h         | H04-02 | DO2 function | 0 to 32<br>See the description of H04-00 for details.  | 0 to 32     | 11      | -    | 16 bits   | During running   | At once        |
| 04h         | H04-03 | DO2 logic    | 0 to 1<br>See the description of H04-01 for details.   | 0 to 1      | 0       | -    | 16 bits   | During running   | At once        |
| 05h         | H04-04 | DO3 function | 0 to 32<br>See the description of H04-00 for details.  | 0 to 32     | 9       | -    | 16 bits   | During running   | At once        |
| 06h         | H04-05 | DO3 logic    | 0 to 1<br>See the description of H04-01 for details.   | 0 to 1      | 0       | -    | 16 bits   | During running   | At once        |

| Para. Group                            |        | Name                                      | Description   | Value Range     | Default | Unit | Data Type | Change Condition | Effective Time |
|--|--------|---|---|-----------------|---------|------|-----------|------------------|----------------|
| HEX                                    | DEC    |   |   |                 |         |      |           |                  |                |
| Index                                  | Para.  |   |   |                 |         |      |           |                  |                |
| 18h                                    | H04-23 | EtherCAT forced DO logic in non-OP status | 0: Status of DO1, DO2, and DO3 unchanged in the non-OP status<br>1: No output in DO1 and status of others unchanged in the non-OP status<br>2: No output in DO2 and status of others unchanged in the non-OP status<br>3: No output in DO1 or DO2 and status of others unchanged in the non-OP status<br>4: No output in DO3 and status of others unchanged in the non-OP status<br>5: No output in DO1 or DO3 and status of others unchanged in the non-OP status<br>6: No output in DO2 or DO3 and status of others unchanged in the non-OP status<br>7: No output in DO1, DO2, or DO3 in the non-OP status | 0 to 7          | 0       | -    | 16 bits   | During running   | At once        |
| 2005h/H05: Position control parameters |        |   |   |                 |         |      |           |                  |                |
| 05h                                    | H05-04 | First-order low-pass filter time constant | -   | 0 to 6553.5     | 0       | ms   | 16 bits   | At stop          | At once        |
| 06h                                    | H05-05 | Moving average filter time constant 1     | -   | 0 to 1000       | 0       | ms   | 16 bits   | At stop          | At once        |
| 07h                                    | H05-06 | Moving average filter time constant 2     | -   | 0 to 128        | 0       | ms   | 16 bits   | At stop          | At once        |
| 08h                                    | H05-07 | Numerator of electronic gear ratio        | -   | 0 to 4294967295 | 1       | 1    | 32 bits   | During running   | At once        |
| 0Ah                                    | H05-09 | Denominator of electronic gear ratio      | -   | 0 to 4294967295 | 1       | 1    | 32 bits   | During running   | At once        |



List of Parameters

| Para. Group |        | Name  | Description  | Value Range                  | Default | Unit | Data Type | Change Condition | Effective Time |
|-------------|--------|---|--|------------------------------|---------|------|-----------|------------------|----------------|
| HEX         | DEC    |   |  |                              |         |      |           |                  |                |
| Index       | Para.  |   |  |                              |         |      |           |                  |                |
| 14h         | H05-19 | Speed feedforward control   | 0: No speed feedforward<br>1: Internal speed feedforward<br>2: 60B1 used as speed feedforward<br>3: Zero phase control | 0 to 3                       | 1       | -    | 16 bits   | At stop          | At once        |
| 15h         | H05-20 | Condition for COIN (positioning completed) signal output                    | 0: Position deviation = Filtered position reference - Position feedback  | 0 to 3                       | 0       | -    | 16 bits   | At stop          | At once        |
| 1F          | H05-30 | Homing function   | 0: Disable<br>6: Current position as the home  | 0, 6                         | 0       | -    | 16 bits   | During running   | At once        |
| 24h         | H05-35 | Homing time limit   | -  | 0 to 6553.5                  | 5000    | s    | 16 bits   | During running   | At once        |
| 25h         | H05-36 | Local home offset   | -  | -1073741824 to +1073741824   | 0       | -    | 32 bits   | During running   | At once        |
| 2Fh         | H05-46 | Position deviation in absolute position linear mode (low 32 bits)           | -  | $-2^{31}$ to $+(2^{31} - 1)$ | 0       | -    | 32 bits   | At stop          | Next power-on  |
| 31h         | H05-48 | Position deviation in absolute position linear mode (high 32 bits)          | -  | $-2^{31}$ to $+(2^{31} - 1)$ | 0       | -    | 32 bits   | At stop          | Next power-on  |
| 33h         | H05-50 | Numerator of mechanical gear ratio  | -  | 1 to 65535                   | 1       | -    | 16 bits   | At stop          | At once        |
| 34h         | H05-51 | Denominator of mechanical gear ratio  | -  | 1 to 65535                   | 1       | -    | 16 bits   | At stop          | At once        |
| 35h         | H05-52 | Pulses per load revolution in absolute position rotation mode (low 32 bits) | -  | 0 to $(2^{32} - 1)$          | 0       | 1 p  | 32 bits   | At stop          | At once        |

| Para. Group                          |        | Name   | Description  | Value Range           | Default | Unit | Data Type | Change Condition | Effective Time |
|--------------------------------------|--------|--|--|-----------------------|---------|------|-----------|------------------|----------------|
| HEX                                  | DEC    |  |  |                       |         |      |           |                  |                |
| Index                                | Para.  |  |  |                       |         |      |           |                  |                |
| 37h                                  | H05-54 | Pulses per load revolution in absolute position rotation mode (high 32 bits) | -  | 0 to ( $2^{32} - 1$ ) | 0       | 1 p  | 32 bits   | At stop          | At once        |
| 2006h/H06: Speed control parameters  |        |  |  |                       |         |      |           |                  |                |
| 04h                                  | H06-03 | Speed reference  | -  | -6000 to +6000        | 200     | RPM  | 16 bits   | During running   | At once        |
| 06h                                  | H06-05 | Acceleration ramp time of speed reference                                    | -  | 0 to 65535            | 0       | RPM  | 16 bits   | During running   | At once        |
| 07h                                  | H06-06 | Deceleration ramp time of speed reference                                    | -  | 0 to 65535            | 0       | RPM  | 16 bits   | During running   | At once        |
| 09h                                  | H06-08 | Forward speed limit  | -  | 0 to 6000             | 6000    | RPM  | 16 bits   | During running   | At once        |
| 0Ah                                  | H06-09 | Reverse speed limit  | -  | 0 to 6000             | 6000    | RPM  | 16 bits   | During running   | At once        |
| 0Bh                                  | H06-10 | Deceleration unit in emergency stop  | 0: x 1<br>1: x 10<br>2: x 100  | 0 to 2                | 0       | -    | 16 bits   | At stop          | At once        |
| 0Ch                                  | H06-11 | Torque feedforward control   | 0: No torque feedforward<br>1: Internal torque feedforward<br>2: 60B2h used as external torque feedforward | 0 to 2                | 1       | -    | 16 bits   | During running   | At once        |
| 0Dh                                  | H06-12 | Acceleration ramp time of jog speed  | -  | 0 to 65535            | 10      | ms   | 16 bits   | During running   | At once        |
| 0Eh                                  | H06-13 | Speed feedforward smoothing filter   | -  | 0 to 2000             | 0       | us   | 16 bits   | During running   | At once        |
| 11h                                  | H06-16 | Threshold of TGON (motor rotation) signal                                    | -  | 0 to 1000             | 20      | RPM  | 16 bits   | During running   | At once        |
| 1Dh                                  | H06-28 | Cogging torque compensation selection  | 0: No<br>1: Yes  | 0 to 1                | 1       | -    | 16 bits   | During running   | At once        |
| 2007h/H07: Torque control parameters |        |  |  |                       |         |      |           |                  |                |

List of Parameters

| Para. Group |        | Name   | Description             | Value Range      | Default | Unit | Data Type | Change Condition | Effective Time |
|-------------|--------|--|-------------------------|------------------|---------|------|-----------|------------------|----------------|
| HEX         | DEC    |  |                         |                  |         |      |           |                  |                |
| Index       | Para.  |  |                         |                  |         |      |           |                  |                |
| 04h         | H07-03 | Torque reference set through keypad                            | -                       | -400.0 to +400.0 | 0       | %    | 16 bits   | During running   | At once        |
| 06h         | H07-05 | Torque reference filter time constant 1                        | -                       | 0 to 30.00       | 0.2     | ms   | 16 bits   | During running   | At once        |
| 07h         | H07-06 | Torque reference filter time constant 2                        | -                       | 0 to 30.00       | 0.27    | ms   | 16 bits   | During running   | At once        |
| 0Ah         | H07-09 | Forward internal torque limit                                  | -                       | 0 to 400.0       | 350     | %    | 16 bits   | During running   | At once        |
| 0Bh         | H07-10 | Reverse internal torque limit                                  | -                       | 0 to 400.0       | 350     | %    | 16 bits   | During running   | At once        |
| 10h         | H07-15 | Emergency-stop torque  | -                       | 0 to 400.0       | 100     | %    | 16 bits   | During running   | At once        |
| 14h         | H07-19 | Internal speed limit in torque control                         | -                       | 0 to 6000        | 3000    | RPM  | 16 bits   | During running   | At once        |
| 15h         | H07-20 | Negative internal speed limit in torque control                | -                       | 0 to 6000        | 3000    | RPM  | 16 bits   | During running   | At once        |
| 16h         | H07-21 | Reference value for torque reach                               | -                       | 0 to 400.0       | 0       | %    | 16 bits   | During running   | At once        |
| 17h         | H07-22 | Torque output value when DO signal for torque reach turned on  | -                       | 0 to 400.0       | 20      | %    | 16 bits   | During running   | At once        |
| 18h         | H07-23 | Torque output value when DO signal for torque reach turned off | -                       | 0 to 400.0       | 10      | %    | 16 bits   | During running   | At once        |
| 19h         | H07-24 | Depth of field-weakening                                       | -                       | 60 to 115        | 115     | %    | 16 bits   | During running   | At once        |
| 1Ah         | H07-25 | Max. permissible demagnetizing current                         | -                       | 1 to 200         | 100     | %    | 16 bits   | During running   | At once        |
| 1Bh         | H07-26 | Field-weakening selection                                      | 0: Disable<br>1: Enable | 0 to 1           | 0       | -    | 16 bits   | At stop          | At once        |

| Para. Group                |        | Name                                  | Description  | Value Range    | Default | Unit | Data Type | Change Condition | Effective Time |
|----------------------------|--------|---------------------------------------|--|----------------|---------|------|-----------|------------------|----------------|
| HEX                        | DEC    |                                       |  |                |         |      |           |                  |                |
| Index                      | Para.  |                                       |  |                |         |      |           |                  |                |
| 1Ch                        | H07-27 | Field-weakening gain                  | -  | 0.001 to 1.000 | 0.03    | -    | 16 bits   | During running   | At once        |
| 25h                        | H07-36 | Time constant of low-pass filter 2    | -  | 0 to 10.00     | 0       | ms   | 16 bits   | During running   | At once        |
| 26h                        | H07-37 | Torque reference filter selection     | 0: First-order filter<br>1: Biquad filter  | 0 to 1         | 0       | -    | 16 bits   | During running   | At once        |
| 27h                        | H07-38 | Biquad filter attenuation ratio       | -  | 0 to 50        | 16      | -    | 16 bits   | At stop          | At once        |
| 2008h/H08: Gain parameters |        |                                       |  |                |         |      |           |                  |                |
| 01h                        | H08-00 | Speed loop gain                       | -  | 0.1 to 2000    | 39      | Hz   | 16 bits   | During running   | At once        |
| 02h                        | H08-01 | Speed loop integral time constant     | -  | 0.15 to 512    | 20.51   | ms   | 16 bits   | During running   | At once        |
| 03h                        | H08-02 | Position loop gain                    | -  | 0.1 to 2000    | 55.7    | Hz   | 16 bits   | During running   | At once        |
| 04h                        | H08-03 | 2nd speed loop gain                   | -  | 0.1 to 2000    | 75      | Hz   | 16 bits   | During running   | At once        |
| 05h                        | H08-04 | 2nd speed loop integral time constant | -  | 0.15 to 512    | 10.61   | ms   | 16 bits   | During running   | At once        |
| 06h                        | H08-05 | 2nd position loop gain                | -  | 0.1 to 2000    | 120     | Hz   | 16 bits   | During running   | At once        |
| 09h                        | H08-08 | 2nd gain mode setting                 | 0: Fixed to the 1st gain set, P/PI switched by bit26 of 60FE<br>1: Switched between the 1st gain set and 2nd gain set as defined by H08-09 | 0 to 1         | 1       | -    | 16 bits   | During running   | At once        |

List of Parameters

| Para. Group |        | Name                                   | Description   | Value Range | Default | Unit | Data Type | Change Condition | Effective Time |
|-------------|--------|--|---|-------------|---------|------|-----------|------------------|----------------|
| HEX         | DEC    |  |   |             |         |      |           |                  |                |
| Index       | Para.  |  |   |             |         |      |           |                  |                |
| 0Ah         | H08-09 | Gain switchover condition              | 0: Fixed to the 1st gain set (PS)<br>1: Switched by bit26 of 60FE<br>2: Torque reference too large (PS)<br>3: Speed reference too large (PS)<br>4: Speed reference change rate too large (PS)<br>5: Speed reference high/low-speed threshold (PS)<br>6: Position deviation too large (P)<br>7: Position reference available (P)<br>8: Positioning completed (P)<br>9: Actual speed (P)<br>10: Position reference+Actual speed (P) | 0 to 10     | 0       | -    | 16 bits   | During running   | At once        |
| 0Bh         | H08-10 | Gain switchover delay                  | -   | 0 to 1000   | 5       | ms   | 16 bits   | During running   | At once        |
| 0Ch         | H08-11 | Gain switchover level                  | -   | 0 to 20000  | 50      | -    | 16 bits   | During running   | At once        |
| 0Dh         | H08-12 | Gain switchover dead time              | -   | 0 to 20000  | 30      | -    | 16 bits   | During running   | At once        |
| 0Eh         | H08-13 | Position gain switchover time          | -   | 0 to 1000   | 3       | ms   | 16 bits   | During running   | At once        |
| 10h         | H08-15 | Load moment of inertia ratio           | -   | 0 to 120    | 3       | -    | 16 bits   | During running   | At once        |
| 12h         | H08-17 | Zero phase delay                       | -   | 0 to 4      | 0       | ms   | 16 bits   | During running   | At once        |
| 13h         | H08-18 | Speed feedforward filter time constant | -   | 0 to 64     | 0.5     | ms   | 16 bits   | During running   | At once        |
| 14h         | H08-19 | Speed feedforward gain                 | -   | 0 to 100    | 0       | %    | 16 bits   | During running   | At once        |

| Para. Group |        | Name   | Description   | Value Range | Default | Unit | Data Type | Change Condition | Effective Time |
|-------------|--------|--|---|-------------|---------|------|-----------|------------------|----------------|
| HEX         | DEC    |  |   |             |         |      |           |                  |                |
| Index       | Para.  |  |   |             |         |      |           |                  |                |
| 15h         | H08-20 | Torque feedforward filter time constant                    | -   | 0 to 64     | 0.5     | ms   | 16 bits   | During running   | At once        |
| 16h         | H08-21 | Torque feedforward gain                                    | -   | 0 to 300    | 0       | %    | 16 bits   | During running   | At once        |
| 17h         | H08-22 | Speed feedback filtering option                            | 0: Inhibited<br>1: Two times<br>2: Four times<br>3: Eight times<br>4: Sixteen times | 0 to 4      | 0       | -    | 16 bits   | At stop          | At once        |
| 18h         | H08-23 | Cutoff frequency of speed feedback low-pass filter         | -   | 100 to 8000 | 8000    | Hz   | 16 bits   | During running   | At once        |
| 19h         | H08-24 | PDF control coefficient                                    | -   | 0 to 200    | 100     | %    | 16 bits   | During running   | At once        |
| 1Ch         | H08-27 | Speed observer cutoff frequency                            | -   | 50 to 600   | 170     | Hz   | 16 bits   | During running   | At once        |
| 1Dh         | H08-28 | Speed observer inertia correction coefficient              | -   | 1 to 1600   | 100     | %    | 16 bits   | During running   | At once        |
| 1Eh         | H08-29 | Speed observer filter time                                 | -   | 0 to 10     | 0.8     | ms   | 16 bits   | During running   | At once        |
| 1Fh         | H08-30 | Disturbance compensation time                              | -   | 0 to 100    | 0.2     | ms   | 16 bits   | During running   | At once        |
| 20h         | H08-31 | Disturbance cutoff frequency                               | -   | 10 to 4000  | 600     | Hz   | 16 bits   | During running   | At once        |
| 21h         | H08-32 | Disturbance compensation gain                              | -   | 0 to 100    | 0       | %    | 16 bits   | During running   | At once        |
| 22h         | H08-33 | Disturbance observer inertia correction coefficient        | -   | 0 to 1600   | 100     | %    | 16 bits   | During running   | At once        |
| 26h         | H08-37 | Phase modulation for medium-frequency jitter suppression 2 | -   | -90 to +90  | 0       | °    | 16 bits   | During running   | At once        |

List of Parameters

| Para. Group |        | Name  | Description          | Value Range | Default | Unit | Data Type | Change Condition | Effective Time |
|-------------|--------|---|----------------------|-------------|---------|------|-----------|------------------|----------------|
| HEX         | DEC    |   |                      |             |         |      |           |                  |                |
| Index       | Para.  |   |                      |             |         |      |           |                  |                |
| 27h         | H08-38 | Frequency of medium-frequency jitter suppression 2              | -                    | 0 to 1000   | 0       | Hz   | 16 bits   | During running   | At once        |
| 28h         | H08-39 | Compensation gain of medium-frequency jitter suppression 2      | -                    | 0 to 300    | 0       | %    | 16 bits   | During running   | At once        |
| 29h         | H08-40 | Speed observer selection  | 0: Disable 1: Enable | 0 to 1      | 0       | -    | 16 bits   | During running   | At once        |
| 2Bh         | H08-42 | Model control selection   | 0: Disable 1: Enable | 0 to 1      | 0       | -    | 16 bits   | During running   | At once        |
| 2Ch         | H08-43 | Model gain  | -                    | 0.1 to 2000 | 40      | -    | 16 bits   | During running   | At once        |
| 2Fh         | H08-46 | Feedforward value   | -                    | 0 to 102.4  | 95      | -    | 16 bits   | During running   | At once        |
| 36h         | H08-53 | Medium- and low-frequency jitter suppression frequency 3        | -                    | 0 to 300    | 0       | Hz   | 16 bits   | During running   | At once        |
| 37h         | H08-54 | Medium- and low-frequency jitter suppression compensation 3     | -                    | 0 to 200    | 0       | %    | 16 bits   | During running   | At once        |
| 39h         | H08-56 | Medium- and low-frequency jitter suppression phase modulation 3 | -                    | 0 to 600    | 100     | %    | 16 bits   | During running   | At once        |
| 3Ch         | H08-59 | Medium- and low-frequency jitter suppression frequency 4        | -                    | 0 to 300    | 0       | Hz   | 16 bits   | During running   | At once        |
| 3Dh         | H08-60 | Medium- and low-frequency jitter suppression compensation 4     | -                    | 0 to 200    | 0       | %    | 16 bits   | During running   | At once        |

| Para. Group |        | Name  | Description             | Value Range | Default | Unit | Data Type | Change Condition | Effective Time |
|-------------|--------|---|-------------------------|-------------|---------|------|-----------|------------------|----------------|
| HEX         | DEC    |   |                         |             |         |      |           |                  |                |
| Index       | Para.  |   |                         |             |         |      |           |                  |                |
| 3Eh         | H08-61 | Medium- and low-frequency jitter suppression phase modulation 4 | -                       | 0 to 600    | 100     | %    | 16 bits   | During running   | At once        |
| 3Fh         | H08-62 | Position loop integral time constant                            | -                       | 0.15 to 512 | 512     | -    | 16 bits   | During running   | At once        |
| 40h         | H08-63 | 2nd position loop integral time constant                        | -                       | 0.15 to 512 | 512     | -    | 16 bits   | During running   | At once        |
| 41h         | H08-64 | Speed observer feedback source                                  | 0: Disable<br>1: Enable | 0 to 1      | 0       | -    | 16 bits   | During running   | At once        |
| 49h         | H08-72 | Viscous friction of zero deviation control                      | -                       | 0 to 100    | 0       | -    | 16 bits   | During running   | At once        |
| 4Ah         | H08-73 | Forward coulomb friction of zero deviation control              | -                       | 0 to 100    | 0       | -    | 16 bits   | During running   | At once        |
| 4Bh         | H08-74 | Reverse coulomb friction of zero deviation control              | -                       | -100 to 0   | 0       | -    | 16 bits   | During running   | At once        |
| 4Ch         | H08-75 | Friction compensation selection of zero deviation control       | 0: Disable<br>1: Enable | 0 to 1      | 0       | -    | 16 bits   | During running   | At once        |
| 4Dh         | H08-76 | Acceleration compensation factor of zero deviation control      | -                       | 0 to 900    | 0       | -    | 16 bits   | During running   | At once        |
| 4Eh         | H08-77 | Static friction of zero deviation control                       | -                       | 0 to 100    | 0       | -    | 16 bits   | During running   | At once        |



List of Parameters

| Para. Group                            |        | Name   | Description   | Value Range | Default | Unit | Data Type | Change Condition | Effective Time |
|--|--------|--|---|-------------|---------|------|-----------|------------------|----------------|
| HEX                                    | DEC    |  |   |             |         |      |           |                  |                |
| Index                                  | Para.  |  |   |             |         |      |           |                  |                |
| 4Fh                                    | H08-78 | Transition speed between coulomb friction and viscous friction of zero deviation control | -   | 0 to 100    | 0       | -    | 16 bits   | During running   | At once        |
| 50h                                    | H08-79 | Initial torque shock of zero deviation control   | -   | 0 to 100    | 0       | -    | 16 bits   | During running   | At once        |
| 51h                                    | H08-80 | Friction compensation delay of zero deviation control                                    | -   | 0 to 1000   | 20      | -    | 16 bits   | During running   | At once        |
| 2009h/H09: Gain auto-tuning parameters |        |  |   |             |         |      |           |                  |                |
| 01h                                    | H09-00 | Gain auto-tuning mode  | 0: Invalid, gain parameters tuned manually<br>1: Valid, gain parameters tuned automatically based on the stiffness level<br>2: Positioning mode, gain parameters tuned automatically based on the stiffness level<br>3: Interpolation mode + Inertia auto-tuning<br>4: Normal mode + Inertia auto-tuning<br>6: Quick positioning mode + Inertia auto-tuning | 0 to 7      | 4       | -    | 16 bits   | During running   | At once        |
| 02h                                    | H09-01 | Stiffness level  | -   | 0 to 41     | 15      | -    | 16 bits   | During running   | At once        |

| Para. Group |        | Name  | Description   | Value Range | Default | Unit | Data Type | Change Condition | Effective Time |
|-------------|--------|---|---|-------------|---------|------|-----------|------------------|----------------|
| HEX         | DEC    |   |   |             |         |      |           |                  |                |
| Index       | Para.  |   |   |             |         |      |           |                  |                |
| 03h         | H09-02 | Adaptive notch mode   | 0: Adaptive notch not updated<br>1: One adaptive notch activated (3rd notch)<br>2: Two adaptive notches activated (3rd and 4th notches)<br>3: Resonance point tested only, displayed in H09-24<br>4: Adaptive notch cleared, values of the 3rd and 4th notches restored to default settings | 0 to 4      | 3       | -    | 16 bits   | During running   | At once        |
| 04h         | H09-03 | Online inertia auto-tuning mode   | 0: Disabled<br>1: Enabled, changing slowly<br>2: Enabled, changing normally<br>3: Enabled, changing quickly   | 0 to 3      | 2       | -    | 16 bits   | During running   | At once        |
| 06h         | H09-05 | Offline inertia auto-tuning mode  | 0: Bidirectional<br>1: Unidirectional   | 0 to 1      | 0       | -    | 16 bits   | At stop          | At once        |
| 07h         | H09-06 | Maximum speed of inertia auto-tuning  | -   | 100 to 1000 | 500     | RPM  | 16 bits   | At stop          | At once        |
| 08h         | H09-07 | Time constant for accelerating to the max. speed during inertia auto-tuning | -   | 20 to 800   | 125     | ms   | 16 bits   | At stop          | At once        |
| 09h         | H09-08 | Waiting time after an individual inertia auto-tuning                        | -   | 50 to 10000 | 800     | ms   | 16 bits   | At stop          | At once        |
| 0Ah         | H09-09 | Number of motor revolutions per inertia auto-tuning                         | -   | 0 to 100    | 1       | -    | 16 bits   | -                | -              |

List of Parameters

| Para. Group |        | Name   | Description | Value Range  | Default | Unit | Data Type | Change Condition | Effective Time |
|-------------|--------|--|-------------|--------------|---------|------|-----------|------------------|----------------|
| HEX         | DEC    |  |             |              |         |      |           |                  |                |
| Index       | Para.  |  |             |              |         |      |           |                  |                |
| 0Ch         | H09-11 | Vibration threshold                          | -           | 0 to 100     | 5       | %    | 16 bits   | During running   | At once        |
| 0Dh         | H09-12 | Frequency of the 1st notch                   | -           | 50 to 8000   | 8000    | Hz   | 16 bits   | During running   | At once        |
| 0Eh         | H09-13 | Width level of the 1st notch                 | -           | 0 to 20      | 2       | -    | 16 bits   | During running   | At once        |
| 0Fh         | H09-14 | Depth level of the 1st notch                 | -           | 0 to 99      | 0       | -    | 16 bits   | During running   | At once        |
| 10h         | H09-15 | Frequency of the 2nd notch                   | -           | 50 to 8000   | 8000    | Hz   | 16 bits   | During running   | At once        |
| 11h         | H09-16 | Width level of the 2nd notch                 | -           | 0 to 20      | 2       | -    | 16 bits   | During running   | At once        |
| 12h         | H09-17 | Depth level of the 2nd notch                 | -           | 0 to 99      | 0       | -    | 16 bits   | During running   | At once        |
| 13h         | H09-18 | Frequency of the 3rd notch                   | -           | 50 to 8000   | 8000    | 1 Hz | 16 bits   | During running   | At once        |
| 14h         | H09-19 | Width level of the 3rd notch                 | -           | 0 to 20      | 2       | -    | 16 bits   | During running   | At once        |
| 15h         | H09-20 | Depth level of the 3rd notch                 | -           | 0 to 99      | 0       | -    | 16 bits   | During running   | At once        |
| 16h         | H09-21 | Frequency of the 4th notch                   | -           | 50 to 8000   | 8000    | 1 Hz | 16 bits   | During running   | At once        |
| 17h         | H09-22 | Width level of the 4th notch                 | -           | 0 to 20      | 2       | -    | 16 bits   | During running   | At once        |
| 18h         | H09-23 | Depth level of the 4th notch                 | -           | 0 to 99      | 0       | -    | 16 bits   | During running   | At once        |
| 19h         | H09-24 | Auto-tuned resonance frequency               | -           | 0 to 5000    | 0       | Hz   | 16 bits   | -                | -              |
| 1Fh         | H09-30 | Tension fluctuation compensation gain        | -           | -100 to +100 | 0       | -    | 16 bits   | -                | -              |
| 20h         | H09-31 | Tension fluctuation compensation filter time | -           | 0 to 25      | 0.5     | -    | 16 bits   | -                | -              |
| 21h         | H09-32 | Gravity compensation value                   | -           | 0 to 100     | 0       | %    | 16 bits   | During running   | At once        |
| 22h         | H09-33 | Forward friction compensation value          | -           | 0 to 100     | 0       | %    | 16 bits   | During running   | At once        |

| Para. Group |        | Name  | Description   | Value Range | Default | Unit | Data Type | Change Condition | Effective Time |
|-------------|--------|---|---|-------------|---------|------|-----------|------------------|----------------|
| HEX         | DEC    |   |   |             |         |      |           |                  |                |
| Index       | Para.  |   |   |             |         |      |           |                  |                |
| 23h         | H09-34 | Reverse friction compensation value                                       | -   | -100 to 0   | 0       | %    | 16 bits   | During running   | At once        |
| 24h         | H09-35 | Friction compensation speed   | -   | 0 to 20     | 2       | -    | 16 bits   | During running   | At once        |
| 25h         | H09-36 | Friction compensation speed   | 0x00: Slow mode + Speed reference<br>0x01: Slow mode + Model speed<br>0x02: Slow mode + Speed feedback<br>0x10: Quick mode + Speed reference<br>0x11: Quick mode + Model speed<br>0x12: Quick mode + Speed feedback | 0 to 19     | 0       | -    | 16 bits   | During running   | At once        |
| 26h         | H09-37 | Vibration monitoring time   | -   | 0 to 65535  | 1200    | -    | 16        | During running   | At once        |
| 27h         | H09-38 | Frequency of low-frequency resonance suppression 1 at the mechanical end  | -   | 1 to 100    | 100     | Hz   | 16 bits   | During running   | At once        |
| 28h         | H09-39 | Low-frequency resonance suppression 1 at the mechanical end               | -   | 0 to 3      | 2       | -    | 16 bits   | At stop          | At once        |
| 2Ah         | H09-41 | Frequency of the 5th notch  | -   | 50 to 8000  | 8000    | Hz   | 16 bits   | During running   | At once        |
| 2Bh         | H09-42 | Width level of the 5th notch  | -   | 0 to 20     | 2       | -    | 16 bits   | At stop          | At once        |
| 2Ch         | H09-43 | Depth level of the 5th notch  | -   | 0 to 99     | 0       | -    | 16 bits   | At stop          | At once        |
| 2Dh         | H09-44 | Frequency of low-frequency resonance suppression 2 at mechanical load end | -   | 0 to 200    | 0       | -    | 16 bits   | During running   | At once        |

List of Parameters

| Para. Group                                |        | Name   | Description             | Value Range | Default | Unit | Data Type | Change Condition | Effective Time |
|--|--------|--|-------------------------|-------------|---------|------|-----------|------------------|----------------|
| HEX  | DEC    |  |                         |             |         |      |           |                  |                |
| Index                                      | Para.  |  |                         |             |         |      |           |                  |                |
| 2Eh  | H09-45 | Responsiveness of low-frequency resonance suppression 2 at the mechanical load end | -                       | 0.01 to 10  | 1       | -    | 16 bits   | During running   | At once        |
| 30h  | H09-47 | Width of low-frequency resonance suppression 2 at mechanical load end              | -                       | 0 to 2      | 100     | -    | 16 bits   | During running   | At once        |
| 32h  | H09-49 | Frequency of low-frequency resonance suppression 3 at mechanical load end          | -                       | 0 to 2000   | 0       | -    | 16 bits   | During running   | At once        |
| 33h  | H09-50 | Responsiveness of low-frequency resonance suppression 3 at mechanical load end     | -                       | 0.01 to 10  | 1       | -    | 16 bits   | During running   | At once        |
| 35h  | H09-52 | Width of low-frequency resonance suppression 3 at mechanical load end              | -                       | 0 to 2      | 1       | -    | 16 bits   | During running   | At once        |
| 39h  | H09-56 | STune mode setting   | -                       | 0 to 4      | 4       | -    | 16 bits   | During running   | At once        |
| 3Ah  | H09-57 | STune resonance suppression switchover frequency                                   | -                       | 0 to 4000   | 900     | Hz   | 16 bits   | During running   | At once        |
| 3Bh  | H09-58 | STune resonance suppression reset selection  | 0: Disable<br>1: Enable | 0 to 1      | 0       | -    | 16 bits   | During running   | At once        |
| 200Ah/H0A: Fault and protection parameters |        |  |                         |             |         |      |           |                  |                |

| Para. Group |        | Name   | Description   | Value Range         | Default  | Unit  | Data Type | Change Condition | Effective Time |
|-------------|--------|--|---|---------------------|----------|-------|-----------|------------------|----------------|
| HEX         | DEC    |  |   |                     |          |       |           |                  |                |
| Index       | Para.  |  |   |                     |          |       |           |                  |                |
| 01h         | H0A-00 | Power input phase loss protection                    | 0: Phase loss fault detected<br>1: Phase loss fault not detected<br>3: Power loss detection enabled<br>Note: In the common bus mode, set 200A-01h to 1. Otherwise, the servo drive cannot enter "rdy" state after power-on. | 0 to 3              | 0        | -     | 16 bits   | During running   | At once        |
| 02h         | H0A-01 | Absolute position limit                              | 0: Disable<br>1: Enable<br>2: Enabled after homing  | 0 to 2              | 0        | -     | 16 bits   | At stop          | At once        |
| 05h         | H0A-04 | Motor overload protection gain                       | -   | 50 to 300           | 100      | -     | 16 bits   | At stop          | At once        |
| 09h         | H0A-08 | Overspeed threshold                                  | -   | 0 to 20000          | 0        | RPM   | 16 bits   | During running   | At once        |
| 0Bh         | H0A-10 | Threshold of excessive local position deviation      | -   | 0 to $(2^{32} - 1)$ | 25185824 | -     | 16 bits   | During running   | At once        |
| 0Dh         | H0A-12 | Runaway protection                                   | 0: Disable<br>1: Enable   | 0 to 1              | 1        | -     | 16 bits   | During running   | At once        |
| 13h         | H0A-18 | IGBT over-temperature threshold                      | -   | 120 to 175          | 135      | °C    | 16 bits   | During running   | At once        |
| 14h         | H0A-19 | Filter time constant of touch probe 1                | -   | 0 to 6.3            | 2        | us    | 16 bits   | During running   | At once        |
| 15h         | H0A-20 | Filter time constant of touch probe 2                | -   | 0 to 6.3            | 2        | us    | 16 bits   | During running   | At once        |
| 16h         | H0A-21 | STO function display selection                       | 0: Display STO status<br>1: Display STO fault   | 0 to 1              | 0        | -     | 16 bits   | During running   | At once        |
| 18h         | H0A-23 | TZ signal filter time                                | -   | 0 to 31             | 15       | 25 ns | 16 bits   | At stop          | Next power-on  |
| 1Ah         | H0A-25 | Filter time constant of speed feedback display value | -   | 0 to 5000           | 50       | ms    | 16 bits   | At stop          | At once        |

List of Parameters

| Para. Group |        | Name  | Description  | Value Range | Default | Unit  | Data Type | Change Condition | Effective Time |
|-------------|--------|---|--|-------------|---------|-------|-----------|------------------|----------------|
| HEX         | DEC    |   |  |             |         |       |           |                  |                |
| Index       | Para.  |   |  |             |         |       |           |                  |                |
| 1Bh         | H0A-26 | Motor overload detection                            | 0: Enable<br>1: Hide motor overload warning (E909.0) and motor overload fault (E620.0) | 0 to 1      | 0       | -     | 16 bits   | At stop          | At once        |
| 1Ch         | H0A-27 | Motor rotation DO speed filter time                 | -  | 0 to 5000   | 50      | ms    | 16 bits   | During running   | At once        |
| 21h         | H0A-32 | Motor stall over-temperature protection time window | -  | 10 to 65535 | 200     | ms    | 16 bits   | During running   | At once        |
| 22h         | H0A-33 | Motor stall over-temperature detection              | 0: Hide<br>1: Enable   | 0 to 1      | 1       | -     | 16 bits   | During running   | At once        |
| 25h         | H0A-36 | Encoder multi-turn overflow fault selection         | 0: Not hide<br>1: Hide   | 0 to 1      | 0       | -     | 16 bits   | During running   | At once        |
| 29h         | H0A-40 | Overtravel compensation switch                      | 0: Enable<br>1: Disable  | 0 to 1      | 0       | -     | 16 bits   | At stop          | At once        |
| 32h         | H0A-49 | Regenerative transistor over-temperature threshold  | -  | 100 to 175  | 115     | °C    | 16 bits   | During running   | At once        |
| 33h         | H0A-50 | Encoder communication fault tolerance threshold     | -  | 0 to 31     | 3       | -     | 16 bits   | During running   | At once        |
| 34h         | H0A-51 | Phase loss detection filter times                   | -  | 3 to 36     | 20      | 55 ms | 16 bits   | During running   | At once        |
| 35h         | H0A-52 | Encoder over-temperature threshold                  | -  | 0 to 175    | 0       | °C    | 16 bits   | During running   | At once        |
| 38h         | H0A-55 | Runaway current threshold                           | -  | 100 to 400  | 200     | %     | 16 bits   | During running   | At once        |
| 39h         | H0A-56 | Overload fault reset delay                          | -  | 0 to 60000  | 10000   | ms    | 16 bits   | During running   | At once        |
| 3Ah         | H0A-57 | Runaway speed threshold                             | -  | 1 to 1000   | 50      | RPM   | 16 bits   | During running   | At once        |

| Para. Group                             |        | Name  | Description   | Value Range      | Default | Unit | Data Type | Change Condition | Effective Time |
|---|--------|---|---|------------------|---------|------|-----------|------------------|----------------|
| HEX                                     | DEC    |   |   |                  |         |      |           |                  |                |
| Index                                   | Para.  |   |   |                  |         |      |           |                  |                |
| 3Bh                                     | H0A-58 | Runaway speed filter time                       | -   | 0.1 to 100       | 2       | ms   | 16 bits   | During running   | Next power-on  |
| 3Ch                                     | H0A-59 | Runaway protection detection time               | -   | 10 to 1000       | 30      | ms   | 16 bits   | During running   | At once        |
| 47h                                     | H0A-70 | Overspeed threshold 2                           | -   | 0 to 20000       | 0       | RPM  | 16 bits   | During running   | At once        |
| 48h                                     | H0A-71 | MS1 motor overload curve switchover             | 0: New overload curve<br>1: Old overload curve<br>2: Disable voltage discharge upon power failure<br>3: Old overload curve and disable voltage discharge upon power failure | 0 to 3           | 0       |      | 16 bits   | During running   | At once        |
| 49h                                     | H0A-72 | Maximum stop time of ramp-to-stop               | -   | 0 to 65535       | 10000   | ms   | 16 bits   | At stop          | At once        |
| 4Ah                                     | H0A-73 | STO 24 V disconnection filter time              | -   | 0 to 5           | 5       | ms   | 16 bits   | During running   | At once        |
| 4Bh                                     | H0A-74 | Fault tolerance filter time of two STO channels | -   | 0 to 10          | 10      | ms   | 16 bits   | During running   | At once        |
| 4Ch                                     | H0A-75 | Servo OFF delay after STO triggered             | -   | 0 to 25          | 20      | ms   | 16 bits   | During running   | At once        |
| <b>200Bh/H0B: Monitoring parameters</b> |        |   |   |                  |         |      |           |                  |                |
| 01h                                     | H0B-00 | Motor speed actual value                        | -   | -32767 to +32767 | 0       | RPM  | 16 bits   | -                | -              |
| 02h                                     | H0B-01 | Speed reference                                 | -   | -32767 to +32767 | 0       | RPM  | 16 bits   | -                | -              |
| 03h                                     | H0B-02 | Internal torque reference                       | -   | -500 to +500     | 0       | %    | 16 bits   | -                | -              |
| 04h                                     | H0B-03 | Monitored DI status                             | -   | 0 to 65535       | 0       | -    | 16 bits   | -                | -              |
| 06h                                     | H0B-05 | Monitored DO status                             | -   | 0 to 65535       | 0       | -    | 16 bits   | -                | -              |



List of Parameters

| Para. Group |        | Name   | Description   | Value Range                  | Default | Unit | Data Type | Change Condition | Effective Time |
|-------------|--------|--|---|------------------------------|---------|------|-----------|------------------|----------------|
| HEX         | DEC    |  |   |                              |         |      |           |                  |                |
| Index       | Para.  |  |   |                              |         |      |           |                  |                |
| 08h         | H0B-07 | Absolute position counter                        | -   | $-2^{31}$ to $+(2^{31} - 1)$ | 0       | 1 p  | 32 bits   | -                | -              |
| 0Ah         | H0B-09 | Mechanical angle                                 | -   | 0 to 360                     | 0       | °    | 16 bits   | -                | -              |
| 0Bh         | H0B-10 | Electrical angle                                 | -   | 0 to 360                     | 0       | °    | 16 bits   | -                | -              |
| 0Dh         | H0B-12 | Average load rate                                | -   | 0 to 800                     | 0       | %    | 16 bits   | -                | -              |
| 10h         | H0B-15 | Position following error (encoder unit)          | -   | -2147483648 to +2147483647   | 0       | p    | 32 bits   | -                | -              |
| 12h         | H0B-17 | Feedback pulse counter                           | -   | -2147483648 to +2147483647   | 0       | p    | 32 bits   | -                | -              |
| 14h         | H0B-19 | Total power-on time                              | -   | 0 to 429496729.5             | 0       | s    | 32 bits   | -                | -              |
| 19h         | H0B-24 | RMS value of phase current                       | -   | 0 to 6553.5                  | 0       | A    | 32 bits   | -                | -              |
| 1Bh         | H0B-26 | Bus voltage                                      | -   | 0 to 6553.5                  | 0       | V    | 16 bits   | -                | -              |
| 1Ch         | H0B-27 | Power module temperature                         | -   | -20 to +200                  | 0       | °C   | 16 bits   | -                | -              |
| 1Dh         | H0B-28 | Absolute encoder fault information given by FPGA | -   | 0 to 65535                   | 0       | -    | 16 bits   | -                | -              |
| 1Eh         | H0B-29 | Axis status information given by FPGA            | -   | 0 to 65535                   | 0       | -    | 16 bits   | -                | -              |
| 1Fh         | H0B-30 | Axis fault information given by FPGA             | -   | 0 to 65535                   | 0       | -    | 16 bits   | -                | -              |
| 20h         | H0B-31 | Encoder fault information                        | -   | 0 to 65535                   | 0       | -    | 16 bits   | -                | -              |
| 22h         | H0B-33 | Fault log  | 0: Present fault<br>1: Last fault<br>2: 2nd to last fault<br>3: 3rd to last fault<br>4: 4th to last fault<br>5: 5th to last fault<br>6: 6th to last fault<br>7: 7th to last fault<br>8: 8th to last fault<br>9: 9th to last fault | 0 to 9                       | 0       | -    | 16 bits   | During running   | At once        |

| Para. Group |        | Name   | Description | Value Range        | Default | Unit | Data Type | Change Condition | Effective Time |
|-------------|--------|--|-------------|--------------------|---------|------|-----------|------------------|----------------|
| HEX         | DEC    |  |             |                    |         |      |           |                  |                |
| Index       | Para.  |  |             |                    |         |      |           |                  |                |
| 23h         | H0B-34 | Fault code of the selected fault   | -           | 0 to 65535         | 0       | -    | 16 bits   | -                | -              |
| 24h         | H0B-35 | Time stamp upon occurrence of the selected fault                                       | -           | 0 to 429496729.5   | 0       | s    | 32 bits   | -                | -              |
| 26h         | H0B-37 | Motor speed upon occurrence of the selected fault                                      | -           | -32767 to +32767   | 0       | RPM  | 16 bits   | -                | -              |
| 27h         | H0B-38 | Motor phase U current upon occurrence of the selected fault                            | -           | -3276.7 to +3276.7 | 0       | A    | 16 bits   | -                | -              |
| 28h         | H0B-39 | Motor phase V current upon occurrence of the selected fault                            | -           | -3276.7 to +3276.7 | 0       | A    | 16 bits   | -                | -              |
| 29h         | H0B-40 | Bus voltage upon occurrence of the selected fault                                      | -           | 0 to 6553.5        | 0       | V    | 16 bits   | -                | -              |
| 2Ah         | H0B-41 | DI status upon occurrence of the selected fault  | -           | 0 to 65535         | 0       | -    | 16 bits   | -                | -              |
| 2Ch         | H0B-43 | DO status upon occurrence of the selected fault  | -           | 0 to 65535         | 0       | -    | 16 bits   | -                | -              |
| 2Eh         | H0B-45 | Internal fault code  | -           | 0 to 65535         | 0       | -    | 16 bits   | -                | -              |
| 2Fh         | H0B-46 | Absolute encoder fault information given by FPGA upon occurrence of the selected fault | -           | 0 to 65535         | 0       | -    | 16 bits   | -                | -              |

List of Parameters

| Para. Group |        | Name  | Description | Value Range                  | Default | Unit | Data Type | Change Condition | Effective Time |
|-------------|--------|---|-------------|------------------------------|---------|------|-----------|------------------|----------------|
| HEX         | DEC    |   |             |                              |         |      |           |                  |                |
| Index       | Para.  |   |             |                              |         |      |           |                  |                |
| 30h         | H0B-47 | System status information given by FPGA upon occurrence of the selected fault | -           | 0 to 65535                   | 0       | -    | 16 bits   | -                | -              |
| 31h         | H0B-48 | System fault information given by FPGA upon occurrence of the selected fault  | -           | 0 to 65535                   | 0       | -    | 16 bits   | -                | -              |
| 32h         | H0B-49 | Encoder fault information upon occurrence of the selected fault               | -           | 0 to 65535                   | 0       | -    | 16 bits   | -                | -              |
| 34h         | H0B-51 | Internal fault code upon occurrence of the selected fault                     | -           | 0 to 65535                   | 0       | -    | 16 bits   | -                | -              |
| 36h         | H0B-53 | Position following error (reference unit)                                     | -           | $-2^{31}$ to $+(2^{31} - 1)$ | 0       | p    | 32 bits   | -                | -              |
| 38h         | H0B-55 | Motor speed actual value  | -           | -6000 to +6000               | 0       | RPM  | 32 bits   | -                | -              |
| 3Ah         | H0B-57 | Bus voltage of the control circuit  | -           | 0 to 6553.5                  | 0       | V    | 16 bits   | -                | -              |
| 3Bh         | H0B-58 | Mechanical absolute position (low 32 bits)                                    | -           | 0 to $2^{32}$                | 0       | p    | 32 bits   | -                | -              |
| 3Dh         | H0B-60 | Mechanical absolute position (high 32 bits)                                   | -           | $-2^{31}$ to $+(2^{31} - 1)$ | 0       | p    | 32 bits   | -                | -              |

| Para. Group |        | Name   | Description  | Value Range                 | Default | Unit | Data Type | Change Condition | Effective Time |
|-------------|--------|--|--|-----------------------------|---------|------|-----------|------------------|----------------|
| HEX         | DEC    |  |  |                             |         |      |           |                  |                |
| Index       | Para.  |  |  |                             |         |      |           |                  |                |
| 40h         | H0B-63 | NotRdy state   | 0: None<br>1: Control circuit power supply error (H0B-57)<br>2: Phase loss detection error<br>3: Main circuit power supply detection error (including short-circuited to ground error)<br>4: Other servo faults<br>5: Short-circuited to ground detection not done | 0 to 5                      | 0       | -    | 16 bits   | -                | -              |
| 43h         | H0B-66 | Encoder temperature                                      | -  | -100 to +200                | 0       | °C   | 16 bits   | -                | -              |
| 44h         | H0B-67 | Load rate of regenerative transistor                     | -  | 0 to 200                    | 0       | %    | 16 bits   | -                | -              |
| 47h         | H0B-70 | Number of revolutions fed back by the absolute encoder   | -  | 0 to 65535                  | 0       | Rev  | 16 bits   | -                | -              |
| 48h         | H0B-71 | Single-turn position feedback of the absolute encoder    | -  | 0 to $(2^{31} - 1)$         | 0       | p    | 32 bits   | -                | -              |
| 4Bh         | H0B-74 | System fault information given by FPGA                   | -  | 0 to 65535                  | 0       | -    | 16 bits   | -                | -              |
| 4Eh         | H0B-77 | Position feedback of the absolute encoder (low 32 bits)  | -  | $-2^{31}$ to $(2^{31} - 1)$ | 0       | p    | 32 bits   | -                | -              |
| 50h         | H0B-79 | Position feedback of the absolute encoder (high 32 bits) | -  | $-2^{31}$ to $(2^{31} - 1)$ | 0       | p    | 32 bits   | -                | -              |

List of Parameters

| Para. Group                              |        | Name  | Description                                    | Value Range                 | Default | Unit | Data Type | Change Condition | Effective Time |
|--|--------|---|--|-----------------------------|---------|------|-----------|------------------|----------------|
| HEX                                      | DEC    |   |  |                             |         |      |           |                  |                |
| Index                                    | Para.  |   |  |                             |         |      |           |                  |                |
| 52h                                      | H0B-81 | Single-turn position of the rotating load (low 32 bits)     | -  | 0 to $(2^{32} - 1)$         | 0       | p    | 32 bits   | -                | -              |
| 54h                                      | H0B-83 | Single-turn position of the rotating load (high 32 bits)    | -  | $-2^{31}$ to $(2^{31} - 1)$ | 0       | p    | 32 bits   | -                | -              |
| 56h                                      | H0B-85 | Single-turn position of the rotating load (reference unit)  | -  | $-2^{31}$ to $(2^{31} - 1)$ | 0       | p    | 32 bits   | -                | -              |
| 5Bh                                      | H0B-90 | Group No. of the abnormal parameter                         | -  | 0 to 65535                  | 0       | -    | 16 bits   | -                | -              |
| 5Ch                                      | H0B-91 | Offset of the abnormal parameter within the parameter group | -  | 0 to 65535                  | 0       | -    | 16 bits   | -                | -              |
| 200Dh/H0D: Auxiliary function parameters |        |   |  |                             |         |      |           |                  |                |
| 01h                                      | H0D-00 | Software reset  | 0: No operation<br>1: Enable                   | 0 to 1                      | 0       | -    | 16 bits   | At stop          | At once        |
| 02h                                      | H0D-01 | Fault reset   | 0: No operation<br>1: Enable                   | 0 to 1                      | 0       | -    | 16 bits   | At stop          | At once        |
| 03h                                      | H0D-02 | Offline inertia auto-tuning selection                       | 0: Disable<br>1: Enable                        | 0 to 1                      | 0       | -    | 16 bits   | At stop          | At once        |
| 04h                                      | H0D-03 | Encoder initial angle auto-tuning                           | 0: No operation<br>1: Enable                   | 0 to 1                      | 0       | -    | 16 bits   | At stop          | At once        |
| 05h                                      | H0D-04 | Read/write in encoder ROM                                   | 0: No operation<br>1: Write ROM<br>2: Read ROM | 0 to 2                      | 0       | -    | 16 bits   | At stop          | At once        |
| 06h                                      | H0D-05 | Emergency stop  | 0: No operation<br>1: Enable                   | 0 to 1                      | 0       | -    | 16 bits   | During running   | At once        |
| 0Ch                                      | H0D-12 | Phase U/V current balance correction                        | 0: Disable<br>1: Enable                        | 0 to 1                      | 0       | -    | 16 bits   | At stop          | At once        |

| Para. Group                              |        | Name   | Description   | Value Range | Default | Unit | Data Type | Change Condition | Effective Time |
|--|--------|--|---|-------------|---------|------|-----------|------------------|----------------|
| HEX                                      | DEC    |  |   |             |         |      |           |                  |                |
| Index                                    | Para.  |  |   |             |         |      |           |                  |                |
| 12h                                      | H0D-17 | Forced DI/DO enable switch                           | 0: No operation<br>1: Forced DI enabled, forced DO disabled<br>2: Forced DI disabled, forced DO enabled<br>3: Forced DI and DO enabled<br>4: EtherCAT forced DO enabled   | 0 to 4      | 0       | -    | 16 bits   | During running   | At once        |
| 13h                                      | H0D-18 | Forced DI value                                      | -   | 0 to 31     | 0       | -    | 16 bits   | During running   | At once        |
| 14h                                      | H0D-19 | Forced DO value                                      | -   | 0 to 7      | 0       | -    | 16 bits   | During running   | At once        |
| 15h                                      | H0D-20 | Absolute encoder reset selection                     | 0: No operation<br>1: Reset encoder fault<br>2: Reset encoder fault and multi-turn data   | 0 to 2      | 0       | -    | 16 bits   | At stop          | At once        |
| 200Eh/H0E: Auxiliary function parameters |        |  |   |             |         |      |           |                  |                |
| 01h                                      | H0E-00 | Node address   | -   | 0 to 127    | 1       | -    | 16 bits   | During running   | At once        |
| 02h                                      | H0E-01 | Save objects written through communication to EEPROM | 0: Parameters and object dictionaries written through communication not saved to EEPROM<br>1: Only parameters written through communication saved to EEPROM<br>2: Only object dictionaries written through communication saved to EEPROM<br>3: Parameters and object dictionaries written through communication saved to EEPROM | 0 to 3      | 3       | -    | 16 bits   | During running   | At once        |
| 15h                                      | H0E-20 | EtherCAT slave name                                  | -   | 0 to 65535  | 0       | -    | 16 bits   | -                | -              |
| 16h                                      | H0E-21 | EtherCAT slave alias                                 | -   | 0 to 65535  | 0       | -    | 16 bits   | At stop          | At once        |

List of Parameters

| Para. Group |        | Name   | Description | Value Range | Default | Unit | Data Type | Change Condition | Effective Time |
|-------------|--------|--|-------------|-------------|---------|------|-----------|------------------|----------------|
| HEX         | DEC    |  |             |             |         |      |           |                  |                |
| Index       | Para.  |  |             |             |         |      |           |                  |                |
| 17h         | H0E-22 | Number of synchronous loss events allowed by EtherCAT                | -           | 1 to 20     | 8       | -    | 16 bits   | During running   | At once        |
| 18h         | H0E-23 | EtherCAT station alias from EEPROM                                   | -           | 0 to 65535  | 0       | -    | 16 bits   | During running   | At once        |
| 19h         | H0E-24 | Number of SYNC loss events   | -           | 0 to 65535  | 0       | -    | 16 bits   | -                | -              |
| 1Ah         | H0E-25 | Max. error value and invalid frames of EtherCAT port 0 per unit time | -           | 0 to 65535  | 0       | -    | 16 bits   | -                | -              |
| 1Bh         | H0E-26 | Max. error value and invalid frames of EtherCAT port 1 per unit time | -           | 0 to 65535  | 0       | -    | 16 bits   | -                | -              |
| 1Ch         | H0E-27 | Max. transfer error of EtherCAT port per unit time                   | -           | 0 to 65535  | 0       | -    | 16 bits   | -                | -              |
| 1Dh         | H0E-28 | Max. EtherCAT data frame processing unit error per unit time         | -           | 0-255       | 0       | -    | 16 bits   | -                | -              |
| 1Eh         | H0E-29 | Max. link loss value of EtherCAT port 0 per unit time                | -           | 0 to 65535  | 0       | -    | 16 bits   | -                | -              |
| 20h         | H0E-31 | EtherCAT synchronization mode setting                                | -           | 0 to 2      | 1       | -    | 16 bits   | At stop          | Next power-on  |
| 21h         | H0E-32 | EtherCAT synchronization error threshold                             | -           | 0 to 4000   | 3000    | us   | 16 bits   | At stop          | At once        |
| 22h         | H0E-33 | EtherCAT state machine status and port connection status             | -           | 0 to 65535  | 0       | -    | 16 bits   | -                | -              |

| Para. Group |        | Name  | Description   | Value Range | Default | Unit | Data Type | Change Condition | Effective Time |
|-------------|--------|---|---|-------------|---------|------|-----------|------------------|----------------|
| HEX         | DEC    |   |   |             |         |      |           |                  |                |
| Index       | Para.  |   |   |             |         |      |           |                  |                |
| 23h         | H0E-34 | Number of excessive position reference increment events in CSP mode | -   | 0 to 7      | 1       | -    | 16 bits   | During running   | At once        |
| 24h         | H0E-35 | AL fault code   | -   | 0 to 65535  | 0       | -    | 16 bits   | -                | -              |
| 25h         | H0E-36 | EtherCAT AL enhanced link selection                                 | 0: Disable<br>1: Enable   | 0 to 1      | 0       | -    | 16 bits   | During running   | Next power-on  |
| 26h         | H0E-37 | EtherCAT XML reset selection  | 0: Disable<br>1: Enable   | 0 to 1      | 0       | -    | 16 bits   | During running   | Next power-on  |
| 51h         | H0E-80 | Modbus baud rate  | 9: 300 bps<br>1: 600 bps<br>2: 1200 bps<br>3: 2400 bps<br>4: 4800 bps<br>5: 9600 bps<br>6: 19200 bps<br>7: 38400 bps<br>8: 57600 bps<br>9: 115200 bps<br>10: 230400 bps | 0 to 10     | 9       | -    | 16 bits   | During running   | At once        |
| 52h         | H0E-81 | Modbus data format  | 0: No parity, 2 stop bits (8-N-2)<br>1: Even parity, 1 stop bit (8-E-1)<br>2: Odd parity, 1 stop bit (8-O-1)<br>3: No parity, 1 stop bit (8-N-1)                        | 0 to 3      | 3       | -    | 16 bits   | During running   | At once        |
| 53h         | H0E-82 | Modbus response delay   | -   | 0 to 20     | 0       | ms   | 16 bits   | During running   | At once        |
| 54h         | H0E-83 | Modbus communication timeout  | -   | 0 to 600    | 0       | ms   | 16 bits   | During running   | At once        |
| 5Bh         | H0E-90 | Modbus version  | -   | 0 to 655.35 | 0       | -    | 16 bits   | -                | -              |
| 5Eh         | H0E-93 | EtherCAT COE version  | -   | 0 to 655.35 | 0       | -    | 16 bits   | -                | -              |
| 61h         | H0E-96 | XML version   | -   | 0 to 655.35 | 0       | -    | 16 bits   | -                | -              |

2018h/H18: Position comparison output



List of Parameters

| Para. Group                           |        | Name                                      | Description  | Value Range | Default | Unit   | Data Type | Change Condition | Effective Time |
|---------------------------------------|--------|---|--|-------------|---------|--------|-----------|------------------|----------------|
| HEX                                   | DEC    |   |  |             |         |        |           |                  |                |
| Index                                 | Para.  |   |  |             |         |        |           |                  |                |
| 01h                                   | H18-00 | Position comparison output selection      | 0: Disable<br>1: Enable (rising edge-triggered)  | -           | 0       | -      | 16 bits   | During running   | At once        |
| 03h                                   | H18-02 | Position comparison resolution            | 0: 24-bit<br>1: 23-bit<br>2: 22-bit<br>3: 21-bit<br>4: 20-bit<br>5: 19-bit<br>6: 18-bit<br>7: 17-bit | -           | 1       | -      | 16 bits   | During running   | At once        |
| 04h                                   | H18-03 | Position comparison mode                  | 0: Individual comparison<br>1: Cyclic comparison   | -           | 0       | -      | 16 bits   | During running   | At once        |
| 05h                                   | H18-04 | Current position as zero                  | 0: Disable<br>1: Enable (rising edge-triggered)  | -           | 0       | -      | 16 bits   | During running   | At once        |
| 06h                                   | H18-05 | Position comparison output width          | -  | -           | 0       | 0.1 ms | 16 bits   | During running   | At once        |
| 08h                                   | H18-07 | Start point of position comparison        | -  | -           | 0       | -      | 16 bits   | During running   | At once        |
| 09h                                   | H18-08 | End point of position comparison          | -  | -           | 0       | -      | 16 bits   | During running   | At once        |
| 0Ah                                   | H18-09 | Current status of position comparison     | -  | -           | 0       | -      | 16 bits   | Uneditable       | At once        |
| 0Bh                                   | H18-10 | Real-time position of position comparison | -  | -           | 0       | -      | 32 bits   | Uneditable       | At once        |
| 0Dh                                   | H18-12 | Zero offset of position comparison        | -  | -           | 0       | -      | 32 bits   | During running   | At once        |
| 2019h/H19: Target position parameters |        |   |  |             |         |        |           |                  |                |
| 01h                                   | H19-00 | Target value of position comparison 1     | -  | -           | 0       | -      | 32 bits   | During running   | At once        |

| Para. Group |        | Name                                     | Description   | Value Range | Default | Unit | Data Type | Change Condition | Effective Time |
|-------------|--------|--|---|-------------|---------|------|-----------|------------------|----------------|
| HEX         | DEC    |  |   |             |         |      |           |                  |                |
| Index       | Para.  |  |   |             |         |      |           |                  |                |
| 03h         | H19-02 | Attribute value of position comparison 1 | 0: Skip this point<br>1: Output DO active signal if current position changes from "less than" to "more than" the comparison point<br>2: Output DO active signal if current position changes from "more than" to "less than" the comparison point<br>3: Output DO active signal in both situations | -           | 0       | -    | 16 bits   | During running   | At once        |
| 04h         | H19-03 | Target value of position comparison 2    | -   | -           | 0       | -    | 32 bits   | During running   | At once        |
| 06h         | H19-05 | Attribute value of position comparison 2 | 0: Skip this point<br>1: Output DO active signal if current position changes from "less than" to "more than" the comparison point<br>2: Output DO active signal if current position changes from "more than" to "less than" the comparison point<br>3: Output DO active signal in both situations | -           | 0       | -    | 16 bits   | During running   | At once        |
| 07h         | H19-06 | Target value of position comparison 3    | -   | -           | 0       | -    | 32 bits   | During running   | At once        |

List of Parameters

| Para. Group |        | Name                                     | Description   | Value Range | Default | Unit | Data Type | Change Condition | Effective Time |
|-------------|--------|--|---|-------------|---------|------|-----------|------------------|----------------|
| HEX         | DEC    |  |   |             |         |      |           |                  |                |
| Index       | Para.  |  |   |             |         |      |           |                  |                |
| 09h         | H19-08 | Attribute value of position comparison 3 | 0: Skip this point<br>1: Output DO active signal if current position changes from "less than" to "more than" the comparison point<br>2: Output DO active signal if current position changes from "more than" to "less than" the comparison point<br>3: Output DO active signal in both situations | -           | 0       | -    | 16 bits   | During running   | At once        |
| 0Ah         | H19-09 | Target value of position comparison 4    | -   | -           | 0       | -    | 32 bits   | During running   | At once        |
| 0Ch         | H19-11 | Attribute value of position comparison 4 | 0: Skip this point<br>1: Output DO active signal if current position changes from "less than" to "more than" the comparison point<br>2: Output DO active signal if current position changes from "more than" to "less than" the comparison point<br>3: Output DO active signal in both situations | -           | 0       | -    | 16 bits   | During running   | At once        |
| 0Dh         | H19-12 | Target value of position comparison 5    | -   | -           | 0       | -    | 32 bits   | During running   | At once        |

| Para. Group |        | Name                                     | Description   | Value Range | Default | Unit | Data Type | Change Condition | Effective Time |
|-------------|--------|--|---|-------------|---------|------|-----------|------------------|----------------|
| HEX         | DEC    |  |   |             |         |      |           |                  |                |
| Index       | Para.  |  |   |             |         |      |           |                  |                |
| 0Fh         | H19-14 | Attribute value of position comparison 5 | 0: Skip this point<br>1: Output DO active signal if current position changes from "less than" to "more than" the comparison point<br>2: Output DO active signal if current position changes from "more than" to "less than" the comparison point<br>3: Output DO active signal in both situations | -           | 0       | -    | 16 bits   | During running   | At once        |
| 10h         | H19-15 | Target value of position comparison 6    | -   | -           | 0       | -    | 32 bits   | During running   | At once        |
| 12h         | H19-17 | Attribute value of position comparison 6 | 0: Skip this point<br>1: Output DO active signal if current position changes from "less than" to "more than" the comparison point<br>2: Output DO active signal if current position changes from "more than" to "less than" the comparison point<br>3: Output DO active signal in both situations | -           | 0       | -    | 16 bits   | During running   | At once        |
| 13h         | H19-18 | Target value of position comparison 7    | -   | -           | 0       | -    | 32 bits   | During running   | At once        |

| Para. Group |        | Name                                     | Description   | Value Range | Default | Unit | Data Type | Change Condition | Effective Time |
|-------------|--------|--|---|-------------|---------|------|-----------|------------------|----------------|
| HEX         | DEC    |  |   |             |         |      |           |                  |                |
| Index       | Para.  |  |   |             |         |      |           |                  |                |
| 15h         | H19-20 | Attribute value of position comparison 7 | 0: Skip this point<br>1: Output DO active signal if current position changes from "less than" to "more than" the comparison point<br>2: Output DO active signal if current position changes from "more than" to "less than" the comparison point<br>3: Output DO active signal in both situations | -           | 0       | -    | 16 bits   | During running   | At once        |
| 16h         | H19-21 | Target value of position comparison 8    | -   | -           | 0       | -    | 32 bits   | During running   | At once        |
| 18h         | H19-23 | Attribute value of position comparison 8 | 0: Skip this point<br>1: Output DO active signal if current position changes from "less than" to "more than" the comparison point<br>2: Output DO active signal if current position changes from "more than" to "less than" the comparison point<br>3: Output DO active signal in both situations | -           | 0       | -    | 16 bits   | During running   | At once        |

#### 4.4 Parameter Group 6000h

The parameter group 6000h contains objects supported by the servo drive in DSP402 device profile.

| Index (HEX) | Sub-index (HEX) | Name                          | Access | PDO Mapping | Data Type | Unit             | Data Range          | Default | Change Condition | Effective Time |
|-------------|-----------------|-------------------------------|--------|-------------|-----------|------------------|---------------------|---------|------------------|----------------|
| 603Fh       | 0               | Error code                    | RO     | TPDO        | Uint 16   | -                | -                   | -       | -                | -              |
| 6040h       | 0               | Control word                  | RW     | RPDO        | Uint 16   | -                | 0 to 65535          | 0       | During running   | At once        |
| 6041h       | 0               | Status word                   | RO     | TPDO        | Uint 16   | -                | -                   | -       | -                | -              |
| 605Ah       | 0               | Quick stop option code        | RW     | No          | int 16    | -                | 0 to 7              | 2       | During running   | At stop        |
| 605Ch       | 0               | Disable operation option code | RW     | No          | int 16    | -                | -4 to +1            | 0       | During running   | At stop        |
| 605Dh       | 0               | Stop option code              | RW     | No          | int 16    | -                | 1 to 3              | 1       | During running   | At stop        |
| 605Eh       | 0               | Fault reaction option code    | RW     | No          | int 16    | -                | -5 to +3            | 2       | During running   | At stop        |
| 6060h       | 0               | Modes of operation            | RW     | RPDO        | int 8     | -                | 0 to 10             | 0       | During running   | At once        |
| 6061h       | 0               | Modes of operation display    | RO     | TPDO        | int 8     | -                | -                   | -       | -                | -              |
| 6062h       | 0               | Position demand value         | RO     | TPDO        | int 32    | Reference unit   | -                   | -       | -                | -              |
| 6063h       | 0               | Position actual value*        | RO     | TPDO        | int 32    | Encoder unit     | -                   | -       | -                | -              |
| 6064h       | 0               | Position actual value         | RO     | TPDO        | int 32    | Reference unit   | -                   | -       | -                | -              |
| 6065h       | 0               | Following error window        | RW     | RPDO        | Uint 32   | Reference unit   | 0 to $(2^{32} - 1)$ | 0       | During running   | At once        |
| 6066h       | 0               | Following error time out      | RW     | RPDO        | Uint 16   | ms               | 0 to 65535          | 0       | During running   | At once        |
| 6067h       | 0               | Position window               | RW     | RPDO        | Uint 32   | Reference unit   | 0 to $(2^{32} - 1)$ | 734     | During running   | At once        |
| 6068h       | 0               | Position window time          | RW     | RPDO        | Uint 16   | ms               | 0 to 65535          | 0       | During running   | At once        |
| 606Ch       | 0               | Velocity actual value         | RO     | TPDO        | int 32    | Reference unit/s | -                   | -       | -                | -              |
| 606Dh       | 0               | Velocity window               | RW     | RPDO        | Uint 16   | RPM              | 0 to 65535          | 10      | During running   | At once        |

List of Parameters

| Index (HEX) | Sub-index (HEX)         | Name                        | Access | PDO Mapping | Data Type | Unit                          | Data Range                 | Default      | Change Condition | Effective Time |
|-------------|-------------------------|-----------------------------|--------|-------------|-----------|-------------------------------|----------------------------|--------------|------------------|----------------|
| 606Eh       | 0                       | Velocity window time        | RW     | RPDO        | Uint 16   | ms                            | 0 to 65535                 | 0            | During running   | At once        |
| 606Fh       | 0                       | Velocity threshold          | RW     | RPDO        | Uint 16   | RPM                           | 0 to 65535                 | 10           | During running   | At once        |
| 6070h       | 0                       | Velocity threshold time     | RW     | RPDO        | Uint 16   | ms                            | 0 to 65535                 | 0            | During running   | At once        |
| 6071h       | 0                       | Target torque               | RW     | RPDO        | int 16    | 0.1%                          | -4000 to +4000             | 0            | During running   | At once        |
| 6072h       | 0                       | Max. torque                 | RW     | RPDO        | Uint 16   | 0.1%                          | 0 to 4000                  | 3500         | During running   | At once        |
| 6074h       | 0                       | Torque demand value         | RO     | TPDO        | int 16    | 0.1%                          | -                          | 0            | -                | -              |
| 6077h       | 0                       | Torque actual value         | RO     | TPDO        | int 16    | 0.1%                          | -                          | 0            | -                | -              |
| 607Ah       | 0                       | Target position             | RW     | RPDO        | int 32    | Reference unit                | $-2^{31}$ to $+2^{31} - 1$ | 0            | During running   | At once        |
| 607Ch       | 0                       | Home offset                 | RW     | RPDO        | int 32    | Reference unit                | $-2^{31}$ to $+2^{31} - 1$ | 0            | During running   | At once        |
| 607D        | Software position limit |                             |        |             |           |                               |                            |              |                  |                |
|             | 0                       | Highest sub-index supported | RO     | No          | Uint 8    | -                             | -                          | 0x02         | -                | -              |
|             | 1                       | Min. position limit         | RW     | RPDO        | int 32    | Reference unit                | $-2^{31}$ to $+2^{31} - 1$ | $-2^{31}$    | During running   | At once        |
|             | 2                       | Max. position limit         | RW     | RPDO        | int 32    | Reference unit                | $-2^{31}$ to $+2^{31} - 1$ | $2^{31} - 1$ | During running   | At once        |
| 607Eh       | 0                       | Polarity                    | RW     | RPDO        | Uint 8    | -                             | 0–255                      | 0            | During running   | At once        |
| 607Fh       | 0                       | Max. profile velocity       | RW     | RPDO        | Uint 32   | Reference unit/s              | 0 to $(2^{32} - 1)$        | 104857600    | During running   | At once        |
| 6081h       | 0                       | Profile velocity            | RW     | RPDO        | Uint 32   | User-defined velocity unit    | 0 to $(2^{32} - 1)$        | 1747627      | During running   | At once        |
| 6083h       | 0                       | Profile acceleration        | RW     | RPDO        | Uint 32   | Reference unit/s <sup>2</sup> | 0 to $(2^{32} - 1)$        | 174762666    | During running   | At once        |
| 6084h       | 0                       | Profile deceleration        | RW     | RPDO        | Uint 32   | Reference unit/s <sup>2</sup> | 0 to $(2^{32} - 1)$        | 174762666    | During running   | At once        |
| 6085h       | 0                       | Quick stop deceleration     | RW     | RPDO        | Uint 32   | Reference unit/s <sup>2</sup> | 0 to $(2^{32} - 1)$        | $2^{31} - 1$ | During running   | At once        |

| Index (HEX) | Sub-index (HEX) | Name                           | Access | PDO Mapping | Data Type | Unit                          | Data Range                 | Default      | Change Condition | Effective Time |
|-------------|-----------------|--------------------------------|--------|-------------|-----------|-------------------------------|----------------------------|--------------|------------------|----------------|
| 6086h       | 0               | Motion profile type            | RW     | RPDO        | int 16    | -                             | -32767 to +32767           | 0            | During running   | At once        |
| 6087h       | 0               | Torque slope                   | RW     | RPDO        | Uint 32   | 0.1%/s                        | 0 to $(2^{32} - 1)$        | $2^{32} - 1$ | During running   | At once        |
| 6091h       | Gear ratio      |                                |        |             |           |                               |                            |              |                  |                |
|             | 0               | Highest sub-index supported    | RO     | No          | Uint 8    | Uint 8                        | -                          | 0x02         | -                | -              |
|             | 1               | Motor revolutions              | RW     | RPDO        | Uint 32   | -                             | 0 to $(2^{32} - 1)$        | 1            | During running   | At once        |
|             | 2               | Shaft revolutions              | RW     | RPDO        | Uint 32   | -                             | 1 to $(2^{32} - 1)$        | 1            | During running   | At once        |
| 6098h       | 0               | Homing method                  | RW     | RPDO        | int 8     | -                             | -2 to +35                  | 1            | During running   | At once        |
| 6099h       | Homing speeds   |                                |        |             |           |                               |                            |              |                  |                |
|             | 0               | Highest sub-index supported    | RO     | No          | Uint 8    | -                             | -                          | 2            | -                | -              |
|             | 1               | Speed during search for switch | RW     | RPDO        | Uint 32   | Reference unit/s              | 0 to $(2^{32} - 1)$        | 1747627      | During running   | At once        |
|             | 2               | Speed during search for zero   | RW     | RPDO        | Uint 32   | Reference unit/s              | 10 to $(2^{32} - 1)$       | 174763       | During running   | At once        |
| 609Ah       | 0               | Homing acceleration            | RW     | RPDO        | Uint 32   | Reference unit/s <sup>2</sup> | 0 to $(2^{32} - 1)$        | 1747626667   | During running   | At once        |
| 60B0h       | 0               | Position offset                | RW     | RPDO        | int 32    | Reference unit                | $-2^{31}$ to $+2^{31} - 1$ | 0            | During running   | At once        |
| 60B1h       | 0               | Velocity offset                | RW     | RPDO        | int 32    | Reference unit/s              | $-2^{31}$ to $+2^{31} - 1$ | 0            | During running   | At once        |
| 60B2h       | 0               | Torque offset                  | RW     | RPDO        | int 16    | 0.10%                         | -4000 to +4000             | 0            | During running   | At once        |
| 60B8h       | 0               | Touch probe function           | RW     | RPDO        | Uint 16   | -                             | 0 to 65535                 | 0            | During running   | At once        |
| 60B9h       | 0               | Touch probe status             | RW     | TPDO        | Uint 16   | -                             | -                          | 0            | -                | -              |
| 60BAh       | 0               | Touch probe 1 positive edge    | RW     | TPDO        | int 32    | Reference unit                | -                          | 0            | -                | -              |
| 60BBh       | 0               | Touch probe 1 negative edge    | RW     | TPDO        | int 32    | Reference unit                | -                          | 0            | -                | -              |



List of Parameters

| Index (HEX) | Sub-index (HEX) | Name                                | Access | PDO Mapping | Data Type | Unit                           | Data Range        | Default      | Change Condition | Effective Time |
|-------------|-----------------|-------------------------------------|--------|-------------|-----------|--------------------------------|-------------------|--------------|------------------|----------------|
| 60BCh       | 0               | Touch probe 2 positive edge         | RW     | TPDO        | int 32    | Reference unit                 | -                 | 0            | -                | -              |
| 60BDh       | 0               | Touch probe 2 negative edge         | RW     | TPDO        | int 32    | Reference unit                 | -                 | 0            | -                | -              |
| 60C5h       | 0               | Max. acceleration                   | RW     | RPDO        | Uint 32   | User-defined acceleration unit | 0 to $2^{32} - 1$ | $2^{31} - 1$ | During running   | At once        |
| 60C6h       | 0               | Max. deceleration                   | RW     | RPDO        | Uint 32   | User-defined acceleration unit | 0 to $2^{32} - 1$ | $2^{31} - 1$ | During running   | At once        |
| 60D5h       | 0               | Touch probe 1 positive edge counter | RO     | TPDO        | Uint 16   | -                              | -                 | 0            | -                | -              |
| 60D6h       | 0               | Touch probe 1 negative edge counter | RO     | TPDO        | Uint 16   | -                              | -                 | 0            | -                | -              |
| 60D7h       | 0               | Touch probe 2 positive edge counter | RO     | TPDO        | Uint 16   | -                              | -                 | 0            | -                | -              |
| 60D8h       | 0               | Touch probe 2 negative edge counter | RO     | TPDO        | Uint 16   | -                              | -                 | 0            | -                | -              |
| 60E0h       | 0               | Positive torque limit value         | RW     | RPDO        | Uint 16   | 0.1%                           | 0 to 4000         | 3500         | During running   | At once        |
| 60E1h       | 0               | Negative torque limit value         | RW     | RPDO        | Uint 16   | 0.1%                           | 0 to 4000         | 3500         | During running   | At once        |

| Index (HEX) | Sub-index (HEX)         | Name                        | Access | PDO Mapping | Data Type | Unit | Data Range | Default | Change Condition | Effective Time |
|-------------|-------------------------|-----------------------------|--------|-------------|-----------|------|------------|---------|------------------|----------------|
| 60E3h       | Supported homing method |                             |        |             |           |      |            |         |                  |                |
|             | 0                       | Highest sub-index supported | RO     | No          | Uint 8    | -    | -          | 31      | -                | -              |
|             | 1                       | 1st supported homing method | RO     | No          | Uint 16   | -    | -          | 769     | -                | -              |
|             | 2                       | 2nd supported homing method | RO     | No          | Uint 16   | -    | -          | 770     | -                | -              |
|             | 3                       | 3rd supported homing method | RO     | No          | Uint 16   | -    | -          | 771     | -                | -              |
|             | 4                       | 4th supported homing method | RO     | No          | Uint 16   | -    | -          | 772     | -                | -              |

List of Parameters

| Index (HEX) | Sub-index (HEX) | Name                         | Access | PDO Mapping | Data Type | Unit | Data Range | Default | Change Condition | Effective Time |
|-------------|-----------------|------------------------------|--------|-------------|-----------|------|------------|---------|------------------|----------------|
| 60E3h       | 5               | 5th supported homing method  | RO     | No          | Uint 16   | -    | -          | 773     | -                | -              |
|             | 6               | 6th supported homing method  | RO     | No          | Uint 16   | -    | -          | 774     | -                | -              |
|             | 7               | 7th supported homing method  | RO     | No          | Uint 16   | -    | -          | 775     | -                | -              |
|             | 8               | 8th supported homing method  | RO     | No          | Uint 16   | -    | -          | 776     | -                | -              |
|             | 9               | 9th supported homing method  | RO     | No          | Uint 16   | -    | -          | 777     | -                | -              |
|             | A               | 10th supported homing method | RO     | No          | Uint 16   | -    | -          | 778     | -                | -              |
|             | B               | 11th supported homing method | RO     | No          | Uint 16   | -    | -          | 779     | -                | -              |
|             | C               | 12th supported homing method | RO     | No          | Uint 16   | -    | -          | 780     | -                | -              |
|             | D               | 13th supported homing method | RO     | No          | Uint 16   | -    | -          | 781     | -                | -              |
|             | E               | 14th supported homing method | RO     | No          | Uint 16   | -    | -          | 782     | -                | -              |

| Index (HEX) | Sub-index (HEX) | Name                         | Access | PDO Mapping | Data Type | Unit | Data Range | Default | Change Condition | Effective Time |
|-------------|-----------------|------------------------------|--------|-------------|-----------|------|------------|---------|------------------|----------------|
| 60E3h       | F               | 15th supported homing method | RO     | No          | Uint 16   | -    | -          | 783     | -                | -              |
|             | 10              | 16th supported homing method | RO     | No          | Uint 16   | -    | -          | 784     | -                | -              |
|             | 11              | 17th supported homing method | RO     | No          | Uint 16   | -    | -          | 785     | -                | -              |
|             | 12              | 18th supported homing method | RO     | No          | Uint 16   | -    | -          | 786     | -                | -              |
|             | 13              | 19th supported homing method | RO     | No          | Uint 16   | -    | -          | 787     | -                | -              |
|             | 14              | 20th supported homing method | RO     | No          | Uint 16   | -    | -          | 788     | -                | -              |
|             | 15              | 21th supported homing method | RO     | No          | Uint 16   | -    | -          | 789     | -                | -              |
|             | 16              | 22th supported homing method | RO     | No          | Uint 16   | -    | -          | 790     | -                | -              |
|             | 17              | 23th supported homing method | RO     | No          | Uint 16   | -    | -          | 791     | -                | -              |
|             | 18              | 24th supported homing method | RO     | No          | Uint 16   | -    | -          | 792     | -                | -              |

List of Parameters







| Index (HEX) | Sub-index (HEX) | Name                             | Access | PDO Mapping | Data Type | Unit           | Data Range        | Default | Change Condition | Effective Time |
|-------------|-----------------|----------------------------------|--------|-------------|-----------|----------------|-------------------|---------|------------------|----------------|
| 60E3h       | 19              | 25th supported homing method     | RO     | No          | Uint 16   | -              | -                 | 793     | -                | -              |
|             | 1A              | 26th supported homing method     | RO     | No          | Uint 16   | -              | -                 | 794     | -                | -              |
|             | 1B              | 27th supported homing method     | RO     | No          | Uint 16   | -              | -                 | 795     | -                | -              |
|             | 1C              | 28th supported homing method     | RO     | No          | Uint 16   | -              | -                 | 796     | -                | -              |
|             | 1D              | 29th supported homing method     | RO     | No          | Uint 16   | -              | -                 | 797     | -                | -              |
|             | 1E              | 30th supported homing method     | RO     | No          | Uint 16   | -              | -                 | 798     | -                | -              |
|             | 1F              | 31th supported homing method     | RO     | No          | Uint 16   | -              | -                 | 799     | -                | -              |
| 60E6h       | 0               | Actual position calculation mode | RW     | No          | Uint 16   | -              | 0 to 1            | 0       | During running   | At once        |
| 60F4h       | 0               | Following error actual value     | RO     | TPDO        | int 32    | Reference unit | -                 | -       | -                | -              |
| 60FCh       | 0               | Position demand value*           | RO     | TPDO        | int 32    | Encoder unit   | -                 | -       | -                | -              |
| 60FDh       | 0               | Digital inputs                   | RO     | TPDO        | Uint 32   | -              | -                 | -       | -                | -              |
| 60FEh       | Digital outputs |                                  |        |             |           |                |                   |         |                  |                |
|             | 0               | DO state                         | RO     | No          | Uint 8    | -              | -                 | 2       | -                | -              |
|             | 1               | Physical outputs                 | RW     | RPDO        | Uint 32   | -              | 0 to $2^{32} - 1$ | 0       | During running   | At once        |
|             | 2               | Bitmask                          | RW     | No          | Uint 32   | -              | 0 to $2^{32} - 1$ | 0       | During running   | At once        |

| Index (HEX) | Sub-index (HEX) | Name                  | Access | PDO Mapping | Data Type | Unit             | Data Range                           | Default | Change Condition | Effective Time |
|-------------|-----------------|-----------------------|--------|-------------|-----------|------------------|--------------------------------------|---------|------------------|----------------|
| 60FFh       | 0               | Target velocity       | RW     | RPDO        | int 32    | Reference unit/s | $-2^{31} - 1$<br>to<br>$+2^{31} - 1$ | 0       | During running   | At once        |
| 6502h       | 0               | Supported drive modes | RO     | No          | Uint 32   | -                | -                                    | 941     | -                | -              |

## 5 Appendix A Display of Monitoring Parameters

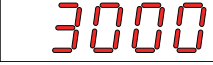

- Group H0B (200B): Displays parameters used to monitor the operating state of the servo drive.
- Set H02-32 (2002–21h) (Default keypad display) properly. After the servo motor operates normally, the keypad switches from "Status display" to "Monitored value display". The parameter group No. is H0B (200B) and the No. within the group is the setpoint of H02-32 (2002–21h).
- For example, if H02-32 (2002–21h) is set to 00 and the motor speed is not 0 RPM, the keypad displays the value of H0B-00 (200B–00h).

The following table describes the monitoring parameters in group H0B.

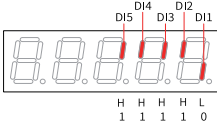
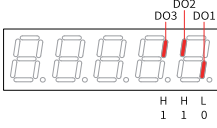
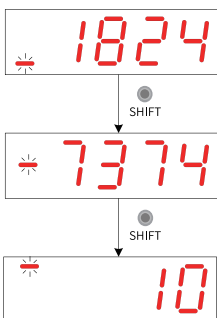



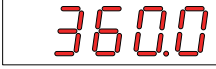

| Para. No. | Name                      | Unit | Meaning   | Example of Display  |
|-----------|---------------------------|------|---|---|
| H0B-00    | Motor speed actual value  | RPM  | Displays the actual motor speed after round-off, which can be accurate to 1 RPM.          | Display of 3000 RPM:<br><br>Display of -3000 RPM:<br> |
| H0B-01    | Speed reference           | RPM  | Displays the present speed reference of the servo drive.                                  | Display of 3000 RPM:<br><br>Display of -3000 RPM:<br> |
| H0B-02    | Internal torque reference | %    | Displays the ratio of actual torque output of the motor to the rated torque of the motor. | Display of 100.0%:<br><br>Display of -100.0%:<br> |



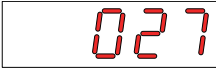



| Para. No. | Name                                       | Unit           | Meaning   | Example of Display   |
|-----------|--|----------------|---|--|
| H0B-03    | Monitored DI status                        | -              | Indicates level status of DI1 to DI5:<br>Upper LED segments ON: high level (indicated by "1")<br>Lower LED segments ON: low level (indicated by "0")<br>The value of H0B-03 read in the software tool is a decimal. | <p>For example, if DI1 is low level and DI2 to DI5 are high level, the corresponding binary value will be "11110", and the value of H0B-03 read in the software tool is 0x001E.<br/>The keypad displays as follows:</p>  |
| H0B-05    | Monitored DO status                        | -              | Indicates level status of DO1 to DO3:<br>Upper LED segments ON: high level (indicated by "1")<br>Lower LED segments ON: low level (indicated by "0")<br>The value of H0B-05 read in the software tool is a decimal. | <p>For example, if DO1 is low level and DO2 to DO3 are high level, the binary value will be "110", and the value of H0B-05 read by the software tool is 0x0006.<br/>The keypad displays as follows:</p>                 |
| H0B-07    | Absolute position counter (32-bit decimal) | Reference unit | Displays current absolute position of the motor (reference unit).   | <p>Display of 1073741824 in reference unit:</p>    |





| Para. No. | Name  | Unit         | Meaning   | Example of Display  |
|-----------|---|--------------|---|---|
| H0B-09    | Mechanical angle                                    | °            | Displays current mechanical angle of the motor.   | Display of 360.0°:<br>  |
| H0B-10    | Electrical angle                                    | °            | Displays current electrical angle of the motor.   | Display of 360.0°:<br>  |
| H0B-11    | Speed corresponding to the input position reference | RPM          | Displays the speed corresponding to the position reference per control cycle of the servo drive.                                    | Display of 3000 RPM:<br><br>Display of -3000 RPM:<br> |
| H0B-12    | Average load rate                                   | %            | Displays the ratio of the average load torque to the rated torque of the motor.   | Display of 100.0%:<br>  |
| H0B-15    | Encoder position deviation counter (32-bit decimal) | Encoder unit | Encoder position deviation = Sum of input position references (encoder unit) – Sum of pulses fed back by the encoder (encoder unit) | Display of 10000 in encoder unit:<br><br>↓ SHIFT<br>  |



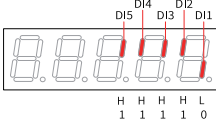



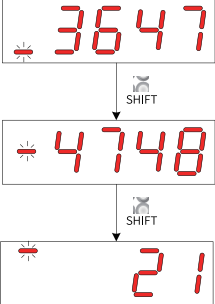

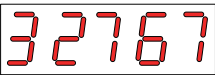
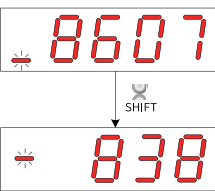
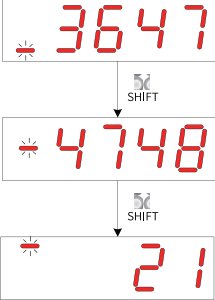
| Para. No. | Name                                    | Unit         | Meaning   | Example of Display  |
|-----------|---|--------------|---|---|
| H0B-17    | Feedback pulse counter (32-bit decimal) | Encoder unit | Counts and displays the number of pulses fed back by the encoder (encoder unit).<br><br><b>Note</b><br>When the motor with absolute encoder is used, H0B-17 only reflects values of the low 32 bits of the motor position feedback. To get the actual motor position feedback, view H0B-77 (Encoder position (low 32 bits)) and H0B-79 (Encoder position (high 32 bits)). | <p>Display of 1073741824 in encoder unit:</p>   |
| H0B-19    | Total power-on time (32-bit decimal)    | s            | Counts and displays the total power-on time of the servo drive.   | <p>Display of 429496729.5s:</p>   |
| H0B-24    | RMS value of phase current              | A            | Displays the RMS value of the phase current of the servo motor.   | <p>Display of 4.60 A:</p>   |
| H0B-26    | Bus voltage                             | V            | Indicates the DC bus voltage of the main circuit, namely the voltage between terminals P $\oplus$ and N $\ominus$ .   | <p>Display of 311.0 V rectified from 220 VAC:</p> <p>Display of 537.0 V rectified from 380 VAC:</p> |

| Para. No. | Name   | Unit | Meaning   | Example of Display   |
|-----------|--|------|---|--|
| H0B-27    | Power module temperature                         | °C   | Displays the temperature of the power module inside the servo drive.  | Display of 27°C:<br>   |
| H0B-33    | Fault log  | -    | Used to select the previous fault to be viewed.<br>0: Present fault<br>1: Last fault<br>2: 2nd to last fault<br>...<br>9: 9th to last fault       | 0: Display of present fault:<br>   |
| H0B-34    | Fault code of the selected fault                 | -    | Displays the fault code of the fault selected in H0B-33. When no fault occurs, the value of H0B-34 is 0.  | If H0B-33 = 0, and H0B-34 = E941.0, the present fault code will be 941.0.<br>Corresponding display:<br>  |
| H0B-35    | Time stamp upon occurrence of the selected fault | s    | Displays the total operating time of the servo drive when the fault displayed in H0B-34 occurred. When no fault occurs, the value of H0B-35 is 0. | If H0B-34 = E941.0, H0B-35 = 107374182.4, the present fault code will be 941.0 and the total operating time of the servo drive is 107374182.4s when the fault occurs.<br><br>↓ SHIFT<br><br>↓ SHIFT<br> |

| Para. No. | Name  | Unit | Meaning  | Example of Display   |
|-----------|---|------|--|--|
| H0B-37    | Motor speed upon occurrence of the selected fault           | RPM  | Displays the servo motor speed when the fault displayed in H0B-34 occurred.<br>When no fault occurs, the value of H0B-37 is 0.   | Display of 3000 RPM:<br><br>Display of -3000 RPM:<br>  |
| H0B-38    | Motor phase U current upon occurrence of the selected fault | A    | Displays the RMS value of motor phase U winding current when the fault displayed in H0B-34 occurred.<br>When no fault occurs, the value of H0B-38 is 0.  | Display of 4.60 A:<br>   |
| H0B-39    | Motor phase V current upon occurrence of the selected fault | A    | Displays the RMS value of motor phase V winding current when the fault displayed in H0B-34 occurred.<br>When no fault occurs, the value of H0B-39 is 0.  | Display of 4.60 A:<br>   |
| H0B-40    | Bus voltage upon occurrence of the selected fault           | V    | Displays the DC bus voltage of the main circuit when the fault displayed in H0B-34 occurred.<br>When no fault occurs, the value of H0B-40 is 0.  | Display of 311.0 V rectified from 220 VAC:<br><br>Display of 537.0 V rectified from 380 VAC:<br> |
| H0B-41    | DI status upon occurrence of the selected fault             | -    | Displays the high/low level status of DI1 to DI5 when the fault displayed in H0B-34 occurred.<br>The method for determining the DI level status is the same as that of H0B-03.<br>When no fault occurs, all DIs are displayed as low level in H0B-41 (indicated by the decimal value 0). | For example, when the value of H0B-41 read in the software tool is 0x0001, the corresponding binary code will be 0000 0000 0000 0001.<br>  |

| Para. No. | Name  | Unit           | Meaning  | Example of Display   |
|-----------|---|----------------|--|--|
| H0B-43    | DO status upon occurrence of the selected fault | -              | Displays the high/low level status of DO1 to DO3 when the fault displayed in H0B-34 occurred. The method for determining the DO level status is the same as that of H0B-05. When no fault occurs, all DOs are displayed as low level in H0B-42 (indicated by the decimal value 0). | <p>Display of H0B-43 = 0x0003:</p>                           |
| H0B-53    | Position deviation counter (32-bit decimal)     | Reference unit | Position deviation = Sum of input position references (reference unit) - Sum of pulses fed back by the encoder (reference unit)  | <p>Display of 10000 in reference unit:</p>                   |
| H0B-55    | Motor speed actual value                        | 0.1 RPM        | Displays actual value of the motor speed, which can be accurate to 0.1 RPM.  | <p>Display of 3000.0 RPM:</p> <p>Display of -3000.0 RPM:</p> |
| H0B-57    | Control circuit voltage                         | V              | Displays the DC voltage of the control circuit.  | <p>Display of 12.0 V:</p>                                    |

| Para. No. | Name  | Unit         | Meaning  | Example of Display   |
|-----------|---|--------------|--|--|
| H0B-58    | Mechanical absolute position (low 32 bits)        | Encoder unit | Displays the mechanical absolute position (low 32 bits) when an absolute encoder is used.    | Display of 2147483647 in encoder unit:<br>   |
| H0B-60    | Mechanical absolute position (high 32 bits)       | Encoder unit | Displays the mechanical absolute position (high 32 bits) when an absolute encoder is used.   | Display of 32767:<br>                        |
| H0B-70    | Number of absolute encoder revolutions            | Rev          | Displays the present number of revolutions of the absolute encoder.                          | Display of 32767:<br>                        |
| H0B-71    | Single-turn position feedback of absolute encoder | Encoder unit | Displays the single-turn position feedback of the absolute encoder.                          | Display of 8388607 in encoder unit:<br>     |
| H0B-77    | Absolute encoder position (low 32 bits)           | Encoder unit | Displays the absolute position (low 32 bits) of the motor when the absolute encoder is used. | Display of 2147483647 in encoder unit:<br> |

| Para. No. | Name  | Unit           | Meaning   | Example of Display  |
|-----------|---|----------------|---|---|
| H0B-79    | Absolute encoder position (high 32 bits)                                  | Encoder unit   | Displays the absolute position (high 32 bits) of the motor when the absolute encoder is used.                             | Display of -1 in encoder unit:<br>  |
| H0B-81    | Single-turn position feedback of the load in rotation mode (low 32 bits)  | Encoder unit   | Displays the position feedback (low 32 bits) of the mechanical load when the absolute system works in the rotation mode.  | Display of 2147483647 in encoder unit:<br><br>↓ SHIFT<br><br>↓ SHIFT<br>        |
| H0B-83    | Single-turn position feedback of the load in rotation mode (high 32 bits) | Encoder unit   | Displays the position feedback (high 32 bits) of the mechanical load when the absolute system works in the rotation mode. | Display of 1 in encoder unit:<br>   |
| H0B-85    | Single-turn position of the load in rotation mode                         | Reference unit | Displays the mechanical absolute position when the absolute system works in the rotation mode.                            | Display of 1073741824 in reference unit:<br><br>↓ SHIFT<br><br>↓ SHIFT<br> |

**Shenzhen Inovance Technology Co., Ltd.**

Add.: Building E, Hongwei Industry Park, Liuxian Road,  
Baocheng No. 70 Zone, Bao'an District, Shenzhen

Tel: +86-755-2979 9595

Fax: +86-755-2961 9897

<http://www.inovance.com>

**Suzhou Inovance Technology Co., Ltd.**

Add.: No. 16 Youxiang Road, Yuexi Town, Wuzhong  
District, Suzhou 215104, P.R. China

Tel: +86-755-2979 6666

Fax: +86-755-2961 6720

<http://www.inovance.com>



19011433A02