

SV660P Series Servo Drive Commissioning Guide

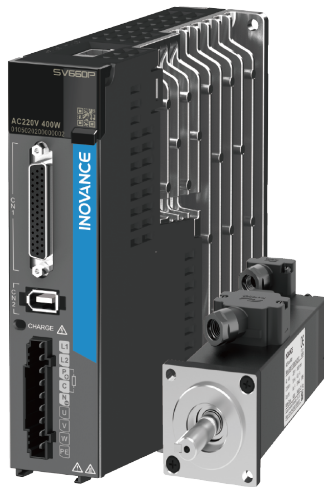

Preface

Overview

The SV660P series high-performance AC servo drive covers a power range from 50 W to 7.5 kW. It supports Modbus, CANopen and CANlink communication protocols and carries necessary communication interfaces to work with the host controller for a networked operation of multiple servo drives.

The SV660P series servo drive supports adaptive stiffness level setting, inertia auto-tuning, and vibration suppression to simplify the operation process. It allows a quiet and stable operation together with an MS1 series high-response servo motor with low or high inertia and a 23-bit single-turn/multi-turn absolute encoder.

The SV660P series servo drive applies to applications requiring quick and accurate position control, speed control and torque control, such as electronic manufacturing machines, manipulators, packing devices, and machine tools.

This guide tells you how to commission the servo drive, including introduction to the commissioning tools, commissioning and operating processes, and common faults and parameters.

More Documents

Name	Data Code
SV660P Series Servo Drive Selection Guide	19011390
SV660P Series Servo Drive Hardware Guide	19011391
SV660P Series Servo Drive Function Guide	19011393

Revision History

Date of Revision	Version	Revision
January 2021	A00	First release

Document Acquisition

This guide is not delivered along with the product. To download the PDF version, visit <http://en.inovance.cn/support/download.html>.

Table of Contents

Preface	1
Fundamental Safety Instructions	4
1 Commissioning Tool	10
1.1 Keypad	10
1.1.1 Introduction to the Keypad	10
1.1.2 Display Modes	11
1.1.3 Parameter Settings	16
1.2 Software Tool	17
2 Commissioning and Operation	19
2.1 Commissioning Flowchart	19
2.2 Commissioning Procedure	20
2.2.1 Inspection Before Operation	20
2.2.2 Power Supply	20
2.2.3 Jogging	21
2.2.4 Parameter Settings	24
2.2.5 Servo-ON	41
2.2.6 Servo Stop	51
3 Troubleshooting	55
3.1 Troubleshooting Upon Startup	55
3.1.1 Position Control Mode	55
3.1.2 Speed Control Mode	60
3.1.3 Torque Control Mode	62
3.2 Troubleshooting During Operation	63
3.2.1 Faults and Warnings	63
3.2.2 Common Solutions to Faults	68
3.2.3 Solutions to Common Warnings	97
3.2.4 Internal Faults	105
4 Parameter Descriptions	106
4.1 Group H00: Servo Motor Parameters	106
4.2 Group H01: Servo Drive Parameters	108
4.3 Group H02: Basic Control Parameters	108
4.4 Group H03: Terminal Input Parameters	111
4.5 Group H04: Terminal Output Parameters	112
4.6 Group H05: Position Control Parameters	114
4.7 Group H06: Speed Control Parameters	120
4.8 Group H07: Torque Control Parameters	121
4.9 Group H08: Gain Parameters	123

4.10	Group H09: Auto-tuning Parameters	126
4.11	Group H0A Fault and Protection Parameters	130
4.12	Group H0B Monitoring Parameters	131
4.13	Group H0C: Communication Parameters	134
4.14	Group H0D: Auxiliary Function Parameters	136
4.15	Group H11: Multi-Position Parameters	137
4.16	Group H12 Multi-Speed Parameters	141
4.17	Group H17: VDI/VDO Parameters	147
4.18	Group H30: Servo Variables Read Through Communication	151
4.19	Group H31: Servo Variables Set Through Communication	151
4.20	DI/DO Function Definitions	152
Appendix A: CANlink Enhanced Axis Control Parameters		159
5	Appendix B Display of Values Monitored Through Keypad	161

Fundamental Safety Instructions

Safety Precautions

1. This chapter presents essential safety instructions for a proper use of the equipment. Before operating the equipment, read through the user guide and comprehend all the safety instructions. Failure to comply with the safety instructions may result in death, severe personal injuries, or equipment damage.
2. "CAUTION", "WARNING", and "DANGER" items in the user guide only indicate some of the precautions that need to be followed; they just supplement the safety precautions.
3. Use this equipment according to the designated environment requirements. Damage caused by improper use is not covered by warranty.
4. Inovance shall take no responsibility for any personal injuries or property damage caused by improper use.

Safety Levels and Definitions



Indicates that failure to comply with the notice will result in death or severe personal injuries.



Indicates that failure to comply with the notice may result in death or severe personal injuries.



Indicates that failure to comply with the notice may result in minor or moderate personal injuries or equipment damage.

General Safety Instructions

- Drawings in the user guide are sometimes shown without covers or protective guards. Remember to install the covers or protective guards as specified first, and then perform operations in accordance with the instructions.
- The drawings in the user guide are shown for illustration only and may be different from the product you purchased.

Unpacking



- Do not install the equipment if you find damage, rust, or signs of use on the equipment or accessories upon unpacking.
- Do not install the equipment if you find water seepage or missing or damaged components upon unpacking.
- Do not install the equipment if you find the packing list does not conform to the equipment you received.



- Check whether the packing is intact and whether there is damage, water seepage, dampness, and deformation before unpacking.
- Unpack the package by following the unpacking sequence. Do not strike the package violently.
- Check whether there is damage, rust, or injuries on the surface of the equipment and equipment accessories before unpacking.
- Check whether the package contents are consistent with the packing list before unpacking.

Storage and Transportation



- Large-scale or heavy equipment must be transported by qualified professionals using specialized hoisting equipment. Failure to comply may result in personal injuries or equipment damage.
- Before hoisting the equipment, ensure the equipment components such as the front cover and terminal blocks are secured firmly with screws. Loosely-connected components may fall off and result in personal injuries or equipment damage.
- Never stand or stay below the equipment when the equipment is being hoisted by the hoisting equipment.
- When hoisting the equipment with a steel rope, ensure the equipment is hoisted at a constant speed without suffering from vibration or shock. Do not turn the equipment over or let the equipment stay hanging in the air. Failure to comply may result in personal injuries or equipment damage.



- Handle the equipment with care during transportation and mind your steps to prevent personal injuries or equipment damage.
- When carrying the equipment with bare hands, hold the equipment casing firmly with care to prevent parts from falling. Failure to comply may result in personal injuries.
- Store and transport the equipment based on the storage and transportation requirements. Failure to comply will result in equipment damage.
- Avoid storing or transporting the equipment in environments with water splash, rain, direct sunlight, strong electric field, strong magnetic field, and strong vibration.
- Avoid storing the equipment for more than three months. Long-term storage requires stricter protection and necessary inspections.
- Pack the equipment strictly before transportation. Use a sealed box for long-distance transportation.
- Never transport the equipment with other equipment or materials that may harm or have negative impacts on this equipment.

Installation



- The equipment must be operated only by professionals with electrical knowledge.

 WARNING

- Read through the user guide and safety instructions before installation.
- Do not install this equipment in places with strong electric or magnetic fields.
- Before installation, check that the mechanical strength of the installation site can bear the weight of the equipment. Failure to comply will result in mechanical hazards.
- Do not wear loose clothes or accessories during installation. Failure to comply may result in an electric shock.
- When installing the equipment in a closed environment (such as a cabinet or casing), use a cooling device (such as a fan or air conditioner) to cool the environment down to the required temperature. Failure to comply may result in equipment over-temperature or a fire.
- Do not retrofit the equipment.
- Do not fiddle with the bolts used to fix equipment components or the bolts marked in red.
- When the equipment is installed in a cabinet or final assembly, a fireproof enclosure providing both electrical and mechanical protections must be provided. The IP rating must meet IEC standards and local laws and regulations.
- Before installing devices with strong electromagnetic interference, such as a transformer, install a shielding device for the equipment to prevent malfunction.
- Install the equipment onto an incombustible object such as a metal. Keep the equipment away from combustible objects. Failure to comply will result in a fire.

 CAUTION

- Cover the top of the equipment with a piece of cloth or paper during installation. This is to prevent unwanted objects such as metal shavings, oil, and water from falling into the equipment and causing faults. After installation, remove the cloth or paper on the top of the equipment to prevent over-temperature caused by poor ventilation due to blocked ventilation holes.
- Resonance may occur when the equipment operating at a constant speed executes variable speed operations. In this case, install the vibration-proof rubber under the motor frame or use the vibration suppression function to reduce resonance.

Wiring

 DANGER

- Equipment installation, wiring, maintenance, inspection, or parts replacement must be performed only by professionals.
- Before wiring, cut off all the power supplies of the equipment, and wait for at least the time designated on the equipment warning label before further operations because residual voltage still exists after power-off. After waiting for the designated time, measure the DC voltage in the main circuit to ensure the DC voltage is within the safe voltage range. Failure to comply will result in an electric shock.
- Do not perform wiring, remove the equipment cover, or touch the circuit board with power ON. Failure to comply will result in an electric shock.
- Check that the equipment is grounded properly. Failure to comply will result in an electric shock.

 WARNING

- Do not connect the input power supply to the output end of the equipment. Failure to comply will result in equipment damage or even a fire.
- When connecting a drive to the motor, check that the phase sequences of the drive and motor terminals are consistent to prevent reverse motor rotation.
- Cables used for wiring must meet cross sectional area and shielding requirements. The shield of the cable must be reliably grounded at one end.
- Fix the terminal screws with the tightening torque specified in the user guide. Improper tightening torque may overheat or damage the connecting part, resulting in a fire.
- After wiring is done, check that all cables are connected properly, with no screws, washers, or exposed cables left inside the equipment. Failure to comply may result in an electric shock or equipment damage.

 CAUTION

- During wiring, follow the proper electrostatic discharge (ESD) procedure, and wear an antistatic wrist strap. Failure to comply will damage the equipment or the internal circuits of the equipment.
- Use shielded twisted pairs for the control circuit. Connect the shield to the grounding terminal of the equipment for grounding purpose. Failure to comply will result in equipment malfunction.

Power-on DANGER

- Before power-on, check that the equipment is installed properly with reliable wiring and the motor can be restarted.
- Check that the power supply meets equipment requirements before power-on to prevent equipment damage or a fire.
- After power-on, do not open the cabinet door or protective cover of the equipment, touch any terminal, or disassemble any unit or component of the equipment. Failure to comply will result in an electric shock.

 WARNING

- Perform a trial run after wiring and parameter setting to ensure the equipment operates safely. Failure to comply may result in personal injuries or equipment damage.
- Before power-on, check that the rated voltage of the equipment is consistent with that of the power supply. Failure to comply may result in a fire.
- Before power-on, check that no one is near the equipment, motor, or machine. Failure to comply may result in death or personal injuries.

Operation DANGER

- The equipment must be operated only by professionals. Failure to comply will result in death or personal injuries.
- Do not touch any connecting terminals or disassemble any unit or component of the equipment during operation. Failure to comply will result in an electric shock.

 WARNING

- Do not touch the equipment casing, fan, or resistor with bare hands to feel the temperature. Failure to comply may result in personal injuries.
- Prevent metal or other objects from falling into the equipment during operation. Failure to comply may result in a fire or equipment damage.

Maintenance

 DANGER

- Equipment installation, wiring, maintenance, inspection, or parts replacement must be performed only by professionals.
- Do not maintain the equipment with power ON. Failure to comply will result in an electric shock.
- Before maintenance, cut off all the power supplies of the equipment and wait for at least the time designated on the equipment warning label.
- In case of a permanent magnet motor, do not touch the motor terminals immediately after power-off because the motor terminals will generate induced voltage during rotation even after the equipment power supply is off. Failure to comply will result in an electric shock.

 WARNING

- Perform routine and periodic inspection and maintenance on the equipment according to maintenance requirements and keep a maintenance record.

Repair

 DANGER

- Equipment installation, wiring, maintenance, inspection, or parts replacement must be performed only by professionals.
- Do not repair the equipment with power ON. Failure to comply will result in an electric shock.
- Before inspection and repair, cut off all the power supplies of the equipment and wait for at least the time designated on the equipment warning label.

 WARNING

- When the fuse is blown or the circuit breaker or earth leakage current breaker (ELCB) trips, wait for at least the time designated on the equipment warning label before power-on or further operations. Failure to comply may result in death, personal injuries, or equipment damage.
- When the equipment is faulty or damaged, the troubleshooting and repair work must be performed by professionals that follow the repair instructions, with repair records kept properly.
- Replace quick-wear parts of the equipment according to the replacement instructions.
- Do not use damaged equipment. Failure to comply may result in death, personal injuries, or severe equipment damage.
- After the equipment is replaced, check the wiring and set parameters again.

Disposal

- Dispose of retired equipment in accordance with local regulations and standards. Failure to comply may result in property damage, personal injuries, or even death.
- Recycle retired equipment by observing industry waste disposal standards to avoid environmental pollution.

Safety Labels

For safe equipment operation and maintenance, comply with the safety labels on the equipment. Do not damage or remove the safety labels. See the following table for descriptions of the safety labels.

Safety Label	Description
	<ul style="list-style-type: none"> • Read through the safety instructions before operating the equipment. Failure to comply may result in death, personal injuries, or equipment damage. • Do not touch the terminals or remove the cover with power ON or within 10 min after power-off. Failure to comply will result in an electric shock.

1 Commissioning Tool

1.1 Keypad

1.1.1 Introduction to the Keypad

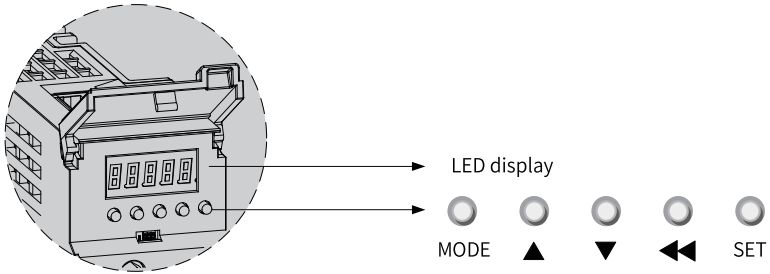







Figure 1-1 Magnified view of the keypad

The keypad, which consists of five LEDs and five keys, is used for data display, parameter setting, user password setting, and general function execution. The following table takes parameter setting as an example to describe the general functions of the keys.

Table 1-1 Descriptions of keys

Name	Symbol	Description
MODE	 MODE	Used to switch among different modes and return to the previous menu.
UP	 ▲	Used to increase the value of the blinking bit.
DOWN	 ▼	Used to decrease the value of the blinking bit.

Name	Symbol	Description
SHIFT		Used to shift the blinking bit and view the high digits of a number consisting of more than 5 digits.
SET		Used to enter the next menu and execute commands such as saving parameter setpoints.

1.1.2 Display Modes

The keypad can be used to display the servo drive status, parameters, faults, and monitored value.

- Status display: Displays current servo drive status, such as servo ready or servo running.
- Parameter display: Displays parameters and their setpoints.
- Fault display: Displays faults and warnings that occur on the servo drive.
- Monitored value display: Displays values of monitoring parameters.

Switchover among different display modes

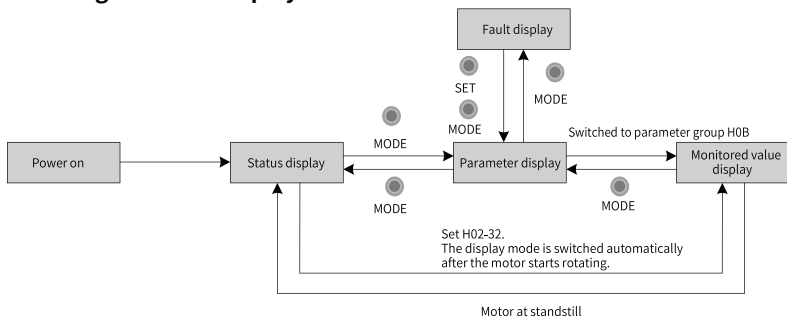
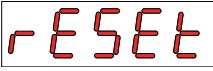





Figure 1-2 Switching among different display modes

- The keypad enters status display mode immediately upon power-on.
- Press MODE to switch among different modes based on the conditions shown in ["Figure 1-2" on page 11](#).
- In the status display mode, set H02-32 (Default keypad display) to select the parameters to be monitored. When the motor rotates, the keypad automatically switches to monitored value display. After the motor stops, the keypad automatically restores to status display.
- In the parameter display mode, after you select parameters to be monitored in group H0B, the keypad switches to the monitored value display mode.

- Once a fault occurs, the keypad enters the fault display mode immediately, with all the five LEDs blinking. Press SET to stop the LEDs from blinking, and then press MODE to switch to the parameter display mode.

Status display

Display	Name	Applicable Occasion	Meaning
	Reset (servo initializing)	At the moment upon power on	The servo drive is in the initialization or reset status. After initialization or reset is done, the servo drive automatically switches to other status.
	Nrd (servo not ready)	Initialization done, but servo drive not ready	The servo drive is not ready to run because the main circuit is not powered on. For details, see Chapter "Troubleshooting".
	Rdy Servo ready	(servo ready)	The servo drive is ready to run and waits for the S-ON signal.
	Run (servo running)	Servo ON (S-ON) signal active (S-ON signal switched on)	The servo drive is in the running state.
	Jog (jogging)	Servo drive in jogging status	See "2.2.3 Jogging" on page 21 for details.

Parameter display

Parameters are divided into 19 groups based on their functions. A parameter can be located quickly based on the parameter group it belongs to. For details on parameters, see Chapter "Parameter List".

- Display of parameter groups

Display	Name	Description
HXX.YY	Parameter group	XX: parameter group No. (decimal) YY: offset within the parameter group (hexadecimal)

For example, "H02-00" is displayed as follows.

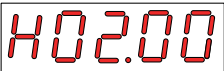
Display	Name	Description
	H02-00	02: parameter group No. 00: offset within the parameter group

- Display of negative numbers and numbers with different lengths
 - Signed number with 4 digits and below or unsigned number with 5 digits and below

Such a number is displayed in a single page (five digits). For signed numbers, the highest bit "-" represents the negative symbol.

For example, "-9999" is displayed as follows.



For example, "65535" is displayed as follows.

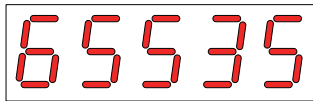

- Signed number with more than 4 digits or unsigned number with more than 5 digits

Such a number is displayed from low to high bits in several pages (5 digits per page): present page + value on present page, as shown in the following figure. Hold down SHIFT for more than 2s to switch to the next page.

For example, "-1073741824" is displayed as follows.

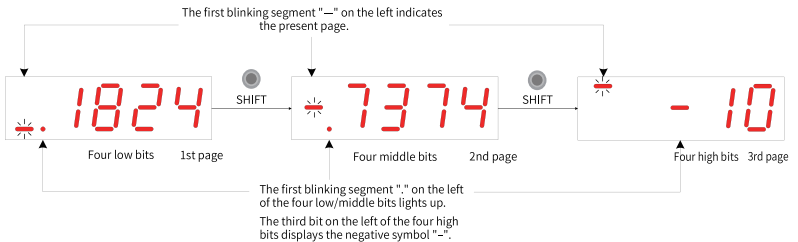

Figure 1-3 Display of "-1073741824"

Example: "1073741824" is displayed as follows:





Figure 1-4 Display of "1073741824"

- Display of the decimal point

Segment "." in the unit's digit indicates the decimal point, which does not blink.

Display	Name	Description
	Decimal point	100.0

- Display of parameter settings

Display	Name	Applicable Occasion	Meaning
	Done (parameter setting done)	The parameter is set successfully.	The parameter is set and saved to the servo drive (Done). The servo drive can execute other operations.
	F.InIt (restored to default)	Parameter initialization is in progress (H02-31 = 1).	The servo drive is in the process of parameter initialization. Switch on the control circuit again after initialization is done.
	Error (wrong password)	The user password (H02-30) is activated and the password entered is wrong.	A wrong password is entered. You need to enter the password again.

Fault display

- The keypad can be used to display present or previous faults and warnings. For analysis and solutions to the faults and warnings, see Chapter "Troubleshooting".
- When a fault or warning occurs, the keypad displays the fault or warning code immediately. When multiple faults or warnings occur, the keypad displays the fault code of the highest fault level.
- You can select the previous fault/warning to be viewed through H0B-33 (Fault record) and view the code of the selected fault/warning in H0B-34.
- You can clear the latest 10 faults or warnings saved in the servo drive by setting H02-31 (Parameter initialization) to 2 (Clear fault records).

For example, Er.941, Er.600, and Er.B00 are displayed as follows:

Display	Name	Description
	Er.941 Present warning code	Er: A fault or warning occurs on the servo drive. 941: Warning code
	Er.600 Present warning code	Er: A fault or warning occurs on the servo drive. 600: Warning code
	Er.B00 Present warning code	Er: A fault or warning occurs on the servo drive. B00: Warning code

Monitored value display

- Group H0B: Displays parameters used to monitor the operating state of the servo drive.
- Set H02-32 (Default keypad display) properly. After the servo motor operates normally, the keypad switches from status display to monitored value display. The parameter group No. is H0B and the No. within the group is the setpoint of H02-32.
- For example, if H02-32 is set to 00 and the motor speed is not 0 RPM, the keypad displays the value of H0B-00.

See the following table for descriptions of H0B-00.

Para. No.	Name	Unit	Meaning	Example of Display
H0B-00	Motor speed actual value	RPM	Displays the actual motor speed after round-off, which can be accurate to 1 RPM.	Display of 3000 RPM: Display of -3000 RPM:

Note

For details of parameter group H0B, see [“Appendix B Display of Monitoring Parameters” on page 161.](#)

1.1.3 Parameter Settings

Example of parameter settings

You can set parameters through the keypad. For details on parameters, see Chapter "Parameter List". The following figure shows how to switch from the position control mode to the speed control mode using the keypad upon power-on.

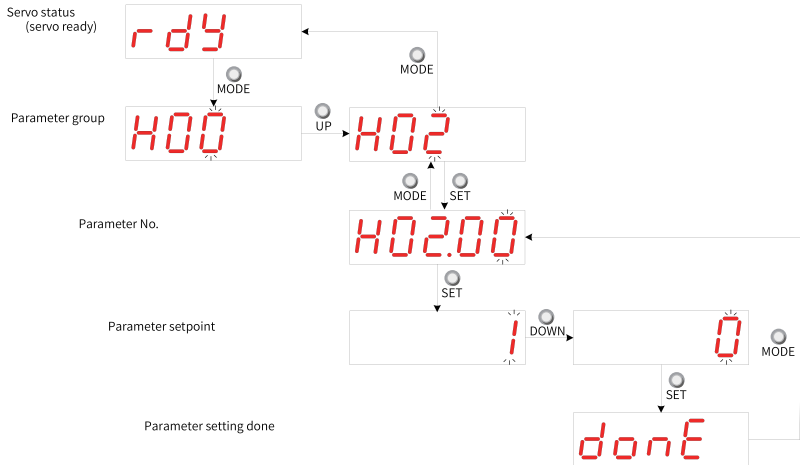

Figure 1-5 Example of parameter setting

- **MODE:** Used to switch the keypad display mode and return to the previous interface.
- **UP/DOWN:** Used to increase or decrease the value of the blinking bit.
- **SHIFT:** Used to shift the blinking bit.
- **SET:** Used to save the present setpoint or switch to the next interface.

After the parameter setting is done, that is, "Done" is displayed on the keypad, press MODE to return to the parameter group interface (interface of "H02-00").

User password

After the user password (H02-30) is activated, only the authorized user can perform parameter settings, other operators can only view the parameters.

- **Setting the user password**
The following figure shows how to set the user password to "00001".

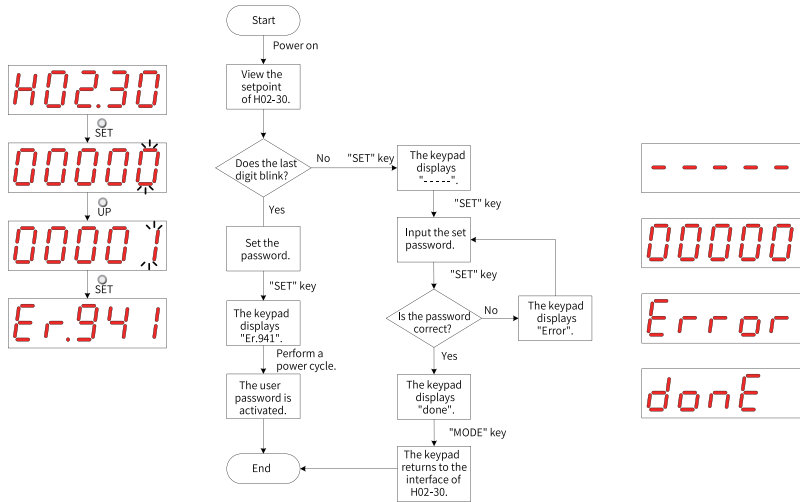

Figure 1-6 Procedure for setting the user password

To change the user password, input the present password first to authorize the access to parameter setting, and then enter H02-30 again to set a new password based on the procedure shown in the preceding figure.

Note

If the last bit does not blink, the access to parameters is password protected. If the last bit blinks, no password is set or the password entered is correct.

- Canceling the user password
Enter the user password, and set H02-30 to "00000" to cancel the user password.

1.2 Software Tool

The software tool InoDriverShop can be downloaded from <http://en.inovance.cn/support/download.html>. The servo drive can communicate with a PC through the communication cable (S6-L-T00-3.0) provided by Inovance or a customized communication cable. See SV660P Series Servo Drive Hardware Guide for the wiring mode.

InoDriverShop features the following functions:

- Oscilloscope: Detects and saves instantaneous data during operation.
- Parameter management: Reads and downloads parameters in batches.
- Database: Identifies parameters of customized software.
- Inertia auto-tuning: Obtains the load inertia ratio through a series of actions.

- Mechanical characteristic analysis: Analyzes the resonance frequency of the mechanical system.
- Motion JOG: Generates a position reference to make the motor reciprocate.
- Gain tuning: Adjusts the stiffness level and monitors the motion data.

InoDriverShop supports 32-bit/64-bit Windows 7 and 64-bit Windows 10 operating systems. For details on how to use InoDriverShop, see the help file of InoDriverShop.

You can use the SV660P commissioning wizard in InoDriverShop to facilitate the on-site commissioning.

2 Commissioning and Operation

2.1 Commissioning Flowchart

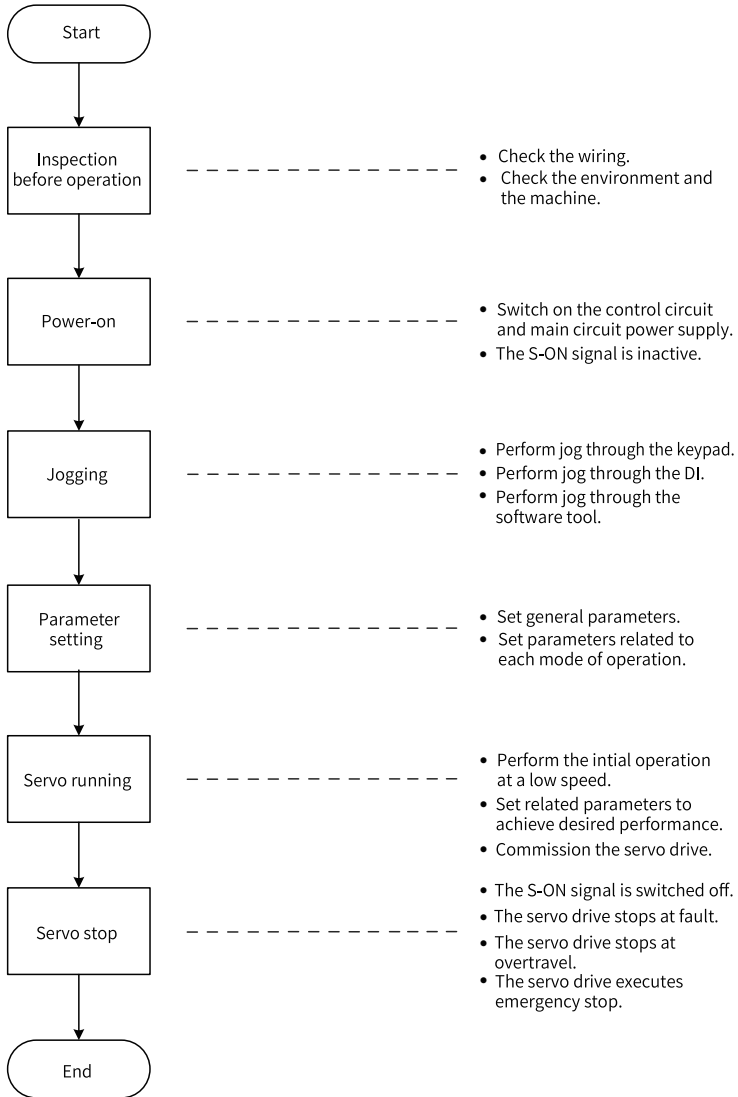

Figure 2-1 Commissioning flowchart of the servo drive

2.2 Commissioning Procedure

2.2.1 Inspection Before Operation

Check the following items before operating the servo drive and the servo motor.

Table 2-1 Checklist before operation

Record	No.	Description
Wiring		
<input type="checkbox"/>	1	The power input terminals (L1, L2/L1, L2, L3/L1C, L2C/R, S, T) of the servo drive are connected properly.
<input type="checkbox"/>	2	The main circuit cables (U, V, W) of the servo motor are connected in the correct phase sequence.
<input type="checkbox"/>	3	No short circuit exists in the power input terminals (L1, L2/L1, L2, L3/R, S, T) or main circuit output terminals (U, V, W) of the servo drive.
<input type="checkbox"/>	4	The control signal cables, such as the brake signal cable and overtravel protection signal cable, are connected properly.
<input type="checkbox"/>	5	The servo drive and servo motor are grounded properly.
<input type="checkbox"/>	6	The cable tension is within the specified range.
<input type="checkbox"/>	7	All the wiring terminals are insulated.
Environment and Mechanical Conditions		
<input type="checkbox"/>	1	No unwanted objects (such as cable terminals and metal chippings) that may cause short circuit are present inside or outside the servo drive.
<input type="checkbox"/>	2	The servo drive and the external regenerative resistor are placed on incombustible objects.
<input type="checkbox"/>	3	The servo motor is installed properly. The motor shaft is connected to the machine securely.
<input type="checkbox"/>	4	The servo motor and the machine it is connected to are in good condition and ready to run.

2.2.2 Power Supply

- Switching on the input power supply
 - The power input terminals for a single-phase 220 V power supply are L1 and L2.
 - The power input terminals for a three-phase power supply are L1, L2, L3/L1C, L2C (control circuit power input terminals)/R, S, T (main circuit power input terminals).

After the power supply is switched on, if the bus voltage indicator is in the normal state and the keypad displays "Reset"→"Nrd"→"Rdy" in sequence, the servo drive is ready to run and waits for the S-ON signal.

- Switching off the S-ON signal
Assign a certain DI of the servo drive with FunIN.1 (S-ON, servo ON) and set the active logic of this DI. Then deactivate this DI through the host controller or an external switch.

☆Related function No.

Function No.	Name	Function	Description
FunIN.1	S-ON	Servo ON	Inactive: Servo motor de-energized Active: Servo motor energized

2.2.3 Jogging



To use the jog function, deactivate the S-ON signal first.

The jog function can be used in the trial run to check whether the motor rotates properly, with no abnormal vibration or noise generated during rotation. You can activate the jog function through the keypad, two pre-configured external DIs, or the software tool. The motor takes the value saved in H06-04 as the jogging speed.

Jog setting through the keypad

- Commissioning procedure

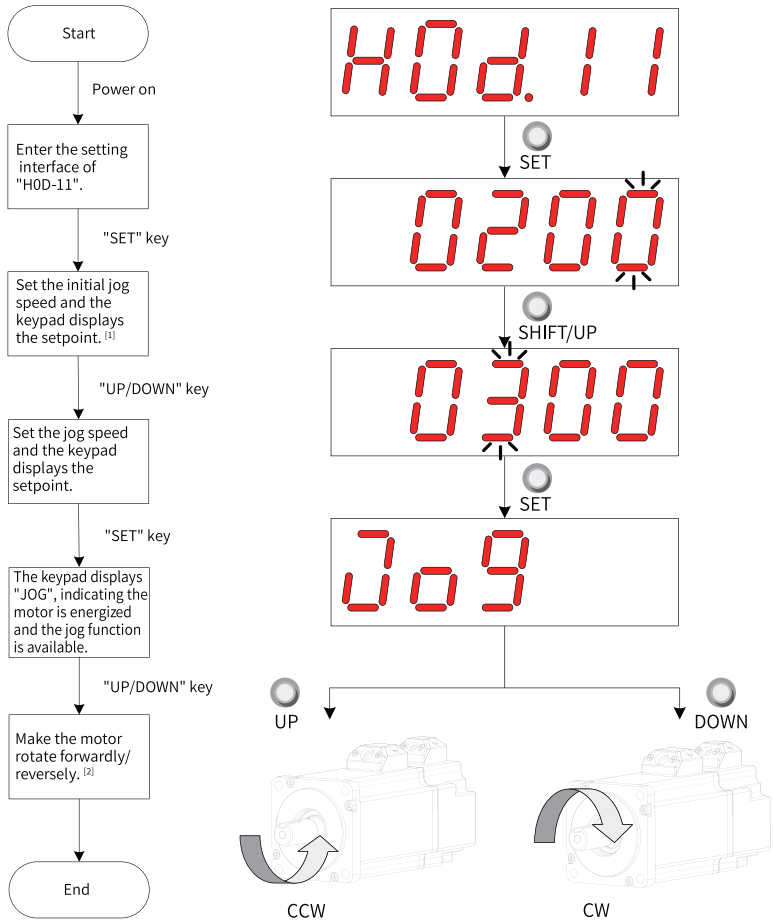

Figure 2-2 Procedure for setting the jog function

Note

- [1]: Press the UP or DOWN key to increase or decrease the motor jogging speed. After exiting from the jog mode, the motor reverts to the initial speed.
- [2]: Press the UP or DOWN key to make the servo motor rotate forwardly or reversely. After you release the key, the motor stops immediately.

• Description of the procedure

1. Enter the jog mode by setting H0D-11 through the keypad.

The keypad displays the default value of H06-04 (Jog speed setpoint) at this moment.

2. Adjust the jog speed through the UP/DOWN key and press the SET key to enter the jog state. The keypad displays "JOG" at this moment.
3. Press the UP/DOWN key to make the motor run forwardly or reversely.
4. Press the MODE key to exit from the jog mode, meanwhile, the setpoint of H06-04 reverts to the default value.

☆Related parameter

Para. No.	Name	Value Range	Unit	Description	Setting Condition	Effective Time	Default
H06-04	Jog speed setpoint	0–6000	RPM	Used to set the jog speed reference.	During running	Immediately	100

- Exiting from jog
Press the MODE key to exit from jog and return to the previous menu.

Jog setting through DIs

Note

The jog function can be activated through DIs in any control mode.

Assign two external DIs with FunIN.18 and FunIN.19 respectively. After setting the jog speed through H06-04, switch on the S-ON signal to perform jog through the DI status.

☆Related function No.

Function No.	Name	Function	Description
FunIN.18	JOGCMD+	Forward jog	Active: Input based on the reference Inactive: Reference input stopped
FunIN.19	JOGCMD-	Reverse jog	Active: Input in reverse to the reference Inactive: Reference input stopped

Jog setting through the software tool

Enter the jog interface of the software tool first, and then set the jog speed through H06-04. After clicking the S-ON button in the interface, you can perform forward or reverse jog through the forward/reverse button in the interface.

When you close the jog interface to exit from the jog mode, H06-04 will be restored to the default value, with previous setpoint abandoned.

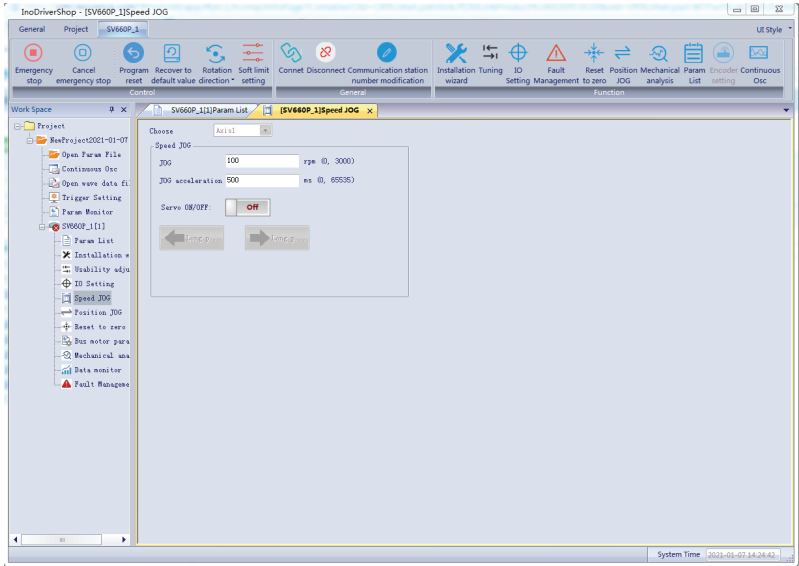

2.2.4 Parameter Settings

Forced DI/DO signals

You can assign different functions to DI/DO terminals by setting parameters in groups H03 and H04 through the keypad (or host controller), so that the host controller can control the servo drive functions through DI signals or use the DO signals outputted by the servo drive.

The servo drive also provides the forced DI/DO signals. The forced DI signals can be used to test the DI function of the servo drive, and the forced DO signals can be used to check the DO signal connection between the host controller and the servo drive.

When the forced DI/DO function is used, the logics of both physical DIs and virtual DIs are determined by the forced DI.

Forced DI signal

After this function is enabled, all DI signal levels are controlled by the forced DI setting (H0D-18) and independent of external DI signal status.

- Operating procedure

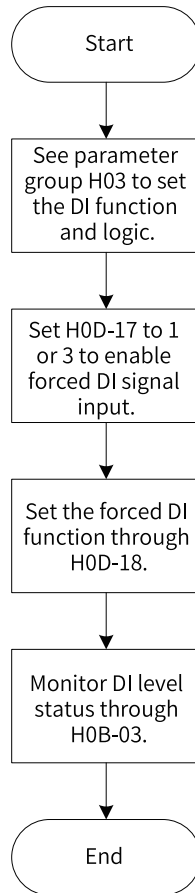

Figure 2-3 Procedure for forced DI signal setting

Related parameter:

Para. No.	Name	Value Range	Description	Setting Condition	Effective Time	Default
H0D-17	Forced DI/DO selection	0: No operation 1: Forced DI enabled, forced DO disabled 2: Forced DO enabled, forced DI disabled 3: Forced DI and DO enabled	Used to select the forced DI/DO function.	During running	Immediately	0

H0D-18 is used to set the forced DI level. The keypad displays the value in hexadecimal. After the hexadecimal value is converted to a binary value, the number "1" indicates high level and "0" indicates low level.

The DI logic is defined by parameters in group H03. H0B-03 is used to monitor the DI level status. The keypad displays the level, and the value of H0B-03 (Monitored DI signal) read in the software tool is a decimal.

- Example:

To activate the DI function assigned to DI1 and deactivate DI functions assigned to DI2...DI9 (DI1 to DI9 are active low), set as follows:

As the value "1" indicates high level and the value "0" indicates low level, the corresponding binary value and hexadecimal value are "110011110" and "19E" respectively. Therefore, set H0D-18 to "19E" through the keypad.

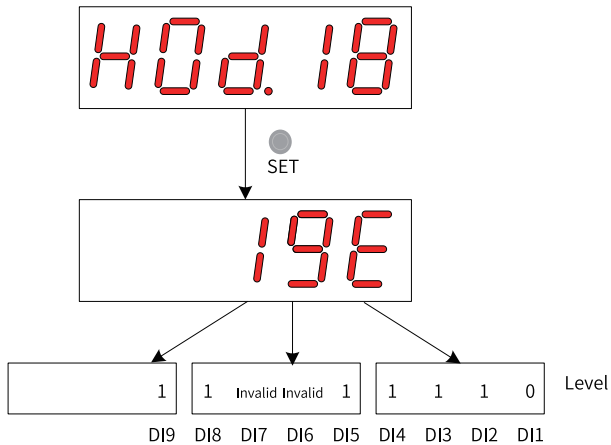

Figure 2-4 Setting of H0D-18

Monitor the DI level status through H0B-03:

If the DI function is normal, the displayed value of H0B-03 is always the same as that of H0D-18.

In this case, DI1 is active low, DI2 to DI9 are active high and the value of H0B-03 read in the software tool is 414 (in decimal). The keypad displays as follows:

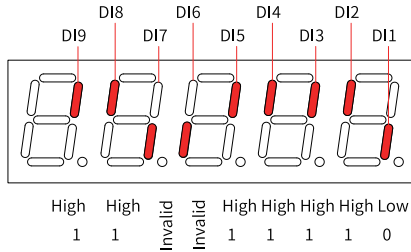

Figure 2-5 DI level status corresponding to H0B-03

- Exit

The forced DI function is not retentive upon power-off. Normal DI function applies after restart, or you can set H0D-17 (Forced DI/DO selection) to 0 (No operation) to return to normal DI mode.

Forced DO signal

After this function is enabled, all DO signal levels are controlled by the forced output setting (H0D-19) and independent of the internal DO status.



Caution

In applications where the servo motor is used to drive a vertical axis, when the brake output signal (FunOUT.9: BK) is active, the brake will be released and the load may fall. Therefore, take protective measures on the machine to prevent falling.

- Operating procedure

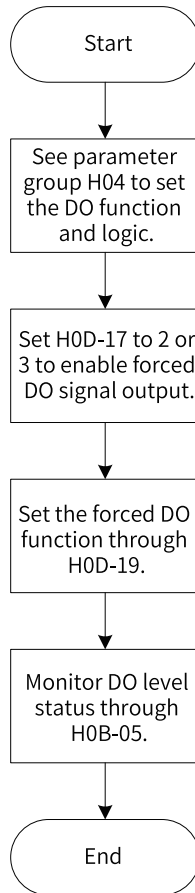

Figure 2-6 Procedure for forced DO signal setting

H0D-19 (Forced DO setting) is used to activate the forced DO function. The keypad displays the value in hexadecimal format. After the hexadecimal value is converted to a binary value, the number "1" indicates the DO function is active and "0" indicates the DO function is inactive.

Parameters in group H04 are used to set the DO logic. H0B-05 is used to monitor the DO level state. The value displayed on the keypad is the level. The value of H0B-05 read in the software tool is a decimal.

- Example:
If the DO function assigned to DO1 is invalid and functions assigned to DO2 to DO5 are valid, set as follows:

As the value "1" indicates the DO function is active and the value "0" indicates the DO function is inactive, the corresponding binary value and hexadecimal value is "11110" and "1E" respectively. Therefore, set H0D-19 to "1E" through the keypad.

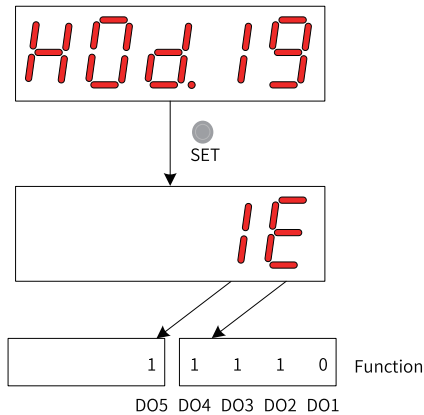

Figure 2-7 Setting of H0D-19

Monitor the DO level status through H0B-05:

If the logics of all the five DOs are "active low", then DO1 is high level and DO2 to DO5 are low level, the corresponding binary number is "00001" and the value of H0B-05 read in the software tool is "1" (in decimal). The keypad displays as follows:

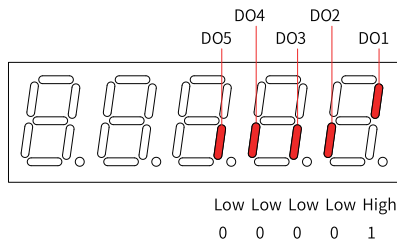

Figure 2-8 Display of H0B-05 when all DOs are active low

If the logics of all the five DOs are "active high", then DO1 is low level and DO2 to DO5 are high level, the corresponding binary number is "11110" and the value of H0B-05 read in the software tool is "30" (in decimal). The keypad displays as follows:

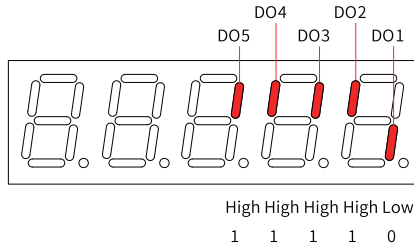

Figure 2-9 Display of H0B-05 when all DOs are active high

- Exit
The forced DO signal is not retentive upon power-off. Normal DO functions are restored after restart, or you can set H0D-17 to 0 to return to the normal DO mode.

Direction of rotation

Set H02-02 to change the direction of rotation directly.

☆Related parameter

Para. No.	Name	Value Range	Description	Setting Condition	Effective Time	Default
H02-02	Direction of rotation	0: CCW as the forward direction 1: CW as the forward direction	Used to set the forward direction viewed from the motor shaft end.	At stop	Next power-on	0

The change of H02-02 does not affect the pulse output form or the sign (+/-) of monitoring parameter values.

The direction of "forward drive" in overtravel prevention is the same as that defined by H02-02.

Output pulse phase selection

The output pulse of the servo drive is phase A + phase B quadrature pulse.

The relation between phase A and phase B pulses can be changed directly through H02-03.

☆Related parameter

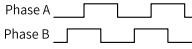
Para. No.	Name	Value Range	Description	Setting Condition	Effective Time	Default
H02-03	Output pulse phase	0: Phase A leads phase B 1: Phase A lags behind phase B	<p>Used to set the phase relation of output pulses.</p> <p>Phase A  Phase B</p> <p>Phase A leads phase B by 90°</p> <hr/> <p>Phase A  Phase B</p> <p>Phase A lags behind phase B by 90°</p>	At stop	Next power-on	0

The change of H02-02 does not affect the pulse output form or the sign (+/-) of monitoring parameter values.

The direction of "forward drive" in overtravel prevention is the same as that defined by H02-02.

Brake settings

The brake is used to prevent the motor shaft from moving and keep the motor and the motion part in locked positions when the servo drive is in the non-operating status.



- Use the built-in brake for position-lock purpose only. Do not use this brake for any other purposes (such as braking) other than position-lock in the stop state.
- The brake coil has no polarity.
- After the servo motor stops, switch off the S-ON signal.
- When a motor with brake starts running, the brake may generate a click sound, which does not affect its function.
- When brake coils are energized (the brake is released), magnetic flux leakage may occur on the shaft end. Pay special attention when using magnetic sensors around the servo motor.

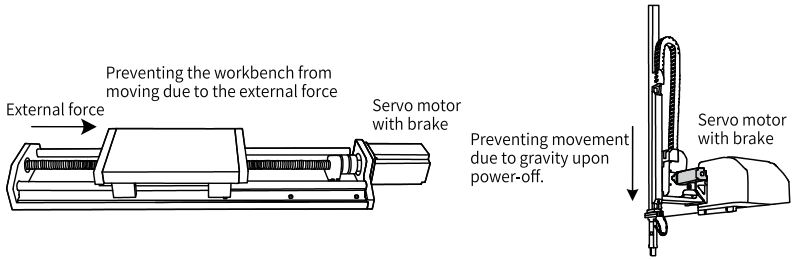

Figure 2-10 Application of the brake

Table 2-2 Brake specifications

Motor Model	Holding Torque (N · m)	Supply Voltage (VDC) ±10%	Coil Resistance (Ω) ±7%	Exciting Current (A)	Release Time (ms)	Apply Time (ms)	Backlash (°)
MS1H1-05B/10B	0.32	24	94.4	0.25	≤ 20	≤ 40	≤ 1.5
MS1H1-20B/40B MS1H4-40B	1.5		75.79	0.32	≤ 20	≤ 60	≤ 1.5
MS1H1-75B/MS1H4-75B	3.2		57.6	0.42	≤ 40	≤ 60	≤ 1
MS1H2-10C/15C/ 20C/25C	8		25	0.96	≤ 30	≤ 85	≤ 0.5
MS1H2-30C/40C/ 50C	16		21.3	1.13	≤ 60	≤ 100	≤ 0.5
MS1H3-85B/13C/ 18C	12		29.7	0.81	≤ 60	≤ 120	≤ 0.5
MS1H3-29C/44C/ 55C/75C	50		14.4	1.67	≤ 100	≤ 200	≤ 0.5

- Brake software setting

For the servo motor with brake, assign FunOUT.9 (BK, brake output) to a certain DO, and set the active logic of this DO.

☆Related function No.

Function No.	Name	Function	Description
FunOUT.9	BK	Brake output	Inactive: The brake power supply is switched off and the brake applies. In this case, the motor is locked. Active: The brake power supply is switched on and the brake is released. In this case, the motor can rotate.

The operating sequences of the brake are different in normal state and fault state.

- Brake sequence in normal state

The brake sequence in normal state is further divided into the following two types:

- Standstill: The actual motor speed is lower than 20 RPM.
- Rotational: The actual motor speed is higher than or equal to 20 RPM.

- Brake sequence for the motor at standstill
It applies when the present motor speed is lower than 20 RPM upon switch-off of the S-ON signal.

 **Caution**

- After the brake output changes from "OFF" to "ON", do not input a position/speed/torque reference within the time defined by H02-09 (Delay from brake output ON to command received). Otherwise, reference loss or an operation error may occur.
 - When the motor is used to drive a vertical axis, the motion parts may move slightly due to gravity or external force. If the S-ON signal is switched off with motor at standstill, the brake output changes to "OFF" immediately. However, within the time defined by H02-10 (Delay from brake output OFF to motor de-energized in static state), the motor is still energized, preventing the load from moving due to gravity or external force.
-

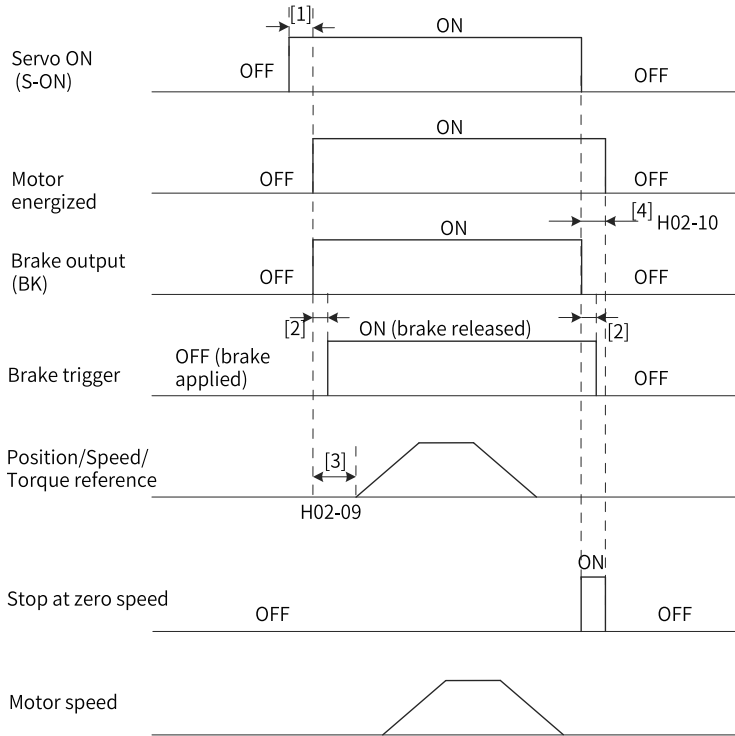

Figure 2-11 Brake timing diagram for the motor at standstill

Note

- [1]: When the S-ON signal is switched on, the brake output is set to "ON" at a delay of about 100 ms and the motor is energized.
- [2]: For delay of brake contactor actions, see ["Table 2-2" on page 32](#).
- [3]: The time interval, starting from the moment when the brake output is set to "ON" to the moment when a command is input, must be longer than H02-09 (Delay from brake output ON to command received).
- [4]: When the S-ON signal is switched off with motor at standstill (motor speed lower than 20 RPM), the brake output is set to "OFF". You can set in H02-10 the delay of the motor in entering the de-energized state when the brake output is OFF.

☆Related parameters

Para. No.	Name	Value Range	Unit	Description	Setting Condition	Effective Time	Default
H02-09	Delay from brake output ON to command received	0–500	ms	Defines the delay from the moment when the brake output (BK) signal is set to "ON" to the moment when the servo drive receives the command. If the brake output (BK) is not used, H02-09 is invalid.	During running	Immediately	250
H02-10	Delay from brake output OFF to motor de-energized in the standstill state	1–1000	ms	Defines the delay from the moment when the brake output signal (BK) is deactivated to the moment when the motor at standstill is de-energized. If the brake output (BK) is not used, H02-10 is invalid.	During running	Immediately	150

- Brake sequence for the motor in rotational state
It applies when the motor speed is higher than or equal to 20 RPM upon switch-off of the S-ON signal.



- When the S-ON signal is switched on, do not input a position/speed/torque reference within the time defined by H02-09 (Delay from brake output ON to command received). Otherwise, reference loss or an operation error may occur.
 - If the S-ON signal is switched off when the motor is still rotating, the motor enters the "Stop at zero speed" state, but the brake output can be set to "OFF" only when one of the following conditions is met:
 - The motor has decelerated to the speed defined by H02-11 (Motor speed threshold at brake output OFF in rotational state) when the time defined by H02-12 (Delay from S-ON OFF to brake output OFF in rotational state) is not reached.
 - The motor speed is still higher than H02-11 though the time defined by H02-12 is reached.
 - The motor is still energized within 50 ms after the brake output changes from "ON" to "OFF". This is to prevent the motion parts from moving due to gravity or external force.
-

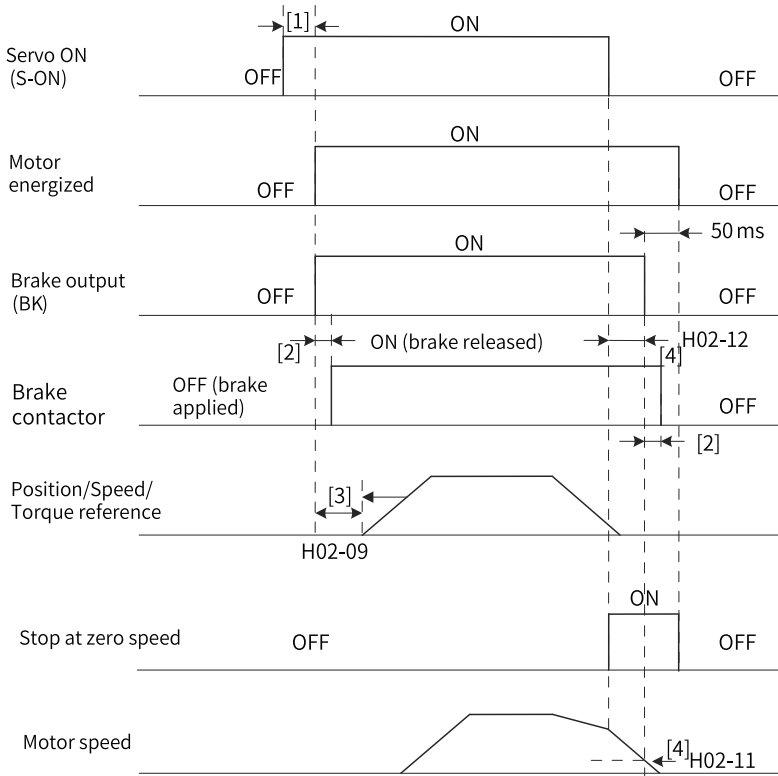

Figure 2-12 Brake timing diagram for the motor in rotational state

Note

- [1]: When the S-ON signal is switched on, the brake output is set to "ON" at a delay of about 100 ms and the motor is energized.
- [2]: For delay of brake contactor actions, see ["Table 2-2" on page 32](#).
- [3]: The time interval, starting from the moment when the brake output is set to "ON" to the moment when a command is input, must be longer than H02-09 (Delay from brake output ON to command received).
- [4]: You can set in H02-11 and H02-12 the OFF delay of brake output when the S-ON signal is switched off in the rotational state. The motor will be de-energized at a delay of 50 ms after the brake output is OFF.

☆Related parameters

Para. No.	Name	Value Range	Unit	Description	Setting Condition	Effective Time	Default
H02-11	Speed threshold at brake output OFF in the rotational state	0–3000	RPM	Defines the motor speed threshold when the brake output (BK) is set to "OFF" in the rotational state. If the brake output (BK) is not used, H02-11 is invalid.	During running	Immediately	30
H02-12	Delay from S-ON OFF to brake output OFF in the rotational state	1–1000	ms	Defines the delay in setting brake output (BK) to "OFF" after the S-ON signal is switched off in the rotational state. If the brake output (BK) is not used, H02-12 is invalid.	During running	Immediately	500

- Brake sequence in fault state

Faults can be classified into No. 1 faults and No. 2 faults based on the stop mode, see Chapter "Troubleshooting" for details. The brake sequences in fault state are further divided into the following two types:

 - For No. 1 faults:

The condition for brake output is the same as the brake sequence for the motor in rotational state, which means the brake output can be set to "OFF" only when any one of the following conditions is met:

 - The motor has decelerated to the speed defined by H02-11 (Motor speed threshold at brake output OFF in rotational state) when the time defined by H02-12 (Delay from S-ON OFF to brake output OFF in rotational state) is not reached.
 - The motor speed is still higher than H02-11 though the time defined by H02-12 has been reached.
 - For No. 2 faults:

When a No. 2 fault occurs and the brake is enabled, the stop mode is forced to "Stop at zero speed, keeping dynamic braking status".

In this case, the servo motor stops at zero speed first. When the motor speed actual value is lower than 20 RPM, the brake output changes to "OFF" immediately but the motor is still energized within the time defined by H02-10, which is the same as the brake sequence for the motor at standstill.

Braking settings

When the torque direction is opposite to the speed direction, the energy generated by the motor is fed back to the servo drive, leading to bus voltage rise. When the bus voltage rises to the braking threshold, the energy must be consumed by a regenerative resistor. Otherwise, the servo drive will be damaged. The regenerative resistor can be a built-in or an external one. However, a built-in regenerative resistor

cannot be used together with an external one. Specifications of the regenerative resistor are shown as follows.

Table 2-3 Specifications of the regenerative resistor

Servo Drive Model	Specifications of Built-in Regenerative Resistor			Min. Permissible Resistance of External Regenerative Resistor (Ω) (H02-21)
	Resistance (Ω)	Power (Pr) (W)	Processing Power (Pa) (W)	
SV660PS1R6I	-	-	-	50
SV660PS2R8I	-	-	-	45
SV660PS5R5I	50	50	25	40
SV660PS7R6I	25	80	40	20
SV660PS012I				15
SV660PT3R5I	100	80	40	80
SV660PT5R4I	100	80	40	60
SV660PT8R4I	50	80	40	45
SV660PT012I				40
SV660PT017I	35	100	50	35
SV660PT021I				25
SV660PT026I				

Note

The built-in regenerative resistor is not available in S1R6 and S2R8 models. You can install an external regenerative resistor as needed.

- Without external load torque
The energy generated upon braking of a reciprocating motor is converted into electric energy which is then fed back to the bus capacitor. When the bus voltage exceeds the braking voltage threshold, the excessive energy will be consumed by the regenerative resistor. The following figure shows the motor speed curve in decelerating from 3000 RPM to a standstill during no-load operation.

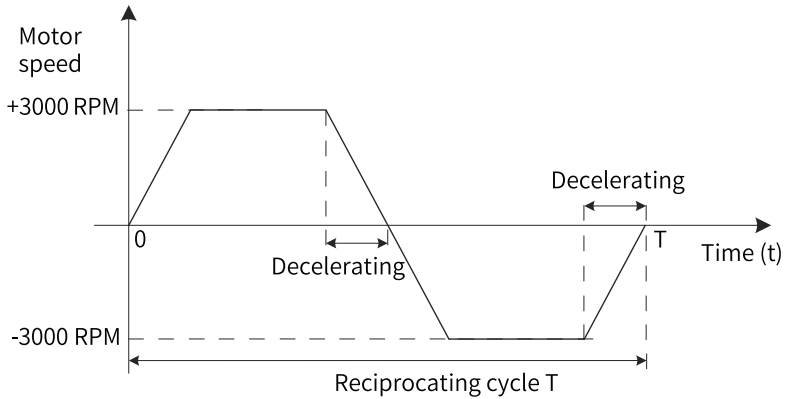

Figure 2-13 Example of motor speed curve (without external load torque)

- Energy calculation data

The built-in regenerative resistor is not available in SV660PS1R6I and SV660PS2R8I models. The energy that can be absorbed by a capacitor is described in section "Wiring and Setting of the Regenerative Resistor" in SV660P Series Servo Drive Hardware Guide. An external regenerative resistor is needed when the rotational energy of the servo motor and the load exceed the values listed in the following table.

Servo Drive Model	Regenerative Energy That Can Be Absorbed	Remarks
SV660PS1R6I	13.15	The input voltage of the main circuit power supply is 220 VAC.
SV660PS2R8I	26.29	

- The following table shows the energy generated by a 220 V motor in decelerating from the rated speed to a standstill during no-load operation.

Capacity (W)	Servo Motor Model MS1H*.*****.*****		Rotor Inertia J (10^{-4} kg·m ²)	Braking Energy E _O (J) Generated in Decelerating From Rated Speed to a Standstill in No-load Operation	Max. Braking Energy Absorbed by the Capacitor E _C (J)
750	MS1H1 (low inertia, small capacity)	MS1H1-75B30CB-*331Z	1.38	6.8	22.4
		MS1H1-75B30CB-*334Z	1.43	7.1	
1000	MS1H2 (low inertia, medium capacity)	MS1H2-10C30CB-*331Z	1.87	9.2	26.7
		MS1H2-10C30CB-*334Z			
1500	MS1H2 (low inertia, medium capacity)	MS1H2-15C30CB-*331Z	2.46	12.2	26.7
		MS1H2-15C30CB-*334Z			47.7

Capacity (W)	Servo Motor Model MS1H*_*****_****		Rotor Inertia J ($10^{-4}\text{kg}\cdot\text{m}^2$)	Braking Energy E _O (J) Generated in Decelerating From Rated Speed to a Standstill in No-load Operation	Max. Braking Energy Absorbed by the Capacitor E _C (J)
850	MS1H3 (medium inertia, medium capacity)	MS1H3-85B15CB-*331Z	13.3	65.8	22.4
		MS1H3-85B15CB-*334Z	14	69.2	
MS1H3-13C15CB-*331Z		17.8	88	22.4	
MS1H3-13C15CB-*334Z		18.5	91.5		
750	MS1H4 (medium inertia, small capacity)	MS1H4-75B30CB-*331Z	2	9.9	22.4
		MS1H4-75B30CB-*334Z	2.012	9.9	

- The following table shows the energy generated by a 380 V motor in decelerating from the rated speed to a standstill during no-load operation.

Capacity (W)	Servo Motor Model MS1H*_*****_****	Rotor Inertia J ($10^{-4}\text{kg}\cdot\text{m}^2$)	Braking Energy E _O (J) Generated in Decelerating From Rated Speed to a Standstill in No-load Operation	Max. Braking Energy Absorbed by the Capacitor E _C (J)		
1000	MS1H2 (low inertia, medium capacity)	MS1H2-10C30CD-*331Z	1.87	9.2	34.3	
		MS1H2-10C30CD-*334Z				
1500		MS1H2-15C30CD-*331Z	2.46	12.2	34.3	
		MS1H2-15C30CD-*334Z				
2000		MS1H2-20C30CD-*331Z	3.06	15.1	50.4	
2500		MS1H2-25C30CD-*331Z	3.65	18	50.4	
3000		MS1H2-30C30CD-*331Z	7.72	38.2	50.4	
4000		MS1H2 (low inertia, medium capacity)	MS1H2-40C30CD-*331Z	12.1	59.8	82.7
5000			MS1H2-50C30CD-*331Z	15.4	76.2	82.7
850		MS1H3 (medium inertia, medium capacity)	MS1H3-85B15CD-*331Z	13.3	65.8	28.2
			MS1H3-85B15CD-*334Z	14	69.2	34.3
1300			MS1H3-13C15CD-*331Z	17.8	88	34.3
			MS1H3-13C15CD-*334Z	18.5	91.5	34.3
1800			MS1H3-18C15CD-*331Z	25	123.6	50.4
	MS1H3-18C15CD-*334Z		25.7	127.1	50.4	
2900	MS1H3-29C15CD-*331Z		55	271.98	50.4	
	MS1H3-29C15CD-*334Z		55	271.98	50.4	
4400	MS1H3-44C15CD-*331Z		88.9	439.6	82.7	
	MS1H3-44C15CD-*334Z		88.9	439.6	82.7	
5500	MS1H3-55C15CD-*331Z		107	529.1	100.8	
	MS1H3-55C15CD-*334Z		107	529.1	100.8	
7500	MS1H3-75C15CD-*331Z		141	697.3	100.8	
	MS1H3-75C15CD-*334Z		141	697.3	100.8	

Note

If the total braking time T is known, you can determine whether an external regenerative resistor is needed and the power required using the formula described in section "Wiring and Setting of Regenerative Resistor" in SV660P Series Servo Drive Hardware Guide.

2.2.5 Servo-ON

Set the S-ON signal to "ON".

When the servo drive is ready to run, the keypad displays "Run"; but if there is no command input at this moment, the servo motor does not rotate and stays locked. After a command is input, the servo motor starts rotating.

Record	No.	Description
<input type="checkbox"/>	1	During initial operation, input a proper command to make the motor run at a low speed and check whether the motor rotates properly.
<input type="checkbox"/>	2	Observe whether the motor rotates in the correct direction. If the direction of rotation is opposite to the expected direction, check the input command and the command direction signal.
<input type="checkbox"/>	3	If the direction of rotation is correct, you can view the actual speed in H0B-00 and the average load rate in H0B-12 through the keypad or the software tool.
<input type="checkbox"/>	4	After checking the preceding conditions, set related parameters to match the actual working conditions.
<input type="checkbox"/>	5	Perform gain auto-tuning according to Chapter "Adjustment" in SV660P Series Servo Drive Function Guide.

Power-on timing diagram

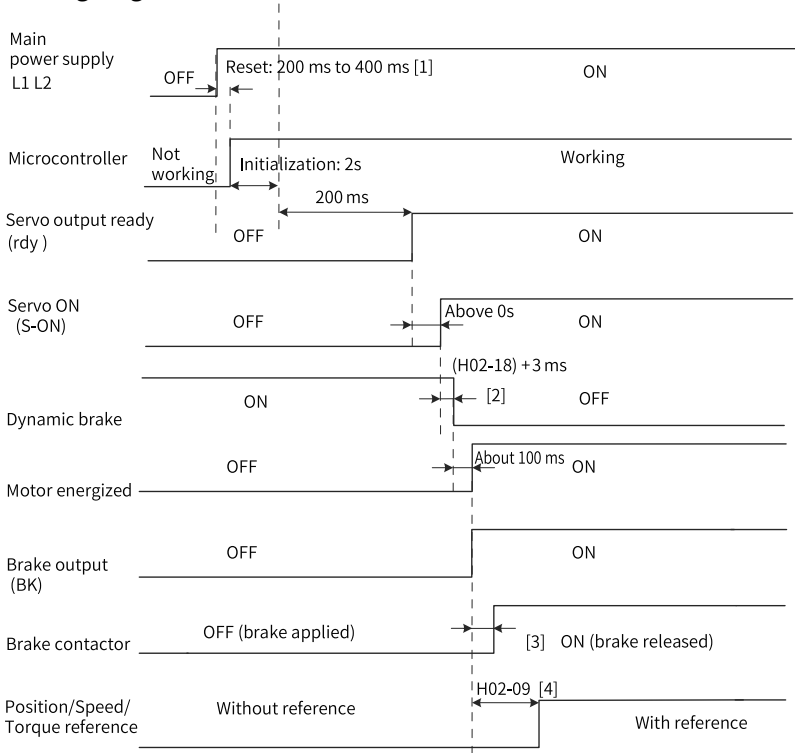

Figure 2-14 Power-on timing diagram

Note

- [1] The reset time is determined by the setup time of the +5V power supply of the micro-processor.
- [2] The dynamic brake is included in the standard configuration.
- [3] For delay of brake contactor actions, see [“Table 2-2” on page 32](#).
- [4] When FunOUT.9 (BK, brake output) is not used, H02-09 is invalid.

Timing diagram upon stop at warning or fault

- No. 1 fault: Coast to stop, keeping de-energized status

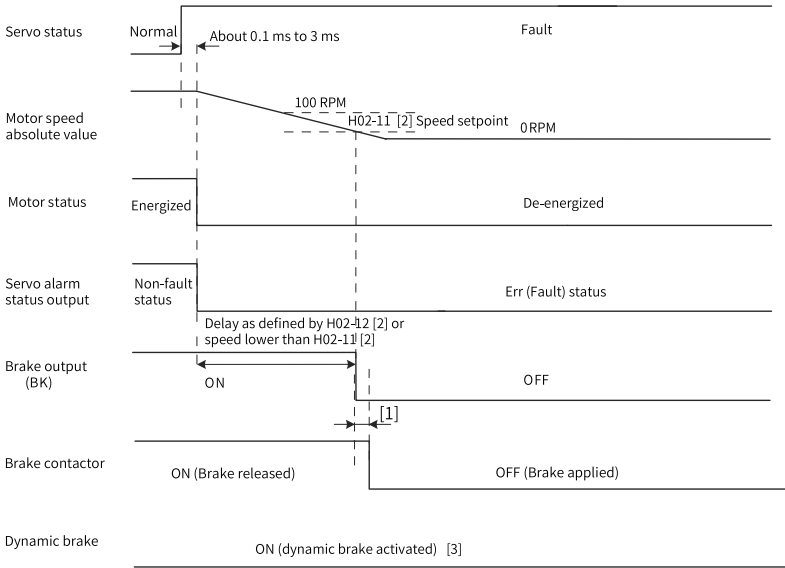

Figure 2-15 Timing diagram of "Coast to stop, keeping de-energized status" at No. 1 fault

Note

- [1] For delay of brake contactor actions, see "Table 2-2" on page 32.
- [2] When FunOUT.9 (BK, brake output) is not used, H02-11 and H02-12 are invalid.
- [3] The dynamic brake is included in the standard configuration.

- No. 1 fault: Dynamic braking stop, keeping de-energized status

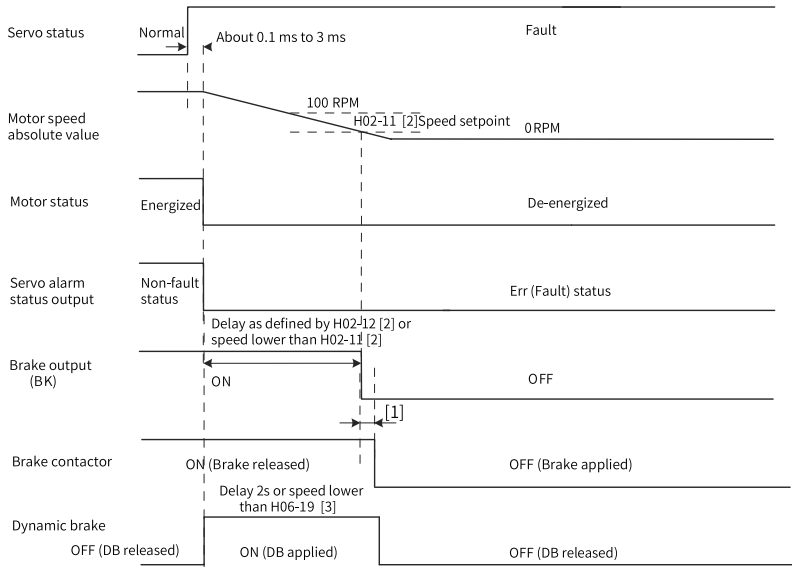

Figure 2-16 Timing diagram of "Dynamic braking stop, keeping de-energized status" at No. 1 fault

Note

- [1] For delay of brake contactor actions, see "Table 2-2" on page 32.
- [2] When FunOUT.9 (BK, brake output) is not used, H02-11 and H02-12 are invalid.
- [3] The DB brake is included in the standard configuration.

- No. 1 fault: Dynamic braking stop, keeping dynamic braking status

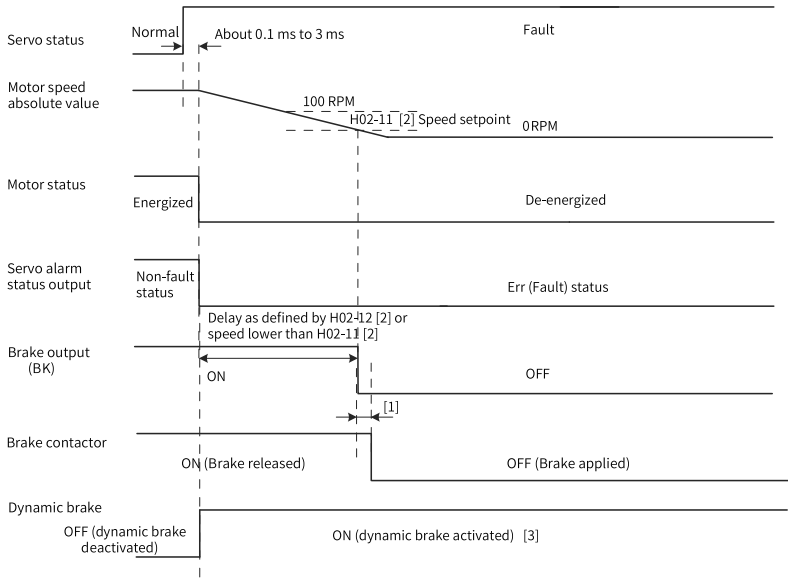

Figure 2-17 Timing diagram of "Dynamic braking stop, keeping dynamic braking status" at No. 1 fault

Note

- [1] For delay of brake contactor actions, see "Table 2-2" on page 32.
- [2] When FunOUT.9 (BK, brake output) is not used, H02-11 and H02-12 are invalid.
- [3] The DB brake is included in the standard configuration.

- No. 2 fault (without brake): Coast to stop, keeping de-energized state

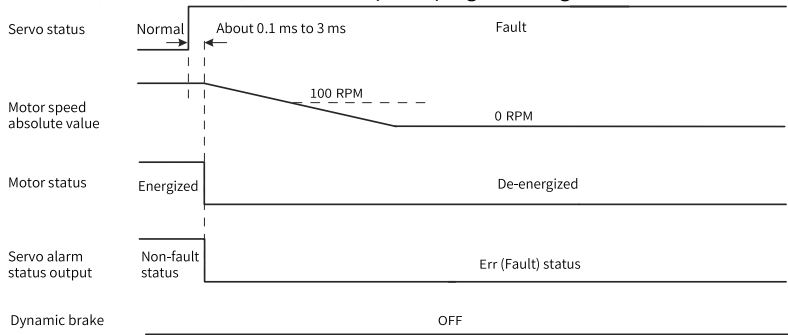

Figure 2-18 Timing diagram of "Coast to stop, keeping de-energized status" at No. 2 fault (without brake)

- No. 2 fault (without brake): Stop at zero speed, keeping de-energized status

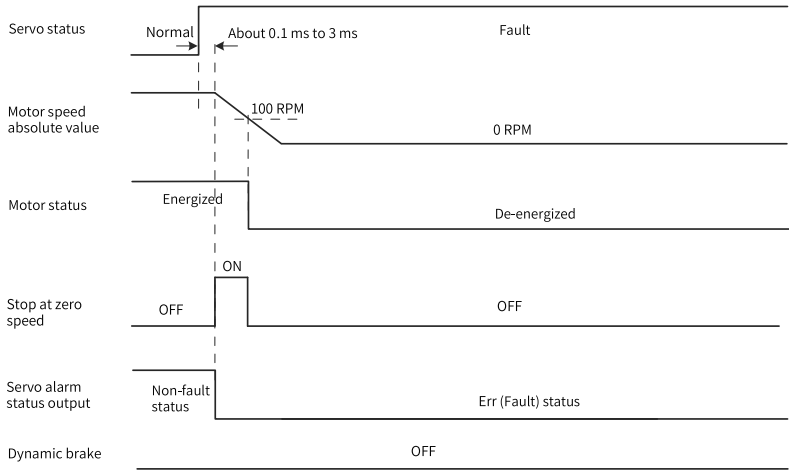

Figure 2-19 Timing diagram of "Stop at zero speed, keeping de-energized state" at No. 2 fault (without brake)

- No. 2 fault (without brake): Stop at zero speed, keeping dynamic braking status

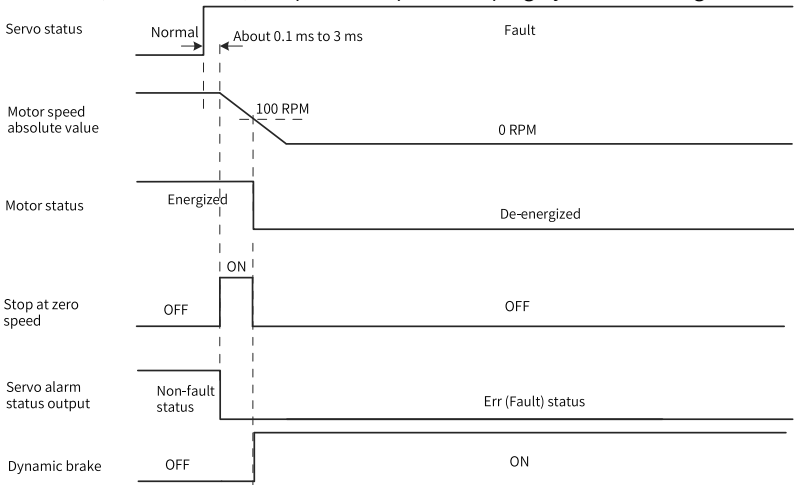

Figure 2-20 Timing diagram of "Stop at zero speed, keeping dynamic braking status" at No. 2 fault (without brake)

- No. 2 fault (without brake): Dynamic braking stop, keeping dynamic braking status

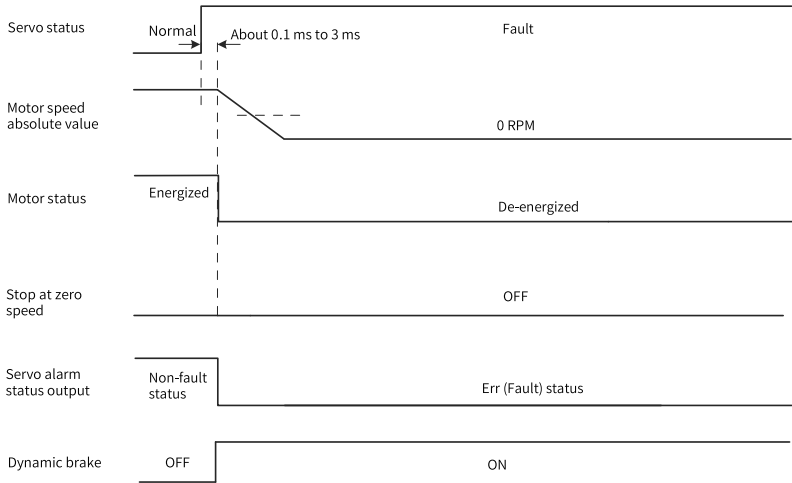

Figure 2-21 Timing diagram of "Dynamic braking stop, keeping dynamic braking status" at No. 2 fault (without brake)

- No. 2 fault (without brake): Dynamic braking stop, keeping de-energized status

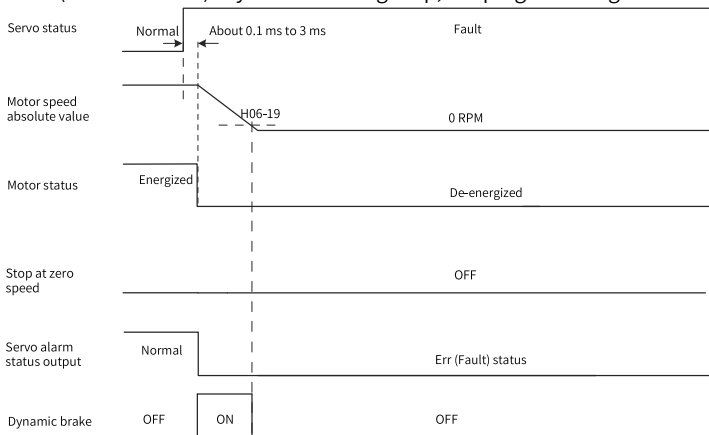

Figure 2-22 Timing diagram of "Dynamic braking stop, keeping de-energized state" at No. 2 fault (without brake)

- No. 2 fault (with brake): Stop at zero speed, keeping dynamic braking status

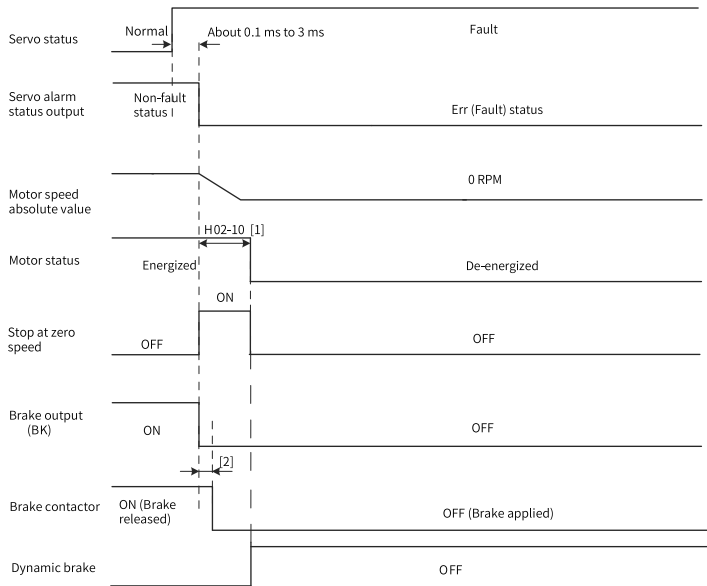

Figure 2-23 Timing diagram of "Stop at zero speed, keeping dynamic braking status" at No. 2 fault (with brake)

Note

- [1] When FunOUT.9 (BK, brake output) is not used, H02-10 is invalid.
- [2] For delay of brake contactor actions, see "Table 2-2" on page 32.
- When a No. 3 warning occurs on the servo drive, such as Er.900 (DI emergency braking), Er.950 (Positive limit switch warning), and Er.952 (Negative limit switch warning), the servo drive stops according to "Figure 2-24 Timing diagram at warnings that cause stop" on page 49.
- Warnings that cause stop: Stop at zero speed, keeping position lock status

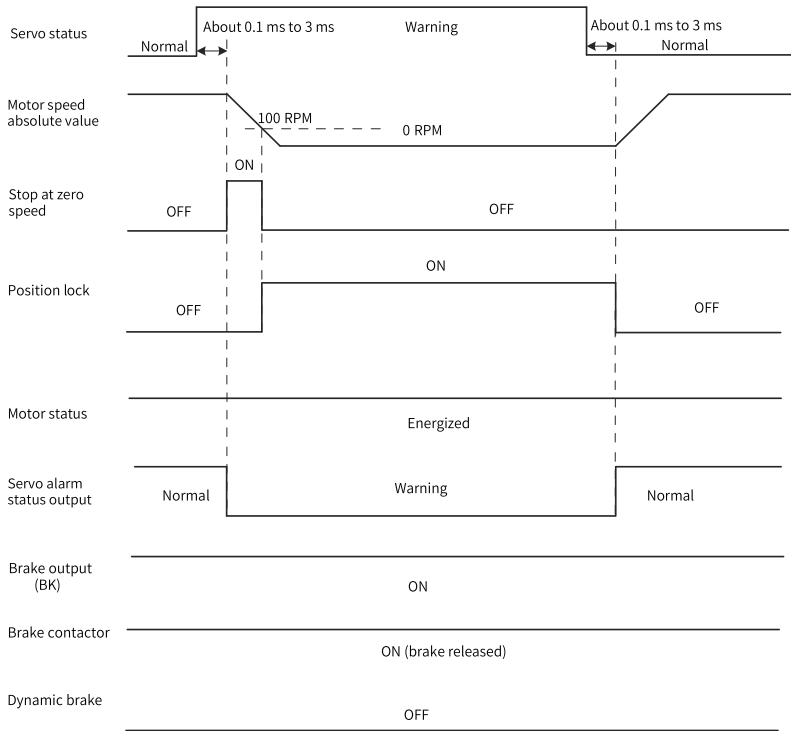

Figure 2-24 Timing diagram at warnings that cause stop

The other warnings do not affect the operation state of the servo drive. The timing diagram for these warnings is shown in [“Figure 2-25 Timing diagram at warnings that do not cause stop” on page 50.](#)

- Warnings that do not cause stop

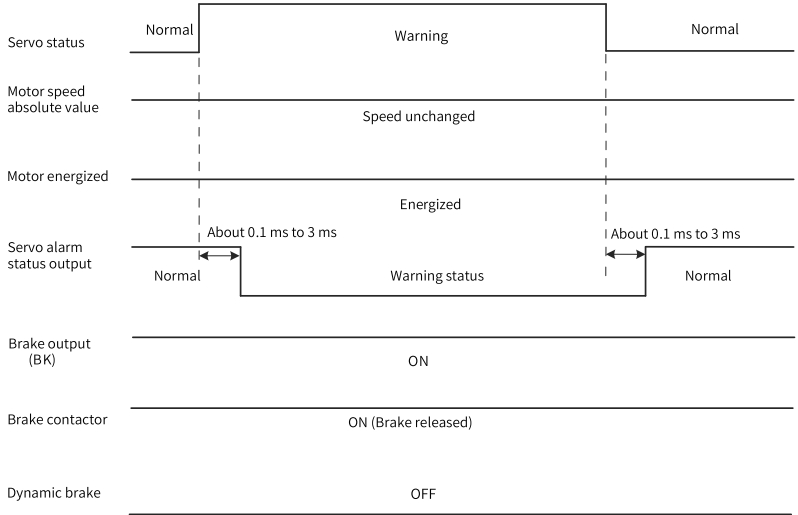

Figure 2-25 Timing diagram at warnings that do not cause stop

● Fault reset

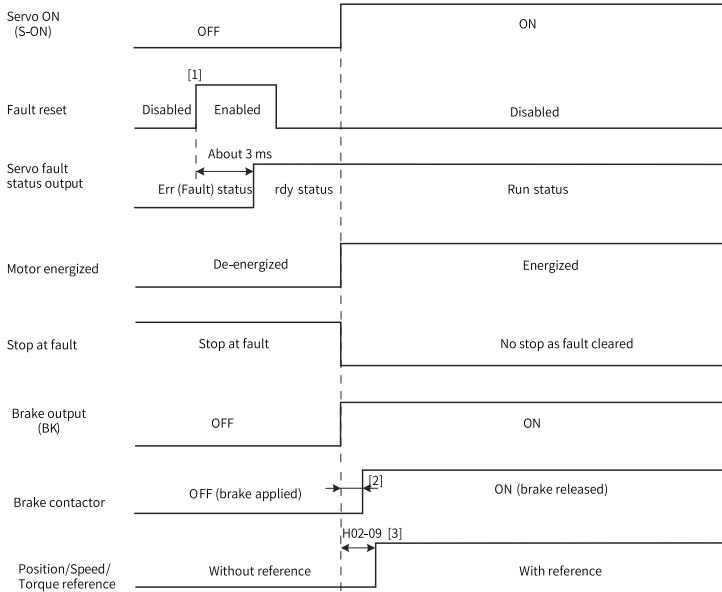

Figure 2-26 Timing diagram of fault reset

Note

- [1] The fault reset signal (FunIN.2: ALM-RST) is edge-triggered.
- [2] For delay of brake contactor actions, see “[Table 2–2](#)” on page 32.
- [3] When FunOUT.9 (BK, brake output) is not used, H02-09 is invalid.

2.2.6 Servo Stop

There are three types of stop modes for the servo drive: coast to stop, stop at zero speed, and dynamic braking stop, along with three types of stop status: de-energized, dynamic braking, and position lock. See the following table for details.

Table 2–4 Comparison of three stop modes

Stop Mode	Mode 1: Coast to stop	Mode 2: Stop at zero speed	Mode 3: Dynamic braking stop
Description	The servo motor is de-energized and coasts to 0 RPM. The deceleration time is affected by the mechanical inertia and mechanical friction.	The servo drive outputs the reverse braking torque and the motor decelerates to 0 RPM quickly.	The three motor phases are short-circuited and the motor decelerates to 0 RPM under the influence of back EMF.
Feature	Mode 1 features a smooth but slow deceleration and a small mechanical shock.	Mode 2 features a quick deceleration but an obvious mechanical shock.	Mode 3 features a quick stop, with deceleration speed higher than mode 1 (coast to stop) but lower than mode 2 (stop at zero speed).

Table 2–5 Comparison of three stop status

De-energized	Position Lock	Dynamic Braking
The motor is de-energized and the motor shaft can be rotated freely after the motor stops rotating.	The motor shaft is locked and cannot be rotated freely after the motor stops rotating.	The motor shaft is braked after the motor stops rotating. The shaft can be rotated slowly under a large external force.

The stop causes can be divided into the following types: stop at S-ON OFF, stop at fault, stop at overtravel, and emergency stop. See the following descriptions for details.

Stop at S-ON OFF

Assign the S-ON function to a certain DI and deactivate the logic of this DI.

☆Related parameter

Para. No.	Name	Value Range	Description	Setting Condition	Effective Time	Default
H02-05	Stop mode at S-ON OFF	0: Coast to stop, keeping de-energized status 1: Stop at zero speed, keeping de-energized status 2: Stop at zero speed, keeping dynamic braking status	Defines the stop mode when the S-ON signal is switched off.	At stop	Immediately	0

Stop at fault

The stop mode varies with the fault type. For fault classification, see [“3.2.1 Faults and Warnings” on page 63](#).

☆Related parameters

Para. No.	Name	Value Range	Description	Setting Condition	Effective Time	Default
H02-06	Stop mode at No. 2 fault	0: Coast to stop, keeping de-energized status 1: Stop at zero speed, keeping de-energized status 2: Stop at zero speed, keeping dynamic braking status 3: Dynamic braking stop, keeping dynamic braking status 4: Dynamic braking stop, keeping de-energized status	Defines the stop mode when a No. 2 fault occurs.	At stop	Immediately	2
H02-08	Stop mode at No. 1 fault	0: Coast to stop, keeping de-energized status 1: Dynamic braking stop, keeping de-energized status 2: Dynamic braking stop, keeping dynamic braking status	Defines the stop mode when a No. 1 fault occurs.	At stop	Immediately	2

Stop at overtravel

★Definitions of terms:

- "Overtravel": The distance of the mechanical movement exceeds the designed range of safe movement.
- "Stop at overtravel": When a motion part moves beyond the range of safe movement, the limit switch outputs a level change to force the motor to stop.

☆Related parameter

Para. No.	Name	Value Range	Description	Setting Condition	Effective Time	Default
H02-07	Stop mode at overtravel	0: Coast to stop, keeping de-energized status 1: Stop at zero speed, keeping position lock status 2: Stop at zero speed, keeping de-energized status	Defines the stop mode when overtravel occurs.	At stop	Immediately	1

When overtravel occurs on a servo motor used to drive a vertical axis, the workpiece may fall. To prevent such risks, set H02-07 to 1. When the workpiece moves linearly, install limit switches to prevent potential mechanical damage. If the limit switch signal is activated, input a command to make the motor (workpiece) run in the opposite direction.

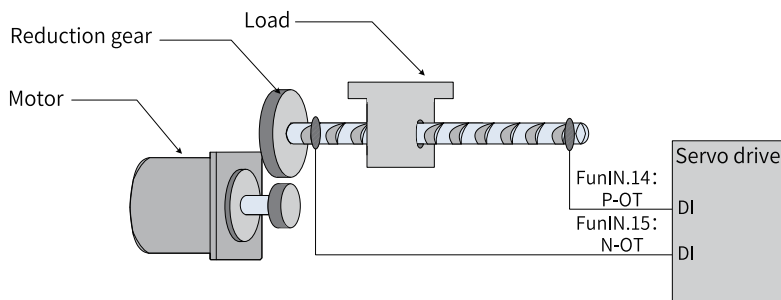

Figure 2-27 Installation of limit switches

To use the limit switch, assign function 14 (FunIN.14: P-OT, positive limit switch) and function 15 (FunIN.15: N-OT, negative limit switch) to two DIs and set the active logic of these DIs. This is to enable the servo drive to receive the level signals input from the limit switches. The servo drive enables or cancels the stop-at-overtravel status based on the DI level status.

☆Related function No.

Function No.	Name	Function	Description
FunIN.14	P-OT	Positive limit switch	When the mechanical movement exceeds the specified range, overtravel prevention will be activated. Inactive: Forward drive permitted Active: Forward drive inhibited
FunIN.15	N-OT	Negative limit switch	When the mechanical movement exceeds the specified range, overtravel prevention will be activated. Invalid: Reverse drive permitted Valid: Reverse drive inhibited

Emergency stop

There are two ways to enable emergency stop, as shown below:

- Using DI function 34: FunIN.34 (EmergencyStop)
- Using the auxiliary function: emergency stop (H0D-05)

☆Related function No.

Function No.	Name	Function	Description
FunIN.34	EmergencyStop	Braking	Inactive: Current operating state unaffected Active: Stop at zero speed, keeping position lock status, Er.900 (DI emergency braking) reported

☆Related parameter

Para. No.	Name	Value Range	Description	Setting Condition	Effective Time	Default
H0D-05	Emergency stop	0: Current operating state unaffected 1: Emergency stop enabled as defined by H02-05 (Stop mode at S-ON off)	Used to enable emergency stop. The stop mode is the same as that upon S-ON signal OFF.	At stop	Immediately	0

3 Troubleshooting

3.1 Troubleshooting Upon Startup

3.1.1 Position Control Mode

Fault diagnosis

Start Process	Fault Symptom	Cause	Confirming Method
Switching on the control circuit (L1C, L2C) and the main circuit (L1, L2/R, S, T/L1, L2, L3)	The LED neither lights up nor displays "rdy".	1. The voltage of the control circuit power supply is abnormal.	The fault persists though CN1, CN2, CN3, and CN4 are disconnected. Measure the AC voltage between L1C and L2C.
		2. The voltage of the main circuit power supply is abnormal.	<ul style="list-style-type: none"> For single-phase 220 V models, measure the AC voltage between L1 and L2. When the DC bus voltage amplitude (voltage between P⊕ and N⊖) is lower than 200 V, the keypad displays "nrd". For three-phase 220 V/380 V models, measure the AC voltage among L1, L2, L3/R, S, T. When the DC bus voltage amplitude (voltage between P⊕ and N⊖) is lower than 460 V, the keypad displays "nrd".
		3. The programming terminal is shorted.	Check whether the programming terminal is shorted.
		4. The servo drive is faulty.	-
	The keypad displays "Er.xxx".	Rectify the fault causes according to "3.2.2 Common Solutions to Faults" on page 68 and "3.2.3 Solutions to Common Warnings" on page 97 .	
The keypad displays "rdy" after preceding faults are cleared.			

Start Process	Fault Symptom	Cause	Confirming Method
Switching on the S-ON signal (S-ON signal switched on)	The keypad displays "Er.xxx".	Rectify the fault causes according to "3.2.2 Common Solutions to Faults" on page 68 and "3.2.3 Solutions to Common Warnings" on page 97 .	
	The servo motor shaft is in the free running state.	1. The S-ON signal is inactive.	<p>Switch the keypad display to the servo status interface and view whether the keypad displays "rdy" instead of "run".</p> <ul style="list-style-type: none"> Check parameters in groups H03 or H17 to see whether FunIN.1 (S-ON) is assigned to a DI. If FunIN.1 is assigned, check whether the corresponding DI logic is active. If FunIN.1 is not assigned, assign FunIN.1 to a DI and activate the logic of this DI. For how to assign FunIN.1 to a DI, see "4.4 Group H03: Terminal Input Parameters" on page 111 and "4.17 Group H17: VDI/VDO Parameters" on page 147. If the keypad keeps displaying "rdy" even though the S-ON signal has been assigned to a DI through parameters in group H03 or H17 and the corresponding DI logic is active, check whether the DI is connected correctly according to Chapter "Wiring" in SV660P Series Servo Drive Hardware Guide.
		2. The control mode is wrong.	Check whether H02-00 (Control mode selection) is set to 1 (Position control mode). If it is set to 2 (Torque control mode), the motor shaft will be de-energized because the default torque reference is 0.
The keypad displays "run" after preceding faults are cleared.			
Inputting position references	The servo motor does not rotate.	The value of the position reference counter (H0B-13) is 0.	<ul style="list-style-type: none"> The high/low-speed pulse input terminal is wired incorrectly. When H05-00 (Position reference source) is set to 0 (pulse reference), check whether the high/low-speed pulse input terminal is wired correctly according to Chapter "Wiring" in SV660P Series Servo Drive Hardware Guide. Meanwhile, check whether the setting of H05-01 (Pulse reference input terminal selection) is matching. No position reference is inputted. Check whether FunIN.13 (Inhibit, position reference inhibited) or FunIN.37 (PulseInhibit, pulse reference inhibited) is used. When H05-00 (Position reference source) is set to 0 (Pulse input), the host controller or other pulse output device does not output pulses. Check whether there are pulses input to the high/low-speed pulse input terminals. For details, see Chapter "Wiring" in SV660P Series Servo Drive Hardware Guide. When H05-00 (Position reference source) is set to 1 (Step reference), check whether H05-05 (Step reference) is 0. If not, check whether FunIN.20 (PosStep, step reference enabled) is assigned to a DI and whether the logic of this DI is active. When H05-00 (Position reference source) is set to 2 (Multi-position reference), check whether parameters in group H11 are set correctly. If yes, check whether FunIN.28 (PosInSen, internal multi-position enable) is assigned to a DI and whether the logic of this DI is active. If interrupt positioning is used, check whether H05-29 (Interrupt positioning cancel) is set to 1 (Enable). If yes, check whether FunIN.29 (XintFree, interrupt positioning cancel) is used to cancel the interrupt positioning state.

Start Process	Fault Symptom	Cause	Confirming Method
Inputting position references	The servo motor rotates in the reverse direction.	The value of the position reference counter (H0B-13) is a negative number.	<ul style="list-style-type: none"> When H05-00 (Position reference source) is set to 0 (Pulse reference), check whether the setting of H05-15 (Pulse reference form) is consistent with the actual input pulses. If not, H05-15 is set improperly or terminals are wired incorrectly. When H05-00 (Position reference source) is set to 1 (Step reference), check whether the value of H05-05 (Step reference) is a positive or a negative number. When H05-00 (Position reference source) is set to 2 (Multi-position reference), check the sign (+/-) of each displacement reference value in parameter group H11. Check whether FunIN.27 (PosDirSel, position reference direction selection) is assigned to a DI and whether the logic of this DI is active. Check whether H02-02 (Direction of rotation) is set properly.
	The servo motor can rotate after preceding faults are cleared.		
Rotating unstably at low speed	The motor speed is unstable during low-speed operation.	Gains are set improperly.	Perform gain auto-tuning according to Chapter "Adjustment" in SV660P Series Servo Drive Function Guide.
	The motor shaft vibrates leftward and rightward.	The load moment of inertia ratio (H08-15) is excessively high.	If the motor can operate safely, perform inertia auto-tuning and gain auto-tuning according to Chapter "Adjustment" in SV660P Series Servo Drive Function Guide.
	The servo motor can rotate properly after preceding fault causes are rectified.		
Running normally	The positioning is inaccurate.	The position deviation is beyond the permissible range.	Check the position reference counter (H0B-13), feedback pulse counter (H0B-17), and the mechanical stop position according to the following section.

Procedure for checking the causes of inaccurate positioning

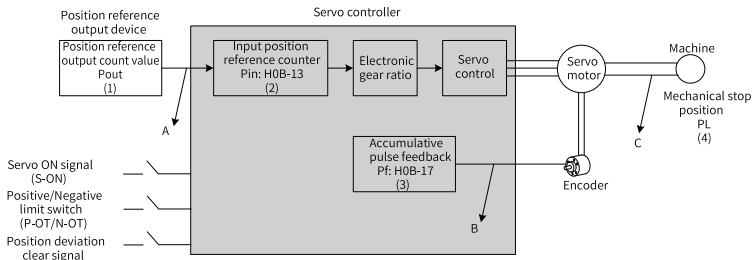

Figure 3-1 Schematic diagram for positioning control

- When inaccurate positioning occurs, check the following four signals in the preceding figure.
 - Output position reference count value (Pout) in the position reference output device (host controller or internal parameters of the servo drive)

- Input position reference count value (Pin) received by the servo drive, corresponding to H0B-13 (Position reference counter)
 - Accumulative pulse feedback value (Pf) returned by the encoder, corresponding to H0B-17 (Feedback pulse counter)
 - Mechanical stop position (PL)
- The A, B, C shown in the preceding figure represent the three causes that lead to inaccurate positioning.
 - A: An input position reference count error occurs due to the noise in the wiring of the host controller and the servo drive.
 - B: The input position reference is interrupted during operation of the motor. Cause: The S-ON signal is switched off, the positive/negative limit switch signal (P-OT or N-OT) is active, or the position deviation clear signal (ClrPosErr) is active.
 - C: Mechanical position slip occurs between the machine and the servo motor.
- In an ideal scenario where the position deviation is 0, the following relations exist:
 - $P_{out} = P_{in}$: Output position reference count value = Input position reference count value
 - $P_{in} \times \text{Electronic gear ratio} = P_f$: Input position reference count value \times Electronic gear ratio = Accumulative pulse feedback
 - $P_f \times \Delta L = PL$: Accumulative pulse feedback \times Corresponding load displacement per position reference = Mechanical stop position
- When inaccurate positioning occurs, check the cause based on the following steps:
 - $P_{out} \neq P_{in}$
Fault cause: A

To rectify cause A, do as follows:
 1. Check whether the pulse input terminals (low-speed or high-speed pulse input terminal, see Chapter "Wiring" in SV660P Series Servo Drive Hardware Guide) are connected with twisted pairs.
 2. If the open-collector input mode for low-speed pulse input terminals is used, change to the differential input mode.
 3. Route pulse input terminals and the main circuit (L1, L2, R, S, T, U, V, W) through different routes.
 4. If low-speed pulse input terminals are used, increase the filter time constant of low-speed pulse input pins (H0A-24). If high-speed pulse input terminals are used, increase the filter time constant of the high-speed pulse input pins (H0A-30).
 - $P_{in} \times \text{Electronic gear ratio} \neq P_f$:
Fault cause: B

To rectify cause B, do as follows:

1. Check whether a fault occurs during operation, causing the servo drive to stop before executing all the commands.
2. If the fault is caused by an active position deviation clear signal (ClrPosErr), check whether the position deviation clear mode (H05-16) is proper.

- Pfx Δ L \neq PL:
Fault cause: C

To rectify cause C, check mechanical connections and find the sliding position.

3.1.2 Speed Control Mode

Start Process	Fault Symptom	Cause	Confirming Method
Switching on the control circuit (L1C, L2C) and the main circuit (L1, L2/R, S, T/ L1, L2, L3)	The LED neither lights up nor displays "rdy".	1. The voltage of the control circuit power supply is abnormal.	The fault persists though CN1, CN2, CN3, and CN4 are disconnected. Measure the AC voltage between L1C and L2C.
		2. The input voltage is abnormal.	<ul style="list-style-type: none"> For single-phase 220 V models, measure the AC voltage between L1 and L2. When the DC bus voltage amplitude (voltage between P⊕ and N⊖) is lower than 200 V, the keypad displays "nrd". For three-phase 220 V/380 V models, measure the AC voltage among L1, L2, L3/R, S, T. When the DC bus voltage amplitude (voltage between P⊕ and N⊖) is lower than 460 V, the keypad displays "nrd".
		3. The programming terminal is shorted.	Check whether the programming terminal is shorted.
		4. The servo drive is faulty.	-
	The keypad displays "Er.xxx".	Rectify the fault causes according to "3.2.2 Common Solutions to Faults" on page 68 and "3.2.3 Solutions to Common Warnings" on page 97 .	
The keypad displays "rdy" after preceding faults are cleared.			
Switching on the S-ON signal (S-ON signal switched on)	The keypad displays "Er.xxx".	Rectify the fault causes according to "3.2.2 Common Solutions to Faults" on page 68 and "3.2.3 Solutions to Common Warnings" on page 97 .	
	The servo motor shaft is in the free running state.	1. The S-ON signal is inactive.	Switch the keypad display to the servo status interface and view whether the keypad displays "rdy" instead of "run". <ul style="list-style-type: none"> Check parameters in groups H03 or H17 to see whether FunIN.1 (S-ON) is assigned to a DI. If FunIN.1 is assigned, check whether the corresponding DI logic is active. If FunIN.1 is not assigned, assign FunIN.1 to a DI and activate the logic of this DI. For how to assign FunIN.1 to a DI, see "4.4 Group H03: Terminal Input Parameters" on page 111 and "4.17 Group H17: VDI/VDO Parameters" on page 147. If the keypad keeps displaying "rdy" even though the S-ON signal has been assigned to a DI through parameters in group H03 or H17 and the corresponding DI logic is active, check whether the DI is connected correctly according to Chapter "Wiring" in SV660P Series Servo Drive Hardware Guide.
		2. The control mode is wrong.	Check whether H02-00 (Control mode selection) is set to 0 (Position control mode). If it is set to 2 (Torque control mode), the motor shaft will be in the free running status because the default torque reference is 0.
The keypad displays "run" after preceding faults are cleared.			

Start Process	Fault Symptom	Cause	Confirming Method
Inputting speed references	The servo motor does not rotate or the motor speed is incorrect.	The speed reference (H0B-01) is 0.	<ul style="list-style-type: none"> • The speed reference selected is wrong. Check whether H06-02 (Speed reference selection) is set correctly. • No speed reference is inputted or the speed reference is abnormal. • When the speed reference is set through the keypad, check whether H06-03 (Speed reference set through keypad) is set correctly. • When the speed reference is set through multi-speed references, check whether parameters in group H12 are set correctly. • When the speed reference is set through communication, check whether H31-09 (Speed reference set through communication) is set correctly. • When the speed reference is set through jog speed references, check whether H06-04 (Jog speed) is set correctly and whether FunIN.18 (JOGCMD+, forward jog) and FunIN.19 (JOGCMD, reverse jog) are assigned to DIs and the DI logics are active. • Check whether H06-05 (Acceleration time constant of speed reference) and H06-06 (Deceleration time constant of speed reference) are set correctly. • Check whether FunIN.12 (ZCLAMP, zero clamp) is misassigned and whether the active logic of the corresponding DI is correct.
Inputting speed references	The servo motor rotates in the reverse direction.	The value of the speed reference (H0B-01) is a negative number.	<ul style="list-style-type: none"> • When the speed reference is set through the keypad, check whether the value of H06-03 (Speed reference set through keypad) is lower than 0. • When the speed reference is set through multi-speed references, check the sign (+/-) of each speed reference value in group H12. • When the speed reference is set through communication, check whether the value of H31-09 (Speed reference set through communication) is lower than 0. • When the speed reference is set through jog speed references, check whether the value of H06-04 (Jog speed) and the active logics of FunIN.18 (JOGCMD+, forward jog) and FunIN.19 (JOGCMD-, reverse jog) match the desired direction of rotation. • Check whether FunIN.26 (SpdDirSel, speed reference direction selection) is assigned to a DI and whether the logic of the DI is active. • Check whether H02-02 (Direction of rotation) is set properly.
The servo motor can rotate after preceding faults are cleared.			
Rotating unstably at low speed	The motor speed is unstable during low-speed operation.	Gains are set improperly.	Perform gain auto-tuning according to Chapter "Adjustment" in SV660P Series Servo Drive Function Guide.
	The motor shaft vibrates leftward and rightward.	The load moment of inertia ratio (H08-15) is excessively high.	If the motor can operate safely, perform inertia auto-tuning according to Chapter "Adjustment" in SV660P Series Servo Drive Function Guide. Perform gain auto-tuning according to Chapter "Adjustment" in SV660P Series Servo Drive Function Guide.

3.1.3 Torque Control Mode

Start Process	Fault Symptom	Cause	Confirming Method
Switching on the control circuit (L1C, L2C) and the main circuit (L1, L2/R, S, T/L1, L2, L3)	The LED neither lights up nor displays "rdy".	1. The voltage of the control circuit power supply is abnormal.	The fault persists though CN1, CN2, CN3, and CN4 are disconnected. Measure the AC voltage between L1C and L2C.
		2. The voltage of the main circuit power supply is abnormal.	<ul style="list-style-type: none"> For single-phase 220 V models, measure the AC voltage between L1 and L2. When the DC bus voltage amplitude (voltage between P⊕ and N⊖) is lower than 200 V, the keypad displays "nrd". For three-phase 220 V/380 V models, measure the AC voltage among L1, L2, L3/R, S, T. When the DC bus voltage amplitude (voltage between P⊕ and ⊖) is lower than 460 V, the keypad displays "nrd".
		3. The programming terminal is shorted.	Check whether the programming terminal is shorted.
		4. The servo drive is faulty.	-
	The keypad displays "Er.xxx".	Rectify the fault causes according to "3.2.2 Common Solutions to Faults" on page 68 and "3.2.3 Solutions to Common Warnings" on page 97 .	
The keypad displays "rdy" after preceding faults are cleared.			
Switching on the S-ON signal (S-ON signal switched on)	The keypad displays "Er.xxx".	Rectify the fault causes according to "3.2.2 Common Solutions to Faults" on page 68 and "3.2.3 Solutions to Common Warnings" on page 97 .	
	The servo motor shaft is in the free running state.	The S-ON signal is inactive.	<ul style="list-style-type: none"> Switch the keypad display to the servo status interface and view whether the keypad displays "rdy" instead of "run". Check parameters in groups H03 or H17 to see whether FunIN.1 (S-ON) is assigned to a DI. If FunIN.1 is assigned, check whether the corresponding DI logic is active. If FunIN.1 is not assigned, assign FunIN.1 to a DI and activate the logic of this DI. For how to assign FunIN.1 to a DI, see "4.4 Group H03: Terminal Input Parameters" on page 111 and "4.17 Group H17: VDI/VDO Parameters" on page 147. If the keypad keeps displaying "rdy" even though the S-ON signal has been assigned to a DI through parameters in group H03 or H17 and the corresponding DI logic is active, check whether the DI is connected correctly according to Chapter "Wiring" in SV660P Series Servo Drive Hardware Guide.
	The keypad displays "run" after preceding faults are cleared.		

Start Process	Fault Symptom	Cause	Confirming Method
Inputting torque references	The servo motor does not rotate.	The internal torque reference (H0B-02) is 0.	<p>The torque reference selected is wrong. Check whether H07-02 (Torque reference source) is set correctly. No torque reference is inputted.</p> <ul style="list-style-type: none"> When the torque reference is set through the keypad, check whether H07-03 (Torque reference set through keypad) is set to 0. When the torque reference is set through communication, check whether H31-11 (Torque reference set through communication) is set to 0.
	The servo motor rotates in the reverse direction.	The value of the internal torque reference (H0B-02) is a negative number.	<ul style="list-style-type: none"> When the torque reference is set through keypad, check whether the value of H07-03 (Torque reference set through keypad) is lower than 0. When the torque reference is set through communication, check whether the value of H31-11 (Torque reference set through communication) is lower than 0. Check whether FunIN.25 (ToqDirSel, speed reference direction selection) is assigned and whether the corresponding DI logic is active. Check whether H02-02 (Direction of rotation) is set properly.
	The servo motor can rotate after preceding faults are cleared.		
Rotating unstably at low speed	The motor speed is unstable during low-speed operation.	Gains are set improperly.	Perform gain auto-tuning.
	The motor shaft vibrates leftward and rightward.	The load moment of inertia ratio (H08-15) is excessively high.	If the servo motor can run safely, perform inertia auto-tuning again. Perform gain auto-tuning.

3.2 Troubleshooting During Operation

3.2.1 Faults and Warnings

Fault and warning levels

Faults and warnings of the servo drive are divided into three levels based on severity: No. 1 > No. 2 > No. 3, as shown below.

- No. 1 non-resettable fault
- No. 1 resettable fault
- No. 2 resettable fault
- No. 3 resettable warning

"Resettable" means the keypad stops displaying the fault/warning status once a "Reset signal" is input.

To stop the keypad from displaying the fault/warning, set H0D-01 to 1 or activate the logic of the DI assigned with FunIN.2 (ALM-RST).

- To reset No. 1 and No. 2 resettable faults, switch off the S-ON signal first and then set H0D-01 to 1 or use FunIN.2 (ALM-RST).
- To reset No. 3 warnings, set H0D-01 to 1 or use FunIN.2 (ALM-RST).

Note

- Some faults and warnings can be reset only after the fault causes are cleared by modifying the settings. However, a reset operation does not necessarily activate the modification.
- The control circuit must be powered off and on again in case of modifications that can be activated only after the power supply (L1, L2/L1, L2, L3/L1C, L2C) is powered off and on again.
- The S-ON signal must be switched off in case of modifications that can be activated only after stop. The servo drive can operate properly only after the modification is activated.

☆Related parameter

Para. No.	Name	Value Range	Description	Setting Condition	Effective Time	De fault
H0D-01	Fault reset	0: No operation 1: Fault/Warning reset	Used to stop the keypad from displaying the fault when a resettable fault/warning occurs. The setpoint is set to 0 immediately after fault reset.	At stop	Immediately	0

☆ Related function No.

Function No.	Name	Function	Description
FunIN.2	ALM-RST	Fault/Warning reset signal	The servo drive may, depending on the warning types, continue running after reset of warnings. When FunIN.2 is assigned to a low-speed DI, the effective level change of this DI must be kept for more than 3 ms. Otherwise, fault reset will be inactive. Do not assign FunIN.2 to a high-speed DI. Otherwise, fault/warning reset will be inactive. <ul style="list-style-type: none"> ● Inactive: Not resetting the fault/warning ● Active: Resetting the fault/warning

Fault and warning log

The servo drive can record the latest 10 faults and warnings and values of status parameters upon the fault/warning event. Among the latest 5 faults/warnings, if a fault/warning occurs repetitively, the servo drive records the fault/warning code and the drive status only once.

A fault/warning will still be saved in the fault log after reset. To remove the fault/warning from the fault log, set H02-31 (System parameter initialization) to 1 or 2.

You can select the specific fault/warning in H0B-33, view the corresponding fault/warning code in H0B-34 and the values of status parameters in H0B-35...H0B-42. For details of these parameters, see Chapter "Parameter List". If no fault occurs, the keypad displays "Er.000" in H0B-34.

The keypad displays "Er.xxx" when you view H0B-34 (Fault code of the selected fault) through the keypad. In "Er.xxx", "xxx" is the fault/warning code. The value of H0B-34 read through the software tool or communication is a decimal, which needs to be converted to a hexadecimal equivalent to indicate the actual fault/warning code. The following table gives examples of such conversion.

Er.xxx	H0B-34 (Decimal)	H0B-34 (Hexadecimal)	Description
Er.101	257	0101	0: No. 1 non-resettable fault 101: Fault code
Er.130	8496	2130	2: No. 1 resettable fault 130: Fault code
Er.121	24865	6121	6: No. 2 resettable fault 121: Fault code
Er.110	57616	E110	E: No. 3 resettable warning 110: Warning code

Faults and warnings

The servo drive can output the fault/warning code of the highest-level.

To output the fault/warning code, assign FunOUT.12 (ALMO1 (AL1), 1st bit of the fault code), FunOUT.13 (ALMO2 (AL2), 2nd bit of the fault code), and FunOUT.14 (ALMO3 (AL3), 3rd bit of the fault code) to three DOs respectively. When different faults/warnings occur, the level of each of the three DOs changes accordingly.

- No. 1 non-resettable faults:

Table 3-1 No. 1 non-resettable fault list

Display	Fault Name	Fault Type	Reset	Code Output		
				AL3	AL2	AL1
Er.101	Internal parameter error	No. 1	No	1	1	1
Er.102	Programmable logic configuration fault	No. 1	No	1	1	1

Display	Fault Name	Fault Type	Reset	Code Output		
				AL3	AL2	AL1
Er.104	Programmable logic interrupted	No. 1	No	1	1	1
Er.105	Internal program error	No. 1	No	1	1	1
Er.108	Parameter storage fault	No. 1	No	1	1	1
Er.120	Product model mismatch	No. 1	No	1	1	1
Er.122	Product mismatch in absolute position mode	No. 1	No	1	1	1
Er.136	Data check error or no parameter stored in the motor ROM	No. 1	No	1	1	1
Er.201	Overcurrent 2	No. 1	No	1	1	0
Er.208	FPGA system sampling operation timeout	No. 1	No	1	1	0
Er.210	Output short-circuited to ground	No. 1	No	1	1	0
Er.220	Phase sequence incorrect	No. 1	No	1	1	0
Er.234	Runaway	No. 1	No	1	1	0
Er.740	Encoder interference	No. 1	No	1	1	1
Er.A33	Encoder data error	No. 1	No	0	1	0
Er.A34	Encoder echo check error	No. 1	No	0	1	0

Note

The value "1" indicates active and "0" indicates inactive. Values "1" and "0" do not indicate high and low levels of the DO.

- No. 1 resettable faults

Table 3-2 No. 1 resettable faults list

Display	Fault Name	Fault Type	Reset	Code Output		
				AL3	AL2	AL1
Er.130	Different DIs assigned with the same function	No. 1	Yes	1	1	1
Er.207	D/Q-axis current overflow	No. 1	Yes	1	1	0
Er.400	Main circuit overvoltage	No. 1	Yes	0	1	1
Er.410	Main circuit undervoltage	No. 1	Yes	0	1	1

Display	Fault Name	Fault Type	Reset	Code Output		
				AL3	AL2	AL1
Er.500	Motor overspeed	No. 1	Yes	0	1	0
Er.602	Angle auto-tuning failure	No. 1	Yes	0	0	0
Er.605	Bootstrap speed too fast	No. 1	Yes	0	0	0
Er.610	Servo drive overload	No. 1	Yes	0	0	0
Er.620	Motor overload	No. 1	Yes	0	0	0
Er.630	Motor stall over-temperature protection	No. 1	Yes	0	0	0
Er.640	Junction temperature too high	No. 1	Yes	0	0	0
Er.650	Heatsink over-temperature	No. 1	Yes	0	0	0
Er.B00	Position deviation too large	No. 1	Yes	1	0	0

- No. 2 resettable faults

Table 3-3 No. 2 resettable fault list

Display	Fault Name	Fault Type	Reset	Code Output		
				AL3	AL2	AL1
Er.121	S-ON command inactive	No. 2	Yes	1	1	1
Er.420	Main circuit phase loss	No. 2	Yes	0	1	1
Er.430	Control circuit undervoltage	No. 2	Yes	0	1	1
Er.510	Pulse output overspeed	No. 2	Yes	0	1	0
Er.600	Inertia auto-tuning failure	No. 2	Yes	0	0	0
Er.660	Vibration too strong	No. 2	Yes	0	0	0
Er.661	Gain values too low	No. 2	Yes	0	0	0
Er.666	Runaway	No. 2	Yes	0	0	0
Er.668	Homing method improper	No. 2	Yes	0	0	0
Er.731	Encoder battery failure	No. 2	Yes	1	1	1
Er.733	Encoder multi-turn counting error	No. 2	Yes	1	1	1
Er.735	Encoder multi-turn counting overflow	No. 2	Yes	1	1	1
Er.B01	Pulse input error	No. 2	Yes	1	0	0
Er.B03	Electronic gear ratio beyond the limit	No. 2	Yes	1	0	0
Er.D03	CAN communication interrupted	No. 2	Yes	1	0	1

- No. 3 resettable warnings

Table 3-4 No. 3 resettable warning list

Display	Name	Fault Type	Reset	Code Output		
				AL3	AL2	AL1
Er.110	Frequency-division pulse output setting error	No. 3	Yes	1	1	1
Er.601	Homing timeout	No. 3	Yes	0	0	0
Er.730	Encoder battery warning	No. 3	Yes	1	1	1
Er.900	DI emergency braking	No. 3	Yes	1	1	1
Er.909	Motor overload warning	No. 3	Yes	1	1	0
Er.920	Regenerative resistor overload	No. 3	Yes	1	0	1
Er.922	Resistance of external regenerative resistor too small	No. 3	Yes	1	0	1
Er.924	Braking transistor over-temperature	No. 3	Yes	1	0	1
Er.939	Motor power cables disconnected	No. 3	Yes	1	0	0
Er.941	Parameter modifications activated at next power-on	No. 3	Yes	0	1	1
Er.942	Parameters saved frequently	No. 3	Yes	0	1	1
Er.950	Forward overtravel warning	No. 3	Yes	0	0	0
Er.952	Reverse overtravel warning	No. 3	Yes	0	0	0
Er.980	Encoder fault	No. 3	Yes	0	0	1
Er.990	Power input phase loss	No. 3	Yes	0	0	1
Er.994	CAN address conflict	No. 3	Yes	0	0	1
Er.A40	Parameter auto-tuning failure	No. 3	Yes	0	1	0

3.2.2 Common Solutions to Faults

- Er.101: Internal parameter error
Cause:
 - The total number of parameters changes, which generally occurs after software update.
 - Values of parameters in groups H02 and above exceed the limit, which generally occurs after software update.

Cause	Confirming Method	Solution
1. The voltage of the control circuit power supply drops instantaneously.	Check whether the control circuit (L1C, L2C) is in the process of power-off or instantaneous power failure occurs.	Restore system parameters to default settings (H02-31 = 1) and write parameters again.
	Measure whether the input voltage of the control circuit on the non-drive side is within the following range: <ul style="list-style-type: none"> ● 220 V servo drive: ● Effective value: 220 V to 240 V ● Allowable deviation: -10% to +10% (198 V to 264 V) ● 380 V servo drive: ● Effective value: 380 V to 440 V ● Allowable deviation: -10% to +10% (342 V to 484 V) 	Increase the power capacity or replace with a servo drive of larger capacity, restore system parameters to default settings (H02-31 = 1), and write parameters again.
2. Instantaneous power failure occurs during parameter storage.	Check whether instantaneous power failure occurs during parameter storage.	Power on the system again, restore system parameters to default settings (H02-31 = 1), and write the parameters again.
3. The number of write operations within a certain period of time exceeds the limit.	Check whether parameters are updated frequently through the host controller.	<ul style="list-style-type: none"> ● Change the write mode and write parameters again. ● The servo drive is faulty, replace the servo drive.
4. The software is updated.	Check whether the software is updated.	Set the servo drive model and servo motor model again, and restore system parameters to default settings (H02-31 = 1).
5. The servo drive is faulty.	If the fault persists though parameters are restored to default settings and the servo drive is powered off and on several times, the servo drive is faulty.	Replace the servo drive.

- Er.102: Programmable logic configuration fault
Cause:
 - The software versions of the FPGA the MCU do not match.
 - The FPGA- or MCU-related hardware is damaged, resulting in communication failure between the MCU and FPGA.

Cause	Confirming Method	Solution
1. The software versions of the FPGA the MCU do not match.	View the MCU software version (H01-00) and FPGA software version (H01-01) through the keypad or the software tool. Check whether the non-zero bits in the most significant bits of these two versions are consistent.	Contact Inovance for technical support. Update to the mutually-matching FPGA or MCU software.
2. The FPGA is faulty.	The fault persists after the servo drive is powered off and on several times.	Replace the servo drive.

- Er.104: Programmable logic interrupted
To distinguish the fault cause, the servo drive displays different internal fault codes under the same external fault code. You can view these internal fault codes in H0B-45.

Cause:

Access to MCU or FPGA times out.

Cause	Confirming Method	Solution
1. The FPGA is faulty (Er.104).	The fault persists after the servo drive is powered off and on several times.	Replace the servo drive.
2. The handshaking between FPGA and MCU is abnormal (Er.100).		
3. Internal operation of the servo drive times out (Er.940).		

- Er.105: Internal program error
Cause:
 - The total number of parameters read/written from EEPROM is abnormal.
 - The parameter value range is abnormal, which generally occurs after software update.

Cause	Confirming Method	Solution
1. An EEPROM fault occurs.	Check the fault causes according to the method described in Er.101	Restore system parameters to default values (H02-31 = 1) and restart the servo drive.
2. The servo drive is faulty.	The fault persists after the servo drive is powered off and on several times.	Replace the servo drive.

- Er.108: Parameter storage fault
Cause:

- Parameter values cannot be written to EEPROM.
- Parameter values cannot be read from EEPROM.

Cause	Confirming Method	Solution
1. An error occurs when writing parameters to EEPROM.	Modify a certain parameter, power off and on the servo drive again and check whether the modification is saved.	If the modification is not saved and the fault persists after the servo drive is powered off and on several times, replace the servo drive.
2. An error occurs when reading data from EEPROM.		

- Er.120: Product model mismatch

Cause:

The rated current of the motor is higher than that of the servo drive.

Cause	Confirming Method	Solution
1. The product (motor or servo drive) code does not exist.	Check the servo drive and servo motor nameplates to ensure that the equipment used is SV660P series servo drive and 23-bit servo motor. Meanwhile, check whether H00-00 (Motor code) is set to 14101.	If the motor code is unknown, set H00-00 to 14101 when using SV660P series servo drive and 23-bit servo motor.
	Check the servo drive code (H01-02) to see whether this servo drive code exists.	If the servo drive code is unknown, set the servo drive code correctly according to the nameplate.
2. The power rating of the motor does not match that of the servo drive.	Check whether the servo drive code (H01-02) matches the serial-type motor code (H00-05).	Replace the unmatched products.

- Er.121: S-ON command inactive

Cause:

A redundant S-ON signal is sent when some auxiliary functions are used.

Cause	Confirming Method	Solution
1. The external S-ON signal is active when servo drive is enabled internally.	Check whether the following auxiliary functions are used: Check whether auxiliary functions (H0D-02, H0D-03, and H0D-12) are used and whether FunIN.1 (S-ON, S-ON signal) is active.	Deactivate the DI assigned with FunIN.1 (both hardware DI and virtual DI).

- Er.122: Product mismatch in absolute position mode

Cause:

The motor does not match in the absolute position mode or the motor code is set improperly.

Cause	Confirming Method	Solution
1. The motor does not match or the motor code is set improperly in the absolute position mode.	<ul style="list-style-type: none"> • Check the motor nameplate to see whether the motor is configured with a multi-turn absolute encoder. • Check whether H00-00 (Motor code) is set properly. 	Reset H00-00 (Motor code) according to the motor nameplate or replace with a matching motor.

- Er.130: Different DIs assigned with the same function

Cause:

- Different DIs, including hardware DIs and virtual DIs, are assigned with the same function.
- The DI function No. exceeds the maximum setting number allowed for DI functions.

Cause	Confirming Method	Solution
1. The same function is assigned to different DIs.	Check whether parameters in groups H03 (H03-02, H03-04...H03-20) and H17 (H17-00, H17-02...H17-30) are assigned with the same non-zero DI function No..	Assign different DI function numbers to parameters in groups H03 or H17, and then restart the control circuit to activate the assignment, or switch off the S-ON signal and send a "RESET" signal to activate the assignment.
2. The DI function No. exceeds the maximum setting number allowed for DI functions.	Check whether the MCU program is updated.	Restore system parameters to default values (H02-31 = 1) and restart the servo drive.
3. Parameters are imported through the software: The same DI function is assigned to or canceled by different DIs.	Check whether a DI function is assigned to or canceled by different DIs when importing parameters through the software.	Modify the value of H03-10 through the software, and then set H03-02.

- Er.136: Data check error or no parameter stored in the motor ROM

Cause:

When the servo drive reads parameters in the encoder ROM, no parameters are saved there or parameter values are inconsistent with the parameter setpoint.

Cause	Confirming Method	Solution
1. The servo drive model does not match the servo motor model.	View the servo drive and servo motor nameplates to check whether the equipment used is SV660P series servo drive and 23-bit servo motor.	Replace with a mutually-matching servo drive and servo motor and power on the system again. When using SV660P series servo drive and 23-bit servo motor, set H00-00 (Motor code) to 14101.
2. A parameter check error occurs or no parameter is saved in the serial encoder ROM.	<ul style="list-style-type: none"> ● Check whether the encoder cable provided by Inovance is used. For cable specifications, see SV660P Series Servo Drive Hardware Guide. The cable must be connected securely without scratching, breaking or poor contact. ● Measure signals PS+, PS-, +5V and GND at both ends of the encoder cable and observe whether signals at both ends are consistent. For signal definitions, see Chapter "Wiring" in SV660P Series Servo Drive Hardware Guide. 	<ul style="list-style-type: none"> ● Use the encoder cable provided by Inovance. Ensure motor terminals and servo drive screws are connected securely. Use a new encoder cable if necessary. ● Route encoder cables and power cables (UVW) through different routes.
3. The servo drive is faulty.	The fault persists after the servo drive is powered off and on again.	Replace the servo drive.

- Er.201: Overcurrent 2

Cause:

Hardware overcurrent is detected.

Cause	Confirming Method	Solution
<p>1. Commands are input simultaneously at the servo drive startup or the reference input is too early.</p>	<p>Check whether a reference is input before the keypad displays "rdy".</p>	<p>Command time sequence: Wait for the keypad to display "rdy", and then switch on the S-ON signal, finally input the reference. Incorporate the reference filter time constant or increase the acceleration/deceleration time if allowed.</p>
<p>2. The regenerative resistor is of small resistance or short-circuited.</p>	<ul style="list-style-type: none"> • If the built-in regenerative resistor is used (H02-25 = 0), check whether terminals P ⊕ and D are jumpered. If yes, measure the resistance between terminals C and D. • If an external regenerative resistor is used (H02-25 = 1 or 2), measure the resistance of the external regenerative resistor between terminals P ⊕ and C. • For specifications of the regenerative resistor, see SV660P Series Servo Drive Selection Guide. 	<ul style="list-style-type: none"> • If the built-in regenerative resistor is used and the resistance is 0, change to use an external regenerative resistor (H02-25 = 1 or 2) and remove the jumper between terminals P ⊕ and D. Select an external regenerative resistor of the same resistance and equal or higher power than the built-in one. • If an external regenerative resistor is used and the resistance is lower than H02-21 (Permissible minimum resistance of regenerative resistor), connect a new regenerative resistor between terminals P ⊕ and C. For specifications of the regenerative resistor, see SV660P Series Servo Drive Selection Guide. • Set H02-26 (Power of external regenerative resistor) and H02-27 (Resistance of external regenerative resistor) to values consistent with the specifications of the external regenerative resistor used.
<p>3. The motor cables are in poor contact.</p>	<p>Check whether the servo drive power cables and motor cables on the U, V, and W side of the servo drive are loosely connected.</p>	<p>Tighten the cables that are loosely connected or disconnected.</p>
<p>4. Motor cables are grounded.</p>	<p>After ensuring the servo drive power cables and motor cables are connected securely, measure whether the insulation resistance between the grounding cable (PE) and servo drive UVW sides is at MΩ-level.</p>	<p>Replace the motor in case of poor insulation.</p>

Cause	Confirming Method	Solution
5. Motor UVW cables are short-circuited.	Disconnect the motor cables and check whether short circuit occurs among U, V, and W phases and whether burrs exist on cable connections.	Connect the motor cables correctly.
6. The motor is damaged due to over-temperature.	Disconnect the motor cables and measure whether the resistance among U, V, and W phases of the motor cable is balanced.	Replace the motor if the resistance is unbalanced.
7. Gains are set improperly and the motor oscillates.	Check whether the motor oscillates or generates a sharp noise during start and operation, or check the current feedback through the software tool.	Perform gain auto-tuning according to Chapter "Adjustment" in SV660P Series Servo Drive Function Guide.
8. The encoder cable is wired incorrectly, aging, or corroded, or the encoder connector is loose.	Check whether the encoder cable provided by Inovance is used and whether the cable is aging, corroded, or loosely connected. Switch off the S-ON signal and rotate the motor shaft manually. Check whether the value of H0B-10 (Electrical angle) changes as the motor shaft rotates.	Re-weld, tighten or replace the encoder cable.
9. The servo drive is faulty.	The fault persists after you disconnect the motor cables and power off and on the servo drive again.	Replace the servo drive.

- Er.207: D/Q-axis current overflow

Cause:

- Abnormal current feedback leads to overflow of the internal register.
- Abnormal encoder feedback leads to an internal register fault.

Cause	Confirming Method	Solution
1. Axis-D/Q current overflows.	If the fault persists after the servo drive is powered off and on several times, the servo drive is faulty.	Replace the servo drive.

- Er.208: FPGA system sampling operation timeout

Cause:

Find the fault cause through the internal fault code H0B-45.

Cause	Confirming Method	Solution
1. The MCU communication times out.	H0B-45 (Internal fault code) = 1208: The internal integrated circuit is damaged.	Replace the servo drive.
2. The encoder communication times out.	H0B-45 (Internal fault code) = 2208: <ul style="list-style-type: none"> • The encoder cable is connected improperly. • The encoder cable is loose. • The encoder cable is too long. • The encoder communication suffers interference. • The encoder is faulty. 	<ul style="list-style-type: none"> • It is recommended to use the cables provided by Inovance. For use of customized cables, check whether the customized cable complies with specifications and whether it is a shielded twisted pair cable. • Check whether the connectors at both ends of the encoder are in good contact and whether any pin retracts. • Contact the manufacturer. • Route the motor cables and encoder cables through different routes. Ensure the servo motor and servo drive are well grounded. • Replace the servo motor.
3. The current sampling times out.	H0B-45 (Internal fault code) = 3208: <ul style="list-style-type: none"> • Check whether ambient devices are generating interference and whether multiple interference sources such as variable-frequency devices are present inside the cabinet. • The internal current sampling chip is damaged. 	<ul style="list-style-type: none"> • Route the high-current cables and low-current cables through different routes. • Replace the servo drive.
4. The FPGA operation times out.	H0B-45 (Internal fault code) = 0208: Determine the fault cause according to preceding causes 1, 2, and 3.	Refer to the solutions for causes 1, 2, and 3.

- Er.210: Output short-circuited to ground
Cause:

An abnormal motor phase current or bus voltage is detected during auto-inspection upon power-on.

- The DC bus voltage exceeds the discharge threshold.
- Phase-U current of servo drives in size C/D/E exceeds 25% of the setpoint of H01-07.
- Overcurrent occurs on phase U and phase P of servo drives in size A/B.

Cause	Confirming Method	Solution
1. The servo drive power cables (UVW) are short-circuited to ground.	Disconnect the motor cables, and measure whether the servo drive power cables (UVW) are short-circuited to ground (PE).	Re-connect or replace the servo drive power cables.
2. The motor is short-circuited to ground.	After ensuring the servo drive power cables and motor cables are connected securely, measure whether the insulation resistance between the grounding cable (PE) and servo drive UVW sides is at MΩ-level.	Replace the motor.
3. The servo drive is faulty.	Remove the power cables from the servo drive, but the fault persists after the servo drive is powered off and on several times.	Replace the servo drive.
4. The motor speed is too high during phase-to-ground detection.	Check whether the motor is in the generating status during power-on.	Reduce the motor speed.

- Er.220: Phase sequence incorrect

Cause:

The UVW phase sequence of the servo drive does not match that of the motor, which is detected during angle auto-tuning.

Cause	Confirming Method	Solution
The UVW phase sequence of the servo drive does not match that of the motor.	Er.220 is reported again during angle auto-tuning though the servo drive is powered off and on several times.	Perform wiring and angle auto-tuning again.

- Er.234: Runaway

Cause:

- The torque reference direction is opposite to the speed feedback direction in the torque control mode.
- The speed feedback direction is opposite to the speed reference direction in the position or speed control mode.

Cause	Confirming Method	Solution
1. The UVW phase sequence is incorrect.	Check whether the UVW phase sequence on the servo drive side is consistent with that on the motor side.	Connect the UVW cables in the correct phase sequence.
2. The interference signal causes an error in the initial phase detection of the motor rotor upon power-on.	The UVW phase sequence is correct. But Er.234 occurs when the servo drive is enabled.	Power off and on the servo drive again.
3. The encoder model is wrong or the wiring is incorrect.	View the servo drive and servo motor nameplates to check whether the equipment used is SV660P series servo drive and servo motor equipped with 23-bit absolute encoder.	Replace with a mutually-matching servo drive and servo motor. For use of SV660P series servo drive and 23-bit servo motor, set H00-00 to 14101. Re-confirm the motor model, encoder type, and encoder cable connections.
4. The encoder cable is wired incorrectly, aging, or corroded, or the encoder connector is loose.	<ul style="list-style-type: none"> • Check whether the encoder cable provided by Inovance is used and whether the cable is aging, corroded, or loose. • Switch off the S-ON signal and rotate the motor shaft manually. Check whether the value of H0B-10 (Electrical angle) changes as the motor shaft rotates. 	Re-weld, tighten or replace the encoder cable.
5. The gravity load in vertical axis applications is too heavy.	Check whether the load of the vertical axis is too heavy. Adjust brake parameters H02-09...H02-12 and observe whether the fault can be cleared.	Lighten the load of the vertical axis, increase the stiffness level, or hide this fault without affecting the safety performance and use of the device.



Caution

Set H0A-12 (Runaway protection) to 0 (Disable) to hide the runaway fault when the motor drives a vertical axis or is driven by the load.

- Er.400: Main circuit overvoltage

Cause:

The DC bus voltage between terminals P⊕ and N⊖ exceeds the overvoltage threshold.

- 220 V servo drive: Normal value: 310 V Overvoltage threshold: 420 V
- 380 V servo drive: Normal value: 540 V Overvoltage threshold: 760 V

Cause	Confirming Method	Solution
1. The voltage input to the main circuit is too high.	Measure whether the input voltage on the main circuit side is within the following range: <ul style="list-style-type: none"> ● 220 V servo drive: <ul style="list-style-type: none"> ● Effective value: 220 V to 240 V ● Allowable deviation: -10% to +10% (198 V to 264 V) ● 380 V servo drive: <ul style="list-style-type: none"> ● Effective value: 380 V to 440 V ● Allowable deviation: -10% to +10% (342 V to 484 V) 	Replace or adjust the power supply according to the specified range.
2. The power supply is unstable or affected by lightning.	Check whether the power supply is unstable, affected by lightning, or within the preceding range.	Connect a surge protection device and then switch on the main circuit and control circuit again. If the fault persists, replace the servo drive.
3. The regenerative resistor fails.	<ul style="list-style-type: none"> ● If the built-in regenerative resistor is used (H02-25 = 0), check whether terminals P ⊕ and D are jumpered. If yes, measure the resistance between terminals C and D. ● If an external regenerative resistor is used (H02-25 = 1 or 2), measure the resistance of the external regenerative resistor between terminals P ⊕ and C. ● For specifications of the regenerative resistor, see SV660P Series Servo Drive Selection Guide. 	<ul style="list-style-type: none"> ● If the resistance is "∞" (infinite), the regenerative resistor is disconnected internally. ● If a built-in regenerative resistor is used, change to use an external regenerative resistor (H02-25 = 1 or 2) and remove the jumper between terminals P ⊕ and D. Select an external regenerative resistor of the same resistance and equal or higher power than the built-in one. ● If an external regenerative resistor is used, replace it with a new one and connect the new one between terminals P ⊕ and C. ● Set H02-26 (Power of external regenerative resistor) and H02-27 (Resistance of external regenerative resistor) to values consistent with the specifications of the external regenerative resistor used.

Cause	Confirming Method	Solution
4. The resistance of the external regenerative resistor is too large, resulting in insufficient energy absorption during braking.	Measure the resistance of the external regenerative resistor between terminals P⊕ and C. Compare the measured value with the recommended value.	Connect a new external regenerative resistor with the recommended resistance between terminals P⊕ and C. Set H02-26 (Power of external regenerative resistor) and H02-27 (Resistance of external regenerative resistor) to values consistent with the specifications of the external regenerative resistor used.
5. The motor is in abrupt acceleration/ deceleration status and the maximum braking energy exceeds the energy absorption value.	Confirm the acceleration/ deceleration time during operation and measure whether the DC bus voltage between terminals P⊕ and N0 exceeds the fault threshold during deceleration.	Ensure the input voltage of the main circuit is within the specified range, and then increase the acceleration/deceleration time if allowed.
6. The bus voltage sampling value deviates greatly from the measured value.	Check whether H0B-26 (Bus voltage) is within the following range: ● 220 V servo drive: H0B-26 > 420 V ● 380 V servo drive: H0B-26 > 760 V Check whether the DC bus voltage detected between terminals P⊕ and N0 is close to the value of H0B-26.	Contact Inovance for technical support.
7. The servo drive is faulty.	The fault persists after the main circuit is powered off and on several times.	Replace the servo drive.

- Er.410: Main circuit undervoltage

Cause:

The DC bus voltage is lower than the undervoltage threshold.

- 220 V servo drive: Normal value: 310 V Undervoltage threshold: 200 V
- 380 V servo drive: Normal value: 540 V Undervoltage threshold: 380 V

Cause	Confirming Method	Solution
1. The power supply of the main circuit is unstable or power failure occurs.	Check the specifications of the input power supply. Measure whether the input voltage of the main circuit on the non-drive side and the drive side is within the following range:	Increase the capacity of the power supply. For details, see SV660P Series Servo Drive Selection Guide.
2. Instantaneous power failure occurs.	<ul style="list-style-type: none"> ● 220 V servo drive: ● Effective value: 220 V to 240 V ● Allowable deviation: -10% to +10% (198 V to 264 V) ● 380 V servo drive: ● Effective value: 380 V to 440 V ● Allowable deviation: -10% to +10% (342 V to 484 V) The voltages of all the three phases need to be measured.	
3. The voltage of the power supply drops during operation.	Monitor the power input voltage and check whether the main circuit power supply is applied to other devices, resulting in insufficient power capacity and voltage dip.	
4. A three-phase servo drive is connected to a single-phase power supply, leading to phase loss.	Check whether the main circuit is wired properly, and whether power input phase loss protection (H0A-00) is hidden.	Replace the cables and connect the main circuit cables correctly. Single-phase: L1, L2 Three-phase: L1, L2, L3/R, S, T
5. The servo drive is faulty.	Check whether H0B-26 (Bus voltage) is within the following range: <ul style="list-style-type: none"> ● 220 V servo drive: $H0B-26 < 200\text{ V}$ ● 380 V servo drive: $H0B-26 < 380\text{ V}$ The fault persists after the main circuit is powered off and on several times.	Replace the servo drive.

- Er.430: Control circuit undervoltage
Cause:
 - 220 V servo drive: Normal value: 310 V Undervoltage threshold: 190 V
 - 380 V servo drive: Normal value: 540 V Undervoltage threshold: 350 V

Cause	Confirming Method	Solution
1. The control circuit power supply is unstable or power-down occurs.	Check whether the control circuit (L1C, L2C) is in the process of power-off or instantaneous power failure occurs.	Power off and on the servo drive again. If power-down occurs unexpectedly, check whether the power supply is stable.
	Check whether the input voltages of control circuit cables are within the following range: <ul style="list-style-type: none"> ● 220 V servo drive: ● Effective value: 220 V to 240 V ● Allowable deviation: -10% to +10% (198 V to 264 V) ● 380 V servo drive: ● Effective value: 380 V to 440 V ● Allowable deviation: -10% to +10% (342 V to 484 V) The voltages of all the three phases need to be measured.	Increase the capacity of the power supply.
2. The control circuit cables are in poor contact.	Check whether control circuit cables are well connected and whether their voltages on the servo drive side (L1, L2, L3) are within the preceding range.	Re-connect or replace control circuit cables.

- Er.500: Motor overspeed

Cause:

The actual speed of the servo motor exceeds the overspeed threshold.

Cause	Confirming Method	Solution
1. The UVW phase sequence of the motor cable is wrong.	Check whether the servo drive power cables are connected in the correct sequence at both ends.	Connect the UVW cables in the correct phase sequence.
2. H0A-08 (Overspeed threshold) is set improperly.	Check whether the overspeed threshold is lower than the maximum speed needed: Overspeed threshold = $1.2 \times$ Maximum motor speed (H0A-08 = 0) Overspeed threshold = H0A-08 (H0A-08 \neq 0, and H0A-08 < $1.2 \times$ Maximum motor speed)	Reset the overspeed threshold according to the mechanical requirements.

Cause	Confirming Method	Solution
<p>3. The input reference exceeds the overspeed threshold.</p>	<p>Check whether the motor speed corresponding to the input reference exceeds the overspeed threshold.</p> <p>When the reference source is pulse references in the position control mode: Motor speed (RPM) =</p> $\frac{\text{Input pulse frequency (Hz)}}{\text{Encoder resolution}} \times \text{Electronic gear ratio} \times 60$ <p>For SV660P servo drives, the encoder resolution is 8388608 PPR.</p>	<ul style="list-style-type: none"> • In the position control mode where the position reference source is pulse references, reduce the pulse reference frequency without affecting the positioning accuracy or decrease the electronic gear ratio if the motor speed allows. • In the speed control mode, view the values of the speed reference and speed limit (H06-06...H06-09) and confirm that both values are within the overpseed threshold. • In the torque control mode, set the speed limit to a value within the overspeed threshold. For speed limit in the torque control mode, see SV660P Series Servo Drive Function Guide.
<p>4. The motor speed overshoots.</p>	<p>Check in the software tool whether the speed feedback exceeds the overspeed threshold.</p>	<p>Perform gain auto-tuning or adjust the operating conditions according to Chapter "Adjustment" in SV660P Series Servo Drive Function Guide.</p>
<p>5. The servo drive is faulty.</p>	<p>The fault persists after the servo drive is powered off and on again.</p>	<p>Replace the servo drive.</p>

● Er.510: Pulse output overspeed

Cause:

The output pulse frequency exceeds the frequency upper limit allowed by the hardware (2 MHz) when pulse output is enabled (H05-38 = 0 or 1).

Cause	Confirming Method	Solution
	When H05-38 (Servo pulse output source) is set to 0 (Encoder frequency-division output), check whether the output pulse frequency corresponding to the motor speed upon fault event exceeds the limit. $\frac{\text{Output pulse frequency (Hz)}}{60} \times \text{H05-17}$	Decrease the value of H05-17 (Encoder frequency-division pulses) to allow the output pulse frequency, within the speed range required by the machine, to drop below the frequency upper limit allowed by the hardware.
The output pulse frequency exceeds the frequency upper limit allowed by the hardware (2 MHz).	The input pulse frequency exceeds 2 MHz or interference exists in the pulse input pins when H05-38 (Servo pulse output source) is set to 1 (Reference pulse synchronous output). <ul style="list-style-type: none"> ● Low-speed pulse input pins: differential input terminals: PULSE+, PULSE-, SIGN+, SIGN-, maximum pulse frequency: 500 kpps ● Open-collector input terminals: PULLHI, PULSE+, PULSE-, SIGN+, SIGN-, maximum pulse frequency: 200 kpps ● High-speed pulse input pins: differential input terminals: HPULSE+, HPULSE-, HSIGN+, HSIGN-, maximum pulse frequency: 2 Mpps 	Decrease the input pulse frequency to a value within the frequency upper limit allowed by hardware. Note: In this case, if you do not modify the electronic gear ratio, the motor speed will be reduced. If the input pulse frequency is high but is still within the frequency upper limit allowed by the hardware, take anti-interference measures (use STP cable for pulse input and set pin filter parameters H0A-24 or H0A-30). This is to prevent false warnings caused by interference pulses superimposed to actual pulse references.

● Er.600: Inertia auto-tuning failure

Cause:

- The vibration cannot be suppressed. You can set notch parameters (H09-12... H09-23) manually to suppress vibration.
- The auto-tuned values fluctuate dramatically. Increase the maximum operating speed, reduce the acceleration/deceleration time, and shorten the stroke of the lead screw during ETune operations.
- Mechanical couplings of the load are loose or eccentric. Rectify the mechanical faults.
- A warning occurs during auto-tuning and causes interruption. Rectify the fault causes and perform inertia auto-tuning again.
- The vibration cannot be suppressed if the load carries a large inertia. In this case, increase the acceleration/deceleration time first to ensure the motor current is unsaturated.

- Er.602: Angle auto-tuning failure
- Er.605: Bootstrap speed too fast
Cause:

The actual motor speed exceeds the rated speed during bootstrap charging of the servo drive.

- Er.610: Servo drive overload
Cause:

The accumulative heat of the servo drive reaches the fault threshold.

- Er.620: Motor overload
Cause:

The accumulative heat of the motor reaches the fault threshold.

Cause	Confirming Method	Solution
1. The motor and encoder cables are connected improperly.	Check the wiring among the servo drive, servo motor and encoder according to the correct wiring diagram.	<ul style="list-style-type: none"> ● Connect cables according to the correct wiring diagram. ● It is recommended to use the cables provided by Inovance. ● When customized cables are used, prepare and connect the customized cables according to the wiring instructions.
2. The load is too heavy and the effective torque output by the motor keeps exceeding the rated torque.	Confirm the overload characteristics of the servo drive or motor. Check whether the average load rate (H0B-12) of the servo drive keeps exceeding 100.0%.	<ul style="list-style-type: none"> ● Replace with a servo drive of higher capacity and a matching servo motor. ● Reduce the load and increase the acceleration/deceleration time.
3. The acceleration/ deceleration is too frequent or the load inertia is too large.	Calculate the mechanical inertia ratio or perform inertia auto-tuning. View the value of H08-15 (Load moment of inertia ratio). Confirm the individual operation cycle when the servo motor operates cyclically.	Increase the acceleration/ deceleration time in an individual operation cycle.
4. Gains are improper or the stiffness level is too high.	Check whether the motor vibrates and generates an abnormal noise during operation.	Adjust gain values again according to Chapter "Adjustment" in SV660P Series Servo Drive Function Guide.

Cause	Confirming Method	Solution
5. The servo drive model or motor model is set improperly.	For SV660P series products, view the serial-type motor code in H00-05 and the servo drive code in H01-02.	View the servo drive nameplate and set the servo drive model (H01-02) and the motor model to proper values to make them match (see SV660P Series Servo Drive Selection Guide for the matching relation).
6. The motor stalls due to mechanical factors, resulting in overload during operation.	<p>Check the reference and the motor speed (H0B-00) through the software tool or the keypad.</p> <ul style="list-style-type: none"> • References in the position control mode: H0B-13 (Input position reference counter) • References in the speed control mode: H0B-01 (Speed reference) • References in the torque control mode: H0B-02 (Internal torque reference) <p>Check whether the reference is not 0 but the motor speed is 0 in the corresponding mode.</p>	Rectify the mechanical factors.
7. The servo drive is faulty.	The fault persists after the servo drive is powered off and on again.	Replace the servo drive.



After overload occurs, wait for at least 30s before clearing the fault or restarting the power supply.

- Er.630: Motor stall over-temperature protection

Cause:

The actual motor speed is lower than 10 RPM but the torque reference reaches the limit, and such status lasts for the time defined by H0A-32.

Cause	Confirming Method	Solution
1. UVW phase loss or incorrect phase sequence occurs on the servo drive.	Perform motor trial run without load and check the wiring.	Connect cables again according to the correct wiring diagram or replace the cables.
2. The servo drive UVW cables or the encoder cables are disconnected.	Check the wiring.	Connect cables again according to the correct wiring diagram or replace the cables.
3. The motor stalls due to mechanical factors.	<p>Check the reference and the motor speed (H0B-00) through the software tool or the keypad.</p> <ul style="list-style-type: none"> •References in the position control mode: H0B-13 (Input position reference counter) •References in the speed control mode: H0B-01 (Speed reference) •References in the torque control mode: H0B-02 (Internal torque reference) <p>Check whether the reference is not 0 but the motor speed is 0 in the corresponding mode.</p>	Eliminate the mechanical factors.

- Er.640: Junction temperature too high

Cause:

The temperatures of the IGBT and diodes reach the over-temperature threshold (H0A-38).

Cause	Confirming Method	Solution
1. The ambient temperature is too high.	Measure the ambient temperature.	Improve the cooling conditions of the servo drive to lower down the ambient temperature.
2. The servo drive is restarted several times to reset the overload fault.	View the fault log (set H0B-33 and view H0B-34) to check whether an overload fault/warning is reported (Er.610, Er.620, Er.630, Er.650, Er.909, Er.920, Er.922).	Change the fault reset method. After overload occurs, wait for 30s before reset. Increase the capacities of the servo drive and servo motor, increase the acceleration/deceleration time and reduce the load.
3. The fan is damaged.	Check whether the fan rotates during operation.	Replace the servo drive.

Cause	Confirming Method	Solution
4. The servo drive is installed in a wrong direction and the clearance between servo drives is improper.	Check whether the servo drive is installed properly.	Install the servo drive according to the installation requirements.
5. The servo drive is faulty.	The fault persists even though the servo drive is restarted five minutes after power-off.	Replace the servo drive.

- Er.650: Heatsink over-temperature

Cause:

The temperature of the servo drive power module is higher than the over-temperature threshold.

Cause	Confirming Method	Solution
1. The ambient temperature is too high.	Measure the ambient temperature.	Improve the cooling conditions of the servo drive to lower down the ambient temperature.
2. The servo drive is restarted several times to reset the overload fault.	View the fault log (set H0B-33 and view H0B-34) to check whether an overload fault/warning is reported (Er.610, Er.620, Er.630, Er.650, Er.909, Er.920, Er.922).	Change the fault reset method. After overload occurs, wait for 30s before reset. Increase the capacities of the servo drive and servo motor, increase the acceleration/deceleration time and reduce the load.
3. The fan is damaged.	Check whether the fan rotates during operation.	Replace the servo drive.
4. The servo drive is installed in a wrong direction and the clearance between servo drives is improper.	Check whether the servo drive is installed properly.	Install the servo drive according to the installation requirements.
5. The servo drive is faulty.	The fault persists even though the servo drive is restarted five minutes after power-off.	Replace the servo drive.
6. The servo drive model is set incorrectly.	Check whether the value of H01-02 is consistent with the model shown on the nameplate. View the servo drive code (H01-02) and check whether the servo drive model exists according to the SV660P Series Servo Drive Selection Guide.	If the servo drive code does not exist, set the servo drive code correctly according to the SV660P Series Servo Drive Selection Guide.

- Er.660 Vibration too strong

Cause:

The vibration is too strong or lasts for too long. The set resonance point will be cleared when Er.660 occurs.

- Setting H08-58 to 1 hides warnings caused by excessively strong vibration.
- Setting H08-58 to 2 hides warnings caused by excessively strong vibration and lasting vibration.

- Er.661: Gain values too low

Cause:

- The vibration cannot be suppressed. Activate vibration suppression manually to dampen the vibration.
- Excessive overshoot occurs during positioning. Check whether the positioning threshold is too low. Increase the acceleration/deceleration time and reduce the response level.
- The command suffers from noise. Modify the electronic gear ratio to improve the command resolution, or increase the command filter time constant in the "Parameter configuration" interface.
- The current fluctuates. Check whether the current of the machine fluctuates periodically.
- The vibration cannot be suppressed if the load carries a large inertia. In this case, increase the acceleration/deceleration time first to ensure the motor current is unsaturated.

- Er.666: Runaway

Cause: A runaway fault occurs. You can hide this fault by setting H0A-02 to 1.

- H09-26 (Response level) is set to a high value and the set inertia range is too large (when the actual inertia is too low or too high). In this case, vibration may occur due to mismatch.
-
- The acceleration/deceleration time is too short, leading to over-saturation.
- The mechanical couplings are loose and the vibration frequency changes frequently.

- Er.668: Homing method improper

Cause:

The homing method does not match the set mode.

Cause	Confirming Method	Solution
1. The motor model does not match the homing method.	View the values of H00-00 (Motor code), H02-01 (Absolute system selection), and H05-69 (Auxiliary homing function). If H05-69 is set to 1 or 3 and H00-00 is set to a value other than 14101 or H02-01 is set to a value other than 0, Er.668 will be reported.	Change the value of H00-00 to 14101 and H02-01 to 0. If other types of fault occurs, the homing method may not be supported.
2. Single-turn homing is configured with the homing trigger mode.	View the values of H05-30 (Homing enable selection), H05-31 (Homing method), and H05-69 (Auxiliary homing function). If H05-69 is set to 1, check whether H05-31 is set to a value between 14 to 16 and whether the setpoint of H05-30 represents electrical homing.	Set H05-30 to a value representing electrical homing. H05-31 represents the homing method corresponding to single-turn homing.
3. Homing is configured with the single-turn homing mode.	Check whether H05-31 is set to a value between 0 to 13. If H05-69 is set to 3, check whether the homing method defined by H05-31 takes Z signal as the home.	Change the homing method defined by H05-31.

- Er.731: Encoder battery failure

Cause:

The battery voltage of the absolute encoder is lower than 3.0 V.

Cause	Confirming Method	Solution
1. The battery is not connected during power-off.	Check whether battery is connected during power-off.	Set H0D-20 (Absolute encoder reset selection) to 1 (No operation) to clear the fault.
2. The encoder battery voltage is too low.	Measure the battery voltage.	Use a new battery with the matching voltage.

- Er.733: Encoder multi-turn count error

Cause:

An encoder multi-turn count error occurs.

Cause	Confirming Method	Solution
1. The encoder is faulty.	Set H0D-20 (Absolute encoder reset function) to 1 (Reset the fault) to clear the fault, but Er.733 persists after the servo drive is powered off and on again.	Replace the motor.

- Er.735: Encoder multi-turn counting overflow

Encoder multi-turn counting overflow is detected.

Cause	Confirming Method	Solution
1. Encoder multi-turn counting overflow is detected when H02-01 (Absolute system selection) is set to 1 (Absolute position linear mode).	-	Set H0D-20 (Absolute encoder reset selection) to 1 (Reset the fault) to clear the fault, and then power on the servo drive again.

- Er.740: Encoder interference

Cause:

The encoder Z signal suffers from interference, resulting in a significant change of the electrical angle corresponding to the Z signal.

Cause	Confirming Method	Solution
1. The encoder is wired improperly.	Check the wiring of the encoder.	Connect the encoder cables according to the correct wiring diagram.
2. The encoder cable is loose.	Check whether field vibration is too strong, which loosens the encoder cable and even damages the encoder.	Re-connect the encoder cables and ensure the encoder terminals are connected securely.

Cause	Confirming Method	Solution
<p>3. The encoder Z signal suffers from interference.</p>	<p>Check the cable layout on site:</p> <ul style="list-style-type: none"> • Check whether ambient devices are generating interference and whether multiple interference sources such as variable-frequency devices are present inside the cabinet. • Make the servo drive stay in "rdy" status and rotate the motor shaft counterclockwise (CCW) manually. Then observe whether the value of H0B-10 (Electrical angle) increases/ decreases smoothly. Turning one circle corresponds to five 0-360° (for Z series motor). For X series motors, turning one circle corresponds to four 0-360°. • If H0B-10 changes abruptly when you rotate the motor shaft, the encoder is faulty. • If no alarm is reported during rotating but the servo drive reports an alarm during operation, interference may be present. 	<ul style="list-style-type: none"> • It is recommended to use the cables provided by Inovance. • If a customized cable is used, check whether this cable is a shielded twisted pair that complies with the specifications. • Route the motor cables and encoder cables through different routes. Ensure the servo motor and servo drive are well grounded. • Check whether the plugs at both ends of the encoder are in good contact and whether any pin retracts.
<p>4. The encoder is faulty.</p>	<p>Replace with a new encoder cable. If the fault no longer occurs after cable replacement, it indicates the original encoder cable is damaged.</p> <p>Keep the motor in a fixed position, perform several power cycles and observe the change of the electrical angle (H0B-10) upon each power cycle, which should be within $\pm 30^\circ$.</p>	<p>Replace with a new encoder cable. If the fault persists after the encoder cable is replaced, the encoder may be faulty. In this case, replace the servo motor.</p>

- Er.A33: Encoder data error

Cause:

Encoder parameters are abnormal.

Cause	Confirming Method	Solution
1. The serial encoder cable is disconnected or loose.	Check the wiring.	Check the connection of the encoder cable to see whether they are connected improperly, broken, or in poor contact. If motor cables and encoder cables are bundled together, separate them.
2. An error occurs when reading/writing serial encoder parameters.	If the fault persists after the servo drive is powered off and on several times, the encoder is faulty.	Replace the servo motor.

- Er.B00: Position deviation too large

Cause:

The position deviation in the position control mode is larger than the setpoint of H0A-10 (Threshold of excessive position deviation).

Cause	Confirming Method	Solution
1. UVW phase loss or incorrect phase sequence occurs on the servo drive.	Perform motor trial run without load and check the wiring.	Connect cables again according to the correct wiring diagram or replace the cables.
2. The servo drive UVW cables or the encoder cables are disconnected.	Check the wiring.	Connect the cables again. The UVW phase sequence on the servo drive side must be consistent with that on the motor side. Replace with new cables if necessary and ensure cables are connected properly.
3. The motor stalls due to mechanical factors.	Check the reference and the motor speed (H0B-00) through the software tool or the keypad. <ul style="list-style-type: none"> ● References in the position control mode: H0B-13 (Input position reference counter) ● References in the speed control mode: H0B-01 (Speed reference) ● References in the torque control mode: H0B-02 (Internal torque reference) Check whether the reference is not 0 but the motor speed is 0 in the corresponding mode.	Eliminate the mechanical factors.

Cause	Confirming Method	Solution
4. The gain values are too low.	Check the position loop gain and speed loop gain of the servo drive. 1st gain set: H08-00 to H08-02 2nd gain set: H08-03 to H08-05	Perform gain auto-tuning or manual gain tuning according to Chapter "Adjustment" in SV660P Series Servo Drive Function Guide.
5. The input pulse frequency is high.	When the position reference source is pulse references, check whether the input pulse frequency is too high. The acceleration/deceleration time is too short or 0.	Reduce the position reference frequency or the electronic gear ratio. When the host controller is used to output position pulses, set the acceleration/deceleration time in the host controller. If the acceleration/deceleration time cannot be set in the host controller, increase the values of H05-04 (First-order low-pass filter time constant) and H05-06 (Average filter time constant).
6. The value of H0A-10 (Threshold of excessive position deviation) is too low against the operating conditions.	Check whether the setpoint of H0A-10 is too low.	Increase the setpoint of H0A-10.
7. The servo drive/motor is faulty.	Monitor the operation waveform through the oscilloscope function in the software tool: position references, position feedback, speed references, and torque references.	If the position reference is not 0 but the position feedback is always 0, replace the servo drive or motor.

- Er.B01: Pulse input error

Cause:

The pulse input frequency is higher than H0A-09 (Maximum position pulse frequency).

Cause	Confirming Method	Solution
1. The pulse input frequency is higher than H0A-09 (Maximum position pulse frequency).	Check whether H0A-09 is lower than the maximum pulse input frequency required by normal operation.	Reset H0A-09 according to the actual requirement. If the pulse output frequency of the host controller is higher than 4 MHz, decrease it.
2. The input pulse suffers from interference.	Check in the software tool whether the position reference increases abruptly or the value of H0B-13 (Position reference counter) exceeds the number of pulses output by host controller. Then, check the grounding condition of cables.	First, use a shielded twisted pair for pulse input and separate pulse input cables from servo drive power cables. Next, when differential input is used in low-speed pulse input terminals (H05-01 = 0), connect the "GND" of the host controller to the "GND" of servo drive; when open-collector input is used, connect the "GND" of the host controller to the "COM" of the servo drive. When high-speed pulse input terminals (H05-01 = 1) are used, only the differential input is available, so connect the "GND" of the host controller to the "GND" of the servo drive. Finally, increase the pin filtering time of pulse input terminals in H0A-24 or H0A-30 depending on the hardware input terminals selected.

- Er.B03: Electronic gear ratio beyond the limit

Cause:

The electronic gear ratio exceeds the limit ($0.001 \times \text{Encoder resolution}/10000$, $4000 \times \text{Encoder resolution}/10000$).

Cause	Confirming Method	Solution
The set electronic gear ratio exceeds the preceding limit.	If H05-02 (Pulses per revolution) is set to 0, check the ratios of H05-07/H05-09 and H05-11/H05-13. If the setpoint of H05-02 is higher than 0, check the ratios of the encoder resolution/H05-02, H05-07/H05-09, and H05-11/H05-13.	Set the ratios of the encoder resolution/H05-02, H05-07/H05-09, and H05-11/H05-13 to values within the preceding range.
Parameters are modified in a wrong sequence.	Change the parameters related to electronic gear ratio: H05-02, H05-07/H05-09, and H05-11/H05-13 are modified in a wrong sequence, which causes the electronic gear ratio to exceed the limit during calculation.	Use the fault reset function or perform a power cycle.

- Er.D03: CAN communication interrupted
Cause:
The CAN communication times out.

Cause	Confirming Method	Solution
The CAN communication is interrupted due to offline slaves.	Check the status of the CAN communication card indicator of the master PLC. The ERR indicator of the master PLC blinks at an interval of 1 Hz and the ERR indicators of some slave PLCs are steady on (When using PLC software tool, you can monitor D78xx in the component monitoring table of the master. "xx" indicates the station no. in decimal. If corresponding D78xx of some configured stations is 5, it indicates a fault occurs on these slaves.)	Check the connection of communication cables between the master and the faulty slave. Check the communication baud rate (H0C-08) of the slave whose ERR indicator keeps on, and adjust the baud rate to the same value as that of the master.
The CAN communication is interrupted due to master offline.	Check the status of the CAN communication card indicator of the master PLC. The ERR indicators of all the slave PLCs are steady on. (When using PLC software tool, you can monitor D78xx in the component monitoring table of the master. "xx" indicates the station no. in decimal. If corresponding D78xx of all configured stations is 5, it indicates a fault occurs on the master.)	Check the cable connections of the master.

3.2.3 Solutions to Common Warnings

- Er.110: Frequency-division pulse output setting error

Cause:

The set encoder frequency-division pulses does not match the threshold defined by the encoder specification when encoder frequency-division output is used (H05-38 = 0).

Cause	Confirming Method	Solution
The number of encoder frequency-division pulses is outside the specified range.	For incremental encoders, the number of frequency-division pulses cannot exceed the encoder resolution. The resolution of a 23-bit serial incremental encoder is 8388608 PPR.	Reset H05-17 (Encoder frequency-division pulses) according to the specification.

- Er.601: Homing failure

Cause:

The home is not found within the time defined by H05-35 when homing is activated (H05-30 = 1 to 5).

Cause	Confirming Method	Solution
1. The home switch fails.	<ul style="list-style-type: none"> • There is only high-speed searching but no low-speed searching during homing. • After high-speed searching, the servo drive keeps low-speed searching in the reverse direction. 	<ul style="list-style-type: none"> • If a hardware DI is used, check whether FunIN.31 (HomeSwitch) is set in parameter group H03 and whether the DI is connected properly. Change the DI logic manually and check the value of H0B-03 to see whether the DI level change is received by the servo drive. If not, the DI switch is wired incorrectly. If yes, an error occurs during homing. For details on the homing operation, see section "Homing Function" in SV660P Series Servo Drive Function Guide. • If a virtual DI (VDI) is used, check whether the VDI is used correctly.
2. The homing time limit is too short.	Check whether the value of H05-35 (Time limit for homing) is too small.	Increase the value of H05-35.
3. The speed in high-speed searching for the home switch signal is too low.	Check the distance between the start position of homing and the home switch. Then check whether the setpoint of H05-32 (Speed in high-speed searching for the home switch signal) is too small, resulting in a long homing process.	Increase the value of H05-32.

- Er.730: Encoder battery warning

Cause:

The battery voltage of the absolute encoder is lower than 3.0 V.

Cause	Confirming Method	Solution
1. The encoder battery voltage is lower than 3.0 V.	Measure the battery voltage.	Use a new battery with the matching voltage.

- Er.900: DI emergency braking

Cause:

The logic of the DI (hardware DI or virtual DI terminal) assigned with FunIN.34 (EmergencyStop) is active.

Cause	Confirming Method	Solution
FunIN.34: Emergency stop, triggered	Check whether the logic of the DI assigned with FunIN.34 (EmergencyStop) is active.	Check the operating mode and clear the active DI braking signal without affecting the safety performance.

- Er.909: Motor overload warning

Cause:

The accumulative heat of the 60Z series motor (200 W and 400 W) reaches the warning threshold.

Cause	Confirming Method	Solution
1. The motor and encoder cables are connected improperly or in poor contact.	Check the wiring among the servo drive, servo motor and the encoder according to the correct wiring diagram.	<ul style="list-style-type: none"> ● Connect cables based on the correct wiring diagram. ● It is recommended to use the cables provided by Inovance. ● When customized cables are used, prepare and connect the cables according to the wiring instructions.
2. The load is too heavy and the effective torque output by the motor keeps exceeding the rated torque.	<p>Confirm the overload characteristics of the servo drive or motor.</p> <p>Check whether the average load rate (H0B-12) of the servo drive keeps exceeding 100.0%.</p>	<ul style="list-style-type: none"> ● Replace with a servo drive of higher capacity and a matching servo motor. ● Reduce the load and increase the acceleration/deceleration time.
3. The acceleration/ deceleration is too frequent or the load inertia is too large.	<p>Check the mechanical inertia ratio or perform inertia auto-tuning.</p> <p>View the value of H08-15 (Load moment of inertia ratio).</p> <p>Confirm the individual operation cycle when the servo motor operates cyclically.</p>	Increase the acceleration/ deceleration time.
4. Gains are improper or the stiffness level is too high.	Check whether the motor vibrates and generates an abnormal noise during operation.	Perform gain auto-tuning again according to Chapter "Adjustment" in SV660P Series Servo Drive Function Guide.
5. The servo drive model or motor model is set improperly.	For SV660P series products, view the serial-type motor code in H00-05 and the servo drive code in H01-02.	View the servo drive nameplate and set the servo drive model (H01-02) and the motor model to proper values to make them match (see SV660P Series Servo Drive Selection Guide for the matching relation).

Cause	Confirming Method	Solution
6. Locked-rotor occurs due to mechanical factors, resulting in overload during operation.	<p>Check the reference and motor speed (H0B-00) through the software tool or the keypad.</p> <ul style="list-style-type: none"> References in the position control mode: H0B-13 (Input position reference counter) References in the speed control mode: H0B-01 (Speed reference) References in the torque control mode: H0B-02 (Internal torque reference) <p>Check whether the value of the reference is not 0 or is very large but the motor speed is 0 in the corresponding mode.</p>	Rectify the mechanical factors.
7. The servo drive is faulty.	Power off and on the servo drive again.	Replace the servo drive if the fault persists after the servo drive is powered off and on again.

- Er.920: Regenerative resistor overload

Cause:

The accumulative heat of the regenerative resistor exceeds the set value.

Cause	Confirming Method	Solution
1. The external regenerative resistor is connected improperly, disconnected or loosened.	Remove the external regenerative resistor and measure whether its resistance is "∞" (infinite).	Replace with a new external regenerative resistor. If the resistance measured is the same as the nominal value, connect the regenerative resistor between terminals P⊕ and C.
	Measure whether resistance between terminals P⊕ and C is "∞" (infinite).	Connect the external regenerative resistor between terminals P⊕ and C with a new cable.
2. The jumper between P ⊕ and D is shorted or disconnected when the built-in regenerative resistor is used.	Measure whether the resistance between terminals P ⊕ and D is "∞" (infinite).	Ensure terminals P ⊕ and D are jumpered.
3. H02-25 (Regenerative resistor type) is set improperly when an external regenerative resistor is used.	View the setpoint of H02-25.	<p>Set H02-25 correctly.</p> <ul style="list-style-type: none"> ● H02-25 = 1 (external regenerative resistor, natural cooling) ● H02-25 = 2 (external regenerative resistor, forced-air cooling)

Cause	Confirming Method	Solution
<p>4. The resistance of the external regenerative resistor used is too large.</p>	<p>Measure the resistance of the external regenerative resistor connected between terminals P⊕ and C, and compare the resistance measured with the value described in section "Specifications of the Regenerative Resistor" in SV660P Series Servo Drive Selection Guide to check whether the resistance is too large.</p>	<p>Select a proper regenerative resistor according to section "Specifications of the Regenerative Resistor" in SV660P Series Servo Drive Selection Guide.</p>
<p>5. The setpoint of H02-27 (Resistance of external regenerative resistor) is larger than resistance of the external regenerative resistor used.</p>	<p>Check whether the value of H02-27 is larger than the resistance of the external regenerative resistor connected between terminals P⊕ and C.</p>	<p>Set H02-27 according to the resistance of the external regenerative resistor used.</p>
<p>6. The input voltage of the main circuit exceeds the specified range.</p>	<p>Check whether the input voltage of the main circuit on the servo drive side is within the following range:</p> <ul style="list-style-type: none"> ● 220 V servo drive: <ul style="list-style-type: none"> ● Effective value: 220 V to 240 V ● Allowable deviation: -10% to +10% (198 V to 264 V) ● 380 V servo drive: <ul style="list-style-type: none"> ● Effective value: 380 V to 440 V ● Allowable deviation: -10% to +10% (342 V to 484 V) 	<p>Replace or adjust the power supply according to the specified range.</p>

Cause	Confirming Method	Solution
7. The load moment of inertia ratio is too large.	Perform moment of inertia auto-tuning according to section "Inertia auto-tuning" in SV660P Series Servo Drive Function Guide or calculate the total mechanical inertia according to mechanical parameters. Check whether the actual load inertia ratio exceeds 30.	Select an external regenerative resistor with large capacity and set H02-26 (Power of the external regenerative resistor) to a value consistent with the actual power.
8. The motor speed is excessively high and the deceleration process is not done within the set time. The motor is in the continuous deceleration status during cyclic operation.	View the motor speed curve during cyclic operation and check whether the motor is in the deceleration status continuously.	Select a servo drive with large capacity. Reduce the load if allowed. Increase the acceleration/ deceleration time if allowed. Increase the cyclic deceleration interval if allowed.
9. The capacity of the servo drive or the regenerative resistor is insufficient.	View the motor speed curve in an individual cycle and calculate whether the maximum braking energy can be absorbed completely.	
10. The servo drive is faulty.	-	Replace with a new servo drive.

- Er.922: Resistance of the external regenerative resistor too small

Cause:

The value of H02-27 (Resistance of external regenerative resistor) is lower than H02-21 (Permissible minimum resistance of regenerative resistor).

Cause	Confirming Method	Solution
When an external regenerative resistor is used (H02-25 = 1 or 2), the resistance of this resistor is lower than the minimum resistance allowed by the servo drive.	Measure the resistance of the external regenerative resistor connected between terminals P \oplus and C to check whether it is smaller than the value of H02-21 (Permissible minimum resistance of regenerative resistor).	<ul style="list-style-type: none"> ● If yes, replace with an external regenerative resistor that matches the servo drive, and connect this resistor between terminals P\oplus and C. If not, set H02-27 to a value consistent with the resistance of this resistor.

- Er.924: Braking transistor over-temperature

Cause:

The estimated temperature of the braking transistor is higher than H0A-38 (Maximum protection threshold).

- Er.939: Motor power cable disconnected

Cause:

The actual phase current of the motor is lower than 10% of the rated current. The actual motor speed is low, but the value of the internal torque reference is high.

Cause	Confirming Method	Solution
Motor power cables are disconnected.	Check whether the difference between H0B-24 (Phase current effective value) and H0B-02 (Internal torque reference) is above 500% and whether H0B-00 (Actual motor speed) is lower than 25% of the rated motor speed.	Re-connect the motor power cables or replace with new cables if necessary.

- Er.941: Parameter modifications activated at next power-on

Cause:

Modifications of some parameters take effect at next power-on. If these parameters are modified, power off and on the servo drive again.

Cause	Confirming Method	Solution
The parameters modified are those whose "Effective time" is "Next power-on".	Check whether parameters you modified are those whose "Effective time" is "Next power-on".	Power off and on the servo drive again.

- Er.942: Parameter saved frequently

Cause:

The number of parameters modified at a time exceeds 200.

Cause	Confirming Method	Solution
Too many parameters are modified and saved to EEPROM (H0C-13 = 1) at a brief interval.	Check whether the host controller executes parameter modifications at a brief interval.	Check the operating mode. For parameters that need not be saved to EEPROM, set H0C-13 to 0.

- Er.950: Forward overtravel warning

Cause:

The logic of DI assigned with FunIN.14 (P-OT, positive limit switch) is active.

Cause	Confirming Method	Solution
1. The logic of the DI assigned with FunIN.14 (P-OT, positive limit switch) is active.	Check whether a certain DI in group H03 is assigned with FunIN.14. Check whether the logic of DI corresponding to the bit of H0B-03 (Monitored DI status) is active.	Check the operating mode. On the prerequisite of ensuring safety, send a reverse run command or rotate the motor to deactivate the logic of DI assigned with FunIN.14.
2. The servo drive position feedback reaches the positive software position limit.	Check whether the position feedback (H0B-17) is close to the value of H0A-41. Check whether the software position limit is set in H0A-40.	Ensure the servo drive references are proper, allowing the load travel range to be within the software position limit range.

- Er.952: Reverse overtravel warning

Cause:

The logic of the DI assigned with FunIN.15 (N-OT, negative limit switch) is active.

Cause	Confirming Method	Solution
1. The logic of the DI assigned with FunIN.15 (N-OT, negative limit switch) is active.	Check whether FunIN.15 is set to a DI through parameters in group H03. Check whether the logic of DI corresponding to the bit of H0B-03 (Monitored DI status) is active.	Check the operating mode. On the prerequisite of ensuring safety, send a forward run command or rotate the motor to deactivate the logic of DI assigned with FunIN.15.
2. The servo drive position feedback reaches the negative software position limit.	Check whether the position feedback (H0B-17) is close to the value of H0A-43. Check whether the software position limit is set in H0A-40.	Ensure the servo drive references are proper, allowing the load travel range to be within the software position limit range.

- Er.980: Encoder fault

Cause:

An encoder algorithm error occurs.

Cause	Confirming Method	Solution
The encoder is faulty.	If the fault persists after the servo drive is powered off and on several times, the encoder is faulty.	Replace the servo motor.

- Er.990: Power input phase loss

Cause:

A three-phase servo drive below 1 kW is allowed to run under a single-phase power supply, but H0A-00 (Power input phase loss fault/warning selection) is set to 1 (Enabled).

Cause	Confirming Method	Solution
When H0A-00 (Power input phase loss fault/warning selection) is set to 1 (Enable phase loss fault and warning), a warning will be reported if a three-phase servo drive (H01-02 = 5) of 0.75 kW is connected to a single-phase power supply, despite that this servo drive allows single-phase power input.	Check whether the three-phase servo drive is allowed to run under a single-phase power supply.	If the warning persists when a three-phase servo drive is connected to a three-phase power supply, handle this warning as described in Er.420 (Main circuit phase loss). If the warning persists when a three-phase servo drive that allows single-phase power input is connected to a single-phase power supply, set H0A-00 (Power input phase loss fault/warning selection) to 0 (Enable phase loss fault and inhibit phase loss warning).

- Er.994: CAN address conflict

Cause	Confirming Method	Solution
The CANlink address conflict occurs.	Check whether H0C-00 (Servo axis address) is allocated repetitively to different slaves.	Allocate a unique address for each slave and ensure H0C-00 is not allocated repetitively.

3.2.4 Internal Faults

When any one of the following fault occurs, contact Inovance for technical support.

- Er.602: Angle auto-tuning failure
- Er.220: Phase sequence incorrect
- Er.A40: Parameter auto-tuning failure
- Er.111: Internal parameter error

4 Parameter Descriptions

Parameter Group	Overview of Parameter Groups
Group H00	Servo motor parameters
Group H01	Servo drive parameters
Group H02	Basic control parameters
Group H03	Terminal input parameters
Group H04	Terminal output parameters
Group H05	Position control parameters
Group H06	Speed control parameters
Group H07	Torque control parameters
Group H08	Gain parameters
Group H09	Auto-tuning parameters
Group H0A	Fault and protection parameters
Group H0B	Monitoring parameters
Group H0C	Communication parameters
Group H0D	Auxiliary functions
Group H11	Multi-position parameters
Group H12	Multi-speed parameters
Group H17	VDI/VDO parameters
Group H30	Servo variables read through communication
Group H31	Servo variables set through communication

4.1 Group H00: Servo Motor Parameters

Para. No.	Name	Value Range	Unit	Default	Effective Time	Setting Condition	Related Mode
H00-00	Motor code	14000: Inovance motor with 20-bit incremental encoder 14101: Inovance motor with 23-bit absolute encoder	-	14101	Next power-on	At stop	All
H00-02	Customized no.	-	-	-	-	At display	-
H00-04	Encoder version	-	-	-	-	At display	-
H00-05	Serial-type motor code	-	-	-	-	At display	-
H00-08	Absolute encoder type	14100: Multi-turn absolute encoder Others: Single-turn absolute encoder	-	-	Next power-on	At stop	All
H00-09	Rated voltage	0-220 1-380	V	-	Next power-on	At stop	-

Para. No.	Name	Value Range	Unit	Default	Effective Time	Setting Condition	Related Mode
H00-10	Rated power	0.01–655.35	kW	-	Next power-on	At stop	-
H00-11	Rated current	0.01–655.35	A	-	Next power-on	At stop	-
H00-12	Rated torque	0.01–655.35	N·m	-	Next power-on	At stop	-
H00-13	Maximum torque	0.10–655.35	N·m	-	Next power-on	At stop	-
H00-14	Rated speed	100–6000	RPM	-	Next power-on	At stop	-
H00-15	Maximum speed	100–6000	RPM	-	Next power-on	At stop	-
H00-16	Moment of inertia Jm	0.01–655.35	kgcm ²	-	Next power-on	At stop	-
H00-17	Number of PMSM pole pairs	2–360	Pole pair	-	Next power-on	At stop	-
H00-18	Stator resistance	0.001–65.535	Ω	-	Next power-on	At stop	-
H00-19	Stator inductance Lq	0.01–655.35	mH	-	Next power-on	At stop	-
H00-20	Stator inductance Ld	0.01–655.35	mH	-	Next power-on	At stop	-
H00-21	Linear back EMF coefficient	0.01–655.35	mV/RPM	-	Next power-on	At stop	-
H00-22	Torque coefficient Kt	0.01–655.35	N·m/Arms	-	Next power-on	At stop	-
H00-23	Electrical constant Te	0.01–655.35	ms	-	Next power-on	At stop	-
H00-24	Mechanical constant Tm	0.01–655.35	ms	-	Next power-on	At stop	-
H00-28	Absolute encoder position offset	0–1073741824	PPR	-	Next power-on	At stop	-
H00-30	Encoder selection (Hex)	0x000: Incremental encoder (UVW-ABZ) 0x013: Inovance encoder	1	0x013	Next power-on	At stop	-
H00-31	Encoder resolution	0–1073741824	PPR	1048576	Next power-on	At stop	-
H00-35	Serial-type motor model	0–65535	1	0	Next power-on	At stop	-
H00-43	Maximum motor current	0.01–655.35	A	0	Next power-on	At stop	-

4.2 Group H01: Servo Drive Parameters

Para. No.	Name	Value Range	Unit	Default	Effective Time	Setting Condition	Related Mode
H01-00	MCU software version	0–65535	-	-	-	At display	-
H01-01	FPGA software version	0–65535	-	-	-	At display	-
H01-02	Servo drive code	0–65535	-	-	Next power-on	At stop	-

4.3 Group H02: Basic Control Parameters

Para. No.	Name	Value Range	Unit	Default	Effective Time	Setting Condition	Related Mode
H02-00	Control mode selection	0: Speed control mode 1: Position control mode 2: Torque control mode 3: Torque control mode ↔ Speed control mode 4: Speed control mode ↔ Position control mode 5: Torque control mode ↔ Position control mode 6: Torque control mode ↔ Speed control mode ↔ Position control mode	-	1	Immediately	At stop	-
H02-01	Absolute system selection	0: Incremental position mode 1: Absolute position linear mode 2: Absolute position rotation mode	-	0	Next power-on	At stop	All
H02-02	Direction of rotation	0: CCW as forward direction (phase A leads phase B) 1: CW as forward direction (reverse mode, phase A lags behind phase B)	-	0	Next power-on	At stop	PST
H02-03	Output pulse phase	0: CCW as forward direction (phase A leads phase B) 1: CW as forward direction (reverse mode, phase A lags behind phase B)	-	0	Next power-on	At stop	PST

Para. No.	Name	Value Range	Unit	Default	Effective Time	Setting Condition	Related Mode
H02-05	Stop mode at S-ON OFF	0: Coast to stop, keeping de-energized state 1: Stop at zero speed, keeping de-energized state 2: Stop at zero speed, keeping dynamic braking state 3: Dynamic braking stop, keeping dynamic braking state	-	0	Immediately	At stop	PST
H02-06	Stop mode at No. 2 fault	0: Coast to stop, keeping de-energized state 1: Stop at zero speed, keeping de-energized state 2: Stop at zero speed, keeping dynamic braking state 3: Dynamic braking stop, keeping dynamic braking state 4: Dynamic braking stop, keeping de-energized state	-	2	Immediately	At stop	PST
H02-07	Stop mode upon overtravel	0: Coast to stop, keeping de-energized state 1: Stop at zero speed, keeping position lock state 2: Stop at zero speed, keeping de-energized state	-	1	Immediately	At stop	PST
H02-08	Stop mode at No. 1 fault	0: Coast to stop, keeping de-energized state 1: Dynamic braking stop, keeping de-energized state 2: Dynamic braking stop, keeping dynamic braking state	-	2	Immediately	At stop	PST
H02-09	Delay from brake output ON to command received	0–500	ms	250	Immediately	During running	PS
H02-10	Delay from brake output OFF to motor de-energized in standstill state	1–1000	ms	150	Immediately	During running	PS
H02-11	Speed threshold at brake output OFF in rotation state	0–3000	RPM	30	Immediately	During running	PS
H02-12	Delay from S-ON OFF to brake output OFF in rotation state	1–1000	ms	500	Immediately	During running	PS

Parameter Descriptions

Para. No.	Name	Value Range	Unit	Default	Effective Time	Setting Condition	Related Mode
H02-15	Warning display on the keypad	0: Output warning information immediately 1: Not output warning information	-	0	Immediately	At stop	PST
H02-18	S-ON filter time constant	0–64	ms	0	Immediately	At stop	PST
H02-21	Permissible minimum resistance of regenerative resistor	-	Ω	-	-	At display	PST
H02-22	Power of built-in regenerative resistor	-	W	-	-	At display	PST
H02-23	Resistance of built-in regenerative resistor	-	Ω	-	-	At display	PST
H02-24	Resistor heat dissipation coefficient	10–100	%	30	Immediately	At stop	PST
H02-25	Regenerative resistor type	0: Built-in 1: External, natural cooling 2: External, forced air cooling 3: No regenerative resistor needed	-	0	Immediately	At stop	PST
H02-26	Power of external regenerative resistor	1–65535	W	-	Immediately	At stop	PST
H02-27	Resistance of external regenerative resistor	1–1000	Ω	-	Immediately	At stop	PST
H02-30	User password	0–65535	-	0	Next power-on	At stop	PST
H02-31	System parameter initialization	0: No operation 1: Restore default settings (parameters in groups H00 and H01 excluded) 2: Clear fault log	-	0	Immediately	At stop	PST
H02-32	Default keypad display	0–99	-	50	Immediately	During running	-
H02-34	CAN software version	-	-	-	-	At display	-

4.4 Group H03: Terminal Input Parameters

Para. No.	Name	Value Range	Unit	Default	Effective Time	Setting Condition	Related Mode
H03-00	DI function assignment 1 (activated upon power-on)	0-0xFFFF Bit0: FunIN.1 Bit1: FunIN.2 ... Bit15: FunIN.16	-	0	Next power-on	During running	-
H03-01	DI function assignment 2 (activated upon power-on)	0-0xFFFF Bit0: FunIN.17 Bit1: FunIN.18 ... Bit15: FunIN.32	-	0	Next power-on	During running	-
H03-02	DI1 function	0-41	-	14	At stop	During running	-
H03-03	DI1 logic	Input polarity: 0-1 0: Active low 1: Active high	-	0	At stop	During running	-
H03-04	DI2 function	0-41	-	15	At stop	During running	-
H03-05	DI2 logic	Input polarity: 0-1 0: Active low 1: Active high	-	0	At stop	During running	-
H03-06	DI3 function	0-41	-	13	At stop	During running	-
H03-07	DI3 logic	Input polarity: 0-1 0: Active low 1: Active high	-	0	At stop	During running	-
H03-08	DI4 function	0-41	-	2	At stop	During running	-
H03-09	DI4 logic	Input polarity: 0-1 0: Active low 1: Active high	-	0	At stop	During running	-
H03-10	DI5 function	0-41	-	1	At stop	During running	-
H03-11	DI5 logic	Input polarity: 0-1 0: Active low 1: Active high	-	0	At stop	During running	-
H03-16	DI8 function	0-41	-	31	At stop	During running	-
H03-17	DI8 logic	Input polarity: 0-1 0: Active low 1: Active high	-	0	At stop	During running	-
H03-18	DI9 function	0-41	-	0	At stop	During running	-

Para. No.	Name	Value Range	Unit	Default	Effective Time	Setting Condition	Related Mode
H03-19	DI9 logic	Input polarity: 0–1 0: Active low 1: Active high	-	0	At stop	During running	-
H03-34	DI function assignment 3 (activated upon power-on)	0–0xFFFF Bit0: FunIN.33 Bit1: FunIN.34 ... Bit15: FunIN.16	-	0	Next power-on	During running	-
H03-35	DI function assignment 4 (activated upon power-on)	0–0xFFFF Bit0: FunIN.49 Bit1: FunIN.50 ... Bit15: FunIN.16	-	0	Next power-on	During running	-
H03-60	DI1 filter time	0–50000	0.01 ms	50	Immediately	During running	-
H03-61	DI2 filter time	0–50000	0.01 ms	50	Immediately	During running	-
H03-62	DI3 filter time	0–50000	0.01 ms	50	Immediately	During running	-
H03-63	DI4 filter time	0–50000	0.01 ms	50	Immediately	During running	-
H03-64	DI5 filter time	0–50000	0.01 ms	50	Immediately	During running	-
H03-65	DI8 filter time	0–50000	0.01 ms	0	Immediately	During running	-
H03-66	DI9 filter time	0–50000	0.01 ms	0	Immediately	During running	-

4.5 Group H04: Terminal Output Parameters

Para. No.	Name	Value Range	Unit	Default	Effective Time	Setting Condition	Related Mode
H04-00	DO1 function	0–24	-	1	At stop	During running	-
H04-01	DO1 logic	Output polarity inversion: 0–1 0: Output low level (L) when active (optocoupler ON) 1: Output high level (H) when active (optocoupler OFF)	-	0	At stop	During running	-
H04-02	DO2 function	0–24	-	5	At stop	During running	-

Para. No.	Name	Value Range	Unit	Default	Effective Time	Setting Condition	Related Mode
H04-03	DO2 logic	Output polarity inversion: 0-1 0: Output low level (L) when active (optocoupler ON) 1: Output high level (H) when active (optocoupler OFF)	-	0	At stop	During running	-
H04-04	DO3 function	0-24	-	9	At stop	During running	-
H04-05	DO3 logic	Output polarity inversion: 0-1 0: Output low level (L) when active (optocoupler ON) 1: Output high level (H) when active (optocoupler OFF)	-	0	At stop	During running	-
H04-06	DO4 function	0-24	-	11	At stop	During running	-
H04-07	DO4 logic	Output polarity inversion: 0-1 0: Output low level (L) when active (optocoupler ON) 1: Output high level (H) when active (optocoupler OFF)	-	0	At stop	During running	-
H04-08	DO5 function	0-24	-	16	At stop	During running	-
H04-09	DO5 logic	Output polarity inversion: 0-1 0: Output low level (L) when active (optocoupler ON) 1: Output high level (H) when active (optocoupler OFF)	-	0	At stop	During running	-
H04-22	DO source	0-31	-	0	Immediately	At stop	-

4.6 Group H05: Position Control Parameters

Para. No.	Name	Value Range	Unit	Default	Effective Time	Setting Condition	Related Mode
H05-00	Position reference source	0: Pulse reference 1: Step reference 2: Multi-position reference	-	0	Immediately	At stop	P
H05-01	Pulse reference input terminal selection	0: Low-speed terminals 1: High-speed terminals	-	0	Immediately	At stop	P
H05-02	Pulses per revolution	0–1048576	PPR	0	Next power-on	At stop	P
H05-04	First-order low-pass filter time constant	0–6553.5	ms	0.0	Immediately	At stop	P
H05-05	Step reference	-9999 to +9999	Reference unit	50	Immediately	At stop	P
H05-06	Moving average filter time constant	0.0–128.0	ms	0.0	Immediately	At stop	P
H05-07	Electronic gear ratio 1 (numerator)	1–1073741824	-	8388608	Immediately	During running	P
H05-09	Electronic gear ratio 1 (denominator)	1–1073741824	-	10000	Immediately	During running	P
H05-11	Electronic gear ratio 2 (numerator)	1–1073741824	-	8388608	Immediately	During running	P
H05-13	Electronic gear ratio 2 (denominator)	1–1073741824	-	10000	Immediately	During running	P
H05-15	Pulse reference form	0: Pulse+Direction, positive logic 1: Pulse+Direction, negative logic 2: Phase A+Phase B quadrature pulse, quadruple frequency 3: CW+CCW	-	0	Next power-on	At stop	P
H05-16	Clear action	0: Position deviation cleared at S-OFF or fault 1: Position deviation cleared at fault 2: Position deviation cleared through ClrPosErr signal input from DI	-	0	Immediately	At stop	P
H05-17	Number of encoder frequency-division pulses	35–32767	PPR	2500	Next power-on	At stop	-

Para. No.	Name	Value Range	Unit	Default	Effective Time	Setting Condition	Related Mode
H05-19	Speed feedforward control	0: No speed feedforward 1: Internal speed feedforward	-	1	Immediately	At stop	P
H05-20	Condition for COIN (positioning completed) signal output	0: Absolute value of position deviation lower than H05-21 1: Absolute value of position deviation lower than H05-21 and filtered position reference being 0 2: Absolute value of position deviation lower than H05-21 and unfiltered position reference being 0 3: Absolute value of position deviation kept lower than H05-21 within the time defined by H05-60 and unfiltered position reference being 0	-	0	Immediately	During running	P
H05-21	Threshold of positioning completed	1-65535	Encoder/Reference unit	5872	Immediately	During running	P
H05-22	Threshold of proximity	1-65535	Encoder/Reference unit	65535	Immediately	During running	P
H05-23	Interrupt positioning selection	0: Disable 1: Enable	-	0	Next power-on	At stop	P
H05-24	Displacement of interrupt positioning	0-1073741824	Reference unit	10000	Immediately	During running	P
H05-26	Constant operating speed in interrupt positioning	0-6000	RPM	200	Immediately	During running	P
H05-27	Acceleration/Deceleration time in interrupt positioning	0-1000	ms	10	Immediately	During running	P
H05-29	Interrupt positioning cancel signal	0: Disable 1: Enable	-	1	Immediately	During running	P

Parameter Descriptions

Para. No.	Name	Value Range	Unit	Default	Effective Time	Setting Condition	Related Mode
H05-30	Homing selection	0: Disabled 1: Homing enabled by the HomingStart signal input from DI 2: Electrical homing enabled by the HomingStart signal input from DI 3: Homing enabled immediately upon power-on 4: Homing performed immediately 5: Electrical homing started 6: Current position as the home 8: DI-triggered position as the home	-	0	Immediately	During running	P

Para. No.	Name	Value Range	Unit	Default	Effective Time	Setting Condition	Related Mode
H05-31	Homing mode	0: Forward, home switch as deceleration point and home 1: Reverse, home switch as deceleration point and home 2: Forward, Z signal as deceleration point and home 3: Reverse, Z signal as deceleration point and home 4: Forward, home switch as deceleration point and Z signal as home 5: Reverse, home switch as deceleration point and Z signal as home 6: Forward, positive limit switch as deceleration point and home 7: Reverse, negative limit switch as deceleration point and home 8: Forward, positive limit switch as deceleration point and Z signal as home 9: Reverse, negative limit switch as deceleration point and Z signal as home 10: Forward, mechanical limit as deceleration point and home 11: Reverse, mechanical limit as deceleration point and home 12: Forward, mechanical limit as deceleration point and Z signal as home 13: Reverse, mechanical limit as deceleration point and Z signal as home 14: Single-turn forward homing 15: Single-turn reverse homing 16: Single-turn nearby homing	-	0	Immediately	During running	P

Parameter Descriptions

Para. No.	Name	Value Range	Unit	Default	Effective Time	Setting Condition	Related Mode
H05-32	Speed in high-speed searching for the home switch signal	0-3000	RPM	100	Immediately	During running	P
H05-33	Speed in low-speed searching for the home switch signal	0-1000	RPM	10	Immediately	During running	P
H05-34	Acceleration/Deceleration time during homing	0-1000	ms	1000	Immediately	During running	P
H05-35	Homing time limit	0-65535	ms	10000	Immediately	During running	P
H05-36	Mechanical home offset	-1073741824 to +1073741824	Reference unit	0	Immediately	During running	P
H05-38	Servo pulse output source	0: Encoder frequency-division output 1: Pulse reference synchronous output 2: Frequency-division or synchronous output inhibited	-	0	Next power-on	At stop	P
H05-39	Electronic gear ratio switchover condition	0: Switching after position reference (in reference unit) kept 0 for 2.5 ms 1: Switching in real time	-	0	Immediately	At stop	P
H05-40	Mechanical home offset and action upon overtravel	0: H05-36 as the coordinate after homing, reverse homing applied after homing triggered again upon overtravel 1: H05-36 as the relative offset after homing, reverse homing applied after homing triggered again upon overtravel 2: H05-36 as the coordinate after homing, reverse homing applied automatically upon overtravel 3: H05-36 as the relative offset after homing, reverse homing applied automatically upon overtravel	-	0	Immediately	At stop	P

Para. No.	Name	Value Range	Unit	Default	Effective Time	Setting Condition	Related Mode
H05-41	Z pulse output polarity	0: Negative (Z pulse being low level) 1: Positive (Z pulse being high level)	-	1	Next power-on	At stop	P
H05-43	Position pulse edge	0: Falling edge-triggered 1: Rising edge-triggered	1	0	Next power-on	During running	PST
H05-46	Position offset in absolute position linear mode (low 32 bits)	-2147483648 to +2147483647	Encoder unit	0	Next power-on	At stop	PST
H05-48	Position offset in absolute position linear mode (high 32 bits)	-2147483648 to +2147483647	Encoder unit	0	Next power-on	At stop	PST
H05-50	Mechanical gear ratio (numerator) in absolute position rotation mode	1-65535	1	65535	Immediately	At stop	All
H05-51	Mechanical gear ratio (denominator) in absolute position rotation mode	1-65535	1	1	Immediately	At stop	All
H05-52	Pulses per load revolution in absolute position rotation mode (low 32 bits)	0-4294967295	Encoder unit	0	Immediately	At stop	All
H05-54	Pulses per load revolution in absolute position rotation mode (high 32 bits)	0-4294967295	Encoder unit	0	Immediately	At stop	All
H05-56	Speed threshold in homing upon hit-and-stop	0-1000	RPM	2	Immediately	During running	P
H05-58	Torque limit in homing upon hit-and-stop	0-300.0	%	100.0%	Immediately	During running	P
H05-59	Window time of COIN (positioning completed) signal	0 to 30000	ms	1	Immediately	During running	P
H05-60	Hold time of COIN (positioning completed) signal	0 to 30000	ms	0	Immediately	During running	P

Para. No.	Name	Value Range	Unit	Default	Effective Time	Setting Condition	Related Mode
H05-61	Number of encoder frequency-division pulses (32-bit)	0 to 262143	PPR	0	Next power-on	At stop	-
H05-66	Homing time unit	0: ms 1: 10 ms 2: 100 ms	1	0	Immediately	At stop	P
H05-69	Auxiliary homing function	0: Disable 1: Enable single-turn homing 2: Record single-turn zero point offset 3: Start a new search for the Z signal (homing) 4: Clear single-turn zero point offset	1	0	Next power-on	At stop	P

4.7 Group H06: Speed Control Parameters

Para. No.	Name	Value Range	Unit	Default	Effective Time	Setting Condition	Related Mode
H06-00	Source of main speed reference A	0: Digital setting (H06-03)	-	0	Immediately	At stop	S
H06-01	Source of auxiliary speed reference B	0: Digital setting (H06-03) 5: Multi-speed reference	-	5	Immediately	At stop	S
H06-02	Speed reference source	0: Source of main speed reference A 1: Source of auxiliary speed reference B 2: A+B 3: Switched between A and B 4: Communication	-	0	Immediately	At stop	S
H06-03	Speed reference set through keypad	-6000 to +6000	RPM	200	Immediately	During running	S
H06-04	Jog speed	0-6000	RPM	100	Immediately	During running	S
H06-05	Acceleration ramp time constant of speed reference	0-65535	ms	0	Immediately	During running	S
H06-06	Deceleration ramp time constant of speed reference	0-65535	ms	0	Immediately	During running	S

Para. No.	Name	Value Range	Unit	Default	Effective Time	Setting Condition	Related Mode
H06-07	Maximum speed limit	0–6000	RPM	6000	Immediately	During running	S
H06-08	Forward speed limit	0–6000	RPM	6000	Immediately	During running	S
H06-09	Reverse speed limit	0–6000	RPM	6000	Immediately	During running	S
H06-11	Torque feedforward selection	0: No torque feedforward 1: Internal torque feedforward	-	1	Immediately	During running	PS
H06-15	Zero clamp speed threshold	0–6000	RPM	10	Immediately	During running	S
H06-16	Threshold of TGOON signal	0–1000	RPM	20	Immediately	During running	S
H06-17	Threshold of V-Cmp signal	0–100	RPM	10	Immediately	During running	S
H06-18	Threshold of V-Arr signal	10–6000	RPM	1000	Immediately	During running	S
H06-19	Threshold of V-Zero signal	1–6000	RPM	10	Immediately	During running	S
H06-28	Cogging torque ripple compensation selection	0–1	-	1	Immediately	During running	PS

4.8 Group H07: Torque Control Parameters

The rated torque of the motor corresponds to 100% of the torque reference.

Para. No.	Name	Value Range	Unit	Default	Effective Time	Setting Condition	Related Mode
H07-00	Source of main torque reference A	0: Digital setting (H07-03)	-	0	Immediately	At stop	T
H07-01	Source of auxiliary torque reference B	0: Digital setting (H07-03) 1: 0 (no function) 2: 0 (no function)	-	1	Immediately	At stop	T
H07-02	Torque reference source	0: Source of main torque reference A 1: Source of auxiliary torque reference B 2: A+B 3: Switched between A and B 4: Communication	-	0	Immediately	At stop	T
H07-03	Torque reference set through keypad	-300.0 to +300.0	%	0	Immediately	During running	T

Parameter Descriptions

Para. No.	Name	Value Range	Unit	Default	Effective Time	Setting Condition	Related Mode
H07-05	Torque reference filter time constant	0–30.00	ms	0.79	Immediately	During running	PST
H07-06	2nd torque reference filter time constant	0–30.00	ms	0.79	Immediately	During running	PST
H07-07	Torque limit source	0: Positive/Negative internal torque limit 1: Positive/Negative external torque limit (selected by P-CL and N-CL)	-	0	Immediately	At stop	PST
H07-09	Positive internal torque limit	0.0–400.0	%	350.0	Immediately	During running	PST
H07-10	Negative internal torque limit	0.0–400.0	%	350.0	Immediately	During running	PST
H07-11	Positive external torque limit	0.0–400.0	%	350.0	Immediately	During running	PST
H07-12	Negative external torque limit	0.0–400.0	%	350.0	Immediately	During running	PST
H07-17	Speed limit source	0: Internal speed limit (speed limit in torque control) 1: Reserved 2: H07-19 or H07-20 as defined by the DI assigned with FunIN.36 (V-SEL)	-	0	Immediately	During running	T
H07-19	Positive speed limit/Speed limit 1 in torque control	0–6000	RPM	3000	Immediately	During running	T
H07-20	Negative speed limit/Speed limit 2 in torque control	0–6000	RPM	3000	Immediately	During running	T
H07-21	Reference value for torque reach	0.0–300.0	%	0.0	Immediately	During running	PST
H07-22	Threshold of valid torque reach	0.0–300.0	%	20.0	Immediately	During running	PST
H07-23	Threshold of invalid torque reach	0.0–300.0	%	10.0	Immediately	During running	PST
H07-40	Speed limit window in torque control mode	0.5–30.0	ms	1.0	Immediately	During running	T

4.9 Group H08: Gain Parameters

Para. No.	Name	Value Range	Unit	Default	Effective Time	Setting Condition	Related Mode
H08-00	Speed loop gain	0.1–2000.0	Hz	400.0	Immediately	During running	PS
H08-01	Speed loop integral time constant	0.15–512.00	ms	19.89	Immediately	During running	PS
H08-02	Position loop gain	0.0–2000.0	Hz	64.0	Immediately	During running	P
H08-03	2nd speed loop gain	0.1–2000.0	Hz	40.0	Immediately	During running	PS
H08-04	2nd speed loop integral time constant	0.15–512.00	ms	40.00	Immediately	During running	PS
H08-05	2nd position loop gain	0.0–2000.0	Hz	64.0	Immediately	During running	P
H08-08	2nd gain set mode	0: Fixed to the 1st gain set, P/PI switched through external DI 1: Gains switched based on the condition defined by H08-09	-	1	Immediately	During running	PST
H08-09	Gain switchover condition	0: Fixed to the 1st gain set (PS) 1: Switched through external DI (PS) 2: Torque reference too large (PS) 3: Speed reference too large (PS) 4: Speed reference change rate too large (PS) 5: Speed reference high/low-speed threshold (PS) 6: Position deviation too large (P) 7: Position reference available (P) 8: Positioning completed (P) 9: Actual speed too large (P) 10: Position reference+Actual speed (P)	-	0	Immediately	During running	PST
H08-10	Gain switchover delay	0.0–1000.0	ms	5.0	Immediately	During running	PST

Parameter Descriptions

Para. No.	Name	Value Range	Unit	Default	Effective Time	Setting Condition	Related Mode
H08-11	Gain switchover level	0–20000	Based on switch over conditions	50	Immediately	During running	PST
H08-12	Gain switchover dead time	0–20000	Based on switch over conditions	30	Immediately	During running	PST
H08-13	Position gain switchover time	0.0–1000.0	ms	3.0	Immediately	During running	P
H08-15	Load moment of inertia ratio	0.00–120.00	Multiplier	1.00	Immediately	During running	PST
H08-18	Speed feedforward filter time constant	0.00–64.00	ms	0.50	Immediately	During running	P
H08-19	Speed feedforward gain	0.0–100.0	%	0.0	Immediately	During running	P
H08-20	Torque feedforward filter time constant	0.00–64.00	ms	0.50	Immediately	At stop	PS
H08-21	Torque feedforward gain	0.0–200.0	%	0.0	Immediately	During running	PS
H08-22	Speed feedback filtering option	0: Inhibited 1: Two times 2: Four times 3: Eight times 4: Sixteen times	-	0	Immediately	At stop	PS
H08-23	Cutoff frequency of speed feedback low-pass filter	100–4000	Hz	4000	Immediately	During running	PS
H08-24	PDFF control coefficient	0.0–100.0	-	100.0	Immediately	During running	PS
H08-27	Speed observer cutoff frequency	10–2000	Hz	170	Immediately	During running	PS
H08-28	Speed inertia correction coefficient	10–10000	%	100	Immediately	During running	PS
H08-29	Speed observer filter time	2–2000	0.01 ms	80	Immediately	During running	PS
H08-31	Disturbance observer cutoff frequency	10–1700	Hz	600	Immediately	During running	PS
H08-32	Disturbance observer compensation coefficient	0–100	%	0	Immediately	During running	PS

Para. No.	Name	Value Range	Unit	Default	Effective Time	Setting Condition	Related Mode
H08-33	Disturbance observer inertia correction coefficient	0–100	%	100	Immediately	During running	PS
H08-40	Speed observer selection	0–1	-	0	Immediately	At stop	PS
H08-41	Disturbance observer torque switch	0–2	-	0	Immediately	During running	PS
H08-42	Model control selection	0–1	-	0	Immediately	At stop	P
H08-43	Model gain	0–10000	-	400	Immediately	During running	P
H08-46	Model feedforward	0–1024	-	950	Immediately	During running	P
H08-51	Model filter time 2	0–2000	0.01 ms	0	Immediately	During running	P
H08-53	Medium- and low-frequency jitter suppression frequency 3	0–6000	0.1 Hz	0	Immediately	During running	P
H08-54	Medium- and low-frequency jitter suppression compensation coefficient 3	0–200	%	0	Immediately	During running	P
H08-56	Medium- and low-frequency jitter suppression phase modulation coefficient 3	0–1600	%	0	Immediately	During running	P
H08-58	Er.660 switch	0–2	-	0	Immediately	During running	PS
H08-59	Medium- and low-frequency jitter suppression frequency 4	0–6000	0.1 Hz	0	Immediately	During running	P
H08-60	Medium- and low-frequency jitter suppression compensation coefficient 4	0–200	%	0	Immediately	During running	P
H08-61	Medium- and low-frequency jitter suppression phase modulation coefficient 4	0–1600	%	0	Immediately	During running	P

Para. No.	Name	Value Range	Unit	Default	Effective Time	Setting Condition	Related Mode
H08-62	Position loop integral time constant	15–51200	0.01 ms	0	Immediately	During running	P
H08-63	2nd position loop integral time constant	15–51200	0.01 ms	0	Immediately	During running	P

4.10 Group H09: Auto-tuning Parameters

Para. No.	Name	Value Range	Unit	Default	Effective Time	Setting Condition	Related Mode
H09-00	Gain auto-tuning mode	0: Disabled, gain parameters tuned manually 1: Standard stiffness level mode, gain parameters tuned automatically based on the stiffness level 2: Positioning mode, gain parameters tuned automatically based on the stiffness level 3: Interpolation mode + Inertia auto-tuning 4: Normal mode + Inertia auto-tuning 6: Quick positioning mode + Inertia auto-tuning	-	0	Immediately	During running	PST
H09-01	Stiffness level	0–41	-	15	Immediately	During running	PST
H09-02	Adaptive notch mode	0: Adaptive notch no longer updated 1: One adaptive notch (3rd notch) activated 2: Two adaptive notches (3rd and 4th notches) activated 3: Resonance point tested only, displayed in H09-24 4: Values of the 3rd and 4th notches restored to default	-	0	Immediately	During running	PST
H09-03	Online inertia auto-tuning mode	0: Disabled 1: Enabled, changing slowly 2: Enabled, changing normally 3: Enabled, changing quickly	-	0	Immediately	During running	RST
H09-04	Low-frequency resonance suppression mode	0: Vibration frequency set manually 1: Vibration frequency set automatically	-	0	Immediately	During running	P

Para. No.	Name	Value Range	Unit	Default	Effective Time	Setting Condition	Related Mode
H09-05	Offline inertia auto-tuning mode	0: Positive/Negative triangular wave mode 1: Jog mode 2: Dual-direction auto-tuning mode 3: Single-direction auto-tuning mode	-	0	Immediately	At stop	PST
H09-06	Maximum speed of inertia auto-tuning	100–1000	RPM	500	Immediately	At stop	PST
H09-07	Time constant for accelerating to the max. speed during inertia auto-tuning	20–800	ms	125	Immediately	At stop	PST
H09-08	Waiting time after an individual inertia auto-tuning	50–10000	ms	800	Immediately	At stop	PST
H09-09	Number of motor revolutions per inertia auto-tuning	0.00–2.00	r	-	-	At display	PST
H09-11	Vibration threshold	0–1000	0.1%	50	Immediately	During running	PS
H09-12	Frequency of the 1st notch	50–4000	Hz	4000	Immediately	During running	PS
H09-13	Width level of the 1st notch	0–20	-	2	Immediately	During running	PS
H09-14	Depth level of the 1st notch	0–99	-	0	Immediately	During running	PS
H09-15	Frequency of the 2nd notch	50–4000	Hz	4000	Immediately	During running	PS
H09-16	Width level of the 2nd notch	0–20	-	2	Immediately	During running	PS
H09-17	Depth level of the 2nd notch	0–99	-	0	Immediately	During running	PS
H09-18	Frequency of the 3rd notch	50–4000	Hz	4000	Immediately	During running	PS
H09-19	Width level of the 3rd notch	0–20	-	2	Immediately	During running	PS

Parameter Descriptions

Para. No.	Name	Value Range	Unit	Default	Effective Time	Setting Condition	Related Mode
H09-20	Depth level of the 3rd notch	0–99	-	0	Immediately	During running	PS
H09-21	Frequency of the 4th notch	50–4000	Hz	4000	Immediately	During running	PS
H09-22	Width level of the 4th notch	0–20	-	2	Immediately	During running	PS
H09-23	Depth level of the 4th notch	0–99	-	0	Immediately	During running	PS
H09-24	Auto-tuned resonance frequency	0–2	Hz	0	-	At display	PS
H09-30	Torque disturbance compensation gain	0.0–100.0	%	0.0	Immediately	During running	PS
H09-31	Filter time constant of torque disturbance observer	0.00–25.00	ms	0.50	Immediately	During running	PS
H09-32	Gravity compensation value	0–1000	0.1%	0	Immediately	During running	P
H09-33	Forward friction compensation	0–1000	0.1%	0	Immediately	During running	P
H09-34	Reverse friction compensation	-1000–0	0.1%	0	Immediately	During running	P
H09-35	Friction compensation speed threshold	1–300	0.1 RPM	0	Immediately	During running	P
H09-36	Friction compensation speed	0–0x12	-	0	Immediately	During running	P
H09-37	Vibration monitoring time	0–65535	1s	1200	Immediately	During running	PS
H09-38	Low-frequency resonance frequency at mechanical load end	1.0–100.0	Hz	100.0	Immediately	During running	P
H09-39	Low-frequency resonance suppression at mechanical load end	0–3	-	2	Immediately	During running	P

Para. No.	Name	Value Range	Unit	Default	Effective Time	Setting Condition	Related Mode
H09-41	Frequency of the 5th notch	50–8000	Hz	4000	Immediately	During running	PS
H09-42	Width level of the 5th notch	0–20	-	2	Immediately	During running	PS
H09-43	Depth level of the 5th notch	0–99	-	0	Immediately	During running	PS
H09-44	Frequency of low-frequency resonance suppression 1 at mechanical load end	0–200.0	Hz	0	Immediately	During running	P
H09-45	Responsiveness of low-frequency resonance suppression 1 at mechanical load end	0.01–10	Hz	1.00	Immediately	During running	P
H09-47	Width of low-frequency resonance suppression 1 at mechanical load end	0–2.00	Hz	1.00	Immediately	During running	P
H09-49	Frequency of low-frequency resonance suppression 2 at mechanical load end	0–200.0	Hz	0	Immediately	During running	P
H09-50	Responsiveness of low-frequency resonance suppression 2 at mechanical load end	0.01–10.00	Hz	1.00	Immediately	During running	P
H09-52	Width of low-frequency resonance suppression 2 at mechanical load end	0–2.00	Hz	1.00	Immediately	During running	P

4.11 Group H0A Fault and Protection Parameters

Para. No.	Name	Value Range	Unit	Default	Effective Time	Setting Condition	Related Mode
H0A-00	Power input phase loss protection	0: Enable phase loss fault and inhibit phase loss warning 1: Enable phase loss fault and warning 2: Inhibit phase loss fault and warning	-	0	Immediately	During running	-
H0A-02	Vibration alarm switch	0: Enable 1: Disable	-	0	Immediately	During running	-
H0A-03	Power-off memory	0: Disable 1: Enable	-	0	Immediately	During running	-
H0A-04	Motor overload protection gain	50–3002	%	100	Immediately	At stop	-
H0A-08	Overspeed threshold	0–10000	RPM	0	Immediately	During running	PST
H0A-09	Maximum position pulse frequency	100–4000	kHz	4000	Immediately	At stop	P
H0A-10	Threshold of excessive position deviation	1–1073741824	Encoder/Reference unit	27486951	Immediately	During running	P
H0A-12	Runaway protection	0: Disable 1: Enable	-	1	Immediately	During running	PST
H0A-16	Threshold of low-frequency resonance position deviation	1–1000	Encoder unit	5	Immediately	During running	P
H0A-17	Position setting unit	0: Encoder unit 1: Reference unit	-	0	Immediately	At stop	P
H0A-19	DI8 filter time constant	0–255	25 ns	80	Next power-on	At stop	-
H0A-20	DI9 filter time constant	0–255	25 ns	80	Next power-on	At stop	-
H0A-24	Filter time constant of low-speed pulse input pin	0–255	25 ns	30	Next power-on	At stop	P
H0A-25	Filter time constant of speed feedback display value	0–5000	ms	50	Immediately	At stop	-

Para. No.	Name	Value Range	Unit	Default	Effective Time	Setting Condition	Related Mode
H0A-26	Motor overload detection	0: Enable 1: Disable 2: No meaning 3: Enable a new motor overload detection	-	3	Immediately	At stop	-
H0A-27	Speed DO filter time constant	0–5000	ms	10	Immediately	At stop	-
H0A-28	Quadrature encoder filter time constant	0–255	25 ns	30	Next power-on	At stop	-
H0A-30	Filter time constant of high-speed pulse input pin	0–255	25 ns	3	Next power-on	At stop	P
H0A-32	Time window of motor stall over-temperature protection	10–65535	ms	200	Immediately	During running	-
H0A-33	Motor stall over-temperature detection	0: Disable 1: Enable	-	1	Immediately	During running	-
H0A-36	Encoder multi-turn overflow fault	0: Not hide 1: Hide	-	0	Immediately	At stop	All
H0A-40	Software position limit	0: Disabled 1: Enabled immediately upon power-on 2: Enabled after homing	-	0	Immediately	At stop	PST
H0A-41	Maximum value of software position limit	-2147483648 to +2147483647	Reference unit	2147483647	Immediately	At stop	PST
H0A-43	Minimum value of software position limit	-2147483648 to +2147483647	Reference unit	-2147483648	Immediately	At stop	PST

4.12 Group H0B Monitoring Parameters

Para. No.	Name	Value Range	Unit	Default	Effective Time	Setting Condition	Related Mode
H0B-00	Motor speed actual value	-	RPM	-	-	At display	PST
H0B-01	Speed reference	-	RPM	-	-	At display	PS
H0B-02	Internal torque reference (relative to the rated torque)	-	%	-	-	At display	PST
H0B-03	Monitored DI status	-	-	-	-	At display	PST

Parameter Descriptions

Para. No.	Name	Value Range	Unit	Default	Effective Time	Setting Condition	Related Mode
H0B-05	Monitored DO status	-	-	-	-	At display	PST
H0B-07	Absolute position counter (32-bit decimal)	-	Reference unit	-	-	At display	PST
H0B-09	Mechanical angle (pulses starting from the home)	-	Encoder unit	-	-	At display	PST
H0B-10	Electrical angle	-	°	-	-	At display	PST
H0B-11	Speed corresponding to the input position reference	-	RPM	-	-	At display	P
H0B-12	Average load rate	-	%	-	-	At display	PST
H0B-13	Input reference pulse counter (32-bit decimal)	-	Reference unit	-	-	At display	P
H0B-15	Encoder position deviation counter (32-bit decimal)	-	Encoder unit	-	-	At display	P
H0B-17	Feedback pulse counter (32-bit decimal)	-	Encoder unit	-	-	At display	PST
H0B-19	Total power-on time (32-bit decimal)	-	s	-	-	At display	PST
H0B-24	RMS value of phase current	-	A	-	-	At display	PST
H0B-26	Bus voltage	-	V	-	-	At display	PST
H0B-27	Power module temperature	-	°C	-	-	At display	PST
H0B-33	Fault log	0: Present fault 1: Last fault 2: 2nd to last fault ... 9: 9th to last fault	-	0	Immediately	During running	PST
H0B-34	Fault code of the selected fault	-	-	-	-	At display	PST
H0B-35	Time stamp upon occurrence of the selected fault	-	s	-	-	At display	PST
H0B-37	Motor speed upon occurrence of the selected fault	-	RPM	-	-	At display	PST
H0B-38	Motor phase U current upon occurrence of the selected fault	-	A	-	-	At display	PST
H0B-39	Motor phase V current upon occurrence of the selected fault	-	A	-	-	At display	PST

Para. No.	Name	Value Range	Unit	Default	Effective Time	Setting Condition	Related Mode
H0B-40	Bus voltage upon occurrence of the selected fault	-	V	-	-	At display	PST
H0B-41	DI status upon occurrence of the selected fault	-	-	-	-	At display	PST
H0B-42	DO status upon occurrence of the selected fault	-	-	-	-	At display	PST
H0B-53	Position deviation counter	-	Reference unit	-	-	At display	P
H0B-55	Motor speed actual value (0.1 RPM)	-	RPM	-	-	At display	PST
H0B-58	Mechanical absolute position (low 32 bits)	-	Encoder unit	0	-	At display	All
H0B-60	Mechanical absolute position (high 32 bits)	-	Encoder unit	0	-	At display	All
H0B-64	Real-time input position reference counter	-	Reference unit	-	-	At display	PST
H0B-70	Number of revolutions fed back by the absolute encoder	-	r	0	-	At display	All
H0B-71	Single-turn position fed back by the absolute encoder	-	Encoder unit	0	-	At display	All
H0B-73	Single-turn offset position of absolute encoder	-	Encoder unit	0	-	At display	All
H0B-77	Absolute position fed back by the absolute encoder (low 32 bits)	-	Encoder unit	0	-	At display	All
H0B-79	Absolute position fed back by the absolute encoder (high 32 bits)	-	Encoder unit	0	-	At display	All
H0B-81	Single-turn position of the rotating load (low 32 bits)	-	Encoder unit	0	-	At display	All
H0B-83	Single-turn position of the rotating load (high 32 bits)	-	Encoder unit	0	-	At display	All
H0B-85	Single-turn position of the rotating load	-	Reference unit	0	-	At display	All

4.13 Group H0C: Communication Parameters

Para. No.	Name	Value Range	Unit	Default	Effective Time	Setting Condition	Related Mode
H0C-00	Servo axis address	1–247 (0: Broadcast address)	-	1	Immediately	During running	PST
H0C-02	Serial baud rate	0: 2400 bps 1: 4800 bps 2: 9600 bps 3: 19200 bps 4: 38400 bps 5: 57600 bps 6: 115200 bps	-	5	Immediately	During running	PST
H0C-03	Modbus data format	0: No parity, 2 stop bits 1: Even parity, 1 stop bit 2: Odd parity, 1 stop bit 3: No parity, 1 stop bit	-	0	Immediately	During running	PST
H0C-08	CAN communication rate	0: 20 kbps 1: 50 kbps 2: 100 kbps 3: 125 kbps 4: 250 kbps 5: 500 kbps 6: 1 Mbps 7: 1 Mbps	-	5	Immediately	During running	PST
H0C-09	Communication VDI	0: Disabled 1: Enable	-	0	Immediately	At stop	PST
H0C-10	VDI default value upon power-on	Bit0: VDI1 default value ... Bit15: VDI16 default value	-	0	Next power-on	During running	PST
H0C-11	Communication VDO	0: Disabled 1: Enable	-	0	Immediately	At stop	PST
H0C-12	Default level of the VDO assigned with function 0	Bit0: VDO1 default value ... Bit15: VDO16 default value	-	0	Immediately	At stop	PST
H0C-13	Update parameter values written through Modbus communication to EEPROM	0: Not updated to EEPROM 1: Updated to EEPROM, except parameters in groups H0B and H0D	-	1	Immediately	During running	PST

Para. No.	Name	Value Range	Unit	Default	Effective Time	Setting Condition	Related Mode
H0C-14	Modbus error code	New protocol: <ul style="list-style-type: none"> ● 0x0001: Illegal function (command code) ● 0x0002: Illegal data address ● 0x0003: Illegal data ● 0x0004: Slave device fault Old protocol: <ul style="list-style-type: none"> ● 0x0002: The command code is not 0x03/0x06/0x10. ● 0x0004: The CRC check code received and calculated by the servo drive differs from the check code in the data frame. ● 0x0008: The parameter to be accessed does not exist. ● 0x0010: The parameter written value exceeds the upper/lower limit. ● 0x0080: The parameter being written is modifiable only in the stop state but the servo drive is in the operating state. 	1	-	-	At display	-
H0C-16	Update parameter values written through CAN communication to EEPROM	0: Not updated to EEPROM 1: Updated to EEPROM, except parameters in groups H0B and H0D	-	0	Immediately	During running	PST
H0C-25	Modbus command response delay	0–5000	ms	1	Immediately	During running	PST
H0C-26	Sequence of Modbus communication data bits	0: High 16 bits before low 16 bits 1: Low 16 bits before high 16 bits	1	1	Immediately	During running	PST
H0C-30	Modbus error frame format	0: Old protocol 1: New protocol (standard protocol)	1	1	Immediately	During running	PST

4.14 Group H0D: Auxiliary Function Parameters

Para. No.	Name	Value Range	Unit	Default	Effective Time	Setting Condition	Related Mode
H0D-00	Software reset	0: No operation 1: Enable	-	0	Immediately	At stop	-
H0D-01	Fault reset	0: No operation 1: Enable	-	0	Immediately	At stop	-
H0D-02	Offline inertia auto-tuning	-	-	-	Immediately	During running	-
H0D-03	Reserved	-	-	-	-	-	-
H0D-05	Emergency stop	0: No operation 1: Enable	-	0	Immediately	During running	-
H0D-11	Jog function	(with filter)	-	-	-	-	-
H0D-17	Forced DI/DO selection	0: No operation 1: Forced DI enabled, forced DO disabled 2: Forced DO enabled, forced DI disabled 3: Forced DI and DO enabled	-	0	Immediately	During running	-
H0D-18	Forced DI setting	0–0x01FF	-	0x01FF	Immediately	During running	-
H0D-19	Forced DO setting	0–0x001F	-	0	Immediately	During running	-
H0D-20	Absolute encoder reset selection	0: No operation 1: Reset encoder fault 2: Reset encoder fault and multi-turn data	-	0	Immediately	At stop	All

4.15 Group H11: Multi-Position Parameters

Para. No.	Name	Value Range	Unit	Default	Effective Time	Setting Condition	Related Mode
H11-00	Multi-position operation mode	0: Individual operation (number of positions defined by H11-01) 1: Cyclic operation (number of positions defined by H11-01) 2: DI-based operation (selected through DI) 3: Cyclic operation (number of positions defined by H11-01) 5: Axis-controlled continuous operation	-	1	Immediately	At stop	P
H11-01	Number of displacement references in multi-position mode	1–16	-	1	Immediately	At stop	P
H11-02	Start displacement no. after pause	Active when H11-00 is set to 0, 1, 3 or 5 0: Continue to execute the unexecuted displacements 1: Start from displacement 1	-	0	Immediately	At stop	P
H11-03	Time unit	0: ms 1: s	-	0	Immediately	At stop	P
H11-04	Displacement reference type	0: Relative displacement reference 1: Absolute displacement reference	-	0	Immediately	During running	P
H11-05	Start displacement no. in sequential operation	0–16	-	0	Immediately	At stop	P
H11-09	Deceleration upon axis-control OFF	0–65535	ms	65535	Immediately	During running	P
H11-10	Start speed of displacement 1	0–6000	RPM	0	Immediately	During running	P
H11-11	Stop speed of displacement 1	0–6000	RPM	0	Immediately	During running	P
H11-12	Displacement 1	-1073741824 to +1073741824	Reference unit	10000	Immediately	During running	P
H11-14	Maximum speed of displacement 1	1–6000	RPM	200	Immediately	During running	P

Parameter Descriptions

Para. No.	Name	Value Range	Unit	Default	Effective Time	Setting Condition	Related Mode
H11-15	Acceleration/ Deceleration time of displacement 1	0–65535	ms (s)	10	Immediately	During running	P
H11-16	Waiting time after displacement 1	0–10000	ms (s)	10	Immediately	During running	P
H11-17	Displacement 2	-1073741824 to +1073741824	Reference unit	10000	Immediately	During running	P
H11-19	Maximum speed of displacement 2	1–6000	RPM	200	Immediately	During running	P
H11-20	Acceleration/ Deceleration time of displacement 2	0–65535	ms (s)	10	Immediately	During running	P
H11-21	Waiting time after displacement 2	0–10000	ms (s)	10	Immediately	During running	P
H11-22	Displacement 3	-1073741824 to +1073741824	Reference unit	10000	Immediately	During running	P
H11-24	Maximum speed of displacement 3	1–6000	RPM	200	Immediately	During running	P
H11-25	Acceleration/ Deceleration time of displacement 3	0–65535	ms (s)	10	Immediately	During running	P
H11-26	Waiting time after displacement 3	0–10000	ms (s)	10	Immediately	During running	P
H11-27	Displacement 4	-1073741824 to +1073741824	Reference unit	10000	Immediately	During running	P
H11-29	Maximum speed of displacement 4	1–6000	RPM	200	Immediately	During running	P
H11-30	Acceleration/ Deceleration time of displacement 4	0–65535	ms (s)	10	Immediately	During running	P
H11-31	Waiting time after displacement 4	0–10000	ms (s)	10	Immediately	During running	P
H11-32	Displacement 5	-1073741824 to +1073741824	Reference unit	10000	Immediately	During running	P
H11-34	Maximum speed of displacement 5	1–6000	RPM	200	Immediately	During running	P
H11-35	Acceleration/ Deceleration time of displacement 5	0–65535	ms (s)	10	Immediately	During running	P
H11-36	Waiting time after displacement 5	0–10000	ms (s)	10	Immediately	During running	P
H11-37	Displacement 6	-1073741824 to +1073741824	Reference unit	10000	Immediately	During running	P

Para. No.	Name	Value Range	Unit	Default	Effective Time	Setting Condition	Related Mode
H11-39	Maximum speed of displacement 6	1-6000	RPM	200	Immediately	During running	P
H11-40	Acceleration/Deceleration time of displacement 6	0-65535	ms (s)	10	Immediately	During running	P
H11-41	Waiting time after displacement 6	0-10000	ms (s)	10	Immediately	During running	P
H11-42	Displacement 7	-1073741824 to +1073741824	Reference unit	10000	Immediately	During running	P
H11-44	Maximum speed of displacement 7	1-6000	RPM	200	Immediately	During running	P
H11-45	Acceleration/Deceleration time of displacement 7	0-65535	ms (s)	10	Immediately	During running	P
H11-46	Waiting time after displacement 7	0-10000	ms (s)	10	Immediately	During running	P
H11-47	Displacement 8	-1073741824 to +1073741824	Reference unit	10000	Immediately	During running	P
H11-49	Maximum speed of displacement 8	1-6000	RPM	200	Immediately	During running	P
H11-50	Acceleration/Deceleration time of displacement 8	0-65535	ms (s)	10	Immediately	During running	P
H11-51	Waiting time after displacement 8	0-10000	ms (s)	10	Immediately	During running	P
H11-52	Displacement 9	-1073741824 to +1073741824	Reference unit	10000	Immediately	During running	P
H11-54	Maximum speed of displacement 9	1-6000	RPM	200	Immediately	During running	P
H11-55	Acceleration/Deceleration time of displacement 9	0-65535	ms (s)	10	Immediately	During running	P
H11-56	Waiting time after displacement 9	0-10000	ms (s)	10	Immediately	During running	P
H11-57	Displacement 10	-1073741824 to +1073741824	Reference unit	10000	Immediately	During running	P
H11-59	Maximum speed of displacement 10	1-6000	RPM	200	Immediately	During running	P
H11-60	Acceleration/Deceleration time of displacement 10	0-65535	ms (s)	10	Immediately	During running	P
H11-61	Waiting time after displacement 10	0-10000	ms (s)	10	Immediately	During running	P

Parameter Descriptions

Para. No.	Name	Value Range	Unit	Default	Effective Time	Setting Condition	Related Mode
H11-62	Displacement 11	-1073741824 to +1073741824	Reference unit	10000	Immediately	During running	P
H11-64	Maximum speed of displacement 11	1-6000	RPM	200	Immediately	During running	P
H11-65	Acceleration/ Deceleration time of displacement 11	0-65535	ms (s)	10	Immediately	During running	P
H11-66	Waiting time after displacement 11	0-10000	ms (s)	10	Immediately	During running	P
H11-67	Displacement 12	-1073741824 to +1073741824	Reference unit	10000	Immediately	During running	P
H11-69	Maximum speed of displacement 12	1-6000	RPM	200	Immediately	During running	P
H11-70	Acceleration/ Deceleration time of displacement 12	0-65535	ms (s)	10	Immediately	During running	P
H11-71	Waiting time after displacement 12	0-10000	ms (s)	10	Immediately	During running	P
H11-72	Displacement 13	-1073741824 to +1073741824	Reference unit	10000	Immediately	During running	P
H11-74	Maximum speed of displacement 13	1-6000	RPM	200	Immediately	During running	P
H11-75	Acceleration/ Deceleration time of displacement 13	0-65535	ms (s)	10	Immediately	During running	P
H11-76	Waiting time after displacement 13	0-10000	ms (s)	10	Immediately	During running	P
H11-77	Displacement 14	-1073741824 to +1073741824	Reference unit	10000	Immediately	During running	P
H11-79	Maximum speed of displacement 14	1-6000	RPM	200	Immediately	During running	P
H11-80	Acceleration/ Deceleration time of displacement 14	0-65535	ms (s)	10	Immediately	During running	P
H11-81	Waiting time after displacement 14	0-10000	ms (s)	10	Immediately	During running	P
H11-82	Displacement 15	-1073741824 to +1073741824	Reference unit	10000	Immediately	During running	P
H11-84	Maximum speed of displacement 15	1-6000	RPM	200	Immediately	During running	P
H11-85	Acceleration/ Deceleration time of displacement 15	0-65535	ms (s)	10	Immediately	During running	P

Para. No.	Name	Value Range	Unit	Default	Effective Time	Setting Condition	Related Mode
H11-86	Waiting time after displacement 15	0–10000	ms (s)	10	Immediately	During running	P
H11-87	Displacement 16	-1073741824 to +1073741824	Reference unit	10000	Immediately	During running	P
H11-89	Maximum speed of displacement 16	1–6000	RPM	200	Immediately	During running	P
H11-90	Acceleration/Deceleration time of displacement 16	0–65535	ms (s)	10	Immediately	During running	P
H11-91	Waiting time after displacement 16	0–10000	ms (s)	10	Immediately	During running	P

4.16 Group H12 Multi-Speed Parameters

Para. No.	Name	Value Range	Unit	Default	Effective Time	Setting Condition	Related Mode
H12-00	Multi-speed operation mode	0: Individual operation (number of speeds defined by H12-01) 1: Cyclic operation (number of speeds defined by H12-01) 2: DI-based operation	-	1	Immediately	At stop	S
H12-01	Number of speed references in multi-speed operation	1–16	-	16	Immediately	At stop	S
H12-02	Operating time unit	0: sec 1: min	-	0	Immediately	During running	S
H12-03	Acceleration time 1	0–65535	ms	10	Immediately	During running	S
H12-04	Deceleration time 1	0–65535	ms	10	Immediately	During running	S
H12-05	Acceleration time 2	0–65535	ms	50	Immediately	During running	S
H12-06	Deceleration time 2	0–65535	ms	50	Immediately	During running	S
H12-07	Acceleration time 3	0–65535	ms	100	Immediately	During running	S
H12-08	Deceleration time 3	0–65535	ms	100	Immediately	During running	S
H12-09	Acceleration time 4	0–65535	ms	150	Immediately	During running	S

Parameter Descriptions

Para. No.	Name	Value Range	Unit	Default	Effective Time	Setting Condition	Related Mode
H12-10	Deceleration time 4	0-65535	ms	150	Immediately	During running	S
H12-20	Speed 1	-6000 to +6000	RPM	0	Immediately	During running	S
H12-21	Operating time of speed 1	0-6553.5	s(min)	5.0	Immediately	During running	S
H12-22	Acceleration/ Deceleration time of speed 1	0: Zero acceleration/ deceleration time 1: Acceleration/ Deceleration time 1 2: Acceleration/ Deceleration time 2 3: Acceleration/ Deceleration time 3 4: Acceleration/ Deceleration time 4	-	0	Immediately	During running	S
H12-23	Speed 2	-6000 to +6000	RPM	100	Immediately	During running	S
H12-24	Operating time of speed 2	0-6553.5	s(min)	5.0	Immediately	During running	S
H12-25	Acceleration/ Deceleration time of speed 2	0: Zero acceleration/ deceleration time 1: Acceleration/ Deceleration time 1 2: Acceleration/ Deceleration time 2 3: Acceleration/ Deceleration time 3 4: Acceleration/ Deceleration time 4	-	0	Immediately	During running	S
H12-26	Speed 3	-6000 to +6000	RPM	300	Immediately	During running	S
H12-27	Operating time of speed 3	0-6553.5	s(min)	5.0	Immediately	During running	S
H12-28	Acceleration/ Deceleration time of speed 3	0: Zero acceleration/ deceleration time 1: Acceleration/ Deceleration time 1 2: Acceleration/ Deceleration time 2 3: Acceleration/ Deceleration time 3 4: Acceleration/ Deceleration time 4	-	0	Immediately	During running	S
H12-29	Speed 4	-6000 to +6000	RPM	500	Immediately	During running	S

Para. No.	Name	Value Range	Unit	Default	Effective Time	Setting Condition	Related Mode
H12-30	Operating time of speed 4	0-6553.5	s(min)	5.0	Immediately	During running	S
H12-31	Acceleration/ Deceleration time of speed 4	0: Zero acceleration/ deceleration time 1: Acceleration/ Deceleration time 1 2: Acceleration/ Deceleration time 2 3: Acceleration/ Deceleration time 3 4: Acceleration/ Deceleration time 4	-	0	Immediately	During running	S
H12-32	Speed 5	-6000 to +6000	RPM	700	Immediately	During running	S
H12-33	Operating time of speed 5	0-6553.5	s(min)	5.0	Immediately	During running	S
H12-34	Acceleration/ Deceleration time of speed 5	0: Zero acceleration/ deceleration time 1: Acceleration/ Deceleration time 1 2: Acceleration/ Deceleration time 2 3: Acceleration/ Deceleration time 3 4: Acceleration/ Deceleration time 4	-	0	Immediately	During running	S
H12-35	Speed 6	-6000 to +6000	RPM	900	Immediately	During running	S
H12-36	Operating time of speed 6	0-6553.5	s(min)	5.0	Immediately	During running	S
H12-37	Acceleration/ Deceleration time of speed 6	0: Zero acceleration/ deceleration time 1: Acceleration/ Deceleration time 1 2: Acceleration/ Deceleration time 2 3: Acceleration/ Deceleration time 3 4: Acceleration/ Deceleration time 4	-	0	Immediately	During running	S
H12-38	Speed 7	-6000 to +6000	RPM	600	Immediately	During running	S
H12-39	Operating time of speed 7	0-6553.5	s(min)	5.0	Immediately	During running	S

Parameter Descriptions

Para. No.	Name	Value Range	Unit	Default	Effective Time	Setting Condition	Related Mode
H12-40	Acceleration/ Deceleration time of speed 7	0: Zero acceleration/ deceleration time 1: Acceleration/ Deceleration time 1 2: Acceleration/ Deceleration time 2 3: Acceleration/ Deceleration time 3 4: Acceleration/ Deceleration time 4	-	0	Immediately	During running	S
H12-41	Speed 8	-6000 to +6000	RPM	300	Immediately	During running	S
H12-42	Operating time of speed 8	0-6553.5	s(min)	5.0	Immediately	During running	S
H12-43	Acceleration/ Deceleration time of speed 8	0: Zero acceleration/ deceleration time 1: Acceleration/ Deceleration time 1 2: Acceleration/ Deceleration time 2 3: Acceleration/ Deceleration time 3 4: Acceleration/ Deceleration time 4	-	0	Immediately	During running	S
H12-44	Speed 9	-6000 to +6000	RPM	100	Immediately	During running	S
H12-45	Operating time of speed 9	0-6553.5	s(min)	5.0	Immediately	During running	S
H12-46	Acceleration/ Deceleration time of speed 9	0: Zero acceleration/ deceleration time 1: Acceleration/ Deceleration time 1 2: Acceleration/ Deceleration time 2 3: Acceleration/ Deceleration time 3 4: Acceleration/ Deceleration time 4	-	0	Immediately	During running	S
H12-47	Speed 10	-6000 to +6000	RPM	-100	Immediately	During running	S
H12-48	Operating time of speed 10	0-6553.5	s(min)	5.0	Immediately	During running	S

Para. No.	Name	Value Range	Unit	Default	Effective Time	Setting Condition	Related Mode
H12-49	Acceleration/ Deceleration time of speed 10	0: Zero acceleration/ deceleration time 1: Acceleration/ Deceleration time 1 2: Acceleration/ Deceleration time 2 3: Acceleration/ Deceleration time 3 4: Acceleration/ Deceleration time 4	-	0	Immediately	During running	S
H12-50	Speed 11	-6000 to +6000	RPM	-300	Immediately	During running	S
H12-51	Operating time of speed 11	0-6553.5	s(min)	5.0	Immediately	During running	S
H12-52	Acceleration/ Deceleration time of speed 11	0: Zero acceleration/ deceleration time 1: Acceleration/ Deceleration time 1 2: Acceleration/ Deceleration time 2 3: Acceleration/ Deceleration time 3 4: Acceleration/ Deceleration time 4	-	0	Immediately	During running	S
H12-53	Speed 12	-6000 to +6000	RPM	-500	Immediately	During running	S
H12-54	Operating time of speed 12	0-6553.5	s(min)	5.0	Immediately	During running	S
H12-55	Acceleration/ Deceleration time of speed 12	0: Zero acceleration/ deceleration time 1: Acceleration/ Deceleration time 1 2: Acceleration/ Deceleration time 2 3: Acceleration/ Deceleration time 3 4: Acceleration/ Deceleration time 4	-	0	Immediately	During running	S
H12-56	Speed 13	-6000 to +6000	RPM	-700	Immediately	During running	S
H12-57	Operating time of speed 13	0-6553.5	s(min)	5.0	Immediately	During running	S

Parameter Descriptions

Para. No.	Name	Value Range	Unit	Default	Effective Time	Setting Condition	Related Mode
H12-58	Acceleration/ Deceleration time of speed 13	0: Zero acceleration/ deceleration time 1: Acceleration/ Deceleration time 1 2: Acceleration/ Deceleration time 2 3: Acceleration/ Deceleration time 3 4: Acceleration/ Deceleration time 4	-	0	Immediately	During running	S
H12-59	Speed 14	-6000 to +6000	RPM	-900	Immediately	During running	S
H12-60	Operating time of speed 14	0-6553.5	s(min)	5.0	Immediately	During running	S
H12-61	Acceleration/ Deceleration time of speed 14	0: Zero acceleration/ deceleration time 1: Acceleration/ Deceleration time 1 2: Acceleration/ Deceleration time 2 3: Acceleration/ Deceleration time 3 4: Acceleration/ Deceleration time 4	-	0	Immediately	During running	S
H12-62	Speed 15	-6000 to +6000	RPM	-600	Immediately	During running	S
H12-63	Operating time of speed 15	0-6553.5	s(min)	5.0	Immediately	During running	S
H12-64	Acceleration/ Deceleration time of speed 15	0: Zero acceleration/ deceleration time 1: Acceleration/ Deceleration time 1 2: Acceleration/ Deceleration time 2 3: Acceleration/ Deceleration time 3 4: Acceleration/ Deceleration time 4	-	0	Immediately	During running	S
H12-65	Speed 16	-6000 to +6000	RPM	-300	Immediately	During running	S

Para. No.	Name	Value Range	Unit	Default	Effective Time	Setting Condition	Related Mode
H12-66	Operating time of speed 16	0–6553.5	s(min)	5.0	Immediately	During running	S
H12-67	Acceleration/ Deceleration time of speed 16	0: Zero acceleration/ deceleration time 1: Acceleration/ Deceleration time 1 2: Acceleration/ Deceleration time 2 3: Acceleration/ Deceleration time 3 4: Acceleration/ Deceleration time 4	-	0	Immediately	During running	S

4.17 Group H17: VDI/VDO Parameters

Para. No.	Name	Value Range	Unit	Default	Effective Time	Setting Condition	Related Mode
H17-00	VDI1 function	0–41	-	0	At stop	During running	-
H17-01	VDI1 logic	0: Active when the written value is 1 1: Active when the written value changes from 0 to 1	-	0	At stop	During running	-
H17-02	VDI2 function	0–41	-	0	At stop	During running	-
H17-03	VDI2 logic	0: Active when the written value is 1 1: Active when the written value changes from 0 to 1	-	0	At stop	During running	-
H17-04	VDI3 function	0–41	-	0	At stop	During running	-
H17-05	VDI3 logic	0: Active when the written value is 1 1: Active when the written value changes from 0 to 1	-	0	At stop	During running	-
H17-06	VDI4 function	0–41	-	0	At stop	During running	-
H17-07	VDI4 logic	0: Active when the written value is 1 1: Active when the written value changes from 0 to 1	-	0	At stop	During running	-
H17-08	VDI5 function	0–41	-	0	At stop	During running	-

Parameter Descriptions

Para. No.	Name	Value Range	Unit	Default	Effective Time	Setting Condition	Related Mode
H17-09	VDI5 logic	0: Active when the written value is 1 1: Active when the written value changes from 0 to 1	-	0	At stop	During running	-
H17-10	VDI6 function	0-41	-	0	At stop	During running	-
H17-11	VDI6 logic	0: Active when the written value is 1 1: Active when the written value changes from 0 to 1	-	0	At stop	During running	-
H17-12	VDI7 function	0-41	-	0	At stop	During running	-
H17-13	VDI7 logic	0: Active when the written value is 1 1: Active when the written value changes from 0 to 1	-	0	At stop	During running	-
H17-14	VDI8 function	0-41	-	0	At stop	During running	-
H17-15	VDI8 logic	0: Active when the written value is 1 1: Active when the written value changes from 0 to 1	-	0	At stop	During running	-
H17-16	VDI9 function	0-41	-	0	At stop	During running	-
H17-17	VDI9 logic	0: Active when the written value is 1 1: Active when the written value changes from 0 to 1	-	0	At stop	During running	-
H17-18	VDI10 function	0-41	-	0	At stop	During running	-
H17-19	VDI10 logic	0: Active when the written value is 1 1: Active when the written value changes from 0 to 1	-	0	At stop	During running	-
H17-20	VDI11 function	0-41	-	0	At stop	During running	-
H17-21	VDI11 logic	0: Active when the written value is 1 1: Active when the written value changes from 0 to 1	-	0	At stop	During running	-
H17-22	VDI12 function	0-41	-	0	At stop	During running	-

Para. No.	Name	Value Range	Unit	Default	Effective Time	Setting Condition	Related Mode
H17-23	VDI12 logic	0: Active when the written value is 1 1: Active when the written value changes from 0 to 1	-	0	At stop	During running	-
H17-24	VDI13 function	0–41	-	0	At stop	During running	-
H17-25	VDI13 logic	0: Active when the written value is 1 1: Active when the written value changes from 0 to 1	-	0	At stop	During running	-
H17-26	VDI14 function	0–41	-	0	At stop	During running	-
H17-27	VDI14 logic	0: Active when the written value is 1 1: Active when the written value changes from 0 to 1	-	0	At stop	During running	-
H17-28	VDI15 function	0–41	-	0	At stop	During running	-
H17-29	VDI15 logic	0: Active when the written value is 1 1: Active when the written value changes from 0 to 1	-	0	At stop	During running	-
H17-30	VDI16 function	0–41	-	0	At stop	During running	-
H17-31	VDI16 logic	0: Active when the written value is 1 1: Active when the written value changes from 0 to 1	-	0	At stop	During running	-
H17-32	VDO virtual level	-	-	-	-	At display	-
H17-33	VDO1 function	0–24	-	0	At stop	During running	-
H17-34	VDO1 logic	0: Output 1 when active 1: Output 0 when active	-	0	At stop	During running	-
H17-35	VDO2 function	0–24	-	0	At stop	During running	-
H17-36	VDO2 logic	0: Output 1 when active 1: Output 0 when active	-	0	At stop	During running	-
H17-37	VDO3 function	0–24	-	0	At stop	During running	-
H17-38	VDO3 logic	0: Output 1 when active 1: Output 0 when active	-	0	At stop	During running	-
H17-39	VDO4 function	0–24	-	0	At stop	During running	-
H17-40	VDO4 logic	0: Output 1 when active 1: Output 0 when active	-	0	At stop	During running	-

Parameter Descriptions

Para. No.	Name	Value Range	Unit	Default	Effective Time	Setting Condition	Related Mode
H17-41	VDO5 function	0–24	-	0	At stop	During running	-
H17-42	VDO5 logic	0: Output 1 when active 1: Output 0 when active	-	0	At stop	During running	-
H17-43	VDO6 function	0–24	-	0	At stop	During running	-
H17-44	VDO6 logic	0: Output 1 when active 1: Output 0 when active	-	0	At stop	During running	-
H17-45	VDO7 function	0–24	-	0	At stop	During running	-
H17-46	VDO7 logic	0: Output 1 when active 1: Output 0 when active	-	0	At stop	During running	-
H17-47	VDO8 function	0–24	-	0	At stop	During running	-
H17-48	VDO8 logic	0: Output 1 when active 1: Output 0 when active	-	0	At stop	During running	-
H17-49	VDO9 function	0–24	-	0	At stop	During running	-
H17-50	VDO9 logic	0: Output 1 when active 1: Output 0 when active	-	0	At stop	During running	-
H17-51	VDO10 function	0–24	-	0	At stop	During running	-
H17-52	VDO10 logic	0: Output 1 when active 1: Output 0 when active	-	0	At stop	During running	-
H17-53	VDO11 function	0–24	-	0	At stop	During running	-
H17-54	VDO11 logic	0: Output 1 when active 1: Output 0 when active	-	0	At stop	During running	-
H17-55	VDO12 function	0–24	-	0	At stop	During running	-
H17-56	VDO12 logic	0: Output 1 when active 1: Output 0 when active	-	0	At stop	During running	-
H17-57	VDO13 function	0–24	-	0	At stop	During running	-
H17-58	VDO13 logic	0: Output 1 when active 1: Output 0 when active	-	0	At stop	During running	-
H17-59	VDO14 function	0–24	-	0	At stop	During running	-
H17-60	VDO14 logic	0: Output 1 when active 1: Output 0 when active	-	0	At stop	During running	-
H17-61	VDO15 function	0–24	-	0	At stop	During running	-
H17-62	VDO15 logic	0: Output 1 when active 1: Output 0 when active	-	0	At stop	During running	-

Para. No.	Name	Value Range	Unit	Default	Effective Time	Setting Condition	Related Mode
H17-63	VDO16 function	0–24	-	0	At stop	During running	-
H17-64	VDO16 logic	0: Output 1 when active 1: Output 0 when active	-	0	At stop	During running	-

4.18 Group H30: Servo Variables Read Through Communication

Para. No.	Name	Value Range	Unit	Default	Effective Time	Setting Condition	Related Mode
H30-00	Servo status read through communication	-	-	-	-	Read-only	PST
H30-01	DO function status 1 read through communication	-	-	-	-	Read-only	PST
H30-02	DO function status 2 read through communication	-	-	-	-	Read-only	PST
H30-03	Input pulse reference sampling value read through communication	-	-	-	-	At display	PST
H30-04	DI status read through communication	-	-	-	-	At display	PST

4.19 Group H31: Servo Variables Set Through Communication

Para. No.	Name	Value Range	Unit	Default	Effective Time	Setting Condition	Related Mode
H31-00	VDI virtual level set through communication	0–65535	-	0	Immediately	During running	PST
H31-04	DO status set through communication	0–31	-	0	Immediately	During running	PST
H31-09	Speed reference set through communication	-6000.000 to +6000.000	RPM	0	Immediately	During running	S
H31-11	Torque reference set through communication	-100.000 to +100.000	%	0	Immediately	During running	T

4.20 DI/DO Function Definitions

Function No.	Name	Function	Description	Remarks
Input Signal Description				
FunIN.1	S-ON	Servo ON	Inactive: Servo motor disabled Active: Servo motor enabled upon power-on	The corresponding terminal logic must be level-triggered. The change of the corresponding DI/VDI or terminal logic is activated at next power-on.
FunIN.2	ALM-RST	Fault and warning reset	Inactive: Disabled Active: Enabled	Edge-triggered will be applied even if level-triggered is selected. To reset No. 1 and No. 2 resettable faults, switch off the S-ON signal first. The servo drive may, depending on the warning types, continue running after warning reset.
FunIN.3	GAIN-SEL	Gain switchover	<ul style="list-style-type: none"> ● H08-09 = 1: ● Inactive: Speed control loop being PI control ● Active: Speed control loop being P control ● H08-09 = 2: ● Inactive: Fixed to the 1st gain set ● Active: Fixed to the 2nd gain set 	It is recommended that the corresponding terminal logic be level-triggered.
FunIN.4	CMD-SEL	Main reference (A)/ Auxiliary reference (B) switchover	Inactive: Current reference being A B: Current reference being B	It is recommended that the corresponding terminal logic be level-triggered.
FunIN.5	DIR-SEL	DI-based multi-speed operation direction	Inactive: Default reference direction Active: Opposite to the reference direction	It is recommended that the corresponding terminal logic be level-triggered.
FunIN.6	CMD1	Multi-reference switchover 1	Used to select a reference from 16 references.	It is recommended that the corresponding terminal logic be level-triggered.
FunIN.7	CMD2	Multi-reference switchover 2	Used to select a reference from 16 references.	It is recommended that the corresponding terminal logic be level-triggered.
FunIN.8	CMD3	Multi-reference switchover 3	Used to select a reference from 16 references.	It is recommended that the corresponding terminal logic be level-triggered.
FunIN.9	CMD4	Multi-reference switchover 4	Used to select a reference from 16 references.	It is recommended that the corresponding terminal logic be level-triggered.

Function No.	Name	Function	Description	Remarks
FunIN.10	M1-SEL	Mode switchover 1	Used to switch among speed control, position control, and torque control based on the selected control mode (H02-00 = 3/4/5).	It is recommended that the corresponding terminal logic be level-triggered.
FunIN.11	M2-SEL	Mode switchover 2	Used to switch among speed control, position control, and torque control based on the selected control mode (H02-00 = 6).	It is recommended that the corresponding terminal logic be level-triggered.
FunIN.12	ZCLAMP	Zero clamp	Active: Zero clamp enabled Inactive: Zero clamp disabled	It is recommended that the corresponding terminal logic be level-triggered.
FunIN.13	INHIBIT	Position reference inhibit	Active: Reference pulse input inhibited Inactive: Reference pulse input allowed	Applies to internal and external position references. The corresponding terminal logic must be level-triggered.
FunIN.14	P-OT	Positive limit switch	Active: Forward drive inhibited Inactive: Forward drive allowed	Overtravel prevention applies when the machine moves beyond the limit. It is recommended that the corresponding terminal logic be level-triggered.
FunIN.15	N-OT	Negative limit switch	Overtravel prevention applies when the machine moves beyond the limit. Active: Reverse drive inhibited Inactive: Reverse drive allowed	It is recommended that the corresponding terminal logic be level-triggered.
FunIN.16	P-CL	Positive external torque limit	The torque limit source is switched based on H07-07 (Torque limit source). H07-07 = 1: Active: Positive external torque limit activated Inactive: Positive internal torque limit activated	It is recommended that the corresponding terminal logic be level-triggered.
FunIN.17	N-CL	Negative external torque limit	The torque limit source is switched based on H07-07 (Torque limit source). H07-07 = 1: Active: Negative external torque limit activated Inactive: Negative internal torque limit deactivated	It is recommended that the corresponding terminal logic be level-triggered.
FunIN.18	JOGCMD+	Forward jog	Active: Input based on the reference Inactive: Reference input stopped	It is recommended that the corresponding terminal logic be level-triggered.

Parameter Descriptions

Function No.	Name	Function	Description	Remarks
FunIN.19	JOGCMD-	Reverse jog	Active: Input in reverse to the reference Inactive: Reference input stopped	It is recommended that the corresponding terminal logic be level-triggered.
FunIN.20	POSSTEP	Step reference selection	Active: Execute step references Inactive: Reference being zero, staying in locked state	It is recommended that the corresponding terminal logic be level-triggered.
FunIN.21	HX1	Hand wheel override signal 1	HX1 active, HX2 inactive: x 10 HX1 inactive, HX2 active: x 100 Others: x 1	It is recommended that the corresponding terminal logic be level-triggered.
FunIN.22	HX2	Hand wheel override signal 2		
FunIN.23	HX_EN	Hand wheel enable signal	Inactive: Position control applied based on H05-00 (Position reference source) Active: Position control applied based on the hand wheel pulse signal received in the position control mode	It is recommended that the corresponding terminal logic be level-triggered.
FunIN.24	GEAR_SEL	Electronic gear ratio switchover	Inactive: Electronic gear ratio 1 Active: Electronic gear ratio 2	It is recommended that the corresponding terminal logic be level-triggered.
FunIN.25	TOQDirSel	Torque reference direction	Inactive: Forward Active: Reverse	It is recommended that the corresponding terminal logic be level-triggered.
FunIN.26	SPDDirSel	Speed reference direction	Inactive: Forward Active: Reverse	It is recommended that the corresponding terminal logic be level-triggered.
FunIN.27	POSDirSel	Position reference direction	Inactive: Actual position reference direction same as the set direction Active: Actual position reference direction opposite to the set direction	It is recommended that the corresponding terminal logic be level-triggered.
FunIN.28	PosInSen	Multi-position reference selection	Inactive: Internal multi-position reference ignored Active: Internal multi-position reference started	It is recommended that the corresponding terminal logic be level-triggered.
FunIN.29	XintFree	Interrupt positioning canceled	Inactive: Disabled Active: Enabled	-

Function No.	Name	Function	Description	Remarks
FunIN.31	HomeSwitch	Home switch	Inactive: Not triggered Active: Triggered	The corresponding terminal logic must be level-triggered. Assign this function to a high-speed DI. If the logic is set to 2 (Rising edge-triggered), the servo drive forcibly changes it to 1 (Active high). If the logic is set to 3 (Falling edge-triggered), the servo drive forcibly changes it to 0 (Active low). If the logic is set to 4 (Rising/Falling edge-triggered), the servo drive forcibly changes it to 0 (Active low).
FunIN.32	HomingStart	Homing function	Inactive: Disabled Active: Enabled	-
FunIN.33	XintInhibit	Interrupt positioning inhibit	Active: Interrupt positioning inhibited Inactive: Interrupt positioning allowed	The corresponding terminal logic must be level-triggered. <ul style="list-style-type: none"> • If the logic is set to 2 (Rising edge-triggered), the servo drive forcibly changes it to 1 (Active high). • If the logic is set to 3 (Falling edge-triggered), the servo drive forcibly changes it to 0 (Active low). • If the logic is set to 4 (Rising/Falling edge-triggered), the servo drive forcibly changes it to 0 (Active low).
FunIN.34	Emergency Stop	Emergency stop	Active: Position lock applied after stop at zero speed Inactive: Current operating state unaffected	It is recommended that the corresponding terminal logic be level-triggered.
FunIN.35	ClrPosErr	Position deviation clear	Active: Enable Inactive: Disable	It is recommended to assign this function to DI8 or DI9.
FunIN.36	V_LmtSel	Internal speed limit source	Inactive: H07-19 as internal speed limit Active: H07-20 as internal speed limit	It is recommended that the corresponding terminal logic be level-triggered.
FunIN.37	PulseInhibit	Pulse reference inhibit	When the position reference source is pulse reference (H05-00 = 0) in the position control mode: Inactive: Respond to pulse references Active: Not respond to pulse references	It is recommended that the corresponding terminal logic be level-triggered.

Parameter Descriptions

Function No.	Name	Function	Description	Remarks
FunIN.38	MultiBlockTrig	Axis control command write interrupted	When the position reference source is multi-position reference (H05-00 = 2) in the position control mode: Inactive: Command not written Active: Command written and interrupt generated	It is recommended that the corresponding terminal logic be level-triggered.
FunIN.39	MultiBlockWr	Axis control command write uninterrupted	When the position reference source is multi-position reference (H05-00 = 2) in the position control mode: Inactive: Command not written Active: Command written and interrupt not generated	It is recommended that the corresponding terminal logic be level-triggered.
FunIN.40	ClrCmdOkAndArOk	Command cleared and positioning completed	Inactive: Command not cleared and positioning completed Active: Command cleared and positioning completed	It is recommended that the corresponding terminal logic be level-triggered.
FunIN.41	HomeRecord	Present position as the home	Inactive: Not triggered Active: Triggered	It is recommended that the corresponding terminal logic be level-triggered.
Output signal function				
FunOUT.1	S-RDY	Servo ready	The servo drive is ready to receive the S-ON signal. Active: Servo ready Inactive: Servo not ready	-
FunOUT.2	TGON	Motor rotation output	Inactive: Absolute value of filtered motor speed lower than H06-16 (Threshold of TGON signal) Active: Absolute value of filtered motor speed reaching H06-16 (Threshold of TGON signal)	-
FunOUT.3	ZERO	Zero speed	Inactive: The difference between the motor speed feedback and the reference value exceeds the threshold defined by H06-19. Active: The difference between the motor speed feedback and the reference value does not exceed the threshold defined by H06-19.	-
FunOUT.4	V-CMP	Speed matching	Active when the absolute value of the difference between the motor speed and the speed reference lower than H06-17 (Threshold of V-Cmp signal) in the speed control mode	-

Function No.	Name	Function	Description	Remarks
FunOUT.5	COIN	Positioning completed	Active when position deviation pulses reaching H05-21 (Threshold of positioning completed) in the position control mode	-
FunOUT.6	NEAR	Proximity	Active when position deviation pulses reaching H05-22 (Threshold of proximity) in the position control mode	-
FunOUT.7	C-LT	Torque limit	Torque limit acknowledge signal: Active: Motor torque limited Inactive: Motor torque unlimited	-
FunOUT.8	V-LT	Speed limit	Speed limit acknowledge signal in the torque control mode: Active: Motor speed limited Inactive: Motor speed unlimited	-
FunOUT.9	BK	Brake output	Brake signal output: Active: Brake released Inactive: Brake applied	-
FunOUT.10	WARN	Warning output	Warning output active (ON)	-
FunOUT.11	ALM	Fault output	Active upon fault event	-
FunOUT.12	ALMO1	Output 3-digit warning code	Output 3-digit warning code	-
FunOUT.13	ALMO2	Output 3-digit warning code	Output 3-digit warning code	-
FunOUT.14	ALMO3	Output 3-digit warning code	Output 3-digit warning code	-
FunOUT.15	Xintcoin	Interrupt positioning completed	Active: Interrupt positioning completed Inactive: Interrupt positioning not completed	-
FunOUT.16	HomeAttain	Homing output	Homing state: Active: Homing applied Inactive: Homing not applied	-
FunOUT.17	ElecHome Attain	Electrical homing output	Electrical homing state: Active: Electrical Homing applied Inactive: Electrical Homing not applied	-
FunOUT.18	ToqReach	Torque reach output	Active: Torque absolute value reaching the setpoint Inactive: Torque absolute value lower than the setpoint	-
FunOUT.19	V-Arr	Speed reach output	Active: Speed feedback reaching the setpoint Inactive: Speed feedback not reaching the setpoint	-

Parameter Descriptions

Function No.	Name	Function	Description	Remarks
FunOUT.20	AngIntRdy	Angle auto-tuning output	Active: Angle auto-tuning completed Inactive: Angle auto-tuning not completed	-
FunOUT.21	DB	Dynamic braking output	Active: Dynamic brake relay opened Inactive: Dynamic brake relay closed	-
FunOUT.22	CmdOk	Internal command output	Active: Internal command completed Inactive: Internal command not completed	-
FunOUT.23	WrNextBlockEn	Write next block enabled	Active: Writing the next block allowed Inactive: Writing the next block inhibited	-
FunOUT.24	McOk	Motion control output	Active: Motion control completed Inactive: Motion control not completed	-

Appendix A: CANlink Enhanced Axis Control Parameters

Table –1 List of default parameters for enhanced axis control

Para. No.	Description	Default
H11-00	Multi-position operation mode	5: Axis-controlled continuous operation
H11-04	Displacement reference type	1: Absolute displacement reference
H11-05	Start displacement no. in sequential operation	1
H11-16	Waiting time after displacement 1	0
H05-00	Main position reference source	2: Multi-position reference
H05-02	Pulses per revolution	10000
H05-30	Homing selection	1: Homing enabled by signal input from DI
H05-31	Homing mode	1: Reverse homing, home switch as the deceleration point and the home
H05-32	Speed in high-speed searching for the home switch signal	200 RPM
H05-33	Speed in low-speed searching for the home switch signal	20 RPM
H05-35	Homing time limit	30000 ms
H05-40	Mechanical home offset and action upon overtravel	3: H05-36 used as the relative offset after homing, searching for the zero point automatically upon hitting the limit
H09-00	Gain auto-tuning mode	1: Standard stiffness level mode
H09-02	Adaptive notch mode	1: Only one notch (3rd notch) activated
H0C-09	Communication VDI	1: Enable
H0C-11	Communication VDO	1: Enable
H04-00	DO1 function	0: No definition
H04-02	DO2 function	0: No definition
H04-04	DO3 function	9: Brake
H04-06	DO4 function	0: No definition
H04-08	VDO5 function	0: No definition
H03-06	DI3 function	0: No definition
H03-08	DI4 function	0: No definition
H03-10	DI5 function	0: No definition
H17-00	VDI1 function	1: Servo ON
H17-02	VDI2 function	18: Forward jog
H17-04	VDI3 function	19: Reverse jog
H17-06	VDI4 function	28: Multi-position reference selection
H17-08	VDI5 function	32 - Homing enable
H17-10	VDI6 function	34 - Emergency stop
H17-12	VDI7 function	2: Fault and warning reset signal
H17-14	VDI8 function	38: Command-write interrupted
H17-15	VDI8 logic	1: Active when the written value changes from 0 to 1
H17-16	VDI9 function	Active: Command-write not interrupted

Para. No.	Description	Default
H17-17	VDI9 logic	1: Active when the written value changes from 0 to 1
H17-18	VDI10 function	40: Positioning and reference completed signal cleared

Note

Instructions for how to use the CANlink enhanced axis control function are as follows:



1. Set H02-31 to 1 to restore all parameters to default values.
 2. Enhanced axis control applies when the value of H11-00 changes to 5. Related parameters will be linked automatically. Detailed setting values are shown in the preceding table.
 3. Parameters listed in the preceding table will be restored to default values when H11-00 changes from 5 to other values.
-

5 Appendix B Display of Values Monitored Through



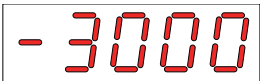
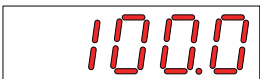
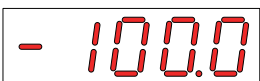

Keypad

- Group H0B: Displays parameters used to monitor the operating state of the servo drive.
- Set H02-32 (Default keypad display) properly. After the servo motor operates normally, the keypad switches from status display to monitored value display. The parameter group No. is H0B and the No. within the group is the setpoint of H02-32.
- For example, if H02-32 is set to 00 and the motor speed is not 0 RPM, the keypad displays the value of H0B-00.





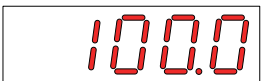

The following table describes the monitoring parameters in group H0B.

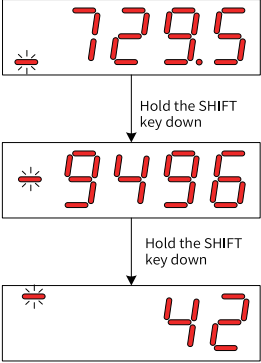

Para. No.	Name	Unit	Meaning	Example of Display
H0B-00	Motor speed actual value	RPM	Displays the actual motor speed after round-off, which can be accurate to 1 RPM.	Display of 3000 RPM:  Display of -3000 RPM: 
H0B-01	Speed reference	RPM	Displays the present speed reference of the servo drive.	Display of 3000 RPM:  Display of -3000 RPM: 
H0B-02	Internal torque reference	0.10%	Displays the percentage of actual torque output of the motor to the rated torque of the motor.	Display of 100.0%:  Display of -100.0%: 





Para. No.	Name	Unit	Meaning	Example of Display
H0B-03	Monitored DI status	-	<p>Displays the optocoupler status of DI1 to DI9:</p> <p>Upper LED segments turned on: The optocoupler is switched off (indicated by "1").</p> <p>Lower LED segments turned on: The optocoupler is switched on (indicated by "0").</p> <p>The value of H0B-03 read in the software tool is a decimal.</p>	<p>For example, if DI1 is low level and DI2 to DI9 are high level:</p> <p>The corresponding binary value is "110011110", and the value of H0B-03 read in the software tool is 414.</p> <p>The keypad displays as follows:</p> <p style="text-align: center;"> High High Invalid High High High High Low 1 1 Invalid 1 1 1 1 0 </p>
H0B-05	Monitored DO status	-	<p>Displays the optocoupler status of DO1 to DO5:</p> <p>Upper LED segments turned on: The optocoupler is switched off (indicated by "1").</p> <p>Lower LED segments turned on: The optocoupler is switched on (indicated by "0").</p> <p>The value of H0B-05 read in the software tool is a decimal.</p>	<p>For example, if DO1 is low level and DO2 to DO5 are high level:</p> <p>The corresponding binary value is "11110", and the value of H0B-05 read in the software tool is 30.</p> <p>The keypad displays as follows:</p> <p style="text-align: center;"> High High High High Low 1 1 1 1 0 </p>
H0B-07	Absolute position counter (32-bit decimal)	Reference unit	<p>Displays the present absolute position of the motor (in reference unit).</p>	<p>Display of 1073741824 in reference unit:</p> <p style="text-align: center;"> SHIFT SHIFT </p>

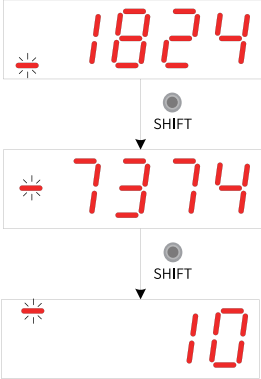

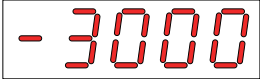
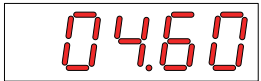
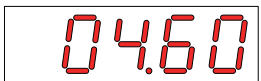
Para. No.	Name	Unit	Meaning	Example of Display
H0B-09	Mechanical angle (pulses starting from the home)	p	<p>Displays present mechanical angle of the motor (p). The value 0 corresponds to the mechanical angle 0°. The maximum value of H0B-09 for an incremental encoder is calculated using the following formula: Encoder PPR x 4 - 1 For example, the maximum value of H0B-09 for a 2500-PPR incremental encoder is 9999. The maximum value of H0B-09 for an absolute encoder is 65535. The actual mechanical angle is calculated using the following formula:</p> $\text{Actual mechanical angle} = \frac{\text{H0B-09}}{\text{H0B-09 max. value} + 1} \times 360.0^\circ$	<p>Display of 10000 p:</p> 
H0B-10	Electrical angle	0.1°	Displays the present electrical angle of the motor.	<p>Display of 360.0°:</p> 
H0B-11	Speed corresponding to the input position reference	RPM	Displays the speed corresponding to the position reference per control cycle of the servo drive.	<p>Display of 3000 RPM:</p>  <p>Display of -3000 RPM:</p> 
H0B-12	Average load rate	0.10%	Displays the percentage of the average load torque to the rated torque of the motor.	<p>Display of 100.0%:</p> 

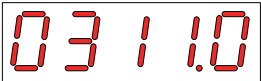
Para. No.	Name	Unit	Meaning	Example of Display
H0B-13	Input position reference counter (32-bit decimal)	Reference unit	Counts and displays the number of input position references.	<p>Display of 1073741824 in reference unit:</p>
H0B-15	Encoder position deviation counter (32-bit decimal)	Encoder unit	Encoder position deviation = Sum of input position references (in encoder unit) - Sum of pulses fed back by the encoder (in encoder unit)	<p>Display of 10000 in encoder unit:</p>
H0B-17	Feedback pulse counter (32-bit decimal)	Encoder unit	Counts and displays the number of pulses fed back by the encoder (in encoder unit).	<p>Display of 1073741824 in encoder unit:</p>

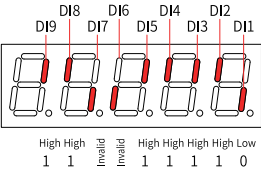
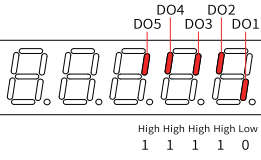
Para. No.	Name	Unit	Meaning	Example of Display
H0B-19	Total power-on time (32-bit decimal)	0.1s	Counts and displays the total power-on time of the servo drive.	<p>Display of 429496729.5s:</p> 
H0B-24	RMS value of phase current	0.01 A	Displays the RMS value of the phase current of the servo motor.	<p>Display of 4.60 A:</p> 
H0B-26	Bus voltage	0.1 V	Displays the DC bus voltage of the main circuit.	<p>Display of 311.0 V rectified from 220 VAC:</p>  <p>Display of 537.0 V rectified from 380 VAC:</p> 
H0B-27	Power module temperature	°C	Displays the temperature of the power module inside the servo drive.	<p>Display of 27°C:</p> 
H0B-33	Fault log	-	Used to select the previous fault to be viewed. 0: Present fault 1: Last fault 2: 2nd to last fault ... 9: 9th to last fault	<p>Display of present fault:</p> 

Para. No.	Name	Unit	Meaning	Example of Display
H0B-34	Fault code of the selected fault	-	Displays the fault code of the fault selected in H0B-33. When no fault occurs, the displayed value of H0B-34 is Er.000.	If H0B-33 = 0, and H0B-34 = Er.941, the present fault code will be 941. Corresponding display: 
H0B-35	Time stamp upon occurrence of the selected fault	s	Displays the total operating time of the servo drive when the fault displayed in H0B-34 occurs. When no fault occurs, the displayed value of H0B-35 is 0.	If H0B-34 = Er.941, H0B-35 = 107374182.4, the present fault code will be 941 and the total operating time of the servo drive is 107374182.4s when the fault occurs. 
H0B-37	Motor speed upon occurrence of the selected fault	RPM	Displays the servo motor speed when the fault displayed in H0B-34 occurs. When no fault occurs, the displayed value of H0B-37 is 0.	Display of 3000 RPM:  Display of -3000 RPM: 
H0B-38	Motor phase U current upon occurrence of the selected fault	0.01 A	Displays the RMS value of the winding current of motor phase U when the fault displayed in H0B-34 occurs. When no fault occurs, the displayed value of H0B-38 is 0.	Display of 4.60 A: 
H0B-39	Motor phase V current upon occurrence of the selected fault	0.01 A	Displays the RMS value of the winding current of motor phase V when the fault displayed in H0B-34 occurs. When no fault occurs, the displayed value of H0B-39 is 0.	Display of 4.60 A: 

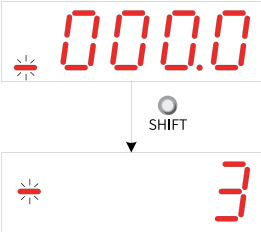
Para. No.	Name	Unit	Meaning	Example of Display
H0B-40	Bus voltage upon occurrence of the selected fault	V	Displays the DC bus voltage of the main circuit when the fault displayed in H0B-34 occurs. When no fault occurs, the value of H0B-40 is 0.	<p>Display of 311.0 V rectified from 220 VAC:</p>  <p>Display of 537.0 V rectified from 380 VAC:</p> 
H0B-41	DI status upon occurrence of the selected fault	-	Displays the high/low level status of DI1 to DI9 when the fault displayed in H0B-34 occurs. The method for determining the DI level state is the same as that of H0B-03. When no fault occurs, all DIs are displayed as low level in H0B-41 (indicated by the decimal value 0).	<p>Display of H0B-41 = 414:</p> 
H0B-42	DO status upon occurrence of the selected fault	-	Displays the high/low level state of DO1 to DO5 when the fault displayed in H0B-34 occurs. The method for determining the DO level status is the same as that of H0B-05. When no fault occurs, all DOs are displayed as low level in H0B-42 (indicated by the decimal value 0).	<p>Display of H0B-42 = 15:</p> 
H0B-53	Position deviation counter (32-bit decimal)	Refer ence unit	Position deviation = Sum of input position references (in reference unit) - Sum of pulses fed back by the encoder (in reference unit)	<p>Display of 10000 in reference unit:</p> 

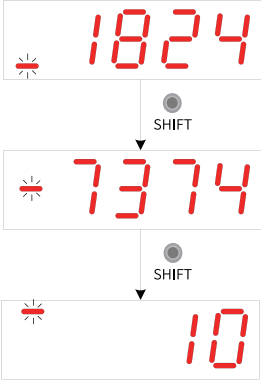
Para. No.	Name	Unit	Meaning	Example of Display
H0B-55	Motor speed actual value	0.1 RPM	Displays actual value of the motor speed, which can be accurate to 0.1 RPM.	<p>Display of 3000.0 RPM:</p>  <p>Display of -3000.0 RPM:</p> 
H0B-64	Real-time input position reference counter	Reference unit	Displays the value of the position reference counter before divided or multiplied by the electronic gear ratio. This value is independent of the servo drive status and the control mode.	<p>Display of 1073741824 in reference unit:</p> 

Shenzhen Inovance Technology Co., Ltd.

Add.: Building E, Hongwei Industry Park, Liuxian Road,
Baocheng No. 70 Zone, Bao'an District, Shenzhen

Tel: +86-755-2979 9595

Fax: +86-755-2961 9897

<http://www.inovance.com>

Suzhou Inovance Technology Co., Ltd.

Add.: No. 16 Youxiang Road, Yuexi Town, Wuzhong
District, Suzhou 215104, P.R. China

Tel: +86-755-2979 6666

Fax: +86-755-2961 6720

<http://www.inovance.com>



19011392A00