

The right choice for the ultimate yield!

LS ELECTRIC strives to maximize your profits in gratitude for choosing us as your partner.

Programmable Logic Control

XBC Standard/Economic Type Main

XGT Series

User Manual

XBC-DR20SU	XBC-DR10E
XBC-DN20S(U)	XBC-DN10E
XBC-DP20SU	XBC-DP10E
XBC-DR30SU	XBC-DR14E
XBC-DN30S(U)	XBC-DN14E
XBC-DP30SU	XBC-DP14E
XBC-DR40SU	XBC-DR20E
XBC-DN40SU	XBC-DN20E
XBC-DP40SU	XBC-DP20E
XBC-DR60SU	XBC-DR30E
XBC-DN60SU	XBC-DN30E
XBC-DP60SU	XBC-DP30E

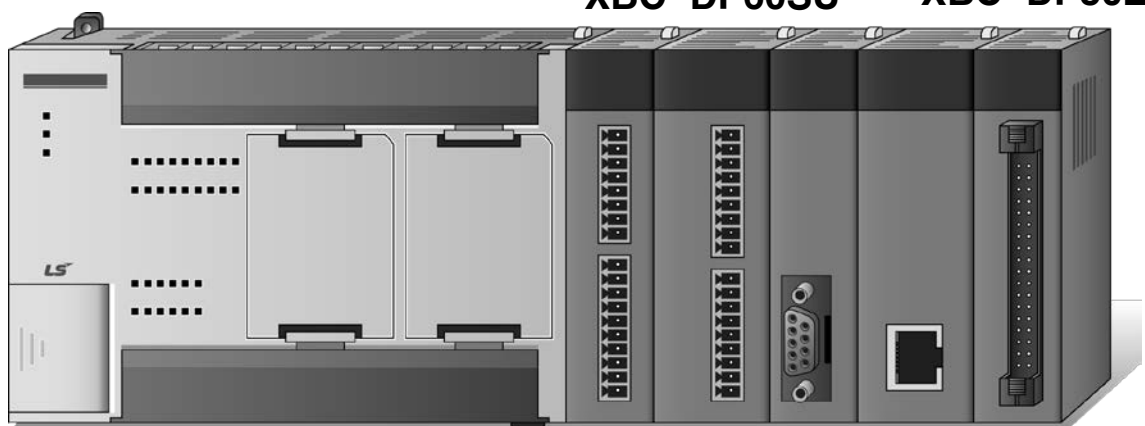

Safety Instructions

- Read this manual carefully before installing, wiring, operating, servicing or inspecting this equipment.
- Keep this manual within easy reach for quick reference.

LSELECTRIC

Before using the product ...

For your safety and effective operation, please read the safety instructions thoroughly before using the product.



- ▶ Safety Instructions should always be observed in order to prevent accident or risk with the safe and proper use the product.
- ▶ Instructions are separated into “Warning” and “Caution”, and the meaning of the terms is as follows;



This symbol indicates the possibility of serious injury or death if some applicable instruction is violated



This symbol indicates the possibility of slight injury or damage to products if some applicable instruction is violated

- ▶ The marks displayed on the product and in the user’s manual have the following meanings.
 -  Be careful! Danger may be expected.
 -  Be careful! Electric shock may occur.
- ▶ The user’s manual even after read shall be kept available and accessible to any user of the product.

Safety Instructions when designing

Warning

- ▶ **Please, install protection circuit on the exterior of PLC to protect the whole control system from any error in external power or PLC module.** Any abnormal output or operation may cause serious problem in safety of the whole system.
 - Install applicable protection unit on the exterior of PLC to protect the system from physical damage such as emergent stop switch, protection circuit, the upper/lowest limit switch, forward/reverse operation interlock circuit, etc.
 - If any system error (watch-dog timer error, module installation error, etc.) is detected during CPU operation in PLC, the whole output is designed to be turned off and stopped for system safety. However, in case CPU error if caused on output device itself such as relay or TR can not be detected, the output may be kept on, which may cause serious problems. Thus, you are recommended to install an addition circuit to monitor the output status.

- ▶ **Never connect the overload than rated to the output module nor allow the output circuit to have a short circuit,** which may cause a fire.

- ▶ **Never let the external power of the output circuit be designed to be On earlier than PLC power,** which may cause abnormal output or operation.

- ▶ **In case of data exchange between computer or other external equipment and PLC through communication or any operation of PLC (e.g. operation mode change), please install interlock in the sequence program to protect the system from any error.** If not, it may cause abnormal output or operation.

Safety Instructions when designing

Caution

- ▶ **I/O signal or communication line shall be wired at least 100mm away from a high-voltage cable or power line.** If not, it may cause abnormal output or operation.

Safety Instructions when designing

Caution

- ▶ **Use PLC only in the environment specified in PLC manual or general standard of data sheet.** If not, electric shock, fire, abnormal operation of the product or flames may be caused.
- ▶ **Before installing the module, be sure PLC power is off.** If not, electric shock or damage on the product may be caused.
- ▶ **Be sure that each module of PLC is correctly secured.** If the product is installed loosely or incorrectly, abnormal operation, error or dropping may be caused.
- ▶ **Be sure that I/O or extension connector is correctly secured.** If not, electric shock, fire or abnormal operation may be caused.
- ▶ **If lots of vibration is expected in the installation environment, don't let PLC directly vibrated.** Electric shock, fire or abnormal operation may be caused.
- ▶ **Don't let any metallic foreign materials inside the product,** which may cause electric shock, fire or abnormal operation..

Safety Instructions when wiring

Warning

- ▶ **Prior to wiring, be sure that power of PLC and external power is turned off.** If not, electric shock or damage on the product may be caused.
- ▶ **Before PLC system is powered on, be sure that all the covers of the terminal are securely closed.** If not, electric shock may be caused

Caution

- ▶ **Let the wiring installed correctly after checking the voltage rated of each product and the arrangement of terminals.** If not, fire, electric shock or abnormal operation may be caused.
- ▶ **Secure the screws of terminals tightly with specified torque when wiring.** If the screws of terminals get loose, short circuit, fire or abnormal operation may be caused.
- *
 - ▶ **Surely use the ground wire of Class 3 for FG terminals, which is exclusively used for PLC.** If the terminals not grounded correctly, abnormal operation may be caused.
 - ▶ **Don't let any foreign materials such as wiring waste inside the module while wiring,** which may cause fire, damage on the product or abnormal operation.

Safety Instructions for test-operation or repair

Warning

- ▶ **Don't touch the terminal when powered.** Electric shock or abnormal operation may occur.
- ▶ **Prior to cleaning or tightening the terminal screws, let all the external power off including PLC power.** If not, electric shock or abnormal operation may occur.
- ▶ **Don't let the battery recharged, disassembled, heated, short or soldered.** Heat, explosion or ignition may cause injuries or fire.

Caution

- ▶ **Don't remove PCB from the module case nor remodel the module.** Fire, electric shock or abnormal operation may occur.
- ▶ **Prior to installing or disassembling the module, let all the external power off including PLC power.** If not, electric shock or abnormal operation may occur.
- ▶ **Keep any wireless installations or cell phone at least 30cm away from PLC.** If not, abnormal operation may be caused.

Safety Instructions for waste disposal

Caution

- ▶ **Product or battery waste shall be processed as industrial waste.** The waste may discharge toxic materials or explode itself.

Revision History

Version	Date	Remark	Page
V 1.0	2010.3	1. First Edition	-
V 1.1	2010.12	1. XGB output module added (XBC-RY08B, XBE-DC16B) 2. Error fixed 3. Sequence diagram on troubleshooting fixed	-
V 1.2	2010.12	1. XGB SU type added (XBC-DN20SU, XBC-DN30SU) 2. RTC option board added (XBO-RTCA)	Chapter 9
V 1.3	2011.06	1. XGB SU type added (XBC-DN40SU, XBC-DN60SU, XBC-DR40SU, XBC-DR60SU) 2. XGB option module added (XBO-DC04A, XBC-TN04A, XBO-M2MB)	- Ch10, Ch11, Ch12
V1.4	2012.01	1. XGB E type added (XBC-DN10E, XBC-DN14E, XBC-DN20E, XBC-DN30E, XBC-DP10E, XBC-DP14E, XBC-DP20E, XBC-DP30E)	-
V1.5	2013.01	1. XGB SU type added (XBC-DP20SU, XBC-DP30SU, XBC-DP40SU, XBC-DP60SU) 2. Data Backup time modified	- 4-14
V1.6	2014.09	1. Domain of Homepage changed 2. RTC Option specification added(Available on slot 9)	Front/Back Cover 2-2,2-4,9-4
V1.7	2015.02	1. Data backup time and available slot added -User should change the battery periodically~ as possible. -RTC can~ 9th slot	9-2 9-5
	2015.07	2. Address& phone number changed 3. Description of using Timer flag added . 4.I/O(Input/Output) terminal error check and modification -Input terminal block error check -Output terminal block error check, SG→PE	BackCover App1-2,App1-7 7-7~7-14 7-15~7-38
		5.New PLC added -XBF-TC04RT/ TC04TT, XBL-PMEC/ PSEA/DSEA	2-1~ 2-9,
		1.New PLC added -XBE-DN32A	7-52, 7-54
		LSIS to change its corporate name to LS ELECTRIC	Entire
V2.0	2022.09	Change domain (lselectric.co.kr -> ls-electric.com)	Entire
V2.1	2023.05	1. Module added (1) XBE-AC08A 2. XBCE_XBCS Max.Load changed 3. Ferrule specification contents added	7-43 7-3
V2.2	2024.06	Warranty period changed	BackCover

About User's Manual

Congratulations on purchasing PLC of LS ELECTRIC Co.,Ltd.

Before use, make sure to carefully read and understand the User's Manual about the functions, performances, installation and programming of the product you purchased in order for correct use and importantly, let the end user and maintenance administrator to be provided with the User's Manual.

The Use's Manual describes the product. If necessary, you may refer to the following description and order accordingly. In addition, you may connect our website(<http://www.ls-electric.com/>) and download the information as a PDF file.

Relevant User's Manual

Title	Description	No. of User Manual
XG5000 User's Manual	It describes how to use XG5000 software especially about online functions such as programming, printing, monitoring and debugging by using XGT series products.	10310000512
XGK/XGB Series Instruction & Programming	It describes how to use the instructions for programming using XGK/XGB series.	10310000510
XGB Analog User's Manual	It describes how to use the specification of analog input/analog output/temperature input module, system configuration and built-in PID control for XGB main unit.	10310000920
XGB Cnet I/F User's Manual	It describes how to use built-in communication function for XGB main unit and external Cnet I/F module.	10310000816
XGB Fast Ethernet I/F User's Manual	It describes how to use XGB FEnet I/F module.	10310000873

© Contents ©

Chapter 1 Introduction	1-1~1-5
------------------------------	---------

1.1 Guide to Use This Manual	1-1
1.2 Features	1-2
1.3 Terminology	1-4

Chapter 2 System Configuration	2-1~2-14
--------------------------------------	----------

2.1 XGB System Configuration	2-1
2.2 Product List	2-3
2.3 Classification and Type of Product Name	2-5
2.3.1 Classification and type of basic unit	2-5
2.3.2 Classification and type of expansion module	2-7
2.3.3 Classification and type of special module	2-8
2.3.4 Classification and type of communication module	2-9
2.4 System Configuration	2-11
2.4.1 Cnet I/F system	2-11
2.4.2 Ethernet system	2-14

Chapter 3 General Specifications	3-1
--	-----

3.1 General Specifications	3-1
----------------------------------	-----

Chapter 4 CPU Specifications	4-1~4-14
------------------------------------	----------

4.1 Performance Specifications	4-1
4.2 Names of Part and Function	4-7
4.3 Power Supply Specifications	4-10
4.4 Calculating Example of Consumption Current/Voltage	4-13
4.5 Data Backup Time	4-14

Chapter 5 Program Configuration and Operation Method	5-1~5-37
--	----------

5.1 Program Instruction	5-1
5.1.1 Program execution methods	5-1
5.1.2 Operation processing during momentary power failure	5-2
5.1.3 Scan time	5-3
5.1.4 Scan Watchdog timer	5-5
5.1.5 Timer processing	5-6
5.1.6 Counter processing	5-9
5.2 Program Execution	5-11
5.2.1 Configuration of program	5-11
5.2.2 Program execution methods.....	5-11
5.2.3 Interrupt	5-13
5.3 Operation Mode	5-25
5.3.1 RUN mode	5-25
5.3.2 STOP mode	5-26
5.3.3 DEBUG mode	5-26
5.3.4 Change operation mode	5-30
5.4 Memory	5-31
5.4.1 Data memory	5-31
5.5 Configuration Diagram of Data Memory	5-33
5.5.1 "S" type	5-33
5.5.2 "H" type	5-34
5.5.3 Data latch area setting.....	5-35

Chapter 6 CPU Functions.....	6-1~6-25
------------------------------	----------

6.1 Type Setting	6-1
6.2 Parameter Setting	6-2
6.2.1 Basic parameter setting	6-2
6.2.2 I/O parameter setting	6-3
6.3 Self-diagnosis Function	6-4
6.3.1 Saving of error log	6-4
6.3.2 Troubleshooting	6-4
6.4 Remote Functions.....	6-6
6.5 Forced Input/Output On and Off Function	6-7
6.5.1 Force I/O setup	6-7
6.5.2 Processing time and method of Forced Input/Output On and Off	6-8
6.6 Direct Input/Output Operation	6-9
6.7 Diagnosis of External Device	6-10
6.8 Allocation of Input/Output Number	6-11

6.9 Online Editing	6-13
6.10 Reading Input/Output Information	6-16
6.11 Monitoring	6-17
6.12 Program Upload Prohibit	6-22
6.13 Clear All PLC	6-23
6.14 Password Setting per Program Block	6-24

Chapter 7 Input/Output Specifications	7-1~7-57
---	----------

7.1 Introduction	7-1
7.2 Main Unit Digital Input Specifications	7-8
7.2.1 XBC-DR10E/ DN10E/ DP10E 6 point DC24V input (Source/Sink type)	7-8
7.2.2 XBC-DR14E/ DN14E/ DP14E 8 point DC24V input (Source/Sink type)	7-9
7.2.3 XBC-DR20E/DN20E/DP20E 12 point DC24V input (Source/Sink type)	7-10
7.2.4 XBC-DR30E/DN30E/ DP30E 18 point DC24V input (Source/Sink type)	7-11
7.2.5 XBC-DR20SU/DN20SU/DP20SU 12 point DC24V input (Source/Sink type)	7-12
7.2.6 XBC- DR30SU/DN30SU/DP30SU 18 point DC24V input (Source/Sink type)	7-13
7.2.7 XBC-DR40SU/DR40SU/ DR40SU 24 point DC24V input (Source/Sink Type)	7-14
7.2.8 XBC-DR60SU/DN60SU/ DP60SU 36 point DC24V input (Source/Sink Type)	7-15
7.3 Main Unit Digital Output Specifications	7-16
7.3.1 XBC-DR10E 4 point relay output.....	7-16
7.3.2 XBC-DR14E 6 point relay output.....	7-17
7.3.3 XBC-DR20E 8 point relay output.....	7-18
7.3.4 XBC-DR30E 12 point relay output.....	7-19
7.3.5 XBC-DN10E 4 point transistor output (Sink type)	7-20
7.3.6 XBC-DN14E 6 point transistor output (Sink type)	7-21
7.3.7 XBC-DN20E 8 point transistor output (Sink type)	7-22
7.3.8 XBC-DN30E 12 point transistor output (Sink type)	7-23
7.3.9 XBC-DP10E 4 point transistor output (Source type)	7-24
7.3.10 XBC-DP14E 6 point transistor output (Source type)	7-25
7.3.11 XBC-DP20E 8 point transistor output (Source type)	7-26
7.3.12 XBC-DP30E 12 point transistor output (Source type)	7-27
7.3.13 XBC-DR20SU 8 point relay output	7-28
7.3.14 XBC-DR30SU 12 point relay output	7-29
7.3.15 XBC-DR40SU 16 point relay output	7-30
7.3.16 XBC-DR60SU 24 point relay output	7-31
7.3.17 XBC-DN20S(U) 8 point transistor output (Sink type)	7-32
7.3.18 XBC-DN30S(U) 12 point transistor output (Sink type)	7-33
7.3.19 XBC-DN40SU 16 point TR output (Sink type)	7-34

7.3.20 XBC-DN60SU 24 point TR output (Sink type)	7-35
7.3.21 XBC-DP20SU 8 point transistor output (Source type).....	7-36
7.3.22 XBC-DP30SU 12 point transistor output (Source type).....	7-37
7.3.23 XBC-DP40SU 16 point TR output (Source type).....	7-38
7.3.24 XBC-DP60SU 24 point TR output (Source type).....	7-39
7.4 Digital Input Module Specifications	7-40
7.4.1 8 point DC24V input module (Source/Sink type)	7-40
7.4.2 16 point DC24V input module (Source/Sink type)	7-41
7.4.3 32 point DC24V input module (Source/Sink type).....	7-42
7.4.3 8 point AC110V input module	7-43
7.5 Digital Output Module Specifications	7-44
7.5.1 8 point relay output module	7-44
7.5.2 8 point relay output module (independent point)	7-45
7.5.3 16 point relay output module	7-46
7.5.4 8 point transistor output module (Sink type)	7-47
7.5.5 16 point transistor output module (Sink type).....	7-48
7.5.6 32 point transistor output module (Sink type).....	7-49
7.5.7 8 point transistor output module (Source type).....	7-50
7.5.8 16 point transistor output module (Source type)	7-51
7.5.9 32 point transistor output module (Source type)	7-52
7.6 Combined Digital I/O module Input Specification	7-53
7.6.1 8 point DC24V input (Source/Sink type).....	7-53
7.6.2 16 point DC24V input (Source/Sink type).....	7-54
7.7 Combined Digital I/O module Output Specification.....	7-55
7.7.1 8 point relay output	7-55
7.7.2 16 point transistor output (Sink type).....	7-56
7.8 IO Wiring by Using Smart Link Board	7-57
7.8.1 Smart link board.....	7-57

Chapter 8 Built-in High-speed Counter Function	8-1~8-54
--	----------

8.1 High-speed Counter Specifications	8-1
8.1.1 Performance specifications	8-1
8.1.2 Designation of parts	8-3
8.1.3 "E" type Functions	8-6
8.1.4 "S(U)" type Functions	8-23
8.2 Installation and Wiring	8-40
8.2.1 Precaution for wiring	8-40
8.2.2 Example of wiring	8-40

8.3 Internal Memory 8-41
 8.3.1 Special area for High-speed counter 8-41
 8.3.2 Error code 8-49
 8.4 Examples: Using High-speed Counter 8-50

Chapter 9 RTC Option Board9-1~9-5

9.1 Battery..... 9-1
 9.1.1 Battery specification 9-1
 9.1.2 Notice in using 9-1
 9.1.3 Life of battery 9-1
 9.1.4 How to change battery 9-2
 9.2 RTC Function..... 9-3
 9.2.1 How to use 9-3
 9.3 Name and Function of Each Part 9-5

Chapter 10 DC Input Option Function 10-1~10-15

10.1 DC input Option Board Specification 10-1
 10.1.1 DC input Option Board Specification 10-1
 10.2 High Speed Counter Specification 10-2
 10.2.1 Performance Specification 10-2
 10.2.2 Name of Each Part 10-3
 10.2.3 Function 10-5
 10.3 Installation and Wiring 10-9
 10.3.1 Power wiring 10-9
 10.3.2 Example of wiring 10-9
 10.4 Internal Memory 10-11
 10.4.1 Special area for High-speed counter 10-11
 10.5 Example using high-speed counter 10-15

Chapter 11 TR Output Option Board 11-1~11-16

11.1 TR Output Option Board Operation Sequence of Positioning 11-1
 11.1.1 Operation Sequence of Positioning 11-1
 11.2 XBO-TN04A Specification 11-2
 11.2.1 Output option board specification 11-2
 11.3 Positioning Specification 11-3

11.3.1 Performance Specification 11-3

11.3.2 Name of each part 11-3

11.3.3 Before Positioning 11-5

11.3.4 Positioning Stop Factor 11-7

11.3.5 Manual operation 11-8

11.3.6 Home return 11-9

11.3.7 Positioning Basic Parameter Setup 11-10

11.4 Positioning Instruction List 11-14

11.5 Positioning Example 11-15

Chapter 12 Memory Module 12-1~12-9

12.1 Memory Module Specification 12-1

12.1.1 Memory module specification 12-1

12.1.2 Memory module structure 12-1

12.1.3 How to use memory module 12-2

12.1.4 How to use when password is set 12-7

Chapter 13 Installation and Wiring 13-1~13-18

13.1 Safety Instruction 13-1

13.1.1 Fail safe circuit 13-3

13.1.2 PLC heat calculation 13-6

13.2 Attachment/Detachment of Modules 13-8

13.2.1 Attachment/Detachment of modules 13-8

13.2.2 Caution in handling 13-13

13.3 Wire 13-14

13.3.1 Power wiring 13-14

13.3.2 I/O Device wiring 13-17

13.3.3 Grounding wiring 13-17

13.3.4 Specifications of wiring cable 13-18

Chapter 14 Maintenance 14-1~14-2

14.1 Maintenance and Inspection 14-1

14.2 Daily Inspection 14-1

14.3 Periodic Inspection 14-2

Chapter 15 Troubleshooting	15-1~15-12
----------------------------------	------------

15.1 Basic Procedure of Troubleshooting	15-1
15.2 Troubleshooting	15-1
15.2.1 Troubleshooting flowchart used with when the PWR(Power) LED turns Off.....	15-2
15.2.2 Troubleshooting flowchart used with when the ERR(Error) LED is flickering	15-3
15.2.3 Troubleshooting flowchart used with when the RUN,STOP LED turns Off.	15-4
15.2.4 Troubleshooting flowchart used with when the I/O part doesn't operate normally..	15-5
15.3 Troubleshooting Questionnaire	15-7
15.4 Troubleshooting Examples	15-8
15.4.1 Input circuit troubles and corrective actions	15-8
15.4.2 Output circuit and corrective actions	15-9
15.5 Error Code List.....	15-11

Appendix 1 Flag List	App. 1-1~App.1-13
----------------------------	-------------------

Appendix 1.1 Special Relay (F) List.....	App. 1-1
Appendix 1.2 Communication Relay (L) List	App. 1-6

Appendix 2 Dimension.....	App.2-1~App.2-4
---------------------------	-----------------

Appendix 3 Compatibility with MASTER-K.....	App.3-1~App.3-6
---	-----------------

Appendix 4 Instruction List.....	App.4-1~App.4-40
----------------------------------	------------------

Appendix 4.1 Classification of Instructions.....	App.4-1
Appendix 4.2 Basic Instructions	App.4-2
Appendix 4.3 Application Instruction	App.4-5
Appendix 4.4 Special/Communication Instruction	App.4-37

Appendix 5 Installation Of Option Board	App.5-1
---	---------

Chapter 1 Introduction

1.1 Guide to Use This Manual

This manual includes specifications, functions and handling instructions for the XGB series PLC.
This manual is divided up into chapters as follows.

No.	Title	Contents
Chapter 1	Introduction	Describes configuration of this manual, unit's features and terminology.
Chapter 2	System Configurations	Describes available units and system configuration in the XGB series.
Chapter 3	General Specifications	Describes general specifications of units used in the XGB series.
Chapter 4	CPU Specifications	Describes performances, specifications and operations.
Chapter 5	Program Configuration and Operation Method	
Chapter 6	CPU Module Functions	
Chapter 7	Input/Output Specifications	Describes operation of basic and input/output.
Chapter 8	Built-in High-speed Counter Function	Describes built-in high-speed counter functions.
Chapter 9	Installation and Wiring	Describes installation, wiring and handling instructions for reliability of the PLC system.
Chapter 10	Maintenance	Describes the check items and method for long-term normal operation of the PLC system.
Chapter 11	Troubleshooting	Describes various operation errors and corrective actions.
Appendix 1	Flag List	Describes the types and contents of various flags.
Appendix 2	Dimension	Shows dimensions of the main units and expansion modules.
Appendix 3	Compatibility with MASTER-K	Describes the compatibility with MASTER-K.
Appendix 4	Instruction List	Describes the special relay and instruction list.

1.2 Features

The features of XGB system are as follows.

(1) The system secures the following high performances.

(a) High Processing Speed

(b) Max. 284 I/O control supporting small & mid-sized system implementation

Item	Type		Reference
	XBC-DRxxE	XBC-DxxxS(U)	
Operation processing speed	0.24 μ s / Step	94ns / Step	-
Max IO contact point	38 points	284 points	In case of using option module 4 points (Coming soon)
Program capacity	4kstep	15kstep	-
Max. no. of expanded stage	Option module 2 stages	7 stages (including option module 2 stages)	-

(c) Enough program capacity

(d) Expanded applications with the support of floating point.

(e) XBC-DRxxE is expressed as “E” type and XBC-DxxxS(U) is expressed as “S(U)” type.

(2) Compact : the smallest size comparing to the same class model of competitors.

(a) Compact panel realized through the smallest size.

(Unit: mm)

Item	Type	Size (W * H * D)	Reference
Basic unit	XBC-Dx20S	135*90*64	“S” type
	XBC-Dx30S		
	XBC-Dx20SU		
	XBC-Dx30SU		
	XBC-Dx40SU	161 * 90 * 64	“SU” type
	XBC-Dx60SU	210 * 90 * 64	
	XBC-Dx10E	100*90*64	“E” type
	XBC-Dx14E		
	XBC-Dx20E	135*90*64	
	XBC-Dx30E		
Extension module	XBE-,XBF-,XBL-	20 * 90 * 60	Basis of minimum size

(3) Easy attachable/extensible system for improved user convenience.

(a) By adopting a removable terminal block connector (M3 X 6 screw), convenience of wiring may be increased.

(“S(U)” type main unit)

(b) By adopting connector coupling method, modules may be easily connected and separated.

(4) Improved maintenance ability with kinds of register, RTC option, comment backup and etc

(a) Convenient programming environment by providing analogue register and index register.

- (b) Improved maintenance ability by operating plural programs and task program through module program.
 - (c) Built-in Flash ROM enabling permanent backup of program without any separate battery.

 - (d) Improved maintenance ability by types of comment backup.
 - (e) Built-in RTC function enabling convenient history and schedule management
- (5) Optimized communication environment.
- (a) With max. 2 channels of built-in COM (1 channel for “E” type (except load port)), communication is available without any expanded of module.
 - (b) Supporting various protocols to improve the convenience (~~leased~~dedicated, Modbus, user-defined communication)
 - (c) Communication module may be additionally increased by adding modules (up to 2 ~~rack~~stages such as Cnet, Enet and etc). (“S(U)” type main unit)
 - (d) Convenient network-diagnostic function through network & communication frame monitoring.
 - (e) Convenient networking to upper systems through Enet or Cnet. (“S(U)” type main unit)
- (6) Applications expanded with a variety of I/O modules.
- (a) 8, 16, 32 points modules provided (if relay output, 8/16 points module).
 - (b) Single input, single output and combined I/O modules supported.
- (7) Applications expanded through analog ~~ue~~exclusive-dedicated register design and full attachable mechanism.
- (a) All analogue modules can be attachable on extension base. (“S(U)” type: up to 7 ~~racks~~stages available)
 - (b) With analog ~~ue~~exclusive-dedicated register(U) and monitoring ~~exclusive-dedicated~~ function, convenient use for I/O is maximized (can designate operations using easy programming of U area and monitoring function)
- (8) Integrated programming environment
- (a) XG 5000: intensified program convenience, diverse monitoring, diagnosis and editing function
 - (b) XG - PD: COM/network parameters setting, frame monitoring, protocol analysis function
- (9) Built-in high speed counter function
- (a) Providing ~~high~~High-speed counter 1phase, 2phase and more additional functions.
 - (b) Providing parameter setting, diverse monitoring and diagnosis function using XG5000.
 - (c) Monitoring function in XG5000 can inspect without program, inspecting external wiring, data setting and others.
- [\(마침표\)](#)
- (10) Built-in position control function (“S(U)” type TR output main unit)
- (a) Supporting max 100Kpps 2 axes.
 - (b) Providing parameter setting, operation data collection, diverse monitoring and diagnosis by using XG5000.
 - (c) Commissioning by monitoring of XG5000, without program, inspecting external wiring and operation data setting.

(11) Built-in PID (“S(U)” type main unit)

- (a) Supporting max. 16 loops.
- (b) Setting parameters by using XG5000 and supporting loop status monitoring conveniently with trend monitor.
- (c) Control constant setting through the improved ~~automatic~~-Auto-tuning function.
- (d) With many other additional functions including PWM output, Δ MV, Δ PV and SV Ramp, improving the control preciseness.
- (e) Supporting types of control modes such as forward/backward mixed operation, 2-stage SV PID control, cascade control and etc.
- (f) A variety of warning functions such as PV MAX and PV variation warning securing the safety.

1.3 Terminology

The following table gives definition of terms used in this manual.

Terms	Definition	Remark
Module	A standard element that has a specified function which configures the system. Devices such as I/O board, which inserted onto the mother board.	Example) Expansion module, Special module, Communication module
Unit	A single module or group of modules that perform an independent operation as a part of PLC systems.	Example) Main unit, Expansion unit
PLC System	A system which consists of the PLC and peripheral devices. A user program can control the system.	-
XG5000	A program and debugging tool for the MASTER-K series. It executes program creation, edit, compile and debugging. (PADT: Programming Added Debugging Tool)	-
XG - PD	Software to execute description, edition of basic parameter, high speed link, P2P parameter, and function of communication diagnosis	-
I/O image area	Internal memory area of the CPU module which used to hold I/O status.	-
Cnet	Computer Network	-
FEnet	Fast Ethernet Network	-
Pnet	Profibus-DP Network	-
Dnet	DeviceNet Network	-
RTC	Abbreviation of 'Real Time Clock'. It is used to call general IC that contains clock function.	-
Watchdog Timer	Supervisors the pre-set execution times of programs and warns if a program is not completed within the pre-set time.	-

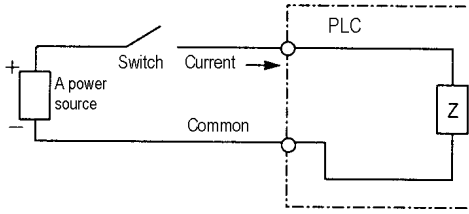
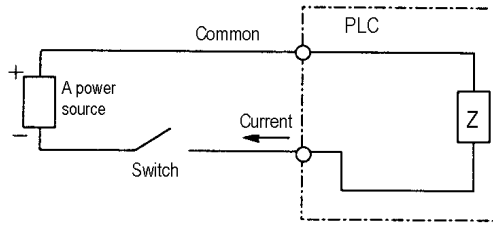
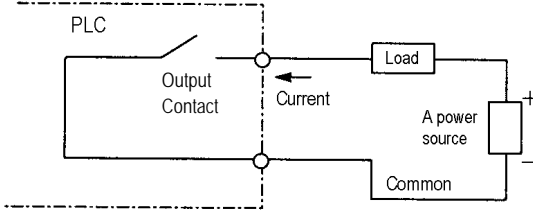
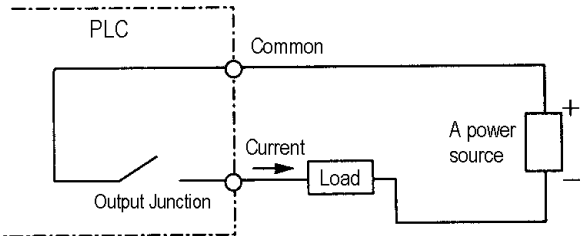
Terms	Definition	Remark
Sink Input	<p>Current flows from the switch to the PLC input terminal if a input signal turns on.</p> 	Z: Input impedance
Source Input	<p>Current flows from the PLC input terminal to the switch after a input signal turns on.</p> 	-
Sink Output	<p>Current flows from the load to the output terminal and the PLC output turn on.</p> 	-
Source Output	<p>Current flows from the output terminal to the load and the PLC output turn on.</p> 	-

Chapter 2 System Configuration

The XGB series has suitable to configuration of the basic, computer link and network systems.

This chapter describes the configuration and features of each system.

2.1 XGB System Configuration

XGB series System Configuration is as follows.

For “E” type, only option module can be attached

For “S” type, up to 7 stages connection is available. But in case of attaching 2 option modules, up to 5 stages connection is available. (For communication module, up to 2 connection is available.)

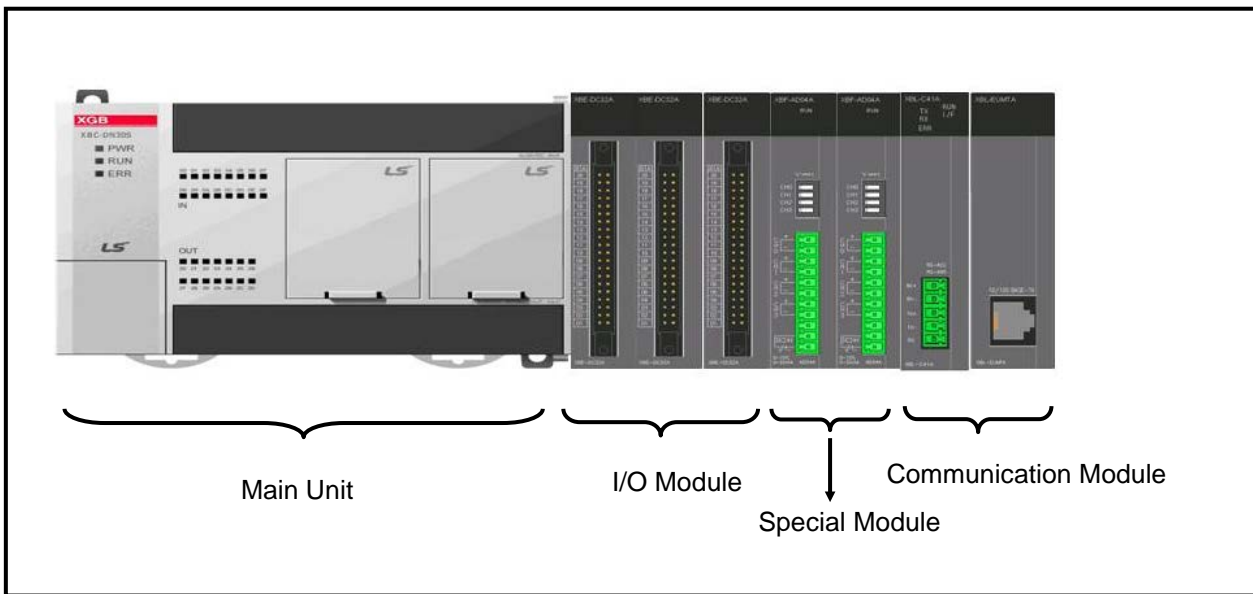

Item		Description
Total I/O points		<ul style="list-style-type: none"> • XBC-DxxxS (“S(U)” type): 20~284 points • XBC-DxxxE (“E” type): 10~38 points
Maximum number of expansion modules	Digital I/O module	• “S(U)” type: Max. 7
	Special module	• “S(U)” type: Max. 7
	Communication I/F module	• “S(U)” type: Max. 2
	Option module	<ul style="list-style-type: none"> • “S(U)” type: Max. 2 • “E” type: Max. 2 (In case of 10/14 points, only one is available)
Items	Main unit	“S” type <ul style="list-style-type: none"> • XBC-DR20/30/40/60SU • XBC-DN20/30/40/60SU
		“E” type <ul style="list-style-type: none"> • XBC-DN20/30S • XBC-DP20/30/40/60SU • XBC-DN10/14/20/30E • XBC-DP10/14/20/30E

Item		Description
Items	Expansion module	Digital I/O module <ul style="list-style-type: none"> • XBE-DC08/16A/B/32A • XBE-RY08A/B/16A • XBE-TN08/16/32A • XBE-DR16A • XBE-TP08/16/32A • XBE-DN32A
		Special module <ul style="list-style-type: none"> • XBF-AD04A • XBF-AD08A • XBF-AD04C • XBF-DC04A • XBF-DC04C • XBF-DV04A • XBF-DV04C • XBF-AH04A • XBF-RD04A • XBF-TC04S • XBF-TC04RT • XBF-TC04TT • XBF-PD02A • XBF-HD02A • XBF-HO02A
		Communication I/F module <ul style="list-style-type: none"> • XBL-C41A • XBL-EMTA • XBL-CSEA • XBL-DSEA • XBL-C21A • XBL-EIMT • XBL-PMEC • XBL-EIPT • XBL-CMEA • XBL-PSEA
	Option module	Digital I/O module <ul style="list-style-type: none"> • XBO-DC04A(High speed counter is available on "SU" type) • XBO-TN04A(Positioning is available on slot 9 of "SU" type)
		Special module <ul style="list-style-type: none"> • XBO-AD02A • XBO-RD01A • XBO-DA02A • XBO-TC02A • XBO-AH02A
		RTC module <ul style="list-style-type: none"> • XBO-RTCA(available on slot 9)
		Memory module <ul style="list-style-type: none"> • XBO-M2MB

2.2 Product List

XGB series' product list is as follows.

Types	Model	Description	Remark	
Main Unit	XBC-DR32H	AC100~240V power supply, DC24V input 16 point, Relay output 16 point		
	XBC-DN32H	AC100~240V power supply, DC24V input 16 point, Transistor output 16 point		
	XBC-DR64H	AC100~240V power supply, DC24V input 32 point, Relay output 32 point		
	XBC-DN64H	AC100~240V power supply, DC24V input 32 point, Transistor output 32 point		
	XBC-DR20SU	AC100~240V power supply, DC 24V input 12 point, relay output 8 point		
	XBC-DN20S(U)	AC100~240V power supply, DC24V input 12 point, transistor 8 point		
	XBC-DP20SU	AC100~240V power supply, DC24V input 12 point, transistor 8 point		
	XBC-DR30SU	AC100~240V power supply, DC 24V input 18 point, relay output 12 point		
	XBC-DN30S(U)	AC100~240V power supply, DC 24V input 18 point, transistor output 12 point		
	XBC-DP30SU	AC100~240V power supply, DC 24V input 18 point, transistor output 12 point		
	XBC-DR40SU	AC100~240V power supply, DC 24V input 24 point, relay output 16 point		
	XBC-DN40SU	AC100~240V power supply, DC 24V input 24 point, transistor output 16 point		
	XBC-DP40SU	AC100~240V power supply, DC 24V input 24 point, transistor output 16 point		
	XBC-DR60SU	AC100~240V power supply, DC 24V input 36 point, relay output 24 point		
	XBC-DN60SU	AC100~240V power supply, DC 24V input 36 point, transistor output 24 point		
	XBC-DP60SU	AC100~240V power supply, DC 24V input 36 point, transistor output 24 point		
	XBC-DR10E	AC100~240V power supply, DC 24V input 6 point, relay output 4 point		
	XBC-DR14E	AC100~240V power supply, DC 24V input 8 point, relay output 6 point		
	XBC-DR20E	AC100~240V power supply, DC 24V input 12 point, relay output 8 point		
	XBC-DR30E	AC100~240V power supply, DC 24V input 18 point, relay output 12 point		
	XBC-DN10E	AC100~240V power supply, DC 24V input 6 point, transistor output 4 point		
	XBC-DN14E	AC100~240V power supply, DC 24V input 8 point, transistor output 6 point		
	XBC-DN20E	AC100~240V power supply, DC 24V input 12 point, transistor output 8 point		
	XBC-DN30E	AC100~240V power supply, DC 24V input 18 point, transistor output 12 point		
	XBC-DP10E	AC100~240V power supply, DC 24V input 6 point, transistor output 4 point		
	XBC-DP14E	AC100~240V power supply, DC 24V input 8 point, transistor output 6 point		
	XBC-DP20E	AC100~240V power supply, DC 24V input 12 point, transistor output 8 point		
	XBC-DP30E	AC100~240V power supply, DC 24V input 18 point, transistor output 12 point		
	XBM-DN16S	DC24V Power supply, DC24V Input 8 point, Transistor output 8 point		
	XBM-DN32S	DC24V Power supply, DC24V Input 16 point, Transistor output 16 point		
	XBM-DR16S	DC24V Power supply, DC24V Input 8 point, Relay output 8 point		
	Expansion Module	XBE-DC08A	DC24V Input 8 point	
		XBE-DC16A/B	DC24V Input 16 point	
XBE-DC32A		DC24V Input 32 point		
XBE-AC08A		AC110V Input 8 point		
XBE-RY08A		Relay output 8 point		
XBE-RY08B		Relay output 8 point (independent point)		
XBE-RY16A		Relay output 16 point		
XBE-TN08A		Transistor output 8 point (sink type)		
XBE-TN16A		Transistor output 16 point (sink type)		
XBE-TN32A		Transistor output 32 point (sink type)		
XBE-TP08A		Transistor output 8 point (source type)		
XBE-TP16A		Transistor output 16 point (source type)		
XBE-TP32A		Transistor output 32 point (source type)		
XBE-DR16A		DC24V Input 8 point, Relay output 8 point		

Types	Model	Description	Remark
	XBE-DN32A	DC24V Input 16 point, Transistor output 16 point (sink type)	

Chapter 2. System Configuration

Types	Model	Description	Remark
Special Module	XBF-AD04A	Current/Voltage input 4 channel	
	XBF-AD04C	Current/Voltage input 4 channel, High resolution	
	XBF-DC04A	Current output 4 channel	
	XBF-DC04C	Voltage output 4 channel, High resolution	
	XBF-DV04A	Voltage output 4 channel	
	XBF-DV04C	Current output 4 channel, High resolution	
	XBF-AH04A	Current/voltage input 2 channel, output 2 channel	
	XBF-RD04A	RTD (Resistance Temperature Detector) input 4 channel	
	XBF-TC04S	TC (Thermocouple) input 4 channel	
	XBF-TC04RT	Temperature controller module (RTD input, 4 roof)	
	XBF-TC04TT	Temperature controller module (TC input, 4 roof)	
	XBF-AD08A	Current/voltage input 8 channel	
	XBF-PD02A	2 axes, line driver type	
	XBF-HD02A	High Speed Counter 2channel, line driver type	
	XBF-HO02A	High Speed Counter 2channel, open collector type	
Communication Module	XBL-C21A	Cnet (RS-232C/Modem) I/F	
	XBL-C41A	Cnet (RS-422/485) I/F	
	XBL-EMTA	Enet I/F	
	XBL-EIMT/F/H	RAPINet I/F	
	XBL-EIPT	EtherNet/IP module	
	XBL-CMEA	CANopen Master	
	XBL-CSEA	CANopen Slave	
	XBL-PMEC	Profibus-DP, Master	
	XBL-PSEA	Profibus-DP, Slave	
XBL-DSEA	DeviceNet, Slave		
Option Module	XBO-AD02A	Current/voltage input 2channel	
	XBO-DA02A	Current/voltage output 2 channel	
	XBO-AH02A	Current/Voltage input 1 channel, output 1 channel	
	XBO-RD01A	RTD input 1 channel	
	XBO-TC02A	Thermocouple input 2 channel	
	XBO-DC04A	DC 24V input 4 point(High speed counter is available on "SU "type)	
	XBO-TN04A	Sink type transistor output 4 channel (Positioning is available on slot 9 of "SU "type)	
	XBO-RTCA	RTC module(available on slot 9)	
	XBO-M2MB	Memory module	
cable	PMC-310S	Connection cable (PC to PLC), 9pin(PC)-6pin(PLC)	
	USB-301A	Connection cable (PC to PLC), USB	

Note

Download Cable (PMC-310S) Diagram

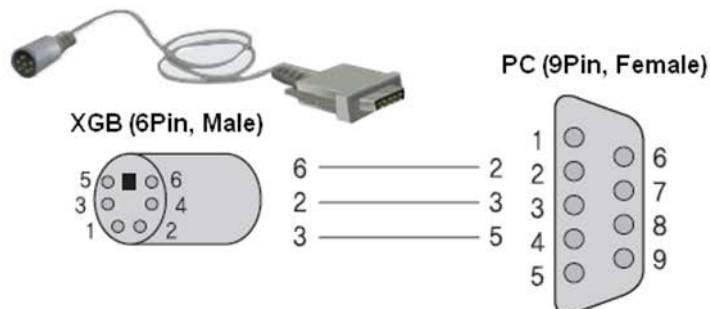

2.3 Classification and Type of Product Name

2.3.1 Classification and type of basic unit

Name of basic unit is classified as follows.

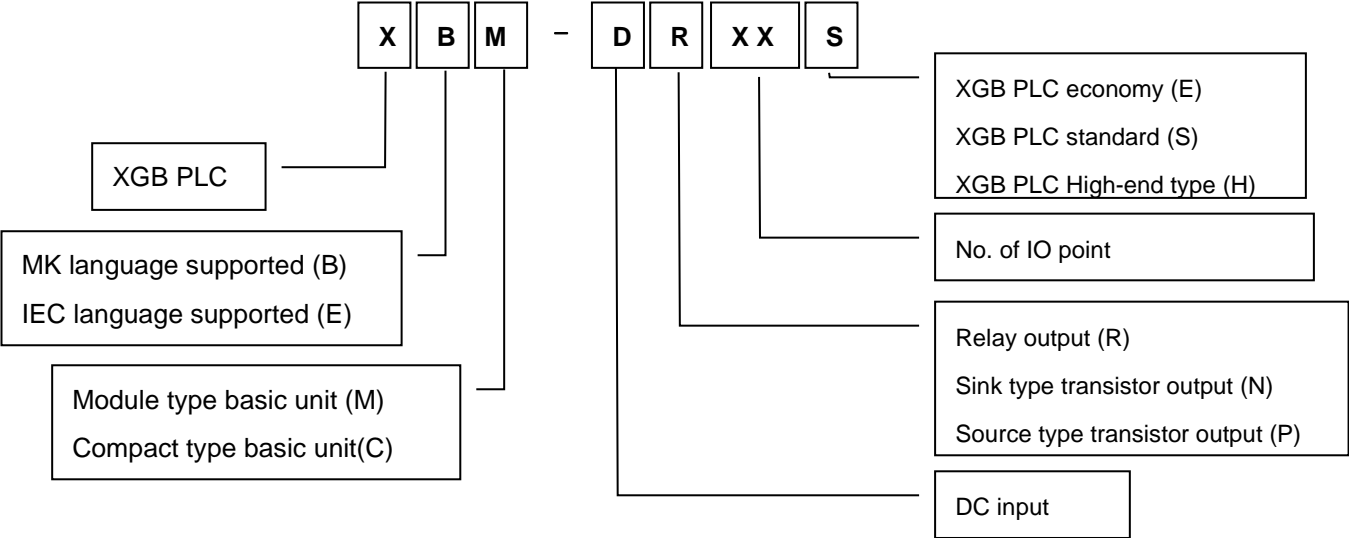

Chapter 2. System Configuration

Classification	Name	DC input	Relay output	Transistor output	Power
Modular type main unit	XBM-DR16S	8 point	8 point	None	DC24V
	XBM-DN16S	8 point	None	8 point	
	XBM-DN32S	16 point	None	16 point	
Compact type main nit	XBC-DR32H	16 point	16 point	None	AC100V~240V
	XBC-DN32H	16 point	None	16 point	
	XBC-DR64H	32 point	32 point	None	
	XBC-DN64H	32 point	None	32 point	
	XBC-DN20S(U)	12 point	None	8 point	
	XBC-DN30S(U)	18 point	None	12 point	
	XBC-DN40SU	24 point	None	16 point	
	XBC-DN60SU	36 point	None	24 point	
	XBC-DP20SU	12 point	None	8 point	
	XBC-DP30SU	18 point	None	12 point	
	XBC-DP40SU	24 point	None	16 point	
	XBC-DP60SU	36 point	None	24 point	
	XBC-DR20SU	12 point	8 point	None	
	XBC-DR30SU	18 point	12 point	None	
	XBC-DR40SU	24 point	16 point	None	
	XBC-DR60SU	36 point	24 point	None	
	XBC-DR10E	6 point	4 point	None	
	XBC-DR14E	8 point	6 point	None	
	XBC-DR20E	12 point	8 point	None	
	XBC-DR30E	18 point	12 point	None	
	XBC-DN10E	6 point	None	4 point	
	XBC-DN14E	8 point	None	6 point	
	XBC-DN20E	12 point	None	8 point	
	XBC-DN30E	18 point	None	12 point	
	XBC-DP10E	6 point	None	4 point	
	XBC-DP14E	8 point	None	6 point	
	XBC-DP20E	12 point	None	8 point	
	XBC-DP30E	18 point	None	12 point	

2.3.2 Classification and type of expansion module

Name of expansion module is classified as follows.

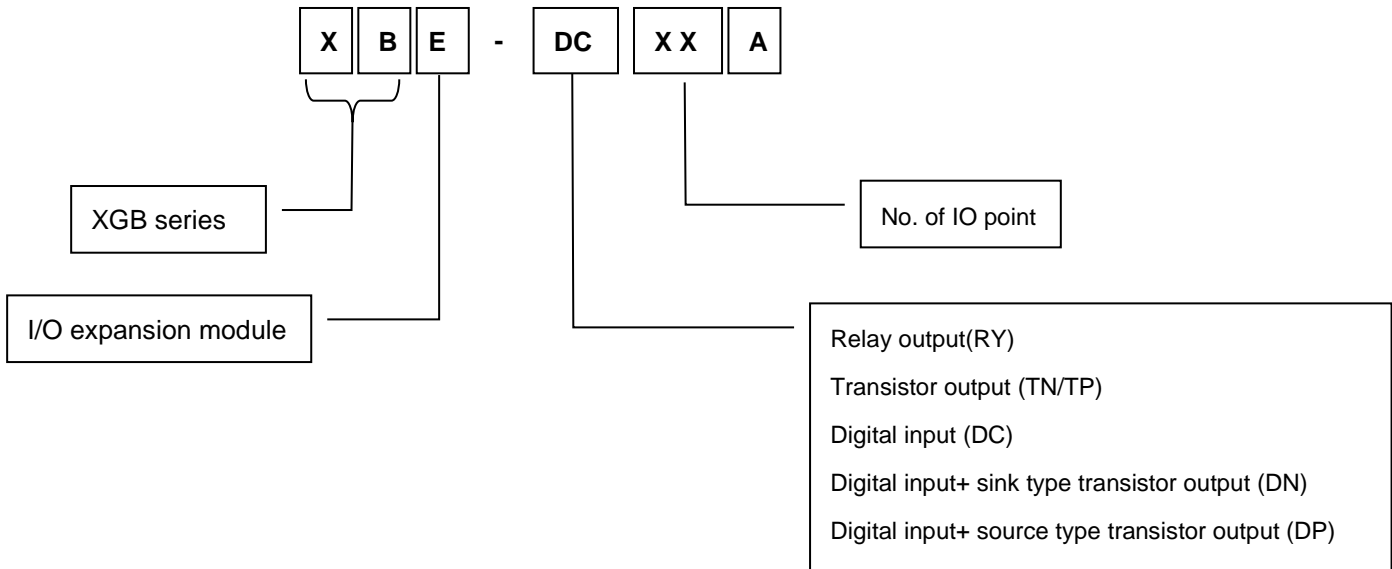

Name	DC input	AC input	Relay output	Transistor output	Reference
XBE-DC08A	8 point	None	None	None	
XBE-DC16A/B	16 point	None	None	None	
XBE-DC32A	32 point	None	None	None	
XBE-AC08A	None	8 point	None	None	
XBE-RY08A/B	None	None	8 point	None	
XBE-RY16A	None	None	16 point	None	
XBE-TN08A	None	None	None	8 point	Sink type
XBE-TN16A	None	None	None	16 point	
XBE-TN32A	None	None	None	32 point	
XBE-TP08A	None	None	None	8 point	Source type
XBE-TP16A	None	None	None	16 point	
XBE-TP32A	None	None	None	32 point	
XBE-DR16A	8 point	None	8 point	None	
XBE-DN32A	16 point	None	None	16 point	Sink type

2.3.3 Classification and type of special module

Special module is classified as follows.

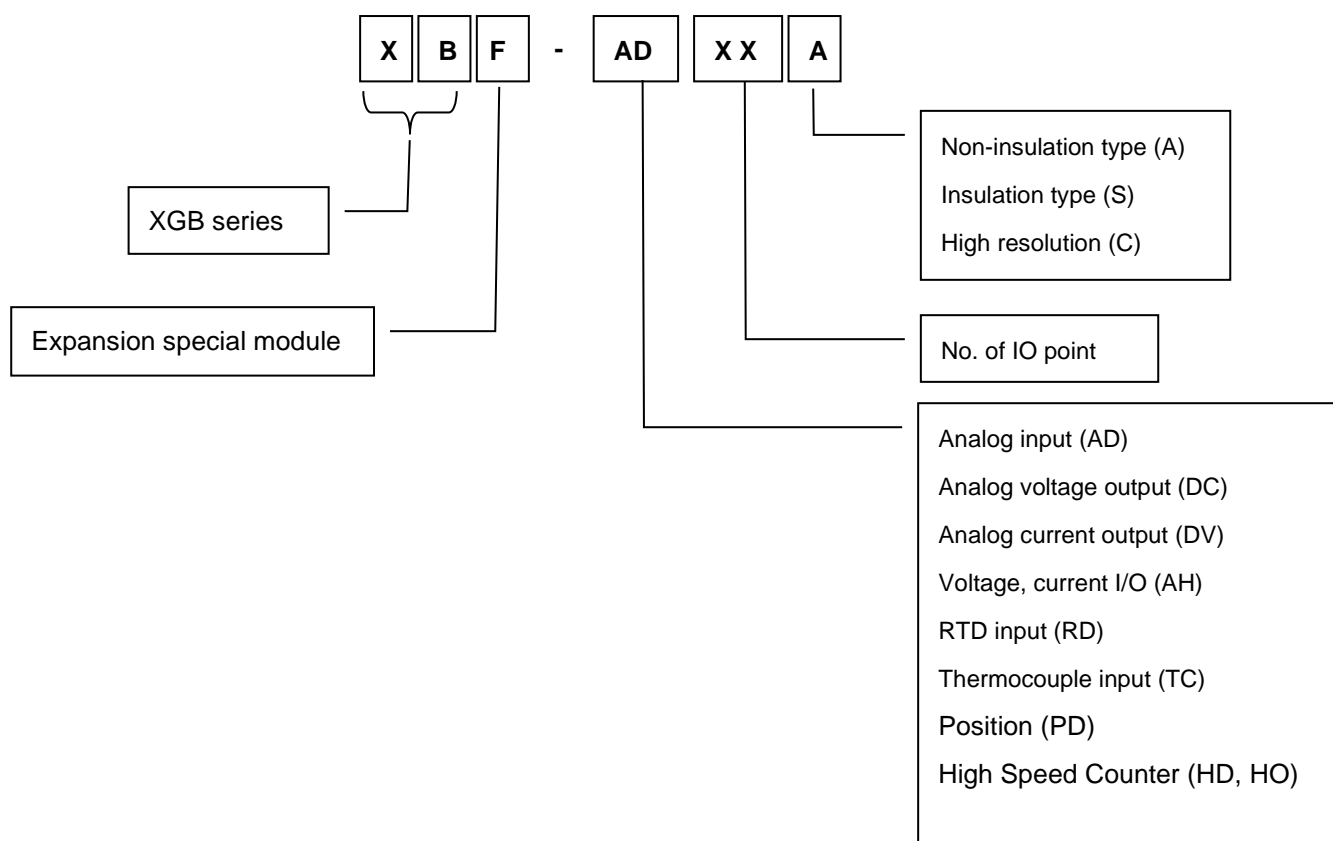

Classification	Name	No. of input ch.	Input type	No. of output ch.	Output type
Analog input	XBF-AD04A/C	4	Voltage/Current	None	-
	XBF-AD08A	8	Voltage/Current	None	-
Analog output	XBF-DC04A/C	None	-	4	Current
	XBF-DV04A/C	None	-	4	Voltage
RTD input	XBF-RD04A	4	PT100/JPT100	None	-
	XBF-RD01A	1	PT100/JPT100	None	-
TC input	XBF-TC04S	4	K, J, T, R	None	-
	XBF-TC04RT	4	PT100/JPT100	4	Transister
	XBF-TC04TT	4	K, J, T, R	4	Transister
Positioning	XBF-PD02A	-	Line Driver	2	Voltage
High Speed Counter	XBF-HD02A	2	Line Driver		
	XBF-HO02A	2	Open Collector		

2.3.4 Classification and type of communication module

Name of communication module is classified as follows.

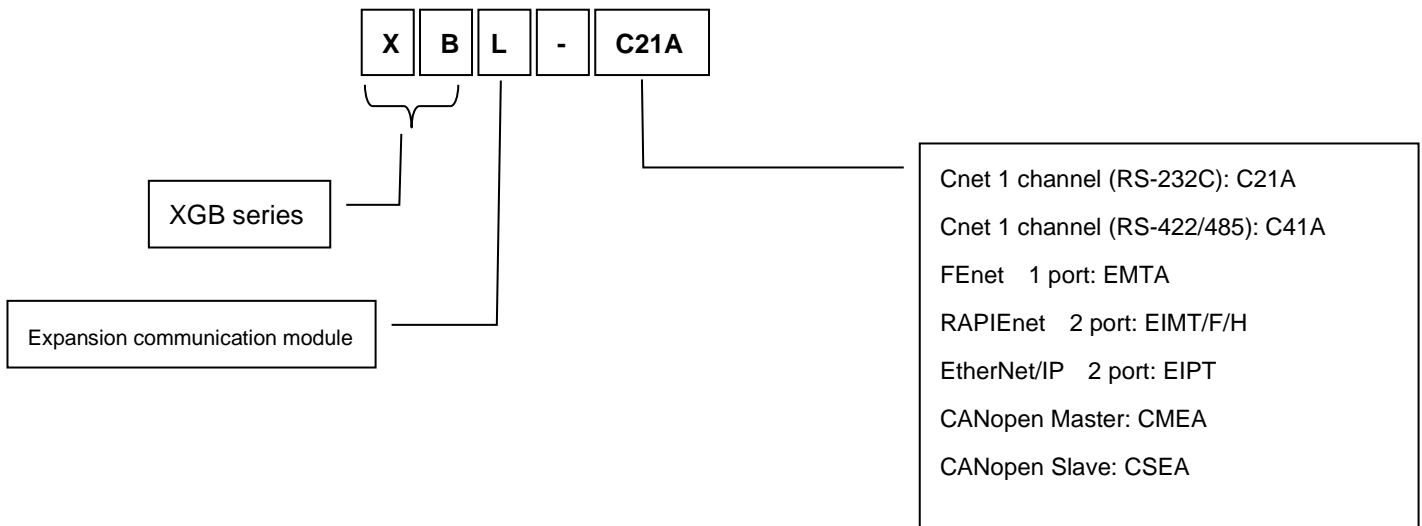

Classification	Name	Type
Cnet Comm. Module	XBL-C21A	RS-232C, 1 channel
	XBL-C41A	RS-422/485, 1 channel
FEnet Comm. Module	XBL-EMTA	Electricity, open type Ethernet
RAPIEnet Comm. Module	XBL-EIMT/EIMF/EIMH	Comm. Module between PLCs, electric media, 100 Mbps industrial Ethernet supported
EtherNet Comm. Module	XBL-EIPT	Open EtherNet I/P
CANopen Comm. Module	XBL-CMEA	CANopen Master
	XBL-CSEA	CANopen Slave
Pnet Comm. Module	XBL-PMEC	Profibus-DP Master
	XBL-PSEA	Profibus-DP Slave
Dnet Comm. Module	XBL-DSEA	DeviceNet Slave

2.3.5 Classification and type of option module

Name of option module is classified as follows.

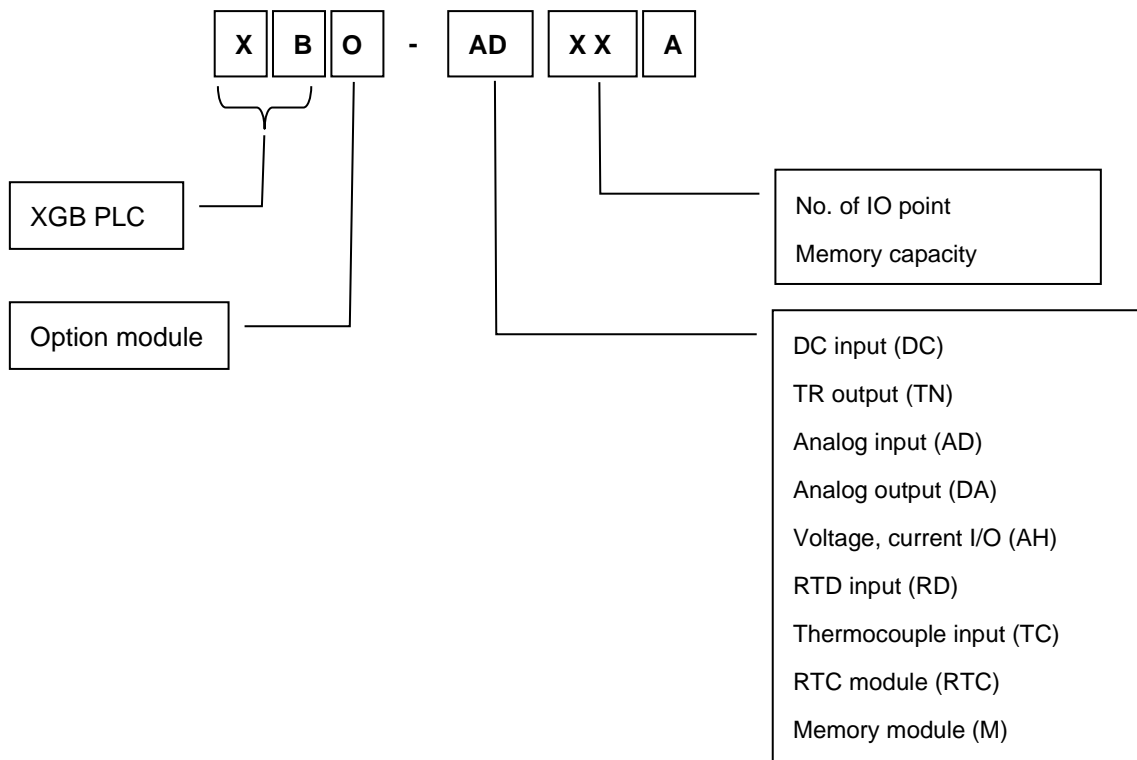

Classification	Name	No. of input CH	Input type	No. of output CH	Output type
DC input	XBO-DC04A	4	DC 24V	None	-
TR output	XBO-TN04A	None	-	4	DC 24V
Analog input	XBO-AD02A	2	Voltage/current	None	
Analog output	XBO-DA02A	None	-	2	Voltage/current
Analog I/O	XBO-AH02A	1	Voltage/current	1	Voltage/current
RTD input	XBO-RD01A	1	PT100/JPT100	None	-
TC input	XBO-TC02A	2	K, J	None	-
RTC module	XBO-RTCA	None	-	None	-
Memory module	XBO-M2MB	None	-	None	-

2.4 System Configuration

2.4.1 Cnet I/F system

Cnet I/F System is used for communication between the main unit and external devices using RS-232C/RS-422 (485) Interface. The XGB series has a built-in RS-232C port, RS-485 port
 For “E” type, only one communication port between RS-232C and RS-485 can be used and you can specify at parameter setting window. For “S” type, RS-232C and RS-485 can be used independently and add RS-232C dedicated Cnet I/F module (XBL-C21A) and RS-422/485 dedicated Cnet I/F module (XBL-C41A). It is possible to configure the following communication system on demand

- (1) 1:1 communication system
 - (a) 1:1 communication of an external device (computer) with main unit using a built-in port (RS-232C/RS-485)

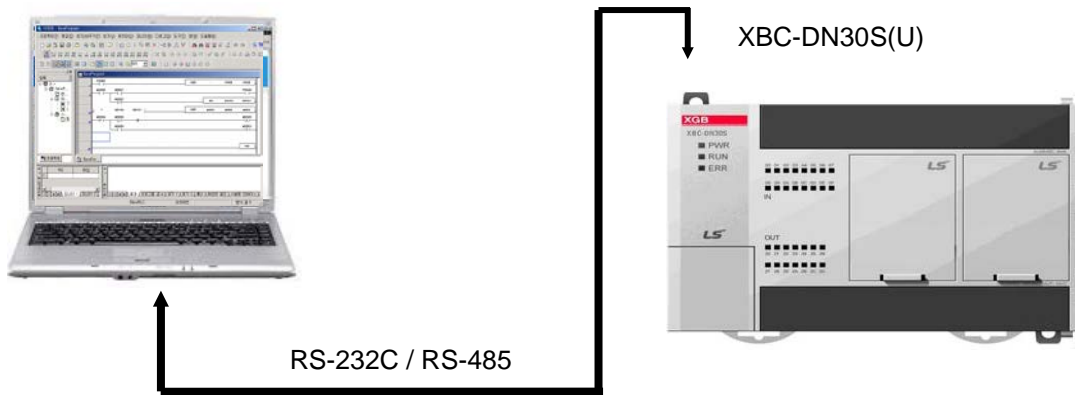

- (b) 1:1 communication with main unit using a built-in RS-485 port
 (In case of built-in RS-232C, it is for connecting to HMI device.)

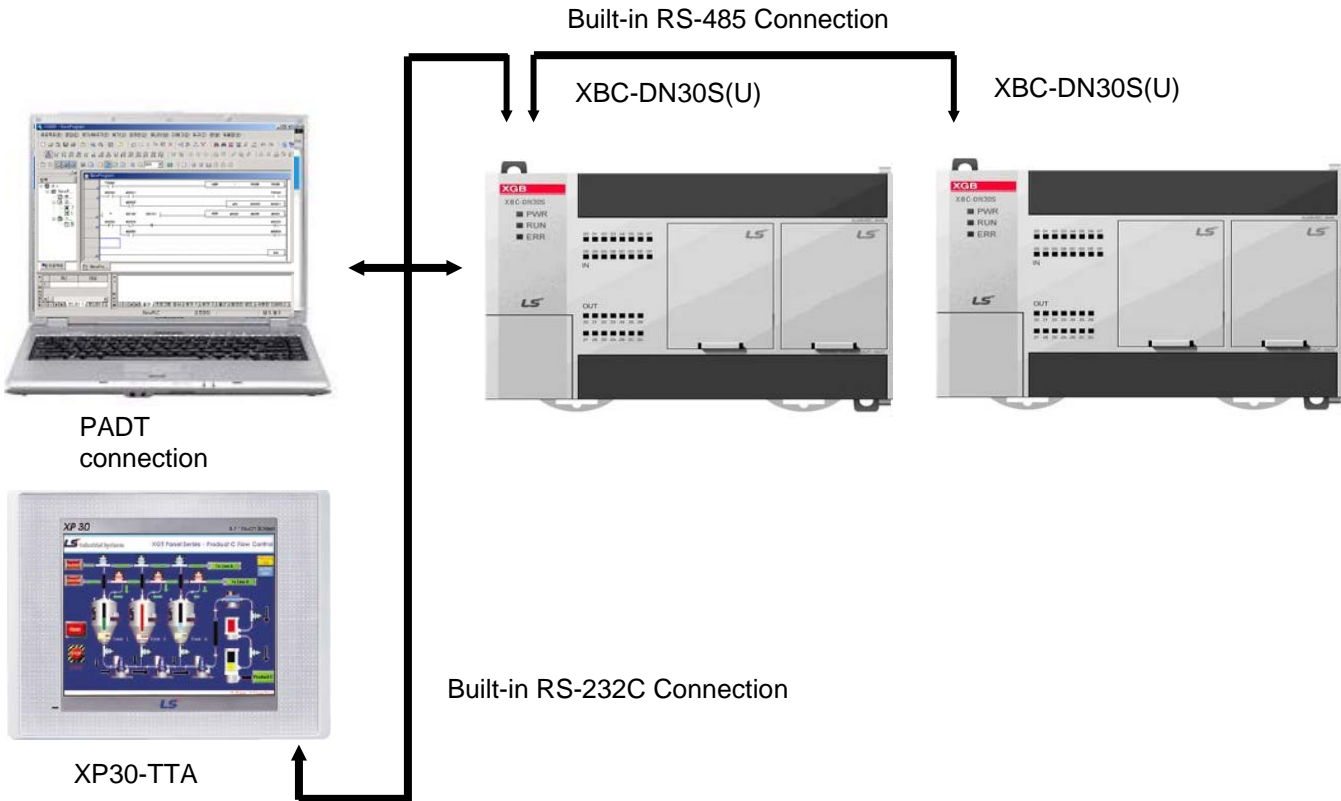

(c) 1:1 RS-232C Communication with remote device via modem by Cnet I/F modules

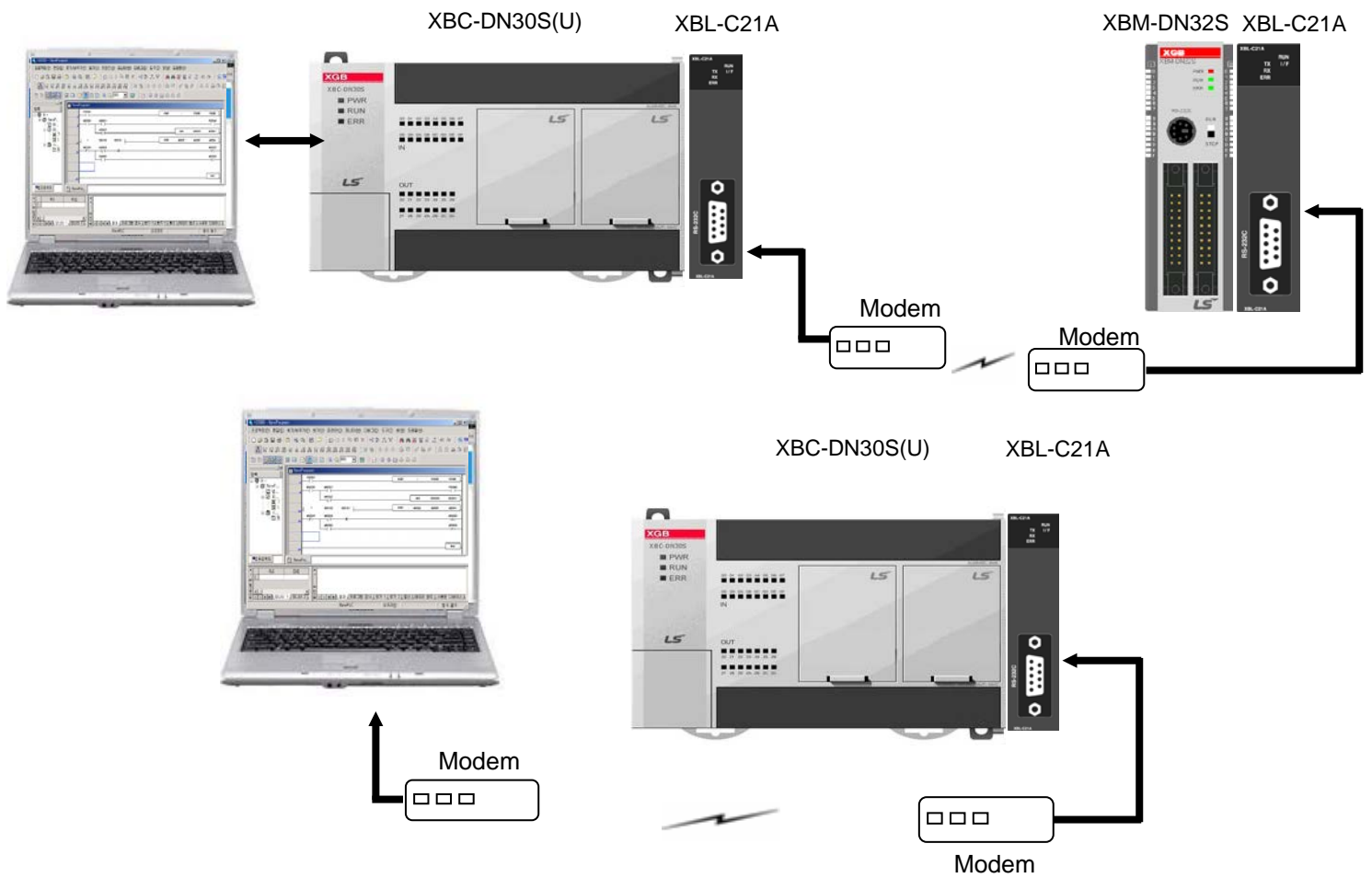

(d) 1:1 communication of an external device (monitoring unit) with main unit using a built-in RS-232C/485 port.

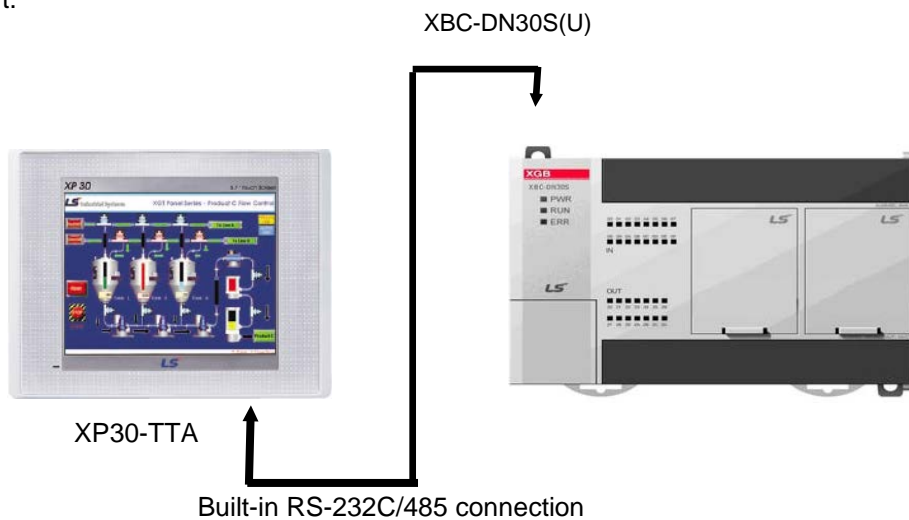

(2) 1:n Communication system

(a) Using RS-485 built-in function can connect between one computer and multiple main units for up to 32 stations.

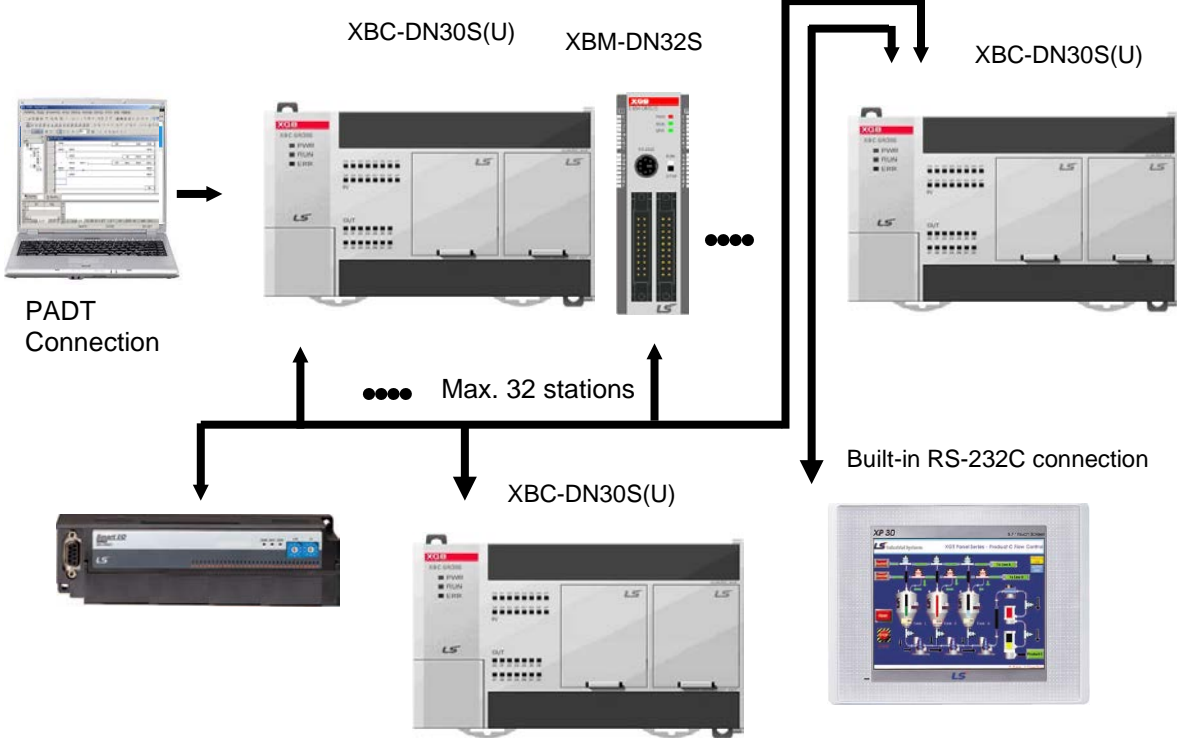

(b) Using RS-485 built-in function/expansion Cnet I/F module can be connect for up to 32 stations.

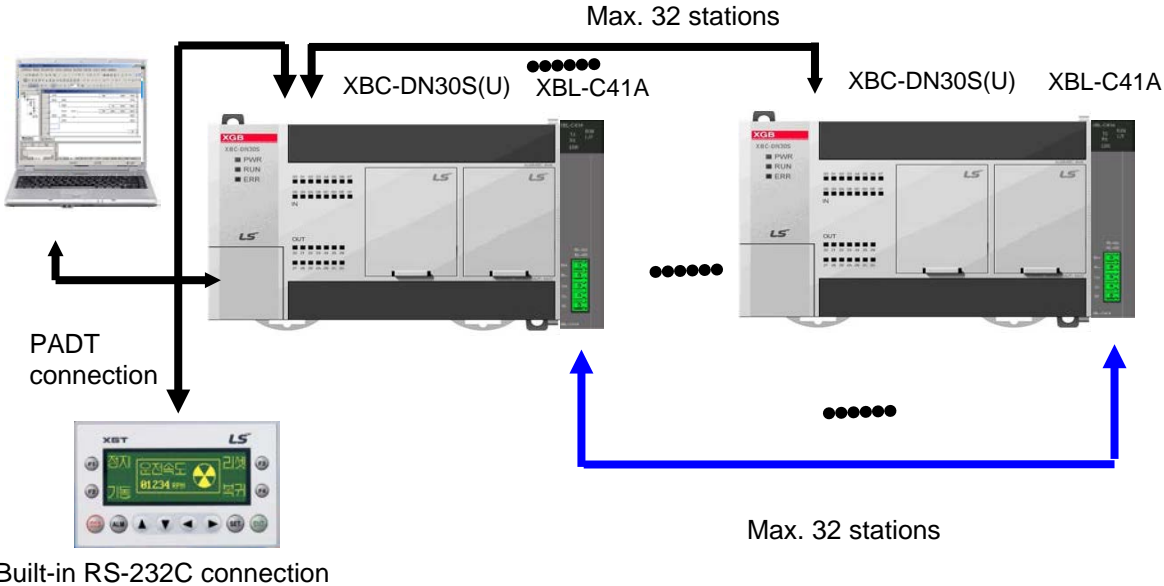

Note

1) Refer to 'XGB Cnet I/F user manual' for details

2.4.2 Ethernet system

Ethernet made by cooperation of Xerox, Intel, DEC is standard LAN connection method (IEEE802.3), which is network connection system using 1.5KB packet with 100Mbps transmission ability. Since Ethernet can combine a variety of computer by network, it is called as standard specification of LAN and diverse products. By adopting CSMA/CD method, it is easy to configure the network and collect large capacity data.

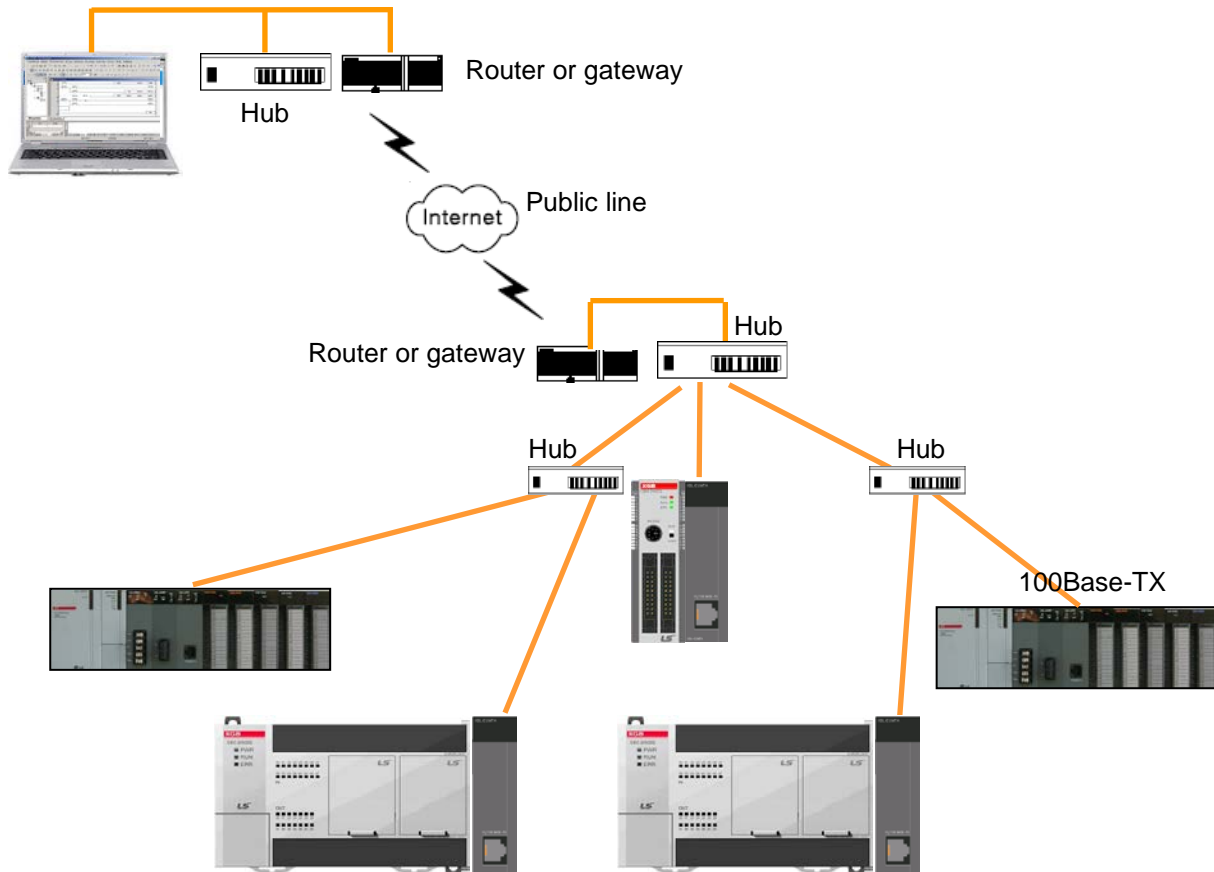

Note

1) Refer to 'XGB FEnet I/F user manual' for details

Chapter 3 General Specifications

3.1 General Specifications

The General specification of XGB series is as below.

No.	Items	Specification	Reference		
1	Ambient Temp.	0 ~ 55 °C	-		
2	Storage Temp.	-25 ~ +70 °C			
3	Ambient humidity	5 ~ 95%RH (Non-condensing)			
4	Storage humidity	5 ~ 95%RH (Non-condensing)			
5	Vibration resistance	Occasional vibration		-	
		Frequency	Acceleration	Amplitude	10 times each direction (X,Y and Z)
		10 ≤ f < 57Hz	-	0.075mm	
		57 ≤ f ≤ 150Hz	9.8m/s ² (1G)	-	
		Continuous vibration			
		Frequency	Acceleration	Amplitude	IEC61131-2
		10 ≤ f < 57Hz	-	0.035mm	
57 ≤ f ≤ 150Hz	4.9m/s ² (0.5G)	-			
6	Shock resistance	<ul style="list-style-type: none"> • Peak acceleration : 147 m/s² (15G) • Duration : 11ms • Half-sine, 3 times each direction per each axis 			
7	Noise resistance	Square wave impulse noise	AC: ±1,500 V DC: ±900 V	LS ELECTRIC standard	
		Electrostatic discharge	Voltage: 4kV (Contact discharge)		
		Radiated electromagnetic field noise	80 ~ 1,000 MHz, 10V/m		
		Fast transient /Burst noise	Segment	Power supply module	Digital/Analog Input/Output, Communication Interface
		Voltage	2kV	1kV	
8	Environment	Free from corrosive gases and excessive dust		-	
9	Altitude	Up to 2,000 ms			
10	Pollution degree	2 or less			
11	Cooling	Air-cooling			

Notes

- 1) IEC (International Electrotechnical Commission):
An international nongovernmental organization which promotes internationally cooperated standardization in electric/electronic field, publishes international standards and manages applicable estimation system related with.
- 2) Pollution degree:
An index indicating pollution degree of the operating environment which decides insulation performance of the devices. For instance, Pollution degree 2 indicates the state generally that only non-conductive pollution occurs. However, this state contains temporary conduction due to dew produced.

Chapter 4 CPU Specifications

4.1 Performance Specifications

The following table shows the general specifications of the XGB compact type CPU (XBC-Dx10/14/20/30E).

Items	Specifications ("E" type)				Remark
	XBC-DR10E	XBC-DR14E	XBC-DR20E	XBC-DR30E	
	XBC-DN10E	XBC-DN14E	XBC-DN20E	XBC-DN30E	
	XBC-DP10E	XBC-DP14E	XBC-DP20E	XBC-DP30E	
Program control method	Reiterative operation, fixed cycle operation, constant scan				-
I/O control method	Scan synchronous batch processing method (Refresh method), Directed by program instruction				
Program language	Ladder Diagram, Instruction List				
Number of instructions	Basic	About 30			
	Application	About 490			
Processing speed (Basic instruction)	0.24 μ S/Step				
Program capacity	4 k steps				
Max. I/O points	14 point Main + 1 option	18 point Main + 1 option	28 point Main + 2 options	38 point Main + 2 options	
Data area	P	P0000 ~ P127F (2,048 point)			
	M	M0000 ~ M255F (4,096 point)			
	K	K00000 ~ K2559F (Special area: K2600~2559F) (40,960 point)			
	L	L00000 ~ L1279F (20,480 point)			
	F	F000 ~ F255F (4,096 point)			
	T	100ms, 10ms, 1ms : T000 ~ T255 (256 point) (Adjustable by parameter setting)			
	C	C000 ~ C255 (256 point)			
	S	S00.00 ~ S127.99			
	D	D0000 ~ D5119 (5120 word)			
	U	U00.00 ~ U07.31 (Analog data refresh area: 256 word, analog data refresh area)			
Z	Z000~Z127 (128 Word)				
Total program	128				-
Initial task	1				
Cyclic task	Max. 8				
I/O task	Max. 4				
Internal device task	Max. 8				
Operation mode	RUN, STOP, DEBUG				
Self-diagnosis function	Detects errors of scan time, memory, I/O				
Program port	RS-232C (Loader)				
Back-up method	Latch area setting in basic parameter				

Items	Specifications ("E" type)				Remark
	XBC-DR10E	XBC-DR14E	XBC-DR20E	XBC-DR30E	
	XBC-DN10E	XBC-DN14E	XBC-DN20E	XBC-DN30E	
	XBC-DP10E	XBC-DP14E	XBC-DP20E	XBC-DP30E	
Internal consumption current	250mA	280mA	350mA	470mA	
	180mA	190mA	200mA	210mA	
	180mA	190mA	200mA	210mA	
Weight	330g	340g	450g	465 g	
	313g	315g	418g	423g	
	313g	315g	418g	423g	

Chapter 4. CPU Specifications

The following table shows the general specifications of the XGB compact type CPU (XBC-DN20/30S).

Items	Specifications ("S" type)		Remark	
	XBC-DN20S	XBC-DN30S		
Program control method	Reiterative operation, fixed cycle operation, constant scan		-	
I/O control method	Scan synchronous batch processing method (Refresh method), Directed by program instruction			
Program language	Ladder Diagram, Instruction List			
Number of instructions	Basic	About 30		
	Application	About 540		
Processing speed (Basic instruction)	94 ns/Step			
Program capacity	15 k steps			
Max. I/O points	244 point (Main + Expansion 7 stages)	254 point (Main + Expansion 7 stages)		
Data area	P	P0000 ~ P1023F (16,384 point)		Word
	M	M0000 ~ M1023F (16,384 point)		
	K	K0000 ~ K4095F (65,536 point)		
	L	L0000 ~ L2047F (32,768 point)		
	F	F0000 ~ F1023F (16,384 point)		
	T	100ms, 10ms, 1ms : T0000 ~ T1023 (1,024 point) (Adjustable by parameter setting)		
	C	C0000 ~ C1023 (1,024)		
	S	S00.00 ~ S127.99		
	D	D0000 ~ D10239 (10,240 word)		
	U	U00.00 ~ U0A.31 (Analog data refresh area: 352 word)		
Z	Z000~Z127 (128 Word)	-		
R	R0000~R10239 (10,240 word)			
Total program	128		-	
Initial task	1			
Cyclic task	Max. 8			
I/O task	Max. 8			
Internal device task	Max. 8			
Operation mode	RUN, STOP, DEBUG			
Self-diagnosis function	Detects errors of scan time, memory, I/O			
Program port	RS-232C 1 channel			
Back-up method	Latch area setting in basic parameter			
Internal consumption current	240 mA	255 mA		
Weight	470g	475g		

The following table shows the general specifications of the XGB compact type CPU (XBC-Dx20/30/40/60SU).

Items	Specifications ("SU" type)				Remark
	XBC-DR20SU	XBC-DR30SU	XBC-DR40SU	XBC-DR60SU	
	XBC-DN20SU	XBC-DN30SU	XBC-DN40SU	XBC-DN60SU	
	XBC-DP20SU	XBC-DP30SU	XBC-DP40SU	XBC-DP60SU	
Program control method	Reiterative operation, fixed cycle operation, constant scan				-
I/O control method	Scan synchronous batch processing method (Refresh method), Directed by program instruction				
Program language	Ladder Diagram, Instruction List				
Number of instructions	Basic	About 30			
	Application	About 540			
Processing speed (Basic instruction)	94 ns/Step				
Program capacity	15 k steps				
Memory	640KB RAM / 1MB Flash				
Max. I/O points	244 point (Main + Expansion 7 stages)	254 point (Main + Expansion 7 stages)	264 point (Main + Expansion 7 stages)	284 point (Main + Expansion 7 stages)	
Data area	P	P0000 ~ P1023F (16,384 point)			
	M	M0000 ~ M1023F (16,384 point)			
	K	K0000 ~ K4095F (65,536 point)			
	L	L0000 ~ L2047F (32,768 point)			
	F	F0000 ~ F1023F (16,384 point)			
	T	100ms, 10ms, 1ms : T0000 ~ T1023 (1,024 point) (Adjustable by parameter setting)			
	C	C0000 ~ C1023 (1,024)			
	S	S00.00 ~ S127.99			
	D	D0000 ~ D10239 (10,240 word)			
	U	U00.00 ~ U0A.31 (Analog data refresh area: 352 word)			
Z	Z000~Z127 (128 Word)				
R	R0000~R10239 (10,240 word)			Word	
Total program	128				-
Initial task	1				
Cyclic task	Max. 8				
I/O task	Max. 8				
Internal device task	Max. 8				
Operation mode	RUN, STOP, DEBUG				
Self-diagnosis function	Detects errors of scan time, memory, I/O				
Program port	RS-232C 1 channel, USB 1 channel				
Back-up method	Latch area setting in basic parameter				

Chapter 4. CPU Specifications

Items	Specifications ("SU" type)				Remark
	XBC-DR20SU	XBC-DR30SU	XBC-DR40SU	XBC-DR60SU	
	XBC-DN20SU	XBC-DN30SU	XBC-DN40SU	XBC-DN60SU	
	XBC-DP20SU	XBC-DP30SU	XBC-DP40SU	XBC-DP60SU	
Internal consumption current	478 mA	626 mA	684 mA	942 mA	
	252 mA	310 mA	288 mA	340 mA	
	305 mA	352 mA	355 mA	394 mA	
Weight	514g	528g	594g	804g	
	475g	476g	578g	636g	
	442g	446g	544g	717g	

Items		Specifications		Remark	
		"E" type	"S(U)" type		
Built-in function	PID control function	Controlled by instructions, Auto-tuning, PWM output, Forced output, Adjustable operation scan time, Anti Windup, Delta MV function, SV-Ramp function Max. 16 loops are supported		Supported in "S(U)" type	
	Cnet I/F function		Dedicated protocol support MODBUS protocol support User defined protocol support Select one port between RS-232C 1 port, RS-485 1 port by parameter		
	High-speed counter	Capacity	1 phase: 4 kHz 4 channel 2 phase: 2 kHz 2 channel	1 phase: 100 kHz 2 channel, 20kHz 6 channel 2 phase: 50 kHz 1 channel, 8kHz 3 channel	
		Counter mode	4 different counter modes according to input pulse and addition/subtraction method		
			<ul style="list-style-type: none"> • 1 phase pulse input: addition/subtraction counter • 1 phase pulse input: addition/subtraction counter by B phase • 2 phase pulse input: addition/subtraction counter 		
		Additional function	<ul style="list-style-type: none"> • 2 phase pulse input: addition/subtraction by rising pulse phase differences • 2 phase pulse input: addition/subtraction by rising/falling pulse phase differences 		
	Additional function		<ul style="list-style-type: none"> • Internal/External preset function • Latch counter function • Comparison output function • Revolution number per unit time function 		
	Positioning function	Basic function	No. of control axis: 2 axes Control method: position/speed control Control unit: pulse Positioning data: 80 data/axis (operation step No. 1~80) Operation mode: End/Keep/Continuous Operation method: Single, Repeated operation		
		Positioning function	Positioning method: Absolute / Incremental Address range: -2,147,483,648 ~ 2,147,483,647 Speed: Max. 100kpps(setting range 1 ~ 100,000pps) Acceleration / Deceleration method : trapezoidal method		Supported in "S(U)" type transistor output
		Return to Origin	By Home and DOG (Off) By Home and DOG (On) By DOG		
		JOG operation	Setting range: 1~100,000 (High / Low speed)		
		Additional function	Inching operation, Speed synchronizing operation, Position synchronizing operation, linear interpolation operation etc.		
	Pulse catch	50 μ s 4 point (P0000 ~ P0003)	10 μ s 2 point (P0000 ~ P0001) 50 μ s 6 point (P0002 ~ P0007)		
External interrupt	4 point: 50 μ s (P0000 ~ P0003)	10 μ s 2 point (P0000 ~ P0001) 50 μ s 6 point (P0002 ~ P0007)			
Input filter	Select among 1,3,5,10,20,70,100 ms (Adjustable)				

4.2 Names of Part and Function

“E” Type

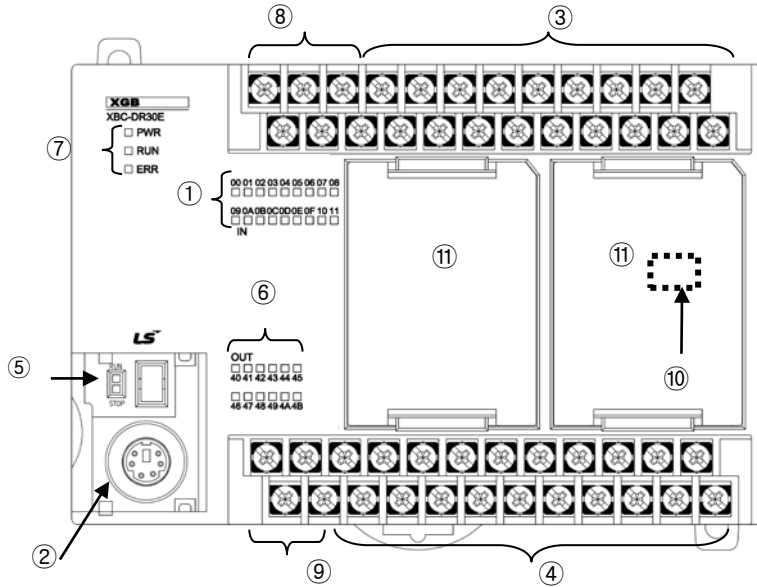

No.	Name	Description
①	Input indicator LED	▪ Input indicator LED
②	PADT connecting connector	▪ PADT connector RS-232C 1 channel
③	Input terminal block	▪ Input terminal block
④	Output terminal block	▪ Output terminal block
⑤	RUN/STOP mode switch	▪ Sets the operation mode of main unit STOP → RUN: execute operation of program RUN → STOP: stop operation of program (In case of STOP, remote mode is available)
⑥	Output indicator LED	▪ Output indicator LED
⑦	Status indicator LED	It indicates CPU module's status. ▪ PWR(Red on): Power status ▪ RUN(Green on): RUN status ▪ Error(Red flickering): In case of error, it is flickering.
⑧	Built-in communication Connecting connector	• Built-in RS-232C/485 connecting connector
⑨	Power supply connector	▪ AC100~240V power supply connector
⑩	OS mode dip switch	▪ Dip switch for setting O/S download/Operation mode On: Boot mode, available to download O/S Off: User mode, available to download program using PADT
⑪	Option board holder	▪For connection option board

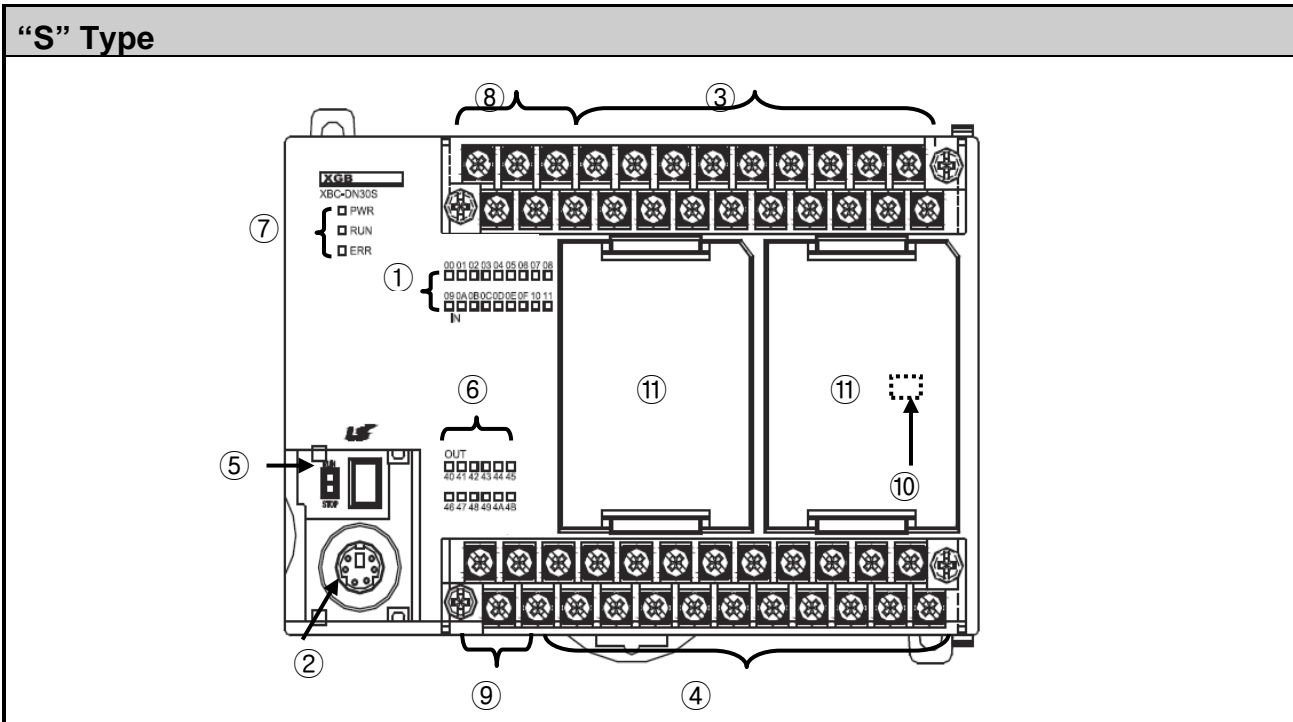

No.	Name	Description
①	Input indicator LED	▪ Input indicator LED
②	PADT connecting connector	▪ PADT connector RS-232C 1 channel
③	Input terminal block	▪ Input terminal block
④	Output terminal block	▪ Output terminal block
⑤	RUN/STOP mode switch	▪ Sets the operation mode of main unit STOP → RUN: execute operation of program RUN → STOP: stop operation of program (In case of STOP, remote mode is available)
⑥	Output indicator LED	▪ Output indicator LED
⑦	Status indicator LED	It indicates CPU module's status. ▪ PWR(Red on): Power status ▪ RUN(Green on): RUN status ▪ Error(Red flickering): In case of error, it is flickering.
⑧	Built-in communication Connecting connector	• Built-in RS-232C/485 connecting connector
⑨	Power supply connector	▪ AC100~240V power supply connector
⑩	OS mode dip switch	▪ Dip switch for setting O/S download/Operation mode On: Boot mode, available to download O/S Off: User mode, available to download program using PADT
⑪	Option board holder	▪ For connection option board

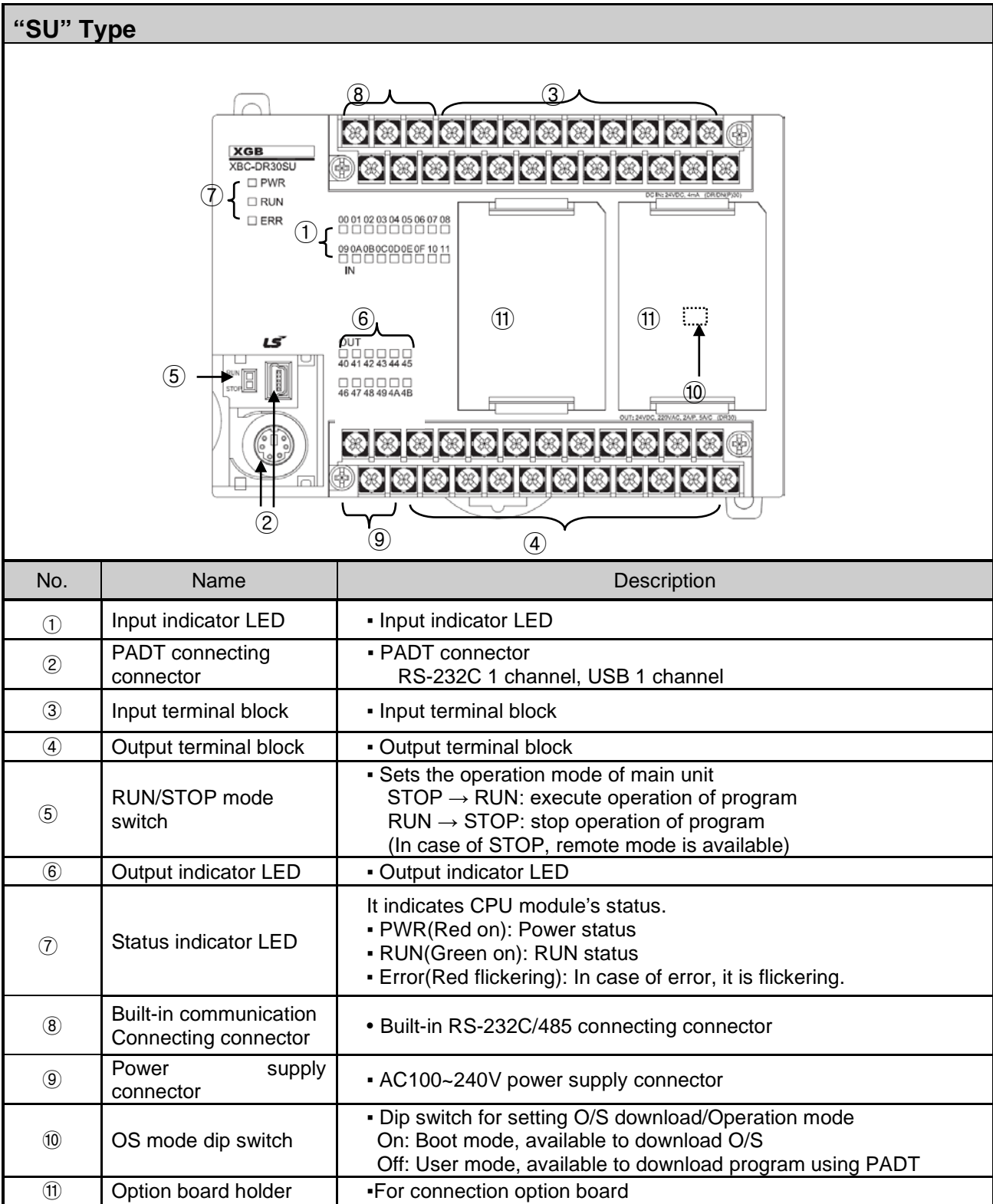

4.3 Power Supply Specifications

It describes the power supply specification of main unit.

Items		Specification						
		XBC-Dx10/14E	XBC-Dx20/30E	XBC-Dx20S(U)	XBC-Dx30S(U)	XBC-Dx40SU	XBC-Dx60SU	
Input	Rated voltage (UL warranty voltage)	AC 100 ~ 240 V						
	Input voltage range	AC85~264V(-15%, +10%)						
	Inrush current	50A _{Peak} or less						
	Input current	0.5A or less (220V), 1A or less (110V)						
	Efficiency	65% or more						
	Permitted momentary power failure	Less than 10 ms						
Output	Rated output	DC5V	500mA	800mA	1.5A	1.5A	2.0A	2.5A
		DC24V	0.2A	0.2A	0.3A	0.3A	0.3A	0.5A
	Output voltage ripple	DC5V (±2%)						
Power supply status indication		LED On when power supply is normal						
Cable specification		0.75 ~ 2 mm ²						

* Use the power supply which has 4 A or more fuse for protecting power supply.

Chapter 4. CPU Specifications

1) Consumption current (DC 5V)

Type	Model	Consumption current (Unit : mA)
Main unit	XBM-DR16S	400
	XBM-DN16S	250
	XBM-DN32S	280
	XBC-DR32H	660
	XBC-DR64H	1,040
	XBC-DN32H	260
	XBC-DN64H	330
	XBC-DN30S	255
	XBC-DN20S	240
	XBC-DN20SU	252
	XBC-DN30SU	270
	XBC-DN40SU	288
	XBC-DN60SU	340
	XBC-DP20SU	305
	XBC-DP30SU	352
	XBC-DP40SU	355
	XBC-DP60SU	394
	XBC-DR20SU	478
	XBC-DR30SU	626
	XBC-DR40SU	684
	XBC-DR60SU	942
	XBC-DR30E	470
	XBC-DR20E	350
	XBC-DR14E	280
	XBC-DR10E	250
	XBC-DN30E	210
	XBC-DN20E	200
	XBC-DN14E	190
	XBC-DN10E	180
	XBC-DP30E	210
	XBC-DP20E	200
	XBC-DP14E	190
XBC-DP10E	180	
Expansion I/O module	XBE-DC32A	50
	XBE-DC16A/B	30
	XBE-DC08A	20
	XBE-AC08A	30
	XBE-RY16A	440
	XBE-RY08A/B	240
	XBE-TN32A	80
	XBE-TN16A	50
	XBE-TN08A	40
	XBE-TP32A	80
	XBE-TP16A	50
	XBE-TP08A	40
	XBE-DR16A	250
	XBE-DN32A	60

Type	Model	Consumption current (Unit : mA)
Expansion special module	XBF-AD04A	120
	XBF-AD08A	105
	XBF-AH04A	120
	XBF-DV04A	110
	XBF-DC04A	110
	XBF-RD04A	100
	XBF-TC04S	100
	XBF-PD02A	500
	XBF-HD02A	260
	XBF-HO02A	200
	XBF-AD04C	100
	XBF-DC04C	160
	XBF-DV04C	160
Expansion communication module	XBL-C21A	120
	XBL-C41A	120
	XBL-EMTA	300
	XBL-EIMT	280
	XBL-EIMF	670
	XBL-EIMH	480
	XBL-EIPT	290
	XBL-CMEA	211
XBL-CSEA	202	
Option module	XBO-DC04A	80
	XBO-TN04A	100
	XBO-AD02A	50
	XBO-DA02A	150
	XBO-AH02A	150
	XBO-RD01A	30
	XBO-TC02A	50
	XBO-RTCA	30
XBO-M2MB	-	

4.4 Calculation Example of Consumption Current/Voltage

Calculate the consumption current and configure the system not to exceed the output current capacity of basic unit.

(1) XGB PLC configuration example 1
Consumption of current/voltage is calculated as follows.

Type	Model	Unit No.	Internal 5V consumption current (Unit : mA)	Remark
Main unit	XBC-DN20S	1	240	In case contact points are On. (Maximum consumption current)
Expansion module	XBE-DC32A	2	50	
	XBE-TN32A	2	80	All channel is used. (Maximum consumption current)
	XBF-AD04A	1	120	
	XBF-DC04A	1	110	
	XBL-C21A	1	110	
Consumption current	850 mA			-
Consumption voltage	4.25 W			$0.85 \times 5V = 4.25W$

In case system is configured as above, since 5V consumption current is total 850mA and 5V output of XGB standard type main unit is maximum 1.5A, normal system configuration is available.

(2) XGB PLC configuration example 2

Type	Model	Unit No.	Internal 5V consumption current (Unit : mA)	Remark
Main unit	XBC-DN30S	1	255	In case all contact points are On. (Maximum consumption current)
Expansion module	XBE-DR16A	2	250	
	XBE-RY16A	2	440	All channel is used. (Maximum consumption current)
	XBF-AD04A	2	120	
	XBL-C21A	1	110	
Consumption current	1,985 mA			-
Consumption voltage	9.925 W			$1.985 \times 5V = 9.925W$

If system is configured as above, total 5V current consumption is exceeded 1,985 mA and it exceeds the 5V output of XGB standard type main unit. Normal system configuration is not available. Although we assume the above example that all contact points are on, please use high-end type main unit which 5V output capacity is higher than standard type main unit.

(3) XGB PLC configuration example 3

Type	Model	Unit No.	Internal 5V consumption current (Unit : mA)	Remark
Main unit	XBC-DN32H	1	260	In case of all contact points are On. (Maximum consumption current)
Expansion module	XBE-DR16A	2	250	
	XBE-RY16A	2	440	
	XBF-AD04A	2	120	All channel is used. (Maximum consumption current)
XBL-C21A	1	110		
Consumption current	1,990 mA			-
Consumption voltage	9.95 W			1.99A × 5V = 9.95W

The above system is an example using XBC-DN32H about system example (2). Unlike (2) example, 5V output capacity of XBC-DN32H is maximum 2A, normal configuration is available.

4.5 Data Backup Time

When RTC module is not installed with main unit, data is kept by super capacitor.
The following table shows the data backup time of the main unit,

Type	Data backup time		Remark
XBC "S" type "SU" type	backup by the Capacitor	18 Days	At normal temperature (25℃)
	RTC module installed	3 Yeas	
XBC "E" type	backup by the Capacitor	5 Days	
	RTC module installed	3 Yeas	

But charge super capacitor enough while power is on over 30 minute.

In case super capacitor is not charged enough or power is off more than data backup time, latch data is not kept and warning occurs. At this time, phenomenon and measure are as follows.

- (1) Phenomenon
 - (a) RUN mode
 - 1) In case of Remote Run mode, operation mode changes to Stop mode. In case of Local Run mode, it operates normally with abnormal data backup warning
 - 2) In case of Stop mode, abnormal data backup warning occurs.
 - (b) Latch data
 - 1) Latch area 1,2 : all data are cleared into "0".
 - 2) K area, F area : all data are cleared into "0".
- (2) Measure
 - (a) In case abnormal data backup warning occurs when turning off and turning on within data backup time, technical assistance of main unit is necessary. Be careful data backup time is getting shorter at high temperature.

Notice

Above data backup time can be different according to temperature condition.

Chapter 5 Program Configuration and Operation Method

5.1 Program Instruction

5.1.1 Program execution methods

(1) Cyclic operation method (Scan)

This is a basic program proceeding method of PLC that performs the operation repeatedly for the prepared program from the beginning to the last step, which is called 'program scan'. The series of processing like this is called 'cyclic operation method'. The processing is divided per stage as below.

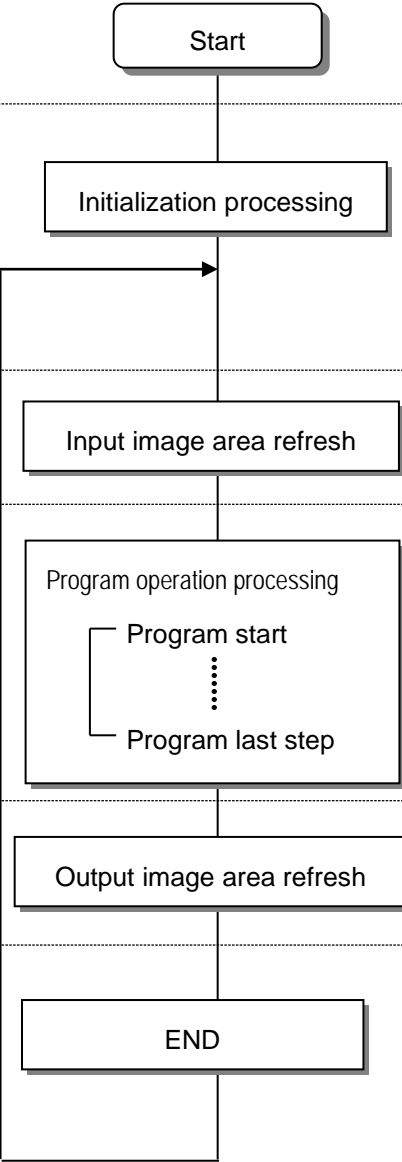
Stage	Processing description
	-
<p>Initialization processing</p>	<ul style="list-style-type: none"> • A stage to start the scan processing which is executed once when power is applied or Reset is executed, as below. <ul style="list-style-type: none"> ▶ I/O module reset ▶ Self-diagnosis execution ▶ Data clear ▶ Address allocation of I/O module and type register • If initializing task is designated, Initializing program is executed.
<p>Input image area refresh</p>	<ul style="list-style-type: none"> • Reads the state of input module and saves it in input image area before starting the operation of program.
<p>Program operation processing</p> <p style="margin-left: 20px;"> Program start ⋮ Program last step </p>	<ul style="list-style-type: none"> • Performs the operation in order from the program start to last step.
<p>Output image area refresh</p>	<ul style="list-style-type: none"> • Performs the operation in order from the program start to last step.
<p>END</p>	<ul style="list-style-type: none"> • A processing stage to return to the first step after CPU module completes 1 scan processing and the processing performed is as below. <ul style="list-style-type: none"> ▶ Update the current value of timer and counter etc. ▶ User event, data trace service ▶ Self-diagnosis ▶ High speed link, P2P e-Service ▶ Check the state of key switch for mode setting

(2) Interrupt operation (Cycle time, Internal device)

This is the method that stops the program operation in proceeding temporarily and carries out the operation processing which corresponds to interrupt program immediately in case that there occurs the status to process emergently during PLC program execution.

The signal to inform this kind of urgent status to CPU module is called 'interrupt signal'. There is a Cycle time signal that operates program every appointed time and external interrupt signal that operates program by external contact ("S" type: P000~P007, "E" type: P000~P003). Besides, there is an internal device start program that starts according to the state change of device assigned inside.

(3) Constant Scan (Fixed Period)

This is the operation method that performs the scan program every appointed time. This stands by for a while after performing all the scan program, and starts again the program scan when it reaches to the appointed time. The difference from constant program is the update of input/output and the thing to perform with synchronization. At constant operation, the scan time indicates the net program processing time where the standby time is deducted. In case that scan time is bigger than 'constant', [F0005C] '_CONSTANT_ER' flag shall be 'ON'.

5.1.2 Operation processing during momentary power failure

CPU module detects the momentary power failure when input power voltage supplied to power module is lower than the standard. If CPU module detects the momentary power failure, it carries out the operation processing as follows.

If momentary power failure within 10 ms is occurred, main unit (CPU) keeps the operation. But, if momentary power failure above 10 ms, the operation is stop and the output is Off. Restart processing like at power input shall be performed.

(1) Momentary power failure within 10 ms

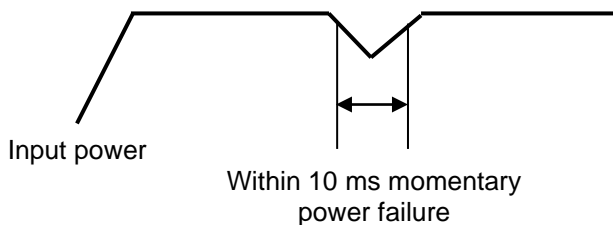

• CPU keeps the operation.

(2) Momentary power failure exceeding 10 ms

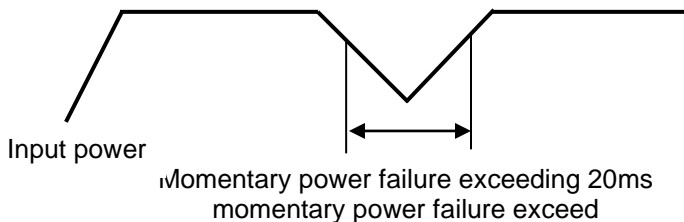

• Restart processing like at power input shall be performed.

Remark

1) Momentary power failure?

This means the state that the voltage of supply power at power condition designated by PLC is lowered as it exceeds the allowable variable range and the short time (some ms ~ some dozens ms) interruption is called 'momentary power failure'.

5.1.3 Scan time

The processing time from program step 0 to the next step 0 is called 'Scan Time'.

(1) Scan time calculation expression

Scan time is the sum of the processing time of scan program and interrupt program prepared by the user and PLC internal time, and is distinguished by the following formula.

$$(a) \text{ Scan time} = \text{Scan program processing time} + \text{Interrupt program processing time} + \text{PLC internal processing time}$$

- Scan program processing time = processing time of user program except interrupt program
- Interrupt program processing time = Sum of interrupt program proceeding time processed during 1 scan
- PLC internal processing time = Self-diagnosis time + I/O refresh time + Internal data processing time + Communication service processing time

(b) Scan time depends on whether to execute interrupt program and communication processing.

Type	MPU processing time		Expansion interface processing time		
	Executing ladder (4Kstep)	PLC internal processing time	Digital I/O module (32 point, 1 unit)	Analog module (8 channel, 1 unit)	Comm. module (main/expansion) (200 byte, 1 block)
"E" type	5.4 ms	1.0 ms	-	-	0.5 ms
"S" type	3.0 ms	0.5 ms	0.3 ms	3.0 ms	0.8 ms

The main unit executes controls along the following steps. A user can estimate the control performance of a system that the user is to structure from the following calculation.

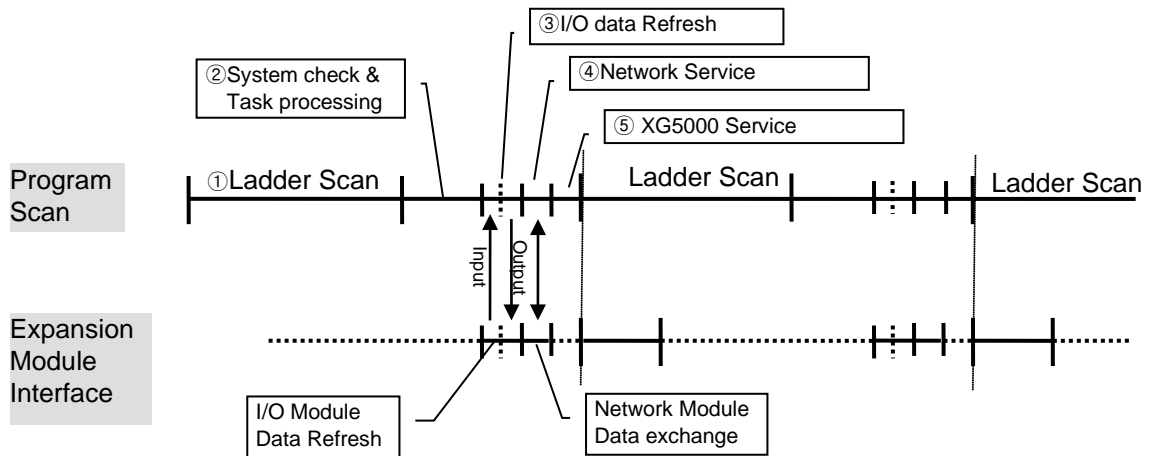

$$\text{Scan time} = \text{① Scan program process} + \text{② System check \& Task process} + \text{③ I/O data Refresh} + \text{④ Network Service} + \text{⑤ XG5000 Service} + \text{⑥ User Task Program process}$$

- ① Scan program process = no. of instruction x process speed per each instruction (refer to XGK/XGB instruction user manual)
- ② System check & Task process: 600 μ s ~ 1.0 ms [varies depending on the usage of auxiliary functions]
- ③ XG5000 Service process time: 100 μ s at the max data monitor
- ④ Task Program process time: sum of task processing time that occurs within a scan; the time calculation by task programs are as same as that of scan program.

(2) Example

The scan time of a system consisting of main unit (program 4kstep) + five 32-point I/O modules + one analog module + one communication modules (200 byte 1 block)

$$\begin{aligned}
 \text{Scan time}(\mu\text{s}) &= \text{ladder execution time} + \text{system processing time} + \text{digital module I/O processing time} + \text{analog I/O processing time} + \text{communication module processing time} + \text{XG5000 Service processing time} \\
 &= (2047 \times (0.67(\text{LOAD}) + 0.80(\text{OUT}))) + (500) + (300 \times 5) + (3000 \times 1) + (800 \times 1) + (100) \mu\text{s} \\
 &= 3009 + 500 + 1500 + 3000 + 800 + 100 \mu\text{s} = 8909 \mu\text{s} \\
 &= 8.9 \text{ ms}
 \end{aligned}$$

(But, in case of online editing or writing XG-PD parameter, scan time increases temporary up to 100ms)

(3) Scan time monitor

(a) Scan time can be monitored 『Online』 - 『PLC Information』 - 『Performance』 .

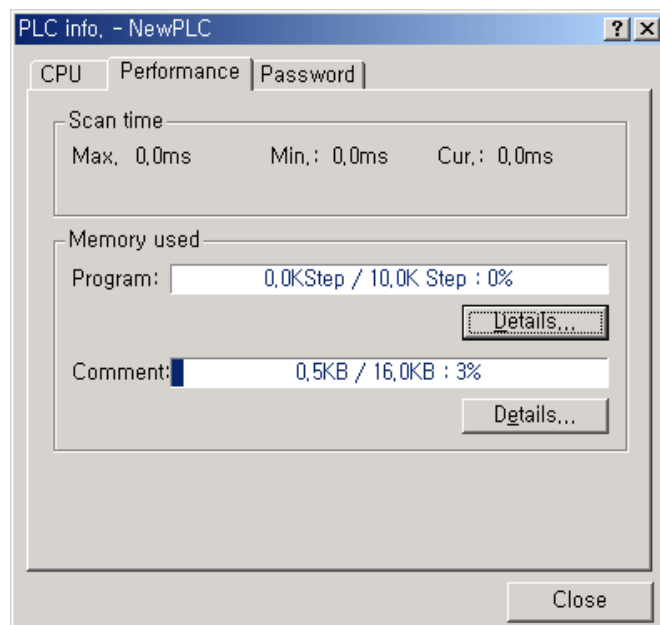
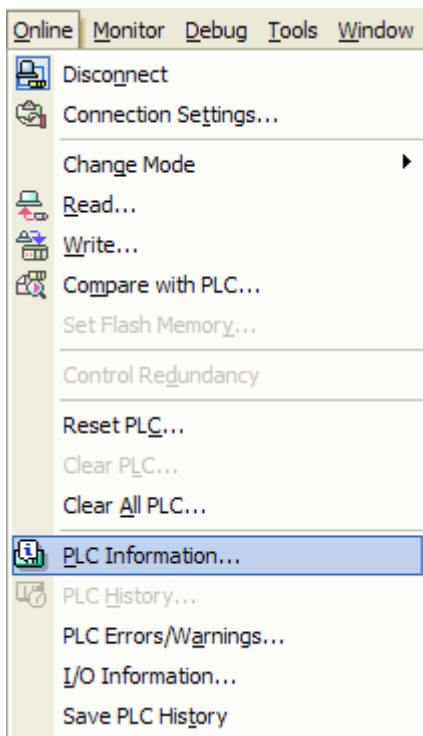

(b) Scan time is save in special relay (F) area as follows.

- F0050: max. value of scan time (unit: 0.1 ms)
- F0051: min. value of scan time (unit: 0.1 ms)
- F0052: current value of scan time (unit: 0.1 ms)

5.1.4 Scan Watchdog timer

WDT (Watchdog Timer) is the function to detect the program congestion by the error of hardware and software of PLC CPU module.

- (1) WDT is the timer used to detect the operation delay by user program error. The detection time of WDT is set in Basic parameter of XG5000.
- (2) If WDT detects the excess of detection setting time while watching the elapsed time of scan during operation, it stops the operation of PLC immediately and keeps or clears the output according to parameter setting
- (3) If the excess of Scan Watchdog Time is expected in the program processing of specific part while performing the user program (FOR ~ NEXT instruction, CALL instruction), clear the timer by using 'WDT' instruction. 'WDT' instruction initializes the elapsed time of Scan Watchdog Timer and starts the time measurement from 0 again.
(For further information of WDT instruction, please refer to Instruction.)
- (4) To clear the error state of watchdog, we can use the following method : power re-supply, manipulation of manual reset switch, mode conversion to STOP mode.

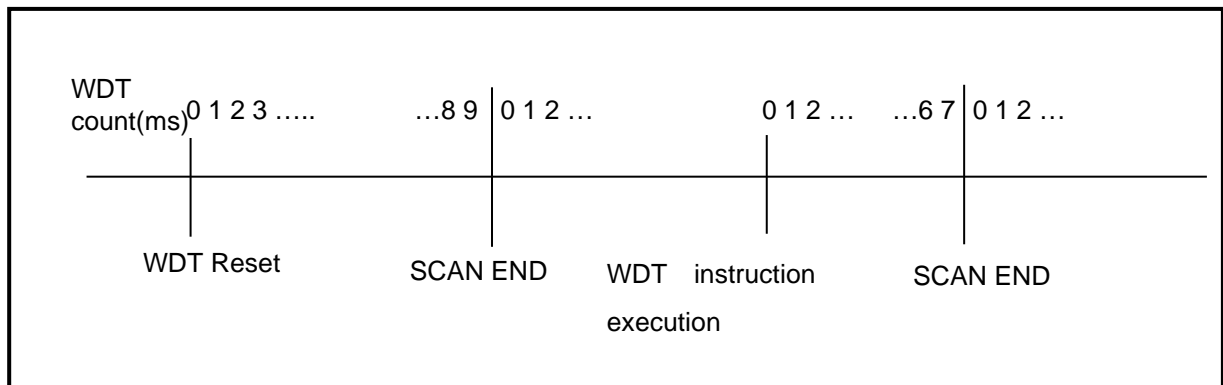

Remark

- 1) The setting range of Watchdog Timer is 10 ~ 1000ms (Unit: 1ms).

5.1.5 Timer processing

The XGB series use up count timer. There are 5 timer instructions such as on-delay (TON), off-delay (TOFF), integral (TMR), monostable (TMON), and re-triggerable (TRTG) timer.

The measuring range of 100msec timer is 0.1 ~ 6553.5 seconds, 10msec timer is 0.01 ~ 655.35 seconds, and that of 1msec timer is 0.001 ~ 65.53 seconds. Please refer to the 'XG5000 User manual' for details.

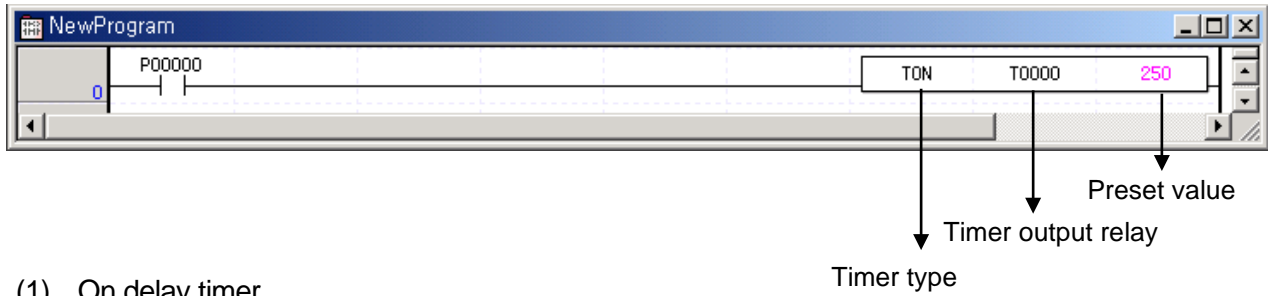

(1) On delay timer

The current value of timer starts to increase from 0 when the input condition of TON instruction turns on. When the current value reaches the preset value (Current value=Preset value), the timer output relay (Txxxx) turns on. When the timer input condition is turned off, the current value becomes 0 and the timer output relay is turned off.

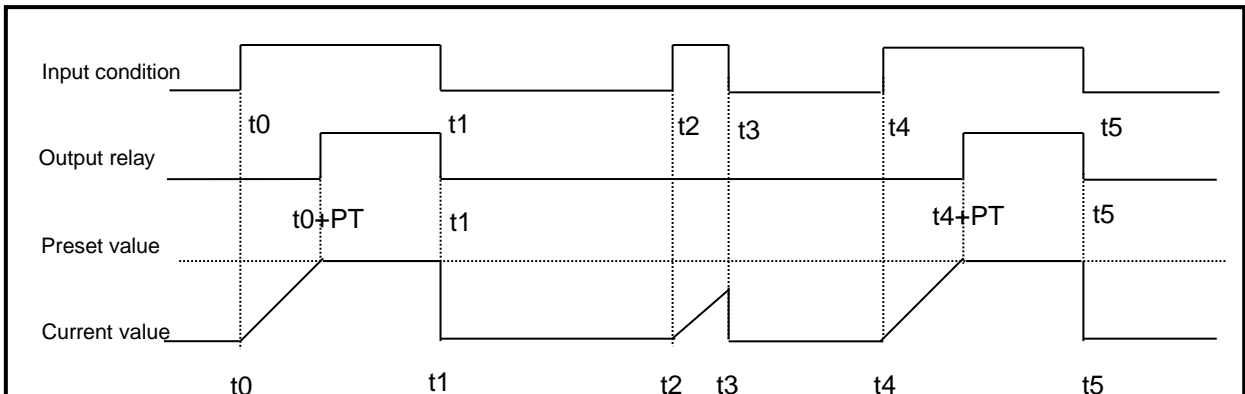

(2) Off delay timer

The current value of timer set as preset value and the timer output relay is turned on when the input condition of TOFF instruction turns on. When the input condition is turned off, the current value starts to decrease. The timer output relay is turned off when the current value reaches 0.

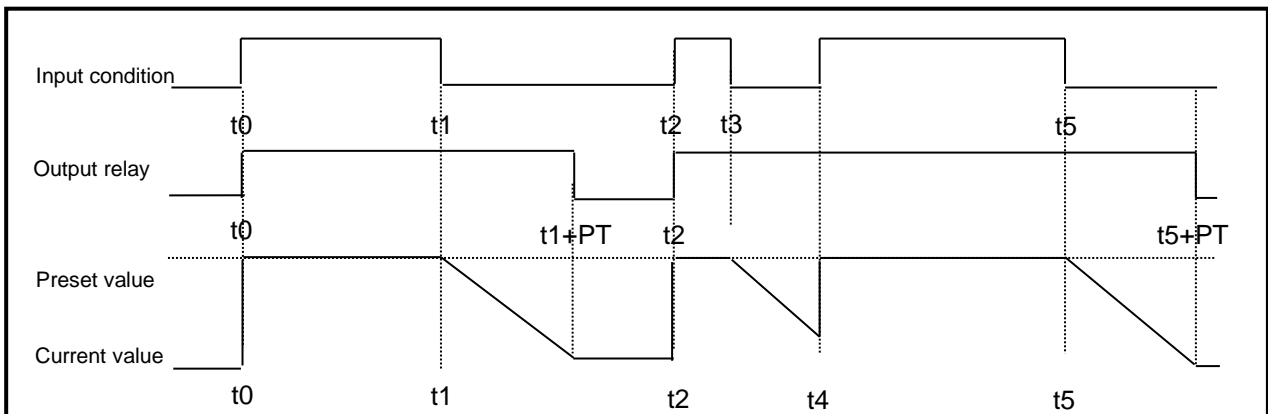

(3) Integral timer

In general, its operation is same as on-delay timer. Only the difference is the current value will not be clear when the input condition of TMR instruction is turned off. It keeps the elapsed value and restart to increase when the input condition is turned on again. When the current value reaches preset value, the timer output relay is turned on.

The current value can be cleared by the RST instruction only.

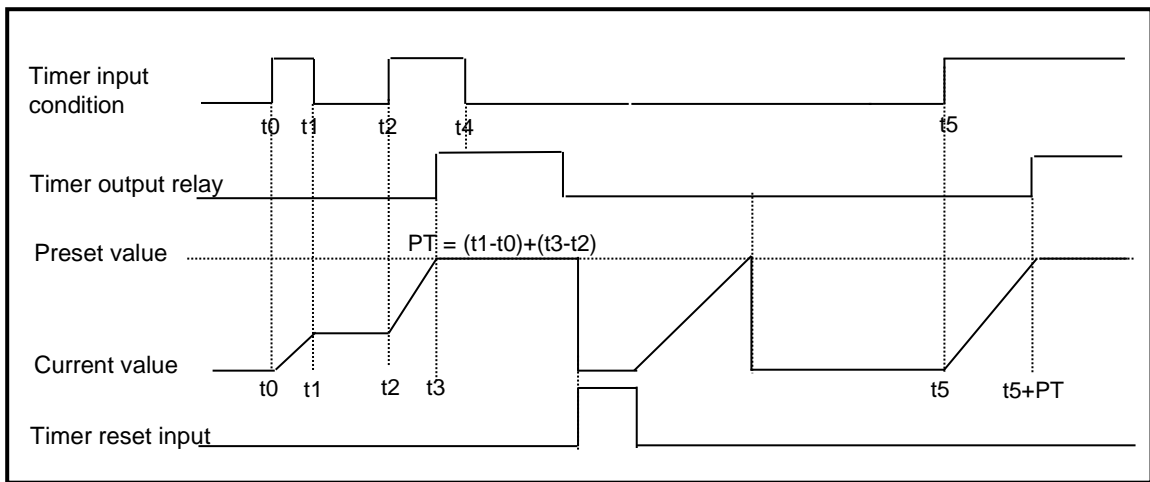

(4) Monostable timer

In general, its operation is same as off-delay timer. However, the change of input condition is ignored while the timer is operating (decreasing). When current value reaches preset value the timer output relay is turned off and current value is cleared.

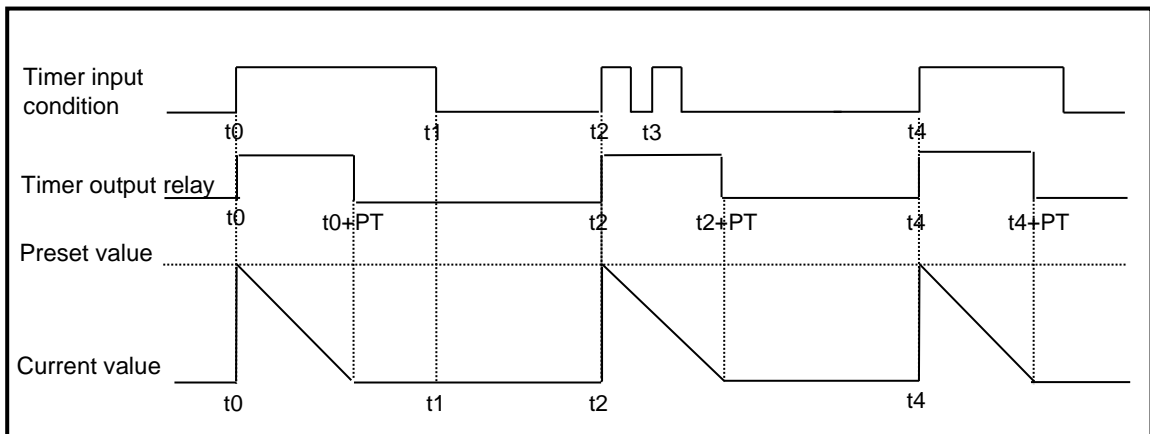

(5) Retriggerable timer

The operation of retriggerable timer is same as that of monostable timer. Only difference is that the retriggerable timer is not ignore the input condition of TRTG instruction while the timer is operating (decreasing). The current value of retriggerable timer will be set as preset value whenever the input condition of TRTG instruction is turned on.

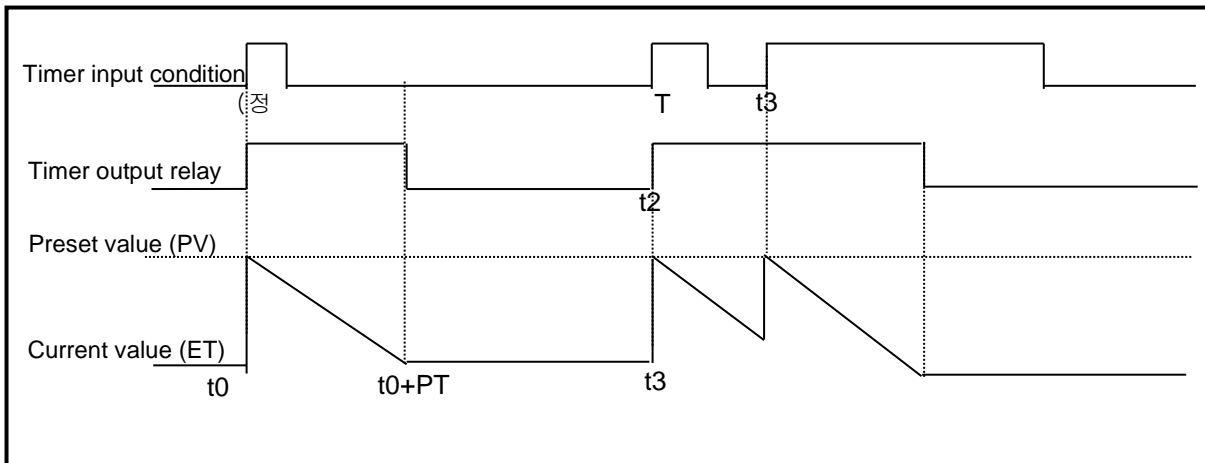

Remark

The Maximum timer error of timers of XGB series is '1 scan time + the time from 0 step to timer instruction'

5.1.6 Counter processing

The counter counts the rising edges of pulses driving its input signal and counts once only when the input signal is switched from off to on. XGB series have 4 counter instructions such as CTU, CTD, CTUD, and CTR. The followings shows brief information for counter operation. Refer to the 'XGB Instruction Manual' for details.

- Up counter increases the current value.
- Down counter decreases the current value.
- Up/Down counter compares the input value from both counters input.
- Ring counter increase the current value and the current value is cleared as 0 when the current value reaches the preset value.

(1)Renewal of counter’s current value and contact On/Off

(a) Up counter

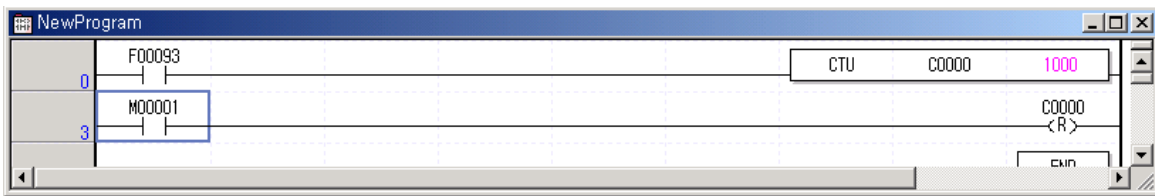

- Up counter increases the current value at the rising edges of input.
- The counter output contact (Cxxx) is turned On when the current value reaches the preset value. When the reset input is turned On, the counter output contact (Cxxx) is turned Off.

(b) Down counter

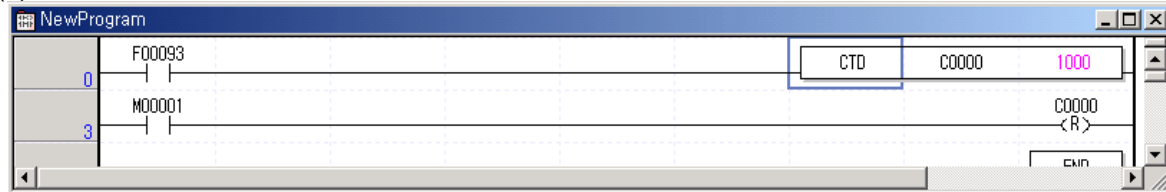

- Down counter decreases the current value at the rising edges of input.
- The counter output contact (Cxxx) is turned On when the current value reaches the preset value. When the reset input is turned On, the counter output contact (Cxxx) is turned Off.

(c) Up/Down counter

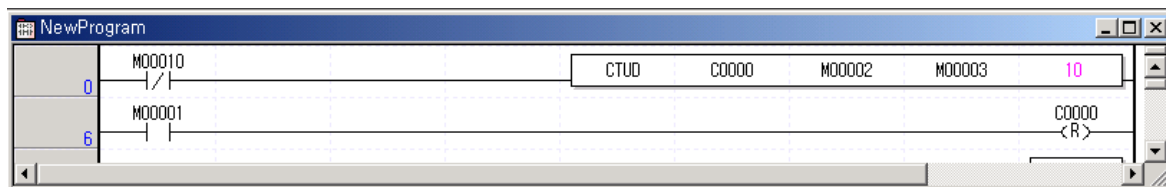

- The current value is increased with the rising edge of up-count input signal, and decreased with the rising edge of down-count input signal. The counter output contact (Cxxx) is turned On when the current value is same as or more than current value. The counter output contact (Cxxx) is turned Off when the current value is same as or less than current value.
- When the reset input is turned On, the current value is cleared as 0.

(d) Ring counter

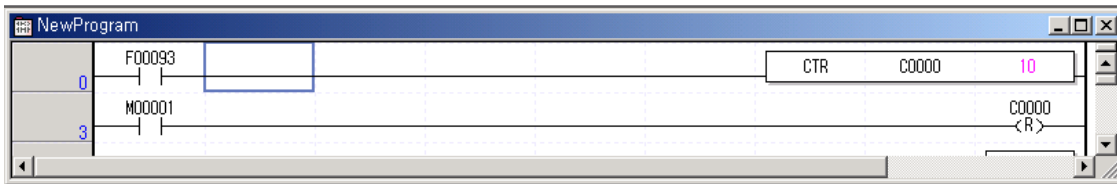

- The current value is increased with the rising edge of the counter input signal, and the counter output contact (Cxxx) is turned on when the current value reaches the preset value. Then the current value and counter output contact (Cxxx) is cleared as 0 when the next rising edge of the counter input signal is applied.
- When the reset input is turned On, the counter output contact is cleared as 0.

(2) Maximum counting speed

The maximum counting speed of determined by the length of scan time. Counting is possible only when the on/off switching time of the counter input signal is longer than scan time.

Maximum counting speed $C_{max} = \frac{n}{100} \times \left(\frac{1}{t_s}\right)$ n : duty (%)
 t_s : scan time [s]

- Duty is the ratio of the input signal's on time to off time as a percentage.

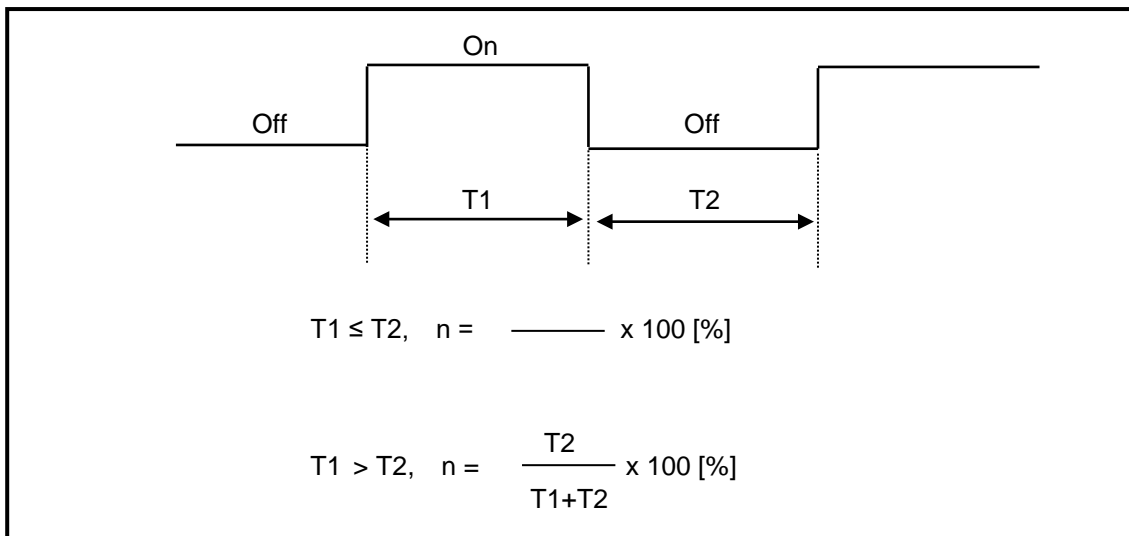

Remark

1) Use of High Speed Counter

In order to counter pulse that is faster than maximum counting speed of normal counter, use built-in High Speed counter function.

5.2 Program Execution

5.2.1 Configuration of program

All functional elements need to execute a certain control process are called as a 'program'. Program is stored in the built-in RAM mounted on a CPU module or flash memory of a external memory module. The following table shows the classification of the program.

Program type	Description
Initializing program	<ul style="list-style-type: none"> It will be executed till the specific Flag 'INIT_DONE' is on. And while the initialization task is executed, cycle task, external interrupt task and internal device task are not executed. I/O refresh, high speed counter and communication are executed
Scan program	<ul style="list-style-type: none"> The scan program is executed regularly in every scan.
Cycle time interrupt program	<ul style="list-style-type: none"> The program is performed according to the fixed time interval in case that the required processing time condition is as below. <ul style="list-style-type: none"> ▶ In case that the faster processing than 1 scan average processing time is required ▶ In case that the longer time interval than 1 scan average processing time is required ▶ In case that program is processed with the appointed time interval
External interrupt program	<ul style="list-style-type: none"> The external interrupt program is performed process on external interrupt signal.
Subroutine program	<ul style="list-style-type: none"> Only when some condition is satisfied.(in case that input condition of CALL instruction is On)

5.2.2 Program execution methods

Here describes the program proceeding method that is executed when the power is applied or key switch is 'RUN'. The program performs the operation processing according to the configuration as below.

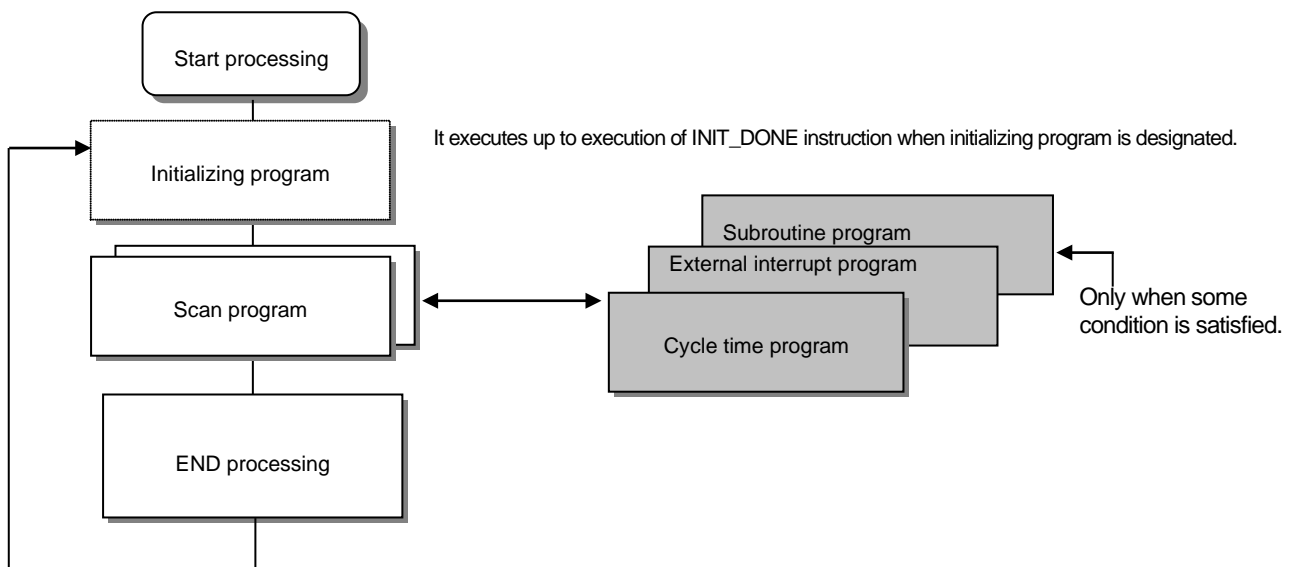

(1) Scan program

(a) Function

- This program performs the operation repeatedly from 0 step to last step in order prepared by the program to process the signal that is repeatedly regularly every scan.
- In case that the execution condition of interrupt by task interrupt or interrupt module while executing program is established, stop the current program in execution and perform the related interrupt program.

(2) Interrupt program

(a) Function

- This program stops the operation of scan program and then processes the related function in prior to process the internal/external signal occurred periodically/non-periodically.

(b) Type

- Task program is divided as below.
 - ▶ Cycle time task program: available to use up to 8.
 - ▶ Internal device task program: available to use up to 8.
 - ▶ I/O (External contact task program): “S” type available to use up to 8. (P000 ~ P007)
“E” type available to use up to 4. (P000~P003)
- Cycle time task program
 - ▶ Performs the program according to the fixed time interval.
- Internal device task program
 - ▶ Performs the corresponding program when the start condition of internal device occurs.
 - ▶ The start condition detection of device shall be performed after processing of scan program.
- I/O (External contact task program)
 - ▶ Performs the program according to the input external signal (“S” type: P000~P007, “E” type: P000~P003).

Remark

- (1) Write the interrupt program as shortly as possible. In case same interrupt occurs repeatedly before completion of interrupt, program is not executed and O/S watch dog error may occur.
- (2) Though interrupt which has lower priority occurs many times during execution of interrupt which has higher priority, interrupt which has lower priority occurs only one time.

5.2.3 Interrupt

For your understanding of Interrupt function, here describes program setting method of XG5000 which is an XGB programming S/W. Example of interrupt setting is as shown bellows.

• Interrupt setting

Interrupt source	Interrupt name	priority	Task No.	Program
Initializing	Interrupt 0_	-	-	-
Cycle time 1	Interrupt 1_cycle time	2	0	Cycle time 1
External	Interrupt 2_external	2	8	External
Internal device	Interrupt 3_internal	3	14	Internal
Cycle time 2	Interrupt 4_cycle time	3	1	Cycle time 2

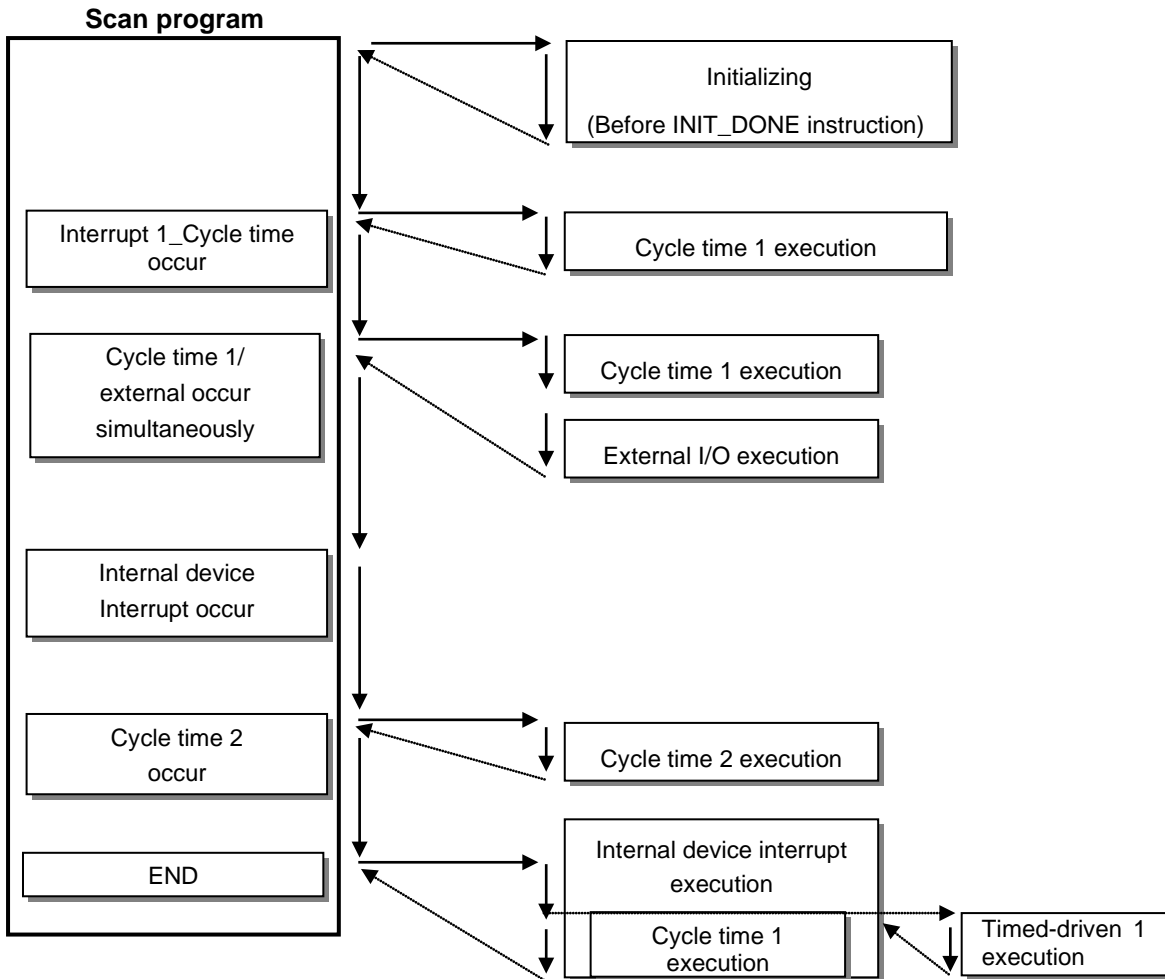

Remark

- In case that several tasks to be executed are waiting, execute from the highest Task Program in priority. When the same priority tasks are waiting, execute from the order occurred.
- While interrupt executing, if the highest interrupt is occurred, the highest interrupt is executed earliest of all.
- When power On, All interrupts are in the state 'Enable'. In case you don't use it, disable the interrupts by using DI instruction. If you want to use it again, enable by using EI instruction.
- Internal device interrupt is executed after END instruction.

(1) How to prepare interrupt program

Generate the task in the project window of XG5000 as below and add the program to be performed by each task. For further information, please refer to XG5000 user's manual.

(It can be additional when XG5000 is not connected with PLC.)

(a) Click right button of mouse on project name and click 『Add item』 - 『Task』 .

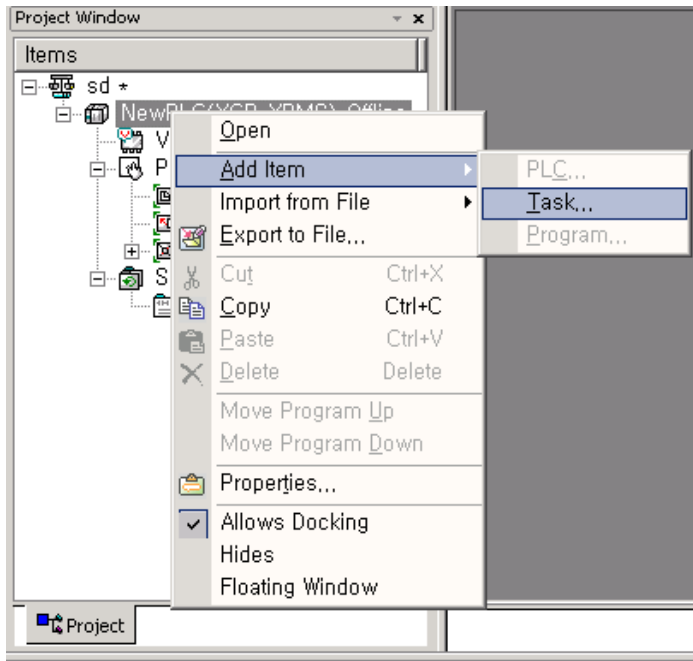

(b) The screen of Task setting is shown. Click 『Initialization』 in Execution condition and make a Task name.

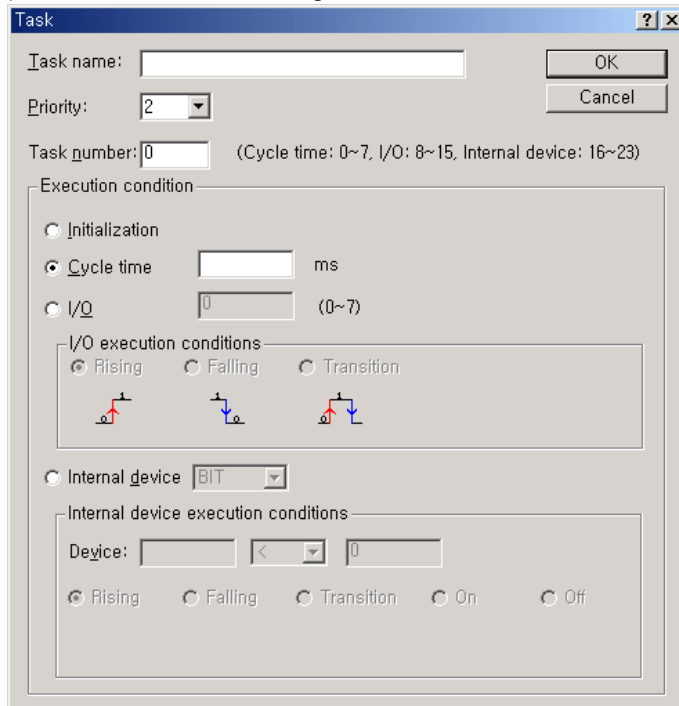

(c) Click right button of mouse at registered task and select 『Add Item』 - 『Program』 .

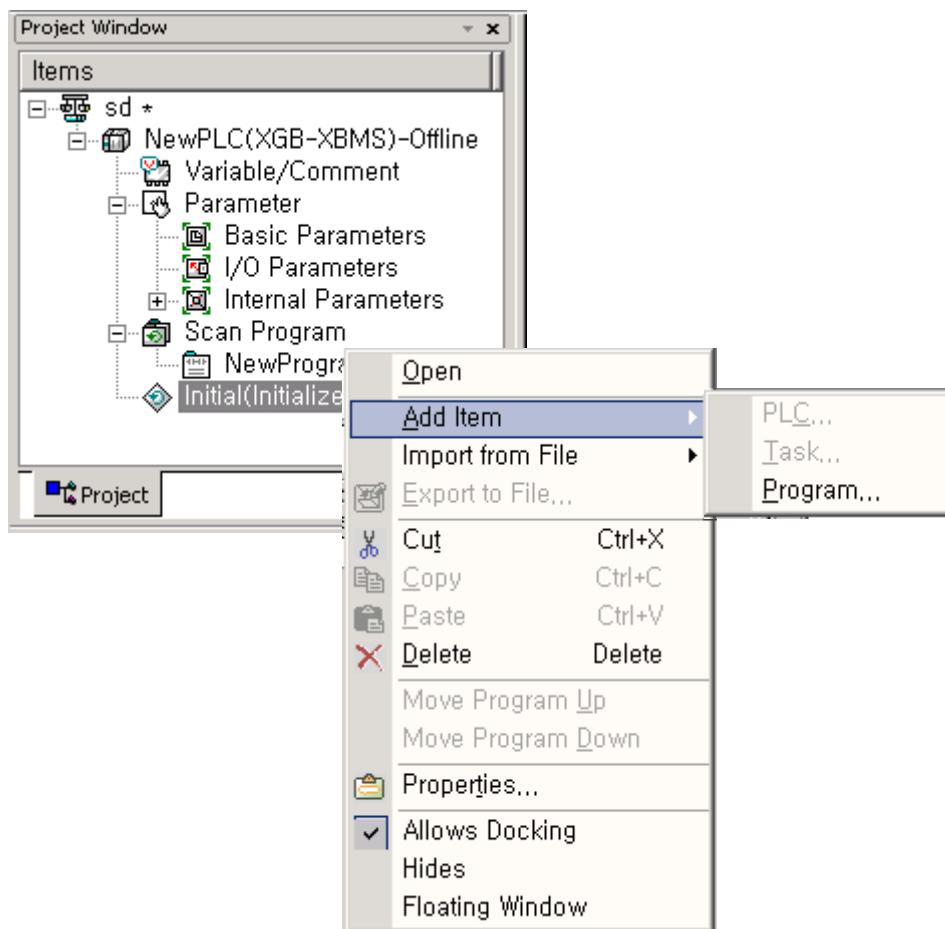

(d) Make initializing program. In initializing program, INIT_DONE instruction must be made. If not, Scan program is not executed.

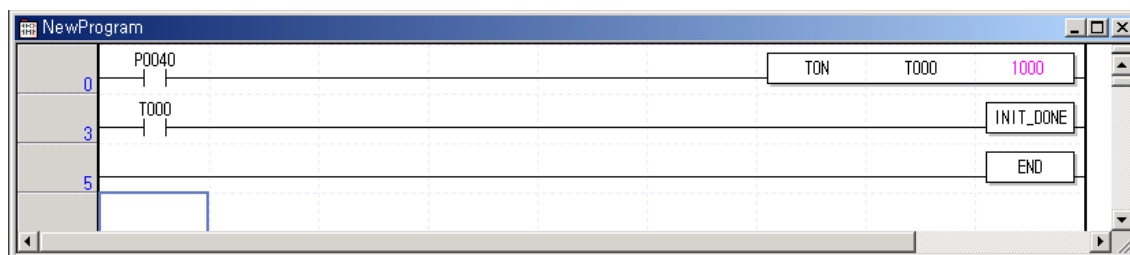

(2) How to prepare Cycle interrupt program

Generate the task in the project window of XG5000 as below and add the program to be performed by each task.
For further information, please refer to XG5000 user's manual.

(It can be additional when XG5000 is not connected with PLC)

- (a) Click right button of mouse at registered task and select 『Add Item』 - 『Task』 .

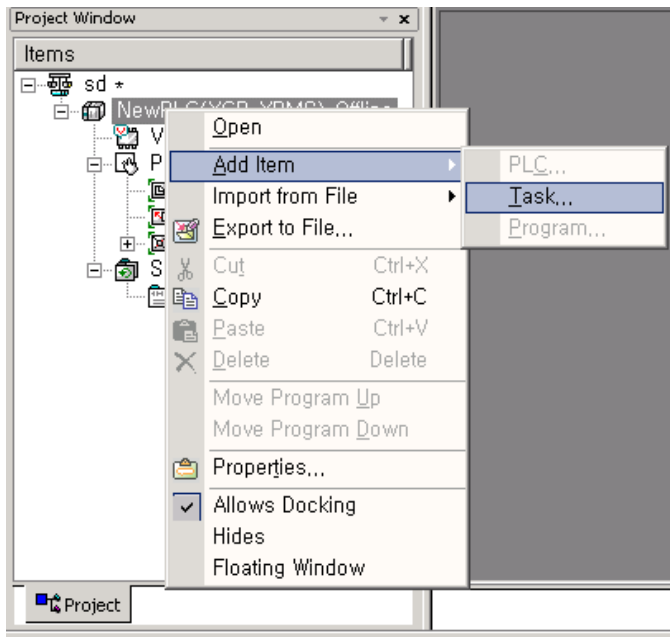

- It shows setting screen of Task.

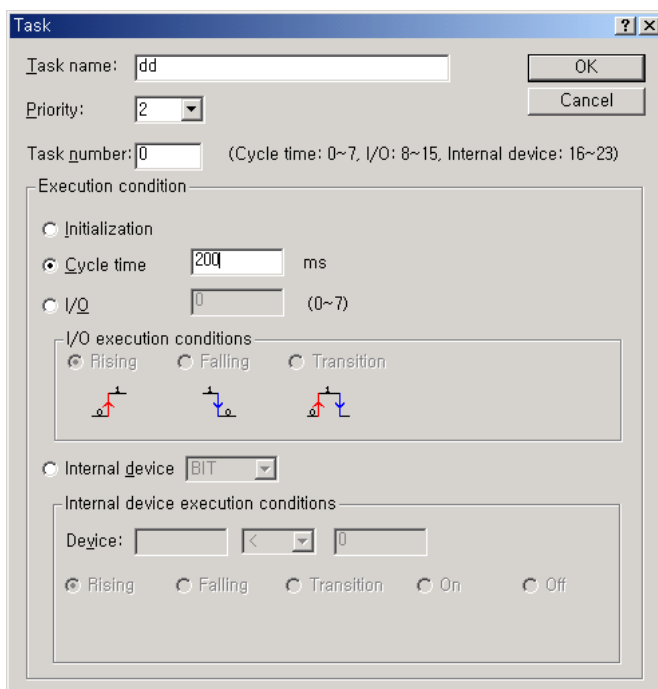

(b) Task type

Classification		Description	Remark
Task name		Make Task name.	Character, number available
Priority		Set the priority of task. (2~7)	"2" is the highest priority number.
Task number		Set the Task number. <ul style="list-style-type: none"> • Cycle time task (0 ~ 7): 8 • External I/O task (8 ~ 15): "S" type: 8, "E" type: 4 • Internal device task (16 ~ 23): 8 	-
Execution condition	Initialization	Set the initial program when running the project.	Till the execution of INIT_DONE instruction
	Cycle time	Set the cyclic interrupt.	0~4294967295 ms available
	I/O	Set the external I/O.	P000 ~ P007 available
	Internal device	Set the internal device to interrupt execution. <ul style="list-style-type: none"> • Bit: Among Rising, Falling, Transition, On, Off • Word: Among >, >=, <, <= 	-

(c) Click right button of mouse at registered task and select 『Add Item』 - 『Program』 .

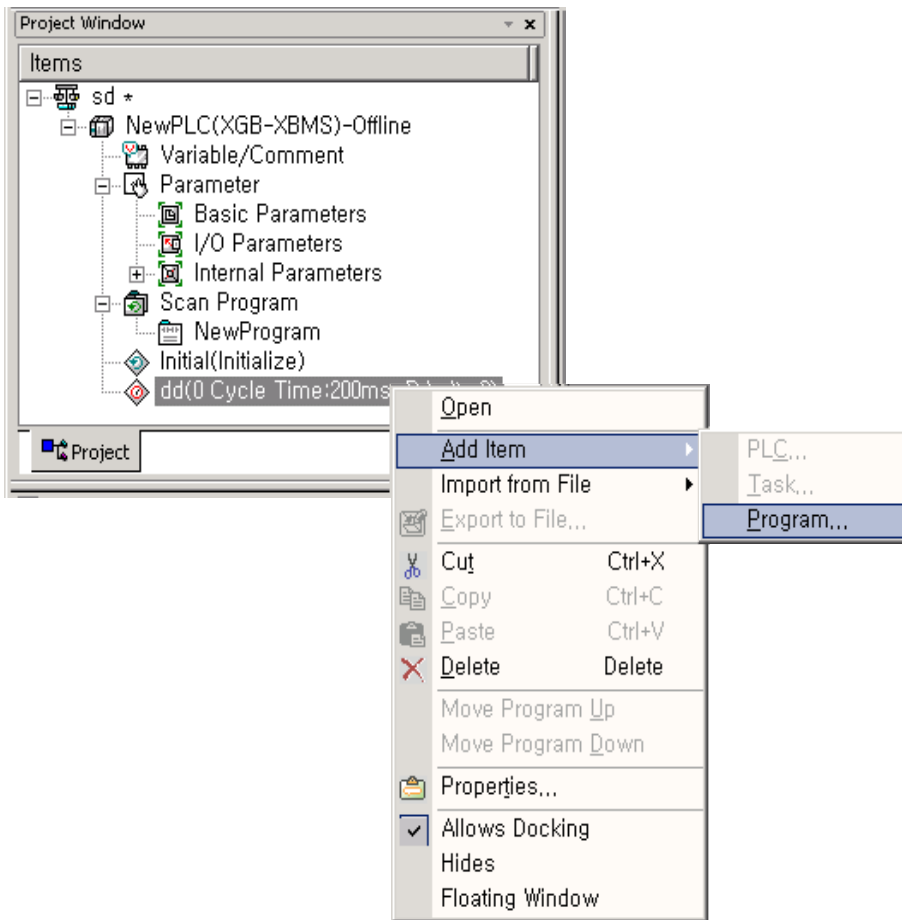

(d) Register the Program name and Program description.

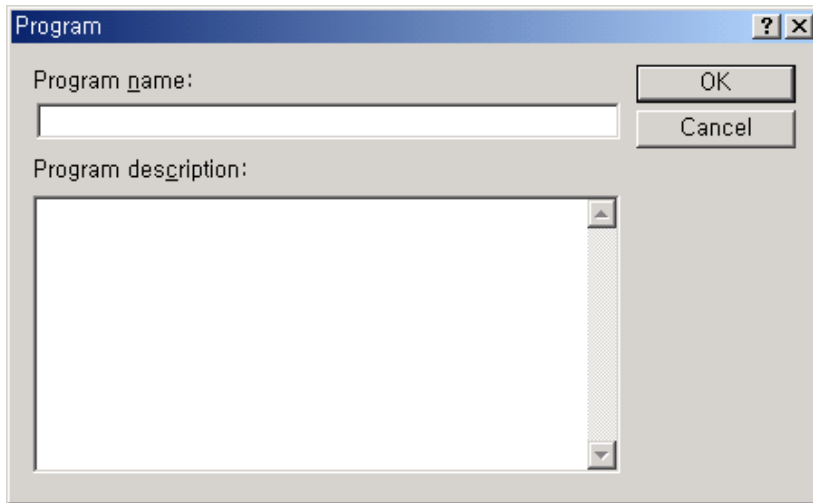

(e) It is displayed the program window to write task program.

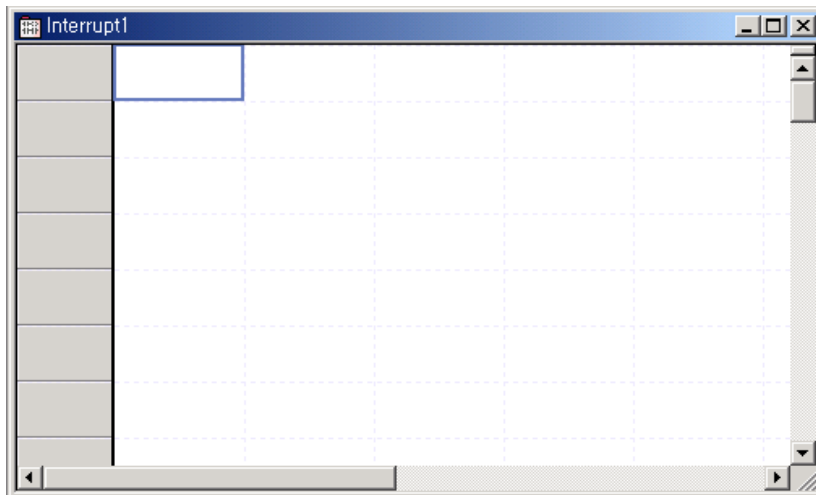

(f) It is displayed the setting in project window.

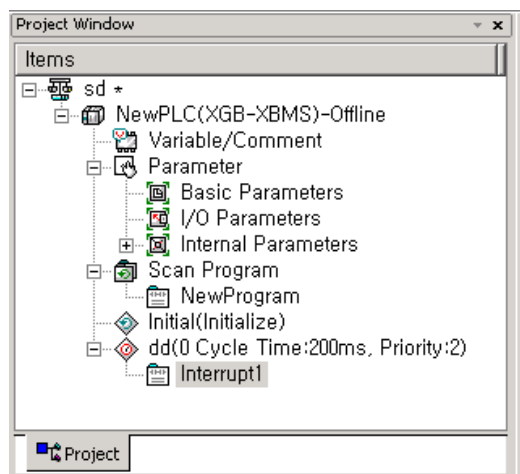

(3) Task type

Task type and function is as follows.

Spec. \ Type	Cycle time task (Interval task)	I/O task (Interrupt task)		Internal device task (Single task)
		“S” type	“E” type	
Max. Task number	8	8	4	8
Start condition	Cyclic (setting up to max. 4,294,967.295 sec. by 1ms unit)	Rising or falling edge of main unit's contact P000 ~P007	Rising or falling edge of main unit's contact P000 ~P003	Internal device execution condition
Detection and execution	Cyclic execution per setting time	Immediate execution at the edge of main unit's contact		Retrieve the condition and execute after completing Scan Program
Detection delay time	Max. 1 ms delay	Max. 0.05 ms delay		Delay as much as max. scan time
Execution priority	2~7 level setting (2 level is highest in priority)	2~7 level setting (2 level is highest in priority)		2~7 level setting (2 level is highest in priority)
Task no.	Within 0~7 range without user duplication	With 8~15 range without user duplication		Within 16~23 range without user duplication

(4) Processing methods of task program

Here describes common processing method and notices for Task program.

(a) Feature of task program

- 1) Task Program is executed only when execution condition occurs without every scan repeat processing.
When preparing Task Program, please consider this point.
- 2) For example, if a timer and counter were used in cyclic task program of 10 second cycle, this timer occurs the tolerance of max. 10 seconds and the counter and the timer and as the counter checks the input status of counter per 10 seconds, the input changed within 10 seconds is not counted up.

(b) Execution priority

- 1) In case that several tasks to be executed are waiting, execute from the highest Task Program in priority.
When the same priority tasks are waiting, execute from the order occurred.
- 2) In case Cycle time task and external I/O task is occurred concurrently, execute from the highest task program.
(In sequence of XG5000 setting)
- 3) The task program priority should be set considering the program features, importance and the emergency when the execution requested.

(c) Processing delay time

There are some causes for Task Program processing delay as below. Please consider this when task setting or program preparation.

- 1) Task detection delay (Refer to detailed description of each task.)
- 2) Program proceeding delay caused by Priority Task Program proceeding
- 3) Input/output data refresh of expansion special module and using PUT, GET instruction.

(d) Relationship of initialize, Scan Program and Task Program

- 1) ser identification task does not start while performing Initialization Task Program.
- 2) As Scan Program is set as lowest priority, if task occurs, stop Scan Program and process Task Program in advance. Accordingly, if task occurs frequently during 1 scan or concentrates intermittently, scan time may extend abnormally. Cares should be taken in case of task condition setting.

(e) Protection of Program in execution from Task Program

- 1) In case that the continuity of program execution is interrupted by high priority Task Program during program execution, it is available to prohibit the execution of Task Program partially for the part in problem. In this case, it is available to perform the program protection by 'DI (Task Program Start Disabled) and 'EI (Task Program Start Enabled)' application instruction.
- 2) Insert 'DI' application instruction in the start position of the part requiring the protection and insert 'EI' application instruction in the position to release. Initialization Task is not influenced by 'DI', 'EI' application instruction.
- 3) If interrupt is occurred while 'CALLP' instruction executing, interrupt program is executed after 'CALLP' instruction execution.

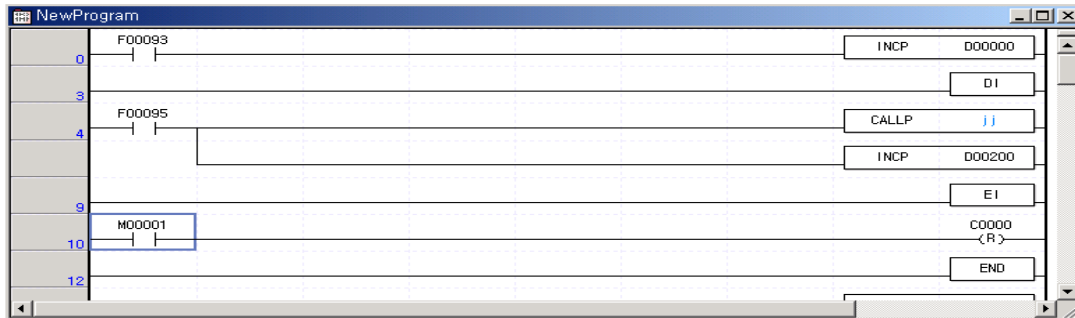

(5) Cyclic task program processing method

Here describes the processing method in case that task (start condition) of Task program is set as Cycle time.

(a) Items to be set in Task

Set the execution cycle and priority which are the start condition of Task program to execution. Check the task no. to manage the task.

(b) Cyclic task processing

Performance the corresponding cyclic task program per setting time interval (execution cycle).

(c) Notice in using cyclic task program

- 1) When cyclic task program is in execution currently or waiting for execution, if the demand to execute the same task program occurs, the new occurred task shall be disregarded.
- 2) Timer that makes a demand to execute cyclic task program only while operation mode is Run mode, shall be added. The shutdown time shall be all disregarded.
- 3) When setting the execution cycle of cyclic task program, consider the possibility that the demand to execute several cyclic task program at the same time occurs.
If 4 cyclic task programs that the cycle is 2sec, 4sec, 10sec and 20sec are used, 4 demands of execution per 20 seconds shall be occurred at the same time and scan time may extend instantaneously.

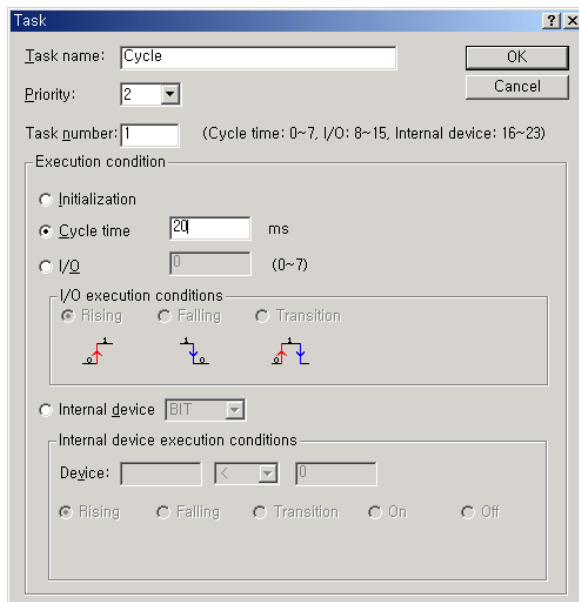

(6) I/O task program processing

It described the I/O task program processing. (“S” type: P000~P007, “E” type: P000~P003)

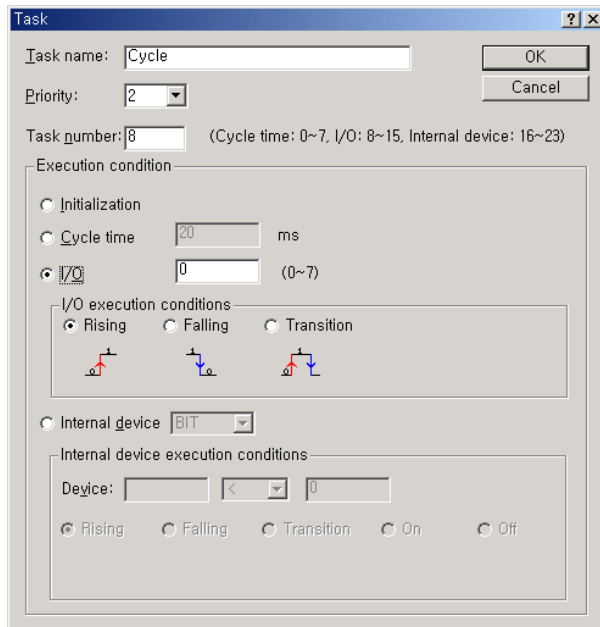

(a) Items to be set in Task

Set the execution condition and priority to the task being executed. Check the task no. to manage the task.

(b) I/O task processing

If interrupt signal from external signal (I/O) is occurred on main unit (“S” type: P000 ~ P007. “E” type: P000~P003), task program is executed by external (I/O) signal.

(c) Precaution in using I/O task program

- 1) If task program which is executed by interrupt signal is on execution or standby status, new task program which is requested by identical I/O is ignored.
- 2) Only operation mode is Run mode, execution request of task program is recognized. Namely, execution request of task program is ignored when operation mode is Stop mode.

(7) Internal device task program processing

Here describes the processing method of international device task program which extended the task (start condition) of task program from contact point to device as execution range.

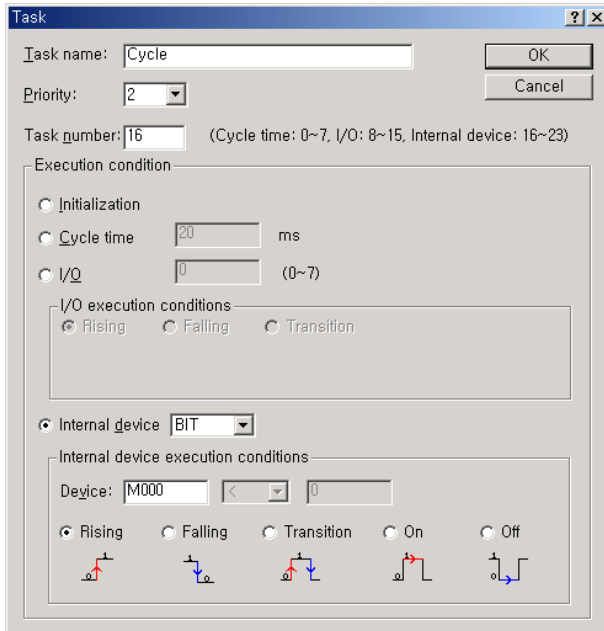

(a) Items to be set in Task

Set the execution condition and priority to the task being executed. Check the task no. for task management.

(b) Internal device task processing

After completing the scan program execution in CPU module, if the condition that becomes the start condition of internal device task program is met, according to the priority, it shall be executed.

(c) Precautions in using internal device task program

- 1) Accordingly, even if the execution condition of internal device task program occurs in Scan Program or Task Program (Cycle time, I/O), it shall not be executed immediately but executed at the time of completion of Scan Program.
- 2) If the demand to execute Internal Device Task Program occurs, the execution condition shall be examined at the time of completion of Scan Program. Accordingly, if the execution condition of Internal Device Task occurs by Scan Program or Task Program (Cycle time) during '1 scan' and disappears, the task shall not be executed as it is not possible to detect the execution at the time of examination of execution condition.

(8) Verification of task program

(a) Is the task setting proper?

If task occurs frequently more than needed or several tasks occur in one scan at the same time, scan time may lengthen or be irregular. In case not possible to change the task setting, verify max. scan time.

(b) Is the priority of task arranged well?

The low priority task program shall be delayed by the high priority task program, which results in disabling the processing within the correct time and even task collision may occur as next task occurs in the state that the execution of previous task is delayed. Consider the emergency of task and execution time etc when setting the priority.

(c) Are task programs made as shortly as possible?

Long running time of the task program can cause the long or irregular scan time or may lead to the conflict of task programs. Make the task programs as shortly as possible.

Especially, when attaching expansion special module, or using PUT,GET instructions, program processing might be delayed.(More than 10ms task cycle is recommended).

(d) Is program protection for the high priority task needed during program execution?

If other task is inserted during task program execution, complete the task in execution and operate the standby tasks in the order of high priority. In case that it is not allowed to insert other task in Scan Program, prevent the insert partially by using 'DI' and 'EI' application instruction. The problem may occur while processing the global variables used commonly with other program or special or communication module.

(9) Program configuration and processing example

If task and program are registered as below.

Interrupt type	Interrupt name	Priority	Task No.	Program
Cycle time	10 ms_cycle time	3	0	Program 1
Internal device	Internal device_M00	5	16	Program 2
I/O	I/O_P00	2	8	Program 3

1) Scan program name: " Scan Program"

2) Execution time respective program: Scan program = 17 ms, Program 1 = 2 ms, Program 2= 7 ms, Program 3 = 2 ms

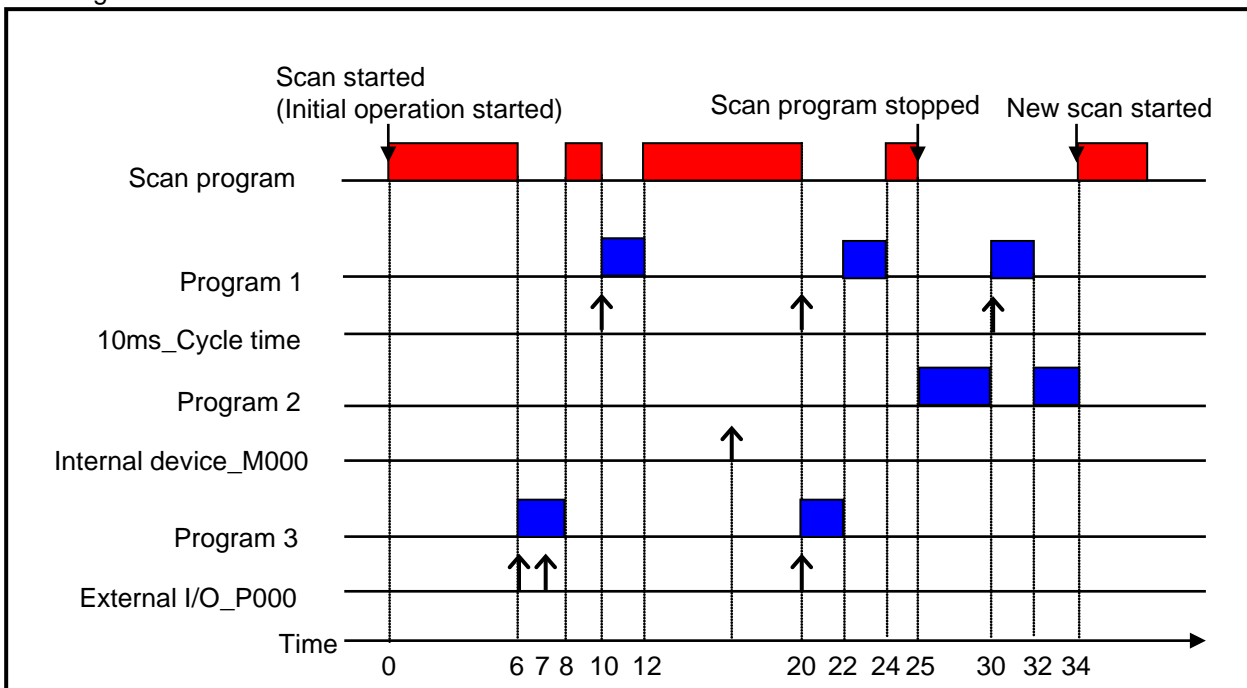

Process per time	
Time (ms)	Process
0	Scan started and scan program started to execute.
0~6	Scan program is executed.
6~8	Scan program is stop because execution external I/O (P000) is requested. And program 3 is executed. Request of execution at 7[ms] is ignored because program 3 has been executing.
8~10	Program 3 is finished and Scan program is continued.
10~12	Scan program is stop by request of '10 ms_Cycle time' interrupt signal and execute program 1.
12~20	Program 1 is finished and Scan program is continued.
20	Request of 'Cycle time' interrupt signal and 'External I/O (P000)' signal is occurred concurrently but priority of 'External I/O' signal is higher than 'Cycle time' interrupt signal so program 3 is executed and program 1 is standby.
20~22	Program 3 is finished and Scan program is continued.
22~24	After program 3 is completed, program 1 (the program of '10ms_Cycle time' is executed.
24~25	P1 execution completed and the stopped scan program execution finished
25	At the finished point of scan program, check the request of Internal device 'M000' execution and execute program 2.
25~30	Program P2 is executed.
30~32	When '10 ms_Cycle time' interrupt signal is occurred, the priority of that is higher than Internal device 'M000' though program 2 is stopped and program 1 is executed.
32~34	P1 executed completed and the stopped P2 execution finished
34	New scan starts (Start scan program execution)

5.3 Operation Mode

For operation mode of CPU module, there are 3 types such as RUN mode, STOP mode and DEBUG mode.. Here describes the operation processing of each operation mode.

5.3.1 RUN mode

This is the mode to executed program operation normally.

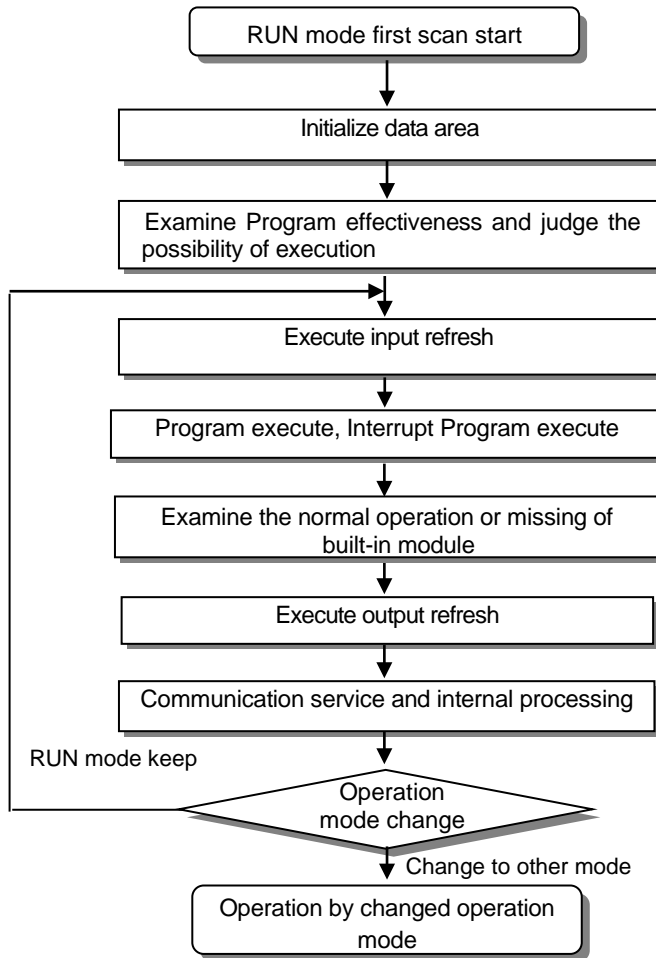

(1) Processing at mode change

At the beginning, execute initialization of data area and examine the effectiveness of program and judge the possibility of execution.

(2) Operation processing contents

Execute I/O refresh and program operation.

- (a) Detects the start condition of Interrupt Program and executes Interrupt Program.
- (b) Examines the normal operation or missing of built-in module.
- (c) Communication service and other internal processing.

5.3.2 STOP mode

This is the mode in stop state without Program operation. It is available to transmit the program through XG5000 only in Remote STOP mode.

- (1) Processing at Mode Change
 - Clear the output image area and execute output refresh.
- (2) Operation Processing Contents
 - (a) Executes I/O refresh.
 - (b) Examines the normal operation or missing of built-in module.
 - (c) Communication service or other internal processing.

5.3.3 DEBUG mode (Supported at “S” type)

This is the mode to detect Program error or trace the operation process and the conversion to this mode is available only in STOP mode. This is the mode to check the program execution state and the contents of each data and verify the program.

- (1) Processing at mode change
 - (a) Initializes the data area at the beginning of mode change.
 - (b) Clears the output image area and execute input refresh.
- (2) Operation processing contents
 - (a) Executes I/O refresh.
 - (b) Debug operation according to setting state.
 - (c) After finishing Debug operation by the end of Program, execute output refresh.
 - (d) Examine the normal operation or missing of built-in module.
 - (e) Executes communication service or other service.
- (3) Debug operation
 - It describes debug mode.

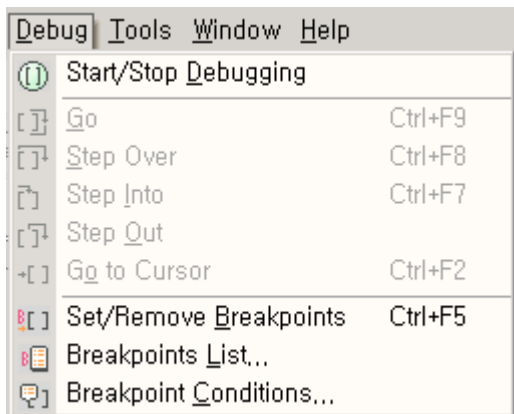

Chapter 5. Program Configuration and Operation Method

Item	Description	Remark
Start/Stop Debugging	Change the debug ↔ stop mode	
Go	It starts debug operation.	
Step Over	It operates by 1 step.	
Step Into	It starts the subroutine program.	Other operation is identical to Step Over.
Step Out	It finished the subroutine program.	
Go to Cursor	It operates to current cursor position.	
Set/Remove Breakpoints	Set/Removes current cursor position to break points.	
Breakpoints List	It displays list of breakpoints.	
Breakpoint Conditions	It specifies device value and number of scan.	

(a) Set/Remove Breakpoints

- Sets breakpoint at current cursor position. After breakpoint setting,  (breakpoint setting indicator) is displayed.

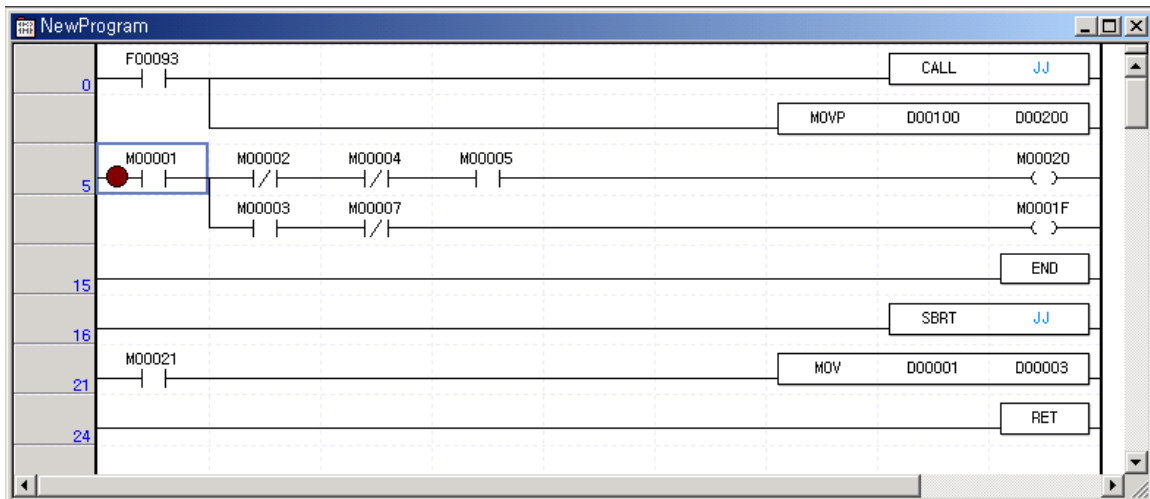

(b) Go

- Run the program to breakpoint. At break-pointer  (stop indicator) is displayed.

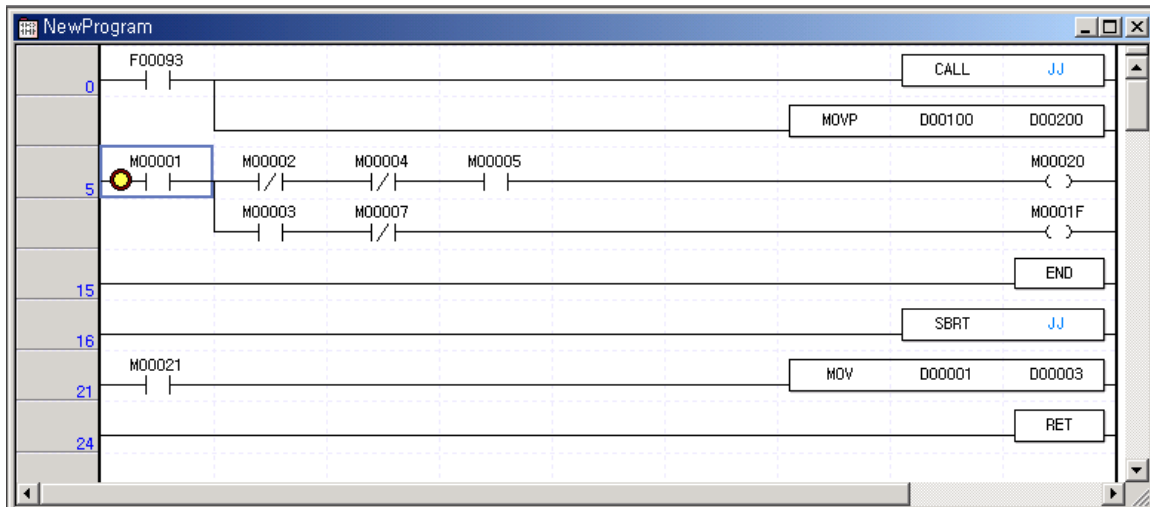

(c) Step Over

- Run the program to next step. At break point, Step over indicator  is displayed.

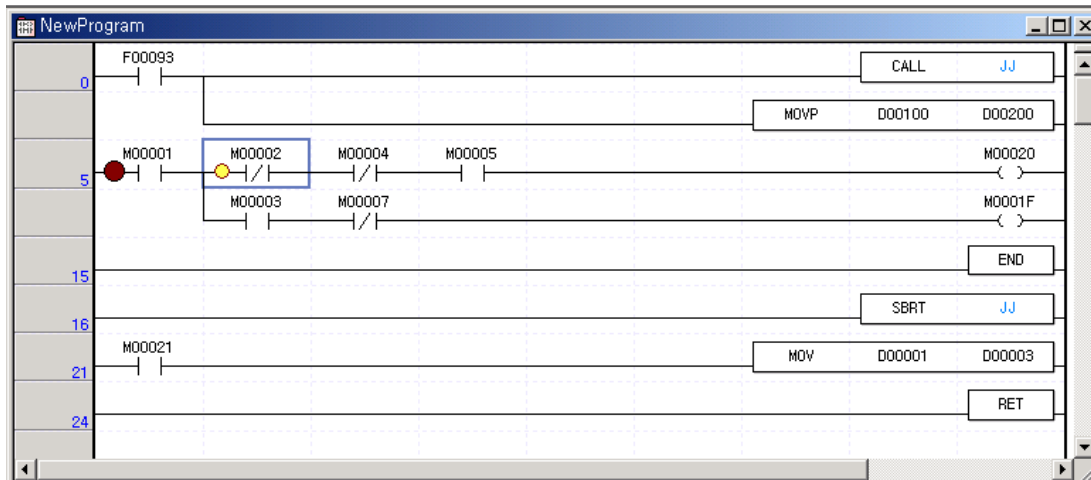

(d) Breakpoint List

- It displays current Breakpoint List. It supports Select All, Reset All, Goto, Remove, Remove All.

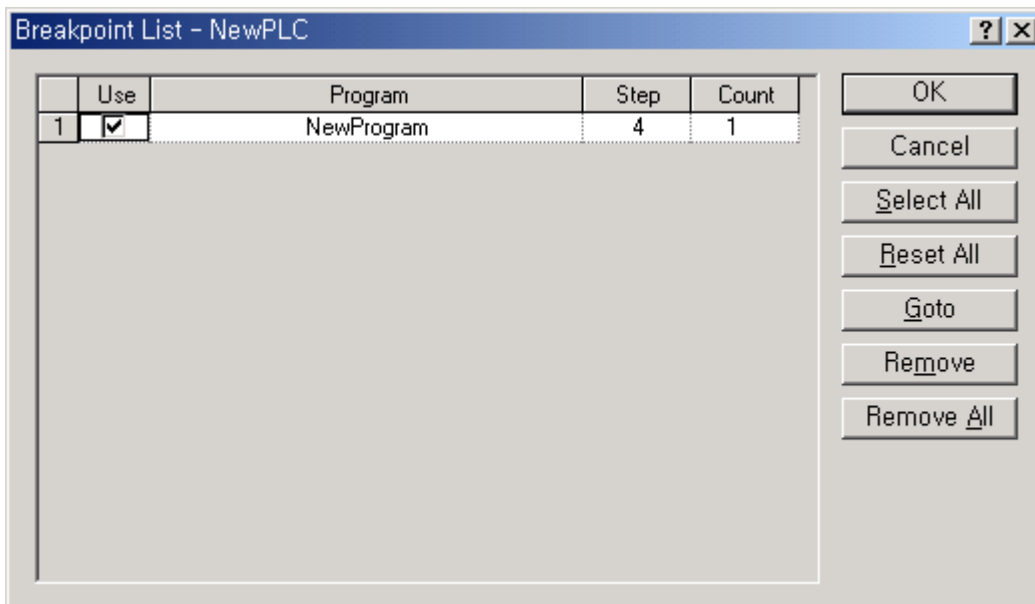

(e) Break condition

- It sets Device Break and Scan Break.

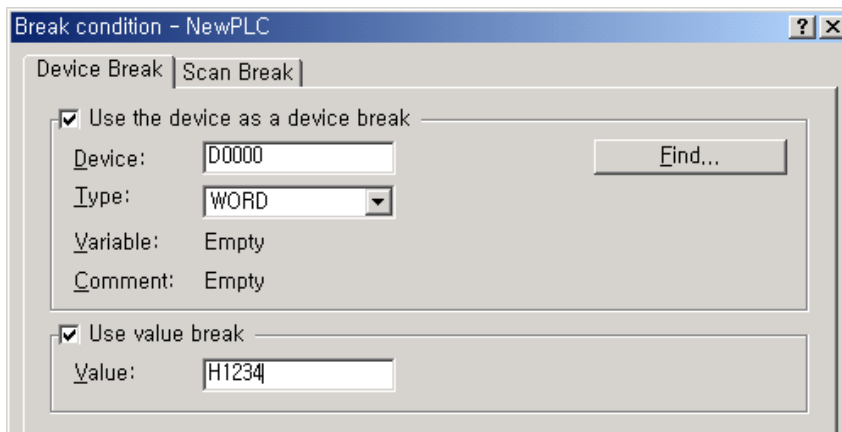

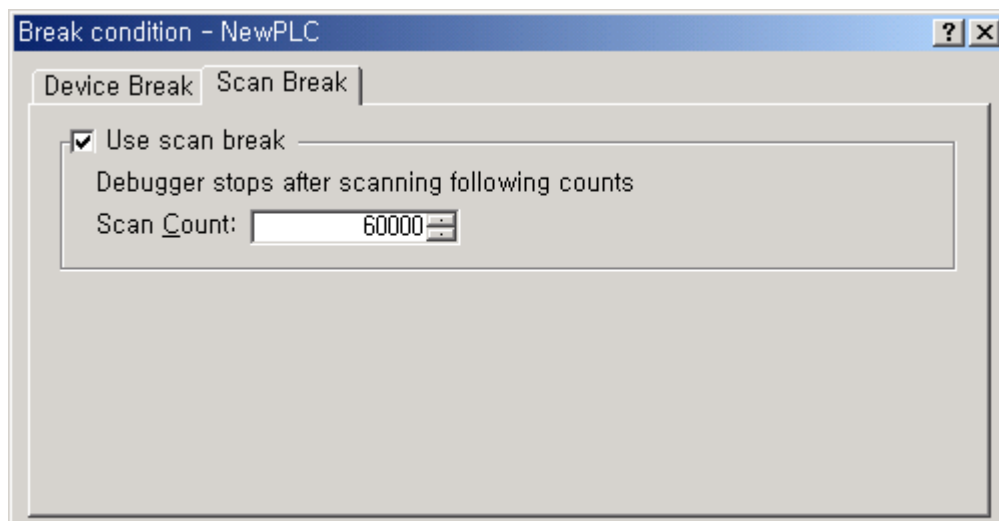

Remark

1) Refer to XG5000 Users Manual 'Chapter 12 Debugging' for detailed information.

5.3.4 Change operation mode

(1) Operation Mode Change Method

The method to change operation mode are as follows.

- (a) By mode key of CPU module
- (b) By connecting the programming tool (XG5000) to communication port of CPU
- (c) By changing the operation mode of other CPU module connected to network by XG5000 connected to communication port of CPU.
- (d) By using XG5000, HMI, computer link module connected to network
- (e) By 'STOP' instruction during program execution

(2) Type of operation mode

The operation mode setting is as follows.

Operation mode switch	XG5000 command	Operation mode
RUN	unchangeable	Local Run
STOP	RUN	Remote Run
	STOP	Remote Stop
	Debug	Debug Run
	Mode change	Previous operation mode
RUN -> STOP	-	Stop

- (a) Remote mode conversion is available only in the state of '**Remote Enabled: On**', '**Mode switch: Stop**'. In case of changing the Remote 'RUN' mode to 'STOP' by switch, operate the switch as follows. (STOP) → RUN → STOP.

 Warning
<p>In case of changing Remote RUN mode to RUN mode by switch, PLC operation continues the operation without interruption.</p> <p>It is available to modify during RUN in RUN mode by switch but the mode change operation by XG5000 is limited. This should be set only in case that remote mode change is not allowed.</p>

5.4 Memory

There are two types of memory in CPU module that the user can use. One is Program Memory that saves the user program written by the user to build the system, and the other is Data Memory that provides the device area to save the data during operation.

5.4.1 Data memory

(1) Bit device area

Various Bit Device are provided per function. The indication method is indicated by device type for first digit, word position by decimal for middle digit and bit position by hexadecimal for the last digit.

Area per device		Device features	Description
"E" type	"S" type		
P0000 ~ P127f	P0000~ P1023f	I/O device "P"	Image area to save the state of I/O device. After reading the input module state, saves it in the corresponding P area and sends P area Data saving the operation result to output module.
M0000 ~ M255f	M0000~ M1023f	Internal device "M"	Internal Memory provided to save Bit Data in Program
L0000 ~ L1279f	L0000~ L2047f	Communication device "L"	Device to indicate high speed link/P2P service state information of communication module.
K00000 ~ K2559f	K00000~ K4095f	Preservation device "K"	Device area to preserve the data during power shutdown, which is used without setting power shutdown preservation parameter separately. (Pay attention to write in special area (K2600 ~ 2559F)).
F0000 ~ F255f	F0000~ F1023f	Special device "F"	System flag area that manages the flag necessary for system operation in PLC.
T0000 ~ T255	T0000~ T1023	Timer device "T"	Area to save the state of contact/current value/set value of timer device
C0000 ~ C255	C0000~ C1023	Counter device "C"	Area to save the state of contact/current value/set value of counter device
S00.00 ~ S127.99	S00.00~ S127.99	Step controller "S" 128 x 100 step	Relay for step control

(2) Word device area

Area per device		Device features	Description
"E" type	"S" type		
D00000 ~ D5119	D0000~ D10239	Data register "D"	Area to preserve the internal data. Bit expression possible. (D0000.0)
U00.00 ~ U0A.31	U00.00~ U0A.31	Analog data register "U"	Register used to read data from special module installed in the slot. Bit expression possible
Z000 ~ Z127	Z000~ Z127	Index register "Z"	Dedicated device to use Index function Bit expression impossible
T0000 ~ T255	T0000~ T1023	Timer current value register "T"	Area to indicate the current value of timer
C0000 ~ C255	C0000~ C1023	Counter current value register "C"	Area to indicate the current value of counter
-	R0000~ R10239	File register "R"	Register for saving file Bit expression available (F0000.0)

5.5 Configuration Diagram of Data Memory

5.5.1 “E” type

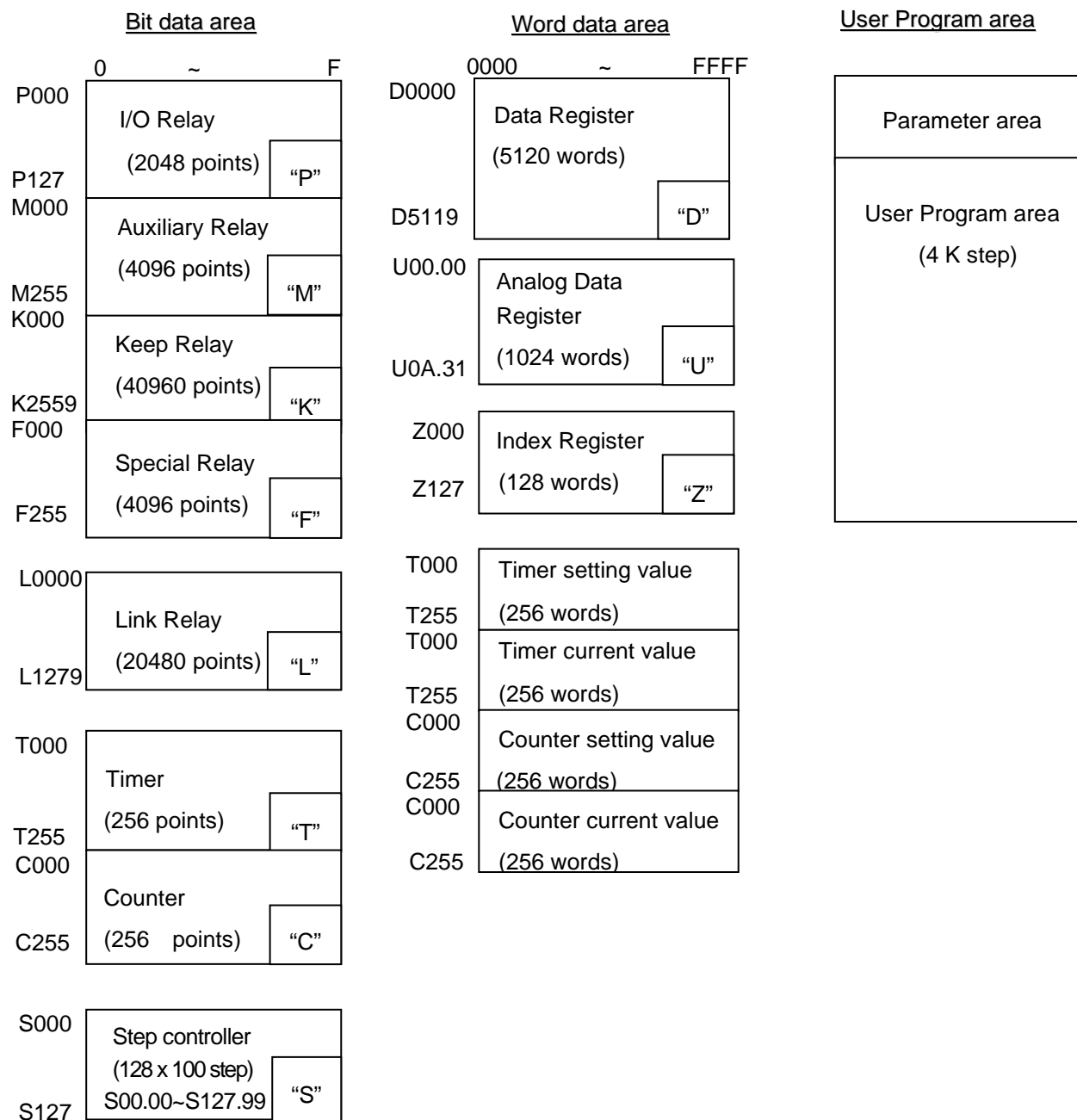

5.5.2 “S” type

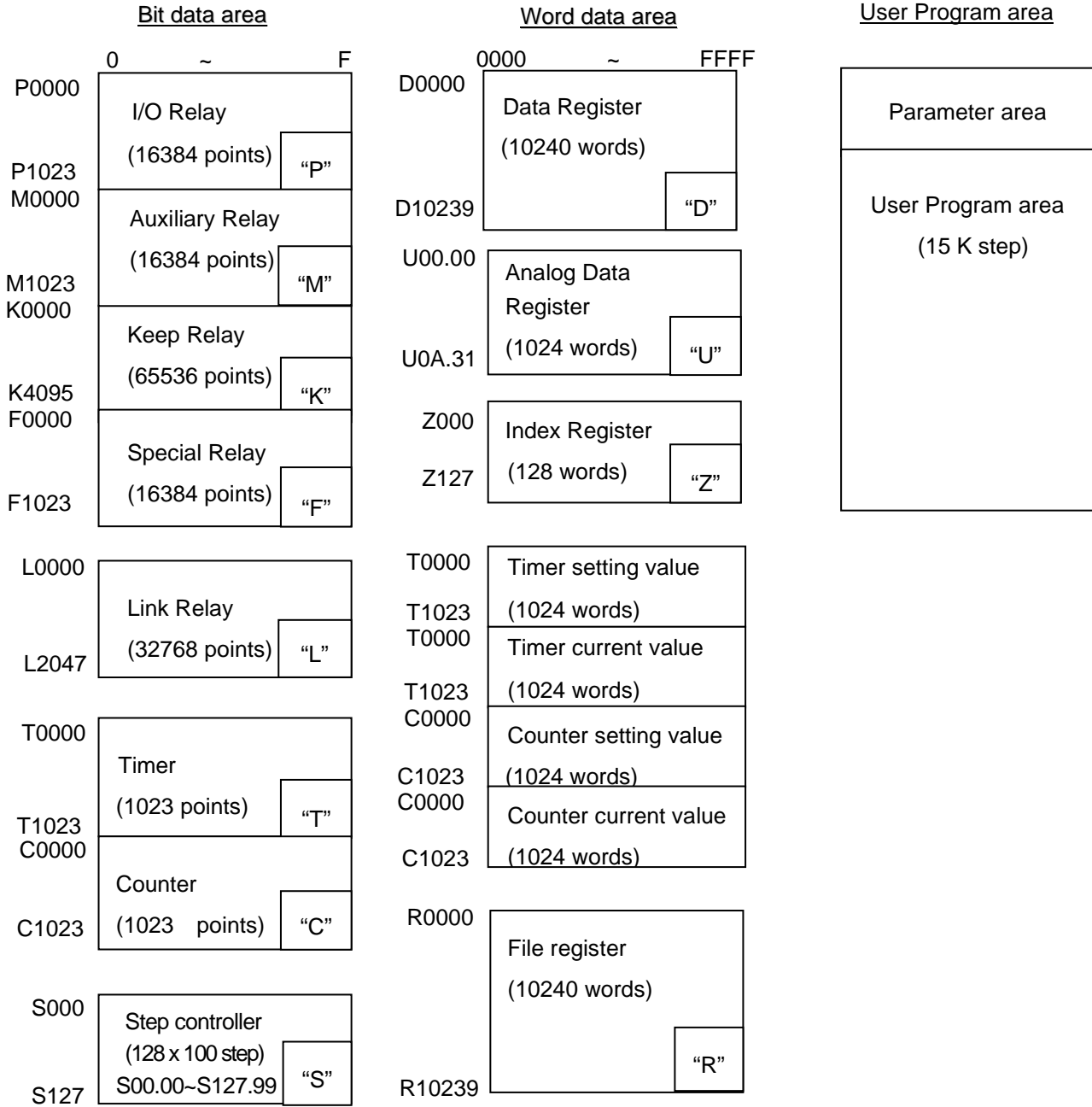

5.5.3 Data latch area setting

When PLC stops and restarts the data required for operation or the data occurred during operation, if you want to keep and use those data, data latch can be used and it is available to use a certain area of some data device as latch area by parameter setting.

The below shows the features for latch device.

Device	1 st latch	2 nd latch	Features
P	X	X	Image area to save the state of I/O device
M	O	O	Internal device area
K	X	X	Device keeping the device state during power shutdown
F	X	X	System flag area
T	O	O	Timer related area (Bit/words both)
C	O	O	Counter related area (Bit/words both)
S	O	O	Relay for step control
D	O	O	General words data save area
U	X	X	Analog Data Register (latch disabled)
L	X	X	High speed link/P2P Service state device of communication module (latch enabled)
Z	X	X	Index dedicated Register (latch disabled)
R	O	O	File register (latch enabled)

Remark

- K, L, R devices are basically latched.

- (1) Latch area setting
 (a) Click Device Area Setup of Basic parameter settings.

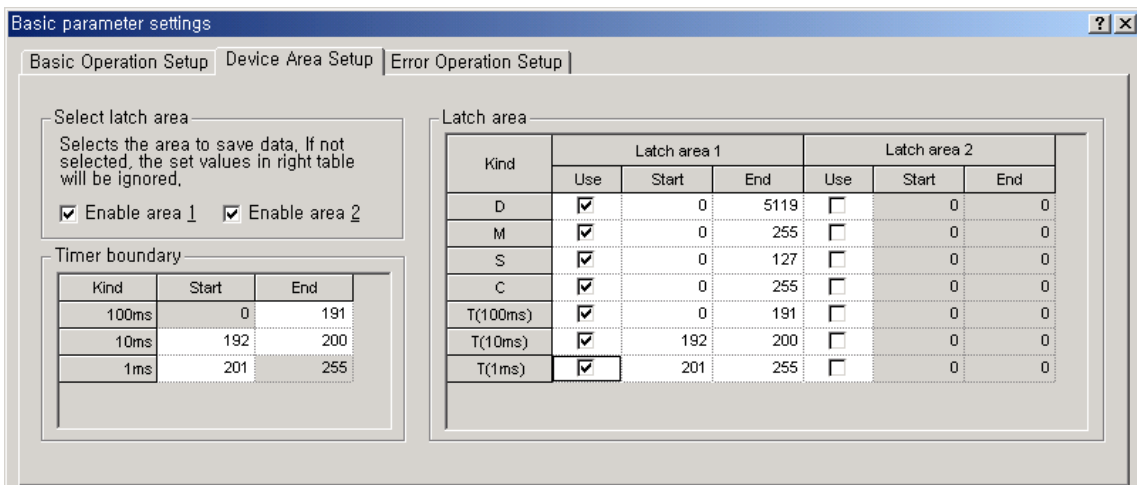

(2) Data latch area operation

- (a) The method to delete the latched data is as below.
- latch 1, latch 2 clear operation by XG5000
 - write by Program (initialization program recommended)
 - write '0' FILL from XG5000 monitor mode.

For keep or reset (clear) operation of latch area data according to PLC operation, please refer to the below table.

No.	Classification	Detailed operation	Latch 1	Latch 2
1	Power change	Off/On	Keep	Keep
2	Reset by XG5000	Overall reset	Reset	Keep
3	Program write (online)	-	Keep	Keep
4	Data broken	SRAM broken by battery error	Reset	Reset
		Data broken by other reason	Reset	Reset
5	XG5000 online	Clear Latch 1	Reset	Keep
		Clear Latch 2	Reset	Reset

- (b) Latch 1 area is cleared by 『Online』 - 『Reset PLC』 - “Overall reset”.

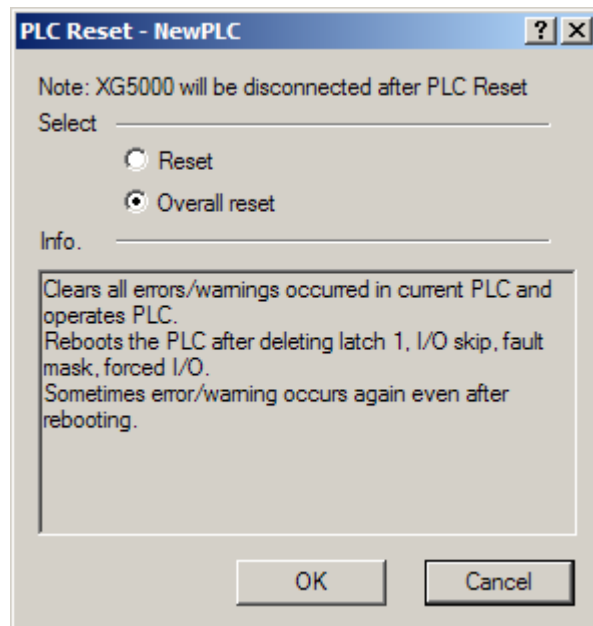
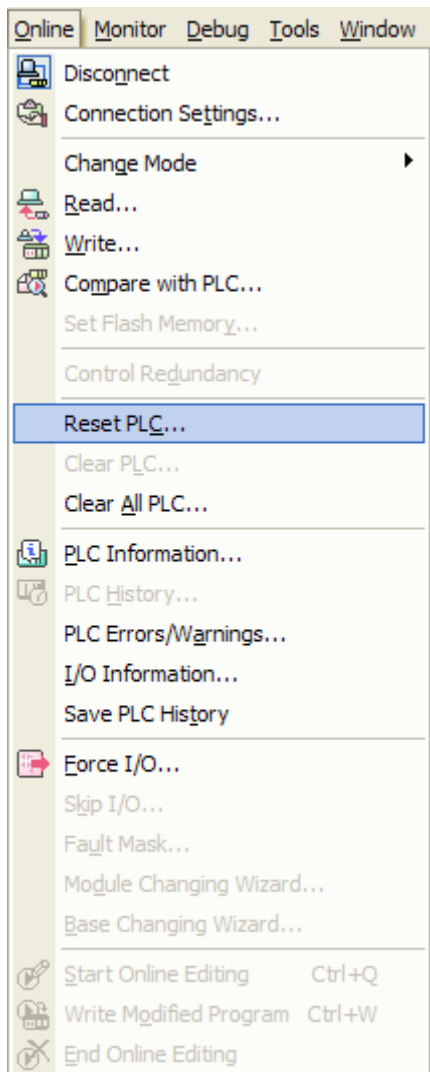

(c) Latch 1, 2 area is cleared by 『Online』 - 『Clear PLC』 .

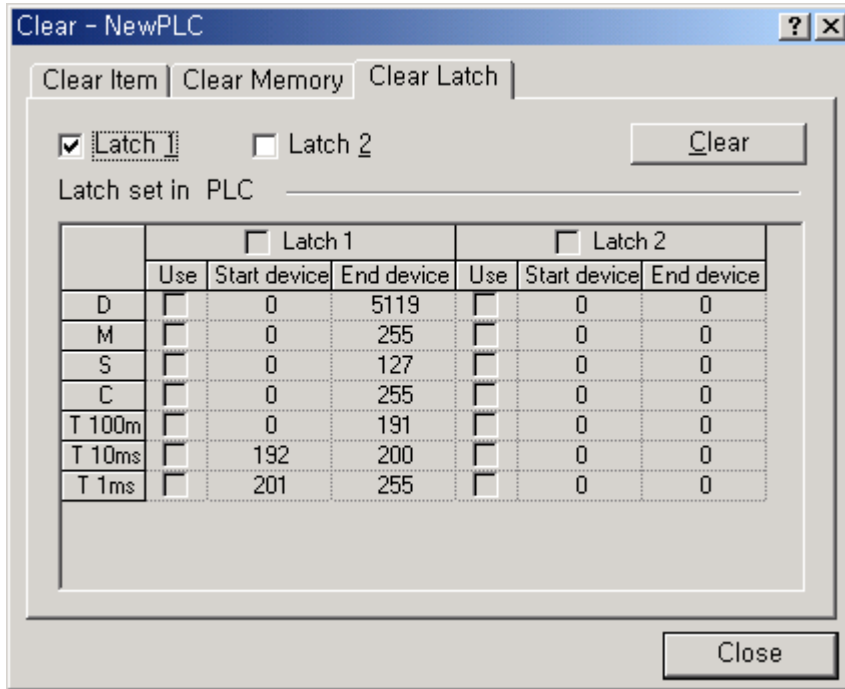

(3) Data initialization

In case of Memory Delete state, the memory of all device shall be cleared as '0'. In case of giving the data value at the beginning according to system, please use the initialization task.

(a) Device area is cleared by click 'Clear' in 『Online』 - 『Clear PLC』 - 『Clear Memory』 .

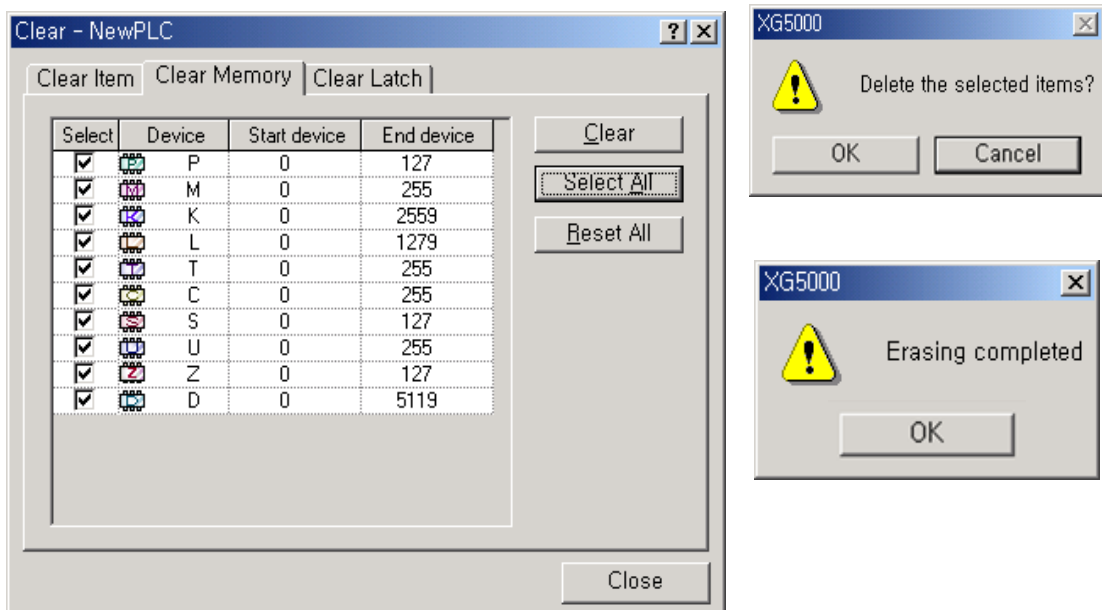

Chapter 6 CPU Functions

6.1 Type Setting

It describes setting of XGB PLC type.

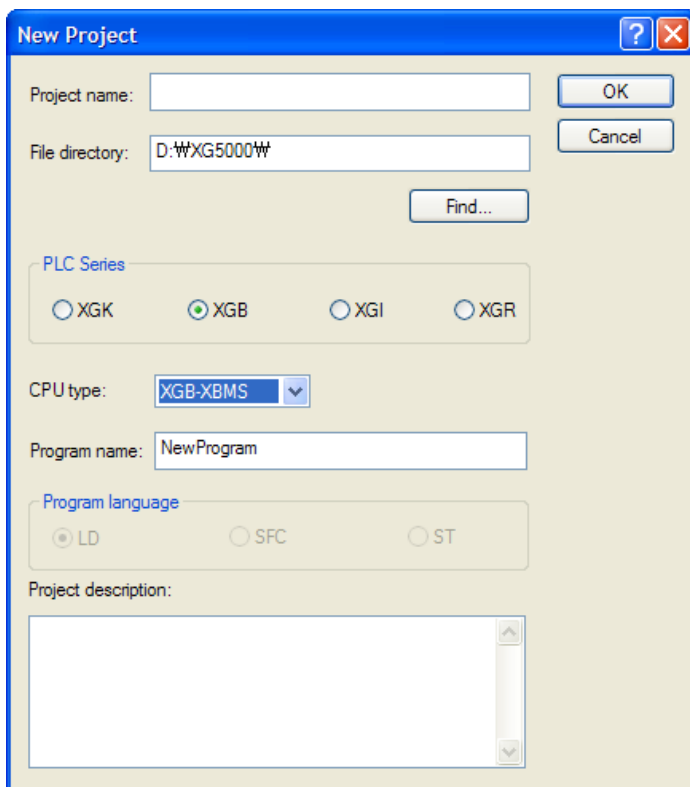

PLC Series	CPU type	Description	Reference
XGB	XGB-DR16C3	Dedicated product	Modular type
	XGB-DR32HL	Dedicated product	Modular type
	XGB-XBCE	“E” type : XBC-DR10/14/20/30E	Compact type
	XGB-XBCH	“H” type : XBC-DR32/64H , XBC-DN32/64H	Compact type
	XGB-XBCS	“S(U)” type : XBC-DR20/30/40/60SU, XBC-DN20/30S(U), XBC-DN40/60SU	Compact type
	XGB-XBMS	“S” type : XBM-DN16/32S , XBM-DR16S	Modular type
	XGB-XECH	“H” type : XEC-DR32/64H, XEC-DN32/64H	Compact type IEC language

Remark

- In case type is different, connection is not available.

6.2 Parameter Setting

This paragraph describes how to set parameters.

6.2.1 Basic parameter setting

Clicking Basic Parameter in the project window shows the following window.

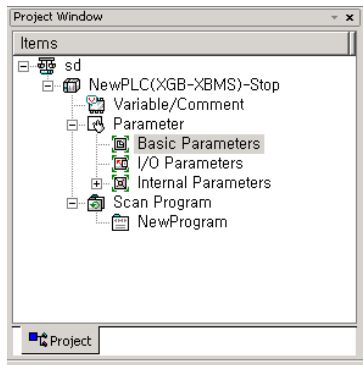

There are three main options ; “Basic Operation Setup” , “Device Area Setup” and “Error Operation Setup”.

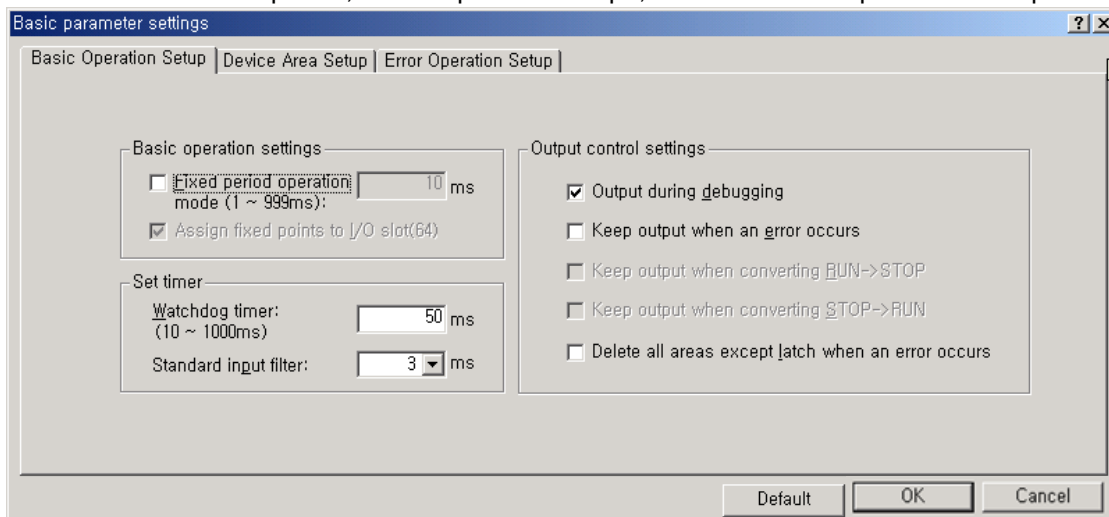

Category	Item	Description	Note
Basic operations	Fixed period operation	Set the time of fixed period operation.	1~999 ms
	Watchdog timer	Set the time of scan watchdog.	10~1000 ms
	Standard input filter	Set the time of standard input filter.	1,3,5,10,20,70,100 ms
	Output during debugging	Set whether to allow output actually during debugging operation.	Allowance/Prohibition
	Keep output when an error occurs	Set whether to preserve output holding function set in I/O parameter in case of error.	Allowance/Prohibition
	Delete all areas except latch when an error occurs	Set whether to clear each device that is not designated as a latch area in case of error	Allowance/Prohibition
Device area	Select latch area	Set the latch area of each device.	-
Error operation	Operation resumes in case of operation error	Set whether to pause or resume operation in case of operation error.	Pause/Resume

6.2.2 I/O parameter setting

This setting is to set and reserve each I/O information. Clicking 『I/O Parameter』 in the project window shows the following setting window.

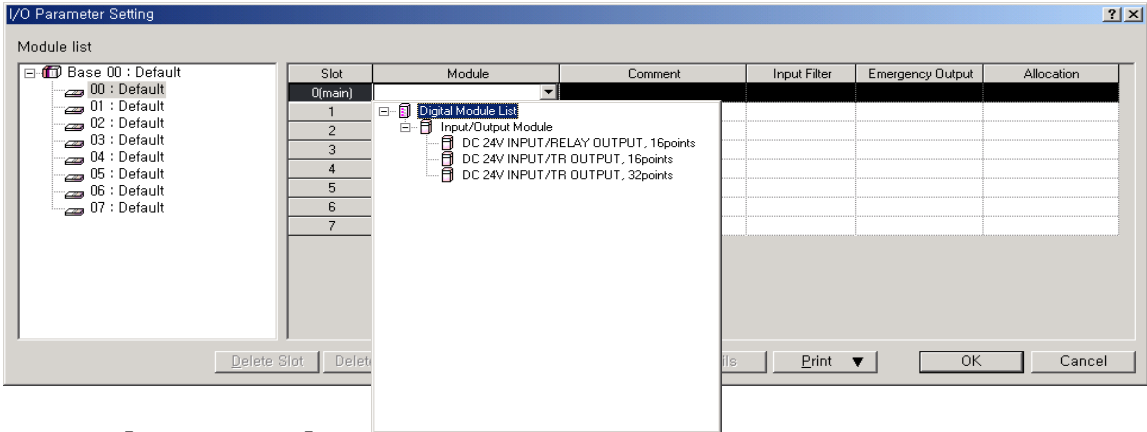

Clicking 『Module』 in 『Slot Position』 indicates a list of modules, in which you may set I/O corresponding to the actual system. Then, the following window is displayed.

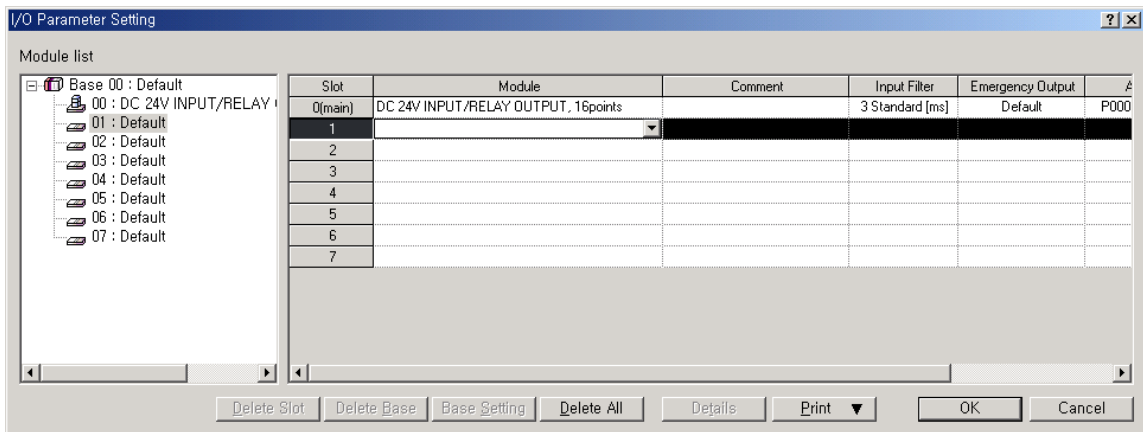

Clicking 『Details』 in 『Slot Position』 shows the following window to set filter and emergency output.

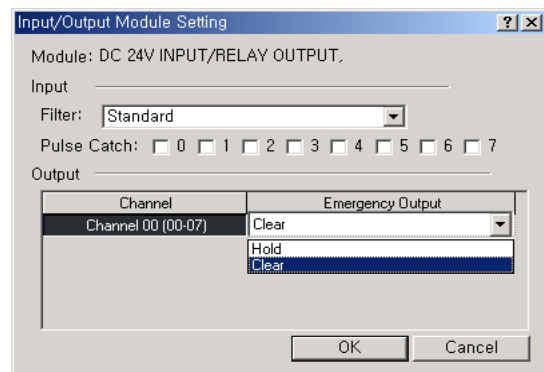
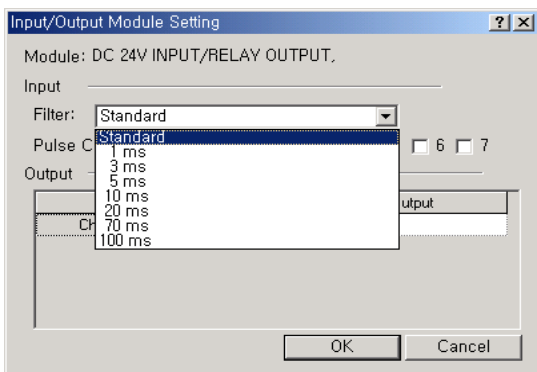

Remark

- (1) If settings are different with I/O module actually accessed, "Inconsistent module type error" occurs, displaying error.
- (2) Without settings, CPU reads each I/O module information and operates.

6.3 Self-diagnosis Function

6.3.1 Saving of error log

CPU module logs errors occurred so that the causes will be identified and fixed easily. Clicking 『Error/Warning』 of 『Online』 shows the current error and previous error log.

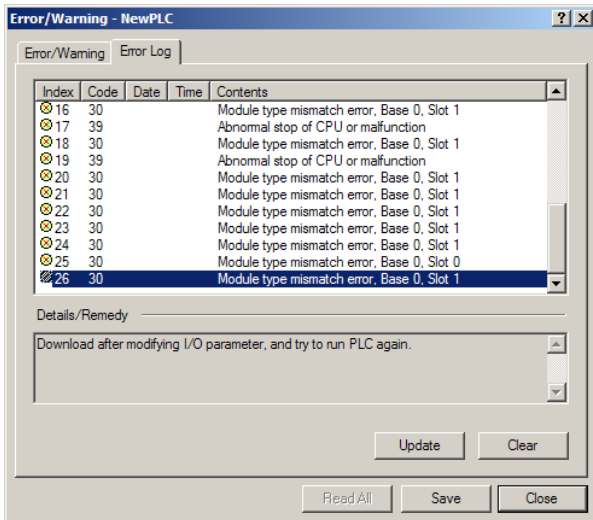

Item	Description	Remarks
Error/Warning	Display the current error/warning.	-
Error Log	Display a log of error/warning occurred.	Saving up to 100

Remark

(1) Saved data are not deleted until selecting a menu of XG5000 and clicking “Delete”.

6.3.2 Troubleshooting

(1) Trouble types

Trouble occurs due to PLC itself, system configuration error or abnormal operation result detected. Trouble is divided into trouble mode stopping operation for the safety and warning mode generating alert to user with a mode in trouble.

The causes troubling PLC system are as follows.

- PLC hardware trouble
- System configuration error
- Operation error while operating user program
- Error detected owing to external device in trouble

(2) Operation mode if trouble occurs

PLC system logs any trouble occurred in flag and determines whether to stop or resume operation depending on trouble mode.

(a) PLC hardware trouble

In case an error occurs so that PLC such as CPU module and power module may not work normally, the system is halted, but any warning may not interfere with the operation.

(b) Operation error while operating user program

Representing an error occurred during operation of user program, in case of numeric operation error, it displays the error in error flag but the system resumes operating. However, if the operation time exceeds by the operation monitoring time limit and I/O module does not control it normally, the system is halted.

(c) Error detected owing to external device in trouble

Representing the detection of external device to be controlled by users program of PLC, if an error is detected, the system is halted, but any warning may not interfere with the operation.

Remark

- (1) If any trouble occurs, the trouble number is saved in a special relay F002,003.
- (2) For details of flag, refer to the appendix 1 Flag List.

6.4 Remote Functions

CPU module may change operation by communication as well as by key switches mounted on the module. To operate it remotely, it is necessary to set 'RUN/STOP' switch to 'STOP'.

- (1) Remote operations are as follows.
 - (a) Operable by accessing to XG5000 through RS-232C port mounted on CPU module.
 - (b) Can operate other PLC connected to PLC network with CPU module connected to XG5000.
- (2) Remote RUN/STOP
 - (a) Remote RUN/STOP is the externally controlled RUN/STOP function.
 - (b) It is convenient when CPU module is located at a position hard to control or when CPU module within control panel is to control RUN/STOP function remotely.
- (3) Remote DEBUG
 - (a) It manages debugging remotely when remote mode is STOP. Namely, DEBUG operation is to execute program operation depending on designated operation conditions.
 - (b) Remote DEBUG is a convenient function when confirming program operation status or data during system debugging.
- (4) Remote Reset
 - (a) Remote reset is to reset CPU module remotely if an error occurs at a place hard to directly control CPU module.
 - (b) Like operation by switches, it supports 'Reset' and 'Overall Reset'.

Remark

- (1) For details regarding remote functions, refer to 'Ch10 Online' of XG5000 Users Manual.

6.5 Forced Input/Output On and Off Function

Force I/O function is used to force to turn I/O areas on or off, regardless of program results.

6.5.1 Force I/O setup

Click 『 Online 』 - 『 Force I/O 』 .

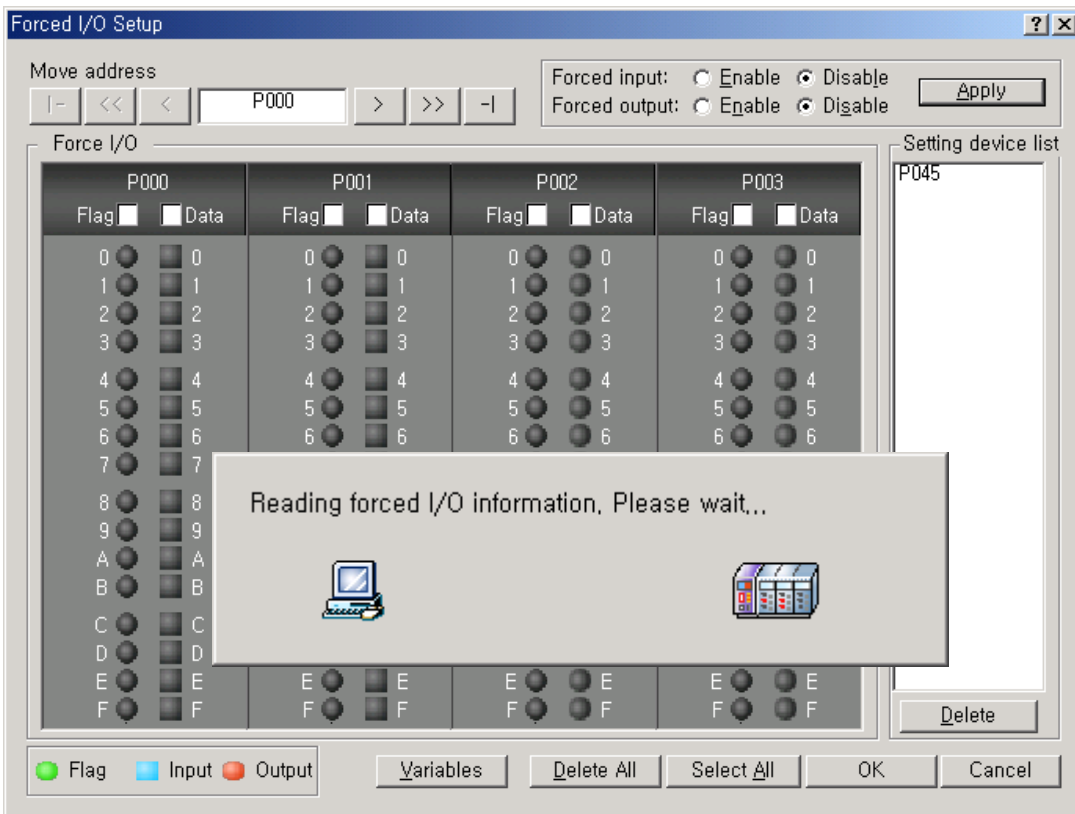

Item		Description
Move address	I- -I	Move to the beginning and end of I/O area (P000↔P127)
	<< >>	Move to ±8 of I/O area displayed at the very left.
	< >	Move to ±1 of I/O area.
Application		Set whether to allow or not Force I/O
Single	Flag	Set whether to allow or not Force I/O by bits.
	Data	Set Force I/O data on or off by bits.
Select All		Set to allow Force I/O with all I/O area on
Delete All		Delete to allow Force I/O with all I/O area off.
Setting device		Display I/O area set as a bit.

6.5.2 Processing time and processing method of Force Input/Output On and Off

(1) Forced Input

Regarding input, at the time of input refresh it replaces the data of contact set as Force On/Off among data read from input module with the data as Force and updates input image area. Therefore, user program executes operations with actual input data while Force input area is operated with data set as Force.

(2) Forced Output

Regarding output, at the time of output refresh upon the execution user program operation, it replaces the data of contact set as Force On/Off among data of output image area containing operation results with data set as Force and outputs the data in output module. Unlike (Force) input, the output image area is not changed by Force On/Off setting.

(3) Cautions when using Force I/O function

- (a) It operates from the time when I/O is individually set as 'Allow' after setting Force data.
- (b) It is possible to set Force input although I/O module is not actually mounted.
- (c) Despite of the power changed Off -> On, operation mode changes or any operation by pressing reset key, the data of which On/Off is set before is kept in CPU module.
- (d) Even in STOP mode, Force I/O data is not removed.
- (e) To set new data from the beginning, it is necessary to deselect all settings of I/O by using 'Delete All' option.

(4) Operation in case of error

- (a) If error occurs after setting forced output, PLC operates based on "Keep output when an error occurs" in Basic parameter and "Emergency output" in I/O parameter.

If you set "Emergency output" as "Clear" after setting "Keep output when an error occurs", output is cleared when an error occurs. If you set "Emergency output" as "Hold" after setting "Keep output when an error occurs", output is held when an error occurs.

- (b) If you don't set "Keep output when an error occurs", output is off when an error occurs.

6.6 Direct Input/Output Operation

Refreshing I/O operates after completion of scan program. If data of I/O is changed while program is scanned, it does not refreshed at the changed moment. Refreshed I/O data is applied after 'END' instruction on program.

This function may be useful when directly reading the status of input contact during program operation by refreshing I/O by means of 'IORF' instruction or outputting operation results to output contact.

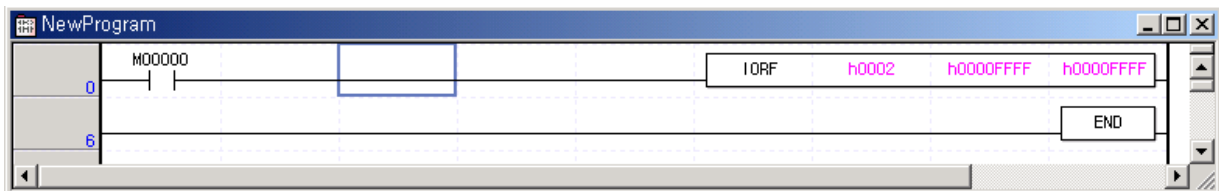

'IORF' command is operated when M00000 is ON. First operand designates slot number. Second operand designates the upper 32 bit data as mask data. Third operand designates the lower 32 bit data as mask data. The bit to refresh set as 1 (hFF) and others set as 0 (h00) (not refreshed).

Remark

- When using IORF instruction to read/write data at expansion module, scan time increases by 2ms. So when executing interrupt task program by external input less than 10ms or cycle time task less than 10ms, task collision may occurs.
- For details regarding IORF instruction, refer to XGK/XGB Instructions List.

6.7 Diagnosis of External Device

This flag is provided for a user to diagnose any fault of external device and, in turn, execute halt or warning of the system. Use of this flag displays faults of external device without any complicated program prepared and monitors fault location without any specific device (XG5000 and etc) or source program.

(1) Detection and classification of faults in external device

- (a) The trouble (fault) of external device may be detected by user program and largely divided, depending on the type, into error and warning; the former requires halt of PLC operation and the latter simply displays the status while PLC keeps working.
- (b) 'Error' uses 'F202 (_ANC_ERR)' and 'Warning' uses 'F203 (_ANC_WB) flag'.
- (c) As the detection request flag, 'Error' uses 'F2002 (_CHK_ANC_ERR) flag' while 'Warning' uses 'F2003 (_CHK_ANC_WB) flag'.

(2) Troubleshooting external device

- (a) When detecting any trouble of external device in user program, it writes a value except '0' by classifying the type, which is defined by a user in 'F202 (_ANC_ERR)' while the detection request flag checks it at the time when the program ends with 'F2002 (_CHK_ANC_ERR) On, and PLC outputs based on the "Emergency Output" setting in I/O parameter, making it as the same error status as detected by PLC itself.
- (b) If any trouble occurs, a user may identify the cause by using XG5000 and alternatively by monitoring 'F202 (_ANC_ERR) flag'.

□ Example

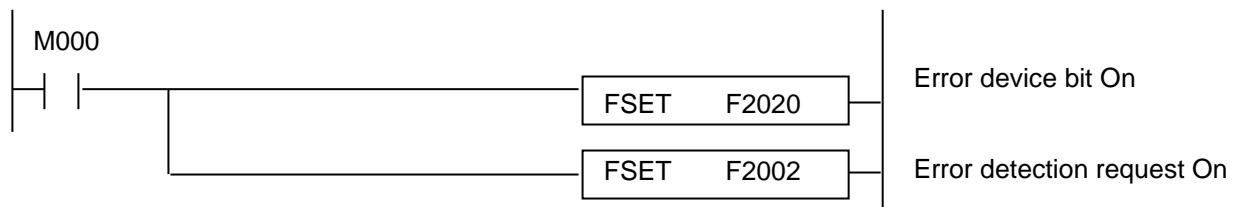

- (c) If any trouble occurs, CPU is in error status and operation halts. At this moment, F2020 and F2002 flags are off (error LED switches on and off every second.)

(3) Processing warning of external device

- (a) When detecting any warning of external device in user program, it turns on a flag in the warning position of system flag 'F203 (_ANC_WB) and if turning on the detection request flag, 'F2003 (_CHK_ANC_WB)', it displays warning at the time when scan program ends. If a warning occurs, the detection request flag, 'F2003 (_CHK_ANC_WB)' is automatically off (F203 is not deleted).
- (b) If a warning occurs, the LED switches on and off every other second.
- (c) If turning off a bit in question of F203 and turning on F2003 bit after processing warning, warning is cancelled and the LED turns off.

□ Example

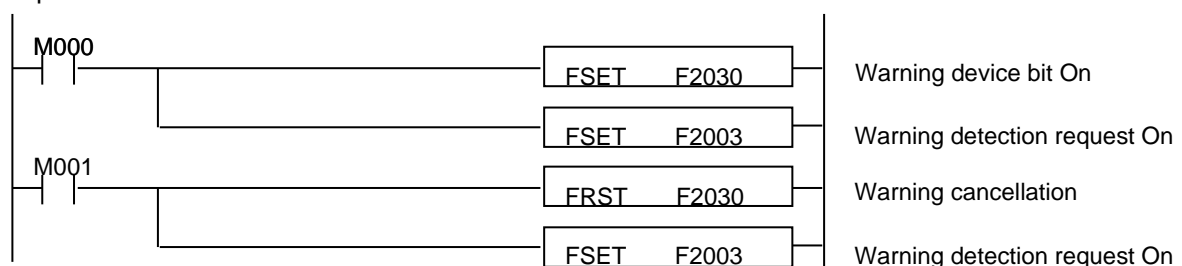

6.8 Allocation of Input/Output Number

Allocation of I/O number is to allocate an address to every I/O of each module to read data from input module and output data to output module when it executes operations. XGB series adopts 64 points occupation to every module.

(1) Allocation of I/O number

124 points are allocated to main unit and 64 points are allocated to every module except main unit (incl. special, communication).

System Configuration

Number of Connection stage	Type	I/O allocation	Remarks
0	XBC-DN30S(U)	Input : P0000 ~ P003F Output : P0040 ~ P007F	Main unit fixed
1	XBE-DC32A	Input : P0080~P011F	Actual input: P0080 ~ P009F
2	XBE-TN32A	Output : P0120 ~ P015F	Actual output : P0120 ~ P013F
3	XBL-C21A	P0160 ~ P019F	-
4	XBF-AD04A	P0200 ~ P023F	-
5	XBF-DV04A	P0240 ~ P027F	-
6	XBE-DC32A	Input : P0280 ~ P031F	Actual input : P0280 ~ P029F
7	XBE-TN32A	Output : P0320 ~ P035F	Actual output : P0320 ~ P033F

Empty I/O point is available for internal relay.

(2) In case of allocating IO of IO parameter, allocation information is displayed.

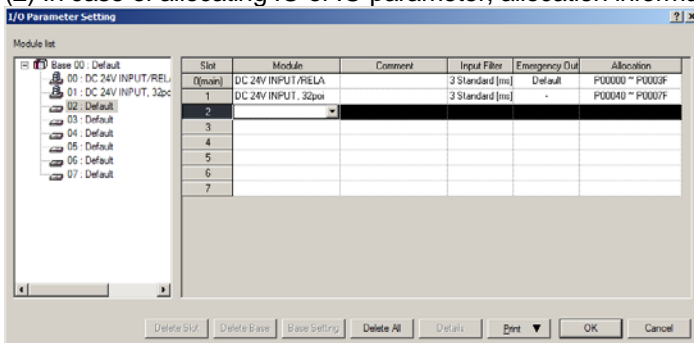

In case of using monitor function of XG5000, I/O allocation information is displayed.

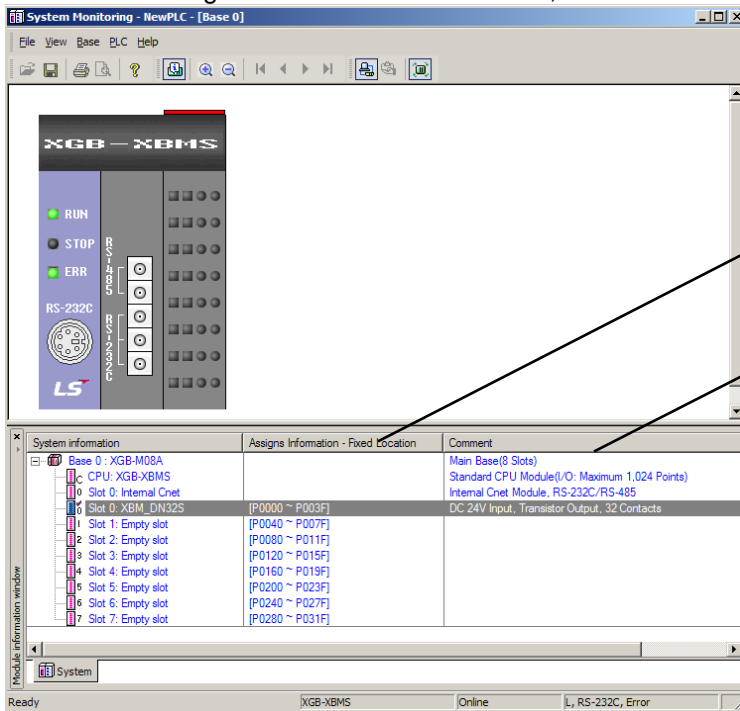

I/O module allocation information

Description of each module

6.9 Online Editing

It is possible to modify program and communication parameter during operation of PLC without control operation stopped. The following describes basic modification. For details of modifying program, refer to XG5000 Users Manual.

Items to be modified during operation are as follows.

- Program
- Communication parameter

(1) It displays programs that are currently running.

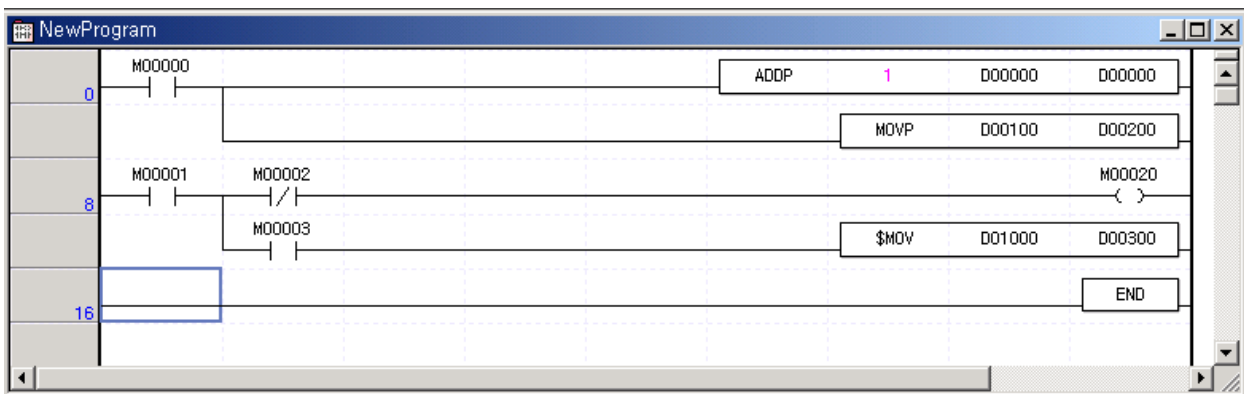

(2) Click 『Online』 - 『Start Online Editing』 .

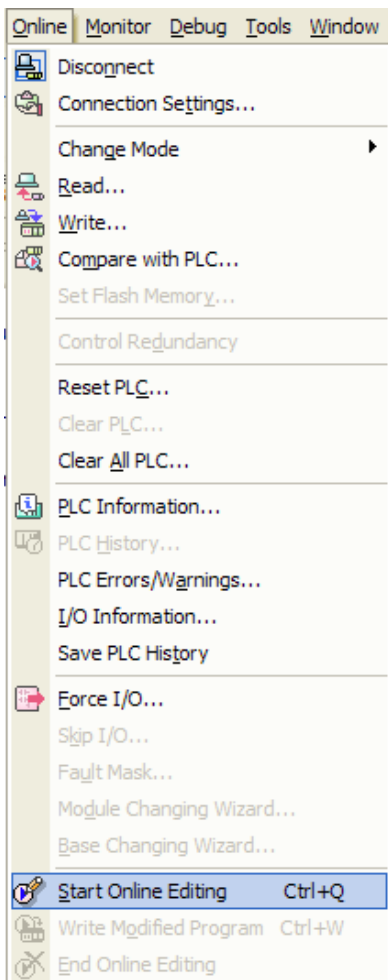

(3) It turns to program modification mode during run when the program background is changed.

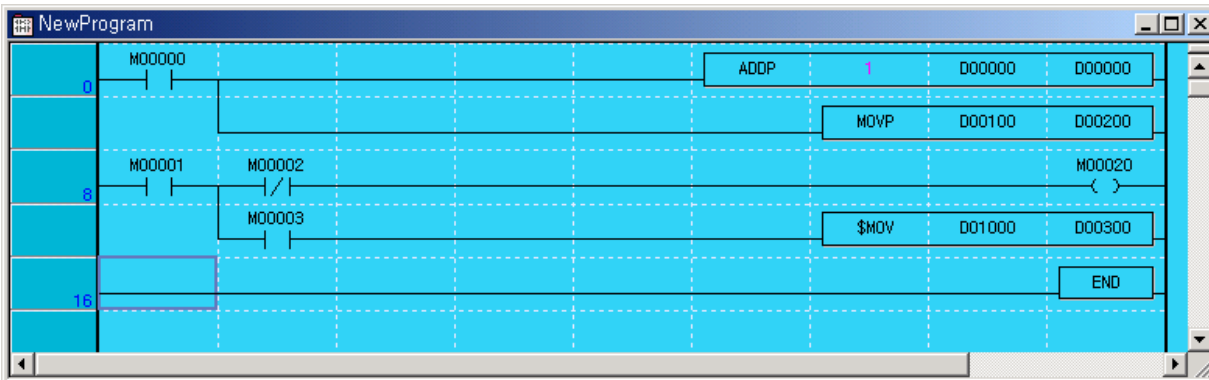

(4) Modifying a program.

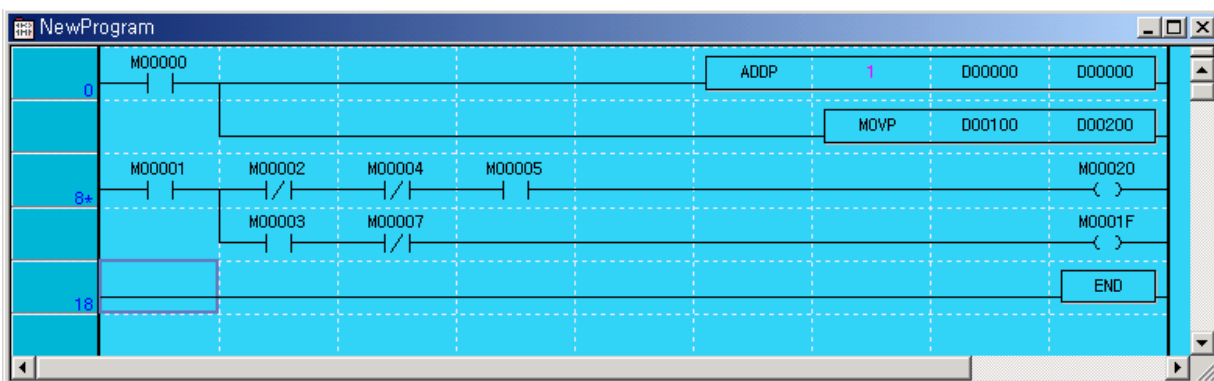

(5) Upon the modification of program, click 『Online』 - 『Write Modified Program』 .

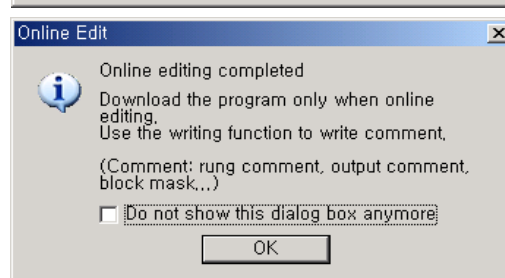
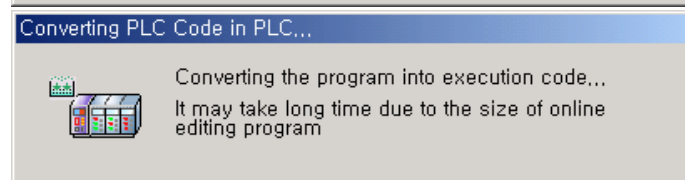
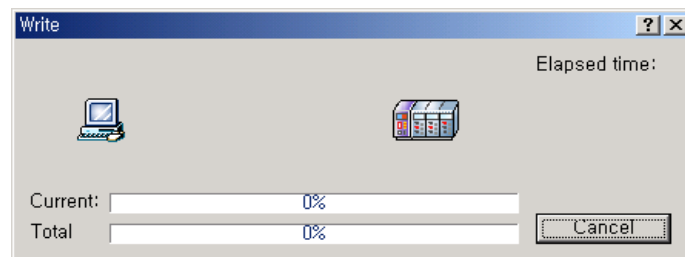
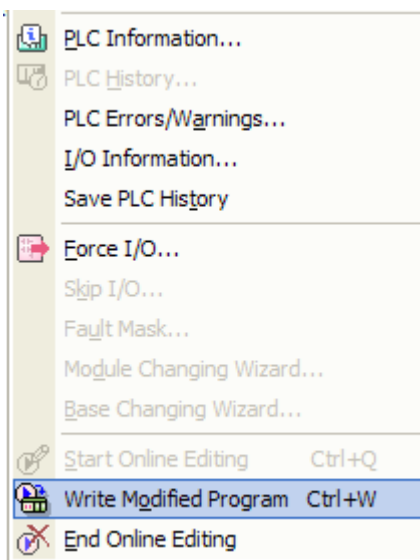

(6) Upon the writing of program, click 『Online』 - 『End Online Editing』 .

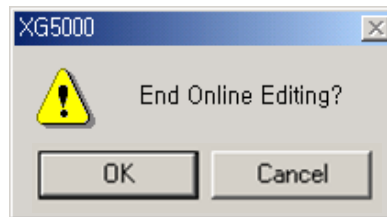
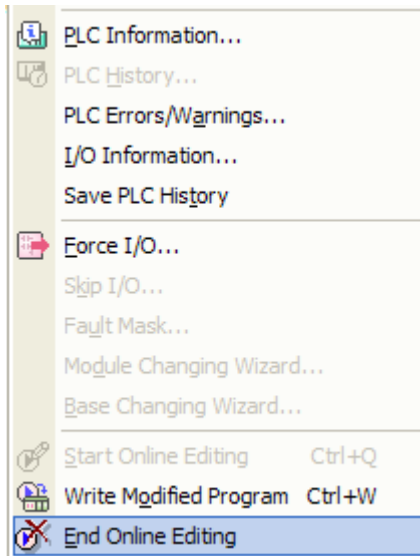

(7) The program background returns and the program modification during run is completed.

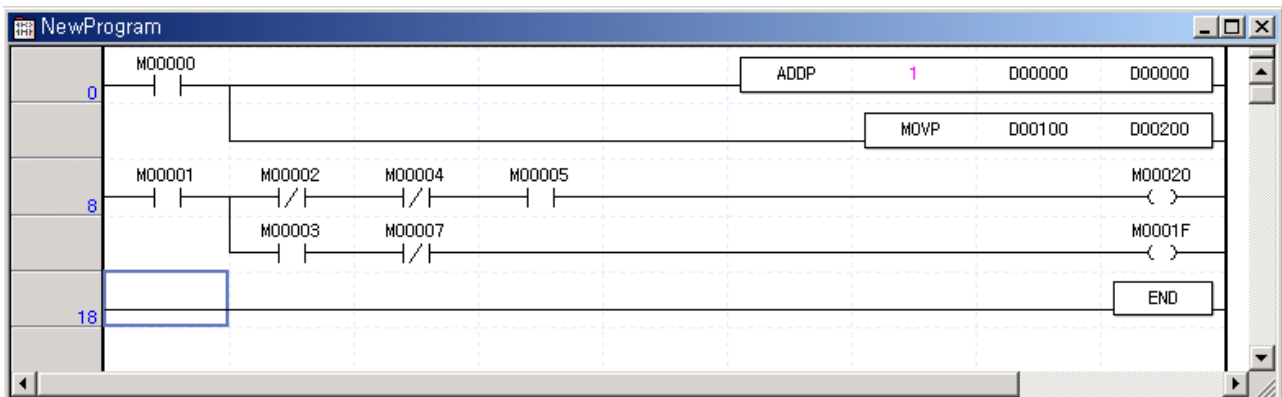

Remark

- For parameter modification during run, change each parameter on XG-PD and click 『Online』 - 『Write Modified Program』 .

6.10 Reading Input/Output Information

It monitors information of individual modules consisted of XGB series system.

- (1) Click 『Online』 - 『I/O Info』 . Then, information of each module connected to the system is monitored.

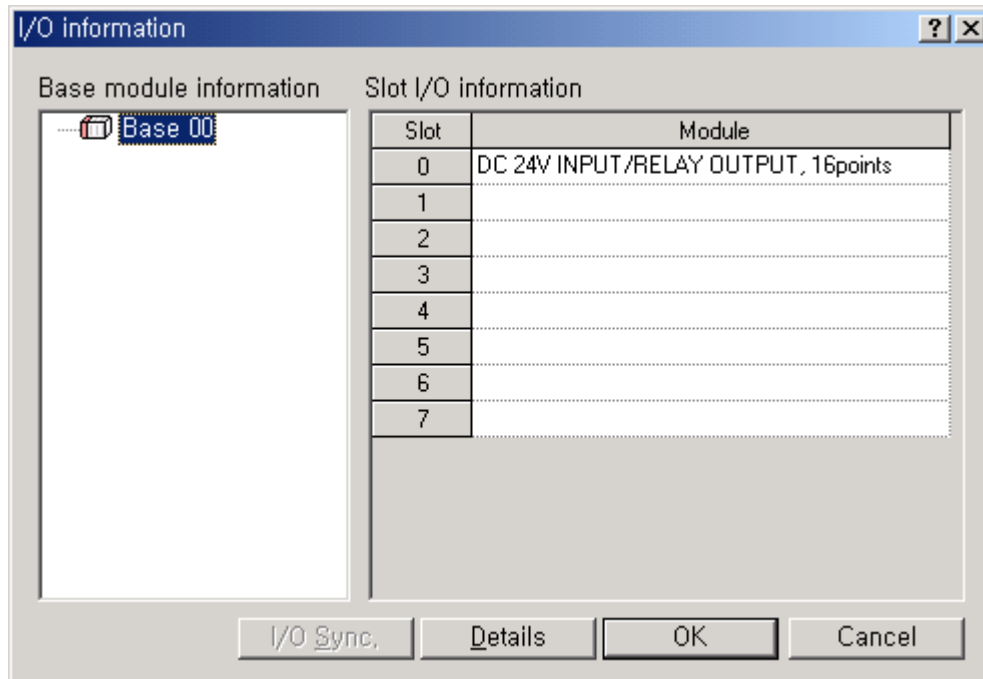

- (2) If clicking Details after selecting a module, it displays detail information of a selected module.

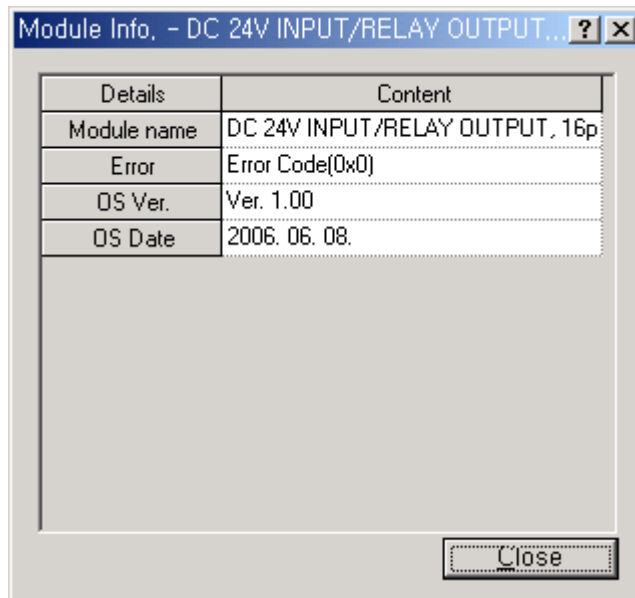

6.11 Monitoring

It monitors system information of XGB series system.

(1) Clicking 『Monitor』 displays the following sub-menus.

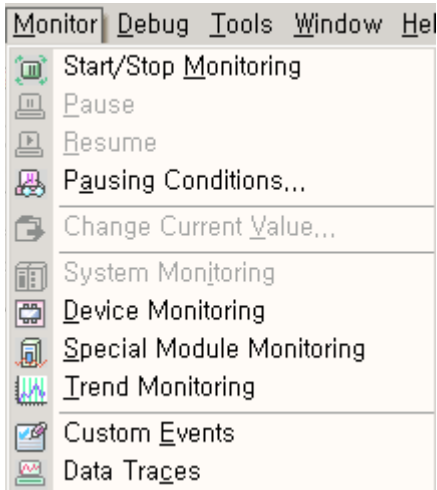

(2) Items and descriptions

Item	Description	Remarks
Start/Stop Monitoring	Designate the start and stop of monitor.	Click for reverse turn.
Pause	Pause monitoring.	-
Resume	Resume paused monitor.	-
Pausing Conditions	Pause monitoring if a preset value of device corresponds to condition.	Monitor resumes; clicking for resume.
Change Current Value	Change the present value of currently selected device.	-
System Monitoring	Monitor general system information.	-
Device Monitoring	Monitor by device (type).	-
Trend Monitoring	Monitor trend of device set in the system.	For details, refer to XG5000 Users Manual.
Custom Events	Monitor the value of device set when an event set by a user occurs.	
Data Traces	Trace the value of device.	

(a) Change current value

- It changes the current value of each device selected in the current program window.

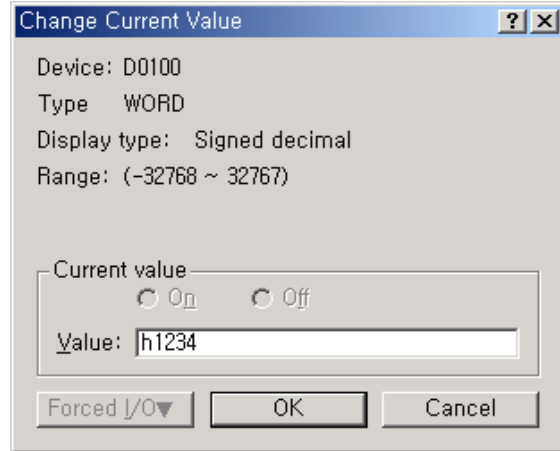
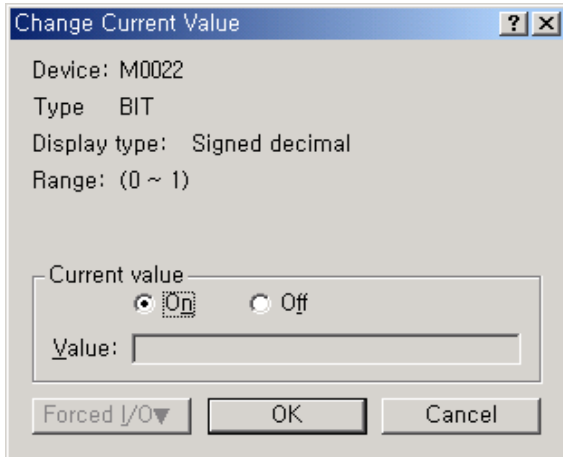

(b) Device monitoring

- It monitors by device (type).

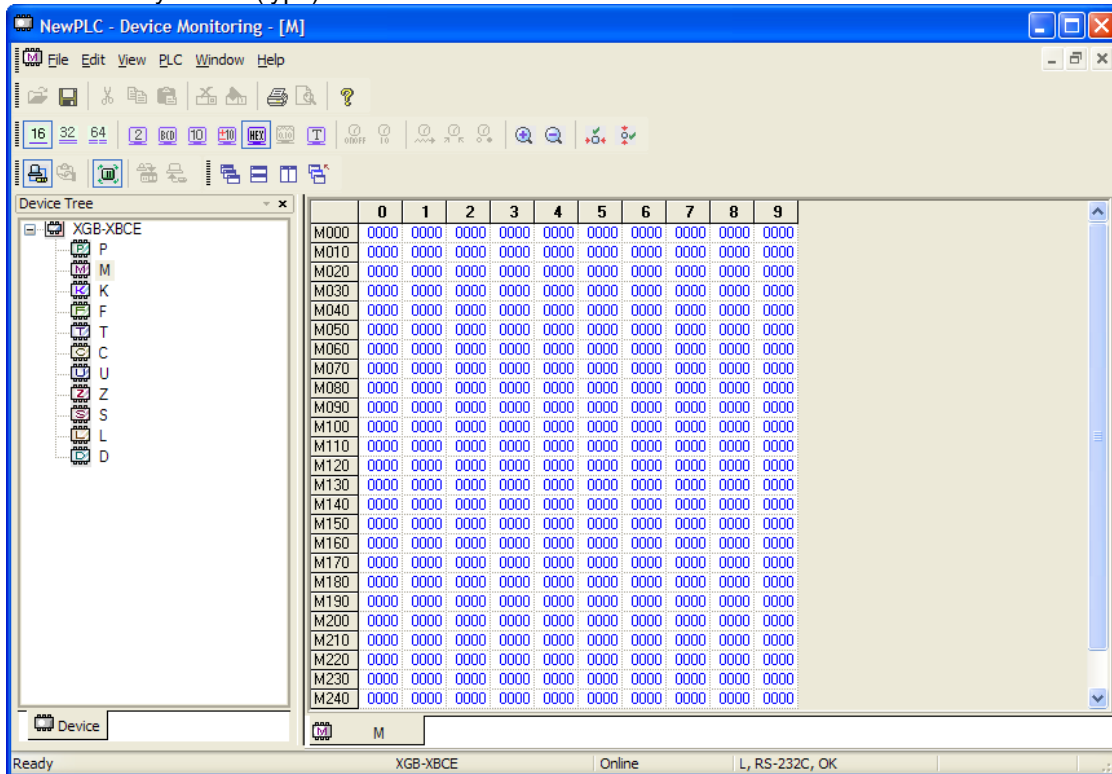

Chapter 6. CPU Functions

(c) Pausing conditions

- It stops monitoring in case a device value set in the program corresponds.

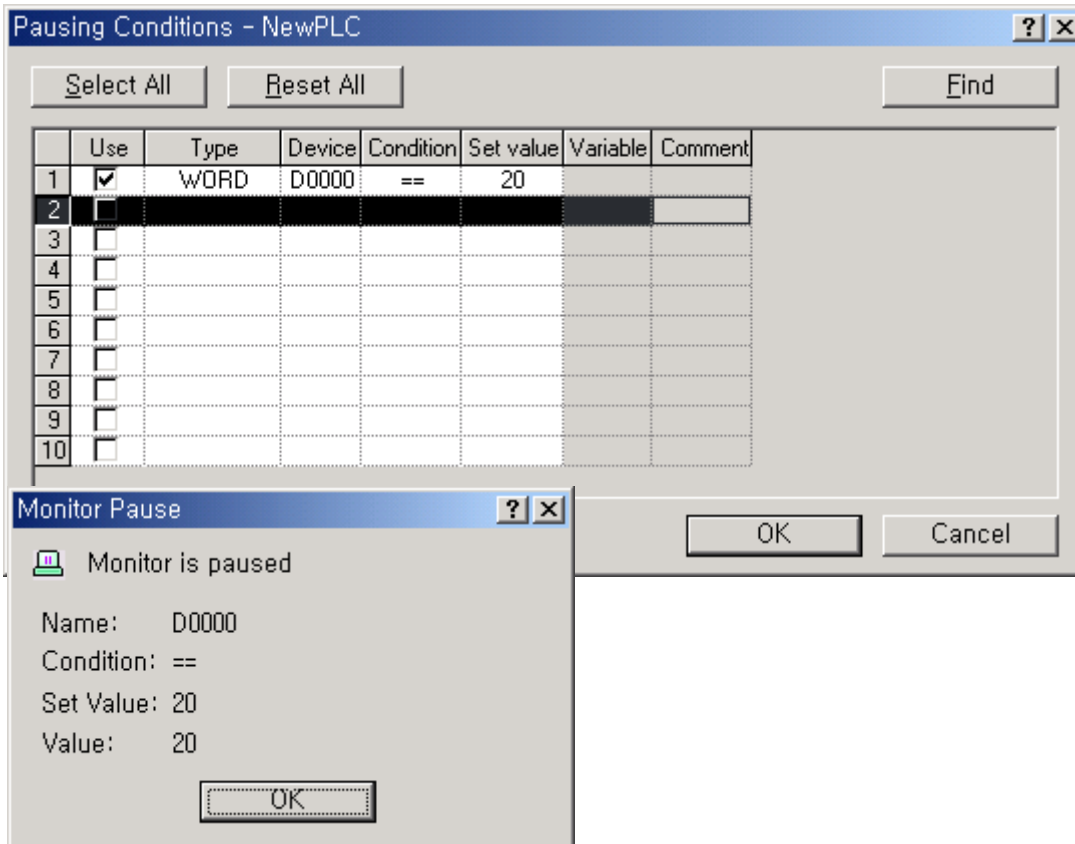

(d) Trend monitoring

- It displays device values graphically.

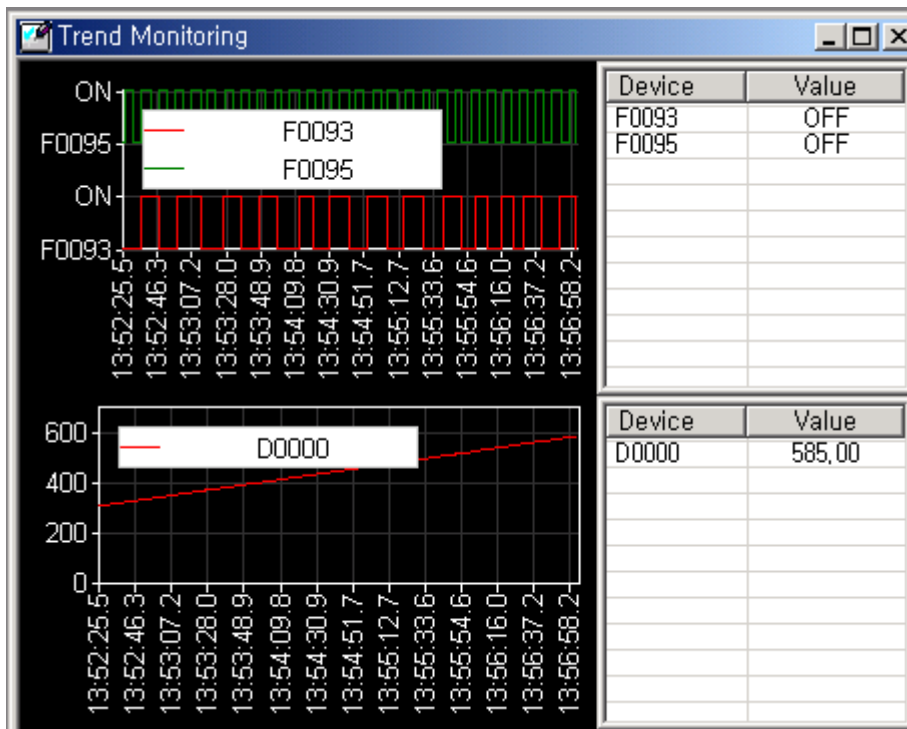

(e) Custom events

1) It monitors detail information when an event set by a user occurs. Additional user event may be registered.

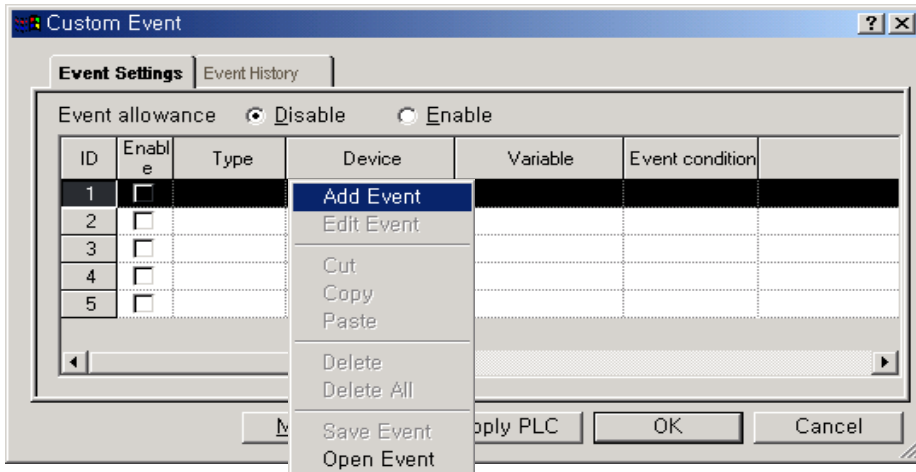

2) It sets basic setting and relative device.

If rising edge of M0000 device occurs, it records the message of an alarm, "Out of order Water Tank 1" and the device values of D0000,L0000,D0100,N1000 are recorded.

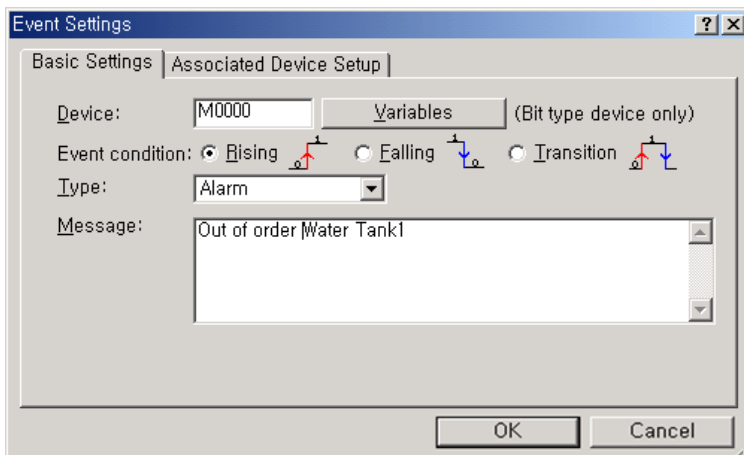

3) Set the relative device(s).

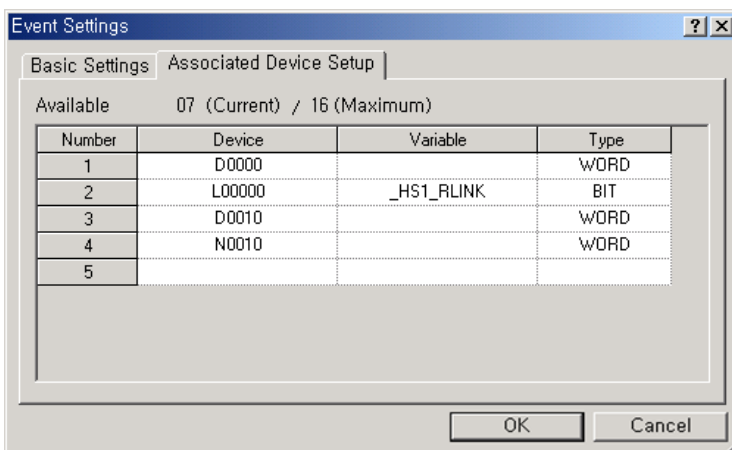

4) Monitor event history of custom event.

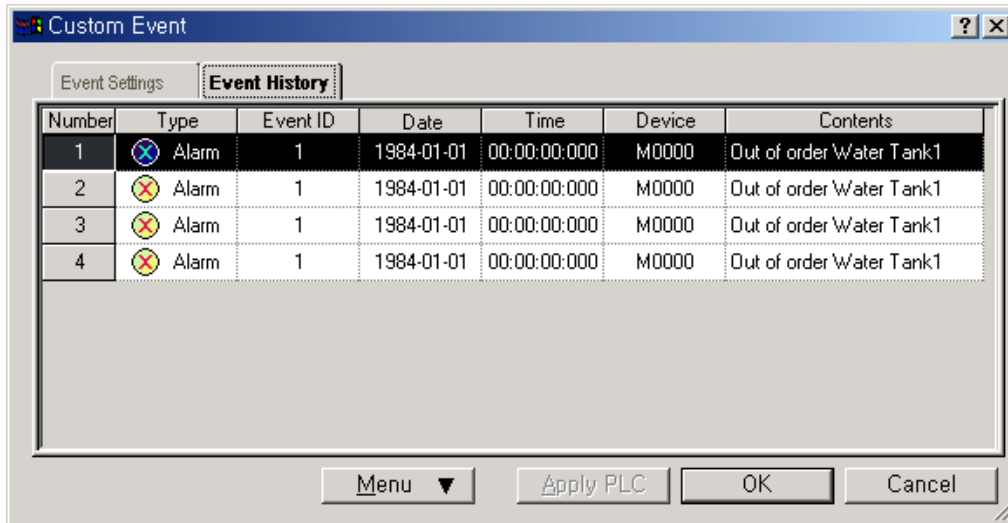

5) Double-clicking a number produced monitors the relative values of device and the detail message as follows.

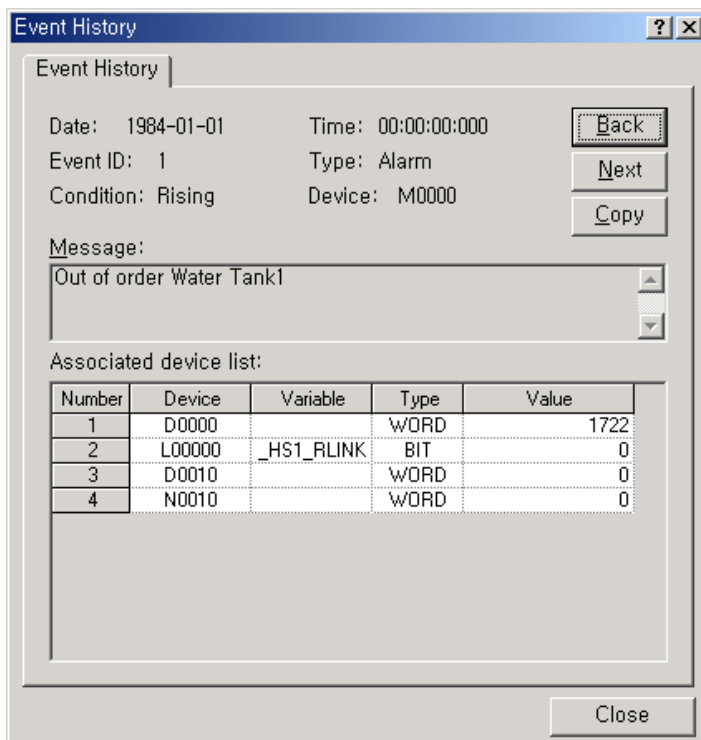

Remark

- For details of monitor, refer to XG5000 Users Manual.

6.12 Program Upload Prohibit

Program Upload Prohibit function prohibits from uploading comment, parameter, program saved on PLC. If Program Upload Prohibit function is set, you can't open from PLC, read PLC and compare PLC.

(1) How to set

(a) Click 『Online』 - 『Write』

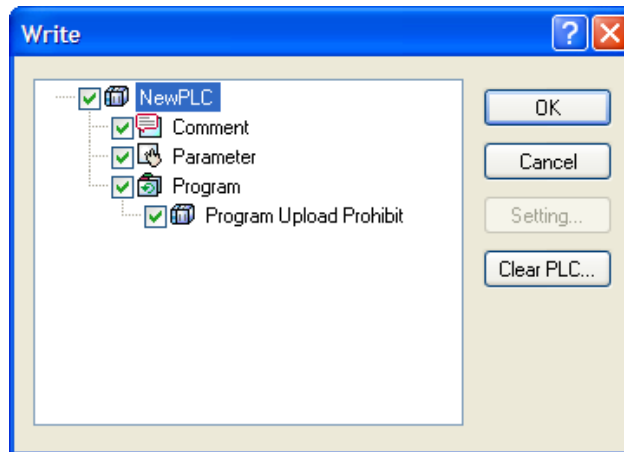

(b) Select "Program" to activate "Program Upload Prohibit"

(c) Select "Program Upload Prohibit" and click OK.

(2) When reading PLC is prohibited, if you try to read PLC, the following dialog box appears. After releasing Program Upload Prohibit, execute reading.

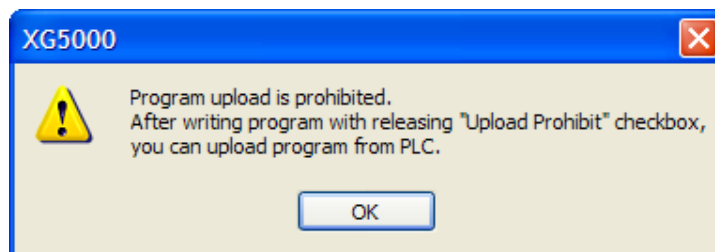

(3) How to release Program Upload Prohibit

(a) Click 『Online』 - 『Write』 .

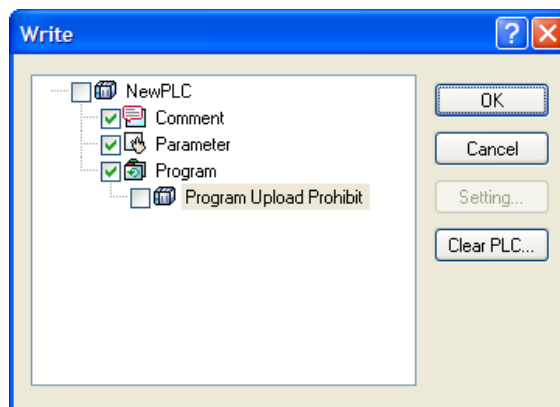

(b) Release Program Upload Prohibit and click OK.

6.13 Clear All PLC

Clear All PLC function clears parameter, program, data, password saved on PLC

(1) How to clear all PLC

(a) Click 『Online』 - 『Clear All PLC』 .

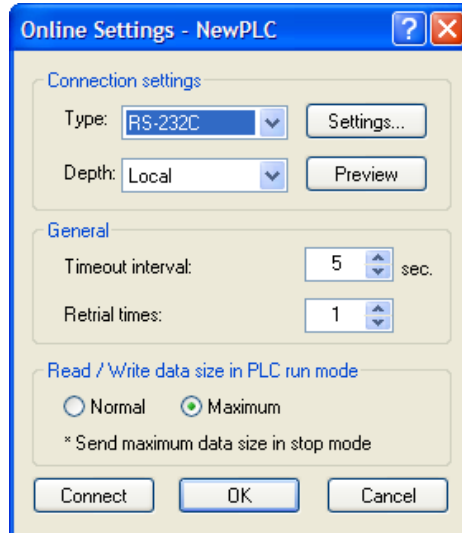

(b) After selection connection method, click 『Connect』 or 『OK』 .

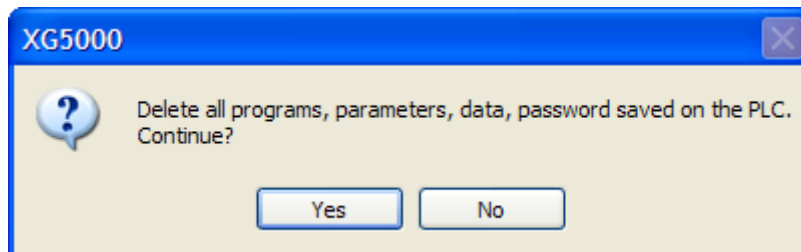

(c) If you select 『Yes』 on the dialog box, PLC program, parameter, data, password will be deleted.

Note

- Clear All PLC function can be executed though not connected.
- If you use Clear All PLC function, password will be deleted. So be careful.
- In case you lose password, use this function to clear password.

6.14 Password Setting per Program Block

Password Setting per Program Block function sets password for each program block. You should input password to open program.

- (1) How to set program block password
 - (a) Click 『Properties』 after selecting program in project window.
 - (b) Click password tap.

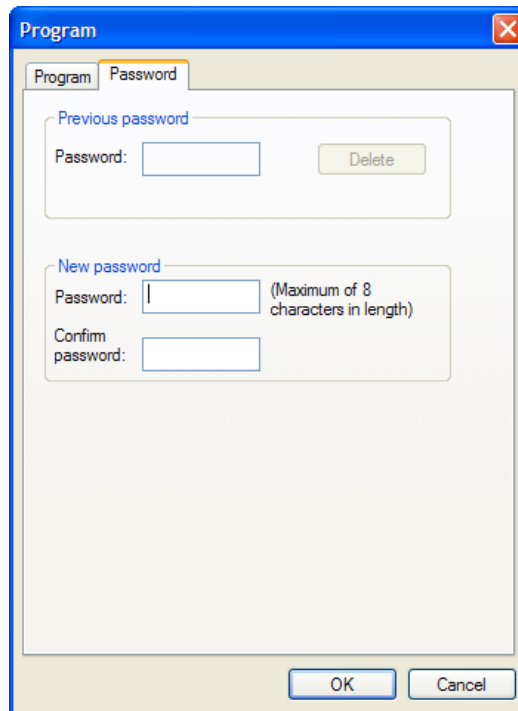

- (c) Click 『OK』 after inputting new password.

- (2) Opening password-set program
 - (a) When you open password-set program, the following window appears.

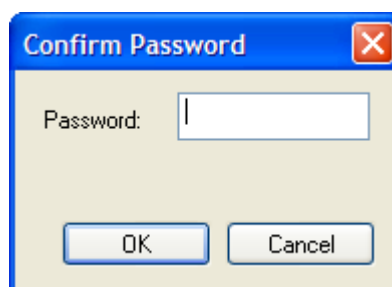

- (b) After inputting correct password, click 『OK』 to open program.

- (3) How to delete program block password
 - (a) After program in project window, click 『Properties』 .
 - (b) Click password tap.

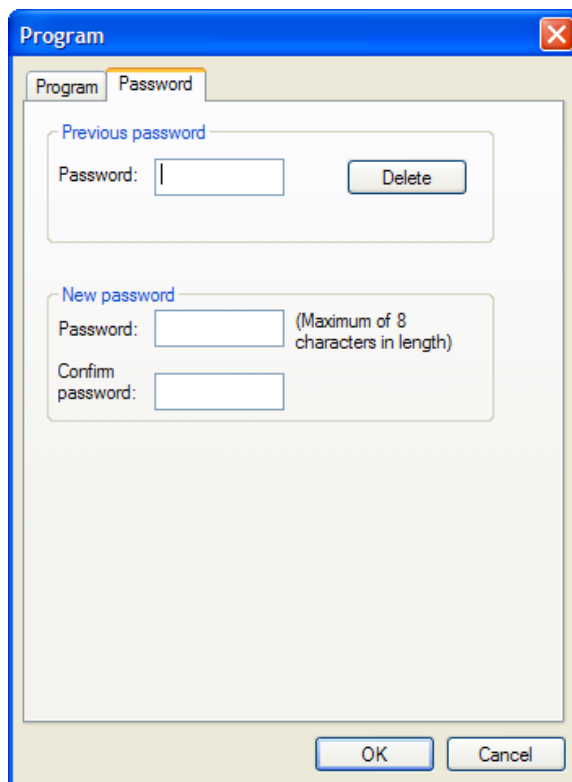

- (c) After inputting previous password, click 「Delete」 .
- (d) Click 「OK」 .

Chapter 7 Input/Output Specifications

7.1 Introduction

Here describes the notices when selecting digital I/O module used for XGB series.

- (1) For the type of digital input, there are two types such as current sink input and current source input.
- (2) The number of max. Simultaneous input contact point is different according to module type. It depends on the input voltage, ambient temperature. Use input module after checking the specification.
- (3) When response to high speed input is necessary, use interrupt input contact point. Up to 8 interrupt points are supported.
- (4) In case that open/close frequency is high or it is used for conductive load open/close, use Transistor output module or triac output module as the durability of Relay Output Module shall be reduced.
- (5) For output module to run the conductive (L) load, max. open/close frequency should be used by 1second On, 1 second Off.
- (6) For output module, in case that counter timer using DC/DC Converter as a load was used, Inrush current may flow in a certain cycle when it is ON or during operation. In this case, if average current is selected, it may cause the failure. Accordingly, if the previous load was used, it is recommended to connect resistor or inductor to the load in serial in order to reduce the impact of Inrush current or use the large module having a max. load current value.

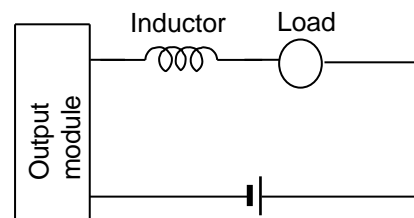
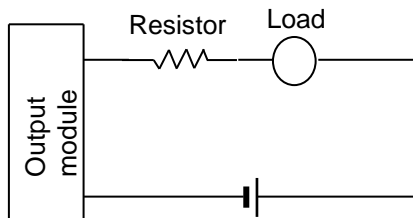

(7) Relay life of Relay output module is shown as below.

Max. life of Relay used in Relay output module is shown as below.

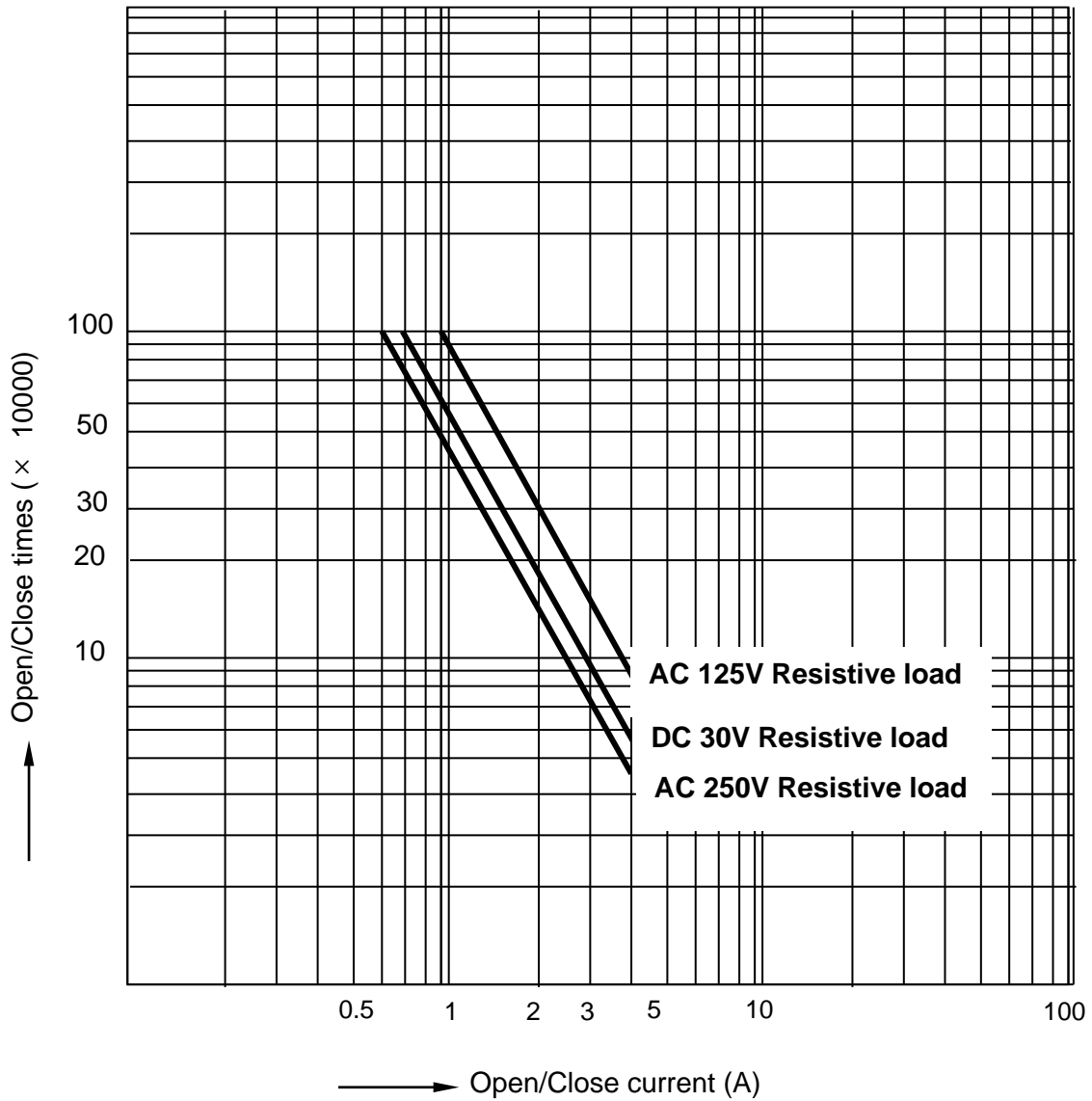

(8) Terminal blocks are of barrier type and pluggable type, and pluggable terminal blocks have screw type and push-in type depending on the connection method.

1) Barrier terminal block

As a terminal block mainly applied to the XGB compact type basic unit, crimp terminals with insulation sleeves cannot be used. Crimp terminals suitable for connection to terminal blocks are as follows.

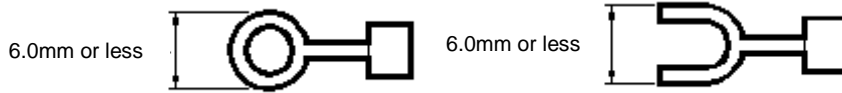

For the size of the wire connected to the terminal block, use a stranded wire of 0.3 to 0.75 mm² and a thickness of 2.8 mm or less. Please note that the allowable current may differ depending on the insulation thickness of the wire.

The tightening torques of the module fixing screws and terminal block screws must be within the following ranges.

Coupling position	Coupling torque range
IO module terminal strip screw (M3 screw)	42 ~ 58 N·cm
IO module terminal strip fixation screw (M3 screw)	66 ~ 89 N·cm
IO module external connector(M2 screw)	18 ~ 22 N·cm

2) Screw connection type plug (PCB plug, Screw connection): XBE-xx08A, XBE-xx16A

As a terminal block mainly applied to the XGB compact type basic unit, crimp terminals with insulation

① Wire size

Number of wires per contact	single wire	stranded wire	When using ferrules with plastic sleeves	When using ferrules without plastic sleeves
1	0.2 ~ 1.5 mm ²	0.2 ~ 1.5 mm ²	0.25 ~ 0.5 mm ²	0.25 ~ 1.5 mm ²
2	0.75 mm ²	0.75 mm ²	0.5 mm ² (Twin Ferrules)	0.25 ~ 0.34 mm ²

② Ferrule size

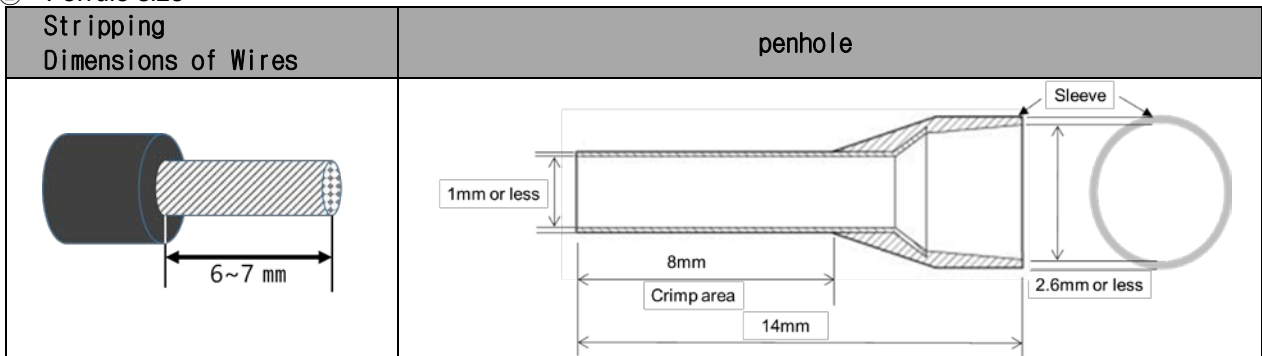

③ Recommended ferrule

Manufacturer	model name	line size	crimping tool
GLW GmbH	DN00508D	0.5 mm ²	CO225 Or CAP4
	DN00308D	0.34 mm ²	
	DN00208D	0.25 mm ²	

Peel off about 6-7 mm of the sheath from the end of the wire and connect it to the ferrule. Excessive

stripping of the sheath can result in poor contact with the crimp area of the ferrule. Tighten the terminal block screws as follows.

Screw thread	M2
Flat screwdriver size	0.4 x 2.5
Tightening torque	0.2 N · m

(11) Relay life graph is not written based on real use. (This is not a guaranteed value). So consider margin. Relay life is specified under following condition.

- (a) Rated voltage, load: 3 million times: 100 million times
- (b) 200V AC 1.5A, 240V AC 1A (COS ϕ =0.7): 1 million times
- (c) 200V AC 0.4A, 240V AC 0.3A (COS ϕ =0.7): 3 million times
- (d) 200V AC 1A, 240V AC 0.5A (COS ϕ =0.35): 1 million times
- (e) 200V AC 0.3A, 240V AC 0.15A (COS ϕ =0.35): 3 million times
- (f) 24V DC 1A, 100V DC 0.1A (L/R=7ms): 1million times
- (g) 24V DC 0.3A, 100V DC 0.03A (L/R=7ms): 3million times

(12) Noise can be inserted into input module. To prevent this noise, the user can set filter for input delay in parameter. Consider the environment and set the input filter time.

Input filter time (ms)	Noise signal pulse size (ms)	Reference
1	0.3	
3	1.8	Initial value
5	3	
10	6	
20	12	
70	45	
100	60	

Chapter 7. Input/Output Specifications

(a) Setting input filter

1) Click I/O Parameter」 in the project window of XG5000

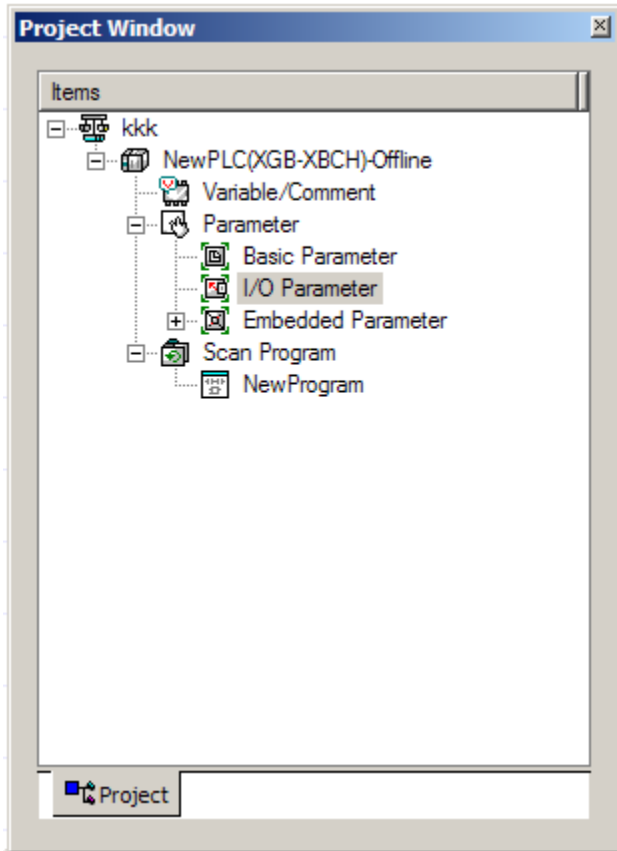

2) Click 『Module』 at the slot location.

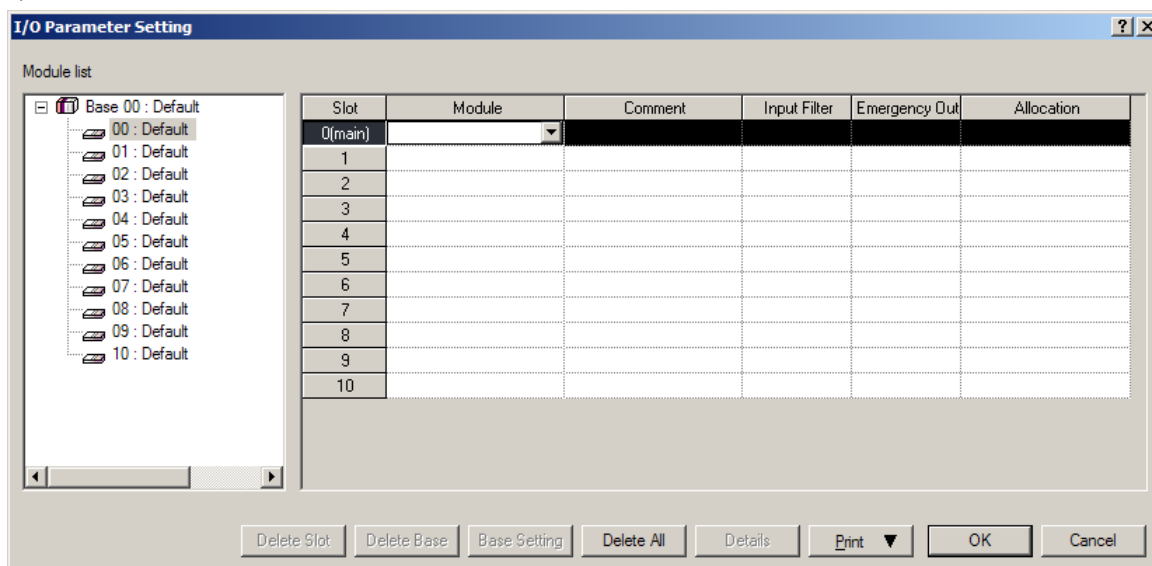

3) Set I/O module really equipped.

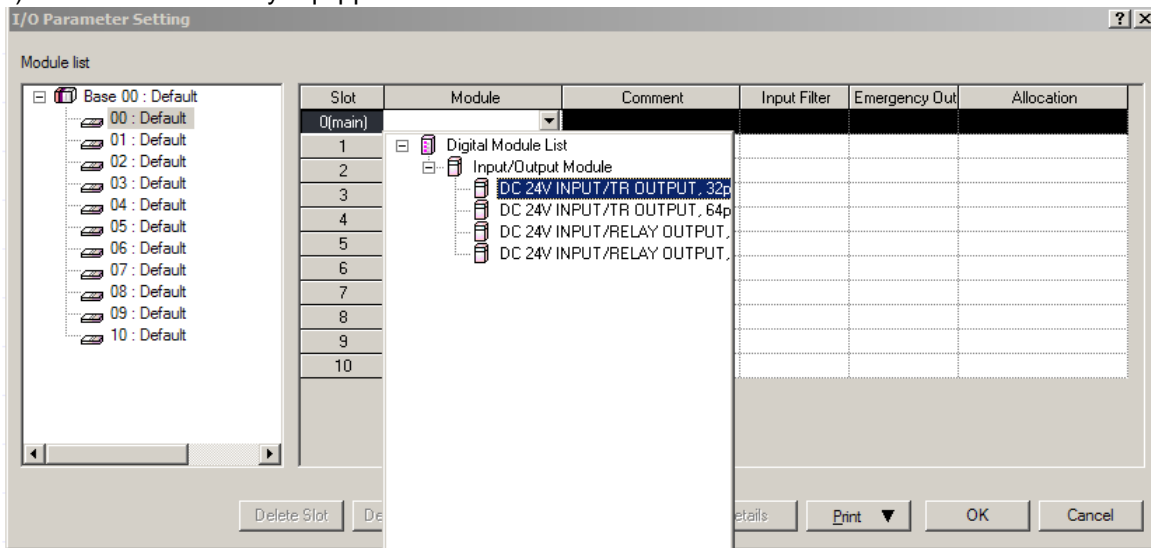

4) After setting I/O module, click Input Filter.

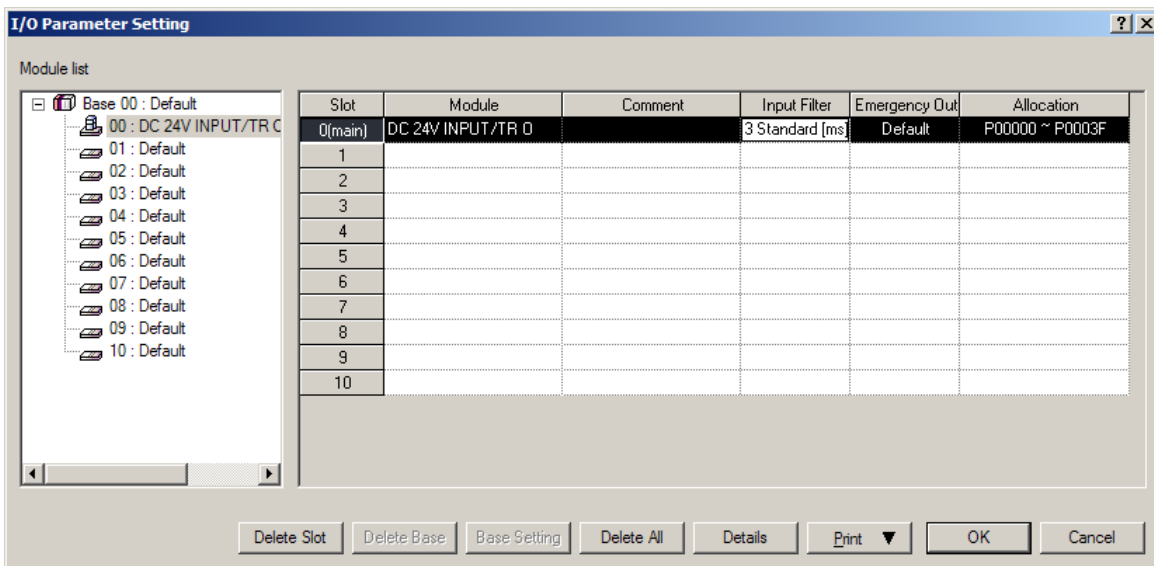

5) Set filter value.

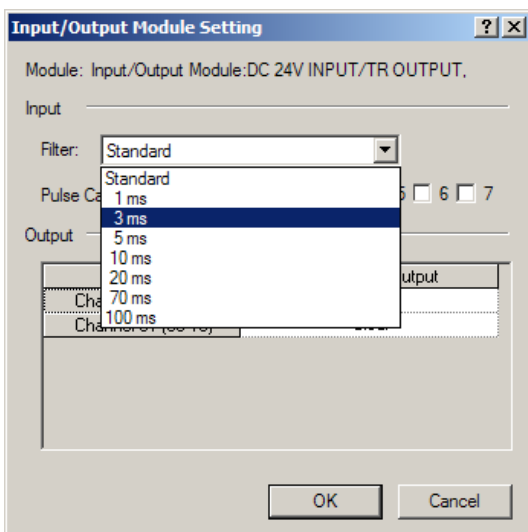

Chapter 7. Input/Output Specifications

(b) Setting output status in case of error

1) Click Emergency Out in the I/O parameter setting window.

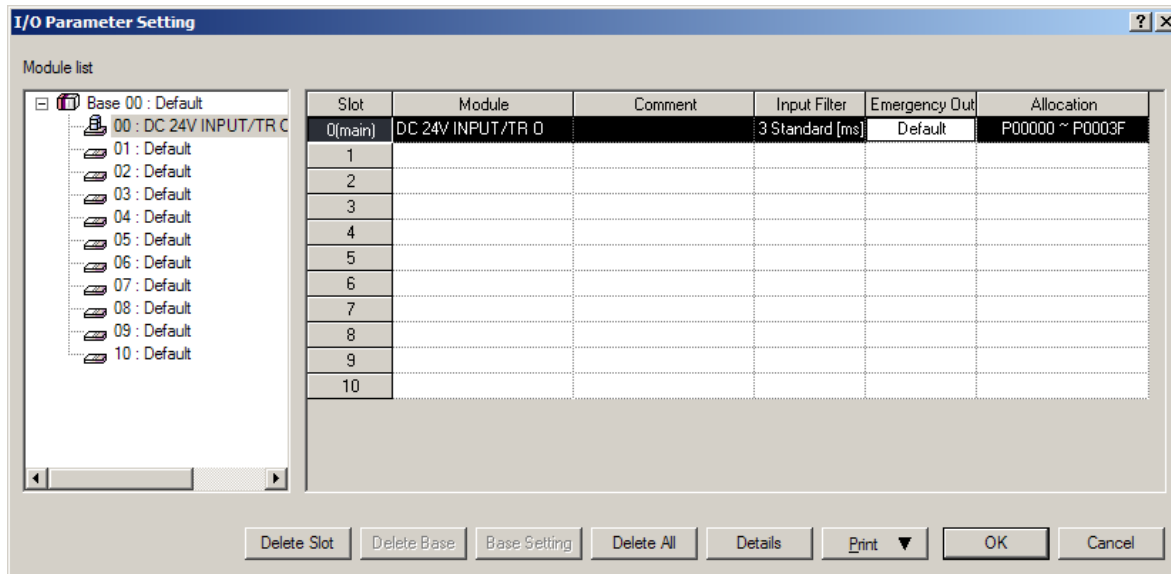

2) Click Emergency Output.

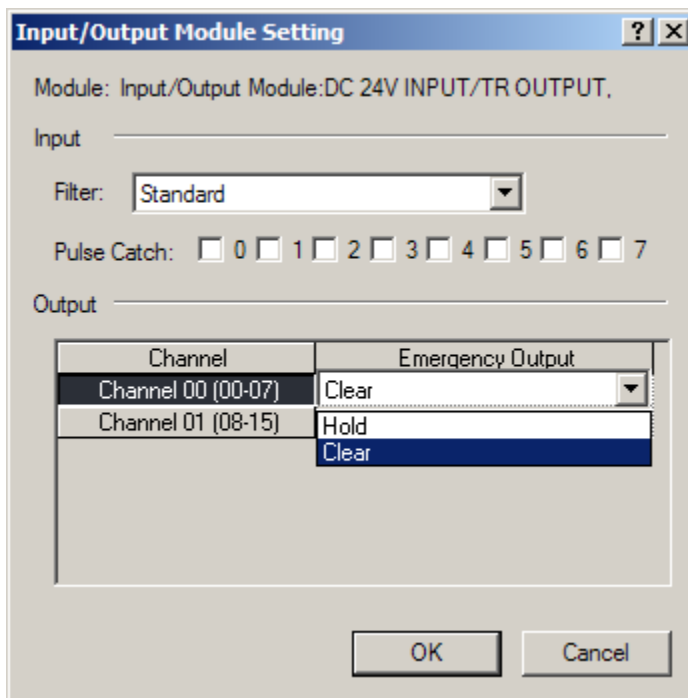

If it is selected as Clear, the output will be Off and if Hold is selected, the output will be kept.

7.2 Main Unit Digital Input Specifications

7.2.1 XBC-DR10E/ DN10E/ DP10E 6 point DC24V input (Source/Sink type)

Model		Main unit					
		XBC-DR10E	XBC-DN10E	XBC-DP10E			
Specification							
Input point		6 point					
Insulation method		Photo coupler insulation					
Rated input voltage		DC24V					
Rated input current		About 4 mA (Contact point 0~3: about 7 mA)					
Operation voltage range		DC20.4~28.8V (within ripple rate 5%)					
On voltage / On current		DC19V or higher / 3 mA or higher					
Off voltage / Off current		DC6V or lower / 1 mA or lower					
Input resistance		About 5.6 kΩ (P00~P03: about 2.7 kΩ)					
Response time	Off → On	1/3/5/10/20/70/100 ms (Set by I/O parameter) Default: 3 ms					
	On → Off						
Insulation pressure		AC560Vrms / 3 cycle (altitude 2000m)					
Insulation resistance		10 MΩ or more by MegOhmMeter					
Common method		6 point / COM					
Proper cable size		0.3 mm ²					
Operation indicator		LED On when Input On					
External connection method		14 point terminal block connector (M3 X 6 screw)					
Weight		330g	313g	313g			
Circuit configuration		No.	Contact	No.	Contact	Type	
<p>Terminal block no.</p>		TB2	485+	TB1	RX	TB1	
		TB4	485-	TB3	TX	TB3	
		TB6	00	TB5	SG	TB5	
		TB8	02	TB7	01	TB7	
		TB10	04	TB9	03	TB9	
		TB12	NC	TB11	05	TB11	
		TB14	COM	TB13	NC	TB13	
						TB14	COM

7.2.2 XBC-DR14E/ DN14E/DP14E 8 point DC24V input (Source/Sink type)

Model		Main unit				
		XBC-DR14E	XBC-DN14E	XBC-DP14E		
Specification						
Input point		8 point				
Insulation method		Photo coupler insulation				
Rated input voltage		DC24V				
Rated input current		About 4 mA (Contact point 0~3: about 7 mA)				
Operation voltage range		DC20.4~28.8V (Within ripple rate 5%)				
On voltage / On current		DC19V or higher / 3 mA or higher				
Off voltage / Off current		DC6V or lower / 1 mA or lower				
Input resistance		About 5.6 kΩ (P00~P03: about 2.7 kΩ)				
Response time	Off → On	1/3/5/10/20/70/100 ms (set by I/O parameter) default: 3 ms				
	On → Off					
Insulation pressure		AC560Vrms / 3 cycle (altitude 2000m)				
Insulation resistance		10 MΩ or more by MegOhmMeter				
Common method		8 point / COM				
Proper cable size		0.3 mm ²				
Operation indicator		LED On when Input On				
External connection method		14 point terminal block connector (M3 X 6 screw)				
Weight		340g	313g	313g		
Circuit configuration		No.	Contact	No.	Contact	Type
<p>Terminal block no.</p>		TB2	485+	TB1	RX	TB1
		TB4	485-	TB3	TX	TB3
		TB6	00	TB5	SG	TB5
		TB8	02	TB7	01	TB7
		TB10	04	TB9	03	TB9
		TB12	06	TB11	05	TB11
		TB14	COM	TB13	07	TB13
		TB14	COM			TB14

7.2.3 XBC-DR20E/ DN20E/DP20E 12 point DC24V input (Source/Sink type)

Model Specification		Main unit				
		XBC-DR20E	XBC-DN20E	XBC-DP20E		
Input point		12 point				
Insulation method		Photo coupler insulation				
Rated input voltage		DC24V				
Rated input current		About 4 mA (Contact point 0~3: about 7 mA)				
Operation voltage range		DC20.4~28.8V (within ripple rate 5%)				
On voltage / On current		DC19V or higher / 3 mA or higher				
Off voltage / Off current		DC6V or lower / 1 mA or lower				
Input resistance		About 5.6 kΩ (P00~P07: about 2.7 kΩ)				
Response time	Off → On	1/3/5/10/20/70/100 ms (set by I/O parameter) default: 3 ms				
	On → Off					
Insulation pressure		AC560Vrms / 3 cycle (altitude 2000m)				
Insulation resistance		10 MΩ or more by MegOhmMeter				
Common method		12 point / COM				
Proper cable size		0.3 mm ²				
Operation indicator		LED On When Input On				
External connection method		24 point terminal block connector (M3 X 6 screw)				
Weight		450g	418g	418g		
Circuit configuration		No.	Contact	No.	Contact	Type
<p>Terminal block no.</p>		TB2	485+	TB1	RX	TB1
		TB4	485-	TB3	TX	TB3
		TB6	00	TB5	SG	TB5
		TB8	02	TB7	01	TB7
		TB10	04	TB9	03	TB9
		TB12	06	TB11	05	TB11
		TB14	08	TB13	07	TB13
		TB16	0A	TB15	09	TB15
		TB18	NC	TB17	0B	TB17
		TB20	NC	TB19	NC	TB19
		TB22	NC	TB21	NC	TB21
		TB24	COM	TB23	NC	TB23

7.2.4 XBC-DR30E/ DR30E/DP30E 18 point DC24V input (Source/Sink type)

Specification		Model						
		XBC-DR30E	XBC-DN30E	XBC-DP30E				
Input point		18 point						
Insulation method		Photo coupler insulation						
Rated input voltage		DC24V						
Rated input current		About 4 mA (Contact point 0~3: about 7 mA)						
Operation voltage range		DC20.4~28.8V (within ripple rate 5%)						
On voltage / On current		DC19V or higher / 3 mA or higher						
Off voltage / Off current		DC6V or lower / 1 mA or lower						
Input resistance		About 5.6 kΩ (P00~P07: about 2.7 kΩ)						
Response time	Off → On	1/3/5/10/20/70/100 ms (set by I/O parameter) default: 3 ms						
	On → Off							
Insulation pressure		AC560Vrms / 3 cycle (altitude 2000m)						
Insulation resistance		10 MΩ or higher by MegOhmMeter						
Common method		18 point / COM						
Proper cable size		0.3 mm ²						
Operation indicator		LED on when Input On						
External connection method		24 point terminal block connector (M3 X 6 screw)						
Weight		465g	423g	423g				
Circuit configuration		No.	Contact	No.	Contact	Type		
		TB2	485+	TB1	RX	TB1		
		TB4	485-	TB3	TX	TB3		
		TB6	00	TB5	SG	TB5		
		TB8	02	TB7	01	TB7		
		TB10	04	TB9	03	TB9		
		TB12	06	TB11	05	TB11		
		TB14	08	TB13	07	TB13		
		TB16	0A	TB15	09	TB15		
		TB18	0C	TB17	0B	TB17		
		TB20	0E	TB19	0D	TB19		
		TB22	10	TB21	0F	TB21		
		TB24	COM	TB23	11	TB23		
								TB24
								COM

7.2.5 XBC-DR20SU/DN20SU/DP20SU 12 point DC24V input (Source/Sink type)

Model		Main unit						
		XBC-DR20SU	XBC-DN20SU	XBC-DP20SU				
Specification								
Input point		12 point						
Insulation method		Photo coupler insulation						
Rated input voltage		DC24V						
Rated input current		About 4 mA (point 0~1: about 16 mA, point 2~7: about 10 mA)						
Operation voltage range		DC20.4~28.8V (within ripple rate 5%)						
On voltage / On current		DC19V or higher / 3 mA or higher						
Off voltage / Off current		DC6V or lower / 1 mA or lower						
Input resistance		About 5.6 kΩ (P00~P01: about 1.5 kΩ, P02~P07: about 2.7 kΩ)						
Response time	Off → On	1/3/5/10/20/70/100 ms (set by I/O parameter) default: 3 ms						
	On → Off							
Insulation pressure		AC560Vrms / 3 cycle (altitude 2000m)						
Insulation resistance		10 MΩ or more by MegOhmMeter						
Common method		12 point / COM						
Proper cable size		0.3 mm ²						
Operation indicator		LED On When Input On						
External connection method		24 point terminal block connector (M3 X 6 screw)						
Weight		514g	475g	475g				
Circuit configuration		No.	Contact	No.	Contact	Type		
<p>Terminal block no.</p>		TB2	485+	TB1	RX	TB1		
		TB4	485-	TB3	TX	TB3		
		TB6	00	TB5	SG	TB5		
		TB8	02	TB7	01	TB7		
		TB10	04	TB9	03	TB9		
		TB12	06	TB11	05	TB11		
		TB14	08	TB13	07	TB13		
		TB16	0A	TB15	09	TB15		
		TB18	NC	TB17	0B	TB17		
		TB20	NC	TB19	NC	TB19		
		TB22	NC	TB21	NC	TB21		
		TB24	COM	TB23	NC	TB23		
						TB24	COM	TB24

7.2.6 XBC-DR30SU/DN30SU/DP30SU 18 point DC24V input (Source/Sink type)

Model		Main unit							
		XBC-DN30SU	XBC-DN30SU	XBC-DN30SU					
Specification									
Input point		18 point							
Insulation method		Photo coupler insulation							
Rated input voltage		DC24V							
Rated input current		About 4 mA (point 0~1: about 16 mA, point 2~7: about 10 mA)							
Operation voltage range		DC20.4~28.8V (within ripple rate 5%)							
On voltage / On current		DC19V or higher / 3 mA or higher							
Off voltage / Off current		DC6V or lower / 1 mA or lower							
Input resistance		About 5.6 kΩ (P00~P01: about 1.5 kΩ, P02~P07: about 2.7 kΩ)							
Response time	Off → On	1/3/5/10/20/70/100 ms (set by I/O parameter) default: 3 ms							
	On → Off								
Insulation pressure		AC560Vrms / 3 cycle (altitude 2000m)							
Insulation resistance		10 MΩ or higher by MegOhmMeter							
Common method		18 point / COM							
Proper cable size		0.3 mm ²							
Operation indicator		LED on when Input On							
External connection method		24 point terminal block connector (M3 X 6 screw)							
Weight		528g	476g	476g					
Circuit configuration		No.	Contact	No.	Contact	Type			
<p>Terminal block no.</p>		TB2	485+	TB1	RX	TB1			
		TB4	485-	TB3	TX	TB3			
		TB6	00	TB5	SG	TB5			
		TB8	02	TB7	01	TB7			
		TB10	04	TB9	03	TB9			
		TB12	06	TB11	05	TB11			
		TB14	08	TB13	07	TB13			
		TB16	0A	TB15	09	TB15			
		TB18	0C	TB17	0B	TB17			
		TB20	0E	TB19	0D	TB19			
		TB22	10	TB21	0F	TB21			
		TB24	COM	TB23	11	TB23			
						TB2	485+	RX	TB1
						TB4	485-	TX	TB3
						TB6	P00	SG	TB5
						TB8	P02	P01	TB7
						TB10	P04	P03	TB9
						TB12	P06	P05	TB11
				TB14	P08	P07	TB13		
				TB16	POA	P09	TB15		
				TB18	POC	P0B	TB17		
				TB20	POE	P0D	TB19		
				TB22	P10	POF	TB21		
				TB24	COM	P11	TB23		

7.2.7 XBC-DR40SU/DN40SU/DP40SU 24 point DC24V input (Source/Sink Type)

Specification	Model	Main unit						
	XBC-DR40SU	XBC-DN40SU	XBC-DP40SU					
Input point	24 point							
Insulation method	Photo coupler insulation							
Rated input voltage	DC24V							
Rated input current	About 4 mA (point 0~1: about 16 mA, point 2~7: about 10 mA)							
Operation voltage range	DC20.4~28.8V (within ripple rate 5%)							
On voltage / On current	DC19V or higher / 3 mA or higher							
Off voltage / Off current	DC6V or lower / 1 mA or lower							
Input resistance	About 5.6 kΩ (P00~P01: about 1.5 kΩ, P02~P07: about 2.7 kΩ)							
Response time	Off → On	1/3/5/10/20/70/100 ms (set by I/O parameter) default: 3 ms						
	On → Off							
Insulation pressure	AC560Vrms / 3 cycle (altitude 2000m)							
Insulation resistance	10 MΩ or higher by MegOhmMeter							
Common method	24 point / COM							
Proper cable size	0.3 mm ²							
Operation indicator	LED on when Input On							
External connection method	30 point terminal block connector (M3 X 6 screw)							
Weight	594g	578g	578g					
Circuit configuration		No.	Contact	No.	Contact	Type		
		TB2	485+	TB1	RX		TB1	RX
		TB3	485-	TB2	485+		TB3	TX
		TB4	485-	TB4	485-		TB5	SG
		TB6	00	TB6	P00		TB7	P01
		TB8	02	TB8	P02		TB9	P03
		TB10	04	TB10	P04		TB11	P05
		TB12	06	TB12	P06		TB13	P07
		TB14	08	TB14	P08		TB15	P09
		TB16	0A	TB16	P0A		TB17	P0B
		TB18	0C	TB18	P0C		TB19	P0D
		TB20	0E	TB20	P0E		TB21	P0F
		TB22	10	TB22	P10		TB23	P11
		TB24	12	TB24	P12		TB25	P13
		TB26	14	TB26	P14		TB27	P15
		TB28	16	TB28	P16		TB29	P17
		TB30	COM	TB30	COM			

7.2.8 XBC-DR60SU/DN60SU/DP60SU 36 point DC24V input (Source/Sink Type)

Specification	Main unit					
	XBC-DR60SU	XBC-DN60SU	XBC-DP60SU			
Input point	36 point					
Insulation method	Photo coupler insulation					
Rated input voltage	DC24V					
Rated input current	About 4 mA (point 0~1: about 16 mA, point 2~7: about 10 mA)					
Operation voltage range	DC20.4~28.8V (within ripple rate 5%)					
On voltage / On current	DC19V or higher / 3 mA or higher					
Off voltage / Off current	DC6V or lower / 1 mA or lower					
Input resistance	About 5.6 kΩ (P00~P01: about 1.5 kΩ, P02~P07: about 2.7 kΩ)					
Response time	Off → On	1/3/5/10/20/70/100 ms (set by I/O parameter) default: 3 ms				
	On → Off					
Insulation pressure	AC560Vrms / 3 cycle (altitude 2000m)					
Insulation resistance	10 MΩ or higher by MegOhmMeter					
Common method	36 point / COM					
Proper cable size	0.3 mm ²					
Operation indicator	LED on when Input On					
External connection method	42 point terminal block connector (M3 X 6 screw)					
Weight	804g	636g	636g			
Circuit configuration						
<p>Terminal block no.</p>		No.	Contact	No.	Contact	Type
		TB2	485+	TB1	RX	
		TB4	485-	TB3	TX	
		TB6	00	TB5	SG	
		TB8	02	TB7	01	
		TB10	04	TB9	03	
		TB12	06	TB11	05	
		TB14	08	TB13	07	
		TB16	0A	TB15	09	
		TB18	0C	TB17	0B	
		TB20	0E	TB19	0D	
		TB22	10	TB21	0F	
		TB24	12	TB23	11	
		TB26	14	TB25	13	
		TB28	16	TB27	15	
		TB30	18	TB29	17	
		TB32	1A	TB31	19	
		TB34	1C	TB33	1B	
		TB36	1E	TB35	1D	
		TB38	20	TB37	1F	
		TB40	22	TB39	21	
		TB42	COM	TB41	23	

7.3 Main Unit Digital Output Specification

7.3.1 XBC-DR10E 4 point relay output

Model		Main unit					
Specification		XBC-DR10E					
Output point	4 point						
Insulation method	Relay insulation						
Rated load voltage/current	DC24V 2A (resistive load) / AC220V 2A (COS Φ = 1), 5A/COMx(x:0~2)						
Min. load voltage/current	DC5V / 1 mA						
Max. load voltage	AC250V, DC125V						
Off leakage current	0.1 mA (AC220V, 60 Hz)						
Max. On/Off frequency	3,600 times / hour						
Surge absorber	None						
Service life	Mechanical	20 million times or more					
	Electrical	Rated load voltage / Current 100,000 times or more					
		AC200V / 1.5A, AC240V / 1A (COS Φ = 0.7) 100,000 times or more					
		AC200V / 1A, AC240V / 0.5A (COS Φ = 0.35) 100,000 times or more					
		DC24V / 1A, DC100V / 0.1A (L / R = 7 ms) 100,000 times or more					
Response time	Off → On	10 ms or less					
	On → Off	12 ms or less					
Common method	2 point / COM						
Proper cable size	Stranded cable 0.3~0.75 mm ² (External diameter 2.8 mm or less)						
Operation indicator	LED On when Output On						
External connection method	14 point terminal block connector (M3 X 6 screw)						
Weight	330g						
Circuit configuration			No.	Contact	No.	Contact	Type
			TB2	PE	TB1	AC100 ~240V	TB1
			TB4	COM0	TB3		TB3
			TB6	COM1	TB5	40	TB5
			TB8	COM2	TB7	41	TB7
			TB10	43	TB9	42	TB9
			TB12	NC	TB11	NC	TB11
			TB14	24G	TB13	24V	TB13
							TB14

7.3.2 XBC-DR14E 6 point relay output

Model		Main unit
Specification		XBC-DR14E
Output point	6 point	
Insulation method	Relay insulation	
Rated load voltage/current	DC24V 2A (resistive load) / AC220V 2A (COSΦ = 1), 5A/COMx(x:0~2)	
Min. load voltage/current	DC5V / 1 mA	
Max. load voltage	AC250V, DC125V	
Off leakage current	0.1 mA (AC220V, 60 Hz)	
Max. On/Off frequency	3,600 times / hour	
Surge absorber	None	
Service life	Mechanical	20 million times or more
	Electrical	Rated load voltage / Current 100,000 times or more
		AC200V / 1.5A, AC240V / 1A (COSΦ = 0.7) 100,000 times or more
		AC200V / 1A, AC240V / 0.5A (COSΦ = 0.35) 100,000 times or more
	DC24V / 1A, DC100V / 0.1A (L / R = 7 ms) 100,000 times or more	
Response time	Off → On	10 ms or less
	On → Off	12 ms or less
Common method	4 point / COM	
Proper cable size	Stranded cable 0.3~0.75 mm ² (External diameter 2.8 mm or less)	
Operation indicator	LED On when Output On	
External connection method	14 point terminal block connector (M3 X 6 screw)	
Weight	340g	

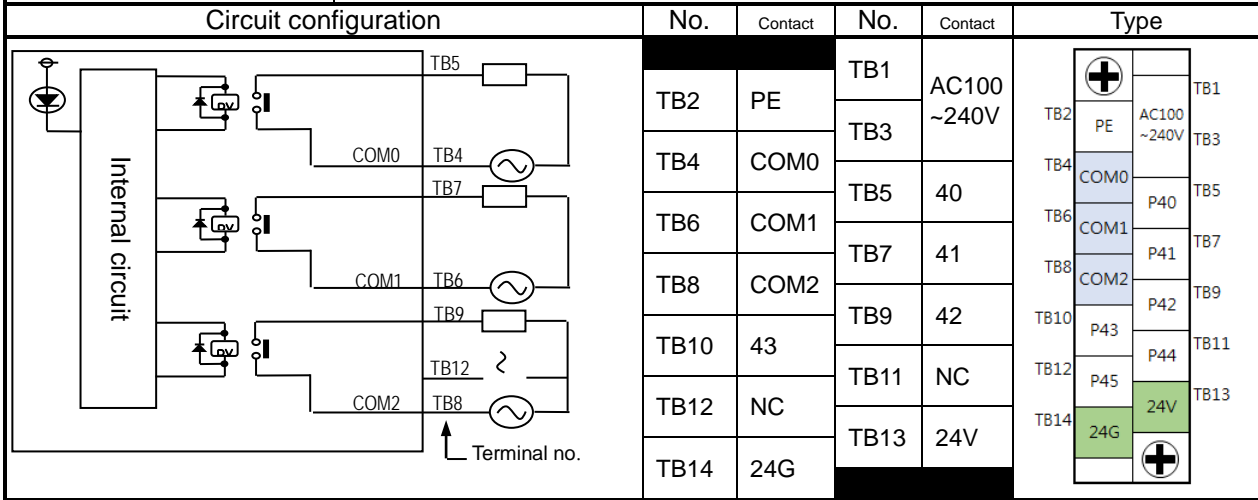

7.3.3 XBC-DR20E 8 point relay output

Model		Main unit																																																																																																					
Specification		XBC-DR20E																																																																																																					
Output point	8 point																																																																																																						
Insulation method	Relay insulation																																																																																																						
Rated load voltage/current	DC24V 2A (resistive load) / AC220V 2A (COSΦ = 1), 5A/COMx(x:0~4)																																																																																																						
Min. load voltage/current	DC5V / 1 mA																																																																																																						
Max. load voltage	AC250V, DC125V																																																																																																						
Off leakage current	0.1 mA (AC220V, 60 Hz)																																																																																																						
Max. On/Off frequency	3,600 times / hour																																																																																																						
Surge absorber	None																																																																																																						
Service life	Mechanical	20 million times or more																																																																																																					
	Electrical	Rated load voltage / Current 100,000 times or more																																																																																																					
		AC200V / 1.5A, AC240V / 1A (COSΦ = 0.7) 100,000 times or more																																																																																																					
		AC200V / 1A, AC240V / 0.5A (COSΦ = 0.35) 100,000 times or more																																																																																																					
Response time	Off → On	10ms or less																																																																																																					
	On → Off	12ms or less																																																																																																					
Common method	4 point / COM (COM0~COM8), 8 point / COM (COM4~COM5)																																																																																																						
Proper cable size	Stranded cable 0.3~0.75 mm ² (External diameter 2.8 mm or less)																																																																																																						
Operation indicator	LED On when Output On																																																																																																						
External connection method	24 point terminal block connector (M3 X 6 screw)																																																																																																						
Weight	450g																																																																																																						
Circuit configuration			<table border="1"> <thead> <tr> <th>No.</th> <th>Contact</th> <th>No.</th> <th>Contact</th> </tr> </thead> <tbody> <tr> <td>TB1</td> <td>AC100 ~240V</td> <td>TB1</td> <td>AC100 ~240V</td> </tr> <tr> <td>TB2</td> <td>PE</td> <td>TB2</td> <td>PE</td> </tr> <tr> <td>TB3</td> <td>COM0</td> <td>TB3</td> <td>COM0</td> </tr> <tr> <td>TB4</td> <td>COM1</td> <td>TB4</td> <td>COM1</td> </tr> <tr> <td>TB5</td> <td>COM2</td> <td>TB5</td> <td>COM2</td> </tr> <tr> <td>TB6</td> <td>COM3</td> <td>TB6</td> <td>COM3</td> </tr> <tr> <td>TB7</td> <td>40</td> <td>TB7</td> <td>40</td> </tr> <tr> <td>TB8</td> <td>41</td> <td>TB8</td> <td>41</td> </tr> <tr> <td>TB9</td> <td>42</td> <td>TB9</td> <td>42</td> </tr> <tr> <td>TB10</td> <td>43</td> <td>TB10</td> <td>43</td> </tr> <tr> <td>TB11</td> <td>NC</td> <td>TB11</td> <td>NC</td> </tr> <tr> <td>TB12</td> <td>44</td> <td>TB12</td> <td>44</td> </tr> <tr> <td>TB13</td> <td>45</td> <td>TB13</td> <td>45</td> </tr> <tr> <td>TB14</td> <td>46</td> <td>TB14</td> <td>46</td> </tr> <tr> <td>TB15</td> <td>47</td> <td>TB15</td> <td>47</td> </tr> <tr> <td>TB16</td> <td>NC</td> <td>TB16</td> <td>NC</td> </tr> <tr> <td>TB17</td> <td>NC</td> <td>TB17</td> <td>NC</td> </tr> <tr> <td>TB18</td> <td>NC</td> <td>TB18</td> <td>NC</td> </tr> <tr> <td>TB19</td> <td>NC</td> <td>TB19</td> <td>NC</td> </tr> <tr> <td>TB20</td> <td>NC</td> <td>TB20</td> <td>NC</td> </tr> <tr> <td>TB21</td> <td>NC</td> <td>TB21</td> <td>NC</td> </tr> <tr> <td>TB22</td> <td>NC</td> <td>TB22</td> <td>NC</td> </tr> <tr> <td>TB23</td> <td>24V</td> <td>TB23</td> <td>24V</td> </tr> <tr> <td>TB24</td> <td>24G</td> <td>TB24</td> <td>24G</td> </tr> </tbody> </table>	No.	Contact	No.	Contact	TB1	AC100 ~240V	TB1	AC100 ~240V	TB2	PE	TB2	PE	TB3	COM0	TB3	COM0	TB4	COM1	TB4	COM1	TB5	COM2	TB5	COM2	TB6	COM3	TB6	COM3	TB7	40	TB7	40	TB8	41	TB8	41	TB9	42	TB9	42	TB10	43	TB10	43	TB11	NC	TB11	NC	TB12	44	TB12	44	TB13	45	TB13	45	TB14	46	TB14	46	TB15	47	TB15	47	TB16	NC	TB16	NC	TB17	NC	TB17	NC	TB18	NC	TB18	NC	TB19	NC	TB19	NC	TB20	NC	TB20	NC	TB21	NC	TB21	NC	TB22	NC	TB22	NC	TB23	24V	TB23	24V	TB24	24G	TB24	24G
No.	Contact	No.	Contact																																																																																																				
TB1	AC100 ~240V	TB1	AC100 ~240V																																																																																																				
TB2	PE	TB2	PE																																																																																																				
TB3	COM0	TB3	COM0																																																																																																				
TB4	COM1	TB4	COM1																																																																																																				
TB5	COM2	TB5	COM2																																																																																																				
TB6	COM3	TB6	COM3																																																																																																				
TB7	40	TB7	40																																																																																																				
TB8	41	TB8	41																																																																																																				
TB9	42	TB9	42																																																																																																				
TB10	43	TB10	43																																																																																																				
TB11	NC	TB11	NC																																																																																																				
TB12	44	TB12	44																																																																																																				
TB13	45	TB13	45																																																																																																				
TB14	46	TB14	46																																																																																																				
TB15	47	TB15	47																																																																																																				
TB16	NC	TB16	NC																																																																																																				
TB17	NC	TB17	NC																																																																																																				
TB18	NC	TB18	NC																																																																																																				
TB19	NC	TB19	NC																																																																																																				
TB20	NC	TB20	NC																																																																																																				
TB21	NC	TB21	NC																																																																																																				
TB22	NC	TB22	NC																																																																																																				
TB23	24V	TB23	24V																																																																																																				
TB24	24G	TB24	24G																																																																																																				

7.3.4 XBC-DR30E 12 point relay output

Model		Main unit			
Specification		XBC-DR30E			
Output point	12 point				
Insulation method	Relay insulation				
Rated load voltage/current	DC24V 2A (resistive load) / AC220V 2A (COSΦ = 1), 5A/COMx(x:0~4)				
Min. load voltage/current	DC5V / 1 mA				
Max. load voltage	AC250V, DC125V				
Off leakage current	0.1 mA (AC220V, 60 Hz)				
Max. On/Off frequency	3,600 times / hour				
Surge absorber	None				
Service life	Mechanical	20 million times or more			
	Electrical	Rated load voltage / Current 100,000 times or more			
		AC200V / 1.5A, AC240V / 1A (COSΦ = 0.7) 100,000 times or more			
		AC200V / 1A, AC240V / 0.5A (COSΦ = 0.35) 100,000 times or more			
	DC24V / 1A, DC100V / 0.1A (L / R = 7 ms) 100,000 times or more				
Response time	Off → On	10 ms or less			
	On → Off	12 ms or less			
Common method	4 point / COM (COM0~COM8), 8 point / COM (COM4~COM5)				
Proper cable size	Stranded cable 0.3~0.75 mm ² (External diameter 2.8 mm or less)				
Operation indicator	LED On when Output On				
External connection method	2 point terminal block connector (M3 X 6 screw)				
Weight	465g				
Circuit configuration					
	No.	Contact	No.	Contact	Type
	TB1	AC100 ~240V	TB1	AC100 ~240V	TB1
	TB2	PE	TB3	AC100 ~240V	TB3
	TB4	COM0	TB5	40	TB5
	TB6	COM1	TB7	41	TB7
	TB8	COM2	TB9	42	TB9
	TB10	43	TB11	NC	TB11
	TB12	COM3	TB13	44	TB13
	TB14	45	TB15	46	TB15
	TB16	47	TB17	NC	TB17
	TB18	COM4	TB19	48	TB19
	TB20	49	TB21	4A	TB21
	TB22	4B	TB23	24V	TB23
TB24	24G			TB24	

7.3.5 XBC-DN10E 4 point transistor output (Sink type)

Model		Main unit																																																																											
Specification		XBC-DN10E																																																																											
Output point		4 point																																																																											
Insulation method		Photo coupler insulation																																																																											
Rated load voltage		DC 12 / 24V																																																																											
Operation load voltage range		DC 10.2 ~ 26.4V																																																																											
Max. load current		0.5A / 1 point, 2A / COMx(x:0~1)																																																																											
Off leakage current		0.1 mA or less																																																																											
Max. inrush current		4A / 10 ms or less																																																																											
Max. voltage drop when On		DC 0.4V or less																																																																											
Surge absorber		Zener diode																																																																											
Response time	Off → On	1 ms or less																																																																											
	On → Off	1 ms or less (rated load, resistive load)																																																																											
Common method		4 point / COM																																																																											
Proper wire size		Stranded wire 0.3~0.75 mm ² (external diameter 2.8 mm or less)																																																																											
External power	Voltage	DC12/24V ± 10% (Ripple voltage 4 Vp-p or less)																																																																											
	Current	25 mA or less (When connecting DC24V)																																																																											
Operation indicator		LED On when Output On																																																																											
External connection method		14 point terminal block connector(M3 X 6 screw)																																																																											
Weight		313g																																																																											
Circuit configuration																																																																													
		<table border="1"> <thead> <tr> <th>No.</th> <th>Contact</th> <th>No.</th> <th>Contact</th> <th>Type</th> </tr> </thead> <tbody> <tr> <td>TB1</td> <td></td> <td>TB1</td> <td>AC100 ~240V</td> <td>+</td> </tr> <tr> <td>TB2</td> <td>PE</td> <td>TB2</td> <td></td> <td>PE</td> </tr> <tr> <td>TB3</td> <td></td> <td>TB3</td> <td></td> <td>AC100 ~240V</td> </tr> <tr> <td>TB4</td> <td>P</td> <td>TB4</td> <td></td> <td>P</td> </tr> <tr> <td>TB5</td> <td></td> <td>TB5</td> <td>40</td> <td>P40</td> </tr> <tr> <td>TB6</td> <td>COM0</td> <td>TB6</td> <td></td> <td>COM0</td> </tr> <tr> <td>TB7</td> <td></td> <td>TB7</td> <td>41</td> <td>P41</td> </tr> <tr> <td>TB8</td> <td>COM1</td> <td>TB8</td> <td></td> <td>COM1</td> </tr> <tr> <td>TB9</td> <td></td> <td>TB9</td> <td>42</td> <td>P42</td> </tr> <tr> <td>TB10</td> <td>43</td> <td>TB10</td> <td></td> <td>P43</td> </tr> <tr> <td>TB11</td> <td></td> <td>TB11</td> <td>NC</td> <td>NC</td> </tr> <tr> <td>TB12</td> <td>NC</td> <td>TB12</td> <td></td> <td>NC</td> </tr> <tr> <td>TB13</td> <td></td> <td>TB13</td> <td>24V</td> <td>24V</td> </tr> <tr> <td>TB14</td> <td>24G</td> <td>TB14</td> <td></td> <td>24G</td> </tr> </tbody> </table>	No.	Contact	No.	Contact	Type	TB1		TB1	AC100 ~240V	+	TB2	PE	TB2		PE	TB3		TB3		AC100 ~240V	TB4	P	TB4		P	TB5		TB5	40	P40	TB6	COM0	TB6		COM0	TB7		TB7	41	P41	TB8	COM1	TB8		COM1	TB9		TB9	42	P42	TB10	43	TB10		P43	TB11		TB11	NC	NC	TB12	NC	TB12		NC	TB13		TB13	24V	24V	TB14	24G	TB14		24G
No.	Contact	No.	Contact	Type																																																																									
TB1		TB1	AC100 ~240V	+																																																																									
TB2	PE	TB2		PE																																																																									
TB3		TB3		AC100 ~240V																																																																									
TB4	P	TB4		P																																																																									
TB5		TB5	40	P40																																																																									
TB6	COM0	TB6		COM0																																																																									
TB7		TB7	41	P41																																																																									
TB8	COM1	TB8		COM1																																																																									
TB9		TB9	42	P42																																																																									
TB10	43	TB10		P43																																																																									
TB11		TB11	NC	NC																																																																									
TB12	NC	TB12		NC																																																																									
TB13		TB13	24V	24V																																																																									
TB14	24G	TB14		24G																																																																									

7.3.6 XBC-DN14E 6 point transistor output (Sink type)

Model		Main unit																																													
Specification		XBC-DN14E																																													
Output point		6 point																																													
Insulation method		Photo coupler insulation																																													
Rated load voltage		DC 12 / 24V																																													
Operation load voltage range		DC 10.2 ~ 26.4V																																													
Max. load current		0.5A / 1 point, 2A / COMx(x:0~1)																																													
Off leakage current		0.1 mA or less																																													
Max. inrush current		4A / 10 ms or less																																													
Max. voltage drop when On		DC 0.4V or less																																													
Surge absorber		Zener diode																																													
Response time	Off → On	1 ms or less																																													
	On → Off	1 ms or less (rated load, resistive load)																																													
Common method		4 point / COM																																													
Proper wire size		Stranded wire 0.3~0.75 mm ² (external diameter 2.8 mm or less)																																													
External power	Voltage	DC12/24V ± 10% (Ripple voltage 4 Vp-p or less)																																													
	Current	25 mA or less (When connecting DC24V)																																													
Operation indicator		LED On when Output On																																													
External connection method		14 point terminal block connector(M3 X 6 screw)																																													
Weight		315g																																													
Circuit configuration		<table border="1"> <thead> <tr> <th>No.</th> <th>Contact</th> <th>No.</th> <th>Contact</th> <th>Type</th> </tr> </thead> <tbody> <tr> <td>TB1</td> <td></td> <td>TB1</td> <td>AC100 ~240V</td> <td>TB1</td> </tr> <tr> <td>TB2</td> <td>PE</td> <td>TB3</td> <td></td> <td>TB3</td> </tr> <tr> <td>TB4</td> <td>P</td> <td>TB5</td> <td>40</td> <td>TB5</td> </tr> <tr> <td>TB6</td> <td>COM0</td> <td>TB7</td> <td>41</td> <td>TB7</td> </tr> <tr> <td>TB8</td> <td>COM1</td> <td>TB9</td> <td>42</td> <td>TB9</td> </tr> <tr> <td>TB10</td> <td>43</td> <td>TB11</td> <td>44</td> <td>TB11</td> </tr> <tr> <td>TB12</td> <td>45</td> <td>TB13</td> <td>24V</td> <td>TB13</td> </tr> <tr> <td>TB14</td> <td>24G</td> <td></td> <td></td> <td>TB14</td> </tr> </tbody> </table>	No.	Contact	No.	Contact	Type	TB1		TB1	AC100 ~240V	TB1	TB2	PE	TB3		TB3	TB4	P	TB5	40	TB5	TB6	COM0	TB7	41	TB7	TB8	COM1	TB9	42	TB9	TB10	43	TB11	44	TB11	TB12	45	TB13	24V	TB13	TB14	24G			TB14
No.	Contact	No.	Contact	Type																																											
TB1		TB1	AC100 ~240V	TB1																																											
TB2	PE	TB3		TB3																																											
TB4	P	TB5	40	TB5																																											
TB6	COM0	TB7	41	TB7																																											
TB8	COM1	TB9	42	TB9																																											
TB10	43	TB11	44	TB11																																											
TB12	45	TB13	24V	TB13																																											
TB14	24G			TB14																																											
<p>Terminal No.</p>																																															

7.3.7 XBC-DN20E 8 point transistor output (Sink type)

Model		Main unit																																																																																																																													
Specification		XBC-DN20E																																																																																																																													
Output point		8 point																																																																																																																													
Insulation method		Photo coupler insulation																																																																																																																													
Rated load voltage		DC 12 / 24V																																																																																																																													
Operation load voltage range		DC 10.2 ~ 26.4V																																																																																																																													
Max. load current		0.5A / 1 point, 2A / COMx(x:0~2)																																																																																																																													
Off leakage current		0.1 mA or less																																																																																																																													
Max. inrush current		4A / 10 ms or less																																																																																																																													
Max. voltage drop when On		DC 0.4V or less																																																																																																																													
Surge absorber		Zener diode																																																																																																																													
Response time	Off → On	1 ms or less																																																																																																																													
	On → Off	1 ms or less (rated load, resistive load)																																																																																																																													
Common method		4 point / COM																																																																																																																													
Proper wire size		Stranded wire 0.3~0.75 mm ² (external diameter 2.8 mm or less)																																																																																																																													
External power	Voltage	DC12/24V ± 10% (Ripple voltage 4 Vp-p or less)																																																																																																																													
	Current	25 mA or less (When connecting DC24V)																																																																																																																													
Operation indicator		LED On when Output On																																																																																																																													
External connection method		24 point terminal block connector(M3 X 6 screw)																																																																																																																													
Weight		418g																																																																																																																													
Circuit configuration																																																																																																																															
		<table border="1"> <thead> <tr> <th>No.</th> <th>Contact</th> <th>No.</th> <th>Contact</th> <th>Type</th> </tr> </thead> <tbody> <tr> <td>TB1</td> <td></td> <td>TB1</td> <td>AC100 ~240V</td> <td></td> </tr> <tr> <td>TB2</td> <td>PE</td> <td>TB2</td> <td>PE</td> <td>AC100 ~240V</td> </tr> <tr> <td>TB3</td> <td></td> <td>TB3</td> <td></td> <td></td> </tr> <tr> <td>TB4</td> <td>P</td> <td>TB4</td> <td>P</td> <td></td> </tr> <tr> <td>TB5</td> <td></td> <td>TB5</td> <td>40</td> <td>P40</td> </tr> <tr> <td>TB6</td> <td>COM0</td> <td>TB6</td> <td>COM0</td> <td>P41</td> </tr> <tr> <td>TB7</td> <td></td> <td>TB7</td> <td>41</td> <td>P42</td> </tr> <tr> <td>TB8</td> <td>COM1</td> <td>TB8</td> <td>COM1</td> <td>P43</td> </tr> <tr> <td>TB9</td> <td></td> <td>TB9</td> <td>42</td> <td>NC</td> </tr> <tr> <td>TB10</td> <td>43</td> <td>TB10</td> <td>COM2</td> <td>P44</td> </tr> <tr> <td>TB11</td> <td></td> <td>TB11</td> <td>NC</td> <td>P45</td> </tr> <tr> <td>TB12</td> <td>COM2</td> <td>TB12</td> <td>44</td> <td>P47</td> </tr> <tr> <td>TB13</td> <td></td> <td>TB13</td> <td>46</td> <td>NC</td> </tr> <tr> <td>TB14</td> <td>45</td> <td>TB14</td> <td>47</td> <td>NC</td> </tr> <tr> <td>TB15</td> <td></td> <td>TB15</td> <td>NC</td> <td>NC</td> </tr> <tr> <td>TB16</td> <td>47</td> <td>TB16</td> <td>NC</td> <td>NC</td> </tr> <tr> <td>TB17</td> <td></td> <td>TB17</td> <td>NC</td> <td>NC</td> </tr> <tr> <td>TB18</td> <td>NC</td> <td>TB18</td> <td>NC</td> <td>NC</td> </tr> <tr> <td>TB19</td> <td></td> <td>TB19</td> <td>NC</td> <td>NC</td> </tr> <tr> <td>TB20</td> <td>NC</td> <td>TB20</td> <td>NC</td> <td>NC</td> </tr> <tr> <td>TB21</td> <td></td> <td>TB21</td> <td>NC</td> <td>NC</td> </tr> <tr> <td>TB22</td> <td>NC</td> <td>TB22</td> <td>NC</td> <td>NC</td> </tr> <tr> <td>TB23</td> <td></td> <td>TB23</td> <td>24V</td> <td>24V</td> </tr> <tr> <td>TB24</td> <td>24G</td> <td>TB24</td> <td>24G</td> <td></td> </tr> </tbody> </table>	No.	Contact	No.	Contact	Type	TB1		TB1	AC100 ~240V		TB2	PE	TB2	PE	AC100 ~240V	TB3		TB3			TB4	P	TB4	P		TB5		TB5	40	P40	TB6	COM0	TB6	COM0	P41	TB7		TB7	41	P42	TB8	COM1	TB8	COM1	P43	TB9		TB9	42	NC	TB10	43	TB10	COM2	P44	TB11		TB11	NC	P45	TB12	COM2	TB12	44	P47	TB13		TB13	46	NC	TB14	45	TB14	47	NC	TB15		TB15	NC	NC	TB16	47	TB16	NC	NC	TB17		TB17	NC	NC	TB18	NC	TB18	NC	NC	TB19		TB19	NC	NC	TB20	NC	TB20	NC	NC	TB21		TB21	NC	NC	TB22	NC	TB22	NC	NC	TB23		TB23	24V	24V	TB24	24G	TB24	24G	
No.	Contact	No.	Contact	Type																																																																																																																											
TB1		TB1	AC100 ~240V																																																																																																																												
TB2	PE	TB2	PE	AC100 ~240V																																																																																																																											
TB3		TB3																																																																																																																													
TB4	P	TB4	P																																																																																																																												
TB5		TB5	40	P40																																																																																																																											
TB6	COM0	TB6	COM0	P41																																																																																																																											
TB7		TB7	41	P42																																																																																																																											
TB8	COM1	TB8	COM1	P43																																																																																																																											
TB9		TB9	42	NC																																																																																																																											
TB10	43	TB10	COM2	P44																																																																																																																											
TB11		TB11	NC	P45																																																																																																																											
TB12	COM2	TB12	44	P47																																																																																																																											
TB13		TB13	46	NC																																																																																																																											
TB14	45	TB14	47	NC																																																																																																																											
TB15		TB15	NC	NC																																																																																																																											
TB16	47	TB16	NC	NC																																																																																																																											
TB17		TB17	NC	NC																																																																																																																											
TB18	NC	TB18	NC	NC																																																																																																																											
TB19		TB19	NC	NC																																																																																																																											
TB20	NC	TB20	NC	NC																																																																																																																											
TB21		TB21	NC	NC																																																																																																																											
TB22	NC	TB22	NC	NC																																																																																																																											
TB23		TB23	24V	24V																																																																																																																											
TB24	24G	TB24	24G																																																																																																																												

7.3.8 XBC-DN30E 12 point transistor output (Sink type)

Model		Main unit																																																																						
Specification		XBC-DN30E																																																																						
Output point		12 point																																																																						
Insulation method		Photo coupler insulation																																																																						
Rated load voltage		DC 12 / 24V																																																																						
Operation load voltage range		DC 10.2 ~ 26.4V																																																																						
Max. load current		0.5A / 1 point, 2A / COMx(x:0~2)																																																																						
Off leakage current		0.1 mA or less																																																																						
Max. inrush current		4A / 10 ms or less																																																																						
Max. voltage drop when On		DC 0.4V or less																																																																						
Surge absorber		Zener diode																																																																						
Response time	Off → On	1 ms or less																																																																						
	On → Off	1 ms or less (rated load, resistive load)																																																																						
Common method		4 point / COM																																																																						
Proper wire size		Stranded wire 0.3~0.75 mm ² (external diameter 2.8 mm or less)																																																																						
External power	Voltage	DC12/24V ± 10% (Ripple voltage 4 Vp-p or less)																																																																						
	Current	25 mA or less (When connecting DC24V)																																																																						
Operation indicator		LED On when Output On																																																																						
External connection method		24 point terminal block connector(M3 X 6 screw)																																																																						
Weight		423g																																																																						
Circuit configuration																																																																								
		<table border="1"> <thead> <tr> <th>No.</th> <th>Contact</th> <th>No.</th> <th>Contact</th> <th>Type</th> </tr> </thead> <tbody> <tr> <td>TB1</td> <td></td> <td>TB1</td> <td>AC100 ~240V</td> <td>TB1</td> </tr> <tr> <td>TB2</td> <td>PE</td> <td>TB3</td> <td></td> <td>TB3</td> </tr> <tr> <td>TB4</td> <td>P</td> <td>TB5</td> <td>40</td> <td>TB5</td> </tr> <tr> <td>TB6</td> <td>COM0</td> <td>TB7</td> <td>41</td> <td>TB7</td> </tr> <tr> <td>TB8</td> <td>COM1</td> <td>TB9</td> <td>42</td> <td>TB9</td> </tr> <tr> <td>TB10</td> <td>43</td> <td>TB11</td> <td>NC</td> <td>TB11</td> </tr> <tr> <td>TB12</td> <td>COM2</td> <td>TB13</td> <td>44</td> <td>TB13</td> </tr> <tr> <td>TB14</td> <td>45</td> <td>TB15</td> <td>46</td> <td>TB15</td> </tr> <tr> <td>TB16</td> <td>47</td> <td>TB17</td> <td>NC</td> <td>TB17</td> </tr> <tr> <td>TB18</td> <td>COM3</td> <td>TB19</td> <td>48</td> <td>TB19</td> </tr> <tr> <td>TB20</td> <td>49</td> <td>TB21</td> <td>4A</td> <td>TB21</td> </tr> <tr> <td>TB22</td> <td>4B</td> <td>TB23</td> <td>24V</td> <td>TB23</td> </tr> <tr> <td>TB24</td> <td>24G</td> <td></td> <td></td> <td></td> </tr> </tbody> </table>	No.	Contact	No.	Contact	Type	TB1		TB1	AC100 ~240V	TB1	TB2	PE	TB3		TB3	TB4	P	TB5	40	TB5	TB6	COM0	TB7	41	TB7	TB8	COM1	TB9	42	TB9	TB10	43	TB11	NC	TB11	TB12	COM2	TB13	44	TB13	TB14	45	TB15	46	TB15	TB16	47	TB17	NC	TB17	TB18	COM3	TB19	48	TB19	TB20	49	TB21	4A	TB21	TB22	4B	TB23	24V	TB23	TB24	24G			
No.	Contact	No.	Contact	Type																																																																				
TB1		TB1	AC100 ~240V	TB1																																																																				
TB2	PE	TB3		TB3																																																																				
TB4	P	TB5	40	TB5																																																																				
TB6	COM0	TB7	41	TB7																																																																				
TB8	COM1	TB9	42	TB9																																																																				
TB10	43	TB11	NC	TB11																																																																				
TB12	COM2	TB13	44	TB13																																																																				
TB14	45	TB15	46	TB15																																																																				
TB16	47	TB17	NC	TB17																																																																				
TB18	COM3	TB19	48	TB19																																																																				
TB20	49	TB21	4A	TB21																																																																				
TB22	4B	TB23	24V	TB23																																																																				
TB24	24G																																																																							

7.3.9 XBC-DP10E 4 point transistor output (Source type)

Model		Main unit																																													
Specification		XBC-DP10E																																													
Output point		4 point																																													
Insulation method		Photo coupler insulation																																													
Rated load voltage		DC 12 / 24V																																													
Operation load voltage range		DC 10.2 ~ 26.4V																																													
Max. load current		0.5A / 1 point, 2A / COMx(x:0~1)																																													
Off leakage current		0.1 mA or less																																													
Max. inrush current		4A / 10 ms or less																																													
Max. voltage drop when On		DC 0.4V or less																																													
Surge absorber		Zener diode																																													
Response time	Off → On	1 ms or less																																													
	On → Off	1 ms or less (rated load, resistive load)																																													
Common method		4 point / COM																																													
Proper wire size		Stranded wire 0.3~0.75 mm ² (external diameter 2.8 mm or less)																																													
External power	Voltage	DC12/24V ± 10% (Ripple voltage 4 Vp-p or less)																																													
	Current	25 mA or less (When connecting DC24V)																																													
Operation indicator		LED On when Output On																																													
External connection method		14 point terminal block connector(M3 X 6 screw)																																													
Weight		313g																																													
Circuit configuration																																															
		<table border="1"> <thead> <tr> <th>No.</th> <th>Contact</th> <th>No.</th> <th>Contact</th> <th>Type</th> </tr> </thead> <tbody> <tr> <td>TB1</td> <td></td> <td>TB1</td> <td>AC100 ~240V</td> <td>TB1</td> </tr> <tr> <td>TB2</td> <td>PE</td> <td>TB3</td> <td></td> <td>TB3</td> </tr> <tr> <td>TB4</td> <td>N</td> <td>TB5</td> <td>40</td> <td>TB5</td> </tr> <tr> <td>TB6</td> <td>COM0</td> <td>TB7</td> <td>41</td> <td>TB7</td> </tr> <tr> <td>TB8</td> <td>COM1</td> <td>TB9</td> <td>42</td> <td>TB9</td> </tr> <tr> <td>TB10</td> <td>43</td> <td>TB11</td> <td>NC</td> <td>TB11</td> </tr> <tr> <td>TB12</td> <td>NC</td> <td>TB13</td> <td>24V</td> <td>TB13</td> </tr> <tr> <td>TB14</td> <td>24G</td> <td></td> <td></td> <td></td> </tr> </tbody> </table>	No.	Contact	No.	Contact	Type	TB1		TB1	AC100 ~240V	TB1	TB2	PE	TB3		TB3	TB4	N	TB5	40	TB5	TB6	COM0	TB7	41	TB7	TB8	COM1	TB9	42	TB9	TB10	43	TB11	NC	TB11	TB12	NC	TB13	24V	TB13	TB14	24G			
No.	Contact	No.	Contact	Type																																											
TB1		TB1	AC100 ~240V	TB1																																											
TB2	PE	TB3		TB3																																											
TB4	N	TB5	40	TB5																																											
TB6	COM0	TB7	41	TB7																																											
TB8	COM1	TB9	42	TB9																																											
TB10	43	TB11	NC	TB11																																											
TB12	NC	TB13	24V	TB13																																											
TB14	24G																																														

7.3.10 XBC-DP14E 6 point transistor output (Source type)

Model		Main unit																																													
Specification		XBC-DP14E																																													
Output point		6 point																																													
Insulation method		Photo coupler insulation																																													
Rated load voltage		DC 12 / 24V																																													
Operation load voltage range		DC 10.2 ~ 26.4V																																													
Max. load current		0.5A / 1 point, 2A / COMx(x:0~1)																																													
Off leakage current		0.1 mA or less																																													
Max. inrush current		4A / 10 ms or less																																													
Max. voltage drop when On		DC 0.4V or less																																													
Surge absorber		Zener diode																																													
Response time	Off → On	1 ms or less																																													
	On → Off	1 ms or less (rated load, resistive load)																																													
Common method		4 point / COM																																													
Proper wire size		Stranded wire 0.3~0.75 mm ² (external diameter 2.8 mm or less)																																													
External power	Voltage	DC12/24V ± 10% (Ripple voltage 4 Vp-p or less)																																													
	Current	25 mA or less (When connecting DC24V)																																													
Operation indicator		LED On when Output On																																													
External connection method		14 point terminal block connector(M3 X 6 screw)																																													
Weight		315g																																													
Circuit configuration																																															
		<table border="1"> <thead> <tr> <th>No.</th> <th>Contact</th> <th>No.</th> <th>Contact</th> <th>Type</th> </tr> </thead> <tbody> <tr> <td>TB1</td> <td>PE</td> <td>TB1</td> <td>AC100 ~240V</td> <td>TB1</td> </tr> <tr> <td>TB2</td> <td>PE</td> <td>TB3</td> <td></td> <td>TB3</td> </tr> <tr> <td>TB4</td> <td>N</td> <td>TB5</td> <td>40</td> <td>TB5</td> </tr> <tr> <td>TB6</td> <td>COM0</td> <td>TB7</td> <td>41</td> <td>TB7</td> </tr> <tr> <td>TB8</td> <td>COM1</td> <td>TB9</td> <td>42</td> <td>TB9</td> </tr> <tr> <td>TB10</td> <td>43</td> <td>TB11</td> <td>44</td> <td>TB11</td> </tr> <tr> <td>TB12</td> <td>45</td> <td>TB13</td> <td>24V</td> <td>TB13</td> </tr> <tr> <td>TB14</td> <td>24G</td> <td></td> <td></td> <td>TB14</td> </tr> </tbody> </table>	No.	Contact	No.	Contact	Type	TB1	PE	TB1	AC100 ~240V	TB1	TB2	PE	TB3		TB3	TB4	N	TB5	40	TB5	TB6	COM0	TB7	41	TB7	TB8	COM1	TB9	42	TB9	TB10	43	TB11	44	TB11	TB12	45	TB13	24V	TB13	TB14	24G			TB14
No.	Contact	No.	Contact	Type																																											
TB1	PE	TB1	AC100 ~240V	TB1																																											
TB2	PE	TB3		TB3																																											
TB4	N	TB5	40	TB5																																											
TB6	COM0	TB7	41	TB7																																											
TB8	COM1	TB9	42	TB9																																											
TB10	43	TB11	44	TB11																																											
TB12	45	TB13	24V	TB13																																											
TB14	24G			TB14																																											

7.3.11 XBC-DP20E 8 point transistor output (Source type)

Model		Main unit																																																																						
Specification		XBC-DP20E																																																																						
Output point		8 point																																																																						
Insulation method		Photo coupler insulation																																																																						
Rated load voltage		DC 12 / 24V																																																																						
Operation load voltage range		DC 10.2 ~ 26.4V																																																																						
Max. load current		0.5A / 1 point, 2A / COMx(x:0~2)																																																																						
Off leakage current		0.1 mA or less																																																																						
Max. inrush current		4A / 10 ms or less																																																																						
Max. voltage drop when On		DC 0.4V or less																																																																						
Surge absorber		Zener diode																																																																						
Response time	Off → On	1 ms or less																																																																						
	On → Off	1 ms or less (rated load, resistive load)																																																																						
Common method		4 point / COM																																																																						
Proper wire size		Stranded wire 0.3~0.75 mm ² (external diameter 2.8 mm or less)																																																																						
External power	Voltage	DC12/24V ± 10% (Ripple voltage 4 Vp-p or less)																																																																						
	Current	25 mA or less (When connecting DC24V)																																																																						
Operation indicator		LED On when Output On																																																																						
External connection method		24 point terminal block connector(M3 X 6 screw)																																																																						
Weight		418g																																																																						
Circuit configuration																																																																								
		<table border="1"> <thead> <tr> <th>No.</th> <th>Contact</th> <th>No.</th> <th>Contact</th> <th>Type</th> </tr> </thead> <tbody> <tr> <td>TB1</td> <td>PE</td> <td>TB1</td> <td>AC100 ~240V</td> <td>TB1</td> </tr> <tr> <td>TB2</td> <td>N</td> <td>TB3</td> <td>40</td> <td>TB3</td> </tr> <tr> <td>TB4</td> <td>COM0</td> <td>TB5</td> <td>41</td> <td>TB5</td> </tr> <tr> <td>TB6</td> <td>COM1</td> <td>TB7</td> <td>42</td> <td>TB7</td> </tr> <tr> <td>TB8</td> <td>43</td> <td>TB9</td> <td>NC</td> <td>TB9</td> </tr> <tr> <td>TB10</td> <td>COM2</td> <td>TB11</td> <td>44</td> <td>TB11</td> </tr> <tr> <td>TB12</td> <td>45</td> <td>TB13</td> <td>46</td> <td>TB13</td> </tr> <tr> <td>TB14</td> <td>47</td> <td>TB15</td> <td>NC</td> <td>TB15</td> </tr> <tr> <td>TB16</td> <td>NC</td> <td>TB17</td> <td>NC</td> <td>TB17</td> </tr> <tr> <td>TB18</td> <td>NC</td> <td>TB19</td> <td>NC</td> <td>TB19</td> </tr> <tr> <td>TB20</td> <td>NC</td> <td>TB21</td> <td>NC</td> <td>TB21</td> </tr> <tr> <td>TB22</td> <td>NC</td> <td>TB23</td> <td>24V</td> <td>TB23</td> </tr> <tr> <td>TB24</td> <td>24G</td> <td></td> <td></td> <td></td> </tr> </tbody> </table>	No.	Contact	No.	Contact	Type	TB1	PE	TB1	AC100 ~240V	TB1	TB2	N	TB3	40	TB3	TB4	COM0	TB5	41	TB5	TB6	COM1	TB7	42	TB7	TB8	43	TB9	NC	TB9	TB10	COM2	TB11	44	TB11	TB12	45	TB13	46	TB13	TB14	47	TB15	NC	TB15	TB16	NC	TB17	NC	TB17	TB18	NC	TB19	NC	TB19	TB20	NC	TB21	NC	TB21	TB22	NC	TB23	24V	TB23	TB24	24G			
No.	Contact	No.	Contact	Type																																																																				
TB1	PE	TB1	AC100 ~240V	TB1																																																																				
TB2	N	TB3	40	TB3																																																																				
TB4	COM0	TB5	41	TB5																																																																				
TB6	COM1	TB7	42	TB7																																																																				
TB8	43	TB9	NC	TB9																																																																				
TB10	COM2	TB11	44	TB11																																																																				
TB12	45	TB13	46	TB13																																																																				
TB14	47	TB15	NC	TB15																																																																				
TB16	NC	TB17	NC	TB17																																																																				
TB18	NC	TB19	NC	TB19																																																																				
TB20	NC	TB21	NC	TB21																																																																				
TB22	NC	TB23	24V	TB23																																																																				
TB24	24G																																																																							

7.3.12 XBC-DP30E 12 point transistor output (Source type)

Model		Main unit																																																																						
Specification		XBC-DP30E																																																																						
Output point		12 point																																																																						
Insulation method		Photo coupler insulation																																																																						
Rated load voltage		DC 12 / 24V																																																																						
Operation load voltage range		DC 10.2 ~ 26.4V																																																																						
Max. load current		0.5A / 1 point, 2A / COMx(x:0~2)																																																																						
Off leakage current		0.1 mA or less																																																																						
Max. inrush current		4A / 10 ms or less																																																																						
Max. voltage drop when On		DC 0.4V or less																																																																						
Surge absorber		Zener diode																																																																						
Response time	Off → On	1 ms or less																																																																						
	On → Off	1 ms or less (rated load, resistive load)																																																																						
Common method		4 point / COM																																																																						
Proper wire size		Stranded wire 0.3~0.75 mm ² (external diameter 2.8 mm or less)																																																																						
External power	Voltage	DC12/24V ± 10% (Ripple voltage 4 Vp-p or less)																																																																						
	Current	25 mA or less (When connecting DC24V)																																																																						
Operation indicator		LED On when Output On																																																																						
External connection method		24 point terminal block connector(M3 X 6 screw)																																																																						
Weight		423g																																																																						
Circuit configuration																																																																								
		<table border="1"> <thead> <tr> <th>No.</th> <th>Contact</th> <th>No.</th> <th>Contact</th> <th>Type</th> </tr> </thead> <tbody> <tr> <td>TB1</td> <td>PE</td> <td>TB1</td> <td>AC100 ~240V</td> <td>TB1</td> </tr> <tr> <td>TB2</td> <td>N</td> <td>TB3</td> <td>40</td> <td>TB3</td> </tr> <tr> <td>TB4</td> <td>COM0</td> <td>TB5</td> <td>41</td> <td>TB5</td> </tr> <tr> <td>TB6</td> <td>COM1</td> <td>TB7</td> <td>42</td> <td>TB7</td> </tr> <tr> <td>TB8</td> <td>43</td> <td>TB9</td> <td>NC</td> <td>TB9</td> </tr> <tr> <td>TB10</td> <td>COM2</td> <td>TB11</td> <td>44</td> <td>TB11</td> </tr> <tr> <td>TB12</td> <td>45</td> <td>TB13</td> <td>46</td> <td>TB13</td> </tr> <tr> <td>TB14</td> <td>47</td> <td>TB15</td> <td>NC</td> <td>TB15</td> </tr> <tr> <td>TB16</td> <td>COM3</td> <td>TB17</td> <td>48</td> <td>TB17</td> </tr> <tr> <td>TB18</td> <td>49</td> <td>TB19</td> <td>4A</td> <td>TB19</td> </tr> <tr> <td>TB20</td> <td>4B</td> <td>TB21</td> <td>24V</td> <td>TB21</td> </tr> <tr> <td>TB22</td> <td>24G</td> <td>TB23</td> <td></td> <td>TB23</td> </tr> <tr> <td>TB24</td> <td></td> <td>TB24</td> <td></td> <td>TB24</td> </tr> </tbody> </table>	No.	Contact	No.	Contact	Type	TB1	PE	TB1	AC100 ~240V	TB1	TB2	N	TB3	40	TB3	TB4	COM0	TB5	41	TB5	TB6	COM1	TB7	42	TB7	TB8	43	TB9	NC	TB9	TB10	COM2	TB11	44	TB11	TB12	45	TB13	46	TB13	TB14	47	TB15	NC	TB15	TB16	COM3	TB17	48	TB17	TB18	49	TB19	4A	TB19	TB20	4B	TB21	24V	TB21	TB22	24G	TB23		TB23	TB24		TB24		TB24
No.	Contact	No.	Contact	Type																																																																				
TB1	PE	TB1	AC100 ~240V	TB1																																																																				
TB2	N	TB3	40	TB3																																																																				
TB4	COM0	TB5	41	TB5																																																																				
TB6	COM1	TB7	42	TB7																																																																				
TB8	43	TB9	NC	TB9																																																																				
TB10	COM2	TB11	44	TB11																																																																				
TB12	45	TB13	46	TB13																																																																				
TB14	47	TB15	NC	TB15																																																																				
TB16	COM3	TB17	48	TB17																																																																				
TB18	49	TB19	4A	TB19																																																																				
TB20	4B	TB21	24V	TB21																																																																				
TB22	24G	TB23		TB23																																																																				
TB24		TB24		TB24																																																																				

7.3.13 XBC-DR20SU 8 point relay output

Model		Main unit		
		XBC-DR20SU		
Specification				
Output point		8 point		
Insulation method		Relay insulation		
Rated load voltage/current		DC24V 2A (resistive load) / AC220V 2A (COSΦ = 1), 5A/COMx(x:0~3)		
Min. load voltage/current		DC5V / 1 mA		
Max. load voltage		AC250V, DC125V		
Off leakage current		0.1 mA (AC220V, 60 Hz)		
Max. On/Off frequency		3,600 times / hour		
Surge absorber		None		
Service life	Mechanical	20 million times or more		
	Electrical	Rated load voltage / Current 100,000 times or more		
		AC200V / 1.5A, AC240V / 1A (COSΦ = 0.7) 100,000 times or more		
		AC200V / 1A, AC240V / 0.5A (COSΦ = 0.35) 100,000 times or more		
Response time	Off → On	10ms or less		
	On → Off	12ms or less		
Common method		4 point / COM (COM0~COM8), 8 point / COM (COM4~COM5)		
Proper cable size		Stranded cable 0.3~0.75 mm ² (External diameter 2.8 mm or less)		
Operation indicator		LED On when Output On		
External connection method		42 point terminal block connector (M3 X 6 screw)		
Weight		450g		
Circuit configuration				
No.	Contact	No.	Contact	Type
TB2	PE	TB1	AC100 ~240V	TB1
TB4	COM0	TB3	40	TB3
TB6	COM1	TB5	41	TB5
TB8	COM2	TB7	42	TB7
TB10	43	TB9	43	TB9
TB12	COM3	TB11	NC	TB11
TB14	45	TB13	44	TB13
TB16	47	TB15	46	TB15
TB18	NC	TB17	NC	TB17
TB20	NC	TB19	NC	TB19
TB22	NC	TB21	NC	TB21
TB24	24G	TB23	24V	TB23

7.3.14 XBC-DR30SU 12 point relay output

Model		Main unit			
Specification		XBC-DR30SU			
Output point	12 point				
Insulation method	Relay insulation				
Rated load voltage/current	DC24V 2A (resistive load) / AC220V 2A (COSΦ = 1), 5A/COMx(x:0~4)				
Min. load voltage/current	DC5V / 1 mA				
Max. load voltage	AC250V, DC125V				
Off leakage current	0.1 mA (AC220V, 60 Hz)				
Max. On/Off frequency	3,600 times / hour				
Surge absorber	None				
Service life	Mechanical	20 million times or more			
	Electrical	Rated load voltage / Current 100,000 times or more			
		AC200V / 1.5A, AC240V / 1A (COSΦ = 0.7) 100,000 times or more			
		AC200V / 1A, AC240V / 0.5A (COSΦ = 0.35) 100,000 times or more			
Response time	Off → On	10 ms or less			
	On → Off	12 ms or less			
Common method	4 point / COM (COM0~COM8), 8 point / COM (COM4~COM5)				
Proper cable size	Stranded cable 0.3~0.75 mm ² (External diameter 2.8 mm or less)				
Operation indicator	LED On when Output On				
External connection method	42 point terminal block connector (M3 X 6 screw)				
Weight	465g				
Circuit configuration					
	No.	Contact	No.	Contact	Type
	TB2	PE	TB1	AC100 ~240V	TB1
	TB4	COM0	TB3		TB3
	TB6	COM1	TB5	40	TB5
	TB8	COM2	TB7	41	TB7
	TB10	43	TB9	42	TB9
	TB12	COM3	TB11	NC	TB11
	TB14	45	TB13	44	TB13
	TB16	47	TB15	46	TB15
	TB18	COM4	TB17	NC	TB17
	TB20	49	TB19	48	TB19
	TB22	4B	TB21	4A	TB21
	TB24	24G	TB23	24V	TB23

7.3.15 XBC-DR40SU 16 point relay output

Model		Main unit
Specification		XBC-DR40SU
Output point	16 point	
Insulation method	Relay insulation	
Rated load voltage/current	DC24V 2A (resistive load) / AC220V 2A (COSΦ = 1), 5A/COMx(x:0~5)	
Min. load voltage/current	DC5V / 1 mA	
Max. load voltage	AC250V, DC125V	
Off leakage current	0.1 mA (AC220V, 60 Hz)	
Max. On/Off frequency	3,600 times / hour	
Surge absorber	None	
Service life	Mechanical	20 million times or more
	Electrical	Rated load voltage / Current 100,000 times or more
		AC200V / 1.5A, AC240V / 1A (COSΦ = 0.7) 100,000 times or more
		AC200V / 1A, AC240V / 0.5A (COSΦ = 0.35) 100,000 times or more
		DC24V / 1A, DC100V / 0.1A (L / R = 7 ms) 100,000 times or more
Response time	Off → On	10ms or less
	On → Off	12ms or less
Common method	4 point / COM (COM0~COM8), 8 point / COM (COM4~COM5)	
Proper cable size	Stranded cable 0.3~0.75 mm ² (External diameter 2.8 mm or less)	
Operation indicator	LED On when Output On	
External connection method	30 point terminal block connector (M3 X 6 screw)	
Weight	594g	

Circuit configuration	No.	Contact	No.	Contact	Type
	TB2	PE	TB1	AC100 ~240V	TB1
	TB4	COM0	TB3		TB3
	TB6	COM1	TB5	40	TB5
	TB8	COM2	TB7	41	TB7
	TB10	43	TB9	42	TB9
	TB12	COM3	TB11	NC	TB11
	TB14	45	TB13	44	TB13
	TB16	47	TB15	46	TB15
	TB18	COM4	TB17	NC	TB17
	TB20	49	TB19	48	TB19
	TB22	4B	TB21	4A	TB21
	TB24	COM5	TB23	NC	TB23
	TB26	4D	TB25	4C	TB25
	TB28	4F	TB27	4E	TB27
	TB30	24G	TB29	24V	TB29

7.3.16 XBC-DR60SU 24 point relay output

Model		Main unit
Specification		XBC-DR60SU
Output point	24 point	
Insulation method	Relay insulation	
Rated load voltage/current	DC24V 2A (resistive load) / AC220V 2A (COSΦ = 1), 5A/COMx(x:0~7)	
Min. load voltage/current	DC5V / 1 mA	
Max. load voltage	AC250V, DC125V	
Off leakage current	0.1 mA (AC220V, 60 Hz)	
Max. On/Off frequency	3,600 times / hour	
Surge absorber	None	
Service life	Mechanical	20 million times or more
	Electrical	Rated load voltage / Current 100,000 times or more
		AC200V / 1.5A, AC240V / 1A (COSΦ = 0.7) 100,000 times or more
		AC200V / 1A, AC240V / 0.5A (COSΦ = 0.35) 100,000 times or more DC24V / 1A, DC100V / 0.1A (L / R = 7 ms) 100,000 times or more
Response time	Off → On	10ms or less
	On → Off	12ms or less
Common method	4 point / COM (COM0~COM8), 8 point / COM (COM4~COM5)	
Proper cable size	Stranded cable 0.3~0.75 mm ² (External diameter 2.8 mm or less)	
Operation indicator	LED On when Output On	
External connection method	30 point terminal block connector (M3 X 6 screw)	
Weight	804g	

Circuit configuration		No.	Contact	No.	Contact	Type
	TB2	PE	TB1	AC100 ~240V	TB1	+
	TB4	COM0	TB3		TB3	PE
	TB6	COM1	TB5	40	TB5	COM0
	TB8	COM2	TB7	41	TB7	COM1
	TB10	43	TB9	42	TB9	COM2
	TB12	COM3	TB11	NC	TB11	COM3
	TB14	45	TB13	44	TB13	COM4
	TB16	47	TB15	46	TB15	COM5
	TB18	COM4	TB17	NC	TB17	COM6
	TB20	49	TB19	48	TB19	COM7
	TB22	4B	TB21	4A	TB21	COM8
	TB24	COM5	TB23	NC	TB23	COM9
	TB26	4D	TB25	4C	TB25	COM10
	TB28	4F	TB27	4E	TB27	COM11
	TB30	COM6	TB29	NC	TB29	COM12
	TB32	51	TB31	50	TB31	COM13
	TB34	53	TB33	52	TB33	COM14
	TB36	COM7	TB35	NC	TB35	COM15
	TB38	55	TB37	54	TB37	COM16
	TB40	57	TB39	56	TB39	COM17
	TB42	24G	TB41	24V	TB41	COM18

7.3.17 XBC-DN20S(U) 8 point transistor output (Sink type)

Model		Main unit				
Specification		XBC-DN20S(U)				
Output point		8 point				
Insulation method		Photo coupler insulation				
Rated load voltage		DC 12 / 24V				
Operation load voltage range		DC 10.2 ~ 26.4V				
Max. load current		0.5A / 1 point, 2A / COMx(x:0~3)				
Off leakage current		0.1 mA or less				
Max. inrush current		4A / 10 ms or less				
Max. voltage drop when On		DC 0.4V or less				
Surge absorber		Zener diode				
Response time	Off → On	1 ms or less				
	On → Off	1 ms or less (rated load, resistive load)				
Common method		4 point / COM				
Proper wire size		Stranded wire 0.3~0.75 mm ² (external diameter 2.8 mm or less)				
External power	Voltage	DC12/24V ± 10% (Ripple voltage 4 Vp-p or less)				
	Current	25 mA or less (When connecting DC24V)				
Operation indicator		LED On when Output On				
External connection method		24 point terminal block connector(M3 X 6 screw)				
Weight		470g				
Circuit configuration						
	No.	Contact	No.	Contact	Type	
	TB2	PE	TB1	AC100 ~240V	TB1	+
	TB4	COM0	TB3		TB3	PE
	TB6	COM1	TB5	40	TB5	COM0
	TB8	COM2	TB7	41	TB7	COM1
	TB10	43	TB9	42	TB9	COM2
	TB12	COM3	TB11	P	TB11	P43
	TB14	45	TB13	44	TB13	COM3
	TB16	47	TB15	46	TB15	P45
	TB18	NC	TB17	NC	TB17	P47
	TB20	NC	TB19	NC	TB19	NC
	TB22	NC	TB21	NC	TB21	NC
	TB24	24G	TB23	24V	TB23	NC
						24V
						+

* The output COM is interconnected inside the product.

7.3.18 XBC-DN30S(U) 12 point transistor output (Sink type)

Model		Main unit
Specification		XBC-DN30S(U)
Output point	12 point	
Insulation method	Photo coupler insulation	
Rated load voltage	DC 12 / 24V	
Operation load voltage range	DC 10.2 ~ 26.4V	
Max. load current	0.5A / 1 point, 2A / COMx(x:0~4)	
Off leakage current	0.1 mA (AC220V, 60 Hz)	
Max. inrush current	4A / 10 ms or less	
Max. voltage drop when On	DC 0.4V or less	
Surge absorber	Zener diode	
Response time	Off → On	1 ms or less
	On → Off	1 ms or less (rated load, resistive load)
Common method	4 point / COM	
Proper wire size	Stranded wire 0.3~0.75 mm ² (external diameter 2.8 mm or less)	
External power	Voltage	DC12/24V ± 10% (Ripple voltage 4 Vp-p or less)
	Current	25 mA or less (When connecting DC24V)
Operation indicator	LED On when Output On	
External connection method	24 point terminal block connector(M3 X 6 screw)	
Weight	475g	

Circuit configuration		No.	Contact	No.	Contact	Type
	TB05			TB1	AC100 ~240V	TB1
	TB04	TB2	PE	TB3		TB3
	TB09	TB4	COM0	TB5	40	TB5
	TB10	TB6	COM1	TB7	41	TB7
	TB08	TB8	COM2	TB9	42	TB9
	TB13	TB10	43	TB11	P	TB11
	TB16	TB12	COM3	TB13	44	TB13
	TB12	TB14	45	TB15	46	TB15
	TB19	TB16	47	TB17	NC	TB17
	TB22	TB18	COM4	TB19	48	TB19
	TB18	TB20	49	TB21	4A	TB21
	TB11	TB22	4B	TB23	24V	TB23
	TB24	24G			TB24	

* The output COM is interconnected inside the product.

7.3.19 XBC-DN40SU 16 point TR output (Sink type)

Model		Main unit					
Specification		XBC-DN40SU					
Output point	16 point						
Insulation method	Photo-coupler insulation						
Rated load voltage	DC 12 / 24V						
Load voltage range	DC 10.2 ~ 26.4V						
Max. load current	0.5A / 1point, 2A / COMx(x:0~5) (P40, P41: 0.1A / 1point)						
Off leakage current	0.1 mA or less						
Max. inrush current	4A / 10 ms or less						
Max. voltage drop when On	DC 0.4V or less						
Surge killer	Zener diode						
Response time	Off → On	1 ms or less					
	On → Off	1 ms or less (rated load, resistive load)					
Common method	4 point / COM						
Proper cable size	Stranded cable 0.3~0.75 mm ² (External diameter 2.8 mm or less)						
External supply power	Voltage	DC12/24V ± 10% (ripple voltage 4 Vp-p or less)					
	Current	25 mA or less (when connecting DC24V)					
Operation indicator	LED On When Output On						
External connection method	30 point terminal block connector (M3 X 6 screw)						
Weight	578g						
Circuit configuration		No.	Contact	No.	Contact	Type	
		TB2	PE	TB1	AC100 ~240V	TB1	
		TB4	COM0	TB3		TB3	
		TB6	COM1	TB5	40	TB5	
		TB8	COM2	TB7	41	TB7	
		TB10	43	TB9	42	TB9	
		TB12	COM3	TB11	P	TB11	
		TB14	45	TB13	44	TB13	
		TB16	47	TB15	46	TB15	
		TB18	COM4	TB17	NC	TB17	
		TB20	49	TB19	48	TB19	
		TB22	4B	TB21	4A	TB21	
		TB24	COM5	TB23	NC	TB23	
		TB26	4D	TB25	4C	TB25	
		TB28	4F	TB27	4E	TB27	
		TB30	24G	TB29	24V	TB29	
				TB1		TB1	
				TB2	PE	TB2	AC100 ~240V
				TB3		TB3	
				TB4	COM0	TB4	P40
				TB5		TB5	P41
				TB6	COM1	TB6	P42
				TB7		TB7	P43
				TB8	COM2	TB8	P44
				TB9		TB9	P45
				TB10	43	TB10	P46
				TB11		TB11	P47
				TB12	COM3	TB12	NC
				TB13		TB13	NC
				TB14	45	TB14	P48
				TB15		TB15	P49
		TB16	47	TB16	P4A		
		TB17		TB17	P4B		
		TB18	COM4	TB18	NC		
		TB19		TB19	NC		
		TB20	49	TB20	P4C		
		TB21		TB21	P4D		
		TB22	4B	TB22	P4E		
		TB23		TB23	24V		
		TB24	COM5	TB24	24G		
		TB25		TB25			
		TB26	4D	TB26			
		TB27		TB27			
		TB28	4F	TB28			
		TB29		TB29			

* The output COM is interconnected inside the product.

7.3.20 XBC-DN60SU 24 point TR output (Sink type)

Model		Main unit						
Specification		XBC-DN60SU						
Output point		24 point						
Insulation method		Photo-coupler insulation						
Rated load voltage		DC 12 / 24V						
Load voltage range		DC 10.2 ~ 26.4V						
Max. load current		0.5A / 1point, 2A / COMx(x:0~7) (P40, P41: 0.1A / 1point)						
Off leakage current		0.1 mA or less						
Max. inrush current		4A / 10 ms or less						
Max. voltage drop when On		DC 0.4V or less						
Surge killer		Zener diode						
Response time	Off → On	1 ms or less						
	On → Off	1 ms or less (rated load, resistive load)						
Common method		4 point / COM						
Proper cable size		Stranded cable 0.3~0.75 mm ² (External diameter 2.8 mm or less)						
External supply power	Voltage	DC12/24V ± 10% (ripple voltage 4 Vp-p or less)						
	Current	25 mA or less (when connecting DC24V)						
Operation indicator		LED On When Output On						
External connection method		42 point terminal block connector (M3 X 6 screw)						
Weight		636g						
Circuit configuration		No.	Contact	No.	Contact	Type		
		TB2	PE	TB1	AC100 ~240V	TB1		
		TB4	COM0	TB3	40	TB3		
		TB6	COM1	TB5	41	TB5		
		TB8	COM2	TB7	42	TB7		
		TB10	43	TB9	P	TB9		
		TB12	COM3	TB11	P	TB11		
		TB14	45	TB13	44	TB13		
		TB16	47	TB15	46	TB15		
		TB18	COM4	TB17	NC	TB17		
		TB20	49	TB19	48	TB19		
		TB22	4B	TB21	4A	TB21		
		TB24	COM5	TB23	NC	TB23		
		TB26	4D	TB25	4C	TB25		
		TB28	4F	TB27	4E	TB27		
		TB30	COM6	TB29	NC	TB29		
		TB32	51	TB31	50	TB31		
		TB34	53	TB33	52	TB33		
		TB36	COM7	TB35	NC	TB35		
		TB38	55	TB37	54	TB37		
		TB40	57	TB39	56	TB39		
		TB42	24G	TB41	24V	TB41		
				TB2	PE	TB2	AC100 ~240V	TB2
				TB4	COM0	TB4	P40	TB4
				TB6	COM1	TB6	P41	TB6
				TB8	COM2	TB8	P42	TB8
				TB10	P43	TB10	P	TB10
				TB12	COM3	TB12	P44	TB12
				TB14	P45	TB14	P46	TB14
				TB16	P47	TB16	NC	TB16
				TB18	COM4	TB18	P48	TB18
				TB20	P49	TB20	P4A	TB20
				TB22	P4B	TB22	NC	TB22
				TB24	COM5	TB24	P4C	TB24
				TB26	P4D	TB26	P4E	TB26
				TB28	P4F	TB28	NC	TB28
				TB30	COM6	TB30	P50	TB30
				TB32	P51	TB32	P52	TB32
				TB34	P53	TB34	NC	TB34
				TB36	COM7	TB36	P54	TB36
				TB38	P55	TB38	P56	TB38
				TB40	P57	TB40	24V	TB40
				TB42	24G	TB42	24V	TB42

* The output COM is interconnected inside the product.

7.3.21 XBC-DP20SU 8 point transistor output (Source type)

Model		Main unit			
Specification		XBC-DP20SU			
Output point	8 point				
Insulation method	Photo coupler insulation				
Rated load voltage	DC 12 / 24V				
Operation load voltage range	DC 10.2 ~ 26.4V				
Max. load current	0.5A / 1point, 2A / COMx(x:0~3) (P40, P41: 0.1A / 1point)				
Off leakage current	0.1 mA or less				
Max. inrush current	4A / 10 ms or less				
Max. voltage drop when On	DC 0.4V or less				
Surge absorber	Zener diode				
Response time	Off → On	1 ms or less			
	On → Off	1 ms or less (rated load, resistive load)			
Common method	4 point / COM				
Proper wire size	Stranded wire 0.3~0.75 mm ² (external diameter 2.8 mm or less)				
External power	Voltage	DC12/24V ± 10% (Ripple voltage 4 Vp-p or less)			
	Current	25 mA or less (When connecting DC24V)			
Operation indicator	LED On when Output On				
External connection method	24 point terminal block connector(M3 X 6 screw)				
Weight	470g				
Circuit configuration					
	No.	Contact	No.	Contact	Type
	TB1	PE	TB1	AC100 ~240V	TB1
	TB2	COM0	TB3	40	TB3
	TB4	COM1	TB5	41	TB5
	TB6	COM2	TB7	42	TB7
	TB8	COM3	TB9	N	TB9
	TB10	43	TB11	44	TB11
	TB12	45	TB13	46	TB13
	TB14	47	TB15	46	TB15
	TB16	NC	TB17	NC	TB17
	TB18	NC	TB19	NC	TB19
	TB20	NC	TB21	NC	TB21
	TB22	NC	TB23	24V	TB23
	TB24	24G			

* The output COM is interconnected inside the product.

7.3.22 XBC-DP30SU 12 point transistor output (Source type)

Specification		Model	Main unit								
			XBC-DP30SU								
Output point		12 point									
Insulation method		Photo coupler insulation									
Rated load voltage		DC 12 / 24V									
Operation load voltage range		DC 10.2 ~ 26.4V									
Max. load current		0.5A / 1point, 2A / COMx(x:0~4) (P40, P41: 0.1A / 1point)									
Off leakage current		0.1 mA (AC220V, 60 Hz)									
Max. inrush current		4A / 10 ms or less									
Max. voltage drop when On		DC 0.4V or less									
Surge absorber		Zener diode									
Response time	Off → On	1 ms or less									
	On → Off	1 ms or less (rated load, resistive load)									
Common method		4 point / COM									
Proper wire size		Stranded wire 0.3~0.75 mm ² (external diameter 2.8 mm or less)									
External power	Voltage	DC12/24V ± 10% (Ripple voltage 4 Vp-p or less)									
	Current	25 mA or less (When connecting DC24V)									
Operation indicator		LED On when Output On									
External connection method		24 point terminal block connector(M3 X 6 screw)									
Weight		475g									
Circuit configuration											
						No.	Contact	No.	Contact	Type	
						TB2	PE	TB1	AC100 ~240V	TB1	+
						TB4	COM0	TB3		TB3	PE
						TB6	COM1	TB5	40	TB5	COM0
						TB8	COM2	TB7	41	TB7	COM1
						TB10	43	TB9	42	TB9	COM2
						TB12	COM3	TB11	P	TB11	P43
						TB14	45	TB13	44	TB13	COM3
						TB16	47	TB15	46	TB15	P45
						TB18	COM4	TB17	NC	TB17	P47
						TB20	49	TB19	48	TB19	COM4
						TB22	4B	TB21	4A	TB21	P49
						TB24	24G	TB23	24V	TB23	P4B
										TB24	24G
											+

* The output COM is interconnected inside the product.

7.3.23 XBC-DP40SU 16 point TR output (Source type)

Model		Main unit
Specification		XBC-DP40SU
Output point		16 point
Insulation method		Photo-coupler insulation
Rated load voltage		DC 12 / 24V
Load voltage range		DC 10.2 ~ 26.4V
Max. load current		0.5A / 1point, 2A / COMx(x:0~5) (P40, P41: 0.1A / 1point)
Off leakage current		0.1 mA or less
Max. inrush current		4A / 10 ms or less
Max. voltage drop when On		DC 0.4V or less
Surge killer		Zener diode
Response time	Off → On	1 ms or less
	On → Off	1 ms or less (rated load, resistive load)
Common method		4 point / COM
Proper cable size		Stranded cable 0.3~0.75 mm ² (External diameter 2.8 mm or less)
External supply power	Voltage	DC12/24V ± 10% (ripple voltage 4 Vp-p or less)
	Current	25 mA or less (when connecting DC24V)
Operation indicator		LED On When Output On
External connection method		30 point terminal block connector (M3 X 6 screw)
Weight		578g

Circuit configuration	No.	Contact	No.	Contact	Type
	TB2	PE	TB1	AC100 ~240V	TB1
	TB4	COM0	TB3		TB3
	TB6	COM1	TB5	40	TB5
	TB8	COM2	TB7	41	TB7
	TB10	43	TB9	42	TB9
	TB12	COM3	TB11	N	TB11
	TB14	45	TB13	44	TB13
	TB16	47	TB15	46	TB15
	TB18	COM4	TB17	NC	TB17
	TB20	49	TB19	48	TB19
	TB22	4B	TB21	4A	TB21
	TB24	COM5	TB23	NC	TB23
	TB26	4D	TB25	4C	TB25
	TB28	4F	TB27	4E	TB27
	TB30	24G	TB29	24V	TB29

* The output COM is interconnected inside the product.

7.3.24 XBC-DP60SU 24 point TR output (Source type)

Model		Main unit
Specification		XBC-DP60SU
Output point		24 point
Insulation method		Photo-coupler insulation
Rated load voltage		DC 12 / 24V
Load voltage range		DC 10.2 ~ 26.4V
Max. load current		0.5A / 1point, 2A / COMx(x:0~7) (P40, P41: 0.1A / 1point)
Off leakage current		0.1 mA or less
Max. inrush current		4A / 10 ms or less
Max. voltage drop when On		DC 0.4V or less
Surge killer		Zener diode
Response time	Off → On	1 ms or less
	On → Off	1 ms or less (rated load, resistive load)
Common method		4 point / COM
Proper cable size		Stranded cable 0.3~0.75 mm ² (External diameter 2.8 mm or less)
External supply power	Voltage	DC12/24V ± 10% (ripple voltage 4 Vp-p or less)
	Current	25 mA or less (when connecting DC24V)
Operation indicator		LED On When Output On
External connection method		42 point terminal block connector (M3 X 6 screw)
Weight		636g

Circuit configuration		No.	Contact	No.	Contact	Type
		TB2	PE	TB1	AC100 ~240V	TB1
		TB4	COM0	TB3		TB3
		TB6	COM1	TB5	40	TB5
		TB8	COM2	TB7	41	TB7
		TB10	43	TB9	42	TB9
		TB12	COM3	TB11	N	TB11
		TB14	45	TB13	44	TB13
		TB16	47	TB15	46	TB15
		TB18	COM4	TB17	NC	TB17
		TB20	49	TB19	48	TB19
		TB22	4B	TB21	4A	TB21
		TB24	COM5	TB23	NC	TB23
		TB26	4D	TB25	4C	TB25
		TB28	4F	TB27	4E	TB27
		TB30	COM6	TB29	NC	TB29
		TB32	51	TB31	50	TB31
		TB34	53	TB33	52	TB33
		TB36	COM7	TB35	NC	TB35
		TB38	55	TB37	54	TB37
		TB40	57	TB39	56	TB39
		TB42	24G	TB41	24V	TB41

* The output COM is interconnected inside the product.

7.4 Digital Input Module Specification

7.4.1 8 point DC24V input module (Source/Sink type)

Model		DC input module		
Specification		XBE-DC08A		
Input point		8 point		
Insulation method		Photo coupler insulation		
Rated input voltage		DC24V		
Rated input current		About 4 mA		
Operation voltage range		DC20.4~28.8V (ripple rate < 5%)		
On Voltage/Current		DC19V or higher / 3 mA or higher		
Off Voltage/Current		DC6V or less / 1 mA or less		
Input resistance		About 5.6 kΩ		
Response time	Off → On	1/3/5/10/20/70/100 ms (set by CPU parameter) Default: 3 ms		
	On → Off			
Insulation pressure		AC560Vrms / 3Cycle (altitude 2000m)		
Insulation resistance		10 MΩ or more by Megohmmeter		
Common method		8 point / COM		
Proper cable size		Stranded pair 0.3~0.75 mm ² (External diameter 2.8 mm or less)		
Current consumption		30 mA (when all point On)		
Operation indicator		Input On, LED On		
External connection method		10 point terminal block connector		
Weight		52 g		
Circuit configuration		No.	Contact	Type
		TB2	0	
		TB2	1	
		TB3	2	
		TB4	3	
		TB5	4	
		TB6	5	
		TB7	6	
		TB8	7	
		TB9	COM	
		TB10	COM	

7.4.2 16 point DC24V input module (Sink/Source type)

Model		DC input module		
Specification		XBE-DC16A	XBE-DC16B	
Input point		16 point		
Insulation method		Photo coupler insulation		
Rated input voltage		DC24V	DC12/24V	
Rated input current		About 4 mA	About 4/8 mA	
Operation voltage range		DC20.4~28.8V (ripple rate < 5%)	DC9.5~30V (ripple rate < 5%)	
On Voltage/Current		DC19V or higher / 3 mA or higher	DC9V or higher / 3 mA or higher	
Off Voltage/Current		DC6V or less / 1 mA or less	DC5V or less / 1 mA or less	
Input resistance		About 5.6 kΩ	About 2.7 kΩ	
Response time	Off → On	1/3/5/10/20/70/100 ms (set by CPU parameter) Default: 3 ms		
	On → Off			
Insulation pressure		AC560Vrms / 3Cycle (altitude 2000m)		
Insulation resistance		10 MΩ or more by Megohmmeter		
Common method		16 point / COM		
Proper cable size		Stranded cable 0.3~0.75 mm ² (External diameter 2.8 mm or less)		
Current consumption		40 mA (when all point On)		
Operation indicator		Input On, LED On		
External connection method		8 pin terminal block connector + 10 pin terminal block connector		
Weight		53 g		
Circuit configuration		No.	Contact	Type
		TB1	0	
		TB2	1	
		TB3	2	
		TB4	3	
		TB5	4	
		TB6	5	
		TB7	6	
		TB8	7	
		TB1	8	
		TB2	9	
TB3	A			
TB4	B			
TB5	C			
TB6	D			
TB7	E			
TB8	F			
TB9	COM			
TB10	COM			

7.4.3 32 point DC24V input module (Source/Sink type)

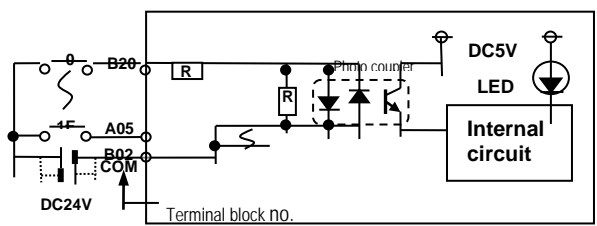
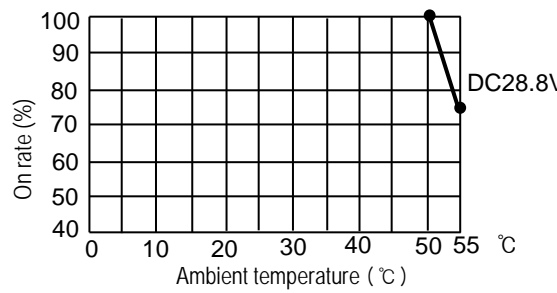
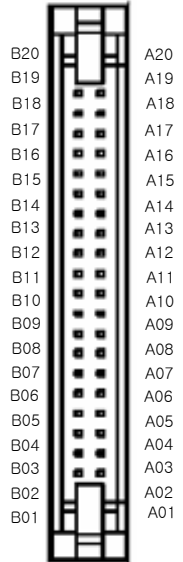
Model		DC input module				
Specification		XBE-DC32A				
Input point		32 point				
Insulation method		Photo coupler insulation				
Rated input voltage		DC24V				
Rated input current		About 4 mA				
Operation voltage range		DC20.4~28.8V (ripple rate < 5%)				
Input Derating		Refer to Derating diagram				
On Voltage/Current		DC 19V or higher / 3 mA or higher				
Off Voltage/Current		DC 6V or less / 1 mA or less				
Input resistance		About 5.6 kΩ				
Response time	Off → On	1/3/5/10/20/70/100 ms (set by CPU parameter) Default:3 ms				
	On → Off					
Insulation pressure		AC 560Vrms / 3 Cycle (altitude 2000m)				
Insulation resistance		10 MΩ or more by Megohmmeter				
Common method		32 point / COM				
Proper cable size		0.3 mm ²				
Current consumption		50 mA (when all point On)				
Operation indicator		Input On, LED On				
External connection method		40 pin connector				
Weight		60g				
Circuit configuration		No.	Contact	No.	Contact	Type
 <p>Input Derating diagram</p> 		B20	00	A20	10	
		B19	01	A19	11	
		B18	02	A18	12	
		B17	03	A17	13	
		B16	04	A16	14	
		B15	05	A15	15	
		B14	06	A14	16	
		B13	07	A13	17	
		B12	08	A12	18	
		B11	09	A11	19	
		B10	0A	A10	1A	
		B09	0B	A09	1B	
		B08	0C	A08	1C	
		B07	0D	A07	1D	
		B06	0E	A06	1E	
		B05	0F	A05	1F	
		B04	NC	A04	NC	
B03	NC	A03	NC			
B02	COM	A02	COM			
B01	COM	A01	COM			

7.4.4 8 point AC110V input module

Model		AC input module
Specification		XBE-AC08A
Input point	8 point	
Insulation method	Photo coupler insulation	
Rated input voltage	AC100-120V(+10/-15%) 50/60 Hz(±3 Hz) (distortion rate < 5%)	
Rated input current	About 8 mA(AC100,60 Hz), About 7mA(AC100, 50 Hz)	
Inrush current	Max. 200 mA 1 ms (AC132V)	
Input Derating	Refer to the below Derating diagram.	
On Voltage/Current	AC80V or higher / 5 mA or higher (50 Hz, 60 Hz)	
Off Voltage/Current	AC30V or lower / 1 mA or lower (50 Hz, 60 Hz)	
Input resistance	About 12 kΩ(60 Hz), About 15 kΩ(50 Hz)	
Response time	Off → On	20 ms or less (AC100V 50 Hz, 60 Hz)
	On → Off	25 ms or less (AC100V 50 Hz, 60 Hz)
Insulation pressure	AC3000Vrms / 3Cycle (altitude 2000m)	
Insulation resistance	10 MΩ or more by Megohmmeter	
Common method	4 point / COM	
Proper cable size	Twisted pair 0.3~0.75 mm ² (external diameter 2.8mm or less)	
Current consumption	30 mA (when all point On)	
Operation indicator	Input On, LED On	
External connection method	10 point terminal block connector	
Weight	70 g	

Circuit configuration	No.	Contact	Type
	TB1	0	
	TB2	1	
	TB3	2	
	TB4	3	
	TB5	COM0	
	TB6	4	
	TB7	5	
	TB8	6	
	TB9	7	
	TB10	COM1	

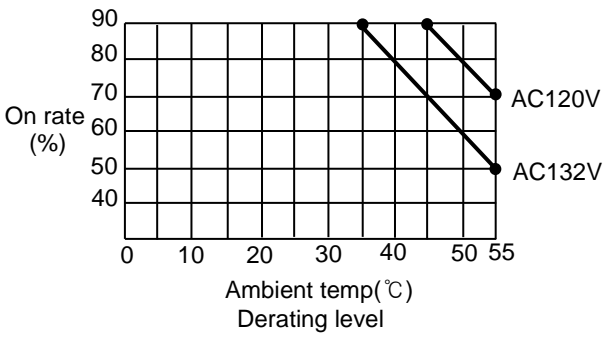

7.5 Digital Output Module Specification

7.5.1 8 point relay output module

Model		Relay output module		
Specification		XBE-RY08A		
Output point		8 point		
Insulation method		Relay insulation		
Rated load voltage / Current		DC24V 2A (Resistive load) / AC220V 2A (COSΨ = 1), 5A/COM		
Min. load voltage/Current		DC5V / 1 mA		
Max. load voltage/Current		AC250V, DC125V		
Off leakage current		0.1 mA (AC220V, 60 Hz)		
Max. On/Off frequency		3,600 times/hr		
Surge absorber		None		
Service life	Mechanical	20 millions times or more		
	Electrical	Rated load voltage / current 100,000 times or more		
		AC200V / 1.5A, AC240V / 1A (COSΨ = 0.7) 100,000 times or more		
		AC200V / 1A, AC240V / 0.5A (COSΨ = 0.35) 100,000 times or more		
		DC24V / 1A, DC100V / 0.1A (L / R = 7 ms) 100,000 times or more		
Response time	Off → On	10 ms or less		
	On → Off	12 ms or less		
Common method		8 point / COM		
Proper cable size		Stranded cable 0.3~0.75 mm ² (External diameter 2.8 mm or less)		
Current consumption		230 mA (when all point On)		
Operation indicator		Output On, LED On		
External connection method		9 point terminal block connector		
Weight		80g		
Circuit configuration		No.	Contact	Type
		TB1	0	
		TB2	1	
		TB3	2	
		TB4	3	
		TB5	4	
		TB6	5	
		TB7	6	
		TB8	7	
		TB9	COM	

7.5.2 8 point relay output module (Independent point)

Model		Relay output module		
Specification		XBE-RY08B		
Output point		8 point		
Insulation method		Relay insulation		
Rated load voltage / Current		DC24V 2A (Resistive load) / AC220V 2A (COSΨ = 1), 2A/COM		
Min. load voltage/Current		DC5V / 1 mA		
Max. load voltage/Current		AC250V, DC125V		
Off leakage current		0.1 mA (AC220V, 60 Hz)		
Max. On/Off frequency		3,600 times/hr		
Surge absorber		None		
Service life	Mechanical	20 millions times or more		
	Electrical	Rated load voltage / current 100,000 times or more		
		AC200V / 1.5A, AC240V / 1A (COSΨ = 0.7) 100,000 times or more		
		AC200V / 1A, AC240V / 0.5A (COSΨ = 0.35) 100,000 times or more		
DC24V / 1A, DC100V / 0.1A (L / R = 7 ms) 100,000 times or more				
Response time	Off → On	10 ms or less		
	On → Off	12 ms or less		
Common method		1 point / COM		
Proper cable size		Stranded cable 0.3~0.75 mm ² (External diameter 2.8 mm or less)		
Current consumption		230 mA (when all point On)		
Operation indicator		Output On, LED On		
External connection method		9 point terminal block connector x 2		
Weight		81g		
Circuit configuration				
		No.	configu ration	No.
		TB1	0	TB1
		TB2	COM0	TB2
		TB3	1	TB3
		TB4	COM1	TB4
		TB5	2	TB5
		TB6	COM2	TB6
		TB7	3	TB7
		TB8	COM3	TB8
		TB9	NC	TB9
		TB1	4	TB1
		TB2	COM4	TB2
		TB3	5	TB3
		TB4	COM5	TB4
		TB5	6	TB5
		TB6	COM6	TB6
		TB7	7	TB7
		TB8	COM7	TB8
		TB9	NC	TB9

7.5.3 16 point relay output module

Specification		Model	Relay output module				
			XBE-RY16A				
Output point		16 point					
Insulation method		Relay insulation					
Rated load voltage/ current		DC24V 2A (Resistive load) / AC220V 2A (COSΨ = 1), 5A/COM					
Min. load voltage/current		DC5V / 1 mA					
Max. load voltage/current		AC250V, DC125V					
Off leakage current		0.1 mA (AC220V, 60 Hz)					
Max. On/Off frequency		3,600 times/hr					
Surge absorber		None					
Service life	Mechanical	20 millions times or more					
	Electrical	Rated load voltage / current 100,000 times or more					
		AC200V / 1.5A, AC240V / 1A (COSΨ = 0.7) 100,000 times or more					
		AC200V / 1A, AC240V / 0.5A (COSΨ = 0.35) 100,000 times or more					
		DC24V / 1A, DC100V / 0.1A (L / R = 7 ms) 100,000 times or more					
Response time	Off → On	10 ms or less					
	On → Off	12 ms or less					
Common method		8 point / COM					
Proper cable size		Stranded cable 0.3~0.75 mm ² (External diameter 2.8 mm or less)					
Current consumption		420 mA (when all point On)					
Operation indicator		Output On, LED On					
External connection method		9 point terminal block connector x 2 ea					
Weight		130g					
Circuit configuration					No.	Contact	Type
					TB1	0	
					TB2	1	
					TB3	2	
					TB4	3	
					TB5	4	
					TB6	5	
					TB7	6	
					TB8	7	
					TB9	COM	
					TB1	8	
					TB2	9	
					TB3	A	
					TB4	B	
					TB5	C	
					TB6	D	
					TB7	E	
					TB8	F	
					TB9	COM	

7.5.4 8 point transistor output module (Sink type)

Model		Transistor output module		
Specification		XBE-TN08A		
Output point		8 point		
Insulation method		Photo coupler insulation		
Rated load voltage		DC 12 / 24V		
Load voltage range		DC 10.2 ~ 26.4V		
Max. load voltage		0.5A / 1 point		
Off leakage current		0.1 mA or less		
Max. inrush current		4A / 10 ms or less		
Max. voltage drop (On)		DC 0.4V or less		
Surge absorber		Zener Diode		
Response time	Off → On	1 ms or less		
	On → Off	1 ms or less (Rated load, resistive load)		
Common method		8 point / COM		
Proper cable size		Stranded cable 0.3~0.75 mm ² (External diameter 2.8 mm or less)		
Current consumption		40 mA (when all point On)		
External power supply	Voltage	DC12/24V ± 10% (ripple voltage 4 Vp-p or less)		
	Current	10 mA or less (DC24V connection)		
Operation indicator		Output On, LED On		
External connection method		10 point terminal block connector		
Weight		53		
Circuit configuration				
		No.	Contact	Type
		TB01	0	
		TB02	1	
		TB03	2	
		TB04	3	
		TB05	4	
		TB06	5	
		TB07	6	
		TB08	7	
		TB09	DC12 /24V	
TB10	COM			

7.5.5 16 point transistor output module (Sink type)

Model		Transistor output module		
Specification		XBE-TN16A		
Output point		16 point		
Insulation method		Photo coupler insulation		
Rated load voltage		DC 12 / 24V		
Load voltage range		DC 10.2 ~ 26.4V		
Max. load voltage		0.5A / 1 point, 2A / 1COM		
Off leakage current		0.1 mA or less		
Max. inrush current		4A / 10 ms or less		
Max. voltage drop (On)		DC 0.4V or less		
Surge absorber		Zener Diode		
Response time	Off → On	1 ms or less		
	On → Off	1 ms or less (Rated load, resistive load)		
Common method		16 point / COM		
Proper cable size		Stranded cable 0.3~0.75 mm ² (External diameter 2.8 mm or less)		
Current consumption		60 mA (when all point On)		
External power supply	Voltage	DC12/24V ± 10% (ripple voltage 4 Vp-p or less)		
	Current	10 mA or less (DC24V connection)		
Operation indicator		Output On, LED On		
External connection method		8 pin terminal block connector + 10 pin terminal block connector		
Weight		54 g		
Circuit configuration				
		No.	Contact	Type
		TB01	0	
		TB02	1	
		TB03	2	
		TB04	3	
		TB05	4	
		TB06	5	
		TB07	6	
		TB08	7	
		TB01	8	
		TB02	9	
		TB03	A	
		TB04	B	
		TB05	C	
		TB06	D	
		TB07	E	
TB08	F			
TB09	DC12 /24V	TB09		
TB10	COM	TB10		

7.5.6 32 point transistor output module (Sink type)

Model		Transistor output module																																																																																							
		XBE-TN32A																																																																																							
Specification																																																																																									
Output point		32 point																																																																																							
Insulation method		Photo coupler insulation																																																																																							
Rated load voltage		DC 12 / 24V																																																																																							
Load voltage range		DC 10.2 ~ 26.4V																																																																																							
Max. load voltage		0.2A / 1 point, 2A / 1COM																																																																																							
Off leakage current		0.1 mA or less																																																																																							
Max. inrush current		0.7A / 10 ms or less																																																																																							
Max. voltage drop (On)		DC 0.4V or less																																																																																							
Surge absorber		Zener Diode																																																																																							
Response time	Off → On	1 ms or less																																																																																							
	On → Off	1 ms or less (Rated load, resistive load)																																																																																							
Common method		32 point / COM																																																																																							
Proper cable size		0.3 mm ²																																																																																							
Current consumption		120 mA (when all point On)																																																																																							
External power supply	Voltage	DC12/24V ± 10% (ripple voltage 4 Vp-p or less)																																																																																							
	Current	20 mA or less (DC24V connection)																																																																																							
Operation indicator		Output On, LED On																																																																																							
External connection method		40 pin connector																																																																																							
Weight		60g																																																																																							
Circuit configuration					Type																																																																																				
					<table border="1"> <thead> <tr> <th>No.</th> <th>Contact</th> <th>No.</th> <th>Contact</th> </tr> </thead> <tbody> <tr><td>B20</td><td>00</td><td>A20</td><td>10</td></tr> <tr><td>B19</td><td>01</td><td>A19</td><td>11</td></tr> <tr><td>B18</td><td>02</td><td>A18</td><td>12</td></tr> <tr><td>B17</td><td>03</td><td>A17</td><td>13</td></tr> <tr><td>B16</td><td>04</td><td>A16</td><td>14</td></tr> <tr><td>B15</td><td>05</td><td>A15</td><td>15</td></tr> <tr><td>B14</td><td>06</td><td>A14</td><td>16</td></tr> <tr><td>B13</td><td>07</td><td>A13</td><td>17</td></tr> <tr><td>B12</td><td>08</td><td>A12</td><td>18</td></tr> <tr><td>B11</td><td>09</td><td>A11</td><td>19</td></tr> <tr><td>B10</td><td>0A</td><td>A10</td><td>1A</td></tr> <tr><td>B09</td><td>0B</td><td>A09</td><td>1B</td></tr> <tr><td>B08</td><td>0C</td><td>A08</td><td>1C</td></tr> <tr><td>B07</td><td>0D</td><td>A07</td><td>1D</td></tr> <tr><td>B06</td><td>0E</td><td>A06</td><td>1E</td></tr> <tr><td>B05</td><td>0F</td><td>A05</td><td>1F</td></tr> <tr><td>B04</td><td>NC</td><td>A04</td><td>NC</td></tr> <tr><td>B03</td><td>NC</td><td>A03</td><td>NC</td></tr> <tr><td>B02</td><td>DC12/24V</td><td>A02</td><td>COM</td></tr> <tr><td>B01</td><td></td><td>A01</td><td></td></tr> </tbody> </table>	No.	Contact	No.	Contact	B20	00	A20	10	B19	01	A19	11	B18	02	A18	12	B17	03	A17	13	B16	04	A16	14	B15	05	A15	15	B14	06	A14	16	B13	07	A13	17	B12	08	A12	18	B11	09	A11	19	B10	0A	A10	1A	B09	0B	A09	1B	B08	0C	A08	1C	B07	0D	A07	1D	B06	0E	A06	1E	B05	0F	A05	1F	B04	NC	A04	NC	B03	NC	A03	NC	B02	DC12/24V	A02	COM	B01		A01	
No.	Contact	No.	Contact																																																																																						
B20	00	A20	10																																																																																						
B19	01	A19	11																																																																																						
B18	02	A18	12																																																																																						
B17	03	A17	13																																																																																						
B16	04	A16	14																																																																																						
B15	05	A15	15																																																																																						
B14	06	A14	16																																																																																						
B13	07	A13	17																																																																																						
B12	08	A12	18																																																																																						
B11	09	A11	19																																																																																						
B10	0A	A10	1A																																																																																						
B09	0B	A09	1B																																																																																						
B08	0C	A08	1C																																																																																						
B07	0D	A07	1D																																																																																						
B06	0E	A06	1E																																																																																						
B05	0F	A05	1F																																																																																						
B04	NC	A04	NC																																																																																						
B03	NC	A03	NC																																																																																						
B02	DC12/24V	A02	COM																																																																																						
B01		A01																																																																																							

7.5.7 8 point transistor output module (Source type)

Specification		Model	Transistor output module				
			XBE-TP08A				
Output point		8 point					
Insulation method		Photo coupler insulation					
Rated load voltage		DC 12 / 24V					
Load voltage range		DC 10.2 ~ 26.4V					
Max. load voltage		0.5A / 1 point					
Off leakage current		0.1 mA or less					
Max. inrush current		4A / 10 ms or less					
Max. voltage drop (On)		DC 0.4V or less					
Surge absorber		Zener Diode					
Response time	Off → On	1 ms or less					
	On → Off	1 ms or less (Rated load, resistive load)					
Common method		8 point / COM					
Proper cable size		Stranded cable 0.3~0.75 mm ² (external diameter 2.8 mm or less)					
Current consumption		40 mA (when all outputs are on)					
External power	Voltage	DC12/24V ± 10% (ripple voltage 4 Vp-p or less)					
	Current	10 mA or less (when connecting DC24V)					
Operation indicator		LED on when output on					
External connection method		10 pin terminal block connector					
Weight		30g					
Circuit configuration					No.	Contact	Type
					TB01	0	
					TB02	1	
					TB03	2	
					TB04	3	
					TB05	4	
					TB06	5	
					TB07	6	
					TB08	7	
					TB09	COM	
					TB10	0V	

7.5.8 16 point transistor output module (Source type)

Specification		Model	Transistor output module				
			XBE-TP16A				
Output point		16 point					
Insulation method		Photo coupler insulation					
Rated load voltage		DC 12 / 24V					
Load voltage range		DC 10.2 ~ 26.4V					
Max. load voltage		0.5A / 1 point, 2A / 1COM					
Off leakage current		0.1 mA or less					
Max. inrush current		4A / 10 ms or less					
Max. voltage drop (On)		DC 0.4V or less					
Surge absorber		Zener Diode					
Response time	Off → On	1 ms or less					
	On → Off	1 ms or less (Rated load, resistive load)					
Common method		16 point / COM					
Proper cable size		Stranded cable 0.3~0.75 mm ² (external diameter 2.8 mm or less)					
Current consumption		60 mA (When all outputs are on)					
External power	Voltage	DC12/24V ± 10% (ripple voltage 4 Vp-p or less)					
	Current	10 mA or less (connecting DC24V)					
Operation indicator		LED On when output On					
External connection method		8 pin terminal block connector + 10 pin terminal block connector					
Weight		40g					
Circuit configuration					No.	Contact	Type
					TB01	0	TB01
					TB02	1	TB02
					TB03	2	TB03
					TB04	3	TB04
					TB05	4	TB05
					TB06	5	TB06
					TB07	6	TB07
					TB08	7	TB08
					TB01	8	TB01
					TB02	9	TB02
					TB03	A	TB03
					TB04	B	TB04
					TB05	C	TB05
					TB06	D	TB06
					TB07	E	TB07
					TB08	F	TB08
					TB09	COM	TB09
					TB10	0V	TB10

7.5.9 32 point transistor output module (Source type)

Model		Transistor output module						
Specification		XBE-TP32A						
Output point		32 point						
Insulation method		Photo coupler insulation						
Rated load voltage		DC 12 / 24V						
Load voltage range		DC 10.2 ~ 26.4V						
Max. load voltage		0.2A / 1 point, 2A / 1COM						
Off leakage current		0.1 mA or less						
Max. inrush current		4A / 10 ms or less						
Max. voltage drop (On)		DC 0.4V or less						
Surge absorber		Zener Diode						
Response time	Off → On	1 ms or less						
	On → Off	1 ms or less (Rated load, resistive load)						
Common method		32 point / COM						
Proper cable size		0.3 mm ²						
Current consumption		120 mA (When all outputs are on)						
External power	Voltage	DC12/24V ± 10% (ripple voltage 4 Vp-p or less)						
	Current	20 mA or less (connecting DC24V)						
Operation indicator		LED On when output On						
External connection method		40 pin connector						
Weight		60g						
Circuit configuration					Type			
					No.	Contact	No.	Contact
					B20	00	A20	10
					B19	01	A19	11
					B18	02	A18	12
					B17	03	A17	13
					B16	04	A16	14
					B15	05	A15	15
					B14	06	A14	16
					B13	07	A13	17
					B12	08	A12	18
					B11	09	A11	19
					B10	0A	A10	1A
					B09	0B	A09	1B
					B08	0C	A08	1C
					B07	0D	A07	1D
					B06	0E	A06	1E
					B05	0F	A05	1F
B04	NC	A04	NC					
B03	NC	A03	NC					
B02	COM	A02	0V					
B01		A01						

7.6 Combined Digital I/O module Input Specification

7.6.1 8 point DC24V input (Source/Sink type)

Model		DC input module		
Specification		XBE-DR16A		
Input point		8 point		
Insulation method		Photo coupler insulation		
Rated input voltage		DC24V		
Rated input current		About 4 mA		
Operation voltage range		DC20.4~28.8V (within ripple rate 5%)		
On Voltage/Current		DC19V or higher / 3 mA or higher		
Off Voltage/Current		DC6V or less / 1 mA or less		
Input resistance		About 5.6 kΩ		
Response time	Off → On	1/3/5/10/20/70/100 ms (set by CPU parameter) Default: 3 ms		
	On → Off			
Insulation pressure		AC560Vrms / 3Cycle (altitude 2000m)		
Insulation resistance		10 MΩ or more by Megohmmeter		
Common method		8 point / COM		
Proper cable size		Stranded cable 0.3~0.75 mm ² (External diameter 2.8 mm or less)		
Current consumption		280 mA (When all inputs and outputs are on)		
Operation indicator		LED on when input on		
External connection method		9 pin terminal block connector		
Weight		81g		
Circuit configuration		No.	Contact	Type
<p>Terminal block no.</p>		TB1	0	
		TB2	1	
		TB3	2	
		TB4	3	
		TB5	4	
		TB6	5	
		TB7	6	
		TB8	7	
		TB9	COM	

7.6.2 16 point DC24V input (Source/Sink type)

Model		DC input module				
Specification		XBE-DN32A				
Input point		16 point				
Insulation method		Photo coupler insulation				
Rated input voltage		DC24V				
Rated input current		About 4 mA				
Operation voltage range		DC20.4~28.8V (ripple rate < 5%)				
Input Derating		Refer to Derating diagram				
On Voltage/Current		DC 19V or higher / 3 mA or higher				
Off Voltage/Current		DC 6V or less / 1 mA or less				
Input resistance		About 5.6 kΩ				
Response time	Off → On	1/3/5/10/20/70/100 ms (set by CPU parameter) Default:3 ms				
	On → Off					
Insulation pressure		AC 560Vrms / 3 Cycle (altitude 2000m)				
Insulation resistance		10 MΩ or more by Megohmmeter				
Common method		16 point / COM				
Proper cable size		0.3 mm ²				
Current consumption		60 mA (When all inputs and outputs are on)				
Operation indicator		Input On, LED On				
External connection method		40 pin connector				
Weight		60g				
Circuit configuration		No.	Contact	No.	Contact	Type
		B20	00	A20	20	
		B19	01	A19	21	
		B18	02	A18	22	
		B17	03	A17	23	
		B16	04	A16	24	
		B15	05	A15	25	
		B14	06	A14	26	
		B13	07	A13	27	
		B12	08	A12	28	
		B11	09	A11	29	
		B10	0A	A10	2A	
		B09	0B	A09	2B	
		B08	0C	A08	2C	
		B07	0D	A07	2D	
		B06	0E	A06	2E	
		B05	0F	A05	2F	
B04	NC	A04	P			
B03	NC	A03	P			
B02	IN_COM	A02	OUT_COM			
B01	IN_COM	A01	OUT_COM			

7.7 Combined Digital I/O module Output Specification

7.7.1 8 point relay output

Model		Relay output module				
Specification		XBE-DR16A				
Output point		8 point				
Insulation method		Relay insulation				
Rated load voltage / Current		DC24V 2A(Resistive load) / AC220V 2A(COSΨ = 1), 5A/COM				
Min. load voltage/Current		DC5V / 1 mA				
Max. load voltage		AC250V, DC125V				
Off leakage current		0.1 mA (AC220V, 60 Hz)				
Max. On/Off frequency		3,600 times/hr				
Surge absorber		None				
Service life	Mechanical	20 millions times or more				
	Electrical	Rated load voltage / current 100,000 times or more				
		AC200V / 1.5A, AC240V / 1A (COSΨ = 0.7) 100,000 times or more				
		AC200V / 1A, AC240V / 0.5A (COSΨ = 0.35) 100,000 times or more				
DC24V / 1A, DC100V / 0.1A (L / R = 7 ms) 100,000 times or more						
Response time	Off → On	10 ms or less				
	On → Off	12 ms or less				
Common method		8 point / COM				
Proper cable size		Stranded cable 0.3~0.75 mm ² (external diameter 2.8 mm or less)				
Current consumption		280 mA (When all inputs and outputs are on)				
Operation indicator		LED on when output on				
External connection method		9 pin terminal block connector				
Weight		81g				
Circuit configuration				No.	Contact	Type
				TB1	0	
				TB2	1	
				TB3	2	
				TB4	3	
				TB5	4	
				TB6	5	
				TB7	6	
				TB8	7	
				TB9	COM	

7.7.2 16 point transistor output (Sink type)

Specification	Model	Transistor output module				
		XBE-DN32A				
Output point	16 point					
Insulation method	Photo coupler insulation					
Rated load voltage	DC 12 / 24V					
Load voltage range	DC 10.2 ~ 26.4V					
Max. load voltage	0.2A / 1 point, 2A / 1COM					
Off leakage current	0.1 mA or less					
Max. inrush current	0.7A / 10 ms or less					
Max. voltage drop (On)	DC 0.4V or less					
Surge absorber	TVS Diode					
Response time	Off → On	1 ms or less				
	On → Off	1 ms or less (Rated load, resistive load)				
Common method	16 point / COM					
Proper cable size	0.3 mm ²					
Current consumption	60 mA (When all inputs and outputs are on)					
External power supply	Voltage	DC12/24V ± 10% (ripple voltage 4 Vp-p or less)				
	Current	20 mA or less (DC24V connection)				
Operation indicator	Output On, LED On					
External connection method	40 pin connector					
Weight	60g					
Circuit configuration		No.	Contact	No.	Contact	Type
		B20	00	A20	20	
		B19	01	A19	21	
		B18	02	A18	22	
		B17	03	A17	23	
		B16	04	A16	24	
		B15	05	A15	25	
		B14	06	A14	26	
		B13	07	A13	27	
		B12	08	A12	28	
		B11	09	A11	29	
		B10	0A	A10	2A	
		B09	0B	A09	2B	
		B08	0C	A08	2C	
		B07	0D	A07	2D	
		B06	0E	A06	2E	
		B05	0F	A05	2F	
B04	NC	A04	P			
B03	NC	A03	P			
B02	IN_COM	A02	OUT_COM			
B01	IN_COM	A01	OUT_COM			

7.8 IO Wiring by Using Smart Link Board

7.8.1 Smart link board

Easy wiring is available by connecting the IO connector with smart link board. The available smart link and IO cable are as follows.

XGB		Smart link		Connection cable		
Item	Model	Model	No. of Pin	Model	Length	Contents
Main unit	XBM-DN32S	SLP-T40P	40	SLT-CT101-XBM	1m	For main unit connection (20Pin + 20Pin)
	XBM-DN16S					
Expansion module	XBE-DC32A	SLP-T40P	40	SLT-CT101-XBE	1m	For expansion module connection (40Pin)
	XBE-TN32A	SLP-T40P	40	SLT-CT101-XBE	1m	
			SLP-RY4A	40	SLP-CT101-XBE	1m

It describes wiring of XGB, SLP-T40P and SLT-CT101-XBM. For wiring of other smart link boards or XGB extension module, refer to XGB user manual for hardware.

1) SLT-T40P terminal array

Terminal array of SLP-T40P is as follows.

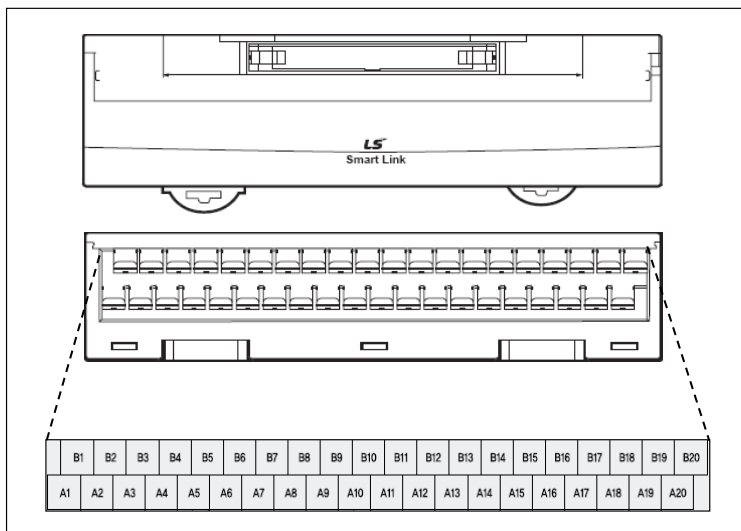

Item	Specification
Rated voltage	AC/DC 125[V]
Rated current	Max. 1[A]
Withstanding voltage	600V 1min
Insulation resistor	100 MΩ (DC500V)
Cable specification	1.25[mm ²] or below
Terminal/screw	M3 X 8L
Torque	6.2 kgf.cm or above
Terminal material	PBT, UL94V-0
Weight	186g

2) Wiring of SLT-T40P and XGB extension module

Wiring of XGB extension module through SLP-T40P and SLT-CT101-XBE is as follows.

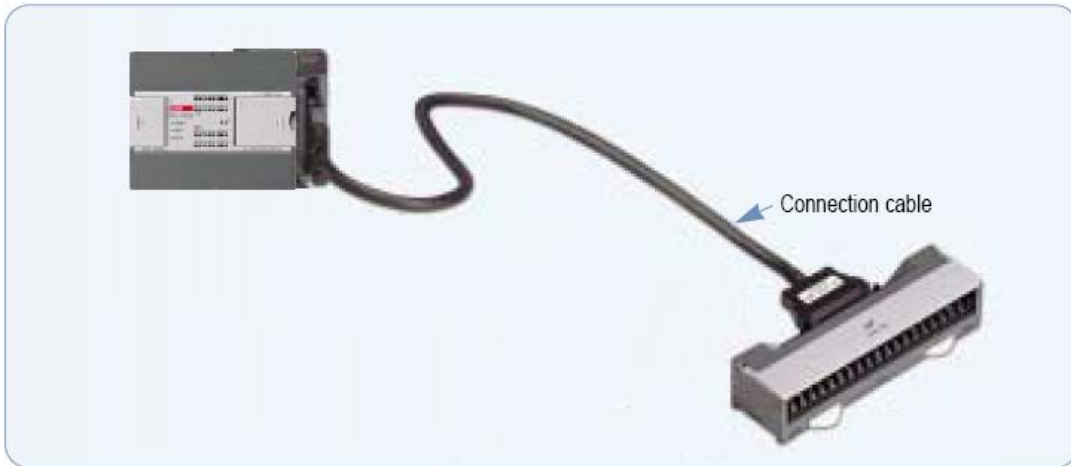

At this time, relationship of XGB IO signal and Smart link board terminal number is as follows. The following figure describes signal allocation when SLT-CT101-XBE is used as connection cable. When the user makes the cable, make sure that wiring is done as figure below.

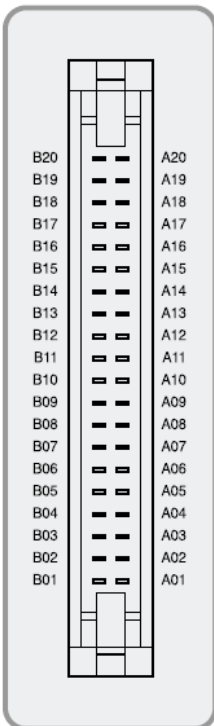

Pin No.	PLC								Terminal block Name	
	XBE-DC32A		XBE-TN32A		XBE-TP32A		Terminal block board (SLP-T40P)			
B20	A20	00	10	00	10	00	10	A1	A11	
B19	A19	01	11	01	11	01	11	B1	B11	
B18	A18	02	12	02	12	02	12	A2	A12	
B17	A17	03	13	03	13	03	13	B2	B12	
B16	A16	04	14	04	14	04	14	A3	A13	
B15	A15	05	15	05	15	05	15	B3	B13	
B14	A14	06	16	06	16	06	16	A4	A14	
B13	A13	07	17	07	17	07	17	B4	B14	
B12	A12	08	18	08	18	08	18	A5	A15	
B11	A11	09	19	09	19	09	19	B5	B15	
B10	A10	0A	1A	0A	1A	0A	1A	A6	A16	
B09	A09	0B	1B	0B	1B	0B	1B	B6	B16	
B09	A08	0C	1C	0C	1C	0C	1C	A7	A17	
B07	A07	0D	1D	0D	1D	0D	1D	B7	B17	
B06	A06	0E	1E	0E	1E	0E	1E	A8	A18	
B05	A05	0F	1F	0F	1F	0F	1F	B8	B18	
B04	A04	NC	NC	NC	NC	NC	NC	A9	A19	
B03	A03	NC	NC	NC	NC	NC	NC	B9	B19	
B02	A02	COM	COM	DC12/24V	COM	COM	DC0V	A10	A20	
B01	A01							B10	B20	

Chapter 7. Input/Output Specifications

3) I/O wiring

- XBE-DC32A (SLP-T40P)

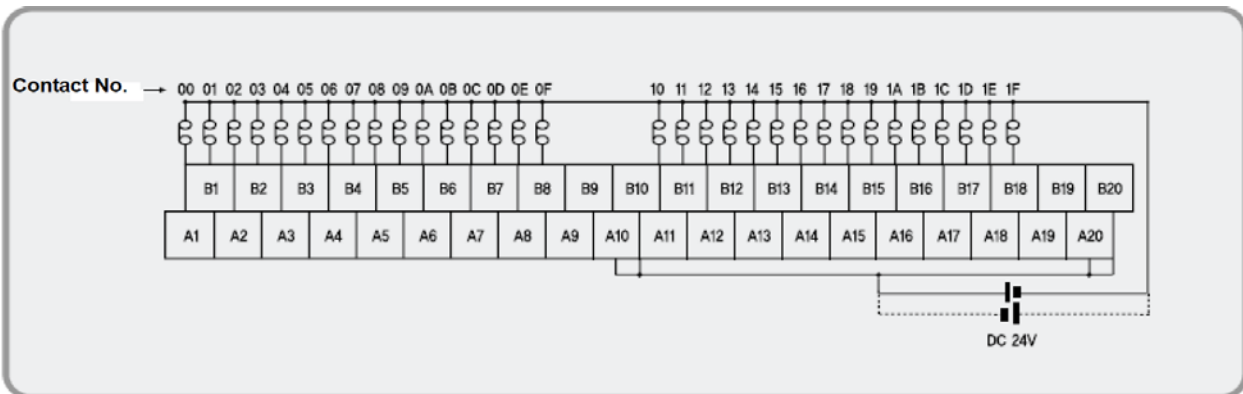

- XBE-TN32A (SLP-T40P)

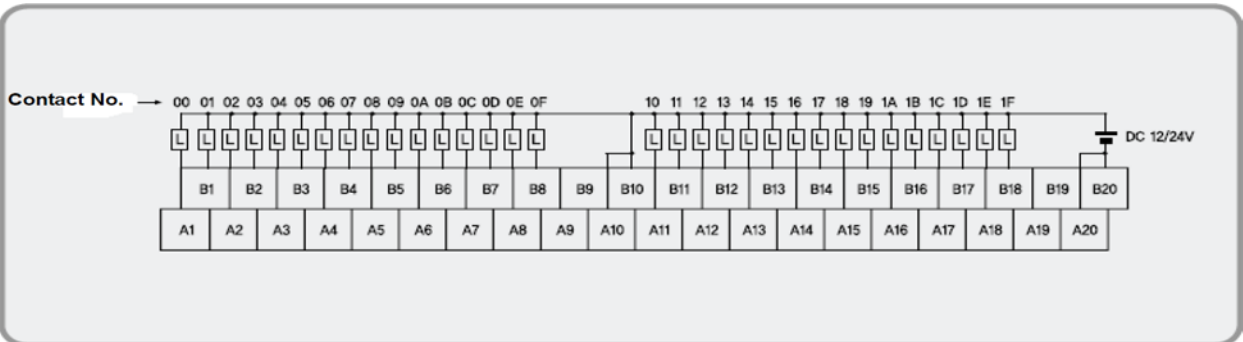

- XBE-TP32A (SLP-T40P)

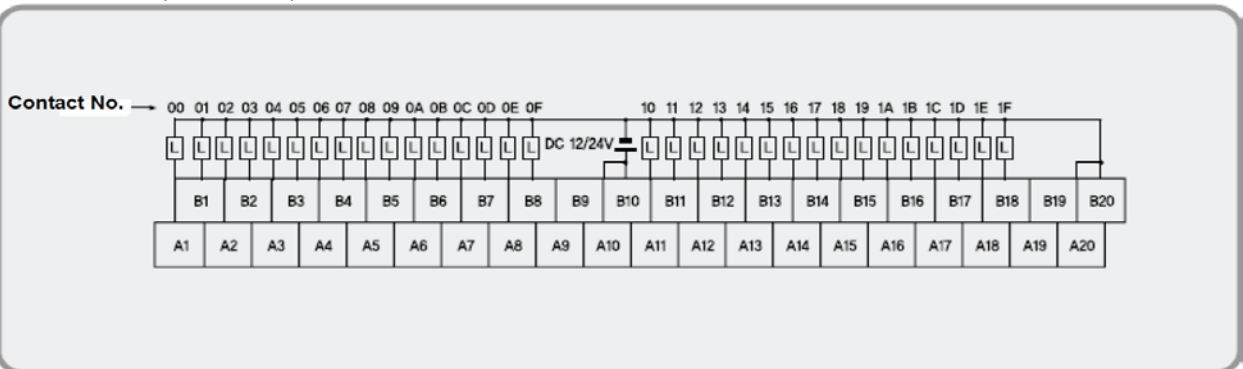

- XBE-TN32A (SLP-RY4A)

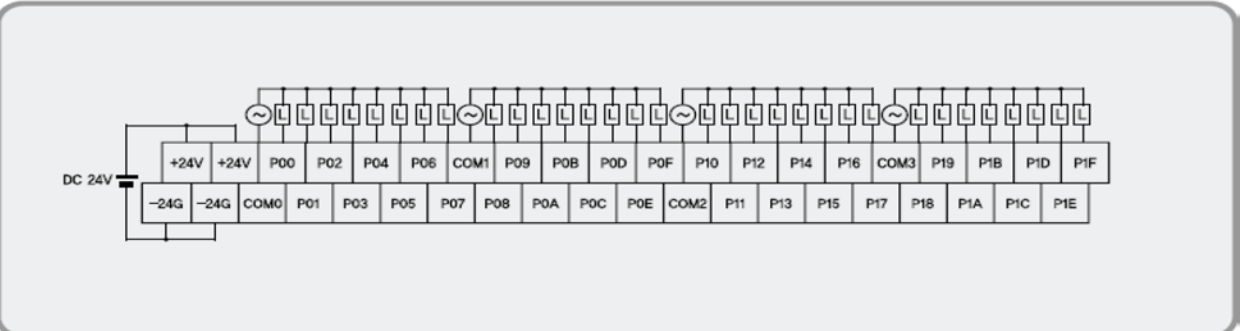

Chapter 8 Built-in High-speed Counter Function

XGB series have built-in function of High-speed counter in main unit. This chapter describes specifications and usage of High-speed counter's function.

8.1 High-speed Counter Specifications

- It describes specifications, setting and usage of function, programming and wiring with external device of built-in main unit.

8.1.1 Performance specifications

(1) Performance specification

Classification		Description		
		"E" type	"S(U)" type	
Count input signal	Signal	A-phase, B-phase		
	Input type	Voltage input (Open collector)		
	Signal level	DC 24V		
Max. count speed		4kpps	100kpps	
Number of channels	1 phase	4kpps 4 channels	100kpps 2 channels/ 20kpps 6 channels	
	2 phase	2kpps 2 channels	50kpps 1 channel / 8kpps 3 channels	
Count range		Signed 32 Bit (-2,147,483,648 ~ 2,147,483,647)		
Count mode (Program setting)		Linear count (if 32-bit range exceeded, Carry/Borrow occurs)		
		Counter max. and min. value is indicated		
		Ring count (repeated count within setting range)		
Input mode (Program setting)		1-phase input		
		2-phase input		
		CW/CCW input		
Signal type		Voltage		
Up/Down setting	1 phase input	Increasing/decreasing operation setting by B-phase input		
		Increasing/decreasing operation setting by program		
	2 phase input	Operating setting by rising edge phase difference	Operating setting by rising/falling edge phase difference	
		CW/CCW	A-phase input: increasing operation B-phase input: decreasing operation	
Multiplication function	1 phase input	1 multiplication		
	2 phase input	2 multiplication	4 multiplication	
	CW/CCW	1 multiplication		
Control input	Signal	Preset instruction input		
	Signal level	DC 24V input type		
	Signal type	Voltage		

Classification		Description	
		"E" type	"S(U)" type
External output	Output points	1 point/channel (for each channel) :uses output contact point of main unit	2 point/channel (for each channel) :use output contact point of main unit
	Type	Selects single-compared (>, >=, =, =<, <) or section-compared output (included or excluded) (program setting)	
	Output type	Relay, Open-collector output (Sink)	
Count Enable		To be set through program (count available only in enable status)	
Preset function		To be set through terminal (contact) or program	
Auxiliary mode (Program setting)		Count Latch Count per unit time (time setting value: 1~60,000ms)	

(2) Counter/Preset input specification

Classification	Spcification
Input voltage	24V DC (20.4V ~ 28.8V)
Input current	4mA
On guranteed voltage (min.)	20.4V
Off guranteed voltage (max.)	6V

Notice

If higher pulse than high speed counter input limit is inputted, 「abnormal operation stop」 error may occur because MPU processing time increases to count fast and memory becomes full.
When using high speed counter, consider this.

8.1.2 Designation of parts

(1) Designation of parts

(a) "E" type

Terminal No.	Names		Usage	
	1-phase	2-phase	1-phase	2-phase
P000	Ch0 counter input	Ch0 A-phase input	Counter input terminal	A-phase input
P001	Ch1 counter input	Ch0 B-phase input	Counter input terminal	B-phase input
P002	Ch2 counter input	Ch2 A-phase input	Counter input terminal	A-phase input
P003	Ch3 counter input	Ch2 B-phase input	Counter input terminal	B-phase input
P004	Ch0 preset 24V	Ch0 preset 24V	Preset input terminal	Preset input terminal
P005	Ch1 preset 24V	-	Preset input terminal	No use
P006	Ch2 preset 24V	Ch2 preset 24V	Preset input terminal	Preset input terminal
P007	Ch4 preset 24V	-	Preset input terminal	No use
COM0	Input common	Input common	Common terminal	Common terminal

(b) "S(U)" type

Terminal No.	Names		Usage	
	1-phase	2-phase	1-phase	2-phase
P000	Ch0 counter input	Ch0 A-phase input	Counter input terminal	A-phase input
P001	Ch1 counter input	Ch0 B-phase input	Counter input terminal	B-phase input
P002	Ch2 counter input	Ch2 A-phase input	Counter input terminal	A-phase input
P003	Ch3 counter input	Ch2 B-phase input	Counter input terminal	B-phase input
P004	Ch4 counter input	Ch4 A-phase input	Counter input terminal	A-phase input
P005	Ch5 counter input	Ch4 B-phase input	Counter input terminal	B-phase input
P006	Ch6 counter input	Ch6 A-phase input	Counter input terminal	A-phase input
P007	Ch7 counter input	Ch6 B-phase input	Counter input terminal	B-phase input
P008	Ch0 preset 24V	Ch0 preset 24V	Preset input terminal	Preset input terminal
P009	Ch1 preset 24V	-	Preset input terminal	No use
P00A	Ch2 preset 24V	Ch2 preset 24V	Preset input terminal	Preset input terminal
P00B	Ch4 preset 24V	-	Preset input terminal	No use
P00C	Ch5 preset 24V	Ch4 preset 24V	Preset input terminal	Preset input terminal
P00D	Ch6 preset 24V	-	Preset input terminal	No use
P00E	Ch7 preset 24V	Ch6 preset 24V	Preset input terminal	Preset input terminal
P00F	Ch8 preset 24V	-	Preset input terminal	No use
COM0	Input common	Input common	Input common	Input common

(2) Interface with external devices

The internal circuit of High-speed counter is as shown below.

(a) "E" type

I/O	Internal circuit	Terminal No.	Signal		Operation	On/Off guaranteed voltage	
			1-phase	2-phase			
Input		P00	Ch 0 Pulse input	Ch 0 A-phase input	On Off	20.4~28.8V 6V or less	
		P01	Ch 1 Pulse input	Ch 0 B-phase input	On Off	20.4~28.8V 6V or less	
		P02	Ch 2 Pulse input	Ch 2 A-phase input	On Off	20.4~28.8V 6V or less	
		P03	Ch 3 Pulse input	Ch 2 B-phase input	On Off	20.4~28.8V 6V or less	
		P04	Ch 0 Preset input	Ch 0 Preset input	On Off	20.4~28.8V 6V or less	
		P05	Ch 1 Preset input	-	On Off	20.4~28.8V 6V or less	
		P06	Ch 2 Preset input	Ch 2 Preset input	On Off	20.4~28.8V 6V or less	
		P07	Ch 3 Preset input	-	On Off	20.4~28.8V 6V or less	
		COM0	COM (input common)				



For XBC-DR10E, there is no physical circuit for P0006 ~ P0007. Turn on this contact point by program.

(b) "S(U)" type

I/O	Internal circuit	Terminal No.	Signal		Operation	On/Off guaranteed voltage
			1-phase	2-phase		
Input		P0000	Ch 0 Pulse input	Ch 0 A-phase input	On Off	20.4~28.8V 6V or less
		P0001	Ch 1 Pulse input	Ch 0 B-phase input	On Off	20.4~28.8V 6V or less
		P0002	Ch 2 Pulse input	Ch 2 A-phase input	On Off	20.4~28.8V 6V or less
		P0003	Ch 3 Pulse input	Ch 2 B-phase input	On Off	20.4~28.8V 6V or less
		P0004	Ch 4 Pulse input	Ch 4 A-phase input	On Off	20.4~28.8V 6V or less
		P0005	Ch 5 Pulse input	Ch 4 B-phase input	On Off	20.4~28.8V 6V or less
		P0006	Ch 6 Pulse input	Ch 6 A-phase input	On Off	20.4~28.8V 6V or less
		P0007	Ch 7 Pulse input	Ch 6 B-phase input	On Off	20.4~28.8V 6V or less
		P0008	Ch 0 Preset input	Ch 0 Preset input	On Off	20.4~28.8V 6V or less
		P0009	Ch 1 Preset input	-	On Off	20.4~28.8V 6V or less
		P000A	Ch 2 Preset input	Ch 2 Preset input	On Off	20.4~28.8V 6V or less
		P000B	Ch 3 Preset input	-	On Off	20.4~28.8V 6V or less
		P000C	Ch 4 Preset input	Ch 4 Preset input	On Off	20.4~28.8V 6V or less
		P000D	Ch 5 Preset input	-	On Off	20.4~28.8V 6V or less
		P000E	Ch 6 Preset input	Ch 6 Preset input	On Off	20.4~28.8V 6V or less
		P000F	Ch 7 Preset input	-	On Off	20.4~28.8V 6V or less
		COM0	COM(input common)			

For XBC-DR/DN20S, there is no physical circuit for P000C ~ P000F. Turn on this contact point by program.

8.1.3 “E” type Functions

(1) Counter mode

(a) High Speed counter module can count High Speed pulses which can not be processed by CPU module’s counter instructions (CTU, CTD, CTUD, etc.), up to binary value of 32 bits (-2,147,483,648 ~ 2,147,483,647).

(b) Available input is 1-phase input, 2-phase input and CW/ CCW input.

(c) Count increasing/decreasing methods are as follows;

- 1) For 1-phase input: (1) Increasing/decreasing count operation by program setting
 (2) Increasing/decreasing count operation by B-phase input signal
- 2) For 2-phase input: setting by difference in phase between A-phase and B-phase
- 3) For CW/CCW input: Increasing operation if B-phase is LOW with A-phase input, and Decreasing operation if A-phase is LOW with B-phase input.

(d) Auxiliary modes are as follows;

- 1) Count Latch
- 2) Periodic Pulse Count

(e) Pulse input mode

1) 1-phase count mode

a) Increasing/decreasing count operation by program setting

- 1-phase 1-input 1-multiplication operation mode

A-phase input pulse counts at rising and increasing/decreasing will be decided by the applicable program.

Increasing/Decreasing classification	A-phase input pulse rising	A-phase input pulse falling
Increasing/decreasing count setting signal Off	Increasing count	-
Increasing/decreasing count setting signal On	Decreasing count	-

• Operation example

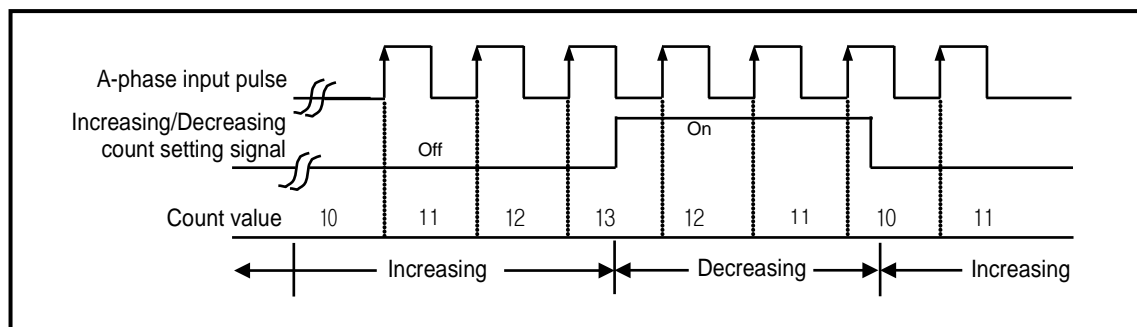

b) Increasing/decreasing count operation by B-phase input signal

- 1-phase 2-input 1-multiplication operation mode

A-phase input pulse counts at rising and increasing/decreasing will be decided by B-phase.

Increasing/Decreasing classification	A-phase input pulse rising	A-phase input pulse falling
B-phase input pulse Off	Increasing count	-
B-phase input pulse On	Decreasing count	-

- Operation example

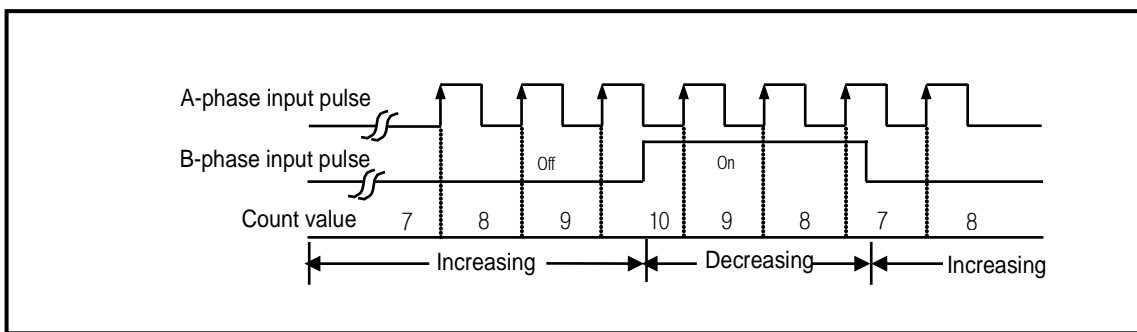

2) 2-phase count mode

- a) 2-phase 2-multiplication operation mode

A-phase input pulse and B-phase input pulse count at rising. If A-phase input is antecedent to B-phase input, increasing operation starts, and if B-phase input is antecedent to A-phase input, decreasing operation starts.

- Operation example

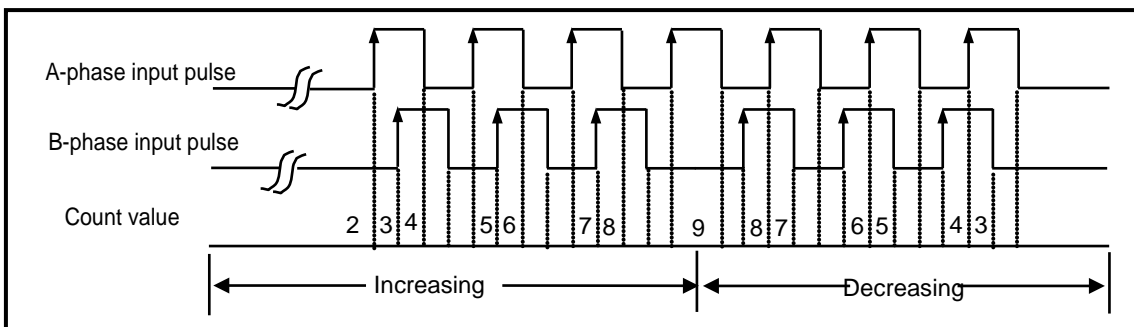

3) CW(Clockwise)/CCW(Counter Clockwise) operation mode

A-phase input pulse counts at rising , or B-phase input pulse counts at rising.

Increasing operation executed when B-phase input pulse is Low with A-phase input pulse at rising, and Decreasing operation executed when A-phase input pulse is Low with B-phase input pulse at rising.

Increasing/Decreasing classification	A-phase input pulse High	A-phase input pulse Low
B-phase input pulse High	-	decreasing count
B-phase input pulse Low	Increasing count	-

▪ Operation example

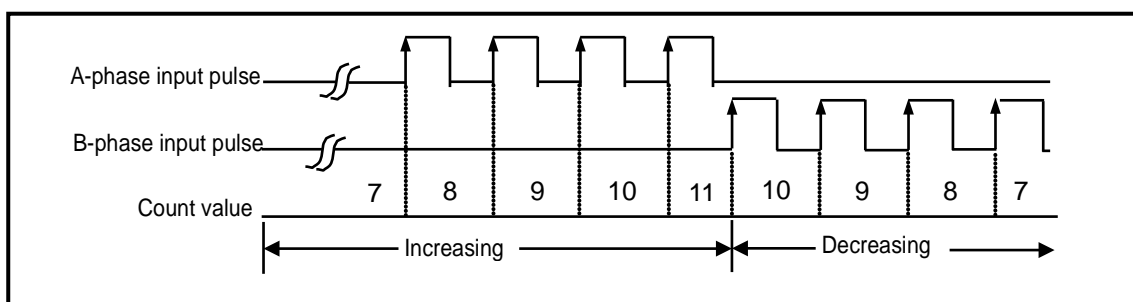

(2) Counter type

2 types of count (Linear counter, Ring counter) can be selected for the applicable use based on functions.

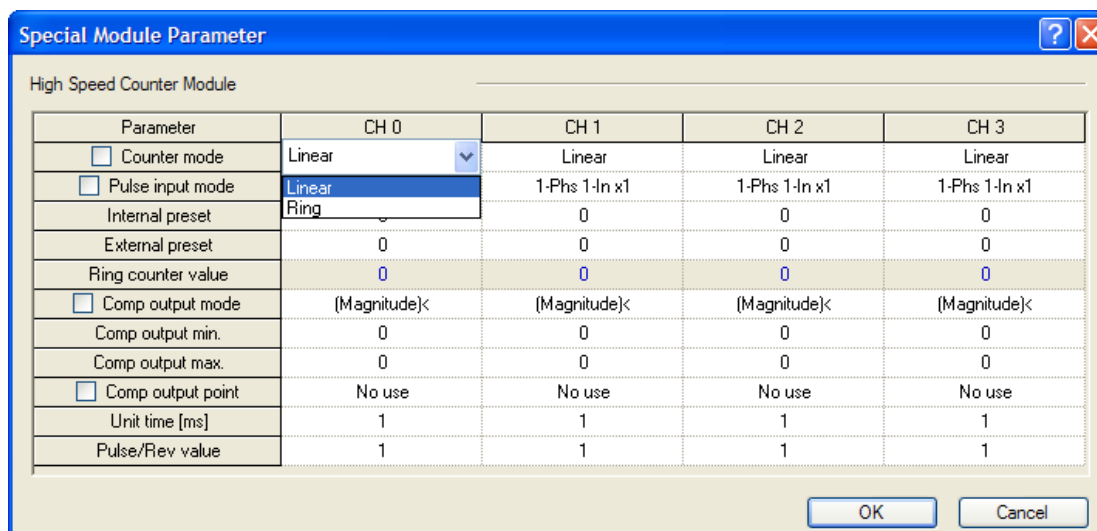

▪ Counter mode is saved at the following special K area.

Mode	Area per each channel (word)				Reference ^{*1)}
	Ch.0	Ch.1	Ch.2	Ch.3	
Counter mode	K300	K330	K360	K390	0 : linear 1 : ring

*1) If counter mode is set as value other than 0, 1, error code '20' will occur.

2 types of count can be selected for the applicable use based on functions.

(a) Linear counter

- 1) Linear Count range: -2,147,483,648 ~ 2,147,483,647
- 2) If count value reaches the maximum value while increased, Carry will occur, and if count value reaches the minimum value while decreased, Borrow will occur.
- 3) If Carry occurs, count stops and increasing is not available but decreasing is available.
- 4) If Borrow occurs, count stops and decreasing is not available but increasing is available.

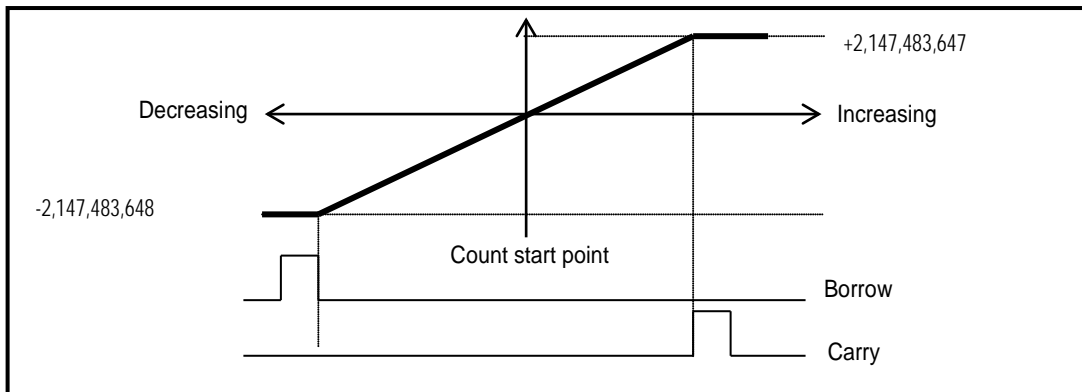

(b) Ring count

- Ring Count range: user-defined minimum value ~ user-defined maximum value
- Count display: If Ring Counted, user-defined minimum value of Ring Count is counted and displayed, but the value is not displayed.

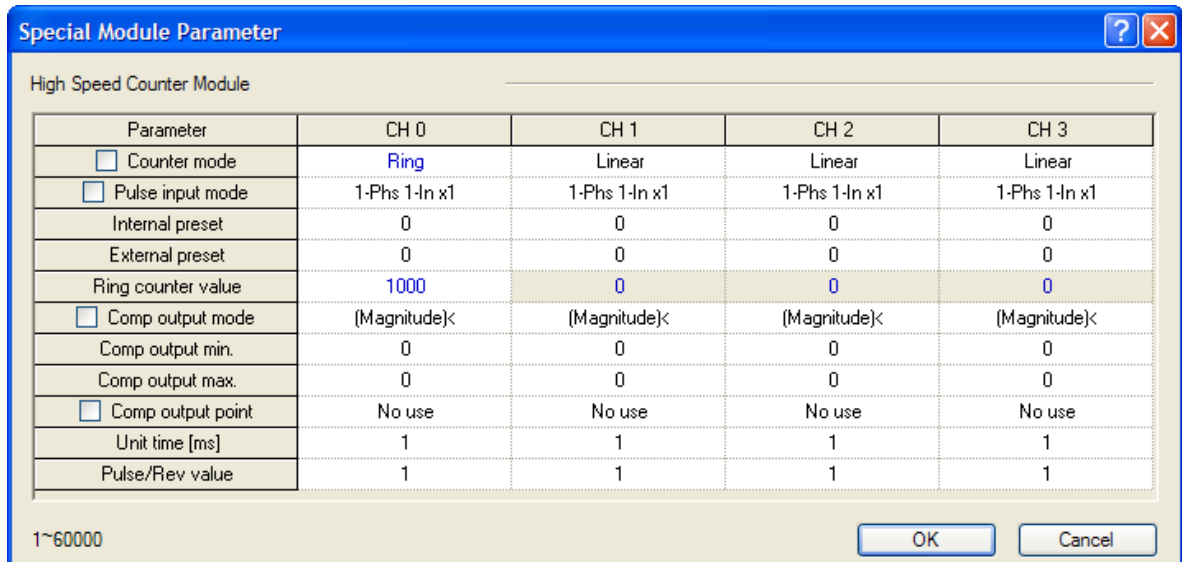

- Ring counter value is saved at the following special K area.

type	Area per each channel (Double word)				Reference
	Ch.0	Ch.1	Ch.2	Ch.3	
Ring counter value	K310	K340	K270	K400	

1) During increasing count

- Even if count value exceeds user-defined maximum value during increasing count, Carry only occurs and count does not stop differently to Linear Count.

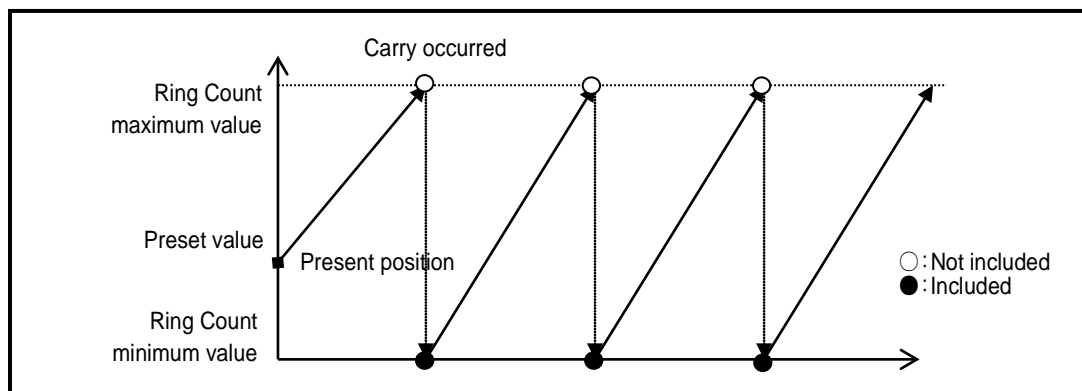

2) During decreasing count

- Even if count value exceeds user-defined minimum value during decreasing count, Borrow only occurs and count does not stop differently to Linear Count.

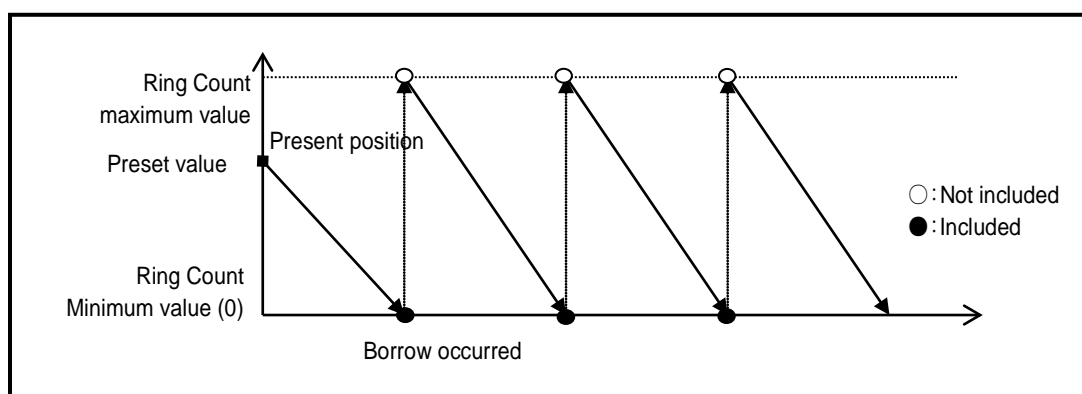

3) Operation when setting Ring Count based on present count value (during increasing count)

- When setting the ring count, the current count value is below the minimum value of the ring counter.
 - Opens an error (Code No. 27), operates as a linear counter, and operates as a ring count when the current count value falls within the range of the ring count (error codes are not cleared).
- When setting the ring count, the current count value is above the maximum value of the ring counter.
 - Displays an error (Code No. 27), operates as a linear counter, and stops counting when the current count value reaches the maximum count value (error code is not cleared).
- When setting the ring count, the current count value is within the user setting range
 - It starts to increase from the current count value, increases to the maximum value set by the user, then becomes the minimum value set by the user and continues to count after carrying a carry.
 - As shown in the figure below, the maximum value is not displayed and the count continues after displaying the minimum value.

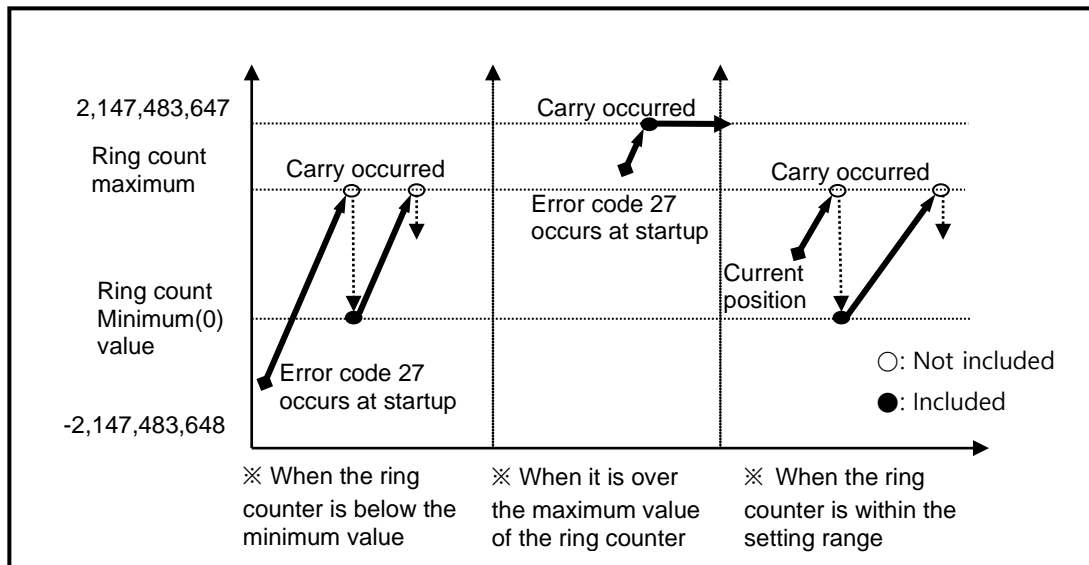

4) Operation when setting Ring Count based on present count value (during decreasing count)

- When setting the ring count, the current count value is below the minimum value of the ring counter.
 - When an error (Code No. 27) is displayed, it operates as a linear counter, and if the current count value falls within the range of the ring count, it operates as a ring counter. (The error code is not cleared)
- When setting the ring count, the current count value is above the maximum value of the link counter.
 - An error (Code No. 27) is displayed, and it operates as a linear counter, but stops counting when the current count value reaches the count minimum value. (The error code is not cleared)
- When setting the ring count, the current count value is within the user setting range
 - It starts to decrease from the current count value, decreases to the minimum value set by the user, and becomes the maximum value set by the user, and then continues counting after Borrow occurs.

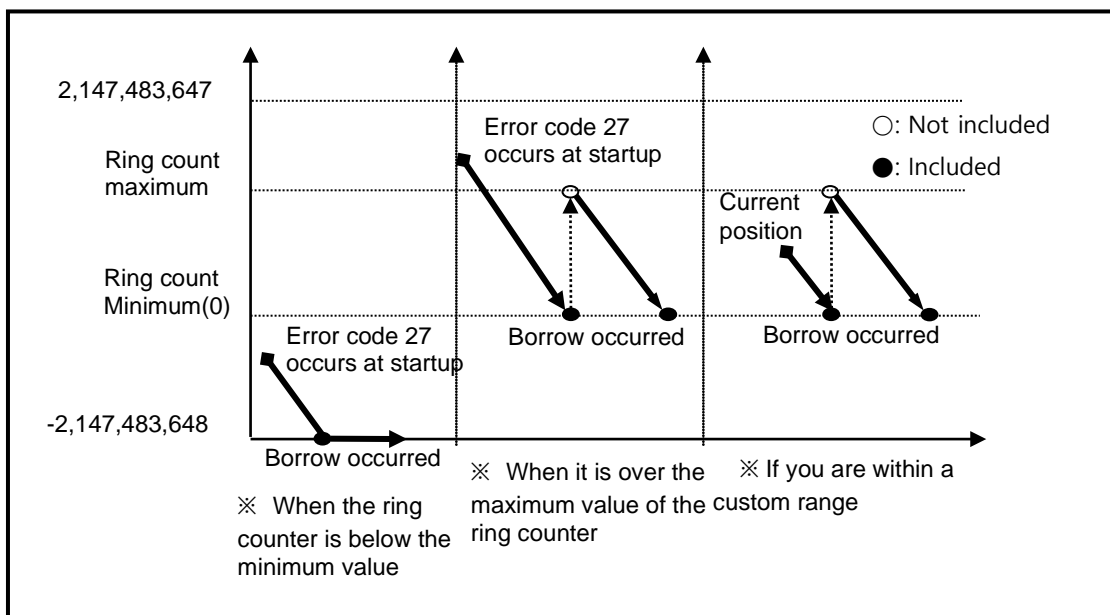

Remark

(1) When using a ring count, be sure to place the count value within the range using a preset or the like.

(3) Compared output

- (a) High Speed counter module has a compared output function used to compare present count value with compared value in size to output as compared.
- (b) Available compared outputs are 2 for 1 channel, which can be used separately.
- (c) Compared output conditions are 7 associated with >, =, < .
- (d) Parameter setting
 - Compared output mode setting

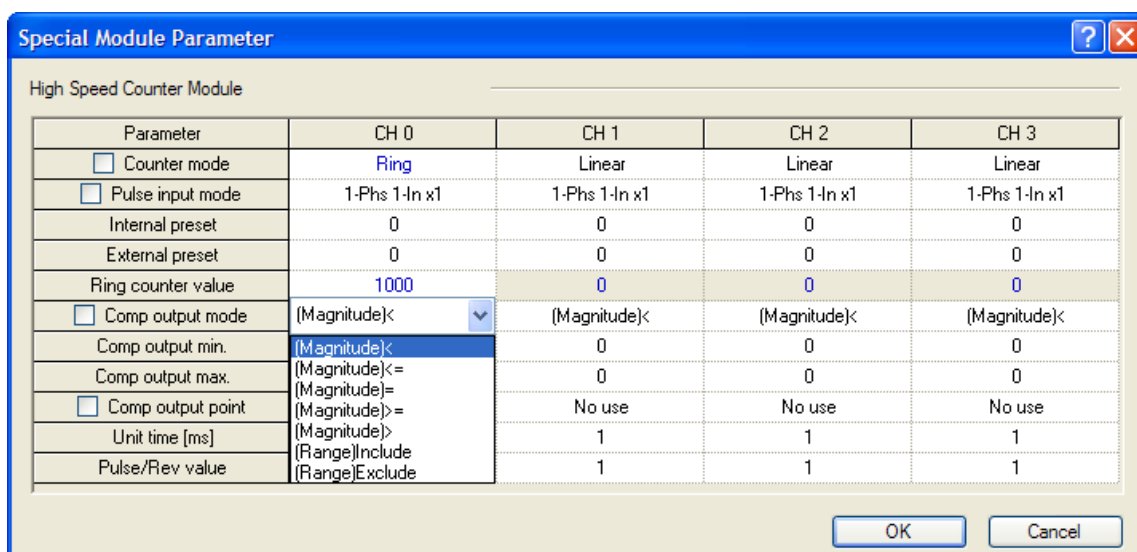

- Upper setting value is saved in special K area.

Compared output condition	Memory address (word)	Value*2)
Present Value < Compared Value	Channel 0 : K302 Channel 1 : K330 Channel 2 : K358 Channel 3 : K386	Set to "0"
Present Value ≤ Compared Value		Set to "1"
Present Value = Compared Value		Set to "2"
Present Value ≥ Compared Value		Set to "3"
Present Value > Compared Value		Set to "4"
Compared value 1 ≤ Count value ≤ Compared value 2		Set to "5"
Count value ≤ Compared value 1, Count value ≥ Compared value 2		Set to "6"

*2) If compared output value not set to 0-6 using counter, error code '23' will be occurred.

- In order to make actual comparison enabled after compared output condition set, the compared enable signal is to be On.

Classification	Area per channel				Operation
	Ch. 0	Ch. 1	Ch. 2	Ch. 3	
Count enable signal	K2600	K2700	K2800	K2900	0: N/A, 1: enable
Compared enable signal	K2604	K2704	K2804	K2904	0: forbidden, 1: enable

- In order to make external output, the compared equivalent output signal (P20~P27) must be set. If Compared output contact is Off, Compared coincidence output signal (internal device) is only output.

Classification	Area per channel				Operation
	Ch. 0	Ch. 1	Ch. 2	Ch. 3	
Compared equivalent output signal	K2612	K2712	K2812	K2912	0: Compared output not equivalent 1: Compared output equivalent

- Comp output point (P40 ~ P43) setting

Special Module Parameter

High Speed Counter Module

Parameter	CH 0	CH 1	CH 2	CH 3
<input type="checkbox"/> Counter mode	Linear	Linear	Linear	Linear
<input type="checkbox"/> Pulse input mode	1-Phs 1-In x1	1-Phs 1-In x1	1-Phs 1-In x1	1-Phs 1-In x1
Internal preset	0	0	0	0
External preset	0	0	0	0
Ring counter value	2	2	2	2
<input type="checkbox"/> Comp output mode	(Magnitude)<	(Magnitude)<	(Magnitude)<	(Magnitude)<
Comp output min.	0	0	0	0
Comp output max.	0	0	0	0
<input type="checkbox"/> Comp output point	No Use	No Use	No Use	No Use
Unit time [ms]	No Use	1	1	1
Pulse/Rev value	P40	1	1	1
	P41			
	P42			
	P43			

OK Cancel

(e) Detailed description for compared output

1) Mode 0 (Present value < Compared value)

- If counted present value is less than compared value, output is sent out, and if present value increases to be equal to or greater than compared value, output is not sent out.

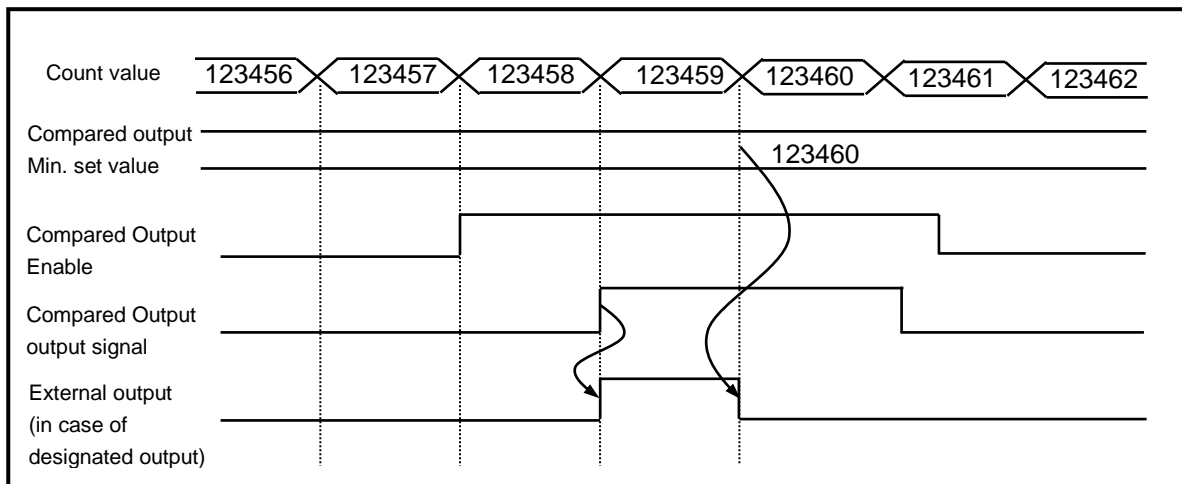

2) Mode1 (Count value ≤ Compared value)

- If present count value is less than or equal to compared value, output is sent out, and if count value increases to be greater than compared value, output is not sent out.

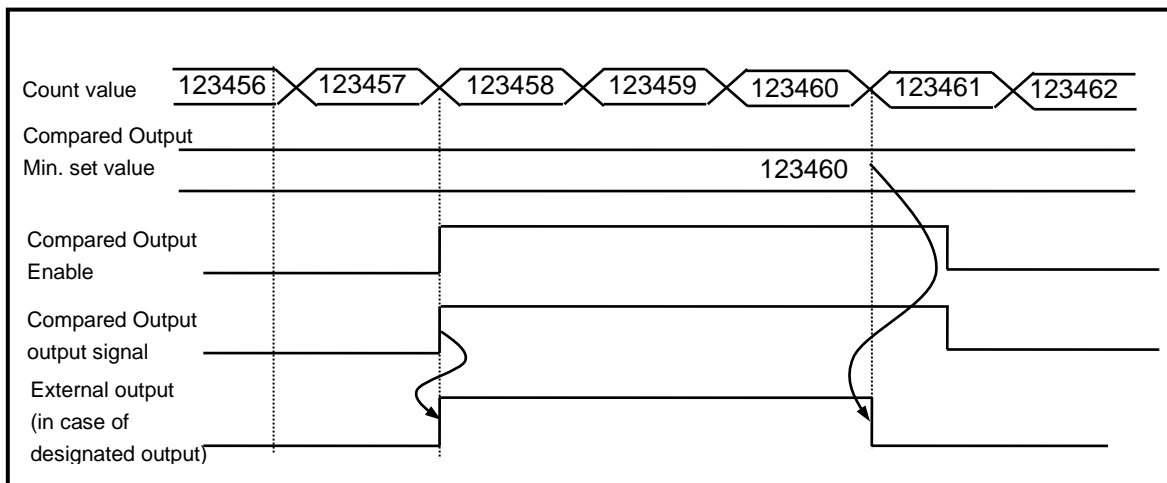

3) Mode 2 (Count value = Compared value)

- If present count value is equal to compared value, output is sent out. In order to turn the output Off, Compared output Enable and Compared output signal is to be On.

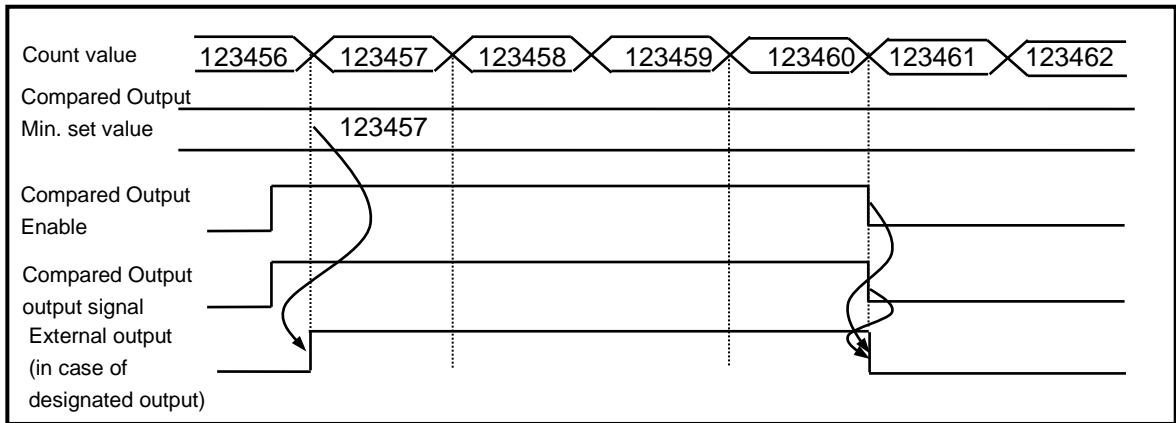

4) Mode 3 (Count value \geq Compared value)

- If present count value is greater than or equal to compared value, output is sent out, and if count value decreases to be less than compared value, output is not sent out.

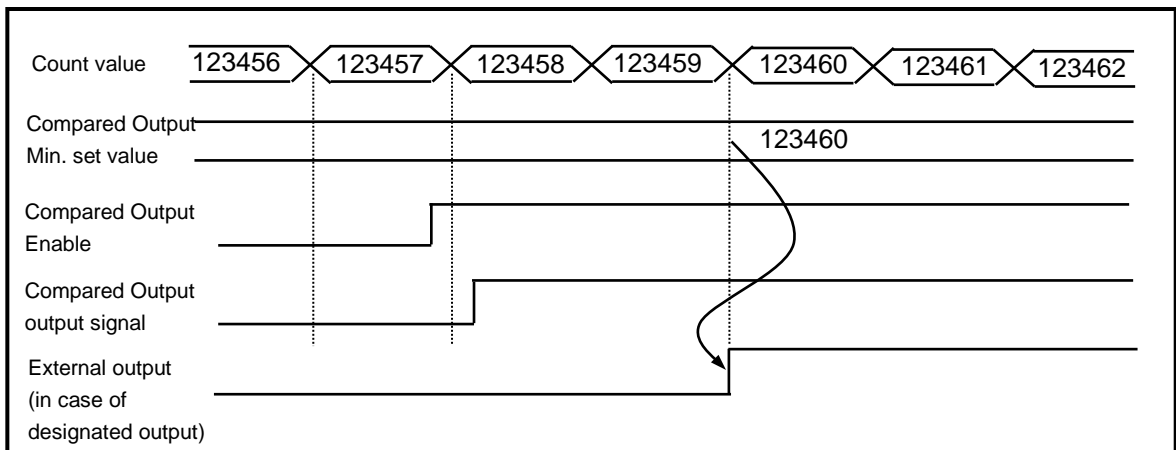

5) Mode 4 (Count value > Compared value)

- If present count value is greater than compared value, output is sent out, and if count value decreases to be less than or equal to compared value, output is not sent out.

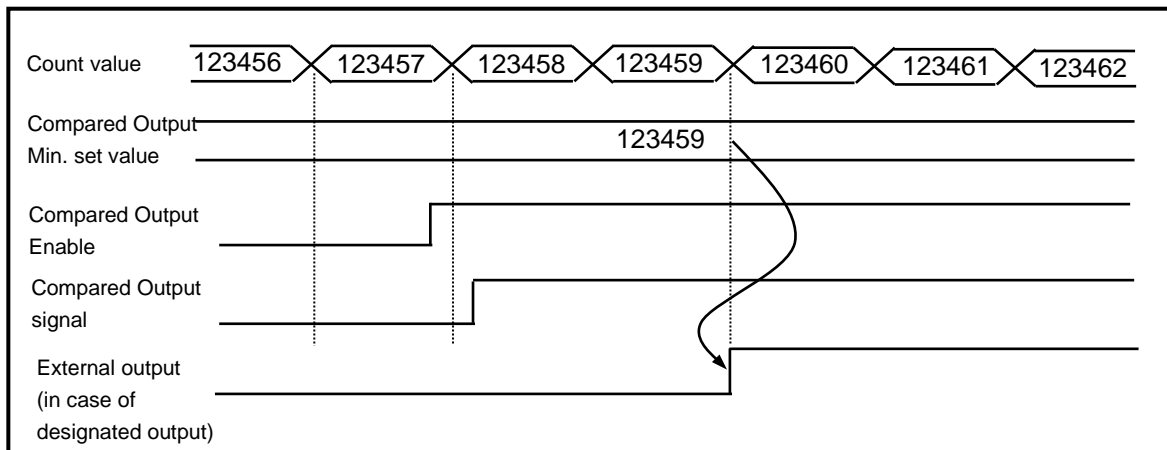

6) Mode 5 (Compared output Min. set value ≤ Count value ≤ Compared output Max. set value)

- If present count value is greater than or equal to compared output Min. value and less than or equal to compared output Max. set value, output is sent out, and if count value increases/decreases to exceed compared value's range, output is not sent out.

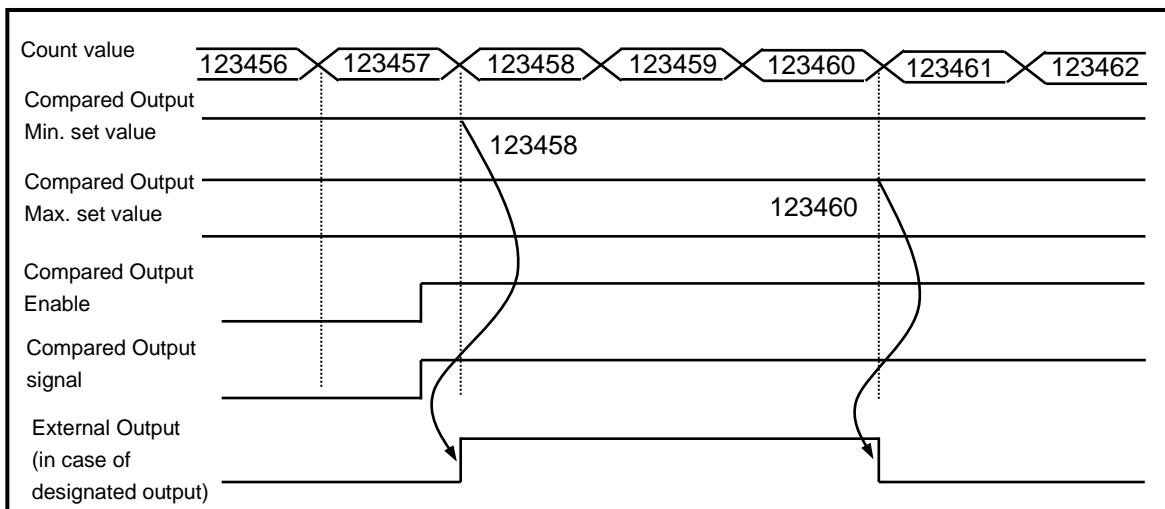

7) Mode 6 (Count value \leq Compared output Min. value, Count value \geq Compared output Max. value)

- If present count value is less than or equal to compared output Min. value and greater than or equal to compared output Max. value, output is sent out, and if count value increases/decreases to exceed compared value's range, output is not sent out.

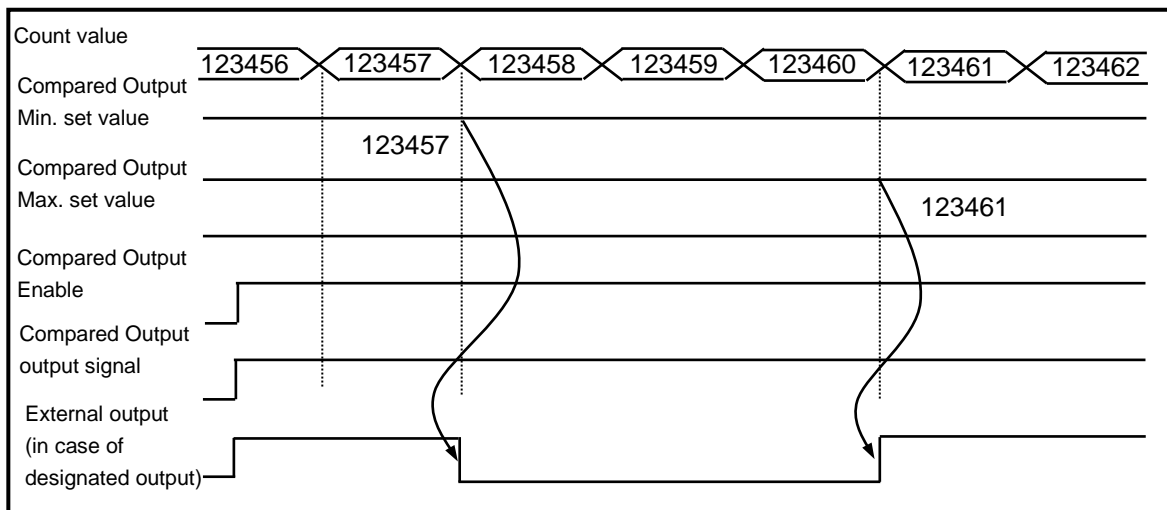

(4) Carry signal

(a) Carry signal occurs

- 1) When count range maximum value of 2,147,483,647 is reached during Linear Count.
- 2) When user-defined maximum value of Ring Count changed to the minimum value during Ring Count.

(b) Count when Carry Signal occurs

- 1) Count stops if Carry occurs during Linear Count.
- 2) Count does not stop even if Carry occurs during Ring Count.

(c) Carry reset

- 1) The Carry generated can be cancelled by Carry/Borrow reset signal On.

Classification	Device area per channel			
	Channel 0	Channel 1	Channel 2	Channel 3
Carry signal	K2610	K2710	K2810	K2910

(5) Borrow signal

(a) Borrow signal occurs

- 1) When count range minimum value of -2,147,483,648 is reached during Linear Count.
- 2) When user-defined minimum value of Ring Count changed to the maximum value during Ring Count.

(b) Count when Borrow signal occurs

- 1) Count stops if Borrow occurs during Linear Count.
- 2) Count does not stop even if Borrow occurs during Ring Count.

(c) Borrow reset

- 1) The Borrow generated can be cancelled by Carry/Borrow reset signal On..

Classification	Device area per channel			
	Channel 0	Channel 1	Channel 2	Channel 3
Borrow signal	K2611	K2711	K2811	K2911

6) Revolution/Unit time

While auxiliary mode enable signal is On, it counts the number of input pulses for a specified time.

(a) Setting

1) Input unit time and pulse number per 1 revolution

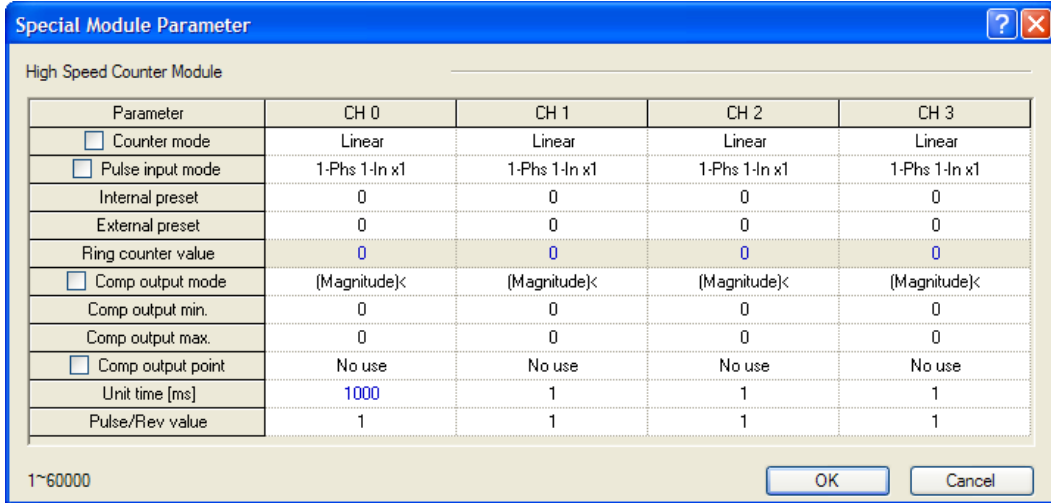

Setting value is saved at the following special K are and user can designate it directly.

Classification	Device area per channel			
	Channel 0	Channel 1	Channel 2	Channel 3
Unit time (1~60000ms) ^{*3)}	K322	K352	K382	K412

^{*3)} If revolution per unit time is enabled and unit time value is other than 1~60000ms, error code '34' occurs.

2) Input pulse number per 1 revolution

Classification	Device area per channel			
	Channel 0	Channel 1	Channel 2	Channel 3
Pulse number /revolution (1~60000) ^{*4)}	K323	K353	K383	K413

^{*4)} If revolution per unit time is enabled and pulse number/revolution is other than 1~60000, error code '35' occurs.

3) If Count function of revolution per unit time is used, enable signal set by On.

Classification	Device area per channel			
	Channel 0	Channel 1	Channel 2	Channel 3
Revolution/unit time command	K2605	K2705	K2805	K2905

(a) Count function of Revolution per Unit time is used to count the number of pulses for a specified time while Enable signal is On.

- (b) With the displayed number of pulses updated for a specified time and the number of pulses per revolution input, Revolution/Unit time can be counted.
- (c) Number of Revolution per 1 second is indicated after number of pulse per 1 revolution is set and time is set to 1 second (1000ms). In order to indicate by Revolutions per minute (RPM), the operation is executed in program.
- (d) The example that number of pulse per 1 revolution set to '1' and time is set to 1000 ms is as shown below. (Ch0)

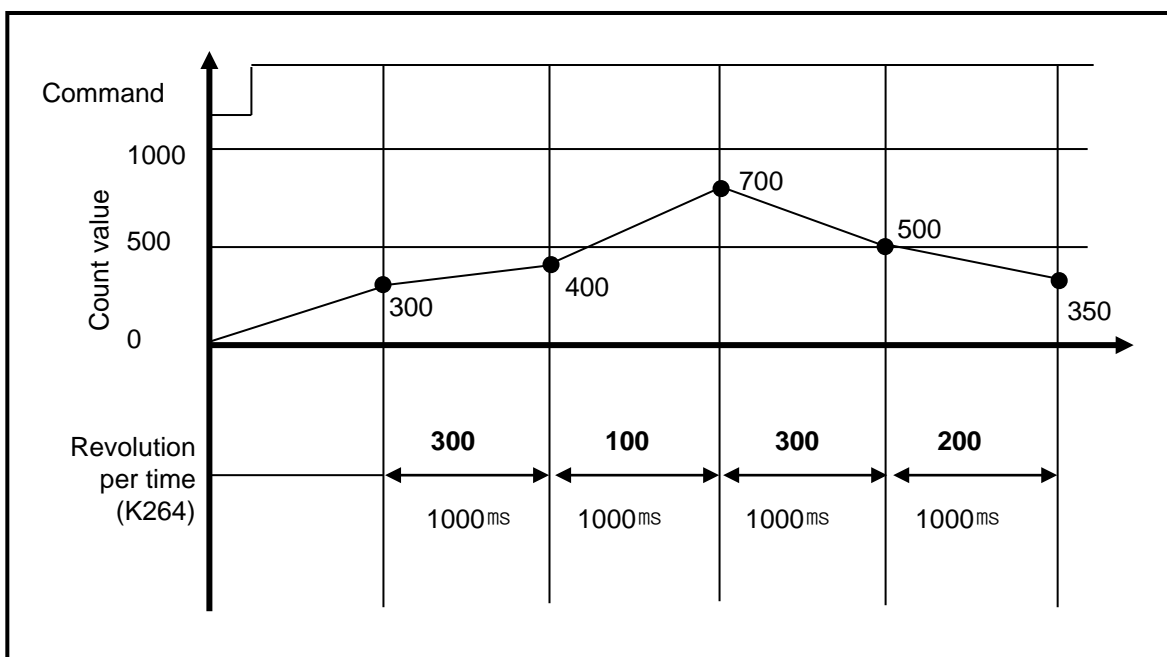

- (f) In order to indicate revolution per minute (RPM), the program is as shown below. In case of DMUL operation, RPM value is saved 64 bit in D100~D103. If operated RPM value is used, it can use to Word or Dword type according to system (case of RPM value is small number).

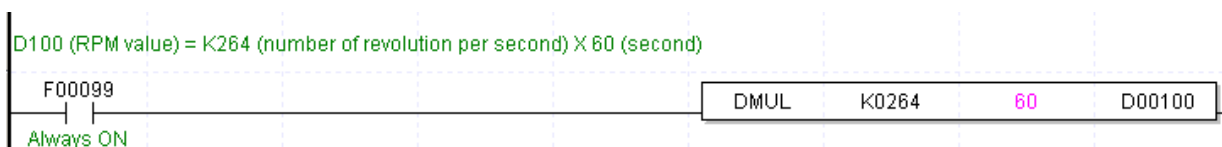

(g) The example that number of pulse per 1 revolution set to '10' and time is set to 60,000 ms is as shown below.

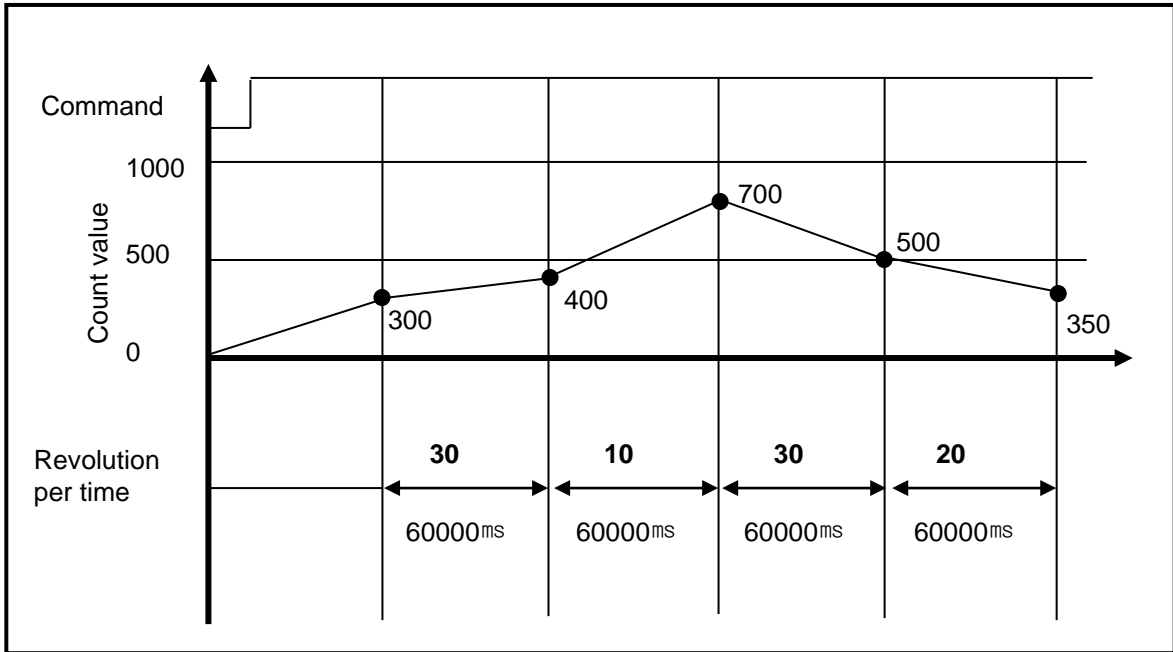

(7) Count latch

(a) When Count latch signal is On, present count value is latched.

(b) Setting

If present counter value is to latch, Count Latch function is set 'Use'.

Classification	Device area per channel			
	Channel 0	Channel 1	Channel 2	Channel 3
Count latch command	K2606	K2706	K2806	K2906

(c) Count latch function is operated when Count latch signal is On. Namely, counter value is not cleared when power supply Off =>On and mode change, it is counted from previous value.

(d) In latch counter function, internal or external preset function has to use for clearing present value.

(8) Preset function

It changes the current value into preset value.

There are two types of preset function, internal preset and external preset. External preset is fixed as input contact point.

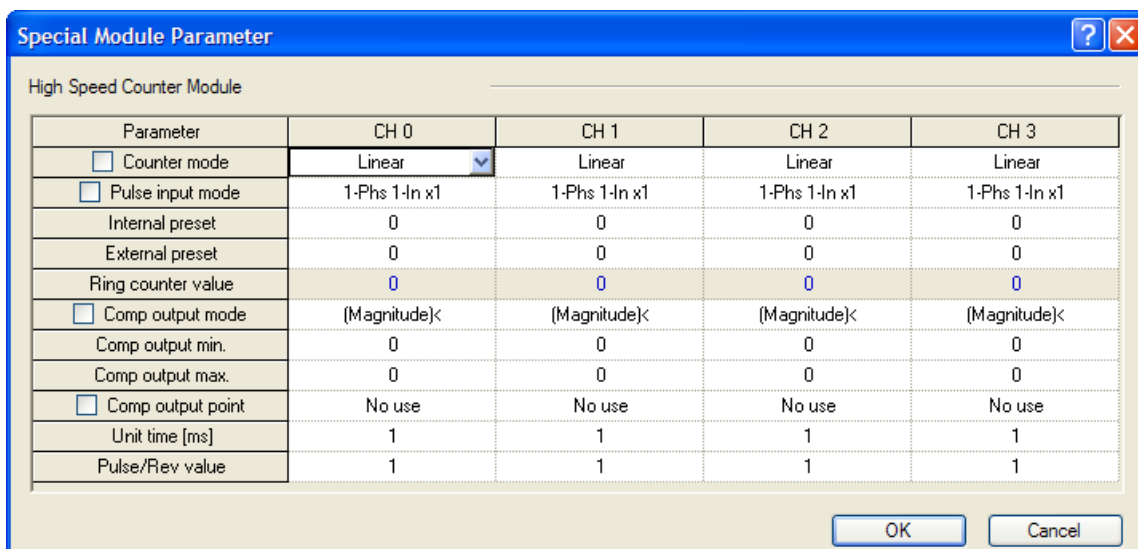

- Preset setting value is saved at the following special K area.

Type	Area per each channel (Double word)				Ref.
	Ch.0	Ch.1	Ch.2	Ch.3	
Internal preset	K304	K334	K364	K394	-
External preset	K306	K336	K366	K396	-

- Preset command is specified through the following special K area, external preset is used by executing the designated input contact point after allowance bit is on.

Type	Area per each channel (Bit)				Ref.
	Ch.0	Ch.1	Ch.2	Ch.3	
Internal preset command	K2601	K2701	K2801	K2901	-
External preset allowance	K2602	K2702	K2802	K2902	-
External preset command	P004	P005	P006	P007	-

8.1.4 “S(U)” type Functions

(1) Counter mode

(a) High Speed counter module can count High Speed pulses which can not be processed by CPU module’s counter instructions (CTU, CTD, CTUD, etc.), up to binary value of 32 bits (-2,147,483,648 ~ 2,147,483,647).

(b) Available input is 1-phase input, 2-phase input and CW/ CCW input.

(c) Count increasing/decreasing methods are as follows;

- 1) For 1-phase input: a) Increasing/decreasing count operation by program setting
b) Increasing/decreasing count operation by B-phase input signal
- 2) For 2-phase input: setting by difference in phase between A-phase and B-phase
- 3) For CW/CCW input: Increasing operation if B-phase is LOW with A-phase input, and Decreasing operation if A-phase is LOW with B-phase input.

(d) Auxiliary modes are as follows;

- 1) Count Latch
- 2) Count function about the number of revolution per unit time

(e) Pulse input mode

1) 1 phase count mode

a) Increasing/decreasing count operation by program setting

- 1-phase 1-input 1-multiplication operation mode

A-phase input pulse counts at rising and increasing/decreasing will be decided by the applicable program.

Increasing/Decreasing classification	A-phase input pulse rising	A-phase input pulse falling
Increasing/decreasing count setting signal Off	Increasing count	-
Increasing/decreasing count setting signal On	Decreasing count	-

• Operation example

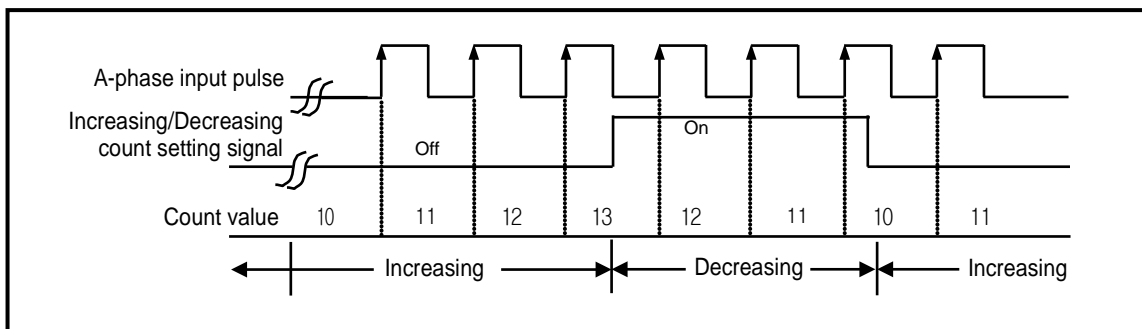

b) Increasing/decreasing count operation by B-phase input signal

- 1-phase 2-input 1-multiplication operation mode

A-phase input pulse counts at rising and increasing/decreasing will be decided by B-phase.

Increasing/Decreasing classification	A-phase input pulse rising	A-phase input pulse falling
B-phase input pulse Off	Increasing count	-
B-phase input pulse On	Decreasing count	-

- Operation example

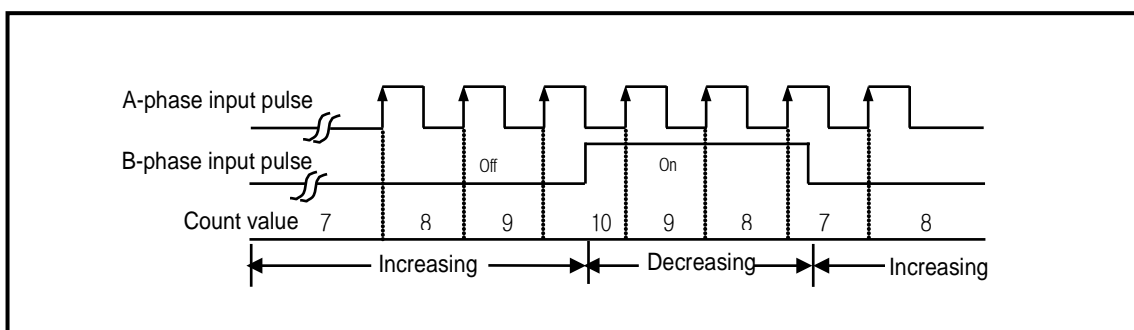

2) 2-phase count mode

- a) 2-phase 4-multiplication operation mode

A-phase input pulse and B-phase input pulse count at rising/falling respectively. If A-phase input is antecedent to B-phase input, increasing operation starts, and if B-phase input is antecedent to A-phase input, decreasing operation starts.

- Operation example

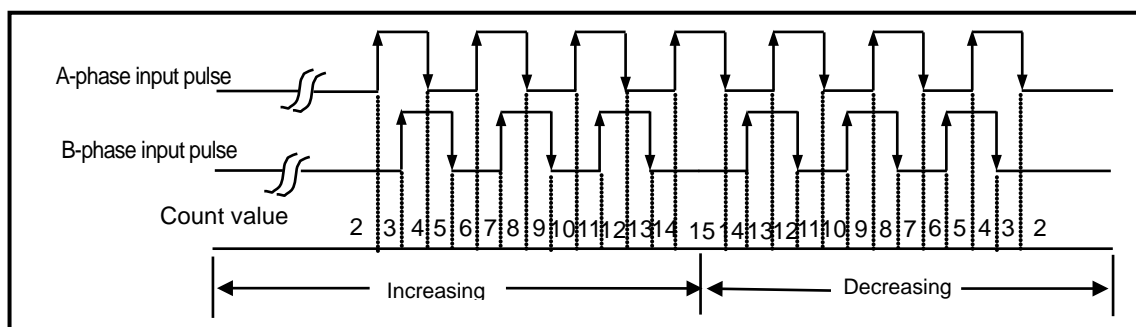

3) CW(Clockwise)/CCW(Counter Clockwise) operation mode

A-phase input pulse counts at rising , or B-phase input pulse counts at rising.

Increasing operation executed when B-phase input pulse is Low with A-phase input pulse at rising, and Decreasing operation executed when A-phase input pulse is Low with B-phase input pulse at rising.

Increasing/Decreasing classification	A-phase input pulse High	A-phase input pulse Low
B-phase input pulse High	-	decreasing count
B-phase input pulse Low	Increasing count	-

• Operation example

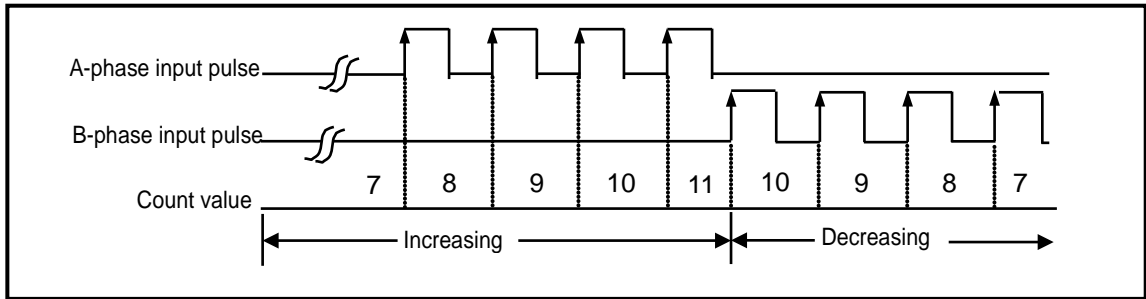

(2) Counter mode

2 types of count (Linear counter, Ring counter) can be selected for the applicable use based on functions.

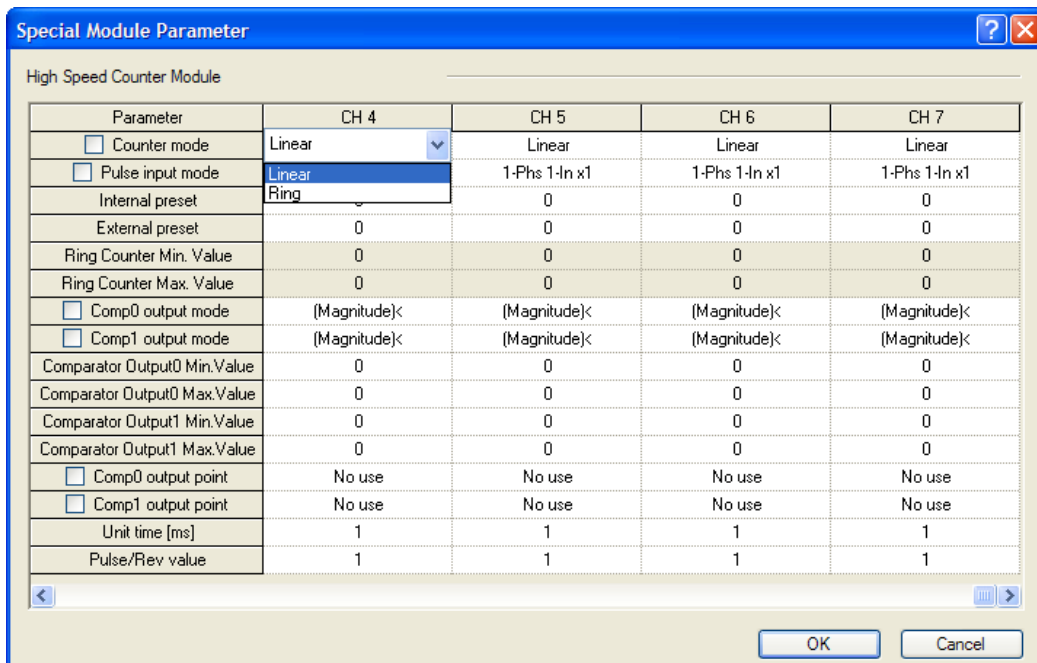

• Counter mode is saved at the following special K area.

Mode	Area per each channel (word)								Ref.
	Ch.0	Ch.1	Ch.2	Ch.3	Ch.4	Ch.5	Ch.6	Ch.7	
Counter mode	K300	K330	K360	K390	K2220	K2250	K2280	K2310	0 : linear 1 : ring

(a) Linear counter

- Linear Count range: -2,147,483,648 ~ 2,147,483,647
- If count value reaches the maximum value while increased, Carry will occur, and if count value reaches the minimum value while decreased, Borrow will occur.
- If Carry occurs, count stops and increasing is not available but decreasing is available.
- If Borrow occurs, count stops and decreasing is not available but increasing is available.

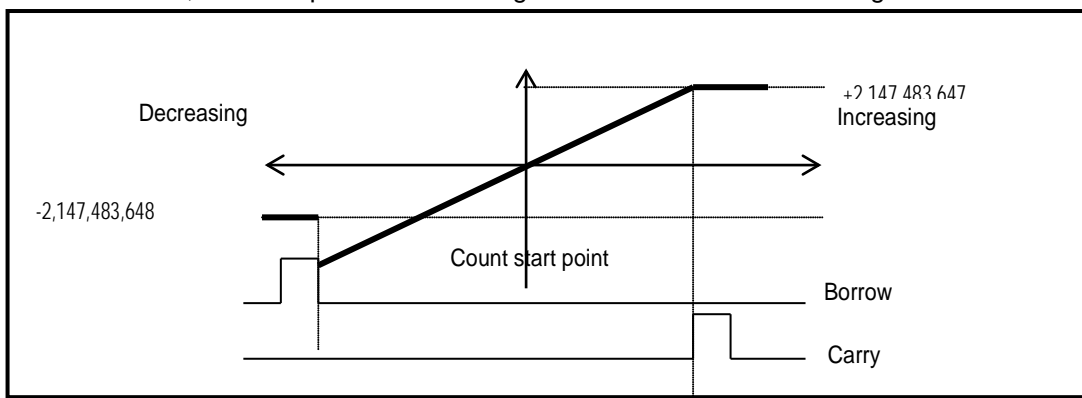

(b) Ring count

Set Ring Counter Min. Value and Max. value. Preset value and compared set value should be in range of ring counter min. value and max. value.

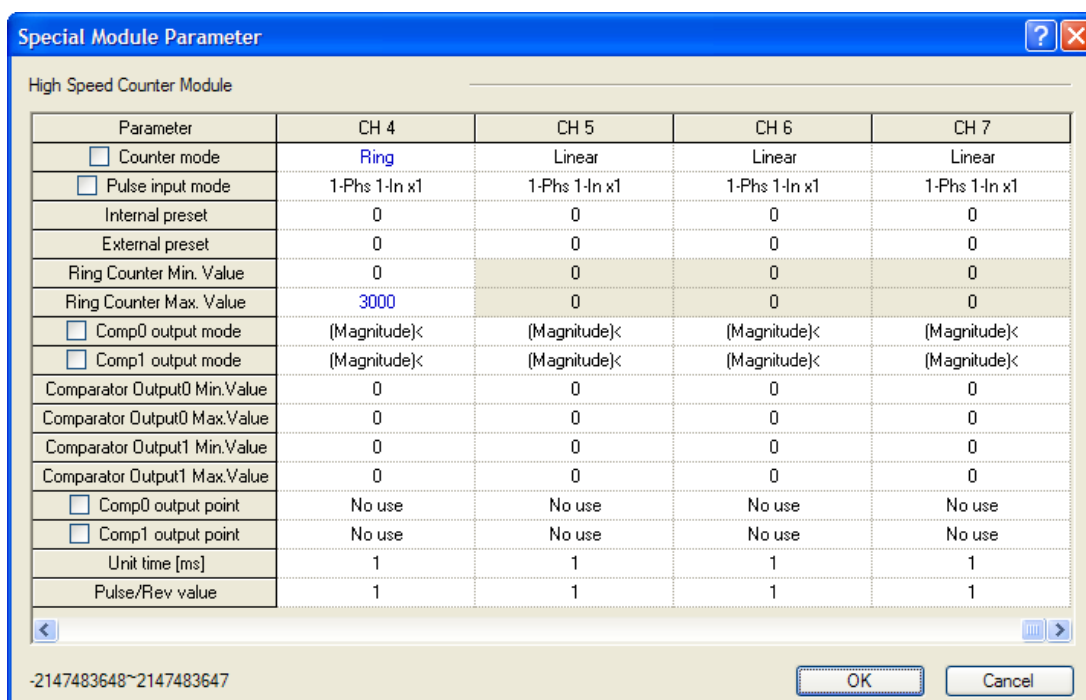

- Ring counter max. and min value is saved at the following special K area.

type	Area per each channel (Double word)								Ref.
	Ch.0	Ch.1	Ch.2	Ch.3	Ch.4	Ch.5	Ch.6	Ch.7	
Ring counter min. value	K308	K338	K368	K398	K2228	K2258	K2288	K2318	-
Ring counter max. value	K310	K340	K270	K400	K2230	K2260	K2290	K2320	-

- Range of Ring counter: user defined min. value ~ user defined max. value
- Counter display: in case of using ring counter, user defined max. value is not displayed.

1) During increasing count

- Even if count value exceeds user-defined maximum value during increasing count, Carry only occurs and count does not stop differently to Linear Count.

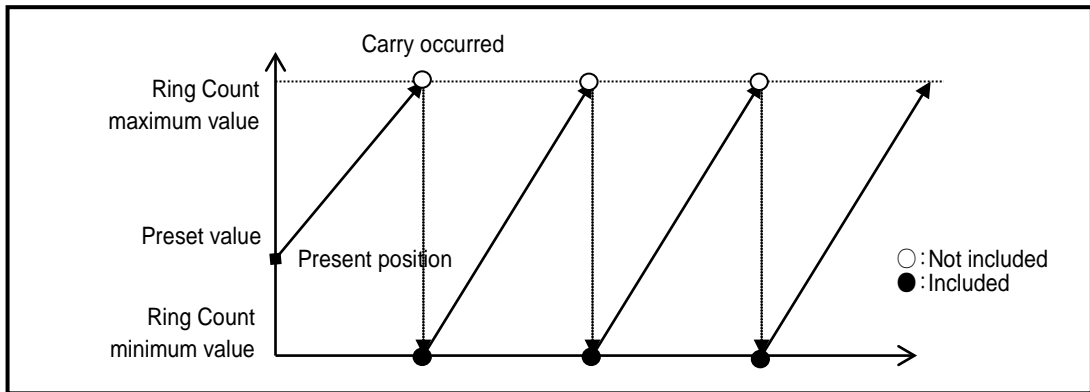

2) During decreasing count

- Even if count value exceeds user-defined minimum value during decreasing count, Borrow only occurs and count does not stop differently to Linear Count.

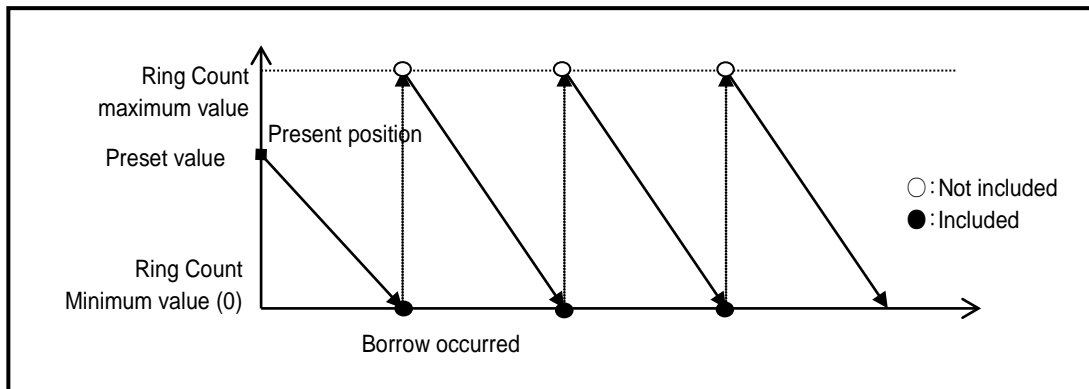

3) Operation when setting Ring Count based on present count value (during increasing count)

- When setting the ring count, the current count value is below the minimum value of the ring counter.
 - Opens an error (Code No. 27), operates as a linear counter, and operates as a ring counter when the current count value falls within the range of the ring counter (error codes are not cleared).
- When setting the ring count, the current count value is above the maximum value of the ring counter.
 - Displays an error (Code No. 27), operates as a linear counter, and stops counting when the current count value reaches the maximum count value (error code is not cleared).
- When setting the ring count, the current count value is within the user setting range
 - It starts to increase from the current count value, increases to the maximum value set by the user, then becomes the minimum value set by the user and continues to count after carrying a carry.
 - As shown in the figure below, the maximum value is not displayed and the count continues after displaying the minimum value.

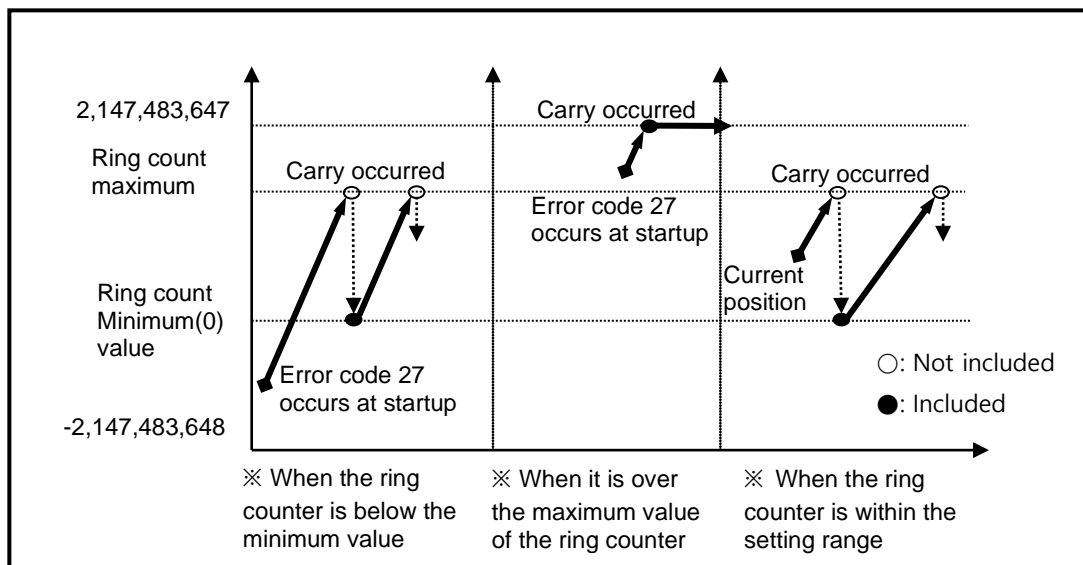

4) Operation when setting Ring Count based on present count value (during decreasing count)

- When setting the ring count, the current count value is below the minimum value of the ring counter.
 - When an error (Code No. 27) is displayed, it operates as a linear counter, and if the current count value falls within the range of the ring count, it operates as a ring count. (The error code is not cleared)
- When setting the ring count, the current count value is above the maximum value of the link counter.
 - An error (Code No. 27) is displayed, and it operates as a linear counter, but stops counting when the current count value reaches the count minimum value. (The error code is not cleared)
- When setting the ring count, the current count value is within the user setting range
 - It starts to decrease from the current count value, decreases to the minimum value set by the user, and becomes the maximum value set by the user, and then continues counting after Borrow occurs.

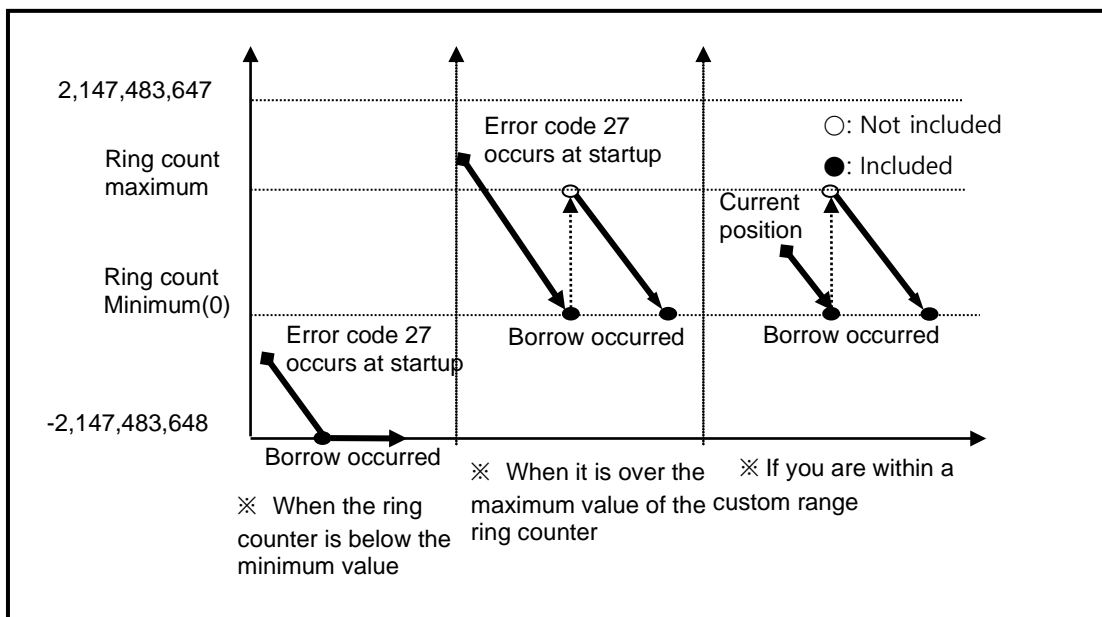

Remark

(1) When using a ring count, be sure to place the count value within the range using a preset or the like.

(3) Compared output

- (a) High Speed counter module has a compared output function used to compare present count value with compared value in size to output as compared.
- (b) Available compared outputs are 2 for 1 channel, which can be used separately.
- (c) Compared output conditions are 7 associated with >, =, < .
- (d) Parameter setting
 - Comp. output mode setting

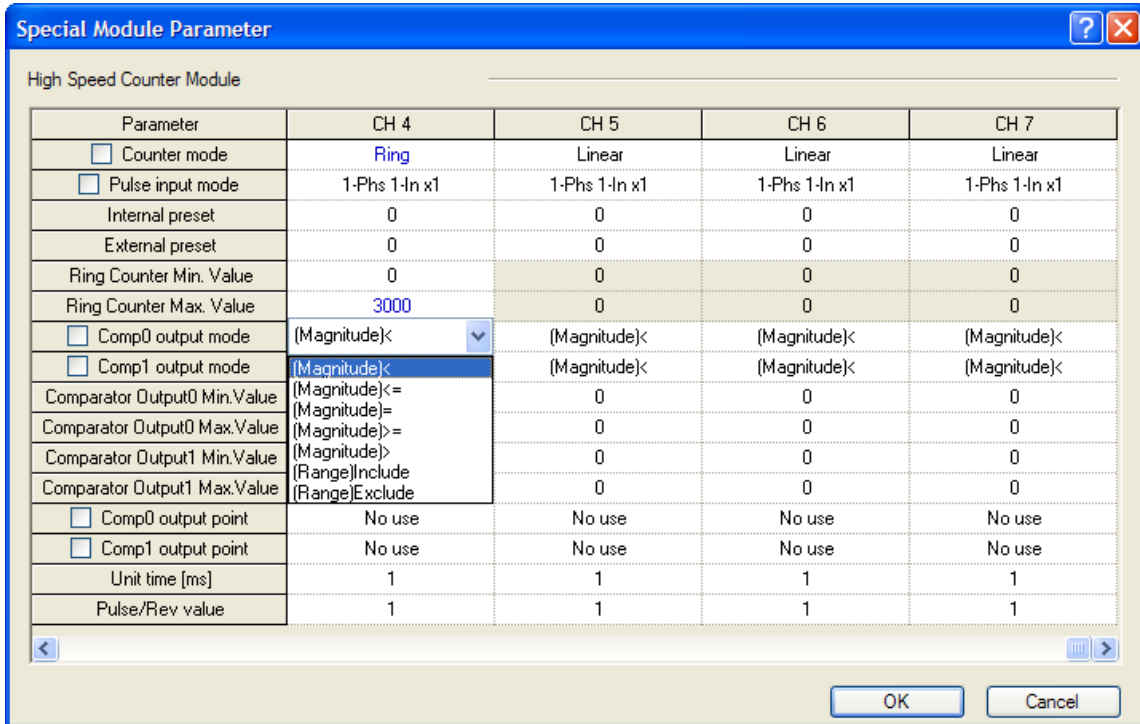

- Upper setting value is saved in special K area.

Compared output condition	Memory address (word)		Value*2)
	Comp output 0	Comp output 1	
Present Value < Compared Value			Set to "0"
Present Value ≤ Compared Value	Ch.0 K302	Ch.0 K303	Set to "1"
Present Value = Compared Value	Ch.1 K332 Ch.2 K362	Ch.1 K333 Ch.2 K363	Set to "2"
Present Value ≥ Compared Value	Ch.3 K392 Ch.4 K2222	Ch.3 K393 Ch.4 K2223	Set to "3"
Present Value > Compared Value	Ch.5 K2252	Ch.5 K2253	Set to "4"
Compared value 1 ≤ Count value ≤ Compared value 2	Ch.6 K2282 Ch.7 K2312	Ch.6 K2283 Ch.7 K2313	Set to "5"
Count value ≤ Compared value 1, Count value ≥ Compared value 2			Set to "6"

*2) If compared output mode set value is other than 0~6 at using counter, error code '23' occurs.

- In order to output the compared output signal, compared output enable flag set to '1' after compared output condition set.

Classification	Area per channel								Operation
	Ch. 0	Ch. 1	Ch. 2	Ch. 3	Ch. 4	Ch. 5	Ch. 6	Ch. 7	
Count enable signal	K2600	K2700	K2800	K2900	K21800	K21900	K22000	K22100	0:disable, 1: enable
Compared 0 enable signal	K2604	K2704	K2804	K2904	K21804	K21904	K22004	K22104	0: disable, 1: enable
Compared 1 enable signal	K2607	K2707	K2807	K2907	K21807	K21907	K22007	K22107	0: disable, 1: enable

- In order to make external output, the compared coincidence output signal (P20~P2F) must be set. If Compared output contact is 'Off' at Special Module Parameter Setting of XG5000, Compared coincidence output signal (internal device) is only output.

Classification	Area per channel							Operation
	Ch. 0	Ch. 1	Ch. 2	Ch.4	Ch.5	Ch. 6	Ch.7	
Compared coincidence output signal 0	K2612	K2712	K2812	K2912	K21812	K22012	K22112	0: Compared output Off 1: Compared output On
Compared coincidence output signal 1	K2613	K2713	K2813	K2913	K21813	K22013	K22113	0: Compared output Off 1: Compared output On

• Comp. output point (P40 ~ P4F) setting

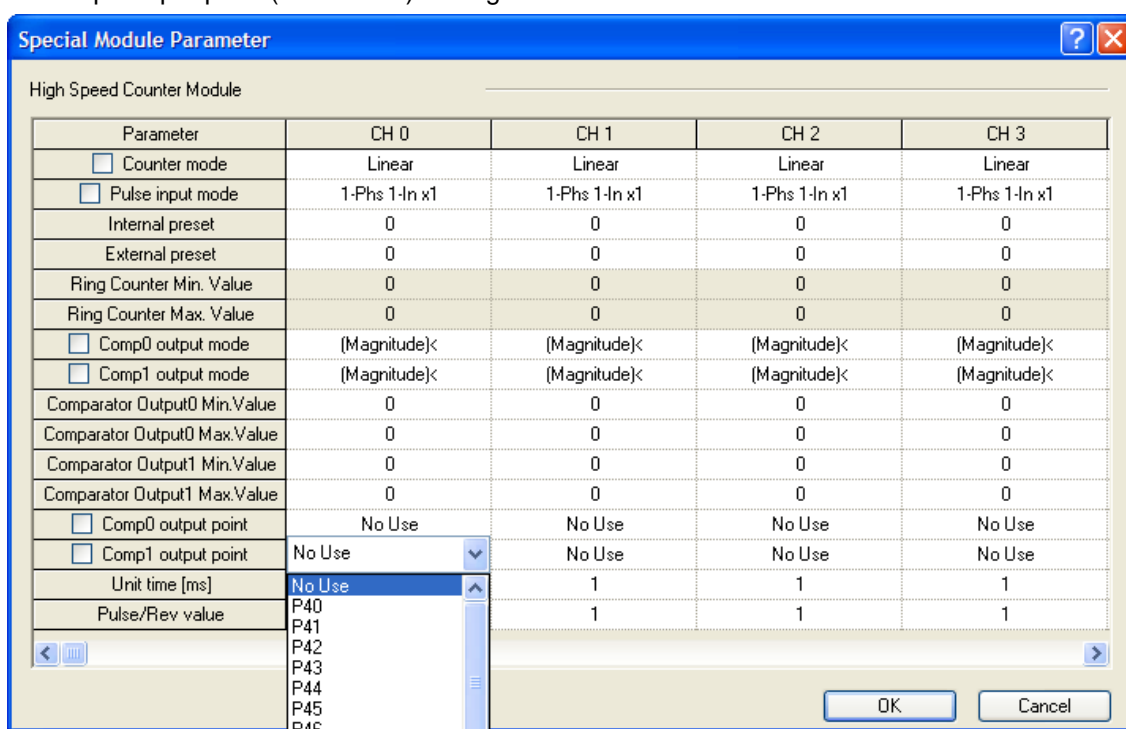

(e) Detail of comparator output

It describes detail of comparator output (based on comparator output 0)

1) Mode 0 (Present value < Compared value)

- If counted present value is less than the minimum value of compared output 0, output is sent out, and if present value increases to be equal to or greater than the minimum value of compared output 0, output is not sent out.

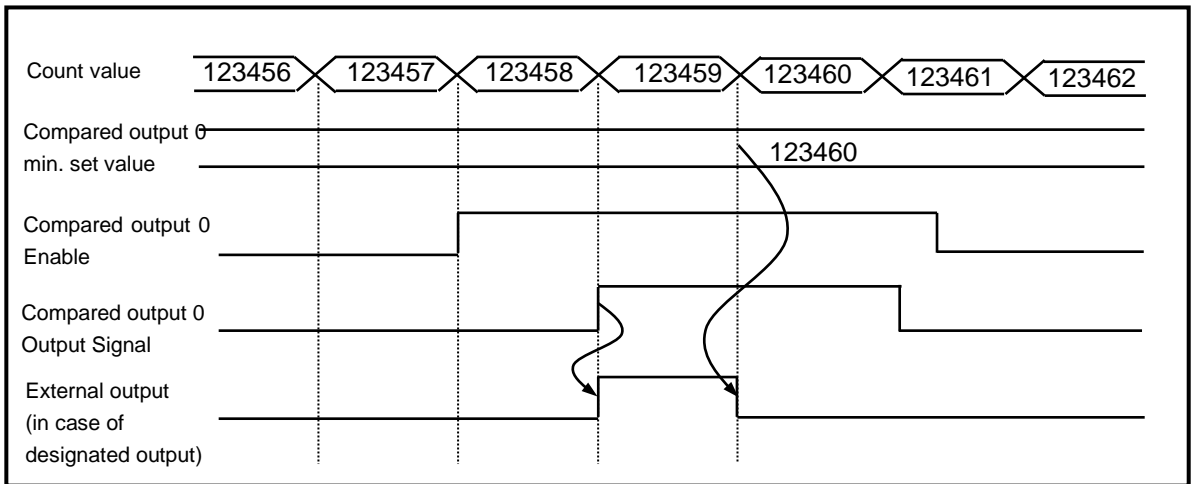

2) Mode1 (Count value ≤ Compared value)

- If present count value is less than or equal to the minimum set value of compared output 0, output is sent out, and if count value increases to be greater than the minimum set value of compared output 0, output is not sent out.

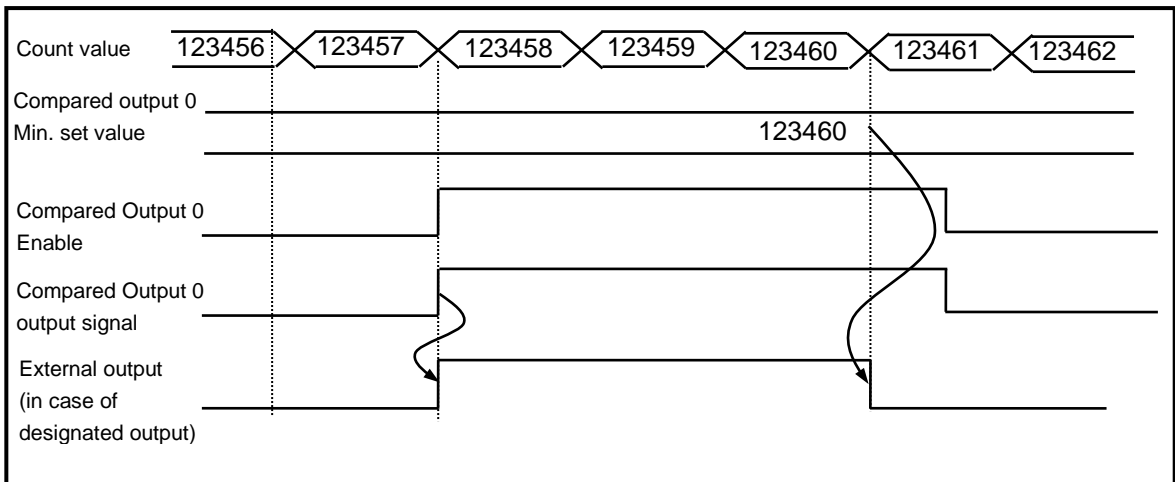

3) Mode 2 (Count value = Compared value)

- If present count value is equal to the minimum set value of compared output 0, output is sent out. In order to turn the output Off, Compared output Enable signal 0 or Compared Coincidence Output Enable signal 0 is to be Off.

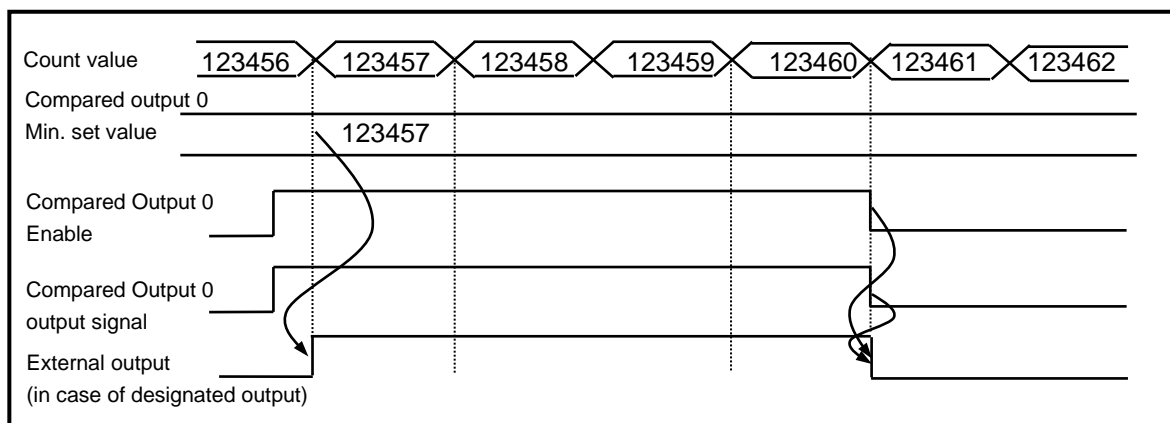

4) Mode 3 (Count value \geq Compared value)

- If present count value is greater than or equal to the minimum set value of compared output 0, output is sent out, and if count value decreases to be less than the minimum set value of compared output 0, output is not sent out.

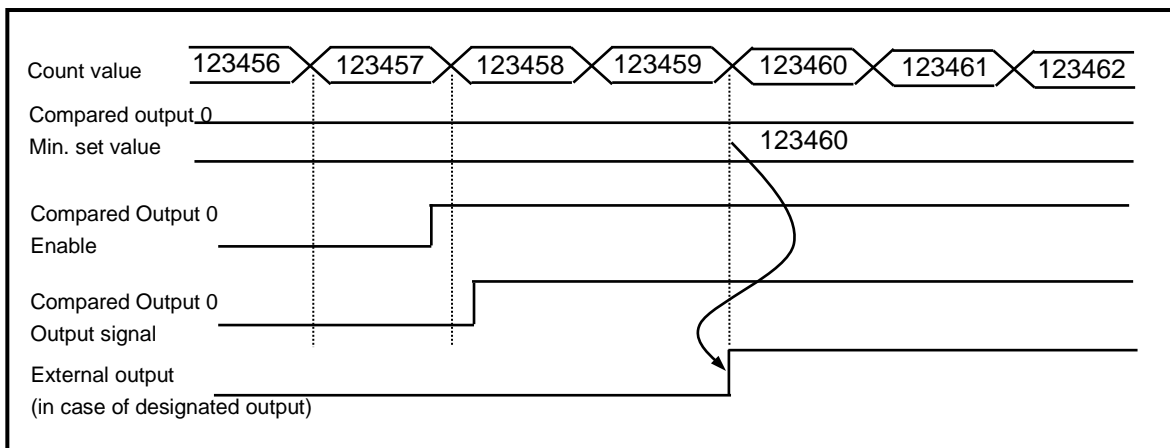

5) Mode 4 (Count value > Compared Output value)

- If present count value is greater than the minimum set value of compared output 0, output is sent out, and if count value decreases to be less than or equal to the minimum set value of compared output 0, output is not sent out.

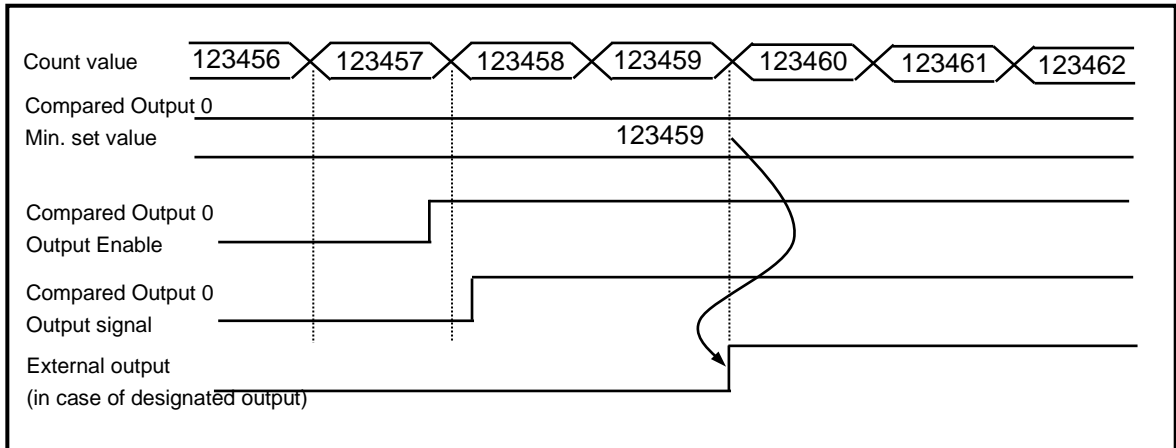

6) Mode 5

(Section comparison: Min. set value of Compared Output 0 ≤ Count value ≤ Max. set value of Compared Output 0)

- If present count value is greater than or equal to the minimum set value of compared output 0 and less than or equal to the maximum set value of compared output 0, output is sent out, and if count value increases/decreases to exceed compared value's range, output is not sent out.

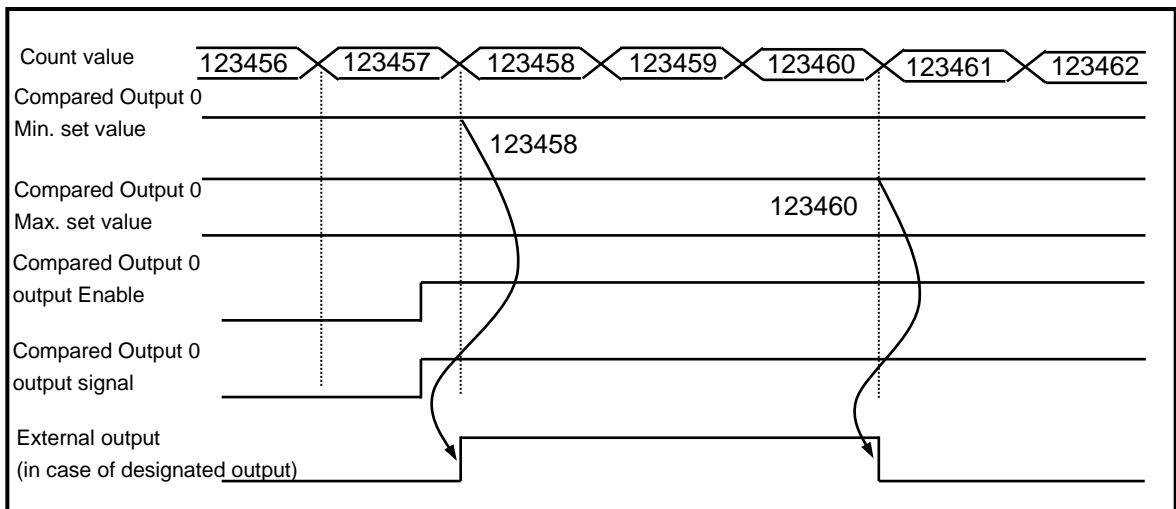

7) Mode 6 (Count value \leq Min. set value of Compared Output 0 or Count value \geq Max. set value of Compared Output 0)

- If present count value is less than or equal to the minimum set value of compared 0 and greater than or equal to the maximum set value of compared 0, output is sent out, and if count value increases/decreases to exceed compared value's range, output is not sent out.

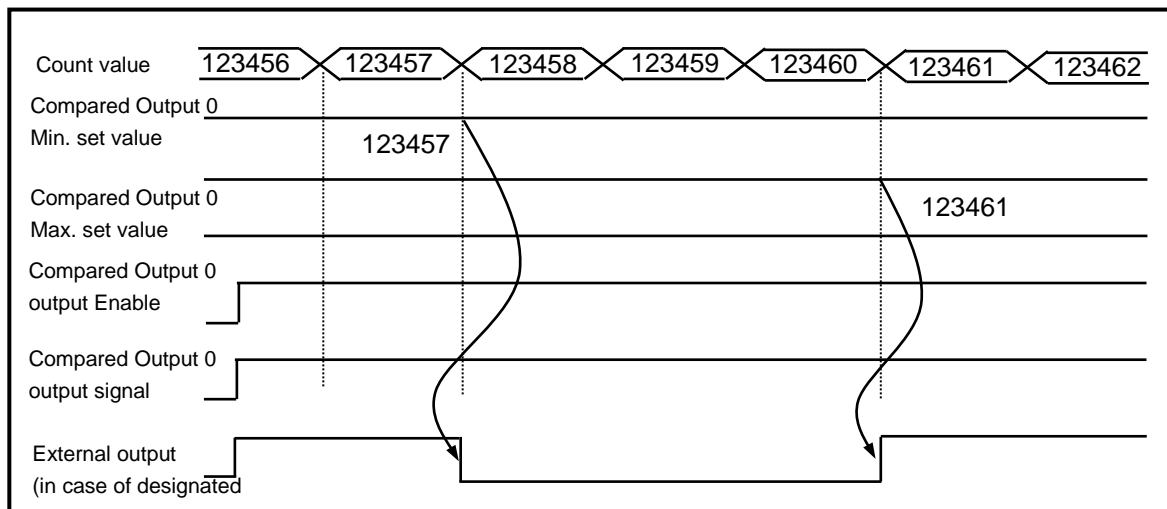

(4) Carry signal

(a) Carry signal occurs

- 1) When count range maximum value of 2,147,483,647 is reached during Linear Count.
- 2) When user-defined maximum value of Ring Count changed to the minimum value during Ring Count.

(b) Count when Carry Signal occurs

- 1) Count stops if Carry occurs during Linear Count.
- 2) Count does not stop even if Carry occurs during Ring Count.

(c) Carry reset

- 1) The Carry generated can be cancelled by Carry/Borrow reset signal On.

Classification	Device area per channel							
	Ch.0	Ch.1	Ch.2	Ch.3	Ch.4	Ch.5	Ch.6	Ch.7
Carry signal	K2610	K2710	K2810	K2910	K21810	K21910	K22010	K22110

(5) Borrow signal

(a) Borrow signal occurs

- 1) When count range minimum value of -2,147,483,648 is reached during Linear Count.
- 2) When user-defined minimum value of Ring Count changed to the maximum value during Ring Count.

(b) Count when Borrow signal occurs

- 1) Count stops if Borrow occurs during Linear Count.
- 2) Count does not stop even if Borrow occurs during Ring Count.

(c) Borrow reset

- 1) The Borrow generated can be cancelled by Carry/Borrow reset signal On.

Classification	Device area per channel							
	Ch.0	Ch.1	Ch.2	Ch.3	Ch.4	Ch.5	Ch.6	Ch.7
Borrow signal	K2611	K2711	K2811	K2911	K21811	K21911	K22011	K22111

(6) Revolution/Unit time

While the Flag about the number of revolution per unit time is On, it counts the number of input pulses for a specified time.

(a) Setting

1) Set the unit time and the number of pulse per 1 revolution.

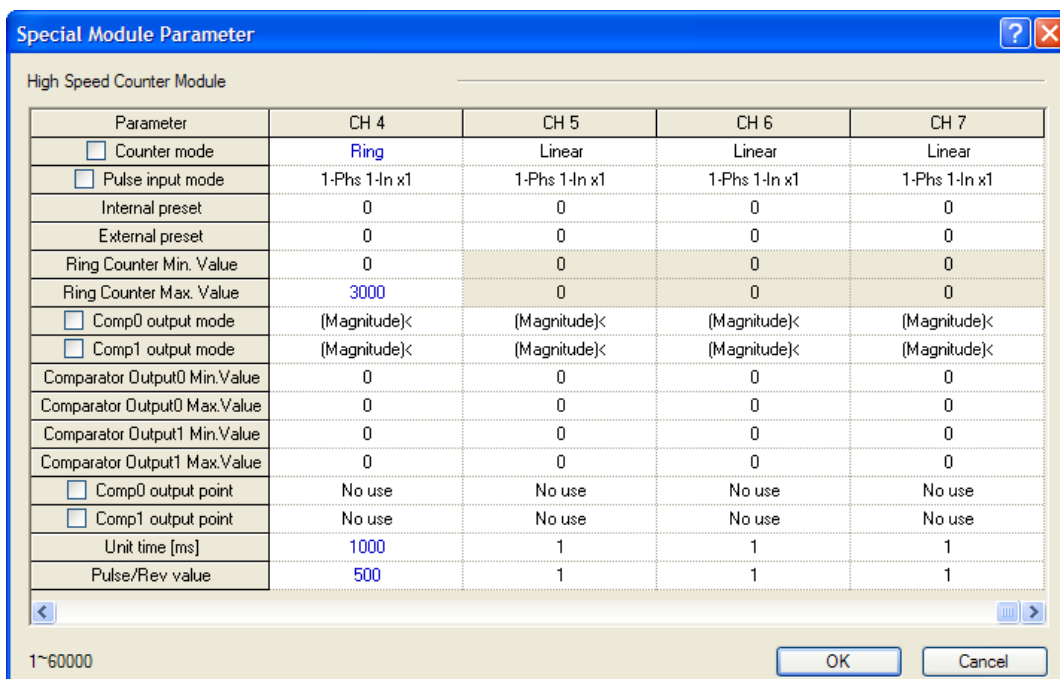

Setting value is saved at the following special K area and user can designate directly.

Class	Device per each channel (Word)								Setting range
	Ch.0	Ch.1	Ch.2	Ch.3	Ch.4	Ch.5	Ch.6	Ch.7	
Unit time	K322	K352	K382	K412	K2242	K2272	K2302	K2332	1~60000ms
Pulse/Rev value	K323	K353	K383	K413	K2243	K2273	K2303	K2333	1~60000

2) In case of using Rev/unit time function, enable the following special K area

Class	Device per each channel (Word)								Operation
	Ch.0	Ch.1	Ch.2	Ch.3	Ch.4	Ch.5	Ch.6	Ch.7	
Rev/unit time command	K2605	K2705	K2805	K2905	K21805	K21905	K22005	K22105	0: disable 1: enable

3) Rev/unit time value is saved at the following special K area.

Class	Device per each channel (Word)								Ref.
	Ch.0	Ch.1	Ch.2	Ch.3	Ch.4	Ch.5	Ch.6	Ch.7	
Rev/unit time	K264	K274	K284	K294	K2184	K2194	K2204	K2214	-

- (b) Count function of Revolution/Unit time is used to count the number of pulses for a specified time while auxiliary mode enable signal is On.
- (c) With the displayed number of pulses updated for a specified time and the number of pulses per revolution input, Revolution/Unit time can be counted.
- (d) Number of Revolution per 1 second is indicated after number of pulse per 1 revolution is set and time is set to 1 second (1000ms). In order to indicate by Revolutions per minute (RPM), the operation is executed in program.
- (e) The example that number of pulse per 1 revolution set to '1' and time is set to 1000 ms is as shown below. (Ch0)

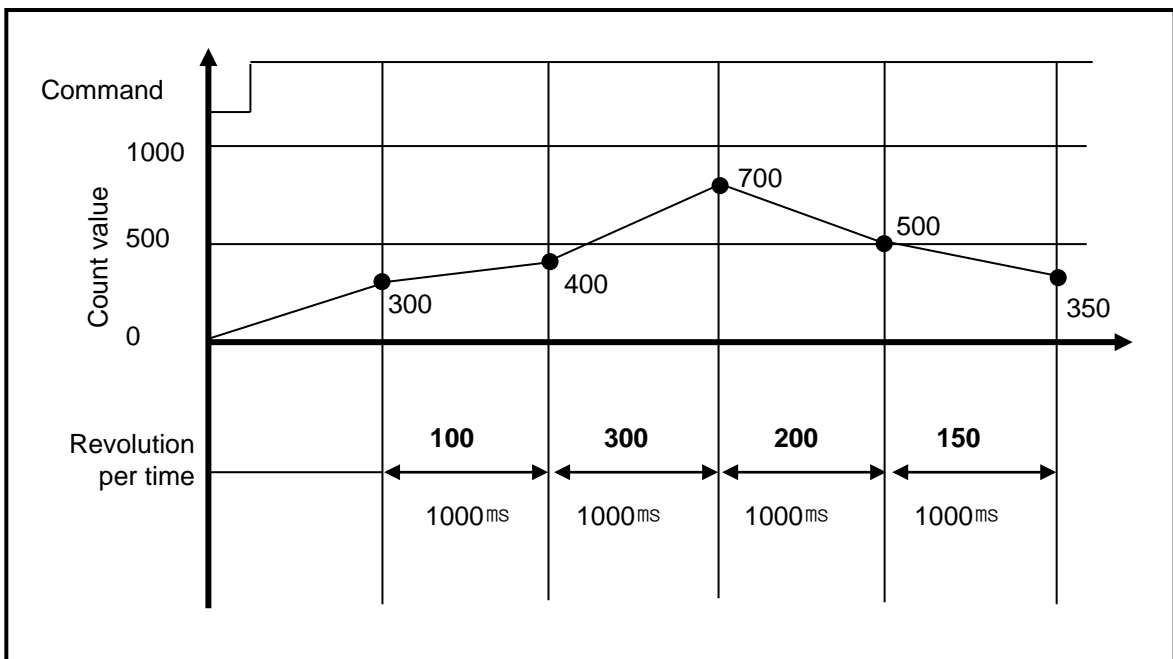

- (f) In order to indicate revolution per minute (RPM), the program is as shown below. In case of DMUL operation, RPM value is saved 64 bit in D100~D103. If operated RPM value is used, it can use to Word or Dword type according to system (case of RPM value is small number).

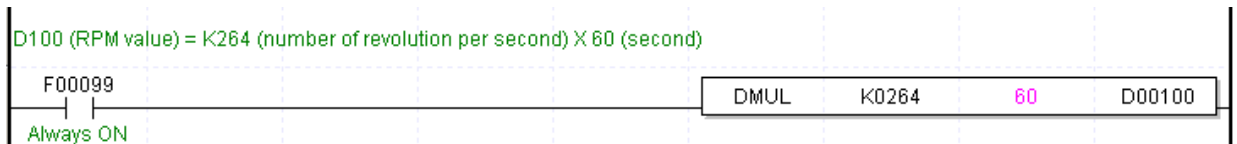

(g) The example that number of pulse per 1 revolution set to '10' and time is set to 60,000 ms is as shown below.

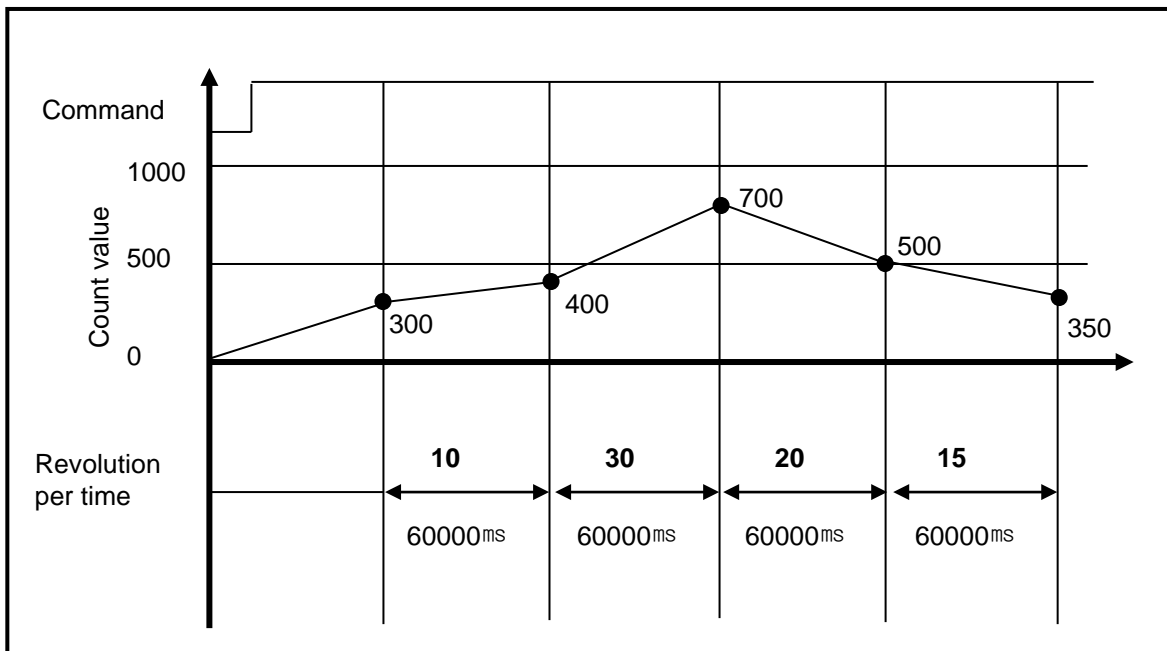

(7) Count latch

When Count latch signal is On, present count value is latched.

▪ Setting

If present counter value is to latch, Count Latch function is set 'Use'.

Class	Device area per channel								Operation
	Ch.0	Ch.1	Ch.2	Ch.3	Ch.4	Ch.5	Ch.6	Ch.7	
Count latch command	K2606	K2706	K2806	K2906	K21806	K21906	K22006	K22106	0: disable 1: enable

- Count latch function is operated when Count latch signal is On. Namely, counter value is not cleared when power supply Off =>On and mode change, it is counted from previous value.
- In latch counter function, internal or external preset function has to use for clearing present value.

(8) Preset function

It changes the current value into preset value.

There are two types of preset function, internal preset and external preset. External preset is fixed as input contact point.

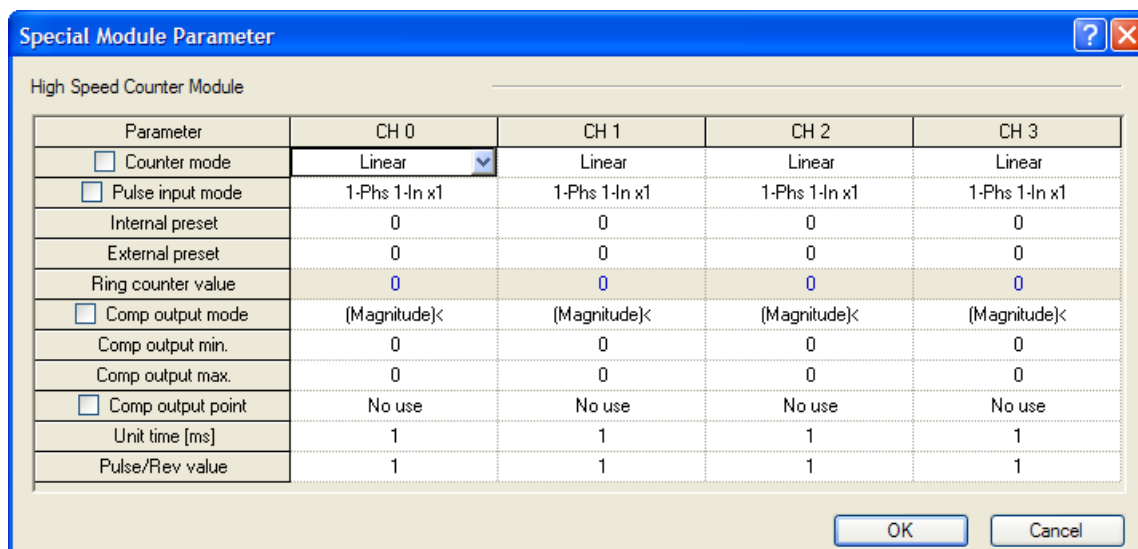

- Preset setting value is saved at the following special K area.

Type	Area per each channel (Double word)								Ref.
	Ch.0	Ch.1	Ch.2	Ch.3	Ch.4	Ch.5	Ch.6	Ch.7	
Internal preset value	K304	K334	K364	K394	K2224	K2254	K2284	K2314	-
External preset value	K306	K336	K366	K396	K2226	K2256	K2286	K2316	-

- Preset command is specified through the following special K area, external preset is used by executing the designated input contact point after allowance bit is on.

Type	Area per each channel (Bit)								Ref.
	Ch.0	Ch.1	Ch.2	Ch.3	Ch.4	Ch.5	Ch.6	Ch.7	
Internal preset command	K2601	K2701	K2801	K2901	K21801	K21901	K22001	K22101	-
External preset allowance	K2602	K2702	K2802	K2902	K21802	K21902	K22002	K22102	-
External preset command	P008	P009	P00A	P00B	P00C	P00D	P00E	P00F	-

8.2 Installation and Wiring

8.2.1 Precaution for wiring

Pay attention to the counteractions against wiring noise especially for High-speed pulse input.

- (1) Surely use twisted pair shielded cable, grounded with 3 class applied.
- (2) Keep away from power cable or I/O line which may cause noise.
- (3) Stabilized power should be used for filter.

- ▶ Connect A-phase only for 1-phase input.
- ▶ Connect A-phase and B-phase for 2-phase input.

8.2.2 Example of wiring

- (1) In case of pulse generator (encoder) is voltage output type

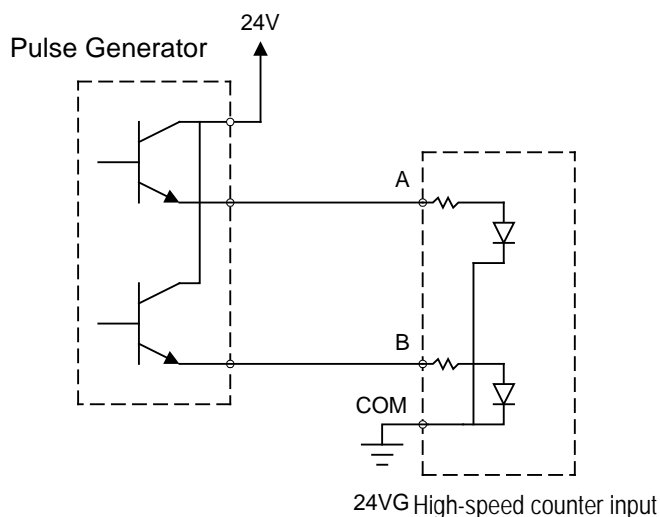

- (2) In case of pulse generator is open collector type

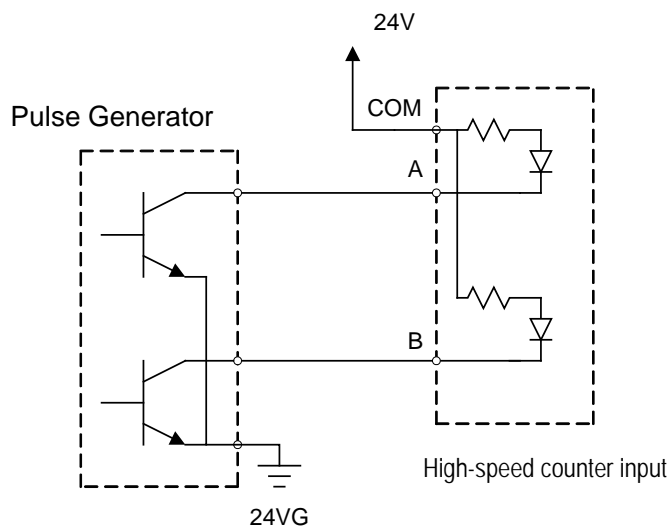

8.3 Internal Memory

8.3.1 Special area for High-speed counter

Parameter and operation command area of built-in high-speed counter use a special K device.

If values set in parameter are changed, it works with the changed values. At the moment, makes sure to use WRT command to save the changed value to flash. If not saved in flash, the changed values with the power off => on and mode changed may not be maintained.

- The following example shows that the internal preset values of CH1 set in parameter are changed by program and saved in flash.
 - Receiving an order command (M000), it moves (MOV) the new internal preset value (5000) to the CH1 present area (K332).
 - To save the changed settings into flash, it uses WRT command. At the moment, slot information is set to '0' in case of built-in function.

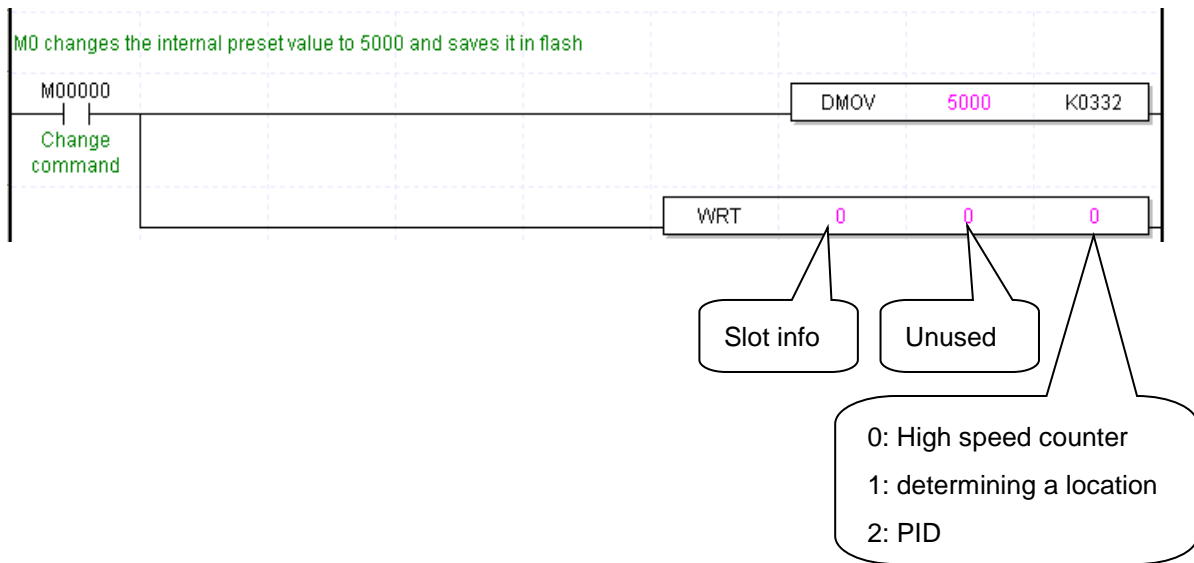

Remark

- (1) In case of saving in flash memory using WRT instruction, processing time of about 200~300ms is required.
- (2) Turning off the PLC power while writing to the flash memory or repetitively using the WRT command may damage the flash memory, so be careful when using it.

(1) "E" type

(a) Parameter setting

Parameter	Description		Device area per channel				Remark
	Value	Setting	Ch 0	Ch 1	Ch 2	Ch 3	
Counter mode	h0000	Linear count	K300	K330	K360	K390	Word
	h0001	Ring count					
Pulse input mode	h0000	1 phase 1 input 1 multiplication	K301	K331	K361	K391	Word
	h0001	1 phase 2 input 1 multiplication					
	h0002	CW / CCW					
	h0003	2 phase 2 multiplication					
Comp. Output mode	h0000	(Magnitude) <	K302	K332	K362	K392	Word
	h0001	(Magnitude) ≤					
	h0002	(Magnitude) =					
	h0003	(Magnitude) ≥					
	h0004	(Magnitude) >					
	h0005	(Range) Include					
	h0006	(Range) Exclude					
Internal preset value setting	-2,147,483,648 ~ 2,147,483,647		K304	K334	K364	K394	DWord
External preset value setting	-2,147,483,648 ~ 2,147,483,647		K306	K336	K366	K396	DWord

Parameter	Description		Device area per channel				Remark
	Value	Setting	Ch 0	Ch 1	Ch 2	Ch 3	
Ring counter Max. value setting	-2,147,483,648 ~ 2,147,483,647		K310	K340	K370	K400	DWord
Comp. Output Min. value setting	-2,147,483,648 ~ 2,147,483,647		K312	K342	K372	K402	DWord
Comp. output Max. value setting	-2,147,483,648 ~ 2,147,483,647		K314	K344	K374	K404	DWord
Comp. output point designation	HFFFF	No use	K320	K350	K380	K410	Word
	h0000	P0020					
	h0001	P0021					
	h0002	P0022					
	h0003	P0023					
	h0004	P0024					
	h0005	P0025					
	h0006	P0026					
h0007	P0027						
Unit time [ms]	1 ~ 60,000		K322	K352	K382	K412	DWord
Pulse/Rev.value	1 ~ 60,000		K323	K353	K383	K413	DWord

(b) Operation command

Parameter	Device area per channel			
	Ch 0	Ch 1	Ch 2	Ch 3
Counter enabling	K2600	K2700	K2800	K2900
Internal preset designation of counter	K2601	K2701	K2801	K2901
External preset enabling of counter	K2602	K2702	K2802	K2902
Designation of decremental counter	K2603	K2703	K2803	K2903
Comp. output enabling	K2604	K2704	K2804	K2904
Enabling of revolution time per unit time	K2605	K2705	K2805	K2905
Designation of latch counter	K2606	K2706	K2806	K2906
Carry signal (Bit)	K2610	K2710	K2810	K2910
Borrow signal	K2611	K2711	K2811	K2911
Comp. output signal	K2612	K2712	K2812	K2912

(c) Area of monitoring

Parameter	Device area per channel				Remark
	Ch 0	Ch 1	Ch 2	Ch 3	
Current counter value	K262	K272	K282	K292	DWord
Revolution time per unit time	K264	K274	K284	K294	DWord

(2) "S(U)" type

(a) Parameter setting

Parameter	Description		Device area per channel				Remark
	Value	Setting	Ch 0	Ch 1	Ch 2	Ch 3	
			Ch 4	Ch 5	Ch 6	Ch 7	
Counter mode	h0000	Linear count	K300	K330	K360	K390	Word
	h0001	Ring count	K2220	K2250	K2280	K2310	
Pulse input mode setting	h0000	1 phase 1 input 1 multiplication	K301	K331	K361	K391	Word
	h0001	1 phase 2 input 1 multiplication					
	h0002	CW / CCW	K2221	K2251	K2281	K2311	Word
	h0003	2 phase 4 multiplication					
Comp. Output 0 mode setting	h0000	(Magnitude) <	K302	K332	K362	K392	Word
	h0001	(Magnitude) ≤					
	h0002	(Magnitude) =					
	h0003	(Magnitude) ≥					
	h0004	(Magnitude) >	K2222	K2252	K2282	K2312	
	h0005	(Range) Include					
	h0006	(Range) Exclude					
Comp. Output 1 mode setting	h0000	(Magnitude) <	K303	K333	K363	K393	Word
	h0001	(Magnitude) ≤					
	h0002	(Magnitude) =					
	h0003	(Magnitude) ≥					
	h0004	(Magnitude) >	K2223	K2253	K2283	K2313	
	h0005	(Range) Include					
	h0006	(Range) Exclude					
Internal preset value setting	-2,147,483,648 ~ 2,147,483,647		K304	K334	K364	K394	DWord
			K2224	K2254	K2284	K2314	
External preset value setting	-2,147,483,648 ~ 2,147,483,647		K306	K336	K366	K396	DWord
			K2226	K2256	K2286	K2316	

Parameter	Description		Device area per channel				Remark
	Value	Setting	Ch 0	Ch 1	Ch 2	Ch 3	
			Ch 4	Ch 5	Ch 6	Ch 7	
Ring counter min. value setting	-2,147,483,648 ~ 2,147,483,645		K308	K338	K368	K398	DWord
			K2228	K2258	K2288	K2318	
Ring counter max. value setting	-2,147,483,646 2,147,483,647		K310	K340	K370	K400	DWord
			K2230	K2260	K2290	K2320	
Comp. output min. value setting	-2,147,483,648 ~ 2,147,483,647		K312	K342	K372	K402	DWord
			K2232	K2262	K2292	K2322	
Comp. output max. value setting	-2,147,483,648 ~ 2,147,483,647		K314	K344	K374	K404	DWord
			K2234	K2264	K2294	K2324	
Comp. output 0 point designation	HFFFF	No use	K320	K350	K380	K410	Word
	h0000	P0020					
	h0001	P0021					
	h0002	P0022					
	h0003	P0023					
	h0004	P0024					
	h0005	P0025					
	h0006	P0026					
	h0007	P0027					
	h0008	P0028	K2240	K2270	K2300	K2330	
	h0009	P0029					
	h000A	P002A					
	h000B	P002B					
	h000C	P002C					
	h000D	P002D					
	h000E	P002E					
h000F	P002F						

Parameter	Description		Device area per channel				Remark
	Value	Setting	Ch 0	Ch 1	Ch 2	Ch 3	
			Ch 4	Ch 5	Ch 6	Ch 7	
Comp. output 1 point designation	HFFFF	No use	K321	K351	K381	K411	Word
	h0000	P0020					
	h0001	P0021					
	h0002	P0022					
	h0003	P0023					
	h0004	P0024					
	h0005	P0025					
	h0006	P0026					
	h0007	P0027	K2241	K2271	K2301	K2331	
	h0008	P0028					
	h0009	P0029					
	h000A	P002A					
	h000B	P002B					
	h000C	P002C					
	h000D	P002D					
	h000E	P002E					
h000F	P002F						
Unit time [ms]	1 ~ 60,000 ms		K322	K352	K382	K412	Word
			K2242	K2272	K2302	K2332	
Pulse/Rev.value	1 ~ 60,000		K323	K353	K383	K413	Word
			K2243	K2273	K2303	K2333	

(b) Operation command

Parameter	Device area per channel							
	Ch 0	Ch 1	Ch 2	Ch 3	Ch 4	Ch 5	Ch 6	Ch 7
Counter enabling	K2600	K2700	K2800	K2900	K21800	K21900	K22000	K22100
Internal preset designation of counter	K2601	K2701	K2801	K2901	K21801	K21901	K22001	K22101
External preset enabling of counter	K2602	K2702	K2802	K2902	K21802	K21902	K22002	K22102
Designation of decremental counter	K2603	K2703	K2803	K2903	K21803	K21903	K22003	K22103
Comp. output 0 enabling	K2604	K2704	K2804	K2904	K21804	K21904	K22004	K22104
Comp. output 1 enabling	K2607	K2707	K2807	K2907	K21807	K21907	K22007	K22107
Enabling of revolution time per unit time	K2605	K2705	K2805	K2905	K21805	K21905	K22005	K22105
Designation of latch counter	K2606	K2706	K2806	K2906	K21806	K21906	K22006	K22100
Carry signal (Bit)	K2610	K2710	K2810	K29100	K21810	K21910	K22010	K22110
Borrow signal	K2611	K2711	K2811	K29101	K21811	K21911	K22011	K22111
Comp. output 0 signal	K2612	K2712	K2812	K29102	K21812	K21912	K22012	K22112
Comp. output 1 signal	K2613	K2713	K2813	K29103	K21813	K21913	K22013	K22113

(c) Area of monitoring

Parameter	Device area per channel							
	Ch 0	Ch 1	Ch 2	Ch 3	Ch 4	Ch 5	Ch 6	Ch 7
Current counter value	K262	K272	K282	K292	K2182	K2192	K2202	K2212
Revolution per unit time	K264	K274	K284	K294	K2184	K2194	K2204	K2214

8.3.2 Error code

It describes errors of the built-in high-speed counter.

- Error occurred is saved in the following area.

Category	Device area per channel								Remark
	Ch0	Ch1	Ch2	Ch3	Ch4	Ch5	Ch6	Ch7	
Error code	K266	K276	K286	K296	K2186	K2196	K2206	K2216	Word

- Error codes and descriptions

Error code (Decimal)	Description
20	Counter type is set out of range
21	Pulse input type is set out of range
22	Requesting #1(3,)channel Run during the operation of #0(2) channel 2 phase(* During #0(2) channel 2 phase inputting, using #1(3)channel is not possible.
23	Compared output type setting is set out of range.
25	Internal preset value is set out of counter range
26	External present value is set out of counter range
27	Ring counter setting is set out of range * Note ring counter setting should be 2 and more.
28	Compared output min. value is set out of permissible max. input range
29	Compared output max. value is set out of permissible max. input range
30	Error of Compared output min. value>Compared output max. value
31	Compared output is set out of the default output value
34	Set value of Unit time is out of the range
35	Pulse value per 1 revolution is set out of range

Remark

- If two and more errors occur, the module saves the latter error code and removes the former one.

8.4 Examples: Using High-speed Counter

It describes examples of using high-speed counter.

(1) Setting high-speed counter parameter

How to set types of parameters to operate a high-speed counter is described as follows.

(a) Set 『Internal Parameters』 in the basic project window.

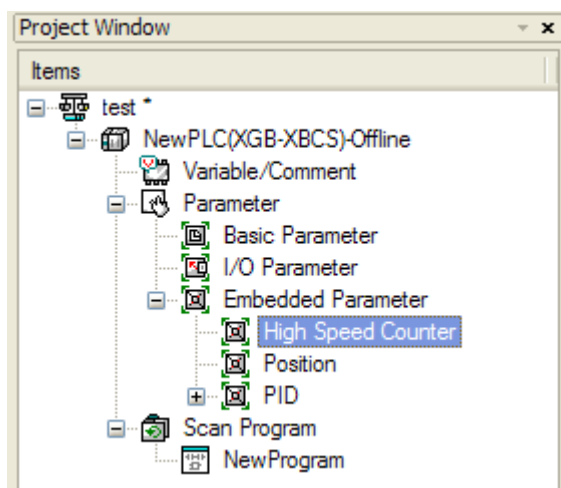

(b) Selecting high-speed counter opens a window to set high-speed counter parameters as follows.

For details regarding each parameter setting, refer to 8.1~8.3.

(Every parameter settings are saved in the special K device area.)

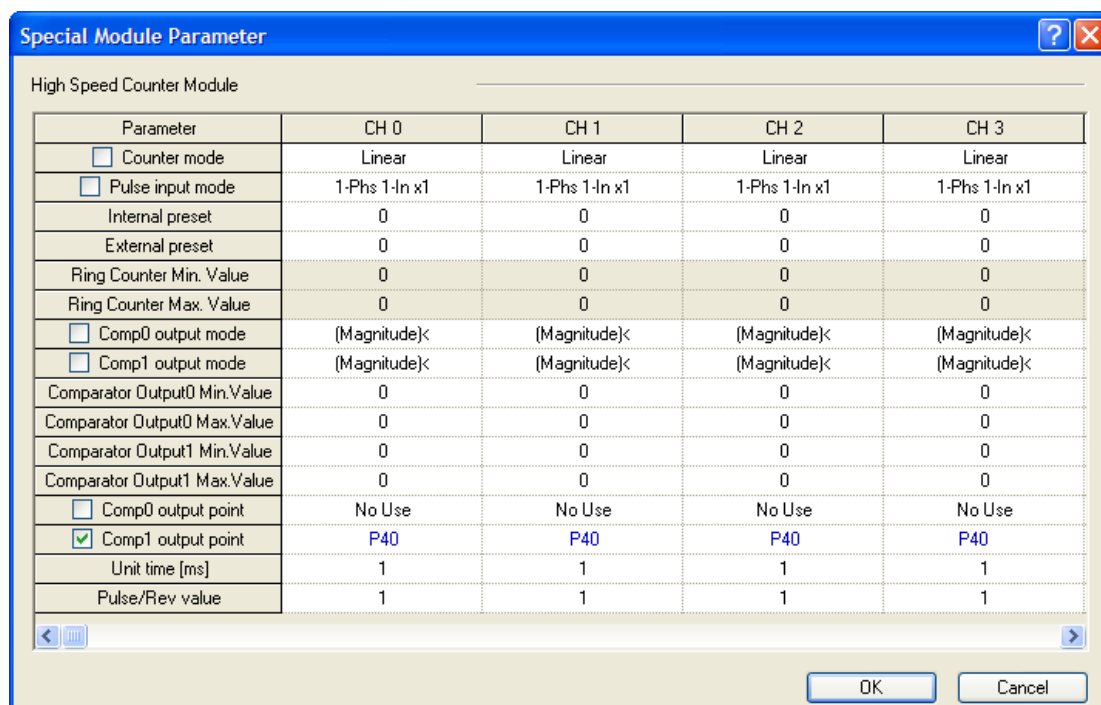

(c) Turn 'ON' the high-speed counter Enable signal (CH0:K2600) in the program.

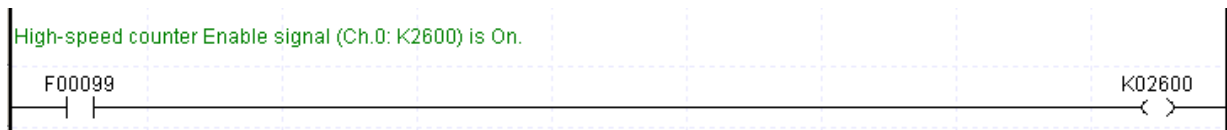

(d) To use additional functions of the high-speed counter, you need to turn on the flag allowing an operation command.

* Refer to 2) Operation Command, <8.3.1 Special K Area for High-speed Counter>

For instance, turn on 2605 bit if among additional functions, rotation number function is used.

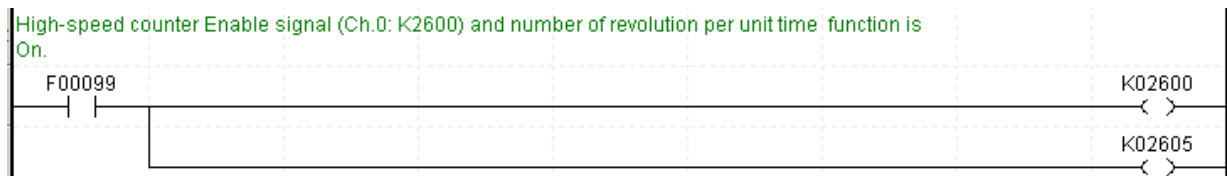

(e) Upon the setting, download program and parameter to PLC.

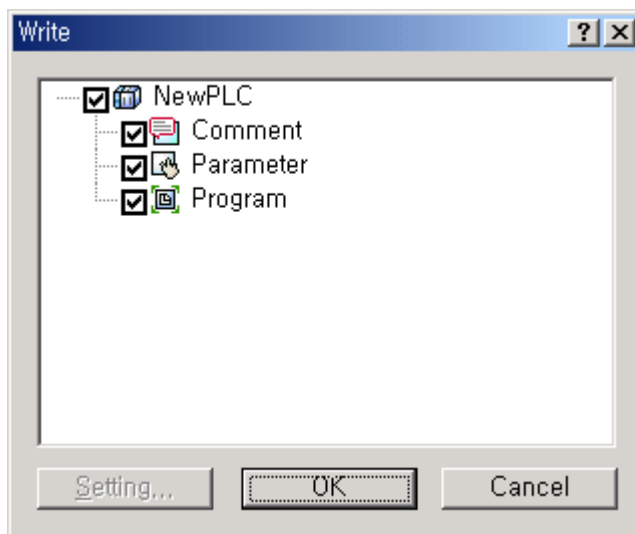

(2) Monitoring and setting command

Monitoring and command setting of high-speed counter are described as follows.

(a) If starting a monitor and clicking a Special Module Monitor, the following window is opened.

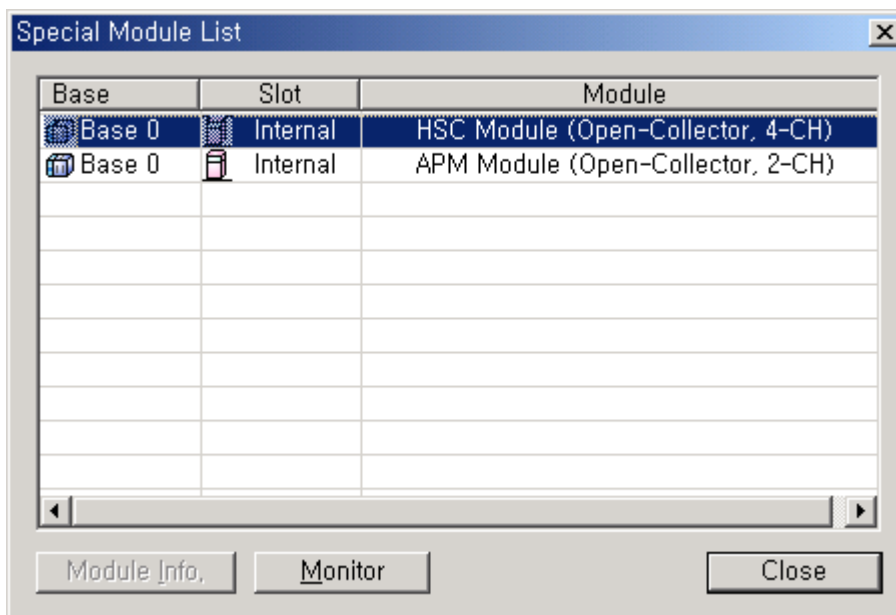
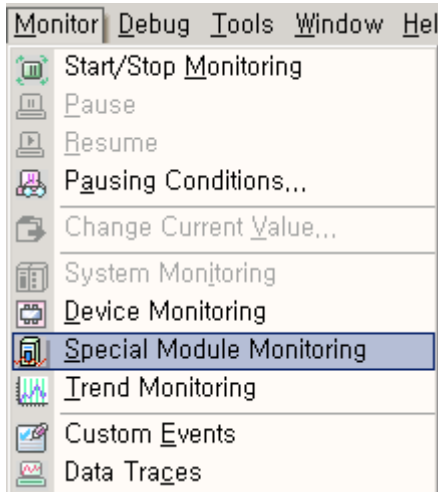

(b) Clicking 『Monitor』 shows monitor and test window of high-speed counter.

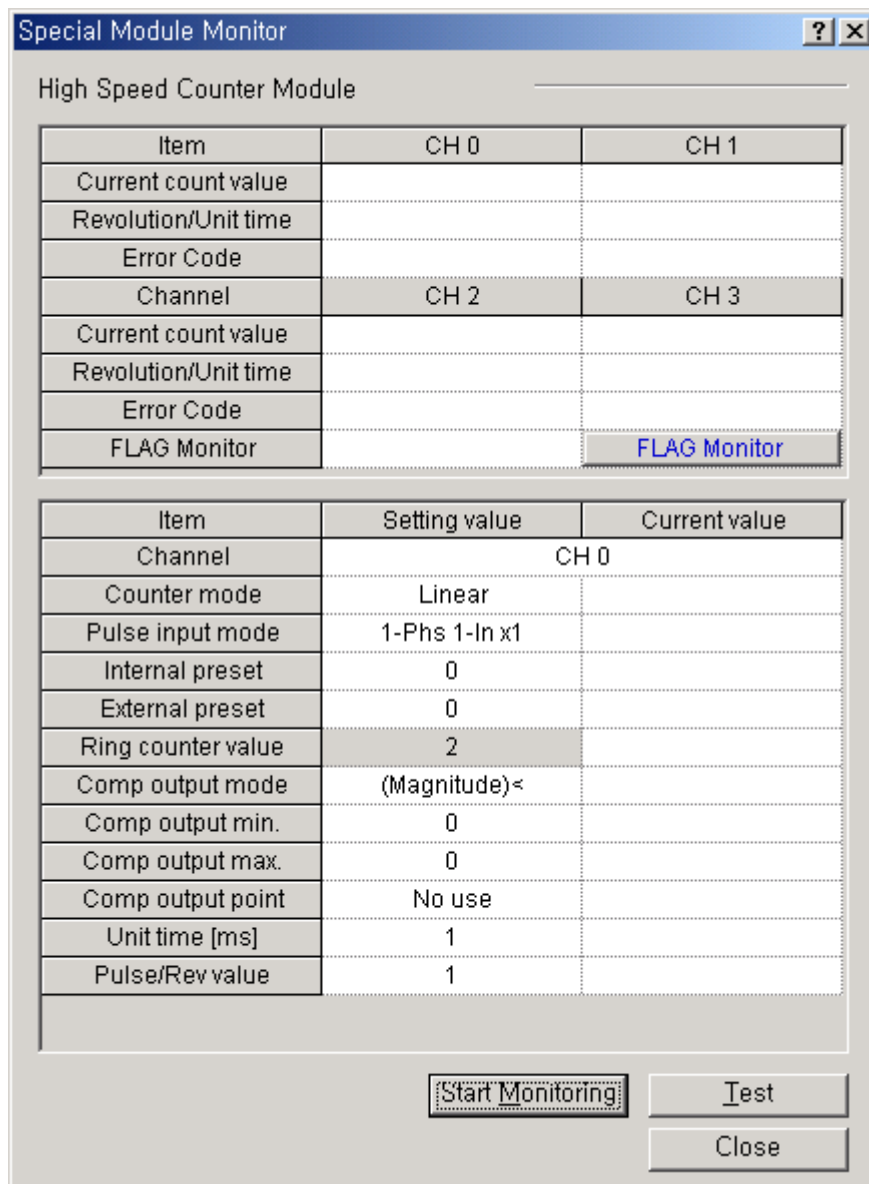

Item	Description
FLAG Monitor	Show flag monitoring and command window of high-speed counter
Start Monitoring	Start monitoring each item (special K device area monitor).
Test	Write each item setting to PLC. (Write the setting to special K device)
Close	Close monitor

- (c) Clicking 『Start Monitoring』 shows the high-speed counter monitor display, in which you may set each parameter. At this moment, if any, changed values are not saved if power off=> on or mode is changed.

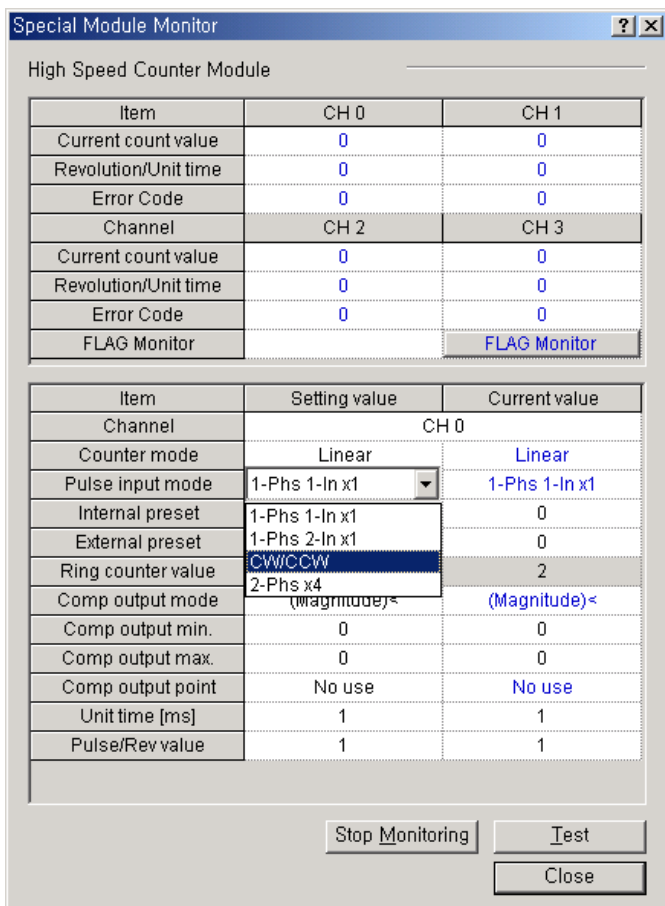

- (d) Clicking 『FLAG Monitor』 shows the monitor of each flag in high-speed counter, in which you may direct operation commands by flags (clicking commands reverse turn).

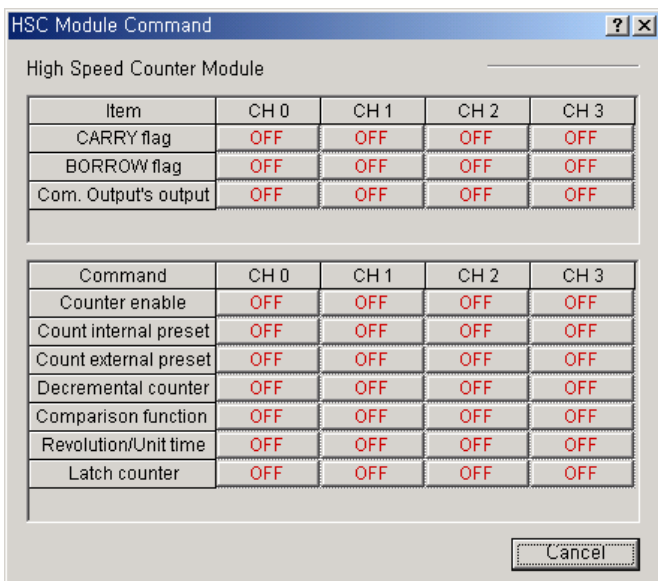

Chapter 9 RTC Option Board

9.1 Battery

9.1.1 Battery specification

Item	Specification
Voltage/Current	DC 3V / 220 mA
Warranty period	3 years (ambient temp.)
Purpose	Program and data backup, RTC operation in case of power failure
Specification	Manganese Dioxide lithium battery
Dimension (mm)	φ 20 X 3.2 mm

9.1.2 Notice in using

- (1) Do not heat the battery or solder the polarity. (It may cause the reduction of life.)
- (2) Do not measure the voltage or short with tester. (It may cause the fire.)
- (3) Do not disassemble the battery.

9.1.3 Life of battery

Life of battery depends on the power failure time and ambient temperature etc..

If battery is getting low, main unit cause the warning, 'battery voltage low warning'. The user can check it by error LED, flag and error message of XG5000.

Since battery works properly for long time, after battery voltage low warning, so the user can take the action after battery voltage low warning occurred.

9.1.4 How to change battery

The user should change the battery used to save the program and backup the data in case of power failure periodically. Though the user eliminate the battery, it works for 30 minute by super capacitor. Change the battery as fast as possible.

Sequence changing battery is as follows.

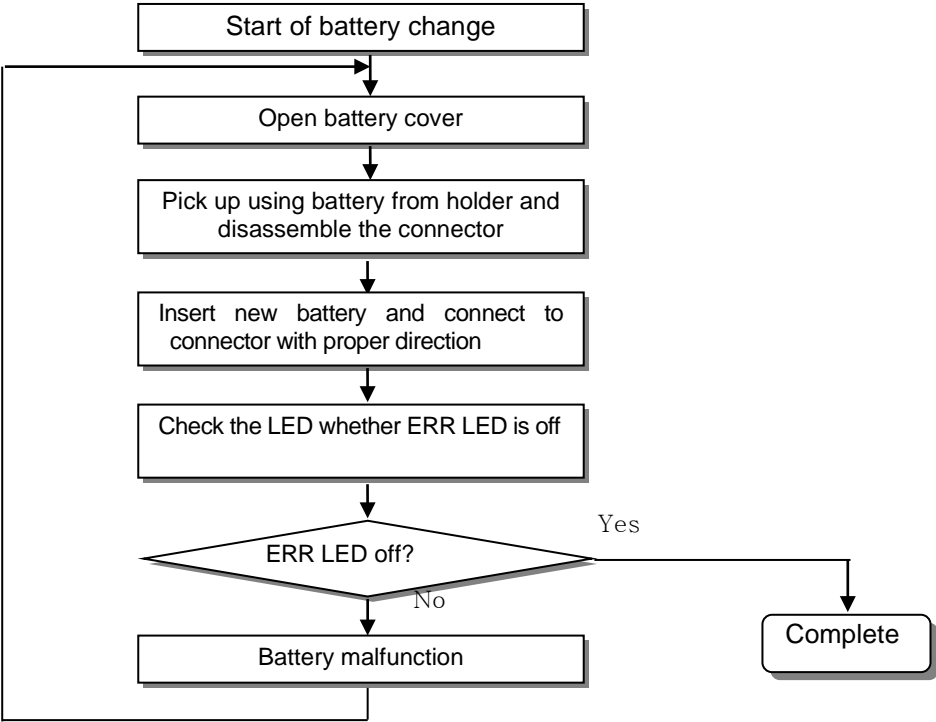

Remark

- 1) Battery for Program and Data back-up can be used with RTC
 - RTC provides advanced back-up function compare to without RTC
 - Refer to 4.5 Data backup time for more details.

9.2 RTC Function

Economic type (XBC-DxxxE), standard type (XBC-DxxxS, XBC-DxxxSU) doesn't support RTC function. If you equip RTC option board, you can use this function for time management of system or error log. RTC function is executed steadily when power is off or instantaneous power cut status. Current time of RTC is renewed every scan by system operation status information flag.

9.2.1 How to use

(1) Reading/setting clock data

(a) Reading or setting from XG5000

- 1) Click 『Online』 의 『PLC Information』 .
- 2) Click PLC RTC tap of PLC Information』 .

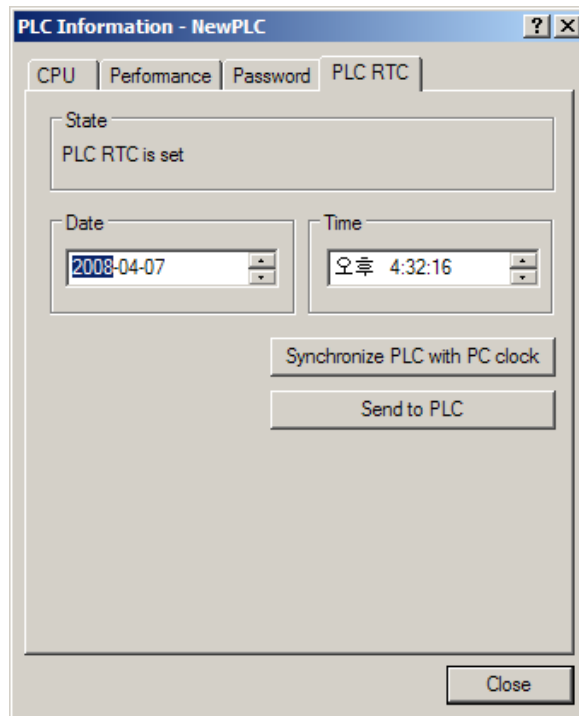
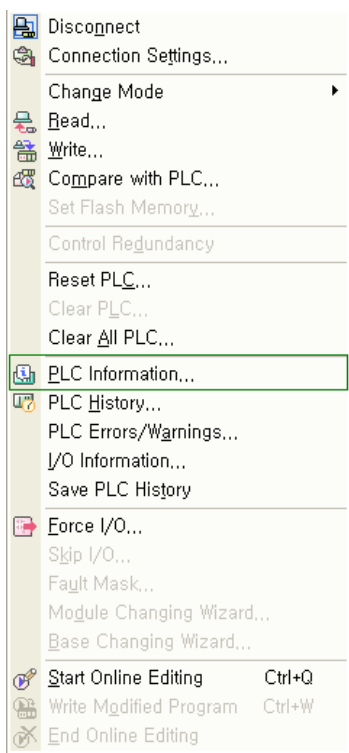

- 3) In case the user wants to send the clock of PC to PLC, press 'Synchronize PLC with PC clock'.
- 4) In case the user wants to send the clock the user wants, change the setting value of Time box and press 'Send to PLC'.

(b) Reading by special relay

The user can monitor as follows by special relay.

Special relay area	Data	Contents
F053	H0710	10year 07month
F054	H1729	29date 17hour
F055	H1020	10second 20minute
F056	H2004	20XXyear, Thursday

(c) Modification of clock data by program

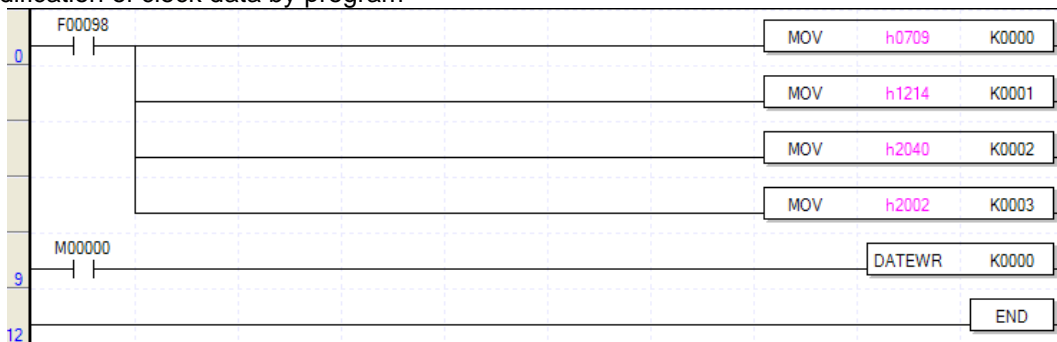

area	Content
M0000	Month, year
M0001	Hour, date
M0002	Second, minute
M0003	Centaury, day

Write clock data to temporary device (P, M, K, L, Z, U, D, R) and turn on/off input contact point M0100.
 (If date and day data is not matched, Write is not available.)
 Monitor and check the above special area (F053~F056)

(d) How to express the day

Number	0	1	2	3	4	5	6
Day	Sunday	Monday	Tuesday	Wednesday	Thursday	Friday	Saturday

(2) Deviation of clock data

±2. 2s / 1 d (normal temperature)

Operating temperature	Max deviation (second/day)
0 °C	-5.5 ~ 1.5
25 °C	-2.2 ~ 2.2
55 °C	-7 ~ 1

Remark

- 1) Initially, RTC may not have any clock data.
- 2) When using the product, first make sure to set the accurate clock data.
- 3) If any data out of the clock data range is written into RTC, it does not work properly.
 i.e.) 14M 32D 25H
- 4) RTC may stop or have an error due to abnormal battery and other causes. The error is released if a new clock data is written.
- 5) Be aware that margin of error depend on operating temperature.

9.3 Name and Function of Each Part

(1) Describes the name and function of each part

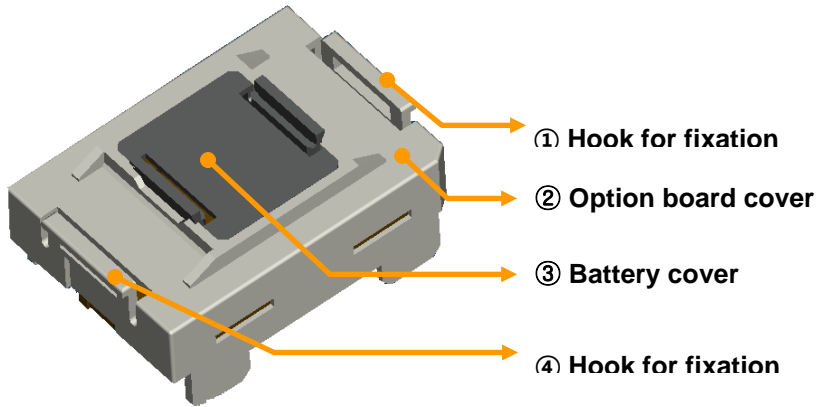

No.	Name	Contents
①④	Hook for fixation	▶ Hook for fixing the option board to main unit
②	Option board cover	▶ Option board cover
③	Battery cover	▶ Battery cover

(2) RTC can operate only in 9th slot.



Chapter 10 DC Input Option Function

This chapter describes specifications and usage of input option board's function.

10.1 DC input Option Board Specification

10.1.1 DC Input Option Board Specification

Specification of XGB input option board is as follows.

Item	DC input specification		Remark
	XBO-DC04A		
Input point	4 points (supports high-speed counter function when installed at standard type)		
Insulation Method	Photo coupler insulation		
Rated input voltage	DC24V		
Rated input current	About 10mA		
Voltage range	DC20.4~28.8V (ripple rate within 5%)		
On voltage / On current	DC19V or above / 3mA or above		
Off voltage / Off current	DC6V or less / 1mA or less		
Input resistance	About 2.7kΩ		
Response time	Off → On	1/3/5/10/20/70/100ms (set through I/O parameter)	
	On → Off	Initial value: 3ms	
Common method	4 points / COM		"
High speed counter	Performance	4kpps 4 channels (based on 1 phase)	when installed at standard type
	Mode	Linear counter	

Circuit configuration

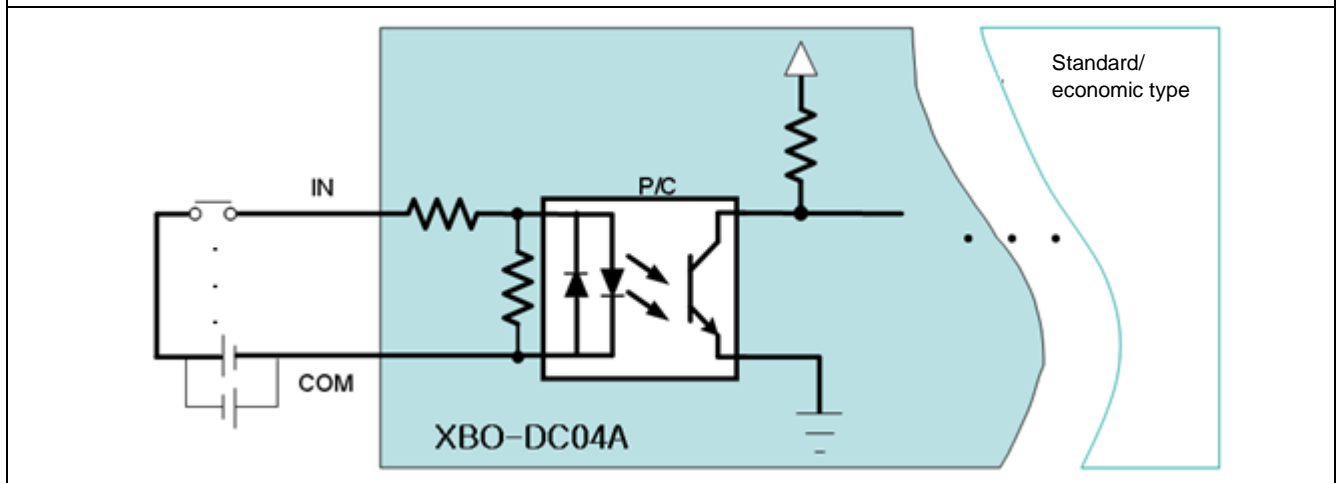

10.2 High Speed Counter Specification

High speed counter function is built in XGB input option board. It describes specifications, setting and usage of function, programming and wiring with external device.

10.2.1 Performance Specification

(1) Performance Specification

Item		Specification
		XBO-DC04A
Count input signal	Signal	A-phase, B-phase
	Input type	Voltage input (Open collector)
	Signal level	DC 24V
Max. count speed		4kpps
No. of channels	1 phase	4kpps 4 channels
	2 phase	2kpps 2 channels
Count range		Signed 32 Bit (-2,147,483,648 ~ 2,147,483,647)
Count type (Program setting)		Linear count (if it exceeds 32-bit range, Carry/Borrow occurs)
Input mode (Program setting)		1-phase input
		2-phase input
Signal type		Voltage
Up/Down setting	1-phase input	Increasing/decreasing operation setting by B-phase input
		Increasing/decreasing operation setting by program
	2-phase input	Automatic setting by difference in phase
Multiplication function	1 phase input	1 multiplication
	2 phase input	2 multiplication
Count Enable		Set by program (Counted on "Enable" statue)
Preset function		Set by program

(2) Counter input specification

Item	Specification
Input voltage	24V DC (20.4V ~ 28.8V)
Input current	10mA
On guranteed voltage (min.)	20.4V
Off guranteed voltage (max.)	6V

10.2.2 Name of Each Part

(1) Name of each part

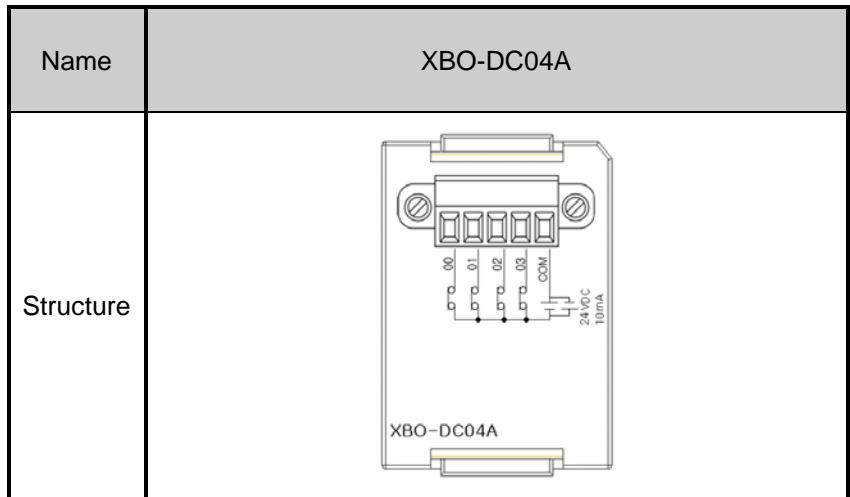

Terminal No.	Name		Usage	
	1-phase	2-phase	1-phase	2-phase
00	Ch0 counter input	Ch0 A-phase input	Counter input terminal	A-phase input terminal
01	Ch1 counter input	Ch0 B-phase input	Counter input terminal	B-phase input terminal
02	Ch2 counter input	Ch2 A-phase input	Counter input terminal	A-phase input terminal
03	Ch3 counter input	Ch2 B-phase input	Counter input terminal	B-phase input terminal
COM	Input common	Input common	Common terminal	Common terminal

(2) Interface with external devices

The following table describes interface with external devices

I/O	Internal circuit	Terminal No.	Signal		Operation	Input guaranteed voltage
			1-phase	2-phase		
Input		00	CH0 Pulse input	CH0 A-phase input	On	20.4~28.8V
					Off	6V or less
		01	CH 1 Pulse input	CH0 B-phase input	On	20.4~28.8V
					Off	6V or less
		02	CH 2 Pulse input	CH2 A-phase input	On	20.4~28.8V
					Off	6V or less
03	CH 3 Pulse input	CH0 B-phase input	On	20.4~28.8V		
			Off	6V or less		
		COM	COM(Input common)			

10.2.3 Function

(1) Counter mode

(a) High Speed counter module can count High Speed pulses which can not be processed by CPU module's counter instructions (CTU, CTD, CTUD, etc.), up to binary value of 32 bits (-2,147,483,648 ~ 2,147,483,647).

(b) Available input mode is 1-phase input, 2-phase input

(c) Count increasing/decreasing methods are as follows;

- 1) 1-phase input : a) Increasing/decreasing count operation by program setting
 b) Increasing/decreasing count operation by B-phase input signal
- 2) 2-phase input : setting by difference in phase between A-phase and B-phase

(d) Auxiliary modes are as follows

1) Count Latch

(e) Input mode

1) 1-phase count mode

a) Increasing/decreasing count operation by program setting

- 1-phase 1-input 1-multiplication

A-phase input pulse is counted at rising and increasing/decreasing will be decided by the program.

Increasing/Decreasing classification	A-phase input pulse rising	A-phase input pulse falling
Increasing/decreasing count setting signal Off	Increasing count	-
Increasing/decreasing count setting signal On	Decreasing count	-

• Operation example

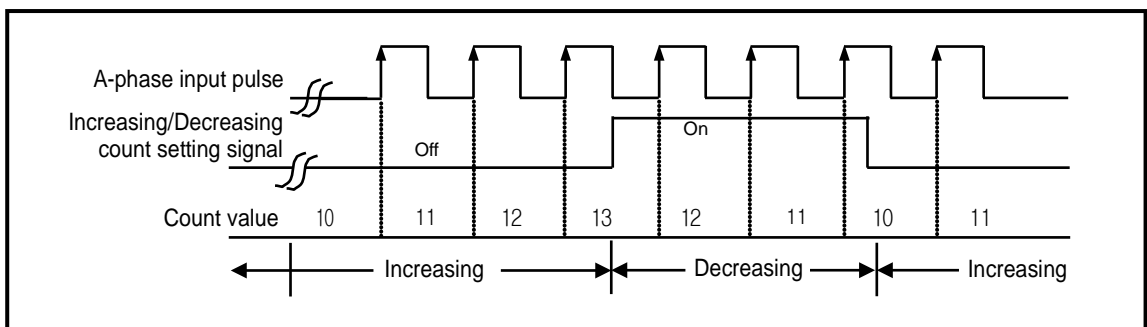

b) Increasing/decreasing count operation by B-phase input signal

•1-phase 2-input 1-multiplication

A-phase input pulse is counted at rising and increasing/decreasing will be decided by B-phase.

Increasing/Decreasing classification	A-phase input pulse rising	A-phase input pulse falling
B-phase input pulse Off	Increasing count	-
B-phase input pulse On	Decreasing count	-

• Operation example

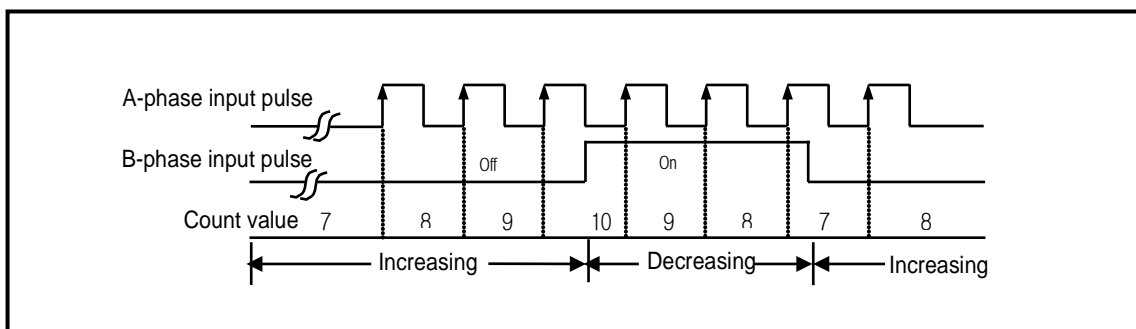

2) 2-phase count mode

a) 2-phase 2-multiplication

A-phase input pulse and B-phase input pulse are counted at rising respectively. If A-phase input is antecedent to B-phase input, increasing operation starts, and if B-phase input is antecedent to A-phase input, decreasing operation starts.

• Operation example

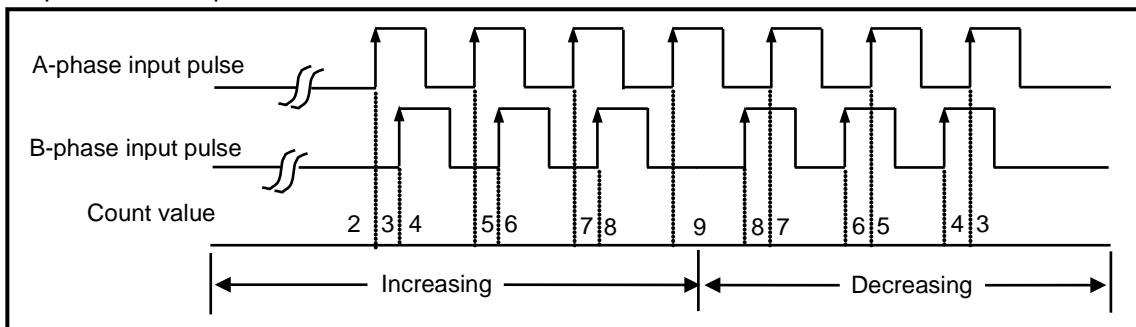

(2) Counter type

Option board supports linear counter.

(a) Linear counter

- 1) Linear Count range: -2,147,483,648 ~ 2,147,483,647
- 2) If count value reaches the maximum value while increased, Carry will occur, and if count value reaches the minimum value while decreased, Borrow will occur.
- 3) If Carry occurs, count stops and increasing is not available but decreasing is available.
- 4) If Borrow occurs, count stops and decreasing is not available but increasing is available.

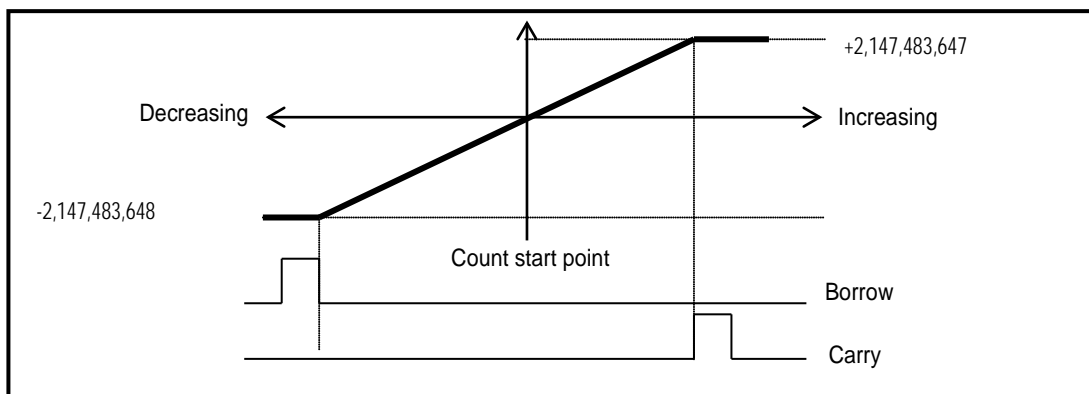

(3) Carry signal

(a) When Carry signal occurs

- 1) When count range maximum value of 2,147,483,647 is reached during Linear Count

(b) Count when Carry Signal occurs

- 1) Count stops if Carry occurs during Linear Count.

(c) Carry reset

- 1) 'Carry reset' instruction is not supported at option board. Reset 'Carry' by using 'Preset' instruction after making the counter value within counter range.

(4) Borrow signal

(a) When Count when Borrow signal occurs

- 1) When count range minimum value of -2,147,483,648 is reached during Linear Count.

(b) Count when Borrow signal occurs

- 1) Count stops if Borrow occurs during Linear Count.

(c) Borrow reset

- 1) 'Carry reset' instruction is not supported at option board. Reset 'Carry' by using 'Preset' instruction after making the counter value within counter range.

(5) Count latch

(a) When Count latch signal is On, present count value is latched

(b) Setting

If present counter value is to latch, Count Latch function is set 'Use'.

Type	Device area per channel				Ref.
	CH0	CH1	CH2	CH3	
When mounted at slot no.9	U9.0.6	U9.8.6	U9.16.6	U9.24.6	0: Disable 1: Enable
When mounted at slot no.10	UA.0.6	UA.8.6	UA.16.6	UA.24.6	

(c) Count latch function is operated when 'Count latch' signal is On. Namely, counter value is not cleared when power supply Off =>On and mode change, it is counted from previous value.

(d) In latch counter function, internal preset function has to be used for clearing present value.

(6) Preset function

It changes the current value into preset value.

- Preset setting value is saved at the following U area.

Type	Area per each channel (Double word)				Ref.
	CH0	CH1	CH2	CH3	
Slot no. 9 internal preset value	U9.6	U9.14	U9.22	U9.30	
Slot no. 10 internal preset value	UA.6	UA.14	UA.22	UA.30	

- Preset command is specified through the following U area

Type	Area per each channel (bit)				Ref.
	CH0	CH1	CH2	CH3	
Internal preset command	U9.0.1	U9.8.1	U9.16.1	U9.24.1	0: Disable 1: Enable
Internal preset command	UA.0.1	UA.8.1	UA.16.1	UA.24.1	

10.3 Installation and Wiring

10.3.1 Precaution for wiring

Pay attention to the counteractions against wiring noise especially for High-speed pulse input

- (1) Surely use twisted pair shielded cable, grounded with 3 class applied.
- (2) Keep away from power cable or I/O line which may cause noise.
- (3) Stabilized power should be used.
 - ▶ Connect A-phase only for 1-phase input.
 - ▶ Connect A-phase and B-phase for 2-phase input.

10.3.2 Example of wiring

- (1) In case of pulse generator (encoder) is voltage output type

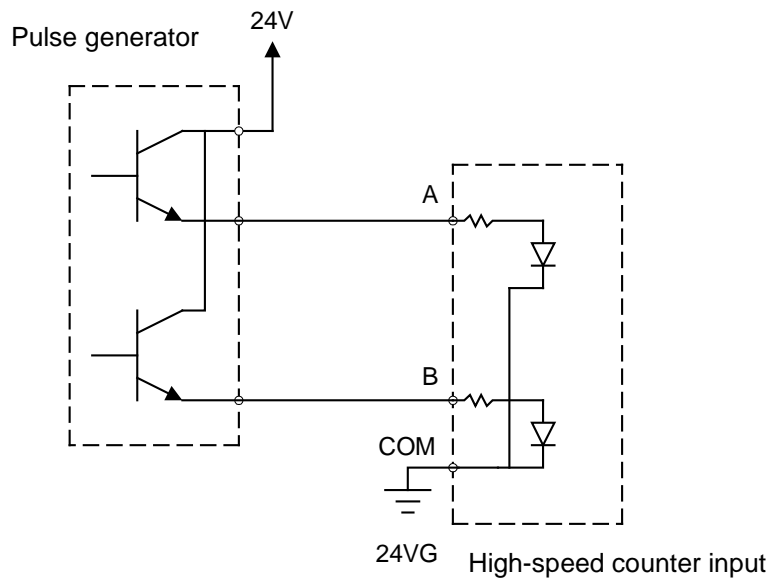

(2) In case of pulse generator is open collector type

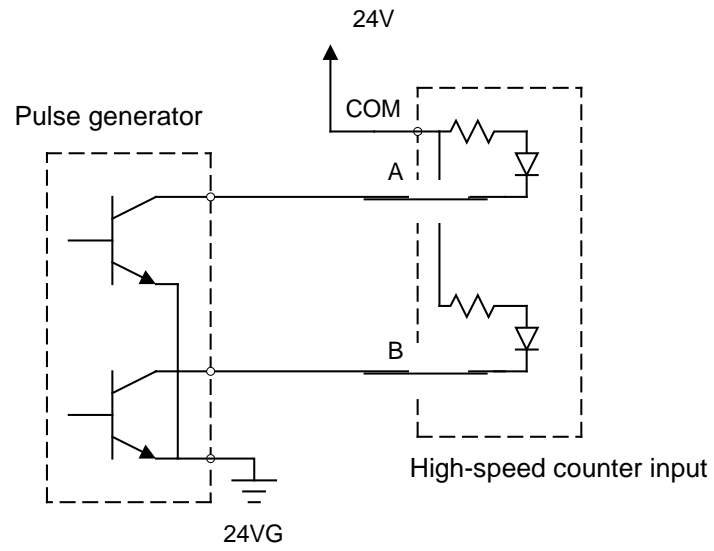

10.4 Internal Memory

10.4.1 Special area for High-speed counter

U device is used for parameter and operation command area of built-in high-speed counter. This chapter describes on how to register basic paramter and each item.

(1) U device auto-registration

(a) Set the module at slot in [I/O parameter]

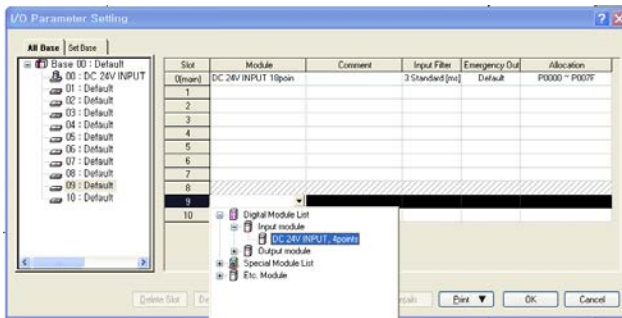

(b) Double-click [Variable/comment]

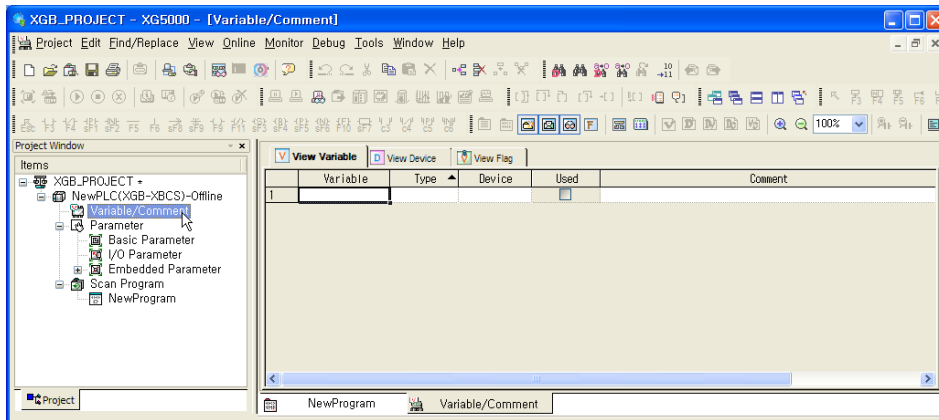

(c) Select 'Register U device' on menu 'Edit'

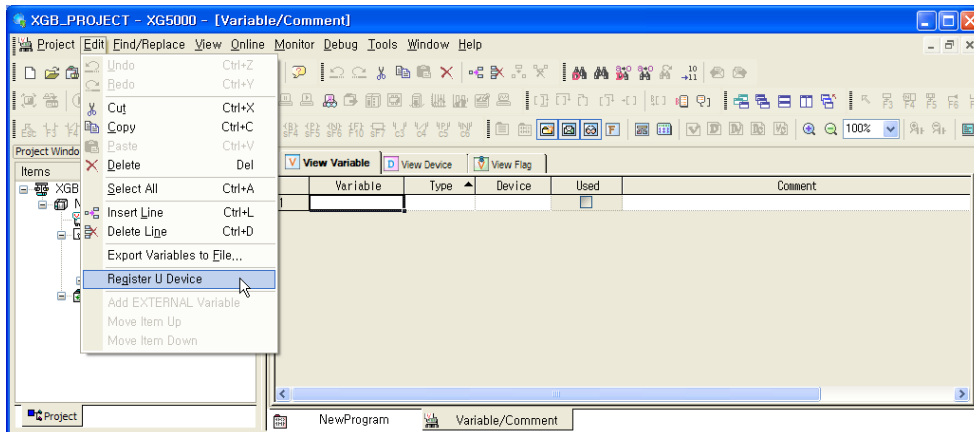

(d) Click 'Yes'.

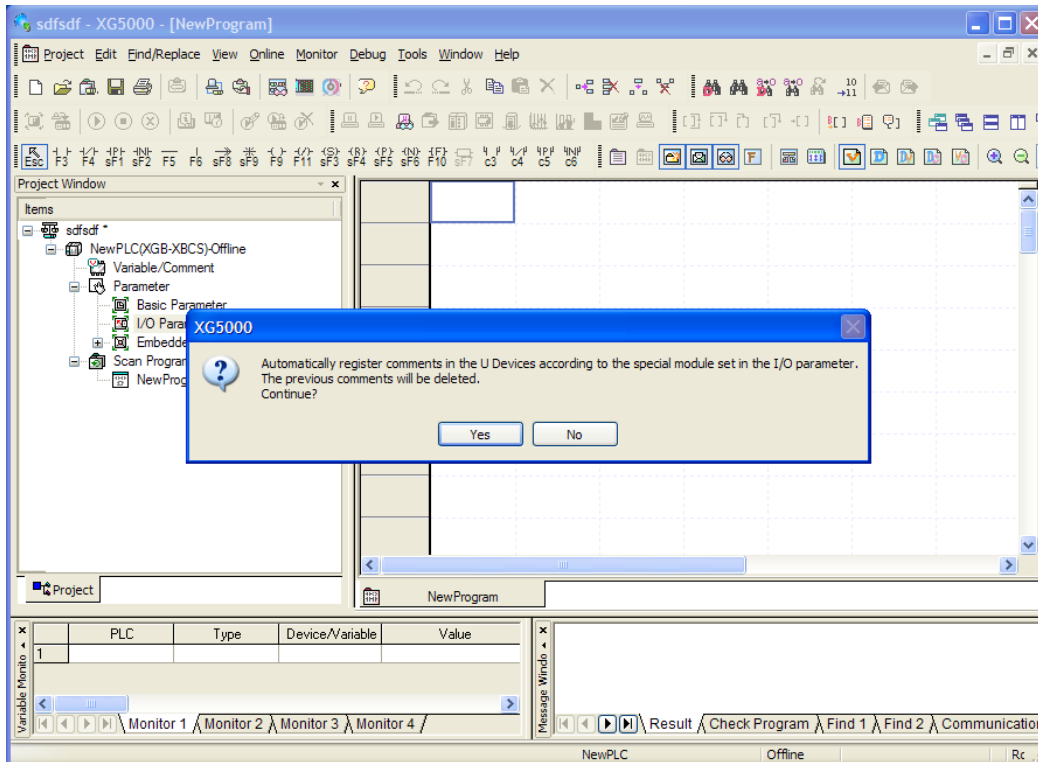

(e) Variables are registered as follows.

Variable Monitoring Window						
	PLC	Type	Device/Var	Value	Variable/Device	Comment
1	NewPLC	BIT	U09.01.1	10	_0009_CH0_Borrow	Input Option Board: CH0 Borrow Flag
2	NewPLC	BIT	U09.01.0	10	_0009_CH0_Carry	Input Option Board: CH0 Carry Flag
3	NewPLC	BIT	U09.00.0	10	_0009_CH0_CNTEN	Input Option Board: CH0 Counter Enable(Level) Command
4	NewPLC	WORD	U09.05	HEX	_0009_CH0_CntMode	Input Option Board: CH0 Counter Mode
5	NewPLC	WORD	U09.02	HEX	_0009_CH0_CurCnt	Input Option Board: CH0 Current Count Value
6	NewPLC	BIT	U09.00.3	10	_0009_CH0_DN	Input Option Board: CH0 Count Inc/Dec Flag
7	NewPLC	WORD	U09.04	HEX	_0009_CH0_ErrCode	Input Option Board: CH0 Error Code
8	NewPLC	WORD	U09.06	HEX	_0009_CH0_IntPrs_Val	Input Option Board: CH0 Internal Preset Setting Value
9	NewPLC	BIT	U09.00.6	10	_0009_CH0_LATCH_EN	Input Option Board: CH0 Latch Counter Enable
10	NewPLC	BIT	U09.00.1	10	_0009_CH0_PREEN	Input Option Board: CH0 Preset Enable(Edge) Command
11	NewPLC	BIT	U09.09.1	10	_0009_CH1_Borrow	Input Option Board: CH1 Borrow Flag
12	NewPLC	BIT	U09.09.0	10	_0009_CH1_Carry	Input Option Board: CH1 Carry Flag
13	NewPLC	BIT	U09.08.0	10	_0009_CH1_CNTEN	Input Option Board: CH1 Counter Enable(Level) Command
14	NewPLC	WORD	U09.13	HEX	_0009_CH1_CntMode	Input Option Board: CH1 Counter Mode
15	NewPLC	WORD	U09.10	HEX	_0009_CH1_CurCnt	Input Option Board: CH1 Current Count Value
16	NewPLC	BIT	U09.08.3	10	_0009_CH1_DN	Input Option Board: CH1 Count Inc/Dec Flag
17	NewPLC	WORD	U09.12	HEX	_0009_CH1_ErrCode	Input Option Board: CH1 Error Code

Note

When registered by "auto-registration", data type is expressed as BIT, WORD. If you want to check with other types such as DINT, DWORD, change the type.

(2) No. 9 slot device area

(a) Action command

Type	Device area per each channel				Ref.
	CH0	CH1	CH2	CH3	
Enable counter	U9.0.0	U9.8.0	U9.16.0	U9.24.0	BIT
Enable internal preset	U9.0.1	U9.8.1	U9.16.1	U9.24.1	BIT
Count inc/dec flag	U9.0.3	U9.8.3	U9.16.3	U9.24.3	BIT
Latch counter enable	U9.0.6	U9.8.6	U9.16.6	U9.24.6	BIT
Pulse input mode	U9.5	U9.13	U9.21	U9.29	INT
Internal preset setting value	U9.6	U9.14	U9.22	U9.30	DINT

(b) Monitor area

Type	Device area per each channel				Ref.
	CH0	CH1	CH2	CH3	
Carry flag	U9.1.0	U9.9.0	U9.17.0	U9.25.0	BIT
Borrow flag	U9.1.1	U9.9.1	U9.17.1	U9.25.1	BIT
Current counter value	U9.2	U9.10	U9.18	U9.26	DINT
Error code	U9.4	U9.12	U9.20	U9.28	INT

(3) No. 10 slot device area

(a) Action command

Type	Device area per each channel				Ref.
	CH0	CH1	CH2	CH3	
Enable counter	UA.0.0	UA.8.0	UA.16.0	UA.24.0	BIT
Enable internal preset	UA.0.1	UA.8.1	UA.16.1	UA.24.1	BIT
Count inc/dec flag	UA.0.3	UA.8.3	U9.16.3	UA.24.3	BIT
Latch counter enable	UA.0.6	UA.8.6	UA.16.6	UA.24.6	BIT
Pulse input mode	UA.5	UA.13	UA.21	UA.29	INT
Internal preset setting value	UA.6	UA.14	UA.22	UA.30	DINT

(b) Monitor area

Type	Device area per each channel				Ref.
	CH0	CH1	CH2	CH3	
Carry flag	UA.1.0	UA.9.0	UA.17.0	UA.25.0	BIT
Borrow flag	UA.1.1	UA.9.1	UA.17.1	UA.25.1	BIT
Current counter value	UA.2	UA.10	UA.18	UA.26	DINT
Error code	UA.4	UA.12	UA.20	UA.28	INT

(4) Parameter setup

(a) Action command

Type	Device status information (based on slot 9, ch0)		Ref.
	CH0	Information	
Enable counter	U9.0.0	0: disable, 1: enable	BIT
Enable internal preset	U9.0.1	0: disable, 1: enable	BIT
Count inc/dec flag	U9.0.3	0: INC, 1: DEC	BIT
Latch counter enable	U9.0.6	0: disable, 1: enable	BIT
Pulse input mode	U9.5	0: 1-phase 1-input 1: 1-phase 2-input 2: 2-phase 2 multiplication	INT
Internal preset setting value	U9.6	-2,147,483,648 ~ 2,147,483,647	DINT

(b) Monitor area

Type	Device status information (based on slot 9, ch0)		Ref.
	CH0	Information	
Carry flag	U9.1.0	0: disable, 1: enable	BIT
Borrow flag	U9.1.1	0: disable, 1: enable	BIT
Current counter value	U9.2	-2,147,483,648 ~ 2,147,483,647	DINT
Error code	U9.4	Indicates error code	INT

10.4.2 Error code

Describes on error of option board high-speed counter

- Describes error code

Error code (Dec.)	Error contents	Ref.
21	Pulse input type range setting error	
22	CH1(3) RUN request while CH0(2) 2-phase RUN * CH1(3) is not available when CH0(2) operate as 2-phase mode	
25	Internal preset value exceeded counter range	

Note

If more than two errors occur, the latest error code is saved and previous error code is removed.

10.5 Example using high-speed counter

Describes on option board high-speed counter example

(1) High-speed counter setup

Set up option board high-speed counter operation by using U area.

(a) Select high-speed counter mode.

Set up high-speed counter mode



(b) If you need 'Preset' function, input 'Preset value' and turn on 'Preset Enable' bit.

Input value to preset



Preset Enable signal ON



(c) Specify 'Latch counter' or 'Up/Down counter'

(d) Turn on 'High-speed counter enable' signal

Turn on High-speed Counter Enable signal (No. 9 slot, No.0 ch) of input option board (XBO-DC04A)



(2) Monitoring

You can check option board high-speed counter value by registering U9.2 (no.0 slot, no.0 ch) at variable monitoring window or program.

Chapter11 TR Output Option Board

This chapter describes specification and how to use the output option board.

11.1 TR Output Option Board Operation Sequence of Positioning

11.1.1 Operation Sequence of Positioning

Operation sequence is as follows. Positioning function of the option board operates only at slot number 9.

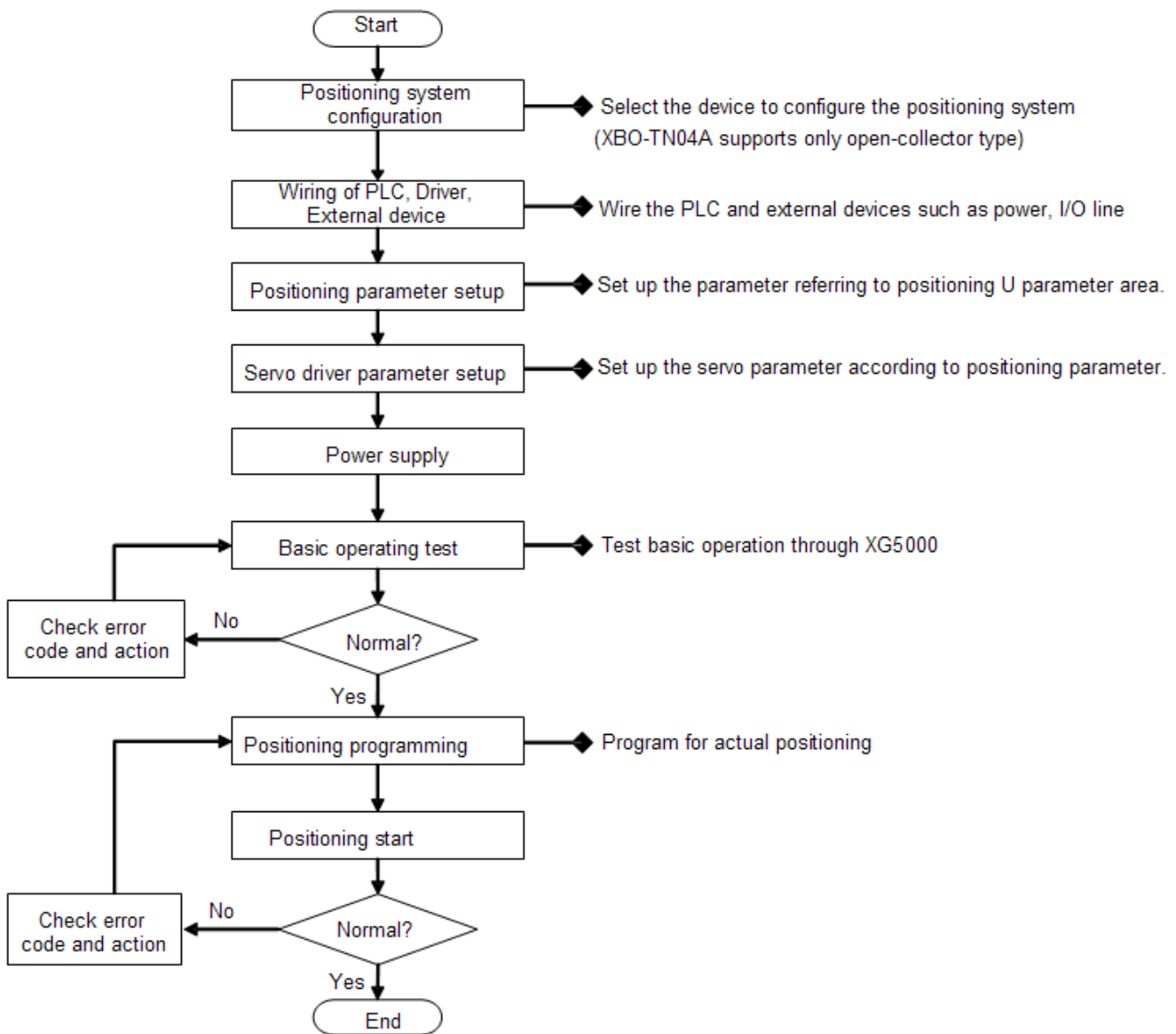

11.2 XBO-TN04A Specification

11.2.1 Output option board specification

Item	Transistor output specification	
	XBO-TN04A	Remark
No. of output	4 (Pulse output function is supported when mounted on standard type)	
Insulation method	Photo coupler insulation	
Rated load voltage	DC 24V	
Max. load current	0.5A/point, 2A/COM	
Surge killer	Zener diode	
Leakage current when Off	0.1mA or less	
Voltage drop when On	DC 1V or less	
Inrush current	3A, 10ms or less	
Response time	Off → On	1ms or less
	On → Off	1ms or less
Operating indicator	-	
Pulse output	No. of axes	2
	Output method	Open collector method
	Control unit	Pulse
	Control speed	10kpps (One option board supported _ No. 9 slot)
	Setting method	Setup by DST instruction

Circuit configuration

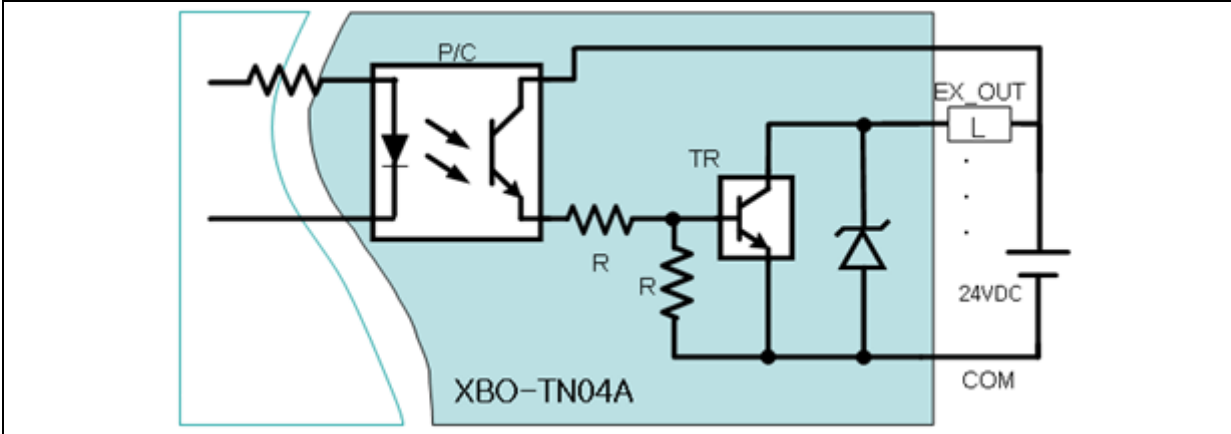

11.3 Positioning Specification

Positioning function is built in XGB output option board. This describes specification, how-to-use, function, programming and wiring of built-in positioning.

11.3.1 Performance Specification

(1) Performance Specification

Model		XBO-TN04A
Item		
No. of axes	2	
Control method	Position control, speed control	
Control unit	Pulse	
Positioning	Method	Incremental
	Address range	-2,147,483,648 ~ 2,147,483,647(pulse)
	Speed range	1 ~ 10,000pps(1pps unit)
Manual operation	JOG operation	
Home return	By DOG	
Max. connection distance	2 m	
Connector	6 Pin connector	

11.3.2 Name of each part

(1) Name of each part

Item	XBO-TN04A	
	Diagram	
Structure		

Connector	Output point No.		Description	Remark
Pulse output	X-axis	00	Positioning X-axis pulse string output point (Open collector output)	High Active
	Y-axis	01	Positioning Y-axis pulse string output point (Open collector output)	
Direction output	X-axis	02	Positioning X-axis direction output point (Open collector output)	
	Y-axis	03	Positioning Y-axis direction output point (Open collector output)	
External power	X/Y-axis	24V	Terminal for external power supply for TR	
Output common	X/Y-axis	COM	Output common terminal	

(2) Output pulse level

Basic option board output pulse is as follows.

Pulse output method	Output signal	Output signal level	
		Forward	Reverse
Pulse+Direction mode	Pulse		
	Direction		

11.3.3 Before Positioning

(1) Positioning function list

Positioning function of XGB option board built-in positioning is as follows.

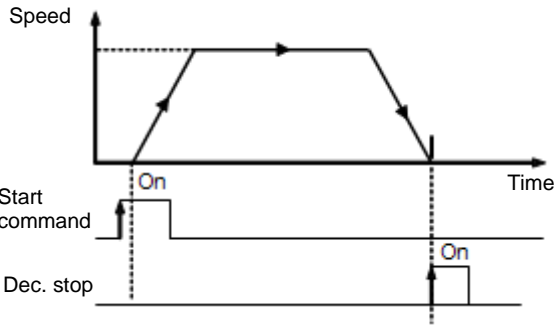
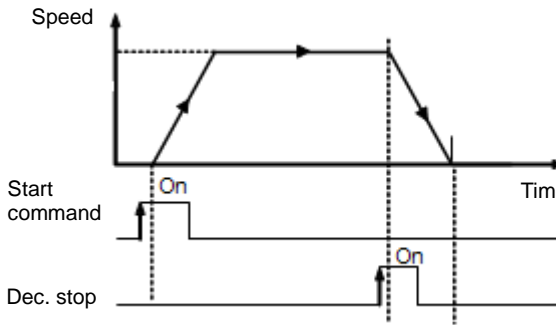
Positioning function	description		Instruction	Ref.
Position control	Operation pattern		DST	
	Operation	<p>If the rising edge of start command is detected, it moves with designated speed to designated position, and complete signal is on (dwell is not supported)</p>		
Speed control	Operation pattern		DST	
	Operation	<p>If the rising edge of start command is detected, it moves with designated speed and stops after deceleration by stop command. At this time, complete signal will not be on.</p>		

Position control

Position control is to move the designated axis from start address (present position) up to target address (movement). There are two position control methods, absolute and incremental.

(a) Control by absolute coordinates (Absolute coordinates)

Object moves from start address to target address. Position control is performed, based on the address designated in Home Return (home address).

Direction is determined by start address and target address.

- Start address < target address: forward positioning
- Start address > target address: reverse positioning

(b) Control by incremental coordinates (incremental coordinates)

Object moves from current position as far as the address set in operation data. At this time, target address is based on start address. Direction is determined by sign (+,-).

- In case Address is positive number: forward positioning (Direction increasing address)
- In case Address is negative number: reverse positioning (Direction decreasing address)

(2) Speed control

Speed control means that object moves with steady speed (steady pulse string) until stop command.

- In case of speed control, direction is determined by sign of Address set in operation data.

Forward : Address is positive number

Reverse : Address is negative number

In the speed control, direction is determined by sign of target address regardless of current position and target position.

For example, current position is 100 and target position is 90, though target position is less than current position, since sign is positive, it moves forward.

Note

- For more information, refer to XGB positioning manual.

11.3.4 Positioning Stop Factor

(1) Stop factor and how to deal with stop factor

- If following factor occurs during positioning, it stops without completing positioning.

In case positioning stops by stop instruction (STP, EMG) or following stop factor, generally, the only axis where stop instruction is executed or stop factor occurs stops.

Operation status Stop factor		Positioning *1	Homing	Jog operation	Axis operation status after stop instruction *2
		Stop by sequence program *3	Dec. stop instruction	Dec. stop	Dec. stop
Emg. Stop instruction	Immediate stop			Error status (Error 481) Output prohibited	
Stop by external signal	External upper limit "On"	Immediate stop		Forward immediate stop	Error status (Error 492)
	External lower limit "On"	Immediate stop		Backward immediate stop	Error status (Error 493)

Note
<p>*1 : Positioning refers to position control, speed control by positioning data.</p> <p>*2 : If axis is 'Output prohibited status' after being stopped, run a instruction to cancel 'Output prohibited status'. (CLR instruction) .</p> <p>*3 : Stop by sequence program refers to stop by "Stop instruction" at XGB program.</p>

(2) Stop Process and Priority

(a) Dec. stop process

- If it stops due to deceleration stop instruction, since positioning operation is not complete, it does not generate positioning completion signal.

(b) Process of emergency stop and external input upper/lower limits

- If emergency stop instruction or external input upper/lower limits are inputted during positioning control, it stops positioning control and turns into 'Output prohibited stats', generating an error.

(c) Stop process priority

The priority of stop process is as follows.

Dec. stop < Emg. stop

(d) Emergency stop

- It immediately stops if it meets emergency stop while performing start-related instructions (indirect start, direct start, Home Return start, jog start).
- Emergency stop generates Error 481.
- Since it turns into “Output prohibited status” and “un-defined origin status”, once emergency stop is executed, execute origin determination (Home return, Current position preset) again to run an instruction that requires defined origin status”

11.3.5 Manual operation

In general, manual operations refer to operation which doesn't use operation data. In output option board, JOG operation is supported.

(1) JOG operation

- Jog operation means positioning by jog operation stat contact point

		Jog forward start	Jog backward start	Jog high speed/low speed
XBO-TN04A	X-axis	U9.1.8	U9.1.9	U9.1.A
	Y-axis	U9.17.8	U9.17.9	U9.17.A

- It is operated by jog speed set in positioning parameter.
- It can be executed when origin is not determined.
- Acceleration/deceleration process is controlled by the duration set in jog acceleration/deceleration time among parameter settings of this software package.
- If jog speed is set out of allowable range, it generates an error and operation is not available

Range	High speed jog operation	1 ~ 100,000	(Unit: 1pps)
	Low speed jog operation	1 ~ jog high speed	

Remark

- Make sure to follow the cautions

$$\text{Bias speed} \leq \text{Jog high speed} \leq \text{Speed limit}$$

11.3.6 Home return

XBO-TN04A supports only "Home return by DOG".

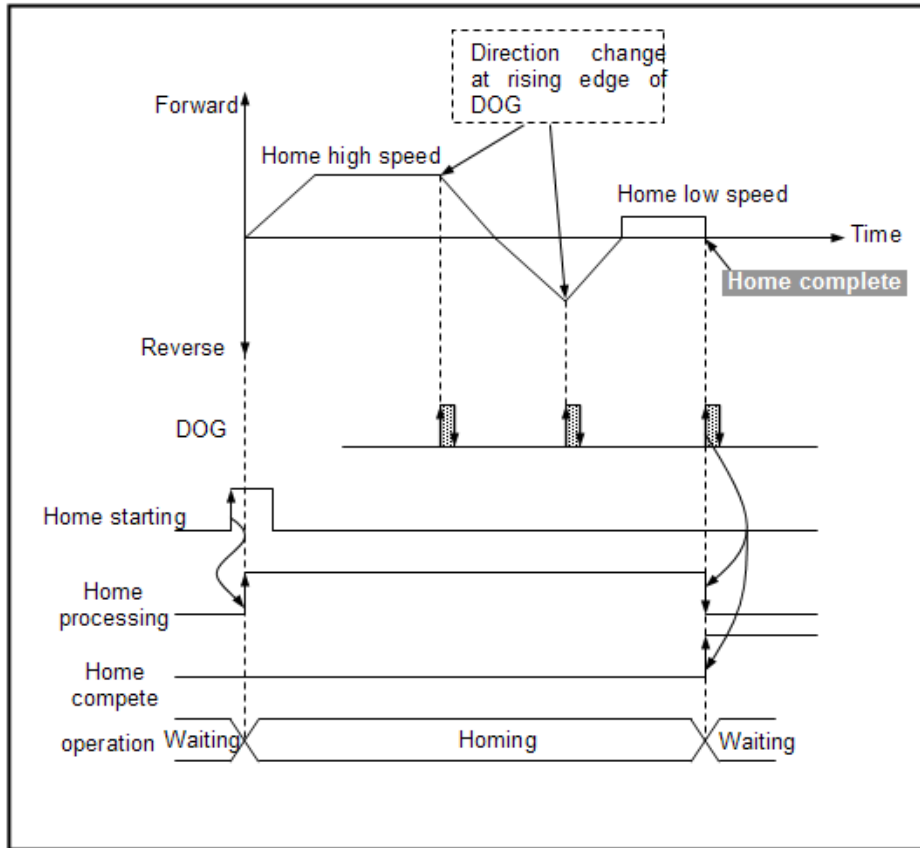

- (a) If homing command (ORG instruction) is executed, it accelerates to home direction set in Home Parameter and it homes with high speed.
(The above figure is example when homing direction is forward)
- (b) While target is homing with high speed, if rising edge of DOG (U9.1.B: X-axis) occurs, target speed decreases and change its direction.
- (c) When it accelerates after changing direction, if rising edge of DOG occurs, it homes with low speed.
- (d) In the homing status with low speed, rising edge occurs of DOG third time, it stops and determines the origin.
- (e) When 'On' time of DOG signal is larger decreasing time, it changes the direction at the falling edge of DOG and moves with low speed and stops at the rising edge of DOG and determines the origin.

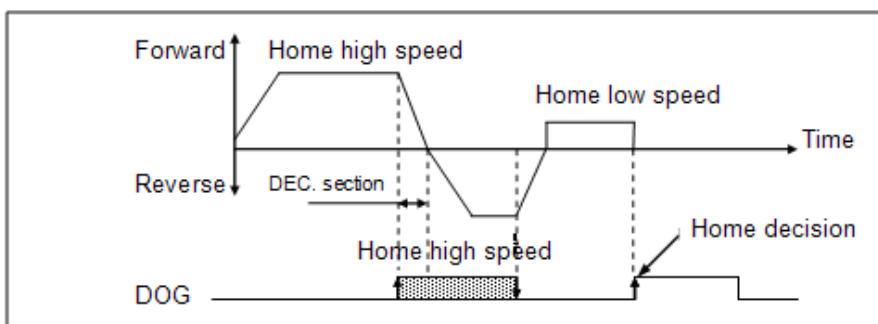

11.3.7 Positioning Basic Parameter Setup

This chapter describes on how to register basic parameter of XGB main output option board positioning function and each item.

(1) U device auto registration

(a) Set up the module at the slot in [I/O Parameter]

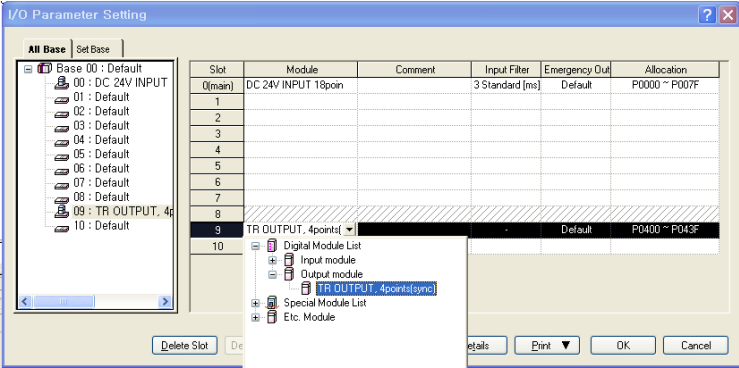

(b) Double-click [Variable/Comment].

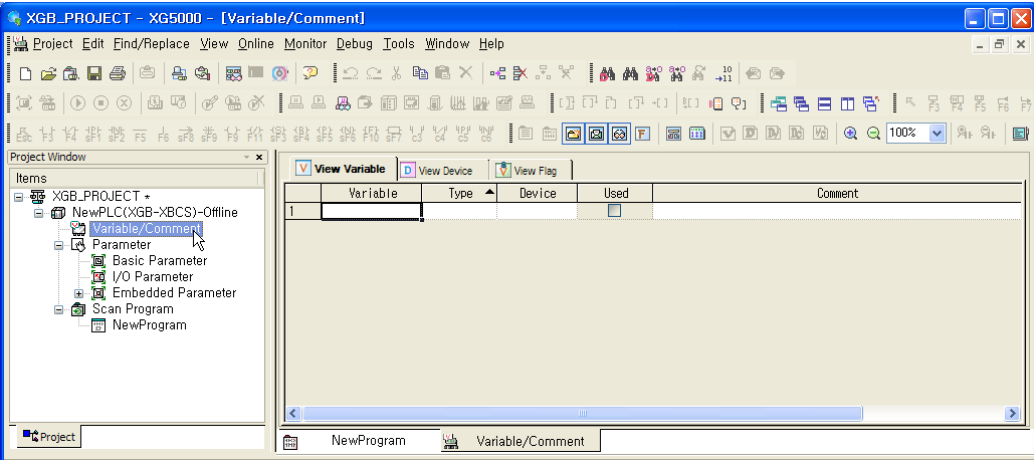

(c) Select "Register U device" on menu 'Edit'.

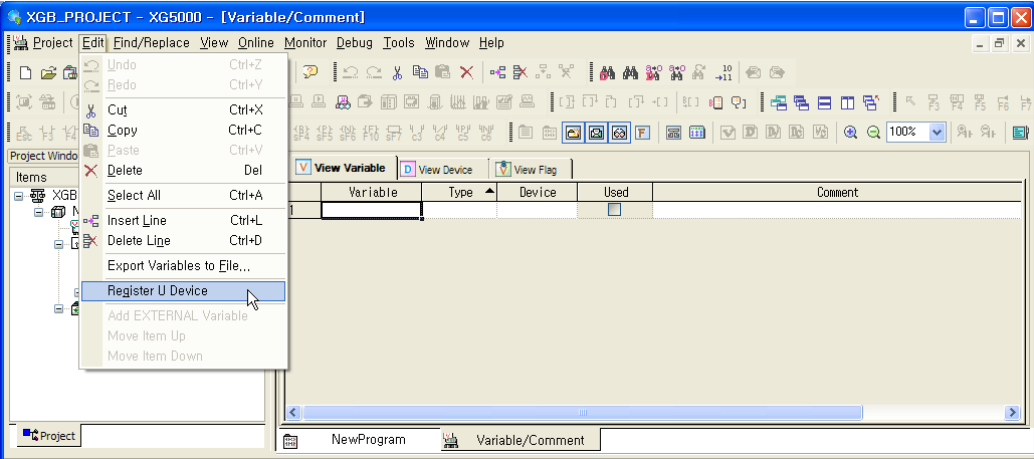

(d) Click 'yes'.

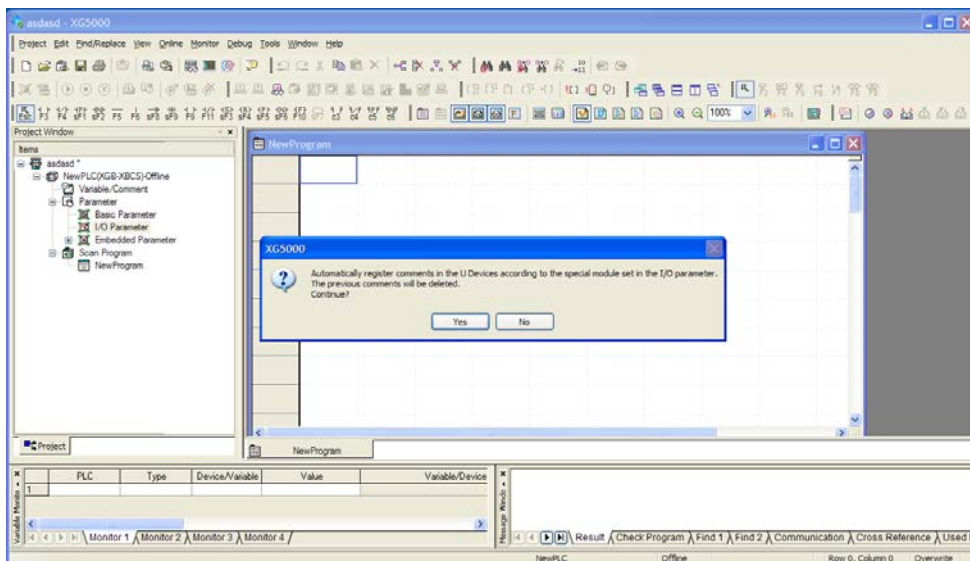

(e) Variables are registered as the screen below.

Variable Monitoring Window						
	PLC	Type	Device/Vari	Value	Variable/Device	Comment
1	NewPLC	BIT	U09.00.0	10	_0009_P0S_X_Busy	XAxis BUSY
2	NewPLC	BIT	U09.00.1	10	_0009_P0S_X_Err	XAxis Error
3	NewPLC	BIT	U09.00.2	10	_0009_P0S_X_Done	XAxis Position Complete
4	NewPLC	BIT	U09.00.3	10	_0009_P0S_X_OriginFix	XAxis Origin Fix
5	NewPLC	BIT	U09.00.4	10	_0009_P0S_X_OutInhibit	XAxis Output Inhibit
6	NewPLC	BIT	U09.00.5	10	_0009_P0S_X_Stop	XAxis Stop
7	NewPLC	BIT	U09.00.6	10	_0009_P0S_X_ULimit	XAxis Upper Limit Detection
8	NewPLC	BIT	U09.00.7	10	_0009_P0S_X_LLimit	XAxis Lower Limit Detection
9	NewPLC	BIT	U09.00.8	10	_0009_P0S_X_Estop	XAxis Emergency Stop
10	NewPLC	BIT	U09.00.9	10	_0009_P0S_X_Dir	XAxis CW/CCW
11	NewPLC	BIT	U09.00.A	10	_0009_P0S_X_Acc	XAxis Move Status(Acceleration)
12	NewPLC	BIT	U09.00.B	10	_0009_P0S_X_Const	XAxis Move Status(Constant)

Note

When variables are registered by above method, variables are expressed by BIT and WORD. If you want to check them as DINT, DOWRD, change the data type.

(2) Positioning parameter of XBO-TN04A

U area of each item is as follows.

Item	Data type	Signal direction	Status information	U area for positioning	
				X-axis	Y-axis
BUSY	BOOL	Output (monitoring)	0: Stop, 1: Run	U9.0.0	U9.16.0
Error			0: No error, 1: Error occurred	U9.0.1	U9.16.1
Positioning complete			0: not complete, 1: complete	U9.0.2	U9.16.2
Home determination			0: not determined, 1: determined	U9.0.3	U9.16.3
Output prohibited			0: output available, 1: output prohibited	U9.0.4	U9.16.4
Stop status			0: not stop status, 1: stop status	U9.0.5	U9.16.5
Upper limit			0: not detect, 1: detect	U9.0.6	U9.16.6
Lower limit			0: not detect, 1: detect	U9.0.7	U9.16.7
EMG. Stop			0: normal status, 1: EMG. Stop status	U9.0.8	U9.16.8
CW/CCW			0: CW, 1: CCW	U9.0.9	U9.16.9
Operation status (accelerating)			0: not accelerating , 1: accelerating	U9.0.A	U9.16.A
Operation status (steady status)			0: not steady status, 1: steady status	U9.0.B	U9.16.B
Operation status (decelerating)			0: not decelerating , 1: decelerating	U9.0.C	U9.16.C
Position control			0: not under position control 1: under position control	U9.0.D	U9.16.D
Speed control			0: not under speed control 1: under speed control	U9.0.E	U9.16.E
Home return			0: not under home return 1: under home return	U9.0.F	U9.16.F
JOG low speed			0: not under JOG low speed 1: under JOG low speed	U9.1.0	U9.17.0
JOG high speed			0: not under JOG high speed 1: under JOG high speed	U9.1.1	U9.17.1
Forward JOG start			Input	0: JOG stop, 1: forward JOG start	U9.1.8
Reverse JOG start		0: JOG stop, 1: Reverse JOG start		U9.1.9	U9.17.9

Item	Data type	Signal direction	Status information	U area for positioning	
				X-axis	Y-axis
JOG low/high speed			0: JOG low speed, 1: JOG high speed	U9.1.A	U9.17.A
DOG			Operate at rising edge	U9.1.B	U9.17.B
Upper limit signal			Detected at falling edge	U9.1.C	U9.17.C
Lower limit signal			Detected at falling edge	U9.1.D	U9.17.D
Home return direction	BOOL	Input	0: CW, 1: CCW	U9.1.E	U9.17.E
Positioning status			0: disable, 1: enable	U9.1.F	U9.17.F
Current position	DINT	Output	-2,147,483,648 ~ 2,147,483,647	U9.2	U9.18
Current speed	WORD		1 ~ 10,000[pulse/s]	U9.4	U9.20
Error code	WORD		Indicates positioning error	U9.5	U9.21
Bias speed	WORD	Input	1 ~ 10,000[pulse/s]	U9.6	U9.22
Speed limit	WORD		1 ~ 10,000[pulse/s]	U9.7	U9.23
Acc. time	WORD		0 ~ 10,000[unit: ms]	U9.8	U9.24
Dec. time	WORD		0 ~ 10,000[unit: ms]	U9.9	U9.25
Home address	DINT		-2,147,483,648 ~ 2,147,483,647	U9.10	U9.26
Home return high speed	WORD		1 ~ 10,000[pulse/s]	U9.12	U9.28
Home return low speed	WORD		1 ~ 10,000[pulse/s]	U9.13	U9.29
JOG high speed	WORD		1 ~ 10,000[pulse/s]	U9.14	U9.30
JOG low speed	WORD	1 ~ 10,000[pulse/s]	U9.15	U9.31	

Note

- For more information on positioning parameter item, refer to XGB built-in positioning manual.

11.4 Positioning Instruction List

Positioning instructions used in XBO-TN04A positioning are summarized as follows.

(1) XBO-TN04A positioning instruction

Instruction	Command	Command condition	XGB built-in positioning manual
ORG	Home return	Slot, command axis	5.2.1
DST	Direct start	Slot, command axis, position, speed, dwell time, M code, control word	5.2.3
STP	Stop	Slot, command axis, dec. time	5.2.9
PRS	Current position preset	Slot, command axis, position	5.2.18
EMG	EMG. Stop	Slot, command axis	5.2.19
CLR	Error reset, output prohibition cancel	Slot, command axis, disable/enable pulse output	5.2.20

Note

- XGB positioning instruction operates at rising edge. Namely, instruction is executed once when execution contact point is on.
- For instruction, refer to XGB positioning manual.
- When using DST instruction in XBO-TN04A, dwell time and M code are not supported.

11.5 Positioning Example

This chapter describes positioning example of XBO-TN04A.

(1) Positioning setup

Option board positioning is set up by U area. Set up each parameter to use positioning function.

(a) Input each parameter value.

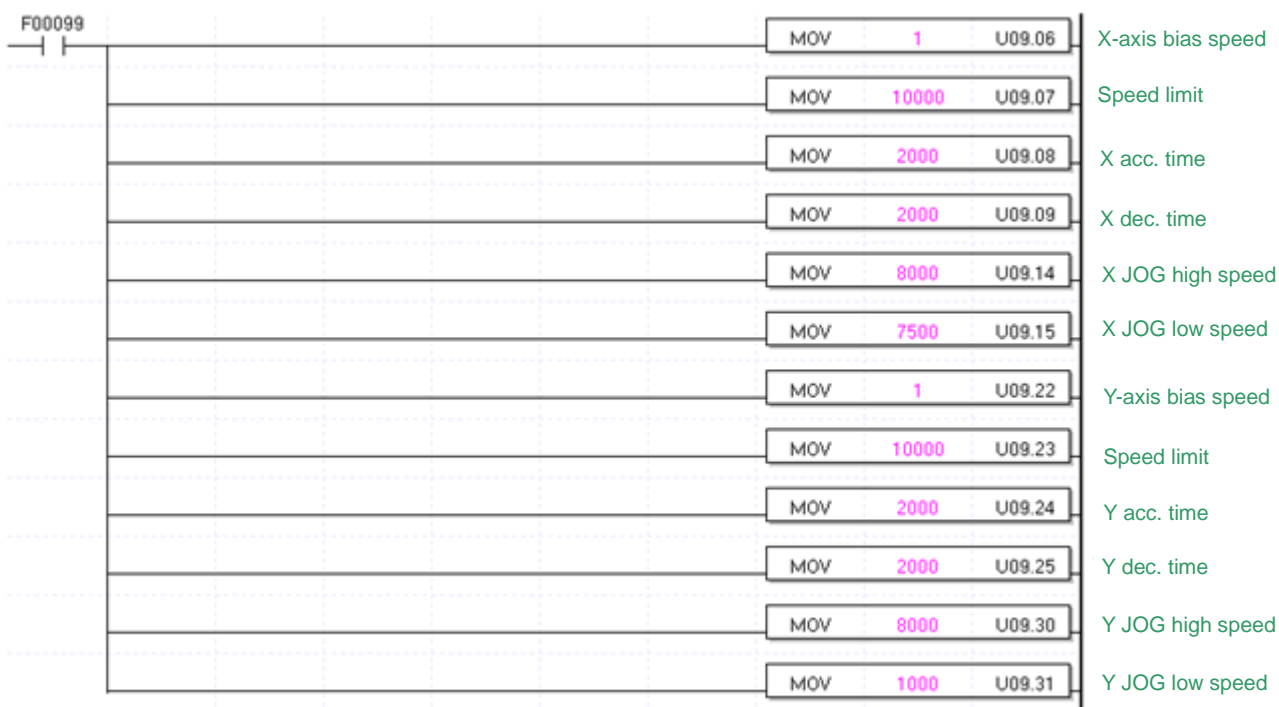

(b) Turn On or Off according to whether to use positioning

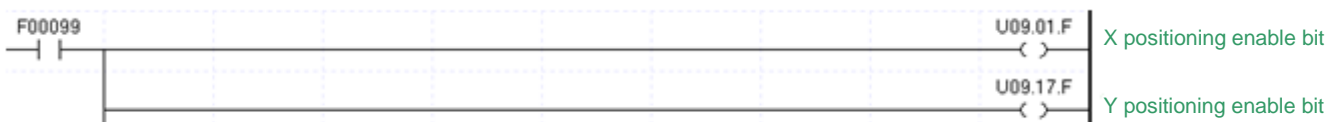

(c) Set up the function as follows.

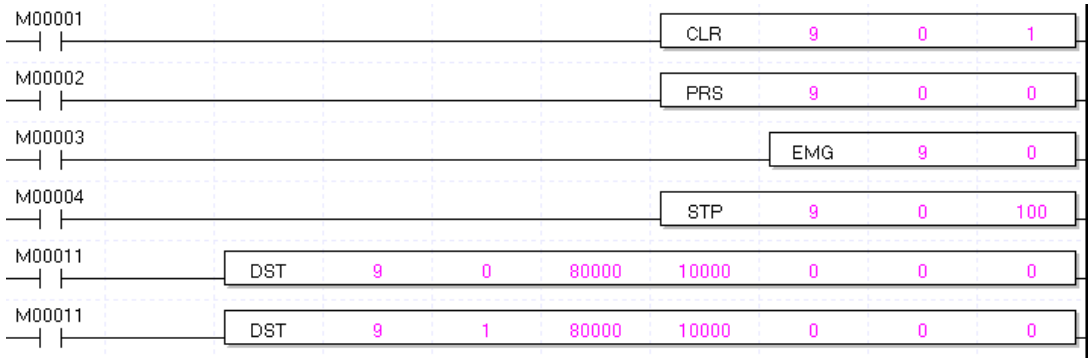

(2) Monitoring

You can check option board posioing speed, crrent position by regstering U9.2, U9.4(No. 9 slot, X-axis) at variable monitor window or program

Chapter12 Memory Module

12.1 Memory Module Specification

You can save user program safely or download user program to PLC without special handling when user program is damaged by using external memory module in XGB PLC

12.1.1 Memory module specification

Item	XBO-M2MB	Ref.
Memory capacity	2MByte	
Memory type	Flash Memory	
Specification	USB supported, Program Read/Write	
Indicator	LED	1. RUN 2. WRITE 3. READ
Operating mode setup	Mode setup by rotary switch	
Operating power supply	RS-232C communication connector, USB connector	5V
Purpose	For moving	

12.1.2 Memory module structure

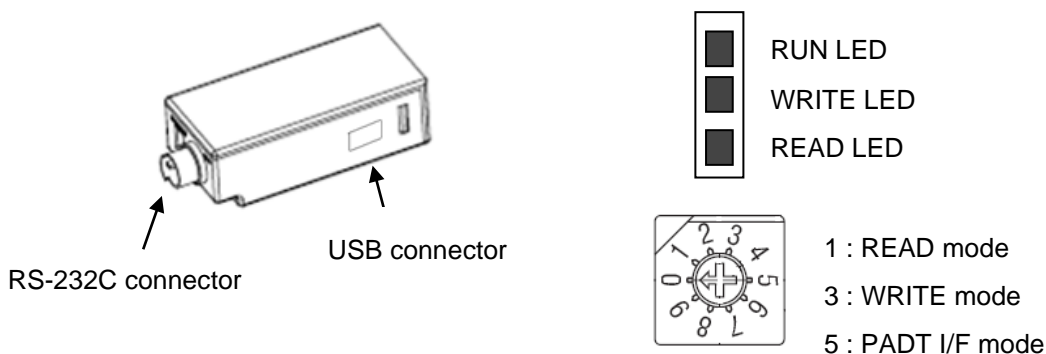

Note

- Memory module can be used for XGB (not supported for XGK/I/R)
- Memory module is not supported at the version below
(XBMS: V2.5 or less, XBCH: V1.8 or less, XECH: V1.2 or less)

12.1.3 How to use memory module

- (1) Save program, parameter, communication parameter at external memory module
 - (a) Set the switch of memory module as 1
 - (b) Install memory module at the RS-232C port of main unit
 - After installation, program and parameter (including communication) is saved into memory module and READ LED is on
 - If Saving program and parameter is complete, READ LED is off
 - (c) Separate memory module from main unit
- (2) Save user program of external memory module at main unit
 - (a) Set the operating mode of main unit as STOP
 - In RUN mode, you can't save program
 - (b) Set the switch of memory module as 3
 - (c) Install the memory module
 - Install it at the RS-232C port of the main unit.
 - PLC program and parameter (including communication) is written and WRITE LED is on
 - If saving program and parameter is complete, WRITE LED is off.
 - (d) If you change operation mode of PLC into RUN, PLC operates with program and parameter saved in memory module.

With the above handling, you can run PLC with program saved in memory module

- (3) Save program of XG5000 at the memory module
 - (a) Set the mode switch of XBO-M2MB as "5" and connect XBO-M2MB to USB port of PC
 - (b) Select Project → Write to Memory on XG5000 menu.

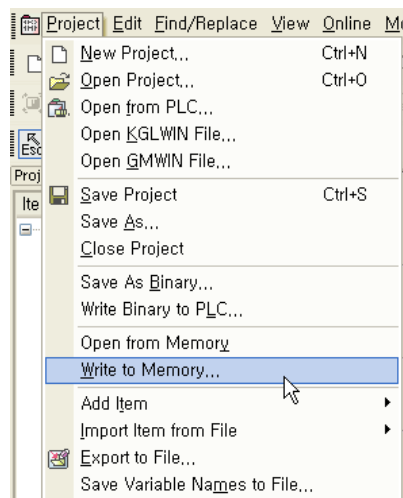

(c) 'Write' window is created as follows.

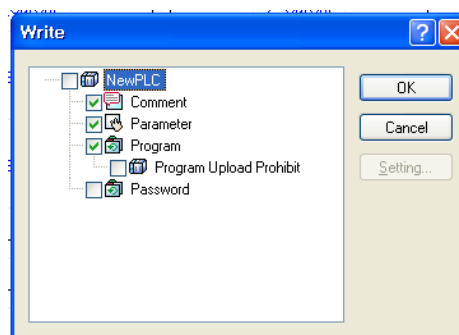

(d) "Writing completed" window appears.

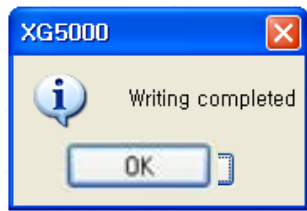
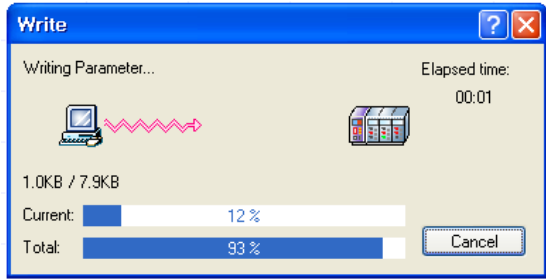

(e) With above method, through PADT, you can save program, parameter, communication parameter at XBO-M2MB

(4) Open from memory module

- (a) Set the mode switch of XBO-M2MB as "5" and connect XBO-M2MB to USB port of PC
- (b) Select "Project → Open from Memory" on XG5000 menu

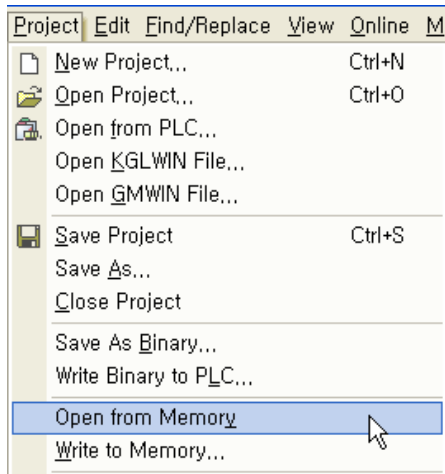

(c) "Read" window is created as follows.

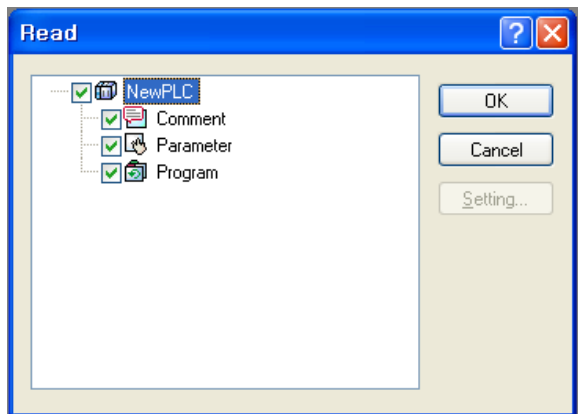

(d) "Reading is completed" window appears.

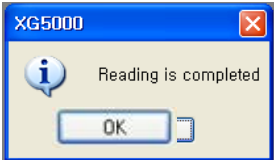
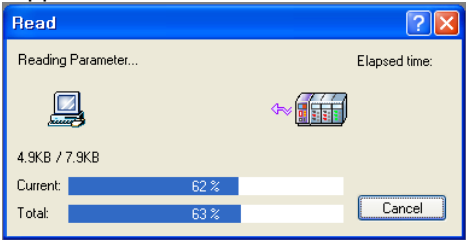

(e) With above method, through PADT, you can save program, parameter, communication parameter from XBO-M2MB

(5) Write to Memory module

- (a) Set the mode switch of XBO-M2MB as "5" and connect XBO-M2MB to USB port
- (b) Click "Online → Write to Memory module" on XG-PD menu

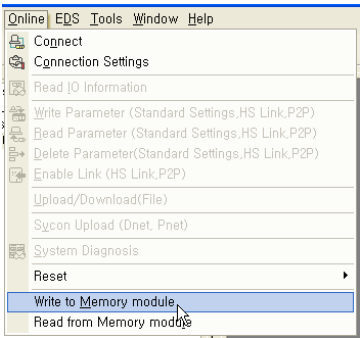

(c) If you click "OK" button, it saves each parameter at the memory module.

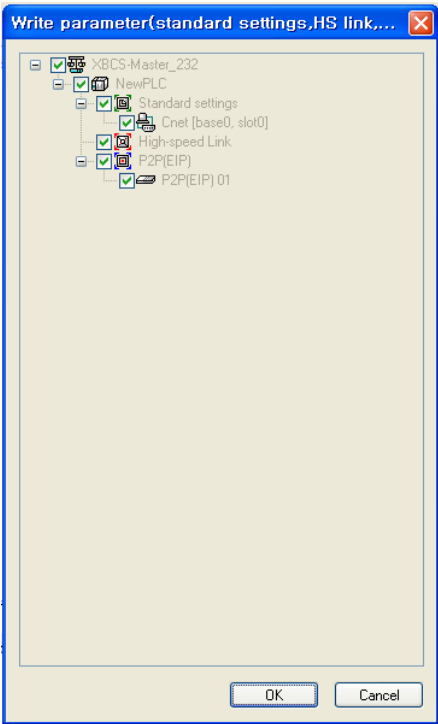

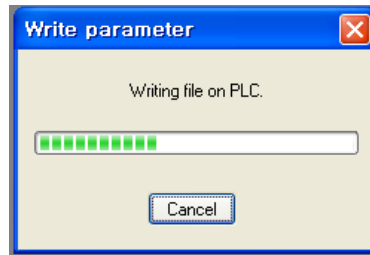

(d) If "Enable Link" window appears, check the item and press "Write"

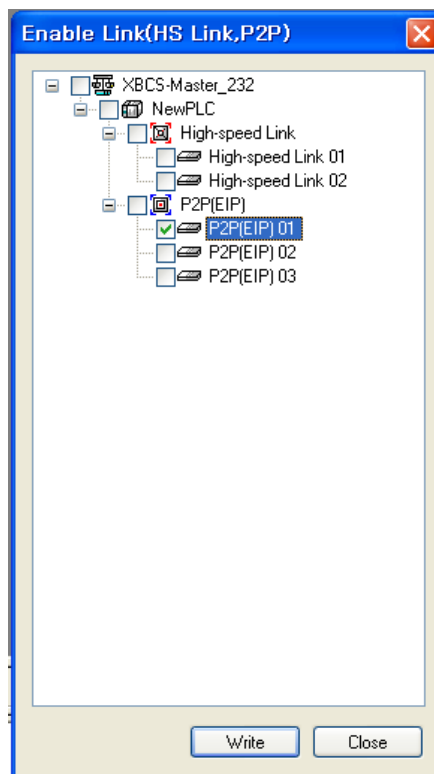

(e) "Enable, Disable" window appears

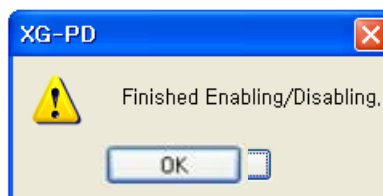

(6) Read from Memory module

- (a) Set the mode switch of XBO-M2MB as “5” and connect XBO-M2MB to USB port of PC
- (b) Select “Online → Read from Memory module” on XG-PD menu.

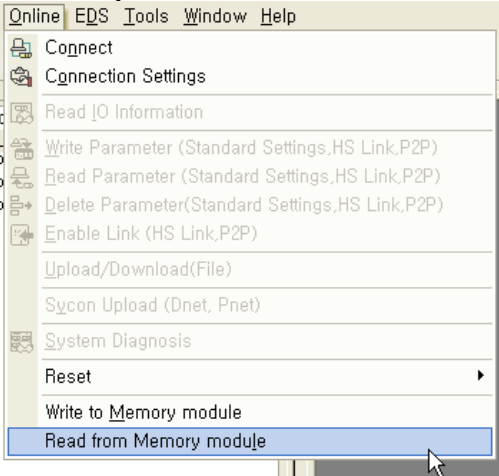

- (c) If you click “OK” button”, it read each parameter form the memory module.

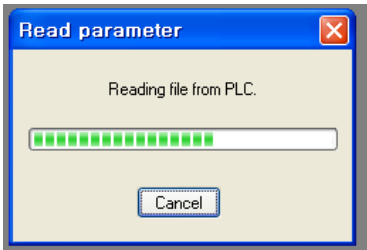
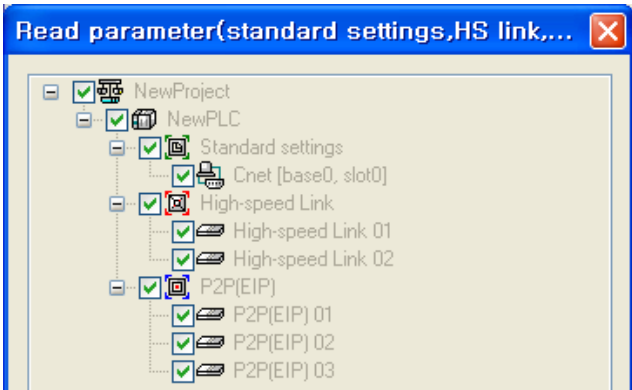

Note

- “Open from memory module” and “Write to Memory module” menus of PADT are activated when PLC is Offline. They are deactivated when PLC is Online.
- When connecting with PADT, connection type should be ‘USB’

12.1.4 How to use when password is set

- (1) When connecting PADT with memory module
 - (a) When setting password at program and writing program to memory module, it is saved according to rotary switch operating mode without functions cancelling the password
 - 1) When writing program, check whether to use password at 'Write' window.

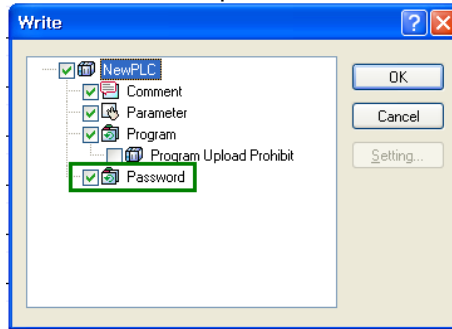

- 2) If you press 'OK' after setting password, program is saved at memory module with that password.

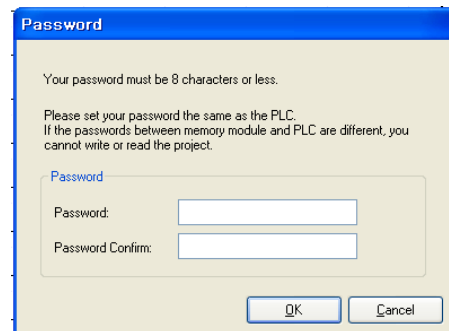

- (b) When reading password-set program to PADT, screen appears, which is same as when password is set in PLC.

- 1) "Password" window is created.

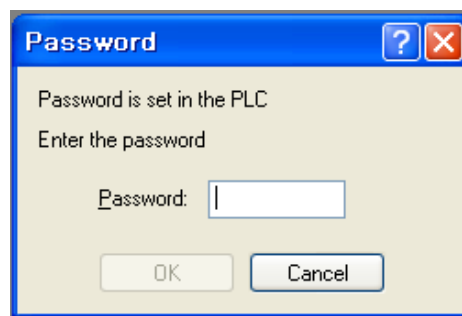

- 2) If you input password same as that in memory module, it reads program.
 - 3) When password is incorrect, error message appears as follows.



(2) Write to PLC by memory module

- (a) When password of program in memory module is not set
 - 1) When no password is set in PLC
 - Saves program of the memory module in PLC
 - 2) When password is set in PLC
 - Writing is not executed

- (b) When password of program in memory module is set
 - 1) When no password is set in PLC
 - Writing to PLC is executed
 - But, password of the memory module is not written to PLC.
 - 2) When password is set in PLC
 - When PLC password is same as that of the memory module, writing is executed.
 - When PLC password is not same as that of the memory module, writing is not executed.
 - (WRITE LED flickers)

(3) Reading program in PLC to memory module

- (a) When password of program in PLC is not set
- 1) When no password is set in the memory module
 - Reads program from PLC
 - 2) When password is set in the memory module
 - After reading, it clears password of the memory module
- (b) When password of program in PLC is set
- 1) When no password is set in the memory module
 - Writing is not executed
 - 2) When password is set in the memory module
 - When PLC password is same as that of the memory module, writing is executed.
 - When PLC password is not same as that of the memory module, writing is not executed.

(4) When LED flickers

	Condition	LED
1	PLC type is not XGB	RUN LED flickers
2	Operating mode changes while being connected to PADT or PLC	RUN LED flickers
3	Connected to PADT while mode switch is "1"	READ LED flickers
4	PLC program upload is prohibited	READ LED flickers
5	You execute reading when password is set in PLC (when password is not same as that of memory module)	READ LED flickers
6	Connected to PADT while mode switch is "3"	WRITE LED flickers
7	You execute writing the memory module when PLC mode is RUN	WRITE LED flickers
8	Connected to the different type of PLC with the type set in the memory module	WRITE LED flickers
9	You executes writing when PLC password is not same as that of memory module	WRITE LED flickers

Note

- Memory module can cancel PLC password and read/write but can't set, delete and change the password.
- Do not run PLC while external memory module is connected to.
- Do not remove memory module while READ/WRITE LED is on.

Chapter 13 Installation and Wiring

13.1 Safety Instruction



Danger

- ▶ Please design protection circuit at the external of PLC for entire system to operate safely because an abnormal output or an malfunction may cause accident when any error of external power or malfunction of PLC module.
 - (1) It should be installed at the external side of PLC to emergency stop circuit, protection circuit, interlock circuit of opposition action such as forward /reverse operation and interlock circuit for protecting machine damage such as upper/lower limit of positioning.
 - (2) If PLC detects the following error, all operation stops and all output is off.
 - (Available to hold output according to parameter setting)
 - (a) When over current protection equipment or over voltage protection operates
 - (b) When self diagnosis function error such as WDT error in PLC CPU occurs
- ▶ In case of error about IO control part that is not detected by PLC CPU, all output is off.

Design Fail Safe circuit at the external of PLC for machine to operate safely. Refer to 13.1.1 Fail Safe circuit.

 - (1) Because of error of output device, Relay, TR, etc., output may not be normal. About output signal that may cause the heavy accident, design supervisory circuit to external.
- ▶ In case load current more than rating or over current by load short flows continuously, danger of heat, fire may occur so design safety circuit to external such as fuse.
- ▶ Design for external power supply to be done first after PLC power supply is done. If external power supply is done first, it may cause accident by misoutput, misoperation.
- ▶ In case communication error occurs, for operation status of each station, refer to each communication manual.
- ▶ In case of controlling the PLC while peripheral is connected to CPU module, configure the interlock circuit for system to operate safely. During operation, in case of executing program change, operation status change, familiarize the manual and check the safety status. Especially, in case of controlling long distance PLC, user may not response to error of PLC promptly because of communication error or etc.

Limit how to take action in case of data communication error between PLC CPU and external device adding installing interlock circuit at the PLC program.



Danger

- ▶ Don't close the control line or communication cable to main circuit or power line. Distance should be more than 100mm. It may cause malfunction by noise.
- ▶ In case of controlling lamp load, heater, solenoid valve, etc. in case of Off -> On, large current (10 times of normal current) may flows, so consider changing the module to module that has margin at rated current.
- ▶ Process output may not work properly according to difference of delay of PLC main power and external power for process (especially DC in case of PLC power On-Off and of start time.
For example, in case of turning on PLC main power after supplying external power for process, DC output module may malfunction when PLC is on, so configure the circuit to turn on the PLC main power first
Or in case of external power error or PLC error, it may cause the malfunction.
- ▶ Not to lead above error to entire system, part causing breakdown of machine or accident should be configured at the external of PLC

(2) System design circuit example (In case of using ERR contact point of power module)

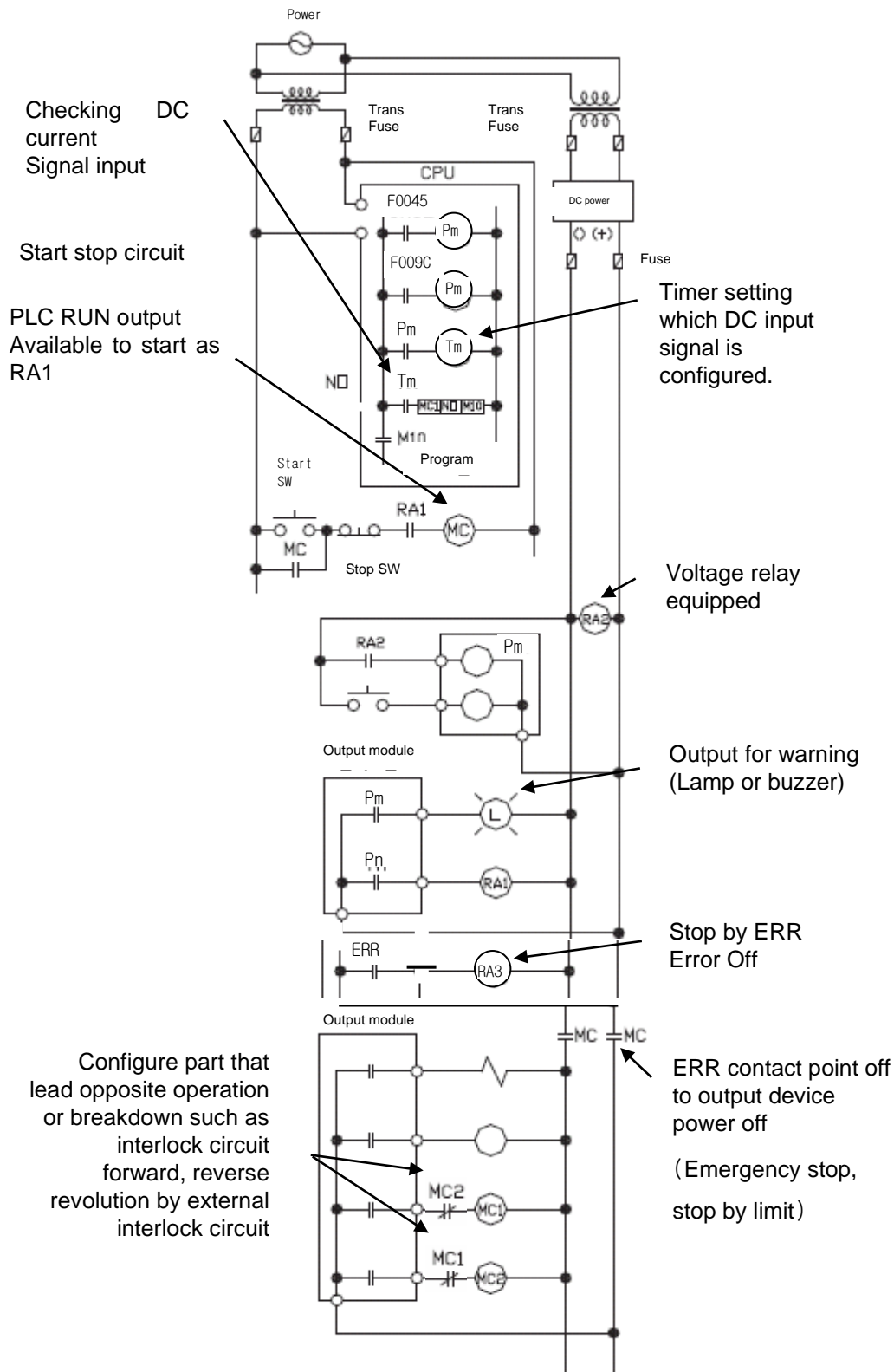

Start sequence of power
In case of AC DC

- (1) Run CPU after turning on power.
- (2) Turn on RA2 with DC power supplied
- (3) Turn on timer after DC power is stable
- (4) Turn on start s/w
- (5) Turn on start switch Output device runs by program through magnetic contactor (MC) [On]

Chapter 13. Installation and Wiring

(3) Fail safe countermeasure in case of PLC error

Error of PLC CPU and memory is detected by self diagnosis but in case error occurs in IO control part, etc., CPU can detect the error. At this case, though it is different according to status of error, all contact point is on or off, so safety may not be guaranteed. Though we do our best to our quality as producer, configure safety circuit preparing that error occurs in PLC and it lead to breakdown or accident.

System example

Main unit	Input 16 point	Input 16 point	Input 16 point	Input 16 point	Output 16 point	Output 16 point
-----------	----------------	----------------	----------------	----------------	-----------------	-----------------

Output module for fail safe

Equip output module for fail safe to last slot of system.

[Fail safe circuit example]

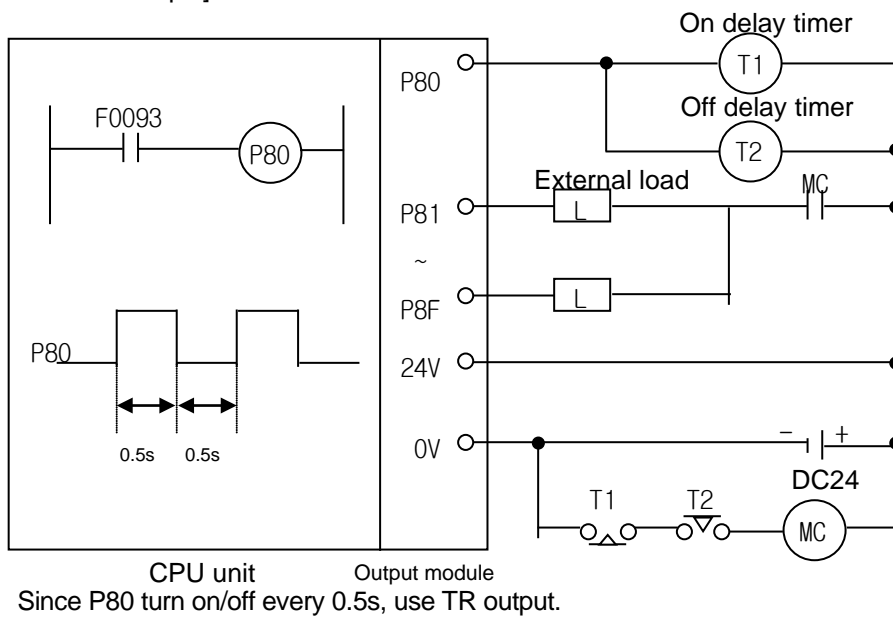

13.1.2 PLC heat calculation

(1) Power consumption of each part

(a) Power consumption of module

The power conversion efficiency of power module is about 70% and the other 30% is gone with heat; 3/7 of the output power is the pure power consumption. Therefore, the calculation is as follows.

- $W_{pw} = 3/7 \{ (I_{5V} \times 5) + (I_{24V} \times 24) \}$ (W)

I_{5V} : power consumption of each module DC5V circuit(internal current consumption)

I_{24V} : the average current consumption of DC24V used for output module
(current consumption of simultaneous On point)

If DC24V is externally supplied or a power module without DC24V is used, it is not applicable.

(b) Sum of DC5V circuit current consumption

The DC5V output circuit power of the power module is the sum of power consumption used by each module.

- $W_{5V} = I_{5V} \times 5$ (W)

(c) DC24V average power consumption(power consumption of simultaneous On point)

The DC24V output circuit's average power of the power module is the sum of power consumption used by each module.

- $W_{24V} = I_{24V} \times 24$ (W)

(d) Average power consumption by output voltage drop of the output module(power consumption of simultaneous On point)

- $W_{out} = I_{out} \times V_{drop} \times \text{output point} \times \text{simultaneous On rate}$ (W)

I_{out} : output current (actually used current) (A)

V_{drop} : voltage drop of each output module (V)

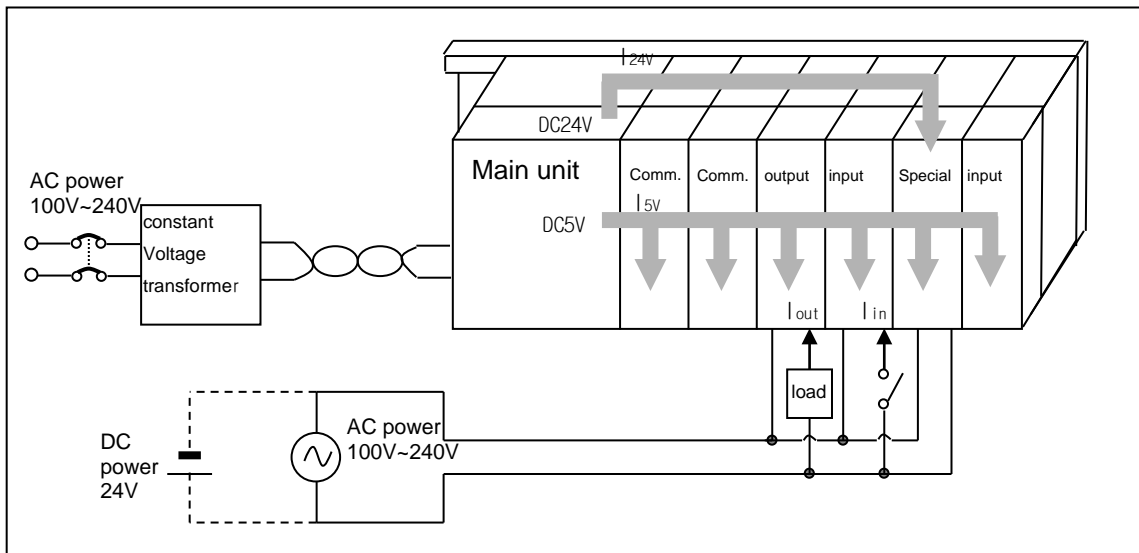

(e) Input average power consumption of input module
(power consumption of simultaneous On point)

- $W_{in} = I_{in} \times E \times \text{input point} \times \text{simultaneous On rate (W)}$
 I_{in} : input current (root mean square value in case of AC) (A)
 E : input voltage (actually used voltage) (V)

(f) Power consumption of special module power assembly

- $W_s = I_{5V} \times 5 + I_{24V} \times 24 + I_{100V} \times 100$ (W)

The sum of power consumption calculated by each block is the power consumption of the entire PLC system.

- $W = W_{PW} + W_{5V} + W_{24V} + W_{out} + W_{in} + W_s$ (W)

Calculate the heats according to the entire power consumption(W) and review the temperature increase within the control panel.

The calculation of temperature rise within the control panel is displayed as follows.

$$T = W / UA \text{ [}^\circ\text{C]}$$

W : power consumption of the entire PLC system (the above calculated value)

A : surface area of control panel [m²]

U : if equalizing the temperature of the control panel by using a fan and others - - - 6

If the air inside the panel is not ventilated - - - - - 4

If installing the PLC in an air-tight control panel, it needs heat-protective(control) design considering the heat from the PLC as well as other devices. If ventilating by vent or fan, inflow of dust or gas may affect the performance of the PLC system.

13.2 Attachment/Detachment of Modules

13.2.1 Attachment/Detachment of modules

Caution in handling

Use PLC in the range of general specification specified by manual.

In case of using out of range, it may cause electric shock, fire, malfunction, damage of product.



Warning

- ▶ Module must be mounted to hook for fixation properly before its fixation. The module may be damaged from over-applied force. If module is not mounted properly, it may cause malfunction.
- ▶ Do not drop or impact the module case, terminal block connector.
- ▶ Do not separate the PCB from case.

(1) Equipment of module

- Eliminate the extension cover at the upper of module.
- Push the module and connect it in agreement with hook for fixation of four edges and hook for connection at the bottom.
- After connection, get down the hook for fixation at the upper part and lower part and fix it completely.

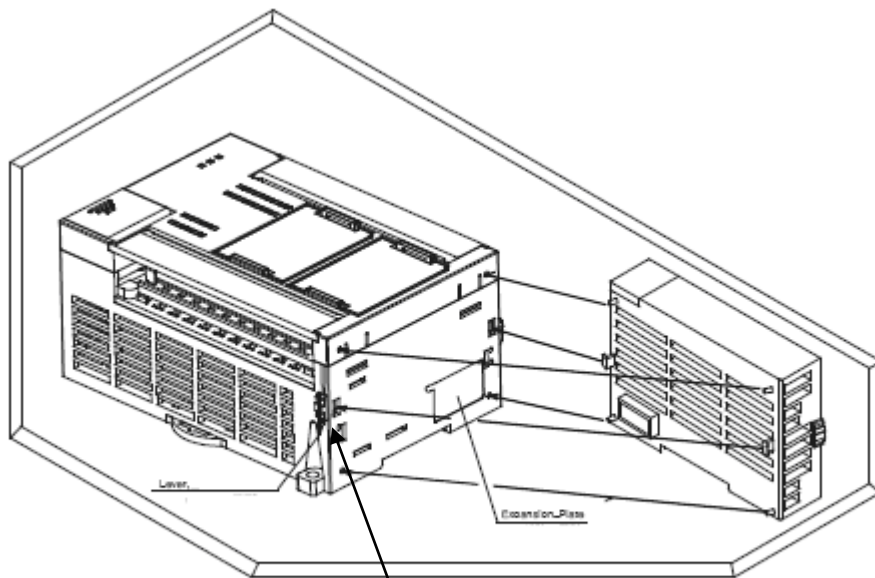

Module fixation (Hook)

(2) Detachment of module

- Get up the hook for fixation of upper part and lower part and disconnect it.
- Detach the module with two hands. (Don't force over-applied force.)

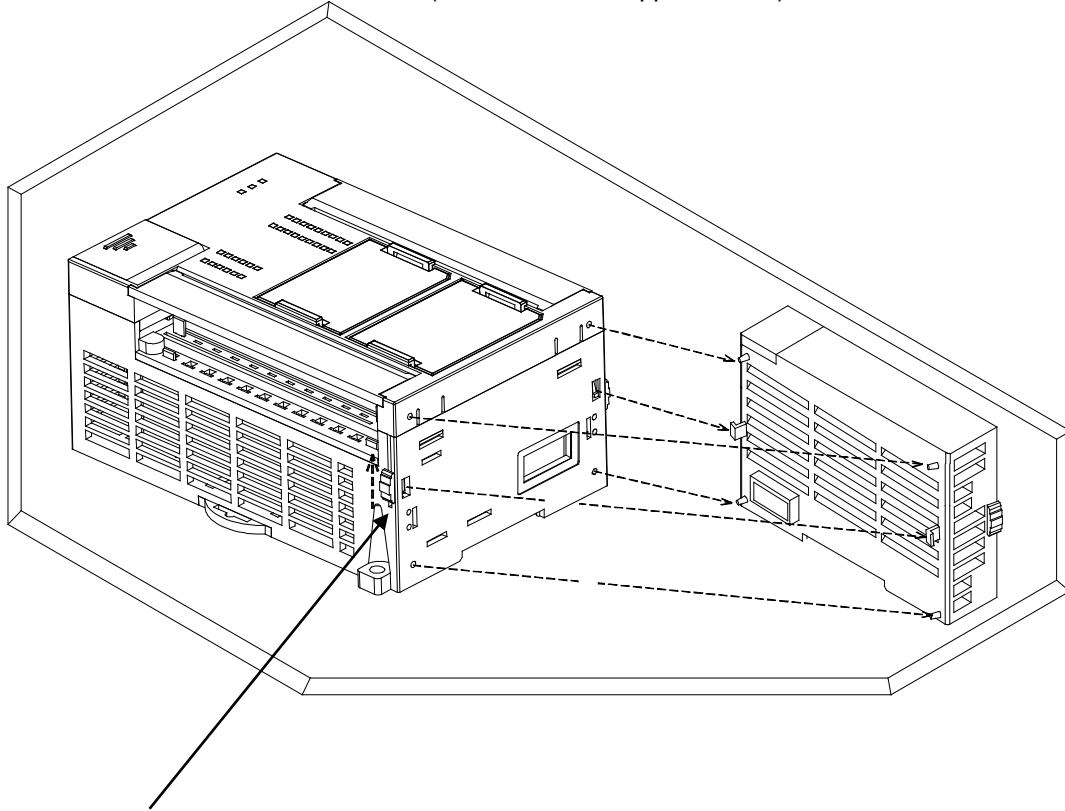

Hook for module fixation



Caution

- ▶ When separating module, don't force over-applied power. If so, hook may be damaged.

(3) Installation of module

XGB PLC is having hook for DIN rail (rail width: 35mm) so that can be installed at DIN rail.

(a) In case of installing at DIN rail

- Pull hook for DIN rail at the bottom of module and install it at DIN rail
- Push hook to fix the module at DIN rail after installing module at DIN rail

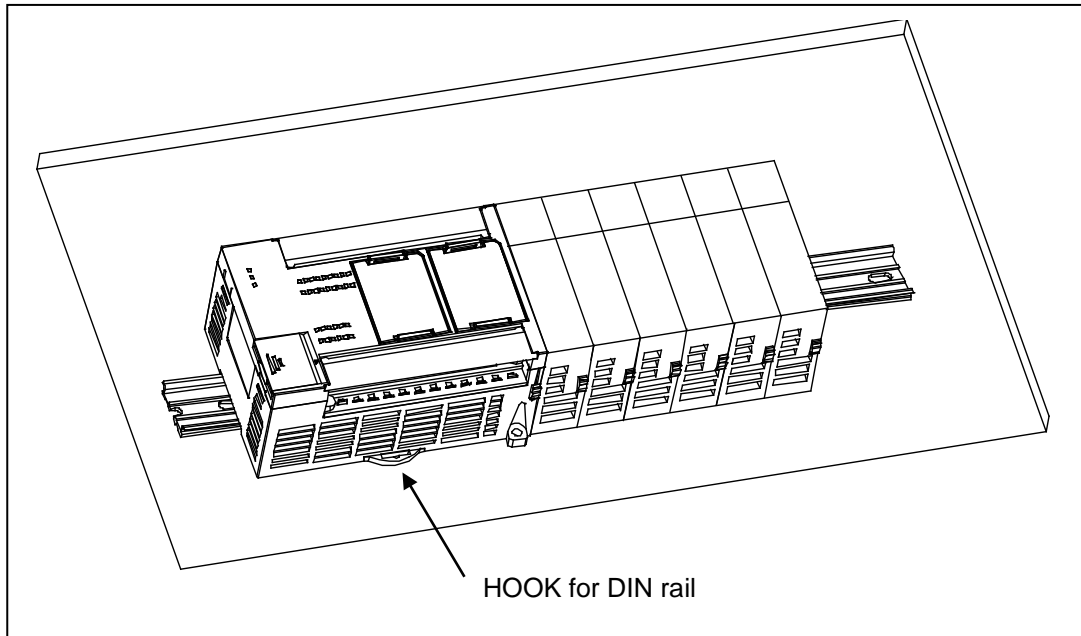

(b) In case of installing at panel

- You can install XGB compact type main unit at panel directly using screw hole
- Use M4 type screw to install the product at panel.

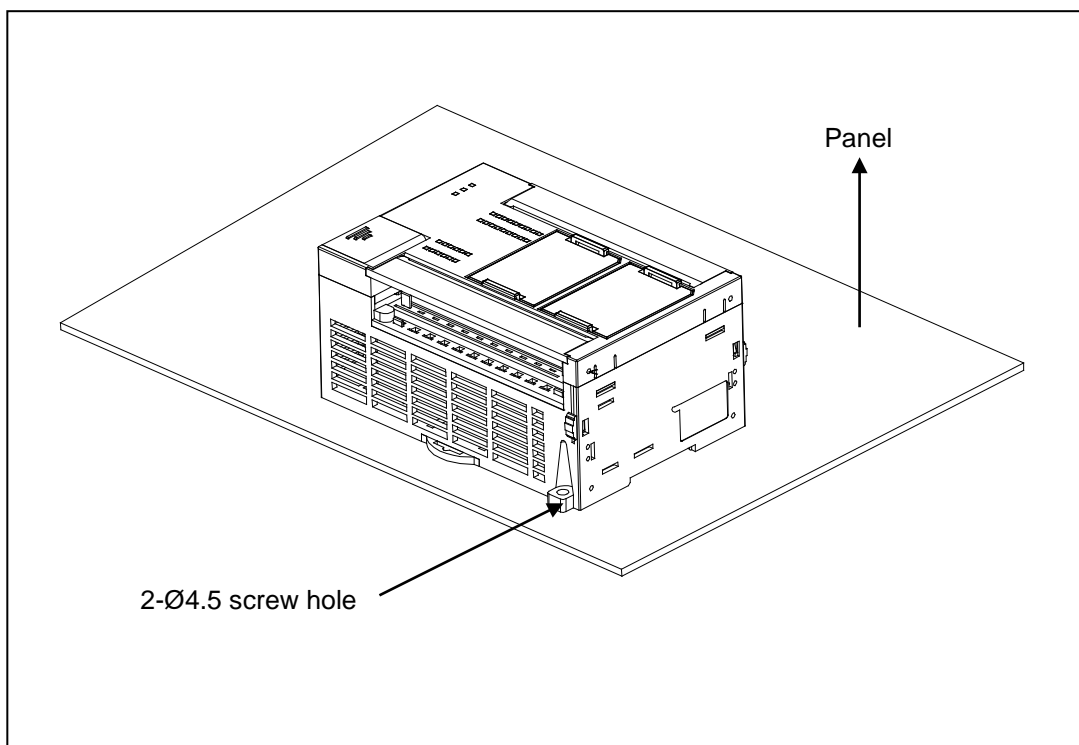

Chapter 13. Installation and Wiring

(4) Module equipment location

Keep the following distance between module and structure or part for well ventilation and easy detachment and attachment.

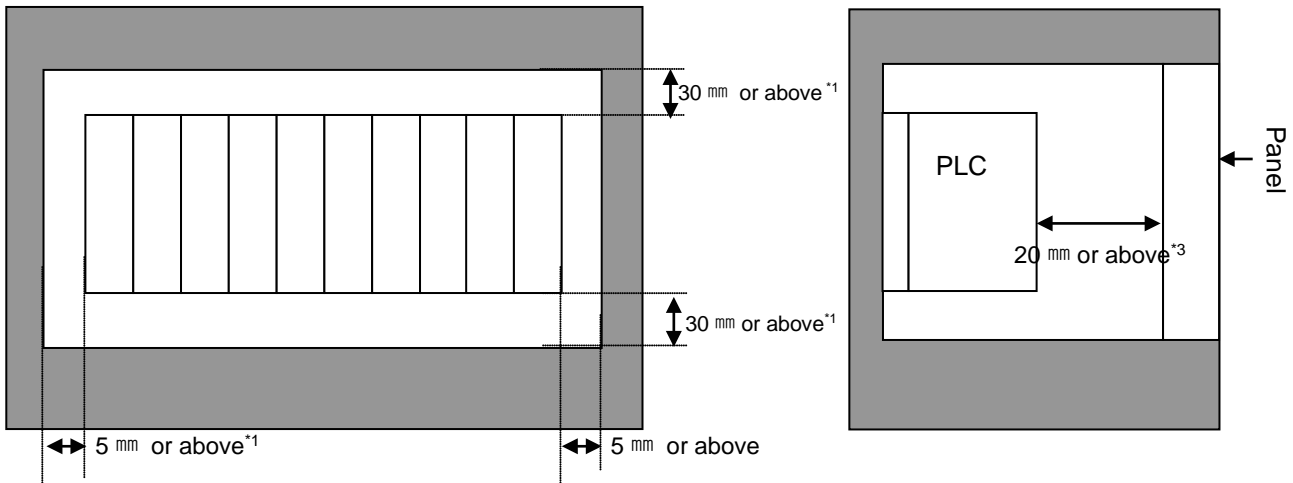

*1 : In case height of wiring duct is less than 50 mm (except this 40mm or above)

*2 : In case of equipping cable without removing near module, 20mm or above

*3 : In case of connector type, 80mm or above

(5) Module equipment direction

(a) For easy ventilation, install like the following figure.

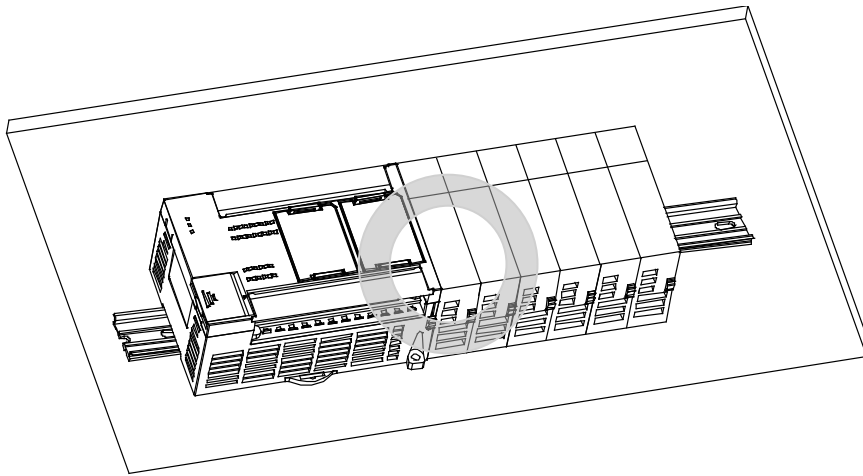

(b) Don't install like the following figure

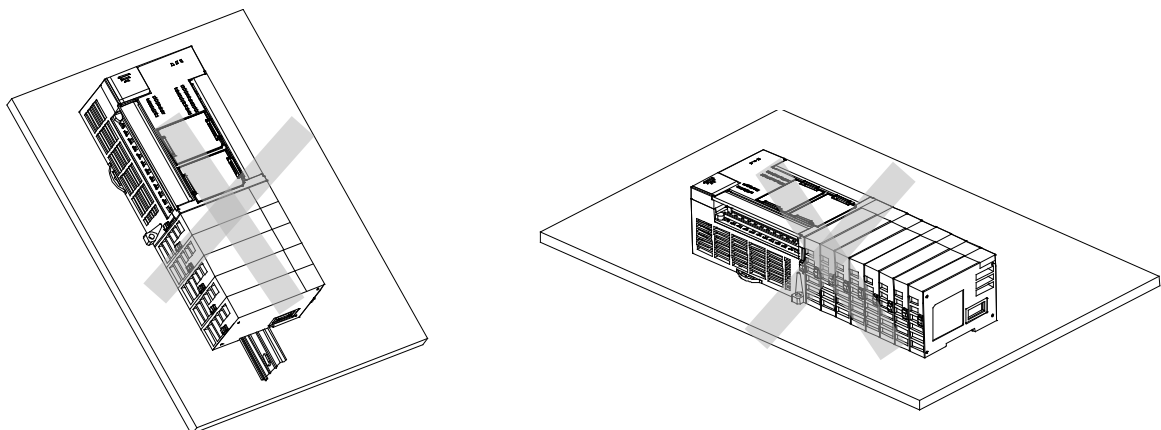

(6) Distance with other device

To avoid radiation noise or heat, keep the distance between PLC and device (connector and relay) as far as the following figure.

Device installed in front of PLC: 100 mm or above

Device installed beside PLC: 50 mm or above

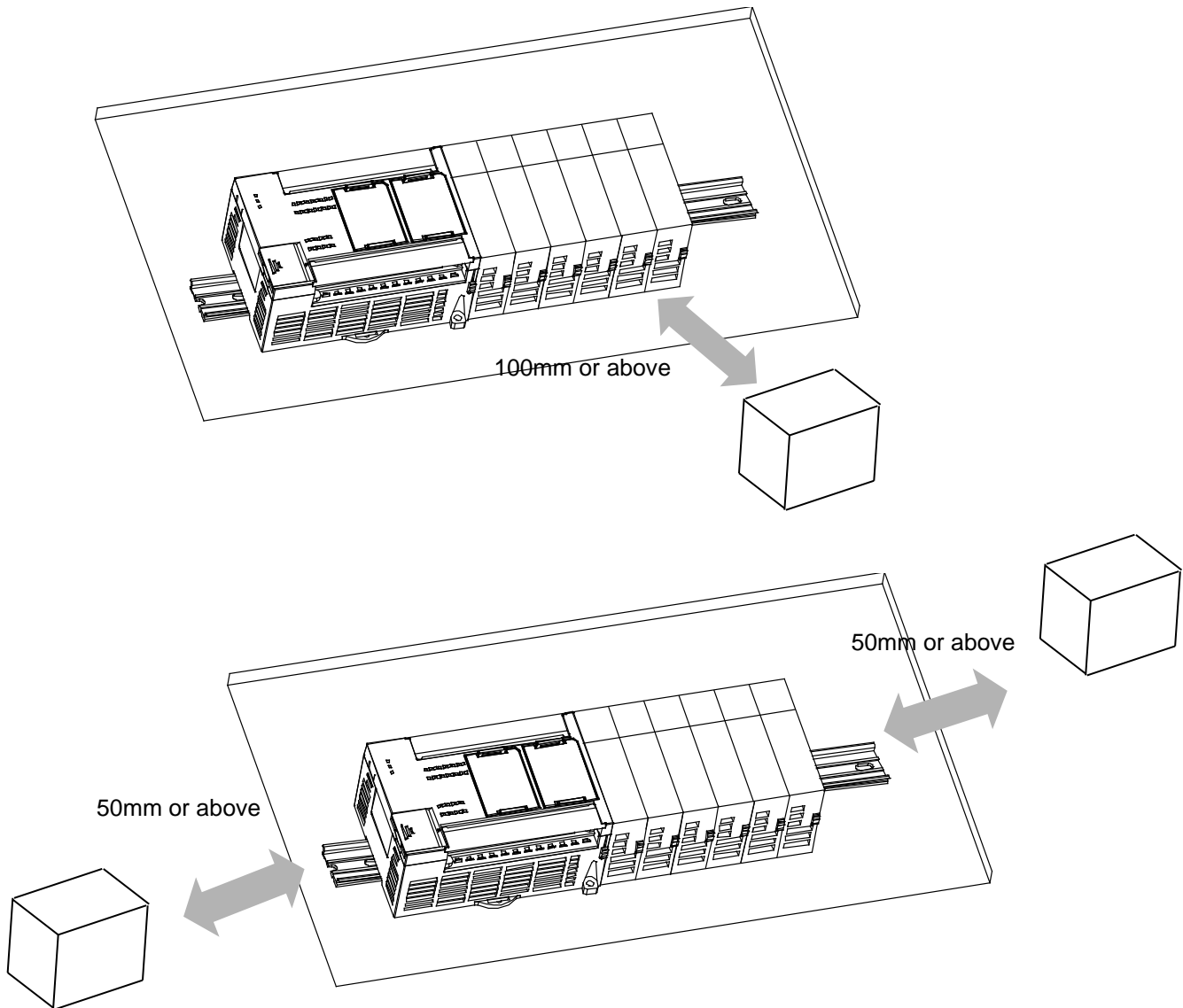

13.2.2 Caution in handling

Here describes caution from open to install

- Don't drop or impact product.
- Don't disassemble the PCB from case. It may cause the error.
- In case of wiring, make sure foreign substance not to enter upper part of module. If it enters, eliminate it.

(1) Caution in handling IO module

It describes caution in handling IO module.

(a) Recheck of IO module specification

For input module, be cautious about input voltage, for output module, if voltage that exceeds the max. open/close voltage is induced, it may cause the malfunction, breakdown or fire.

(b) Used wire

When selecting wire, consider ambient temp, allowed current and minimum size of wire is AWG22(0.3mm²) or above.

(c) Environment

In case of wiring IO module, if device or material that induce high heat is too close or oil contacts wire too long time, it may cause short, malfunction or error.

(d) Polarity

Before supplying power of module which has terminal block, check the polarity.

(e) Wiring

- In case of wiring IO with high voltage line or power line, induced obstacle may cause error.
- Let no cable pass the IO operation indication part (LED).
(You can't discriminate the IO indication.)
- In case induced load is connected with output module, connect the surge killer or diode load to load in parallel. Connect cathode of diode to + side of power.

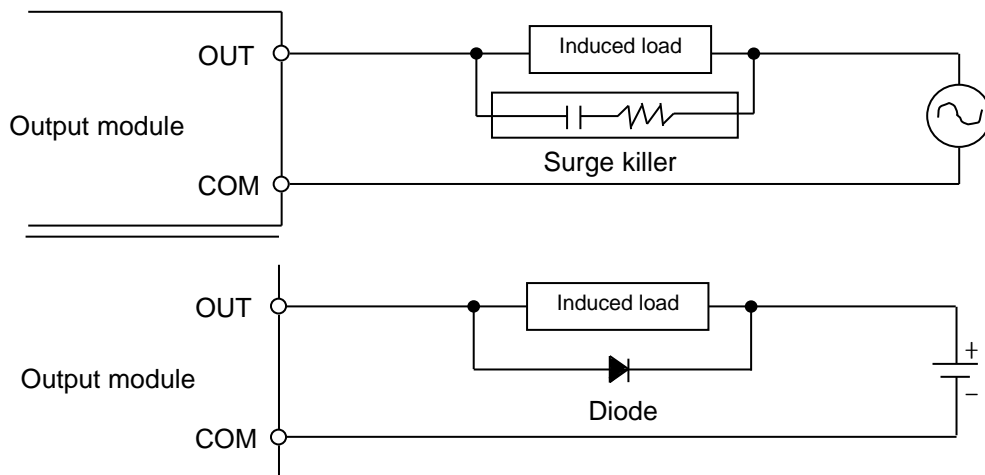

(f) Terminal block

Check close adhesion status. Let no foreign material of wire enter into PLC when wiring terminal block or processing screw hole. At this case, it may cause malfunction.

(g) Don't impact to IO module or don't disassemble the PCB from case.

13.3 Wire

In case using system, it describes caution about wiring.

Danger

- ▶ When wiring, cut off the external power.
- ▶ If all power is cut, it may cause electric shock or damage of product.
- ▶ In case of flowing electric or testing after wiring, equip terminal cover included in product. If not, it may cause electric shock.

Caution

- ▶ Do D type ground (type 3 ground) or above dedicated for PLC for FG and LG terminal. It may cause electric shock or malfunction.
- ▶ When wiring module, check the rated voltage and terminal array and do properly. If rating is different, it may cause fire, malfunction.
- ▶ For external connecting connector, use designated device and solder. If connecting is not safe, it may cause short, fire, malfunction.
- ▶ For screwing, use designated torque range. If it is not fit, it may cause short, fire, malfunction.
- ▶ Let no foreign material enter such as garbage or disconnection part into module. It may cause fire, malfunction, error.

13.3.1 Power wiring

(1) In case voltage regulation is larger than specified, connect constant voltage transformer.

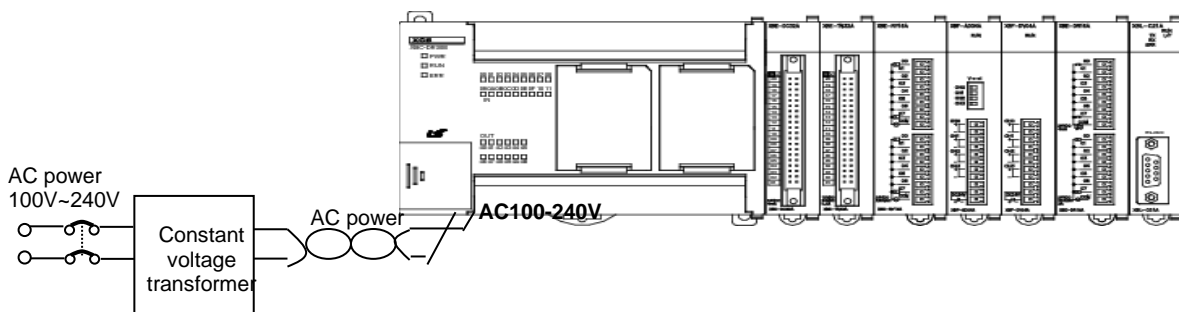

(2) Connect noise that include small noise between line and earth.
(When there are many noise, connect insulated transformer.)

Chapter 13. Installation and Wiring

(3) Isolate the PLC power, I/O devices and power devices as follows.

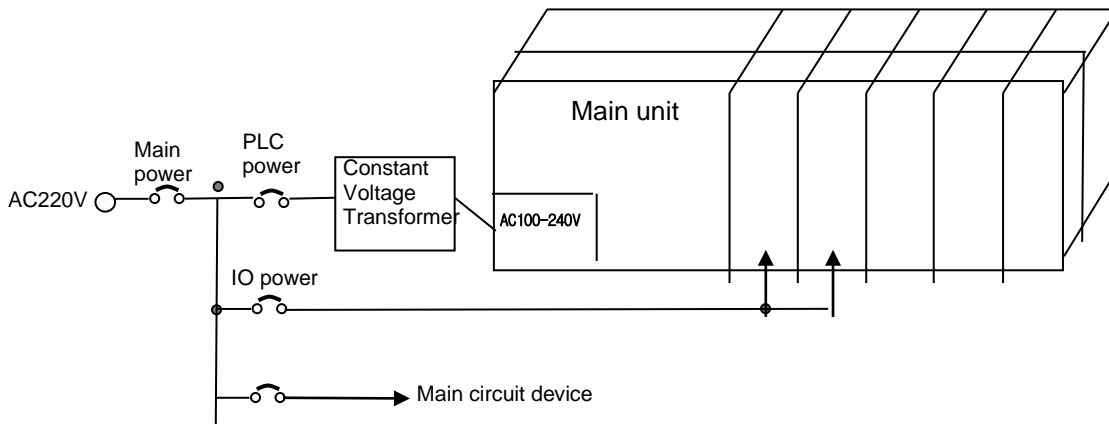

(4) If using DC24V of the main unit

- (a) Do not connect DC24V of several power modules in parallel. It may cause the destruction of a module.
- (b) If a power module can not meet the DC24V output capacity, supply DC24V externally as presented below.

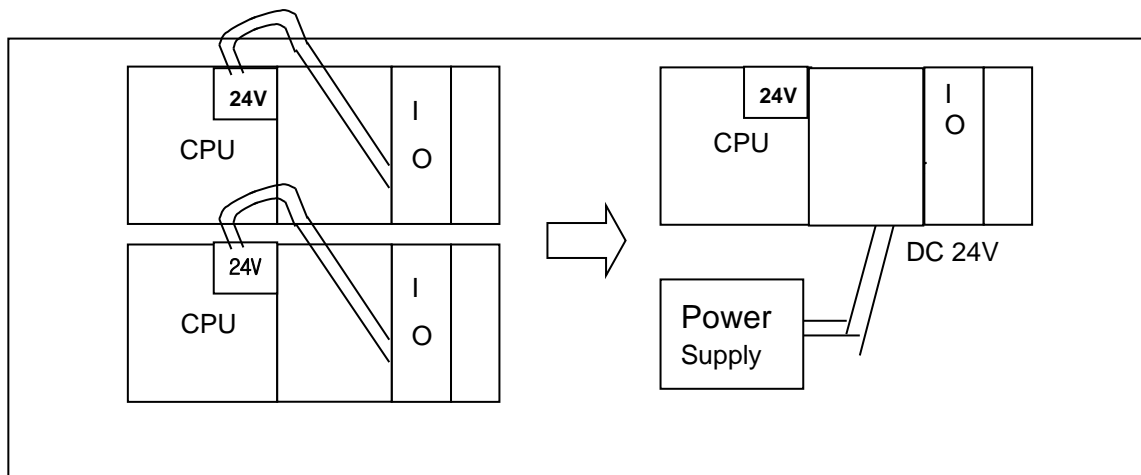

(5) AC110V/AC220V/DC24V cables should be compactly twisted and connected in the shortest distance.

(6) AC110V/AC220V cable should be as thick as possible(2mm^2) to reduce voltage drop.

(7) AC110V/ DC24V cables should not be installed close to main circuit cable(high voltage/high current) and I/O signal cable. They should be 100mm away from such cables

(8) To prevent surge from lightning, use the lightning surge absorber as presented below.

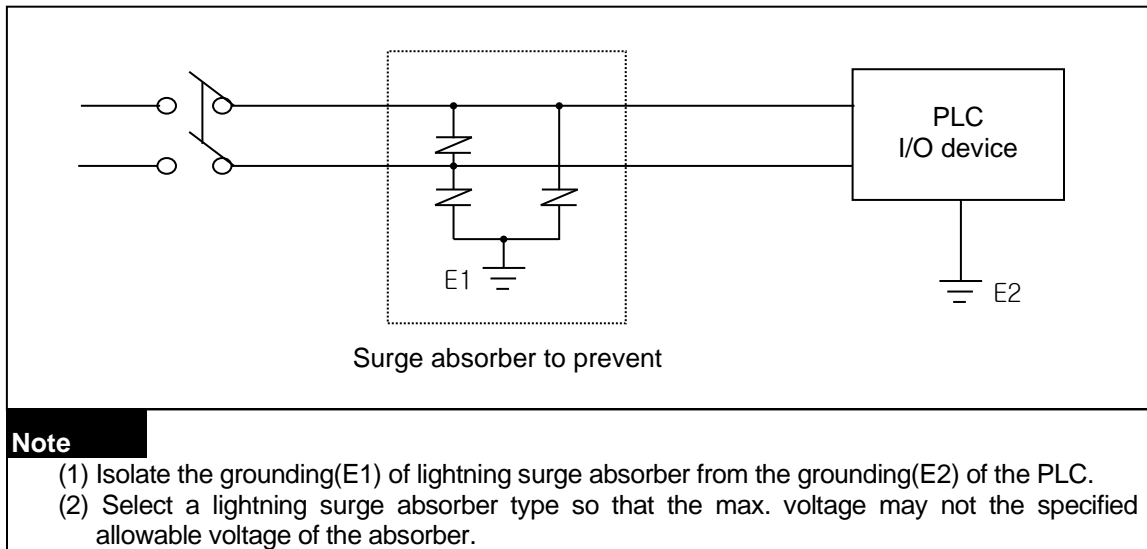

(9) When noise may be intruded inside it, use an insulated shielding transformer or noise filter.

(10) Wiring of each input power should be twisted as short as possible and the wiring of shielding transformer or noise filter should not be arranged via a duct.

(11) All field-wiring connections to this unit shall be from Limited Voltage / Limited Current, below 24Vdc isolated secondary source with an output fused with a 4A fuse max. or class 2 secondary circuits as defined in UL 508, 17th Edition.

13.3.2 I/O Device wiring

- (1) The size of I/O device cable is limited to 0.3~2 mm² but it is recommended to select a size(0.3 mm²) to use conveniently.
- (2) Please isolate input signal line from output signal line.
- (3) I/O signal lines should be wired 100mm and more away from high voltage/high current main circuit cable.
- (4) Batch shield cable should be used and the PLC side should be grounded unless the main circuit cable and power cable can not be isolated.

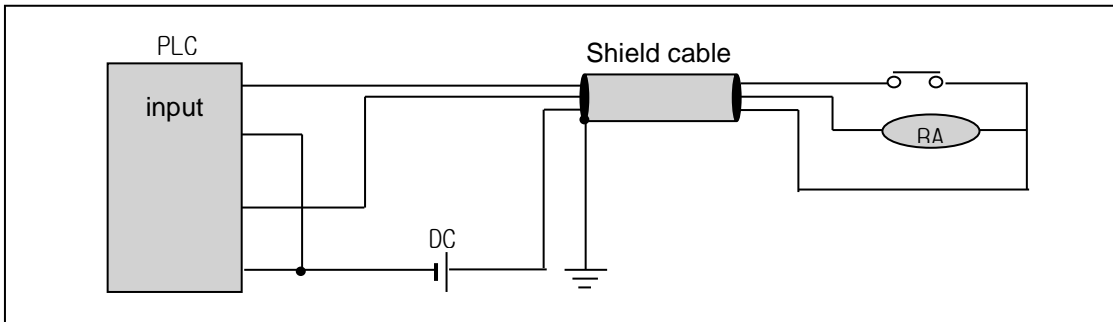

- (5) When applying pipe-wiring, make sure to firmly ground the piping.

13.3.3 Grounding wiring

- (1) The PLC contains a proper noise measure, so it can be used without any separate grounding if there is a large noise. However, if grounding is required, please refer to the followings.
- (2) For grounding, please make sure to use the exclusive grounding.
For grounding construction, apply type 3 grounding(grounding resistance lower than 100 Ω)
- (3) If the exclusive grounding is not possible, use the common grounding as presented in B) of the figure below.

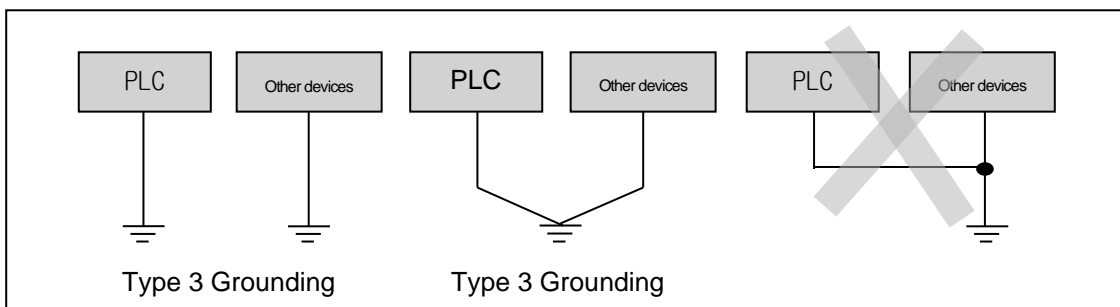

A) Exclusive grounding : best B) common grounding : good C) common grounding: defective

- (4) Use the grounding cable more than 2 mm². To shorten the length of the grounding cable, place the grounding point as close to the PLC as possible.
- (5) If any malfunction from grounding is detected, separate the FG of the base from the grounding.

13.3.4 Specifications of wiring cable

The specifications of cable used for wiring are as follows.

Types of external connection	Cable specification (mm ²)		Wire Type	Temperature rating
	Lower limit	Upper limit		
Digital input	0.18 (AWG24)	1.5 (AWG16)	Cu	60°C/75°C
Digital output	0.18 (AWG24)	2.0 (AWG14)		
Analogue I/O	0.18 (AWG24)	1.5 (AWG16)		
Communication	0.18 (AWG24)	1.5 (AWG16)		
Main power	1.5 (AWG16)	2.5 (AWG12)		
Protective grounding	1.5 (AWG16)	2.5 (AWG12)		

Chapter 14 Maintenance

Be sure to perform daily and periodic maintenance and inspection in order to maintain the PLC in the best conditions.

14.1 Maintenance and Inspection

The I/O module mainly consist of semiconductor devices and its service life is semi-permanent. However, periodic inspection is requested for ambient environment may cause damage to the devices. When inspecting one or two times per six months, check the following items.

Check Items		Judgment	Corrective Actions
Change rate of input voltage		Within change rate of input voltage (Less than -15% to +20%)	Hold it with the allowable range.
Power supply for input/output		Input/Output specification of each module	Hold it with the allowable range of each module.
Ambient environment	Temperature	0 ~ + 55°C	Adjust the operating temperature and humidity with the defined range.
	Humidity	5 ~ 95%RH	
	Vibration	No vibration	Use vibration resisting rubber or the vibration prevention method.
Play of modules		No play allowed	Securely enrage the hook.
Connecting conditions of terminal screws		No loose allowed	Retighten terminal screws.
Spare parts		Check the number of Spare parts and their Store conditions	Cover the shortage and improve the conditions.

14.2 Daily Inspection

The following table shows the inspection and items which are to be checked daily.

Check Items		Check Points	Judgment	Corrective Actions
Connection conditions of base		Check the screws.	Screws should not be loose.	Retighten Screws.
Connection conditions of Input/Output module		Check the connecting screws Check module cover.	Screws should not be loose.	Retighten Screws.
Connecting conditions of terminal block or extension cable		Check for loose mounting screws.	Screws should not be loose.	Retighten Screws.
		Check the distance between solderless terminals.	Proper clearance should be provided.	Correct.
		Connecting of expansion cable.	Connector should not be loose.	Correct.
LED indicator	PWR LED	Check that the LED is On.	On(Off indicates an error)	See chapter 4.
	Run LED	Check that the LED is On during Run.	On (flickering or On indicates an error)	See chapter 4.
	ERR LED	Check that the LED is Off during Run.	Flickering indicates an error	See chapter 4.
	Input LED	Check that the LED turns On and Off.	On when input is On, Off when input is off.	See chapter 4.
	Output LED	Check that the LED turns On and Off	On when output is On, Off when output is off	See chapter 4.

14.3 Periodic Inspection

Check the following items once or twice every six months, and perform the needed corrective actions.

Check Items		Checking Methods	Judgment	Corrective Actions
Ambient environment	Ambient temperature	- Measure with thermometer and hygrometer - measure corrosive gas	0 ~ 55 °C	Adjust to general standard (Internal environmental standard of control section)
	Ambient Humidity		5 ~ 95%RH	
	Ambient pollution level		There should be no corrosive gases	
PLC Conditions	Looseness, Ingress	The module should be move the unit	The module should be mounted securely.	Retighten screws
	dust or foreign material	Visual check	No dust or foreign material	
Connecting conditions	Loose terminal screws	Re-tighten screws	Screws should not be loose	Retighten
	Distance between terminals	Visual check	Proper clearance	Correct
	Loose connectors	Visual check	Connectors should not be loose.	Retighten connector mounting screws
Line voltage check		Measure voltage between input terminals	DC24V: DC20.4 ~ 28.8V	Change supply power

Chapter 15 Troubleshooting

The following explains contents, diagnosis and corrective actions for various errors that can occur during system operation.

15.1 Basic Procedure of Troubleshooting

System reliability not only depends on reliable equipment but also on short downtimes in the event of fault. The short discovery and corrective action is needed for speedy operation of system. The following shows the basic instructions for troubleshooting.

(1) Visual checks

Check the following points.

- Machine operating condition (in stop and operation status)
- Power On/Off
- Status of I/O devices
- Condition of wiring (I/O wires, extension and communications cables)
- Display states of various indicators (such as POWER LED, RUN LED, ERR LED and I/O LED)

After checking them, connect peripheral devices and check the operation status of the PLC and the program contents.

(2) Trouble Check

Observe any change in the error conditions during the following.

- Switch to the STOP position, and then turn the power on and off.

(3) Narrow down the possible causes of the trouble where the fault lies, i.e.:

- Inside or outside of the PLC ?
- I/O module or another module?
- PLC program?

15.2 Troubleshooting

This section explains the procedure for determining the cause of troubles as well as the errors and corrective actions.

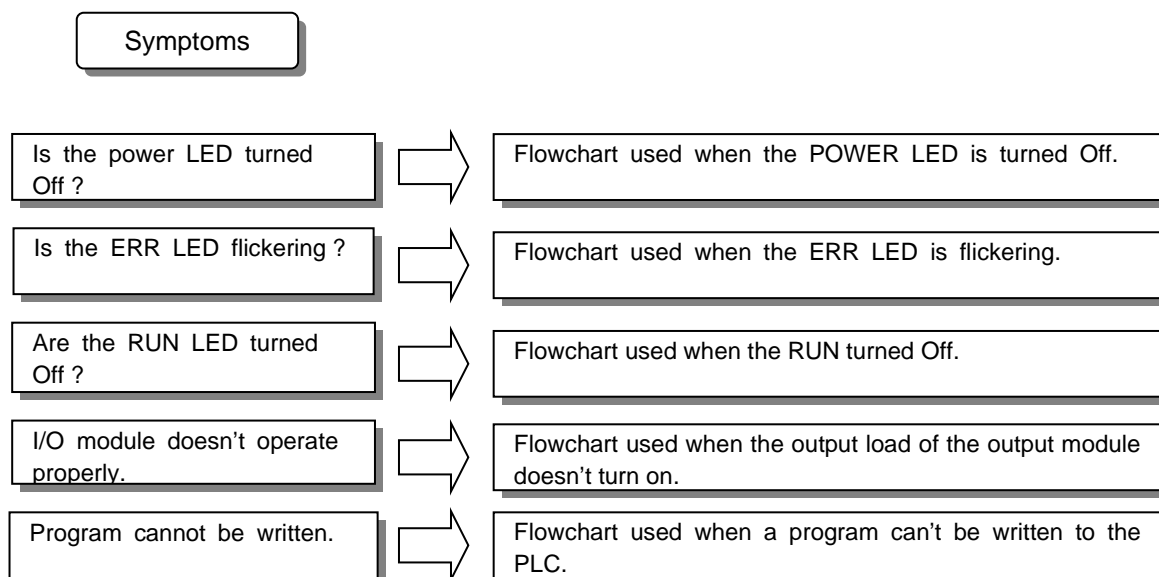

15.2.1 Troubleshooting flowchart used when the PWR (Power) LED turns Off.

The following flowchart explains corrective action procedure used when the power is supplied or the power LED turns Off during operation.

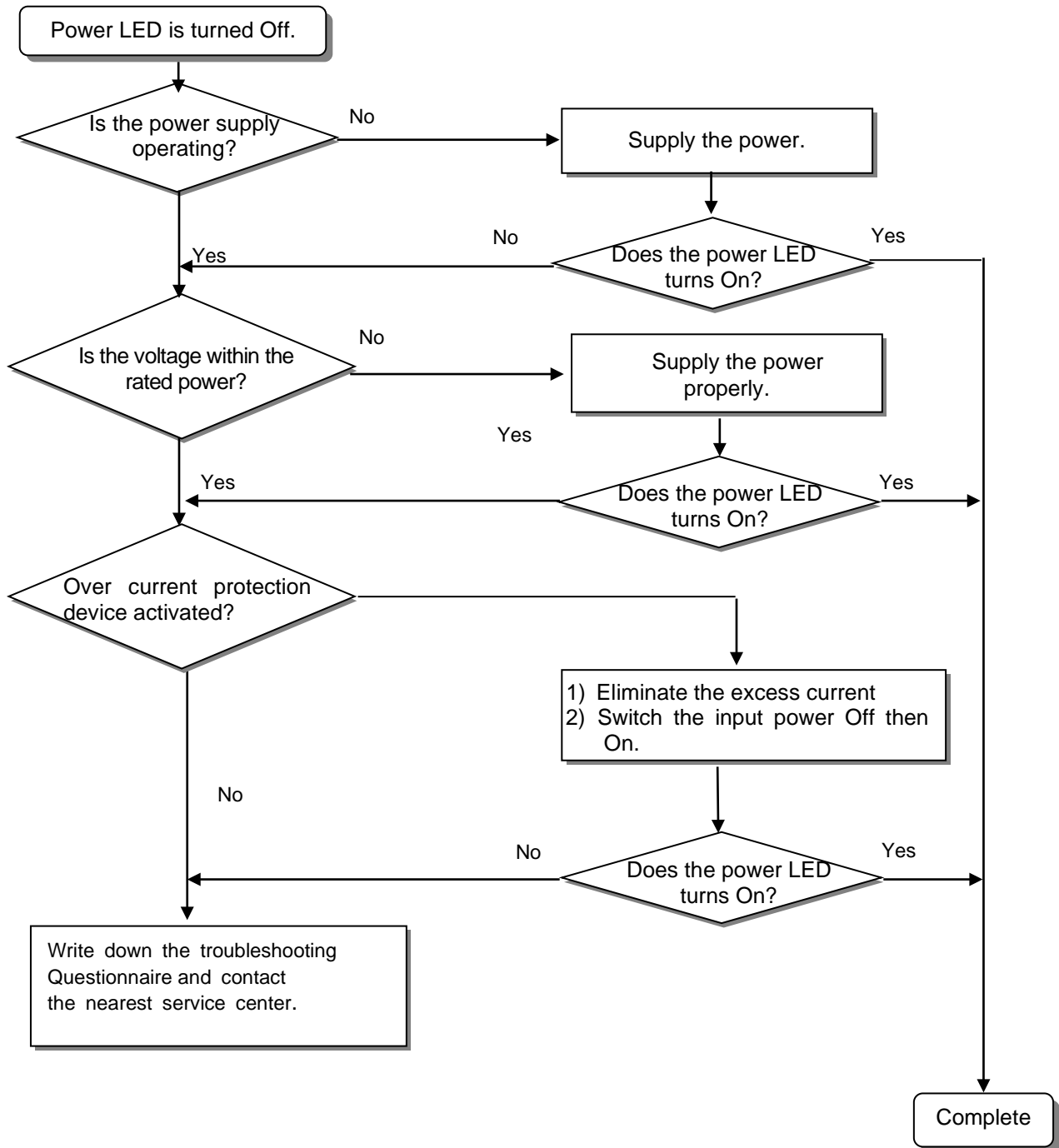

15.2.2 Troubleshooting flowchart used with when the ERR (Error) LED is flickering

The following flowchart explains corrective action procedure use when the power is supplied starts or t he ERR LED is flickering during operation.

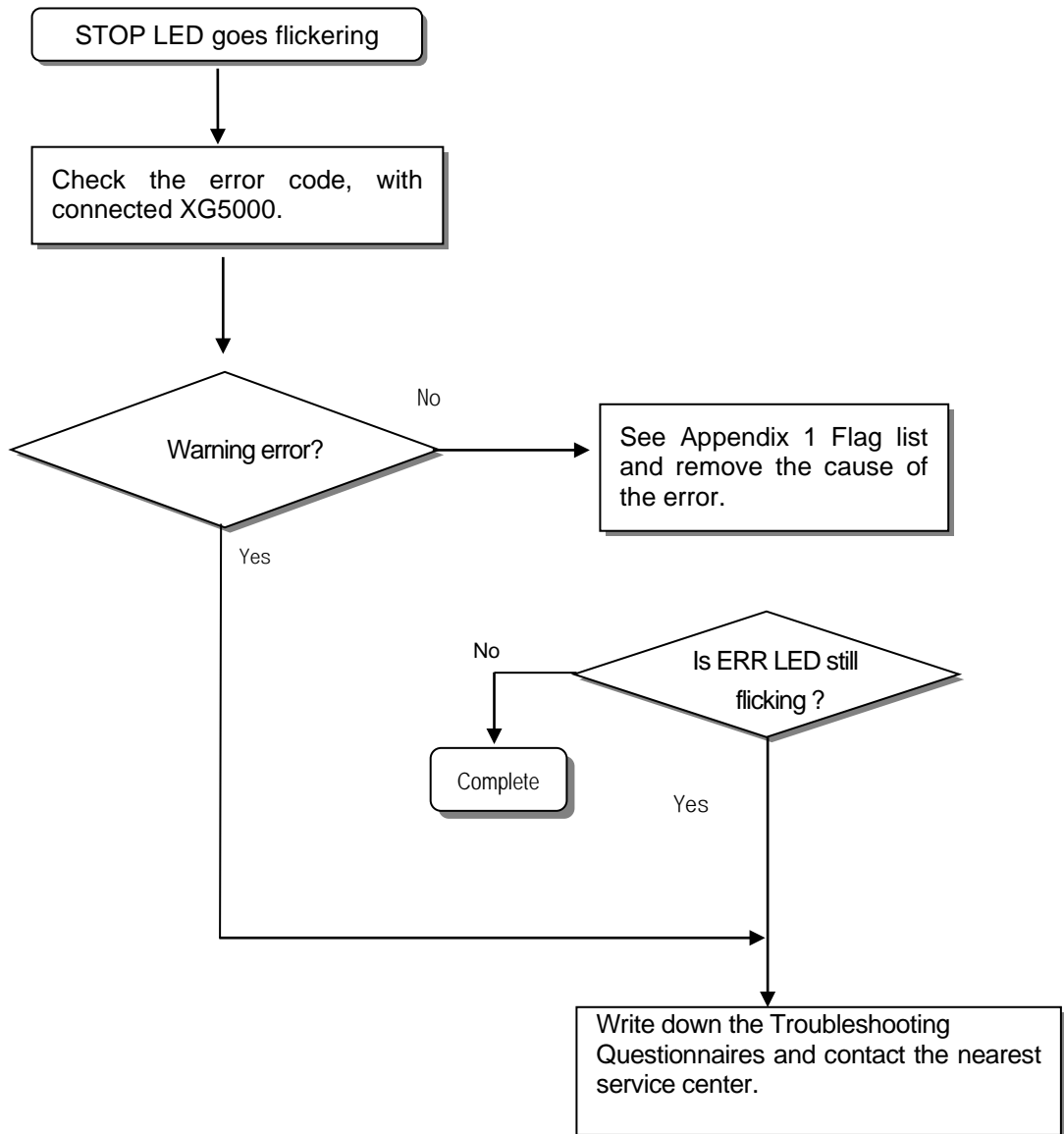

 Warning
Though warning error appears, PLC system doesn't stop but corrective action is needed promptly. If not, it may cause the system failure.

15.2.3 Troubleshooting flowchart used with when the RUN , STOP LED turns Off.

The following flowchart explains corrective action procedure to treat the lights-out of RUN LED when the power is supplied, operation starts or operation is in the process.

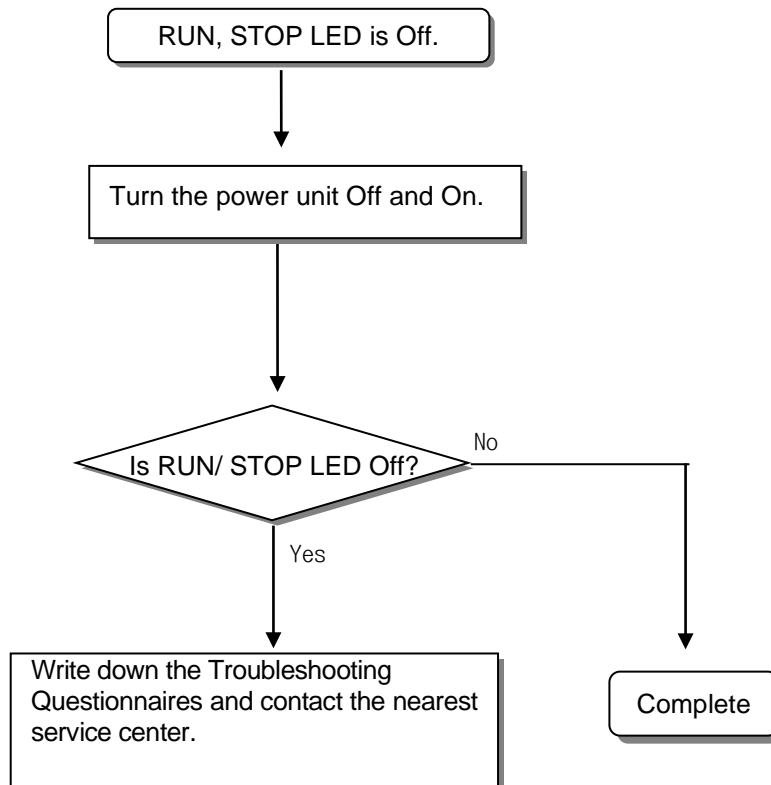

15.2.4 Troubleshooting flowchart used when the I/O part doesn't operate normally.

The following flowchart explains corrective action procedure used when the I/O module doesn't operate normally.

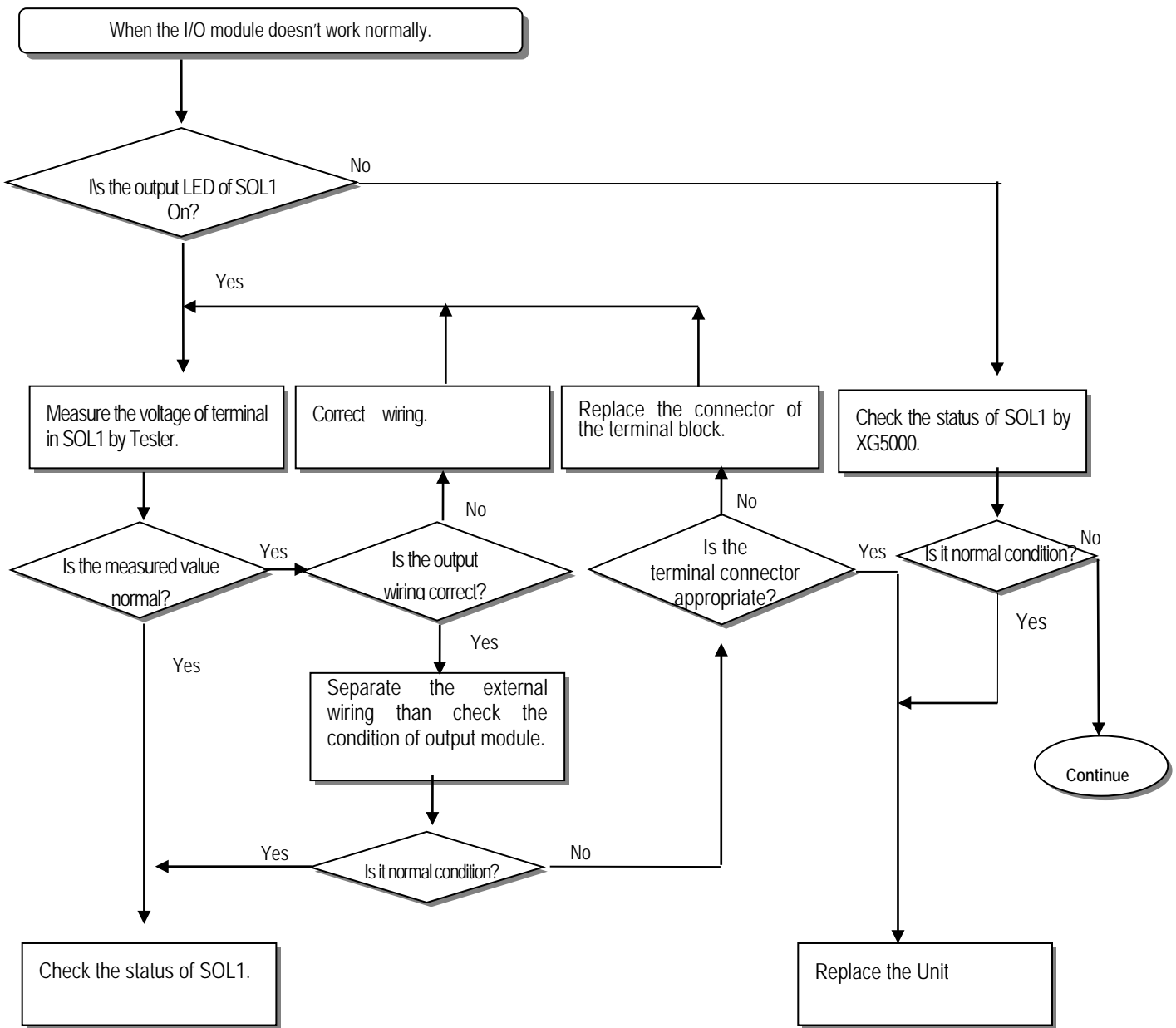

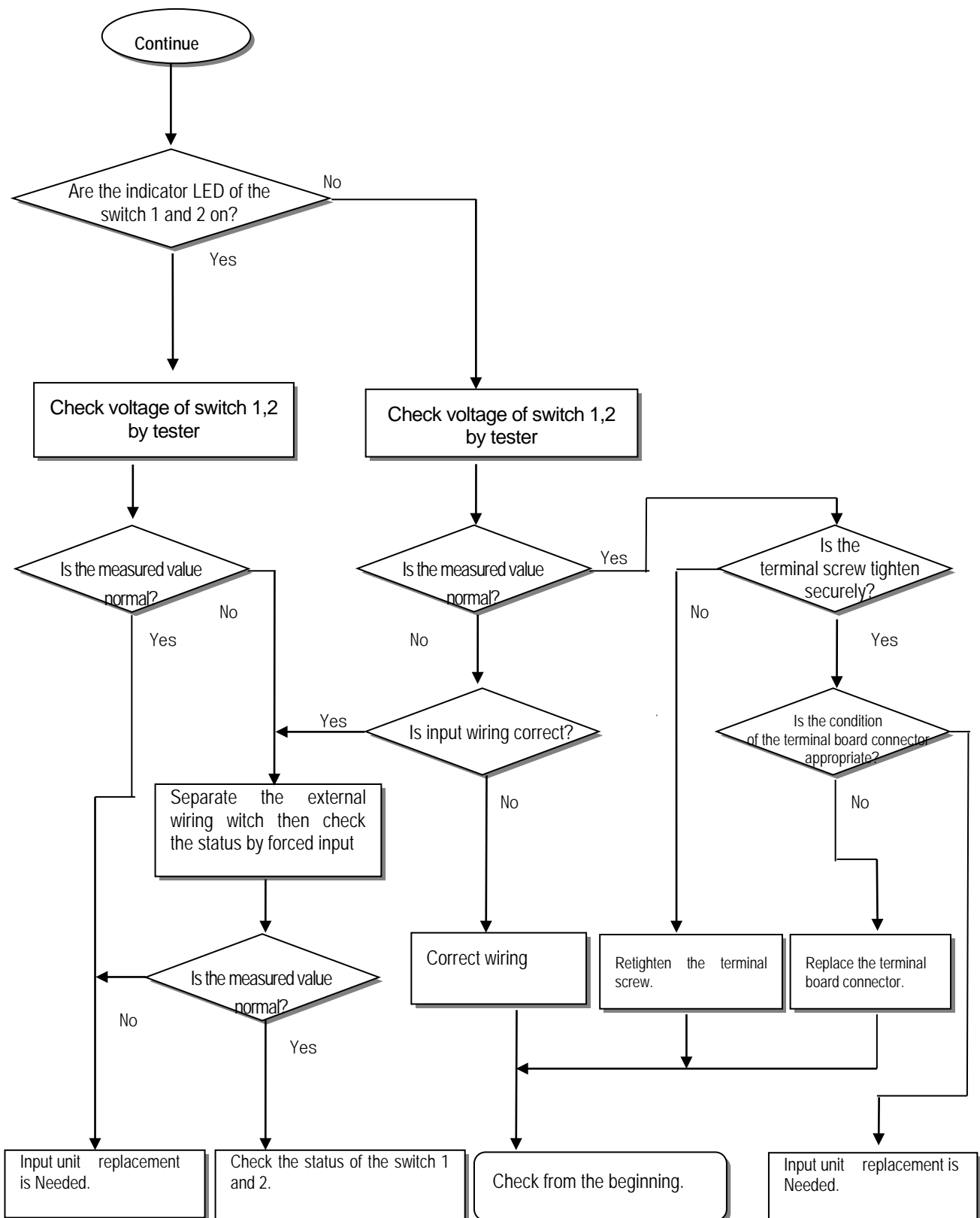

15.3 Troubleshooting Questionnaire

When problems have been met during operation of the XGC series, please write down this Questionnaires and contact the service center via telephone or facsimile.

• For errors relating to special or communication modules, use the questionnaire included in the User's manual of the unit.

1. Telephone & FAX No

Tell)

FAX)

2. Using equipment model:

3. Details of using equipment

CPU model: () OS version No.:() Serial No.()

XG5000 (for program compile) version No.: ()

4.General description of the device or system used as the control object:

5. The kind of the base unit:

- Operation by the mode setting switch (),
- Operation by the XG5000 or communications (),
- External memory module operation (),

6. Is the ERR. LED of the CPU module turned On ? Yes(), No()

7. XG5000 error message:

8. History of corrective actions for the error message in the article 7:

9. Other tried corrective actions:

10. Characteristics of the error

- Repetitive(): Periodic(), Related to a particular sequence(), Related to environment()
- Sometimes(): General error interval:

11. Detailed Description of error contents:

12. Configuration diagram for the applied system:

15.4 Troubleshooting Examples

Possible troubles with various circuits and their corrective actions are explained.

15.4.1 Input circuit troubles and corrective actions

The followings describe possible troubles with input circuits, as well as corrective actions.

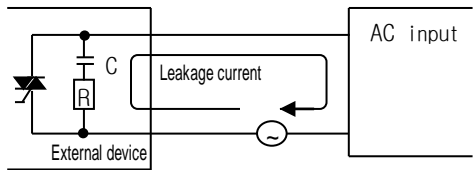
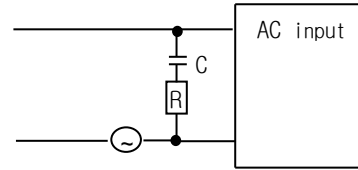
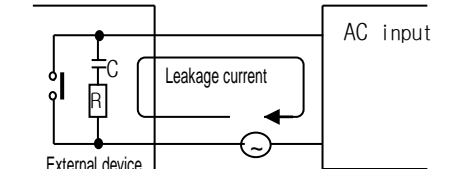
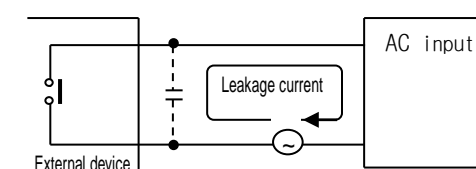
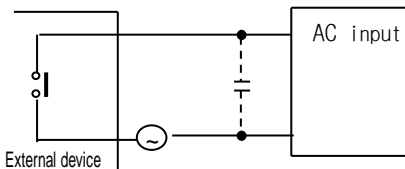
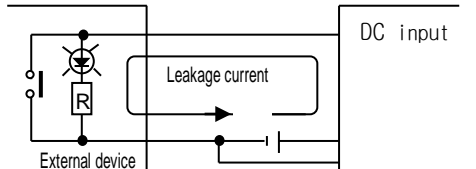
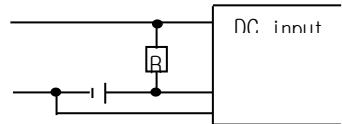
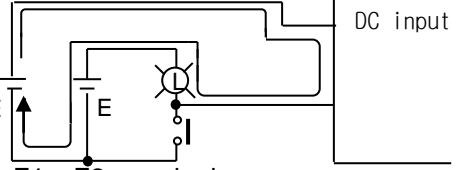
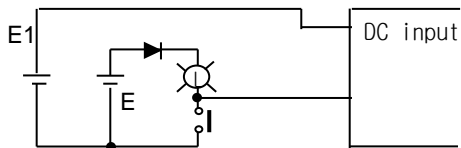
Condition	Cause	Corrective Actions
Input signal doesn't turn off.	Leakage current of external device (Such as a drive by non-contact switch) 	<ul style="list-style-type: none"> Connect an appropriate register and capacity, which will make the voltage lower across the terminals of the input module. 
Input signal doesn't turn off. (Neon lamp may be still on)	Leakage current of external device (Drive by a limit switch with neon lamp) 	<ul style="list-style-type: none"> CR values are determined by the leakage current value. – Recommended value C : 0.1 ~ 0.47 μF R: 47 ~ 120 Ω (1/2W) Or make up another independent display circuit.
Input signal doesn't turn off.	Leakage current due to line capacity of wiring cable. 	<ul style="list-style-type: none"> Locate the power supply on the external device side as shown below. 
Input signal doesn't turn off.	Leakage current of external device (Drive by switch with LED indicator) 	<ul style="list-style-type: none"> Connect an appropriate register, which will make the voltage higher than the OFF voltage across the input module terminal and common terminal. 
Input signal doesn't turn off.	<ul style="list-style-type: none"> Sneak current due to the use of two different power supplies.  <ul style="list-style-type: none"> E1 > E2, sneaked. 	<ul style="list-style-type: none"> Use only one power supply. Connect a sneak current prevention diode. 

15.4.2 Output circuit and corrective actions

The following describes possible troubles with output circuits, as well as their corrective actions.

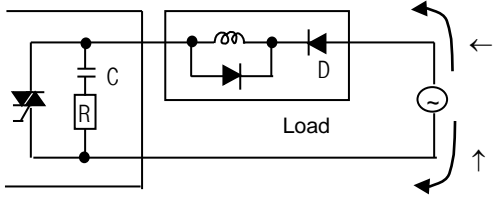
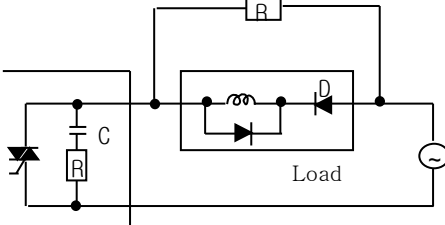
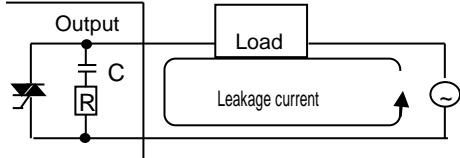
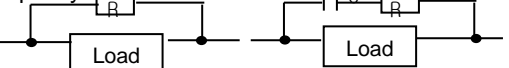
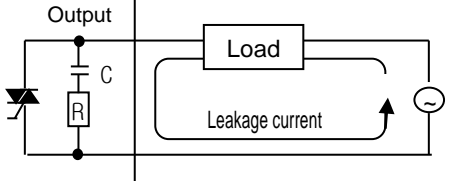
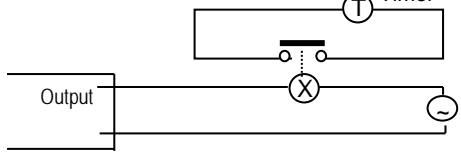
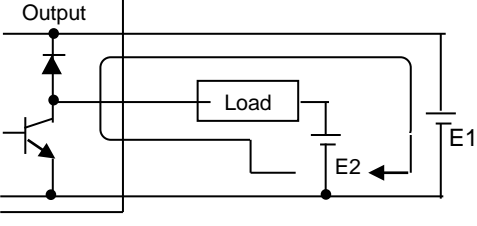
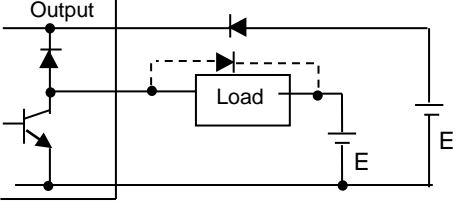
Condition	Cause	Corrective Action
<p>When the output is off, excessive voltage is applied to the load.</p>	<ul style="list-style-type: none"> • Load is half-wave rectified inside (in some cases, it is true of a solenoid) • When the polarity of the power supply is as shown in ①, C is charged. When the polarity is as shown in ②, the voltage charged in C plus the line voltage are applied across D. Max. voltage is approx. $2\sqrt{2}$.  <p>*) If a resistor is used in this way, it does not pose a problem to the output element. But it may make the performance of the diode (D), which is built in the load, drop to cause problems.</p>	<ul style="list-style-type: none"> • Connect registers of tens to hundreds KΩ across the load in parallel. 
<p>The load doesn't turn off.</p>	<ul style="list-style-type: none"> • Leakage current by surge absorbing circuit, which is connected to output element in parallel. 	<ul style="list-style-type: none"> • Connect C and R across the load, which are of registers of tens KΩ. When the wiring distance from the output module to the load is long, there may be a leakage current due to the line capacity. 
<p>When the load is C-R type timer, time constant fluctuates.</p>	<ul style="list-style-type: none"> • Leakage current by surge absorbing circuit, which is connected to output element in parallel. 	<ul style="list-style-type: none"> • Drive the relay using a contact and drive the C-R type timer using the since contact. • Use other timer than the C-R contact some timers have half-wave rectified internal circuits therefore, be cautious. 
<p>The load does not turn off.</p>	<ul style="list-style-type: none"> • Sneak current due to the use of two different power supplies.  <p>$E1 < E2$, sneaks. E1 is off (E2 is on), sneaks.</p>	<ul style="list-style-type: none"> • Use only one power supply. • Connect a sneak current prevention diode.  <p>If the load is the relay, etc, connect a counter-electromotive voltage absorbing code as shown by the dot line.</p>

Output circuit troubles and corrective actions (continued).

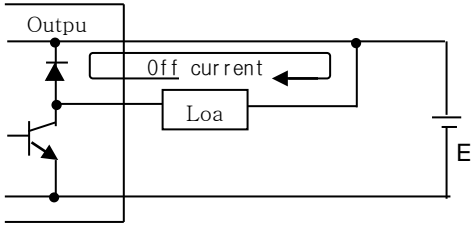
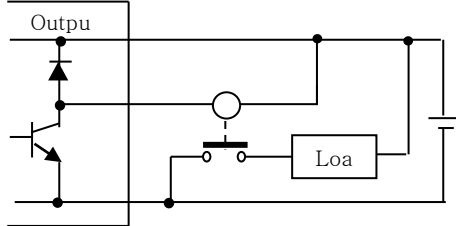
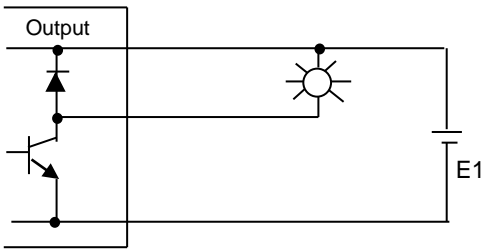
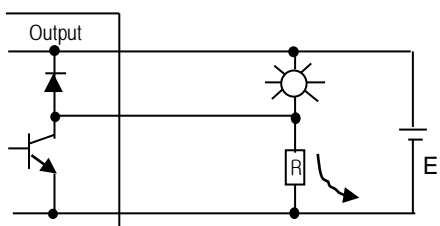
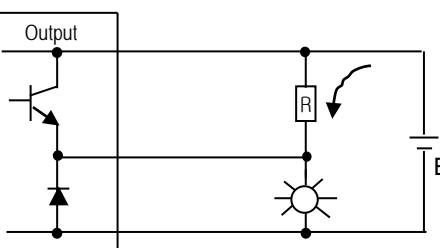
Condition	Cause	Corrective actions
<p>The load off response time is long.</p>	<ul style="list-style-type: none"> Over current at off state [The large solenoid current fluidic load (L/R is large) such as is directly driven with the transistor output.  <ul style="list-style-type: none"> The off response time can be delayed by one or more second as some loads make the current flow across the diode at the off time of the transistor output. 	<ul style="list-style-type: none"> Insert a small L/R magnetic contact and drive the load using the same contact. 
<p>Output transistor is destroyed.</p>	<p>Surge current of the white lamp</p>  <p>A surge current of 10 times or more when turned on.</p>	<ul style="list-style-type: none"> To suppress the surge current make the dark current of 1/3 to 1/5 rated current flow.  <p>Sink type transistor output</p>  <p>Source type transistor output</p>

15.5 Error Code List

Error code	Error cause	Action (restart mode after taking an action)	Operation status	LED status	Diagnosis point
23	Program to execute is abnormal	Start after reloading the program	Warning	0.5 second Flicker	RUN mode
24	I/O parameter error	Start after reloading I/O parameter, Battery change if battery has a problem. Check the preservation status after I/O parameter reloading and if error occurs, change the unit.	Warning	0.5 second Flicker	Reset RUN mode switching
25	Basic parameter error	Start after reloading Basic parameter, Change battery if it has a problem. Check the preservation status after Basic parameter reloading and if error occurs, change the unit.	Warning	0.5 second Flicker	Reset RUN mode switching
30	Module set in parameter and the installed module does not match	modify the module or parameter and then restart.	Warning	0.5 second Flicker	RUN mode switching
31	Module falling during operation or additional setup	After checking the position of attachment/detachment of expansion module during Run mode	Warning	0.1 second Flicker	Every scan
33	Data of I/O module does not access normally during operation.	After checking the position of slot where the access error occurs by XG5000, change the module and restart (acc.to parameter.)	Heavy error	0.1 second Flicker	Scan end
34	Normal access of special/link module data during operation not available	After checking the position of slot that access error occurred by XG5000, change the module and restart (acc.to parameter).	Heavy error	0.1 second Flicker	Scan end
39	Abnormal stop of CPU or malfunction	Abnormal system end by noise or hard ware error. 1) If it occurs repeatedly when power reinput, request service center 2) Noise measures	Heavy error	0.1 second Flicker	Ordinary time
40	Scan time of program during operation exceeds the scan watchdog time designated by parameter.	After checking the scan watchdog time designated by parameter, modify the parameter or the program and then restart.	Warning	0.5 second Flicker	While running the program
41	Operation error occurs while running the user program.	Remove operation error → reload the program and restart.	Warning	0.5 second Flicker	While running the program
44	Timer index user error	After reloading a timer index program modification, start	Warning	0.5 second Flicker	Scan end
50	Heavy error of external device	Refer to Heavy error detection flag and modifies the device and restart. (Acc. Parameter)	Heavy error	1 second Flicker	Scan end
60	E_STOP function executed	After removing error causes which starts E_STOP function in program, power reinput	Heavy error	1 second Flicker	While running the program

Error code	Error cause	Action (restart mode after taking an action)	Operation status	LED status	Diagnosis point
500	Data memory backup not possible	If not error in battery, power reinput Remote mode is switched to STOP mode.	Warning	1 second Flicker	Reset
501	Abnormal clock data	Setting the time by XG5000 if there is no error	Warning	0.1 second Flicker	Ordinary time
502	Battery voltage falling	Battery change at power On status	Warning	0.1 second Flicker	Ordinary time

Appendix 1 Flag List

Appendix 1.1 Special Relay (F) List

(1) “S(U)” type

Word	Bit	Variables	Function	Description
F000~1	-	_SYS_STATE	Mode and state	Indicates PLC mode and operation State.
	F0000	_RUN	Run	Run state.
	F0001	_STOP	Stop	Stop state.
	F0002	_ERROR	Error	Error state.
	F0003	_DEBUG	Debug	Debug state.
	F0004	_LOCAL_CON	Local control	Local control mode.
	F0006	_REMOTE_CON	Remote mode	Remote control mode.
	F0008	_RUN_EDIT_ST	Editing during RUN	Editing program download during RUN.
	F0009	_RUN_EDIT_CHK	Editing during RUN	Internal edit processing during RUN.
	F000A	_RUN_EDIT_DONE	Edit done during RUN	Edit is done during RUN.
	F000B	_RUN_EDIT_END	Edit end during RUN	Edit is ended during RUN.
	F000C	_CMOD_KEY	Operation mode	Operation mode changed by key.
	F000D	_CMOD_LPADT	Operation mode	Operation mode changed by local PADT.
	F000E	_CMOD_RPADT	Operation mode	Operation mode changed by Remote PADT.
	F000F	_CMOD_RLINK	Operation mode	Operation mode changed by Remote communication module.
	F0010	_FORCE_IN	Forced input	Forced input state.
	F0011	_FORCE_OUT	Forced output	Forced output state.
	F0014	_MON_On	Monitor	Monitor on execution.
	F0015	_USTOP_On	Stop	Stop by Stop function.
	F0016	_ESTOP_On	EStop	Stop by EStop function.
	F0017	_CONPILE_MODE	Compile	Compile on execution.
	F0018	_INIT_RUN	Initialize	Initialization task on execution.
	F001C	_PB1	Program Code 1	Program Code 1 selected.
	F001D	_PB2	Program Code 2	Program Code 2 selected.
F001E	_CB1	Compile Code 1	Compile Code 1 selected.	
F001F	_CB2	Compile Code2	Compile Code 2 selected.	
F002~3	-	_CNF_ER	System error	Reports heavy error state of system.
	F0021	_IO_TYER	Module Type error	Module Type does not match.
	F0022	_IO_DEER	Module detachment error	Module is detached.
	F0024	_IO_RWER	Module I/O error	Module I/O error.
	F0025	_IP_IFER	Module interface error	Special/communication module interface error.
	F0026	_ANNUM_ER	External device error	Detected heavy error in external Device.

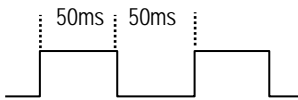
Word	Bit	Variable	Function	Description
F002~3	F0028	_BPRM_ER	Basic parameter	Basic parameter error.
	F0029	_IOPRM_ER	IO parameter	I/O configuration parameter error.
	F002A	_SPPRM_ER	Special module parameter	Special module parameter is Abnormal.
	F002B	_CPPRM_ER	Communication module parameter	Communication module parameter is abnormal.
	F002C	_PGM_ER	Program error	Program error.
	F002D	_CODE_ER	Code error	Program Code error.
	F002E	_SWDT_ER	System watchdog	System watchdog operated.
	F0030	_WDT_ER	Scan watchdog	Scan watchdog operated.
F004	-	_CNF_WAR	System warning	Reports light error state of system.
	F0041	_DBCK_ER	Backup error	Data backup error.
	F0043	_ABSD_ER	Operation shutdown error	Stop by abnormal operation.
	F0046	_ANNUM_WAR	External device error	Detected light error of external device.
	F0048	_HS_WAR1	High speed link 1	High speed link – parameter 1 error.
	F0049	_HS_WAR2	High speed link 2	High speed link – parameter 2 error.
	F0054	_P2P_WAR1	P2P parameter 1	P2P – parameter 1 error.
	F0055	_P2P_WAR2	P2P parameter 2	P2P – parameter 2 error.
	F0056	_P2P_WAR3	P2P parameter 3	P2P – parameter 3 error.
	F005C	_CONSTANT_ER	Constant error	Constant error.
F009	-	_USER_F	User contact	Timer used by user.
	F0090	_T20MS	20ms	<p>As a clock signal available at user program, it reverses On/Off every half period. Since clock signal is dealt with at the end of scan, there may be delay or distortion according to scan time. So use clock that's longer than scan time. Clock signal is Off status at the start of scan program and task program.</p>  <p style="text-align: center;">_T100ms clock</p>
	F0091	_T100MS	100ms	
	F0092	_T200MS	200ms	
	F0093	_T1S	1s Clock	
	F0094	_T2S	2 s Clock	
	F0095	_T10S	10 s Clock	
	F0096	_T20S	20 s Clock	
	F0097	_T60S	60 s Clock	
	F0099	_On	Ordinary time On	
	F009A	_Off	Ordinary time Off	Always Off state Bit.
	F009B	_1On	1scan On	First scan On Bit.
	F009C	_1Off	1scan Off	First scan OFF bit.
	F009D	_STOG	Reversal	Reversal every scan.

Appendix 1. Flag List

Word	Bit	Variable	Function	Description
F010	-	_USER_CLK	User Clock	Clock available for user setting.
	F0100	_USR_CLK0	Setting scan repeat	On/Off as much as set scan Clock 0.
	F0101	_USR_CLK1	Setting scan repeat	On/Off as much as set scan Clock 1.
	F0102	_USR_CLK2	Setting scan repeat	On/Off as much as set scan Clock 2.
	F0103	_USR_CLK3	Setting scan repeat	On/Off as much as set scan Clock 3.
	F0104	_USR_CLK4	Setting scan repeat	On/Off as much as set scan Clock 4.
	F0105	_USR_CLK5	Setting scan repeat	On/Off as much as set scan Clock 5.
	F0106	_USR_CLK6	Setting scan repeat	On/Off as much as set scan Clock 6.
	F0107	_USR_CLK7	Setting scan repeat	On/Off as much as set scan Clock 7.
F011	-	_LOGIC_RESULT	Logic result	Indicates logic results.
	F0110	_LER	operation error	On during 1 scan in case of operation error.
	F0111	_ZERO	Zero flag	On when operation result is 0.
	F0112	_CARRY	Carry flag	On when carry occurs during operation.
	F0113	_ALL_Off	All output OFF	On in case that all output is Off.
	F0115	_LER_LATCH	Operation error Latch	Keeps On during operation error.
F012	-	_CMP_RESULT	Comparison result	Indicates the comparison result.
	F0120	_LT	LT flag	On in case of "less than".
	F0121	_LTE	LTE flag	On in case of "equal or less than".
	F0122	_EQU	EQU flag	On in case of "equal".
	F0123	_GT	GT flag	On in case of "greater than".
	F0124	_GTE	GTE flag	On in case of "equal or greater than".
	F0125	_NEQ	NEQ flag	On in case of "not equal".
F014	-	_FALS_NUM	FALS no.	Indicates FALS no.
F015	-	_PUTGET_ERR0	PUT/GET error 0	Main base Put / Get error.
F023	-	_PUTGET_NDR0	PUT/GET end 0	Main base Put/Get end.
F044	-	_CPU_TYPE	CPU Type	Indicates information for CPU Type.
F045	-	_CPU_VER	CPU version	Indicates CPU version.
F046	-	_OS_VER	OS version	Indicates OS version.
F048	-	_OS_DATE	OS date	Indicates OS distribution date.
F050	-	_SCAN_MAX	Max. scan time	Indicates max. scan time.
F051	-	_SCAN_MIN	Min. scan time	Indicates min. scan time.
F052	-	_SCAN_CUR	Current scan time	Current scan time.
F0053	-	_MON_YEAR	Month/year	Clock data (month/year) Supported when using RTC option module
F0054	-	_TIME_DAY	Hour/date	Clock data (hour/date) Supported when using RTC option module
F0055	-	_SEC_MIN	Second/minute	Clock data (Second/minute) Supported when using RTC option module

Word	Bit	Variable	Function	Description
F0056	-	_HUND_WK	Hundred year/week	Clock data (Hundred year/week) Supported when using RTC option module
F057	-	_FPU_INFO	N/A	-
	F0570	_FPU_LFLAG_I	N/A	-
	F0571	_FPU_LFLAG_U	N/A	-
	F0572	_FPU_LFLAG_O	N/A	-
	F0573	_FPU_LFLAG_Z	N/A	-
	F0574	_FPU_LFLAG_V	N/A	-
	F057A	_FPU_FLAG_I	N/A	-
	F057B	_FPU_FLAG_U	N/A	-
	F057C	_FPU_FLAG_O	N/A	-
	F057D	_FPU_FLAG_Z	N/A	-
	F057E	_FPU_FLAG_V	N/A	-
F057F	_FPU_FLAG_E	Irregular input	Reports in case of irregular input.	
F058	-	_ERR_STEP	Error step	Saves error step.
F060	-	_REF_COUNT	Refresh	Increase when module Refresh.
F062	-	_REF_OK_CNT	Refresh OK	Increase when module Refresh is normal.
F064	-	_REF_NG_CNT	Refresh NG	Increase when module Refresh is Abnormal.
F066	-	_REF_LIM_CNT	Refresh Limit	Increase when module Refresh is abnormal (Time Out).
F068	-	_REF_ERR_CNT	Refresh Error	Increase when module Refresh is Abnormal.
F070	-	_MOD_RD_ERR_CNT	-	-
F072	-	_MOD_WR_ERR_CNT	-	-
F074	-	_CA_CNT	-	-
F076	-	_CA_LIM_CNT	-	-
F078	-	_CA_ERR_CNT	-	-
F080	-	_BUF_FULL_CNT	Buffer Full	Increase when CPU internal buffer is full.
F082	-	_PUT_CNT	Put count	Increase when Put count.
F084	-	_GET_CNT	Get count	Increase when Get count.
F086	-	_KEY	Current key	indicates the current state of local key.
F088	-	_KEY_PREV	Previous key	indicates the previous state of local key
F090	-	_IO_TYER_N	Mismatch slot	Module Type mismatched slot no.
F091	-	_IO_DEER_N	Detach slot	Module detached slot no.
F093	-	_IO_RWER_N	RW error slot	Module read/write error slot no.
F094	-	_IP_IFER_N	IF error slot	Module interface error slot no.
F096	-	_IO_TYER0	Module Type 0 error	Main base module Type error.

Appendix 1. Flag List

Word	Bit	Variable	Function	Description
F104	-	_IO_DEER0	Module Detach 0 error	Main base module Detach error.
F120	-	_IO_RWER0	Module RW 0 error	Main base module read/write error.
F128	-	_IO_IFER_0	Module IF 0 error	Main base module interface error.
F140	-	_AC_FAIL_CNT	Power shutdown times	Saves the times of power shutdown.
F142	-	_ERR_HIS_CNT	Error occur times	Saves the times of error occur.
F144	-	_MOD_HIS_CNT	Mode conversion times	Saves the times of mode conversion.
F146	-	_SYS_HIS_CNT	History occur times	Saves the times of system history.
F148	-	_LOG_ROTATE	N/A	
F150	-	_BASE_INFO0	Slot information 0	Main base slot information.
F200	-	_USER_WRITE_F	Available contact point	Contact point available in program.
	F2000	_RTC_WR	RTC RW	Data write and read in RTC.
	F2001	_SCAN_WR	Scan WR	Initializing the value of scan.
	F2002	_CHK_ANC_ERR	Request detection of external serious error	Request detection of external error.
	F2003	_CHK_ANC_WAR	Request detection of external slight error (warning)	Request detection of external slight error (warning).
F201	-	_USER_STAUS_F	User contact point	User contact point.
	F2010	_INIT_DONE	Initialization completed	Initialization complete displayed.
F202	-	_ANC_ERR	Display information of external serious error	Display information of external serious error
F203	-	_ANC_WAR	Display information of external slight error (warning)	Display information of external slight error (warning)
F210	-	_MON_YEAR_DT	Month/year	Clock data (month/year) Supported when using RTC option module
F211	-	_TIME_DAY_DT	Hour/date	Clock data (hour/date) Supported when using RTC option module
F212	-	_SEC_MIN_DT	Second/minute	Clock data (Second/minute) Supported when using RTC option module
F213	-	_HUND_WK_DT	Hundred year/week	Clock data (Hundred year/week) Supported when using RTC option module

(2) "E" type

Word	Bit	Variables	Function	Description
F000~1	-	_SYS_STATE	Mode and state	Indicates PLC mode and operation State.
	F0000	_RUN	Run	Run state.
	F0001	_STOP	Stop	Stop state.
	F0002	_ERROR	Error	Error state.
	F0003	_DEBUG	N/A	
	F0004	_LOCAL_CON	Local control	Local control mode.
	F0006	_REMOTE_CON	Remote mode	Remote control mode.
	F0008	_RUN_EDIT_ST	Editing during RUN	Editing program download during RUN.
	F0009	_RUN_EDIT_CHK	Editing during RUN	Internal edit processing during RUN.
	F000A	_RUN_EDIT_DONE	Edit done during RUN	Edit is done during RUN.
	F000B	_RUN_EDIT_END	Edit end during RUN	Edit is ended during RUN.
	F000C	_CMOD_KEY	Operation mode	Operation mode changed by key.
	F000D	_CMOD_LPADT	Operation mode	Operation mode changed by local PADT.
	F000E	_CMOD_RPADT	Operation mode	Operation mode changed by Remote PADT.
	F000F	_CMOD_RLINK	Operation mode	Operation mode changed by Remote communication module.
	F0010	_FORCE_IN	Forced input	Forced input state.
	F0011	_FORCE_OUT	Forced output	Forced output state.
	F0014	_MON_On	Monitor	Monitor on execution.
	F0015	_USTOP_On	Stop	Stop by Stop function.
	F0016	_ESTOP_On	EStop	Stop by EStop function.
	F0017	_CONPILE_MODE	Compile	Compile on execution.
	F0018	_INIT_RUN	Initialize	Initialization task on execution.
	F001C	_PB1	Program Code 1	Program Code 1 selected.
	F001D	_PB2	Program Code 2	Program Code 2 selected.
F001E	_CB1	Compile Code 1	Compile Code 1 selected.	
F001F	_CB2	Compile Code2	Compile Code 2 selected.	
F002~3	-	_CNF_ER	System error	Reports heavy error state of system.
	F0021	_IO_TYER	Module Type error	Module Type does not match.
	F0022	_IO_DEER	Module detachment error	Module is detached.
	F0024	_IO_RWER	Module I/O error	Module I/O error.
	F0025	_IP_IFER	Module interface error	Special/communication module interface error.
	F0026	_ANNUM_ER	External device error	Detected heavy error in external Device.

Appendix 1. Flag List

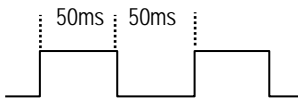
Word	Bit	Variable	Function	Description
F002~3	F0028	_BPRM_ER	Basic parameter	Basic parameter error.
	F0029	_IOPRM_ER	IO parameter	I/O configuration parameter error.
	F002A	_SPPRM_ER	Special module parameter	Special module parameter is Abnormal.
	F002B	_CPPRM_ER	Communication module parameter	Communication module parameter is abnormal.
	F002C	_PGM_ER	Program error	Program error.
	F002D	_CODE_ER	Code error	Program Code error.
	F002E	_SWDT_ER	System watchdog	System watchdog operated.
	F0030	_WDT_ER	Scan watchdog	Scan watchdog operated.
F004	-	_CNF_WAR	System warning	Reports light error state of system.
	F0041	_DBCK_ER	Backup error	Data backup error.
	F0043	_ABSD_ER	Operation shutdown error	Stop by abnormal operation.
	F0046	_ANNUM_WAR	External device error	Detected light error of external device.
	F0048	_HS_WAR1	N/A	
	F0049	_HS_WAR2	N/A	
	F0054	_P2P_WAR1	P2P parameter 1	P2P – parameter 1 error.
	F0055	_P2P_WAR2	N/A	
	F0056	_P2P_WAR3	N/A	
	F005C	_CONSTANT_ER	Constant error	Constant error.
F009	-	_USER_F	User contact	Timer used by user.
	F0090	_T20MS	20ms	As a clock signal available at user program, it reverses On/Off every half period. Since clock signal is dealt with at the end of scan, there may be delay or distortion according to scan time. So use clock that's longer than scan time. Clock signal is Off status at the start of scan program and task program. _T100ms clock 
	F0091	_T100MS	100ms	
	F0092	_T200MS	200ms	
	F0093	_T1S	1s Clock	
	F0094	_T2S	2 s Clock	
	F0095	_T10S	10 s Clock	
	F0096	_T20S	20 s Clock	
	F0097	_T60S	60 s Clock	
	F0099	_On	Ordinary time On	
	F009A	_Off	Ordinary time Off	Always Off state Bit.
	F009B	_1On	1scan On	First scan On Bit.
	F009C	_1Off	1scan Off	First scan OFF bit.
	F009D	_STOG	Reversal	Reversal every scan.

Word	Bit	Variable	Function	Description
F010	-	_USER_CLK	User Clock	Clock available for user setting.
	F0100	_USR_CLK0	Setting scan repeat	On/Off as much as set scan Clock 0.
	F0101	_USR_CLK1	Setting scan repeat	On/Off as much as set scan Clock 1.
	F0102	_USR_CLK2	Setting scan repeat	On/Off as much as set scan Clock 2.
	F0103	_USR_CLK3	Setting scan repeat	On/Off as much as set scan Clock 3.
	F0104	_USR_CLK4	Setting scan repeat	On/Off as much as set scan Clock 4.
	F0105	_USR_CLK5	Setting scan repeat	On/Off as much as set scan Clock 5.
	F0106	_USR_CLK6	Setting scan repeat	On/Off as much as set scan Clock 6.
	F0107	_USR_CLK7	Setting scan repeat	On/Off as much as set scan Clock 7.
F011	-	_LOGIC_RESULT	Logic result	Indicates logic results.
	F0110	_LER	operation error	On during 1 scan in case of operation error.
	F0111	_ZERO	Zero flag	On when operation result is 0.
	F0112	_CARRY	Carry flag	On when carry occurs during operation.
	F0113	_ALL_Off	All output OFF	On in case that all output is Off.
	F0115	_LER_LATCH	Operation error Latch	Keeps On during operation error.
F012	-	_CMP_RESULT	Comparison result	Indicates the comparison result.
	F0120	_LT	LT flag	On in case of "less than".
	F0121	_LTE	LTE flag	On in case of "equal or less than".
	F0122	_EQU	EQU flag	On in case of "equal".
	F0123	_GT	GT flag	On in case of "greater than".
	F0124	_GTE	GTE flag	On in case of "equal or greater than".
	F0125	_NEQ	NEQ flag	On in case of "not equal".
F014	-	_FALS_NUM	FALS no.	Indicates FALS no.
F015	-	_PUTGET_ERR0	PUT/GET error 0	Main base Put / Get error.
F023	-	_PUTGET_NDR0	PUT/GET end 0	Main base Put/Get end.
F044	-	_CPU_TYPE	CPU Type	Indicates information for CPU Type.
F045	-	_CPU_VER	CPU version	Indicates CPU version.
F046	-	_OS_VER	OS version	Indicates OS version.
F048	-	_OS_DATE	OS date	Indicates OS distribution date.
F050	-	_SCAN_MAX	Max. scan time	Indicates max. scan time.
F051	-	_SCAN_MIN	Min. scan time	Indicates min. scan time.
F052	-	_SCAN_CUR	Current scan time	Current scan time.
F0053	-	_MON_YEAR	Month/year	Clock data (month/year) Supported when using RTC option module
F0054	-	_TIME_DAY	Hour/date	Clock data (hour/date) Supported when using RTC option module
F0055	-	_SEC_MIN	Second/minute	Clock data (Second/minute) Supported when using RTC option

Appendix 1. Flag List

Word	Bit	Variable	Function	Description
				module
F0056	-	_HUND_WK	Hundred year/week	Clock data (Hundred year/week) Supported when using RTC option module
F057	-	_FPU_INFO	N/A	-
	F0570	_FPU_LFLAG_I	N/A	-
	F0571	_FPU_LFLAG_U	N/A	-
	F0572	_FPU_LFLAG_O	N/A	-
	F0573	_FPU_LFLAG_Z	N/A	-
	F0574	_FPU_LFLAG_V	N/A	-
	F057A	_FPU_FLAG_I	N/A	-
	F057B	_FPU_FLAG_U	N/A	-
	F057C	_FPU_FLAG_O	N/A	-
	F057D	_FPU_FLAG_Z	N/A	-
	F057E	_FPU_FLAG_V	N/A	-
F057F	_FPU_FLAG_E	Irregular input	Reports in case of irregular input.	
F058	-	_ERR_STEP	Error step	Saves error step.
F060	-	_REF_COUNT	Refresh	Increase when module Refresh.
F062	-	_REF_OK_CNT	Refresh OK	Increase when module Refresh is normal.
F064	-	_REF_NG_CNT	Refresh NG	Increase when module Refresh is Abnormal.
F066	-	_REF_LIM_CNT	Refresh Limit	Increase when module Refresh is abnormal (Time Out).
F068	-	_REF_ERR_CNT	Refresh Error	Increase when module Refresh is Abnormal.
F070	-	_MOD_RD_ERR_CNT	-	-
F072	-	_MOD_WR_ERR_CNT	-	-
F074	-	_CA_CNT	-	-
F076	-	_CA_LIM_CNT	-	-
F078	-	_CA_ERR_CNT	-	-
F080	-	_BUF_FULL_CNT	Buffer Full	Increase when CPU internal buffer is full.
F082	-	_PUT_CNT	Put count	Increase when Put count.
F084	-	_GET_CNT	Get count	Increase when Get count.
F086	-	_KEY	Current key	indicates the current state of local key.
F088	-	_KEY_PREV	Previous key	indicates the previous state of local key
F090	-	_IO_TYER_N	Mismatch slot	Module Type mismatched slot no.
F091	-	_IO_DEER_N	Detach slot	Module detached slot no.
F093	-	_IO_RWER_N	RW error slot	Module read/write error slot no.
F094	-	_IP_IFER_N	IF error slot	Module interface error slot no.
F096	-	_IO_TYER0	Module Type 0 error	Main base module Type error.

Word	Bit	Variable	Function	Description
F104	-	_IO_DEER0	Module Detach 0 error	Main base module Detach error.
F120	-	_IO_RWER0	Module RW 0 error	Main base module read/write error.
F128	-	_IO_IFER_0	Module IF 0 error	Main base module interface error.
F140	-	_AC_FAIL_CNT	N/A	
F142	-	_ERR_HIS_CNT	N/A	
F144	-	_MOD_HIS_CNT	N/A	
F146	-	_SYS_HIS_CNT	History occur times	Saves the times of system history.
F148	-	_LOG_ROTATE	N/A	
F150	-	_BASE_INFO0	Slot information 0	Main base slot information.
F200	-	_USER_WRITE_F	Available contact point	Contact point available in program.
	F2000	_RTC_WR	RTC RW	Data write and read in RTC.
	F2001	_SCAN_WR	Scan WR	Initializing the value of scan.
	F2002	_CHK_ANC_ERR	Request detection of external serious error	Request detection of external error.
	F2003	_CHK_ANC_WAR	Request detection of external slight error (warning)	Request detection of external slight error (warning).
F201	-	_USER_STAUS_F	User contact point	User contact point.
	F2010	_INIT_DONE	Initialization completed	Initialization complete displayed.
F202	-	_ANC_ERR	Display information of external serious error	Display information of external serious error
F203	-	_ANC_WAR	Display information of external slight error (warning)	Display information of external slight error (warning)
F210	-	_MON_YEAR_DT	Month/year	Clock data (month/year) Supported when using RTC option module
F211	-	_TIME_DAY_DT	Hour/date	Clock data (hour/date) Supported when using RTC option module
F212	-	_SEC_MIN_DT	Second/minute	Clock data (Second/minute) Supported when using RTC option module
F213	-	_HUND_WK_DT	Hundred year/week	Clock data (Hundred year/week) Supported when using RTC option module

Appendix 1.2 Communication Relay (L) List

Here describes data link communication relay(L). (Supported in “S(U)” type)

(1) High-speed Link 1

Device	Keyword	Type	Description
L000	_HS1_RLINK	Bit	<p>High speed link parameter 1 normal operation of all station</p> <p>Indicates normal operation of all station according to parameter set in High speed link, and On under the condition as below.</p> <ol style="list-style-type: none"> 1. In case that all station set in parameter is RUN mode and no error, 2. All data block set in parameter is communicated normally, and 3. The parameter set in each station itself is communicated normally. <p>Once RUN_LINK is On, it keeps On unless stopped by LINK_DISABLE.</p>
L001	_HS1_LTRBL	Bit	<p>Abnormal state after _HS1RLINK On</p> <p>In the state of _HSmRLINK flag On, if communication state of the station set in the parameter and data block is as follows, this flag shall be On.</p> <ol style="list-style-type: none"> 1. In case that the station set in the parameter is not RUN mode, or 2. There is an error in the station set in the parameter, or 3. The communication state of data block set in the parameter is not good. <p>LINK TROUBLE shall be On if the above 1, 2 & 3 conditions occur, and if the condition return to the normal state, it shall be OFF again.</p>
L0020 ~ L005F	_HS1_STATE[k] (k = 00~63)	Bit Array	<p>High speed link parameter 1, K block general state</p> <p>Indicates the general state of communication information for each data block of setting parameter. _HS1_STATE[k] = HS1MOD[k]&_HS1TRX[k]&(~_HS1_ERR[k])</p>
L0060 ~ L009F	_HS1_MOD[k] (k = 00~63)	Bit Array	<p>High speed link parameter 1, k block station RUN operation mode</p> <p>Indicates operation mode of station set in K data block of parameter.</p>
L0100 ~ L013F	_HS1_TRX[k] (k = 00~63)	Bit Array	<p>Normal communication with High speed link parameter 1, k block station</p> <p>Indicates if communication state of Kdata of parameter is communicated smoothly according to the setting.</p>
L0140 ~ L017F	_HS1_ERR[k] (k = 00~63)	Bit Array	<p>High speed link parameter 1, K block station operation error mode</p> <p>Indicates if the error occurs in the communication state of k data block of parameter.</p>
L0180 ~ L021F	_HS1_SETBLOCK[k]	Bit Array	<p>High speed link parameter 1, K block setting</p> <p>Indicates whether or not to set k data block of parameter.</p>

(2) High-speed Link2

Device	Keyword	Type	Description
L0260	_HS2_RLINK	Bit	High-speed link parameter 2 normal operation of all station. Indicates normal operation of all station according to parameter set in High-speed link and On under the condition as below. 1. In case that all station set in parameter is Run mode and no error 2. All data block set in parameter is communicated and 3. The parameter set in each station itself is communicated normally. Once RUN_LINK is On, it keeps On unless stopped by LINK_DISABLE.
L0261	_HS2_LTRBL	Bit	Abnormal state after _HS2RLINK On. In the state of _HSmRLINK flag On, if communication state of the station set in the parameter and data block is as follows, this flag shall be On. 1. In case that the station set in the parameter is not RUN mode, or 2. There is an error in the station set in the parameter, or 3. The communication state of data block set in the parameter is not good. LINK TROUBLE shall be On if the above 1, 2 & 3 conditions occur, and if the condition return to the normal state, it shall be OFF again.
L0280 ~ L031F	_HS2_STATE[k] (k = 00~63)	Bit Array	High speed link parameter 1, k block general state. Indicates the general state of communication information for each data block of setting parameter. $_HS2_STATE[k]=HS2MOD[k]\&_HS2TRX[k]\&(\sim_HS2_ERR[k])$
L0320 ~ L035F	_HS2_MOD[k] (k = 00~63)	Bit Array	High speed link parameter 1, k block station RUN operation mode. Indicates operation mode of station set in k data block of parameter.
L0360 ~ L039F	_HS2_TRX[k] (k = 00~63)	Bit Array	Normal communication with High speed link parameter 1, K block station. Indicates if communication state of K data of parameter is communicated smoothly according to the setting.
L0400 ~ L043F	_HS2_ERR[k] (k = 00~63)	Bit Array	High speed link parameter 1, K block station operation error mode. Indicates if the error occurs in the communication state of k data block of parameter.
L0440 ~ L047F	_HS2_SETBLOCK[k]	Bit Array	High speed link parameter 1, K block setting. Indicates whether or not to set k data block of parameter.

Appendix 1. Flag List

(3) Common area

Communication flag list according to P2P service setting.

P2P parameter: "S" type 1~3, "E" type 1

P2P block: "S" type and "E" type 0~31

Device	Keyword	Type	Description
L5120	_P2P1_NDR00	Bit	Indicates P2P parameter 1, 0 Block service normal end.
L5121	_P2P1_ERR00	Bit	Indicates P2P parameter 1, 0 Block service abnormal end.
L513	_P2P1_STATUS00	Word	Indicates error code in case of P2P parameter 1, 0 Block service abnormal end.
L514	_P2P1_SVCCNT00	DWord	Indicates P2P parameter 1, 0 Block service normal count.
L516	_P2P1_ERRCNT00	DWord	Indicates P2P parameter 1, 0 Block service abnormal count.
L5180	_P2P1_NDR01	Bit	P2P parameter 1, 1 Block service normal end.
L5181	_P2P1_ERR01	Bit	P2P parameter 1, 1 Block service abnormal end.
L519	_P2P1_STATUS01	Word	Indicates error code in case of P2P parameter 1, 1 Block service abnormal end.
L520	_P2P1_SVCCNT01	DWord	Indicates P2P parameter 1, 1 Block service normal count.
L522	_P2P1_ERRCNT01	DWord	Indicates P2P parameter 1, 1 Block service abnormal count.
L524~L529	-	Word	P2P parameter 1,2 Block service total.
L530~L535	-	Word	P2P parameter 1,3 Block service total.
L536~L697	-	Word	P2P parameter 1,4~30 Block service total.
L698~L703	-	Word	P2P parameter 1,31 Block service total.

Appendix 2 Dimension (Unit: mm)

(1) Economy type main unit ("E" type)

- XBC-DR10/14E, XBC-DN10/14E, XBC-DP10/14E

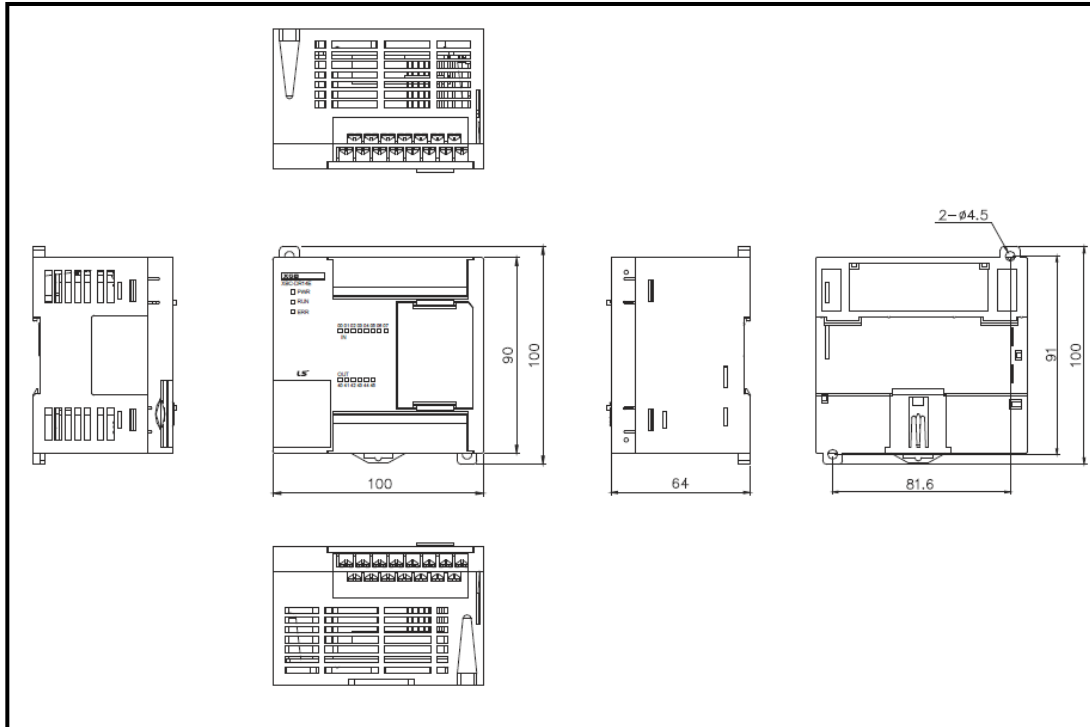

- XBC-DR20/30E, XBC-DN20/30E, XBC-DP20/30E

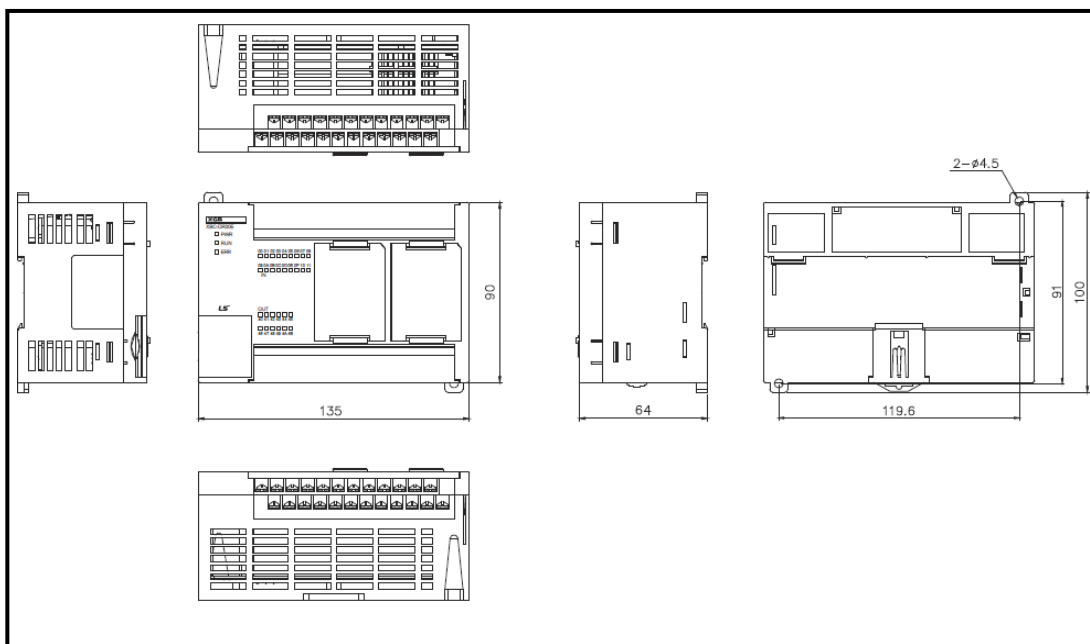

(2) Standard type main unit ("S(U)" type)

- XBC-DN20/30S(U), XBC-DR20/30SU, XBC-DP20/30SU

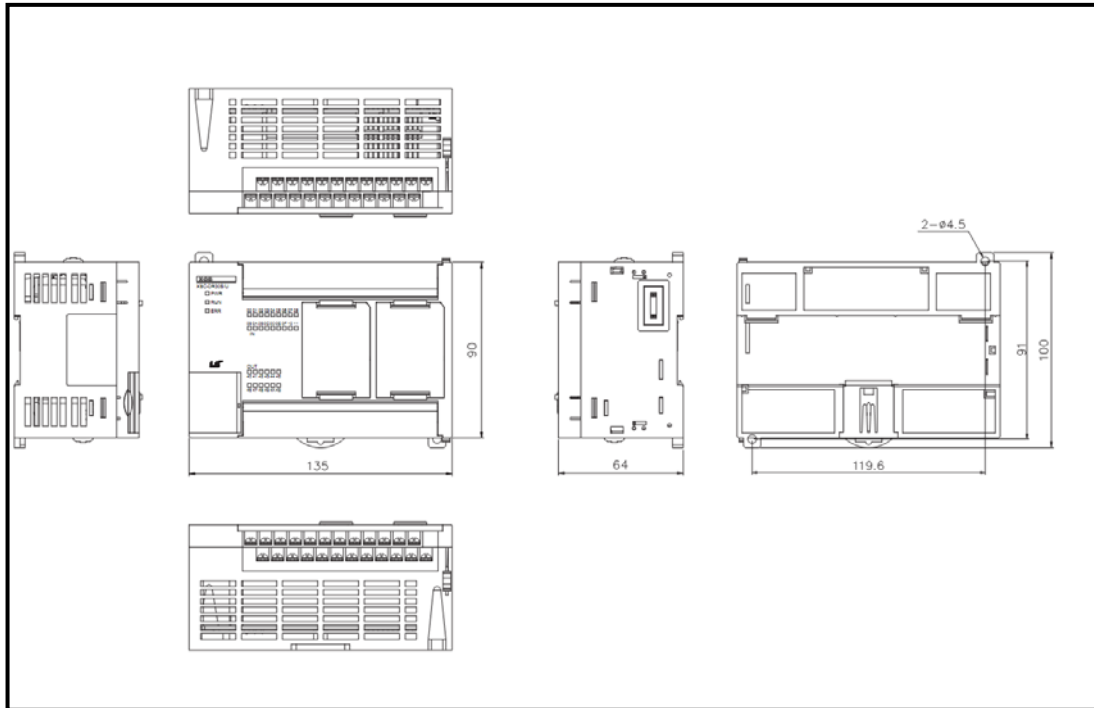

- XBC-DN40SU, XBC-DR40SU , XBC-DP40SU

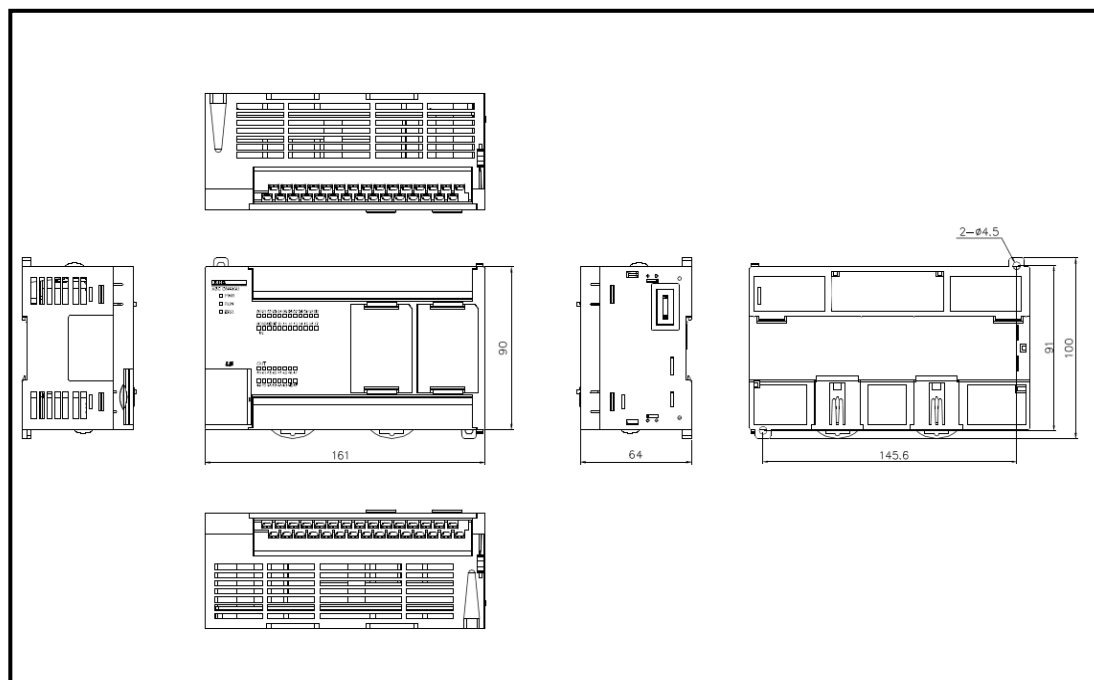

Appendix 2. Dimensions

- XBC-DN60SU, XBC-DR60SU, XBC-DP60SU

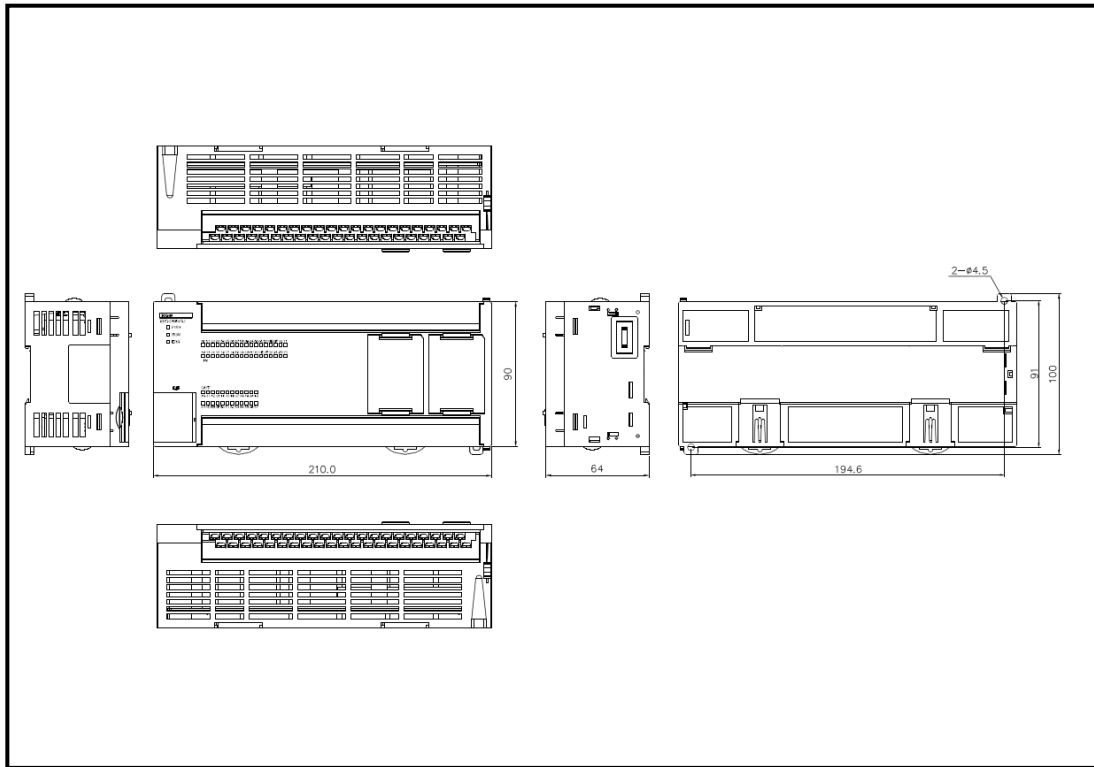

(3) Extension I/O module

-. XBE-DC32A, XBE-TN32A, XBE-DP32A, XBE-DN32A

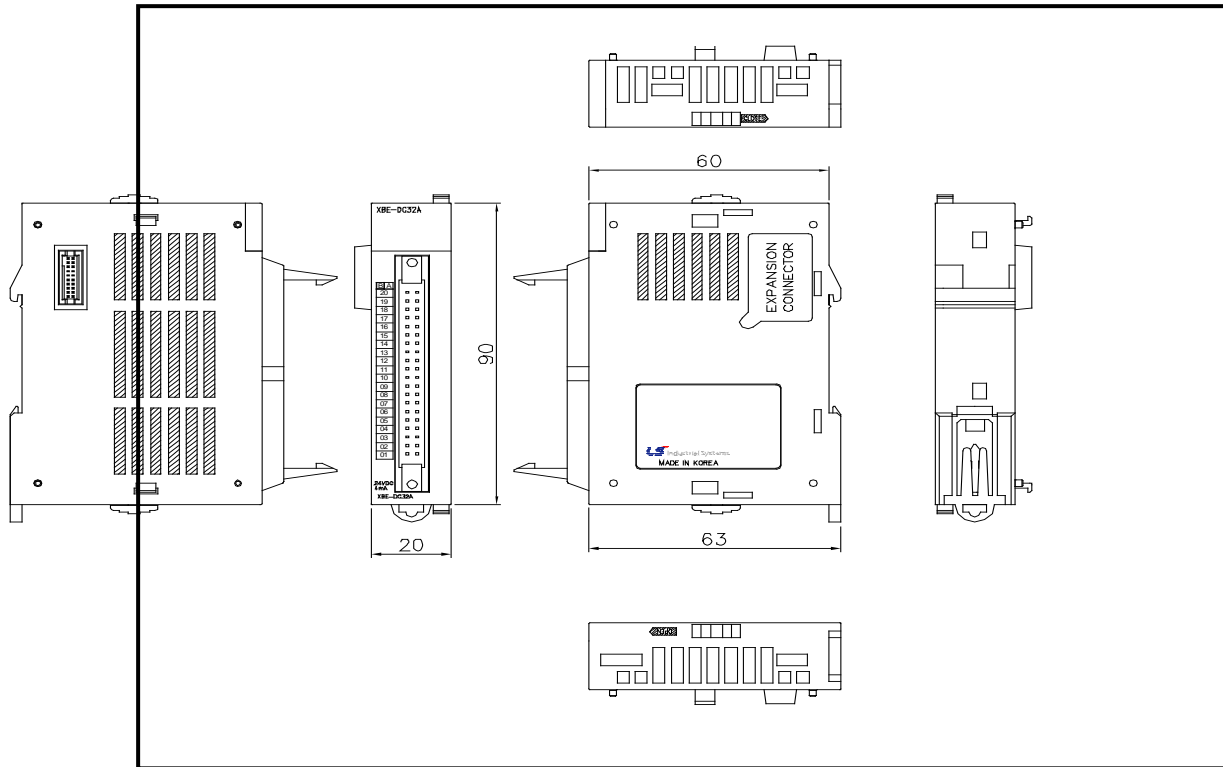

-. XBE-RY16A

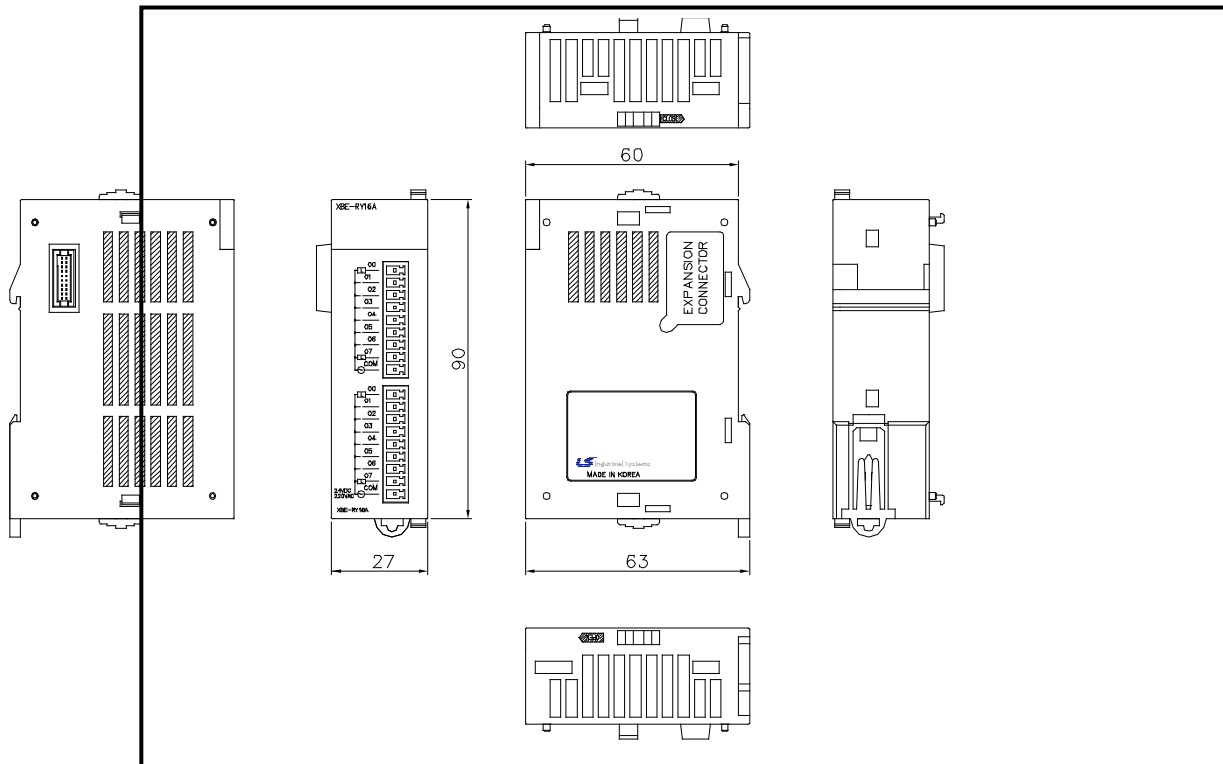

Appendix 2. Dimensions

- XBE-DC08A, XBE-DC16A, XBE-TN08A, XBE-TP08A, XBE-TN16A, XBE-TP16A, XBE-AC08A

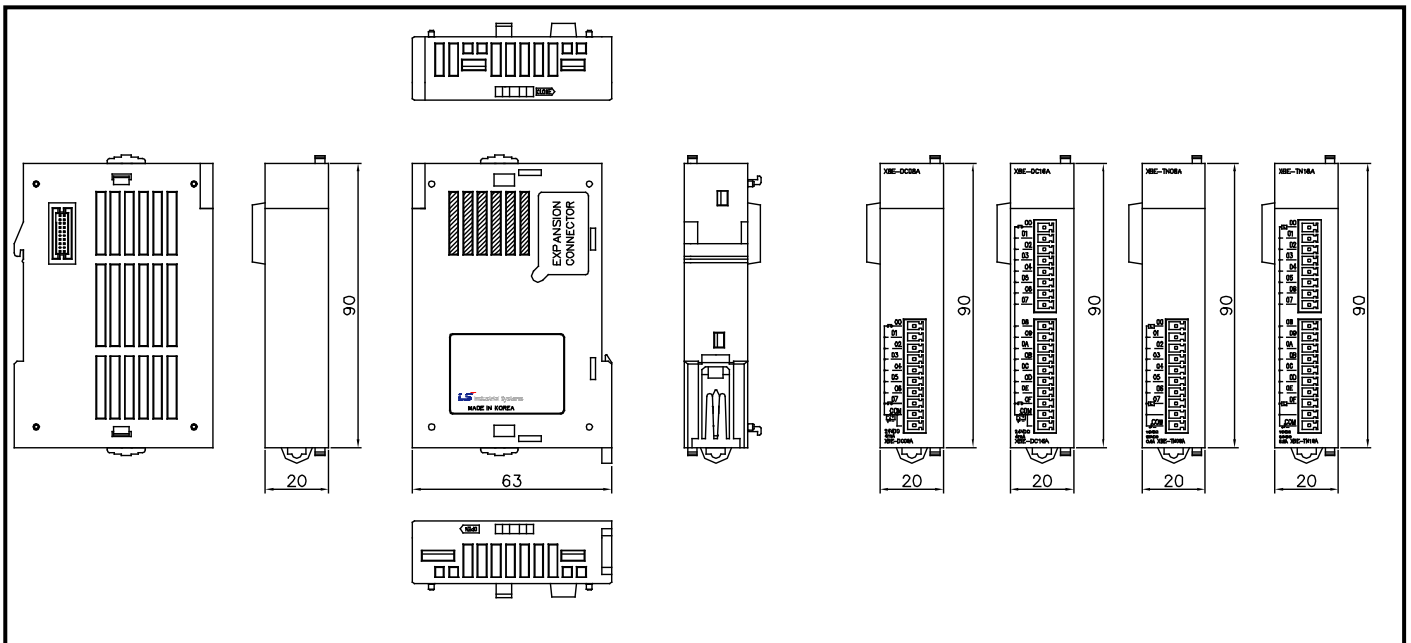

- XBE-DR16A, XBE-RY08A

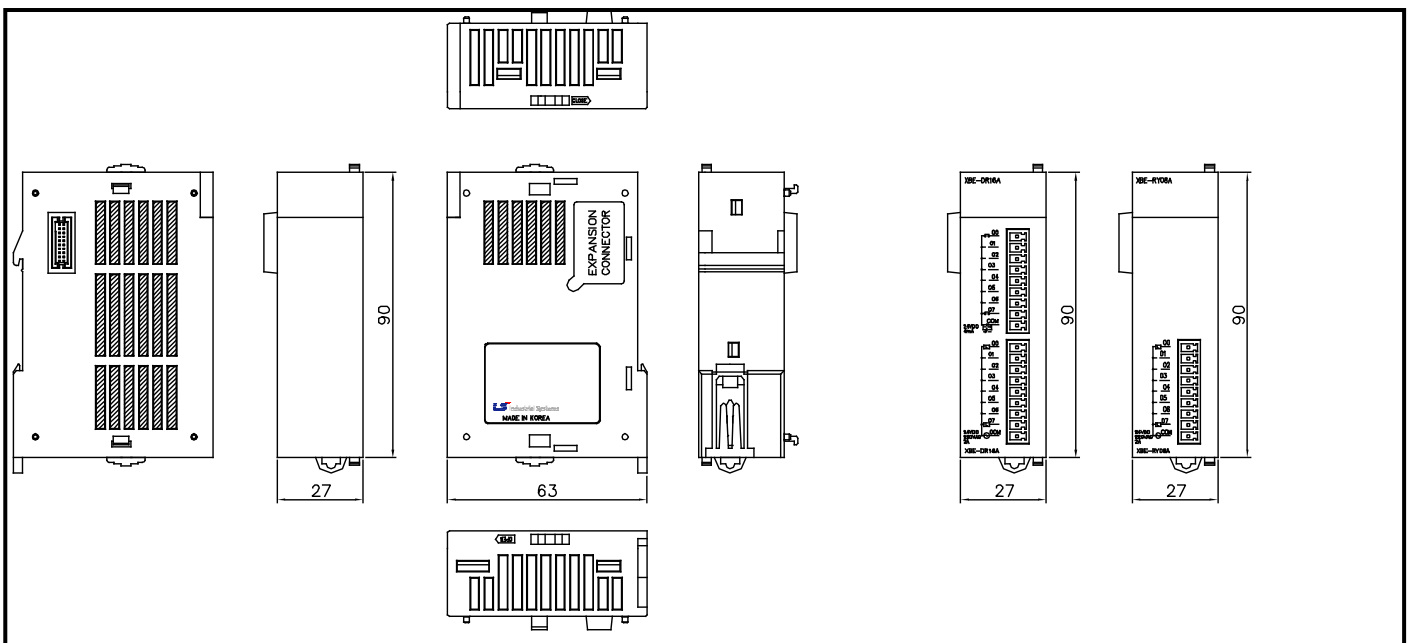

Appendix 3 Compatibility with MASTER-K (Special Relay)

MASTER-K		Symbol	XGB	
Device	Function		Device	Function
F0000	RUN mode	_RUN	F0000	RUN Edit mode
F0001	Program mode	_STOP	F0001	Program mode
F0002	Pause mode	_ERROR	F0002	Error mode
F0003	Debug mode	_DEBUG	F0003	Debug mode
F0004	N/A	_LOCAL_CON	F0006	Remote mode
F0005	N/A	_MODBUS_CON	F0006	Remote mode
F0006	Remote mode	_REMOTE_CON	F0006	Remote mode
F0007	User memory setup	-	F0007	N/A
F0008	N/A	_RUN_EDIT_ST	F0008	Editing during RUN
F0009	N/A	_RUN_EDIT_CHK	F0009	Editing during RUN
F000A	User memory operation	_RUN_EDIT_DONE	F000A	Edit done during RUN
F000B	N/A	_RUN_EDIT_END	F000B	Edit end during RUN
F000C	N/A	_CMOD_KEY	F000C	Operation mode change by KEY
F000D	N/A	_CMOD_LPADT	F000D	Operation mode change by PADT
F000E	N/A	_CMOD_RPADT	F000E	Operation mode change by Remote PADT
F000F	STOP command execution	_CMOD_RLINK	F000F	Operation mode change cause by remote communication module
F0010	Ordinary time On	_FORCE_IN	F0010	Forced input
F0011	Ordinary time Off	_FORCE_OUT	F0011	Forced output
F0012	1 Scan On	_SKIP_ON	F0012	I/O Skip execution
F0013	1 Scan Off	_EMASK_ON	F0013	Error mask execution
F0014	Reversal every Scan	_MON_ON	F0014	Monitor execution
F0015 ~ F001C	N/A	_USTOP_ON	F0015	Stop by Stop Function
		_ESTOP_ON	F0016	Stop by ESTOP Function
		_CONPILE_MODE	F0017	Compile
		_INIT_RUN	F0018	Initialize
		-	F0019 ~ F001F	N/A
		_PB1	F001C	Program Code 1
F001D	N/A	_PB2	F001D	Program Code 2
F001E	N/A	_CB1	F001E	Compile code 1
F001F	N/A	_CB2	F001F	Compile code 2

Appendix 3. Compatibility with MASTER-K

MASTER-K		Symbol	XGB	
Device	Function		Device	Function
F0020	1 Step RUN	_CPU_ER	F0020	CPU configuration error
F0021	Break Point RUN	_IO_TYER	F0021	Module type mismatch error
F0022	Scan RUN	_IO_DEER	F0022	Module detach error
F0023	Contact value match RUN	_FUSE_ER	F0023	Fuse cutoff error
F0024	Word value match RUN	_IO_RWER	F0024	I/O module read/write error
F0025 ~ F002F	N/A	_IP_IFER	F0025	Special/communication module interface error
		_ANNUM_ER	F0026	Heavy error detection of external equipment error
		-	F0027	N/A
		_BPRM_ER	F0028	Basic parameter error
		_IOPRM_ER	F0029	I/O configuration parameter error
		_SPPRM_ER	F002A	Special module parameter error
		_CPPRM_ER	F002B	Communication module parameter error
		_PGM_ER	F002C	Program error
		_CODE_ER	F002D	Program Code error
		_SWDT_ER	F002E	System watchdog error
		_BASE_POWER_ER	F002F	Base power error
F0030	Heavy error	_WDT_ER	F0030	Scan watchdog
F0031	Light error	-	F0031	-
F0032	WDT error	-	F0032	-
F0033	I/O combination error	-	F0033	-
F0034	Battery voltage error	-	F0034	-
F0035	Fuse error	-	F0035	-
F0036 ~ F0038	N/A	-	F0036 ~ F0038	-
F0039	Backup normal	-	F0039	-
F003A	Clock data error	-	F003A	-
F003B	Program change	-	F003B	-
F003C	Program change error	-	F003C	-
F003D ~ F003F	N/A	-	F003D ~ F003F	N/A
F0040~ F005F	N/A	_RTC_ER	F0040	RTC data error
		_DBCK_ER	F0041	Data backup error
		_HBCK_ER	F0042	Hot restart disabled error
		_ABSD_ER	F0043	Abnormal operation stop
		_TASK_ER	F0044	Task collision
		_BAT_ER	F0045	Battery error
		_ANNUM_ER	F0046	Light error detection of external equipment

Appendix 3. Compatibility with MASTER-K

MASTER-K		Symbol	XGB	
Device	Function		Device	Function
F0040 ~ F005F	N/A	_LOG_FULL	F0047	Log memory full warning
		_HS_WAR1	F0048	High speed link parameter 1 error
		_HS_WAR2	F0049	High speed link parameter 2 error
		-	F004A ~ F0053	N/A
		_P2P_WAR1	F0054	P2P parameter 1 error
		_P2P_WAR2	F0055	P2P parameter 2 error
		_P2P_WAR3	F0056	P2P parameter 3 error
		-	F0057 ~ F005B	N/A
		_Constant_ER	F005C	Constant error
-	F005D ~ F005F	N/A		
F0060 ~ F006F	Error Code save	-	F0060 ~ F006F	N/A
F0070 ~ F008F	Fuse cutoff save	-	F0070 ~ F008F	N/A
F0090	20ms cycle Clock	_T20MS	F0090	20ms cycle Clock
F0091	100ms cycle Clock	_T100MS	F0091	100ms cycle Clock
F0092	200ms cycle Clock	_T200MS	F0092	200ms cycle Clock
F0093	1s cycle Clock	_T1S	F0093	1s cycle Clock
F0094	2s cycle Clock	_T2S	F0094	2s cycle Clock
F0095	10s cycle Clock	_T10S	F0095	10s cycle Clock
F0096	20s cycle Clock	_T20S	F0096	20s cycle Clock
F0097	60s cycle Clock	_T60S	F0097	60s cycle Clock
F0098 ~F009F	N/A	-	F0098	N/A
		_ON	F0099	Ordinary time On
		_OFF	F009A	Ordinary time Off
		_1ON	F009B	1 Scan On
		_1OFF	F009C	1 Scan Off
		_STOG	F009D	Reversal every Scan
-	F009B ~ F009F	N/A		
F0100	User Clock 0	-	F0100	User Clock 0
F0101	User Clock 1	-	F0101	User Clock 1
F0102	User Clock 2	-	F0102	User Clock 2
F0103	User Clock 3	-	F0103	User Clock 3
F0104	User Clock 4	-	F0104	User Clock 4
F0105	User Clock 5	-	F0105	User Clock 5
F0106	User Clock 6	-	F0106	User Clock 6
F0107	User Clock 7	-	F0107	User Clock 7

Appendix 3. Compatibility with MASTER-K

MASTER-K		Symbol	XGB	
Device	Function		Device	Function
F0108 ~ F010F		-	F0108 ~ F010F	N/A
F0110	Operation error flag	_Ler	F0110	Operation error flag
F0111	Zero flag	_Zero	F0111	Zero flag
F0112	Carry flag	_Carry	F0112	Carry flag
F0113	Full output Off	_All_Off	F0113	Full output Off
F0114	Common RAM R/W error	-	F0114	N/A
F0115	Operation error flag (latch)	_Ler_Latch	F0115	Operation error flag(latch)
F0116 ~ F011F		-	F0116 ~ F011F	N/A
F0120	LT flag	_LT	F0120	LT flag
F0121	LTE flag	_LTE	F0121	LTE flag
F0122	EQU flag	_EQU	F0122	EQU flag
F0123	GT flag	_GT	F0123	GT flag
F0124	GTE flag	_GTE	F0124	GTE flag
F0125	NEQ flag	_NEQ	F0125	NEQ flag
F0126 ~ F012F	N/A	-	F0126 ~ F012F	N/A
F0130~ F013F	AC Down Count	_AC_F_CNT	F0130~ F013F	AC Down Count
F0140~ F014F	FALS no.	_FALS_NUM	F0140~ F014F	FALS no.
F0150~ F015F	PUT/GET error flag	_PUTGET_ERR	F0150~ F030F	PUT/GET error flag
		CPU TYPE	F0440 ~ F044F	CPU TYPE
		CPU VERSION	F0450 ~ F045F	CPU VERSION
		OS version no.	F0460 ~ F047F	System OS version no.
F0160~ F049F	N/A	OS date	F0480 ~ F049F	System OS DATE

Appendix 3. Compatibility with MASTER-K

MASTER-K		Symbol	XGB	
Device	Function		Device	Function
F0500~ F050F	Max. Scan time	_SCAN_MAX	F0500~ F050F	Max. Scan time
F0510~ F051F	Min. Scan time	_SCAN_MIN	F0510~ F051F	Min. Scan time
F0520~ F052F	Current Scan time	_SCAN_CUR	F0520~ F052F	Current Scan time
F0530~ F053F	Clock data (year/month)	_YEAR_MON	F0530~ F053F	Clock data (year/month)
F0540~ F054F	Clock data (day/hr)	_DAY_TIME	F0540~ F054F	Clock data(day/hr)
F0550~ F055F	Clock data (min/sec)	_MIN_SEC	F0550~ F055F	Clock data(min/sec)
F0560~ F056F	Clock data (100year/weekday)	_HUND_WK	F0560~ F056F	Clock data(100year/weekday)
F0570~ F058F	N/A	_FPU_LFlag_I	F0570	-
		_FPU_LFlag_U	F0571	-
		_FPU_LFlag_O	F0572	-
		_FPU_LFlag_Z	F0573	-
		_FPU_LFlag_V	F0574	-
		-	F0575 ~ F0579	N/A
		_FPU_Flag_I	F057A	-
		_FPU_Flag_U	F057B	-
		_FPU_Flag_O	F057C	-
		_FPU_Flag_Z	F057D	-
		_FPU_Flag_V	F057E	-
		_FPU_Flag_E	F057F	-
	Error Step		F0580~ F058F	Error step save
F0590~ F059F	Error step save	-	F0590~ F059F	N/A
F0600~ F060F	FMM detailed error information	_REF_COUNT	F060~F061	Refresh Count
F0610~ F063F	N/A	_REF_OK_CNT	F062~F063	Refresh OK Count
-	-	_REF_NG_CNT	F064~F065	Refresh NG Count
-	-	_REF_LIM_CNT	F066~F067	Refresh Limit Count
-	-	_REF_ERR_CNT	F068~F069	Refresh Error Count
-	-	_MOD_RD_ERR_CNT	F070~F071	MODULE Read Error Count
-	-	_MOD_WR_ERR_CNT	F072~F073	MODULE Write Error Count
-	-	_CA_CNT	F074~F075	Cmd Access Count
-	-	_CA_LIM_CNT	F076~F077	Cmd Access Limit Count
-	-	_CA_ERR_CNT	F078~F079	Cmd Access Error Count
-	-	_BUF_FULL_CNT	F080~F081	Buffer Full Count

Note

1. When you convert the project written by KGLWIN in MASTER-K series (K80S, K200S, K300S, and K1000S) into XG5000 project, some instructions used in only MASTER-K is not converted. And the previous parameter used in MASTER-K is converted into default value.
2. XGB economy type project can be converted into XGB standard type project but parameter is converted into default value.
3. When you convert the XGB standard type project into XGB economy type project, some instructions used in only XGB standard type is not converted. And the parameter is converted into default value.

Appendix 4 Instruction List

Appendix 4.1 Classification of Instructions

Classification	Instructions	Details	Remarks
Basic Instructions	Contact Point Instruction	LOAD, AND, OR related Instructions	
	Unite Instruction	AND LOAD, OR LOAD, MPUSH, MLOAD, MPOP	
	Reverse Instruction	NOT	
	Master Control Instruction	MCS, MCSCLR	
	Output Instruction	OUT, SET, RST, 1 Scan Output Instruction, Output Reverse Instruction (FF)	
	Sequence/Last-input Preferred Instruction	Step Control Instruction (SET Sxx.xx, OUT Sxx.xx)	
	End Instruction	END	
	Non-Process Instruction	NOP	
	Timer Instruction	TON, TOFF, TMR, TMON, TRTG	
	Counter Instruction	CTD, CTU, CTUD, CTR	
Application Instructions	Data Transfer Instruction	Transfers specified Data, Group, String	4/8/64 Bits available
	Conversion Instruction	Converts BIN/BCD of specified Data & Group	4/8 Bits available
	Data Type Conversion Instruction	Converts Integer/Real Number	
	Output Terminal Compare Instruction	Saves compared results in special relay	Compare to Unsigned
	Input Terminal Compare Instruction	Saves compared results in BR. Compares Real Number, String & Group. Compares 3 Operands	Compare to Signed
	Increase/Decrease Instruction	Increases or decreases specified data 1 by 1	4/8 Bits available
	Rotate Instruction	Rotates specified data to the left and right, including Carry	4/8 Bits available
	Move Instruction	Moves specified data to the left and right, word by word, bit by bit	4/8 Bits available
	Exchange Instruction	Exchanges between devices, higher & lower byte, group data	
	BIN Operation Instruction	Addition, Subtraction, Multiplication & Division for Integer/ Real Number, Addition for String, Addition & Subtraction for Group	
	BCD Operation Instruction	Addition, Subtraction, Multiplication, Division.	
	Logic Operation Instruction	Logic Multiplication, Logic Addition, Exclusive OR, Exclusive NOR, Group Operation	
	System Instruction	Error Display, WDT Initialize, Output Control, Operation Stop, etc.	
	Data Process Instruction	Encode, Decode, Data Disconnect/Connect, Search, Align, Max., Min., Total, Average, etc.	
	Data Table Process Instruction	Data Input/Output of Data Table	
	String Process Instruction	String related Convert, Comment Read, String Extract, ASCII Convert, HEX Convert, String Search, etc.	
	Special Function Instruction	Trigonometric Function, Exponential/Log Function, Angle/ Radian Convert, etc.	
	Data Control Instruction	Max/Min Limit Control, Dead-zone Control, Zone Control	
	Time related Instruction	Date Time Data Read/Write, Time Data Adjust & Convert	
	Diverge Instruction	JMP, CALL	
	Loop Instruction	FOR/NEXT/BREAK	
	Flag related Instruction	Carry Flag Set/Reset, Error Flag Clear	
	Special/Communication related Instruction	Data Read/Write by BUSCON Direct Access	
Interrupt related Instruction	Interrupt Enable/Disable		
Signal Reverse Instruction	Reverse Integer/Real Signals, Absolute Value Operation		
File related Instruction	Block Read/Write/Compare/Convert, Flash data Transmission		

Appendix 4.2 Basic Instructions

(1) Contact point instruction

Classification	Designations	Symbol	Description	Support	
				XGK	XGB
Contact Point	LOAD		A Contact Point Operation Start	○	○
	LOAD NOT		B Contact Point Operation Start	○	○
	AND		A Contact Point Series-Connected	○	○
	AND NOT		B Contact Point Series-Connected	○	○
	OR		A Contact Point Parallel-Connected	○	○
	OR NOT		B Contact Point Parallel-Connected	○	○
	LOADP		Positive Convert Detected Contact Point	○	○
	LOADN		Negative Convert Detected Contact Point	○	○
	ANDP		Positive Convert Detected Contact Point Series-	○	○
	ANDN		Negative Convert Detected Contact Point Series-	○	○
	ORP		Positive Convert Detected Contact Point Parallel-	○	○
	ORN		Negative Convert Detected Contact Point Parallel-	○	○

(2) Union instruction

Classification	Designations	Symbol	Description	Support	
				XGK	XGB
Unite	AND LOAD		A,B Block Series-Connected	○	○
	OR LOAD		A,B Block Parallel-Connected	○	○
	MPUSH		Operation Result Push up to present	○	○
	MLOAD		Operation Result Load Previous to Diverge Point	○	○
	MPOP		Operation Result Pop Previous to Diverge Point	○	○

Appendix 4 Instruction List

(3) Reverse instruction

Classification	Designations	Symbol	Description	Support	
				XGK	XGB
Reverse	NOT		Previous Operation results Reverse	○	○

(4) Master Control instruction

Classification	Designations	Symbol	Description	Support	
				XGK	XGB
Master Control	MCS		Master Control Setting (n:0~7)	○	○
	MCSCLR		Master Control Cancel (n:0~7)	○	○

(5) Output instruction

Classification	Designations	Symbol	Description	Support	
				XGK	XGB
Output	OUT		Operation Results Output	○	○
	OUT NOT		Operation Results Reverse Output	○	○
	OUTP		1 Scan Output if Input Condition rises	○	○
	OUTN		1 Scan Output if Input Condition falls	○	○
	SET		Contact Point Output ON kept	○	○
	RST		Contact Point Output OFF kept	○	○
	FF		Output Reverse if Input Condition rises	○	○

(6) Sequence/Last-input preferred instruction

Classification	Designations	Symbol	Description	Support	
				XGK	XGB
Step Control	SET S		Sequence Control	○	○
	OUT S		Last-input Preferred	○	○

(7) End instruction

Classification	Designations	Symbol	Description	Support	
				XGK	XGB
End	END		Program End	○	○

(8) Non-process instruction

Classification	Designations	Symbol	Description	Support	
				XGK	XGB
Non-Process	NOP	Ladder not displayed	Non-Process Instruction, used in Nimonic	○	○

(9) Timer instruction

Classification	Designations	Symbol	Description	Support	
				XGK	XGB
Timer	TON			○	○
	TOFF			○	○
	TMR			○	○
	TMON			○	○
	TRTG			○	○

(10) Counter instruction

Classification	Designations	Symbol	Description	Support	
				XGK	XGB
Counter	CTD			○	○
	CTU			○	○
	CTUD			○	○
	CTR			○	○

Appendix 4.3 Application Instruction

(1) Data transfer instruction

Classification	Designations	Symbol	Description	Support	
				XGK	XGB
16 bits Transfer	MOV		(S) → (D)	○	○
	MOV P		(S) → (D)	○	○
32 bits Transfer	DMOV		(S+1,S) → (D+1,D)	○	○
	DMOV P		(S+1,S) → (D+1,D)	○	○
Short Real Number Transfer	RMOV		(S+1,S) → (D+1,D)	○	○
	RMOV P		(S+1,S) → (D+1,D)	○	○
Long Real Number Transfer	LMOV		(S+3,S+2,S+1,S) → (D+3,D+2,D+1,D)	○	○
	LMOV P		(S+3,S+2,S+1,S) → (D+3,D+2,D+1,D)	○	○
4 bits Transfer	MOV4			○	○
	MOV4 P			○	○
8 bits Transfer	MOV8			○	○
	MOV8 P			○	○
1's complement Transfer	CMOV		1's complement (S) → (D)	○	○
	CMOV P		1's complement (S) → (D)	○	○
	DCMOV		1's complement (S+1,S) → (D+1,D)	○	○
	DCMOV P		1's complement (S+1,S) → (D+1,D)	○	○
16 bits Group Transfer	GMOV			○	○
	GMOV P			○	○
Multiple Transfer	FMOV			○	○
	FMOV P			○	○
Specified Bits Transfer	BMOV			○	○
	BMOV P			○	○
Specified Bits Group Transfer	GBMOV			○	○
	GBMOV P			○	○

(1) Data Transfer Instruction (continued)

Classification	Designations	Symbol	Description	Support	
				XGK	XGB
String Transfer	\$MOV	$\boxed{\$MOV} \quad S \quad D$	String started from (S) → String started from (D)	○	○
	\$MOVP	$\boxed{\$MOVP} \quad S \quad D$		○	○

(2) BCD/BIN conversion instruction

Classification	Designations	Symbol	Description	Support		
				XGK	XGB	
BCD Conversion	BCD	$\boxed{BCD} \quad S \quad D$	(S) → To BCD → (D) ↑ BIN(0~9999)	○	○	
	BCDP	$\boxed{BCDP} \quad S \quad D$				
	DBCDCD	$\boxed{DBCDCD} \quad S \quad D$	(S+1,S) → To BCD → (D+1,D) ↑ BIN(0~99999999)	○	○	
	DBCDCP	$\boxed{DBCDCP} \quad S \quad D$				
4/8 Bits BCD Conversion	BCD4	$\boxed{BCD4} \quad S_b \quad D_b$	(S _b):Bit, BIN(0~9) b15 → To 4bit BCD → b0 ↑ (D _b): Bit	○	○	
	BCD4P	$\boxed{BCD4P} \quad S_b \quad D_b$				
	BCD8	$\boxed{BCD8} \quad S_b \quad D_b$	(S _b):Bit, BIN(0~99) b15 → To 8bit BCD → b0 ↑ (D _b):Bit	○	○	
	BCD8P	$\boxed{BCD8P} \quad S_b \quad D_b$				
BIN Conversion	BIN	$\boxed{BIN} \quad S \quad D$	(S) → To BIN → (D) ↑ BCD(0~9999)	○	○	
	BINP	$\boxed{BINP} \quad S \quad D$				
	DBIN	$\boxed{DBIN} \quad S \quad D$	(S+1,S) → To BIN → (D+1,D) ↑ BCD(0~99999999)	○	○	
	DBINP	$\boxed{DBINP} \quad S \quad D$				
4/8 Bits BIN Conversion	BIN4	$\boxed{BIN4} \quad S_b \quad D_b$	(S _b):Bit, BCD(0~9) b15 → To 4bit BIN → b0 ↑ (D _b):Bit	○	○	
	BIN4P	$\boxed{BIN4P} \quad S_b \quad D_b$				
	BIN8	$\boxed{BIN8} \quad S_b \quad D_b$	(S _b):Bit, BCD(0~99) b15 → To bit BIN → b0 ↑ (D _b):Bit	○	○	
	BIN8P	$\boxed{BIN8P} \quad S_b \quad D_b$				
Group BCD,BIN Conversion	GBCD	$\boxed{GBCD} \quad S \quad D \quad N$	□ Data (S) to N converted to BCD, and (D) to N saved	○	○	
	GBCDP	$\boxed{GBCDP} \quad S \quad D \quad N$				
	GBIN	$\boxed{GBIN} \quad S \quad D \quad N$		□ Data (S) to N converted to BIN, and (D) to N saved	○	○
	GBINP	$\boxed{GBINP} \quad S \quad D \quad N$				

(3) Data type conversion instruction

Classification	Designations	Symbol	Description	Support	
				XGK	XGB
16 Bits Integer/Real Conversion	I2R	$\boxed{\text{I2R}} \quad \boxed{\text{S}} \quad \boxed{\text{D}}$	(S) $\xrightarrow{\text{To Real}}$ (D+1,D) \uparrow Int(-32768~32767)	○	○
	I2RP	$\boxed{\text{I2RP}} \quad \boxed{\text{S}} \quad \boxed{\text{D}}$			
	I2L	$\boxed{\text{I2L}} \quad \boxed{\text{S}} \quad \boxed{\text{D}}$	(S) $\xrightarrow{\text{To Long}}$ (D+3,D+2,D+1,D) \uparrow Int(-32768~32767)	○	○
	I2LP	$\boxed{\text{I2LP}} \quad \boxed{\text{S}} \quad \boxed{\text{D}}$			
32 Bits Integer/Real Conversion	D2R	$\boxed{\text{D2R}} \quad \boxed{\text{S}} \quad \boxed{\text{D}}$	(S+1,S) $\xrightarrow{\text{To Real}}$ (D+1,D) \uparrow Dint(-2147483648~2147483647)	○	○
	D2RP	$\boxed{\text{D2RP}} \quad \boxed{\text{S}} \quad \boxed{\text{D}}$			
	D2L	$\boxed{\text{D2L}} \quad \boxed{\text{S}} \quad \boxed{\text{D}}$	(S+1,S) $\xrightarrow{\text{To Long}}$ (D+3,D+2,D+1,D) \uparrow Dint(-2147483648~2147483647)	○	○
	D2LP	$\boxed{\text{D2LP}} \quad \boxed{\text{S}} \quad \boxed{\text{D}}$			
Short Real/Integer Conversion	R2I	$\boxed{\text{R2I}} \quad \boxed{\text{S}} \quad \boxed{\text{D}}$	(S+1,S) $\xrightarrow{\text{To INT}}$ (D) \uparrow Whole Sing Real Range	○	○
	R2IP	$\boxed{\text{R2IP}} \quad \boxed{\text{S}} \quad \boxed{\text{D}}$			
	R2D	$\boxed{\text{R2D}} \quad \boxed{\text{S}} \quad \boxed{\text{D}}$	(S+1,S) $\xrightarrow{\text{To DINT}}$ (D+1,D) \uparrow Whole Sing Real Range	○	○
	R2DP	$\boxed{\text{R2DP}} \quad \boxed{\text{S}} \quad \boxed{\text{D}}$			
Long Real/Integer Conversion	L2I	$\boxed{\text{L2I}} \quad \boxed{\text{S}} \quad \boxed{\text{D}}$	(S+3,S+2,S+1,S) $\xrightarrow{\text{To INT}}$ (D) \uparrow Whole Double Real Range	○	○
	L2IP	$\boxed{\text{L2IP}} \quad \boxed{\text{S}} \quad \boxed{\text{D}}$			
	L2D	$\boxed{\text{L2D}} \quad \boxed{\text{S}} \quad \boxed{\text{D}}$	(S+3,S+2,S+1,S) $\xrightarrow{\text{To DINT}}$ (D+1,D) \uparrow Whole Double Real Range	○	○
	L2DP	$\boxed{\text{L2DP}} \quad \boxed{\text{S}} \quad \boxed{\text{D}}$			

Remark

Integer value and Real value will be saved respectively in quite different format. For such reason, Real Number Data should be converted as applicable before used for Integer Operation.

(4) Comparison instruction

Classification	Designations	Symbol	Description	Support	
				XGK	XGB
Unsigned Compare with Special Relay used	CMP		CMP(S1,S2) and applicable Flag SET (S1, S2 is Word)	○	○
	CMPP				
	DCMP		CMP(S1,S2) and applicable Flag SET (S1, S2 is Double Word)	○	○
	DCMPP				
4/8 Bits Compare	CMP4		CMP(S1,S2) and applicable Flag SET (S1, S2 is Nibble)	○	○
	CMP4P				
	CMP8		CMP(S1,S2) and applicable Flag SET (S1, S2 is Byte)	○	○
	CMP8P				
Table Compare	TCMP		CMP(S1,S2)) CMP(S1+15,S2+15) Result:(D) ~ (D+15), 1 if identical	○	○
	TCMPP				
	DTCMP		CMP((S1+1,S1),(S2+1,S2)) CMP((S1+31,S1+30),(S2+31,S2+30)) Result:(D) ~ (D+15)	○	○
	DTCMPP				
Group Compare (16 Bits)	GEQ		Compares S1 data to S2 data word by word, and saves its result in Device (D) bit by bit from the lower bit (N ≤ 16)	○	○
	GEQP				
	GGT				
	GGTP				
	GLT				
	GLTP				
	GGE				
	GGEP				
	GLE				
	GLEP				
	GNE				
	GNEP				

Remark

CMP(P), DCMP(P), CMP4(P), CMP8(P), TCMP(P) & DTCMP(P) Instructions all process the results of Unsigned Compare. All the other Compare Instructions will perform Signed Compare.

4) Comparison instruction (continued)

Classification	Designations	Symbol	Description	Support	
				XGK	XGB
Group Compare (32 Bits)	GDEQ	$\text{---} \boxed{\text{GDEQ}} \boxed{\text{S1}} \boxed{\text{S2}} \boxed{\text{D}} \boxed{\text{N}} \text{---}$	Compares S1 data to S2 data 2 by 2 words, and saves its result in Device (D) bit by bit from the lower bit ($N \leq 16$)	○	○
	GDEQP	$\text{---} \boxed{\text{GDEQP}} \boxed{\text{S1}} \boxed{\text{S2}} \boxed{\text{D}} \boxed{\text{N}} \text{---}$		○	○
	GDGT	$\text{---} \boxed{\text{GDGT}} \boxed{\text{S1}} \boxed{\text{S2}} \boxed{\text{D}} \boxed{\text{N}} \text{---}$		○	○
	GDGTP	$\text{---} \boxed{\text{GDGTP}} \boxed{\text{S1}} \boxed{\text{S2}} \boxed{\text{D}} \boxed{\text{N}} \text{---}$		○	○
	GDLT	$\text{---} \boxed{\text{GDLT}} \boxed{\text{S1}} \boxed{\text{S2}} \boxed{\text{D}} \boxed{\text{N}} \text{---}$		○	○
	GDLTP	$\text{---} \boxed{\text{GDLTP}} \boxed{\text{S1}} \boxed{\text{S2}} \boxed{\text{D}} \boxed{\text{N}} \text{---}$		○	○
	GDGE	$\text{---} \boxed{\text{GDGE}} \boxed{\text{S1}} \boxed{\text{S2}} \boxed{\text{D}} \boxed{\text{N}} \text{---}$		○	○
	GDGEP	$\text{---} \boxed{\text{GDGEP}} \boxed{\text{S1}} \boxed{\text{S2}} \boxed{\text{D}} \boxed{\text{N}} \text{---}$		○	○
	GDLE	$\text{---} \boxed{\text{GDLE}} \boxed{\text{S1}} \boxed{\text{S2}} \boxed{\text{D}} \boxed{\text{N}} \text{---}$		○	○
	GDLEP	$\text{---} \boxed{\text{GDLEP}} \boxed{\text{S1}} \boxed{\text{S2}} \boxed{\text{D}} \boxed{\text{N}} \text{---}$		○	○
	GDNE	$\text{---} \boxed{\text{GDNE}} \boxed{\text{S1}} \boxed{\text{S2}} \boxed{\text{D}} \boxed{\text{N}} \text{---}$		○	○
	GDNEP	$\text{---} \boxed{\text{GDNEP}} \boxed{\text{S1}} \boxed{\text{S2}} \boxed{\text{D}} \boxed{\text{N}} \text{---}$		○	○

(4) Comparison instruction (continued)

Classification	Designations	Symbol	Description	Support	
				XGK	XGB
16 Bits Data Compare (LOAD)	LOAD=		Compares (S1) to (S2), and saves its result in Bit Result(BR) (Signed Operation)	○	○
	LOAD>				
	LOAD<				
	LOAD>=				
	LOAD<=				
	LOAD<>				
16 Bits Data Compare (AND)	AND=		Performs AND operation of (S1) & (S2) Compare Result and Bit Result (BR), and then saves its result in BR (Signed Operation)	○	○
	AND>				
	AND<				
	AND>=				
	AND<=				
	AND<>				
16 Bits Data Compare (OR)	OR=		Performs OR operation of (S1) & (S2) Compare Result and Bit Result (BR), and then saves its result in BR (Signed Operation)	○	○
	OR<=				
	OR<>				
32 Bits Data Compare (LOAD)	LOADD=		Compares (S1) to (S2), and saves its result in Bit Result(BR) (Signed Operation)		
	LOADD>				
	LOADD<				
	LOADD>=				
	LOADD<=				
	LOADD<>				

Remark

Comparison instruction for input process the result of Signed comparison instruction generally. To process Unsigned comparison, Use comparison instruction for input.

(4) Comparison instruction (continued)

Classification	Designations	Symbol	Description	Support	
				XGK	XGB
32 Bits Data Compare (AND)	ANDD=		Performs AND operation of (S1) & (S2) Compare Result and Bit Result (BR), and then saves its result in BR (Signed Operation)	○	○
	ANDD>				
	ANDD<				
	ANDD>=				
	ANDD<=				
	ANDD<>				
32bt Data Compare (OR)	ORD=		Performs OR operation of (S1) & (S2) Compare Result and Bit Result (BR), and then saves its result in BR (Signed Operation)	○	○
	ORD>				
	ORD<				
	ORD>=				
	ORD<=				
	ORD<>				
Short Real Number Compare (LOAD)	LOADR=		Performs OR operation of (S1) & (S2) Compare Result and Bit Result (BR), and then saves its result in BR (Signed Operation)	○	○
	LOADR>				
	LOADR<				
	LOADR>=				
	LOADR<=				
	LOADR<>				
Short Real Number Compare (AND)	ANDR=		Compares (S1+1,S) to (S2+1,S2) and saves its result in Bit Result (BR) (Signed Operation)	○	○
	ANDR>				
	ANDR<				
	ANDR>=				
	ANDR<=				
	ANDR<>				

(4) Comparison instruction (continued)

Classification	Designations	Symbol	Description	Support	
				XGK	XGB
Real Number Compare (OR)	ORR=		Compares (S1+1,S1) to (S2+1,S2) and saves its result in Bit Result (BR) (Signed Operation)	○	○
	ORR>				
	ORR<				
	ORR>=				
	ORR<=				
	ORR<>				
Long Real Number Compare (LOAD)	LOADL=		Compares (S1+3,S1+2,S1+1,S) to (S2+3,S2+2, S2+1,S2) and saves its result in Bit Result(BR) (Signed Operation)	○	○
	LOADL>				
	LOADL<				
	LOADL>=				
	LOADL<=				
	LOADL<>				
Long Real Number Compare (AND)	ANDL=		Performs AND operation of (S1+1,S1) & (S2+1,S2) Compare Result and Bit Result(BR), and then saves its result in BR (Signed Operation)	○	○
	ANDL>				
	ANDL<				
	ANDL>=				
	ANDL<=				
	ANDL<>				

(4) Comparison instruction (continued)

Classification	Designations	Symbol	Description	Support	
				XGK	XGB
Double Real Number Compare (OR)	ORL=		Performs OR operation of (S1 +1,S1) & (S2+1,S2) Compare Result and Bit Result(BR), and then saves its result in BR (Signed Operation)	○	○
	ORL>				
	ORL<				
	ORL>=				
	ORL<=				
	ORL<>				
String Compare (LOAD)	LOAD\$=		Compares (S1) to (S2) Starting String and saves its result in Bit Result(BR)	○	○
	LOAD\$>				
	LOAD\$<				
	LOAD\$>=				
	LOAD\$<=				
	LOAD\$<>				
String Compare (AND)	AND\$=		Performs AND operation of (S 1) & (S2) Starting String Compare Result and Bit Result(BR), and then saves its result in BR	○	○
	AND\$>				
	AND\$<				
	AND\$>=				
	AND\$<=				
	AND\$<>				

(4) Comparison instruction (continued)

Classification	Designations	Symbol	Description	Support	
				XGK	XGB
String Compare (OR)	OR\$=		Performs OR operation of (S1) & (S2) Starting String Compare Result and Bit Result(BR), and then saves its result in BR	○	○
	OR\$>				
	OR\$<				
	OR\$>=				
	OR\$<=				
	OR\$<>				
16 Bits Data Group Compare (LOAD)	LOADG=		Compares (S1), (S1+1), ..., (S1+N) to (S2), (S2+1), ..., (S2+N) 1 to 1, and then saves 1 in Bit Result(BR) if each value compared meets given condition	○	○
	LOADG>				
	LOADG<				
	LOADG>=				
	LOADG<=				
	LOADG<>				
16 Bits Data Group Compare (AND)	ANDG=		Performs AND operation of (S1), (S1+1), ..., (S1+N) & (S2), (S2+1), ..., (S2+N) 1 to 1 Compare Result and Bit Result (BR), and then saves its result in BR	○	○
	ANDG>				
	ANDG<				
	ANDG>=				
	ANDG<=				
	ANDG<>				
16 Bits Data Group Compare (OR)	ORG=		Performs OR operation of (S1), (S1+1), ..., (S1+N) & (S2), (S2+1), ..., (S2+N) 1 to 1 Compare Result and Bit Result (BR), and then saves its result in BR	○	○
	ORG>				
	ORG<				
	ORG>=				
	ORG<=				
	ORG<>				

(4) Comparison instruction (continued)

Classification	Designations	Symbol	Description	Support	
				XGX	XGB
32 Bits Data Group Compare (LOAD)	LOADDG=		Compares (S1), (S1+1), ..., (S1+N) to (S2), (S2+1), ..., (S2+N) 1 to 1, and then saves 1 in Bit Result(BR) if each value compared meets given condition	○	○
	LOADDG>				
	LOADDG<				
	LOADDG>=				
	LOADDG<=				
	LOADDG<>				
32 Bits Data Group Compare (AND)	ANDDG=		Performs AND operation of (S1), (S1+1), ..., (S1+N) & (S2), (S2+1), ..., (S2+N) 1 to 1 Compare Result and Bit Result(BR), and then saves its result in BR	○	○
	ANDDG>				
	ANDDG<				
	ANDDG>=				
	ANDDG<=				
	ANDDG<>				
32 Bits Data Group Compare (OR)	ORDG=		Performs OR operation of (S1), (S1+1), ..., (S1+N) & (S2), (S2+1), ..., (S2+N) 1 to 1 Compare Result and Bit Result(BR), and then saves its result in BR	○	○
	ORDG>				
	ORDG<				
	ORDG>=				
	ORDG<=				
	ORDG<>				

(4) Comparison instruction (continued)

Classification	Designations	Symbol	Description	Support	
				XGK	XGB
Three 16-Bit Data Compare (LOAD)	LOAD3=		Saves 1 in Bit Result(BR) if each value of (S1), (S2), (S3) meets given condition	○	○
	LOAD3>				
	LOAD3<				
	LOAD3>=				
	LOAD3<=				
	LOAD3<>				
Three 16-Bit Data Compare (AND)	AND3=		Performs AND operation of (S1), (S2), (S3) Compare Result by given condition and Bit Result (BR), and then saves its result in BR	○	○
	AND3>				
	AND3<				
	AND3>=				
	AND3<=				
	AND3<>				
Three 32-Bit Data Compare (OR)	OR3=		Performs OR operation of (S1), (S2), (S3) Compare Result by given condition and Bit Result (BR), and then saves its result in BR	○	○
	OR3>				
	OR3<				
	OR3>=				
	OR3<=				
	OR3<>				
Three 16-Bit Data Compare (LOAD)	LOADD3=		Saves 1 in Bit Result(BR) if each value of (S1+1,S1), (S2+ 1,S2), (S3+1,S3) meets given condition	○	○
	LOADD3>				
	LOADD3<				
	LOADD3>=				
	LOADD3<=				
	LOADD3<>				

(4) Comparison instruction (continued)

Classification	Designations	Symbol	Description	Support	
				XGK	XGB
Three 32-Bit Data Compare (AND)	ANDD3=		Performs AND operation of (S1+1,S1), (S2+1,S2), (S3+1,S3) Compare Result by given condition and Bit Result (BR), and then saves its result in BR	○	○
	ANDD3>				
	ANDD3<				
	ANDD3>=				
	ANDD3<=				
	ANDD<>				
Three 32-Bit Data Compare (OR)	ORD3=		Performs OR operation of (S1+1,S1), (S2+1,S2), (S3+1,S3) Compare Result by given condition and Bit Result (BR), and then saves its result in BR	○	○
	ORD3>				
	ORD3<				
	ORD3>=				
	ORD3<=				
	ORD3<>				

(5) Increase/Decrease instruction

Classification	Designations	Symbol	Description	Support	
				XGK	XGB
BIN Data Increase / Decrease (Signed)	INC		$(D)+1 \longrightarrow (D)$	2	4-94
	INCP				
	DINC		$(D+1,D)+1 \longrightarrow (D+1,D)$	2	
	DINCP				
	DEC		$(D)-1 \longrightarrow (D)$	2	4-96
	DECP				
	DDEC		$(D+1,D)-1 \longrightarrow (D+1,D)$	2	
	DDECP				
4/8 Bits Data Increase / Decrease (Signed)	INC4		$(D:x \text{ bit} \sim D:x \text{ bit}+4) + 1$	2	4-95
	INC4P		$\longrightarrow (D:x \text{ bit} \sim D:x \text{ bit}+4)$	3	
	INC8		$(D:x \text{ bit} \sim D:x \text{ bit}+8) + 1$	2	
	INC8P		$\longrightarrow (D:x \text{ bit} \sim D:x \text{ bit}+8)$	3	
	DEC4		$(D:x \text{ bit} \sim D:x \text{ bit}+4) - 1$	2	4-97
	DEC4P		$\longrightarrow (D:x \text{ bit} \sim D:x \text{ bit}+4)$	3	
	DEC8		$(D:x \text{ bit} \sim D:x \text{ bit}+8) - 1$	2	
	DEC8P		$\longrightarrow (D:x \text{ bit} \sim D:x \text{ bit}+8)$	3	
BIN Data Increase / Decrease (Unsigned)	INCUP		$(D)+1 \longrightarrow (D)$	2	4-98
	INCUCP				
	DINCUP		$(D+1,D)+1 \longrightarrow (D+1,D)$	2	
	DINCUCP				
	DECUP		$(D)-1 \longrightarrow (D)$	2	4-99
	DECUCP				
	DDECUP		$(D+1,D)-1 \longrightarrow (D+1,D)$	2	
	DDECUCP				

(6) Rotation instruction

Classification	Designations	Symbol	Description	Support	
				XGK	XGB
Rotate to Left	ROL			○	○
	ROLP				
	DROL				
	DROLP				
4/8 Bits Rotate to Left	ROL4			○	○
	ROL4P				
	ROL8				
	ROL8P				
Rotate to Right	ROR			○	○
	RORP				
	DROR				
	DRORP				
4/8 Bits Rotate to Right	ROR4			○	○
	ROR4P				
	ROR8				
	ROR8P				
Rotate to Left (including Carry)	RCL			○	○
	RCLP				
	DRCL				
	DRCLP				
4/8 Bits Rotate to Left (including Carry)	RCL4			○	○
	RCL4P				
	RCL8				
	RCL8P				
Rotate to Right (including Carry)	RCR			○	○
	RCRP				
	DRCR				
	DRCRP				
4/8 Bits Rotate to Right (including Carry)	RCR4			○	○
	RCR4P				
	RCR8				
	RCR8P				

(7) Move instruction

Classification	Designations	Symbol	Description	Support	
				XGK	XGB
Bits Move	BSFT			○	○
	BSFTP				
Move to Higher Bit	BSFL			○	○
	BSFLP				
	DBSFL				
	DBSFLP				
Move to Higher Bit within 4/8 Bits range	BSFL4			○	○
	BSFL4P				
	BSFL8				
	BSFL8P				
Move to Lower Bit	BSFR			○	○
	BSFRP				
	DBSFR				
	DBSFRP				
Move to Lower Bit within 4/8 Bits range	BSFR4			○	○
	BSFR4P				
	BSFR8				
	BSFR8P				
Word Move	WSFT			○	○
	WSFTP				
Word Data Move to Left/Right	WSFL			○	○
	WSFLP				
	WSFR				
	WSFRP				
Bit Move	SR		Moves N bits starting from Db bit along Input direction (I) and Move direction (D)	○	○

(8) Exchange instruction

Classification	Designations	Symbol	Description	Support	
				XGK	XGB
Data Exchange	XCHG		(D1) ↔ (D2)	○	○
	XCHGP				
	DXCHG		(D1+1, D1) ↔ (D2+1, D2)		
	DXCHGP				
Group Data Exchange	GXCHG			○	○
	GXCHGP				
Higher/Lower Byte Exchange	SWAP			○	○
	SWAPP				
Group Byte Exchange	GSWAP		Exchanges Higher/Lower Byte of Words N starting from D	○	○
	GSWAPP				

(9) BIN operation instruction

Classification	Designations	Symbol	Description	Support	
				XGK	XGB
Integer Addition (Signed)	ADD		$(S1)+(S2) \longrightarrow (D)$	○	○
	ADDP				
	DADD		$(S1+1,S1)+(S2+1,S2) \longrightarrow (D+1,D)$		
	DADDP				
Integer Subtraction (Signed)	SUB		$(S1)-(S2) \longrightarrow (D)$	○	○
	SUBP				
	DSUB		$(S1+1,S1)-(S2+1,S2) \longrightarrow (D+1,D)$		
	DSUBP				
Integer Multiplication (Signed)	MUL		$(S1) \times (S2) \longrightarrow (D+1,D)$	○	○
	MULP				
	DMUL		$(S1+1,S1) \times (S2+1,S2) \longrightarrow (D+3,D+2,D+1,D)$		
	DMULP				
Integer Division (Signed)	DIV		$(S1) \div (S2) \longrightarrow \begin{matrix} (D) \text{ Quotient} \\ (D+1) \text{ Remainder} \end{matrix}$	○	○
	DIVP				
	DDIV		$(S1+1,S1) \div (S2+1,S2) \longrightarrow \begin{matrix} (D+1,D) \text{ Quotient} \\ (D+3,D+2) \text{ Remainder} \end{matrix}$		
	DDIVP				
Integer Addition (Unsigned)	ADDU		$(S1)+(S2) \longrightarrow (D)$	○	○
	ADDUP				
	DADDU		$(S1+1,S1)+(S2+1,S2) \longrightarrow (D+1,D)$		
	DADDUP				
Integer Subtraction (Unsigned)	SUBU		$(S1)-(S2) \longrightarrow (D)$	○	○
	SUBUP				
	DSUBU		$(S1+1,S1)-(S2+1,S2) \longrightarrow (D+1,D)$		
	DSUBUP				
Integer Multiplication (Unsigned)	MULU		$(S1) \times (S2) \longrightarrow (D+1,D)$	○	○
	MULUP				
	DMULU		$(S1+1,S1) \times (S2+1,S2) \longrightarrow (D+3,D+2,D+1,D)$		
	DMULUP				

(9) BIN operation instruction (continued)

Classification	Designations	Symbol	Description	Support	
				XGK	XGB
Integer Division (Unsigned)	DIVU		$(S1) \div (S2) \longrightarrow$ (D) Quotient (D+1) Remainder	○	○
	DIVUP				
	DDIVU		$(S1+1, S1) \div (S2+1, S2)$ \longrightarrow (D+1, D) Quotient (D+3, D+2) Remainder		
	DDIVUP				
Real Number Addition	RADD		$(S1+1, S1) + (S2+1, S2)$ \longrightarrow (D+1, D)	○	○
	RADDP				
	LADD		$(S1+3, S1+2, S1+1, S1)$ $+ (S2+3, S2+2, S2+1, S2)$ \longrightarrow (D+3, D+2, D+1, D)		
	LADDP				
Real Number Subtraction	RSUB		$(S1+1, S1) - (S2+1, S2)$ \longrightarrow (D+1, D)	○	○
	RSUBP				
	LSUB		$(S1+3, S1+2, S1+1, S1)$ $- (S2+3, S2+2, S2+1, S2)$ \longrightarrow (D+3, D+2, D+1, D)		
	LSUBP				
Real Number Multiplication	RMUL		$(S1+1, S1) \times (S2+1, S2)$ \longrightarrow (D+1, D)	○	○
	RMULP				
	LMUL		$(S1+3, S1+2, S1+1, S1)$ $\times (S2+3, S2+2, S2+1, S2)$ \longrightarrow (D+3, D+2, D+1, D)		
	LMULP				
Real Number Division	RDIV		$(S1+1, S1) \div (S2+1, S2)$ \longrightarrow (D+1, D)	○	○
	RDIVP				
	LDIV		$(S1+3, S1+2, S1+1, S1)$ $\div (S2+3, S2+2, S2+1, S2)$ \longrightarrow (D+3, D+2, D+1, D)		
	LDIVP				
String Addition	\$ADD		Connects S1 String with S2 String to save in D	○	○
	\$ADDP				
Group Addition	GADD			○	○
	GADDP				
Group Subtraction	GSUB			○	○
	GSUBP				

(10) BCD operation instruction

Classification	Designations	Symbol	Description	Support	
				XGK	XGB
BCD Addition	ADDB	$\text{---} \boxed{\text{ADDB}} \boxed{S1} \boxed{S2} \boxed{D} \text{---}$	$(S1)+(S2) \longrightarrow (D)$	○	○
	ADDBP	$\text{---} \boxed{\text{ADDBP}} \boxed{S1} \boxed{S2} \boxed{D} \text{---}$			
	DADDB	$\text{---} \boxed{\text{DADDB}} \boxed{S1} \boxed{S2} \boxed{D} \text{---}$	$(S1+1,S1)+(S2+1,S2)$ $\longrightarrow (D+1,D)$		
	DADDBP	$\text{---} \boxed{\text{DADDBP}} \boxed{S1} \boxed{S2} \boxed{D} \text{---}$			
BCD Subtraction	SUBB	$\text{---} \boxed{\text{SUBB}} \boxed{S1} \boxed{S2} \boxed{D} \text{---}$	$(S1)-(S2) \longrightarrow (D)$	○	○
	SUBBP	$\text{---} \boxed{\text{SUBBP}} \boxed{S1} \boxed{S2} \boxed{D} \text{---}$			
	DSUBB	$\text{---} \boxed{\text{DSUBB}} \boxed{S1} \boxed{S2} \boxed{D} \text{---}$	$(S1+1,S1)-(S2+1,S2)$ $\longrightarrow (D+1,D)$		
	DSUBBP	$\text{---} \boxed{\text{DSUBBP}} \boxed{S1} \boxed{S2} \boxed{D} \text{---}$			
BCD Multiplication	MULB	$\text{---} \boxed{\text{MULB}} \boxed{S1} \boxed{S2} \boxed{D} \text{---}$	$(S1) \times (S2) \longrightarrow (D+1,D)$	○	○
	MULBP	$\text{---} \boxed{\text{MULBP}} \boxed{S1} \boxed{S2} \boxed{D} \text{---}$			
	DMULB	$\text{---} \boxed{\text{DMULB}} \boxed{S1} \boxed{S2} \boxed{D} \text{---}$	$(S1+1,S1) \times (S2+1,S2)$ $\longrightarrow (D+3,D+2,D+1,D)$		
	DMULBP	$\text{---} \boxed{\text{DMULBP}} \boxed{S1} \boxed{S2} \boxed{D} \text{---}$			
BCD Division	DIVB	$\text{---} \boxed{\text{DIVB}} \boxed{S1} \boxed{S2} \boxed{D} \text{---}$	$(S1) \div (S2) \longrightarrow \begin{matrix} (D) \text{ Quotient} \\ (D+1) \text{ Remainder} \end{matrix}$	○	○
	DIVBP	$\text{---} \boxed{\text{DIVBP}} \boxed{S1} \boxed{S2} \boxed{D} \text{---}$			
	DDIVB	$\text{---} \boxed{\text{DDIVB}} \boxed{S1} \boxed{S2} \boxed{D} \text{---}$	$(S1+1,S1) \div (S2+1,S2)$ $\longrightarrow \begin{matrix} (D+1,D) \text{ Quotient} \\ (D+3,D+2) \text{ Remainder} \end{matrix}$		
	DDIVBP	$\text{---} \boxed{\text{DDIVBP}} \boxed{S1} \boxed{S2} \boxed{D} \text{---}$			

(11) Logic operation instruction

Classification	Designations	Symbol	Description	Basic Steps	Page
Logic Multiplication	WAND		Word AND $(S1) \wedge (S2) \longrightarrow (D)$	○	○
	WANDP				
	DWAND		DWord AND $(S1+1, S1) \wedge (S2+1, S2) \longrightarrow (D+1, D)$		
	DWANDP				
Logic Addition	WOR		Word OR $(S1) \vee (S2) \longrightarrow (D)$	○	○
	WORP				
	DWOR		DWord OR $(S1+1, S1) \vee (S2+1, S2) \longrightarrow (D+1, D)$		
	DWORP				
Exclusive OR	WXOR		Word Exclusive OR $(S1) \nabla (S2) \longrightarrow (D)$	○	○
	WXORP				
	DWXOR		DWord Exclusive OR $(S1+1, S1) \nabla (S2+1, S2) \longrightarrow (D+1, D)$		
	DWXORP				
Exclusive NOR	WXNR		Word Exclusive NOR $(S1) \nabla (S2) \longrightarrow (D)$	○	○
	WXNRP				
	DWXNR		DWord Exclusive NOR $(S1+1, S1) \nabla (S2+1, S2) \longrightarrow (D+1, D)$		
	DWXNRP				
Group Logic Operation	GWAND			○	○
	GWANDP				
	GWOR				
	GWORP				
	GWXOR				
	GWXORP				
	GWXNR				
	GWXNRP				

(12) Data process instruction

Classification	Designations	Symbol	Description	Support	
				XGK	XGB
Bit Check	BSUM			○	○
	BSUMP				
	DBSUM				
	DBSUMP				
Bit Reset	BRST		Resets N Bits (starting from D) to 0	○	○
	BRSTP				
Encode	ENCO			○	○
	ENCOP				
Decode	DECO			○	○
	DECOP				
Data Disconnect & Connect	DIS			○	○
	DISP				
	UNI				
	UNIP				
Word/Byte Conversion	WTOB			○	○
	WTOBP				
	BTOW				
	BTOWP				
I/O Refresh	IORF		Right after masking I/O data (located on S1) with S2 and S3 data, perform process	○	○
	IORFP				
Data Search	SCH		Finds S1 value within S2 ~ N range and saves the first identical valued position in D and S1's identical valued total number in D+1	○	○
	SCHP				
	DSCH				
	DSCHP				
Max. Value Search	MAX		Saves the max value in D among N words starting from S	○	○
	MAXP				
	DMAX		Saves the max value in D among N double words starting from S		
	DMAXP				

(12) Data process instruction (continued)

Classification	Designations	Symbol	Description	Support	
				XGK	XGB
Min. Value Search	MIN		Saves the min value in D among N words starting from S	○	○
	MINP				
	DMIN		Saves the min value in D among N double words starting from S		
	DMINP				
Sum	SUM		Adds up N words starting from S to save in D	○	○
	SUMP				
	DSUM		Adds up N double words starting from S to save in D		
	DSUMP				
Average	AVE		Averages N words starting from S to save in D	○	○
	AVEP				
	DAVE		Averages N double words starting from S to save in D		
	DAVEP				
MUX	MUX			○	○
	MUXP				
	DMUX				
	DMUXP				
Data Detect	DETECT		Detects N data from S1, to save the first value larger than S2 in D, and the extra number in D+1	○	○
	DETECTP				
Ramp Signal Output	RAMP		Saves linear-changed value in D1 during n3 scanning of initial value n1 to final n2 and present scanning number in D1+1, and changes D2 value to ON after completed	○	○
Data Align	SORT		S : Head Address of Sort Data n1 : Number of Words to sort n1+1 : Sorting Method n2: Operation number per Scan D1 : ON if complete D2 : Auxiliary Area	○	○
	SORTP				

(13) Data table process instruction

Classification	Designations	Symbol	Description	Support	
				XGK	XGB
Data Write	FIWR	$\boxed{\text{FIWR}} \quad \boxed{\text{S}} \quad \boxed{\text{D}}$	Adds S to the last of Data Table D ~ D+N, and increases Data Table Length(N) saved in D by 1	○	○
	FIWRP	$\boxed{\text{FIWRP}} \quad \boxed{\text{S}} \quad \boxed{\text{D}}$			
First-input Data Read	FIFRD	$\boxed{\text{FIFRD}} \quad \boxed{\text{S}} \quad \boxed{\text{D}}$	Moves first data, S+1 of Data Table S ~ S+N to D (pull 1 place after origin deleted) and decreases Data Table Length(N) saved in D by 1 S	○	○
	FIFRDP	$\boxed{\text{FIFRDP}} \quad \boxed{\text{S}} \quad \boxed{\text{D}}$			
Last-Input Data Read	FILRD	$\boxed{\text{FILRD}} \quad \boxed{\text{S}} \quad \boxed{\text{D}}$	Moves last data, S+N of Data Table S ~ S+N to D (origin deleted) and decreases Data Table Length(N) saved in D by 1 S	○	○
	FILRDP	$\boxed{\text{FILRDP}} \quad \boxed{\text{S}} \quad \boxed{\text{D}}$			
Data Insert	FIINS	$\boxed{\text{FINS}} \quad \boxed{\text{S}} \quad \boxed{\text{D}} \quad \boxed{\text{n}}$	Adds S to 'N'th place of Data Table D ~ D+N (origin data pulled by 1), and increases Data Table Length(N) saved in D by 1	○	○
	FIINSP	$\boxed{\text{FINSP}} \quad \boxed{\text{S}} \quad \boxed{\text{D}} \quad \boxed{\text{n}}$			
Data Pull	FIDEL	$\boxed{\text{FDEL}} \quad \boxed{\text{S}} \quad \boxed{\text{D}} \quad \boxed{\text{n}}$	Deletes 'N'th data of Data Table S ~ S+N (pull 1 place) and decreases Data Table Length(N) saved in D by 1	○	○
	FIDELP	$\boxed{\text{FDELP}} \quad \boxed{\text{S}} \quad \boxed{\text{D}} \quad \boxed{\text{n}}$			

(14) Display instruction

Classification	Designations	Symbol	Description	Support	
				XGK	XGB
7 Segment Display	SEG	$\boxed{\text{SEG}} \quad \boxed{\text{S}} \quad \boxed{\text{D}} \quad \boxed{\text{Z}}$	Converts S Data to 7-Segment as adjusted in Z Format so to save in D	○	○
	SEGP	$\boxed{\text{SEGP}} \quad \boxed{\text{S}} \quad \boxed{\text{D}} \quad \boxed{\text{Z}}$			

Appendix 4 Instruction List

(15) String Process instruction

Classification	Designations	Symbol	Description	Support	
				XGK	XGB
Convert to Decimal ASCII Cord	BINDA	— <input type="text" value="BINDA"/> <input type="text" value="S"/> <input type="text" value="D"/> —	Converts S of 1-word BIN value to Decimal ASCII Cord to save in starting D	○	○
	BINDAP	— <input type="text" value="BINDAP"/> <input type="text" value="S"/> <input type="text" value="D"/> —			
	DBINDA	— <input type="text" value="DBINDA"/> <input type="text" value="S"/> <input type="text" value="D"/> —	Converts S of 2-word BIN value to Decimal ASCII Cord to save in starting D		
	DBINDAP	— <input type="text" value="DBINDAP"/> <input type="text" value="S"/> <input type="text" value="D"/> —			
Convert to Hexadecimal ASCII Cord	BINHA	— <input type="text" value="BINHA"/> <input type="text" value="S"/> <input type="text" value="D"/> —	Converts S of 1-word BIN value to Hexadecimal ASCII Cord to save in starting D	○	○
	BINHAP	— <input type="text" value="BINHAP"/> <input type="text" value="S"/> <input type="text" value="D"/> —			
	DBINHA	— <input type="text" value="DBINHA"/> <input type="text" value="S"/> <input type="text" value="D"/> —	Converts S of 2-word BIN value to Hexadecimal ASCII Cord to save in starting D		
	DBINHAP	— <input type="text" value="DBINHAP"/> <input type="text" value="S"/> <input type="text" value="D"/> —			
Convert BCD to Decimal ASCII Cord	BCDDA	— <input type="text" value="BCDDA"/> <input type="text" value="S"/> <input type="text" value="D"/> —	Converts S of 1-word BCD to ASCII Cord to save in starting D	○	○
	BCDDAP	— <input type="text" value="BCDDAP"/> <input type="text" value="S"/> <input type="text" value="D"/> —			
	DBCDDA	— <input type="text" value="DBCDDA"/> <input type="text" value="S"/> <input type="text" value="D"/> —	Converts S of 2-word BCD to ASCII Cord to save in starting D		
	DBCDDAP	— <input type="text" value="DBCDDAP"/> <input type="text" value="S"/> <input type="text" value="D"/> —			
Convert Decimal ASCII to BIN	DABIN	— <input type="text" value="DABIN"/> <input type="text" value="S"/> <input type="text" value="D"/> —	Converts S S+2,S+1,S's Decimal ASCII Cord to BIN to save in D	○	○
	DABINP	— <input type="text" value="DABINP"/> <input type="text" value="S"/> <input type="text" value="D"/> —			
	DDABIN	— <input type="text" value="DDABIN"/> <input type="text" value="S"/> <input type="text" value="D"/> —	Converts S+5~S's Decimal ASCII Cord to BIN value to save in D+1 & D		
	DDABINP	— <input type="text" value="DDABINP"/> <input type="text" value="S"/> <input type="text" value="D"/> —			
Convert Hexadecimal ASCII to BIN	HABIN	— <input type="text" value="HABIN"/> <input type="text" value="S"/> <input type="text" value="D"/> —	Converts S+1,S's Hexadecimal ASCII Cord to BIN value to save in D	○	○
	HABINP	— <input type="text" value="HABINP"/> <input type="text" value="S"/> <input type="text" value="D"/> —			
	DHABIN	— <input type="text" value="DHABIN"/> <input type="text" value="S"/> <input type="text" value="D"/> —	Converts S+3~S's Hexadecimal ASCII Cord to BIN to save in D		
	DHABINP	— <input type="text" value="DHABINP"/> <input type="text" value="S"/> <input type="text" value="D"/> —			
Convert Decimal ASCII to BCD	DABCD	— <input type="text" value="DABCD"/> <input type="text" value="S"/> <input type="text" value="D"/> —	Converts S+1,S's Decimal ASCII Cord to BCD to save in D	○	○
	DABCDP	— <input type="text" value="DABCDP"/> <input type="text" value="S"/> <input type="text" value="D"/> —			
	DDABCD	— <input type="text" value="DDABCD"/> <input type="text" value="S"/> <input type="text" value="D"/> —	Converts S+3~S's Decimal ASCII Cord to BCD to save in D		
	DDABCDP	— <input type="text" value="DDABCDP"/> <input type="text" value="S"/> <input type="text" value="D"/> —			
String Length Detect	LEN	— <input type="text" value="LEN"/> <input type="text" value="S"/> <input type="text" value="D"/> —	Saves String Length with S starting in D	○	○
	LENP	— <input type="text" value="LENP"/> <input type="text" value="S"/> <input type="text" value="D"/> —			

(15) String process instruction (continued)

Classification	Designations	Symbol	Description	Support	
				XGK	XGB
Convert BIN16/32 to String	STR	—STR S1 S2 D—	Adjusts S2 saved word data to S1 saved place number to convert to String and save in D	○	○
	STRP	—STRP S1 S2 D—			
	DSTR	—DSTR S1 S2 D—	Adjusts S2 saved double word data to S1 saved place number to convert to String and save in D		
	DSTRP	—DSTRP S1 S2 D—			
Convert String to BIN16/32	VAL	—VAL S D1 D2—	Adjusts S saved string to number to save in word D1 and saves the place number in D2	○	○
	VALP	—VALP S D1 D2—			
	DVAL	—DVAL S D1 D2—	Adjusts S saved string to number to save in double word D1 and saves the place number in D2		
	DVALP	—DVALP S D1 D2—			
Convert Real Number to String	RSTR	—RSTR S1 S2 D—	Adjusts Floating decimal point point Real Number Data (S1: number, S2: places) to String format to save in D	○	X
	RSTRP	—RSTRP S1 S2 D—			
	LSTR	—LSTR S1 S2 D—	Adjusts Floating decimal point point Double Real Number Data (S1:number, S2:places) to String format to save in D		
	LSTRP	—LSTRP S1 S2 D—			
Convert String to Real Number	STRR	—STRR S D—	Converts String S to Floating decimal point point Real Number Data to save in D	○	X
	STRRP	—STRRP S D—			
	STRL	—STRL S D—	Converts String S to Floating decimal point point Double Real Number Data to save in D		
	STRLP	—STRLP S D—			
ASCII Conversion	ASC	—ASC S D cw—	Converts BIN Data to ASCII in Nibble unit, based on cw's format from S to save in D	○	○
	ASCP	—ASCP S D cw—			
HEX Conversion	HEX	—HEX S D N—	Converts 2N ASCII saved in N words from S in byte unit to Nibble unit of Hexadecimal BIN so to save in D	○	○
	HEXP	—HEXP S D N—			
String Extract from Right	RIGHT	—RIGHT S D N—	Extracts n string from S string's final letter to save in starting D	○	○
	RIGHTP	—RIGHTP S D N—			
String Extract from Left	LEFT	—LEFT S D N—	Extracts n string from S string's first letter to save in starting D	○	○
	LEFTP	—LEFTP S D N—			
String Random Extract	MID	—MID S1 S2 D—	Extracts string which conforms to S2 condition among S1 string to save in starting D	○	○
	MIDP	—MIDP S1 S2 D—			

(15) String process instruction (continued)

Classification	Designations	Symbol	Description	Basic Steps	Page
String Random Replace	REPLACE	— REPLACE S1 D S2 —	Processes S1 String as applicable to S2 Condition to save in D String	○	○
	REPLACEP	— REPLACEP S1 D S2 —			
String Find	FIND	— FIND S1 S2 D N —	Finds identical String to S2 in S1 ~ N data to save the absolute position in D	○	○
	FINDP	— FINDP S1 S2 D N —			
Parse Real Number to BCD	RBCD	— RBCD S1 S2 D —	Adjusts Floating decimal point point Real Number Data S1 to S2 place to convert to BCD, and then to save in D	○	X
	RBCDP	— RBCDP S1 S2 D —			
	LBCD	— LBCD S1 S2 D —	Adjusts Floating decimal point point Double Real Number Data S1 to S2 place to convert to BCD, and then to save in D		
	LBCDP	— LBCDP S1 S2 D —			
Convert BCD Data to Real Number	BCDR	— BCDR S1 S2 D —	Adjusts BCD Data S1 to S2 place to convert to Floating decimal point point Real Number, and then to save in D	○	X
	BCDRP	— BCDRP S1 S2 D —			
	BCDL	— BCDR S1 S2 D —	Adjusts BCD Data S1 to S2 place to convert to Floating decimal point point Double Real Number, and then to save in D		
	BCDLP	— BCDLP S1 S2 D —			

(16) Special function instruction

Classification	Designations	Symbol	Description	Basic Steps	Page
SIN Operation	SIN		$SIN(S+1,S) \longrightarrow (D+1,D)$	○	○
	SINP				
COS Operation	COS		$COS(S+1,S) \longrightarrow (D+1,D)$	○	○
	COSP				
TAN Operation	TAN		$TAN(S+1,S) \longrightarrow (D+1,D)$	○	○
	TANP				
RAD Conversion	RAD		$(S+1,S) \longrightarrow (D+1,D)$ Converts angle to radian	○	○
	RADP				
Angle Conversion	DEG		$(S+1,S) \longrightarrow (D+1,D)$ Converts radian to angle	○	○
	DEGP				
Square Root Operation	SQRT		$\sqrt{(S+1,S)} \longrightarrow (D+1,D)$	○	○
	SQRTP				

Appendix 4 Instruction List

(17) Data control instruction

Classification	Designations	Symbol	Description	Basic Steps	Page
Limit Control	LIMIT	$\boxed{\text{LIMIT}} \quad \boxed{S1} \boxed{S2} \boxed{S3} \boxed{D}$	If $S1 < S2$, then $D = S2$ If $S2 < S1 < S3$, then $D = S1$ If $S3 < S1$, then $D = S3$	○	○
	LIMITP	$\boxed{\text{LIMITP}} \quad \boxed{S1} \boxed{S2} \boxed{S3} \boxed{D}$			
	DLIMIT	$\boxed{\text{DLIMIT}} \quad \boxed{S1} \boxed{S2} \boxed{S3} \boxed{D}$			
	DLIMITP	$\boxed{\text{DLIMITP}} \quad \boxed{S1} \boxed{S2} \boxed{S3} \boxed{D}$			
Dead-zone Control	DZONE	$\boxed{\text{DZONE}} \quad \boxed{S1} \boxed{S2} \boxed{S3} \boxed{D}$	If $S1 < -S2$, then $D = S1 + S2 - S2(S3/100)$ If $-S2 < S1 < S2$, then $D = (S3/100)S1$ If $S1 < S2$, then $D = S1 - S2 + S2(S3/100)$	○	○
	DZONEP	$\boxed{\text{DZONEP}} \quad \boxed{S1} \boxed{S2} \boxed{S3} \boxed{D}$			
	DDZONE	$\boxed{\text{DDZONE}} \quad \boxed{S1} \boxed{S2} \boxed{S3} \boxed{D}$			
	DDZONEP	$\boxed{\text{DDZONEP}} \quad \boxed{S1} \boxed{S2} \boxed{S3} \boxed{D}$			
Vertical-zone Control	VZONE	$\boxed{\text{VZONE}} \quad \boxed{S1} \boxed{S2} \boxed{S3} \boxed{D}$	If $S1 < -S2(S3/100)$, then $D = S1 - S2 + S2(S3/100)$ If $-S2(S3/100) < S1 < S2(S3/100)$, then $D = (100/S3)S1$ If $S1 < S2(S3/100)$, then $D = S1 + S2 - S2(S3/100)$	○	○
	VZONEP	$\boxed{\text{VZONEP}} \quad \boxed{S1} \boxed{S2} \boxed{S3} \boxed{D}$			
	DVZONE	$\boxed{\text{DVZONE}} \quad \boxed{S1} \boxed{S2} \boxed{S3} \boxed{D}$			
	DVZONEP	$\boxed{\text{DVZONEP}} \quad \boxed{S1} \boxed{S2} \boxed{S3} \boxed{D}$			
Built-in PID Control Instruction	PIDRUN	$\boxed{\text{PIDRUN}} \quad \boxed{N}$	Operates PID Loop N	○	○
	PIDPAUSE	$\boxed{\text{PIDPAUSE}} \quad \boxed{N}$	Stops PID Loop N momentarily	○	X
	PIDPRMT	$\boxed{\text{PIDPRMT}} \quad \boxed{S} \quad \boxed{N}$	Changes PID Loop N's Parameter. (SV(word) / Ts(word) / Kp(real) / Ti(real) / Td(real))	○	X
	PIDAT	$\boxed{\text{PIDRUN}} \quad \boxed{N}$	Start of PID loop Auto-tuning	X	○
	PIDCAS	$\boxed{\text{PIDPRMT}} \quad \boxed{S} \quad \boxed{N}$	Start of PID loop cascade operation	X	○
	PIDHBD	$\boxed{\text{PIDPRMT}} \quad \boxed{S} \quad \boxed{N}$	Start of PID loop combination operation	X	○

(18) Time related instruction



Classification	Designations	Symbol	Description	Support	
				XGK	XGB
Date/Time Data Read	DATERD		Reads PLC Time to save in D ~ D+6 (Yr/Mn/Dt/Hr/Mn/Sd/Day)	○	X
	DATERDP				
Date/Time Data Write	DATEWR		Input S ~ S+6's Time Data in PLC (Yr/Mn/Dt/Hr/Mn/Sd/Day)	○	X
	DATEWRP				
Time Data Increase	ADDCLK		Adds S1 ~ S1+2 & S2 ~ S2+2 Time Data to save in D ~ D+2 in Time Data format (Hr/Mn/Sd)	○	X
	ADDCLKP				
Time Data Decrease	SUBCLK		Extracts S2 ~ S2+2's Time Data from S1 ~ S1+2 to save in D ~ D+2 in Time Data format (Hr/Mn/Sd)	○	X
	SUBCLKP				
Time Data Format Conversion	SECOND		Converts Time Data S ~ S+2 to seconds to save in double word D	○	X
	SECONDP				
	HOUR		Converts the seconds saved in double word S to Hr/Mn/Sd to save in D ~ D+2	○	X
	HOURP				

(19) Divergence instruction

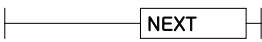

Classification	Designations	Symbol	Description	Support	
				XGK	XGB
Divergence Instruction	JMP		Jumps to LABEL location	○	○
	LABEL		Jumps and designates the location to move to		
Subroutine Call Functional	CALL		Calls Function applicable to LABEL	○	○
	CALLP				
	SBRT		Designates Function to be called by CALL		
	RET		RETURN		

Appendix 4 Instruction List





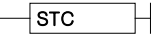
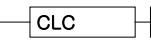

(20) Loop instruction

Classification	Designations	Symbol	Description	Support	
				XGK	XGB
Loop Instruction	FOR		Operates FOR~NEXT section n times	○	○
	NEXT				
	BREAK		Escapes from FOR~NEXT section	○	○

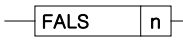

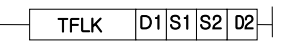
(21) Flag instruction

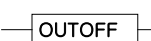
Classification	Designations	Symbol	Description	Support	
				XGK	XGB
Carry Flag Set, Reset	STC		Carry Flag (F0112) SET	○	○
	CLC		Carry Flag (F0112) RESET		
Error Flag Clear	CLE		Error Latch Flag (F0115) RESET	○	○

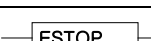
(22) System instruction

Classification	Designations	Symbol	Description	Support	
				XGK	XGB
Error Display	FALS		Self Diagnosis (Error Display)	○	○
Scan Cluck	DUTY		On during n1 Scan, Off during n2 Scan	○	○
Time Cluck	TFLK		On during S1 set time, Off during S2 set time	○	○
WDT Initialize	WDT		Watch Dog Timer Clear	○	○
	WDTP				
Output Control	OUTOFF		All Output Off	○	○
Operation Stop	STOP		Finishes applicable scan to end PLC Operation	○	○
Emergent Operation Stop	ESTOP		Ends PLC operation right after Instruction executed	○	○

(23) Interrupt related instruction

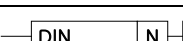
Classification	Designations	Symbol	Description	Support	
				XGK	XGB
All Channels Interrupt Setting	EI		All Channels Interrupt allowed	○	○
	DI		All Channel Interrupt prohibited		
Individual Channel Interrupt Setting	EIN		Individual Channel Interrupt allowed	○	○
	DIN		Individual Channel Interrupt prohibited		

(24) Sign reversion instruction

Classification	Designations	Symbol	Description	Support	
				XGK	XGB
2's complement	NEG		Saves D value again in D with 2's complement taken	○	○
	NEGP				
	DNEG		Saves (D+1,D) value again in (D+1,D) with 2's complement taken		
	DNEGP				
Real Number Data Sign Reverse	RNEG		Reverses D Real Number Sign then to save again	○	○
	RNEGP				
	LNEGR		Reverses D Double Real Number Sign then to save again		
	LNEGP				
Absolute Value Operation	ABS		Converts D highest Bit to 0	○	○
	ABSP				
	DABS		Converts (D+1,D) highest Bit to 0		
	DABSP				

(25) File related instruction

Classification	Designations	Symbol	Description	Support	
				XGK	XGB
Block Conversion	RSET		Changes Block Number of file register to S Number	○	X
	RSETP				
Flash Word Data Transfer	EMOV		Transfers S2 word data in S1 Block to D	○	X
	EMOVP				
Flash Double Word Data Transfer	EDMOV		Transfers S2+1, S2 double word data in S1 Block to D+1, D	○	X
	EDMOVP				
Block Read	EBREAD		Reads Flash Memory Block	○	X
Block Write	EBWRITE		Writes Flash Memory Block	○	X
Block Compare	EBCMP		Compares R Area's Bank with Flash Area's Block	○	X

Appendix 4.4 Special/Communication Instruction

(1) Communication module related instruction

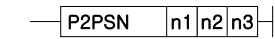
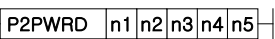
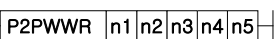
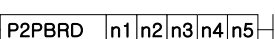
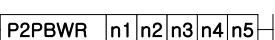
Classification	Designations	Symbol	Description	Support	
				XGK	XGB
Station No. Set	P2PSN		Sets opposite station No. for P2P Communication. n1:P2P No., n2:Block, n3:Station No.	○	X
Read Area Set (WORD)	P2PWRD		Sets word data Read Area n1:P2P No., n2:Block, n3:Variable sequence, n4:Variable Size, n5:Device	○	X
Write Area Set (WORD)	P2PWWR		Sets word data Write Area n1:P2P No., n2:Block, n3:Variable sequence, n4:Variable Size, n5:Device	○	X
Read Area Set (BIT)	P2PBRD		Sets bit data Read Area n1:P2P No., n2:Block, n3:Variable sequence, n4: Variable Size, n5:Device	○	X
Write Area Set (BIT)	P2PBWR		Sets bit data Write Area n1:P2P No., n2:Block, n3:Variable sequence, n4:Variable Size, n5:Device	○	X

(2) Special module common instruction

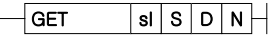
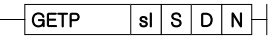
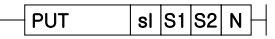
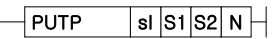
Classification	Designations	Symbol	Description	Support	
				XGK	XGB
Special Module Read/Write	GET		Reads data of special module memory is installed on	○	○
	GETP				
	PUT		Writes data on special module memory is installed on	○	○
	PUTP				

(3) Exclusive positioning instruction

Classification	Designations	Symbol	Description	Support									
				XGK	XGB								
Return to Origin Point	ORG	— <table border="1" style="display: inline-table; vertical-align: middle;"><tr><td>ORG</td><td>sl</td><td>ax</td></tr></table> —	ORG	sl	ax	Instructions Positioning Module's ax axis installed on sl slot to return to Origin Point	○	○					
ORG	sl	ax											
Floating Origin Point	FLT	— <table border="1" style="display: inline-table; vertical-align: middle;"><tr><td>FLT</td><td>sl</td><td>ax</td></tr></table> —	FLT	sl	ax	Instructions Positioning Module's ax axis installed on sl slot to set Floating Origin Point	○	○					
FLT	sl	ax											
Direct Start	DST	— <table border="1" style="display: inline-table; vertical-align: middle;"><tr><td>DST</td><td>sl</td><td>ax</td><td>n1</td><td>n2</td><td>n3</td><td>n4</td><td>n5</td></tr></table> —	DST	sl	ax	n1	n2	n3	n4	n5	Instructions Positioning Module's ax axis installed on sl slot to start directly with Target Position(n1), Target Speed(n2), Dwell Time(n3), M Code(n4) & Control Word(n5)	○	○
DST	sl	ax	n1	n2	n3	n4	n5						
Indirect Start	IST	— <table border="1" style="display: inline-table; vertical-align: middle;"><tr><td>IST</td><td>sl</td><td>ax</td><td>n</td></tr></table> —	IST	sl	ax	n	Instructions Positioning Module's ax axis installed on sl slot to start n step indirectly	○	○				
IST	sl	ax	n										
Linear Interpolation	LIN	— <table border="1" style="display: inline-table; vertical-align: middle;"><tr><td>LIN</td><td>sl</td><td>ax</td><td>n1</td><td>n2</td></tr></table> —	LIN	sl	ax	n1	n2	Instructions Positioning Module's ax axis installed on sl slot to let n2 axes operate n1 step by Linear Interpolation	○	○			
LIN	sl	ax	n1	n2									
Circular Interpolation	CIN	— <table border="1" style="display: inline-table; vertical-align: middle;"><tr><td>CIN</td><td>sl</td><td>ax</td><td>n1</td><td>n2</td></tr></table> —	CIN	sl	ax	n1	n2	Instructions Positioning Module's ax axis installed on sl slot to let n2 axes operate n1 step by Circular Interpolation	○	X			
CIN	sl	ax	n1	n2									
Simultaneous Start	SST	— <table border="1" style="display: inline-table; vertical-align: middle;"><tr><td>SST</td><td>sl</td><td>ax</td><td>n1</td><td>n2</td><td>n3</td><td>n4</td></tr></table> —	SST	sl	ax	n1	n2	n3	n4	Instructions Positioning Module's ax axis installed on sl slot to let n4 axes operate n1(X), n2(Y), n3(Z) steps by Simultaneous Start	○	○	
SST	sl	ax	n1	n2	n3	n4							
Speed/Position Control Switch	VTP	— <table border="1" style="display: inline-table; vertical-align: middle;"><tr><td>VTP</td><td>sl</td><td>ax</td></tr></table> —	VTP	sl	ax	Instructions Positioning Module's ax axis installed on sl slot to switch Speed to Position Control	○	○					
VTP	sl	ax											
Position/Speed Control Switch	PTV	— <table border="1" style="display: inline-table; vertical-align: middle;"><tr><td>PTV</td><td>sl</td><td>ax</td></tr></table> —	PTV	sl	ax	Instructions Positioning Module's ax axis installed on sl slot to switch Position to Speed Control	○	○					
PTV	sl	ax											
Decelerated Stop	STP	— <table border="1" style="display: inline-table; vertical-align: middle;"><tr><td>STP</td><td>sl</td><td>ax</td></tr></table> —	STP	sl	ax	Instructions Positioning Module's ax axis installed on sl slot to stop as decelerated.	○	○					
STP	sl	ax											
Skip	SKP	— <table border="1" style="display: inline-table; vertical-align: middle;"><tr><td>SKP</td><td>sl</td><td>ax</td></tr></table> —	SKP	sl	ax	Instructions Positioning Module's ax axis installed on sl slot to skip	○	X					
SKP	sl	ax											
Position Synchronization	SSP	— <table border="1" style="display: inline-table; vertical-align: middle;"><tr><td>SSP</td><td>sl</td><td>ax</td><td>n1</td><td>n2</td><td>n3</td></tr></table> —	SSP	sl	ax	n1	n2	n3	Instructions Positioning Module's ax axis installed on sl slot to do Position Sync with main axis of n3, n1 sync-positioned and n2 step operated	○	○		
SSP	sl	ax	n1	n2	n3								
Speed Synchronization	SSS	— <table border="1" style="display: inline-table; vertical-align: middle;"><tr><td>SSS</td><td>sl</td><td>ax</td><td>n1</td><td>n2</td><td>n3</td></tr></table> —	SSS	sl	ax	n1	n2	n3	Instructions Positioning Module's ax axis installed on sl slot to do Speed Sync with main axis of n3, n1 master and n2 slave	○	○		
SSS	sl	ax	n1	n2	n3								
Position Override	POR	— <table border="1" style="display: inline-table; vertical-align: middle;"><tr><td>POR</td><td>sl</td><td>ax</td><td>n</td></tr></table> —	POR	sl	ax	n	Instructions Positioning Module's ax axis installed on sl slot to override Position to change the target position to n	○	○				
POR	sl	ax	n										

(4) Exclusive position control instruction (continued)

Classification	Designations	Symbol	Description	Support	
				XGK	XGB
Speed Override	SOR		Instructions Positioning Module's ax axis installed on sl slot to override Speed to change the target speed to n	○	○
Position specified Speed Override	PSO		Instructions Positioning Module's ax axis installed on sl slot to override position specified speed to change the target speed to n2 from n1 position	○	○
Continuous Operation	NMV		Instructions Positioning Module's ax axis installed on sl slot to operate continuously to n step	○	X
Inching	INCH		Instructions Positioning Module's ax axis installed on sl slot to inch to n position	○	○
Return to Position Previous to Manual Operation	RTP		Instructions Positioning Module's ax axis installed on sl slot to return to position previous to manual operation	○	X
Operation Step Change	SNS		Instructions Positioning Module's ax axis installed on sl slot to change operation step to n	○	○
Repeated Operation Step Change	SRS		Instructions Positioning Module's ax axis installed on sl slot to change repeated operation step to n	○	X
M Code Off	MOF		Instructions Positioning Module's ax axis installed on sl slot to make M code off	○	○
Present Position Change	PRS		Instructions Positioning Module's ax axis to change present position to n	○	○
Zone Allowed	ZOE		Allows zone output of Positioning Module installed on sl slot	○	X
Zone Prohibited	ZOD		Prohibits zone output of Positioning Module installed on sl slot	○	X
Encoder Value change	EPRS		Changes Encoder Value of Positioning Module installed on sl slot to n	○	X
Teaching	TEA		Changes n1 step's target position or speed of Positioning Module's ax axis installed on sl slot	○	X
Teaching Array	TEAA		Changes multiple target positions or speed of Positioning Module's ax axis installed on sl slot	○	X
Emergent Stop	EMG		Instructions Positioning Module installed on sl slot to perform Emergent Stop	○	○

(5) Exclusive position control instruction (continued)

Classification	Designations	Symbol	Description	Support	
				XGK	XGB
Error Reset	CLR	— CLR sl ax n	Resets Error originated from Positioning Module's ax axis installed on sl slot	○	○
Error History Reset	ECLR	— ECLR sl ax	Deletes Error History originated from Positioning Module's ax axis installed on sl slot	○	X
Point Operation	PST	— PST sl ax n	Performs Point Operation of Positioning Module's ax axis installed on sl slot	○	X
Basic Parameter Teaching	TBP	— TBP sl ax n1 n2	Changes n2 to n1 among basic parameters of Positioning Module's ax axis installed on sl slot	○	X
Extended Parameter Teaching	TEP	— TEP sl ax n1 n2	Changes n2 to n1 among extended parameters of Positioning Module's ax axis installed on sl slot	○	X
Return to Origin Point Parameter Teaching	THP	— THP sl ax n1 n2	Changes n2 to n1 among returned parameters to origin point of Positioning Module's ax axis installed on sl slot	○	X
Manual Operation Parameter Teaching	TMP	— TMP sl ax n1 n2	Changes n2 to n1 among manual operation parameters of Positioning Module's ax axis installed on sl slot	○	X
Input Signal Parameter Teaching	TSP	— TSP sl ax n	Changes input signal parameter of Positioning Module's ax axis installed on sl slot to the value set in n1	○	X
Common Parameter Teaching	TCP	— TCP sl ax n1 n2	Changes n2 to n1 among common parameters of Positioning Module installed on sl slot	○	X
Parameter Save	WRT	— WRT sl ax n	Instructions Positioning Module's ax axis installed on sl slot to save present parameter of n axis in flash ROM.	○	○
Present State Read	SRD	— SRD sl ax D	Reads and saves present state of Positioning Module's ax axis installed on sl slot in D area of CPU	○	X
Point Operation Step Write	PWR	— PWR sl ax S n1	Writes value of S area of CPU on point operation step area of Positioning Module's ax axis installed on sl slot in	○	X
Plural Teaching Data Write	TWR	— TWR sl ax S n1	Writes n value of S area of CPU on plural teaching dada area of Positioning Module's ax axis installed on sl slot in	○	X

Warranty

1. Warranty Period

The product you purchased is guaranteed for 36 months from the date of manufacture.

2. Scope of Warranty

- (1) The initial diagnosis of faults is basically conducted by your company. However, upon your request, our company or our service network can undertake this task for a fee. If the cause of the fault lies with our company, this service will be provided free of charge.
- (2) This warranty only applies if the product is used under normal conditions according to the specifications and precautions described in the handling instructions, user manuals, catalogs, and caution labels.
- (3) Even within the free warranty period, the following cases will be subject to paid repairs:
 - 1) Replacement of consumable and life-limited parts (e.g., relays, fuses, electrolytic capacitors, fans, LCDs, batteries, etc.)
 - 2) Failures or damages caused by improper storage, handling, negligence, or accidents by the customer
 - 3) Failures resulting from the customer's hardware or software design
 - 4) Failures due to modifications without our consent
(Repairs will be refused, even for a fee, if recognized as modified or repaired outside our company)
 - 5) Failures that could have been avoided if the customer's equipment, in which our product is incorporated, had safety devices required by legal regulations or common industry standards
 - 6) Failures that could have been prevented if maintenance and replacement of consumable parts were performed normally according to the handling instructions or user manuals
 - 7) Failures and damages to the product caused by using connected equipment or inappropriate consumables
 - 8) Failures caused by external factors such as fire, abnormal voltage, force majeure, and natural disasters such as earthquakes, lightning, salt damage, wind, and flood damage
 - 9) Failures due to reasons that could not be predicted with the scientific and technical standards at the time of our shipment
 - 10) Other failures, damages, or defects recognized as the responsibility of your company

Environmental Policy

LS ELECTRIC Co., Ltd supports and observes the environmental policy as below.

Environmental Management

LS ELECTRIC considers the environmental preservation as the preferential management subject and every staff of LS ELECTRIC use the reasonable endeavors for the pleasurable environmental preservation of the earth.

About disposal of the Product.

LS ELECTRIC' PLC unit is designed to protect the environment. For the disposal, separate aluminum, iron and synthetic resin (cover) from the product as they are reusable.



www.ls-electric.com

LS ELECTRIC Co., Ltd.

■ Headquarter

LS-ro 127(Hogye-dong) Dongan-gu, Anyang-si, Gyeonggi-Do, 14119, Korea

■ Seoul Office

LS Yongsan Tower, 92, Hangang-daero, Yongsan-gu, Seoul, 04386, Korea

Tel: 82-2-2034-4033, 4888, 4703 Fax: 82-2-2034-4588

E-mail: automation@ls-electric.com

■ Overseas Subsidiaries

• LS ELECTRIC Japan Co., Ltd. (Tokyo, Japan)

Tel: 81-3-6268-8241 E-Mail: japan@ls-electric.com

• LS ELECTRIC (Dalian) Co., Ltd. (Dalian, China)

Tel: 86-411-8730-6495 E-Mail: china.dalian@lselectric.com.cn

• LS ELECTRIC (Wuxi) Co., Ltd. (Wuxi, China)

Tel: 86-510-6851-6666 E-Mail: china.wuxi@lselectric.com.cn

• LS ELECTRIC Middle East FZE (Dubai, U.A.E.)

Tel: 971-4-886-5360 E-Mail: middleeast@ls-electric.com

• LS ELECTRIC Europe B.V. (Hoofddorp, Netherlands)

Tel: 31-20-654-1424 E-Mail: europartner@ls-electric.com

• LS ELECTRIC America Inc. (Chicago, USA)

Tel: 1-800-891-2941 E-Mail: sales.us@lselectricamerica.com

• LS ELECTRIC Turkey Co., Ltd.

Tel: 90-212-806-1225 E-Mail: turkey@ls-electric.com

■ Overseas Branches

• LS ELECTRIC Tokyo Office (Japan)

Tel: 81-3-6268-8241 E-Mail: tokyo@ls-electric.com

• LS ELECTRIC Beijing Office (China)

Tel: 86-10-5095-1631 E-Mail: china.auto@lselectric.com.cn

• LS ELECTRIC Shanghai Office (China)

Tel: 86-21-5237-9977 E-Mail: china.auto@lselectric.com.cn

• LS ELECTRIC Guangzhou Office (China)

Tel: 86-20-3818-2883 E-Mail: china.auto@lselectric.com.cn

• LS ELECTRIC Chengdu Office (China)

Tel: 86-28-8670-3201 E-Mail: china.auto@lselectric.com.cn

• LS ELECTRIC Qingdao Office (China)

Tel: 86-532-8501-2065 E-Mail: china.auto@lselectric.com.cn

• LS ELECTRIC Nanjing Office (China)

Tel: 86-25-8467-0005 E-Mail: china.auto@lselectric.com.cn

• LS ELECTRIC Bangkok Office (Thailand)

Tel: 66-90-950-9683 E-Mail: thailand@ls-electric.com

• LS ELECTRIC Jakarta Office (Indonesia)

Tel: 62-21-2933-7614 E-Mail: indonesia@ls-electric.com

• LS ELECTRIC Moscow Office (Russia)

Tel: 7-499-682-6130 E-Mail: info@lselectric-ru.com

• LS ELECTRIC America Western Office (Irvine, USA)

Tel: 1-949-333-3140 E-Mail: america@ls-electric.com

Disclaimer of Liability

LS ELECTRIC has reviewed the information in this publication to ensure consistency with the hardware and software described. However, LS ELECTRIC cannot guarantee full consistency, nor be responsible for any damages or compensation, since variance cannot be precluded entirely. Please check again the version of this publication before you use the product.

© LS ELECTRIC Co., Ltd 2015 All Right Reserved.

2024.06