

The right choice for the ultimate yield!

LS ELECTRIC strives to maximize your profits in gratitude for choosing us as your partner.

Programmable Logic Controller

XGB Main unit(XEM-H2/HP Type)

XGB Series

User Manual

XEM-DR14H2
XEM-DN16H2
XEM-DP16H2
XEM-DN32H2
XEM-DN32HP
XEM-DP32H2
XEM-DP32HP



Safety Instructions

- Read this manual carefully before installing, wiring, operating, servicing or inspecting this equipment.
- Keep this manual within easy reach for quick reference.

LSELECTRIC

Before using the product ...

For your safety and effective operation, please read the safety instructions thoroughly before using the product.



- ▶ Safety Instructions should always be observed in order to prevent accident or risk with the safe and proper use the product.
- ▶ Instructions are separated into “Warning” and “Caution”, and the meaning of the terms is as follows;

 **Warning**

Indicates a potentially hazardous situation which, if not avoided, could result in death or serious injury

 **Caution**

Indicates a potentially hazardous situation which, if not avoided, may result in minor or moderate injury. It may also be used to alert against unsafe practices

- ▶ The marks displayed on the product and in the user's manual have the following meanings.
 -  Be careful! Danger may be expected.
 -  Be careful! Electric shock may occur.
- ▶ The user's manual even after read shall be kept available and accessible to any user of the product.

Safety Instructions when designing

Warning

- ▶ **Please, install protection circuit on the exterior of PLC to protect the whole control system from any error in external power or PLC module.** Any abnormal output or operation may cause serious problem in safety of the whole system.
 - Install applicable protection unit on the exterior of PLC to protect the system from physical damage such as emergent stop switch, protection circuit, the upper/lowest limit switch, forward/reverse operation interlock circuit, etc.
 - If any system error (watch-dog timer error, module installation error, etc.) is detected during CPU operation in PLC, the whole output is designed to be turned off and stopped for system safety. However, in case CPU error if caused on output device itself such as relay or TR can not be detected, the output may be kept on, which may cause serious problems. Thus, you are recommended to install an addition circuit to monitor the output status.

- ▶ **Never connect the overload than rated to the output module nor allow the output circuit to have a short circuit,** which may cause a fire.

- ▶ **Never let the external power of the output circuit be designed to be On earlier than PLC power,** which may cause abnormal output or operation.

- ▶ **In case of data exchange between computer or other external equipment and PLC through communication or any operation of PLC (e.g. operation mode change), please install interlock in the sequence program to protect the system from any error.** If not, it may cause abnormal output or operation.

Safety Instructions when designing

Caution

- ▶ **I/O signal or communication line shall be wired at least 100mm away from a high-voltage cable or power line.** If not, it may cause abnormal output or operation.

Safety Instructions when designing

Caution

- ▶ **Use PLC only in the environment specified in PLC manual or general standard of data sheet.** If not, electric shock, fire, abnormal operation of the product or flames may be caused.
- ▶ **Before installing the module, be sure PLC power is off.** If not, electric shock or damage on the product may be caused.
- ▶ **Be sure that each module of PLC is correctly secured.** If the product is installed loosely or incorrectly, abnormal operation, error or dropping may be caused.
- ▶ **Be sure that I/O or extension connector is correctly secured.** If not, electric shock, fire or abnormal operation may be caused.
- ▶ **If lots of vibration is expected in the installation environment, don't let PLC directly vibrated.** Electric shock, fire or abnormal operation may be caused.
- ▶ **Don't let any metallic foreign materials inside the product,** which may cause electric shock, fire or abnormal operation..

Safety Instructions when wiring

Warning

- ▶ **Prior to wiring, be sure that power of PLC and external power is turned off.** If not, electric shock or damage on the product may be caused.
- ▶ **Before PLC system is powered on, be sure that all the covers of the terminal are securely closed.** If not, electric shock may be caused

Caution

- ▶ **Let the wiring installed correctly after checking the voltage rated of each product and the arrangement of terminals.** If not, fire, electric shock or abnormal operation may be caused.
- ▶ **Secure the screws of terminals tightly with specified torque when wiring.** If the screws of terminals get loose, short circuit, fire or abnormal operation may be caused.
- *
 - ▶ **Surely use the ground wire of Class 3 for FG terminals, which is exclusively used for PLC.** If the terminals not grounded correctly, abnormal operation may be caused.
 - ▶ **Don't let any foreign materials such as wiring waste inside the module while wiring,** which may cause fire, damage on the product or abnormal operation.

Safety Instructions for test-operation or repair

Warning

- ▶ **Don't touch the terminal when powered.** Electric shock or abnormal operation may occur.
- ▶ **Prior to cleaning or tightening the terminal screws, let all the external power off including PLC power.** If not, electric shock or abnormal operation may occur.
- ▶ **Don't let the battery recharged, disassembled, heated, short or soldered.** Heat, explosion or ignition may cause injuries or fire.

Caution

- ▶ **Don't remove PCB from the module case nor remodel the module.** Fire, electric shock or abnormal operation may occur.
- ▶ **Prior to installing or disassembling the module, let all the external power off including PLC power.** If not, electric shock or abnormal operation may occur.
- ▶ **Keep any wireless installations or cell phone at least 30cm away from PLC.** If not, abnormal operation may be caused.

Safety Instructions for waste disposal

Caution

- ▶ **Product or battery waste shall be processed as industrial waste.** The waste may discharge toxic materials or explode itself.

Revision History

Version	Date	Remark	Part	Page
V 1.0	2018.07	1. First Edition	-	-
V1.1	2020.02	1. Added XBM-DP32H2/HP Main Unit 2. Improved I/O Wiring Diagram 3. Added Counter Clear Function 4. Added PID Derivative term	2, 3 2 2	3-29 4-21 5-19
V 1.2	2020.06	LSIS to change its corporate name to LS ELECTRIC		Entire
V1.3	2021.05	Variable data read/write memory address modification (3-axis operation data)	3	11-24
V1.4	2021.09	1. Modification of terminating resistor switch description 2. Modify partner port range	1 4	1-Ch3 4-Ch1
V1.5	2021.12	1. Corrected the error in the error code description section.	4	4-Ch2
V1.6	2022.06	1. Instructions for System Configuration changed	1	2-9
V1.7	2022.09	Change domain (lselectric.co.kr -> ls-electric.com)		Entire
V1.8	2022.10	Minimum distance specification between nodes added	4	1-3
V1.9	2023.05	1. Instructions for System Configuration changed	1	2-9
V2.0	2023.06	1. Module added (1)XBE-AC08A 2. Ferrule specification contents added	2	3-11 3-3
V2.1	2023.09	1. Web server link changed	4	1-78
V2.2	2023.12	1. Main unit added (1) XEM-DN16H2 (2) XEM-DP16H2 (3) XEM-DR14H2 2. Failsafe circuit schematic change 3. Smart link board module added	Entire 1 2	Entire 4-3 3-34
V2.3	2024.06	1. Warranty period, scope changed	6	

About User's Manual

Congratulations on purchasing PLC of LS ELECTRIC Co.,Ltd.

Before use, make sure to carefully read and understand the User's Manual about the functions, performances, installation and programming of the product you purchased in order for correct use and importantly, let the end user and maintenance administrator to be provided with the User's Manual.

The Use's Manual describes the product. If necessary, you may refer to the following description and order accordingly. In addition, you may connect our website(<http://www.ls-electric.com/>) and download the information as a PDF file.

Relevant User's Manual

Title	Description	No. of User Manual
XG5000 User's Manual	It describes how to use XG5000 software especially about online functions such as programming, printing, monitoring and debugging by using XGT series products.	10310000512
XGI/XGR/XEC Series Instruction & Programming	It describes how to use the instructions for programming using XGB(IEC language) series.	10310000833
XEC Ultimate Performance XGB Unit	It describes how to use XGB main unit, system configuration, mechanism ,program function ,input/output function, Built-in High-speed Counter, Datalog, PID Control, Built-in Communication function, Built-in Position, Built-in Analog input/output..	10310001407
XGB Analog User's Manual	It describes how to use the specification of analog input/analog output/temperature input module, system configuration and built-in PID control for XGB main unit.	10310000920
XGB Position User's Manual	It describes how to use built-in Position function for XGB main unit.	10310000927
XGB Cnet I/F User's Manual	It describes how to use built-in communication function for XGB main unit and external Cnet I/F module.	10310000816
XGB Fast Ethernet I/F User's Manual	It describes how to use XGB FENet I/F module.	10310000873
CANopen Communication Module	It describes how to use XGB CANopen Communication Module	10310001245
EtherNet/IP Communication Module	It describes how to use XGB EtherNet/IP Communication module	10310001159
XGB Profibus-DP I/F (Master) User's Manual	It describes how to use XGB Profibus-DP I/F (Master) Communication Module	10310001310
XGB Profibus-DP I/F (Slave) User's Manual	It describes how to use XGB Profibus-DP I/F (Slave) Communication Module	10310001410
XGB DeviceNet I/F (Slave) User's Manual	It describes how to use XGB DeviceNet I/F (Slave) Communication Module	10310001414
XGB High speed counter module User's Manual	It describes how to use High speed counter(XBF-HO02A, XBF-HD02A)	10310001240

◎ Contents ◎

1: System

Chapter 1 Introduction	1-1~1-19
-------------------------------------	-----------------

1.1 Guide to Use This Manual	1-1
1.2 Features	1-3
1.3 Terminology	1-6

Chapter 2 System Configuration	2-1~2-14
---	-----------------

2.1 Table of Products Configuration	2-1
2.2 Classification and Type of Product Name	2-3
2.3 XEM-H2/HP Type System Configuration	2-8

Chapter 3 Specifications	3-1~3-9
---------------------------------------	----------------

3.1 Names and Functions of Each Part	3-1
3.2 General specifications	3-3
3.3 Power specifications	3-4
3.4 Battery	3-7
3.5 Performance specifications	3-8

Chapter 4 Installation and wiring	4-1~4-18
--	-----------------

4.1 Parameter & Operation data	4-1
4.2 Attachment/Detachment of Modules	4-7
4.3 Wire	4-13

Chapter 5 Maintenance.....5-1~5-2

5.1 Maintenance and Inspection..... 5-1
 5.2 Daily Inspection..... 5-1
 5.3 Periodic Inspection..... 5-2

Chapter 6 Troubleshooting6-1~6-13

6.1 Basic Procedure of Troubleshooting 6-1
 6.2 Troubleshooting 6-1
 6.3 Troubleshooting Questionnaire 6-7
 6.4 Troubleshooting Examples 6-8
 6.5 Error Code List 6-12

Chapter 7 EMC Standard7-1~7-4

7.1 Requirements for Conformance to EMC Directive 7-1
 7.2 Requirement to Conform to the Low-voltage Directive..... 7-4

2: Basic Functions

Chapter 1 Program Configuration and Operation Method1-1~1-34

1.1 Programming Basics	1-1
1.2 Operation Mode	1-24
1.3 Memory.....	1-30

Chapter 2 CPU Function.....2-1~2-31
--

2.1 Type Setting	2-1
2.2 Parameter Setting.....	2-2
2.3 Self-Diagnosis Function	2-5
2.4 RTC Function.....	2-13
2.5 Remote Function	2-16
2.6 I/O forced On/Off Function	2-17
2.7 Direct I/O Function	2-19
2.9 Function saving the operation history	2-20
2.10 Modification procedures during RUN.....	2-22
2.11 Read I/O information	2-25
2.12 Monitoring Functions.....	2-26
2.13 Function to delete all of the PLC.....	2-31

Chapter 3 Input/Output Specifications3-1~3-36
--

3.1 Introduction	3-1
3.2 Main Unit Digital Input Specifications	3-5
3.3 Main Unit Digital Output Specifications	3-7
3.4 Digital Input Specifications	3-12
3.5 Digital Output Specifications	3-16
3.6 Combined Digital I/O module Input Specification	3-25
3.7 Combined Digital I/O module Output Specification	3-27
3.8 I/O modules' Functions	3-29

Chapter 4 Built-in High-speed Counter Function4-1~4-30

4.1 High-speed Counter Specifications.....	4-1
4.2 Installation and Wiring.....	4-22
4.3 Internal Memory.....	4-23
4.4 Examples: Using High-speed Counter	4-27

Chapter 5 Built-in PID Function.....5-1~5-51

5.1 Features of Built-in PID Function.....	5-1
5.2 Basic Theory of PID Control.....	5-2
5.3 Functional Specifications of PID Control	5-9
5.4 Usage of PID Control Functions	5-10
5.5 PID Instructions.....	5-26
5.6 PID Auto-tuning	5-29
5.7 Example Programs.....	5-38
5.8 Error / Warning Codes	5-50

3: Positioning

Chapter 1 Overview	1-1~1-13
1.1 General	1-1
1.2 Purpose of Positioning Control	1-3
1.3 Signal Flow of Positioning.....	1-3
1.4 Function overview of embedded positioning	1-5
Chapter 2 Specifications	2-1~2-8
2.1 Performance Specifications	2-1
2.2 External Interface I/O Specifications	2-3
Chapter 3 Operation Order and Installation	3-1~3-6
3.1 Operation Order.....	3-1
3.2 Installation	3-2
3.3 Notices in Wiring	3-3
Chapter 4 Positioning Control	4-1~4-3
4.1 Positioning task.....	4-1
Chapter 5 Positioning Parameter & Operation Data	5-1~5-30
5.1 Parameter & Operation data	5-1
5.2 Basic Parameter	5-2
5.3 Extended Parameter.....	5-6
5.4 Manual Parameter	5-18
5.5 Homing Parameter	5-19
5.6 I/O Signal Parameter	5-23
5.7 Common Parameter	5-24

5.8 Operation Data.....	5-26
-------------------------	------

Chapter 6 Internal Memory and I/O Signal.....	6-1~6-18
--	-----------------

6.1 Internal Memory.....	6-1
--------------------------	-----

6.2 K area Signal.....	6-9
------------------------	-----

Chapter 7 Function block.....	7-1~7-60
--------------------------------------	-----------------

7.1 Common items of function blocks.....	7-1
--	-----

7.2 Positioning module function block.....	7-5
--	-----

7.3 How to use function block dedicated for positioning module	7-7
--	-----

Chapter 8 Program	8-1~8-54
--------------------------------	-----------------

8.1 Example of Programming	8-1
----------------------------------	-----

Chapter 9 Functions	9-1~9-164
----------------------------------	------------------

9.1 Homing.....	9-1
-----------------	-----

9.2 Positioning Control.....	9-12
------------------------------	------

9.3 Manual Operation Control	9-103
------------------------------------	-------

9.4 Synchronous Control.....	9-110
------------------------------	-------

9.5 Modification Function of Control	9-129
--	-------

9.6 Auxiliary Function of Control	9-147
---	-------

9.7 Data Modification Function	9-153
--------------------------------------	-------

Chapter 10 Positioning Error Information & Solutions	10-1~10-15
---	-------------------

10.1 Positioning Error Information & Solutions.....	10-1
---	------

Chapter 11 Internal Memory Address of “Read/Write Variable Data” command	11-1~10-155
---	--------------------

11.1 Parameter memory address	11-1
-------------------------------------	------

11.2 Axis1 operation data memory address 11-6
11.3 Axis2 operation data memory address 11-15
11.4 Axis3 operation data memory address 11-24
11.5 Axis4 operation data memory address 11-33
11.6 Axis5 operation data memory address 11-42
11.7 Axis6 operation data memory address 11-51
11.8 CAM data memory address 11-60
11.9 user CAM data memory address 11-153

4: Communication

Chapter 1 Built-in FEnet Communication 1-1~1-98
--

1.1 Outline 1-1
1.2 Specifications 1-3
1.3 Specifications of installation and a trial run 1-8
1.4 Configuration of FEnet communication system 1-12
1.5 Protocols for each service 1-14
1.6 Dedicated services 1-29
1.7 P2P services 1-35
1.8 High speed link 1-62
1.9 Remote communication 1-70
1.10 E-mail Transfer(SMTP) 1-76
1.11 Time synchronization(SNTP) 1-91
1.12 Trouble Shooting 1-97

Chapter 2 Built-in Cnet Communication 2-1~2-122
--

2.1 General 2-1
2.2 Specification 2-2
2.3 Cnet Communication System Configuration 2-8
2.4 Basic Setting for Communication 2-15

2.5 Remote Connection.....	2-25
2.6 Server Function and P2P service.....	2-36
2.7 XGT Dedicated Protocol	2-64
2.8 LSBus Protocol	2-84
2.9 MODBUS Protocol.....	2-90
2.10 Diagnosis Function	2-105
2.11 Example Program	2-114
2.12 Error Code.....	2-139

Appendix

Appendix 1 Flag List	App. 1-1~App.1-9
----------------------------	------------------

Appendix 1.1 Special Relay (F) List.....	App. 1-1
Appendix 1.2 Communication Relay (L) List.....	App. 1-5
Appendix 1.3 Network Register (N) List	App. 1-7

Appendix 2 Dimension	App.2-1~App.2-4
----------------------------	-----------------

Appendix 3 Instruction List	App.3-1~App.3-18
-----------------------------------	------------------

Appendix 3.1 Basic Function	App.3-1
Appendix 3.2 GLOFA Function	App.3-13
Appendix 3.3 Array Operation Function	App.3-13
Appendix 3.4 Basic Function Block.....	App.3-14

Part 1. System

Chapter 1 Introduction

1.1 Guide to this Manual

This manual includes specifications, functions and handling instructions for XGB series PLC. This manual is divided up into chapters as follows

	No.	Title	Contents
1.System	Chapter 1	Introduction	Describes configuration of this manual, unit's features and terminology.
	Chapter 2	System Configurations	Describes available units and system configuration in the XGB series.
	Chapter 3	Specifications	Describes general specifications of units used in the XGB series.
	Chapter 4	CPU Specifications	Describes performances, specifications and operations.
	Chapter 5	Maintenance	Describes the check items and method for long-term normal operation of the PLC system.
	Chapter 6	Troubleshooting	Describes various operation errors and corrective actions.
	Chapter 7	EMC Specifications	Describes system configuration following EMC specification.
2.Main	Chapter 1	Program Configuration and Operation Method	Describes performances, specifications and operations.
	Chapter 2	CPU Specifications	
	Chapter 3	Input/Output Specifications	Describes operation of basic and input/output.
	Chapter 4	Built-in High-speed Counter Function	Describes built-in high-speed counter functions.
	Chapter 5	Built-in PID Function	Describes Built-in PID Function
3.Positioning	Chapter 1	Overview	Describes the specification, method to use each positioning function, programming and the wiring with external equipment of embedded positioning function.
	Chapter 2	Specifications	Describes general specifications of Positioning function.
	Chapter 3	Operation Order and Installation	Describes the Operation order in case of positioning operation by embedded positioning.
	Chapter 4	Positioning Control	Describes Positioning task, which synchronize with positioning control period.
	Chapter 5	Positioning Parameter & Operation Data	Describes parameter and operation data about positioning module.

3. Positioning	Chapter 6	Internal Memory and I/O Signal	Describes the internal memory used for positioning module if XEC CPU module is used.
	Chapter 7	Function Block	Describes the positioning function blocks used in XEC CPU Module.
	Chapter 8	Program	Describes the positioning program.
	Chapter 9	Functions	Describes the positioning functions.
	Chapter 10	Positioning Error Information & Solutions	Describes the positioning error types and its solutions.
	Chapter 11	Internal Memory Address of "Read/Write Variable Data" command	Describes Internal Memory Address of "Read/Write Variable Data" command.
4. Communications	Chapter 1	Built-in FEnet Communication	Describes Ethernet communications.
	Chapter 2	Built-in Cnet Communication	Describes serial (232/485) communications.
5. Appendix	Appendix 1	Flag List	Describes the types and contents of various flags.
	Appendix 2	Dimension	Shows dimensions of the main units and expansion modules.
	Appendix 3	Instruction List	Describes the special relay and instruction list.

1.2 Features

The features of XGB system are as follows.

1.2.1 Advanced Performances

(1) Rapid Processing Speed

The processing speed has been improved up to more than 75% compared to the existing XEM PLC.

Items	XEC-H Type	XEM-H2/HP Type	Remarks
Sequence command	84 ns	40 ns	Based on MLOAD command
Data command	1.6 μ S	1.1 μ S	Based on MOV(WORD) command
Real	4.9 μ S	2.1 μ S	ADD(REAL) command
	4.9 μ S	2.2 μ S	MUL(REAL) command
Long Real	9.2 μ S	4.6 μ S	ADD(LREAL) command
	10.4 μ S	7.8 μ S	MUL(LREAL) command

(2) Program/Data memory expanded

Items	XEC-H Type	XEM-H2/HP Type	Remarks
Program capacity	200KB	384KB	
Data Capacity	48KB	96KB	Based on Auto variable(A) + M area

(3) Advanced functions

- Built-in 10/100 BASE-TX Ethernet(max 16 channel P2P service)
- provide EtherCAT expansion module

(4) Permanent data back up: permanent data backup is available by implementing MRAM.

1.2.2 Flexibility of System Configuration

(1) The small and medium-sized system can be established, which controls up to 256 points I/O through 7-stage expansion.

(2) Compact size

Compared to the existing XGB basic unit, this product has various embedded functions to enhance functionality and has a reduced size so you can install it even in a small space. (Unit : mm)

Type	Model	Size (W * H * D)	Remarks
Basic unit	XEM-DN32H2 / XEM-DN32HP XEM-DP32H2 / XEM-DP32HP XEM-DN16H2, XEM-DP16H2, XEM-DR14H2	42 * 90 * 64	
	XBF-,XBE-,XBL-	20* 90 * 60	Based on minimum size

(3) Securing compatibility of the existing expansion/special/communication module

All types of the existing XGB expansion/special/communication modules are available.

(4) Expanding the applications through various expansion modules

- It provides 8 points, 16 points, 32 points module I/O expansion module (In the case of relay output, 8/16 points module) with single input, single output, mixed I/O module.
- It supports various special modules such as positioning, high-speed counter, analog I/O, temperature input, temperature control.
- It provides various communication I/F modules such as Cnet, FEnet, RAPIEnet, CANOpen, Profibus-DP, DeviceNet.

1.2.3 Powerful Embedded Functions

- (1) Embedded high-speed counter function
 - The high-speed counter with up to 200kpps 4 channels(based on 1 phase 1 input 1 multiplication) is embedded.
 - Various additional functions such as comparative readout, comparative task, frequency measurement, revolutions per hour, etc. are provided.
 - Parameter setting using XG5000, various monitoring and diagnosis functions are provided.
 - You can conduct a trial run through XG5000's monitoring without the program so you can easily check of abnormalities of external wirings and data setting.
- (2) Embedded communication function
 - It has embedded Cnet 2 channels and Enet 1 channel at the same time.
 - It can communicate with other devices very easily without the special communication I/F module by using the embedded communication function.
 - It enhances convenience by providing various protocols such as dedicated communication, customization, etc.
 - You can check the communication state very easily thanks to the diagnosis function and
 - Transmitting receiving frame monitoring function.
- (3) Embedded PID function
 - It supports the embedded PID control function up to 16 loops.
 - It provides parameter setting using XG5000, convenient loop state monitoring through trend monitor.
 - You can get the control constant easily by the improved automatic synchronization function.
 - You can improve control accuracy by using various additional functions such as PWM output, ΔMV , ΔPV , SV Ramp, etc.
 - It provides various control modes such as forward/reverse mixed operation, shock free conversion control, cascade control, etc.
 - You can secure stability through various alarm functions such as PV MAX, PV change warning, etc.
- (4) Embedded position control function (XEM-H2: 2axis, XEM-HP: 6axis. Only supported by TR output models)
 - The open collector output positioning function with up to 200kpps 6-axis is embedded.
 - It provides parameter setting using XG-PM which support operation data edition, diverse monitoring and diagnosis functions.
 - You can conduct a trial run through XG-PM monitoring without the program so you can easily check the external wirings and operation data.

1.2.4 Easy maintenance

- (1) Program modularize for Multi-programing and multi tasks for maintenance are available.
- (2) Built-in RTC(real time clock) function make it possible to control schedule maintenance and history.
- (3) Integrated program environment
 - Separated XG5000(ladder programming, parameter setting, monitoring) and XG-PD(communication and network parameter setting, frame monitoring) have combined in one XG.5000. It is possible to control PLC in one programming.

1.3 Terminology

1.3.1 General term

The following table gives definition of terms used in this manual.

Terms	Definition	Remark
Module	A standard element that has a specified function which configures the system. Devices such as I/O board, which inserted onto the mother board.	Example) Expansion module, Special module, Communication module
Unit	A single module or group of modules that perform an independent operation as a part of PLC systems.	Example) Main unit, Expansion unit
PLC System	A system which consists of the PLC and peripheral devices. A user program can control the system.	-
XG5000	A program and debugging tool for the XGB series. It executes program creation, edit, compile and debugging. (PADT: Programming Added Debugging Tool)	-
XG-PM	Exclusive tool for modifying position parameter like Built-in position, network type position	
I/O image area	Internal memory area of the CPU module which used to hold I/O status.	
Cnet	Computer Network	-
FEnet	Fast Ethernet Network	-
RAPInet	RAPInet Network	-
CANopen	Controller Area Network	-
Pnet	Profibus-DP Network	-
Dnet	DeviceNet Network	-
RTC	Abbreviation of 'Real Time Clock'. It is used to call general IC that contains clock function.	-
Watchdog Timer	Supervisors the pre-set execution times of programs and warns if a program is not completed within the pre-set time.	-

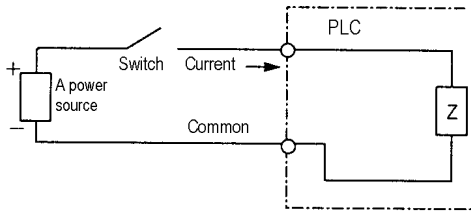
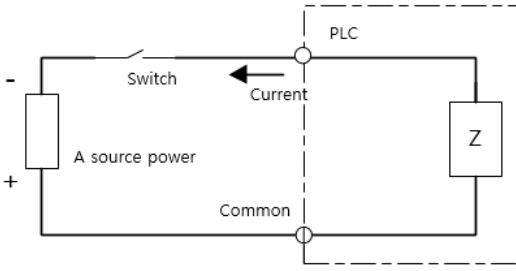
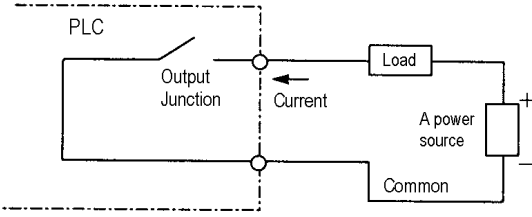
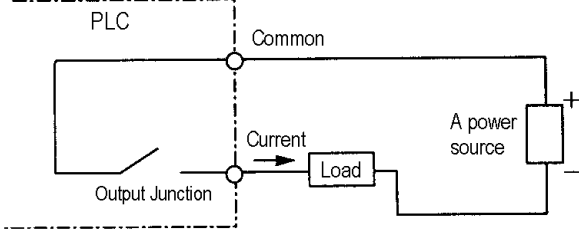
Terms	Definition	Remark
Task	It refers to the program start condition. There are 6 types such as initialization, constant cycle, internal contact, external contact, high-speed counter task, and positioning task.	
Sink Input	<p>Current flows from the switch to the PLC input terminal if a input signal turns on.</p> 	Z: Input impedance
Source Input	<p>Current flows from the PLC input terminal to the switch after a input signal turns on.</p> 	Z: Input impedance
Sink Output	<p>Current flows from the load to the output terminal and the PLC output turn on.</p> 	-
Source Output	<p>Current flows from the output terminal to the load and the PLC output turn on.</p> 	-

1.3.2 Serial communication term

(1) Communication type

(a) Simplex

This is the communication type that data is transferred in a constant direction. Information can not be transferred in the reverse direction.

(b) Half-Duplex

Data is transferred in two ways with one cable if time interval provided, though it can't be transferred simultaneously.

(c) Full-Duplex

Data is simultaneously transferred and received in two ways with two cables.

(2) Transmission type

(a) Serial transmission

This type transmits bit by bit via 1 cable. The speed of transmission is slow, but the cost of installation is low and the software is simplified.

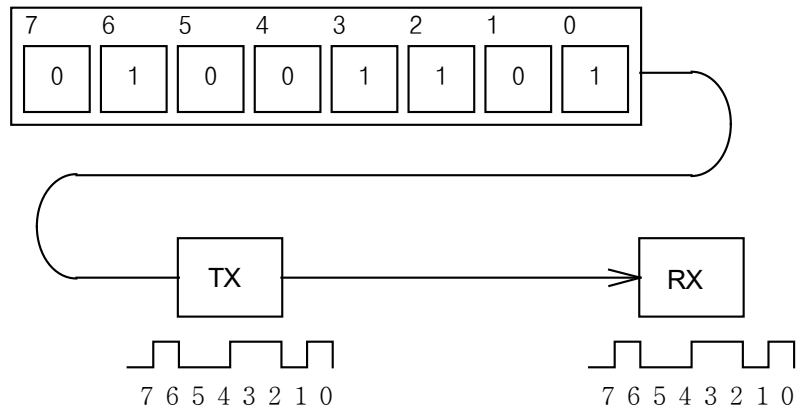

RS-232C, RS-422 and RS-485 are the examples

(b) Parallel transmission

This type is used in printer, etc., which transmits data in unit of 1 byte, so the speed is high and the accuracy of data is reliable. However, the longer the transmission distance is, the higher the cost of installation is geometrically.

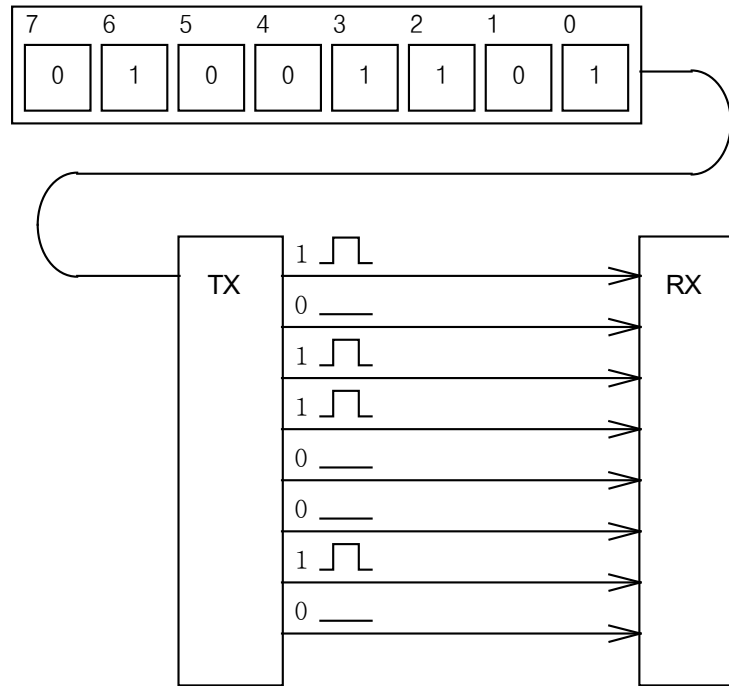

(3) Asynchronous Communication

This communication type transmits characters one by one synchronously in serial transmission. At this time, synchronous signal (Clock, etc.) is not transmitted. Character code is transmitted with a start bit attached to the head of 1 character, and it is finished with a stop bit attached to the tail.

※ For transmitting KOREA

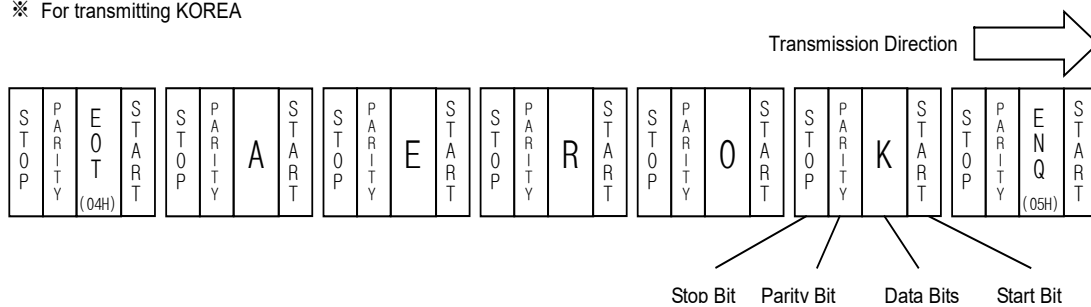

(4) Protocol

This is communication rule established in relation between the transmission side and the receiving side of information in order to send and accept information between two computers/terminals or more without error, effectively, and reliably. In general, this specifies call establishment, connection, structure of message exchange form, re-transmission of error message, procedure of line inversion, and character synchronization between terminals, etc.

(5) BPS(Bits Per Second)와 CPS(Characters Per Second)

BPS is a unit of transfer rate that represents how many bits are transferred per second. CPS is the number of the characters transferred for a second. Generally, one character is 1Byte (8Bits), so CPS is the number of bytes which can be transferred per second.

(6) Node

Node is a term that means the connected nodes of the data in the network tree structure, generally network is composed of a great number of nodes, and is also expressed as the station number.

(7) Packet

Packet, a compound term of package and bucket used for packet exchange type to send information as divided in a unit of packet, separates transferred data into the defined length to add a header that presents the correspondent addresses (station No., etc.) thereto.

(8) Port

Port is meant to be the part of the data process device which sends or receives the data from a remote control terminal in data communications, but in Cnet serial communication is meant to be the RS-232C or RS-422 port.

(9) RS-232C

RS-232C is the interface to link a modem with a terminal and to link a modem with a computer, and is also the serial communications specification established by EIA according to the recommendations of the CCITT. This is also used to link the null modem directly as well as the modem linkage. The disadvantage is that the transfer length is short and that only 1 : 1 communication is available, and the specifications which have overcome this disadvantage are RS-422 and RS-485.

(10) RS-422/RS-485

As one of the serial transmission specifications, its transferring length is long with 1 : N connection available compared to RS-232C. The difference of these two specifications is that RS-422 uses 4 signals of TX(+), TX(-), RX(+) and RX(-), while RS-485 has 2 signals of (+) & (-), where data is sent and received through the same signal line. Accordingly, RS-422 executes the full-duplex type of communication and RS-485 executes the half-duplex type of communication.

(11) Half Duplex Communication

Two-way communication is available, however simultaneous communication of transmission & receiving isn't available. This communication type is applied to RS-485 for instance. It is used a lot for multi-drop communication type which communicates via one signal line by several stations. Half Duplex Communication results from the transmission characteristic performed by stations one by one not allowing simultaneous transmission by multi stations due to the data damage of data impact caused by the simultaneous multi-transmission of the stations. The figure below shows an example of structure based on Half Duplex Communication. Each station in communication with the terminal as linked with each other can send or receive data via one line so to execute communication with all stations, where multi-server is advantageously available.

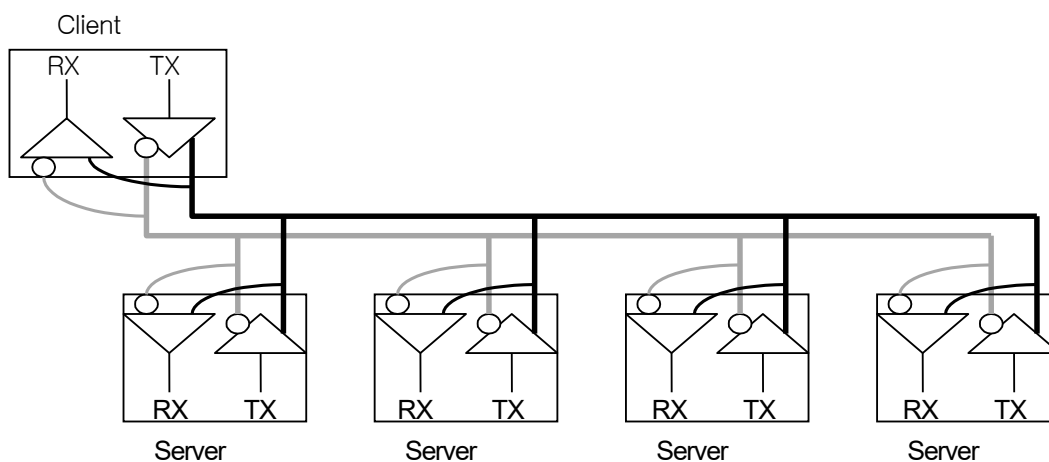

(12) Full Duplex Communication

Two way-communications of simultaneous transmission & receiving is available. This communication type is applied to RS-232C & RS-422. Since the transmission line is separated from the receiving line, simultaneous transmission & receiving is available without data impact, so called as Full Duplex Communication. The figure shows an example of structure based on RS-422 of Full Duplex Communication. Since transmission terminal of the client station and receiving terminals of the sever stations are connected to one line, and transmission terminals of the sever stations are linked with receiving terminal of the client station, the communication between sever stations is unavailable with the restricted function of multi-server.

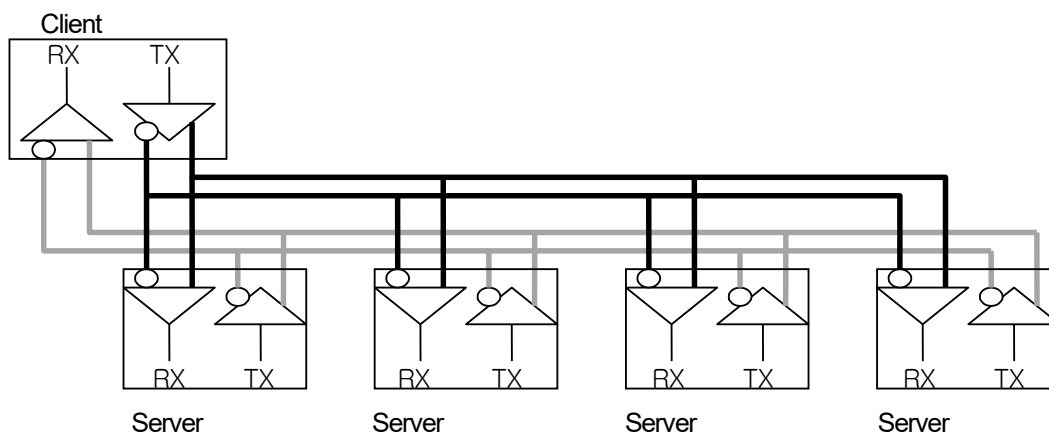

Chapter 1 Introduction

(13) BCC (Block Check Character)

As serial transmission may have signals distorted due to undesirable noise in transmission line, BCC is used as data to help receiving side to check the signals if normal or distorted and to detect errors in signals as compared with the received BCC after calculating BCC by receiving side itself using the data input to the front terminal of BCC.

(14) XG5000 service

This is the function to remotely perform programming, reading/writing user's program, debugging, and monitoring, etc. without moving the physical connection of XG5000 in the network system where PLC is connected to Cnet I/F module. Especially, it is convenient to control a remote PLC via modem.

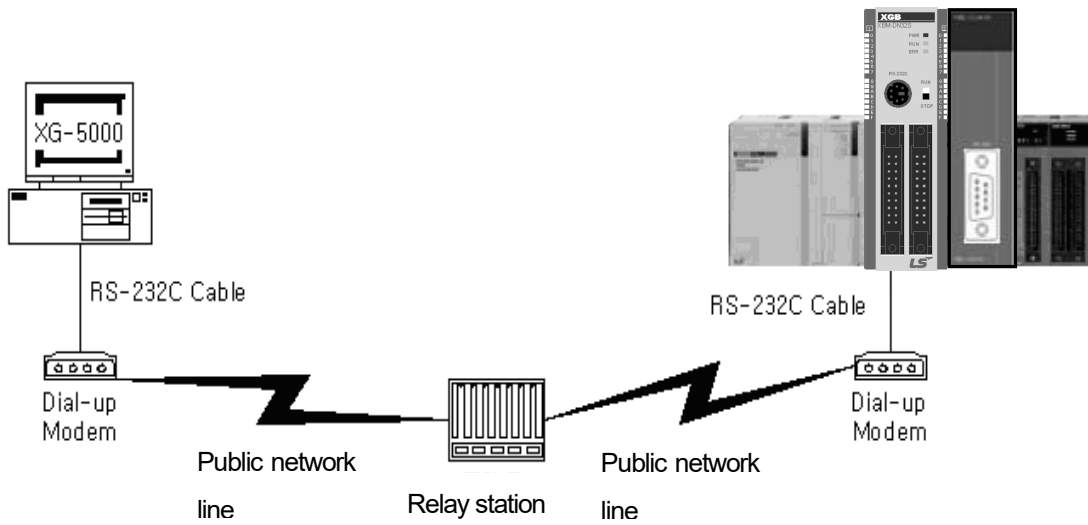

* XG5000 : Programming software of XGT PLC for Windows

(15) Frame

Frame is composed of transmitted and received data as in a specified form in data communication including additional information of segments [station No., command, parameter by command], control characters [ENQ, ACK, EOT, ETX] for synchronization, parity for detecting error, and BCC. The structure of frame used for serial communication of Cnet is as follows.

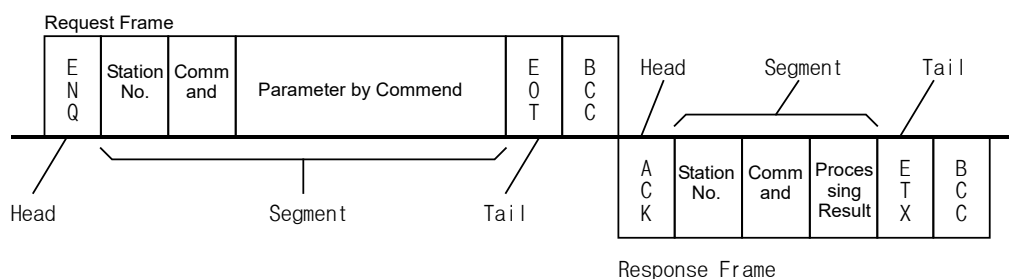

[Structure of general Tx/Rx frame]

- Head: ASCII value indicating frame start.
- Tail: ASCII value indicating frame end.
- BCC (Block Check Character)
 - ◆ Check data for Tx/Rx frame
 - ◆ Used to inspect reliability of data with such various methods as ADD, OR, Exclusive OR, MULTPLY, etc

(16) Reset

This function is used to initialize the communication module with errors.

Use XG-PD to select [On-Line] → [Reset] so to execute Reset, which will restart PLC.

1.3.3 Ethernet term

This chapter describes about the general terminology of FEnet I/F module. For more detail, refer to professional book on the Ethernet.

(1) IEEE 802.3

IEEE 802.3 specifies standards for CSMA/CD based Ethernet. Exactly it is a LAN based on CSMA/CD (Carrier Sense Multiple Access with Collision Detection) Ethernet designed by IEEE 802.3 group, which is classified into detailed projects as specified below;

- A) IEEE P802.3 - 10G Base T study Group
- B) IEEE P802.3ah - Ethernet in the First Mile Task Force
- C) IEEE P802.3ak - 10G Base-CX4 Task Force

※ Ethernet and IEEE 802.3 are standardized at RFC894 and RFC1042 so each should process another frame.

(2) ARP (Address Resolution Protocol)

Protocol to search for MAC address by means of correspondent IP address on the Ethernet LAN

(3) Bridge

A device used to connect two networks so to be operated as one network. Bridge is used not only to connect two different types of networks but also to divide one big network into two small networks in order to increase the performance.

(4) Client

A user of the network service, or a computer or program (mainly the one requesting services) using other computer's resource.

(5) CSMA/CD(Carrier Sense Multiple Access with Collision Detection)

Each client checks if there is any sign prior to transmission of data to the network (Carrier Sense) and then sends its data when the network is empty. At this time, all the clients have the equal right to send (Multiple Access). If two or more clients send data, collision may occur. The client who detects the collision tries to send again in a specific time.

(6) DNS (Domain Name System)

A method used to convert alphabetic Domain Name on the Internet to its identical Internet number (namely, IP address)

(7) Dot Address

Shows IP address of '100.100.100.100', where each figure is displayed in decimal with 1 byte occupied respectively for 4 bytes in total.

(8) E-mail Address

The address of the user with login account for the specific machine connected via the Internet. Usually user's ID @ domain name (machine name) is assigned. In other words, it will be like hjee@microsoft.com, where @ is called as

'at' displayed with shift+2 pressed on the keyboard. The letters at the back of @ are for the domain name of specific company (school, institute,...) connected with the Internet, and the letters in front of @ are for the user ID registered in the machine. The last letters of the domain name are for the highest level. USA generally uses the following abbreviation as specified below, and Korea uses .kr to stand for Korea. .com : usually for companies) / .edu : usually for educational organizations such as universities. / .ac(academy) is mostly used in Korea / .gov : for governmental organizations. For example, nasa.gov is for NASA (government) / .mil : military related sites. For example, af.mil is for USA air force (military) / .org : private organizations / .au : Australia / .uk : the United Kingdom / .ca : Canada / .kr : Korea / .jp : Japan / .fr : France / .tw : Taiwan, etc.

(9) Ethernet

A representative LAN connection system (IEEE 802.3) developed by Xerox, Intel and DEC of America which can send about 10Mbps and use the packet of 1.5kB. Since Ethernet can allow various types of computers to be connected as one via the network, it has been called a pronoun of LAN as a universal standard with various products available, not limited to some specific companies.

(10) FTP (File Transfer Protocol)

An application program used to transfer files between computers among application programs providing TCP/IP protocol. If an account is allowed to the computer to log in, fast log in the computer is available wherever the computer is so to copy files.

(11) Gateway

Software/Hardware used to translate for two different protocols to work together, which is equivalent to the gateway necessary to exchange information with the different system.

(12) Header

Part of the packet including self station number, correspondent station number and error checking area.

(13) HTML

Hypertext Markup Language, standard language of WWW. In other words, it is a language system to prepare Hypertext documents. The document made of HTML can be viewed through the web browser

(14) HTTP

Hypertext Transfer Protocol, standard protocol of WWW. It is a protocol supporting the hypermedia system.

(15) ICMP (Internet Control Message Protocol)

An extended protocol of IP address used to create error messages and test packets to control the Internet.

(16) IP (Internet Protocol)

Protocol of network layers for the Internet

(17) IP Address

Address of respective computers on the Internet made of figures binary of 32 bits (4 bytes) to distinguish the applicable machine on the Internet. Classified into 2 sections, network distinguishing address and host distinguishing address. The network address and the host address is respectively divided into class A, B and C based on the bits allotted. IP address since it shall be unique all over the world, shall be decided not optionally but as assigned by NIC(Network Information Center) of the applicable district when joining the Internet. In Korea, KRNIC(Korea Network Information Center) is in charge of this work. Ex.) 165.244.149.190

(18) ISO (International Organization for Standardization)

A subsidiary organization of UN establishing and managing the international standards

(19) LAN (Local Area Network)

Called also as local area communication network or district information communication network, which allows lots of computers to exchange data with each other as connected though communication cable within a limited area such as in an office or a building

(20) MAC (Medium Access Control)

A method used to decide which device should use the network during given time on the broadcast network

(21) Node

Each computer connected with the network is called Node

(22) Packet

A package of data which is the basic unit used to send through the network. Usually the package is made of several tens or hundreds of bytes with the header attached in front to which its destination and other necessary information are added

(23) PORT number

Used to classify the applications on TCP/UDP.

Ex.) 21/tcp : Telet

(24) PPP (Point-to-Point Protocol)

Phone communication protocol which allows packet transmission in connecting with the Internet. In other words, normal phone cable and modem can be used for the computer to connect through TCP/IP with this most general Internet protocol.

Similar to SLIP, however with modern communication protocol factors such as error detection and data compression, it demonstrates more excellent performance than SLIP.

(25) Protocol

Contains regulations related with mutual information transmission method between computers connected with each other through the network. The protocol may specify detailed interface between machines in Low level (for example, which bit/byte should go out through the line) or high level of message exchange regulations as files are transferred through the Internet.

(26) Router

A device used to transfer the data packet between the networks. It sends the data packet to its final destination, waits if the network is congested, or decides which LAN is good to connect to at the LAN junction. Namely, it is a special computer/software used to control the two or more networks connected.

(27) Server

The side which passively responds to the client's request and shares its resources.

(28) TCP (Transmission Control Protocol)

A transport layer protocol for the Internet

- Data Tx/Rx through connection
- Multiplexing
- Transmission reliable
- Emergent data transmission supported

(29) TCP/IP (Transmission Control Protocol/Internet Protocol)

Transmission protocol used for communication among different kinds of computers, which makes the communication available between general PC and medium host, IBM PC and MAC, and medium or large-sized different types of computer. It is also used as a general term for information transmission protocol between computer networks including FTP, Telnet, SMTP, etc. TCP divides data into packets to send through IP and the packets sent will be united back together through TCP.

(30) Telnet

It means remote login via Internet. To login to remote host via TELNET, account of that host is necessary. But for some hosts providing public service, you can connect without account

Chapter 1 Introduction

(31) Token Ring

As short-distance network using Token to connect to network having physical ring structure, one of the Node connection methods at network. If node sending data gets Token, then node gets right to send message packet. Realistically structured examples are IEEE 802.5, ProNet-1080 and FDDI. Terms called Token is used as IEEE 802.5

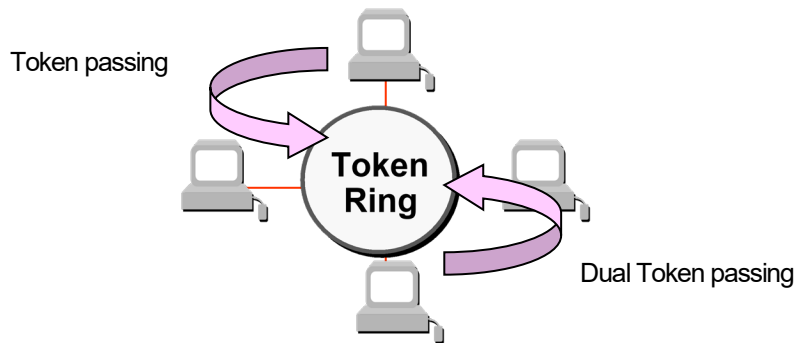

(32) UDP (User Datagram Protocol)

A transport layer protocol for the Internet

- High speed communication because of communication without connection
- Multiplexing
- Lower reliability than TCP in transmission (Tough data doesn't arrive, it doesn't send data again)

(33) Auto-Negotiation

Fast Ethernet is that Ethernet exchanges information like operation speed, duplex mode.

1. Detect disconnection
2. Decide the specification of network device
3. Change connection speed

(34) FDDI (Fiber Distributed Data Interface)

Based on optical cable, provides 100Mbps, Shared Media Network as Dual Ring method, Token Passing is done in two-way.

Max 200km distance for entire network, Max 2km between Nodes, Max 500 nodes. Generally, this used as Backbone Network.

(35) Reset

This is function used when you want to initialize the communication module to clear the error

Select [Online] → [Rest] in the XG-PD

If you execute this function, PLC will restart.

Chapter 2 System Configuration

You can configure various systems by using the XEM-H2/HP Type basic unit and expansion · special communication I/F modules. This chapter describes how to configure the system through the XEM-H2/HP Type basic unit.

2.1 Table of Products Configuration

The available configurations for the XEM -H2/HP Type PLC system are as table below.

Types	Model	Description	Remark
Main Unit	XEM-DR14H2	DC24V power supply, DC24V input 8 point, Relay output 6 point	OS : V3.0 or above
	XEM-DN16H2	DC24V power supply, DC24V input 8 point, Transistor output 8 point(sink) Built-in position 2 axis	
	XEM-DP16H2	DC24V power supply, DC24V input 8 point, Transistor output 8 point(source) Built-in position 2 axis	
	XEM-DN32H2	DC24V power supply, DC24V input 16 point, Transistor output 16 point(sink) Built-in position 2 axis	H/W : V2.0 O/S:V2.1 or above
	XEM-DN32HP	DC24V power supply, DC24V input 16 point, Transistor output 16 point(sink) Built-in position 6 axis	
	XEM-DP32H2	DC24V power supply, DC24V input 16 point, Transistor output 16 point(Source) Built-in position 2 axis	
	XEM-DP32HP	DC24V power supply, DC24V input 16 point, Transistor output 16 point(Source) Built-in position 6 axis	
Expansion Unit	XBE-DC08A	DC24V Input 8 point	Input
	XBE-DC16A/B	DC24V Input 16 point	
	XBE-DC32A	DC24V Input 32 point	
	XBE-AC08A	AC110V Input 8 point	
	XBE-RY08A	Relay output 8 point	Output
	XBE-RY08B	Relay output 8 point(isolated output)	
	XBE-RY16A	Relay output 16 point	
	XBE-TN08A	Transistor output 8 point (sink type)	
	XBE-TN16A	Transistor output 16 point (sink type)	
	XBE-TN32A	Transistor output 32 point (sink type)	
	XBE-TP08A	Transistor output 8 point (source type)	
	XBE-TP16A	Transistor output 16 point (source type)	
	XBE-TP32A	Transistor output 32 point (source type)	
	XBE-DR16A	DC24V Input 8 point, Relay output 8 point	
	XBE-DN32A	DC24V Input 8 point, Transistor output 16 point (sink type)	

Types	Model	Description	Remark
Special Module	XBF-AD04A	Current/Voltage input 4 channel, 1/4000 resolution	Analog In/Out
	XBF-AD04C	Current/Voltage input 4 channel, 1/16000 resolution	
	XBF-AD08A	Current/Voltage input 8 channel, 1/4000 resolution	
	XBF-DC04A	Current output 4 channel, 1/4000 resolution	
	XBF-DC04C	Current output 4 channel, High resolution, 1/16000 resolution	
	XBF-DV04A	Voltage output 4 channel, 1/4000 resolution	
	XBF-DV04C	Voltage output 4 channel, 1/16000 resolution	
	XBF-AH04A	Current/Voltage input 2 channel, Current/Voltage output 2 channel, 1/4000 resolution	
	XBF-RD04A	RTD (Resistance Temperature Detector) input 4 channel, Pt100, Jpt100	Temperature
	XBF-RD01A	RTD (Resistance Temperature Detector) input 1 channel, Pt100, Jpt100	
	XBF-TC04S	TC (Thermocouple) input 4 channel	Positioning
	XBF-PD02A	Position 2Axis, Line Drive type, Max 2Mpps	
	XBF-HD02A	High Speed Counter 2 channel, Line Drive Type	Counter
	XBF-HO02A	High Speed Counter 2 channel, Open Collector Type	
	XBF-TC04RT	Temperature controller module (RTD input, 4 roof)	Temperature
	XBF-TC04TT	Temperature controller module (TC input, 4 roof)	
	XBF-PN04B	Network position (Open type Ethercat) 4 Axis	Positioning
	XBF-PN08B	Network position (Open type Ethercat) 8 Axis	
	XBF-LD02S	Loadcell input, insulation type	Loadcell
Communication Module	XBL-C21A	Cnet (RS-232C/Modem) I/F	-
	XBL-C41A	Cnet (RS-422/485) I/F	-
	XBL-EMTA	Enet I/F	-
	XBL-EIMT/F/H	RAPIEnet I/F 2 UTP cable	-
	XBL-EIPT	EtherNet I/P Module	-
	XBL-CMEA	CANopen Master/I/F	-
	XBL-CSEA	CANopen Slave I/F	-
	XBL-PMEC	Profibus-DP, Master	-
	XBL-PSEA	Profibus-DP, Slave	
	XBL-DSEA	DeviceNet, Slave	
	XBL-RMWA	Rnet, Master /F	
	USB-301A	Connection cable (PC to PLC), USB	

Notice

LS ELECTRIC CO., LTD. has consistently developed and launched new products.
For new products that are not included to this manual, please contact a nearby exclusive agency.

2.2 Classification and Type of Product Name

2.2.1 Classification and type of basic unit

Name of basic unit is classified as follows.

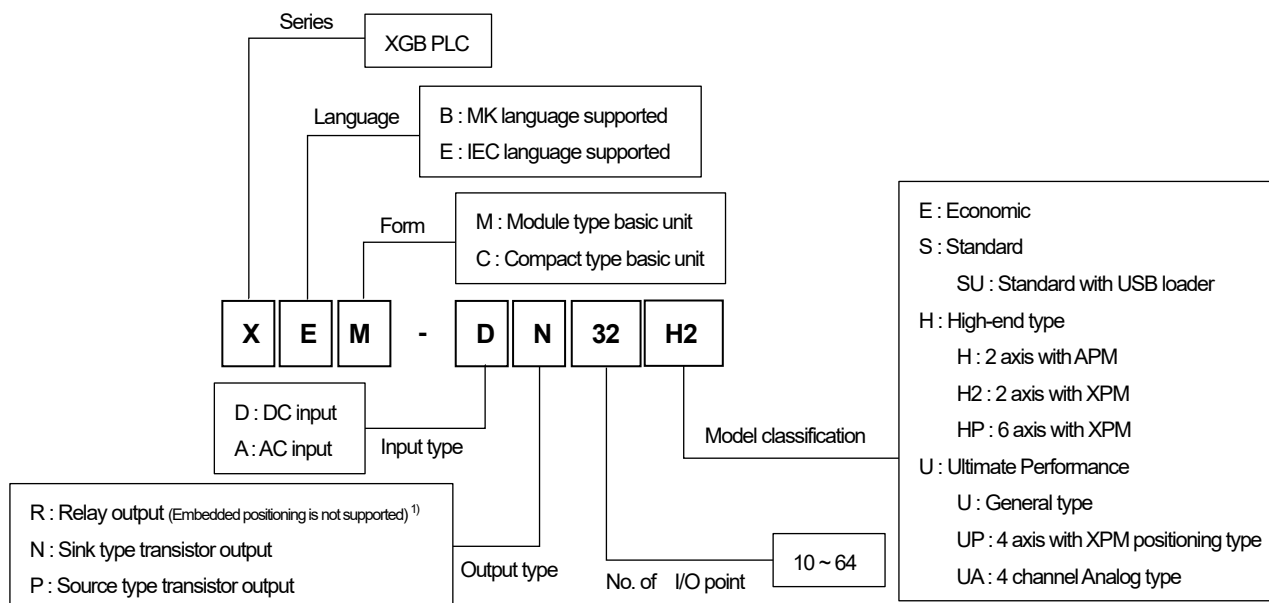

1) Exceptionally, XBC/XEC-DR28UP model supports embedded positioning function

Classification	Name	DC input	Transistor output	Relay output	Power
Module type basic unit	XEM-DR14H2	8 point	None	6 point	DC24V
	XEM-DN16H2	8 point	8 point	None	
	XEM-DP16H2	8 point	8 point	None	
	XEM-DN32H2	16 point	16 point	None	
	XEM-DN32HP	16 point	16 point	None	
	XEM-DP32H2	16 point	16 point	None	
	XEM-DP32HP	16 point	16 point	None	
Compact type basic unit	XEC-DR32H	16 point	None	16 point	AC100V-240V
	XEC-DN32H	16 point	16 point	None	
	XEC-DR64H	32 point	None	32 point	
	XEC-DN64H	32 point	32 point	None	
	XEC-DN20SU	12 point	8 point	None	
	XEC-DN30SU	18 point	12 point	None	
	XEC-DN40SU	24 point	16 point	None	
	XEC-DN60SU	36 point	24 point	None	
	XEC-DR20SU	12 point	None	8 point	
	XEC-DR30SU	18 point	None	12 point	
	XEC-DR40SU	24 point	None	16 point	
XEC-DR60SU	36 point	None	24 point		

Classification	Name	DC input	Transistor output	Relay output	Power
Compact type basic unit	XEC-DR10E	6 point	None	4 point	AC100V~240V
	XEC-DR14E	8 point	None	6 point	
	XEC-DR20E	12 point	None	8 point	
	XEC-DR30E	18 point	None	12 point	
	XEC-DN10E	6 point	4 point	None	
	XEC-DN14E	8 point	6 point	None	
	XEC-DN20E	12 point	8 point	None	
	XEC-DN30E	18 point	12 point	None	
	XEC-DP10E	6 point	4 point	None	
	XEC-DP14E	8 point	6 point	None	
	XEC-DP20E	12 point	8 point	None	
	XEC-DP30E	18 point	12 point	None	
	XEC-DN32U	16 point	16 point	None	
	XEC-DP32U	16 point	16 point	None	
	XEC-DR28U	16 point	None	12 point	
	XEC-DN32UP	16 point	16 point	None	
	XEC-DP32UP	16 point	16 point	None	
	XEC-DR28UP	16 point	None	12 point	
	XEC-DN32UA	16 point	16 point	None	
	XEC-DP32UA	16 point	16 point	None	
	XEC-DR28UA	16 point	None	12 point	
	XEC-DN32U/DC	16 point	16 point	None	DC24V
	XEC-DP32U/DC	16 point	16 point	None	
	XEC-DR28U/DC	16 point	None	12 point	
	XEC-DN32UP/DC	16 point	16 point	None	
	XEC-DP32UP/DC	16 point	16 point	None	
	XEC-DR28UP/DC	16 point	None	12 point	
	XEC-DN32UA/DC	16 point	16 point	None	
XEC-DP32UA/DC	16 point	16 point	None		
XEC-DR28UA/DC	16 point	None	12 point		

2.2.2 Classification and type of expansion module

Name of expansion module is classified as follows.

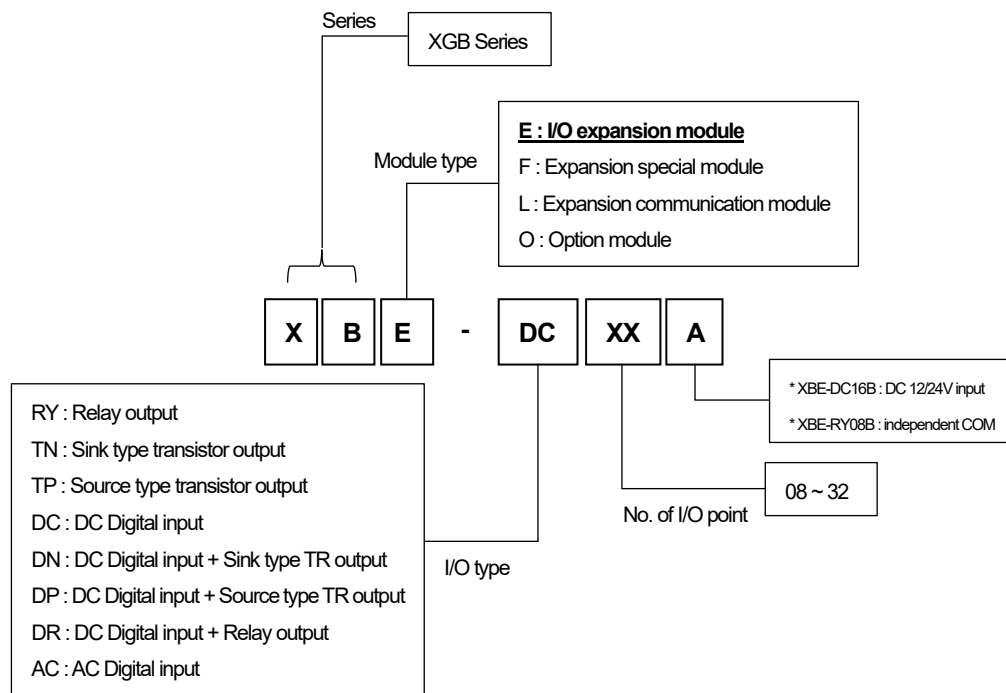

Name	DC input	Relay output	Transistor output	Reference
XBE-DC08A	8 point	None	None	Input
XBE-DC16A/B	16 point	None	None	
XBE-DC32A	32 point	None	None	
XBE-AC08A	8 point (AC)	None	None	
XBE-RY08A/B	None	8 point	None	Relay Output
XBE-RY16A	None	16 point	None	
XBE-TN08A	None	None	8 point (sink type)	Sink type Output
XBE-TN16A	None	None	16 point (sink type)	
XBE-TN32A	None	None	32 point (sink type)	
XBE-TP08A	None	None	8 point (source type)	Source type Output
XBE-TP16A	None	None	16 point (source type)	
XBE-TP32A	None	None	32 point (source type)	
XBE-DR16A	8 point	8 point	None	In/Output
XBE-DN32A	16 point	None	16 point (sink type)	

2.2.3 Classification and type of special module

Special module is classified as follows.

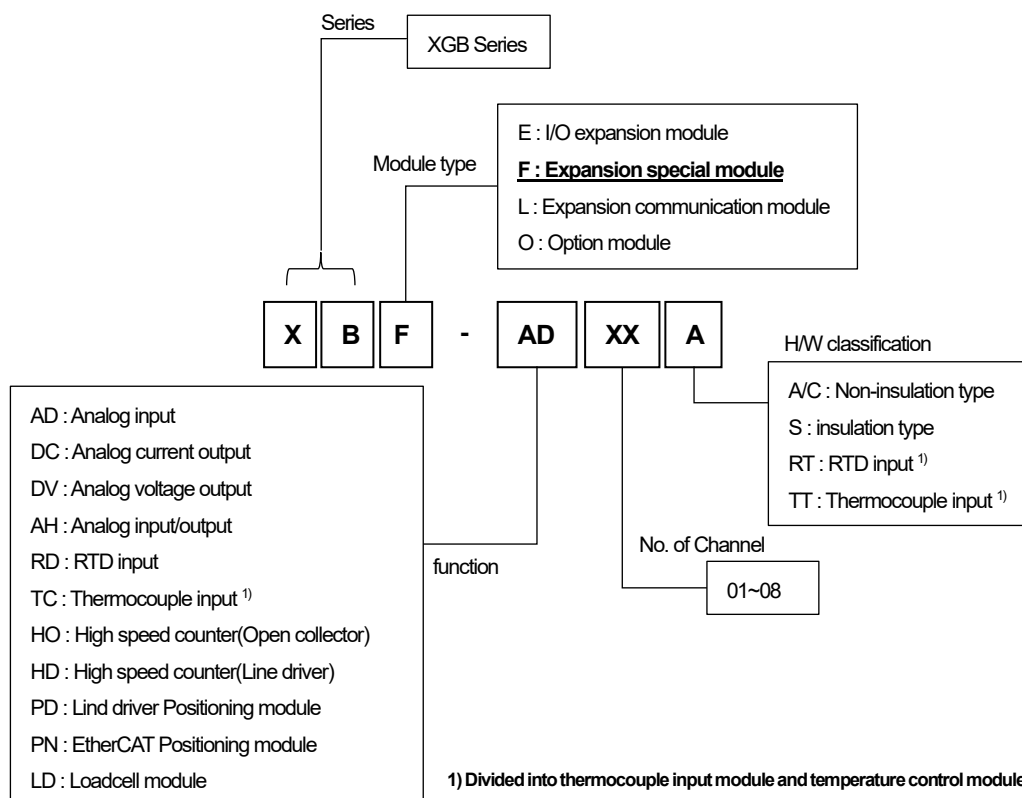

Classification	Name	No. of input ch.	Input type	No. of output ch.	Output type
Analog input	XBF-AD04A/C	4	Voltage/Current	None	-
	XBF-AD08A	8	Voltage/Current	None	-
Analog output	XBF-DC04A/C	None	-	4	Current
	XBF-DV04A/C	None	-	4	Voltage
Analog In/Output	XBF-AH04A	2	Voltage/Current	2	Voltage/Current
RTD input	XBF-RD01A	1	PT100/JPT100	None	-
	XBF-RD04A	4	PT100/JPT100	None	-
TC input	XBF-TC04S	4	K, J, T, R	None	-
	XBF-TC04RT	4	PT100/JPT100	4	Transister
	XBF-TC04TT	4	K, J, T, R	4	Transister
Positioning	XBF-PD02A	2	Line Driver	2	Voltage
	XBF-PN04B	4	Line Driver	4	EtherCAT
	XBF-PN08B	8	Line Driver	8	EtherCAT
High Speed Counter	XBF-HD02A	2	Line Driver	-	Voltage
	XBF-HO02A	2	Open Collector	-	Voltage
Loadcell	XBF-LD02A	2	Voltage	-	-

2.2.4 Classification and type of communication module

Name of communication module is classified as follows.

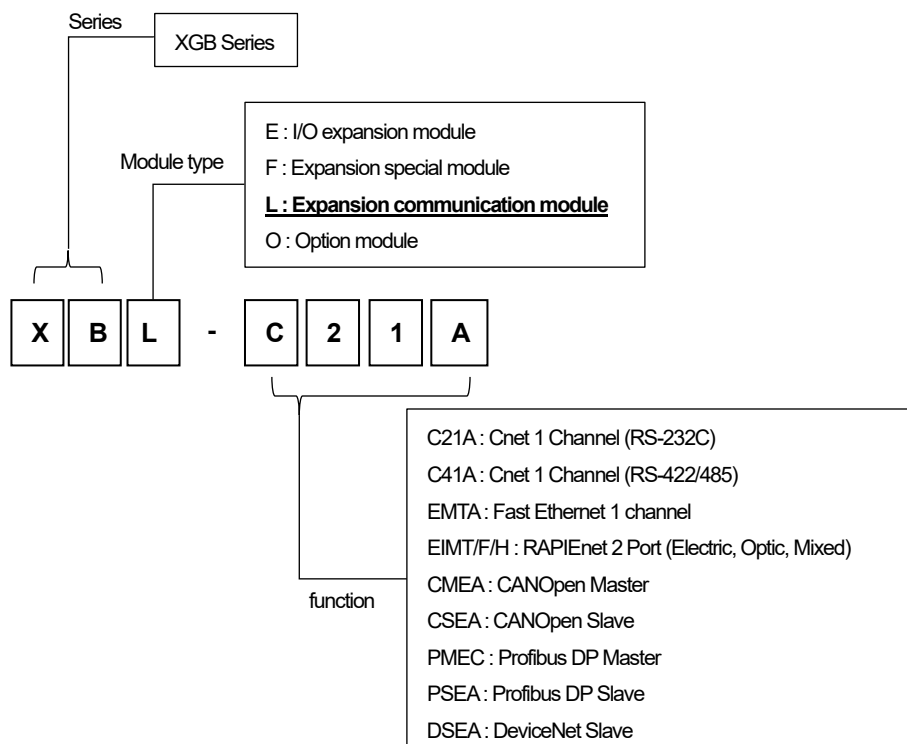

Classification	Name	Type
Cnet Comm. Module	XBL-C21A	RS-232C, 1 channel
	XBL-C41A	RS-422/485, 1 channel
FEnet Comm. Module	XBL-EMTA	Electricity, open type Ethernet
Rnet Comm. Module	XBL-RMEA	RemoteNet Master
RAPIEnet Comm. Module	XBL-EIMT/EIMF/EIMH	Comm. Module between PLCs, electric, optic, and mixed (electric& optic) 100 Mbps industrial Ethernet supported
EtherNet Comm. Module	XBL-EIPT	Open EtherNet I/P
CANopen Comm. Module	XBL-CMEA	CANopen Master
	XBL-CSEA	CANopen Slave
Pnet Comm. Module	XBL-PMEC	Profibus-DP Master
	XBL-PSEA	Profibus-DP Slave
DeviceNet Comm. Module	XBL-DSEA	DeviceNet Slave

2.3 XEM -H2/HP Type System Configuration

2.3.1 How to configure the System

You can configure the system by using the XEM-H2/HP Type PLC as below.

You can connect to the expansion modules up to 7EA.

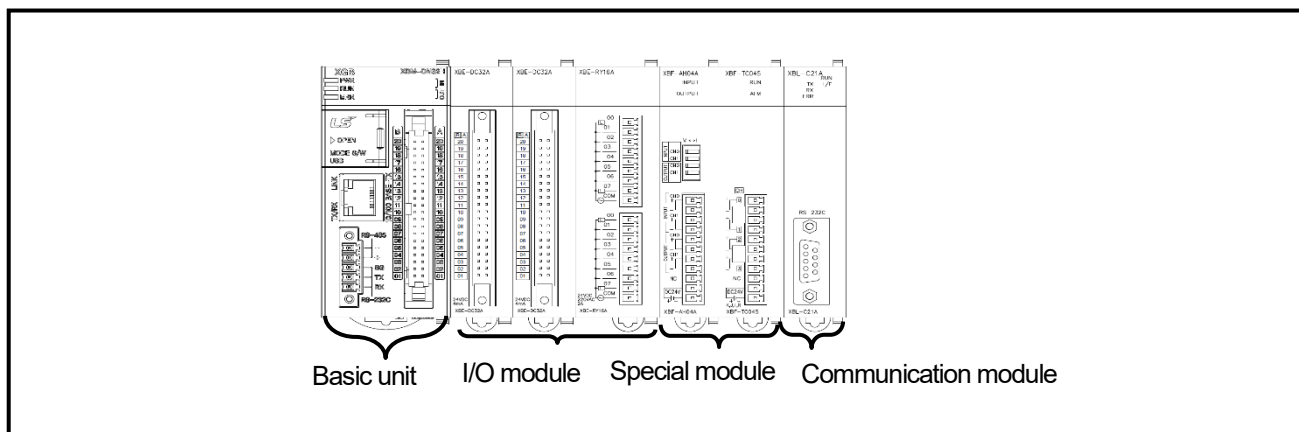

Items		Description				
Number of I/O configuration points		<ul style="list-style-type: none"> • XEM-DR14H2 : 14 points~256 points • XEM-DP16H2 : 16 points~256 points • XEM-DN32H2 : 32 points~256 points • XEM-DP32H2 : 32 points~256 points 	<ul style="list-style-type: none"> • XEM-DN16H2 : 16 points~256 points • XEM-DN32HP : 32 points~256 points 			
Number of accessible expansion modules	Digital I/O module	• Up to 7 EA				
	Special module	• Up to 7 EA				
	Communication module	• Up to 2 EA				
	High speed expansion module	• Up to 2 EA (Can be expanded for 2 slots just behind the basic unit)				
	Option module	• Cannot be installed.				
Configuration of products	Main Unit	XEM series	<ul style="list-style-type: none"> • XEM-DR14H2 • XEM-DN32H2 • XEM-DP32HP 	<ul style="list-style-type: none"> • XEM-DN16H2 • XEM-DN32HP 	<ul style="list-style-type: none"> • XEM-DP16H2 • XEM-DP32H2 	
	Expansion module	Digital I/O module	<ul style="list-style-type: none"> • XBE-DC08/16/32A • XBE-DC16B • XBE-DR16A 	<ul style="list-style-type: none"> • XBE-TN08/16/32A • XBE-TP08/16/32A • XBE-DN32A 	<ul style="list-style-type: none"> • XBE-RY08/16A • XBE-RY08B 	
		Special module	<ul style="list-style-type: none"> • XBF-AD04A • XBF-AD04C • XBF-AD08A • XBF-AH04A • XBF-RD04A • XBF-RD01A 	<ul style="list-style-type: none"> • XBF-DC04A • XBF-DC04C • XBF-DV04A • XBF-DV04C • XBF-TC04S • XBF-PD02A 	<ul style="list-style-type: none"> • XBF-HO02A • XBF-HD02A • XBF-TC04RT • XBF-TC04TT • XBF-LD02S 	
		Communication module	<ul style="list-style-type: none"> • XBL-C41A • XBL-EMTA • XBL-PMEC • XBL-RMEA 	<ul style="list-style-type: none"> • XBL-C21A • XBL-EIMT/F/H • XBL-EIPT 	<ul style="list-style-type: none"> • XBL-PSEA • XBL-CMEA/CSEA • XBL-DSEA 	
		High speed I/F module	<ul style="list-style-type: none"> • XBF-PN04B 	<ul style="list-style-type: none"> • XBF-PN08B 		

2.3.2 Instructions for System Configuration

(1) High speed expansion module

XEM H2/HP type PLC supports high-speed expansion I/F to speed up expansion module processing.

This section explains the precautions when configuring the system using the high-speed expansion module and the general expansion module.

- There are two types of high-speed expansion modules using high-speed expansion I/F: XBF-PN04B and XBF-PN08B.
- XEM H2/HP type can use both general and high-speed expansion modules.
- The high-speed expansion module can be installed only in the 2nd or 3rd slot.
- If the high-speed expansion module is installed in the 3rd slot, the high-speed expansion module must be present in the 2nd slot as well.
- High-speed expansion module cannot be installed behind general expansion module. Therefore, the high-speed expansion module and the general expansion module in case of mixed use, the general expansion module must be installed behind the high-speed expansion module.
- Expansion communication module can be installed up to 2 units as before.
- The table below shows an example of system configuration when using a high-speed expansion module and a general expansion module.

(◇ : General expansion module (Special, I/O), ◎ : General expansion module (Communication), ◆ : High speed expansion modules)

Basic Unit	Slot Number					Definitions of Operations	Remarks
	No.1	No.2	No.3	No.4	No.6~8		
XBM-H2/HP Type	◆	◆	◎ OR ◇			Slot 2, 3: high-speed expansion module, slot 3~8: general expansion module	2 communication modules work
	◆		◎ OR ◇			Slot 2, 3: high-speed expansion module, slot 3~8: general expansion module	2 communication modules work
	◇	◆	◎	◇	◇	Not configurable (Cannot use high-speed expansion module after general expansion module)	
	◆	◆	◆	◇	◇	Not configurable (exceeds the allowable number of high-speed expansion modules)	
	◎	◎	◎	◇	◇	Not configurable (exceeds the allowable number of communication modules)	
	◇	◇	◎	◎	◇	Consists of only general expansion modules	2 communication modules work
Existing XGB	◎	◎	◇	◇	◇	Consists of only general expansion modules	2 communication modules work
	◎	◎	◎	◇	◇	Not configurable (exceeds the allowable number of communication modules)	
	◆	◎	◎	◇	◇	Not configurable (high-speed expansion module is not supported)	

(2) How to allocate slots for expansion modules

-In the case of the XEM-H2/HP, built-in Ethernet occupies No.1 slot. Accordingly, No.2 slot is allocated for the first expansion module.

-In the case of the XEM-H2/HP type, empty slot is allocated for No.1.

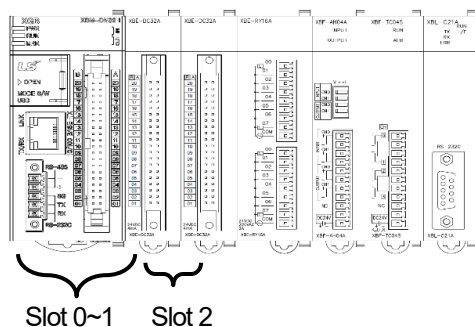

2.3.3 Embedded Communication System Configuration

2.3.3.1 Embedded Cnet I/F System Configuration

The Cnet I/F system is the system to transmit/receive external devices including PC and data through RS-232C/RS-422 I/F. In the case of Built-in Cnet, RS-232C and RS-485 communication I/F are respectively embedded. Moreover, you can additionally install the Cnet I/F module (XBL-C21A) for RS-232C only that is the expansion module and Cnet I/F module (XBL-C41A) for 485 only so it is possible to build up various communication systems for the purposes. Some examples of communication systems are represented here, which can be configured by the Cnet I/F embedded in XGB basic unit.

(1) 1:1 connection with the HMI by using the basic unit's embedded RS-232C or RS-485 port

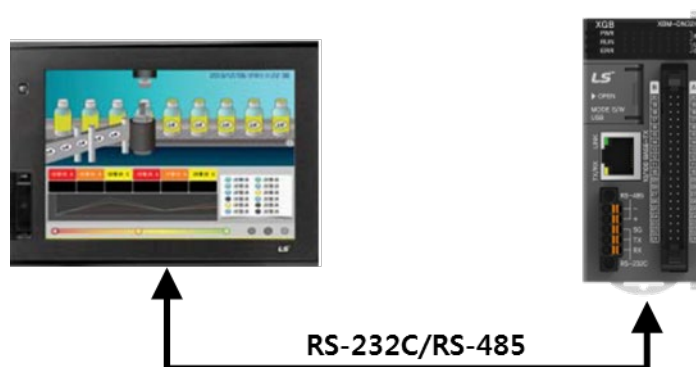

(2) Communication with the other PLC through the basic unit's embedded RS-485 port/ 1:1 connection with the HMI through the embedded RS-232C port

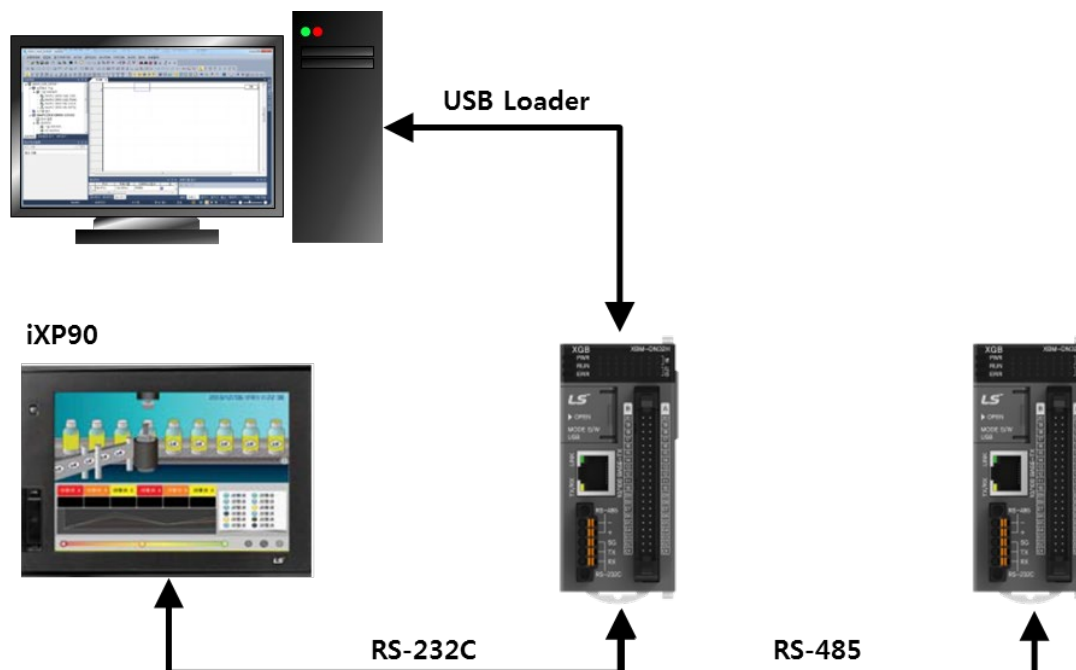

- (3) Configuring 1:N communication system with the maximum 32 stations by using the basic unit's embedded RS-485 port

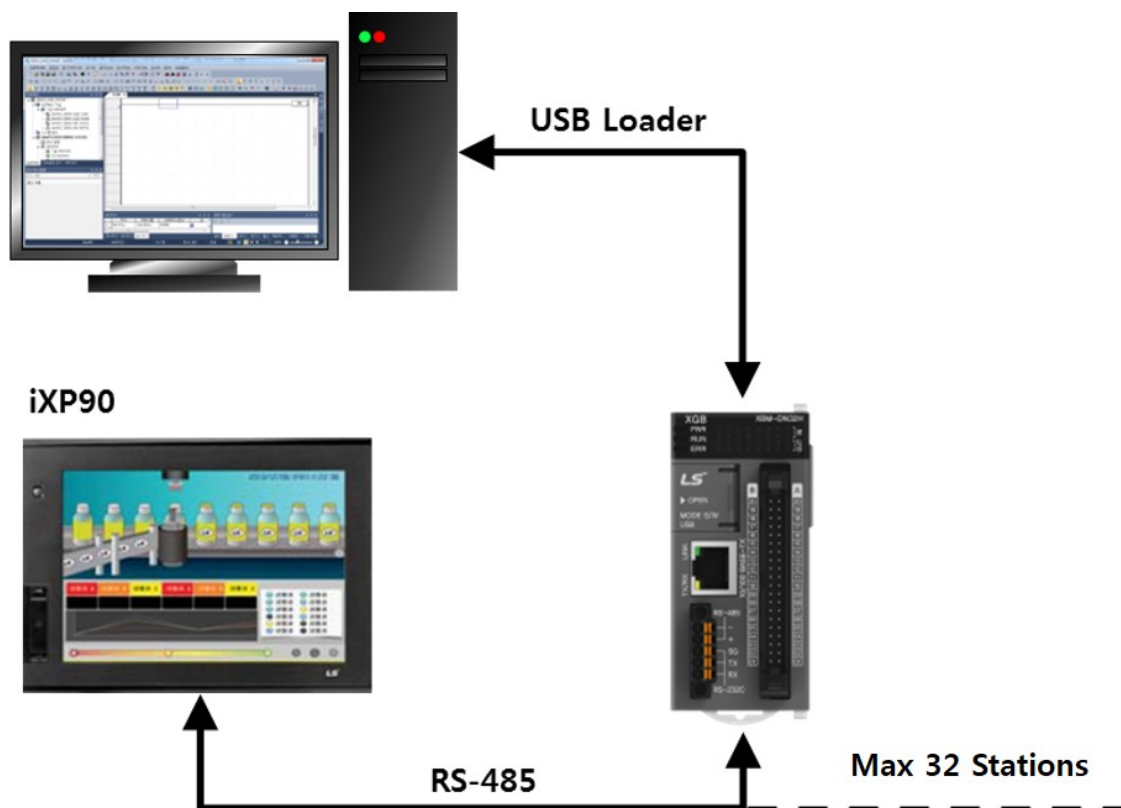
**Notice**

For detailed specifications of the embedded Cnet communication, refer to Part4 Communication in this manual.
For detailed specifications of the expansion Cnet communication module, refer to "XGB Cnet I/F" manual.

2.3.3.2 Embedded Ethernet I/F System Configuration

The Ethernet is the typical LAN interface (IEEE802.3) developed commonly by Xerox, Intel, DEC of U.S.A. It is the network connection system with the transfer capacity of 100Mbps and packets of 1.5kB. The Ethernet can integrate different types of computers through network so it is regarded as the representative LAN interface. It is not the standard for a specific company but the common standard so you can find various products. In addition, it can control communication through CSMA/CD and builds up the network easily, furthermore, can collect high-capacity data.

(1) Ethernet system's block diagram

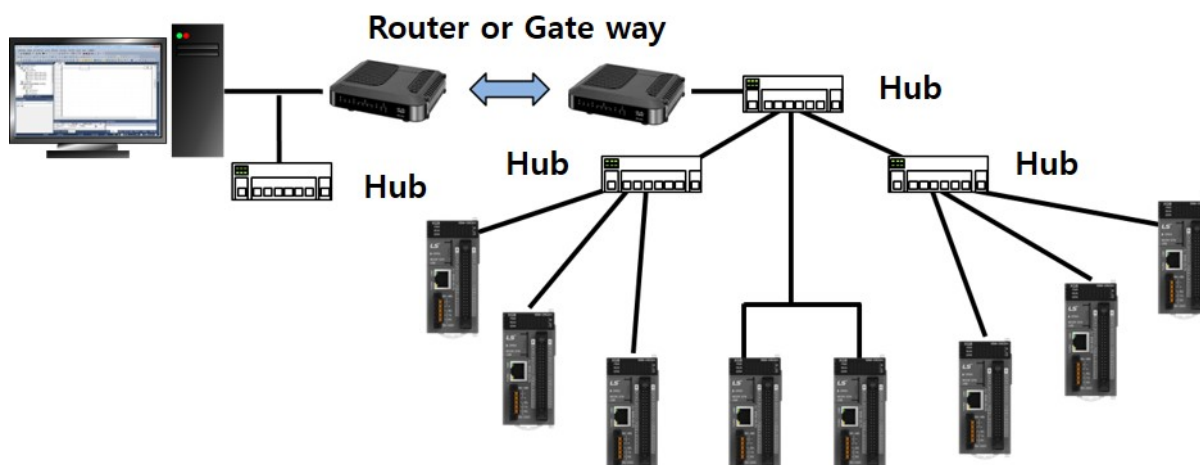

Notice

For more details on how to the above LS ELECTRIC's network system configuration and Enet system configuration, refer to Chap.5 Embedded Communication and "XGB FEnet I/F" of this manual.

Chapter 3 Specifications

3.1 Names and Functions of Each Part

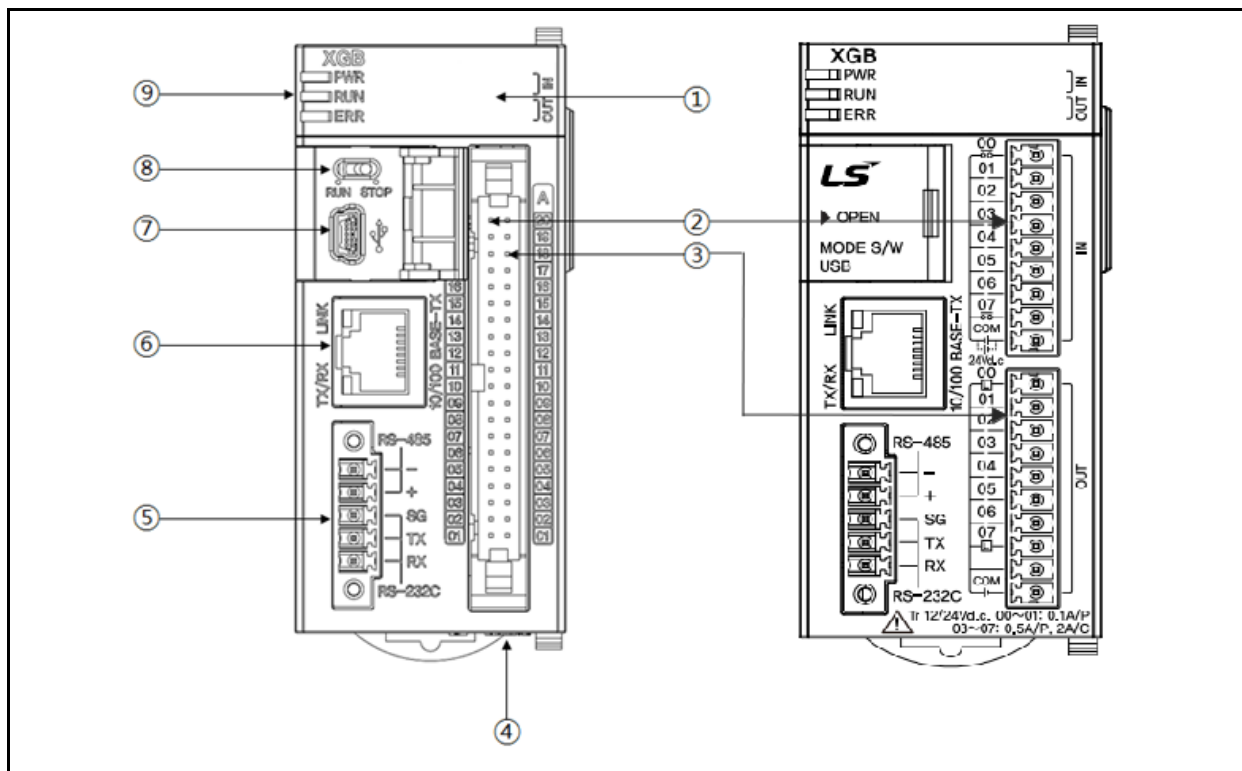

No	Names	Purposes
①	LED for displaying input, output	■ Displays the On/Off status of input, output contacts
②	I/O Connector	Input points ■ Terminal block receiving the actual input signal
③		Output points ■ Terminal block outputting the actual output signal
④	Built-in serial communication connecting connector	■ Built-in RS-232C/485 connecting connector
⑤	Built-in ethernet connecting connector	■ Built-in Enet connecting connector
⑥	PADT connecting connector	■ PADT connecting connector
⑦	RUN/STOP mode switch	■ Sets the basic unit's operation mode. <ul style="list-style-type: none"> • STOP → RUN : Program's operation is executed. • RUN → STOP : Program's operation is stopped. (In case of STOP, the remote operation is available.)
⑧	Status display LED	■ Displays the basic unit's operation status. <ul style="list-style-type: none"> • PWR(Red light On) : The power is supplied. • RUN(Green light On) : During RUN mode • ERR(Flickering red light) : Occurrence of errors during operation

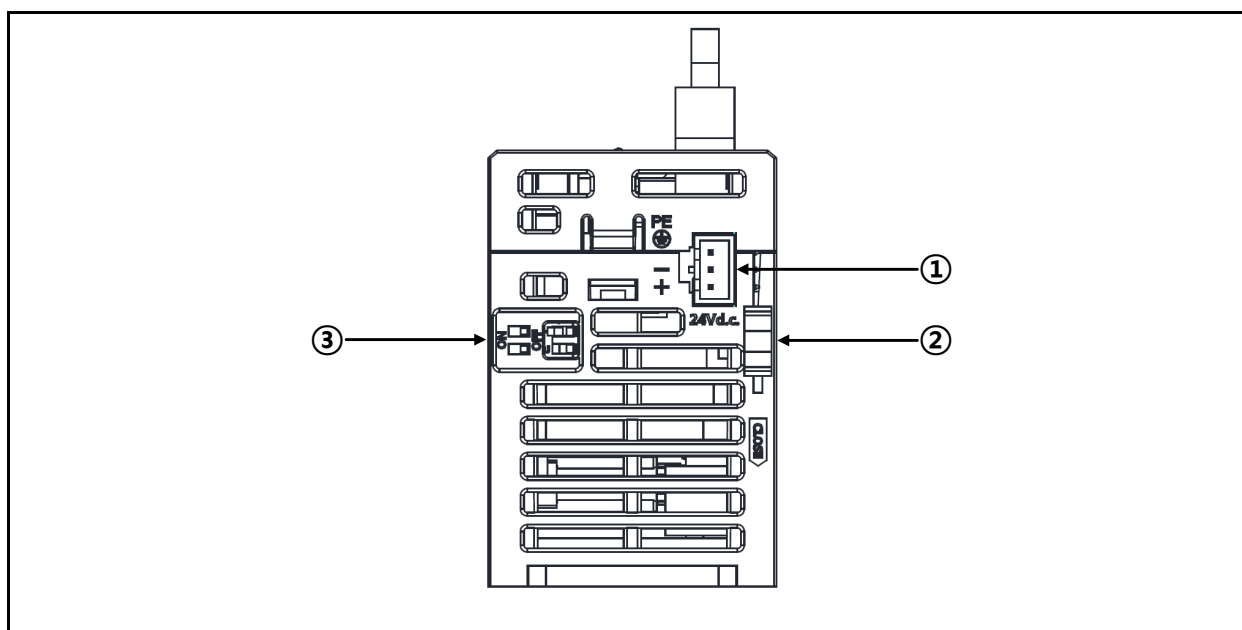

No	Names	Purposes
①	Power terminal	■ Power supply terminal (DC24V)
②	Expansion module hook	■ Fix hook when installing extension module
③	Terminating resistance selector switch	■ Terminating resistance selector switch for built-in RS-485 <ul style="list-style-type: none"> • Switch both On : Use of Terminating resistance • Switch both Off : Not use of Terminating resistance

3.2 General specifications

No.	Items	Specification	Reference		
1	Ambient Temp.	0 ~ 55 °C	-		
2	Storage Temp.	-25 ~ +70 °C			
3	Ambient humidity	5 ~ 95%RH (Non-condensing)			
4	Storage humidity	5 ~ 95%RH (Non-condensing)			
5	Vibration	Occasional vibration		-	
		Frequency	Acceleration	Pulse width	10 times each direction (X,Y and Z)
		5≤f< 8.4Hz	-	3.5mm	
		8.4≤f≤150Hz	9.8m/s ² (1G)	-	
		Continuous vibration			
		Frequency	Acceleration	Pulse width	
		5≤f< 8.4Hz	-	1.75mm	
8.4≤f≤150Hz	4.9m/s ² (0.5G)	-			
6	Shocks	<ul style="list-style-type: none"> • Peak acceleration : 147 m/s²(15G) • Duration : 11ms • Pulse wave type : Half-sine (3 times each direction per each axis) 			
7	Impulse noise	Square wave impulse noise	AC: ±1,500 V DC: ±900 V	LS ELECTRIC standard	
		Electrostatic discharge	Voltage: 4kV (Contact discharge)		IEC61131-2 IEC61000-4-2
		Radiated electromagnetic field noise	80 ~ 1,000MHz, 10 V/m		IEC61131-2, IEC61000-4-3
		Fast transient /Burst noise	Classification	Power supply	Digital/Analog Input/Output, Communication Interface
		Voltage	2kV	1kV	
8	Operation ambience	Free from corrosive gases and excessive dust		-	
9	Altitude	Less than 2,000m			
10	Pollution degree	Less than 2			
11	Cooling method	Air-cooling			

Notes

1) IEC (International Electrotechnical Commission)

: An international civil community that promotes international cooperation for standardization of electric/ electro technology, publishes international standard and operates suitability assessment system related to the above.

2) Pollution Degree

: An index to indicate the pollution degree of used environment that determines the insulation performance of the device. For example, pollution degree 2 means the state to occur the pollution of non-electric conductivity generally, but the state to occur temporary electric conduction according to the formation of dew.

3.3 Power specifications

This section describes XEM-H2/HP PLC basic unit's power specifications.

Items		Specification	condition
Input	Input volatage range	DC20.4~28.8V(-15%, + 20%)	-15%, + 20% of rated voltage
	Rated input voltage	DC24V	
	Input current	1A or less	Input max +DC28.8V load
	Inrush current	70 Apeak or less	Input max +DC28.8V load
	Efficiency	60% or more	Input max +DC28.8V load
	Permitted momentary power failure	1ms or less	Input max +DC28.8V load
Ouput	Rated output voltage	DC 5V(±2%)	
	Output current	2.0A	
Power supply status indication		LED On when power supply is normal	
Cable specification		0.75 ~ 2 mm ²	

* For protection of the power supply, you are recommended to use the power supply with the maximum of 4A fuse.

Notice

(1) Allowable instantaneous interruption time

It is the time to maintain the normal output voltage(normal operation) on the condition that the input voltage(DC24V) is lower than the lowest rated input voltage (DC20.4V).

(2) Use UL certified power supply

- Device, Power supply, should meet Class 2 or LVLC(Limited voltage Limited circuit).

3.3.1 Consumption current

Type	Model	Description	Consumption current (Unit : mA)
Main unit	XEM-DR14H2	DC24V input 8 point, output 6 point (relay)	393
	XEM-DN16H2	DC24V input 8 point, output 8 point (sink)	292
	XEM-DP16H2	DC24V input 8 point, output 8 point (source)	300
	XEM-DN32H2/HP	DC24V input 16 point, output 16 point (sink)	540
	XEM-DP32H2/HP	DC24V input 16 point, output 16 point (Source)	540
Expansion I/O module	XBE-DC32A	DC24V input 32 point	50
	XBE-DC16A/B	DC24V input 32point, DC12/24V input 16point	40
	XBE-DC08A	DC24V input 8point	20
	XBE-AC08A	AC110V input 8 point	30
	XBE-RY16A	Relay output 16point	440
	XBE-RY08A/B	Relay output 8 point, Relay output 8point(independent)	240
	XBE-TN32/16/08A	TR output 32/16/8 point(sink)	80/50/40
	XBE-DR16A	DC24 input 8point, Relay output 8point	250
XBE-TP32/16/08A	TR output 32/16/8 point(source)	80/50/40	
Expansion Special module	XBF-AD04A	Current/Voltage input 4 channel, 1/4000 resolution	120
	XBF-AD08A	Current/Voltage input 8 channel, 1/4000 resolution	105
	XBF-AH04A	Current/Voltage input 2 channel, output 2 channel, 1/4000 resolution	120
	XBF-DV04A	Voltage output 4channel, 1/4000 resolution	110
	XBF-DC04A	Current output 4channel, 1/4000 resolution	110
	XBF-RD04A	RTD input 4channel, Pt100, Jpt100	100
	XBF-RD01A	RTD input 1channel, Pt100, Jpt100	100
	XBF-TC04S	TC input 4channel, TC K/J/T/R type)0~65,535)	100
	XBF-PD02A	Positioning 2 axis (line drive), max. out 2Mbps	500
	XBF-HO02A	HSC open collector, 2channel	270
	XBF-HD02A	HSC line drive, 2channel	330
	XBF-AD04C	Current/Voltage input 4channel, 1/16000 resolution	105
	XBF-DC04C	Current output 4channel, 1/16000 resolution	70
	XBF-DV04C	Voltage output 4channel, 1/16000 resolution	70
	XBF-TC04RT	Temp. control module (RTD input, 4loop)	120
	XBF-TC04TT	Temp. control module (TC input, 4loop)	120
	XBF-LD02S	Loadcell input	110
Expansion Communication module	XBL-C21A	Cnet RS-232C 1Ch	110
	XBL-C41A	Cnet RS-422 1Ch	110
	XBL-EMTA	Fast Ethernet 1Ch	190
	XBL-EIMT/F/H	RAPIDnet electric/optic/mixed 1ch	280/670/480
	XBL-EIPT	EtherNet/IP electric 1ch	400
	XBL-CMEA	CANopen Master 1Ch	150
	XBL-CSEA	CANopen Master 1Ch	150
	XBL-PMEC	Profibus-DP, Master	300
	XBL-PSEA	Profibus-DP, Slave	230
	XBL-DSEA	DeviceNet, Slave	100
	XBL-RMEA	Rnet, Master	250

3.3.2 Calculation Example of Consumption Current/Voltage

Calculate the consumption current and configure the system not to exceed the output current capacity of main unit. Refer to 3.3.1 for each module's consumption current.

(1) XGB PLC configuration example 1

Consumption of current/voltage is calculated as follows.

Type	Model	Unit No.	Internal 5V consumption current (Unit : mA)	Remark
Main unit	XEM-DN32HP	1	540	In case all contact points are On. (Maximum consumption current)
Expansion module	XBE-DC32A	2	50	
	XBE-TN32A	2	80	
	XBF-AD04A	1	120	All channel is used. (Maximum consumption current)
	XBF-DC04A	1	110	
XBL-C21A	1	110		
Consumption current	1140mA			-
Consumption voltage	5.7W			$1.14A \times 5V = 5.7W$

In case system is configured as above, since 5V consumption current is total 1,140 mA and 5V output of main unit is maximum 2A, normal system configuration is available.

(2) XGB PLC configuration example 2

Type	Model	Unit No.	Internal 5V consumption current (Unit : mA)	Remark
Main unit	XEM-DN32HP	1	540	In case all contact points are On. (Maximum consumption current)
Expansion module	XBE-DR16A	2	250	
	XBE-RY16A	2	440	
	XBF-AD04A	2	120	All channel is used. (Maximum consumption current)
	XBL-C21A	1	110	
Consumption current	2,150mA			-
Consumption voltage	10.75W			$2.15 \times 5V = 10.75W$

In case system is configured as above, since 5V consumption current is total 2,150 mA and 5V output of XGB 32 points main unit is maximum 2A, configuration is not available. This total consumption current is calculated when all input/output points are on. For safety for system, it is recommended to use higher specification of main unit.

3.4 Battery

3.4.1 Battery specifications

Items	Specifications										
Nominal voltage / current	DC 3.0V / 6.5 mAh										
Warranty term	3 years (at room temperature)										
Purpose	RTC operation during the blackout										
Charging time	<table border="1"> <caption>Charging Time Data</caption> <thead> <tr> <th>Charging Time (h)</th> <th>Charging Percentage (%)</th> </tr> </thead> <tbody> <tr> <td>4</td> <td>25%</td> </tr> <tr> <td>24</td> <td>65%</td> </tr> <tr> <td>36</td> <td>80%</td> </tr> <tr> <td>72</td> <td>100%</td> </tr> </tbody> </table>	Charging Time (h)	Charging Percentage (%)	4	25%	24	65%	36	80%	72	100%
Charging Time (h)	Charging Percentage (%)										
4	25%										
24	65%										
36	80%										
72	100%										
Backup time	About 6 months(25°C) <table border="1"> <thead> <tr> <th>surrounding temperature</th> <th>Back-up time</th> </tr> </thead> <tbody> <tr> <td>70°C</td> <td>about 195 days</td> </tr> <tr> <td>25°C</td> <td>about 183 days</td> </tr> <tr> <td>-25°C</td> <td>about 133 days</td> </tr> </tbody> </table>	surrounding temperature	Back-up time	70°C	about 195 days	25°C	about 183 days	-25°C	about 133 days		
surrounding temperature	Back-up time										
70°C	about 195 days										
25°C	about 183 days										
-25°C	about 133 days										

3.4.2 Instruction for Use

- (1) It is impossible to exchange inner battery
- (2) Do not apply heat or solder electrode (It may cause a battery's life-shortening)
- (3) Do not measure voltage with a tester or short-circuit (It may be the cause of a fire.)
- (4) Do not disassemble the battery.
- (5) Do not change the battery on purpose.

3.4.3 Battery Life

Battery's life may be different depending on the conditions of blackout time, service temperature, etc.

Battery can be charged when power is on, and be used for RTC function.

Battery can be discharged when PLC power have been off for a long time. When you put power on PLC, it will be charged automatically. Program and data backup should be preserved with no regard to battery discharge.

3.5 Performance specifications

The XEM-H2/HP unit's common performance specifications for CPU are as below.

Items		Specifications		Remark	
		XEM-DN32H2/XEM-DN32HP/ XEM-DP32H2/XEM-DP32HP XEM-DR14H2, XEM-DN16H2, XEM-DP16H2			
Program control method		Cyclic execution of stored program, Time-driven interrupt, Process-driven interrupt			
I/O control method		Batch processing by simultaneous scan (Refresh method), Directed by program instruction			
Program language		LD(Ladder Diagram), Instruction List, SFC (Sequential Function Chart), ST (Structured Text)			
Number of instructions	Operator	18			
	Basic function	136+Real number operation function			
	Basic function block	43			
	Dedicated function block	Special function dedicated function			
Processing speed (Basic instruction)		40ns/step			
Program capacity		384KB			
Max. I/O points		256 points (Main + Expansion 7 stages)			
Data area	Automatic variable (A)	64KB (All area retain setting available)			
	Input variable (I)	2 KB (%IX15.15.63)			
	Output variable (Q)	2 KB (%QX15.15.63)			
	Direct variable	M	32KB (All area retain setting available)		
		R	32KB * 2block		
		W	64KB		
	Flag variable	F	4KB		
		K	8KB		
		L	8KB		
		U	576KB		
N		N0000 ~ N10239 (10,240 word)			
Total program		256			
Initial task	Initial task	1			
	Cyclic task	Max 16			
	I/O task	Max 8			
	Internal device task	Max 16			
	High Speed Counter task	Max 4			
	Positioning task	1			
Operation mode		RUN, STOP, DEBUG			
Self-diagnosis function		Detects errors of scan time, memory, I/O and power supply			
Program port		USB 1 channel			
Back-up method		Latch area setting in basic parameter			
Internal consumption current		540mA(XEM-DN/DP32H2(HP)), 393mA(XEM-DR14H2), 292mA(XEM-DN16H2), 300mA(XEM-DP16H2)			
Weight		134g(XEM-DN32H2(HP)), 140g(XEM-DP32H2(HP)), 140g(XEM-DN16H2), 140g(XEM-DP16H2), 150g(XEM-DR14H2)			

Items		Specifications		Remark
		XEM-DN32H2/XEM-DN32HP/ XEM-DP32H2/XEM-DP32HP XEM-DR14H2, XEM-DN16H2, XEM-DP16H2		
Built-in Function	PID control		Control by instruction, auto-tuning, PWM output, Forced output, Operation scan time setting, Antiwindup, Delta MV, SV lamp, Hybrid operation, Cascade operation	
	Cnet	PID control	Dedicated protocol(XGT) Modbus protocol User defined protocol , LS bus(inverter protocol)	
		Channel	RS-232C 1 port and RS-485 1 port	
	Enet	Transfer spec	Cable: 100Base-TX, Speed: 100Mbps, Auto-MDIX ^{*1} , IEEE 802.3	
		Topology	Star	
		Diagnosis	Module information, Service condition	
		Protocol	XGT dedicated, Modbus TCP/IP, user define frame	
		Service	P2P, High Speed link, Remote connection, SMTP, SNTP, Auto scan	
	High Speed Counter	Performance	1 phase: 200kHz(2 phase: 100kHz)	
		channels	1phase 4 channels, 2 phase 2 channels	
		Counter mode	4 counter modes are supported based on input pulse and INC/DEC method • 1 pulse operation Mode : INC/DEC count by program • 1 pulse operation Mode : INC/DEC count by phase B pulse input • 2 pulse operation Mode : INC/DEC count by input pulse • 2 pulse operation Mode : INC/DEC count by difference of phase	
		Function	• Internal/external preset • Latch counter • Compare output • No. of rotation per unit time	
	Position	Basic function	No. of control axis: 6axis (XEM-H2: 2 axis) Control method : Position control, Speed control, Speed/Position control, Position/Speed control Control Unit: Pulse, mm, inch, degree Position data: 400 steps for each axis(1~400) Operation mode: end, keep, continuous Operation method: single, repeat	Only TR output model supports embedded positioning
		Interpolation function	• 2/3/4/5/6 axis linear interpolation(XEM-H2: 2 axis linear interpolation) • 2 axis circular interpolation • 3 axis helical interpolation(not supported in XEM-H2)	
		Position	Absolute method / Incremental method Position address range: -2,147,483,648 ~ 2,147,483,647(Pulse) Speed: max. 200kpps Acc/dec processing: Trapezoid-shaped , S-curve	
		Origin return method	DOG + HOME (Off), DOG + HOME(On), Upper/Lower limit + HOME, DOG, High speed, Upper/Lower limit, HOME	
		Jog operation	Jog Operation, MPG Operation, Inching Operation	
	Pulse catch		10μs 4point(%IX0.0.0~%IX0.0.3), 50μs 4point(%IX0.0.4~%IX0.0.7)	
	External point Interrupt		10μs 4point(%IX0.0.0~%IX0.0.3), 50μs 4point(%IX0.0.4~%IX0.0.7)	
	Input filter		1,3,5,10,20,70,100ms	

*1 Auto-MDIX(Automatic medium-dependent interface crossover) : It is the function to automatically detect whether the cable connected to the Ethernet port is peer-to-peer(straight) or cross cable

Chapter 4 Installation and wiring

4.1 Parameter & Operation data



Danger

▶ Please design protection circuit at the external of PLC for entire system to operate safely because an abnormal output or an malfunction may cause accident when any error of external power or malfunction of PLC module.

(1) It should be installed at the external side of PLC to emergency stop circuit, protection circuit, interlock circuit of opposition action such as forward /reverse operation and interlock circuit for protecting machine damage such as upper/lower limit of positioning.

(2) If PLC detects the following error, all operation stops and all output is off.

(Available to hold output according to parameter setting)

(a) When over current protection equipment or over voltage protection operates

(b) When self diagnosis function error such as WDT error in PLC CPU occurs

▶ When error about IO control part that is not detected by PLC CPU, all output is off.

Design Fail Safe circuit at the external of PLC for machine to operate safely. Refer to 4.1.1 Fail Safe circuit.

(1) Because of error of output device, Relay, TR, etc., output may not be normal. About output signal that may cause the heavy accident, design supervisory circuit to external.

▶ When load current is more than rating or over current by load short flows continuously, danger of heat, fire may occur so design safety circuit to external such as fuse.

▶ Design for external power supply to be done first after PLC power supply is done. If external power supply is done first, it may cause accident by misoutput, misoperation.

▶ In case communication error occurs, for operation status of each station, refer to each communication manual.

▶ In case of controlling the PLC while peripheral is connected to CPU module, configure the interlock circuit for system to operate safely. During operation, in case of executing program change, operation status change, familiarize the manual and check the safety status. Especially, in case of controlling long distance PLC, user may not response to error of PLC promptly because of communication error or etc.

Limit how to take action in case of data communication error between PLC CPU and external device adding installing interlock circuit at the PLC program.

 **Danger**

- ▶ Don't close the control line or communication cable to main circuit or power line. Distance should be more than 100mm.
It may cause malfunction by noise.

- ▶ In case of controlling lamp load, heater, solenoid valve, etc. in case of Off -> On, large current (10 times of normal current) may flows, so consider changing the module to module that has margin at rated current.

- ▶ Process output may not work properly according to difference of delay of PLC main power and external power for process (especially DC in case of PLC power On-Off and of start time.
For example, in case of turning on PLC main power after supplying external power for process, DC output module may malfunction when PLC is on, so configure the circuit to turn on the PLC main power first
Or in case of external power error or PLC error, it may cause the malfunction.

- ▶ Not to lead above error to entire system, part causing breakdown of machine or accident should be configured at the external of PLC

Chapter 4 Installation and wiring

4.1.1 fail safe circuit

(1) example of system design

In case of AC

In case of AC . DC

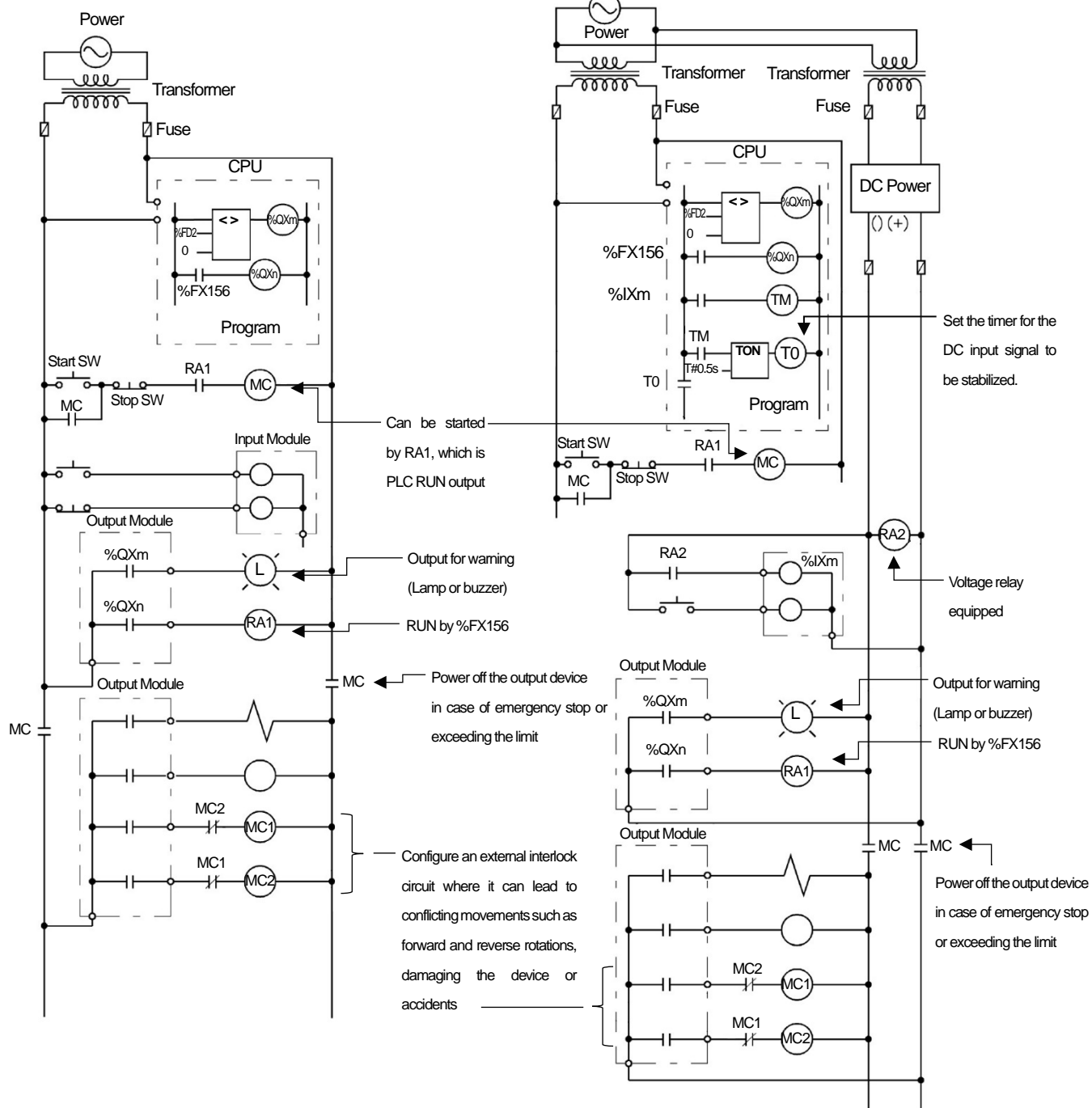

Start Sequence of power

In case of AC

- 1) Turn on the power
- 2) Run CPU.
- 3) Turn on the start SW.
- 4) Output device runs by program through Magnetic Contactor(MC) On.

Start Sequence of power

In case of AC-DC

- 1) Turn on the power.
- 2) Run CPU.
- 3) RA2 Turns on as DC power on
- 4) Turn on the timer after DC power is stabilized.
- 5) Turn on the start SW.
- 6) Output device runs by program through Magnetic Contactor(MC) On.

(2) Fail Safe Measures in case of PLC failures

Failures of the PLC CPU and memory are detected by self-diagnosis but if there are some problems with I/O control part, etc, the failure may not be detected from the CPU. In this case, it can be different depending on the failure status, all contacts may be On or Off so normal operation or safety of the controlled subject cannot be guaranteed.

We have done our best to assure quality but in case there are some problems with the PLC, please configure the fail safe circuit on the outside to prevent damage of the equipment or accident due to some cause. The below is the example of system configuration with the fail safe circuit.

<System example>

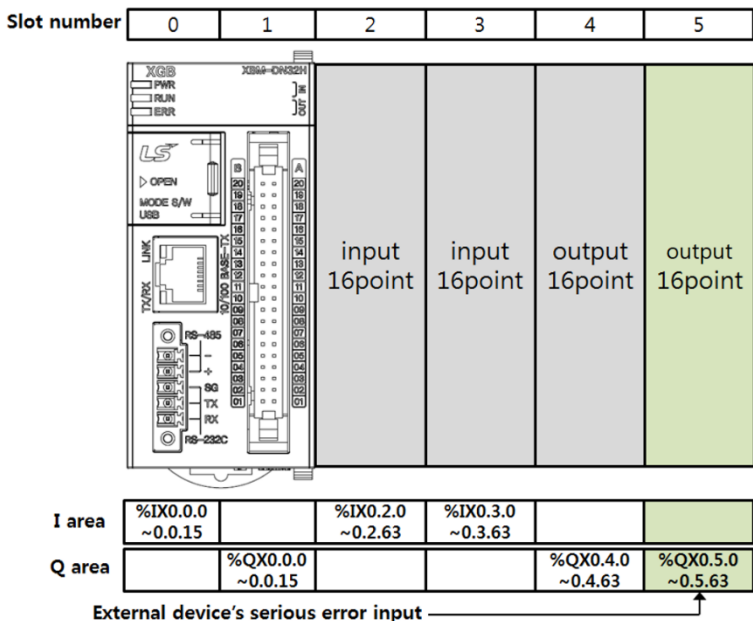

* Equip output module for fail safe to last slot of system.

[Fail safe circuit example]

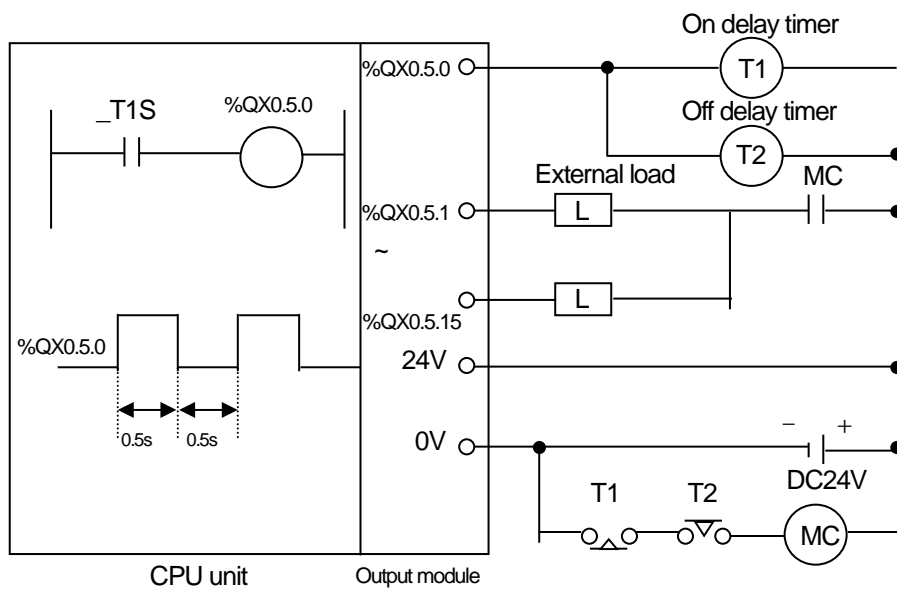

Since %QX0.5.0 turn on/off every 0.5s, use TR output.

4.1.2 PLC heat calculation

(1) Power consumption of each part

(a) Power consumption of module

The power conversion efficiency of power module is about 70% and the other 30% is gone with heat; 3/7 of the output power is the pure power consumption. Therefore, the calculation is as follows.

- $W_{pw} = 3/7 \{ (I_{5V} \times 5) + (I_{24V} \times 24) \}$ (W)

I_{5V} : power consumption of each module DC5V circuit (internal current consumption)

I_{24V} : the average current consumption of DC24V used for output module
(Current consumption of simultaneous On point)

If DC24V is externally supplied or a power module without DC24V is used, it is not applicable.

(b) Sum of DC5V circuit current consumption

The DC5V output circuit power of the power module is the sum of power consumption used by each module.

- $W_{5V} = I_{5V} \times 5$ (W)

(c) DC24V average power consumption (power consumption of simultaneous On point)

The DC24V output circuit's average power of the power module is the sum of power consumption used by each module.

- $W_{24V} = I_{24V} \times 24$ (W)

(d) Average power consumption by output voltage drop of the output module (power consumption of simultaneous On point)

- $W_{out} = I_{out} \times V_{drop} \times \text{output point} \times \text{simultaneous On rate}$ (W)

I_{out} : output current (actually used current) (A)

V_{drop} : voltage drop of each output module (V)

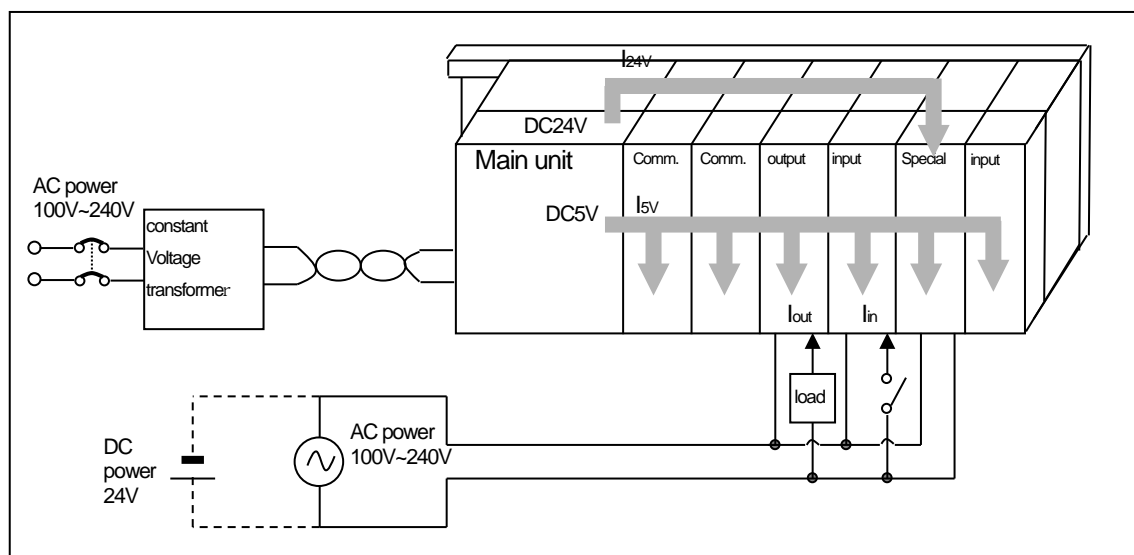

(e) Input average power consumption of input module

(Power consumption of simultaneous On point)

- $W_{in} = I_{in} \times E \times X$ input point X simultaneous On rate (W)

I_{in} : input current (root mean square value in case of AC) (A)

E : input voltage (actually used voltage) (V)

(f) Power consumption of special module power assembly

- $W_s = I_{5V} \times 5 + I_{24V} \times 24 + I_{100V} \times 100$ (W)

The sum of power consumption calculated by each block is the power consumption of the entire PLC system.

- $W = W_{PW} + W_{5V} + W_{24V} + W_{out} + W_{in} + W_s$ (W)

Calculate the heats according to the entire power consumption (W) and review the temperature increase within the control panel.

The calculation of temperature rise within the control panel is displayed as follows.

$$T = W / UA \text{ [}^\circ\text{C]}$$

W : power consumption of the entire PLC system (the above calculated value)

A : surface area of control panel [m^2]

U : if equalizing the temperature of the control panel by using a fan and others : 6

If the air inside the panel is not ventilated: 4

If installing the PLC in an air-tight control panel, it needs heat-protective (control) design considering the heat from the PLC as well as other devices. If ventilating by vent or fan, inflow of dust or gas may affect the performance of the PLC system.

4.2 Attachment/Detachment of Modules

Here describes about basic parameter of embedded positioning.

4.2.1 Attachment/Detachment of modules

Caution in handling

Use PLC in the range of general specification specified by manual.

In case of usage out of range, it may cause electric shock, fire, malfunction, damage of product.



Remark

- ▶ Module must be mounted to hook for fixation properly before its fixation.
The module may be damaged from over-applied force. If module is not mounted properly, it may cause malfunction.
- ▶ Do not drop or impact the module case, terminal block connector.
- ▶ Do not separate PCB from case.

(1) Equipment of module

- Eliminate the Extension Cover at the product.
- Push the product and connect it in agreement with Hook For Fixation of four edges and Hook For Connection at the bottom.
- After connection, push down the Hook For Fixation and fix it completely.

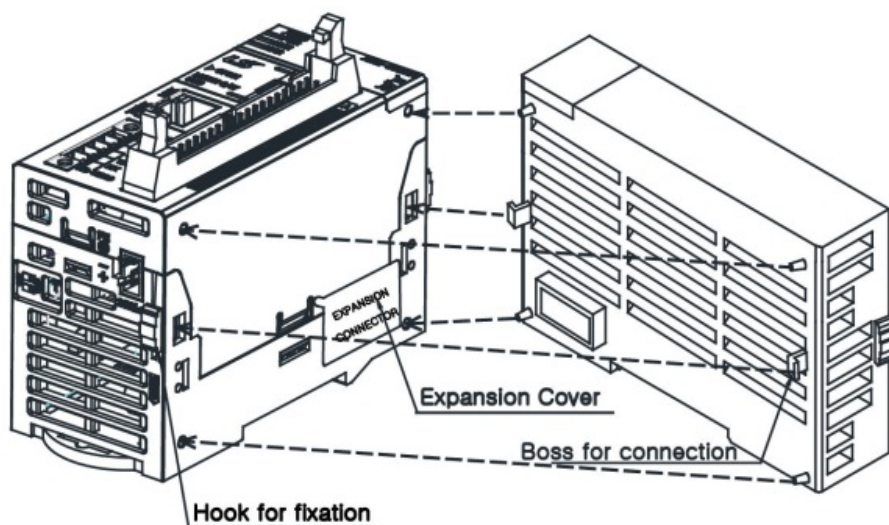

(2) Detachment of module

- Push up the Hook For Disconnection, and then detach the product with two hands.
(Do not detach the product by force)



Remark

- ▶ When separating module, do not apply excessive force. If so, hook may be damaged.
-If used outside the range, electric shock, fire, malfunction, or damage to the product may cause damage.

(3) Installation of module

XGB PLC has a hook for DIN rail (rail width: 35mm) so that can be installed at DIN rail.

(a) In case of installing at DIN rail

- Pull the hook as shown below for DIN rail at the bottom of module and install it at DIN rail
- Push the hook to fix the module at DIN rail after installing module at DIN rail

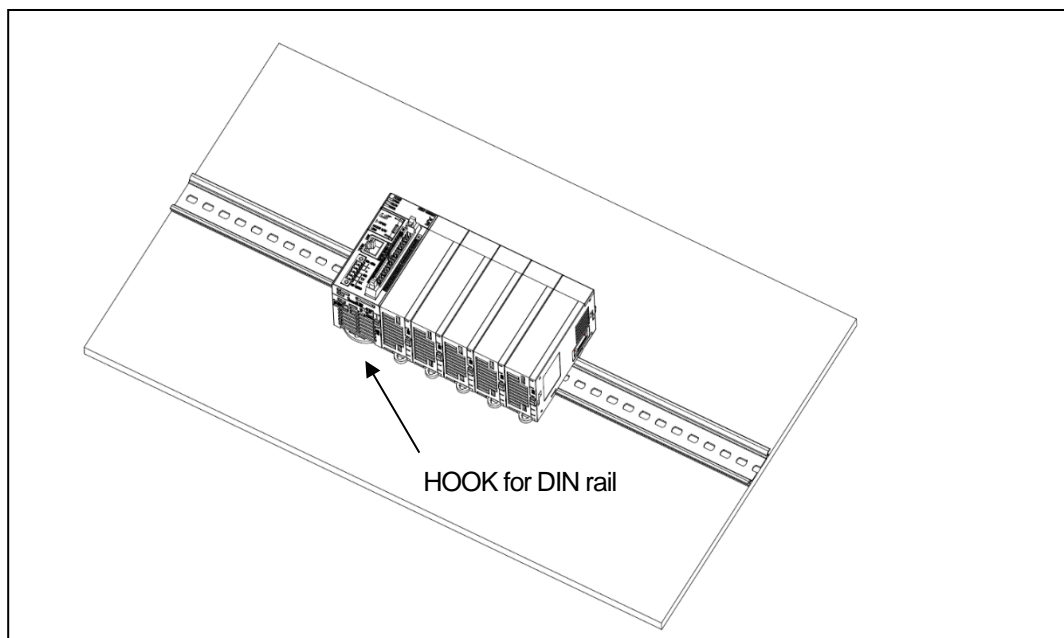

(b) In case of installing at panel

- You can install XGB compact type main unit onto a panel directly using screw hole
- Use M4 type screw to install the product onto a panel.

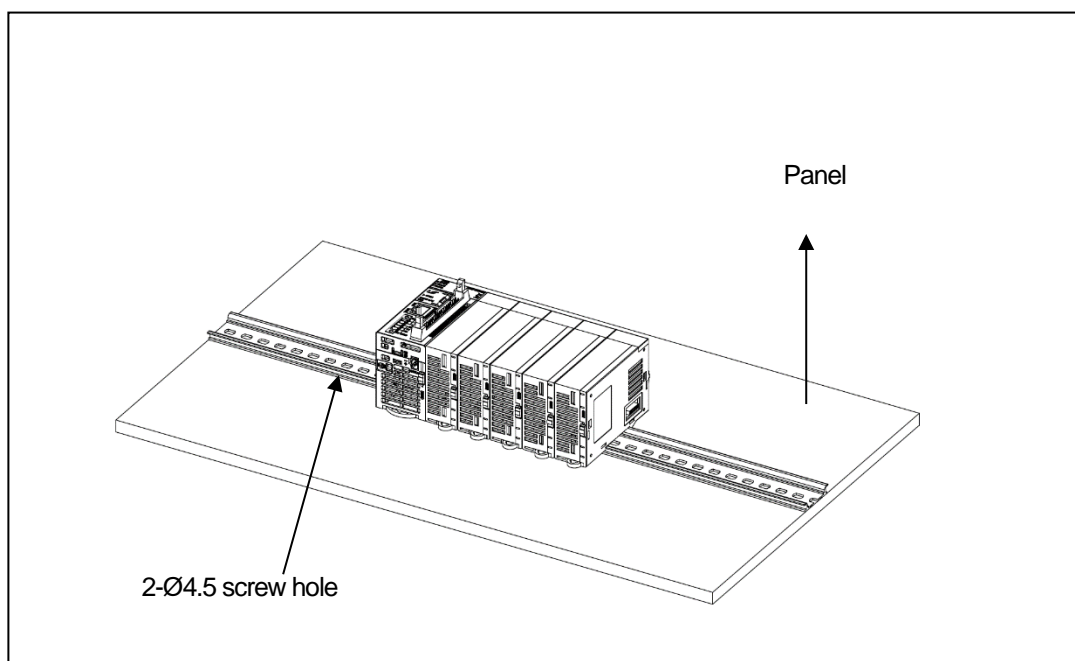

(4) Module equipment location

Keep the following distance between module and structure or part for ventilation, easy detachment and attachment.

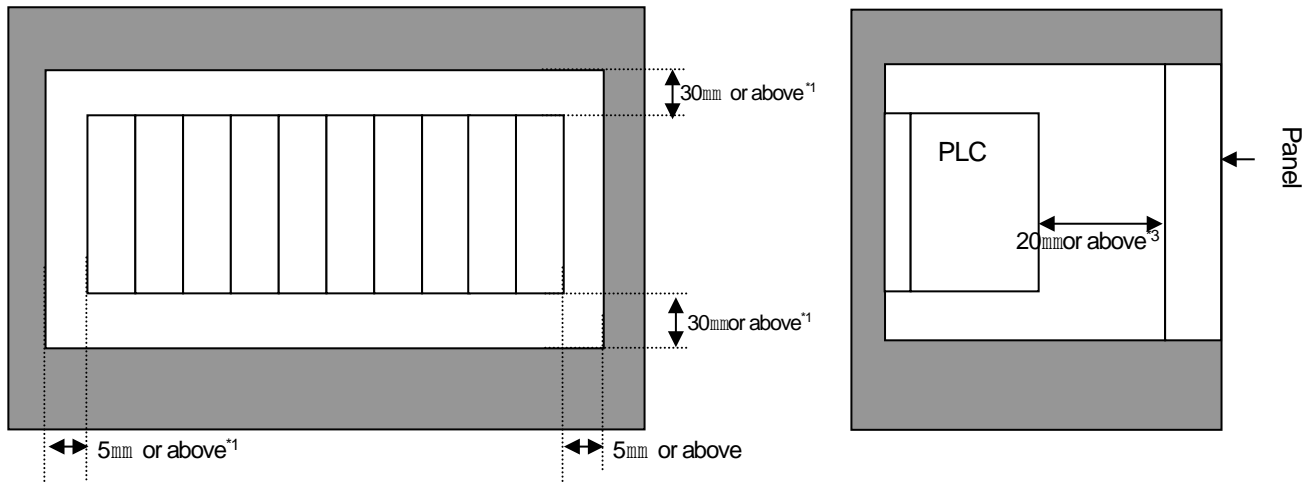

*1 : In case height of wiring duct is less than 50 mm (except this 40mm or more)

*2 : In case of equipping cable without removing near module, 20mm or more

*3 : In case of connector type, 20mm or above

(5) Module equipment direction

(a) For easy ventilation, install as shown below.

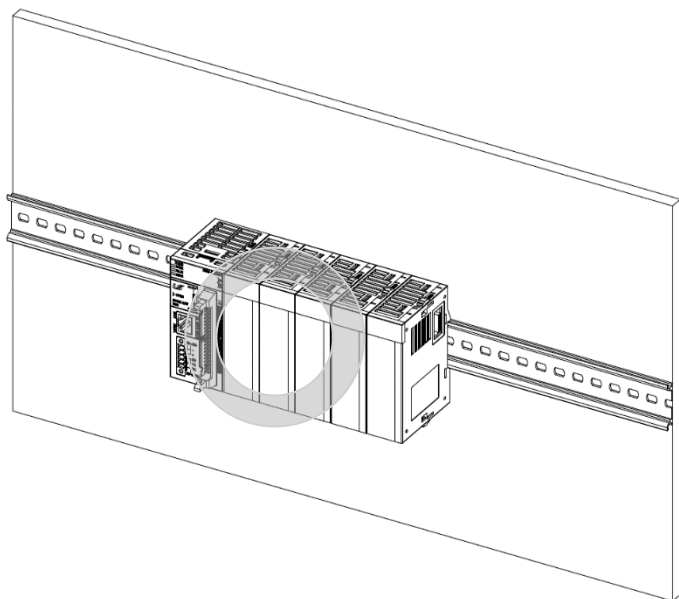

(b) Don't install as shown below.

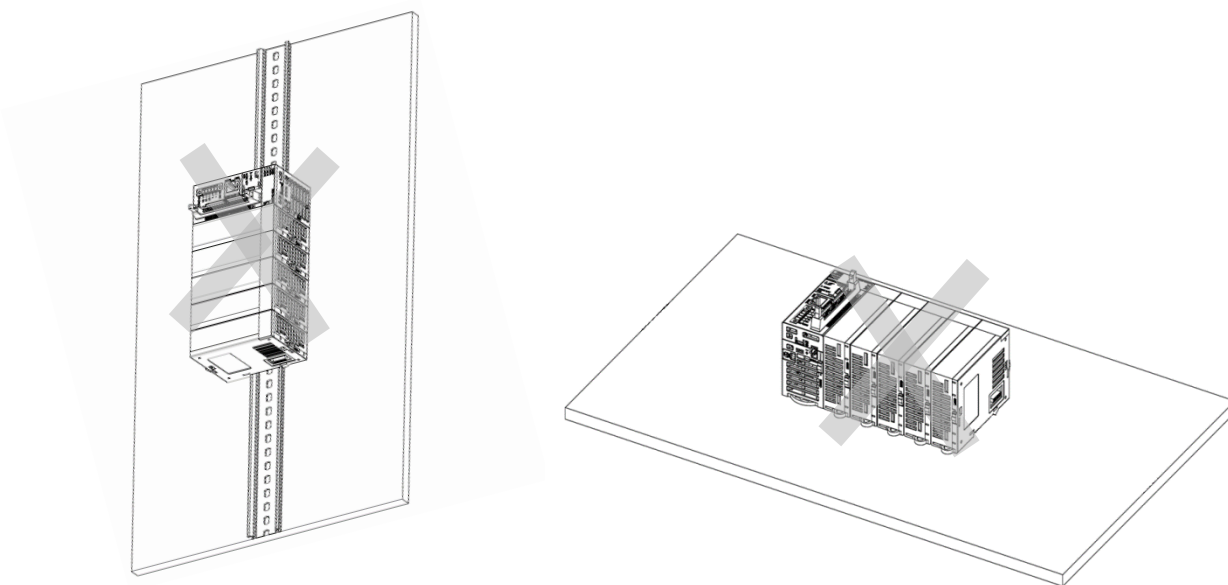

(6) Distance with other device

To avoid radiation noise or heat, keep the distance between PLC and device (connector and relay) as far as the following figure.

Device installed in front of PLC: 100 mm or more

Device installed beside PLC: 50 mm or more

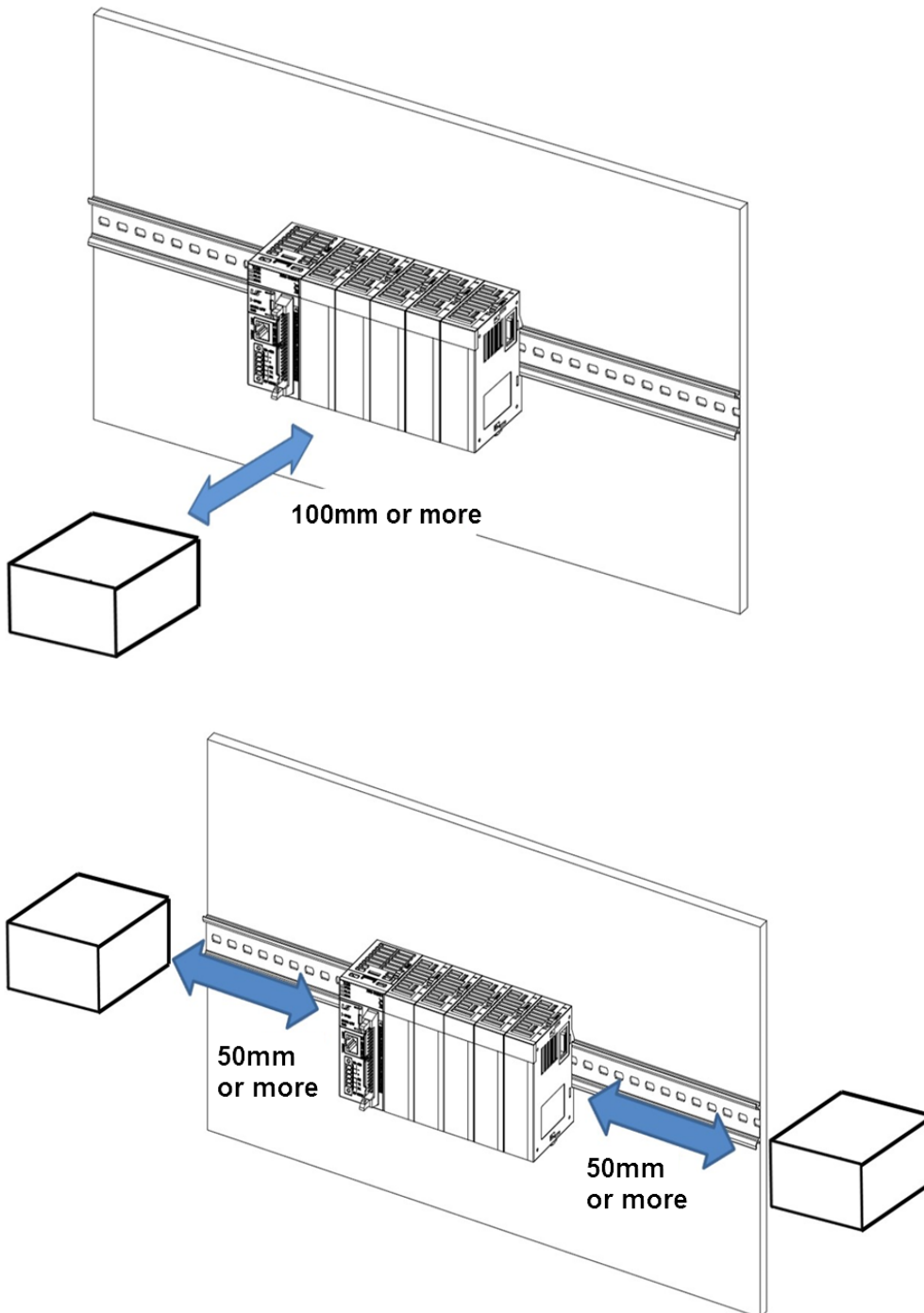

4.2.2 Caution in handling

Here describes caution from open to install

- Don't drop or impact product.
- Don't disassemble the PCB from case. It may cause an error.
- In case of wiring, make sure foreign substance not to enter upper part of module. If it enters, eliminate it.

(1) Caution in handling IO module

It describes caution in handling IO module.

(a) Recheck of IO module specification

For input module, be cautious about input voltage, for output module, if voltage that exceeds the max. open/close voltage is induced, it may cause the malfunction, breakdown or fire.

(b) Used wire

When selecting wire, consider ambient temp, allowed current and minimum size of wire is AWG22(0.3mm²) or above.

(c) Environment

In case of wiring IO module, if device or material that induce high heat is too close or oil contacts wire too long time, it may cause short, malfunction or error.

(d) Polarity

Before supplying power of module which has terminal block, check the polarity.

(e) Wiring

- In case of wiring IO with high voltage line or power line, induced obstacle may cause error.
- Let no cable pass the IO operation indication part (LED).
(You can't discriminate the IO indication.)
- In case induced load is connected with output module, connect the surge killer or diode load in parallel. Connect cathode of diode to + side of power.

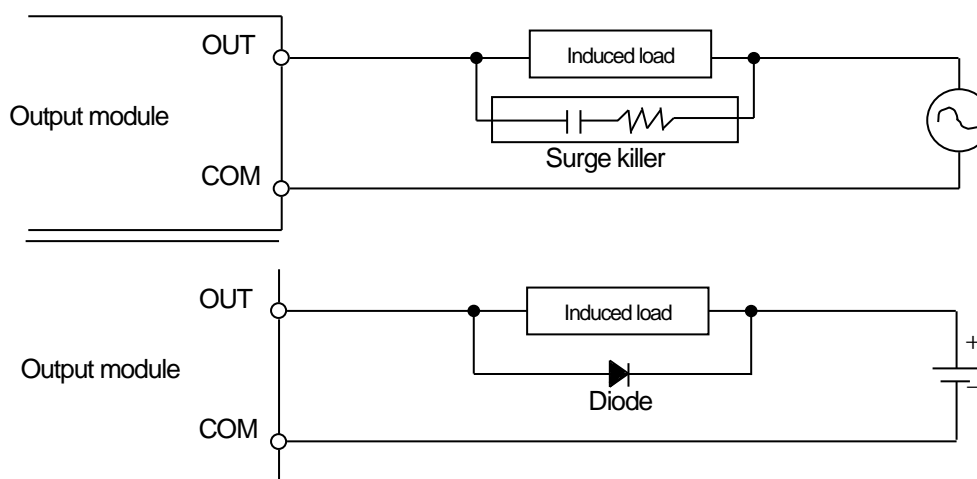

(f) Terminal block

Check close adhesion status. Let no foreign material enter into PLC when wiring terminal block or processing screw hole as it may cause malfunction, it may cause malfunction.

(g) Don't impact IO module or don't disassemble the PCB from case.

4.3 Wire

In case using system, it describes caution about wiring.



Danger

- ▶ When wiring, cut off the external power.
- ▶ If all power is cut, it may cause electric shock or damage of product.
- ▶ In case of flowing electric or testing after wiring, equip terminal cover included in product. If not, it may cause electric shock.



Remark

- ▶ Do D type ground (type 3 ground) or above dedicated for PLC for FG and LG terminal. It may cause electric shock or malfunction.
- ▶ When wiring module, check the rated voltage and terminal array and do properly. If rating is different, it may cause fire, malfunction.
- ▶ For external connecting connector, use designated device and solder. If connecting is not safe, it may cause short, fire, malfunction.
- ▶ For screwing, use designated torque range. If it is not fit, it may cause short, fire, malfunction.
- ▶ Let no foreign material enter such as garbage or disconnection part into module. It may cause fire, malfunction, error.

4.3.1 Power wiring

(1) AC110V/AC220V/DC24V cables should be compactly twisted and connected in the shortest distance

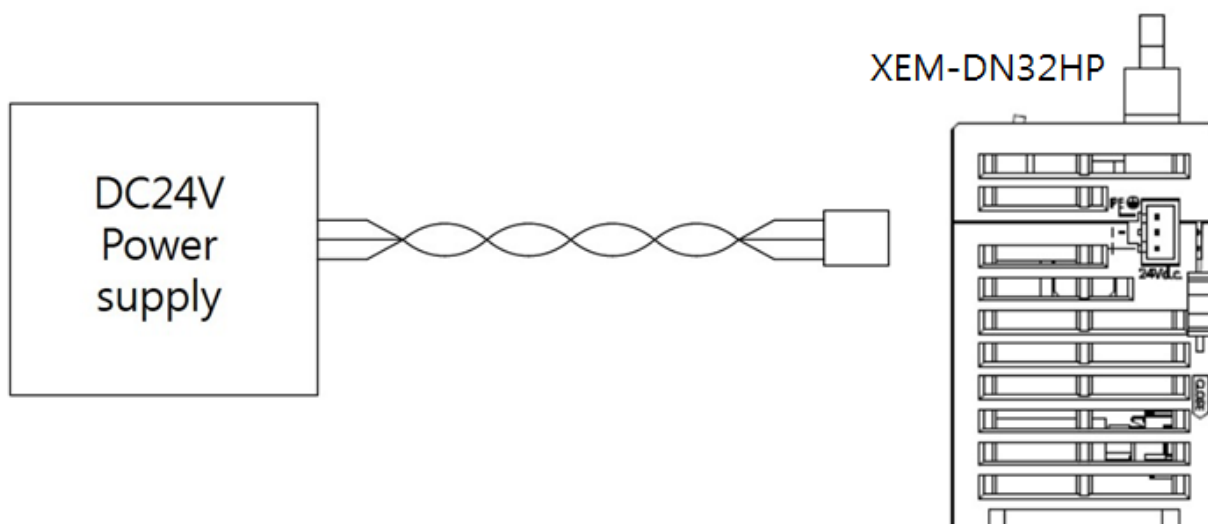

(2) DC Power supply capacity should be 1A or more

(3) Isolate the PLC power, I/O devices and power devices as follows.

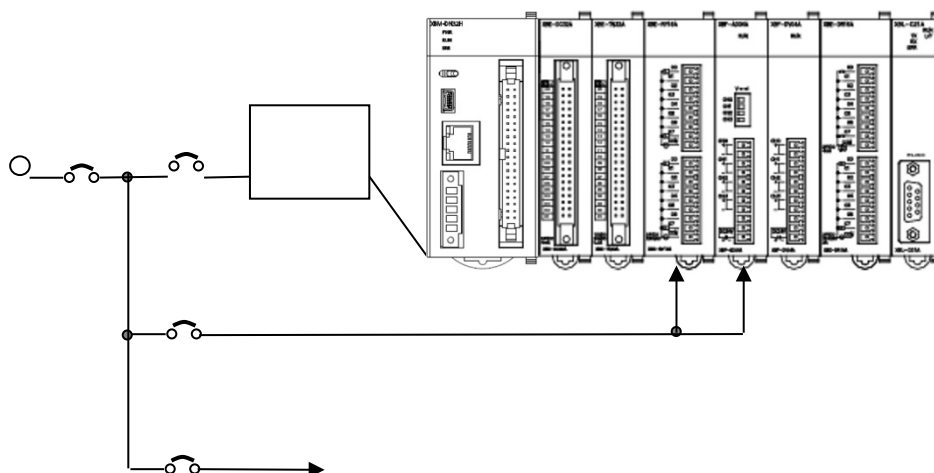

(4) AC110V/AC220V cable should be as thick as possible(2mm²) to reduce voltage drop

(5) AC110V/ DC24V cables should not be installed close to main circuit cable (high voltage/high current) and I/O signal cable. They should be at least 100mm away from such cables.

(6) To prevent surge from lightning, use the lightning surge absorber as presented below.

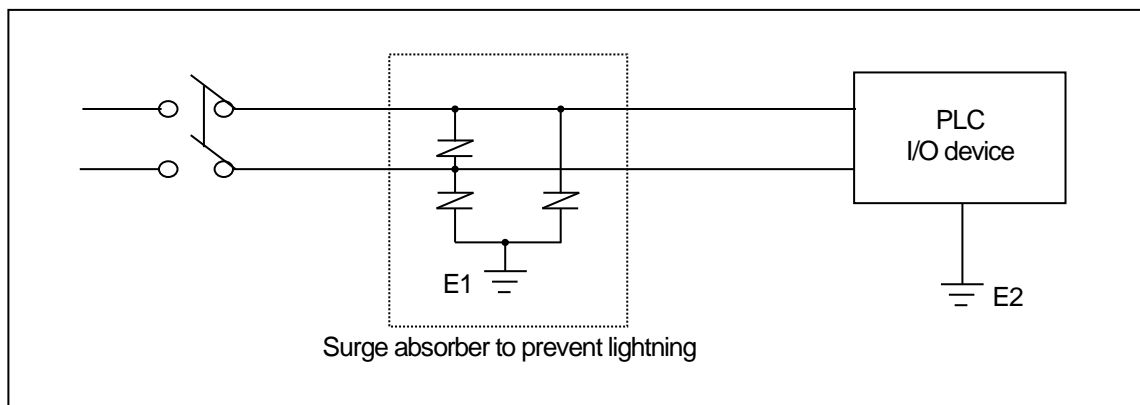

(7) When noise may be intruded inside it, use an insulated shielding transformer or noise filter.

(8) Wiring of each input power should be twisted as short as possible and the wiring of shielding transformer or noise filter should not be arranged via a duct.

(9) All field-wiring connections to this unit shall be from Limited Voltage / Limited Current, below 24Vdc isolated secondary source with an output fused with 4A fuse max. or class 2 secondary circuits as defined in UL 508, 17th Edition.

Remark

- (1) Isolate the grounding(E1) of lightning surge absorber from the grounding(E2) of the PLC.
- (2) Select a lightning surge absorber type so that the max. voltage may not be the specified allowable voltage of the absorber.

4.3.2 I/O Device wiring

- (1) The size of I/O device cable is limited to 0.3~2 mm² but it is recommended to select a size(0.3 mm²) to use conveniently.
- (2) Please isolate input signal line from output signal line.
- (3) I/O signal lines should be wired 100mm and more away from high voltage/high current main circuit cable.
- (4) Batch shield cable should be used and the PLC side should be grounded unless the main circuit cable and power cable can not be isolated.

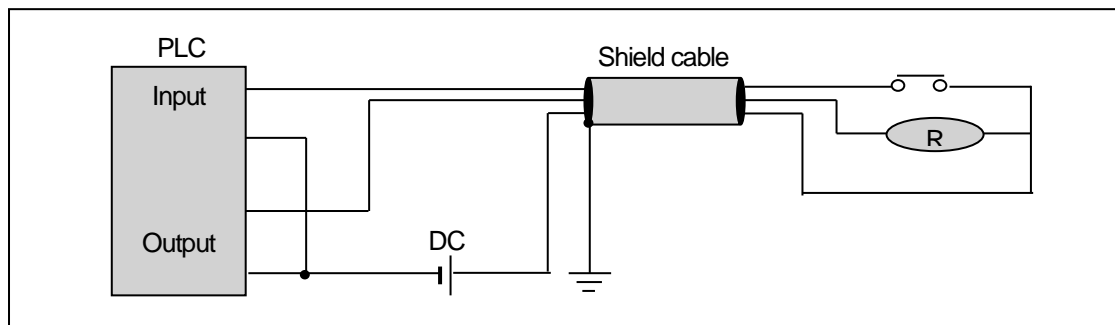

- (5) When applying pipe-wiring, make sure to firmly ground the piping.

(6) Example of input module.

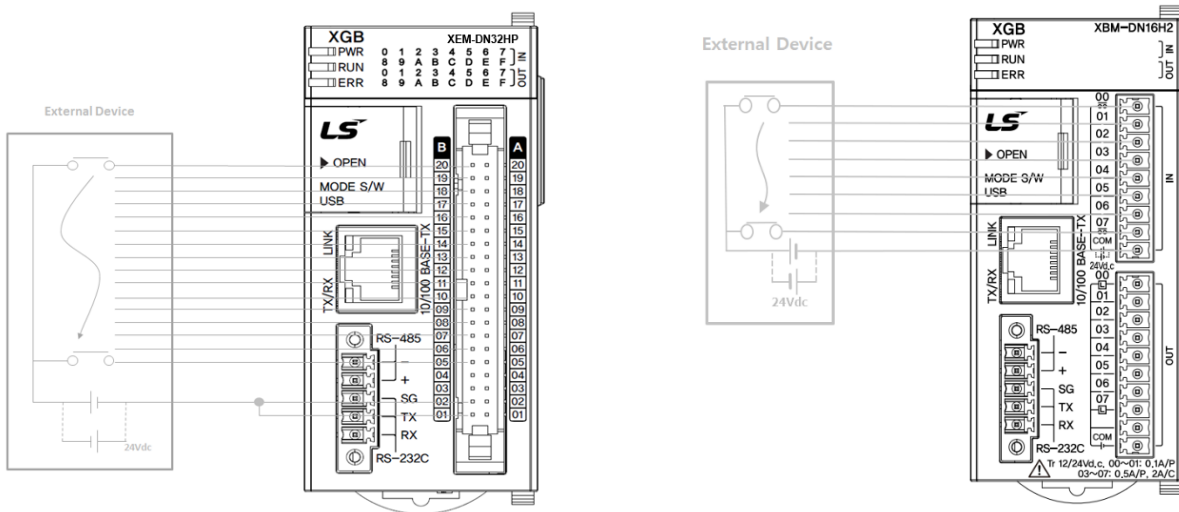

(7) Example of output module.

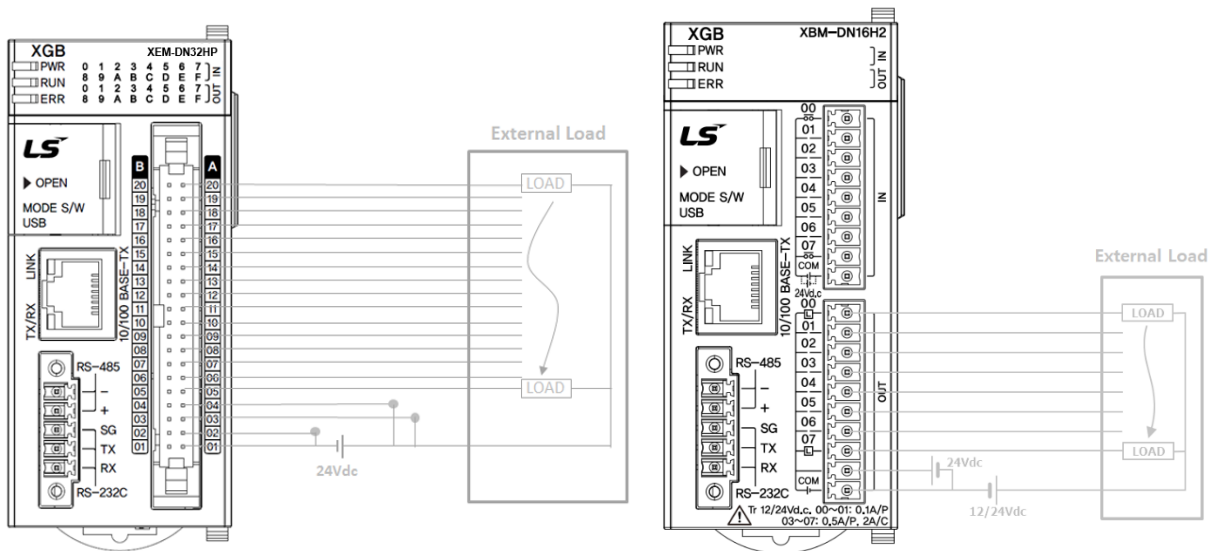

Notes

1) For reducing noise and improving system safety, add Dummy resistor to increase load current

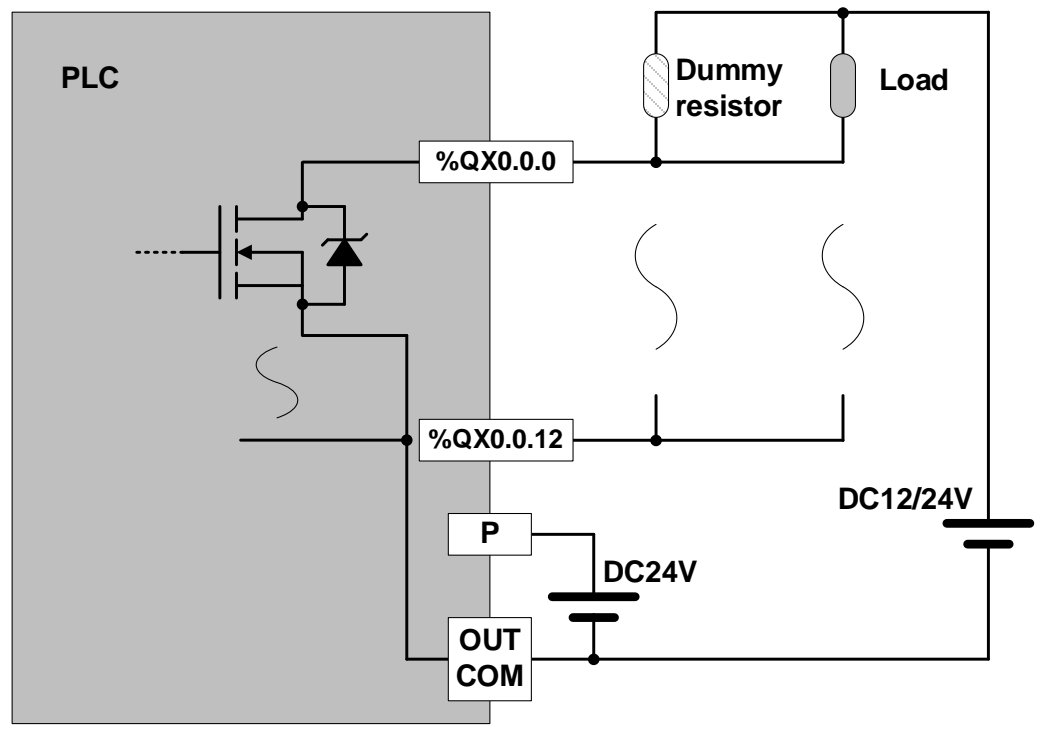

When using Positioning instruction, out current should be 10mA~100mA

List	Description
Load Voltage	DC12V / DC24V
Range of Load current	10mA ~100mA
Output frequency	200kpps or below

4.3.3 Grounding wiring

(1) The PLC contains a proper noise measure, so it can be used without any separate grounding if there is a large noise. However, if grounding is required, please refer to the followings.

(2) For grounding, please make sure to use the exclusive grounding.

For grounding construction, apply type 3 grounding (grounding resistance lower than 100 Ω)

(3) If the exclusive grounding is not possible, use the common grounding as presented in B) of the figure below.

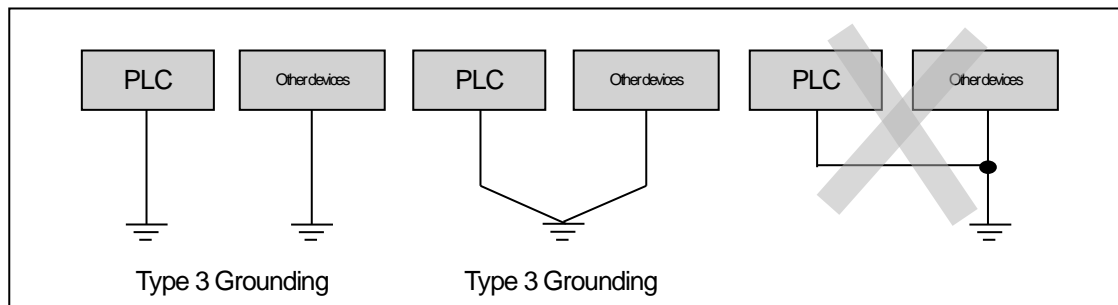

A) Exclusive grounding : best B) common grounding : good C) common grounding: defective

(4) Use the grounding cable more than 2 mm². To shorten the length of the grounding cable, place the grounding point as close to the PLC as possible.

(5) If any malfunction from grounding is detected, separate the FG of the base from the grounding.

4.3.4 Specifications of wiring cable

The specifications of cable used for wiring are as follows.

Types of external connection	Cable specification (mm ²)		Wire Type	Temperature rating
	Lower limit	Upper limit		
Digital input	0.18 (AWG24)	1.5 (AWG16)	Cu	60°C/75°C
Digital output	0.18 (AWG24)	2.0 (AWG14)		
Analogue I/O	0.18 (AWG24)	1.5 (AWG16)		
Communication	0.18 (AWG24)	1.5 (AWG16)		
Main power	1.5 (AWG16)	2.5 (AWG12)		
Protective grounding	1.5 (AWG16)	2.5 (AWG12)		

Chapter 5 Maintenance

Be sure to perform daily and periodic maintenance and inspection in order to maintain the PLC in the best conditions.

5.1 Maintenance and Inspection

The I/O module mainly consist of semiconductor devices and its service life is semi-permanent. However, periodic inspection is requested for ambient environment may cause damage to the devices. When inspecting one or two times per six months, check the following items.

Check Items		Judgment	Corrective Actions
Change rate of input voltage		Within change rate of input voltage	Hold it with the allowable range.
Power supply for input/output		Input/Output specification of each module	Hold it with the allowable range of each module.
Ambient environment	Temperature	0 ~ +55℃	Adjust the operating temperature and humidity with the defined range.
	Humidity	5 ~ 95%RH	
	Vibration	No vibration	Use vibration resisting rubber or the vibration prevention method.
Play of modules		No play allowed	Securely engage the hook.
Connecting conditions of terminal screws		No loose allowed	Retighten terminal screws.
Spare parts		Check the number of Spare parts and their Store conditions	Cover the shortage and improve the conditions.

5.2 Daily Inspection

The following table shows the inspection and items which are to be checked daily.

Check Items		Check Points	Judgment	Corrective Actions
PLC Panel Attachment Status		Check the loosening of mounting screws	Must be securely attached	Retighten Screws.
Connection conditions of Input/Output module		Check Hook for fixation	Placed in CLOSE	Retighten Screws.
Connecting conditions of terminal block or extension cable		Check for loose mounting screws.	Screws should not be loose.	Retighten Screws.
		Check the distance between solderless terminals.	Proper clearance should be provided.	Correct.
		Connecting of expansion cable.	Connector should not be loose.	Correct.
LED indicator	PWR LED	Check that the LED is On.	On (Off indicates an error)	
	Run LED	Check that the LED is On during Run.	On (flickering or Off indicates an error)	
	ERR LED	Check that the LED is Off during Run.	Flickering indicates an error	
	Input LED	Check that the LED turns On and Off.	On when input is On, Off when input is off.	
	Output LED	Check that the LED turns On and Off	On when output is On, Off when output is off	

5.3 Periodic Inspection

Check the following items once or twice every six months, and perform corrective actions as needed.

Check Items		Checking Methods	Judgment	Corrective Actions
Ambient environment	Ambient temperature	-. Measure with thermometer and hygrometer	0 ~ 55 °C	Adjust to general standard (Internal environmental standard of control section)
	Ambient Humidity		5 ~ 95%RH	
	Ambient pollution level	-. measure corrosive gas	There should be no corrosive gases	
PLC Conditions	Looseness, Ingress	Move each module	The module should be mounted securely.	Retighten screws
	dust or foreign material	Visual check	No dust or foreign material	
Connecting conditions	Loose terminal screws	Re-tighten screws	Screws should not be loose	Retighten
	Distance between terminals	Visual check	Proper clearance	Correct
	Loose connectors	Visual check	Connectors should not be loose.	Retighten connector mounting screws
Line voltage check		Measure voltage between input terminals	Specification	Change supply power

Chapter 6 Troubleshooting

The following explains contents, diagnosis and corrective actions for various errors that can occur during system operation.

6.1 Basic Procedure of Troubleshooting

System reliability not only depends on reliable equipment but also on short downtimes in the event of fault. The short discovery and corrective action are needed for speedy operation of system. The following shows the basic instructions for troubleshooting.

(1) Visual checks

Check the following points.

- Machine operating condition (in stop and operation status)
- Power On/Off
- Status of I/O devices
- Condition of wiring (I/O wires, extension and communications cables)
- Display states of various indicators (such as POWER LED, RUN LED, ERR LED and I/O LED)

After checking them, connect peripheral devices and check the operation status of the PLC and the program contents.

(2) Trouble Check

Observe any change in the error conditions during the following.

- Switch to the STOP position, and then turn the power on and off.

(3) Narrow down the possible causes of the trouble where the fault lies, i.e.:

- Inside or outside of the PLC ?
- I/O module or another module?
- PLC program?

6.2 Troubleshooting

This section explains the procedure for determining the cause of troubles as well as the errors and corrective actions.

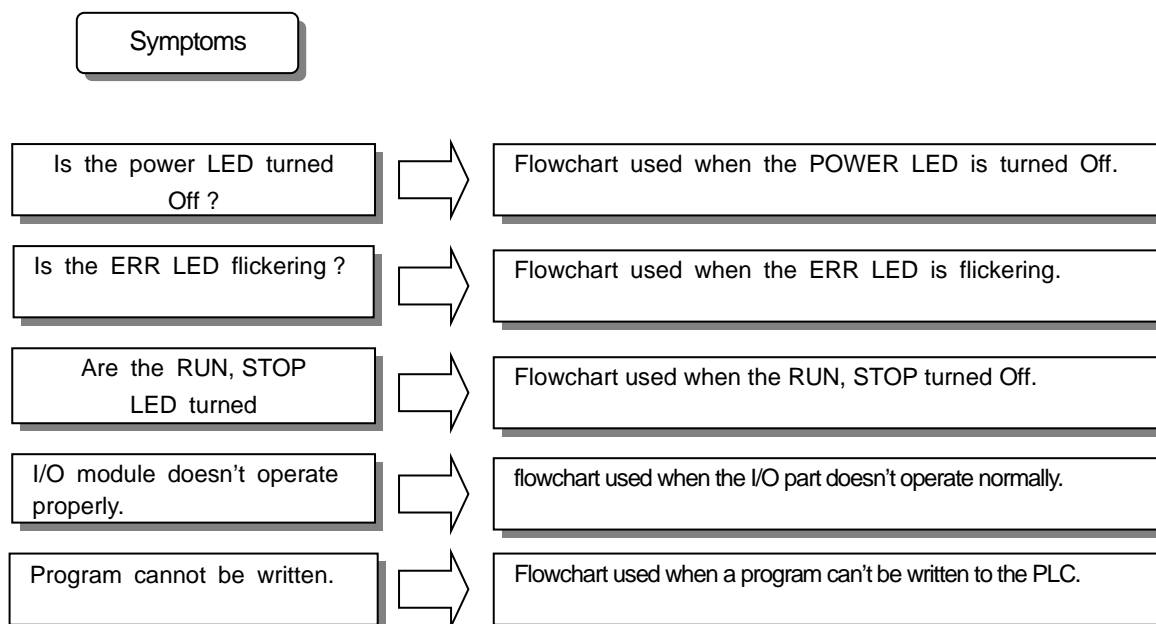

6.2.1 Troubleshooting flowchart used when the PWR (Power) LED turns Off

The following flowchart explains corrective action procedure used when the power is supplied or the power LED turns Off during operation.

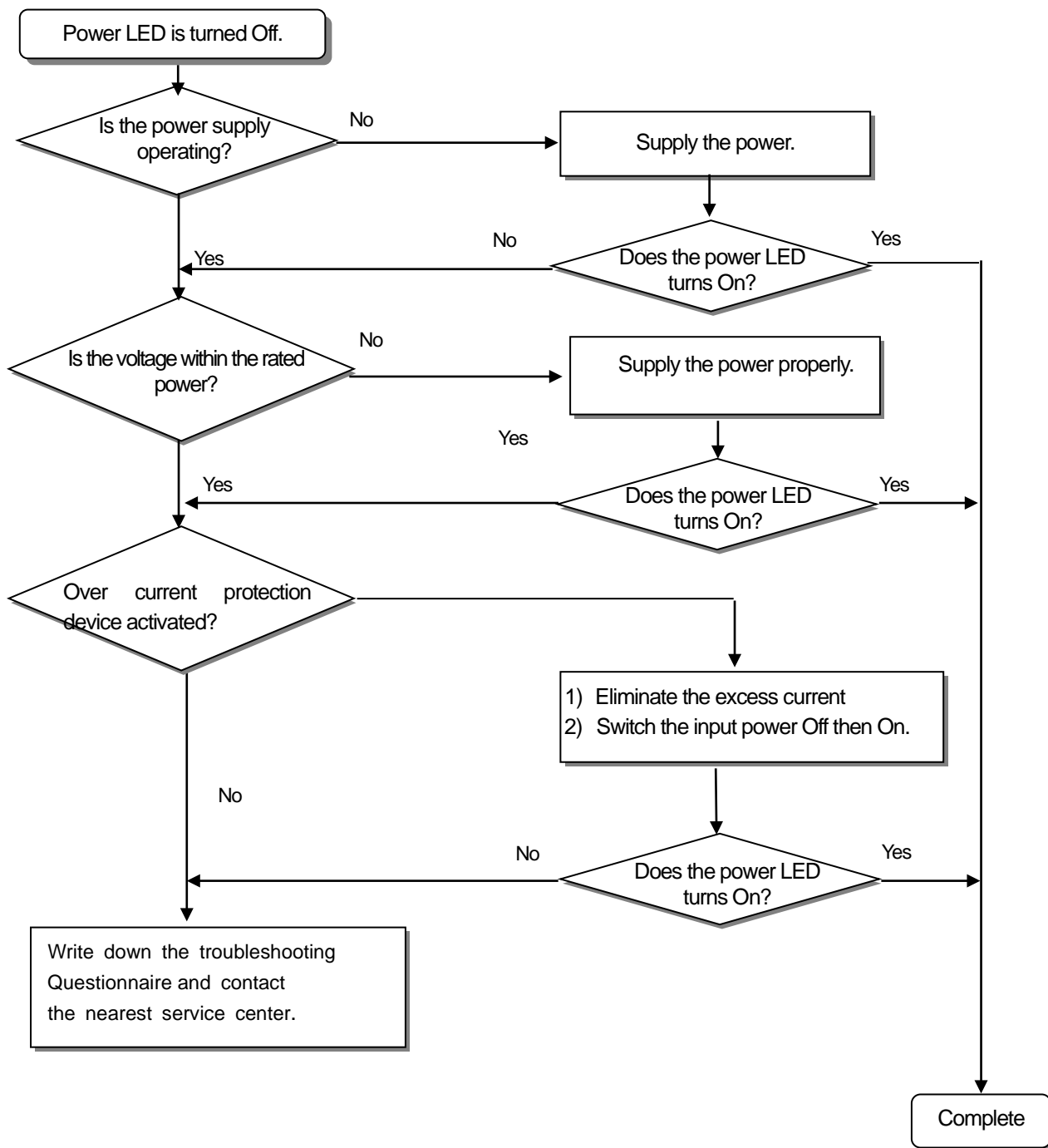

6.2.2 Troubleshooting flowchart used with when the ERR (Error) LED is flickering

The following flowchart explains corrective action procedure used when the power is supplied starts or the ERR LED is flickering during operation.

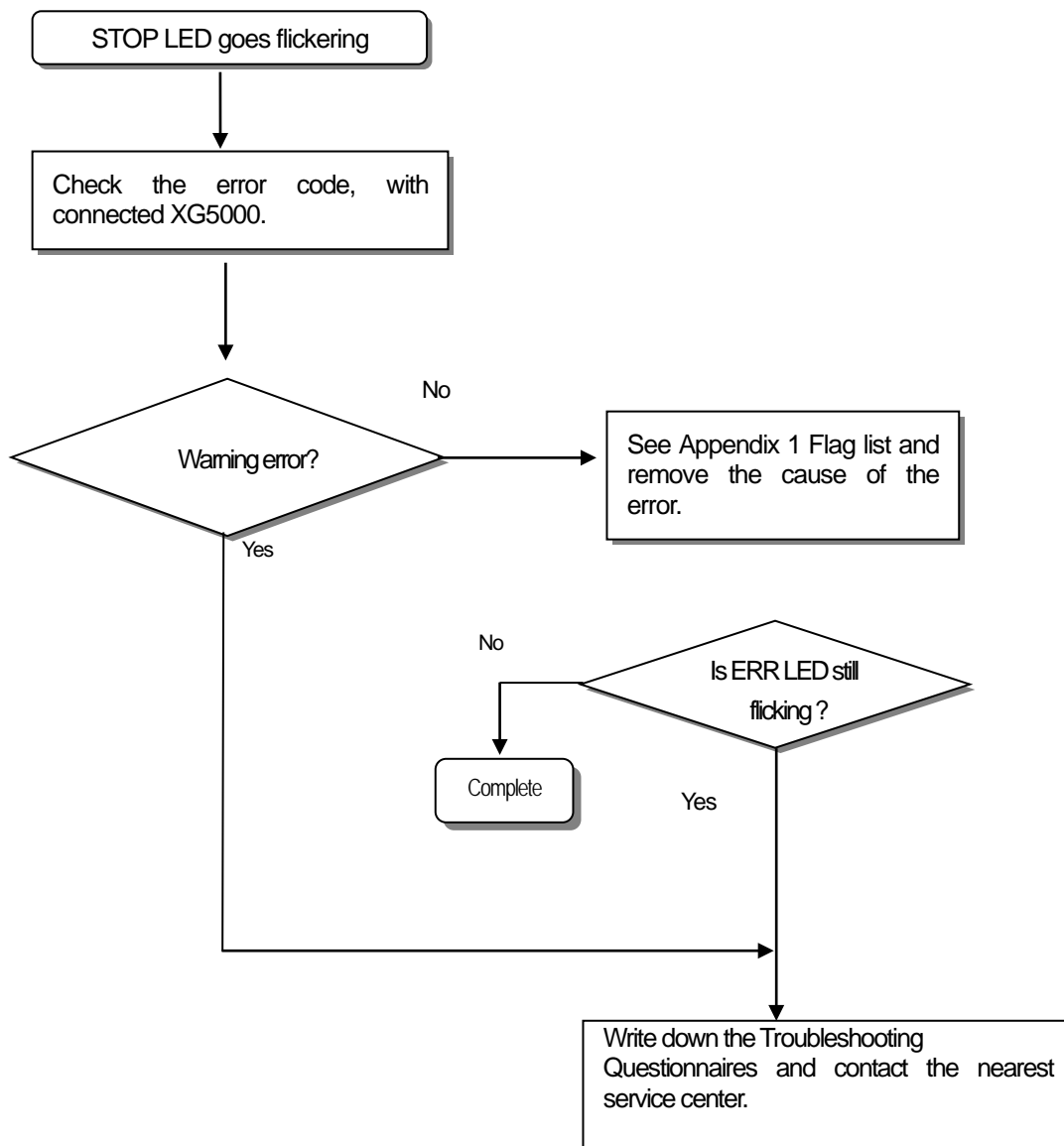

Warning

Though warning error appears, PLC system doesn't stop but corrective action is needed promptly. If not, it may cause the system failure.

6.2.3 Troubleshooting flowchart used with when the RUN , STOP LED turns Off.

The following flowchart explains corrective action procedure to treat the lights-out of RUN LED when the power is supplied, operation starts or is in the process.

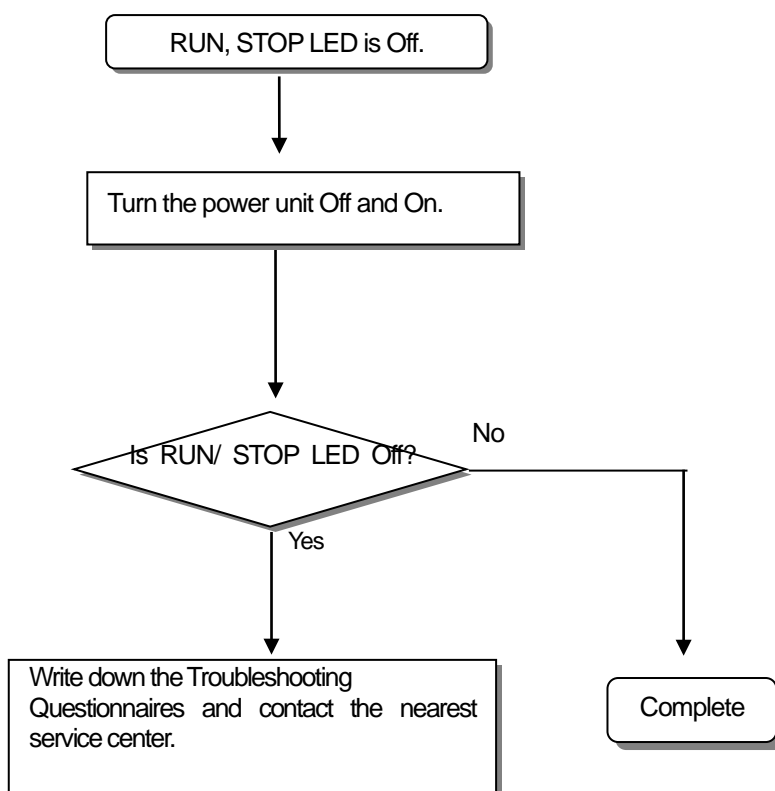

6.2.4 Troubleshooting flowchart used when the I/O part doesn't operate normally.

The following flowchart explains corrective action procedure used when the I/O module doesn't operate normally.

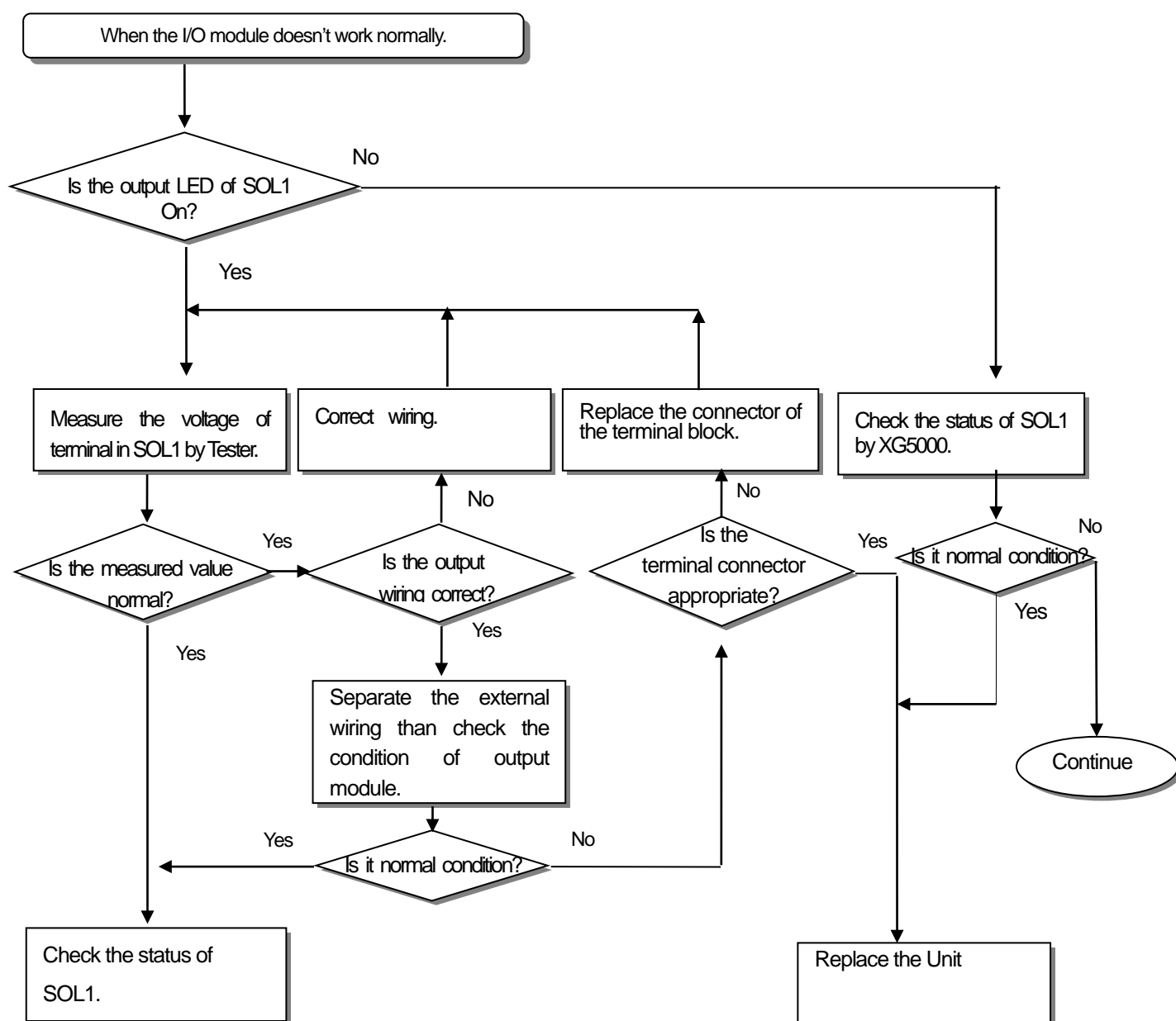
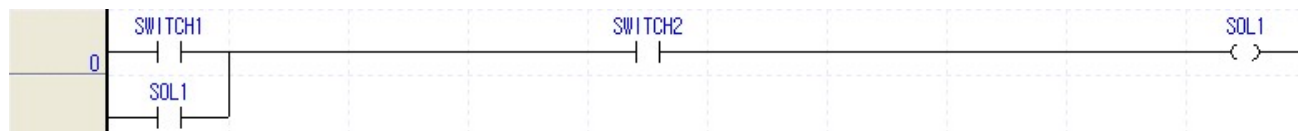

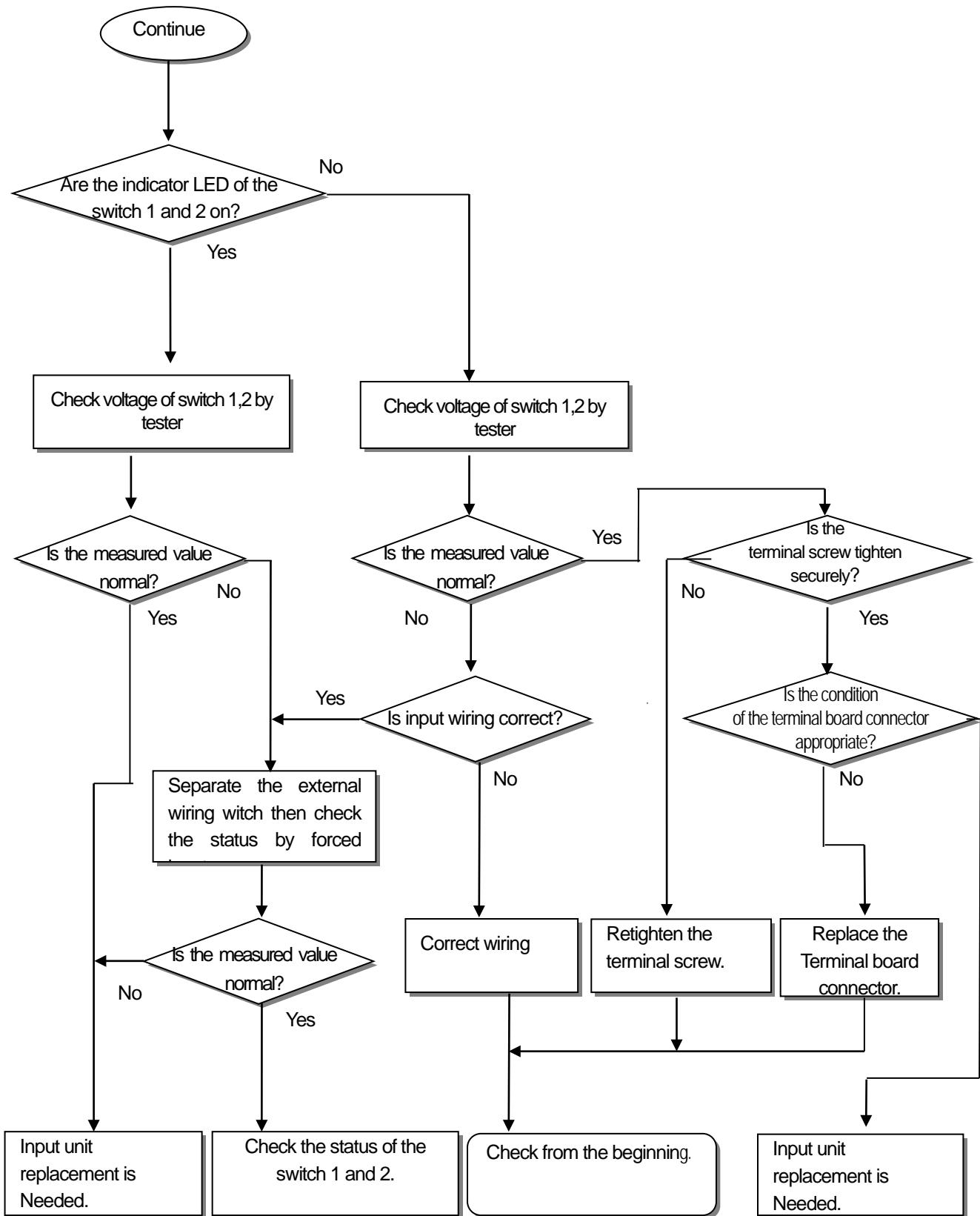

6.3 Troubleshooting Questionnaire

If any problem occurs during the operation of XGB series, please write down this Questionnaires and contact the service center via telephone or facsimile.

- For errors relating to special or communication modules, use the questionnaire included in the User's manual of the unit.

1. Telephone & FAX No

Tell)

FAX)

2. Using equipment model:

3. Details of using equipment

CPU model: () OS version No.: () Serial No. ()

XG5000 (for program compile) version No.: ()

4. General description of the device or system used as the control object:

5. The kind of the base unit:

– Operation by the mode setting switch (),

– Operation by the XG5000 or communications (),

– External memory module operation (),

6. Is the STOP. LED of the CPU module turned On ? Yes (), No ()

7. XG5000 error message:

8. History of corrective actions for the error message in the article 7:

9. Other tried corrective actions:

10. Characteristics of the error

• Repetitive (): Periodic (), Related to a particular sequence (), Related to environment ()

• Sometimes (): General error interval:

11. Detailed Description of error contents:

12. Configuration diagram for the applied system:

6.4 Troubleshooting Examples

Possible troubles with various circuits and their corrective actions are explained.

6.4.1 Input circuit troubles and corrective actions

The followings describe possible troubles with input circuits, as well as corrective actions.

Condition	Cause	Corrective Actions
Input signal doesn't turn off.	Leakage current of external device (Such as a drive by non-contact switch)	<ul style="list-style-type: none"> Connect an appropriate register and capacity, which will make the voltage lower across the terminals of the input module.
Input signal doesn't turn off. (Neon lamp may be still on)	Leakage current of external device (Drive by a limit switch with neon lamp)	<ul style="list-style-type: none"> CR values are determined by the leakage current value. – Recommended value C : 0.1 ~ 0.47μF R: 47 ~ 120 Ω (1/2W) Or make up another independent display circuit.
Input signal doesn't turn off.	Leakage current due to line capacity of wiring cable.	<ul style="list-style-type: none"> Locate the power supply on the external device side as shown below.
Input signal doesn't turn off.	Leakage current of external device (Drive by switch with LED indicator)	<ul style="list-style-type: none"> Connect an appropriate register, which will make the voltage higher than the OFF voltage across the input module terminal and common terminal.

Chapter 6 Troubleshooting

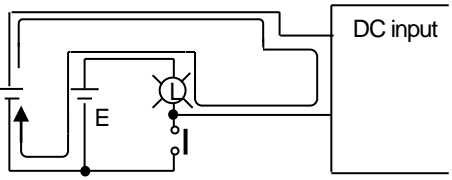
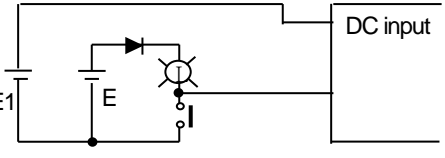
<p>Input signal doesn't turn off.</p>	<ul style="list-style-type: none"> • Sneak current due to the use of two different power supplies.  <p>• E1 > E2, sneaked.</p>	<ul style="list-style-type: none"> • Use only one power supply. • Connect a sneak current prevention diode. 
---------------------------------------	---	--

6.4.2 Output circuit and corrective actions

The following describes possible troubles with output circuits, as well as their corrective actions.

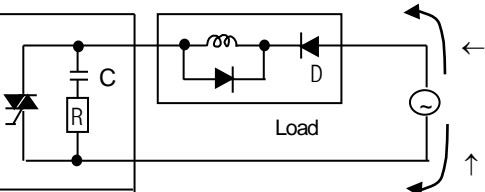
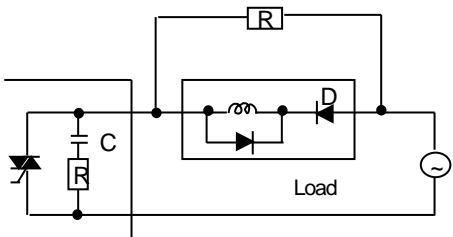
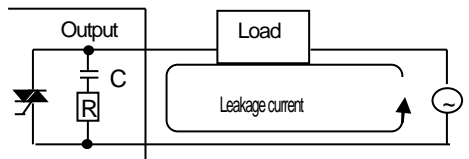
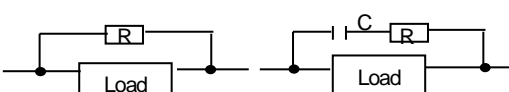
Condition	Cause	Corrective Action
<p>When the output is off, excessive voltage is applied to the load.</p>	<ul style="list-style-type: none"> • Load is half-wave rectified inside (in some cases, it is true of a solenoid) • When the polarity of the power supply is as shown in ①, C is charged. When the polarity is as shown in ②, the voltage charged in C plus the line voltage are applied across D. Max. voltage is approx. $2\sqrt{2}$.  <p>*) If a resistor is used in this way, it does not pose a problem to the output element. But it may make the performance of the diode (D), which is built in the load, drop to cause problems.</p>	<ul style="list-style-type: none"> • Connect registers of tens to hundreds KΩ across the load in parallel. 
<p>The load doesn't turn off.</p>	<ul style="list-style-type: none"> • Leakage current by surge absorbing circuit, which is connected to output element in parallel. 	<ul style="list-style-type: none"> • Connect C and R across the load, which are registers of tens KΩ. When the wiring distance from the output module to the load is long, there may be a leakage current due to the line capacity. 

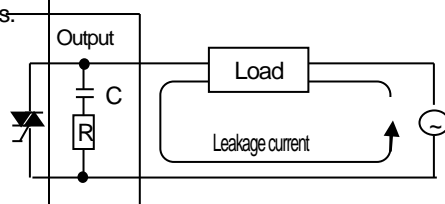
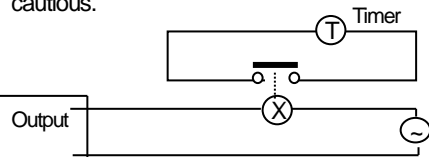
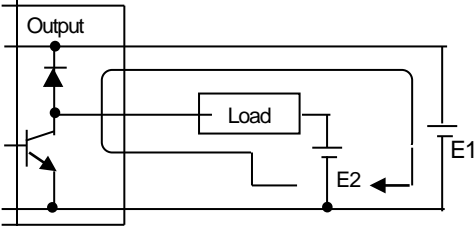
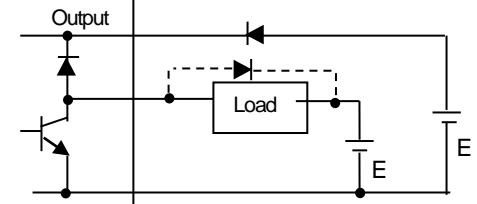
<p>When the load is C-R type timer, time constant fluctuates.</p>	<ul style="list-style-type: none"> Leakage current by surge absorbing circuit, which is connected to output element in parallel. 	<ul style="list-style-type: none"> Drive the relay using a contact and drive the C-R type timer using the since contact. Use other timer than the C-R contact some timers have half-wave rectified internal circuits therefore, be cautious. 
<p>The load does not turn off.</p>	<ul style="list-style-type: none"> Sneak current due to the use of two different power supplies.  <p>$E1 < E2$, sneaks. E1 is off (E2 is on), sneaks.</p>	<ul style="list-style-type: none"> Use only one power supply. Connect a sneak current prevention diode.  <p>If the load is the relay, etc, connect a counter-electromotive voltage absorbing code as shown by the dot line.</p>

Output circuit troubles and corrective actions (continued).

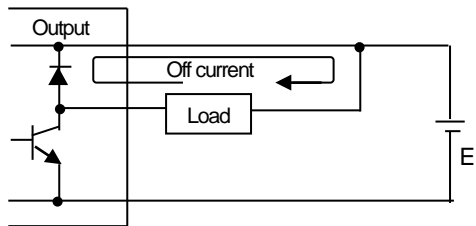
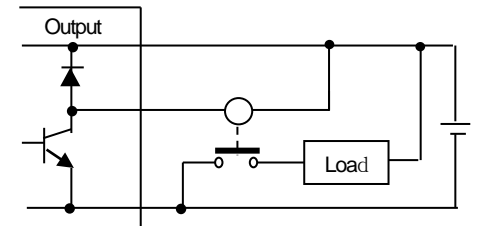
Condition	Cause	Corrective actions
<p>The load off response time is long.</p>	<ul style="list-style-type: none"> Over current at off state [The large solenoid current fluidic load (L/R is large) such as is directly driven with the transistor output.  <ul style="list-style-type: none"> The off response time can be delayed by one or more second as some loads make the current flow across the diode at the off time of the transistor output. 	<ul style="list-style-type: none"> Insert a small L/R magnetic contact and drive the load using the same contact. 

Chapter 6 Troubleshooting

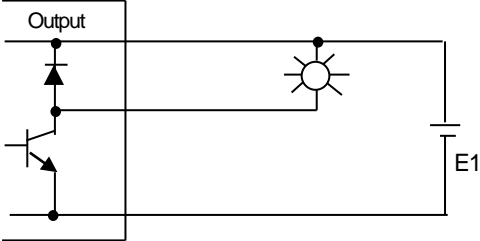
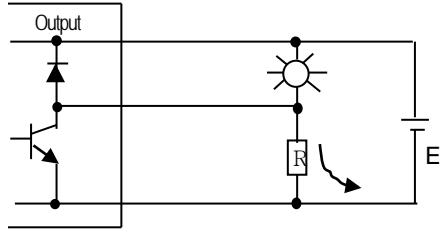
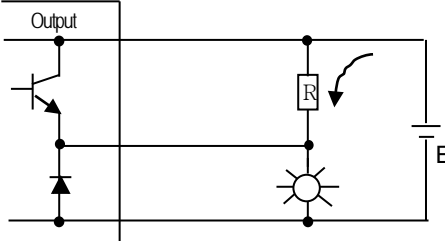
<p>Output transistor is destroyed.</p>	<p>Surge current of the white lamp on.</p>  <p>A surge current of 10 times or more when turned on.</p>	<ul style="list-style-type: none"> To suppress the surge current make the dark current of 1/3 to 1/5 rated current flow.  <p>Sink type transistor output</p>  <p>Source type transistor output</p>
--	---	---

6.5 Error Code List

Error code (Dec)	Error cause	Action (restart mode after taking an action)	Operation status	LED status	Diagnosis point
23	Program to execute is abnormal	Start after reloading the program	Warning	0.5 second Flicker	RUN mode
24	I/O parameter error	Start after reloading I/O parameter, Battery change if battery has a problem. Check the preservation status after I/O parameter reloading and if error occurs, change the unit.	Warning	0.5 second Flicker	Reset RUN mode switching
25	Basic parameter error	Start after reloading Basic parameter, Change battery if it has a problem. Check the preservation status after Basic parameter reloading and if error occurs, change the unit.	Warning	0.5 second Flicker	Reset RUN mode switching
26	Compile error exceed	Reduce the program and down.	Warning	0.5 second Flicker	RUN mode switching
27	Compile error	Check the program	Warning	0.5 second Flicker	RUN mode switching
30	Module set in parameter and the installed module does not match	modify the module or parameter and then restart.	Warning	0.5 second Flicker	RUN mode switching
31	Module falling during operation or additional setup	After checking the position of attachment/detachment of expansion module during Run mode	Heavy error	0.1 second Flicker	Every scan
33	Data of I/O module does not access normally during operation.	After checking the position of slot where the access error occurs by XG5000, change the module and restart (acc.to parameter.)	Heavy error	0.1 second Flicker	Scan end
34	Normal access of special/link module data during operation not available	After checking the position of slot that access error occurred by XG5000, change the module and restart (acc.to parameter).	Heavy error	0.1 second Flicker	Scan end
38	Extension Module exceed	Extension module is attached over 10 slot or communication module is attached over 3 slot	Heavy error	0.1 second Flicker	RUN mode switching
39	Abnormal stop of CPU or malfunction	Abnormal system end by noise or hard ware error. 1) If it occurs repeatedly when power reinput, request service center 2) Noise measures	Heavy error	0.1 second Flicker	Ordinary time
40	Scan time of program during operation exceeds the scan watchdog time designated by parameter.	After checking the scan watchdog time designated by parameter, modify the parameter or the program and then restart.	Warning	0.5 second Flicker	While running the program

Chapter 6 Troubleshooting

Error code (Dec)	Error cause	Action (restart mode after taking an action)	Operation status	LED status	Diagnosis point
41	Operation error occurs while running the user program.	Remove operation error → reload the program and restart.	Warning	0.5 second Flicker	While running the program
44	Timer index user error	After reloading a timer index program modification, start	Warning	0.5 second Flicker	Scan end
50	Heavy error of external device	Refer to Heavy error detection flag and modifies the device and restart. (Acc. Parameter)	Warning	0.5 second Flicker	Scan end
55	Task confliction	Check task occurrence	Warning	1 second Flicker	Every time
60	E_STOP function executed	After removing error causes which starts E_STOP function in program, power reinput	Warning	1 second Flicker	While running the program
500	Data memory backup not possible	If not error in battery, power reinput Remote mode is switched to STOP mode.	Warning	1 second Flicker	Reset
501	Abnormal clock data	Setting the time by XG5000 if there is no error	Warning	1second Flicker	Ordinary time

Chapter 7 EMC Standard

The following explains contents, diagnosis and corrective actions for various errors that can occur during system operation.

7.1 Requirements for Conformance to EMC Directive

The EMC Directive specifies the products must "be so constructed that they do not cause excessive electromagnetic interference (emissions) and are not unduly affected by electromagnetic interference (immunity)". The applicable products are requested to meet these requirements.

This section summarizes the precautions on conformance to the EMC Directive of the machinery assembled using PLC XGB series. The details of these precautions are based on the requirements and the applicable standards control. However, LS ELECTRIC will not guarantee that the overall machinery manufactured according to the these details conforms to the below-described directives. The method of conformance to the EMC directive and the judgment on whether or not the machinery conforms to the EMC Directive must be determined finally by the manufacturer of the machinery.

7.1.1 EMC Standard

The standards applicable to the EMC Directive are listed below.

Table13-1

Specification	Test item	Test details	Standard value
EN50081-2	EN55011 Radiated noise * 2	Electromagnetic emissions from the product are measured	30~230 MHz QP : 50 dB μ V/m * 1 230~1000 MHz QP : 57 dB μ V/m
	EN55011 Conducted noise	Electromagnetic emissions from the product to the power line is measured	150~500 kHz QP : 79 dB Mean: 66 dB 500~230 MHz QP : 73 dB Mean: 60 dB
EN61131-2	EN61000-4-2 Electrostatic immunity	Immunity test in which static electricity is applied to the case of the equipment	15 kV Aerial discharge 8 kV Contact discharge
	EN61000-4-4 Fast transient burst noise	Immunity test in which burst noise is applied to the power line and signal lines	Power line: 2 kV Digital I/O : 1 kV Analog I/O, signal lines: 1 kV
	EN61000-4-3 Radiated field AM modulation	Immunity test in which field is irradiated to the product	10V/m, 26~1000 MHz 80%AM modulation @ 1 kHz
	EN61000-4-12 Damped oscillatory wave immunity	Immunity Testing of Fluctuating Damped Oscillation in Electric Power Line	Power line: 1 kV Digital I/O (24V or higher): 1 kV

* 1) QP: Quasi-peak value, Mean: Average value

* 2) The PLC is an open type device (device installed to another device) and must be installed in a conductive control panel. The tests for the corresponding items were performed while the PLC was installed inside a control panel.

7.1.2 Control Panel

The PLC is an open type device (device installed to another device) and must be installed in a control panel. This is needed to prevent electric shock by touching XGB PLC and reduce the PLC-generated noise. Install the XGB PLC in a metallic panel to reduce PLC-generated EMI (Electro-magnetic interference),

The specifications for the control panel are as follows:

(1) Control panel

The PLC control panel must have the following features:

- (a) Use SPCC (Cold Rolled Mild Steel) for the control panel.
- (b) The steel plate should be thicker than 1.6mm.
- (c) Use isolating transformers to protect the power supply from external surge voltage.
- (d) The control panel must have a structure which the radio waves does not leak out.

For example, make the door as a box-structure so that the panel body and the door are overlapped each other. This structure reduces the surge voltage generate by PLC.

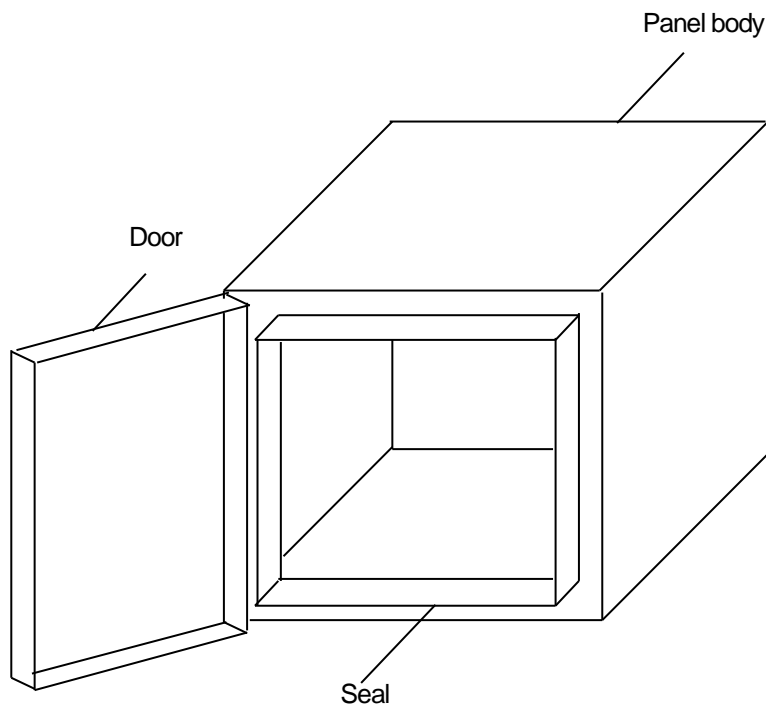

- (e) To ensure good electrical contact with the control panel or base plate, mask painting and weld so that good surface contact can be made between the panel and plate.

(2) Connection of power and earth wires

Earthing and power supply wires for the PLC system must be connected as described below.

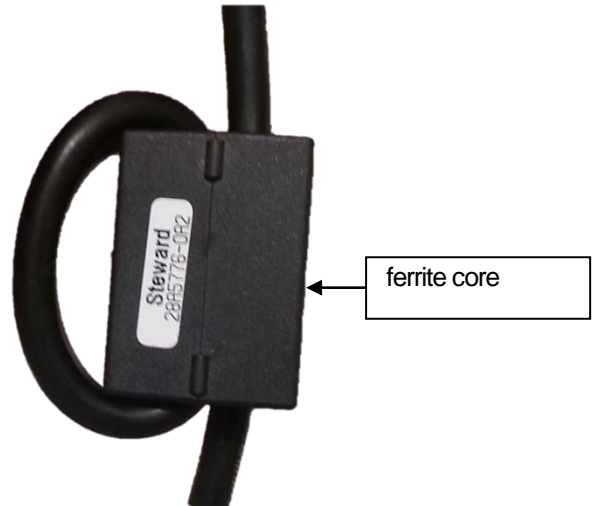

- (a) Earth the control panel with a thick wire so that a low impedance connection to ground can be ensured even at high frequencies.
- (b) The function of LG (Line Ground) and FG (Frame Ground) terminals is to pass the noise generated in the PLC system to the ground, so an impedance that is as low as possible must be ensured.
- (c) The earthing wire itself can generate the noise, so wire as short and thick to prevent from acting as an antenna.
- (d) Attach ferrite core under the power cable to satisfy CE specification.

[ferrite core]

manufacture	name	External Dimension (mm)				maximum cable diameter (mm)	address
		A	B	C	D		
Laird	28A3851-0A2	30.00	13.00	33.70	30.00	12.85	www.lairdtech.com
Laird	28A5776-0A2	29.20	20.00	42.00	42.00	19.40	www.lairdtech.com
Coilmaster	C2L RU130B	31.50	13.00	33.00	31.50	13.00	www.coilmaster.com.tw
TDK	ZCAT3035-1330	30.00	13.00	34.00	30.00	13.00	www.tdk.com

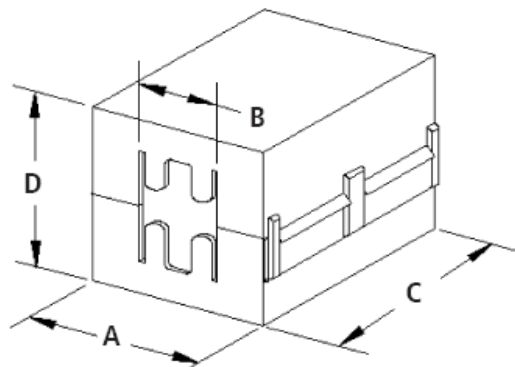

7.2 Requirement to Conform to the Low-voltage Directive

The low-voltage directive requires each device that operates with the power supply ranging from 50V to 1000VAC and 75V to 1500VDC to satisfy the safety requirements. Cautions and installation and wiring of the PLC XGB series to conform to the low-voltage directive are described in this section.

The described contents in this manual are based on the requirements and the applicable standards control. However, LS ELECTRIC will not guarantee that the overall machinery manufactured according to the these details conforms to the above regulation. The method of conformance to the EMC directive and the judgment on whether or not the machinery conforms to the EMC Directive must be determined finally by the manufacturer of the machinery.

7.2.1 Standard Applied for XGB Series

The XGB PLC complies with EN6100-1 (safety of equipment used in measurement and control laboratories).

XGB series PLCs have been developed in accordance with the above standards for modules operating at rated voltage of AC50V / DC75V or higher.

7.2.2 XGB Series PLC Selection

(1) Power and CPU

Since the rated voltage of the main unit is less than the DC24V rating, it is outside the scope of the low voltage command.

(2) I/O module

There are dangerous voltages (voltages higher than 42.4V peak) inside the I/O modules of the AC110/220V rated I/O voltages. Therefore, the CE mark-compliant models are enhanced in insulation internally between the primary and secondary.

The I/O modules of DC24V or less rating are out of the low-voltage directive application range.

(3) Special module, Communication module

The special module and communication modules are DC24V or less in rated voltage, therefore they are out of the low-voltage directive application range.

Part 2. Basic Function

This Chapter covers the details of programming and operations, monitoring of basic unit

Chapter 1 Program Configuration and Operation Method

1.1 Programming Basics

1.1.1 Programming Method

The basic unit supports programming method of repetitive operation interrupt operation, fixed operation.

(1) Repetitive operation mode (Scan)

It means the basic programming method of the PLC.

It is the method that performs the written program repetitively from the first step to the last one and a series of such procedures is called 'program scan'. A series of such processing is called the repetitive operation mode and it can be divided as below.

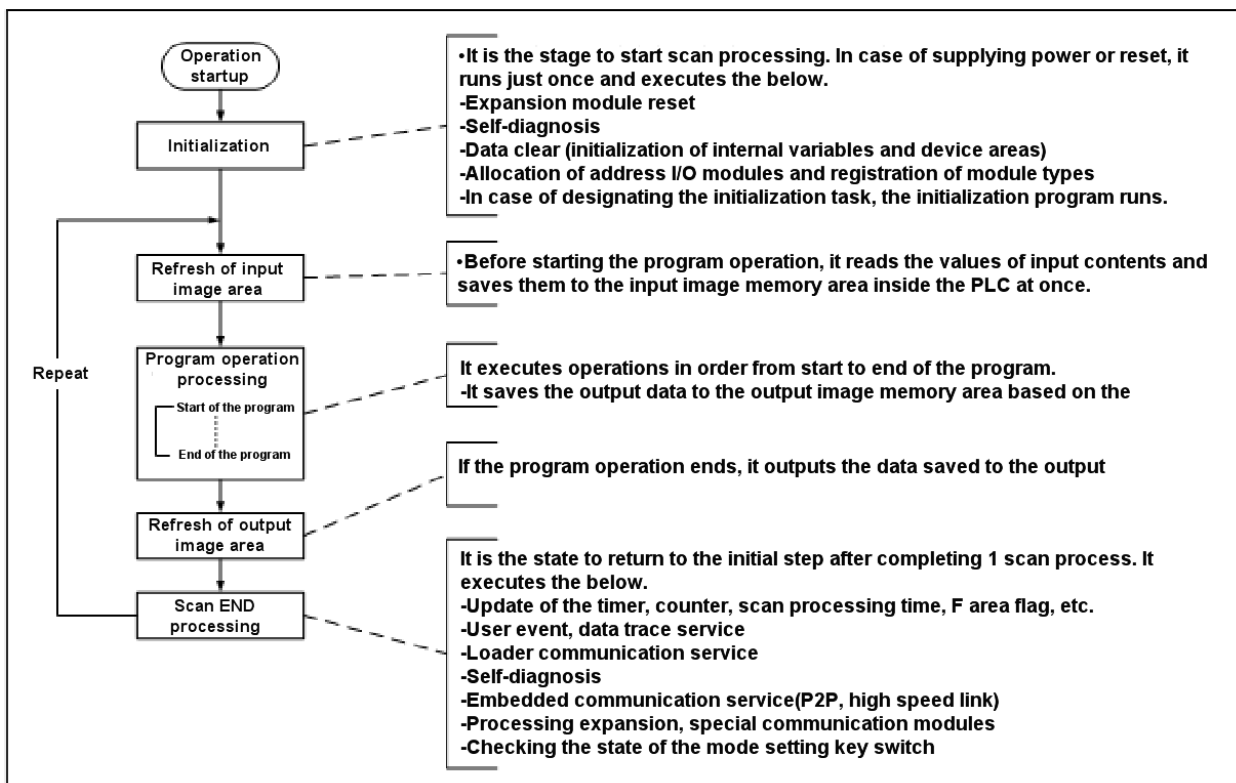

(2) Interrupt operation mode

(fixed cycle, external interrupt, internal device start, high speed counter, positioning control)

It is the mode that suspends the currently executed scan program operation and handles the interrupt program immediately when urgent priority matter occurs during execution of the PLC scan program. The signals that inform the CPU of such interrupt occurrence is called 'interrupt signal' and there are 4 kinds as below. For more details on each interrupt operation, refer to Section 1.1.5 ~ 1.1.10.

(For the positioning interrupt operation method, refer to Chapter 3 Built-in Positioning)

- Fixed cycle signal: Interrupt signal occurring at the fixed interval
- External input signal: External contact (%IX0.0.0~%IX0.0.7) input signal
- Internal device: In case the internal device value is matched with the set occurrence condition
- High speed counter: In case the high speed counter current value is matched with the set value
- Position : An interrupt signal generated at a predetermined time interval

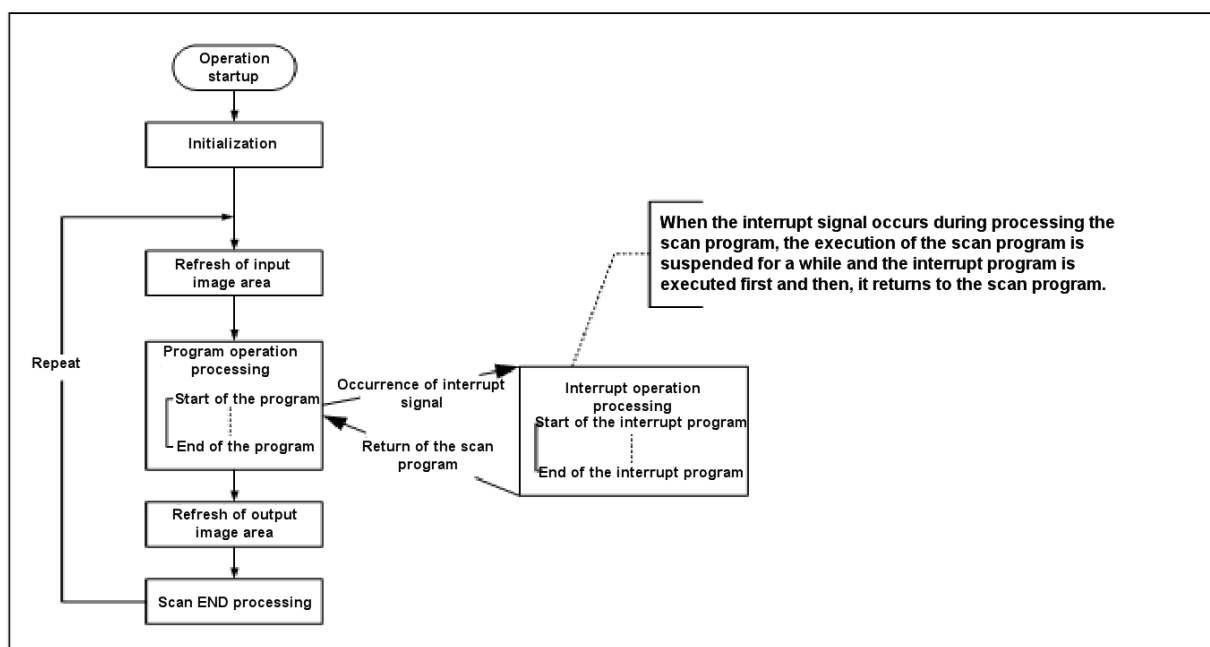

(3) Fixed Cycle Operation mode

It is the mode that executes the scan program every fixed time.

After executing all scan programs, it stands by until the fixed cycle time and then, the next scan will resume at the specified time.

At this time, the current scan time displayed in F area indicates the net program processing time except waiting time. If the actual scan program processing time is longer than the fixed cycle, fixed cycle error flag will be turned On. The flags related to fixed cycle operation are as below.

Bit	Flag Name	Name	Description
%FX92	_CONSTANT_ER	Fixed cycle error	In case the actual scan time is longer than the fixed cycle set value
%FX128	_CONSTANT_RUN	Fixed cycle operation is running	Turned ON during fixed cycle operation

1.1.2 Execution processing in case of instantaneous interruption

If the input power voltage supplied to basic unit is lower than the specification, the PLC will detect instantaneous interruption.

When the PLC detects instantaneous interruption, the following execution processing will run.

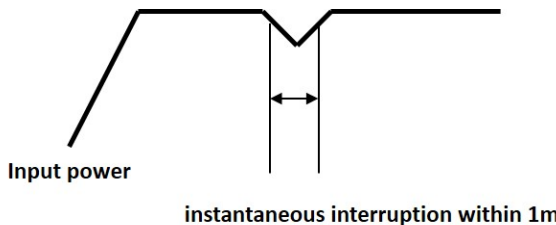
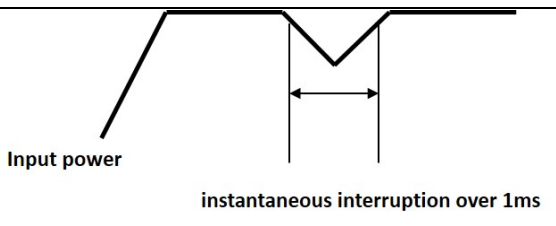
Blackout time	Execution processing
 <p>Input power</p> <p>instantaneous interruption within 1ms</p>	<ol style="list-style-type: none"> (1) Execution is interrupted, maintaining output state of when instantaneous interruption occurred. (2) If instantaneous interruption is canceled, execution will resume. (3) In case execution is suspended due to instantaneous interruption, timer measurement and one for fixed cycle interrupt will be continuously run.
 <p>Input power</p> <p>instantaneous interruption over 1ms</p>	<ol style="list-style-type: none"> (1) If instantaneous interruption exceeds 1ms, the PLC will execute restart like the time when power is supplied.

The below figure shows the PLC's execution processing flow chart when instantaneous interruption occurs.

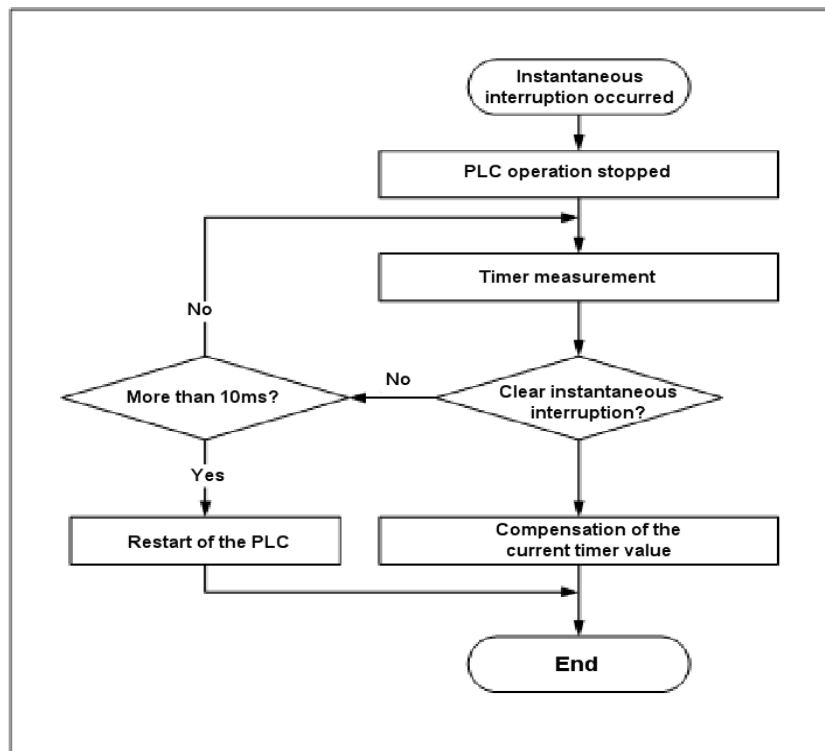

Notice

Instantaneous interruption means the state that the PLC exceeds the allowable variation range of the specified power and is lower than the range. The brief (several ms ~ dozens of ms) blackout is called instantaneous interruption.

1.1.3 Scan Time

The scan time is the time that takes to complete a single control operation from step 0 of the full scan program to step 0 of the next scan; it is directly connected to the system's control performance.

(1) Scan time formula

The scan time is the sum of the process time of the scan program and interrupt program written by a user and the PLC's internal END processing time; it can be calculated by the below formula.

(a) Scan time = scan program processing time + interrupt program processing time + PLC internal processing time

- Scan program processing time = Processing time of the user program excluding the interrupt program
- Interrupt program processing time = Sum of the interrupt program running time processed for 1 scan
- PLC internal processing time = Self-diagnosis time + I/O refresh time + internal data processing time + communication service processing time (processing XG5000 service and embedded communication)

Model	MPU processing time		Expansion interface processing time		
	Scan program running (32K)	PLC internal Processing time	Digital I/O module (32 points, 1 EA)	Analog module (8 channels, 1EA)	Communication module (200 byte, 1 block)
XEM-DN32HP	7.2 ms	0.8ms	0.3ms	2.0ms	0.8ms

XBM 'HP' unit performs the control operation based on the below sequence. Accordingly, you can estimate the rough control performance of the system to be designed by using the below calculation method.

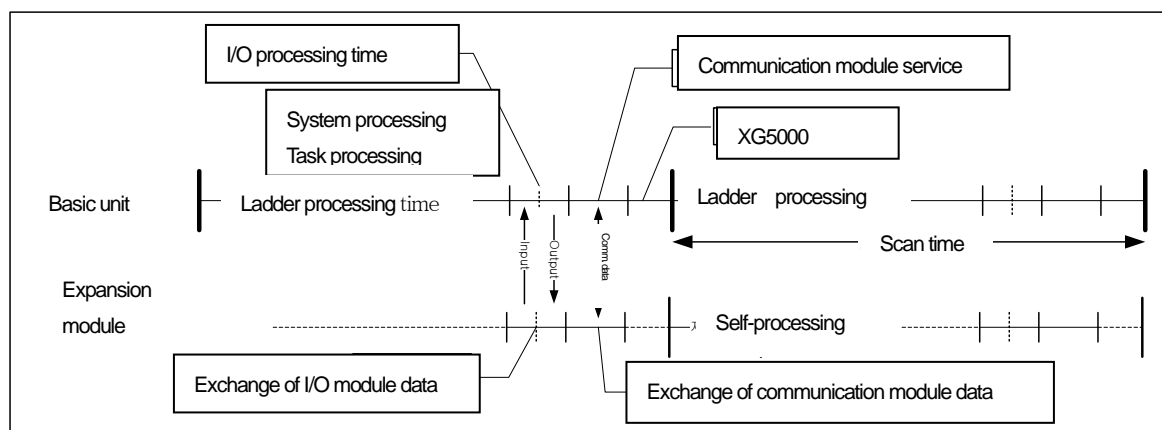

Scan time = Ladder running time + system processing time + digital module I/O processing time + analog I/O processing time + communication module processing time + XG5000 Service processing time

Chapter 1 Program Configuration and Operation Method

(2) Example of calculating the scan time

The example of the PLC's system configuration and the calculation result of the scan time are as follows.

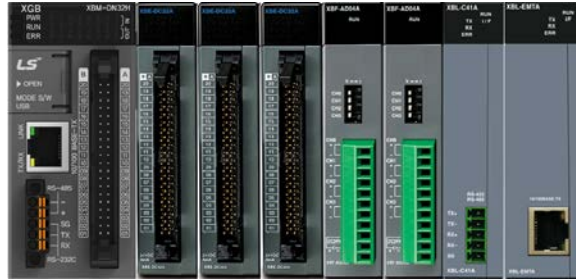

Items	System Configuration							
	Basic unit	SLOT2	SLOT3	SLOT4	SLOT5	SLOT6	SLOT7	SLOT8
Product name	XEM-DN32HP	XBE-DC32A * 3EA			XBF-AD04A * 2EA		XBL-C41A	XBL-EMTA
Operating conditions	200KB	-			-		200 Byte per module, 1 block	

Scan time = Ladder running time + system processing time + digital I/O processing time + analog I/O processing time + communication module processing time + XG5000 Service processing time = 7.2 + 0.8 + 0.3*3 + 2.0*2 + 0.8*2 + 0.1 = 14.6ms

However, in the event of changing during RUN or writing communication parameters with XG5000, it requires converting the program changed during RUN into executable machine code in the PLC or other internal processing operations for changed communication parameters so the scan time may be temporarily increased by several ms or more.

(3) Verification of the scan time

The PLC's scan time can be verified by using XG5000 or flag as below.

(a) How to use XG5000: Click 『Online』 - 『Diagnosis』 - 『PLC information』 - 『Performance』 .

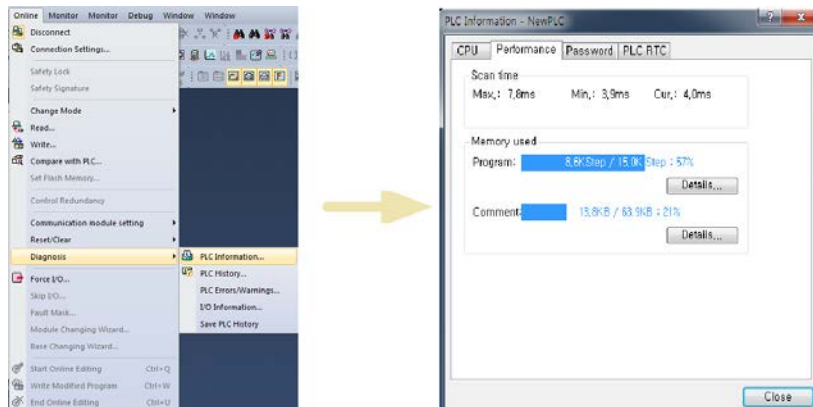

(b) How to use flag : The scan time is saved in the below system flag (F) area.

WORD	Flag Name	Name	Description
%FW50	_SCAN_MAX	Maximum scan time	The longest scan time (update in case of occurrence only), in 0.1ms
%FW51	_SCAN_MIN	Minimum scan time	The shortest scan time (update in case of occurrence only), in 0.1ms
%FW52	_SCAN_CUR	Current scan time	Running time of this scan (scan update), in 0.1ms

1.1.4 Program Composition

The program is composed of all function factors required to perform a specific control and they are saved in the basic unit's RAM or flash memory. The function factors to execute the program can be generally divided as below.

Function factors	Executing details
Initialization program	<ul style="list-style-type: none"> • After applying power, it is the program that is firstly executed after completing the self-initialization operations required to operate the PLC. It should run until the INIT_DONE command executes. • When the initialization program runs, only the initialization program is available until the INIT_DONE command runs; the scan program and fixed cycle, external interrupt, internal device task program are not executed. All other embedded functions such as I/O refresh, high speed counter, communication are normally executed. • It is used to program various operations required for the initial settings of the system configured with the high performance XGB PLC.
Scan program	<ul style="list-style-type: none"> • Repeated regularly at every scan. It performs the operation repetitively from the first step to the last step in order of being written. • If the fixed cycle interrupt, external contact interrupt, high speed counter interrupt occur during execution of the scan program, it will stop the scan program and return to the scan program after executing the relevant interrupt program.
Fixed cycle interrupt program	<ul style="list-style-type: none"> • Executed at every set cycle regardless of the scan program. It can be applied to execute the following time conditions. <ul style="list-style-type: none"> ▶ Execution at the shorter time interval than 1 scan processing time ▶ Execution at the longer time interval than 1 scan processing time ▶ Execution at the fixed time interval
External contact interrupt program	<ul style="list-style-type: none"> • Executed every time the input conditions (rising edge, falling edge, transition) of the set external input signal occur. It can be applied when immediate execution is required for external input conditions.
High speed counter interrupt program	<ul style="list-style-type: none"> • Executed when the high speed counter's current value is matched with the set value.
positioning interrupt program	<ul style="list-style-type: none"> • refer to Part 3 Built-in Positioning
Internal device interrupt program	<ul style="list-style-type: none"> • Executed when the set internal device is matched with relational conditions. • Detects whether starting conditions of the internal device interrupt occurs during END after executing the scan program
Subroutine program	<ul style="list-style-type: none"> • Executed only when the input condition of the CALL command is On.

Notice

1) Make the interrupt program as shortly as possible. In case the same interrupt occurs repeatedly during executing the interrupt program, O/S watchdog error may occur with non-execution of the scan program.

(In case the self-interrupt occurs during executing the interrupt program, task conflict error may occur.)

2) Although interrupts with low priority occur several times during executing the one with high priority, the interrupt will run just once so you should pay attention to set up the priority.

1.1.5 Interrupt

(1) Interrupt processing flow chart

It describes the PLC's operation flow chart, giving you the example of setting the interrupt program as below.

• Interrupt setting

Interrupt type	Interrupt Name	Priority	Task No.	Program Name	Remarks
Initialization	Interrupt0	-	-	Initialization program	
Fixed cycle 1	Interrupt1	2	0	Fixed cycle 1	
External	Interrupt2	2	16	External	
Internal device	Interrupt3	3	24	Internal device	
High speed counter	Interrupt4	4	40	High speed counter	
Fixed cycle 2	Interrupt5	3	1	Fixed cycle 2	

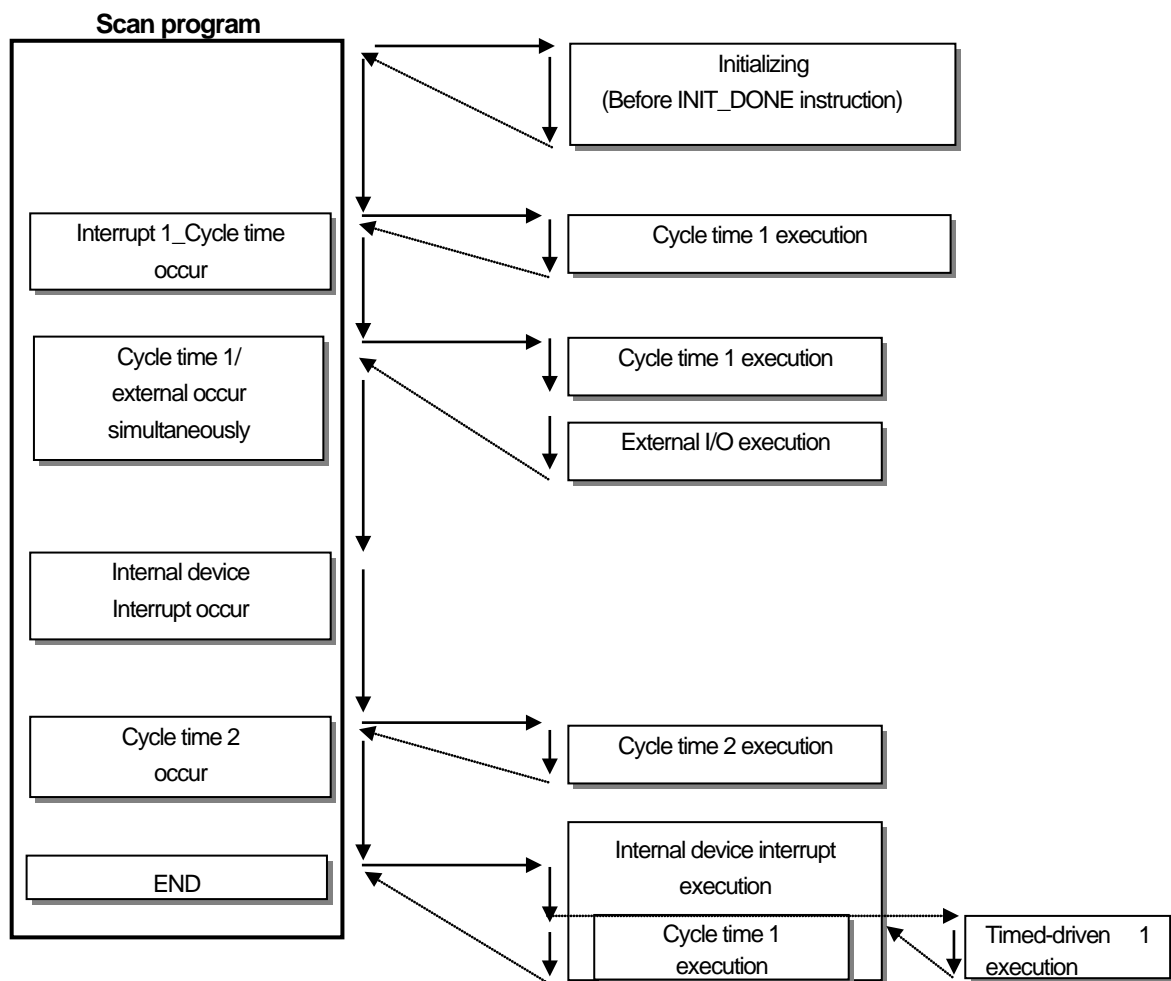

Notice

- 1) If the interrupt with the same priority occur at the same time, the early set interrupt will be executed first. (In case 'interrupt 1' and 'interrupt 2' occur at the same time, 'interrupt 1' will be executed first.)
- 2) If the interrupt with higher priority occurs during execution of interrupts, the interrupt with higher priority will be executed first.
- 3) All interrupts are allowable (Enable) when the power is On. If you want to run by interrupt program or prohibit them, you can use EI, DI command.
- 4) The internal device interrupt will run after getting the END command.

Chapter 1 Program Configuration and Operation Method

(2) Types and operation standards of tasks

The types and operation standards of tasks that are available for the high performance small-sized PLC are as below.

Type Spec.	Fixed cycle task	External contact task	Internal contact task	High speed counter task	positioning task
Maximum number	16 EA	8 EA	16 EA	4 EA	1EA
Start conditions	Fixed cycle (Can be set up to 4,294,967.295 seconds, in 1ms)	Rising or falling edge of the basic unit %IX0.0.0~%IX0.0.7 input contacts	Internal device's designated conditions	High speed counter comparative output 0 / The minimum set value is matched	Fixed cycle (can be set up to 10ms in 1ms increments)
Detection and Execution	Executed cyclically at every setting time	Executed immediately when the edge of the basic unit %IX0.0.0~%IX0.0.7 input contacts occur	Executed with searching conditions after completing the scan program	Executed when the current counter value is matched with the minimum set value of the comparative output 0	Executed cyclically at every setting time
Detection delay Time	Delayed for the maximum of 1ms	Within the maximum of 0.05ms	Delayed as much as the maximum scan time	Within the maximum of 0.25ms	Delayed for the maximum of 1ms
Priority of executions	2 ~ 7 level setting (2 level has the highest priority)	Same as the left	Same as the left	Same as the left	Cannot set priority (Has a higher priority than other tasks)
Task No.	Designated without overlapped users in the range of 0~15	Designated without overlapped users in the range of 16~23	Designated without overlapped users in the range of 24~39	Designated without overlapped users in the range of 40~43	44

(3) Processing method of the task program

It describes the common processing methods and instructions for the task program.

(a) Characteristics of the task program

- In contrast with the scan program, the task program runs only when the execution conditions occur without repetition processing. When writing the task program, consider this point.
For example, if the timer and counter are applied to the task program with the fixed cycle of 10 seconds, the maxim error of 10 seconds may occur in the timer. The counter reflects the input state every 10 seconds so the input that changed within 10 seconds is not counted.

(b) Execution priority

- In case several tasks to be executed stand by, the task program with high priority should be processed first. If the tasks with the same priority stand by, they should be processed in order of occurrence.
- When the fixed cycle task and external contact task occur at the same time, the task set early by XG5000 will be executed by priority.
- Set up the priority of the task programs in consideration of characteristics, importance of the programs and urgency of required executions.

(c) Processing delay time

The delay of task program processing is caused by the below causes. Consider these factors when setting up tasks and writing programs.

Chapter 1 Program Configuration and Operation Method

- Delayed detection of tasks (Refer to the detailed description of each task.)
 - Program execution delay due to execution of the preceding task program
 - Input/output data refresh of expansion special module
- (d) Relation between the initialization, scan program and the task program
- When executing the initialization task program, the fixed cycle, external contact, high speed counter, internal contact task cannot be started.
 - The scan program has the lowest priority so when the task occurs, the scan program will be suspended and the task program will be executed preemptively. Accordingly, in case the tasks occur frequently during one scan or they converge intermittently, the scan time may be extended abnormally. You should consider this point when setting tasks.
- (e) Protection of the currently running scan program by prohibiting tasks execution
- If you do not want the scan program to be suspended by the task program with high priority during executing the scan program, you can partially prohibit the execution of task programs by using the below DI, EI command in order to protect the scan program.
- (When the power is supplied to the PLC, the initial values of all tasks are EI (allowable) state.)

Command	Use	Description
EI		Allows the start of all tasks.
DI		Prohibits the start of all tasks.

(4) Verification of task program

After writing the task program, verify it based on the following instructions.

(a) Are the occurrence conditions of tasks proper?

If tasks occur frequently beyond necessity or if several tasks occur in one scan, the scan time may be extended or become irregular. / If you cannot change task settings, check the maximum scan time.

(b) Are the priorities of tasks arranged well?

The task program with low priority may be delayed and fail to be executed in time due to the task program with high priority, in some cases, the pending tasks occur redundantly during execution of the preceding tasks so it may lead to tasks conflicts.

Set up the priority in consideration of urgency, running time, etc. of tasks.

(c) Are task programs made as shortly as possible?

Long running time of the task program can cause the long or irregular scan time or may lead to the conflict of task programs. Make the task programs as shortly as possible.

Especially, when attaching expansion special module, or using PUT,GET instructions, program processing might be delayed. (More than 10ms task cycle is recommended).

When making the task program with fixed cycle, the task program should be executed within 10% of the operation cycle of the shortest task among several tasks.

Ex.) When the task program's running time is 1ms, the fixed cycle time should be more than 10ms.

Chapter 1 Program Configuration and Operation Method

(d) Is the protection of the program needed for the task with high priority during execution of the program?

If the other task interrupts during execution of the task program, after the executing task is completed, among pending tasks, the one will run in order of priority. If you do not want interruption of other tasks during execution of the task program, protect the program with DI, EI applied commands.

(5) Example of program configuration and processing

The example of the program execution sequence is given under the registered tasks and programs as below.

• Registered task programs

Interrupt source	Interrupt Name	Priority	Task No.	Program Name	running time
Fixed cycle	10ms_fixed cycle	3	0	Program1	2ms
Internal contact	Internalcontact_M00	5	24	Program2	7ms
External contact	Externalcontact_P08	2	16	Program3	2ms
-	-	-	-	Scan program	17ms

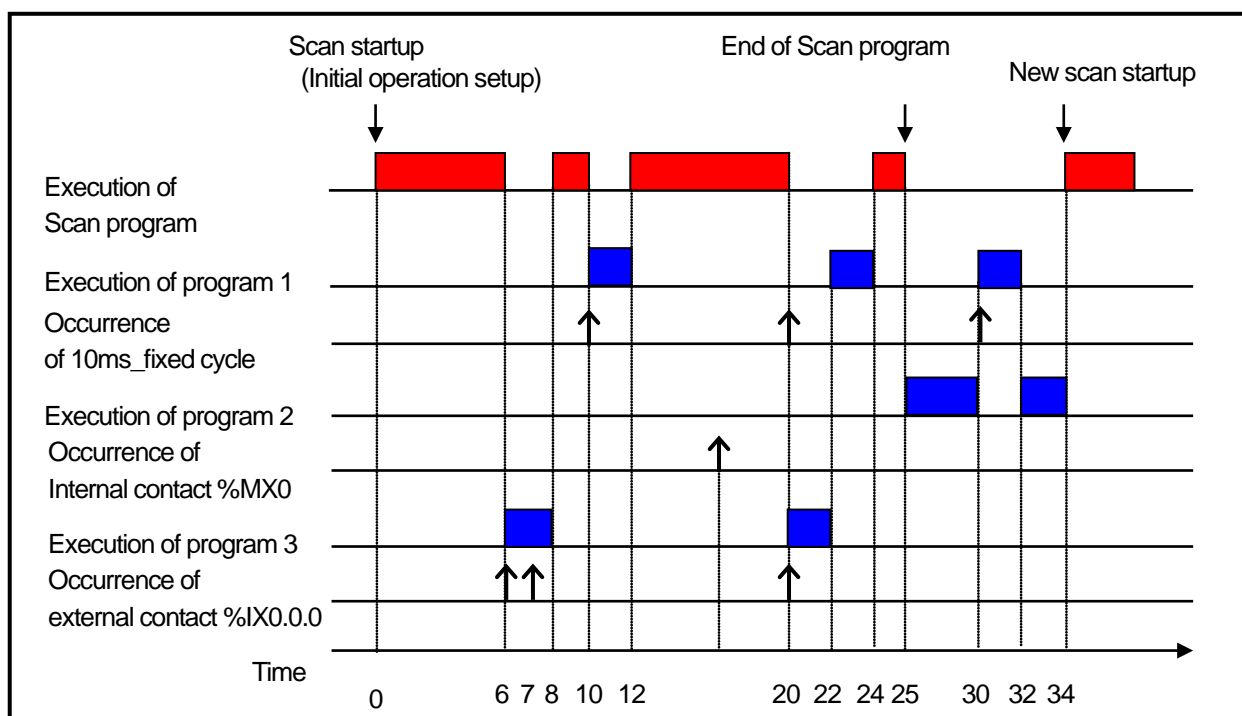

Time (ms)	Executed details
0~6	The scan program starts and is executed.
6~8	Request on running the external contact interrupt is entered and the scan program is interrupted and the program 3 runs. There is the request on rerun at 7[ms] but it is ignored since the program is running.
8~10	The execution of the program 3 is completed and the scan program will run continuously.
10~12	There is the request on running 10ms_fixed cycle interrupt so the scan program is interrupted and the program 1 runs.
12~20	The execution of the program 1 is completed and the scan program that was interrupted runs continuously.
20	Although there are the requests on 10ms_fixed cycle interrupt and the external contact interrupt at the same time, the external contact interrupt has higher priority so the program 3 runs and the program 1 stands by for execution.

Time (ms)	Executed details
20~22	The scan program is interrupted and the program 3 runs.
22~24	The execution of the program 3 is completed and the pending 10ms_fixed cycle interrupt program 1 runs.
24~25	The execution of the program 1 is completed and the scan program is finished.
25	The program 2 is executed by checking the interrupt request on internal contact_M0 of P2 at the time of completion of the scan program.
25~30	The program 2 runs.
30~32	The request on 10ms_fixed cycle interrupt occurs and the 10ms_fixed cycle has higher priority so the program 2 is interrupted and the program 1 runs.
32~34	The execution of the program 1 is completed and the program 2 that was interrupted is finished.
34	The new scan starts (startup of executing the scan program)

1.1.6 Initialization task

(1) How to set up the task

You can add initialization tasks in the project window of XG5000 as below and add the programs to be executed. For more details, refer to the XG5000 manual. (You cannot add tasks on online. After disconnecting the PLC, add tasks.)

- (a) Adding task: Select 『Project』 – 『Add Items』 – 『Task』 or after clicking with the right mouse button on the project name of the project tree, select 『Add Items』 - 『Task』 as shown in the below figure.

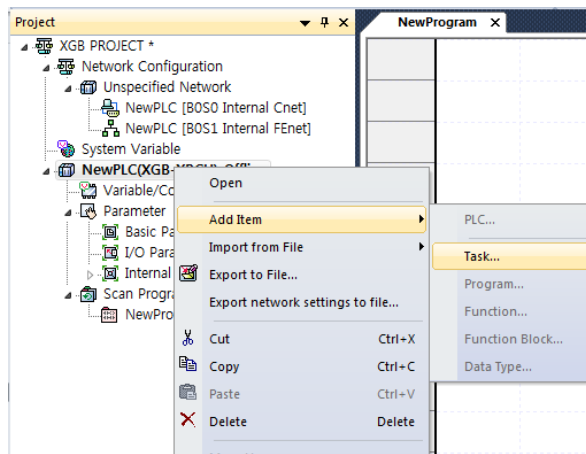

- (b) The screen for registering the task will be displayed. Click 『Initialization』 in the execution conditions and enter the task name.

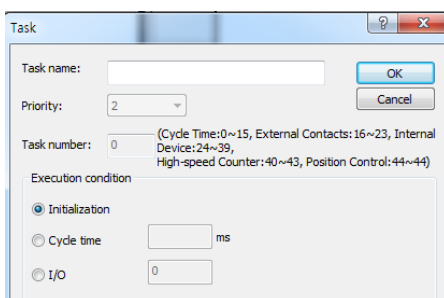

(c) Click on the right mouse button on the registered task and click 『Add Items』 - 『Program』 .

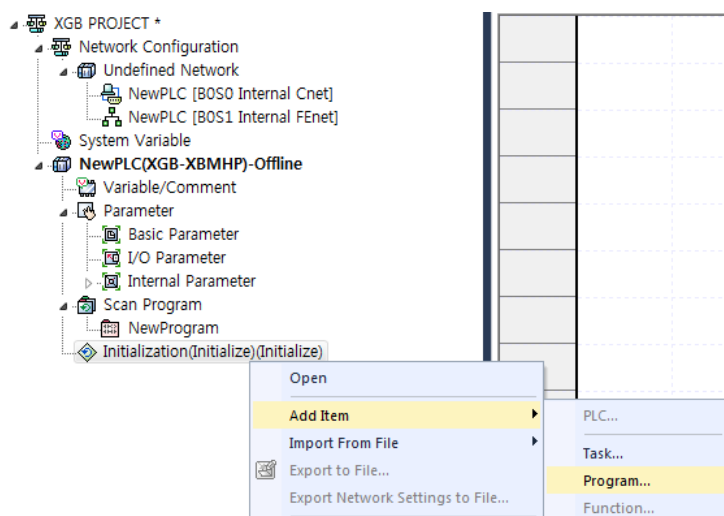

(d) Make the necessary initialization program and make sure to include the INIT_DONE command to the initialization task program.

(If the operation conditions of INIT_DONE runs, the initialization task is ended and the scan program runs.)

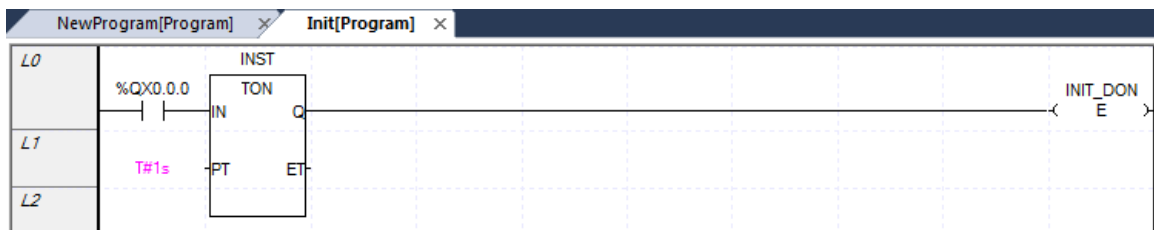
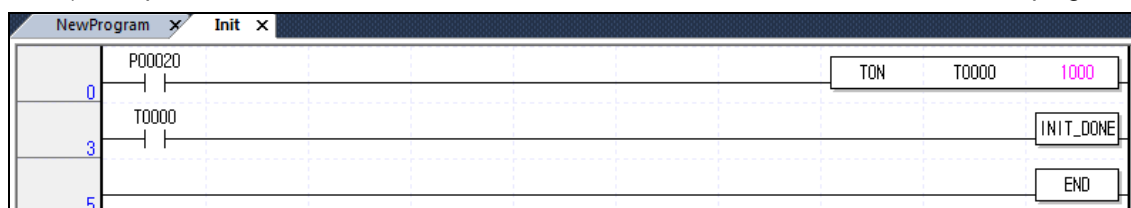

1.1.7 Fixed cycle task

(1) How to set up the task

- (a) Adding tasks: Select 『Project』 – 『Add Items』 – 『Task』 or after clicking with the right mouse button on the project name of the project tree, select 『Add Items』 - 『Task』 as shown in the below figure.

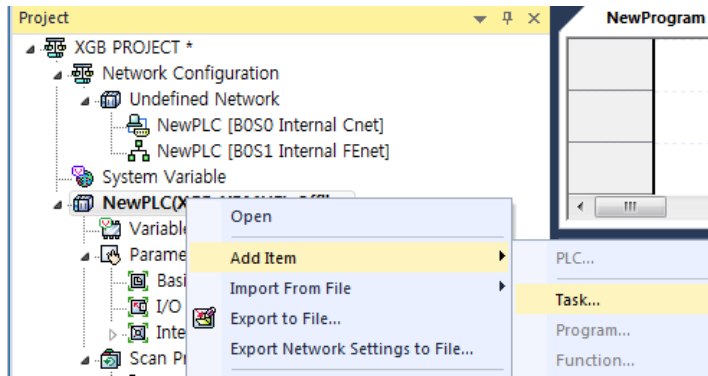

- (b) The screen for registering the task will be displayed. Click 『Fixed cycle』 in the execution conditions and after entering the task name, input the items required for setting as below

Items	Input range	Description
priority	2~7	Designates the priority of tasks.
Task No.	0~15	Designates the task number. The numbers overlapped with are not available.
cycle	1~4,294,967,295 (ms)	Designates the task's running cycle.

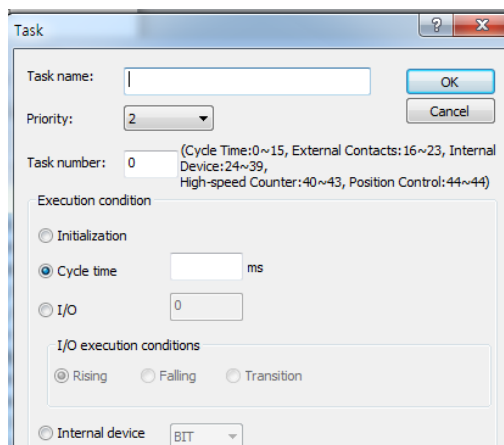

(c) Click on the right mouse button on the registered task and click 『Add Items』 - 『Program』 .

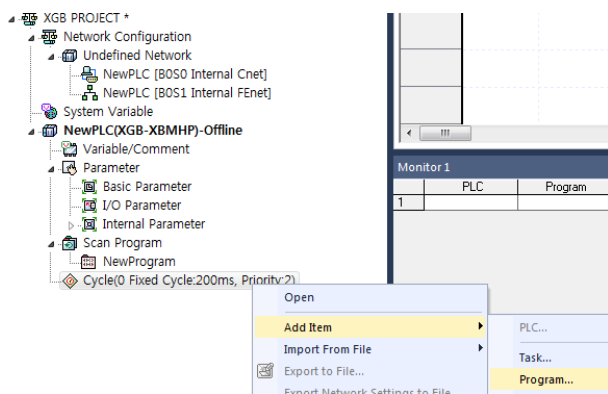

(d) Register the task program name and comment.

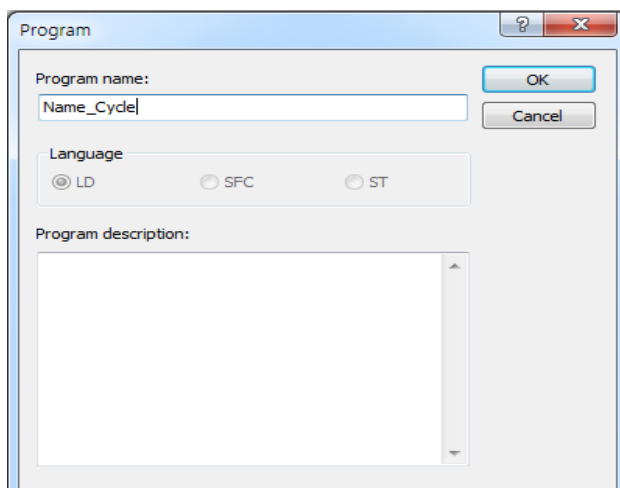

(e) If the program window for writing the task program is displayed, you can make the task program here.



(2) Instructions to use the fixed cycle task

The corresponding task program with fixed cycle runs at every set time interval (running cycle) and keep the below instructions in mind.

- When the specific task program with the fixed cycle runs currently or stands by for execution, if the request on running the same task program occurs, the newly occurred task will be ignored.
- The timer generating the request on running the task program with fixed cycle works only when the operation mode is RUN mode. Ignore all the blackout time.
- When setting up the running cycle of the task program with fixed cycle, the request on running several task programs should not occur.

If you apply 4 task programs with the fixed cycle of 2 seconds, 4 seconds, 10 seconds, 20 seconds, 4 execution requests occur simultaneously every 20 seconds and 4 tasks runs at once so the scan time may be longer momentarily.

1.1.8 External contact task

(1) How to set up the task

- (a) Adding tasks: Select 『Project』 – 『Add Items』 – 『Task』 or after clicking with the right mouse button on the project name of the project tree, select 『Add Items』 - 『Task』 as shown in the below figure.

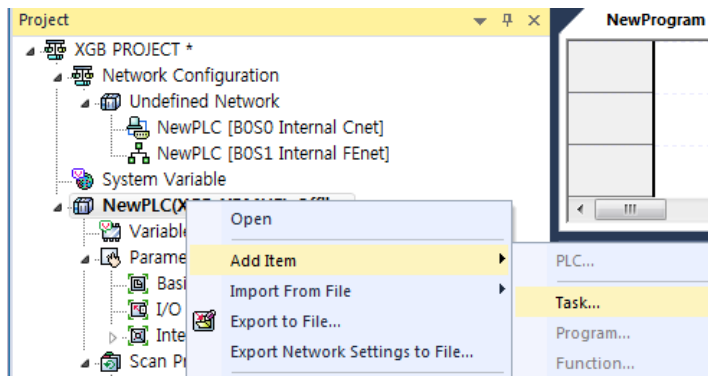

- (b) The screen for registering the task will be displayed. Click 『External contact』 in the execution conditions and after entering the task name, input the items required for setting as below.

Items	Input range	Description
Priority	2~7	Designates the priority of tasks.
Task No.	16~23	Designates the task number. The numbers overlapped with are not available.
Contact No.	0~7	Designates the task start contact number.
Starting conditions	rising, falling, transition	Sets up starting conditions of tasks.

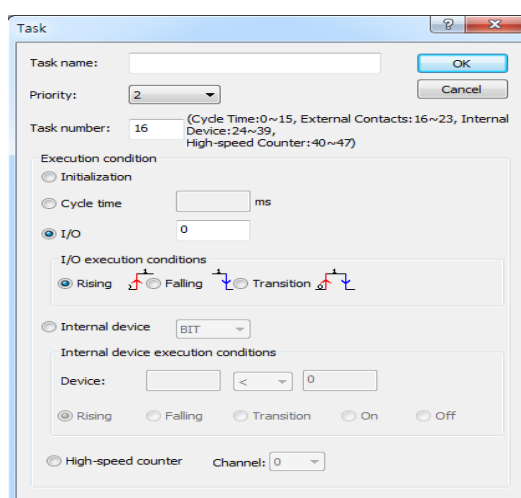

- (c) Click on the right mouse button on the registered task and click 『Add Items』 - 『Program』 .

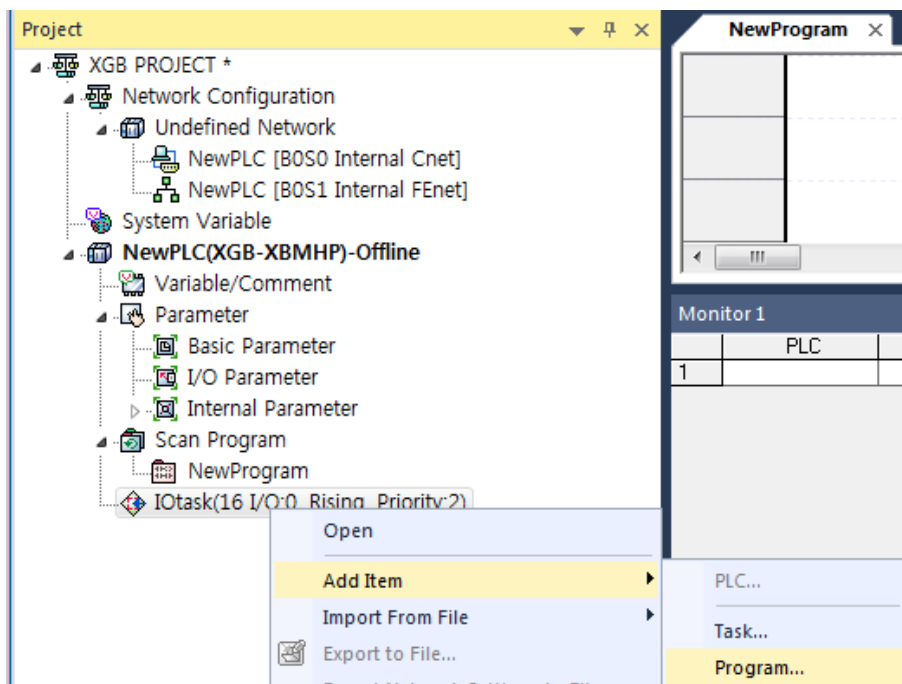

(d) Register the task program name and comment.

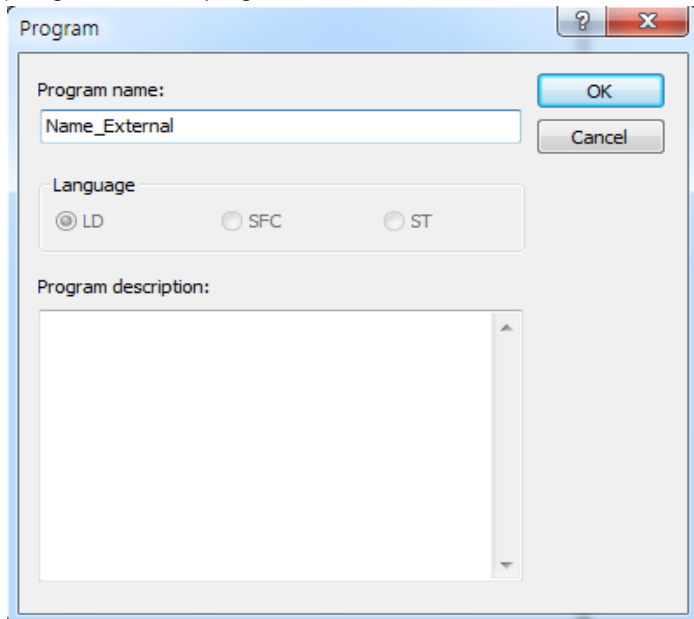

(e) If the program window for writing the task program is displayed, you can make the task program here.

(3) Instructions to use the external contact task

When the rising, falling or transition conditions occur in the set input contact, the corresponding external contact task program runs and keep the below instructions in mind.

- 8 external contacts are available in the range of %IX0.0.0~%IX0.0.7.
- When the specific external contact task program runs currently or stands by for execution, if the request on running the same input task program occurs, the newly occurred task will be ignored.
- The input contact monitoring for the external contact tasks is executed only when the operation mode is RUN mode. The input contact monitoring for task startup is not executed in STOP mode.
- The detection delay time of the external contact task is approximately 50us.
- When designing the system, several external contact tasks should not start at the same time.

If %IX0.0.0~%IX0.0.7 contacts are ON at the same time under all the external contacts of %IX0.0.0~%IX0.0.7 are set as the external contact tasks, 8 external contact task programs run at one so the scan time may be longer momentarily.

1.1.9 Internal device task

(1) How to set up the task

- (a) Adding tasks: Select 『Project』 – 『Add Items』 – 『Task』 or after clicking with the right mouse button on the project name of the project tree, select 『Add Items』 - 『Task』 as shown in the below figure.

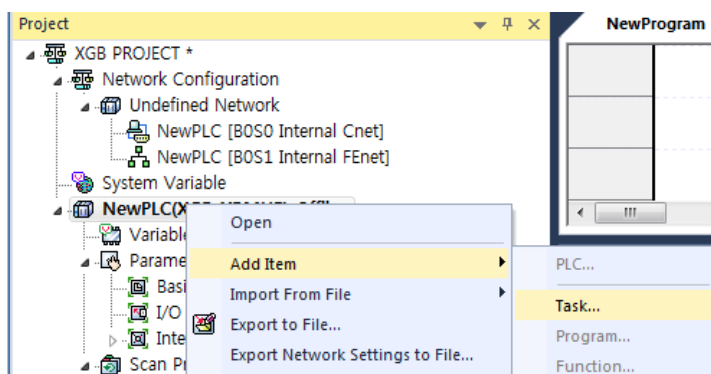

- (b) The screen for registering the task will be displayed. Click 『Internal device』 in the execution conditions and after entering the task name, input the items required for setting as below.

Items		Input range	Description	
Priority		2~7	Designates the priority of tasks..	
Task No.		24~39	Designates the task number. The numbers overlapped with are not available.	
Internal device		BIT, WORD	Selects the device type that will start the task.	
Device		Direct input	Input directly the device that will start the task and set the startup conditions.	
Startup conditions	Bit	Rising, falling, transition, On, Off	Rising	Starts the task in case of rising edge.
			Falling	Starts the task in case of falling edge.
			Transition	Starts the task in case of rising or falling edge.
			On	Starts every scan task during ON.
			Off	Starts every scan task during OFF.
	Word	<, <=, ==, >=, >	<	Starts the task when the word is less than the set value.
			<=	Starts the task when the word is less than or equal to the set value.
			==	Starts the task when the word is the same as the set value.
			>=	Starts the task when the word is more than or equal to the set value.
			>	Starts the task when the word is more than the set value.

Chapter 1 Program Configuration and Operation Method

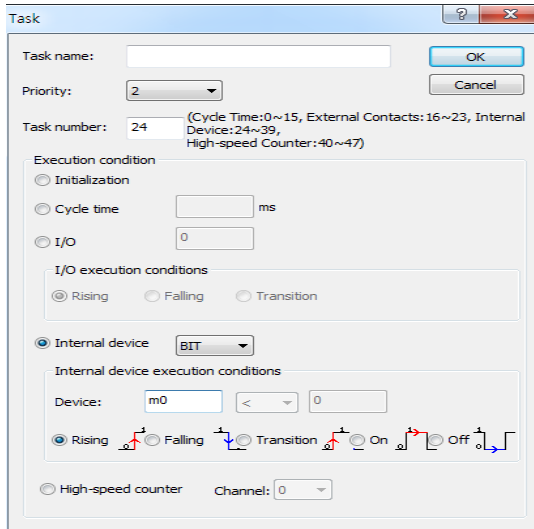

(c) Click on the right mouse button on the registered task and click 『Add Items』 - 『Program』 .

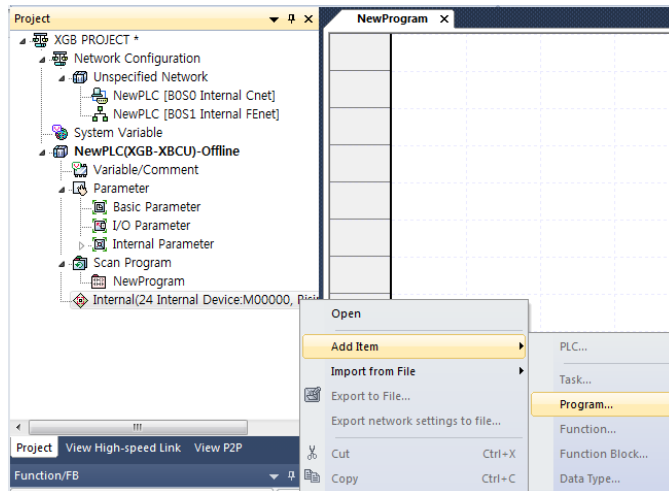

(d) Register the task program name and comment.

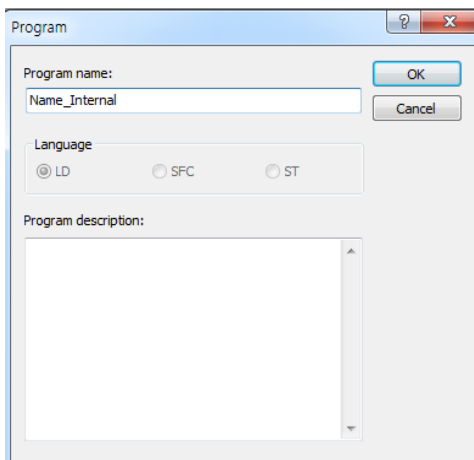

(e) If the program window for writing the task program is displayed, you can make the task program here.

(2) Instructions to use the internal device task

The internal contact task detects the startup conditions of the internal device set by the scan END and runs the relevant internal device task program. Keep the below instructions in mind.

- The internal device task program runs when the scan program is completed. Accordingly, although the execution conditions of the internal device task program occur in the scan programs or task programs (fixed cycle, external contact, high speed counter), it will run at the time of completing the scan program instead of running immediately.
- In the case of the internal device task, the execution conditions are searched when the scan program is completed. Accordingly, if the execution conditions of the internal device task occur and dissipate by the scan program or other task programs, the task will not run since the execution conditions cannot be detected at the time of searching the conditions.

1.1.10 High speed counter task

(1) How to set up the task

- (a) Adding tasks: Select 『Project』 – 『Add Items』 – 『Task』 or after clicking with the right mouse button on the project name of the project tree, select 『Add Items』 - 『Task』 as shown in the below figure.

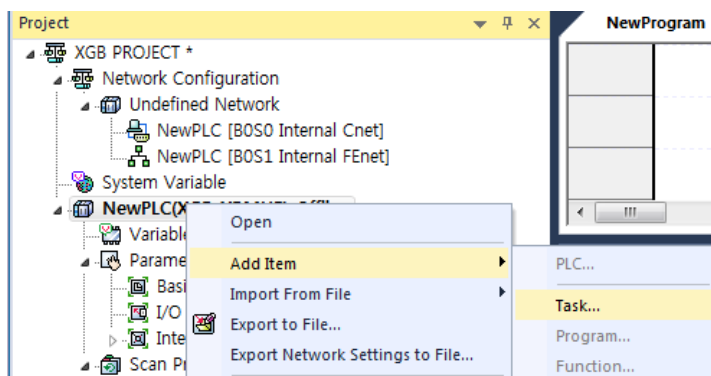

- (b) The screen for registering the task will be displayed. Click 『High speed counter』 in the execution conditions and after entering the task name, select the channel.

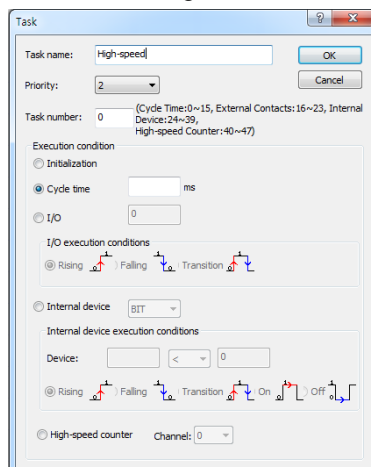

- (c) Click on the right mouse button on the registered task and click 『Add Items』 - 『Program』 .

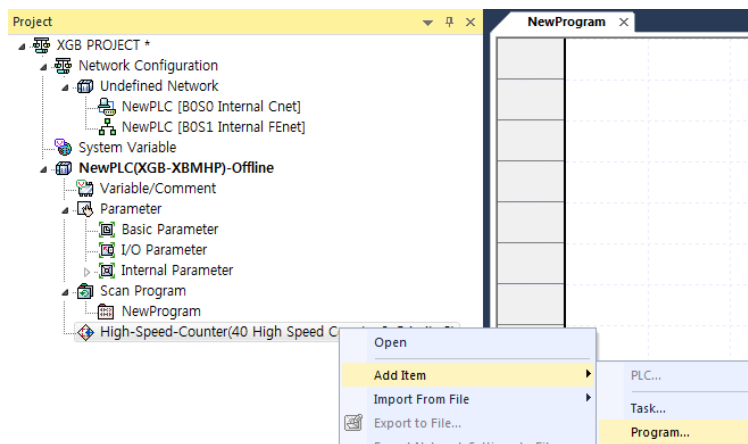

(d) Register the task program name and comment.

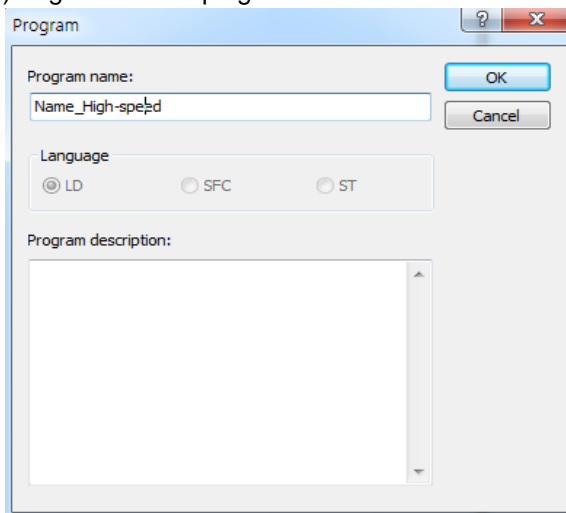

(e) If the program window for writing the task program is displayed, you can make the task program here.

(2) Instructions to use the high speed counter task

- When the high speed counter's current value in the selected channel becomes equal to the comparative output set value of 0 of the relevant channel in the below Fig., the high speed counter task will be detected and the task program will run.
- You can check whether the conditions of the high speed counter task occur at every 250us cycle so detection delay may occur up to 250us.
- The operations of the high speed counter task are performed only when the operation mode is RUN mode.

1.1.11 Positioning control task

(1) How to set up the task

- (c) Adding tasks: Select 『Project』 – 『Add Items』 – 『Task』 or after clicking with the right mouse button on the project name of the project tree, select 『Add Items』 - 『Task』 as shown in the below figure.

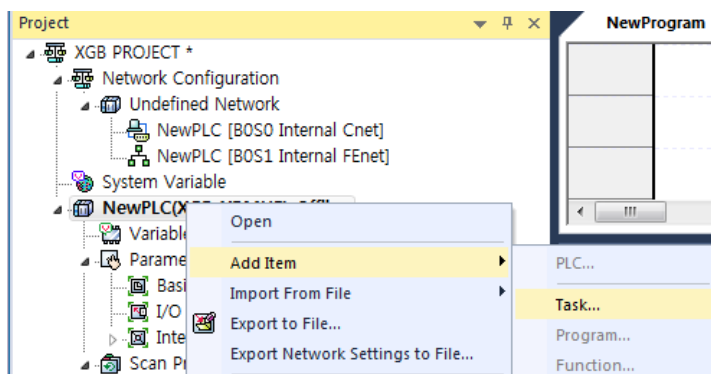

- (d) The screen for registering the task will be displayed. Click 『Position control task』 in the execution conditions and after entering the task name, select the channel.

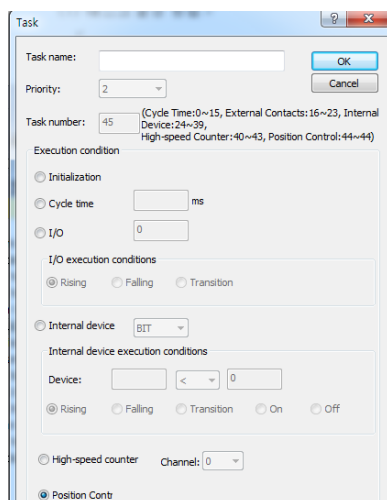

- (c) Click on the right mouse button on the registered task and click 『Add Items』 - 『Program』 .

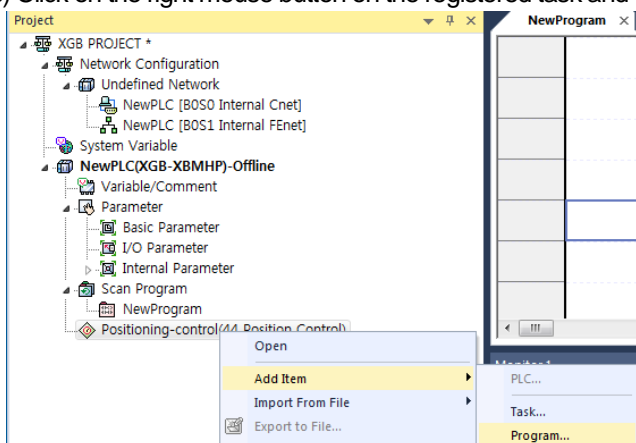

(d) Register the task program name and comment.

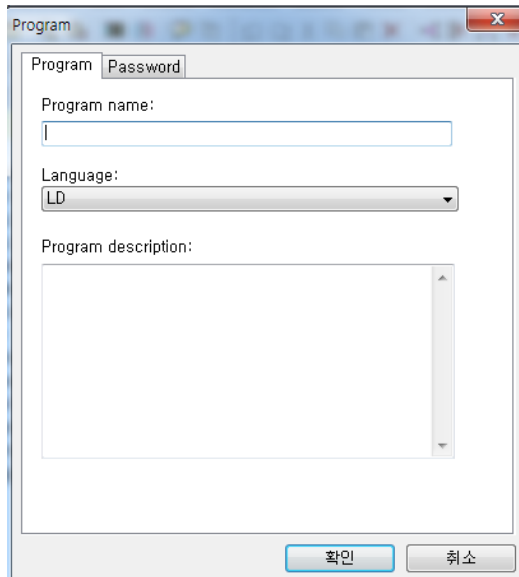

The screenshot shows a 'Program' dialog box with the following fields and controls:

- Program name:** A text input field.
- Language:** A dropdown menu currently set to 'LD'.
- Program description:** A large text area for entering a comment.
- Buttons:** '확인' (OK) and '취소' (Cancel) buttons at the bottom.

(e) Details of Positioning control task: refer to Part3 Ch04 Positioning Control

1.2 Operation mode

The XGB PLC has 3 operation modes; RUN mode, STOP mode, DEBUG mode.

This section describes the execution processing of each operation mode.

1.2.1 RUN mode

It is the mode executing the program normally.

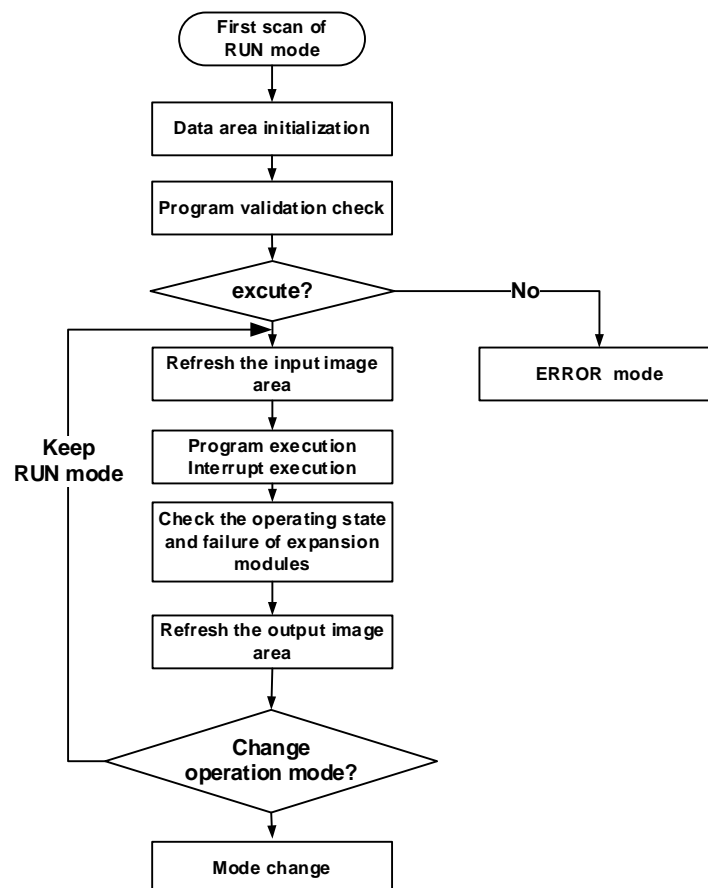

(1) When changing the mode from other into RUN

Initialize the data area at the beginning stage and check the validity of the program to determine whether it can be executed or not.

(2) Execution processing details

I/O Refresh and program operation are executed.

- (a) The interrupt program is executed by detecting the startup conditions of the interrupt program.
- (b) Normal operation or fail of the equipped module is checked.
- (c) Communication services are executed with other internal processing.

1.2.2 STOP Mode

It is the mode of block state without operations of the program. In STOP mode, you can write the programs and parameters through XG5000.

- (1) When changing the mode from other into STOP
Eliminate the output image area and execute Output Refresh.
- (2) Execution processing details
 - (a) I/O Refresh is executed.
 - (b) Normal operation or fail of the equipped module is checked.
 - (c) Communication services are executed with other internal processing.

1.2.3 DEBUG Mode

This is the mode to detect Program error or trace the operation process and the conversion to this mode is available only in STOP mode. This is the mode to check the program execution state and the contents of each data and verify the program.

- (1) Processing at mode change
 - (a) Initializes the data area at the beginning of mode change.
 - (b) Clears the output image area and execute input refresh.
- (2) Operation processing contents
 - (a) Executes I/O refresh.
 - (b) Debug operation according to setting state.
 - (c) After finishing Debug operation by the end of Program, execute output refresh.
 - (d) Examine the normal operation or missing of module.
 - (e) Executes communication service or other service.

Chapter 1 Program Configuration and Operation Method

(3) Debug operation

☐ It describes debug mode.

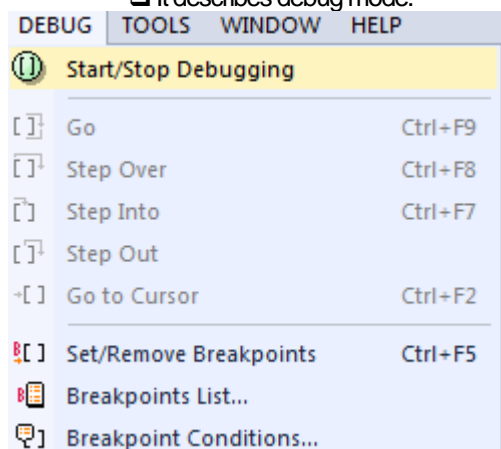

Item	Description	Remark
Start/Stop Debugging	Change the debug ↔ stop mode	
Go	It starts debug operation.	
Step Over	It operates by 1 step.	
Step Into	It starts the subroutine program.	Other operation is identical to Step Over.
Step Out	It finished the subroutine program.	
Go to Cursor	It operates to current cursor position.	
Set/Remove Breakpoints	Set/Removes current cursor position to break points.	
Breakpoints List	It displays list of breakpoints.	
Breakpoint Conditions	It specifies device value and number of scan.	

(a) Set/Remove Breakpoints

- Sets breakpoint at current cursor position. After breakpoint setting, (breakpoint setting indicator) is displayed.

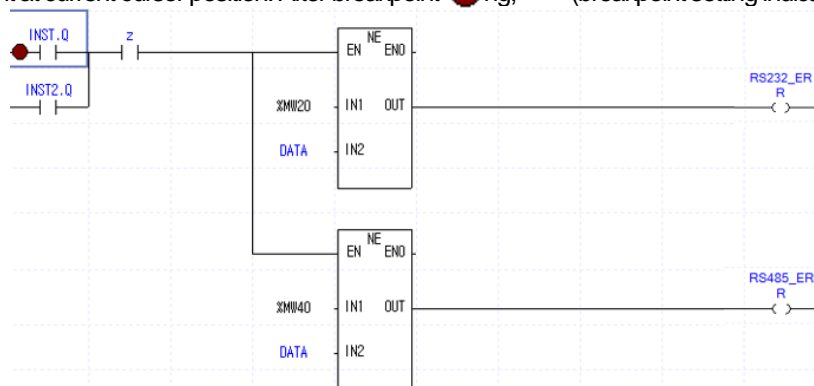

Chapter 1 Program Configuration and Operation Method

(b) Go

- Run the program to breakpoint. At breakpoint (stop indicator) is displayed.

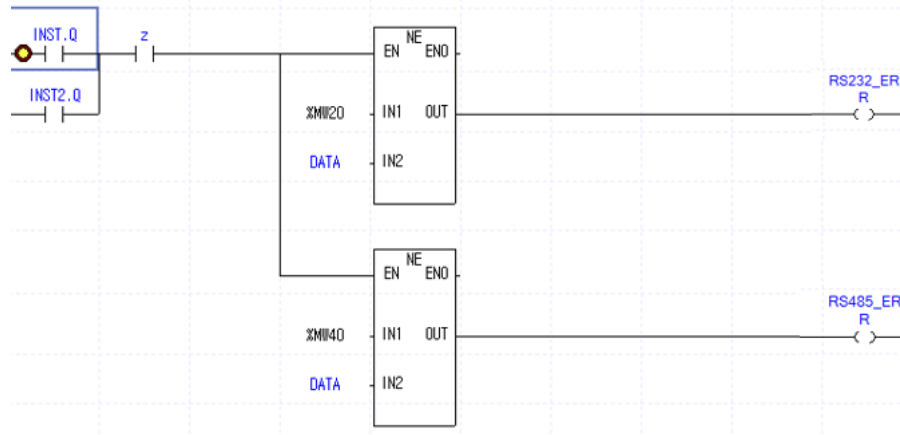

(c) Step Over

- Run the program to next step. Step over indicator is displayed.

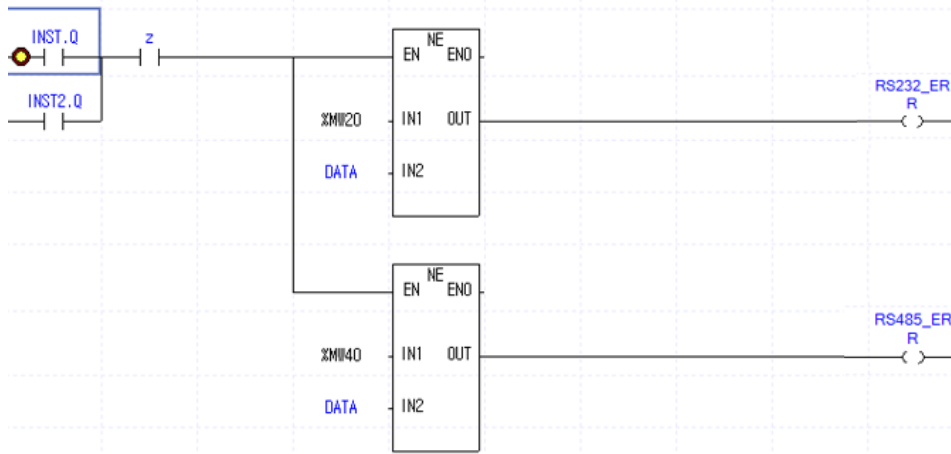

(d) Breakpoint List

- It displays current Breakpoint List. It supports Select All, Reset All, Goto, Remove, Remove All.

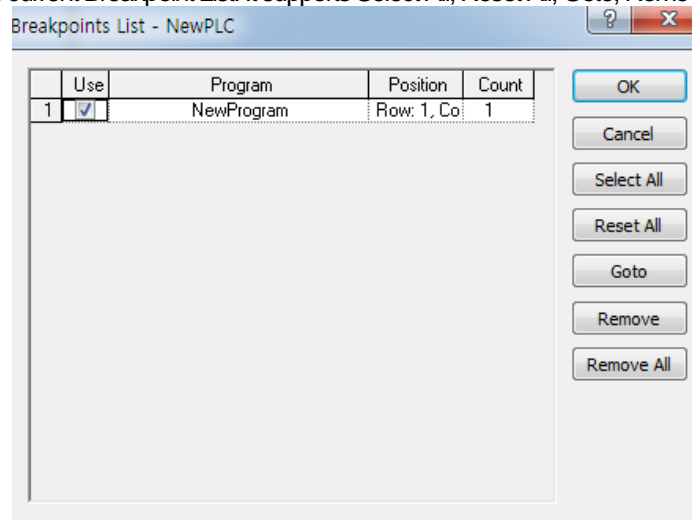

(e) Break condition

▪ It sets Device Break and Scan Break.

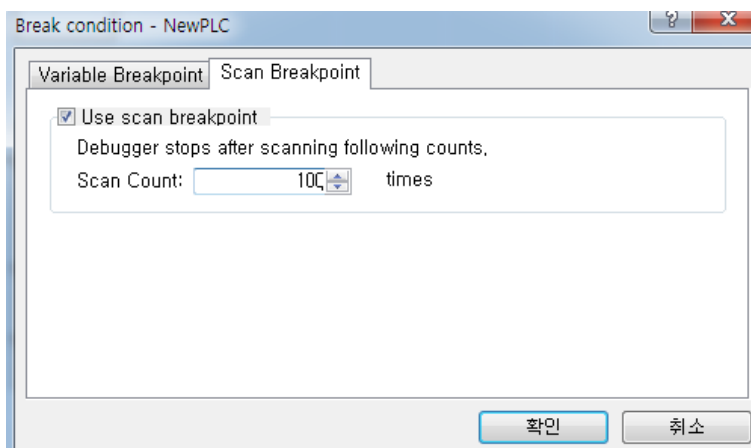
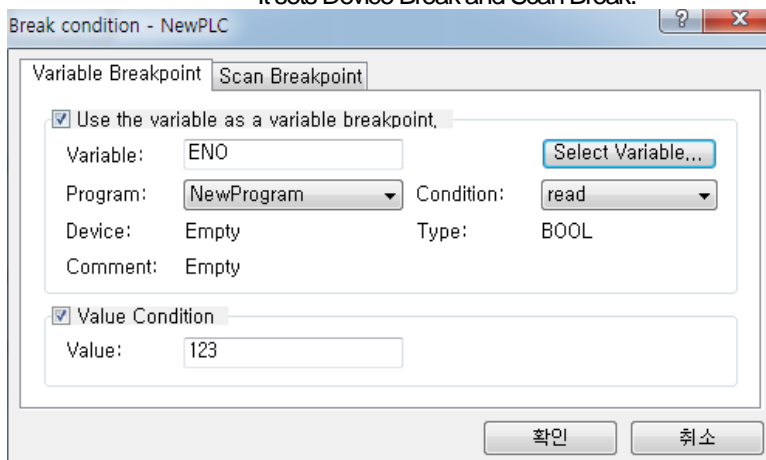

Notice

1) Refer to XG5000 Users Manual 'Chapter 12 Debugging' for detailed information.

1.2.4 Change of operation modes

(1) How to change operation modes

You can change the operation mode with the below methods.

- (a) Change by the mode key of the basic unit
- (b) Change by connecting the programming tool (XG5000) to the PLC
- (c) Changing the operation mode of the other basic unit connected to network with XG5000 accessed to the basic unit 1 (remote access)
- (d) Change by using XG5000, HMI, communication module connected to the network
- (e) Change by the 'STOP' command during execution of the program

(2) Kinds of operation modes

The following operation modes are set by the mode setting key of the basic unit and XG5000's commands.

Operation mode switch	XG5000 command	Operation mode	Remarks
RUN	Unchangeable	Local RUN	When the operation mode switch is located in RUN position, the mode change by XG5000 is impossible.
STOP	RUN	remote RUN	
	STOP	remote STOP	
	Debug	Debug	
RUN → STOP	-	STOP	

- (a) The mode change by XG5000 is available only when the operation mode switch is in **STOP** state.
- (b) If you want to change the mode into 'STOP' with a switch in the remote RUN state by XG5000, operate the switch as **STOP → RUN → STOP**.

Notice

- In case the mode is changed into RUN by a switch in the remote RUN mode, the PLC is operates continuously without intermission.
- Modificaiton is possible during run in the RUN mode by a switch but the mode change operaitons through XG5000 are restricted. Only when mode change is not allowable in a remote site, set the mode switch in RUN position.

1.3 Memory

1.3.1 Data memory

Contents and size of data memory are as follows.

Item		Size
Data memory entire area		204KB
System area : • I/O information table • Forced I/O table • Reserved area		20KB
Flag area	System flag (F)	4KB
	Analog image flag (U)	576B
	Internal special flag (K)	8KB
	High speed link (L)	8KB
	P2P flag (N)	20KB
Input image area (%I)		2KB
Output image area (%Q)		2KB
R area (%R)		32KBx2block
Direct variable area (%M)		32KB
Symbolic variable area (maximum)		64KB

1.3.2 Memory block diagram

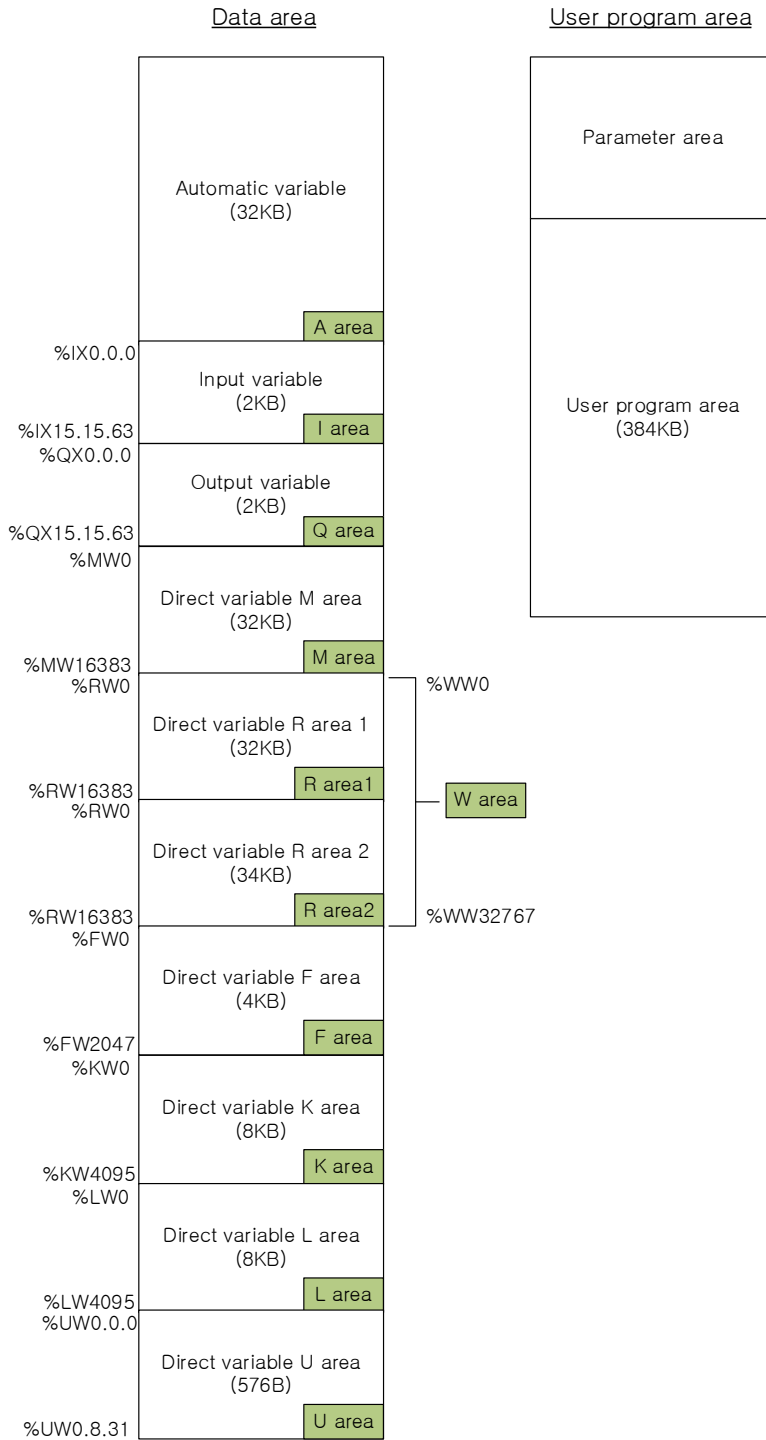

1.3.3 Setup of the data latch area

In case you want to keep the data necessary for operation and the data made during operation when PLC stops and restarts, Default(automatic) Variable Retain is used and some area of M area can be set as Retain area through parameter setting

The following is characteristic table about the device available for Retain setting

Device	Retain setting	Retain Status	Characteristic
Default	O	According to setting	As for automatic variable area, Retain setting is available
M	O	According to setting	As for internal contact point area, Retain setting is available at parameter
K	X	O	In case of power failure, contact point is kept
F	X	X	System flag area
U	X	X	Analog data register (Retain is not available)
L	X	X	High speed link/P2P service status contact point of communication module (Retain is available)
N	X	O	P2P service address area of communication module (Retain is available)
R	X	O	Flash memory dedicated area (Retain is available)

Notice

•K, N, R devices can be basically latched without setting parameters.

(1) Initialization of data according to restart mode

There are three variable related with restart mode (Default, initialization and retain variable). Initialization method about each variable in case of executing restart mode is as follows.

Variable assignment \ Mode	COLD	WARM
Default	Initialized as '0'	Initialized as '0'
Retain	Initialized as '0'	Hold previous value
Initialization	Initialized as user defined value	Initialized as user defined value
Retain & Initialization	Initialized as user defined value	Hold previous value

Notice

Terms on three types of variable are as follows.

- (1) Default variable : variable not set as INIT or Retain variable
- (2) INIT variable : initial value is set
- (3) Retain variable : Holds previous value

(2) Operation of data retain area

Method on deleting the Retain data is as follows.

- RESET through XG5000 (Overall Reset)
- Execute "Clear PLC" through XG5000 at STOP mode

Chapter 1 Program Configuration and Operation Method

- Writing by program (Initialization program recommended)
- Writing '0' FILL etc at XG5000 monitor mode

For holding of retain area data or reset (clear) operation according to PLC operation, refer to the following table.

Classification	Retain	M area Retain	R area
Reset	Hold previous value	Hold previous value	Hold previous value
Overall reset	Initialized as '0'	Initialized as '0'	Hold previous value
STOP→RUN	Hold previous value	Hold previous value	Hold previous value

(3) Initialization of data

If PLC becomes 'Clear Memory' status, memory of all devices are deleted as '0'. When you want to specify initial value, use initialization task. At CPU module, there are two types of built-in memory. One is program memory to save program made by user, for user to structure system, Another is data memory providing device area saving data during operation.

Chapter 1 Program Configuration and Operation Method

Chapter 2 CPU Function

2.1 Type Setting

This section describes setting XGB PLC models.

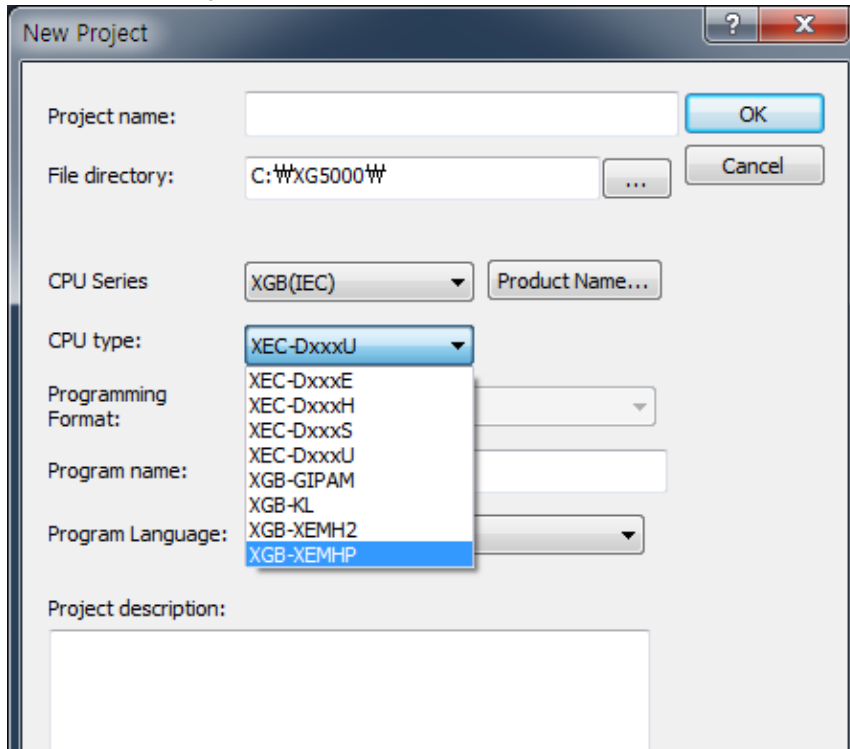

PLC Name	CPU Type	Language	Description	Remarks
XGB(IEC)	XGB-XECE	IEC language	Economic : XEC-DR10/14/20/30E XEC-DN10/14/20/30E, XEC-DP10/14/20/30E	Compact type
	XGB-XECH	IEC language	Deluxe: XEC-DR32/64H, XEC-DN32/64H XEC-DP32/64H	Compact type (DC power PLC included)
	XGB-XECS	IEC language	Standard : XEC-DR20/30/40/60SU, XEC-DN20/30/40/60SU	Compact type
	XGB-XECU	IEC language	High performance : XEC-DN32U, XEC-DN32UP, XEC-DN32UA XEC-DP32U, XEC-DP32UP, XEC-DP32UA XEC-DR28U, XEC-DR28UP, XEC-DR28UA	Compact type (DC power PLC included)
	XGB-GIPAM	IEC language	LS ELECTRIC relay only	-
	XGB-KL	IEC language	Dedicated	Compact type
	XGB-XEMH2	IEC language	Deluxe 2axis XPM positioning: XEM-DN/DP32H2, XEM-DN/DP16H2 Deluxe Relay output : XEM-DR14H2	Modular type
	XGB-XEMHP	IEC language	Deluxe 6axis XPM positioning : XEM-DN32HP, XEM-DP32HP	

2.2 Parameter Setting

This section describes XGB PLC's parameter setting.

2.2.1 Basic parameter setting

If you click the basic parameter in the project window, the below screen will be displayed.

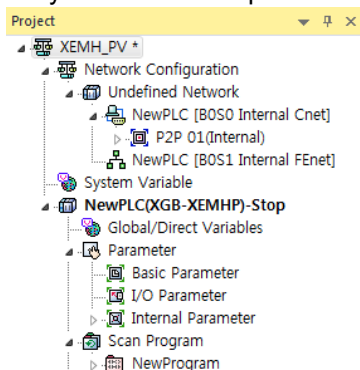

You can set up 3 items; 'Basic operation setting', 'Device area setting', 'Error operation setting'.

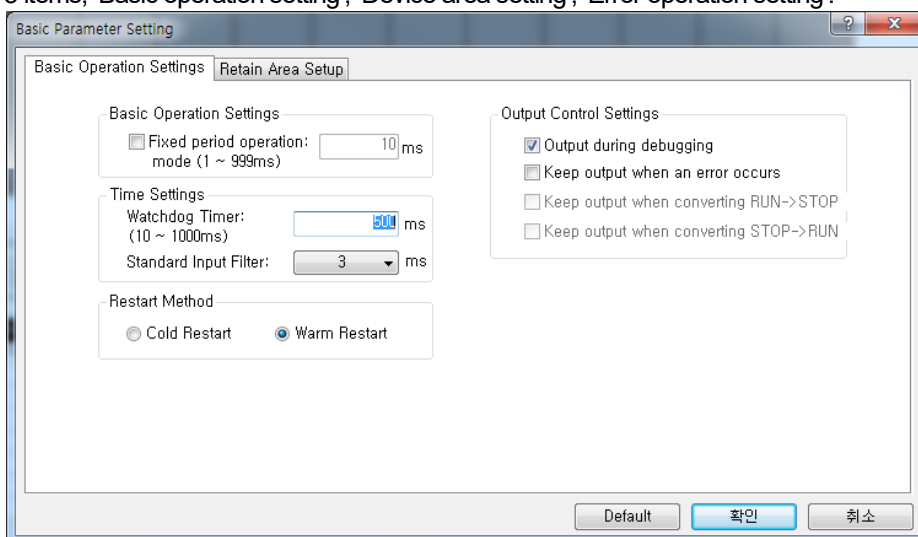

Classification	Items	Descriptions	Set values
Basic operations	Fixed cycle operation	Set the fixed cycle operation time.	1~999ms
	Watchdog timer	Set the scan Watch Dog's time.	10~1000ms
	Standard input filter	Set the standard input filter's time.	1,3,5,10,20,70,100ms
	Restart Mode	Set restart mode	Cold, Warm
	Output during debugging	Set whether allowing the actual output during debug operation.	Allowable/Prohibited
	Output Hold when errors occur	Determine whether allowing the Output Hold function set in I/O parameters when errors occur	Allowable/Prohibited
Device area setting	Selection of latch area	Set each device's latch area.	%MW0~%MW16383

2.2.2 I/O parameters Setting

It is the function to set up and reserve the information for each I/O. If you click 『I/O Parameter』 in the project window, the below setting window will be displayed.

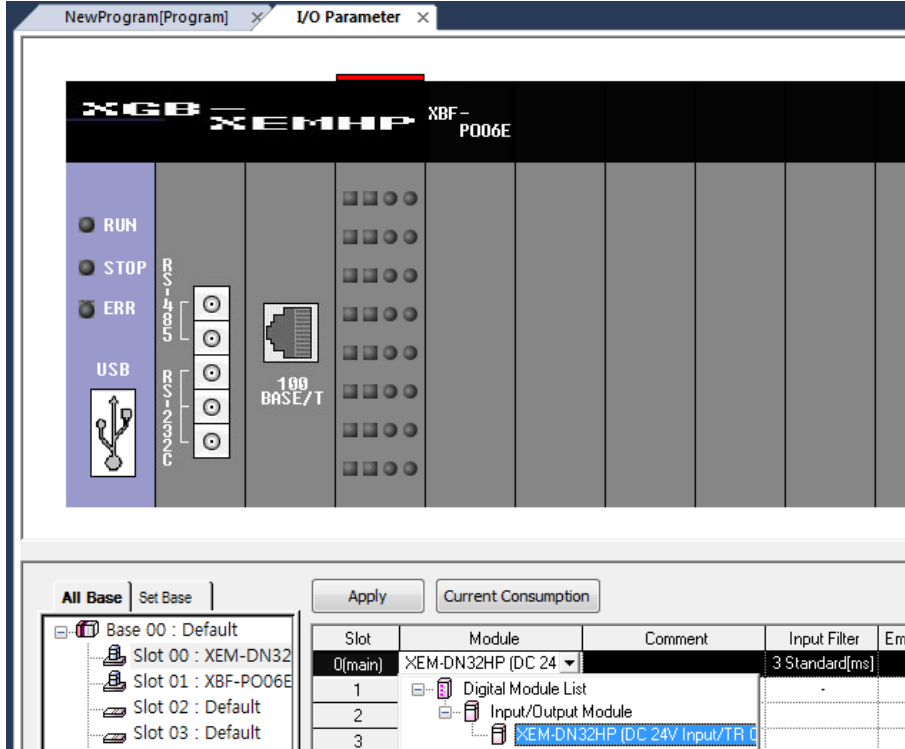

If you click the 『Module』 in the 『slot』 position, the list of each module will be displayed. Then, choose the module that is matched with the actual system to be configured. The selected slot will be displayed as below.

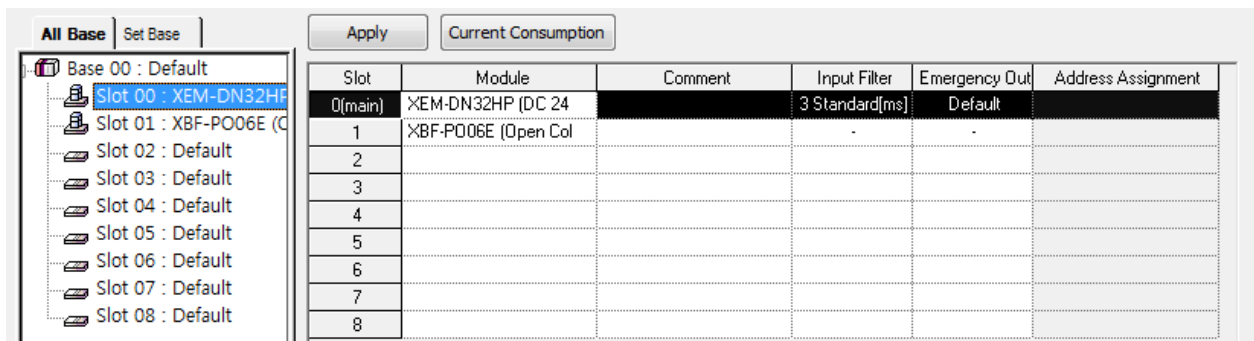

If you press 『In Detail』 button on the slot image or the relevant slot position in the base window as below, the window for setting the filter, emergency output will be displayed.

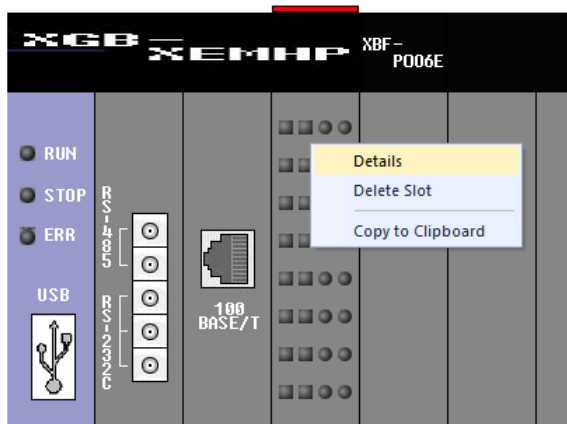

Slot	Module	Comment	Input Filter	Emergency Out	Address Assignment
Slot 00	XEM-DN32HP	EM-DN32HP (DC 24	3 Standard(ms)	Default	
Slot 01	XEM-DN32HP	BF-P006E (Open Col			
Slot 02					
Slot 03					
Slot 04					
Slot 05	Default				
Slot 06	Default				
Slot 07	Default				
Slot 08	Default				

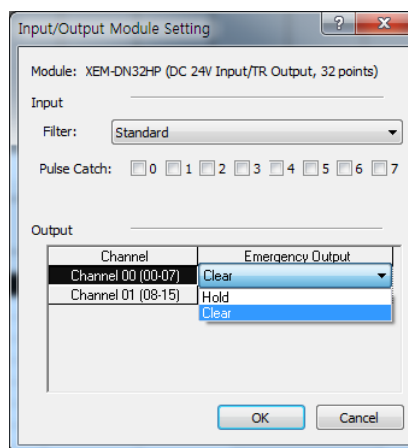
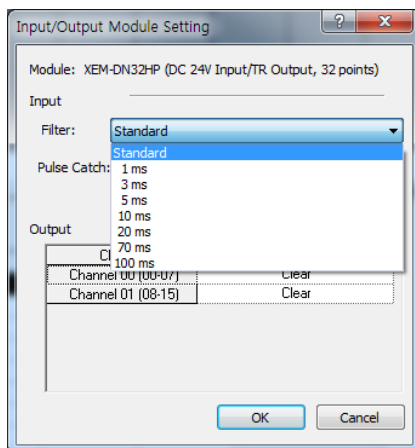

Notice

- In case each set details are different from the actually accessed I/O module, 'Module Type Mismatch Error' occur and the error will be displayed.
- If there is no setting, the CPU reads each I/O module's information for operation.

2.3 Self-Diagnosis Function

The Self-Diagnosis function is the function for the CPU part to diagnose the PLC system for defects. In case errors occur during supplying the power to the PLC system or during operation, it detects errors to prevent malfunction of the system and preventive maintenance.

2.3.1 Scan Watchdog timer (Scan Watchdog Timer)

The WDT (Watchdog Timer) is the function to detect the congestion of programs caused by PLC module's hardware or software.

(1) The Watchdog timer is the timer to be used to detect operation delay caused by the user program error. You can set up the Watchdog timer's detection time in XG5000's basic parameters as below (Initial value: 500ms).

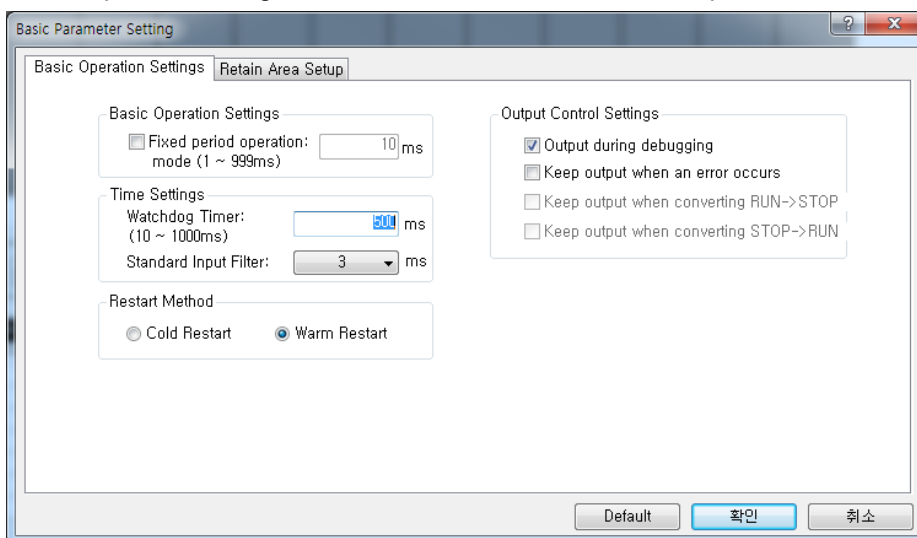

(2) The Watchdog timer monitors the scanning time during operation and when set detection time is exceeded, it stops the PLC's operations immediately. At this time, the output status is maintained or cleared based on the details of 'Output Hold when errors occur'.

(3) If it is expected that the Scan Watchdog Time is exceeded since it takes more time to process the specific part of the user programs (in case of using FOR ~ NEXT command, CALL command, etc.), clear the Watchdog timer through the 'WDT_RST' command.

The 'WDT_RST' command initializes the scan Watchdog time and restarts measuring time from 0.

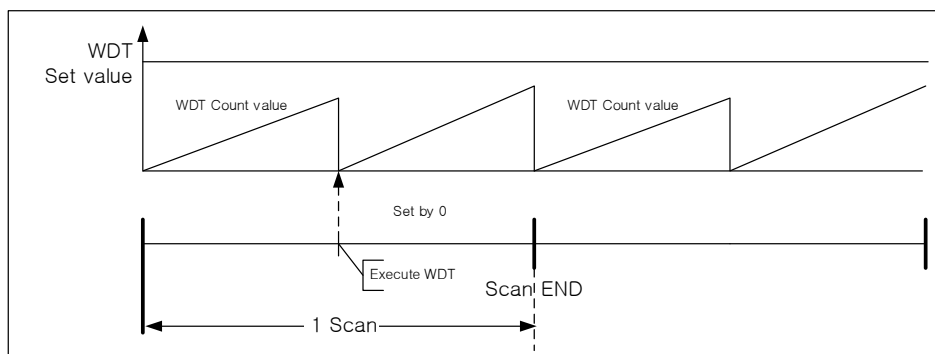

(Example of initializing scan Watchdog timer through the WDT command)

(4) In case the Watchdog error occurs, you can clear the error by resupplying the power or converting the mode into STOP.

2.3.2 Function to save error history

When errors occur, XGB basic unit records the error history to clean up causes easily. If you click 『Online』 - 『Error/Warning』, you can see the current errors and the history. Remove the causes of errors referring to the details and corrective measures of each error item.

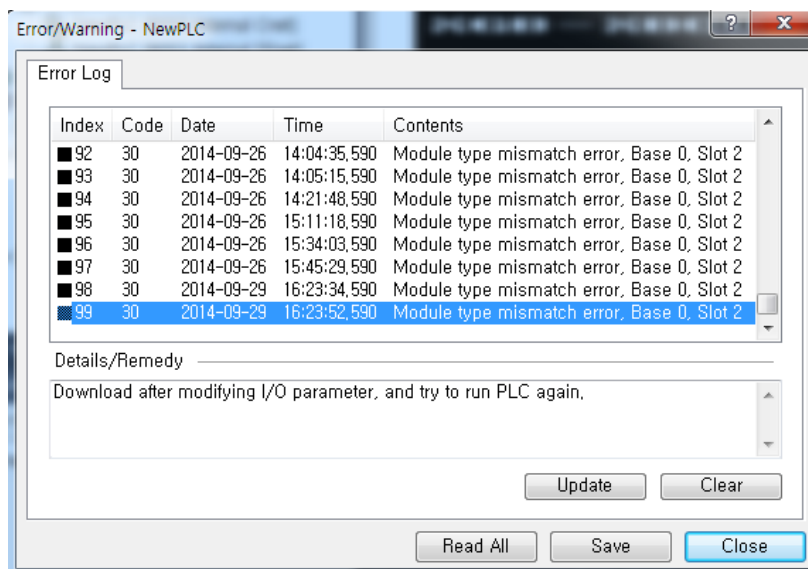

Items	Description	Remarks
Error/Warning	Displays the current Error/Warning.	-
Error history	Displays Error/Warning occurred in order of time.	Saving up to 100

Notice

If you click 'Delete' in the Error/Warning window, all the saved error history will be deleted.
In case the error histories exceed 100EA, the histories are deleted in order from the one that occurred first and the 100EA recent histories are saved

2.3.3 Failure Management

(1) Failure Types

The troubles are caused by failure of the PLC itself, system configuration's error, error detection of operational results, etc. They can be divided into the failure mode stopping the operation for system safety; minor failure mode that informs a user of failure warning and resumes the operation.

The failures of the PLC system are mainly caused by the below.

- PLC hardware's problems
- System configuration's error
- Operational error during execution of user programs
- Detection of errors caused by external device failure

(2) Operation mode in case of failures

In case failures occur, the PLC system records the failure details in the special flag (F area) and determines whether resuming the operation based on the failure mode.

- In case of the PLC hardware's failure
In case there are problems with the CPU, power, etc. that the PLC cannot work normally, the system will be

Chapter 2 CPU Function

stopped; In case of minor failures such as a battery's low voltage, the warning is displayed and the operation will be resumed.

- In case of system configuration's error

It is the failure occurred when the actual PLC's module configuration is not matched with the module configuration set in XG5000. The system will be stopped.

- Computational error during execution of user programs

In case of the numeric operation error (Ex.: in case the denominator of division operation is 0) occurred during execution of user programs, the details will be displayed in the error flag and the system will resume the operation. If the operational time exceeds the operation delay monitoring set time during operation or equipped I/O modules cannot be normally controlled, the system will be stopped.

Notice

- When operational errors occur during executing programs, you can determine whether resuming the operation based on the settings of "Basic parameter -> Error operations setting -> Resume the operation in case of operational errors" of the XG5000 project.
- This parameter's default value is set as "Resume the operation in case of operational errors".

- Detection of errors caused by external device failure

The failure of the external control device can be detected by the PLC's user program; in case of detecting failures, the system will be stopped; in case of detecting minor failures, only the detection status will be displayed and the operation will be continued. (For the detailed use of the function to detect external device's failures, refer to the 2.3.5 Failure Diagnosis Function for the External Device.)

The information on failures occurrence is saved in the special relay (F area). Among F area flags, the information related to the failures are as below.

Word	Bit	Flag Name	Function	Description
%FW0	%FX2	_ERROR	ERROR	ERROR status
%FW2~3	-	_CNF_ER	System error	Reports the failure status of the system.
	%FX33	_IO_TYER	Module type error	The module type is not matched.
	%FX34	_IO_DEER	Module separation error	The module is separated.
	%FX36	_IO_RWER	Module I/O error	There are some problems with the module I/O.
	%FX37	_IP_IFER	Module interface error	There are some problems with the special / communication module interface.
	%FX38	_ANNUM_ER	External device failure	Failures are detected from the external device.
	%FX40	_BPRM_ER	Basic parameters	There are some problems with the basic parameters.
	%FX41	_IOPRM_ER	IO parameters	There are some problems with I/O parameters.
	%FX42	_SPPRM_ER	Special module parameters	Abnormal special module parameters
	%FX43	_CPPRM_ER	Communication module parameters	Abnormal communication module parameters
	%FX44	_PGM_ER	Program error	There are some errors with the program.
	%FX45	_CODE_ER	Code error	There are some errors with the program code.
	%FX46	_SWDT_ER	System Watch dog	The system Watchdog works.
	%FX48	_WDT_ER	Scan Watch dog	The scan Watchdog works.

Word	Bit	Flag Name	Function	Description
%FW4	-	_CNF_WAR	System warning	Reports the minor failure status of the system.
	%FX65	_DBCK_ER	Backup error	There are some problems with data backup.
	%FX67	_ABSD_ER	Shutdown caused by abnormal operation	Stoppage caused by abnormal operation.
	%FX68	_TASK_ER	Task collision	Task collision
	-	_BAT_ER	Battery error	Battery error
	%FX70	_ANNUM_WAR	External device failure	Minor failures are detected from the external device.
	%FX72	_HS_WAR1	High speed link1	High speed link – more than parameter1
	%FX73	_HS_WAR2	High speed link2	High speed link – more than parameter2
	%FX84	_P2P_WAR1	P2P parameter1	P2P – more than parameter1
	%FX85	_P2P_WAR2	P2P parameter2	P2P – more than parameter2
	%FX86	_P2P_WAR3	P2P parameter3	P2P – more than parameter3
%FW11	-	_CONSTANT_ER	Fixed cycle error	Fixed cycle error
	-	_LOGIC_RESULT	Logic result	Displays the logic result.
	%FX176	_EER	Operational error	It Is On during 1 scan in case of operational error.
	%FX179	_ALL_Off	All outputs Off	It is On when all outputs are Off.
	%FX181	_LER	Operational error latch	It maintains 0 in case of operational error.
%FW15	-	_PUTGET_ERR0	PUT/GET error 0	main base PUT / GET error
%FW23	-	_PUTGET_NDR0	PUT/GET completion 0	main base PUT / GET completion
%FD30	-	_REF_COUNT	Refresh	Increases when executing module REFRESH
%FD31	-	_REF_OK_CNT	Refresh OK	Increases when module REFRESH is normal.
%FD32	-	_REF_NG_CNT	Refresh NG	Increases when module REFRESH is abnormal.
%FW90	-	_IO_TYER_N	Mismatch slot	Displays the slot number with the mismatch module type.
%FW91	-	_IO_DEER_N	Slot with separated module	Displays the slot number with the separated module.
%FW93	-	_IO_RWER_N	RW error slot	Displays the slot number with module Read/Write error
%FW95	-	_IP_IFER_N	IF error slot	Displays the slot number with module interface error
%FW96	-	_IO_TYER0	Module type 0 error	Main base's module type error
%FW104	-	_IO_DEER0	Module separation 0 error	Main base's module separation error
%FW120	-	_IO_RWER0	Module RW 0 error	Main base's module Read/Write error
%FW128	-	_IP_IFER_0	Module IF 0 error	Main base's module interface error
%FW202	-	_ANC_ERR	Information on the external device's failure	Displays the information on the external device's failure
%FW203	-	_ANC_WAR	Information on the external device's minor failure	Displays the information on the external device's minor failure

Notice

- For more details on the whole flags, refer to the Appendix 1 Flag Table of the Outline of this manual.

2.3.4 Function to check the expansion module

It is the function to check whether I/O modules work normally during startup and operation. It checks the status of every scan expansion module and the PLC checks whether the following situations occur.

- In case the module that is different from the set parameter is installed at the time of initial operation or failure is suspected
- In case expansion modules are detached or failure is suspected.

If abnormal conditions are detected, the basic unit's ERR LED will be flickering and the PLC will be stopped.

2.3.5 Failure Diagnosis Function for the External Device

It is the function to detect the failure of the external device, which connected to the PLC to realize stoppage of the system and warning easily. Through this function, you can detect the external device's failure without complex programming and can monitor the failure position without special devices (XG5000, etc.) or programs.

You can use the failure diagnosis function for the external devices as below.

(1) Failure types of external devices

- The failures of external devices are divided into the two types; failure (error) detected by combination of user programs and special relay (F area) requires stoppage of the PLC operation; minor failure (warning) that continues the PLC's operation and displays the detection status only.

(2) Flag to detect failures of external devices

The following flag types are used to diagnose failures of external devices.

Word	Bit	Flag Name	Function	Description
%FW202	-	_ANC_ERR	Information on the external device's failures	Input the error code of user-defined serious failure of external device.
%FW203	-	_ANC_WAR	Information on the external device's MINOR failures	Input the error code of user-defined minor failure of external device.
-	%FX38	_ANNUM_ER	detection of external serious error	It is On when the external device's serious failure occurs.
-	%FX70	_ANNUM_WAR	detection of external slight error	It is On when the external device's minor failure occurs.
-	%FX3202	_CHK_ANC_ER R	Request detection of external serious error	It is the command flag asking to detect the external device's serious failure.
-	%FX3203	_CHK_ANC_WA R	Request detection of external slight error minor failure	It is the command flag asking to detect the external device's minor failure.

(3) Detecting the external device's serious failures

The following programs are detecting the external device's serious failures.

- Save the error code that can be distinguished by external device's serious failures in %FW202 (_ANC_ERR) through the FWRITE command as below. (Input the values excluding 0)
- In case the external device's serious failures occur, %FX3202 (_CHK_ANC_ERR) flag will be On.
- When the scan program is completed, the PLC checks whether %FX3202 (_CHK_ANC_ERR) is ON and detects serious failures.
- If the external device's serious failures occur, the PLC will be in error status and will stop the operation. Then, %FX38 (_ANNUM_ER) is ON and %FX3202 flag is automatically Off. All outputs works based on IO parameter's emergency output settings.
- When failures occur, through XG5000, a user can figure out the causes of failures by monitoring %FW202

(_ANC_ERR)flag.

- (f) The below figure describes the example of the program detecting the external device's serious failures with operation details.

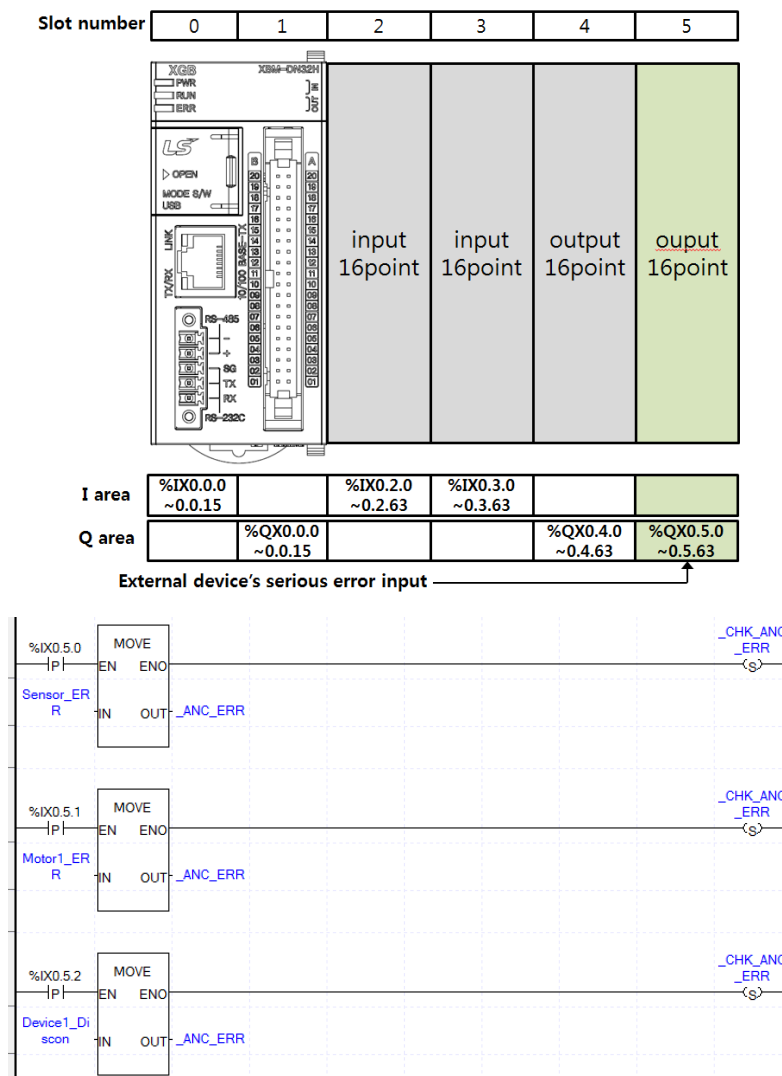

<Example of the system configuration and program >

- In this example, assume that the input signal to detect the external device's failures is connected to the input module of No.5 slot in the system configuration as below.
 - In case of the sensor failure, %IX0.5.0 is ON. The error code is the value saved in auto variable device 'Sensor_ERR'.
 - In case of the motor failure, %IX0.5.1 is ON. The error code is the value saved in auto variable device 'Motor1_ERR'.
 - When the device 1 is disconnected, %IX0.5.2 is ON. The error code is the value saved in auto variable device 'Device1_Discon'.
- In the above programming, when %IX0.5.0 is On (In case of sensor failure), the value of 'Sensor_ERR' is saved in %FW202 (_ANC_ERR) and %FX3202 (_CHK_ANC_ERR) will be On.
- If %FX3202 is ON, it is detected by the scan end and the external device's serious failures are generated.
- You can detect the failure of motor 1, disconnection of device 1 in the same way.

- After accessing to XG5000, a user can check which external devices have failures by verifying the %FW202 value and can take follow-up measures.

(4) How to detect the external device's minor failures

The following programming is used to detect the external device's minor failures.

- Save the warning code that can be distinguished by external device's minor failures in %FW203 (_ANC_WAR) through the FWRITE command as below. (Input the values excluding 0)
- In case the external device's minor failures occur, %FX3203 (_CHK_ANC_WAR) flag will be On.
- When the scan program is completed, the PLC checks whether %FX3203 (_CHK_ANC_WAR) is ON and detects minor failures.
- If the external device's minor failures occur, the ERR LED will be flickering at 2 seconds interval and the PLC will run continuously. Then, %FX70 (_ANNUM_WAR) is ON and %FX3203 flag is automatically Off. All outputs works based on IO parameter's emergency output settings.
- When minor failures occur, through XG5000, a user can figure out the causes of failures by monitoring %FW203 (_ANC_WAR) flag.
- If you input 0 again to %FW203 (_ANC_WAR) after removing the causes of failures and turn ON %FW3203 (_CHK_ANC_WAR) again, detection of minor failures is canceled.
- The below figure describes the example of the program detecting the external device's minor failures with operation details.

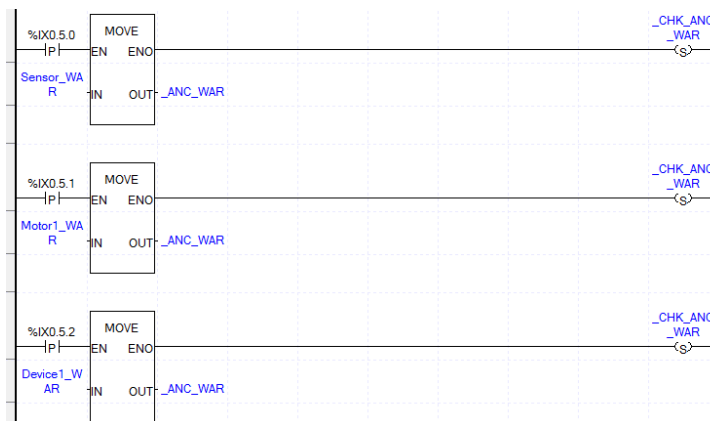
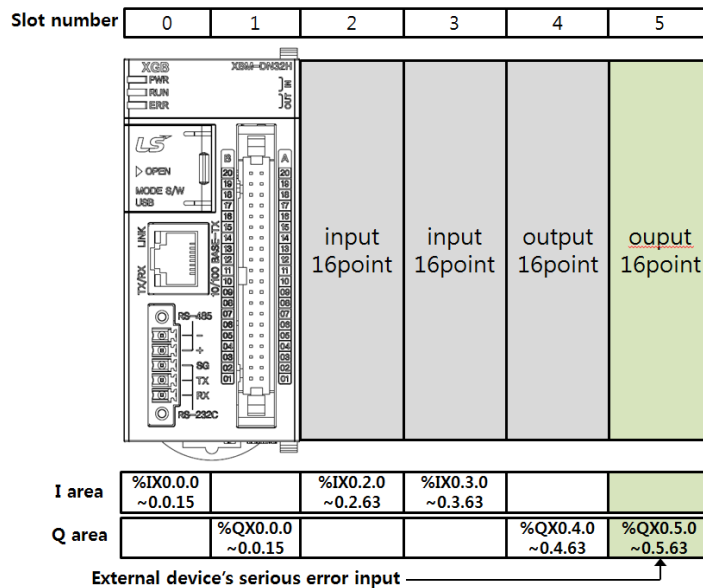

< Example of the system configuration and program >

- In this example, assume that the input signal to detect the external device's minor failures is connected to the input module of No.5 slot in the system configuration as below.
 - In case of the sensor warning, %IX0.5.0 is ON. The warning code is the value saved in auto variable device 'Sensor_WAR'.
 - In case of the motor warning, %IX0.5.1 is ON. The warning code is the value saved in auto variable device 'Motor1_WAR'.
 - When the device is warned, %IX0.5.0\2 is ON. The warning code is the value saved in auto variable device 'Device1_WAR'.
- In the above programming, when %IX0.5.0 is On (in case of sensor failure), the value of 'Sense_WAR' is saved in %FW203 (_ANC_WAR) and %FX3203 (_CHK_ANC_WAR) will be On.
- If %FX3203 is ON, it is detected by the scan end and the external device's serious failures are generated.
- You can detect the warnings on motor 1 and device 1 in the same way.
- After accessing to XG5000, a user can check which external devices have minor failures by verifying the %FW203 value and can take follow-up measures.

2.4 RTC Function

XEM-H2/HP unit has the clock (RTC) function and the clock keeps working thanks to the battery backup even when the power is Off. You can use the embedded RTC's time data for time management such as the system's operating history or failure history, etc. The RTC's current time is updated every scan based on the operation status information flag of the system.

2.4.1 How to use the RTC Function

(1) Read/Set clock data

(a) Read/Set from XG5000

- 1) Click 『Online』 - 『Diagnosis』 - 『PLC information』 .
- 2) Click the PLC clock tab of 『PLC information』 .

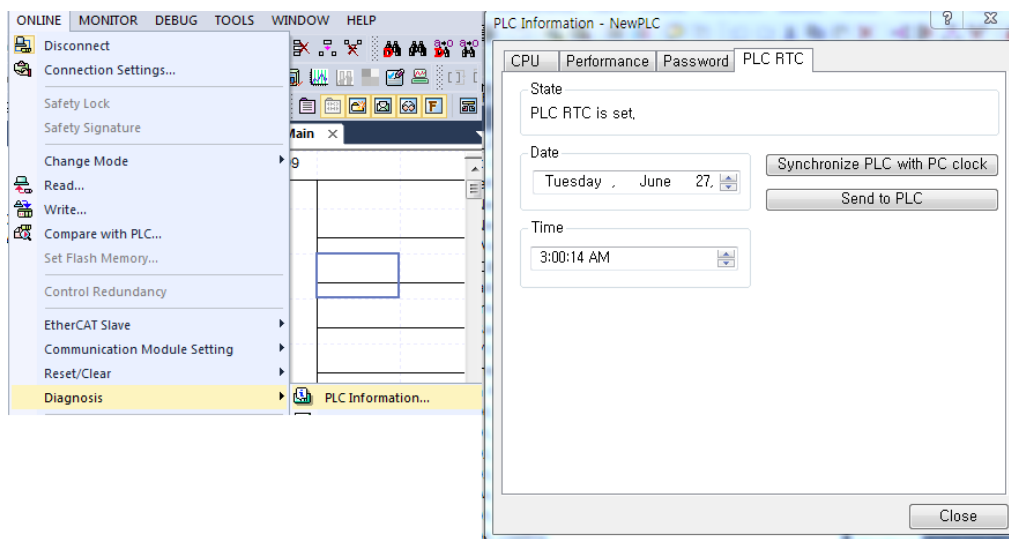

3) If you want to transfer the PLC's time to the PLC, click the PC clock and synchronization button.

4) If you want to set up your preferred time, after changing the set values of the data and time box, click them to the PLC.

(b) Read with the special relay

You can monitor the data with the special relay as below.

Word	Flag Name	Name	Data	Description
%FW53	__MON__YEAR	Clock data (month/year)	16#0709	July, xx09
%FW54	__TIME__DAY	Clock data (hour/day)	16#1214	14h.12th
%FW55	__SEC__MIN	Clock data (second/minute)	16#2040	20 min. 40 sec.
%FW56	__HUND__WK	Clock data (Year/week)	16#2003	20xx,Wed.

(c) Example of changing the clock data through programs

You can change the clock data through the programs as below.

Function Block	Variable	Description
	REQ	Executes the function with rising pulse input
	DATA	TIME data to input
	DONE	Without an error, it is 1
	STAT	If an error occurs, an error code is written

Variable	Content	Example	Variable	Content	Example
DATA[0]	Year	16#18	DATA[4]	Minute	16#35
DATA[1]	Month	16#03	DATA[5]	Second	16#15
DATA[2]	Day	16#10	DATA[6]	No check	-
DATA[3]	Hour	16#11	DATA[7]	Year	16#20

The above example is "2018-03-10 11:35:15"
Day of the week data is not separately entered. The day of the week will be automatically set.

(d) Example of changing the clock data through system flag

You can change the clock data by writing the clock data as below without using the function block and turning %FX3200(_RTC_WR) 'On'.

Flag	Flag name	Content	Setting range
%FW210	_MON_YEAR_DT	Clock data(Month/Year)	2000~2099(Year), 1~12(Month)
%FW211	_TIME_DAY_DT	Clock data(Hour/Date)	1~31(Day), 0~23(Hour)
%FW212	_SEC_MIN_DT	Clock data(Second/Minute)	0~59(Minute), 0~59(Second)
%FW213	_HUND_WK_DT	Clock data(100Years/Day)	2000s,0~6(Sun.~Sat.)

(e) How to express the day

No.	0	1	2	3	4	5	6
Day	Sun.	Mon.	Tue.	Wed.	Thu.	Fri.	Sat.

(2) Time error

The RTC's error is different depending on the service temperature.

temperature	max error(sec/day)	normal condition(sec/day)
0℃	-4.67 ~ 1.56	-1.55
25℃	-3.11 ~ 1.96	0.58
55℃	-10.37 ~ -1.56	-5.97

Notice

- The clock data may not be stated in the shipped product so you need to set up the clock data correctly before use.
- If you write unserviceable clock data in the RTC, it will not work properly.
Ex.) 25:00, 32th, 14 month
- In case the RTC stops or error occurs due to a battery failure, if you write the new clock data in the RTC, the error will be cleared.

2.5 Remote Function

In XGB basic unit, you can change the operation mode through the key switch attached to the module or through communication. For remote operation, put the basic unit's mode change switch on STOP position.

(1) The kinds of remote operations are as below.

- Access to XG5000 and operation through the USB port installed in the basic unit
- You can operate the other PLCs connected to the network by using the PLC's communication functions when XG5000 is connected to the basic unit.
- You can control the PLC's operation status with HMI software, etc. through the dedicated communication

(2) Remote RUN/STOP

- It is the function to execute RUN/STOP through communication modules through the outside.
- This convenient function can be helpfully used when the PLC is installed in the bad palace to operate or you need to RUN/STOP the CPU modules of a control panel from the outside.

(3) Remote DEBUG

- It is the function to execute DEBUG when the operation mode switch is on STOP position. DEBUG is the function to execute the program operation based on the specified operating conditions.
- This convenient function can be helpfully used when you need to check the program's progress or each data's details during the system's debugging works.

(4) Remote reset

- It is the function to reset the CPU module by remote control when errors occur.
- 'Reset' and 'Overall Reset' are available.

Notice

- For more details on how to operate the remote functions, refer to 'Chap.10 Online' of the XG5000 manual.

2.6 I/O forced On/Off Functions

The forced I/O function is used to turn On/Off I/O areas by force regardless of the results of program execution.

2.6.1 Forced I/O setting method

Click 『Online』 - 『 Forced I/O setting 』 .

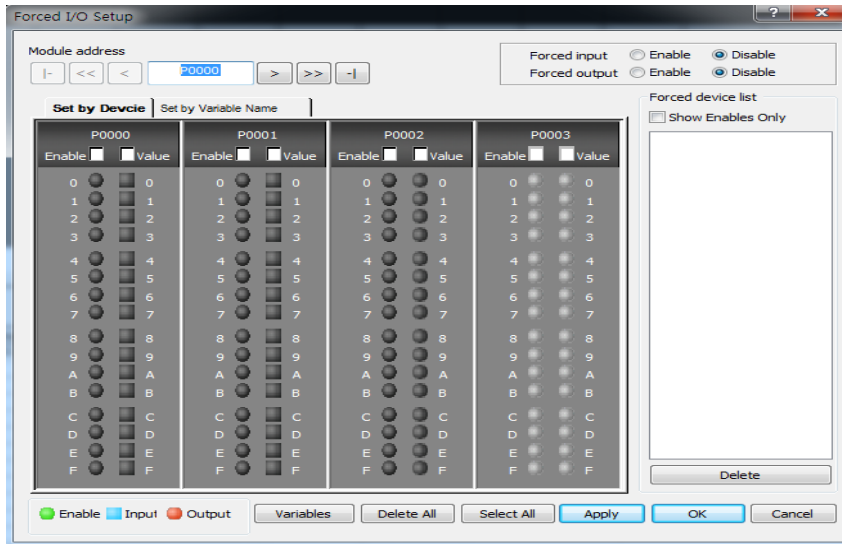

The below table represents the items related to the forced I/O setting.

Item		Description	Remarks
Movement of address		You can select the base and slot.	
Apply		You can set the forced input and output Enable / Unable	
Individual	Data	You can set the forced I/O Enable / Unable by bit.	
	Flag	You can set the forced I/O data (On/Off) by bit.	
View variables/comments		You can check the set input, output variables.	
Select All		You can set the forced I/O Enable under the condition that the whole I/O areas are On.	
Delete All		You can delete the forced I/O Enable under the condition that the whole I/O areas are Off.	
Set device		It displays the I/O area where even one bit is set.	

2.6.2 Time to process the forced I/O On / Off and processing method

(1) Forced input

When the forced input is set, among the data read from the input model at the time of Refresh, the data of the contact set as the forced On/Off is replaced by the forced set data to update the input image area. Accordingly, during program operation, among the actual input data, the forced set area is operated with the results replaced by the forced set data.

(2) Forced output

After completing the operation of user programs, at the time of output Refresh, among the data of the output image areas including the operation results, the data of the contact set as the forced On/Off is replaced by the forced set data, and then, they are output. Accordingly, in contrast with the forced input, in the case of the forced output, the data of the output image area shows the same data with the program operation results but the actual output changes by the forced output On/Off settings.

(3) Instructions to use the Forced I/O functions

- It works from the time of setting each I/O 'Enable' after setting the forced data.
- Although the actual I/O modules are not equipped, the forced input can be set.
- In spite of Off-> On of the power, change of operation modes and operation by the reset key
The previously set On/Off data is stored in the PLC.
- Even in STOP mode, the forced input and output data is not eliminated.
- When you try to set the new data from the beginning, cancel all settings of I/O by using 'Delete All' before use.

(4) Operations in case of errors

- When errors occur after setting the forced output, it works based on 「Output Hold when errors occur」 of output control settings in the basic parameters and 「Emergency Output」 of the I/O parameters. In case of error occurrence, if you select the emergency output as 「Clear」 after setting Output Hold when errors occur」, the output is off when errors occur; if you choose 「Hold」, the output status will be maintained.
- In case 「Output Hold when errors occur」 is not set in the output control setting of the basic parameters, the output is Off.

2.7 Direct I/O Operation Function

I/O contact's Refresh is executed after the scan program is finished. Accordingly, the data of the I/O contact that changes during execution of programs is refreshed to the I/O data of when the END command is executed instead of being refreshed when the data changes.

If you need to immediately refresh the I/O data during execution of the program, through DIFEC_IN, DIREC_OUT command, you can directly read the input contact status for operation or can directly print out the operation results in the output contact.

Block	Variable	Contents
	EN	When EN=1 Function execute
	BASE	Base number (XGB= 0)
	SLOT	Output module slot number
	MASK_L	Set non-update bit among lower 32bit
	MASK_H	Set non-update bit among higher 32bit
	ENO	When no error, ENO=1
	OUT	When updating output data is finished OUT=1

The below figure indicates the example of the direct I/O operation through the DIFEC_IN, DIREC_OUT command.

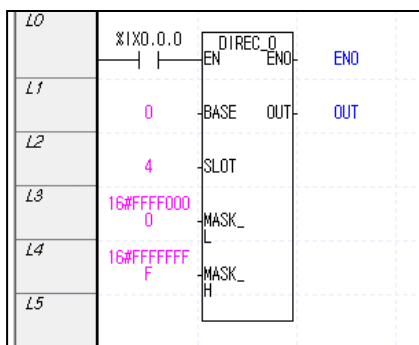

- (1) Input base number 0 and slot number 4 where output module is equipped
- (2) Since data to output is 16 bit during scan, enable lower 16 bit among value of MASK_L (16#FFFF0000)
- (3) If execution condition (%IX0.0.0) is On, DIREC_O (Immediate refresh of output module) is executed and data of output module is set as 2#0111_0111_0111_0111.

Notice

- When writing/Reading DIREC_IN, DIREC_OUT in expansion module, it takes 1~2ms times
 - Possibility of Task collision o when using cyclic task or internal task. Which operates in short term of between two input signal.
- For more information refer to XGI/XGB Instruction manual.

2.8 Function saving the operation history

There are 4 types of operation history; error history, mode conversion history, power down history and system history. The occurrence time, frequency, operating details of each event are saved in the memory and you can conveniently monitor the data through XG5000. The operation history is saved in the PLC unless it is deleted through XG5000.

2.8.1 Error history

It saves the error history occurred during operation.

- The error code, date, time, error details are saved.
- The histories can be saved up to 100 EA.
- It is automatically canceled when the memory backup is cleared due to the battery's low voltage, etc.

2.8.2 Mode conversion history

It saves the information on the changed mode and time when changing the operation mode.

- It saves the data, time, mode conversion details.
- The histories can be saved up to 100 EA.

2.8.3 Power down history

On or Off time of the power is saved as the ON/OFF information.

- ON/OFF information, date and time are saved.
- The histories can be saved up to 100 EA.

2.9.4 System history

It saves the operation history of the system occurred during operation.

- The date, time and details of operation changes are saved.
- The histories related to system operation are saved; XG5000 operation information, change of the key switch position, etc.
- The histories can be saved up to 100 EA.

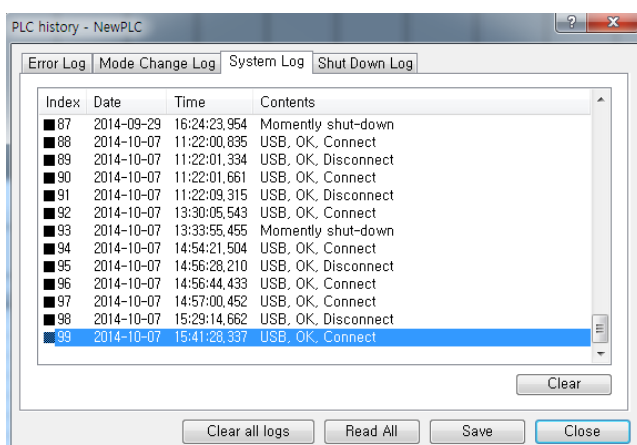

2.9 How to allocate I/O No.

Allocation of I/O No. is to allocate the address to each module's I/O terminals to read the data from the input modules and output the data in the output modules when executing operation. In the XGB PLC, all modules occupy 64 points.

(1) Allocation of I/O No.

The basic unit occupies 2 slots of No.1 so 128 points are allocated and all remaining expansion module occupies 64 points. (including special, communication modules)

Example of allocating I/O No. based on the system configuration

Slot No.	Model	I/O allocation	Remarks
0	XEM-DN32HP	Input : %IX0.0.0~%IX0.0.63 Output : %QX0.0.0~%QX0.0.63	Actual input : %IX0.0.0 ~ %IX0.0.15 Actual output : %QX0.0.0 ~ %QX0.0.15
1	Embedded special functions	Input : %IX0.1.0~%IX0.1.63 Output : %QX0.1.0~%QX0.1.63	-
2	XBE-DC32A	Input : %IX0.2.0~%IX0.2.63 Output : %QX0.2.0~%QX0.2.63	Actual input : %IX0.2.0 ~ %IX0.2.31
3	XBE-TN32A	Input : %IX0.3.0~%IX0.3.63 Output : %QX0.3.0~%QX0.3.63	Actual output : %QX0.3.0~%QX0.3.31
4	XBL-C21A	Input : %IX0.4.0~%IX0.4.63 Output : %QX0.4.0~%QX0.4.63	-
5	XBF-AD04A	Input : %IX0.5.0~%IX0.5.63 Output : %QX0.5.0~%QX0.5.63	-
6	XBF-DV04A	Input : %IX0.6.0~%IX0.6.63 Output : %QX0.6.0~%QX0.6.63	-
7	XBE-DC32A	Input : %IX0.7.0~%IX0.7.63 Output : %QX0.7.0~%QX0.7.63	Actual input : %IX0.7.0~%IX0.7.31
8	XBE-TN32A	Input : %IX0.8.0~%IX0.8.63 Output : %QX0.8.0~%QX0.8.63	Actual output : : %QX0.8.0 ~ %QX0.8.31

* The number of empty I/O points can be used as the internal relay.

* In the case of the high performance XGB basic type, it does not have the embedded special function corresponding to No.1 slot but occupies No.1 slot as an empty slot.

2.10 Program Modification during operation (Modification during RUN)

You can modify the programs and communication parameters without stopping control operations during running the PLC. The below describes the basic modification method. For more details on Modification during RUN, refer to the XG5000 manual.

The items that can be modified during RUN are limited to programs, network parameters. You cannot modify adding tasks, deletion, parameters, etc. during RUN.

2.10.1 Modification Procedures during RUN

(1) It shows the currently running program.

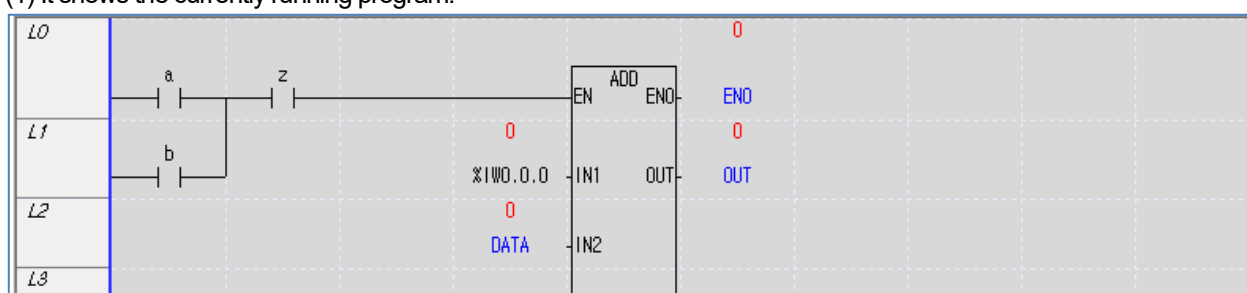

(2) Click 『Online』 - 『Start Modification Online Editing』 .

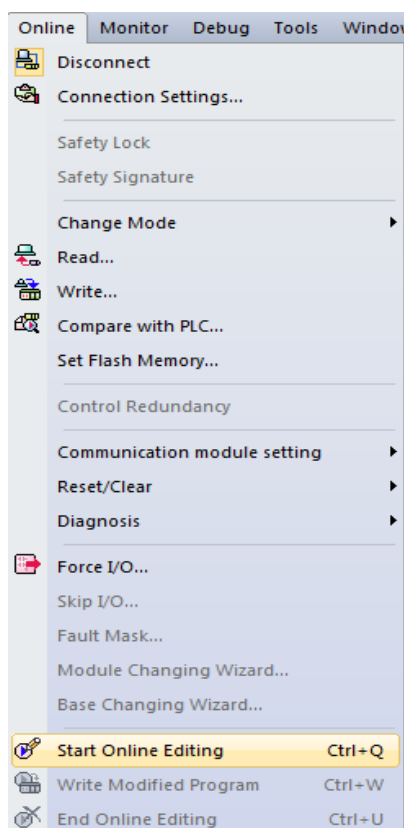

Chapter 2 CPU Function

(3) Then, the background color of the program window changes and it is converted into the mode of modification during RUN.

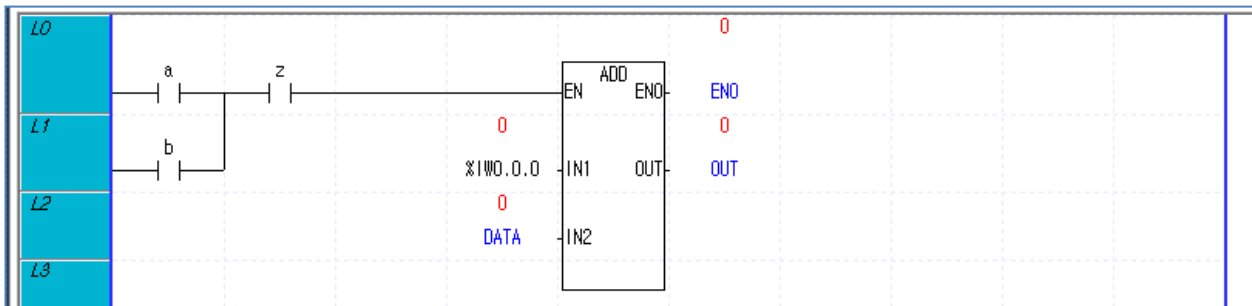

(4) You can modify the program.

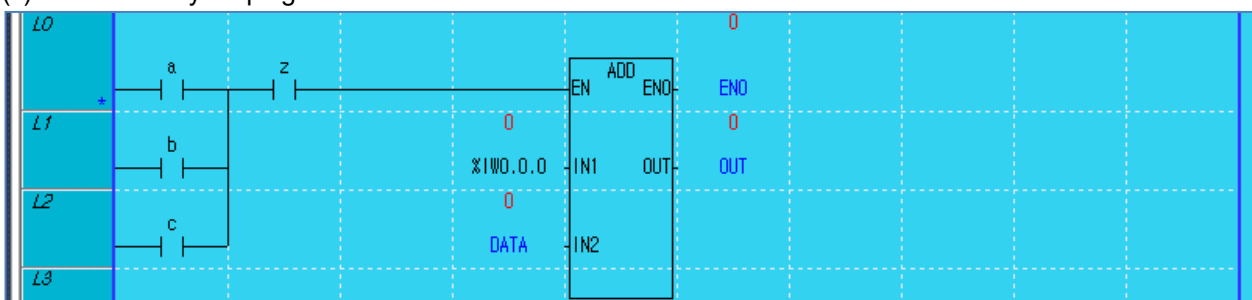

(5) When the modification of the program is completed, click 『Online』 - 『Write Modified Program』

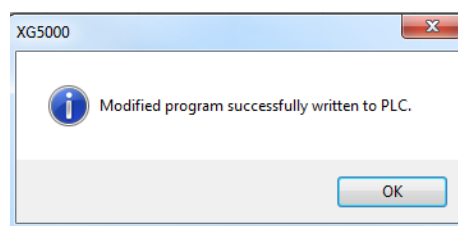
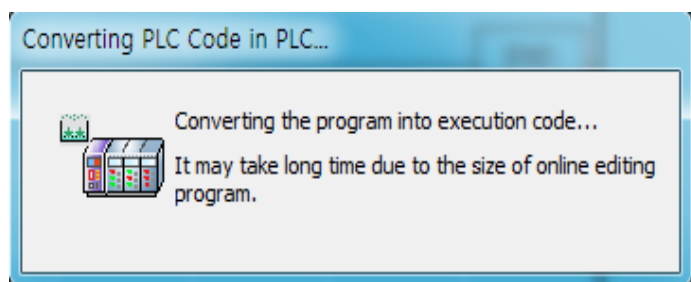
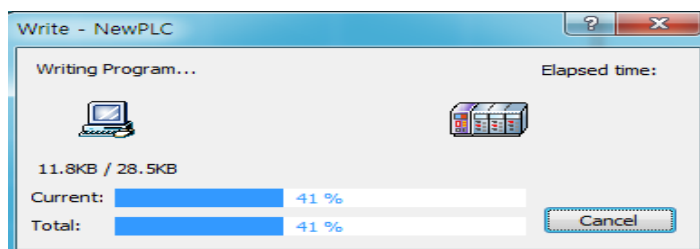
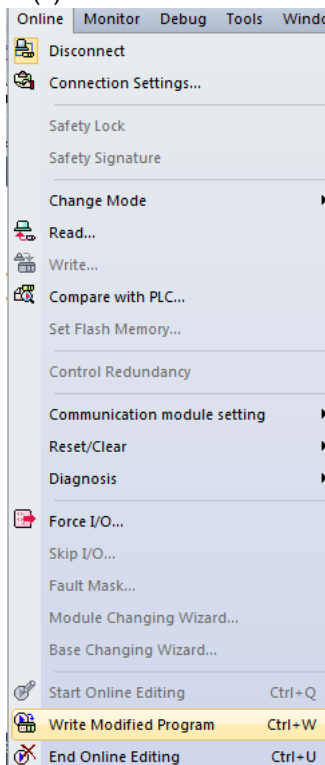

(6) When Write Program is completed, Online Editing』 .

click 『Online』 - 『End

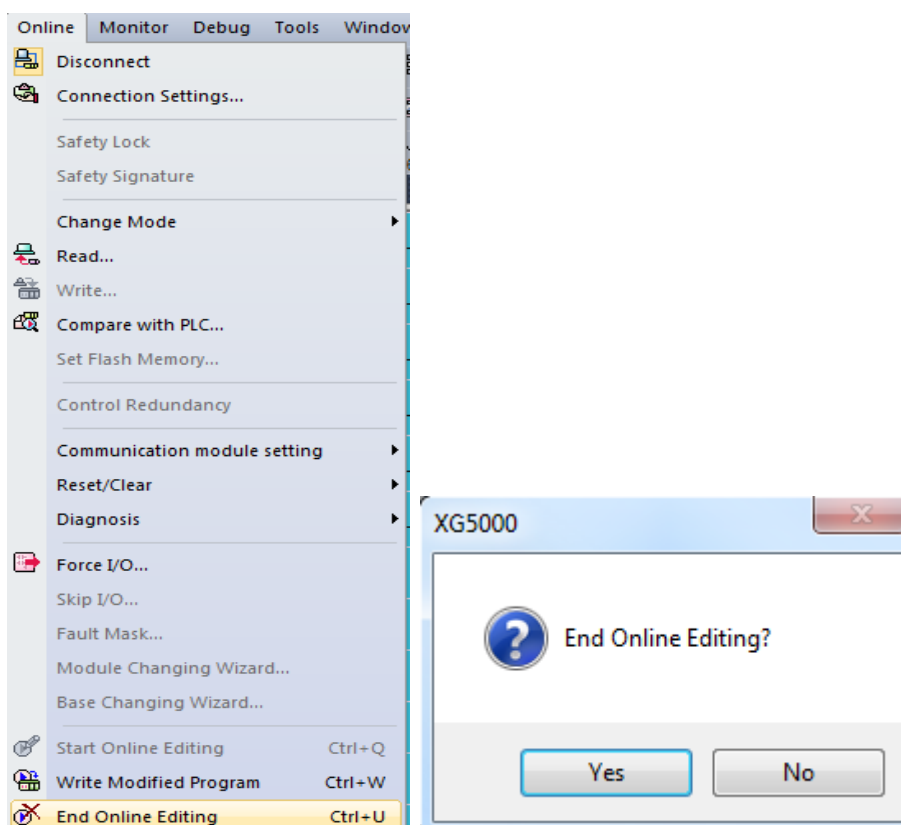

(7) The background color of the program window changes into the original one and modification during RUN is completed.

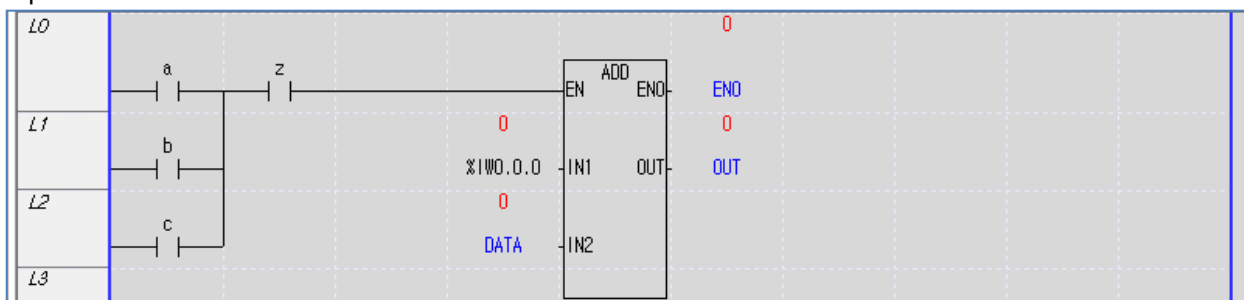

Notice

- For Modification of communication parameters during RUN, after changing the network configuration items of XG5000 in the RUN status without going into the Modification during RUN menu, click 『Online』 - 『Write』 and choose 'Network Parameter' to execute Write.

2.11 Read I/O information

It is the function to monitor each module's information comprising the XGB PLC system.

(1) If you click 『Online』 - 『I/O Information』, the information of each module of connected systems will be monitored.

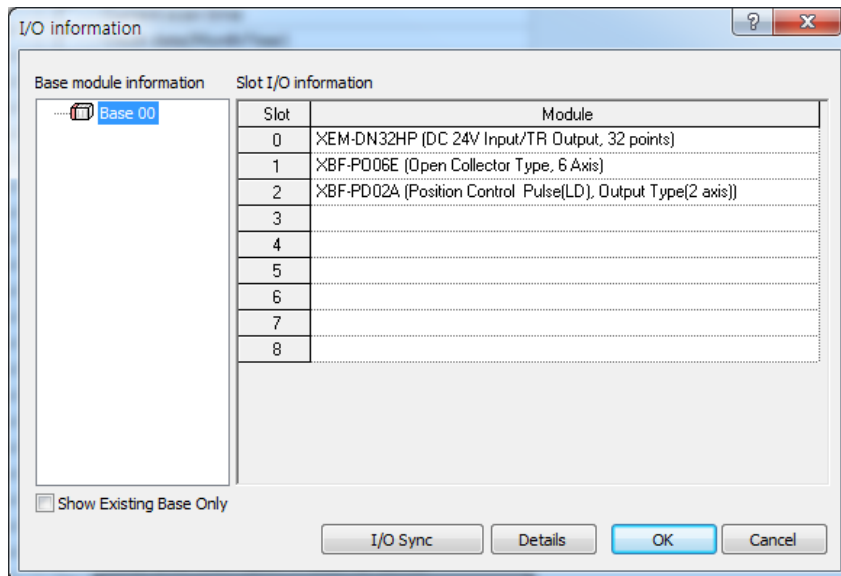

(2) If you click 'Detailed Information' after choosing the module, the details on the module will be displayed.

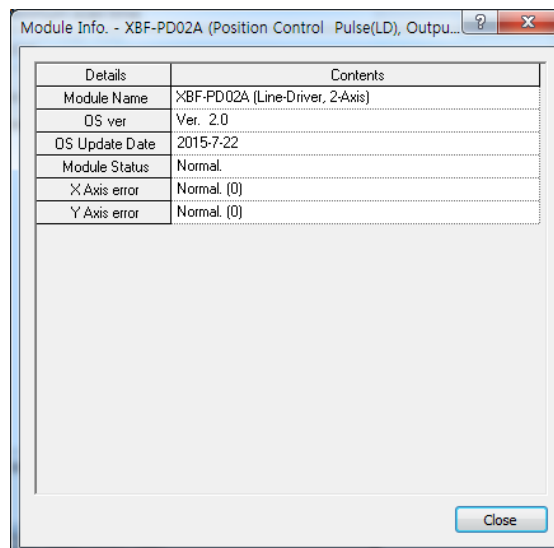

2.12 Monitoring Functions

It is the function to monitor the XGB PLC system's general information.

(1) If you click 『Monitor』, the submenu will be displayed as below.

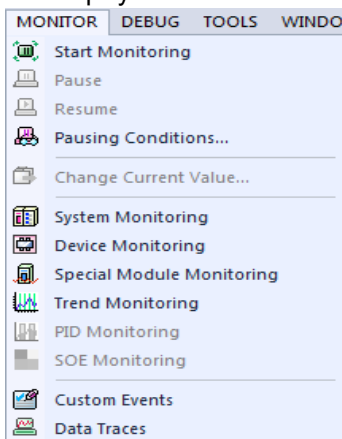

(2) The below table provides the descriptions on each item.

Items	Descriptions	Remarks
Start/End monitor	Specifies the startup and end of the monitor.	Changes every time you click
Pause	Suspends the monitor.	
Resume	Executes the suspended monitor again.	
Pausing Conditions	It is the function to suspend the monitor when the set device's value is matched with the conditions.	Restarts when you click 'Restart Monitor'
Change the Current value	Changes the currently selected device's current value.	
System Monitoring	Monitors the current system's general information.	
Device Monitoring	It is the function to monitor each device.	
Trend Monitoring	Monitors the set device's trend.	
Custom Events	Monitors the set device's value when the event specified by a user occurs.	For more details, refer to the XG-5000 manual.
Data Trace	Traces the set device's value.	

(a) Changing the current value

It is the function to change the current value of each selected device in the program window.

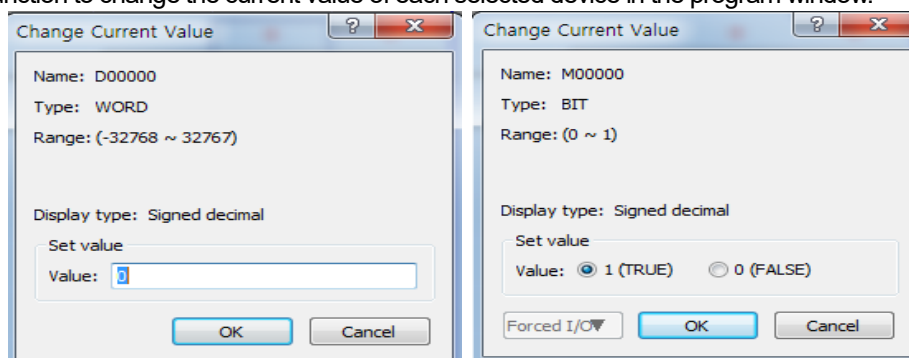

(b) Device monitor

Chapter 2 CPU Function

It is the monitoring function by device.

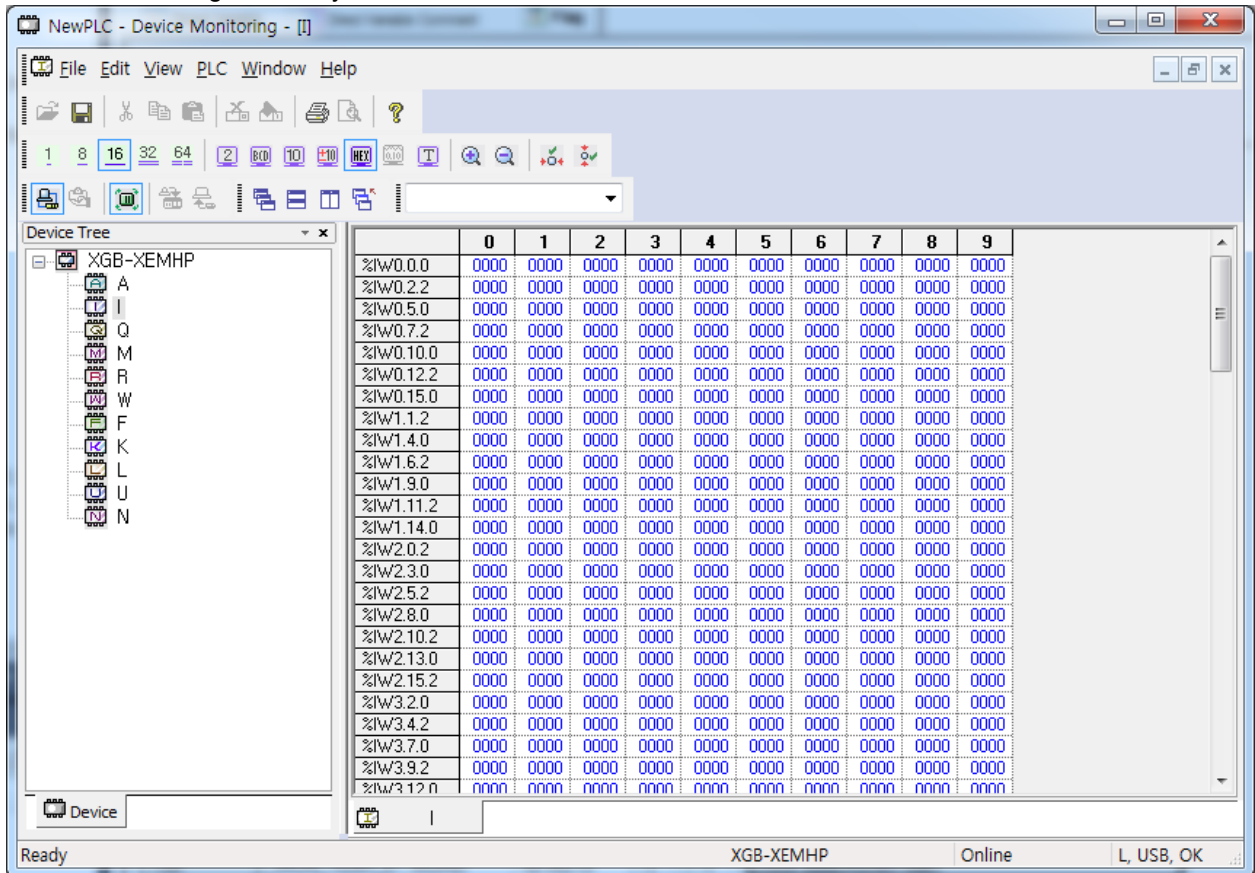

(c) Monitor suspension setting

It is the function to stop monitoring when the set device value is matched.

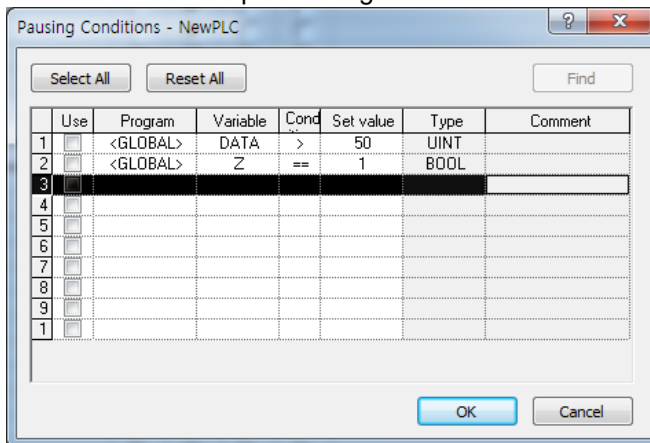

(d) Trend Monitor

It is the function to represent the set device value in a graphic form. The value represented on the graph is not the data collected by the PLC at the right timing but the value read from XG5000 through the communication function. Accordingly, communication delay can occur so it may not be matched with the actual data collected at the right cycle.

You are recommended to use the Trend Monitor function to check the rough data trend.

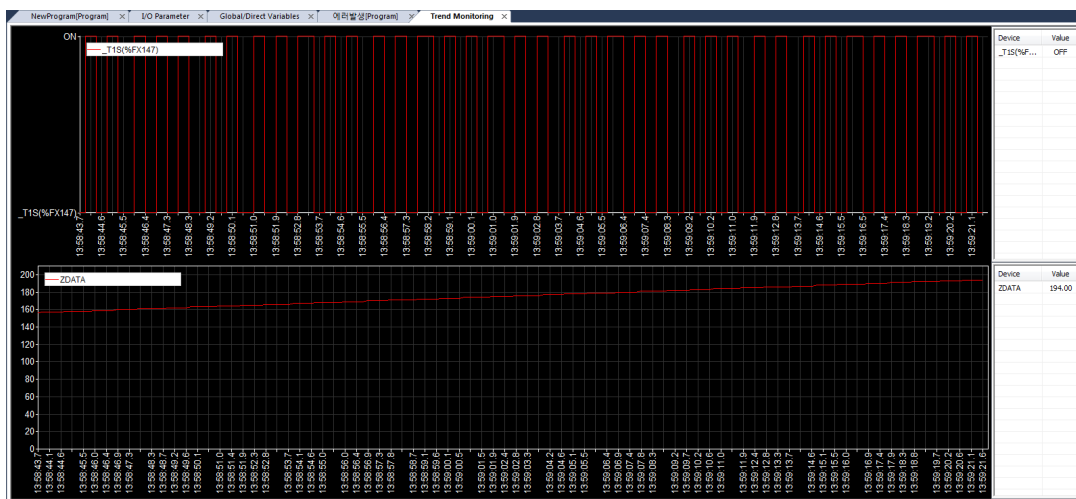

(e) Custom event

1) It is the function to monitor the detailed information when the event set by a user occurs.

Register the user event additionally.

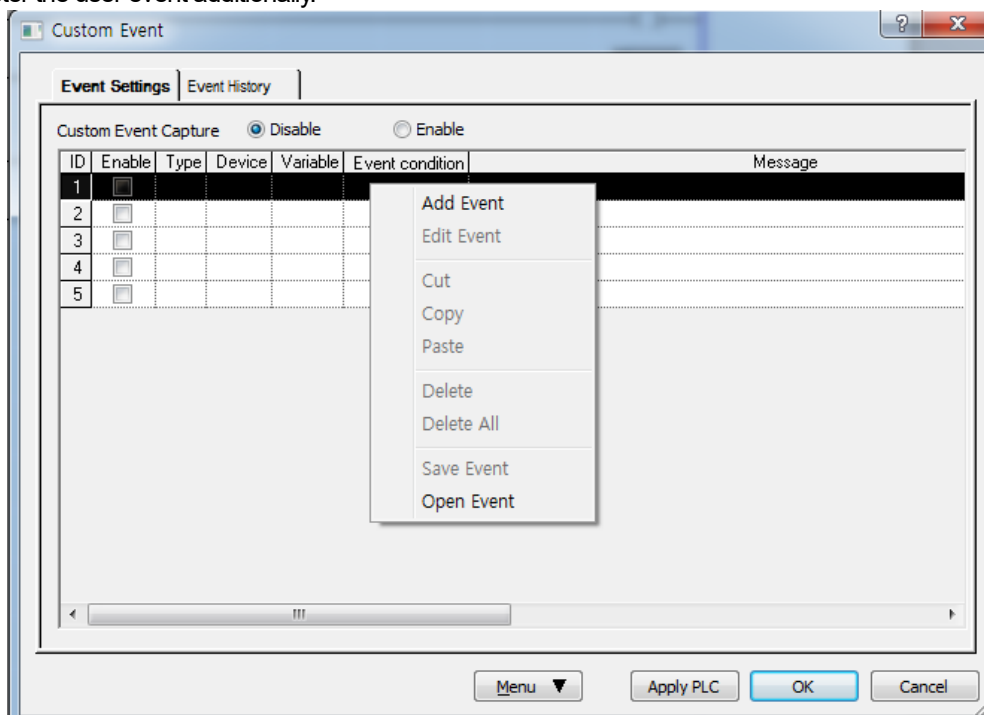

Chapter 2 CPU Function

2) Establish the basic settings and related device.

In case the rising edge of %MX0 device occur, the Alarm message "Tank 1 Error-> Check" is recorded with the then values of %MW100 and auto variable "DATA" devices.

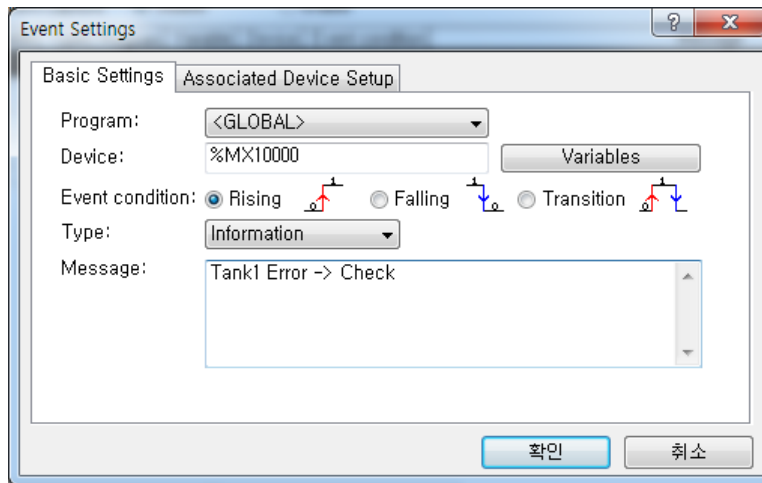

3) Set up the associated device.

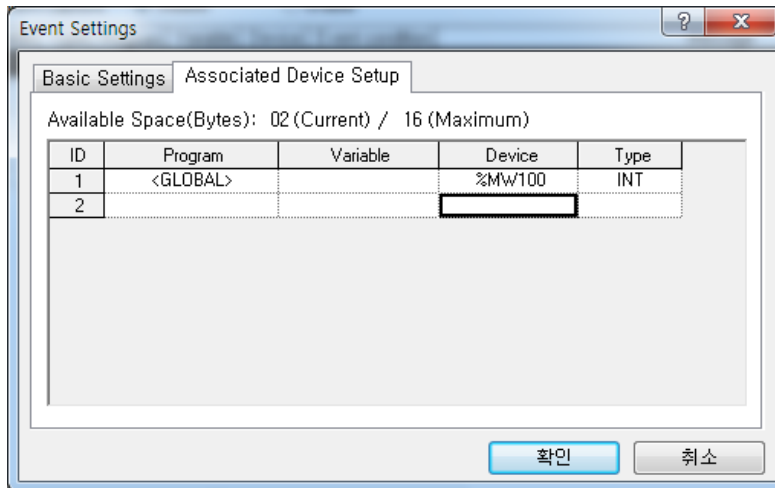

4) It monitors the user event history.

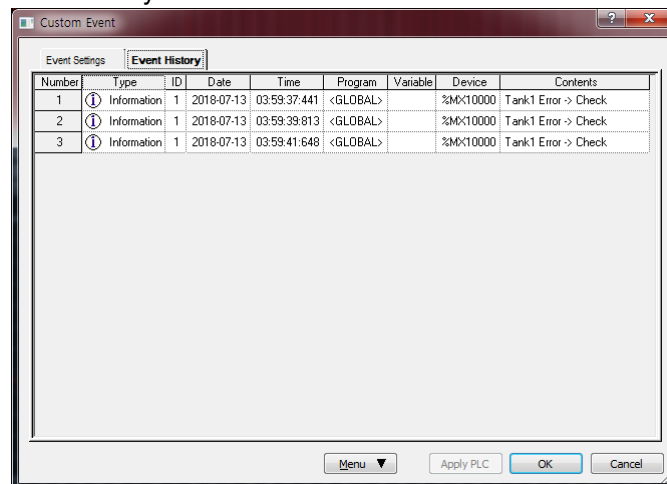

5) If you double-click the occurrence number, the detailed value of the device at the time of occurrence will be

monitored with the details as below.

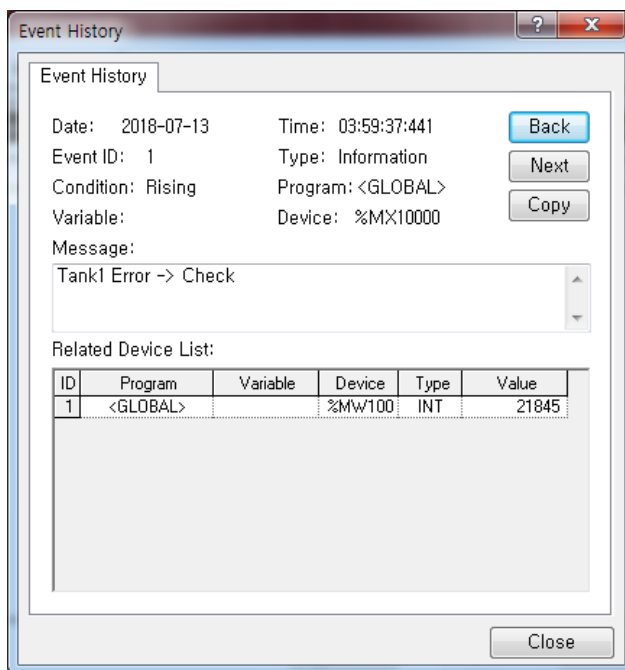
**Notice**

- For more details on the monitor, refer to the XG5000 manual.

2.13 Function to delete all of the PLC

The function to delete all of PLC is the initialization function to delete all programs, parameters, passwords, data stored in the PLC.

(1) How to delete all of PLC

(a) Click 『Online』 - 『Delete all of PLC 』 .

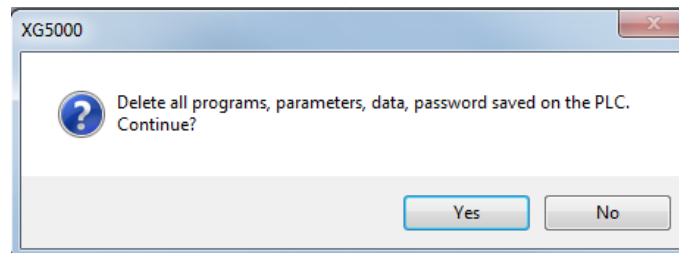

(b) If you choose 『Yes』 in the dialog box, the window for selecting the connection method with the PLC to be deleted is created.

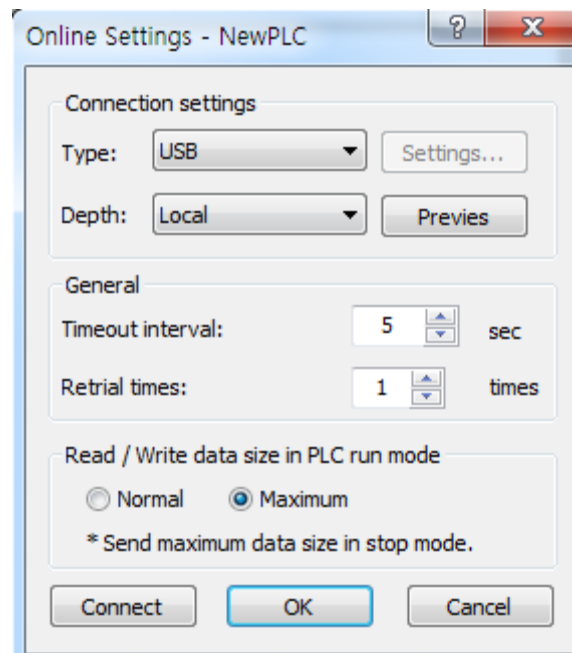

(c) After choosing the connection method with the PLC to be deleted, if you click 『Access』 or 『OK』 , all PLC programs, parameters, data, passwords will be deleted.

Notice

- Although the initial PLC is not connected, the function is executed. You can connect to the PLC after assess setting.
- If you use the function to delete all of PLC, all PLCs' internal data including passwords will be completely deleted so be careful of this.
- If you use the function to delete all of PLC when the password is lost, it is possible to connect to the PLC so you can reuse the PLC.

Chapter 3 Input/Output Specifications

3.1 Introduction

Here describes the notices when selecting digital I/O module used for XGB series.

- (1) For the type of digital input, there are two types such as current sink input and current source input.
- (2) The number of max. Simultaneous input contact point is different according to module type. It depends on the input voltage, ambient temperature. Use input module after checking the specification.
- (3) When response to high speed input is necessary, use interrupt input contact point. Up to 8 interrupt points are supported.
- (4) In case that open/close frequency is high or it is used for conductive load open/close, use Transistor output module or triac output module as the durability of Relay Output Module shall be reduced.
- (5) For output module to run the inductive (L) load, max. open/close frequency should be used by 1 second On, 1 second Off.
- (6) For output module, in case that counter timer using DC/DC Converter as a load was used, Inrush current may flow in a certain cycle when it is ON or during operation. In this case, if average current is selected, it may cause the failure. Accordingly, if the previous load was used, it is recommended to connect resistor or inductor to the load in serial in order to reduce the impact of Inrush current or use the large module having a max. load current value.

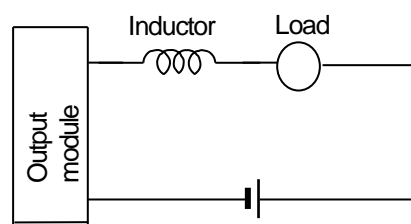
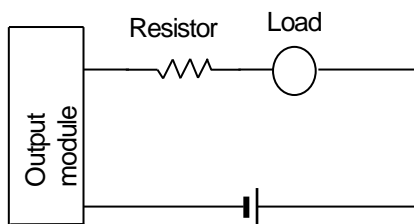

(7) Relay life of Relay output module is shown as below.

Max. life of Relay used in Relay output module is shown as below.

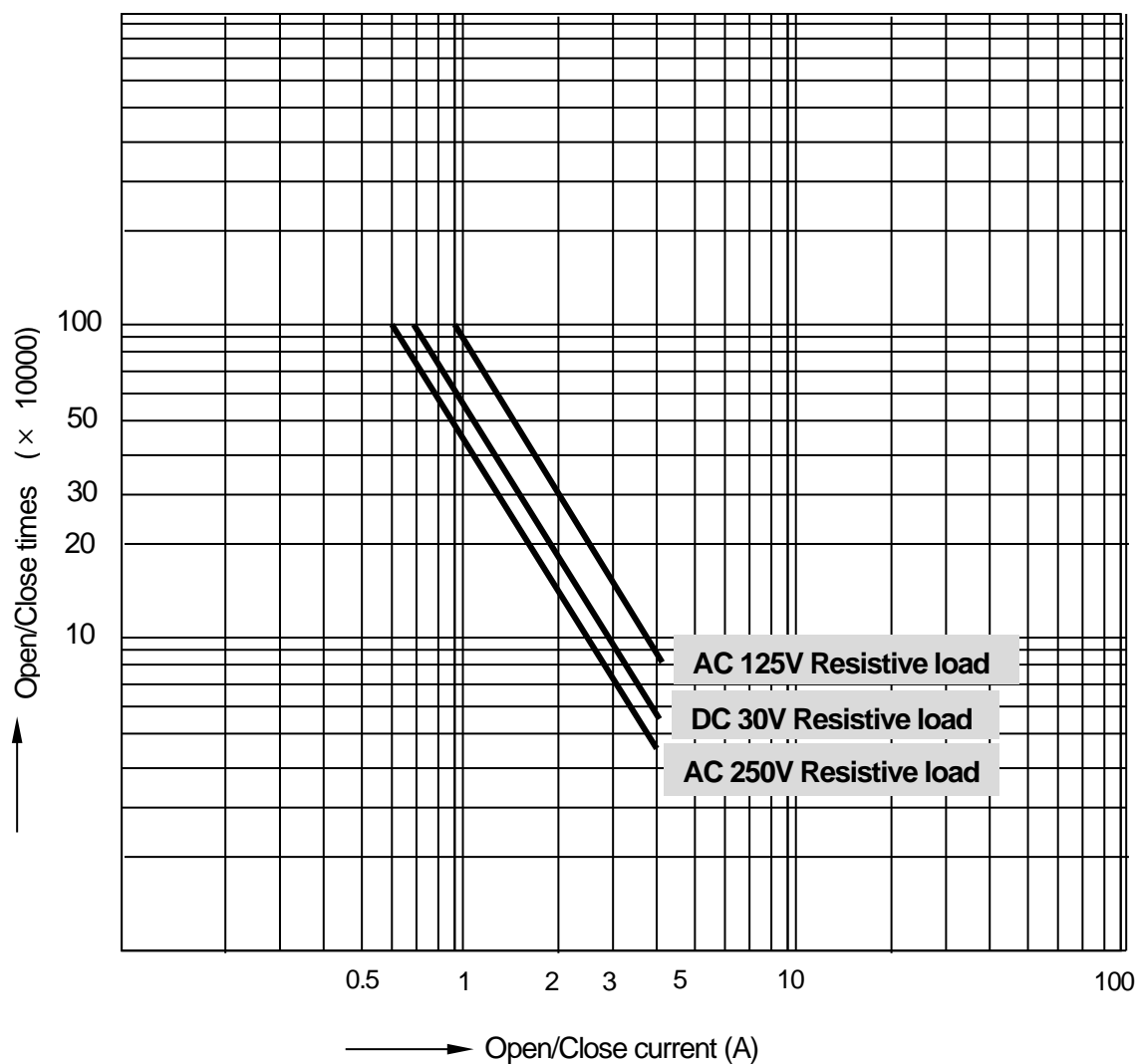

(8) Relay life graph is not written based on real use.

(This is not a guaranteed value). So consider margin. Relay life is specified under following condition.

Rated voltage	load	Lifespan	Rated voltage	load	Lifespan
200V	AC 1.5A	1 million times	200V	AC 1 A	1 million times
240V	AC 1A (COS Ø=0.7)	1 million times	240V	AC 0.5A (COS Ø=0.35)	1 million times
200V	AC 0.4A	3 million times	200V	AC 0.3A	3 million times
240V	AC 0.3A (COS Ø=0.7)	3 million times	240V	AC 0.15A (COS Ø=0.35)	3 million times
24V	DC 1A	1 million times	24V	DC 0.3A	3 million times
100V	DC 0.1A (L/R=7ms)	1 million times	100V	DC 0.03A (L/R=7ms)	3 million times

Chapter 3 Input/Output Specifications

(9) Terminal blocks are of barrier type and pluggable type, and pluggable terminal blocks have screw type and push-in type depending on the connection method.

1) Barrier terminal block

As a terminal block mainly applied to the XGB compact type basic unit, crimp terminals with insulation sleeves cannot be used. Crimp terminals suitable for connection to terminal blocks are as follows.



For the size of the wire connected to the terminal block, use a stranded wire of 0.3 to 0.75 mm² and a thickness of 2.8 mm or less. Please note that the allowable current may differ depending on the insulation thickness of the wire.

The tightening torques of the module fixing screws and terminal block screws must be within the following ranges.

Coupling position	Coupling torque range
IO module terminal strip screw (M3 screw)	42 ~ 58 N·cm
IO module terminal strip fixation screw(M3 screw)	66 ~ 89 N·cm
IO module external connector(M2 screw)	18 ~ 22 N·cm

2) Screw connection type plug (PCB plug, Screw connection):XBE-xx08A, XBE-xx16A

As a terminal block mainly applied to the XGB compact type basic unit, crimp terminals with insulation

① Wire size

Number of wires per contact	single wire	stranded wire	When using ferrules with plastic sleeves	When using ferrules without plastic sleeves
1	0.2 ~ 1.5 mm ²	0.2 ~ 1.5 mm ²	0.25 ~ 0.5 mm ²	0.25 ~ 1.5 mm ²
2	0.75 mm ²	0.75 mm ²	0.5 mm ² (Twin Ferrules)	0.25 ~ 0.34 mm ²

② Ferrule size

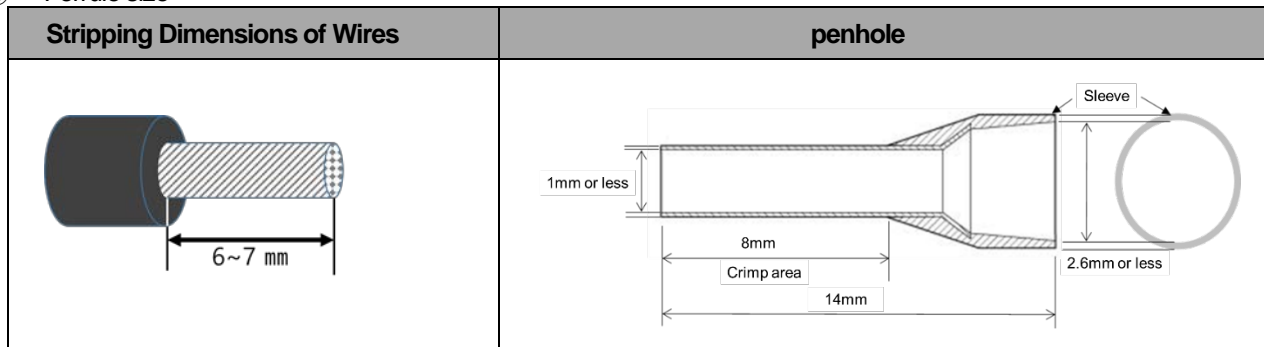

③ Recommended ferrule

Manufacturer	model name	line size	crimping tool
GLW GmbH	DN00508D	0.5 mm ²	CO225 Or CAP4
	DN00308D	0.34 mm ²	
	DN00208D	0.25 mm ²	

Peel off about 6-7 mm of the sheath from the end of the wire and connect it to the ferrule. Excessive stripping of the sheath can result in poor contact with the crimp area of the ferrule. Tighten the terminal block screws as follows.

Screw thread	M2
Flat screwdriver size	0.4 x 2.5
Tightening torque	0.2 N · m

(10) Noise can be inserted into input module. To prevent this noise, the user can set filter for input delay in parameter. Consider the environment and set the input filter time.

Input filter time (ms)	Noise signal pulse size (ms)	Reference
1	0.3	
3	1.8	Initial value
5	3	
10	6	
20	12	
70	45	
100	60	

(11) Use power cable as follow

Item	Cable Standard	Cable type	Immunity of Temp.	Torque
Power and protection GND	24AWG	Cu	80°C	-

3.2 Main Unit Digital Input Specifications

3.2.1 XEM-DN16H2, XEM-DP16H2, XEM-DR14H2 8 point DC24V input (Source/Sink Type)

Specification		Model	Main Unit		
			XEM-DN16H2/XEM-DP16H2/XEM-DR14H2		
Input point		8 points			
Insulation method		Photocoupler insulation			
Rated input voltage		DC 24V			
Rated input current		About 4mA (Contact point %IX0.0.0 ~ %IX0.0.3 : about 5mA)			
Operation voltage range		DC 20.4 ~ 28.8V (within ripple rate 5%)			
On voltage / On current		DC 19V or higher / 3mA or higher(Contact point 0 ~ 3 : 3.5mA or higher)			
Off voltage / Off current		DC6V or lower / 1mA or lower			
Input Resistance		About 5.6 k Ω (%IX0.0.0 ~ %IX0.0.3 : About 4.7 k Ω)			
Response time	Off \rightarrow On	1/3/5/10/20/70/100 ms (Set by I/O parameter) Default: 3 ms			
	On \rightarrow Off				
Insulation withstand voltage		AC850Vrms / 3cycle (altitude 2000m)			
Insulation resistance		10 M Ω or more by MegOhmMeter			
Common method		8 point / COM			
Proper cable size		0.3 mm ²			
Operation indicator		LED lights up when input is On			
External connection method		9 point terminal block connector			
Weight		140g			
Circuit configuration			No.	Contact	Type
			TB1	%IX0.0.0	
			TB2	%IX0.0.1	
			TB3	%IX0.0.2	
			TB4	%IX0.0.3	
			TB5	%IX0.0.4	
			TB6	%IX0.0.5	
			TB7	%IX0.0.6	
			TB8	%IX0.0.7	
			TB9	IN_COM	

3.2.2 XEM-DN32H2/HP, XEM-DP32H2/HP 16 point DC24V input (Source/Sink Type)

Model		Main unit				
Specification		XEM-DN32H2/HP, XEM-DP32H2/HP				
Input point		16 point				
Insulation method		Photo coupler insulation				
Rated input voltage		DC24V				
Rated input current		About 4mA (Contact point 0~3: about 7mA)				
Operation voltage range		DC20.4~28.8V (within ripple rate 5%)				
On voltage / On current		DC19V or higher / 3mA or higher				
Off voltage / Off current		DC6V or lower / 1mA or lower				
Input resistance		About 5.6k Ω (%IX0.0.0~%IX0.0.3: about 4.7k Ω)				
Response time	Off \rightarrow On	1/3/5/10/20/70/100ms (Set by I/O parameter) Default: 3ms				
	On \rightarrow Off					
Insulation pressure		AC560Vrms / 3 cycle (altitude 2000m)				
Insulation resistance		10M Ω or more by MegOhmMeter				
Common method		16 point / COM				
Proper cable size		0.3mm ²				
Operation indicator		LED On when Input On				
External connection method		40point connector				
Weight		134g				
Circuit configuration		No.	Contact	No.	Contact	Type
		B20	%IX0.0.0	A20	%QX0.0.0	
		B19	%IX0.0.1	A19	%QX0.0.1	
		B18	%IX0.0.2	A18	%QX0.0.2	
		B17	%IX0.0.3	A17	%QX0.0.3	
		B16	%IX0.0.4	A16	%QX0.0.4	
		B15	%IX0.0.5	A15	%QX0.0.5	
		B14	%IX0.0.6	A14	%QX0.0.6	
		B13	%IX0.0.7	A13	%QX0.0.7	
		B12	%IX0.0.8	A12	%QX0.0.8	
		B11	%IX0.0.9	A11	%QX0.0.9	
		B10	%IX0.0.10	A10	%QX0.0.10	
		B09	%IX0.0.11	A09	%QX0.0.11	
		B08	%IX0.0.12	A08	%QX0.0.12	
		B07	%IX0.0.13	A07	%QX0.0.13	
		B06	%IX0.0.14	A06	%QX0.0.14	
		B05	%IX0.0.15	A05	%QX0.0.15	
B04	NC	A04	P			
B03	NC	A03	P			
B02	IN_COM	A02	OUT_COM			
B01	IN_COM	A01	OUT_COM			

3.3 Main Unit Digital Output Specifications

3.3.1 XEM-DR14H2 6 point relay output

Specification		Model	Main unit	
			XEM-DR14H2	
Output point		6 point		
Insulation method		Relay insulation		
Rated load voltage / current		DC 24V 2A (Resistive load) / AC220V 2A (COS Φ = 1), 5A/COM		
Min. load voltage / current		DC5V / 1mA		
Max. load voltage		AC250V, DC125V		
Off leakage current		0.1mA (AC220V, 60Hz)		
Max. On/Off frequency		3,600times / hr		
Surge absorber		None		
Service life	Mechanical	20 million times or more		
	Electrical	Rated load voltage / current : 100,000 times or more		
		AC200V / 1.5A, AC240V / 1A (COS Φ = 0.7) : 100,000 times or more		
		AC200V / 1A, AC240V / 0.5A (COS Φ = 0.35) : 100,000 times or more		
		DC24V / 1A, DC100V / 0.1A (L / R = 7ms) : 100,000 times or more		
Response Time	Off \rightarrow On	10ms or less		
	On \rightarrow Off	12ms or less		
Common method		6 points / COM		
Proper cable size		Stranded cable 0.3~0.75mm ² (External diameter 2.8mm or less)		
Current Consumption		385mA (When all point is On)		
Operation indicator		LED lights up when output is ON		
External Connection method		10 point terminal block connector		
Weight		150g		
Circuit Configuration				
		No.	Contact	Type
		TB01	%QX0.0.0	
		TB02	%QX0.0.1	
		TB03	%QX0.0.2	
		TB04	%QX0.0.3	
		TB05	%QX0.0.4	
		TB06	%QX0.0.5	
		TB07	OUT_COM	
		TB08	N.C.	
		TB09	N.C.	
TB10	N.C.			

3.3.2 XEM-DN16H2 8 point transistor output (Sink type)

Specification		Model	Main Unit		
			XEM-DN16H2		
Output Point		8 point			
Insulation method		Photocoupler insulation			
Rated load voltage		DC 12 / 24V			
Operation load voltage range		DC 10.2 ~ 26.4V			
Max. load current		0.5A / 1 point, Positioning output(%QX0.0.0, %QX.0.0.1) : 0.1A / 1 point, 2A / 1COM			
Off leakage current		0.1mA or less			
Max. inrush current		4A / 10ms or less			
Max. voltage drop when ON		DC 0.4V or less			
Surge absorber		TVS diode			
Response time	Off → On	1ms or less			
	On → Off	1ms or less (rated load, resistive load)			
Common method		8 point / COM			
Proper wire size		Stranded wire 0.3~0.75mm ² (external diameter 2.8mm or less)			
External power	Voltage	DC 12/24V ± 10% (Ripple voltage 4 Vp-p or less)			
	Current	35mA or less (When connecting DC24V)			
Operation indicator		LED lights up when output is ON			
External connection method		10 point terminal block connector			
Weight		140g			
Circuit configuration			No. Contact Type		
			TB01	%QX0.0.0	
			TB02	%QX0.0.1	
			TB03	%QX0.0.2	
			TB04	%QX0.0.3	
			TB05	%QX0.0.4	
			TB06	%QX0.0.5	
			TB07	%QX0.0.6	
			TB08	%QX0.0.7	
			TB09	P	
			TB10	OUT_COM	

3.3.3 XEM-DP16H2 8 point transistor output (Source type)

Specification		Model	Main Unit				
			XEM-DP16H2				
Output point		8 point					
Insulation method		Photocoupler method					
Rated load voltage		DC 12 / 24V					
Operation load voltage range		DC 10.2 ~ 26.4V					
Max. load current		0.5A / 1 point, Positioning output (%QX0.0.0, %QX0.0.1): 0.1A / 1point, 2A / 1COM					
Off leakage current		0.1mA or less					
Max. inrush current		4A / 10ms or less					
Max. voltage drop when On		DC 0.4V or less					
Surge absorber		TVS diode					
Response time	Off → On	1ms or less					
	On → Off	1ms or less (rated load, resistive load)					
Common method		8 point / COM					
Proper wire size		Stranded wire 0.3~0.75mm ² (External diameter 2.8mm or less)					
External power	Voltage	DC 12 / 24V ± 10% (Ripple voltage 4 Vp-p or less)					
	Current	30mA or less (When connecting DC24V)					
Operation indicator		LED lights up when output is On					
External connection method		10 point terminal block connector					
Weight		140g					
Circuit configuration					No.	Contact	Type
					TB01	%QX0.0.0	
					TB02	%QX0.0.1	
					TB03	%QX0.0.2	
					TB04	%QX0.0.3	
					TB05	%QX0.0.4	
					TB06	%QX0.0.5	
					TB07	%QX0.0.6	
					TB08	%QX0.0.7	
					TB09	OUT_COM	
					TB10	N	

3.3.4 XEM-DN32H2/HP 16 point transistor output (Sink type)

Specification		Model	Main unit				
		XEM-DN32H2/XEM-DN32HP					
Output point		16 point					
Insulation method		Photo coupler insulation					
Rated load voltage		DC 12/24V					
Operation load voltage range		DC 10.2 ~ 26.4V					
Max. load current		%QX0.0.0 ~ 11: 0.1A / 1point, %QX0.0.12~15: 0.5A / 1 point, 2A / 1COM					
Off leakage current		0.1mA or less					
Max. inrush current		4A / 10ms or less					
Max. voltage drop when On		DC 0.4V or less					
Surge absorber		TVS diode					
Response time	Off → On	1ms or less					
	On → Off	1ms or less (rated load, resistive load)					
Common method		16 point / COM					
Proper wire size		Stranded wire 0.3~0.75mm ² (external diameter 2.8mm or less)					
External power	Voltage	DC12/24V ± 10% (Ripple voltage 4 Vp-p or less)					
	Current	80mA or less (When connecting DC24V)					
Operation indicator		LED On when Output On					
External connection method		40 point connector					
Weight		134g					
Circuit configuration			No.	Contact	No.	Contact	Type
			B20	%IX0.0.0	A20	%QX0.0.0	
			B19	%IX0.0.1	A19	%QX0.0.1	
			B18	%IX0.0.2	A18	%QX0.0.2	
			B17	%IX0.0.3	A17	%QX0.0.3	
			B16	%IX0.0.4	A16	%QX0.0.4	
			B15	%IX0.0.5	A15	%QX0.0.5	
			B14	%IX0.0.6	A14	%QX0.0.6	
			B13	%IX0.0.7	A13	%QX0.0.7	
			B12	%IX0.0.8	A12	%QX0.0.8	
			B11	%IX0.0.9	A11	%QX0.0.9	
			B10	%IX0.0.10	A10	%QX0.0.10	
			B09	%IX0.0.11	A09	%QX0.0.11	
			B08	%IX0.0.12	A08	%QX0.0.12	
			B07	%IX0.0.13	A07	%QX0.0.13	
			B06	%IX0.0.14	A06	%QX0.0.14	
			B05	%IX0.0.15	A05	%QX0.0.15	
B04	NC	A04	P				
B03	NC	A03	P				
B02	IN_COM	A02	OUT_COM				
B01	IN_COM	A01	OUT_COM				

3.3.5 XEM-DP32H2/HP 16 point transistor output (Source type)

Specification		Model	Main unit			
		XEM-DP32H2/XEM-DP32HP				
Output point		16 point				
Insulation method		Photo coupler insulation				
Rated load voltage		DC 12/24V				
Operation load voltage range		DC 10.2 ~ 26.4V				
Max. load current		%QX0.0.0 ~ 11: 0.1A / 1point, %QX0.0.12~15: 0.5A / 1 point, 2A / 1COM				
Off leakage current		0.1mA or less				
Max. inrush current		4A / 10ms or less				
Max. voltage drop when On		DC 0.4V or less				
Surge absorber		TVS diode				
Response time	Off → On	1ms or less				
	On → Off	1ms or less (rated load, resistive load)				
Common method		16 point / COM				
Proper wire size		Stranded wire 0.3~0.75mm ² (external diameter 2.8mm or less)				
External power	Voltage	DC12/24V ± 10% (Ripple voltage 4 Vp-p or less)				
	Current	50mA or less (When connecting DC24V)				
Operation indicator		LED On when Output On				
External connection method		40 point terminal block connector				
Weight		140g				
Circuit configuration			No.	Contact	Type	
			B20	%IX0.0.0	A20	%QX0.0.0
			B19	%IX0.0.1	A19	%QX0.0.1
			B18	%IX0.0.2	A18	%QX0.0.2
			B17	%IX0.0.3	A17	%QX0.0.3
			B16	%IX0.0.4	A16	%QX0.0.4
			B15	%IX0.0.5	A15	%QX0.0.5
			B14	%IX0.0.6	A14	%QX0.0.6
			B13	%IX0.0.7	A13	%QX0.0.7
			B12	%IX0.0.8	A12	%QX0.0.8
			B11	%IX0.0.9	A11	%QX0.0.9
			B10	%IX0.0.10	A10	%QX0.0.10
			B09	%IX0.0.11	A09	%QX0.0.11
			B08	%IX0.0.12	A08	%QX0.0.12
			B07	%IX0.0.13	A07	%QX0.0.13
			B06	%IX0.0.14	A06	%QX0.0.14
			B05	%IX0.0.15	A05	%QX0.0.15
B04	NC	A04	OUT_COM			
B03	NC	A03	OUT_COM			
B02	IN_COM	A02	N			
B01	IN_COM	A01	N			

3.4 Digital Input Specifications

3.4.1 8 point DC24V input module (Source/Sink type)

Model		DC input module		
		XBE-DC08A		
Specification				
Input point		8 point		
Insulation method		Photo coupler insulation		
Rated input voltage		DC24V		
Rated input current		About 4mA		
Operation voltage range		DC20.4~28.8V (ripple rate < 5%)		
On Voltage/Current		DC19V or higher / 3 mA or higher		
Off Voltage/Current		DC6V or less / 1mA or less		
Input resistance		About 5.6kΩ		
Response time	Off → On	1/3/5/10/20/70/100ms (set by CPU parameter) Default: 3ms		
	On → Off			
Insulation pressure		AC560Vrms / 3Cycle (altitude 2000m)		
Insulation resistance		10MΩ or more by Megohmmeter		
Common method		8 point / COM		
Proper cable size		Stranded pair 0.3~0.75mm ² (External diameter 2.8mm or less)		
Current consumption		30mA (when all point On)		
Operation indicator		Input On, LED On		
External connection method		10 point terminal block connector		
Weight		52 g		
Circuit configuration		No.	Contact	Type
		TB1	0	
		TB2	1	
		TB3	2	
		TB4	3	
		TB5	4	
		TB6	5	
		TB7	6	
		TB8	7	
		TB9	COM	
		TB10	COM	

3.4.2 16 point DC24V input module (Source/Sink type)

Specification	Model	DC input module		
		XBE-DC16A	XBE-DC16B	
Input point	16 point			
Insulation method	Photo coupler insulation			
Rated input voltage	DC24V	DC12/24V		
Rated input current	About 4mA	About 4/8mA		
Operation voltage range	DC20.4~28.8V (ripple rate < 5%)	DC9.5~30V (ripple rate < 5%)		
On Voltage/Current	DC19V or higher / 3 mA or higher	DC9V or higher / 3 mA or higher		
Off Voltage/Current	DC6V or less / 1mA or less	DC5V or less / 1mA or less		
Input resistance	About 5.6kΩ	About 2.7kΩ		
Response time	Off → On	1/3/5/10/20/70/100ms (set by CPU parameter) Default: 3ms		
	On → Off			
Insulation pressure	AC560Vrms / 3Cycle (altitude 2000m)			
Insulation resistance	10MΩ or more by Megohmmeter			
Common method	16 point / COM			
Proper cable size	Stranded cable 0.3~0.75mm ² (External diameter 2.8mm or less)			
Current consumption	40mA (when all point On)			
Operation indicator	Input On, LED On			
External connection method	8 pin terminal block connector + 10 pin terminal block connector			
Weight	53 g			
Circuit configuration		No.	Contact	Type
<p>Terminal block no.</p>		TB1	0	
		TB2	1	
		TB3	2	
		TB4	3	
		TB5	4	
		TB6	5	
		TB7	6	
		TB8	7	
		TB1	8	
		TB2	9	
TB3	A			
TB4	B			
TB5	C			
TB6	D			
TB7	E			
TB8	F			
TB9	COM			
TB10	COM			

3.4.3 32 point DC24V input module (Source/Sink type)

Specification	Model	DC input module				
	XBE-DC32A					
Input point	32 point					
Insulation method	Photo coupler insulation					
Rated input voltage	DC24V					
Rated input current	About 4mA					
Operation voltage range	DC20.4~28.8V (ripple rate < 5%)					
Input Derating	Refer to Derating diagram					
On Voltage/Current	DC 19V or higher / 3 mA or higher					
Off Voltage/Current	DC 6V or less / 1 mA or less					
Input resistance	About 5.6kΩ					
Response time	Off → On	1/3/5/10/20/70/100ms (set by CPU parameter) Default:3ms				
	On → Off					
Insulation pressure	AC 560Vrms / 3 Cycle (altitude 2000m)					
Insulation resistance	10MΩ or more by Megohmmeter					
Common method	32 point / COM					
Proper cable size	0.3mm ²					
Current consumption	50mA (when all point On)					
Operation indicator	Input On, LED On					
External connection method	40 pin connector					
Weight	60g					
Circuit configuration		No.	Contact	No.	Contact	Type
		B20	00	A20	10	
		B19	01	A19	11	
		B18	02	A18	12	
		B17	03	A17	13	
		B16	04	A16	14	
		B15	05	A15	15	
		B14	06	A14	16	
		B13	07	A13	17	
		B12	08	A12	18	
		B11	09	A11	19	
		B10	0A	A10	1A	
		B09	0B	A09	1B	
		B08	0C	A08	1C	
		B07	0D	A07	1D	
		B06	0E	A06	1E	
		B05	0F	A05	1F	
		B04	NC	A04	NC	
		B03	NC	A03	NC	
		B02	COM	A02	COM	
		B01	COM	A01	COM	

Chapter 3 Input/Output Specifications

3.4.4 8 point AC110V input module

Model		AC input module		
Specification		XBE-AC08A		
Input point		8 point		
Insulation method		Photo coupler insulation		
Rated input voltage		AC100-120V(+10/-15%) 50/60 Hz(±3 Hz) (distortion rate < 5%)		
Rated input current		About 8 mA(AC100,60 Hz), About 7mA(AC100, 50 Hz)		
Inrush current		Max. 200 mA 1 ms (AC132V)		
Input Derating		Refer to the below Derating diagram.		
On Voltage/Current		AC80V or higher / 5 mA or higher (50 Hz, 60 Hz)		
Off Voltage/Current		AC30V or lower / 1 mA or lower (50 Hz, 60 Hz)		
Input resistance		About 12 kΩ(60 Hz), About 15 kΩ(50 Hz)		
Response time	Off → On	20 ms or less (AC100V 50 Hz, 60 Hz)		
	On → Off	25 ms or less (AC100V 50 Hz, 60 Hz)		
Insulation pressure		AC3000Vrms / 3Cycle (altitude 2000m)		
Insulation resistance		10 MΩ or more by Megohmmeter		
Common method		4 point / COM		
Proper cable size		Twisted pair 0.3~0.75 mm ² (external diameter 2.8mm or less)		
Current consumption		30 mA (when all point On)		
Operation indicator		Input On, LED On		
External connection method		10 point terminal block connector		
Weight		70 g		
Circuit configuration		No.	Contact	Type
<p>AC110V * COM : TB5, TB10</p>		TB1	0	
		TB2	1	
		TB3	2	
		TB4	3	
		TB5	COM0	
		TB6	4	
		TB7	5	
		TB8	6	
		TB9	7	
		TB10	COM1	

3.5 Digital Output Specifications

3.5.1 8 point relay output module

Specification		Model	Relay output module		
			XBE-RY08A		
Output point		8 point			
Insulation method		Relay insulation			
Rated load voltage / Current		DC24V 2A (Resistive load) / AC220V 2A (COS Ψ = 1), 5A/COM			
Min. load voltage/Current		DC5V / 1mA			
Max. load voltage/Current		AC250V, DC125V			
Off leakage current		0.1mA (AC220V, 60Hz)			
Max. On/Off frequency		3,600 times/hr			
Surge absorber		None			
Service life	Mechanical	20 millions times or more			
	Electrical	Rated load voltage / current 100,000 times or more			
		AC200V / 1.5A, AC240V / 1A (COS Ψ = 0.7) 100,000 times or more			
		AC200V / 1A, AC240V / 0.5A (COS Ψ = 0.35) 100,000 times or more			
DC24V / 1A, DC100V / 0.1A (L / R = 7ms) 100,000 times or more					
Response time	Off \rightarrow On	10ms or less			
	On \rightarrow Off	12ms or less			
Common method		8 point / COM			
Proper cable size		Stranded cable 0.3~0.75mm ² (External diameter 2.8mm or less)			
Current consumption		230mA (when all point On)			
Operation indicator		Output On, LED On			
External connection method		9 point terminal block connector			
Weight		80g			
Circuit configuration			No.	Contact	Type
<p>Terminal block no.</p>			TB1	0	
			TB2	1	
			TB3	2	
			TB4	3	
			TB5	4	
			TB6	5	
			TB7	6	
			TB8	7	
			TB9	COM	

3.5.2 8 point relay output module (Independent point)

Model Specification		Relay output module				
		XBE-RY08B				
Output point		8 point				
Insulation method		Relay insulation				
Rated load voltage / Current		DC24V 2A (Resistive load) / AC220V 2A (COS Ψ = 1), 2A/COM				
Min. load voltage/Current		DC5V / 1mA				
Max. load voltage/Current		AC250V, DC125V				
Off leakage current		0.1mA (AC220V, 60Hz)				
Max. On/Off frequency		3,600 times/hr				
Surge absorber		None				
Service life	Mechanical	20 millions times or more				
	Electrical	Rated load voltage / current 100,000 times or more				
		AC200V / 1.5A, AC240V / 1A (COS Ψ = 0.7) 100,000 times or more				
		AC200V / 1A, AC240V / 0.5A (COS Ψ = 0.35) 100,000 times or more				
		DC24V / 1A, DC100V / 0.1A (L / R = 7ms) 100,000 times or more				
Response time	Off \rightarrow On	10ms or less				
	On \rightarrow Off	12ms or less				
Common method		1 point / COM				
Proper cable size		Stranded cable 0.3~0.75mm ² (External diameter 2.8mm or less)				
Current consumption		230mA (when all point On)				
Operation indicator		Output On, LED On				
External connection method		9 point terminal block connector x 2				
Weight		81g				
Circuit configuration				No.	Contact	No.
				TB1	0	
				TB2	COM0	
				TB3	1	
				TB4	COM1	
				TB5	2	
				TB6	COM2	
				TB7	3	
				TB8	COM3	
				TB9	NC	
				TB1	4	
				TB2	COM4	
				TB3	5	
				TB4	COM5	
				TB5	6	
				TB6	COM6	
				TB7	7	
				TB8	COM7	
				TB9	NC	

3.5.3 16 point relay output module

Model		Relay output module		
Specification		XBE-RY16A		
Output point		16 point		
Insulation method		Relay insulation		
Rated load voltage/ current		DC24V 2A (Resistive load) / AC220V 2A (COS Ψ = 1), 5A/COM		
Min. load voltage/current		DC5V / 1mA		
Max. load voltage/current		AC250V, DC125V		
Off leakage current		0.1mA (AC220V, 60Hz)		
Max. On/Off frequency		3,600 times/hr		
Surge absorber		None		
Service life	Mechanical	20 millions times or more		
	Electrical	Rated load voltage / current 100,000 times or more		
		AC200V / 1.5A, AC240V / 1A (COS Ψ = 0.7) 100,000 times or more		
		AC200V / 1A, AC240V / 0.5A (COS Ψ = 0.35) 100,000 times or more		
		DC24V / 1A, DC100V / 0.1A (L / R = 7ms) 100,000 times or more		
Response time	Off \rightarrow On	10ms or less		
	On \rightarrow Off	12ms or less		
Common method		8 point / COM		
Proper cable size		Stranded cable 0.3~0.75mm ² (External diameter 2.8mm or less)		
Current consumption		420mA (when all point On)		
Operation indicator		Output On, LED On		
External connection method		9 point terminal block connector x 2 ea		
Weight		130g		
Circuit configuration				
		No.	Contact	Type
		TB1	0	
		TB2	1	
		TB3	2	
		TB4	3	
		TB5	4	
		TB6	5	
		TB7	6	
		TB8	7	
		TB9	COM	
		TB1	8	
		TB2	9	
		TB3	A	
		TB4	B	
		TB5	C	
		TB6	D	
		TB7	E	
		TB8	F	
		TB9	COM	

3.5.4 8 point transistor output module (Sink type)

Specification		Model	Transistor output module				
			XBE-TN08A				
Output point		8 point					
Insulation method		Photo coupler insulation					
Rated load voltage		DC 12 / 24V					
Load voltage range		DC 10.2 ~ 26.4V					
Max. load voltage		0.5A / 1 point					
Off leakage current		0.1mA or less					
Max. inrush current		4A / 10ms or less					
Max. voltage drop (On)		DC 0.4V or less					
Surge absorber		Zener Diode					
Response time	Off → On	1ms or less					
	On → Off	1ms or less (Rated load, resistive load)					
Common method		8 point / COM					
Proper cable size		Stranded cable 0.3~0.75mm ² (External diameter 2.8mm or less)					
Current consumption		40mA (when all point On)					
External power supply	Voltage	DC12/24V ± 10% (ripple voltage 4 Vp-p or less)					
	Current	10mA or less (DC24V connection)					
Operation indicator		Output On, LED On					
External connection method		10 point terminal block connector					
Weight		52g					
Circuit configuration					No.	Contact	Type
					TB01	0	
					TB02	1	
					TB03	2	
					TB04	3	
					TB05	4	
					TB06	5	
					TB07	6	
					TB08	7	
					TB09	DC12 / 24V	
					TB10	COM	

3.5.5 16 point transistor output module (Sink type)

Specification	Model	Transistor output module			
		XBE-TN16A			
Output point	16 point				
Insulation method	Photo coupler insulation				
Rated load voltage	DC 12 / 24V				
Load voltage range	DC 10.2 ~ 26.4V				
Max. load voltage	0.5A / 1 point, 2A / 1COM				
Off leakage current	0.1mA or less				
Max. inrush current	4A / 10ms or less				
Max. voltage drop (On)	DC 0.4V or less				
Surge absorber	Zener Diode				
Response time	Off → On	1ms or less			
	On → Off	1ms or less (Rated load, resistive load)			
Common method	16 point / COM				
Proper cable size	Stranded cable 0.3~0.75mm ² (External diameter 2.8mm or less)				
Current consumption	60mA (when all point On)				
External power supply	Voltage	DC12/24V ± 10% (ripple voltage 4 Vp-p or less)			
	Current	10mA or less (DC24V connection)			
Operation indicator	Output On, LED On				
External connection method	8 pin terminal block connector + 10 pin terminal block connector				
Weight	54 g				
Circuit configuration		No.	Contact	Type	
		TB01	0		
		TB02	1		TB01
		TB03	2		TB02
		TB04	3		TB03
		TB05	4		TB04
		TB06	5		TB05
		TB07	6		TB06
		TB08	7		TB07
		TB01	8	TB08	
		TB02	9	TB01	
		TB03	A	TB02	
		TB04	B	TB03	
		TB05	C	TB04	
		TB06	D	TB05	
		TB07	E	TB06	
		TB08	F	TB07	
TB09	DC12 / 24V	TB08			
TB10	COM	TB09			

Chapter 3 Input/Output Specifications

3.5.6 32 point transistor output module (Sink type)

Specification		Model	Transistor output module			
			XBE-TN32A			
Output point		32 point				
Insulation method		Photo coupler insulation				
Rated load voltage		DC 12 / 24V				
Load voltage range		DC 10.2 ~ 26.4V				
Max. load voltage		0.5A / 1 point, 2A / 1COM				
Off leakage current		0.1mA or less				
Max. inrush current		0.7A / 10ms or less				
Max. voltage drop (On)		DC 0.4V or less				
Surge absorber		Zener Diode				
Response time	Off → On	1ms or less				
	On → Off	1ms or less (Rated load, resistive load)				
Common method		32 point / COM				
Proper cable size		0.3mm ²				
Current consumption		120mA (when all point On)				
External power supply	Voltage	DC12/24V ± 10% (ripple voltage 4 Vp-p or less)				
	Current	20mA or less (DC24V connection)				
Operation indicator		Output On, LED On				
External connection method		40 pin connector				
Weight		60g				
Circuit configuration						
		No.	Contact	No.	Contact	Type
		B20	00	A20	10	
		B19	01	A19	11	
		B18	02	A18	12	
		B17	03	A17	13	
		B16	04	A16	14	
		B15	05	A15	15	
		B14	06	A14	16	
		B13	07	A13	17	
		B12	08	A12	18	
		B11	09	A11	19	
		B10	0A	A10	1A	
		B09	0B	A09	1B	
		B08	0C	A08	1C	
		B07	0D	A07	1D	
		B06	0E	A06	1E	
		B05	0F	A05	1F	
		B04	NC	A04	NC	
		B03	NC	A03	NC	
		B02	DC12/ 24V	A02	COM	
		B01		A01		

3.5.7 8 point transistor output module (Source type)

Specification		Model	Transistor output module		
		XBE-TP08A			
Output point		8 point			
Insulation method		Photo coupler insulation			
Rated load voltage		DC 12 / 24V			
Load voltage range		DC 10.2 ~ 26.4V			
Max. load voltage		0.5A / 1 point			
Off leakage current		0.1mA or less			
Max. inrush current		4A / 10ms or less			
Max. voltage drop (On)		DC 0.4V or less			
Surge absorber		Zener Diode			
Response time	Off → On	1ms or less			
	On → Off	1ms or less (Rated load, resistive load)			
Common method		8 point / COM			
Proper cable size		Stranded cable 0.3~0.75mm ² (external diameter 2.8mm or less)			
Current consumption		40mA (when all outputs are on)			
External power	Voltage	DC12/24V ± 10% (ripple voltage 4 Vp-p or less)			
	Current	10mA or less (when connecting DC24V)			
Operation indicator		LED on when output on			
External connection method		10 pin terminal block connector			
Weight		30g			
Circuit configuration			No.	Contact	Type
			TB01	0	
			TB02	1	
			TB03	2	
			TB04	3	
			TB05	4	
			TB06	5	
			TB07	6	
			TB08	7	
			TB09	COM	
			TB10	0V	

3.5.8 16 point transistor output module (Source type)

Specification		Model	Transistor output module			
			XBE-TP16A			
Output point		16 point				
Insulation method		Photo coupler insulation				
Rated load voltage		DC 12 / 24V				
Load voltage range		DC 10.2 ~ 26.4V				
Max. load voltage		0.5A / 1 point, 2A / 1COM				
Off leakage current		0.1mA or less				
Max. inrush current		4A / 10ms or less				
Max. voltage drop (On)		DC 0.4V or less				
Surge absorber		Zener Diode				
Response time	Off → On	1ms or less				
	On → Off	1ms or less (Rated load, resistive load)				
Common method		16 point / COM				
Proper cable size		Stranded cable 0.3~0.75mm ² (external diameter 2.8mm or less)				
Current consumption		60mA (When all outputs are on)				
External power	Voltage	DC12/24V ± 10% (ripple voltage 4 Vp-p or less)				
	Current	10mA or less (connecting DC24V)				
Operation indicator		LED On when output On				
External connection method		8 pin terminal block connector + 10 pin terminal block connector				
Weight		40g				
Circuit configuration						
			No.	Contact	Type	
			TB01	0		TB01
			TB02	1		TB02
			TB03	2		TB03
			TB04	3		TB04
			TB05	4		TB05
			TB06	5		TB06
			TB07	6		TB07
			TB08	7		TB08
			TB01	8		TB01
			TB02	9		TB02
			TB03	A		TB03
			TB04	B		TB04
			TB05	C		TB05
			TB06	D		TB06
			TB07	E		TB07
			TB08	F		TB08
TB09	COM	TB09				
TB10	0V	TB10				

3.5.9 32 point transistor output module (Source type)

Specification		Model	Transistor output module																																																																																									
			XBE-TP32A																																																																																									
Output point		32 point																																																																																										
Insulation method		Photo coupler insulation																																																																																										
Rated load voltage		DC 12 / 24V																																																																																										
Load voltage range		DC 10.2 ~ 26.4V																																																																																										
Max. load voltage		0.5A / 1 point, 2A / 1COM																																																																																										
Off leakage current		0.1mA or less																																																																																										
Max. inrush current		4A / 10 ms or less																																																																																										
Max. voltage drop (On)		DC 0.4V or less																																																																																										
Surge absorber		Zener Diode																																																																																										
Response time	Off → On	1ms or less																																																																																										
	On → Off	1ms or less (Rated load, resistive load)																																																																																										
Common method		32 point / COM																																																																																										
Proper cable size		0.3mm ²																																																																																										
Current consumption		120mA (When all outputs are on)																																																																																										
External power	Voltage	DC12/24V ± 10% (ripple voltage 4 Vp-p or less)																																																																																										
	Current	20mA or less (connecting DC24V)																																																																																										
Operation indicator		LED On when output On																																																																																										
External connection method		40 pin connector																																																																																										
Weight		60g																																																																																										
Circuit configuration						<table border="1"> <thead> <tr> <th>No.</th> <th>Contact</th> <th>No.</th> <th>Contact</th> <th>Type</th> </tr> </thead> <tbody> <tr><td>B20</td><td>00</td><td>A20</td><td>10</td><td rowspan="32"> </td> </tr> <tr><td>B19</td><td>01</td><td>A19</td><td>11</td></tr> <tr><td>B18</td><td>02</td><td>A18</td><td>12</td></tr> <tr><td>B17</td><td>03</td><td>A17</td><td>13</td></tr> <tr><td>B16</td><td>04</td><td>A16</td><td>14</td></tr> <tr><td>B15</td><td>05</td><td>A15</td><td>15</td></tr> <tr><td>B14</td><td>06</td><td>A14</td><td>16</td></tr> <tr><td>B13</td><td>07</td><td>A13</td><td>17</td></tr> <tr><td>B12</td><td>08</td><td>A12</td><td>18</td></tr> <tr><td>B11</td><td>09</td><td>A11</td><td>19</td></tr> <tr><td>B10</td><td>0A</td><td>A10</td><td>1A</td></tr> <tr><td>B09</td><td>0B</td><td>A09</td><td>1B</td></tr> <tr><td>B08</td><td>0C</td><td>A08</td><td>1C</td></tr> <tr><td>B07</td><td>0D</td><td>A07</td><td>1D</td></tr> <tr><td>B06</td><td>0E</td><td>A06</td><td>1E</td></tr> <tr><td>B05</td><td>0F</td><td>A05</td><td>1F</td></tr> <tr><td>B04</td><td>NC</td><td>A04</td><td>NC</td></tr> <tr><td>B03</td><td>NC</td><td>A03</td><td>NC</td></tr> <tr><td>B02</td><td>COM</td><td>A02</td><td>0V</td></tr> <tr><td>B01</td><td>COM</td><td>A01</td><td>0V</td></tr> </tbody> </table>	No.	Contact	No.	Contact	Type	B20	00	A20	10		B19	01	A19	11	B18	02	A18	12	B17	03	A17	13	B16	04	A16	14	B15	05	A15	15	B14	06	A14	16	B13	07	A13	17	B12	08	A12	18	B11	09	A11	19	B10	0A	A10	1A	B09	0B	A09	1B	B08	0C	A08	1C	B07	0D	A07	1D	B06	0E	A06	1E	B05	0F	A05	1F	B04	NC	A04	NC	B03	NC	A03	NC	B02	COM	A02	0V	B01	COM	A01	0V
No.	Contact	No.	Contact	Type																																																																																								
B20	00	A20	10																																																																																									
B19	01	A19	11																																																																																									
B18	02	A18	12																																																																																									
B17	03	A17	13																																																																																									
B16	04	A16	14																																																																																									
B15	05	A15	15																																																																																									
B14	06	A14	16																																																																																									
B13	07	A13	17																																																																																									
B12	08	A12	18																																																																																									
B11	09	A11	19																																																																																									
B10	0A	A10	1A																																																																																									
B09	0B	A09	1B																																																																																									
B08	0C	A08	1C																																																																																									
B07	0D	A07	1D																																																																																									
B06	0E	A06	1E																																																																																									
B05	0F	A05	1F																																																																																									
B04	NC	A04	NC																																																																																									
B03	NC	A03	NC																																																																																									
B02	COM	A02	0V																																																																																									
B01	COM	A01	0V																																																																																									

3.6 Combined Digital I/O module Input Specification

3.6.1 8 point DC24V input (Source/Sink type)

Specification		Model	DC input module		
			XBE-DR16A		
Input point		8 point			
Insulation method		Photo coupler insulation			
Rated input voltage		DC24V			
Rated input current		About 4mA			
Operation voltage range		DC20.4~28.8V (within ripple rate 5%)			
On Voltage/Current		DC19V or higher / 3mA or higher			
Off Voltage/Current		DC6V or less / 1mA or less			
Input resistance		About 5.6kΩ			
Response time	Off → On	1/3/5/10/20/70/100ms (set by CPU parameter) Default: 3ms			
	On → Off				
Insulation pressure		AC560Vrms / 3Cycle (altitude 2000m)			
Insulation resistance		10MΩ or more by Megohmmeter			
Common method		8 point / COM			
Proper cable size		Stranded cable 0.3~0.75mm ² (External diameter 2.8mm or less)			
Current consumption		280mA (When all inputs and outputs are on)			
Operation indicator		LED on when input on			
External connection method		9 pin terminal block connector			
Weight		81g			
Circuit configuration			No.	Contact	Type
			TB1	0	
			TB2	1	
			TB3	2	
			TB4	3	
			TB5	4	
			TB6	5	
			TB7	6	
			TB8	7	
			TB9	COM	

3.6.2 8 point DC24V input (Source/Sink type)

Model		DC input module				
Specification		XBE-DN32A				
Input point		16 point				
Insulation method		Photo coupler insulation				
Rated input voltage		DC24V				
Rated input current		About 4mA				
Operation voltage range		DC20.4~28.8V (ripple rate < 5%)				
Input Derating		Refer to Derating diagram				
On Voltage/Current		DC 19V or higher / 3 mA or higher				
Off Voltage/Current		DC 6V or less / 1 mA or less				
Input resistance		About 5.6kΩ				
Response time	Off → On	1/3/5/10/20/70/100ms (set by CPU parameter) Default:3ms				
	On → Off					
Insulation pressure		AC 560Vrms / 3 Cycle (altitude 2000m)				
Insulation resistance		10MΩ or more by Megohmmeter				
Common method		16 point / COM				
Proper cable size		0.3mm ²				
Current consumption		60mA (When all inputs and outputs are on)				
Operation indicator		Input On, LED On				
External connection method		40 pin connector				
Weight		60g				
Circuit configuration		No.	Contact	No.	Contact	Type
Input Derating diagram						
		B20	00	A20	20	
		B19	01	A19	21	
		B18	02	A18	22	
		B17	03	A17	23	
		B16	04	A16	24	
		B15	05	A15	25	
		B14	06	A14	26	
		B13	07	A13	27	
		B12	08	A12	28	
		B11	09	A11	29	
		B10	0A	A10	2A	
		B09	0B	A09	2B	
		B08	0C	A08	2C	
		B07	0D	A07	2D	
		B06	0E	A06	2E	
		B05	0F	A05	2F	
		B04	NC	A04	P	
		B03	NC	A03	P	
		B02	IN_COM	A02	OUT_COM	
		B01	IN_COM	A01	OUT_COM	

3.7 Combined Digital I/O module Output Specification

3.7.1 8 point relay output

Model		Relay output module		
		XBE-DR16A		
Specification				
Output point		8 point		
Insulation method		Relay insulation		
Rated load voltage / Current		DC24V 2A (Resistive load) / AC220V 2A (COS Ψ = 1), 5A/COM		
Min. load voltage/Current		DC5V / 1mA		
Max. load voltage		AC250V, DC125V		
Off leakage current		0.1mA (AC220V, 60Hz)		
Max. On/Off frequency		3,600 times/hr		
Surge absorber		None		
Service life	Mechanical	20 millions times or more		
	Electrical	Rated load voltage / current 100,000 times or more		
		AC200V / 1.5A, AC240V / 1A (COS Ψ = 0.7) 100,000 times or more		
		AC200V / 1A, AC240V / 0.5A (COS Ψ = 0.35) 100,000 times or more		
Response time		DC24V / 1A, DC100V / 0.1A (L / R = 7ms) 100,000 times or more		
Response time	Off \rightarrow On	10ms or less		
	On \rightarrow Off	12ms or less		
Common method		8 point / COM		
Proper cable size		Stranded cable 0.3~0.75mm ² (external diameter 2.8mm or less)		
Current consumption		280mA (When all inputs and outputs are on)		
Operation indicator		LED on when output on		
External connection method		9 pin terminal block connector		
Weight		81g		
Circuit configuration				
		No.	Contact	Type
		TB1	0	
		TB2	1	
		TB3	2	
		TB4	3	
		TB5	4	
		TB6	5	
		TB7	6	
		TB8	7	
TB9	COM			

3.7.2 16 point transistor output (Sink type)

Model		Transistor output module				
Specification		XBE-DN32A				
Output point		16 point				
Insulation method		Photo coupler insulation				
Rated voltage		DC12/24V				
Operation voltage range		DC10.2~26.4V				
Max. load current		0.2A / 1 point, 2A / 1COM				
Off leakage current		0.1mA or less				
Max. load voltage		0.7A / 10ms or less				
Max. voltage drop (On)		DC 0.4V or less				
Surge absorber		TVS Diode				
Response time	Off → On	1ms or less				
	On → Off	1ms or less (Rated load, resistive load)				
Common method		32 point / COM				
Proper cable size		0.3mm ²				
Current consumption		60mA (when all point On)				
External power	Voltage	DC12/24V ± 10% (ripple voltage 4 Vp-p or less)				
	Current	20mA or less (connecting DC24V)				
Operation indicator		LED On when output On				
External connection method		40 pin terminal block connector				
Weight		60g				
Circuit configuration		No.	Contact	No.	Contact	Type
		B20	00	A20	20	
		B19	01	A19	21	
		B18	02	A18	22	
		B17	03	A17	23	
		B16	04	A16	24	
		B15	05	A15	25	
		B14	06	A14	26	
		B13	07	A13	27	
		B12	08	A12	28	
		B11	09	A11	29	
		B10	0A	A10	2A	
		B09	0B	A09	2B	
		B08	0C	A08	2C	
		B07	0D	A07	2D	
		B06	0E	A06	2E	
		B05	0F	A05	2F	
B04	NC	A04	P			
B03	NC	A03	P			
B02	IN_COM	A02	OUT_COM			
B01		A01				

3.8 I/O modules' Functions

3.8.1 Input filter function

The XGB PLC's input modules have the input filter function to prevent the external noise signal flowed into the input signal. For more details on the input filter function, refer to the below.

(1) Purposes and Operations of the input filter function

Under the environment with serious noise or in the case of the equipment that is greatly affected by the input signal's pulse width, the system may receive incorrect input depending on the input signal status. To prevent such incorrect input, the input filter function does not regard the signal that is shorter than the set time by a user as input. In the case of the XGB PLC, you can set the input filter time in the range of 1ms~100ms.

The below timing chart represents the operations of the input filter function.

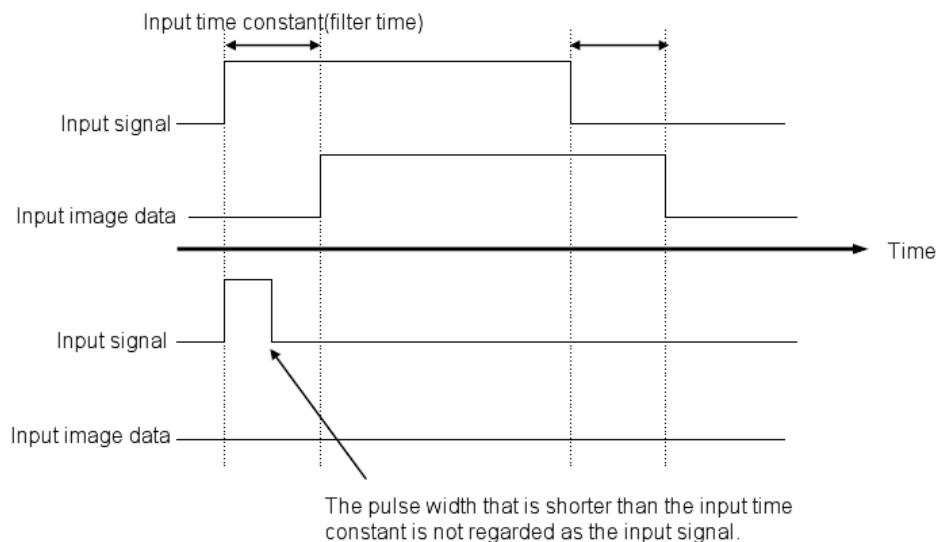

(2) How to set Input filter

1) Click [I/O Parameter] in XG5000

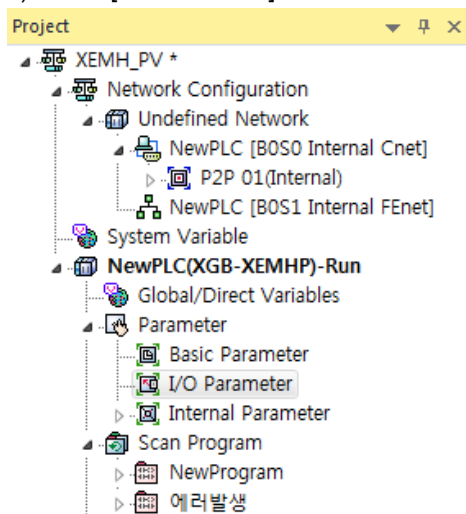

2) Click [Module] in Slot

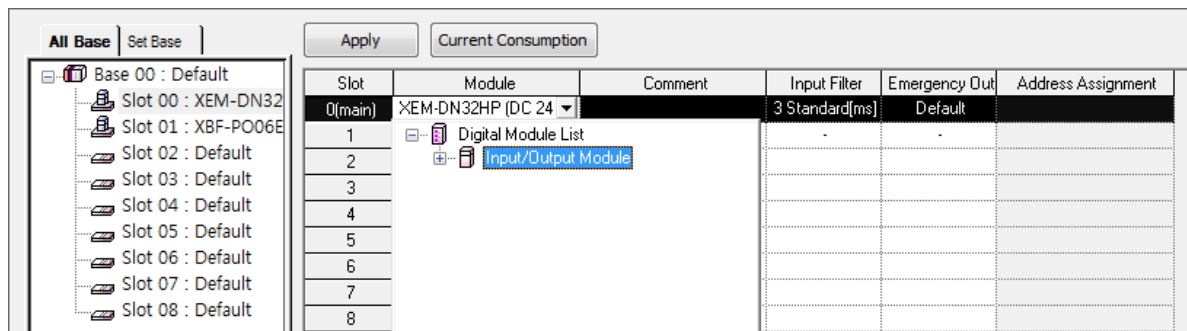

3) Set I/O Module

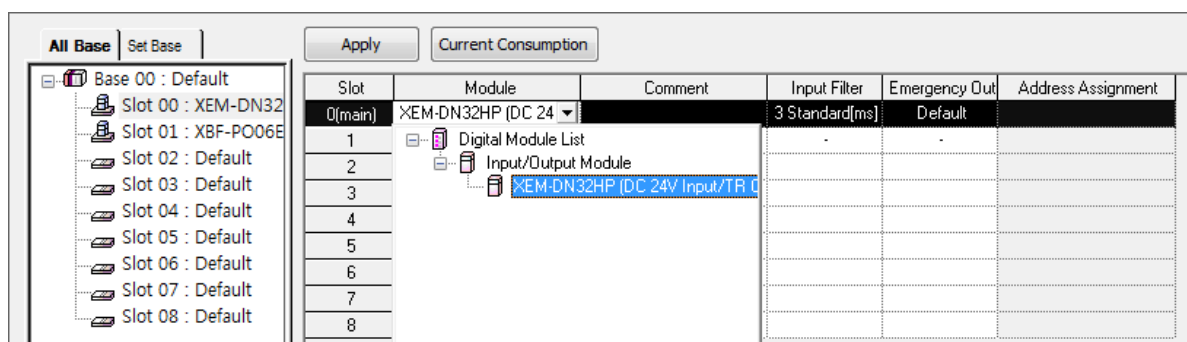

4) Click the below box and set Input filter

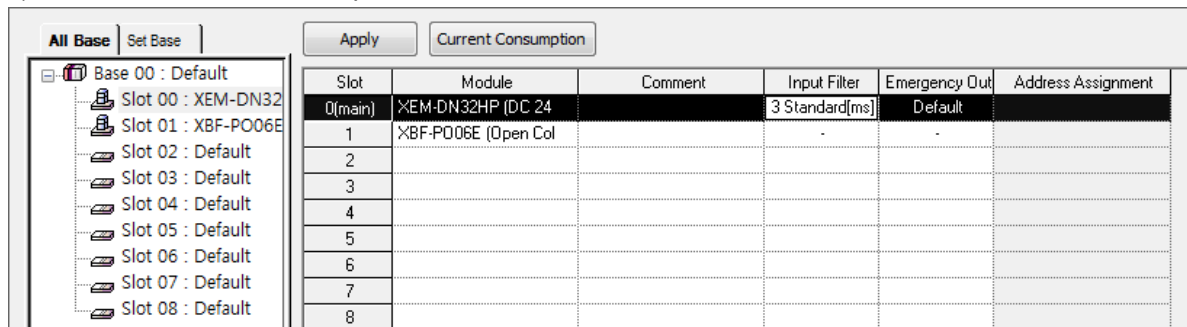

5) Set Input filter

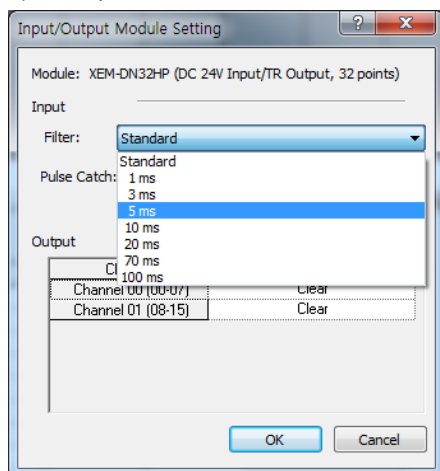

3.8.2 Emergency output function

The XGB PLC's output module supports the emergency output function to determine whether maintaining the output status of the output module or clearing it when the PLC is stopped due to errors.

You can set the emergency output by 8 points. For more details on how to set the emergency output, refer to the below.

(1) Click the below box

Slot	Module	Comment	Input Filter	Emergency Out	Address Assignment
0(main)	XEM-DN32HP (DC 24)		3 Standard[ms]	Default	
1	XBF-PO06E (Open Col)				
2					
3					
4					
5					
6					
7					
8					

(2) Set Emergency output

Module: XEM-DN32HP (DC 24V Input/TR Output, 32 points)

Input

Filter: Standard

Pulse Catch: 0 1 2 3 4 5 6 7

Output

Channel	Emergency Output
Channel 00 (00-07)	Clear
Channel 01 (08-15)	Hold

OK Cancel

When the emergency output is cleared, the output is turned off when the operation is stopped because an error occurs in the PLC. If you select hold Maintain output status.

3.8.3 Pulse Catch Function

The XGB PLC basic unit has the input contacts(%IX0.0.0 ~ %IX0.0.7)for Pulse Catch with 8 points. Through these contacts, it is possible to receive the very short pulse signal that cannot be recognized by the normal digital input.

(1) Purposes and Operations of the Pulse Catch function

The PLC's input data is refreshed in a lump once every scan. Accordingly, the very short pulse signal that is input during scan and is off before the scan is finished cannot be recognized as input. If you need to recognize and process such short pulse signal, you can use the Pulse Catch function. If you apply this function, the short pulse of the minimum of 10 μ s (%IX0.0.0 ~ %IX0.0.7:50 μ s)can be recognized.

The below timing chart represents the operations of the Pulse Catch function.

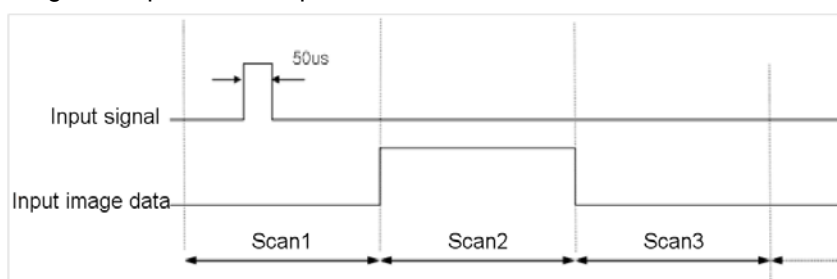

Step	Processing details
Scan 1	When the minimum pulse signal of 50 μ s is input, the CPU part will detect the fact and save the status.
Scan 2	System pulse catch data area is On.
Scan 3	System pulse catch data area is Off.

(2) Setting pulse catch

1) Click basic module

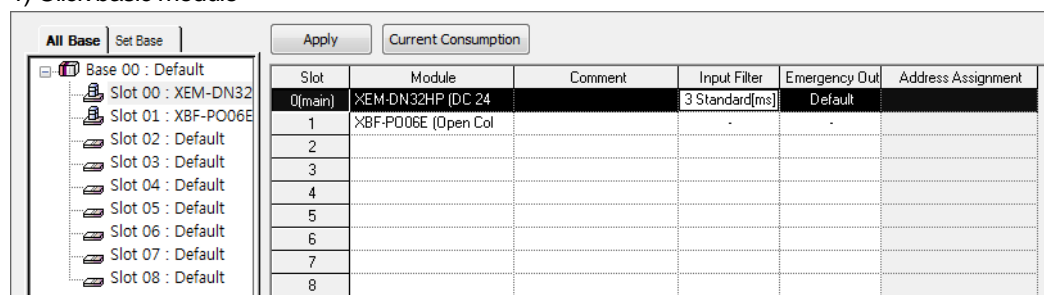

2) Set pulse catch

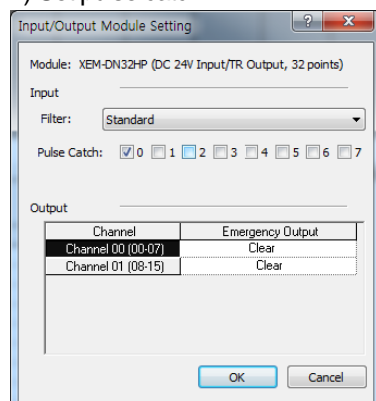

(3) Setting pulse catch

1) Pulse catch flags are stored in below device

Word flags	Bit flags	Variable	Description
_PLC_CATCH[] (%FW173)	%FX2768	_PLS_CATCH_0	Input contact 0 pulse catch result
	%FX2769	_PLS_CATCH_1	Input contact 1 pulse catch result
	%FX2770	_PLS_CATCH_2	Input contact 2 pulse catch result
	%FX2771	_PLS_CATCH_3	Input contact 3 pulse catch result
	%FX2772	_PLS_CATCH_4	Input contact 4 pulse catch result
	%FX2773	_PLS_CATCH_5	Input contact 5 pulse catch result
	%FX2774	_PLS_CATCH_6	Input contact 6 pulse catch result
	%FX2775	_PLS_CATCH_7	Input contact 7 pulse catch result

3.8.4 Smart link board

Easy wiring is available by connecting the IO connector with smart link board.

The available smart link and IO cable are as follows.

XGB		Smart link		Connection cable		
Item	Model	Model	Pin	Model	Length	Contents
Main unit	XEM-DN32H(P) XEM-DP32H(P)	XTB-40H (TG7-1H40S)	40	C40HH-05SB-XBI C40HH-10SB-XBI	0.5~1m	For main unit connection (40Pin)
	Expansion module	XBE-DC32A	XTB-40H (TG7-1H40S)	40	C40HH-05SB-XBE C40HH-10SB-XBE C40HH-15SB-XBE C40HH-20SB-XBE C40HH-30SB-XBE	0.5m~ 3m
XBE-TN32A		XTB-40H (TG7-1H40S)	40	For expansion module connection (40Pin) Exclusive for relay built-in type		
		R32C-NS5A-40P	40	For expansion module connection (40Pin)		
XBE-TP32A		XTB-40H (TG7-1H40S)	40	For expansion module connection (40Pin)		
		R32C-PS5A-40P	40	For expansion module connection (40Pin) Exclusive for relay built-in type		
XBE-DN32A	XTB-40H (TG7-1H40S)	40	For expansion module connection (40Pin)			

1) XTB-40H terminal array

Terminal array of XTB-40H is as follows.

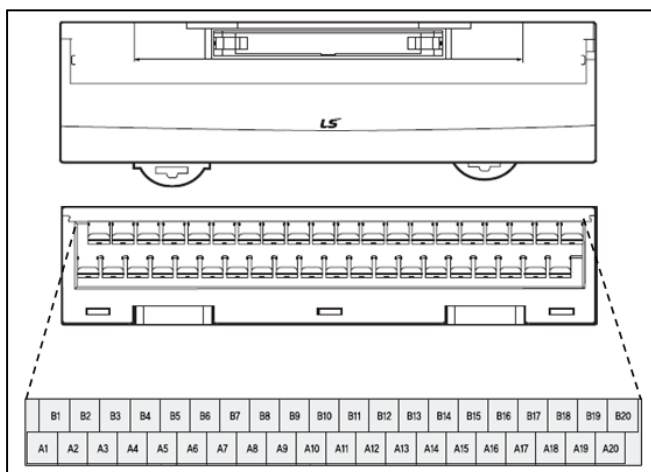

Item	Specification	
Rated voltage	AC125 / DC 24[V]	
Rated current	Max. 1[A]	
Withstanding voltage	500V 1min	
Insulation resistor	100MΩ (DC500V)	
Cable specification	AWG22-16 (1.5mm ² / MAX)	
Terminal/screw	M3 X 8L	
Torque	1.2N · m (12kgf · cm)	
material	Terminal	Modified PP0
	Cover	Polycarbonate
	PCB	Epoxy 1.6t

Chapter 3 Input/Output Specifications

- 2) Wiring of XTB-40H and XGB main unit
 Wiring of XGB main unit through XTB-40H and C40HH-10SB-XBI is as follows.

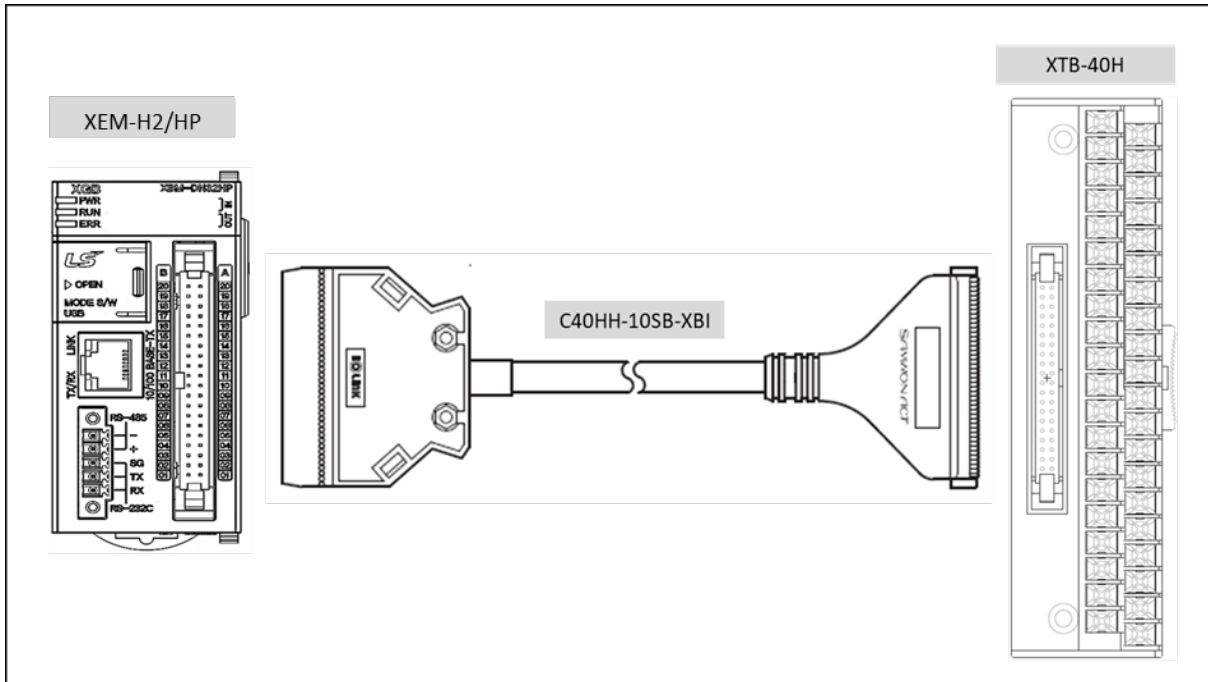

If you reverse the direction of the cables, the I/O connections of the XEM-H2/HP and XTB-40H will be different. So be careful about the direction of cable connection.

The relationship between the input/output signals of the XGB I/O signal and Smart Link board terminal number is shown in the figure below.

The following figure describes signal assignment when the C40HH-10SB-XBI is used in connection.

When the user makes the cable, make sure that wiring is done as figure below.

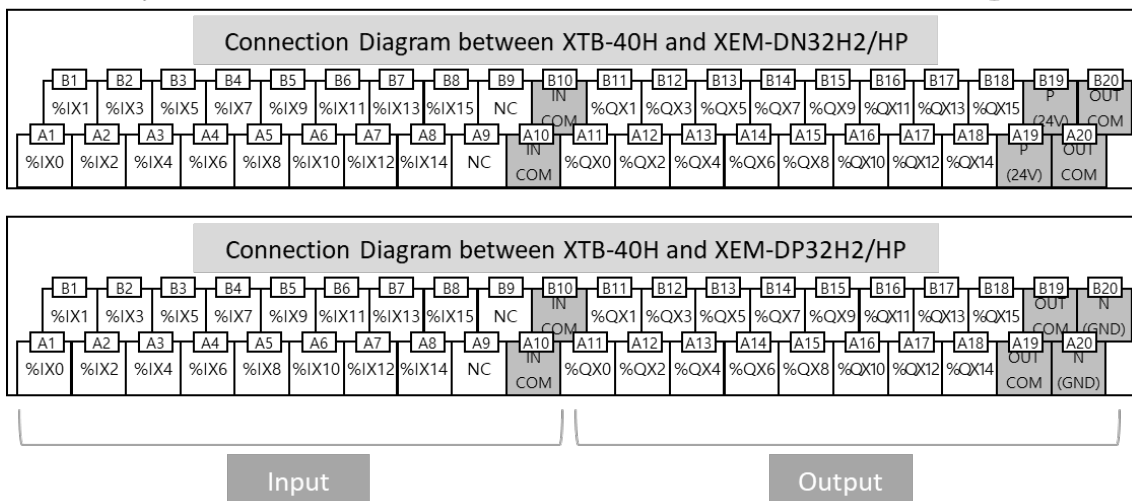
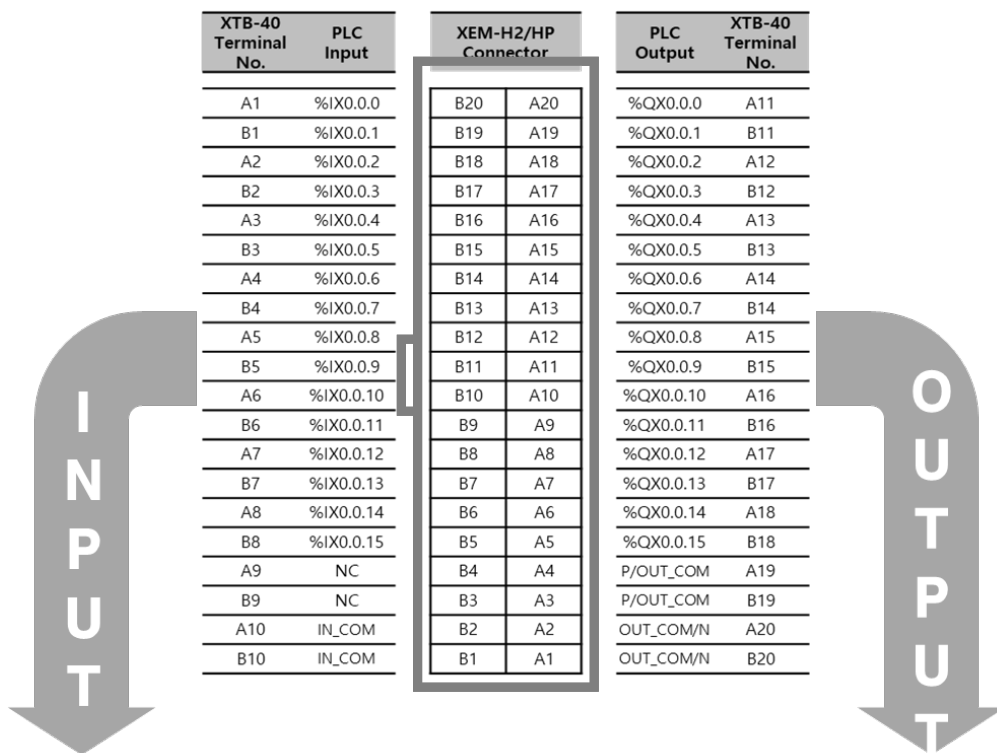

Chapter 3 Input/Output Specifications

3) Wiring of XTB-40H and XGB extension module

Wiring of XGB extension module through XTB-40H and C40HH-10SB-XBE is as follows.

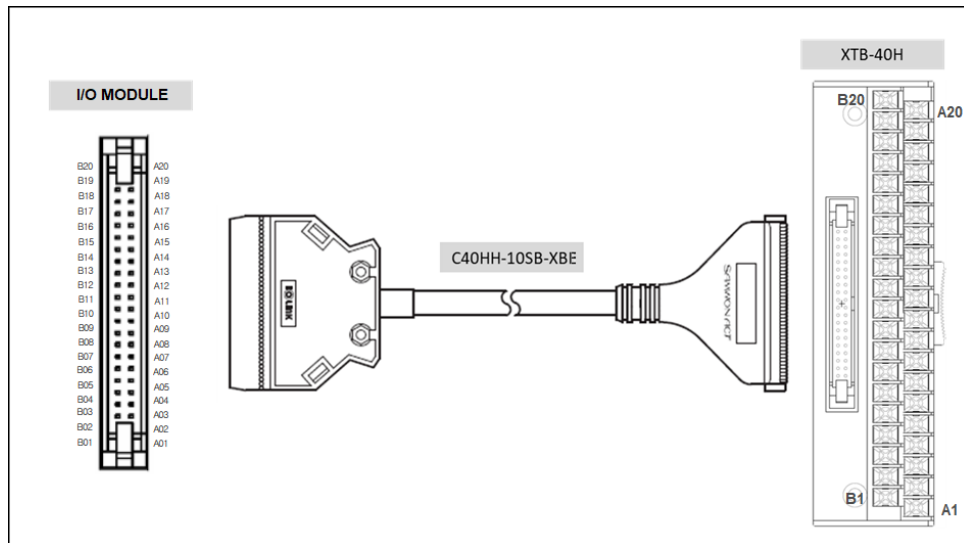

If you reverse the direction of the cables, the I/O connections of the XGB I/O module and XTB-40H will be different. So be careful about the direction of cable connection.

The relationship between the input/output signals of the XGB I/O signal and Smart Link board terminal number is shown in the table below.

The following table describes signal assignment when the C40HH-10SB-XBE is used in connection.

When the user makes the cable, make sure that wiring is done as table below.

Pin No.		PLC								Terminal Block Pin No.	
		XBE-DC32A		XBE-TN32A		XBE-TP32A		XBE-DN32A		XTB-40H	
B20	A20	00	10	00	10	00	10	00	10	B20	A20
B19	A19	01	11	01	11	01	11	01	11	B19	A19
B18	A18	02	12	02	12	02	12	02	12	B18	A18
B17	A17	03	13	03	13	03	13	03	13	B17	A17
B16	A16	04	14	04	14	04	14	04	14	B16	A16
B15	A15	05	15	05	15	05	15	05	15	B15	A15
B14	A14	06	16	06	16	06	16	06	16	B14	A14
B13	A13	07	17	07	17	07	17	07	17	B13	A13
B12	A12	08	18	08	18	08	18	08	18	B12	A12
B11	A11	09	19	09	19	09	19	09	19	B11	A11
B10	A10	0A	1A	0A	1A	0A	1A	0A	1A	B10	A10
B09	A09	0B	1B	0B	1B	0B	1B	0B	1B	B9	A9
B08	A08	0C	1C	0C	1C	0C	1C	0C	1C	B8	A8
B07	A07	0D	1D	0D	1D	0D	1D	0D	1D	B7	A7
B06	A06	0E	1E	0E	1E	0E	1E	0E	1E	B6	A6
B05	A05	0F	1F	0F	1F	0F	1F	0F	1F	B5	A5
B04	A04	NC	NC	NC	NC	NC	NC	NC	DC	B4	A4
B03	A03	NC	NC	NC	NC	NC	NC	NC	12/24V	B3	A3
B02	A02	COM	COM	DC	COM	COM	DC0V	IN	OUT	B2	A2
B01	A01			12/24V				COM	COM	COM	B1

Chapter 4 Built-in High-speed Counter Function

XGB series have built-in function of High-speed counter in main unit. This chapter describes specifications and usage of High-speed counter's function

4.1 High-speed Counter Specifications

4.1.1 Performance Specifications

(1) Performance specifications

Classification		Spcification
Count input signal	Signal	A-phase, B-phase
	Input type	Voltage input (Open collector)
	Signal level	DC 24V
Max. count speed		200kpps
Number of channels	1 phase	200kpps 4 channels
	2 phase	100kpps 2 channels
Count range		Signed 32 Bit (-2,147,483,648 ~ 2,147,483,647)
Count mode (Program setting)		Linear count (if 32-bit range exceeded, Carry/Borrow occurs) Counter max. and min. value is indicated Ring count (repeated count within setting range)
Input mode (Program setting)		1-phase input 2-phase input CW/CCW input
Signal type		Voltage
Up/Down setting	1 phase input	Increasing/decreasing operation setting by B-phase input
		Increasing/decreasing operation setting by program
	2 phase input	Operating setting by rising/falling edge phase difference
CW/CCW	A-phase input: increasing operation	
	B-phase input: decreasing operation	
Multiplication function	1 phase input	1 multiplication
	2 phase input	4 multiplication
	CW/CCW	1 multiplication
Control input	Signal	Preset instruction input(%IX0.0.4 ~ %IX0.0.7)
	Signal level	DC 24V input type
	Signal type	Voltage
External output	Output points	2 point/channel (for each channel);use output contact point of main unit
	Type	Selects single-compared (>, >=, =, <=, <) or section-compared output (included or excluded) (program setting)
	Output type	Transistor output
Count Enable		To be set through program (count available only in enable status)
Preset function		To be set through terminal (contact) or program
Auxiliary mode (Program setting)		Count Latch Frequency Measure Count per unit time (time setting value: 1~60,000ms) Count pause

(2) Counter/Preset input specification

Classification	Spcification
Input voltage	24V DC (20.4V ~ 28.8V)
Input current	4mA
On guaranteed voltage (min.)	20.4V
Off guaranteed voltage (max.)	6V

Chapter 4 Built-in High-speed Counter Function

4.1.2 Designation of Parts

(1) Designation of parts

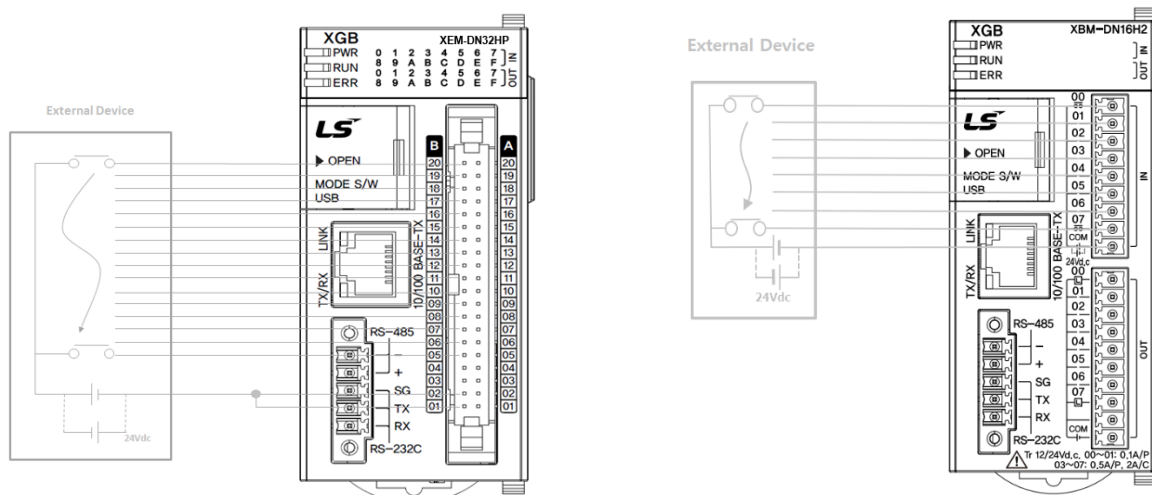

Terminal No.		Names		Usage	
32-point model	14/16-point model	1-phase	2-phase	1-phase	2-phase
B20	00	Ch0 counter input	Ch0 A-phase input	Counter input terminal	A-phase input
B19	01	Ch1 counter input	Ch0 B-phase input	Counter input terminal	B-phase input
B18	02	Ch2 counter input	Ch2 A-phase input	Counter input terminal	A-phase input
B17	03	Ch3 counter input	Ch2 B-phase input	Counter input terminal	B-phase input
B16	04	Ch0 preset 24V	Ch0 preset 24V	Preset input terminal	Preset input terminal
B15	05	Ch1 preset 24V	-	Preset input terminal	No use
B14	06	Ch2 preset 24V	Ch2 preset 24V	Preset input terminal	Preset input terminal
B13	07	Ch3 preset 24V	-	Preset input terminal	No use
B12	-				
B11	-				
B10	-				
B09	-				
B08	-				
B07	-				
B06	-				
B05	-				
B04	-				
B03	-				
B02	COM	Input common	Input common	Common terminal	Common terminal
B01		Input common	Input common	Common terminal	Common terminal

(2) Interface with external devices

I/O	Internal circuit	Terminal No.		Signal		Operation	On/Off guaranteed voltage
		32-point model	14/16-point model	1-phase	2-phase		
Input		B20	00	Ch 0 Pulse input	Ch 0 A-phase input	On	20.4~28.8V
						Off	6V or less
		B19	01	Ch 1 Pulse input	Ch 0 B-phase input	On	20.4~28.8V
						Off	6V or less
		B18	02	Ch 2 Pulse input	Ch 2 A-phase input	On	20.4~28.8V
						Off	6V or less
		B17	03	Ch 3 Pulse input	Ch 2 B-phase input	On	20.4~28.8V
						Off	6V or less
		B16	04	Ch 0 Preset input	Ch 0 Preset input	On	20.4~28.8V
						Off	6V or less
B15	05	Ch 1 Preset input	-	On	20.4~28.8V		
				Off	6V or less		
B14	06	Ch 2 Preset input	Ch 2 Preset input	On	20.4~28.8V		
				Off	6V or less		
B13	07	Ch 2 Preset input	-	On	20.4~28.8V		
				Off	6V or less		
		B01/B02	COM	COM (input common)			

4.1.3 Functions of High-speed Counter

(1) Counter mode

(a) High Speed counter function can count High Speed pulses which can not be processed by CPU module's counter instructions (CTU, CTD, CTUD, etc.), up to binary value of 32 bits (-2,147,483,648 ~ 2,147,483,647).

(b) Available input is 1-phase input, 2-phase input and CW/ CCW input.

(c) Count increasing/decreasing methods are as follows;

- For 1-phase input: a) Increasing/decreasing count operation by program setting
b) Increasing/decreasing count operation by B-phase input signal
- For 2-phase input: setting by difference in phase between A-phase and B-phase
- For CW/CCW input: Increasing operation if B-phase is LOW with A-phase input, and Decreasing operation if A-phase is LOW with B-phase input.

(d) Auxiliary modes are as follows;

- Latch counter
- Count function about the number of revolution per unit time
- Frequency measure function
- Count prohibited function

(e) Pulse input mode

1) 1 phase count mode

a) Increasing/decreasing count operation by program setting

- 1-phase 1-input 1-multiplication operation mode

A-phase input pulse counts at rising and increasing/decreasing will be decided by the applicable program.

Increasing/Decreasing classification	A-phase input pulse rising	A-phase input pulse falling
Increasing/decreasing count setting signal Off	Increasing count	-
Increasing/decreasing count setting signal On	Decreasing count	-

• Operation example

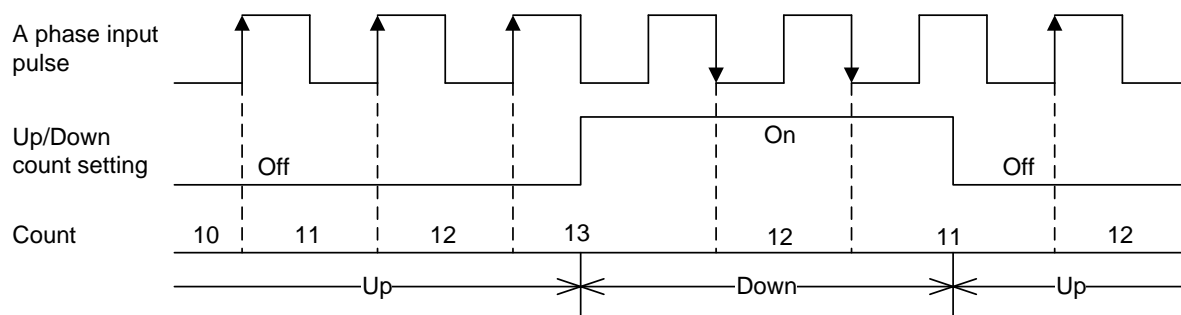

b) Increasing/decreasing count operation by B-phase input signal

- 1-phase 2-input 1-multiplication operation mode

A-phase input pulse counts at rising and increasing/decreasing will be decided by B-phase.

Increasing/Decreasing classification	A-phase input pulse rising	A-phase input pulse falling
B-phase input pulse Off	Increasing count	-
B-phase input pulse On	Decreasing count	-

• Operation example

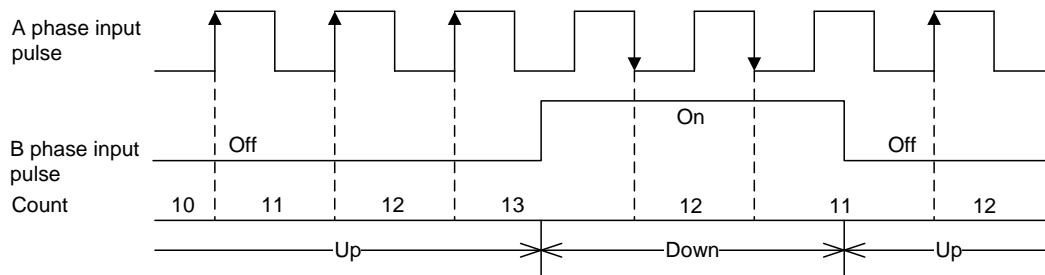

2) 2-phase count mode

a) 2-phase 4-multiplication operation mode

A-phase input pulse and B-phase input pulse count at rising/falling respectively. If A-phase input is antecedent to B-phase input, increasing operation starts, and if B-phase input is antecedent to A-phase input, decreasing operation starts.

• Operation example

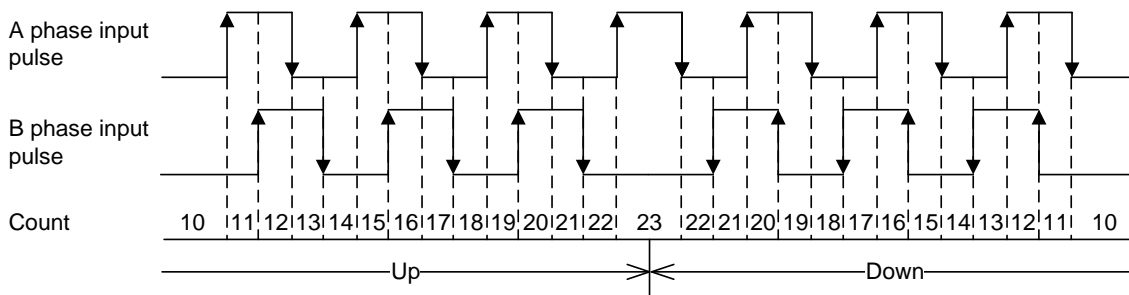

3) CW(Clockwise)/CCW(Counter Clockwise) operation mode

A-phase input pulse counts at rising, or B-phase input pulse counts at rising.

Increasing operation executed when B-phase input pulse is Low with A-phase input pulse at rising, and Decreasing operation executed when A-phase input pulse is Low with B-phase input pulse at rising.

Increasing/Decreasing classification	A-phase input pulse High	A-phase input pulse Low
B-phase input pulse High	-	decreasing count
B-phase input pulse Low	Increasing count	-

• Operation example

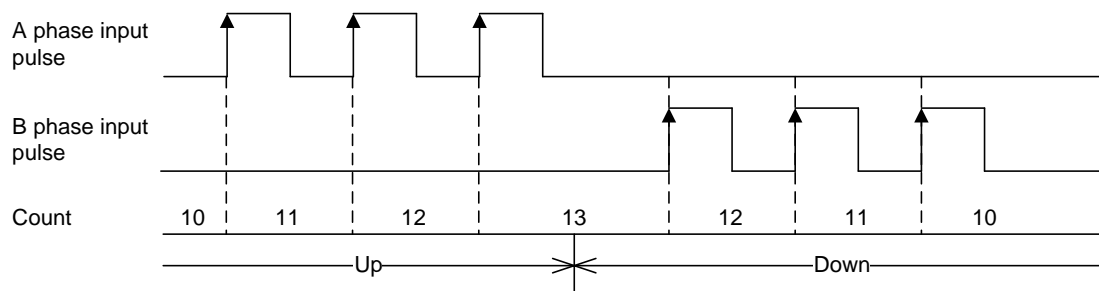

Chapter 4 Built-in High-speed Counter Function

(2) Counter mode

2 types of count (Linear counter, Ring counter) can be selected for the applicable use based on functions.

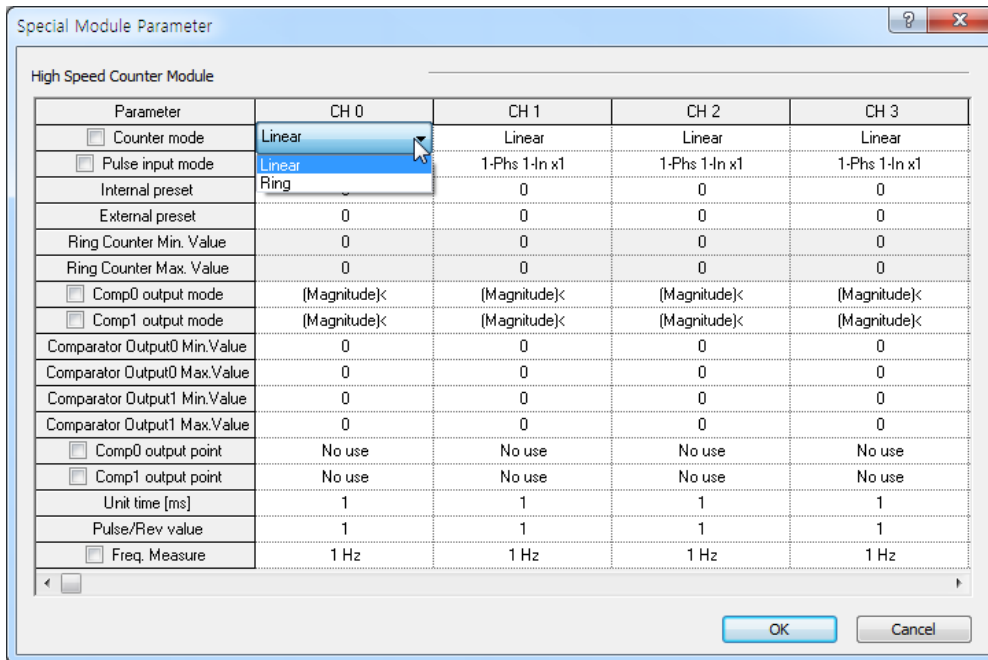

- Counter mode is saved at the following special K area.

Mode	Area per each channel (word)				Reference ⁽¹⁾
	Ch.0	Ch.1	Ch.2	Ch.3	
Counter mode	%KW300	%KW330	%KW360	%KW390	0 : linear 1 : ring

(a) Linear counter

- Linear Count range: -2,147,483,648 ~ 2,147,483,647
- If count value reaches the maximum value while increased, Carry will occur, and if count value reaches the minimum value while decreased, Borrow will occur.
- If Carry occurs, count stops and increasing is not available but decreasing is available.
- If Borrow occurs, count stops and decreasing is not available but increasing is available.

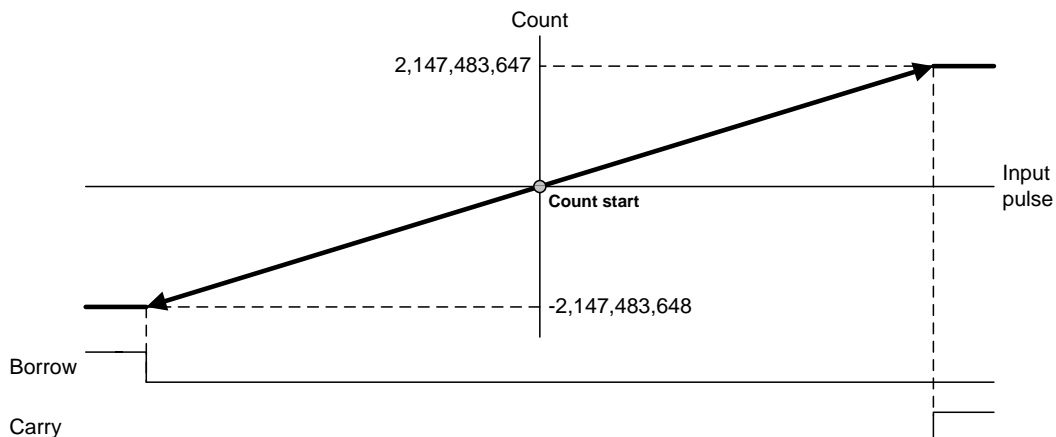

(b) Ring count

Set Ring Counter Min. Value and Max. value. Preset value and compared set value should be in range of ring counter min. value and max. value.

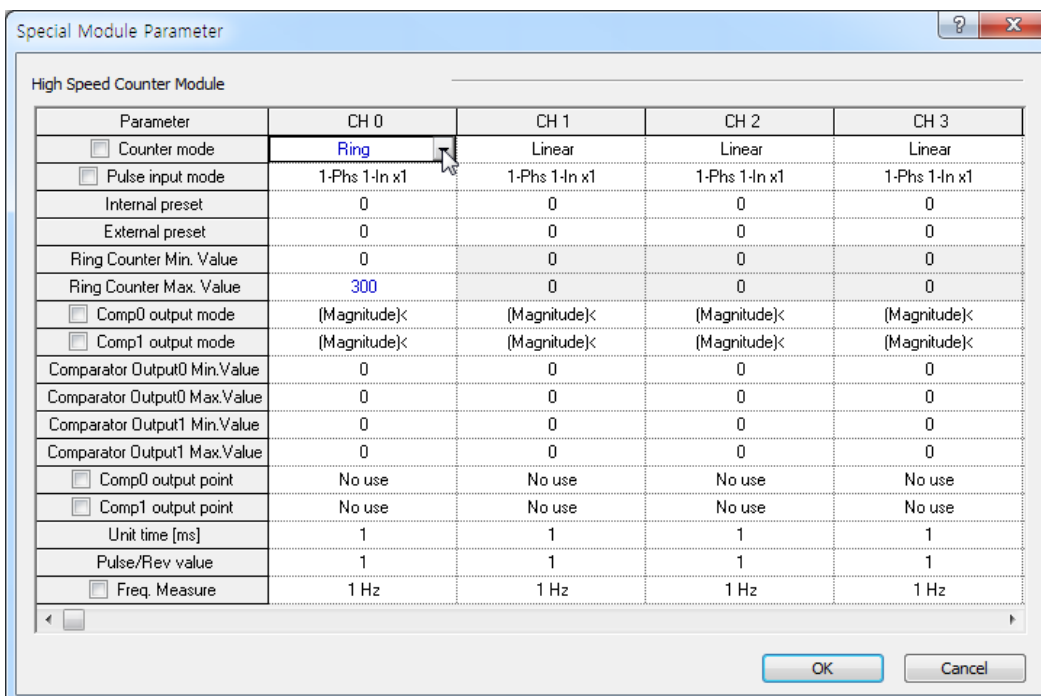

Ring counter max. and min value is saved at the following special K area.

type	Area per each channel (Double word)				Reference
	Ch.0	Ch.1	Ch.2	Ch.3	
Ring counter Min. value	%KD154	%KD169	%KD184	%KD199	
Ring counter Max. value	%KD155	%KD170	%KD185	%KD200	

- Range of Ring counter: user defined min. value ~ user defined max. value
- Counter display: in case of using ring counter, user defined max. value is not displayed.

1) During increasing count

Even if count value exceeds user-defined maximum value during increasing count, Carry only occurs and count does not stop differently to Linear Count.

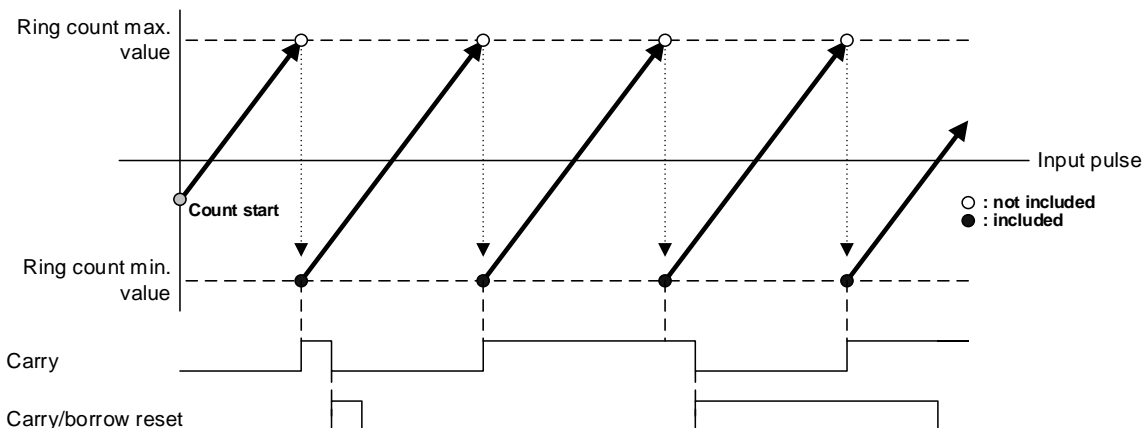

Chapter 4 Built-in High-speed Counter Function

2) During decreasing count

Even if count value exceeds user-defined minimum value during decreasing count, Borrow only occurs and count does not stop differently to Linear Count.

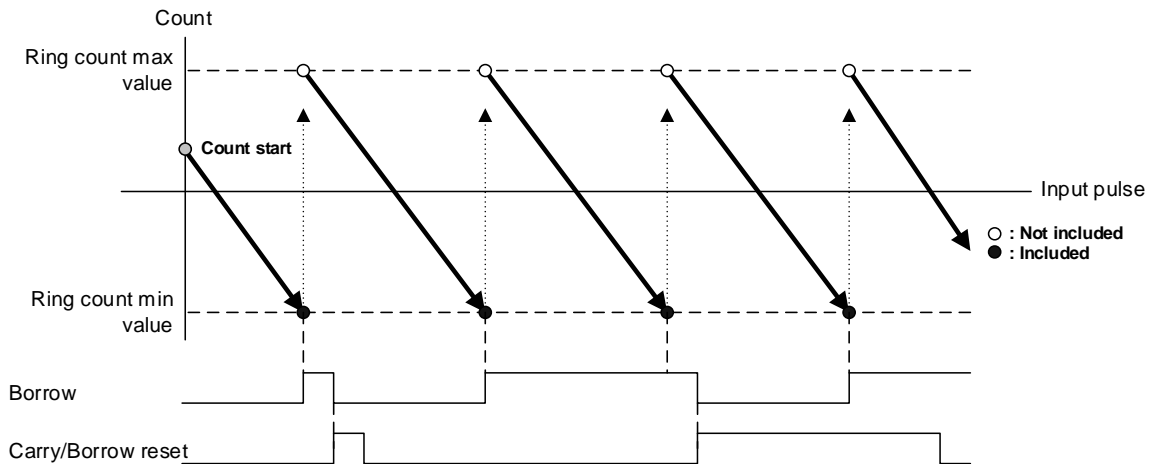

3) Operation when setting the ring count according to the current count value (at the count of addition)

- When setting the ring count, the current count value is below the minimum value of the ring counter.
 - Opens an error (Code No. 27), operates as a linear counter, and operates as a ring counter when the current count value falls within the range of the ring counter (error codes are not cleared).
- When setting the ring count, the current count value is above the maximum value of the ring counter.
 - Displays an error (Code No. 27), operates as a linear counter, and stops counting when the current count value reaches the maximum count value (error code is not cleared).
- When setting the ring count, the current count value is within the user setting range
 - It starts to increase from the current count value, increases to the maximum value set by the user, then becomes the minimum value set by the user and continues to count after carrying a carry.
 - As shown in the figure below, the maximum value is not displayed and the count continues after displaying the minimum value.

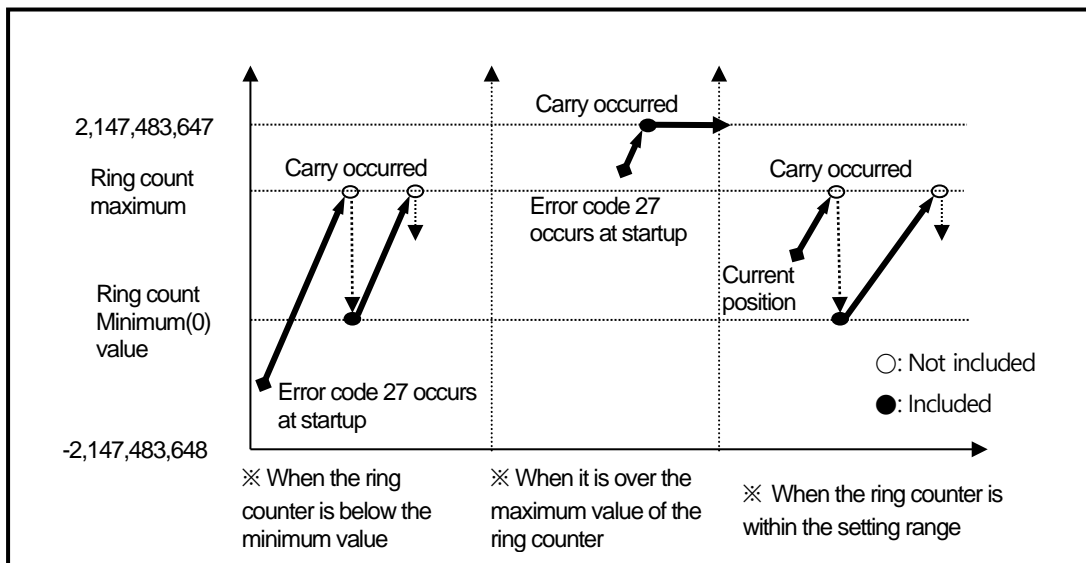

- 4) Operation when setting the ring count according to the current count value (when subtracting count)
- When setting the ring count, the current count value is below the minimum value of the ring counter.
 - When an error (Code No. 27) is displayed, it operates as a linear counter, and if the current count value falls within the range of the ring count, it operates as a ring counter. (The error code is not cleared)
 - When setting the ring count, the current count value is above the maximum value of the link counter.
 - An error (Code No. 27) is displayed, and it operates as a linear counter, but stops counting when the current count value reaches the count minimum value. (The error code is not cleared)
 - When setting the ring count, the current count value is within the user setting range
 - It starts to decrease from the current count value, decreases to the minimum value set by the user, and becomes the maximum value set by the user, and then continues counting after Borrow occurs.

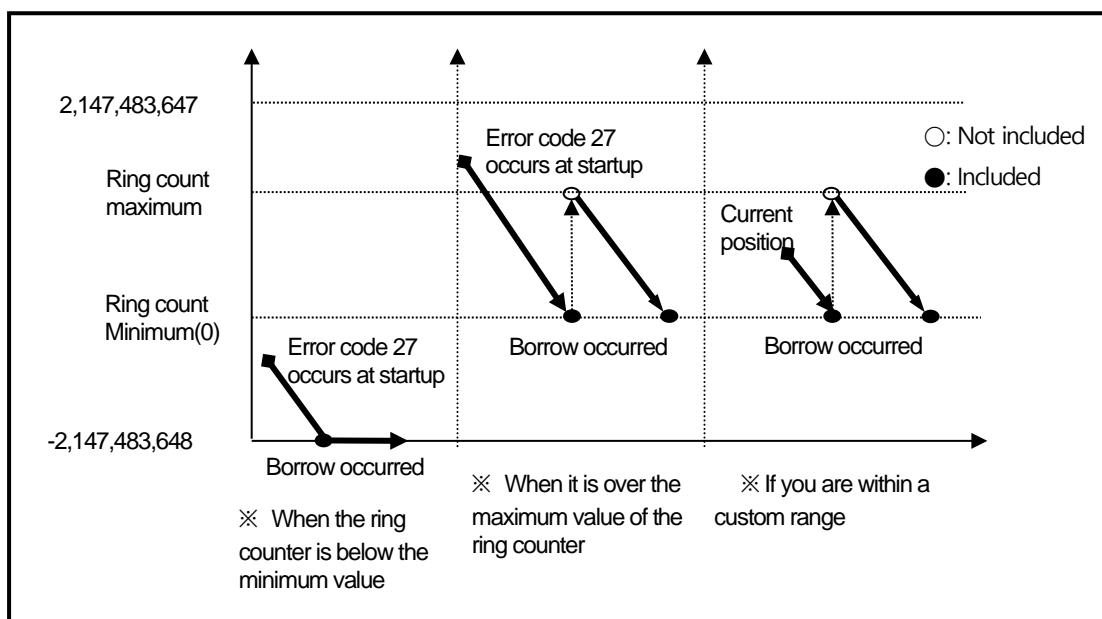

Remark

- (1) When using a ring count, be sure to place the count value within the range using a preset or the like.

Chapter 4 Built-in High-speed Counter Function

(3) Compared output

- (a) High Speed counter module has a compared output function used to compare present count value with compared value in size to output as compared.
- (b) Available compared outputs are 2 for 1 channel, which can be used separately.
- (c) Compared output conditions are 7 associated with $>$, $=$, $<$.
- (d) Parameter setting

• Comp. output mode setting

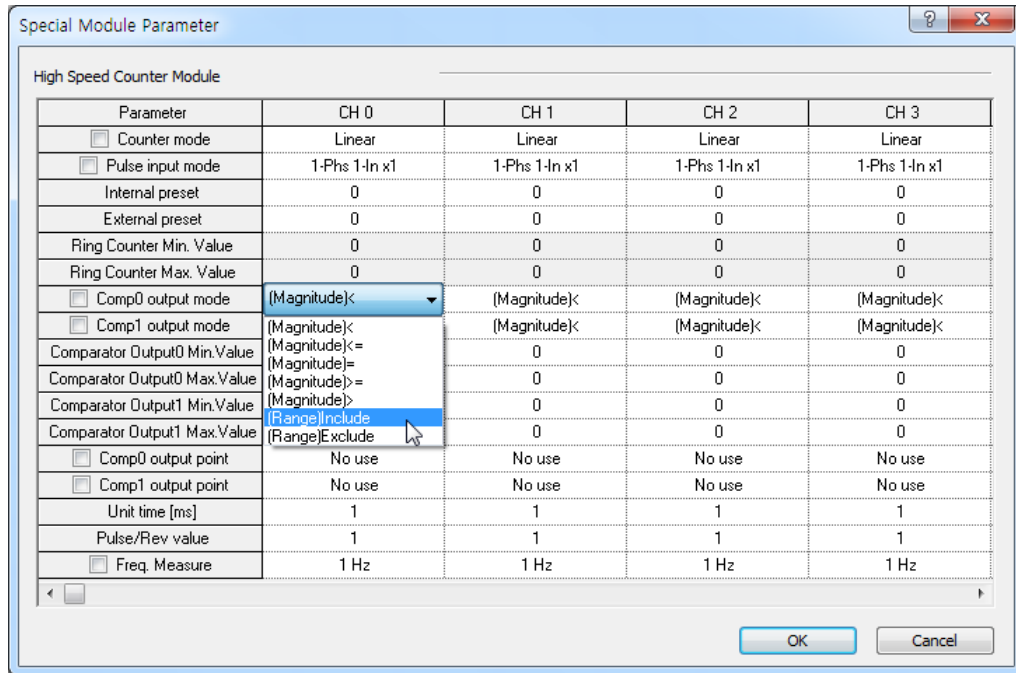

• Upper setting value is saved in special K area.

Compared output condition	Memory address (word)		Value ²⁾
	Comp output 0	Comp output 1	
Present Value < Compared Value	Ch.0 %KW302 Ch.1 %KW 332 Ch.2 %KW 362 Ch.3 %KW 392	Ch.0 %KW 303 Ch.1 %KW 333 Ch.2 %KW 363 Ch.3 %KW 393	Set to "0"
Present Value ≤ Compared Value			Set to "1"
Present Value = Compared Value			Set to "2"
Present Value ≥ Compared Value			Set to "3"
Present Value > Compared Value			Set to "4"
Compared value 1 ≤ Count value ≤ Compared value 2			Set to "5"
Count value ≤ Compared value 1, Count value ≥ Compared value 2			Set to "6"

²⁾ If compared output mode set value is other than 0~6 at using counter, error code '23' occurs.

Chapter 4 Built-in High-speed Counter Function

- In order to output the compared output signal, compared output enable flag set to '1' after compared output condition set.

Classification	Area per channel				Operation
	Ch. 0	Ch. 1	Ch. 2	Ch. 3	
Count enable signal	%KX4160	%KX4320	%KX4480	%KX4640	0: N/A, 1: enable
Compared enable0 signal	%KX4164	%KX4324	%KX4484	%KX4644	0: forbidden, 1: enable
Compared enable1 signal	%KX4167	%KX4327	%KX4487	%KX4647	0: forbidden, 1: enable

- In order to make external output, the compared coincidence output signal (P20~P2F) must be set. If Compared output contact is 'Off' at Special Module Parameter Setting of XG5000, Compared coincidence output signal (internal device) is only output.

Classification	Area per channel				Operation
	Ch. 0	Ch. 1	Ch. 2	Ch. 3	
Comparator output signal0	%KX4178	%KX4338	%KX4498	%KX4658	0: Compared output not equivalent 1: Compared output equivalent
Comparator output signal1	%KX4179	%KX4339	%KX4499	%KX4659	0: Compared output not equivalent 1: Compared output equivalent

- Comp. output point (%QX0.0.0 ~ %QX0.0.15) setting

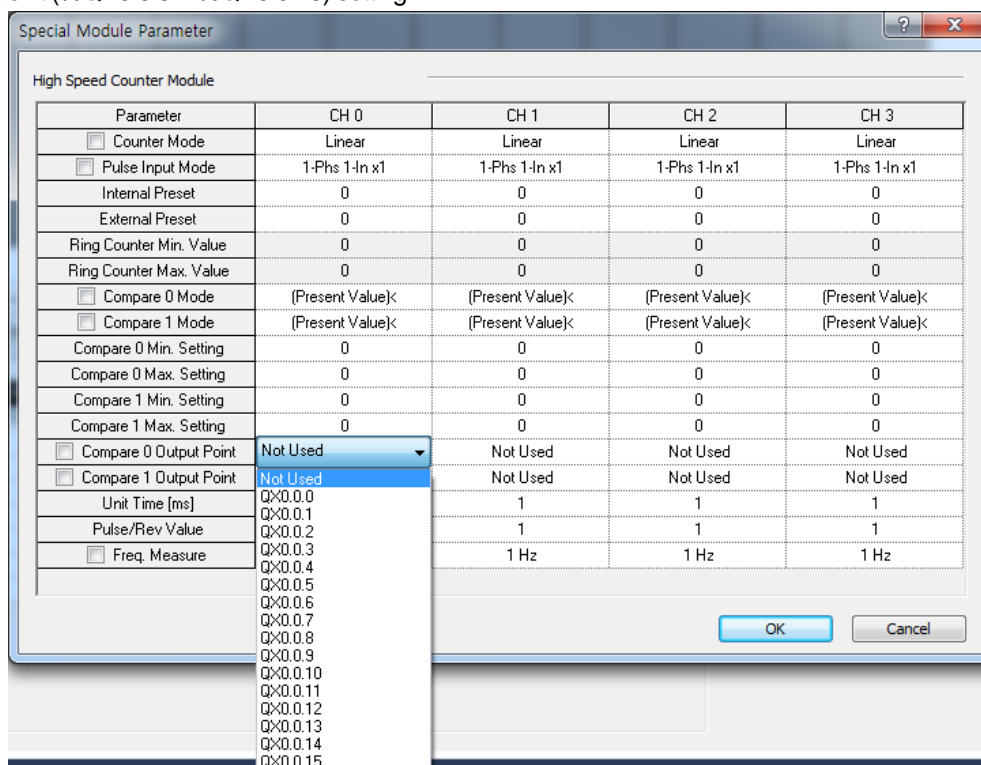

Chapter 4 Built-in High-speed Counter Function

(e) Detail of comparator output

It describes detail of comparator output (based on comparator output 0)

1) Mode 0 (Present value < Compared value)

If counted present value is less than the minimum value of compared output 0, output is sent out, and if present value increases to be equal to or greater than the minimum value of compared output 0, output is not sent out.

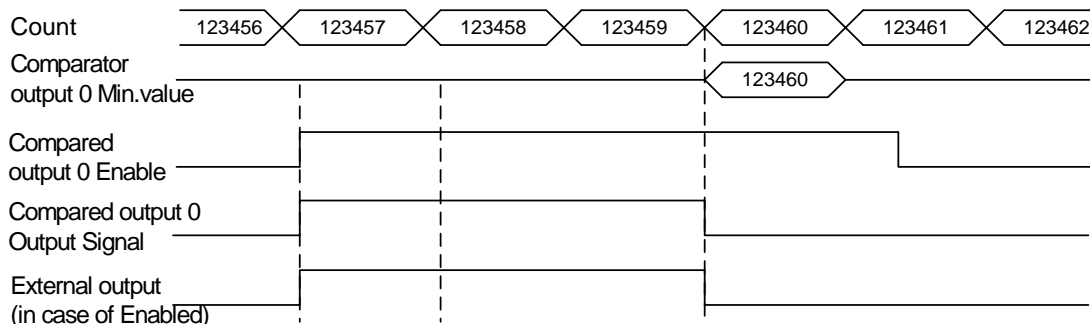

2) Mode1 (Count value ≤ Compared value)

If present count value is less than or equal to the minimum set value of compared output 0, output is sent out, and if count value increases to be greater than the minimum set value of compared output 0, output is not sent out.

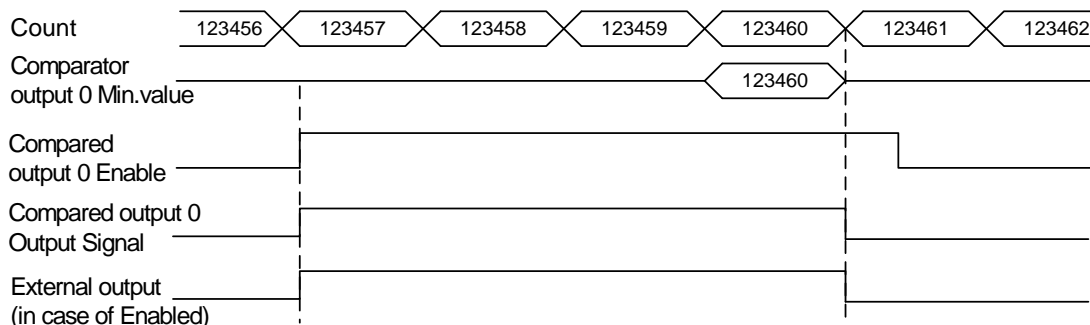

3) Mode 2 (Count value = Compared value)

If present count value is equal to the minimum set value of compared output 0, output is On. The output will keep turning on even if count value is changed from set value when count value is increased or decreased. In order to turn the output Off, Compared output Enable signal 0 is to be Off, or Compared match flag of K area and External output point are forced to be Off

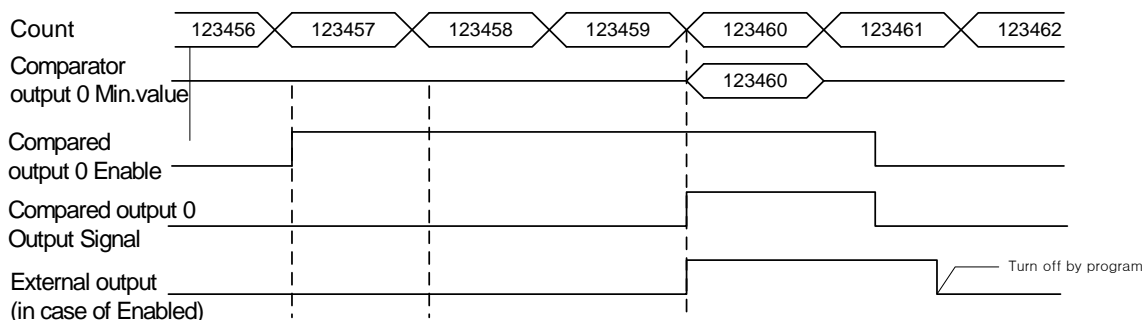

4) Mode 3 (Count value \geq Compared value)

If present count value is greater than or equal to the minimum set value of compared output 0, output is sent out, and if count value decreases to be less than the minimum set value of compared output 0, output is not sent out.

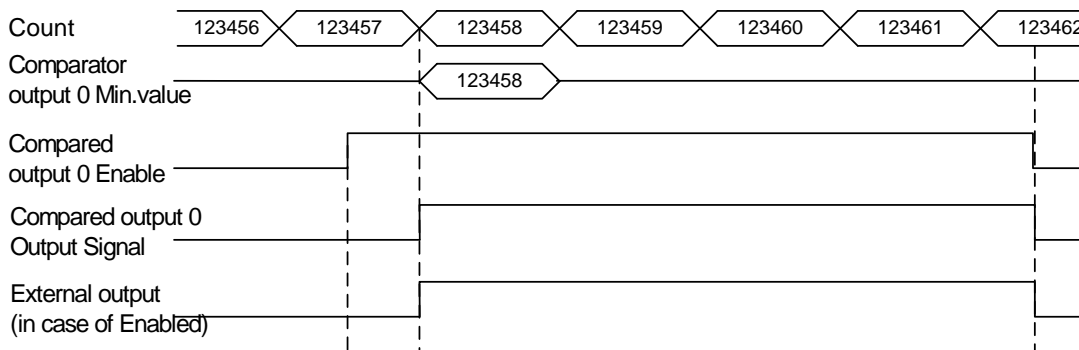
5) Mode 4 (Count value $>$ Compared Output value)

If present count value is greater than the minimum set value of compared output 0, output is sent out, and if count value decreases to be less than or equal to the minimum set value of compared output 0, output is not sent out.

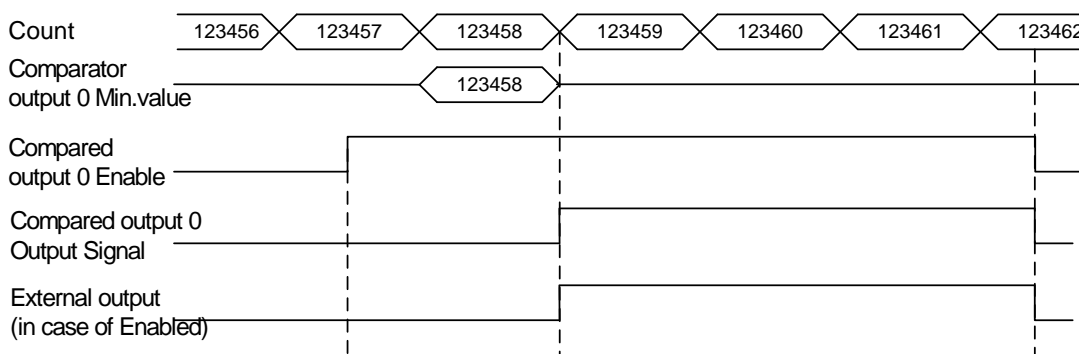

6) Mode 5

(Section comparison: Min. set value of Compared Output 0 \leq Count value \leq Max. set value of Compared Output 0)

If present count value is greater than or equal to the minimum set value of compared output 0 and less than or equal to the maximum set value of compared output 0, output is sent out, and if count value increases/decreases to exceed compared value's range, output is not sent out.

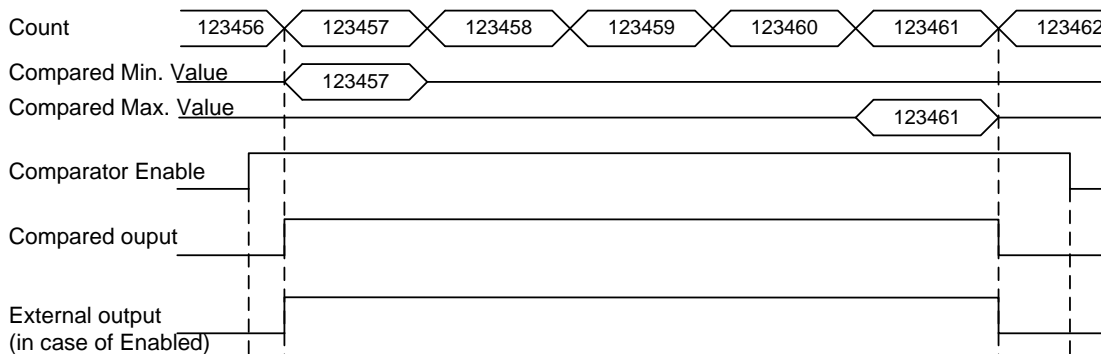

Chapter 4 Built-in High-speed Counter Function

- 7) Mode 6 (Count value \leq Min. set value of Compared Output 0 or Count value \geq Max. set value of Compared Output 0)
 If present count value is less than or equal to the minimum set value of compared 0 and greater than or equal to the maximum set value of compared 0, output is sent out, and if count value increases/decreases to exceed compared value's range, output is not sent out.

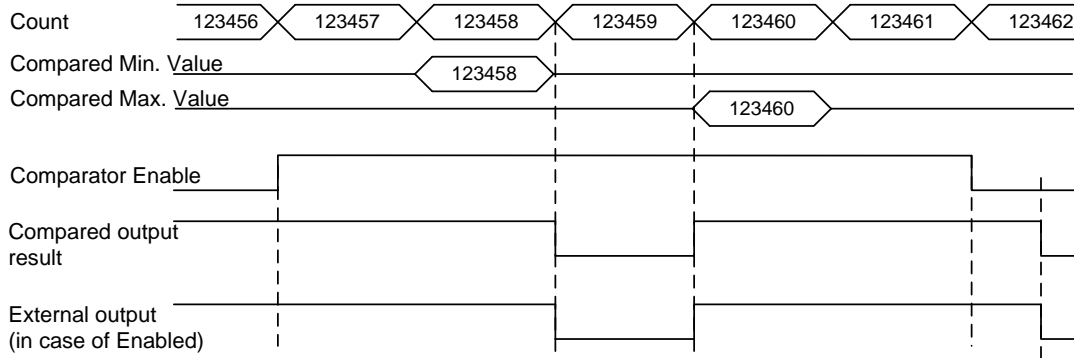

Remark

Ultimate performance XGB main unit checks present count value every $250\mu\text{s}$ and executes compared output function. Therefore, it can take maximum $250\mu\text{s}$ delay to detect compared condition.

(4) Carry signal

(a) Carry signal occurs

- 1) When count range maximum value of 2,147,483,647 is reached during Linear Count.
- 2) When user-defined maximum value of Ring Count changed to the minimum value during Ring Count.

(b) Count when Carry Signal occurs

- 1) Count stops if Carry occurs during Linear Count.
- 2) Count does not stop even if Carry occurs during Ring Count.

(c) Carry reset

- 1) The Carry generated can be cancelled by turning off the associated device area in the program.

Classification	Device area per channel(BIT)			
	Channel 0	Channel 1	Channel 2	Channel 3
Carry signal	%KX4176	%KX4336	%KX4496	%KX4656

(5) Borrow signal

(a) Borrow signal occurs

- 1) When count range minimum value of -2,147,483,648 is reached during Linear Count.
- 2) When user-defined minimum value of Ring Count changed to the maximum value during Ring Count.

(b) Count when Borrow signal occurs

- 1) Count stops if Borrow occurs during Linear Count.
- 2) Count does not stop even if Borrow occurs during Ring Count.

(c) Borrow reset

- 1) The Borrow generated can be cancelled by turning off the associated device area in the program.

Classification	Device area per channel(BIT)			
	Channel 0	Channel 1	Channel 2	Channel 3
Borrow signal	%KX4177	%KX4337	%KX4497	%KX4657

(6) Revolution/Unit time

While the Flag about the number of revolution per unit time is On, it counts the number of input pulses for the specified unit time so that the number of revolution per unit time is calculated.

(a) Setting

1) Set the unit time and the number of pulse per 1 revolution.

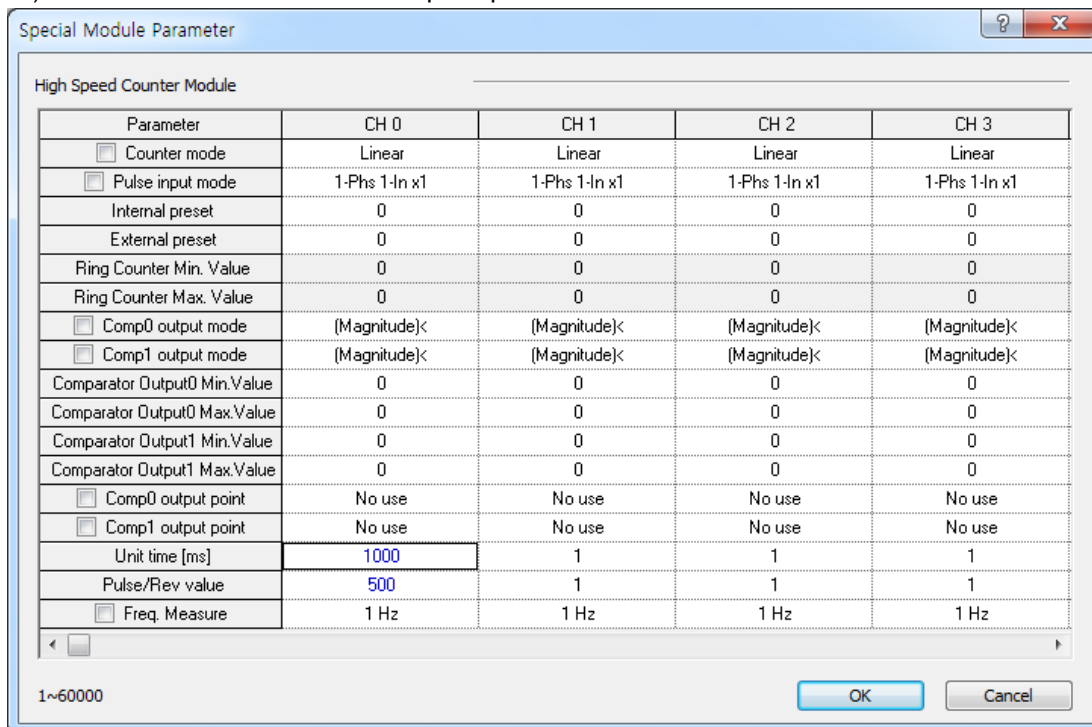

Setting value is saved at the following special K area and user can designate directly.

Classification	Device area per channels (WORD)				Operation
	Channel 0	Channel 1	Channel 2	Channel 3	
Unit time (1~60000ms)	%KW322	%KW352	%KW382	%KW412	1~60000ms
Pulse number /revolution (1~60000)	%KW323	%KW353	%KW383	%KW13	1~60000

2) In case of using Rev/unit time function, enable the following special K area

Classification	Device area per channels(BIT)				Operation
	Channel 0	Channel 1	Channel 2	Channel 3	
Revolution/unit time command	%KX4165	%KX4325	%KX4485	%KX4645	0: disable 1: enable

3) Rev/unit time value is saved at the following special K area.

Classification	Device area per channels(DWORD)			
	Channel 0	Channel 1	Channel 2	Channel 3
Revolution Per Unit	%KD132	%KD137	%KD142	%KD147

Chapter 4 Built-in High-speed Counter Function

(b) Count function of Revolution/Unit time is used to count the number of pulses for a specified time while auxiliary mode enable signal is On so that the number of revolution per unit time is calculated as follow.

$$\text{Input pulse} \left(\frac{\text{pls}}{\text{sec}} \right) \times \frac{\text{unit time}(\text{ms}) \times \frac{1}{1000}}{\text{number of pulses per a revolution}(\text{pls})} = \text{Revolution/Unit time}$$

(c) Number of Revolution per 1 second is indicated after number of pulse per 1 revolution is set and time is set to 1 second (1000ms). In order to indicate by Revolutions per minute (RPM), set the Unit time to 1 minute(60,000ms).

(d) In case of that number of pulse per 1 revolution set to '10', the example of calculating Revolution/Unit time is as shown below.

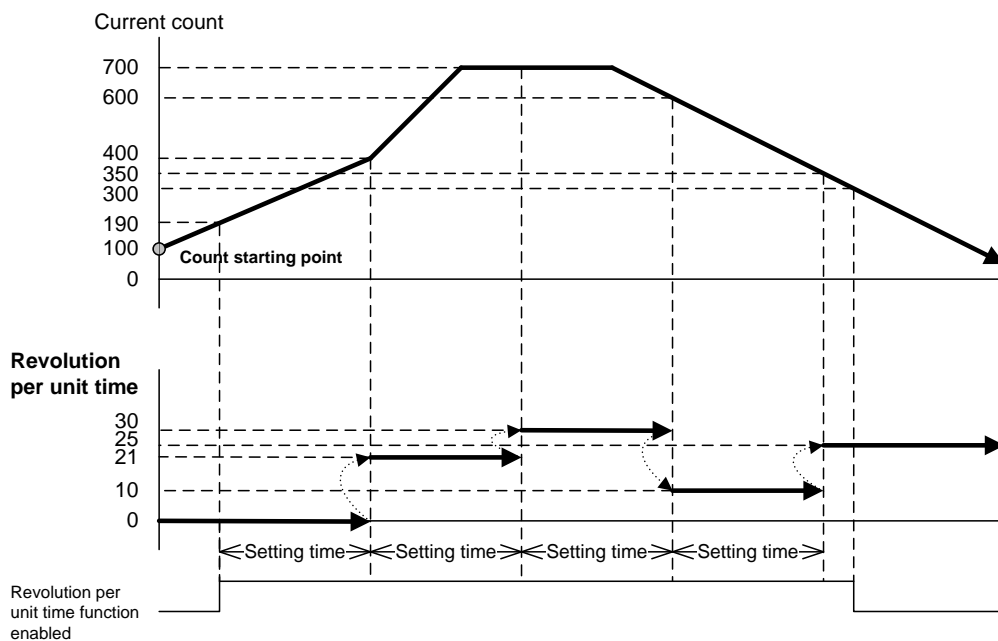

(7) Latch counter function

Latch counter function latches the current counter value when the power is turned off in case of that latch counter enable signal is On.

- Setting: If present counter value is to latch, set Count Latch Enable flag to On.

Classification	Device area per channel(BIT)				Operation
	Channel 0	Channel 1	Channel 2	Channel 3	
Count latch command	%KX4166	%KX4326	%KX4486	%KX4646	0: disable 1: enable

- Count latch function is operated when Count latch signal is On. Namely, counter value is not cleared when power supply Off =>On and mode change, it is counted from previous value.
- In latch counter function, internal or external preset function has to use for clearing present value.

(8) Preset function

It changes the current value into preset value.

There are two types of preset function, internal preset and external preset. External preset is fixed as input contact point of main unit (%IX0.0.4 ~%IX0.0.7).

Parameter	CH 0	CH 1	CH 2	CH 3
<input type="checkbox"/> Counter mode	Linear	Linear	Linear	Linear
<input type="checkbox"/> Pulse input mode	1-Phs 1-In x1	1-Phs 1-In x1	1-Phs 1-In x1	1-Phs 1-In x1
Internal preset	100	0	0	0
External preset	200	0	0	0
Ring Counter Min. Value	0	0	0	0
Ring Counter Max. Value	0	0	0	0
<input type="checkbox"/> Comp0 output mode	(Magnitude)<	(Magnitude)<	(Magnitude)<	(Magnitude)<
<input type="checkbox"/> Comp1 output mode	(Magnitude)<	(Magnitude)<	(Magnitude)<	(Magnitude)<
Comparator Output0 Min.Value	0	0	0	0
Comparator Output0 Max.Value	0	0	0	0
Comparator Output1 Min.Value	0	0	0	0
Comparator Output1 Max.Value	0	0	0	0
<input type="checkbox"/> Comp0 output point	No use	No use	No use	No use
<input type="checkbox"/> Comp1 output point	No use	No use	No use	No use
Unit time [ms]	1	1	1	1
Pulse/Rev value	1	1	1	1
<input type="checkbox"/> Freq. Measure	1 Hz	1 Hz	1 Hz	1 Hz

- Preset setting value is saved at the following special K area.

Type	Area per each channel (DWORD)				Ref.
	Ch.0	Ch.1	Ch.2	Ch.3	
Internal preset	%KD152	%KD167	%KD182	%KD197	-
External preset	%KD153	%KD168	%KD183	%KD198	-

- Preset command is specified through the following special K area, external preset is used by executing the designated input contact point after allowance bit is on.

Type	Area per each channel (BIT)				Ref.
	Ch.0	Ch.1	Ch.2	Ch.3	
Internal preset command	%KX4161	%KX4321	%KX4481	%KX4641	-
External preset allowance	%KX4162	%KX4322	%KX4482	%KX4642	-
External preset command	%IX0.0.4	%IX0.0.5	%IX0.0.6	%IX0.0.7	-

- External preset is executed in case of that rising edge of external preset input contact is occurred when external preset allowance is enabled.

Chapter 4 Built-in High-speed Counter Function

(9) Frequency measurement function

The function measures and displays the frequency for every measurement cycle when frequency measurement enable flag is On.

(a) Setting

- 1) Set up Frequency Measure mode.

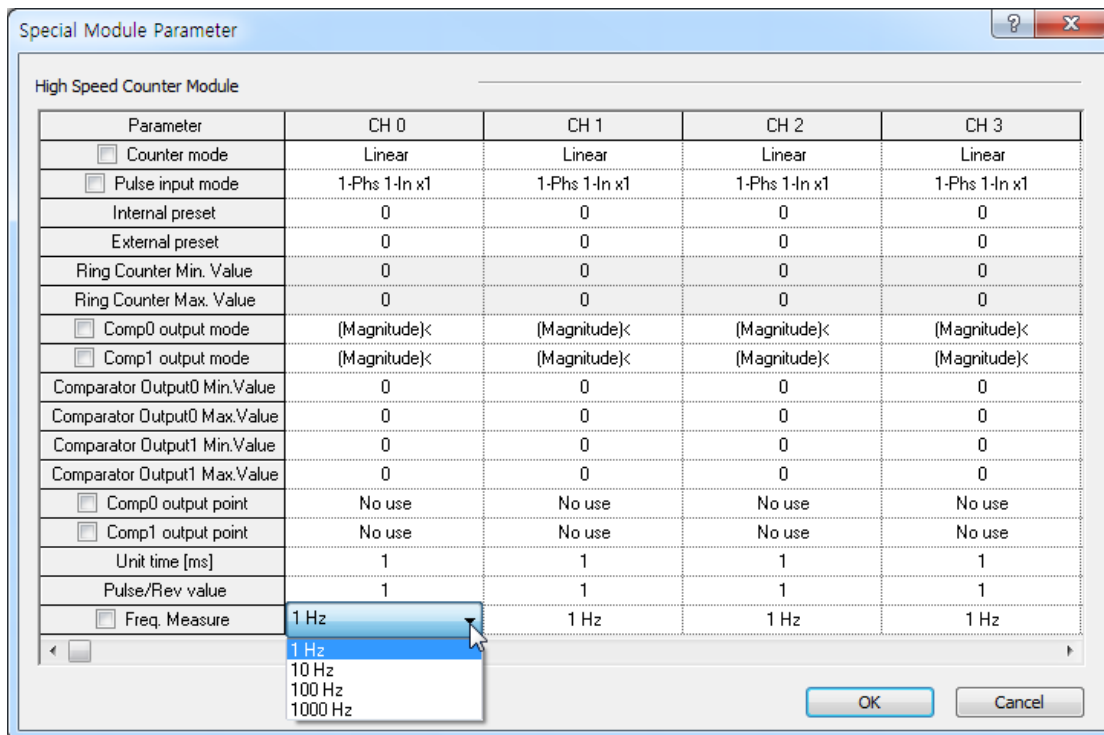

Setting value is saved at the following special K area and user can designate directly.

Class	Area per each channel (WORD)				Operation
	Ch.0	Ch.1	Ch.2	Ch.3	
Frequency Measuring Period	%KW324	%KW354	%KW384	%KW414	1, 10, 100, 1000 Hz

- 2) Set Frequency measurement enable flag to 'Enable' when using frequency measurement function.

Class	Area per each channel (BIT)				Operation
	Ch.0	Ch.1	Ch.2	Ch.3	
Frequency measurement enable command	%KX4168	%KX4328	%KX4488	%KX4648	0: disable 1: enable

- 3) Frequency measurement value is saved at the following special K area.

Class	Area per each channel (DWORD)				Ref.
	Ch.0	Ch.0	Ch.0	Ch.0	
Frequency measurement value	%KD134	%KD139	%KD144	%KD149	

- 4) Frequency input mode can be specified as below, whose update cycle and resolution will be decided based on the applicable mode.

Frequency unit setting	Unit[Hz]	Updated cycle[ms]
0	1	1000
1	10	100
2	100	10
3	1000	1

- 5) In case of setting up the frequency unit to 1Hz, the operation of frequency measurement function is as show below.

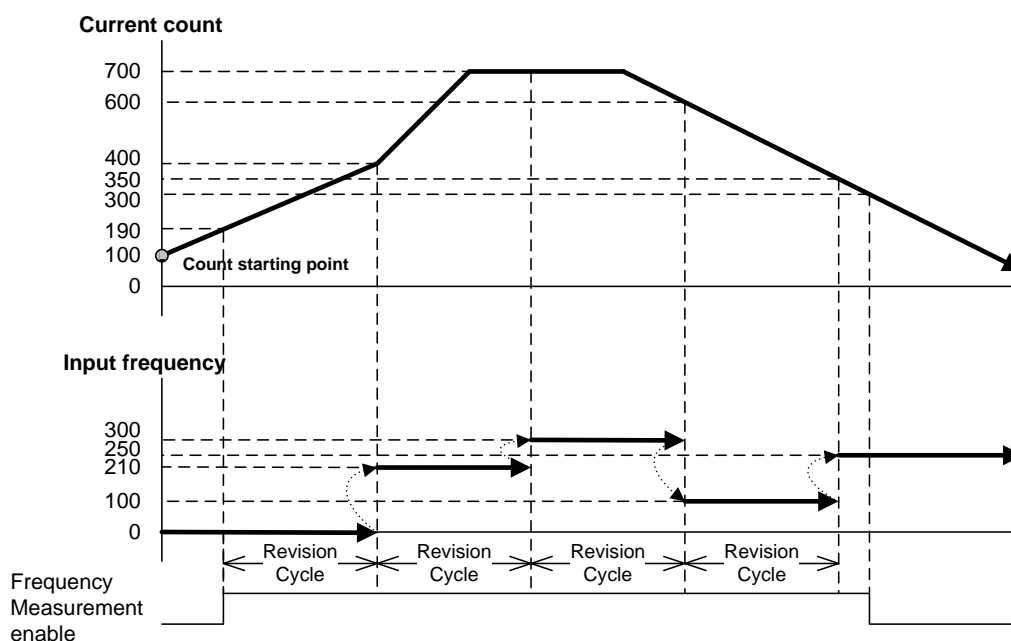

(10) Count pause

Count operation is not executed even if pulses are input when count pause flag is On.

Set the count pause signal to On when using count pause function.

Class	Area per each channel (BIT)				Operation
	Ch.0	Ch.0	Ch.0	Ch.0	
Count pause	%KX4170	%KX4330	%KX4490	%KX4650	0: disable 1: enable

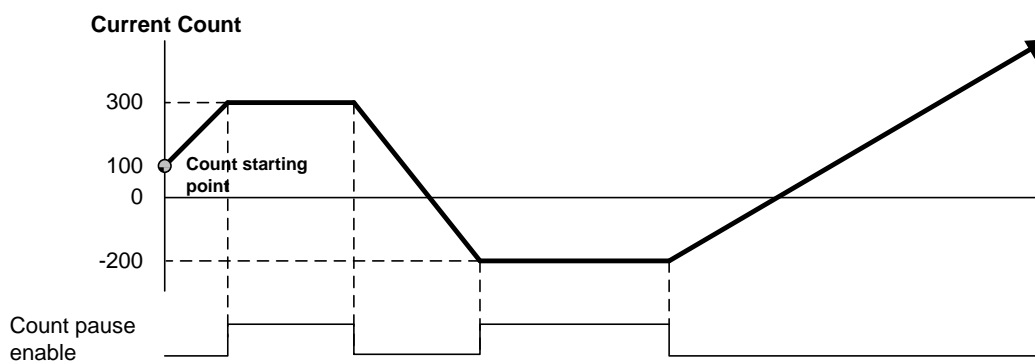

Chapter 4 Built-in High-speed Counter Function

(11) Counter clear

The current count is changed to 0 the moment the counter clear enable flag is turned on. The counter clear function operates at the rising edge of the flag enable command.

Type	Area per each channel (BIT)				Operation
	Ch.0	Ch.1	Ch.2	Ch.3	
Counter Clear	%KX4169	%KX4329	%KX4489	%KX4649	0: Disable 1: Enable

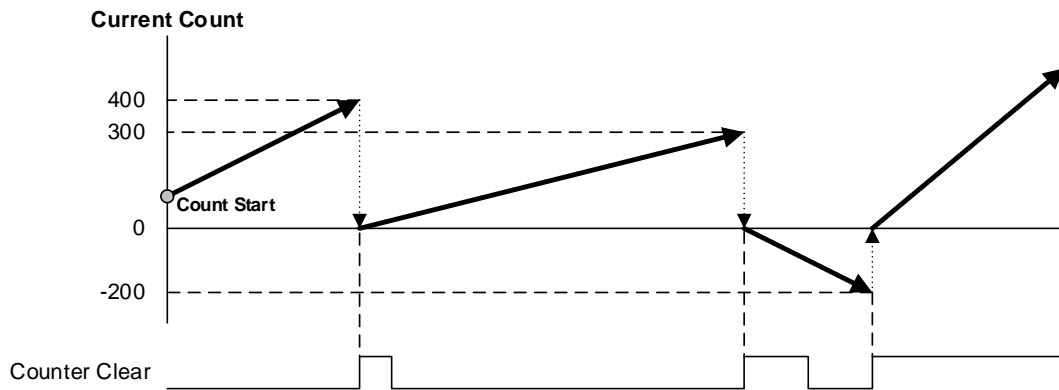

4.2 Installation and Wiring

4.2.1 Precaution for Wiring

Pay attention to the counteractions against wiring noise especially for high-speed counter input.

- (1) Make sure of using separate cables for the power line and external I/O signal line of high-speed counter module so that it is not affected from surge or induced noise from power line.
- (2) The wire has to be selected by considering the permitted current and the ambient temperature.
- (3) If the wire is so near with high temperature machines and materials, or is contacted with oil for a long time, it can be short circuit or malfunction.
- (4) Check the polarity before applying external I/O signal to terminal.
- (5) In case of that the high voltage line and the power line are wired at the same time, the induced interruption is caused. So it can be a reason for abnormal operation or malfunction.
- (6) When using pipe for wiring, grounding for pipe is necessary.
- (7) Use shielded twisted pair cable for wiring pulse input to high-speed counter. If it is speculated that there is a noise source for wiring between high-speed counter and connected devices.
- (8) Connect only A-phase in case of 1-phase input.
- (9) Wire with due regard to maximum output length of pulse generator and wiring should be as short as possible.
- (10) Make sure of grounding with class 3 grounding which is dedicated to the PLC.

4.2.2 Example of Wiring

- (1) When pulse generator(encoder) is voltage output.

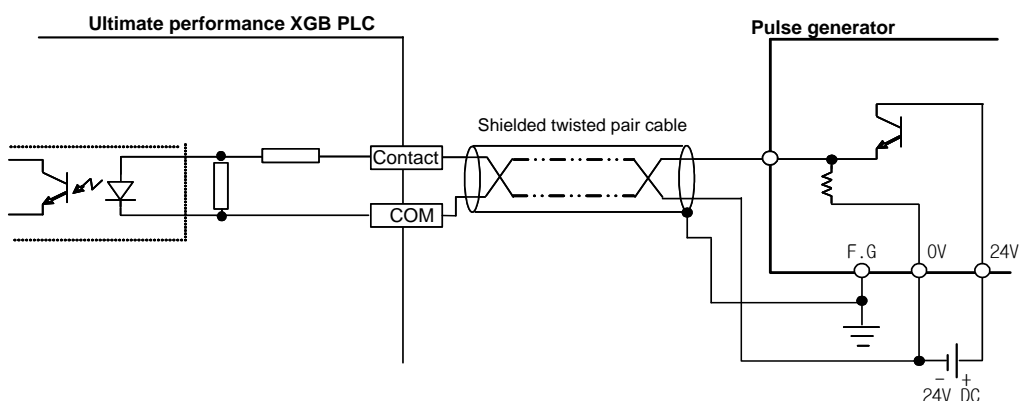

- (2) When pulse generator is open-collector output type.

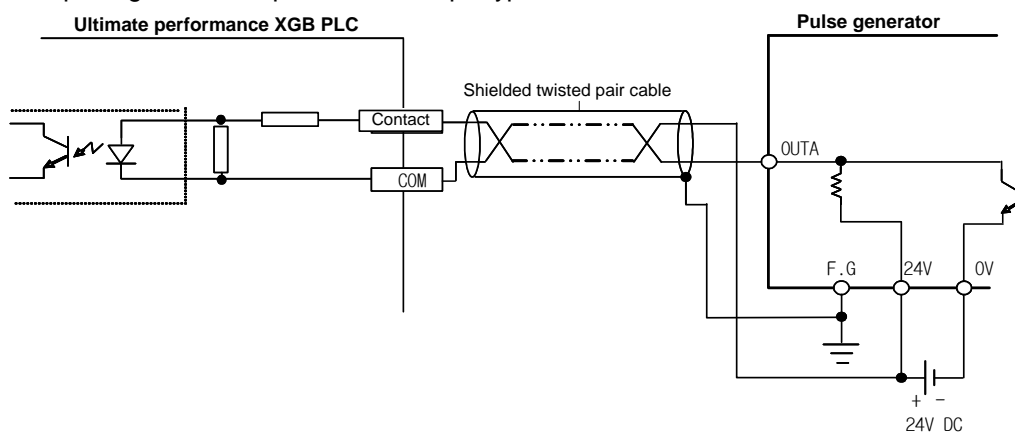

4.3 Internal Memory

4.3.1 Special Area for High-speed Counter

Parameter and operation command area of built-in high-speed counter use special K devices.

If values set in parameter are changed, it works with the changed values.

(1) Parameter setting area

Parameter	Description		Device area per channel				Remark
	Value	Setting	Ch 0	Ch 1	Ch 2	Ch 3	
Counter mode	h0000	Linear count	%KW300	%KW330	%KW360	%KW390	Word
	h0001	Ring count					
Pulse input mode setting	h0000	1 phase 1 input 1 multiplication	%KW301	%KW331	%KW361	%KW391	Word
	h0001	1 phase 2 input 1 multiplication					
	h0002	CW / CCW					Word
	h0003	2 phase 4 multiplication					
Comp. Output 0 mode setting	h0000	(Magnitude) <	%KW302	%KW332	%KW362	%KW392	Word
	h0001	(Magnitude) ≤					
	h0002	(Magnitude) =					
	h0003	(Magnitude) ≥					
	h0004	(Magnitude) >					
	h0005	(Range) Include					
	h0006	(Range) Exclude					
Comp. Output 1 mode setting	h0000	(Magnitude) <	%KW303	%KW333	%KW363	%KW393	Word
	h0001	(Magnitude) ≤					
	h0002	(Magnitude) =					
	h0003	(Magnitude) ≥					
	h0004	(Magnitude) >					
	h0005	(Range) Include					
	h0006	(Range) Exclude					
Internal preset Value setting	-2,147,483,648 ~ 2,147,483,647		%KD152	%KD167	%KD182	%KD197	DWord
External preset Value setting	-2,147,483,648 ~ 2,147,483,647		%KD153	%KD168	%KD183	%KD198	DWord
Ring counter min. value setting	-2,147,483,648 ~ 2,147,483,645		%KD154	%KD169	%KD184	%KD199	DWord
Ring counter max. value setting	-2,147,483,646 ~ 2,147,483,647		%KD155	%KD170	%KD185	%KD200	DWord
Comp. output min. value setting	-2,147,483,648 ~ 2,147,483,647		%KD156	%KD171	%KD186	%KD201	DWord
Comp. output max. value setting	-2,147,483,648 ~ 2,147,483,647		%KD157	%KD172	%KD187	%KD202	DWord

Chapter 4 Built-in High-speed Counter Function

Parameter	Description		Device area per channel				Remark
	Value	Setting	Ch 0	Ch 1	Ch 2	Ch 3	
Comp. output 0 point designation	HFFFF	No use	%KW320	%KW350	%KW380	%KW410	Word
	h0000	%QX0.0.1					
	h0001	%QX0.0.2					
	h0002	%QX0.0.3					
	h0003	%QX0.0.4					
	h0004	%QX0.0.5					
	h0005	%QX0.0.6					
	h0006	%QX0.0.7					
	h0007	%QX0.0.8					
	h0008	%QX0.0.9					
	h0009	%QX0.0.10					
	h000A	%QX0.0.11					
	h000B	%QX0.0.12					
	h000C	%QX0.0.13					
	h000D	%QX0.0.14					
	h000E	%QX0.0.15					
h000F	%QX0.0.16						
Comp. output 1 point designation	HFFFF	No use	%KW321	%KW351	%KW381	%KW411	Word
	h0000	%QX0.0.1					
	h0001	%QX0.0.2					
	h0002	%QX0.0.3					
	h0003	%QX0.0.4					
	h0004	%QX0.0.5					
	h0005	%QX0.0.6					
	h0006	%QX0.0.7					
	h0007	%QX0.0.8					
	h0008	%QX0.0.9					
	h0009	%QX0.0.10					
	h000A	%QX0.0.11					
	h000B	%QX0.0.12					
	h000C	%QX0.0.13					
	h000D	%QX0.0.14					
	h000E	%QX0.0.15					
h000F	%QX0.0.16						
Unit time [ms]	1 ~ 60,000 ms		%KW322	%KW352	%KW382	%KW412	Word
Pulse/Rev.value	1 ~ 60,000		%KW323	%KW353	%KW383	%KW413	Word
Frequency Measurement cycle setting	h0000	1Hz	%KW324	%KW354	%KW384	%KW414	Word
	h0001	10Hz					
	h0002	100Hz					
	h0003	1000Hz					
							Word

Chapter 4 Built-in High-speed Counter Function

(b) Operation command

Parameter	Device area per channel			
	Ch 0	Ch 1	Ch 2	Ch 3
Counter enabling	%KX4160	%KX4320	%KX4480	%KX4640
Internal preset designation of counter0	%KX4161	%KX4321	%KX4481	%KX4641
External preset enabling of counter1	%KX4162	%KX4322	%KX4482	%KX4642
Designation of decremental counter	%KX4163	%KX4323	%KX4483	%KX4643
Comp. output enabling	%KX4164	%KX4324	%KX4484	%KX4644
Enabling of revolution time per unit time	%KX4167	%KX4327	%KX4487	%KX4647
Designation of latch counter	%KX4165	%KX4325	%KX4485	%KX4645
Carry signal (Bit)	%KX4166	%KX4326	%KX4486	%KX4646
Borrow signal	%KX4168	%KX4328	%KX4488	%KX4648
Comp. output signal	%KX4176	%KX4336	%KX4496	%KX4656

(c) Monitor Area

Parameter	Device area per channel				Remark
	Ch 0	Ch 1	Ch 2	Ch 3	
Current counter value	%KD131	%KD136	%KD141	%KD146	DWORD
Revolution time per unit time	%KD132	%KD137	%KD142	%KD147	DWORD
Frequency measurement	%KD134	%KD139	%KD144	%KD149	

4.3.2 Error code

It describes errors of the built-in high-speed counter.

- Error occurred is saved in the following area.

Category	Device area per channel				Remark
	Ch0	Ch1	Ch2	Ch3	
Error code	%KW266	%KW276	%KW286	%KW296	WORD

- Error codes and descriptions

Error code (Decimal)	Description
20	Counter type is set out of range
21	Pulse input type is set out of range
22	Requesting #1(3,)channel Run during the operation of #0(2) channel 2 phase * During #0(2) channel 2 phase inputting, using #1(3)channel is not possible.
23	Compared output type setting is set out of range.
25	Internal preset value is set out of counter range
26	External present value is set out of counter range
27	Ring counter setting is set out of range * Note ring counter setting should be 2 and more.
28	Compared output min. value is set out of permissible max. input range
29	Compared output max. value is set out of permissible max. input range
30	Error of Compared output min. value>Compared output max. value
31	Compared output is set out of the default output value
34	Set value of Unit time is out of the range
35	Pulse value per 1 revolution is set out of range
36	Compared output min. value is set out of permissible max. input range (Comp. output 1)
37	Compared output max. value is set out of permissible max. input range (Comp. output 1)
38	Error of Compared output min. value>Compared output max. value (Comp. output 1)
39	Compared output is set out of the default output value (Comp. output 1)
40	Frequency measurement cycle setting error

Remark

If two and more errors occur, the module displays the latest error code.

Chapter 4 Built-in High-speed Counter Function

4.4 Example of Using High-speed Counter

It describes examples of using high-speed counter.

(1) Setting high-speed counter parameter

How to set types of parameters to operate a high-speed counter is described as follows.

(a) Set 『Internal Parameters』 in the basic project window.

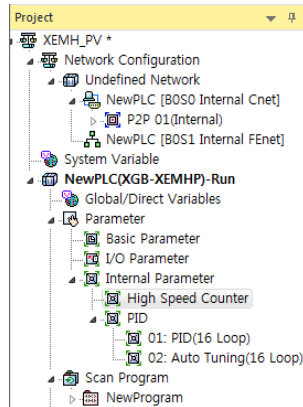

(b) Selecting high-speed counter opens a window to set high-speed counter parameters as follows.

(Every parameter settings are saved in the special K device area.)

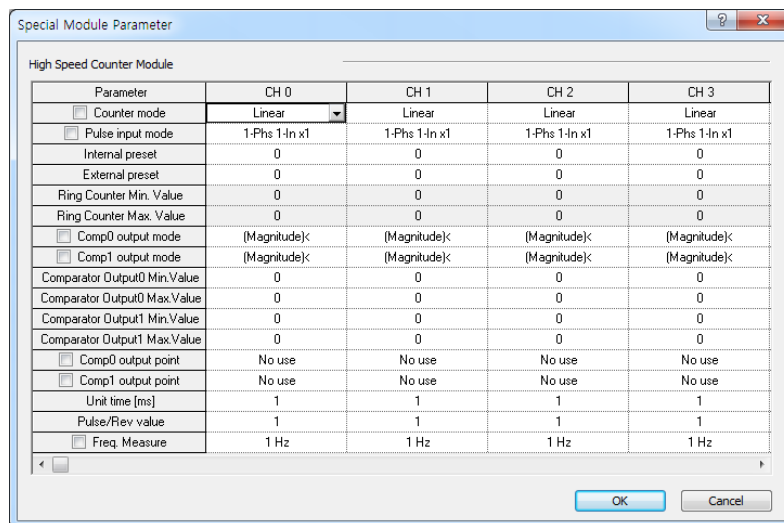

(c) Upon the setting, download program and parameter to PLC.

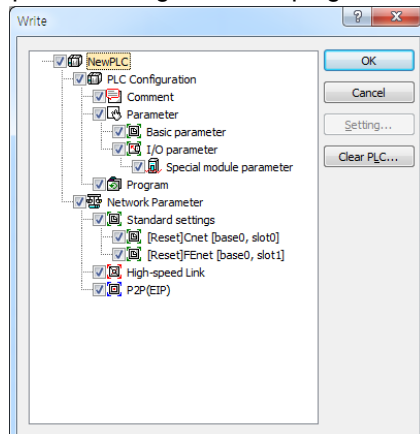

(c) Turn 'ON' the high-speed counter Enable signal (CH0:%KX4160) in the program.

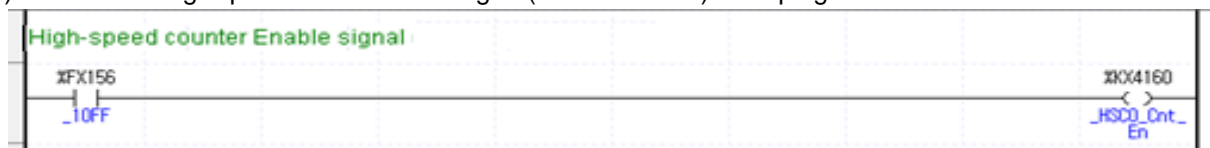

(d) To use additional functions of the high-speed counter, you need to turn on the flag allowing an operation command.

* Refer to <4.3.1 Special Area for High-speed Counter>

For instance, turn on K2605 bit if among additional functions in order to use revolution time per unit time function.

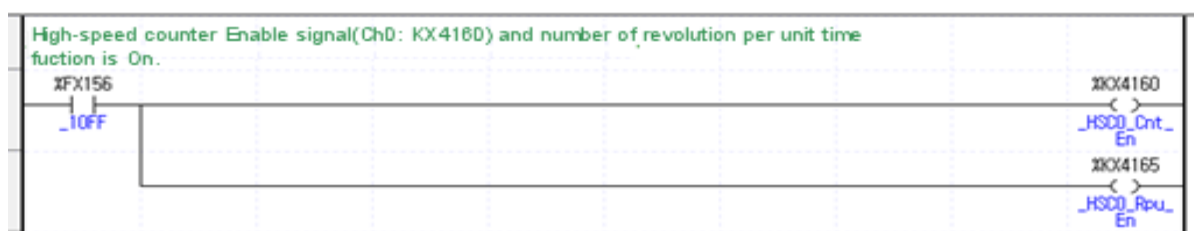

(2) Monitoring and setting command

Monitoring and command setting of high-speed counter are described as follows.

(a) If starting a monitor and clicking a Special Module Monitor, the following window is opened.

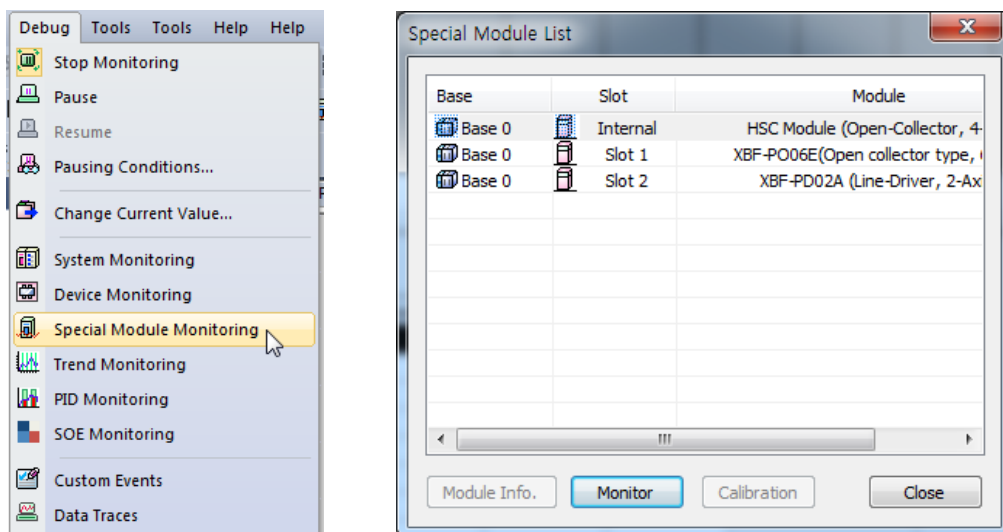

Chapter 4 Built-in High-speed Counter Function

(b) Clicking 『Monitor』 shows monitor and test window of high-speed counter.

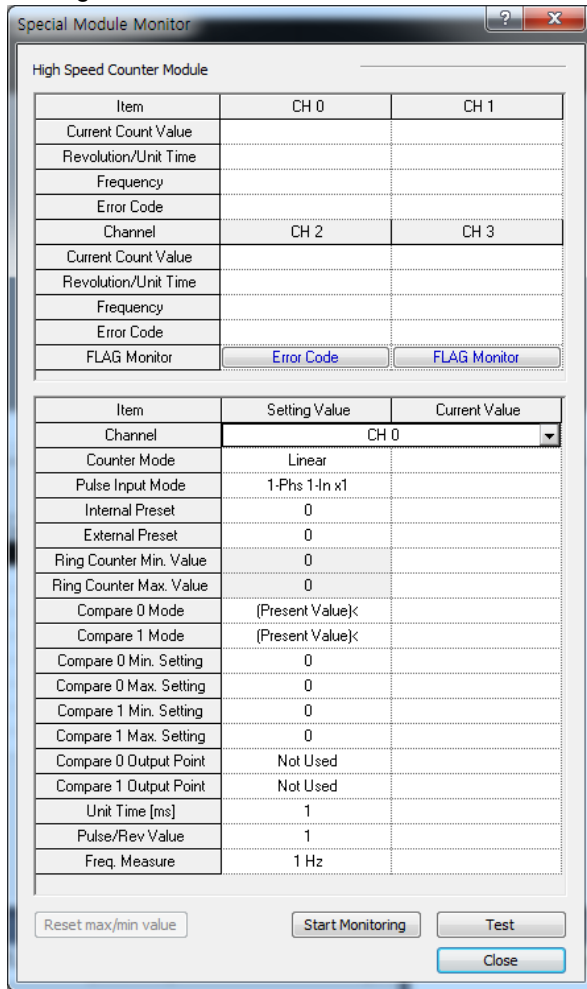

Item	Description
FLAG Monitor	Show flag monitoring and command window of high-speed counter
Start Monitoring	Start monitoring each item (special K device area monitor).
Test	Write each item setting to PLC. (Write the setting to special K device)
Close	Close monitor

(c) Clicking 『Start Monitoring』 shows the high-speed counter monitor display, in which you may set each parameter. At this moment, if any, changed values are not saved if power off=> on or mode is changed.

- (d) Clicking 『FLAG Monitor』 shows the monitor of each flag in high-speed counter, in which you may direct operation commands by flags (clicking commands reverse turn).

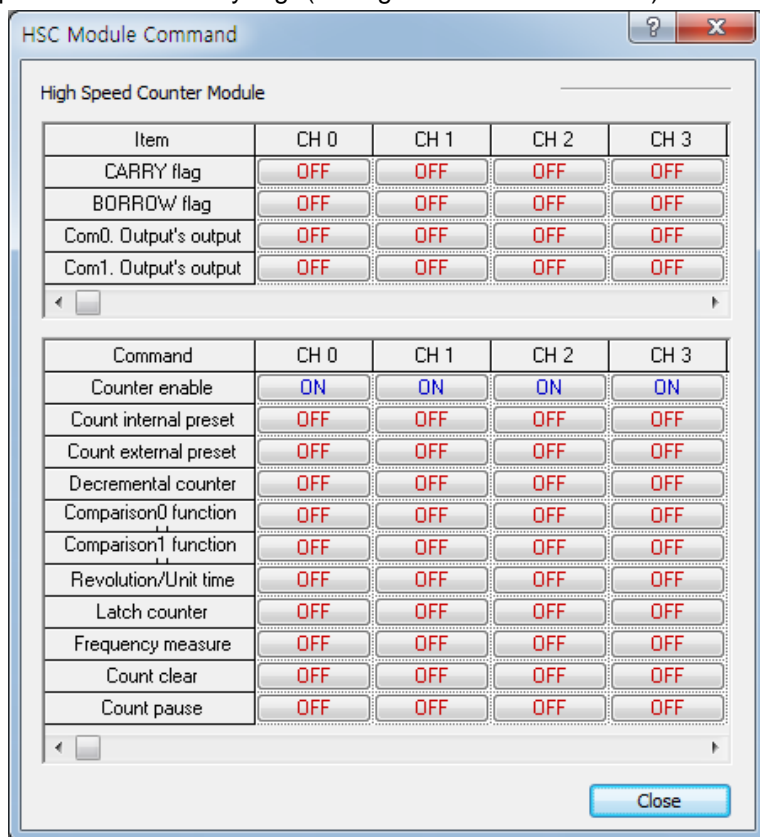

Chapter 5. Built-in PID Function

5.1 Features of Built-in PID Function

Here describes built-in PID (Proportional Integral Derivative) function. When there is plant (target of control), Control means that the user changes the status such as velocity, temperature, position, voltage, current etc. as the user wishes. Here describes PID control that is most frequently used among diverse control methods.

Basic concept of PID control is as follows. First, it detects the PV (Process Value) through sensor and calculates what the difference with SV (Set value) is. Then it outputs MV (Manipulated Value) for PV to be same with SV.

At this time, 3 types of operation, such as Proportion, Integration, Derivation is executed according to the requirement of the user. PID control has high compatibility, flexibility, affordability in comparison with Robust control and Linear optimal control. In case of other control methods, since control device can be applied to the system after mathematical analysis of system, if system or the requirement of the user changes, the analysis of system is done again. But in case of PID control, PID device copes with change of system or requirement of the user with simple auto-tunings without analysis of system rapidly.

The figure 5.1 is example indicating system configuration of temperature control of heating system.

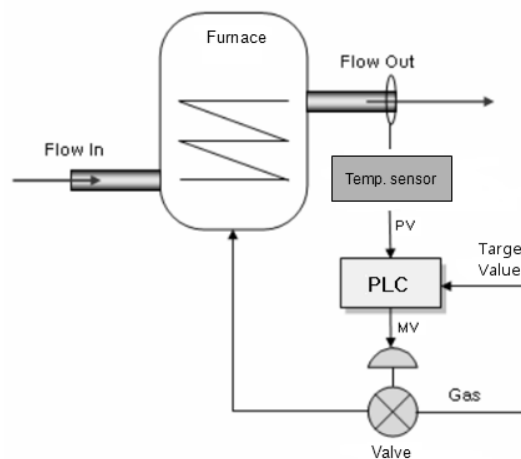

<Figure 5.1PID Temperature control system with PLC>

At this time, PLC becomes control device for this system, output temperature of heating system becomes target for control. And temperature sensor and valve becomes devices to detect and manipulate the status of system respectively. If temperature sensor detects the output temperature and inputs that to PLC, PLC manipulate the valve status through PID operation and control the quantity of gas that goes into heating system. So temperature of heating system changes. This process is called control loop and PID control is executed by repeating the control loop. The control loop is repeated with a cycle of ms ~ s.

The built-in PID control functions of XBM feature as follows.

- (1) Since operations are executed within CPU part, it can be controlled by PID parameters and PLC program without PID module.
- (2) A variety of controls can be selected
 - That is, a user can easily select P operation, PI operation and PID operation.
- (3) Precise control operation
 - It can make precise PID control operations possible through floating point operations.
- (4) PWM (Pulse Width Modulation) output available.
 - It outputs control operation results to the output contact point designated by a user through PWM.
- (5) Improving convenience of control settings and monitoring
 - Through parameter setting method and K area flag, it maximizes control parameter settings during operation and convenience of monitoring
- (6) Freely selectable operation direction
 - Forward, reverse and mixed forward/reverse operations are available
- (7) Cascade operation realizing quick and precise PID control
 - It can increase quickness of response to disturbance through cascade loop.
- (8) Various additional functions
 - PID control can be achieved by various methods a user wishes because set value ramp, the present value follow-up, limiting change of values and types of alarm functions are provided.

5.2 Basic Theory of PID Control

Here describes basic theory of PID control and how to configure PID control.

(1) Terms

Terms used in this user manual are as follows.

- PV: status of plant detected by sensor (Process value)
- SV: Target value (Set Value) to control plant, if control is done normally, PV should follow the SV.
- E: error between SV and PV. It can be expressed as (SV-PV).
- Kp: proportional coefficient
- Ti: Integral time constant. Sometimes called integral time
- Td: Derivative time constant. Sometimes called derivative time
- MV: Control input or control device output. The input to plant to make PV follow the V
- Ts: Sampling time, a cycle of operation to execute PID control

(2) PID operation expression

Basic PID operation expressions are as follows.

$$E = SV - PV \quad (5.2.1)$$

$$MV_p = K_p E \quad (5.2.2)$$

$$MV_i = \frac{K_p}{T_i} \int E dt \quad (5.2.3)$$

$$MV_d = K_p T_d \frac{dE}{dt} \quad (5.2.4)$$

$$MV = MV_p + MV_i + MV_d \quad (5.2.5)$$

PID control operation expressions of XGB series are more complicate than expression (5.2.1) ~ (5.2.5) mathematically but those are based on the above expression. The followings describe the characteristics of control process with an example that controls the output temperature of heating system in figure 5.1. At this example, the system and PID parameters imaginary to help the comprehension and those may be different with real heating system. If the heating system in figure 5.1 is expressed as second order system with transfer function like expression (5.2.6) in frequency domain, it is expressed as differential equation like expression (5.2.6) in the time domain.

$$\text{Transfer function} = \frac{32}{(2s+1)(3s+5)} \quad (5.2.6)$$

$$\frac{6}{32} \frac{d^2 y(t)}{dt^2} + \frac{13}{32} \frac{dy(t)}{dt} + 5y(t) = x(t) \quad (5.2.7)$$

That is, $x(t)$ is Manipulated value and $y(t)$ is Process value.

At this system, we assume that the PID parameter is specified as shown below to describe the PID control operation.

Items	Value	Items	Value
Output temperature of heating system (PV)	0°C	Proportional coefficient (K_P)	5
Target temperature (SV)	50°C	Integral time (T_i)	3s
Cycle of operation	0.01s	Derivative time (T_d)	0.19s

<Table 5.1 example of control of heating system>

At this system, if we assume that target value of output temperature is 50°C and initial value of output temperature is 0°C, SV and PV becomes 50 and 0 respectively. In case of this, PID controller acts as follows.

(3) Proportional control (P control)

In the proportional control, the controller yields output that is proportional to error.

Manipulated value of controller by Proportional control is as follows.

$$MV_P = E \times K_P \quad (5.2.8)$$

(a) If P control starts, output of controller by initial P operation is as follows.

$$MV_0 = 50 \times 5 = 250$$

If P control is executed for 10 seconds, output temperature will be as table 5.2.

If this is expressed with graph, it will be as Figure 5.2.

Time	Target temp.	Proportional coefficient	Output temp.	Error
0	50	5	0	50
1	50	5	44.98	5.02
2	50	5	53.08	-3.08
3	50	5	50.15	-0.15
4	50	5	48.42	1.58
5	50	5	48.28	1.72
6	50	5	48.44	1.56
7	50	5	48.49	1.51
8	50	5	48.49	1.51
9	50	5	48.49	1.51

< Table 5.2 example of Proportional control >

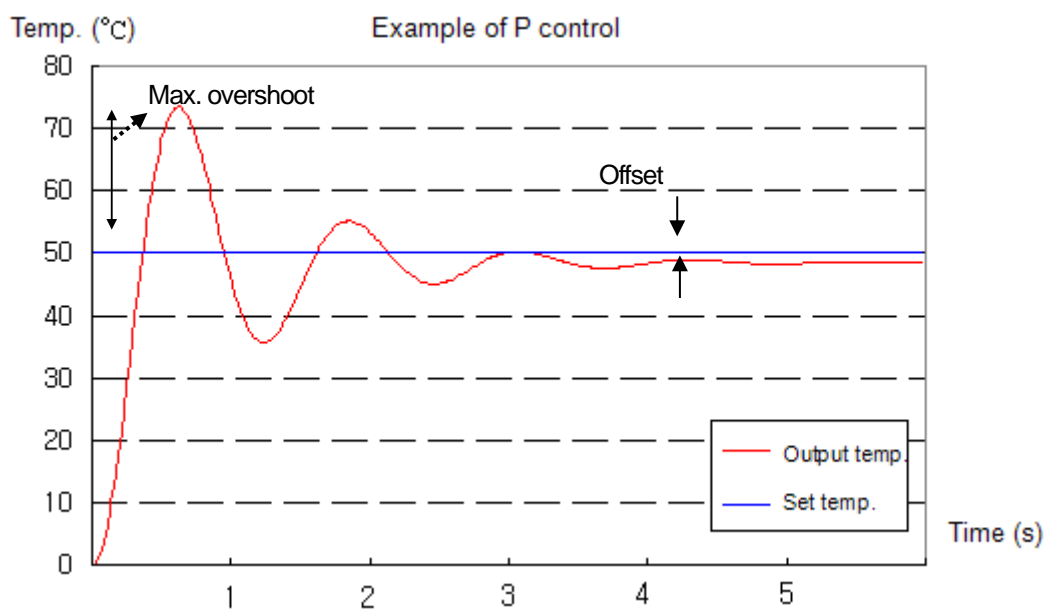

< Figure5.2 simulation of proportional control >

- (b) Concerning the result of simulation, it has the maximum overshoot of about 23.4°C at 0.62s and after 7s, it converges at 48.49°C with offset of 1.51°C (about 3%).

(c) Offset is an unavoidable error when only P control is executed. Offset decreases proportional to P coefficient but overshoot increases proportional to P coefficient. Table 5.3 and Figure 5.3 is simulation of offset and overshoot according to P coefficient.

Time	Target temperature	Kp = 5	Kp = 2.5	Kp = 1
0	50	0	0	0
1	50	45.02	63.46	46.67
2	50	53.11	42.52	46.77
3	50	50.15	47.93	41.38
4	50	50.22	47.25	41.60
5	50	48.27	46.96	43.30
6	50	48.35	46.92	43.25
7	50	48.44	46.90	43.21
8	50	48.53	46.90	43.18
9	50	48.53	46.90	43.18

<Table 5.3 Temperature- time table according to P coefficient>

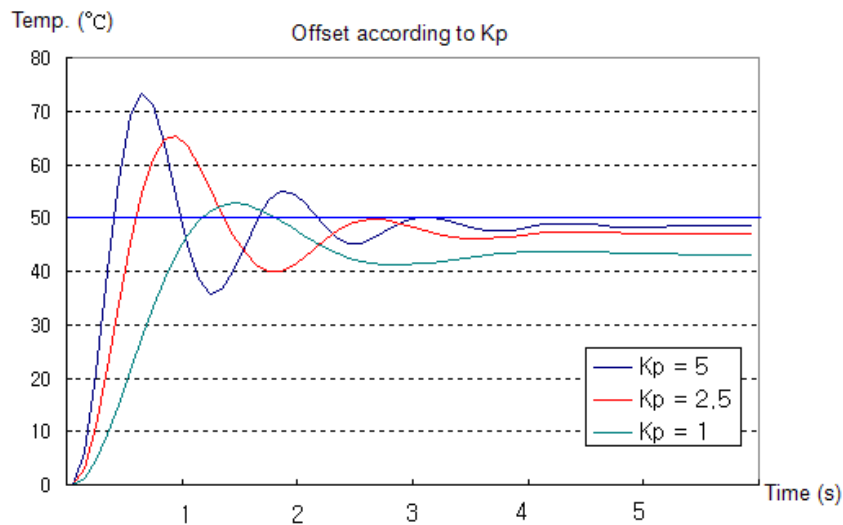

< Figure 5.3 Temperature- time graph according to P coefficient >

(c) Considering table 5.3, as P coefficient decreases, offset increases but overshoot decreases.

(d) Generally, offset can't be solved with only P control. In order to remove the offset, P control and I control is used together.

(4) Proportional Integral Control (PI Control)

In I control, it yields the output proportional to error accumulated according to time. And the expression is as follows.

$$MV_i = \frac{K_P}{T_i} \int E dt \quad (5.2.9)$$

(a) In the expression 5.2.9, T_i means the time takes for MV_i , output by I control, to be added into real output.

(b) Generally, I control is used with P control. So the expression of PI control is as follows.

$$MV = MV_P + MV_i = E \times K_P + \frac{K_P}{T_i} \int E dt \quad (5.2.10)$$

(c) In the above heating system, the simulation results are as shown in the table 5.4 when proportional coefficient is 2.5 and integral time is 1.5s.

Time	Target temp.	Proportional coefficient	Integral time	P Control	PI Control
0	50	2.5	1.5	0	0
1	50	2.5	1.5	63.46	74.41
2	50	2.5	1.5	42.52	40.63
3	50	2.5	1.5	47.93	52.99
4	50	2.5	1.5	47.05	49.67
5	50	2.5	1.5	46.96	49.70
6	50	2.5	1.5	47.12	50.38
7	50	2.5	1.5	47.03	49.76
8	50	2.5	1.5	47.07	50.14
9	50	2.5	1.5	47.06	49.94
10	50	2.5	1.5	47.06	50.02
11	50	2.5	1.5	47.06	49.99
12	50	2.5	1.5	47.06	50.00
13	50	2.5	1.5	47.06	50.00
14	50	2.5	1.5	47.06	50.00
15	50	2.5	1.5	47.06	50.00

< Table 5.4 Temperature- time table according to P coefficient >

(d) Considering table 5.4 and Figure 5.4, if P and I control is used together, offset is removed and temp. converges at 50°C, target temp. after 12s

- (e) But in this case, convergence time is longer than that of P control and overshoot is larger. Generally, as integral time increases, overshoot decrease. About this, refer to the Figure 5.5.

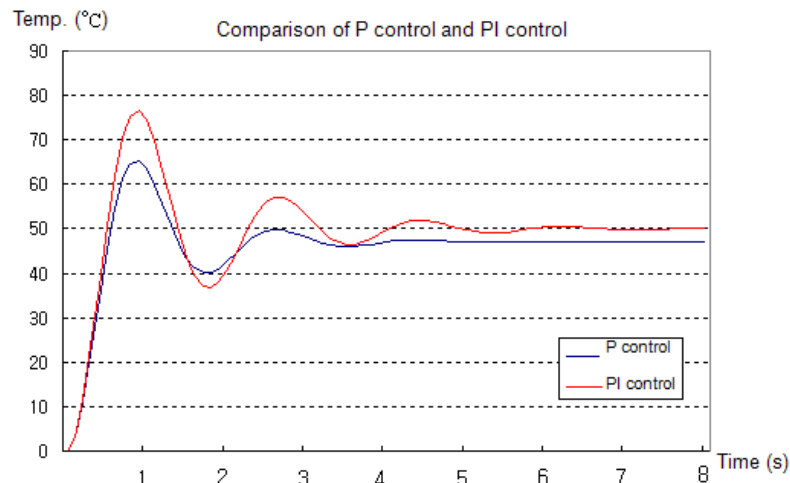

< Figure5.4 Temp.- time graph >

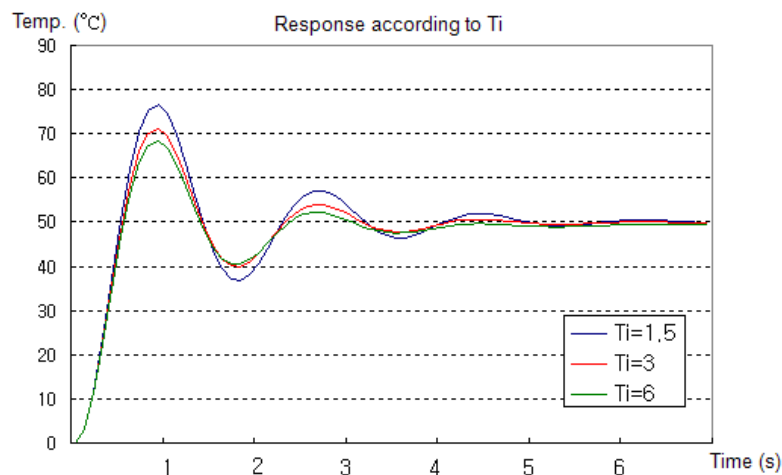

< Figure 5.5 overshoot according to integral time >

- (f) Like this, if I control is used, overshoot is larger. According to system, large overshoot can be problem. In order to solve this, PID control is used.
- (5) Proportional integral derivative control (PID control)

In D control, when status of system changes rapidly, D control yields the output to reduce the error. Namely, D control yields the output proportional to change velocity of current status. So if D control is used, response speed of controller about status change of system increases, and overshoot decreases. Output of controller by D control is as shown in expression 5.2.11.

$$MV_d = K_P T_d \frac{dE}{dt} \quad (5.2.11)$$

(a) In the expression 5.2.11, T_d means the time takes for MV_d output by I control, to be added into real output.

(b) Generally, D control is not used solely but with PD control. So PID control is expressed as expression 5.2.12.

$$MV = MV_p + MV_i + MV_d = E \times K_p + \frac{K_p}{T_i} \int E dt + K_p T_d \frac{dE}{dt} \quad (5.2.12)$$

(c) The Figure 5.6 is simulation result when PID control is applied to above heating system.

Time	Target temp.	Proportional coefficient	Integral time	Derivative time	PI Control	PID Control
0	50	2.5	1.5	0.3	0	0
1	50	2.5	1.5	0.3	74.41	55.50
2	50	2.5	1.5	0.3	40.63	56.33
3	50	2.5	1.5	0.3	52.99	52.50
4	50	2.5	1.5	0.3	49.67	50.92
5	50	2.5	1.5	0.3	49.70	50.34
6	50	2.5	1.5	0.3	50.38	50.12
7	50	2.5	1.5	0.3	49.76	50.05
8	50	2.5	1.5	0.3	50.14	50.02
9	50	2.5	1.5	0.3	49.94	50.01
10	50	2.5	1.5	0.3	50.02	50.00
11	50	2.5	1.5	0.3	49.99	50.00
12	50	2.5	1.5	0.3	50.00	50.00
13	50	2.5	1.5	0.3	50.00	50.00

< Table 5.5 comparison of PI control and PID control >

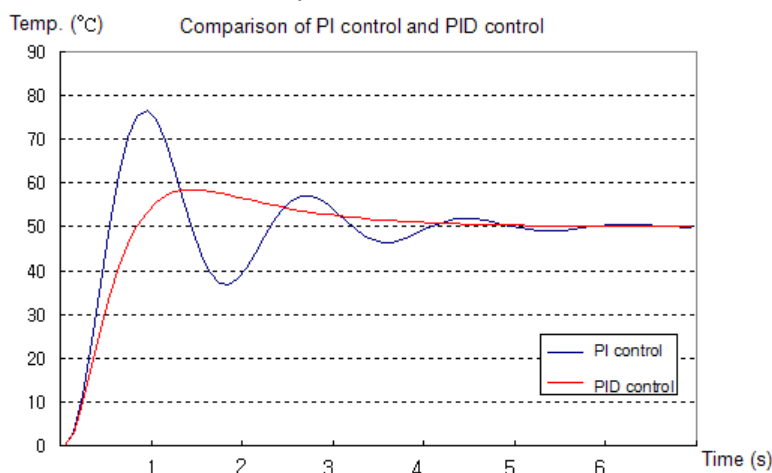

< Figure 5.6 comparison of PI control and PID control >

(d) Considering table 5.5, in case PID control is used, max. overshoot decreases from 16.5°C to 8.5°C. At this time, P coefficient, integral time, derivative time are not optimal values, just one of the examples. Actually, P coefficient, integral time, derivative time values vary according to PID control system.

5.3 Functional Specifications of PID Control

The performance specifications of the built-in PID control function in XGB series are summarized in the below table.

Item		Specifications
No. of loops		16 Loop
Scope of setting PID constants	Proportional constant(P)	Real number (0 ~ 3.40282347e+38)
	Integral constant(I)	Real number (0 ~ 3.40282347e+38), unit: second
	Differential constant(D)	Real number (0 ~ 3.40282347e+38), unit: second
Scope of set value		INT (-32,768 ~ 32,767)
Scope of present value		INT (-32,768 ~ 32,767)
Scope of maneuver value		INT (-32,768 ~ 32,767)
Scope of manual maneuver value		INT (-32,768 ~ 32,767)
Indication	RUN/STOP	Operation: PID RUN Flag On (by loops) Stop: PID RUN Flag Off (by loops)
	Error	Normal: PID Error Flag Off (by loops) Error: PID Error Flag On, Error code occurrence (by loops)
	Warning	Normal: PID Warning Flag Off (by loops) Error: PID Warning Flag On, Warnig code occurrence (by loops)
Control operation		Control of P,PI,PD and PID, control of forward/reverse operation
Control interval		10.0ms ~ 6,553.6ms (0.1msUnit)
Additional functions	PWM output	Supportable
	Mixed forward/reverse output	Supportable
	Limiting change of present value	INT (-32,768 ~ 32,767)
	Limiting change of maneuver value	INT (-32,768 ~ 32,767)
	Equally dividing set value	0 ~ 65,536 (frequency of control cycle time)
	Present value follow-up	0 ~ 65,536 (frequency of control cycle time)
	Cascade control	Supportable.
	Min./max. present value	-32,768 ~ 32,767
	Differential filter	0.01 ~ 655.35 (x 100 Scaled Up)
	Dead band setting	0 ~ 65,535
	Prevention of dual integral accumulation	Supportable
	PID operation pause	Supportable

< Table 5.6 built-in PID control performance specification >

5.4 Usage of PID Control Functions

5.4.1 PID Control Parameter Setting

To use the built-in PID control function of XGB series, it is necessary to set PID control parameters by loops in the parameter window and operate it through the commands. Here, it explains parameters to use PID control functions and how to set them.

(1) PID parameter settings

Follow the steps below to set the PID control function parameters of XGB series.

- (a) If selecting the built-in parameters in Parameter of the project window, it shows the built-in parameter setting window as in below figure.

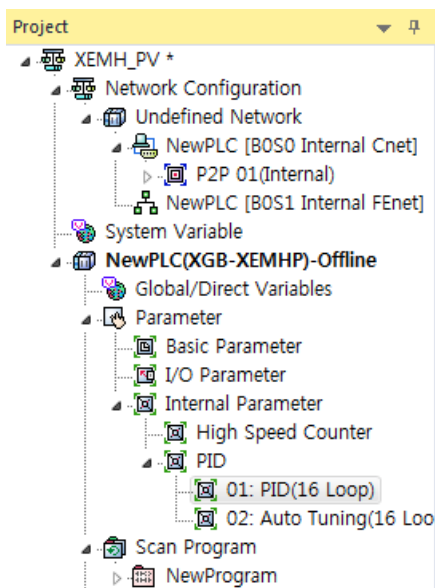

< Figure 5.7 Parameters setting window >

- (b) If selecting PID Control, it shows the PID control parameter setting window as in below figure.

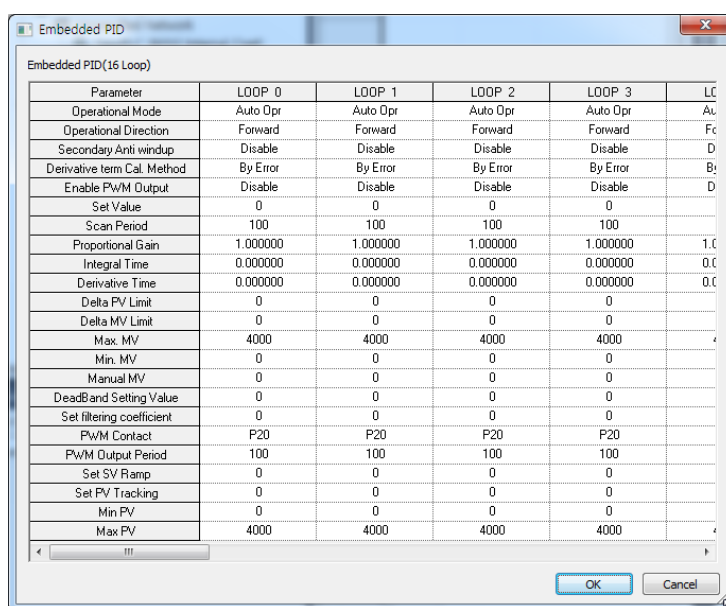

[Figure 5.8 Built-in PID function parameters setting window]

Chapter 5 Built-in PID Function

(c) Input items

The items to set in the built-in PID function parameter window and the available scope of them are summarized in below table.

Items	Description	Scope
RUN mode	Set the operation mode of PID control.	Auto/manual operation
RUN direction	Set the operation direction of PID control.	Forward/reverse
Prevention of dual integral accumulation	Set whether to allow dual integral accumulation.	Disabled/enabled
PWM output	Set whether to allow PWM output of maneuver value.	Disabled/enabled
Operation cycle time	Set the operation cycle time of PID control cycle.	100 ~ 65535
Set value	Set target control value.	-32,768 ~ 32,767
Proportional gain	Set proportional gain.	Real number
Integral time	Set integral time.	Real number
Differential time	Set differential time.	Real number
Limiting change of present value	Set the limited change of present value per operation cycle.	-32,768 ~ 32,767
Limiting change of maneuver value	Set the limited change of maneuver value per operation cycle.	-32,768 ~ 32,767
Max. maneuver value	Set the max. maneuver value for control.	-32,768 ~ 32,767
Min. maneuver value	Set the min. maneuver value for control.	-32,768 ~ 32,767
Manual maneuver value	Set the manual maneuver value for control.	-32,768 ~ 32,767
DeadBand setting	Set the deadband width of the set value.	0 ~ 65,535
Differential filter value	Set the filter coefficient of differential operation.	0 ~ 65,535
PWM junction	Set the junction to which PWM output is out.	P20 ~ P3F
PWM output cycle	Set the output cycle of PWM output.	100 ~ 65,535
Set value ramp	Set the frequency of set value ramp.	0 ~ 65,535
Present value follow-up	Set the follow-up frequency of the present value follow-up function.	0 ~ 65,535
Min. present value	Set the min. value of the input present value.	-32,768 ~ 32,767
Max. present value	Set the max. value of input present value.	-32,768 ~ 32,767

< Table 5.7 PID function parameter setting items >

(2) Description of Setting of PID Parameters

(a) Operation mode

It is the mode to set the operation for PID control of a loop in question.

The available scope is automatic operation or manual operation.

If automatic operation is selected, it outputs the PID control result internally operated by the input PID control parameter as the maneuver value while if manual operation is selected, it outputs the value input to the manual maneuver value parameter without PID operation modified. The default is automatic operation.

(b) Operation direction

It is designed to set the operation direction for PID control of a loop in question. The available scope is forward or reverse direction. At the moment, forward direction means increase of PV when MV increases; reverse direction means decrease PV when MV increases. For instance, a heater is a kind of forward direction system because PV(temperature) increases when output(heating) increases. A refrigerator is a kind of reverse direction system in which PV(temperature) decreases when output increases.

(c) Prevention of dual integral accumulation

It makes dual integral accumulation function enabled/disabled. To understand integral accumulation prevention function, it is necessary to explain the phenomenon of integral accumulation first of all. Every drive has a limit. That is, a motor is limited to the speed and a valve can become status overcoming the complete open/close. If it happens that MV output from a control is beyond the output limit of a drive, its output is maintained as saturated, which may deteriorate the control performance of a system and shorten the life of a drive. Formula (5.2.3) shows that the integral control among PID control output components accumulates errors as time goes on, from which it may take more time to return the normal status after the actuator is saturated in a system of which response characteristically is slow. It is so called integral accumulation phenomenon as illustrated in Fig. 5.9, which shows that if the initial error is very large, the error is continuously accumulated by integral control. Accordingly, a drive is saturated within its output upper limit while the control signal is getting larger, keeping being saturated for a long while until the drift becomes negative and the integral term turns small enough. Due to the operation, the PV may have a large over-shoot as seen in the figure. Such a wind-up phenomenon may occur if the initial drift is large or by a large disturbance or due to malfunction of a device.

The PID function of XGB series is basically with the integral accumulation prevention function, cutting off any integral accumulation phenomenon. In addition, it can detect a time when SV is suddenly decreased, providing a more strong dual integral accumulation prevention function.

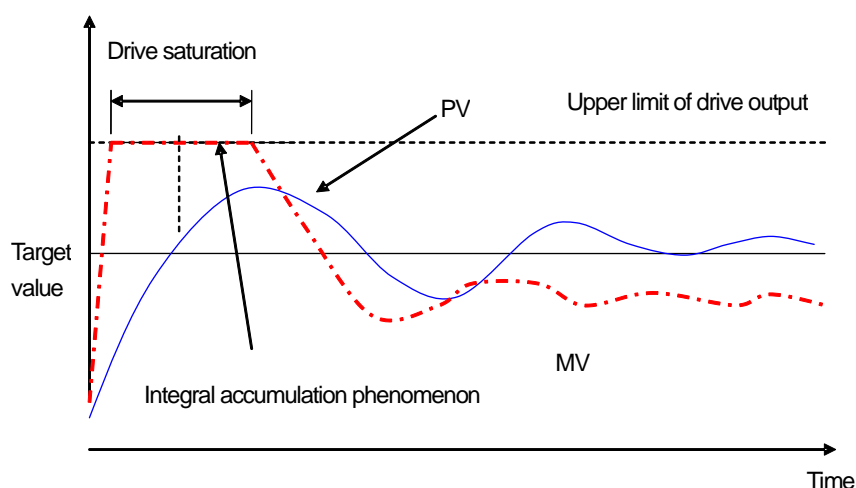

< Figure 5.9 Integral accumulation phenomenon >

(d) PWM Output Enabled

PWM output means an output method to turn a junction on – off with a duty proportional to control output calculated by a uniform output cycle. If PWM output is enabled, it realizes PWM output in accordance with PWM output cycle set in the parameter of PWM output junction(%QX0.0.0 ~ 0.0.31)designated in the parameter. At the moment, the PWM output cycle follows the PWM output cycle separately set in PID operation cycle. PWM output cycle is available between 10ms ~ 6553.5ms (setting value: 100 ~ 65,535) while it is set at a unit of integer per 0.1ms.

(Be aware, actual PWM output value have max. 2ms output err)

figure shows the relation between PID control output and PWM output.

Ex) if PWM output cycle: 1 second, PWM output junction: %QX0.0.0, max. output: 10000, min. output: 0

Time	Output	%QX0.0.0 junction operation
0 sec	5000	0.5 sec On, 0.5 sec Off
1 sec	3000	0.3 sec On, 0.7 sec Off

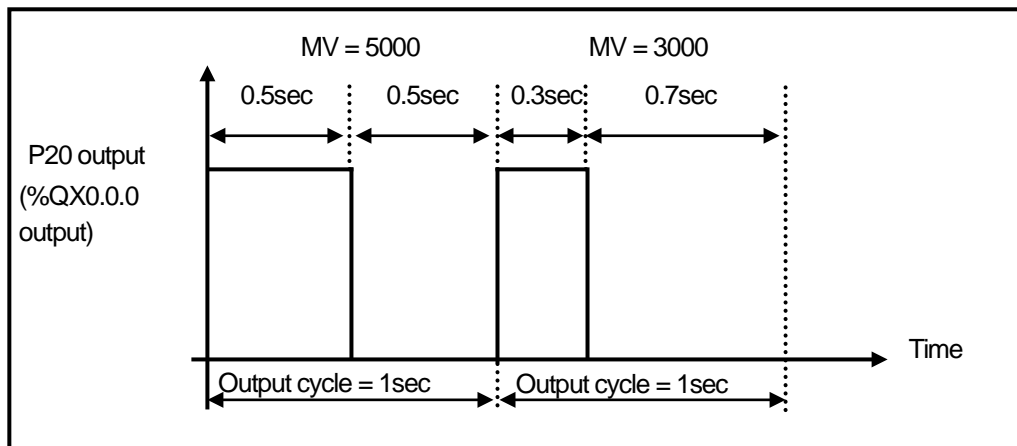

[Figure 5.10 Relation between PWM output cycle and MV]

(e) Set value

It sets the target of a loop in question, that is, the target status a user wishes to control. In case of the PID control built in XGB, physical values (temperature, flow rate, pressure and etc) of an object to control is not meaningful and instead, it should use the physical amount of an object to control after converting them into numerals. For instance, in order to control a system using a sensor that the output is 0V when its heating device temperature is 0°C while it is 10V when the temperature is 100°C as much as 50°C, it is necessary to set SV as 2000 (as long as it uses AD input module XBE-AD04A).

(f) Operation cycle

It sets the cycle to yield control output by executing the built-in PID operation. The setting cycle is 0.1ms and available between 10ms ~ 6553.5ms (setting value: 100 ~ 65,535) while it is set at a unit of integer per 0.1ms. For instance, to set PID operation per 100ms, set the operation cycle as 1000.

(g) Proportional gain

It is intended to set the proportional coefficient of a PID loop in question (K_p). As larger K_p , the proportional control operation is getting stronger. The scope is real number.

(h) Integral time

It sets the integral time of PID loop in question (T_i). As larger the integral time, the integral operation is getting weaker. The scope is real number at the unit of second.

(i) Differential time

It sets the differential time of PID loop in question (T_d). As larger the differential time, the differential operation is getting stronger. The scope is real number at the unit of second.

(j) Limiting change of present value

It sets the limit of change in present value of PID loop in question. If PV suddenly changes due to signal components such as sensor's malfunction, noise or disturbance during control of PID, it may cause sudden change of PID control output. To prevent the phenomenon, a user can set the max. limit of change in present value that is allowed per PID operation cycle. If the change of present value is limited accordingly, it may calculate the present value as much as the limit although the present value is changed more than the limit once the limit of change in present value is set. If using the PV change limit function, it may prevent against sudden change of control output owing to noise or etc. If it is, however, set too small, it may reduce the response speed to the PV change of an actual system, not to sudden change by noise or etc, so it is necessary to set the value appropriately according to the environment of a system to control in order that the PV toward the set value does not take a longer time. The available scope is between -32,768~32,767. If setting the PV change limit as 0, the function is not available.

(k) Limiting change of MV (Δ MV function)

It limits the max. size that control output, which is output by PID operation is changed at a time. The output MV in this operation cycle is not changed more than the max. change limit set in the previous operation cycle. The function has an effect to prevent a drive from operating excessively due to sudden change of output by preventing sudden change of output resulting from instantaneous change of set value. If it is, however, set too small, it may cause taking a longer time until PV reaches to its target, so it is necessary to adjust it appropriately. The available scope is between -32,768 ~ 32,767. If setting it as 0, the function does not work.

(l) Max. MV

It sets the max. value of control output that may be output by the result of PID operation. The available scope is between -32,768 ~ 32,767. If it exceeds the max. output designated by PID operation result, it outputs the set max. output and alerts the max. output excess warning. For the types and description of warnings, refer to Error/Warning Codes.

(m) Min. MV

It sets the min. value of control output that may be output by the result of PID operation. The available scope is between -32,768 ~ 32,767. If it is smaller than the min. output value designated by PID operation result, it outputs the set min. MV and alerts the min. output shortage warning. For the types and description of warnings, refer to Error/Warning Codes.

(n) Manual MV

It sets the output when the operation mode is manual. The available scope is between -32,768 ~ 32,767.

(o) DeadBand setting

It sets the deadband between set value and present value. Although it may be important to reduce normal status reply of PV for its set value even when MV fluctuates heavily, depending on control system, it may be more important to reduce the frequent change of MV although the normal status reply is somewhat getting larger. DeadBand may be useful in the case. Below figure shows an example of DeadBand setting.

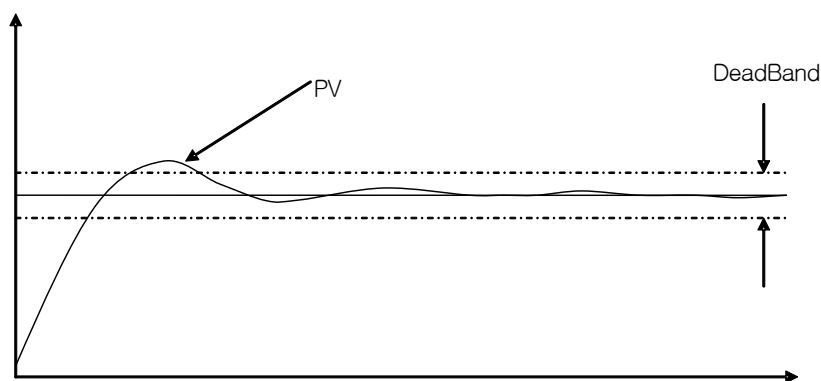

[Figure 5.11 Example of DeadBand setting]

If setting deadband as in the figure, the PID control built in XGB may regard the error between PV and set value as 0 as long as PV is within the available scope of deadband from set value.

That is, in this case, the change of MV is reduced. The available scope of setting is between 0 ~ 65,535 and if it is set as 0, it does not work.

(o) Differential Filter Value Setting

It sets the coefficient of differential filter. Since differential control outputs in proportion to gradient of error and gradient of PV change, it may suddenly change MV as it generates a large response to instantaneous noise or disturbance. To prevent it, XGB series uses a value to which PV is filtered mathematically for differential control. Differential filter value is the coefficient to determine the filter degree for differential control. As smaller differential value set, as stronger differential operation is. The available scope is between 0 ~ 65,535 and if it is set as 0, the differential filter does not work.

(p) Setting set value ramp

Since the drift is suddenly large if SV is heavily changed during PID control, MV is also changed heavily to correct it. Such an operation may cause excessive operation of a system to control and a drive. To prevent it, SV ramp is used, changing SV gradually step by step when modifying SV during operation. If using the function, SV is gradually changed by SV ramp when SV is changed during PID control. At the moment, SV ramp setting represents the frequency of PID operation cycle taken from when SV starts changing to when it reaches to the final SV. For instance, if SV is to be changed from 1000 to 2000 during operation as PID operation cycle is 10ms and its SV ramp is 500, SV may reach to 2000 after $500 \times 10\text{ms} = 5$ seconds, that is, as it increases each 2 per operation cycle and after the 500th operation scans. The available scope of setting is between 0 ~ 65,535 and it is set as 0, it does not work.

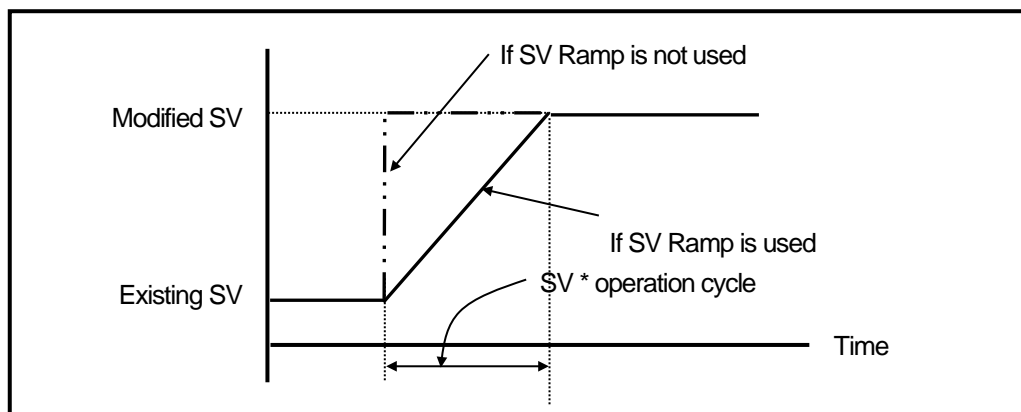

[Figure 5.12 SV Ramp function]

(q) PV Follow-up setting

It is intended to prevent any excessive operation of a drive resulting from sudden change of output at the initial control and changes SV gradually from PV at the time when PID operation starts, not directly to SV in case control just turns from stop to operation mode or it changes from manual to automatic operation. At the moment, SV represents the frequency of PID operation cycles taken from when control starts to when it reaches to the set SV (other operations are same as SV ramp function). The available scope is between 0 ~ 65,535. If SV is changed again while PV follow-up is in operation, the SV would be also changed according to SV ramp.

(r) Min./max. PV

It sets the min./max. value entered as the present value of PID control. The available scope is between -32,768 ~ 32,767.

5.4.2 PID Flags

The parameter set by the XGB series built-in PID control function is saved into the flash memory of the basic unit. Such parameters are moved to K area for the built-in PID function as soon as PLC turns from STOP to RUN mode. PID control operation by PID control command is executed through K area data for PID functions. Therefore, if a user changes the value in the trend monitor window or variable monitor window during operation, PID operation is executed by the changed value. At the moment, if PLC is changed to RUN again after being changed to STOP, it loads the parameters in flash memory to K area, so the data changed in K area is lost. Thus, to keep applying the parameters adjusted in K area, it is necessary to write the parameter set in K area to flash memory by using WRT command. (In case of IEC, APM_WRT)

(1) PID Flag Configuration

K area flags for XGB series built-in PID control function are summarized in the below table.

Loop	K area	IEC type	Symbol	Data type	Default	Description
Common	K12000~F	%KX19200~15	_PID_MAN	Bit	Auto	PID output designation (0:auto, 1>manual)
	K12010~F	%KX19216~31	_PID_PAUSE	Bit	RUN	PID pause (0:RUN, 1:pause)
	K12020~F	%KX19232~47	_PID_REV	Bit	Forward	Control direction(0:forward, 1:reverse) operation control
	K12030~F	%KX19248~63	_PID_AW2D	Bit	Disabled	Dual integral accumulation Prevention (0:enabled, 1:disabled)
	K12060~F	%KX19296~311	_PID_D_on_ERR	Bit	ERR	PID Derivative term (0:on PV, 1:on ERR)
	K12040~F	%KX19264~79	_PID_REM_RUN	Bit	Disabled	PID remote operation (0:disabled, 1:enabled)
	K1205~K1207	%KW1205~%KW1207	Reserved	WORD	-	Reserved area
	K12080~F	%KX19328~43	_PID_PWM_EN	Bit	Disabled	PWM output enable (0:disabled, 1:enabled)
	K12090~F	%KX19344~59	_PID_STD	Bit	-	PID operation indication (0:stop, 1:run)
	K12100~F	%KX19360~75	_PID_ALARM	Bit	-	PID warning (0:normal, 1:warning)
	K12110~F	%KX19376~91	_PID_ERROR	Bit	-	PID error(0:normal, 1:error)
	K12120~F	%KX19392~407	_PID_MV_BMPL	Bit	Disabled	PID MV BuMPLess changeover (0:disabled, 1:enabled)
	K1213~K1215	%KW1213~%KW1215	Reserved	WORD	-	Reserved
Loop 0	K1216	%KW1216	_PID00_SV	INT	0	PID SV
	K1217	%KW1217	_PID00_T_s	WORD	100	PID operation cycle[0.1ms]
	K1218	%KD609	_PID00_K_p	REAL	1	PID proportional constant
	K1220	%KD610	_PID00_T_i	REAL	0	PID integral time[sec]
	K1222	%KD611	_PID00_T_d	REAL	0	PID differential time[sec]
	K1224	%KW1224	_PID00_d_PV_max	WORD	0	PID PV change limit
	K1225	%KW1225	_PID00_d_MV_max	WORD	0	PID MV change limit
	K1226	%KW1226	_PID00_MV_max	INT	4000	PID MV max. value limit
	K1227	%KW1227	_PID00_MV_min	INT	0	PID MV min. value limit
	K1228	%KW1228	_PID00_MV_man	INT	0	PID manual output
	K1229	%KW1229	_PID00_PV	INT	-	PID PV

< Table 5.8 K area flags for PID control >

Chapter 5 Built-in PID Function

Loop	K area	IEC type	Symbol	Data type	Default	Description
Loop 0	K1230	%KW1230	_PID00_PV_old	INT	-	PID PV of previous cycle
	K1231	%KW1231	_PID00_MV	INT	0	PID MV
	K1232	%KD616	_PID00_ERR	DINT	-	PID control error
	K1234	%KD617	_PID00_MV_p	REAL	0	PID MV proportional value component
	K1236	%KD618	_PID00_Mv_i	REAL	0	PID MV integral control component
	K1238	%KD619	_PID00_MV_d	REAL	0	PID MV differential control component
	K1240	%KW1240	_PID00_DB_W	WORD	0	PID deadband setting
	K1241	%KW1241	_PID00_Td_lag	WORD	0	PID differential filter coefficient
	K1242	%KW1242	_PID00_PWM	WORD	H'20	PID PWM junction setting
	K1243	%KW1243	_PID00_PWM_Prd	WORD	100	PID PWM output cycle
	K1244	%KW1244	_PID00_SV_RAMP	WORD	0	PID SV Ramp value
	K1245	%KW1245	_PID00_PV_Track	WORD	0	PID PV follow-up setting
	K1246	%KW1246	_PID00_PV_MIN	INT	0	PID PV min. value limit
	K1247	%KW1247	_PID00_PV_MAX	INT	4000	PID PV max. value limit
	K1248	%KW1248	_PID00_ALM_CODE	Word	0	PID warning code
	K1249	%KW1249	_PID00_ERR_CODE	Word	0	PID error code
	K1250	%KW1250	_PID00_CUR_SV	INT	0	PID SV of current cycle
		K1251-1255	%KW1251-1255	Reserved	WORD	-
Loop 1	K1256~K1295	%KW1256~%KW1295	-	-	-	PID Loop1 control parameter
~						
Loop16	K1816~K1855	%KW1816~%KW1855	-	-	-	PID Loop16 control parameter

< Table 5.8 K area flags for PID control (continued) >

K1200 ~ K1211 areas are the common bit areas of PID loops while each bit represents the status of each PID control loop. Therefore, each 16 bits, the max number of loops of XGB PID control represents loop status and setting respectively. K1216 ~ K1255 areas are K areas for PID control loop 0 and save the loop 0 setting and status. It also contains parameters such as SV, operation cycle, proportional coefficient, integral time and differential time set in the built-in parameter window and the XGB built-in PID function executes PID control by each device value in question. In addition, the output data such as MV calculated and output while PID control is executed is also saved into the K areas. By changing the values in K areas, control setting may be changed any time during PID control.

Remark

By changing value of area, you can change control setting whenever you want during the PID control

1) PID control flag expression : `_PID[n]_xxx`

→ [n] : loop number

→ xxx : flag function

Ex) `_PID10_K_p` : means `K_p` of loop 10.

(2) PID flag function

Each function of K area flags for XGB series built-in PID control function is summarized as follows.

(a) Common bit area

The area is a flag collecting operation setting and information consisting of bits to each 16 loop. Each bit of each word device represents the information of each loop. That is, 'n' th bit represents the information about PID loop n.

1) _PID_MAN (PID RUN mode setting)

Flag name	address	IEC type address	Unit	Setting
_PID_MAN (PID RUN mode setting)	K1200n	%KX19200 + n	BIT	Available

It determines whether to operate the PID control of n loop automatically or manually. For more information about RUN mode, refer to 5.4.1 PID control parameter setting. If the bit is off, it operates automatically; if on, it runs manually.

2) _PID_PAUSE (PID Pause setting)

Flag name	Address	IEC type address	Unit	Setting
_PID_PAUSE (PID pause setting)	K1201n	%KX19216 + n	BIT	Available

It changes PID control of n loop to pause status. If PID control is paused, the control MV is fixed as the output at the time of pause. At the moment, PID operation is continued internally with output fixed. If changing pause status to operation status again, it resumes control, so it may take a longer time until the PV is going to SV once system status is largely changed during pause. If the bit is off, it cancels pause; if on, it operates as paused.

3) _PID_REV (PID RUN direction setting)

Flag name	Address	IEC type address	Unit	Setting
_PID_REV (PID RUN direction setting)	K1202n	%KX19232 + n	BIT	Available

It sets the RUN direction of PID control of 'n'th loop. For more information about run direction, refer to 7.2.3 PID control parameter setting. If the bit is off, it operates normally; if on, it operates reversely.

4) _PID_AW2D (Dual Integral accumulation prevention setting)

Flag name	Address	IEC type address	Unit	Setting
_PID_AW2D (dual integral accumulation prevention setting)	K1203n	%KX19248 + n	BIT	Available

It sets enable/disable of dual integral accumulation prevention of 'n'th loop. For more information about dual integral accumulation prevention, refer to 7.2.3 PID control parameter setting. If the bit is off, it is enabled; if on, it is disabled.

Chapter 5 Built-in PID Function

5) _PID_D_on_ERR (PID Derivative term)

Flag name	Address	IEC type address	Unit	Setting
_PID_D_on_ERR (PID Derivative term)	K1206n	%KX12060 + n	BIT	Available

Set the D operation source of the nth loop to PV / ERR.

6) _PID_REM_RUN (PID remote operation setting)

Flag name	Address	IEC type address	Unit	Setting
_PID_REM_RUN (PID remote run setting)	K1204n	%KX19264 + n	BIT	Available

XGB series built-in PID function can be started by both run from command's start junction and remote run bit setting. That is, XGB starts PID control if PIDRUN command's start junction is on or remote run setting bit is on. Namely, if one of them is on, it executed PID control.

7) _PID_PWM_EN (PWM output enable)

Flag name	Address	IEC type address	Unit	Setting
_PID_PWM_EN (PWM output enable)	K1208n	%KX19328 + n	BIT	Available

It determines whether to output the MV of PID control of 'n'th loop as PWM output. For more information about PWM output, refer to 5.2.3 PID control parameter setting. If the bit is off, it is disabled; if on, it is enabled.

8) _PID_STD (PID RUN status indication)

Flag name	Address	IEC type address	Unit	Setting
_PID_STD (PID RUN status indication)	K1209n	%KX19344 + n	BIT	Unavailable

It indicates the PID control RUN status of 'n'th loop. If a loop is running or paused, it is on while if it stops or has an error during RUN, it is off. In the area as monitoring area, it is changed to the current run status by PLC although a user enters any value temporarily.

9) _PID_ALARM (PID Warning occurrence)

Flag name	Address	IEC type address	Unit	Setting
_PID_ALARM (PID Warning occurrence)	K1210n	%KX19360 + n	BIT	Unavailable

It indicates warning if any warning occurs during PID control of 'n'th loop. Once a warning occurs during PID control operation of a loop, it is on while if it is normal, it is off. At the moment, despite of warning, PID control continues without interruption, but it is desirable to check warning information and take a proper measure. Once a warning occurs, the warning code is also indicated in warning code area of a loop. For more information about the types of warning codes and measures, refer to 5.5. In the area as monitoring area, it is changed to the current run status by PLC although a user

enters any value temporarily.

10) _PID_ERROR (PID Error occurrence)

Flag name	Address	IEC type address	Unit	Setting
_PID_ERROR (PID error occurrence)	K1211n	%KX19376 + n	BIT	Unavailable

If an error that discontinues running during PID control of 'n' th loop occurs, it indicates the error's occurrence. If an error generates warning, it is on; if normal, it is off. When an error occurs, PID control stops and MV is output as the min. output set in parameter. Also, if an error occurs, the error code is indicated in the error code area of a loop. For more information about type of error codes and measures, refer to 5.5. In the area as monitoring area, it is changed to the current run status by PLC although a user enters any value temporarily.

11) _PID_MV_BMPL (PID MV BuMPLess changeover)

Flag name	Address	IEC type address	Unit	Setting
_PID_MV_BMPL (PID MV BuMPLess changeover)	K1212n	%KX19392 + n	BIT	Available

This allows to not only determine an appropriate MV value through operation so that MV can continue smoothly when the corresponding PID loop changes from manual to auto output mode, but also reflect the MV value to the internal state so as to stabilize MV. This function shows an algorithm difference between single operation and cascade operation, but both operations are performed by this bit.

If the corresponding bit (in cascade operation, the corresponding bit of the master/slave loop is On) is On, Bumpless changeover is performed. If it is Off, The [Default] Bumpless changeover function is Disabled

(b) PID Flag area by loops

PID flag areas by loops are allocated between K1216 ~ K1855(%KW1216 ~ %KW1855) and for totally 16 loops, each 40 words is allocated per loop. Therefore, the individual data areas of 'n' th loop are between K (1216+16*n) ~ K (1255+16*n)(%KW(1216+16*n) ~ %KW(1255+16*n)). Every setting of the PID flag areas by loops may be changed during PID control operation. Once the settings are changed, they are applied from the next PID control cycle.

1) _PIDxx_SV (PID xx Loop SV setting)

Flag name	Address	IEC type address	Unit	Scope
_PIDxx_SV (PID xx Loop SV setting)	K1216+16*xx	%KW1216+16*xx	INT	-32,768 ~ 32,767

It sets/indicates the SV of PID control of 'xx' th loop. For more information about SV, refer to 5.2.3 PID control parameter setting. The available scope is between -32,768 ~ 32,767.

2) _PIDxx_T_s (PID xx Loop operation cycle)

Flag name	Address	IEC type address	Unit	Scope
_PIDxx_T_s (PID xx Loop operation cycle)	K1217+16*xx	%KW1217+16*xx	WORD	100 ~ 65,535

It sets/indicates the operation cycle of PID control of 'xx' th loop. For more information about operation cycle, refer to 5.2.3

Chapter 5 Built-in PID Function

PID control parameter setting. The available scope is between 100 ~ 65,535.

3) _PIDxx_K_p (PID xx Loop proportional constant)

Flag name	Address	IEC type address	Unit	Scope
<u>_PIDxx_K_p</u> (PID xx Loop proportional constant)	K1218+16*xx	%KD609+20*xx	REAL	Real number

It sets/indicates the proportional constant of PID control of 'xx' th loop. For more information about proportional constant, refer to 7.2.3 PID Control Parameter Setting. The available scope is real number (-3.40282347e+38 ~ -1.17549435e-38 , 0 , 1.17549435e-38 ~ 3.40282347e+38). If it is, however, set as 0 and lower, the PID control of a loop generates an error and does not work.

4) _PIDxx_T_i (PID xx Loop Integral time)

Flag name	Address	IEC type address	Unit	Scope
<u>_PIDxx_T_i</u> (PID xx Loop integral time)	K1220+16*xx	%KD610+20*xx	REAL	Real number

It sets/indicates integral time of PID control of 'xx' th loop. The available scope is real number. If it is set as 0 and lower, it does not execute integral control.

5) _PIDxx_T_d (PID xx Loop differential time)

Flag name	Address	IEC type address	Unit	Scope
<u>_PIDxx_T_d</u> (PID xx Loop differential time)	K1222+16*xx	%KD611+20*xx	REAL	Real number

It sets/indicates differential time of PID control of 'xx' th loop. The available scope is real number. If it is set as 0 and lower, it does not execute differential control.

6) _PIDxx_d_PV_max (PV change limit)

Flag name	Address	IEC type address	Unit	Scope
<u>_PIDxx_d_PV_max</u> (PV change limit)	K1224+16*xx	%KW1224+16*xx	WORD	0 ~ 65,535

It sets the PV change limit of 'xx' th loop.

For more information about PV change limit, refer to 5.2.3 PID control parameter setting. If it is set as 0, the PV change limit function does not work.

7) _PIDxx_d_MV_max (MV change limit)

Flag name	Address	IEC type address	Unit	Scope
<u>_PIDxx_d_MV_max</u> (MV change limit)	K1225+16*xx	%KW1225+16*xx	WORD	0 ~ 65,535

It sets the MV change limit of 'xx'th loop. For more information about MV change limit, refer to 5.2.3 PID control parameter setting. If it is set as 0, the MV change limit function does not work.

8) `_PIDxx_MV_max`, `_PIDxx_MV_min`, `_PIDxx_MV_man` (max. MV, min. MV, manual MV)

Flag name	Address	IEC type address	Unit	Scope
<code>_PIDxx_MV_max</code> (max. MV)	K1226+16*xx	%KW1226+16*xx	INT	-32,768 ~ 32,767
<code>_PIDxx_MV_min</code> (min. MV)	K1227+16*xx	%KW K1227+16*xx		
<code>_PIDxx_MV_man</code> (manual MV)	K1228+16*xx	%KW K1228+16*xx		

It sets the max. MV, min. MV and manual MV of 'xx' th loop. For more information about max. MV, min. MV and manual MV, refer to 5.2.3 PID control parameter setting. If the max. MV is set lower than the min. MV, the PID control loop generates an error and does not work.

9) `_PIDxx_PV` (prevent value)

Flag name	Address	IEC type address	Unit	Scope
<code>_PIDxx_PV</code> (present value)	K1229+16*xx	%KW1229+16*xx	INT	-32,768 ~ 32,767

It is the area that receives the present value of 'xx' th PID control loop. PV is the present status of the system to control and is normally saved into U device via input devices such as A/D input module if it is entered from a sensor. The value is used to execute PID operation by moving to `_PIDxx_PV` by means of commands like MOV.

10) `_PIDxx_PV_OLD` (PV of previous control cycle)

Flag name	Address	IEC type address	Unit	Scope
<code>_PIDxx_PV_OLD</code> (PV of previous control cycle)	K1230+16*xx	%KW1230+16*xx	INT	Unavailable

The area indicates the PV just before the xx th PID control loop. The flag, as a dedicated monitoring flag, would be updated by PLC although a user directly enters it.

11) `_PIDxx_MV` (Control MV)

Flag name	Address	IEC type address	Unit	Scope
<code>_PIDxx_MV</code> (control MV)	K1231+16*xx	%KW1231+16*xx	INT	Unavailable

The area shows the MV of 'xx' th PID control loop. As the area in which XGB built-in PID operation result is output every PID control cycle, it delivers the value in the area to U device every scanning by using commands like MOV in the program and outputs to D/A output module, operating a drive.

Chapter 5 Built-in PID Function

12) _PIDxx_ERR (Present error)

Flag name	Address	IEC type address	Unit	Scope
_PIDxx_ERR (present error)	K1232+16*xx	%KW1232+16*xx	DINT	Unavailable

The areas shows the current error of 'xx' th PID control loop. It is also used as an indicator about how much gap the present status has with a desired status and if an error is 0, it means the control system reaches a desired status exactly. Therefore, if control starts, error is quickly reduced at transient state and it reaches normal state, maintaining remaining drift as 0, it could be an ideal control system. The flag, as a dedicated monitoring, is updated although a user directly enters it.

13) _PIDxx_MV_p, _PIDxx_MV_i, _PIDxx_MV_d (P/I/D control components of MV)

Flag name	Address	IEC type address	Unit	Scope
_PIDxx_MV_p (MV proportional control component)	K1234+16*xx	%KD616+20*xx	REAL	Unavailable
_PIDxx_MV_i (MV integral control component)	K1236+16*xx	%KD617+20*xx		
_PIDxx_MV_d (MV differential control component)	K1238+16*xx	%KD618+20*xx		

It indicates 'n' th loop MV by classifying proportional control MV, integral control max. MV and differential control MV. The entire MV consists of the sum of these three components. The flag, as a dedicated monitoring, is updated although a user directly enters it.

14) _PIDxx_DB_W (DeadBand setting)

Flag name	Address	IEC type address	Unit	Scope
_PIDxx_DB_W (DeadBand setting)	K1240+16*xx	%KW1232+16*xx	WORD	0 ~ 65,535

It sets the deadband of 'xx' th loop. For more information about Deadband function, refer to 5.2.3 PID control parameter setting. If it is set as 0, the function does not work.

15) _PIDxx_Td_lag (Differential filter coefficient)

Flag name	Address	IEC type address	Unit	Scope
_PIDxx_Td_lag (differential filter coefficient)	K1241+16*xx	%KW1241+16*xx	WORD	0 ~ 65,535

It sets the differential filter coefficient of 'xx' th loop. For more information about differential filter coefficient, refer to 5.2.3 PID control parameter setting. If it is set as 0, the function does not work.

16) _PIDxx_PWM (PWM output junction setting)

Flag name	Address	IEC type address	Unit	Scope
_PID00_PWM (PWM output junction setting)	K1242+16*xx	%KW1242+16*xx	WORD	H'20 ~ H'3F

It sets the junction to which PWM output of 'xx' th loop is output. PWM output junction is valid only between H'20 ~ H'3F. If any other value is entered, PWM output does not work.

17) _PIDxx_PWM_Prd (PWM Output cycle setting)

Flag name	Address	IEC type address	Unit	Scope
_PIDxx_PWM_Prd (PWM output cycle setting)	K1243+16*xx	%KW1243+16*xx	WORD	100 ~ 65,535

It sets the PWM output cycle of 'xx' th loop. The available scope is between 100 ~ 65,535 at the unit of 0.1ms.

18) _PIDxx_SV_RAMP (SV ramp setting)

Flag name	Address	IEC type address	Unit	Scope
_PIDxx_SV_RAMP (SV ramp setting)	K1244+16*xx	%KW1244+16*xx	WORD	0 ~ 65,535

It sets the SV ramp value of 'xx' th loop. For more information about SV ramp of PV, refer to 5.2.3 PID control parameter setting. If it is set as 0, the function does not work.

19) _PIDxx_PV_Track (PV follow-up setting)

Flag name	Address	IEC type address	Unit	Scope
_PIDxx_PV_Track (PV follow-up setting)	K1245+16*xx	%KW1245+16*xx	WORD	0 ~ 65,535

It sets the PV follow-up SV of 'xx' th loop. For more information about PV follow-up, refer to 5.2.3 PID control parameter setting. If it is set as 0, the function does not work.

20) _PIDxx_PV_MIN, _PIDxx_PV_MAX (Min. PV input, Max. PV input)

Flag name	Address	IEC type address	Unit	Scope
_PIDxx_MV_p (MV proportional control component)	K1246+16*xx	%KW1246+16*xx	INT	-32,768 ~ 32,767
_PIDxx_MV_i (MV integral control component)	K1247+16*xx	%KW1247+16*xx		

It sets the min./max. PV of 'xx' th loop.

21) _PIDxx_ALM_CODE (Warning code)

Flag name	Address	IEC type address	Unit	Scope
_PIDxx_ALM_CODE (Warning code)	K1248+16*xx	%KW1248+16*xx	WORD	Unavailable

It indicates warning code if a warning occurs during 'xx' th loop run. The flag, as a dedicated monitoring, is updated although a user directly enters it. For more information about warning code, refer to 5.5.

22) _PIDxx_ERR_CODE (Error code)

Flag name	Address	IEC type address	Unit	Scope
_PIDxx_ERR_CODE (error code)	K1249+16*xx	%KW1249+16*xx	WORD	Unavailable

It indicates error code if an error occurs during 'xx' th loop run. The flag, as a dedicated monitoring, is updated although a user directly enters it. For more information about warning code, refer to 5.5.

23) _PIDxx_CUR_SV (SV of the present cycle)

Flag name	Address	IEC type address	Unit	Scope
_PIDxx_CUR_SV (SV of the present cycle)	K1250+16*xx	%KW1250+16*xx	INT	Unavailable

It indicates SV currently running of 'xx' th loop. If SV is changing due to SV ramp or PV follow-up function, it shows the currently changing PV. The flag, as a dedicated monitoring, is updated although a user directly enters it.

5.5 PID Instructions

It describes PID control commands used in XGB series. The command type of PID control used in XGB series built-in PID control is 4.

(1) PIDRUN

PIDRUN is used to execute PID control by loops.

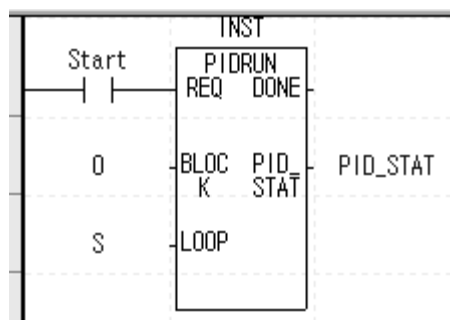

- Operand S means the loop no. to execute PID control and available only for constant(0~15).
- If start signal contact is on, the PID control of a loop starts.

Item	Indication	Flag name	Contents
ALARM	16#0001	PV_MIN_MAX_ALM	Current value exceeds range of maximum, minimum value
	16#0002	PID_SCANTIME_ALM	Operation cycle is too short.
	16#0003	PID_dPV_WARN	Variation of current value of this PID cycle exceeds the current value variation limit.
	16#0004	PID_dMV_WARN	Variation of manipulated value of this PID cycle exceeds the manipulated value variation limit.
	16#0005	PID_MV_MAX_WARN	Manipulated value of this PID cycle exceeds maximum manipulated value.
	16#0006	PID_MV_MIN_WARN	Manipulated value of this PID cycle is smaller than minimum manipulated value.
ERROR	16#0100	MV_MIN_MAX_ERR	Maximum manipulated value is set to be smaller than minimum manipulated value.
	16#0200	PV_MIN_MAX_ERR	Maximum current value is set to be smaller than current manipulated value.
	16#0300	PWM_PERIOD_ERR	PWM output cycle is set to be smaller than 100(10ms).
	16#0400	SV_RANGE_ERR	In case of forward operation, set value at start of auto-tuning is smaller than current value. In case of reverse operation, set value at start of auto-tuning is larger than current value.
	16#0500	PWM_ADDRESS_ERR	PWM output is set as contact point other than %QX0.0.0~0.0.31.
	16#0600	P_GAIN_SET_ERR	Proportional constant is set to be smaller than 0.
	16#0700	I_TIME_SET_ERR	Integral constant is set to be smaller than 0
	16#0800	D_TIME_SET_ERR	Differential constant is set to be smaller than 0
	16#0900	CONTROL_MODE_ERR	Control mode is other than P, PI, PD and PID.
	16#0B00	PID_PERIOD_ERR;	PIC operation cycle is set to be smaller than 100(10ms)
	16#0C00	HBD_WRONG_DIR	In combined operation, directional parameter of forward operation loop is set as reverse operation or directional parameter of reverse operation loop is set as forward operation
	16#0D00	HBD_SV_NOT_MATC H	In combined operation, set values of two loops are different
16#0E00	LOOP_EXCEED	PID LOOP number is larger 15	

Chapter 5 Built-in PID Function

(2) PIDCAS

PIDCAS is a command to execute CASCADE control.

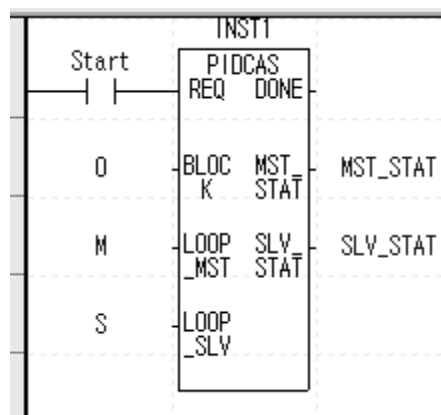

- Operand M and S mean master loop and slave loop respectively and available only for constant(0~15).
- If start signal contact is on, cascade control is executed through master loop and slave loop.

Cascade control is called a control method which is intended to increase control stability through quick removal of disturbance by connecting two PID control loops in series and is structured as follows.

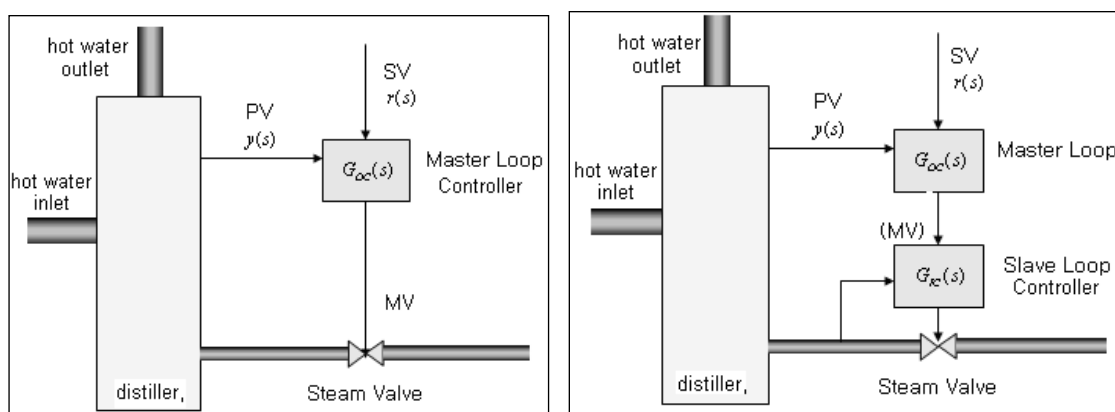

[Figure 5.13 Comparison of single loop control and cascade control]

Looking at the figure, it is found that cascade control contains slave loop control within external control loop. That is, the control output of external loop PID control is entered as SV of the internal loop control. Therefore, if steam valve suffers from disturbance in the figure, single loop PID control may not be modified until PV, $y(s)$ appears while cascade control is structured to remove any disturbance by the internal PID loop control before any disturbance that occurs in its internal loop affects the PV, $y(s)$, so it can early remove the influence from disturbance.

XGB internal PID control connects two PID control loops each other, making cascade control possible. At the moment, MV of external loop is automatically entered as the SV of internal loop, so it is not necessary to enter it through program.

(3) PIDHBD

PIDHBD is a command to execute the mixed forward/reverse E control.

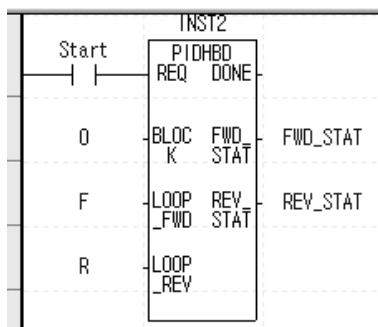

- Operand F and R represent forward operation loop and reverse operation loop and available only for constant(0~15).
- If start signal contact is on, it starts the mixed forward/reverse operation from the designated forward/reverse loops.

The mixed forward/reverse control is called a control method to control forward operation control output and reverse operation control operation alternatively to a single control process. The XGB built-in PID control enables the mixed forward/reverse control by connecting two PID control loops set as forward/reverse operations. At the moment, it uses PIDHBD command. For more information about the command, refer to 5.2.5. The mixed forward/reverse run is executed as follows in the XGB built-in PID control.

(a) Commencement of mixed run

If PIDHBD command starts first, it starts reverse run when PV is higher than SV; it starts forward run if PV is lower than SV.

(b) Conversion of RUN direction

The conversion of run direction is executed according to the following principles. In case of forward operation run, it keeps running by converting to reverse operation once PV is over SV + DeadBand value. At the moment, the DeadBand setting value uses the deadband of a loop set for forward operation. If PV is below SV - DeadBand value during reverse operation, it also keeps running by converting to forward operation. In the case, the DeadBand setting uses the deadband of a loop set for reverse loop. It may be illustrated as 5.14.

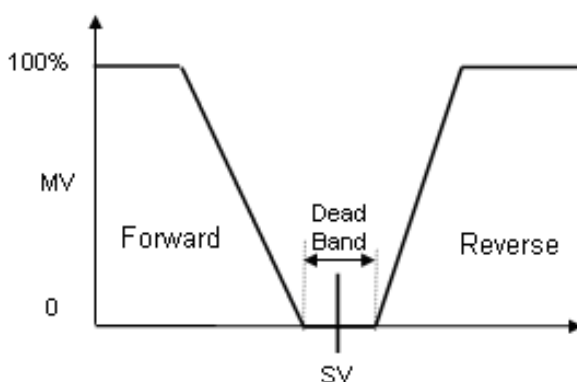

[Figure 5.14 Conversion of RUN direction in the mixed forward/reverse control]

- (c) At the moment, every control parameter uses the parameter of a loop set for forward operation while MV is output to MV output area of a loop of forward operation. Reversely, every control parameter uses the parameter of a loop set for reverse operation during reverse operation run while MV is also output to MV output area of reverse operation loop.

5.6 PID Auto-tuning

5.6.1 Basic Theory of PID Auto-tuning

It describes the function of PID auto-tuning.

The performance of PID controller is very different according to P, I, D coefficient. Generally, It is very difficult and takes long time to predict the system and set P, I, D coefficient because of non-periodical disturbance, interference of other control loop, dynamic characteristic of control system though the engineer is good at handling the PID controller. So auto-tuning that sets the PID coefficient automatically is very useful. Generally, there are many methods in setting the PID coefficient. Here, it will describe Relay Auto-tuning.

(1) PID coefficient setting by Relay auto-tuning

It makes critical oscillation by force and uses the width and period of oscillation to specify the PID coefficient. It applies max. output and min. output to control system for auto-tuning. Then, oscillation with steady period and steady width occurs around the Set value like figure 5.15, and it can calculate the boundary gain by using it like expression (5.3.1).

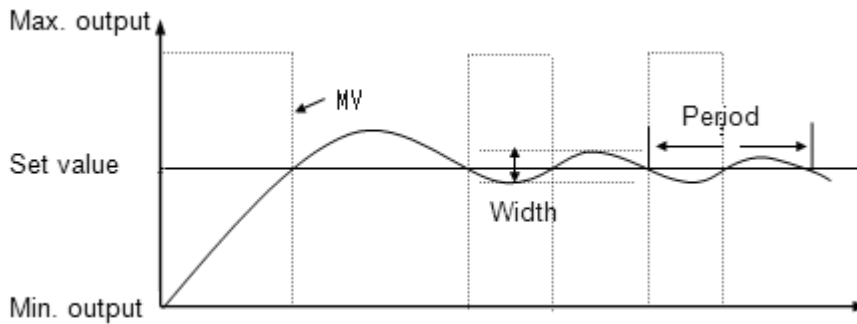

< Figure 5.15 Relay auto-tuning >

$$K_u = \frac{4 \times (\text{Max.output} - \text{Min.output})}{\pi \times \text{width}} \quad (5.4.1)$$

At this time, oscillation period is called boundary period. If boundary gain and period is specified, use table 5.9, Ziegler & Nichols tuning table to specify the PID coefficient. This Relay tuning is relatively simple to configure and easy to know the boundary gain and period so it is used frequently and XGB built-in PID auto-tuning uses this method.

Controller	Proportional gain (Kp)	Integral time(Ti)	Differential time(Td)
P	$0.5K_u$	-	-
PI	$0.45K_u$	$P_u / 1.2$	-
PID	$0.6K_u$	$P_u / 2$	$P_u / 8$

< Table 5.9 Ziegler & Nichols tuning table >

5.6.2 PID Auto-tuning Function Specifications

The specifications of the XGB series built-in PID auto-tuning function are summarized as in Table.

Item		Specifications
Scope of SV		INT (-32,768 ~ 32,767)
Scope of PV		INT (-32,768 ~ 32,767)
Scope of MV		INT (-32,768 ~ 32,767)
Error indication		Normal: error flag off Error: error flag off, error code occurs
AT direction setting		Forward/Reverse
Control cycle		100 ~ 65,536 (0.1msUnit)
Additional function	PWM output	Supportable
	Hysteresis	Supportable

[Table 5.10 Spec. of built-in PID auto-tuning function]

5.6.3 Auto-tuning Parameter Setting

To use the XGB series auto-tuning function, it is necessary to start it by using a command after setting auto-tuning parameters by loops in the parameter window. It explains the parameters to use auto-tuning function and how to set them.

(1) Auto-tuning parameter setting

To set the parameters of XGB series auto-tuning function, follow the steps.

- (a) If selecting parameter in project window and the built-in parameter, it shows the built-in parameter setting window as seen in below figure.

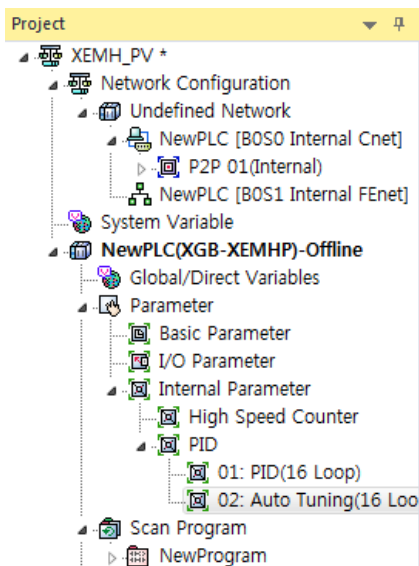

< Figure 5.16 Built-in parameter setting window >

Chapter 5 Built-in PID Function

(b) If selecting auto-tuning, it shows the parameter setting window as seen in Figure 5.17.

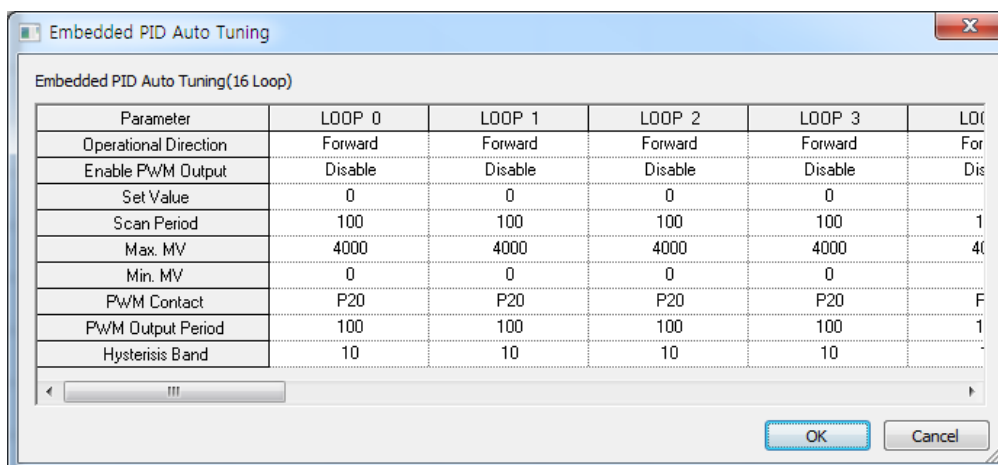

<Figure 5.17 Built-in auto-tuning function parameter setting window>

(c) Input items

Table shows the items to set in auto-tuning parameter window and the available scopes.

Items	Description	Scope
RUN direction	Set the run direction of auto-tuning.	Forward/reverse
PWM output enable	Set whether to set PWM output of MV enabled/disabled.	Disable/enable
SV	Set SV.	-32,768 ~ 32,767
Operation time	Set auto-tuning operation time.	100 ~ 65535
Max. MV	Set the max. MV in control.	-32,768 ~ 32,767
Min. mV	Set the min. MV in control.	-32,768 ~ 32,767
PWM junction designation	Designate the junction to which PWM output is output.	P20 ~ P3F
PWM output cycle	Set the output cycle of PWM output.	100 ~ 65,535
Hysteresis setting	Set the hysteresis of auto-tuning MV.	0 ~ 65,535

< Table 5.11 Auto-tuning function parameter setting items>

(2) Description of auto-tuning parameters and how to set them

(a) RUN direction

RUN direction is to set the direction of auto-tuning run of a loop. The available option is forward or reverse. The former (forward) means that PV increase when MV increases while the latter (reverse) means PV decreases when MV increases. For instance, a heater is a kind of forward direction system because PV (temperature) increases when output (heating) increases. A refrigerator is a kind of reverse direction system in which PV (temperature) decreases when output increases.

(b) PWM output enable

PWM output means an output method to turn a junction on – off with a duty proportional to control output calculated by a uniform output cycle. If PWM output is enabled, it realizes PWM output in accordance with PWM output cycle set in the parameter of PWM output junction (P20 ~ P3F) (%QX0.0.0~%QX0.0.31) designated in the parameter. At the moment, the PWM output cycle follows the PWM output cycle separately set in auto-tuning operation cycle.

(c) SV

It sets the auto-tuning SV of a loop in question. Similar to PID control, physical values (temperature, flow rate, pressure and etc) of an object to control is not meaningful and instead, it should use the physical amount of an object to control after converting them into numerals. For instance, in order to control a system using a sensor that the output is 0V when its heating device temperature is 0°C while it is 10V when the temperature is 100°C as much as 50°C, it is necessary to set SV as 2000(as long as it uses AD input module XBE-AD04A).

(d) Operation time

It sets the cycle to execute operation for auto-tuning. The setting cycle is 0.1ms and available between 10ms ~ 6553.5ms (setting value: 100 ~ 65,535) while it is set at a unit of integer per 0.1ms.

(e) Max./min. MV

It sets the max./min. value of output for auto-tuning. The available scope is between -32,768 ~ 32,767. If the max. MV is set lower than min. MV, the auto-tuning function of a loop generates an error and does not work.

(f) Hysteresis setting

Looking at relay tuning in Figure 5.15, it shows it outputs the max. MV as auto-tuning starts but it converts to min. output as PV is over SV and then, it converts to the max. output as PV is lower than SV. However, if input PV contains noise components or reply components, auto-tuning ends by a slight vibration of PV around SV, yielding incorrect tuning result. To prevent it, hysteresis may be set. XGB auto-tuning converts output at SV + Hysteresis when PV increases or at SV - Hysteresis when it decreases once hysteresis is set. With it, it may prevent incorrect tuning by a slight vibration around SV.

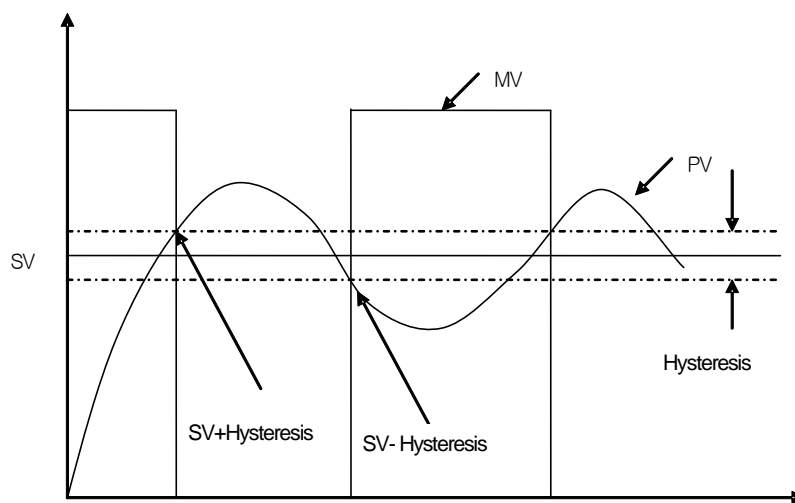

[Figure 5.16 Example of Hysteresis setting]

5.6.4 Auto-tuning Flags

The parameters set in the XGB series auto-tuning function are saved to the flash memory of basic unit. Such parameters are moved to K area for auto-tuning function as soon as PLC enters to RUN mode from STOP. Auto-tuning operation using auto-tuning command is achieved by data in K area. At the moment, if PLC is changed to RUN again after being changed to STOP, it takes the parameters in flash memory to K area, so the data changed in K area is lost. Therefore, to continuously apply the parameters adjusted in K area, it is necessary to write the parameters set in K area into flash memory by using WRT command. (In case of IEC type, APM_WRT function block)

(1) Auto-tuning flag configuration

The K area flags of XGB series auto-tuning function are summarized in Table 5.12.

Loops	K area	IEC type	Symbol	Data type	Default	Description
Common	K18560~F	%KX29696 ~%KX29711	_AT_REV	Bit	Forward	Auto-tuning direction(0:forward, 1:reverse)
	K18570~F	%KX29712 ~%KX29727	_AT_PWM_EN	Bit	Disable	PWM output enable(0:disable, 1:enable)
	K18580~F	%KX29728 ~%KX29743	_AT_ERROR	Bit	-	Auto-tuning error(0:normal,1:error)
	K1859	%KW1859	Reserved	WORD	-	Reserved area
Loop0	K1860	%KW1860	_AT00_SV	INT	0	AT SV – loop 00
	K1861	%KW1861	_AT00_T_s	WORD	100	AT operation cycle (T_s)[0.1msec]
	K1862	%KW1862	_AT00_MV_max	INT	4000	AT MV max. value limit
	K1863	%KW1863	_AT00_MV_min	INT	0	AT MV min. value limit
	K1864	%KW1864	_AT00_PWM	WORD	0	AT PWM junction setting
	K1865	%KW1865	_AT00_PWM_Prd	WORD	0	AT PWM output cycle
	K1866	%KW1866	_AT00_HYS_val	WORD	0	AT hysteresis setting
	K1867	%KW1867	_AT00_STATUS	WORD	0	AT auto-tuning status indication
	K1868	%KW1868	_AT00_ERR_CODE	WORD	0	AT error code
	K1869	%KD	_AT00_K_p	REAL	0	AT result proportional coefficient
	K1871	-	_AT00_T_i	REAL	0	AT result integral time
	K1873	-	_AT00_T_d	REAL	0	AT result differential time
	K1875	-	_AT00_PV	INT	0	AT PV
	K1876	-	_AT00_MV	INT	0	AT MV
	K1877~1879	%KW1877 ~%KW1879	Reserved	Word	0	Reserved area

[Table 5.12 K area flags for auto-tuning]

K1856 ~ K1859 areas (In case of IEC type, %KW1856~%KW1859) are the common bit areas for auto-tuning and each bit represents auto-tuning loop status respectively. K1860~K1879(%KW1860 ~ %KW1879) areas save the setting and status of loop 0 as the K area for auto-tuning loop 0. In the area, the parameters such as PV, operation cycle and etc set in the built-in parameter window are saved and the XGB built-in auto-tuning function executes auto-tuning by the device values and saves the results into the K areas.

(2) Auto-tuning flag function

Each function of K area flags for XGB series auto-tuning is summarized as follows.

A) Common bit area

The area is a flag collecting operation setting and information consisting of bits to each 16 loop. Each bit of each word device represents the information of each loop.

1) `_AT_REV` (auto-tuning run direction setting)

Flag name	Address	IEC type address	Unit	Setting
<code>_AT_REV</code> (PID RUN direction setting)	K1856n	%KX29696 + n	BIT	Available

It determines the run direction of auto-tuning of 'n' th loop. If the bit is off, it is forward operation; if on, it is reverse operation.

2) `_AT_PWM_EN` (PWM output enable)

Flag name	Address	IEC type address	Unit	Setting
<code>_AT_PWM_EN</code> (PWM output enable)	K1857	%KX29713 + n	BIT	Available

It sets whether to output the auto-tuning MV of 'n' th loop as PWM output. If the bit is off, it is disabled; if on, it is enabled.

3) `_AT_ERROR` (Auto-tuning error occurrence)

Flag name	Address	IEC type address	Unit	Setting
<code>_PID_ERROR</code> (PID error occurrence)	K1858n	%KX29728 + n	BIT	Unavailable

It indicates the error in case an error that discontinues operation during auto-tuning of 'n' th loop occurs. If an error occurs, it is on; if normal, it is off. Once an error occurs, auto-tuning stops and the MV is output as the min. output set in the parameter. Also, if an error occurs, it indicates the error code in the error code area of a loop. For more information about error code types and measures, refer to 5.5. The area, as a dedicated monitor area, is updated although a user directly enters it.

B) Auto-tuning flag area by loops

The auto-tuning flag areas by loops are K1860 ~ K2179(%KW1860 ~ %KW2179) and each 20 words per loop are allocated to totally 16 loops. Therefore, individual data area of 'n' th loop is between K (1860+16*n) ~ K (1879+16*n)(%KW(1860+16*n) ~ %KW(1879+16*n)).

1) `_ATxx_SV` (auto-tuning xx Loop SV setting)

Flag name	Address	IEC type address	Unit	Scope
<code>_ATxx_SV</code> (AT xx Loop SV setting)	K1860+16*xx	%KW1860+16*xx	INT	-32,768 ~ 32,767

It sets/indicates the auto-tuning SV of 'xx' th loop.
The available scope is between -32,768 ~ 32,767.

Chapter 5 Built-in PID Function

2) _ATxx_T_s (Auto-tuning xx Loop operation cycle)

Flag name	Address	IEC type address	Unit	Scope
_PIDxx_T_s (Auto-tuning xx Loop operation cycle)	K1861+16*xx	%KW1861+16*xx	WORD	100 ~ 65,535

It sets/indicates the operation cycle of 'xx' th loop auto-tuning. The available scope is 100 ~ 65,535.

3) _ATxx_MV_max, _ATxx_MV_min(max. MV, min. MV)

Flag name	Address	IEC type address	Unit	Scope
_PIDxx_MV_max (Max. MV)	K1862+16*xx	%KW1862+16*xx	INT	-32,768 ~ 32,767
_PIDxx_MV_min (Min. MV)	K1863+16*xx	%KW1863+16*xx		

It sets max. MV and min. MV of 'xx' th loop respectively. If the max. MV is set lower than min. MV, the auto-tuning loop generates an error and does not work.

4) _ATxx_PWM (AT output junction setting)

Flag name	Address	IEC type address	Unit	Scope
_AT00_PWM (AT output junction setting)	K1864+16*xx	%KW1864+16*xx	WORD	H'20 ~ H'3F

It sets the junction that PWM output of 'xx' th loop is output. The PWM output junction is valid only between H'20 ~ H'3F (hex). If any other value is entered, PWM output does not work.

5) _ATxx_PWM_Prd (PWM output cycle setting)

Flag name	Address	IEC type address	Unit	Scope
_ATxx_PWM_Prd (PWM output cycle setting)	K1865+16*xx	%KW1865+16*xx	WORD	100 ~ 65,535

It sets the PWM output cycle of 'xx' th loop. The available scope is between 100 ~ 65,535 at the unit of 0.1ms.

6) _ATxx_HYS_val (Hysteresis setting)

Flag name	Address	IEC type address	Unit	Scope
_ATxx_HYS_val (Hysteresis setting)	K1866+16*xx	%KW1866+16*xx	WORD	0 ~ 65,535

It sets the hysteresis of 'xx' th loop. For more information about hysteresis function, refer to 5.3.3 Auto-Tuning Parameter Setting. If it is set as 0, it does not work.

7) _ATxx_STATUS (Auto-tuning status)

Flag name	Address	IEC type address	Unit	Scope
_ATxx_STATUS (Auto-tuning status)	K1867+16*xx	%KW1867+16*xx	WORD	Unavailable

It indicates the auto-tuning status of 'xx' th loop. If auto-tuning is in operation, it is 1(h0001); if completed, it is 128(h0080). In any other cases, it shows 0(h0000).

8) _ATxx_ERR_CODE (Error code)

Flag name	Address	IEC type address	Unit	Scope
_ATxx_ERR_CODE (Error code)	K1868+16*xx	%KW1868+16*xx	WORD	Unavailable

It indicates error code in case an error occurs during the auto-tuning of 'xx'th loop. The flag, as a dedicated monitor, is updated although a user directly enters it. For more information about error code, refer to 5.5.

9) _ATxx_K_p, _ATxx_T_i, _ATxx_T_d (AT result proportional coefficient, integral time, differential time)

Flag name	Address	IEC type address	Unit	Scope
_ATxx_K_p (proportional coefficient)	K1869+16*xx	%KD934+20*xx	Real	Unavailable
_ATxx_T_i (integral time)	K1871+16*xx	%KD1004+20*xx		
_ATxx_T_d (differential time)	K1873+16*xx	%K1005+20*xx		

The area indicates proportional coefficient, integral time and differential time calculated after the auto-tuning of 'xx' th loop is normally completed. The flag, as a dedicated monitoring, updated although a user directly enters it.

10) _ATxx_PV (PV)

Flag name	Address	IEC type address	Unit	Scope
_ATxx_PV (PV)	K1875+16*xx	%KW1875+16*xx	INT	-32,768 ~ 32,767

It is the area to receive PV of 'xx' th auto-tuning loop. PV is the present status of a system to control and in case of PID control, the entry from a sensor is saved into U device through input devices such as A/D input module and it moves the value to _ATxx_PV by using commands such as MOV every scanning, executing auto-tuning.

11) _ATxx_MV (Auto-tuning MV)

Flag name	Address	IEC type address	Unit	Scope
_ATxx_MV (auto-tuning MV)	K1876+16*xx	%KW1876+16*xx	INT	Unavailable

It is the area to output MV of 'xx' th auto-tuning loop. Every auto-tuning cycle, it saves XGB auto-tuning and it delivers the value in the area by using commands like MOV in a program and operates a drive every scanning.

5.6.5 Auto-tuning Instructions

The commands used in XGB series auto-tuning are as follows.

1) PIDAT

PIDAT is a command to execute auto-tuning by loops.

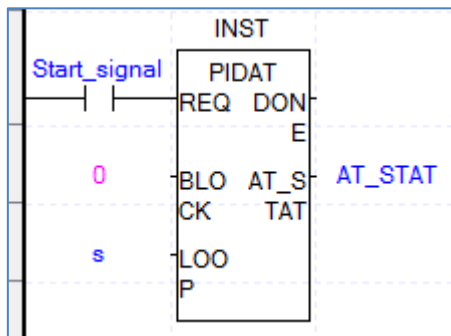

- Operand S means the loop no. to execute auto-tuning and available only for constant(0~15).
- If start signal contact is on, the PID control of a loop starts.

5.7 Example Programs

The paragraph explains example programs regarding the directions of XGB built-in PID function.

The example programs are explained with water level system as illustrated in 5.17.

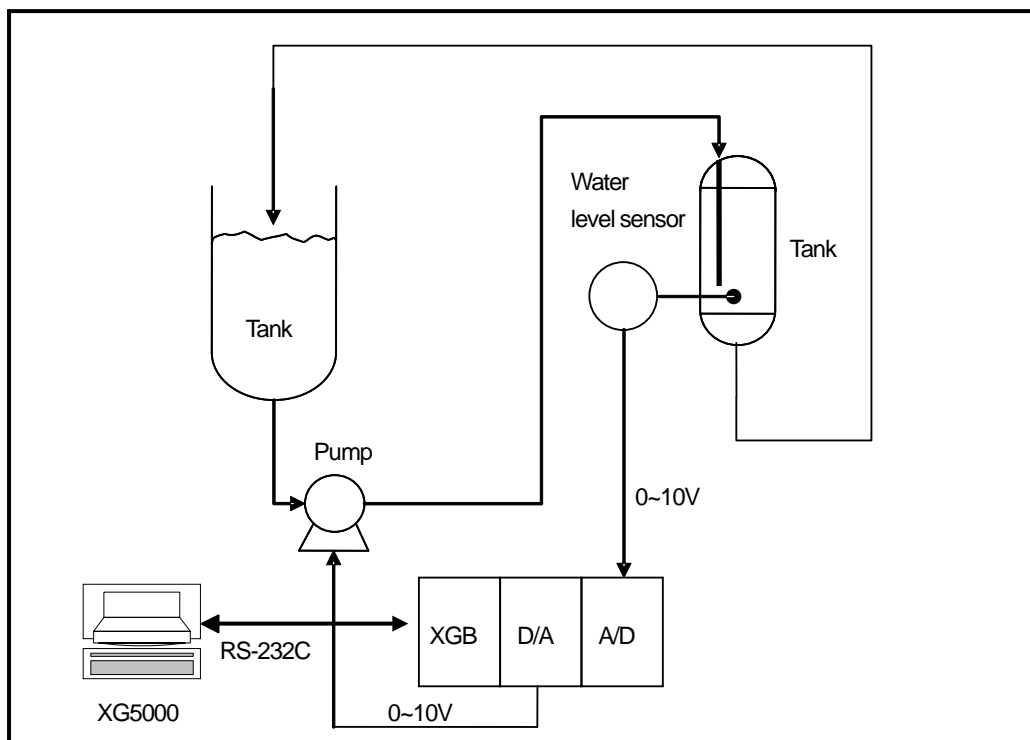

[Figure 5.17 Example of water level control system]

5.7.1 Example System Structure

The example system in figure is an example of a system to control a pail's water level to a desired level. The pail's water level is sensed by a water level sensor and entered to A/D input module while PID control operation result, MV is output to a pump through D/A output module, controlling a pump's rotation velocity, regulating the water amount flowing into a pail and regulating the water level as desired. Each mechanism is explained as follows.

(1) XGB basic unit

The XGB basic unit operates by PID control operating PID control operation. It receives PV from A/D input module (XBF-AD04A), executes the built-in PID control operation, output the MV to D/A (XBF-DV04A) and executes PID control.

(2) A/D input module (XBF-AD04A)

It functions as receiving PV of an object to control from a water level sensor and delivering it to basic unit. XBF-AD04A is a 4CH analog input module and settings of analog input types and scopes can be changed in the I/O parameter setting window appeared when selecting I/O parameter in the parameter item of project window. For more information, refer to Analog I/O Module.

(3) D/A output module (XBF-DV04A)

It functions as delivering control MV from basic unit to a drive (pump). XBF-DV04A is a 4CH analog voltage output module and ranges 0 ~ 10V. For detail setting, refer to Analog I/O Module.

Chapter 5 Built-in PID Function

(4) Water Level Sensor

A water level sensor plays a role to deliver the PV of an object to control to XGB by measuring the water level of a pail and outputting it within 0 ~ 10V. Since the types and output scope of water level sensors varies, the output scope of a sensor should be identical with that of A/D input module's input scope. The example uses a water level sensor outputting between 0 ~ 10V.

(5) Drive (pump)

A drive uses a pump that receives control output of XGF-DV04A and of which rotation velocity is variable. For accurate PID control, the output scope of XBF-DV04A (0~10V) should be same with that of a pump's control input. The example uses a pump that receives its control input between 0 ~ 10V.

5.7.2 Example of PID Auto-tuning

Here, with examples, it explains how to calculate proportional constant, integral time and differential time by using PID auto-tuning function

(1) PID auto-tuning parameter setting

- (a) If double-clicking Parameter – Built-in Parameter – PID – Auto-tuning parameter in the project window, it opens up the auto-tuning parameter setting window as illustrated in Figure 5.18.

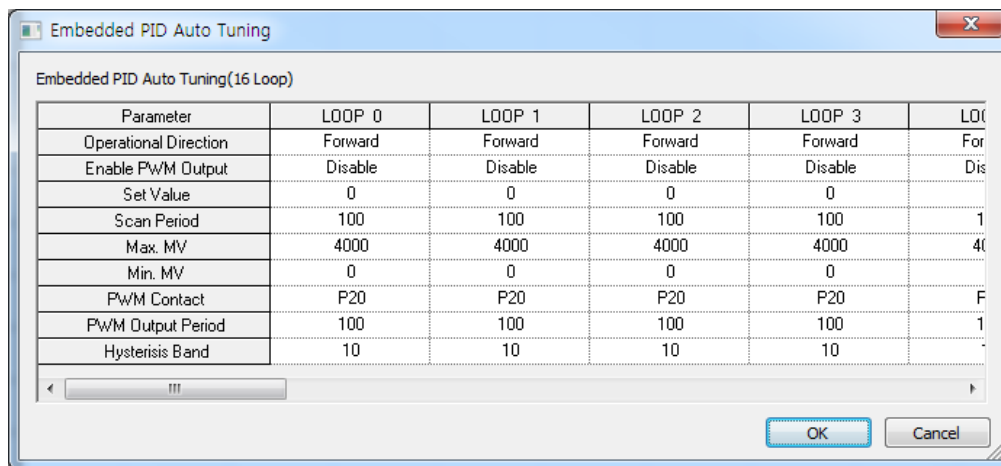

[Figure 5.18 Auto-tuning parameter setting window]

- (b) Set each parameter and click OK.

In the example, Loop 0 is set as follows.

- RUN direction: forward
 - Since in the system, water level is going up as MV increases and pump's rotation velocity increases, it should be set as forward operation.
- PWM output: disabled
 - In the example, auto-tuning using PWM is not executed. Therefore, PWM output is set as disabled.
- SV: 1000(2.5V)
 - It shows an example in which XBF-AD04A is set as the voltage input of 0~10V.

- Max. MV: 4000
 - Max. MV is set as 4000. If MV is 4000, XBF-DV04A outputs 10V.
- Min. MV: 0
 - Min. MV is set as 0. If MV is 0, XBF-DV04A outputs 0V.
- PWM junction, PWM output cycle
 - It is not necessary to set it because the example does not use PWM output.
- Hysteresis setting: 10

(2) A/D input module parameter setting

- (a) If double-clicking Parameter – I/O parameter, it opens up the setting window as illustrated in figure 5.19.

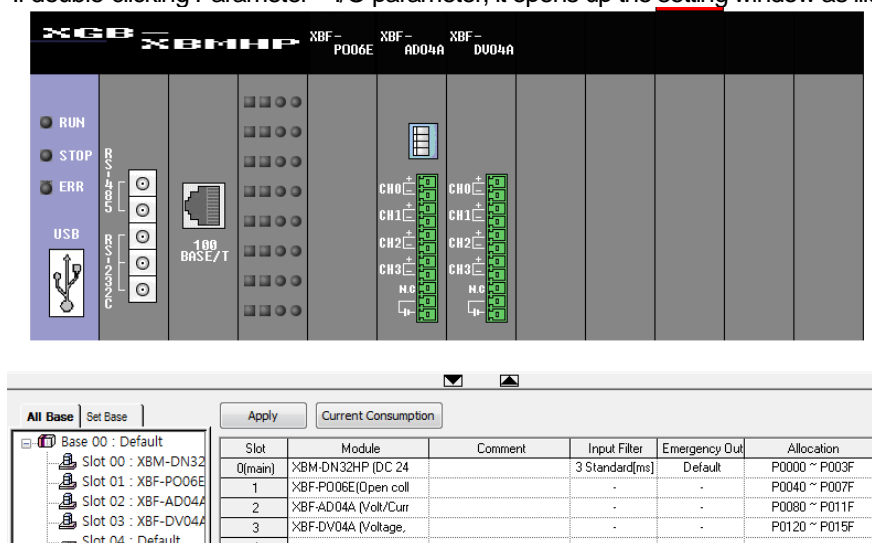

[Figure 5.19 I/O parameter setting window]

- (b) If selecting A/D module for a slot in A/D input module, it opens up the setting window as illustrated in Figure 5.20.

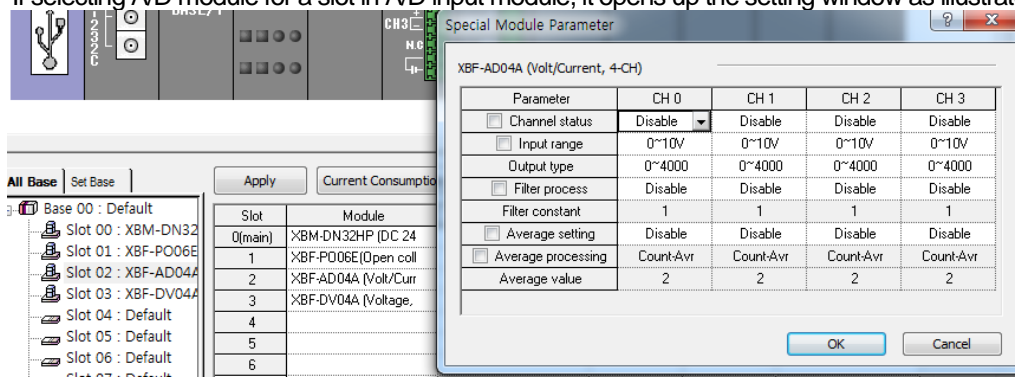

[Figure 5.20 A/D input mode setting window]

Chapter 5 Built-in PID Function

(c) Check A/D Module operation parameter and click OK. The example is set as follows.

- RUN CH: CH0 RUN
 - The example receives the water level sensor input as CH0.
- Input scope: 0 ~ 10V
 - Set XBF-AD04A input scope as 0 ~ 10V so that it should be identical with the output scope of water level sensor.
- Output data type: 0 ~ 4000
 - It converts the input 0 ~ 10V to digital value from 0 ~ 4000 and delivers it to basic unit.
 - In the case, the resolving power of digital value 1 is $10/4000 = 2.5\text{mV}$
- Filter process, averaging: disabled
 - The example sets the input values in order that filter process and averaging are not available.
 - For more information about each function, refer to Analog Manual.

(3) D/A Output Module Parameter setting

- (a) Set the parameter of D/A output module(XBF-DV04A) that output MV to a drive.
How to set them is as same as A/D input module. In the example, it is set as follows.

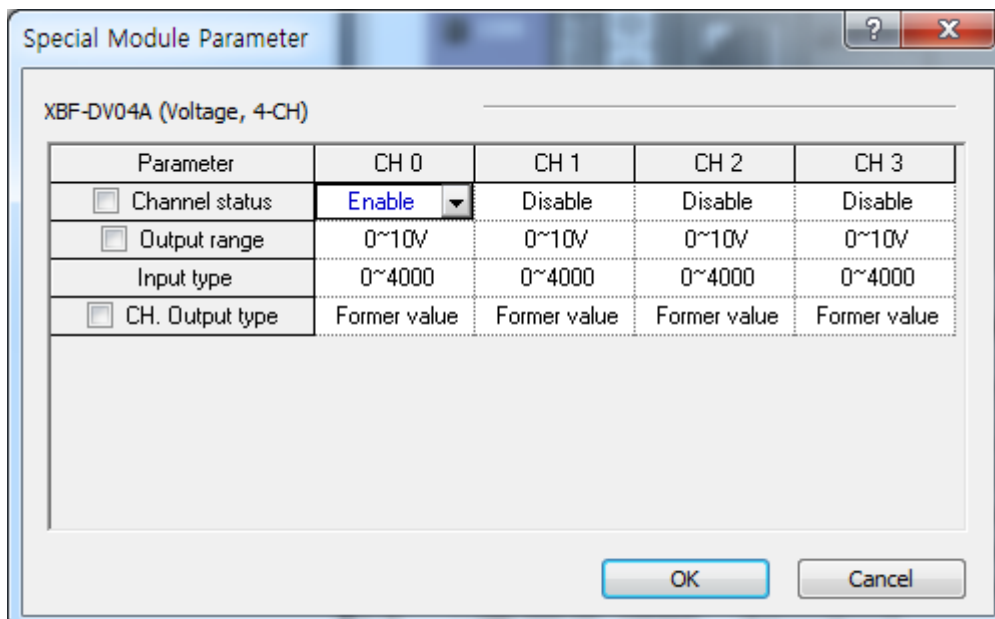

- RUN CH: CH0 RUN
 - In the example, MV is output as CH0 of D/A output module.
- Output range : 0 ~ 10V
- Input type: 0 ~ 4000

(4) Example of PID Auto-tuning program

The example of PID auto-tuning program is illustrated as Figure 5.21.

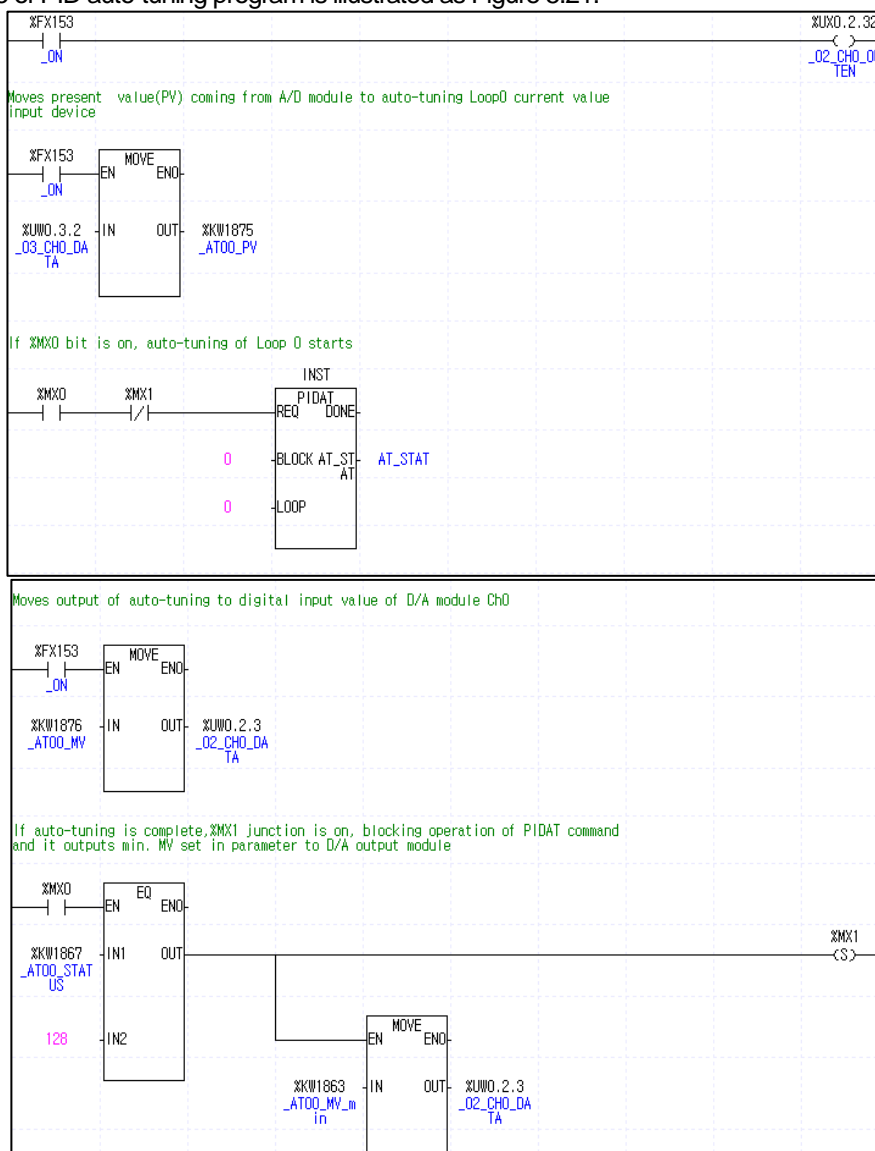

< Figure 5.21 Auto-tuning example program >

(a) Devices used

Device	Data type	Application
%FX153	BIT	It is always on, so it readily operates once PLC is RUN.
%UX0.2.32	BIT	It starts operation of CH0 of Slot 2 D/A output module.
%UW0.3.2	INT	PV entered to A/D input module.
%UW0.2.3	INT	MV entered to D/A output module.
%KW1875	INT	Device to which PV is entered for LOOP 0 auto-tuning
%KW1876	INT	Device to which auto-tuning MV of LOOP 0 is output.
%KW1867	WORD	Device to which auto-tuning status indicates.
%KW1863	INT	Min. MV of auto-tuning designated in parameter.

Chapter 5 Built-in PID Function

(b) Program explanation

- 1) Since F0099(always on) is ON if PLC is converted form STOP to RUN, CH0 of A/D and D/A starts operating.
- 2) At the moment, PV entered to CH0 of A/D is moved to K1875, the input device of PV and saved accordingly.
- 3) Once M0000 junction is on, the auto-tuning of loop 0 starts.
- 4) The auto-tuning MV of loop 0 that is output by PIDAT command is output to D/A output module by line 14 MOV command.
- 5) If auto-tuning is complete or there is any error during auto-tuning, M0001 junction is set, blocking operation of PIDAT command and it outputs min. MV set in parameter to D/A output module.

(c) Monitoring and changing PID control variables using K area

In XGB series built-in auto-tuning, it can monitor and change RUN status of auto-tuning by using K area allocated as fixed area by loops.

1) Variable registration

If selecting “Register in Variable/Description” by right clicking in the variable monitor window, “Variable/Device Selection” window appears. Select “Item” as PID, deselect “View All” and enter 0(means loop number) in “Parameter No”, K area device list to save every setting and status of loop 0 appears as shown Figure 5.22. Then, if selecting a variable to monitor and clicking “OK”, a selected device is registered to variable monitor window as illustrated in Figure 5.23. Through the monitor window, a user can monitor auto-tuning run status or change the settings.

	Variable	Type	Address	System Variable	Comment
1	_PID00_MAN	BOOL	%KX19200	<input type="checkbox"/>	PID Output Select (0:Auto, 1:Manual) - Loop00
2	_PID00_PAUSE	BOOL	%KX19216	<input type="checkbox"/>	PID PAUSE (0:STOP or RUN 1:Pause) - Loop00
3	_PID00_REV	BOOL	%KX19232	<input type="checkbox"/>	PID Operate Direction (0:Forward, 1:Reverse) - Loop00
4	_PID00_AW2D	BOOL	%KX19248	<input type="checkbox"/>	PID Anti Wind-up2 (0:Enable, 1:Disable) - Loop00
5	_PID00_REM_R	BOOL	%KX19264	<input type="checkbox"/>	PID Remote RUN bit for HMI (0:STOP 1:RUN) - Loop00
6	_PID00_P_on_P	BOOL	%KX19280	<input type="checkbox"/>	PID Proportional term (0:on ERR, 1:on PV) - Loop00
7	_PID00_D_on_E	BOOL	%KX19296	<input type="checkbox"/>	PID Derivative term (0:on PV, 1:on ERR) - Loop00
8	_PID00_AT_EN	BOOL	%KX19312	<input type="checkbox"/>	PID Autotune (0:Disable, 1:Enable) - Loop00
9	_PID00_PWM_E	BOOL	%KX19328	<input type="checkbox"/>	PID PWM Enable (0:Disable, 1:Enable) - Loop00
10	_PID00_STD	BOOL	%KX19344	<input type="checkbox"/>	PID RUN Status (0:Stop, 1:Run) - Loop00
11	_PID00_ALARM	BOOL	%KX19360	<input type="checkbox"/>	PID Warning (0: Normal 1: Alarm Occurs) - Loop00
12	_PID00_ERROR	BOOL	%KX19376	<input type="checkbox"/>	PID Error (0: Normal 1: Error Occurs) - Loop00
13	_PID00_SV	INT	%KW1216	<input type="checkbox"/>	PID Set Value (SV) - Loop00
14	_PID00_T_s	WORD	%KW1217	<input type="checkbox"/>	PID Sampling Time (T_s)[0.1msec] - Loop00
15	_PID00_K_p	REAL	%KD609	<input type="checkbox"/>	PID P - Constant (K_p) - Loop00
16	_PID00_T_i	REAL	%KD610	<input type="checkbox"/>	PID I - Constant (T_i)[sec] - Loop00
17	_PID00_T_d	REAL	%KD611	<input type="checkbox"/>	PID D - Constant (T_d)[sec] - Loop00
18	_PID00_d_PV	WORD	%KW1224	<input type="checkbox"/>	PID Max. delta_PV Limit - Loop00
19	_PID00_d_MV	WORD	%KW1225	<input type="checkbox"/>	PID Max. delta_MV Limit - Loop00
20	_PID00_MV_ma	INT	%KW1226	<input type="checkbox"/>	PID Max. MV - Loop00
21	_PID00_MV_min	INT	%KW1227	<input type="checkbox"/>	PID Min. MV - Loop00
22	_PID00_MV_ma	INT	%KW1228	<input type="checkbox"/>	PID Manual MV - Loop00
23	_PID00_PV	INT	%KW1229	<input type="checkbox"/>	PID Process Value (PV) - Loop00
24	_PID00_PV_old	INT	%KW1230	<input type="checkbox"/>	PID One step previous PV - Loop00
25	_PID00_MV	INT	%KW1231	<input type="checkbox"/>	PID Manipulated Value (MV) - Loop00
26	_PID00_ERRR	DINT	%KD616	<input type="checkbox"/>	PID Control error value - Loop00
27	_PID00_MV_p	REAL	%KD617	<input type="checkbox"/>	PID P component of the MV - Loop00
28	_PID00_MV_i	REAL	%KD618	<input type="checkbox"/>	PID I component of the MV - Loop00
29	_PID00_MV_d	REAL	%KD619	<input type="checkbox"/>	PID D component of the MV - Loop00

[Figure 5.22 Variable registration window]

Monitor 1							
	PLC	Program	Variable/Device	Value	Type	Device/Variable	Comment
1	NewPLC	NewProgram	_PID00_MAN	10	BOOL	%KX19200	PID Output Select (0:Auto, 1:Manual) - Loop00
2	NewPLC	NewProgram	_PID00_PAUSE	10	BOOL	%KX19216	PID PAUSE (0:STOP or RUN 1:Pause) - Loop00
3	NewPLC	NewProgram	_PID00_REV	10	BOOL	%KX19232	PID Operate Direction (0:Forward, 1:Reverse) - Loop00
4	NewPLC	NewProgram	_PID00_AW2D	10	BOOL	%KX19248	PID Anti Wind-up2 (0:Enable, 1:Disable) - Loop00
5	NewPLC	NewProgram	_PID00_REM_RUN	10	BOOL	%KX19264	PID Remote RUN bit for HMI (0:STOP 1:RUN) - Loop00
6	NewPLC	NewProgram	_PID00_P_on_PV	10	BOOL	%KX19280	PID Proportional term (0:on ERR, 1:on PV) - Loop00
7	NewPLC	NewProgram	_PID00_D_on_ERR	10	BOOL	%KX19296	PID Derivative term (0:on PV, 1:on ERR) - Loop00
8	NewPLC	NewProgram	_PID00_AT_EN	10	BOOL	%KX19312	PID Autotune (0:Disable, 1:Enable) - Loop00
9	NewPLC	NewProgram	_PID00_PWM_EN	10	BOOL	%KX19328	PID PWM Enable (0:Disable, 1:Enable) - Loop00
10	NewPLC	NewProgram	_PID00_STD	10	BOOL	%KX19344	PID RUN Status (0:Stop, 1:Run) - Loop00
11	NewPLC	NewProgram	_PID00_ALARM	10	BOOL	%KX19360	PID Warning (0: Normal 1: Alarm Occurs) - Loop00
12	NewPLC	NewProgram	_PID00_ERROR	10	BOOL	%KX19376	PID Error (0: Normal 1: Error Occurs) - Loop00

[Figure 5.23 Auto-tuning variables registered]

Chapter 5 Built-in PID Function

(5) Observing RUN status by using trend monitor function

Since it is possible to monitor the operation status of XGB series built-in auto-tuning graphically, it is useful to monitor the operation status of auto-tuning clearly.

(a) If selecting Monitor – Trend monitor menu, it shows the trend monitor window as illustrated in Figure 5.24.

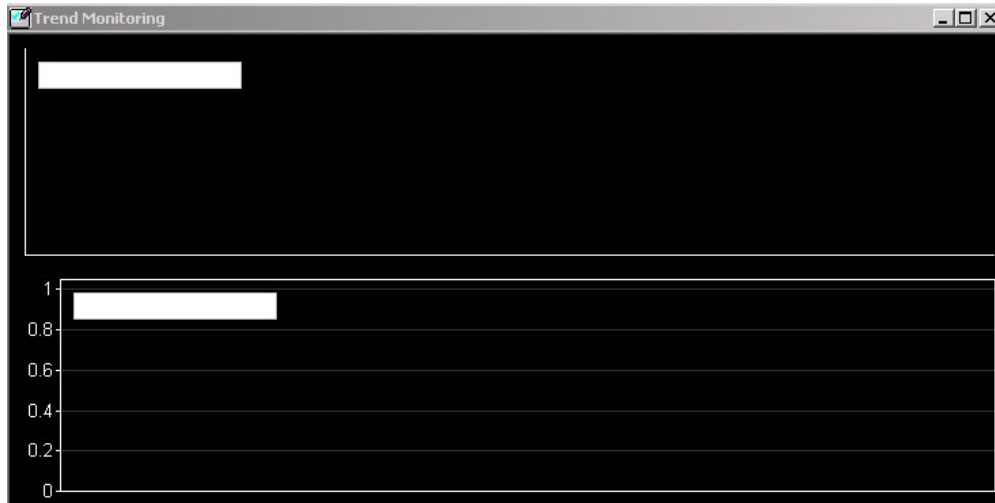

[Figure 5.24 Trend Monitor window]

(b) If right-clicking trend setting, a user can select a variable to monitor as illustrated in Figure 5.25.

ID	Device	Variable Name	Type
1			

[Figure 5.25 window to register trend monitor variable]

(c) For more information about trend monitor, refer to “XG5000 Use’s Manual.”

5.7.3 Stand-alone Operation After PID Auto-tuning

Here, with example, it explains how to execute PID control followed by PID auto-tuning.

(1) PID auto-tuning parameter setting

- PID auto-tuning parameters are set as same as examples of 5.4.2 Example of PID Auto-tuning.

(2) Setting parameters of A/D input module and D/A output module

- Set the parameters of A/D input module and D/A output module as same as the example in 5.4.2 Example of PID Auto-tuning.

(3) PID parameter setting

- (a) If double-clicking Parameter – Built-in Parameter – PID – PID Parameter, it shows the built-in PID parameter setting window as seen in Figure 5.26.

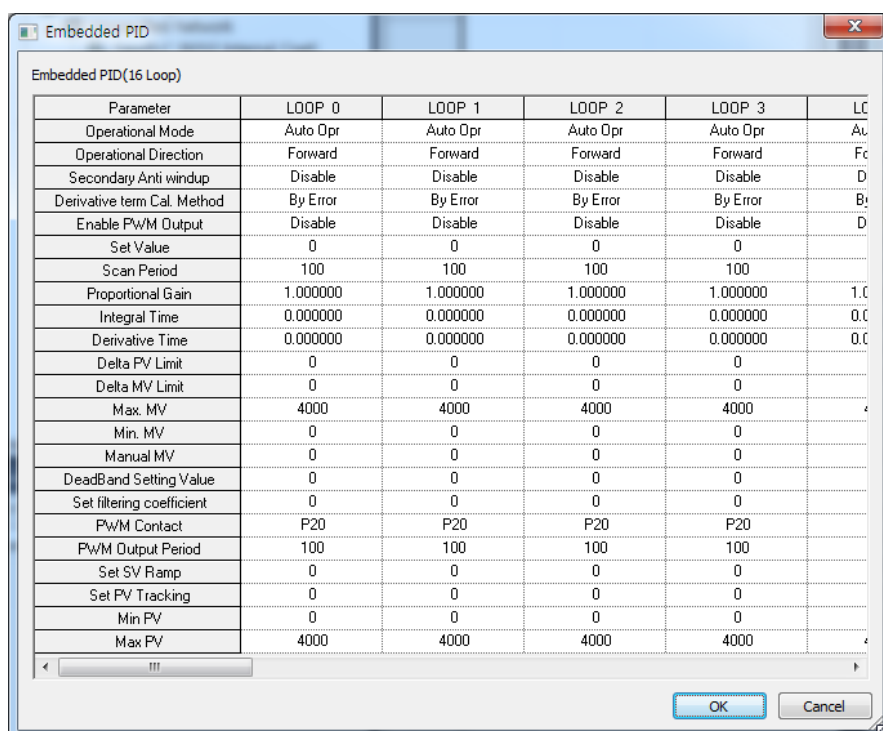

[Figure 5.26 Auto-tuning parameter setting window]

- (b) Set each parameter and click OK.

In the example, Loop 0 is set as follows.

- RUN mode: automatic
 - Set as automatic in order that PID control is executed as the built-in PID operation outputs MV.
- RUN direction: forward
 - Since in the system, water level is going up as MV increases and pump's rotation velocity increases, it should be set as forward operation.
- PWM Output: disabled
 - In the example, auto-tuning using PWM is not executed. Therefore, PWM output is set as disabled.

Chapter 5 Built-in PID Function

- SV: 1000(2.5V)
 - It shows an example in which XBF-AD04A is set as the voltage input of 0~10V
- Operation cycle: 1000
 - In the example, it is set that PID control is executed every 100ms.
- Proportional gain, integral time and differential time
 - It should be initially set as 1,0,0 because PID auto-tuning results is used with PID constant.
- Max. MV: 4000
 - Max. MV is set as 4000. If MV is 4000, XBF-DV04A outputs 10V.
- DeadBand: 0
 - It is set as 0 because the example does not use DeadBand function.
- Differential filter setting: 0
 - it is also set as 0 because the example does not use differential filter.
- Min. MV: 0
 - Min. MV is set as 0. If MV is 0, XBF-DV04A outputs 0V.
- PWM junction, PWM output cycle
 - It is not necessary to set them because the example does not use PWM output.
- SV ramp, PV follow-up: 0
 - It is not necessary to set SV ramp and PV follow-up because the example does not use them.
- Min. PV, Max. PV: 0
 - Set them as 0 and 4000 respectively so that it could be identical with A/D input module's input scope.

(c) Example of PID control program after PID auto-tuning

The program example for PID auto-tuning is illustrated as Figure 5.27.

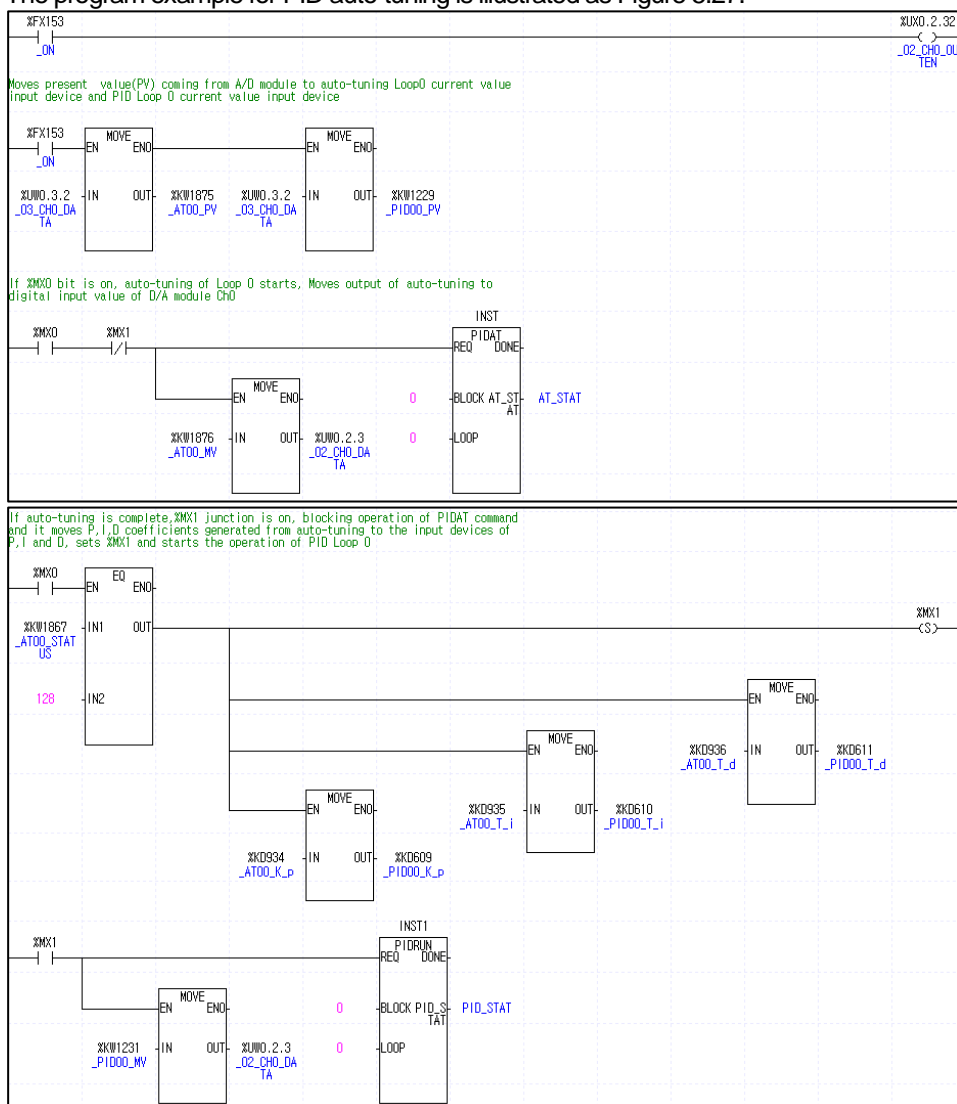

[Figure 5.27 Example program of PID control after auto-tuning]

1) Devices used

Device	Data type	Application
%FX153	BIT	It is always on, so it readily operates once PLC is RUN.
%UX0.2.32	BIT	It starts operation of CH0 of Slot 2 D/A output module.
%UW0.3.2	INT	PV entered to A/D input module.
%UW0.2.3	INT	MV entered to D/A output module.
%KW1875	INT	Device to which PV is entered for LOOP 0 auto-tuning
%KW1876	INT	Device to which auto-tuning MV of LOOP 0 is output.
%KW1867	WORD	Device to which auto-tuning status indicates.
%KD934	REAL	proportional coefficient calculated after the auto-tuning
%KD935	REAL	integral time calculated after the auto-tuning.
%KD936	REAL	differential time calculated after the auto-tuning.

Chapter 5 Built-in PID Function

%KD609	REAL	proportional coefficient of PID designated in parameter.
%KD610	REAL	integral time of PID designated in parameter.
%KD611	REAL	differential time of PID designated in parameter.
%KW1231	INT	MV of PID

2) Program explanation

- a) Since F0099 (always on) is ON if PLC is converted from STOP to RUN, CH0 of A/D and D/A starts operating.
- b) Once M0000(%MX0) junction is on, the auto-tuning of loop 0 starts. At the moment, PV entered to CH0 of A/D is moved to K1875, the PV input device of loop 0 and saved accordingly.
- c) The auto-tuning MV of Loop 0 output by PIDAT command is output to D/A output module by line 11, MOV command.
- d) Once auto-tuning is complete, it moves P, I, D coefficients generated from auto-tuning to the input devices of P, I and D, K1218, K1220 and K1222, (%KD934, %KD935, %KD936) sets M001 and starts the operation of PID loop 0.

5.8 Error / Warning Codes

It describes error codes and warning codes of the XGB built-in PID function. The error codes and warning codes that may occur during use of the XGB built-in PID function are summarized as table. If any error or warning occurs, remove potential causes of the error by referring to the tables.

5.8.1 Error Codes

Error codes	Indications	Measures
H'0001	MV_MIN_MAX_ERR	It occurs when max. MV is set lower than min. MV. Make sure to set max. MV larger than min. MV.
H'0002	PV_MIN_MAX_ERR	It occurs when max. PV is set lower min. Pv. Make sure to set max. PV larger than min. PV.
H'0003	PWM_PERIOD_ERR	It occurs when the period of auto tuning or PID operation loop is set under 100(10ms). Make sure to set output period more than 100.
H'0004	SV_RANGE_ERR	It occurs when SV is larger than PV at the start time of auto-tuning if auto-tuning is forward or when SV is larger than PV at the start time of auto-tuning if auto-tuning is reverse.
H'0005	PWM_ADDRESS_ERR	It occurs when the junction designated as PWM output junction is beyond between P20 ~ P3F.
H'0006	P_GAIN_SET_ERR	It occurs when proportional constant is set lower than 0.
H'0007	I_TIME_SET_ERR	It occurs when integral time is set lower than 0.
H'0008	D_TIME_SET_ERR	It occurs when differential time is set lower than 0.
H'0009	CONTROL_MODE_ERR	It occurs when control mode is not P, PI, PD or PID.
H'000A	TUNE_DIR_CHG_ERR	It occurs when operation direction is changed during auto-tuning. Never attempt to change operation direction during auto-tuning.
H000B	PID_PERIOD_ERR	It occurs when period of operation is smaller than 100 (10ms) at Auto-tuning or PID operation. Make sure to set period of operation larger than 100.
H000C	HBD_WRONG_DIR	In mixed operation, It occurs when the direction parameter of forward operation set to reverse operation or the direction parameter of reverse operation set to forward operation. Make sure set to appropriate direction each loop.
H000D	HBD_SV_NOT_MATCH	In mixed operation, it occurs when the Set value of each loop is not concurrent. Make sure set to Set value concurrently.
-	-	If the PID LOOP number is outside the settable range, the command will not be executed without an error code. The range that can be set is 0 ~ 15.

[Table 5.13 : PID error codes]

5.8.2 Warning Codes

Error codes	Indications	Measures
H'0001	PV_MIN_MAX_ALM	It occurs when the set PV is beyond the min./max. PV.
H'0002	PID_SCANTIME_ALM	It occurs when PID operation cycle is too short. It is desirable to set PID operation cycle longer than PLC scan time.
H'0003	PID_dPV_WARN	It occurs when the PV change of PID cycle exceeds PV change limit.
H'0004	PID_dMV_WARN	It occurs when the PV cycle MV change exceeds MV change limit.
H'0005	PID_MV_MAX_WARN	It occurs when the calculated MV of PID cycle exceeds the max. MV.
H'0006	PID_MV_MIN_WARN	It occurs when the calculated MV of PID cycle is smaller than the min. MV

[Table 5.14 : PID error codes]

Part 3. Embedded Positioning

Chapter 1 Overview

Part 3 describes the specification, method to use each positioning function, programming and the wiring with external equipment of embedded positioning function.

1.1 Characteristics

The characteristics of positioning module are as follows.

- (1) The positioning function is embedded in XEM-H2/HP PLC.
- (2) Various positioning control function

It has various functions needed for positioning system such as positioning control, speed control etc.

The operation data including positioning address and operation method, operation pattern is available to set up to 400 for each axis. With this operation data, positioning for each axis is available.

- (a) Various sing-axis operations are available.

- 1) Position Control
- 2) Speed Control
- 3) Feed Control
- 4) Multi-axis Synchronous Start
- 5) Point Operation

- (b) Various Multi-axis Operations are available.

- 1) Circular arc Interpolation
- 2) Linear Interpolation
- 3) Helical Interpolation
- 4) Ellipse Interpolation

- (c) Switching Control in operation is available.

- 1) Position/Speed Control Switching
- 2) Speed/Position Control Switching.

- (d) Cam Control is available.

It is available to create up to 8 kinds of cam data with various cam profile of XG-PM Software.

e) Various Homing Control Function.

1) 7 methods are available for Homing.

- a) Origin detection after DOG Off
- b) Origin detection after deceleration in case of DOG On
- c) Origin detection by the HOME and upper/lower limit
- d) Origin detection by DOG
- e) High speed Origin detection
- f) Origin detection by upper/lower limit
- g) Origin detection by HOME

2) It is Available to set the origin of machine without homing by setting the floating origin

(f) For the Acceleration/Deceleration method, it is available to select trapezoid or S curve.

(3) High speed start process .

The start time of positioning is less than(control Parameter-control period*2)ms..

In addition, there is no delay time between axes in synchronous start and interpolation start.

(4) Easy maintenance.

Various data such as operation data, operation parameter are saved on FLASH Memory in PLC. Therefore, data will be saved permanently. Max writing count of the flash memory is 100,000.

(5) Self-diagnosis, monitoring and test are available with XG-PM software package.

- (a) Monitoring (Module & External Input/output Signal) Function
- (b) Trace Function
- (c) Trend Function
- (d) Reading and Saving Module Parameter/Operation Data
- (e) Creation of Cam Data
- (f) Providing details about errors and the solution for it
- (g) Print Function of various forms
- (h) Editing operation data in Excel program is available

(6) Advanced XEM can create positioning tasks that match positioning controls. The positioning task work in cycle as set in Control period of the Common parameters. Positioning task time is included in control period of common parameter. Positioning control period error occurs when sum of positioning operation time and positioning task execution time exceed Control period, which set in Common parameter.

1.2 Purpose of Positioning Control

The purpose of positioning is to transfer the objects (tools etc.) with setting speed from the current position and stop them on the setting position correctly. And high precision positioning is available by positioning pulse string signal as it is connected to various control driving devices such as servo driving devices or stepping motor.

In application, it can be used widely with engineering machine, semiconductor assembly machine, grinder, small machine center, lifter etc.

1.3 Signal Flow of Embedded Positioning

The flow of PLC system using the embedded positioning is as follows.

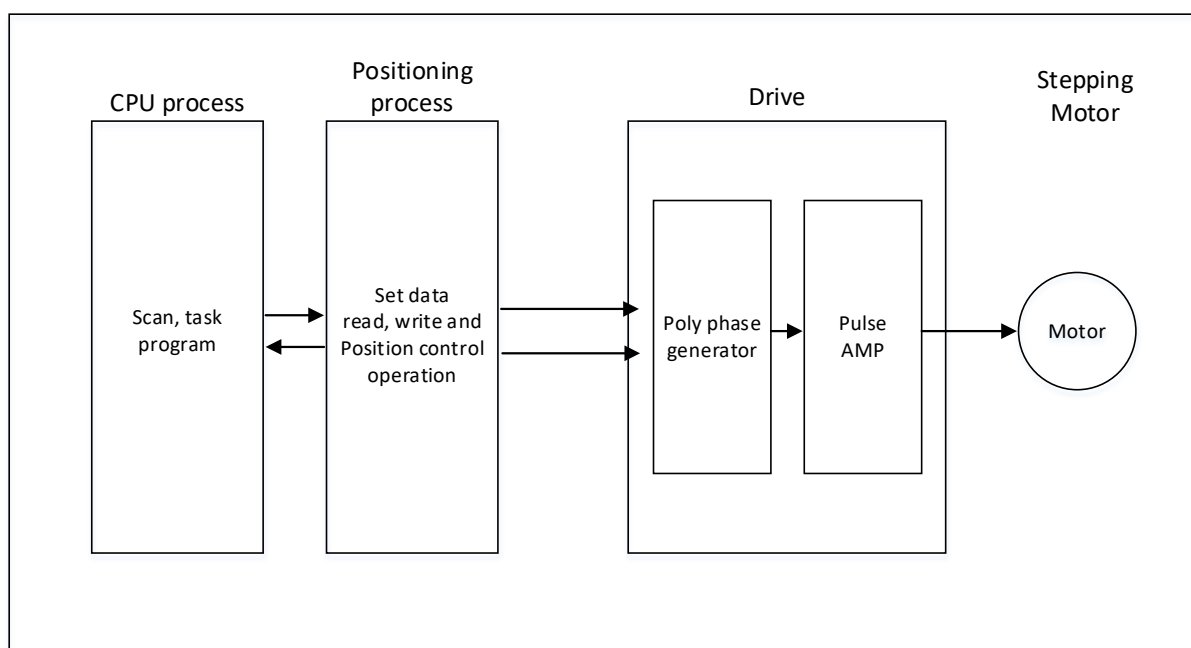

Fig. 1.1 Overview of Position Control for Stepping Motor

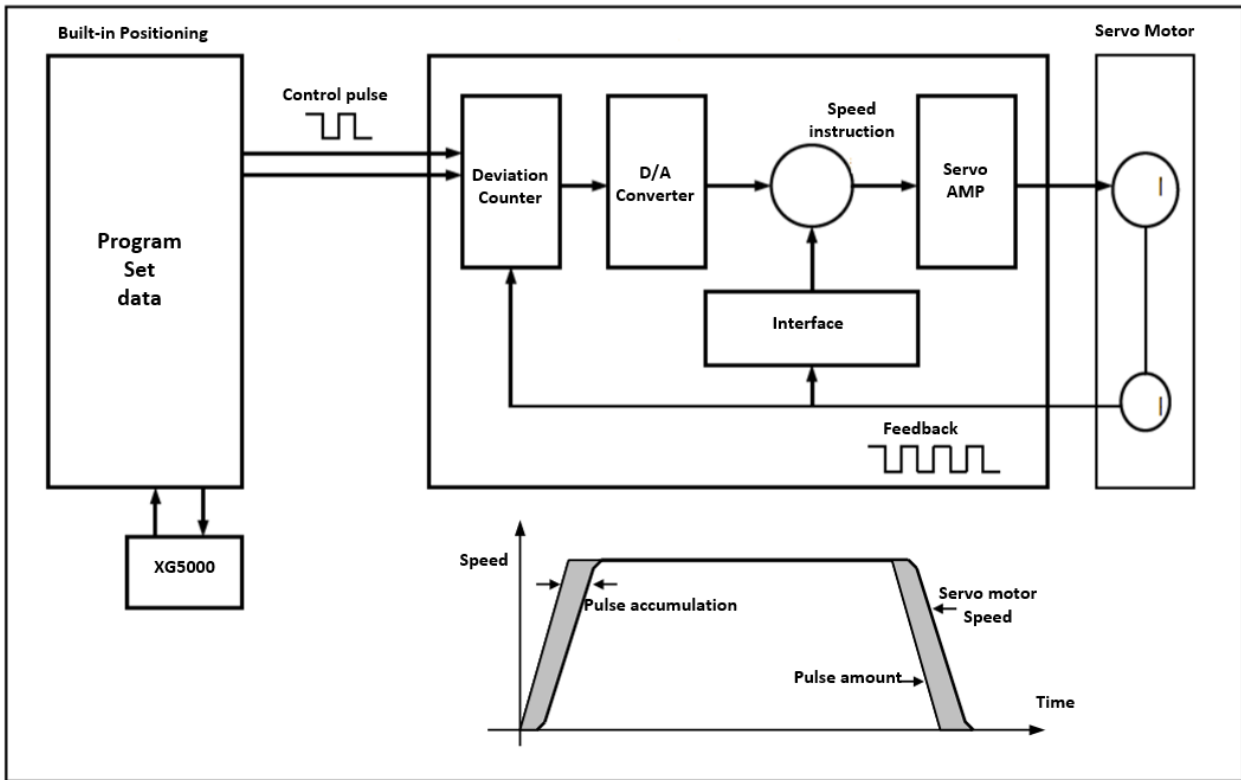
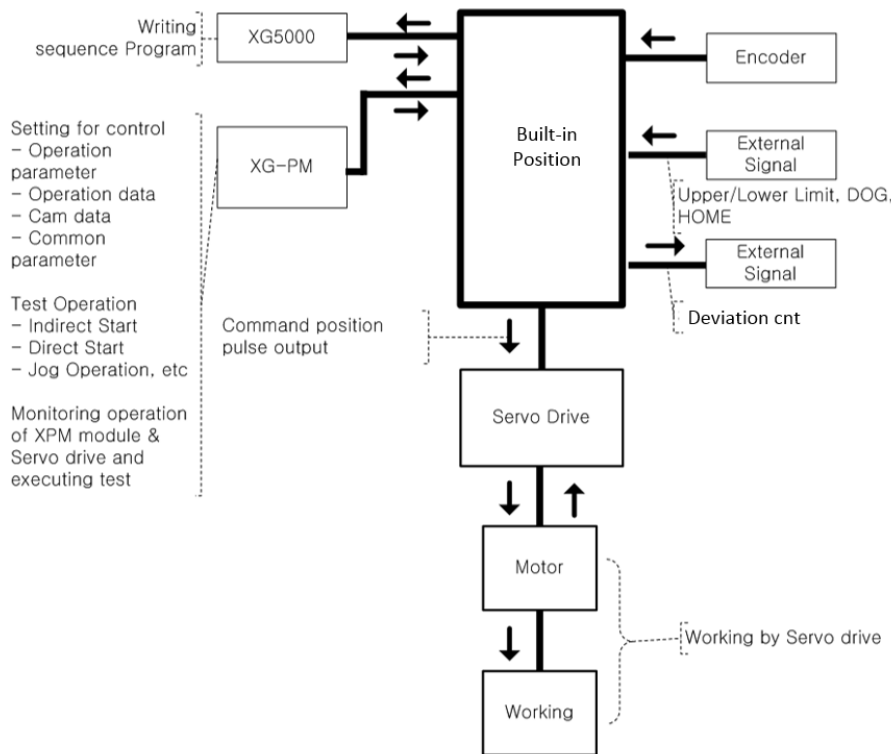

Fig. 1.2 Overview of Position Control for Servo Motor



1.4 Function overview of embedded positioning

Describe Representative functions of APM module (Coordinate & Linear Interpolation, Circular Interpolation & Stop) briefly.

1.4.1 Position Control

Execute positioning control for the designated axis from the starting position(current position) to goal position(the position to move to).

(1) Control by Absolute coordinates

- (a) Execute positioning control from starting position to goal position designated in positioning data
- (b) Positioning control is executed based on origin designated in homing
- (c) Moving direction is decided by starting position and goal position.
 - Starting Position < Goal Position : Forward Positioning Operation
 - Starting Position > Goal Position : Reverse Positioning Operation

[Example]

■ Starting Position : 1000

■ Goal Position : 8000

Value of Forward movement is 7000 ($7000=8000-1000$)

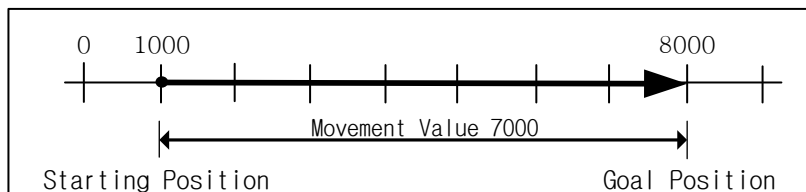

(2) Control by Incremental Coordinates

- (a) Execute positioning control from starting position as much as goal movement value.

The difference from absolute coordinates control is that the goal position is movement value, not position value.
- (b) Moving direction depends on sign of movement value.
 - Positive value (+ or 0) : Positioning operation with forward direction
 - Negative value (-) : Positioning operation with reverse direction

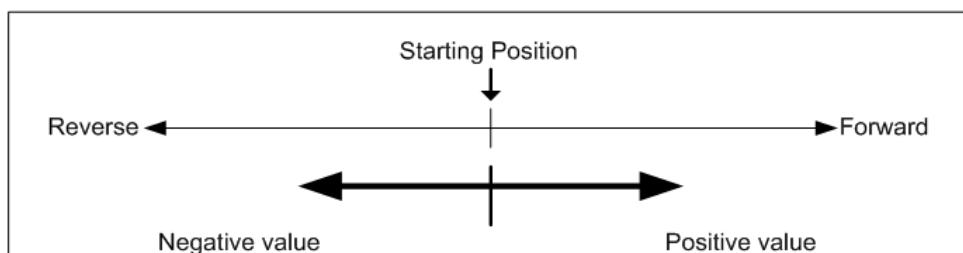

[Example]

- Starting Position : 5000
- Goal Position : -7000

In this condition, it moves reversely and stops at -2000.

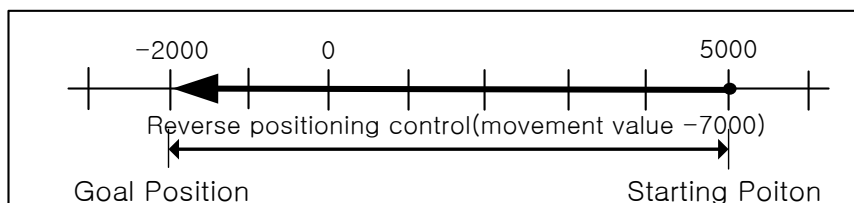

1.4.2 Interpolation Control

(1) Linear Interpolation Control

Execute linear interpolation control with designated axis at start position (Current position).

Combination of interpolation axis is unlimited and it is available to execute max. 4 axis linear interpolation control

(a) Linear interpolation by absolute coordinates

- 1) Execute linear interpolation from starting position to goal position designated by positioning data.
- 2) Positioning control is executed based on origin designated in homing.
- 3) Movement direction is designated by starting position & goal position of each axis.
 - Starting position < Goal position : Positioning operation with forward direction
 - Starting position > Goal position : Positioning operation with reverse direction

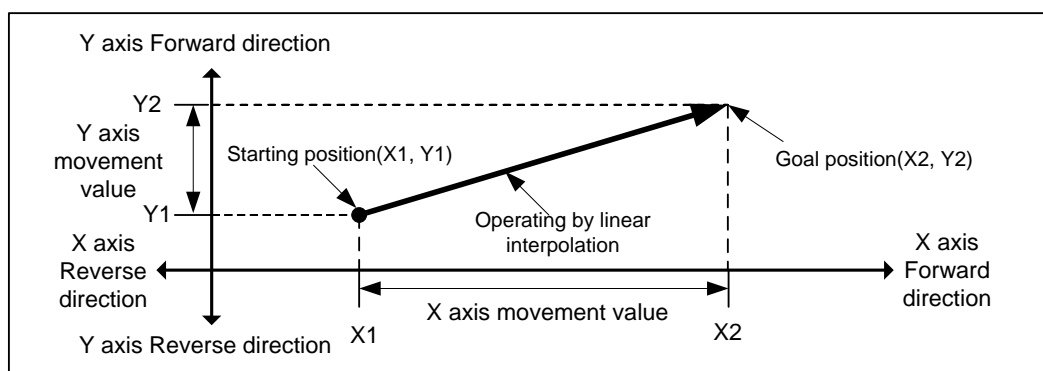

[Example]

- Starting Position (1000, 4000)
- Goal Position (10000, 1000)

In this condition, operation is as follows.

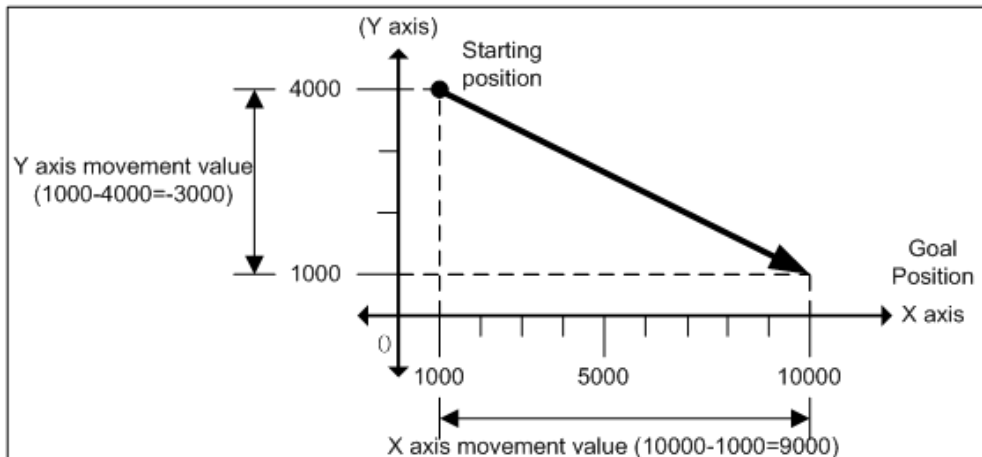

(b) Linear Interpolation by incremental coordinates

- 1) Goal value becomes movement value
- 2) Moving direction depends on movement value is positive or negative.
 - Positive value (+ or 0) : Positioning operation with forward direction
 - Negative value (-) : Positioning operation with reverse direction

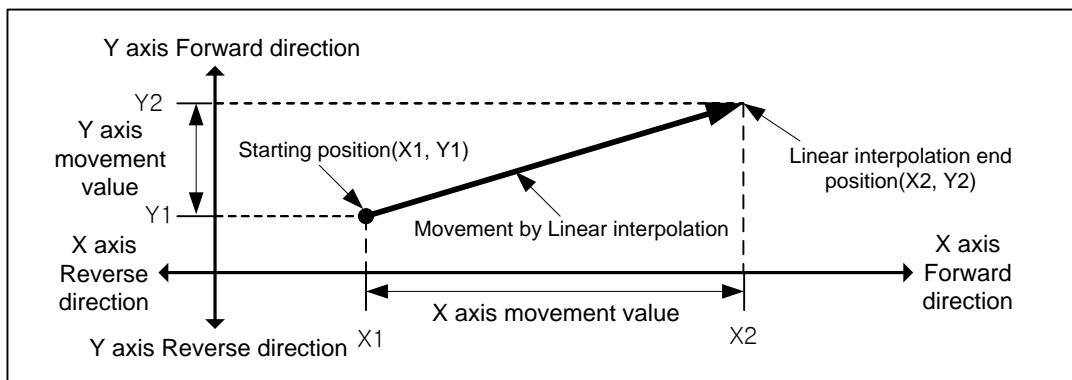

[Example]

- Starting position (1000, 4000)
- Goal position (9000, -3000)

In this condition, operation is as follows.

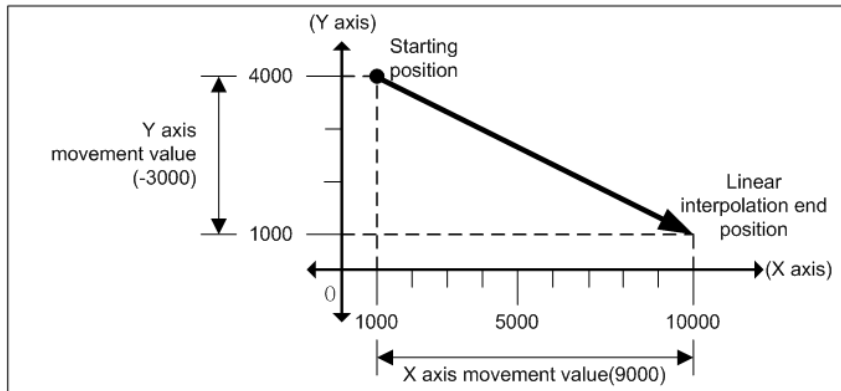

(2) Circular Interpolation Control

Execute interpolation operation along the trace of circle with 2 axes in direction that already designated for each axis.

Circular interpolation has 3 types according to auxiliary point, Middle point method passing auxiliary point, Center point method using auxiliary point as center of circle and Radius method using auxiliary point as radius of circle.

In addition, it is available to be executed more than 360° circular interpolation according to the value of “circular interpolation turns”.

There is no limitation for the combination of 2 axes that used in circular interpolation. (Available to use any 2 of axis 1~4)

(a) Circular interpolation with middle point designation form.

- 1) Starts operating at starting position and execute circular interpolation through the designated middle point.
- 2) There will be a circular arc whose center point is crossing point of perpendicular bisection between starting position and middle point or middle point and goal position.

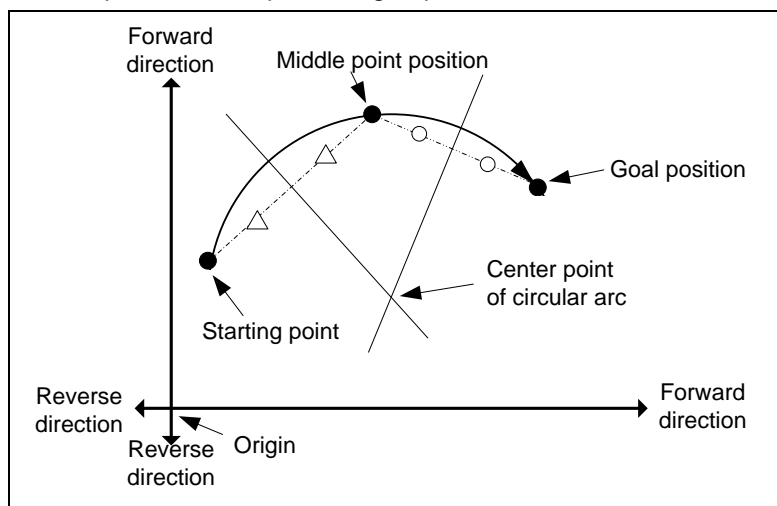

3) Control unit “degree” is not available to be used for circular interpolation control.

4) Movement direction is automatically designated by goal position and auxiliary point of circular interpolation

(b) Circular interpolation with center point designation form

- 1) Starts operating from starting position and execute circular interpolation along trace of circle that has distance from starting point to designated center point as radius.

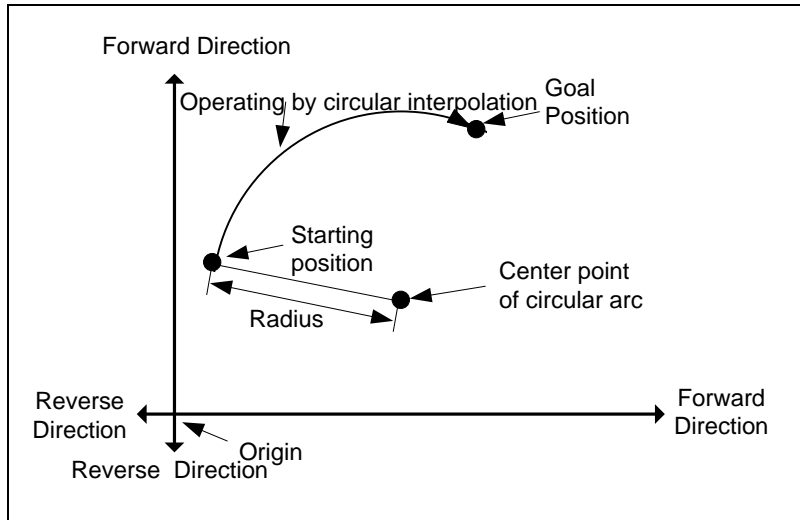

- 2) If the goal position is same as starting position, it is available to have an operation like a circle that has distance from starting point to auxiliary point as its radius

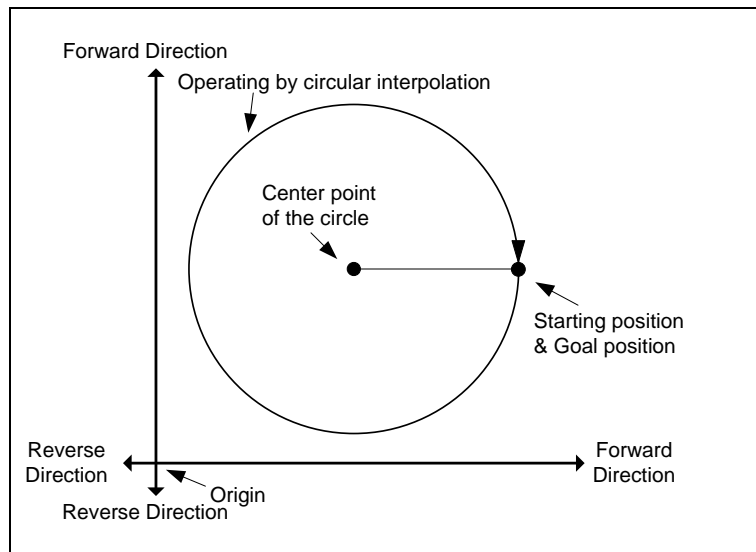

- 3) Control unit "degree" is not available to be used for circular interpolation control.
- 4) Direction is determined in setting of "Cir int. mode" (Center point CW, Center point CCW).

(c) Circular interpolation with radius designation form

- 1) Starts operating from starting position and execute circular interpolation along trace of circular arc that has value designated in auxiliary point of main axis as it radius. Depending on size setting of circular arc ($<180^\circ$, $\geq 180^\circ$), center point of circular arc will be different.

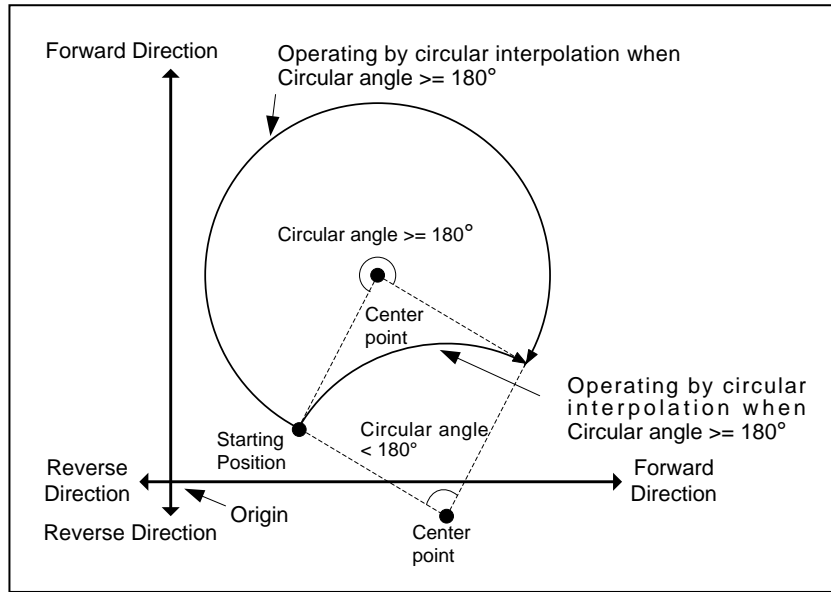

- 2) In radius designation form, goal position can't be set the same as starting position.
- 3) Control unit "degree" is not available to be used for circular interpolation control.
- 4) The direction and arc size are determined in "Cir. int. mode".

(3) Helical Interpolation

- (1) Moves along the designated trace of circular arc depending on circular arc interpolation setting and executes linear interpolation synchronously.
- (2) It is available to execute helical interpolation of more than 360° depending on 'Circular interpolation turns' setting.
- (3) The combination of axis that used for helical interpolation control is unlimited, 3 axes among axis1 ~ 4 are used.

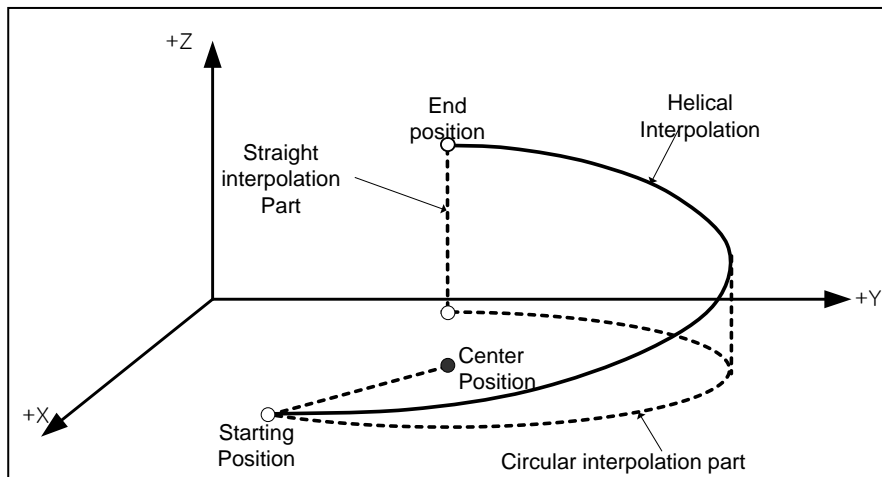

1.4.3 Speed Control

- (1) It is executed by positioning operation start command (Direct start, Indirect start, Synchronous start) and keeps operating with designated speed until Dec. stop command.
- (2) Speed control has forward operation and reverse operation.
 - (a) Forward operation : Position value ≥ 0
 - (b) Reverse operation : Position value < 0
- (3) In case of speed control, M code will be on only when M code mode is "With".
- (4) Operating Timing

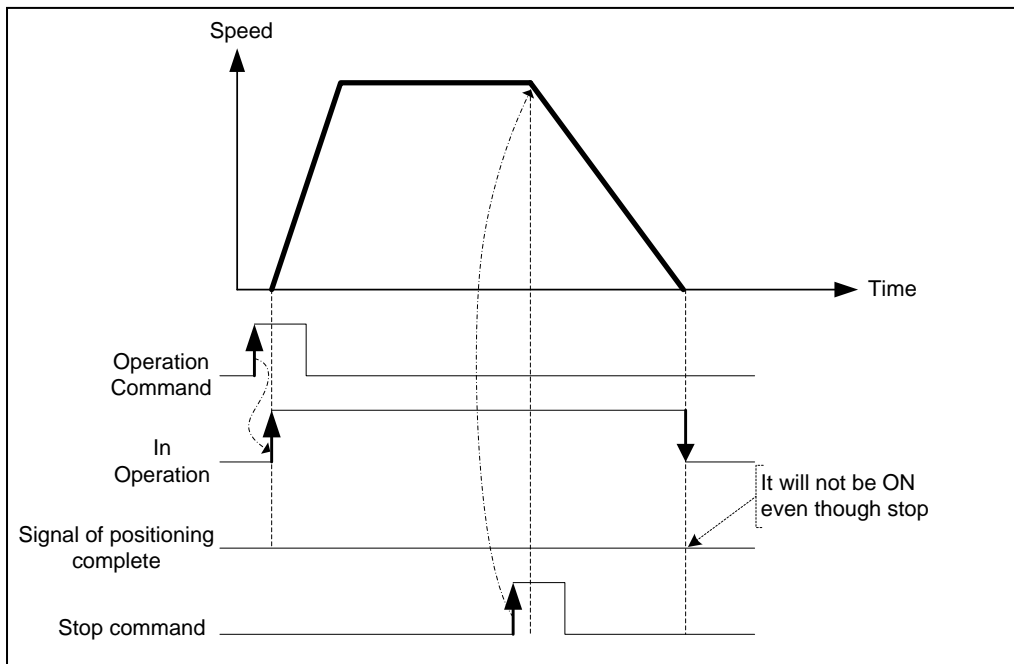

1.4.4 FEED Control

- (1) After executed by positioning start, reset the current position as 0 and start positioning as much as movement value already set.
- (2) Movement direction is decided by movement value.
- (3) Feed control has forward direction operation and reverse direction operation.
 - (a) Forward direction : Position value ≥ 0
 - (b) Reverse direction : Position value < 0
- (4) Operation timing is as follows.

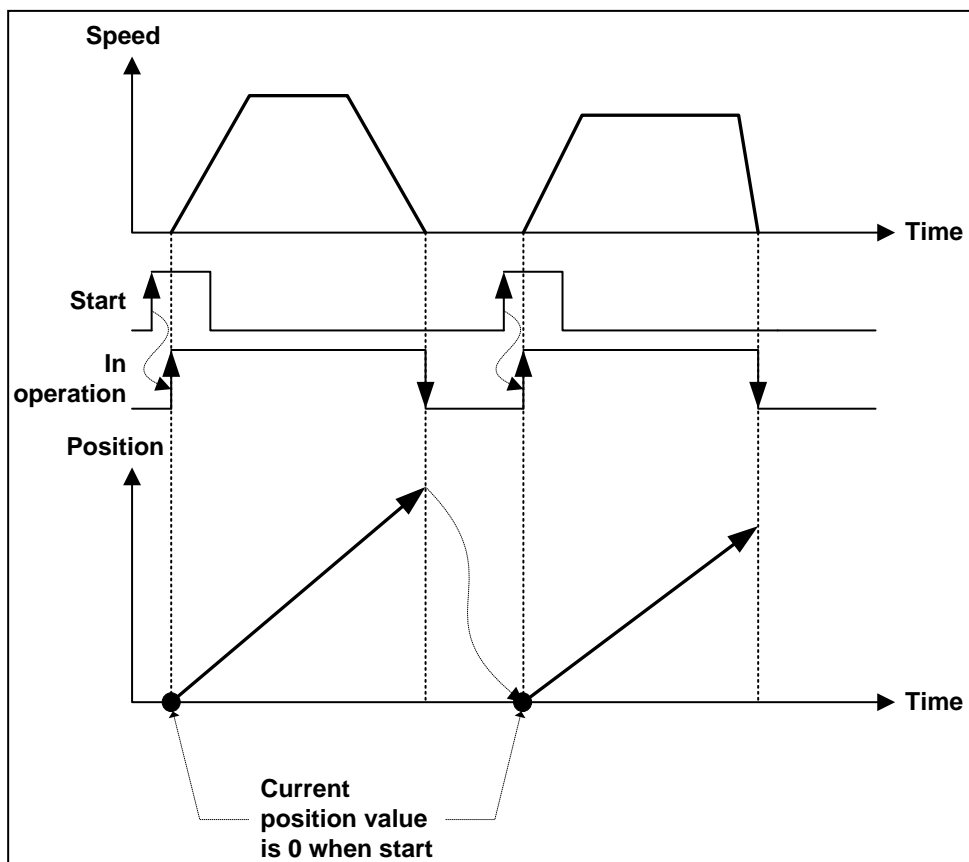

Chapter 2 Specifications

2.1 Performance Specifications

The following table shows the performance specifications of Embedded Positioning.

Model		XEM-DN(DP)16H2, XEM-DN(DP)32H2	XEM-DN(DP)32HP		
Items					
No. of control axis		2		6	
Interpolation function		<ul style="list-style-type: none"> ▪ 2 axis linear interpolation ▪ 2 axis circular interpolation 		<ul style="list-style-type: none"> ▪ 2/3/4/5/6 axis linear interpolation ▪ 2 axis circular interpolation ▪ 3 axis helical interpolation 	
Control method		Position control, Speed control, Speed/Position control, Position/Speed control, Feed control			
Control unit		Pulse, mm, inch, degree			
Positioning data		Each axis can have up to 400 operation data .(Operation step number : 1 ~ 400) Available to set with software package (XG-PM) or program			
XG-PM	Connection	USB port of CPU			
	Setting data	Common, Basic, Extended, Manual operation, Homing, Input/output signal parameter, Operation data, Cam data, Command information			
	Monitor	Operation information, Trace, Input terminal information, Error information			
Back-up		Save the parameter, operation data in Flash ROM (No need of Battery, Max. 100,000 cycle)			
POSITIONING	Positioning method	Absolute method/Incremental method			
	Position address range		Absolute	Incremental	Speed/Position, Position/Speed Switching control
		mm	-214748364.8 ~ 214748364.7(μm)	-214748364.8 ~ 214748364.7(μm)	-214748364.8 ~ 214748364.7(μm)
		Inch	-21474.83648 ~ 21474.83647	-21474.83648 ~ 21474.83647	-21474.83648 ~ 21474.83647
		degree	-21474.83648 ~ 21474.83647	-21474.83648 ~ 21474.83647	-21474.83648 ~ 21474.83647
		pulse	-2147483648 ~ 2147483647	-2147483648 ~ 2147483647	-2147483648 ~ 2147483647
	Speed range	mm	0.01 ~ 21474836.47 (mm/min)		
Inch		0.001 ~ 2147483.647 (Inch/ min)			
degree		0.001 ~ 2147483.647 (degree/ min)			
pulse		1 ~ 200,000(pulse/sec): Line driver			
rpm		0.1 ~ 100000.0(RPM)			
- mm,Inch,degree cannot exceed 200,000 pulse/sec					
Acc./Dec. process		Trapezoid type, S-Curve			
Acc./Dec. time		0 ~ 2,147,483,647ms selection is available from 4 types of acceleration/deceleration pattern			
Manual Operation		Jog Operation, MPG Operation, Inching Operation			
Homing method		DOG + HOME (Off), DOG + HOME(On), upper limit + HOME, DOG, High speed, Upper/Lower limit, HOME			
Speed change function		Speed change (Percent/Absolute value)			

Items \ Model	XEM-DN(DP)32H2/HP	XEM-DN(DP)16H2
Control Period	1~10ms	
Max. speed	200 kpps, (Low-Active)	
Connector	40 Pin connector	10 Pin Terminal block connector
Size of use cable	AWG #24	

2.2 External Interface I/O Specifications

Here describes the I/O interface for external equipment.

2.2.1 Input Specifications

External input signal of Built-in Positioning can be set by P area where user can set the device in Extended parameter.
(In case of HOME signal, I area range can be set %IX0.0.0~%IX0.0.15)

2.2.2 Output Specifications

Deviation signal can be set by Q area where user can set the device in Extended parameter.

2.2.3 Positioning output

(In case of 2 axis XEM refer to only 1,2 axis)

Type		XEM-DN32H2 / XEM-DN32HP (Sink)			
Contact no.	1axis	%QX0.0.0		%QX0.0.6	Ref.
	2axis	%QX0.0.1		%QX0.0.7	
	3axis	%QX0.0.2		%QX0.0.8	
	4axis	%QX0.0.3		%QX0.0.9	
	5axis	%QX0.0.4		%QX0.0.10	
	6axis	%QX0.0.5		%QX0.0.11	
Signal name		Pulse string output		Direction output	
Rated load voltage	DC12~24V (DC10.2~26.4V)				
Max. load current	0.1A/1 point or below				
Insulation method	Photo-coupler insulation				
Inrush current	4A/10ms or below				
Voltage drop when On	DC 0.4V or below				
Leakage current when Off	0.1mA or below				
Response time	5us or below (10mA or above)				
Circuit configuration and connector array		No.	Contact	No.	Contact
		B20	%IX0.0.0	A20	%QX0.0.0
		B19	%IX0.0.1	A19	%QX0.0.1
		B18	%IX0.0.2	A18	%QX0.0.2
		B17	%IX0.0.3	A17	%QX0.0.3
		B16	%IX0.0.4	A16	%QX0.0.4
		B15	%IX0.0.5	A15	%QX0.0.5
		B14	%IX0.0.6	A14	%QX0.0.6
		B13	%IX0.0.7	A13	%QX0.0.7
		B12	%IX0.0.8	A12	%QX0.0.8
		B11	%IX0.0.9	A11	%QX0.0.9
		B10	%IX0.0.10	A10	%QX0.0.10
		B9	%IX0.0.11	A9	%QX0.0.11
		B8	%IX0.0.12	A8	%QX0.0.12
		B7	%IX0.0.13	A7	%QX0.0.13
		B6	%IX0.0.14	A6	%QX0.0.14
		B5	%IX0.0.15	A5	%QX0.0.15
		B4	NC	A4	P
B3	NC	A3	P		
B2	IN_COM	A2	OUT_COM		
B1	IN_COM	A1	OUT_COM		

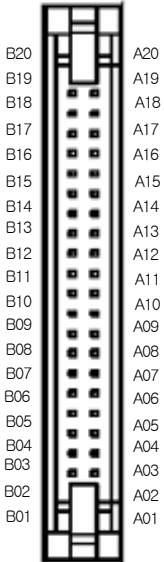
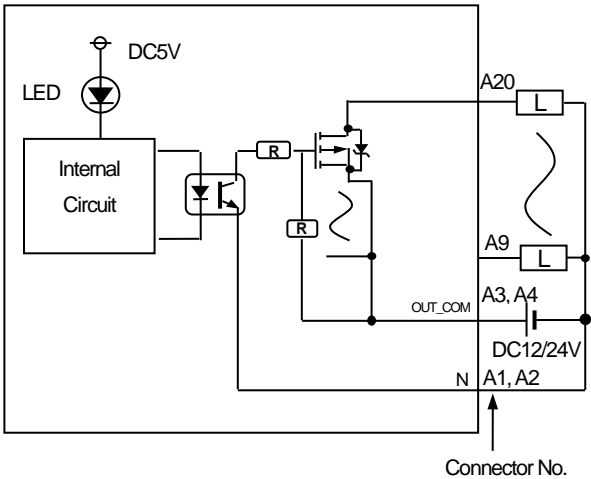
Type		XEM-DP32H2 / XEM-DP32HP (Source)		Ref.		
Contact no.	1axis	%QX0.0.0	%QX0.0.6			
	2axis	%QX0.0.1	%QX0.0.7			
	3axis	%QX0.0.2	%QX0.0.8			
	4axis	%QX0.0.3	%QX0.0.9			
	5axis	%QX0.0.4	%QX0.0.10			
	6axis	%QX0.0.5	%QX0.0.11			
Signal name	Pulse string output		Direction output			
Rated load voltage	DC12~24V (DC10.2~26.4V)					
Max. load current	0.1A/1 point or below					
Insulation method	Photo-coupler insulation					
Inrush current	4A/10ms or below					
Voltage drop when On	DC 0.4V or below					
Leakage current when Off	0.1mA or below					
Response time	5 μ s or below (10mA or above)					
Circuit configuration and connector array		No.	Contact	No.	Contact	
		B20	%IX0.0.0	A20	%QX0.0.0	
		B19	%IX0.0.1	A19	%QX0.0.1	
		B18	%IX0.0.2	A18	%QX0.0.2	
		B17	%IX0.0.3	A17	%QX0.0.3	
		B16	%IX0.0.4	A16	%QX0.0.4	
		B15	%IX0.0.5	A15	%QX0.0.5	
		B14	%IX0.0.6	A14	%QX0.0.6	
		B13	%IX0.0.7	A13	%QX0.0.7	
		B12	%IX0.0.8	A12	%QX0.0.8	
		B11	%IX0.0.9	A11	%QX0.0.9	
		B10	%IX0.0.10	A10	%QX0.0.10	
		B9	%IX0.0.11	A9	%QX0.0.11	
		B8	%IX0.0.12	A8	%QX0.0.12	
		B7	%IX0.0.13	A7	%QX0.0.13	
		B6	%IX0.0.14	A6	%QX0.0.14	
		B5	%IX0.0.15	A5	%QX0.0.15	
B4	NC	A4	OUT_COM			
B3	NC	A3	OUT_COM			
B2	IN_COM	A2	N			
B1	IN_COM	A1	N			



Spec.		Type																									
		XEM-DN16H2																									
Contact No.	1axis	%QX0.0.0	%QX0.0.6	Ref.																							
	2axis	%QX0.0.1	%QX0.0.7																								
Signal name		Pulse string output	Direction output																								
Rated load voltage		DC12~24V (DC10.2~26.4V)																									
Max. load voltage		0.1A/ 1 point or below																									
Insulation method		Photocoupler insulation																									
Inrush current		4A/10 ms or below																									
Voltage drop when On		DC 0.4V or below																									
Leakage current when Off		0.1 mA or below																									
Response time		5 μs or below(10mA or above)																									
Circuit configuration and connector array				<table border="1"> <thead> <tr> <th>No.</th> <th>Contact</th> </tr> </thead> <tbody> <tr><td>TB01</td><td>%QX0.0.0</td></tr> <tr><td>TB02</td><td>%QX0.0.1</td></tr> <tr><td>TB03</td><td>%QX0.0.2</td></tr> <tr><td>TB04</td><td>%QX0.0.3</td></tr> <tr><td>TB05</td><td>%QX0.0.4</td></tr> <tr><td>TB06</td><td>%QX0.0.5</td></tr> <tr><td>TB07</td><td>%QX0.0.6</td></tr> <tr><td>TB08</td><td>%QX0.0.7</td></tr> <tr><td>TB09</td><td>P</td></tr> <tr><td>TB10</td><td>OUT_COM</td></tr> </tbody> </table>		No.	Contact	TB01	%QX0.0.0	TB02	%QX0.0.1	TB03	%QX0.0.2	TB04	%QX0.0.3	TB05	%QX0.0.4	TB06	%QX0.0.5	TB07	%QX0.0.6	TB08	%QX0.0.7	TB09	P	TB10	OUT_COM
				No.	Contact																						
				TB01	%QX0.0.0																						
				TB02	%QX0.0.1																						
				TB03	%QX0.0.2																						
				TB04	%QX0.0.3																						
				TB05	%QX0.0.4																						
				TB06	%QX0.0.5																						
				TB07	%QX0.0.6																						
				TB08	%QX0.0.7																						
				TB09	P																						
TB10	OUT_COM																										
<table border="1"> <tbody> <tr><td>TB01</td></tr> <tr><td>TB02</td></tr> <tr><td>TB03</td></tr> <tr><td>TB04</td></tr> <tr><td>TB05</td></tr> <tr><td>TB06</td></tr> <tr><td>TB07</td></tr> <tr><td>TB08</td></tr> <tr><td>TB09</td></tr> <tr><td>TB10</td></tr> </tbody> </table>		TB01	TB02	TB03	TB04	TB05	TB06	TB07	TB08	TB09	TB10																
TB01																											
TB02																											
TB03																											
TB04																											
TB05																											
TB06																											
TB07																											
TB08																											
TB09																											
TB10																											

Type		XEM-DP16H2			
Spec.	Contact No.	1axis	%QX0.0.0	%QX0.0.6	Ref.
		2axis	%QX0.0.1	%QX0.0.7	
Signal name		Pulse string output		Direction output	
Rated load voltage		DC12~24V (DC10.2~26.4V)			
Max. load current		0.1A/ 1 point or below			
Insulation method		Photocoupler insulation			
Inrush current		4A/10 ms or below			
Voltage drop when On		DC 0.4V or below			
Leakage current when Off		0.1 mA or below			
Response time		5 μ S or below(10mA or above)			
Circuit configuration and connector array		No.	Contact		
		TB01	%QX0.0.0	TB01 TB02 TB03 TB04 TB05 TB06 TB07 TB08 TB09 TB10	
		TB02	%QX0.0.1		
		TB03	%QX0.0.2		
		TB04	%QX0.0.3		
		TB05	%QX0.0.4		
		TB06	%QX0.0.5		
		TB07	%QX0.0.6		
		TB08	%QX0.0.7		
		TB09	OUT_COM		
		TB10	N		

2.2.4 External Equipment and Interface Specifications

Output pulse of XGB built-in positioning consists of Pulse + Direction like figure below.

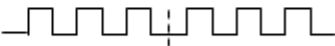
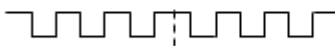
At this time, output level of Low Active and High Active can be specified by positioning parameter and K area flag dedicated for positioning.

Pulse output type	Output signal	Output signal level				Reference
		High Active mode		Low Active mode		
		Forward	Reverse	Forward	Reverse	
Pulse + direction mode	Pulse					Supported by S, H, HP type
	Direction					

Chapter 3 Operation Order and Installation

3.1 Operation Order

This chapter describes the Operation order in case of positioning operation by embedded positioning.

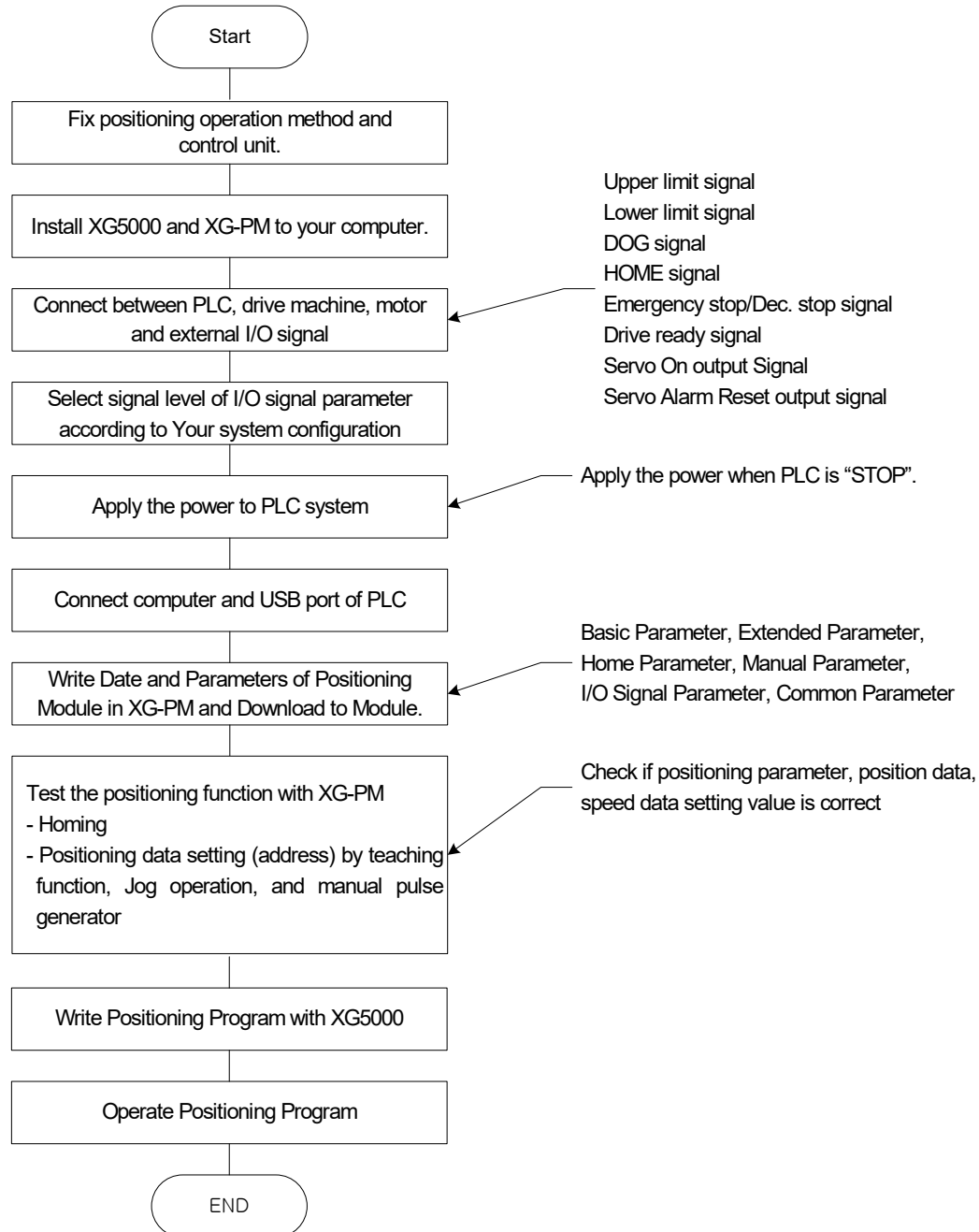

3.2 Installation

3.2.1 Installation Environment

This machine has a good reliability regardless of installation environment but cares should be taken in the following items to guarantee the reliability and safety of the system.

(1) Environment Condition

- Install the control panel available for water-proof, anti-vibration.
- The place free from continuous impact or vibration.
- The place not exposed to direct rays.
- The place with no dew phenomena by rapid temperature change.
- The place where surrounding temperature maintains 0-55°C.

(2) Installation Construction

- In case of processing the screw hole or wiring, cares should be taken not to put the wiring remnants to PLC inside.
- Install on the good place to operate.
- Do not install the high voltage machine on the same Panel.
- The distance from duct or surrounding module shall be more than 50mm.
- Ground to the place where surrounding noise environment is good enough.

3.2.2 Notices in Handling

Here describes the notices in handling the positioning module from opening to installation.

- (1) Do not fall down or apply the strong impact.
- (2) Do not remove PCB from the case. It may cause the failure.
- (3) In wiring, cares should be taken not to put the wiring remnants or foreign materials to the upper part of module. If something entered, it should be removed.
- (4) The removal of module in the status of power ON is prohibited.
- (5) When using the system of positioning control, please use it after you've set up the origin.
When Power On or Off, change of pulse output could occurred by Power On or Off.

3.3 Notices in Wiring

3.3.1 Notices in Wiring

- 1) The length of connecting cable between positioning module and drive machine shall be as short as possible (Max. 10m).
- 2) For alternating current and external I/O signal of positioning module, it is required to use the separate cables to avoid the surge or induction noise generated from the alternating current.
- 3) The wires should be selected considering surrounding temperature, allowable current and it is recommended to be more than max. size AWG22 (0.3mm²).
- 4) In wiring, if it is too close to the high temperature machine or material or it is directly contacted to the oil for a long time, the short-circuit will occur that may cause the damage or malfunction.
- 5) Make sure to check the polarity before applying the external contact signal to the terminal board.
- 6) In case of wiring the high voltage cable and power cables together, the induction noise occurs that may cause the malfunction or failure.
- 7) In case of wiring by the pipe, the grounding of pipe is required.
- 8) In case that there may be the noise source in wiring between positioning module and drive machine, it is required to use and connect Twist pair and shielded cable for the wiring of output pulse that comes from the positioning and enters into the motor drive.

3.3.2 Connection Example of Servo

- (1) XGT Servo
(a) XDL-S series

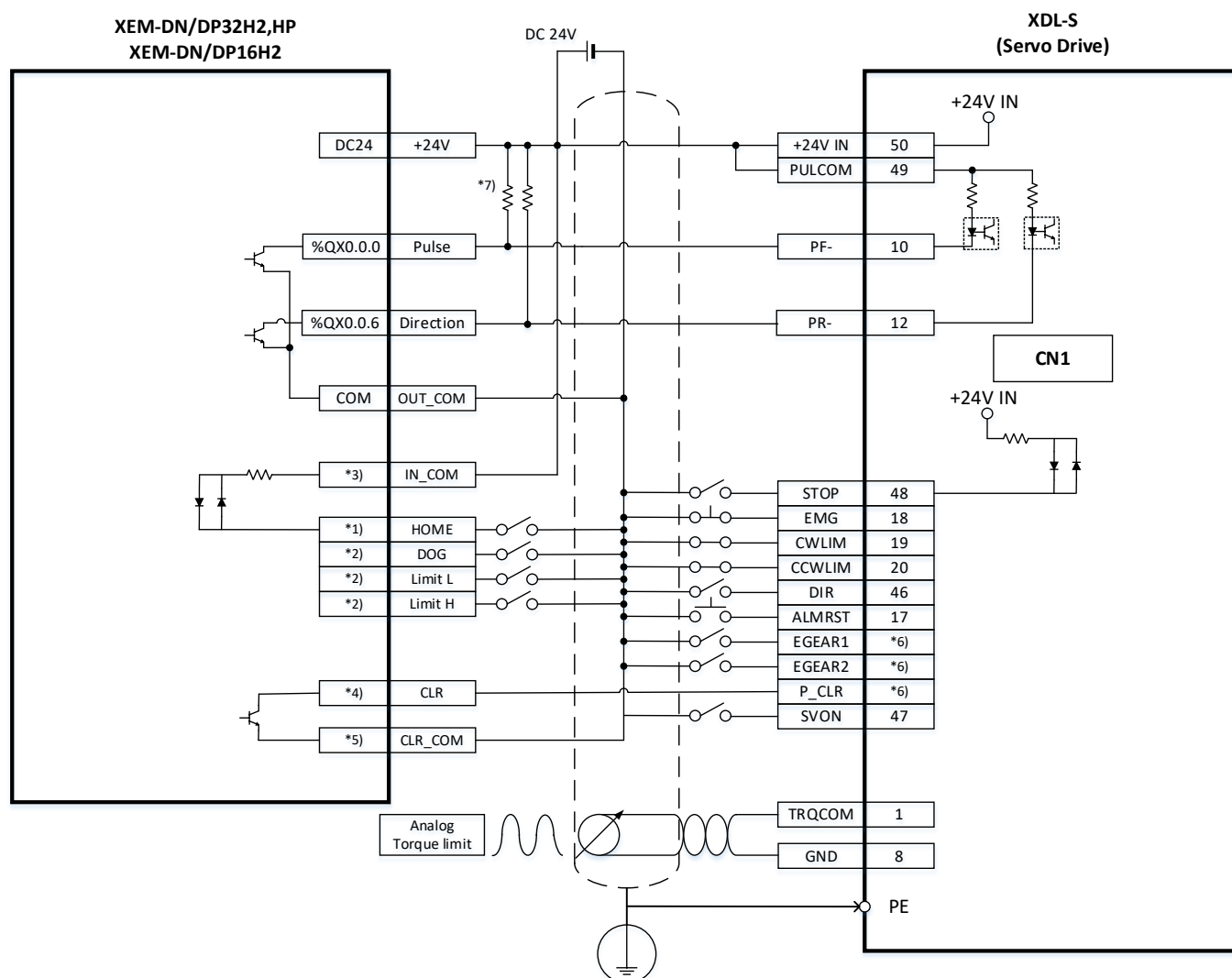

- 1) The home position signal can be set to %IX0.0.0~%IX0.0.15 through the input/output signal parameter setting
- 2) Other input signals, except the origin, can set the entire area of I device.
- 3) For COM for each input, connect the COM contact corresponding to the set I device.
- 4) The deviation clear signal can set the area of the Q device. set the
- 5) For COM for deviation clear, connect the COM contact corresponding to the set Q device.
- 6) EGEAR1, EGEAR2, P_CLR are not allocated. For more information refer to Servo manual.
- 7) Transister Off time tend to be long when load current is small. In case of reducing off time, add dummy resister as above wiring.

(2) Connection with stepping motor driver
 (a) DC5V power

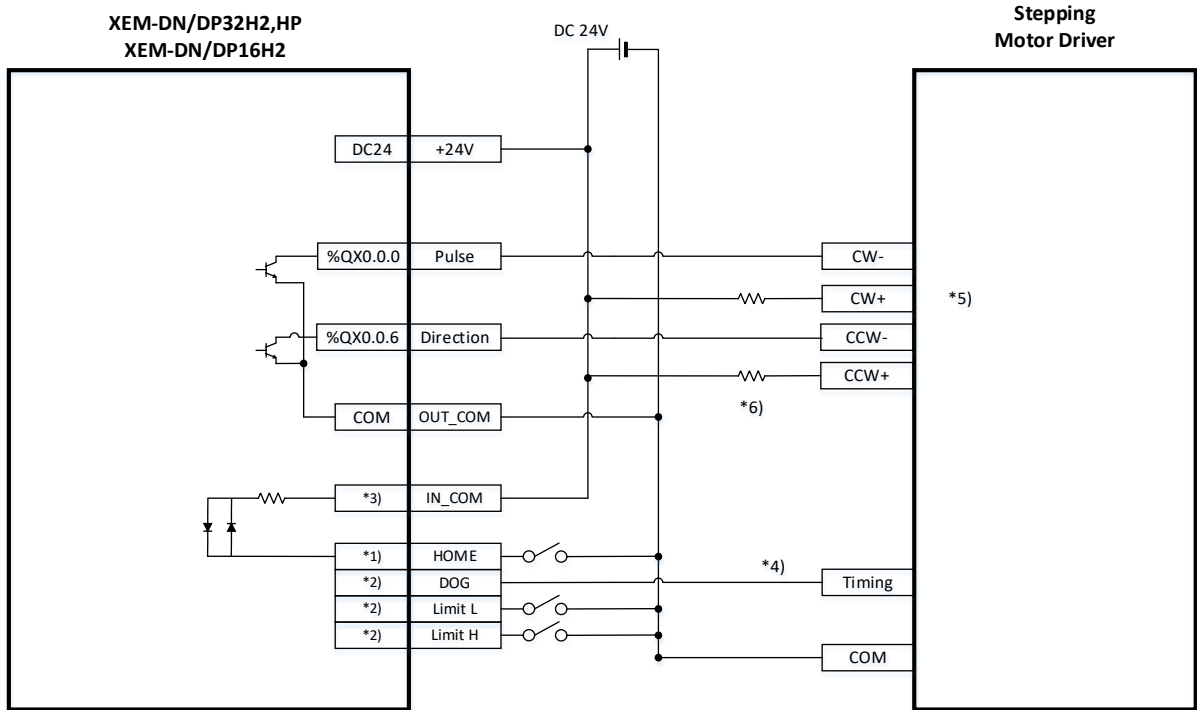

(b) DC24V power

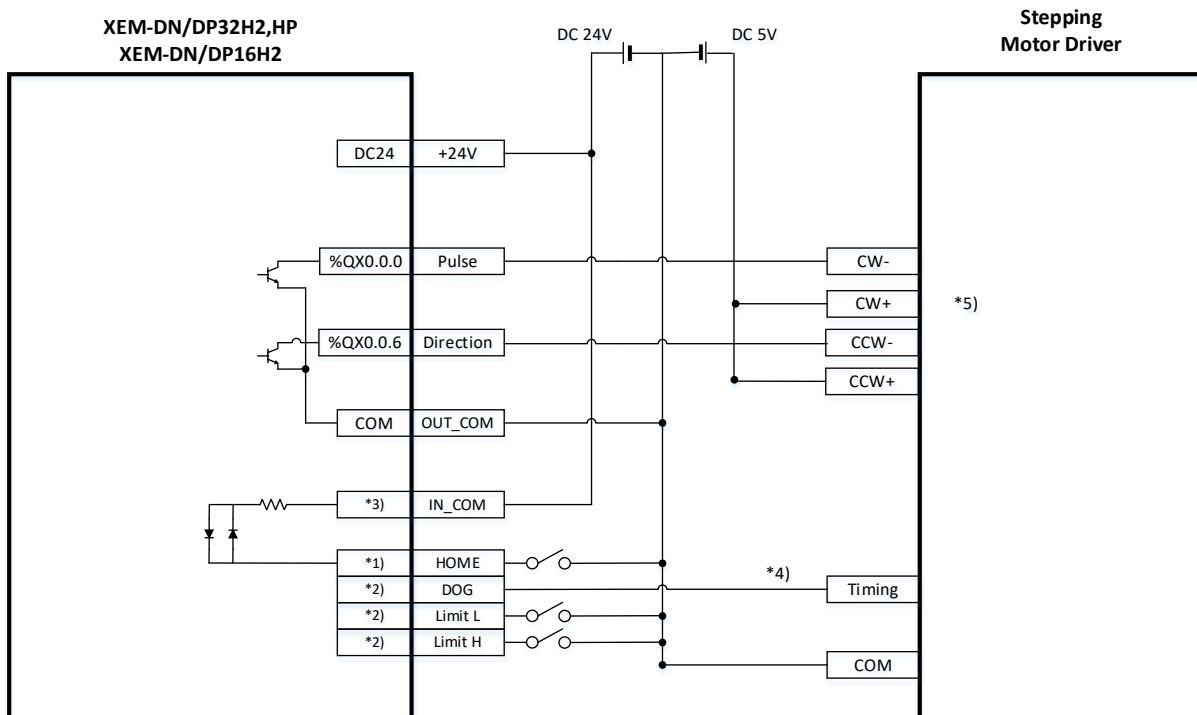

- 1) The home position signal can be set to %IX0.0.0~%IX0.0.15 through the input/output signal parameter setting
- 2) Other input signals, except the origin, can set the entire area of I device.
- 3) For COM for each input, connect the COM contact corresponding to the set I device.
- 4) For the VEXTA RKD series, TIMING output is 'On' whenever the motor rotates 7.2 degrees. For accurate homing, T output and home sensor must be configured as AND circuits. Do not use TIMING output signal according to the system characteristics, use the origin sensor for homing signal or homing by the dog signal. (The home input rating of XGB is DC24V)
- 5) Only pulse + direction mode can be output, be sure to change the input mode of the stepping motor driver to 1-phase input mode.
- 6) In case of using DC24V power, use the proper resistor in series with the driver.

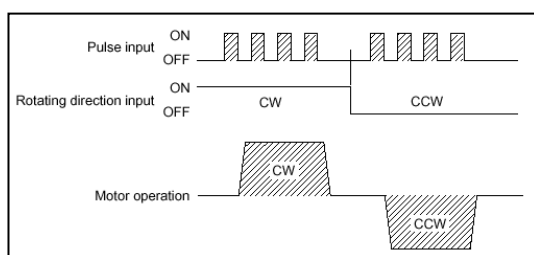

Chapter 4 Positioning Control

4.1 Positioning task

Here describes Positioning task, which synchronize with positioning control period

4.1.1 Positioning control task

The XEM-DN32HP has a position control task that synchronizes with the positioning control period.

4.1.2 Operation of Positioning control task

Position control tasks provide built-in I / O refresh to increase the responsiveness of signal, which changed or enabled in Position control task. Positioning control tasks are performed prior to the start of the positioning operation and have a higher priority than the scan. However, the position control task waits for the execution while communicating with the expansion module such as refreshing extension module refresh. If the sum of the position control task execution time and the positioning operation time is greater than the control period set in the common parameter, an error occurs and the position control task is not executed.

If exceeded control period error, increase the control period of common parameter up to 10ms or adjust the position control task program. The following shows the operation flow of the scan program and existing tasks(fixed cycle, internal / external contact, high-speed counter) and positioning task

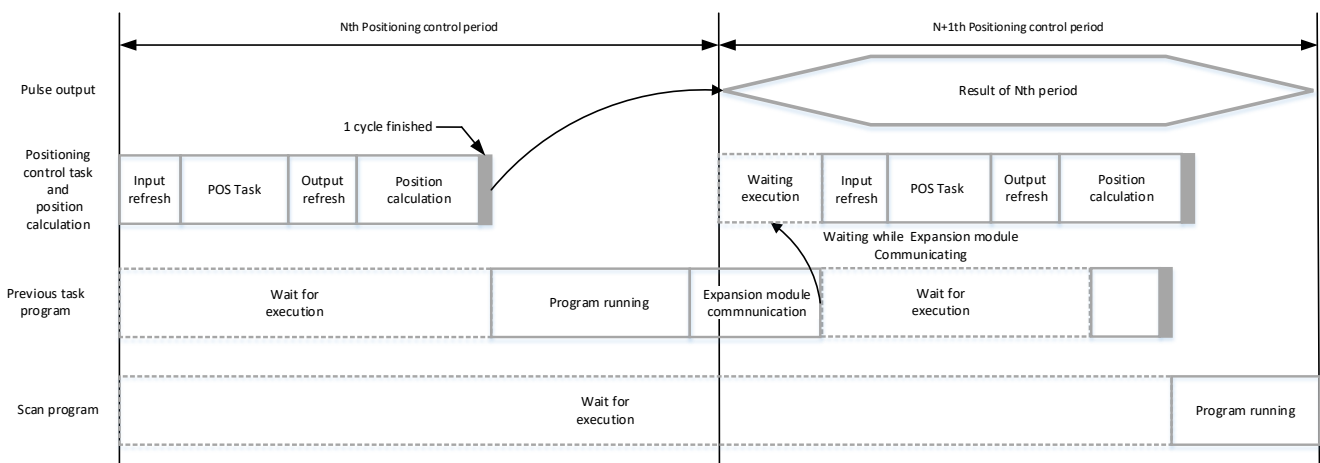

The position control task and the position control operation match the cycle. The processing priority is higher than the scan program and the existing task program and operates at the same priority level as the position control operation. The position control task waits while communicating with the expansion unit in the scan program or task program. the position control task execution time and position control operation time are larger than the positioning control period, the position control period error occurs and the positioning task does not operate. However, the position control operation operates even in the error state.

Notes

- ▶ systems using expansion units, set the position control cycle to at least 3 ms. Expansion unit communication time takes several hundreds of us to 2ms. Therefore, if the control period is set to 1 ms and an expansion unit is used, control cycle errors may occur frequently.

4.1.3 Built-in position control command operation

The built-in position control commands mainly include start command and non-start command. Start command is a command to perform position control operation over several scans such as direct start or indirect start. Non-start instruction is data processing related instruction to complete the operation within one scan such as reading current status and presetting current. The non-start instruction entered from the scan program or task program is applied to the positioning operation unit immediately after the instruction is executed. On the other hand, the start command is processed by the position control operator. Since the position control operation is synchronous, the start command input from the position control task is processed by the position control operation unit. It is processed at the same time. Therefore, it is convenient to use the position control task to synchronize the start of multiple axes.

For example, if you want to operate the 1-axis and 2-axis at the same time by direct starting, use the command in the position control task. Direct start of 1-axis and 2-axis starts simultaneously.

(1) Instruction processing in scan program and existing task program

The scan program has a lower priority than the position control operation. Therefore, when the position control processing period is reached during the operation of the scan program, the scan program processing enters the execution standby state and processes the position control operation.

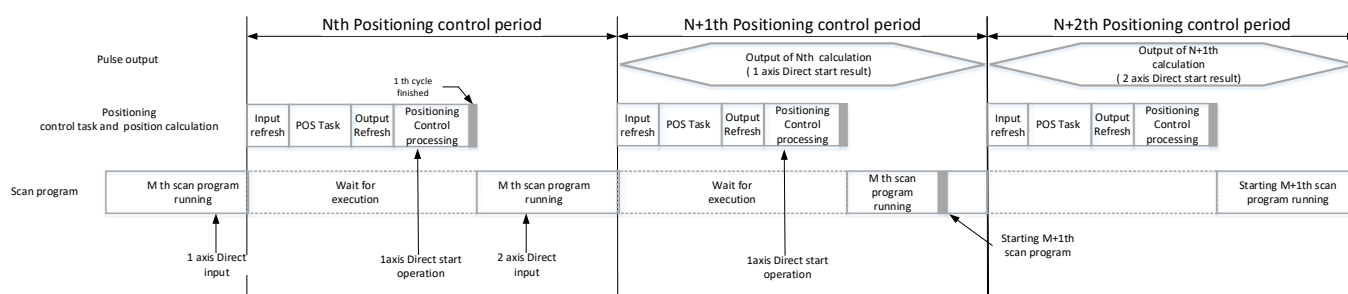

In the scan program as above, when start command is input to different operation axis in the same scan, the start time of axis operation may be different

In the scan program as above, when input of start command for each different axis comes in the same scan, actual operating time of each axis should be different.

(2) Instruction processing in position control task program

Since the POS task operates in a structure in which one scan is completed within the positioning control cycle, the start commands for the different axes executed in the same scan are simultaneously output. This is convenient when precise synchronous control between axes is required.

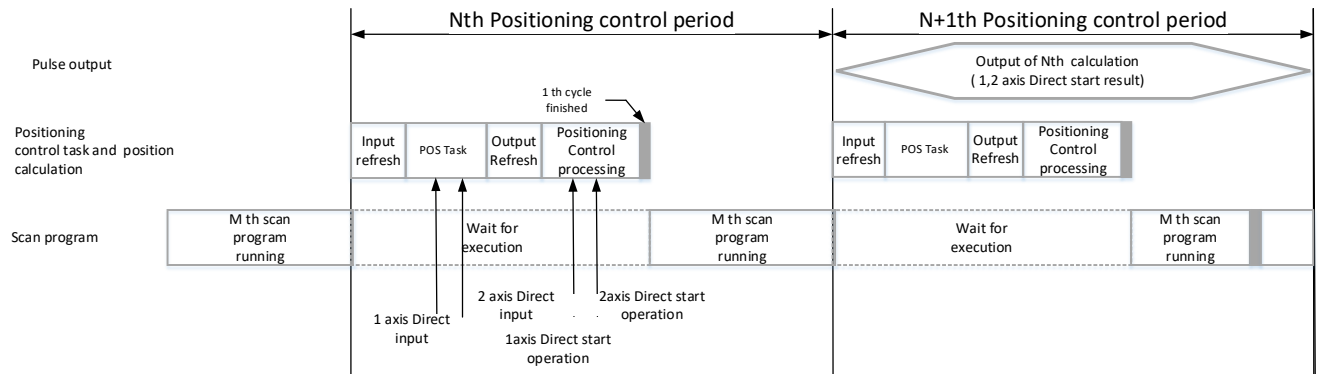

Chapter 5 Positioning Parameter & Operation Data

This chapter describes parameter and operation data to be set by software package with embedded positioning. Item of Parameter and operation data should be set for each axis(But common parameter shall be applied to all axis)

5.1 Parameter & Operation data

This picture describe process of parameter and operation data saved in the PLC.

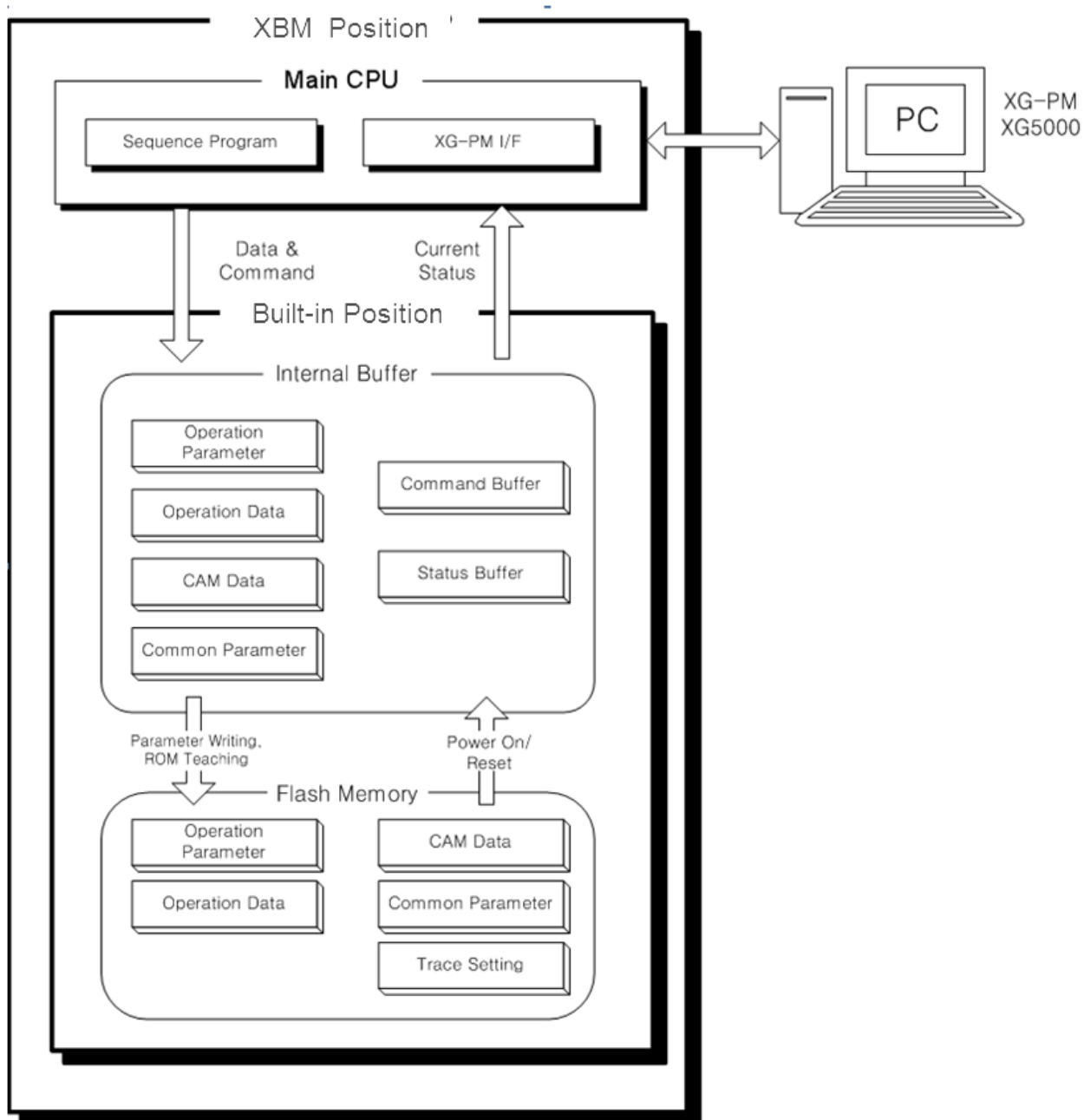

5.2 Basic Parameter

Here describes about basic parameter of embedded positioning.

5.2.1 Basic parameter

Item		Setting range
Speed limit 1)		mm : 1 ~ 2,147,483,647 [X10 ⁻² mm/min] Inch : 1 ~ 2,147,483,647 [X10 ⁻³ Inch/ min] degree : 1 ~ 2,147,483,647 [X10 ⁻³ degree/ min] pulse : 1 ~ 200,000 [pulse/Sec]
Acceleration time 1		0 ~ 2,147,483,647 [ms]
Acceleration time 2		
Acceleration time 3		
Acceleration time 4		
Deceleration time 1		0 ~ 2,147,483,647 [ms]
Deceleration time 2		
Deceleration time 3		
Deceleration time 4		
Deceleration time for EMG stop		0 ~ 2,147,483,647 [ms]
Pulse per revolution		1 ~ 200,000,000
Travel per revolution		mm : 1 ~ 200,000,000 [X10 ⁻⁴ mm] (1 ~ 200,000,000 [X10 ⁻¹ μm]) Inch : 1 ~ 200,000,000 [X10 ⁻⁵ Inch] degree : 1 ~ 200,000,000 [X10 ⁻⁵ degree]
Control word	unit (bit 2 ~ 3)	0:Pulse, 1:mm, 2:Inch, 3:Degree
	Unit multiplier(bit 4 ~ 5)	0: x 1, 1: x 10, 2: x 100, 3: x 1000
	Speed unit (bit 6)	0: unit/time, 1: rpm
Pulse output mode		0:CW/CCW, 1:PLS/DIR, 2:PHASE
Bias speed 2)		mm : 1 ~ 2,147,483,647 [X10 ⁻² mm/min] Inch : 1 ~ 2,147,483,647 [X10 ⁻³ Inch/ min] degree : 1 ~ 2,147,483,647 [X10 ⁻³ degree/ min] pulse : 1 ~ 200,000 [pulse/Sec]

1) The mm, inch, degree unit is not available when a value converted to the pulse/sec unit is greater than 200,000.

2) The bias speed can not greater than the speed limit.

Notes

For Deceleration time, when it stops by DEC. stop, DEC. time set in command is applied. At this time, if DEC. time is set as 0 in command, DEC. time set in basic parameter is applied. In case it stops by EMG stop because of internal factor, not external factor, EMG stop deceleration time in basic parameter is applied.

5.2.2 Basic parameter setting

(1) Unit

- (a) You can set the command unit for positioning control according to control object. The command unit (mm, inch, pulse, degree) can be set for each axis separately.
- (b) In case of changing the unit setting, as the value of other parameter and operation data does not change, the value of parameter or operation data should be set within the setting range of the unit to be changed.
- Ex) mm, inch, pulse : X-Y Table, Conveyor
degree : a body of rotation (360degree/revolution)

(2) Pulse per Revolution

- (a) Only in case of using mm, inch, degree as a positioning command unit, you should set pulse per revolution
- (b) In case of using SERVO, you should set the value of "the number of out put pulse per revolution".
If this value does not correspond with parameter value of servo drive, command and motor action may be different.
- Travel per pulse = Transfer per rotation (Al) / Pulse per rotation (Ap)
- Ex1) Speed: 60mm/min, Al:2000um, Ap: 200pls/revolution
60mm/min = 1mm/sec = 1000um/sec
1000um = 0.5 Revolution = 100pls
→ Pulse output speed is 100pls/sec when driving 60mm/min speed.

(3) Travel per rotation and unit multiplier

- (a) Only in case of using mm, inch, degree as a positioning command unit, you should set travel per revolution and multiplier
- (b) Actual Machine's travel distance per revolution of motor is determined by the structure of machine.
If the lead of ball screw (mm/rev) is PB and the rate of deceleration is 1/n,
Transfer amount per revolution (AL) = PB × 1/n.
- (c) Settable Travel per revolution (Al) is as below

Setting unit	mm	Inch	degree
Travel per revolution	0.1 ~ 20000000.0 um	0.00001 ~ 2000.00000 inch	0.00001 ~ 2000.00000 degree

In case Transfer amount per revolution (AL) exceeds the above range, The travel per rotation (Al) should be set as follows:

- Transfer amount (AL) = PB × 1/n = Travel per rotation (Al) × Unit multiplier (Am)

[Note]

In case unit is mm, unit multiplier (Am) can be 1, 10, 100, 1000.

If the value of "PB × 1/n" exceeds 20,000,000.0μm, it is required to adjust the unit multiplier so that the travel per rotation (Al) does not exceed 20,000,000.0μm.

Ex1) In case that (AL) = PB × 1/n = 2500000.0μm(= 2500mm)
→ Transfer amount per revolution (AL) = (Al) × (Am) = 25000000 × 1

Ex2) In case that (AL) = PB × 1/n = 25000000.0μm(= 25000mm)
→ Transfer amount per revolution (AL) = (Al) × (Am) = 25000000 × 10 = 250000000 × 100

(4) Speed Limit, Acceleration Time, Deceleration Time

(a) Speed Limit

The Speed limit means available maximum speed of positioning operation

All of the operating speed in positioning operation should be set to be lower than speed limit.

(b) Acceleration Time

Acceleration Time is the time required to reach the limit speed which is set by parameter from zero speed(stop state).

(It doesn't mean the time require to reach the Target speed)

(c) Deceleration Time

Deceleration Time is the time required to reach zero speed(stop state) from the limit speed which is set by parameter.

(It doesn't mean the time require to reach zero speed from the operating speed.)

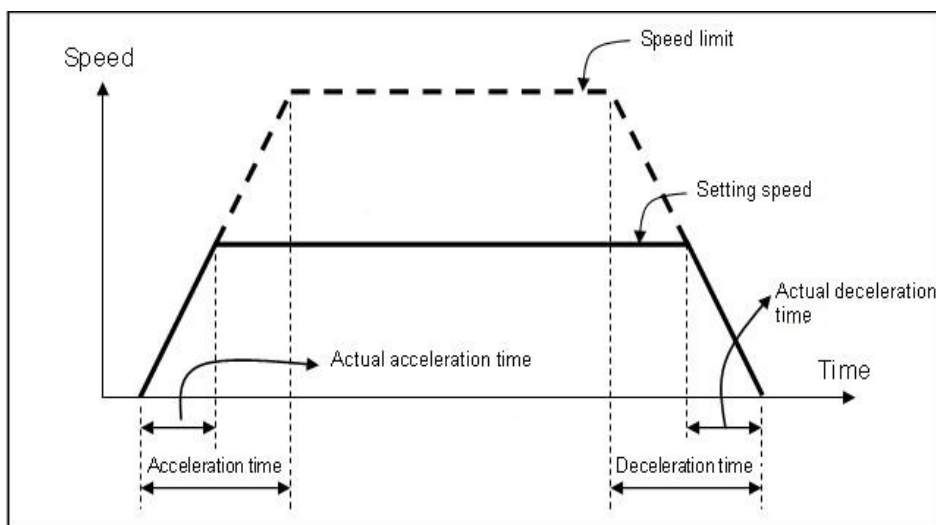

(5) Pulse Output Enable/Disenable

Built-in Position use output. If you disable pulse output for the axes that you do not use, you can use it as a normal output contact.

(6) Bias Speed

Because the stepping motor has unstable torque near zero speed, 0~bias speed is skipped in operation to smooth the rotation of motor and reduce the positioning time..

(a) The setting range is 0 ~ 200,000[pps] in case of pulse unit.

If the Unit parameter is not "Pulse", The bias speed should be not less than 1 when converted to "pulse unit" by Travel per revolution and pulse per revolution. if this value is smaller than 1, The PLC occurs error code "105" and adjust bias speed to satisfy above condition automatically .

[Note]

In case, Unit = mm, Pulse per revolution = 100 pls, Travel per revolution = 10000.0um, Unit multiplier

Available minimum bias speed can be calculated as below.

EX1) Travel per revolution (Al) = 10000.0um, Pulse per revolution(Ap)=1000pls

Trael per pulse = Travel per revolution (Al) / Pulse per revolution (Ap)

$$= 10000.0\text{um}/100\text{pls}$$

$$= 10.0\text{um}/\text{pls} = 0.6\text{mm}/\text{min}.$$

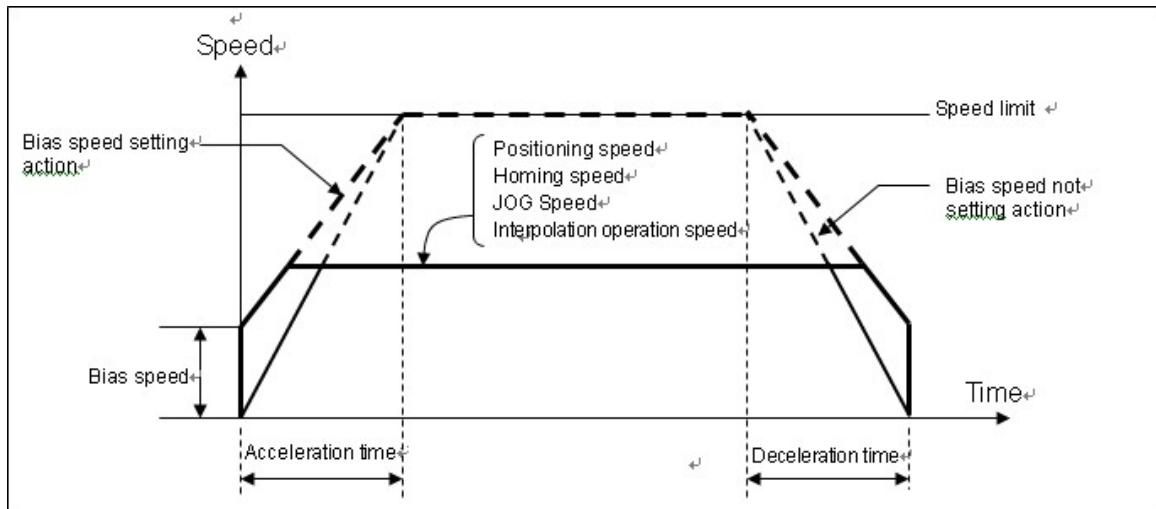

Note

1. If Bias speed is set as high, total operation time shall be reduced but if the setting value is too high, it may cause the occurrence of impact sound in the start/end time and forces the excessive effect to the machine. Cares shall be taken in using..
2. The bias speed should be set within the range as follows :
 - 1) Bias speed \leq Positioning speed data
 - 2) Bias speed \leq Homing-low speed \leq Homing-high speed
 - 3) Bias speed \leq JOG low speed \leq JOG high speed
3. It causes error in connection with bias speed in the following example..
 - 1) Bias speed $>$ Positioning speed data : error code 153
 - 2) Bias speed $>$ Homing-high speed : error code 133
 - 3) Bias speed $>$ Homing-low speed : error code 134
 - 4) Bias speed $>$ JOG high speed : error code 121
 - 5) Bias speed $>$ JOG high speed : error code 122
 - 6) Bias speed $>$ inching speed : error code 123
 - 7) Converted Bias speed $>$ 1pulse/s: error code 105

5.3 Extended Parameter

It describes about extended parameter of positioning module.

5.3.1 Contents of extended parameter

Extended parameter Items		Setting Range
	Software upper limit	mm : -2,147,483,648 ~ 2,147,483,647[X10 ⁻⁴ mm] (-2,147,483,648 ~ 2,147,483,647[X10 ⁻¹ μm])
	Software lower limit	Inch: -2,147,483,648 ~ 2,147,483,647[X10 ⁻⁵ Inch] degree: -2,147,483,648 ~ 2,147,483,647[X10 ⁻⁵ degree] pulse: -2,147,483,648 ~ 2,147,483,647[pulse]
	Infinite running repeat position	mm: 1 ~ 2,147,483,647[X10 ⁻⁴ mm] (1 ~ 2,147,483,647[X10 ⁻¹ μm]) Inch: 1 ~ 2,147,483,647[X10 ⁻⁵ Inch] degree: 1 ~ 2,147,483,647[X10 ⁻⁵ degree] pulse: 1 ~ 2,147,483,647[pulse]
	Backlash compensation amount	mm: 0 ~ 65,535[X10 ⁻⁴ mm] (0 ~ 65,535[X10 ⁻¹ μm]) inch: 0 ~ 65,535[X10 ⁻⁵ Inch] degree: 0 ~ 65,535[X10 ⁻⁵ degree] pulse: 0 ~ 65,535[pulse]
	Position completion time	0 ~ 65,535[ms]
	S-Curve ratio(%)	1 ~ 100
	Arc insertion position in 2-axis linear interpolation continuous operation	mm: 0 ~ 2,147,483,647[X10 ⁻⁴ mm] (0 ~ 2,147,483,647[X10 ⁻¹ μm]) Inch: 0 ~ 2,147,483,647[X10 ⁻⁵ Inch] degree: 0 ~ 2,147,483,647[X10 ⁻⁵ degree] pulse: 0 ~ 2,147,483,647[pulse]
	Servo reset output ON duration	1~5000[ms]
Control word	Pulse output direction (bit 0)	0: CW, 1: CCW
	Acceleration/Deceleration pattern (bit 1)	0:Trapezoid operation, 1:S-Curve operation
	M Code mode(bit 2 ~ 3)	0: NONE, 1: WITH, 2: AFTER
	Interpolation speed selection (bit 4)	0: main axis speed, 1: synthetic speed
	Software limit detection during speed control (bit 5)	0:Don't detect, 1: Detect

Extended parameter Items		Setting Range
Control word	Speed/Position switching coordinate (bit 9)	0: Incremental, 1: Absolute
	Reserved (bit 10 ~ 11)	-
	Infinite running repeat (bit 12)	0: Disable, 1: Enable
	Interpolation continuous operation Type (bit 13)	0 : Pass target position, 1 : Pass near position
	Arc insertion in 2-axis linear interpolation continuous operation (bit 14)	0 : Don't insert , 1 : Insert arc continuous operation
	Pos.-specified speed override coordinate (bit 15)	0: absolute, 1: incremental

5.3.2 Extended parameter setting

(1) Software upper/Lower Limit

- (a) The function is designed so that the machine does not execute the positioning operation out of the range by setting the range of machine available to move through software upper limit and software lower limit. That is, this function is used to prevent any breakaway by incorrect operation position setting and incorrect operation by user program fault.
- (b) External input upper/lower limit can be also set besides the software upper/lower limit.

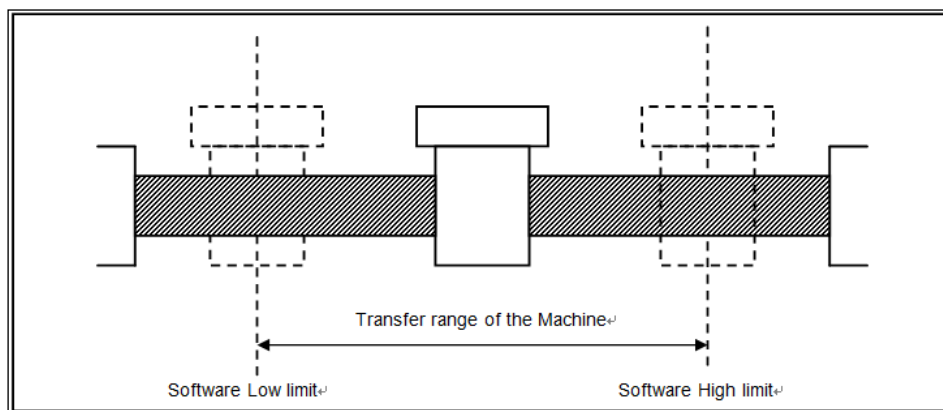

- (c) The range check of software upper/lower limit is done at the start of operation and during operating.
- (d) If the software upper/lower limit is detected, error (Software upper limit error: 501, Software lower limit error: 502) occurs and the pulse output of positioning module shall be disabled.
Therefore, when you want to operate again, it is required to reset error and release the 'output inhibition' before using.
- (e) Setting range

Unit	Software upper/lower limit range
pulse	-2,147,483,648 ~ 2,147,483,647[pulse]
mm	-2,147,483,648 ~ 2,147,483,647[X10 ⁻⁴ mm]
Inch	-2,147,483,648 ~ 2,147,483,647[X10 ⁻⁵ Inch]
degree	-2,147,483,648 ~ 2,147,483,647[X10 ⁻⁵ degree]

* Software upper limit value always should be higher than software lower limit, at least same

- (f) If the software upper/lower limit was set by default value (upper limit: 2,147,483,647, lower limit: -2,147,483,648) or same value, then it wouldn't detect upper/lower limit.

(2) Infinite running repeat position

- (a) When using "Infinite running repeat" mode, it sets the repeated position value.
- (b) This is applied when "Infinite running repeat" in the extended parameter is "1: Enable". When this parameter setting value is "0: Disable", command position and current position is expressed within position expression range according to value set in "Unit" of basic parameter.
- (c) When "Infinite running repeat" parameter is "1: enable", command position and current position is expressed as 0 ~ "infinite running repeat position-1".

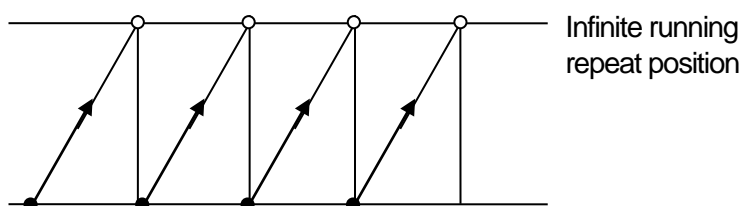

(d) Setting range

Unit	Infinite running repeat position range
pulse	1 ~ 2,147,483,647[pulse]
mm	1 ~ 2,147,483,647[X10 ⁻⁴ mm]
Inch	1 ~ 2,147,483,647[X10 ⁻⁵ Inch]
degree	1 ~ 2,147,483,647[X10 ⁻⁵ degree]

(3) Infinite running repeat

- (a) It sets whether to enable or disable "Infinite running repeat"
- (b) When you set "Infinite running repeat" as "1: enable", command position and current position refreshes within the range set in "Infinite running repeat position" periodically.
- (c) When you don't use "Infinite running repeat" function, set as "0: disable".

(4) Backlash Compensation Amount

- (a) In case that a gear, screw etc is combined to the motor axis, The tolerance that the machine does not work by the wear, when the rotation direction changes, is called as 'Backlash'. Therefore, when you change the rotation direction, it is required to add the backlash compensation amount to the positioning amount for output.
- (b) This is used for positioning operation, inching operation and jog operation
- (c) Setting range

Unit	Backlash setting range
pulse	0 ~ 65,535[pulse]
mm	0 ~ 65,535[X10 ⁻⁴ mm]
Inch	0 ~ 65,535[X10 ⁻⁵ Inch]
degree	0 ~ 65,535[X10 ⁻⁵ degree]

Chapter 5 Positioning Parameter & Operation Data

- (d) As presented in the following figure, if the position moved 1m to the right and again 1m to the left, it is not possible to reach the original position by backlash. At this time, it is required to add backlash compensation amount.

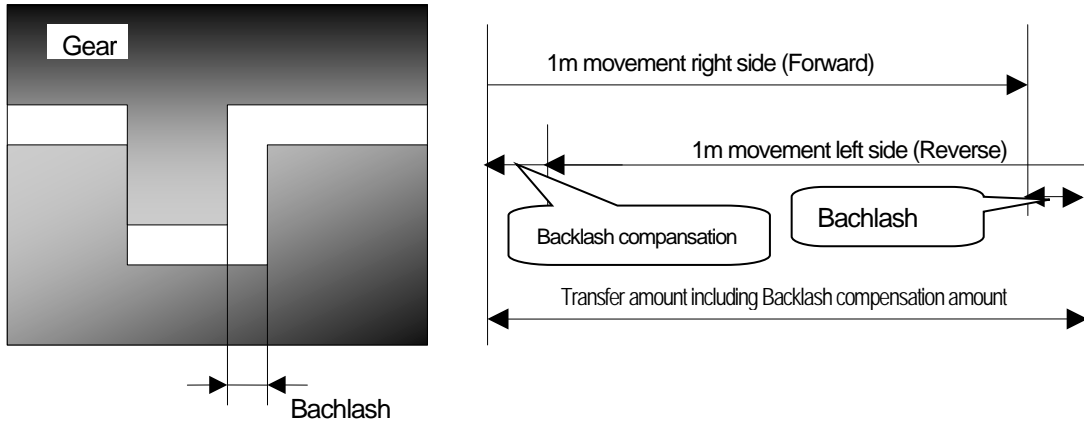

- (e) It compensates by adding backlash compensation pulse to current output pulse within speed limit.
In case backlash compensation amount is bigger than Max. output Pulse (Speed limit \times Control cycle) for one control cycle, distribute compensation amount to several control cycles

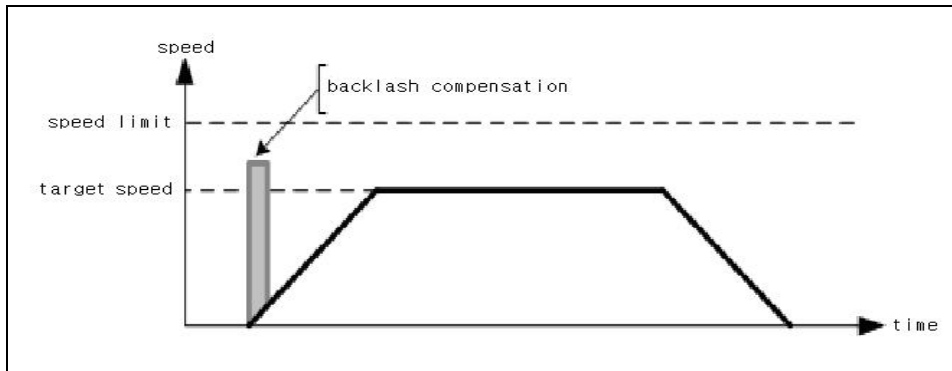

A,B,C,D : Relative position

P0 ,P1,P2,P3 : transfer amount of load

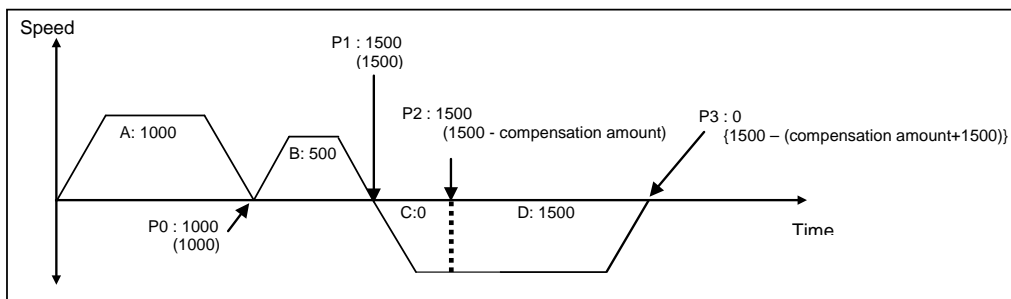

Notes

In case backlash compensation is bigger than Max. Pulse (Speed limit × Control cycle) for one control cycle, progress is as shown below. For example, in case that Speed limit is 100000 and backlash is 250, backlash compensation is bigger than Max. output Pulse ($100000\text{pps} \times 0.001\text{s} = 100$) for one control cycle, and performed for several control cycles. In this case, the number of output pulse which comes from positioning module per one control cycle is different according to Acc. time. Compensation pulse is added to above pulse for total pulse output to be smaller than Max. output pulse for one control cycle. So the number of control cycle compensation acts is different.

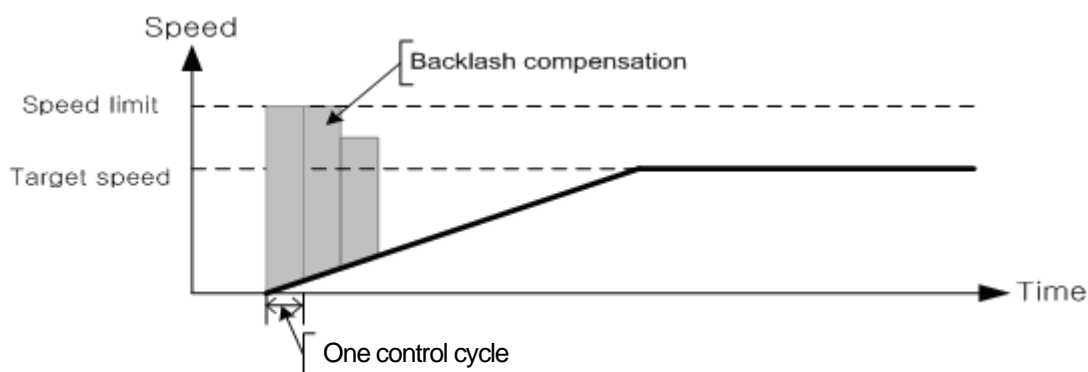
**(5) Positioning Completion Time**

(a) Positioning completion signal shall be OFF after sustaining "ON" for Positioning Completion Time after positioning is completed and positioning completion signal becomes "ON" in single operation, repeat operation, keep operation, continuous operation, linear interpolation operation, circular interpolation operation, speed/position switching control operation, inching operation

At this time, if all start command is executed while positioning completion signal is ON, completion signal shall be OFF immediately. In case of keep operation and continuous mode operation, positioning completion signal will be on after all steps end.

(b) The setting range is 0 ~ 65,535 (unit: 1 ms).

(c) The action of single operation mode is as follows.

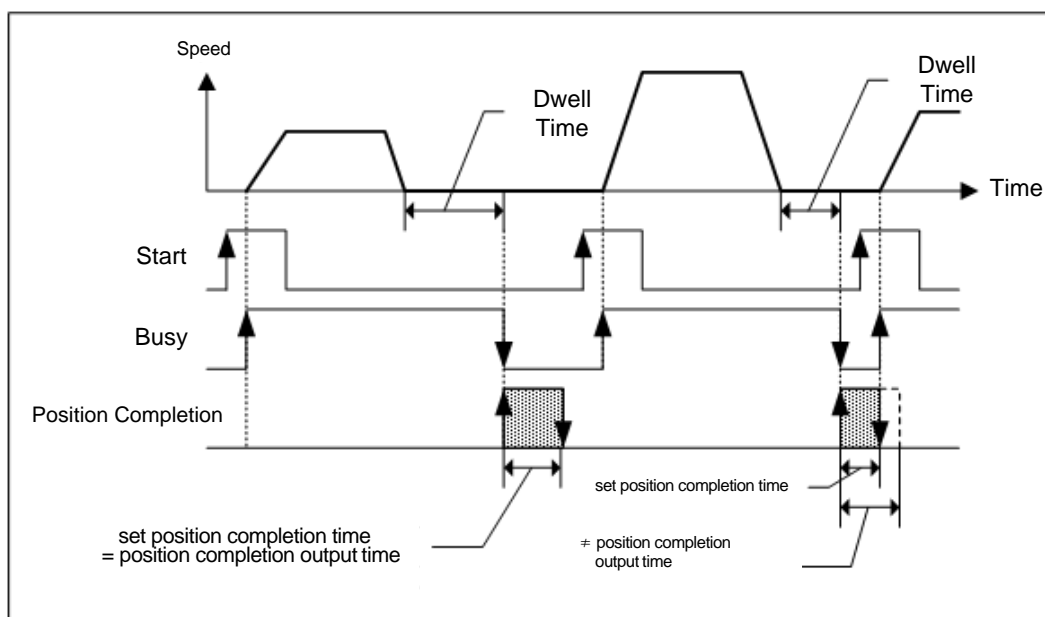

(d) The action of Keep operation mode is as follows :

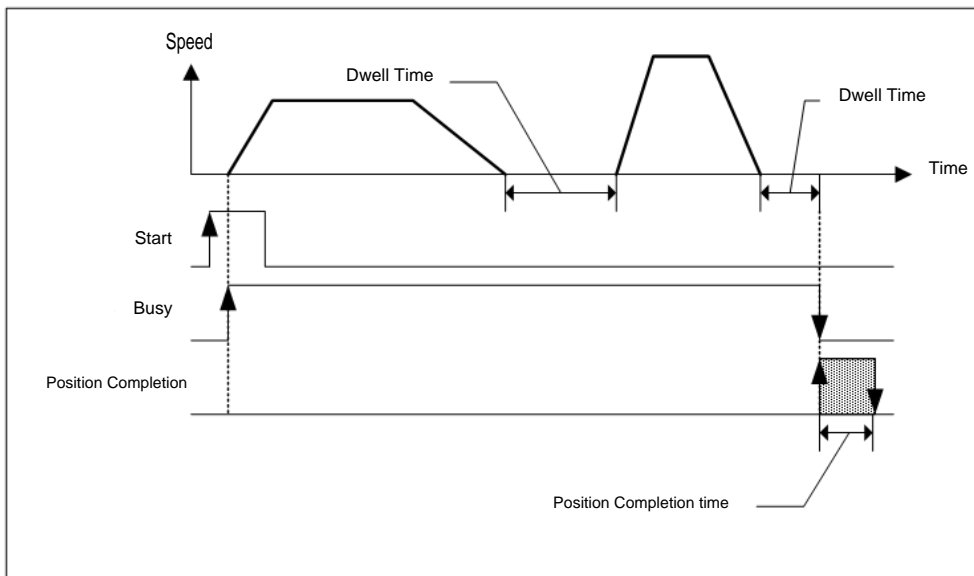

(e) The action of Continuous operation mode is as follows.

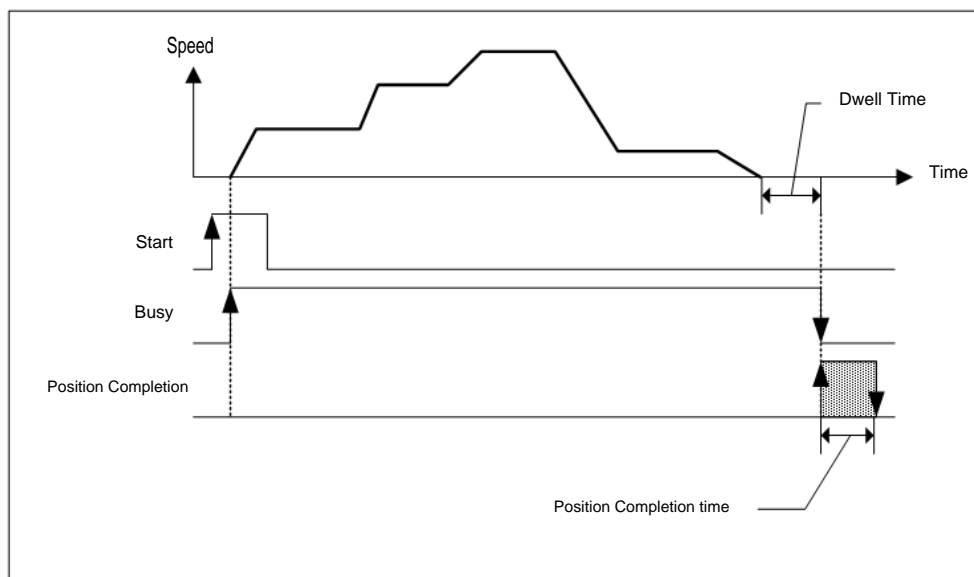

(6) Pulse output direction

- (a) This is used to set machine's actual movement direction according to pulse output direction (rotation direction of motor) of positioning function.
- (b) If pulse output direction is set as "CW" and machine moves forward direction in case of forward direction operation, it is set correctly.
- (c) If pulse output direction is set as "CW" and machine moves reverse direction in case of forward direction operation, it is not set correctly. Set the pulse output direction as "CCW". In case of forward direction operation, if machine moves forward direction, it is set correctly.
- (d) In the following figure, pulse output level is set as Low Active"

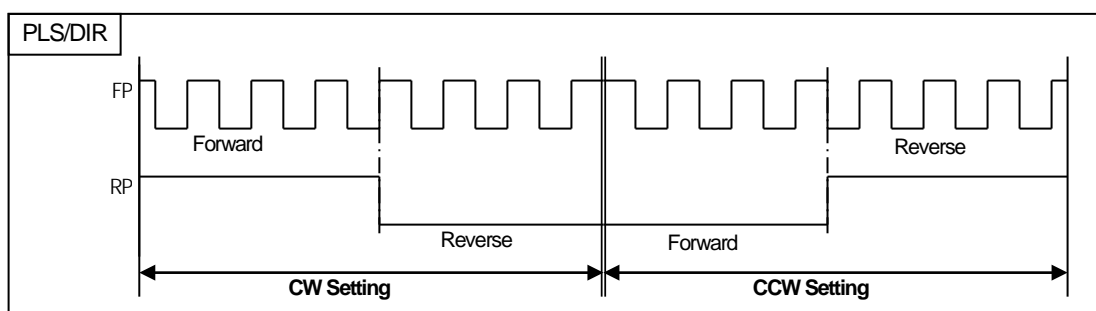

(7) M Code Output

- (a) M code mode set by parameter shall be applied to all positioning data of the corresponding axis.
- (b) Available to set M code number differently at each operation step no. of positioning data.
- (c) M code number setting range : 1 ~ 65,535
- (d) Available to read and use M code for the identification of operation step no. in operation and the execution of auxiliary works (Clamp, tool change etc).
- (e) M code signal occurring during the operation shall be reset by "MOF" command.

Notes

If you execute the next step after the positioning is completed and M code signal is "ON", the next operation step no. does not work and the error code(233) will occur. Therefore, in order to execute the positioning of the next operation step number, M code signal should be "OFF" by "MOF" command

- (f) There are two kinds of M code mode according to the output timing of M code signal: With mode and After mode
(In case of setting NONE, There is no M code signal, even if M code No. was set.)

1) With mode

It turns on the M code signal and outputs M code number with start of positioning [Indirect start, direct start and simultaneous start].

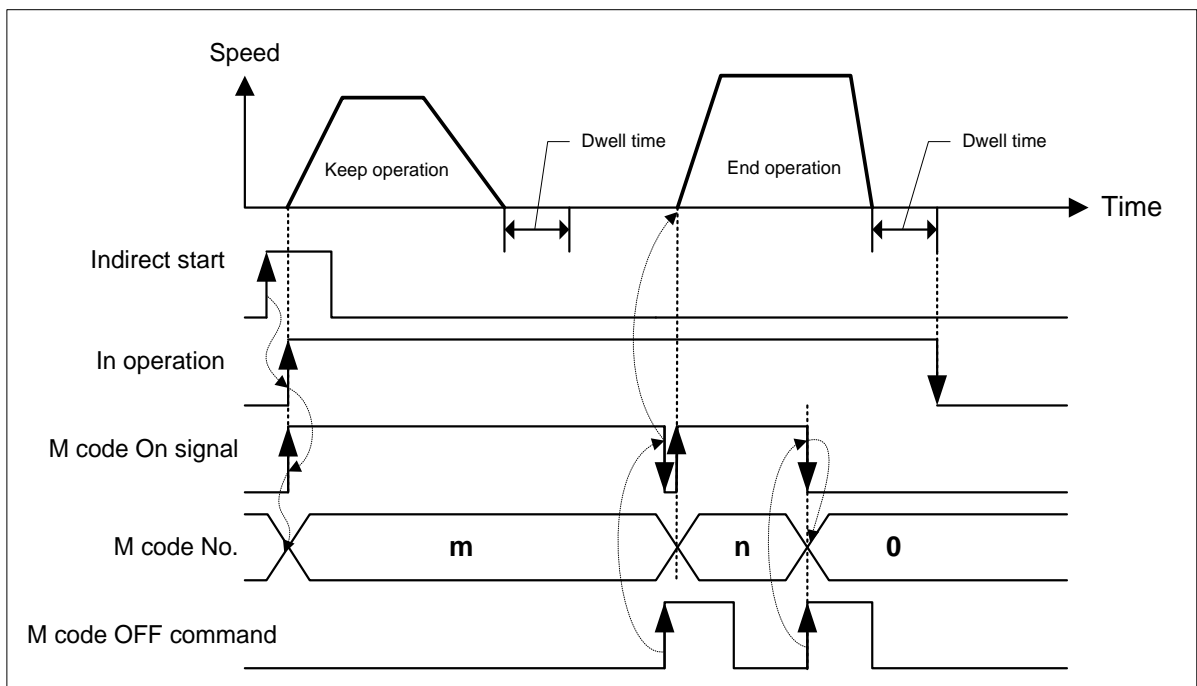

2) After mode

It turns on the M code signal and outputs M code number after completion of positioning [indirect start, direct start and simultaneous start].

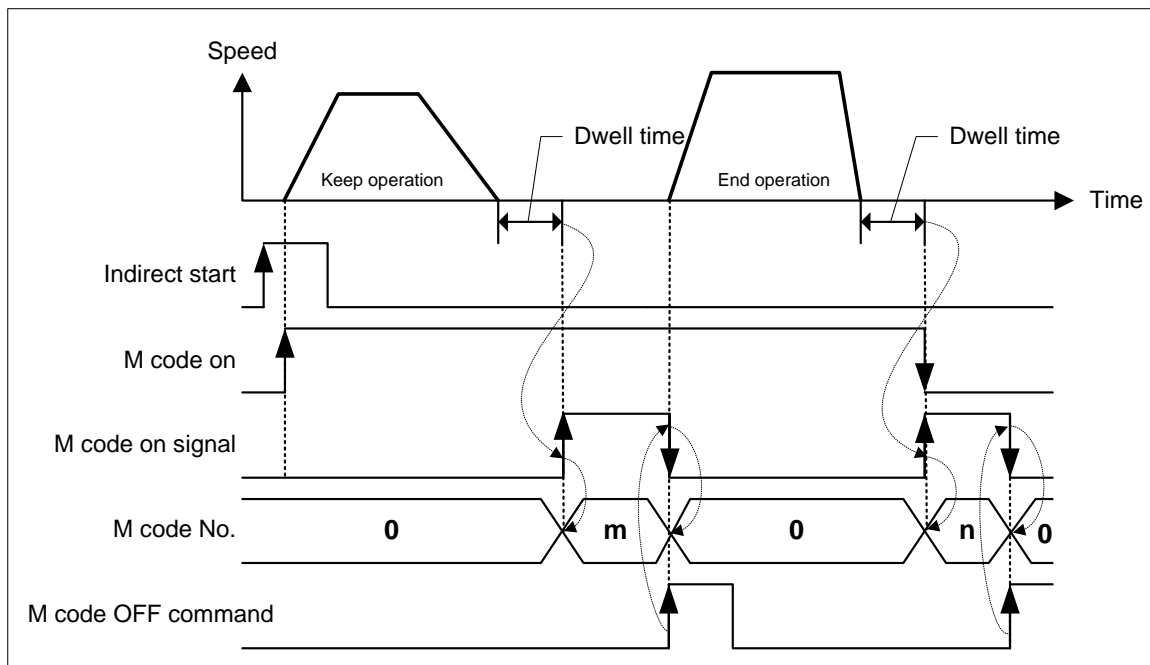

(8) Interpolation speed selection

It selects whether to consider the operation speed of the position data as main axis speed or synthetic speed.

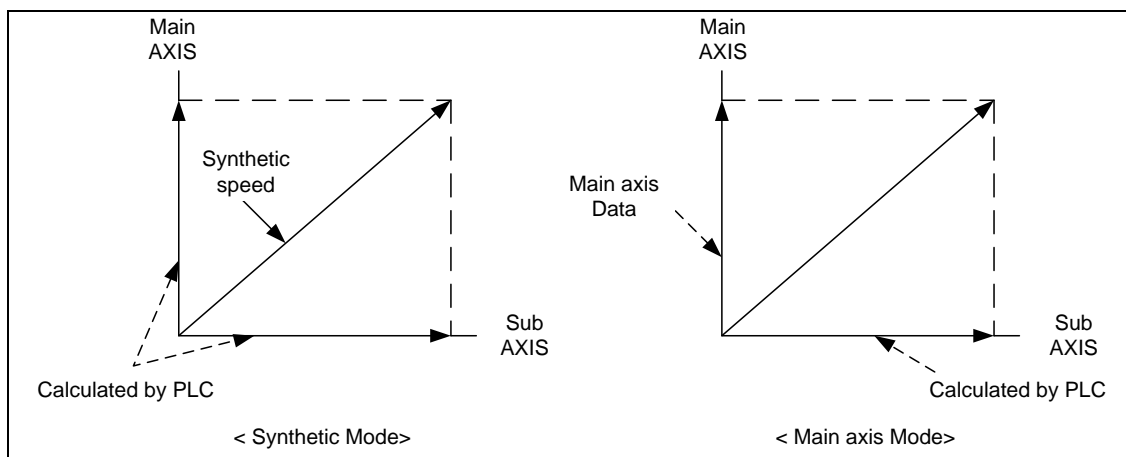

(9) Software limit detect

- Selects whether to stop the operation or not when detecting software limit.
- If the software upper/lower limit is set as default value (upper limit: 2,147,483,647, lower limit: -2,147,483,648) or same value, it wouldn't detect software upper/lower limit.

(10) Acceleration/Deceleration Pattern

- (a) There are 2 kinds of Acceleration/Deceleration operation pattern: Trapezoid operation and S-Curve operation.
- (b) In case of positioning operation, it is available to select operation pattern (either trapezoid operation or S-Curve operation) at the section of acceleration and de deceleration.
- (c) As it is not possible to use S-Curve operation pattern in case of continuous operation mode and speed override, care should be taken in setting.
- (d) By using S-Curve acceleration/deceleration, it is available to protect the motor from the load effect at the point that the motor starts to move the moving object and stops it.

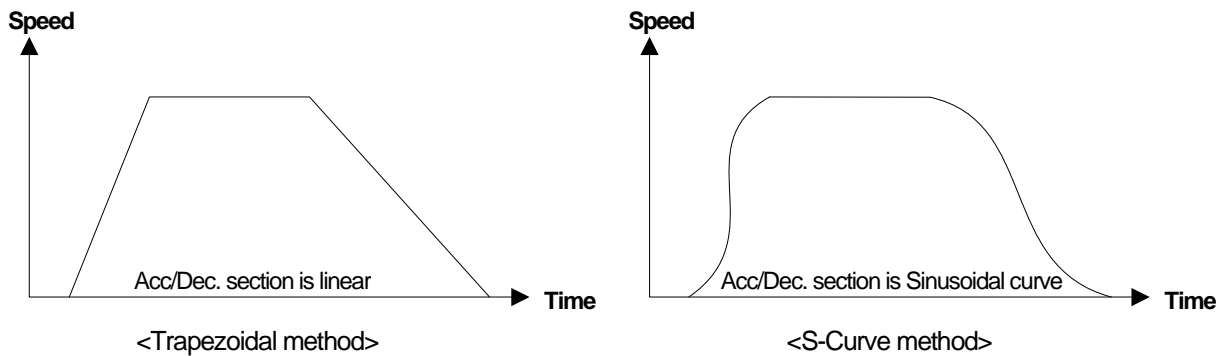

(11) S-curve rate

- (a) In case of selecting S-Curve operation as an acceleration/deceleration pattern, S-Curve rate (1~100%) should be set.
- (b) According to S-Curve rate, S-Curve operation pattern shall be formed in accordance with Sinusoidal curve.
- (c) If S-Curve rate is 1%, it becomes the same as trapezoid operation and if the 100% rate is set, it becomes the acceleration/deceleration curve which is the closest to the Sinusoidal Curve.
- (d) The figure as below shows the example of S-Curve rate setting

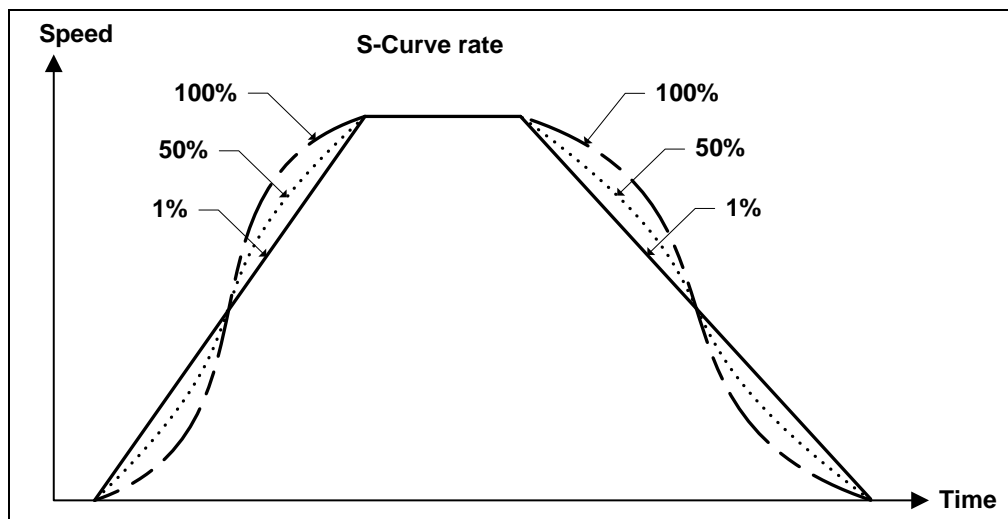

(12) Linear interpolation positioning method

In case control method is linear interpolation or circular interpolation and operation method is continuous operation, positioning control will be different in accordance with the value set in "Int continuous opr. Type".

The two method types of interpolation control continuous operation are as follows;

- Pass target position (Passes designated target position)
- Pass near position (Before reaching target position of current step, moves to target position of next step)

Setting range of the Interpolation continuous operation positioning method is as follows;

Items	Setting value	Description
Interpolation continuous operation method	0 : Pass target position	In case of continuous operation from current step to next step, it passes target position of current step.
	1 : Pass near position	In case of continuous operation from current step to next step, it passes near target position of current step

For further information, please refer to operation mode (4) continuous operation of 9.2.2 positioning control.

(13) Arc insertion during 2-axis linear interpolation continuous operation

When executing linear interpolation, determine whether to add arc during 2-axis linear interpolation continuous operation.

Here describes Arc insertion during 2-axis linear interpolation continuous operation

Setting item	Setting Value	Content
Arc insertion during 2-axis linear interpolation continuous operation	0 : Don't insert	When executing 2-axis linear continuous interpolation, doesn't inserts arc. .
	1 : insert arc	When executing 2-axis linear continuous interpolation, inserts arc.

For further information about Arc insertion during 2-axis linear interpolation continuous operation, please refer to (4) 2-axis linear interpolation continuous operation arc insertion of 2-axis linear interpolating control of 9.2.6.

(14) Arc insertion position

When 「Arc insertion」 was set as "insert arc", confirm the position where it was set by 'inputting circular arc continuous operation', reset start position of circular interpolation(Goal position of linear path 1) and goal position (Start position of linear path 2).

This is the setting of 'Position-specified speed override coordinate'.

Item	Setting value	Content
Position of inputting circular arc from axis 2 linear interpolation continuous operation	0 ~ 2,147,483,647	Set the position that circular will be inputted. It is relative distance from goal position..

For further information about inputting circular arc from axis 2 linear interpolation continuous operation, please refer to (4) inputting circular arc from axis 2 linear interpolation continuous operation of control linear interpolation (9.2.6).

(15) Position-specified speed override coordinate

Position-specified speed override command is the command changing the operation speed when the object reaches the specified position. At this time, operation may be different according to the type of position value. Position value can be absolute position value or incremental position value.

This is the setting of 'Position-specified speed override coordinate'.

Item	Setting value	Content
Position-specified speed override coordinate	0 : ABS	Speed changes at the specified absolute position.
	1 : INC	Speed changes at the position as far as the set value from start position.

For further information, refer to 9.5.6 position-specified speed override.

(16) Speed/Position switching coordinate

If "Speed/Position switching command" is executed during speed control, speed control changes into position control and executes position control with the value set in target position. At this time, this sets whether to consider the target position as absolute position value or incremental position value.

This is the setting of "Speed/Position switching coordinate".

Item	Setting value	Content
Speed/position switching coordinate	0 : INC	Executes positioning as far as the set value from position where speed/position switching command is executed.
	1 : ABS	Considers the set value as absolute position and executes positioning into the set absolute position.

For further information, refer to 9.2.14 speed/position switching control.

5.4 Manual Operation Parameter

Here describes Manual operation parameter of embedded positioning.

Manual operation parameter use in event that operation of JOG, Inching is used

5.4.1 Manual Operation Parameter

Manual operating parameter item	Setting range
JOG high speed	mm : 1 ~ 2,147,483,647 [X10 ⁻² mm/ min] Inch : 1 ~ 2,147,483,647 [X10 ⁻³ Inch/ min]
JOG low speed	degree : 1 ~ 2,147,483,647 [X10 ⁻³ degree/min] pulse : 1 ~ 200,000 [pulse/sec]
JOG acceleration speed (ms)	0 ~ 2,147,483,647 [ms]
JOG deceleration speed (ms)	
Inching Speed	mm : 1 ~ 65,535[X10 ⁻² mm/min] Inch : 1 ~ 65,535[X10 ⁻³ Inch/min] degree : 1 ~ 65,535[X10 ⁻³ degree/min] pulse : 1 ~ 65,535[pulse/sec]

5.4.2 Manual Operation Parameter Setting

(1) JOG high Speed

- Jog speed is related to Jog operation (a kind of manual operation) and has 2 types of operation : Jog low speed operation and Jog high speed operation.
- For further information, please refer to 9.3.1 JOG Operation.
- JOG high speed operation has operation pattern as acceleration, constant speed, deceleration section. Therefore, acceleration section and deceleration section is controlled by JOG acceleration/deceleration time.
- Jog high speed setting range
All of control by embedded positioning is made within speed limit. Therefore, jog high speed also couldn't exceed the speed limit and must be larger than jog low speed.
(Notices when setting the high speed : Bias speed ≤ Jog low speed ≤ Jog high speed ≤ Speed limit)

(2) JOG Low Speed

- JOG low speed operation has operation pattern as acceleration, constant speed, deceleration section.
- JOG low speed setting range : Bias speed ~ Jog high speed

(3) JOG Acceleration/Deceleration Time

- This means JOG acceleration/deceleration time when Jog high speed and low speed operation.
- JOG acceleration/deceleration time setting range : 0 ~ 2,147,483,647 [ms]
In case of 0, operates according to acceleration time 1 and deceleration time 1 of parameter..

(4) Inching Speed

- The speed necessary for inching operation is set here.
- Inching speed setting range : 1 ~ 65,535(unit: 1pps)

5.5 Homing Parameter

Here is describes about homing parameter of embedded positioning.

Homing parameter is needed when positioning module return to origin.

5.5.1 Homing Parameter

Homing Parameter option		Setting range
Origin address		mm : -2147483648 ~ 2147483647 [$\times 10^{-4}$ mm] (-2147483648 ~ 2147483647 [$\times 10^{-1}$ μm]) Inch : -2147483648 ~ 2147483647 [$\times 10^{-5}$ Inch] degree : -2147483648 ~ 2147483647 [$\times 10^{-5}$ degree] pulse : -2147483648 ~ 2147483647 [pulse]
Homing-high speed		mm : Bias Speed ~ Speed Limit(Homing Low Speed<=Homing high Speed) Inch : Bias Speed ~ Speed Limit(Homing Low Speed<=Homing high Speed)
Homing-low speed		degree : Bias Speed ~ Speed Limit(Homing Low Speed<=Homing high Speed) pulse : Bias Speed ~ Speed Limit(Homing Low Speed<=Homing high Speed)
Homing Acceleration time		0 ~ 2,147,483,647 [ms]
Homing deceleration time		
Homing dwell time		0 ~ 65,535[ms]
Origin compensation amount		mm : -2147483648 ~ 2147483647 [$\times 10^{-3}$ mm] (-2147483648 ~ 2147483647 [$\times 10^{-1}$ μm]) Inch : -2147483648 ~ 2147483647 [$\times 10^{-5}$ Inch] degree : -2147483648 ~ 2147483647 [$\times 10^{-5}$ degree] pulse : -2147483648 ~ 2147483647 [pulse]
Homing restart waiting time		0 ~ 65,535[ms]
Control word	Homing mode(bit 0 ~ 2)	0:Dog/Home(Off), 1: Dog/Home (On), 2:Upper-Lower Limit/Home, 3:Dog, 4:High Speed Homing, 5: Upper-Lower Limit, 6: Home
	Homing direction(bit 3)	0:forward direction, 1:reverse direction

5.5.2 Homing parameter setting

(1) Homing Method

(a) There are 7 kinds of Homing method.

Homing method	XG-PM Software package indication
Origin detection after DOG OFF	0: DOG/origin(OFF)
Origin detection after deceleration when DOG ON	1: DOG/origin(ON)
Origin detection by the origin and Upper/Lower limit	2: High/low limit/origin
Origin detection by DOG	3: DOG
High speed homing	4: High speed origin
Origin detection by Upper/Lower limit	5: High/low limit
Origin detection by HOME	6: HOME

(b) For further information of homing method, please refer to 9.1 homing of chapter 8

(2) Homing direction

(a) There are 2 kinds of homing direction, forward direction and reverse direction.

(b) In case of homing command was set by forward, begin to homing operation to currently increasing direction of position, searching needed external signal for homing.

(c) In case of homing command was set by reverse, begin to homing operation to currently decreasing direction of position, searching needed external signal for homing.

(3) Origin Address

(a) When homing is completed by homing command, the value set by homing address shall be used to change the present address value.

(b) Setting range of homing address: -2,147,483,648 ~ 2,147,483,647(unit: pulse)

(4) Origin compensation amount

- If the machine origin is deviated slightly – the difference between the setting value and the actual transfer amount caused by the mechanical tolerance - at the origin detection (Z phase input), this is used to compensate the tolerance.
- If origin compensation amount is set, PLC outputs additional pulses as much as data amount set as origin compensation amount after detecting origin. If origin compensation amount is (+), it moves to the homing direction. if origin compensation amount is (-), it moves to the opposite direction of homing.
- Origin compensation amount setting range : -2,147,483,648 ~ 2,147,483,647 (unit: pulse)
- This picture is one of the examples about homing method that was applied by homing compensation amount from "Origin detection after DOG OFF".

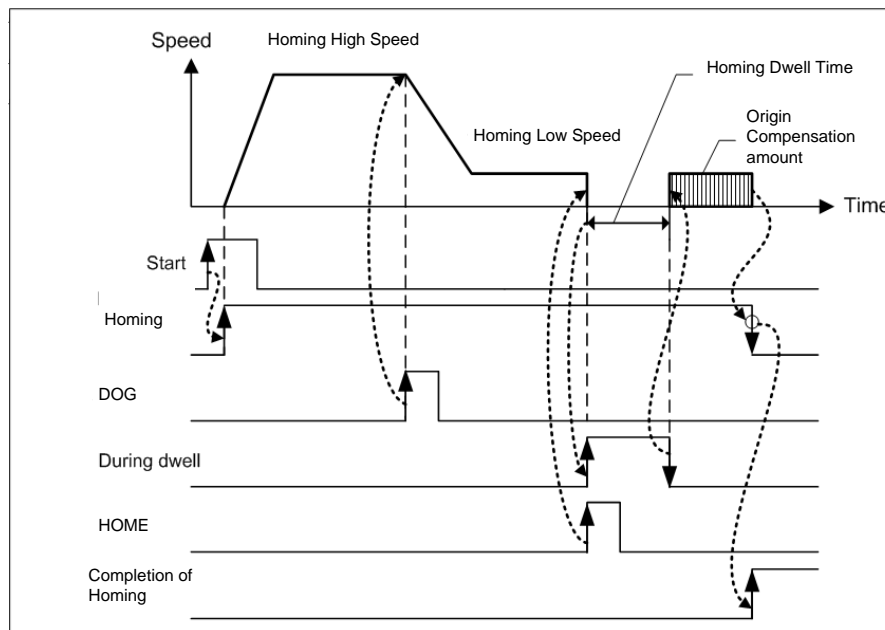

(5) Homing-High speed

- There are 2 kinds of homing speed : high speed and low speed.
- There is two stage in homing action ; 'Detecting Home' & 'Detecting Home area'.
PLC stop moving immediately when detects the Home signal. therefore when homing speed is fast, there can be difference between "the origin signal" and "the stopped position of machine" . Therefore, The moving speed must be low enough to stop in the correct home signal position and this speed is "homing low speed". But, need to move as fast as possible until detecting " Home Area(DOG)". This speed is is "homing High speed".
- All of the control by positioning module doing work within speed limit. And Homing high speed also can't exceed speed limit. And, Homing high speed must be faster than or same with homing low speed.
 - Bias speed \leq Homing-low speed \leq Homing-high speed \leq Speed limit

(6) Homing-Low speed

- The speed that acts to the constant speed section from high speed section via deceleration section by homing command.

Notes

When setting the homing speed, it is recommended to set the homing-low speed as low speed as possible.
If setting the low speed as "too fast", it may cause the incorrect origin signal detection.

(7) Homing restart waiting time

- (a) It is standby time until restart "Homing" automatically in case that can't complete "Homing" by detection of high/low limit during homing operation. (b) Motor do not move while it was set by reset time.
- (b) Motor do not move while this time.

(8) Homing accelerating speed/ deceleration speed

- (a) When operates by homing command, it will be accelerate or decelerate by the homing acceleration time and homing deceleration time".
- (b) Available range is 0 ~ 2,147,483,647 [ms].
if it is set by '0', It will be accelerate or decelerate according to acceleration/deceleration time¹ of basic parameter when homing.

(9) Homing dwell time

- (a) This is the time needed to maintain the precise stop accuracy of SERVO motor when using the SERVO motor for positioning.
- (b) Practically, Dwell time is the time needed to remove the residual pulse of deviation counter after completion of positioning and especially Dwell time when returning to the origin is called as "homing dwell time".
- (c) Setting range of Homing dwell time : 0 ~ 65,535(unit: 1ms)

5.6 I/O Signal Parameter

Here describes using input/output signal parameter in embedded positioning.
Input/output signal parameter use to decide active level of input signal.

5.6.1 I/O Signal Parameter

Input/output signal parameter Item	Setting range
High limit signal	0 : A contact(Normally Open), 1 : B contact(Normally Close)
Low limit signal	
DOG signal	
Home signal	
Deviation signal	
Upper limit signal	All P area
lower limit signal	All P area
DOG signal	Output P area
HOME signal	All P area

5.6.2 Setting Range of I/O Signal Parameter

In case of setting the input signal by A contact, it acts when external is ON and in case of setting by B contact, it acts when external signal is OFF.

- (1) If setting the upper limit signal of input signal parameter by A contact and the lower limit signal by B contact, the upper limit is detected when external upper limit signal is ON while the lower limit is detected when external upper signal is OFF.
- (2) If selecting Emergency stop from External stop selection of extended parameter, the external input signal is used by Emergency stop signal. And if setting Emergency stop signal of input signal parameter by A contact, the positioning module stop immediately when Emergency stop signal is ON. On the contrary, if setting Emergency stop signal of input signal parameter by B contact, the positioning module stop immediately when external Emergency stop signal is OFF.
- (3) If setting the home signal of input signal parameter by A contact, the origin is detected when external home signal is 'Rising edge', while if setting by B contact, the origin is detected when external home signal is 'Falling edge'.

5.7 Common Parameter

Here describes common parameter of embedded positioning.

The parameter which was related with embedded positioning is applied to all of the parameter.

5.7.1 Common parameter

Common Parameter Item		Setting range
Control word	Pulse output level	0: Low Active, 1: High Active
	Speed override	0: % designate, 1 : Speed designate
	Control period	1~10ms

5.7.2 Common Parameter Setting

(1) Speed override

(a) When operate changing speed command (Speed override, Positioning speed override, etc), select speed(will be changed) or percentage of goal speed.

(b) In case of setting percentage (%) can set each from 0.01% to 655.35%(unit: 0.01%)

(4) Continuous Operarion

(a) The embedded positioning function generate speed profile for each predetermined period.

If continuous operation is disabled, Speed profile will be generated every 1ms and will be generated every 5ms if enabled

(b) if Continuous Operation parameter is disabled, Continuous operation command can not be executed (Error Code 160 occurs)

(c) The figure below shows example of generated speed profile of trapezoidal acceleration.

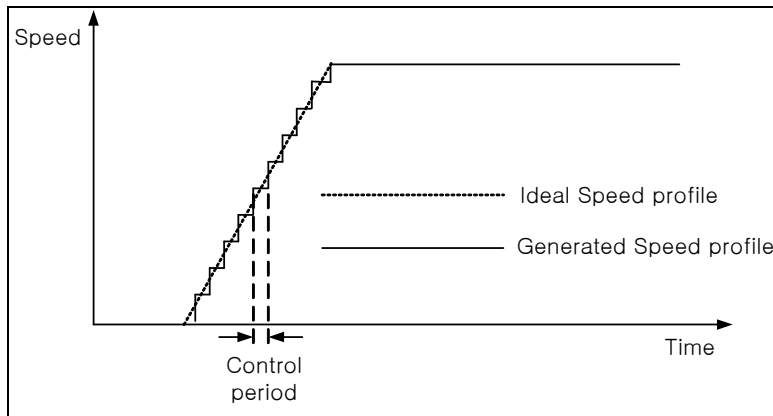

5.8 Operation Data

Here describes Operation Data of positioning module.

Can set 400 operation data per each axis, operation of circular interpolation and Linear interpolation act in accordance with information of operation data.

5.8.1 Operation Data

Operation data item	Setting range																
Goal position	mm : -2147483648 ~ 2147483647 [X10 ⁻⁴ mm] (-2147483648 ~ 2147483647 [X10 ⁻¹ μm])																
Circular interpolation aux. Position *1	Inch : -2147483648 ~ 2147483647 [X10 ⁻⁵ Inch] degree : -2147483648 ~ 2147483647 [X10 ⁻⁵ degree] pulse : -2147483648 ~ 2147483647 [pulse]																
Operation speed	mm : Bias Speed ~ Speed Limit Inch : Bias Speed ~ Speed Limit degree : Bias Speed ~ Speed Limit pulse : Bias Speed ~ Speed Limit																
Dwell time	0 ~ 65,535[ms]																
M Code no.	0 ~ 65,535																
Setting the axis of ordinates	<table border="1"> <thead> <tr> <th>Bit 7</th> <th>Bit 6</th> <th>Bit 5</th> <th>Bit 4</th> <th>Bit 3</th> <th>Bit 2</th> <th>Bit 1</th> <th>Bit 0</th> </tr> </thead> <tbody> <tr> <td>-</td> <td>-</td> <td>-</td> <td>-</td> <td>축4</td> <td>축3</td> <td>축2</td> <td>축1</td> </tr> </tbody> </table>	Bit 7	Bit 6	Bit 5	Bit 4	Bit 3	Bit 2	Bit 1	Bit 0	-	-	-	-	축4	축3	축2	축1
Bit 7	Bit 6	Bit 5	Bit 4	Bit 3	Bit 2	Bit 1	Bit 0										
-	-	-	-	축4	축3	축2	축1										
Helical interpolation axis	0, 1 axis ~ 4 axis (Set'0', normal circular interpolation)																
The number of circular interpolation turn	0~65,535																
Control Word	Coordinate (bit 0)	0:absolute, 1:incremental															
	Control method (bit 1~3)	0:Single axis positioning, 1: Single axis speed control 2: Single axis Feed control, 3: linear interpolation, 4: Circular interpolation															
	Operation method	0:Singular, 1:Repeat															
	Operation pattern	0:end, 1:Keep, 2: Continuous															
	Circular size (bit 7)	0: Arc <180 1: Arc >=180															
	Acceleration No. (bit 8~9)	0 ~ 3															
	Deceleration No. (bit 10~11)	0 ~ 3															
	Circular interpolation method(bit 12~13)	0:midpoint, 1:center point, 2:radius															
Circular interpolating direction (bit 14)	0:CW, 1:CCW																

Notes

*1 The circular interpolation can not be executed in degree unit. Therefore it is idle to set value at the circular interpolating auxiliary position item.

5.8.2 Operation Data Setting

(1) Step No

- (a) The setting range of positioning data as serial no. is 0 ~ 400.
- (b) The first Starting step of operation data is no.1 step.

Notes

In case of designating step number as '0' with indirect start, Simultaneous start, Position synchronous start, it means current operation step.

(2) Coordinate

- (a) Coordinate of position data includes absolute coordinate and incremental coordinate.

1) Absolute Method

- a) This carries out the positioning control from the current position to the goal position (the goal position assigned by positioning data).
- b) Positioning is carried out based on the assigned position of homing (origin address).
- c) Transfer direction shall be determined by the current position and goal position.
 - ▶ Start position < Goal position : forward direction positioning
 - ▶ Start position > Goal position : reverse direction positioning

[Example]

- When current position : 1000 , Goal position : 8000, forward direction transfer amount is 7000(8000-1000).

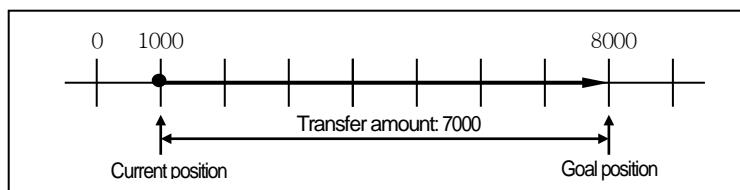
**Notes**

Positioning by Absolute method (Absolute coordinate) can start only in the state that the origin is determined. If starting in the state that the origin is not determined, Error will occur.

2) Incremental method

- a) This carries out the positioning control as much as goal transfer amount from the current position.
- b) Transfer direction shall be determined by the sign of transfer amount..
 - When transfer direction is (+) or no sign : forward direction positioning (position increase direction)
 - When transfer direction is (-) : reverse direction positioning (position decrease direction)

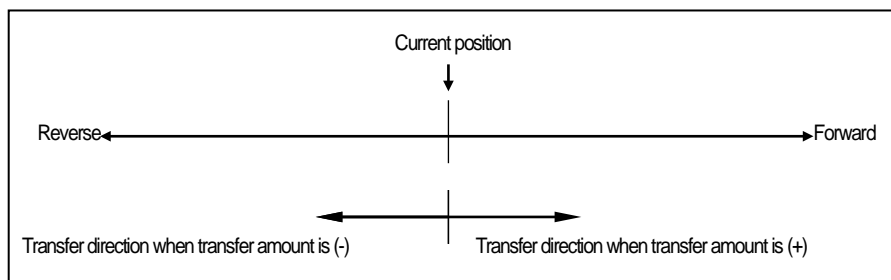

[Example]

- When current position : 5000 , Goal position : -7000, the positioning shall be done at -2000 position.

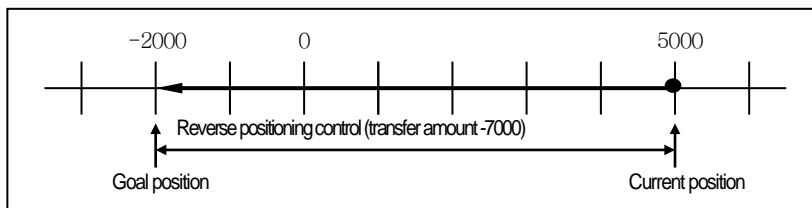
**(3) Control Method**

- Select the control method: single-axis position control, single-axis Speed control, single-axis Feed control, linear interpolation, circular interpolation.
- For further information, please refer to 9.2 Positioning control of Chapter 8 “Function”.

Notes

Set coordinate and control method in all at the same time in “control method” item with positioning software package.
 And the software package “Control Method” item is same as follows
 Absolute, Single-axis Positioning Control / Absolute, Single-axis Speed Control
 / Absolute, Single-axis FEED control / Absolute, linear Interpolation / Absolute, Circular Interpolation
 / Relative, Single-axis Positioning Control / Relative, Single-axis Speed Control / Relative, Single-axis FEED control
 / Relative, linear Interpolation / Relative, Circular Interpolation

(4) Operation Pattern (End/Keep/Continuous)

- Operation pattern is setting item, how can step of operation data connect with next step and operate.
- Select one operation pattern from End, Keep, Continuous operation.
- For further information, please refer to 9.2.2 operation mode of Positioning control of Chapter 9 “Function”.

(5) Operation Method (Singular/Repeat)

- Operating Method is an option for selecting a operating step after finish operating step from the driving data setting step.
- In case of setting singular, it will be select next step after finish operating settled step. If you set by Repeat, It will be select settled Repeat step after finish operating settled step.
- Select one positioning operation pattern from Singular, Repeat operation.
- For further information, please refer to 9.2.2 operation mode of positioning control of Chapter 8 “Function”.

Notes

Set operation pattern and operation method at the “operation method” item with XG-PM software package.
 These are “operation method” item;
 Singular,End / Singular,Keep / Singular,Continuous / Repeat,End / Repeat,Continuous / Repeat,Continuous.

(6) Goal Position

- This is the area to set the transfer amount of position data as “position value”.
- The setting range is $-2,147,483,648 \sim 2,147,483,647$ [unit]

(7) M Code

- (a) M code is applied to the whole axis in a bundle by M code mode set by positioning parameter and is given to each operation step no. as a Number within the setting range to use at Program.
- (b) The setting range is 1 ~ 65,535
- (c) M code no. can be identified by read by the operation state code
- (d) For further information, please refer to M code output of chapter 5.3.2.(7)

(8) Acceleration/Deceleration No

- (a) The dual acceleration/deceleration time setting is available by setting the acceleration/deceleration time 1/2/3/ 4 of basic parameter as acceleration/deceleration no. 1/2/3/4 respectively.

(9) Operation Speed

- (a) Operation speed is the goal speed which it is applied when it operate positioning
- (b) Operation speed is set within the range that does not exceed Speed limit of basic parameter.

(10) Dwell Time

- (a) This is the waiting time before carrying out the next positioning operation after completing one positioning operation.
- (b) Setting range is 0 ~ 65,535 (ms).
- (c) Especially, in case of using SERVO motor, this is the data to set the waiting time by the stable stop state as positioning module is in the stop state but actual SERVO motor does not reach to the goal position or in transition state.
- (d) While dwell time is active, the corresponding axis of positioning module maintains "ON" of the "Busy Flag" and if dwell time proceeds, "Busy Flag" becomes "OFF" and the positioning end signal becomes "ON".

(11) Setting Axis of ordinates

- (a) This is an option for axis of ordinates of driving shaft when should operate at least over 2 axis such as linear interpolation or circular interpolation.
- (b) Setting each bit from 1 axis to 4 axis. Each bit is as follows

Bit 7	Bit 6	Bit 5	Bit 4	Bit 3	Bit 2	Bit 1	Bit 0
-	-	-	-	Axis 4	Axis 3	Axis 2	Axis 1

- (c) Could choice multiple axes. For example, If choice axis 2 and axis 4 as axis of ordinates, set "000A" by hexadecimal in setting axis of ordinates.

(12) Circular interpolating auxiliary position

- (a) This is an option for setting auxiliary data when the circular interpolation operates.
- (b) According to circular interpolation, mean of circular interpolating auxiliary position is decided.
It means midpoint which is through by circular arc in midpoint method.
It is central point of circular arc in central point method. And It is radius of circular arc in radius method.
- (c) In case that circular interpolation method is radius, be valid only value of circular interpolating auxiliary position of principal axis.
- (d) For further information, please refer to "Circular interpolating control" of 9.2.9 ~ 9.2.11.

(13) Circular interpolating method

- (a) This is an option for method setting from circular interpolating operation.
- (b) There are three method for circular interpolation; midpoint, central point, radius.
- (c) For further information, please refer to "Circular interpolation control" of 9.2.9 ~ 9.2.11.

(14) Circular interpolating direction

- (a) This is an option for setting direction of drawing circle from circular interpolating operation when the operation starts.
- (b) Circular interpolation direction is based on drawing circular interpolation when the principal axis is axis 'X' and the axis of ordinates is axis 'Y'.
- (c) This option is ignored from circular interpolation of midpoint because circular interpolating direction is selected by position of midpoint.
- (d) For further information, please refer to circular interpolation of 9.2.9 ~ 9.2.11.

(15) Circular arc size

- (a) When circular interpolating method is set by radius method, User can select one of 2 circular arcs.
- (b) Select one of over the 180-degree circular interpolation or under the 180-degree circular interpolation.
- (c) This option is ignored in the circular interpolation of midpoint method and central point method.
- (d) For further information, please refer to designating radius circular interpolation of 9.2.11

Notes

Positioning software package set as follows at a time;

- circular arc method, circular interpolating direction, circular arc size with 'Circular interpolating mode'.

Software package 'Circular interpolating mode' is as follows ;

- Midpoint / Central point, CW / Central point, CCW / Radius, CW, Circular arc < 180-degree / Radius , CW ,
Circular arc >= 180-degree / Radius, CCW, Circular arc < 180-degree / Radius, CCW, Circular arc >= 180-degree

(16) The number of circular interpolating turn

- (a) This is an option setting the number of rotation of circular arc when operating over the 360-degree.
- (b) Setting range is 1 ~ 65,535.

(17) Helical interpolation axis

- (a) It is item which is setting axis for linear operation in operating helical interpolation.
- (b) Settled axis from helical interpolation rectilinearly operates to settled position at the goal position.
- (c) For further information, please refer to helical interpolating control of 9.2.12.

Chapter 6 Internal Memory and I/O Signal

6.1 Internal Memory

Here describes the internal memory used for positioning module if XGB Main unit

Internal memory is used when executing direct Data read/write between positioning module and PLC CPU by using PUP(PUTP), GET(GETP) command instead of using the dedicated command. For Data read/write using the dedicated command, please refer to 7.2 Dedicated Command

6.1.1 Step Data during Point Start

(1) Memory Address of POINT Start Step Data

Memory Address						Description
1 axis	2 axis	3 axis	4 axis	5 axis	6 axis	
2A1	32D	3B9	445	4D1	55D	Point Operation Step 1
2A2	32E	3BA	446	4D2	55E	Point Operation Step 2
2A3	32F	3BB	447	4D3	55F	Point Operation Step 3
2A4	330	3BC	448	4D4	560	Point Operation Step 4
2A5	331	3BD	449	4D5	561	Point Operation Step 5
2A6	332	3BE	44A	4D6	562	Point Operation Step 6
2A7	333	3BF	44B	4D7	563	Point Operation Step 7
2A8	334	3C0	44C	4D8	564	Point Operation Step 8
2A9	335	3C1	44D	4D9	565	Point Operation Step 9
2AA	336	3C2	44E	4DA	566	Point Operation Step 10
2AB	337	3C3	44F	4DB	567	Point Operation Step 11
2AC	338	3C4	450	4DC	568	Point Operation Step 12
2AD	339	3C5	451	4DD	569	Point Operation Step 13
2AE	33A	3C6	452	4DE	56A	Point Operation Step 14
2AF	33B	3C7	453	4DF	56B	Point Operation Step 15
2B0	33C	3C8	454	4E0	56C	Point Operation Step 16
2B1	33D	3C9	455	4E1	56D	Point Operation Step 17
2B2	33E	3CA	456	4E2	56E	Point Operation Step 18
2B3	33F	3CB	457	4E3	56F	Point Operation Step 19
2B4	340	3CC	458	4E4	570	Point Operation Step 20

(2) POINT Start Step Data Setting

- (a) The POINT start step data setting command for POINT start during POINT operation is XPM_PST.
- (b) References for XPM_PST (command of XEM-H2/HP point operating) and XPWR (command of point operating step data setting) are on 'Chapter 7.3.38'.
- (c) In PLC program, POINT operation data setting during POINT operation should be done in the step before POINT operation command is executed for normal action of POINT operation.

6.1.2 Teaching Data

(1) Memory Address of Teaching Data

Memory Address						Description
1 axis	2 axis	3 axis	4 axis	5axis	6 axis	
280	30C	398	424	4B0	53C	Teaching Data1(LOWER)
281	30D	399	425	4B1	53D	Teaching Data1(UPPER)
282	30E	39A	426	4B2	53E	Teaching Data2(LOWER)
283	30F	39B	427	4B3	53F	Teaching Data2(UPPER)
284	310	39C	428	4B4	540	Teaching Data3(LOWER)
285	311	39D	429	4B5	541	Teaching Data3(UPPER)
286	312	39E	42A	4B6	542	Teaching Data4(LOWER)
287	313	39F	42B	4B7	543	Teaching Data4(UPPER)
288	314	3A0	42C	4B8	544	Teaching Data5(LOWER)
289	315	3A1	42D	4B9	545	Teaching Data5(UPPER)
28A	316	3A2	42E	4BA	546	Teaching Data6(LOWER)
28B	317	3A3	42F	4BB	547	Teaching Data6(UPPER)
28C	318	3A4	430	4BC	548	Teaching Data7(LOWER)
28D	319	3A5	431	4BD	549	Teaching Data7(UPPER)
28E	31A	3A6	432	4BE	54A	Teaching Data8(LOWER)
28F	31B	3A7	433	4BF	54B	Teaching Data8(UPPER)
290	31C	3A8	434	4C0	54C	Teaching Data9(LOWER)
291	31D	3A9	435	4C1	54D	Teaching Data9(UPPER)
292	31E	3AA	436	4C2	54E	Teaching Data10(LOWER)
293	31F	3AB	437	4C3	54F	Teaching Data10(UPPER)
294	320	3AC	438	4C4	550	Teaching Data11(LOWER)
295	321	3AD	439	4C5	551	Teaching Data11(UPPER)
296	322	3AE	43A	4C6	552	Teaching Data12(LOWER)
297	323	3AF	43B	4C7	553	Teaching Data12(UPPER)
298	324	3B0	43C	4C8	554	Teaching Data13(LOWER)
299	325	3B1	43D	4C9	555	Teaching Data13(UPPER)
29A	326	3B2	43E	4CA	556	Teaching Data14(LOWER)
29B	327	3B3	43F	4CB	557	Teaching Data14(UPPER)
29C	328	3B4	440	4CC	558	Teaching Data15(LOWER)
29D	329	3B5	441	4CD	559	Teaching Data15(UPPER)
29E	32A	3B6	442	4CE	55A	Teaching Data16(LOWER)
29F	32B	3B7	443	4CF	55B	Teaching Data16(UPPER)

(2) Setting

- (a) The command of Teaching data setting is XPM_ATEA
- (b) References for XPM_ATEA (command of Teaching) and XPM_WRT (command of Teaching Data Setting) are on 'Chapter 7.3.25'.
- (c) In PLC program, in order to carry out the normal action of Teaching command, the Teaching data setting should be done in the step before Teaching command is executed.

6.1.3 Step Data of Simultaneous Start

(1) Step Data of Simultaneous Start Memory Address

Memory Address						Description
1 axis	2 axis	3 axis	4 axis	5 axis	6 axis	
2B6	342	3CE	45A	4E6	572	Simultaneous Start 1axis Step Number
2B7	343	3CF	45B	4E7	573	Simultaneous Start 2axis Step Number
2B8	344	3D0	45C	4E8	574	Simultaneous Start 3axis Step Number
2B9	345	3D1	45D	4E9	575	Simultaneous Start 4axis Step Number
2BA	346	3D2	45E	4EA	576	Simultaneous Start 5axis Step Number
2BB	347	3D3	45F	4EB	577	Simultaneous Start 6axis Step Number

(2) Setting

- (a) The command for Step Data of Simultaneous Start setting is XPM_SST
- (b) References for XPM_SST (command of Simultaneous Start) on 'Chapter 7.3.5
- (c) In PLC program, in order to carry out the normal action of Simultaneous Start, the Step data setting of Simultaneous Start should be done in the step before Simultaneous Start command is executed.

6.1.4 Status Information

(1) Memory Address of Status Information

XSRD Command Device Offset	Memory Address						Description
	1 axis	2 axis	3 axis	4 axis	5 axis	6 axis	
0	2C0	34C	3D8	464	4F0	57C	Operation state bit information (Lower)
1	2C1	34D	3D9	465	4F1	57D	Operation state bit information (Upper)
2	2C2	34E	3DA	466	4F2	57E	Axis information
3	2C3	34F	3DB	467	4F3	57F	External I/O signal state
4	2C4	350	3DC	468	4F4	580	Current Position (LOWER)
5	2C5	351	3DD	469	4F5	581	Current Position (UPPER)
6	2C6	352	3DE	46A	4F6	582	Current Position (LOWER)
7	2C7	353	3DF	46B	4F7	583	Current Position (UPPER)
8	2C8	354	3E0	46C	4F8	584	Step Number
9	2C9	355	3E1	46D	4F9	585	M Code Number
10	2CA	356	3E2	46E	4FA	586	Current error information
11	2CB	357	3E3	46F	4FB	587	Error information 1
12	2CC	358	3E4	470	4FC	588	Error information 2
13	2CD	359	3E5	471	4FD	589	Error information 3
14	2CE	35A	3E6	472	4FE	58A	Error information 4
15	2CF	35B	3E7	473	4FF	58B	Error information 5
16	2D0	35C	3E8	474	500	58C	Error information 6
17	2D1	35D	3E9	475	501	58D	Error information 7
18	2D2	35E	3EA	476	502	58E	Error information 8
19	2D3	35F	3EB	477	503	58F	Error information 9
20	2D4	360	3EC	478	504	590	Error information 10
21	2D5	361	3ED	479	505	591	Encoder Value1 (LOWER)
22	2D6	362	3EE	47A	506	592	Encoder Value1 (UPPER)
23	2D7	363	3EF	47B	507	593	Encoder Value2 (LOWER)
24	2D8	364	3F0	47C	508	594	Encoder Value2 (UPPER)
25	2D9	365	3F1	47D	509	595	Encoder Value3 (LOWER)
26	2DA	366	3F2	47E	50A	596	Encoder Value3 (UPPER)
27	2DB	367	3F3	47F	50B	597	Encoder Value4 (LOWER)
28	2DC	368	3F4	480	50C	598	Encoder Value4 (UPPER)

(2) Setting

- (a) The area of state information of internal memory is the Read only area. Thus, it is available to use only by GET, GETP command. (PUT, PUTP command is not allowed to use in this area).
- (b) The command of State Information ready only is XPM_SRD
- (c) If you use only command XPM_SRD, the information of axis status is read at the same time.
- (d) If you want to choose to read among the state information, it is available to read memory address of above table using by GET/GETP

(e) Status Information details

1) Operation State Bit Information (Lower)

Memory Address						Information
1 axis	2 axis	3 axis	4 axis	3 axis	4 axis	
2C0	34C	3D8	464	4F0	57C	Operation State Bit Information (LOWER)

Bit 0	In operation	[0: Stop 1: In operation]
Bit 1	Error	[0: No Error 1: Error]
Bit 2	Position Completed	[0: Not completed, 1: Completed]
Bit 3	M code signal	[0: M code Off, 1: M code On]
Bit 4	Homing state	[0: Not Fixed, 1:Fixed]
Bit 5	No use	
Bit 6	Stop state	[0: Not stop by stop command, 1: Stop by stop command]
Bit 7	Variable Data Read/Write	[0: Variable data access finished, 1: Variable data access is on going]
Bit 8	Upper Limit Detection	[0: No Detection, 1: Detection]
Bit 9	Lower Limit Detection	[0: No Detection, 1: Detection]
Bit 10	Emergency Stop state	[0: Normal, 1: Emergency Stop]
Bit 11	Direction	[0: Forward, 1: Reverse]
Bit 12	Acceleration State	[0: Not Accelerating, 1: Accelerating]
Bit 13	Constant Speed state	[0: Not Constant speed, 1: Constant speed]
Bit 14	Deceleration state	[0: Not Decelerating, 1: Decelerating]
Bit 15	Dwell State	[0: No Dwelling, 1: Dwelling]

2) Operation State Bit Information (Upper)

Memory Address						Information
1 axis	2 axis	3 axis	4 axis	5 axis	6 axis	
2C1	34D	3D9	465	4F1	57D	Operation State Bit Information

Bit 0	[SNG] Position Controlling	[0: Position not in control, 1: Position in control]
Bit 1	[SNG]Speed Controlling	[0: Speed not in control, 1: Speed in control]
Bit 2	Linear Interpolation	[0: Not in operation, 1: In operation]
Bit 3	No use	[0]
Bit 4	Circular Interpolation in Operation	[0: Not in operation, 1: In operation]
Bit 5	Homing Operating	[0: Not in operation, 1: In operation]
Bit 6	Synchronous Start by Position in Operation	[0: Not in operation, 1: In operation]
Bit 7	Synchronous Start by speed in Operation	[0: Not in operation, 1: In operation]
Bit 8	JOG Operation	[0: Not in operation, 1: In operation]
Bit 9	No use	[0]
Bit 10	Inching in Operation	
Bit 11	No use	[0]
Bit 12	RTP in Operation	[0: Not in operation, 1: In operation]
Bit 13	CAM in Operation	[0: Not in operation, 1: In operation]
Bit 14	FEED in Operation	
Bit 15	Circular in Operation	[0: Not in operation, 1: In operation]

3) Axis Information

Memory Address						Information
1 axis	2 axis	3 axis	4 axis	5 axis	6 axis	
2C2	34E	3DA	466	4F2	57E	Axis Information

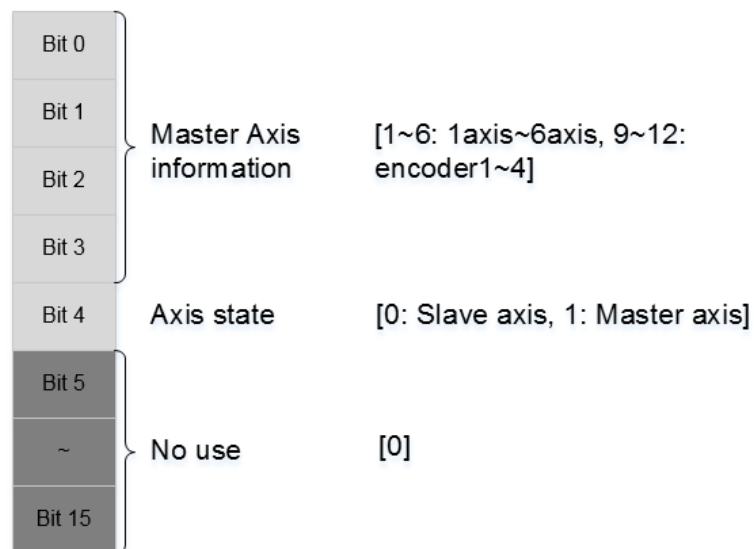

4) External I/O Signal State

Memory Address						Information
1 axis	2 axis	3 axis	4 axis	5 axis	6 axis	
2C3	34F	3DB	467	4F3	57F	External I/O Signal State

Bit 0	No use	[0]
Bit 1		
Bit 2		
Bit 3		
Bit 4	Upper limit Signal	[0: Upper limit Signal OFF, 1: Upper limit Signal ON]
Bit 5	Lower limit Signal	[0: Lower limit Signal OFF, 1: Lower limit Signal ON]
Bit 6	HOME	[0: HOME signal OFF, 1: HOME signal ON]
Bit 7	DOG	[0: DOG signal OFF, 1: DOG signal ON]
Bit 8	No use	[0]
Bit 9		
Bit 10		
Bit 11		
Bit 12		
Bit 13		
Bit 14		
Bit 15		

6.2 K area Signal

Here describes the contents and functions of K area signal for the exchange of data between Positioning and CPU.

6.2.1 Contents of K area Signal

- (1) Built-in positioning signal displays on K area.
- (2) Built-in Positioning ready signal (%KX7007) becomes “ON” only when Modules are in normal state in H/W and it always keeps “ON” regardless of PLC operation mode.
- (3) Output Signal

This is the signal, which transfers to positioning module from PLC CPU.

Comment	Variable	K area	Type	R/W
1Axis Busy	_POS_1_Busy	%KX6720	BIT	R
2Axis Busy	_POS_2_Busy	%KX7040	BIT	R
3Axis Busy	_POS_3_Busy	%KX7360	BIT	R
4Axis Busy	_POS_4_Busy	%KX7680	BIT	R
5Axis Busy	_POS_5_Busy	%KX8000	BIT	R
6Axis Busy	_POS_6_Busy	%KX8320	BIT	R
1Axis Error	_POS_1_Err	%KX6721	BIT	R
2Axis Error	_POS_2_Err	%KX7041	BIT	R
3Axis Error	_POS_3_Err	%KX7361	BIT	R
4Axis Error	_POS_4_Err	%KX7681	BIT	R
5Axis Error	_POS_5_Err	%KX8001	BIT	R
6Axis Error	_POS_6_Err	%KX8321	BIT	R
1Axis Position Complete	_POS_1_Done	%KX6722	BIT	R
2Axis Position Complete	_POS_2_Done	%KX7042	BIT	R
3Axis Position Complete	_POS_3_Done	%KX7362	BIT	R
4Axis Position Complete	_POS_4_Done	%KX7682	BIT	R
5Axis Position Complete	_POS_5_Done	%KX8002	BIT	R
6Axis Position Complete	_POS_6_Done	%KX8322	BIT	R
1Axis M Code ON	_POS_1_McodeOn	%KX6723	BIT	R
2Axis M Code ON	_POS_2_McodeOn	%KX7043	BIT	R
3Axis M Code ON	_POS_3_McodeOn	%KX7363	BIT	R
4Axis M Code ON	_POS_4_McodeOn	%KX7683	BIT	R
5Axis M Code ON	_POS_5_McodeOn	%KX8003	BIT	R
6Axis M Code ON	_POS_6_McodeOn	%KX8323	BIT	R

Comment	Variable	K area	Type	R/W
1Axis Home Complete	_POS_1_OriginFix	%KX6724	BIT	R
2Axis Home Complete	_POS_2_OriginFix	%KX7044	BIT	R
3Axis Home Complete	_POS_3_OriginFix	%KX7364	BIT	R
4Axis Home Complete	_POS_4_OriginFix	%KX7684	BIT	R
5Axis Home Complete	_POS_5_OriginFix	%KX8004	BIT	R
6Axis Home Complete	_POS_6_OriginFix	%KX8324	BIT	R
1Axis Output Enable	_POS_1_PlsOutEn	%KX6725	BIT	R
2Axis Output Enable	_POS_2_PlsOutEn	%KX7045	BIT	R
3Axis Output Enable	_POS_3_PlsOutEn	%KX7365	BIT	R
4Axis Output Enable	_POS_4_PlsOutEn	%KX7685	BIT	R
5Axis Output Enable	_POS_5_PlsOutEn	%KX8005	BIT	R
6Axis Output Enable	_POS_6_PlsOutEn	%KX8325	BIT	R
1Axis Stop	_POS_1_Stop	%KX6726	BIT	R
2Axis Stop	_POS_2_Stop	%KX7046	BIT	R
3Axis Stop	_POS_3_Stop	%KX7366	BIT	R
4Axis Stop	_POS_4_Stop	%KX7686	BIT	R
5Axis Stop	_POS_5_Stop	%KX8006	BIT	R
6Axis Stop	_POS_6_Stop	%KX8326	BIT	R
1Axis Variable Data Read/Write	_POS_1_VarWriteBusy	%KX6727	BIT	R
2Axis Variable Data Read/Write	_POS_2_VarWriteBusy	%KX7047	BIT	R
3Axis Variable Data Read/Write	_POS_3_VarWriteBusy	%KX7367	BIT	R
4Axis Variable Data Read/Write	_POS_4_VarWriteBusy	%KX7687	BIT	R
5Axis Variable Data Read/Write	_POS_5_VarWriteBusy	%KX8007	BIT	R
6Axis Variable Data Read/Write	_POS_6_VarWriteBusy	%KX8327	BIT	R
1Axis Upper Limit Detection	_POS_1_ULimit	%KX6728	BIT	R
2Axis Upper Limit Detection	_POS_2_ULimit	%KX7048	BIT	R
3Axis Upper Limit Detection	_POS_3_ULimit	%KX7368	BIT	R
4Axis Upper Limit Detection	_POS_4_ULimit	%KX7688	BIT	R
5Axis Upper Limit Detection	_POS_5_ULimit	%KX8008	BIT	R
6Axis Upper Limit Detection	_POS_6_ULimit	%KX8328	BIT	R
1Axis Lower Limit Detection	_POS_1_LLimit	%KX6729	BIT	R
2Axis Lower Limit Detection	_POS_2_LLimit	%KX7049	BIT	R
3Axis Lower Limit Detection	_POS_3_LLimit	%KX7369	BIT	R
4Axis Lower Limit Detection	_POS_4_LLimit	%KX7689	BIT	R
5Axis Lower Limit Detection	_POS_5_LLimit	%KX8009	BIT	R
6Axis Lower Limit Detection	_POS_6_LLimit	%KX8329	BIT	R

Comment	Variable	K area	Type	R/W
1Axis Emergency Stop	_POS_1_Estop	%KX6730	BIT	R
2Axis Emergency Stop	_POS_2_Estop	%KX7050	BIT	R
3Axis Emergency Stop	_POS_3_Estop	%KX7370	BIT	R
4Axis Emergency Stop	_POS_4_Estop	%KX7690	BIT	R
5Axis Emergency Stop	_POS_5_Estop	%KX8010	BIT	R
6Axis Emergency Stop	_POS_6_Estop	%KX8330	BIT	R
1Axis CW/CCW	_POS_1_Dir	%KX6731	BIT	R
2Axis CW/CCW	_POS_2_Dir	%KX7051	BIT	R
3Axis CW/CCW	_POS_3_Dir	%KX7371	BIT	R
4Axis CW/CCW	_POS_4_Dir	%KX7691	BIT	R
5Axis CW/CCW	_POS_5_Dir	%KX8011	BIT	R
6Axis CW/CCW	_POS_6_Dir	%KX8331	BIT	R
1Axis Acceleration state	_POS_1_Acc	%KX6732	BIT	R
2Axis Acceleration state	_POS_2_Acc	%KX7052	BIT	R
3Axis Acceleration state	_POS_3_Acc	%KX7372	BIT	R
4Axis Acceleration state	_POS_4_Acc	%KX7692	BIT	R
5Axis Acceleration state	_POS_5_Acc	%KX8012	BIT	R
6Axis Acceleration state	_POS_6_Acc	%KX8332	BIT	R
1Axis Constant speed state	_POS_1_Const	%KX6733	BIT	R
2Axis Constant speed state	_POS_2_Const	%KX7053	BIT	R
3Axis Constant speed state	_POS_3_Const	%KX7373	BIT	R
4Axis Constant speed state	_POS_4_Const	%KX7693	BIT	R
5Axis Constant speed state	_POS_5_Const	%KX8013	BIT	R
6Axis Constant speed state	_POS_6_Const	%KX8333	BIT	R
1Axis Deceleration state	_POS_1_Dec	%KX6734	BIT	R
2Axis Deceleration state	_POS_2_Dec	%KX7054	BIT	R
3Axis Deceleration state	_POS_3_Dec	%KX7374	BIT	R
4Axis Deceleration state	_POS_4_Dec	%KX7694	BIT	R
5Axis Deceleration state	_POS_5_Dec	%KX8014	BIT	R
6Axis Deceleration state	_POS_6_Dec	%KX8334	BIT	R
1Axis Dwell state	_POS_1_Dwell	%KX6735	BIT	R
2Axis Dwell state	_POS_2_Dwell	%KX7055	BIT	R
3Axis Dwell state	_POS_3_Dwell	%KX7375	BIT	R
4Axis Dwell state	_POS_4_Dwell	%KX7695	BIT	R
5Axis Dwell state	_POS_5_Dwell	%KX8015	BIT	R
6Axis Dwell state	_POS_6_Dwell	%KX8335	BIT	R

Comment	Variable	K area	Type	R/W
1Axis POSition control	_POS_1_Position	%KX6736	BIT	R
2Axis Position control	_POS_2_Position	%KX7056	BIT	R
3Axis Position control	_POS_3_Position	%KX7376	BIT	R
4Axis Position control	_POS_4_Position	%KX7696	BIT	R
5Axis Position control	_POS_5_Position	%KX8016	BIT	R
6Axis Position control	_POS_6_Position	%KX8336	BIT	R
1Axis Speed control	_POS_1_Speed	%KX6737	BIT	R
2Axis Speed control	_POS_2_Speed	%KX7057	BIT	R
3Axis Speed control	_POS_3_Speed	%KX7377	BIT	R
4Axis Speed control	_POS_4_Speed	%KX7697	BIT	R
5Axis Speed control	_POS_5_Speed	%KX8017	BIT	R
6Axis Speed control	_POS_6_Speed	%KX8337	BIT	R
1Axis Linear interpolation running	_POS_1_LinearInt	%KX6738	BIT	R
2Axis Linear interpolation running	_POS_2_LinearInt	%KX7058	BIT	R
3Axis Linear interpolation running	_POS_3_LinearInt	%KX7378	BIT	R
4Axis Linear interpolation running	_POS_4_LinearInt	%KX7698	BIT	R
5Axis Linear interpolation running	_POS_5_LinearInt	%KX8018	BIT	R
6Axis Linear interpolation running	_POS_6_LinearInt	%KX8338	BIT	R
1Axis Circular interpolation running	_POS_1_CircleInt	%KX6740	BIT	R
2Axis Circular interpolation running	_POS_2_CircleInt	%KX7060	BIT	R
3Axis Circular interpolation running	_POS_3_CircleInt	%KX7380	BIT	R
4Axis Circular interpolation running	_POS_4_CircleInt	%KX7700	BIT	R
5Axis Circular interpolation running	_POS_5_CircleInt	%KX8020	BIT	R
6Axis Circular interpolation running	_POS_6_CircleInt	%KX8340	BIT	R
1Axis Homing	_POS_1_Home	%KX6741	BIT	R
2Axis Homing	_POS_2_Home	%KX7061	BIT	R
3Axis Homing	_POS_3_Home	%KX7381	BIT	R
4Axis Homing	_POS_4_Home	%KX7701	BIT	R
5Axis Homing	_POS_5_Home	%KX8021	BIT	R
6Axis Homing	_POS_6_Home	%KX8341	BIT	R
1Axis POSition sync running	_POS_1_PosSync	%KX6742	BIT	R
2Axis Position sync running	_POS_2_PosSync	%KX7062	BIT	R
3Axis Position sync running	_POS_3_PosSync	%KX7382	BIT	R
4Axis Position sync running	_POS_4_PosSync	%KX7702	BIT	R
5Axis Position sync running	_POS_5_PosSync	%KX8022	BIT	R
6Axis Position sync running	_POS_6_PosSync	%KX8342	BIT	R

Chapter 6 Internal Memory and I/O Signal

Comment	Variable	K area	Type	R/W
1Axis speed sync running	_POS_1_SpdSync	%KX6743	BIT	R
2Axis speed sync running	_POS_2_SpdSync	%KX7063	BIT	R
3Axis speed sync running	_POS_3_SpdSync	%KX7383	BIT	R
4Axis speed sync running	_POS_4_SpdSync	%KX7703	BIT	R
5Axis speed sync running	_POS_5_SpdSync	%KX8023	BIT	R
6Axis speed sync running	_POS_6_SpdSync	%KX8343	BIT	R
1Axis Jog running	_POS_1_JogBusy	%KX6744	BIT	R
2Axis Jog running	_POS_2_JogBusy	%KX7064	BIT	R
3Axis Jog running	_POS_3_JogBusy	%KX7384	BIT	R
4Axis Jog running	_POS_4_JogBusy	%KX7704	BIT	R
5Axis Jog running	_POS_5_JogBusy	%KX8024	BIT	R
6Axis Jog running	_POS_6_JogBusy	%KX8344	BIT	R
1Axis Inching running	_POS_1_Inching	%KX6746	BIT	R
2Axis Inching running	_POS_2_Inching	%KX7066	BIT	R
3Axis Inching running	_POS_3_Inching	%KX7386	BIT	R
4Axis Inching running	_POS_4_Inching	%KX7706	BIT	R
5Axis Inching running	_POS_5_Inching	%KX8026	BIT	R
6Axis Inching running	_POS_6_Inching	%KX8346	BIT	R
1Axis RTP running	_POS_1_RtpVusy	%KX6748	BIT	R
2Axis RTP running	_POS_2_RtpVusy	%KX7068	BIT	R
3Axis RTP running	_POS_3_RtpVusy	%KX7388	BIT	R
4Axis RTP running	_POS_4_RtpVusy	%KX7708	BIT	R
5Axis RTP running	_POS_5_RtpVusy	%KX8028	BIT	R
6Axis RTP running	_POS_6_RtpVusy	%KX8348	BIT	R
1Axis CAM running	_POS_1_Cam	%KX6749	BIT	R
2Axis CAM running	_POS_2_Cam	%KX7069	BIT	R
3Axis CAM running	_POS_3_Cam	%KX7389	BIT	R
4Axis CAM running	_POS_4_Cam	%KX7709	BIT	R
5Axis CAM running	_POS_5_Cam	%KX8029	BIT	R
6Axis CAM running	_POS_6_Cam	%KX8349	BIT	R
1Axis Feed control running	_POS_1_Feed	%KX6750	BIT	R
2Axis Feed control running	_POS_2_Feed	%KX7070	BIT	R
3Axis Feed control running	_POS_3_Feed	%KX7390	BIT	R
4Axis Feed control running	_POS_4_Feed	%KX7710	BIT	R
5Axis Feed control running	_POS_5_Feed	%KX8030	BIT	R
6Axis Feed control running	_POS_6_Feed	%KX8350	BIT	R

Comment	Variable	K area	Type	RW
1Axis Ellipse interpolation running	_POS_1_Ellipse	%KX6751	BIT	R
2Axis Ellipse interpolation running	_POS_2_Ellipse	%KX7071	BIT	R
3Axis Ellipse interpolation running	_POS_3_Ellipse	%KX7391	BIT	R
4Axis Ellipse interpolation running	_POS_4_Ellipse	%KX7711	BIT	R
5Axis Ellipse interpolation running	_POS_5_Ellipse	%KX8031	BIT	R
6Axis Ellipse interpolation running	_POS_6_Ellipse	%KX8351	BIT	R
1Axis Main axis	_POS_1_MstAxis	%KX6752	NIBBLE	R
2Axis Main axis	_POS_2_MstAxis	%KX7072	NIBBLE	R
3Axis Main axis	_POS_3_MstAxis	%KX7392	NIBBLE	R
4Axis Main axis	_POS_4_MstAxis	%KX7712	NIBBLE	R
5Axis Main axis	_POS_5_MstAxis	%KX8032	NIBBLE	R
6Axis Main axis	_POS_6_MstAxis	%KX8352	NIBBLE	R
1Axis main/slave status	_POS_1_AxisStatus	%KX6756	BIT	R
2Axis main/slave status	_POS_2_AxisStatus	%KX7076	BIT	R
3Axis main/slave status	_POS_3_AxisStatus	%KX7396	BIT	R
4Axis main/slave status	_POS_4_AxisStatus	%KX7716	BIT	R
5Axis main/slave status	_POS_5_AxisStatus	%KX8036	BIT	R
6Axis main/slave status	_POS_6_AxisStatus	%KX8356	BIT	R
1Axis Positive limit signal	_POS_1_ULSigStatus	%KX6772	BIT	R
2Axis Positive limit signal	_POS_2_ULSigStatus	%KX7092	BIT	R
3Axis Positive limit signal	_POS_3_ULSigStatus	%KX7412	BIT	R
4Axis Positive limit signal	_POS_4_ULSigStatus	%KX7732	BIT	R
5Axis Positive limit signal	_POS_5_ULSigStatus	%KX8052	BIT	R
6Axis Positive limit signal	_POS_6_ULSigStatus	%KX8372	BIT	R
1Axis Negative limit signal	_POS_1_LLSigStatus	%KX6773	BIT	R
2Axis Negative limit signal	_POS_2_LLSigStatus	%KX7093	BIT	R
3Axis Negative limit signal	_POS_3_LLSigStatus	%KX7413	BIT	R
4Axis Negative limit signal	_POS_4_LLSigStatus	%KX7733	BIT	R
5Axis Negative limit signal	_POS_5_LLSigStatus	%KX8053	BIT	R
6Axis Negative limit signal	_POS_6_LLSigStatus	%KX8373	BIT	R
1Axis Home signal	_POS_1_HomeSigStatus	%KX6774	BIT	R
2Axis Home signal	_POS_2_HomeSigStatus	%KX7094	BIT	R
3Axis Home signal	_POS_3_HomeSigStatus	%KX7414	BIT	R
4Axis Home signal	_POS_4_HomeSigStatus	%KX7734	BIT	R
5Axis Home signal	_POS_5_HomeSigStatus	%KX8054	BIT	R
6Axis Home signal	_POS_6_HomeSigStatus	%KX8374	BIT	R

Chapter 6 Internal Memory and I/O Signal

Comment	Variable	K area	Type	R/W
1Axis Dog signal	_POS_1_DogSigStatus	%KX6775	BIT	R
2Axis Dog signal	_POS_2_DogSigStatus	%KX7095	BIT	R
3Axis Dog signal	_POS_3_DogSigStatus	%KX7415	BIT	R
4Axis Dog signal	_POS_4_DogSigStatus	%KX7735	BIT	R
5Axis Dog signal	_POS_5_DogSigStatus	%KX8055	BIT	R
6Axis Dog signal	_POS_6_DogSigStatus	%KX8375	BIT	R
1Axis Current Position	_POS_1_CurPos	%KD212	DINT	R
2Axis Current Position	_POS_2_CurPos	%KD222	DINT	R
3Axis Current Position	_POS_3_CurPos	%KD232	DINT	R
4Axis Current Position	_POS_4_CurPos	%KD242	DINT	R
5Axis Current Position	_POS_5_CurPos	%KD252	DINT	R
6Axis Current Position	_POS_6_CurPos	%KD262	DINT	R
1Axis Current Speed	_POS_1_CurSpd	%KD213	DWORD	R
2Axis Current Speed	_POS_2_CurSpd	%KD223	DWORD	R
3Axis Current Speed	_POS_3_CurSpd	%KD233	DWORD	R
4Axis Current Speed	_POS_4_CurSpd	%KD243	DWORD	R
5Axis Current Speed	_POS_5_CurSpd	%KD253	DWORD	R
6Axis Current Speed	_POS_6_CurSpd	%KD263	DWORD	R
1Axis Step Number	_POS_1_Step	%KW428	WORD	R
2Axis Step Number	_POS_2_Step	%KW448	WORD	R
3Axis Step Number	_POS_3_Step	%KW468	WORD	R
4Axis Step Number	_POS_4_Step	%KW488	WORD	R
5Axis Step Number	_POS_5_Step	%KW508	WORD	R
6Axis Step Number	_POS_6_Step	%KW528	WORD	R
1Axis M Code number	_POS_1_MCodeNum	%KW429	WORD	R
2Axis M Code number	_POS_2_MCodeNum	%KW449	WORD	R
3Axis M Code number	_POS_3_MCodeNum	%KW469	WORD	R
4Axis M Code number	_POS_4_MCodeNum	%KW489	WORD	R
5Axis M Code number	_POS_5_MCodeNum	%KW509	WORD	R
6Axis M Code number	_POS_6_MCodeNum	%KW529	WORD	R
1Axis Error Code	_POS_1_ErrCode	%KW430	WORD	R
2Axis Error Code	_POS_2_ErrCode	%KW450	WORD	R
3Axis Error Code	_POS_3_ErrCode	%KW470	WORD	R
4Axis Error Code	_POS_4_ErrCode	%KW490	WORD	R
5Axis Error Code	_POS_5_ErrCode	%KW510	WORD	R
6Axis Error Code	_POS_6_ErrCode	%KW530	WORD	R

Comment	Variable	K area	Type	R/W
1Axis Target position	_POS_1_TargetPos	%KD216	DINT	R
2Axis Target position	_POS_2_TargetPos	%KD226	DINT	R
3Axis Target position	_POS_3_TargetPos	%KD236	DINT	R
4Axis Target position	_POS_4_TargetPos	%KD246	DINT	R
5Axis Target position	_POS_5_TargetPos	%KD256	DINT	R
6Axis Target position	_POS_6_TargetPos	%KD266	DINT	R
1Axis Target speed	_POS_1_TargetSpd	%KD217	DWORD	R
2Axis Target speed	_POS_2_TargetSpd	%KD227	DWORD	R
3Axis Target speed	_POS_3_TargetSpd	%KD237	DWORD	R
4Axis Target speed	_POS_4_TargetSpd	%KD247	DWORD	R
5Axis Target speed	_POS_5_TargetSpd	%KD257	DWORD	R
6Axis Target speed	_POS_6_TargetSpd	%KD267	DWORD	R
1Axis Positive jog command	_POS_1_CwJogStart	%KX6976	BIT	R/W
2Axis Positive jog command	_POS_2_CwJogStart	%KX7296	BIT	R/W
3Axis Positive jog command	_POS_3_CwJogStart	%KX7616	BIT	R/W
4Axis Positive jog command	_POS_4_CwJogStart	%KX7936	BIT	R/W
5Axis Positive jog command	_POS_5_CwJogStart	%KX8256	BIT	R/W
6Axis Positive jog command	_POS_6_CwJogStart	%KX8576	BIT	R/W
1Axis Negative jog command	_POS_1_CcwJogStart	%KX6977	BIT	R/W
2Axis Negative jog command	_POS_2_CcwJogStart	%KX7297	BIT	R/W
3Axis Negative jog command	_POS_3_CcwJogStart	%KX7617	BIT	R/W
4Axis Negative jog command	_POS_4_CcwJogStart	%KX7937	BIT	R/W
5Axis Negative jog command	_POS_5_CcwJogStart	%KX8257	BIT	R/W
6Axis Negative jog command	_POS_6_CcwJogStart	%KX8577	BIT	R/W
1Axis Jog speed command	_POS_1_JogLowHigh	%KX6978	BIT	R/W
2Axis Jog speed command	_POS_2_JogLowHigh	%KX7298	BIT	R/W
3Axis Jog speed command	_POS_3_JogLowHigh	%KX7618	BIT	R/W
4Axis Jog speed command	_POS_4_JogLowHigh	%KX7938	BIT	R/W
5Axis Jog speed command	_POS_5_JogLowHigh	%KX8258	BIT	R/W
6Axis Jog speed command	_POS_6_JogLowHigh	%KX8578	BIT	R/W
Internal position control ready	_POS_Rdy	%KX7007	BIT	R
Internal position control data saving	_POS_Writing	%KX7006	BIT	R
Encoder1 current position	_ENC1_CurPos	%KD269	DINT	R
Encoder2 current position	_ENC2_CurPos	%KD270	DINT	R
Encoder3 current position	_ENC3_CurPos	%KD271	DINT	R
Encoder4 current position	_ENC4_CurPos	%KD272	DINT	R

Comment	Variable	K area	Type	R/W
Current internal position control time(us)	_POS_TASK_SCAN_CUR	%KW546	WORD	R
Maximum internal position control time(us)	_POS_TASK_SCAN_MAX	%KW547	WORD	R
Internal position control period error	_POS_TASK_SCAN_ERR	%KW548	WORD	R

6.2.2 Usage of I/O Signal

(1) JOG Operation

- (a) Forward/Reverse Jog Signals show the direction of Jog Operation. The Jog operation shall be divided into Forward/Reverse direction according to the On/Off signals. When Forward Jog Signal is On, it starts Forward Operation and When Jog Signal is Off, it starts Reverse Operation. When both signals Off, it stops Jog Signals. When both signals On, it does Forward Jog Signal.

Forward Jog Signal	Reverse Jog Signal	Jog Operation Status
On	Off	Forward Jog Operation
Off	On	Reverse Jog Operation
Off	Off	Stop
On	On	Forward Jog Operation

- (b) If Jog direction is changed during Jog operation, it slows down at first and then operates as the direction it changed.
- (c) According to value of Jog low/high Signals, it could operate with low/high speed. When jog low/high signals Off, it operates with low speed and when they are ON, it operates with high speed.
- (d) If you change value of low/high jog signals during Jog operation, there will be no stop and apply the speed as you changed.

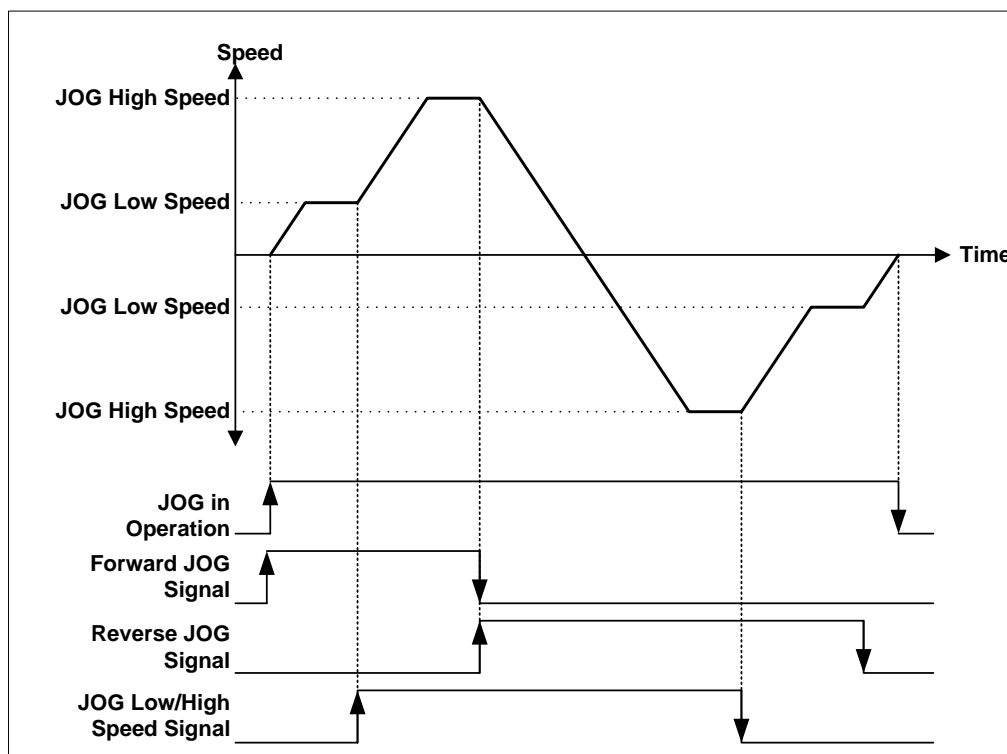

Chapter.7 Function block

It describes the function blocks used for the high-performance XGB embedded positioning.

7.1 Common items of function blocks

The common I/O variables used for the positioning function blocks are as follows.

I/O	Variable Name	Data type	Details
Input	REQ	BOOL	Execution request of function block -If the conditions connected to this area are established during executing the program and it leads to "0→1" (edge or level), function blocks will run.
	BASE	USINT	Base position number. - The area is used to set up the numbers of the bases where positioning modules are equipped. - Embedded positioning base No.: 0(Fixed)
	SLOT	USINT	Embedded positioning slot - The area is used to set up the numbers of slots where positioning modules are equipped. - Embedded positioning slot No.: 1(Fixed)
	AXIS	USINT	Used axis No. - 1 ~ 6: 1 axis ~ 46axis - If the values other than set value are selected, "error6" will occur.
Output	DONE	BOOL	Displaying the status that the execution of function blocks is completed. -When the function block is completed without error, "1" will be output and maintained until next execution; If error occurs, "0" will be output.
	STAT	UINT	Displaying error state - The area outputs the error No. when errors occur during executing function blocks.

(1) The errors that occur in STAT variables of the positioning function blocks are as follows.

STAT	Details	Description
0	Normal	If function blocks are normally executed, DONE=1, STAT=0 will be output.
1	Base No. setting error	It occurs when the base No.(BASE)'s set values are out of the range.
3	Slot No. setting error	It occurs when the slot No.(SLOT)'s set values are out of the range(1 ~ 11).
4	Empty slot error	It occurs when the module is not installed in the position that is specified as BASE, SLOT.
5	Mismatch of positioning modules	It occurs when other modules are installed instead of the positioning modules in the position that is specified as BASE, SLOT.
6	Axis No. error	It occurs when the axis No.(AXIS)'s set values are out of the range(1 ~ 4).
10	Overlapping execution error of function blocks	It occurs when the previous function block that was executed prior to the current one has not yet read by the positioning module. After the previously executed function block is read by the positioning module, execute the other function block. It takes maximum 10ms for the positioning module to read the function block after execution.
11	Input variables setting error	It occurs when the set values of variables are out of the range except BASE, SLOT, AXIS. Check the range of settable values for the variables in each function block.
101 ~ 811	Positioning module error	The error occurs from the positioning module as a result of executing function blocks.

(2) The setting ranges of the position and speed of the positioning function blocks are as follows. In this manual, pulse and speed are based on the unit of pulse/sec

Area	Setting unit	Setting range
Position	pulse	-2,147,483,648 ~ 2,147,483,647[pulse]
	mm	-2,147,483,648 ~ 2,147,483,647[x 10 ⁻⁴ mm]
	inch	-2,147,483,648 ~ 2,147,483,647[x 10 ⁻⁵ inch]
	degree	-2,147,483,648 ~ 2,147,483,647[x 10 ⁻⁵ degree]
Speed	pulse/second	1 ~ 2,000,000 [pulse/second]
	mm/minute	1 ~ 2,147,483,647 [X10 ⁻² mm/minute]
	inch/minute	1 ~ 2,147,483,647 [X10 ⁻³ Inch/minute]
	degree/minute	1 ~ 2,147,483,647 [X10 ⁻³ degree/minute]

(3) For the type and size of the data mainly used for the positioning function blocks, refer to the below table.

No.	Reserved word	Data type	Size(Bit)	Range
1	BOOL	Boolean	1	0, 1
2	SINT	Short Integer	8	-128 ~ 127
3	USINT	Unsigned Short Integer	8	0 ~ 255
4	INT	Integer	16	-32768 ~ 32767
5	UINT	Unsigned Integer	16	0 ~ 65535
6	DINT	Double Integer	32	-2147483648 ~ 2147483647
7	UDINT	Unsigned Double Integer	32	0 ~ 4294967295

7.1.1 Pulse Width modulation output command

- Pulse width modulation (APM_PWM) is the operation to turn the output contact on/off with a fixed period and a specified duty ratio.
- XEM-H2 can output two contacts %QX0.0.0 and QX0.0.1, XEM-HP can output six contacts
- PWM operation can be output with the positioning pulse example, to output PWM to the %QX0.0.0 contact, disabled.
For example, to output PWM to the %QX0.0.0 contact, disable the pulse output enable setting of the positioning 1 axis basic parameter using % QX0.0.0 contact as output.

(1) Pulse width modulation output command (APM_PWM)

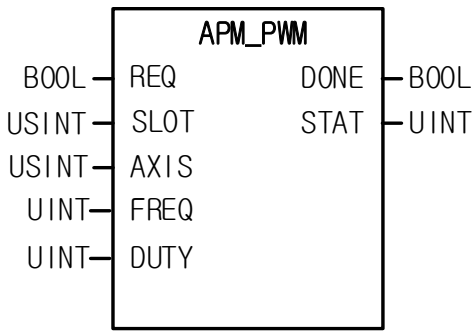
Function Block Type	Details
	<p>Input</p> <p>REQ : Request for executing function block SLOT : Setting up the numbers of the bases where modules are equipped. (XEM-H2, XEM-HP are fixed as 1) AXIS : Specifying contact point to command. 0~5 : %QX0.0.0~%QX0.0.5 FREQ : Setting the output cycle. (ms) 1~20000 DUTY : OFF Duty rate (%) 0~100</p> <p>Output</p> <p>DONE : Keeping 1 after the initial operation STAT : Outputting error No. that occurred during executing function blocks.</p>

(a) Function

This instruction is used to issue a PWM output command on the XEM-H2/HP output contact.

While the input condition is ON, the pulse is output to the contact specified by ax of XGB output contact with the cycle set to n1 and the OFF duty set to n2.

(b) Error

If the value specified FREQ or DUTY is out of the settable range, error codes 603 and 604 are output to STAT, respectively, and the command is not executed.

Note

- It is not applicable even if the output cycle is changed during PWM output.

(2) Example of using command

The operation of the PWM command is explained using the following program as an example.
 An example of using the PWM command is described based on %QX0.0.0.

(a) Program example

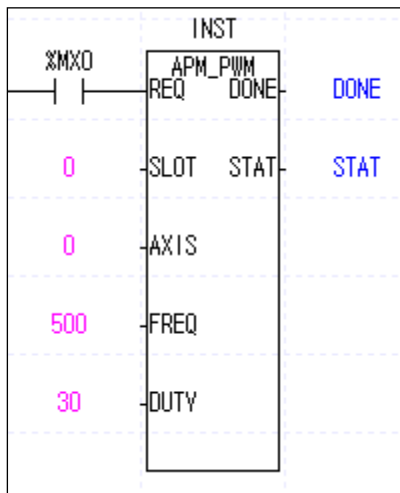

(b) Used Device

Device	Description
%MX0	PWM output command signal

(c) Program Operation

- %QX0.0.0 contact outputs the PWM signal out while %MX0 used as PWM command signal is on.
 (It doesn't work in case of the basic parameter pulse output of the embedded positioning 1 axis using %QX0.0.0 is set to output.)
- If the PWM command executed, the pulse will output as specified output cycle (500ms in this case) and off duty (30 % in this case).

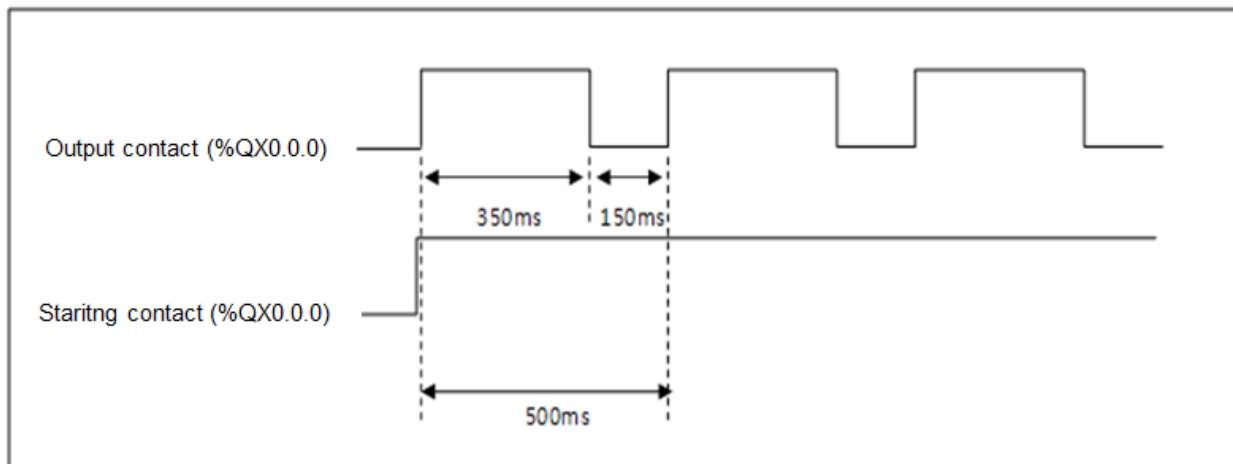

Chapter 7 Function block

7.2 Positioning module function block

No.	Name	Description	Operating conditions
1	XPM_ORG	Homing Start	Edge
2	XPM_FLT	Floating Origin Setting	Edge
3	XPM_DST	Direct Start	Edge
4	XPM_IST	Indirect Start	Edge
5	XPM_SST	Simultaneous Start	Edge
6	XPM_VTP	Speed/Position Switching Control	Edge
7	XPM_VTPP	Position specified Speed/Position Switching Control	Edge
8	XPM_PTV	Position/Speed Switching Control	Edge
9	XPM_STP	Deceleration Stop	Edge
10	XPM_SKP	Skip Operation	Edge
11	XPM_SSP	Position Synchronization	Edge
12	XPM_SSS	Speed Synchronization	Edge
13	XPM_SSSP	Position Assigned Speed Synchronization	Edge
14	XPM_POR	Position Override	Edge
15	XPM_SOR	Speed Override	Edge
16	XPM_PSO	Position Assigned Speed Override	Edge
17	XPM_NMV	Continuous Operation	Edge
18	XPM_INC	Inching Operation	Edge
19	XPM_RTP	Repeat Step Number Change	Edge
20	XPM_SNS	Start Step Change	Edge
21	XPM_SRS	Repeat operation step no. change	Edge
22	XPM_MOF	M Code Release	Edge
23	XPM_PRS	Current Position Change	Edge
24	XPM_EPRESB	Encoder Value Preset (XEM-H2, XEM-HP Embedded Position Only)	Edge
25	XPM_ATEA	Teaching array	Edge
26	XPM_SBP	Basic parameter teaching	Edge
27	XPM_SEP	Extended parameter teaching	Edge
28	XPM_SHP	Homing parameter teaching	Edge
29	XPM_SMP	Manual operation parameter teaching	Edge
30	XPM_SIP	I/O signal parameter teaching	Edge
31	XPM_SCP	Common Parameter Teaching	Edge
32	XPM_SMD	Operation Data Teaching	Edge
33	XPM_VRD	Read Variable Data	Edge
34	XPM_VWR	Write Variable Data	Edge
35	XPM_EMG	Emergency Stop	Edge
36	XPM_RST	Error Reset	Edge
37	XPM_HRST	Error History Reset	Edge
38	XPM_PST	Point Start	Edge
39	XPM_WRT	Parameter/operation data save	Edge
40	XPM_CRD	Operation Information Read	Level
41	XPM_SRD	Operation State Read	Level
42	XPM_ENCRDB	Encoder Value Read(XEM-H2, XEM-HP Embedded Position Only)	Level
43	XPM_JOG	JOG Operation	Level

44	XPM_CAM	CAM Operation	Edge
45	XPM_CAMO	Main Axis Offset CAM Operation	Edge
46	XPM_ELIN	Ellipse Interpolation	Edge
47	XPM_RSTR	Restart	Edge

Notice

1. Dedicated commands for the embedded positioning can be divided into; the command that works on the rising edge, namely, when input conditions are “On”, it performs operations only once. To perform operations again, input conditions should be “Off” and then, “On”; the command that works at a high level, namely, it keeps performing operations while input conditions are “On” and when input conditions are “Off”, it does not work.

Notice

▷ With the exception of XPM_SRD, XPM_CRD, XPM_ENCRD, the only one positioning function block should be executed for the axis within a single scan. If you use the program as the below example, the function block will not work properly.

When executing different function blocks

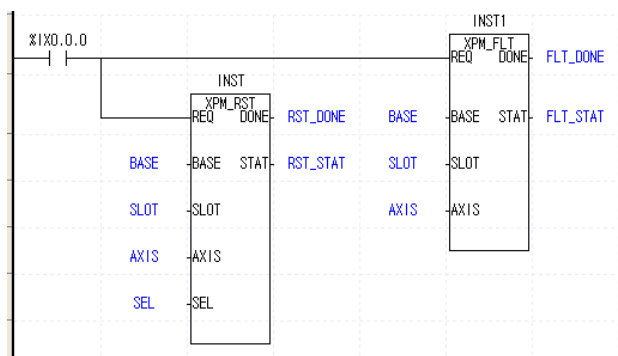

When executing the same function blocks

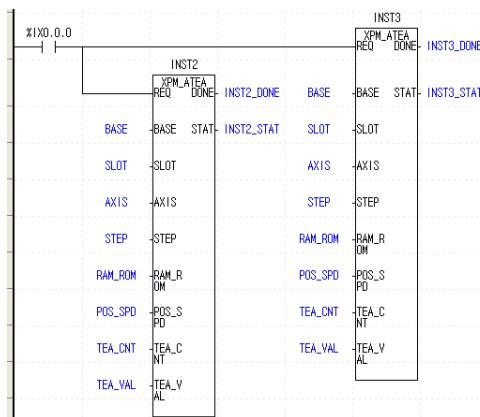

▷ For the different axis, you can simultaneously execute the same function blocks.

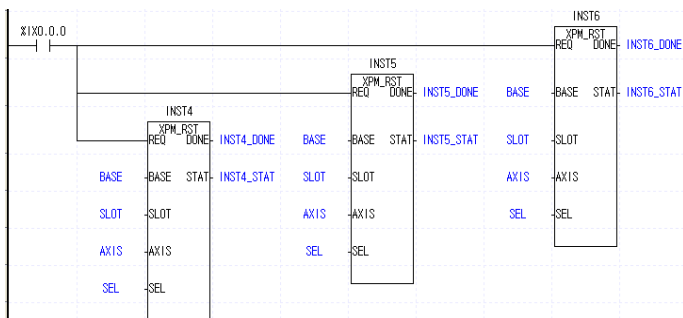

However, in the case of XPM_VRD, you cannot simultaneously execute function blocks within a single scan not only for the same axis but also for different ones. If you execute the XPM_VRD commands at the same time in one scan, the error code 811 will occur and XPM_VRD will not work after the first XPM_VRD.

7.3 How to use function block dedicated for positioning module

7.3.1 Homing Start (XPM_ORG)

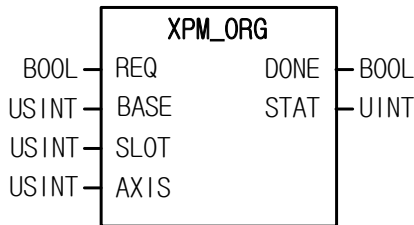
Function Block Type	Details
	<p>Input</p> <p>REQ : Request for executing function blocks</p> <p>BASE : Setting up the numbers of the bases where modules are equipped</p> <p>SLOT : Setting up the numbers of slots where modules are equipped</p> <p>AXIS : Specifying the axis to give commands 1 ~ 6: 1 axis ~ 6 axis</p> <p>Output</p> <p>DONE : Keeping 1 after the initial operation</p> <p>STAT : Outputting error No. that occurred during executing function blocks</p>

- (1) It gives homing command to the positioning module.
- (2) It is the operation command to find the origin of the machine based on homing mode with direction, compensation amount, speed(high speed, low speed), address and dwell time that are set as homing parameters of each axis.
- (3) The homing command is sent to the axis specified as AXIS of the embedded positioning.
- (4) In AXIS, you can set up the axis to command and select one among 1~6. If the values other than set value are selected, "Error 6" will occur.
- (5) When the homing command is normally performed, homing will start up based on the way set in "homing mode" of "Homing parameters".
- (6) Refer to "9.1 Homing" for details on the home return operation.

7.3.2 Setting the floating origin point (XPM_FLT)

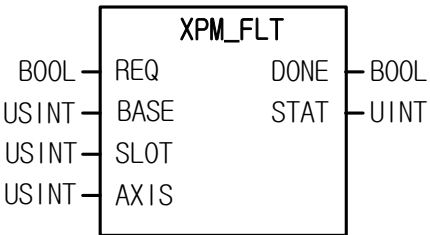
Function Block Type	Details
	<p>Input</p> <p>REQ : Request for executing function blocks</p> <p>BASE : Setting up the numbers of the bases where modules are equipped</p> <p>SLOT : Setting up the numbers of slots where modules are equipped</p> <p>AXIS : Specifying the axis to give commands 1 ~ 6: 1 axis ~ 6 axis</p> <p>Output</p> <p>DONE : Keeping 1 after the initial operation</p> <p>STAT : Outputting error No. that occurred during executing function blocks</p>

- (1) If the floating origin setting command is executed, the current position is changed to the origin address of the origin return parameter, and the origin determination signal (bit) is turned on.
- (2) Floating origin setting is set at the current position at the time the command is executed, different from homing, and can be set only when the axis is not in the operation.
- (3) In AXIS, you can set up the axis to command based on the below setting range. If the values other than set value are selected, "error 6" will occur. Setting range: 1 ~ 6 (1 axis ~ 6 axis)

7.3.3 Direct start (XPM_DST)

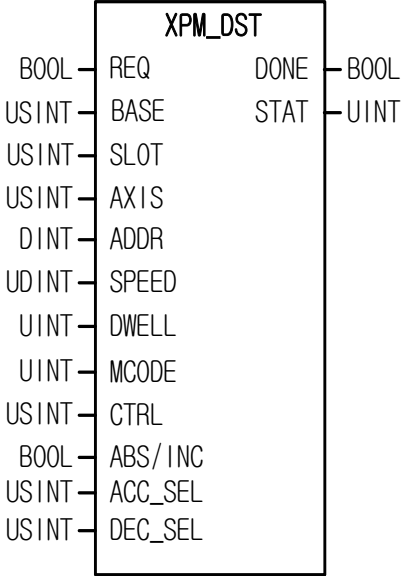
Function Block Type	Details
	<p>Input</p> <p>REQ : Request for executing function blocks</p> <p>BASE : Setting up the numbers of the bases where modules are equipped</p> <p>SLOT : Setting up the numbers of slots where modules are equipped</p> <p>AXIS : Specifying the axis to give commands 1 ~ 6: 1 ~ 6 axis</p> <p>ADDR : Setting up the target position address -2147483648 ~ +2147483647</p> <p>SPEED : Setting up the target speed</p> <p>DWELL : Setting up dwell time 0 ~ 65535[ms]</p> <p>M code : Setting up M code value</p> <p>CTRL : Control mode setting 0: position control, 1: speed control, 2: Feed control, 3: the shortest distance control</p> <p>ABS/INC: Setting absolute coordinate/relative coordinate 0: absolute coordinate, 1: relative coordinate</p> <p>ACC_SEL: Setting up acceleration time No. 0: acceleration time1, 1: acceleration time2 2: acceleration time3, 3: acceleration time4</p> <p>DCC_SEL: Setting up deceleration time No. 0: deceleration time 1, 1: deceleration time 2 2: deceleration time 3, 3: deceleration time 4</p> <p>Output</p> <p>DONE : Keeping 1 after the initial operation</p> <p>STAT : Outputting error No. that occurred during executing function blocks</p>

- (1) The direct start command is designated to the axis specified as AXIS of the embedded positioning.
- (2) It can be used when you want to operate directly the machine by setting the target position address, operating speed, dwell time, M code No., control mode, coordinate, acceleration and deceleration time No. rather than depending on operating data.
- (3) In AXIS, you can set up the axis to command and select one among 1~6. If the values other than set value are selected, "Error 6" will occur.
- (4) In case of the values set for SPEED, CTRL, TIME_SEL exceed the setting range, "error11" will occur in STAT.

7.3.4 Indirect start (XPM_IST)

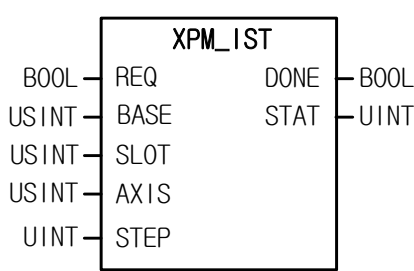
Function Block Type	Details
	<p>Input</p> <p>REQ : Request for executing function blocks</p> <p>BASE : Setting up the numbers of the bases where modules are equipped</p> <p>SLOT : Setting up the numbers of slots where modules are equipped</p> <p>AXIS : Specifying the axis to give commands 1 ~ 6: 1 axis ~ 6 axis</p> <p>STEP : Step No. to operate 0 ~ 400</p> <p>Output</p> <p>DONE : Keeping 1 after the initial operation</p> <p>STAT : Outputting error No. that occurred during executing function blocks</p>

- (1) The indirect start command is designated to the axis specified as AXIS of the embedded positioning.
- (2) It can be used when you want to operate the machine by setting operation step No. of the axis that is set as operating data.
- (3) In AXIS, you can set up the axis to command and select one among 1 ~ 6. If the values other than set value are selected, "error 6" will occur.
- (4) In case the set value of STEP exceed the setting range (0 ~ 400), "error11" will occur in STAT.
- (5) If you set 0 for STEP, the current step will be operated
- (6) Depending on the operation pattern of the operated step (END, Keep, Continuous), several steps may be operated by one indirect start command if the operation pattern is keep or continuous. Continuous operation is available in case of the continuous parameter allow/disable is set to "allow".
- (7) The linear interpolation and a circular arc interpolation, helical interpolation is performed with indirect start command by setting control mode of operating data.

7.3.5 Simultaneous start (XPM_SST)

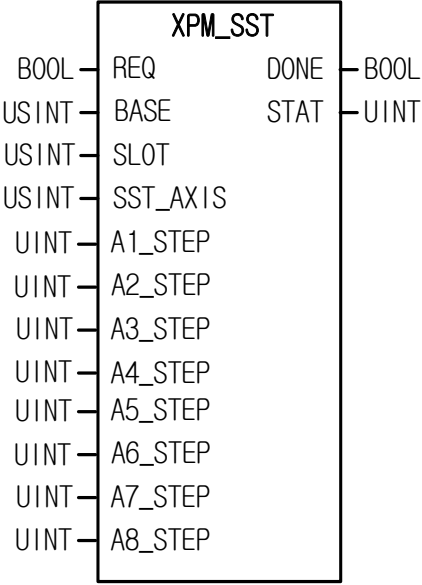
Function Block Type	Details
	<p>Input</p> <p>REQ : Request for executing function blocks</p> <p>BASE : Setting up the numbers of the bases where modules are equipped</p> <p>SLOT : Setting up the numbers of slots where modules are equipped</p> <p>SST_AXIS : Setting synchronous start axis 0bit ~ 5bit: 1axis ~ 6axis Setting the bit for each axis</p> <p>A1_STEP : 1axis step No. to start up</p> <p>A2_STEP : 2axis step No. to start up</p> <p>A3_STEP : 3axis step No. to start up</p> <p>A4_STEP : 4axis step No. to start up</p> <p>A5_STEP : 5axis step No. to start up</p> <p>A6_STEP : 6axis step No. to start up</p> <p>A7_STEP : N/A</p> <p>A8_STEP : N/A</p> <p>Output</p> <p>DONE : Keeping 1 after the initial operation</p> <p>STAT : Outputting error No. that occurred during executing function blocks</p>

(1) The simultaneous start command is designated to the axis specified as AXIS of the embedded positioning.

(2) It can be used when you want to start the operation of more than 2 axis simultaneously.

(3) In A1_STEP ~ A6_STEP, set the number of step to be operated by simultaneous start of each axis from 1 axis to 6 axis.

(4) If the values other than set value are selected, "error 6" will occur. Set each bit by setting as below.

7bit	6bit	5bit	4bit	3bit	2bit	1bit	0bit
-	-	6axis	5axis	4axis	3axis	2axis	1axis

7.3.6 Speed/position switching control (XPM_VTP)

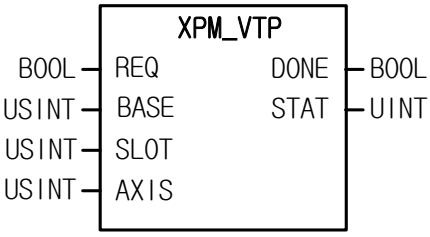
Function Block Type	Details
	<p>Input</p> <p>REQ : Request for executing function blocks</p> <p>BASE : Setting up the numbers of the bases where modules are equipped</p> <p>SLOT : Setting up the numbers of slots where modules are equipped</p> <p>AXIS : Specifying the axis to give commands 1 ~ 6: 1axis ~ 6axis</p> <p>Output</p> <p>DONE : Keeping 1 after the initial operation</p> <p>STAT : Outputting error No. that occurred during executing function blocks</p>

- (1) The speed/position switching control command is designated to the axis specified as AXIS of the embedded positioning.
- (2) When the speed/position control switching command is given to the specified axis where speed operation was applied, the operation mode will be converted from speed control into position control and positioning operation will run with the position value set when starting speed control.
- (3) In AXIS, you can set up the axis to command based on the below setting range. If the values other than set value are selected, "error6" will occur. Setting range: 1 ~ 6(1axis ~ 6axis)

7.3.7 Position specified Speed/Position Switching Control (XPM_VTPP)

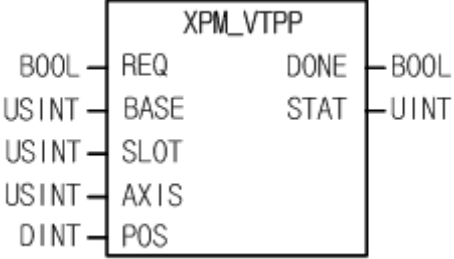
Function Block Type	Details
	<p>Input</p> <p>REQ : Request for executing function blocks</p> <p>BASE : Setting up the numbers of the bases where modules are equipped</p> <p>SLOT : Setting up the numbers of slots where modules are equipped</p> <p>AXIS : Specifying the axis to give commands 1 ~ 6: 1axis ~ 6axis</p> <p>POS : Travel amount of position -2,147,483,648 ~ 2,147,483,647</p> <p>Output</p> <p>DONE : Keeping 1 after the initial operation</p> <p>STAT : Outputting error No. that occurred during executing function blocks</p>

- (1) The position specified speed/position switching command is designated to the axis specified as AXIS of the embedded positioning.
- (2) When the position specified speed/position switching command is given to the specified axis where speed control operation was applied, the operation mode will be converted from speed control into position control and then, positioning operation will run as far as the position travel amount set in POS.
- (3) In AXIS, you can set up the axis to command based on the below setting range. If the values other than set value are selected, "error6" will occur. Setting range: 1 ~ 6(1axis ~ 6axis)

7.3.8 Position/speed switching control (XPM_PTV)

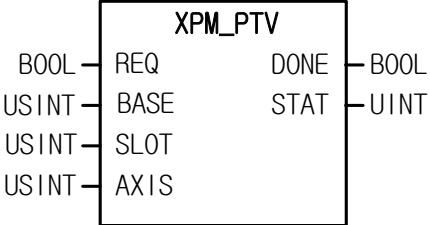
Function Block Type	Details
	<p>Input</p> <p>REQ : Request for executing function blocks</p> <p>BASE : Setting up the numbers of the bases where modules are equipped</p> <p>SLOT : Setting up the numbers of slots where modules are equipped</p> <p>AXIS : Specifying the axis to give commands 1 ~ 6: 1axis ~ 6axis</p> <p>Output</p> <p>DONE : Keeping 1 after the initial operation</p> <p>STAT : Outputting error No. that occurred during executing function blocks</p>

- (1) The position/speed switching command is designated to the axis specified as AXIS of the embedded positioning.
- (2) When the position/speed control switching command is given to the axis where position control operation was applied with the determined travel amount, the operation mode will be converted from position control into speed control. It will run until the factors of stoppage such as deceleration stop, etc occur.
- (3) When this command is executed, speed control will be applied with the undetermined origin.
- (4) In AXIS, you can set up the axis to command based on the below setting range. If the values other than set value are selected, "error6" will occur. Setting range: 1 ~ 6(1axis ~ 6axis)

7.3.9 Deceleration Stop (XPM_STP)

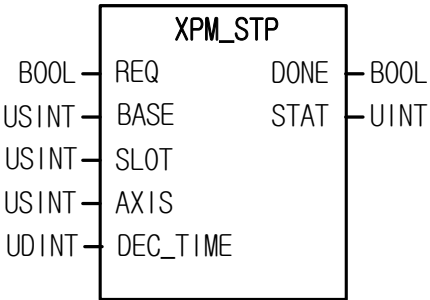
Function Block Type	Details
	<p>Input</p> <p>REQ : Request for executing function blocks</p> <p>BASE : Setting up the numbers of the bases where modules are equipped</p> <p>SLOT : Setting up the numbers of slots where modules are equipped</p> <p>AXIS : Specifying the axis to give commands 1 ~ 6: 1axis ~ 6axis</p> <p>DEC_TIME : Deceleration down-time 0: Acceleration/deceleration time applied when operation starts 1 ~ 2147483647: 1 ~ 2147483647ms</p> <p>Output</p> <p>DONE : Keeping 1 after the initial operation</p> <p>STAT : Outputting error No. that occurred during executing function blocks</p>

- (1) The deceleration stop command is designated to the axis specified as AXIS of the embedded positioning.
- (2) If the stop command is given during running by operating data, after deceleration stop, the operation restarts by the start command.
- (3) If deceleration stop command is executed in speed synchronization or position synchronization, CAM operation, depending on the current operating control state, speed synchronization or position synchronization, CAM operation will be finished.
- (4) The deceleration stop command can be executed not only in acceleration and constant speed area but also in deceleration area.
- (5) The deceleration time that means the time from start to stop can be set in the range of 0 ~ 2,147,483,647ms. If the value is set as 0, it will stop by the set deceleration time when operation starts.
- (6) The deceleration time means the time required from the speed limit of the axis's basic parameters to stop.
- (7) In AXIS, you can set up the axis to command and select one among 1~6. If the values other than set value are selected, "error 6" will occur.

7.3.10 Skip Operation (XPM_SKP)

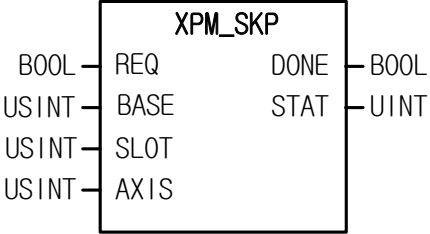
Function Block Type	Details
	<p>Input</p> <p>REQ : Request for executing function blocks</p> <p>BASE : Setting up the numbers of the bases where modules are equipped</p> <p>SLOT : Setting up the numbers of slots where modules are equipped</p> <p>AXIS : Specifying the axis to give commands 1 ~ 6: 1axis ~ 6axis</p> <p>Output</p> <p>DONE : Keeping 1 after the initial operation</p> <p>STAT : Outputting error No. that occurred during executing function blocks</p>

- (1) The skip operation command is designated to the axis specified as AXIS of the embedded positioning.
- (2) It is used to move to the next step without running the operation step. In other words, stop and end the operation of the step currently in operation, and continue the operation in the next step.
- (3) Each time run this command, it will skip the current operating step and move to the next one.
- (4) In AXIS, you can set up the axis to command based on the below setting range. If the values other than set value are selected, "error 6" will occur. Setting range: 1 ~ 6(1axis ~ 6axis)

7.3.11 Position synchronization (XPM_SSP)

Function Block Type	Details
	<p>Input</p> <p>REQ : Request for executing function blocks</p> <p>BASE : Setting up the numbers of the bases where modules are equipped</p> <p>SLOT : Setting up the numbers of slots where modules are equipped</p> <p>AXIS : Specifying the axis to give commands 1 ~ 6: 1axis ~ 6axis</p> <p>STEP : Step No. to operate 0 ~ 400</p> <p>MST_AXIS : Setting position synchronization of the major axis 1 ~ 6: 1 ~ 6axis, 9~12: encoder 1~4</p> <p>MST_ADDR : Setting the position of the major axis to perform position synchronization -2,147,483,648 ~ 2,147,483,647</p> <p>Output</p> <p>DONE : Keeping 1 after the initial operation</p> <p>STAT : Outputting error No. that occurred during executing function blocks</p>

- (1) The position synchronization command is designated to the axis specified as AXIS of the embedded positioning.
- (2) The axis that gives command is regarded as the minor axis. When the axis set as the major axis reaches the established synchronized position, the operation step set by the command axis will run.
- (3) In AXIS, you can set up the axis to command based on the below setting range. If the values other than set value are selected, "error 6" will occur. Setting range: 1 ~ 6(1axis ~ 6axis)
- (4) In MST_AXIS, you can set up the major axis of position synchronization among the below range. If the values other than set value are selected, "error 11" will occur. Setting range: 1 ~ 6(1axis ~ 6axis), 9 ~ 12(encoder 1 ~ 4)

7.3.12 Speed synchronization (XPM_SSS)

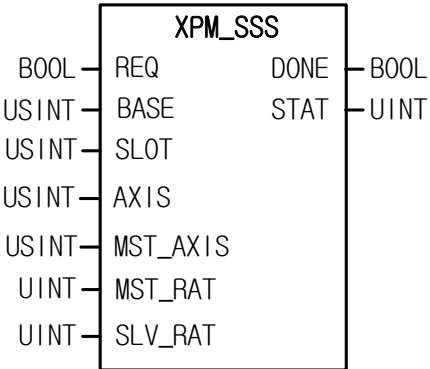
Function Block Type	Details
	<p>Input</p> <p>REQ : Request for executing function blocks</p> <p>BASE : Setting up the numbers of the bases where modules are equipped</p> <p>SLOT : Setting up the numbers of slots where modules are equipped</p> <p>AXIS : Specifying the axis to give commands 1 ~ 6: 1axis ~ 6axis</p> <p>MST_AXIS : Setting the major axis for speed synchronization 1 ~ 6: 1axis ~ 6axis, 9 ~ 12: encoder 1 ~ 4</p> <p>MST_RAT : Setting the major axis's speed ratio -32768 ~ 32767</p> <p>SLV_RAT : Setting the minor axis's speed ratio -32768 ~ 32767</p> <p>Output</p> <p>DONE : Keeping 1 after the initial operation</p> <p>STAT : Outputting error No. that occurred during executing function blocks</p>

- (1) The speed synchronization command is designated to the axis specified as AXIS of the embedded positioning.
- (2) It is used to control the operating speed between two axes at the set ratio.
- (3) There is no rule about the size between the major axis's speed ratio and the minor axis's speed ratio. In other words, if the major axis's speed ratio is bigger than the minor axis's speed ratio, the major axis moves faster than the minor axis; if the minor axis's speed ratio is bigger than the major axis's speed ratio, the minor axis moves faster than the major axis.
- (4) In AXIS, you can set up the axis to command based on the below setting range. If the values other than set value are selected, "error 6" will occur. Setting range: 1 ~ 6(1axis ~ 5axis)
- (5) In MST_AXIS, you can set up the major axis of speed synchronization among the below range. If the values other than set value are selected, "error 11" will occur. Setting range: 1 ~ 6(1axis ~ 6axis), 9~12(encoder 1~4)
- (6) Minor axis's operating direction runs in the same direction of major axis in case of the speed synchronization ratio (minor axis ratio/major axis ratio) is a positive number, and runs in the opposite direction of the major axis in case of the speed synchronization ratio is a negative number. For example, if the major ratio is set as 3 and the minor ratio is set as 2, while major axis moving 3000, minor axis will moving 2000.

7.3.13 Position Assigned Speed Synchronization (XPM_SSSP)

Function Block Type	Details
	<p>Input</p> <p>REQ : Request for executing function blocks</p> <p>BASE : Setting up the numbers of the bases where modules are equipped</p> <p>SLOT : Setting up the numbers of slots where modules are equipped</p> <p>AXIS : Specifying the axis to give commands 1 ~ 6: 1axis ~ 6axis</p> <p>MST_AXIS : Setting the major axis for speed synchronization 1 ~ 6: 1axis ~ 6axis, 9 ~ 12: encoder 1~ 4</p> <p>MST_RAT : Setting the major axis's speed ratio -32768 ~ 32767</p> <p>SLV_RAT : Setting the minor axis's speed ratio -32768 ~ 32767</p> <p>POS : Target position -2,147,483,648 ~ 2,147,483,647</p> <p>Output</p> <p>DONE : Keeping 1 after the initial operation</p> <p>STAT : Outputting error No. that occurred during executing function blocks</p>

- (1) The position assigned speed synchronization command is designated to the axis specified as AXIS of the embedded positioning.
- (2) It is used to control the operating speed between two axes at the set ratio. If the minor axis's position reaches the point set by POS, it will stop after finishing speed synchronization.
- (3) There is no rule about the size between the major axis's speed ratio and the minor axis's speed ratio. Namely, if the major axis's speed ratio is bigger than the minor axis's speed ratio, the major axis moves faster than the minor axis; if the minor axis's speed ratio is bigger than the major axis's speed ratio, the minor axis moves faster than the major axis.
- (4) In AXIS, you can set up the axis to command based on the below setting range. If the values other than set value are selected, "error 6" will occur. Setting range: 1 ~ 6(1axis ~ 6axis)
- (5) In MST_AXIS, you can set up the major axis of speed synchronization among the below range. If the values other than set value are selected, "error 11" will occur. Setting range: 1 ~ 6(1axis ~ 6axis), 9 ~ 12(encoder 1 ~ 4)
- (6) Minor axis's operating direction runs in the same direction of major axis in case of the speed synchronization ratio (minor axis ratio/major axis ratio) is a positive number, and runs in the opposite direction of the major axis in case of the speed synchronization ratio is a negative number. For example, if the major ratio is set as 3, the minor ratio is set as 2, target position is set as 1,000,000, while major axis moving 3000, minor axis will moving 2000. Likewise, it will stop when the position of minor axis is 1,000,000.

7.3.14 Position override (XPM_POR)

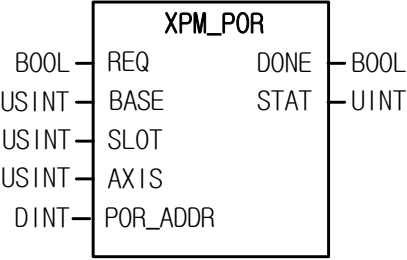
Function Block Type	Details
	<p>Input</p> <p>REQ : Request for executing function blocks</p> <p>BASE : Setting up the numbers of the bases where modules are equipped</p> <p>SLOT : Setting up the numbers of slots where modules are equipped</p> <p>AXIS : Specifying the axis to give commands 1 ~ 6: 1axis ~ 6axis</p> <p>POR_ADDR : Setting the new target position -2,147,483,648 ~ 2,147,483,647</p> <p>Output</p> <p>DONE : Keeping 1 after the initial operation</p> <p>STAT : Outputting error No. that occurred during executing function blocks</p>

- (1) The position override command is designated to the axis specified as AXIS of the embedded positioning.
- (2) It is used to change the target position while the command axis is running.
- (3) If you perform position override after passing the point for position override, it will stop at the current position and then, changes its direction and moves to the position set in POR_ADDR.
- (4) In POR_ADDR, you can set up the target position to change.
- (5) The value set for the position override is absolute coordinate position.
- (6) In AXIS, you can set up the axis to command based on the below setting range. If the values other than set value are selected, "error6" will occur. Setting range: 1 ~ 6(1axis ~ 6axis)

7.3.15 Speed override (XPM_SOR)

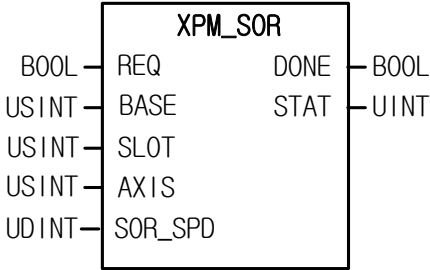
Function Block Type	Details
	<p>Input</p> <p>REQ : Request for executing function blocks</p> <p>BASE : Setting up the numbers of the bases where modules are equipped</p> <p>SLOT : Setting up the numbers of slots where modules are equipped</p> <p>AXIS : Specifying the axis to give commands 1 ~ 6: 1axis ~ 6axis</p> <p>SOR_SPD :Setting new operating speed value</p> <p>Output</p> <p>DONE : Keeping 1 after the initial operation</p> <p>STAT : Outputting error No. that occurred during executing function blocks</p>

- (1) The speed override command is designated to the axis specified as AXIS of the embedded positioning.
- (2) It is used to change the operating speed while the command axis is running.
- (3) SOR_SPD can be set as “%” or “speed value (unit/time)” based on the values set in “speed override” of the command parameters.
 - In case the unit of speed override value is %, the setting area is 1 ~ 65,535 that indicates 0.01% ~ 655.35%.
 - In case the unit of speed override value is speed value, the setting area is 1 ~ speed limit and at this time, the speed limit is the vale set in “speed limit” of basic parameters. In addition, the unit of speed override value follows the axis’s unit.
- (6) In AXIS, you can set up the axis to command based on the below setting range. If the values other than set value are selected, “error 6” will occur. Setting range: 1 ~ 6(1axis ~ 6axis)

7.3.16 Position Assigned Speed Override (XPM_PSO)

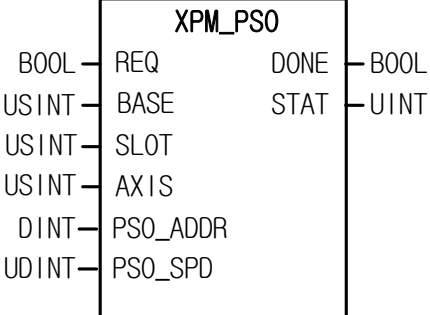
Function Block Type	Details
	<p>Input</p> <p>REQ : Request for executing function blocks</p> <p>BASE : Setting up the numbers of the bases where modules are equipped</p> <p>SLOT : Setting up the numbers of slots where modules are equipped</p> <p>AXIS : Specifying the axis to give commands 1 ~ 6: 1axis ~ 6axis</p> <p>PSO_ADDR : Position to change speed -2,147,483,648 ~ 2,147,483,647</p> <p>PSO_SPD : Setting the new operating speed value</p> <p>Output</p> <p>DONE : Keeping 1 after the initial operation</p> <p>STAT : Outputting error No. that occurred during executing function blocks</p>

- (1) The position assigned speed override command is designated to the axis specified as AXIS of the embedded positioning.
- (2) It is used to change the operating speed after reaching a certain position in the state that the command axis is running.
- (3) PSO_SPD can be set as “%” or “speed value (unit/time)” based on the values set in “speed override” of the command parameters.
 - In case the unit of speed override value is %, the setting area is 1 ~ 65,535 that indicates 0.01% ~ 655.35%.
 - In case the unit of speed override value is speed value, the setting area is 1 ~ speed limit and at this time, the speed limit is the value set in “speed limit” of basic parameters. In addition, the unit of speed override value follows the axis’s unit.
- (4) In AXIS, you can set up the axis to command based on the below setting range. If the values other than set value are selected, “error 6” will occur. Setting range: 1 ~ 6(1axis ~ 6axis)

7.3.17 Continuous operation (XPM_NMV)

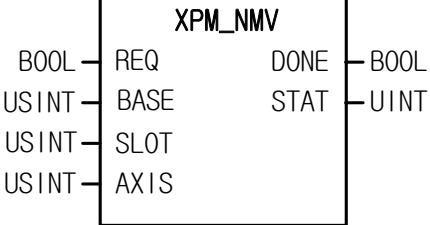
Function Block Type	Details
	<p>Input</p> <p>REQ : Request for executing function blocks</p> <p>BASE : Setting up the numbers of the bases where modules are equipped</p> <p>SLOT : Setting up the numbers of slots where modules are equipped</p> <p>AXIS : Specifying the axis to give commands 1 ~ 6: 1axis ~ 6axis</p> <p>Output</p> <p>DONE : Keeping 1 after the initial operation</p> <p>STAT : Outputting error No. that occurred during executing function blocks</p>

- (1) The command for continuous operation is sent to the axis specified as AXIS of the embedded positioning.
- (2) It is used to move to the next operating step without stopping the command axis in the currently operating step.
- (3) When the continuous operation command is executed, the currently operating step No. is changed into the next step No. and position operation will proceed with the next step's speed and target position. The connection with the next step is performed by the continuous operation pattern.
- (4) The continuous operation command changes the operation pattern of the currently running step only and does not change the operation data.
- (5) In AXIS, you can set up the axis to command based on the below setting range. If the values other than set value are selected, "error6" will occur. Setting range: 1 ~ 6(1axis ~ 6axis)

7.3.18 Inching Operation (XPM_INC)

Function Block Type	Details
	<p>Input</p> <p>REQ : Request for executing function blocks</p> <p>BASE : Setting up the numbers of the bases where modules are equipped</p> <p>SLOT : Setting up the numbers of slots where modules are equipped</p> <p>AXIS : Specifying the axis to give commands 1 ~ 6: 1axis ~ 6axis</p> <p>INCH_VAL: Amount of travel to move through inching operation -2,147,483,648 ~ 2,147,483,647</p> <p>Output</p> <p>DONE : Keeping 1 after the initial operation</p> <p>STAT : Outputting error No. that occurred during executing function blocks</p>

- (1) The inching operation command is designated to the axis specified as AXIS of the embedded positioning.
- (2) Inching operation is a kind of manual operations. It is used to process minute movements as quantitative operation.
- (3) The speed of inching operation is set in manual operation parameters.
- (4) In AXIS, you can set up the axis to command and select one among 1~6. If the values other than set value are selected, "error 6" will occur.

7.3.19 Return to the position of pre-manual operation (XPM_RTP)

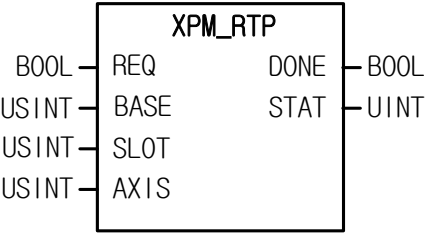
Function Block Type	Details
	<p>Input</p> <p>REQ : Request for executing function blocks</p> <p>BASE : Setting up the numbers of the bases where modules are equipped</p> <p>SLOT : Setting up the numbers of slots where modules are equipped</p> <p>AXIS : Specifying the axis to give commands 1 ~ 6: 1axis ~ 6axis</p> <p>Output</p> <p>DONE : Keeping 1 after the initial operation</p> <p>STAT : Outputting error No. that occurred during executing function blocks</p>

- (1) The command for returning to the position of pre-manual operation is designated to the axis specified as AXIS of the embedded positioning.
- (2) When the position is changed by manual operation after positioning, the command can be used to return to the position of pre-manual operation.
- (3) In AXIS, you can set up the axis to command and select one among 1~6. If the values other than set value are selected, "error 6" will occur.

7.3.20 Start step change (XPM_SNS)

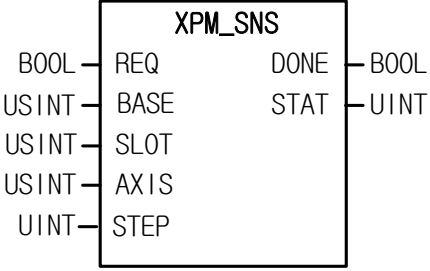
Function Block Type	Details
	<p>Input</p> <p>REQ : Request for executing function blocks</p> <p>BASE : Setting up the numbers of the bases where modules are equipped</p> <p>SLOT : Setting up the numbers of slots where modules are equipped</p> <p>AXIS : Specifying the axis to give commands 1 ~ 6: 1axis ~ 6axis</p> <p>STEP : Setting the operation step No. to run 1 ~ 400</p> <p>Output</p> <p>DONE : Keeping 1 after the initial operation</p> <p>STAT : Outputting error No. that occurred during executing function blocks</p>

- (1) The change start step command is designated to the axis specified as AXIS of the embedded positioning.
- (2) It is used to change the operation step of the command axis.
- (3) In AXIS, you can set up the axis to command based on the below setting range. If the values other than set value are selected, "error 6" will occur. Setting range:1 ~ 6(1axis ~ 6axis)
- (4) In STEP, you can set up the step No. to start the repetitive operation. The range of set values is 1 ~ 400 and if the values other than set value are selected, "error 11" will occur.

7.3.21 Repeat operation step no. change (XPM_SRS)

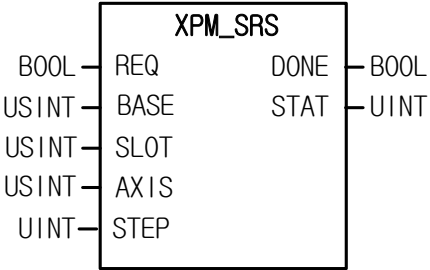
Function Block Type	Details
	<p>Input</p> <p>REQ : Request for executing function blocks</p> <p>BASE : Setting up the numbers of the bases where modules are equipped</p> <p>SLOT : Setting up the numbers of slots where modules are equipped</p> <p>AXIS : Specifying the axis to give commands 1 ~ 6: 1axis ~ 6axis</p> <p>STEP : Setting the repetitive step No. to change 1 ~ 400</p> <p>Output</p> <p>DONE : Keeping 1 after the initial operation</p> <p>STAT : Outputting error No. that occurred during executing function blocks</p>

- (1) The repeat operation step no. change command is designated to the axis specified as AXIS of the embedded positioning.
- (2) The command is used to start the operation in a certain operating step by specifying the start step No. of repetitive operation when running the repetitive operation that the command is given during running with the operation data, it returns to the repetitive operation step.
- (3) In AXIS, you can set up the axis to command based on the below setting range. If the values other than set value are selected, "error 6" will occur. Setting range: 1 ~ 6(1axis ~ 6axis)
- (4) In STEP, you can set up the step no. to start the repetitive operation. The range of set values is 1 ~ 400 and if the values other than set value are selected, "error 11" will occur.

7.3.22 M Code Release (XPM_MOF)

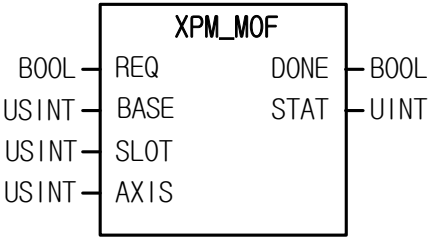
Function Block Type	Details
	<p>Input</p> <p>REQ : Request for executing function blocks</p> <p>BASE : Setting up the numbers of the bases where modules are equipped</p> <p>SLOT : Setting up the numbers of slots where modules are equipped</p> <p>AXIS : Specifying the axis to give commands 1 ~ 6: 1axis ~ 6axis</p> <p>Output</p> <p>DONE : Keeping 1 after the initial operation</p> <p>STAT : Outputting error No. that occurred during executing function blocks</p>

- (1) The command for clearing M code is sent to the axis specified as AXIS of the embedded positioning.
- (2) In case the M code is set as 'With' or 'After Mode' in each axis's parameters, when the command axis's M code signal is On, it can be used to turn Off this signal. Namely, it changes the M code signal into Off and M code No. into On.
- (3) In AXIS, you can set up the axis to command based on the below setting range. If the values other than set value are selected, "error 6" will occur. Setting range: 1 ~ 6(1axis ~ 6axis)
- (4) It can be performed while operating,

7.3.23 Current position change (XPM_PRS)

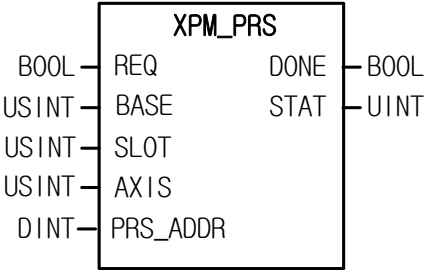
Function Block Type	Details
	<p>Input</p> <p>REQ : Request for executing function blocks</p> <p>BASE : Setting up the numbers of the bases where modules are equipped</p> <p>SLOT : Setting up the numbers of slots where modules are equipped</p> <p>AXIS : Specifying the axis to give commands 1 ~ 6: 1axis ~ 6axis</p> <p>PRS_ADDR : Setting the current position value to change -2,147,483,648 ~ 2,147,483,647</p> <p>Output</p> <p>DONE : Keeping 1 after the initial operation</p> <p>STAT : Outputting error No. that occurred during executing function blocks</p>

- (1) The current position change command is designated to the axis specified as AXIS of the embedded positioning.
- (2) The command is used to change the current position into an arbitrary position. If it is executed with the undetermined origin, the signal for determining the origin will be On and the current position will be changed into the set value (PRS_ADDR).
- (3) In AXIS, you can set up the axis to command based on the below setting range. If the values other than set value are selected, "error 6" will occur. Setting range: 1 ~ 6(1axis ~ 6axis)

7.3.24 Encoder value preset (XPM_EPRES)

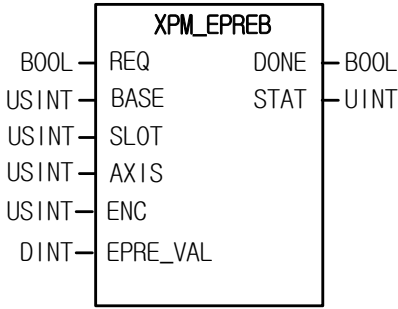
Function Block Type	Details
	<p>Input</p> <p>REQ : Request for executing function blocks</p> <p>BASE : Setting up the numbers of the bases where modules are equipped</p> <p>SLOT : Setting up the numbers of slots where modules are equipped</p> <p>AXIS : Specifying the axis to give commands 1 ~ 6: 1axis ~ 6axis</p> <p>ENC : Encoder number 0 ~ 3: encoder 1 ~ encoder 4</p> <p>EPRE_VAL : Set encoder preset value (encoder min. ~ encoder max. -1)</p> <p>Output</p> <p>DONE : Keeping 1 after the initial operation</p> <p>STAT : Outputting error No. that occurred during executing function blocks</p>

- (1) The encoder value preset command is designated to the axis specified as AXIS of the embedded positioning.
- (2) The command is used to change the current value of the encoder to the setting value of EPRE_VAL
- (3) The input range of EPRE_VAL is "Minimum value of Ring-count ~ Maximum value of Ring-count -1" if the embedded Positioning set as ring-count.
- (4) In AXIS, you can set up the axis to command based on the below setting range. If the values other than set value are selected, "error 6" will occur. Setting range: 1 ~ 6(1axis ~ 6axis)
 - (a) The input range of the encoder position value is from the ring-count minimum value ~ ring-count maximum value -1. If the values other than set value are selected, error code 535 will occur and preset is not performed.
 - (b) Set the encoder (OP3) value between 0 ~ 3. If the values other than set value are selected, "error 11" will occur and preset is not performed.
 - (c) If the major axis to be changed the position is operating, error code 532 will occur, and the preset is not performed.
 - (d) The encoder value preset command has no area to select the command axis. If an error occurs, it is displayed on the axis 1 error code.
 - (e) To operate the encoder value preset command, the high-speed count channel mapped with the encoder must to be enabled

7.3.25 Teaching Array (XPM_ATEA)

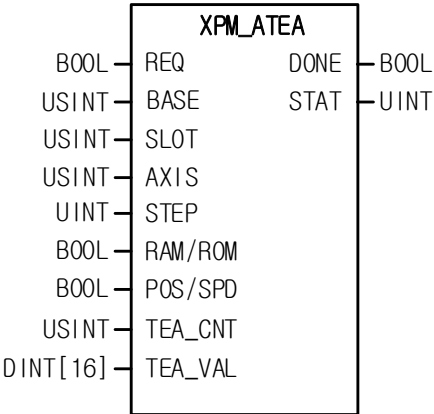
Function Block Type	Details
	<p>Input</p> <p>REQ : Request for executing function blocks</p> <p>BASE : Setting up the numbers of the bases where modules are equipped</p> <p>SLOT : Setting up the numbers of slots where modules are equipped</p> <p>AXIS : Specifying the axis to give commands 1 ~ 6: 1axis ~ 6axis</p> <p>STEP : Setting the step No. to teach 0 ~ 400</p> <p>RAM/ROM : Selecting RAM teaching and ROM teaching type 0 : RAM teaching, 1 : ROM teaching</p> <p>POS/SPD : Selecting position teaching and speed teaching type 0 : position teaching, 1 : speed teaching</p> <p>TEA_CNT : Setting the number of teaching data 1 ~ 16</p> <p>TEA_VAL : Setting teaching values</p> <p>Output</p> <p>DONE : Keeping 1 after the initial operation</p> <p>STAT : Outputting error No. that occurred during executing function blocks</p>

- (1) The teaching array command is designated to the axis specified as AXIS of the embedded positioning.
- (2) The speed teaching can be used when a user wants to apply the arbitrary speed value to a specific step's operating data; the position teaching can be used when a user wants to set the arbitrary position value for a specific step's operating data.
- (3) It is used when you want to change the target position or speed values up to 16EA at once by using the multiple teaching function blocks.
- (4) In AXIS, you can set up the axis to command and select one among 1~6. If the values other than set value are selected, "error6" will occur.
- (5) The teaching command can be executed only when all axis are in a stopped state.
- (6) In STEP, you can set the step No. of the operating data to teach and select one among 0 ~ 400. If the values other than set value are selected, "error 11" will occur.
- (7) In TEA_CNT, you can set the number of teaching data up to 16EA. If the values other than set value are selected, "error 11" will occur.
- (8) The operating data that is set as "0" in RAM/ROM and changed by teaching commands is valid only while the power is On. If you want to maintain the changed operating data even while the power is Off, set the RAM/ROM as "1" and perform the teaching commands or after teaching operating data, save the changed parameter value to the Flash by using the commands for saving parameters/operating data(XPM_WRT).
- (9) If you change the data through ROM teaching, it will be saved to the FLASH together with the previous operating data changed by RAM teaching including the operating data changed by the current commands. However, for different axis other than the relevant ones, the previous data will not be saved to the FLASH.

7.3.26 Basic parameter teaching (XPM_SBP)

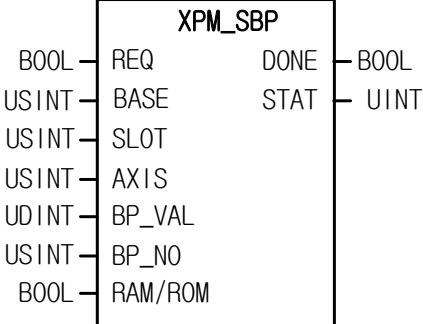
Function Block Type	Details
	<p>Input</p> <p>REQ : Request for executing function blocks</p> <p>BASE : Setting up the numbers of the bases where modules are equipped</p> <p>SLOT : Setting up the numbers of slots where modules are equipped</p> <p>AXIS : Specifying the axis to give commands 1 ~ 6: 1 ~ 6axis</p> <p>BP_VAL : Basic parameter values to change</p> <p>BP_NO : Basic parameter items No. to change</p> <p>RAM/ROM : Method on how to save parameters 0: SAVING TO RAM 1: SAVING TO ROM</p> <p>Output</p> <p>DONE : Keeping 1 after the initial operation</p> <p>STAT : Outputting error No. that occurred during executing function blocks</p>

- (1) The basic parameter teaching command is designated to the specified axis in AXIS of the embedded positioning.
- (2) The parameter value that is set as "0" in RAM/ROM and changed by the basic parameter teaching commands is valid only while the power is On. If you want to maintain the changed parameter value even while the power is Off, set the value as "1" in RAM/ROM and perform the basic parameter teaching commands or after teaching basic parameters, save the changed parameter value to the Flash by using the commands for saving parameters/operating data (XPM_WRT).
- (3) In AXIS, you can set up the axis to command and select one among 1~6. If the values other than set value are selected, "error6" will occur.
- (4) The command for setting basic parameters can be executed only when all axis are in a stopped state.
- (5) If you change the data through ROM teaching, it will be saved to the FLASH together with the previous parameters changed by RAM teaching including the parameters changed by the current commands. However, for different axis other than the relevant ones, the previous data will not be saved to the FLASH.
- (6) You can set up the values for basic parameter items No. as below.

Set value	Item	Setting range
1	Speed limit	mm : 0 ~ 2,147,483,647 [X10-2mm/minute]
		Inch : 0 ~ 2,147,483,647 [X10-3Inch/minute]
		degree : 0 ~ 2,147,483,647 [X10-3 degree/minute]
		pulse : 0 ~ 2,000,000 [pulse/second]
2	Acceleration time 1	0 ~ 2,147,483,647 [ms]
3	Acceleration time 2	
4	Acceleration time 3	
5	Acceleration time 4	

Chapter 7 Function block

Set value	Item	Setting range
6	Deceleration time 1	0 ~ 2,147,483,647 [ms]
7	Deceleration time 2	
8	Deceleration time 3	
9	Deceleration time 4	
10	Abrupt stop deceleration time	0 ~ 2,147,483,647 [ms]
11	The number of divided output pulses per revolution	1 ~ 200,000,000
12	Travel distance per revolution	
13	Unit	0:Pulse, 1:mm, 2:Inch, 3:Degree
14	Unit double precision	0: x 1, 1: x 10, 2: x 100, 3: x 1000
15	Speed command unit	0: unit/time, 1: rpm
16	Bias speed	1 ~ speed limit
17	Pulse output enable	0: disable, 1: enable

7.3.27 Extended parameter teaching (XPM_SEP)

Function Block Type	Details
	<p>Input</p> <p>REQ : Request for executing function blocks BASE : Setting up the numbers of the bases where modules are equipped SLOT : Setting up the numbers of slots where modules are equipped AXIS : Specifying the axis to give commands 1 ~ 6: 1axis ~ 6axis EP_VAL : Extended parameter values to change EP_NO : Extended parameter items No. to change RAM/ROM : Method on how to save parameters 0: SAVING TO RAM 1: SAVING TO ROM</p> <p>Output</p> <p>DONE : Keeping 1 after the initial operation STAT : Outputting error No. that occurred during executing function blocks</p>

- (1) The extended parameter teaching is sent to the axis specified as AXIS of the embedded positioning.
- (2) The parameter value that is set as "0" in RAM/ROM and changed by the extended parameter setting commands is valid only while the power is On. If you want to maintain the changed parameter value even while the power is Off, set the value as "1" in RAM/ROM and perform the extended parameter teaching commands or after teaching extended parameters, save the changed parameter value to the Flash by using the commands for saving parameters/operating data(XPM_WRT).
- (3) In AXIS, you can set up the axis to command and select one among 1~6. If the values other than set value are selected, "error6" will occur.
- (4) The command for setting extended parameters can be executed only when all axis are in a stopped state.
- (5) You can set up the values for extended parameter items No. as below.

Set Value	Item	Setting range
1	Soft upper limit	mm :-2147483648 ~ 2147483647[X10-4mm] Inch:-2147483648 ~ 2147483647[X10-5Inch]
2	Soft lower limit	degree:-2147483648 ~ 2147483647[X10-5degree] pulse:-2147483648 ~ 2147483647[pulse]
3	Compensation amount of backlash	mm: 0 ~ 65,535[X10-4mm] inch: 0 ~ 65,535[X10-5Inch] degree: 0 ~ 65,535[X10-5degree] pulse: 0 ~ 65,535[pulse]
4	Completion time of positioning	0 ~ 65,535[ms]
5	S-curve ratio	1 ~ 100
6	2 axis linear interpolated continuous operation with insertion position of a circular arc	mm: 0 ~ 2147483647[X10-4mm] Inch: 0 ~ 2147483647[X10-5Inch] degree: 0 ~ 2147483647[X10-5degree] pulse: 0 ~ 2147483647[pulse]

Chapter 7 Function block

Set Value	Item	Setting range
7	Acceleration/deceleration pattern	0: Trapezoidal operation, 1: S-curve operation
8	M code mode	0: None, 1: With, 2: After
9	Detection of upper / lower limit during speed control	0: No detected, 1: Detected
10	Interpolated continuous operation positioning type	0: Passing the target position , 1: Passing the vicinity
11	2 axis linear interpolated continuous operation with insertion of a circular arc	0: No insertion of a circular arc, 1: Continuous operation with insertion of a circular arc
12	Positioning speed override coordinate	0: Absolute coordinate, 1: Relative coordinate
13	Pulse output direction	0: Forward, 1:Reverse
14	Position repeating Infinite length	mm: 1 ~ 2147483647[X10-4mm] Inch: 1 ~ 2147483647[X10-5Inch] degree: 1 ~ 2147483647[X10-5degree] pulse: 1 ~ 2147483647[pulse]
15	Repetition of Infinite length	0: Prohibited, 1: Allowed
16	Speed/position switching coordinate	0: Relative coordinate, 1: Relative coordinate
17	Selection of interpolation speed	0: Major axis speed 1: Resultant speed

- (6) If you change the data through ROM teaching, it will be saved to the FLASH together with the previous parameters changed by RAM teaching including the parameters changed by the current commands. However, for different axis other than the relevant ones, the previous data will not be saved to the FLASH.

7.3.28 Homing parameters teaching (XPM_SHP)

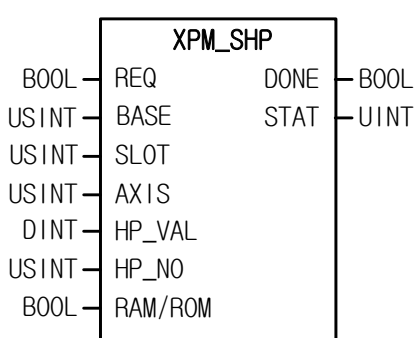
Function Block Type	Details
	<p>Input</p> <p>REQ : Request for executing function blocks</p> <p>BASE : Setting up the numbers of the bases where modules are equipped</p> <p>SLOT : Setting up the numbers of slots where modules are equipped</p> <p>AXIS : Specifying the axis to give commands (1 ~ 6: 1axis ~ 6axis)</p> <p>HP_VAL : Homing parameter values to change</p> <p>HP_NO : Items No. of homing parameters to change</p> <p>RAM/ROM : Method on how to save parameters (0: RAM, 1: ROM)</p> <p>Output</p> <p>DONE : Keeping 1 after the initial operation</p> <p>STAT : Outputting error No. that occurred during executing function blocks</p>

- (1) The homing parameter teaching command is designated to the axis specified as AXIS of the embedded positioning.
- (2) The parameter value that is set as "0" in RAM/ROM and changed by the homing parameter teaching commands is valid only while the power is On. If you want to maintain the changed parameter value even while the power is Off, set the RAM/ROM as "1" and perform the homing parameter teaching commands or after teaching homing parameters, save the changed parameter value to the Flash by using the commands for saving parameters/operating data(XPM_WRT).
- (3) In AXIS, you can set up the axis to command and select one among 1~4. If the values other than set value are selected, "error6" will occur.
- (4) The command for setting homing parameters can be executed only when all axis are in a stopped state.
- (5) You can set up the values for homing parameter items No. as below.

Set value	Item	Setting range
1	Home position	mm : -2147483648 ~ 2147483647 [X10 ⁻⁴ mm]
		Inch : -2147483648 ~ 2147483647 [X10 ⁻⁵ Inch]
		degree : -2147483648 ~ 2147483647 [X10 ⁻⁵ degree]
		pulse : -2147483648 ~ 2147483647 [pulse]
2	Homing high speed	mm : 1 ~ 2,147,483,647 [X10 ⁻² mm/minute]
3	Homing low speed	Inch : 1 ~ 2,147,483,647 [X10 ⁻³ Inch/minute]
		degree : 1 ~ 2,147,483,647 [X10 ⁻³ degree/minute]
		pulse : 1 ~ 2,000,000 [pulse/second]

Chapter 7 Function block

4	Homing acceleration time	0 ~ 2,147,483,647 [ms]
5	Homing deceleration time	
6	Homing dwell time	0 ~ 65,535[ms]
7	Compensation amount of origin	mm : -2147483648 ~ 2147483647 [$\times 10^{-3}$ mm] Inch : -2147483648 ~ 2147483647 [$\times 10^{-5}$ Inch] degree : -2147483648 ~ 2147483647 [$\times 10^{-5}$ degree] pulse : -2147483648 ~ 2147483647 [pulse]
8	Homing restart-up time	0 ~ 65,535[ms]
9	Homing mode	0:Approximate origin/origin(Off), 1:Approximate origin/origin(On), 2:Upper/lower limit/origin, 3:Approximate origin, 4:High speed origin, 5:Upper/lower limit, 6:Origin
10	Homing direction	0:Forward, 1:Reverse

- (6) If you change the data through ROM teaching, it will be saved to the FLASH together with the previous parameters changed by RAM teaching including the parameters changed by the current commands. However, for different axis other than the relevant ones, the previous data will not be saved to the FLASH.

7.3.29 Manual operation parameters teaching(XPM_SMP)

Function Block Type	Details
	<p>Input</p> <p>REQ : Request for executing function blocks BASE : Setting up the numbers of the bases where modules are equipped SLOT : Setting up the numbers of slots where modules are equipped AXIS : Specifying the axis to give commands 1 ~ 6: 1axis ~ 6axis MP_VAL : Manual operation parameter values to change MP_NO : Manual operation parameter items No. to change RAM/ROM : Method on how to save parameters 0: SAVING TO RAM 1: SAVING TO ROM</p> <p>Output</p> <p>DONE : Keeping 1 after the initial operation STAT : Outputting error No. that occurred during executing function blocks</p>

- (1) The manual operation parameters teaching command is designated to the axis specified as AXIS of the embedded positioning.
- (2) The parameter value that is set as "0" in RAM/ROM and changed by the commands for teaching manual operation parameters is valid only while the power is On. If you want to maintain the changed parameter value even while the power is Off, set the RAM/ROM as "1" and perform the commands for teaching manual operation parameters or after setting manual operation parameters, save the changed parameter value to the Flash by using the commands for saving parameters/operating data(XPM_WRT).
- (3) In AXIS, you can set up the axis to command and select one among 1~6. If the values other than set value are selected, "error6" will occur.
- (4) The command for setting manual operation parameters can be executed only when all axis are in a stopped state.
- (5) You can set up the values for manual operation parameter items No. as below.

Set value	Item	Setting range
1	JOG high speed	mm : 1 ~ 2,147,483,647 [X10-2mm/minute]
2	JOG low speed	Inch : 1 ~ 2,147,483,647 [X10-3Inch/minute]
		degree : 1 ~ 2,147,483,647 [X10-3 degree/minute]
		pulse : 1 ~ 2,000,000 [pulse/second]
3	JOG acceleration time	0 ~ 2,147,483,647 [ms]
4	JOG deceleration time	
5	Inchingspeed	mm : 1 ~ 65,535[X10-2mm/minute]

		Inch : 1 ~ 65,535[X10-3Inch/minute] degree : 1 ~ 65,535[X10-3 degree/minute] pulse : 1 ~ 65,535[pulse/second]
--	--	---

- (6) If you change the data through ROM teaching, it will be saved to the FLASH together with the previous parameters changed by RAM teaching including the parameters changed by the current commands. However, for different axis other than the relevant ones, the previous data will not be saved to the FLASH.

7.3.30 I/O signal parameter teaching (XPM_SIP)

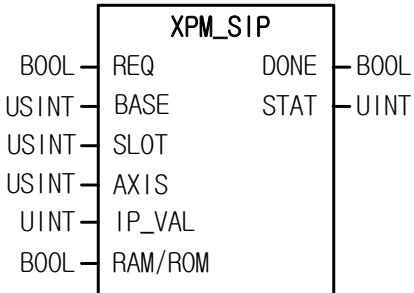
Function Block Type	Details
	<p>Input</p> <p>REQ : Request for executing function blocks</p> <p>BASE : Setting up the numbers of the bases where modules are equipped</p> <p>SLOT : Setting up the numbers of slots where modules are equipped</p> <p>AXIS : Specifying the axis to give commands 1 ~ 6: 1axis ~ 6axis</p> <p>IP_VAL : External signal parameter value to change Set the signal allocated for each Bit</p> <p>RAM/ROM : Method on how to save parameters 0: SAVING TO RAM 1: SAVING TO ROM</p> <p>Output</p> <p>DONE : Keeping 1 after the initial operation</p> <p>STAT : Outputting error No. that occurred during executing function blocks</p>

- (1) The I/O signal parameter teaching command is designated to the axis specified as AXIS of the embedded positioning.
- (2) The parameter value that is set as "0" in RAM/ROM and changed by the commands for teaching external signal parameters is valid only while the power is On. If you want to maintain the changed parameter value even while the power is Off, set the RAM/ROM as "1" and perform the commands for teaching external signal parameters or after setting external signal parameters, save the changed parameter value to the Flash by using the commands for saving parameters/operating data(XPM_WRT).
- (3) In AXIS, you can set up the axis to command and select one among 1~6. If the values other than set value are selected, "error6" will occur.
- (4) The command for setting input signal parameters can be executed only when all axis are in a stopped state.
- (5) The set value of each external signal setting area indicates the below. 0: A contact, 1: B contact
- (6) The external signals allocated for each Bit of I/O signal parameters to change are as follows. If bit set value is 3 (b11), the signal setting will ignored and maintain previous set value.

Bit	Signal	Setting Range
0~1	Upper limit signal	0: not used, 1: A contact, 2: B contact, C: maintain previous value
2~3	Lower limit signal	0: not used, 1: A contact, 2: B contact, C: maintain previous value
4~5	Approximate origin signal	0: not used, 1: A contact, 2: B contact, C: maintain previous value
6~7	Origin signal	0: not used, 1: A contact, 2: B contact, C: maintain previous value
8~9	Deviation clear signal	0: not used, 1: A contact, 2: B contact, C: maintain previous value
10 ~ 15	N/A	-

Note

To use I/O signal of the XEM H embedded positioning, must mapped I, Q device.

I, Q device set as %IX0.0.0 or QX0.0.0 for initial value. If you don't mapping I, Q device on I/O signal and enable I/O signal to XPM_SIP, it is applied based on the initial setting value.

For proper operation, mapping the I, Q device on each I/O signal using XG-PM before setting I/O signal parameter to XPM_SIP.

7.3.31 Common parameters teaching (XPM_SCP)

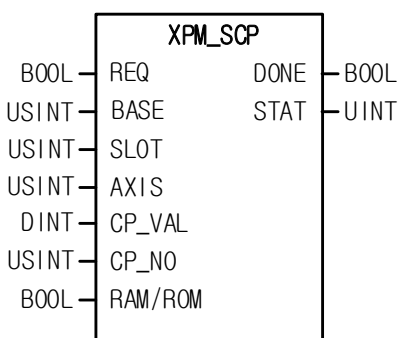
Function Block Type	Details
	<p>Input</p> <p>REQ : Request for executing function blocks BASE : Setting up the numbers of the bases where modules are equipped SLOT : Setting up the numbers of slots where modules are equipped AXIS : Specifying the axis to give commands 1 ~ 6: 1axis ~ 6axis CP_VAL : Values of common parameters to change CP_NO : Common parameter items No. to change RAM/ROM : Method on how to save parameters 0: SAVING TO RAM 1: SAVING TO ROM</p> <p>Output</p> <p>DONE : Keeping 1 after the initial operation STAT : Outputting error No. that occurred during executing function blocks</p>

- (1) The common parameter teaching command is designated to the axis specified as AXIS of the embedded positioning.
- (2) The parameter value that is set as "0" in RAM/ROM and changed by the commands for teaching common parameters is valid only while the power is On. If you want to maintain the changed parameter value even while the power is Off, set the RAM/ROM as "1" and perform the commands for teaching common parameters or after teaching common parameters, save the changed parameter value to the Flash by using the commands for saving parameters/operating data(XPM_WRT).
- (3) In AXIS, you can set up the axis to command and select one among 1~6. If the values other than set value are selected, "error6" will occur.
- (4) You can set up the values for common parameter items No. as below.

Set value	Item	Setting range
1	Speed override mode	0 : Designation of %, 1 : Designation of speed
2	Pulse output level	0 : Low Active, 1 : High Active
3	Control cycle	1~10(ms), maintain previous value when setting other value

- (5) If you change the data through ROM teaching, the operation data that has been changed to RAM teaching previously including the operation data changed by the current command is also permanently saved.
- (6) The common parameter setting command can be executed when all axes are stopped.

7.3.32 Operation data teaching (XPM_SMD)

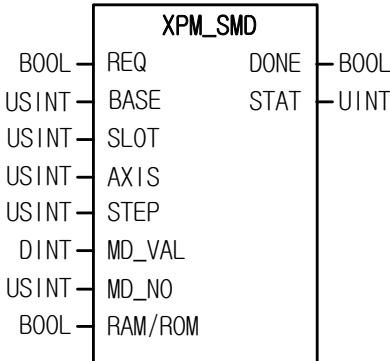
Function Block Type	Details
 <p>The diagram shows a rectangular block labeled 'XPM_SMD'. On the left side, there are eight input lines: a BOOL line for 'REQ', two USINT lines for 'BASE' and 'SLOT', two USINT lines for 'AXIS' and 'STEP', a DINT line for 'MD_VAL', a USINT line for 'MD_NO', and a BOOL line for 'RAM/ROM'. On the right side, there are two output lines: a BOOL line for 'DONE' and a UINT line for 'STAT'.</p>	<p>Input</p> <p>REQ : Request for executing function blocks</p> <p>BASE : Setting up the numbers of the bases where modules are equipped</p> <p>SLOT : Setting up the numbers of slots where modules are equipped</p> <p>AXIS : Specifying the axis to give commands 1 ~ 6: 1axis ~ 6axis</p> <p>STEP : Operation step No. to change 0 ~ 400</p> <p>MD_VAL : Operating data value to change</p> <p>MD_NO : Operating data items No. to change</p> <p>RAM/ROM : Method on how to save parameters 0: SAVING TO RAM, 1: SAVING TO ROM</p> <p>Output</p> <p>DONE : Keeping 1 after the initial operation</p> <p>STAT : Outputting error No. that occurred during executing function blocks</p>

- (1) The operation data teaching command is designated to the axis specified as AXIS of the embedded positioning.
- (2) The operating data that is set as "0" in RAM/ROM and changed by the commands for teaching operating data is valid only while the power is On. If you want to maintain the changed operating data even while the power is Off, set the RAM/ROM as "1" and perform the commands for teaching operating data or after teaching operating data, save the changed parameter value to the Flash by using the commands for saving parameters/operating data(XPM_WRT).
- (3) In AXIS, you can set up the axis to command and select one among 1~6. If the values other than set value are selected, "error6" will occur.
- (4) The operation data teaching command can be executed while the axis is running, but for the step in operation, it operates according to the setting value before teaching. When the operation is started again after the end of operation, the operation is performed according to the setting value changed to teaching.
- (5) You can set up the values for operation data teaching items No. as below.

Set value	Item	Set Range
1	Set Position	mm : -2147483648 ~ 2147483647 [X10-4mm] Inch : -2147483648 ~ 2147483647 [X10-5Inch] degree : -2147483648 ~ 2147483647 [X10-5degree] pulse : -2147483648 ~ 2147483647 [pulse]
2	Circular interpolation auxiliary position	Within possible position range of the circular interpolation setting
3	Operating speed	mm : 0 ~ 2,147,483,647 [X10-2mm/분]

		Inch : 0 ~ 2,147,483,647 [X10-3Inch/분] degree : 0 ~ 2,147,483,647 [X10-3 degree/분] pulse : 0 ~ 2,000,000 [pulse/초]												
4	Dwell time	0 ~ 65,535[ms]												
5	Mcode No.	0 ~ 65,535												
6	Minor axis setting	Bit unit setting <table border="1"> <tr> <td>Bit 5</td> <td>Bit 4</td> <td>Bit 3</td> <td>Bit 2</td> <td>Bit 1</td> <td>Bit 0</td> </tr> <tr> <td>Axis 6</td> <td>Axis 5</td> <td>Axis 4</td> <td>Axis 3</td> <td>Axis 2</td> <td>Axis 1</td> </tr> </table>	Bit 5	Bit 4	Bit 3	Bit 2	Bit 1	Bit 0	Axis 6	Axis 5	Axis 4	Axis 3	Axis 2	Axis 1
Bit 5	Bit 4	Bit 3	Bit 2	Bit 1	Bit 0									
Axis 6	Axis 5	Axis 4	Axis 3	Axis 2	Axis 1									
7	Helical interpolation axis	0, axis1 ~ axis6 (0: General circular interpolation)												
8	Circular interpolation turns	0~65,535												
9	Coordinate	0: absolute, 1: relative												
10	Control method	0:single-axis position control, 1:single axis speed control, 2:single- axis Feed control, 3:linear interpolation, 4:circular interpolation												
11	Operating method	0:single, 1:repeat												
12	Operating pattern	0:end, 1:keep, 2:continue												
13	Size of circular arc	0:circular arc<180 1:circular arc>=180												
14	Acc. No	0 ~ 3												
15	Dec. No.	0 ~ 3												
16	Circular interpolation mode	0:middle point, 1:center point, 2:radius												
17	Direction of circular interpolation	0:CW, 1:CCW												

- (6) If you change the data through ROM teaching, the operation data that has been changed to RAM teaching previously including the operation data changed by the current command is also permanently saved.

7.3.33 Read Variable Data (XPM_VRD)

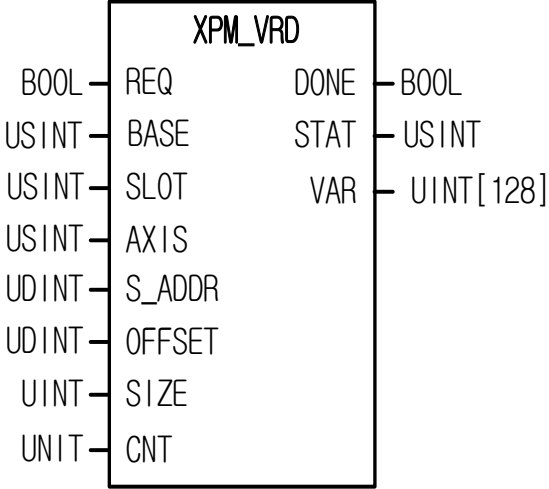
Function Block Type	Details
	<p>Input</p> <p>REQ : Request for executing function blocks</p> <p>BASE : Setting up the numbers of the bases where modules are equipped</p> <p>SLOT : Setting up the numbers of slots where modules are equipped</p> <p>AXIS : Specifying the axis to give commands 1 ~ 6: 1axis ~ 6axis</p> <p>S_ADDR : Start address of the module internal memory of the data to read 0 ~ 143367</p> <p>OFFSET : Offset of between data blocks to read 0 ~ 143367</p> <p>SIZE : Size of data blocks to read 1 ~ 128</p> <p>CNT : The number of data blocks to read 1 ~ 128</p> <p>Output</p> <p>DONE : Keeping 1 after the initial operation</p> <p>STAT : Outputting error No. that occurred during executing function blocks</p> <p>VAR : PLC device where the read data is stored.</p>

- (1) The read variable data command is designated to the positioning module to read directly parameters, operating data, CAM data.
- (2) It is possible to read the desired data by specifying parameters and operating data, CAM data's module internal memory address directly.
- (3) Among parameters, operating data, CAM data of the embedded positioning, the command is to read as much data as the "SIZE" in WORDs from the position set as "S_ADDR" in positioning module internal memory to the specified device of "VAR". In case "CNT" is more than 2, it reads the blocks one by one, which are as distant as "OFFSET" from the "S_ADDR" position as many times as "CNT"-1 and saves them to the specified device of "VAR".
- (4) The maximum data size(SIZE x CNT) that can be read with a command is 128 WORD.
- (5) The command for "Read Variable Data" can run even during operation.
- (6) In AXIS, you can set up the axis to command and select one among 1~6. If the values other than set value are selected, "error 6" will occur.
- (7) In case the size(SIZE x CNT) of the data to read is 0 or exceeds 128 WORD, error "11" will occur in STAT.
- (8) Although reading variable data is executed for different axis, it can run only once in one scan. If you run reading variable data more than twice in one scan, error code(811) will occur and the remaining operations except the first reading variable data will not work.

7.3.34 Write variable data (XPM_VWR)

Function Block Type	Details
	<p>Input</p> <p>REQ : Request for executing function blocks</p> <p>BASE : Setting up the numbers of the bases where modules are equipped</p> <p>SLOT : Setting up the numbers of slots where modules are equipped</p> <p>AXIS : Specifying the axis to give commands 1 ~ 6: 1axis ~ 6axis</p> <p>VAR : PLC device where the data to write is saved</p> <p>T_ADDR : Start address of the module internal memory of the data to write 0 ~ 143367</p> <p>OFFSET : Offset of between data blocks to write 0 ~ 65535</p> <p>SIZE : Size of the data blocks to write 1 ~ 128</p> <p>CNT : Number of data blocks to write 1 ~ 128</p> <p>Output</p> <p>DONE : Keeping 1 after the initial operation</p> <p>STAT : Outputting error No. that occurred during executing function blocks</p>

- (1) The write variable data command is designated to the positioning module to write directly parameters, operating data, CAM data.
- (2) It is possible to write the desired data by specifying parameters and operating data, CAM data's module internal memory address directly.
- (3) Among parameters, operating data, CAM data of the embedded positioning internal memory, the command is to write as much data as the "SIZE" in WORDs from the "T_ADDR" position of the PLC program to the specified device of "VAR". In case the number of blocks, "CNT" is more than 2, it writes the data one by one to the blocks which are as distant as "OFFSET" from the ones located in "T_ADDR" position as many times as "CNT"-1.
- (4) The maximum data size(SIZE x CNT) that can be written with a command is 128 WORD.
- (5) The command for "Writing Variable Data" cannot run during operation.
- (6) In AXIS, you can set up the axis to command and select one among 1~6. Establishing the values other than set ones will lead to "error6".
- (7) In case the size(SIZE x CNT) of the data to read is 0 or exceeds 128 WORD, error "11" will occur in STAT.
- (8) If the number of blocks(CNT) is more than 2 and block offset(OFFSET) is smaller than the block size(CNT), the module internal memory blocks where the data will be written are overlapping so error "11" will occur in STAT.
- (9) When executing XPM_WRT, compatibility of data should be checked for all access areas. Especially, the user CAM area is set as 0 initially but if you input 0 again through XPM_WRT, data compatibility error will occur(error code 704~708). For data setting of the user CAM area, refer to 9.4.4 User CAM Operation.

7.3.35 Emergency Stop (XPM_EMG)

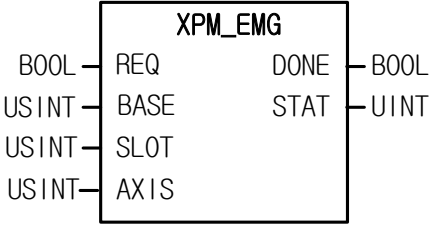
Function Block Type	Details
	<p>Input</p> <p>REQ : Request for executing function blocks</p> <p>BASE : Setting up the numbers of the bases where modules are equipped</p> <p>SLOT : Setting up the numbers of slots where modules are equipped</p> <p>AXIS : Specifying the axis to give commands 1 ~ 6: 1axis ~ 6axis</p> <p>Output</p> <p>DONE : Keeping 1 after the initial operation</p> <p>STAT : Outputting error No. that occurred during executing function blocks</p>

- (1) The emergency stop command is designated to the axis specified as AXIS of the embedded positioning.
- (2) It is used when you have to stop the operation immediately due to emergency. The axis where this command is applied will be in a stopped state.
- (3) During Emergency Stop, the deceleration time is the value set in "Deceleration time at abrupt stop" of the basic parameters of each axis.
- (4) In AXIS, you can set up the axis to command and select one among 1~6. If the values other than set value are selected, "error 6" will occur.

7.3.36 Error reset (XPM_RST)

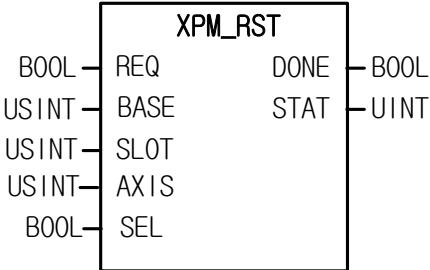
Function Block Type	Details
	<p>Input</p> <p>REQ : Request for executing function blocks</p> <p>BASE : Setting up the numbers of the bases where modules are equipped</p> <p>SLOT : Setting up the numbers of slots where modules are equipped</p> <p>AXIS : Specifying the axis to give commands 1 ~ 6: 1axis ~ 6axis</p> <p>SEL : Selecting axis error/common error 0: axis error (Set as 0 all the time)</p> <p>Output</p> <p>DONE : Keeping 1 after the initial operation</p> <p>STAT : Outputting error No. that occurred during executing function blocks</p>

- (1) The error reset command is sent to the axis specified as AXIS of the embedded positioning.
- (2) In AXIS, you can set up the axis to command based on the below setting range. If the values other than set value are selected, "error 6" will occur. Setting range: 1 ~ 6(1axis ~ 6axis)
- (3) When parameters exceed the setting range or errors occur during operation, the command is used to reset the errors.
- (4) In SEL, you can select the error type to reset. If the value is "0", the error occurred in the command axis of each axis will be reset. In XEM embedded positioning, the value should be set as "0" all the time. If the value is "1", "error 11" will occur.

7.3.37 Error history reset (XPM_HRST)

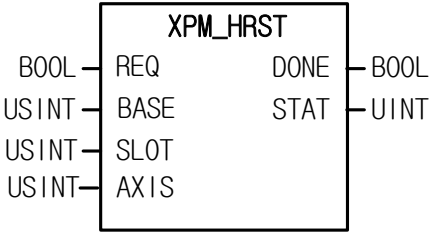
Function Block Type	Details
	<p>Input</p> <p>REQ : Request for executing function blocks</p> <p>BASE : Setting up the numbers of the bases where modules are equipped</p> <p>SLOT : Setting up the numbers of slots where modules are equipped</p> <p>AXIS : Specifying the axis to give commands 1 ~ 6: 1axis ~ 6axis</p> <p>Output</p> <p>DONE : Keeping 1 after the initial operation</p> <p>STAT : Outputting error No. that occurred during executing function blocks</p>

- (1) The error history reset command is designated to the axis specified as AXIS of the embedded positioning.
- (2) In AXIS, you can set up the axis to command based on the below setting range. If the values other than set value are selected, "error 6" will occur. Setting range: 1 ~ 6(1axis ~ 6axis)
- (3) When parameters exceed the setting range or errors occur during operation, it saves the errors to the module up to 10. The command is used to reset the error history.

7.3.38 Point operation (XPM_PST)

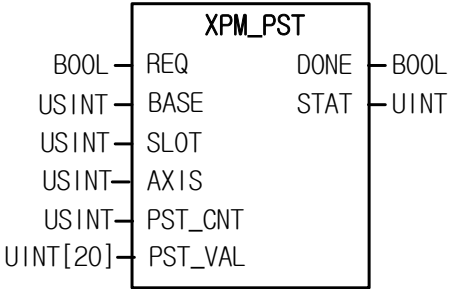
Function Block Type	Details
	<p>Input</p> <p>REQ : Request for executing function blocks</p> <p>BASE : Setting up the numbers of the bases where modules are equipped</p> <p>SLOT : Setting up the numbers of slots where modules are equipped</p> <p>AXIS : Specifying the axis to give commands 1 ~ 6: 1axis ~ 6axis</p> <p>PST_CMT : Setting the number of point operation steps 1 ~ 20</p> <p>PST_VAL : Setting point operation step No. 0 ~ 400</p> <p>Output</p> <p>DONE : Keeping 1 after the initial operation</p> <p>STAT : Outputting error No. that occurred during executing function blocks</p>

- (1) The start-up command is sent to the axis specified as AXIS of the embedded positioning.
- (2) In AXIS, you can set up the axis to command and select one among 1~6. If the values other than set value are selected, "error 6" will occur.
- (3) It can be used to operate continuously the machine without a stop by setting operation steps up to 20 during PTP(Point to Point) operation with only one command. If PST_CNT or PST_VAL has the values other than set ones, "error6" will occur.
- (4) Point operation allows the maximum of 20 point steps. Accordingly, the variables of UNIT array type with 20 elements can be used for PST_VAL.

7.3.39 Parameter/operation data save (XPM_WRT)

Function Block Type	Details
	<p>Input</p> <p>REQ : Request for executing function blocks</p> <p>BASE : Setting up the numbers of the bases where modules are equipped</p> <p>SLOT : Setting up the numbers of slots where modules are equipped</p> <p>AXIS : Specifying the axis to give commands 1 ~ 6: 1axis ~ 6axis</p> <p>WRT_AXIS : Setting axis to save (by setting each bit) 0bit ~ 5bit: 1axis ~ 6axis</p> <p>Output</p> <p>DONE : Keeping 1 after the initial operation</p> <p>STAT : Outputting error No. that occurred during executing function blocks</p>

- (1) The parameter/operation data save command is designated to the axis specified as AXIS of the embedded positioning.
- (2) In AXIS, you can set up the axis to command and select one among 1~4. If the values other than set value are selected, "error 6" will occur.
- (3) After function blocks are normally performed, it saves the current parameters and operating data of the axis set in WRT_AXIS to the Flash so that the data can be maintained even when the power is off.
- (4) For setting WRT_AXIS, select the Bit corresponding to each axis.

15 ~ 4 Bit	5Bit	4Bit	3Bit	2Bit	1Bit	0Bit
N/A	6axis	5axis	4axis	3axis	2axis	1axis

For example, to select 2 axis and 3 axis, you can set them as "16#06".

- (5) If you modify the data with the command for writing variable data (XPM_VWR), the CAM data that changed during XPM_WRT will be saved to the Flash.
- (6) The parameter/operation data save command is cannot be executed when the axis is running.

7.3.40 Operation Information Read (XPM_CRD)

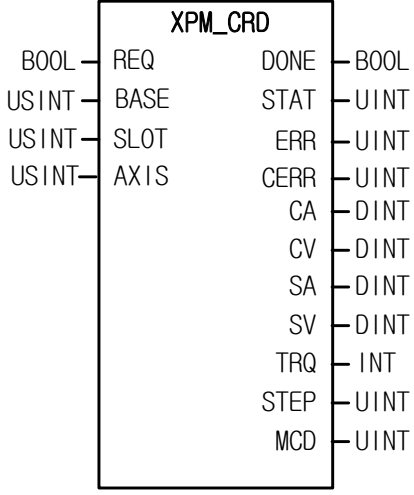
Function Block Type	Details
	<p>Input</p> <p>REQ : Request for executing function blocks</p> <p>BASE : Setting up the numbers of the bases where modules are equipped</p> <p>SLOT : Setting up the numbers of slots where modules are equipped</p> <p>AXIS : Specifying the axis to give commands 1 ~ 6: 1axis ~ 6axis</p> <p>Output</p> <p>DONE : Keeping 1 after the initial operation</p> <p>STAT : Outputting error No. that occurred during executing function blocks</p> <p>ERR :Displaying axis error</p> <p>CERR : Displaying common error</p> <p>CA : Displaying command position</p> <p>CV : Displaying command speed</p> <p>SA : Displaying the current position</p> <p>SV : Displaying the current speed</p> <p>TRQ : Displaying the current torque</p> <p>STEP : Displaying the current operating data step No.</p> <p>MCD : Displaying the current M code value</p>

- (1) The current operating state of the specified axis is read in the AXIS of the embedded positioning.
- (2) The read operating data is saved to the variables set in the output of function blocks.
- (3) In AXIS, you can set up the axis to command and select one among 1~6(1axis~6axis).
If the values other than set value are selected, "error6" will occur.
- (4) You can read and monitor the command position, command speed, current position, current speed, torque, operating data No., M code values of the set axis or use them as conditions for the user program. (Embedded positioning, there is no torque data)
- (5) "-" speed of the command speed(CV) or the current speed(SV) indicates the reverse direction.
- (6) Embedded positioning is the pulse output type; the current position and the current speed indicate the same values with the command position, command speed.
- (7) TRQ indicates the current Servo Drive's torque state and XECU embedded positioning that is the pulse output type is displayed as 0.

7.3.41 Operation State Read (XPM_SRD)

Function Block Type	Details																																				
<div style="text-align: center; border: 1px solid black; padding: 10px; width: fit-content; margin: auto;"> <p>XPM_SRD</p> <table style="width: 100%; border-collapse: collapse;"> <tr> <td style="width: 15%; text-align: right;">BOOL</td> <td style="width: 15%; text-align: left;">REQ</td> <td style="width: 15%; text-align: right;">DONE</td> <td style="width: 15%; text-align: left;">BOOL</td> </tr> <tr> <td style="text-align: right;">USINT</td> <td style="text-align: left;">BASE</td> <td style="text-align: right;">STAT</td> <td style="text-align: left;">UINT</td> </tr> <tr> <td style="text-align: right;">USINT</td> <td style="text-align: left;">SLOT</td> <td style="text-align: right;">ST1</td> <td style="text-align: left;">BOOL[8]</td> </tr> <tr> <td style="text-align: right;">USINT</td> <td style="text-align: left;">AXIS</td> <td style="text-align: right;">ST2</td> <td style="text-align: left;">BOOL[8]</td> </tr> <tr> <td></td> <td></td> <td style="text-align: right;">ST3</td> <td style="text-align: left;">BOOL[8]</td> </tr> <tr> <td></td> <td></td> <td style="text-align: right;">ST4</td> <td style="text-align: left;">BOOL[8]</td> </tr> <tr> <td></td> <td></td> <td style="text-align: right;">ST5</td> <td style="text-align: left;">BOOL[8]</td> </tr> <tr> <td></td> <td></td> <td style="text-align: right;">ST6</td> <td style="text-align: left;">BOOL[8]</td> </tr> <tr> <td></td> <td></td> <td style="text-align: right;">ST7</td> <td style="text-align: left;">BOOL[8]</td> </tr> </table> </div>	BOOL	REQ	DONE	BOOL	USINT	BASE	STAT	UINT	USINT	SLOT	ST1	BOOL[8]	USINT	AXIS	ST2	BOOL[8]			ST3	BOOL[8]			ST4	BOOL[8]			ST5	BOOL[8]			ST6	BOOL[8]			ST7	BOOL[8]	<p>Input</p> <p>REQ : Request for executing function blocks</p> <p>BASE : Setting up the numbers of the bases where modules are equipped</p> <p>SLOT : Setting up the numbers of slots where modules are equipped</p> <p>AXIS : Specifying the axis to give commands 1 ~ 6: 1axis ~ 6axis</p> <p>Output</p> <p>DONE : Keeping 1 after the initial operation</p> <p>STAT : Outputting error No. that occurred during executing function blocks</p> <p>ST1 : State 1</p> <p>ST2 : State 2</p> <p>ST3 : State 3</p> <p>ST4 : State 4</p> <p>ST5 : State 5</p> <p>ST6 : State 6</p> <p>ST7 : State 7</p>
BOOL	REQ	DONE	BOOL																																		
USINT	BASE	STAT	UINT																																		
USINT	SLOT	ST1	BOOL[8]																																		
USINT	AXIS	ST2	BOOL[8]																																		
		ST3	BOOL[8]																																		
		ST4	BOOL[8]																																		
		ST5	BOOL[8]																																		
		ST6	BOOL[8]																																		
		ST7	BOOL[8]																																		

- (1) The command to read the bit information of the current operating state of the specified axis is sent to the AXIS of the embedded positioning.
- (2) The read bit information of the current operating state is saved to the variables set in ST1 ~ ST7
- (3) In AXIS, you can set up the axis to command and select one among 1~6. If the values other than set value are selected, "error6" will occur.
- (4) The details of output variables ST1 ~ ST7 of the function block to read the current operating state bit can be used for The program.

	Bit	Description	Bit	Description
ST1	[0]	Operating(0:Stop, 1:BUSY)	[4]	Origin determination state(0:undetermined, 1:determined)
	[1]	Error state	[5]	-
	[2]	Completion of positioning	[6]	Stop state
	[3]	M code On signal(0:Off, 1:On)	[7]	-
ST2	[0]	Detection of the external upper limit	[4]	Accelerating
	[1]	Detection of the external lower limit	[5]	At constant speed
	[2]	Emergency Stop state	[6]	Decelerating
	[3]	Direction(0:forward, 1:reverse)	[7]	Dwelling
ST3	[0]	1 axis position control operating	[4]	Circular interpolation operating
	[1]	1 axis speed control operating	[5]	Homing operating
	[2]	Linear interpolation operating	[6]	Position synchronous operating
	[3]	-	[7]	Speed synchronous operating
ST4	[0]	JOG operating	[4]	In the process of returning to the position of pre-manual operation
	[1]	-	[5]	CAM control operating
	[2]	Inching operating	[6]	Feed control operating
	[3]	-	[7]	Ellipse interpolation operating
ST5	[0]	Major axis data 1 ~ 6: 1axis ~ 6axis 9 ~ 12: encoder 1 ~ 6	[4]	Axis state(0:minor axis, 1: major axis)
	[1]		[5]	-
	[2]		[6]	-
	[3]		[7]	-
ST6	[0]	Emergency Stop/deceleration Stop signal	[4]	External upper limit signal
	[1]	-	[5]	External lower limit signal
	[2]	-	[6]	Origin signal
	[3]	-	[7]	Approximate origin signal
ST7	[0]	-	[4]	Servo On output signal
	[1]	-	[5]	Servo alarm reset signal
	[2]	-	[6]	-
	[3]	-	[7]	-

7.3.42 Encoder value read (XPM_ENCRDB)

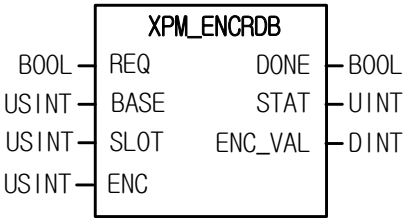
Function Block Type	Details
	<p>Input</p> <p>REQ : Request for executing function blocks</p> <p>BASE : Setting up the numbers of the bases where modules are equipped</p> <p>SLOT : Setting up the numbers of slots where modules are equipped</p> <p>ENC : Encoder No. (set as 0 all the time) 0 ~ 3: Encoder 1 ~ Encoder 4</p> <p>Output</p> <p>DONE : Keeping 1 after the initial operation</p> <p>STAT : Outputting error No. that occurred during executing function blocks</p> <p>ENC_VAL : Encoder's current values</p>

- (1) The encoder value read command is designated to the embedded positioning.
- (2) Then, the obtained current values of the encoder are displayed in ENC_VAL,
- (3) You can set up the encoder to read in ENC.

7.3.43 JOG Operation (XPM_JOG)

Function Block Type	Details
	<p>Input</p> <p>REQ : Request for executing function blocks</p> <p>BASE : Setting up the numbers of the bases where modules are equipped</p> <p>SLOT : Setting up the numbers of slots where modules are equipped</p> <p>AXIS : Specifying the axis to give commands 1 ~ 6: 1axis ~ 6axis</p> <p>JOG_DIR : Setting the rotating direction during JOG operation 0:forward, 1:reverse</p> <p>LOW/HIGH : Setting the JOG speed during JOG operation 0:JOG low-speed operation, 1:JOG high-speed operation</p> <p>Output</p> <p>DONE : Keeping 1 after the initial operation</p> <p>STAT : Outputting error No. that occurred during executing function blocks</p>

- (1) The JOG operation command is designated to the axis specified as AXIS of the embedded positioning.
- (2) It is the manual operation function for a test and is used to verify the system operations, wiring state, position address for teaching. You can choose either high speed or low speed.
- (3) The operating conditions of JOG function block are level type. Namely, when the access condition of input variables REQ is On, pulses are output based on the set value; when the access condition of input variables REQ is Off, it stops.
- (4) If you change the set values of LOW/HIGH in the state that operating conditions are On(during JOG operation), speed will be changed without stopping JOG operation; if you change set values of LOW/HIGH, after deceleration stop and change of direction, JOG operation will be continued.
- (5) In AXIS, you can set up the axis to command and select one among 1~6. If the values other than set value are selected, "error 6" will occur.

7.3.44 CAM Operation (XPM_CAM)

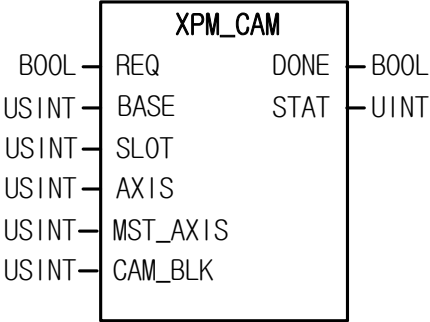
Function Block Type	Details
	<p>Input</p> <p>REQ : Request for executing function blocks</p> <p>BASE : Setting up the numbers of the bases where modules are equipped</p> <p>SLOT : Setting up the numbers of slots where modules are equipped</p> <p>AXIS : Specifying the axis to give commands 1 ~ 6: 1axis ~ 6axis</p> <p>MST_AXIS : Setting the major axis 1 ~ 6: 1axis ~ 6axis, 9 ~ 12: encoder 1 ~ 4</p> <p>CAM_BLK : Setting CAM blocks 1 ~ 9: 1block ~ 9block</p> <p>Output</p> <p>DONE : Keeping 1 after the initial operation</p> <p>STAT : Outputting error No. that occurred during executing function blocks</p>

- (1) The CAM operation command is sent to the axis specified as AXIS of the embedded positioning.
- (2) The command performs CAM operation for the relevant axis by using CAM major axis and CAM data blocks.
- (3) When executing the CAM operation command, although the minor axis (one set in AXIS) is displayed as 'During Operation', the motor actually does not run. When the axis set as the major one starts up, the motor starts running to the position of the minor axis corresponding to the major axis's position based on CAM data blocks' values set in CAM block (CAM_BLK).
- (4) In AXIS, you can set up the axis to command based on the below setting range. If the values other than set value are selected, "error6" will occur. Setting range: 1 ~ 6(1axis ~ 6axis)
- (5) In MST_AXIS, you can set up the major axis of CAM operation among the below range. If the values other than set value are selected, "error 11" will occur.
Setting range: 1 ~ 6(1axis ~ 6axis), 9 ~ 12 (encoder 1 ~ 4)
- (6) In CAM_BLK, you can set up the CAM block No. to run among the below range. If the values other than set value are selected, "error 11" will occur.
Setting range: 1 ~ 9(block1 ~ block9)
- (7) You can set up CAM data in the positioning package with the maximum of 8 blocks.
- (8) To use User CAM Operation, set the CAM block No. as 9.
- (9) In the case of User CAM Operation, even during operation, you can change the user CAM data with the command for writing variable data
- (10) For more details on User CAM Operation, refer to "9.4.4 User CAM Operation".

7.3.45 Main Axis Offset CAM Operation (XPM_CAMO)

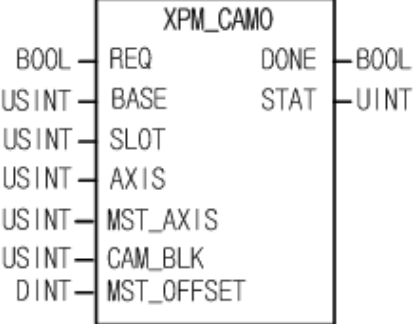
Function Block Type	Details
	<p>Input</p> <p>REQ : Request for executing function blocks</p> <p>BASE : Setting up the numbers of the bases where modules are equipped</p> <p>SLOT : Setting up the numbers of slots where modules are equipped</p> <p>AXIS : Specifying the axis to give commands 1 ~ 6: 1axis ~ 6axis</p> <p>MST_AXIS : Setting the major axis 1 ~ 6: 1axis ~ 6axis, 9 ~ 12: encoder 1 ~ 4</p> <p>CAM_BLK : Setting CAM block 1 ~ 9: 1block ~ 9block</p> <p>MST_OFFSET : Setting the travel amount of the major axis's offset position -2147483648 ~ 2147483647</p> <p>Output</p> <p>DONE : Keeping 1 after the initial operation</p> <p>STAT : Outputting error No. that occurred during executing function blocks</p>

- (1) The CAM operation command is designated to the axis specified as AXIS of the embedded positioning.
- (2) The command performs CAM operation for the relevant axis by using CAM major axis and CAM data blocks.
- (3) When executing the CAM operation command, although the minor axis (one set in AXIS) is displayed as 'During Operation', the motor actually does not run. After the axis set as the major one starts up and it moves as far as the travel amount of the major axis's offset position, the motor starts running to the position of the minor axis corresponding to the major axis's position based on CAM data blocks' values set in CAM block (CAM_BLK).
- (4) In AXIS, you can set up the axis to command based on the below setting range. If the values other than set value are selected, "error6" will occur. Setting range: 1 ~ 6(1axis ~ 6axis)
- (5) In MST_AXIS, you can set up the major axis of CAM operation among the below range. If the values other than set value are selected, "error 11" will occur. Setting range: 1 ~ 6(1axis ~ 6axis), 9 ~ 12(encoder 1 ~ 12)
- (6) In CAM_BLK, you can set up the CAM block No. to run among the below range. If the values other than set value are selected, "error 11" will occur. Setting range: 1 ~ 9(block1 ~ block9)
- (7) You can set up CAM data in the positioning package with the maximum of 9 blocks(User CAM block: 1EA).

7.3.46 Ellipse interpolation (XPM_ELIN)

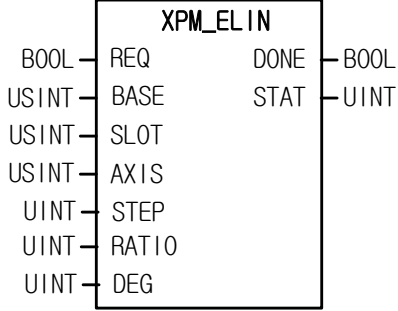
Function Block Type	Details
	<p>Input</p> <p>REQ : Request for executing function blocks</p> <p>BASE : Setting up the numbers of the bases where modules are equipped</p> <p>SLOT : Setting up the numbers of slots where modules are equipped</p> <p>AXIS : Specifying the axis to give commands 1 ~ 6: 1axis ~ 6axis</p> <p>STEP : Step No. to operate</p> <p>RATIO : ellipse ratio(%)</p> <p>DEG : Operating angle</p> <p>Output</p> <p>DONE : Keeping 1 after the initial operation</p> <p>STAT : Outputting error No. that occurred during executing function blocks</p>

- (1) The command for ellipse interpolation is sent to the axis specified as AXIS of the embedded positioning.
- (2) For the specified step of STEP in the specified axis, the ellipse interpolation is performed at the angle set in DEG in the ratio set in RATIO.
- (3) The ellipse interpolation distorts the operating data of the step that is set as circular interpolation in the ratio of ellipse ratio(RATIO) and performs ellipse operation at the operating angle set in DEG. Therefore, the step of the operating data set in STEP should be set up based on circular interpolation control.
- (4) The ellipse ratio can be set in the range of 1 ~ 65535 and its unit is [X10-2 %]. Namely, if the value is set as 65535, you will get 655.35%.
- (5) The operating angle can be set in the range of 1 ~ 65535 and its unit is [X10-1 degree]. Namely, if the value is set as 3650, you will get 365.0 degree.
- (6) In AXIS, you can set up the axis to command and select one among 1~6. If the values other than set value are selected, "error 6" will occur.

7.3.47 Restart (XPM_RSTR)

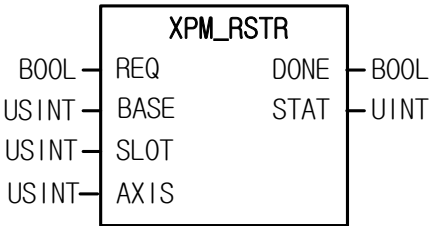
Function Block Type	Details
	<p>Input</p> <p>REQ : Request for executing function blocks</p> <p>BASE : Setting up the numbers of the bases where modules are equipped</p> <p>SLOT : Setting up the numbers of slots where modules are equipped</p> <p>AXIS : Specifying the axis to give commands 1 ~ 6: 1axis ~ axis</p> <p>Output</p> <p>DONE : Keeping 1 after the initial operation</p> <p>STAT : Outputting error No. that occurred during executing function blocks</p>

- (1) The restart command is designated to the AXIS (command axis) of the embedded positioning.
- (2) It is used to restart up the axis that went through deceleration stop during operation and the axis where the command is executed will restart with the previous operating data.
- (3) If other operations are performed before restart up the axis that went through deceleration stop, the restart-up command will not run.
- (4) In AXIS, you can set up the axis to command and select one among 1~6. If the values other than set value are selected, "error 6" will occur.

Chapter 8 Program

Here describes the basic program that operate positioning module case by using its commands.

8.1 Example of Programming

8.1.1 General description

Here we supposed the embedded positioning of PLC. In the real usage, you need to change its value according to your system configuration.

8.1.2 Current State Read

(1) Operation state read (XPM_SRD)

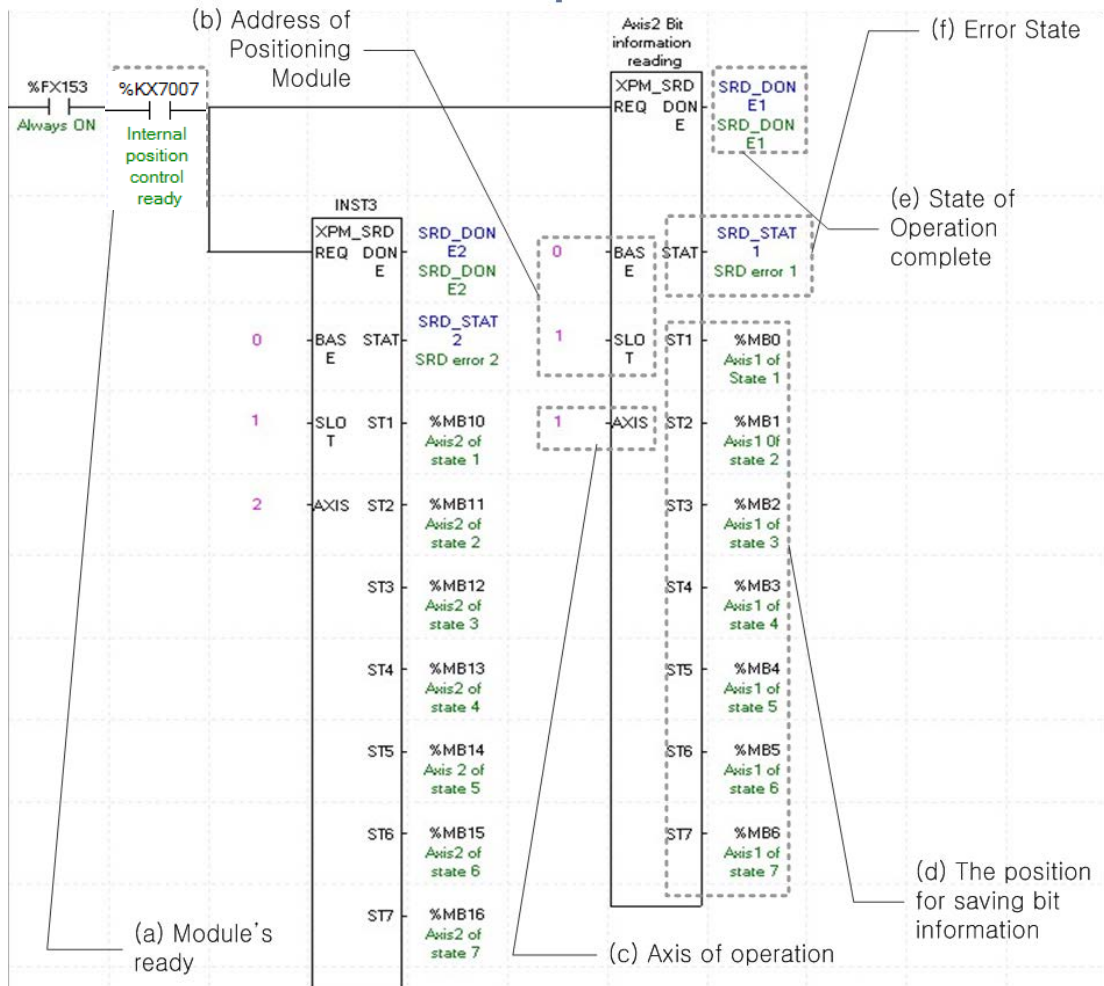

(a) Module ready state

When the positioning module is ready to receive the command without abnormality after the power is turned on, it becomes "On".

(b) Address of Positioning Module

The high performance XEM embedded positioning is fixed on slot 1.

(c) Axis for command

If you want to make a command for each axis, you must set the axis on which to issue the command. XEM-HP can control up to 6 axes and XEM-H2 can control up to 2 axes. In command, 1 ~ 6 refer to 1 ~ 6 axes.

(d) Bit information save area

Use XPM_SRD to set the device to store the bit state value of the axis read from the positioning module. This device can be used as a condition in the sequence program. For example, in the above example program, the current bit state of 1 axis is stored in% MB0 ~% MB6. Refer to "7.3.41 Read Current Operation Status Bit Information (XPM_SRD)" for a detailed description of the stored device. The bit information stored in the device can be used as a condition for executing another command. For example, to use the signal during operation of axis 1 in the above example program, set it to% MB0.0. To apply the error status of axis 2, set it to% MB10.1.

(e) Execution complete state

If the function block is completed without error, "1" is output and "1" is maintained until the next execution. If an error occurs, "0" is output.

(f) Error state

If an error occurs during execution of function block, error number is output.

(2) Read Operation information

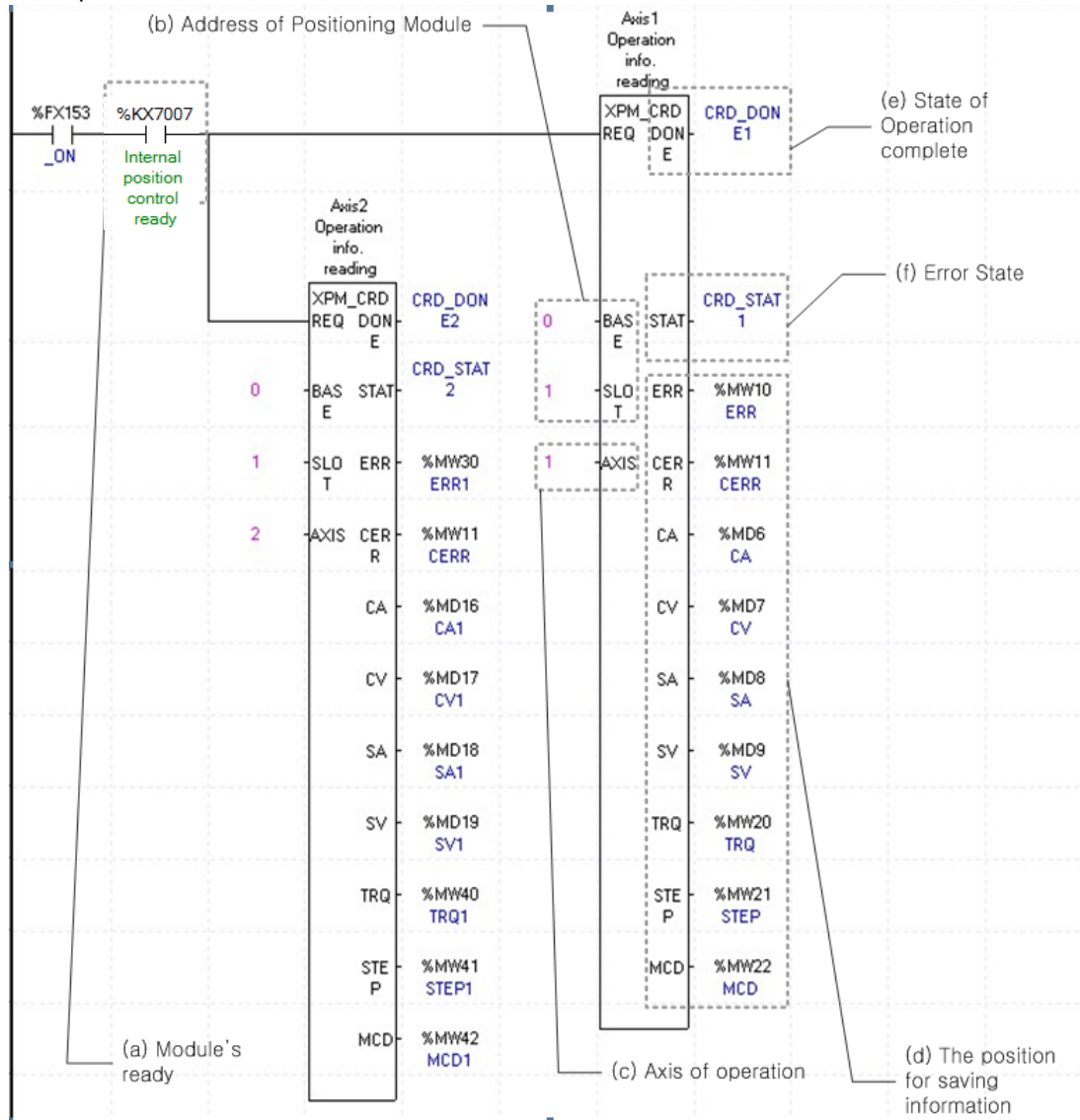

(a) Module ready state

When the positioning module is ready to receive the command without abnormality after the power is turned on, it becomes "On".

(b) Address of Positioning Module

The high performance XEM embedded positioning is fixed on slot 0.

(c) Axis for command

If you want to make a command for each axis, you must set the axis on which to issue the command. XEM-HP can control up to 6 axes and XEM-H2 can control up to 2 axes. In command, 1 ~ 6 refer to 1 ~ 6 axis.

(d) Bit information save area

Use XPM_CRD to set the device to store the operation state value of the axis read from the positioning module. You can use this device as a monitoring value in a sequence program. For example, in the above example program, the current position value of 1 axis is stored in %MD8. Refer to "7.3.40 Read Operation Information (XPM_CRD)" for a detailed description of the stored device.

(e) Execution complete state

If the function block is completed without error, "1" is output and "1" is maintained until the next execution. If an error occurs, "0" is output.

(f) Error state

If an error occurs during execution of function block, error number is output.

(3) Read encoder value

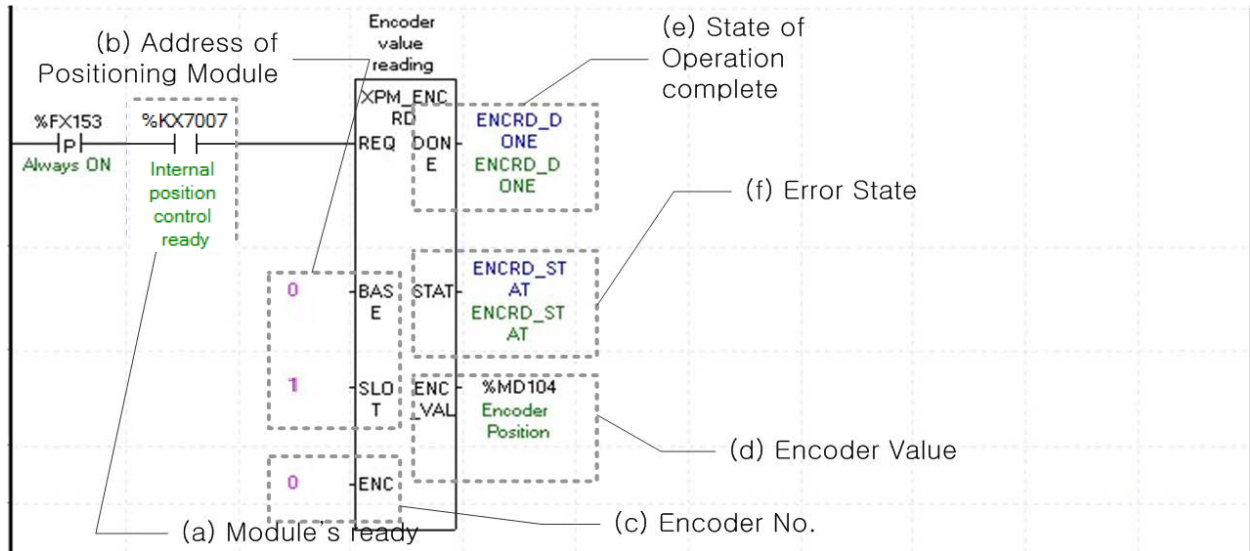

(a) Module ready state

When the positioning module is ready to receive the command without abnormality after the power is turned on, it becomes "On".

(b) Positioning module mounting position

In order to lower the command, you must set the position where the positioning module to place the command is to be mounted. The high performance XEM embedded positioning is fixed on slot 0, base 1.

(c) Encoder number

Set encoder number to read encoder value.

(d) Encoder Value

Set encoder number to read encoder value.

(e) Execution complete state

If the function block is completed without error, "1" is output and "1" is maintained until the next execution. If an error occurs, "0" is output.

(f) Error state

If an error occurs during execution of function block, error number is output.

8.1.3 Operation Test

(1) Floating Origin Setting

Decide origin of current motor's position without set a machinery origin.

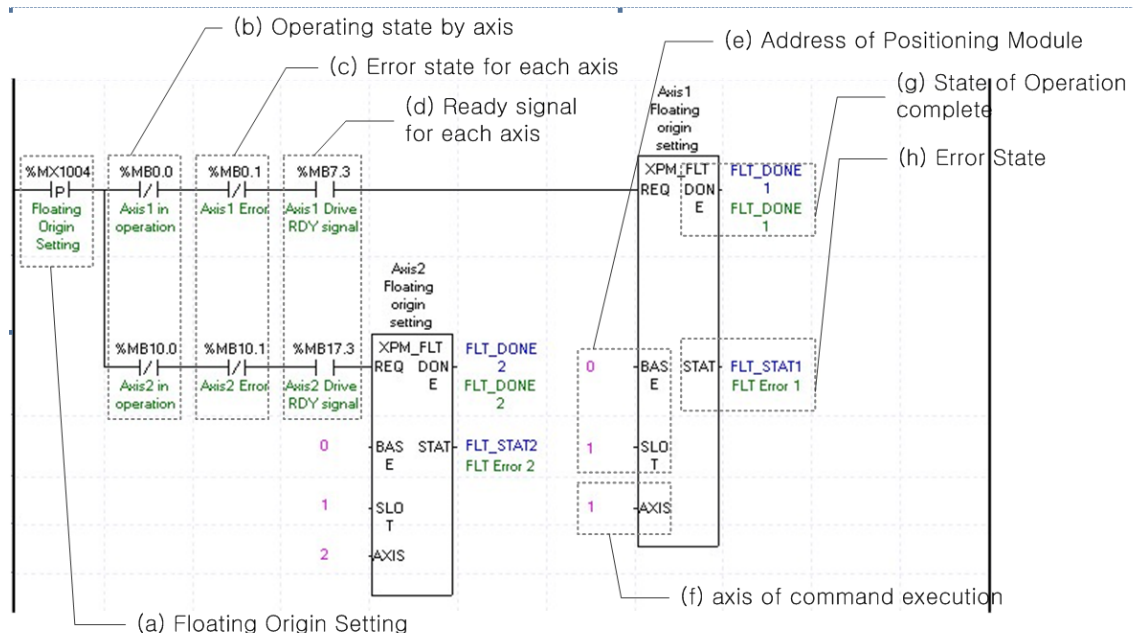

(a) Condition of running a Floating Origin Setting

The condition for executing the command XPM_FLT.

(b) Operating state of each axis

When the example program of "8.1.2 Reading current status" is applied, it is "operating" signal for each axis. Turns on when the axis is running. Since the floating origin setting command can not be executed when the axis is in operation, the condition is set so that the axis is not in operation. If the floating origin setting command is executed while the axis is in operation, error 211 occurs.

(c) Error state for each axis

According to exercise from "Chapter 8.1.2 Current State Reading," it is a signal of "Error state" for each axis. It turns on when an error occurred. Operation will only work when there is no error. If you want to operate a system regardless of errors, you can just inactivate the function.

(d) Ready signal for each axis

According to exercise from "Chapter 8.1.2 Current State Reading," it is a signal of "Drive Ready" for each axis. This command only works when this is the condition for Floating Origin Setting is on. If it is not set as "ON," the "error 212" would be appeared.

(e) Address of Positioning Module

The high performance XEM embedded positioning is fixed on slot 0.

(f) Axis for command

If you want to make a command for each axis, you must set the axis on which to issue the command. XEM-HP can control up to 6 axes and XEM-H2 can control up to 2 axes. In command, 1 ~ 6 refer to 1 ~ 6 axis.

(g) Execution complete state

If the function block is completed without error, "1" is output and "1" is maintained until the next execution. If an error occurs, "0" is output.

(h) Error state

If an error occurs during execution of function block, error number is output

(2) Jog Operation

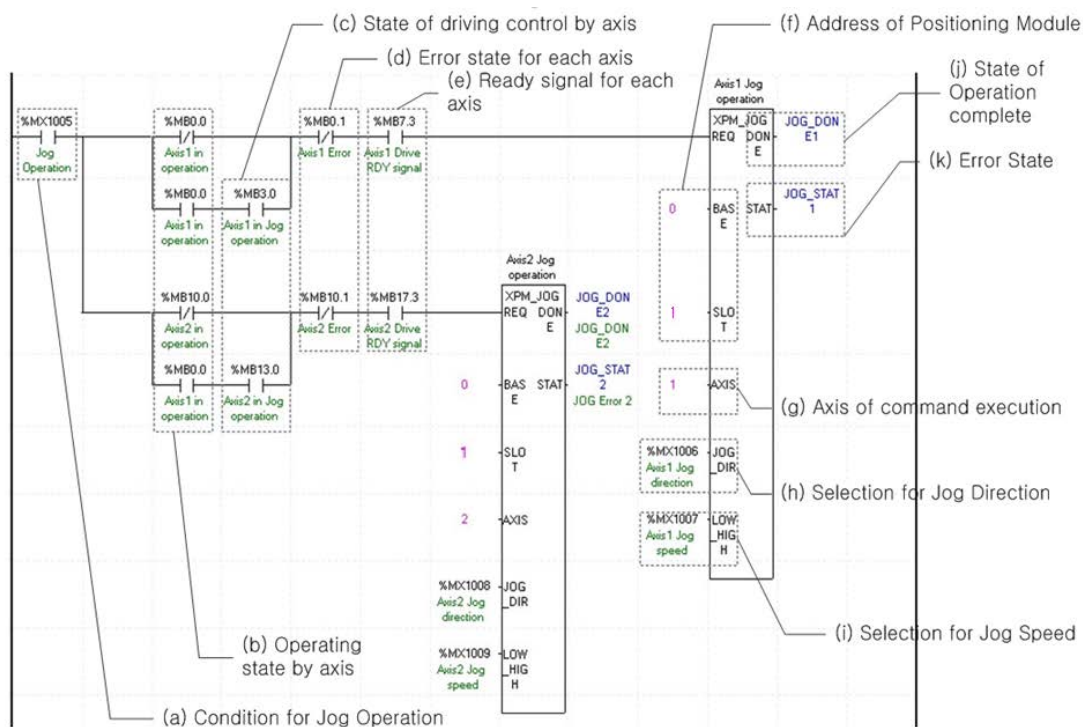

(a) Condition of Jog Operation

This is the condition for executing jog operation command. In the above example program, if Jog operation contact is OFF, 1 axis and 2 axis are negative jog low speed operation, and when Jog operation contact is ON, 1 axis and 2 axis are forward jog high speed operation.

(b) Operating state by axis

Jog Operation can only be working when the state of axis set as Jog Operation. In this example above, specific axis set as Jog Operation otherwise it is not operating.

(c) State of driving control by axis

According to exercise from "Chapter 8.1.2 Current State Reading," it is a signal of "Jog Operating" for each axis. It turns on when it is operating. Jog Operation configuration can be changed while it is operating.

(d) Error state for each axis

According to exercise from "Chapter 8.1.2 Current State Reading," it is a signal of "Error state" for each axis. It turns on when an error occurred. Operation will only work when there is no error. If you want to operate a system regardless of errors, you can just inactivate the function.

(e) Ready signal for each axis

According to exercise from "Chapter 8.1.2 Current State Reading," it is a signal of "Drive Ready" for each axis. This command only works when the condition of Jog Operation is on. If it is not set as "ON," the "error 413" would be appeared.

(f) Address of Positioning Module

In this example, Positioning Module is fixed at the 1 slot of 0 bases.

(g) Axis of command execution

Set an axis to execute Jog Operation. XEM-HP can control up to 6 axes and XEM-H2 can control up to 2 axes. It is available to set 1 ~ 6(axis1~axis6) on "Axis of command execution" of Jog operation command.

(h) Selection for Jog Direction

Set the direction of Jog operation. If Input value is 0, it will execute Jog operation in forward direction. If Input value is

Chapter 8 Program

1, it will execute Jog operation in reverse direction. Direction is can be changed in operation.

(i) Selection for Jog Speed

Set the speed of Jog operation. If Input value is 0, it will execute low speed Jog operation. If Input value is 1, it will execute high speed Jog operation. Operating speed can be changed in operation.

(j) State of Operation complete

If function block is completed without error, "1" will be outputted and maintain "1" until the next operation. If error occurred, "0" will be outputted.

(k) Error State

This is the area that output error no. if there are errors in operation of function block.

(3) Inching Operation

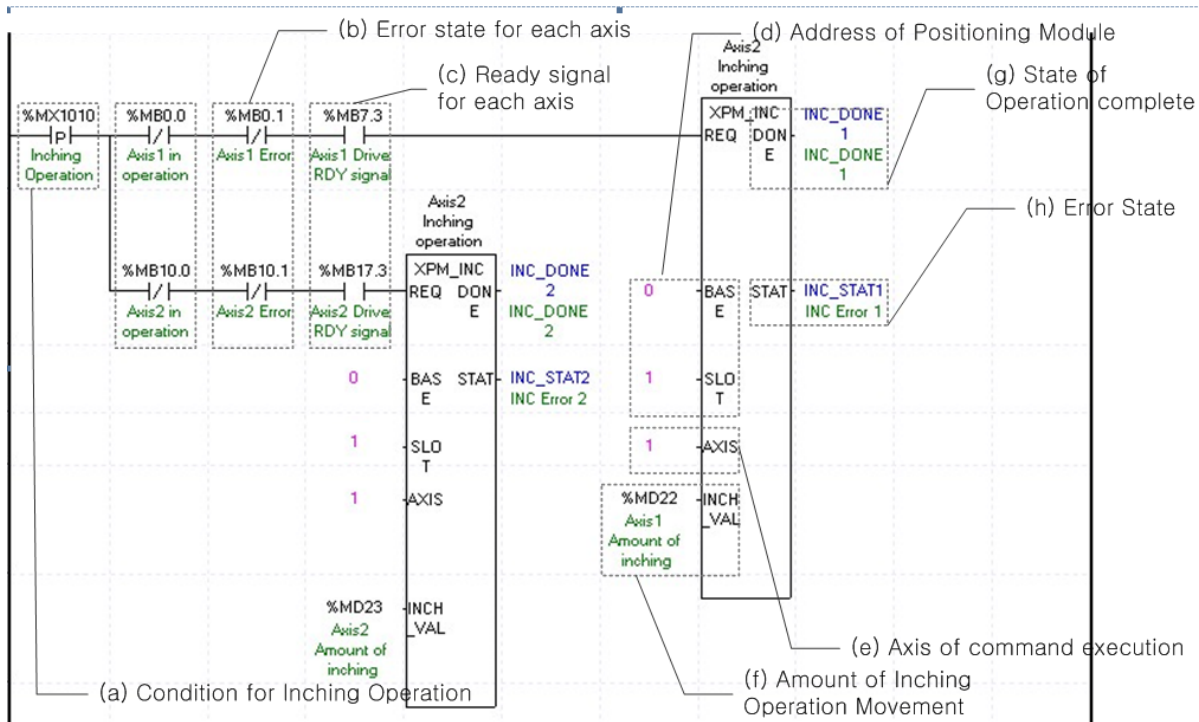

(a) Condition of Inching Operation

Condition of Inching Operation Command (XPM_INC)

(b) Operating state for each axis

According to exercise from "Chapter 8.1.2 Current State Reading," it is a signal of "Inching Operating" for each axis. It turns on when it is operating. Inching Operation can not be configured while it is running hence configuration will only be configured when it is not running. If you execute Inching Operation while it is running, the "error 401" would be appeared.

(c) Error state for each axis

According to exercise from "Chapter 8.1.2 Current State Reading," it is a signal of "Error state" for each axis. It turns on when an error occurred. Operation will only work when there is no error. If you want to operate a system regardless of errors, you can just inactivate the function.

(d) Address of Positioning Module

The high performance XEM embedded positioning is fixed on slot 0.

(e) Axis for command

If you want to make a command for each axis, you must set the axis on which to issue the command. XEM-HP can control up to 6 axes and XEM-H2 can control up to 2 axes. In command, 1 ~ 6 refer to 1 ~ 6 axis.

(f) Amount of Inching Operation Movement

Measure the amount of moving range by Inching Operation.

(4) Return to the position before Manual Operation

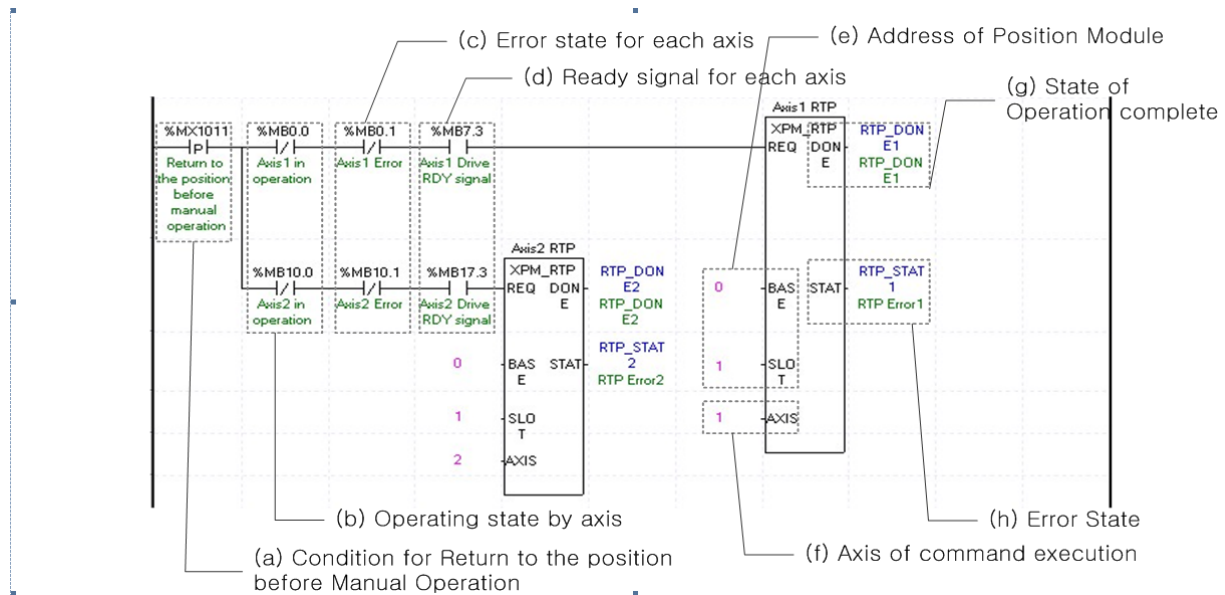

(a) Condition of Return to the position before Manual Operation

The condition of return to the position before manual operation (XPM RTP).

(b) Operating state of each axis

According to exercise from "Chapter 8.1.2 Current State Reading," it is a signal of "Manual Operating" for each axis. It turns on when it is operating. Inching Operation can not be configured while it is running hence configuration will only be configured when it is not running.

(c) Error state for each axis

According to exercise from "Chapter 8.1.2 Current State Reading," it is a signal of "Error state" for each axis. It turns on when an error occurred. Operation will only work when there is no error. If you want to operate a system regardless of errors, you can just inactivate the function.

(d) Ready signal for each axis

According to exercise from "Chapter 8.1.2 Current State Reading," it is a signal of "Drive Ready" for each axis. This command only works when this is the condition for Manual Operation is on. If it is not set as "ON," the "error 434" would be appeared.

(e) Address of Positioning Module

The high performance XEM embedded positioning is fixed on slot 0.

(f) Axis for command

If you want to make a command for each axis, you must set the axis on which to issue the command. XEM-HP can control up to 6 axes and XEM-H2 can control up to 2 axes. In command, 1 ~ 6 refer to 1 ~ 6 axis.

(g) Execution complete state

If the function block is completed without error, "1" is output and "1" is maintained until the next execution. If an error occurs, "0" is output.

(h) Error state

If an error occurs during execution of function block, error number is output

(i) When manual operation is running, the other operations are going back to its original position such as Jog Operation and Inching Operation. Reference for Manual Operation is from "Chapter 9.3.3."

8.1.4 Parameter and Operation Data Setting

(1) Parameter Setting

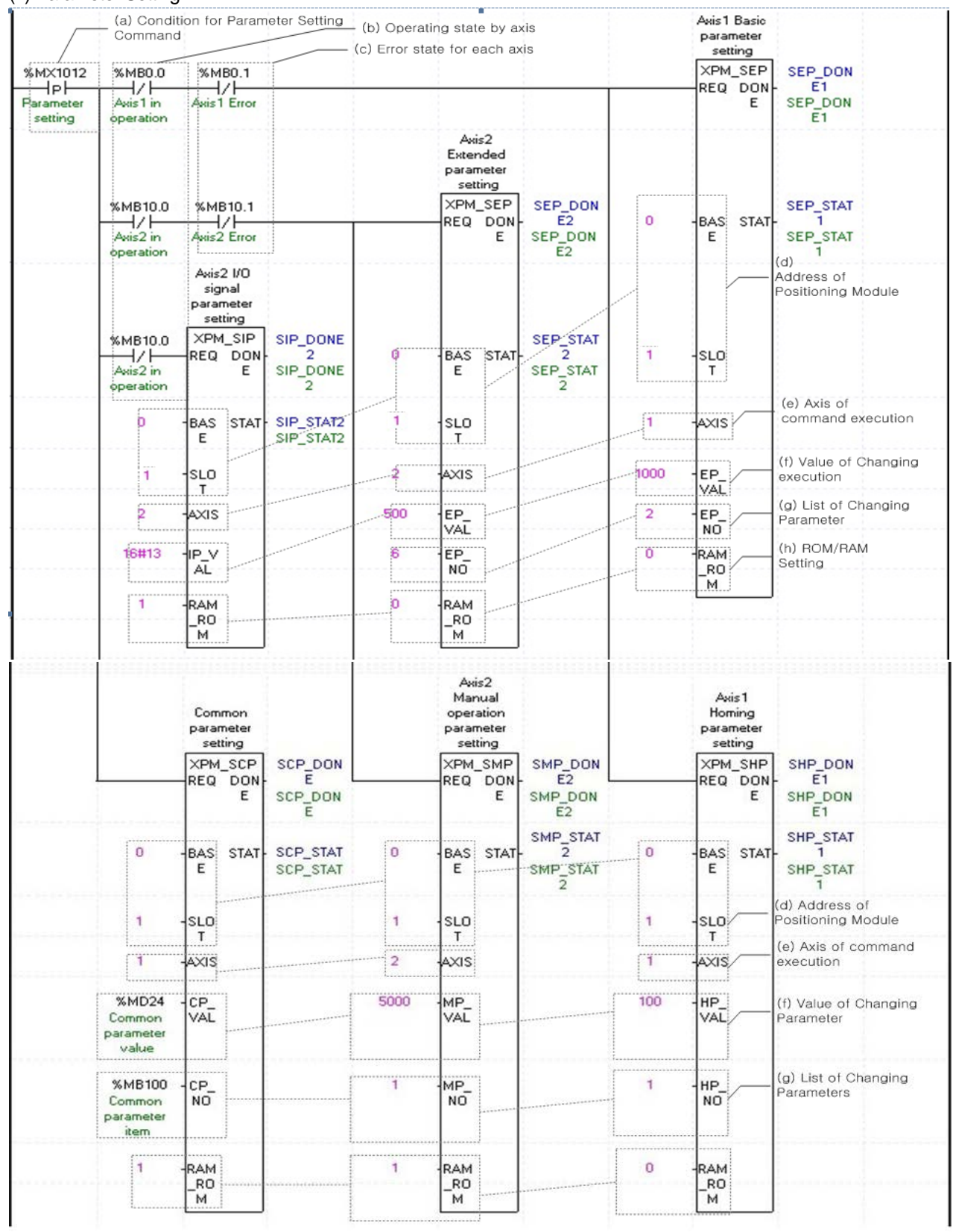

Chapter 8 Program

(a) Condition of Return to the position before Manual Operation

The condition of parameter setting commands (XPM_SBP, XPM_SEP, XPM_SHP, XPM_SMP, XPM_SIP, XPM_SCP).

(b) Operating state of each axis

According to exercise from "Chapter 8.1.2 Current State Reading," it is a signal of "Manual Operating" for each axis. It turns on when it is operating. Inching Operation can not be configured while it is running hence configuration will only be configured when it is not running. If parameter setting command is executed while axis is running, error 471 occurs.

(c) Error state for each axis

According to exercise from "Chapter 8.1.2 Current State Reading," it is a signal of "Error state" for each axis. It turns on when an error occurred. Operation will only work when there is no error. If you want to operate a system regardless of errors, you can just inactivate the function.

(d) Address of Positioning Module

The high performance XEM embedded positioning is fixed on slot 1.

(e) Axis for command

If you want to make a command for each axis, you must set the axis on which to issue the command.

XEM-HP can control up to 6 axes and XEM-H2 can control up to 2 axes. In command, 1 ~ 6 refer to 1 ~ 6 axis.

(f) Parameter value to change

Set the value of each parameter item to be changed. The values corresponding to the parameters are shown in "Chapter 7. Function Block", refer to each parameter setting function block. In the case of the external signal parameter setting command (XPM_SIP), it becomes the external signal parameter value instead of the specific item value.

(g) Parameter item to change

Set the item to be changed by the parameter value (f) set in the instruction. When the command is executed, the parameter value set in this item is changed to the set parameter value (f). The values corresponding to the parameters are shown in "Chapter 7. Function Block", refer to each parameter setting function block. In the case of the external signal parameter setting command (XPM_SIP), this part is not applicable because the entire external signal parameter value is changed instead of the specific item value

(h) RAM/ROM Setting

Set the changed parameter value only when power is applied to the module (RAM setting), whether to keep the module even when power is not applied (ROM setting). When the value of this item is set to "0", the RAM setting becomes the RAM setting and the ROM setting becomes "1". The ROM setting can be performed only when all axes are stopped. There are no limitations on the number of parameter ROM settings to be performed.

(i) The execution contents of each function block are as follows.

XPM_SBP: Acceleration time 1 of axis 1 basic parameter is set to 1000ms in RAM

XPM_SEP: Axis 2 extended parameter 2 axis linear interpolation continuous operation set the circular insertion position to 500 by RAM

XPM_SHP: Sets the home position of axis 1 home return parameter to 100

XPM_SMP: Set the jog high speed of axis 2 manual operation parameter to 5000 by ROM setting

XPM_SIP: Axis 2 I / O signal parameter value is 16 # 13 (Preserves upper limit, Does not use lower limit, Near point A contact point, ROM setting by using deviation clear)

XPM_SCP: ROM setting of % MD24 value of % MB100 item of common parameter

(2) Operating Data Setting

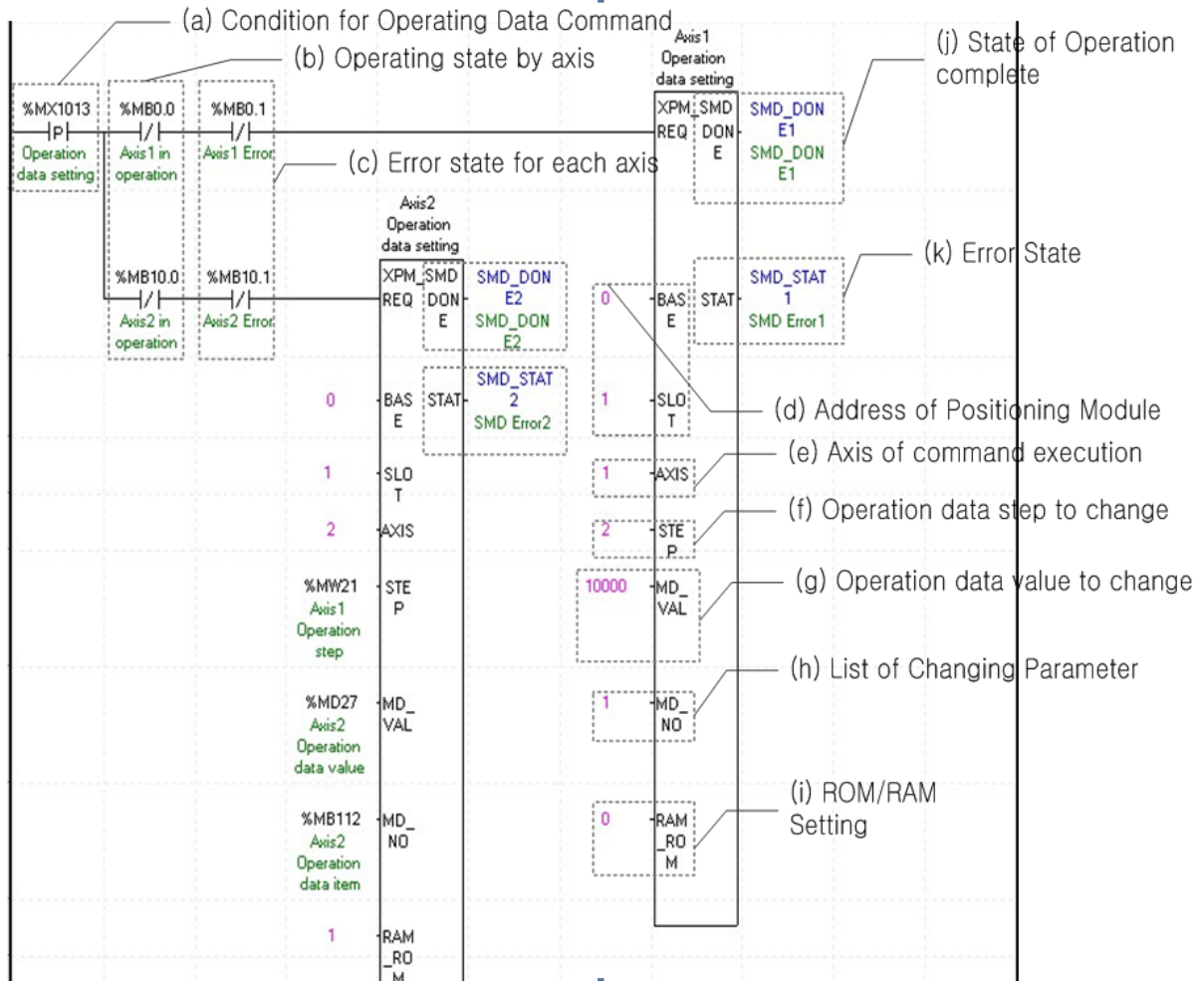

(a) Condition of operating data setting

The condition of operating data setting (XPM_SMD).

(b) Operating state of each axis

According to exercise from "Chapter 8.1.2 Current State Reading," it is a signal of "Manual Operating" for each axis. It turns on when it is operating. Inching Operation can not be configured while it is running hence configuration will only be configured when it is not running.

(c) Error state for each axis

According to exercise from "Chapter 8.1.2 Current State Reading," it is a signal of "Error state" for each axis. It turns on when an error occurred. Operation will only work when there is no error. If you want to operate a system regardless of errors, you can just inactivate the function.

(d) Address of Positioning Module

The high performance XEM embedded positioning is fixed on slot 1.

(e) Axis for command

If you want to make a command for each axis, you must set the axis on which to issue the command.

XEM-HP can control up to 6 axes and XEM-H2 can control up to 2 axes. In command, 1 ~ 6 refer to 1 ~ 6 axis.

(f) Operating data step to be changed

Set the operation data step number to be changed by the operation data setting instruction. XEMH can set operation data of 400 steps for each axis. This item can be set from 0 to 400, and 1 to 400 means 1 step to 400 steps. When set to "0", it means "current step" of operation data of the axis.

Chapter 8 Program

(g) Operating value to changed

Set operating data item value to change.

(h) Operating data item to changed

Set the operation data item to be changed to the operation data value (h) set in the command. When the command is executed, the operation data value set in this item is changed to the set operation data value (h). The values corresponding to each item of operation data are as follows. For example, if the operation data setting command is executed after setting "1000" to the operation data value to be changed and "4" to the operation data item, the dwell time value of the operation data is changed to "1000ms".

Setting Value	Items
1	Goal Position
2	Circular interpolation auxiliary position
3	Operating speed
4	Dwell Time
5	M code No.
6	sub axis setting
7	Helical interpolation axis
8	The number of circular interpolation turn
9	Coordinates
10	Control method
11	Operating method
12	Operating pattern
13	Size of Circular arc
14	Acc. No.
15	Dec. No.
16	Circular interpolation method
17	Circular interpolation direction

(i) RAM/ROM Setting

Set the changed parameter value only when power is applied to the module (RAM setting), whether to keep the module even when power is not applied (ROM setting). When the value of this item is set to "0", the RAM setting becomes the RAM setting and the ROM setting becomes "1". The ROM setting can be performed only when all axes are stopped. There are no limitations on the number of parameter ROM settings to be performed.

(j) Execution complete state

If the function block is completed without error, "1" is output and "1" is maintained until the next execution. If an error occurs, "0" is output.

(k) Error state

If an error occurs during execution of function block, error number is output

(l) The execution contents of each function block are as follows.

Axis 1 operation data setting: Set the target position of axis 1 operation data No. 2 step to 10000 RAM setting

Axis 2 operation data setting: Axis 2 operation data% MW41 (Axis 2 operation step) The% MB112 (Axis 2 operation data item) item is set to% MD27 (Axis 2 operation data value)

(3) Operation Data Teaching Array

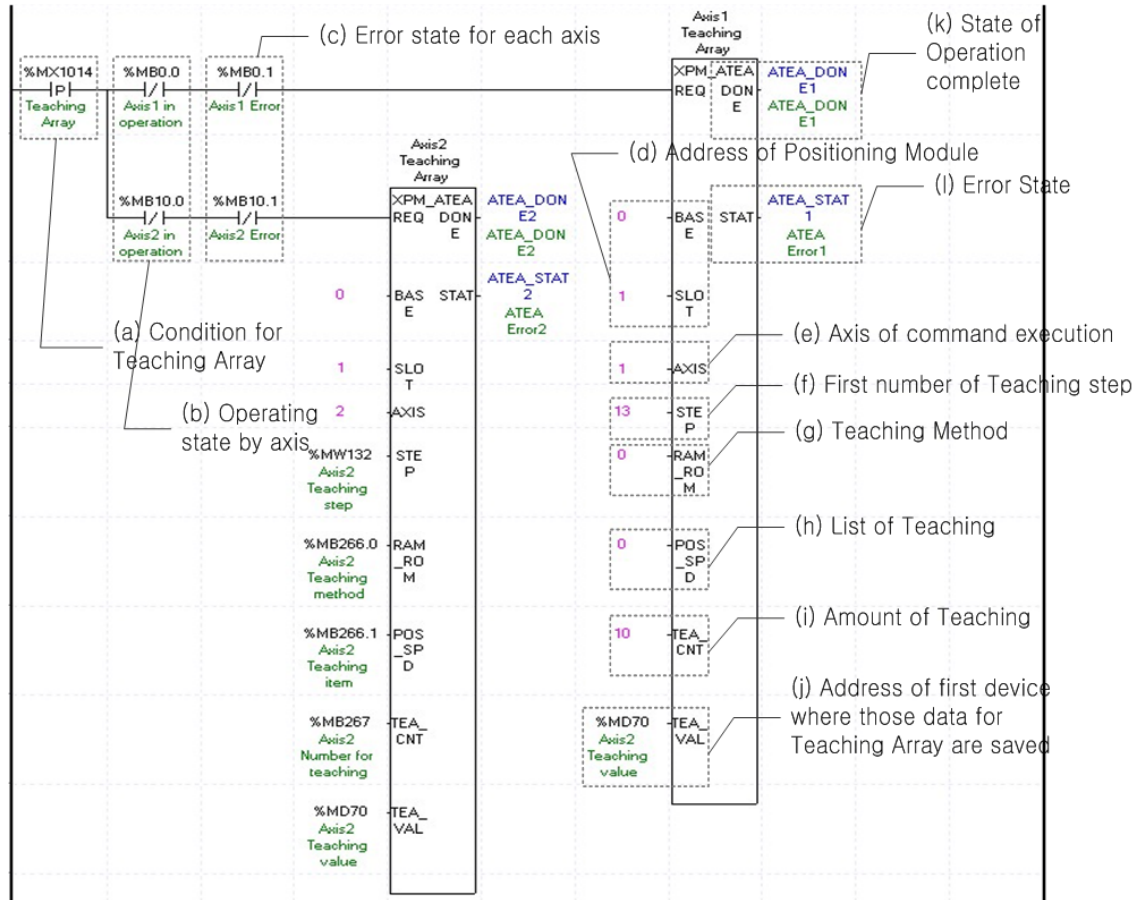

- (a) Condition of teaching array
The condition of teaching array (XPM_ATEA).
- (b) Operating state of each axis
According to exercise from "Chapter 8.1.2 Current State Reading," it is a signal of "Manual Operating" for each axis. It turns on when it is operating. Inching Operation can not be configured while it is running hence configuration will only be configured when it is not running.
- (c) Error state for each axis
According to exercise from "Chapter 8.1.2 Current State Reading," it is a signal of "Error state" for each axis. It turns on when an error occurred. Operation will only work when there is no error. If you want to operate a system regardless of errors, you can just inactivate the function.
- (d) Address of Positioning Module
The high performance XEM embedded positioning is fixed on slot 1.
- (e) Axis for command
If you want to make a command for each axis, you must set the axis on which to issue the command.
XEM-HP can control up to 6 axes and XEM-H2 can control up to 2 axes. In command, 1 ~ 6 refer to 1 ~ 6 axis.
- (f) Address of first device of the step to teach
To execute a Teaching Array, you need to set a specific value first. For example, the teaching of axis 1 of the above example program is done from step 13 to 10, that is, step 13 to step 22.
- (g) Teaching method
Set the changed operation data value only when power is applied to the module (RAM teaching), or when the module is not powered (ROM teaching). When the value of this item is set to "0", RAM teaching is performed when the

Chapter 8 Program

instruction is executed, and when it is set to "1", ROM teaching is performed. The ROM setting can be performed only when all axes are stopped. There is no limit to the number of times that ROM teaching is performed.

(h) Teaching item

Set items to be changed by Teaching among operation data items. Items that can be changed by teaching multiple teaching are "Target position" and "Operation speed". When set to "0", the target position is set. When "1" is set, it means operation speed.

(i) Number of teaching

Set the number of steps to perform teaching. XEM can teach multiple teaching of max. 16 data.

(j) Address of first device of teaching array data

To execute a Teaching Array, you need to set a specific value first. TWR commands are using for set up those Teaching Array data. It has to be done before actual Teaching Array operation. Teaching Data will be set up depends on number of first device as below table.

(j) Address of first device where those data for Teaching Array are saved

In order to perform teaching multiple times, the data values to be taught must be set first. Teaching data is set according to the head number of the device in the following form.

No.	Device No.	Teaching array data
1	Device + 0	Teaching array data1
2	Device + 2	Teaching array data2
3	Device + 4	Teaching array data3
4	Device + 6	Teaching array data4
5	Device + 8	Teaching array data5
6	Device + 10	Teaching array data6
7	Device + 12	Teaching array data7
8	Device + 14	Teaching array data8
9	Device + 16	Teaching array data9
10	Device + 18	Teaching array data10
11	Device + 20	Teaching array data11
12	Device + 22	Teaching array data12
13	Device + 24	Teaching array data13
14	Device + 26	Teaching array data14
15	Device + 28	Teaching array data15
16	Device + 30	Teaching array data16

(k) Execution complete state

If the function block is completed without error, "1" is output and "1" is maintained until the next execution. If an error

(l) Error state

If an error occurs during execution of function block, error number is output

(m) The execution contents of each function block are as follows.

Axis 1 teaching array: Position value of 13 steps from axis 1 to 10 steps (step 22) is stored in% MD50 ~% MD59 and RAM teaching

Axis 2 teaching Array:% MW132 (Axis 2 Teaching Step) of axis 2 Starting% MB2666.1 item from% MD70 to% MB267 stored value% MB266.0 method

(4) Saving Current Data

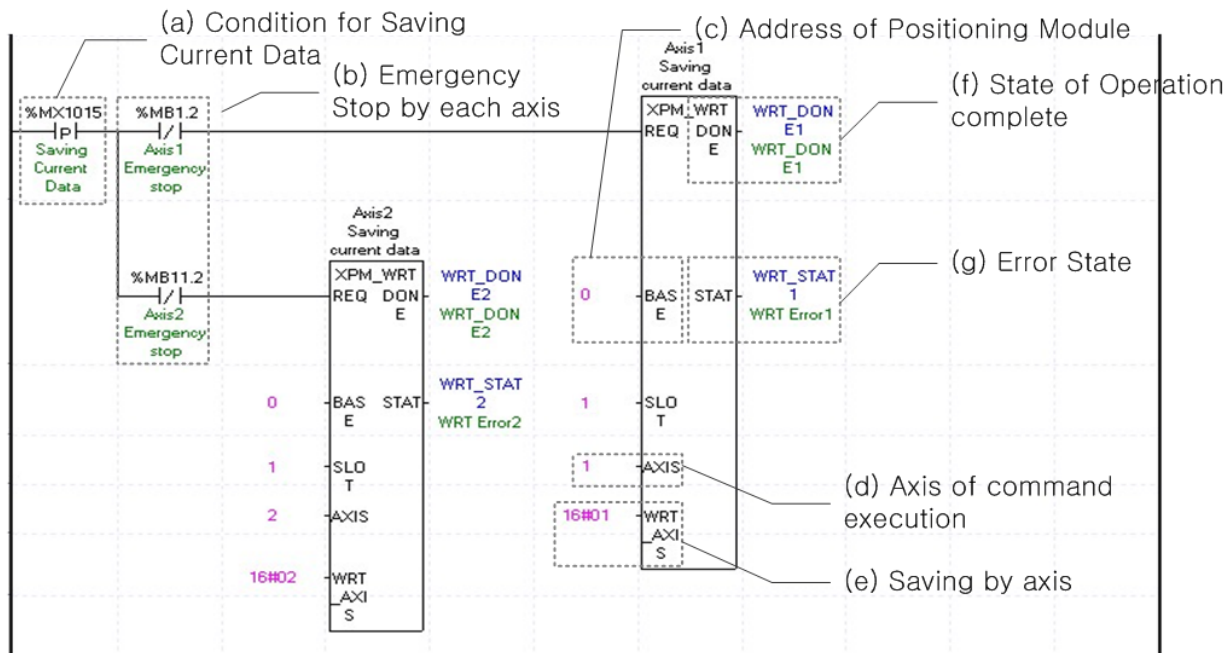

(a) Condition of Saving Current Data

The condition of saving current data command (XPM_WRT)

(b) Emergency Stop by each axis

According to exercise from “Chapter 8.1.2 Current State Reading,” it is a signal of “State of Emergency Stop” for each axis. It turns on when it is Emergency Stop. Emergency Stop can not be configured while it is running hence configuration will only be configured when it is not running.

(c) Address of Positioning Module

The high performance XEM embedded positioning is fixed on slot 1.

(d) Axis for command

If you want to make a command for each axis, you must set the axis on which to issue the command.

XEM-HP can control up to 6 axes and XEM-H2 can control up to 2 axes. In command, 1 ~ 6 refer to 1 ~ 6 axis.

(e) Saving axis

Sets the axis on which to execute the current data save command. Axis selection is set by setting each bit corresponding to axis as shown in the table below. Therefore, you can select and save multiple axes to be saved in one command without executing the commands for each axis like the example program. The current data (operation data, module parameters) of the axis on which the current data save instruction has been executed is stored in nonvolatile memory and is maintained even when power is not applied.

15 ~ 4 Bit	5Bit	4Bit	3Bit	2Bit	1Bit	0Bit
N/A	axis 6	axis 5	axis 4	axis 3	axis 2	axis 1

(f) Execution complete state

If the function block is completed without error, "1" is output and "1" is maintained until the next execution. If an error occurs, "0" is output.

(g) Error state

If an error occurs during execution of function block, error number is output

8.1.5 Positioning Operation

(1) Homing

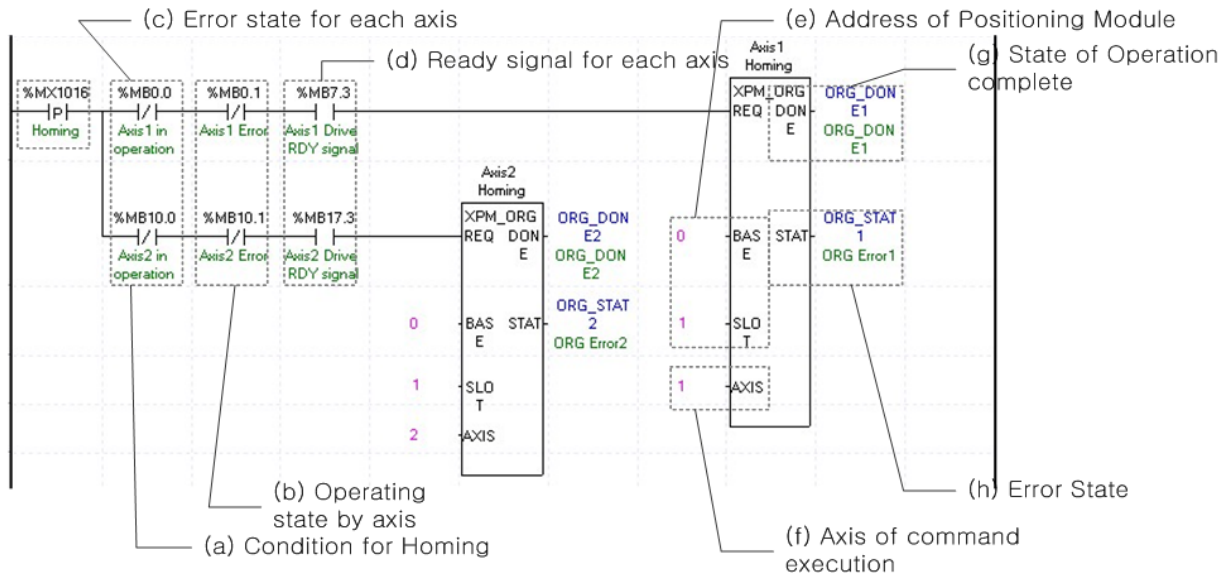

(a) Condition of homing

The condition of Homing command (XPM_ORG)

(b) Operating state of each axis

According to exercise from “Chapter 8.1.2 Current State Reading,” it is a signal of “Manual Operating” for each axis. It turns on when it is operating. Inching Operation can not be configured while it is running hence configuration will only be configured when it is not running.

(c) Error state for each axis

According to exercise from “Chapter 8.1.2 Current State Reading,” it is a signal of “Error state” for each axis. It turns on when an error occurred. Operation will only work when there is no error. If you want to operate a system regardless of errors, you can just inactivate the function.

(d) Ready signal for each axis

According to exercise from “Chapter 8.1.2 Current State Reading,” it is a signal of “Drive Ready” for each axis. This command only works when this is the condition for Drive Ready is on. If it is not set as “ON,” the “error 295” would be appeared.

(e) Address of Positioning Module

The high performance XEM embedded positioning is fixed on slot 1.

(f) Axis for command

If you want to make a command for each axis, you must set the axis on which to issue the command.

XEM-HP can control up to 6 axes and XEM-H2 can control up to 2 axes. In command, 1 ~ 6 refer to 1 ~ 6 axis.

(g) Execution complete state

If the function block is completed without error, “1” is output and “1” is maintained until the next execution. If an error occurs, “0” is output.

(h) Error state

If an error occurs during execution of function block, error number is output

(i) For more information, reference for Homing is in the “Chapter 9.1.Homing”

(2) Direct Start

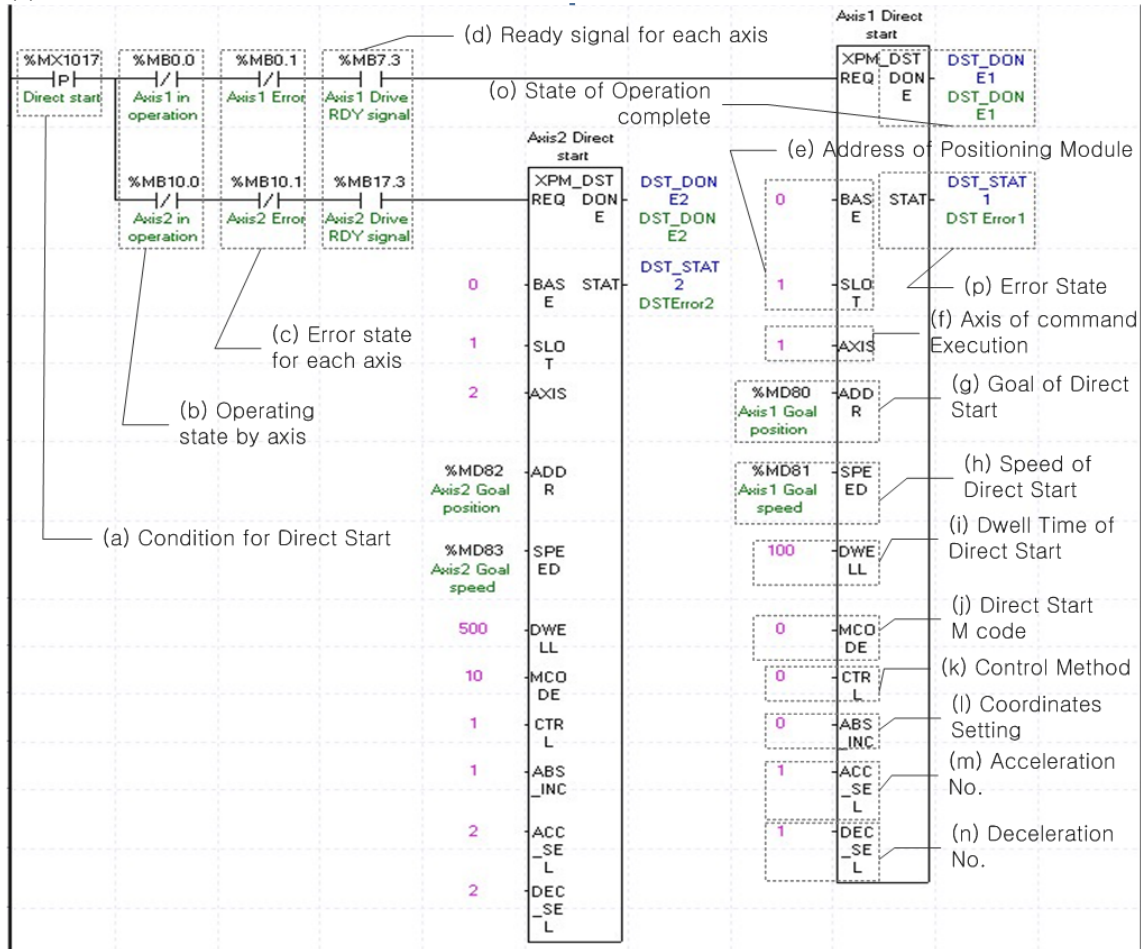

(a) Condition of Direct Start

The condition of Direct Start command (XPM_DST)

(b) Operating state of each axis

According to exercise from “Chapter 8.1.2 Current State Reading,” it is a signal of “Manual Operating” for each axis. It turns on when it is operating. Inching Operation can not be configured while it is running hence configuration will only be configured when it is not running.

(c) Error state for each axis

According to exercise from “Chapter 8.1.2 Current State Reading,” it is a signal of “Error state” for each axis. It turns on when an error occurred. Operation will only work when there is no error. If you want to operate a system regardless of errors, you can just inactivate the function.

(d) Ready signal for each axis

According to exercise from “Chapter 8.1.2 Current State Reading,” it is a signal of “Drive Ready” for each axis. This command only works when this is the condition for Drive Ready is on. If it is not set as “ON,” the “error 225” would be appeared.

(e) Address of Positioning Module

The high performance XEM embedded positioning is fixed on slot 1.

(f) Axis for command

If you want to make a command for each axis, you must set the axis on which to issue the command.

XEM-HP can control up to 6 axes and XEM-H2 can control up to 2 axes. In command, 1 ~ 6 refer to 1 ~ 6 axis.

Chapter 8 Program

- (g) Direct start target position
Decide changing position of Direct Start command. In this example above, the initialized value is "device," but you can also change it with "real numbers," which data type is "DINT."
- (h) Direct start target speed
Decide goal speed of Direct Start. In this example above, the initialized value is "device," but you can also change it with "real numbers," which data type is "UDINT."
- (i) Dwell time of Direct Start
Dwell Time consider as a total amount of time from beginning of Direct Start operation that reach to the goal position and make output of Positioning Done Signal. That means after done its operation, direct Start will make a Positioning done signal. Its unit is "ms," and type is "UINT"
- (j) Direct Start M code
You can set a value of M code which are displaying of Operating Parameter by Direct Start. The way of M code outputs are "Parameter Expansion, M code Mode," within the "None, With, After." It will make an M code besides you choose "None" for its parameter. For more information, reference for M code is in the "Chapter 4.3.2"
- (k) Control Method
Set direct start control method. Perform the following operation according to the setting value.
0: Position Control
1: Speed Control
2: Feed Control
- (l) Coordinate Setting
Set direct start operation coordinates. Perform the following operation according to the setting value.
0: Absolute
1: Relative
- (m) Acceleration time number
Sets the acceleration time number for positioning control. Depending on the set value, acceleration is executed at the corresponding acceleration time of the basic parameter.
0: Acceleration time 1
1: Acceleration time 2
2: Acceleration time 3
3: Acceleration time 4
- (n) Deceleration time number
0: Deceleration time 1
1: Deceleration time 2
2: Deceleration time 3
3: Deceleration time 4
- (o) Execution complete state
If the function block is completed without error, "1" is output and "1" is maintained until the next execution. If an error occurs, "0" is output.
- (p) Error state
If an error occurs during execution of function block, error number is output
- (q) The function block used in the example is as follows.
Axis 1 Direct Start: Position control is performed with axis 1 target position% MD80 (axis 1 target position), target speed% MD81 (axis 1 target speed), dwell time 100 ms, M code 0, absolute coordinate, acceleration time 1.
Axis 2 Direct Start: Speed control is performed with axis 2 target position% MD82 (axis 2 target position), target speed% MD83 (axis 2 target speed), dwell time 500 ms, M code 10, relative coordinate, acceleration time 2,

(3) Indirect Start

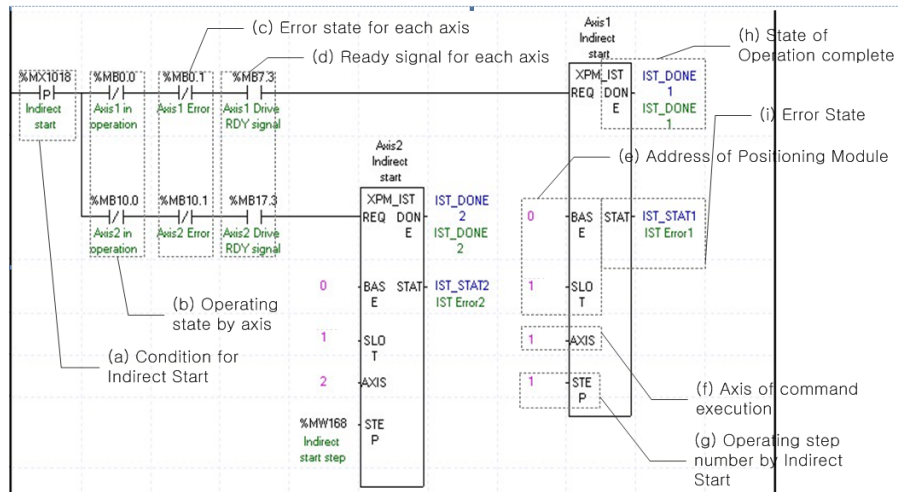

(a) Condition of Indirect Start

The condition of Indirect Start command (XPM_IST)

(b) Operating state of each axis

According to exercise from "Chapter 8.1.2 Current State Reading," it is a signal of "Manual Operating" for each axis. It turns on when it is operating. Inching Operation can not be configured while it is running hence configuration will only be configured when it is not running.

(c) Error state for each axis

According to exercise from "Chapter 8.1.2 Current State Reading," it is a signal of "Error state" for each axis. It turns on when an error occurred. Operation will only work when there is no error. If you want to operate a system regardless of errors, you can just inactivate the function.

(d) Ready signal for each axis

According to exercise from "Chapter 8.1.2 Current State Reading," it is a signal of "Drive Ready" for each axis. This command only works when this is the condition for Drive Ready is on. If it is not set as "ON," the "error 235" would be appeared.

(e) Address of Positioning Module

The high performance XEM embedded positioning is fixed on slot 1.

(f) Axis for command

If you want to make a command for each axis, you must set the axis on which to issue the command.

XEM-HP can control up to 6 axes and XEM-H2 can control up to 2 axes. In command, 1 ~ 6 refer to 1 ~ 6 axis.

(g) Step no. of executing Indirect Start

Set the step number of the operation data of the instruction axis to be executed by the indirect start instruction.

(h) Execution complete state

If the function block is completed without error, "1" is output and "1" is maintained until the next execution. If an error occurs, "0" is output.

(i) Error state

If an error occurs during execution of function block, error number is output

(j) Indirect start operates by appointing step of position data for each axis. Therefore it could run those commands of Positioning control, Speed control, Feed control, Linear circular interpolation depends on setting of positioning data. For more information, reference for Setting of Operating Data is in the "Chapter5.8."

(k) The function block used in the example is as follows.

Axis 1 Indirect start: Indirect start of axis 1 step 1 is executed.

Axis 2 indirect start: % MW168 (indirect start step) of axis 2 Execute step indirectly.

(4) Ellipse Interpolation

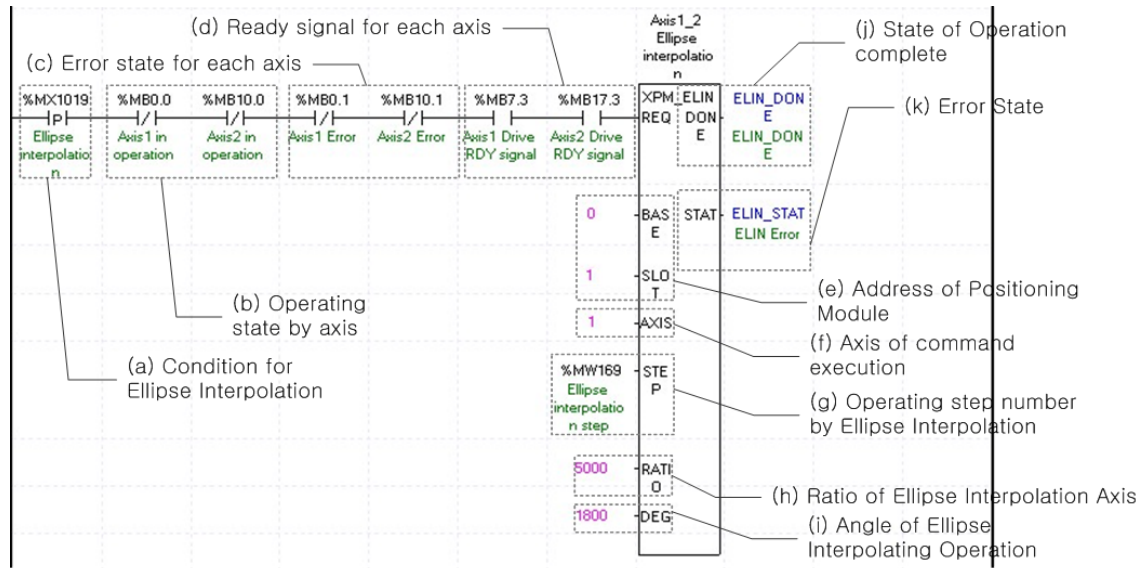

(a) Condition of Ellipse Interpolation

The condition of Ellipse Interpolation command (XPM_ELIN)

(b) Operating state of each axis

According to exercise from "Chapter 8.1.2 Current State Reading," it is a signal of "Manual Operating" for each axis. It turns on when it is operating. Inching Operation can not be configured while it is running hence configuration will only be configured when it is not running.

(c) Error state for each axis

According to exercise from "Chapter 8.1.2 Current State Reading," it is a signal of "Error state" for each axis. It turns on when an error occurred. Operation will only work when there is no error. If you want to operate a system regardless of errors, you can just inactivate the function.

(d) Ready signal for each axis

According to exercise from "Chapter 8.1.2 Current State Reading," it is a signal of "Drive Ready" for each axis. This command only works when this is the condition for Drive Ready is on. If a Drive Ready of main axis is not set as "ON," the "error 549" would be appeared and If a Drive Ready of subordinate axis is not set as "ON," the "error 550" would be appeared and

(e) Address of Positioning Module

The high performance XEM embedded positioning is fixed on slot 1.

(f) Axis for command

If you want to make a command for each axis, you must set the axis on which to issue the command.

XEM-HP can control up to 6 axes and XEM-H2 can control up to 2 axes. In command, 1 ~ 6 refer to 1 ~ 6 axis.

(g) Step no. of executing Ellipse Interpolation

Set the step number of the operation data of the instruction axis to be executed by the ellipse interpolation instruction.

The operation step of the sub-axis is the same as the operation step of the main axis.

(h) Ratio between ellipse interpolation axes

Set the ratio of the main axis to the subordinate axis in the circular interpolation trajectory set in the operation data.

That is, it is used to transform the arc locus into an elliptical locus using the ratio of the main axis to the vertical axis. The unit is $[X10^{-2}\%]$. For details on the operation of elliptic interpolation, refer to "9.2.13 elliptic interpolation control".

(i) Ellipse interpolation operation angle

Sets the angle to be driven by ellipse interpolation. The unit is $[X10^{-1} \text{ degree}]$. For details on the operation of ellipse interpolation, refer to "9.2.13 ellipse interpolation control".

(j) Execution complete state

If the function block is completed without error, "1" is output and "1" is maintained until the next execution. If an error occurs, "0" is output.

(k) Error state

If an error occurs during execution of function block, error number is output

(l) The function block used in the example is as follows.

Axis 1_2 ellipse interpolation: Executes ellipse interpolation with axis ratio of 50% and size of 180% with axis 1 operation as main axis and axis 2 as sub-axis% MW169 (ellipse interpolation step)

(5) Simultaneous Start

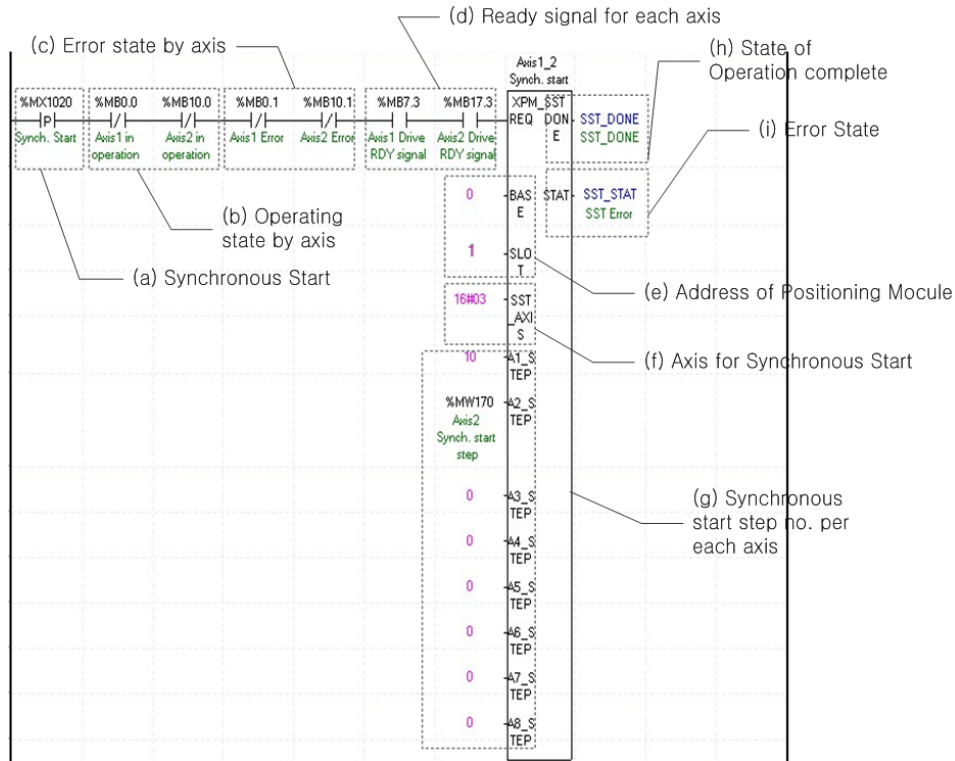

(a) Condition of Simultaneous Start

The condition of Simultaneous start (XPM_SST).

(b) Operating state of each axis

According to exercise from "Chapter 8.1.2 Current State Reading," it is a signal of "Manual Operating" for each axis. It turns on when it is operating. Inching Operation can not be configured while it is running hence configuration will only be configured when it is not running.

(c) Error state for each axis

According to exercise from "Chapter 8.1.2 Current State Reading," it is a signal of "Error state" for each axis. It turns on when an error occurred. Operation will only work when there is no error. If you want to operate a system regardless of errors, you can just inactivate the function.

(d) Ready signal for each axis

According to exercise from "Chapter 8.1.2 Current State Reading," it is a signal of "Drive Ready" for each axis. This command only works when this is the condition for Drive Ready is on. If it is not set as "ON," the "error 295" would be appeared.

(e) Address of Positioning Module

The high performance XEM embedded positioning is fixed on slot 1.

(f) Axis for simultaneous start

Sets simultaneous start axis. The simultaneous start axis is set by setting the bit corresponding to each axis of the word data to "1". The corresponding axis of Bit is as follows.

15 ~ 4 Bit	5Bit	4Bit	3Bit	2Bit	1Bit	0Bit
N/A	Axis 6	Axis 5	Axis4	Axis3	Axis2	Axis1

Since "16 # 03" is set in the example program, it is set to operate 1 axis and 2 axes simultaneously.

(g) Simultaneous start step number per axis

Set the step number to execute simultaneous start of each axis. Since high performance XEM-HP can control up to 6 axes,

A7_STEP ~ A8_STEP input is not used.

(h) Execution complete state

If the function block is completed without error, "1" is output and "1" is maintained until the next execution. If an error occurs, "0" is output.

(i) Error state

If an error occurs during execution of function block, error number is output

(j) The function block used in the example is as follows.

Axis 1_2 Simultaneous start: Executes the 10th operation step of axis 1 and % MW170 (axis 2 simultaneous start step) steps of axis 2 at the same time.

(6) Point Operation

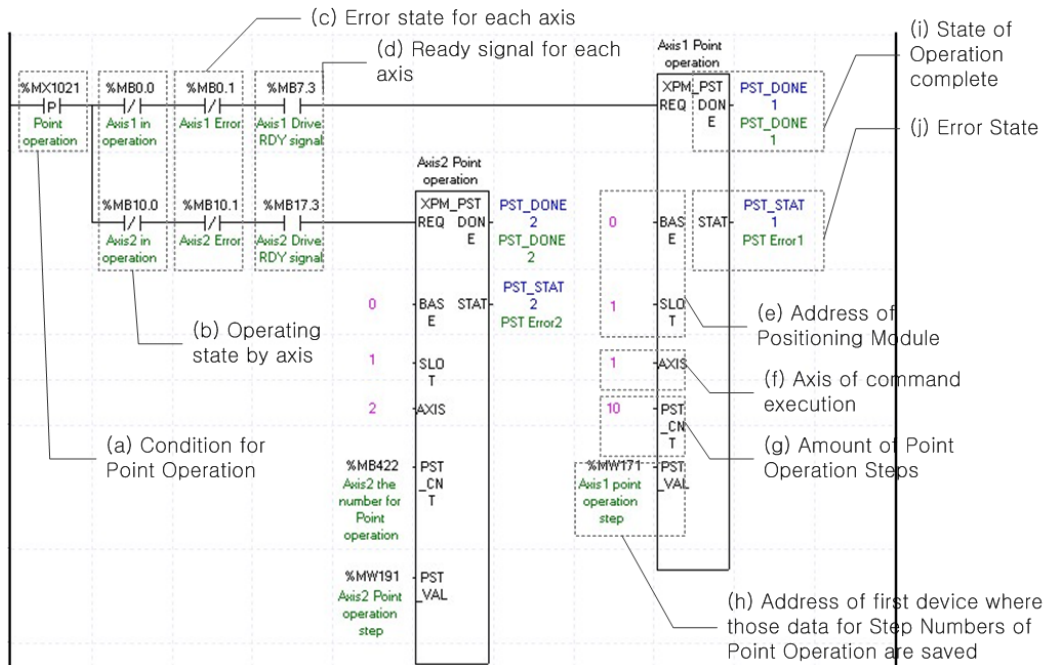

(a) Condition of Point Operation

The condition of Point Operation (XPM_PST)

(b) Operating state of each axis

According to exercise from "Chapter 8.1.2 Current State Reading," it is a signal of "Manual Operating" for each axis. It turns on when it is operating. Inching Operation can not be configured while it is running hence configuration will only be configured when it is not running.

(c) Error state for each axis

According to exercise from "Chapter 8.1.2 Current State Reading," it is a signal of "Error state" for each axis. It turns on when an error occurred. Operation will only work when there is no error. If you want to operate a system regardless of errors, you can just inactivate the function.

(d) Ready signal for each axis

According to exercise from "Chapter 8.1.2 Current State Reading," it is a signal of "Drive Ready" for each axis. This command only works when this is the condition for Drive Ready is on.

(e) Address of Positioning Module

In this example, Positioning Module is fixed at the 1 slot of 0 bases.

(f) Axis of command execution

You can set an axis for Parameter Setting. XEM-HP can control up to 6 axes and XEM-H2 can control up to 2 axes. In the "execution of axis" from the configuration of Parameter Setting, you can set a value for axis1 through axis6.

(g) Amount of Point Operation Steps

Decide how many steps will be operated. In this example above, 10 Point Operation steps are set in the axis1. Therefore, the step no. saved in %MW171 ~ %MW180 will be executed by point operation. For the details about point operation, refer to "(4) Point operation" of "9.2.17 Positioning start".

(h) Address of first device where those data for Step Numbers of Point Operation are saved

To execute a Point Operation, you need to set a specific value first. Point Operation Step Data will be set up depends on number of first device as below table.

Value	Device No.	Point Operating Step Data
1	Device + 0	Point Operating Step Data 1
2	Device + 1	Point Operating Step Data 2
3	Device + 2	Point Operating Step Data 3
4	Device + 3	Point Operating Step Data 4
5	Device + 4	Point Operating Step Data 5
6	Device + 5	Point Operating Step Data 6
7	Device + 6	Point Operating Step Data 7
8	Device + 7	Point Operating Step Data 8
9	Device + 8	Point Operating Step Data 9
10	Device + 9	Point Operating Step Data 10
11	Device + 10	Point Operating Step Data 11
12	Device + 11	Point Operating Step Data 12
13	Device + 12	Point Operating Step Data 13
14	Device + 13	Point Operating Step Data 14
15	Device + 14	Point Operating Step Data 15
16	Device + 15	Point Operating Step Data 16
17	Device + 16	Point Operating Step Data 17
18	Device + 17	Point Operating Step Data 18
19	Device + 18	Point Operating Step Data 19
20	Device + 19	Point Operating Step Data 20

(i) State of Operation complete

If function block is completed without error, "1" will be outputted and maintain "1" until the next operation. If error occurred, "0" will be outputted.

(j) Error State

This is the area that output error no. if there are errors in operation of function block.

(7) Speed Synchronization

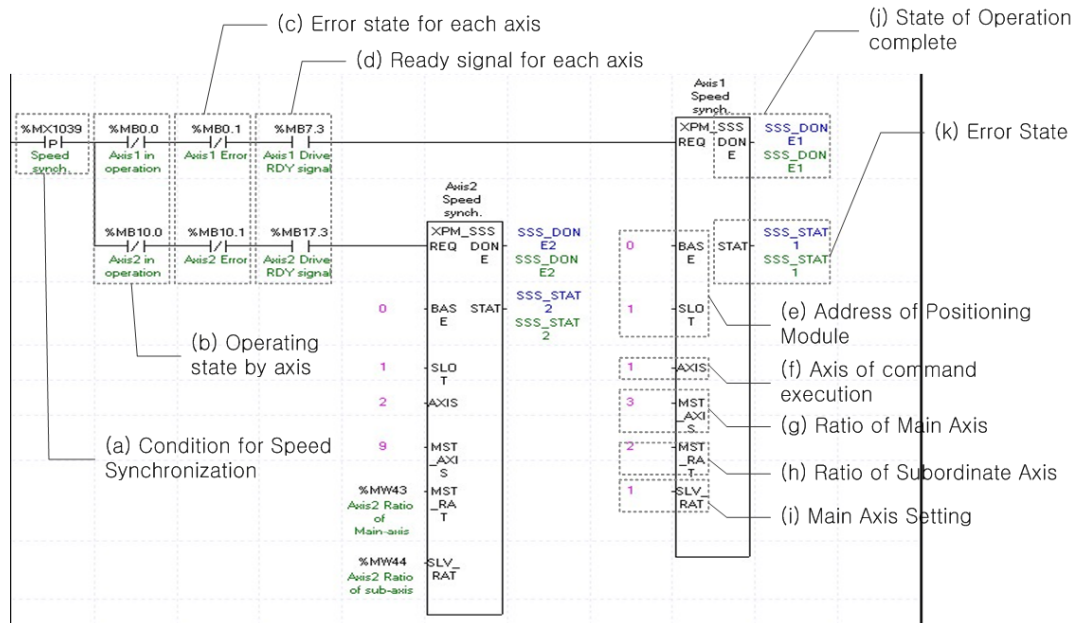

(a) This is the condition for Speed Synchronization

This is the condition for Speed Synchronization Command (XPM_SSS)

(b) Operating state by axis

According to exercise from "Chapter 8.1.2 Current State Reading," it is a signal of "Operating" for each axis. It turns on when it is operating. Operating Data Setting can not be configured while it is running hence configuration will only be configured when it is not running. If you execute Speed Synchronization while it is running, the "error 351" would be appeared.

(c) Error state for each axis

According to exercise from "Chapter 8.1.2 Current State Reading," it is a signal of "Error state" for each axis. It turns on when an error occurred. Operation will only work when there is no error. If you want to operate a system regardless of errors, you can just inactivate the function.

(d) Ready signal for each axis

According to exercise from "Chapter 8.1.2 Current State Reading," it is a signal of "Drive Ready" for each axis. This command only works when this is the condition for Drive Ready is on. If a Drive Ready of main axis is not set as "ON," the "error 354" would be appeared.

(e) Address of Positioning Module

In this example, Positioning Module is fixed at the 1 slot of 0 bases.

(f) Axis of command execution

You can set an axis for Parameter Setting. XEM-HP can control up to 6 axes and XEM-H2 can control up to 2 axes. In the "execution of axis" from the configuration of Parameter Setting, you can set a value for axis1 through axis6.

(g) Main Axis Setting

Set a main axis to operate Speed Synchronization. This setting is for main axis of Speed Synchronization. This setting cannot be set as same value as Axis of command execution, and possible setting values are as below.

(h) Ratio of Main Axis

Set value for Ratio of Main Axis to execute a Speed Synchronization.

(i) Ratio of Subordinate Axis

Set value for Ratio of Subordinate Axis to execute a Speed Synchronization. In this example above, the ratio of main and subordinate axis is 2:1. Meaning that operational speed ratio of those axis is 2 to 1. So, if main axis is operating in

speed of 10000, subordinate axis will be operating in speed of 5000.

Set value	Main Axis
1	Axis 1
2	Axis 2
3	Axis 3
4	Axis 4
5	Axis 5
6	Axis 6
7	-
8	-
9	Encoder1
10	Encoder2
11	Encoder3
12	Encoder4

(j) State of Operation complete

If function block is completed without error, "1" will be outputted and maintain "1" until the next operation. If error occurred, "0" will be outputted.

(k) Error State

This is the area that output error no. if there are errors in operation of function block.

(l) For more information, reference for Speed Synchronization is in the "Chapter 9.4.1."

(8) Position Assign Speed Synchronization

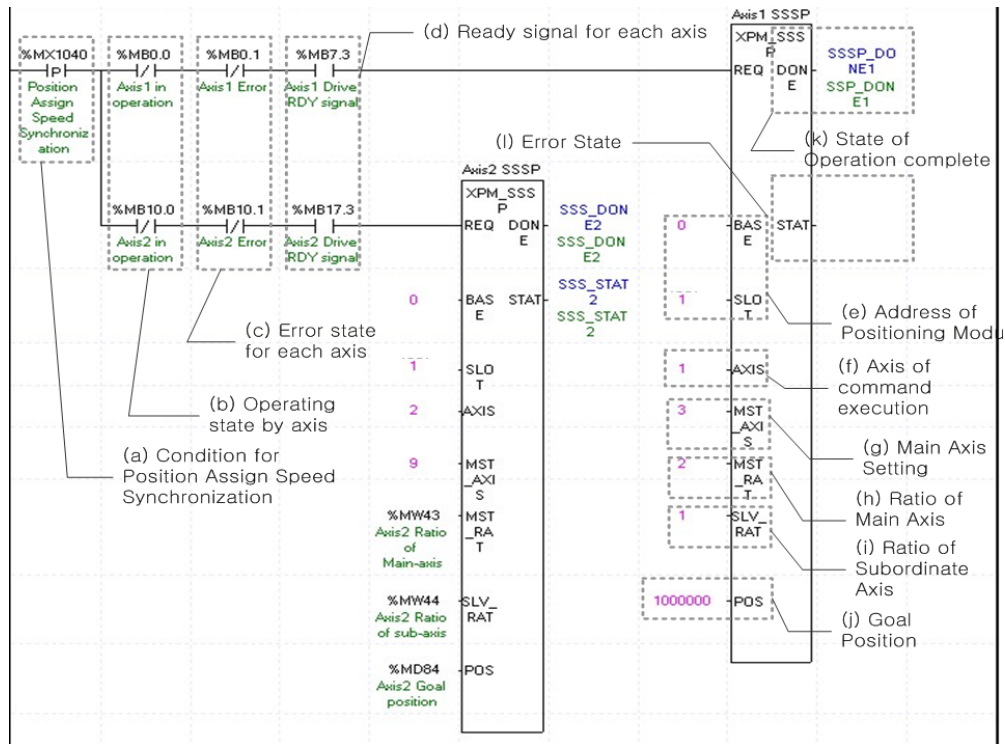

(a) This is the condition for Position Assign Speed Synchronization

This is the condition for Position Assign Speed Synchronization Command (XPM_SSSP)

(b) Operating state by axis

According to exercise from "Chapter 8.1.2 Current State Reading," it is a signal of "Operating" for each axis. It turns on when it is operating. Operating Data Setting can not be configured while it is running hence configuration will only be configured if it is not running. If you execute Position Assign Speed Synchronization while it is running, the "error 351" would be appeared.

(c) Error state for each axis

According to exercise from "Chapter 8.1.2 Current State Reading," it is a signal of "Error state" for each axis. It turns on when an error occurred. Operation will only work when there is no error. If you want to operate a system regardless of errors, you can just inactivate the function.

(d) Ready signal for each axis

According to exercise from "Chapter 8.1.2 Current State Reading," it is a signal of "Drive Ready" for each axis. This command only works when this is the condition for Drive Ready is on. If a Drive Ready of main axis is not set as "ON," the "error 354" would be appeared.

(e) Address of Positioning Module

In this example, Positioning Module is fixed at the 1 slot of 0 bases.

(f) Axis of command execution

You can set an axis for Parameter Setting. XEM-HP can control up to 6 axes and XEM-H2 can control up to 2 axes. In the "execution of axis" from the configuration of Parameter Setting, you can set a value for axis1 through axis6.

(g) Main Axis Setting

Set a main axis to operate Speed Synchronization. This setting is for main axis of Speed Synchronization. This setting cannot be set as same value as Axis of command execution, and possible setting values are as below.

(h) Ratio of Main Axis

Set value for Ratio of Main Axis to execute a Speed Synchronization.

(i) Ratio of Subordinate Axis

Set value for Ratio of Subordinate Axis to execute a Speed Synchronization. In this example above, the ratio of main and subordinate axis is 2:1. Meaning that operational speed ratio of those axes are 2 to 1. So, if main axis is operating in speed of 10000, subordinate axis will be operating in speed of 5000.

Set value	Main Axis
1	Axis 1
2	Axis 2
3	Axis 3
4	Axis 4
5	Axis 5
6	Axis 6
7	-
8	-
9	Encoder1
10	Encoder2
11	Encoder3
12	Encoder4

(j) Goal Position

Set goal of Position Assign Speed Synchronization. Once Axis of command execution reaches the goal position, Speed Synchronization ends and operation will be stop immediately.

(k) State of Operation complete

If function block is completed without error, "1" will be outputted and maintain "1" until the next operation. If error occurred, "0" will be outputted.

(l) Error State

This is the area that output error no. if there are errors in operation of function block.

(m) For more information, reference for Position Assign Speed Synchronization is in the "Chapter 9.4.1."

(9) Synchronous Start by Position

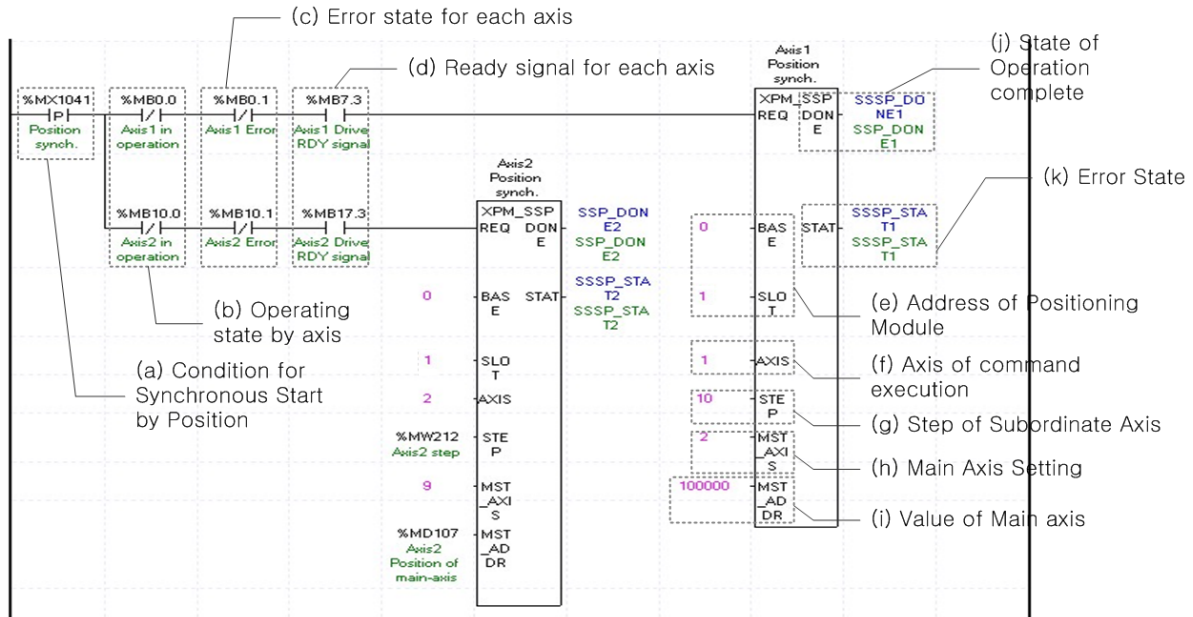

(a) This is the condition for Synchronous Start by Position

This is the condition for Synchronous Start by Position Command (XPM_SSP)

(b) Operating state by axis

According to exercise from "Chapter 8.1.2 Current State Reading," it is a signal of "Operating" for each axis. It turns on when it is operating. Operating Data Setting can not be configured while it is running hence configuration will only be configured when it is not running. If you execute Synchronous Start by Position while it is running, the "error 341" would be appeared.

(c) Error state for each axis

According to exercise from "Chapter 8.1.2 Current State Reading," it is a signal of "Error state" for each axis. It turns on when an error occurred. Operation will only work when there is no error. If you want to operate a system regardless of errors, you can just inactivate the function.

(d) Ready signal for each axis

According to exercise from "Chapter 8.1.2 Current State Reading," it is a signal of "Drive Ready" for each axis. This command only works when this is the condition for Drive Ready is on. If a Drive Ready of main axis is not set as "ON," the "error 354" would be appeared.

(e) Address of Positioning Module

In this example, Positioning Module is fixed at the 1 slot of 0 bases.

(f) Axis of command execution

You can set an axis for Parameter Setting. XEM-HP can control up to 6 axes and XEM-H2 can control up to 2 axes. In the "execution of axis" from the configuration of Parameter Setting, you can set a value for axis1 through axis6.

(g) Step of Subordinate Axis

Set step number for Subordinate Axis to execute a Speed Synchronization.

(h) Main Axis Setting

Set a main axis to operate Speed Synchronization. This setting is for main axis of Speed Synchronization.

This setting cannot be set as same value as Axis of command execution, and possible setting values are as below.

(i) Value of Main Axis

Set value for Main Axis to execute Synchronous Start by Position. Therefore main axis will be executed the command when the subordinate axis reaches this set value.

Set value	Main Axis
1	Axis 1
2	Axis 2
3	Axis 3
4	Axis 4
5	Axis 5
6	Axis 6
7	-
8	-
9	Encoder1
10	Encoder2
11	Encoder3
12	Encoder4

(j) State of Operation complete

If function block is completed without error, "1" will be outputted and maintain "1" until the next operation. If error occurred, "0" will be outputted.

(k) Error State

This is the area that output error no. if there are errors in operation of function block.

(l) For more information, reference for Synchronous Start by Position is in the "Chapter 9.4.2."

(10) CAM Operation

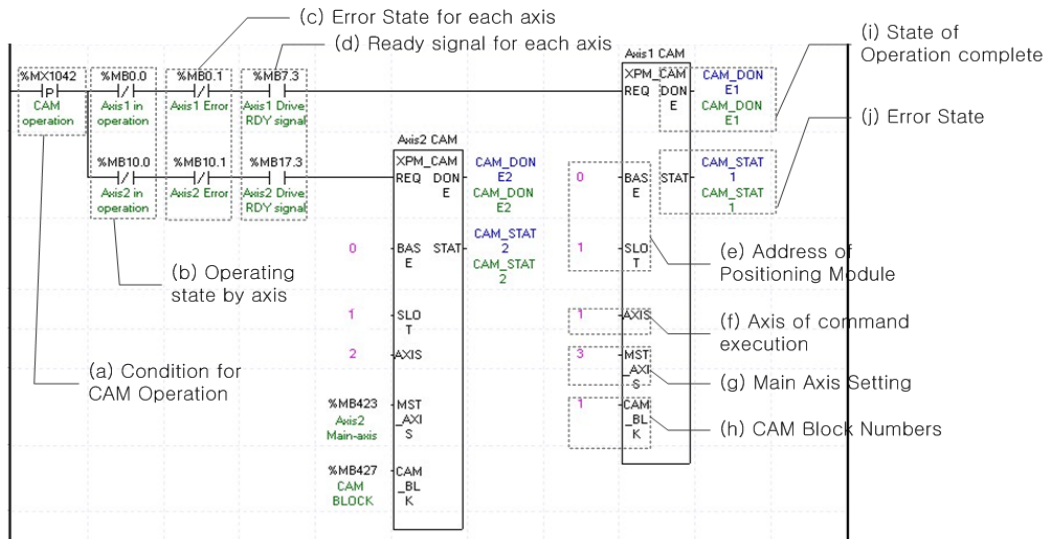

(a) This is the condition for CAM Operation

This is the condition for CAM Operation Command (XPM_CAM)

(b) Operating state by axis

According to exercise from "Chapter 8.1.2 Current State Reading," it is a signal of "Operating" for each axis. It turns on when it is operating. Operating Data Setting can not be configured while it is running hence configuration will only be configured when it is not running. If you execute CAM Operation while it is running, the "error 701" would be appeared.

(c) Error state for each axis

According to exercise from "Chapter 8.1.2 Current State Reading," it is a signal of "Error state" for each axis. It turns on when an error occurred. Operation will only work when there is no error. If you want to operate a system regardless of errors, you can just inactivate the function.

(d) Ready signal for each axis

According to exercise from "Chapter 8.1.2 Current State Reading," it is a signal of "Drive Ready" for each axis. This command only works when this is the condition for Drive Ready is on. If a Drive Ready of main axis is not set as "ON," the "error 703" would be appeared.

(e) Address of Positioning Module

In this example, Positioning Module is fixed at the 1 slot of 0 bases.

(f) Axis of command execution

You can set an axis for Parameter Setting. XEM-HP can control up to 6 axes and XEM-H2 can control up to 2 axes. In the "execution of axis" from the configuration of Parameter Setting, you can set a value for axis1 through axis6.

(g) Main Axis Setting

Setting of main axis to operate. This setting is for main axis of CAM Operating. This setting cannot be set as same value as Axis of command execution. Can set a value 1~6, meaning from axis1 to axis 6 and set a value 9~12, meaning from encoder 1 to encoder 4

(h) CAM Block Numbers

Setting for Block Numbers of CAM data to operate CAM operation. XEM-HP/H2 support 8 CAM Blocks. The CAM Data for each Block would be downloaded to module written from Software Package.

(i) Main Axis offset

In case main offset assigned CAM operation command(XPM_CAM0) Second axis set the main axis offset Starting position. When starting command, move to position set in main axis offset and then second axis start CAM operation.

(j) State of Operation complete

If function block is completed without error, "1" will be outputted and maintain "1" until the next operation. If error

occurred, "0" will be outputted.

(k) Error State

This is the area that output error no. if there are errors in operation of function block.

(l) For more information, reference of CAM Operation is in the "Chapter 9.4.3."

(11) Deceleration Stop

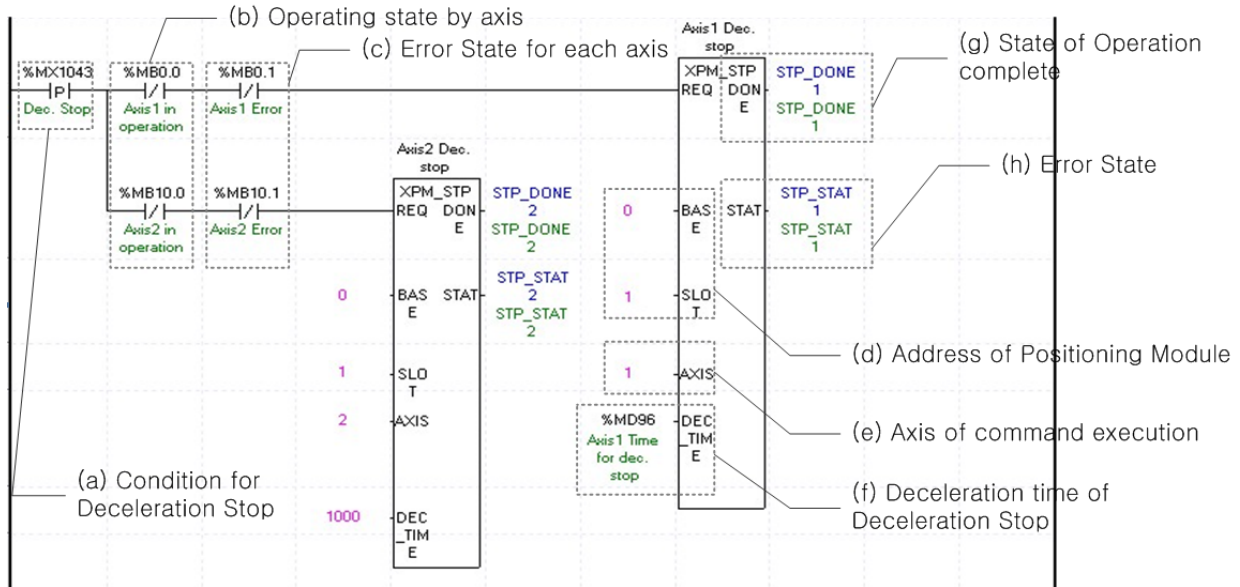

(a) This is the condition for Deceleration Stop

This is the condition for Deceleration Stop Command (XPM_STP)

(b) Operating state by axis

According to exercise from "Chapter 8.1.2 Current State Reading," it is a signal of "Operating" for each axis. It turns on when it is operating. Operating Data Setting can not be configured while it is running hence configuration will only be configured when it is not running.

(c) Error state for each axis

According to exercise from "Chapter 8.1.2 Current State Reading," it is a signal of "Error state" for each axis. It turns on when an error occurred. Operation will only work when there is no error. If you want to operate a system regardless of errors, you can just inactivate the function.

(d) Address of Positioning Module

In this example, Positioning Module is fixed at the 1 slot of 0 bases.

(e) Axis of command execution

You can set an axis for Parameter Setting. XEM-HP can control up to 6 axes and XEM-H2 can control up to 2 axes. In the "execution of axis" from the configuration of Parameter Setting, you can set a value for axis1 through axis6.

(f) Deceleration time of Deceleration Stop

Set a deceleration time of Deceleration Stop operation. Unit of Deceleration Stop is [ms]. Since this time refers deceleration time from the speed limit, there might be little difference between Deceleration Stop set time and actual stop time. The range of deceleration time is "0~2,147,483,674." 1~2,147,483,674 means Deceleration Time set as 1ms ~ 2,147483674ms. If it set as "0," it will be operated with set deceleration value. Also it use to stop Speed Synchronous Operation or CAM Operation while Speed and CAM Operation. During this time Deceleration Time is meaningless, CAM Operation Is just cancelled.

(g) State of Operation complete

If function block is completed without error, "1" will be outputted and maintain "1" until the next operation. If error occurred, "0" will be outputted.

(h) Error State

This is the area that output error no. if there are errors in operation of function block.

(i) For more information, reference of Deceleration Stop is in the "Chapter 9.2.18."

(j) Operation of each function block is as follows.

Axis1 Dec. Time : When axis1 is in operation, decelerate to %MD96(axis1 Dec. stop Time), then stop.

Axis2 Dec. Time : When axis 2 is in operation, decelerate to 1000ms, then stop.

(12) Emergency Stop

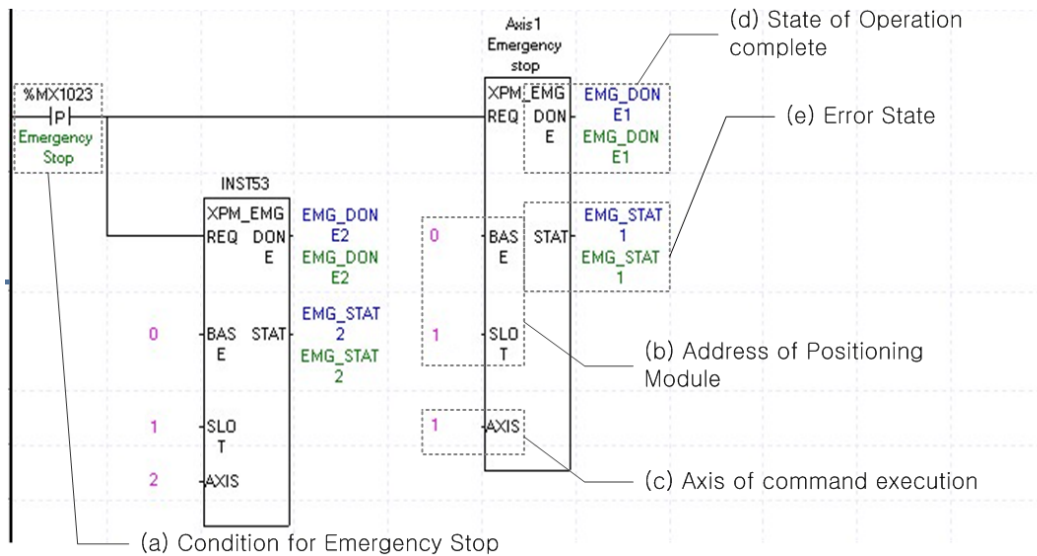

- (a) This is the condition for Emergency Stop
This is the condition for Emergency Stop Command (XPM_EMG)
- (b) Address of Positioning Module
In this example, Positioning Module is fixed at the 1 slot of 0 bases.
- (c) Axis of command execution
You can set an axis for Parameter Setting. XEM-HP can control up to 6 axes and XEM-H2 can control up to 2 axes. In the “execution of axis” from the configuration of Parameter Setting, you can set a value for axis1 through axis6.
- (d) State of Operation complete
If function block is completed without error, “1” will be outputted and maintain “1” until the next operation. If error occurred, “0” will be outputted.
- (e) Error State
This is the area that output error no. if there are errors in operation of function block.
- (f) Emergency Stop is operating by each axis.
Once Emergency Stop command executes the error “481” would be occurred. With the set value for deceleration time, it will be decelerated and stop the operation
- (g) For more information, reference of Emergency Stop is in the “Chapter 9.2.18.”

(13) M code Off

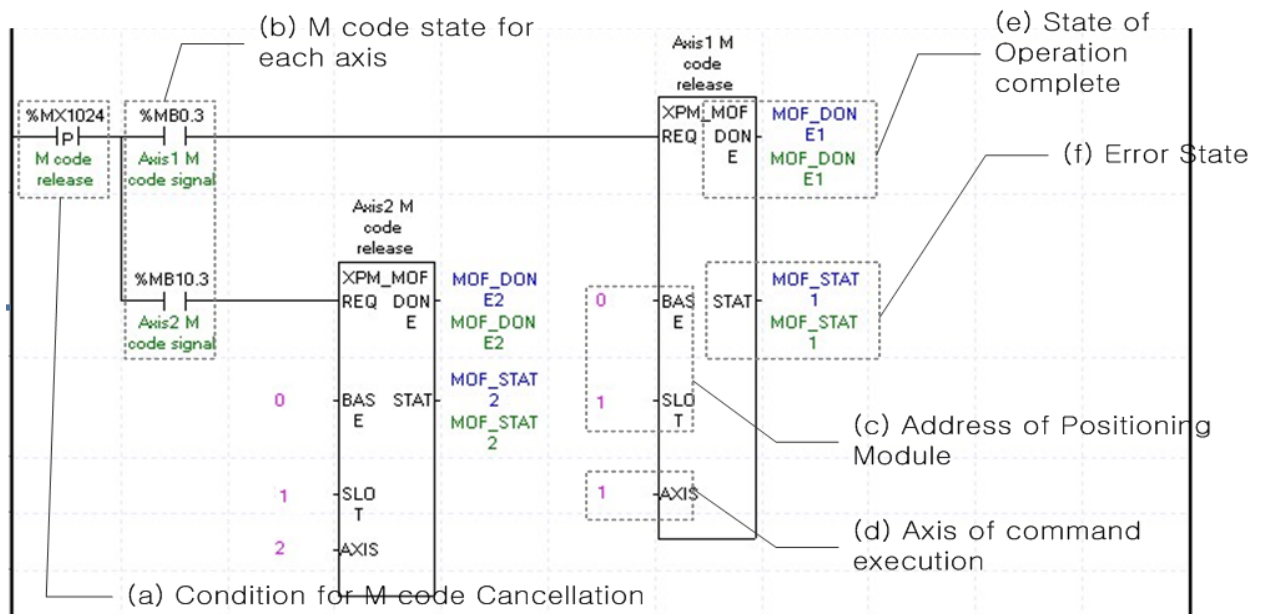

(a) This is the condition for M code Cancellation

This is the condition for M code Cancellation (XPM_MOF). Once M code Cancellation command executed, number of M code would be change to "0," and signal of M code to "Off."

(b) M code state for each axis

According to exercise from "Chapter 8.1.2 Current State Reading," it is a signal of "M Code" for each axis. It turns on when it is operating. M code Cancellation command can only be valid once M code are generated. The condition for execution is operation possible when it is "On."

(c) Address of Positioning Module

In this example, Positioning Module is fixed at the 1 slot of 0 bases.

(d) Axis of command execution

You can set an axis for Parameter Setting. XEM-HP can control up to 6 axes and XEM-H2 can control up to 2 axes. In the "execution of axis" from the configuration of Parameter Setting, you can set a value for axis1 through axis6.

(e) State of Operation complete

If function block is completed without error, "1" will be outputted and maintain "1" until the next operation. If error occurred, "0" will be outputted.

(f) Error State

This is the area that output error no. if there are errors in operation of function block.

(g) For more information, reference of M code Cancellation is in the "Chapter 9.6.2."

8.1.6 Operation Setting Change while Operating

(1) Speed Override

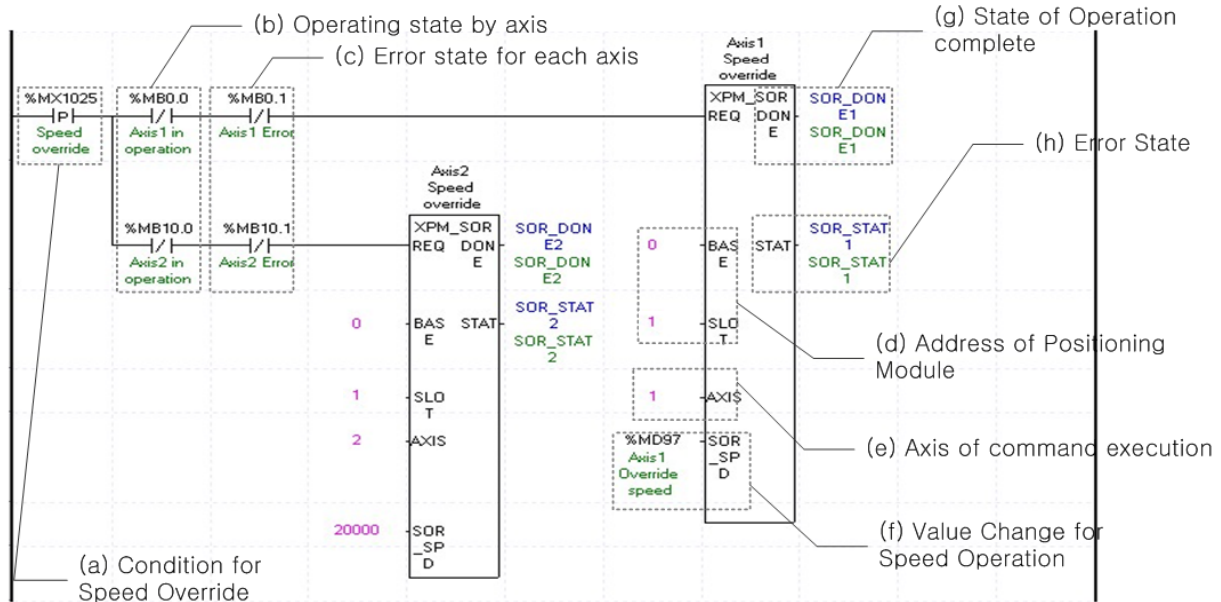

(a) This is the condition for Speed Override

This is the condition for Speed Override Command (XPM_SOR)

(b) Operating state by axis

According to exercise from "Chapter 8.1.2 Current State Reading," it is a signal of "Operating" for each axis. It turns on when it is operating. Operating Data Setting can not be configured while it is running hence configuration will only be configured when it is not running. If you execute Speed Override while it is running, the "error 371" would be appeared.

(c) Error state for each axis

According to exercise from "Chapter 8.1.2 Current State Reading," it is a signal of "Error state" for each axis. It turns on when an error occurred. Operation will only work when there is no error. If you want to operate a system regardless of errors, you can just inactivate the function.

(d) Address of Positioning Module

In this example, Positioning Module is fixed at the 1 slot of 0 bases.

(e) Axis of command execution

You can set an axis for Parameter Setting. XEM-HP can control up to 6 axes and XEM-H2 can control up to 2 axes. In the "execution of axis" from the configuration of Parameter Setting, you can set a value for axis1 through axis6.

(f) Value Change for Speed Operation

Set speed value. According to Speed Override from common parameters, it is a signal of "%" or "Speed Value" depends on setting of category. Also, when Speed Override set as Speed Value, it means Unit/Time depends on Speed Command Unit from basic parameters, or it means "rpm." If a changing Operation Speed Value is "%," then the unit would be $[X10^{-2}\%]$. If it is "rpm," then the unit would be $X10^{-1}\text{rpm}$.

(g) State of Operation complete

If function block is completed without error, "1" will be outputted and maintain "1" until the next operation. If error occurred, "0" will be outputted.

(h) Error State

This is the area that output error no. if there are errors in operation of function block.

(i) The function block in the example above is as follows.

Axis1 Speed Override : The operating speed of axis1 will be changed to speed value saved in %MD97 and then

continue to operate.

Axis2 Speed Override : The operating speed of axis2 will be changed to 20000 and then continue to operate.

(j) For more information, reference of Speed Override is in the "Chapter 9.5.5."

(2) Position Override

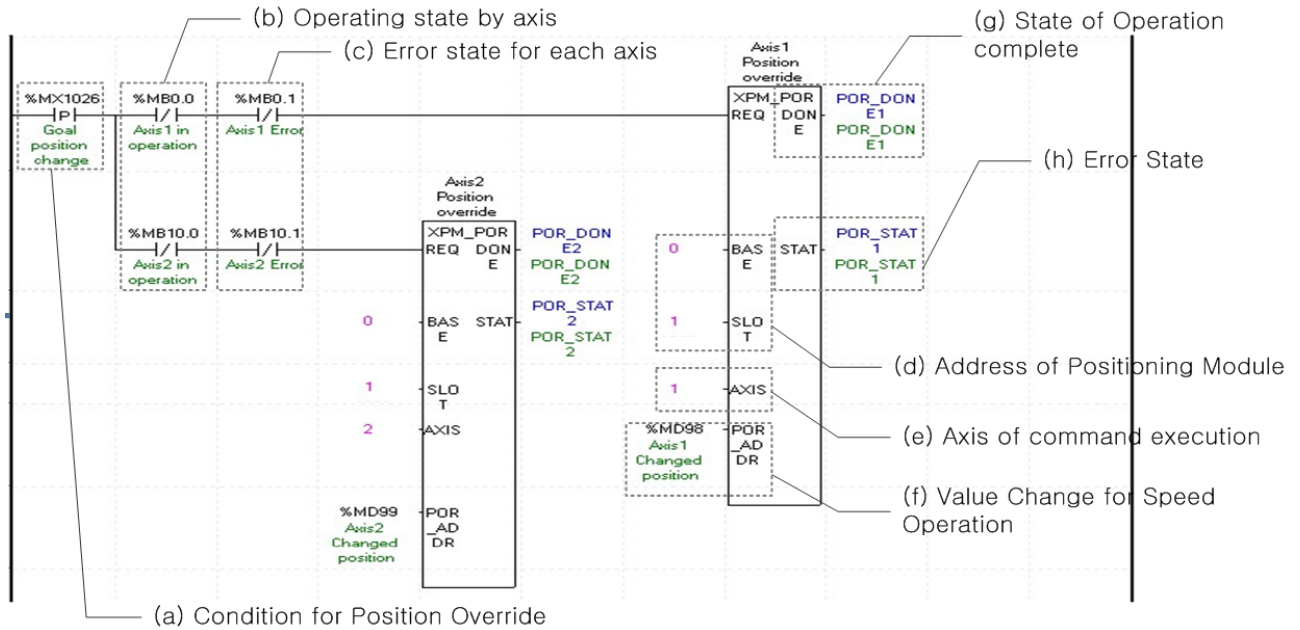

(a) This is the condition for Position Override

This is the condition for Position Override Command (XPM_POR)

(b) Operating state by axis

According to exercise from "Chapter 8.1.2 Current State Reading," it is a signal of "Operating" for each axis. It turns on when it is operating. Operating Data Setting can not be configured while it is running hence configuration will only be configured when it is not running. If you execute Position Override while it is running, the "error 361" would be appeared.

(c) Error state for each axis

According to exercise from "Chapter 8.1.2 Current State Reading," it is a signal of "Error state" for each axis. It turns on when an error occurred. Operation will only work when there is no error. If you want to operate a system regardless of errors, you can just inactivate the function.

(d) Address of Positioning Module

In this example, Positioning Module is fixed at the 1 slot of 0 bases.

(e) Axis of command execution

You can set an axis for Parameter Setting. XEM-HP can control up to 6 axes and XEM-H2 can control up to 2 axes. In the "execution of axis" from the configuration of Parameter Setting, you can set a value for axis1 through axis6.

(f) Change for Goal Position Value

Setting Value Change for Goal Position Value. The unit of this value depends on "Unit" category. Once Position Override commands are executed, the goal position of executed axis will be changed to set goal position.

(g) State of Operation complete

If function block is completed without error, "1" will be outputted and maintain "1" until the next operation. If error occurred, "0" will be outputted.

(h) Error State

This is the area that output error no. if there are errors in operation of function block.

(i) The function block in the example above is as follows.

Axis1 Position Override : Goal position of axis1 is changed to the value saved in %MD98.

Axis2 Position Override : Goal position of axis2 is changed to the value saved in %MD99.

(j) For more information, reference of Position Override is in the "Chapter 9.5.4."

(3) Position Assign Speed Override

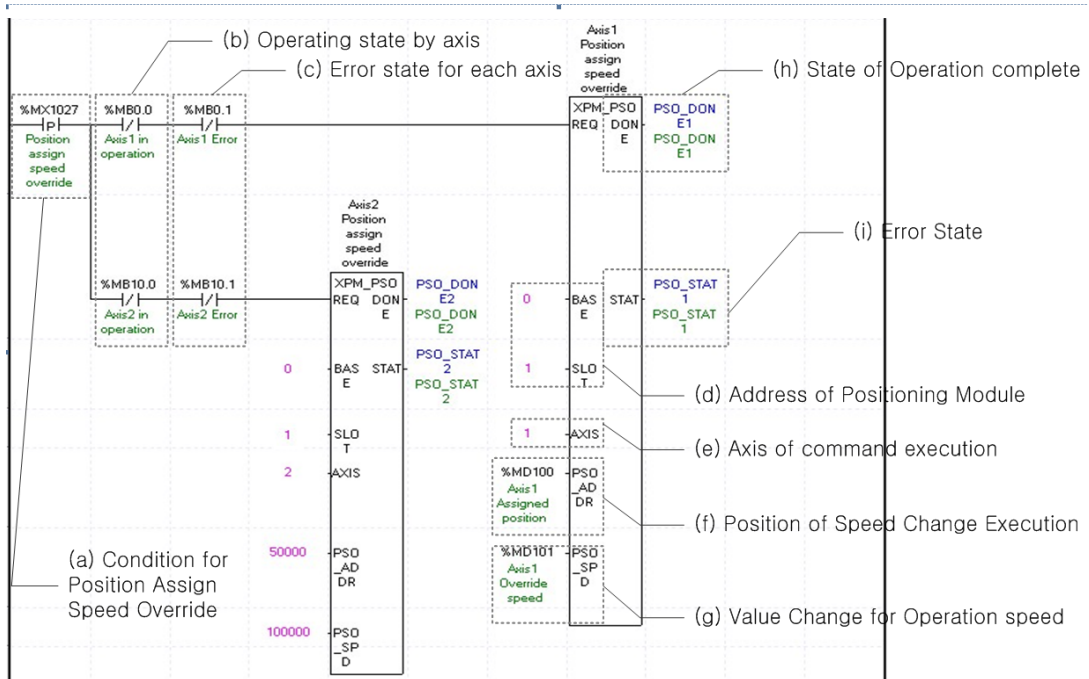

(a) This is the condition for Position Assign Speed Override

This is the condition for Position Assign Speed Override Command (XPM_PSO)

(b) Operating state by axis

According to exercise from “Chapter 8.1.2 Current State Reading,” it is a signal of “Operating” for each axis. It turns on when it is operating. Operating Data Setting can not be configured while it is running hence configuration will only be configured when it is not running. If you execute Position Assign Speed Override while it is running, the “error 381” would be appeared.

(c) Error state for each axis

According to exercise from “Chapter 8.1.2 Current State Reading,” it is a signal of “Error state” for each axis. It turns on when an error occurred. Operation will only work when there is no error. If you want to operate a system regardless of errors, you can just inactivate the function.

(d) Address of Positioning Module

In this example, Positioning Module is fixed at the 1 slot of 0 bases.

(e) Axis of command execution

You can set an axis for Parameter Setting. XEM-HP can control up to 6 axes and XEM-H2 can control up to 2 axes. In the “execution of axis” from the configuration of Parameter Setting, you can set a value for axis1 through axis6.

(f) Position of Speed Change Execution

Set the position of Speed Change. Once the actual position located at set position with speed override command running, the speed change commands are executed.

(g) Value Change for Operation speed

Set the Value Change for Operation speed. According to Speed Override from common parameters, it is a signal of “%” or “Speed Value” depends on setting of category. Also, when Speed Override set as Speed Value, it means Unit/Time depends on Speed Command Unit from basic parameters, or it means “rpm.” If a changing Operation Speed Value is “%,” then the unit would be [X10⁻²%]. If it is “rpm,” then the unit would be X10⁻¹rpm].

(h) State of Operation complete

If function block is completed without error, “1” will be outputted and maintain “1” until the next operation. If error occurred, “0” will be outputted.

(i) Error State

This is the area that output error no. if there are errors in operation of function block.

(j) The function block in the example above is as follows.

Axis1 Positioning Speed Override : When the current position of axis1 become the same position as the position saved in %MD100, the speed value will be changed to the speed saved in %MD92.

Axis2 Positioning Speed Override : When the current position of axis1 become 50000, the speed will be changed to 100000.

(k) For more information, reference of Position Assign Speed Override is in the "Chapter 9.5.6."

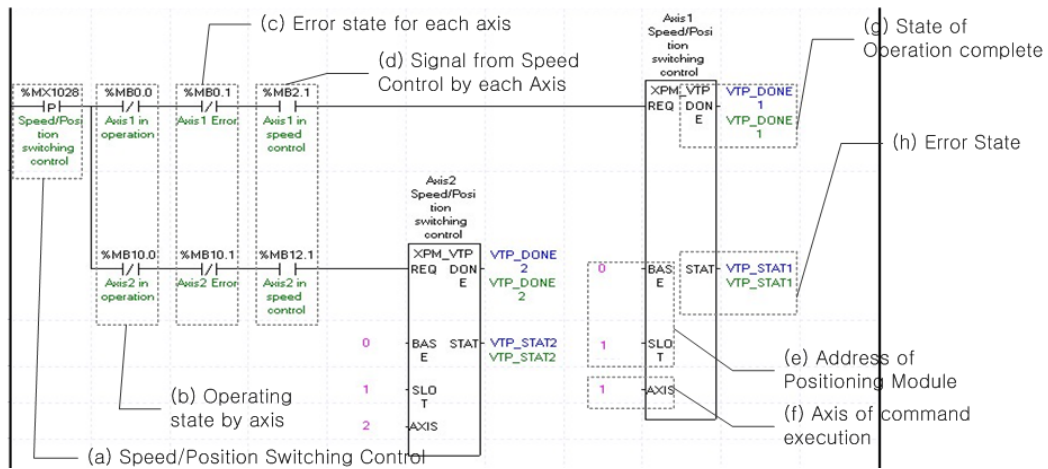
(4) Speed/Position Switching Control

(a) This is the condition for Speed/Position Switching Control

This is the condition for Speed/Position Switching Control Command (XPM_VTP)

(b) Operating state by axis

According to exercise from "Chapter 8.1.2 Current State Reading," it is a signal of "Operating" for each axis. It turns on when it is operating. Operating Data Setting can not be configured while it is running hence configuration will only be configured when it is not running. If you execute Speed/Position Switching Control while it is running, the "error 301" would be appeared.

(c) Error state for each axis

According to exercise from "Chapter 8.1.2 Current State Reading," it is a signal of "Error state" for each axis. It turns on when an error occurred. Operation will only work when there is no error. If you want to operate a system regardless of errors, you can just inactivate the function.

(d) Signal from Speed Control by each Axis

According to exercise from "Chapter 8.1.2 Current State Reading," it is a signal of "Speed Control state" for each axis. It turns on when it is operating. Speed/Position Switching Control Setting can only be configured while it is running. If you execute Speed/Position Switching Control while it is not running, the "error 302" would be appeared.

(e) Address of Positioning Module

In this example, Positioning Module is fixed at the 1 slot of 0 bases.

(f) Axis of command execution

You can set an axis for Parameter Setting. XEM-HP can control up to 6 axes and XEM-H2 can control up to 2 axes. In the "execution of axis" from the configuration of Parameter Setting, you can set a value for axis1 through axis6.

(g) State of Operation complete

If function block is completed without error, "1" will be outputted and maintain "1" until the next operation. If error occurred, "0" will be outputted.

(h) Error State

This is the area that output error no. if there are errors in operation of function block.

(5) Position-specified Speed/Position Control Switching

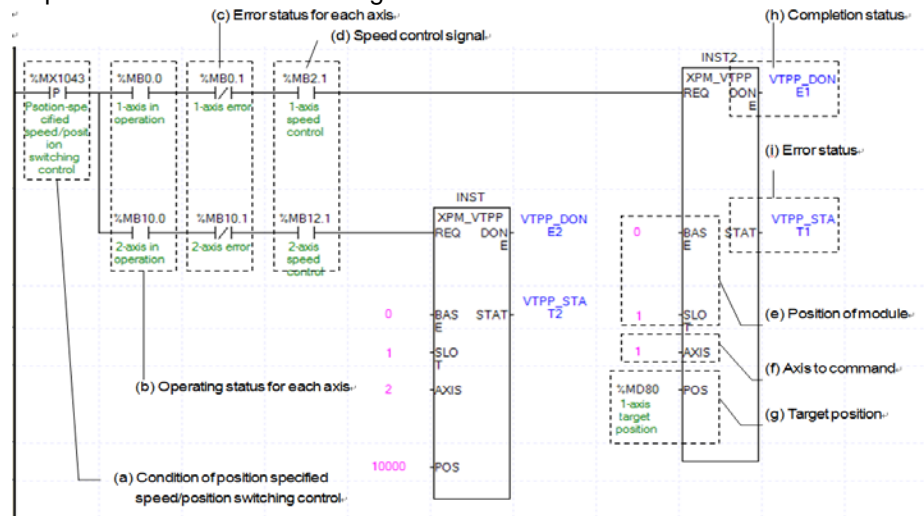

(a) Condition to perform “position-specified speed/position switching control”

Condition to perform control command (XPM_VTPP) for position-specified speed/position switching

(b) Operation state for each axis

In case that an example program of “8.1.2 Read Current State” is applied, it is a signal showing that each axis is “operating.” If a relevant axis is running, it becomes ‘On’. A condition has been set to make the control command for position specified speed/position switching valid only when the relevant axis is running. If the control command for position specified switching is carried out when the relevant axis is not running, No.301 Error will take place.

(c) Error State for each axis

In case that an example program of “8.1.2 Read Current State” is applied, it is a signal showing “Error State” for each axis. If any error takes place, it becomes ‘On’. A condition has been set to perform a control command only when there is no error with the relevant axis. If the user wants to execute a command regardless of the occurrence of errors, he/she may remove this condition.

(d) Speed Control Signal for each axis

In case that an example program of “8.1.2 Read Current State” is applied, it is a signal showing each axis is “controlling its speed.” If the relevant axis is running under speed control, it becomes ‘On.’ A condition has been set to make the control command for position specified speed/position switching control valid only when the relevant axis is in a speed control status. If the control command is carried out when the relevant axis is not in a speed control status, No.302 Error will take place.

(e) Position of a module

For the example program above, it is assumed that positioning modules are installed on NO.0 Base and No. 1 Slot.

(f) Axis to make a command

You can set an axis for Parameter Setting. XEM-HP can control up to 6 axes and XEM-H2 can control up to 2 axes. In the “execution of axis” from the configuration of Parameter Setting, you can set a value for axis1 through axis6.

(g) Transfer amount

After the control command for position specified speed/position control switching is executed, convert from speed control to position control and moves by transfer amount.

(h) Completion state

If any function block is completely executed without any error, it displays and maintains “1” until the next execution while it displays “0” if any error takes place.

(i) Error state

If any error takes place when any function block is executed, this area generates its error number.

(6) Position/ Speed Switching Control

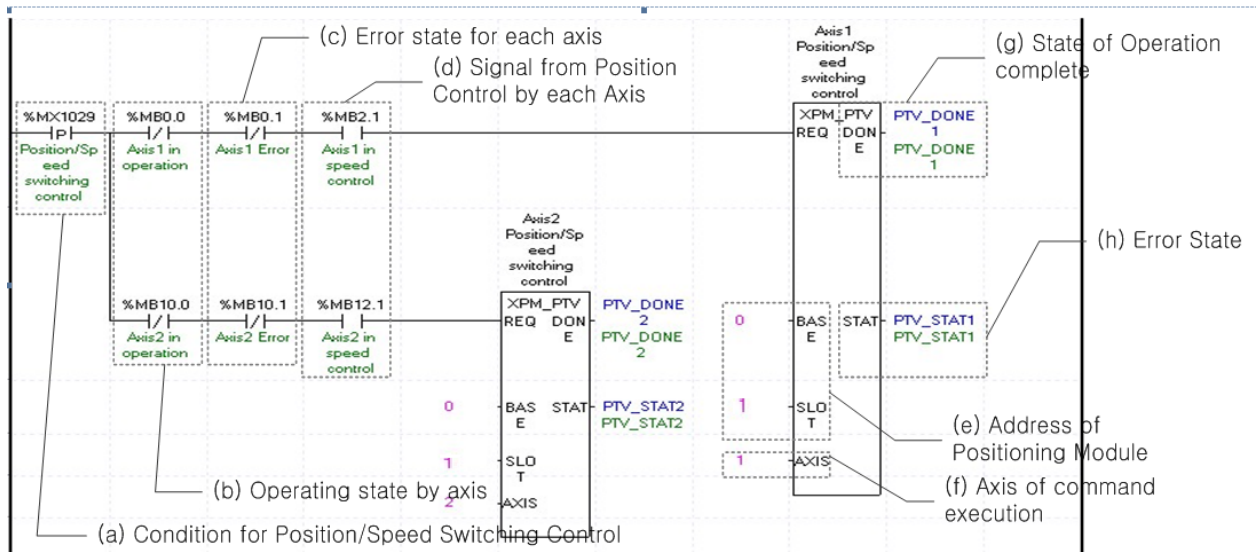

- (a) This is the condition for Position/ Speed Switching Control
This is the condition for Position/ Speed Switching Control Command (XPM_PTV)
- (b) Operating state by axis
According to exercise from “Chapter 8.1.2 Current State Reading,” it is a signal of “Operating” for each axis. It turns on when it is operating. Operating Data Setting can not be configured while it is running hence configuration will only be configured when it is not running. If you execute Position/ Speed Switching Control while it is running, the “error 311” would be appeared.
- (c) Error state for each axis
According to exercise from “Chapter 8.1.2 Current State Reading,” it is a signal of “Error state” for each axis. It turns on when an error occurred. Operation will only work when there is no error. If you want to operate a system regardless of errors, you can just inactivate the function.
- (d) Signal from Position Control by each Axis
According to exercise from “Chapter 8.1.2 Current State Reading,” it is a signal of “Position Control state” for each axis. It turns on when it is operating. Position/ Speed Switching Control Setting can only be configured while it is running. If you execute Position/Speed Switching Control while it is not running, the “error 317” would be appeared.
- (e) Address of Positioning Module
In this example, Positioning Module is fixed at the 1 slot of 0 bases.
- (f) Axis of command execution
You can set an axis for Parameter Setting. XEM-HP can control up to 6 axes and XEM-H2 can control up to 2 axes. In the “execution of axis” from the configuration of Parameter Setting, you can set a value for axis1 through axis6.
- (g) State of Operation complete
If function block is completed without error, “1” will be outputted and maintain “1” until the next operation. If error occurred, “0” will be outputted.
- (h) Error State
This is the area that output error no. if there are errors in operation of function block.

(7) Skip Operation

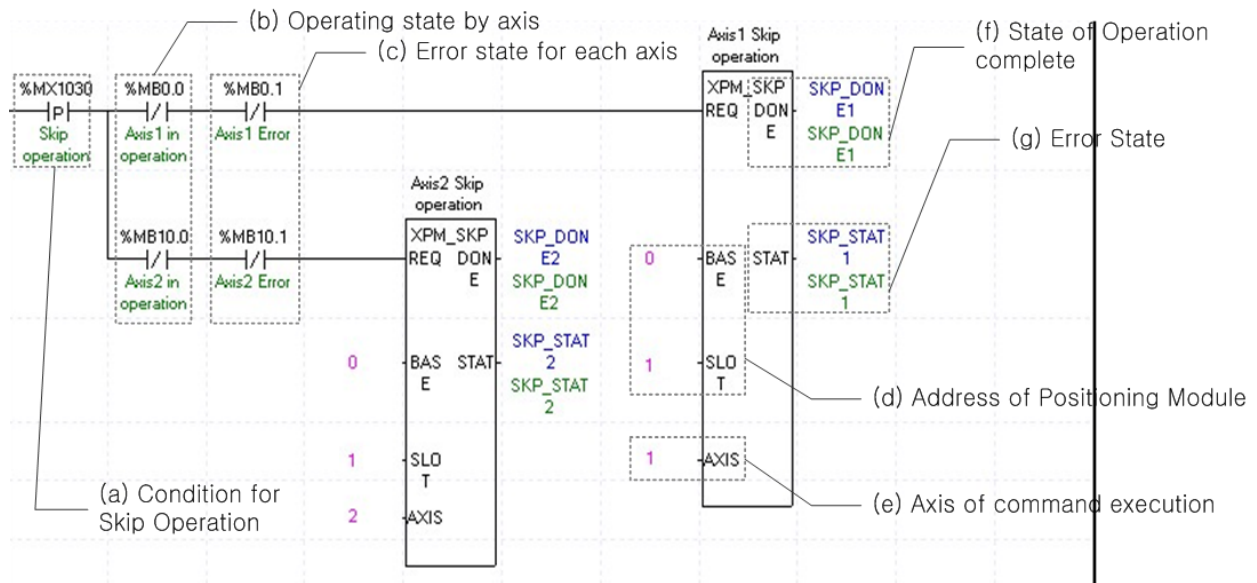

(a) This is the condition for Skip Operation

This is the condition for Skip Operation Command (XPM_SKP) Once Skip Operation is executed, current operation step is stop and will go to operate with next step.

(b) Operating state by axis

According to exercise from "Chapter 8.1.2 Current State Reading," it is a signal of "Operating" for each axis. It turns on when it is operating. Operating Data Setting can not be configured while it is running hence configuration will only be configured when it is not running. If you execute Skip Operation while it is running, the "error 331" would be appeared.

(c) Error state for each axis

According to exercise from "Chapter 8.1.2 Current State Reading," it is a signal of "Error state" for each axis. It turns on when an error occurred. Operation will only work when there is no error. If you want to operate a system regardless of errors, you can just inactivate the function.

(d) Address of Positioning Module

In this example, Positioning Module is fixed at the 1 slot of 0 bases.

(e) Axis of command execution

You can set an axis for Parameter Setting. XEM-HP can control up to 6 axes and XEM-H2 can control up to 2 axes. In the "execution of axis" from the configuration of Parameter Setting, you can set a value for axis1 through axis6.

(f) State of Operation complete

If function block is completed without error, "1" will be outputted and maintain "1" until the next operation. If error occurred, "0" will be outputted.

(g) Error State

This is the area that output error no. if there are errors in operation of function block.

(h) For more information, reference of Skip Operation is in the "Chapter 9.5.3."

(8) Continuous Operation

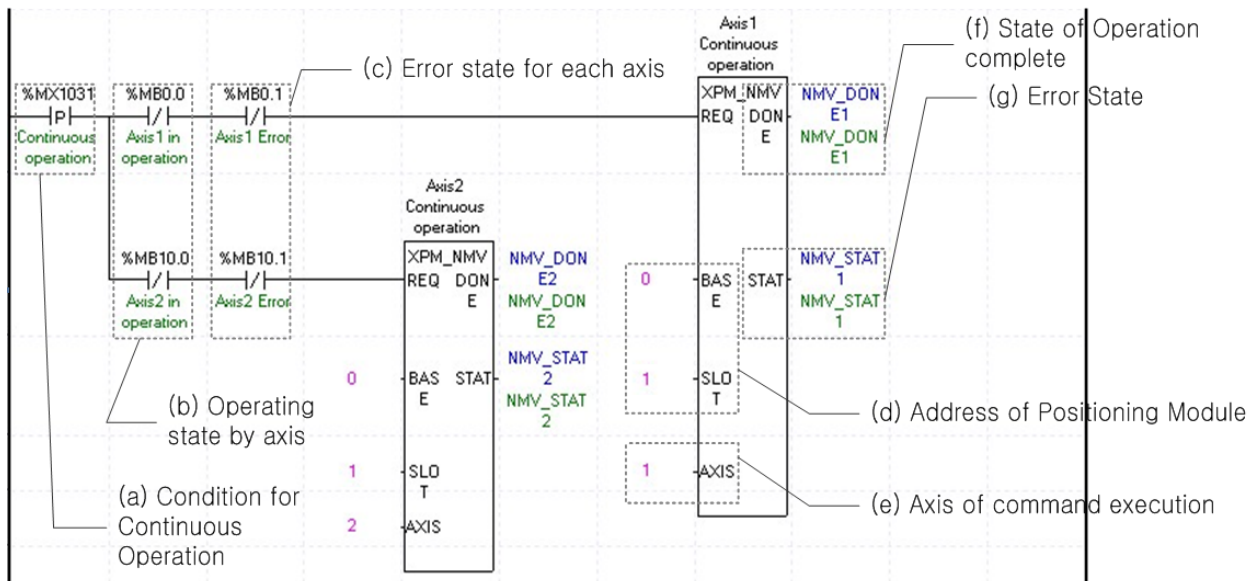

(a) This is the condition for Continuous Operation

This is the condition for Continuous Operation Command (XPM_NMV). Once Continuous Operation is executed, current operation step and next operation step would be operated continuously.

(b) Operating state by axis

According to exercise from "Chapter 8.1.2 Current State Reading," it is a signal of "Operating" for each axis. It turns on when it is operating. Operating Data Setting can not be configured while it is running hence configuration will only be configured when it is not running. If you execute Continuous Operation while it is running, the "error 391" would be appeared.

(c) Error state for each axis

According to exercise from "Chapter 8.1.2 Current State Reading," it is a signal of "Error state" for each axis. It turns on when an error occurred. Operation will only work when there is no error. If you want to operate a system regardless of errors, you can just inactivate the function.

(d) Address of Positioning Module

In this example, Positioning Module is fixed at the 1 slot of 0 bases.

(e) Axis of command execution

You can set an axis for Parameter Setting. XEM-HP can control up to 6 axes and XEM-H2 can control up to 2 axes. In the "execution of axis" from the configuration of Parameter Setting, you can set a value for axis1 through axis6.

(f) State of Operation complete

If function block is completed without error, "1" will be outputted and maintain "1" until the next operation. If error occurred, "0" will be outputted.

(g) Error State

This is the area that output error no. if there are errors in operation of function block.

(h) For more information, reference of Continuous Operation is in the "Chapter 9.5.2."

(9) Current Step Change (Start Step Number Change)

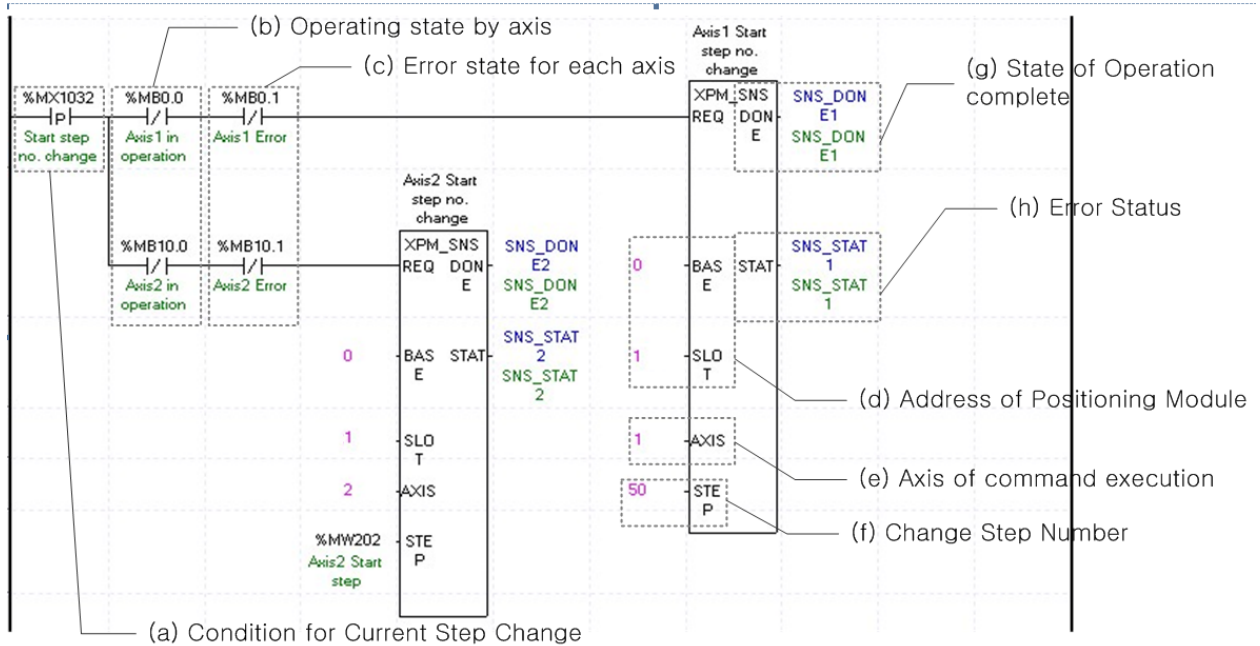

(a) This is the condition for Current Step Change

This is the condition for Current Step Change Command (XPM_SNS). Once Current Step Change is executed, current operation step will move set step.

(b) Operating state by axis

According to exercise from "Chapter 8.1.2 Current State Reading," it is a signal of "Operating" for each axis. It turns on when it is operating. Operating Data Setting can not be configured while it is running hence configuration will only be configured when it is not running. If you execute Current Step Change while it is running, the "error 441" would be appeared.

(c) Error state for each axis

According to exercise from "Chapter 8.1.2 Current State Reading," it is a signal of "Error state" for each axis. It turns on when an error occurred. Operation will only work when there is no error. If you want to operate a system regardless of errors, you can just inactivate the function.

(d) Address of Positioning Module

In this example, Positioning Module is fixed at the 1 slot of 0 bases.

(e) Axis of command execution

You can set an axis for Parameter Setting. XEM-HP can control up to 6 axes and XEM-H2 can control up to 2 axes. In the "execution of axis" from the configuration of Parameter Setting, you can set a value for axis1 through axis6.

(f) Change Step Number

Set change step number by Current Step Change. XEM-HP/H2 support 400 step operation data for each Axis. Therefore, the range of step number setting of Current Step Change is 1~400.

(g) State of Operation complete

If function block is completed without error, "1" will be outputted and maintain "1" until the next operation. If error occurred, "0" will be outputted.

(h) Error State

This is the area that output error no. if there are errors in operation of function block.

(i) For more information, reference of Current Step Change is in the "Chapter 9.5.9."

(10) Repeat Step No. Change

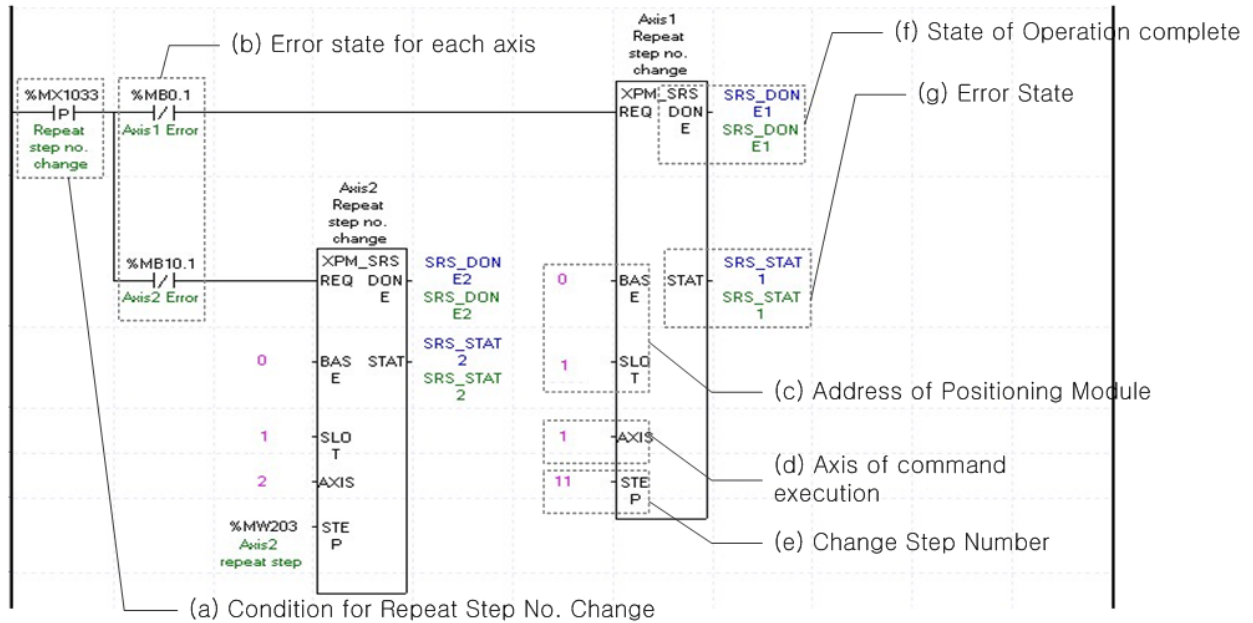

(a) This is the condition for Repeat Step No. Change

This is the condition for Repeat Step No. Change Command (XPM_SRS). Once Repeat Step No. Change is executed, current operation step will move set step. It will execute a operation when set of Operation Method is "Repeat."

(b) Error state for each axis

According to exercise from "Chapter 8.1.2 Current State Reading," it is a signal of "Error state" for each axis. It turns on when an error occurred. Operation will only work when there is no error. If you want to operate a system regardless of errors, you can just inactivate the function.

(c) Address of Positioning Module

In this example, Positioning Module is fixed at the 1 slot of 0 bases.

(d) Axis of command execution

You can set an axis for Parameter Setting. XEM-HP can control up to 6 axes and XEM-H2 can control up to 2 axes. In the "execution of axis" from the configuration of Parameter Setting, you can set a value for axis1 through axis6.

(e) Change Step Number

Set change step number by Current Step Change. XEM-HP/H2 support 400 step operation data for each Axis.

Therefore, the range of step number setting of Current Step Change is 1~400. In the example, Axis1 and axis2 are changed to step no.11 and step no. saved in %MW203.

(f) State of Operation complete

If function block is completed without error, "1" will be outputted and maintain "1" until the next operation. If error occurred, "0" will be outputted.

(g) Error State

This is the area that output error no. if there are errors in operation of function block.

(h) For more information, reference of Repeat Step No. Change is in the "Chapter 9.5.10."

(11) Current Position Preset

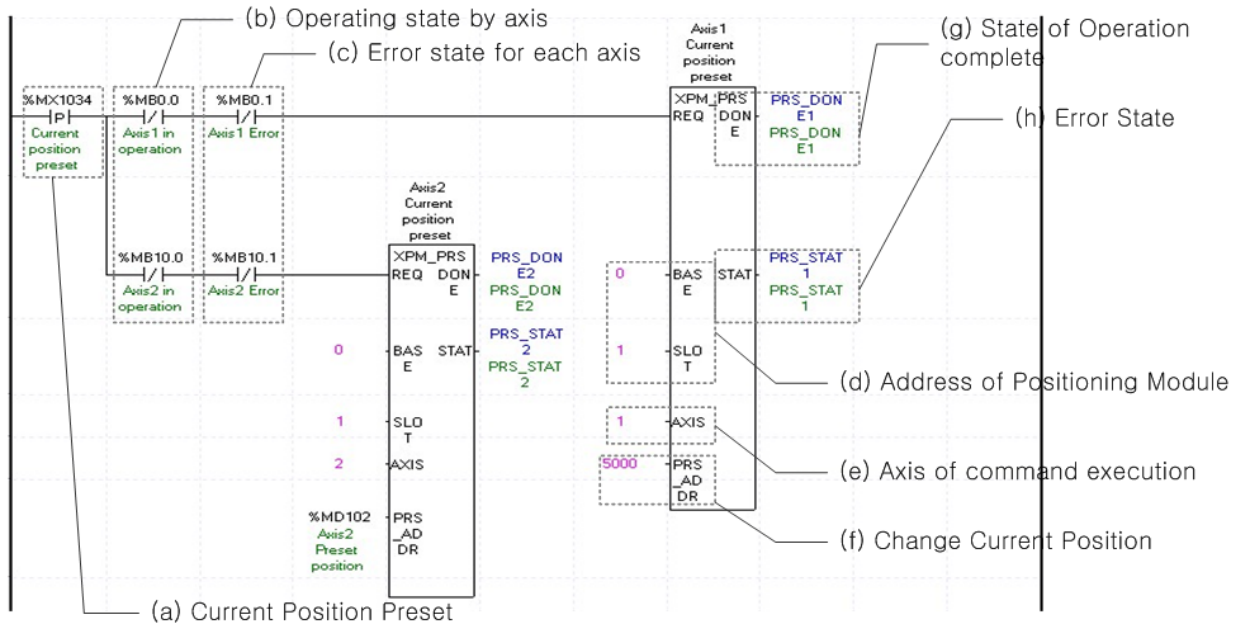

(a) This is the condition for Current Position Preset

This is the condition for Current Position Preset Command (XPM_PRS). Once Current Position Preset is executed, current operation step will move to set step. If the origin has not set yet, the origin would be set to origin decided.

(b) Operating state by axis

According to exercise from "Chapter 8.1.2 Current State Reading," it is a signal of "Operating" for each axis. It turns on when it is operating. Operating Data Setting can not be configured while it is running hence configuration will only be configured when it is not running. If you execute Current Position Preset while it is running, the "error 451" would be appeared.

(c) Error state for each axis

According to exercise from "Chapter 8.1.2 Current State Reading," it is a signal of "Error state" for each axis. It turns on when an error occurred. Operation will only work when there is no error. If you want to operate a system regardless of errors, you can just inactivate the function.

(d) Address of Positioning Module

In this example, Positioning Module is fixed at the 1 slot of 0 bases.

(e) Axis of command execution

You can set an axis for Parameter Setting. XEM-HP can control up to 6 axes and XEM-H2 can control up to 2 axes. In the "execution of axis" from the configuration of Parameter Setting, you can set a value for axis1 through axis6.

(f) Change Current Position

Set change current position by Current Position Preset. Unit follows the value from "Unit" of basic parameter. In the example, Axis1 and axis2 are changed to 5000 and the position saved in %MD102.

(g) State of Operation complete

If function block is completed without error, "1" will be outputted and maintain "1" until the next operation. If error occurred, "0" will be outputted.

(h) Error State

This is the area that output error no. if there are errors in operation of function block.

(i) For more information, reference of Current Position Preset is in the "Chapter 9.5.7."

(12) Encoder Preset

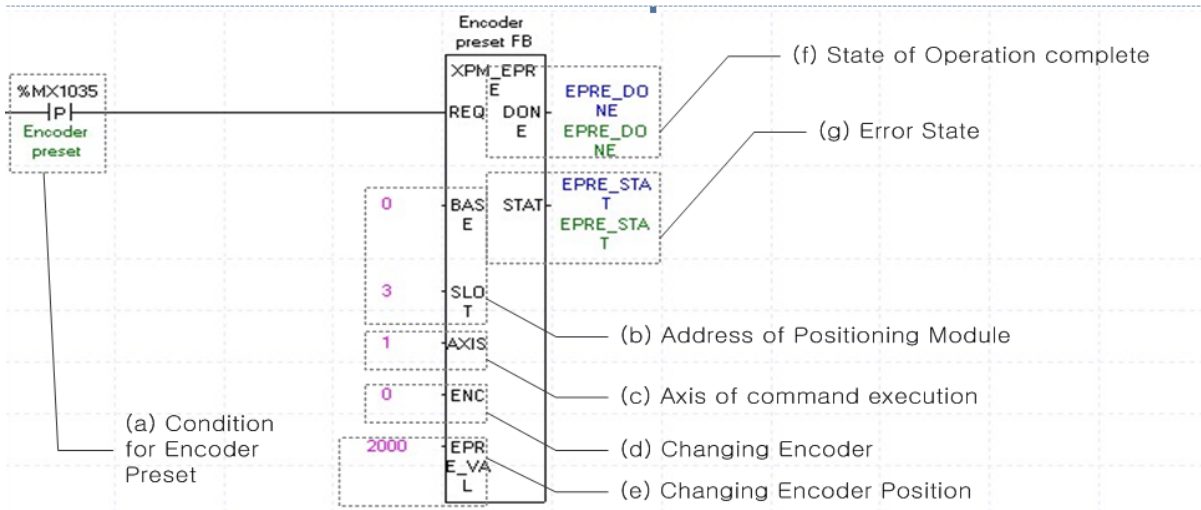

(a) This is the condition for Encoder Preset

This is the condition for Encoder Preset Command (XPM_EPRE). Once Encoder Preset is executed, current operation step will move to set step.

(b) Address of Positioning Module

In this example, Positioning Module is fixed at the 1 slot of 0 bases.

(c) Axis of command execution

You can set an axis for Parameter Setting. XEM-HP can control up to 6 axes and XEM-H2 can control up to 2 axes. In the "execution of axis" from the configuration of Parameter Setting, you can set a value for axis1 through axis6.

(d) Changing Encoder

Set Changing Encoder to execute a preset. XPM 1 to 3

(e) Changing Encoder Position

Set for Changing Encoder Position. In the example, the encoder position is changed to 2000.

(f) State of Operation complete

If function block is completed without error, "1" will be outputted and maintain "1" until the next operation. If error occurred, "0" will be outputted.

(g) Error State

This is the area that output error no. if there are errors in operation of function block.

(h) For more information, reference of Encoder Preset is in the "Chapter 9.5.8."

8.1.7 Error

(1) Error Reset

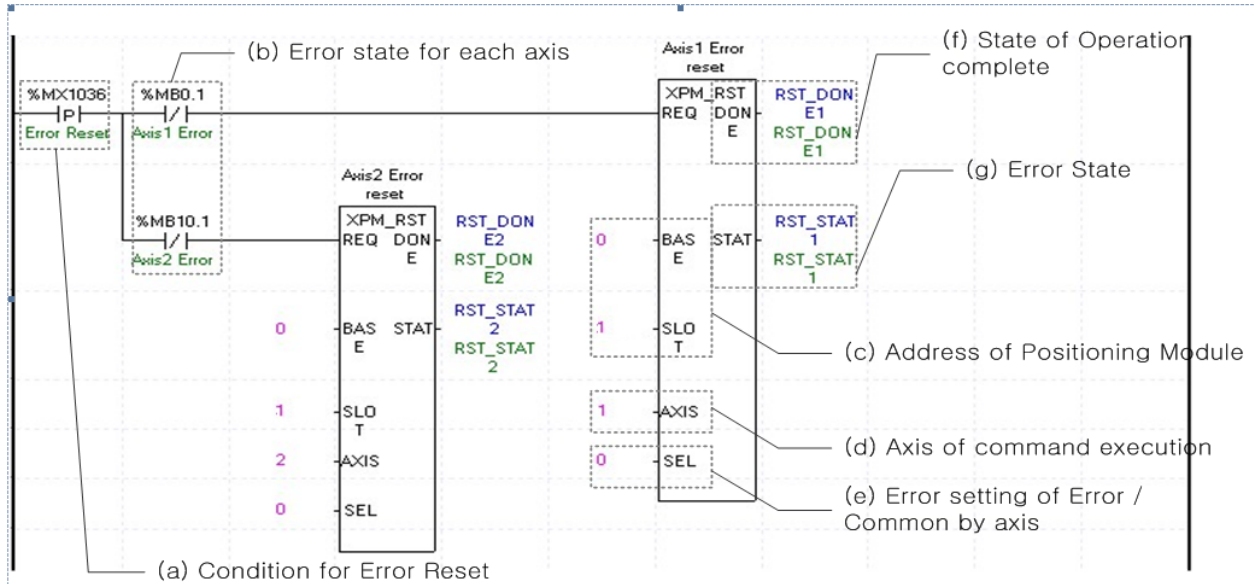

(a) This is the condition for Error Reset

This is the condition for Error Reset Command (XPM_RST). Once Error Reset is executed, it erases errors of module form each axis.

(b) Error state for each axis

According to exercise from “Chapter 8.1.2 Current State Reading,” it is a signal of “Error state” for each axis. It turns on when an error occurred. Operation will only work when there is no error. If you want to operate a system regardless of errors, you can just inactivate the function.

(c) Address of Positioning Module

In this example, Positioning Module is fixed at the 1 slot of 0 bases.

(d) Axis of command execution

You can set an axis for Parameter Setting. XEM-HP can control up to 6 axes and XEM-H2 can control up to 2 axes. In the “execution of axis” from the configuration of Parameter Setting, you can set a value for axis1 through axis6.

(e) Error setting of Error/Common by axis

Depending on the errors, if it is set by “0”, erase the errors in operation of each axis, if it is set by “1”, erase the common errors of each modules.

(f) State of Operation complete

If function block is completed without error, “1” will be outputted and maintain “1” until the next operation. If error occurred, “0” will be outputted.

(g) Error State

This is the area that output error no. if there are errors in operation of function block.

(2) Error History Reset

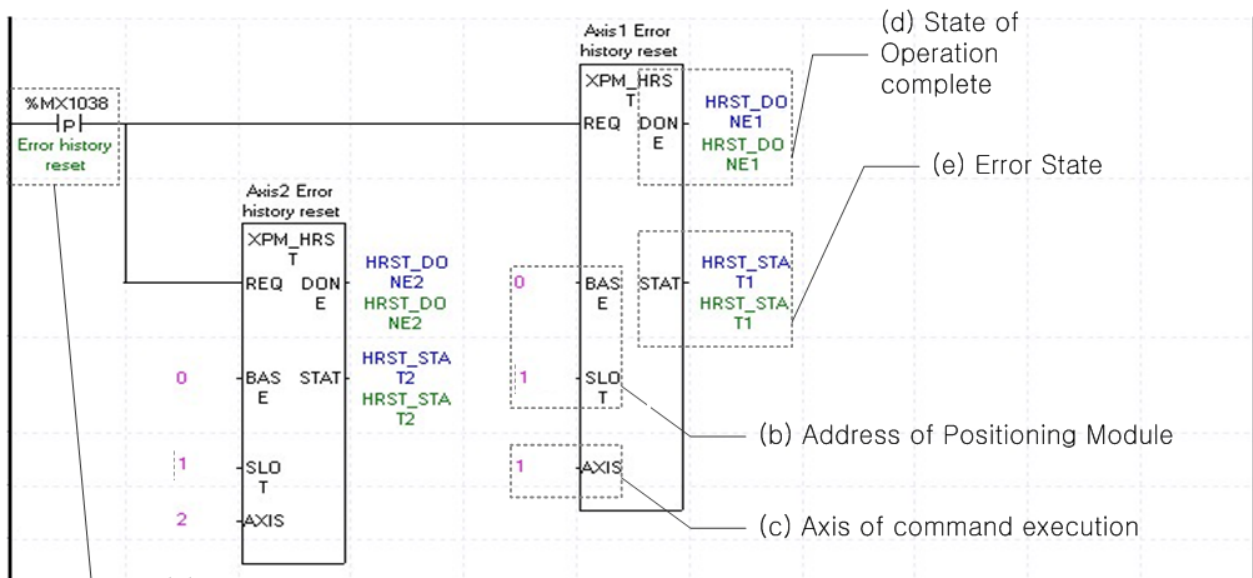

(a) This is the condition for Error History Reset

This is the condition for Error History Reset Command (XPM_HRST). Once Error Reset is executed, it erases history of generated errors of module. XEM-HP/H2 has ten error histories by each axis. It will be saved to FRAM, remain still even there is no power.

(b) Address of Positioning Module

In this example, Positioning Module is fixed at the 1 slot of 0 bases.

(c) Axis of command execution

You can set an axis for Parameter Setting. XEM-HP can control up to 6 axes and XEM-H2 can control up to 2 axes. In the "execution of axis" from the configuration of Parameter Setting, you can set a value for axis1 through axis6.

(d) State of Operation complete

If function block is completed without error, "1" will be outputted and maintain "1" until the next operation. If error occurred, "0" will be outputted.

(e) Error State

This is the area that output error no. if there are errors in operation of function block.

Chapter 9 Functions

9.1 Homing

Homing is carried out to confirm the origin of the machine when applying the power. In case of homing, it is required to set homing parameter per axis. If the origin position is determined by homing, the origin detection signal is not recognized during positioning operation.

9.1.1 Homing method

(1) Methods using DOG signal

- (a) Origin detection after DOG "Off" (0:DOG /HOME(Off))
- (b) Origin detection after deceleration when DOG "On" (1: DOG /HOME(On))
- (c) Origin detection by DOG (3: DOG)

(2) Methods without using DOG signal

- (a) Origin detection by Home and upper/lower limit (2: U.L.Limit /Home)
 - (b) High speed Homing (4: High speed)
 - (c) Origin detection by upper/Lowerlimit (5: Upper/Lower limit)
 - (d) Origin detection by Home (6: Home)
- ※ () is homing parameter selection item of XG-PM software package.

9.1.2 Parameters for Homing

- (1) Home position
- (2) Home high speed
- (3) Home low speed
- (4) Homing acceleration time
- (5) Homing deceleration time
- (6) Homing dwell time
- (7) Origin compensation amount
- (8) Homing reset waiting time
- (9) Homing mode
- (10) Homing Direction

※ For further information about homing parameters and setting value, please refer to Chapter 5.

NOTE

Homing is performed by receiving signals generated from the outside while rotating the motor. When the final origin complete signal is input, the home position is completed after stopping. The signals required for home return are shown below.

- (1)HOME signal: It is used as operating sequence and final origin confirmation signal when detecting origin after approximate origin Off, origin detection after deceleration when approximate origin On, origin detection by origin and upper / lower limit, origin detection by origin. To use the origin signal, specify the P device to be mapped to the origin signal of the external signal parameter and set the corresponding contact level to A contact or B contact. The P device that can be mapped to the origin signal is the high-performance XBM's built-in input P
- (2)Dog signal: This is the signal used for the operating sequence when determining the home position by the approximate origin method in the homing method. In particular, it is used as the final origin determination signal in the home position detection operation by the near home position. To use the approximate origin signal, specify the P device to be mapped to the approximate origin signal of the external signal parameter and set the corresponding contact level to A contact or B contact.
- (3)Upper/lower signal: Used to check the upper and lower limits of the machine coordinate during home return. In particular, it is a signal used for the operation sequence when detecting the origin by the origin and the upper / lower limit, and the origin by the upper / lower limit. To use the upper / lower limit signal, specify the P device to be mapped to the upper / lower limit signal of the external signal parameter and set the corresponding
- (4)Deviation clear signal: This signal is used to cancel the residual pulse of servo drive after completion of origin determination. Since the servo drive must output a deviation count clear signal before outputting all residual pulses, use the high-performance XBM built-in output as the P device to be mapped to the deviation counter clear signal as much as possible. When using the P contact output of the extension module, the output time may not be constant depending on the position control cycle and the corresponding

9.1.3 Origin Detection after DOG Off (0: DOG /HOME(Off))

This is the method using the DOG and HOME signal and the action by homing command is as follows.

(1) Operation

- (a) Accelerates to the setting homing direction and acts by homing high speed.
- (b) At the rising edge DOG signal it decelerates and acts by homing low speed.
- (c) If HOME signal is entered after the DOG signal has changed from "On" to "Off", the origin shall be determined and it stops pulse output.

■ Operating Pattern

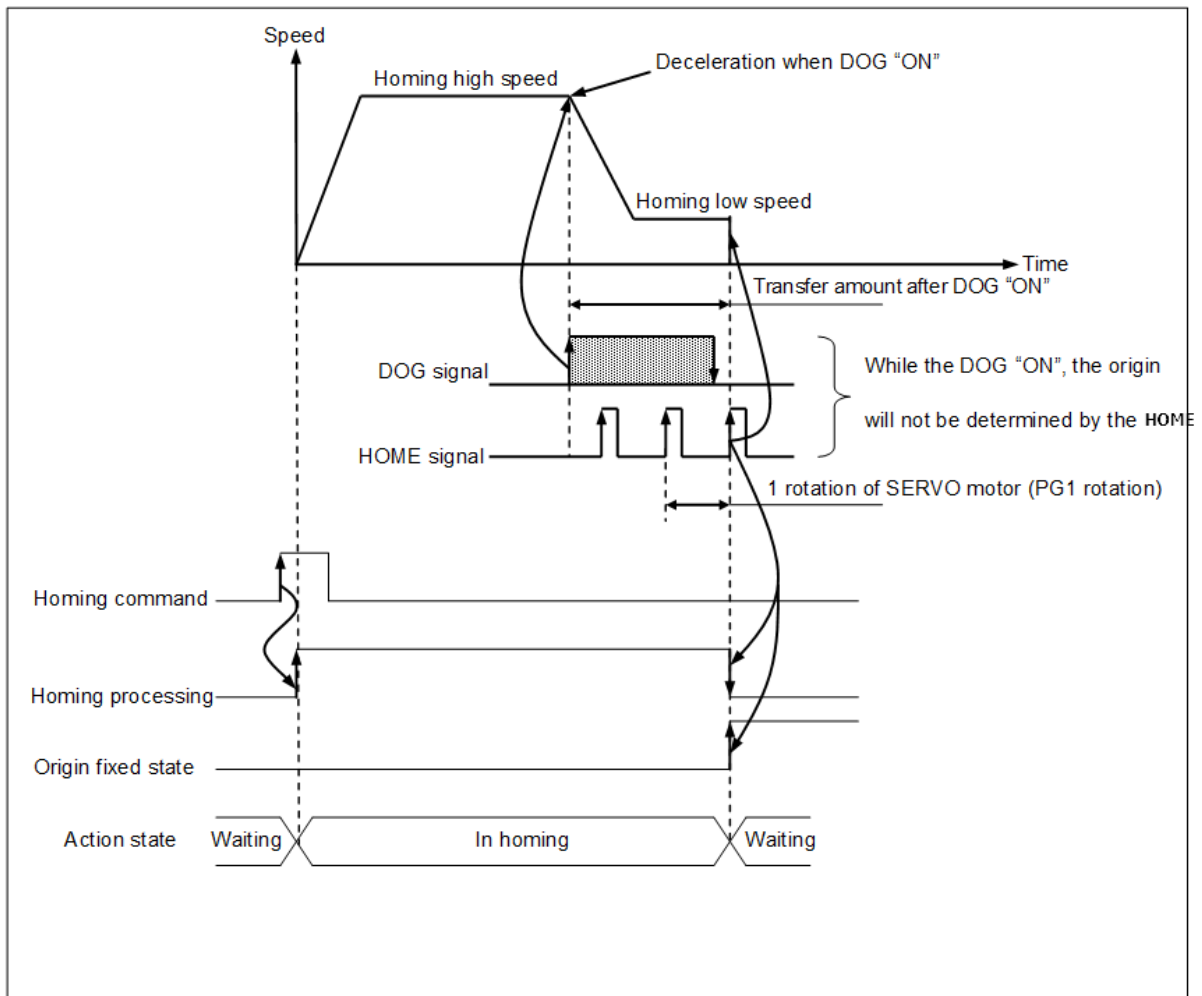

NOTE

1. While DOG signal maintains "On", the origin will not be determined by HOME signal. That is, when DOG signal changes from "Off" to "On" (acceleration section -> homing high speed), from "On" to "Off" (deceleration section -> homing low speed) and then when the HOME changes from "Off" to "On", the origin will be determined.

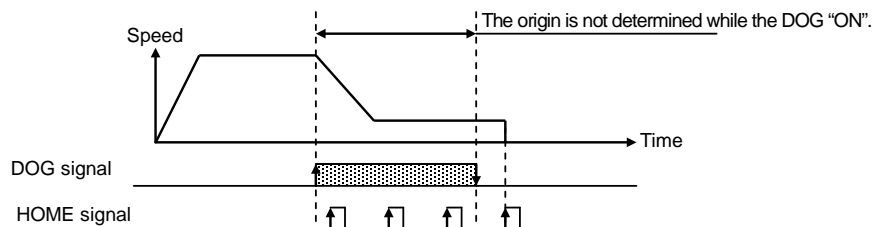

2. While the homing speed acts to the deceleration section by homing high speed after the DOG signal is changed from "Off" to "On", from "On" to "Off", the origin will not be determined even if encounters the HOME input.

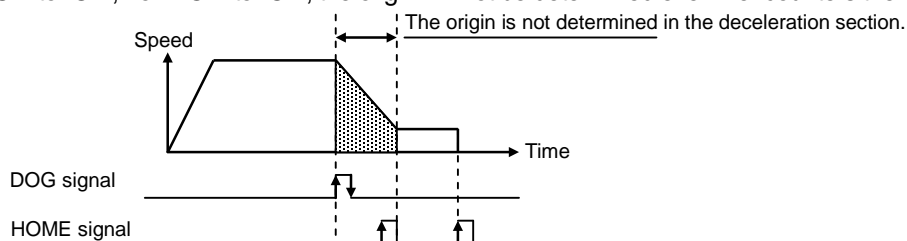

3. If the DOG signal is changed from "Off" to "On", from "On" to "Off" and encounters external upper/lower limit while waiting the HOME input, the action is as follow.

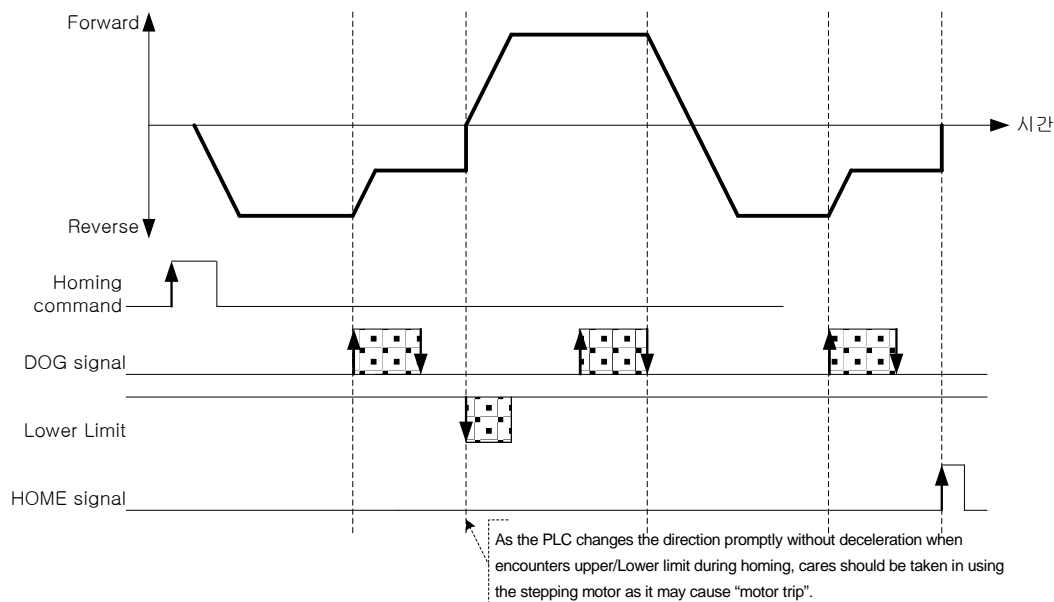

4. If "On" time of the origin is too short, the positioning module can not recognize it.

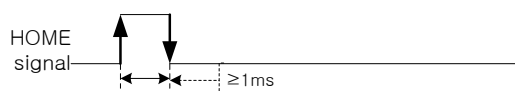

9.1.4 Origin Detection after Deceleration when DOG On(1: DOG /HOME(On))

This is the method using the DOG and HOME signal and the action by homing command is as follows.

(1) Operation

- Accelerates to the setting homing direction and acts by homing high speed.
- At the rising edge DOG signal it decelerates and acts by homing low speed.
- while the DOG signal is "On" and the homing low speed is active, the origin shall be determined if HOME signal is entered.

■ Operating Pattern

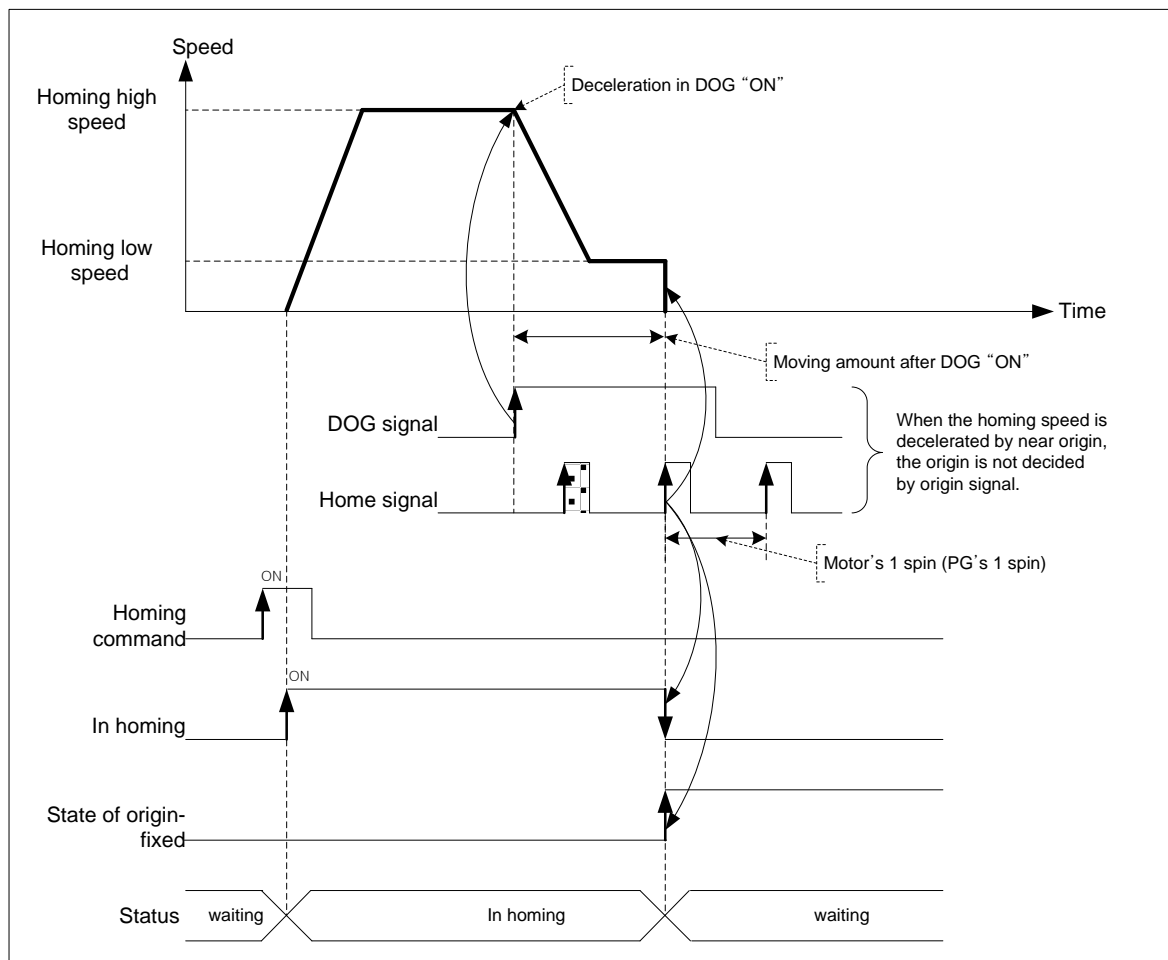

Note

- Once the DOG signal is "On", when the homing speed acts from high speed to low speed via deceleration section, if the HOME is entered in the state that the DOG signal is "ON", the origin will be determined promptly. That is, The origin will not be determined by the HOME signal during the decelerating.
- When encounters the Upper/Lower limit signal before HOME after the DOG signal has changed from "Off" to "On", the action will be the same as the method of Article 9.1.3
- If "On" time of HOME signal is short, the positioning module can not recognize it.

9.1.5 Origin Detection by Origin and High/Low Limit (2: U.L Limit/Home)

This is the method using the DOG and HOME and the action by homing command is as follows.

(1) Operation

- (a) Accelerates to the setting homing direction and acts by homing high speed.
- (b) If Upper/Lower signal is entered, it transferred to opposite direction and acts by homing low speed.
- (c) If encounters the HOME signals while the homing low speed is active, the origin would be determined and it stops..

■ Operating Pattern

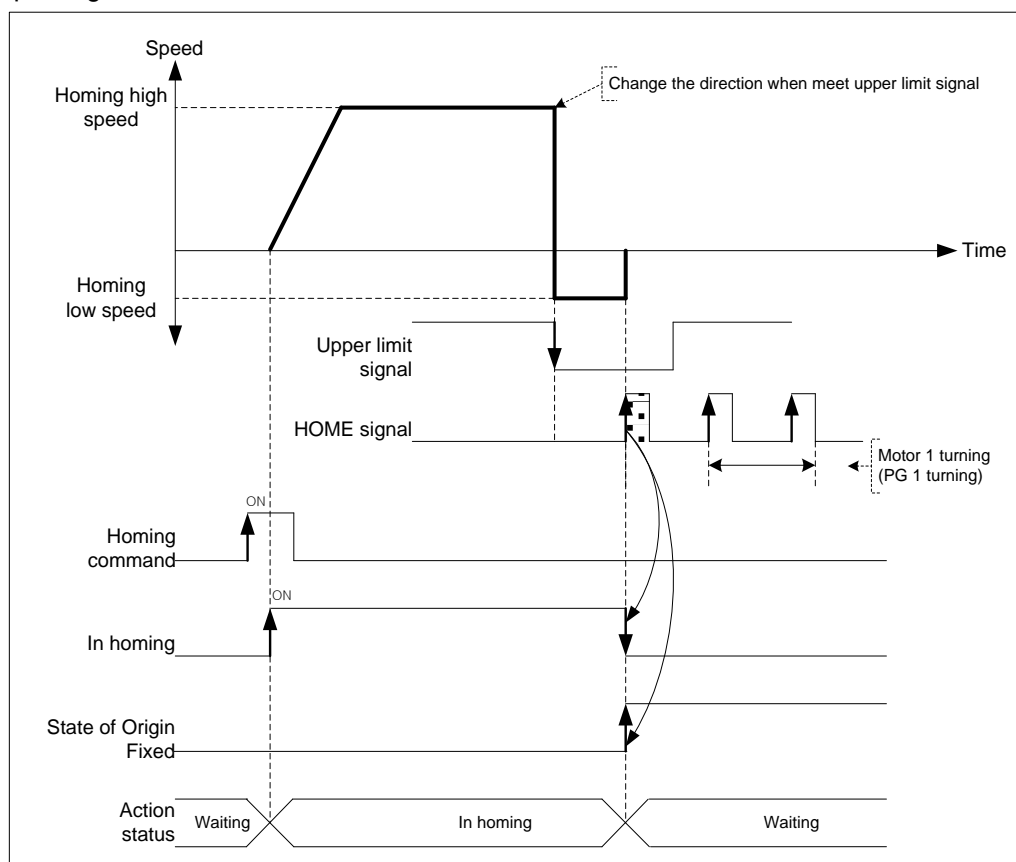

Note

In case that HOME signal is "ON" before entering the Upper/Lower limit signal, it carries out the homing low speed operation when the Upper/Lower limit signal is entered and when HOME is "ON", the origin will be determined

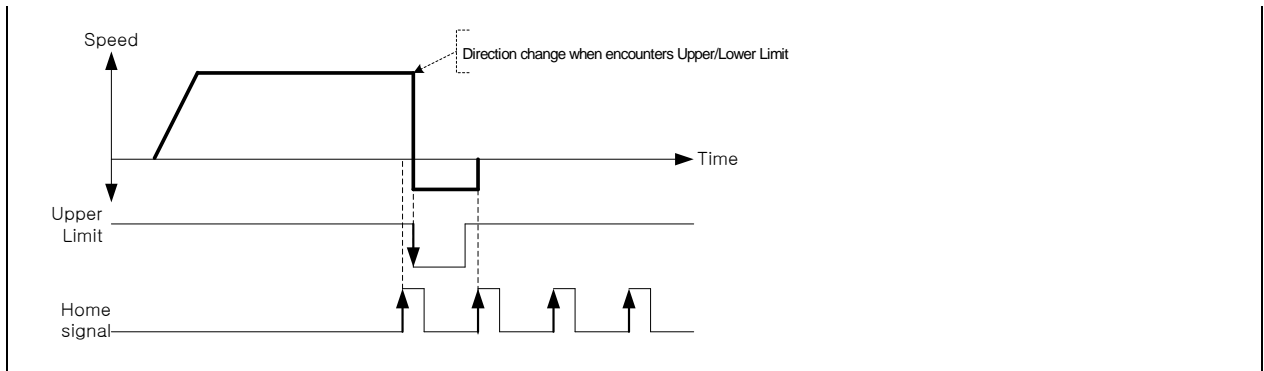

9.1.6 Origin Detection by DOG signal (3: DOG)

This is used when determines the origin only by using the DOG signal.

(1) Operation

- Accelerates to the setting homing direction and acts by homing high speed.
- If DOG signal is entered, it decelerates and transferred to opposite direction acts by homing high speed.
- When it operates in opposite direction, if DOG is entered again, it decelerates and transferred to opposite direction and acts by homing low speed.
- If encounters the DOG signals again while the homing low speed is active, the origin would be determined and it stops..

■ Operating Pattern

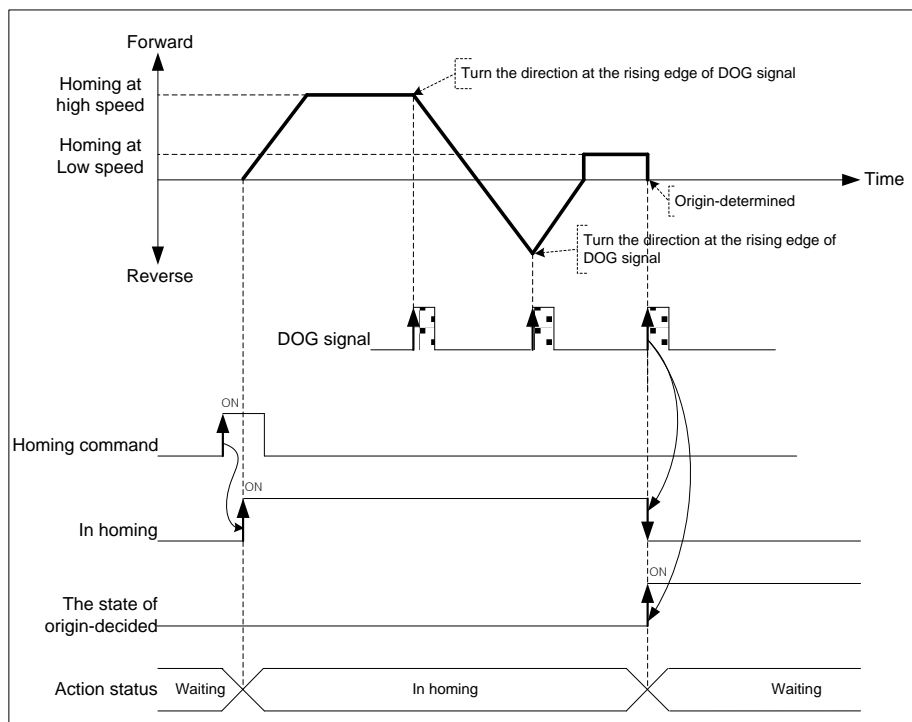

Note

If "ON" time of DOG is longer than deceleration time, the action is as follows.

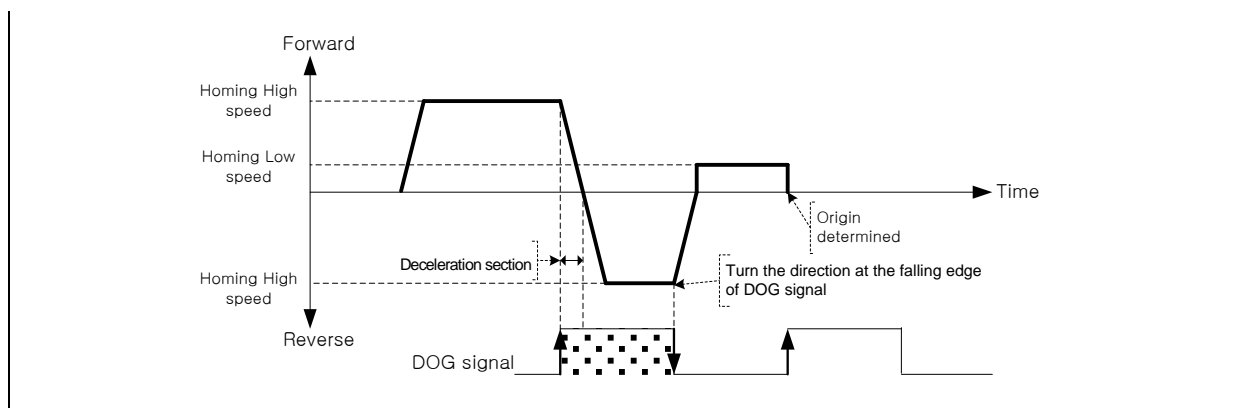

9.1.7 High Speed Homing (4: High Speed)

High speed origin detection is one of the homing methods that returns to the origin determination position without detection of external signal (DOG, HOME, Upper/Lower limit) when returning to the mechanical origin position after completion of the mechanical homing.

(1) Operation

- Once Homing command executes, it operates positioning with high speed and homing from current position
- When using High speed homing, it should be carried out in the state that the positioning by 6 types of mechanical homing, by floating origin, or by the current position preset is completed in advance.

■ Operating Pattern

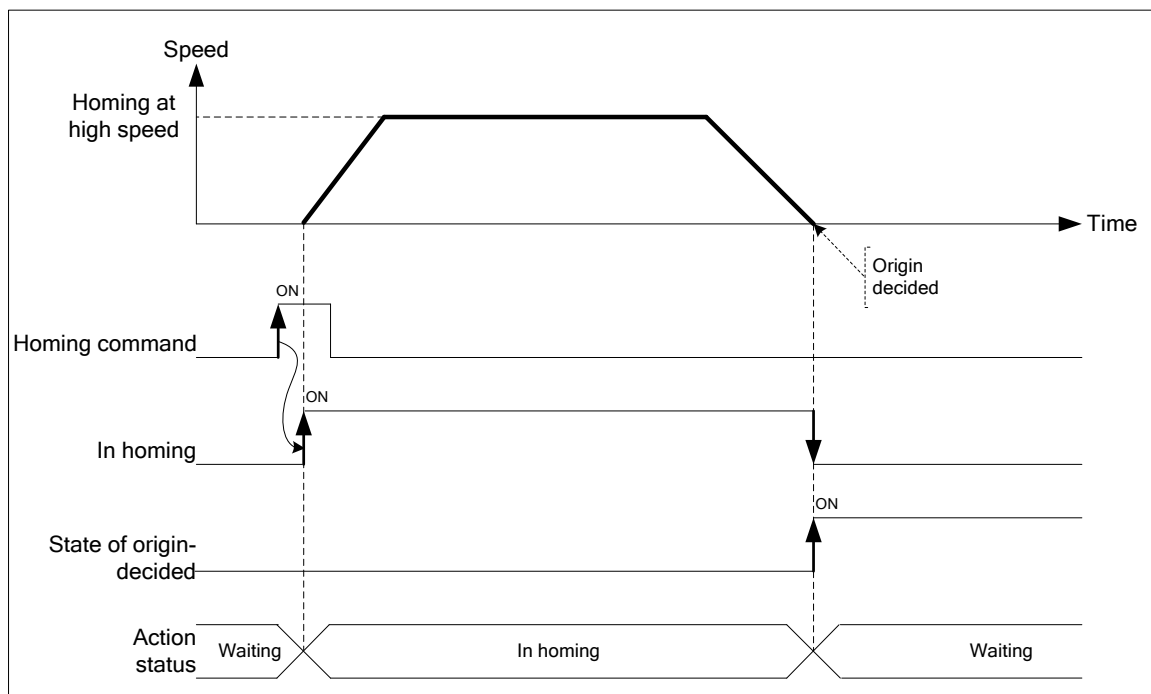

9.1.8 Origin Detection by Upper/Lower Limit (5: Upper/Lower Limit)

This is the homing method using the Upper/Lower limit signal and is used when not using the HOME or DOG signal

(1) Operation

- It accelerates to the setting homing direction and acts by homing high speed.
- If Upper/Lower limit signal is entered, it transferred to opposite direction and acts by homing low speed.
- If Upper/Lower limit signal is turned off while the homing low speed is active, the origin would be determined and it stops.

■ Operating Pattern

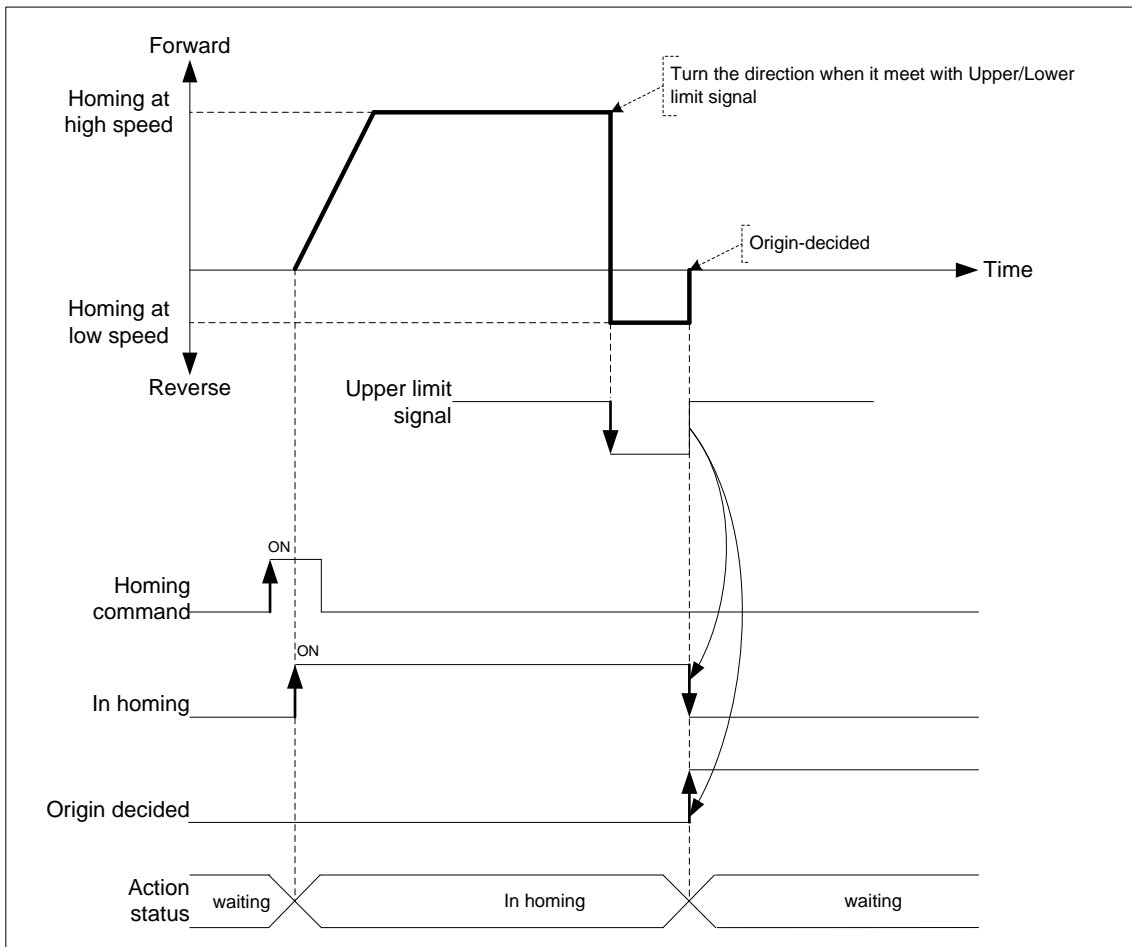

9.1.9 Origin Detection by HOME (6: Home)

This is used when determines the origin only by using the HOME signal.

(1) Operation

- It accelerates to the setting homing direction and acts by homing high speed.
- In this case, if HOME signal is entered, it decelerates and transferred to opposite direction acts by homing high speed.
- When it operates in opposite direction, if HOME is entered again, it decelerates and transferred to opposite direction and acts by homing low speed.
- If encounters the HOME signals again, the origin would be determined and it stops.

■ Operating Pattern

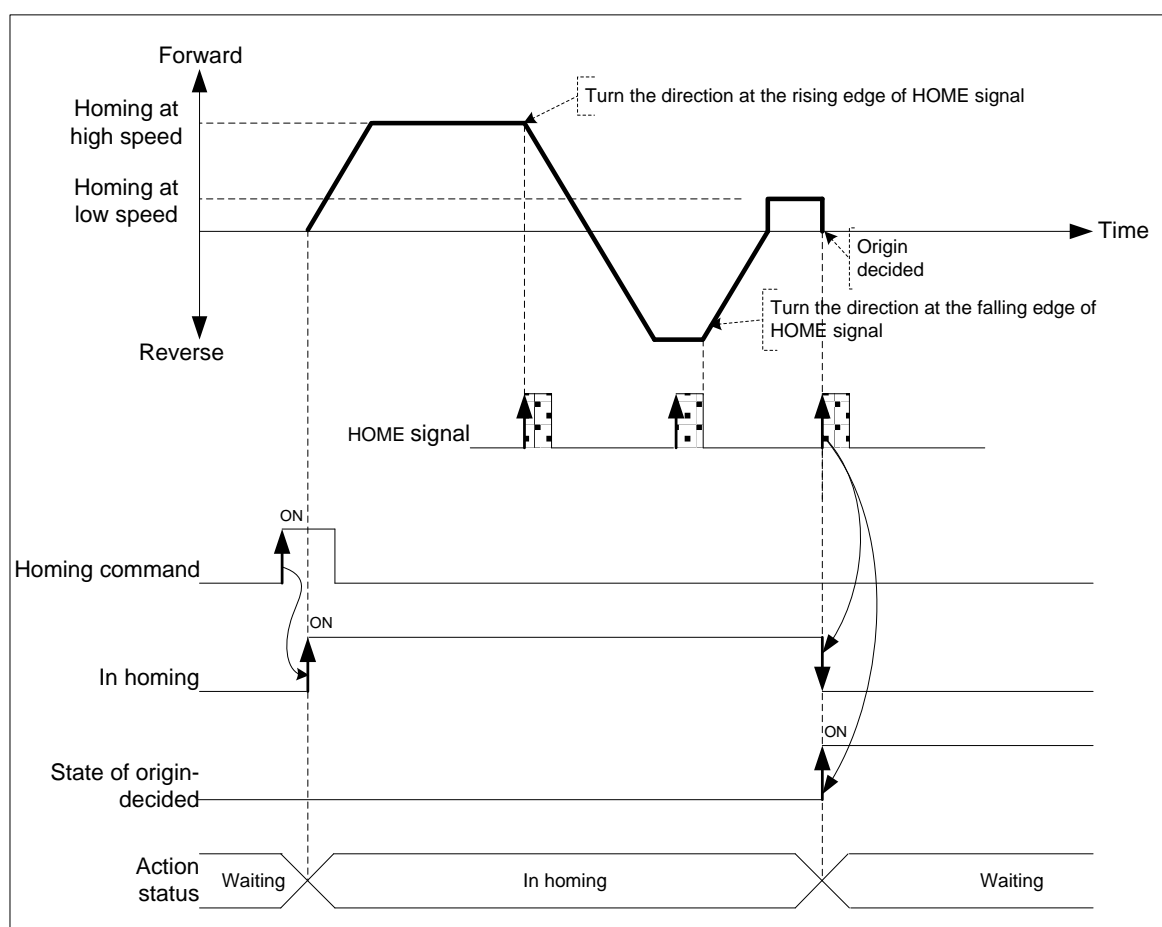

Note

1. If "ON" time of DOG is longer than deceleration time, the action is as follows

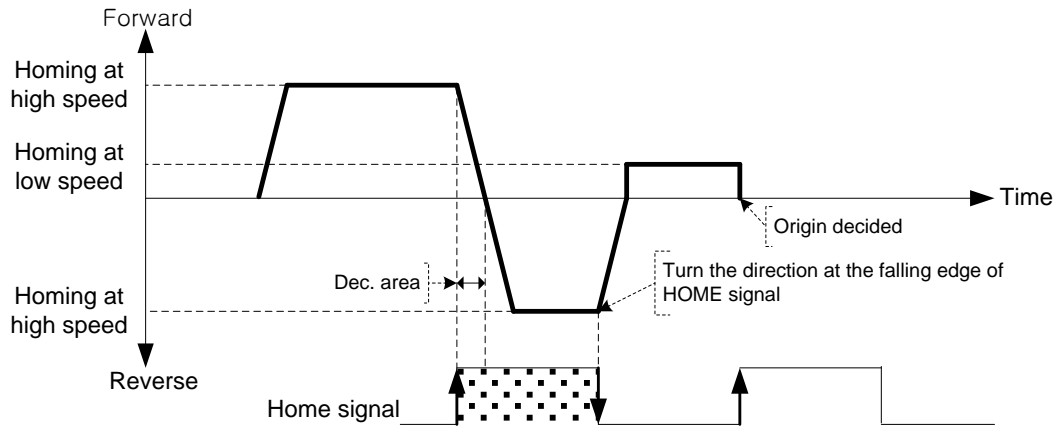

2. It acts as follows if Lower limit (if homing direction is forward, upper limit) signal is entered before HOME signal is entered..

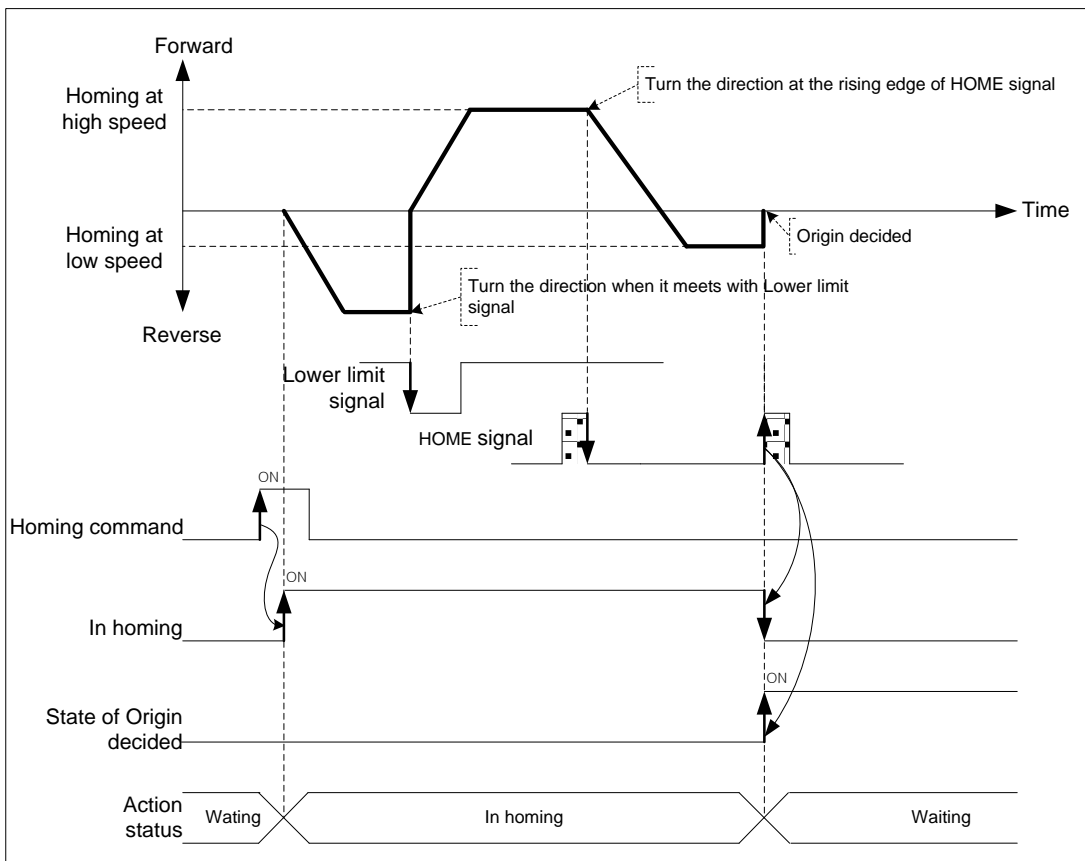

9.2 Positioning Control

Positioning control execute using data which set on the 「Operation Data」. Positioning Control includes Single-axis Position control, Single-axis Speed Control, Single-axis Feed Control, Interpolation control, Speed/Position Switching control, Position/Speed Switching control.

Positioning Control		Control Method	Operation
Positioning Control	Single-axis Position Control	Absolute, Single-axis Position Control Incremental, Single-axis Position Control	Specified axis executes positioning control from the beginning (current position) to the goal position.
	Single-axis Feed Control	Absolute, Single-axis Feed Control Incremental, Single-axis Feed Control	The starting position (the current stop position), changes to 0 and executes positioning control as much as setting amount of movement. .
	Linear Interpolation	Absolute, Linear Interpolation Incremental, Linear Interpolation	Executing linear interpolation control by using starting address (current stop position) from the axis (2 axes or more) to the target position.
	Circular Interpolation	Absolute, Circular Interpolation Incremental, Circular Interpolation	Execute positioning control until goal position by the trajectory of arc and control sub-axis as using axis-2 according to data of main axis.
	Helical Interpolation		Set by helical interpolation axis, execute linear interpolation control until goal position by the trajectory of arc and control sub-axis as using axis-3 according to data of main axis.
Ellipse Interpolation	Execute positioning control until goal position by trajectory angle of the ellipse is set to operate and control sub-axis as using axis- 2 according to data of main axis.		
Speed Control		Absolute, Single-axis Speed Control Incremental, Single-axis Speed Control	Execute Speed control as setting speed until deceleration stop command is entered.
Speed/Position Switching Control		Absolute, Single-axis Speed Control Incremental, Single-axis Speed Control	Speed controlling and then speed / position switching command or speed / position control switching input signal is entered, speed control switch to position control and execute positioning control as much as target position.
Position/Speed Switching Control		Absolute, Single-axis Position Control Incremental, single-axis Position Control	Position controlling and then position / speed switching command is executed, position control switch to speed control and execute speed control as setting speed until deceleration stop command is entered.

9.2.1 Operation Data for Positioning Control

Describe the Operation data and Setting to execute positioning control.

Operation Data	Setting
Control Method	Set the Type of control and Standard coordinates of Positioning control.
Operation Method	Set the control method of continuous operation data.
Goal Position	Set the absolute target position or distance of positioning control.
Operation Speed	Set the value of operation speed during operation control.
Acceleration Number	Set the operation number of operation control during acceleration time. Acceleration Number is selected from basic parameters which are Acceleration Number1, 2, 3, and 4.
Deceleration Number	Set the operation number of operation control during deceleration time. Deceleration Number is selected from basic parameters which are Deceleration Number1, 2, 3, and 4.
M Code	Set the M Code when using the code number for sub operation of positioning control.
Dwell Time	After complete the positioning control, set the time until servo drive complete positioning control.
Sub Axis Setting	Set the sub axis during interpolation control.
Circular Interpolation	Set the secondary data (middle point, center point and radius) during circular interpolation.
Circular Interpolation Mode	Set the generating method of arc (middle point, center point and radius) during circular interpolation.
Circular Interpolation Turn Number	Set the number of arcs to draw during circular interpolation.
Helical Interpolation	Set the axis to run linear operation during helical interpolation.

Note

It is available to set the operation data each of 1~400 steps and axis1~6.

9.2.2 Operation mode of Positioning Control

Operation mode describes various configurations for how to operate the positioning data using several operation step no. and how to determine the speed of position data.

Operation mode types are as follows

Control Method	Operation Method	Operation Pattern	Executable	Operation
Single-axis Position Control	Single	End	○	Finish after the completion of the current step position control
		Keep	○	Continue to the next step after the completion of the current step position control
		Continuous	○	Continue to the next step continuously without stop.
	Repeat	End	○	Change the step No. to the Repeat step No. after the completion of the current step position control.
		Keep	○	Continue to the repeat step No. after the completion of the current step position control
		Continuous	○	The current step and the repeat step No. continuously without stop
Single-axis Speed Control	Single	End	○	Speed control using current step's DATA
		Keep	○	Speed control using current step's DATA. If VTP command executed, continue to the next step after the completion of the current step's positioning.
		Continuous	X	Errors
	Repeat	End	○	Speed control using current step's DATA
		Keep	○	Speed control using current step's DATA. If VTP command executed, continue to the repeat step No. after the completion of the current step's positioning.
		Continuous	X	Errors
Single-axis FEED Control	Single	End	○	Finish after the completion of the current step's FEED control
		Keep	○	Continue to the next step after the completion of the current step FEED control
		Continuous	X	Errors
	Repeat	End	○	Change the step No. to the Repeat step No. after the completion of the current step FEED control.
		Keep	○	Continue to the repeat step No. after the completion of the current step FEED control
		Continuous	X	Errors
Linear Interpolation	Single	End	○	Finish after the completion of the current step's linear interpolation
		Keep	○	Continue to the next step after the completion of the current step s linear interpolation
		Continuous	○	Continue to the next linear interpolation step continuously without stop
	Repeat	End	○	Change the step No. to the Repeat step No. after the completion of the current step linear interpolation.
		Keep	○	Continue to the repeat step No. after the completion of the current step s linear interpolation
		Continuous	○	The current linear interpolation and the repeat step No. continuously without stop
Circular Interpolation	Single	End	○	Finish after the completion of the current step's circular interpolation
		Keep	○	Continue to the next step after the completion of the current step s circular interpolation
		Continuous	○	Continue to the next circular interpolation step continuously without stop
	Repeat	End	○	Change the step No. to the Repeat step No. after the completion of the current step circular interpolation.
		Keep	○	Continue to the repeat step No. after the completion of the current step s circular interpolation
		Continuous	○	The current circular interpolation and the repeat step No. continuously without stop

Note

1. Operation mode shall be set from PLC Program or Operation data of XG-PM.
2. Operation data can be set up to 400 from operation step no. 1 ~ 400 at each axis.
3. With one time start command, positioning operation method by one operation step positioning data and positioning operation method by several operation step in order shall be determined by operation mode of each positioning data set.
3. With one time start command, positioning operation method by one operation step positioning data and positioning operation method by several operation step in order shall be determined by operation mode of each positioning data set.
4. when executing continuous operation, The continuous operation item of common parameter must be set to "Enable". if Continuous Operation parameter is disabled, Continuous operation command can not be executed

(1) End Operation (Single)

- (a) With one time start command, the positioning to the goal position is executed and the positioning shall be completed at the same time as the dwell time proceeds.
- (b) The positioning completion of this operation mode can be used as operation mode of last positioning data of Keep operation mode and Continuous operation mode.
- (c) Operation direction shall be determined by the value of address.
- (d) Operation action is trapezoid(or S-Curve) type operation that has acceleration, constant, deceleration section according to the setting speed and position data but the operation pattern according to the setting value is as follows.

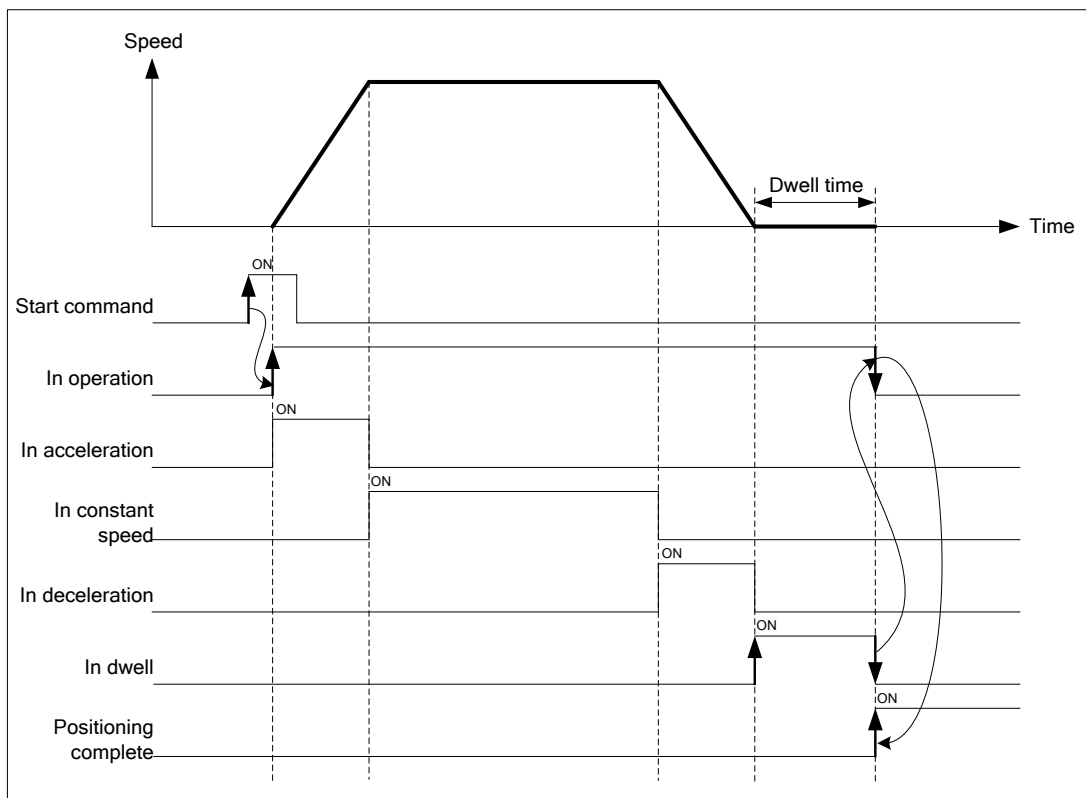
1) Normal Operation Patterns

2) Abnormal Operation Patterns

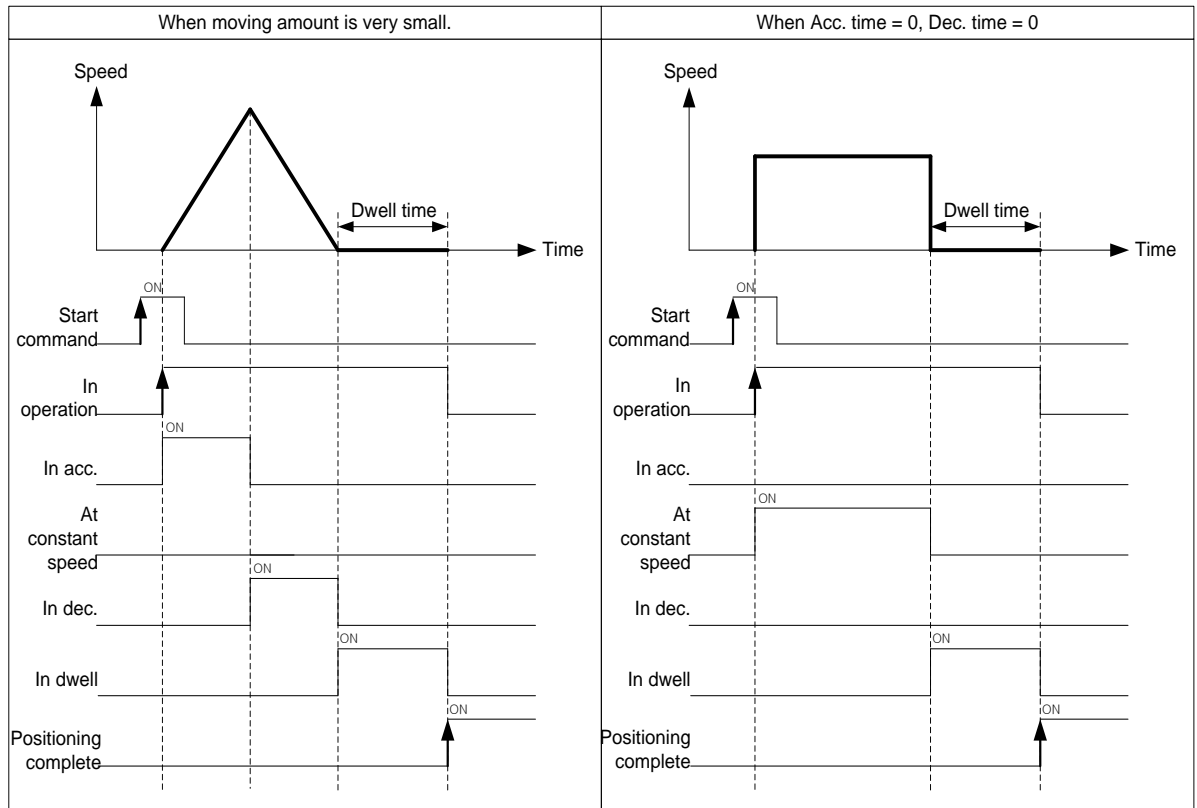

[Example]

- When indirect start command is executed[when Step No. of command is set to 0].
- Starting command execute total four times.

■ Setting of XG-PM

Step NO.	Control Method	Operation Method	Goal Position [pls]	Operation Speed [pls/s]	Accel NO.	Decel NO.	M Code	Dwell Time
1	Absolute Single-axis Positioning Control	Single,End	10000	1000	1	1	0	0
2	Absolute Single-axis Positioning Control	Single,End	15000	500	1	1	0	0
3	Absolute Single-axis Positioning Control	Single,End	25000	1000	1	1	0	0
4	Absolute Single-axis Positioning Control	Single,End	30000	500	1	1	0	0

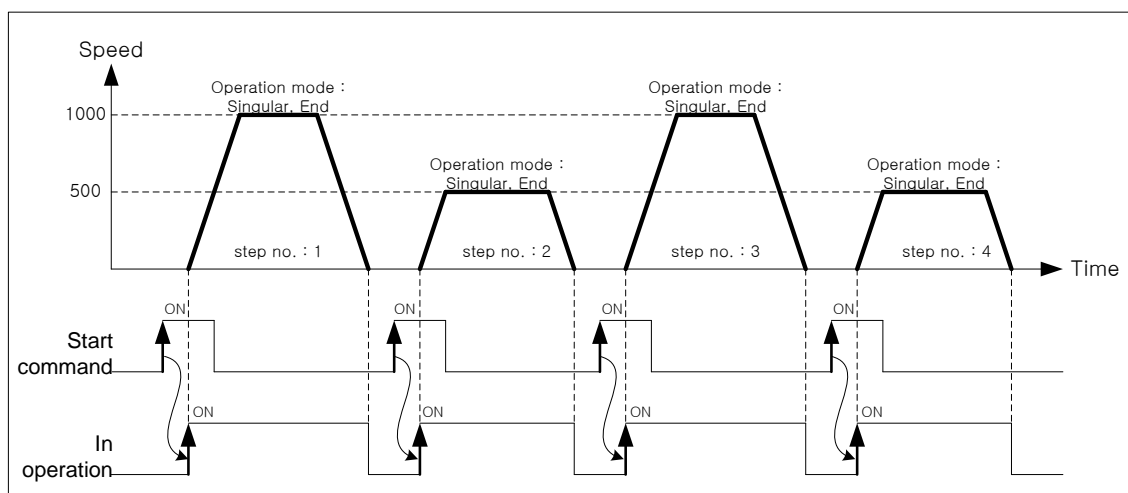
■ Operation Pattern

The operating step for each starting command will be [1] → [2] → [3] → [4].

(2) End Operation (Repeat)

- With one time start command, the positioning to the goal position is executed and the positioning shall be completed at the same time as the dwell time proceeds.
- The operation pattern of Repeat operation mode is same as that of Single operation but the different thing is to determine next operation by operation step no. assigned by repeat step no. change command after positioning completion of Repeat operation mode.
- Therefore, if Repeat step no. change command was not executed, the step no. "1" shall be assigned after positioning completion of Repeat operation mode and operated at next Start command. Thus, this operation can be used for the structure that several operation steps are repeated.
- In case that operation step is set as the value except "0" (1~400) for Indirect Start, the positioning operation shall be done with the setting step no. regardless of the current operation step no. But, if the step no. is set as "0", the positioning operation shall be done with the current step no. changed by Repeat operation mode.
- Operation direction shall be determined by position address.
- Repeat operation step no. change command is available to execute during operation.

[Example 1]

- When indirect start command is executed [when Step No. of command is set to 0].
- Starting command execute total four times.

■ Setting of XG-PM

Step NO.	Control Method	Operation Method	Goal Position [pls]	Operation Speed [pls/s]	Accel NO.	Decel NO.	M Code	Dwell Time
1	Absolute Single-axis Positioning Control	Single,End	10000	1000	1	1	0	0
2	Absolute Single-axis Positioning Control	Repeat,End	15000	500	1	1	0	0
3	Absolute Single-axis Positioning Control	Single,End	25000	1000	1	1	0	0
4	Absolute Single-axis Positioning Control	Repeat,End	30000	500	1	1	0	0

■ Operation Pattern

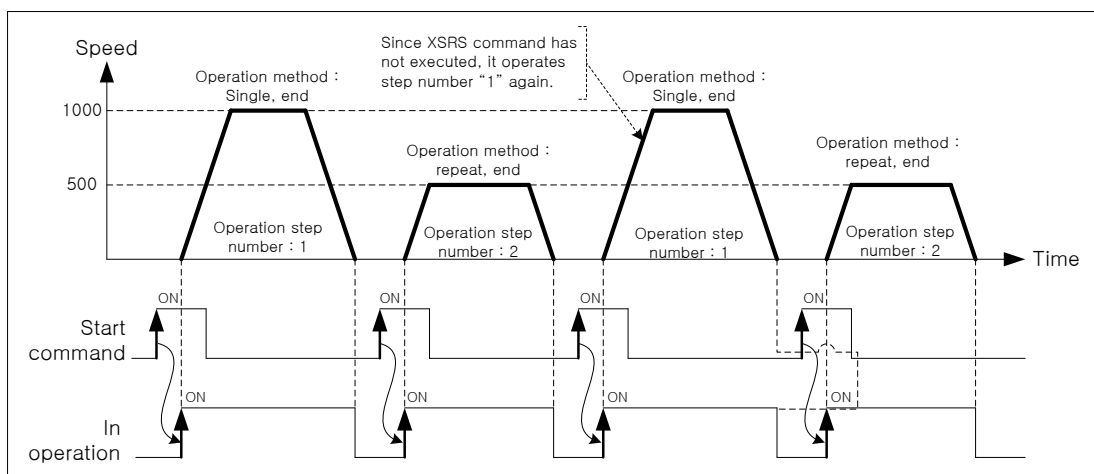

The operating step for each starting command will be [1] → [2] → [1] → [2].

The operating step3 and step4 will not be executed

[Example 2]

- When indirect start command is executed[when Step No. of command is set to 0].
- After the first starting command, change repeat operation step number as "3" by Change repeat step number command(XSRS).
- Execute starting command 3 times more.

■ Setting of XG-PM

Step NO.	Control Method	Operation Method	Goal Position [pls]	Operation Speed [pls/s]	Accel NO.	Decel NO.	M Code	Dwell Time
1	Absolute Single-axis Positioning Control	Single,End	10000	1000	1	1	0	0
2	Absolute Single-axis Positioning Control	Repeat,End	15000	500	1	1	0	0
3	Absolute Single-axis Positioning Control	Single,End	25000	1000	1	1	0	0
4	Absolute Single-axis Positioning Control	Repeat,End	30000	500	1	1	0	0

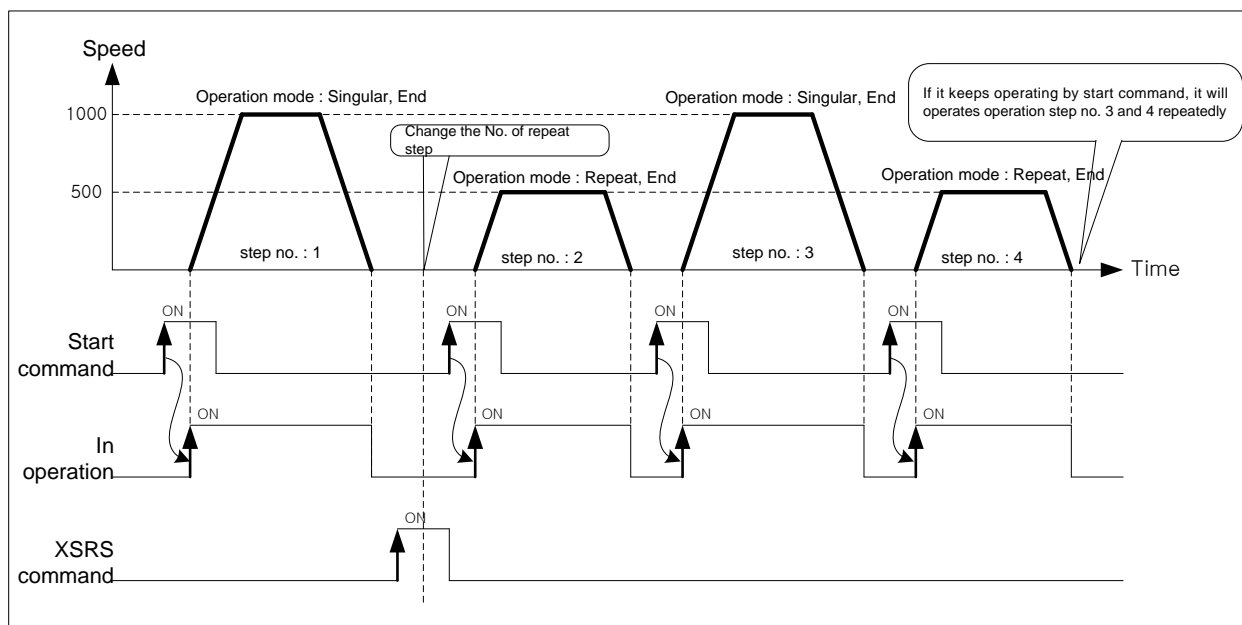
■ Operation Pattern

The operating step for each starting command will be [1] → [2] → [3] → [4].

(3) Keep Operation

- (a) With one time Start command, the positioning to the goal position of operation step is executed and the positioning shall be completed at the same time as dwell time proceeds and without additional start command, the positioning of operation step for (current operation step no. +1) shall be done.
- (b) Keep operation mode is available to execute several operation steps in order.
- (c) Set the operation pattern by 'End' when executing the last step of Keep operation.
- (d) When operation pattern is Keep, continue operation until operation pattern come out as 'End'. If there is no "END" operation pattern, execute until operation step No. 400. and if operation pattern of step 400 is not "End", error occurs and operation will be stop. When operation pattern of step 400 is 'Repeat,Keep", execute operation data of Repeat Step Number.
- (e) Operation direction shall be determined by setting value of goal position.

[Example]

- When indirect start command is executed[when Step No. of command is set to 0].
- Starting command execute total two times.

■ Setting of XG-PM

Step NO.	Control Method	Operation Method	Goal Position [pls]	Operation Speed [pls/s]	Accel NO.	Decel NO.	M Code	Dwell Time
1	Absolute Single-axis Positioning Control	Single,Keep	10000	1000	1	1	0	0
2	Absolute Single-axis Positioning Control	Single,Keep	15000	500	1	1	0	0
3	Absolute Single-axis Positioning Control	Single,End	25000	1000	1	1	0	0
4	Absolute Single-axis Positioning Control	Single,End	30000	500	1	1	0	0

■ Operation Pattern

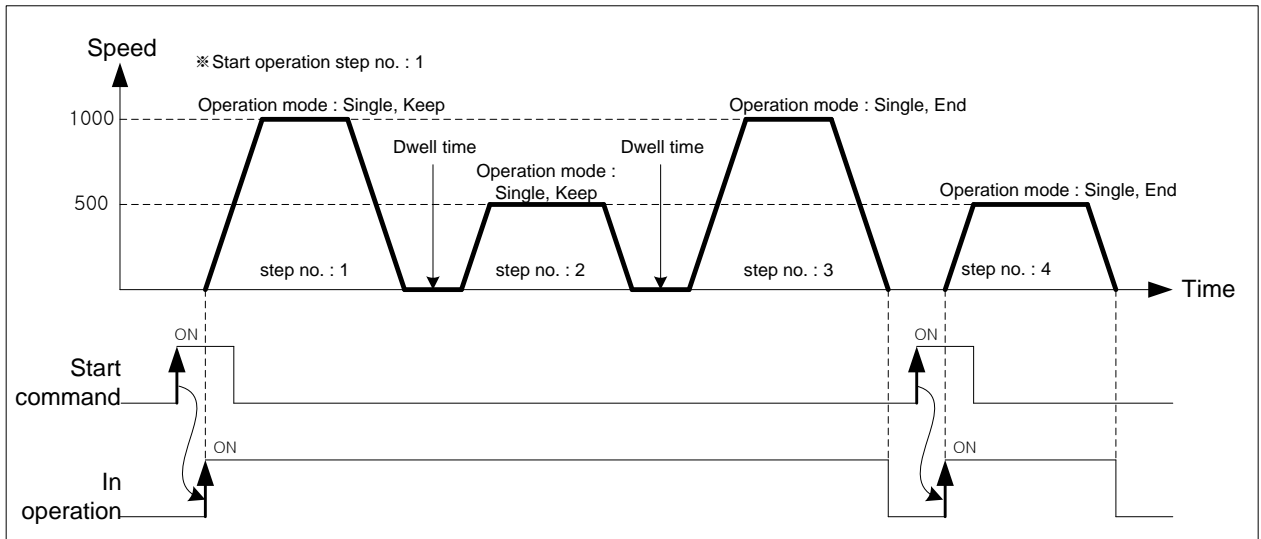

The operating step for each starting command will be [1 → 2 → 3] → [4].

(4) Continuous Operation

(a) Continuous Operation Overview

- 1) With one time Start command, the positioning for operation step set by continuous operation mode is executed to the goal position without stop and the positioning shall be completed at the same time as dwell time proceeds.
- 2) if the moving amount of next operation step is smaller than the deceleration distance from current position, the "Look ahead control" is activated to avoid immediate stop at [operation speed \neq bias speed].
- 3) Steps of dwell time set as 'Continuous' operation mode is ignored, steps of dwell time set as 'End' operation pattern is valid.
- 4) When you execute 'Continuous' operation mode, always set as 'End' for the very last operation step.
- 5) When operation pattern is continuous, continue operation until operation pattern come out as 'End'. If there is no "END" operation pattern, execute until operation step No. 400. and if operation pattern of step 400 is not "End", error occurs and operation will be stop. When operation pattern of step 400 is 'Repeat, continuous", execute operation data of Repeat Step Number.
- 6) Operation direction shall be determined by setting value of goal position.
- 7) If you want to operate with the position and speed of next step before the current operation step reaches the goal position, the operation by the Next Move continuous operation (XNMV) command is available.
- 8) 「Next Move continuous operation」 (XNMV) command can be executes in the acceleration, constant speed, deceleration section of Continuous operation.
- 9) when executing continuous operation, The continuous operation item of common parameter must be set to "Enable". Control period will be 5ms if continuous operation is enabled and it will be 1ms if continuous operation is disabled. therefore it is recommended to disable this parameter if continuous operation is not required.

[Example]

- When indirect start command is executed[when Step No. of command is set to 0].
- Starting command execute one time.

■ Setting of XG-PM

Step NO.	Control Method	Operation Method	Goal Position [pls]	Operation Speed [pls/s]	Accel NO.	Decel NO.	M Code	Dwell Time
1	Absolute Single-axis Positioning Control	Single,Cont	10000	500	1	1	0	0
2	Absolute Single-axis Positioning Control	Single,Cont	30000	1000	1	1	0	0
3	Absolute Single-axis Positioning Control	Single,End	40000	300	1	1	0	0

■ Operation Pattern

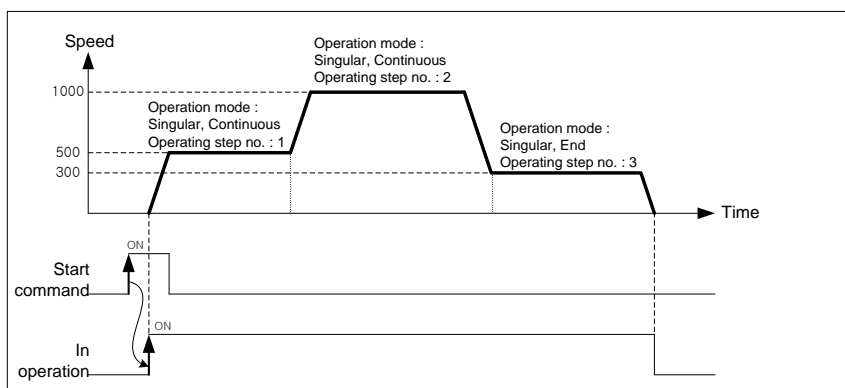

Operating step that execute according to starting command order will be [1 → 2 → 3].

Note

1. When operation method is continuous, sometimes it can be changed to next operation step speed before reaching the amount of movement current step's goal position. This is operation to change operating speed continuously, The remained moving amount of current step is operated in next step.
(The remaining distance is less than the distance can be moved within 1 control cycle at current speed)
2. If the control method is set as linear or circular interpolation and the operation method is set as continuous, operating speed of positioning will be different according to the interpolation continuous operation positioning method of extended parameter.
refer to continuous operation of interpolation control for detail.

(b) Look Ahead

- 1) if the moving amount of next operation step is smaller than the deceleration distance from current position, the "Look ahead control" is activated to avoid immediate stop at [operation speed \neq bias speed].
- 2) The "Look Ahead control" is control method which calculate the available entry speed for next step by goal position of current and next step and change current speed. if the moving amount of next operation step is smaller than the deceleration distance from current position, it will decrease the current speed to make stop speed and bias speed equal..
- 3) XBM-H(P) embedded positioning executes the "Look Ahead" using goal position of total 3 steps including current step..

The difference of general continuous operation and Look Ahead control is as below.

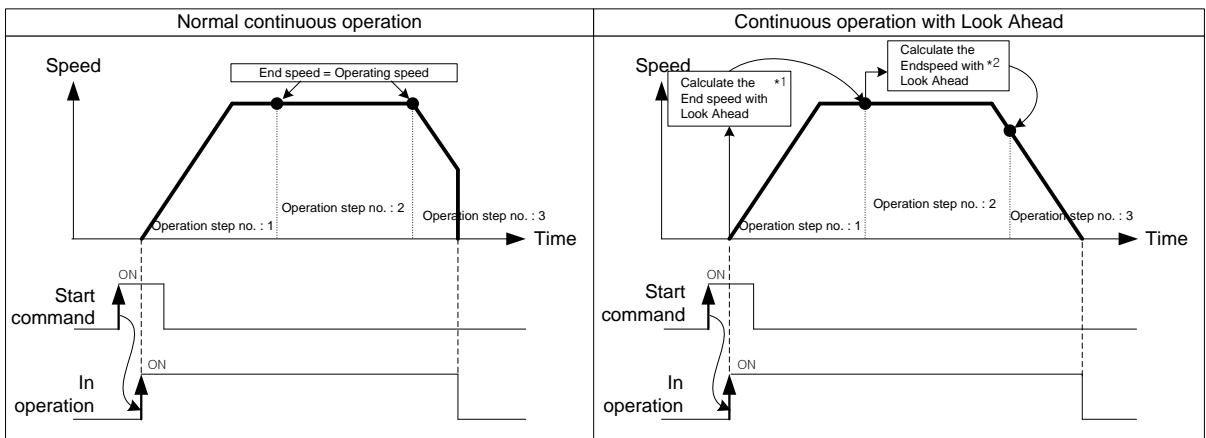

*1 : moving amount of Step 2 and Step 3 is more than the deceleration stop distance from operation speed. So, endpoint speed = operation speed.

*2 : When moving amount of step 3 is smaller than deceleration stop distance from operation speed of step 2. Therefore, it calculate available end point speed for step 2 by goal position of step2,3 and change speed to this..

(c) Continuous operation of interpolation control

When control method is linear or circular interpolation and operation method is Continuous, positioning operation is different according to the setting value by extended parameter of 「Continuous interpolation positioning method」. There are two methods of interpolation.

One is 「Passing Goal Position」 which passes through the specified goal position and the other is 「Near Passing」 which proceed to the next step at near position not to exceed a specified goal position.

「continuous interpolation positioning method」 setting of expanded parameter is as below.

Item	Setting Value	Contents
Continuous interpolation positioning method	0 : Passing Goal Position	Execute Continuous Operation which passes exact goal position of current step which set on operation data.
	1 : Near Passing	Execute Continuous operation which passes near position not to exceed a current step's goal position..

1) Passing Goal Position Continuous Operation

「Passing Goal Position」 Continuous Operation must be passing by goal position to the data set on goal position when changing from current step to next step. In the interpolation control, when execute a continuous operation from current step to next step, there can be mechanical vibration caused by discontinuous operating speed because of remaining moving amount.

XBM-H(P) use the speed compensation. It can solve mechanical vibration problem and execute Continuous operation which user set by from goal position to next step.

Next, describing the principle of 「passing goal position」 Continuous operation

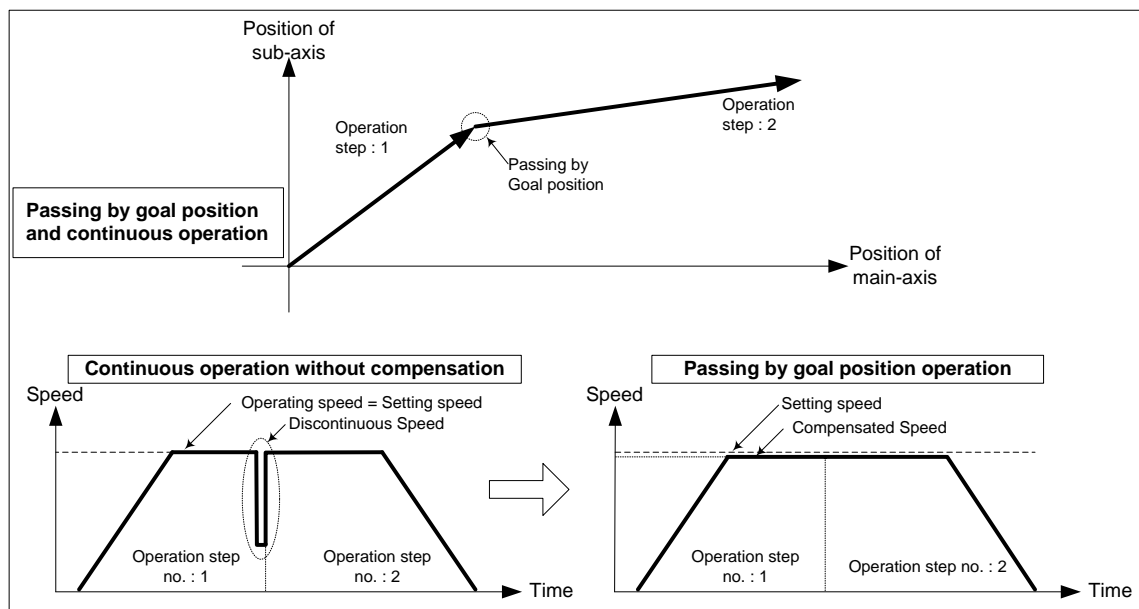

It decrease speed of acceleration, constant speed section as much as remaining amount of movement at the last section of current step to compensate position if operates as passing goal position operation.

Because next step can start with compensated speed, can avoid occurrence of discontinuous operating speed.

2) Near Passing Continuous Operation

It changes to the next step at near position not exceeding goal position of current step.

This is the way to eliminate discontinuous operating speed which occurs by remaining amount of movement data at the last of current step.

Next, describing the principle of 「Near Passing」 Continuous operation.

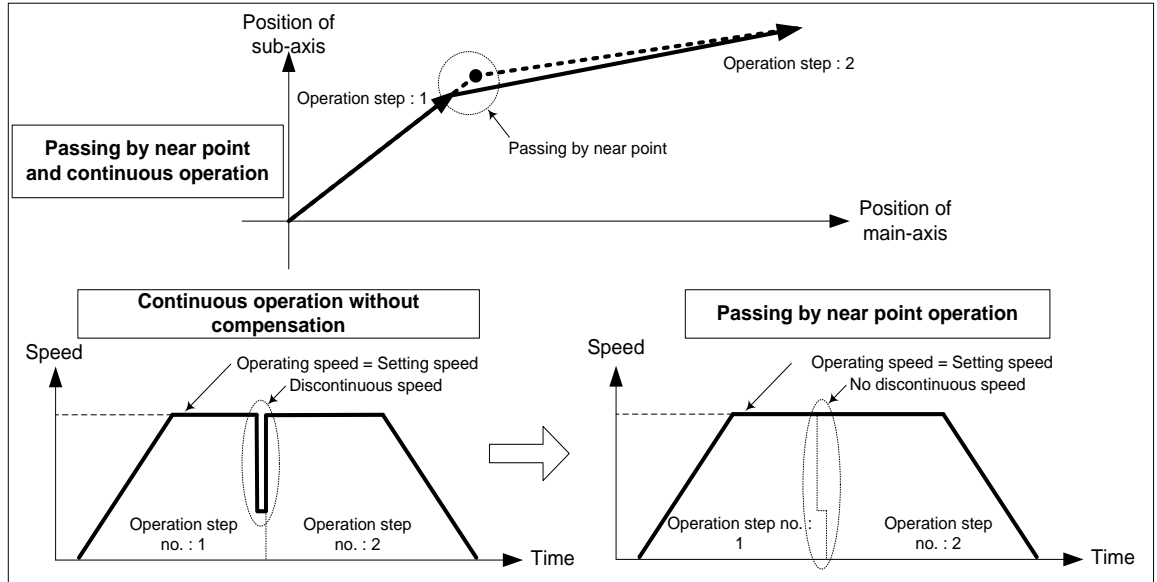

In the picture above, during general Continuous Operation, Occurring speed discontinuity because of remaining amount of movement at the last operation step NO.1. 「Near Passing」 Continuous Operation, you can move the remaining amount of movement to next step and execute Continuous Operation without speed discontinuity.

Note

When using 「Near passing」 continuous operation, sometimes it operates with next step speed before reaching the amount of movement set on goal position to remove the discontinuity of speed.

However in the case of Interpolation Continuous Operation control, it can have a gap with trajectory data which user set if it operates speed of the next step before reaching the goal position.

The following is the maximum difference of position for each axis.

- Difference of maximum axis position $< (\text{speed of each axis (pls / s)} \times \text{control cycle (= 1ms or 5ms)})$

(d) Deceleration Stop of Continuous Operation

Continuous operation control is decelerating and positioning completed during the 'End' operation step. However, next time, it keeps next step operation after decelerating as bias speed

- 1) When the moving direction of current executing operation step and the moving direction of next step is different (the case of single positioning control only)

■ Setting of XG-PM

Step NO.	Control Method	Operation Method	Goal Position [pls]	Operation Speed[pls/s]	Accel NO.	Decel NO.	M Code	Dwell Time
1	Absolute Single-axis Positioning Control	Single Continuous	10000	1000	1	1	0	0
2	Absolute Single-axis Positioning Control	Single End	3000	300	1	1	0	0

■ Operation Pattern

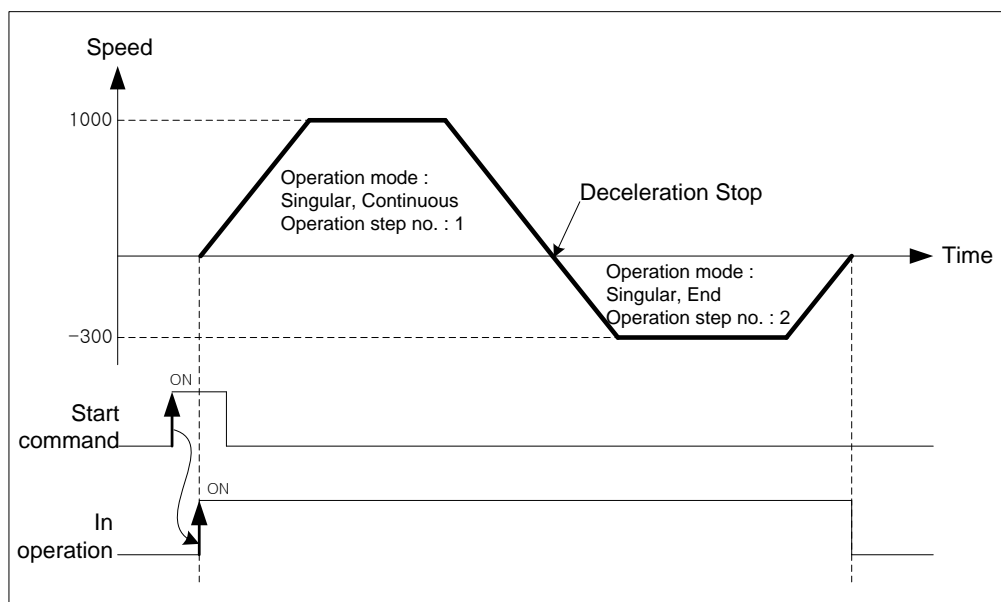

The Step1 will be operated by the start command. however, because the goal position of next step is on opposite direction from the goal position of step1, it stops after deceleration, and then operate Step2 to a opposite direction.

- 2) When the moving amount of next step is 0

When the next step's moving amount is 0, operation speed will be 0 during one control period.

■ Setting of XG-PM

Step NO.	Control Method	Operation Method	Goal Position [pls]	Operation Speed [pls/s]	Accel NO.	Decel NO.	M Code	Dwell Time
1	Absolute Single-axis Positioning Control	Single Continuous	10000	1000	1	1	0	0
2	Absolute Single-axis Positioning Control	Single Continuous	10000	700	1	1	0	0
3	Absolute Single-axis Positioning Control	Single End	15000	500	1	1	0	0

■ Operation Pattern

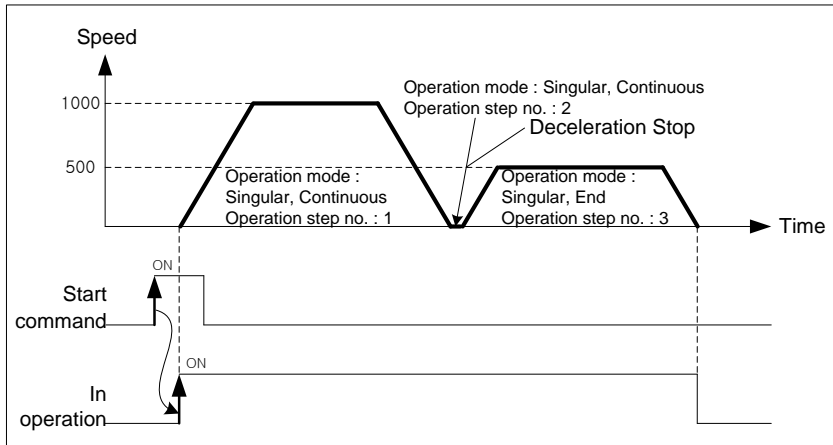

The Step1 will be operated by the start command. However, because the moving amount of next step is 0, it stops after deceleration, and then operates Step3 after 1 control period.

3) If there is an error on the operation data of next step

If there is an error on the next step's data(for example, if the operation speed of next step is 0 or if the operation method of current step is 「Single-axis Positioning Control」 but operation method of Next step is 「Single-axis FEED Control」), it stops after deceleration after current step's operation, and then completes operation.

■ Setting of XG-PM

Step NO.	Control Method	Operation Method	Goal Position [pls]	Operation Speed [pls/s]	Accel NO.	Decel NO.	M Code	Dwell Time
1	Absolute Single-axis Positioning Control	Single Continuous	10000	1000	1	1	0	0
2	Absolute Single-axis Feed Control	Single Continuous	20000	1000	1	1	0	0
3	Absolute Single-axis Positioning Control	Single End	30000	1000	1	1	0	0

■ Operation Pattern

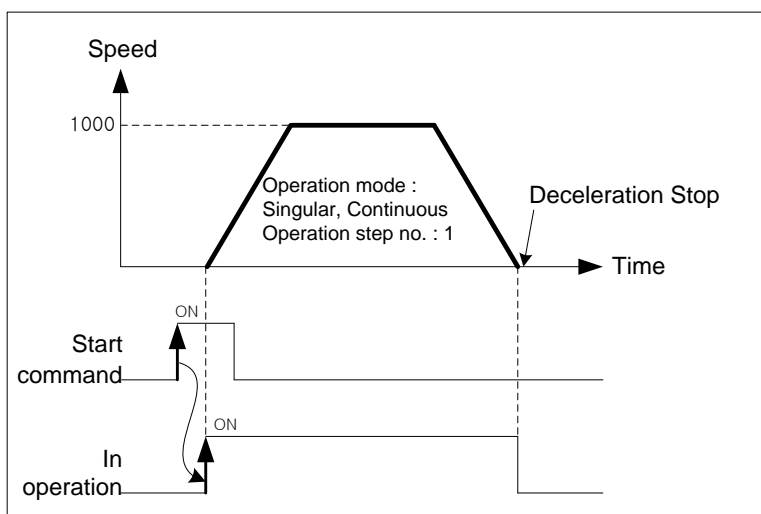

Note

During Continuous Operation of Linear interpolation or circular interpolation, because the PLC does not check the direction of movement, does not deceleration stop even if the moving direction is changed. Therefore, if there is opposite direction of goal position set on operation data, it may cause damages to machine because of rapid direction changing. In this case, use the operation method of 「Keep」 to prevent the damage for system.

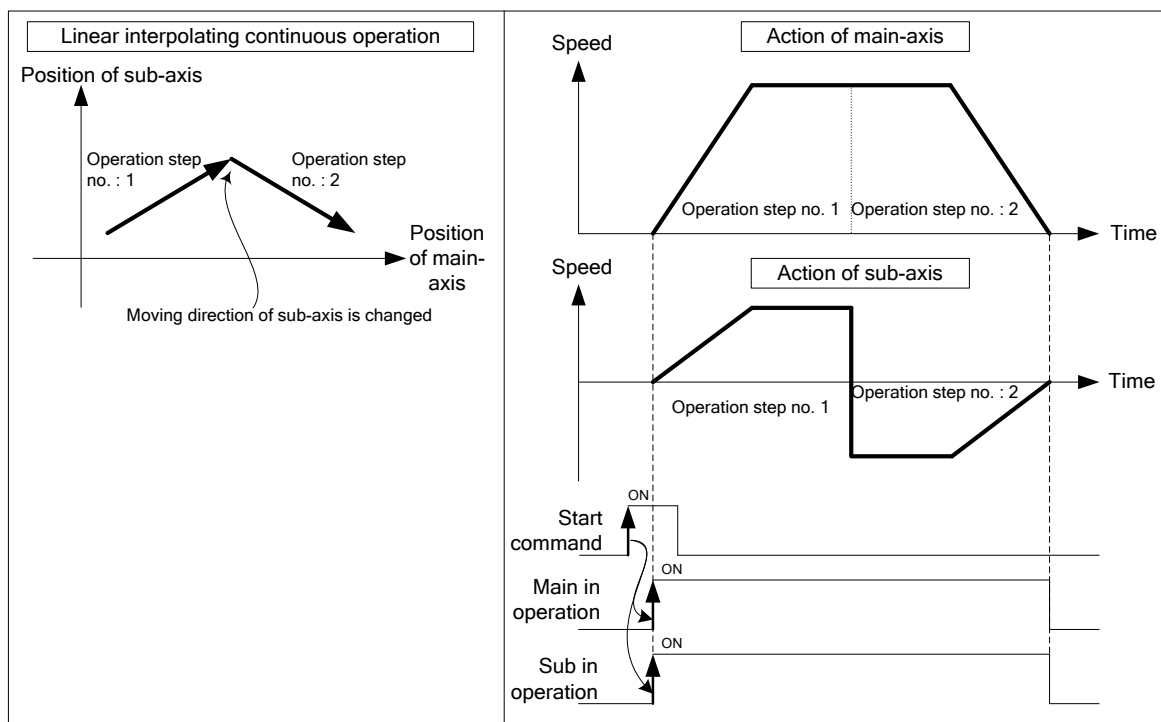

9.2.3 Single-axis Positioning Control

After executed by the start positioning operation command (「Direct start」 , 「Indirect start」 , 「Simultaneous start」), positioning control from specified axis (the current stop position) to goal position (the position to move).

(1) Control by Absolute method (Absolute coordinate) (「Absolute, Single-axis Positioning Control」)

- (a) Positioning control from start position to goal position (the position assigned by positioning data). Positioning control is carried out based on the position assigned (origin position) by homing.
- (b) Moving direction shall be determined by start position and goal position.
 - ▶ Start position < Goal position: forward direction positioning
 - ▶ Start position > Goal position: reverse direction positioning

[Example] Set the Absolute Coordinates as follow, Operate single-axis positioning control.

- ▷ Start position: 1000,
- ▷ Goal position: 8000

The transfer amount to forward direction shall be 7000 ($7000=8000-1000$).

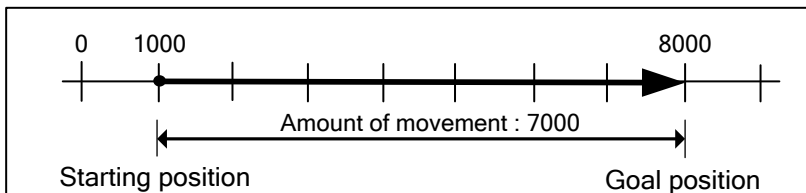

■ Setting of XG-PM

Step NO.	Control Method	Operation Method	Goal Position [pls]	Operation Speed [pls/s]	Accel NO.	Decel NO.	M Code	Dwell Time
1	Absolute Single-axis Positioning Control	Single End	8000	1000	1	1	0	100

■ Operation Pattern

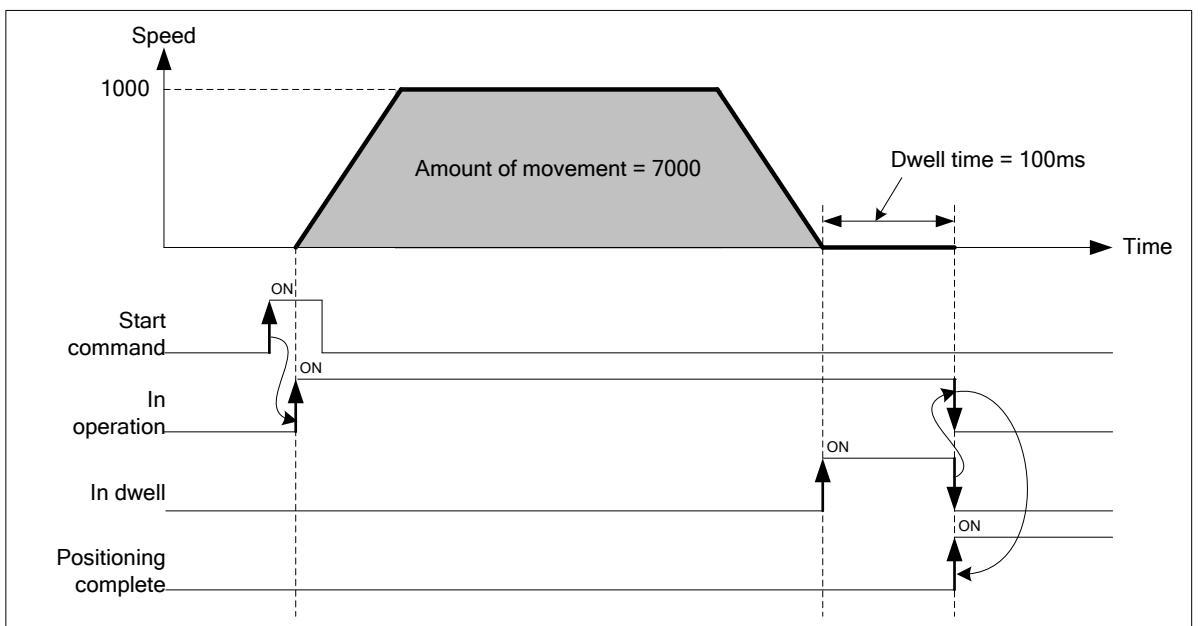

(2) Control by Incremental method (Relative coordinate) (「Relative, Single-axis Positioning Control」)

- (a) Positioning control as much as the goal transfer amount from start position. Unlike the absolute coordinates of goal position, it is not a value of specified on goal position; it is a moving amount of current position.
- (b) Transfer direction shall be determined by the sign of transfer amount.
- ▷ Transfer direction (+) or no sign: forward direction (current position increase) positioning
 - ▷ Transfer direction (-) : reverse direction (current position decrease) positioning

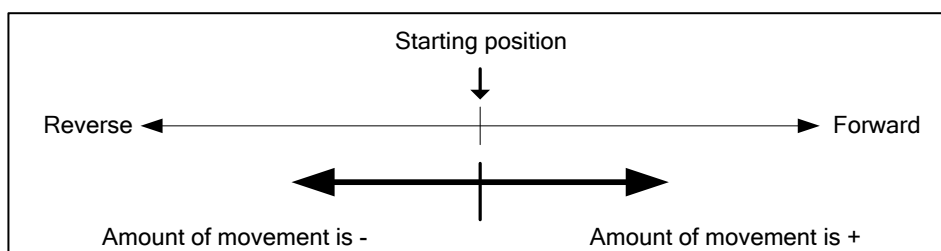

[Example] Set the Relative Coordinates as follow, Operate single-axis positioning control.

▷ Start position: 5000,

▷ Goal position: -7000

This will be reverse direction and positioning will be at the point of -2000.

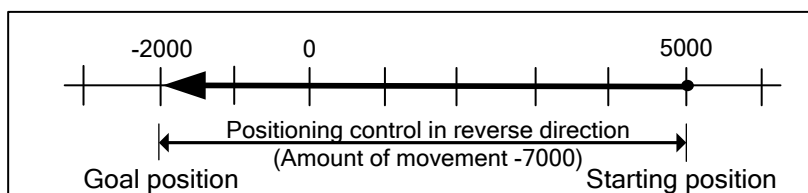

■ Setting of XG-PM

Step NO.	Control Method	Operation Method	Goal Position [pls]	Operation Speed [pls/s]	Accel NO.	Decel NO.	M Code	Dwell Time
1	Incremental Single-axis Positioning Control	Single End	-7000	1000	1	1	0	100

■ Operation Pattern

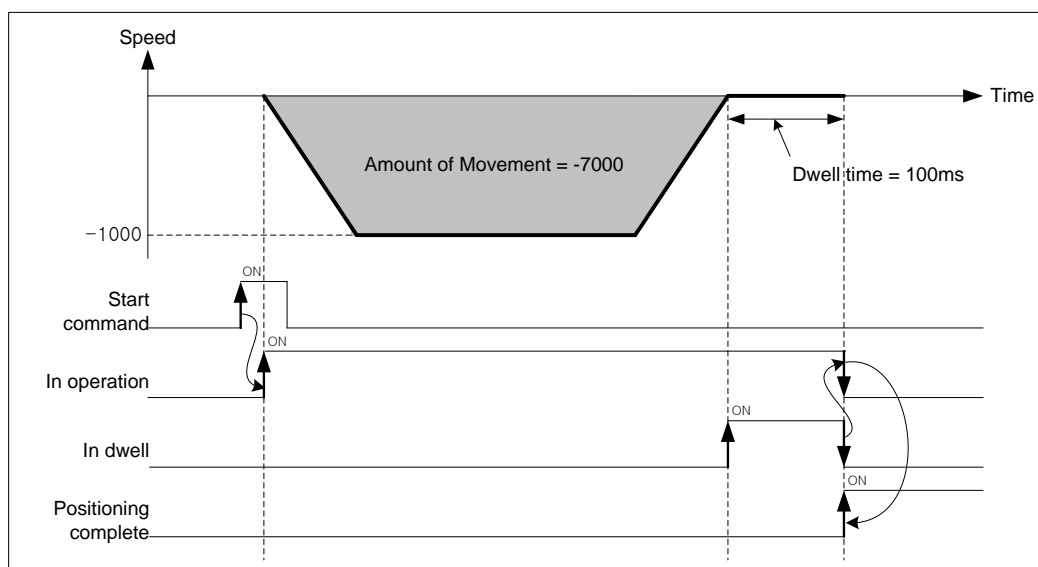

9.2.4 Single-axis Speed Control

After executed by the start positioning operation command (「Direct start」, 「Indirect start」, 「Simultaneous start」), this controls the speed by the setting speed until deceleration stop command is entered.

(1) Features of Control

- (a) Speed control contains 2 types of start : Forward direction start and Reverse direction start.
 - ▷ Forward direction : when position value is positive number (+) ("0" included)
 - ▷ Reverse direction : when position value is negative number (-)
- (b) In case of using speed control, the following items of operation data do not affect.
 - ▷ Coordinates, Operation method, Dwell time
 - ▷ "Absolute, single-axis speed control", "Relative, single-axis speed control" execute same operation.
- (c) Accelerating operation of speed control operate with acceleration number and time on setting data, decelerating operation operate with deceleration number and time of a command 「deceleration stop」

(2) Operation Timing

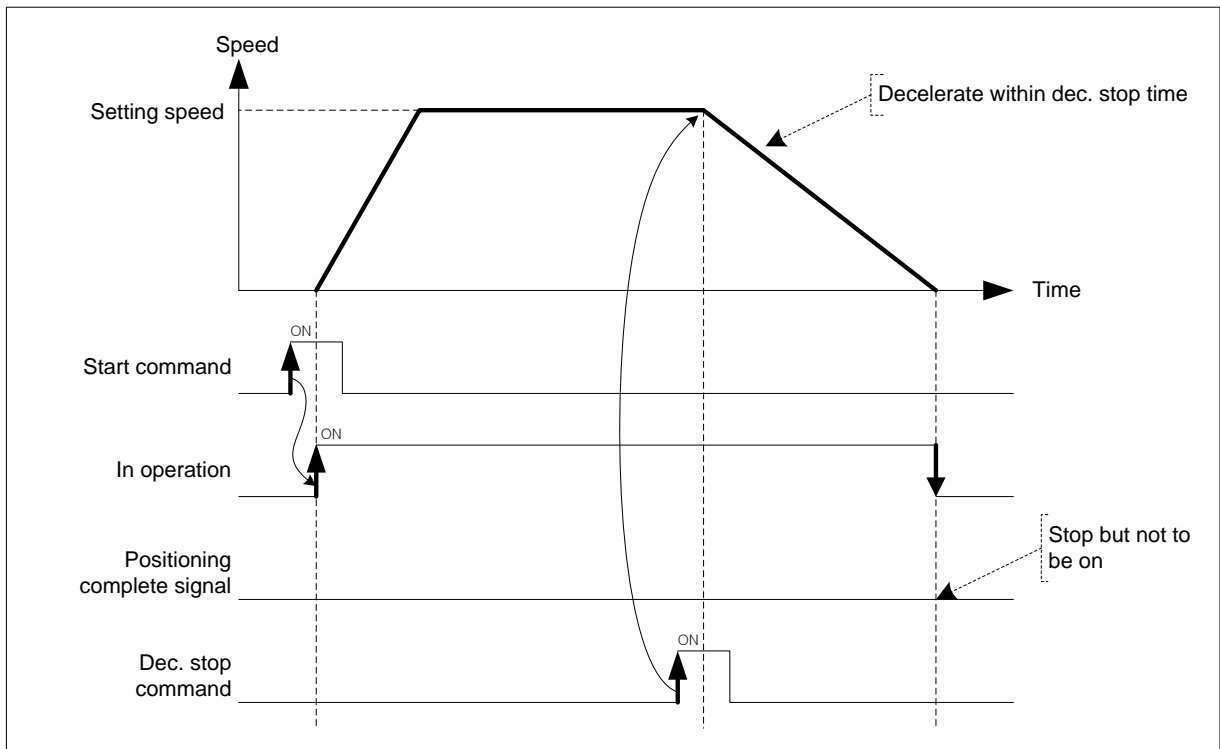

(3) Restrictions

- (a) Set the operation pattern of speed control as 'End' or 'Keep'. When it is set on "Continuous", error occurs (error code: 236) and can not execute speed control.
- (b) Using as speed control, only when 「M code mode」 of extended parameter is "with", M code signal is "On". (When "After mode", M code signal is not "On".)

(c) Speed control of software upper/lower limit checking change according to the setting of the speed control of software upper/lower limit check.

Item	Setting Value	Contents
During Speed Control S/W Upper/Lower limit	0 : Not Detect	During Speed Control, do not operate to check the range of upper/lower limit of software
	1 : Detect	During Speed Control, operate to check the range of upper/lower limit of software

(4) Setting of XG-PM

Step NO.	Control Method	Operation Method	Goal Position [pls]	Operation Speed [pls/s]	Accel NO.	Decel NO.	M Code	Dwell Time
1	Absolute Single-axis Speed Control	Single End	100	1000	1	1	0	0

9.2.5 Single-axis Feed Control

After executed by the start positioning operation command (「Direct start」, 「Indirect start」, 「Simultaneous start」), change current stop position as '0', positioning control until setting goal position.

(1) Features of control

- (a) The value set on goal position is moving amount. That is, moving direction is decided by the code of setting goal position.
 - ▷ Forward direction : when position address is positive number (+) ("0" included)
 - ▷ Reverse direction : when position address is negative number (-)
- (b) In case of using Single-axis Feed Control, the following items of operation data do not affect.
 - ▷ Coordinates
 - ▷ "Absolute, single-axis speed control", "Relative, single-axis speed control" execute same operation.

(2) Operation Timing

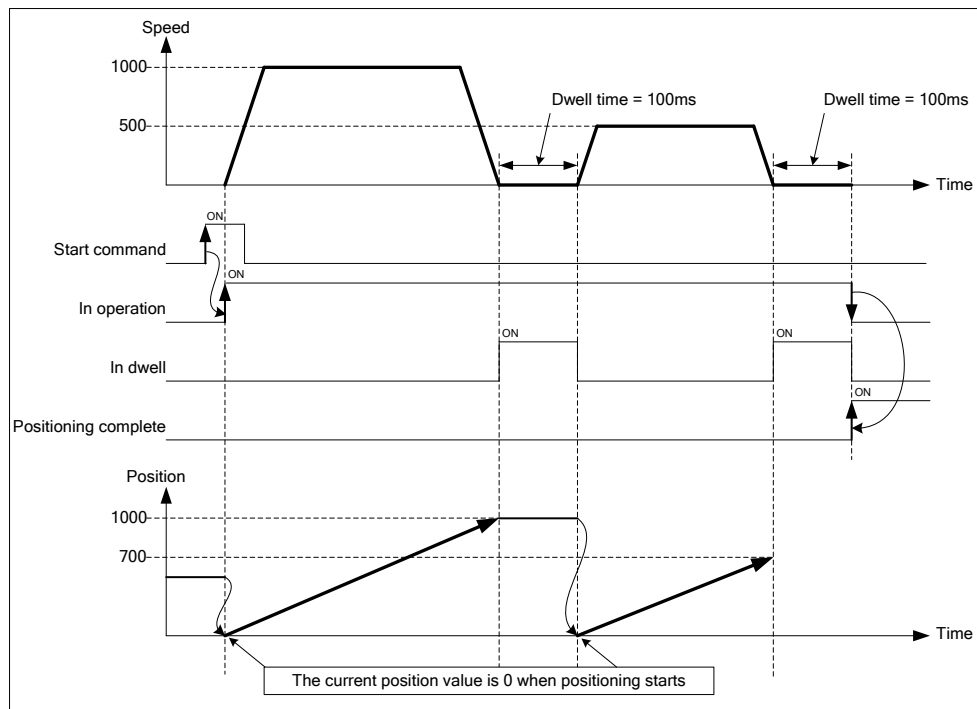

(3) Restrictions

- (a) Set the operation pattern of Feed control as 'End' or 'Keep'. When it is set on "Continuous", error occurs (error code: 230) and can not execute Feed control.

(4) Setting of XG-PM

Step NO.	Control Method	Operation Method	Goal Position [pls]	Operation Speed [pls/s]	Accel NO.	Decel NO.	M Code	Dwell Time
1	Absolute Single-axis Feed Control	Single Keep	1000	1000	1	1	0	100
2	Absolute Single-axis Feed Control	Single End	700	500	1	1	0	100

9.2.6 Linear Interpolation Control with 2 axes

After executed by positioning operation start command (「Indirect start」, 「Synchronous start」), then executing interpolation control from starting position to the goal position with interpolation axis set as the main axis and sub axis.

(1) Linear interpolation control with absolute coordinates (「Absolute, Linear Interpolation」)

- (a) Execute linear interpolation from starting position to the goal position designated on positioning data. Positioning control is on basis of the designated position from homing.
- (b) The direction of movement depends on the starting position and the goal position for each axis.
 - Starting position < Goal position : Positioning operation in forward
 - Starting position > Goal position : Positioning operation in reverse

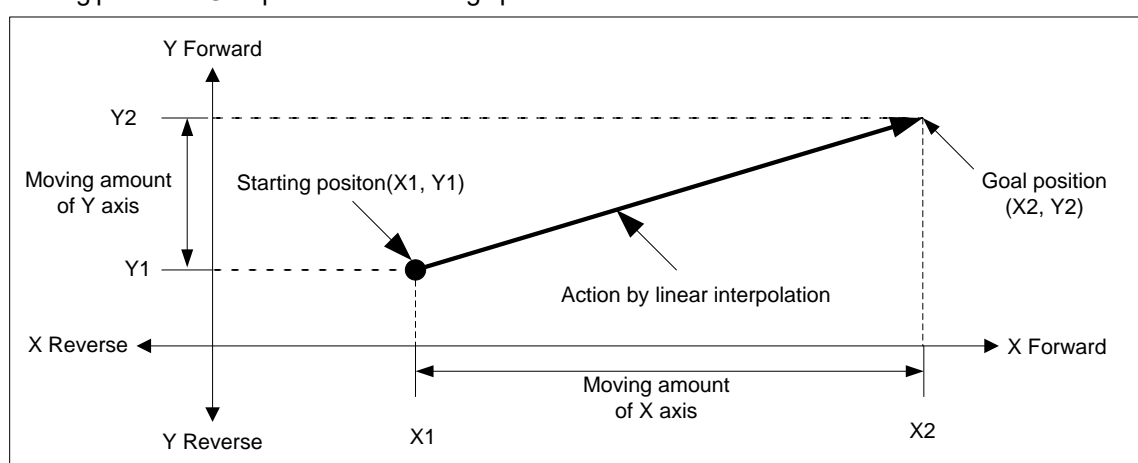

(c) Restrictions

Linear interpolation with 2 axes may not be executed in the case below.

- 「Sub axis setting」 Error (error code : 253)
 - 「Sub axis setting」 of main axis operating data is "Axis-undecided"
 - 「Sub axis setting」 of main axis operating data is the same as main axis no.
 - 「Sub axis setting」 of main axis operating data exceeds the settable axis No.

Note

Because more than 2 axes are in action, so need user to pay attention

(1) The commands available are as follows.

Speed override, Dec. time, Emergent stop, Skip operation, Continuous operation

(2) The commands unavailable in linear interpolation are as follows.

Position/Speed switching control, Position override

(3) The parameter items which work depending on the value of each axis are as follows.

Backlash compensation, Software Upper/Lower limit

(d) Setting example of operating data

Items	Main-axis setting	Sub-axis setting	Description
Control method	Absolute, Linear interpolation	Absolute, Single axis position control ^{*1}	When linear interpolation control is executed by the method of absolute coordinates, set 「Absolute, Linear interpolation」 on the main axis
Operating method	Singular, End	-	Set the operating method to execute linear interpolation
Goal position [pls]	10000	5000	Set the goal position to position on main-axis and sub-axis
Operating speed [pls/s]	1000	-	Use speed-designated method of main axis for linear interpolation
Acc. no.	No.1	-	Set acc. no. for acceleration (no.1 ~ no.4)
Dec. no.	No.2	-	Set dec. no. for deceleration (no.1 ~ no.4)
M code	0	-	When need to execute auxiliary work synchronizing with linear interpolation
Dwell time	500	-	Set dwell time(ms) to outputting the signal positioning completion
Sub-axis setting	Axis2	-	Set an axis to be used as sub-axis among settable axis in operating data of main-axis

^{*1} : It does not need to be set. Whatever value is set as, it does not affect linear interpolation.

Note

Linear interpolation control is executed on the basis of operating data of main axis.

Items other than "coordinate" and "target position" during setting of subordinate axis during linear interpolation operation do not affect linear interpolation operation. That is, setting any value does not affect the operation and does not cause an error. Since the coordinate setting of the longitudinal axis control method indicates whether the target position on the vertical axis is an absolute coordinate or a relative coordinate, when the linear interpolation is controlled by the relative coordinate system, the coordinate of the vertical axis must be set to "relative".

[Example] axis1 and axis2 are main and sub axis each. Execute linear interpolation by the setting as follows

■ Starting position (1000, 4000), Goal position (10000, 1000) : In this condition, the operation is as follows.

■ Setting example of XG-PM

▪ Operating data of main-axis(axis1)

Step NO.	Control Method	Operation Method	Goal Position [pls]	Operation Speed [pls/s]	Accel NO.	Decel NO.	M Code	Dwell Time	Sub axis setting
1	Absolute, Linear	Singular, End	10000	3000	1	1	0	100	Axis 2

▪ Operating data of sub-axis(axis2)

Step NO.	Control Method	Operation Method	Goal Position [pls]	Operation Speed [pls/s]	Accel NO.	Decel NO.	M Code	Dwell Time	Sub axis setting
1	Absolute, Single positioning control	Singular, End	1000	0	1	1	0	0	Axis-undecided

■ Operating pattern

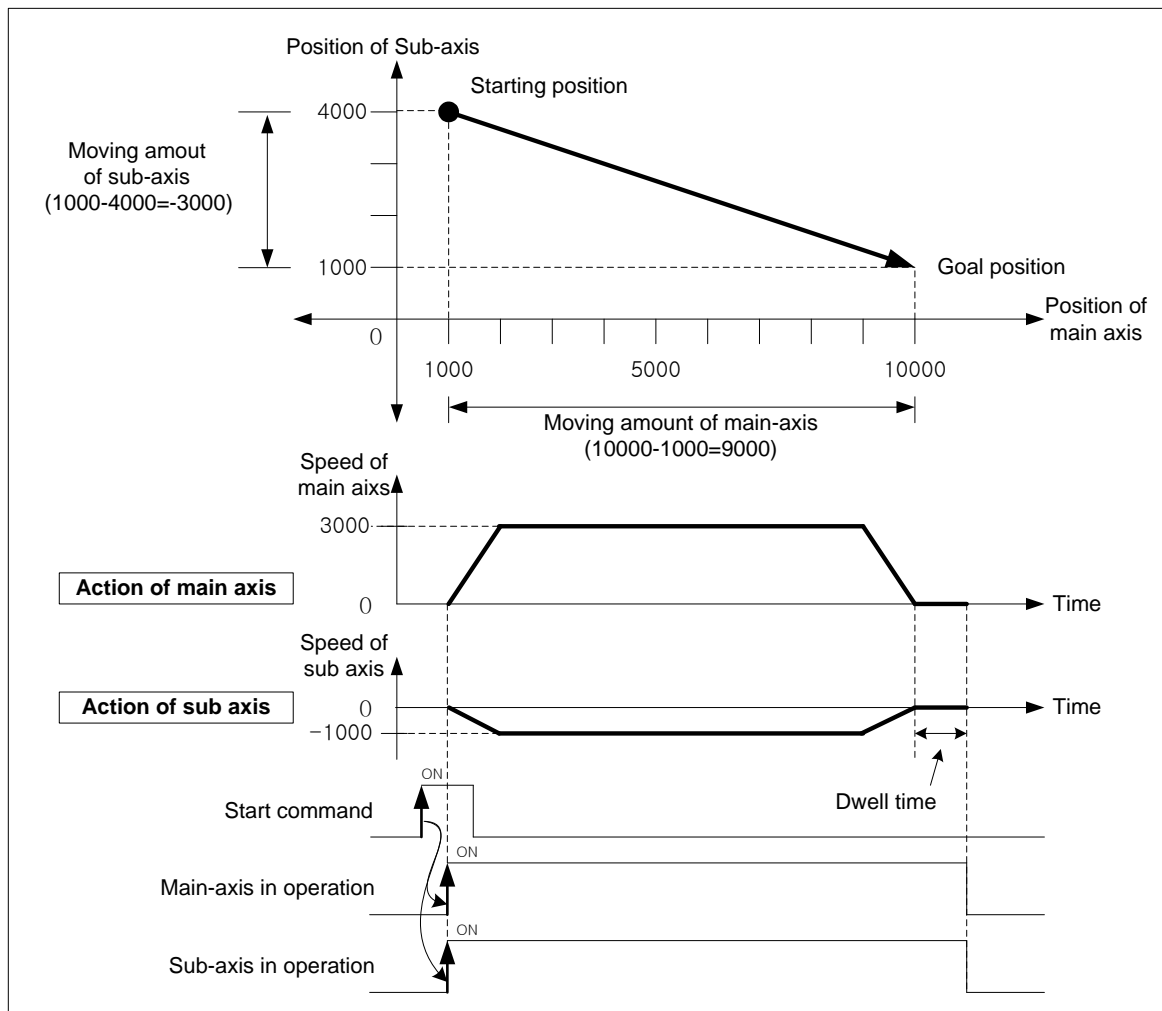

(2) Linear interpolation control with relative coordinates (「Relative, Linear Interpolation」)

- (a) Execute 2 axes linear interpolation from starting position to the goal position. Positioning control is on basis of the current stop position.
- (b) Moving direction depends on the sign of the goal position (Moving amount)
- The sign is positive (+ or nothing) : Positioning operation in forward
 - The sign is negative (-) : Positioning operation in reverse

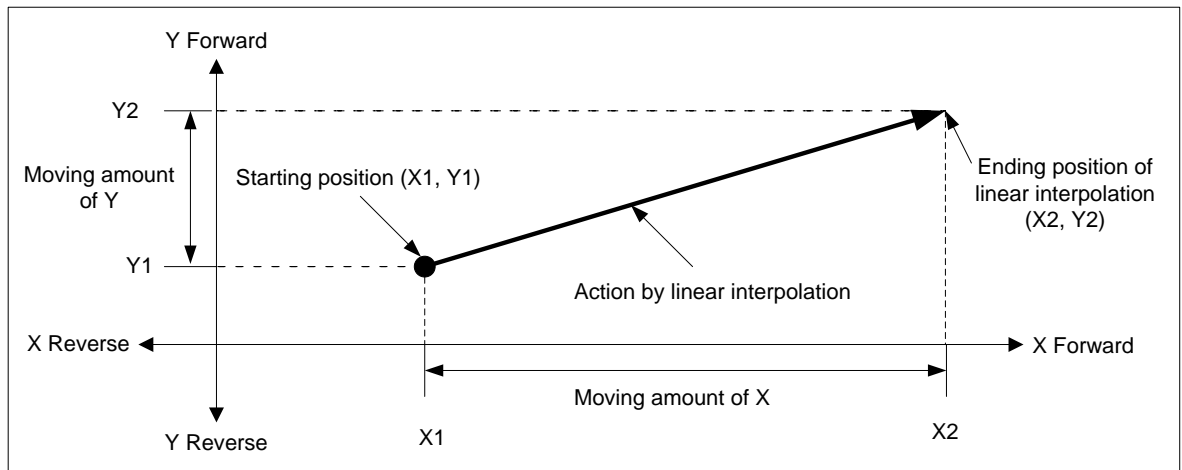

(c) Restrictions

Linear interpolation with 2 axes may not be executed in the case below.

- 「Sub-axis setting」 error (error code : 253)
 - 「Sub-axis setting」 value of main axis operating data is "Axis-undecided"
 - 「Sub-axis setting」 value of main axis operating data is same as the main axis no.
 - 「Sub-axis setting」 value of main axis operating data exceeds settable axis no.

(d) Setting example of operation data

Items	Main-axis setting	Sub-axis setting	Description
Control method	ABS, (LIN)INT	ABS, (SIN)POS	When linear interpolation control is executed by the method of relative coordinates, set 「Relative, Linear interpolation」 on the main axis
Operating method	Singular, End	- *1	Set the operating method to execute linear interpolation
Goal position[pls]	10000	5000	Set the goal position to position on main & sub-axis
Operating speed [pls/s]	1000	-	Use speed-designated method of main axis for linear interpolation
Acc. no.	No.1	-	Set acc. no. for acceleration (no.1 ~ no.4)
Dec. no.	No.2	-	Set dec. no. for deceleration (no.1 ~ no.4)
M code	0	-	When need to execute auxiliary work synchronizing with linear interpolation
Dwell time	500	-	Set dwell time(ms) to outputting the signal positioning completion
Sub-axis setting	Axis2	-	Set an axis to be used as sub-axis among settable axis in operating data of main-axis

*1 : It does not need to be set. Whatever value is set as, it does not affect linear interpolation.

Note

Linear interpolation control executes the operation based on the item set in the operation data of the main axis (command axis).

Items other than "coordinate" and "target position" during setting of subordinate axis during linear interpolation operation do not affect linear interpolation operation. That is, setting any value does not affect the operation and does not cause an error.

Since the coordinate setting of the longitudinal axis control method indicates whether the target position on the vertical axis is an absolute coordinate or a relative coordinate, when the linear interpolation is controlled by the relative coordinate system, the coordinate of the vertical axis must be set to "relative".

[Example] axis1 and axis2 are main and sub axis each. Execute linear interpolation by the setting as follows.

■ Starting position (1000, 4000), Goal position (9000, -3000) : In this condition, the operation is as follows.

■ Setting example of XG-PM

▪ Operating data of main-axis(axis1)

Step NO.	Control Method	Operation Method	Goal Position [pls]	Operation Speed [pls/s]	Accel NO.	Decel NO.	M Code	Dwell Time	Sub axis setting
1	Absolute, Linear	Singular, End	9000	3000	1	1	0	100	Axis2

▪ Operating data of sub-axis(axis2)

Step NO.	Control Method	Operation Method	Goal Position [pls]	Operation Speed [pls/s]	Accel NO.	Decel NO.	M Code	Dwell Time	Sub axis setting
1	Absolute, Single positioning control	Singular, End	-3000	0	1	1	0	0	None

■ Operating pattern

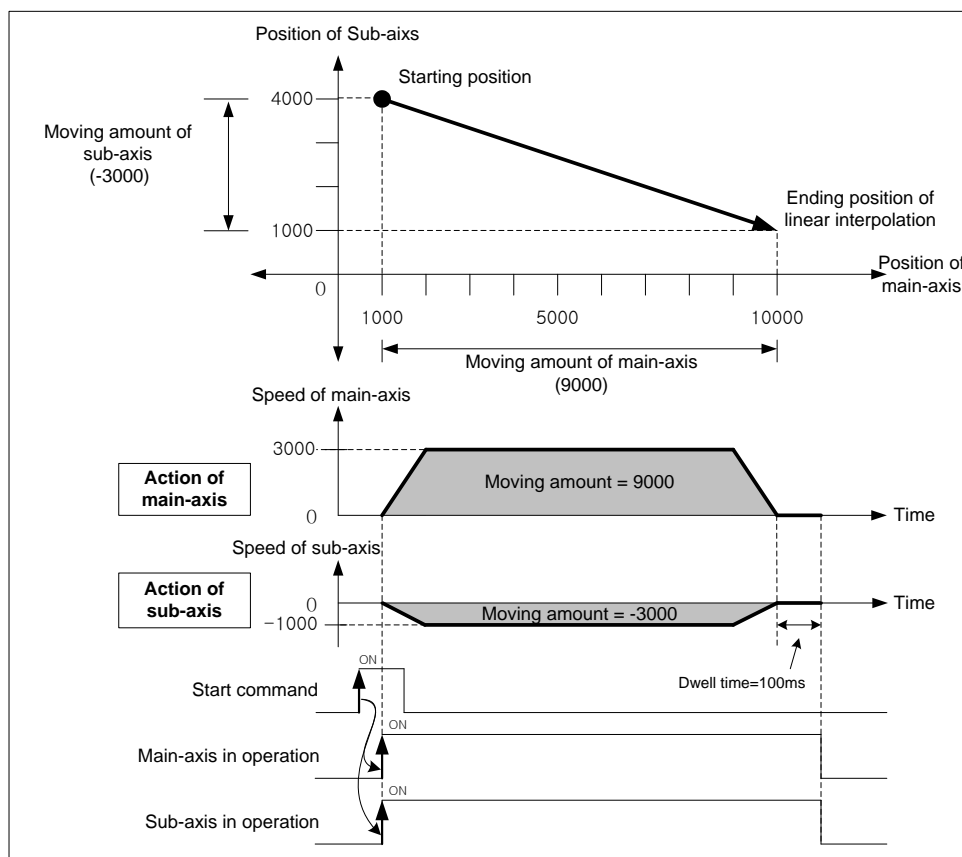

(3) Speed in 2 axes linear interpolation control

Operating speed in linear interpolation is according to the method of main-axis designating. After operating speed is set on command axis (main), the designated axis for interpolation is operated by PLC's calculating each moving amount. Speed of sub-axis and actual speed of machine are calculated as follows.

■ Speed in 2 axes linear interpolation

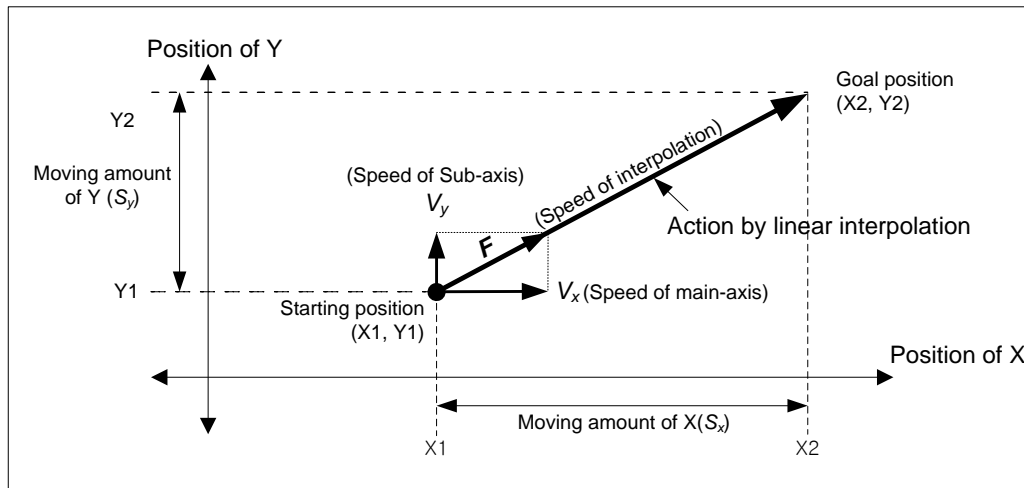

$$\text{Speed of sub}(V_y) = \text{Speed of main}(V_x) \times \frac{\text{Moving amount of Sub}(S_y)}{\text{Moving amount of Main}(S_x)}$$

$$\text{Interpolating speed}(F) = \sqrt{V_x^2 + V_y^2}$$

[Example]

- Starting position (2000, 1000)
- Goal position (6000, 4000)
- Operating speed : 400 [pls/s]

Speed of sub-axis and interpolating speed are as follows.

$$\text{Speed of sub-axis} = 400 \times \frac{3000}{4000} = 300 \text{ [pls/s]}$$

$$\text{Interpolating speed} = \sqrt{400^2 + 300^2} = 500 \text{ [pls/s]}$$

■ Speed in 2 axes linear interpolation (when Synthetic speed is selected)

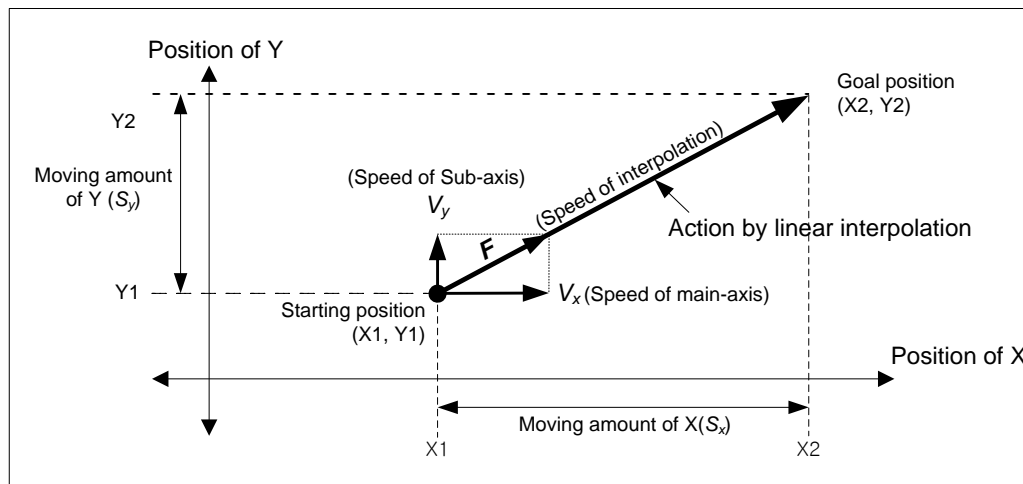

Interpolating speed(F) = Operating speed of main axis

$$\text{Interpolating moving amount(S)} = \sqrt{S_x^2 + S_y^2}$$

$$\text{Speed of main-axis} = \text{Interpolating speed(F)} \times \frac{\text{Main axis moving amount}(S_x)}{\text{Synthetic axis moving amount(S)}}$$

$$\text{Speed of sub-axis} = \text{Interpolating speed(F)} \times \frac{\text{Sub axis moving amount}(S_y)}{\text{Synthetic axis moving amount(S)}}$$

[Example]

- Starting position (2000, 1000)
- Goal position (6000, 4000)
- Synthetic speed : 400 [pls/s]

Speed of sub-axis and interpolating speed are as follows.

$$\text{Interpolating moving amount(S)} = \sqrt{4000^2 + 3000^2} = 5000$$

$$\text{Speed of main-axis} = 400 \times \frac{4000}{5000} = 320$$

$$\text{Speed of sub-axis} = 400 \times \frac{3000}{5000} = 240 \text{ [pls/s]}$$

Note

(1) Speed limit for Sub-axis

When using linear interpolation control and moving distance of main < moving distance of sub, it is possible that sub-axis speed calculated by PLC exceeds 「Speed limit」 of basic parameter. In this case, error (error code : 261) arises and sub-axis speed is recalculated, then sub-axis continues to operate. To prevent that errors arise, operate it at the speed below limit.

(2) The speed when the distance main-axis moved is 0

When the distance main-axis moved is 0, the operating speed of main-axis operating data becomes actual interpolating speed. In the case that the distance main-axis moved is 0 and executing 2 axes linear interpolation, only sub-axis operates at the speed set on command axis.

■ Setting example of XG-PM

▪ Operating data of Main-axis

Step no.	Control method	Operating method	Goal position [pls]	Operating speed [pls/s]	Acc. no.	Dec. no.	M code	Dwell time	Sub axis setting
1	Absolute, Linear interpolation	Singular, Continuous	5000	1000	No.1	No.1	0	100	Axis2
2	Absolute, Linear interpolation	Singular, End	5000	1000	No.1	No.1	0	100	Axis2

▪ Operating data of Sub-axis

Step no.	Control method	Operating method	Goal position [pls]	Operating speed [pls/s]	Acc. no.	Dec. no.	M code	Dwell time	Sub axis setting
1	Absolute, single position control	Singular, End	1000	0	No.1	No.1	0	0	None
2	Absolute, single position control	Singular, End	3000	0	No.1	No.1	0	0	None

■ Operating pattern

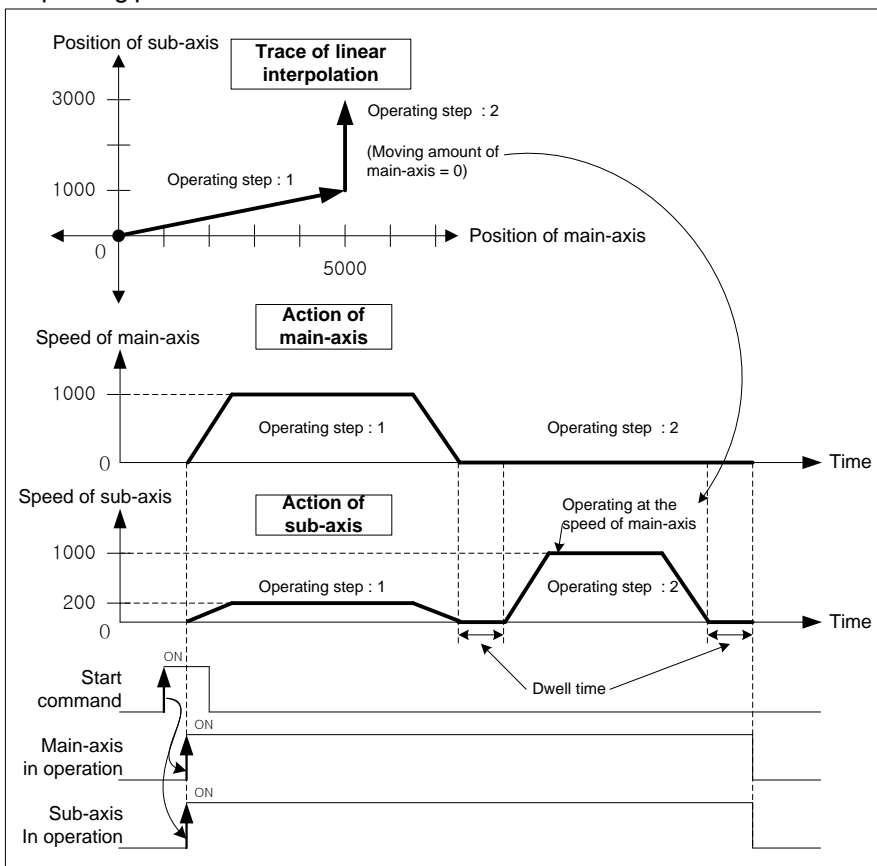

(4) 2 axes linear interpolating continuous operation with circular arc interpolation

When the operation method is set as “continuous” and the direction of movement changes rapidly, machine is possible to be damaged. When it does not have to position to the goal position, user may interpolate ‘circular interpolating operation’ between two trace to make operation softer and smoother.

(a) Operation order

- 1) Confirm the execution of 2 axes linear interpolating continuous operation with circular arc interpolation when linear interpolation starts. It may be set in 「2 axes linear interpolating continuous operation with circular arc interpolation」 of extended parameter.

Setting items	Setting value	Description
2 axes linear interpolating continuous operation with circular arc interpolation	0 : Not to execute	When executing it, not to interpolate circular arc
	1 : To execute	When executing it, interpolate circular arc

- 2) Reset the starting position of circular interpolation (Goal position of Linear trace 1) and the goal position (Starting position of Linear trace 2) through checking the position circular arc will be interpolated at. The position circular arc will be interpolation at may be set in 「Circular arc interpolating position」 of extended parameter.

Setting items	Setting value	Description
2 axes linear interpolating continuous operation with circular arc interpolation	0 ~ 2147483647	Set the position circular arc will be interpolated at. This value means the relative distance from the goal position of linear trace 1.

- 3) Execute linear interpolation to the starting position of circular arc and continue to execute circular interpolation at the same speed as linear interpolation. After finish the circular interpolation, continue to execute linear interpolation at the same speed.

(b) Operating pattern

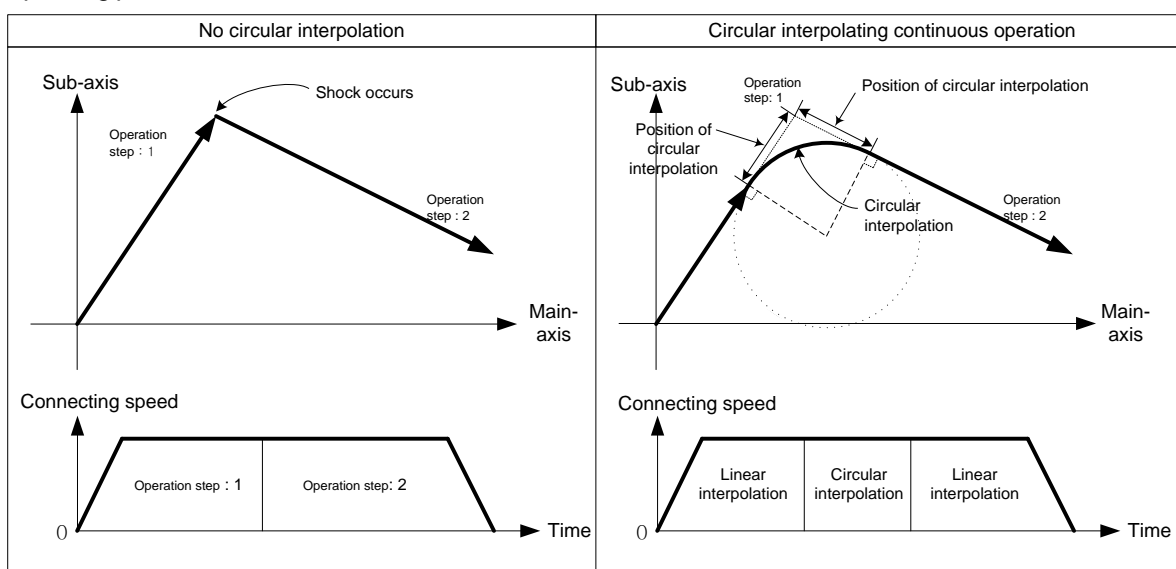

Chapter 9 Functions

(c) Restrictions

Circular interpolation is not executed in the case below but linear interpolation is executed to the goal position.

- Operating method of operation data is “End” or “Continue”
- Position of circular arc interpolating is bigger than linear trace 1, 2 (Error code : 262)
- Trace of both linear interpolations are on the same line

[Example] Execute linear interpolation when the extended parameter setting is same as follows at the current position (0,0)

Extended parameter	Setting value
2 axes linear interpolating continuous operation with circular arc interpolation	1 : Circular arc interpolating continuous operation
Position of 2 axes linear interpolating continuous operation with circular arc interpolation	2000

■ Setting example of XG-PM

▪ Operating data of Main-axis

Step no.	Control method	Operating method	Goal pos[pls]	speed [pls/s]	Acc. no.	Dec. no.	M code	Dwell time	Sub axis setting
1	Absolute, Linear interpolation	singular, continuous	0	3000	No.1	No.1	0	0	Axis2
2	Absolute, Linear interpolation	singular, continuous	5000	3000	No.1	No.1	0	0	Axis2
3	Absolute, Linear interpolation	singular, end	5000	3000	No.1	No.1	0	100	Axis2

▪ Operating data of Sub-axis

Step no.	Control method	Operating method	Goal pos[pls]	speed [pls/s]	Acc. no.	Dec. no.	M code	Dwell time	Sub axis setting
1	Absolute, single axis position control	singular, end	1000	0	No.1	No.1	0	0	None
2	Absolute, single axis position control	singular, end	1000	0	No.1	No.1	0	0	None
3	Absolute, single axis position control	singular, end	4000	0	No.1	No.1	0	0	None

■ Operating pattern

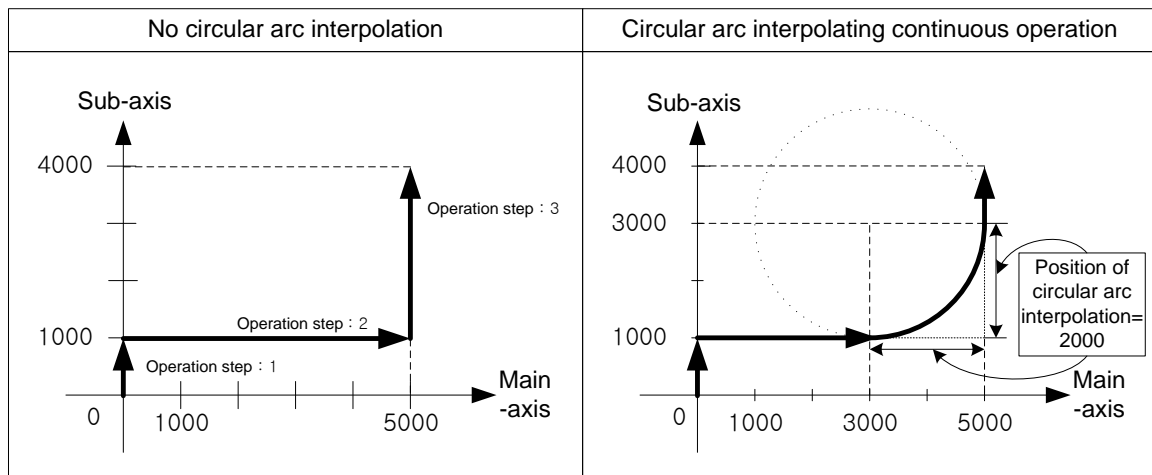

■ Description about action

When executing operation step no.1, execute linear interpolation to original goal position (0,1000) without circular arc interpolation because position to interpolate circular arc(2000) is bigger than the length of line 1(1000).

When finishing linear interpolation to goal position of operation step no.1 and executing operation step no.2, because position to interpolate circular arc(2000) is smaller than line length of step no.2(5000) and no.3(3000), so recalculate the starting position (Goal position of linear trace no.1) and the goal position (Starting position of linear trace no.2) of circular interpolation.

After continue to execute linear interpolation to the recalculated goal position of operation step no.2(3000,1000), then execute circular interpolation to recalculated starting position of operation step no.3(5000,3000).

After circular interpolation, execute linear interpolation to the goal position of operation step no.3(5000,4000), Positioning will be complete.

9.2.7 Linear Interpolation Control with 3 axes

After executed by positioning operation start command (「Indirect start」 , 「Synchronous start」), then executing interpolation control from starting position to the goal position with interpolation axis set as the main axis and sub axis.

(1) Linear interpolation control with absolute coordinates (「Absolute, Linear Interpolation」)

- (a) Execute linear interpolation with 3 axes from starting position to the goal position designated on positioning data.
Positioning control is on basis of the designated position from homing.
- (b) The direction of movement depends on the starting position and the goal position for each axis.
 - Starting position < Goal position : Positioning operation in forward
 - Starting position > Goal position : Positioning operation in reverse

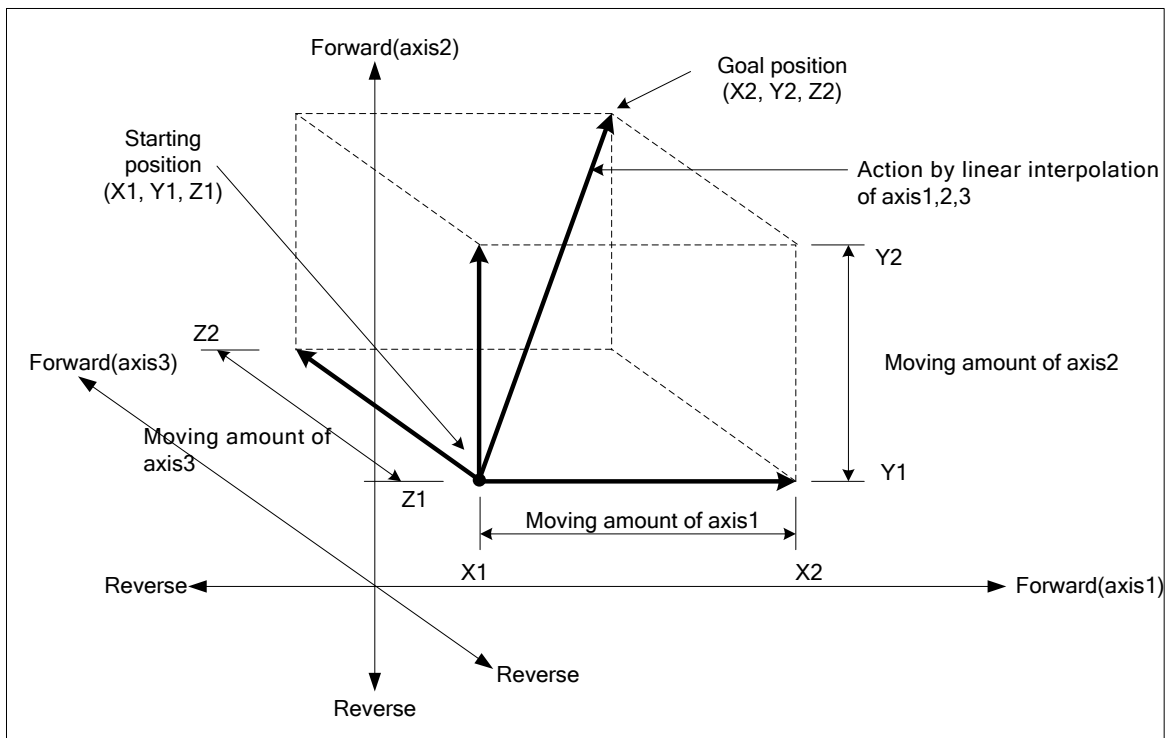

(c) Restrictions

Linear interpolation with 3 axes may not be executed in the case below.

- 「Sub axis setting」 Error (error code : 253)
 - 「Sub axis setting」 of main axis operating data is "Axis-undecided"
 - 「Sub axis setting」 of main axis operating data is the same as main axis no.
 - 「Sub axis setting」 of main axis operating data exceeds the settable axis no. of module now using
- If only one axis is set as sub axis, execute "linear interpolation control with 2 axes".

(d) Setting example of operating data

Setting items	Main-axis setting (axis1)	Sub-axis setting(axis2)	Sub-axis setting(axis3)	Description
Control method	Absolute, Linear interpolation	- ^{*1}	- ^{*1}	When linear interpolation control is executed by the method of absolute coordinates, set 「Absolute, Linear interpolation」 on the main axis
Operating method	Singular, End	-		Set the operating method to execute linear interpolation
Goal position [pls]	5000	6000	4000	Set the goal position to position on main-axis and sub-axis
Operating speed [pls/s]	1000	-		Use speed-designated method of main axis for linear interpolation
Acc. no.	No.1	-		Set acc. no. for acceleration (no.1 ~ no.4)
Dec. no.	No.2	-		Set dec. no. for deceleration. (no.1 ~ no.4)
M code	0	-		When need to execute auxiliary work synchronizing with linear interpolation
Dwell time	500	-		Set dwell time(ms) to outputting the signal positioning completion
Sub-axis setting	Axis2, Axis3	-		Set an axis to be used as sub-axis among settable axis in operating data of main-axis

^{*1} : It does not need to be set. Whatever value is set as, it does not affect linear interpolation.

Note

Linear interpolation control is executed on the basis of operating data of main axis.

Items other than "coordinate" and "target position" during setting of subordinate axis during linear interpolation operation do not affect linear interpolation operation. That is, setting any value does not affect the operation and does not cause an error.

Since the coordinate setting of the longitudinal axis control method indicates whether the target position on the vertical axis is an absolute coordinate or a relative coordinate, when the linear interpolation is controlled by the absolute coordinate system, the coordinate of the vertical axis must be set to "absolute".

Chapter 9 Functions

[Example] axis1 is main axis, axis2 and axis3 are sub axis. Execute linear interpolation by the setting as follows.

- Starting position (2000, 1000, 1000), Goal position (5000, 6000, 4000)

In this condition, the operation is as follows.

- Setting example of XG-PM

- Operating data of main-axis(axis1)

Step no.	Control method	Operating method	Goal position [pls]	Operating speed [pls/s]	Acc. no.	Dec. no.	M code	Dwell time	Sub axis setting
1	Absolute, Linear	Singular, End	5000	1000	No.1	No.1	0	100	Axis2

- Operating data of sub-axis1(axis2)

Step no.	Control method	Operating method	Goal position [pls]	Operating speed [pls/s]	Acc. no.	Dec. no.	M code	Dwell time	Sub axis setting
1	Absolute, Single axis positioning control	Singular, End	6000	0	No.1	No.1	0	0	None

- Operating data of sub-axis2(axis3)

Step no.	Control method	Operating method	Goal position [pls]	Operating speed [pls/s]	Acc. no.	Dec. no.	M code	Dwell time	Sub axis setting
1	Absolute, Single axis positioning control	Singular, End	4000	0	No.1	No.1	0	0	None

- Operating pattern

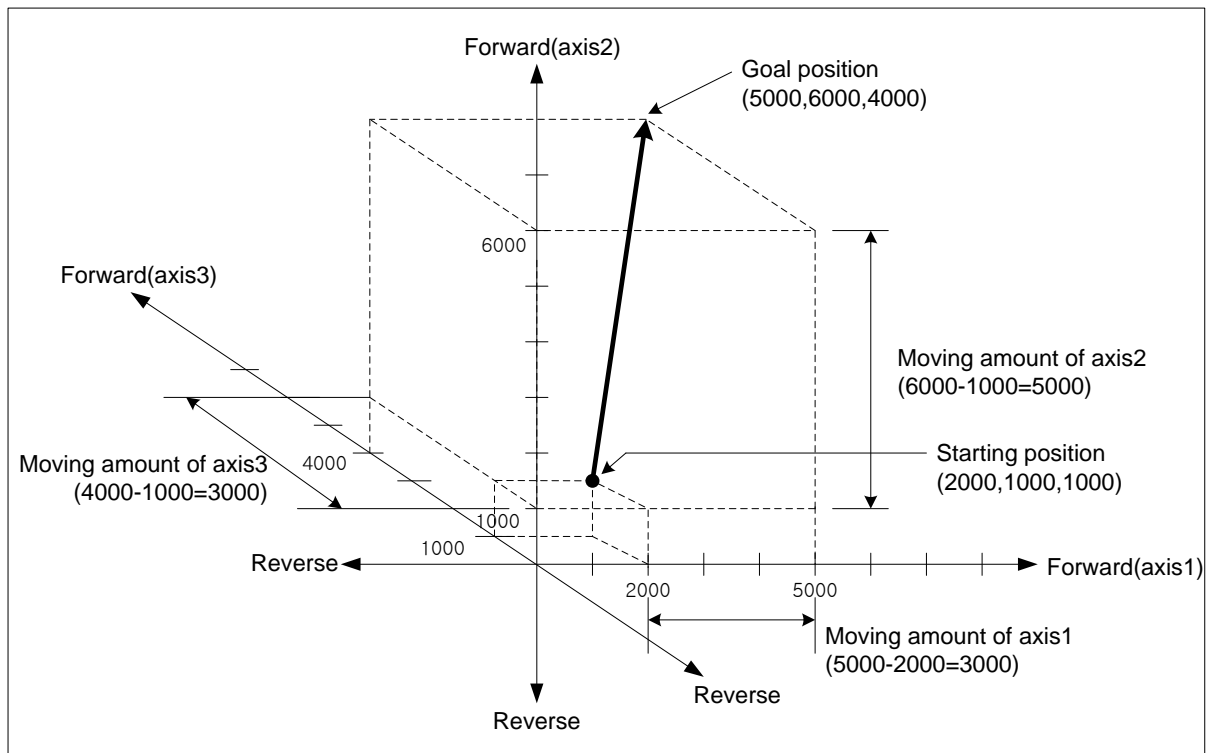

(2) Linear interpolation control with relative coordinates (「Relative, Linear Interpolation」)

- (a) Execute 3 axes linear interpolation from starting position to the goal position. Positioning control is on basis of the current stop position.
- (b) Moving direction depends on the sign of the goal position (Moving amount)
- The sign is positive (+ or nothing) : Positioning operation in forward
 - The sign is negative (-) : Positioning operation in reverse

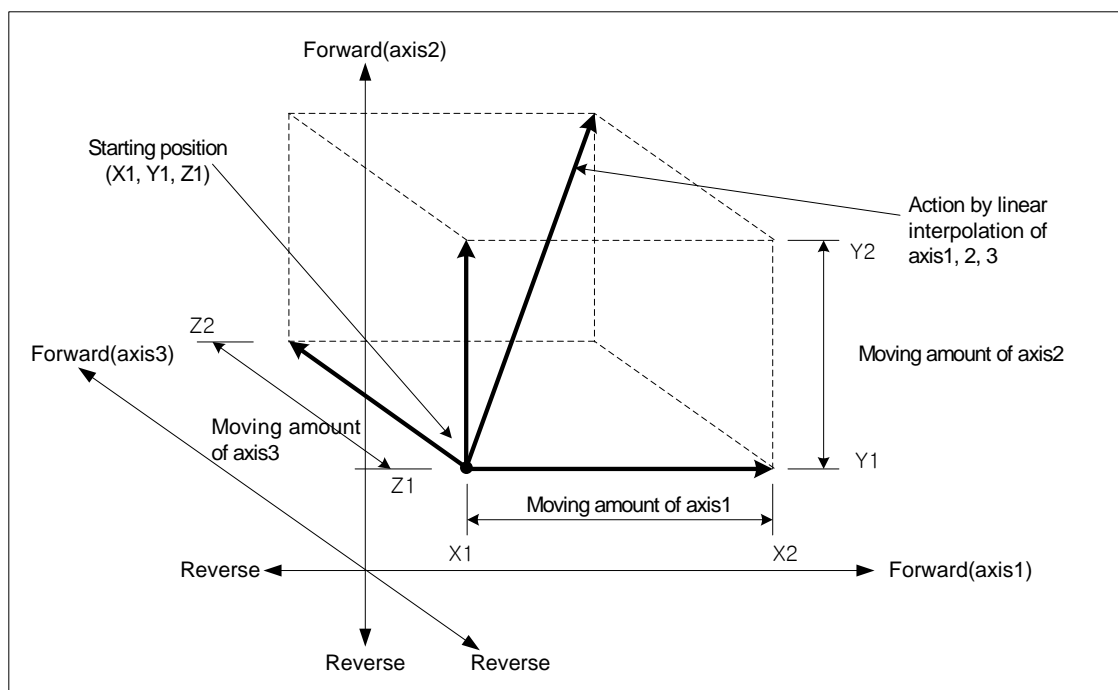

(c) Restrictions

Linear interpolation with 3 axes may not be executed in the case below.

- 「Sub-axis setting」 error (error code : 253)
 - 「Sub-axis setting」 value of main axis operating data is "Axis-undecided"
 - 「Sub-axis setting」 value of main axis operating data is same as the main axis no.
 - 「Sub-axis setting」 value of main axis operating data exceeds settable axis no.
- If only one axis is set as sub axis, execute "linear interpolation control with 2 axes".

(d) Setting example of operating data

Setting items	Main-axis setting (axis1)	Sub-axis setting(axis2)	Sub-axis setting(axis3)	Description
Control method	Absolute, Linear interpolation	REL, SIN.POS*1	REL, SIN, POS*1	When linear interpolation control is executed by the method of absolute coordinates, set 「Absolute, Linear interpolation」 on the main axis
Operating method	Singular, End	-		Set the operating method to execute linear interpolation
Goal position[pls]	5000	6000	4000	Set the goal position to position on main-axis and sub-axis
Operating speed[pls/s]	1000	-		Use speed-designated method of main axis for linear interpolation
Acc. no.	No.1	-		Set acc. no. for acceleration (no.1 ~ no.4)
Dec. no.	No.2	-		Set dec. no. for deceleration (no.1 ~ no.4)
M code	0	-		When need to execute auxiliary work synchronizing with linear interpolation
Dwell time	500	-		Set dwell time(ms) to outputting the signal positioning completion
Sub-axis setting	Axis2, Axis3	-		Set an axis to be used as sub-axis among settable axis in operating data of main-axis

*1 : It does not need to be set. Whatever value is set as, it does not affect linear interpolation.

Note

Linear interpolation control is executed on the basis of operating data of main axis.

Items other than "coordinate" and "target position" during setting of subordinate axis during linear interpolation operation do not affect linear interpolation operation. That is, setting any value does not affect the operation and does not cause an error.

Since the coordinate setting of the longitudinal axis control method indicates whether the target position on the vertical axis is an absolute coordinate or a relative coordinate, when the linear interpolation is controlled by the relative coordinate system, the coordinate of the vertical axis must be set to "relative".

[Example] axis1 and axis2 are main and sub axis each. Execute linear interpolation by the setting as follows

- Starting position (2000, 1000, 1000), Goal position (5000, 6000, 4000) : In this condition, the operation is as follows.
- Setting example of XG-PM

▫ Operating data of main-axis(axis1)

Step no.	Control method	Operating method	Goal position [pls]	Operating speed [pls/s]	Acc. no.	Dec. no.	M code	Dwell time	Sub axis setting
1	Absolute, Linear	Singular, End	5000	1000	No.1	No.1	0	100	Axis2

▫ Operating data of sub-axis1 (axis2)

Step no.	Control method	Operating method	Goal position [pls]	Operating speed [pls/s]	Acc. no.	Dec. no.	M code	Dwell time	Sub axis setting
1	Absolute, Single axis positioning control	Singular, End	6000	0	No.1	No.1	0	0	None

▫ Operating data of sub-axis2(axis3)

Step no.	Control method	Operating method	Goal position [pls]	Operating speed [pls/s]	Acc. no.	Dec. no.	M code	Dwell time	Sub axis setting
1	Absolute, Single axis positioning control	Singular, End	4000	0	No.1	No.1	0	0	None

■ Operating pattern

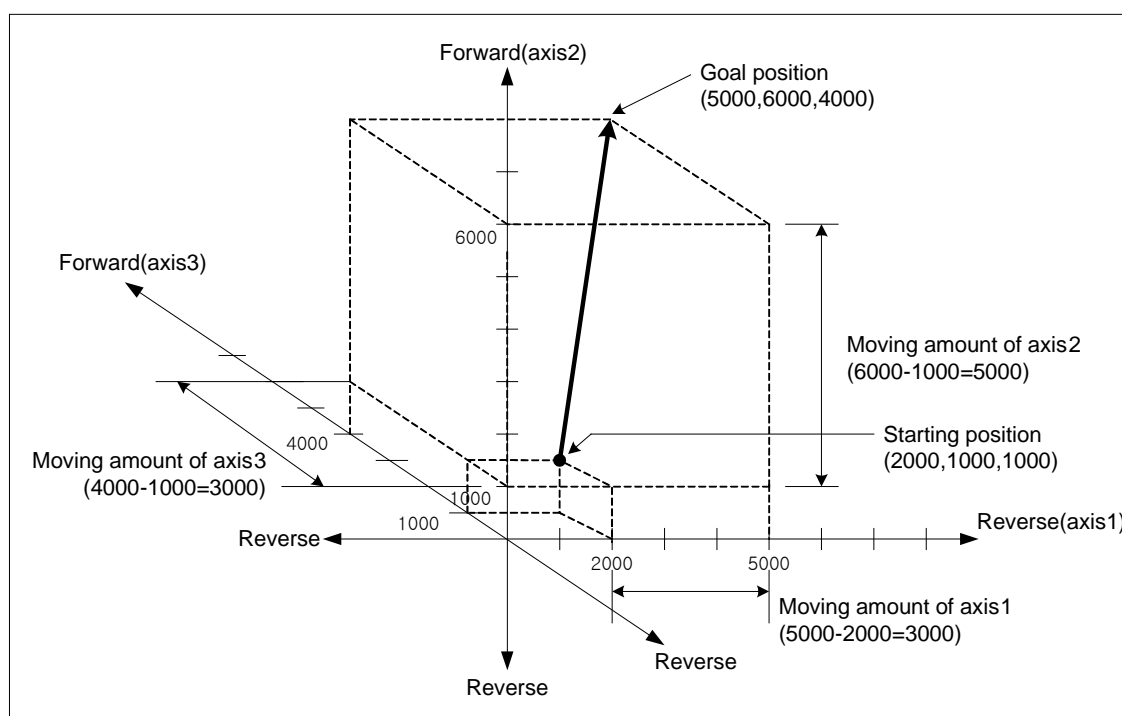

(3) Speed in 3 axes linear interpolation control

Operating speed in linear interpolation is according to the method of main-axis designating. After operating speed is set on command axis (main), the designated axis for interpolation is operated by embedded positioning module's calculating each moving amount. Speed of sub-axis and actual speed of machine are calculated as follows.

■ Speed in 3 axes linear interpolation

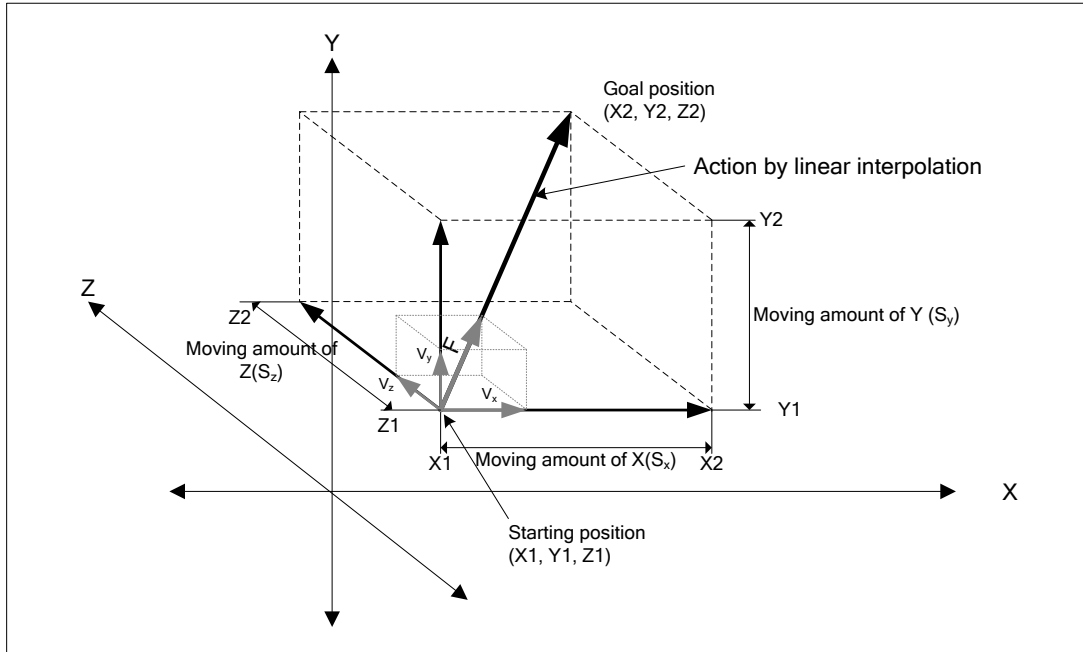

$$\text{Speed of sub}(V_y) = \text{Speed of main}(V_x) \times \frac{\text{Moving amount of Sub}(S_y)}{\text{Moving amount of Main}(S_x)}$$

$$\text{Speed of sub}(V_z) = \text{Speed of main}(V_x) \times \frac{\text{Moving amount of sub}(S_z)}{\text{Moving amount of main}(S_x)}$$

$$\text{Interpolating speed}(F) = \sqrt{V_x^2 + V_y^2 + V_z^2}$$

[Example]

- Starting position (2000, 1000, 1000)
- Goal position (6000, 5000, 6000)
- Operating speed : 400 [pls/s]

Speed of sub-axis and interpolating speed are as follows.

$$\text{Speed of sub-axis1} = 400 \times \frac{3000}{4000} = 300 \text{ [pls/s]}$$

$$\text{Speed of sub-axis2} = 400 \times \frac{5000}{4000} = 500 \text{ [pls/s]}$$

$$\text{Interpolating speed} = \sqrt{400^2 + 300^2 + 500^2} \approx 707 \text{ [pls/s]}$$

■ Speed in 3 axes linear interpolation

(When the interpolation speed selection is set to the composite speed)

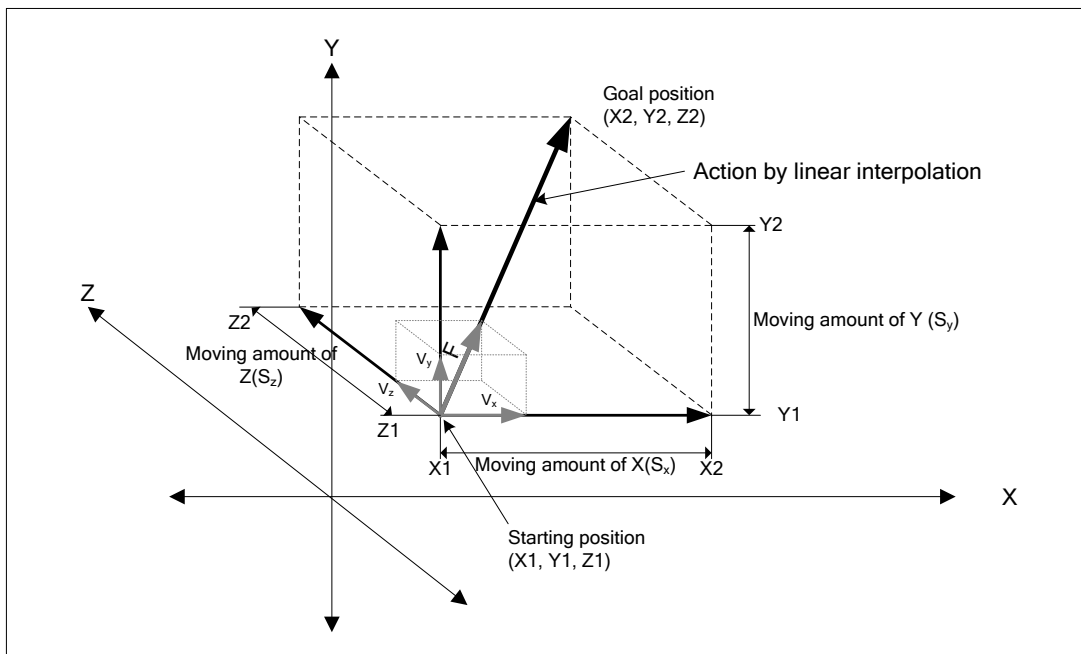

Interpolating speed (F) = Main axis's target position

$$\text{Moving Amount (S)} = \sqrt{S_x^2 + S_y^2 + S_z^2}$$

$$\text{Speed of Main (V}_x\text{)} = \text{interpolating speed (F)} \times \frac{\text{Main Axis's Movement (S}_x\text{)}}{\text{Moving Amount (S)}}$$

$$\text{Sub1 Speed (V}_y\text{)} = \text{Interpolating speed (F)} \times \frac{\text{Sub1's Movement (S}_y\text{)}}{\text{Moving Amount (S)}}$$

$$\text{Sub2 Speed (V}_z\text{)} = \text{Interpolating speed (F)} \times \frac{\text{Sub2's Movement (S}_z\text{)}}{\text{Moving Amount (S)}}$$

[예]

- Starting point (2000, 1000, 1000),
- Target position (6000, 5000, 6000)
- Speed : 400 [pls/s]

In the above cases, the spindle speed and subordinate axis speed are as follows

$$\text{Interpolation movement amount} = \sqrt{4000^2 + 4000^2 + 5000^2} \approx 7549.8$$

$$\text{Main Speed} = 400 \times \frac{4000}{7549.8} \approx 211.9$$

$$\text{Sub1 Speed} = 400 \times \frac{4000}{7549.8} \approx 211.9 \text{ [pls/s]}$$

$$\text{Sub2 Speed} = 400 \times \frac{5000}{7549.8} \approx 264.9 \text{ [pls/s]}$$

Note

(1) Speed limit for Sub-axis

When using linear interpolation control and moving distance of main < moving distance of sub, it is possible that sub-axis speed calculated by embedded positioning module exceeds 「Speed limit」 of basic parameter. In this case, error (error code : 261) arises and sub-axis speed is recalculated, then sub-axis continues to operate. To prevent that errors arise, operate it at the speed below limit.

(2) The speed when the distance main-axis moved is 0

When the distance main-axis moved is 0, the operating speed of main-axis operating data becomes actual interpolating speed.

In case of linear interpolation with more than 3 axes, the speed of sub-axis is calculated by the formula below.

$$\text{Speed of sub-axis } (V_y) = \text{Interpolating speed } (F) \times \frac{\text{Moving amount of sub-axis } (S_y)}{\text{Merged moving amount } (S_f)}$$

$$\text{Speed of sub-axis } (V_z) = \text{Interpolating speed } (F) \times \frac{\text{Moving amount of sub-axis } (S_z)}{\text{Merged moving amount } (S_f)}$$

9.2.8 Linear Interpolation Control with 4 axes

After executed by positioning operation start command (「Indirect start」, 「Synchronous start」), then executing interpolation control from starting position to the goal position with interpolation axis set as the main axis and sub axis. Combination of interpolation axis is unlimited and maximum 6 axes(XBMH:2axes) linear interpolation control is available. Characteristics of action are same as linear interpolation control with 3 axes. For the details, refer to linear interpolation control with 3 axes.

(1) Linear interpolation control with absolute coordinates (「Absolute, Linear Interpolation」)

- (a) Execute linear interpolation from starting position to the goal position designated on positioning data. Positioning control is on basis of the designated position from homing.
- (b) The direction of movement depends on the starting position and the goal position for each axis.
 - Starting position < Goal position : Positioning operation in forward
 - Starting position > Goal position : Positioning operation in reverse

(2) Linear interpolation control with relative coordinates (「Relative, Linear Interpolation」)

- (a) Execute 4 axes linear interpolation from starting position to the goal position. Positioning control is on basis of the current stop position.
- (b) Moving direction depends on the sign of the goal position (Moving amount)
 - The sign is positive (+ or nothing) : Positioning operation in forward
 - The sign is negative (-) : Positioning operation in reverse

(3) Speed in 4 axes linear interpolation control

The operation speed for linear interpolation control is selected from the interpolation speed selection item of the extended parameter, and the main-axis speed or the composite speed is used to specify the operation data target speed of the main axis. If the operation speed is specified in the command axis (main axis), the positioning module calculates and operates the interpolation axes specified in the main axis and sub-axis settings according to the movement amount of each axis. The vertical axis speed and the interpolation speed of the actual machine are calculated as follows.

$$\text{Speed of sub - axis(axis2)} (V_2) = \text{Speed of main - axis}(V_1) \times \frac{\text{Moving amount of sub - axis}(S_2)}{\text{Moving amount of main - axis}(S_1)}$$

$$\text{Speed of sub - axis(axis3)} (V_3) = \text{Speed of main - axis}(V_1) \times \frac{\text{Moving amount of sub - axis}(S_3)}{\text{Moving amount of main - axis}(S_1)}$$

$$\text{Speed of sub - axis(axis4)}(V_4) = \text{Speed of main - axis}(V_1) \times \frac{\text{Moving amount of sub - axis}(S_4)}{\text{Moving amount of main - axis}(S_1)}$$

$$\text{Interpolating Speed}(F) = \sqrt{V_1^2 + V_2^2 + V_3^2 + V_4^2}$$

- In case of selecting composite speed as an interpolation speed

$$\text{Interpolation Speed}(F) = \text{Target speed set in the main-axis operation data}$$

$$\text{Moving amount of compound (S)} = \sqrt{S_1^2 + S_2^2 + S_3^2 + \dots + S_4^2}$$

$$\text{main axis speed (V}_1\text{)} = \text{interpolation speed (F)} \times \frac{\text{Moving amount of main - axis (S}_1\text{)}}{\text{Moving amount of composite (S)}}$$

$$\text{Sub axis speed (V}_2\text{)} = \text{interpolation (F)} \times \frac{\text{Moving amount of sub - axis1 (S}_2\text{)}}{\text{Moving amount of composite (S)}}$$

$$\text{Sub axis 2 speed (V}_3\text{)} = \text{interpolation speed (F)} \times \frac{\text{Moving amount of sub - axis2 (S}_3\text{)}}{\text{Moving amount of composite (S)}}$$

$$\text{Sub axis 5 speed (V}_6\text{)} = \text{interpolation speed (F)} \times \frac{\text{Moving amount of sub - axis 5 (S}_6\text{)}}{\text{Moving amount of composite (S)}}$$

9.2.9 Designate Midpoint of Circular Interpolation

It was progressed by start command of positioning operation (「Indirect start」, 「direct start」) and operate interpolation following the path of circular which is through midpoint that is set by 2 axes.

And, Can progress circular interpolation of over 360 degrees by the set number of circular interpolation.

The combination of 2 axes for circular interpolation is unlimited. User can randomly use 2 axes from axis 1 to axis 6. (axis 1 ~ 2 for XEMH)

(1) Control of circular interpolation by absolute coordinate, designate midpoint(Absolute, circular interpolation)

- (a) Operate circular interpolation from starting point and pass the midpoint that is set operation data to target point.
- (b) To be made path of circular interpolation with start position, midpoint and a crossing which is perpendicular divide equally position of midpoint and target position.
- (c) Movement direction is decided automatically depends on set target position and auxiliary point of circular interpolation.

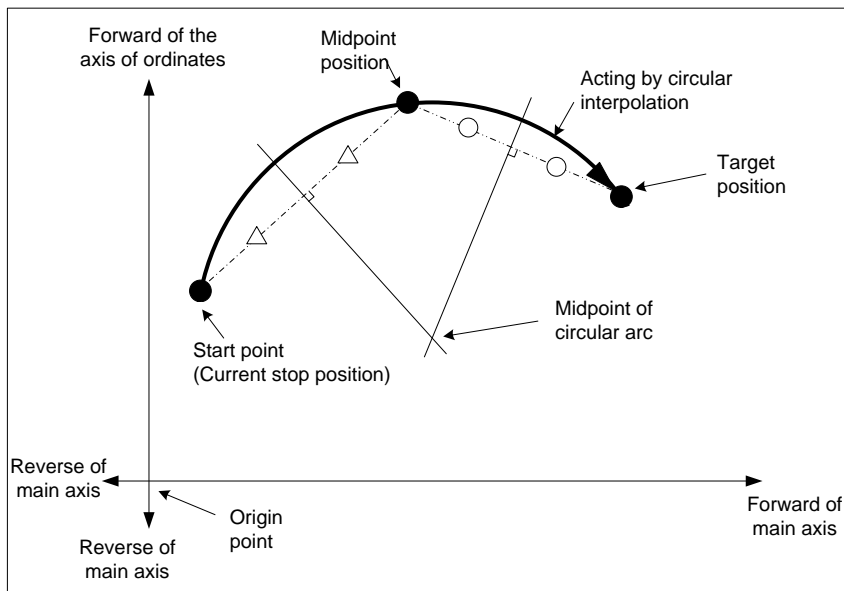

(d) Restriction

- User can't draw circle which is starting point same with last point on the circular interpolation of midpoint designation method. If you want to draw circle, please use method of midpoint.
- User cannot progress circular interpolation of midpoint designation method with following cases.
 - 「Sub axis setting」 disorder (Error code : 279)
 - In case of the value of 「Sub axis setting」 of main axis operation data is no setting axis
 - In case of the value of 「Sub axis setting」 of the main axis operation data same with the number of main axis,
 - In case of value of 「Sub axis setting」 of main axis operation data exceed the axis No. of module which is can set.
 - In case of "degree" is set as item of main axis or sub axis, (Error code : 282(Main axis), 283(Sub axis))
 - Midpoint that is designated as auxiliary point same with start position or target position. (Error code : 284)
 - In case of start position same with target position (Error code : 285)
 - In case of calculated radius of circular arc exceed 2147483647pls (Error code : 286)
 - In case of auxiliary position and target position in a straight line from start position, (Error code : 287)

Note

Have to be careful, because 2 axes work both in the circular interpolation maneuver.

(1) Available auxiliary operation is as follows ;

- Speed override, Deceleration stop, Emergency stop, Skip operation

(2) Operation of circular interpolation unavailable command is as follows ;

- Position/Speed conversion control, Position override, Continuous operation

(3) The parameter item which is operated by set value of each axis is as follows ;

- amount of compensate of Backlash, high limit of software, low limit of software on the item of expansion parameter

(e) Example of setting operation data

Setting item	Main axis (axis1) setting	Sub axis (axis 2) setting	Contents
Control method	Absolute, circular interpolation	- *1	Set 「absolute, circular interpolation」 on main axis, when control circular interpolation by absolute coordinates.
Operation method	Singleness, End	-	Set operation method for circular interpolation.
Target position [pls]	10000	0	Set the target position for positioning on the main axis and sub axis.
Operation speed [pls/s]	1000	-	Circular interpolation use method of designating composition speed
Acceleration speed	No.1	-	Set the acceleration time No. for acceleration. (No.1 ~ 4)
Deceleration speed	No.2	-	Set the deceleration time No. for deceleration. (No.1 ~ 4)
M code	0	-	Set it for progressing auxiliary operation depends on circular interpolation operation.
Dwell time	500	-	set the dwell time taken until plc outputs the signal which informs users of finishing the position decision
The axis of ordinates setting	Axis 2	-	Set axis as sub axis among settable axes of module which is using for now on the main axis operation data.
Circular interpolation Auxiliary point	5000	5000	Set midpoint for passing circular arc on the method of the designating midpoint.
Circular interpolation mode	Midpoint	-	In case of using the method of designating midpoint, set 「midpoint」 on the main axis.
Circular interpolation The number of rotations	0	-	When user want to draw circle which is over 360 degrees, set the number of rotations of circular arc.
Helical interpolation	Do not use	-	In case of using circular interpolation, set 「Do not use」 on the main axis.

- *1 : Do not need setting. Whatever you set, there is no effect to circular interpolation.

Note

The circular interpolation control of the method of designating midpoint operate by standards of set item on the operation data of main axis (command axis).

When circular interpolation operation of the method of designating midpoint, there is no effect except for 「Target position」, 「Auxiliary point of circular interpolation」 on the axis of setting. What ever you take for the value, there is no effect to operate, there is no error.

[Example] Operate circular interpolation of designating midpoint and absolute coordinate (main axis; axis 1, sub axis; axis 2)

■ In case of Start position (0, 0), Target position (10000, 6000), Auxiliary point (2000, 6000), operation is as follows;

■ Example of setting in the XG-PM

▪ Main axis(axis1) operation data

Step No.	Control Method	Operation method	Target position [pls]	Operation Speed [pls/s]	Acc. Speed	Dec. Speed	M code	Dwell time	Sub axis setting	Circular interpolation Auxiliary point	Circular interpolation mode	The number of rotations of Circular interpolation	Helical interpolation
1	Absolute, Circular interpolation	Singleness, End	10000	1000	No. 1	No. 1	0	100	Axis 2	10000	Midpoint	0	Do not use

▪ The axis(axis 2) of ordinates operation data

Step No.	Control Method	Operation method	Target position [pls]	Operation Speed [pls/s]	Acc. Speed	Dec. speed	M code	Dwell time	Sub axis setting	Circular interpolation Auxiliary point	Circular interpolation mode	The number of rotations of Circular interpolation	Helical interpolation
1	Absolute, Reduction positioning control	Singleness End	6000	0	No. 1	No. 1	0	0	Do not setting axis	7500	Midpoint	0	Do not use

■ Operation pattern

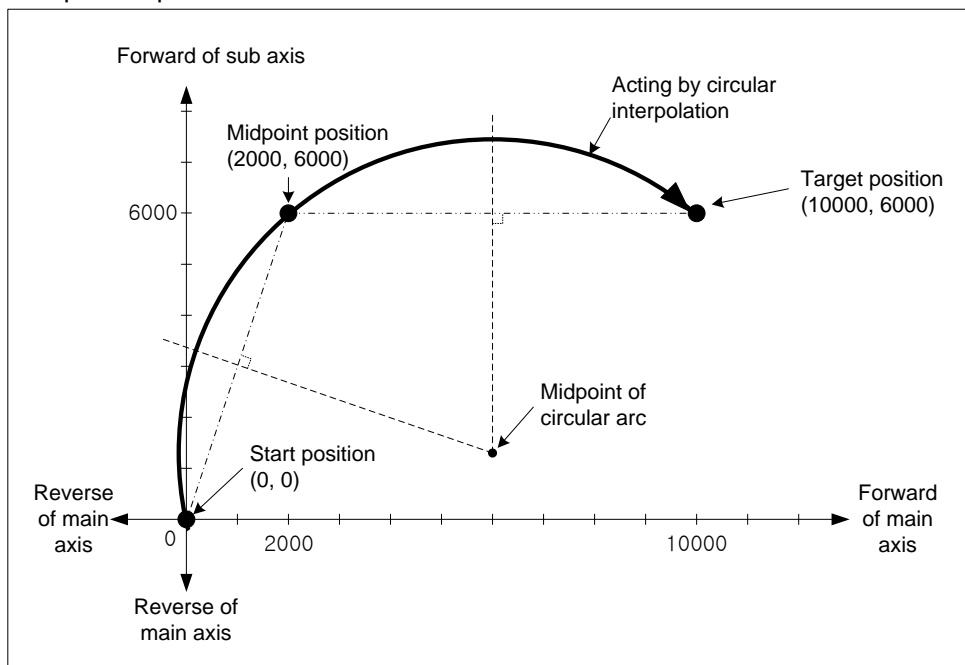

(2) Circular interpolation by relative coordinates, the method of designating midpoint
(Relative, circular interpolation)

- (a) Operate circular interpolation from start position and go through midpoint to target position as amount of set movement.
- (b) Midpoint position is the incremented position as set value on 「the circular interpolation auxiliary point」 from current stop position.
- (c) The intersection of perpendicular bisectors of starting position and midpoint, the current stop position and the goal position will be the center-point of the arc.
- (d) Movement direction is decided by set target position and circular interpolation auxiliary point.

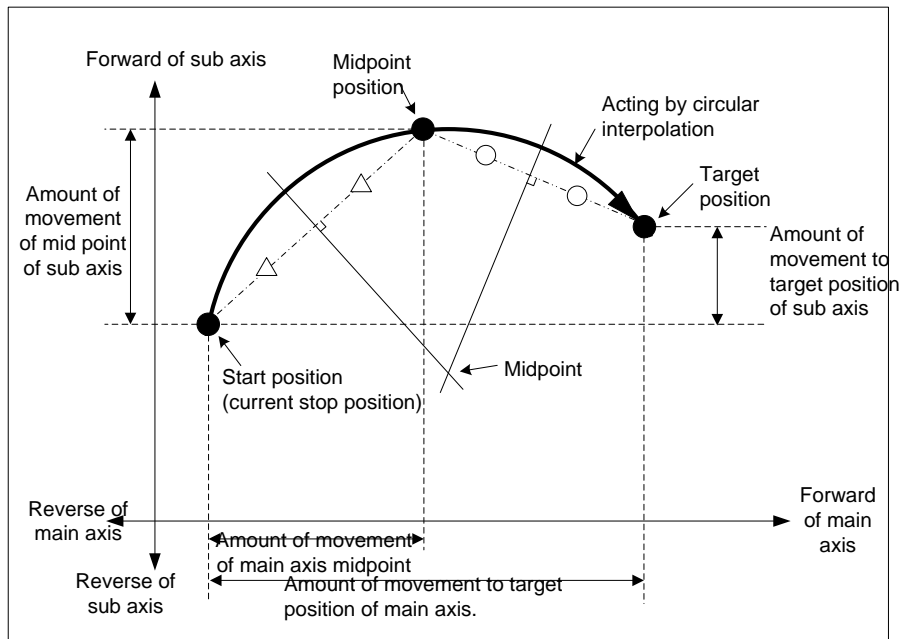

(e) Restriction

- Can not draw circle which starting point is the same with last point on the circular interpolation of the method of designating midpoint. When want to draw circle, should use midpoint method.
- In this following case, it will be error and can not working circular interpolation of method of designating midpoint.
 - 「Sub axis setting」 disorder (Error code : 279)
 - It is axis-undecided that the value of sub axis of main axis operation data.
 - The value of 「Sub axis setting」 of main axis operation data is set is same with main axis No.
 - The value of 「Sub axis setting」 of main axis operation data exceed axis No. of settable module which is using.
 - In case of "Degree" is set as control item of main/sub axis. (Error code : 282(Main axis), 283(Sub axis))
 - In case of midpoint which is designated as auxiliary point is same with start position and target position. (Error code : 284)
 - In case of start position same with target position. (Error code : 285)
 - Radius of calculated circle exceed 2147483647pls (Error code : 286)
 - Start position is in alignment with auxiliary position and target position. (Error code : 287)

(f) Example of operation data setting

Setting item	Main axis(axis 1) setting	Sub axis(axis 2) setting	Contents
Control method	Relative, Circular interpolation	- *1	When control circular interpolation by relative coordinates, set 「relative, circular interpolation」 on main axis.
Operation method	Singleness, End	-	Set operation method for circular interpolation.
Target position [pls]	10000	0	Set target position as a amount of increment of stop position for positioning on the main axis, sub axis.
Operation speed [pls/s]	1000	-	Circular interpolation use method of designating composition speed. Set composition speed on the main axis.
Acceleration speed	No.1	-	Set acceleration time No. for acceleration. (No.1 ~ No.4)
Deceleration speed	No. 2	-	Set deceleration time No. for deceleration. (No.1 ~ No.4)
M code	0	-	Set it when user wants to progress other auxiliary action with circular interpolation operation.
Dwell time	500	-	set the dwell time taken until plc outputs the signal which informs users of finishing the position decision
Sub axis setting	Axis 2	-	Set axis among the settable axes of current module on the main axis operation for sub.
Circular interpolation auxiliary point	5000	5000	Set the middle point that the arc with mid-point designating method would pass by as an increment from the current stop position
Circular interpolation mode	Midpoint	-	Set "midpoint", when use method of designating midpoint.
The number of rotations of circular interpolation	0	-	Set the number of rotations for drawing circle that it is over 360 degrees.
Helical interpolation	Not use	-	Set "not use", when use circular interpolation.

- *1 : Do not need setting. Whatever user set, there is no effect to circular interpolation.

Note

Circular interpolation of method of designating midpoint is depends on item that it is set on operation data of main axis (command axis).

There is no effect to circular interpolation operation except for 「Target position」 and 「Circular interpolation auxiliary point」, when operate circular interpolation of method of designating midpoint. Whatever user set, there is no effect and no error.

[Example] Operate circular interpolation of method of designating relative coordinate midpoint with axis 1 (main axis), with axis 2 (sub axis)

■ Start position : (1000, 1000)

Target position (amount of movement) setting : (8000, 4000)

Auxiliary point (amount of movement) setting : (5000, 5000)

In this case operation is as follows:

■ Example of setting XG-PM

▪ Main axis(axis 1) Operation data

Step No.	Control Method	Operation method	Target position [pls]	Operation Speed [pls/s]	Acc. Speed	Dec. Speed	M code	Dwell time	Sub axis setting	Circular interpolation Auxiliary point	Circular interpolation mode	The number of rotations of Circular interpolation	Helical interpolation
1	Relative, Circular interpolation	Singleness, End	8000	1000	No. 1	No. 1	0	100	Axis 2	5000	Midpoint	0	Do not use

▪ Sub axis(axis 2) Operation data

Step No.	Control Method	Operation method	Target position [pls]	Operation Speed [pls/s]	Acc. Speed	Dec. Speed	M code	Dwell time	Sub axis setting	Circular interpolation Auxiliary point	Circular interpolation mode	The number of rotations of Circular interpolation	Helical interpolation
1	Absolute, Reduction positioning control	Singleness, End	4000	0	No. 1	No. 1	0	0	Axis-undecided	5000	Midpoint	0	Do not use

■ Operation pattern

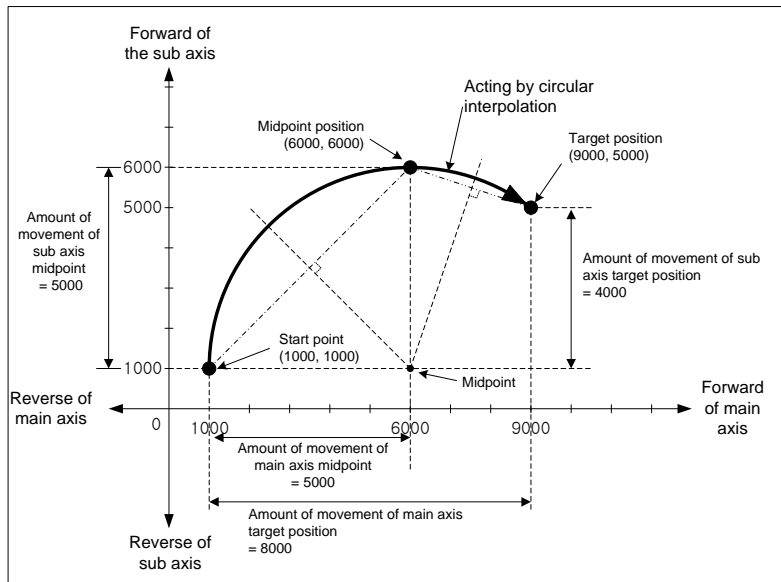

9.2.10 Circular interpolation control of designating midpoint

Operate interpolation up to trace of the circle after operate by starting command of positioning operation (「indirect start」, 「Start at a time」). And then, Midpoint is center of circle and it is move to rotation direction of circular interpolation.

「The number of rotations of circular interpolation」 can operate circular interpolation which is over 360 degrees with setting value.

There is no limit for composition of axis 2 that it needs to use circular interpolation control. User can select 2 axes from axis1 to axis 6 randomly.

(1) Circular interpolation by method of absolute coordinate, designating midpoint

(Absolute, Circular interpolation)

(a) Operate from start position and circular interpolate to target position with the trace of circle. And the circle has radius which distance is to set midpoint position. 「Circular interpolation auxiliary point」 is midpoint of this circle.

(b) Moving direction depends on set direction on “circular interpolation mode” of operation data.

- 「Midpoint, CW」 - Circular interpolation go clockwise from current position.
- 「Midpoint, CCW」 - Circular interpolation go counterclockwise from current position.

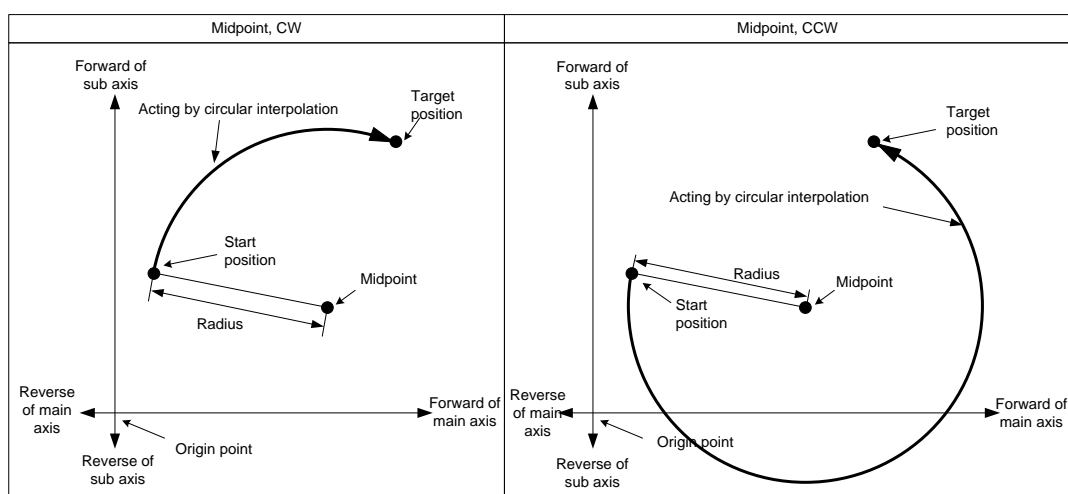

(c) If target position is same with start position, can progress circular interpolation. And the circle radius is distance from midpoint to starting position (=target position)

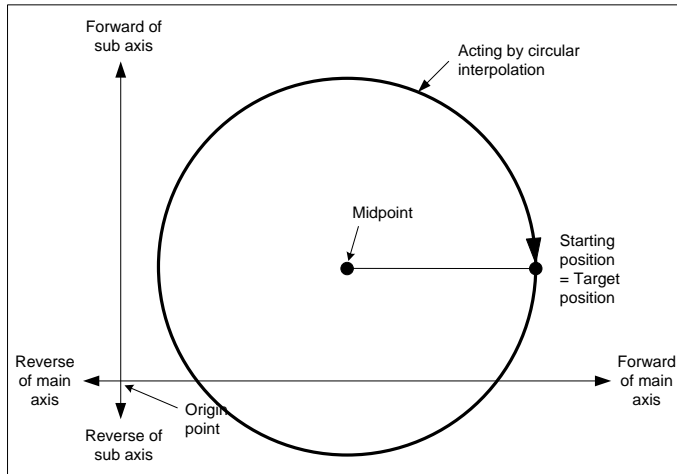

(d) Condition

- In this following case, to be error and can not progress circular interpolation control of method of designating midpoint.
 - 「Sub axis setting」 disorder (Error code : 279)
 - In case of the value of 「Sub axis setting」 of main axis operation data is “axis-undecided”,
 - In case of the value of 「Sub axis setting」 of main axis operation data is same with main axis No. by setting.
 - In case of the value of 「Sub axis setting」 of main axis operation data exceed settable axis No.
 - In case of “degree” is set as item of main/sub axis control, (Error code : 282(Main axis), 283(Sub axis))
 - In case of midpoint which is set as auxiliary point is same with starting/target position, (Error code : 284)
 - In case of calculated radius of circle exceed 2147483647pls, (Error code : 286)

Note

Should be careful during starting circular interpolation, because 2 axes act at a time.

1. Available auxiliary operation is as follows:

- Speed override, Deceleration stop, Emergency stop, Skip operation

2. Unavailable command with circular interpolation is as follows:

- Position/Speed conversion control, Position override, Consecutive operation

3. The parameter item that it is operated by set value each axes is as follows:

- Amount of backlash compensation of expansion parameter item, Software high limit, Software low limit

(e) Example of operation data setting

Setting item	Main axis(axis1) setting	Sub axis(axis2) setting	Contents
Control method	Absolute, Circular interpolation	- *1	When control circular interpolation by relative coordinates, set 「relative, circular interpolation」 on main axis.
Operation method	Singleness, End	-	Set operation method for circular interpolation.
Target position [pls]	10000	0	Set target position as a amount of increment of stop position for positioning on the main axis, sub axis.
Operation speed [pls/s]	1000	-	Circular interpolation use method of designating composition speed. Set composition speed on the main axis.
Acceleration speed	No.1	-	Set acceleration time No. for acceleration. (No.1 ~ No.4)
Deceleration speed	No.2	-	Set deceleration time No. for deceleration. (No.1 ~ No.4)
M code	0	-	Set it when user wants to progress other auxiliary action with circular interpolation operation.
Dwell time	500	-	set the dwell time taken until plc outputs the signal which informs users of finishing the position decision
Sub axis setting	Axis 2	-	Set axis among the settable axes of current module on the main axis operation for sub.
Circular interpolation auxiliary point	5000	-5000	Set the center-point on the method of designating center-point.
Circular interpolation mode	Midpoint, CW	-	In case of using the method of designating center-point, set the 「center-point, CW」 or 「center-point, CCW」 by moving direction of circular arc.
The number of rotations of circular interpolation	0	-	Set the number of rotations for drawing circle that it is over 360 degrees.
Helical interpolation	Not use	-	Set "not use", when use circular interpolation.

*1 : Do not need setting. Whatever user set, there is no effect to circular interpolation.

Note

Circular interpolation of method of designating midpoint is depends on item that it is set on operation data of main axis (command axis).

There is no effect to circular interpolation operation except for 「Target position」 and 「Circular interpolation auxiliary point」, when operate circular interpolation of method of designating midpoint. Whatever user set, there is no effect and no error.

Chapter 9 Functions

[Example] Operate circular interpolation of designating midpoint and absolute coordinate (main axis; axis 1, sub axis; axis 2)

■ In case of Start position (0, 0), Target position (0, 0), Auxiliary point (1000, 1000), direction of rotation :CW operation is as follows;

■ Example of setting in the XG-PM

▪ Main axis(axis1) operation data

Step No.	Control Method	Operation method	Target position [pls]	Operation Speed [pls/s]	Acc. Speed	Dec. Speed	M code	Dwell time	Sub axis setting	Circular interpolation Auxiliary point	Circular interpolation mode	The number of rotations of Circular interpolation	Helical interpolation
1	Absolute, Circular interpolation	Singleness, End	0	1000	No. 1	No. 1	0	100	Axis 2	1000	Centerpoint, CW	0	Do not use

▪ Sub axis(axis 2) operation data

Step No.	Control Method	Operation method	Target position [pls]	Operation Speed [pls/s]	Acc. Speed	Deceleration Speed	M code	Dwell time	Sub axis setting	Circular interpolation Auxiliary point	Circular Interpolation mode	The number of rotations of Circular interpolation	Helical interpolation
1	Absolute, Reduction positioning control	Singleness, End	0	0	No.1	No.1	0	0	Axis-undecided	1000	Centerpoint	0	Do not use

■ Operation pattern

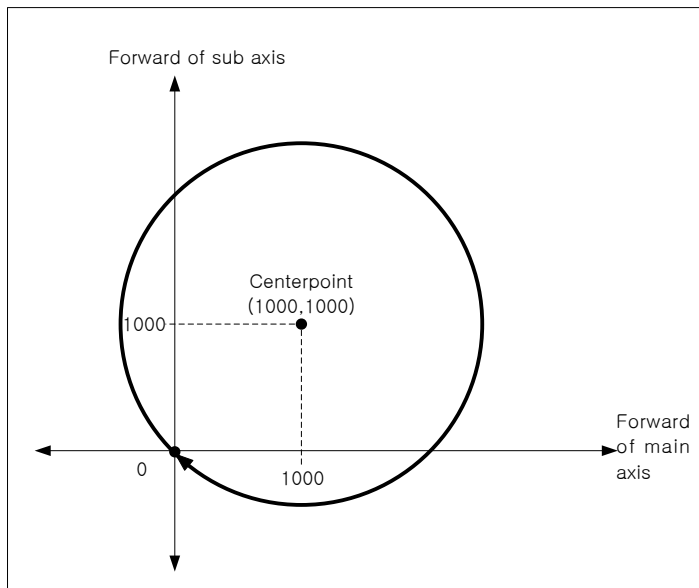

(2) Circular interpolation control by the method of relative coordinate, designating center-point

(「Relative, Circular interpolation」)

(a) Start operating at starting position and then execute circular interpolation by moving amount already set, along the trace of the arc which has a distance between starting position and designated mid-point as radius. 「Circular interpolation auxiliary point」 means the moving amount between the current position and mid-point.

(b) Moving direction is decided to set direction on “circular interpolation mode” of operation data.

- 「Center-point, CW」 - Circular interpolation go clockwise from current position..
- 「Center-point, CCW」 - Circular interpolation go counterclockwise from current position.

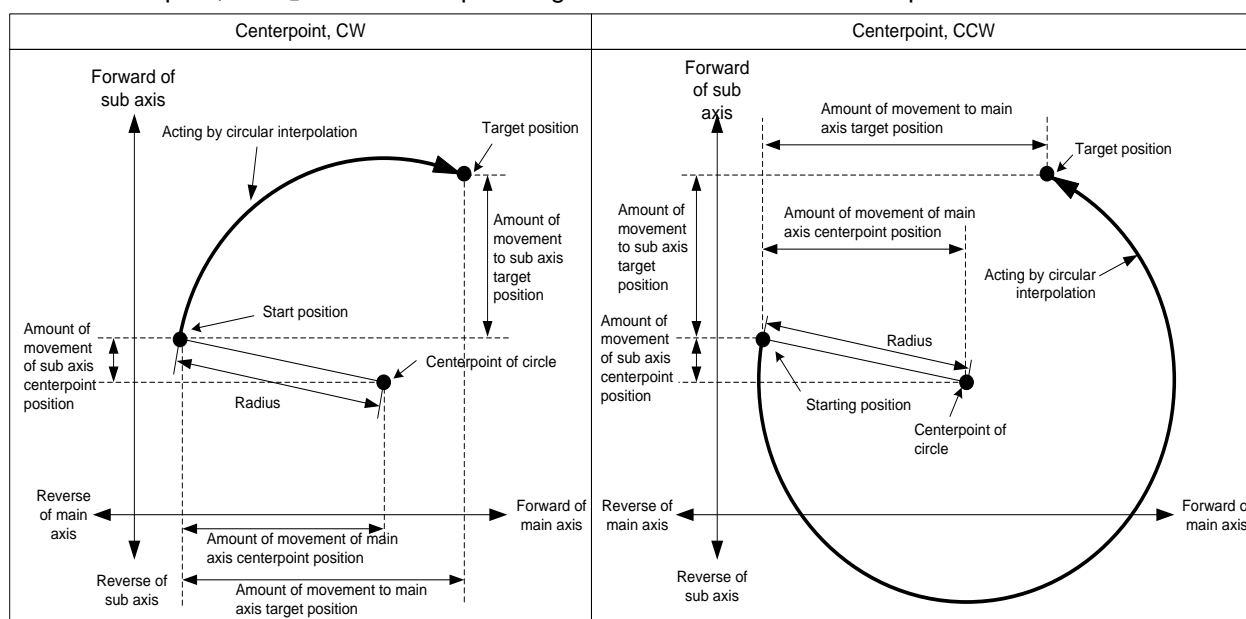

(c) If set target position of main axis and sub axis as “0”, then starting position will be same with target position and can progress circular interpolation that it is drawing circle. The radius of the circle is distance from starting position to center-point.

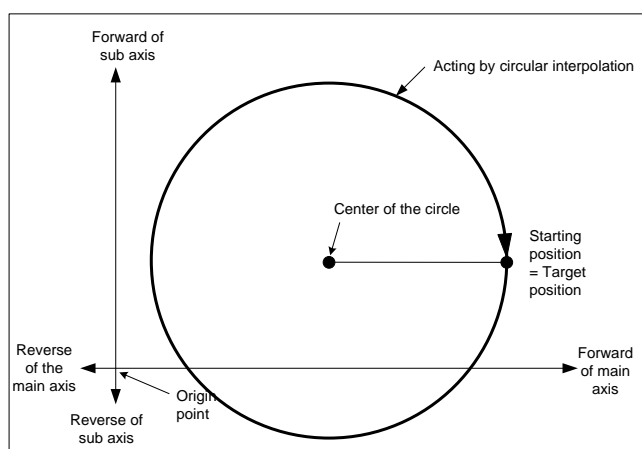

Chapter 9 Functions

(d) Condition

- User cannot progress circular interpolation of midpoint designation method with following cases.
 - 「Sub axis setting」 disorder (Error code: 279)
 - In case of the value of 「Sub axis setting」 of main axis operation data is no setting axis,
 - In case of the value of 「Sub axis setting」 of the main axis operation data same with the number of main axis,
 - In case of value of 「Sub axis setting」 of main axis operation data exceed the axis No. of module which is can set ,
 - In case of “degree” is set as item of main axis or sub axis, (Error code: 282(Main axis), 283(Sub axis))
 - Midpoint that is designated as auxiliary point same with start position or target position. (Error code: 284)
 - In case of start position same with target position (Error code: 285)
 - In case of calculated radius of circular arc exceed 2147483647pls (Error code: 286)

(e) Example of operation data setting

Setting item	Main axis(axis1) setting	Sub axis(axis2) setting	Contents
Control method	Relative, Circular interpolation	- *1	When control circular interpolation by relative coordinates, set 「relative, circular interpolation」 on main axis.
Operation method	Singleness, End	-	Set operation method for circular interpolation.
Target position [pls]	10000	0	Set target position as the amount of increment of stop position for positioning on the main axis, sub axis.
Operation speed [pls/s]	1000	-	Circular interpolation use method of designating composition speed. Set composition speed on the main axis.
Acceleration speed	No.1	-	Set acceleration time No. for acceleration. (No.1 ~ No.4)
Deceleration speed	No.2	-	Set deceleration time No. for deceleration. (No.1 ~ No.4)
M code	0	-	Set it when users want to progress other auxiliary action with circular interpolation operation.
Dwell time	500	-	set the dwell time taken until plc outputs the signal which informs users of finishing the position decision
Sub axis setting	Axis 2	-	Set axis among the settable axes of current module on the main axis operation for sub.
Circular interpolation auxiliary point	5000	-5000	Set the center-point position by amount of increment of current stop position on the method of designating center-point.
Circular interpolation mode	Midpoint, CW	-	In case of using the method of designating center-point, set the 「center-point, CW」 or 「center-point, CCW」 by moving direction of circular arc.
The number of rotations of circular interpolation	0	-	Set the number of rotations for drawing circle that it is over 360 degrees.
Helical interpolation	Not use	-	Set “not use”, when use circular interpolation.

- *1 : Do not need setting. Whatever user set, there is no effect to circular interpolation.

Note

Circular interpolation of method of designating midpoint is depends on item that it is set on operation data of main axis command axis).

There is no effect to circular interpolation operation except for 「Target position」 and 「Circular interpolation auxiliary point」, when operate circular interpolation of method of designating midpoint. Whatever user set, there is no effect and no error.

[Example] Operate circular interpolation of the method of designating relative coordinate centerpoint with axis 1 (main axis), with axis 2 (sub axis)

■ Start position: (0, 0)

Target position (amount of movement) setting: (2000, 0)

Auxiliary point (amount of movement) setting: (1000, 0)

Direction of rotations: CW

In this case operation is as follows:

■ Example of setting XG-PM

▪ Main axis (axis 1) Operation data

Step No.	Control Method	Operation method	Target position [pls]	Operation Speed [pls/s]	Acc. Speed	Dec. Speed	M code	Dwell time	Sub axis setting	Circular interpolation Auxiliary point	Circular Interpolation mode	The number of rotations of Circular interpolation	Helical Interpolation
1	Relative, Circular interpolation	Singleness, Continue	2000	1000	No. 1	No. 1	0	100	Axis 2	1000	Center-point ,CW	0	Do not use
1	Relative, Circular interpolation	Singleness, End	2000	1000	No. 1	No. 1	0	100	Axis 2	1000	Center-point ,CW	0	Do not use

▪ Sub axis (axis 2) Operation data

Step No.	Control Method	Operation method	Target position [pls]	Operation Speed [pls/s]	Acc. Speed	Dec. Speed	M code	Dwell time	Sub axis setting	Circular interpolation Auxiliary point	Circular Interpolation mode	The number of rotations of Circular interpolation	Helical interpolation
1	Absolute, Reduction positioning control	Singleness, End	0	0	No. 1	No. 1	0	0	Axis-undecided	0	Midpoint	0	Do not use
1	Absolute, Reduction positioning control	Singleness, End	0	0	No. 1	No. 1	0	0	Axis-undecided	0	Midpoint	0	Do not use

■ Operation pattern

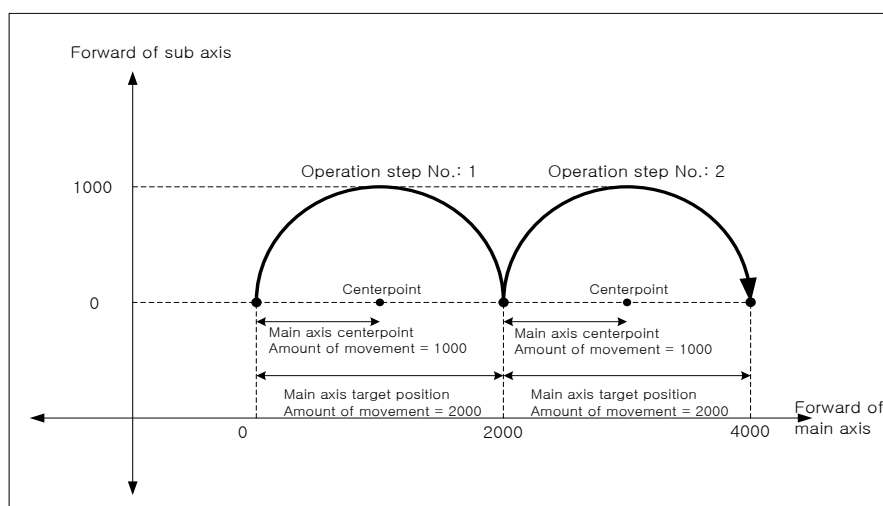

Chapter 9 Functions

(3) Circular interpolation control which radius of starting point is different with radius of ending point.

(「Relative, Circular interpolation」)

(a) According to set value of target position, distance A which it is distance from start point to center point is different with distance B which it is distance from target position to center point (End point, Radius) on circular interpolation control of the method of designating center point. Sometimes do not operate normally.

When starting point radius have difference with end point radius, calculate each speed on the set operation speed, and operate circular interpolation control with compensating radius.

(b) In case of starting point radius has some difference with ending point radius, compensating speed is as follows:

- Radius of starting point > Radius of ending point: The more near from target position, the slower.
- Radius of starting point < Radius of ending point: The more near from target position, the faster.

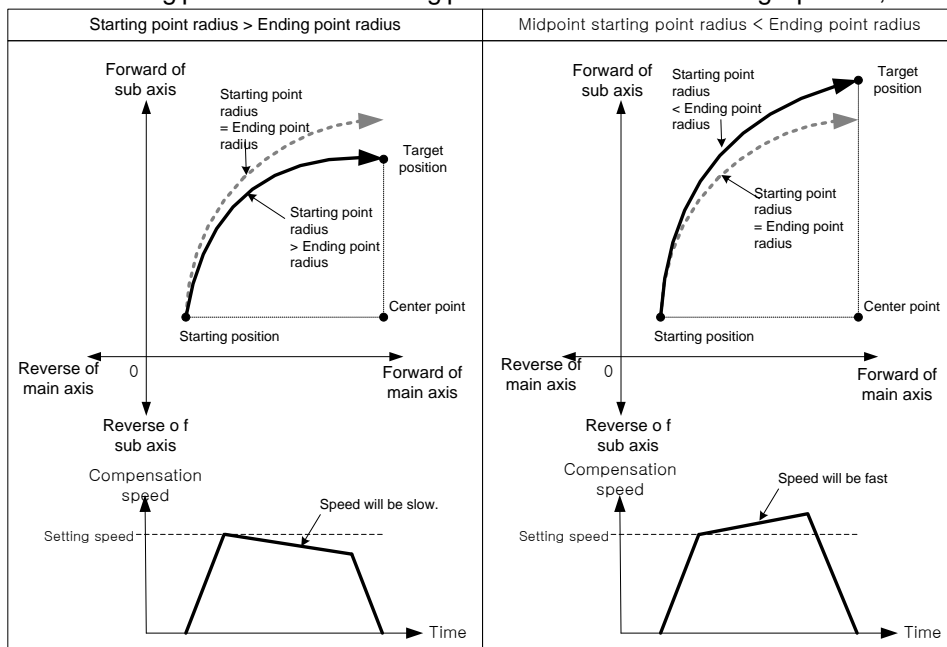

Note

In case of "Starting point radius < Ending point radius", the more operate circular interpolation, the faster. Sometimes exceed 「Speed limit」 of parameter. When operate circular interpolation, in case of starting point radius shorter than ending point radius, lower speed for never exceeding 「Speed limit」.

Can operate no exceed 「Speed limit」, even if it is near to target position.

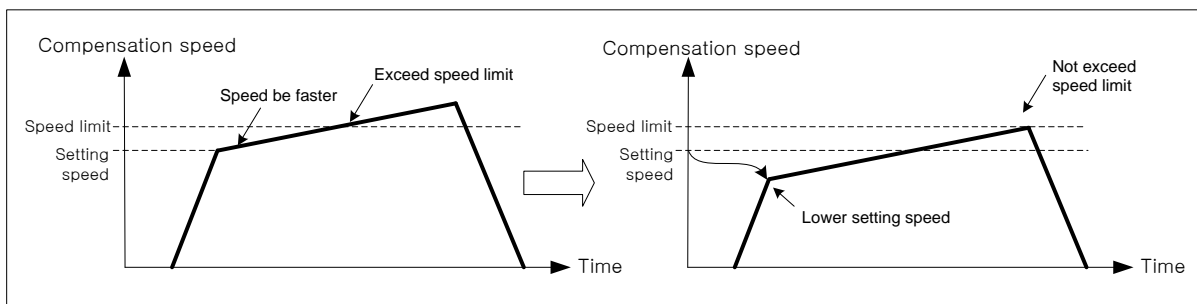

(4) Absolute coordinate function of the number of circular interpolation's rotation

- In case of circular interpolation setting exceed 1 on circular interpolation control of the method of absolute coordinate, designating center point. To set of the number of circular interpolation's rotations operate the number of rotations at the absolute coordinate of first start.
- Even if decelerate and stop, operate origin circular interpolation by restart.
- Condition

In this following case position is changed after deceleration stop command. The number of circular interpolation's rotation is not the number of absolute rotations. It operate by the number of relative rotations.

- After operate positioning command except for current step indirect start (Directing start, Jog operation, Inching operation, Sync. operation, etc),
- After progress position changing command,

[Example] Progress circular interpolation that is the method of absolute, designating center point. And then axis 1 is main axis, axis 2 is sub axis.

- In this case of Starting position (100, 500), Target position (400, 500), Auxiliary position (600, 500), Direction of rotations: CW, operating is as follows:

■ Example of setting XG-PM

- Main axis (axis 1) operation data

Step No.	Control Method	Operation method	Target position [pls]	Operation Speed [pls/s]	Acc. Speed	Dec. Speed	M code	Dwell time	Sub axis setting	Circular interpolation Auxiliary point	Circular Interpolation mode	The number of rotations of Circular interpolation	Helical interpolation
1	Absolute, circular interpolation	Singleness, End	600	1000	No.1	No.1	0	100	Axis 2	600	Midpoint, CW	3	Do not use

- Sub axis (axis 2) operation data

Step No.	Control Method	Operation method	Target position [pls]	Operation Speed [pls/s]	Acc. Speed	Dec. Speed	M code	Dwell time	Sub axis setting	Circular interpolation Auxiliary point	Circular Interpolation mode	The number of rotations of Circular interpolation	Helical interpolation
1	Absolute, Reduction positioning control	Singleness, End	300	0	No.1	No.1	0	0	Axis-undecided	500	Midpoint	0	Do not use

■ Operation pattern

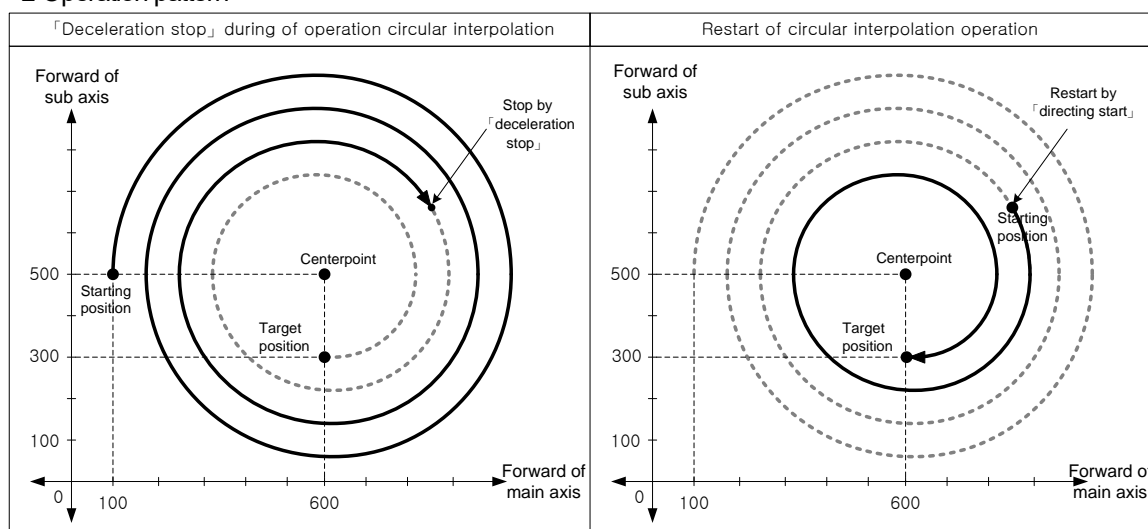

When decelerating in circular interpolation by dec. stop command and restart the same step no., not that executing circular interpolation after circular interpolation being executed 3 times, but that positioning at the goal position after going around 1 time, because 2 times of circular interpolation was executed in former operation.

9.2.11 Circular interpolation control with designated radius

After being executed by positioning operation start (「Indirect start」, 「Sync. start」), then it operates along the trace of the circle made by circular interpolation with 2 axes. According to 「The turn no. of circular interpolation」, circular interpolation which is bigger than 360° is available to be executed.

Combination of 2 axes for a circular interpolation is not limited. User may use any 2 axes from axis1 ~ axis4.

(1) Circular interpolation by method of absolute and designating radius (「Absolute, Circular interpolation」)

(a) Start operating at starting position and execute circular interpolation along the trace of the circle which has radius set on circular interpolation auxiliary point of main-axis operating data. Center point of Circular arc depends on the turning direction (CW, CCW) of 「Circular interpolation mode」 and size setting of circular arc (Circular arc<180°, Circular arc>=180°).

Circular interpolation mode	Description
Radius, CW, Arc<180°	Execute circular interpolation in clockwise and the arc is smaller than 180°
Radius, CW, Arc>=180°	Execute circular interpolation in clockwise and the arc is bigger than 180°
Radius, CCW, Arc<180°	Execute circular interpolation in counterclockwise and the arc is smaller than 180° or same.
Radius, CCW, Arc>=180°	Execute circular interpolation in counterclockwise and the arc is bigger than 180° or same.

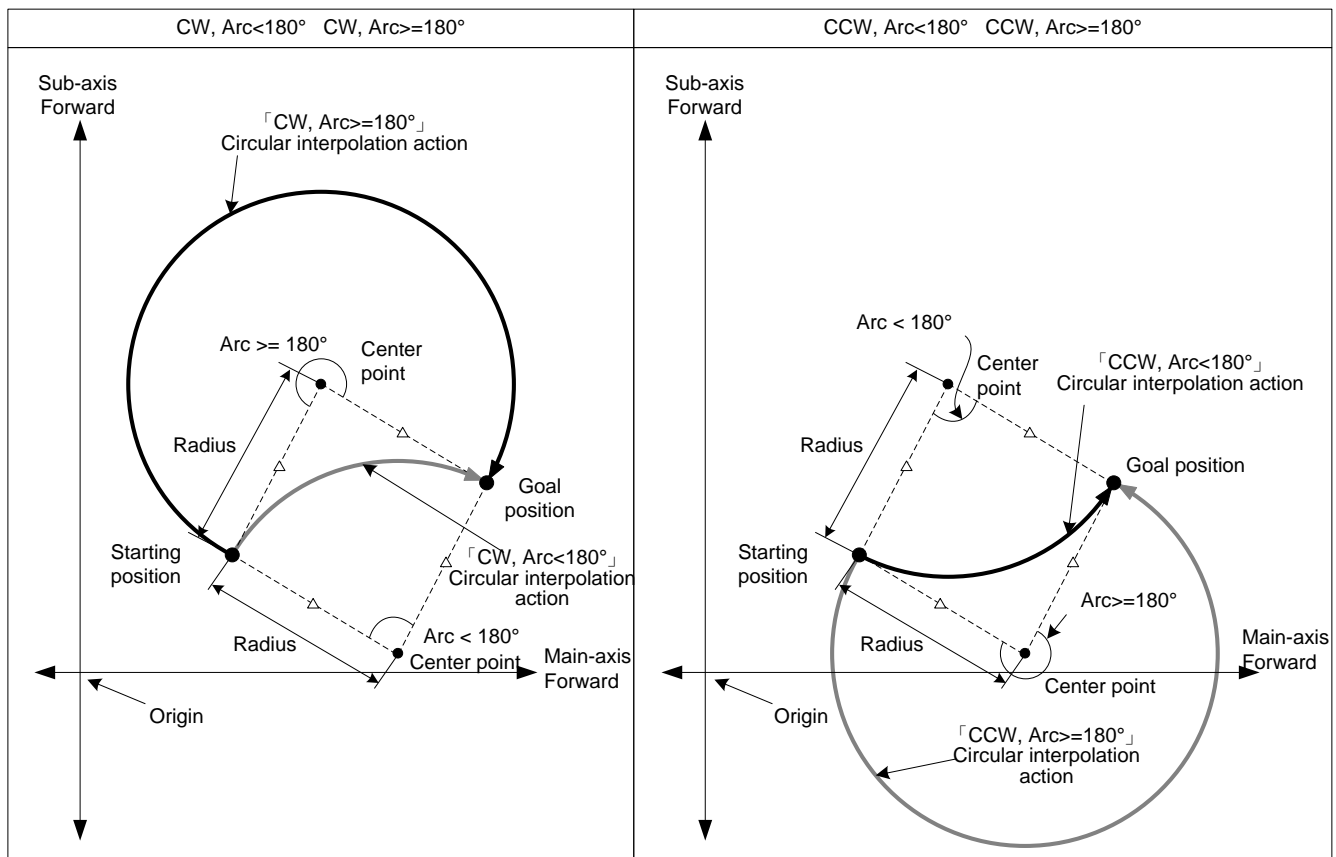

(b) Restrictions

- Circular interpolation with designating radius method may not draw an exact circle that the starting position and ending position are same. If user wants to draw an exact circle, use circular interpolation with center point method.
 - In the cases below, error would arise and circular interpolation may not be executed.
 - 「Sub-axis setting」 error (error code:279)
 - Value of 「Sub-axis setting」 is "Axis-undecided"
 - 「Sub axis setting」 of main axis operating data is the same as main axis no.
 - 「Sub axis setting」 of main axis operating data exceeds the settable axis no. of module now using.
 - Control unit of main or sub axis is set as "degree". (error code : 282(main), 283(sub))
 - Starting position and goal position are same (error code:285)
 - Radius value of circular interpolation of main-axis operating data is smaller than half of the length from starting position to goal position
 - Radius < (R x 0.8) : Error (error code:270)
 - (R x 0.8) <= Radius < R
- : Execute circular interpolation after reset the radius to R. In other words, execute circular interpolation by setting the center of the line from starting position to goal position as center point.

Note

If executing circular interpolation start, 2 axes will operate at the same time. Need user to pay attention.

(1) Auxiliary operations may be used are as follows.

- Speed override, Dec. stop, Emergent stop, Skip operation.

(2) The commands may not be used in circular interpolating operation are as follows.

- Position/Speed switching control, Position override, Continuous operation

(3) The parameter items operating by standards of each axis are as follows.

- Amount of backlash revision in extended parameter items, Software high limit, Software low limit

(c) Setting example of Operating data

Items	Main-axis setting	Sub-axis setting	Description
Control Method	Absolute, Circular interpolation	- *1	When executing circular interpolation with absolute coordinates, set 「Absolute, Circular interpolation」 on main
Operating Method	Singular, End	-	Set the method to execute circular interpolation
Goal position[pls]	10000	0	Set the goal position to execute on Main, Sub, Helical axis
Operating speed[pls/s]	1000	-	Use connecting speed designation method for circular interpolation. Set connecting speed on main-axis
Acc. no.	No.1	-	Set no. of acc. time to use in acceleration (no1~4)
Dec. no.	No.2	-	Set no. of dec. time to use in deceleration (no1~4)
M code	0	-	Set it when executing another auxiliary operation synchronizing with circular interpolation
Dwell time	500	-	Set dwell time for outputting positioning complete
Sub-axis setting	Axis2	-	Set an axis to use as sub-axis among the axis available on main-axis operating data.
Auxiliary point	7000	-	Set the radius on main-axis
Circular interpolation	Radius, CW, Arc<180°	-	If use radius designation method, set 「Radius」 on main-axis and set moving direction of arc and size of arc
The No. of Turns	-	-	Set the no. of turns of arc for making a circle bigger than 360°
Helical	Not use	-	When using circular interpolation, set it to 「Not use」

- *1 : It means that no need to be set. Whatever value it is, it dose not affect circular interpolation.

Note

(1) Circular interpolation control of Radius designation method is executed on the basis of the items set on operating data. When it is executed, only 「Goal position」 can affect circular interpolation. In other words, whatever value is set as, it does not affect the action and no errors arise.

(2) When setting the circular interpolating auxiliary point (radius) of main-axis, it must be bigger than the half of the length between starting position and goal position. If it is smaller than the half(R) and the value is higher than 80% of R, circular interpolation which has middle point between starting position and goal position as center-point is executed. If it is smaller than the half(R) and the value is lower than 80% of R, error (error code:270) arises and circular interpolation is not executed.

[Example] Axis1 is main-axis and Axis2 is sub-axis. Execute circular interpolation with relative coordinates and designated radius.

- Starting position (1000, 1000), Goal position (9000, 1000), Auxiliary point (5000, 0)

Moving direction of arc : CCW, Size of arc : Arc $\geq 180^\circ$

The action is as follows in the condition above

- Setting example in XG-PM

▪ Main-axis(Axis1) Operating data

Step No.	Control method	Operation Method	Goal position [pls]	Operating speed [pls/s]	Acc. No.	Dec. No.	M Code	Dwell Time	Sub-axis Setting	Auxiliary Point	Circular interpolation mode	The no. of turns	Helical interpolation
1	Absolute, Circular interpolation	Singular, End	9000	1000	No.1	No.1	0	100	Axis2	5000	Radius, CW, Arc <180	0	Not use

▪ Sub-axis(Axis2) Operating data

Step No.	Control method	Operation Method	Goal position [pls]	Operating speed [pls/s]	Acc. No.	Dec. No.	M Code	Dwell Time	Sub-axis Setting	Auxiliary Point	Circular interpolation mode	The no. of turns	Helical interpolation
1	Absolute, single axis position control	Singular, End	1000	0	No.1	No.1	0	100	Axis2	5000	Radius, CW, Arc <180	0	Not use

- Operation pattern

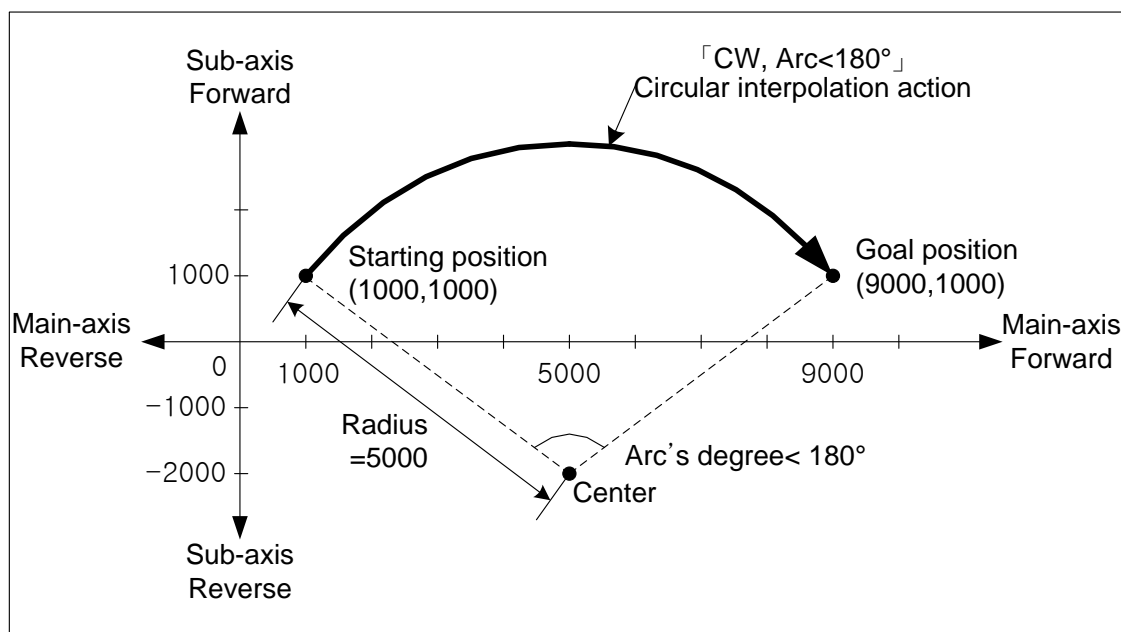

Chapter 9 Functions

(2) Circular interpolation by method of relative and designating radius (「Relative, Circular interpolation」)

- (a) Start operating from starting position and then execute circular interpolation by increment set on goal position along the trace of the circle which has the value set on circular interpolation auxiliary point of main-axis operation data as a radius. Circular arc depends on the moving direction of 「Circular interpolation mode」 (CW, CCW) and setting of arc size (Arc<180°, Arc>=180°)

Circular interpolation mode	Description
Radius, CW, Arc<180°	Execute circular interpolation with center-point of arc which smaller than 180° in direction of CW
Radius, CW, Arc >=180°	Execute circular interpolation with center-point of arc which bigger than 180° in direction of CW
Radius, CCW, Arc<180°	Execute circular interpolation with center-point of arc which smaller than 180° in direction of CCW
Radius, CCW, Arc>=180°	Execute circular interpolation with center-point of arc which bigger than 180° in direction of CWW

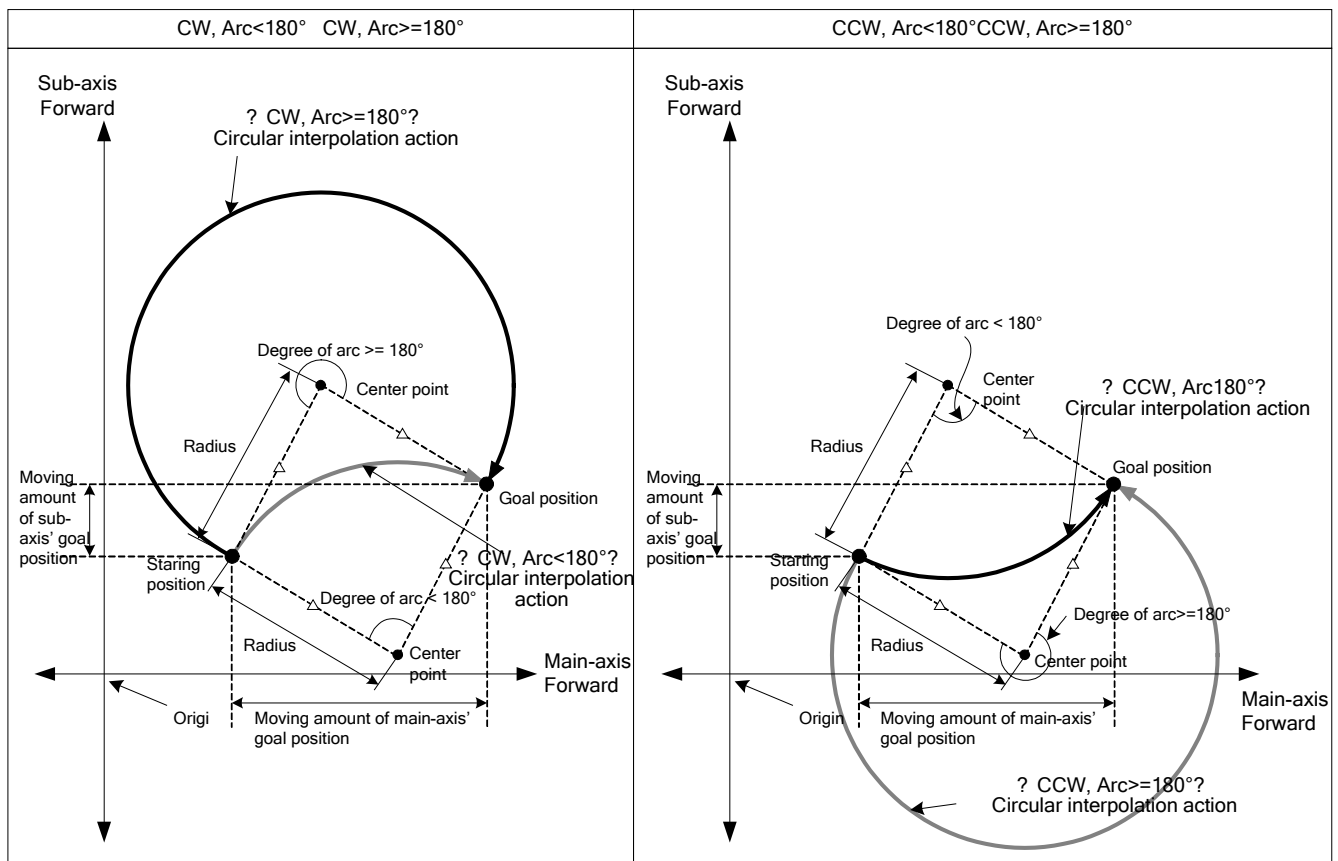

(b) Restrictions

- Circular interpolation with designating radius method may not draw an exact circle that the starting position and ending position are same. If user wants to draw an exact circle, use circular interpolation with center point method.
 - In the cases below, error would arise and circular interpolation may not be executed.
 - 「Sub-axis setting」 error (error code: 279)
 - Value of 「Sub-axis setting」 is “Axis-undecided”
 - 「Sub axis setting」 of main axis operating data is the same as main axis no.
 - 「Sub axis setting」 of main axis operating data exceeds the settable axis no. of module now using.
 - Control unit of main or sub axis is set as “degree”. (error code : 282(main), 283(sub))
 - Starting position and goal position are same (error code: 285)
 - Radius value of circular interpolation of main-axis operating data is smaller than half of the length from starting position to goal position
 - Radius < (R x 0.8) : Error (error code: 270)
 - (R x 0.8) <= Radius < R
- : Execute circular interpolation after reset the radius to R. In other words, execute circular interpolation by setting the center of the line from starting position to goal position as center point.

(c) Setting example of Operating data

Items	Main-axis setting	Sub-axis setting	Description
Control Method	Relative, Circular interpolation	- *1	When executing circular interpolation with absolute coordinates, set 「Relative, Circular interpolation」 on main
Operating Method	Singular, End	-	Set the method to execute circular interpolation
Goal position[pls]	10000	0	Set the goal position to execute on Main, Sub, Helical axis
Operating speed[pls/s]	1000	-	Use connecting speed designation method for circular interpolation. Set connecting speed on main-axis
Acc. no.	No.1	-	Set no. of acc. time to use in acceleration (no1~4)
Dec. no.	No.2	-	Set no. of dec. time to use in deceleration (no1~4)
M code	0	-	Set it when executing another auxiliary operation synchronizing with circular interpolation
Dwell time	500	-	Set dwell time for outputting positioning complete
Sub-axis setting	Axis2	-	Set an axis to use as sub-axis among the axis available on main-axis operating data.
Auxiliary point	7000	-	Set the radius on main-axis
Circular interpolation	Radius, CW, Arc<180°	-	If use middle-point-designation method, set 「Middle-point」 on main-axis
The No. of Turns	-	-	Set the no. of turns of arc for making a circle bigger than 360°
Helical	Not use	-	When using circular interpolation, set it to 「Not use」

- *1 : It means that no need to be set. Whatever value it is, it dose not affect circular interpolation.

Note

(1) Circular interpolation control of Radius designation method is executed on the basis of the items set on operating data. When it is executed, only 「Goal position」 can affect circular interpolation. In other words, whatever value is set as, it does not affect the action and no errors arise.

(2) When setting the circular interpolating auxiliary point (radius) of main-axis, it must be bigger than the half of the length between starting position and goal position. If it is smaller than the half(R) and the value is higher than 80% of R, circular interpolation which has middle point between starting position and goal position as center-point is executed. If it is smaller than the half(R) and the value is lower than 80% of R, error (error code:270) arises and circular interpolation is not executed.

[Example] Axis1 is main-axis and Axis2 is sub-axis. Execute circular interpolation with relative coordinates and designated radius.

- Starting position (1000, 1000), Goal position (8000, 0), Auxiliary point (5000, 0)

Moving direction of arc : CCW, Size of arc : Arc $\geq 180^\circ$

The action is as follows in the condition above

- Setting example in XG-PM

- Main-axis(Axis1) Operating data

Step No.	Control method	Operation Method	Goal position [pls]	Operating speed [pls/s]	Acc. No.	Dec. No.	M Code	Dwell Time	Sub-axis Setting	Auxiliary Point	Circular interpolation mode	The no. of turns	Helical interpolation
1	Relative, Circular interpolation	Singular, End	8000	1000	No.1	No.1	0	100	Axis2	5000	Radius, CCW, Arc ≥ 180	0	Not use

- Sub-axis(Axis2) Operating data

Step No.	Control method	Operation Method	Goal position [pls]	Operating speed [pls/s]	Acc. No.	Dec. No.	M Code	Dwell Time	Sub-axis Setting	Auxiliary Point	Circular interpolation mode	The no. of turns	Helical interpolation
1	Absolute, single axis position control	Singular, End	1000	0	No.1	No.1	0	100	Axis2	0	Middle point	0	Not use

- Operation pattern

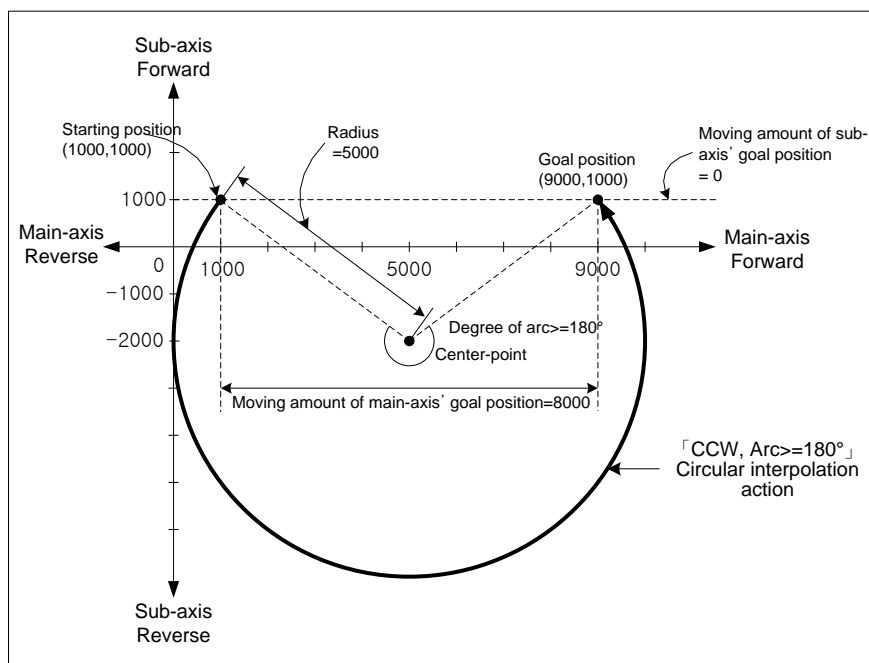

9.2.12 Helical Interpolation Control

After executed by positioning operation start command (Indirect, Synchronous), 2 axes move along the circular arc, an axis execute linear interpolation synchronizing with circular interpolation.

It may execute helical interpolation of bigger scale than 360°

Combinations of axis to use are not limited and 3 axes are used among axis1~axis6. (XEMH is 2axis, cannot use helical interpolation)

(1) Characteristics of control

- (a) After setting operating data to circular interpolation, then set a helical interpolation axis on the item "Helical interpolation", the helical interpolation will be executed.
- (b) The direction of circular arc depends on the goal position and the mode of circular interpolation, the direction of helical axis depends on the coordinates setting and the goal position.
 - The case of 「Absolute, Circular interpolation」
 - Starting position < Goal position : Positioning operation in forward direction
 - Starting position > Goal position : Positioning operation in reverse direction
 - The case of 「Relative, Circular interpolation」
 - Positive sign (+) or No sign : Positioning operation in forward direction
 - Negative sign (-) : Positioning operation in reverse direction

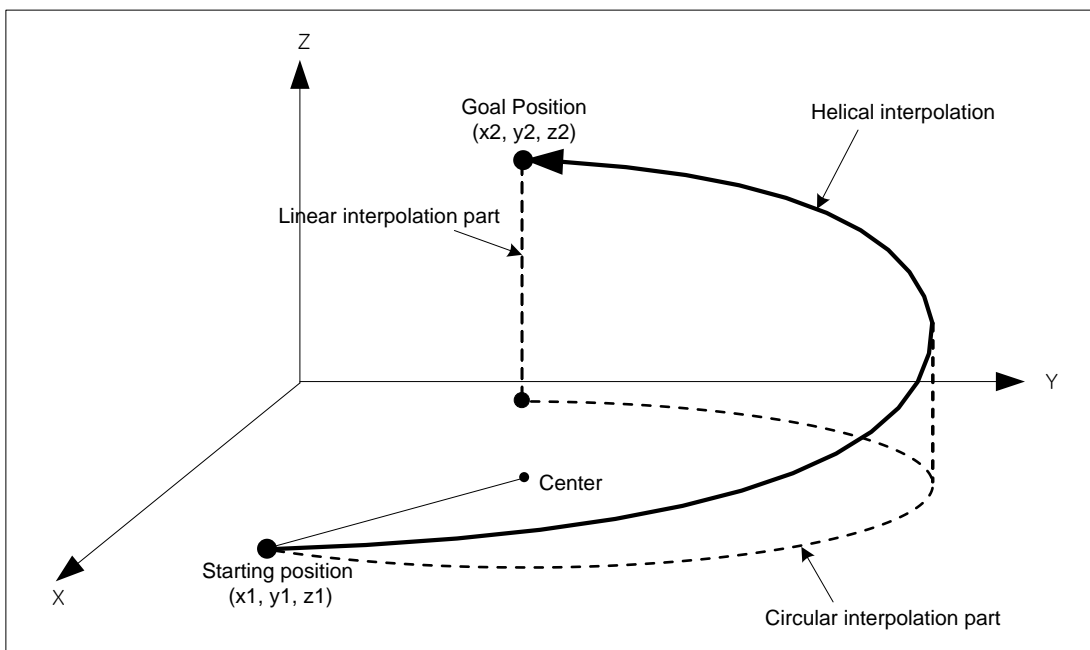

(2) Restrictions

- (a) The restrictions of helical interpolation are same as various kinds of circular interpolation depending on the mode of circular interpolation.
- (b) If user sets 「Helical Interpolation」 to "Not use", it will be same as the action of circular interpolation.
- (c) If user sets the goal position of helical interpolation axis to the same starting position, it will be same as the action of circular interpolation.

Note

If executing helical interpolation, 3 axes will operate at the same time. Need user to pay attention.

(1) Auxiliary operations may be used are as follows.

- Speed override, Dec. stop, Emergent stop, Skip operation.

(2) The commands may not be used in circular interpolating operation are as follows.

- Position/Speed switching control, Position override, Continuous operation

(3) The parameter items operating by standards of each axis are as follows.

- Amount of backlash revision in extended parameter items, Software high limit, Software low limit

(3) Example of operation data setting

Items	Main axis(axis1) Setting	Sub axis(axis2) Setting	Helical axis(axis3) setting	Description
Control method	Absolute, Circular interpolation	- *1	- *1	Circular interpolation must be set when executing helical interpolation
Operation method	Singular, End	-	-	Set operation method for helical interpolation
Goal position[pls]	10000	0	10000	Set the goal position on main, sub, helical axis for executing positioning.
Operation speed[pls/s]	1000	-	-	Helical interpolation designates composition speed of circular interpolation part
Acc. no.	No.1	-	-	Set acc. time no. used in acceleration (no.1 ~ no.4)
Dec. no	No.2	-	-	Set dec. time no. used in deceleration (no.1 ~ no.4)
M code	0	-	-	Set it when user needs to synchronize another auxiliary operation with helical interpolation.
Dwell time	500	-	-	Set dwell time(ms) for outputting positioning complete signal
Sub axis setting	Axis2	-	-	Set an axis to be used as sub axis from settable axis on main axis operation data
Auxiliary point of Circular interpolation	5000	5000	-	Set auxiliary data of circular interpolation action
Circular interpolation mode	Middle point	-	-	Set circular interpolation mode to be used in circular action of helical interpolation
No. of turn of circular interpolation	0	-	-	Set the no. of turn of circular arc when user need to execute helical interpolation of bigger degree than 360°
Helical interpolation	Axis3	-	-	Set an axis to be used as helical interpolation axis from settable axis on main axis operation data

- *1 : This item does not need to be set. Whatever it is set as, it dose not affect circular interpolation.

Note

Helical interpolation control is executed on the item basis set on operation data of main axis.

When executing circular interpolation of helical interpolation, only "Goal position", "Auxiliary point of circular interpolation" items of sub axis setting and "Goal position" item of helical axis setting affect helical interpolation. In other words, Whatever the setting value is, it does not affect operation and cause any errors.

[Example] Execute helical interpolation of absolute coordinates, center point designating method and axis1, axis2, axis3 are main, sub, helical axis.

- The action in the case (Starting point (650, 400, 0), Goal position (400, 1200, 350), Auxiliary point (800, 400)) is as follows.
- Setting example of XG-PM
 - Operation data of main axis(axis1)

Step no.	Control method	Operating method	Goal position [pls]	Operating speed [pls/s]	Acc. no.	Dec. no.	M code	Dwell time	Sub axis setting	Auxiliary point of circular interpolation	Circular interpolation mode	No. of turn of circular interpolation	Helical interpolation
1	Absolute, circular interpolation	Singular, End	400	1000	No.1	No.1	0	100	Axis2	800	Middle point, CCW	0	Axis3

- Operation data of sub axis(axis2)

Step no.	Control method	Operating method	Goal position [pls]	Operating speed [pls/s]	Acc. no.	Dec. no.	M code	Dwell time	Sub axis setting	Auxiliary point of circular interpolation	Circular interpolation mode	No. of turn of circular interpolation	Helical interpolation
1	Absolute, single axis position control	Singular, End	1200	0	No.1	No.1	0	100	-	400	Middle point	0	Not use

- Operation data of sub axis(axis2)

Step no.	Control method	Operating method	Goal position [pls]	Operating speed [pls/s]	Acc. no.	Dec. no.	M code	Dwell time	Sub axis setting	Auxiliary point of circular interpolation	Circular interpolation mode	No. of turn of circular interpolation	Helical interpolation
1	Absolute, single axis position control	Singular, End	350	0	No.1	No.1	0	100	-	0	Middle point	0	Not use

- Operating pattern

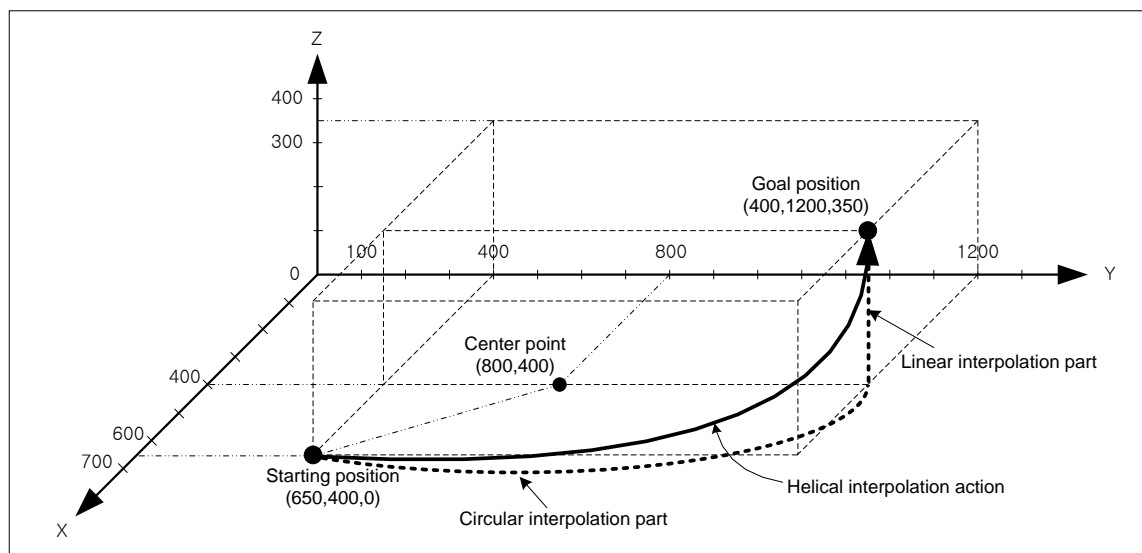

9.2.13 Ellipse Interpolation Control

Execute ellipse interpolation at ellipse rate and the moving angle of circular interpolation operating data and ellipse interpolation command.

Combinations of axis to be used in ellipse interpolation control are unlimited and 2 axes from axis1~4 are used.

(1) Characteristics of Control

(a) Ellipse interpolation is set with circular interpolation of center-designated method and the rate and size of ellipse is set with auxiliary data of "ellipse interpolation command"

Auxiliary data	Setting value	Description
Ratio of ellipse (%)	0 ~ 65535	Set the ratio of horizontal axis and vertical axis with the ratio to the circle (1 = 0.01%)
Size(Degree) of ellipse	0 ~ 65535	Set the degree of ellipse's movement (1 = 0.1°)

(b) Moving direction of ellipse is decided by the direction set on "circular interpolation mode" of operation data.

- 「Center point, CW」 - Execute ellipse interpolation in clockwise.
- 「Center point, CCW」 - Execute ellipse interpolation in counterclockwise.

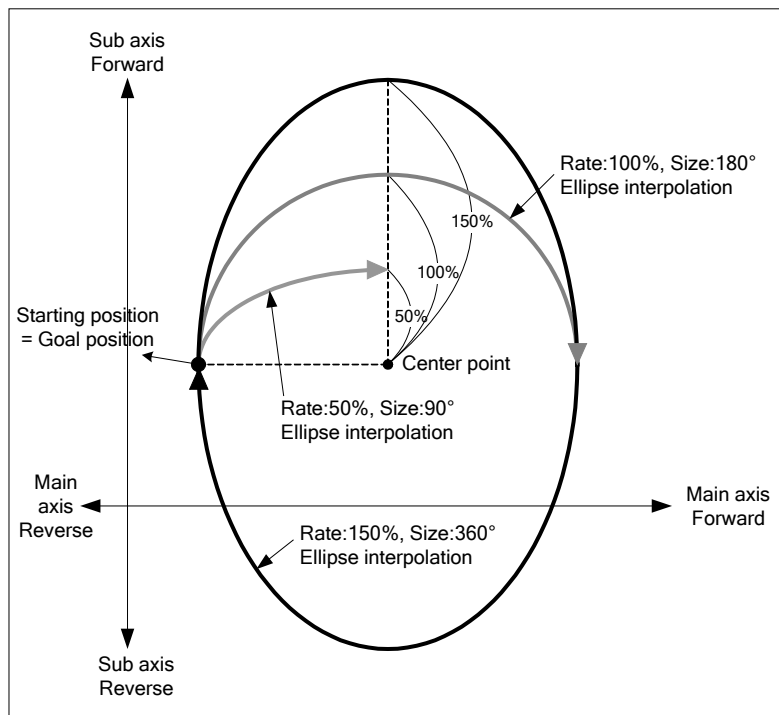

(c) Starting position and goal position must be same when executing ellipse interpolation.

(d) When executing ellipse interpolation, the radius changes continuously and composing speed also changes depending on the ratio of ellipse. When the ratio of ellipse is bigger than 100%, operating speed of sub axis and composing speed get faster. So it calls user's attention. Sub axis of ellipse interpolation is not limited by "speed limit", so user must set operating speed below limit.

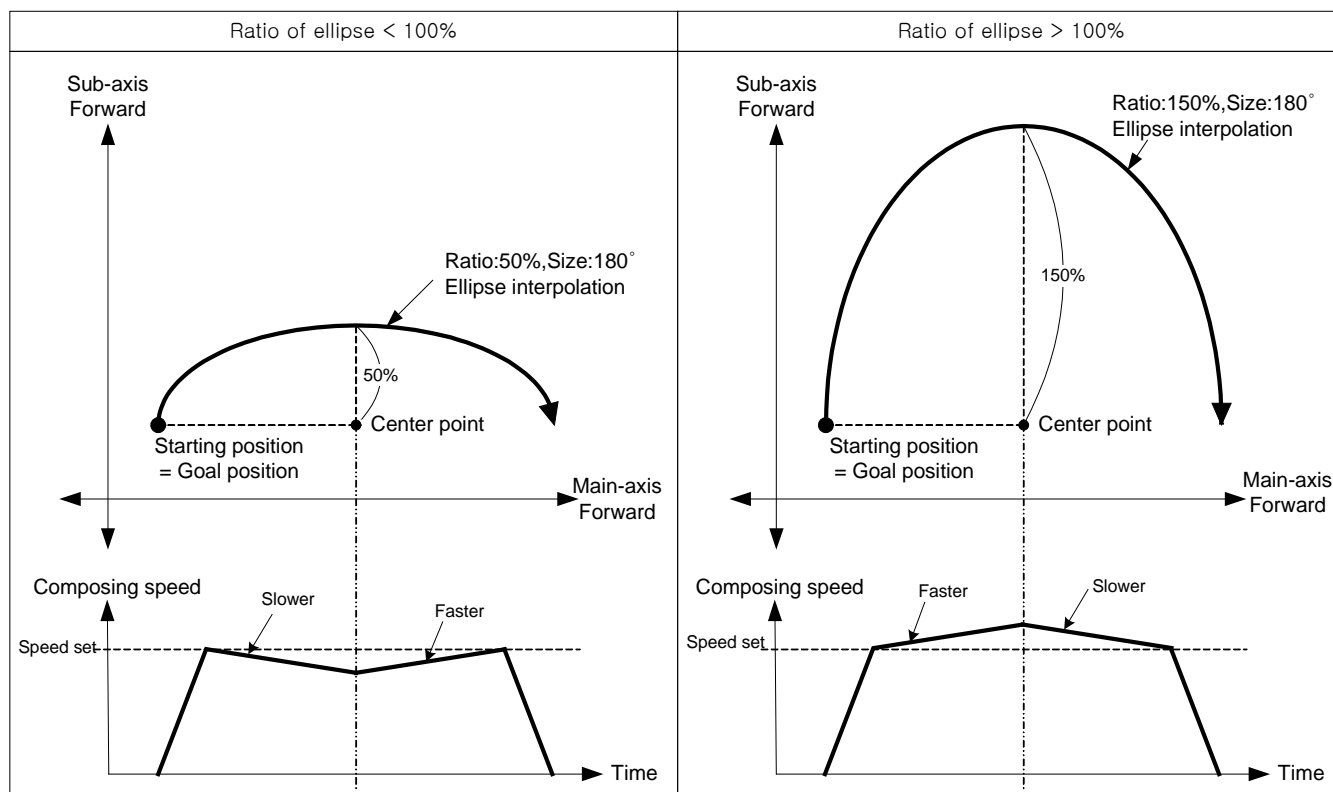

(2) Restrictions

(a) Ellipse interpolation may not be executed in the case below.

- 「Sub-axis setting」 Error (error code : 547)
 - The value of sub-axis setting of main axis operating data is "Axis-undecided".
 - The value of sub-axis setting of main axis operating data is set equally to the no. of main-axis.
 - The value of sub-axis setting of main axis operating data is set wrongly. (Exceeding settable axis no.)
 - An axis of helical interpolation is set.
- Control unit of main or sub axis is set as "degree". (error code : 551(main), 552(sub))
- The center point designated as auxiliary point is the same as starting position or goal position. (error code : 553)
- The radius of circular arc that calculated exceeds 2147483647pls. (error code : 554)
- The operating method is "continuous" or "go on". (error code : 556)

If user executes ellipse interpolation, End operation must be set before use.
- Starting position and Goal position are different. (error code : 558)
- Size of circular arc (Moving degree) is 0. (error code : 559)

Note

Need user to heed the synchronous operation of 2 axes in ellipse interpolation start.

1. Auxiliary operations available are as follows.
 - Speed override, Dec. stop, Emergent stop, Skip operation
2. The commands unavailable in ellipse interpolating operation are as follows.
 - Position/Speed switching control, Position override, Continuous operation
3. Parameter items of each axis on setting value basis are as follows.
 - Backlash revision of extended parameter, Software high limit, Software low limit

(3) Setting example of operation data

Items	Main-axis setting	Sub-axis setting	Description
Control Method	Absolute, Circular interpolation	- *1	Set circular interpolation when executing ellipse interpolation
Operating Method	Singular, End	-	“End” must be set in ellipse interpolation
Goal position[pls]	10000	0	Set the goal position to execute on Main, Sub, Helical axis
Operating speed[pls/s]	1000	-	Designate composing speed for circular interpolation part in ellipse interpolation
Acc. no.	No.1	-	Set no. of acc. time to use in acceleration (no1~4)
Dec. no.	No.2	-	Set no. of dec. time to use in deceleration (no1~4)
M code	0	-	Set it when executing another auxiliary operation synchronizing with ellipse interpolation
Dwell time	500	-	Set dwell time for outputting positioning complete
Sub-axis setting	Axis2	-	Set an axis to use as sub-axis among the axis available on main-axis operating data.
Auxiliary point	5000	5000	Set the center point of ellipse
Circular interpolation	Center point, CW	-	Must be set center point when using ellipse interpolation
The No. of Turns	-	-	The no. of turn is not operated in ellipse interpolation
Helical	Not use	-	Set axis of helical interpolation as “Not Use” in ellipse interpolation

- *1 : It means that no need to be set. Whatever value it is, it dose not affect circular interpolation.

Note

Ellipse interpolation control is executed by the standard set on operating data of main-axis.

When executing ellipse interpolation, only 「Goal position」 and 「Auxiliary point of circular interpolation」 affect the operation of ellipse interpolation. In other words, whatever value is set to, it does not affect operation and no errors arise.

[Example] Execute ellipse interpolation with 20% of ellipse ratio, 360° of movement degree and relative coordinates

- Starting position (100, 100),
Setting of goal position : (0, 0)
Setting of auxiliary point : (500, 200)
Direction of operation : CW

■ Example setting in XG-PM

▪ Operation data of Main-axis(axis1)

Step no.	Control method	Operating method	Goal position [pls]	Operating speed [pls/s]	Acc. No.	Dec. No.	M code	Dwell Time	Setting Sub axis	Auxiliary point of circular interpolation	Circular interpolation mode	The no. of turns	Helical interpolation
1	Relative, circular interpolation	Singular, End	0	1000	No.1	No.1	0	100	Axis2	800	Center,CW	0	Not use

▪ Operation data of Sub-axis(axis2)

Step no.	Control method	Operating method	Goal position [pls]	Operating speed [pls/s]	Acc. No.	Dec. No.	M code	Dwell Time	Setting Sub axis	Auxiliary point of circular interpolation	Circular interpolation mode	The no. of turns	Helical interpolation
1	Absolute, Single axis position control	Singular, End	0	0	No.1	No.1	0	0	Undecided	400	Middle point	0	Not use

■ Operating data

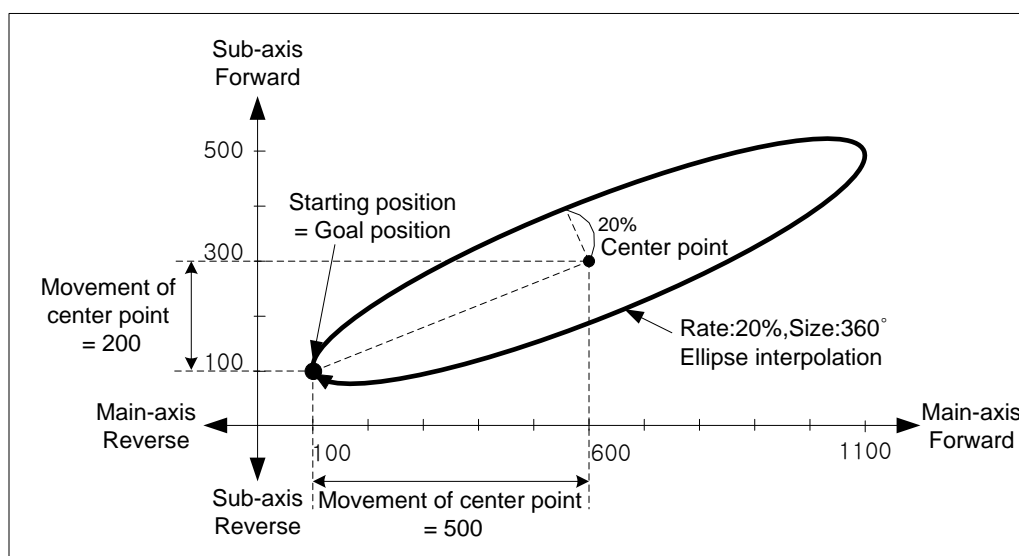
**Note**

- (1) If the degree of ellipse is not 360°, the goal position and actual position after stop operating are not same.
- (2) If the ratio of ellipse is 0%, the trace of ellipse interpolation is shown as straight line. Ratio of ellipse need to be set to above 0.

9.2.14 Speed/Position Switching Control

The setting axis by positioning start carries out the speed control and is switched from speed control to position control when speed/position switching signal is entered to the positioning module inside or outside, and then carries out the positioning as much as goal transfer amount.

(1) Characteristics of Control

- Set control method of operating data as "Single axis speed control" and executing positioning with 「Speed/Position Switching」 in speed control operation.
- Direction of movement depends on the sign of value.
 - Forward : The position value is Positive(+)
 - Reverse : The position value is Negative(-)
- For using 「External speed/position switching control」, "External speed/position switching control" must be set as '1 : Allowed'

Item	Setting value	Description
External speed/position switching control	0 : Absolute	Executes the positioning at the incremented position by the value set at the position where the speed / position switching command was executed.
	1 : Relative	The set position value is regarded as an absolute position and the positioning is executed at the set absolute position

- In speed/position switching control, the value of coordinates has no affection. In other words, actions of "Absolute, Single axis speed control" and "Relative, Single axis speed control" are same.

(2) Operation timing

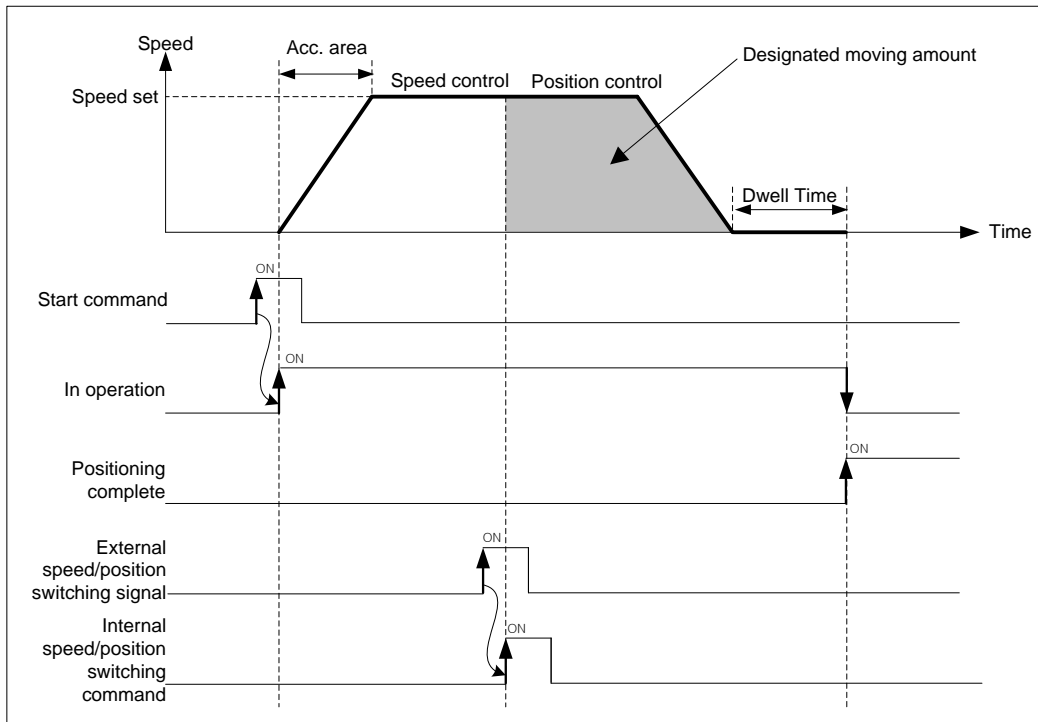

(3) Restrictions

- (a) Operation pattern of speed control has to be set as "End" or "Go on". If "Continuous" is set as, error (error code:236) arises and speed control may not be executed.
- (b) If the value of goal position is 0, speed/position switching command may not be executed. In this case, it continues to operate with speed control.

(4) Setting example of operation data

Items	Setting value	Description
Control method	Absolute, Single axis speed control	When executing speed/position switching control, set single axis speed control
Operating method	Singular, End	When executing speed/position switching control, set "end" or "continuous"
Goal position [pls]	10000	After inputting speed/position switching control, set moving amount to position.
Operating speed [pls/s]	1000	Set the operating speed of speed/position switching control
Acc. no.	No1	Set acc. no. used in acceleration (no.1~4)
Dec. no.	No.2	Set dec. no. used in deceleration (no.1~4)
M code	0	Set it when user needs to execute another auxiliary work synchronizing with speed/position switching control
Dwell time	500	Set dwell time(ms) between switching command's inputting and positioning completion's outputting

9.2.15 Position specified Speed/Position Switching Control

The setting axis by positioning start carries out the speed control and is switched from speed control to position control when speed/position switching signal is entered to the positioning module, and then carries out the positioning by transfer amount.

(1) Characteristics of Control

- (a) Set control method of operating data as “Single axis speed control” and execute 「Speed/Position Switching」 in speed control operation.
- (b) Set the speed/position switching coordinate

Item	Setting value	Description
speed/position switching coordinate	0 : Relative	Operates as relative coordinates from the position at command executed.
	1 : Absolute	Operates as absolute coordinates regardless of executed position..

- (c) In speed/position switching control, the value of coordinates has no affection. In other words, actions of “Absolute, single axis speed control” and “Relative, single axis speed control” are same.
- (d) In Position specified speed/position control, a target position set in the operation data or direct start is ignored and it moves according to target position operand of 「Position specified speed/position switching control」 command

(2) Operation timing

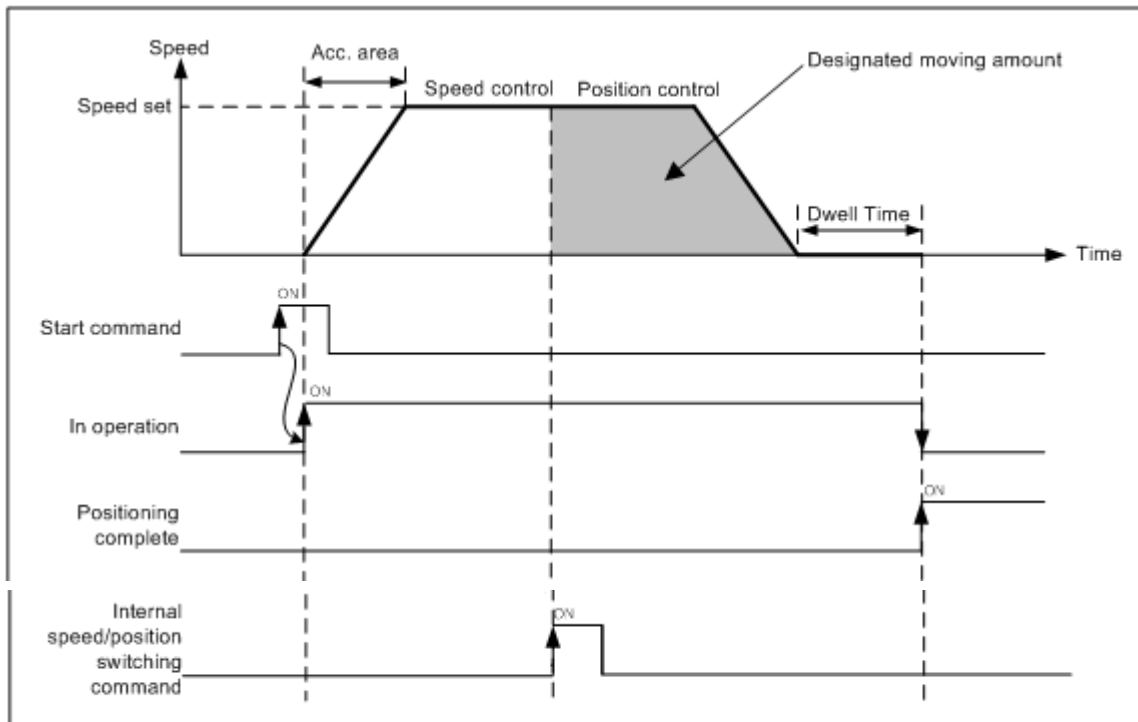

(3) Restrictions

- (a) Operation pattern of speed control has to be set as “End” or “Go on”. If “Continuous” is set as, error (error code:236) arises and speed control may not be executed.
- (b) If the value of goal position is 0, position specified speed/position switching command may not be executed. In this case, it continues to operate with speed control.

(4) Setting example of operation data

Items	Setting value	Description
Control method	Absolute, Single axis speed control	When executing speed/position switching control, set single axis speed control
Operating method	Singular, End	When executing speed/position switching control, set “end” or “continuous”
Goal position [pls]	10000	After inputting speed/position switching control, set moving amount to position.
Operating speed [pls/s]	1000	Set the operating speed of speed/position switching control
Acc. no.	No1	Set acc. no. used in acceleration (no.1~4)
Dec. no.	No.2	Set dec. no. used in deceleration (no.1~4)
M code	0	Set it when user needs to execute another auxiliary work synchronizing with speed/position switching control
Dwell time	500	Set dwell time(ms) between switching command's inputting and positioning completion's outputting

9.2.16 Position/Speed Switching Control

The setting axis by positioning start carries out the position control and is switched from position control to speed control when position/speed switching signal is entered to the positioning module inside, and then it stops by deceleration stop or SKIP operation or continues next operation.

(1) Characteristics of Control

- (a) Set control method of operating data as "Single axis position control" and user may change position control to speed control with 「Speed/Position Switching」
- (b) Direction of movement depends on the sign of value and coordinates
 - 「Absolute, Single axis position control」
 - Starting position < Goal position : Positioning in forward direction
 - Starting position > Goal position : Positioning in reverse direction
 - 「Relative, Single axis position control」
 - The value of goal position has positive sign (+) : Positioning in forward direction
 - The value of goal position has negative sign (-) : Positioning in reverse direction

(2) Operating timing

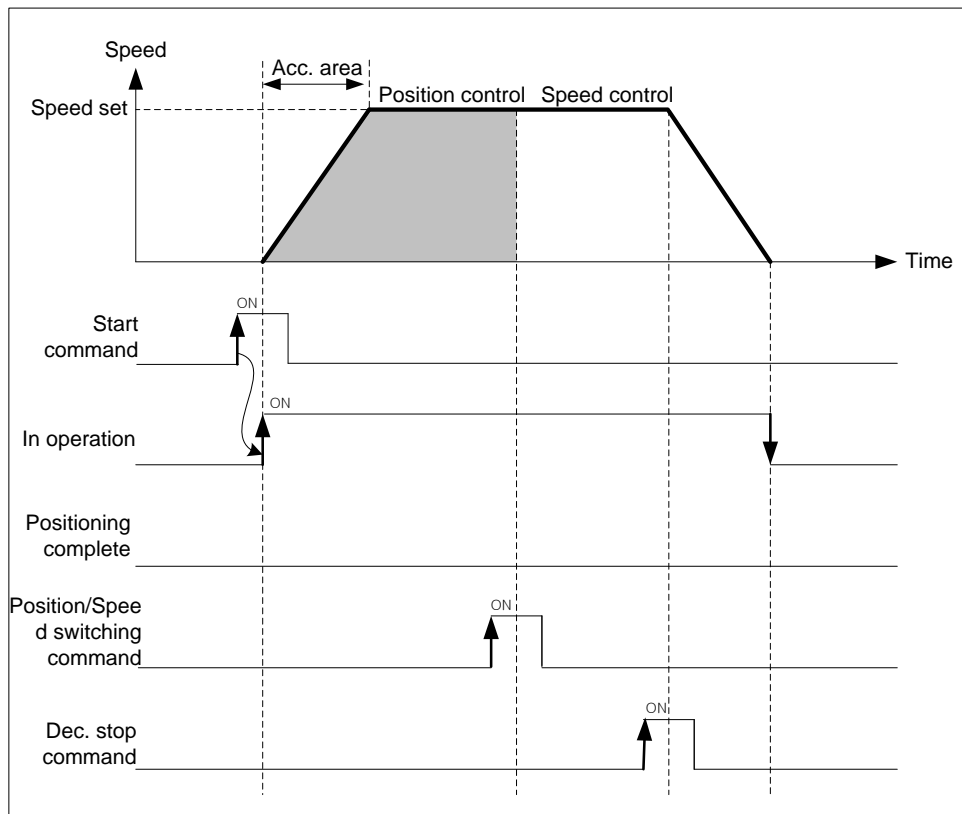

(3) Restrictions

- (a) Position/speed switching command is not inputted before positioning to the goal position, it stops by deceleration and finishes the positioning.
- (b) After position/speed switching, software high/low limit check depends on "Soft high/low limit in speed control" of extended parameter.

Items	Setting value	Description
Soft high/low in speed control	0 : Not detect	Not to execute checking for software high/low limit in speed control
	1 : Detect	Execute checking for software high/low limit in speed control

(4) Setting example of operation data

Items	Setting value	Description
Control method	Absolute, Single axis speed control	When executing position/speed switching control, set single axis speed control
Operating method	Singular, End	Set operating method for position control
Goal position [pls]	10000	Set the value of goal position for position control
Operating speed [pls/s]	1000	Set the operating speed of position/speed switching control
Acc. no.	No.1	Set acc. no. used in acceleration (no.1~4)
Dec. no.	No.2	Set dec. no. used in deceleration (no.1~4)
M code	0	Set it when user needs to execute another auxiliary work synchronizing with speed/position switching control
Dwell time	500	When it is executed with position control and without position/speed switching command, set dwell time between positioning and complete signal's outputting.

9.2.17 Start of Positioning

In case of stop in action of dynamic positioning, can positioning by restart. Three Starting types are general start, Simultaneous start, point operation. Operating signal is have to "OFF", when it start.

(1) Direct start

(a) Do not use operating data, directly input positioning data by auxiliary data and perform positioning control.

(b) Setting auxiliary data of direct start.

Setting item	Contents
Target position	Set target position of control.
Operating speed	Set operating speed of control.
Dwell time	Set dwell time (ms) that it is from positioning to outputting signal of positioning. (0~65535)
M code	Set for performing auxiliary action which is depending on set control.(0~65535)
Acceleration time No.	Set acceleration time number for acceleration. (No.1 ~ No.4)
Reduction time No.	Set reduction time number for reduction. (No.1 ~ No.4)
Coordinate	Set coordinate about target position of set control.(absolute, relative)
Control method	When command of converting position/speed is not inputted and only operated by positioning control, set dwell time (ms) that it is from positioning to outputting signal of positioning. (0:Positioning, 1:Speed control, 2:Feed control)

Note

Direct start only can use when it is shortened operation. In case that Interpolation operation, use indirect starts.

(2) Indirect Start

(a) Start control of positioning by designating step number of operation data which was saved in positioning module.

(b) Setting auxiliary data of indirect start

Setting item	Contents
Operation step	Set step number of operation data what you need operating.(0 or 1 ~ 400)

Note

Set 'O' operation step of Indirect start and carry out command of indirect start. And then start operation data which was saved in step number.

(3) Simultaneous start

- (a) According to axis information and setting step, Simultaneous start positioning operation data of axis 2 ~ axis 6.
 (b) When Input stop command, only it decelerates and stops on the corresponding axis. In case of Simultaneous start setting step number is current operating step number. Input start command, and then according to relative coordinate and absolute coordinate, operate positioning.
 (c) Condition

In these cases can not operate all of the axes which were set simultaneous start by error.

- When occurred error in over an axis among setting axes of simultaneous start. (Output error code in its axis.)
- When command axis of simultaneous start was wrong. (Error code : 296)
 - Only set command axis (Set over 2 axes is necessary.)
 - In case of exceeding number of possible setting axis of current using module among the possible setting axes

[Example] Set Simultaneous start of axis 1, axis 2, axis 3 is as follows;

- Current position of axis 1: 0, Operation step: 1
 Current position of axis 2: 0, Operation step: 3
 Current position of axis 3: 0, Operation step: 10

■ Example of setting XG-PM

- Operation data of axis 1

Step No.	Control method	Operation method	Target position [pls]	Operation speed [pls/s]	Acceleration No.	Deceleration No.	M code	Dwell time
1	Absolute, Shorten position control	Single, Continuous	1000	1000	1	1	0	0
2	Absolute, Shorten position control	Single, End	1800	800	1	1	0	100

- Operation data of axis 2

Step No.	Control method	Operation method	Target position [pls]	Operation speed [pls/s]	Acceleration No.	Deceleration No.	M code	Dwell time
3	Absolute, Shorten position control	Single, End	900	500	2	2	0	0

- Operation data of axis 3

Step No.	Control method	Operation method	Target position [pls]	Operation speed [pls/s]	Acceleration No.	Deceleration No.	M code	Dwell time
10	Absolute, Shorten speed control	Single, End	1000	300	3	3	0	100

■ Operation pattern

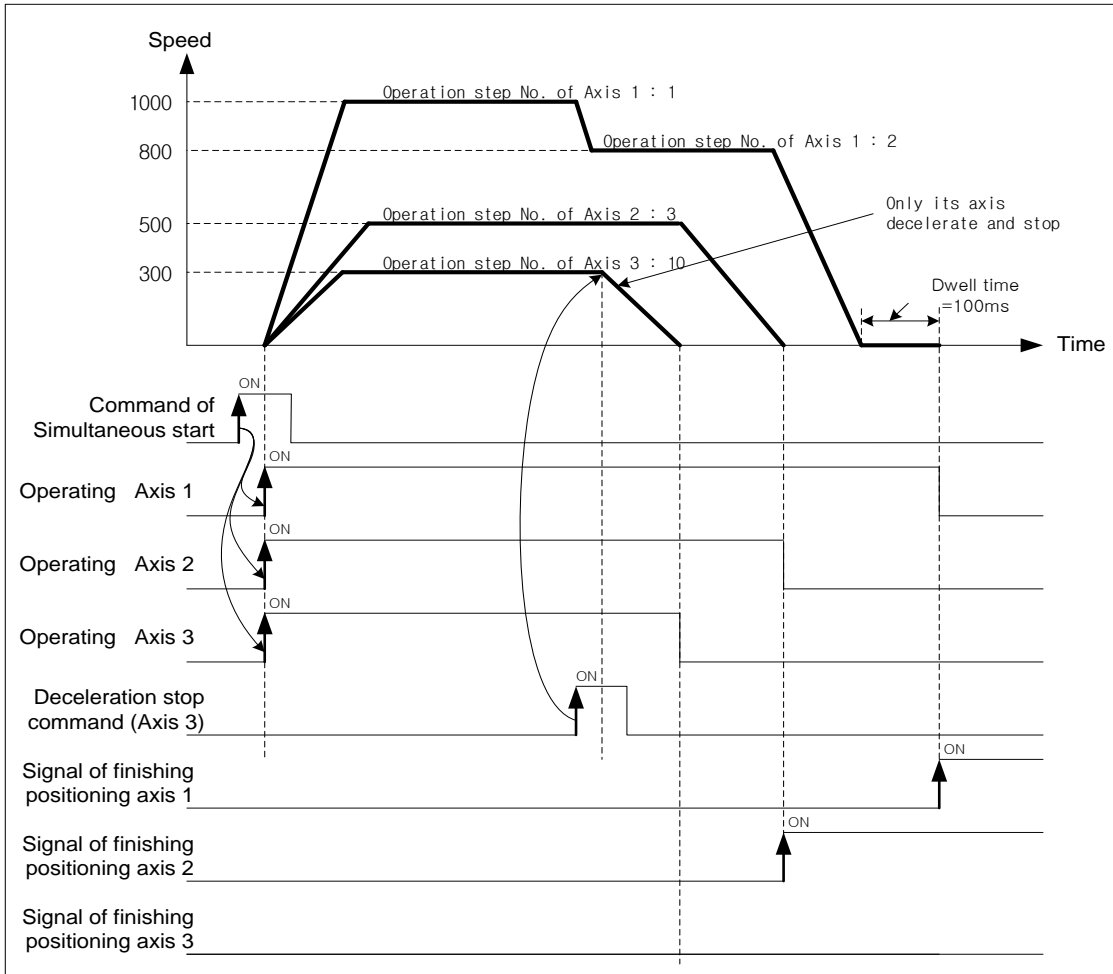

(4) Point operation

- (a) Point maneuvering is a positioning drive also called ptp drive. Which processes the sequential data of user defined steps in order
- (b) It can be appointed 20 steps by point operation.
- (c) Start point maneuvers as much as the number of set points from setting step (point1), irrespective of end, continue, automatic operation mode.

[Example] Point operation of axis 1 is as follows;

- The number of point operation: 4
Point operation step No. : 1, 2, 10, 20
Current position of Axis 1 : 0
- Example of setting XG-PM

Step No.	Control method	Operation method	Target position [pls]	Operation speed [pls/s]	Acceleration No.	Deceleration No.	M code	Dwell time
1	Absolute, Shorten position control	Singleness, End	1000	1000	1	1	0	20
2	Absolute, Shorten position control	Singleness, End	3000	2000	1	1	0	20
10	Absolute, Shorten position control	Singleness, Keep	6000	3000	1	1	0	20
11	Absolute, Shorten position control	Singleness, Keep	10000	4000	1	1	0	20
12	Absolute, Shorten position control	Singleness, Keep	15000	5000	1	1	0	20
13	Absolute, Shorten position control	Singleness, End	25000	6000	1	1	0	20
20	Absolute, Shorten position control	Singleness, Continue	45000	7000	1	1	0	0
21	Absolute, Shorten position control	Singleness, continue	75000	8000	1	1	0	0
22	Absolute, Shorten position control	Singleness, End	0	9000	1	1	0	0

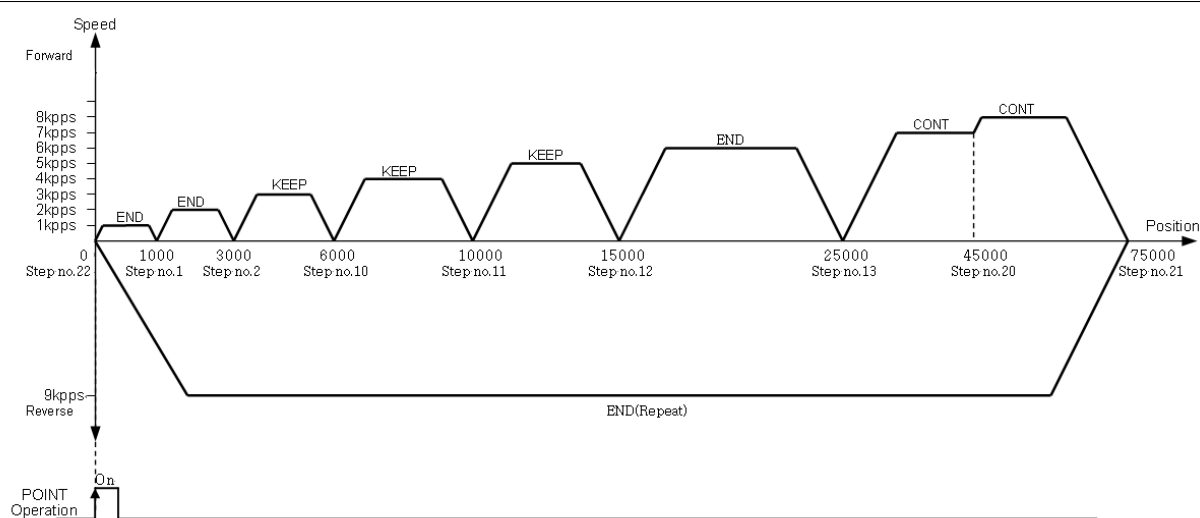

9.2.18 Positioning stop

Here describes factor which are stop axis during operation.

(1) Stop command and Stop factor

Command & Stop factor of stop positioning operating is as follows;

- (a) It will stop, when stop command is "On" or there are some stop factors at each axis. But, interpolation control (linear interpolation, Circular interpolation, helical interpolation, elliptic interpolation)

In case of there is stop command or stop factor on main axis, operation axes of interpolation control will stop.

Status Stop factor		Positioning ^{*1}	Homing ^{*2}	Jog Operation	Speed synchronous Cam control	Status of Axis after stop	M code On Status of signal
Parameter setting ^{*3}	Exceed soft high-limit	Prompt stop	No Detection	Prompt stop ^{*5}		Error (Error501)	No change
	Exceed soft low-limit	Prompt stop	No Detection	Prompt stop		Error (Error502)	No change
Sequence program ^{*4}	Deceleration stop command	Deceleration stop	Deceleration stop	Error 322 (Keep operation)	Deceleration ^{*6} stop	Stop On	No change
	Emergency stop command	Sudden stop				Error (Error481)	"Off"
External signal	External high-limit "On"	Sudden stop		When operate to forward, sudden stop	Sudden stop ^{*7}	Error (Error492)	No change
	External low-limit "On"	Sudden stop		When operate to reverse, sudden stop	Sudden stop	Error (Error493)	No change
XG-PM Software	Deceleration stop command	Deceleration stop	Deceleration stop	Error322 (Keep operation)	Deceleration stop	Stop "On"	No change
	Emergency stop command	Sudden stop				Stop "On"	"Off"

Note

*1 : Positioning means position control, speed control, interpolation control, speed/position switching control, position/speed switching control, position/torque control by positioning data.

*2 : When complete homing, approximate origin and HOME signal do not effect to positioning control.

*3 : Only work while software high/low limit on the speed control of expansion parameter at the speed control operation mode is set "1:detection"

*4 : Sequence program means XGT program type.

*5 : Output speed become "0", when it has factor of stop.

*6 : Speed goes to "0" while the deceleration stop time of deceleration stop command support data decelerates as a set time.

*7 : Speed goes to "0" decelerate by set time as 「sudden stop, deceleration」 of parameter.

(2) Deceleration Stop

- (a) If meet emergency stop while operate indirect start, direct start, simultaneous start, start operation, homing operation, inching operation, it will sudden stop.
- (b) Deceleration stop command not different at these sections: acceleration section, constant section, deceleration section.
- (c) If it is decelerated and stopped by deceleration stop command, will not be completed positioning operation as set target position. And...
- No signal for completely positioning
 - M code signal cannot be "On" during "After" mode of "M code" mode.
- (d) If it receives order for indirect start command (step No. = current step No.) while it is stop,
- Positioning of absolute coordinate method: Operate amount of the position reminder which it isn't outputted on the current operation step.
 - Positioning of relative coordinate method: Operate as set movement at the target position.
- (e) There are two type of deceleration stop: Internal/external deceleration stop.
- Internal deceleration stop command
It decelerate and stop by XG-PM and 「deceleration stop」 command of sequence program as set support data.
 - External deceleration stop signal
In case of input signal of external emergency stop/deceleration stop to be "On", it will be decelerated and stopped by set deceleration time in current positioning operation.
Have to set item of "select external emergency stop/deceleration stop" of expansion parameter for using input signal of external emergency stop/deceleration stop as external deceleration stop command.

Item	Setting value	Contents
Select external emergency stop/ deceleration stop	0: Emergency stop	Use as "emergency stop" signal when input external signal.
	1: Deceleration stop	Use as "deceleration stop" signal when input external signal.

(f) Condition

- When command internal deceleration stop
The value of deceleration time can bigger than set value of deceleration time by auxiliary data.
- If deceleration stop command is inputted while operate Jog, error (error code: 322) will be made. Use "Stop Jog" command for Jog operation stop.

(g) Movement Time

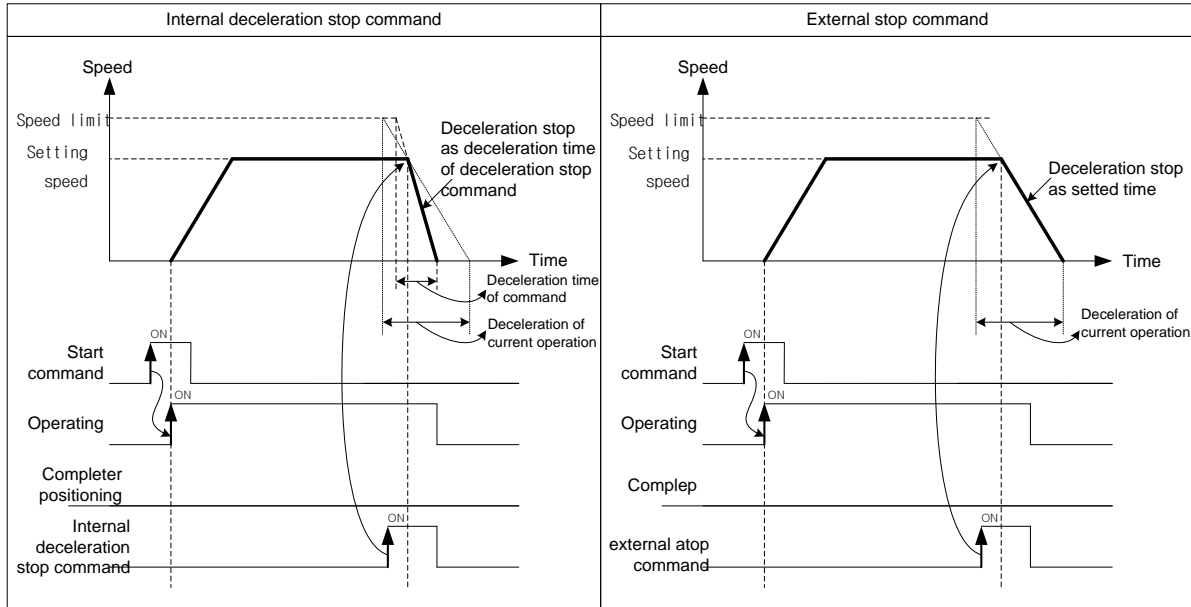

- If the deceleration distance is longer than distance to target position when input deceleration stop command during positioning control operation, it will be stopped at the target position.

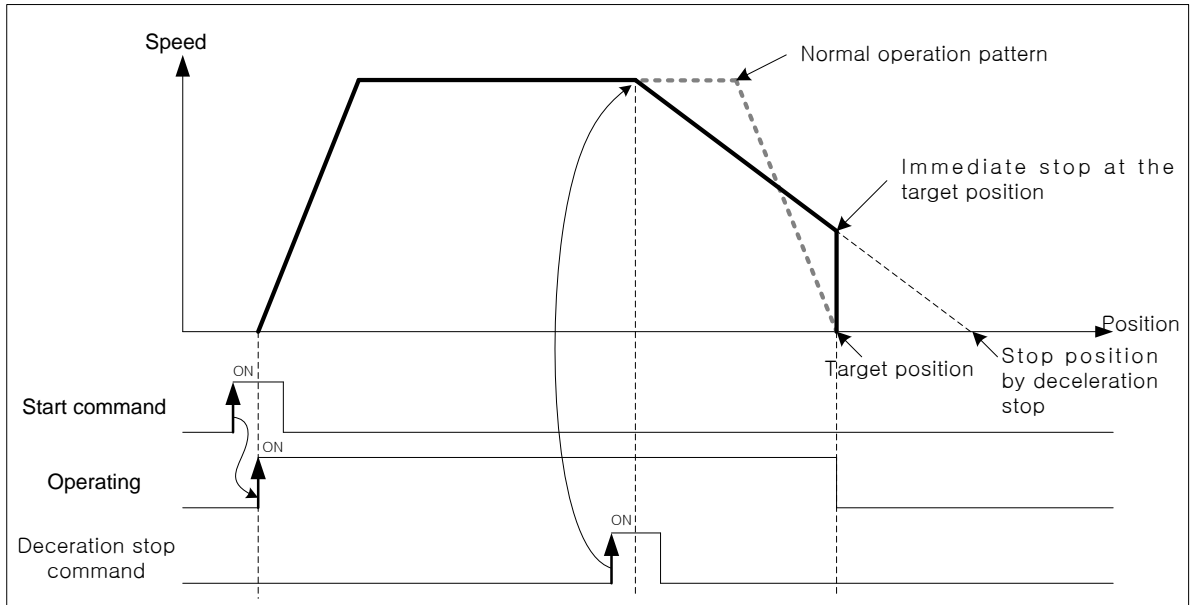

(3) Emergency Stop

- (a) It will be decelerated, stopped and occurred error as set time in 「deceleration time when it is suddenly stopped」 during indirect start, direct start, start at the same time, synch. operation, homing operation, jog operation, inching operation, when it be emergency stopped during operation.
- (b) In case of internal emergency stop, error 481 will occur and in case of external emergency stop, error 491 will occur.
- (c) M code signal will be “Off” after Emergency stop.
- (d) Internal emergency stop command

To be decelerated and stopped by 「emergency stop」 command of XG-PM & Sequence program as set time in 「deceleration time when it is suddenly stopped」, and error will be occurred.

■ Setting related parameter (Basic parameter)

Item	Setting value	Contents
When sudden stop, deceleration time	0 ~ 2147483647 [ms]	Set deceleration time for using when detect hardware high/low limit signal. Deceleration time express needed time for deceleration as bias speed at speed limit, when suddenly stop.

(e) Motion timing

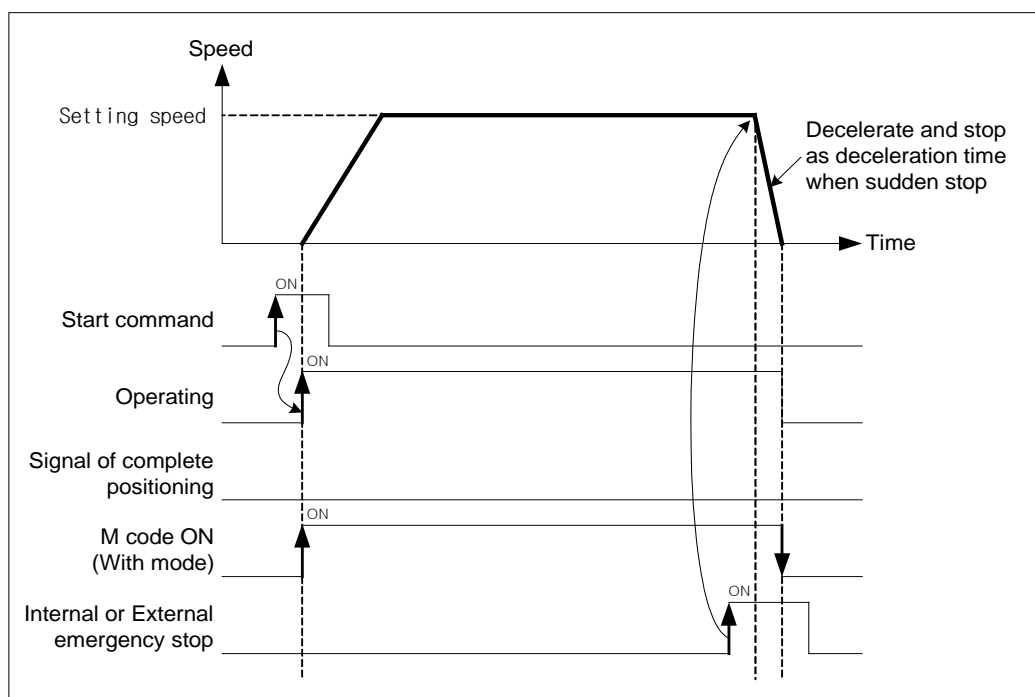

(4) Stop hardware by high/low limit

- (a) When positioning control, if the signal of hardware high/low limit is inputted, then stop positioning control and it will be decelerated and stopped as set time at 「deceleration time when it is suddenly stopped」, and error will be occurred.
- (b) In case of external input stroke high limit error, error 492 will occur and in case of external input stroke low limit error, error 493 will occur.

■ Setting related parameter (basic parameter)

Item	Setting value	Content
When sudden stop, deceleration time	0 ~ 2147483647 [ms]	Set deceleration time for using when detect hardware high/low limit signal. Deceleration time express needed time for deceleration as bias speed at speed limit, when suddenly stop.

(c) Motion timing

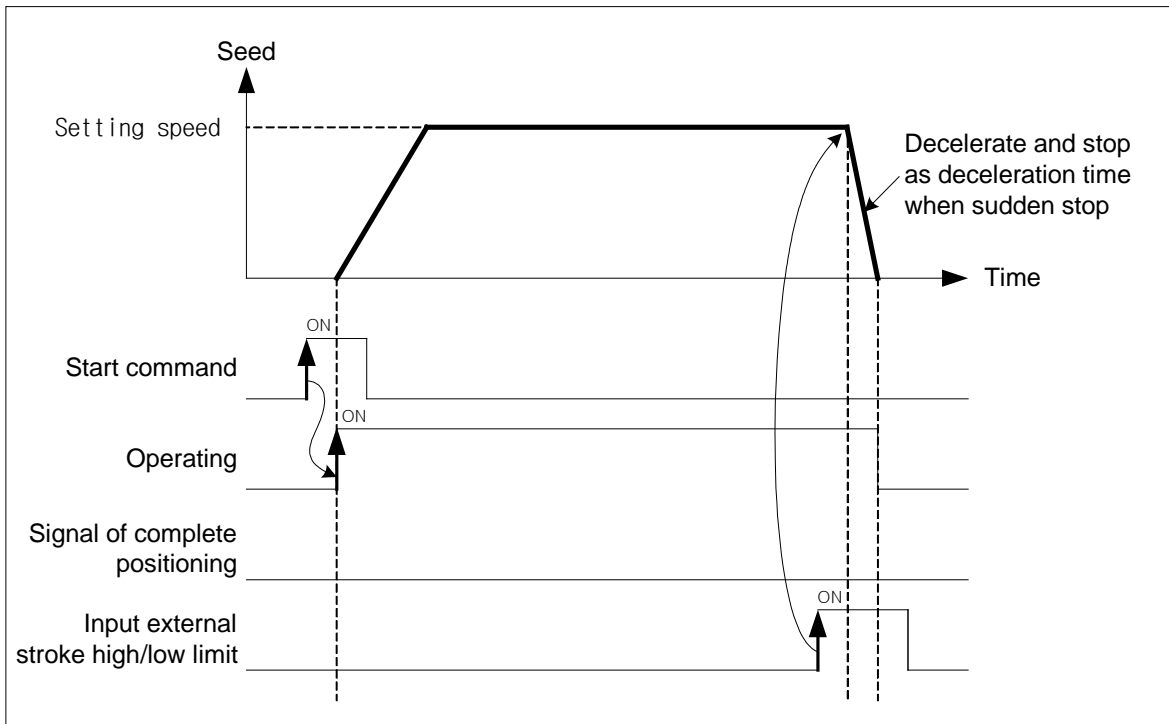

(5) Stop by software high/limit

- (a) When positioning control, if value of current command position out of set value of expansion parameter in 「software high limit」 and 「software low limit」, it will promptly be stopped without outputting value of command position.
- (b) If value of command position to be out of software high limit range, will occur error 501, and if it to be out of software low limit range, will occur error 502.

■ Setting related parameter (expansion parameter)

Item	Setting value	Contents
Software high limit	-2147483648 ~ 2147483647	Set position of software high limit.
Software low limit	-2147483648 ~ 2147483647	Set position of software low limit.

(c) Condition

Software high/low limit not to be checked in the following case:

- In case of setting Software high/low limits as maximum (2147483647), minimum (-2147483648)
- In case of “Software high limit = Software low limit”

(d) Motion timing

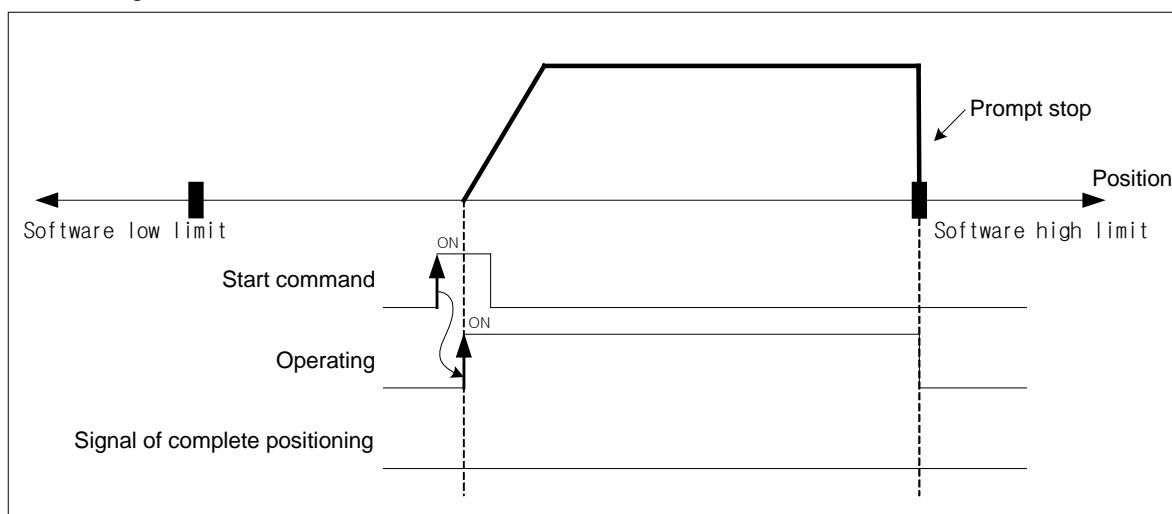

(6) The priority of stop process

The priority of stop process of positioning module is as follows:

Deceleration stop < Sudden stop

When encounter factor of sudden stop in deceleration stop of positioning, it will be suddenly stopped. In case of sudden stop deceleration time bigger than deceleration stop time, it will be decelerated and stopped as set deceleration stop time.

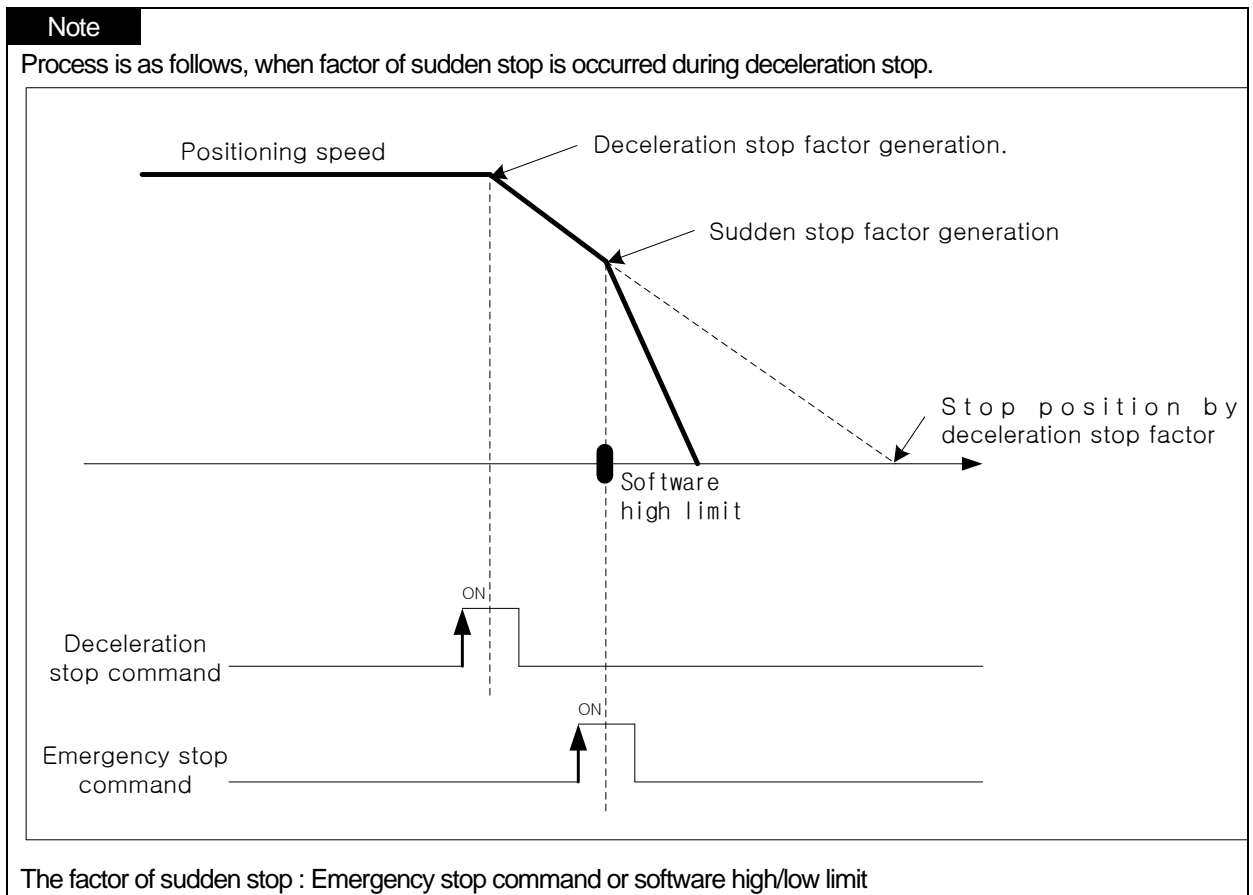

(7) Stop command under interpolation operation

- (a) If encounters stop command during interpolation operation (linear interpolation, circular interpolation, helical interpolation, elliptic interpolation), it carries out the deceleration stop. It depends on the trace of wheels of origin.
- (b) When it restarts after deceleration stop, indirect start command carries out operation to target position of positioning. And then, operation depends on absolute coordinate and relative coordinate.
- (c) Stop command during interpolation operation can external/internal deceleration stop.
- (d) Deceleration stop command should be progressed at main axis which is operating for interpolation.
- (e) Operation pattern

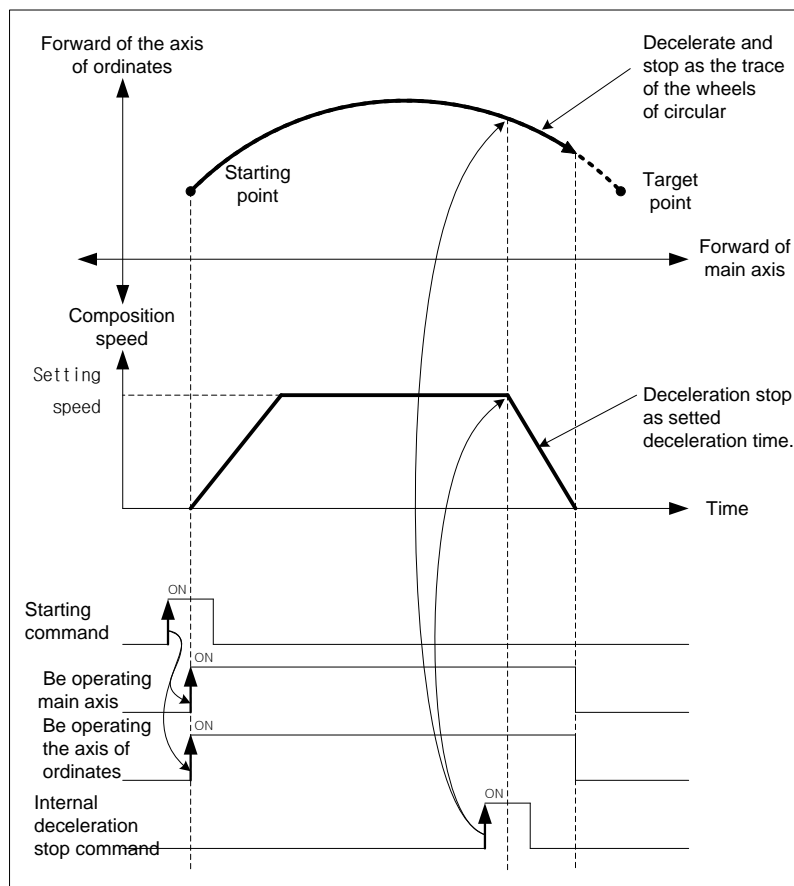

(8) Restart after Positioning stop

(a) Deceleration stop

When indirect start after deceleration stop, operate positioning as set operation step.

In case of using with mode, Signal "On" of M code has to "Off" for restart.

Signal On of M code have to be changed "Off" by 「Cancellation M code (XMOF)」 command.

(b) Restart after Internal/External emergency stop

In case of emergency stop, signal On of M code will automatically be "Off", therefore can operate positioning as set operation step, when it operate indirect start.

9.3 Manual Operation Control

Manual control is a function that execute random positioning according to user's demand without operation data. Manual operations include Jog operation, Manual pulse generator operation, inching operation, previous position movement of manual operation etc.

9.3.1 Jog Operation

(1) Characteristic of Control

(a) Jog Operation is

- Execute positioning control at jog high/low speed depending on the signal of high/low speed during forward/reverse jog start signal is being ON.
- Positioning is started by Jog command from the state that the origin is determined. The value of positioning starts changing, user can monitor it.
- This is a way of manual operation that can be executed before determination of origin.

(b) Acceleration/Deceleration process and Jog speed

The acceleration/deceleration processing is controlled based on the setting time of Jog acceleration/ deceleration time from XG-PM manual operation parameter setting.

Set the Jog speed on Jog high/low speed of XG-PM manual operation parameter setting.

If Jog speed is set out of the setting range, error will occur and the operation does not work.

■ Parameter setting (Manual Parameter)

Item	Setting value	Description
Jog High Speed	1 ~ Speed limit	Set Jog speed. Jog high speed must be set below speed limit
Jog Low Speed	1 ~ Jog High Speed	Set Jog speed. Jog low speed must be set below Jog high speed
Jog Acc. Time	0 ~ 2147483647	Set the acc. Time used in acceleration of Jog operation
Jog Dec. Time	0 ~ 2147483647	Set the dec. time used in deceleration of Jog operation

Note

If "Jog Acc. Time" is 0, it operates at "Acc. Time1" of basic parameter.

If "Jog Dec. Time" is 0, it operates at "Dec. Time1" of basic parameter.

(2) Operation Timing

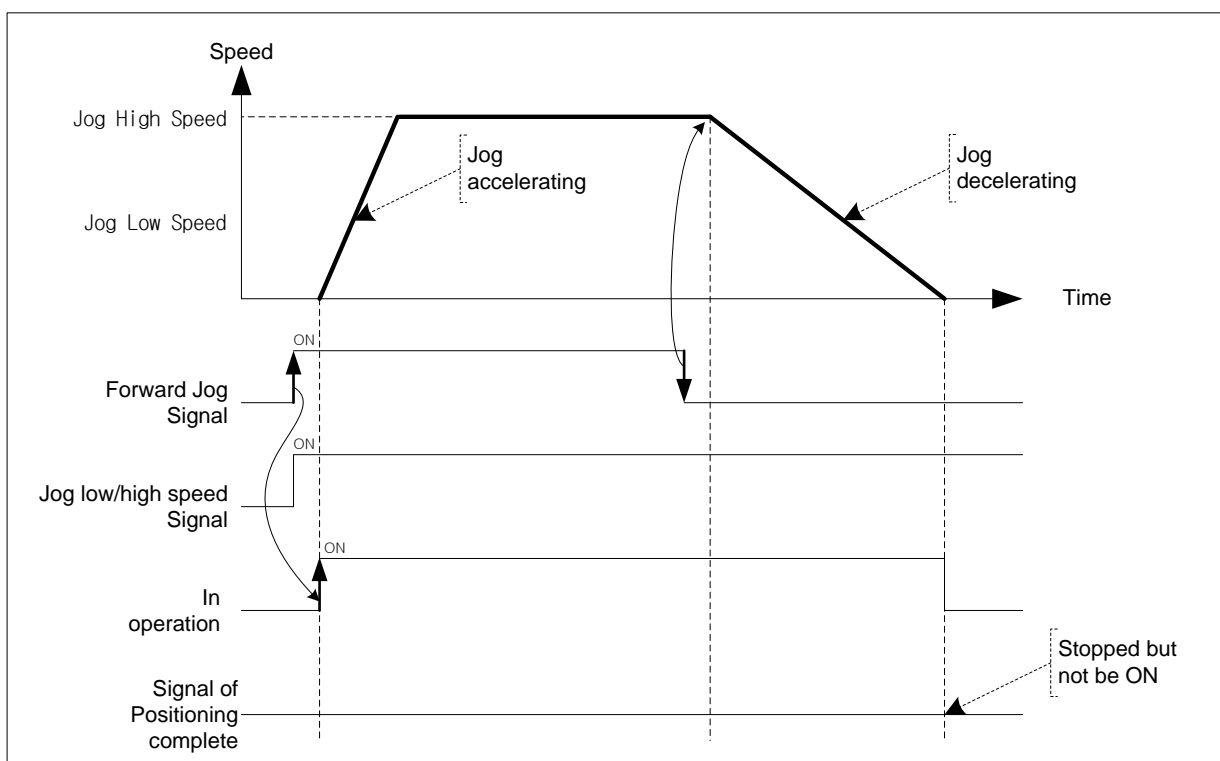

Note

Notices for setting Jog speed are as follows.

Bias Speed ≤ Jog High Speed ≤ Speed Limit

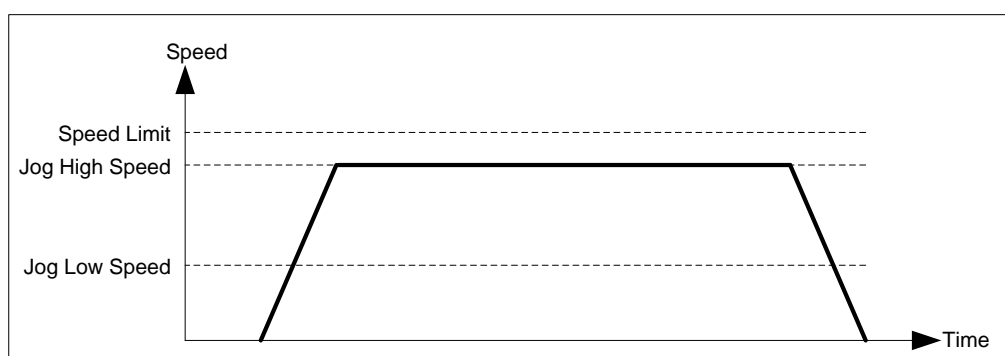

(3) Restrictions

You can not execute Jog operation in the case as follows.

- Value of Jog High Speed exceeds the speed limit of basic parameter (Error code : 121)
- Value of Jog Low Speed exceeds the value of Jog high speed. (Error code : 122)

(4) Jog Operation Start

Jog operation start consists of Start by XG-PM and Start by Sequence program. The start by sequence program is that execute Jog operation with output contact of CPU.

Axis	Direction of Signal : CPU -> Positioning module	
	Output Signal	Description
Axis1	%KX6976	Axis1 Forward Jog
	%KX6977	Axis1 Reverse Jog
	%KX6978	Axis1 Jog Low/High Speed
Axis2	%KX7296	Axis2 Forward Jog
	%KX72976	Axis2 Reverse Jog
	%KX7298	Axis2 Jog Low/High Speed
Axis3	%KX7616	Axis3 Forward Jog
	%KX76176	Axis3 Reverse Jog
	%KX7618	Axis3 Jog Low/High Speed
Axis4	%KX7936	Axis4 Forward Jog
	%KX7937	Axis4 Reverse Jog
	%KX7938	Axis4 Jog Low/High Speed
Axis5	%KX8256	Axis5 Forward Jog
	%KX8257	Axis5 Reverse Jog
	%KX8258	Axis5 Jog Low/High Speed
Axis6	%KX8576	Axis6 Forward Jog
	%KX8577	Axis6 Reverse Jog
	%KX8578	Axis6 Jog Low/High Speed

[Example] Execute Jog start in the order as follows.

- Forward Jog Low speed Operation -> Forward Jog High speed Operation -> Stop
- Reverse Jog High speed Operation -> Reverse Jog Low speed Operation -> Stop

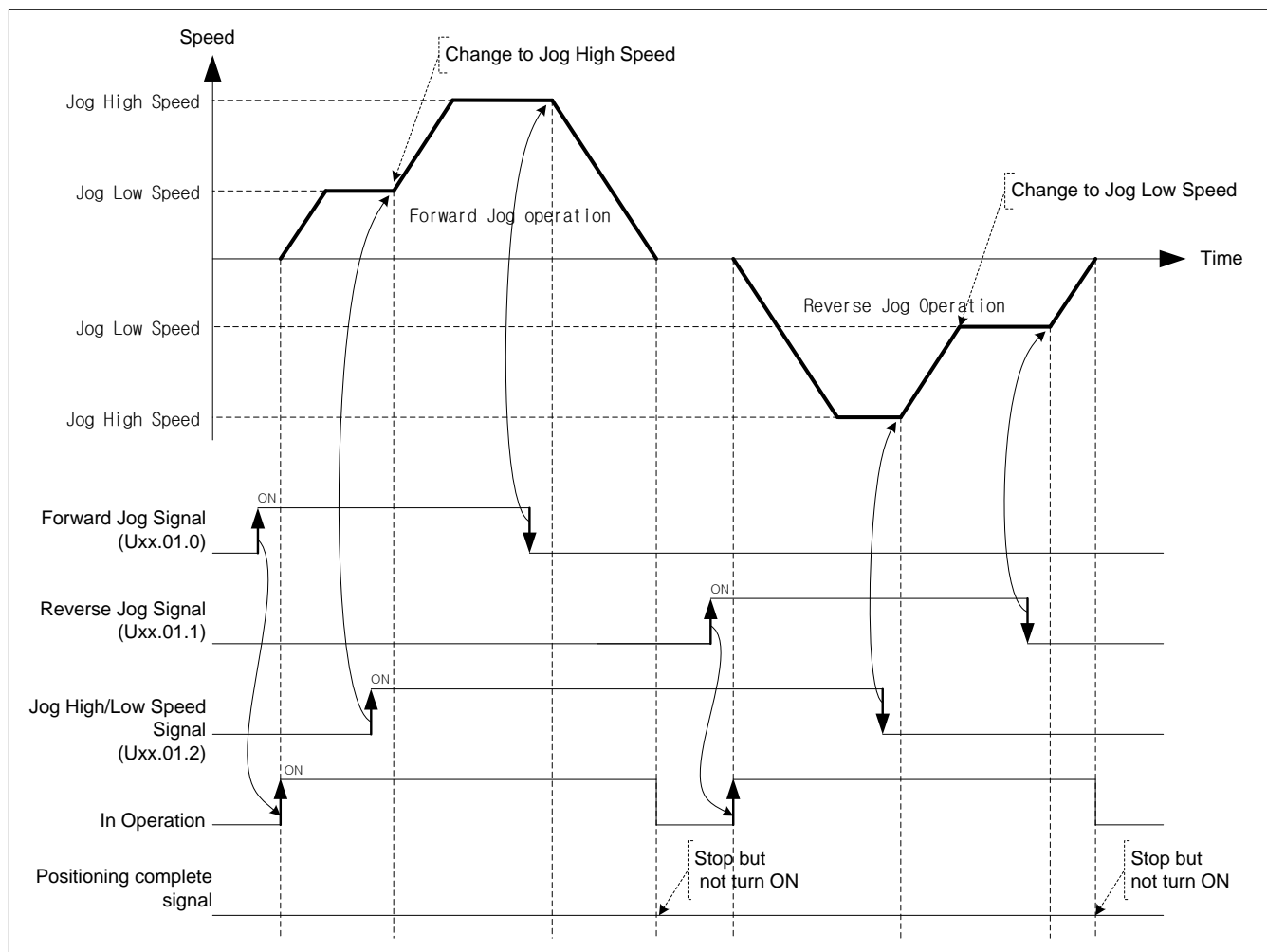

Note

Dec. stop command will not be executed in Jog Operation.
Jog operation will stop if turn the Jog signal of the current operating direction Off.

9.3.2 Inching Operation

This is a kind of manual operation and executing positioning at the speed already set on manual operation parameter as much as the amount of movement already set on the data of inching operation command.

(1) Characteristics of Control

- (a) While the operation by ON/OFF of Jog signal is difficult in moving to the correct position as the operation starts and stops according to the command, the inching command enables to set the desired transfer amount easily and reach the goal point.
- (b) Thus, it is available to reach the correct goal position by moving fast near the working position by Jog command and operating the detail movement by inching command.
- (c) The setting range is $-2147483648 \sim 2147483647$ Pulse.
- (d) The direction of moving depends on the amount of inching.
 - The amount is POSITIVE(+) : Positioning operation in forward direction
 - The amount is NEGATIVE(-) : Positioning operation in reverse direction
- (e) Acc./Dec process and Inching speed

Use Jog acc./dec. Time of manual operation as acc./dec. time of Inching operation.

Set Jog acc./dec. time on "Jog acc./dec. time" of manual operation parameter setting of XG-PM.

Set Inching speed on "Inching speed" of manual operation parameter setting.

If inching speed is set out of the setting range, error will occur and the operation does not work.

■ Related parameter setting (Manual operation parameter)

Items	Setting value	Description
Jog acc. Time	0 ~ 2147483647	Set the accelerating time for acceleration of Inching operation
Jog dec. Time	0 ~ 2147483647	Set the decelerating time for deceleration of Inching operation
Inching Speed	1 ~ Speed limit	Set the speed of Inching operation

(2) Operation Timing

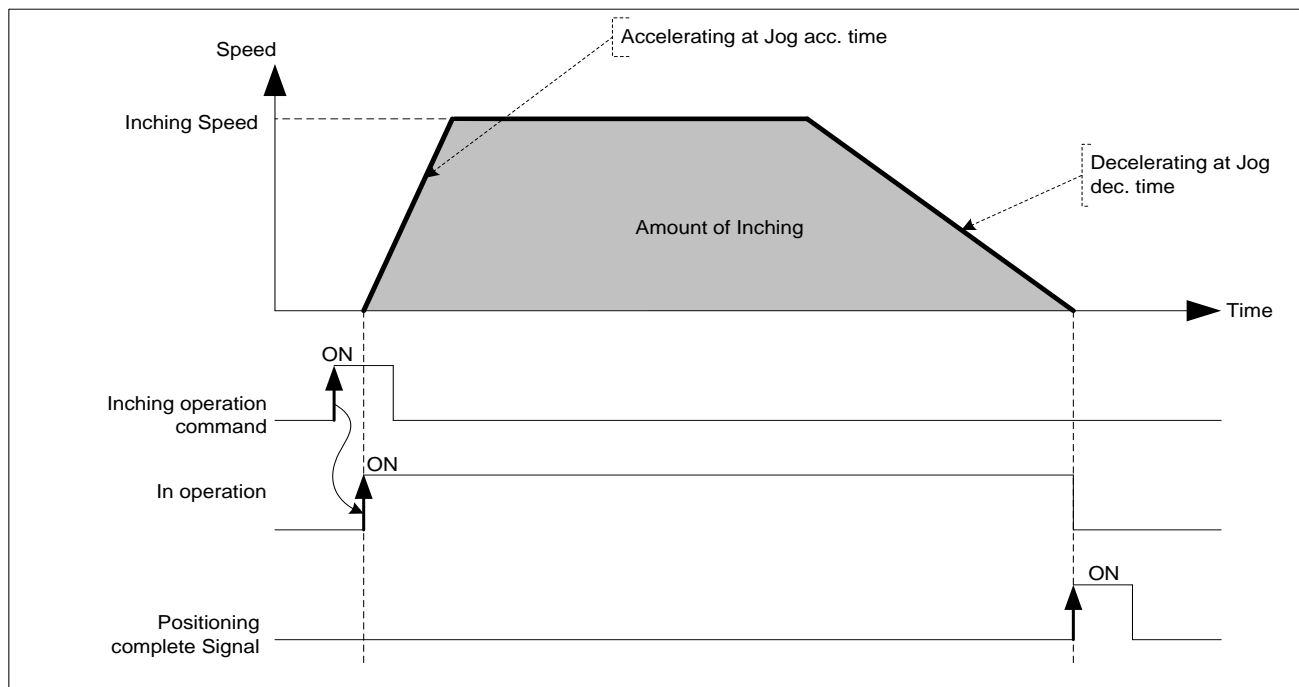

9.3.3 Returning to the previous position of manual operation

This positioning control function is used to return to the position address that the positioning is completed before manual operation when the position is changed by manual operation (Jog operation, inching operation).

(1) Characteristic of Control

(a) Direction of moving depends on the current position and the previous position of manual operation.

- Starting position < The previous position of manual operation : Forward direction
- Starting position > The previous position of manual operation : Reverse direction

(b) Acc./Dec. process and the speed of return

Acc./Dec. time of returning is the same as homing acc./dec. time of homing parameter.

Set acc./dec. time on homing acc./dec. time of homing parameter of XG-PM.

If returning speed is set out of the setting range, error will occur and the operation does not work.

■ Related parameter setting (Homing Parameter)

Item	Setting value	Description
Homing speed	1 ~ Speed limit	Set returning speed
Homing acc. time	0 ~ 2147483647	Set acc. time used in return
Homing dec. time	0 ~ 2147483647	Set dec. time used in return

(2) Operation timing

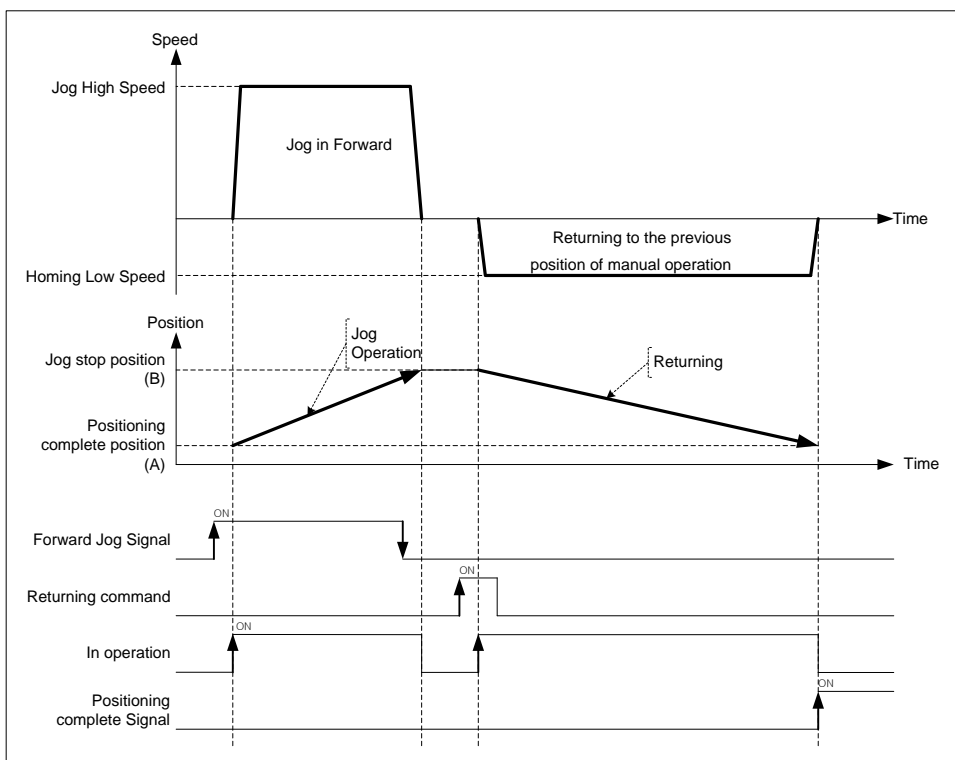

If value of the current position is "A" after positioning control operation and the positioning value changed by Jog operation is "B", execute positioning to "A" when executing the returning to the previous position of manual operation.

9.4 Synchronous Control

This is the command that control the operation synchronizing with the main axis or operating of encoder.

9.4.1 Speed Synchronous Control

This is the command that synchronize with sub axis in speed and control operation depending on speed synchronous rate already set when main axis starts.

(1) Characteristic of Control

(a) Start and Stop is repeated depending on operating of main axis after execution of speed synchronous command. The operating direction of sub axis and the main's are same.

(b) The operating direction of sub axis depends on the ratio of speed sync. $\left(\frac{SubAxis}{MainAxis}\right)$. If it is positive, the direction is forward. If it is negative, the direction is reverse.

(c) If execute speed sync. command, it will be the state of operating and remain in the state of speed sync. operation before release of speed sync. command.

(d) Auxiliary data of speed sync. command

The auxiliary data used in speed sync. command is as follows.

Item	Setting value	Description
Main Axis	1(axis1) ~ 6(axis6), 9~12(Encoder1~4)	Set the main axis of speed sync.
Ratio of Main axis	-32768 ~ 32767	Set the ratio of main axis at speed sync. ratio.
Ratio of Sub axis	-32768 ~ 32767	Set the ratio of sub axis at speed sync. ratio..

Ratio of Speed sync. is calculated as follows.

$$Ratio = \frac{SubAxis}{MainAxis}$$

It is possible to set like "Ratio of Main axis(Absolute) < Ratio of Sub axis(Absolute)" at setting ratio of speed sync.

Operating speed of sub axis is calculated as follows.

$$\begin{aligned} \text{Operating speed of SubAxis} &= \text{Operating Speed of MainAxis} \times \text{Ratio of speed sync.} \\ &= \text{Operating Speed of MianAxis} \times \frac{\text{Ratio of SubAxis}}{\text{Ratio of MainAxis}} \end{aligned}$$

(e) Modifying the ratio of speed sync. in operation is available.

When modify the ratio, if there is too big gap between the former ratio and the current ratio, the machine is possible to be damaged.

(2) Operation Timing

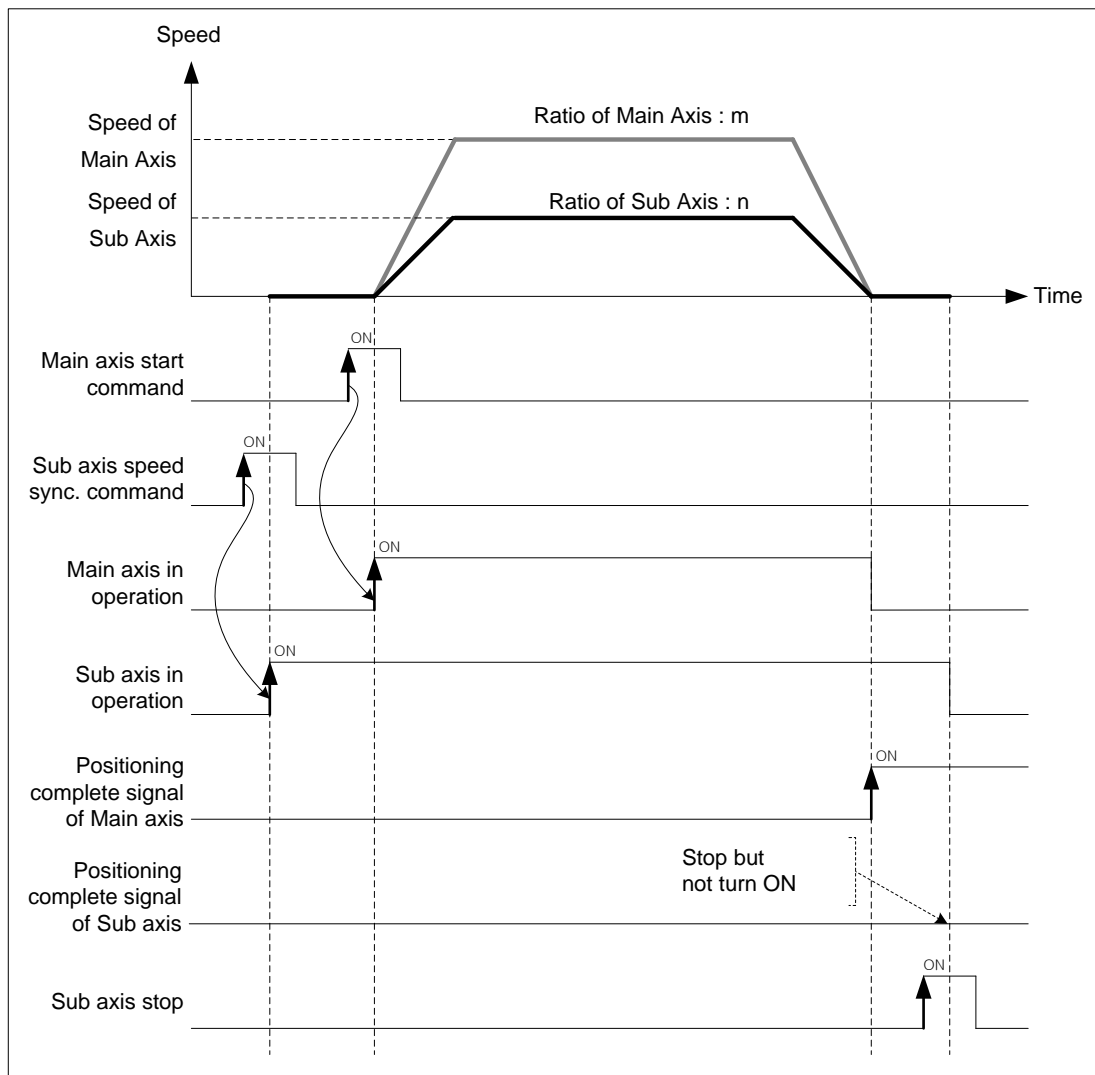

(3) Restrictions

You can not execute Jog operation in the case as follows.

- If speed sync. is executed in being On of M code signal, error (code:353) arises. Make M code "off" with M code release command (XMOF) before use.
- In the case that the axis set as main axis is not the axis can be set or the case that the setting of main axis is the same as the setting of command axis, error (code"355) arises. Set the main axis among the axis available to be set.
- If the speed of main axis exceeds the speed limit, error (code:357) arises. In the case, the speed of main axis has to be down below the speed limit.

In the case that the speed of main axis exceeds the speed limit, error arises and it decelerate in "Dec. time of emergent stop".

Note

If master axis is encoder, input frequency can be recognized as 1000pps even though the actual input speed is lower than 1000pps. In this case, the speed limit error can be occurs according to synchronous ratio. Therefore, Care must be taken when master axis is encoder.

[Example] axis1 is main axis, axis2 is sub axis. Operate at “ratio of main axis : ratio of sub axis = 2 : 1” at the beginning and then execute speed sync. control changing the ratio to “ratio of main axis : ratio of sub axis = 1 : 2”

■ Example of setting in XG-PM

▫ Operation data of main axis(axis1)

Step no.	Control method	Operation method	Goal Position [pls]	Operating speed [pls/s]	Acc. no.	Dec. no.	M code	Dwell Time
1	Relative, Reduction position control	Single, End	10000	2000	No. 1	No. 1	0	0

■ Operating pattern

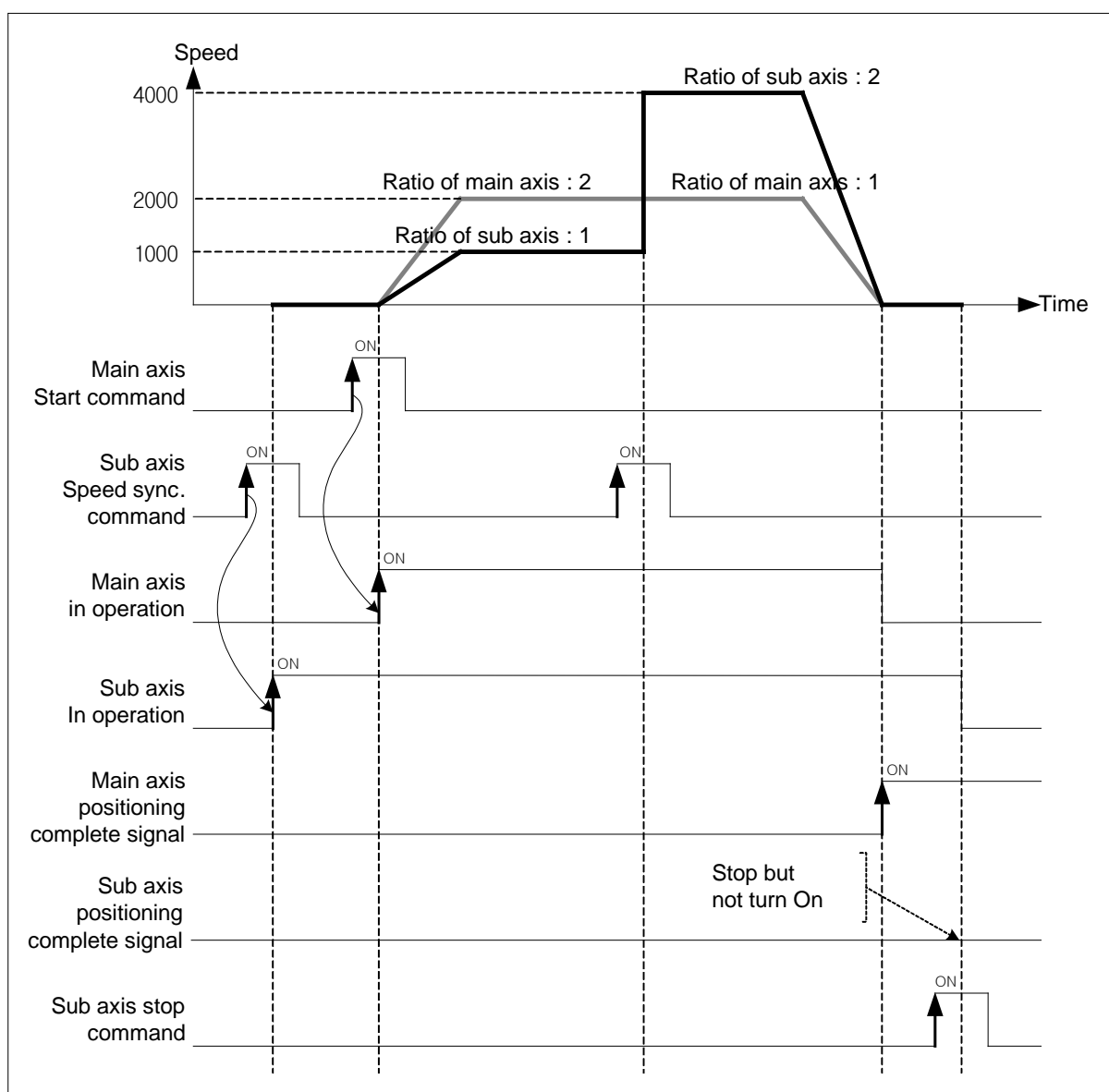

(4) Speed synchronous control with encoder

- (a) Set encoder as the main axis of speed sync. and execute positioning control by ratio of speed sync. that consists of pulse speed from encoder, ratio of main axis and ratio of sub axis.
- (b) This command is used in the case that executing thorough positioning manually.
- (c) After executed speed sync. command, when the pulse string is inputted, speed sync. control starts.
- (d) Operate regardless of the state of origin.
- (e) The pulse inputted by encoder increase of decrease the position value of encoder.
- (f) The direction of moving depends on encoder pulse input mode and ratio of speed sync.
 - Encoder direction in PHASE A/B 1multiplying
 - Positioning in forward direction : Input pulse of A phase is ahead of B's
 - Positioning in reverse direction : Input pulse of B phase is ahead of A's

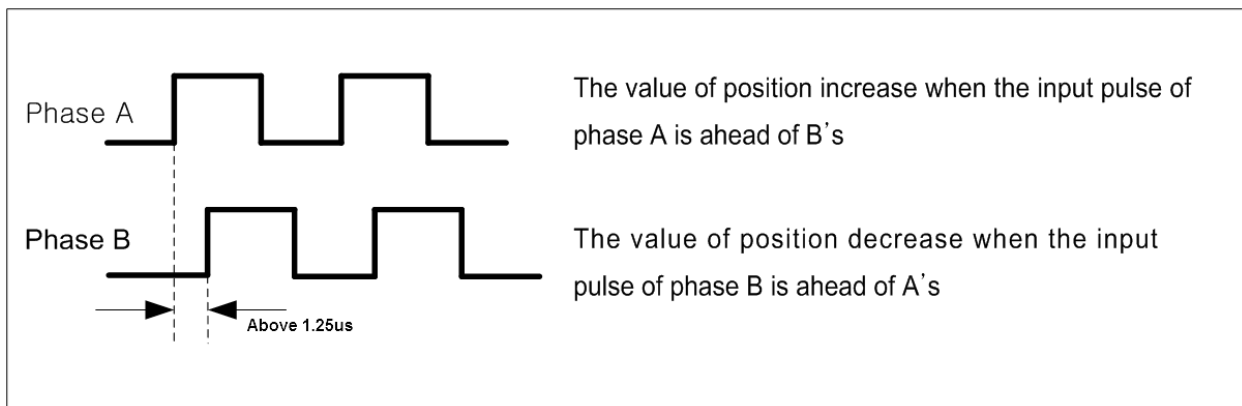

- The operating direction of sub axis depends on $Ratio\ of\ speed\ sync. \left(\frac{Ratio\ of\ SubAxis}{Ratio\ of\ MainAxis} \right)$. If it is positive,

operating direction will be forward direction of encoder. If it is negative, operating direction will be reverse direction of encoder.

[Example] Execute speed sync. control with encoder (main axis), axis2(sub axis) at “the ratio of main axis : the ratio of sub axis = 1 : 2”.

(Hypothesize that the input speed of encoder is 1Kpps)

When the direction of encoder is forward, the operating direction of sub axis is reverse. When the direction of encoder is reverse, the operating direction of sub axis is forward.

■ Operating pattern

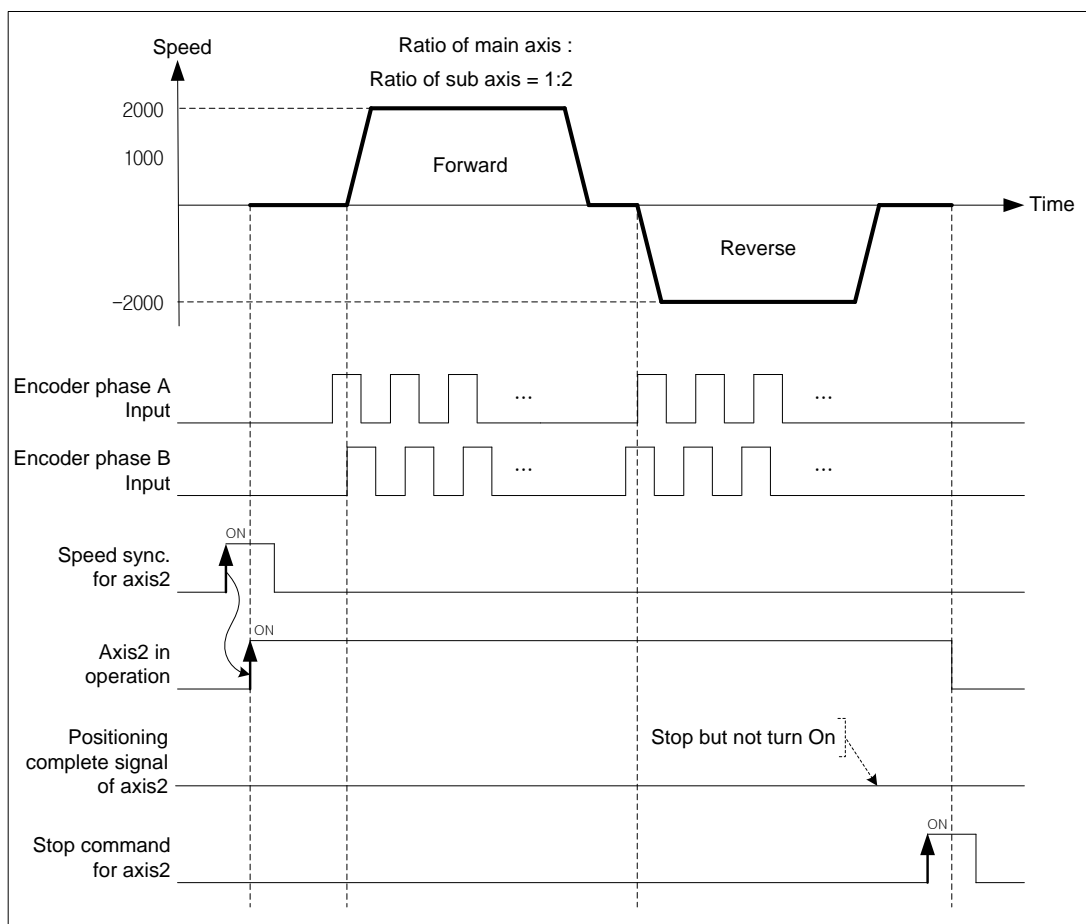

(5) Positioning speed sync. control

- (a) The basic operation of positioning speed sync. control is similar to speed synchronization. After executing positioning speed sync. command, start and stop are repeated depending on operation of main axis. The direction of sub axis and the direction of main axis are same.
- (b) The operating direction of sub axis depends on *Ratio of speed sync.* ($\frac{\text{Ratio of SubAxis}}{\text{Ratio of MainAxis}}$). If it is positive, operating direction will be forward direction of main axis. If it is negative, operating direction will be reverse direction of main axis.
- (c) If give speed sync. command to sub axis, it will be changed to the operating state and stay at operating state until release command.
- (d) If the current position of sub axis become the goal position, it stops speed sync. and stay there. For the details, refer to "Speed sync. control".
- (e) Auxiliary data of positioning speed sync. command.

The auxiliary data used in speed sync. is as follows.

Items	Setting value	Description
Main axis	1(axis1) ~ 4(axis4), 9(Encoder)	Set main axis
Ratio of main axis	-32768 ~ 32767	Set ratio of main axis
Ratio of sub axis	-32768 ~ 32767	Set ratio of sub axis
Goal position	-2147483648 ~ 2147483647	Set the goal position of positioning speed sync.

(f) Operation timing

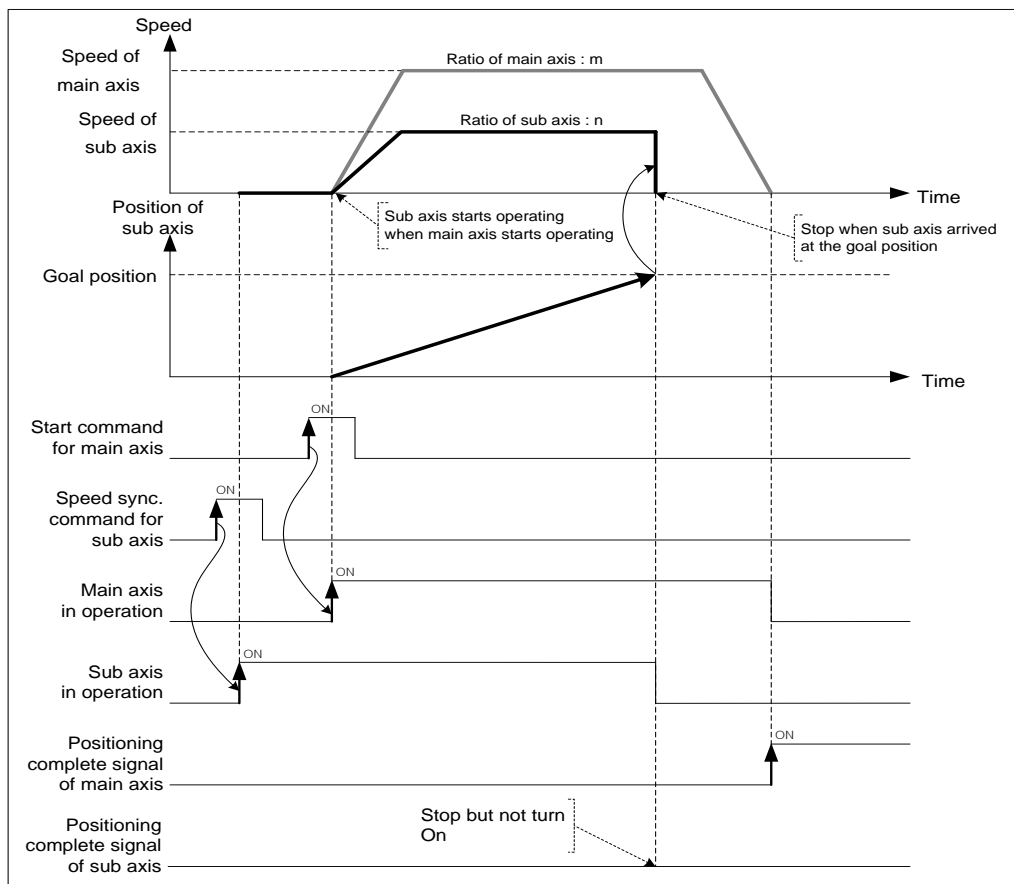

(a) 동작 타이밍

9.4.2 Position synchronous control

Start positioning with step no. and operation data when the current position of main axis is same as the position set in position sync.

(1) Characteristics of control

- (a) Synchronous Start by Position (SSP) command is carried out only in case that the main axis is in the origin determination state.
- (b) SSP command starts by the synchronization of the subordinate axis according to the current position of the main axis.
- (c) SSP carries out the SSP command at the subordinate axis.
- (d) If SSP command is executed, it becomes the state in operation and the actual operation is carried out at the subordinate axis where the current position of the main axis is the setting position of the position synchronous start.
- (e) In case of cancellation after executing the SSP command at the subordinate axis, if you execute the stop command, the SSP command shall be released.
- (f) The auxiliary data of position sync. command

The auxiliary data used in position sync. is as follows.

Items	Setting Value	Description
Position of position sync.	-2147483648 ~ 2147483647	Set the position of main axis in position sync. control
Operation step	1 ~ 400	Set the step no. to be executed when the main axis arrives at the position for position sync.
Main axis	1(axis1) ~ 6(axis4), 9~12 (Encoder1~4)	Set the main axis of position sync.

Note

Even though the current position of main axis and the setting value set on position sync. are not exactly same, if the current position of main axis is at between the position of main axis of previous scan and the current position of main axis, the sub axis will be executed with the positioning data of step no. set on operation step.

(2) Operation timing

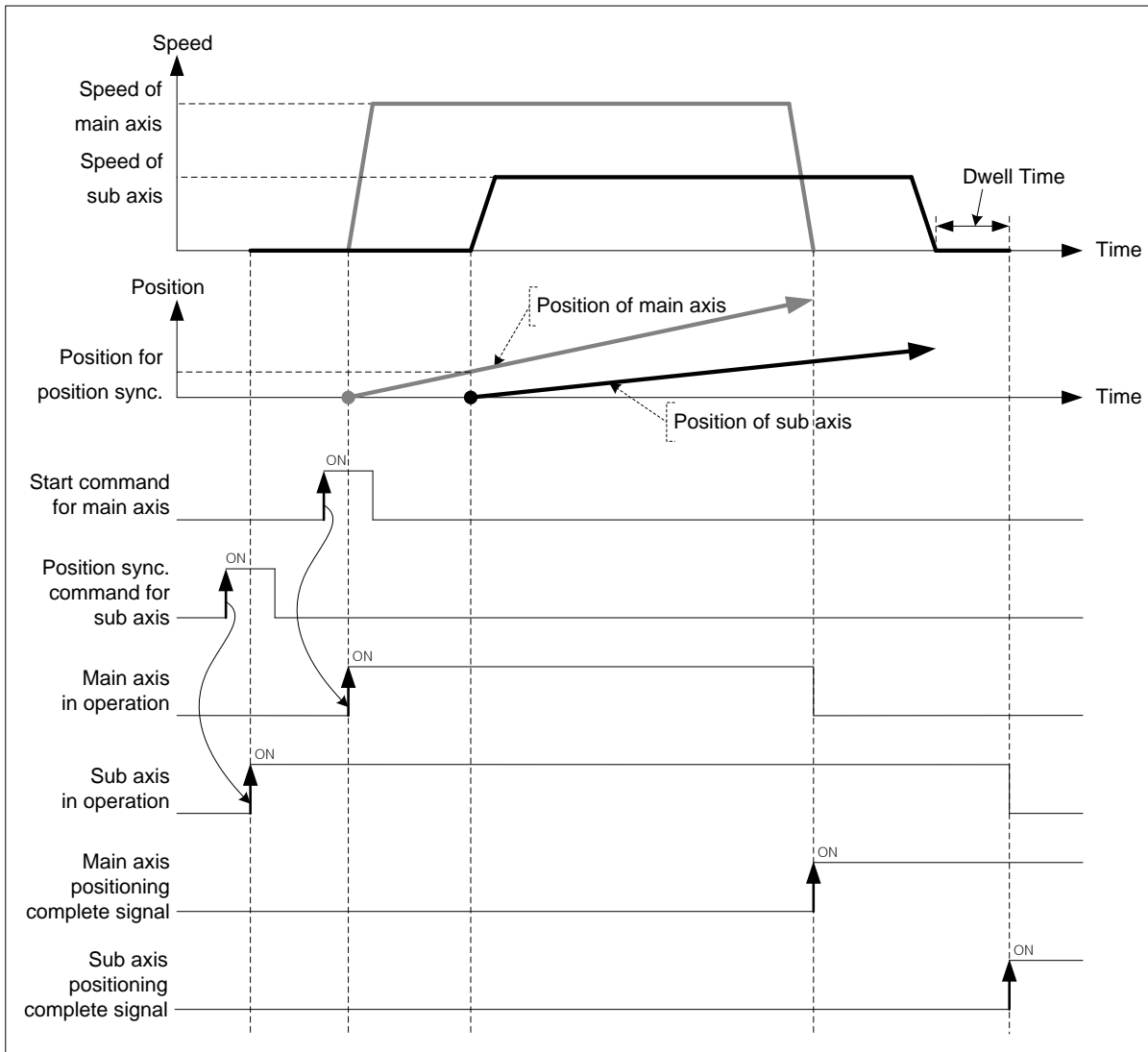

(3) Restrictions

Position sync. control can be executed in the case below.

- If position sync. command is executed in M code signal is On, error (code:343) arises. Use it after making M code "Off" with M code release command(XMOF).
- If the current main axis is not the axis can be set on the current module or main axis and command axis are the same axis, error (code:355) arises. Set the main axis among one of the axis can be set on module.

[Example] Axis1 is main axis, axis2 is sub axis. The position of main axis for position sync. is 1000, execute position sync. with operation data no.10.

■ The current position of axis1 : 0

The current position of axis2 : 0

■ Example in XG-PM

▪ Main axis (axis1) Operation data

Step no.	Control method	Operation	Goal position [pls]	Operating speed [pls/s]	Acc. no.	Dec. no.	M code	Dwell time
1	Relative, Single axis position control	Single axis, End	2000	1000	No. 1	No. 1	0	0

▪ Sub axis (axis2) Operation data

Step no.	Control method	Operation	Goal position [pls]	Operating speed [pls/s]	Acc. no.	Dec. no.	M code	Dwell time
10	Relative, Single axis position control	Single axis, End	2000	2000	No. 2	No. 2	0	0

■ Operating pattern

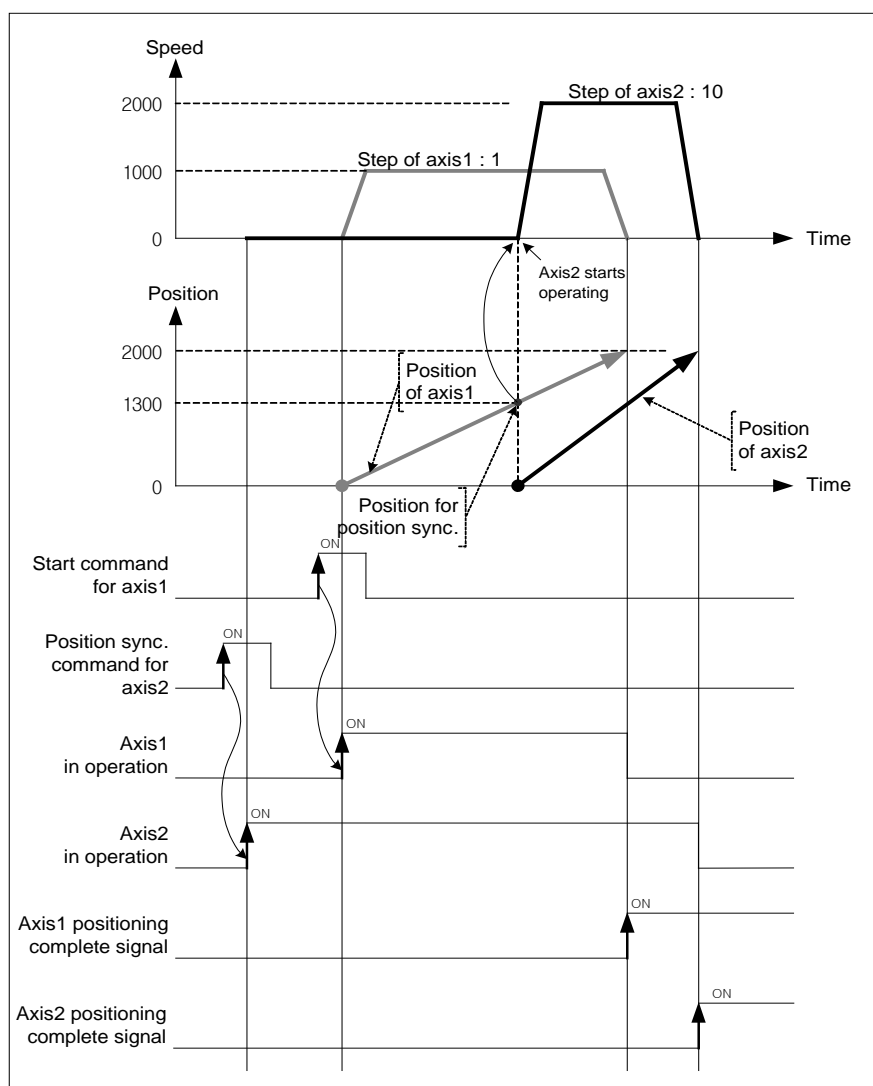

9.4.3 CAM Operation

CAM axis control synchronizing with the position of main motor.

(1) Characteristics of Control

(a) Replace existing mechanical work of CAM with software CAM operation

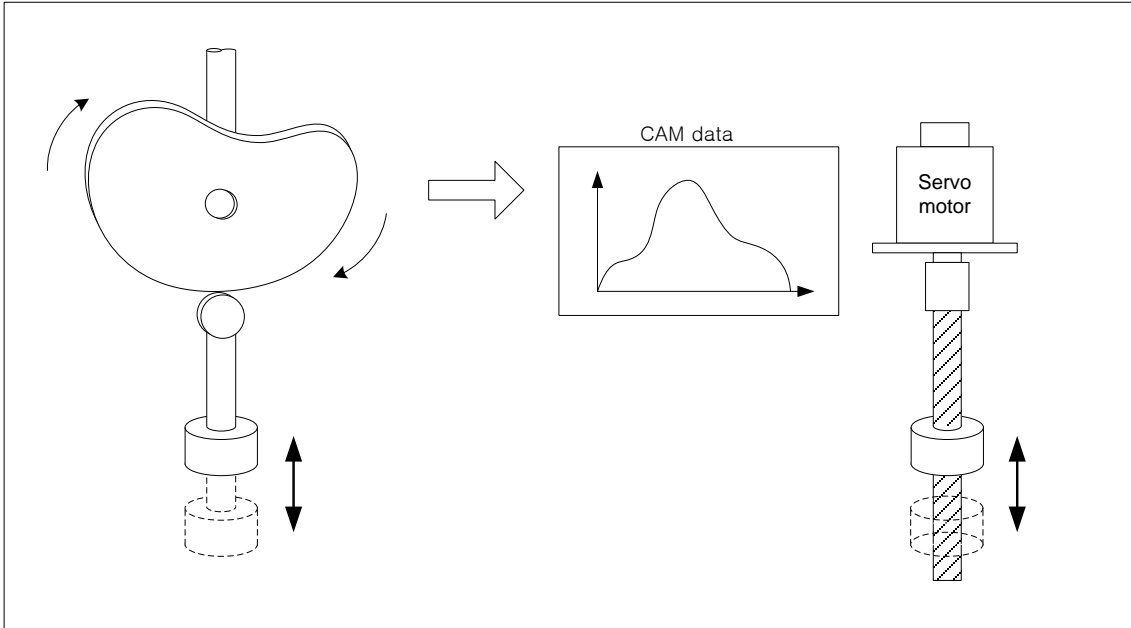

(b) You may write max. 9 CAM data blocks and apply it to each axis.

(c) Each block consists of 2048 CAM data.

(d) Auxiliary data of CAM command

Auxiliary data used in CAM command is as follows.

Item	Setting value	Description
Main Axis	1(Axis1) ~ 6(Axis6), 9 ~ 12 (Encoder 1 ~ 4)	Set the main axis of CAM operation Encoder 1 ~ 4 is using each HSC ch 0~4
CAM block	1(no.1) ~ 8(no.8), 9 (user CAM)	Set CAM block no.
Main axis offset	-2147483648 ~ 2147483647	Set the position of main-axis position as offset value if main-axis reaches this position, the sub-axis starts CAM operation.

Encoder can not be used as main axis.

You may set different CAM block no. for each axis. In addition, it is possible to execute CAM operation with the same CAM block. In order to use user CAM operation, you have to set up CAM block number as 9.

(e) You can make sub-axis start the CAM operation at the specified position of main-axis by setting the "Main axis offset".

Main axis offset setting is available at "Offset specified CAM start command (XPM_CAMO).

(f) Create CAM data by setting CAM parameter on XG-PM to use CAM.

(g) After main axis is operated, input the calculated value per CAM block setting and point unit based on the current value per rotation of main axis. For the detail description, refer to "(3) Principle of CAM operation".

(h) If CAM operation is executed on sub axis, it become 'operating status' and keep executing CAM operation with CAM data according to the position of main axis until stop command.

(2) CAM Parameter

The table below describes the parameter items for writing CAM data.

Item	Setting Range	Description
Main/Sub axis parameter	Unit	pulse, mm, inch, degree
	Transfer distance per 1 rotation	Depending on Unit
	No. of Pulse per 1 rotation	1 ~ 200000000
CAM control mode	Control method	Repeat, Increase
	Point unit	No. of pulse per 1 rotation
CAM block data	Starting position of main axis	Depending on Unit
	Ending position of main axis	
	Starting position of sub axis	
	Ending position of sub axis	
	CAM curve	Straight Line ~ 7 th curve

(a) Main/Sub parameter setting

1) Unit

Set the control unit of main/sub axis. Set the same as the value already set on "Unit" of basic parameter.

Item	Setting Range	Remarks
Unit of main axis	pulse, mm, inch, degree	-
Unit of sub axis	pulse, mm, inch	Degree may not be used.

2) Transfer distance per 1 rotation

Set the transfer distance per 1 rotation of main/sub axis. The unit of transfer distance is according to 1).

If the unit is "mm" or "inch", this value is the maximum last position of main/sub axis.

Transfer distance per 1 rotation is depending on unit.

■ Setting range for transfer distance per 1 rotation

Unit	Setting Range	Remarks
pulse	-	No need to set
mm	0.1 ~ 20000000.0 um	The maximum last position of main/sub axis
inch	0.00001 ~ 2000.00000 inch	The maximum last position of main/sub axis
degree	360.00000 Fixed	No need to set The maximum last position of main/sub axis

3) No. of pulse per 1 rotation

Set the no. of pulse per 1 rotation of main/sub axis.

If the unit is "pulse", the value is the maximum last position of main/sub axis

Chapter 9 Functions

(b) CAM control mode setting

1) Control method

Set the form of CAM repeat pattern. "Repeat mode" and "Increase mode" may be set.

▪ Repeat (Two-way mode)

Execute round-trip motion repeatedly in the range already set from starting position of sub axis to ending position according to the position of main axis in 1 rotation.

When CAM data is created in repeat, the ending position of the last step of sub axis user last set must be set as 0.

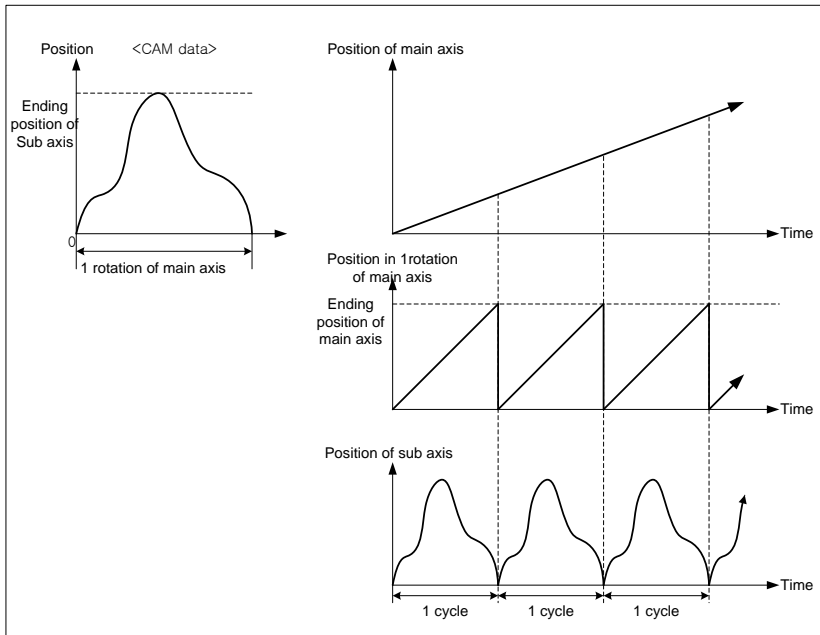

▪ Increase (Feed mode)

Execute CAM operation from starting position of sub axis to ending position according to the position in 1 rotation of main axis.

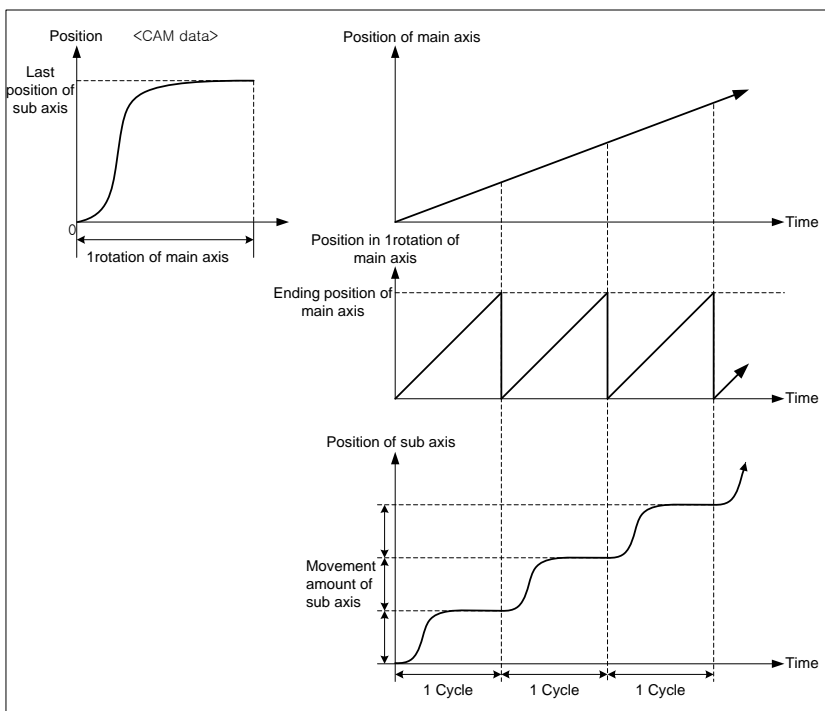

2) Point unit

Set the resolution ranging from starting position of main axis to ending position of main axis on each step data of CAM block data setting. When CAM data is created, calculate the position of sub axis corresponding to the position of main axis from the starting position of main axis by point unit. The smaller point unit is, the more no. of CAM data is, so you may execute much smoother CAM operation. However, if point unit is small, no. of CAM data exceeds 2048, so there is a chance that user can not create CAM data.

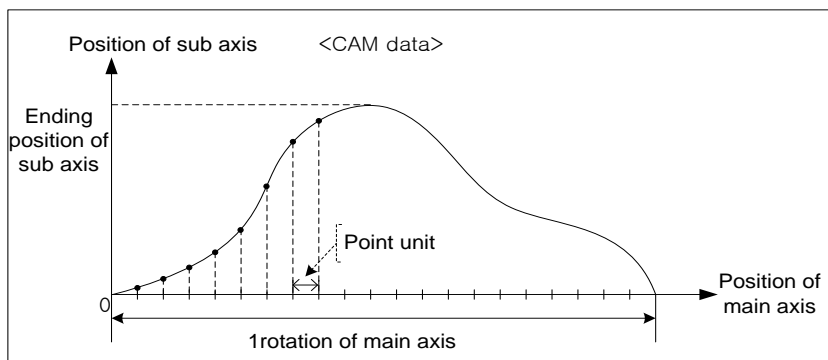
**Note**

When set CAM block data after point unit setting, "Ending position of main axis" must be set as positive multiple number of point unit. For example, if the unit of main axis is "degree" and point unit is 10, "Ending position of main axis" must be set as multiple number of 10 like 40, 90, 180, ...

(c) CAM block data setting

20 data sections may be set in a CAM block and every section may have specific curve.

1) Starting position of main axis

Set the starting position of main axis in designated section. Starting position of main axis is the same as the ending position of main axis in previous section.

2) Ending position of main axis

Set ending position of main axis in designated section. The ending position of main axis in the last section must be set as much as the transfer distance per 1 rotation set on main/sub axis parameter.

3) Starting position of sub axis

Set the starting position of sub axis corresponding to the starting position of main axis in the designated section. Starting position of sub axis is the same as the ending position of sub axis in previous section.

4) Ending position of sub axis

Set ending position of sub axis corresponding to the ending position of main axis in the designated section. If control method is "Repeat (Two-way mode)", the ending position of sub axis in the last section must be 0. If control method is "Increase(Feed mode)", the ending position of sub axis in the last section generally has to be set as much as the transfer distance per 1 rotation set on main/sub axis parameter.

5) CAM curve

Set CAM specific curve to create data ranging from starting position of sub axis to ending position of sub axis in the designated section. The position of sub axis is calculated by characteristic of selected CAM curve, the position of main axis increase by point unit at the same time.

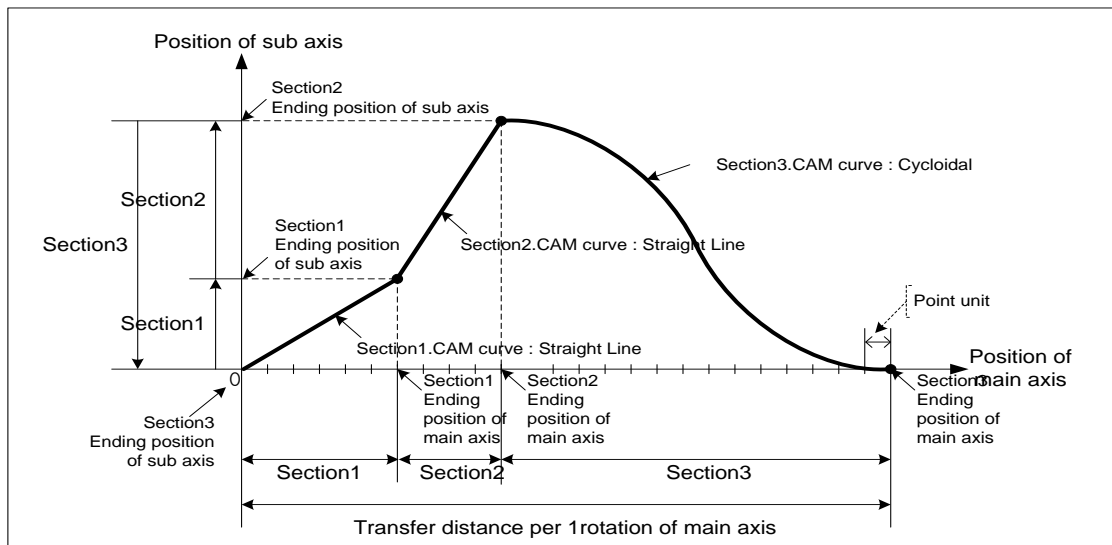

There are 22 kinds of CAM curve.

Describe characteristic of each CAM curve on next page.

■ Characteristic of CAM curve

Name	Acc. type	Position (S_{max})	Speed (V_{max})	Acc. (A_{max})	Jerk (J_{max})
Straight Line		1.00000	0.00000	0.00000	0.00000
Constant Acceleration		1.00000	2.00000	4.00000	0.00000
Simple Harmonic		1.00000	1.57076	4.93409	2.46735
No-Dwell Simple Harmonic		1.00000	1.57076	4.93409	2.46735
Double Harmonic		1.00000	2.04047	5.55125	0.10285
Reverse Double Harmonic		1.00000	2.04048	9.86605	4.93455
No-Dwell Modified Constant Velocity		1.00000	1.22203	7.67383	3.83881
Modified Constant Velocity		1.00000	1.27526	8.00947	0.98712
No-Dwell Modified Trapezoid		1.00000	1.71788	4.19885	2.09942
One-Dwell Modified Trapezoid		1.00000	1.91589	4.43866	55.77788
Modified Trapezoid		1.00000	1.99975	4.88812	0.30562
Asymmetrical Modified Trapezoid		1.00000	1.99982	6.11015	0.47620
One-Dwell Cycloidal		1.00000	1.75953	5.52756	0.17345
Cycloidal		1.00000	1.99985	6.28273	0.19715
Asymmetrical Cycloidal		1.00000	1.99989	7.85304	0.30783
One-Dwell Trapezoid		1.00000	1.73636	4.91007	0.30699
Reverse Trapezoid		1.00000	2.18193	6.16975	0.38579
Trapezoid		1.00000	2.18193	6.17044	0.38579
One-Dwell Modified Sine		1.00000	1.65978	5.21368	0.32603
Modified Sine		1.00000	1.75953	5.52697	0.34562
5th Curve		1.00000	1.87500	5.77350	60.00000
7th Curve		1.00000	2.18750	7.51283	41.99646

(3) Principle of CAM operation

- (a) When CAM operation command is executed, the current position of main axis is recognized as 0.
 (b) When the main axis starts operating, "the current position in 1 rotation of main axis" increase to "no. of pulse per 1 rotation (-1)" then become 0. The position value (0~"no. of pulse per 1 rotation (-1)") is repeated.
 (c) Calculate CAM data step no. corresponding to "the current position per 1 rotation" with "point unit" of CAM parameter.

$$\text{Cam Data Step no.} = \frac{\text{Current Positio per 1rotation of Main Axis}}{\text{Point Unit}}$$

For example, if the position of main axis at the beginning of CAM operation is 1000, the current position is 1073 and point unit is 10, the step no. of CAM data is as follows.

$$\begin{aligned} \text{Cam Data Step no.} &= \frac{\text{Current Positio per 1rotation of Main Axis}}{\text{Point Unit}} \\ &= \frac{1073 - 1000}{10} \\ &= 7.3 \end{aligned}$$

- (d) Calculate update position of sub axis with CAM data step. If main axis is forward direction, calculate the position of sub axis with the position corresponding to "the part of positive number of CAM data step no." and the position corresponding to "the part of positive number of CAM data step no. +1".

$$\begin{aligned} &\text{Position of sub axis} \\ &= \{(\text{Step position of CAM data} + 1) - (\text{Step position of CAM data})\} \times \text{Decimal part of CAM data step no.} \\ &\quad + (\text{Step position of CAM data}) \end{aligned}$$

For example, if position value of sub axis of step 7 is 395 and step 8's is 475, the position of sub axis is as follows.

$$\begin{aligned} \text{Position of sub axis} &= 395 + (475 - 395) \times 0.3 \\ &= 395 + 24 \\ &= 419 \end{aligned}$$

(4) Operation timing

(a) General CAM command

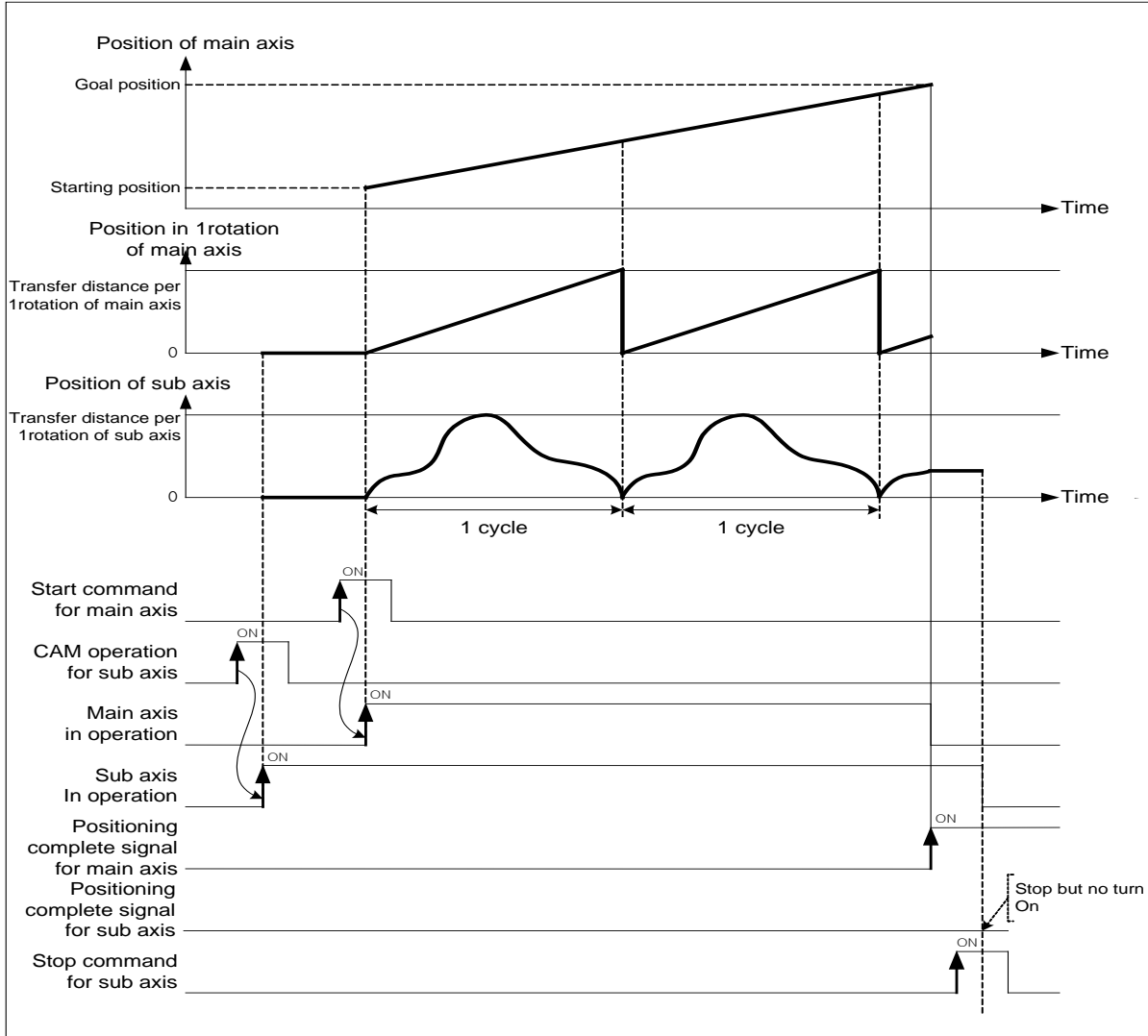

(a) Master axis offset designated CAM command

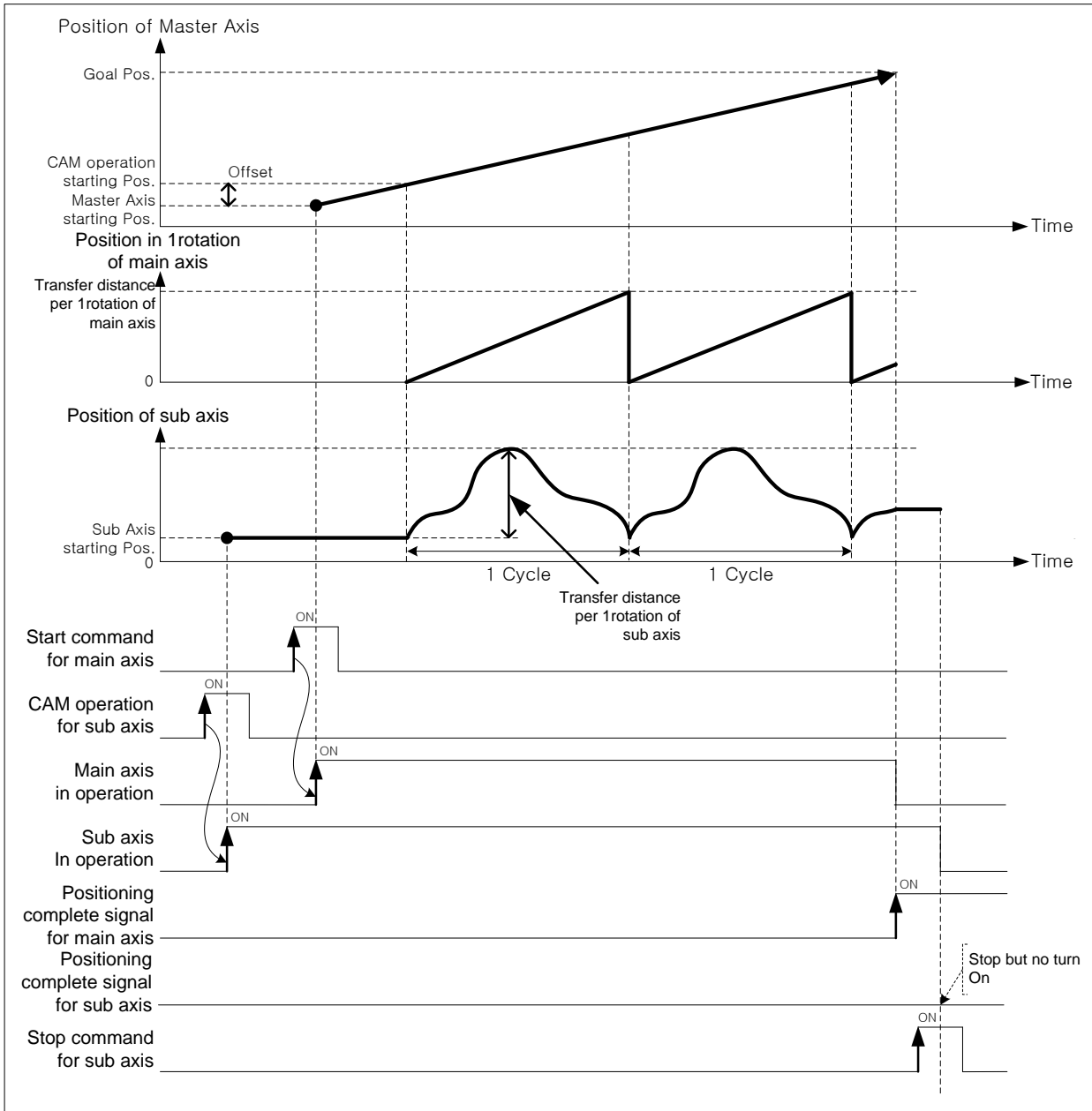

(5) Restrictions

CAM operation command may not be executed in the cases below.

- If execute CAM operation command in being On of M code, error (code:702) arises. Make M code "OFF" with "M code release (XMOF)" command before use.
- If the current main axis is not the axis can be set on the current module or main axis and command axis are the same axis, error (code:704) arises. Set the main axis among one of the axis can be set on module.
- If speed of main axis is too fast and speed of sub axis exceeds speed limit, error (code:708) arises. In this case, you have to lower the operation speed.

9.4.4 User CAM Operation

User CAM operation, like CAM operation, executes CAM axis control in which CAM data shown as CAM curve synchronize with position of the motor set as main-axis. The difference with CAM operation is that user sets up CAM data not in XG-PM but in PLC program (XG5000), and the number of CAM data is 30.

1) Operation

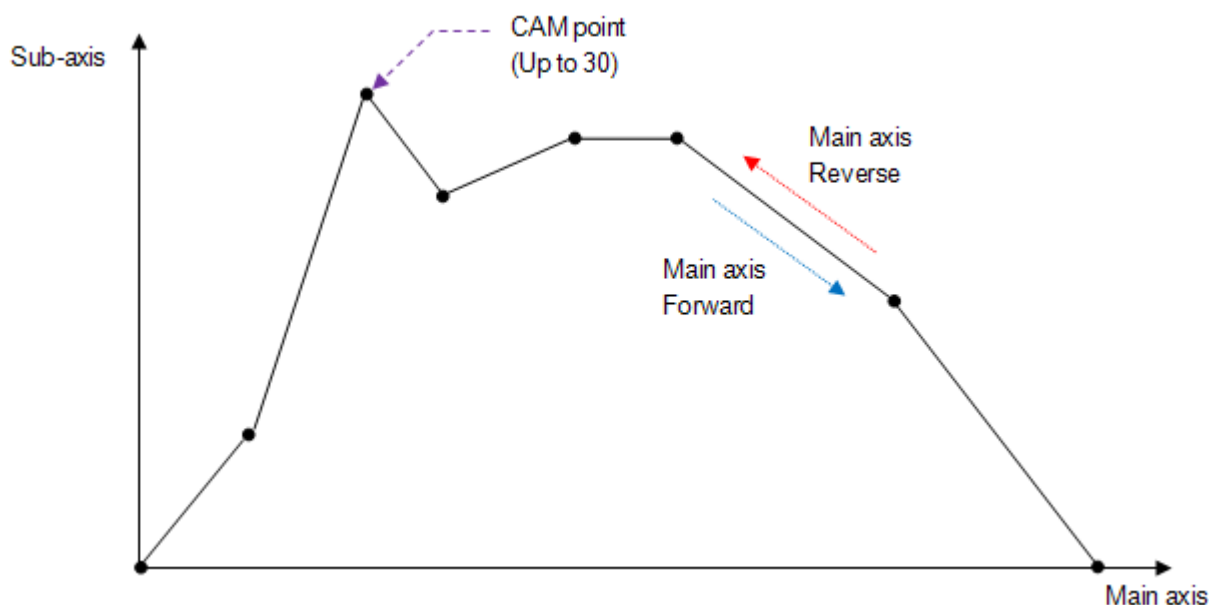

Like figure above, you can set up maximum 30 CAM data points, and it operates CAM curve between CAM points with straight line. CAM point data is set up at sub-axis and as type of (main-axis position, sub-axis position). CAM data point can be saved at the specified memory address of each axis by using “Write Variable Data” (XPM_VWR) command. For memory address to save CAM data point of each axis, refer to 11.9 User CAM data memory address.

Note

User cam data can be changed by variable data writing command during user cam operation. The changed user cam data is reflected after the completion of one cycle of the current user cam data.

It can be used in applications where it is necessary to change the cam pattern without stopping while operating the user cam. If you change the user cam data, it takes time to calculate according to the unit for each point. To change the user cam data during operation, set the control period to 5 ms or more.

9.5 Modification Function of Control

9.5.1 Floating Origin Setting

This is used to force to set the current position as the origin without carrying out the homing action of the machine.

(1) Characteristic of Control

- (a) Modify the current position into “Homing end position” of homing parameter and become Origin-decided status.
- (b) After floating origin setting command is executed, the current position is changed to “The position of homing completion” of homing parameter.
- (c) Related parameter (Homing Parameter)

Items	Setting value	Description
Position of homing completion	-2147483648 ~ 2147483647	Set the position after homing completion or floating origin setting

Note

Floating origin setting just executes forced origin-decision from the current position to origin completion position. So user need to take notice as follows.

- (1) When error arose, clear the cause of error and reset,
- (2) set floating origin again,
- (3) change the operation step no. to operate with start step no. change command and then execute.

(2) Operation timing

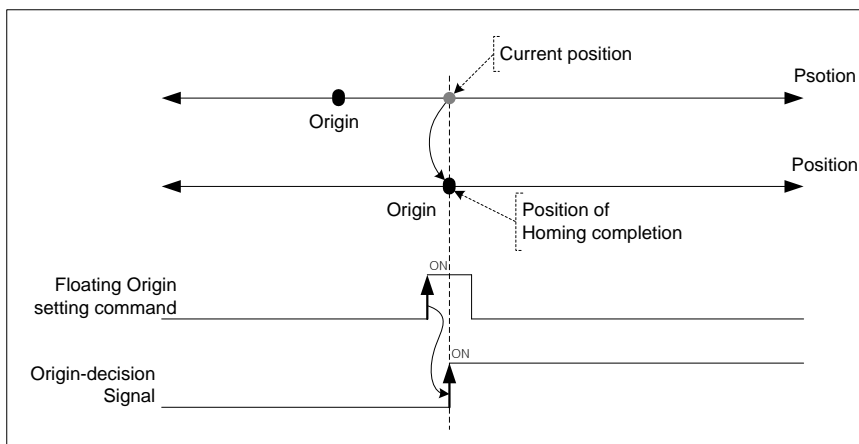

(3) Restrictions

If drive ready signal is in “OFF”, floating origin setting command is not executed but error (code:212)arises. When drive ready signal is in “ON”, execute floating origin setting command.

9.5.2 Continuous Operation

Execute positioning control changing the current operation step no. to the next one.

(1) Characteristics of Control

- When continuous operation command is executed, operating speed is changed into the speed of next operation step directly.
- This command may be used in End, Go on, Continuous mode and used at Acc., Dec., Steady speed section.
- If continuous operation command is executed in operation, the current operation step no. is changed to the next step no. and keep operating.
- There are differences of operation depending on between absolute coordinates and relative coordinates.

(2) Operation timing

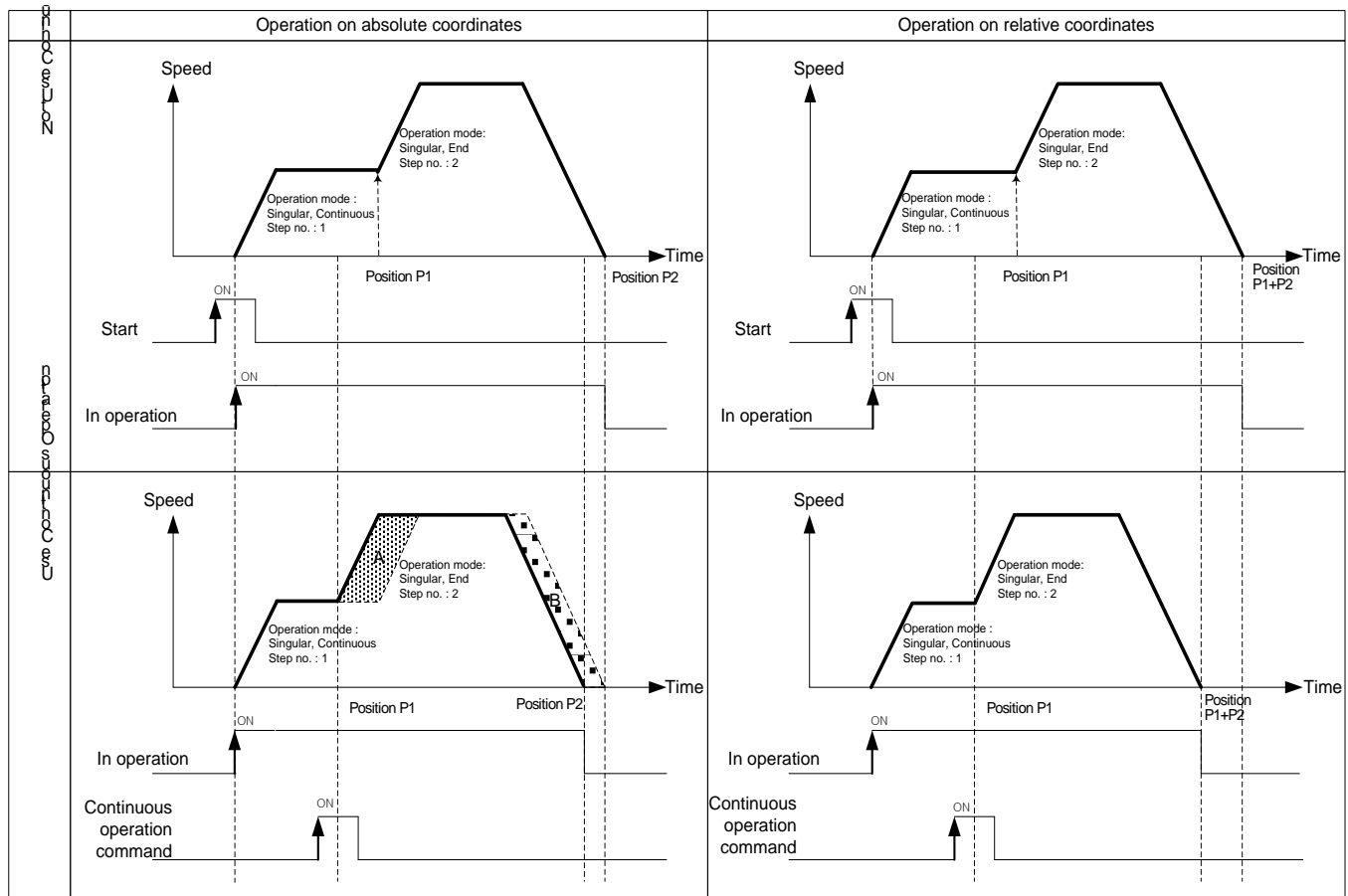

- The goal positions of continuous operation on absolute coordinates are same, so the goal position is the same as the position before and after continuous operation. Therefore, the current position positioned by continuous operation is P2. (A area and B area both are same size)
- When continuous operation is executed on relative coordinates, the movement amount between current position and goal position is the real goal position. Therefore, the goal position is different from the one without continuous operation. The position positioned by continuous operation is P1 + P2.

(3) Restrictions

In the cases below, continuous operation is not executed and previous operation is being kept.

- (a) Acc./Dec. pattern of extended parameter is "S-curve operation". (error code : 390)
- (b) It is in dwell. (error code : 392)
- (c) The current control is not single axis position control or linear interpolation. (error code : 393)
- (d) Speed data value of operation step to be executed next is 0 or exceeds the speed limit. (error code : 394)
- (e) Execute continuous operation command on sub axis. (error code : 395)
- User has to execute continuous operation command on main axis in linear interpolation.
- (f) Execute continuous operation command on axis in circular interpolation. (error code : 396)
- (g) Execute continuous operation on sub axis in sync. operation. (error code : 397)
- (h) The current operation step no. is the last step(400) of operation data. (error code : 399)
- (i) The current axis in operation is executed by direct start command. (error code : 400)

[Example] Execute continuous operation on axis1 operating by absolute, single axis position control

- Current position of Axis1 : 0
- Setting example in XG-PM
- Operation data of axis1

Step no.	Control method	Operation	Goal position [pls]	Operation speed [pls/s]	Acc. no.	Dec. no.	M code	Dwell time
1	Absolute, single axis position control	Singular, end	1000	1000	No.1	No.1	0	0
2	Absolute, single axis position control	Singular, end	5000	2000	No.1	No.1	0	0

■ Operation pattern

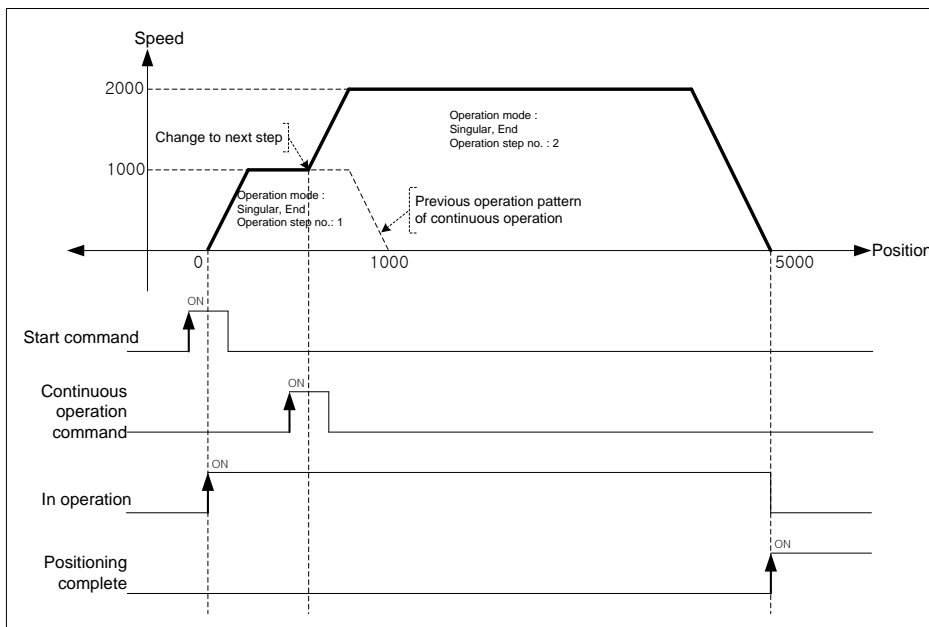

9.5.3 Skip Operation

Decelerate and stop the current operation step and change to the operation data of next operation step no., then execute positioning control.

(1) Characteristics of Control

- SKIP operation command stops the operation and carries out the operation of next step after executing the command other than Continuous operation command (Next Move).
- This is used in case that the operation mode is End, Keep, Continuous and the operation pattern is in Acceleration, Constant speed, Deceleration section.
- If SKIP operation command is executed in the status that the operation data of next step is not yet set, Error 151 will occur.
- When set position data, there would be differences on skip operation command depending on absolute coordinates and relative coordinates,

(2) Operation timing

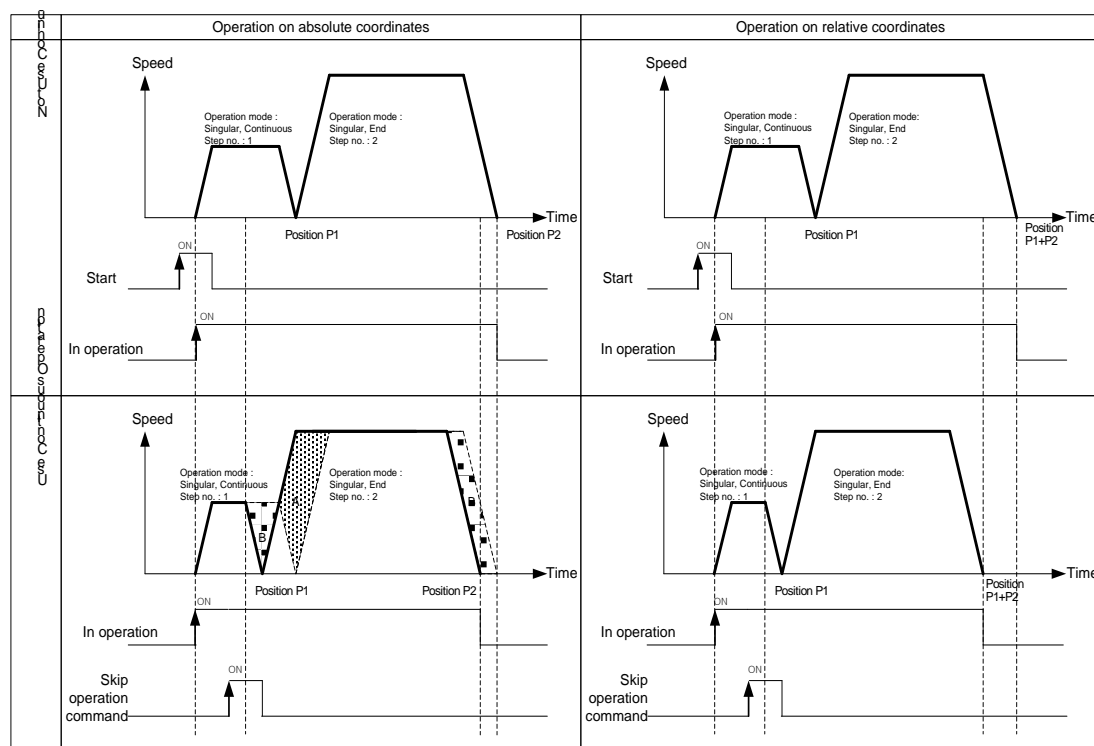

- The goal position of next operation step after skip operation command is executed on absolute coordinates is the same as the case did not execute skip operation. Therefore, current position positioned by skip operation is P2. (A area and B area both are same size)
- When skip operation is executed on relative coordinates, the movement amount between current position and goal position is the real goal position. Therefore, the goal position is different from the one without continuous operation. The position positioned by skip operation is P1 + P2.

(3) Restrictions

In the cases below, skip operation is not executed and previous operation is being kept.

- (a) Execute skip operation command on the sub axis of linear interpolation. (error code:332)
Skip operation in linear interpolation operation must be executed on main axis.
- (b) Execute skip operation command on the sub axis of sync. operation. (error code:333)
- (c) Execute skip operation command on the axis in Jog operation. (error code:335)
- (d) The current axis is executed by direct start. (error code:336)
- (e) Execute skip operation on the axis in Inching operation. (error code:337)
- (f) Execute skip operation on the sub axis of circular interpolation. (error code:338)
Skip operation in circular interpolation operation must be executed on main axis.

[Example] Execute skip operation command on axis1 operating by absolute and single axis position control.

- Current position of axis1 : 0
- Setting example in XG-PM
 - Operation data of axis1

Step no.	Control method	Operation method	Goal position [pls]	Operating speed [pls/s]	Acc.no.	Dec.no.	M code	Dwell time
1	Absolute, Single axis position control	Singular,End	1000	1000	No.1	No.1	0	0
2	Absolute, Single axis position control	Singular,End	5000	2000	No.1	No.1	0	0

■ Operation pattern

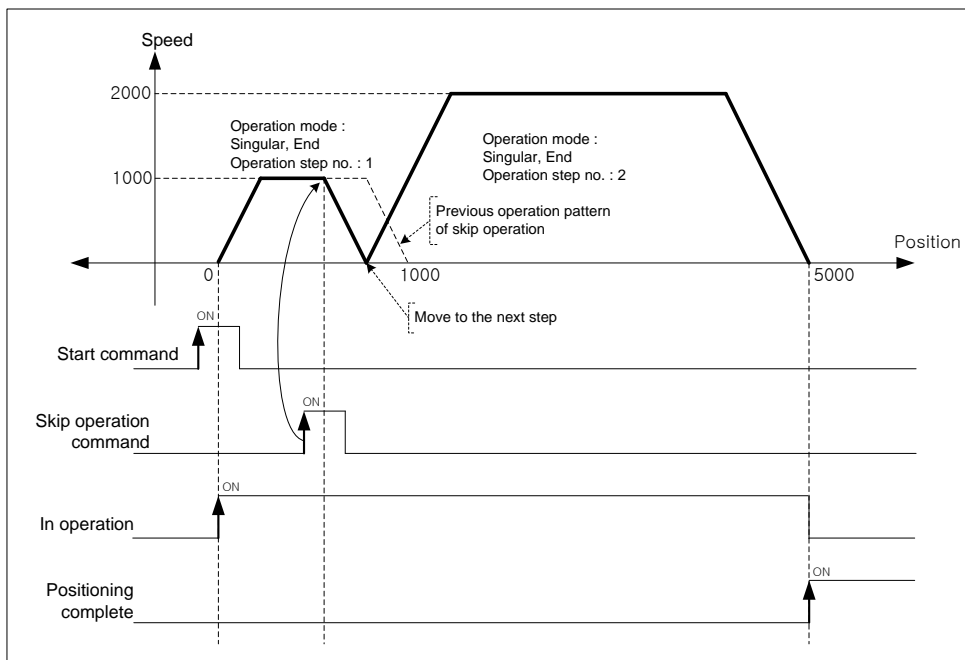

9.5.4 Position Override

This is used to change the goal position during positioning operation by positioning data.

(1) Characteristics of Control

- (a) Position override command is used in the operation pattern (Acceleration, Constant speed, Deceleration section) and the available operation mode is End operation, Keep operation, Continuous operation.
- (b) Position setting range is $-2147483648 \sim 2147483647$ Pulse.
- (c) As the operation is different according to Position Override command during operation, cares should be taken in using.
In other words, if position of position override at the moment of commanding position override is bigger than the position it stopped at, the positioning direction would be forward. If it is smaller, the direction would be reverse.
- (d) This command may be executed several times in operation.

(2) Operation timing

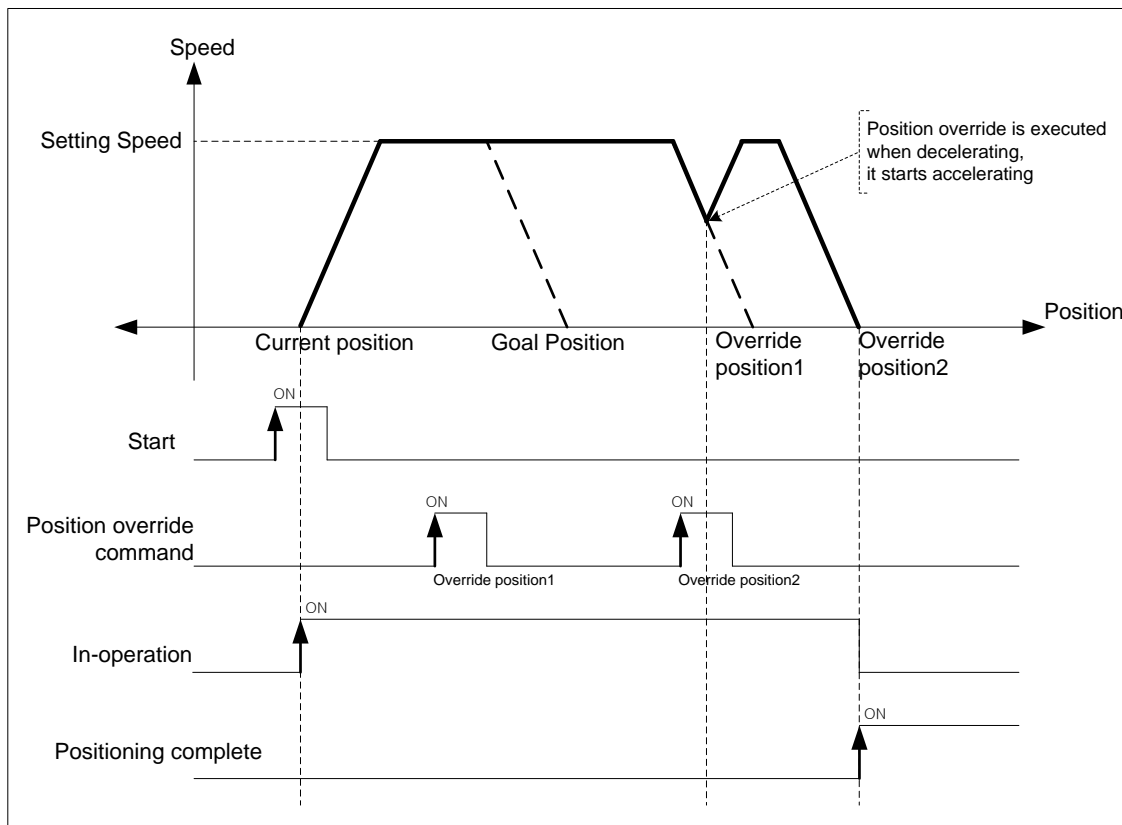

If position override is executed in operation, the goal position is changed to override position1 and keep operating. If position override for override position2 is executed at dec. area, positioning is finished by acc. speed already set at override position2.

- The case that override position is smaller than decelerating stop position.

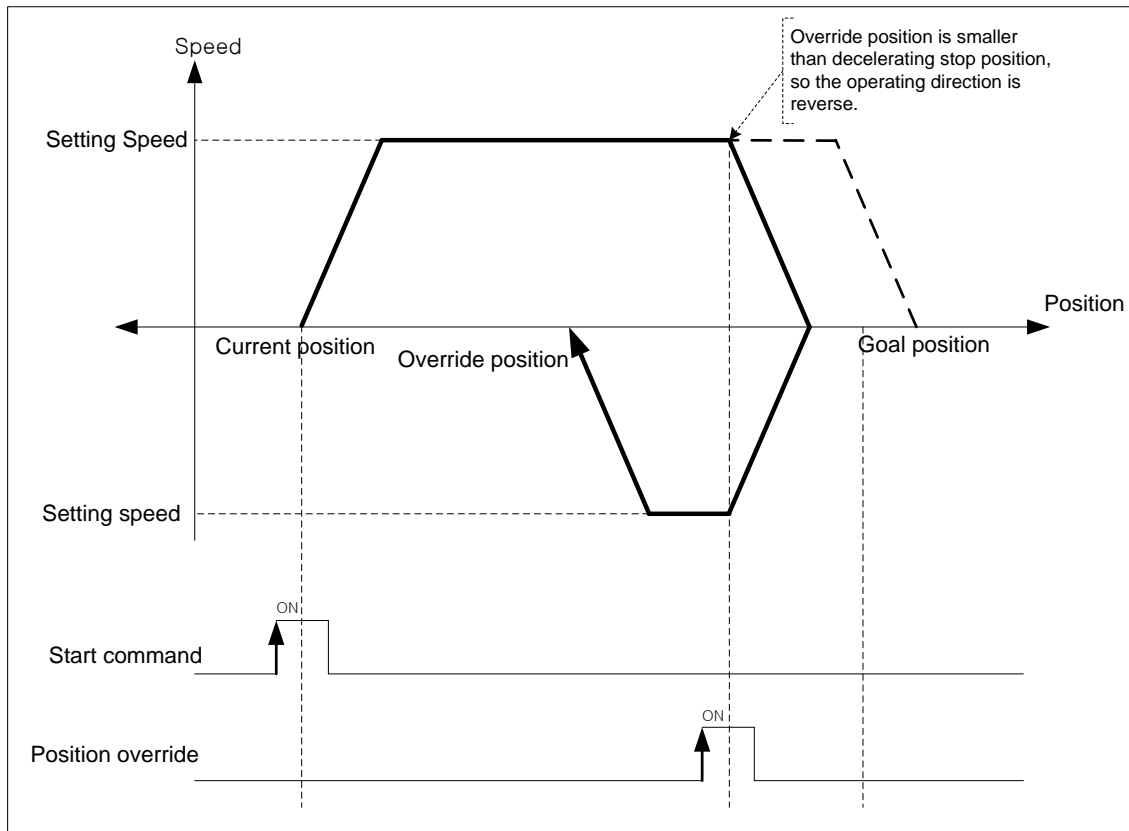

(3) Restrictions

In the cases below, position override is not executed and previous operation is being kept.

- Execute position override in dwell. (error code:362)
- Current operation is not positioning control(single axis positioning, Inching operation). (error code:363)
- Execute position override on the axis operating linear interpolation. (error code:364)
- Execute position override on the axis operating circular interpolation. (error code:365)
- Execute position override on the sub axis of sync. operation. (error code:366)

[Example] Execute position override on axis1 operating by absolute, single axis position control.

- Current position of axis1 : 0

- Setting example in XG-PM

- Operation data of axis1

Step no.	Control method	Operation method	Goal position [pls]	Operation speed [pls/s]	Acc.no.	Dec.no.	M code	Dwell time
1	Absolute single axis position control	Singular, End	1000	1000	No.1	No.1	0	0
2	Absolute single axis position control	Singular, End	5000	2000	No.1	No.1	0	0

- Operation pattern

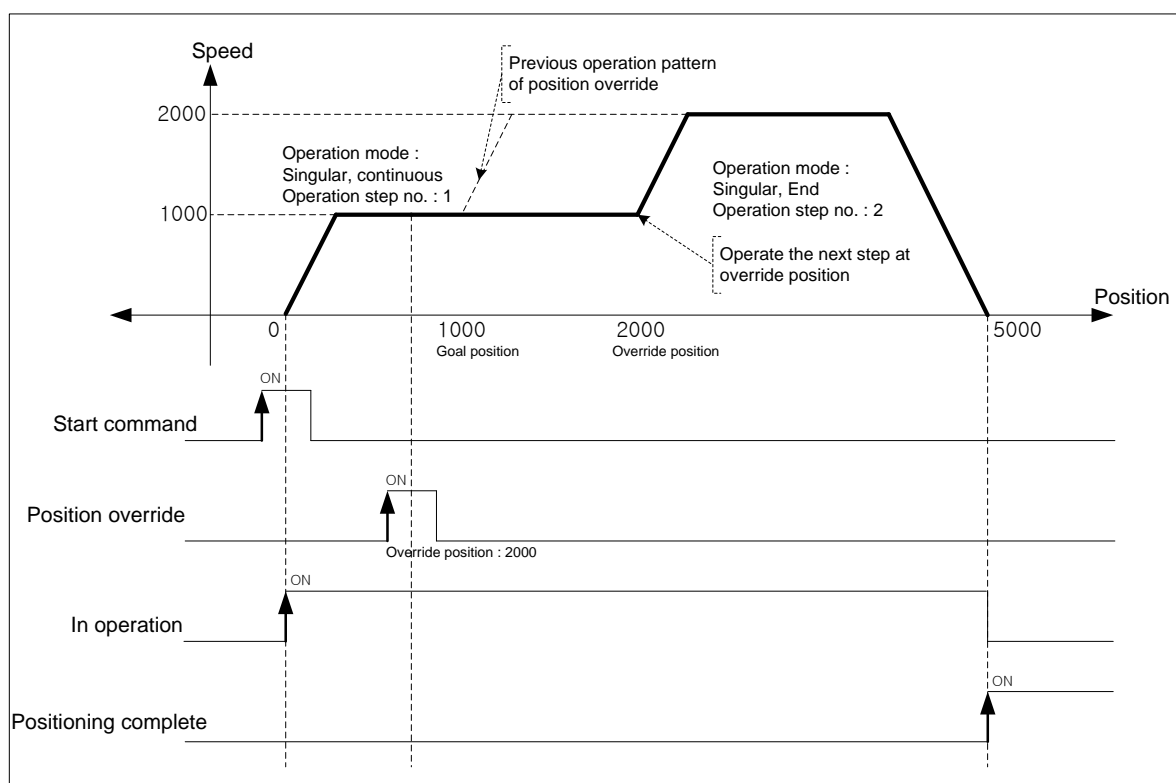

Note

If operation pattern is “continuous” and override position is bigger than goal position, keep operating at current speed then continue to operate the next step. If override position is smaller than goal position, execute decelerating stop and position in reverse direction, then continue to operate the next step.

9.5.5 Speed Override

When user wants to change the operation speed of positioning control, user may change the speed with speed override command.

(1) Characteristics of Control

- (a) Speed override command is available in acc./steady speed area and available operation modes are “end”, “go on” and “continuous”.
- (b) It may be executed several times in operation.
- (c) User may set speed override value as “%setting” or “speed setting” on [Speed override] of common parameter.
- (d) Related parameter setting (common parameter)

Items	Setting value	Description
Speed override	0 : %setting	Set the speed override setting value by %
	1 : speed setting	Set the speed override setting value with exact number

(e) Auxiliary data of speed override command setting

Items	Setting value	Description
Speed	1 ~ 65535 (1=0.01%)	Set the speed override setting value with percentage (If it is 100%, set 10000)
	1 ~ Speed limit	Set the speed override setting value directly

(2) Operation timing

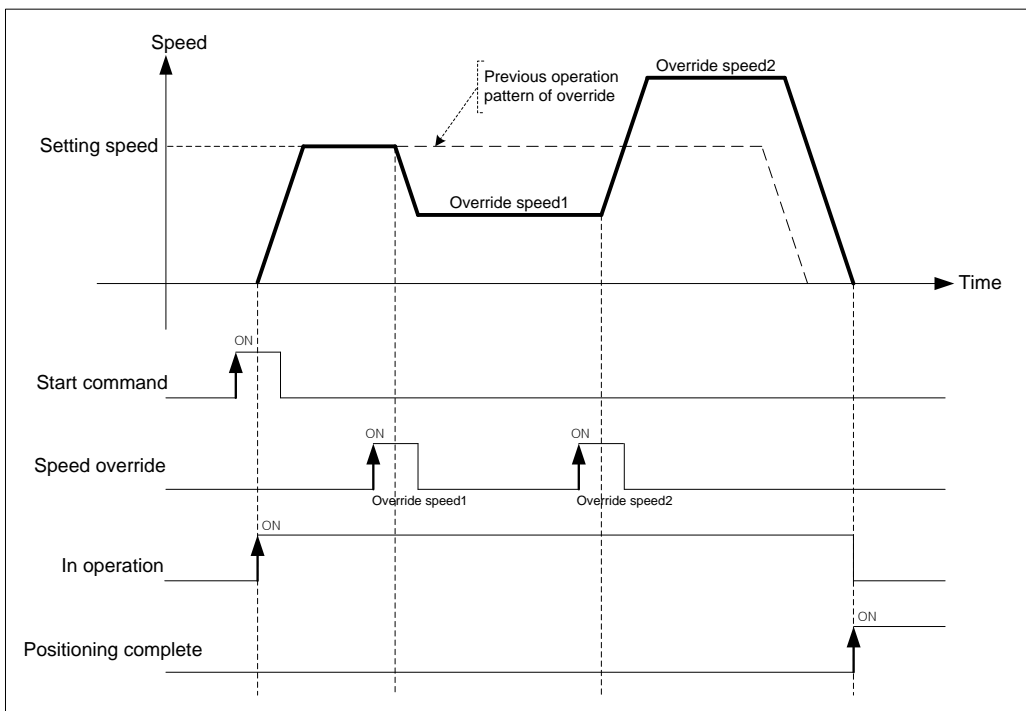

현재 운전 중인 위치결정 제어의 운전 속도를 변경하고자 하는 경우에 속도 오버라이드 명령을 사용하여 운전 속도를 변경할 수 있습니다.

(3) Restrictions

In the cases below, speed override is not executed and previous operation is being kept.

- Value of speed override exceeds speed limit of basic parameter. (error code:372)
Speed value of Speed override must be below speed limit.
Override speed of linear interpolation for each axis need to be below speed limit.
- Execute speed override on the sub axis of linear interpolation. (error code:373)
In linear interpolation, speed override must be executed on main axis.
- Execute speed override on the sub axis of circular interpolation. (error code:374)
In circular interpolation, speed override must be executed on main axis.'
- Execute speed override on sub axis of sync. operation. (error code:375)
- Execute speed override in dec. area. (error code:377)
- In the case that acc./dec. pattern of extended parameter is "S-curve operation". (error code:378)

[Example] Execute speed override(50%→100%→200%→150%) on axis1 operating by absolute, single axis position control.

- Current position of axis1 : 0
"Speed override" of common parameter : Set %
"Speed limit" of basic parameter : 3000 [pls/s]

■ Setting example of XG-PM

▪ Operation data of axis1

Step no.	Control method	Operation method	Goal position [pls]	Operation speed [pls/s]	Acc.no.	Dec.no.	M code	Dwell time
1	Absolute, single axis position control	Singular, End	1000	2000	No.1	No.1	0	0

■ Operation pattern

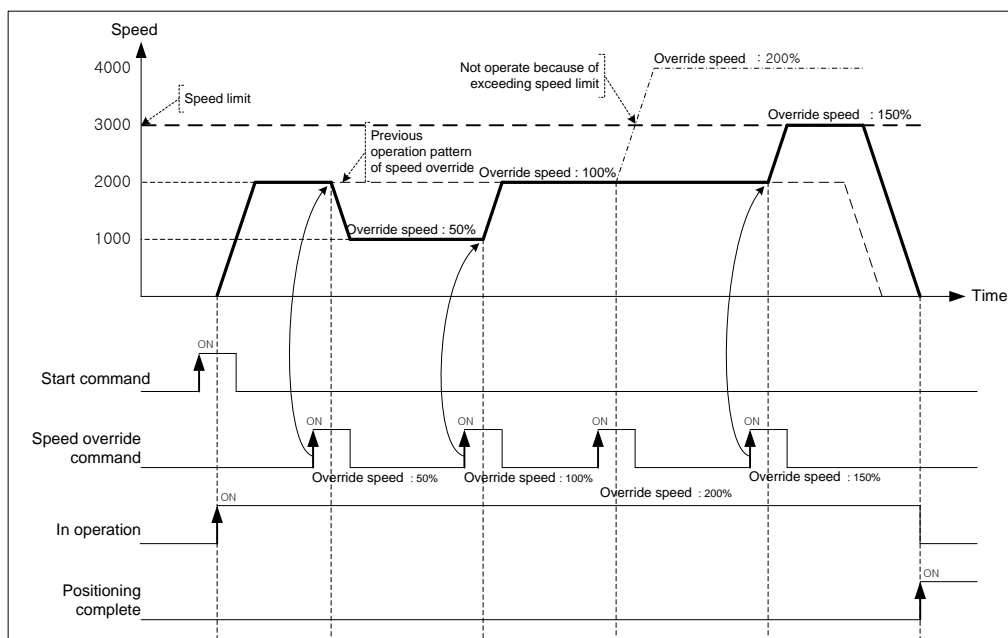

9.5.6 Position designated Speed Override

This is the command to operate by the changed operation speed if it reaches the setting position during positioning operation.

(1) Characteristics of Control

- (a) This command is used only in Acceleration and Constant speed section from operation pattern and the available operation mode is End, Keep, Continuous operation.
- (b) As this command is not carried out in Deceleration section, cares should be taken in using.
- (c) The position setting range is $-2147483648 \sim 2147483647$ Pulse.
- (d) User may set speed override value as “%setting” or “speed setting” on [Speed override] of common parameter.
- (e) User may select that consider the designated position value on “coordinates of positioning speed override” of extended parameter as an absolute position or a relative position.
- (f) Related parameter setting

■ Common parameter

Items	Setting value	Description
Speed override	0 : Set %	Set the value of speed override by %
	1 : Set speed	Set the value of speed override with exact number

■ Extended parameter

Items	Setting value	Description
Coordinates of positioning speed override	0 : Absolute	Speed override is executed in the designated absolute position
	1 : Relative	Start speed override from the position increment added

(g) Auxiliary data setting of positioning speed override command

Items	Setting value	Description
Position	$-2147483648 \sim 2147483647$	Set the position to start speed override
Speed	1 ~ 65535 (1=0.01%)	If speed override is “%”, set the speed by % (100% is 10000)
	1 ~ Speed limit	If speed override is “Exact number”, set the speed with exact number

Note

While the current position is not exactly same as the value set on speed override, if the position of speed override is at between previous scan and current scan, speed override is executed at the speed set.

(2) Operation timing

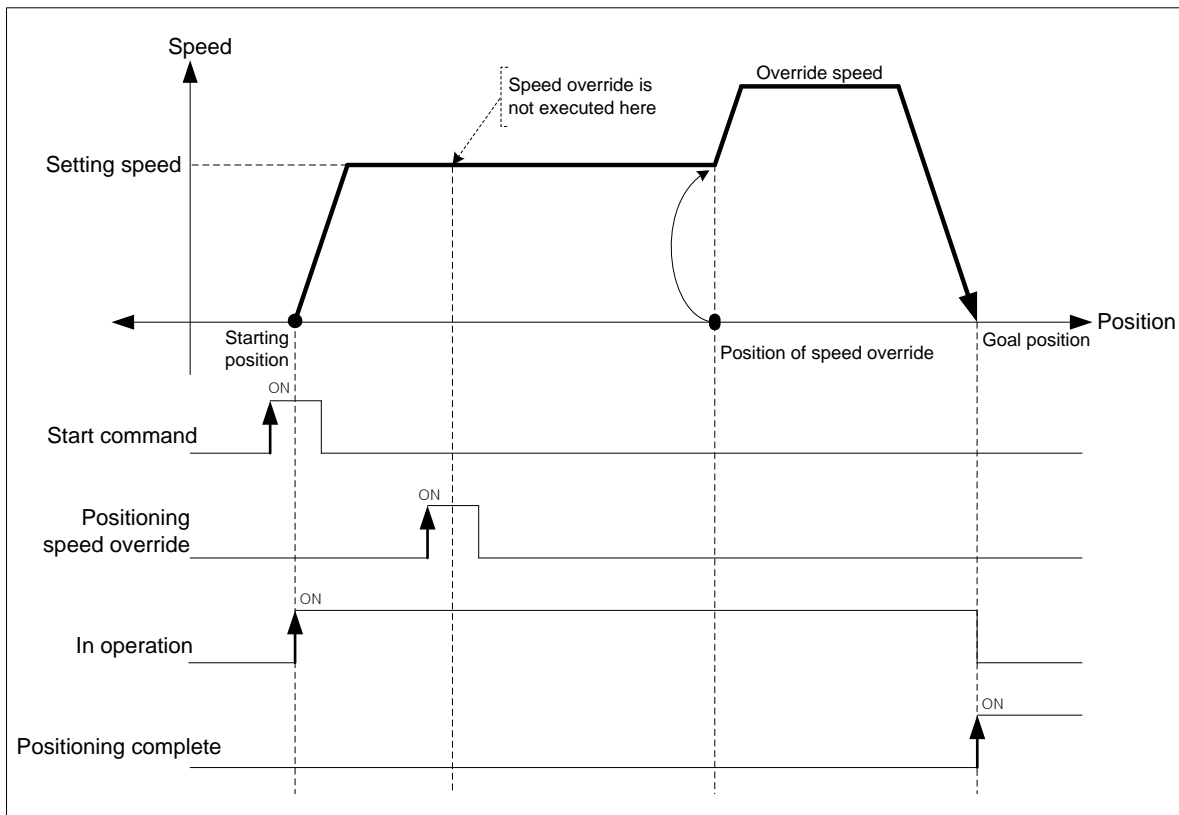

(3) Restrictions

In the cases below, positioning speed override is not executed and previous operation is being kept.

- (a) Current operation is not positioning (single axis position control, Inching operation) control. (error code:382)
- (b) The value of speed override exceeds speed limit of basic parameter. (error code:383)
The speed value of speed override must be below speed limit.
Override speed of linear interpolation for each axis need to be below speed limit.
- (c) Execute positioning speed override on the sub axis of linear interpolation. (error code:384)
In linear interpolation, positioning speed override must be executed on main axis.
- (d) Execute speed override on the sub axis of circular interpolation. (error code:385)
In circular interpolation, positioning speed override must be executed on main axis.
- (e) Execute speed override on sub axis of sync. operation. (error code:386)
- (f) In the case that acc./dec. pattern of extended parameter is "S-curve operation". (error code:389)
- (g) If execute positioning speed override in dec. area., although error does not arise but speed override is not executed. However, execute positioning speed override command in non-dec. area and speed override is executed when it is decelerating, error arises. (error code:377)

[Example] Execute positioning speed override at 4000 [pls/s] at 2000(position of speed override) on axis1 operating by absolute, single axis position control.

- Current position of axis1 : 0
 - 「Speed override」 of common parameter : Speed setting
 - 「Speed limit」 of basic parameter : 5000 [pls/s]
 - 「Coordinates of positioning speed override」 of extended parameter : Absolute

■ Setting example in XG-PM

▪ Operation data of axis1

Step no.	Control method	Operation method	Goal position [pls]	Operation speed [pls/s]	Acc.no.	Dec.no.	M code	Dwell time
1	Absolute single axis position control	Singular, End	5000	2000	No.1	No.1	0	0

■ Operation pattern

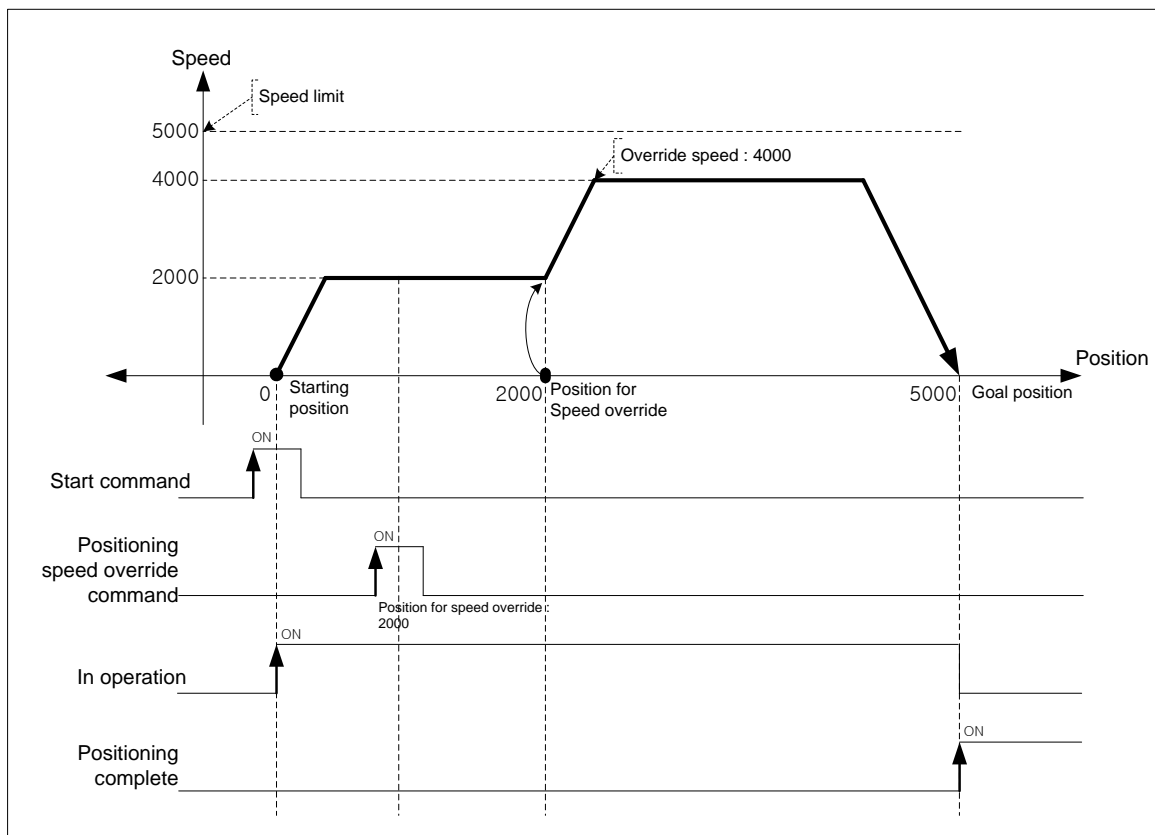

9.5.7 Current Position Preset

This command is for changing the current position value to the value at user's pleases.

(1) Characteristics of Control

- If user uses this command, the origin-undecided status becomes origin-decided status.
- When the current position is changed by position changing command, the mechanical origin position is changed. If user wants to use the mechanical origin again, has to execute homing command.
- The current position preset command may not be executed in operation.
- Auxiliary data setting of current position preset command.

Items	Setting value	Description
Position	-2147483648 ~ 2147483647	Set the position to change

(2) Operation timing

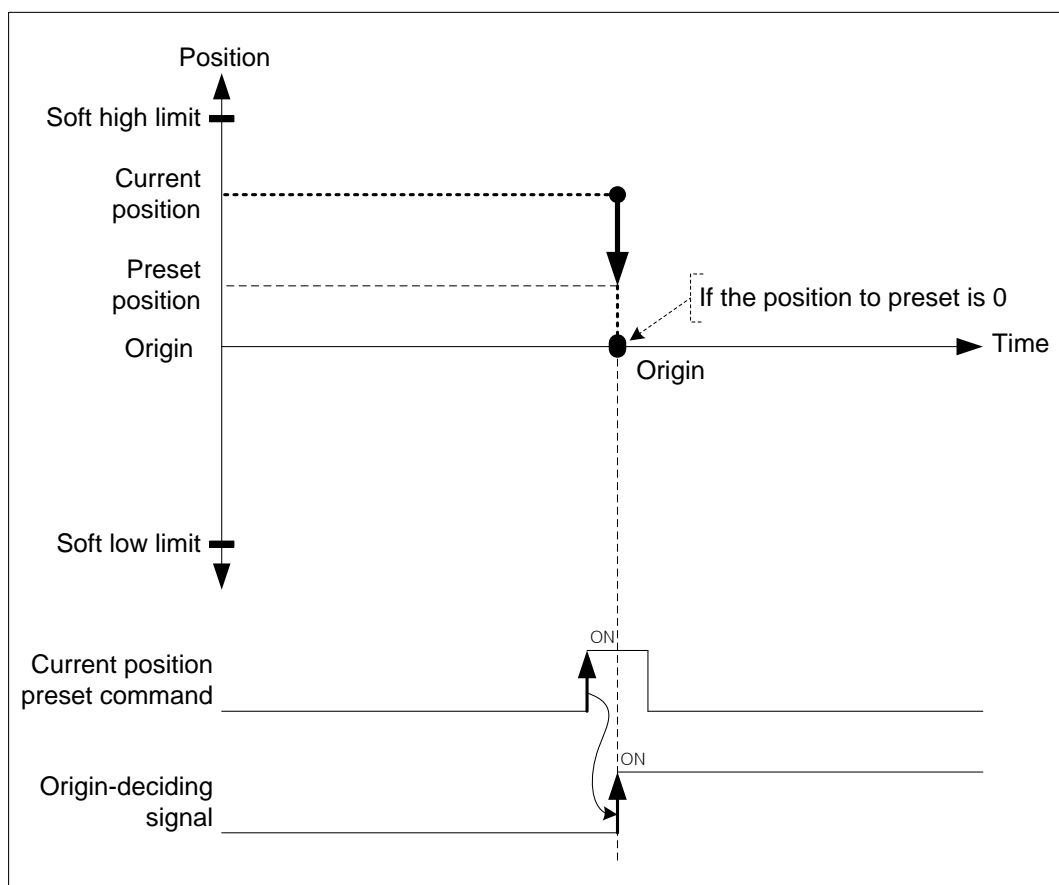

(3) Restrictions

In the cases below, current position preset is not executed and error arises.

- Setting value of current position preset exceeds soft high/low limit of extended parameter. (error code:452)

9.5.8 Encoder Preset

This command is for changing the value of current encoder position to the value at user's pleases.

(1) Characteristics of Control

- (a) User may change the current position value.
- (b) If there is an encoder being main axis, the speed of sub axis is possible to be changed dramatically, so encoder preset command may not be executed.
- (c) Encoder preset command should be executed in the status that external encoder pulse input is not entered.
- (d) Auxiliary data setting of encoder preset command

Items	Setting value	Description
Position	-2147483648 ~ 2147483647	Set the encoder position to change on selected encoder
Types	0 ~ 3 : Encoder	Select the encoder to change. Since encoders 1 to 4 use built-in high-speed counter channels 0 to 3, the current position of the high-speed counter used for each channel is also preset at encoder preset.

(2) Operation timing

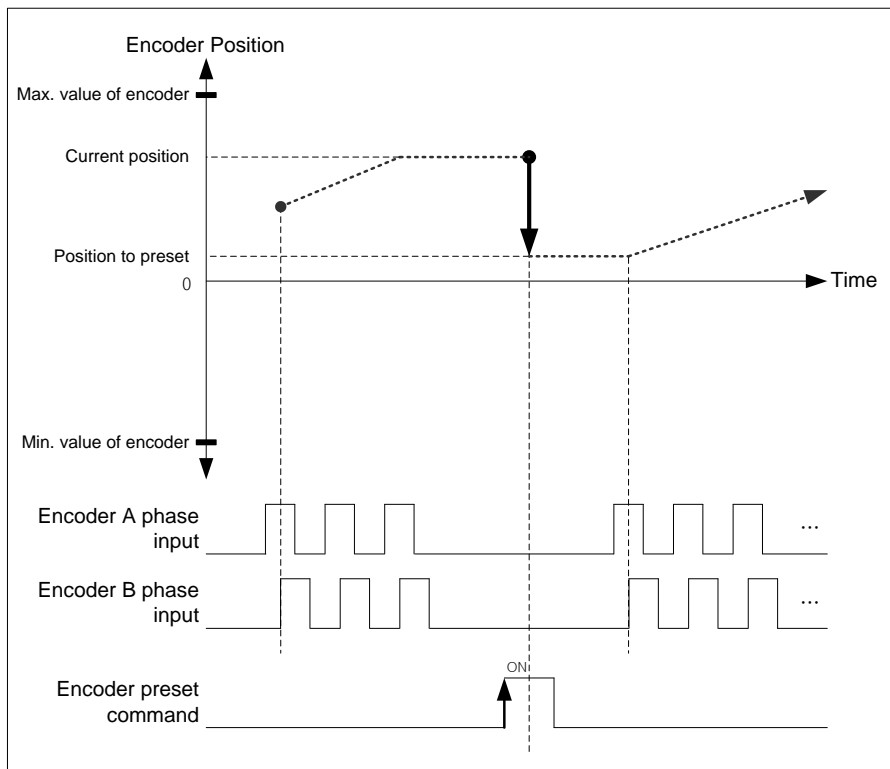

(3) Restrictions

In the cases below, encoder preset command may not be executed and error arises.

- (a) There is an encoder as a main axis (error code: 532)

- (b) Position value of encoder preset exceeds the max./min. value of encoder of common parameter.
(error code:534)

9.5.9 Start Step no. Change

This command is for changing the current step no. when executing indirect start command.

(1) Characteristics of Control

- (a) When starting with setting step no. as 0 in indirect start command, current operation step no. is executed. The current step no. may be changed by start step no. change command.
(b) This command may be only executed in stop motion or error arises.
(c) Auxiliary data setting of start step no. change command.

Items	Setting value	Description
Step	1 ~ 400	Set the step no. to change

(2) Operation timing

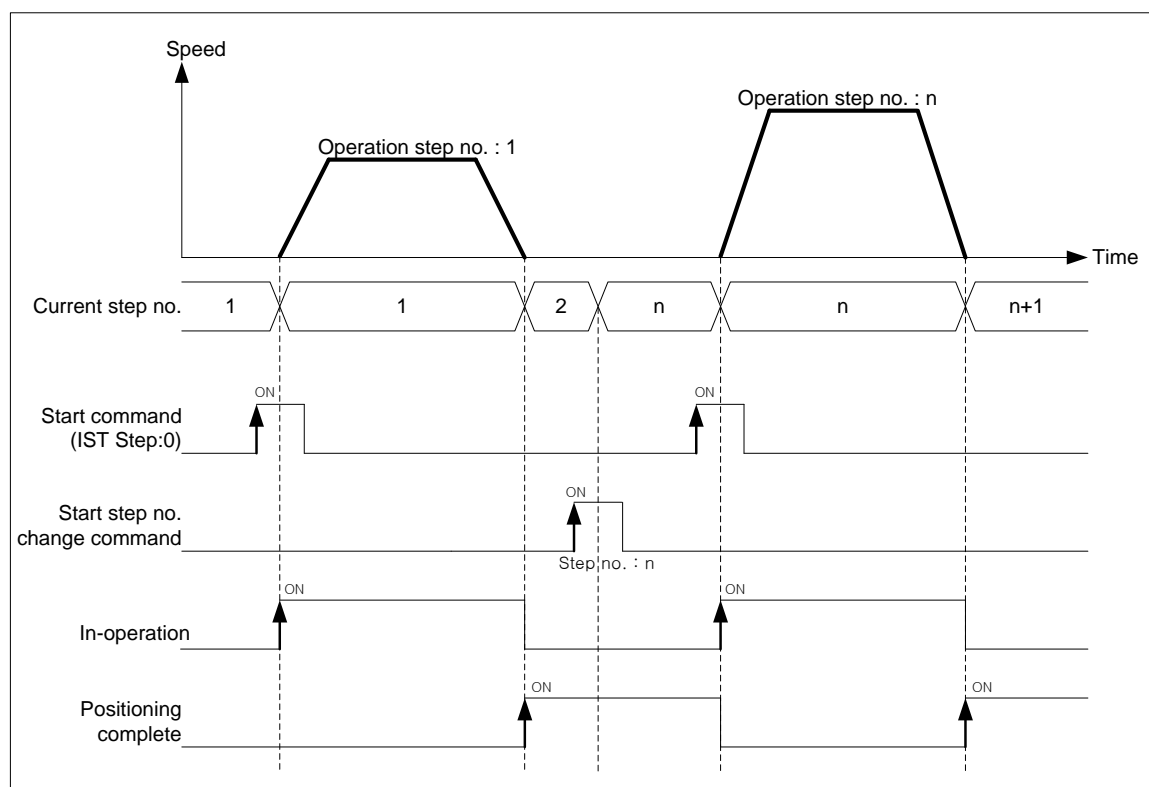

(3) Restrictions

In the case below, start step no. change command is not executed.

- (a) Step no. to change is out of 0 ~ 400. (error code:442)
If step no. is 0, keep the current step no.

9.5.10 Repeat Operation Step no. Change

This command is for changing the repeat operation step no will be executed next.

(1) Characteristics of Control

- (a) In case of repeat operation mode setting (End, Keep, Continuous operation), the current operation step no. will be changed automatically to operate the step no.1 when repeat operation mode setting step completes the positioning operation but if start step no. change command is executed in repeat operation, the step no. will be changed with the assigned step no. not the step no.1 .
- (b) The repeat operation step no. change command can be executed during positioning operation.
- (c) Auxiliary data setting of repeat operation step no. change command

Items	Setting value	Description
Step	1 ~ 400	Set the repeat operation step no. to change

(2) Operation timing

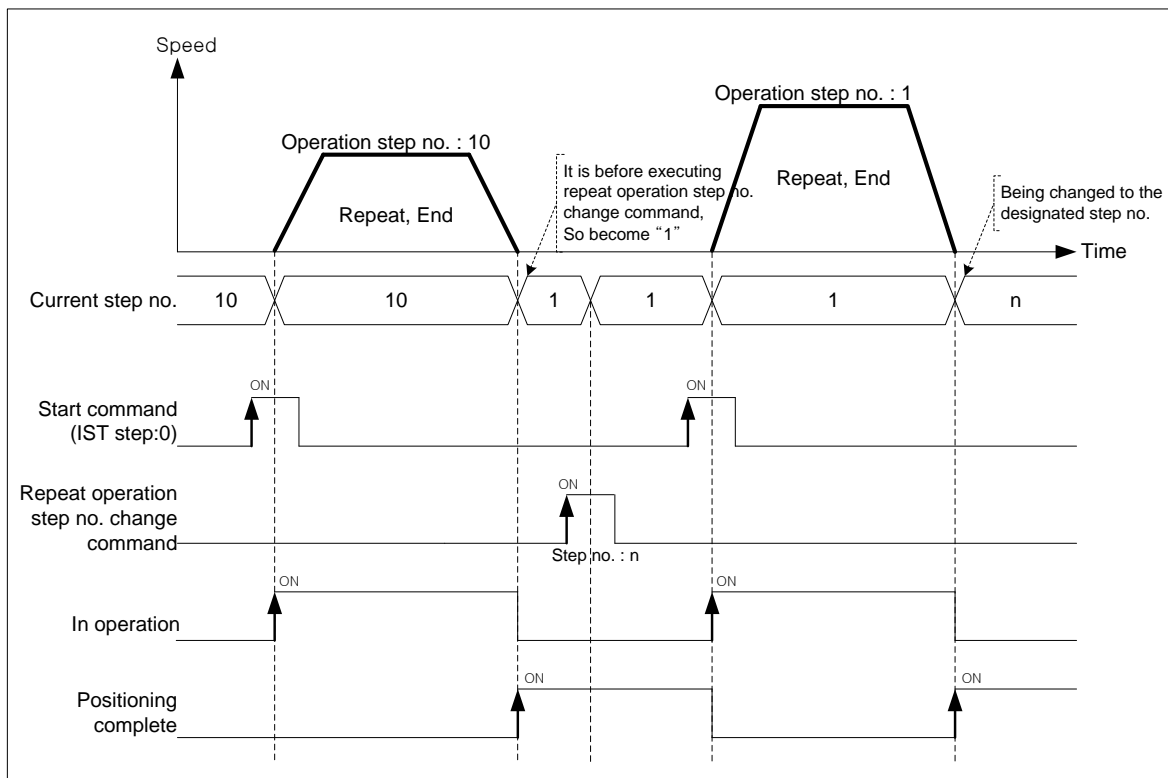

Note

The current operation step is not changed at the moment of executing the command. After "Repeat" positioning data operation is finished, it is changed to the step designated by repeat operation step no. change command.

(3) Restrictions

In the case below, repeat operation step no. change command is not executed.

(a) Step no. to change is out of 0 ~ 400. (error code:442)

If the step no. is 0, keep the previous step no.

[Example] Execute repeat operation step no. change command on axis1 operating by absolute, single axis position control.

■ Current position of axis1 : 0

■ Setting example in XG-PM

▫ Operation data of axis1

Step no.	Control method	Operation method	Goal position [pls]	Operation speed [pls/s]	Acc. no.	Dec. no.	M code	Dwell time
1	Absolute single axis position control	Singular, Go on	1000	1000	No.1	No.1	0	0
2	Absolute single axis position control	Singular, continuous	2000	2000	No.1	No.1	0	0
3	Absolute single axis position control	Singular, continuous	4000	3000	No.1	No.1	0	0
4	Absolute single axis position control	Repeat, Continuous	2000	3000	No.1	No.1	0	0
5	Absolute single axis position control	Singular, End.	5000	2000	No.1	No.1	0	0

■ Operation pattern

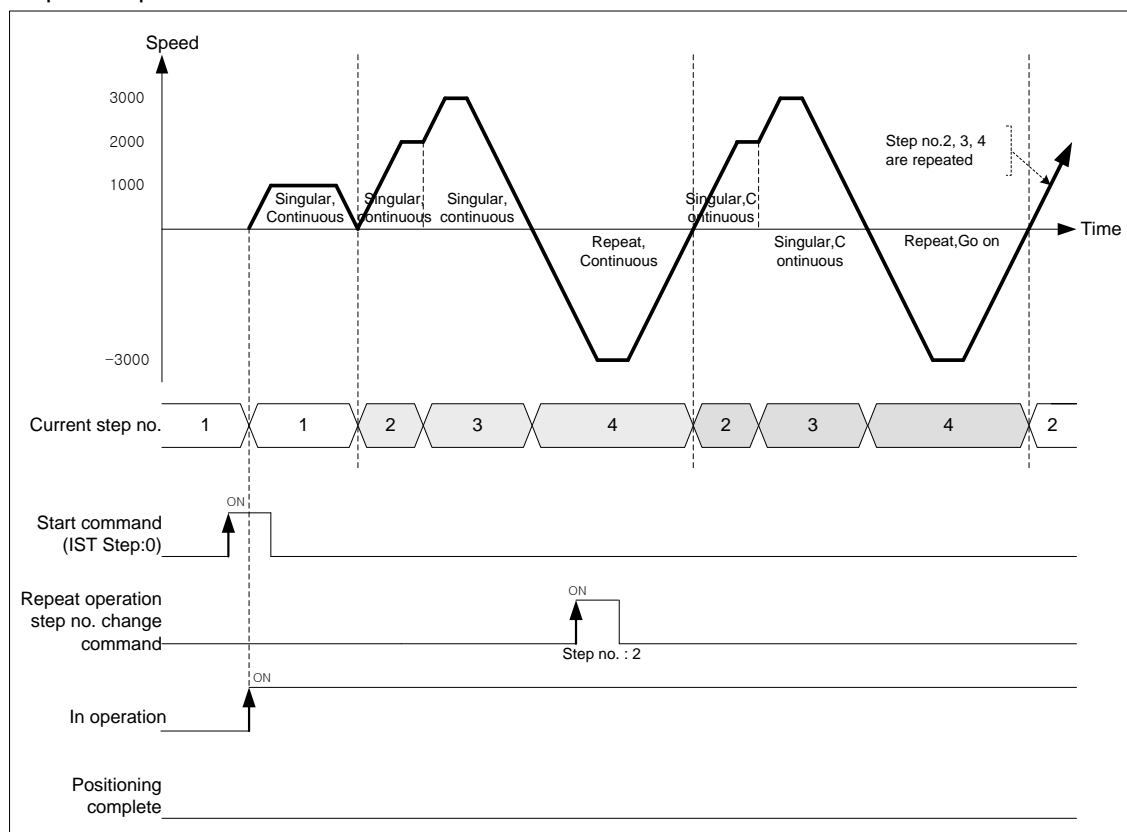

9.6 Auxiliary Function of Control

9.6.1 High/Low limit

Positioning module includes Hardware high/low limit and Software high/low limit.

(1) Hardware High/Low Limit

- This is used to stop the positioning module promptly before reaching Stroke limit/Stroke End of the Driver by installing the stroke limit of positioning module inside Stroke limit/Stroke end of the Driver. In this case, if it is out of the high limit, Error 492 will occur and if it is out of the low limit, Error 493 will occur.
- Input of high/low limit switch is connected to input/out terminal block.
- When positioning module is not in the controllable area, positioning operation is not executed.
- If it is stopped by hardware high/low limit detection, move it into the controllable area with Jog operation in reverse direction of detected signal.
- Hardware high/low limit is shown as follows.

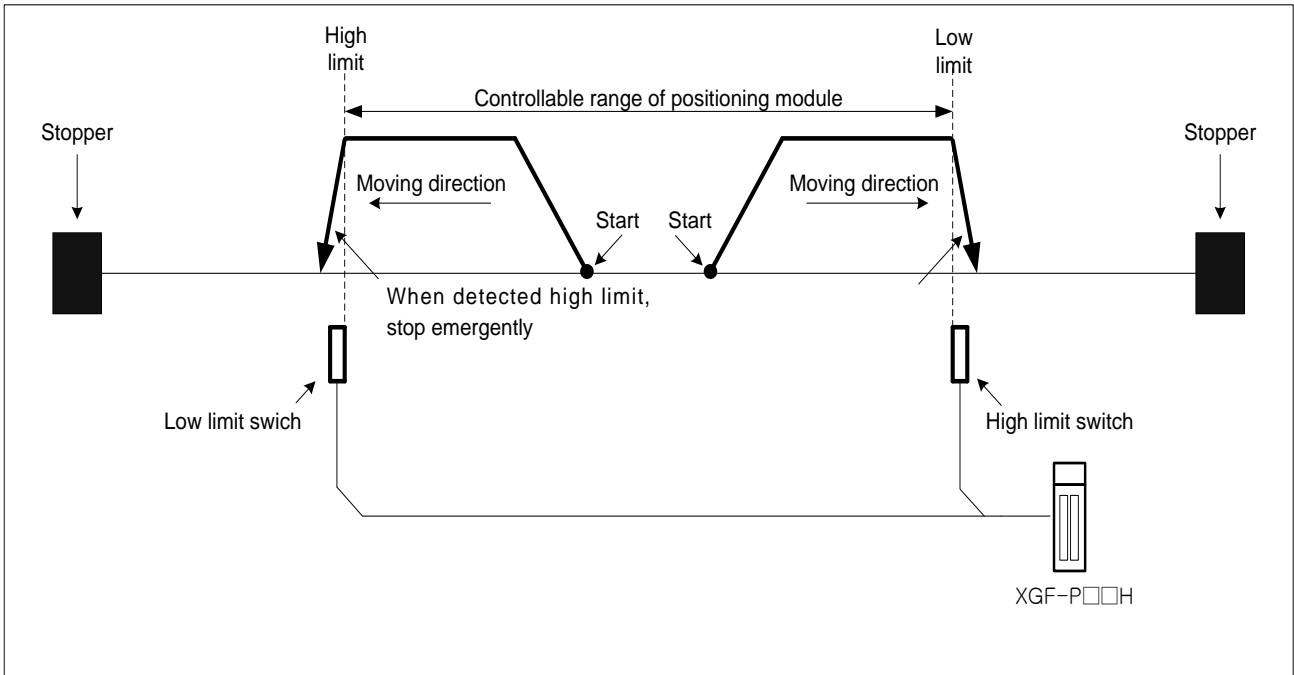

(f) Emergent stop when hardware high/low limit is detected

When hardware high/low limit is detected, stop the current positioning control and then decelerate within "Dec. time for Emergent stop".

■ Related parameter setting (Basic parameter)

Items	Setting value	Description
Dec. time of Emergent stop	0 ~ 2147483647 [ms]	Set the dec. time for emergent stop. Dec. time for emergent stop means the time needed at decelerating by bias speed.

(2) Software High/Low Limit

- (a) This command is for setting the movable range of machine as software high/low limit. If it is out of the range in operation, stop emergently within dec. time for emergency. In other words, this command is for preventing errors, malfunctions and being out of range.
- (b) If it is out of the range of software high/low limit, set external input high/low limit for use.
- (c) Checking range of software high/low limit is executed at the beginning.
- (d) If software high/low limit is detected, error arises. (High limit error:501, Low limit error:502)
- (e) User may set the position value of high/low limit on extended parameter.

■ Related parameter setting (Extended parameter)

Items	Setting value	Description
Soft High Limit	-2147483648 ~ 2147483647	Set the position of soft high limit
Soft Low Limit	-2147483648 ~ 2147483647	Set the position of soft low limit

- (f) Software high/low limit is shown as follows.

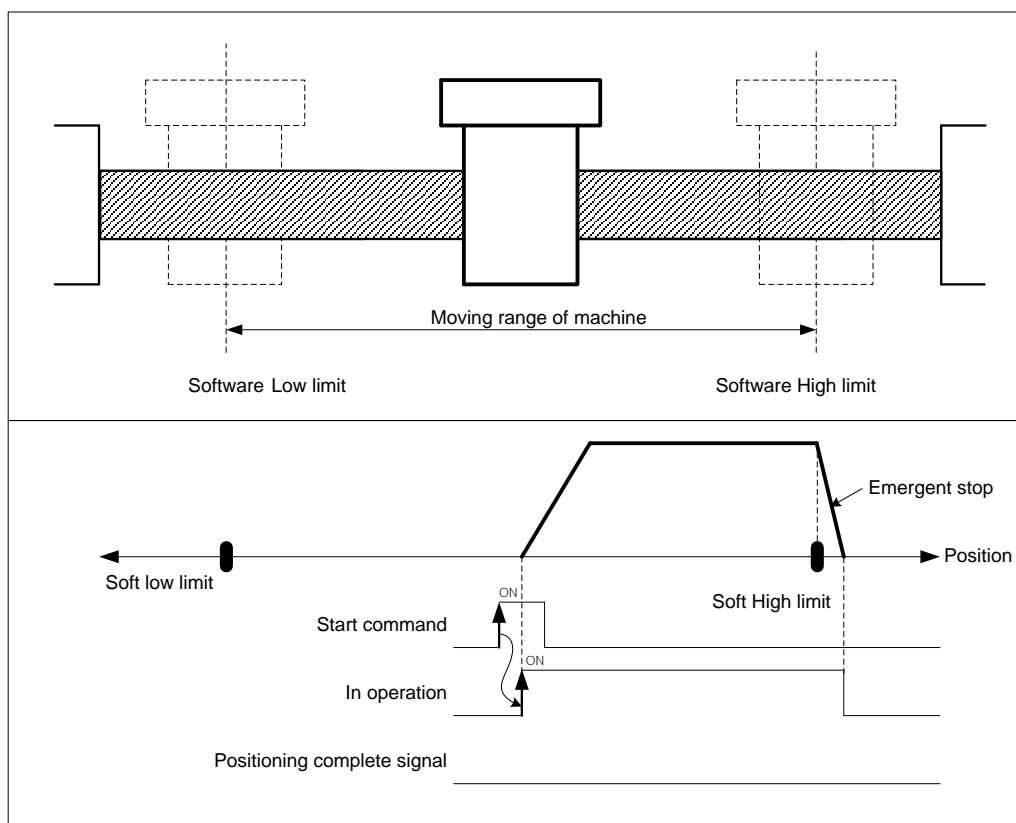

- (g) In the case below, software high/low limit are not detected.

- The value of soft high limit 2147483647, the value of soft low limit is -2147483648
- The value of soft high and low limit are same. (High limit = Low limit)

Note

(1) It does not detect software high/low limit in origin-undecided state

(2) Not to detect software high/low limit

If the value of current position becomes 2147483647 in forward operation, the current position becomes -2147483646 and keeps operating in forward direction.

If the value of current position becomes -2147483647 in reverse operation, the current position becomes 2147483646 and keeps operating in reverse direction.

9.6.2 M code

This is used to confirm the current operation step no. and carry out the auxiliary work (Clamp, Drill rotation, Tool change etc.) by reading M Code from the program.

(1) Characteristics of Control

- M code should be set in the M code item of operation data.(Setting range : 0~ 65535)
- If M code is set as "0", M code signal will not occur.
- If M code occurs, M code no.(1 ~ 65535) and M code signal (On) will occur simultaneously.
- In case of Keep operation mode, if M code no. and M code signal occur, it becomes standby for the next step; if executing M code release (MOF) command, it carries out Keep operation to the next step without start command.
- In continuous operation mode, even if M code no. and M code On signal occur, not to wait but execute continuous operation to the next step.
- User may turn M code signal off and set M code no. to 0 with M code release command. M code release command can be used even during operation.
- M code mode is set from M code output item of extended parameter. (0 : NONE, 1 : WITH, 2 : AFTER)

■ Related parameter setting (Extended parameter)

Items	Setting value	Description
M code mode	0 : None	Not to output M code signal and M code no.
	1 : With	Start and turn M code signal on at the same time, then output M code no. set in operation data.
	2 : After	After finishing positioning by start command, turn M code signal on and then output M code no. set in operation data.

(2) Operation timing

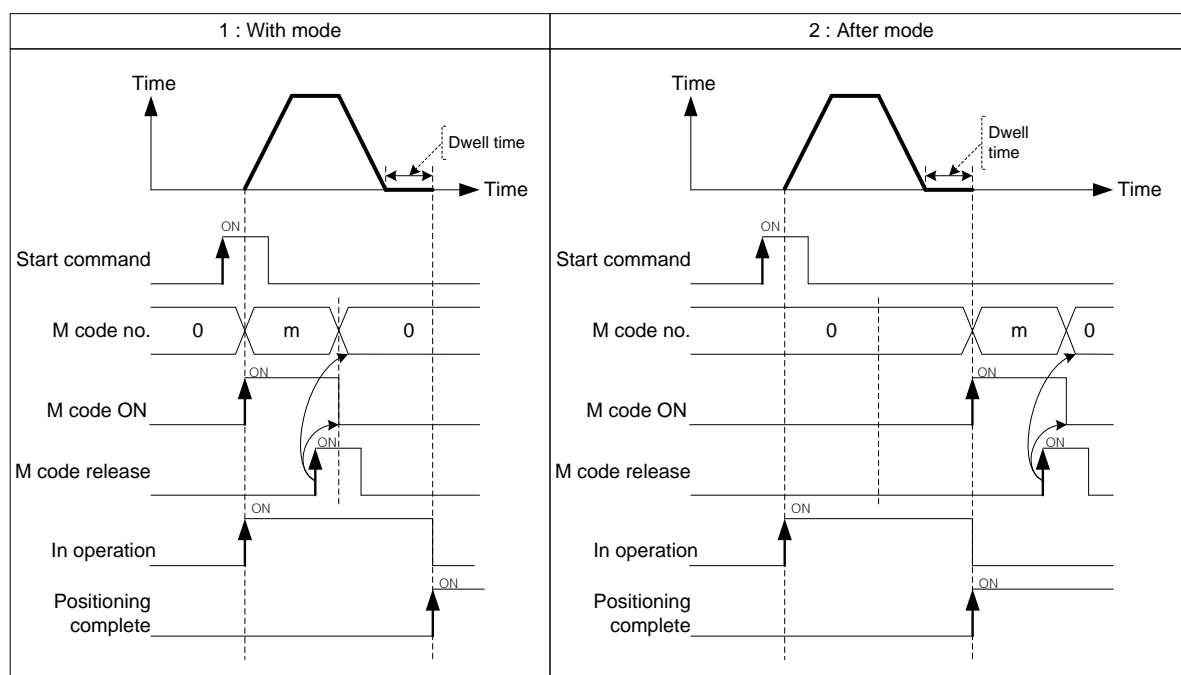

Chapter 9 Functions

[Example] Set M code no. in operation data as follows and execute absolute, single axis positioning control.

- Current position of axis1 : 0
M code mode of basic parameter : With

- Setting example in XG-PM

- Operation data of axis1

Step no.	Control method	Operation method	Goal position [pls]	Operation speed [pls/s]	Acc. no.	Dec. no.	M code	Dwell time
1	Absolute, single axis positioning control	Singular, continuous	1000	2000	No.1	No.1	100	100
2	Absolute, single axis positioning control	Singular, continuous	3000	2000	No.1	No.1	200	100
3	Absolute, single axis positioning control	Singular, continuous	5000	2000	No.1	No.1	300	100

- Operation pattern

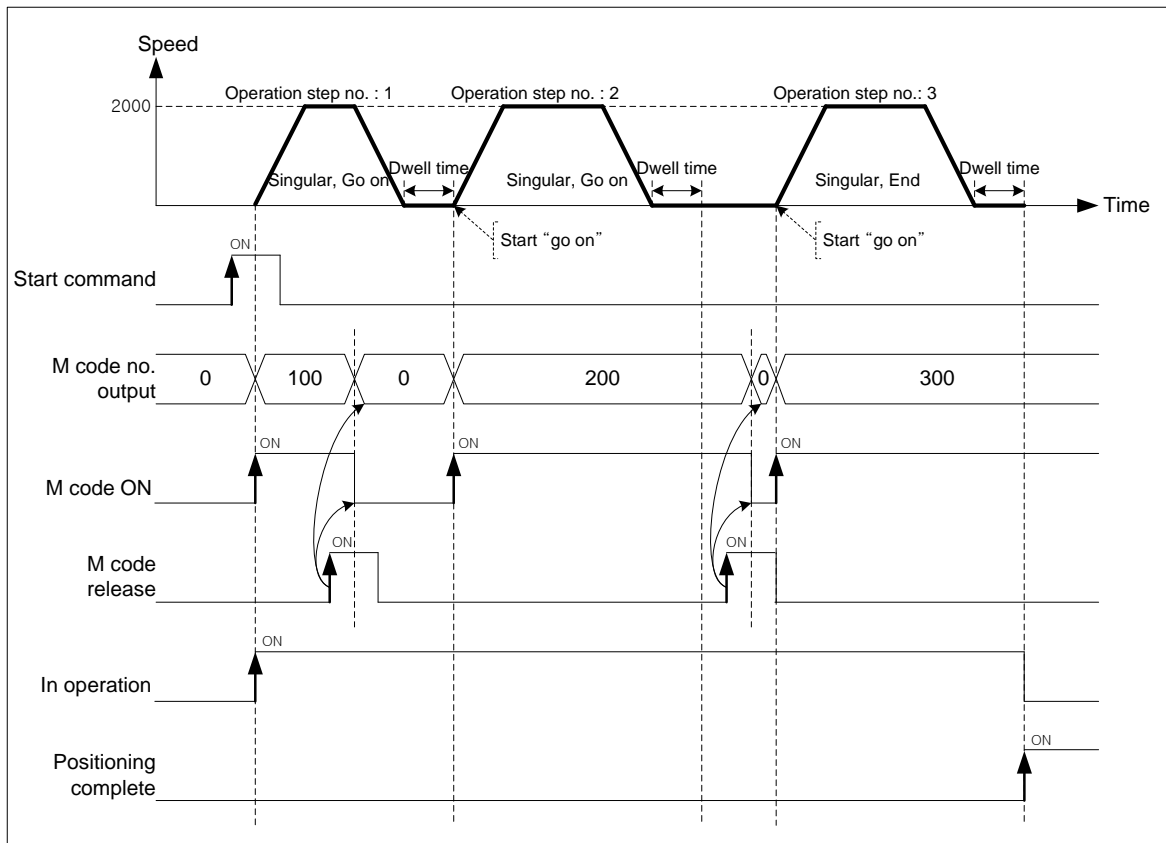

9.6.3 Infinite running repeat function

This is used to repeat operation between "0" and "infinite running repeat position-1". It is activated when the infinite running repeat parameter is "enabled".

(1) Characteristics of Control

- Not allowed to set negative value for infinite running repeat position. Infinite running repeat position can be designated between 1~2,147,483,647.
- If the current position is outside the range of infinite length iterations and you set infinite length iterations to allow, the current position is changed within the range calculated by infinite iterations.
- The operation range is infinite running repeat position set value -1.
- There is no command to execute infinite running repeat, it is activated and deactivated by turning on and off the infinite running repeat enable bit of the extended parameter.
- Set infinite running repeat to allow, the operation is as follows.

■ Operation pattern

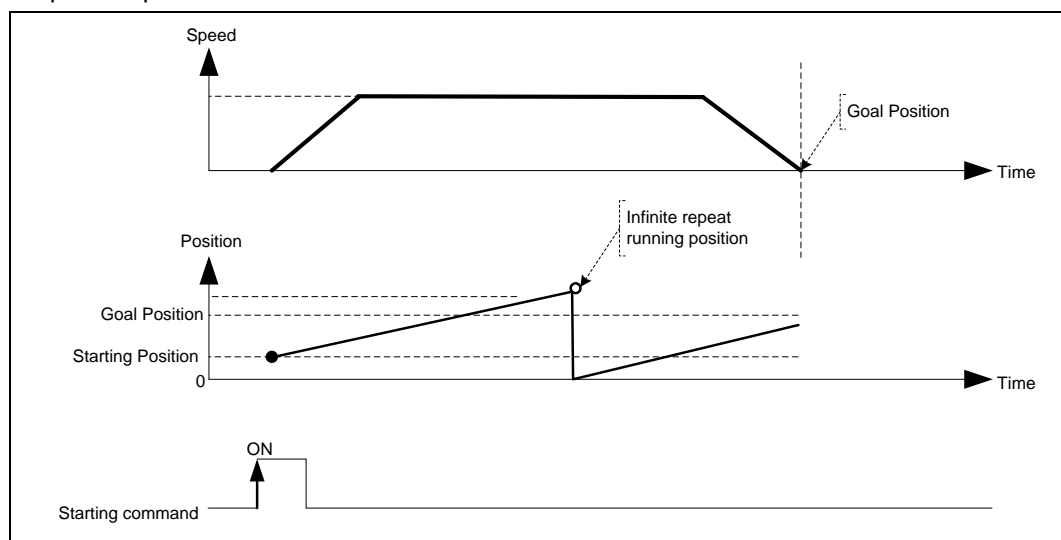

9.7 Data Modification Function

This function is for changing operation data and operation parameter of embedded positioning module

9.7.1 Teaching Array

User may change the operating speed and the goal position of the step user designated with teaching command but without XG-PM.

(1) Characteristics of Control

- (a) This command is for changing operating speed or the goal position on several steps.
- (b) User may change maximum 16 data.
- (c) RAM teaching and ROM teaching are available depending on the saving position.
 - RAM teaching
When executing teaching to operation data of module and operating module in power connection, user may change speed value or position value but the speed value and position value are not saved in non-power connection.
 - ROM teaching
When executing teaching to operation data of module and operating module in power connection, user may change speed value or position value and operation data is saved permanently even in non-power connection.
- (d) The value of goal position being changed is position teaching, the value of operating speed being changed is speed teaching.
- (e) The axis in operation may be the subject of position teaching or speed teaching.
- (f) If user changes the value of goal position or operating speed frequently, this command is very useful for it.
- (g) Auxiliary data setting of teaching array command

Items	Setting value	Description
Step	0 ~ 400	Set the step no. for teaching
Position	0 : RAM teaching 1 : ROM teaching	Set the method of teaching
Data	0 : Position 1 : Speed	Set the data items for teaching
The No.	1 ~ 16	Set the number of operating step

- (h) Teaching Array command is available to be executed when the axis is operating. But teaching data of operating step do not apply instantly. Operating step data will apply end of present step operation

Note

The teaching data must be set in the data setting area for teaching array before teaching array command is executed. Refer to the teaching array command XTWR.

(2) Restrictions

Teaching array command may not be executed in the case as follows.

(a) The number of teaching array is out of the range (1~16). (Error code: 462)

(b) Teaching step no. is out of the range (1~400). (Error code: 465)

Total number (Teaching step no. + The number of Teaching) must be below 400.

9.7.2 Parameter Change from Program

User may modify the operation parameter set on XG-PM with teaching command for each parameter.

(1) Characteristics of Control

- (a) There are 6 kinds of parameter teaching command. (Basic, Extended, Manual operation, Homing, External signal, common parameter teaching)
- (b) Parameter teaching is not available in operation.
- (c) RAM teaching and ROM teaching are available depending on the saving position.
 - RAM teaching
When executing teaching to operation data of module and operating module in power connection, user may change speed value or position value but the speed value and position value are not saved in non-power connection.
 - ROM teaching
When executing teaching to operation data of module and operating module in power connection, user may change speed value or position value and operation data is saved permanently even in non-power connection.

(2) Basic Parameter Teaching

(a) Change the setting value of designated item from basic parameter of module into teaching data.

(b) Auxiliary data setting of basic parameter teaching command

Item	Setting value		Description	
Teaching data	Refer to "setting range"		Set the teaching value of parameter selected	
			Setting range	
Teaching item	1	Speed limit	1 ~ 2147483647	Choose the parameter item to do execute teaching
	2	Acc.time 1	0 ~ 2147483647	
	3	Acc.time 2		
	4	Acc.time 3		
	5	Acc.time 4		
	6	Dec.time 1		
	7	Dec.time 2		
	8	Dec.time 3		
	9	Dec.time 4		
	10	Emergent Dec.time		
	11	Plse/rotation		
	12	Transferring distance/rotation	1 ~ 200000000	
	13	Unit	0:pulse 1:mm 2:inch 3:degree	
	14	Double precision of unit	0:x1 1:x10 2:x100 3:x1000	
	15	Speed unit	0: unit/time 1: rpm	
	16	Bias speed	1 ~ Speed limit	
	17	Pulse output mode	0:CW/CCW 1:PLS/DIR 2:PHASE	
Teaching method	0 : RAM Teaching 1 : ROM Teaching		Set the teaching method	

For the details about basic parameter items and setting value, refer to "Chapter 5 Positioning Parameter & Operation Data."

Chapter 9 Functions

(3) Extended Parameter Teaching

(a) Change the setting value of designated item from extended parameter of module into teaching data.

(b) Auxiliary data setting of extended parameter teaching command

Items	Setting value		Description	
Teaching data	Refer to "Setting range"		Set the teaching value of parameter selected	
			Setting value	
Teaching items	1	Soft high limit	-2147483648 ~ 2147483647	Select the parameter item to execute teaching
	2	Soft low limit	-2147483648 ~ 2147483647	
	3	Backlash compensation	0 ~ 65535	
	4	Positioning complete Output time	0 ~ 65535	
	5	Ratio of S-curve	1 ~ 100	
	6	Circular interpolating position of 2 axes linear interpolation continuous operation	0 ~ 2147483647	
	7	Acc./Dec. Pattern	0 : Trapezoid operation 1 : S-curve operation	
	8	M code mode	0 : None, 1 : With, 2 : After	
	9	Soft high/low limit In speed control	0 : Not to detect 1 : Detect	
	10	Servo reset retention time	1 ~ 5000[ms]	
	11	Positioning method of interpolation continuous operation	0 : Pass the goal position 1 : Pass near position	
	12	Circular interpolation of 2 axes linear interpolating continuous operation	0 : No circular interpolation 1 : Circular interpolating continuous operation	
	13	External emergent/dec. stop	0 : Emergent stop 1 : Dec. stop	
	14	Coordinates of positioning speed override	0 : Absolute 1 : Relative	
	15	Pulse output direction	0: Forward, 1: Reverse	
	16	Infinite running repeat position	1 ~ 2147483647	
	17	Infinite running repeat enable/disable	0: Disable, 1: Enable	
	18	Speed/Position switching coordinate	0: Incremental 1: Absolute	
	19	Interpolation speed selection	0: Main axis speed 1: Synthetic speed	
Teaching method	0 : RAM teaching 1 : ROM teaching		Set the teaching method	

For the details about basic parameter items and setting value, refer to "Chapter 4 parameter and operation data".

(4) Homing Parameter Teaching

(a) Change the setting value of designated item from homing parameter of module into teaching data.

(b) Auxiliary data setting of homing parameter teaching command

Items	Setting value	Description		
Teaching data	Refer to "setting range"	Set the teaching value of parameter selected		
		Setting range		
Teaching items	1	Position of origin	-2147483648 ~ 2147483647	Select the parameter item to execute teaching
	2	High speed homing	Bias speed ~ Speed limit	
	3	Low speed homing	Bias speed ~ Speed of High speed homing	
	4	Acc.time for homing	0 ~ 2147483647	
	5	Dec.time for homing		
	6	Dwell time for homing	0 ~ 65535	
	7	Origin revision	-2147483648 ~ 2147483647	
	8	Restart time for homing	0 ~ 65535	
	9	Homing mode	0 : Near Origin/Origin (Off) 1 : Near Origin /Origin (On) 2 : High/Low limit Origin 3 : Near Origin 4 : High speed origin 5 : High/Low limit 6 : Origin	
	10	Direction for homing	0 : Forward 1 : Reverse	
Teaching method	0 : RAM teaching 1 : ROM teaching	Set the teaching method		

For the details about basic parameter items and setting value, refer to "Chapter 4 parameter and operation data".

(5) Manual Operation Parameter Teaching

- (a) Change the setting value of designated item from manual operation parameter of module into teaching data.
 (b) Auxiliary data setting of manual operation parameter teaching command

Items	Setting value		Description	
Teaching data	Refer to "setting range"		Set the teaching value of parameter selected	
			Setting range	
Teaching items	1	Jog high speed	Bias speed ~ Speed limit	Select the parameter item to execute teaching
	2	Jog low speed	Bias speed ~ Jog high speed	
	3	Jog acc. time	0 ~ 2147483647	
	4	Jog dec. time		
	5	Inching speed	Bias speed ~ Speed limit	
Teaching method	0 : RAM teaching 1 : ROM teaching		Set the teaching method	

For the details about basic parameter items and setting value, refer to "Chapter 4 parameter and operation data".

(6) I/O Signal Parameter Teaching

- (a) Change the setting value of designated item from I/O signal parameter of module into teaching data.
 (b) Auxiliary data setting of I/O signal parameter teaching command

Items	Setting value		Description
Teaching data	Bit 0~1	High limit signal	Sets the input format of the input signal parameter. If the bit value is 0, the corresponding signal is not used, 1 if it is contact A, 2 if it is contact B, or b11 (3) when teaching instruction.
	Bit 2~3	Low limit signal	
	Bit 4~5	DOG signal	
	Bit 6~7	HOME signal	
	Bit 8~9	Deviation clear signal	
	Bit 10 ~ Bit 15	-	
Teaching method	0 : RAM teaching 1 : ROM teaching		Set the teaching method

For the details about basic parameter items and setting value, refer to "Chapter 5 parameter and operation data".

(7) Common Parameter Teaching

- (a) Change the setting value of designated item from common parameter of XPM module into teaching data.
 (b) Auxiliary data setting of common parameter teaching command

Items	Setting value		Description	
Teaching data	Refer to "setting range"		Set the teaching value of parameter selected	
			Setting range	
Teaching items	1	Speed override	0 : % setting 1 : speed setting	Select the parameter item to execute teaching
	2	Pulse output level	0 : Low Active 1 : High Active	
	3	Control cycle	1~10(ms)	
Teaching method	0 : RAM teaching 1 : ROM teaching		Set the teaching method	

For the details about basic parameter items and setting value, refer to "Chapter 5 parameter and operation data".

9.7.3 Operation Data Change from Program

User may modify the positioning operation data set on XG-PM with operation data teaching command.

(1) Characteristics of Control

- (a) Change setting value of designated step and item from PLC's operation data into teaching data.
- (b) Operation data teaching command is available to be executed when the axis is operating. But teaching data of operating step do not apply instantly. Operating step data will apply end of present step operation.
- (c) RAM teaching and ROM teaching are available depending on the saving position.

- RAM teaching

When executing teaching to operation data of embedded positioning and operating embedded positioning in power connection, user may change speed value or position value but the speed value and position value are not saved in non-power connection.

- ROM teaching

When executing teaching to operation data of embedded positioning and operating embedded positioning in power connection, user may change speed value or position value and operation data is saved permanently even in non-power connection. .(The number of Rom teaching time is limited. /about 1,000,000 times)

(d) Auxiliary data setting of operation data teaching command

Items	Setting value		Description
Teaching data	Refer to "Setting range"		Set the teaching value of parameter selected
			Setting range
Teaching items	1	Goal position	-2147483648 ~ 2147483647
	2	Auxiliary point of Circular interpolation	-2147483648 ~ 2147483647
	3	Operating speed	1 ~ Speed limit
	4	Dwell time	0 ~ 65535
	5	M code	0 ~ 65535
	6	Set a sub axis	Set it on Bit 0 ~ Bit 3 0 : Not be set 1 : Be set
	7	Helical interpolation (Only XBM-HP)	0 : Not use 1 ~6 : axis1 ~ axis6
	8	No. of circular interpolation turn	0 ~ 65535
	9	Coordinates	0 : Absolute 1 : Relative
	10	Control method	0 : single axis position control 1 : single axis speed control 2 : single axis Feed control 3 : Linear interpolation control 4 : Circular interpolation control
	11	Operating method	0 : Singular 1 : Repeat
	12	Operating pattern	0 : End 1 : Keep 2 : Continuous
	13	Size of circular arc	0 : Circular arc < 180 1 : Circular arc >= 180
	14	Acc. no.	0 ~ 3
	15	Dec. no.	0 ~ 3
	16	Method of circular interpolation	0 : Middle point 1 : Center point 2 : Radius
	17	Direction of circular interpolation	0 : CW 1 : CCW
Step no.	0 ~ 400		Set the step no. of operation data to execute teaching
Teaching method	0 : RAM Teaching 1 : ROM Teaching		Set the teaching method

For the details about basic parameter items and setting value, refer to "Chapter 5 parameter and operation data".

9.7.4 Write/Read Variable Data

Parameter, operation data, CAM data can be read by "Read Variable Data" command and written by "Write Variable Data" command directly.

(1) Read Variable Data

- (a) You read data you want by designating module internal memory address of parameter, operation data, CAM data directly.
- (b) Reads data as many as "Block size" starting position set in "Read address" with WORD unit to CPU among parameter, operation data, CAM data. In case "CNT" is higher than 2, reads blocks with interval of "Block offset" starting "Read address" as many as "CNT"-1.
- (c) Max. data size (block size x No. of block) you can read with one command is 128 WORD
- (d) "Read Variable Data" command can be executed in operation.
- (e) Auxiliary data setting of "Read Variable Data" command

Item	Setting value	Description
Read address	0 ~ 143,367	Sets head address of Read Data
Block offset	0 ~ 143,367	Sets offset between blocks of Read Data
Block size	1 ~ 128	Sets size of block
No. of block	1 ~ 128	Sets No. of Read Block

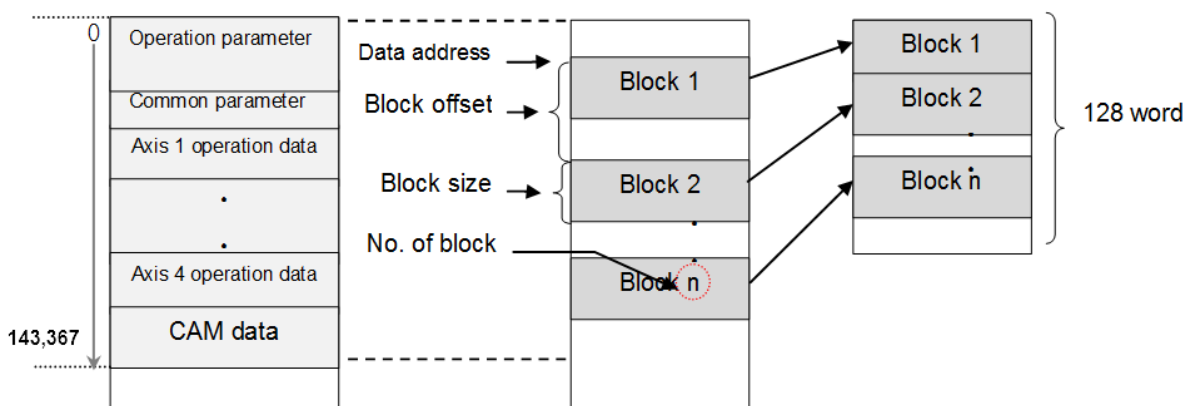

(f) Restriction

In the following case, error occurs and can't execute "Read Variable Data" command

- Data setting error (Error code: 711)
 - Read data size (Block size x No. of block) is 0 or higher than 128 WORD.
 - Read data address [Read address + {block offset x (No. of block -1)} + Block size] is higher than last address value (49586)

Note

If you execute "Read Variable Data" command in XGB PLC, Read data from positioning module is saved in common area. To save in device for using in PLC program, use GETM command [Read address: 0, data size: Read data size (DWORD)]

In XGB PLC, Read data is saved in register set in Function Block automatically.

(2) Write Variable Data

- (a) You write data you want by designating module internal memory address of parameter, operation data, CAM data directly.
- (b) Writes data set in PLC program as many as "Block size" starting position set in "Write address" with WORD unit among parameter, operation data, CAM data of positioning module. In case "No. of block" is higher than 2, writes blocks with interval of "OFFSET" starting "Write address" as many as "CNT"-1.
- (c) Max. data size (Block size x No. of block) you can write with one command is 128 WORD.
- (d) "Read Variable Data" command can't be executed in operation. But "Read Variable Data" command can be executed to User CAM data in User CAM operation.
- (e) After executing "Write Variable Data" command, since the changed value is maintained while power is on, in order to keep the changed value, execute "Save parameter/Operation data" command
- (f) Auxiliary data setting of "Write Variable Data" command

Item	Setting value	Description
Data device	0 ~ 49586	Sets device where data to write to module is saved
Write address	0 ~ 49586	Sets head address of positioning module internal memory
Block offset	0 ~ 49586	Sets offset between blocks of Write data
Block size	1 ~ 128	Sets size of block
No. of block	1 ~ 128	Sets No. of Write block

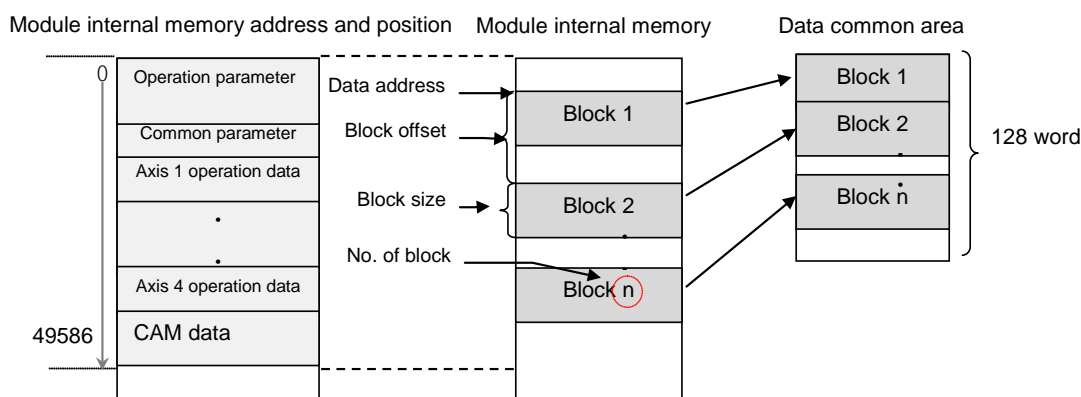

(g) Restriction

In the following case, error occurs and can't execute "Read Variable Data" command

- Data range setting error (Error code: 711)
 - Write data size (Block size x No. of block) is 0 or higher than 128 WORD
 - Write data address [Write address + {Block offset x (No. of block -1)} + Block size] is higher than last address value (49586)
- Block overlap error (Error code: 713)
 - In case module internal block to write is overlapped each other
(In case no. of block is higher than 2, block offset is smaller than block size)
- Execution inhibition error in operation (Error code: 712)
 - Any axis of positioning module is in operation

Chapter 9 Functions

Chapter 10 Positioning Error Information & Solutions

Here describes the positioning error types and its solutions.

(1) Error Information of Basic Parameter

Error Code	Error Description	Solutions
101	Max. speed value of Basic Parameter exceeds the range.	The speed limit of basic parameter for pulse units are bigger than bias speed and less than 200,000
102	Bias speed value of Basic Parameter exceeds the range.	Bias speed of Basic Parameter should be less than max. speed of Basic Parameter.
104	Circular interpolation(Ellipse interpolation) cannot be executed because the speed limit of the basic parameter that is converted into angular velocity, is equal to or greater than 180 degrees.	Retry after lowering the speed limit of the circular interpolation(ellipse interpolation) main axis.
105	Bias speed value of basic parameter is out of range.	The value of the bias speed of basic parameter, enter one or more based on the pulse unit. Bias speed of basic parameter is reset to the minimum value of the bias speed.

(2) Error Information of Expanded Parameter

Error Code	Error Description	Solutions
111	Extended Parameter software upper/lower limit range error	S/W upper limit of Extended Parameter should be greater than or equal to S/W lower limit of Extended Parameter. .
112	M Code Mode value of Extended Parameter exceeds the range.	M Code output of Extended Parameter is 0:None, 1:With, 2:After. Select one among three.
113	S-Curve rate of Extended Parameter exceeds the range.	Change S-Curve rate of Extended Parameter to be more than 1 and less than 100

(3) Error Information of Manual Operation Parameter

Error Code	Error Description	Solutions
121	Jog high speed value of Manual operation parameter exceeds the range.	Set Jog high speed of Manual operation parameter to be greater than or equal to bias speed of Basic Parameter and less than or equal to max. speed of Basic Parameter.
122	Jog low speed value of Manual operation parameter exceeds the range.	Set Jog low speed of Manual operation parameter to be more than 1 and less than Jog high speed of Manual operation parameter.
123	Inching speed value of Manual operation parameter exceeds the range.	Set Inching speed of Manual operation parameter to be greater than or equal to bias speed of Basic Parameter and less than or equal to max. speed of Basic parameter.

Chapter 10 Positioning Error Information & Solutions

(4) Error Information of Homing Origin Parameter

Error Code	Error Description	Solutions
131	Homing mode value of Homing parameter exceeds the range.	Homing method of Homing parameter is 0:Dog/Origin(Off), 1:Dog/Origin(On),2:High/low limit/Origin, 3: Near Point, 4:High speed origin, 5: High/low, 6:Origin Select one among seven.
132	Homing address of Homing parameter exceeds the range.	Set Homing address of Homing parameter to be greater than S/W low limit of Extended parameter and less than S/W high limit of Extended Parameter.
133	Homing high speed value of Homing parameter exceeds the range.	Set Homing high speed of Homing parameter to be greater than or equal to bias speed of Basic parameter and less than or equal to max. speed of Basic parameter.
134	Homing low speed value of Homing parameter exceeds the range.	Set Homing low speed of Homing parameter to be greater than or equal to bias speed of Basic parameter and less than or equal to Homing high speed of Homing parameter.

(5) Error Information of Operating Data

Error Code	Error Description	Solutions
151	Not available to set operation speed value of Operation data as "0".	Set operation speed to be greater than "0".
152	Operation speed of Operation data exceeds max. speed value.	Set operation speed to be less than or equal to max. speed set in the Basic Parameter.
153	Operation speed of Operation data is set less than bias speed.	Set operation speed to be greater than or equal to bias speed set in Basic Parameter.
155	Exceeds End/Go on/Continuous operation setting range of Operation data.	Set one from operation pattern (0:End, 1:Go on, 2: Continuous) of operation data to operate
156	Even the operation pattern settled continuous, next command cannot support continuous operation.	Set for abstract positioning control or speed control. If it is for current step command then next step command should be a interpolation command.
157	Even the operation pattern settled continuous, next command cannot support axis of current command.	If operation pattern is continuous, them set both Operation data and next step operation data equally
158	Even the operation pattern set continuous, current command cannot support continuous current command.	Continuous operation only can be operated when it is shortening position control, linear interpolation, and circular interpolation. In other commands, set operation option to end or continuous.
159	Goal position of operation data exceeds the range.	For positioning control operating change goal position more than 2,147,483,648 and less than 2,147,483,647.

Chapter 10 Positioning Error Information & Solutions

(6) Error Information of Data Writing

Error Code	Error Description	Solutions
171	Parameter writing command cannot be done because of start command execution while XG-PM is sending common parameter	Once current operation is done, eliminate error with error-reset command, then execute writing command again. Do not execute start operation while parameter sending.
172	Parameter writing command cannot be done because of start command execution while XG-PM is sending operating parameter.	Once current operation is done, eliminate error with error-reset command, then execute writing command again. Do not execute start operation while parameter sending.
173	Parameter writing command cannot be done because of start command execution while XG-PM is sending operating data.	Once current operation is done, eliminate error with error-reset command, then execute writing command again. Do not execute start operation while operating data sending.
174	Parameter writing command cannot be done because of start command execution while XG-PM is sending CAM data.	Once current operation is done, eliminate error with error-reset command, then execute writing command again. Do not execute start operation while CAM data sending.
175	Start command cannot be executed while writing sending-parameters or operating-data from XG-PM.	Execute again once writing of parameter or operating data are done.
176	It can not be saved during flash or during start-up	Data can not be written to the flash during start-up. Stop all axis startup and execute flash write again.

(7) Error Information of Positioning command and Step control

Error Code	Error Description	Solutions
190	Home return HOME signal contact set value error	Set the home position signal between %IX0.0.0 and %IX0.0.15
191	P contact point index range error	Set the P device index to a value between 0 and F.
192	I / O device duplication setting error	do not overlap Setting the I / O signals ithin the same channel. Duplicate input / output signals are not reflected in operation.

Chapter 10 Positioning Error Information & Solutions

Error Code	Error Description	Solutions
201	Homing command is not available to carry out in operation status	Check if the command axis is in operation or not when giving the homing command
203	Homing command is not available to carry out in the Driver ready OFF status	Check if the Driver ready signal of command is OFF when giving the homing command
211	Floating point setting command is not available to carry out in operation status	Check if the command axis is in operation when giving floating point setting command
212	Floating point setting command is not available to carry out in the Driver ready OFF status	Check if the Driver ready signal of command axis is OFF when giving the floating point setting command
221	Direct start command is not available to carry out in operation status	Check if the command axis is in operation when giving direct start command
223	Not possible to carry out Direct Start command in the state of M Code ON.	Check if M code signal of command axis is ON when Direct Start command is executed. XPM_MOF command can make M Code OFF.
224	Not possible to carry out Direct Start command at the absolute coordinate in the origin unsettled state.	Not possible to carry out absolute coordinate operation in the origin unsettled state. Check the coordinate of operation data to operate and the current origin determination. Available to carry out absolute coordinate operation after origin determination by Homing command or floating origin setting command.
225	Not possible to carry out Direct Start command in the state of Servo Ready OFF.	Check if Driver Ready signal of command axis is OFF when Direct Start command is executed.
226	Shortest Distance Control of Direct Start can't be executed in Incremental coordinate.	Change the coordinate from Absolute coordinate to Incremental coordinate.
227	Invalid target position in case of Shortest Distance Control at Unlimited Length Repeat mode	For Shortest Distance Control at Unlimited Length Repeat mode, target position should be higher than 0 and smaller than "Unlimited Length Repeat Position" of Extended Parameter.
230	Not possible to carry out continuous operating out Indirect Start command in the state of feed control.	Execute indirect start with setting of feed control for operation control, continuous for operating pattern if it is set as continuous or end.
231	Not possible to carry out Indirect Start command in the state of in operation.	Check if command axis is in operation when Indirect Start command is executed.
233	Not possible to carry out Indirect Start command in the state of M Code ON.	Check if M code signal of command axis is ON when Indirect Start command is executed Available to make M Code OFF by XPM_MOF command.
234	Not possible to carry out Indirect Start command at the absolute coordinate in the origin unsettled state.	Not available to carry out absolute coordinate operation in the origin unsettled state. Check the coordinate of step to operate and the current origin determination state. Available to carry out absolute coordinate operation after origin determination by Homing command or floating origin setting command.
235	Not possible to carry out Indirect Start command in the state of Servo Ready OFF.	Check if Driver Ready signal of command axis is OFF when Indirect Start command is executed.
236	Not possible to carry out Continuous operation of Indirect Start at speed control.	Check if there is no step that control method is set as speed control in the middle of Continuous operation of position control among Operation data and operation pattern is set as Continuous.

Chapter 10 Positioning Error Information & Solutions

Error Code	Error Description	Solutions
237	Step no. of POINT start is limited up to 20.	Set the step no. for POINT start to be less than 20 and greater than 1
238	Not possible to carry out Continuous operation of Indirect Start at S-Curve acceleration /deceleration pattern.	Check if acc./dec. pattern of extended parameter of command axis is set as S-Curve.
241	Not possible to carry out Linear interpolation Start in the state that main axis of linear interpolation is in operation.	Check if main axis is in operation when Linear interpolation command is executed.
242	Not possible to carry out Linear interpolation Start in the state that subordinate axis 1 of linear interpolation is in operation.	Check if subordinate axis 1 is in operation when Linear interpolation command is executed.
247	Not possible to carry out Linear interpolation Start in the state that M Code signal of main axis of Linear interpolation is ON.	Check if M Code signal of main axis is ON when Linear interpolation command is executed. Available to make M Code OFF by XPM_MOF command.
248	Not possible to carry out Linear interpolation Start in the state that M Code signal of subordinate axis 1 of Linear interpolation is ON.	Check if M Code signal of subordinate axis 1 is ON when Linear interpolation command is executed. Available to make M Code OFF by XPM_MOF command.
250	Not possible to carry out positioning operation of absolute coordinate in the state that main axis of Linear interpolation is origin unsettled.	Not available to carry out absolute coordinate operation in the origin unsettled state. Check the coordinate of step to operate and the current origin determination state. Available to carry out absolute coordinate operation after origin determination by Homing command or floating origin setting command.
251	Not possible to carry out positioning operation of absolute coordinate in the state that subordinate axis 1 of Linear interpolation is origin unsettled.	Not available to carry out absolute coordinate operation in the origin unsettled state. Check the coordinate of step to operate and the current origin determination state. Available to carry out absolute coordinate operation after origin determination by Homing command or floating origin setting command.
253	In case that main axis and subordinate axis is set wrong in Linear interpolation. (the case that the subordinate axis is not assigned, the case that only one axis is assigned, or the case that no axis is assigned)	Check if the subordinate axis is not assigned, or only one axis is assigned, or no axis is assigned when Linear interpolation command is executed.
254	Not possible to carry out the operation as Servo Ready is OFF at the main axis of Linear interpolation	Check if Driver Ready signal of master axis is OFF when Linear interpolation command is executed.
255	Not possible to carry out the operation as Servo Ready is OFF at the subordinate axis of Linear interpolation	Check if Driver Ready signal of subordinate axis is OFF when Linear interpolation command is executed.
261	Main axis speed of linear interpolation exceeds its speed limit.	Set low for main axis speed so that linear interpolation speed limit would not exceeds.
262	Not possible to insert the circular because the position of 2axis continuous linear interpolation circular insertion are longer than goal position.	Set low for position of 2 axis linear interpolation continuous operating circular insertion from expanded parameter, smaller than goal position.
263	Not possible to insert the circular because two lines of 2axis continuous linear interpolation circular insertion are at the same position.	Set again for goal position or set "0:Not insert circular" for 2 axis linear interpolation continuous operating circular insertion.

Chapter 10 Positioning Error Information & Solutions

Error Code	Error Description	Solutions
264	Not possible to insert the circular because the radius of 2axis continuous linear interpolation circular insertion are bigger than 2147483647.	Set again for goal position so those two lines would not be at the same location or set "0:Not insert circular" for 2 axis linear interpolation continuous operating circular insertion then execute linear interpolation.
265	Not possible to insert the circular because the radius of 2axis continuous linear interpolation circular insertion are rarely small or its speed limits are too high.	Make bigger for circular insert position and less for speed limit or set "0:Not insert circular" for 2 axis linear interpolation continuous operating circular insertion then execute linear interpolation.
266	Not possible to insert the circular because the circular of 2axis continuous linear interpolation circular insertion are at the same position from where it is supposedly located.	Set again for goal position so those two lines would not be at the same location or set "0:Not insert circular" for 2 axis linear interpolation continuous operating circular insertion then execute linear interpolation.
267	Interpolation operation can not be executed in upper / lower limit error or emergency stop state.	Execute the command after removing the upper / lower limit error of subordinate axis or releasing emergency stop state
270	Error of radius setting from radius circular interpolation.	Set radius setting from circular interpolation main axis operating data for 80% bigger than its half distance of beginning point to end point.
271	Not possible to carry circular interpolation start in the state that main axis of circular interpolation is in operation.	Check if main axis is in operation when circular interpolation command is executed.
272	Not possible to carry circular interpolation start in the state that subordinate axis of circular interpolation is in operation	Check if subordinate axis is in operation when circular interpolation command is executed.
275	Not possible to carry circular interpolation start in the state that M Code signal of main axis of circular interpolation is ON.	Check if M Code signal of main axis is ON when circular interpolation command is executed. Available to make M Code OFF by XPM_MOF command.
276	Not possible to carry circular interpolation start in the state that M Code signal of subordinate axis of circular interpolation is ON.	Check if M Code signal of subordinate axis is ON when circular interpolation command is executed. Available to make M Code OFF by XPM_MOF command.
277	Not possible to carry positioning operation of absolute coordinate in the state that main axis of circular interpolation is origin unsettled.	Not available to carry out absolute coordinate operation in the origin unsettled state. Check the coordinate of step to operate and the current origin determination state. Available to carry out absolute coordinate operation after origin determination by Homing command or floating origin setting command.
278	Not possible to carry positioning operation of absolute coordinate in the state that subordinate axis of circular interpolation is origin unsettled	Not available to carry out absolute coordinate operation in the origin unsettled state. Check the coordinate of step to operate and the current origin determination state. Available to carry out absolute coordinate operation after origin determination by Homing command or floating origin setting command.
279	Incorrect setting of main axis from circular Interpolation. (Either, unset main axis, incorrect helical interpolation axis, exceeding number of current possible operating axis)	Execute circular interpolation after 1.Set one more operational axis from circular interpolation data except main axis 2. Set one more operate able axis from helical interpolation.
280	Not possible to carry out the operation as Drive Ready is OFF in main axis of circular interpolation.	Check if Driver Ready signal of main axis is OFF when circular interpolation command is executed.
281	Not possible to carry out the operation as Drive Ready is OFF in subordinate axis of circular interpolation.	Check if Driver Ready signal of subordinate axis 1 is OFF when circular interpolation command is executed.

Chapter 10 Positioning Error Information & Solutions

Error Code	Error Description	Solutions
282	Not possible to carry out degree operation in circular interpolation.	Check if the unit of Basic Parameter of main axis of circular interpolation command is set as degree.
283	Not possible to carry out degree operation in circular interpolation.	Check if the unit of Basic Parameter of subordinate axis of circular interpolation command is set as degree.
284	Not possible to carry out the operation if start point =center point (middle point) or center point (middle point) =end point in circular interpolation.	Check if the center point or middle point is set as the same point as start point or end point in circular interpolation.
285	The start point and end point is Not possible to be same in the middle point mode of circular interpolation.	Check if circular interpolation method of Common parameter is set as middle point and if the position of start point is not the same as end point..
286	Radius setting error in circular interpolation.	The radius of the circle to carry out circular interpolation operation is up to 2,147,483,647pulse. Check if it is set in order to carry out the circular interpolation more than the size
287	Not possible to carry out the operation as linear profile comes out of circular interpolation.	Check if circular interpolation method of Common parameter is set as Middle point and the middle point is set to be aligned with start point and end point.
290	Since angular velocity is greater than 90°, correct circle cannot be drawn.	Set operation speed lower than 90° for circular Interpolation angular velocity.
291	Not possible to carry out Synchronous Start command in the state of in operation.	Check if the Error occurred axis is included in Synchronous Start command and if there is no axis in operation when the command is executed.
293	Not possible to carry out Synchronous Start command in the state of M Code ON.	Check if the Error occurred axis is included in Synchronous Start command and if M Code signal is ON when the command is executed. Available to make M Code OFF by XMOF command
294	Not possible to carry out Synchronous Start command in case that there is no goal position.	Check if the Error occurred axis is included in Synchronous Start command, and if the goal position of operation data of the step to operate is not the same as the current position for absolute coordinate and is set as "0" for relative coordinate.
295	Not possible to carry out Synchronous Start command in the state that Servo Ready is OFF.	Check if the Error occurred axis is included in Synchronous Start command, and if Driver Ready signal is OFF when the command is executed.
296	In case that Synchronous Start command axis setting is wrong.	Check if only one axis of Simultaneous Start command is assigned. The axis assignment address means 0 bit : 1 axis, 1 bit :2Y axis, 2 bit : 3 axis, 3 bit : 4axis and each bit is set as "1" for axis assignment
297	An error occurred from axis of synchronous start operating.	Execute synchronous start after eliminate an error element from error occurred axis.
301	Not possible to carry out Speed/Position control switching command not in the state of in operation.	Check if the axis is 'stop' state when speed/position control switching command is executed.
302	Not possible to carry out Speed/Position control switching command not in the state of speed control.	Check if the axis is 'speed control' state when speed/position control switching command is executed.
303	Not possible to carry out Speed/Position control switching command at subordinate axis of Synchronous Start operation.	Check if the axis is in operation by subordinate axis of Synchronous Start operation when speed/position control switching command is executed.

Chapter 10 Positioning Error Information & Solutions

Error Code	Error Description	Solutions
304	Not possible to carry out Speed/Position control switching command if there is no goal position.	Check if the operation has the goal position when speed /position control switching command is executed.
306	For "position specified speed/position switching instruction", when "Unlimited length repetition= enable" and "Speed/position switching coordinate=absolute", the position value which makes the object go in the opposite direction is not valid.	For "position specified speed/position switching instruction", input the positive position value for the forward direction and the negative position value for the reverse direction.
311	Not possible to carry out Position/Speed control switching command not in the state of in operation.	Check if the axis is 'stop' state when position/speed control switching command is executed.
312	Not possible to carry out Position/Speed control switching command at subordinate axis of Synchronous Start operation.	Check if the axis is in operation by subordinate axis of Synchronous Start operation when position/speed control switching command is executed.
313	Not possible to carry out Position/Speed control switching command in the state of circular interpolation operation.	Check if the axis is in circular interpolation operation when position/speed control switching command is executed.
314	Not possible to carry out Position/Speed control switching command in the state of Linear interpolation operation.	Check if the axis is in linear interpolation operation when position/speed control switching command is executed.
316	Not possible to carry out Position/Speed switching command in the state of decreasing section.	Execute Position/Speed switching command before the decreasing of axis, while in increasing section or regular section.
317	Not possible to carry out Position/Speed switching command when it is not either at the positioning control or inching operation	Execute Position/Speed switching command while the commanding axis is positioning control or inching operation
322	Not possible to carry out deceleration stop command in the state of Jog operation.	Not possible to carry out deceleration stop command in the state of Jog operation.
324	Deceleration time setting from deceleration stop commands are out of range.	The range of deceleration time is between 0 and 2147483647. Execute deceleration command after set the value from its range.
331	Not possible to carry out Skip command not in the state of in operation.	Check if the axis is 'stop' state when Skip command is executed.
332	Not possible to carry out Skip command for subordinate axis of Linear interpolation operation.	Check if the axis is in operation by subordinate axis of Linear interpolation when Skip command is executed.
333	Not possible to carry out Skip command for subordinate axis of Synchronous Start operation.	Check if the axis is in operation by subordinate axis of Synchronous Start operation when Skip command is executed.
335	Not possible to carry out Skip command in the state of Jog operation.	Check if the axis is in Jog operation when Skip command is executed.
336	Not possible to carry out Skip command in the state of Direct Start operation.	Check if the axis is in Direct Start operation when Skip command is executed.
337	Not possible to carry out Skip command in the state of Inching operation.	Check if the axis is in Inching operation when Skip command is executed.
338	Not possible to carry out Skip command for subordinate axis of circular interpolation operation.	Check if the axis is in operation by subordinate axis of circular interpolation operation when Skip command is executed.

Chapter 10 Positioning Error Information & Solutions

Error Code	Error Description	Solutions
341	Not possible to carry out Synchronous Start by Position command in the state of in operation.	Check if the axis is in operation when Synchronous Start by Position command is executed.
343	Not possible to carry out Synchronous Start by Position command in the state of M Code ON.	Check if the M Code signal of the axis is ON when Synchronous Start by Position command is executed. Available to make M Code OFF by XPM_MOF command.
344	Not possible to carry out Synchronous Start by Position command at the absolute coordinate in the state of origin unsettled.	Not available to carry out absolute coordinate operation in the origin unsettled state. Check the coordinate of step to operate and the current origin determination state. Available to carry out absolute coordinate operation after origin determination by Homing command or floating origin setting command.
345	Not possible to carry out Synchronous Start by Position command in the state that Servo Ready is OFF.	Check if Driver Ready signal of the axis is OFF when Synchronous Start by Position command is executed.
346	Not possible to carry out Synchronous Start by Position command in the state that the origin of main axis is not settled.	Check if main axis is in the origin unsettled state when Synchronous Start command is executed.
347	There is error in setting main axis/subordinate axis of Synchronous Start by Position command.	Check if main axis of Synchronous Start by Position command is set as the same as command axis. Main axis is set by writing 1~6(Axis1 ~ Axis6) and 9~12(Encoder) to the setting address.
350	Not possible to carry out Synchronous Start by Speed command in the state of in operation of main axis.	Execute Synchronous Start by Speed command while main axis is not operating when it is state of stop.
351	Not possible to carry out Synchronous Start by Speed command in the state of in operation.	Check if the axis is in operation when Synchronous Start by Speed command is executed.
353	Not possible to carry out Synchronous Start by Speed command in the state of M Code ON.	Check if the M Code signal of the axis is ON when Synchronous Start by Speed command is executed. Available to make M Code OFF by XPM_MOF command.
354	Not possible to carry out Synchronous Start by Speed command in the state that Servo Ready is OFF.	Check if Driver Ready signal of the axis is OFF when Synchronous Start by speed command is executed.
355	There is error in setting main axis/subordinate axis of Synchronous Start by Speed command.	Check if main axis of Synchronous Start by Speed command is set as the same as command axis. Main axis is set by writing 1~6(Axis1 ~ Axis6) and 9~12(Encoder) to the setting address.
356	There is error in main axis rate (main axis rate=0) of Synchronous start by speed command.	Main axis rate of Synchronous start by speed can't be 0. Set as -32768 ~ 32767 except 0.
357	The speed of Synchronous Start by Speed command cannot exceeds its speed limit.	Set low for main axis ratio/second axis ratio values so The value would not exceed its limitation.
361	Not possible to carry out Position Override command not in the state of in operation (Busy).	Check if the axis is 'stop' state when Position Override command is executed.
362	Not possible to carry out Position Override command not in the state of in dwell.	Check if the axis is in dwell when Position Override command is executed..
363	Not possible to carry out Position Override command not in the state of positioning operation.	Check if the axis is in operation by position control when Position Override command is executed.
364	Not possible to carry out Position Override command for the axis of Linear interpolation operation.	Check if the axis is in Linear interpolation operation when Position Override command is executed.

Chapter 10 Positioning Error Information & Solutions

Error Code	Error Description	Solutions
365	Not possible to carry out Position Override command for the axis of circular interpolation operation.	Check if the axis is in circular interpolation operation when Position Override command is executed.
366	Not possible to carry out Position Override command for the subordinate axis of Synchronous operation.	Check if the axis is in operation by subordinate axis of Synchronous Start operation when Position Override command is executed.
371	Not possible to carry out Speed Override command not in the state of in operation (Busy).	Check if the axis is 'stop' state when Speed Override is executed.
372	Exceeds the range of speed override value.	Speed value of Speed Override command should be less than or equal to max. speed set in Basic Parameter. Check the speed value.
373	Not possible to carry out Speed Override command for the subordinate axis of Linear interpolation operation.	Check if the axis is in operation by subordinate axis of Linear interpolation operation when Speed Override command is executed.
374	Not possible to carry out Speed Override command for the axis of circular interpolation operation.	Check if the axis is in operation by subordinate axis of circular interpolation operation when Speed Override command is executed.
375	Not possible to carry out Speed Override command for the subordinate axis of Synchronous operation.	Check if the axis is in operation by subordinate axis of Synchronous Start operation when Speed Override command is executed.
377	Not possible to carry out Speed Override command in the deceleration section.	Check if the axis is in the state of deceleration stop when Speed Override command is executed.
378	Not possible to carry out Speed Override command in S-curve acceleration/deceleration pattern.	Check if the acceleration/deceleration pattern of Extended Parameter of command axis is set as S-Curve.
381	Not possible to carry out Random position speed override command not in the state of in operation.	Check if the axis is 'stop' state when Random position speed override command is executed.
382	Not possible to carry out Random position speed override command not in positioning operation.	Check if the axis is in speed control operation when Random position speed override command is executed.
383	Exceeds the speed override value range of Random position speed override command.	Speed value of Random position speed override command should be less than or equal to max. speed set in Basic Parameter. Check the speed value.
384	Not possible to carry out Random position speed override command for the subordinate axis of Linear interpolation operation.	Check if the axis is in operation by subordinate axis of Linear interpolation operation when Random position speed override command is executed.
385	Not possible to carry out Random position speed override command for the axis of circular interpolation operation.	Check if the axis is in circular interpolation operation when Speed Override command is executed.
386	Not possible to carry out Random position speed override command for the subordinate axis of Synchronous operation.	Check if the axis is in operation by subordinate axis of Synchronous Start operation when Speed Override command is executed.
389	Not possible to carry out Random position speed override command in S-Curve acceleration / deceleration pattern.	Check if the acceleration/deceleration pattern of Extended Parameter of command axis is set as S-Curve
390	Not possible to carry out Continuous operation command in S-Curve acceleration/deceleration pattern.	Check if the acceleration/deceleration pattern of Extended Parameter of command axis is set as S-Curve
391	Not possible to carry out Continuous operation command not in the state of in operation.	Check if the axis is 'stop' state when Continuous operation command is executed.
392	Not possible to carry out Continuous operation command not in the state of in dwell.	Check if the axis is in dwell when Continuous operation command is executed.

Chapter 10 Positioning Error Information & Solutions

Error Code	Error Description	Solutions
393	Not possible to carry out Continuous operation command not in the settled of positioning operation.	Check if the axis is in speed control operation when Continuous operation command is executed.
394	Speed data value of Continuous operation command exceeds the allowable range.	Speed value of Continuous operation command should be less than or equal to max. speed set in Basic Parameter. Check the speed value.
395	Not possible to carry out Continuous operation command for the subordinate axis of Linear interpolation operation.	Check if the axis is in operation by subordinate axis of Linear interpolation operation when Continuous operation command is executed.
396	Not possible to carry out Continuous operation command for the axis of circular interpolation operation axis.	Check if the axis is in circular interpolation operation when Continuous operation command is executed.
397	Not possible to carry out Continuous operation command for the subordinate axis of Synchronous operation.	Check if the axis is in operation by subordinate axis of Synchronous Start operation when Continuous operation command is executed.
399	Not possible to carry out Continuous operation command at the last step of Operation data.	Check if the axis is in operation of 400 th step when Continuous operation command is executed.
400	Not possible to carry out Continuous operation command in the state of Direct Start operation.	Check if the axis is in operation by Direct Start command that Continuous operation command is executed.
401	Not possible to carry out Inching command in the state of in operation.	Check if the axis is in operation when Inching command is executed.
403	Not possible to carry out Inching command in the state that Drive Ready is OFF.	Check if Drive Ready signal of the axis is OFF when Inching command is executed.
411	Not possible to carry out Jog Start command in the state of in operation.	Check if the axis is in operation when Jog Start command is executed.
413	Not possible to carry out Jog Start command in the state that Servo Ready is OFF.	Check if Driver Ready signal of the axis is OFF when Jog Start command is executed.
431	Not possible to carry out Return to the Position before Manual Operation in the state of in operation.	Check if the axis is in operation when Return to the position before manual operation command is executed .
434	Not possible to carry out Return to the Position before Manual Operation in the state that Drive Ready is OFF.	Check if Driver Ready signal of the axis is ON when Return to the position before manual operation command is executed.
441	Not possible to carry out Start step no. Change/Repeat Operation Start step no. assignment command in the state of in operation.	Check if the axis is in operation when Start step no. change /repeat command is executed.
442	Exceeds the step assignment range of Start step no. Change/Repeat Operation Start step no. assignment command.	Check if the setting step value of Start step no. change command or repeat operation start step no. assignment command is greater than or equal to 1 and less than or equal to 400.
451	Not possible to carry out Current Position Preset command in the state of in operation.	Check if the axis is in operation when Current position preset command is executed.
452	Not possible to set the auxiliary position data value out of range of software high/low limit while Current Position Preset command is executed.	Check if the position value of current position preset command is within the range of soft high /low limit set in Extended Parameter.
461	Not possible to carry out Position Teaching command in the state of in operation.	Check if the axis is in operation when Position teaching command is executed.

Chapter 10 Positioning Error Information & Solutions

Error Code	Error Description	Solutions
462	Not possible to carry out Teaching Array command for the data over 16.	Check if the data no. of Teaching Array command is set in the range that is greater than or equal to 1 and less than or equal to 16.
463	Not possible to carry out Speed Teaching command in the state of in operation.	Check if the axis is in operation when Speed teaching command is executed.
465	Error from step number appointing which are about to execute teaching operation.	Make sure step for teaching operation is smaller than 400 or same as 400.
466	Teaching list error for multi teaching command.	Execute teaching command after set teaching data list as 0:position or 1:speed
467	Teaching method error for multi teaching command.	Execute teaching command after set teaching method as 0:position or 1:speed
471	Parameter teaching command cannot be Executed while its operating.	Check if the axis was operating when parameter teaching commands are executing
472	Operating data teaching command cannot be Executed while its operating.	Check if the axis was operating when operating Data teaching commands are executing
473	Set data cannot be teaching.	Execute teaching command after setting right value for parameter teaching data or operating data teaching list.
474	Parameter/Operation data saving commands cannot be done while the axis is operating.	Check if the axis is operating when Parameter/ Operation data saving commands are operating. Execute Parameter/Operation command when any axis are not operating.
475	Error of value for teaching data is out of range.	Execute teaching command after setting value of parameter teaching or operating data teaching data among its set range.
476	Error of value for teaching method is out of range.	Execute teaching command after setting value of parameter teaching or operating data teaching data for 1(RAM teaching) or 2(ROM teaching).
477	Parameter/operation data may be damaged because of power failure during saving parameter/operation data.	Write parameter/operation data by "Writing Project" instruction at XG-PM.
481	Internal emergency stop	Eliminate reason of emergency stop and execute XPM_CLR command to delete the error.
491	Error of external emergency stop	Eliminate reason of emergency stop and execute XPM_CLR command to delete the error.
492	Hard Upper Error	Be out of limited external upper signal range by using counter direct jog command. Then execute XPM_CLR command to delete the error.
493	Hard Lower Error	Be out of limited external lower signal range by using direct jog command. Then execute XPM_CLR command to delete the error.
501	Soft Upper Error	Be out of limited soft upper range by using counter direct jog command. Then execute XPM_CLR command to delete the error.
502	Soft Lower Error	Be out of limited soft upper range by using direct jog command. Then execute XCLR command to delete the error.

Chapter 10 Positioning Error Information & Solutions

Error Code	Error Description	Solutions
511	Inappropriate command	Check the commands are appropriate. Look up the references for COMMANDS.
512	Step number of auxiliary data is out of range.	Commands set for bigger than 400. Set it Between 1 and 400.
522	The command cannot be done when the signal of Drive Ready is OFF during the operation.	Execute again once Drive Ready is ON.
531	Error for Encoding number exceed from Encoder preset command.	Execute Encoder preset command after set "0" For encoder number.
532	Preset command cannot be done because of the axis which using encoder as a main axis	Execute Encoder preset when the encoder using axis is not operating
535		
541	Ellipse interpolation cannot be operated while main axis of circular interpolation is operating.	Execute the Ellipse interpolation command when main axis is not operating.
542	Ellipse interpolation cannot be operated while support axis of circular interpolation is operating.	Execute the circular interpolation command when subordinate axis is not operating
543	Ellipse interpolation start cannot be operated when M code from main axis circular interpolation is "ON."	Execute Ellipse interpolation command after set M code from main axis Ellipse interpolation is "OFF" with XPM_MOF command.
544	Ellipse interpolation start cannot be operated when M code from subordinate axis circular interpolation is "ON."	Execute Ellipse interpolation command after set M code from subordinate axis Ellipse interpolation is "OFF" with XPM_MOF command.
545	Unable to execute the determine absolute coordinate position operation when ellipse interpolation main axis is not positioned.	Execute Ellipse interpolation command after set main axis as a state of being origin with homing command or floating origin setting.
546	Unable to execute the determine absolute coordinate position operation when ellipse interpolation sub axis is not positioned.	Execute Ellipse interpolation command after set sub axis as a state of being origin with homing command or floating origin setting.
547	Incorrect setting for main and subordinate axis from Ellipse interpolation.(Unset for main/subordinate axis Set as Helical interpolation Exceed number of possible current operating Axis.)	Execute Ellipse interpolation after set a axis From subordinate axis setting beside its main axis and unset Helical interpolation.
548	Ellipse interpolation cannot be operated with middle point setting and radius setting.	Ellipse interpolation only can operate in center point setting. Execute Ellipse interpolation after changing operating data Ellipse interpolation mode for center point setting.
549	Cannot be operated when Drive Ready of Ellipse interpolation main axis is "OFF."	Execute Ellipse interpolation command after Drive Ready is "ON" of main axis.
550	Cannot be operated when Drive Ready of Ellipse interpolation subordinate axis is "OFF."	Execute Ellipse interpolation command after Drive Ready is "ON" of subordinate axis.
551	Cannot be operated when unit of Ellipse interpolation main axis is "degree."	Execute Ellipse interpolation command after Basic parameter unit is "degree" of main axis.
552	Cannot be operated when unit of Ellipse interpolation subordinate axis is "degree."	Execute Ellipse interpolation command after basic parameter unit is "degree" of subordinate axis.
553	Cannot be operated when three parameters of Ellipse interpolation are same. (start point=main point=end point)	Execute Ellipse interpolation command after set those parameters differently. (start point, main point, end point)

Chapter 10 Positioning Error Information & Solutions

Error Code	Error Description	Solutions
554	Radius setting error from Ellipse interpolation.	The range of possible execution for Ellipse Interpolation is between 0 and 2147483647. Set radius of circle from its range, smaller than 2147483647pulse.
555	Exact circle cannot be draw because of degree of Ellipse interpolation is bigger than 90°	Set lower for operation speed so that degree of Ellipse interpolation is smaller than 90°
556	Continuous operation cannot be done for Ellipse interpolation.	Execute Ellipse interpolation after terminate operation step of circular interpolation.
557	Ellipse interpolation only can be operated when control setting is circular interpolation.	Execute Ellipse interpolation after change control setting for drive step of Ellipse interpolation to circular interpolation.
558	Operation cannot be executed when beginning point and end point of ellipse interpolation are not same.	Execute Ellipse interpolation after set the goal Position of ellipse interpolation operating step Same as current position.
559	Operation cannot be executed when operating degree of ellipse interpolation is "0."	Set the value of operating degree for ellipse interpolation, larger than "0."(1~65535)
571	Operation cannot be executed because of error from sub-coordinate axis of main axis by current axis.	Check the error from subordinate axis of main axis by current axis whether it is occurred during the operation of current axis.
572	Operation cannot be executed because of error from sub coordinate axis of main axis by interpolated axis.	Check the error from subordinate axis of main axis by current axis whether it is occurred during the operation of interpolated axis.
701	Not possible to carry out CAM command in the state of in operation.	Execute CAM command when main axis is not operating.
702	Not possible to carry out CAM command in the state of M Code ON	Execute CAM command after set M Code OFF from commanding axis with XPM_MOF.
703	Not possible to carry out CAM command in the state that Drive Ready is OFF.	Execute CAM command when Drive Ready is "ON."
704	Error of setting main/subordinate axis from CAM command.	Set main axis for CAM command as other axis besides its command axis from connecting axis. Main axis is set by writing 1~6(Axis1 ~ Axis6) and 9~12(Encoder) to the setting address.
705	CAM command of main axis cannot be executed during the operation.	Execute CAM command when the main axis setting of CAM command is not operating.
706	Error of CAM block setting from CAM command.	Execute CAM command after set a CAM block from CAM command as bigger than 1 and smaller than 8.
707	Error for CAM data of appointed block from CAM command.	Execute CAM command after set right data for appointed block from CAM command.
708	The speed of subordinate axis from CAM command cannot exceed its speed limit.	Set lower speed for main axis so that speed of subordinate axis from CAM data which is calculated by subordinate position would not exceed its speed limit.

Chapter 10 Positioning Error Information & Solutions

Error Code	Error Description	Solutions
710	The speed of the master axis of cam command is so high that moving position per control period exceeds the master axis scope.	After slow down the speed of the master axis then operate the axis.
711	Data area setting value (block size and no. of block) of Variable Data Read/Write command is out of range.	Set the block size and no. of block for [block size X no. of block] to be 1~128.
712	Variable Data Write command can't be executed during operation.	Check whether any axis is under operation when executing the Variable Data Write command
713	Block area of Variable Data Write command is overlapped so Writing is unavailable.	In case the number of block is more than 2, set the block set to be larger than block size. (Or set the block size to be smaller than block offset)
721	Restart is impossible, After the command that restart is not supported like Circular interpolation,	Before using restart command, check if the command that restart is not supported is used.
722	Restart command can't be executed during operation.	Check whether any axis is under operation.
733	The module (H / W) currently used does not support the setting position output function.	In order to use the setting position output function, please replace with the module (H / W) that supports the function
801	Current module of command axis is set lager than number of possible operating axis.	Execute after set a possible operating number of command axis for current module.
811	Previous command is not processed. It is impossible to execute command additionally.	Check previous command is executed. If the process is finished, execute other command additionally

Chapter 11 Internal Memory Address of “Read/Write Variable Data” command

11.1 Parameter memory address

	Axis 1		Axis 2		Axis 3		Axis 4		Axis 5		Axis 6		
	DEC	HEX	DEC	HEX	DEC	HEX	DEC	HEX	DEC	HEX	DEC	HEX	
Basic Parameter	0	0	80	50	160	A0	240	F0	320	140	400	190	Speed limit (Low)
	1	1	81	51	161	A1	241	F1	321	141	401	191	Speed limit (High)
	2	2	82	52	162	A2	242	F2	322	142	402	192	Bias speed (Low)
	3	3	83	53	163	A3	243	F3	323	143	403	193	Bias speed (High)
	4	4	84	54	164	A4	244	F4	324	144	404	194	Acc. time1 (Low)
	5	5	85	55	165	A5	245	F5	325	145	405	195	Acc. time1 (High)
	6	6	86	56	166	A6	246	F6	326	146	406	196	Acc. time2 (Low)
	7	7	87	57	167	A7	247	F7	327	147	407	197	Acc. time2 (High)
	8	8	88	58	168	A8	248	F8	328	148	408	198	Acc. time3 (Low)
	9	9	89	59	169	A9	249	F9	329	149	409	199	Acc. time3 (High)
	10	A	90	5A	170	AA	250	FA	330	14A	410	19A	Acc. time4 (Low)
	11	B	91	5B	171	AB	251	FB	331	14B	411	19B	Acc. time4 (High)
	12	C	92	5C	172	AC	252	FC	332	14C	412	19C	Dec. time1 (Low)
	13	D	93	5D	173	AD	253	FD	333	14D	413	19D	Dec. time1 (High)
	14	E	94	5E	174	AE	254	FE	334	14E	414	19E	Dec. time2 (Low)
	15	F	95	5F	175	AF	255	FF	335	14F	415	19F	Dec. time2 (High)
	16	10	96	60	176	B0	256	100	336	150	416	1A0	Dec. time3 (Low)
	17	11	97	61	177	B1	257	101	337	151	417	1A1	Dec. time3 (High)
	18	12	98	62	178	B2	258	102	338	152	418	1A2	Dec. time4 (Low)
	19	13	99	63	179	B3	259	103	339	153	419	1A3	Dec. time4 (High)
	20	14	100	64	180	B4	260	104	340	154	420	1A4	Dec. time for EMG stop (Low)
	21	15	101	65	181	B5	261	105	341	155	421	1A5	Dec. time for EMG stop (High)
	22	16	102	66	182	B6	262	106	342	156	422	1A6	Pulse per rotation (Low)
	23	17	103	67	183	B7	263	107	343	157	423	1A7	Pulse per rotation (High)
	24	18	104	68	184	B8	264	108	344	158	424	1A8	Distance per rotation (Low)
	25	19	105	69	185	B9	265	109	345	159	425	1A9	Distance per rotation (High)
	26	1A	106	6A	186	BA	266	10A	346	15A	426	1AA	CONTROL WORD
27	1B	107	6B	187	BB	267	10B	347	15B	427	1AB	Rsvd.	
Extended parameter	28	1C	108	6C	188	BC	268	10C	348	15C	428	1AC	S/W upper limit (Low)
	29	1D	109	6D	189	BD	269	10D	349	15D	429	1AD	S/W upper limit (High)
	30	1E	110	6E	190	BE	270	10E	350	15E	430	1AE	S/W lower limit (Low)
	31	1F	111	6F	191	BF	271	10F	351	15F	431	1AF	S/W lower limit (High)
	32	20	112	70	192	C0	272	110	352	160	432	1B0	Backlash compensation
	33	21	113	71	193	C1	273	111	353	161	433	1B1	Position completion time

Chapter 11 Internal Memory Address of “Read/Write Variable Data” command

	34	22	114	72	194	C2	274	112	354	162	434	1B2	S-curve ratio
	35	23	115	73	195	C3	275	113	355	163	435	1B3	Rsvd.
	36	24	116	74	196	C4	276	114	356	164	436	1B4	Infinite repeat position(Low)
	37	25	117	75	197	C5	277	115	357	165	437	1B5	Infinite repeat position (High)
	38	26	118	76	198	C6	278	116	358	166	438	1B6	Arc insertion position (Low)
	39	27	119	77	199	C7	279	117	359	167	439	1B7	Arc insertion position (High)
	40	28	120	78	200	C8	280	118	360	168	440	1B8	CONTROL WORD
	41	29	121	79	201	C9	281	119	361	169	441	1B9	Rsvd.
Manual operation parameter	42	2A	122	7A	202	CA	282	11A	362	16A	442	1BA	JOG high speed (Low)
	43	2B	123	7B	203	CB	283	11B	363	16B	443	1BB	JOG high speed (High)
	44	2C	124	7C	204	CC	284	11C	364	16C	444	1BC	JOG low speed (Low)
	45	2D	125	7D	205	CD	285	11D	365	16D	445	1BD	JOG low speed (High)
	46	2E	126	7E	206	CE	286	11E	366	16E	446	1BE	JOG acc. time (Low)
	47	2F	127	7F	207	CF	287	11F	367	16F	447	1BF	JOG acc. time (High)
	48	30	128	80	208	D0	288	120	368	170	448	1C0	JOG dec. time (Low)
	49	31	129	81	209	D1	289	121	369	171	449	1C1	JOG dec. time (High)
	50	32	130	82	210	D2	290	122	370	172	450	1C2	Inching speed
	51	33	131	83	211	D3	291	123	371	173	451	1C3	Rsvd
Homing parameter	52	34	132	84	212	D4	292	124	372	174	452	1C4	Home position (Low)
	53	35	133	85	213	D5	293	125	373	175	453	1C5	Home position (High)
	54	36	134	86	214	D6	294	126	374	176	454	1C6	Home high speed (Low)
	55	37	135	87	215	D7	295	127	375	177	455	1C7	Home high speed (High)
	56	38	136	88	216	D8	296	128	376	178	456	1C8	Home low speed (Low)
	57	39	137	89	217	D9	297	129	377	179	457	1C9	Home low speed (High)
	58	3A	138	8A	218	DA	298	12A	378	17A	458	1CA	Home acc. time (Low)
	59	3B	139	8B	219	DB	299	12B	379	17B	459	1CB	Home acc. time (High)
	60	3C	140	8C	220	DC	300	12C	380	17C	460	1CC	Home dec. time (Low)
	61	3D	141	8D	221	DD	301	12D	381	17D	461	1CD	Home dec. time (High)
	62	3E	142	8E	222	DE	302	12E	382	17E	462	1CE	Home compensation (Low)
	63	3F	143	8F	223	DF	303	12F	383	17F	463	1CF	Home compensation (High)
	64	40	144	90	224	E0	304	130	384	180	464	1D0	Home restart time
	65	41	145	91	225	E1	305	131	385	181	465	1D1	Home dwell time
	66	42	146	92	226	E2	306	132	386	182	466	1D2	CONTROL WORD
67	43	137	89	207	CF	277	115	387	183	467	1D3	Rsvd	
I/O signal parameter	68	44	148	94	228	E4	308	134	388	184	468	1D4	I/O signal parameter
	69	45	149	95	229	E5	309	135	389	185	469	1D5	Rsvd.
	70	46	150	96	230	E6	310	136	390	186	470	1D6	Upper limit signal

Chapter 11 Internal Memory Address of “Read/Write Variable Data” command

													WORD OFFSET	
	71	47	151	97	231	E7	311	137	391	187	471	1D7	Upper limit signal bit Index	
	72	48	152	98	232	E8	312	138	392	188	472	1D8	lower limit signal WORD OFFSET	
	73	49	153	99	233	E9	313	139	393	189	473	1D9	lower limit signal bit Index	
	74	4A	154	9A	234	EA	314	13A	394	18A	474	1DA	DOG WORD OFFSET	
	75	4B	155	9B	235	EB	315	13B	395	18B	475	1DB	DOG bit Index	
	76	4C	156	9C	236	EC	316	13C	396	18C	476	1DC	HOME WORD OFFSET	
	77	4D	157	9D	237	ED	317	13D	397	18D	477	1DD	HOME bit Index	
	78	4E	158	9E	238	EE	318	13E	398	18E	478	1DE	Deviation CNT WORD OFFSET	
	79	4F	159	9F	239	EF	319	13F	399	18F	479	1DF	Deviation CNT bit Index	
Common parameter												640	280	CONTROL WORD
												641	281	Rsvd
												642	282	Rsvd
												643	283	Rsvd
												644	284	Rsvd
												645	285	Rsvd
												646	286	Rsvd
												647	287	Rsvd
												648	288	Rsvd
												648	289	Rsvd

Chapter 11 Internal Memory Address of “Read/Write Variable Data” command

(1) Basic parameter Control Word

Bit position	Contents
Pulse output mode (bit 2 ~ 3)	0: pulse
	1: mm
	2: inch
	3: degree
Unit multiplier (bit 4 ~ 5)	0: x1
	1: x10
	2: x100
	3: x1000
Speed command unit (bit 6)	0:Unit/Time
	1:rpm

(2) Extended parameter Control Word

Bit position	Contents
Pulse output direction (bit 0)	0: CW, 1: CCW
Acceleration/Deceleration pattern (bit 1)	0:Trapezoid operation, 1:S-Curve operation
M Code mode(bit 2 ~ 3)	0: NONE, 1: WITH, 2: AFTER
Interpolation speed selection (bit 4)	0: main axis speed, 1: synthetic speed
Software limit detection during speed control (bit 5)	0:Don't detect, 1: Detect
Reserved (bit6~8)	-
Speed/Position switching coordinate (bit 9)	0: Incremental, 1: Absolute
Reserved (bit 10 ~ 11)	-
Infinite running repeat (bit 12)	0: Disable, 1: Enable
Interpolation continuous operation Type (bit 13)	0 : Pass target position, 1 : Pass near position
Arc insertion in 2-axis linear interpolation continuous operation (bit 14)	0 : Don't insert , 1 : Insert arc continuous operation
Pos.-specified speed override coordinate(bit 15)	0: absolute, 1: incremental

(3) Homing parameter Control Word

Bit position	Contents
Home method (bit 0 ~ 2)	0: DOG/HOME(OFF)
	1: DOG/HOME(ON)
	2: U.L. Limit/HOME
	3: DOG
	4: High speed
	5: Upper/lower limit
	6: Home
Home direction (bit 3)	0: Forward
	1: Reverse

(4) I/O signal parameter Control Word

Bit position and contents	
bit0~1: High limit	0: No use
bit2~3: Low limit	1: A
bit4~5: DOG	2: B
bit6~7: HOME	
bit8~9: Deviation clear	

(5) Common parameter Control Word

Bit position	Contents
Control period(bit4~7)	1ms~10ms
Speed override (bit 8)	0: Specify %
	1: Specify speed
Pulse output level (bit 15)	0: Low Active
	1: High Active

11.2 Axis 1 operation data memory address

Step	Target position		Cir. int. auxiliary point		Operation speed		Dwell time	M code	Sub. Axis setting	Helical int.	Circular int. turns	Control word
	Low	High	Low	High	Low	High						
1	650	651	652	653	654	655	656	657	658	659	660	661
2	662	663	664	665	666	667	668	669	670	671	672	673
3	674	675	676	677	678	679	680	681	682	683	684	685
4	686	687	688	689	690	691	692	693	694	695	696	697
5	698	699	700	701	702	703	704	705	706	707	708	709
6	710	711	712	713	714	715	716	717	718	719	720	721
7	722	723	724	725	726	727	728	729	730	731	732	733
8	734	735	736	737	738	739	740	741	742	743	744	745
9	746	747	748	749	750	751	752	753	754	755	756	757
10	758	759	760	761	762	763	764	765	766	767	768	769
11	770	771	772	773	774	775	776	777	778	779	780	781
12	782	783	784	785	786	787	788	789	790	791	792	793
13	794	795	796	797	798	799	800	801	802	803	804	805
14	806	807	808	809	810	811	812	813	814	815	816	817
15	818	819	820	821	822	823	824	825	826	827	828	829
16	830	831	832	833	834	835	836	837	838	839	840	841
17	842	843	844	845	846	847	848	849	850	851	852	853
18	854	855	856	857	858	859	860	861	862	863	864	865
19	866	867	868	869	870	871	872	873	874	875	876	877
20	878	879	880	881	882	883	884	885	886	887	888	889
21	890	891	892	893	894	895	896	897	898	899	900	901
22	902	903	904	905	906	907	908	909	910	911	912	913
23	914	915	916	917	918	919	920	921	922	923	924	925
24	926	927	928	929	930	931	932	933	934	935	936	937
25	938	939	940	941	942	943	944	945	946	947	948	949
26	950	951	952	953	954	955	956	957	958	959	960	961
27	962	963	964	965	966	967	968	969	970	971	972	973
28	974	975	976	977	978	979	980	981	982	983	984	985
29	986	987	988	989	990	991	992	993	994	995	996	997
30	998	999	1000	1001	1002	1003	1004	1005	1006	1007	1008	1009
31	1010	1011	1012	1013	1014	1015	1016	1017	1018	1019	1020	1021
32	1022	1023	1024	1025	1026	1027	1028	1029	1030	1031	1032	1033
33	1034	1035	1036	1037	1038	1039	1040	1041	1042	1043	1044	1045
34	1046	1047	1048	1049	1050	1051	1052	1053	1054	1055	1056	1057
35	1058	1059	1060	1061	1062	1063	1064	1065	1066	1067	1068	1069
36	1070	1071	1072	1073	1074	1075	1076	1077	1078	1079	1080	1081
37	1082	1083	1084	1085	1086	1087	1088	1089	1090	1091	1092	1093
38	1094	1095	1096	1097	1098	1099	1100	1101	1102	1103	1104	1105
39	1106	1107	1108	1109	1110	1111	1112	1113	1114	1115	1116	1117
40	1118	1119	1120	1121	1122	1123	1124	1125	1126	1127	1128	1129
41	1130	1131	1132	1133	1134	1135	1136	1137	1138	1139	1140	1141

Chapter 11 Internal Memory Address of “Read/Write Variable Data” command

42	1142	1143	1144	1145	1146	1147	1148	1149	1150	1151	1152	1153
43	1154	1155	1156	1157	1158	1159	1160	1161	1162	1163	1164	1165
44	1166	1167	1168	1169	1170	1171	1172	1173	1174	1175	1176	1177
45	1178	1179	1180	1181	1182	1183	1184	1185	1186	1187	1188	1189
46	1190	1191	1192	1193	1194	1195	1196	1197	1198	1199	1200	1201
47	1202	1203	1204	1205	1206	1207	1208	1209	1210	1211	1212	1213
48	1214	1215	1216	1217	1218	1219	1220	1221	1222	1223	1224	1225
49	1226	1227	1228	1229	1230	1231	1232	1233	1234	1235	1236	1237
50	1238	1239	1240	1241	1242	1243	1244	1245	1246	1247	1248	1249
51	1250	1251	1252	1253	1254	1255	1256	1257	1258	1259	1260	1261
52	1262	1263	1264	1265	1266	1267	1268	1269	1270	1271	1272	1273
53	1274	1275	1276	1277	1278	1279	1280	1281	1282	1283	1284	1285
54	1286	1287	1288	1289	1290	1291	1292	1293	1294	1295	1296	1297
55	1298	1299	1300	1301	1302	1303	1304	1305	1306	1307	1308	1309
56	1310	1311	1312	1313	1314	1315	1316	1317	1318	1319	1320	1321
57	1322	1323	1324	1325	1326	1327	1328	1329	1330	1331	1332	1333
58	1334	1335	1336	1337	1338	1339	1340	1341	1342	1343	1344	1345
59	1346	1347	1348	1349	1350	1351	1352	1353	1354	1355	1356	1357
60	1358	1359	1360	1361	1362	1363	1364	1365	1366	1367	1368	1369
61	1370	1371	1372	1373	1374	1375	1376	1377	1378	1379	1380	1381
62	1382	1383	1384	1385	1386	1387	1388	1389	1390	1391	1392	1393
63	1394	1395	1396	1397	1398	1399	1400	1401	1402	1403	1404	1405
64	1406	1407	1408	1409	1410	1411	1412	1413	1414	1415	1416	1417
65	1418	1419	1420	1421	1422	1423	1424	1425	1426	1427	1428	1429
66	1430	1431	1432	1433	1434	1435	1436	1437	1438	1439	1440	1441
67	1442	1443	1444	1445	1446	1447	1448	1449	1450	1451	1452	1453
68	1454	1455	1456	1457	1458	1459	1460	1461	1462	1463	1464	1465
69	1466	1467	1468	1469	1470	1471	1472	1473	1474	1475	1476	1477
70	1478	1479	1480	1481	1482	1483	1484	1485	1486	1487	1488	1489
71	1490	1491	1492	1493	1494	1495	1496	1497	1498	1499	1500	1501
72	1502	1503	1504	1505	1506	1507	1508	1509	1510	1511	1512	1513
73	1514	1515	1516	1517	1518	1519	1520	1521	1522	1523	1524	1525
74	1526	1527	1528	1529	1530	1531	1532	1533	1534	1535	1536	1537
75	1538	1539	1540	1541	1542	1543	1544	1545	1546	1547	1548	1549
76	1550	1551	1552	1553	1554	1555	1556	1557	1558	1559	1560	1561
77	1562	1563	1564	1565	1566	1567	1568	1569	1570	1571	1572	1573
78	1574	1575	1576	1577	1578	1579	1580	1581	1582	1583	1584	1585
79	1586	1587	1588	1589	1590	1591	1592	1593	1594	1595	1596	1597
80	1598	1599	1600	1601	1602	1603	1604	1605	1606	1607	1608	1609
81	1610	1611	1612	1613	1614	1615	1616	1617	1618	1619	1620	1621
82	1622	1623	1624	1625	1626	1627	1628	1629	1630	1631	1632	1633
83	1634	1635	1636	1637	1638	1639	1640	1641	1642	1643	1644	1645
84	1646	1647	1648	1649	1650	1651	1652	1653	1654	1655	1656	1657
85	1658	1659	1660	1661	1662	1663	1664	1665	1666	1667	1668	1669
86	1670	1671	1672	1673	1674	1675	1676	1677	1678	1679	1680	1681
87	1682	1683	1684	1685	1686	1687	1688	1689	1690	1691	1692	1693
88	1694	1695	1696	1697	1698	1699	1700	1701	1702	1703	1704	1705

Chapter 11 Internal Memory Address of “Read/Write Variable Data” command

89	1706	1707	1708	1709	1710	1711	1712	1713	1714	1715	1716	1717
90	1718	1719	1720	1721	1722	1723	1724	1725	1726	1727	1728	1729
91	1730	1731	1732	1733	1734	1735	1736	1737	1738	1739	1740	1741
92	1742	1743	1744	1745	1746	1747	1748	1749	1750	1751	1752	1753
93	1754	1755	1756	1757	1758	1759	1760	1761	1762	1763	1764	1765
94	1766	1767	1768	1769	1770	1771	1772	1773	1774	1775	1776	1777
95	1778	1779	1780	1781	1782	1783	1784	1785	1786	1787	1788	1789
96	1790	1791	1792	1793	1794	1795	1796	1797	1798	1799	1800	1801
97	1802	1803	1804	1805	1806	1807	1808	1809	1810	1811	1812	1813
98	1814	1815	1816	1817	1818	1819	1820	1821	1822	1823	1824	1825
99	1826	1827	1828	1829	1830	1831	1832	1833	1834	1835	1836	1837
100	1838	1839	1840	1841	1842	1843	1844	1845	1846	1847	1848	1849
101	1850	1851	1852	1853	1854	1855	1856	1857	1858	1859	1860	1861
102	1862	1863	1864	1865	1866	1867	1868	1869	1870	1871	1872	1873
103	1874	1875	1876	1877	1878	1879	1880	1881	1882	1883	1884	1885
104	1886	1887	1888	1889	1890	1891	1892	1893	1894	1895	1896	1897
105	1898	1899	1900	1901	1902	1903	1904	1905	1906	1907	1908	1909
106	1910	1911	1912	1913	1914	1915	1916	1917	1918	1919	1920	1921
107	1922	1923	1924	1925	1926	1927	1928	1929	1930	1931	1932	1933
108	1934	1935	1936	1937	1938	1939	1940	1941	1942	1943	1944	1945
109	1946	1947	1948	1949	1950	1951	1952	1953	1954	1955	1956	1957
110	1958	1959	1960	1961	1962	1963	1964	1965	1966	1967	1968	1969
111	1970	1971	1972	1973	1974	1975	1976	1977	1978	1979	1980	1981
112	1982	1983	1984	1985	1986	1987	1988	1989	1990	1991	1992	1993
113	1994	1995	1996	1997	1998	1999	2000	2001	2002	2003	2004	2005
114	2006	2007	2008	2009	2010	2011	2012	2013	2014	2015	2016	2017
115	2018	2019	2020	2021	2022	2023	2024	2025	2026	2027	2028	2029
116	2030	2031	2032	2033	2034	2035	2036	2037	2038	2039	2040	2041
117	2042	2043	2044	2045	2046	2047	2048	2049	2050	2051	2052	2053
118	2054	2055	2056	2057	2058	2059	2060	2061	2062	2063	2064	2065
119	2066	2067	2068	2069	2070	2071	2072	2073	2074	2075	2076	2077
120	2078	2079	2080	2081	2082	2083	2084	2085	2086	2087	2088	2089
121	2090	2091	2092	2093	2094	2095	2096	2097	2098	2099	2100	2101
122	2102	2103	2104	2105	2106	2107	2108	2109	2110	2111	2112	2113
123	2114	2115	2116	2117	2118	2119	2120	2121	2122	2123	2124	2125
124	2126	2127	2128	2129	2130	2131	2132	2133	2134	2135	2136	2137
125	2138	2139	2140	2141	2142	2143	2144	2145	2146	2147	2148	2149
126	2150	2151	2152	2153	2154	2155	2156	2157	2158	2159	2160	2161
127	2162	2163	2164	2165	2166	2167	2168	2169	2170	2171	2172	2173
128	2174	2175	2176	2177	2178	2179	2180	2181	2182	2183	2184	2185
129	2186	2187	2188	2189	2190	2191	2192	2193	2194	2195	2196	2197
130	2198	2199	2200	2201	2202	2203	2204	2205	2206	2207	2208	2209
131	2210	2211	2212	2213	2214	2215	2216	2217	2218	2219	2220	2221
132	2222	2223	2224	2225	2226	2227	2228	2229	2230	2231	2232	2233
133	2234	2235	2236	2237	2238	2239	2240	2241	2242	2243	2244	2245
134	2246	2247	2248	2249	2250	2251	2252	2253	2254	2255	2256	2257
135	2258	2259	2260	2261	2262	2263	2264	2265	2266	2267	2268	2269

Chapter 11 Internal Memory Address of “Read/Write Variable Data” command

136	2270	2271	2272	2273	2274	2275	2276	2277	2278	2279	2280	2281
137	2282	2283	2284	2285	2286	2287	2288	2289	2290	2291	2292	2293
138	2294	2295	2296	2297	2298	2299	2300	2301	2302	2303	2304	2305
139	2306	2307	2308	2309	2310	2311	2312	2313	2314	2315	2316	2317
140	2318	2319	2320	2321	2322	2323	2324	2325	2326	2327	2328	2329
141	2330	2331	2332	2333	2334	2335	2336	2337	2338	2339	2340	2341
142	2342	2343	2344	2345	2346	2347	2348	2349	2350	2351	2352	2353
143	2354	2355	2356	2357	2358	2359	2360	2361	2362	2363	2364	2365
144	2366	2367	2368	2369	2370	2371	2372	2373	2374	2375	2376	2377
145	2378	2379	2380	2381	2382	2383	2384	2385	2386	2387	2388	2389
146	2390	2391	2392	2393	2394	2395	2396	2397	2398	2399	2400	2401
147	2402	2403	2404	2405	2406	2407	2408	2409	2410	2411	2412	2413
148	2414	2415	2416	2417	2418	2419	2420	2421	2422	2423	2424	2425
149	2426	2427	2428	2429	2430	2431	2432	2433	2434	2435	2436	2437
150	2438	2439	2440	2441	2442	2443	2444	2445	2446	2447	2448	2449
151	2450	2451	2452	2453	2454	2455	2456	2457	2458	2459	2460	2461
152	2462	2463	2464	2465	2466	2467	2468	2469	2470	2471	2472	2473
153	2474	2475	2476	2477	2478	2479	2480	2481	2482	2483	2484	2485
154	2486	2487	2488	2489	2490	2491	2492	2493	2494	2495	2496	2497
155	2498	2499	2500	2501	2502	2503	2504	2505	2506	2507	2508	2509
156	2510	2511	2512	2513	2514	2515	2516	2517	2518	2519	2520	2521
157	2522	2523	2524	2525	2526	2527	2528	2529	2530	2531	2532	2533
158	2534	2535	2536	2537	2538	2539	2540	2541	2542	2543	2544	2545
159	2546	2547	2548	2549	2550	2551	2552	2553	2554	2555	2556	2557
160	2558	2559	2560	2561	2562	2563	2564	2565	2566	2567	2568	2569
161	2570	2571	2572	2573	2574	2575	2576	2577	2578	2579	2580	2581
162	2582	2583	2584	2585	2586	2587	2588	2589	2590	2591	2592	2593
163	2594	2595	2596	2597	2598	2599	2600	2601	2602	2603	2604	2605
164	2606	2607	2608	2609	2610	2611	2612	2613	2614	2615	2616	2617
165	2618	2619	2620	2621	2622	2623	2624	2625	2626	2627	2628	2629
166	2630	2631	2632	2633	2634	2635	2636	2637	2638	2639	2640	2641
167	2642	2643	2644	2645	2646	2647	2648	2649	2650	2651	2652	2653
168	2654	2655	2656	2657	2658	2659	2660	2661	2662	2663	2664	2665
169	2666	2667	2668	2669	2670	2671	2672	2673	2674	2675	2676	2677
170	2678	2679	2680	2681	2682	2683	2684	2685	2686	2687	2688	2689
171	2690	2691	2692	2693	2694	2695	2696	2697	2698	2699	2700	2701
172	2702	2703	2704	2705	2706	2707	2708	2709	2710	2711	2712	2713
173	2714	2715	2716	2717	2718	2719	2720	2721	2722	2723	2724	2725
174	2726	2727	2728	2729	2730	2731	2732	2733	2734	2735	2736	2737
175	2738	2739	2740	2741	2742	2743	2744	2745	2746	2747	2748	2749
176	2750	2751	2752	2753	2754	2755	2756	2757	2758	2759	2760	2761
177	2762	2763	2764	2765	2766	2767	2768	2769	2770	2771	2772	2773
178	2774	2775	2776	2777	2778	2779	2780	2781	2782	2783	2784	2785
179	2786	2787	2788	2789	2790	2791	2792	2793	2794	2795	2796	2797
180	2798	2799	2800	2801	2802	2803	2804	2805	2806	2807	2808	2809
181	2810	2811	2812	2813	2814	2815	2816	2817	2818	2819	2820	2821
182	2822	2823	2824	2825	2826	2827	2828	2829	2830	2831	2832	2833

Chapter 11 Internal Memory Address of “Read/Write Variable Data” command

183	2834	2835	2836	2837	2838	2839	2840	2841	2842	2843	2844	2845
184	2846	2847	2848	2849	2850	2851	2852	2853	2854	2855	2856	2857
185	2858	2859	2860	2861	2862	2863	2864	2865	2866	2867	2868	2869
186	2870	2871	2872	2873	2874	2875	2876	2877	2878	2879	2880	2881
187	2882	2883	2884	2885	2886	2887	2888	2889	2890	2891	2892	2893
188	2894	2895	2896	2897	2898	2899	2900	2901	2902	2903	2904	2905
189	2906	2907	2908	2909	2910	2911	2912	2913	2914	2915	2916	2917
190	2918	2919	2920	2921	2922	2923	2924	2925	2926	2927	2928	2929
191	2930	2931	2932	2933	2934	2935	2936	2937	2938	2939	2940	2941
192	2942	2943	2944	2945	2946	2947	2948	2949	2950	2951	2952	2953
193	2954	2955	2956	2957	2958	2959	2960	2961	2962	2963	2964	2965
194	2966	2967	2968	2969	2970	2971	2972	2973	2974	2975	2976	2977
195	2978	2979	2980	2981	2982	2983	2984	2985	2986	2987	2988	2989
196	2990	2991	2992	2993	2994	2995	2996	2997	2998	2999	3000	3001
197	3002	3003	3004	3005	3006	3007	3008	3009	3010	3011	3012	3013
198	3014	3015	3016	3017	3018	3019	3020	3021	3022	3023	3024	3025
199	3026	3027	3028	3029	3030	3031	3032	3033	3034	3035	3036	3037
200	3038	3039	3040	3041	3042	3043	3044	3045	3046	3047	3048	3049
201	3050	3051	3052	3053	3054	3055	3056	3057	3058	3059	3060	3061
202	3062	3063	3064	3065	3066	3067	3068	3069	3070	3071	3072	3073
203	3074	3075	3076	3077	3078	3079	3080	3081	3082	3083	3084	3085
204	3086	3087	3088	3089	3090	3091	3092	3093	3094	3095	3096	3097
205	3098	3099	3100	3101	3102	3103	3104	3105	3106	3107	3108	3109
206	3110	3111	3112	3113	3114	3115	3116	3117	3118	3119	3120	3121
207	3122	3123	3124	3125	3126	3127	3128	3129	3130	3131	3132	3133
208	3134	3135	3136	3137	3138	3139	3140	3141	3142	3143	3144	3145
209	3146	3147	3148	3149	3150	3151	3152	3153	3154	3155	3156	3157
210	3158	3159	3160	3161	3162	3163	3164	3165	3166	3167	3168	3169
211	3170	3171	3172	3173	3174	3175	3176	3177	3178	3179	3180	3181
212	3182	3183	3184	3185	3186	3187	3188	3189	3190	3191	3192	3193
213	3194	3195	3196	3197	3198	3199	3200	3201	3202	3203	3204	3205
214	3206	3207	3208	3209	3210	3211	3212	3213	3214	3215	3216	3217
215	3218	3219	3220	3221	3222	3223	3224	3225	3226	3227	3228	3229
216	3230	3231	3232	3233	3234	3235	3236	3237	3238	3239	3240	3241
217	3242	3243	3244	3245	3246	3247	3248	3249	3250	3251	3252	3253
218	3254	3255	3256	3257	3258	3259	3260	3261	3262	3263	3264	3265
219	3266	3267	3268	3269	3270	3271	3272	3273	3274	3275	3276	3277
220	3278	3279	3280	3281	3282	3283	3284	3285	3286	3287	3288	3289
221	3290	3291	3292	3293	3294	3295	3296	3297	3298	3299	3300	3301
222	3302	3303	3304	3305	3306	3307	3308	3309	3310	3311	3312	3313
223	3314	3315	3316	3317	3318	3319	3320	3321	3322	3323	3324	3325
224	3326	3327	3328	3329	3330	3331	3332	3333	3334	3335	3336	3337
225	3338	3339	3340	3341	3342	3343	3344	3345	3346	3347	3348	3349
226	3350	3351	3352	3353	3354	3355	3356	3357	3358	3359	3360	3361
227	3362	3363	3364	3365	3366	3367	3368	3369	3370	3371	3372	3373
228	3374	3375	3376	3377	3378	3379	3380	3381	3382	3383	3384	3385
229	3386	3387	3388	3389	3390	3391	3392	3393	3394	3395	3396	3397

Chapter 11 Internal Memory Address of “Read/Write Variable Data” command

230	3398	3399	3400	3401	3402	3403	3404	3405	3406	3407	3408	3409
231	3410	3411	3412	3413	3414	3415	3416	3417	3418	3419	3420	3421
232	3422	3423	3424	3425	3426	3427	3428	3429	3430	3431	3432	3433
233	3434	3435	3436	3437	3438	3439	3440	3441	3442	3443	3444	3445
234	3446	3447	3448	3449	3450	3451	3452	3453	3454	3455	3456	3457
235	3458	3459	3460	3461	3462	3463	3464	3465	3466	3467	3468	3469
236	3470	3471	3472	3473	3474	3475	3476	3477	3478	3479	3480	3481
237	3482	3483	3484	3485	3486	3487	3488	3489	3490	3491	3492	3493
238	3494	3495	3496	3497	3498	3499	3500	3501	3502	3503	3504	3505
239	3506	3507	3508	3509	3510	3511	3512	3513	3514	3515	3516	3517
240	3518	3519	3520	3521	3522	3523	3524	3525	3526	3527	3528	3529
241	3530	3531	3532	3533	3534	3535	3536	3537	3538	3539	3540	3541
242	3542	3543	3544	3545	3546	3547	3548	3549	3550	3551	3552	3553
243	3554	3555	3556	3557	3558	3559	3560	3561	3562	3563	3564	3565
244	3566	3567	3568	3569	3570	3571	3572	3573	3574	3575	3576	3577
245	3578	3579	3580	3581	3582	3583	3584	3585	3586	3587	3588	3589
246	3590	3591	3592	3593	3594	3595	3596	3597	3598	3599	3600	3601
247	3602	3603	3604	3605	3606	3607	3608	3609	3610	3611	3612	3613
248	3614	3615	3616	3617	3618	3619	3620	3621	3622	3623	3624	3625
249	3626	3627	3628	3629	3630	3631	3632	3633	3634	3635	3636	3637
250	3638	3639	3640	3641	3642	3643	3644	3645	3646	3647	3648	3649
251	3650	3651	3652	3653	3654	3655	3656	3657	3658	3659	3660	3661
252	3662	3663	3664	3665	3666	3667	3668	3669	3670	3671	3672	3673
253	3674	3675	3676	3677	3678	3679	3680	3681	3682	3683	3684	3685
254	3686	3687	3688	3689	3690	3691	3692	3693	3694	3695	3696	3697
255	3698	3699	3700	3701	3702	3703	3704	3705	3706	3707	3708	3709
256	3710	3711	3712	3713	3714	3715	3716	3717	3718	3719	3720	3721
257	3722	3723	3724	3725	3726	3727	3728	3729	3730	3731	3732	3733
258	3734	3735	3736	3737	3738	3739	3740	3741	3742	3743	3744	3745
259	3746	3747	3748	3749	3750	3751	3752	3753	3754	3755	3756	3757
260	3758	3759	3760	3761	3762	3763	3764	3765	3766	3767	3768	3769
261	3770	3771	3772	3773	3774	3775	3776	3777	3778	3779	3780	3781
262	3782	3783	3784	3785	3786	3787	3788	3789	3790	3791	3792	3793
263	3794	3795	3796	3797	3798	3799	3800	3801	3802	3803	3804	3805
264	3806	3807	3808	3809	3810	3811	3812	3813	3814	3815	3816	3817
265	3818	3819	3820	3821	3822	3823	3824	3825	3826	3827	3828	3829
266	3830	3831	3832	3833	3834	3835	3836	3837	3838	3839	3840	3841
267	3842	3843	3844	3845	3846	3847	3848	3849	3850	3851	3852	3853
268	3854	3855	3856	3857	3858	3859	3860	3861	3862	3863	3864	3865
269	3866	3867	3868	3869	3870	3871	3872	3873	3874	3875	3876	3877
270	3878	3879	3880	3881	3882	3883	3884	3885	3886	3887	3888	3889
271	3890	3891	3892	3893	3894	3895	3896	3897	3898	3899	3900	3901
272	3902	3903	3904	3905	3906	3907	3908	3909	3910	3911	3912	3913
273	3914	3915	3916	3917	3918	3919	3920	3921	3922	3923	3924	3925
274	3926	3927	3928	3929	3930	3931	3932	3933	3934	3935	3936	3937
275	3938	3939	3940	3941	3942	3943	3944	3945	3946	3947	3948	3949
276	3950	3951	3952	3953	3954	3955	3956	3957	3958	3959	3960	3961

Chapter 11 Internal Memory Address of “Read/Write Variable Data” command

277	3962	3963	3964	3965	3966	3967	3968	3969	3970	3971	3972	3973
278	3974	3975	3976	3977	3978	3979	3980	3981	3982	3983	3984	3985
279	3986	3987	3988	3989	3990	3991	3992	3993	3994	3995	3996	3997
280	3998	3999	4000	4001	4002	4003	4004	4005	4006	4007	4008	4009
281	4010	4011	4012	4013	4014	4015	4016	4017	4018	4019	4020	4021
282	4022	4023	4024	4025	4026	4027	4028	4029	4030	4031	4032	4033
283	4034	4035	4036	4037	4038	4039	4040	4041	4042	4043	4044	4045
284	4046	4047	4048	4049	4050	4051	4052	4053	4054	4055	4056	4057
285	4058	4059	4060	4061	4062	4063	4064	4065	4066	4067	4068	4069
286	4070	4071	4072	4073	4074	4075	4076	4077	4078	4079	4080	4081
287	4082	4083	4084	4085	4086	4087	4088	4089	4090	4091	4092	4093
288	4094	4095	4096	4097	4098	4099	4100	4101	4102	4103	4104	4105
289	4106	4107	4108	4109	4110	4111	4112	4113	4114	4115	4116	4117
290	4118	4119	4120	4121	4122	4123	4124	4125	4126	4127	4128	4129
291	4130	4131	4132	4133	4134	4135	4136	4137	4138	4139	4140	4141
292	4142	4143	4144	4145	4146	4147	4148	4149	4150	4151	4152	4153
293	4154	4155	4156	4157	4158	4159	4160	4161	4162	4163	4164	4165
294	4166	4167	4168	4169	4170	4171	4172	4173	4174	4175	4176	4177
295	4178	4179	4180	4181	4182	4183	4184	4185	4186	4187	4188	4189
296	4190	4191	4192	4193	4194	4195	4196	4197	4198	4199	4200	4201
297	4202	4203	4204	4205	4206	4207	4208	4209	4210	4211	4212	4213
298	4214	4215	4216	4217	4218	4219	4220	4221	4222	4223	4224	4225
299	4226	4227	4228	4229	4230	4231	4232	4233	4234	4235	4236	4237
300	4238	4239	4240	4241	4242	4243	4244	4245	4246	4247	4248	4249
301	4250	4251	4252	4253	4254	4255	4256	4257	4258	4259	4260	4261
302	4262	4263	4264	4265	4266	4267	4268	4269	4270	4271	4272	4273
303	4274	4275	4276	4277	4278	4279	4280	4281	4282	4283	4284	4285
304	4286	4287	4288	4289	4290	4291	4292	4293	4294	4295	4296	4297
305	4298	4299	4300	4301	4302	4303	4304	4305	4306	4307	4308	4309
306	4310	4311	4312	4313	4314	4315	4316	4317	4318	4319	4320	4321
307	4322	4323	4324	4325	4326	4327	4328	4329	4330	4331	4332	4333
308	4334	4335	4336	4337	4338	4339	4340	4341	4342	4343	4344	4345
309	4346	4347	4348	4349	4350	4351	4352	4353	4354	4355	4356	4357
310	4358	4359	4360	4361	4362	4363	4364	4365	4366	4367	4368	4369
311	4370	4371	4372	4373	4374	4375	4376	4377	4378	4379	4380	4381
312	4382	4383	4384	4385	4386	4387	4388	4389	4390	4391	4392	4393
313	4394	4395	4396	4397	4398	4399	4400	4401	4402	4403	4404	4405
314	4406	4407	4408	4409	4410	4411	4412	4413	4414	4415	4416	4417
315	4418	4419	4420	4421	4422	4423	4424	4425	4426	4427	4428	4429
316	4430	4431	4432	4433	4434	4435	4436	4437	4438	4439	4440	4441
317	4442	4443	4444	4445	4446	4447	4448	4449	4450	4451	4452	4453
318	4454	4455	4456	4457	4458	4459	4460	4461	4462	4463	4464	4465
319	4466	4467	4468	4469	4470	4471	4472	4473	4474	4475	4476	4477
320	4478	4479	4480	4481	4482	4483	4484	4485	4486	4487	4488	4489
321	4490	4491	4492	4493	4494	4495	4496	4497	4498	4499	4500	4501
322	4502	4503	4504	4505	4506	4507	4508	4509	4510	4511	4512	4513
323	4514	4515	4516	4517	4518	4519	4520	4521	4522	4523	4524	4525

Chapter 11 Internal Memory Address of “Read/Write Variable Data” command

324	4526	4527	4528	4529	4530	4531	4532	4533	4534	4535	4536	4537
325	4538	4539	4540	4541	4542	4543	4544	4545	4546	4547	4548	4549
326	4550	4551	4552	4553	4554	4555	4556	4557	4558	4559	4560	4561
327	4562	4563	4564	4565	4566	4567	4568	4569	4570	4571	4572	4573
328	4574	4575	4576	4577	4578	4579	4580	4581	4582	4583	4584	4585
329	4586	4587	4588	4589	4590	4591	4592	4593	4594	4595	4596	4597
330	4598	4599	4600	4601	4602	4603	4604	4605	4606	4607	4608	4609
331	4610	4611	4612	4613	4614	4615	4616	4617	4618	4619	4620	4621
332	4622	4623	4624	4625	4626	4627	4628	4629	4630	4631	4632	4633
333	4634	4635	4636	4637	4638	4639	4640	4641	4642	4643	4644	4645
334	4646	4647	4648	4649	4650	4651	4652	4653	4654	4655	4656	4657
335	4658	4659	4660	4661	4662	4663	4664	4665	4666	4667	4668	4669
336	4670	4671	4672	4673	4674	4675	4676	4677	4678	4679	4680	4681
337	4682	4683	4684	4685	4686	4687	4688	4689	4690	4691	4692	4693
338	4694	4695	4696	4697	4698	4699	4700	4701	4702	4703	4704	4705
339	4706	4707	4708	4709	4710	4711	4712	4713	4714	4715	4716	4717
340	4718	4719	4720	4721	4722	4723	4724	4725	4726	4727	4728	4729
341	4730	4731	4732	4733	4734	4735	4736	4737	4738	4739	4740	4741
342	4742	4743	4744	4745	4746	4747	4748	4749	4750	4751	4752	4753
343	4754	4755	4756	4757	4758	4759	4760	4761	4762	4763	4764	4765
344	4766	4767	4768	4769	4770	4771	4772	4773	4774	4775	4776	4777
345	4778	4779	4780	4781	4782	4783	4784	4785	4786	4787	4788	4789
346	4790	4791	4792	4793	4794	4795	4796	4797	4798	4799	4800	4801
347	4802	4803	4804	4805	4806	4807	4808	4809	4810	4811	4812	4813
348	4814	4815	4816	4817	4818	4819	4820	4821	4822	4823	4824	4825
349	4826	4827	4828	4829	4830	4831	4832	4833	4834	4835	4836	4837
350	4838	4839	4840	4841	4842	4843	4844	4845	4846	4847	4848	4849
351	4850	4851	4852	4853	4854	4855	4856	4857	4858	4859	4860	4861
352	4862	4863	4864	4865	4866	4867	4868	4869	4870	4871	4872	4873
353	4874	4875	4876	4877	4878	4879	4880	4881	4882	4883	4884	4885
354	4886	4887	4888	4889	4890	4891	4892	4893	4894	4895	4896	4897
355	4898	4899	4900	4901	4902	4903	4904	4905	4906	4907	4908	4909
356	4910	4911	4912	4913	4914	4915	4916	4917	4918	4919	4920	4921
357	4922	4923	4924	4925	4926	4927	4928	4929	4930	4931	4932	4933
358	4934	4935	4936	4937	4938	4939	4940	4941	4942	4943	4944	4945
359	4946	4947	4948	4949	4950	4951	4952	4953	4954	4955	4956	4957
360	4958	4959	4960	4961	4962	4963	4964	4965	4966	4967	4968	4969
361	4970	4971	4972	4973	4974	4975	4976	4977	4978	4979	4980	4981
362	4982	4983	4984	4985	4986	4987	4988	4989	4990	4991	4992	4993
363	4994	4995	4996	4997	4998	4999	5000	5001	5002	5003	5004	5005
364	5006	5007	5008	5009	5010	5011	5012	5013	5014	5015	5016	5017
365	5018	5019	5020	5021	5022	5023	5024	5025	5026	5027	5028	5029
366	5030	5031	5032	5033	5034	5035	5036	5037	5038	5039	5040	5041
367	5042	5043	5044	5045	5046	5047	5048	5049	5050	5051	5052	5053
368	5054	5055	5056	5057	5058	5059	5060	5061	5062	5063	5064	5065
369	5066	5067	5068	5069	5070	5071	5072	5073	5074	5075	5076	5077
370	5078	5079	5080	5081	5082	5083	5084	5085	5086	5087	5088	5089

Chapter 11 Internal Memory Address of “Read/Write Variable Data” command

371	5090	5091	5092	5093	5094	5095	5096	5097	5098	5099	5100	5101
372	5102	5103	5104	5105	5106	5107	5108	5109	5110	5111	5112	5113
373	5114	5115	5116	5117	5118	5119	5120	5121	5122	5123	5124	5125
374	5126	5127	5128	5129	5130	5131	5132	5133	5134	5135	5136	5137
375	5138	5139	5140	5141	5142	5143	5144	5145	5146	5147	5148	5149
376	5150	5151	5152	5153	5154	5155	5156	5157	5158	5159	5160	5161
377	5162	5163	5164	5165	5166	5167	5168	5169	5170	5171	5172	5173
378	5174	5175	5176	5177	5178	5179	5180	5181	5182	5183	5184	5185
379	5186	5187	5188	5189	5190	5191	5192	5193	5194	5195	5196	5197
380	5198	5199	5200	5201	5202	5203	5204	5205	5206	5207	5208	5209
381	5210	5211	5212	5213	5214	5215	5216	5217	5218	5219	5220	5221
382	5222	5223	5224	5225	5226	5227	5228	5229	5230	5231	5232	5233
383	5234	5235	5236	5237	5238	5239	5240	5241	5242	5243	5244	5245
384	5246	5247	5248	5249	5250	5251	5252	5253	5254	5255	5256	5257
385	5258	5259	5260	5261	5262	5263	5264	5265	5266	5267	5268	5269
386	5270	5271	5272	5273	5274	5275	5276	5277	5278	5279	5280	5281
387	5282	5283	5284	5285	5286	5287	5288	5289	5290	5291	5292	5293
388	5294	5295	5296	5297	5298	5299	5300	5301	5302	5303	5304	5305
389	5306	5307	5308	5309	5310	5311	5312	5313	5314	5315	5316	5317
390	5318	5319	5320	5321	5322	5323	5324	5325	5326	5327	5328	5329
391	5330	5331	5332	5333	5334	5335	5336	5337	5338	5339	5340	5341
392	5342	5343	5344	5345	5346	5347	5348	5349	5350	5351	5352	5353
393	5354	5355	5356	5357	5358	5359	5360	5361	5362	5363	5364	5365
394	5366	5367	5368	5369	5370	5371	5372	5373	5374	5375	5376	5377
395	5378	5379	5380	5381	5382	5383	5384	5385	5386	5387	5388	5389
396	5390	5391	5392	5393	5394	5395	5396	5397	5398	5399	5400	5401
397	5402	5403	5404	5405	5406	5407	5408	5409	5410	5411	5412	5413
398	5414	5415	5416	5417	5418	5419	5420	5421	5422	5423	5424	5425
399	5426	5427	5428	5429	5430	5431	5432	5433	5434	5435	5436	5437
400	5438	5439	5440	5441	5442	5443	5444	5445	5446	5447	5448	5449

11.3 Axis 2 operation data memory address

Step	Target position		Cir. int. auxiliary point		Operation speed		Dwell time	M code	Sub. Axis setting	Helical int.	Circular int. turns	Control word
	Low	High	Low	High	Low	High						
1	5450	5451	5452	5453	5454	5455	5456	5457	5458	5459	5460	5461
2	5462	5463	5464	5465	5466	5467	5468	5469	5470	5471	5472	5473
3	5474	5475	5476	5477	5478	5479	5480	5481	5482	5483	5484	5485
4	5486	5487	5488	5489	5490	5491	5492	5493	5494	5495	5496	5497
5	5498	5499	5500	5501	5502	5503	5504	5505	5506	5507	5508	5509
6	5510	5511	5512	5513	5514	5515	5516	5517	5518	5519	5520	5521
7	5522	5523	5524	5525	5526	5527	5528	5529	5530	5531	5532	5533
8	5534	5535	5536	5537	5538	5539	5540	5541	5542	5543	5544	5545
9	5546	5547	5548	5549	5550	5551	5552	5553	5554	5555	5556	5557
10	5558	5559	5560	5561	5562	5563	5564	5565	5566	5567	5568	5569
11	5570	5571	5572	5573	5574	5575	5576	5577	5578	5579	5580	5581
12	5582	5583	5584	5585	5586	5587	5588	5589	5590	5591	5592	5593
13	5594	5595	5596	5597	5598	5599	5600	5601	5602	5603	5604	5605
14	5606	5607	5608	5609	5610	5611	5612	5613	5614	5615	5616	5617
15	5618	5619	5620	5621	5622	5623	5624	5625	5626	5627	5628	5629
16	5630	5631	5632	5633	5634	5635	5636	5637	5638	5639	5640	5641
17	5642	5643	5644	5645	5646	5647	5648	5649	5650	5651	5652	5653
18	5654	5655	5656	5657	5658	5659	5660	5661	5662	5663	5664	5665
19	5666	5667	5668	5669	5670	5671	5672	5673	5674	5675	5676	5677
20	5678	5679	5680	5681	5682	5683	5684	5685	5686	5687	5688	5689
21	5690	5691	5692	5693	5694	5695	5696	5697	5698	5699	5700	5701
22	5702	5703	5704	5705	5706	5707	5708	5709	5710	5711	5712	5713
23	5714	5715	5716	5717	5718	5719	5720	5721	5722	5723	5724	5725
24	5726	5727	5728	5729	5730	5731	5732	5733	5734	5735	5736	5737
25	5738	5739	5740	5741	5742	5743	5744	5745	5746	5747	5748	5749
26	5750	5751	5752	5753	5754	5755	5756	5757	5758	5759	5760	5761
27	5762	5763	5764	5765	5766	5767	5768	5769	5770	5771	5772	5773
28	5774	5775	5776	5777	5778	5779	5780	5781	5782	5783	5784	5785
29	5786	5787	5788	5789	5790	5791	5792	5793	5794	5795	5796	5797
30	5798	5799	5800	5801	5802	5803	5804	5805	5806	5807	5808	5809
31	5810	5811	5812	5813	5814	5815	5816	5817	5818	5819	5820	5821
32	5822	5823	5824	5825	5826	5827	5828	5829	5830	5831	5832	5833
33	5834	5835	5836	5837	5838	5839	5840	5841	5842	5843	5844	5845
34	5846	5847	5848	5849	5850	5851	5852	5853	5854	5855	5856	5857
35	5858	5859	5860	5861	5862	5863	5864	5865	5866	5867	5868	5869
36	5870	5871	5872	5873	5874	5875	5876	5877	5878	5879	5880	5881
37	5882	5883	5884	5885	5886	5887	5888	5889	5890	5891	5892	5893
38	5894	5895	5896	5897	5898	5899	5900	5901	5902	5903	5904	5905
39	5906	5907	5908	5909	5910	5911	5912	5913	5914	5915	5916	5917
40	5918	5919	5920	5921	5922	5923	5924	5925	5926	5927	5928	5929
41	5930	5931	5932	5933	5934	5935	5936	5937	5938	5939	5940	5941

Chapter 11 Internal Memory Address of “Read/Write Variable Data” command

42	5942	5943	5944	5945	5946	5947	5948	5949	5950	5951	5952	5953
43	5954	5955	5956	5957	5958	5959	5960	5961	5962	5963	5964	5965
44	5966	5967	5968	5969	5970	5971	5972	5973	5974	5975	5976	5977
45	5978	5979	5980	5981	5982	5983	5984	5985	5986	5987	5988	5989
46	5990	5991	5992	5993	5994	5995	5996	5997	5998	5999	6000	6001
47	6002	6003	6004	6005	6006	6007	6008	6009	6010	6011	6012	6013
48	6014	6015	6016	6017	6018	6019	6020	6021	6022	6023	6024	6025
49	6026	6027	6028	6029	6030	6031	6032	6033	6034	6035	6036	6037
50	6038	6039	6040	6041	6042	6043	6044	6045	6046	6047	6048	6049
51	6050	6051	6052	6053	6054	6055	6056	6057	6058	6059	6060	6061
52	6062	6063	6064	6065	6066	6067	6068	6069	6070	6071	6072	6073
53	6074	6075	6076	6077	6078	6079	6080	6081	6082	6083	6084	6085
54	6086	6087	6088	6089	6090	6091	6092	6093	6094	6095	6096	6097
55	6098	6099	6100	6101	6102	6103	6104	6105	6106	6107	6108	6109
56	6110	6111	6112	6113	6114	6115	6116	6117	6118	6119	6120	6121
57	6122	6123	6124	6125	6126	6127	6128	6129	6130	6131	6132	6133
58	6134	6135	6136	6137	6138	6139	6140	6141	6142	6143	6144	6145
59	6146	6147	6148	6149	6150	6151	6152	6153	6154	6155	6156	6157
60	6158	6159	6160	6161	6162	6163	6164	6165	6166	6167	6168	6169
61	6170	6171	6172	6173	6174	6175	6176	6177	6178	6179	6180	6181
62	6182	6183	6184	6185	6186	6187	6188	6189	6190	6191	6192	6193
63	6194	6195	6196	6197	6198	6199	6200	6201	6202	6203	6204	6205
64	6206	6207	6208	6209	6210	6211	6212	6213	6214	6215	6216	6217
65	6218	6219	6220	6221	6222	6223	6224	6225	6226	6227	6228	6229
66	6230	6231	6232	6233	6234	6235	6236	6237	6238	6239	6240	6241
67	6242	6243	6244	6245	6246	6247	6248	6249	6250	6251	6252	6253
68	6254	6255	6256	6257	6258	6259	6260	6261	6262	6263	6264	6265
69	6266	6267	6268	6269	6270	6271	6272	6273	6274	6275	6276	6277
70	6278	6279	6280	6281	6282	6283	6284	6285	6286	6287	6288	6289
71	6290	6291	6292	6293	6294	6295	6296	6297	6298	6299	6300	6301
72	6302	6303	6304	6305	6306	6307	6308	6309	6310	6311	6312	6313
73	6314	6315	6316	6317	6318	6319	6320	6321	6322	6323	6324	6325
74	6326	6327	6328	6329	6330	6331	6332	6333	6334	6335	6336	6337
75	6338	6339	6340	6341	6342	6343	6344	6345	6346	6347	6348	6349
76	6350	6351	6352	6353	6354	6355	6356	6357	6358	6359	6360	6361
77	6362	6363	6364	6365	6366	6367	6368	6369	6370	6371	6372	6373
78	6374	6375	6376	6377	6378	6379	6380	6381	6382	6383	6384	6385
79	6386	6387	6388	6389	6390	6391	6392	6393	6394	6395	6396	6397
80	6398	6399	6400	6401	6402	6403	6404	6405	6406	6407	6408	6409
81	6410	6411	6412	6413	6414	6415	6416	6417	6418	6419	6420	6421
82	6422	6423	6424	6425	6426	6427	6428	6429	6430	6431	6432	6433
83	6434	6435	6436	6437	6438	6439	6440	6441	6442	6443	6444	6445
84	6446	6447	6448	6449	6450	6451	6452	6453	6454	6455	6456	6457
85	6458	6459	6460	6461	6462	6463	6464	6465	6466	6467	6468	6469
86	6470	6471	6472	6473	6474	6475	6476	6477	6478	6479	6480	6481
87	6482	6483	6484	6485	6486	6487	6488	6489	6490	6491	6492	6493
88	6494	6495	6496	6497	6498	6499	6500	6501	6502	6503	6504	6505

Chapter 11 Internal Memory Address of “Read/Write Variable Data” command

89	6506	6507	6508	6509	6510	6511	6512	6513	6514	6515	6516	6517
90	6518	6519	6520	6521	6522	6523	6524	6525	6526	6527	6528	6529
91	6530	6531	6532	6533	6534	6535	6536	6537	6538	6539	6540	6541
92	6542	6543	6544	6545	6546	6547	6548	6549	6550	6551	6552	6553
93	6554	6555	6556	6557	6558	6559	6560	6561	6562	6563	6564	6565
94	6566	6567	6568	6569	6570	6571	6572	6573	6574	6575	6576	6577
95	6578	6579	6580	6581	6582	6583	6584	6585	6586	6587	6588	6589
96	6590	6591	6592	6593	6594	6595	6596	6597	6598	6599	6600	6601
97	6602	6603	6604	6605	6606	6607	6608	6609	6610	6611	6612	6613
98	6614	6615	6616	6617	6618	6619	6620	6621	6622	6623	6624	6625
99	6626	6627	6628	6629	6630	6631	6632	6633	6634	6635	6636	6637
100	6638	6639	6640	6641	6642	6643	6644	6645	6646	6647	6648	6649
101	6650	6651	6652	6653	6654	6655	6656	6657	6658	6659	6660	6661
102	6662	6663	6664	6665	6666	6667	6668	6669	6670	6671	6672	6673
103	6674	6675	6676	6677	6678	6679	6680	6681	6682	6683	6684	6685
104	6686	6687	6688	6689	6690	6691	6692	6693	6694	6695	6696	6697
105	6698	6699	6700	6701	6702	6703	6704	6705	6706	6707	6708	6709
106	6710	6711	6712	6713	6714	6715	6716	6717	6718	6719	6720	6721
107	6722	6723	6724	6725	6726	6727	6728	6729	6730	6731	6732	6733
108	6734	6735	6736	6737	6738	6739	6740	6741	6742	6743	6744	6745
109	6746	6747	6748	6749	6750	6751	6752	6753	6754	6755	6756	6757
110	6758	6759	6760	6761	6762	6763	6764	6765	6766	6767	6768	6769
111	6770	6771	6772	6773	6774	6775	6776	6777	6778	6779	6780	6781
112	6782	6783	6784	6785	6786	6787	6788	6789	6790	6791	6792	6793
113	6794	6795	6796	6797	6798	6799	6800	6801	6802	6803	6804	6805
114	6806	6807	6808	6809	6810	6811	6812	6813	6814	6815	6816	6817
115	6818	6819	6820	6821	6822	6823	6824	6825	6826	6827	6828	6829
116	6830	6831	6832	6833	6834	6835	6836	6837	6838	6839	6840	6841
117	6842	6843	6844	6845	6846	6847	6848	6849	6850	6851	6852	6853
118	6854	6855	6856	6857	6858	6859	6860	6861	6862	6863	6864	6865
119	6866	6867	6868	6869	6870	6871	6872	6873	6874	6875	6876	6877
120	6878	6879	6880	6881	6882	6883	6884	6885	6886	6887	6888	6889
121	6890	6891	6892	6893	6894	6895	6896	6897	6898	6899	6900	6901
122	6902	6903	6904	6905	6906	6907	6908	6909	6910	6911	6912	6913
123	6914	6915	6916	6917	6918	6919	6920	6921	6922	6923	6924	6925
124	6926	6927	6928	6929	6930	6931	6932	6933	6934	6935	6936	6937
125	6938	6939	6940	6941	6942	6943	6944	6945	6946	6947	6948	6949
126	6950	6951	6952	6953	6954	6955	6956	6957	6958	6959	6960	6961
127	6962	6963	6964	6965	6966	6967	6968	6969	6970	6971	6972	6973
128	6974	6975	6976	6977	6978	6979	6980	6981	6982	6983	6984	6985
129	6986	6987	6988	6989	6990	6991	6992	6993	6994	6995	6996	6997
130	6998	6999	7000	7001	7002	7003	7004	7005	7006	7007	7008	7009
131	7010	7011	7012	7013	7014	7015	7016	7017	7018	7019	7020	7021
132	7022	7023	7024	7025	7026	7027	7028	7029	7030	7031	7032	7033
133	7034	7035	7036	7037	7038	7039	7040	7041	7042	7043	7044	7045
134	7046	7047	7048	7049	7050	7051	7052	7053	7054	7055	7056	7057
135	7058	7059	7060	7061	7062	7063	7064	7065	7066	7067	7068	7069

Chapter 11 Internal Memory Address of “Read/Write Variable Data” command

136	7070	7071	7072	7073	7074	7075	7076	7077	7078	7079	7080	7081
137	7082	7083	7084	7085	7086	7087	7088	7089	7090	7091	7092	7093
138	7094	7095	7096	7097	7098	7099	7100	7101	7102	7103	7104	7105
139	7106	7107	7108	7109	7110	7111	7112	7113	7114	7115	7116	7117
140	7118	7119	7120	7121	7122	7123	7124	7125	7126	7127	7128	7129
141	7130	7131	7132	7133	7134	7135	7136	7137	7138	7139	7140	7141
142	7142	7143	7144	7145	7146	7147	7148	7149	7150	7151	7152	7153
143	7154	7155	7156	7157	7158	7159	7160	7161	7162	7163	7164	7165
144	7166	7167	7168	7169	7170	7171	7172	7173	7174	7175	7176	7177
145	7178	7179	7180	7181	7182	7183	7184	7185	7186	7187	7188	7189
146	7190	7191	7192	7193	7194	7195	7196	7197	7198	7199	7200	7201
147	7202	7203	7204	7205	7206	7207	7208	7209	7210	7211	7212	7213
148	7214	7215	7216	7217	7218	7219	7220	7221	7222	7223	7224	7225
149	7226	7227	7228	7229	7230	7231	7232	7233	7234	7235	7236	7237
150	7238	7239	7240	7241	7242	7243	7244	7245	7246	7247	7248	7249
151	7250	7251	7252	7253	7254	7255	7256	7257	7258	7259	7260	7261
152	7262	7263	7264	7265	7266	7267	7268	7269	7270	7271	7272	7273
153	7274	7275	7276	7277	7278	7279	7280	7281	7282	7283	7284	7285
154	7286	7287	7288	7289	7290	7291	7292	7293	7294	7295	7296	7297
155	7298	7299	7300	7301	7302	7303	7304	7305	7306	7307	7308	7309
156	7310	7311	7312	7313	7314	7315	7316	7317	7318	7319	7320	7321
157	7322	7323	7324	7325	7326	7327	7328	7329	7330	7331	7332	7333
158	7334	7335	7336	7337	7338	7339	7340	7341	7342	7343	7344	7345
159	7346	7347	7348	7349	7350	7351	7352	7353	7354	7355	7356	7357
160	7358	7359	7360	7361	7362	7363	7364	7365	7366	7367	7368	7369
161	7370	7371	7372	7373	7374	7375	7376	7377	7378	7379	7380	7381
162	7382	7383	7384	7385	7386	7387	7388	7389	7390	7391	7392	7393
163	7394	7395	7396	7397	7398	7399	7400	7401	7402	7403	7404	7405
164	7406	7407	7408	7409	7410	7411	7412	7413	7414	7415	7416	7417
165	7418	7419	7420	7421	7422	7423	7424	7425	7426	7427	7428	7429
166	7430	7431	7432	7433	7434	7435	7436	7437	7438	7439	7440	7441
167	7442	7443	7444	7445	7446	7447	7448	7449	7450	7451	7452	7453
168	7454	7455	7456	7457	7458	7459	7460	7461	7462	7463	7464	7465
169	7466	7467	7468	7469	7470	7471	7472	7473	7474	7475	7476	7477
170	7478	7479	7480	7481	7482	7483	7484	7485	7486	7487	7488	7489
171	7490	7491	7492	7493	7494	7495	7496	7497	7498	7499	7500	7501
172	7502	7503	7504	7505	7506	7507	7508	7509	7510	7511	7512	7513
173	7514	7515	7516	7517	7518	7519	7520	7521	7522	7523	7524	7525
174	7526	7527	7528	7529	7530	7531	7532	7533	7534	7535	7536	7537
175	7538	7539	7540	7541	7542	7543	7544	7545	7546	7547	7548	7549
176	7550	7551	7552	7553	7554	7555	7556	7557	7558	7559	7560	7561
177	7562	7563	7564	7565	7566	7567	7568	7569	7570	7571	7572	7573
178	7574	7575	7576	7577	7578	7579	7580	7581	7582	7583	7584	7585
179	7586	7587	7588	7589	7590	7591	7592	7593	7594	7595	7596	7597
180	7598	7599	7600	7601	7602	7603	7604	7605	7606	7607	7608	7609
181	7610	7611	7612	7613	7614	7615	7616	7617	7618	7619	7620	7621
182	7622	7623	7624	7625	7626	7627	7628	7629	7630	7631	7632	7633

Chapter 11 Internal Memory Address of “Read/Write Variable Data” command

183	7634	7635	7636	7637	7638	7639	7640	7641	7642	7643	7644	7645
184	7646	7647	7648	7649	7650	7651	7652	7653	7654	7655	7656	7657
185	7658	7659	7660	7661	7662	7663	7664	7665	7666	7667	7668	7669
186	7670	7671	7672	7673	7674	7675	7676	7677	7678	7679	7680	7681
187	7682	7683	7684	7685	7686	7687	7688	7689	7690	7691	7692	7693
188	7694	7695	7696	7697	7698	7699	7700	7701	7702	7703	7704	7705
189	7706	7707	7708	7709	7710	7711	7712	7713	7714	7715	7716	7717
190	7718	7719	7720	7721	7722	7723	7724	7725	7726	7727	7728	7729
191	7730	7731	7732	7733	7734	7735	7736	7737	7738	7739	7740	7741
192	7742	7743	7744	7745	7746	7747	7748	7749	7750	7751	7752	7753
193	7754	7755	7756	7757	7758	7759	7760	7761	7762	7763	7764	7765
194	7766	7767	7768	7769	7770	7771	7772	7773	7774	7775	7776	7777
195	7778	7779	7780	7781	7782	7783	7784	7785	7786	7787	7788	7789
196	7790	7791	7792	7793	7794	7795	7796	7797	7798	7799	7800	7801
197	7802	7803	7804	7805	7806	7807	7808	7809	7810	7811	7812	7813
198	7814	7815	7816	7817	7818	7819	7820	7821	7822	7823	7824	7825
199	7826	7827	7828	7829	7830	7831	7832	7833	7834	7835	7836	7837
200	7838	7839	7840	7841	7842	7843	7844	7845	7846	7847	7848	7849
201	7850	7851	7852	7853	7854	7855	7856	7857	7858	7859	7860	7861
202	7862	7863	7864	7865	7866	7867	7868	7869	7870	7871	7872	7873
203	7874	7875	7876	7877	7878	7879	7880	7881	7882	7883	7884	7885
204	7886	7887	7888	7889	7890	7891	7892	7893	7894	7895	7896	7897
205	7898	7899	7900	7901	7902	7903	7904	7905	7906	7907	7908	7909
206	7910	7911	7912	7913	7914	7915	7916	7917	7918	7919	7920	7921
207	7922	7923	7924	7925	7926	7927	7928	7929	7930	7931	7932	7933
208	7934	7935	7936	7937	7938	7939	7940	7941	7942	7943	7944	7945
209	7946	7947	7948	7949	7950	7951	7952	7953	7954	7955	7956	7957
210	7958	7959	7960	7961	7962	7963	7964	7965	7966	7967	7968	7969
211	7970	7971	7972	7973	7974	7975	7976	7977	7978	7979	7980	7981
212	7982	7983	7984	7985	7986	7987	7988	7989	7990	7991	7992	7993
213	7994	7995	7996	7997	7998	7999	8000	8001	8002	8003	8004	8005
214	8006	8007	8008	8009	8010	8011	8012	8013	8014	8015	8016	8017
215	8018	8019	8020	8021	8022	8023	8024	8025	8026	8027	8028	8029
216	8030	8031	8032	8033	8034	8035	8036	8037	8038	8039	8040	8041
217	8042	8043	8044	8045	8046	8047	8048	8049	8050	8051	8052	8053
218	8054	8055	8056	8057	8058	8059	8060	8061	8062	8063	8064	8065
219	8066	8067	8068	8069	8070	8071	8072	8073	8074	8075	8076	8077
220	8078	8079	8080	8081	8082	8083	8084	8085	8086	8087	8088	8089
221	8090	8091	8092	8093	8094	8095	8096	8097	8098	8099	8100	8101
222	8102	8103	8104	8105	8106	8107	8108	8109	8110	8111	8112	8113
223	8114	8115	8116	8117	8118	8119	8120	8121	8122	8123	8124	8125
224	8126	8127	8128	8129	8130	8131	8132	8133	8134	8135	8136	8137
225	8138	8139	8140	8141	8142	8143	8144	8145	8146	8147	8148	8149
226	8150	8151	8152	8153	8154	8155	8156	8157	8158	8159	8160	8161
227	8162	8163	8164	8165	8166	8167	8168	8169	8170	8171	8172	8173
228	8174	8175	8176	8177	8178	8179	8180	8181	8182	8183	8184	8185
229	8186	8187	8188	8189	8190	8191	8192	8193	8194	8195	8196	8197

Chapter 11 Internal Memory Address of “Read/Write Variable Data” command

230	8198	8199	8200	8201	8202	8203	8204	8205	8206	8207	8208	8209
231	8210	8211	8212	8213	8214	8215	8216	8217	8218	8219	8220	8221
232	8222	8223	8224	8225	8226	8227	8228	8229	8230	8231	8232	8233
233	8234	8235	8236	8237	8238	8239	8240	8241	8242	8243	8244	8245
234	8246	8247	8248	8249	8250	8251	8252	8253	8254	8255	8256	8257
235	8258	8259	8260	8261	8262	8263	8264	8265	8266	8267	8268	8269
236	8270	8271	8272	8273	8274	8275	8276	8277	8278	8279	8280	8281
237	8282	8283	8284	8285	8286	8287	8288	8289	8290	8291	8292	8293
238	8294	8295	8296	8297	8298	8299	8300	8301	8302	8303	8304	8305
239	8306	8307	8308	8309	8310	8311	8312	8313	8314	8315	8316	8317
240	8318	8319	8320	8321	8322	8323	8324	8325	8326	8327	8328	8329
241	8330	8331	8332	8333	8334	8335	8336	8337	8338	8339	8340	8341
242	8342	8343	8344	8345	8346	8347	8348	8349	8350	8351	8352	8353
243	8354	8355	8356	8357	8358	8359	8360	8361	8362	8363	8364	8365
244	8366	8367	8368	8369	8370	8371	8372	8373	8374	8375	8376	8377
245	8378	8379	8380	8381	8382	8383	8384	8385	8386	8387	8388	8389
246	8390	8391	8392	8393	8394	8395	8396	8397	8398	8399	8400	8401
247	8402	8403	8404	8405	8406	8407	8408	8409	8410	8411	8412	8413
248	8414	8415	8416	8417	8418	8419	8420	8421	8422	8423	8424	8425
249	8426	8427	8428	8429	8430	8431	8432	8433	8434	8435	8436	8437
250	8438	8439	8440	8441	8442	8443	8444	8445	8446	8447	8448	8449
251	8450	8451	8452	8453	8454	8455	8456	8457	8458	8459	8460	8461
252	8462	8463	8464	8465	8466	8467	8468	8469	8470	8471	8472	8473
253	8474	8475	8476	8477	8478	8479	8480	8481	8482	8483	8484	8485
254	8486	8487	8488	8489	8490	8491	8492	8493	8494	8495	8496	8497
255	8498	8499	8500	8501	8502	8503	8504	8505	8506	8507	8508	8509
256	8510	8511	8512	8513	8514	8515	8516	8517	8518	8519	8520	8521
257	8522	8523	8524	8525	8526	8527	8528	8529	8530	8531	8532	8533
258	8534	8535	8536	8537	8538	8539	8540	8541	8542	8543	8544	8545
259	8546	8547	8548	8549	8550	8551	8552	8553	8554	8555	8556	8557
260	8558	8559	8560	8561	8562	8563	8564	8565	8566	8567	8568	8569
261	8570	8571	8572	8573	8574	8575	8576	8577	8578	8579	8580	8581
262	8582	8583	8584	8585	8586	8587	8588	8589	8590	8591	8592	8593
263	8594	8595	8596	8597	8598	8599	8600	8601	8602	8603	8604	8605
264	8606	8607	8608	8609	8610	8611	8612	8613	8614	8615	8616	8617
265	8618	8619	8620	8621	8622	8623	8624	8625	8626	8627	8628	8629
266	8630	8631	8632	8633	8634	8635	8636	8637	8638	8639	8640	8641
267	8642	8643	8644	8645	8646	8647	8648	8649	8650	8651	8652	8653
268	8654	8655	8656	8657	8658	8659	8660	8661	8662	8663	8664	8665
269	8666	8667	8668	8669	8670	8671	8672	8673	8674	8675	8676	8677
270	8678	8679	8680	8681	8682	8683	8684	8685	8686	8687	8688	8689
271	8690	8691	8692	8693	8694	8695	8696	8697	8698	8699	8700	8701
272	8702	8703	8704	8705	8706	8707	8708	8709	8710	8711	8712	8713
273	8714	8715	8716	8717	8718	8719	8720	8721	8722	8723	8724	8725
274	8726	8727	8728	8729	8730	8731	8732	8733	8734	8735	8736	8737
275	8738	8739	8740	8741	8742	8743	8744	8745	8746	8747	8748	8749
276	8750	8751	8752	8753	8754	8755	8756	8757	8758	8759	8760	8761

Chapter 11 Internal Memory Address of “Read/Write Variable Data” command

277	8762	8763	8764	8765	8766	8767	8768	8769	8770	8771	8772	8773
278	8774	8775	8776	8777	8778	8779	8780	8781	8782	8783	8784	8785
279	8786	8787	8788	8789	8790	8791	8792	8793	8794	8795	8796	8797
280	8798	8799	8800	8801	8802	8803	8804	8805	8806	8807	8808	8809
281	8810	8811	8812	8813	8814	8815	8816	8817	8818	8819	8820	8821
282	8822	8823	8824	8825	8826	8827	8828	8829	8830	8831	8832	8833
283	8834	8835	8836	8837	8838	8839	8840	8841	8842	8843	8844	8845
284	8846	8847	8848	8849	8850	8851	8852	8853	8854	8855	8856	8857
285	8858	8859	8860	8861	8862	8863	8864	8865	8866	8867	8868	8869
286	8870	8871	8872	8873	8874	8875	8876	8877	8878	8879	8880	8881
287	8882	8883	8884	8885	8886	8887	8888	8889	8890	8891	8892	8893
288	8894	8895	8896	8897	8898	8899	8900	8901	8902	8903	8904	8905
289	8906	8907	8908	8909	8910	8911	8912	8913	8914	8915	8916	8917
290	8918	8919	8920	8921	8922	8923	8924	8925	8926	8927	8928	8929
291	8930	8931	8932	8933	8934	8935	8936	8937	8938	8939	8940	8941
292	8942	8943	8944	8945	8946	8947	8948	8949	8950	8951	8952	8953
293	8954	8955	8956	8957	8958	8959	8960	8961	8962	8963	8964	8965
294	8966	8967	8968	8969	8970	8971	8972	8973	8974	8975	8976	8977
295	8978	8979	8980	8981	8982	8983	8984	8985	8986	8987	8988	8989
296	8990	8991	8992	8993	8994	8995	8996	8997	8998	8999	9000	9001
297	9002	9003	9004	9005	9006	9007	9008	9009	9010	9011	9012	9013
298	9014	9015	9016	9017	9018	9019	9020	9021	9022	9023	9024	9025
299	9026	9027	9028	9029	9030	9031	9032	9033	9034	9035	9036	9037
300	9038	9039	9040	9041	9042	9043	9044	9045	9046	9047	9048	9049
301	9050	9051	9052	9053	9054	9055	9056	9057	9058	9059	9060	9061
302	9062	9063	9064	9065	9066	9067	9068	9069	9070	9071	9072	9073
303	9074	9075	9076	9077	9078	9079	9080	9081	9082	9083	9084	9085
304	9086	9087	9088	9089	9090	9091	9092	9093	9094	9095	9096	9097
305	9098	9099	9100	9101	9102	9103	9104	9105	9106	9107	9108	9109
306	9110	9111	9112	9113	9114	9115	9116	9117	9118	9119	9120	9121
307	9122	9123	9124	9125	9126	9127	9128	9129	9130	9131	9132	9133
308	9134	9135	9136	9137	9138	9139	9140	9141	9142	9143	9144	9145
309	9146	9147	9148	9149	9150	9151	9152	9153	9154	9155	9156	9157
310	9158	9159	9160	9161	9162	9163	9164	9165	9166	9167	9168	9169
311	9170	9171	9172	9173	9174	9175	9176	9177	9178	9179	9180	9181
312	9182	9183	9184	9185	9186	9187	9188	9189	9190	9191	9192	9193
313	9194	9195	9196	9197	9198	9199	9200	9201	9202	9203	9204	9205
314	9206	9207	9208	9209	9210	9211	9212	9213	9214	9215	9216	9217
315	9218	9219	9220	9221	9222	9223	9224	9225	9226	9227	9228	9229
316	9230	9231	9232	9233	9234	9235	9236	9237	9238	9239	9240	9241
317	9242	9243	9244	9245	9246	9247	9248	9249	9250	9251	9252	9253
318	9254	9255	9256	9257	9258	9259	9260	9261	9262	9263	9264	9265
319	9266	9267	9268	9269	9270	9271	9272	9273	9274	9275	9276	9277
320	9278	9279	9280	9281	9282	9283	9284	9285	9286	9287	9288	9289
321	9290	9291	9292	9293	9294	9295	9296	9297	9298	9299	9300	9301
322	9302	9303	9304	9305	9306	9307	9308	9309	9310	9311	9312	9313
323	9314	9315	9316	9317	9318	9319	9320	9321	9322	9323	9324	9325

Chapter 11 Internal Memory Address of “Read/Write Variable Data” command

324	9326	9327	9328	9329	9330	9331	9332	9333	9334	9335	9336	9337
325	9338	9339	9340	9341	9342	9343	9344	9345	9346	9347	9348	9349
326	9350	9351	9352	9353	9354	9355	9356	9357	9358	9359	9360	9361
327	9362	9363	9364	9365	9366	9367	9368	9369	9370	9371	9372	9373
328	9374	9375	9376	9377	9378	9379	9380	9381	9382	9383	9384	9385
329	9386	9387	9388	9389	9390	9391	9392	9393	9394	9395	9396	9397
330	9398	9399	9400	9401	9402	9403	9404	9405	9406	9407	9408	9409
331	9410	9411	9412	9413	9414	9415	9416	9417	9418	9419	9420	9421
332	9422	9423	9424	9425	9426	9427	9428	9429	9430	9431	9432	9433
333	9434	9435	9436	9437	9438	9439	9440	9441	9442	9443	9444	9445
334	9446	9447	9448	9449	9450	9451	9452	9453	9454	9455	9456	9457
335	9458	9459	9460	9461	9462	9463	9464	9465	9466	9467	9468	9469
336	9470	9471	9472	9473	9474	9475	9476	9477	9478	9479	9480	9481
337	9482	9483	9484	9485	9486	9487	9488	9489	9490	9491	9492	9493
338	9494	9495	9496	9497	9498	9499	9500	9501	9502	9503	9504	9505
339	9506	9507	9508	9509	9510	9511	9512	9513	9514	9515	9516	9517
340	9518	9519	9520	9521	9522	9523	9524	9525	9526	9527	9528	9529
341	9530	9531	9532	9533	9534	9535	9536	9537	9538	9539	9540	9541
342	9542	9543	9544	9545	9546	9547	9548	9549	9550	9551	9552	9553
343	9554	9555	9556	9557	9558	9559	9560	9561	9562	9563	9564	9565
344	9566	9567	9568	9569	9570	9571	9572	9573	9574	9575	9576	9577
345	9578	9579	9580	9581	9582	9583	9584	9585	9586	9587	9588	9589
346	9590	9591	9592	9593	9594	9595	9596	9597	9598	9599	9600	9601
347	9602	9603	9604	9605	9606	9607	9608	9609	9610	9611	9612	9613
348	9614	9615	9616	9617	9618	9619	9620	9621	9622	9623	9624	9625
349	9626	9627	9628	9629	9630	9631	9632	9633	9634	9635	9636	9637
350	9638	9639	9640	9641	9642	9643	9644	9645	9646	9647	9648	9649
351	9650	9651	9652	9653	9654	9655	9656	9657	9658	9659	9660	9661
352	9662	9663	9664	9665	9666	9667	9668	9669	9670	9671	9672	9673
353	9674	9675	9676	9677	9678	9679	9680	9681	9682	9683	9684	9685
354	9686	9687	9688	9689	9690	9691	9692	9693	9694	9695	9696	9697
355	9698	9699	9700	9701	9702	9703	9704	9705	9706	9707	9708	9709
356	9710	9711	9712	9713	9714	9715	9716	9717	9718	9719	9720	9721
357	9722	9723	9724	9725	9726	9727	9728	9729	9730	9731	9732	9733
358	9734	9735	9736	9737	9738	9739	9740	9741	9742	9743	9744	9745
359	9746	9747	9748	9749	9750	9751	9752	9753	9754	9755	9756	9757
360	9758	9759	9760	9761	9762	9763	9764	9765	9766	9767	9768	9769
361	9770	9771	9772	9773	9774	9775	9776	9777	9778	9779	9780	9781
362	9782	9783	9784	9785	9786	9787	9788	9789	9790	9791	9792	9793
363	9794	9795	9796	9797	9798	9799	9800	9801	9802	9803	9804	9805
364	9806	9807	9808	9809	9810	9811	9812	9813	9814	9815	9816	9817
365	9818	9819	9820	9821	9822	9823	9824	9825	9826	9827	9828	9829
366	9830	9831	9832	9833	9834	9835	9836	9837	9838	9839	9840	9841
367	9842	9843	9844	9845	9846	9847	9848	9849	9850	9851	9852	9853
368	9854	9855	9856	9857	9858	9859	9860	9861	9862	9863	9864	9865
369	9866	9867	9868	9869	9870	9871	9872	9873	9874	9875	9876	9877
370	9878	9879	9880	9881	9882	9883	9884	9885	9886	9887	9888	9889

Chapter 11 Internal Memory Address of “Read/Write Variable Data” command

371	9890	9891	9892	9893	9894	9895	9896	9897	9898	9899	9900	9901
372	9902	9903	9904	9905	9906	9907	9908	9909	9910	9911	9912	9913
373	9914	9915	9916	9917	9918	9919	9920	9921	9922	9923	9924	9925
374	9926	9927	9928	9929	9930	9931	9932	9933	9934	9935	9936	9937
375	9938	9939	9940	9941	9942	9943	9944	9945	9946	9947	9948	9949
376	9950	9951	9952	9953	9954	9955	9956	9957	9958	9959	9960	9961
377	9962	9963	9964	9965	9966	9967	9968	9969	9970	9971	9972	9973
378	9974	9975	9976	9977	9978	9979	9980	9981	9982	9983	9984	9985
379	9986	9987	9988	9989	9990	9991	9992	9993	9994	9995	9996	9997
380	9998	9999	10000	10001	10002	10003	10004	10005	10006	10007	10008	10009
381	10010	10011	10012	10013	10014	10015	10016	10017	10018	10019	10020	10021
382	10022	10023	10024	10025	10026	10027	10028	10029	10030	10031	10032	10033
383	10034	10035	10036	10037	10038	10039	10040	10041	10042	10043	10044	10045
384	10046	10047	10048	10049	10050	10051	10052	10053	10054	10055	10056	10057
385	10058	10059	10060	10061	10062	10063	10064	10065	10066	10067	10068	10069
386	10070	10071	10072	10073	10074	10075	10076	10077	10078	10079	10080	10081
387	10082	10083	10084	10085	10086	10087	10088	10089	10090	10091	10092	10093
388	10094	10095	10096	10097	10098	10099	10100	10101	10102	10103	10104	10105
389	10106	10107	10108	10109	10110	10111	10112	10113	10114	10115	10116	10117
390	10118	10119	10120	10121	10122	10123	10124	10125	10126	10127	10128	10129
391	10130	10131	10132	10133	10134	10135	10136	10137	10138	10139	10140	10141
392	10142	10143	10144	10145	10146	10147	10148	10149	10150	10151	10152	10153
393	10154	10155	10156	10157	10158	10159	10160	10161	10162	10163	10164	10165
394	10166	10167	10168	10169	10170	10171	10172	10173	10174	10175	10176	10177
395	10178	10179	10180	10181	10182	10183	10184	10185	10186	10187	10188	10189
396	10190	10191	10192	10193	10194	10195	10196	10197	10198	10199	10200	10201
397	10202	10203	10204	10205	10206	10207	10208	10209	10210	10211	10212	10213
398	10214	10215	10216	10217	10218	10219	10220	10221	10222	10223	10224	10225
399	10226	10227	10228	10229	10230	10231	10232	10233	10234	10235	10236	10237
400	10238	10239	10240	10241	10242	10243	10244	10245	10246	10247	10248	10249

11.4 Axis 3 operation data memory address

Step	Target position		Cir. int. auxiliary point		Operation speed		Dwell time	M code	Sub. Axis setting	Helical int.	Circular int. turns	Control word
	Low	High	Low	High	Low	High						
1	10250	10251	10252	10253	10254	10255	10256	10257	10258	10259	10260	10261
2	10262	10263	10264	10265	10266	10267	10268	10269	10270	10271	10272	10273
3	10274	10275	10276	10277	10278	10279	10280	10281	10282	10283	10284	10285
4	10286	10287	10288	10289	10290	10291	10292	10293	10294	10295	10296	10297
5	10298	10299	10300	10301	10302	10303	10304	10305	10306	10307	10308	10309
6	10310	10311	10312	10313	10314	10315	10316	10317	10318	10319	10320	10321
7	10322	10323	10324	10325	10326	10327	10328	10329	10330	10331	10332	10333
8	10334	10335	10336	10337	10338	10339	10340	10341	10342	10343	10344	10345
9	10346	10347	10348	10349	10350	10351	10352	10353	10354	10355	10356	10357
10	10358	10359	10360	10361	10362	10363	10364	10365	10366	10367	10368	10369
11	10370	10371	10372	10373	10374	10375	10376	10377	10378	10379	10380	10381
12	10382	10383	10384	10385	10386	10387	10388	10389	10390	10391	10392	10393
13	10394	10395	10396	10397	10398	10399	10400	10401	10402	10403	10404	10405
14	10406	10407	10408	10409	10410	10411	10412	10413	10414	10415	10416	10417
15	10418	10419	10420	10421	10422	10423	10424	10425	10426	10427	10428	10429
16	10430	10431	10432	10433	10434	10435	10436	10437	10438	10439	10440	10441
17	10442	10443	10444	10445	10446	10447	10448	10449	10450	10451	10452	10453
18	10454	10455	10456	10457	10458	10459	10460	10461	10462	10463	10464	10465
19	10466	10467	10468	10469	10470	10471	10472	10473	10474	10475	10476	10477
20	10478	10479	10480	10481	10482	10483	10484	10485	10486	10487	10488	10489
21	10490	10491	10492	10493	10494	10495	10496	10497	10498	10499	10500	10501
22	10502	10503	10504	10505	10506	10507	10508	10509	10510	10511	10512	10513
23	10514	10515	10516	10517	10518	10519	10520	10521	10522	10523	10524	10525
24	10526	10527	10528	10529	10530	10531	10532	10533	10534	10535	10536	10537
25	10538	10539	10540	10541	10542	10543	10544	10545	10546	10547	10548	10549
26	10550	10551	10552	10553	10554	10555	10556	10557	10558	10559	10560	10561
27	10562	10563	10564	10565	10566	10567	10568	10569	10570	10571	10572	10573
28	10574	10575	10576	10577	10578	10579	10580	10581	10582	10583	10584	10585
29	10586	10587	10588	10589	10590	10591	10592	10593	10594	10595	10596	10597
30	10598	10599	10600	10601	10602	10603	10604	10605	10606	10607	10608	10609
31	10610	10611	10612	10613	10614	10615	10616	10617	10618	10619	10620	10621
32	10622	10623	10624	10625	10626	10627	10628	10629	10630	10631	10632	10633
33	10634	10635	10636	10637	10638	10639	10640	10641	10642	10643	10644	10645
34	10646	10647	10648	10649	10650	10651	10652	10653	10654	10655	10656	10657
35	10658	10659	10660	10661	10662	10663	10664	10665	10666	10667	10668	10669
36	10670	10671	10672	10673	10674	10675	10676	10677	10678	10679	10680	10681
37	10682	10683	10684	10685	10686	10687	10688	10689	10690	10691	10692	10693
38	10694	10695	10696	10697	10698	10699	10700	10701	10702	10703	10704	10705
39	10706	10707	10708	10709	10710	10711	10712	10713	10714	10715	10716	10717
40	10718	10719	10720	10721	10722	10723	10724	10725	10726	10727	10728	10729
41	10730	10731	10732	10733	10734	10735	10736	10737	10738	10739	10740	10741

Chapter 11 Internal Memory Address of “Read/Write Variable Data” command

42	10742	10743	10744	10745	10746	10747	10748	10749	10750	10751	10752	10753
43	10754	10755	10756	10757	10758	10759	10760	10761	10762	10763	10764	10765
44	10766	10767	10768	10769	10770	10771	10772	10773	10774	10775	10776	10777
45	10778	10779	10780	10781	10782	10783	10784	10785	10786	10787	10788	10789
46	10790	10791	10792	10793	10794	10795	10796	10797	10798	10799	10800	10801
47	10802	10803	10804	10805	10806	10807	10808	10809	10810	10811	10812	10813
48	10814	10815	10816	10817	10818	10819	10820	10821	10822	10823	10824	10825
49	10826	10827	10828	10829	10830	10831	10832	10833	10834	10835	10836	10837
50	10838	10839	10840	10841	10842	10843	10844	10845	10846	10847	10848	10849
51	10850	10851	10852	10853	10854	10855	10856	10857	10858	10859	10860	10861
52	10862	10863	10864	10865	10866	10867	10868	10869	10870	10871	10872	10873
53	10874	10875	10876	10877	10878	10879	10880	10881	10882	10883	10884	10885
54	10886	10887	10888	10889	10890	10891	10892	10893	10894	10895	10896	10897
55	10898	10899	10900	10901	10902	10903	10904	10905	10906	10907	10908	10909
56	10910	10911	10912	10913	10914	10915	10916	10917	10918	10919	10920	10921
57	10922	10923	10924	10925	10926	10927	10928	10929	10930	10931	10932	10933
58	10934	10935	10936	10937	10938	10939	10940	10941	10942	10943	10944	10945
59	10946	10947	10948	10949	10950	10951	10952	10953	10954	10955	10956	10957
60	10958	10959	10960	10961	10962	10963	10964	10965	10966	10967	10968	10969
61	10970	10971	10972	10973	10974	10975	10976	10977	10978	10979	10980	10981
62	10982	10983	10984	10985	10986	10987	10988	10989	10990	10991	10992	10993
63	10994	10995	10996	10997	10998	10999	11000	11001	11002	11003	11004	11005
64	11006	11007	11008	11009	11010	11011	11012	11013	11014	11015	11016	11017
65	11018	11019	11020	11021	11022	11023	11024	11025	11026	11027	11028	11029
66	11030	11031	11032	11033	11034	11035	11036	11037	11038	11039	11040	11041
67	11042	11043	11044	11045	11046	11047	11048	11049	11050	11051	11052	11053
68	11054	11055	11056	11057	11058	11059	11060	11061	11062	11063	11064	11065
69	11066	11067	11068	11069	11070	11071	11072	11073	11074	11075	11076	11077
70	11078	11079	11080	11081	11082	11083	11084	11085	11086	11087	11088	11089
71	11090	11091	11092	11093	11094	11095	11096	11097	11098	11099	11100	11101
72	11102	11103	11104	11105	11106	11107	11108	11109	11110	11111	11112	11113
73	11114	11115	11116	11117	11118	11119	11120	11121	11122	11123	11124	11125
74	11126	11127	11128	11129	11130	11131	11132	11133	11134	11135	11136	11137
75	11138	11139	11140	11141	11142	11143	11144	11145	11146	11147	11148	11149
76	11150	11151	11152	11153	11154	11155	11156	11157	11158	11159	11160	11161
77	11162	11163	11164	11165	11166	11167	11168	11169	11170	11171	11172	11173
78	11174	11175	11176	11177	11178	11179	11180	11181	11182	11183	11184	11185
79	11186	11187	11188	11189	11190	11191	11192	11193	11194	11195	11196	11197
80	11198	11199	11200	11201	11202	11203	11204	11205	11206	11207	11208	11209
81	11210	11211	11212	11213	11214	11215	11216	11217	11218	11219	11220	11221
82	11222	11223	11224	11225	11226	11227	11228	11229	11230	11231	11232	11233
83	11234	11235	11236	11237	11238	11239	11240	11241	11242	11243	11244	11245
84	11246	11247	11248	11249	11250	11251	11252	11253	11254	11255	11256	11257
85	11258	11259	11260	11261	11262	11263	11264	11265	11266	11267	11268	11269
86	11270	11271	11272	11273	11274	11275	11276	11277	11278	11279	11280	11281
87	11282	11283	11284	11285	11286	11287	11288	11289	11290	11291	11292	11293
88	11294	11295	11296	11297	11298	11299	11300	11301	11302	11303	11304	11305

Chapter 11 Internal Memory Address of “Read/Write Variable Data” command

89	11306	11307	11308	11309	11310	11311	11312	11313	11314	11315	11316	11317
90	11318	11319	11320	11321	11322	11323	11324	11325	11326	11327	11328	11329
91	11330	11331	11332	11333	11334	11335	11336	11337	11338	11339	11340	11341
92	11342	11343	11344	11345	11346	11347	11348	11349	11350	11351	11352	11353
93	11354	11355	11356	11357	11358	11359	11360	11361	11362	11363	11364	11365
94	11366	11367	11368	11369	11370	11371	11372	11373	11374	11375	11376	11377
95	11378	11379	11380	11381	11382	11383	11384	11385	11386	11387	11388	11389
96	11390	11391	11392	11393	11394	11395	11396	11397	11398	11399	11400	11401
97	11402	11403	11404	11405	11406	11407	11408	11409	11410	11411	11412	11413
98	11414	11415	11416	11417	11418	11419	11420	11421	11422	11423	11424	11425
99	11426	11427	11428	11429	11430	11431	11432	11433	11434	11435	11436	11437
100	11438	11439	11440	11441	11442	11443	11444	11445	11446	11447	11448	11449
101	11450	11451	11452	11453	11454	11455	11456	11457	11458	11459	11460	11461
102	11462	11463	11464	11465	11466	11467	11468	11469	11470	11471	11472	11473
103	11474	11475	11476	11477	11478	11479	11480	11481	11482	11483	11484	11485
104	11486	11487	11488	11489	11490	11491	11492	11493	11494	11495	11496	11497
105	11498	11499	11500	11501	11502	11503	11504	11505	11506	11507	11508	11509
106	11510	11511	11512	11513	11514	11515	11516	11517	11518	11519	11520	11521
107	11522	11523	11524	11525	11526	11527	11528	11529	11530	11531	11532	11533
108	11534	11535	11536	11537	11538	11539	11540	11541	11542	11543	11544	11545
109	11546	11547	11548	11549	11550	11551	11552	11553	11554	11555	11556	11557
110	11558	11559	11560	11561	11562	11563	11564	11565	11566	11567	11568	11569
111	11570	11571	11572	11573	11574	11575	11576	11577	11578	11579	11580	11581
112	11582	11583	11584	11585	11586	11587	11588	11589	11590	11591	11592	11593
113	11594	11595	11596	11597	11598	11599	11600	11601	11602	11603	11604	11605
114	11606	11607	11608	11609	11610	11611	11612	11613	11614	11615	11616	11617
115	11618	11619	11620	11621	11622	11623	11624	11625	11626	11627	11628	11629
116	11630	11631	11632	11633	11634	11635	11636	11637	11638	11639	11640	11641
117	11642	11643	11644	11645	11646	11647	11648	11649	11650	11651	11652	11653
118	11654	11655	11656	11657	11658	11659	11660	11661	11662	11663	11664	11665
119	11666	11667	11668	11669	11670	11671	11672	11673	11674	11675	11676	11677
120	11678	11679	11680	11681	11682	11683	11684	11685	11686	11687	11688	11689
121	11690	11691	11692	11693	11694	11695	11696	11697	11698	11699	11700	11701
122	11702	11703	11704	11705	11706	11707	11708	11709	11710	11711	11712	11713
123	11714	11715	11716	11717	11718	11719	11720	11721	11722	11723	11724	11725
124	11726	11727	11728	11729	11730	11731	11732	11733	11734	11735	11736	11737
125	11738	11739	11740	11741	11742	11743	11744	11745	11746	11747	11748	11749
126	11750	11751	11752	11753	11754	11755	11756	11757	11758	11759	11760	11761
127	11762	11763	11764	11765	11766	11767	11768	11769	11770	11771	11772	11773
128	11774	11775	11776	11777	11778	11779	11780	11781	11782	11783	11784	11785
129	11786	11787	11788	11789	11790	11791	11792	11793	11794	11795	11796	11797
130	11798	11799	11800	11801	11802	11803	11804	11805	11806	11807	11808	11809
131	11810	11811	11812	11813	11814	11815	11816	11817	11818	11819	11820	11821
132	11822	11823	11824	11825	11826	11827	11828	11829	11830	11831	11832	11833
133	11834	11835	11836	11837	11838	11839	11840	11841	11842	11843	11844	11845
134	11846	11847	11848	11849	11850	11851	11852	11853	11854	11855	11856	11857
135	11858	11859	11860	11861	11862	11863	11864	11865	11866	11867	11868	11869

Chapter 11 Internal Memory Address of “Read/Write Variable Data” command

136	11870	11871	11872	11873	11874	11875	11876	11877	11878	11879	11880	11881
137	11882	11883	11884	11885	11886	11887	11888	11889	11890	11891	11892	11893
138	11894	11895	11896	11897	11898	11899	11900	11901	11902	11903	11904	11905
139	11906	11907	11908	11909	11910	11911	11912	11913	11914	11915	11916	11917
140	11918	11919	11920	11921	11922	11923	11924	11925	11926	11927	11928	11929
141	11930	11931	11932	11933	11934	11935	11936	11937	11938	11939	11940	11941
142	11942	11943	11944	11945	11946	11947	11948	11949	11950	11951	11952	11953
143	11954	11955	11956	11957	11958	11959	11960	11961	11962	11963	11964	11965
144	11966	11967	11968	11969	11970	11971	11972	11973	11974	11975	11976	11977
145	11978	11979	11980	11981	11982	11983	11984	11985	11986	11987	11988	11989
146	11990	11991	11992	11993	11994	11995	11996	11997	11998	11999	12000	12001
147	12002	12003	12004	12005	12006	12007	12008	12009	12010	12011	12012	12013
148	12014	12015	12016	12017	12018	12019	12020	12021	12022	12023	12024	12025
149	12026	12027	12028	12029	12030	12031	12032	12033	12034	12035	12036	12037
150	12038	12039	12040	12041	12042	12043	12044	12045	12046	12047	12048	12049
151	12050	12051	12052	12053	12054	12055	12056	12057	12058	12059	12060	12061
152	12062	12063	12064	12065	12066	12067	12068	12069	12070	12071	12072	12073
153	12074	12075	12076	12077	12078	12079	12080	12081	12082	12083	12084	12085
154	12086	12087	12088	12089	12090	12091	12092	12093	12094	12095	12096	12097
155	12098	12099	12100	12101	12102	12103	12104	12105	12106	12107	12108	12109
156	12110	12111	12112	12113	12114	12115	12116	12117	12118	12119	12120	12121
157	12122	12123	12124	12125	12126	12127	12128	12129	12130	12131	12132	12133
158	12134	12135	12136	12137	12138	12139	12140	12141	12142	12143	12144	12145
159	12146	12147	12148	12149	12150	12151	12152	12153	12154	12155	12156	12157
160	12158	12159	12160	12161	12162	12163	12164	12165	12166	12167	12168	12169
161	12170	12171	12172	12173	12174	12175	12176	12177	12178	12179	12180	12181
162	12182	12183	12184	12185	12186	12187	12188	12189	12190	12191	12192	12193
163	12194	12195	12196	12197	12198	12199	12200	12201	12202	12203	12204	12205
164	12206	12207	12208	12209	12210	12211	12212	12213	12214	12215	12216	12217
165	12218	12219	12220	12221	12222	12223	12224	12225	12226	12227	12228	12229
166	12230	12231	12232	12233	12234	12235	12236	12237	12238	12239	12240	12241
167	12242	12243	12244	12245	12246	12247	12248	12249	12250	12251	12252	12253
168	12254	12255	12256	12257	12258	12259	12260	12261	12262	12263	12264	12265
169	12266	12267	12268	12269	12270	12271	12272	12273	12274	12275	12276	12277
170	12278	12279	12280	12281	12282	12283	12284	12285	12286	12287	12288	12289
171	12290	12291	12292	12293	12294	12295	12296	12297	12298	12299	12300	12301
172	12302	12303	12304	12305	12306	12307	12308	12309	12310	12311	12312	12313
173	12314	12315	12316	12317	12318	12319	12320	12321	12322	12323	12324	12325
174	12326	12327	12328	12329	12330	12331	12332	12333	12334	12335	12336	12337
175	12338	12339	12340	12341	12342	12343	12344	12345	12346	12347	12348	12349
176	12350	12351	12352	12353	12354	12355	12356	12357	12358	12359	12360	12361
177	12362	12363	12364	12365	12366	12367	12368	12369	12370	12371	12372	12373
178	12374	12375	12376	12377	12378	12379	12380	12381	12382	12383	12384	12385
179	12386	12387	12388	12389	12390	12391	12392	12393	12394	12395	12396	12397
180	12398	12399	12400	12401	12402	12403	12404	12405	12406	12407	12408	12409
181	12410	12411	12412	12413	12414	12415	12416	12417	12418	12419	12420	12421
182	12422	12423	12424	12425	12426	12427	12428	12429	12430	12431	12432	12433

Chapter 11 Internal Memory Address of “Read/Write Variable Data” command

183	12434	12435	12436	12437	12438	12439	12440	12441	12442	12443	12444	12445
184	12446	12447	12448	12449	12450	12451	12452	12453	12454	12455	12456	12457
185	12458	12459	12460	12461	12462	12463	12464	12465	12466	12467	12468	12469
186	12470	12471	12472	12473	12474	12475	12476	12477	12478	12479	12480	12481
187	12482	12483	12484	12485	12486	12487	12488	12489	12490	12491	12492	12493
188	12494	12495	12496	12497	12498	12499	12500	12501	12502	12503	12504	12505
189	12506	12507	12508	12509	12510	12511	12512	12513	12514	12515	12516	12517
190	12518	12519	12520	12521	12522	12523	12524	12525	12526	12527	12528	12529
191	12530	12531	12532	12533	12534	12535	12536	12537	12538	12539	12540	12541
192	12542	12543	12544	12545	12546	12547	12548	12549	12550	12551	12552	12553
193	12554	12555	12556	12557	12558	12559	12560	12561	12562	12563	12564	12565
194	12566	12567	12568	12569	12570	12571	12572	12573	12574	12575	12576	12577
195	12578	12579	12580	12581	12582	12583	12584	12585	12586	12587	12588	12589
196	12590	12591	12592	12593	12594	12595	12596	12597	12598	12599	12600	12601
197	12602	12603	12604	12605	12606	12607	12608	12609	12610	12611	12612	12613
198	12614	12615	12616	12617	12618	12619	12620	12621	12622	12623	12624	12625
199	12626	12627	12628	12629	12630	12631	12632	12633	12634	12635	12636	12637
200	12638	12639	12640	12641	12642	12643	12644	12645	12646	12647	12648	12649
201	12650	12651	12652	12653	12654	12655	12656	12657	12658	12659	12660	12661
202	12662	12663	12664	12665	12666	12667	12668	12669	12670	12671	12672	12673
203	12674	12675	12676	12677	12678	12679	12680	12681	12682	12683	12684	12685
204	12686	12687	12688	12689	12690	12691	12692	12693	12694	12695	12696	12697
205	12698	12699	12700	12701	12702	12703	12704	12705	12706	12707	12708	12709
206	12710	12711	12712	12713	12714	12715	12716	12717	12718	12719	12720	12721
207	12722	12723	12724	12725	12726	12727	12728	12729	12730	12731	12732	12733
208	12734	12735	12736	12737	12738	12739	12740	12741	12742	12743	12744	12745
209	12746	12747	12748	12749	12750	12751	12752	12753	12754	12755	12756	12757
210	12758	12759	12760	12761	12762	12763	12764	12765	12766	12767	12768	12769
211	12770	12771	12772	12773	12774	12775	12776	12777	12778	12779	12780	12781
212	12782	12783	12784	12785	12786	12787	12788	12789	12790	12791	12792	12793
213	12794	12795	12796	12797	12798	12799	12800	12801	12802	12803	12804	12805
214	12806	12807	12808	12809	12810	12811	12812	12813	12814	12815	12816	12817
215	12818	12819	12820	12821	12822	12823	12824	12825	12826	12827	12828	12829
216	12830	12831	12832	12833	12834	12835	12836	12837	12838	12839	12840	12841
217	12842	12843	12844	12845	12846	12847	12848	12849	12850	12851	12852	12853
218	12854	12855	12856	12857	12858	12859	12860	12861	12862	12863	12864	12865
219	12866	12867	12868	12869	12870	12871	12872	12873	12874	12875	12876	12877
220	12878	12879	12880	12881	12882	12883	12884	12885	12886	12887	12888	12889
221	12890	12891	12892	12893	12894	12895	12896	12897	12898	12899	12900	12901
222	12902	12903	12904	12905	12906	12907	12908	12909	12910	12911	12912	12913
223	12914	12915	12916	12917	12918	12919	12920	12921	12922	12923	12924	12925
224	12926	12927	12928	12929	12930	12931	12932	12933	12934	12935	12936	12937
225	12938	12939	12940	12941	12942	12943	12944	12945	12946	12947	12948	12949
226	12950	12951	12952	12953	12954	12955	12956	12957	12958	12959	12960	12961
227	12962	12963	12964	12965	12966	12967	12968	12969	12970	12971	12972	12973
228	12974	12975	12976	12977	12978	12979	12980	12981	12982	12983	12984	12985
229	12986	12987	12988	12989	12990	12991	12992	12993	12994	12995	12996	12997

Chapter 11 Internal Memory Address of “Read/Write Variable Data” command

230	12998	12999	13000	13001	13002	13003	13004	13005	13006	13007	13008	13009
231	13010	13011	13012	13013	13014	13015	13016	13017	13018	13019	13020	13021
232	13022	13023	13024	13025	13026	13027	13028	13029	13030	13031	13032	13033
233	13034	13035	13036	13037	13038	13039	13040	13041	13042	13043	13044	13045
234	13046	13047	13048	13049	13050	13051	13052	13053	13054	13055	13056	13057
235	13058	13059	13060	13061	13062	13063	13064	13065	13066	13067	13068	13069
236	13070	13071	13072	13073	13074	13075	13076	13077	13078	13079	13080	13081
237	13082	13083	13084	13085	13086	13087	13088	13089	13090	13091	13092	13093
238	13094	13095	13096	13097	13098	13099	13100	13101	13102	13103	13104	13105
239	13106	13107	13108	13109	13110	13111	13112	13113	13114	13115	13116	13117
240	13118	13119	13120	13121	13122	13123	13124	13125	13126	13127	13128	13129
241	13130	13131	13132	13133	13134	13135	13136	13137	13138	13139	13140	13141
242	13142	13143	13144	13145	13146	13147	13148	13149	13150	13151	13152	13153
243	13154	13155	13156	13157	13158	13159	13160	13161	13162	13163	13164	13165
244	13166	13167	13168	13169	13170	13171	13172	13173	13174	13175	13176	13177
245	13178	13179	13180	13181	13182	13183	13184	13185	13186	13187	13188	13189
246	13190	13191	13192	13193	13194	13195	13196	13197	13198	13199	13200	13201
247	13202	13203	13204	13205	13206	13207	13208	13209	13210	13211	13212	13213
248	13214	13215	13216	13217	13218	13219	13220	13221	13222	13223	13224	13225
249	13226	13227	13228	13229	13230	13231	13232	13233	13234	13235	13236	13237
250	13238	13239	13240	13241	13242	13243	13244	13245	13246	13247	13248	13249
251	13250	13251	13252	13253	13254	13255	13256	13257	13258	13259	13260	13261
252	13262	13263	13264	13265	13266	13267	13268	13269	13270	13271	13272	13273
253	13274	13275	13276	13277	13278	13279	13280	13281	13282	13283	13284	13285
254	13286	13287	13288	13289	13290	13291	13292	13293	13294	13295	13296	13297
255	13298	13299	13300	13301	13302	13303	13304	13305	13306	13307	13308	13309
256	13310	13311	13312	13313	13314	13315	13316	13317	13318	13319	13320	13321
257	13322	13323	13324	13325	13326	13327	13328	13329	13330	13331	13332	13333
258	13334	13335	13336	13337	13338	13339	13340	13341	13342	13343	13344	13345
259	13346	13347	13348	13349	13350	13351	13352	13353	13354	13355	13356	13357
260	13358	13359	13360	13361	13362	13363	13364	13365	13366	13367	13368	13369
261	13370	13371	13372	13373	13374	13375	13376	13377	13378	13379	13380	13381
262	13382	13383	13384	13385	13386	13387	13388	13389	13390	13391	13392	13393
263	13394	13395	13396	13397	13398	13399	13400	13401	13402	13403	13404	13405
264	13406	13407	13408	13409	13410	13411	13412	13413	13414	13415	13416	13417
265	13418	13419	13420	13421	13422	13423	13424	13425	13426	13427	13428	13429
266	13430	13431	13432	13433	13434	13435	13436	13437	13438	13439	13440	13441
267	13442	13443	13444	13445	13446	13447	13448	13449	13450	13451	13452	13453
268	13454	13455	13456	13457	13458	13459	13460	13461	13462	13463	13464	13465
269	13466	13467	13468	13469	13470	13471	13472	13473	13474	13475	13476	13477
270	13478	13479	13480	13481	13482	13483	13484	13485	13486	13487	13488	13489
271	13490	13491	13492	13493	13494	13495	13496	13497	13498	13499	13500	13501
272	13502	13503	13504	13505	13506	13507	13508	13509	13510	13511	13512	13513
273	13514	13515	13516	13517	13518	13519	13520	13521	13522	13523	13524	13525
274	13526	13527	13528	13529	13530	13531	13532	13533	13534	13535	13536	13537
275	13538	13539	13540	13541	13542	13543	13544	13545	13546	13547	13548	13549
276	13550	13551	13552	13553	13554	13555	13556	13557	13558	13559	13560	13561

Chapter 11 Internal Memory Address of “Read/Write Variable Data” command

277	13562	13563	13564	13565	13566	13567	13568	13569	13570	13571	13572	13573
278	13574	13575	13576	13577	13578	13579	13580	13581	13582	13583	13584	13585
279	13586	13587	13588	13589	13590	13591	13592	13593	13594	13595	13596	13597
280	13598	13599	13600	13601	13602	13603	13604	13605	13606	13607	13608	13609
281	13610	13611	13612	13613	13614	13615	13616	13617	13618	13619	13620	13621
282	13622	13623	13624	13625	13626	13627	13628	13629	13630	13631	13632	13633
283	13634	13635	13636	13637	13638	13639	13640	13641	13642	13643	13644	13645
284	13646	13647	13648	13649	13650	13651	13652	13653	13654	13655	13656	13657
285	13658	13659	13660	13661	13662	13663	13664	13665	13666	13667	13668	13669
286	13670	13671	13672	13673	13674	13675	13676	13677	13678	13679	13680	13681
287	13682	13683	13684	13685	13686	13687	13688	13689	13690	13691	13692	13693
288	13694	13695	13696	13697	13698	13699	13700	13701	13702	13703	13704	13705
289	13706	13707	13708	13709	13710	13711	13712	13713	13714	13715	13716	13717
290	13718	13719	13720	13721	13722	13723	13724	13725	13726	13727	13728	13729
291	13730	13731	13732	13733	13734	13735	13736	13737	13738	13739	13740	13741
292	13742	13743	13744	13745	13746	13747	13748	13749	13750	13751	13752	13753
293	13754	13755	13756	13757	13758	13759	13760	13761	13762	13763	13764	13765
294	13766	13767	13768	13769	13770	13771	13772	13773	13774	13775	13776	13777
295	13778	13779	13780	13781	13782	13783	13784	13785	13786	13787	13788	13789
296	13790	13791	13792	13793	13794	13795	13796	13797	13798	13799	13800	13801
297	13802	13803	13804	13805	13806	13807	13808	13809	13810	13811	13812	13813
298	13814	13815	13816	13817	13818	13819	13820	13821	13822	13823	13824	13825
299	13826	13827	13828	13829	13830	13831	13832	13833	13834	13835	13836	13837
300	13838	13839	13840	13841	13842	13843	13844	13845	13846	13847	13848	13849
301	13850	13851	13852	13853	13854	13855	13856	13857	13858	13859	13860	13861
302	13862	13863	13864	13865	13866	13867	13868	13869	13870	13871	13872	13873
303	13874	13875	13876	13877	13878	13879	13880	13881	13882	13883	13884	13885
304	13886	13887	13888	13889	13890	13891	13892	13893	13894	13895	13896	13897
305	13898	13899	13900	13901	13902	13903	13904	13905	13906	13907	13908	13909
306	13910	13911	13912	13913	13914	13915	13916	13917	13918	13919	13920	13921
307	13922	13923	13924	13925	13926	13927	13928	13929	13930	13931	13932	13933
308	13934	13935	13936	13937	13938	13939	13940	13941	13942	13943	13944	13945
309	13946	13947	13948	13949	13950	13951	13952	13953	13954	13955	13956	13957
310	13958	13959	13960	13961	13962	13963	13964	13965	13966	13967	13968	13969
311	13970	13971	13972	13973	13974	13975	13976	13977	13978	13979	13980	13981
312	13982	13983	13984	13985	13986	13987	13988	13989	13990	13991	13992	13993
313	13994	13995	13996	13997	13998	13999	14000	14001	14002	14003	14004	14005
314	14006	14007	14008	14009	14010	14011	14012	14013	14014	14015	14016	14017
315	14018	14019	14020	14021	14022	14023	14024	14025	14026	14027	14028	14029
316	14030	14031	14032	14033	14034	14035	14036	14037	14038	14039	14040	14041
317	14042	14043	14044	14045	14046	14047	14048	14049	14050	14051	14052	14053
318	14054	14055	14056	14057	14058	14059	14060	14061	14062	14063	14064	14065
319	14066	14067	14068	14069	14070	14071	14072	14073	14074	14075	14076	14077
320	14078	14079	14080	14081	14082	14083	14084	14085	14086	14087	14088	14089
321	14090	14091	14092	14093	14094	14095	14096	14097	14098	14099	14100	14101
322	14102	14103	14104	14105	14106	14107	14108	14109	14110	14111	14112	14113
323	14114	14115	14116	14117	14118	14119	14120	14121	14122	14123	14124	14125

Chapter 11 Internal Memory Address of “Read/Write Variable Data” command

324	14126	14127	14128	14129	14130	14131	14132	14133	14134	14135	14136	14137
325	14138	14139	14140	14141	14142	14143	14144	14145	14146	14147	14148	14149
326	14150	14151	14152	14153	14154	14155	14156	14157	14158	14159	14160	14161
327	14162	14163	14164	14165	14166	14167	14168	14169	14170	14171	14172	14173
328	14174	14175	14176	14177	14178	14179	14180	14181	14182	14183	14184	14185
329	14186	14187	14188	14189	14190	14191	14192	14193	14194	14195	14196	14197
330	14198	14199	14200	14201	14202	14203	14204	14205	14206	14207	14208	14209
331	14210	14211	14212	14213	14214	14215	14216	14217	14218	14219	14220	14221
332	14222	14223	14224	14225	14226	14227	14228	14229	14230	14231	14232	14233
333	14234	14235	14236	14237	14238	14239	14240	14241	14242	14243	14244	14245
334	14246	14247	14248	14249	14250	14251	14252	14253	14254	14255	14256	14257
335	14258	14259	14260	14261	14262	14263	14264	14265	14266	14267	14268	14269
336	14270	14271	14272	14273	14274	14275	14276	14277	14278	14279	14280	14281
337	14282	14283	14284	14285	14286	14287	14288	14289	14290	14291	14292	14293
338	14294	14295	14296	14297	14298	14299	14300	14301	14302	14303	14304	14305
339	14306	14307	14308	14309	14310	14311	14312	14313	14314	14315	14316	14317
340	14318	14319	14320	14321	14322	14323	14324	14325	14326	14327	14328	14329
341	14330	14331	14332	14333	14334	14335	14336	14337	14338	14339	14340	14341
342	14342	14343	14344	14345	14346	14347	14348	14349	14350	14351	14352	14353
343	14354	14355	14356	14357	14358	14359	14360	14361	14362	14363	14364	14365
344	14366	14367	14368	14369	14370	14371	14372	14373	14374	14375	14376	14377
345	14378	14379	14380	14381	14382	14383	14384	14385	14386	14387	14388	14389
346	14390	14391	14392	14393	14394	14395	14396	14397	14398	14399	14400	14401
347	14402	14403	14404	14405	14406	14407	14408	14409	14410	14411	14412	14413
348	14414	14415	14416	14417	14418	14419	14420	14421	14422	14423	14424	14425
349	14426	14427	14428	14429	14430	14431	14432	14433	14434	14435	14436	14437
350	14438	14439	14440	14441	14442	14443	14444	14445	14446	14447	14448	14449
351	14450	14451	14452	14453	14454	14455	14456	14457	14458	14459	14460	14461
352	14462	14463	14464	14465	14466	14467	14468	14469	14470	14471	14472	14473
353	14474	14475	14476	14477	14478	14479	14480	14481	14482	14483	14484	14485
354	14486	14487	14488	14489	14490	14491	14492	14493	14494	14495	14496	14497
355	14498	14499	14500	14501	14502	14503	14504	14505	14506	14507	14508	14509
356	14510	14511	14512	14513	14514	14515	14516	14517	14518	14519	14520	14521
357	14522	14523	14524	14525	14526	14527	14528	14529	14530	14531	14532	14533
358	14534	14535	14536	14537	14538	14539	14540	14541	14542	14543	14544	14545
359	14546	14547	14548	14549	14550	14551	14552	14553	14554	14555	14556	14557
360	14558	14559	14560	14561	14562	14563	14564	14565	14566	14567	14568	14569
361	14570	14571	14572	14573	14574	14575	14576	14577	14578	14579	14580	14581
362	14582	14583	14584	14585	14586	14587	14588	14589	14590	14591	14592	14593
363	14594	14595	14596	14597	14598	14599	14600	14601	14602	14603	14604	14605
364	14606	14607	14608	14609	14610	14611	14612	14613	14614	14615	14616	14617
365	14618	14619	14620	14621	14622	14623	14624	14625	14626	14627	14628	14629
366	14630	14631	14632	14633	14634	14635	14636	14637	14638	14639	14640	14641
367	14642	14643	14644	14645	14646	14647	14648	14649	14650	14651	14652	14653
368	14654	14655	14656	14657	14658	14659	14660	14661	14662	14663	14664	14665
369	14666	14667	14668	14669	14670	14671	14672	14673	14674	14675	14676	14677
370	14678	14679	14680	14681	14682	14683	14684	14685	14686	14687	14688	14689

Chapter 11 Internal Memory Address of “Read/Write Variable Data” command

371	14690	14691	14692	14693	14694	14695	14696	14697	14698	14699	14700	14701
372	14702	14703	14704	14705	14706	14707	14708	14709	14710	14711	14712	14713
373	14714	14715	14716	14717	14718	14719	14720	14721	14722	14723	14724	14725
374	14726	14727	14728	14729	14730	14731	14732	14733	14734	14735	14736	14737
375	14738	14739	14740	14741	14742	14743	14744	14745	14746	14747	14748	14749
376	14750	14751	14752	14753	14754	14755	14756	14757	14758	14759	14760	14761
377	14762	14763	14764	14765	14766	14767	14768	14769	14770	14771	14772	14773
378	14774	14775	14776	14777	14778	14779	14780	14781	14782	14783	14784	14785
379	14786	14787	14788	14789	14790	14791	14792	14793	14794	14795	14796	14797
380	14798	14799	14800	14801	14802	14803	14804	14805	14806	14807	14808	14809
381	14810	14811	14812	14813	14814	14815	14816	14817	14818	14819	14820	14821
382	14822	14823	14824	14825	14826	14827	14828	14829	14830	14831	14832	14833
383	14834	14835	14836	14837	14838	14839	14840	14841	14842	14843	14844	14845
384	14846	14847	14848	14849	14850	14851	14852	14853	14854	14855	14856	14857
385	14858	14859	14860	14861	14862	14863	14864	14865	14866	14867	14868	14869
386	14870	14871	14872	14873	14874	14875	14876	14877	14878	14879	14880	14881
387	14882	14883	14884	14885	14886	14887	14888	14889	14890	14891	14892	14893
388	14894	14895	14896	14897	14898	14899	14900	14901	14902	14903	14904	14905
389	14906	14907	14908	14909	14910	14911	14912	14913	14914	14915	14916	14917
390	14918	14919	14920	14921	14922	14923	14924	14925	14926	14927	14928	14929
391	14930	14931	14932	14933	14934	14935	14936	14937	14938	14939	14940	14941
392	14942	14943	14944	14945	14946	14947	14948	14949	14950	14951	14952	14953
393	14954	14955	14956	14957	14958	14959	14960	14961	14962	14963	14964	14965
394	14966	14967	14968	14969	14970	14971	14972	14973	14974	14975	14976	14977
395	14978	14979	14980	14981	14982	14983	14984	14985	14986	14987	14988	14989
396	14990	14991	14992	14993	14994	14995	14996	14997	14998	14999	15000	15001
397	15002	15003	15004	15005	15006	15007	15008	15009	15010	15011	15012	15013
398	15014	15015	15016	15017	15018	15019	15020	15021	15022	15023	15024	15025
399	15026	15027	15028	15029	15030	15031	15032	15033	15034	15035	15036	15037
400	15038	15039	15040	15041	15042	15043	15044	15045	15046	15047	15048	15049

11.5 Axis 4 operation data memory address

Step	Target position		Cir. int. auxiliary point		Operation speed		Dwell time	Mcode	Sub Axis	Helical int.	Circular int. turns	Control word
	Low	High	Low	High	Low	High						
1	15050	15051	15052	15053	15054	15055	15056	15057	15058	15059	15060	15061
2	15062	15063	15064	15065	15066	15067	15068	15069	15070	15071	15072	15073
3	15074	15075	15076	15077	15078	15079	15080	15081	15082	15083	15084	15085
4	15086	15087	15088	15089	15090	15091	15092	15093	15094	15095	15096	15097
5	15098	15099	15100	15101	15102	15103	15104	15105	15106	15107	15108	15109
6	15110	15111	15112	15113	15114	15115	15116	15117	15118	15119	15120	15121
7	15122	15123	15124	15125	15126	15127	15128	15129	15130	15131	15132	15133
8	15134	15135	15136	15137	15138	15139	15140	15141	15142	15143	15144	15145
9	15146	15147	15148	15149	15150	15151	15152	15153	15154	15155	15156	15157
10	15158	15159	15160	15161	15162	15163	15164	15165	15166	15167	15168	15169
11	15170	15171	15172	15173	15174	15175	15176	15177	15178	15179	15180	15181
12	15182	15183	15184	15185	15186	15187	15188	15189	15190	15191	15192	15193
13	15194	15195	15196	15197	15198	15199	15200	15201	15202	15203	15204	15205
14	15206	15207	15208	15209	15210	15211	15212	15213	15214	15215	15216	15217
15	15218	15219	15220	15221	15222	15223	15224	15225	15226	15227	15228	15229
16	15230	15231	15232	15233	15234	15235	15236	15237	15238	15239	15240	15241
17	15242	15243	15244	15245	15246	15247	15248	15249	15250	15251	15252	15253
18	15254	15255	15256	15257	15258	15259	15260	15261	15262	15263	15264	15265
19	15266	15267	15268	15269	15270	15271	15272	15273	15274	15275	15276	15277
20	15278	15279	15280	15281	15282	15283	15284	15285	15286	15287	15288	15289
21	15290	15291	15292	15293	15294	15295	15296	15297	15298	15299	15300	15301
22	15302	15303	15304	15305	15306	15307	15308	15309	15310	15311	15312	15313
23	15314	15315	15316	15317	15318	15319	15320	15321	15322	15323	15324	15325
24	15326	15327	15328	15329	15330	15331	15332	15333	15334	15335	15336	15337
25	15338	15339	15340	15341	15342	15343	15344	15345	15346	15347	15348	15349
26	15350	15351	15352	15353	15354	15355	15356	15357	15358	15359	15360	15361
27	15362	15363	15364	15365	15366	15367	15368	15369	15370	15371	15372	15373
28	15374	15375	15376	15377	15378	15379	15380	15381	15382	15383	15384	15385
29	15386	15387	15388	15389	15390	15391	15392	15393	15394	15395	15396	15397
30	15398	15399	15400	15401	15402	15403	15404	15405	15406	15407	15408	15409
31	15410	15411	15412	15413	15414	15415	15416	15417	15418	15419	15420	15421
32	15422	15423	15424	15425	15426	15427	15428	15429	15430	15431	15432	15433
33	15434	15435	15436	15437	15438	15439	15440	15441	15442	15443	15444	15445
34	15446	15447	15448	15449	15450	15451	15452	15453	15454	15455	15456	15457
35	15458	15459	15460	15461	15462	15463	15464	15465	15466	15467	15468	15469
36	15470	15471	15472	15473	15474	15475	15476	15477	15478	15479	15480	15481
37	15482	15483	15484	15485	15486	15487	15488	15489	15490	15491	15492	15493
38	15494	15495	15496	15497	15498	15499	15500	15501	15502	15503	15504	15505
39	15506	15507	15508	15509	15510	15511	15512	15513	15514	15515	15516	15517
40	15518	15519	15520	15521	15522	15523	15524	15525	15526	15527	15528	15529

Chapter 11 Internal Memory Address of “Read/Write Variable Data” command

41	15530	15531	15532	15533	15534	15535	15536	15537	15538	15539	15540	15541
42	15542	15543	15544	15545	15546	15547	15548	15549	15550	15551	15552	15553
43	15554	15555	15556	15557	15558	15559	15560	15561	15562	15563	15564	15565
44	15566	15567	15568	15569	15570	15571	15572	15573	15574	15575	15576	15577
45	15578	15579	15580	15581	15582	15583	15584	15585	15586	15587	15588	15589
46	15590	15591	15592	15593	15594	15595	15596	15597	15598	15599	15600	15601
47	15602	15603	15604	15605	15606	15607	15608	15609	15610	15611	15612	15613
48	15614	15615	15616	15617	15618	15619	15620	15621	15622	15623	15624	15625
49	15626	15627	15628	15629	15630	15631	15632	15633	15634	15635	15636	15637
50	15638	15639	15640	15641	15642	15643	15644	15645	15646	15647	15648	15649
51	15650	15651	15652	15653	15654	15655	15656	15657	15658	15659	15660	15661
52	15662	15663	15664	15665	15666	15667	15668	15669	15670	15671	15672	15673
53	15674	15675	15676	15677	15678	15679	15680	15681	15682	15683	15684	15685
54	15686	15687	15688	15689	15690	15691	15692	15693	15694	15695	15696	15697
55	15698	15699	15700	15701	15702	15703	15704	15705	15706	15707	15708	15709
56	15710	15711	15712	15713	15714	15715	15716	15717	15718	15719	15720	15721
57	15722	15723	15724	15725	15726	15727	15728	15729	15730	15731	15732	15733
58	15734	15735	15736	15737	15738	15739	15740	15741	15742	15743	15744	15745
59	15746	15747	15748	15749	15750	15751	15752	15753	15754	15755	15756	15757
60	15758	15759	15760	15761	15762	15763	15764	15765	15766	15767	15768	15769
61	15770	15771	15772	15773	15774	15775	15776	15777	15778	15779	15780	15781
62	15782	15783	15784	15785	15786	15787	15788	15789	15790	15791	15792	15793
63	15794	15795	15796	15797	15798	15799	15800	15801	15802	15803	15804	15805
64	15806	15807	15808	15809	15810	15811	15812	15813	15814	15815	15816	15817
65	15818	15819	15820	15821	15822	15823	15824	15825	15826	15827	15828	15829
66	15830	15831	15832	15833	15834	15835	15836	15837	15838	15839	15840	15841
67	15842	15843	15844	15845	15846	15847	15848	15849	15850	15851	15852	15853
68	15854	15855	15856	15857	15858	15859	15860	15861	15862	15863	15864	15865
69	15866	15867	15868	15869	15870	15871	15872	15873	15874	15875	15876	15877
70	15878	15879	15880	15881	15882	15883	15884	15885	15886	15887	15888	15889
71	15890	15891	15892	15893	15894	15895	15896	15897	15898	15899	15900	15901
72	15902	15903	15904	15905	15906	15907	15908	15909	15910	15911	15912	15913
73	15914	15915	15916	15917	15918	15919	15920	15921	15922	15923	15924	15925
74	15926	15927	15928	15929	15930	15931	15932	15933	15934	15935	15936	15937
75	15938	15939	15940	15941	15942	15943	15944	15945	15946	15947	15948	15949
76	15950	15951	15952	15953	15954	15955	15956	15957	15958	15959	15960	15961
77	15962	15963	15964	15965	15966	15967	15968	15969	15970	15971	15972	15973
78	15974	15975	15976	15977	15978	15979	15980	15981	15982	15983	15984	15985
79	15986	15987	15988	15989	15990	15991	15992	15993	15994	15995	15996	15997
80	15998	15999	16000	16001	16002	16003	16004	16005	16006	16007	16008	16009
81	16010	16011	16012	16013	16014	16015	16016	16017	16018	16019	16020	16021
82	16022	16023	16024	16025	16026	16027	16028	16029	16030	16031	16032	16033
83	16034	16035	16036	16037	16038	16039	16040	16041	16042	16043	16044	16045
84	16046	16047	16048	16049	16050	16051	16052	16053	16054	16055	16056	16057
85	16058	16059	16060	16061	16062	16063	16064	16065	16066	16067	16068	16069
86	16070	16071	16072	16073	16074	16075	16076	16077	16078	16079	16080	16081

Chapter 11 Internal Memory Address of “Read/Write Variable Data” command

87	16082	16083	16084	16085	16086	16087	16088	16089	16090	16091	16092	16093
88	16094	16095	16096	16097	16098	16099	16100	16101	16102	16103	16104	16105
89	16106	16107	16108	16109	16110	16111	16112	16113	16114	16115	16116	16117
90	16118	16119	16120	16121	16122	16123	16124	16125	16126	16127	16128	16129
91	16130	16131	16132	16133	16134	16135	16136	16137	16138	16139	16140	16141
92	16142	16143	16144	16145	16146	16147	16148	16149	16150	16151	16152	16153
93	16154	16155	16156	16157	16158	16159	16160	16161	16162	16163	16164	16165
94	16166	16167	16168	16169	16170	16171	16172	16173	16174	16175	16176	16177
95	16178	16179	16180	16181	16182	16183	16184	16185	16186	16187	16188	16189
96	16190	16191	16192	16193	16194	16195	16196	16197	16198	16199	16200	16201
97	16202	16203	16204	16205	16206	16207	16208	16209	16210	16211	16212	16213
98	16214	16215	16216	16217	16218	16219	16220	16221	16222	16223	16224	16225
99	16226	16227	16228	16229	16230	16231	16232	16233	16234	16235	16236	16237
100	16238	16239	16240	16241	16242	16243	16244	16245	16246	16247	16248	16249
101	16250	16251	16252	16253	16254	16255	16256	16257	16258	16259	16260	16261
102	16262	16263	16264	16265	16266	16267	16268	16269	16270	16271	16272	16273
103	16274	16275	16276	16277	16278	16279	16280	16281	16282	16283	16284	16285
104	16286	16287	16288	16289	16290	16291	16292	16293	16294	16295	16296	16297
105	16298	16299	16300	16301	16302	16303	16304	16305	16306	16307	16308	16309
106	16310	16311	16312	16313	16314	16315	16316	16317	16318	16319	16320	16321
107	16322	16323	16324	16325	16326	16327	16328	16329	16330	16331	16332	16333
108	16334	16335	16336	16337	16338	16339	16340	16341	16342	16343	16344	16345
109	16346	16347	16348	16349	16350	16351	16352	16353	16354	16355	16356	16357
110	16358	16359	16360	16361	16362	16363	16364	16365	16366	16367	16368	16369
111	16370	16371	16372	16373	16374	16375	16376	16377	16378	16379	16380	16381
112	16382	16383	16384	16385	16386	16387	16388	16389	16390	16391	16392	16393
113	16394	16395	16396	16397	16398	16399	16400	16401	16402	16403	16404	16405
114	16406	16407	16408	16409	16410	16411	16412	16413	16414	16415	16416	16417
115	16418	16419	16420	16421	16422	16423	16424	16425	16426	16427	16428	16429
116	16430	16431	16432	16433	16434	16435	16436	16437	16438	16439	16440	16441
117	16442	16443	16444	16445	16446	16447	16448	16449	16450	16451	16452	16453
118	16454	16455	16456	16457	16458	16459	16460	16461	16462	16463	16464	16465
119	16466	16467	16468	16469	16470	16471	16472	16473	16474	16475	16476	16477
120	16478	16479	16480	16481	16482	16483	16484	16485	16486	16487	16488	16489
121	16490	16491	16492	16493	16494	16495	16496	16497	16498	16499	16500	16501
122	16502	16503	16504	16505	16506	16507	16508	16509	16510	16511	16512	16513
123	16514	16515	16516	16517	16518	16519	16520	16521	16522	16523	16524	16525
124	16526	16527	16528	16529	16530	16531	16532	16533	16534	16535	16536	16537
125	16538	16539	16540	16541	16542	16543	16544	16545	16546	16547	16548	16549
126	16550	16551	16552	16553	16554	16555	16556	16557	16558	16559	16560	16561
127	16562	16563	16564	16565	16566	16567	16568	16569	16570	16571	16572	16573
128	16574	16575	16576	16577	16578	16579	16580	16581	16582	16583	16584	16585
129	16586	16587	16588	16589	16590	16591	16592	16593	16594	16595	16596	16597
130	16598	16599	16600	16601	16602	16603	16604	16605	16606	16607	16608	16609
131	16610	16611	16612	16613	16614	16615	16616	16617	16618	16619	16620	16621
132	16622	16623	16624	16625	16626	16627	16628	16629	16630	16631	16632	16633

Chapter 11 Internal Memory Address of “Read/Write Variable Data” command

133	16634	16635	16636	16637	16638	16639	16640	16641	16642	16643	16644	16645
134	16646	16647	16648	16649	16650	16651	16652	16653	16654	16655	16656	16657
135	16658	16659	16660	16661	16662	16663	16664	16665	16666	16667	16668	16669
136	16670	16671	16672	16673	16674	16675	16676	16677	16678	16679	16680	16681
137	16682	16683	16684	16685	16686	16687	16688	16689	16690	16691	16692	16693
138	16694	16695	16696	16697	16698	16699	16700	16701	16702	16703	16704	16705
139	16706	16707	16708	16709	16710	16711	16712	16713	16714	16715	16716	16717
140	16718	16719	16720	16721	16722	16723	16724	16725	16726	16727	16728	16729
141	16730	16731	16732	16733	16734	16735	16736	16737	16738	16739	16740	16741
142	16742	16743	16744	16745	16746	16747	16748	16749	16750	16751	16752	16753
143	16754	16755	16756	16757	16758	16759	16760	16761	16762	16763	16764	16765
144	16766	16767	16768	16769	16770	16771	16772	16773	16774	16775	16776	16777
145	16778	16779	16780	16781	16782	16783	16784	16785	16786	16787	16788	16789
146	16790	16791	16792	16793	16794	16795	16796	16797	16798	16799	16800	16801
147	16802	16803	16804	16805	16806	16807	16808	16809	16810	16811	16812	16813
148	16814	16815	16816	16817	16818	16819	16820	16821	16822	16823	16824	16825
149	16826	16827	16828	16829	16830	16831	16832	16833	16834	16835	16836	16837
150	16838	16839	16840	16841	16842	16843	16844	16845	16846	16847	16848	16849
151	16850	16851	16852	16853	16854	16855	16856	16857	16858	16859	16860	16861
152	16862	16863	16864	16865	16866	16867	16868	16869	16870	16871	16872	16873
153	16874	16875	16876	16877	16878	16879	16880	16881	16882	16883	16884	16885
154	16886	16887	16888	16889	16890	16891	16892	16893	16894	16895	16896	16897
155	16898	16899	16900	16901	16902	16903	16904	16905	16906	16907	16908	16909
156	16910	16911	16912	16913	16914	16915	16916	16917	16918	16919	16920	16921
157	16922	16923	16924	16925	16926	16927	16928	16929	16930	16931	16932	16933
158	16934	16935	16936	16937	16938	16939	16940	16941	16942	16943	16944	16945
159	16946	16947	16948	16949	16950	16951	16952	16953	16954	16955	16956	16957
160	16958	16959	16960	16961	16962	16963	16964	16965	16966	16967	16968	16969
161	16970	16971	16972	16973	16974	16975	16976	16977	16978	16979	16980	16981
162	16982	16983	16984	16985	16986	16987	16988	16989	16990	16991	16992	16993
163	16994	16995	16996	16997	16998	16999	17000	17001	17002	17003	17004	17005
164	17006	17007	17008	17009	17010	17011	17012	17013	17014	17015	17016	17017
165	17018	17019	17020	17021	17022	17023	17024	17025	17026	17027	17028	17029
166	17030	17031	17032	17033	17034	17035	17036	17037	17038	17039	17040	17041
167	17042	17043	17044	17045	17046	17047	17048	17049	17050	17051	17052	17053
168	17054	17055	17056	17057	17058	17059	17060	17061	17062	17063	17064	17065
169	17066	17067	17068	17069	17070	17071	17072	17073	17074	17075	17076	17077
170	17078	17079	17080	17081	17082	17083	17084	17085	17086	17087	17088	17089
171	17090	17091	17092	17093	17094	17095	17096	17097	17098	17099	17100	17101
172	17102	17103	17104	17105	17106	17107	17108	17109	17110	17111	17112	17113
173	17114	17115	17116	17117	17118	17119	17120	17121	17122	17123	17124	17125
174	17126	17127	17128	17129	17130	17131	17132	17133	17134	17135	17136	17137
175	17138	17139	17140	17141	17142	17143	17144	17145	17146	17147	17148	17149
176	17150	17151	17152	17153	17154	17155	17156	17157	17158	17159	17160	17161
177	17162	17163	17164	17165	17166	17167	17168	17169	17170	17171	17172	17173
178	17174	17175	17176	17177	17178	17179	17180	17181	17182	17183	17184	17185

Chapter 11 Internal Memory Address of “Read/Write Variable Data” command

179	17186	17187	17188	17189	17190	17191	17192	17193	17194	17195	17196	17197
180	17198	17199	17200	17201	17202	17203	17204	17205	17206	17207	17208	17209
181	17210	17211	17212	17213	17214	17215	17216	17217	17218	17219	17220	17221
182	17222	17223	17224	17225	17226	17227	17228	17229	17230	17231	17232	17233
183	17234	17235	17236	17237	17238	17239	17240	17241	17242	17243	17244	17245
184	17246	17247	17248	17249	17250	17251	17252	17253	17254	17255	17256	17257
185	17258	17259	17260	17261	17262	17263	17264	17265	17266	17267	17268	17269
186	17270	17271	17272	17273	17274	17275	17276	17277	17278	17279	17280	17281
187	17282	17283	17284	17285	17286	17287	17288	17289	17290	17291	17292	17293
188	17294	17295	17296	17297	17298	17299	17300	17301	17302	17303	17304	17305
189	17306	17307	17308	17309	17310	17311	17312	17313	17314	17315	17316	17317
190	17318	17319	17320	17321	17322	17323	17324	17325	17326	17327	17328	17329
191	17330	17331	17332	17333	17334	17335	17336	17337	17338	17339	17340	17341
192	17342	17343	17344	17345	17346	17347	17348	17349	17350	17351	17352	17353
193	17354	17355	17356	17357	17358	17359	17360	17361	17362	17363	17364	17365
194	17366	17367	17368	17369	17370	17371	17372	17373	17374	17375	17376	17377
195	17378	17379	17380	17381	17382	17383	17384	17385	17386	17387	17388	17389
196	17390	17391	17392	17393	17394	17395	17396	17397	17398	17399	17400	17401
197	17402	17403	17404	17405	17406	17407	17408	17409	17410	17411	17412	17413
198	17414	17415	17416	17417	17418	17419	17420	17421	17422	17423	17424	17425
199	17426	17427	17428	17429	17430	17431	17432	17433	17434	17435	17436	17437
200	17438	17439	17440	17441	17442	17443	17444	17445	17446	17447	17448	17449
201	17450	17451	17452	17453	17454	17455	17456	17457	17458	17459	17460	17461
202	17462	17463	17464	17465	17466	17467	17468	17469	17470	17471	17472	17473
203	17474	17475	17476	17477	17478	17479	17480	17481	17482	17483	17484	17485
204	17486	17487	17488	17489	17490	17491	17492	17493	17494	17495	17496	17497
205	17498	17499	17500	17501	17502	17503	17504	17505	17506	17507	17508	17509
206	17510	17511	17512	17513	17514	17515	17516	17517	17518	17519	17520	17521
207	17522	17523	17524	17525	17526	17527	17528	17529	17530	17531	17532	17533
208	17534	17535	17536	17537	17538	17539	17540	17541	17542	17543	17544	17545
209	17546	17547	17548	17549	17550	17551	17552	17553	17554	17555	17556	17557
210	17558	17559	17560	17561	17562	17563	17564	17565	17566	17567	17568	17569
211	17570	17571	17572	17573	17574	17575	17576	17577	17578	17579	17580	17581
212	17582	17583	17584	17585	17586	17587	17588	17589	17590	17591	17592	17593
213	17594	17595	17596	17597	17598	17599	17600	17601	17602	17603	17604	17605
214	17606	17607	17608	17609	17610	17611	17612	17613	17614	17615	17616	17617
215	17618	17619	17620	17621	17622	17623	17624	17625	17626	17627	17628	17629
216	17630	17631	17632	17633	17634	17635	17636	17637	17638	17639	17640	17641
217	17642	17643	17644	17645	17646	17647	17648	17649	17650	17651	17652	17653
218	17654	17655	17656	17657	17658	17659	17660	17661	17662	17663	17664	17665
219	17666	17667	17668	17669	17670	17671	17672	17673	17674	17675	17676	17677
220	17678	17679	17680	17681	17682	17683	17684	17685	17686	17687	17688	17689
221	17690	17691	17692	17693	17694	17695	17696	17697	17698	17699	17700	17701
222	17702	17703	17704	17705	17706	17707	17708	17709	17710	17711	17712	17713
223	17714	17715	17716	17717	17718	17719	17720	17721	17722	17723	17724	17725
224	17726	17727	17728	17729	17730	17731	17732	17733	17734	17735	17736	17737

Chapter 11 Internal Memory Address of “Read/Write Variable Data” command

225	17738	17739	17740	17741	17742	17743	17744	17745	17746	17747	17748	17749
226	17750	17751	17752	17753	17754	17755	17756	17757	17758	17759	17760	17761
227	17762	17763	17764	17765	17766	17767	17768	17769	17770	17771	17772	17773
228	17774	17775	17776	17777	17778	17779	17780	17781	17782	17783	17784	17785
229	17786	17787	17788	17789	17790	17791	17792	17793	17794	17795	17796	17797
230	17798	17799	17800	17801	17802	17803	17804	17805	17806	17807	17808	17809
231	17810	17811	17812	17813	17814	17815	17816	17817	17818	17819	17820	17821
232	17822	17823	17824	17825	17826	17827	17828	17829	17830	17831	17832	17833
233	17834	17835	17836	17837	17838	17839	17840	17841	17842	17843	17844	17845
234	17846	17847	17848	17849	17850	17851	17852	17853	17854	17855	17856	17857
235	17858	17859	17860	17861	17862	17863	17864	17865	17866	17867	17868	17869
236	17870	17871	17872	17873	17874	17875	17876	17877	17878	17879	17880	17881
237	17882	17883	17884	17885	17886	17887	17888	17889	17890	17891	17892	17893
238	17894	17895	17896	17897	17898	17899	17900	17901	17902	17903	17904	17905
239	17906	17907	17908	17909	17910	17911	17912	17913	17914	17915	17916	17917
240	17918	17919	17920	17921	17922	17923	17924	17925	17926	17927	17928	17929
241	17930	17931	17932	17933	17934	17935	17936	17937	17938	17939	17940	17941
242	17942	17943	17944	17945	17946	17947	17948	17949	17950	17951	17952	17953
243	17954	17955	17956	17957	17958	17959	17960	17961	17962	17963	17964	17965
244	17966	17967	17968	17969	17970	17971	17972	17973	17974	17975	17976	17977
245	17978	17979	17980	17981	17982	17983	17984	17985	17986	17987	17988	17989
246	17990	17991	17992	17993	17994	17995	17996	17997	17998	17999	18000	18001
247	18002	18003	18004	18005	18006	18007	18008	18009	18010	18011	18012	18013
248	18014	18015	18016	18017	18018	18019	18020	18021	18022	18023	18024	18025
249	18026	18027	18028	18029	18030	18031	18032	18033	18034	18035	18036	18037
250	18038	18039	18040	18041	18042	18043	18044	18045	18046	18047	18048	18049
251	18050	18051	18052	18053	18054	18055	18056	18057	18058	18059	18060	18061
252	18062	18063	18064	18065	18066	18067	18068	18069	18070	18071	18072	18073
253	18074	18075	18076	18077	18078	18079	18080	18081	18082	18083	18084	18085
254	18086	18087	18088	18089	18090	18091	18092	18093	18094	18095	18096	18097
255	18098	18099	18100	18101	18102	18103	18104	18105	18106	18107	18108	18109
256	18110	18111	18112	18113	18114	18115	18116	18117	18118	18119	18120	18121
257	18122	18123	18124	18125	18126	18127	18128	18129	18130	18131	18132	18133
258	18134	18135	18136	18137	18138	18139	18140	18141	18142	18143	18144	18145
259	18146	18147	18148	18149	18150	18151	18152	18153	18154	18155	18156	18157
260	18158	18159	18160	18161	18162	18163	18164	18165	18166	18167	18168	18169
261	18170	18171	18172	18173	18174	18175	18176	18177	18178	18179	18180	18181
262	18182	18183	18184	18185	18186	18187	18188	18189	18190	18191	18192	18193
263	18194	18195	18196	18197	18198	18199	18200	18201	18202	18203	18204	18205
264	18206	18207	18208	18209	18210	18211	18212	18213	18214	18215	18216	18217
265	18218	18219	18220	18221	18222	18223	18224	18225	18226	18227	18228	18229
266	18230	18231	18232	18233	18234	18235	18236	18237	18238	18239	18240	18241
267	18242	18243	18244	18245	18246	18247	18248	18249	18250	18251	18252	18253
268	18254	18255	18256	18257	18258	18259	18260	18261	18262	18263	18264	18265
269	18266	18267	18268	18269	18270	18271	18272	18273	18274	18275	18276	18277
270	18278	18279	18280	18281	18282	18283	18284	18285	18286	18287	18288	18289

Chapter 11 Internal Memory Address of “Read/Write Variable Data” command

271	18290	18291	18292	18293	18294	18295	18296	18297	18298	18299	18300	18301
272	18302	18303	18304	18305	18306	18307	18308	18309	18310	18311	18312	18313
273	18314	18315	18316	18317	18318	18319	18320	18321	18322	18323	18324	18325
274	18326	18327	18328	18329	18330	18331	18332	18333	18334	18335	18336	18337
275	18338	18339	18340	18341	18342	18343	18344	18345	18346	18347	18348	18349
276	18350	18351	18352	18353	18354	18355	18356	18357	18358	18359	18360	18361
277	18362	18363	18364	18365	18366	18367	18368	18369	18370	18371	18372	18373
278	18374	18375	18376	18377	18378	18379	18380	18381	18382	18383	18384	18385
279	18386	18387	18388	18389	18390	18391	18392	18393	18394	18395	18396	18397
280	18398	18399	18400	18401	18402	18403	18404	18405	18406	18407	18408	18409
281	18410	18411	18412	18413	18414	18415	18416	18417	18418	18419	18420	18421
282	18422	18423	18424	18425	18426	18427	18428	18429	18430	18431	18432	18433
283	18434	18435	18436	18437	18438	18439	18440	18441	18442	18443	18444	18445
284	18446	18447	18448	18449	18450	18451	18452	18453	18454	18455	18456	18457
285	18458	18459	18460	18461	18462	18463	18464	18465	18466	18467	18468	18469
286	18470	18471	18472	18473	18474	18475	18476	18477	18478	18479	18480	18481
287	18482	18483	18484	18485	18486	18487	18488	18489	18490	18491	18492	18493
288	18494	18495	18496	18497	18498	18499	18500	18501	18502	18503	18504	18505
289	18506	18507	18508	18509	18510	18511	18512	18513	18514	18515	18516	18517
290	18518	18519	18520	18521	18522	18523	18524	18525	18526	18527	18528	18529
291	18530	18531	18532	18533	18534	18535	18536	18537	18538	18539	18540	18541
292	18542	18543	18544	18545	18546	18547	18548	18549	18550	18551	18552	18553
293	18554	18555	18556	18557	18558	18559	18560	18561	18562	18563	18564	18565
294	18566	18567	18568	18569	18570	18571	18572	18573	18574	18575	18576	18577
295	18578	18579	18580	18581	18582	18583	18584	18585	18586	18587	18588	18589
296	18590	18591	18592	18593	18594	18595	18596	18597	18598	18599	18600	18601
297	18602	18603	18604	18605	18606	18607	18608	18609	18610	18611	18612	18613
298	18614	18615	18616	18617	18618	18619	18620	18621	18622	18623	18624	18625
299	18626	18627	18628	18629	18630	18631	18632	18633	18634	18635	18636	18637
300	18638	18639	18640	18641	18642	18643	18644	18645	18646	18647	18648	18649
301	18650	18651	18652	18653	18654	18655	18656	18657	18658	18659	18660	18661
302	18662	18663	18664	18665	18666	18667	18668	18669	18670	18671	18672	18673
303	18674	18675	18676	18677	18678	18679	18680	18681	18682	18683	18684	18685
304	18686	18687	18688	18689	18690	18691	18692	18693	18694	18695	18696	18697
305	18698	18699	18700	18701	18702	18703	18704	18705	18706	18707	18708	18709
306	18710	18711	18712	18713	18714	18715	18716	18717	18718	18719	18720	18721
307	18722	18723	18724	18725	18726	18727	18728	18729	18730	18731	18732	18733
308	18734	18735	18736	18737	18738	18739	18740	18741	18742	18743	18744	18745
309	18746	18747	18748	18749	18750	18751	18752	18753	18754	18755	18756	18757
310	18758	18759	18760	18761	18762	18763	18764	18765	18766	18767	18768	18769
311	18770	18771	18772	18773	18774	18775	18776	18777	18778	18779	18780	18781
312	18782	18783	18784	18785	18786	18787	18788	18789	18790	18791	18792	18793
313	18794	18795	18796	18797	18798	18799	18800	18801	18802	18803	18804	18805
314	18806	18807	18808	18809	18810	18811	18812	18813	18814	18815	18816	18817
315	18818	18819	18820	18821	18822	18823	18824	18825	18826	18827	18828	18829
316	18830	18831	18832	18833	18834	18835	18836	18837	18838	18839	18840	18841

Chapter 11 Internal Memory Address of “Read/Write Variable Data” command

317	18842	18843	18844	18845	18846	18847	18848	18849	18850	18851	18852	18853
318	18854	18855	18856	18857	18858	18859	18860	18861	18862	18863	18864	18865
319	18866	18867	18868	18869	18870	18871	18872	18873	18874	18875	18876	18877
320	18878	18879	18880	18881	18882	18883	18884	18885	18886	18887	18888	18889
321	18890	18891	18892	18893	18894	18895	18896	18897	18898	18899	18900	18901
322	18902	18903	18904	18905	18906	18907	18908	18909	18910	18911	18912	18913
323	18914	18915	18916	18917	18918	18919	18920	18921	18922	18923	18924	18925
324	18926	18927	18928	18929	18930	18931	18932	18933	18934	18935	18936	18937
325	18938	18939	18940	18941	18942	18943	18944	18945	18946	18947	18948	18949
326	18950	18951	18952	18953	18954	18955	18956	18957	18958	18959	18960	18961
327	18962	18963	18964	18965	18966	18967	18968	18969	18970	18971	18972	18973
328	18974	18975	18976	18977	18978	18979	18980	18981	18982	18983	18984	18985
329	18986	18987	18988	18989	18990	18991	18992	18993	18994	18995	18996	18997
330	18998	18999	19000	19001	19002	19003	19004	19005	19006	19007	19008	19009
331	19010	19011	19012	19013	19014	19015	19016	19017	19018	19019	19020	19021
332	19022	19023	19024	19025	19026	19027	19028	19029	19030	19031	19032	19033
333	19034	19035	19036	19037	19038	19039	19040	19041	19042	19043	19044	19045
334	19046	19047	19048	19049	19050	19051	19052	19053	19054	19055	19056	19057
335	19058	19059	19060	19061	19062	19063	19064	19065	19066	19067	19068	19069
336	19070	19071	19072	19073	19074	19075	19076	19077	19078	19079	19080	19081
337	19082	19083	19084	19085	19086	19087	19088	19089	19090	19091	19092	19093
338	19094	19095	19096	19097	19098	19099	19100	19101	19102	19103	19104	19105
339	19106	19107	19108	19109	19110	19111	19112	19113	19114	19115	19116	19117
340	19118	19119	19120	19121	19122	19123	19124	19125	19126	19127	19128	19129
341	19130	19131	19132	19133	19134	19135	19136	19137	19138	19139	19140	19141
342	19142	19143	19144	19145	19146	19147	19148	19149	19150	19151	19152	19153
343	19154	19155	19156	19157	19158	19159	19160	19161	19162	19163	19164	19165
344	19166	19167	19168	19169	19170	19171	19172	19173	19174	19175	19176	19177
345	19178	19179	19180	19181	19182	19183	19184	19185	19186	19187	19188	19189
346	19190	19191	19192	19193	19194	19195	19196	19197	19198	19199	19200	19201
347	19202	19203	19204	19205	19206	19207	19208	19209	19210	19211	19212	19213
348	19214	19215	19216	19217	19218	19219	19220	19221	19222	19223	19224	19225
349	19226	19227	19228	19229	19230	19231	19232	19233	19234	19235	19236	19237
350	19238	19239	19240	19241	19242	19243	19244	19245	19246	19247	19248	19249
351	19250	19251	19252	19253	19254	19255	19256	19257	19258	19259	19260	19261
352	19262	19263	19264	19265	19266	19267	19268	19269	19270	19271	19272	19273
353	19274	19275	19276	19277	19278	19279	19280	19281	19282	19283	19284	19285
354	19286	19287	19288	19289	19290	19291	19292	19293	19294	19295	19296	19297
355	19298	19299	19300	19301	19302	19303	19304	19305	19306	19307	19308	19309
356	19310	19311	19312	19313	19314	19315	19316	19317	19318	19319	19320	19321
357	19322	19323	19324	19325	19326	19327	19328	19329	19330	19331	19332	19333
358	19334	19335	19336	19337	19338	19339	19340	19341	19342	19343	19344	19345
359	19346	19347	19348	19349	19350	19351	19352	19353	19354	19355	19356	19357
360	19358	19359	19360	19361	19362	19363	19364	19365	19366	19367	19368	19369
361	19370	19371	19372	19373	19374	19375	19376	19377	19378	19379	19380	19381
362	19382	19383	19384	19385	19386	19387	19388	19389	19390	19391	19392	19393

Chapter 11 Internal Memory Address of “Read/Write Variable Data” command

363	19394	19395	19396	19397	19398	19399	19400	19401	19402	19403	19404	19405
364	19406	19407	19408	19409	19410	19411	19412	19413	19414	19415	19416	19417
365	19418	19419	19420	19421	19422	19423	19424	19425	19426	19427	19428	19429
366	19430	19431	19432	19433	19434	19435	19436	19437	19438	19439	19440	19441
367	19442	19443	19444	19445	19446	19447	19448	19449	19450	19451	19452	19453
368	19454	19455	19456	19457	19458	19459	19460	19461	19462	19463	19464	19465
369	19466	19467	19468	19469	19470	19471	19472	19473	19474	19475	19476	19477
370	19478	19479	19480	19481	19482	19483	19484	19485	19486	19487	19488	19489
371	19490	19491	19492	19493	19494	19495	19496	19497	19498	19499	19500	19501
372	19502	19503	19504	19505	19506	19507	19508	19509	19510	19511	19512	19513
373	19514	19515	19516	19517	19518	19519	19520	19521	19522	19523	19524	19525
374	19526	19527	19528	19529	19530	19531	19532	19533	19534	19535	19536	19537
375	19538	19539	19540	19541	19542	19543	19544	19545	19546	19547	19548	19549
376	19550	19551	19552	19553	19554	19555	19556	19557	19558	19559	19560	19561
377	19562	19563	19564	19565	19566	19567	19568	19569	19570	19571	19572	19573
378	19574	19575	19576	19577	19578	19579	19580	19581	19582	19583	19584	19585
379	19586	19587	19588	19589	19590	19591	19592	19593	19594	19595	19596	19597
380	19598	19599	19600	19601	19602	19603	19604	19605	19606	19607	19608	19609
381	19610	19611	19612	19613	19614	19615	19616	19617	19618	19619	19620	19621
382	19622	19623	19624	19625	19626	19627	19628	19629	19630	19631	19632	19633
383	19634	19635	19636	19637	19638	19639	19640	19641	19642	19643	19644	19645
384	19646	19647	19648	19649	19650	19651	19652	19653	19654	19655	19656	19657
385	19658	19659	19660	19661	19662	19663	19664	19665	19666	19667	19668	19669
386	19670	19671	19672	19673	19674	19675	19676	19677	19678	19679	19680	19681
387	19682	19683	19684	19685	19686	19687	19688	19689	19690	19691	19692	19693
388	19694	19695	19696	19697	19698	19699	19700	19701	19702	19703	19704	19705
389	19706	19707	19708	19709	19710	19711	19712	19713	19714	19715	19716	19717
390	19718	19719	19720	19721	19722	19723	19724	19725	19726	19727	19728	19729
391	19730	19731	19732	19733	19734	19735	19736	19737	19738	19739	19740	19741
392	19742	19743	19744	19745	19746	19747	19748	19749	19750	19751	19752	19753
393	19754	19755	19756	19757	19758	19759	19760	19761	19762	19763	19764	19765
394	19766	19767	19768	19769	19770	19771	19772	19773	19774	19775	19776	19777
395	19778	19779	19780	19781	19782	19783	19784	19785	19786	19787	19788	19789
396	19790	19791	19792	19793	19794	19795	19796	19797	19798	19799	19800	19801
397	19802	19803	19804	19805	19806	19807	19808	19809	19810	19811	19812	19813
398	19814	19815	19816	19817	19818	19819	19820	19821	19822	19823	19824	19825
399	19826	19827	19828	19829	19830	19831	19832	19833	19834	19835	19836	19837
400	19838	19839	19840	19841	19842	19843	19844	19845	19846	19847	19848	19849

11.6 Axis 5 operation data memory address

Step	Target position		Cir. int. auxiliary point		Operation speed		Dwell time	Mcode	Sub Axis	Helical int.	Circular int. turns	Control word
	Low	High	Low	High	Low	High						
1	19850	19851	19852	19853	19854	19855	19856	19857	19858	19859	19860	19861
2	19862	19863	19864	19865	19866	19867	19868	19869	19870	19871	19872	19873
3	19874	19875	19876	19877	19878	19879	19880	19881	19882	19883	19884	19885
4	19886	19887	19888	19889	19890	19891	19892	19893	19894	19895	19896	19897
5	19898	19899	19900	19901	19902	19903	19904	19905	19906	19907	19908	19909
6	19910	19911	19912	19913	19914	19915	19916	19917	19918	19919	19920	19921
7	19922	19923	19924	19925	19926	19927	19928	19929	19930	19931	19932	19933
8	19934	19935	19936	19937	19938	19939	19940	19941	19942	19943	19944	19945
9	19946	19947	19948	19949	19950	19951	19952	19953	19954	19955	19956	19957
10	19958	19959	19960	19961	19962	19963	19964	19965	19966	19967	19968	19969
11	19970	19971	19972	19973	19974	19975	19976	19977	19978	19979	19980	19981
12	19982	19983	19984	19985	19986	19987	19988	19989	19990	19991	19992	19993
13	19994	19995	19996	19997	19998	19999	20000	20001	20002	20003	20004	20005
14	20006	20007	20008	20009	20010	20011	20012	20013	20014	20015	20016	20017
15	20018	20019	20020	20021	20022	20023	20024	20025	20026	20027	20028	20029
16	20030	20031	20032	20033	20034	20035	20036	20037	20038	20039	20040	20041
17	20042	20043	20044	20045	20046	20047	20048	20049	20050	20051	20052	20053
18	20054	20055	20056	20057	20058	20059	20060	20061	20062	20063	20064	20065
19	20066	20067	20068	20069	20070	20071	20072	20073	20074	20075	20076	20077
20	20078	20079	20080	20081	20082	20083	20084	20085	20086	20087	20088	20089
21	20090	20091	20092	20093	20094	20095	20096	20097	20098	20099	20100	20101
22	20102	20103	20104	20105	20106	20107	20108	20109	20110	20111	20112	20113
23	20114	20115	20116	20117	20118	20119	20120	20121	20122	20123	20124	20125
24	20126	20127	20128	20129	20130	20131	20132	20133	20134	20135	20136	20137
25	20138	20139	20140	20141	20142	20143	20144	20145	20146	20147	20148	20149
26	20150	20151	20152	20153	20154	20155	20156	20157	20158	20159	20160	20161
27	20162	20163	20164	20165	20166	20167	20168	20169	20170	20171	20172	20173
28	20174	20175	20176	20177	20178	20179	20180	20181	20182	20183	20184	20185
29	20186	20187	20188	20189	20190	20191	20192	20193	20194	20195	20196	20197
30	20198	20199	20200	20201	20202	20203	20204	20205	20206	20207	20208	20209
31	20210	20211	20212	20213	20214	20215	20216	20217	20218	20219	20220	20221
32	20222	20223	20224	20225	20226	20227	20228	20229	20230	20231	20232	20233
33	20234	20235	20236	20237	20238	20239	20240	20241	20242	20243	20244	20245
34	20246	20247	20248	20249	20250	20251	20252	20253	20254	20255	20256	20257
35	20258	20259	20260	20261	20262	20263	20264	20265	20266	20267	20268	20269
36	20270	20271	20272	20273	20274	20275	20276	20277	20278	20279	20280	20281
37	20282	20283	20284	20285	20286	20287	20288	20289	20290	20291	20292	20293
38	20294	20295	20296	20297	20298	20299	20300	20301	20302	20303	20304	20305
39	20306	20307	20308	20309	20310	20311	20312	20313	20314	20315	20316	20317
40	20318	20319	20320	20321	20322	20323	20324	20325	20326	20327	20328	20329
41	20330	20331	20332	20333	20334	20335	20336	20337	20338	20339	20340	20341
42	20342	20343	20344	20345	20346	20347	20348	20349	20350	20351	20352	20353
43	20354	20355	20356	20357	20358	20359	20360	20361	20362	20363	20364	20365

Chapter 11 Internal Memory Address of “Read/Write Variable Data” command

44	20366	20367	20368	20369	20370	20371	20372	20373	20374	20375	20376	20377
45	20378	20379	20380	20381	20382	20383	20384	20385	20386	20387	20388	20389
46	20390	20391	20392	20393	20394	20395	20396	20397	20398	20399	20400	20401
47	20402	20403	20404	20405	20406	20407	20408	20409	20410	20411	20412	20413
48	20414	20415	20416	20417	20418	20419	20420	20421	20422	20423	20424	20425
49	20426	20427	20428	20429	20430	20431	20432	20433	20434	20435	20436	20437
50	20438	20439	20440	20441	20442	20443	20444	20445	20446	20447	20448	20449
51	20450	20451	20452	20453	20454	20455	20456	20457	20458	20459	20460	20461
52	20462	20463	20464	20465	20466	20467	20468	20469	20470	20471	20472	20473
53	20474	20475	20476	20477	20478	20479	20480	20481	20482	20483	20484	20485
54	20486	20487	20488	20489	20490	20491	20492	20493	20494	20495	20496	20497
55	20498	20499	20500	20501	20502	20503	20504	20505	20506	20507	20508	20509
56	20510	20511	20512	20513	20514	20515	20516	20517	20518	20519	20520	20521
57	20522	20523	20524	20525	20526	20527	20528	20529	20530	20531	20532	20533
58	20534	20535	20536	20537	20538	20539	20540	20541	20542	20543	20544	20545
59	20546	20547	20548	20549	20550	20551	20552	20553	20554	20555	20556	20557
60	20558	20559	20560	20561	20562	20563	20564	20565	20566	20567	20568	20569
61	20570	20571	20572	20573	20574	20575	20576	20577	20578	20579	20580	20581
62	20582	20583	20584	20585	20586	20587	20588	20589	20590	20591	20592	20593
63	20594	20595	20596	20597	20598	20599	20600	20601	20602	20603	20604	20605
64	20606	20607	20608	20609	20610	20611	20612	20613	20614	20615	20616	20617
65	20618	20619	20620	20621	20622	20623	20624	20625	20626	20627	20628	20629
66	20630	20631	20632	20633	20634	20635	20636	20637	20638	20639	20640	20641
67	20642	20643	20644	20645	20646	20647	20648	20649	20650	20651	20652	20653
68	20654	20655	20656	20657	20658	20659	20660	20661	20662	20663	20664	20665
69	20666	20667	20668	20669	20670	20671	20672	20673	20674	20675	20676	20677
70	20678	20679	20680	20681	20682	20683	20684	20685	20686	20687	20688	20689
71	20690	20691	20692	20693	20694	20695	20696	20697	20698	20699	20700	20701
72	20702	20703	20704	20705	20706	20707	20708	20709	20710	20711	20712	20713
73	20714	20715	20716	20717	20718	20719	20720	20721	20722	20723	20724	20725
74	20726	20727	20728	20729	20730	20731	20732	20733	20734	20735	20736	20737
75	20738	20739	20740	20741	20742	20743	20744	20745	20746	20747	20748	20749
76	20750	20751	20752	20753	20754	20755	20756	20757	20758	20759	20760	20761
77	20762	20763	20764	20765	20766	20767	20768	20769	20770	20771	20772	20773
78	20774	20775	20776	20777	20778	20779	20780	20781	20782	20783	20784	20785
79	20786	20787	20788	20789	20790	20791	20792	20793	20794	20795	20796	20797
80	20798	20799	20800	20801	20802	20803	20804	20805	20806	20807	20808	20809
81	20810	20811	20812	20813	20814	20815	20816	20817	20818	20819	20820	20821
82	20822	20823	20824	20825	20826	20827	20828	20829	20830	20831	20832	20833
83	20834	20835	20836	20837	20838	20839	20840	20841	20842	20843	20844	20845
84	20846	20847	20848	20849	20850	20851	20852	20853	20854	20855	20856	20857
85	20858	20859	20860	20861	20862	20863	20864	20865	20866	20867	20868	20869
86	20870	20871	20872	20873	20874	20875	20876	20877	20878	20879	20880	20881
87	20882	20883	20884	20885	20886	20887	20888	20889	20890	20891	20892	20893
88	20894	20895	20896	20897	20898	20899	20900	20901	20902	20903	20904	20905
89	20906	20907	20908	20909	20910	20911	20912	20913	20914	20915	20916	20917

Chapter 11 Internal Memory Address of “Read/Write Variable Data” command

90	20918	20919	20920	20921	20922	20923	20924	20925	20926	20927	20928	20929
91	20930	20931	20932	20933	20934	20935	20936	20937	20938	20939	20940	20941
92	20942	20943	20944	20945	20946	20947	20948	20949	20950	20951	20952	20953
93	20954	20955	20956	20957	20958	20959	20960	20961	20962	20963	20964	20965
94	20966	20967	20968	20969	20970	20971	20972	20973	20974	20975	20976	20977
95	20978	20979	20980	20981	20982	20983	20984	20985	20986	20987	20988	20989
96	20990	20991	20992	20993	20994	20995	20996	20997	20998	20999	21000	21001
97	21002	21003	21004	21005	21006	21007	21008	21009	21010	21011	21012	21013
98	21014	21015	21016	21017	21018	21019	21020	21021	21022	21023	21024	21025
99	21026	21027	21028	21029	21030	21031	21032	21033	21034	21035	21036	21037
100	21038	21039	21040	21041	21042	21043	21044	21045	21046	21047	21048	21049
101	21050	21051	21052	21053	21054	21055	21056	21057	21058	21059	21060	21061
102	21062	21063	21064	21065	21066	21067	21068	21069	21070	21071	21072	21073
103	21074	21075	21076	21077	21078	21079	21080	21081	21082	21083	21084	21085
104	21086	21087	21088	21089	21090	21091	21092	21093	21094	21095	21096	21097
105	21098	21099	21100	21101	21102	21103	21104	21105	21106	21107	21108	21109
106	21110	21111	21112	21113	21114	21115	21116	21117	21118	21119	21120	21121
107	21122	21123	21124	21125	21126	21127	21128	21129	21130	21131	21132	21133
108	21134	21135	21136	21137	21138	21139	21140	21141	21142	21143	21144	21145
109	21146	21147	21148	21149	21150	21151	21152	21153	21154	21155	21156	21157
110	21158	21159	21160	21161	21162	21163	21164	21165	21166	21167	21168	21169
111	21170	21171	21172	21173	21174	21175	21176	21177	21178	21179	21180	21181
112	21182	21183	21184	21185	21186	21187	21188	21189	21190	21191	21192	21193
113	21194	21195	21196	21197	21198	21199	21200	21201	21202	21203	21204	21205
114	21206	21207	21208	21209	21210	21211	21212	21213	21214	21215	21216	21217
115	21218	21219	21220	21221	21222	21223	21224	21225	21226	21227	21228	21229
116	21230	21231	21232	21233	21234	21235	21236	21237	21238	21239	21240	21241
117	21242	21243	21244	21245	21246	21247	21248	21249	21250	21251	21252	21253
118	21254	21255	21256	21257	21258	21259	21260	21261	21262	21263	21264	21265
119	21266	21267	21268	21269	21270	21271	21272	21273	21274	21275	21276	21277
120	21278	21279	21280	21281	21282	21283	21284	21285	21286	21287	21288	21289
121	21290	21291	21292	21293	21294	21295	21296	21297	21298	21299	21300	21301
122	21302	21303	21304	21305	21306	21307	21308	21309	21310	21311	21312	21313
123	21314	21315	21316	21317	21318	21319	21320	21321	21322	21323	21324	21325
124	21326	21327	21328	21329	21330	21331	21332	21333	21334	21335	21336	21337
125	21338	21339	21340	21341	21342	21343	21344	21345	21346	21347	21348	21349
126	21350	21351	21352	21353	21354	21355	21356	21357	21358	21359	21360	21361
127	21362	21363	21364	21365	21366	21367	21368	21369	21370	21371	21372	21373
128	21374	21375	21376	21377	21378	21379	21380	21381	21382	21383	21384	21385
129	21386	21387	21388	21389	21390	21391	21392	21393	21394	21395	21396	21397
130	21398	21399	21400	21401	21402	21403	21404	21405	21406	21407	21408	21409
131	21410	21411	21412	21413	21414	21415	21416	21417	21418	21419	21420	21421
132	21422	21423	21424	21425	21426	21427	21428	21429	21430	21431	21432	21433
133	21434	21435	21436	21437	21438	21439	21440	21441	21442	21443	21444	21445
134	21446	21447	21448	21449	21450	21451	21452	21453	21454	21455	21456	21457
135	21458	21459	21460	21461	21462	21463	21464	21465	21466	21467	21468	21469

Chapter 11 Internal Memory Address of “Read/Write Variable Data” command

136	21470	21471	21472	21473	21474	21475	21476	21477	21478	21479	21480	21481
137	21482	21483	21484	21485	21486	21487	21488	21489	21490	21491	21492	21493
138	21494	21495	21496	21497	21498	21499	21500	21501	21502	21503	21504	21505
139	21506	21507	21508	21509	21510	21511	21512	21513	21514	21515	21516	21517
140	21518	21519	21520	21521	21522	21523	21524	21525	21526	21527	21528	21529
141	21530	21531	21532	21533	21534	21535	21536	21537	21538	21539	21540	21541
142	21542	21543	21544	21545	21546	21547	21548	21549	21550	21551	21552	21553
143	21554	21555	21556	21557	21558	21559	21560	21561	21562	21563	21564	21565
144	21566	21567	21568	21569	21570	21571	21572	21573	21574	21575	21576	21577
145	21578	21579	21580	21581	21582	21583	21584	21585	21586	21587	21588	21589
146	21590	21591	21592	21593	21594	21595	21596	21597	21598	21599	21600	21601
147	21602	21603	21604	21605	21606	21607	21608	21609	21610	21611	21612	21613
148	21614	21615	21616	21617	21618	21619	21620	21621	21622	21623	21624	21625
149	21626	21627	21628	21629	21630	21631	21632	21633	21634	21635	21636	21637
150	21638	21639	21640	21641	21642	21643	21644	21645	21646	21647	21648	21649
151	21650	21651	21652	21653	21654	21655	21656	21657	21658	21659	21660	21661
152	21662	21663	21664	21665	21666	21667	21668	21669	21670	21671	21672	21673
153	21674	21675	21676	21677	21678	21679	21680	21681	21682	21683	21684	21685
154	21686	21687	21688	21689	21690	21691	21692	21693	21694	21695	21696	21697
155	21698	21699	21700	21701	21702	21703	21704	21705	21706	21707	21708	21709
156	21710	21711	21712	21713	21714	21715	21716	21717	21718	21719	21720	21721
157	21722	21723	21724	21725	21726	21727	21728	21729	21730	21731	21732	21733
158	21734	21735	21736	21737	21738	21739	21740	21741	21742	21743	21744	21745
159	21746	21747	21748	21749	21750	21751	21752	21753	21754	21755	21756	21757
160	21758	21759	21760	21761	21762	21763	21764	21765	21766	21767	21768	21769
161	21770	21771	21772	21773	21774	21775	21776	21777	21778	21779	21780	21781
162	21782	21783	21784	21785	21786	21787	21788	21789	21790	21791	21792	21793
163	21794	21795	21796	21797	21798	21799	21800	21801	21802	21803	21804	21805
164	21806	21807	21808	21809	21810	21811	21812	21813	21814	21815	21816	21817
165	21818	21819	21820	21821	21822	21823	21824	21825	21826	21827	21828	21829
166	21830	21831	21832	21833	21834	21835	21836	21837	21838	21839	21840	21841
167	21842	21843	21844	21845	21846	21847	21848	21849	21850	21851	21852	21853
168	21854	21855	21856	21857	21858	21859	21860	21861	21862	21863	21864	21865
169	21866	21867	21868	21869	21870	21871	21872	21873	21874	21875	21876	21877
170	21878	21879	21880	21881	21882	21883	21884	21885	21886	21887	21888	21889
171	21890	21891	21892	21893	21894	21895	21896	21897	21898	21899	21900	21901
172	21902	21903	21904	21905	21906	21907	21908	21909	21910	21911	21912	21913
173	21914	21915	21916	21917	21918	21919	21920	21921	21922	21923	21924	21925
174	21926	21927	21928	21929	21930	21931	21932	21933	21934	21935	21936	21937
175	21938	21939	21940	21941	21942	21943	21944	21945	21946	21947	21948	21949
176	21950	21951	21952	21953	21954	21955	21956	21957	21958	21959	21960	21961
177	21962	21963	21964	21965	21966	21967	21968	21969	21970	21971	21972	21973
178	21974	21975	21976	21977	21978	21979	21980	21981	21982	21983	21984	21985
179	21986	21987	21988	21989	21990	21991	21992	21993	21994	21995	21996	21997
180	21998	21999	22000	22001	22002	22003	22004	22005	22006	22007	22008	22009
181	22010	22011	22012	22013	22014	22015	22016	22017	22018	22019	22020	22021

Chapter 11 Internal Memory Address of “Read/Write Variable Data” command

182	22022	22023	22024	22025	22026	22027	22028	22029	22030	22031	22032	22033
183	22034	22035	22036	22037	22038	22039	22040	22041	22042	22043	22044	22045
184	22046	22047	22048	22049	22050	22051	22052	22053	22054	22055	22056	22057
185	22058	22059	22060	22061	22062	22063	22064	22065	22066	22067	22068	22069
186	22070	22071	22072	22073	22074	22075	22076	22077	22078	22079	22080	22081
187	22082	22083	22084	22085	22086	22087	22088	22089	22090	22091	22092	22093
188	22094	22095	22096	22097	22098	22099	22100	22101	22102	22103	22104	22105
189	22106	22107	22108	22109	22110	22111	22112	22113	22114	22115	22116	22117
190	22118	22119	22120	22121	22122	22123	22124	22125	22126	22127	22128	22129
191	22130	22131	22132	22133	22134	22135	22136	22137	22138	22139	22140	22141
192	22142	22143	22144	22145	22146	22147	22148	22149	22150	22151	22152	22153
193	22154	22155	22156	22157	22158	22159	22160	22161	22162	22163	22164	22165
194	22166	22167	22168	22169	22170	22171	22172	22173	22174	22175	22176	22177
195	22178	22179	22180	22181	22182	22183	22184	22185	22186	22187	22188	22189
196	22190	22191	22192	22193	22194	22195	22196	22197	22198	22199	22200	22201
197	22202	22203	22204	22205	22206	22207	22208	22209	22210	22211	22212	22213
198	22214	22215	22216	22217	22218	22219	22220	22221	22222	22223	22224	22225
199	22226	22227	22228	22229	22230	22231	22232	22233	22234	22235	22236	22237
200	22238	22239	22240	22241	22242	22243	22244	22245	22246	22247	22248	22249
201	22250	22251	22252	22253	22254	22255	22256	22257	22258	22259	22260	22261
202	22262	22263	22264	22265	22266	22267	22268	22269	22270	22271	22272	22273
203	22274	22275	22276	22277	22278	22279	22280	22281	22282	22283	22284	22285
204	22286	22287	22288	22289	22290	22291	22292	22293	22294	22295	22296	22297
205	22298	22299	22300	22301	22302	22303	22304	22305	22306	22307	22308	22309
206	22310	22311	22312	22313	22314	22315	22316	22317	22318	22319	22320	22321
207	22322	22323	22324	22325	22326	22327	22328	22329	22330	22331	22332	22333
208	22334	22335	22336	22337	22338	22339	22340	22341	22342	22343	22344	22345
209	22346	22347	22348	22349	22350	22351	22352	22353	22354	22355	22356	22357
210	22358	22359	22360	22361	22362	22363	22364	22365	22366	22367	22368	22369
211	22370	22371	22372	22373	22374	22375	22376	22377	22378	22379	22380	22381
212	22382	22383	22384	22385	22386	22387	22388	22389	22390	22391	22392	22393
213	22394	22395	22396	22397	22398	22399	22400	22401	22402	22403	22404	22405
214	22406	22407	22408	22409	22410	22411	22412	22413	22414	22415	22416	22417
215	22418	22419	22420	22421	22422	22423	22424	22425	22426	22427	22428	22429
216	22430	22431	22432	22433	22434	22435	22436	22437	22438	22439	22440	22441
217	22442	22443	22444	22445	22446	22447	22448	22449	22450	22451	22452	22453
218	22454	22455	22456	22457	22458	22459	22460	22461	22462	22463	22464	22465
219	22466	22467	22468	22469	22470	22471	22472	22473	22474	22475	22476	22477
220	22478	22479	22480	22481	22482	22483	22484	22485	22486	22487	22488	22489
221	22490	22491	22492	22493	22494	22495	22496	22497	22498	22499	22500	22501
222	22502	22503	22504	22505	22506	22507	22508	22509	22510	22511	22512	22513
223	22514	22515	22516	22517	22518	22519	22520	22521	22522	22523	22524	22525
224	22526	22527	22528	22529	22530	22531	22532	22533	22534	22535	22536	22537
225	22538	22539	22540	22541	22542	22543	22544	22545	22546	22547	22548	22549
226	22550	22551	22552	22553	22554	22555	22556	22557	22558	22559	22560	22561
227	22562	22563	22564	22565	22566	22567	22568	22569	22570	22571	22572	22573

Chapter 11 Internal Memory Address of “Read/Write Variable Data” command

228	22574	22575	22576	22577	22578	22579	22580	22581	22582	22583	22584	22585
229	22586	22587	22588	22589	22590	22591	22592	22593	22594	22595	22596	22597
230	22598	22599	22600	22601	22602	22603	22604	22605	22606	22607	22608	22609
231	22610	22611	22612	22613	22614	22615	22616	22617	22618	22619	22620	22621
232	22622	22623	22624	22625	22626	22627	22628	22629	22630	22631	22632	22633
233	22634	22635	22636	22637	22638	22639	22640	22641	22642	22643	22644	22645
234	22646	22647	22648	22649	22650	22651	22652	22653	22654	22655	22656	22657
235	22658	22659	22660	22661	22662	22663	22664	22665	22666	22667	22668	22669
236	22670	22671	22672	22673	22674	22675	22676	22677	22678	22679	22680	22681
237	22682	22683	22684	22685	22686	22687	22688	22689	22690	22691	22692	22693
238	22694	22695	22696	22697	22698	22699	22700	22701	22702	22703	22704	22705
239	22706	22707	22708	22709	22710	22711	22712	22713	22714	22715	22716	22717
240	22718	22719	22720	22721	22722	22723	22724	22725	22726	22727	22728	22729
241	22730	22731	22732	22733	22734	22735	22736	22737	22738	22739	22740	22741
242	22742	22743	22744	22745	22746	22747	22748	22749	22750	22751	22752	22753
243	22754	22755	22756	22757	22758	22759	22760	22761	22762	22763	22764	22765
244	22766	22767	22768	22769	22770	22771	22772	22773	22774	22775	22776	22777
245	22778	22779	22780	22781	22782	22783	22784	22785	22786	22787	22788	22789
246	22790	22791	22792	22793	22794	22795	22796	22797	22798	22799	22800	22801
247	22802	22803	22804	22805	22806	22807	22808	22809	22810	22811	22812	22813
248	22814	22815	22816	22817	22818	22819	22820	22821	22822	22823	22824	22825
249	22826	22827	22828	22829	22830	22831	22832	22833	22834	22835	22836	22837
250	22838	22839	22840	22841	22842	22843	22844	22845	22846	22847	22848	22849
251	22850	22851	22852	22853	22854	22855	22856	22857	22858	22859	22860	22861
252	22862	22863	22864	22865	22866	22867	22868	22869	22870	22871	22872	22873
253	22874	22875	22876	22877	22878	22879	22880	22881	22882	22883	22884	22885
254	22886	22887	22888	22889	22890	22891	22892	22893	22894	22895	22896	22897
255	22898	22899	22900	22901	22902	22903	22904	22905	22906	22907	22908	22909
256	22910	22911	22912	22913	22914	22915	22916	22917	22918	22919	22920	22921
257	22922	22923	22924	22925	22926	22927	22928	22929	22930	22931	22932	22933
258	22934	22935	22936	22937	22938	22939	22940	22941	22942	22943	22944	22945
259	22946	22947	22948	22949	22950	22951	22952	22953	22954	22955	22956	22957
260	22958	22959	22960	22961	22962	22963	22964	22965	22966	22967	22968	22969
261	22970	22971	22972	22973	22974	22975	22976	22977	22978	22979	22980	22981
262	22982	22983	22984	22985	22986	22987	22988	22989	22990	22991	22992	22993
263	22994	22995	22996	22997	22998	22999	23000	23001	23002	23003	23004	23005
264	23006	23007	23008	23009	23010	23011	23012	23013	23014	23015	23016	23017
265	23018	23019	23020	23021	23022	23023	23024	23025	23026	23027	23028	23029
266	23030	23031	23032	23033	23034	23035	23036	23037	23038	23039	23040	23041
267	23042	23043	23044	23045	23046	23047	23048	23049	23050	23051	23052	23053
268	23054	23055	23056	23057	23058	23059	23060	23061	23062	23063	23064	23065
269	23066	23067	23068	23069	23070	23071	23072	23073	23074	23075	23076	23077
270	23078	23079	23080	23081	23082	23083	23084	23085	23086	23087	23088	23089
271	23090	23091	23092	23093	23094	23095	23096	23097	23098	23099	23100	23101
272	23102	23103	23104	23105	23106	23107	23108	23109	23110	23111	23112	23113
273	23114	23115	23116	23117	23118	23119	23120	23121	23122	23123	23124	23125

Chapter 11 Internal Memory Address of “Read/Write Variable Data” command

274	23126	23127	23128	23129	23130	23131	23132	23133	23134	23135	23136	23137
275	23138	23139	23140	23141	23142	23143	23144	23145	23146	23147	23148	23149
276	23150	23151	23152	23153	23154	23155	23156	23157	23158	23159	23160	23161
277	23162	23163	23164	23165	23166	23167	23168	23169	23170	23171	23172	23173
278	23174	23175	23176	23177	23178	23179	23180	23181	23182	23183	23184	23185
279	23186	23187	23188	23189	23190	23191	23192	23193	23194	23195	23196	23197
280	23198	23199	23200	23201	23202	23203	23204	23205	23206	23207	23208	23209
281	23210	23211	23212	23213	23214	23215	23216	23217	23218	23219	23220	23221
282	23222	23223	23224	23225	23226	23227	23228	23229	23230	23231	23232	23233
283	23234	23235	23236	23237	23238	23239	23240	23241	23242	23243	23244	23245
284	23246	23247	23248	23249	23250	23251	23252	23253	23254	23255	23256	23257
285	23258	23259	23260	23261	23262	23263	23264	23265	23266	23267	23268	23269
286	23270	23271	23272	23273	23274	23275	23276	23277	23278	23279	23280	23281
287	23282	23283	23284	23285	23286	23287	23288	23289	23290	23291	23292	23293
288	23294	23295	23296	23297	23298	23299	23300	23301	23302	23303	23304	23305
289	23306	23307	23308	23309	23310	23311	23312	23313	23314	23315	23316	23317
290	23318	23319	23320	23321	23322	23323	23324	23325	23326	23327	23328	23329
291	23330	23331	23332	23333	23334	23335	23336	23337	23338	23339	23340	23341
292	23342	23343	23344	23345	23346	23347	23348	23349	23350	23351	23352	23353
293	23354	23355	23356	23357	23358	23359	23360	23361	23362	23363	23364	23365
294	23366	23367	23368	23369	23370	23371	23372	23373	23374	23375	23376	23377
295	23378	23379	23380	23381	23382	23383	23384	23385	23386	23387	23388	23389
296	23390	23391	23392	23393	23394	23395	23396	23397	23398	23399	23400	23401
297	23402	23403	23404	23405	23406	23407	23408	23409	23410	23411	23412	23413
298	23414	23415	23416	23417	23418	23419	23420	23421	23422	23423	23424	23425
299	23426	23427	23428	23429	23430	23431	23432	23433	23434	23435	23436	23437
300	23438	23439	23440	23441	23442	23443	23444	23445	23446	23447	23448	23449
301	23450	23451	23452	23453	23454	23455	23456	23457	23458	23459	23460	23461
302	23462	23463	23464	23465	23466	23467	23468	23469	23470	23471	23472	23473
303	23474	23475	23476	23477	23478	23479	23480	23481	23482	23483	23484	23485
304	23486	23487	23488	23489	23490	23491	23492	23493	23494	23495	23496	23497
305	23498	23499	23500	23501	23502	23503	23504	23505	23506	23507	23508	23509
306	23510	23511	23512	23513	23514	23515	23516	23517	23518	23519	23520	23521
307	23522	23523	23524	23525	23526	23527	23528	23529	23530	23531	23532	23533
308	23534	23535	23536	23537	23538	23539	23540	23541	23542	23543	23544	23545
309	23546	23547	23548	23549	23550	23551	23552	23553	23554	23555	23556	23557
310	23558	23559	23560	23561	23562	23563	23564	23565	23566	23567	23568	23569
311	23570	23571	23572	23573	23574	23575	23576	23577	23578	23579	23580	23581
312	23582	23583	23584	23585	23586	23587	23588	23589	23590	23591	23592	23593
313	23594	23595	23596	23597	23598	23599	23600	23601	23602	23603	23604	23605
314	23606	23607	23608	23609	23610	23611	23612	23613	23614	23615	23616	23617
315	23618	23619	23620	23621	23622	23623	23624	23625	23626	23627	23628	23629
316	23630	23631	23632	23633	23634	23635	23636	23637	23638	23639	23640	23641
317	23642	23643	23644	23645	23646	23647	23648	23649	23650	23651	23652	23653
318	23654	23655	23656	23657	23658	23659	23660	23661	23662	23663	23664	23665
319	23666	23667	23668	23669	23670	23671	23672	23673	23674	23675	23676	23677

Chapter 11 Internal Memory Address of “Read/Write Variable Data” command

320	23678	23679	23680	23681	23682	23683	23684	23685	23686	23687	23688	23689
321	23690	23691	23692	23693	23694	23695	23696	23697	23698	23699	23700	23701
322	23702	23703	23704	23705	23706	23707	23708	23709	23710	23711	23712	23713
323	23714	23715	23716	23717	23718	23719	23720	23721	23722	23723	23724	23725
324	23726	23727	23728	23729	23730	23731	23732	23733	23734	23735	23736	23737
325	23738	23739	23740	23741	23742	23743	23744	23745	23746	23747	23748	23749
326	23750	23751	23752	23753	23754	23755	23756	23757	23758	23759	23760	23761
327	23762	23763	23764	23765	23766	23767	23768	23769	23770	23771	23772	23773
328	23774	23775	23776	23777	23778	23779	23780	23781	23782	23783	23784	23785
329	23786	23787	23788	23789	23790	23791	23792	23793	23794	23795	23796	23797
330	23798	23799	23800	23801	23802	23803	23804	23805	23806	23807	23808	23809
331	23810	23811	23812	23813	23814	23815	23816	23817	23818	23819	23820	23821
332	23822	23823	23824	23825	23826	23827	23828	23829	23830	23831	23832	23833
333	23834	23835	23836	23837	23838	23839	23840	23841	23842	23843	23844	23845
334	23846	23847	23848	23849	23850	23851	23852	23853	23854	23855	23856	23857
335	23858	23859	23860	23861	23862	23863	23864	23865	23866	23867	23868	23869
336	23870	23871	23872	23873	23874	23875	23876	23877	23878	23879	23880	23881
337	23882	23883	23884	23885	23886	23887	23888	23889	23890	23891	23892	23893
338	23894	23895	23896	23897	23898	23899	23900	23901	23902	23903	23904	23905
339	23906	23907	23908	23909	23910	23911	23912	23913	23914	23915	23916	23917
340	23918	23919	23920	23921	23922	23923	23924	23925	23926	23927	23928	23929
341	23930	23931	23932	23933	23934	23935	23936	23937	23938	23939	23940	23941
342	23942	23943	23944	23945	23946	23947	23948	23949	23950	23951	23952	23953
343	23954	23955	23956	23957	23958	23959	23960	23961	23962	23963	23964	23965
344	23966	23967	23968	23969	23970	23971	23972	23973	23974	23975	23976	23977
345	23978	23979	23980	23981	23982	23983	23984	23985	23986	23987	23988	23989
346	23990	23991	23992	23993	23994	23995	23996	23997	23998	23999	24000	24001
347	24002	24003	24004	24005	24006	24007	24008	24009	24010	24011	24012	24013
348	24014	24015	24016	24017	24018	24019	24020	24021	24022	24023	24024	24025
349	24026	24027	24028	24029	24030	24031	24032	24033	24034	24035	24036	24037
350	24038	24039	24040	24041	24042	24043	24044	24045	24046	24047	24048	24049
351	24050	24051	24052	24053	24054	24055	24056	24057	24058	24059	24060	24061
352	24062	24063	24064	24065	24066	24067	24068	24069	24070	24071	24072	24073
353	24074	24075	24076	24077	24078	24079	24080	24081	24082	24083	24084	24085
354	24086	24087	24088	24089	24090	24091	24092	24093	24094	24095	24096	24097
355	24098	24099	24100	24101	24102	24103	24104	24105	24106	24107	24108	24109
356	24110	24111	24112	24113	24114	24115	24116	24117	24118	24119	24120	24121
357	24122	24123	24124	24125	24126	24127	24128	24129	24130	24131	24132	24133
358	24134	24135	24136	24137	24138	24139	24140	24141	24142	24143	24144	24145
359	24146	24147	24148	24149	24150	24151	24152	24153	24154	24155	24156	24157
360	24158	24159	24160	24161	24162	24163	24164	24165	24166	24167	24168	24169
361	24170	24171	24172	24173	24174	24175	24176	24177	24178	24179	24180	24181
362	24182	24183	24184	24185	24186	24187	24188	24189	24190	24191	24192	24193
363	24194	24195	24196	24197	24198	24199	24200	24201	24202	24203	24204	24205
364	24206	24207	24208	24209	24210	24211	24212	24213	24214	24215	24216	24217
365	24218	24219	24220	24221	24222	24223	24224	24225	24226	24227	24228	24229

Chapter 11 Internal Memory Address of “Read/Write Variable Data” command

366	24230	24231	24232	24233	24234	24235	24236	24237	24238	24239	24240	24241
367	24242	24243	24244	24245	24246	24247	24248	24249	24250	24251	24252	24253
368	24254	24255	24256	24257	24258	24259	24260	24261	24262	24263	24264	24265
369	24266	24267	24268	24269	24270	24271	24272	24273	24274	24275	24276	24277
370	24278	24279	24280	24281	24282	24283	24284	24285	24286	24287	24288	24289
371	24290	24291	24292	24293	24294	24295	24296	24297	24298	24299	24300	24301
372	24302	24303	24304	24305	24306	24307	24308	24309	24310	24311	24312	24313
373	24314	24315	24316	24317	24318	24319	24320	24321	24322	24323	24324	24325
374	24326	24327	24328	24329	24330	24331	24332	24333	24334	24335	24336	24337
375	24338	24339	24340	24341	24342	24343	24344	24345	24346	24347	24348	24349
376	24350	24351	24352	24353	24354	24355	24356	24357	24358	24359	24360	24361
377	24362	24363	24364	24365	24366	24367	24368	24369	24370	24371	24372	24373
378	24374	24375	24376	24377	24378	24379	24380	24381	24382	24383	24384	24385
379	24386	24387	24388	24389	24390	24391	24392	24393	24394	24395	24396	24397
380	24398	24399	24400	24401	24402	24403	24404	24405	24406	24407	24408	24409
381	24410	24411	24412	24413	24414	24415	24416	24417	24418	24419	24420	24421
382	24422	24423	24424	24425	24426	24427	24428	24429	24430	24431	24432	24433
383	24434	24435	24436	24437	24438	24439	24440	24441	24442	24443	24444	24445
384	24446	24447	24448	24449	24450	24451	24452	24453	24454	24455	24456	24457
385	24458	24459	24460	24461	24462	24463	24464	24465	24466	24467	24468	24469
386	24470	24471	24472	24473	24474	24475	24476	24477	24478	24479	24480	24481
387	24482	24483	24484	24485	24486	24487	24488	24489	24490	24491	24492	24493
388	24494	24495	24496	24497	24498	24499	24500	24501	24502	24503	24504	24505
389	24506	24507	24508	24509	24510	24511	24512	24513	24514	24515	24516	24517
390	24518	24519	24520	24521	24522	24523	24524	24525	24526	24527	24528	24529
391	24530	24531	24532	24533	24534	24535	24536	24537	24538	24539	24540	24541
392	24542	24543	24544	24545	24546	24547	24548	24549	24550	24551	24552	24553
393	24554	24555	24556	24557	24558	24559	24560	24561	24562	24563	24564	24565
394	24566	24567	24568	24569	24570	24571	24572	24573	24574	24575	24576	24577
395	24578	24579	24580	24581	24582	24583	24584	24585	24586	24587	24588	24589
396	24590	24591	24592	24593	24594	24595	24596	24597	24598	24599	24600	24601
397	24602	24603	24604	24605	24606	24607	24608	24609	24610	24611	24612	24613
398	24614	24615	24616	24617	24618	24619	24620	24621	24622	24623	24624	24625
399	24626	24627	24628	24629	24630	24631	24632	24633	24634	24635	24636	24637
400	24638	24639	24640	24641	24642	24643	24644	24645	24646	24647	24648	24649

11.7 Axis 6 operation data memory address

Step	Target position		Cir. int. auxiliary point		Operation speed		Dwell time	Mcode	Sub Axis	Helical int.	Circular int. turns	Control word
	Low	High	Low	High	Low	High						
1	24650	24651	24652	24653	24654	24655	24656	24657	24658	24659	24660	24661
2	24662	24663	24664	24665	24666	24667	24668	24669	24670	24671	24672	24673
3	24674	24675	24676	24677	24678	24679	24680	24681	24682	24683	24684	24685
4	24686	24687	24688	24689	24690	24691	24692	24693	24694	24695	24696	24697
5	24698	24699	24700	24701	24702	24703	24704	24705	24706	24707	24708	24709
6	24710	24711	24712	24713	24714	24715	24716	24717	24718	24719	24720	24721
7	24722	24723	24724	24725	24726	24727	24728	24729	24730	24731	24732	24733
8	24734	24735	24736	24737	24738	24739	24740	24741	24742	24743	24744	24745
9	24746	24747	24748	24749	24750	24751	24752	24753	24754	24755	24756	24757
10	24758	24759	24760	24761	24762	24763	24764	24765	24766	24767	24768	24769
11	24770	24771	24772	24773	24774	24775	24776	24777	24778	24779	24780	24781
12	24782	24783	24784	24785	24786	24787	24788	24789	24790	24791	24792	24793
13	24794	24795	24796	24797	24798	24799	24800	24801	24802	24803	24804	24805
14	24806	24807	24808	24809	24810	24811	24812	24813	24814	24815	24816	24817
15	24818	24819	24820	24821	24822	24823	24824	24825	24826	24827	24828	24829
16	24830	24831	24832	24833	24834	24835	24836	24837	24838	24839	24840	24841
17	24842	24843	24844	24845	24846	24847	24848	24849	24850	24851	24852	24853
18	24854	24855	24856	24857	24858	24859	24860	24861	24862	24863	24864	24865
19	24866	24867	24868	24869	24870	24871	24872	24873	24874	24875	24876	24877
20	24878	24879	24880	24881	24882	24883	24884	24885	24886	24887	24888	24889
21	24890	24891	24892	24893	24894	24895	24896	24897	24898	24899	24900	24901
22	24902	24903	24904	24905	24906	24907	24908	24909	24910	24911	24912	24913
23	24914	24915	24916	24917	24918	24919	24920	24921	24922	24923	24924	24925
24	24926	24927	24928	24929	24930	24931	24932	24933	24934	24935	24936	24937
25	24938	24939	24940	24941	24942	24943	24944	24945	24946	24947	24948	24949
26	24950	24951	24952	24953	24954	24955	24956	24957	24958	24959	24960	24961
27	24962	24963	24964	24965	24966	24967	24968	24969	24970	24971	24972	24973
28	24974	24975	24976	24977	24978	24979	24980	24981	24982	24983	24984	24985
29	24986	24987	24988	24989	24990	24991	24992	24993	24994	24995	24996	24997
30	24998	24999	25000	25001	25002	25003	25004	25005	25006	25007	25008	25009
31	25010	25011	25012	25013	25014	25015	25016	25017	25018	25019	25020	25021
32	25022	25023	25024	25025	25026	25027	25028	25029	25030	25031	25032	25033
33	25034	25035	25036	25037	25038	25039	25040	25041	25042	25043	25044	25045
34	25046	25047	25048	25049	25050	25051	25052	25053	25054	25055	25056	25057
35	25058	25059	25060	25061	25062	25063	25064	25065	25066	25067	25068	25069
36	25070	25071	25072	25073	25074	25075	25076	25077	25078	25079	25080	25081
37	25082	25083	25084	25085	25086	25087	25088	25089	25090	25091	25092	25093
38	25094	25095	25096	25097	25098	25099	25100	25101	25102	25103	25104	25105
39	25106	25107	25108	25109	25110	25111	25112	25113	25114	25115	25116	25117
40	25118	25119	25120	25121	25122	25123	25124	25125	25126	25127	25128	25129
41	25130	25131	25132	25133	25134	25135	25136	25137	25138	25139	25140	25141
42	25142	25143	25144	25145	25146	25147	25148	25149	25150	25151	25152	25153
43	25154	25155	25156	25157	25158	25159	25160	25161	25162	25163	25164	25165

Chapter 11 Internal Memory Address of “Read/Write Variable Data” command

44	25166	25167	25168	25169	25170	25171	25172	25173	25174	25175	25176	25177
45	25178	25179	25180	25181	25182	25183	25184	25185	25186	25187	25188	25189
46	25190	25191	25192	25193	25194	25195	25196	25197	25198	25199	25200	25201
47	25202	25203	25204	25205	25206	25207	25208	25209	25210	25211	25212	25213
48	25214	25215	25216	25217	25218	25219	25220	25221	25222	25223	25224	25225
49	25226	25227	25228	25229	25230	25231	25232	25233	25234	25235	25236	25237
50	25238	25239	25240	25241	25242	25243	25244	25245	25246	25247	25248	25249
51	25250	25251	25252	25253	25254	25255	25256	25257	25258	25259	25260	25261
52	25262	25263	25264	25265	25266	25267	25268	25269	25270	25271	25272	25273
53	25274	25275	25276	25277	25278	25279	25280	25281	25282	25283	25284	25285
54	25286	25287	25288	25289	25290	25291	25292	25293	25294	25295	25296	25297
55	25298	25299	25300	25301	25302	25303	25304	25305	25306	25307	25308	25309
56	25310	25311	25312	25313	25314	25315	25316	25317	25318	25319	25320	25321
57	25322	25323	25324	25325	25326	25327	25328	25329	25330	25331	25332	25333
58	25334	25335	25336	25337	25338	25339	25340	25341	25342	25343	25344	25345
59	25346	25347	25348	25349	25350	25351	25352	25353	25354	25355	25356	25357
60	25358	25359	25360	25361	25362	25363	25364	25365	25366	25367	25368	25369
61	25370	25371	25372	25373	25374	25375	25376	25377	25378	25379	25380	25381
62	25382	25383	25384	25385	25386	25387	25388	25389	25390	25391	25392	25393
63	25394	25395	25396	25397	25398	25399	25400	25401	25402	25403	25404	25405
64	25406	25407	25408	25409	25410	25411	25412	25413	25414	25415	25416	25417
65	25418	25419	25420	25421	25422	25423	25424	25425	25426	25427	25428	25429
66	25430	25431	25432	25433	25434	25435	25436	25437	25438	25439	25440	25441
67	25442	25443	25444	25445	25446	25447	25448	25449	25450	25451	25452	25453
68	25454	25455	25456	25457	25458	25459	25460	25461	25462	25463	25464	25465
69	25466	25467	25468	25469	25470	25471	25472	25473	25474	25475	25476	25477
70	25478	25479	25480	25481	25482	25483	25484	25485	25486	25487	25488	25489
71	25490	25491	25492	25493	25494	25495	25496	25497	25498	25499	25500	25501
72	25502	25503	25504	25505	25506	25507	25508	25509	25510	25511	25512	25513
73	25514	25515	25516	25517	25518	25519	25520	25521	25522	25523	25524	25525
74	25526	25527	25528	25529	25530	25531	25532	25533	25534	25535	25536	25537
75	25538	25539	25540	25541	25542	25543	25544	25545	25546	25547	25548	25549
76	25550	25551	25552	25553	25554	25555	25556	25557	25558	25559	25560	25561
77	25562	25563	25564	25565	25566	25567	25568	25569	25570	25571	25572	25573
78	25574	25575	25576	25577	25578	25579	25580	25581	25582	25583	25584	25585
79	25586	25587	25588	25589	25590	25591	25592	25593	25594	25595	25596	25597
80	25598	25599	25600	25601	25602	25603	25604	25605	25606	25607	25608	25609
81	25610	25611	25612	25613	25614	25615	25616	25617	25618	25619	25620	25621
82	25622	25623	25624	25625	25626	25627	25628	25629	25630	25631	25632	25633
83	25634	25635	25636	25637	25638	25639	25640	25641	25642	25643	25644	25645
84	25646	25647	25648	25649	25650	25651	25652	25653	25654	25655	25656	25657
85	25658	25659	25660	25661	25662	25663	25664	25665	25666	25667	25668	25669
86	25670	25671	25672	25673	25674	25675	25676	25677	25678	25679	25680	25681
87	25682	25683	25684	25685	25686	25687	25688	25689	25690	25691	25692	25693
88	25694	25695	25696	25697	25698	25699	25700	25701	25702	25703	25704	25705
89	25706	25707	25708	25709	25710	25711	25712	25713	25714	25715	25716	25717

Chapter 11 Internal Memory Address of “Read/Write Variable Data” command

90	25718	25719	25720	25721	25722	25723	25724	25725	25726	25727	25728	25729
91	25730	25731	25732	25733	25734	25735	25736	25737	25738	25739	25740	25741
92	25742	25743	25744	25745	25746	25747	25748	25749	25750	25751	25752	25753
93	25754	25755	25756	25757	25758	25759	25760	25761	25762	25763	25764	25765
94	25766	25767	25768	25769	25770	25771	25772	25773	25774	25775	25776	25777
95	25778	25779	25780	25781	25782	25783	25784	25785	25786	25787	25788	25789
96	25790	25791	25792	25793	25794	25795	25796	25797	25798	25799	25800	25801
97	25802	25803	25804	25805	25806	25807	25808	25809	25810	25811	25812	25813
98	25814	25815	25816	25817	25818	25819	25820	25821	25822	25823	25824	25825
99	25826	25827	25828	25829	25830	25831	25832	25833	25834	25835	25836	25837
100	25838	25839	25840	25841	25842	25843	25844	25845	25846	25847	25848	25849
101	25850	25851	25852	25853	25854	25855	25856	25857	25858	25859	25860	25861
102	25862	25863	25864	25865	25866	25867	25868	25869	25870	25871	25872	25873
103	25874	25875	25876	25877	25878	25879	25880	25881	25882	25883	25884	25885
104	25886	25887	25888	25889	25890	25891	25892	25893	25894	25895	25896	25897
105	25898	25899	25900	25901	25902	25903	25904	25905	25906	25907	25908	25909
106	25910	25911	25912	25913	25914	25915	25916	25917	25918	25919	25920	25921
107	25922	25923	25924	25925	25926	25927	25928	25929	25930	25931	25932	25933
108	25934	25935	25936	25937	25938	25939	25940	25941	25942	25943	25944	25945
109	25946	25947	25948	25949	25950	25951	25952	25953	25954	25955	25956	25957
110	25958	25959	25960	25961	25962	25963	25964	25965	25966	25967	25968	25969
111	25970	25971	25972	25973	25974	25975	25976	25977	25978	25979	25980	25981
112	25982	25983	25984	25985	25986	25987	25988	25989	25990	25991	25992	25993
113	25994	25995	25996	25997	25998	25999	26000	26001	26002	26003	26004	26005
114	26006	26007	26008	26009	26010	26011	26012	26013	26014	26015	26016	26017
115	26018	26019	26020	26021	26022	26023	26024	26025	26026	26027	26028	26029
116	26030	26031	26032	26033	26034	26035	26036	26037	26038	26039	26040	26041
117	26042	26043	26044	26045	26046	26047	26048	26049	26050	26051	26052	26053
118	26054	26055	26056	26057	26058	26059	26060	26061	26062	26063	26064	26065
119	26066	26067	26068	26069	26070	26071	26072	26073	26074	26075	26076	26077
120	26078	26079	26080	26081	26082	26083	26084	26085	26086	26087	26088	26089
121	26090	26091	26092	26093	26094	26095	26096	26097	26098	26099	26100	26101
122	26102	26103	26104	26105	26106	26107	26108	26109	26110	26111	26112	26113
123	26114	26115	26116	26117	26118	26119	26120	26121	26122	26123	26124	26125
124	26126	26127	26128	26129	26130	26131	26132	26133	26134	26135	26136	26137
125	26138	26139	26140	26141	26142	26143	26144	26145	26146	26147	26148	26149
126	26150	26151	26152	26153	26154	26155	26156	26157	26158	26159	26160	26161
127	26162	26163	26164	26165	26166	26167	26168	26169	26170	26171	26172	26173
128	26174	26175	26176	26177	26178	26179	26180	26181	26182	26183	26184	26185
129	26186	26187	26188	26189	26190	26191	26192	26193	26194	26195	26196	26197
130	26198	26199	26200	26201	26202	26203	26204	26205	26206	26207	26208	26209
131	26210	26211	26212	26213	26214	26215	26216	26217	26218	26219	26220	26221
132	26222	26223	26224	26225	26226	26227	26228	26229	26230	26231	26232	26233
133	26234	26235	26236	26237	26238	26239	26240	26241	26242	26243	26244	26245
134	26246	26247	26248	26249	26250	26251	26252	26253	26254	26255	26256	26257
135	26258	26259	26260	26261	26262	26263	26264	26265	26266	26267	26268	26269

Chapter 11 Internal Memory Address of “Read/Write Variable Data” command

136	26270	26271	26272	26273	26274	26275	26276	26277	26278	26279	26280	26281
137	26282	26283	26284	26285	26286	26287	26288	26289	26290	26291	26292	26293
138	26294	26295	26296	26297	26298	26299	26300	26301	26302	26303	26304	26305
139	26306	26307	26308	26309	26310	26311	26312	26313	26314	26315	26316	26317
140	26318	26319	26320	26321	26322	26323	26324	26325	26326	26327	26328	26329
141	26330	26331	26332	26333	26334	26335	26336	26337	26338	26339	26340	26341
142	26342	26343	26344	26345	26346	26347	26348	26349	26350	26351	26352	26353
143	26354	26355	26356	26357	26358	26359	26360	26361	26362	26363	26364	26365
144	26366	26367	26368	26369	26370	26371	26372	26373	26374	26375	26376	26377
145	26378	26379	26380	26381	26382	26383	26384	26385	26386	26387	26388	26389
146	26390	26391	26392	26393	26394	26395	26396	26397	26398	26399	26400	26401
147	26402	26403	26404	26405	26406	26407	26408	26409	26410	26411	26412	26413
148	26414	26415	26416	26417	26418	26419	26420	26421	26422	26423	26424	26425
149	26426	26427	26428	26429	26430	26431	26432	26433	26434	26435	26436	26437
150	26438	26439	26440	26441	26442	26443	26444	26445	26446	26447	26448	26449
151	26450	26451	26452	26453	26454	26455	26456	26457	26458	26459	26460	26461
152	26462	26463	26464	26465	26466	26467	26468	26469	26470	26471	26472	26473
153	26474	26475	26476	26477	26478	26479	26480	26481	26482	26483	26484	26485
154	26486	26487	26488	26489	26490	26491	26492	26493	26494	26495	26496	26497
155	26498	26499	26500	26501	26502	26503	26504	26505	26506	26507	26508	26509
156	26510	26511	26512	26513	26514	26515	26516	26517	26518	26519	26520	26521
157	26522	26523	26524	26525	26526	26527	26528	26529	26530	26531	26532	26533
158	26534	26535	26536	26537	26538	26539	26540	26541	26542	26543	26544	26545
159	26546	26547	26548	26549	26550	26551	26552	26553	26554	26555	26556	26557
160	26558	26559	26560	26561	26562	26563	26564	26565	26566	26567	26568	26569
161	26570	26571	26572	26573	26574	26575	26576	26577	26578	26579	26580	26581
162	26582	26583	26584	26585	26586	26587	26588	26589	26590	26591	26592	26593
163	26594	26595	26596	26597	26598	26599	26600	26601	26602	26603	26604	26605
164	26606	26607	26608	26609	26610	26611	26612	26613	26614	26615	26616	26617
165	26618	26619	26620	26621	26622	26623	26624	26625	26626	26627	26628	26629
166	26630	26631	26632	26633	26634	26635	26636	26637	26638	26639	26640	26641
167	26642	26643	26644	26645	26646	26647	26648	26649	26650	26651	26652	26653
168	26654	26655	26656	26657	26658	26659	26660	26661	26662	26663	26664	26665
169	26666	26667	26668	26669	26670	26671	26672	26673	26674	26675	26676	26677
170	26678	26679	26680	26681	26682	26683	26684	26685	26686	26687	26688	26689
171	26690	26691	26692	26693	26694	26695	26696	26697	26698	26699	26700	26701
172	26702	26703	26704	26705	26706	26707	26708	26709	26710	26711	26712	26713
173	26714	26715	26716	26717	26718	26719	26720	26721	26722	26723	26724	26725
174	26726	26727	26728	26729	26730	26731	26732	26733	26734	26735	26736	26737
175	26738	26739	26740	26741	26742	26743	26744	26745	26746	26747	26748	26749
176	26750	26751	26752	26753	26754	26755	26756	26757	26758	26759	26760	26761
177	26762	26763	26764	26765	26766	26767	26768	26769	26770	26771	26772	26773
178	26774	26775	26776	26777	26778	26779	26780	26781	26782	26783	26784	26785
179	26786	26787	26788	26789	26790	26791	26792	26793	26794	26795	26796	26797
180	26798	26799	26800	26801	26802	26803	26804	26805	26806	26807	26808	26809
181	26810	26811	26812	26813	26814	26815	26816	26817	26818	26819	26820	26821

Chapter 11 Internal Memory Address of “Read/Write Variable Data” command

182	26822	26823	26824	26825	26826	26827	26828	26829	26830	26831	26832	26833
183	26834	26835	26836	26837	26838	26839	26840	26841	26842	26843	26844	26845
184	26846	26847	26848	26849	26850	26851	26852	26853	26854	26855	26856	26857
185	26858	26859	26860	26861	26862	26863	26864	26865	26866	26867	26868	26869
186	26870	26871	26872	26873	26874	26875	26876	26877	26878	26879	26880	26881
187	26882	26883	26884	26885	26886	26887	26888	26889	26890	26891	26892	26893
188	26894	26895	26896	26897	26898	26899	26900	26901	26902	26903	26904	26905
189	26906	26907	26908	26909	26910	26911	26912	26913	26914	26915	26916	26917
190	26918	26919	26920	26921	26922	26923	26924	26925	26926	26927	26928	26929
191	26930	26931	26932	26933	26934	26935	26936	26937	26938	26939	26940	26941
192	26942	26943	26944	26945	26946	26947	26948	26949	26950	26951	26952	26953
193	26954	26955	26956	26957	26958	26959	26960	26961	26962	26963	26964	26965
194	26966	26967	26968	26969	26970	26971	26972	26973	26974	26975	26976	26977
195	26978	26979	26980	26981	26982	26983	26984	26985	26986	26987	26988	26989
196	26990	26991	26992	26993	26994	26995	26996	26997	26998	26999	27000	27001
197	27002	27003	27004	27005	27006	27007	27008	27009	27010	27011	27012	27013
198	27014	27015	27016	27017	27018	27019	27020	27021	27022	27023	27024	27025
199	27026	27027	27028	27029	27030	27031	27032	27033	27034	27035	27036	27037
200	27038	27039	27040	27041	27042	27043	27044	27045	27046	27047	27048	27049
201	27050	27051	27052	27053	27054	27055	27056	27057	27058	27059	27060	27061
202	27062	27063	27064	27065	27066	27067	27068	27069	27070	27071	27072	27073
203	27074	27075	27076	27077	27078	27079	27080	27081	27082	27083	27084	27085
204	27086	27087	27088	27089	27090	27091	27092	27093	27094	27095	27096	27097
205	27098	27099	27100	27101	27102	27103	27104	27105	27106	27107	27108	27109
206	27110	27111	27112	27113	27114	27115	27116	27117	27118	27119	27120	27121
207	27122	27123	27124	27125	27126	27127	27128	27129	27130	27131	27132	27133
208	27134	27135	27136	27137	27138	27139	27140	27141	27142	27143	27144	27145
209	27146	27147	27148	27149	27150	27151	27152	27153	27154	27155	27156	27157
210	27158	27159	27160	27161	27162	27163	27164	27165	27166	27167	27168	27169
211	27170	27171	27172	27173	27174	27175	27176	27177	27178	27179	27180	27181
212	27182	27183	27184	27185	27186	27187	27188	27189	27190	27191	27192	27193
213	27194	27195	27196	27197	27198	27199	27200	27201	27202	27203	27204	27205
214	27206	27207	27208	27209	27210	27211	27212	27213	27214	27215	27216	27217
215	27218	27219	27220	27221	27222	27223	27224	27225	27226	27227	27228	27229
216	27230	27231	27232	27233	27234	27235	27236	27237	27238	27239	27240	27241
217	27242	27243	27244	27245	27246	27247	27248	27249	27250	27251	27252	27253
218	27254	27255	27256	27257	27258	27259	27260	27261	27262	27263	27264	27265
219	27266	27267	27268	27269	27270	27271	27272	27273	27274	27275	27276	27277
220	27278	27279	27280	27281	27282	27283	27284	27285	27286	27287	27288	27289
221	27290	27291	27292	27293	27294	27295	27296	27297	27298	27299	27300	27301
222	27302	27303	27304	27305	27306	27307	27308	27309	27310	27311	27312	27313
223	27314	27315	27316	27317	27318	27319	27320	27321	27322	27323	27324	27325
224	27326	27327	27328	27329	27330	27331	27332	27333	27334	27335	27336	27337
225	27338	27339	27340	27341	27342	27343	27344	27345	27346	27347	27348	27349
226	27350	27351	27352	27353	27354	27355	27356	27357	27358	27359	27360	27361
227	27362	27363	27364	27365	27366	27367	27368	27369	27370	27371	27372	27373

Chapter 11 Internal Memory Address of “Read/Write Variable Data” command

228	27374	27375	27376	27377	27378	27379	27380	27381	27382	27383	27384	27385
229	27386	27387	27388	27389	27390	27391	27392	27393	27394	27395	27396	27397
230	27398	27399	27400	27401	27402	27403	27404	27405	27406	27407	27408	27409
231	27410	27411	27412	27413	27414	27415	27416	27417	27418	27419	27420	27421
232	27422	27423	27424	27425	27426	27427	27428	27429	27430	27431	27432	27433
233	27434	27435	27436	27437	27438	27439	27440	27441	27442	27443	27444	27445
234	27446	27447	27448	27449	27450	27451	27452	27453	27454	27455	27456	27457
235	27458	27459	27460	27461	27462	27463	27464	27465	27466	27467	27468	27469
236	27470	27471	27472	27473	27474	27475	27476	27477	27478	27479	27480	27481
237	27482	27483	27484	27485	27486	27487	27488	27489	27490	27491	27492	27493
238	27494	27495	27496	27497	27498	27499	27500	27501	27502	27503	27504	27505
239	27506	27507	27508	27509	27510	27511	27512	27513	27514	27515	27516	27517
240	27518	27519	27520	27521	27522	27523	27524	27525	27526	27527	27528	27529
241	27530	27531	27532	27533	27534	27535	27536	27537	27538	27539	27540	27541
242	27542	27543	27544	27545	27546	27547	27548	27549	27550	27551	27552	27553
243	27554	27555	27556	27557	27558	27559	27560	27561	27562	27563	27564	27565
244	27566	27567	27568	27569	27570	27571	27572	27573	27574	27575	27576	27577
245	27578	27579	27580	27581	27582	27583	27584	27585	27586	27587	27588	27589
246	27590	27591	27592	27593	27594	27595	27596	27597	27598	27599	27600	27601
247	27602	27603	27604	27605	27606	27607	27608	27609	27610	27611	27612	27613
248	27614	27615	27616	27617	27618	27619	27620	27621	27622	27623	27624	27625
249	27626	27627	27628	27629	27630	27631	27632	27633	27634	27635	27636	27637
250	27638	27639	27640	27641	27642	27643	27644	27645	27646	27647	27648	27649
251	27650	27651	27652	27653	27654	27655	27656	27657	27658	27659	27660	27661
252	27662	27663	27664	27665	27666	27667	27668	27669	27670	27671	27672	27673
253	27674	27675	27676	27677	27678	27679	27680	27681	27682	27683	27684	27685
254	27686	27687	27688	27689	27690	27691	27692	27693	27694	27695	27696	27697
255	27698	27699	27700	27701	27702	27703	27704	27705	27706	27707	27708	27709
256	27710	27711	27712	27713	27714	27715	27716	27717	27718	27719	27720	27721
257	27722	27723	27724	27725	27726	27727	27728	27729	27730	27731	27732	27733
258	27734	27735	27736	27737	27738	27739	27740	27741	27742	27743	27744	27745
259	27746	27747	27748	27749	27750	27751	27752	27753	27754	27755	27756	27757
260	27758	27759	27760	27761	27762	27763	27764	27765	27766	27767	27768	27769
261	27770	27771	27772	27773	27774	27775	27776	27777	27778	27779	27780	27781
262	27782	27783	27784	27785	27786	27787	27788	27789	27790	27791	27792	27793
263	27794	27795	27796	27797	27798	27799	27800	27801	27802	27803	27804	27805
264	27806	27807	27808	27809	27810	27811	27812	27813	27814	27815	27816	27817
265	27818	27819	27820	27821	27822	27823	27824	27825	27826	27827	27828	27829
266	27830	27831	27832	27833	27834	27835	27836	27837	27838	27839	27840	27841
267	27842	27843	27844	27845	27846	27847	27848	27849	27850	27851	27852	27853
268	27854	27855	27856	27857	27858	27859	27860	27861	27862	27863	27864	27865
269	27866	27867	27868	27869	27870	27871	27872	27873	27874	27875	27876	27877
270	27878	27879	27880	27881	27882	27883	27884	27885	27886	27887	27888	27889
271	27890	27891	27892	27893	27894	27895	27896	27897	27898	27899	27900	27901
272	27902	27903	27904	27905	27906	27907	27908	27909	27910	27911	27912	27913
273	27914	27915	27916	27917	27918	27919	27920	27921	27922	27923	27924	27925

Chapter 11 Internal Memory Address of “Read/Write Variable Data” command

274	27926	27927	27928	27929	27930	27931	27932	27933	27934	27935	27936	27937
275	27938	27939	27940	27941	27942	27943	27944	27945	27946	27947	27948	27949
276	27950	27951	27952	27953	27954	27955	27956	27957	27958	27959	27960	27961
277	27962	27963	27964	27965	27966	27967	27968	27969	27970	27971	27972	27973
278	27974	27975	27976	27977	27978	27979	27980	27981	27982	27983	27984	27985
279	27986	27987	27988	27989	27990	27991	27992	27993	27994	27995	27996	27997
280	27998	27999	28000	28001	28002	28003	28004	28005	28006	28007	28008	28009
281	28010	28011	28012	28013	28014	28015	28016	28017	28018	28019	28020	28021
282	28022	28023	28024	28025	28026	28027	28028	28029	28030	28031	28032	28033
283	28034	28035	28036	28037	28038	28039	28040	28041	28042	28043	28044	28045
284	28046	28047	28048	28049	28050	28051	28052	28053	28054	28055	28056	28057
285	28058	28059	28060	28061	28062	28063	28064	28065	28066	28067	28068	28069
286	28070	28071	28072	28073	28074	28075	28076	28077	28078	28079	28080	28081
287	28082	28083	28084	28085	28086	28087	28088	28089	28090	28091	28092	28093
288	28094	28095	28096	28097	28098	28099	28100	28101	28102	28103	28104	28105
289	28106	28107	28108	28109	28110	28111	28112	28113	28114	28115	28116	28117
290	28118	28119	28120	28121	28122	28123	28124	28125	28126	28127	28128	28129
291	28130	28131	28132	28133	28134	28135	28136	28137	28138	28139	28140	28141
292	28142	28143	28144	28145	28146	28147	28148	28149	28150	28151	28152	28153
293	28154	28155	28156	28157	28158	28159	28160	28161	28162	28163	28164	28165
294	28166	28167	28168	28169	28170	28171	28172	28173	28174	28175	28176	28177
295	28178	28179	28180	28181	28182	28183	28184	28185	28186	28187	28188	28189
296	28190	28191	28192	28193	28194	28195	28196	28197	28198	28199	28200	28201
297	28202	28203	28204	28205	28206	28207	28208	28209	28210	28211	28212	28213
298	28214	28215	28216	28217	28218	28219	28220	28221	28222	28223	28224	28225
299	28226	28227	28228	28229	28230	28231	28232	28233	28234	28235	28236	28237
300	28238	28239	28240	28241	28242	28243	28244	28245	28246	28247	28248	28249
301	28250	28251	28252	28253	28254	28255	28256	28257	28258	28259	28260	28261
302	28262	28263	28264	28265	28266	28267	28268	28269	28270	28271	28272	28273
303	28274	28275	28276	28277	28278	28279	28280	28281	28282	28283	28284	28285
304	28286	28287	28288	28289	28290	28291	28292	28293	28294	28295	28296	28297
305	28298	28299	28300	28301	28302	28303	28304	28305	28306	28307	28308	28309
306	28310	28311	28312	28313	28314	28315	28316	28317	28318	28319	28320	28321
307	28322	28323	28324	28325	28326	28327	28328	28329	28330	28331	28332	28333
308	28334	28335	28336	28337	28338	28339	28340	28341	28342	28343	28344	28345
309	28346	28347	28348	28349	28350	28351	28352	28353	28354	28355	28356	28357
310	28358	28359	28360	28361	28362	28363	28364	28365	28366	28367	28368	28369
311	28370	28371	28372	28373	28374	28375	28376	28377	28378	28379	28380	28381
312	28382	28383	28384	28385	28386	28387	28388	28389	28390	28391	28392	28393
313	28394	28395	28396	28397	28398	28399	28400	28401	28402	28403	28404	28405
314	28406	28407	28408	28409	28410	28411	28412	28413	28414	28415	28416	28417
315	28418	28419	28420	28421	28422	28423	28424	28425	28426	28427	28428	28429
316	28430	28431	28432	28433	28434	28435	28436	28437	28438	28439	28440	28441
317	28442	28443	28444	28445	28446	28447	28448	28449	28450	28451	28452	28453
318	28454	28455	28456	28457	28458	28459	28460	28461	28462	28463	28464	28465
319	28466	28467	28468	28469	28470	28471	28472	28473	28474	28475	28476	28477

Chapter 11 Internal Memory Address of “Read/Write Variable Data” command

320	28478	28479	28480	28481	28482	28483	28484	28485	28486	28487	28488	28489
321	28490	28491	28492	28493	28494	28495	28496	28497	28498	28499	28500	28501
322	28502	28503	28504	28505	28506	28507	28508	28509	28510	28511	28512	28513
323	28514	28515	28516	28517	28518	28519	28520	28521	28522	28523	28524	28525
324	28526	28527	28528	28529	28530	28531	28532	28533	28534	28535	28536	28537
325	28538	28539	28540	28541	28542	28543	28544	28545	28546	28547	28548	28549
326	28550	28551	28552	28553	28554	28555	28556	28557	28558	28559	28560	28561
327	28562	28563	28564	28565	28566	28567	28568	28569	28570	28571	28572	28573
328	28574	28575	28576	28577	28578	28579	28580	28581	28582	28583	28584	28585
329	28586	28587	28588	28589	28590	28591	28592	28593	28594	28595	28596	28597
330	28598	28599	28600	28601	28602	28603	28604	28605	28606	28607	28608	28609
331	28610	28611	28612	28613	28614	28615	28616	28617	28618	28619	28620	28621
332	28622	28623	28624	28625	28626	28627	28628	28629	28630	28631	28632	28633
333	28634	28635	28636	28637	28638	28639	28640	28641	28642	28643	28644	28645
334	28646	28647	28648	28649	28650	28651	28652	28653	28654	28655	28656	28657
335	28658	28659	28660	28661	28662	28663	28664	28665	28666	28667	28668	28669
336	28670	28671	28672	28673	28674	28675	28676	28677	28678	28679	28680	28681
337	28682	28683	28684	28685	28686	28687	28688	28689	28690	28691	28692	28693
338	28694	28695	28696	28697	28698	28699	28700	28701	28702	28703	28704	28705
339	28706	28707	28708	28709	28710	28711	28712	28713	28714	28715	28716	28717
340	28718	28719	28720	28721	28722	28723	28724	28725	28726	28727	28728	28729
341	28730	28731	28732	28733	28734	28735	28736	28737	28738	28739	28740	28741
342	28742	28743	28744	28745	28746	28747	28748	28749	28750	28751	28752	28753
343	28754	28755	28756	28757	28758	28759	28760	28761	28762	28763	28764	28765
344	28766	28767	28768	28769	28770	28771	28772	28773	28774	28775	28776	28777
345	28778	28779	28780	28781	28782	28783	28784	28785	28786	28787	28788	28789
346	28790	28791	28792	28793	28794	28795	28796	28797	28798	28799	28800	28801
347	28802	28803	28804	28805	28806	28807	28808	28809	28810	28811	28812	28813
348	28814	28815	28816	28817	28818	28819	28820	28821	28822	28823	28824	28825
349	28826	28827	28828	28829	28830	28831	28832	28833	28834	28835	28836	28837
350	28838	28839	28840	28841	28842	28843	28844	28845	28846	28847	28848	28849
351	28850	28851	28852	28853	28854	28855	28856	28857	28858	28859	28860	28861
352	28862	28863	28864	28865	28866	28867	28868	28869	28870	28871	28872	28873
353	28874	28875	28876	28877	28878	28879	28880	28881	28882	28883	28884	28885
354	28886	28887	28888	28889	28890	28891	28892	28893	28894	28895	28896	28897
355	28898	28899	28900	28901	28902	28903	28904	28905	28906	28907	28908	28909
356	28910	28911	28912	28913	28914	28915	28916	28917	28918	28919	28920	28921
357	28922	28923	28924	28925	28926	28927	28928	28929	28930	28931	28932	28933
358	28934	28935	28936	28937	28938	28939	28940	28941	28942	28943	28944	28945
359	28946	28947	28948	28949	28950	28951	28952	28953	28954	28955	28956	28957
360	28958	28959	28960	28961	28962	28963	28964	28965	28966	28967	28968	28969
361	28970	28971	28972	28973	28974	28975	28976	28977	28978	28979	28980	28981
362	28982	28983	28984	28985	28986	28987	28988	28989	28990	28991	28992	28993
363	28994	28995	28996	28997	28998	28999	29000	29001	29002	29003	29004	29005
364	29006	29007	29008	29009	29010	29011	29012	29013	29014	29015	29016	29017
365	29018	29019	29020	29021	29022	29023	29024	29025	29026	29027	29028	29029

Chapter 11 Internal Memory Address of “Read/Write Variable Data” command

366	29030	29031	29032	29033	29034	29035	29036	29037	29038	29039	29040	29041
367	29042	29043	29044	29045	29046	29047	29048	29049	29050	29051	29052	29053
368	29054	29055	29056	29057	29058	29059	29060	29061	29062	29063	29064	29065
369	29066	29067	29068	29069	29070	29071	29072	29073	29074	29075	29076	29077
370	29078	29079	29080	29081	29082	29083	29084	29085	29086	29087	29088	29089
371	29090	29091	29092	29093	29094	29095	29096	29097	29098	29099	29100	29101
372	29102	29103	29104	29105	29106	29107	29108	29109	29110	29111	29112	29113
373	29114	29115	29116	29117	29118	29119	29120	29121	29122	29123	29124	29125
374	29126	29127	29128	29129	29130	29131	29132	29133	29134	29135	29136	29137
375	29138	29139	29140	29141	29142	29143	29144	29145	29146	29147	29148	29149
376	29150	29151	29152	29153	29154	29155	29156	29157	29158	29159	29160	29161
377	29162	29163	29164	29165	29166	29167	29168	29169	29170	29171	29172	29173
378	29174	29175	29176	29177	29178	29179	29180	29181	29182	29183	29184	29185
379	29186	29187	29188	29189	29190	29191	29192	29193	29194	29195	29196	29197
380	29198	29199	29200	29201	29202	29203	29204	29205	29206	29207	29208	29209
381	29210	29211	29212	29213	29214	29215	29216	29217	29218	29219	29220	29221
382	29222	29223	29224	29225	29226	29227	29228	29229	29230	29231	29232	29233
383	29234	29235	29236	29237	29238	29239	29240	29241	29242	29243	29244	29245
384	29246	29247	29248	29249	29250	29251	29252	29253	29254	29255	29256	29257
385	29258	29259	29260	29261	29262	29263	29264	29265	29266	29267	29268	29269
386	29270	29271	29272	29273	29274	29275	29276	29277	29278	29279	29280	29281
387	29282	29283	29284	29285	29286	29287	29288	29289	29290	29291	29292	29293
388	29294	29295	29296	29297	29298	29299	29300	29301	29302	29303	29304	29305
389	29306	29307	29308	29309	29310	29311	29312	29313	29314	29315	29316	29317
390	29318	29319	29320	29321	29322	29323	29324	29325	29326	29327	29328	29329
391	29330	29331	29332	29333	29334	29335	29336	29337	29338	29339	29340	29341
392	29342	29343	29344	29345	29346	29347	29348	29349	29350	29351	29352	29353
393	29354	29355	29356	29357	29358	29359	29360	29361	29362	29363	29364	29365
394	29366	29367	29368	29369	29370	29371	29372	29373	29374	29375	29376	29377
395	29378	29379	29380	29381	29382	29383	29384	29385	29386	29387	29388	29389
396	29390	29391	29392	29393	29394	29395	29396	29397	29398	29399	29400	29401
397	29402	29403	29404	29405	29406	29407	29408	29409	29410	29411	29412	29413
398	29414	29415	29416	29417	29418	29419	29420	29421	29422	29423	29424	29425
399	29426	29427	29428	29429	29430	29431	29432	29433	29434	29435	29436	29437
400	29438	29439	29440	29441	29442	29443	29444	29445	29446	29447	29448	29449

11.8 CAM data memory address

	Block 1	Block 2	Block 3	Block 4	Block 5	Block 6	Block 7	Block 8	
CAM Main axis per rotation distance(Low)	41820	46050	50280	54510	58740	62970	67200	71430	
CAM Main axis distance per rotation (High)	41821	46051	50281	54511	58741	62971	67201	71431	
CAM Main axis pulse per rotation (Low)	41822	46052	50282	54512	58742	62972	67202	71432	
CAM Main axis pulse per rotation (High)	41823	46053	50283	54513	58743	62973	67203	71433	
CAM Sub axis distance per rotation (Low)	41824	46054	50284	54514	58744	62974	67204	71434	
CAM Sub axis distance per rotation (High)	41825	46055	50285	54515	58745	62975	67205	71435	
CAM Sub axis pulse per rotation (Low)	41826	46056	50286	54516	58746	62976	67206	71436	
CAM Sub axis pulse per rotation (High)	41827	46057	50287	54517	58747	62977	67207	71437	
CAM Data End Step(WORD)	41828	46058	50288	54518	58748	62978	67208	71438	
CAM Data Info(WORD) Bit 0~1: Main axis Unit Bit 2~3: Sub axis Unit Bit 8: CAM mode(0: repeat, 1: increase)	41829	46059	50289	54519	58749	62979	67209	71439	
User Data[0]	Main axis end pos(low 16bit)	41830	46060	50290	54520	58750	62980	67210	71440
	Main axis end pos(high 16bit)	41831	46061	50291	54521	58751	62981	67211	71441
	Sub axis end pos(low 16bit)	41832	46062	50292	54522	58752	62982	67212	71442
	Sub axis end pos(high 16bit)	41833	46063	50293	54523	58753	62983	67213	71443
	CAM Curve	41834	46064	50294	54524	58754	62984	67214	71444
	-	41835	46065	50295	54525	58755	62985	67215	71445
User Data[1]	Main axis end pos(low 16bit)	41836	46066	50296	54526	58756	62986	67216	71446
	Main axis end pos(high 16bit)	41837	46067	50297	54527	58757	62987	67217	71447
	Sub axis end pos(low 16bit)	41838	46068	50298	54528	58758	62988	67218	71448
	Sub axis end pos(high 16bit)	41839	46069	50299	54529	58759	62989	67219	71449
	CAM Curve	41840	46070	50300	54530	58760	62990	67220	71450
	-	41841	46071	50301	54531	58761	62991	67221	71451
User Data[2]	Main axis end pos(low 16bit)	41842	46072	50302	54532	58762	62992	67222	71452
	Main axis end pos(high 16bit)	41843	46073	50303	54533	58763	62993	67223	71453
	Sub axis end pos(low 16bit)	41844	46074	50304	54534	58764	62994	67224	71454
	Sub axis end pos(high 16bit)	41845	46075	50305	54535	58765	62995	67225	71455
	CAM Curve	41846	46076	50306	54536	58766	62996	67226	71456
	-	41847	46077	50307	54537	58767	62997	67227	71457
User Data[3]	Main axis end pos(low 16bit)	41848	46078	50308	54538	58768	62998	67228	71458
	Main axis end pos(high 16bit)	41849	46079	50309	54539	58769	62999	67229	71459
	Sub axis end pos(low 16bit)	41850	46080	50310	54540	58770	63000	67230	71460
	Sub axis end pos(high 16bit)	41851	46081	50311	54541	58771	63001	67231	71461
	CAM Curve	41852	46082	50312	54542	58772	63002	67232	71462
	-	41853	46083	50313	54543	58773	63003	67233	71463
User Data[4]	Main axis end pos(low 16bit)	41854	46084	50314	54544	58774	63004	67234	71464
	Main axis end pos(high 16bit)	41855	46085	50315	54545	58775	63005	67235	71465
	Sub axis end pos(low 16bit)	41856	46086	50316	54546	58776	63006	67236	71466
	Sub axis end pos(high 16bit)	41857	46087	50317	54547	58777	63007	67237	71467
	CAM Curve	41858	46088	50318	54548	58778	63008	67238	71468
	-	41859	46089	50319	54549	58779	63009	67239	71469
User Data[5]	Main axis end pos(low 16bit)	41860	46090	50320	54550	58780	63010	67240	71470

Chapter 11 Internal Memory Address of “Read/Write Variable Data” command

	Main axis end pos(high 16bit)	41861	46091	50321	54551	58781	63011	67241	71471
	Sub axis end pos(low 16bit)	41862	46092	50322	54552	58782	63012	67242	71472
	Sub axis end pos(high 16bit)	41863	46093	50323	54553	58783	63013	67243	71473
	CAM Curve	41864	46094	50324	54554	58784	63014	67244	71474
	-	41865	46095	50325	54555	58785	63015	67245	71475
User Data[6]	Main axis end pos(low 16bit)	41866	46096	50326	54556	58786	63016	67246	71476
	Main axis end pos(high 16bit)	41867	46097	50327	54557	58787	63017	67247	71477
	Sub axis end pos(low 16bit)	41868	46098	50328	54558	58788	63018	67248	71478
	Sub axis end pos(high 16bit)	41869	46099	50329	54559	58789	63019	67249	71479
	CAM Curve	41870	46100	50330	54560	58790	63020	67250	71480
-	41871	46101	50331	54561	58791	63021	67251	71481	
User Data[7]	Main axis end pos(low 16bit)	41872	46102	50332	54562	58792	63022	67252	71482
	Main axis end pos(high 16bit)	41873	46103	50333	54563	58793	63023	67253	71483
	Sub axis end pos(low 16bit)	41874	46104	50334	54564	58794	63024	67254	71484
	Sub axis end pos(high 16bit)	41875	46105	50335	54565	58795	63025	67255	71485
	CAM Curve	41876	46106	50336	54566	58796	63026	67256	71486
-	41877	46107	50337	54567	58797	63027	67257	71487	
User Data[8]	Main axis end pos(low 16bit)	41878	46108	50338	54568	58798	63028	67258	71488
	Main axis end pos(high 16bit)	41879	46109	50339	54569	58799	63029	67259	71489
	Sub axis end pos(low 16bit)	41880	46110	50340	54570	58800	63030	67260	71490
	Sub axis end pos(high 16bit)	41881	46111	50341	54571	58801	63031	67261	71491
	CAM Curve	41882	46112	50342	54572	58802	63032	67262	71492
-	41883	46113	50343	54573	58803	63033	67263	71493	
User Data[9]	Main axis end pos(low 16bit)	41884	46114	50344	54574	58804	63034	67264	71494
	Main axis end pos(high 16bit)	41885	46115	50345	54575	58805	63035	67265	71495
	Sub axis end pos(low 16bit)	41886	46116	50346	54576	58806	63036	67266	71496
	Sub axis end pos(high 16bit)	41887	46117	50347	54577	58807	63037	67267	71497
	CAM Curve	41888	46118	50348	54578	58808	63038	67268	71498
-	41889	46119	50349	54579	58809	63039	67269	71499	
User Data[10]	Main axis end pos(low 16bit)	41890	46120	50350	54580	58810	63040	67270	71500
	Main axis end pos(high 16bit)	41891	46121	50351	54581	58811	63041	67271	71501
	Sub axis end pos(low 16bit)	41892	46122	50352	54582	58812	63042	67272	71502
	Sub axis end pos(high 16bit)	41893	46123	50353	54583	58813	63043	67273	71503
	CAM Curve	41894	46124	50354	54584	58814	63044	67274	71504
-	41895	46125	50355	54585	58815	63045	67275	71505	
User Data[11]	Main axis end pos(low 16bit)	41896	46126	50356	54586	58816	63046	67276	71506
	Main axis end pos(high 16bit)	41897	46127	50357	54587	58817	63047	67277	71507
	Sub axis end pos(low 16bit)	41898	46128	50358	54588	58818	63048	67278	71508
	Sub axis end pos(high 16bit)	41899	46129	50359	54589	58819	63049	67279	71509
	CAM Curve	41900	46130	50360	54590	58820	63050	67280	71510
-	41901	46131	50361	54591	58821	63051	67281	71511	
User Data[12]	Main axis end pos(low 16bit)	41902	46132	50362	54592	58822	63052	67282	71512
	Main axis end pos(high 16bit)	41903	46133	50363	54593	58823	63053	67283	71513
	Sub axis end pos(low 16bit)	41904	46134	50364	54594	58824	63054	67284	71514
	Sub axis end pos(high 16bit)	41905	46135	50365	54595	58825	63055	67285	71515
	CAM Curve	41906	46136	50366	54596	58826	63056	67286	71516

Chapter 11 Internal Memory Address of “Read/Write Variable Data” command

	-	41907	46137	50367	54597	58827	63057	67287	71517
User Data[13]	Main axis end pos(low 16bit)	41908	46138	50368	54598	58828	63058	67288	71518
	Main axis end pos(high 16bit)	41909	46139	50369	54599	58829	63059	67289	71519
	Sub axis end pos(low 16bit)	41910	46140	50370	54600	58830	63060	67290	71520
	Sub axis end pos(high 16bit)	41911	46141	50371	54601	58831	63061	67291	71521
	CAM Curve	41912	46142	50372	54602	58832	63062	67292	71522
	-	41913	46143	50373	54603	58833	63063	67293	71523
User Data[14]	Main axis end pos(low 16bit)	41914	46144	50374	54604	58834	63064	67294	71524
	Main axis end pos(high 16bit)	41915	46145	50375	54605	58835	63065	67295	71525
	Sub axis end pos(low 16bit)	41916	46146	50376	54606	58836	63066	67296	71526
	Sub axis end pos(high 16bit)	41917	46147	50377	54607	58837	63067	67297	71527
	CAM Curve	41918	46148	50378	54608	58838	63068	67298	71528
	-	41919	46149	50379	54609	58839	63069	67299	71529
User Data[15]	Main axis end pos(low 16bit)	41920	46150	50380	54610	58840	63070	67300	71530
	Main axis end pos(high 16bit)	41921	46151	50381	54611	58841	63071	67301	71531
	Sub axis end pos(low 16bit)	41922	46152	50382	54612	58842	63072	67302	71532
	Sub axis end pos(high 16bit)	41923	46153	50383	54613	58843	63073	67303	71533
	CAM Curve	41924	46154	50384	54614	58844	63074	67304	71534
	-	41925	46155	50385	54615	58845	63075	67305	71535
User Data[16]	Main axis end pos(low 16bit)	41926	46156	50386	54616	58846	63076	67306	71536
	Main axis end pos(high 16bit)	41927	46157	50387	54617	58847	63077	67307	71537
	Sub axis end pos(low 16bit)	41928	46158	50388	54618	58848	63078	67308	71538
	Sub axis end pos(high 16bit)	41929	46159	50389	54619	58849	63079	67309	71539
	CAM Curve	41930	46160	50390	54620	58850	63080	67310	71540
	-	41931	46161	50391	54621	58851	63081	67311	71541
User Data[17]	Main axis end pos(low 16bit)	41932	46162	50392	54622	58852	63082	67312	71542
	Main axis end pos(high 16bit)	41933	46163	50393	54623	58853	63083	67313	71543
	Sub axis end pos(low 16bit)	41934	46164	50394	54624	58854	63084	67314	71544
	Sub axis end pos(high 16bit)	41935	46165	50395	54625	58855	63085	67315	71545
	CAM Curve	41936	46166	50396	54626	58856	63086	67316	71546
	-	41937	46167	50397	54627	58857	63087	67317	71547
User Data[18]	Main axis end pos(low 16bit)	41938	46168	50398	54628	58858	63088	67318	71548
	Main axis end pos(high 16bit)	41939	46169	50399	54629	58859	63089	67319	71549
	Sub axis end pos(low 16bit)	41940	46170	50400	54630	58860	63090	67320	71550
	Sub axis end pos(high 16bit)	41941	46171	50401	54631	58861	63091	67321	71551
	CAM Curve	41942	46172	50402	54632	58862	63092	67322	71552
	-	41943	46173	50403	54633	58863	63093	67323	71553
User Data[19]	Main axis end pos(low 16bit)	41944	46174	50404	54634	58864	63094	67324	71554
	Main axis end pos(high 16bit)	41945	46175	50405	54635	58865	63095	67325	71555
	Sub axis end pos(low 16bit)	41946	46176	50406	54636	58866	63096	67326	71556
	Sub axis end pos(high 16bit)	41947	46177	50407	54637	58867	63097	67327	71557
	CAM Curve	41948	46178	50408	54638	58868	63098	67328	71558
	-	41949	46179	50409	54639	58869	63099	67329	71559
Step Offset(Float)		41950	46180	50410	54640	58870	63100	67330	71560
	-	41951	46181	50411	54641	58871	63101	67331	71561
Total pulse		41952	46182	50412	54642	58872	63102	67332	71562

Chapter 11 Internal Memory Address of “Read/Write Variable Data” command

-	41953	46183	50413	54643	58873	63103	67333	71563
CAM Data[0](Low)	41954	46184	50414	54644	58874	63104	67334	71564
CAM Data[0](High)	41955	46185	50415	54645	58875	63105	67335	71565
CAM Data[1](Low)	41956	46186	50416	54646	58876	63106	67336	71566
CAM Data[1](High)	41957	46187	50417	54647	58877	63107	67337	71567
CAM Data[2](Low)	41958	46188	50418	54648	58878	63108	67338	71568
CAM Data[2](High)	41959	46189	50419	54649	58879	63109	67339	71569
CAM Data[3](Low)	41960	46190	50420	54650	58880	63110	67340	71570
CAM Data[3](High)	41961	46191	50421	54651	58881	63111	67341	71571
CAM Data[4](Low)	41962	46192	50422	54652	58882	63112	67342	71572
CAM Data[4](High)	41963	46193	50423	54653	58883	63113	67343	71573
CAM Data[5](Low)	41964	46194	50424	54654	58884	63114	67344	71574
CAM Data[5](High)	41965	46195	50425	54655	58885	63115	67345	71575
CAM Data[6](Low)	41966	46196	50426	54656	58886	63116	67346	71576
CAM Data[6](High)	41967	46197	50427	54657	58887	63117	67347	71577
CAM Data[7](Low)	41968	46198	50428	54658	58888	63118	67348	71578
CAM Data[7](High)	41969	46199	50429	54659	58889	63119	67349	71579
CAM Data[8](Low)	41970	46200	50430	54660	58890	63120	67350	71580
CAM Data[8](High)	41971	46201	50431	54661	58891	63121	67351	71581
CAM Data[9](Low)	41972	46202	50432	54662	58892	63122	67352	71582
CAM Data[9](High)	41973	46203	50433	54663	58893	63123	67353	71583
CAM Data[10](Low)	41974	46204	50434	54664	58894	63124	67354	71584
CAM Data[10](High)	41975	46205	50435	54665	58895	63125	67355	71585
CAM Data[11](Low)	41976	46206	50436	54666	58896	63126	67356	71586
CAM Data[11](High)	41977	46207	50437	54667	58897	63127	67357	71587
CAM Data[12](Low)	41978	46208	50438	54668	58898	63128	67358	71588
CAM Data[12](High)	41979	46209	50439	54669	58899	63129	67359	71589
CAM Data[13](Low)	41980	46210	50440	54670	58900	63130	67360	71590
CAM Data[13](High)	41981	46211	50441	54671	58901	63131	67361	71591
CAM Data[14](Low)	41982	46212	50442	54672	58902	63132	67362	71592
CAM Data[14](High)	41983	46213	50443	54673	58903	63133	67363	71593
CAM Data[15](Low)	41984	46214	50444	54674	58904	63134	67364	71594
CAM Data[15](High)	41985	46215	50445	54675	58905	63135	67365	71595
CAM Data[16](Low)	41986	46216	50446	54676	58906	63136	67366	71596
CAM Data[16](High)	41987	46217	50447	54677	58907	63137	67367	71597
CAM Data[17](Low)	41988	46218	50448	54678	58908	63138	67368	71598
CAM Data[17](High)	41989	46219	50449	54679	58909	63139	67369	71599
CAM Data[18](Low)	41990	46220	50450	54680	58910	63140	67370	71600
CAM Data[18](High)	41991	46221	50451	54681	58911	63141	67371	71601
CAM Data[19](Low)	41992	46222	50452	54682	58912	63142	67372	71602
CAM Data[19](High)	41993	46223	50453	54683	58913	63143	67373	71603
CAM Data[20](Low)	41994	46224	50454	54684	58914	63144	67374	71604
CAM Data[20](High)	41995	46225	50455	54685	58915	63145	67375	71605
CAM Data[21](Low)	41996	46226	50456	54686	58916	63146	67376	71606
CAM Data[21](High)	41997	46227	50457	54687	58917	63147	67377	71607
CAM Data[22](Low)	41998	46228	50458	54688	58918	63148	67378	71608

Chapter 11 Internal Memory Address of “Read/Write Variable Data” command

	CAM Data[22](High)	41999	46229	50459	54689	58919	63149	67379	71609
	CAM Data[23](Low)	42000	46230	50460	54690	58920	63150	67380	71610
	CAM Data[23](High)	42001	46231	50461	54691	58921	63151	67381	71611
	CAM Data[24](Low)	42002	46232	50462	54692	58922	63152	67382	71612
	CAM Data[24](High)	42003	46233	50463	54693	58923	63153	67383	71613
	CAM Data[25](Low)	42004	46234	50464	54694	58924	63154	67384	71614
	CAM Data[25](High)	42005	46235	50465	54695	58925	63155	67385	71615
	CAM Data[26](Low)	42006	46236	50466	54696	58926	63156	67386	71616
	CAM Data[26](High)	42007	46237	50467	54697	58927	63157	67387	71617
	CAM Data[27](Low)	42008	46238	50468	54698	58928	63158	67388	71618
	CAM Data[27](High)	42009	46239	50469	54699	58929	63159	67389	71619
	CAM Data[28](Low)	42010	46240	50470	54700	58930	63160	67390	71620
	CAM Data[28](High)	42011	46241	50471	54701	58931	63161	67391	71621
	CAM Data[29](Low)	42012	46242	50472	54702	58932	63162	67392	71622
	CAM Data[29](High)	42013	46243	50473	54703	58933	63163	67393	71623
	CAM Data[30](Low)	42014	46244	50474	54704	58934	63164	67394	71624
	CAM Data[30](High)	42015	46245	50475	54705	58935	63165	67395	71625
	CAM Data[31](Low)	42016	46246	50476	54706	58936	63166	67396	71626
	CAM Data[31](High)	42017	46247	50477	54707	58937	63167	67397	71627
	CAM Data[32](Low)	42018	46248	50478	54708	58938	63168	67398	71628
	CAM Data[32](High)	42019	46249	50479	54709	58939	63169	67399	71629
	CAM Data[33](Low)	42020	46250	50480	54710	58940	63170	67400	71630
	CAM Data[33](High)	42021	46251	50481	54711	58941	63171	67401	71631
	CAM Data[34](Low)	42022	46252	50482	54712	58942	63172	67402	71632
	CAM Data[34](High)	42023	46253	50483	54713	58943	63173	67403	71633
	CAM Data[35](Low)	42024	46254	50484	54714	58944	63174	67404	71634
	CAM Data[35](High)	42025	46255	50485	54715	58945	63175	67405	71635
	CAM Data[36](Low)	42026	46256	50486	54716	58946	63176	67406	71636
	CAM Data[36](High)	42027	46257	50487	54717	58947	63177	67407	71637
	CAM Data[37](Low)	42028	46258	50488	54718	58948	63178	67408	71638
	CAM Data[37](High)	42029	46259	50489	54719	58949	63179	67409	71639
	CAM Data[38](Low)	42030	46260	50490	54720	58950	63180	67410	71640
	CAM Data[38](High)	42031	46261	50491	54721	58951	63181	67411	71641
	CAM Data[39](Low)	42032	46262	50492	54722	58952	63182	67412	71642
	CAM Data[39](High)	42033	46263	50493	54723	58953	63183	67413	71643
	CAM Data[40](Low)	42034	46264	50494	54724	58954	63184	67414	71644
	CAM Data[40](High)	42035	46265	50495	54725	58955	63185	67415	71645
	CAM Data[41](Low)	42036	46266	50496	54726	58956	63186	67416	71646
	CAM Data[41](High)	42037	46267	50497	54727	58957	63187	67417	71647
	CAM Data[42](Low)	42038	46268	50498	54728	58958	63188	67418	71648
	CAM Data[42](High)	42039	46269	50499	54729	58959	63189	67419	71649
	CAM Data[43](Low)	42040	46270	50500	54730	58960	63190	67420	71650
	CAM Data[43](High)	42041	46271	50501	54731	58961	63191	67421	71651
	CAM Data[44](Low)	42042	46272	50502	54732	58962	63192	67422	71652
	CAM Data[44](High)	42043	46273	50503	54733	58963	63193	67423	71653
	CAM Data[45](Low)	42044	46274	50504	54734	58964	63194	67424	71654

Chapter 11 Internal Memory Address of “Read/Write Variable Data” command

	CAM Data[45](High)	42045	46275	50505	54735	58965	63195	67425	71655
	CAM Data[46](Low)	42046	46276	50506	54736	58966	63196	67426	71656
	CAM Data[46](High)	42047	46277	50507	54737	58967	63197	67427	71657
	CAM Data[47](Low)	42048	46278	50508	54738	58968	63198	67428	71658
	CAM Data[47](High)	42049	46279	50509	54739	58969	63199	67429	71659
	CAM Data[48](Low)	42050	46280	50510	54740	58970	63200	67430	71660
	CAM Data[48](High)	42051	46281	50511	54741	58971	63201	67431	71661
	CAM Data[49](Low)	42052	46282	50512	54742	58972	63202	67432	71662
	CAM Data[49](High)	42053	46283	50513	54743	58973	63203	67433	71663
	CAM Data[50](Low)	42054	46284	50514	54744	58974	63204	67434	71664
	CAM Data[50](High)	42055	46285	50515	54745	58975	63205	67435	71665
	CAM Data[51](Low)	42056	46286	50516	54746	58976	63206	67436	71666
	CAM Data[51](High)	42057	46287	50517	54747	58977	63207	67437	71667
	CAM Data[52](Low)	42058	46288	50518	54748	58978	63208	67438	71668
	CAM Data[52](High)	42059	46289	50519	54749	58979	63209	67439	71669
	CAM Data[53](Low)	42060	46290	50520	54750	58980	63210	67440	71670
	CAM Data[53](High)	42061	46291	50521	54751	58981	63211	67441	71671
	CAM Data[54](Low)	42062	46292	50522	54752	58982	63212	67442	71672
	CAM Data[54](High)	42063	46293	50523	54753	58983	63213	67443	71673
	CAM Data[55](Low)	42064	46294	50524	54754	58984	63214	67444	71674
	CAM Data[55](High)	42065	46295	50525	54755	58985	63215	67445	71675
	CAM Data[56](Low)	42066	46296	50526	54756	58986	63216	67446	71676
	CAM Data[56](High)	42067	46297	50527	54757	58987	63217	67447	71677
	CAM Data[57](Low)	42068	46298	50528	54758	58988	63218	67448	71678
	CAM Data[57](High)	42069	46299	50529	54759	58989	63219	67449	71679
	CAM Data[58](Low)	42070	46300	50530	54760	58990	63220	67450	71680
	CAM Data[58](High)	42071	46301	50531	54761	58991	63221	67451	71681
	CAM Data[59](Low)	42072	46302	50532	54762	58992	63222	67452	71682
	CAM Data[59](High)	42073	46303	50533	54763	58993	63223	67453	71683
	CAM Data[60](Low)	42074	46304	50534	54764	58994	63224	67454	71684
	CAM Data[60](High)	42075	46305	50535	54765	58995	63225	67455	71685
	CAM Data[61](Low)	42076	46306	50536	54766	58996	63226	67456	71686
	CAM Data[61](High)	42077	46307	50537	54767	58997	63227	67457	71687
	CAM Data[62](Low)	42078	46308	50538	54768	58998	63228	67458	71688
	CAM Data[62](High)	42079	46309	50539	54769	58999	63229	67459	71689
	CAM Data[63](Low)	42080	46310	50540	54770	59000	63230	67460	71690
	CAM Data[63](High)	42081	46311	50541	54771	59001	63231	67461	71691
	CAM Data[64](Low)	42082	46312	50542	54772	59002	63232	67462	71692
	CAM Data[64](High)	42083	46313	50543	54773	59003	63233	67463	71693
	CAM Data[65](Low)	42084	46314	50544	54774	59004	63234	67464	71694
	CAM Data[65](High)	42085	46315	50545	54775	59005	63235	67465	71695
	CAM Data[66](Low)	42086	46316	50546	54776	59006	63236	67466	71696
	CAM Data[66](High)	42087	46317	50547	54777	59007	63237	67467	71697
	CAM Data[67](Low)	42088	46318	50548	54778	59008	63238	67468	71698
	CAM Data[67](High)	42089	46319	50549	54779	59009	63239	67469	71699
	CAM Data[68](Low)	42090	46320	50550	54780	59010	63240	67470	71700

Chapter 11 Internal Memory Address of “Read/Write Variable Data” command

	CAM Data[68](High)	42091	46321	50551	54781	59011	63241	67471	71701
	CAM Data[69](Low)	42092	46322	50552	54782	59012	63242	67472	71702
	CAM Data[69](High)	42093	46323	50553	54783	59013	63243	67473	71703
	CAM Data[70](Low)	42094	46324	50554	54784	59014	63244	67474	71704
	CAM Data[70](High)	42095	46325	50555	54785	59015	63245	67475	71705
	CAM Data[71](Low)	42096	46326	50556	54786	59016	63246	67476	71706
	CAM Data[71](High)	42097	46327	50557	54787	59017	63247	67477	71707
	CAM Data[72](Low)	42098	46328	50558	54788	59018	63248	67478	71708
	CAM Data[72](High)	42099	46329	50559	54789	59019	63249	67479	71709
	CAM Data[73](Low)	42100	46330	50560	54790	59020	63250	67480	71710
	CAM Data[73](High)	42101	46331	50561	54791	59021	63251	67481	71711
	CAM Data[74](Low)	42102	46332	50562	54792	59022	63252	67482	71712
	CAM Data[74](High)	42103	46333	50563	54793	59023	63253	67483	71713
	CAM Data[75](Low)	42104	46334	50564	54794	59024	63254	67484	71714
	CAM Data[75](High)	42105	46335	50565	54795	59025	63255	67485	71715
	CAM Data[76](Low)	42106	46336	50566	54796	59026	63256	67486	71716
	CAM Data[76](High)	42107	46337	50567	54797	59027	63257	67487	71717
	CAM Data[77](Low)	42108	46338	50568	54798	59028	63258	67488	71718
	CAM Data[77](High)	42109	46339	50569	54799	59029	63259	67489	71719
	CAM Data[78](Low)	42110	46340	50570	54800	59030	63260	67490	71720
	CAM Data[78](High)	42111	46341	50571	54801	59031	63261	67491	71721
	CAM Data[79](Low)	42112	46342	50572	54802	59032	63262	67492	71722
	CAM Data[79](High)	42113	46343	50573	54803	59033	63263	67493	71723
	CAM Data[80](Low)	42114	46344	50574	54804	59034	63264	67494	71724
	CAM Data[80](High)	42115	46345	50575	54805	59035	63265	67495	71725
	CAM Data[81](Low)	42116	46346	50576	54806	59036	63266	67496	71726
	CAM Data[81](High)	42117	46347	50577	54807	59037	63267	67497	71727
	CAM Data[82](Low)	42118	46348	50578	54808	59038	63268	67498	71728
	CAM Data[82](High)	42119	46349	50579	54809	59039	63269	67499	71729
	CAM Data[83](Low)	42120	46350	50580	54810	59040	63270	67500	71730
	CAM Data[83](High)	42121	46351	50581	54811	59041	63271	67501	71731
	CAM Data[84](Low)	42122	46352	50582	54812	59042	63272	67502	71732
	CAM Data[84](High)	42123	46353	50583	54813	59043	63273	67503	71733
	CAM Data[85](Low)	42124	46354	50584	54814	59044	63274	67504	71734
	CAM Data[85](High)	42125	46355	50585	54815	59045	63275	67505	71735
	CAM Data[86](Low)	42126	46356	50586	54816	59046	63276	67506	71736
	CAM Data[86](High)	42127	46357	50587	54817	59047	63277	67507	71737
	CAM Data[87](Low)	42128	46358	50588	54818	59048	63278	67508	71738
	CAM Data[87](High)	42129	46359	50589	54819	59049	63279	67509	71739
	CAM Data[88](Low)	42130	46360	50590	54820	59050	63280	67510	71740
	CAM Data[88](High)	42131	46361	50591	54821	59051	63281	67511	71741
	CAM Data[89](Low)	42132	46362	50592	54822	59052	63282	67512	71742
	CAM Data[89](High)	42133	46363	50593	54823	59053	63283	67513	71743
	CAM Data[90](Low)	42134	46364	50594	54824	59054	63284	67514	71744
	CAM Data[90](High)	42135	46365	50595	54825	59055	63285	67515	71745
	CAM Data[91](Low)	42136	46366	50596	54826	59056	63286	67516	71746

Chapter 11 Internal Memory Address of “Read/Write Variable Data” command

	CAM Data[91](High)	42137	46367	50597	54827	59057	63287	67517	71747
	CAM Data[92](Low)	42138	46368	50598	54828	59058	63288	67518	71748
	CAM Data[92](High)	42139	46369	50599	54829	59059	63289	67519	71749
	CAM Data[93](Low)	42140	46370	50600	54830	59060	63290	67520	71750
	CAM Data[93](High)	42141	46371	50601	54831	59061	63291	67521	71751
	CAM Data[94](Low)	42142	46372	50602	54832	59062	63292	67522	71752
	CAM Data[94](High)	42143	46373	50603	54833	59063	63293	67523	71753
	CAM Data[95](Low)	42144	46374	50604	54834	59064	63294	67524	71754
	CAM Data[95](High)	42145	46375	50605	54835	59065	63295	67525	71755
	CAM Data[96](Low)	42146	46376	50606	54836	59066	63296	67526	71756
	CAM Data[96](High)	42147	46377	50607	54837	59067	63297	67527	71757
	CAM Data[97](Low)	42148	46378	50608	54838	59068	63298	67528	71758
	CAM Data[97](High)	42149	46379	50609	54839	59069	63299	67529	71759
	CAM Data[98](Low)	42150	46380	50610	54840	59070	63300	67530	71760
	CAM Data[98](High)	42151	46381	50611	54841	59071	63301	67531	71761
	CAM Data[99](Low)	42152	46382	50612	54842	59072	63302	67532	71762
	CAM Data[99](High)	42153	46383	50613	54843	59073	63303	67533	71763
	CAM Data[100](Low)	42154	46384	50614	54844	59074	63304	67534	71764
	CAM Data[100](High)	42155	46385	50615	54845	59075	63305	67535	71765
	CAM Data[101](Low)	42156	46386	50616	54846	59076	63306	67536	71766
	CAM Data[101](High)	42157	46387	50617	54847	59077	63307	67537	71767
	CAM Data[102](Low)	42158	46388	50618	54848	59078	63308	67538	71768
	CAM Data[102](High)	42159	46389	50619	54849	59079	63309	67539	71769
	CAM Data[103](Low)	42160	46390	50620	54850	59080	63310	67540	71770
	CAM Data[103](High)	42161	46391	50621	54851	59081	63311	67541	71771
	CAM Data[104](Low)	42162	46392	50622	54852	59082	63312	67542	71772
	CAM Data[104](High)	42163	46393	50623	54853	59083	63313	67543	71773
	CAM Data[105](Low)	42164	46394	50624	54854	59084	63314	67544	71774
	CAM Data[105](High)	42165	46395	50625	54855	59085	63315	67545	71775
	CAM Data[106](Low)	42166	46396	50626	54856	59086	63316	67546	71776
	CAM Data[106](High)	42167	46397	50627	54857	59087	63317	67547	71777
	CAM Data[107](Low)	42168	46398	50628	54858	59088	63318	67548	71778
	CAM Data[107](High)	42169	46399	50629	54859	59089	63319	67549	71779
	CAM Data[108](Low)	42170	46400	50630	54860	59090	63320	67550	71780
	CAM Data[108](High)	42171	46401	50631	54861	59091	63321	67551	71781
	CAM Data[109](Low)	42172	46402	50632	54862	59092	63322	67552	71782
	CAM Data[109](High)	42173	46403	50633	54863	59093	63323	67553	71783
	CAM Data[110](Low)	42174	46404	50634	54864	59094	63324	67554	71784
	CAM Data[110](High)	42175	46405	50635	54865	59095	63325	67555	71785
	CAM Data[111](Low)	42176	46406	50636	54866	59096	63326	67556	71786
	CAM Data[111](High)	42177	46407	50637	54867	59097	63327	67557	71787
	CAM Data[112](Low)	42178	46408	50638	54868	59098	63328	67558	71788
	CAM Data[112](High)	42179	46409	50639	54869	59099	63329	67559	71789
	CAM Data[113](Low)	42180	46410	50640	54870	59100	63330	67560	71790
	CAM Data[113](High)	42181	46411	50641	54871	59101	63331	67561	71791
	CAM Data[114](Low)	42182	46412	50642	54872	59102	63332	67562	71792

Chapter 11 Internal Memory Address of “Read/Write Variable Data” command

	CAM Data[114](High)	42183	46413	50643	54873	59103	63333	67563	71793
	CAM Data[115](Low)	42184	46414	50644	54874	59104	63334	67564	71794
	CAM Data[115](High)	42185	46415	50645	54875	59105	63335	67565	71795
	CAM Data[116](Low)	42186	46416	50646	54876	59106	63336	67566	71796
	CAM Data[116](High)	42187	46417	50647	54877	59107	63337	67567	71797
	CAM Data[117](Low)	42188	46418	50648	54878	59108	63338	67568	71798
	CAM Data[117](High)	42189	46419	50649	54879	59109	63339	67569	71799
	CAM Data[118](Low)	42190	46420	50650	54880	59110	63340	67570	71800
	CAM Data[118](High)	42191	46421	50651	54881	59111	63341	67571	71801
	CAM Data[119](Low)	42192	46422	50652	54882	59112	63342	67572	71802
	CAM Data[119](High)	42193	46423	50653	54883	59113	63343	67573	71803
	CAM Data[120](Low)	42194	46424	50654	54884	59114	63344	67574	71804
	CAM Data[120](High)	42195	46425	50655	54885	59115	63345	67575	71805
	CAM Data[121](Low)	42196	46426	50656	54886	59116	63346	67576	71806
	CAM Data[121](High)	42197	46427	50657	54887	59117	63347	67577	71807
	CAM Data[122](Low)	42198	46428	50658	54888	59118	63348	67578	71808
	CAM Data[122](High)	42199	46429	50659	54889	59119	63349	67579	71809
	CAM Data[123](Low)	42200	46430	50660	54890	59120	63350	67580	71810
	CAM Data[123](High)	42201	46431	50661	54891	59121	63351	67581	71811
	CAM Data[124](Low)	42202	46432	50662	54892	59122	63352	67582	71812
	CAM Data[124](High)	42203	46433	50663	54893	59123	63353	67583	71813
	CAM Data[125](Low)	42204	46434	50664	54894	59124	63354	67584	71814
	CAM Data[125](High)	42205	46435	50665	54895	59125	63355	67585	71815
	CAM Data[126](Low)	42206	46436	50666	54896	59126	63356	67586	71816
	CAM Data[126](High)	42207	46437	50667	54897	59127	63357	67587	71817
	CAM Data[127](Low)	42208	46438	50668	54898	59128	63358	67588	71818
	CAM Data[127](High)	42209	46439	50669	54899	59129	63359	67589	71819
	CAM Data[128](Low)	42210	46440	50670	54900	59130	63360	67590	71820
	CAM Data[128](High)	42211	46441	50671	54901	59131	63361	67591	71821
	CAM Data[129](Low)	42212	46442	50672	54902	59132	63362	67592	71822
	CAM Data[129](High)	42213	46443	50673	54903	59133	63363	67593	71823
	CAM Data[130](Low)	42214	46444	50674	54904	59134	63364	67594	71824
	CAM Data[130](High)	42215	46445	50675	54905	59135	63365	67595	71825
	CAM Data[131](Low)	42216	46446	50676	54906	59136	63366	67596	71826
	CAM Data[131](High)	42217	46447	50677	54907	59137	63367	67597	71827
	CAM Data[132](Low)	42218	46448	50678	54908	59138	63368	67598	71828
	CAM Data[132](High)	42219	46449	50679	54909	59139	63369	67599	71829
	CAM Data[133](Low)	42220	46450	50680	54910	59140	63370	67600	71830
	CAM Data[133](High)	42221	46451	50681	54911	59141	63371	67601	71831
	CAM Data[134](Low)	42222	46452	50682	54912	59142	63372	67602	71832
	CAM Data[134](High)	42223	46453	50683	54913	59143	63373	67603	71833
	CAM Data[135](Low)	42224	46454	50684	54914	59144	63374	67604	71834
	CAM Data[135](High)	42225	46455	50685	54915	59145	63375	67605	71835
	CAM Data[136](Low)	42226	46456	50686	54916	59146	63376	67606	71836
	CAM Data[136](High)	42227	46457	50687	54917	59147	63377	67607	71837
	CAM Data[137](Low)	42228	46458	50688	54918	59148	63378	67608	71838

Chapter 11 Internal Memory Address of “Read/Write Variable Data” command

	CAM Data[137](High)	42229	46459	50689	54919	59149	63379	67609	71839
	CAM Data[138](Low)	42230	46460	50690	54920	59150	63380	67610	71840
	CAM Data[138](High)	42231	46461	50691	54921	59151	63381	67611	71841
	CAM Data[139](Low)	42232	46462	50692	54922	59152	63382	67612	71842
	CAM Data[139](High)	42233	46463	50693	54923	59153	63383	67613	71843
	CAM Data[140](Low)	42234	46464	50694	54924	59154	63384	67614	71844
	CAM Data[140](High)	42235	46465	50695	54925	59155	63385	67615	71845
	CAM Data[141](Low)	42236	46466	50696	54926	59156	63386	67616	71846
	CAM Data[141](High)	42237	46467	50697	54927	59157	63387	67617	71847
	CAM Data[142](Low)	42238	46468	50698	54928	59158	63388	67618	71848
	CAM Data[142](High)	42239	46469	50699	54929	59159	63389	67619	71849
	CAM Data[143](Low)	42240	46470	50700	54930	59160	63390	67620	71850
	CAM Data[143](High)	42241	46471	50701	54931	59161	63391	67621	71851
	CAM Data[144](Low)	42242	46472	50702	54932	59162	63392	67622	71852
	CAM Data[144](High)	42243	46473	50703	54933	59163	63393	67623	71853
	CAM Data[145](Low)	42244	46474	50704	54934	59164	63394	67624	71854
	CAM Data[145](High)	42245	46475	50705	54935	59165	63395	67625	71855
	CAM Data[146](Low)	42246	46476	50706	54936	59166	63396	67626	71856
	CAM Data[146](High)	42247	46477	50707	54937	59167	63397	67627	71857
	CAM Data[147](Low)	42248	46478	50708	54938	59168	63398	67628	71858
	CAM Data[147](High)	42249	46479	50709	54939	59169	63399	67629	71859
	CAM Data[148](Low)	42250	46480	50710	54940	59170	63400	67630	71860
	CAM Data[148](High)	42251	46481	50711	54941	59171	63401	67631	71861
	CAM Data[149](Low)	42252	46482	50712	54942	59172	63402	67632	71862
	CAM Data[149](High)	42253	46483	50713	54943	59173	63403	67633	71863
	CAM Data[150](Low)	42254	46484	50714	54944	59174	63404	67634	71864
	CAM Data[150](High)	42255	46485	50715	54945	59175	63405	67635	71865
	CAM Data[151](Low)	42256	46486	50716	54946	59176	63406	67636	71866
	CAM Data[151](High)	42257	46487	50717	54947	59177	63407	67637	71867
	CAM Data[152](Low)	42258	46488	50718	54948	59178	63408	67638	71868
	CAM Data[152](High)	42259	46489	50719	54949	59179	63409	67639	71869
	CAM Data[153](Low)	42260	46490	50720	54950	59180	63410	67640	71870
	CAM Data[153](High)	42261	46491	50721	54951	59181	63411	67641	71871
	CAM Data[154](Low)	42262	46492	50722	54952	59182	63412	67642	71872
	CAM Data[154](High)	42263	46493	50723	54953	59183	63413	67643	71873
	CAM Data[155](Low)	42264	46494	50724	54954	59184	63414	67644	71874
	CAM Data[155](High)	42265	46495	50725	54955	59185	63415	67645	71875
	CAM Data[156](Low)	42266	46496	50726	54956	59186	63416	67646	71876
	CAM Data[156](High)	42267	46497	50727	54957	59187	63417	67647	71877
	CAM Data[157](Low)	42268	46498	50728	54958	59188	63418	67648	71878
	CAM Data[157](High)	42269	46499	50729	54959	59189	63419	67649	71879
	CAM Data[158](Low)	42270	46500	50730	54960	59190	63420	67650	71880
	CAM Data[158](High)	42271	46501	50731	54961	59191	63421	67651	71881
	CAM Data[159](Low)	42272	46502	50732	54962	59192	63422	67652	71882
	CAM Data[159](High)	42273	46503	50733	54963	59193	63423	67653	71883
	CAM Data[160](Low)	42274	46504	50734	54964	59194	63424	67654	71884

Chapter 11 Internal Memory Address of “Read/Write Variable Data” command

	CAM Data[160](High)	42275	46505	50735	54965	59195	63425	67655	71885
	CAM Data[161](Low)	42276	46506	50736	54966	59196	63426	67656	71886
	CAM Data[161](High)	42277	46507	50737	54967	59197	63427	67657	71887
	CAM Data[162](Low)	42278	46508	50738	54968	59198	63428	67658	71888
	CAM Data[162](High)	42279	46509	50739	54969	59199	63429	67659	71889
	CAM Data[163](Low)	42280	46510	50740	54970	59200	63430	67660	71890
	CAM Data[163](High)	42281	46511	50741	54971	59201	63431	67661	71891
	CAM Data[164](Low)	42282	46512	50742	54972	59202	63432	67662	71892
	CAM Data[164](High)	42283	46513	50743	54973	59203	63433	67663	71893
	CAM Data[165](Low)	42284	46514	50744	54974	59204	63434	67664	71894
	CAM Data[165](High)	42285	46515	50745	54975	59205	63435	67665	71895
	CAM Data[166](Low)	42286	46516	50746	54976	59206	63436	67666	71896
	CAM Data[166](High)	42287	46517	50747	54977	59207	63437	67667	71897
	CAM Data[167](Low)	42288	46518	50748	54978	59208	63438	67668	71898
	CAM Data[167](High)	42289	46519	50749	54979	59209	63439	67669	71899
	CAM Data[168](Low)	42290	46520	50750	54980	59210	63440	67670	71900
	CAM Data[168](High)	42291	46521	50751	54981	59211	63441	67671	71901
	CAM Data[169](Low)	42292	46522	50752	54982	59212	63442	67672	71902
	CAM Data[169](High)	42293	46523	50753	54983	59213	63443	67673	71903
	CAM Data[170](Low)	42294	46524	50754	54984	59214	63444	67674	71904
	CAM Data[170](High)	42295	46525	50755	54985	59215	63445	67675	71905
	CAM Data[171](Low)	42296	46526	50756	54986	59216	63446	67676	71906
	CAM Data[171](High)	42297	46527	50757	54987	59217	63447	67677	71907
	CAM Data[172](Low)	42298	46528	50758	54988	59218	63448	67678	71908
	CAM Data[172](High)	42299	46529	50759	54989	59219	63449	67679	71909
	CAM Data[173](Low)	42300	46530	50760	54990	59220	63450	67680	71910
	CAM Data[173](High)	42301	46531	50761	54991	59221	63451	67681	71911
	CAM Data[174](Low)	42302	46532	50762	54992	59222	63452	67682	71912
	CAM Data[174](High)	42303	46533	50763	54993	59223	63453	67683	71913
	CAM Data[175](Low)	42304	46534	50764	54994	59224	63454	67684	71914
	CAM Data[175](High)	42305	46535	50765	54995	59225	63455	67685	71915
	CAM Data[176](Low)	42306	46536	50766	54996	59226	63456	67686	71916
	CAM Data[176](High)	42307	46537	50767	54997	59227	63457	67687	71917
	CAM Data[177](Low)	42308	46538	50768	54998	59228	63458	67688	71918
	CAM Data[177](High)	42309	46539	50769	54999	59229	63459	67689	71919
	CAM Data[178](Low)	42310	46540	50770	55000	59230	63460	67690	71920
	CAM Data[178](High)	42311	46541	50771	55001	59231	63461	67691	71921
	CAM Data[179](Low)	42312	46542	50772	55002	59232	63462	67692	71922
	CAM Data[179](High)	42313	46543	50773	55003	59233	63463	67693	71923
	CAM Data[180](Low)	42314	46544	50774	55004	59234	63464	67694	71924
	CAM Data[180](High)	42315	46545	50775	55005	59235	63465	67695	71925
	CAM Data[181](Low)	42316	46546	50776	55006	59236	63466	67696	71926
	CAM Data[181](High)	42317	46547	50777	55007	59237	63467	67697	71927
	CAM Data[182](Low)	42318	46548	50778	55008	59238	63468	67698	71928
	CAM Data[182](High)	42319	46549	50779	55009	59239	63469	67699	71929
	CAM Data[183](Low)	42320	46550	50780	55010	59240	63470	67700	71930

Chapter 11 Internal Memory Address of “Read/Write Variable Data” command

	CAM Data[183](High)	42321	46551	50781	55011	59241	63471	67701	71931
	CAM Data[184](Low)	42322	46552	50782	55012	59242	63472	67702	71932
	CAM Data[184](High)	42323	46553	50783	55013	59243	63473	67703	71933
	CAM Data[185](Low)	42324	46554	50784	55014	59244	63474	67704	71934
	CAM Data[185](High)	42325	46555	50785	55015	59245	63475	67705	71935
	CAM Data[186](Low)	42326	46556	50786	55016	59246	63476	67706	71936
	CAM Data[186](High)	42327	46557	50787	55017	59247	63477	67707	71937
	CAM Data[187](Low)	42328	46558	50788	55018	59248	63478	67708	71938
	CAM Data[187](High)	42329	46559	50789	55019	59249	63479	67709	71939
	CAM Data[188](Low)	42330	46560	50790	55020	59250	63480	67710	71940
	CAM Data[188](High)	42331	46561	50791	55021	59251	63481	67711	71941
	CAM Data[189](Low)	42332	46562	50792	55022	59252	63482	67712	71942
	CAM Data[189](High)	42333	46563	50793	55023	59253	63483	67713	71943
	CAM Data[190](Low)	42334	46564	50794	55024	59254	63484	67714	71944
	CAM Data[190](High)	42335	46565	50795	55025	59255	63485	67715	71945
	CAM Data[191](Low)	42336	46566	50796	55026	59256	63486	67716	71946
	CAM Data[191](High)	42337	46567	50797	55027	59257	63487	67717	71947
	CAM Data[192](Low)	42338	46568	50798	55028	59258	63488	67718	71948
	CAM Data[192](High)	42339	46569	50799	55029	59259	63489	67719	71949
	CAM Data[193](Low)	42340	46570	50800	55030	59260	63490	67720	71950
	CAM Data[193](High)	42341	46571	50801	55031	59261	63491	67721	71951
	CAM Data[194](Low)	42342	46572	50802	55032	59262	63492	67722	71952
	CAM Data[194](High)	42343	46573	50803	55033	59263	63493	67723	71953
	CAM Data[195](Low)	42344	46574	50804	55034	59264	63494	67724	71954
	CAM Data[195](High)	42345	46575	50805	55035	59265	63495	67725	71955
	CAM Data[196](Low)	42346	46576	50806	55036	59266	63496	67726	71956
	CAM Data[196](High)	42347	46577	50807	55037	59267	63497	67727	71957
	CAM Data[197](Low)	42348	46578	50808	55038	59268	63498	67728	71958
	CAM Data[197](High)	42349	46579	50809	55039	59269	63499	67729	71959
	CAM Data[198](Low)	42350	46580	50810	55040	59270	63500	67730	71960
	CAM Data[198](High)	42351	46581	50811	55041	59271	63501	67731	71961
	CAM Data[199](Low)	42352	46582	50812	55042	59272	63502	67732	71962
	CAM Data[199](High)	42353	46583	50813	55043	59273	63503	67733	71963
	CAM Data[200](Low)	42354	46584	50814	55044	59274	63504	67734	71964
	CAM Data[200](High)	42355	46585	50815	55045	59275	63505	67735	71965
	CAM Data[201](Low)	42356	46586	50816	55046	59276	63506	67736	71966
	CAM Data[201](High)	42357	46587	50817	55047	59277	63507	67737	71967
	CAM Data[202](Low)	42358	46588	50818	55048	59278	63508	67738	71968
	CAM Data[202](High)	42359	46589	50819	55049	59279	63509	67739	71969
	CAM Data[203](Low)	42360	46590	50820	55050	59280	63510	67740	71970
	CAM Data[203](High)	42361	46591	50821	55051	59281	63511	67741	71971
	CAM Data[204](Low)	42362	46592	50822	55052	59282	63512	67742	71972
	CAM Data[204](High)	42363	46593	50823	55053	59283	63513	67743	71973
	CAM Data[205](Low)	42364	46594	50824	55054	59284	63514	67744	71974
	CAM Data[205](High)	42365	46595	50825	55055	59285	63515	67745	71975
	CAM Data[206](Low)	42366	46596	50826	55056	59286	63516	67746	71976

Chapter 11 Internal Memory Address of “Read/Write Variable Data” command

	CAM Data[206](High)	42367	46597	50827	55057	59287	63517	67747	71977
	CAM Data[207](Low)	42368	46598	50828	55058	59288	63518	67748	71978
	CAM Data[207](High)	42369	46599	50829	55059	59289	63519	67749	71979
	CAM Data[208](Low)	42370	46600	50830	55060	59290	63520	67750	71980
	CAM Data[208](High)	42371	46601	50831	55061	59291	63521	67751	71981
	CAM Data[209](Low)	42372	46602	50832	55062	59292	63522	67752	71982
	CAM Data[209](High)	42373	46603	50833	55063	59293	63523	67753	71983
	CAM Data[210](Low)	42374	46604	50834	55064	59294	63524	67754	71984
	CAM Data[210](High)	42375	46605	50835	55065	59295	63525	67755	71985
	CAM Data[211](Low)	42376	46606	50836	55066	59296	63526	67756	71986
	CAM Data[211](High)	42377	46607	50837	55067	59297	63527	67757	71987
	CAM Data[212](Low)	42378	46608	50838	55068	59298	63528	67758	71988
	CAM Data[212](High)	42379	46609	50839	55069	59299	63529	67759	71989
	CAM Data[213](Low)	42380	46610	50840	55070	59300	63530	67760	71990
	CAM Data[213](High)	42381	46611	50841	55071	59301	63531	67761	71991
	CAM Data[214](Low)	42382	46612	50842	55072	59302	63532	67762	71992
	CAM Data[214](High)	42383	46613	50843	55073	59303	63533	67763	71993
	CAM Data[215](Low)	42384	46614	50844	55074	59304	63534	67764	71994
	CAM Data[215](High)	42385	46615	50845	55075	59305	63535	67765	71995
	CAM Data[216](Low)	42386	46616	50846	55076	59306	63536	67766	71996
	CAM Data[216](High)	42387	46617	50847	55077	59307	63537	67767	71997
	CAM Data[217](Low)	42388	46618	50848	55078	59308	63538	67768	71998
	CAM Data[217](High)	42389	46619	50849	55079	59309	63539	67769	71999
	CAM Data[218](Low)	42390	46620	50850	55080	59310	63540	67770	72000
	CAM Data[218](High)	42391	46621	50851	55081	59311	63541	67771	72001
	CAM Data[219](Low)	42392	46622	50852	55082	59312	63542	67772	72002
	CAM Data[219](High)	42393	46623	50853	55083	59313	63543	67773	72003
	CAM Data[220](Low)	42394	46624	50854	55084	59314	63544	67774	72004
	CAM Data[220](High)	42395	46625	50855	55085	59315	63545	67775	72005
	CAM Data[221](Low)	42396	46626	50856	55086	59316	63546	67776	72006
	CAM Data[221](High)	42397	46627	50857	55087	59317	63547	67777	72007
	CAM Data[222](Low)	42398	46628	50858	55088	59318	63548	67778	72008
	CAM Data[222](High)	42399	46629	50859	55089	59319	63549	67779	72009
	CAM Data[223](Low)	42400	46630	50860	55090	59320	63550	67780	72010
	CAM Data[223](High)	42401	46631	50861	55091	59321	63551	67781	72011
	CAM Data[224](Low)	42402	46632	50862	55092	59322	63552	67782	72012
	CAM Data[224](High)	42403	46633	50863	55093	59323	63553	67783	72013
	CAM Data[225](Low)	42404	46634	50864	55094	59324	63554	67784	72014
	CAM Data[225](High)	42405	46635	50865	55095	59325	63555	67785	72015
	CAM Data[226](Low)	42406	46636	50866	55096	59326	63556	67786	72016
	CAM Data[226](High)	42407	46637	50867	55097	59327	63557	67787	72017
	CAM Data[227](Low)	42408	46638	50868	55098	59328	63558	67788	72018
	CAM Data[227](High)	42409	46639	50869	55099	59329	63559	67789	72019
	CAM Data[228](Low)	42410	46640	50870	55100	59330	63560	67790	72020
	CAM Data[228](High)	42411	46641	50871	55101	59331	63561	67791	72021
	CAM Data[229](Low)	42412	46642	50872	55102	59332	63562	67792	72022

Chapter 11 Internal Memory Address of “Read/Write Variable Data” command

	CAM Data[229](High)	42413	46643	50873	55103	59333	63563	67793	72023
	CAM Data[230](Low)	42414	46644	50874	55104	59334	63564	67794	72024
	CAM Data[230](High)	42415	46645	50875	55105	59335	63565	67795	72025
	CAM Data[231](Low)	42416	46646	50876	55106	59336	63566	67796	72026
	CAM Data[231](High)	42417	46647	50877	55107	59337	63567	67797	72027
	CAM Data[232](Low)	42418	46648	50878	55108	59338	63568	67798	72028
	CAM Data[232](High)	42419	46649	50879	55109	59339	63569	67799	72029
	CAM Data[233](Low)	42420	46650	50880	55110	59340	63570	67800	72030
	CAM Data[233](High)	42421	46651	50881	55111	59341	63571	67801	72031
	CAM Data[234](Low)	42422	46652	50882	55112	59342	63572	67802	72032
	CAM Data[234](High)	42423	46653	50883	55113	59343	63573	67803	72033
	CAM Data[235](Low)	42424	46654	50884	55114	59344	63574	67804	72034
	CAM Data[235](High)	42425	46655	50885	55115	59345	63575	67805	72035
	CAM Data[236](Low)	42426	46656	50886	55116	59346	63576	67806	72036
	CAM Data[236](High)	42427	46657	50887	55117	59347	63577	67807	72037
	CAM Data[237](Low)	42428	46658	50888	55118	59348	63578	67808	72038
	CAM Data[237](High)	42429	46659	50889	55119	59349	63579	67809	72039
	CAM Data[238](Low)	42430	46660	50890	55120	59350	63580	67810	72040
	CAM Data[238](High)	42431	46661	50891	55121	59351	63581	67811	72041
	CAM Data[239](Low)	42432	46662	50892	55122	59352	63582	67812	72042
	CAM Data[239](High)	42433	46663	50893	55123	59353	63583	67813	72043
	CAM Data[240](Low)	42434	46664	50894	55124	59354	63584	67814	72044
	CAM Data[240](High)	42435	46665	50895	55125	59355	63585	67815	72045
	CAM Data[241](Low)	42436	46666	50896	55126	59356	63586	67816	72046
	CAM Data[241](High)	42437	46667	50897	55127	59357	63587	67817	72047
	CAM Data[242](Low)	42438	46668	50898	55128	59358	63588	67818	72048
	CAM Data[242](High)	42439	46669	50899	55129	59359	63589	67819	72049
	CAM Data[243](Low)	42440	46670	50900	55130	59360	63590	67820	72050
	CAM Data[243](High)	42441	46671	50901	55131	59361	63591	67821	72051
	CAM Data[244](Low)	42442	46672	50902	55132	59362	63592	67822	72052
	CAM Data[244](High)	42443	46673	50903	55133	59363	63593	67823	72053
	CAM Data[245](Low)	42444	46674	50904	55134	59364	63594	67824	72054
	CAM Data[245](High)	42445	46675	50905	55135	59365	63595	67825	72055
	CAM Data[246](Low)	42446	46676	50906	55136	59366	63596	67826	72056
	CAM Data[246](High)	42447	46677	50907	55137	59367	63597	67827	72057
	CAM Data[247](Low)	42448	46678	50908	55138	59368	63598	67828	72058
	CAM Data[247](High)	42449	46679	50909	55139	59369	63599	67829	72059
	CAM Data[248](Low)	42450	46680	50910	55140	59370	63600	67830	72060
	CAM Data[248](High)	42451	46681	50911	55141	59371	63601	67831	72061
	CAM Data[249](Low)	42452	46682	50912	55142	59372	63602	67832	72062
	CAM Data[249](High)	42453	46683	50913	55143	59373	63603	67833	72063
	CAM Data[250](Low)	42454	46684	50914	55144	59374	63604	67834	72064
	CAM Data[250](High)	42455	46685	50915	55145	59375	63605	67835	72065
	CAM Data[251](Low)	42456	46686	50916	55146	59376	63606	67836	72066
	CAM Data[251](High)	42457	46687	50917	55147	59377	63607	67837	72067
	CAM Data[252](Low)	42458	46688	50918	55148	59378	63608	67838	72068

Chapter 11 Internal Memory Address of “Read/Write Variable Data” command

	CAM Data[252](High)	42459	46689	50919	55149	59379	63609	67839	72069
	CAM Data[253](Low)	42460	46690	50920	55150	59380	63610	67840	72070
	CAM Data[253](High)	42461	46691	50921	55151	59381	63611	67841	72071
	CAM Data[254](Low)	42462	46692	50922	55152	59382	63612	67842	72072
	CAM Data[254](High)	42463	46693	50923	55153	59383	63613	67843	72073
	CAM Data[255](Low)	42464	46694	50924	55154	59384	63614	67844	72074
	CAM Data[255](High)	42465	46695	50925	55155	59385	63615	67845	72075
	CAM Data[256](Low)	42466	46696	50926	55156	59386	63616	67846	72076
	CAM Data[256](High)	42467	46697	50927	55157	59387	63617	67847	72077
	CAM Data[257](Low)	42468	46698	50928	55158	59388	63618	67848	72078
	CAM Data[257](High)	42469	46699	50929	55159	59389	63619	67849	72079
	CAM Data[258](Low)	42470	46700	50930	55160	59390	63620	67850	72080
	CAM Data[258](High)	42471	46701	50931	55161	59391	63621	67851	72081
	CAM Data[259](Low)	42472	46702	50932	55162	59392	63622	67852	72082
	CAM Data[259](High)	42473	46703	50933	55163	59393	63623	67853	72083
	CAM Data[260](Low)	42474	46704	50934	55164	59394	63624	67854	72084
	CAM Data[260](High)	42475	46705	50935	55165	59395	63625	67855	72085
	CAM Data[261](Low)	42476	46706	50936	55166	59396	63626	67856	72086
	CAM Data[261](High)	42477	46707	50937	55167	59397	63627	67857	72087
	CAM Data[262](Low)	42478	46708	50938	55168	59398	63628	67858	72088
	CAM Data[262](High)	42479	46709	50939	55169	59399	63629	67859	72089
	CAM Data[263](Low)	42480	46710	50940	55170	59400	63630	67860	72090
	CAM Data[263](High)	42481	46711	50941	55171	59401	63631	67861	72091
	CAM Data[264](Low)	42482	46712	50942	55172	59402	63632	67862	72092
	CAM Data[264](High)	42483	46713	50943	55173	59403	63633	67863	72093
	CAM Data[265](Low)	42484	46714	50944	55174	59404	63634	67864	72094
	CAM Data[265](High)	42485	46715	50945	55175	59405	63635	67865	72095
	CAM Data[266](Low)	42486	46716	50946	55176	59406	63636	67866	72096
	CAM Data[266](High)	42487	46717	50947	55177	59407	63637	67867	72097
	CAM Data[267](Low)	42488	46718	50948	55178	59408	63638	67868	72098
	CAM Data[267](High)	42489	46719	50949	55179	59409	63639	67869	72099
	CAM Data[268](Low)	42490	46720	50950	55180	59410	63640	67870	72100
	CAM Data[268](High)	42491	46721	50951	55181	59411	63641	67871	72101
	CAM Data[269](Low)	42492	46722	50952	55182	59412	63642	67872	72102
	CAM Data[269](High)	42493	46723	50953	55183	59413	63643	67873	72103
	CAM Data[270](Low)	42494	46724	50954	55184	59414	63644	67874	72104
	CAM Data[270](High)	42495	46725	50955	55185	59415	63645	67875	72105
	CAM Data[271](Low)	42496	46726	50956	55186	59416	63646	67876	72106
	CAM Data[271](High)	42497	46727	50957	55187	59417	63647	67877	72107
	CAM Data[272](Low)	42498	46728	50958	55188	59418	63648	67878	72108
	CAM Data[272](High)	42499	46729	50959	55189	59419	63649	67879	72109
	CAM Data[273](Low)	42500	46730	50960	55190	59420	63650	67880	72110
	CAM Data[273](High)	42501	46731	50961	55191	59421	63651	67881	72111
	CAM Data[274](Low)	42502	46732	50962	55192	59422	63652	67882	72112
	CAM Data[274](High)	42503	46733	50963	55193	59423	63653	67883	72113
	CAM Data[275](Low)	42504	46734	50964	55194	59424	63654	67884	72114

Chapter 11 Internal Memory Address of “Read/Write Variable Data” command

	CAM Data[275](High)	42505	46735	50965	55195	59425	63655	67885	72115
	CAM Data[276](Low)	42506	46736	50966	55196	59426	63656	67886	72116
	CAM Data[276](High)	42507	46737	50967	55197	59427	63657	67887	72117
	CAM Data[277](Low)	42508	46738	50968	55198	59428	63658	67888	72118
	CAM Data[277](High)	42509	46739	50969	55199	59429	63659	67889	72119
	CAM Data[278](Low)	42510	46740	50970	55200	59430	63660	67890	72120
	CAM Data[278](High)	42511	46741	50971	55201	59431	63661	67891	72121
	CAM Data[279](Low)	42512	46742	50972	55202	59432	63662	67892	72122
	CAM Data[279](High)	42513	46743	50973	55203	59433	63663	67893	72123
	CAM Data[280](Low)	42514	46744	50974	55204	59434	63664	67894	72124
	CAM Data[280](High)	42515	46745	50975	55205	59435	63665	67895	72125
	CAM Data[281](Low)	42516	46746	50976	55206	59436	63666	67896	72126
	CAM Data[281](High)	42517	46747	50977	55207	59437	63667	67897	72127
	CAM Data[282](Low)	42518	46748	50978	55208	59438	63668	67898	72128
	CAM Data[282](High)	42519	46749	50979	55209	59439	63669	67899	72129
	CAM Data[283](Low)	42520	46750	50980	55210	59440	63670	67900	72130
	CAM Data[283](High)	42521	46751	50981	55211	59441	63671	67901	72131
	CAM Data[284](Low)	42522	46752	50982	55212	59442	63672	67902	72132
	CAM Data[284](High)	42523	46753	50983	55213	59443	63673	67903	72133
	CAM Data[285](Low)	42524	46754	50984	55214	59444	63674	67904	72134
	CAM Data[285](High)	42525	46755	50985	55215	59445	63675	67905	72135
	CAM Data[286](Low)	42526	46756	50986	55216	59446	63676	67906	72136
	CAM Data[286](High)	42527	46757	50987	55217	59447	63677	67907	72137
	CAM Data[287](Low)	42528	46758	50988	55218	59448	63678	67908	72138
	CAM Data[287](High)	42529	46759	50989	55219	59449	63679	67909	72139
	CAM Data[288](Low)	42530	46760	50990	55220	59450	63680	67910	72140
	CAM Data[288](High)	42531	46761	50991	55221	59451	63681	67911	72141
	CAM Data[289](Low)	42532	46762	50992	55222	59452	63682	67912	72142
	CAM Data[289](High)	42533	46763	50993	55223	59453	63683	67913	72143
	CAM Data[290](Low)	42534	46764	50994	55224	59454	63684	67914	72144
	CAM Data[290](High)	42535	46765	50995	55225	59455	63685	67915	72145
	CAM Data[291](Low)	42536	46766	50996	55226	59456	63686	67916	72146
	CAM Data[291](High)	42537	46767	50997	55227	59457	63687	67917	72147
	CAM Data[292](Low)	42538	46768	50998	55228	59458	63688	67918	72148
	CAM Data[292](High)	42539	46769	50999	55229	59459	63689	67919	72149
	CAM Data[293](Low)	42540	46770	51000	55230	59460	63690	67920	72150
	CAM Data[293](High)	42541	46771	51001	55231	59461	63691	67921	72151
	CAM Data[294](Low)	42542	46772	51002	55232	59462	63692	67922	72152
	CAM Data[294](High)	42543	46773	51003	55233	59463	63693	67923	72153
	CAM Data[295](Low)	42544	46774	51004	55234	59464	63694	67924	72154
	CAM Data[295](High)	42545	46775	51005	55235	59465	63695	67925	72155
	CAM Data[296](Low)	42546	46776	51006	55236	59466	63696	67926	72156
	CAM Data[296](High)	42547	46777	51007	55237	59467	63697	67927	72157
	CAM Data[297](Low)	42548	46778	51008	55238	59468	63698	67928	72158
	CAM Data[297](High)	42549	46779	51009	55239	59469	63699	67929	72159
	CAM Data[298](Low)	42550	46780	51010	55240	59470	63700	67930	72160

Chapter 11 Internal Memory Address of “Read/Write Variable Data” command

	CAM Data[298](High)	42551	46781	51011	55241	59471	63701	67931	72161
	CAM Data[299](Low)	42552	46782	51012	55242	59472	63702	67932	72162
	CAM Data[299](High)	42553	46783	51013	55243	59473	63703	67933	72163
	CAM Data[300](Low)	42554	46784	51014	55244	59474	63704	67934	72164
	CAM Data[300](High)	42555	46785	51015	55245	59475	63705	67935	72165
	CAM Data[301](Low)	42556	46786	51016	55246	59476	63706	67936	72166
	CAM Data[301](High)	42557	46787	51017	55247	59477	63707	67937	72167
	CAM Data[302](Low)	42558	46788	51018	55248	59478	63708	67938	72168
	CAM Data[302](High)	42559	46789	51019	55249	59479	63709	67939	72169
	CAM Data[303](Low)	42560	46790	51020	55250	59480	63710	67940	72170
	CAM Data[303](High)	42561	46791	51021	55251	59481	63711	67941	72171
	CAM Data[304](Low)	42562	46792	51022	55252	59482	63712	67942	72172
	CAM Data[304](High)	42563	46793	51023	55253	59483	63713	67943	72173
	CAM Data[305](Low)	42564	46794	51024	55254	59484	63714	67944	72174
	CAM Data[305](High)	42565	46795	51025	55255	59485	63715	67945	72175
	CAM Data[306](Low)	42566	46796	51026	55256	59486	63716	67946	72176
	CAM Data[306](High)	42567	46797	51027	55257	59487	63717	67947	72177
	CAM Data[307](Low)	42568	46798	51028	55258	59488	63718	67948	72178
	CAM Data[307](High)	42569	46799	51029	55259	59489	63719	67949	72179
	CAM Data[308](Low)	42570	46800	51030	55260	59490	63720	67950	72180
	CAM Data[308](High)	42571	46801	51031	55261	59491	63721	67951	72181
	CAM Data[309](Low)	42572	46802	51032	55262	59492	63722	67952	72182
	CAM Data[309](High)	42573	46803	51033	55263	59493	63723	67953	72183
	CAM Data[310](Low)	42574	46804	51034	55264	59494	63724	67954	72184
	CAM Data[310](High)	42575	46805	51035	55265	59495	63725	67955	72185
	CAM Data[311](Low)	42576	46806	51036	55266	59496	63726	67956	72186
	CAM Data[311](High)	42577	46807	51037	55267	59497	63727	67957	72187
	CAM Data[312](Low)	42578	46808	51038	55268	59498	63728	67958	72188
	CAM Data[312](High)	42579	46809	51039	55269	59499	63729	67959	72189
	CAM Data[313](Low)	42580	46810	51040	55270	59500	63730	67960	72190
	CAM Data[313](High)	42581	46811	51041	55271	59501	63731	67961	72191
	CAM Data[314](Low)	42582	46812	51042	55272	59502	63732	67962	72192
	CAM Data[314](High)	42583	46813	51043	55273	59503	63733	67963	72193
	CAM Data[315](Low)	42584	46814	51044	55274	59504	63734	67964	72194
	CAM Data[315](High)	42585	46815	51045	55275	59505	63735	67965	72195
	CAM Data[316](Low)	42586	46816	51046	55276	59506	63736	67966	72196
	CAM Data[316](High)	42587	46817	51047	55277	59507	63737	67967	72197
	CAM Data[317](Low)	42588	46818	51048	55278	59508	63738	67968	72198
	CAM Data[317](High)	42589	46819	51049	55279	59509	63739	67969	72199
	CAM Data[318](Low)	42590	46820	51050	55280	59510	63740	67970	72200
	CAM Data[318](High)	42591	46821	51051	55281	59511	63741	67971	72201
	CAM Data[319](Low)	42592	46822	51052	55282	59512	63742	67972	72202
	CAM Data[319](High)	42593	46823	51053	55283	59513	63743	67973	72203
	CAM Data[320](Low)	42594	46824	51054	55284	59514	63744	67974	72204
	CAM Data[320](High)	42595	46825	51055	55285	59515	63745	67975	72205
	CAM Data[321](Low)	42596	46826	51056	55286	59516	63746	67976	72206

Chapter 11 Internal Memory Address of “Read/Write Variable Data” command

	CAM Data[321](High)	42597	46827	51057	55287	59517	63747	67977	72207
	CAM Data[322](Low)	42598	46828	51058	55288	59518	63748	67978	72208
	CAM Data[322](High)	42599	46829	51059	55289	59519	63749	67979	72209
	CAM Data[323](Low)	42600	46830	51060	55290	59520	63750	67980	72210
	CAM Data[323](High)	42601	46831	51061	55291	59521	63751	67981	72211
	CAM Data[324](Low)	42602	46832	51062	55292	59522	63752	67982	72212
	CAM Data[324](High)	42603	46833	51063	55293	59523	63753	67983	72213
	CAM Data[325](Low)	42604	46834	51064	55294	59524	63754	67984	72214
	CAM Data[325](High)	42605	46835	51065	55295	59525	63755	67985	72215
	CAM Data[326](Low)	42606	46836	51066	55296	59526	63756	67986	72216
	CAM Data[326](High)	42607	46837	51067	55297	59527	63757	67987	72217
	CAM Data[327](Low)	42608	46838	51068	55298	59528	63758	67988	72218
	CAM Data[327](High)	42609	46839	51069	55299	59529	63759	67989	72219
	CAM Data[328](Low)	42610	46840	51070	55300	59530	63760	67990	72220
	CAM Data[328](High)	42611	46841	51071	55301	59531	63761	67991	72221
	CAM Data[329](Low)	42612	46842	51072	55302	59532	63762	67992	72222
	CAM Data[329](High)	42613	46843	51073	55303	59533	63763	67993	72223
	CAM Data[330](Low)	42614	46844	51074	55304	59534	63764	67994	72224
	CAM Data[330](High)	42615	46845	51075	55305	59535	63765	67995	72225
	CAM Data[331](Low)	42616	46846	51076	55306	59536	63766	67996	72226
	CAM Data[331](High)	42617	46847	51077	55307	59537	63767	67997	72227
	CAM Data[332](Low)	42618	46848	51078	55308	59538	63768	67998	72228
	CAM Data[332](High)	42619	46849	51079	55309	59539	63769	67999	72229
	CAM Data[333](Low)	42620	46850	51080	55310	59540	63770	68000	72230
	CAM Data[333](High)	42621	46851	51081	55311	59541	63771	68001	72231
	CAM Data[334](Low)	42622	46852	51082	55312	59542	63772	68002	72232
	CAM Data[334](High)	42623	46853	51083	55313	59543	63773	68003	72233
	CAM Data[335](Low)	42624	46854	51084	55314	59544	63774	68004	72234
	CAM Data[335](High)	42625	46855	51085	55315	59545	63775	68005	72235
	CAM Data[336](Low)	42626	46856	51086	55316	59546	63776	68006	72236
	CAM Data[336](High)	42627	46857	51087	55317	59547	63777	68007	72237
	CAM Data[337](Low)	42628	46858	51088	55318	59548	63778	68008	72238
	CAM Data[337](High)	42629	46859	51089	55319	59549	63779	68009	72239
	CAM Data[338](Low)	42630	46860	51090	55320	59550	63780	68010	72240
	CAM Data[338](High)	42631	46861	51091	55321	59551	63781	68011	72241
	CAM Data[339](Low)	42632	46862	51092	55322	59552	63782	68012	72242
	CAM Data[339](High)	42633	46863	51093	55323	59553	63783	68013	72243
	CAM Data[340](Low)	42634	46864	51094	55324	59554	63784	68014	72244
	CAM Data[340](High)	42635	46865	51095	55325	59555	63785	68015	72245
	CAM Data[341](Low)	42636	46866	51096	55326	59556	63786	68016	72246
	CAM Data[341](High)	42637	46867	51097	55327	59557	63787	68017	72247
	CAM Data[342](Low)	42638	46868	51098	55328	59558	63788	68018	72248
	CAM Data[342](High)	42639	46869	51099	55329	59559	63789	68019	72249
	CAM Data[343](Low)	42640	46870	51100	55330	59560	63790	68020	72250
	CAM Data[343](High)	42641	46871	51101	55331	59561	63791	68021	72251
	CAM Data[344](Low)	42642	46872	51102	55332	59562	63792	68022	72252

Chapter 11 Internal Memory Address of “Read/Write Variable Data” command

	CAM Data[344](High)	42643	46873	51103	55333	59563	63793	68023	72253
	CAM Data[345](Low)	42644	46874	51104	55334	59564	63794	68024	72254
	CAM Data[345](High)	42645	46875	51105	55335	59565	63795	68025	72255
	CAM Data[346](Low)	42646	46876	51106	55336	59566	63796	68026	72256
	CAM Data[346](High)	42647	46877	51107	55337	59567	63797	68027	72257
	CAM Data[347](Low)	42648	46878	51108	55338	59568	63798	68028	72258
	CAM Data[347](High)	42649	46879	51109	55339	59569	63799	68029	72259
	CAM Data[348](Low)	42650	46880	51110	55340	59570	63800	68030	72260
	CAM Data[348](High)	42651	46881	51111	55341	59571	63801	68031	72261
	CAM Data[349](Low)	42652	46882	51112	55342	59572	63802	68032	72262
	CAM Data[349](High)	42653	46883	51113	55343	59573	63803	68033	72263
	CAM Data[350](Low)	42654	46884	51114	55344	59574	63804	68034	72264
	CAM Data[350](High)	42655	46885	51115	55345	59575	63805	68035	72265
	CAM Data[351](Low)	42656	46886	51116	55346	59576	63806	68036	72266
	CAM Data[351](High)	42657	46887	51117	55347	59577	63807	68037	72267
	CAM Data[352](Low)	42658	46888	51118	55348	59578	63808	68038	72268
	CAM Data[352](High)	42659	46889	51119	55349	59579	63809	68039	72269
	CAM Data[353](Low)	42660	46890	51120	55350	59580	63810	68040	72270
	CAM Data[353](High)	42661	46891	51121	55351	59581	63811	68041	72271
	CAM Data[354](Low)	42662	46892	51122	55352	59582	63812	68042	72272
	CAM Data[354](High)	42663	46893	51123	55353	59583	63813	68043	72273
	CAM Data[355](Low)	42664	46894	51124	55354	59584	63814	68044	72274
	CAM Data[355](High)	42665	46895	51125	55355	59585	63815	68045	72275
	CAM Data[356](Low)	42666	46896	51126	55356	59586	63816	68046	72276
	CAM Data[356](High)	42667	46897	51127	55357	59587	63817	68047	72277
	CAM Data[357](Low)	42668	46898	51128	55358	59588	63818	68048	72278
	CAM Data[357](High)	42669	46899	51129	55359	59589	63819	68049	72279
	CAM Data[358](Low)	42670	46900	51130	55360	59590	63820	68050	72280
	CAM Data[358](High)	42671	46901	51131	55361	59591	63821	68051	72281
	CAM Data[359](Low)	42672	46902	51132	55362	59592	63822	68052	72282
	CAM Data[359](High)	42673	46903	51133	55363	59593	63823	68053	72283
	CAM Data[360](Low)	42674	46904	51134	55364	59594	63824	68054	72284
	CAM Data[360](High)	42675	46905	51135	55365	59595	63825	68055	72285
	CAM Data[361](Low)	42676	46906	51136	55366	59596	63826	68056	72286
	CAM Data[361](High)	42677	46907	51137	55367	59597	63827	68057	72287
	CAM Data[362](Low)	42678	46908	51138	55368	59598	63828	68058	72288
	CAM Data[362](High)	42679	46909	51139	55369	59599	63829	68059	72289
	CAM Data[363](Low)	42680	46910	51140	55370	59600	63830	68060	72290
	CAM Data[363](High)	42681	46911	51141	55371	59601	63831	68061	72291
	CAM Data[364](Low)	42682	46912	51142	55372	59602	63832	68062	72292
	CAM Data[364](High)	42683	46913	51143	55373	59603	63833	68063	72293
	CAM Data[365](Low)	42684	46914	51144	55374	59604	63834	68064	72294
	CAM Data[365](High)	42685	46915	51145	55375	59605	63835	68065	72295
	CAM Data[366](Low)	42686	46916	51146	55376	59606	63836	68066	72296
	CAM Data[366](High)	42687	46917	51147	55377	59607	63837	68067	72297
	CAM Data[367](Low)	42688	46918	51148	55378	59608	63838	68068	72298

Chapter 11 Internal Memory Address of “Read/Write Variable Data” command

	CAM Data[367](High)	42689	46919	51149	55379	59609	63839	68069	72299
	CAM Data[368](Low)	42690	46920	51150	55380	59610	63840	68070	72300
	CAM Data[368](High)	42691	46921	51151	55381	59611	63841	68071	72301
	CAM Data[369](Low)	42692	46922	51152	55382	59612	63842	68072	72302
	CAM Data[369](High)	42693	46923	51153	55383	59613	63843	68073	72303
	CAM Data[370](Low)	42694	46924	51154	55384	59614	63844	68074	72304
	CAM Data[370](High)	42695	46925	51155	55385	59615	63845	68075	72305
	CAM Data[371](Low)	42696	46926	51156	55386	59616	63846	68076	72306
	CAM Data[371](High)	42697	46927	51157	55387	59617	63847	68077	72307
	CAM Data[372](Low)	42698	46928	51158	55388	59618	63848	68078	72308
	CAM Data[372](High)	42699	46929	51159	55389	59619	63849	68079	72309
	CAM Data[373](Low)	42700	46930	51160	55390	59620	63850	68080	72310
	CAM Data[373](High)	42701	46931	51161	55391	59621	63851	68081	72311
	CAM Data[374](Low)	42702	46932	51162	55392	59622	63852	68082	72312
	CAM Data[374](High)	42703	46933	51163	55393	59623	63853	68083	72313
	CAM Data[375](Low)	42704	46934	51164	55394	59624	63854	68084	72314
	CAM Data[375](High)	42705	46935	51165	55395	59625	63855	68085	72315
	CAM Data[376](Low)	42706	46936	51166	55396	59626	63856	68086	72316
	CAM Data[376](High)	42707	46937	51167	55397	59627	63857	68087	72317
	CAM Data[377](Low)	42708	46938	51168	55398	59628	63858	68088	72318
	CAM Data[377](High)	42709	46939	51169	55399	59629	63859	68089	72319
	CAM Data[378](Low)	42710	46940	51170	55400	59630	63860	68090	72320
	CAM Data[378](High)	42711	46941	51171	55401	59631	63861	68091	72321
	CAM Data[379](Low)	42712	46942	51172	55402	59632	63862	68092	72322
	CAM Data[379](High)	42713	46943	51173	55403	59633	63863	68093	72323
	CAM Data[380](Low)	42714	46944	51174	55404	59634	63864	68094	72324
	CAM Data[380](High)	42715	46945	51175	55405	59635	63865	68095	72325
	CAM Data[381](Low)	42716	46946	51176	55406	59636	63866	68096	72326
	CAM Data[381](High)	42717	46947	51177	55407	59637	63867	68097	72327
	CAM Data[382](Low)	42718	46948	51178	55408	59638	63868	68098	72328
	CAM Data[382](High)	42719	46949	51179	55409	59639	63869	68099	72329
	CAM Data[383](Low)	42720	46950	51180	55410	59640	63870	68100	72330
	CAM Data[383](High)	42721	46951	51181	55411	59641	63871	68101	72331
	CAM Data[384](Low)	42722	46952	51182	55412	59642	63872	68102	72332
	CAM Data[384](High)	42723	46953	51183	55413	59643	63873	68103	72333
	CAM Data[385](Low)	42724	46954	51184	55414	59644	63874	68104	72334
	CAM Data[385](High)	42725	46955	51185	55415	59645	63875	68105	72335
	CAM Data[386](Low)	42726	46956	51186	55416	59646	63876	68106	72336
	CAM Data[386](High)	42727	46957	51187	55417	59647	63877	68107	72337
	CAM Data[387](Low)	42728	46958	51188	55418	59648	63878	68108	72338
	CAM Data[387](High)	42729	46959	51189	55419	59649	63879	68109	72339
	CAM Data[388](Low)	42730	46960	51190	55420	59650	63880	68110	72340
	CAM Data[388](High)	42731	46961	51191	55421	59651	63881	68111	72341
	CAM Data[389](Low)	42732	46962	51192	55422	59652	63882	68112	72342
	CAM Data[389](High)	42733	46963	51193	55423	59653	63883	68113	72343
	CAM Data[390](Low)	42734	46964	51194	55424	59654	63884	68114	72344

Chapter 11 Internal Memory Address of “Read/Write Variable Data” command

	CAM Data[390](High)	42735	46965	51195	55425	59655	63885	68115	72345
	CAM Data[391](Low)	42736	46966	51196	55426	59656	63886	68116	72346
	CAM Data[391](High)	42737	46967	51197	55427	59657	63887	68117	72347
	CAM Data[392](Low)	42738	46968	51198	55428	59658	63888	68118	72348
	CAM Data[392](High)	42739	46969	51199	55429	59659	63889	68119	72349
	CAM Data[393](Low)	42740	46970	51200	55430	59660	63890	68120	72350
	CAM Data[393](High)	42741	46971	51201	55431	59661	63891	68121	72351
	CAM Data[394](Low)	42742	46972	51202	55432	59662	63892	68122	72352
	CAM Data[394](High)	42743	46973	51203	55433	59663	63893	68123	72353
	CAM Data[395](Low)	42744	46974	51204	55434	59664	63894	68124	72354
	CAM Data[395](High)	42745	46975	51205	55435	59665	63895	68125	72355
	CAM Data[396](Low)	42746	46976	51206	55436	59666	63896	68126	72356
	CAM Data[396](High)	42747	46977	51207	55437	59667	63897	68127	72357
	CAM Data[397](Low)	42748	46978	51208	55438	59668	63898	68128	72358
	CAM Data[397](High)	42749	46979	51209	55439	59669	63899	68129	72359
	CAM Data[398](Low)	42750	46980	51210	55440	59670	63900	68130	72360
	CAM Data[398](High)	42751	46981	51211	55441	59671	63901	68131	72361
	CAM Data[399](Low)	42752	46982	51212	55442	59672	63902	68132	72362
	CAM Data[399](High)	42753	46983	51213	55443	59673	63903	68133	72363
	CAM Data[400](Low)	42754	46984	51214	55444	59674	63904	68134	72364
	CAM Data[400](High)	42755	46985	51215	55445	59675	63905	68135	72365
	CAM Data[401](Low)	42756	46986	51216	55446	59676	63906	68136	72366
	CAM Data[401](High)	42757	46987	51217	55447	59677	63907	68137	72367
	CAM Data[402](Low)	42758	46988	51218	55448	59678	63908	68138	72368
	CAM Data[402](High)	42759	46989	51219	55449	59679	63909	68139	72369
	CAM Data[403](Low)	42760	46990	51220	55450	59680	63910	68140	72370
	CAM Data[403](High)	42761	46991	51221	55451	59681	63911	68141	72371
	CAM Data[404](Low)	42762	46992	51222	55452	59682	63912	68142	72372
	CAM Data[404](High)	42763	46993	51223	55453	59683	63913	68143	72373
	CAM Data[405](Low)	42764	46994	51224	55454	59684	63914	68144	72374
	CAM Data[405](High)	42765	46995	51225	55455	59685	63915	68145	72375
	CAM Data[406](Low)	42766	46996	51226	55456	59686	63916	68146	72376
	CAM Data[406](High)	42767	46997	51227	55457	59687	63917	68147	72377
	CAM Data[407](Low)	42768	46998	51228	55458	59688	63918	68148	72378
	CAM Data[407](High)	42769	46999	51229	55459	59689	63919	68149	72379
	CAM Data[408](Low)	42770	47000	51230	55460	59690	63920	68150	72380
	CAM Data[408](High)	42771	47001	51231	55461	59691	63921	68151	72381
	CAM Data[409](Low)	42772	47002	51232	55462	59692	63922	68152	72382
	CAM Data[409](High)	42773	47003	51233	55463	59693	63923	68153	72383
	CAM Data[410](Low)	42774	47004	51234	55464	59694	63924	68154	72384
	CAM Data[410](High)	42775	47005	51235	55465	59695	63925	68155	72385
	CAM Data[411](Low)	42776	47006	51236	55466	59696	63926	68156	72386
	CAM Data[411](High)	42777	47007	51237	55467	59697	63927	68157	72387
	CAM Data[412](Low)	42778	47008	51238	55468	59698	63928	68158	72388
	CAM Data[412](High)	42779	47009	51239	55469	59699	63929	68159	72389
	CAM Data[413](Low)	42780	47010	51240	55470	59700	63930	68160	72390

Chapter 11 Internal Memory Address of “Read/Write Variable Data” command

	CAM Data[413](High)	42781	47011	51241	55471	59701	63931	68161	72391
	CAM Data[414](Low)	42782	47012	51242	55472	59702	63932	68162	72392
	CAM Data[414](High)	42783	47013	51243	55473	59703	63933	68163	72393
	CAM Data[415](Low)	42784	47014	51244	55474	59704	63934	68164	72394
	CAM Data[415](High)	42785	47015	51245	55475	59705	63935	68165	72395
	CAM Data[416](Low)	42786	47016	51246	55476	59706	63936	68166	72396
	CAM Data[416](High)	42787	47017	51247	55477	59707	63937	68167	72397
	CAM Data[417](Low)	42788	47018	51248	55478	59708	63938	68168	72398
	CAM Data[417](High)	42789	47019	51249	55479	59709	63939	68169	72399
	CAM Data[418](Low)	42790	47020	51250	55480	59710	63940	68170	72400
	CAM Data[418](High)	42791	47021	51251	55481	59711	63941	68171	72401
	CAM Data[419](Low)	42792	47022	51252	55482	59712	63942	68172	72402
	CAM Data[419](High)	42793	47023	51253	55483	59713	63943	68173	72403
	CAM Data[420](Low)	42794	47024	51254	55484	59714	63944	68174	72404
	CAM Data[420](High)	42795	47025	51255	55485	59715	63945	68175	72405
	CAM Data[421](Low)	42796	47026	51256	55486	59716	63946	68176	72406
	CAM Data[421](High)	42797	47027	51257	55487	59717	63947	68177	72407
	CAM Data[422](Low)	42798	47028	51258	55488	59718	63948	68178	72408
	CAM Data[422](High)	42799	47029	51259	55489	59719	63949	68179	72409
	CAM Data[423](Low)	42800	47030	51260	55490	59720	63950	68180	72410
	CAM Data[423](High)	42801	47031	51261	55491	59721	63951	68181	72411
	CAM Data[424](Low)	42802	47032	51262	55492	59722	63952	68182	72412
	CAM Data[424](High)	42803	47033	51263	55493	59723	63953	68183	72413
	CAM Data[425](Low)	42804	47034	51264	55494	59724	63954	68184	72414
	CAM Data[425](High)	42805	47035	51265	55495	59725	63955	68185	72415
	CAM Data[426](Low)	42806	47036	51266	55496	59726	63956	68186	72416
	CAM Data[426](High)	42807	47037	51267	55497	59727	63957	68187	72417
	CAM Data[427](Low)	42808	47038	51268	55498	59728	63958	68188	72418
	CAM Data[427](High)	42809	47039	51269	55499	59729	63959	68189	72419
	CAM Data[428](Low)	42810	47040	51270	55500	59730	63960	68190	72420
	CAM Data[428](High)	42811	47041	51271	55501	59731	63961	68191	72421
	CAM Data[429](Low)	42812	47042	51272	55502	59732	63962	68192	72422
	CAM Data[429](High)	42813	47043	51273	55503	59733	63963	68193	72423
	CAM Data[430](Low)	42814	47044	51274	55504	59734	63964	68194	72424
	CAM Data[430](High)	42815	47045	51275	55505	59735	63965	68195	72425
	CAM Data[431](Low)	42816	47046	51276	55506	59736	63966	68196	72426
	CAM Data[431](High)	42817	47047	51277	55507	59737	63967	68197	72427
	CAM Data[432](Low)	42818	47048	51278	55508	59738	63968	68198	72428
	CAM Data[432](High)	42819	47049	51279	55509	59739	63969	68199	72429
	CAM Data[433](Low)	42820	47050	51280	55510	59740	63970	68200	72430
	CAM Data[433](High)	42821	47051	51281	55511	59741	63971	68201	72431
	CAM Data[434](Low)	42822	47052	51282	55512	59742	63972	68202	72432
	CAM Data[434](High)	42823	47053	51283	55513	59743	63973	68203	72433
	CAM Data[435](Low)	42824	47054	51284	55514	59744	63974	68204	72434
	CAM Data[435](High)	42825	47055	51285	55515	59745	63975	68205	72435
	CAM Data[436](Low)	42826	47056	51286	55516	59746	63976	68206	72436

Chapter 11 Internal Memory Address of “Read/Write Variable Data” command

	CAM Data[436](High)	42827	47057	51287	55517	59747	63977	68207	72437
	CAM Data[437](Low)	42828	47058	51288	55518	59748	63978	68208	72438
	CAM Data[437](High)	42829	47059	51289	55519	59749	63979	68209	72439
	CAM Data[438](Low)	42830	47060	51290	55520	59750	63980	68210	72440
	CAM Data[438](High)	42831	47061	51291	55521	59751	63981	68211	72441
	CAM Data[439](Low)	42832	47062	51292	55522	59752	63982	68212	72442
	CAM Data[439](High)	42833	47063	51293	55523	59753	63983	68213	72443
	CAM Data[440](Low)	42834	47064	51294	55524	59754	63984	68214	72444
	CAM Data[440](High)	42835	47065	51295	55525	59755	63985	68215	72445
	CAM Data[441](Low)	42836	47066	51296	55526	59756	63986	68216	72446
	CAM Data[441](High)	42837	47067	51297	55527	59757	63987	68217	72447
	CAM Data[442](Low)	42838	47068	51298	55528	59758	63988	68218	72448
	CAM Data[442](High)	42839	47069	51299	55529	59759	63989	68219	72449
	CAM Data[443](Low)	42840	47070	51300	55530	59760	63990	68220	72450
	CAM Data[443](High)	42841	47071	51301	55531	59761	63991	68221	72451
	CAM Data[444](Low)	42842	47072	51302	55532	59762	63992	68222	72452
	CAM Data[444](High)	42843	47073	51303	55533	59763	63993	68223	72453
	CAM Data[445](Low)	42844	47074	51304	55534	59764	63994	68224	72454
	CAM Data[445](High)	42845	47075	51305	55535	59765	63995	68225	72455
	CAM Data[446](Low)	42846	47076	51306	55536	59766	63996	68226	72456
	CAM Data[446](High)	42847	47077	51307	55537	59767	63997	68227	72457
	CAM Data[447](Low)	42848	47078	51308	55538	59768	63998	68228	72458
	CAM Data[447](High)	42849	47079	51309	55539	59769	63999	68229	72459
	CAM Data[448](Low)	42850	47080	51310	55540	59770	64000	68230	72460
	CAM Data[448](High)	42851	47081	51311	55541	59771	64001	68231	72461
	CAM Data[449](Low)	42852	47082	51312	55542	59772	64002	68232	72462
	CAM Data[449](High)	42853	47083	51313	55543	59773	64003	68233	72463
	CAM Data[450](Low)	42854	47084	51314	55544	59774	64004	68234	72464
	CAM Data[450](High)	42855	47085	51315	55545	59775	64005	68235	72465
	CAM Data[451](Low)	42856	47086	51316	55546	59776	64006	68236	72466
	CAM Data[451](High)	42857	47087	51317	55547	59777	64007	68237	72467
	CAM Data[452](Low)	42858	47088	51318	55548	59778	64008	68238	72468
	CAM Data[452](High)	42859	47089	51319	55549	59779	64009	68239	72469
	CAM Data[453](Low)	42860	47090	51320	55550	59780	64010	68240	72470
	CAM Data[453](High)	42861	47091	51321	55551	59781	64011	68241	72471
	CAM Data[454](Low)	42862	47092	51322	55552	59782	64012	68242	72472
	CAM Data[454](High)	42863	47093	51323	55553	59783	64013	68243	72473
	CAM Data[455](Low)	42864	47094	51324	55554	59784	64014	68244	72474
	CAM Data[455](High)	42865	47095	51325	55555	59785	64015	68245	72475
	CAM Data[456](Low)	42866	47096	51326	55556	59786	64016	68246	72476
	CAM Data[456](High)	42867	47097	51327	55557	59787	64017	68247	72477
	CAM Data[457](Low)	42868	47098	51328	55558	59788	64018	68248	72478
	CAM Data[457](High)	42869	47099	51329	55559	59789	64019	68249	72479
	CAM Data[458](Low)	42870	47100	51330	55560	59790	64020	68250	72480
	CAM Data[458](High)	42871	47101	51331	55561	59791	64021	68251	72481
	CAM Data[459](Low)	42872	47102	51332	55562	59792	64022	68252	72482

Chapter 11 Internal Memory Address of “Read/Write Variable Data” command

	CAM Data[459](High)	42873	47103	51333	55563	59793	64023	68253	72483
	CAM Data[460](Low)	42874	47104	51334	55564	59794	64024	68254	72484
	CAM Data[460](High)	42875	47105	51335	55565	59795	64025	68255	72485
	CAM Data[461](Low)	42876	47106	51336	55566	59796	64026	68256	72486
	CAM Data[461](High)	42877	47107	51337	55567	59797	64027	68257	72487
	CAM Data[462](Low)	42878	47108	51338	55568	59798	64028	68258	72488
	CAM Data[462](High)	42879	47109	51339	55569	59799	64029	68259	72489
	CAM Data[463](Low)	42880	47110	51340	55570	59800	64030	68260	72490
	CAM Data[463](High)	42881	47111	51341	55571	59801	64031	68261	72491
	CAM Data[464](Low)	42882	47112	51342	55572	59802	64032	68262	72492
	CAM Data[464](High)	42883	47113	51343	55573	59803	64033	68263	72493
	CAM Data[465](Low)	42884	47114	51344	55574	59804	64034	68264	72494
	CAM Data[465](High)	42885	47115	51345	55575	59805	64035	68265	72495
	CAM Data[466](Low)	42886	47116	51346	55576	59806	64036	68266	72496
	CAM Data[466](High)	42887	47117	51347	55577	59807	64037	68267	72497
	CAM Data[467](Low)	42888	47118	51348	55578	59808	64038	68268	72498
	CAM Data[467](High)	42889	47119	51349	55579	59809	64039	68269	72499
	CAM Data[468](Low)	42890	47120	51350	55580	59810	64040	68270	72500
	CAM Data[468](High)	42891	47121	51351	55581	59811	64041	68271	72501
	CAM Data[469](Low)	42892	47122	51352	55582	59812	64042	68272	72502
	CAM Data[469](High)	42893	47123	51353	55583	59813	64043	68273	72503
	CAM Data[470](Low)	42894	47124	51354	55584	59814	64044	68274	72504
	CAM Data[470](High)	42895	47125	51355	55585	59815	64045	68275	72505
	CAM Data[471](Low)	42896	47126	51356	55586	59816	64046	68276	72506
	CAM Data[471](High)	42897	47127	51357	55587	59817	64047	68277	72507
	CAM Data[472](Low)	42898	47128	51358	55588	59818	64048	68278	72508
	CAM Data[472](High)	42899	47129	51359	55589	59819	64049	68279	72509
	CAM Data[473](Low)	42900	47130	51360	55590	59820	64050	68280	72510
	CAM Data[473](High)	42901	47131	51361	55591	59821	64051	68281	72511
	CAM Data[474](Low)	42902	47132	51362	55592	59822	64052	68282	72512
	CAM Data[474](High)	42903	47133	51363	55593	59823	64053	68283	72513
	CAM Data[475](Low)	42904	47134	51364	55594	59824	64054	68284	72514
	CAM Data[475](High)	42905	47135	51365	55595	59825	64055	68285	72515
	CAM Data[476](Low)	42906	47136	51366	55596	59826	64056	68286	72516
	CAM Data[476](High)	42907	47137	51367	55597	59827	64057	68287	72517
	CAM Data[477](Low)	42908	47138	51368	55598	59828	64058	68288	72518
	CAM Data[477](High)	42909	47139	51369	55599	59829	64059	68289	72519
	CAM Data[478](Low)	42910	47140	51370	55600	59830	64060	68290	72520
	CAM Data[478](High)	42911	47141	51371	55601	59831	64061	68291	72521
	CAM Data[479](Low)	42912	47142	51372	55602	59832	64062	68292	72522
	CAM Data[479](High)	42913	47143	51373	55603	59833	64063	68293	72523
	CAM Data[480](Low)	42914	47144	51374	55604	59834	64064	68294	72524
	CAM Data[480](High)	42915	47145	51375	55605	59835	64065	68295	72525
	CAM Data[481](Low)	42916	47146	51376	55606	59836	64066	68296	72526
	CAM Data[481](High)	42917	47147	51377	55607	59837	64067	68297	72527
	CAM Data[482](Low)	42918	47148	51378	55608	59838	64068	68298	72528

Chapter 11 Internal Memory Address of “Read/Write Variable Data” command

	CAM Data[482](High)	42919	47149	51379	55609	59839	64069	68299	72529
	CAM Data[483](Low)	42920	47150	51380	55610	59840	64070	68300	72530
	CAM Data[483](High)	42921	47151	51381	55611	59841	64071	68301	72531
	CAM Data[484](Low)	42922	47152	51382	55612	59842	64072	68302	72532
	CAM Data[484](High)	42923	47153	51383	55613	59843	64073	68303	72533
	CAM Data[485](Low)	42924	47154	51384	55614	59844	64074	68304	72534
	CAM Data[485](High)	42925	47155	51385	55615	59845	64075	68305	72535
	CAM Data[486](Low)	42926	47156	51386	55616	59846	64076	68306	72536
	CAM Data[486](High)	42927	47157	51387	55617	59847	64077	68307	72537
	CAM Data[487](Low)	42928	47158	51388	55618	59848	64078	68308	72538
	CAM Data[487](High)	42929	47159	51389	55619	59849	64079	68309	72539
	CAM Data[488](Low)	42930	47160	51390	55620	59850	64080	68310	72540
	CAM Data[488](High)	42931	47161	51391	55621	59851	64081	68311	72541
	CAM Data[489](Low)	42932	47162	51392	55622	59852	64082	68312	72542
	CAM Data[489](High)	42933	47163	51393	55623	59853	64083	68313	72543
	CAM Data[490](Low)	42934	47164	51394	55624	59854	64084	68314	72544
	CAM Data[490](High)	42935	47165	51395	55625	59855	64085	68315	72545
	CAM Data[491](Low)	42936	47166	51396	55626	59856	64086	68316	72546
	CAM Data[491](High)	42937	47167	51397	55627	59857	64087	68317	72547
	CAM Data[492](Low)	42938	47168	51398	55628	59858	64088	68318	72548
	CAM Data[492](High)	42939	47169	51399	55629	59859	64089	68319	72549
	CAM Data[493](Low)	42940	47170	51400	55630	59860	64090	68320	72550
	CAM Data[493](High)	42941	47171	51401	55631	59861	64091	68321	72551
	CAM Data[494](Low)	42942	47172	51402	55632	59862	64092	68322	72552
	CAM Data[494](High)	42943	47173	51403	55633	59863	64093	68323	72553
	CAM Data[495](Low)	42944	47174	51404	55634	59864	64094	68324	72554
	CAM Data[495](High)	42945	47175	51405	55635	59865	64095	68325	72555
	CAM Data[496](Low)	42946	47176	51406	55636	59866	64096	68326	72556
	CAM Data[496](High)	42947	47177	51407	55637	59867	64097	68327	72557
	CAM Data[497](Low)	42948	47178	51408	55638	59868	64098	68328	72558
	CAM Data[497](High)	42949	47179	51409	55639	59869	64099	68329	72559
	CAM Data[498](Low)	42950	47180	51410	55640	59870	64100	68330	72560
	CAM Data[498](High)	42951	47181	51411	55641	59871	64101	68331	72561
	CAM Data[499](Low)	42952	47182	51412	55642	59872	64102	68332	72562
	CAM Data[499](High)	42953	47183	51413	55643	59873	64103	68333	72563
	CAM Data[500](Low)	42954	47184	51414	55644	59874	64104	68334	72564
	CAM Data[500](High)	42955	47185	51415	55645	59875	64105	68335	72565
	CAM Data[501](Low)	42956	47186	51416	55646	59876	64106	68336	72566
	CAM Data[501](High)	42957	47187	51417	55647	59877	64107	68337	72567
	CAM Data[502](Low)	42958	47188	51418	55648	59878	64108	68338	72568
	CAM Data[502](High)	42959	47189	51419	55649	59879	64109	68339	72569
	CAM Data[503](Low)	42960	47190	51420	55650	59880	64110	68340	72570
	CAM Data[503](High)	42961	47191	51421	55651	59881	64111	68341	72571
	CAM Data[504](Low)	42962	47192	51422	55652	59882	64112	68342	72572
	CAM Data[504](High)	42963	47193	51423	55653	59883	64113	68343	72573
	CAM Data[505](Low)	42964	47194	51424	55654	59884	64114	68344	72574

Chapter 11 Internal Memory Address of “Read/Write Variable Data” command

	CAM Data[505](High)	42965	47195	51425	55655	59885	64115	68345	72575
	CAM Data[506](Low)	42966	47196	51426	55656	59886	64116	68346	72576
	CAM Data[506](High)	42967	47197	51427	55657	59887	64117	68347	72577
	CAM Data[507](Low)	42968	47198	51428	55658	59888	64118	68348	72578
	CAM Data[507](High)	42969	47199	51429	55659	59889	64119	68349	72579
	CAM Data[508](Low)	42970	47200	51430	55660	59890	64120	68350	72580
	CAM Data[508](High)	42971	47201	51431	55661	59891	64121	68351	72581
	CAM Data[509](Low)	42972	47202	51432	55662	59892	64122	68352	72582
	CAM Data[509](High)	42973	47203	51433	55663	59893	64123	68353	72583
	CAM Data[510](Low)	42974	47204	51434	55664	59894	64124	68354	72584
	CAM Data[510](High)	42975	47205	51435	55665	59895	64125	68355	72585
	CAM Data[511](Low)	42976	47206	51436	55666	59896	64126	68356	72586
	CAM Data[511](High)	42977	47207	51437	55667	59897	64127	68357	72587
	CAM Data[512](Low)	42978	47208	51438	55668	59898	64128	68358	72588
	CAM Data[512](High)	42979	47209	51439	55669	59899	64129	68359	72589
	CAM Data[513](Low)	42980	47210	51440	55670	59900	64130	68360	72590
	CAM Data[513](High)	42981	47211	51441	55671	59901	64131	68361	72591
	CAM Data[514](Low)	42982	47212	51442	55672	59902	64132	68362	72592
	CAM Data[514](High)	42983	47213	51443	55673	59903	64133	68363	72593
	CAM Data[515](Low)	42984	47214	51444	55674	59904	64134	68364	72594
	CAM Data[515](High)	42985	47215	51445	55675	59905	64135	68365	72595
	CAM Data[516](Low)	42986	47216	51446	55676	59906	64136	68366	72596
	CAM Data[516](High)	42987	47217	51447	55677	59907	64137	68367	72597
	CAM Data[517](Low)	42988	47218	51448	55678	59908	64138	68368	72598
	CAM Data[517](High)	42989	47219	51449	55679	59909	64139	68369	72599
	CAM Data[518](Low)	42990	47220	51450	55680	59910	64140	68370	72600
	CAM Data[518](High)	42991	47221	51451	55681	59911	64141	68371	72601
	CAM Data[519](Low)	42992	47222	51452	55682	59912	64142	68372	72602
	CAM Data[519](High)	42993	47223	51453	55683	59913	64143	68373	72603
	CAM Data[520](Low)	42994	47224	51454	55684	59914	64144	68374	72604
	CAM Data[520](High)	42995	47225	51455	55685	59915	64145	68375	72605
	CAM Data[521](Low)	42996	47226	51456	55686	59916	64146	68376	72606
	CAM Data[521](High)	42997	47227	51457	55687	59917	64147	68377	72607
	CAM Data[522](Low)	42998	47228	51458	55688	59918	64148	68378	72608
	CAM Data[522](High)	42999	47229	51459	55689	59919	64149	68379	72609
	CAM Data[523](Low)	43000	47230	51460	55690	59920	64150	68380	72610
	CAM Data[523](High)	43001	47231	51461	55691	59921	64151	68381	72611
	CAM Data[524](Low)	43002	47232	51462	55692	59922	64152	68382	72612
	CAM Data[524](High)	43003	47233	51463	55693	59923	64153	68383	72613
	CAM Data[525](Low)	43004	47234	51464	55694	59924	64154	68384	72614
	CAM Data[525](High)	43005	47235	51465	55695	59925	64155	68385	72615
	CAM Data[526](Low)	43006	47236	51466	55696	59926	64156	68386	72616
	CAM Data[526](High)	43007	47237	51467	55697	59927	64157	68387	72617
	CAM Data[527](Low)	43008	47238	51468	55698	59928	64158	68388	72618
	CAM Data[527](High)	43009	47239	51469	55699	59929	64159	68389	72619
	CAM Data[528](Low)	43010	47240	51470	55700	59930	64160	68390	72620

Chapter 11 Internal Memory Address of “Read/Write Variable Data” command

	CAM Data[528](High)	43011	47241	51471	55701	59931	64161	68391	72621
	CAM Data[529](Low)	43012	47242	51472	55702	59932	64162	68392	72622
	CAM Data[529](High)	43013	47243	51473	55703	59933	64163	68393	72623
	CAM Data[530](Low)	43014	47244	51474	55704	59934	64164	68394	72624
	CAM Data[530](High)	43015	47245	51475	55705	59935	64165	68395	72625
	CAM Data[531](Low)	43016	47246	51476	55706	59936	64166	68396	72626
	CAM Data[531](High)	43017	47247	51477	55707	59937	64167	68397	72627
	CAM Data[532](Low)	43018	47248	51478	55708	59938	64168	68398	72628
	CAM Data[532](High)	43019	47249	51479	55709	59939	64169	68399	72629
	CAM Data[533](Low)	43020	47250	51480	55710	59940	64170	68400	72630
	CAM Data[533](High)	43021	47251	51481	55711	59941	64171	68401	72631
	CAM Data[534](Low)	43022	47252	51482	55712	59942	64172	68402	72632
	CAM Data[534](High)	43023	47253	51483	55713	59943	64173	68403	72633
	CAM Data[535](Low)	43024	47254	51484	55714	59944	64174	68404	72634
	CAM Data[535](High)	43025	47255	51485	55715	59945	64175	68405	72635
	CAM Data[536](Low)	43026	47256	51486	55716	59946	64176	68406	72636
	CAM Data[536](High)	43027	47257	51487	55717	59947	64177	68407	72637
	CAM Data[537](Low)	43028	47258	51488	55718	59948	64178	68408	72638
	CAM Data[537](High)	43029	47259	51489	55719	59949	64179	68409	72639
	CAM Data[538](Low)	43030	47260	51490	55720	59950	64180	68410	72640
	CAM Data[538](High)	43031	47261	51491	55721	59951	64181	68411	72641
	CAM Data[539](Low)	43032	47262	51492	55722	59952	64182	68412	72642
	CAM Data[539](High)	43033	47263	51493	55723	59953	64183	68413	72643
	CAM Data[540](Low)	43034	47264	51494	55724	59954	64184	68414	72644
	CAM Data[540](High)	43035	47265	51495	55725	59955	64185	68415	72645
	CAM Data[541](Low)	43036	47266	51496	55726	59956	64186	68416	72646
	CAM Data[541](High)	43037	47267	51497	55727	59957	64187	68417	72647
	CAM Data[542](Low)	43038	47268	51498	55728	59958	64188	68418	72648
	CAM Data[542](High)	43039	47269	51499	55729	59959	64189	68419	72649
	CAM Data[543](Low)	43040	47270	51500	55730	59960	64190	68420	72650
	CAM Data[543](High)	43041	47271	51501	55731	59961	64191	68421	72651
	CAM Data[544](Low)	43042	47272	51502	55732	59962	64192	68422	72652
	CAM Data[544](High)	43043	47273	51503	55733	59963	64193	68423	72653
	CAM Data[545](Low)	43044	47274	51504	55734	59964	64194	68424	72654
	CAM Data[545](High)	43045	47275	51505	55735	59965	64195	68425	72655
	CAM Data[546](Low)	43046	47276	51506	55736	59966	64196	68426	72656
	CAM Data[546](High)	43047	47277	51507	55737	59967	64197	68427	72657
	CAM Data[547](Low)	43048	47278	51508	55738	59968	64198	68428	72658
	CAM Data[547](High)	43049	47279	51509	55739	59969	64199	68429	72659
	CAM Data[548](Low)	43050	47280	51510	55740	59970	64200	68430	72660
	CAM Data[548](High)	43051	47281	51511	55741	59971	64201	68431	72661
	CAM Data[549](Low)	43052	47282	51512	55742	59972	64202	68432	72662
	CAM Data[549](High)	43053	47283	51513	55743	59973	64203	68433	72663
	CAM Data[550](Low)	43054	47284	51514	55744	59974	64204	68434	72664
	CAM Data[550](High)	43055	47285	51515	55745	59975	64205	68435	72665
	CAM Data[551](Low)	43056	47286	51516	55746	59976	64206	68436	72666

Chapter 11 Internal Memory Address of “Read/Write Variable Data” command

	CAM Data[551](High)	43057	47287	51517	55747	59977	64207	68437	72667
	CAM Data[552](Low)	43058	47288	51518	55748	59978	64208	68438	72668
	CAM Data[552](High)	43059	47289	51519	55749	59979	64209	68439	72669
	CAM Data[553](Low)	43060	47290	51520	55750	59980	64210	68440	72670
	CAM Data[553](High)	43061	47291	51521	55751	59981	64211	68441	72671
	CAM Data[554](Low)	43062	47292	51522	55752	59982	64212	68442	72672
	CAM Data[554](High)	43063	47293	51523	55753	59983	64213	68443	72673
	CAM Data[555](Low)	43064	47294	51524	55754	59984	64214	68444	72674
	CAM Data[555](High)	43065	47295	51525	55755	59985	64215	68445	72675
	CAM Data[556](Low)	43066	47296	51526	55756	59986	64216	68446	72676
	CAM Data[556](High)	43067	47297	51527	55757	59987	64217	68447	72677
	CAM Data[557](Low)	43068	47298	51528	55758	59988	64218	68448	72678
	CAM Data[557](High)	43069	47299	51529	55759	59989	64219	68449	72679
	CAM Data[558](Low)	43070	47300	51530	55760	59990	64220	68450	72680
	CAM Data[558](High)	43071	47301	51531	55761	59991	64221	68451	72681
	CAM Data[559](Low)	43072	47302	51532	55762	59992	64222	68452	72682
	CAM Data[559](High)	43073	47303	51533	55763	59993	64223	68453	72683
	CAM Data[560](Low)	43074	47304	51534	55764	59994	64224	68454	72684
	CAM Data[560](High)	43075	47305	51535	55765	59995	64225	68455	72685
	CAM Data[561](Low)	43076	47306	51536	55766	59996	64226	68456	72686
	CAM Data[561](High)	43077	47307	51537	55767	59997	64227	68457	72687
	CAM Data[562](Low)	43078	47308	51538	55768	59998	64228	68458	72688
	CAM Data[562](High)	43079	47309	51539	55769	59999	64229	68459	72689
	CAM Data[563](Low)	43080	47310	51540	55770	60000	64230	68460	72690
	CAM Data[563](High)	43081	47311	51541	55771	60001	64231	68461	72691
	CAM Data[564](Low)	43082	47312	51542	55772	60002	64232	68462	72692
	CAM Data[564](High)	43083	47313	51543	55773	60003	64233	68463	72693
	CAM Data[565](Low)	43084	47314	51544	55774	60004	64234	68464	72694
	CAM Data[565](High)	43085	47315	51545	55775	60005	64235	68465	72695
	CAM Data[566](Low)	43086	47316	51546	55776	60006	64236	68466	72696
	CAM Data[566](High)	43087	47317	51547	55777	60007	64237	68467	72697
	CAM Data[567](Low)	43088	47318	51548	55778	60008	64238	68468	72698
	CAM Data[567](High)	43089	47319	51549	55779	60009	64239	68469	72699
	CAM Data[568](Low)	43090	47320	51550	55780	60010	64240	68470	72700
	CAM Data[568](High)	43091	47321	51551	55781	60011	64241	68471	72701
	CAM Data[569](Low)	43092	47322	51552	55782	60012	64242	68472	72702
	CAM Data[569](High)	43093	47323	51553	55783	60013	64243	68473	72703
	CAM Data[570](Low)	43094	47324	51554	55784	60014	64244	68474	72704
	CAM Data[570](High)	43095	47325	51555	55785	60015	64245	68475	72705
	CAM Data[571](Low)	43096	47326	51556	55786	60016	64246	68476	72706
	CAM Data[571](High)	43097	47327	51557	55787	60017	64247	68477	72707
	CAM Data[572](Low)	43098	47328	51558	55788	60018	64248	68478	72708
	CAM Data[572](High)	43099	47329	51559	55789	60019	64249	68479	72709
	CAM Data[573](Low)	43100	47330	51560	55790	60020	64250	68480	72710
	CAM Data[573](High)	43101	47331	51561	55791	60021	64251	68481	72711
	CAM Data[574](Low)	43102	47332	51562	55792	60022	64252	68482	72712

Chapter 11 Internal Memory Address of “Read/Write Variable Data” command

	CAM Data[574](High)	43103	47333	51563	55793	60023	64253	68483	72713
	CAM Data[575](Low)	43104	47334	51564	55794	60024	64254	68484	72714
	CAM Data[575](High)	43105	47335	51565	55795	60025	64255	68485	72715
	CAM Data[576](Low)	43106	47336	51566	55796	60026	64256	68486	72716
	CAM Data[576](High)	43107	47337	51567	55797	60027	64257	68487	72717
	CAM Data[577](Low)	43108	47338	51568	55798	60028	64258	68488	72718
	CAM Data[577](High)	43109	47339	51569	55799	60029	64259	68489	72719
	CAM Data[578](Low)	43110	47340	51570	55800	60030	64260	68490	72720
	CAM Data[578](High)	43111	47341	51571	55801	60031	64261	68491	72721
	CAM Data[579](Low)	43112	47342	51572	55802	60032	64262	68492	72722
	CAM Data[579](High)	43113	47343	51573	55803	60033	64263	68493	72723
	CAM Data[580](Low)	43114	47344	51574	55804	60034	64264	68494	72724
	CAM Data[580](High)	43115	47345	51575	55805	60035	64265	68495	72725
	CAM Data[581](Low)	43116	47346	51576	55806	60036	64266	68496	72726
	CAM Data[581](High)	43117	47347	51577	55807	60037	64267	68497	72727
	CAM Data[582](Low)	43118	47348	51578	55808	60038	64268	68498	72728
	CAM Data[582](High)	43119	47349	51579	55809	60039	64269	68499	72729
	CAM Data[583](Low)	43120	47350	51580	55810	60040	64270	68500	72730
	CAM Data[583](High)	43121	47351	51581	55811	60041	64271	68501	72731
	CAM Data[584](Low)	43122	47352	51582	55812	60042	64272	68502	72732
	CAM Data[584](High)	43123	47353	51583	55813	60043	64273	68503	72733
	CAM Data[585](Low)	43124	47354	51584	55814	60044	64274	68504	72734
	CAM Data[585](High)	43125	47355	51585	55815	60045	64275	68505	72735
	CAM Data[586](Low)	43126	47356	51586	55816	60046	64276	68506	72736
	CAM Data[586](High)	43127	47357	51587	55817	60047	64277	68507	72737
	CAM Data[587](Low)	43128	47358	51588	55818	60048	64278	68508	72738
	CAM Data[587](High)	43129	47359	51589	55819	60049	64279	68509	72739
	CAM Data[588](Low)	43130	47360	51590	55820	60050	64280	68510	72740
	CAM Data[588](High)	43131	47361	51591	55821	60051	64281	68511	72741
	CAM Data[589](Low)	43132	47362	51592	55822	60052	64282	68512	72742
	CAM Data[589](High)	43133	47363	51593	55823	60053	64283	68513	72743
	CAM Data[590](Low)	43134	47364	51594	55824	60054	64284	68514	72744
	CAM Data[590](High)	43135	47365	51595	55825	60055	64285	68515	72745
	CAM Data[591](Low)	43136	47366	51596	55826	60056	64286	68516	72746
	CAM Data[591](High)	43137	47367	51597	55827	60057	64287	68517	72747
	CAM Data[592](Low)	43138	47368	51598	55828	60058	64288	68518	72748
	CAM Data[592](High)	43139	47369	51599	55829	60059	64289	68519	72749
	CAM Data[593](Low)	43140	47370	51600	55830	60060	64290	68520	72750
	CAM Data[593](High)	43141	47371	51601	55831	60061	64291	68521	72751
	CAM Data[594](Low)	43142	47372	51602	55832	60062	64292	68522	72752
	CAM Data[594](High)	43143	47373	51603	55833	60063	64293	68523	72753
	CAM Data[595](Low)	43144	47374	51604	55834	60064	64294	68524	72754
	CAM Data[595](High)	43145	47375	51605	55835	60065	64295	68525	72755
	CAM Data[596](Low)	43146	47376	51606	55836	60066	64296	68526	72756
	CAM Data[596](High)	43147	47377	51607	55837	60067	64297	68527	72757
	CAM Data[597](Low)	43148	47378	51608	55838	60068	64298	68528	72758

Chapter 11 Internal Memory Address of “Read/Write Variable Data” command

	CAM Data[597](High)	43149	47379	51609	55839	60069	64299	68529	72759
	CAM Data[598](Low)	43150	47380	51610	55840	60070	64300	68530	72760
	CAM Data[598](High)	43151	47381	51611	55841	60071	64301	68531	72761
	CAM Data[599](Low)	43152	47382	51612	55842	60072	64302	68532	72762
	CAM Data[599](High)	43153	47383	51613	55843	60073	64303	68533	72763
	CAM Data[600](Low)	43154	47384	51614	55844	60074	64304	68534	72764
	CAM Data[600](High)	43155	47385	51615	55845	60075	64305	68535	72765
	CAM Data[601](Low)	43156	47386	51616	55846	60076	64306	68536	72766
	CAM Data[601](High)	43157	47387	51617	55847	60077	64307	68537	72767
	CAM Data[602](Low)	43158	47388	51618	55848	60078	64308	68538	72768
	CAM Data[602](High)	43159	47389	51619	55849	60079	64309	68539	72769
	CAM Data[603](Low)	43160	47390	51620	55850	60080	64310	68540	72770
	CAM Data[603](High)	43161	47391	51621	55851	60081	64311	68541	72771
	CAM Data[604](Low)	43162	47392	51622	55852	60082	64312	68542	72772
	CAM Data[604](High)	43163	47393	51623	55853	60083	64313	68543	72773
	CAM Data[605](Low)	43164	47394	51624	55854	60084	64314	68544	72774
	CAM Data[605](High)	43165	47395	51625	55855	60085	64315	68545	72775
	CAM Data[606](Low)	43166	47396	51626	55856	60086	64316	68546	72776
	CAM Data[606](High)	43167	47397	51627	55857	60087	64317	68547	72777
	CAM Data[607](Low)	43168	47398	51628	55858	60088	64318	68548	72778
	CAM Data[607](High)	43169	47399	51629	55859	60089	64319	68549	72779
	CAM Data[608](Low)	43170	47400	51630	55860	60090	64320	68550	72780
	CAM Data[608](High)	43171	47401	51631	55861	60091	64321	68551	72781
	CAM Data[609](Low)	43172	47402	51632	55862	60092	64322	68552	72782
	CAM Data[609](High)	43173	47403	51633	55863	60093	64323	68553	72783
	CAM Data[610](Low)	43174	47404	51634	55864	60094	64324	68554	72784
	CAM Data[610](High)	43175	47405	51635	55865	60095	64325	68555	72785
	CAM Data[611](Low)	43176	47406	51636	55866	60096	64326	68556	72786
	CAM Data[611](High)	43177	47407	51637	55867	60097	64327	68557	72787
	CAM Data[612](Low)	43178	47408	51638	55868	60098	64328	68558	72788
	CAM Data[612](High)	43179	47409	51639	55869	60099	64329	68559	72789
	CAM Data[613](Low)	43180	47410	51640	55870	60100	64330	68560	72790
	CAM Data[613](High)	43181	47411	51641	55871	60101	64331	68561	72791
	CAM Data[614](Low)	43182	47412	51642	55872	60102	64332	68562	72792
	CAM Data[614](High)	43183	47413	51643	55873	60103	64333	68563	72793
	CAM Data[615](Low)	43184	47414	51644	55874	60104	64334	68564	72794
	CAM Data[615](High)	43185	47415	51645	55875	60105	64335	68565	72795
	CAM Data[616](Low)	43186	47416	51646	55876	60106	64336	68566	72796
	CAM Data[616](High)	43187	47417	51647	55877	60107	64337	68567	72797
	CAM Data[617](Low)	43188	47418	51648	55878	60108	64338	68568	72798
	CAM Data[617](High)	43189	47419	51649	55879	60109	64339	68569	72799
	CAM Data[618](Low)	43190	47420	51650	55880	60110	64340	68570	72800
	CAM Data[618](High)	43191	47421	51651	55881	60111	64341	68571	72801
	CAM Data[619](Low)	43192	47422	51652	55882	60112	64342	68572	72802
	CAM Data[619](High)	43193	47423	51653	55883	60113	64343	68573	72803
	CAM Data[620](Low)	43194	47424	51654	55884	60114	64344	68574	72804

Chapter 11 Internal Memory Address of “Read/Write Variable Data” command

	CAM Data[620](High)	43195	47425	51655	55885	60115	64345	68575	72805
	CAM Data[621](Low)	43196	47426	51656	55886	60116	64346	68576	72806
	CAM Data[621](High)	43197	47427	51657	55887	60117	64347	68577	72807
	CAM Data[622](Low)	43198	47428	51658	55888	60118	64348	68578	72808
	CAM Data[622](High)	43199	47429	51659	55889	60119	64349	68579	72809
	CAM Data[623](Low)	43200	47430	51660	55890	60120	64350	68580	72810
	CAM Data[623](High)	43201	47431	51661	55891	60121	64351	68581	72811
	CAM Data[624](Low)	43202	47432	51662	55892	60122	64352	68582	72812
	CAM Data[624](High)	43203	47433	51663	55893	60123	64353	68583	72813
	CAM Data[625](Low)	43204	47434	51664	55894	60124	64354	68584	72814
	CAM Data[625](High)	43205	47435	51665	55895	60125	64355	68585	72815
	CAM Data[626](Low)	43206	47436	51666	55896	60126	64356	68586	72816
	CAM Data[626](High)	43207	47437	51667	55897	60127	64357	68587	72817
	CAM Data[627](Low)	43208	47438	51668	55898	60128	64358	68588	72818
	CAM Data[627](High)	43209	47439	51669	55899	60129	64359	68589	72819
	CAM Data[628](Low)	43210	47440	51670	55900	60130	64360	68590	72820
	CAM Data[628](High)	43211	47441	51671	55901	60131	64361	68591	72821
	CAM Data[629](Low)	43212	47442	51672	55902	60132	64362	68592	72822
	CAM Data[629](High)	43213	47443	51673	55903	60133	64363	68593	72823
	CAM Data[630](Low)	43214	47444	51674	55904	60134	64364	68594	72824
	CAM Data[630](High)	43215	47445	51675	55905	60135	64365	68595	72825
	CAM Data[631](Low)	43216	47446	51676	55906	60136	64366	68596	72826
	CAM Data[631](High)	43217	47447	51677	55907	60137	64367	68597	72827
	CAM Data[632](Low)	43218	47448	51678	55908	60138	64368	68598	72828
	CAM Data[632](High)	43219	47449	51679	55909	60139	64369	68599	72829
	CAM Data[633](Low)	43220	47450	51680	55910	60140	64370	68600	72830
	CAM Data[633](High)	43221	47451	51681	55911	60141	64371	68601	72831
	CAM Data[634](Low)	43222	47452	51682	55912	60142	64372	68602	72832
	CAM Data[634](High)	43223	47453	51683	55913	60143	64373	68603	72833
	CAM Data[635](Low)	43224	47454	51684	55914	60144	64374	68604	72834
	CAM Data[635](High)	43225	47455	51685	55915	60145	64375	68605	72835
	CAM Data[636](Low)	43226	47456	51686	55916	60146	64376	68606	72836
	CAM Data[636](High)	43227	47457	51687	55917	60147	64377	68607	72837
	CAM Data[637](Low)	43228	47458	51688	55918	60148	64378	68608	72838
	CAM Data[637](High)	43229	47459	51689	55919	60149	64379	68609	72839
	CAM Data[638](Low)	43230	47460	51690	55920	60150	64380	68610	72840
	CAM Data[638](High)	43231	47461	51691	55921	60151	64381	68611	72841
	CAM Data[639](Low)	43232	47462	51692	55922	60152	64382	68612	72842
	CAM Data[639](High)	43233	47463	51693	55923	60153	64383	68613	72843
	CAM Data[640](Low)	43234	47464	51694	55924	60154	64384	68614	72844
	CAM Data[640](High)	43235	47465	51695	55925	60155	64385	68615	72845
	CAM Data[641](Low)	43236	47466	51696	55926	60156	64386	68616	72846
	CAM Data[641](High)	43237	47467	51697	55927	60157	64387	68617	72847
	CAM Data[642](Low)	43238	47468	51698	55928	60158	64388	68618	72848
	CAM Data[642](High)	43239	47469	51699	55929	60159	64389	68619	72849
	CAM Data[643](Low)	43240	47470	51700	55930	60160	64390	68620	72850

Chapter 11 Internal Memory Address of “Read/Write Variable Data” command

	CAM Data[643](High)	43241	47471	51701	55931	60161	64391	68621	72851
	CAM Data[644](Low)	43242	47472	51702	55932	60162	64392	68622	72852
	CAM Data[644](High)	43243	47473	51703	55933	60163	64393	68623	72853
	CAM Data[645](Low)	43244	47474	51704	55934	60164	64394	68624	72854
	CAM Data[645](High)	43245	47475	51705	55935	60165	64395	68625	72855
	CAM Data[646](Low)	43246	47476	51706	55936	60166	64396	68626	72856
	CAM Data[646](High)	43247	47477	51707	55937	60167	64397	68627	72857
	CAM Data[647](Low)	43248	47478	51708	55938	60168	64398	68628	72858
	CAM Data[647](High)	43249	47479	51709	55939	60169	64399	68629	72859
	CAM Data[648](Low)	43250	47480	51710	55940	60170	64400	68630	72860
	CAM Data[648](High)	43251	47481	51711	55941	60171	64401	68631	72861
	CAM Data[649](Low)	43252	47482	51712	55942	60172	64402	68632	72862
	CAM Data[649](High)	43253	47483	51713	55943	60173	64403	68633	72863
	CAM Data[650](Low)	43254	47484	51714	55944	60174	64404	68634	72864
	CAM Data[650](High)	43255	47485	51715	55945	60175	64405	68635	72865
	CAM Data[651](Low)	43256	47486	51716	55946	60176	64406	68636	72866
	CAM Data[651](High)	43257	47487	51717	55947	60177	64407	68637	72867
	CAM Data[652](Low)	43258	47488	51718	55948	60178	64408	68638	72868
	CAM Data[652](High)	43259	47489	51719	55949	60179	64409	68639	72869
	CAM Data[653](Low)	43260	47490	51720	55950	60180	64410	68640	72870
	CAM Data[653](High)	43261	47491	51721	55951	60181	64411	68641	72871
	CAM Data[654](Low)	43262	47492	51722	55952	60182	64412	68642	72872
	CAM Data[654](High)	43263	47493	51723	55953	60183	64413	68643	72873
	CAM Data[655](Low)	43264	47494	51724	55954	60184	64414	68644	72874
	CAM Data[655](High)	43265	47495	51725	55955	60185	64415	68645	72875
	CAM Data[656](Low)	43266	47496	51726	55956	60186	64416	68646	72876
	CAM Data[656](High)	43267	47497	51727	55957	60187	64417	68647	72877
	CAM Data[657](Low)	43268	47498	51728	55958	60188	64418	68648	72878
	CAM Data[657](High)	43269	47499	51729	55959	60189	64419	68649	72879
	CAM Data[658](Low)	43270	47500	51730	55960	60190	64420	68650	72880
	CAM Data[658](High)	43271	47501	51731	55961	60191	64421	68651	72881
	CAM Data[659](Low)	43272	47502	51732	55962	60192	64422	68652	72882
	CAM Data[659](High)	43273	47503	51733	55963	60193	64423	68653	72883
	CAM Data[660](Low)	43274	47504	51734	55964	60194	64424	68654	72884
	CAM Data[660](High)	43275	47505	51735	55965	60195	64425	68655	72885
	CAM Data[661](Low)	43276	47506	51736	55966	60196	64426	68656	72886
	CAM Data[661](High)	43277	47507	51737	55967	60197	64427	68657	72887
	CAM Data[662](Low)	43278	47508	51738	55968	60198	64428	68658	72888
	CAM Data[662](High)	43279	47509	51739	55969	60199	64429	68659	72889
	CAM Data[663](Low)	43280	47510	51740	55970	60200	64430	68660	72890
	CAM Data[663](High)	43281	47511	51741	55971	60201	64431	68661	72891
	CAM Data[664](Low)	43282	47512	51742	55972	60202	64432	68662	72892
	CAM Data[664](High)	43283	47513	51743	55973	60203	64433	68663	72893
	CAM Data[665](Low)	43284	47514	51744	55974	60204	64434	68664	72894
	CAM Data[665](High)	43285	47515	51745	55975	60205	64435	68665	72895
	CAM Data[666](Low)	43286	47516	51746	55976	60206	64436	68666	72896

Chapter 11 Internal Memory Address of “Read/Write Variable Data” command

	CAM Data[666](High)	43287	47517	51747	55977	60207	64437	68667	72897
	CAM Data[667](Low)	43288	47518	51748	55978	60208	64438	68668	72898
	CAM Data[667](High)	43289	47519	51749	55979	60209	64439	68669	72899
	CAM Data[668](Low)	43290	47520	51750	55980	60210	64440	68670	72900
	CAM Data[668](High)	43291	47521	51751	55981	60211	64441	68671	72901
	CAM Data[669](Low)	43292	47522	51752	55982	60212	64442	68672	72902
	CAM Data[669](High)	43293	47523	51753	55983	60213	64443	68673	72903
	CAM Data[670](Low)	43294	47524	51754	55984	60214	64444	68674	72904
	CAM Data[670](High)	43295	47525	51755	55985	60215	64445	68675	72905
	CAM Data[671](Low)	43296	47526	51756	55986	60216	64446	68676	72906
	CAM Data[671](High)	43297	47527	51757	55987	60217	64447	68677	72907
	CAM Data[672](Low)	43298	47528	51758	55988	60218	64448	68678	72908
	CAM Data[672](High)	43299	47529	51759	55989	60219	64449	68679	72909
	CAM Data[673](Low)	43300	47530	51760	55990	60220	64450	68680	72910
	CAM Data[673](High)	43301	47531	51761	55991	60221	64451	68681	72911
	CAM Data[674](Low)	43302	47532	51762	55992	60222	64452	68682	72912
	CAM Data[674](High)	43303	47533	51763	55993	60223	64453	68683	72913
	CAM Data[675](Low)	43304	47534	51764	55994	60224	64454	68684	72914
	CAM Data[675](High)	43305	47535	51765	55995	60225	64455	68685	72915
	CAM Data[676](Low)	43306	47536	51766	55996	60226	64456	68686	72916
	CAM Data[676](High)	43307	47537	51767	55997	60227	64457	68687	72917
	CAM Data[677](Low)	43308	47538	51768	55998	60228	64458	68688	72918
	CAM Data[677](High)	43309	47539	51769	55999	60229	64459	68689	72919
	CAM Data[678](Low)	43310	47540	51770	56000	60230	64460	68690	72920
	CAM Data[678](High)	43311	47541	51771	56001	60231	64461	68691	72921
	CAM Data[679](Low)	43312	47542	51772	56002	60232	64462	68692	72922
	CAM Data[679](High)	43313	47543	51773	56003	60233	64463	68693	72923
	CAM Data[680](Low)	43314	47544	51774	56004	60234	64464	68694	72924
	CAM Data[680](High)	43315	47545	51775	56005	60235	64465	68695	72925
	CAM Data[681](Low)	43316	47546	51776	56006	60236	64466	68696	72926
	CAM Data[681](High)	43317	47547	51777	56007	60237	64467	68697	72927
	CAM Data[682](Low)	43318	47548	51778	56008	60238	64468	68698	72928
	CAM Data[682](High)	43319	47549	51779	56009	60239	64469	68699	72929
	CAM Data[683](Low)	43320	47550	51780	56010	60240	64470	68700	72930
	CAM Data[683](High)	43321	47551	51781	56011	60241	64471	68701	72931
	CAM Data[684](Low)	43322	47552	51782	56012	60242	64472	68702	72932
	CAM Data[684](High)	43323	47553	51783	56013	60243	64473	68703	72933
	CAM Data[685](Low)	43324	47554	51784	56014	60244	64474	68704	72934
	CAM Data[685](High)	43325	47555	51785	56015	60245	64475	68705	72935
	CAM Data[686](Low)	43326	47556	51786	56016	60246	64476	68706	72936
	CAM Data[686](High)	43327	47557	51787	56017	60247	64477	68707	72937
	CAM Data[687](Low)	43328	47558	51788	56018	60248	64478	68708	72938
	CAM Data[687](High)	43329	47559	51789	56019	60249	64479	68709	72939
	CAM Data[688](Low)	43330	47560	51790	56020	60250	64480	68710	72940
	CAM Data[688](High)	43331	47561	51791	56021	60251	64481	68711	72941
	CAM Data[689](Low)	43332	47562	51792	56022	60252	64482	68712	72942

Chapter 11 Internal Memory Address of “Read/Write Variable Data” command

	CAM Data[689](High)	43333	47563	51793	56023	60253	64483	68713	72943
	CAM Data[690](Low)	43334	47564	51794	56024	60254	64484	68714	72944
	CAM Data[690](High)	43335	47565	51795	56025	60255	64485	68715	72945
	CAM Data[691](Low)	43336	47566	51796	56026	60256	64486	68716	72946
	CAM Data[691](High)	43337	47567	51797	56027	60257	64487	68717	72947
	CAM Data[692](Low)	43338	47568	51798	56028	60258	64488	68718	72948
	CAM Data[692](High)	43339	47569	51799	56029	60259	64489	68719	72949
	CAM Data[693](Low)	43340	47570	51800	56030	60260	64490	68720	72950
	CAM Data[693](High)	43341	47571	51801	56031	60261	64491	68721	72951
	CAM Data[694](Low)	43342	47572	51802	56032	60262	64492	68722	72952
	CAM Data[694](High)	43343	47573	51803	56033	60263	64493	68723	72953
	CAM Data[695](Low)	43344	47574	51804	56034	60264	64494	68724	72954
	CAM Data[695](High)	43345	47575	51805	56035	60265	64495	68725	72955
	CAM Data[696](Low)	43346	47576	51806	56036	60266	64496	68726	72956
	CAM Data[696](High)	43347	47577	51807	56037	60267	64497	68727	72957
	CAM Data[697](Low)	43348	47578	51808	56038	60268	64498	68728	72958
	CAM Data[697](High)	43349	47579	51809	56039	60269	64499	68729	72959
	CAM Data[698](Low)	43350	47580	51810	56040	60270	64500	68730	72960
	CAM Data[698](High)	43351	47581	51811	56041	60271	64501	68731	72961
	CAM Data[699](Low)	43352	47582	51812	56042	60272	64502	68732	72962
	CAM Data[699](High)	43353	47583	51813	56043	60273	64503	68733	72963
	CAM Data[700](Low)	43354	47584	51814	56044	60274	64504	68734	72964
	CAM Data[700](High)	43355	47585	51815	56045	60275	64505	68735	72965
	CAM Data[701](Low)	43356	47586	51816	56046	60276	64506	68736	72966
	CAM Data[701](High)	43357	47587	51817	56047	60277	64507	68737	72967
	CAM Data[702](Low)	43358	47588	51818	56048	60278	64508	68738	72968
	CAM Data[702](High)	43359	47589	51819	56049	60279	64509	68739	72969
	CAM Data[703](Low)	43360	47590	51820	56050	60280	64510	68740	72970
	CAM Data[703](High)	43361	47591	51821	56051	60281	64511	68741	72971
	CAM Data[704](Low)	43362	47592	51822	56052	60282	64512	68742	72972
	CAM Data[704](High)	43363	47593	51823	56053	60283	64513	68743	72973
	CAM Data[705](Low)	43364	47594	51824	56054	60284	64514	68744	72974
	CAM Data[705](High)	43365	47595	51825	56055	60285	64515	68745	72975
	CAM Data[706](Low)	43366	47596	51826	56056	60286	64516	68746	72976
	CAM Data[706](High)	43367	47597	51827	56057	60287	64517	68747	72977
	CAM Data[707](Low)	43368	47598	51828	56058	60288	64518	68748	72978
	CAM Data[707](High)	43369	47599	51829	56059	60289	64519	68749	72979
	CAM Data[708](Low)	43370	47600	51830	56060	60290	64520	68750	72980
	CAM Data[708](High)	43371	47601	51831	56061	60291	64521	68751	72981
	CAM Data[709](Low)	43372	47602	51832	56062	60292	64522	68752	72982
	CAM Data[709](High)	43373	47603	51833	56063	60293	64523	68753	72983
	CAM Data[710](Low)	43374	47604	51834	56064	60294	64524	68754	72984
	CAM Data[710](High)	43375	47605	51835	56065	60295	64525	68755	72985
	CAM Data[711](Low)	43376	47606	51836	56066	60296	64526	68756	72986
	CAM Data[711](High)	43377	47607	51837	56067	60297	64527	68757	72987
	CAM Data[712](Low)	43378	47608	51838	56068	60298	64528	68758	72988

Chapter 11 Internal Memory Address of “Read/Write Variable Data” command

	CAM Data[712](High)	43379	47609	51839	56069	60299	64529	68759	72989
	CAM Data[713](Low)	43380	47610	51840	56070	60300	64530	68760	72990
	CAM Data[713](High)	43381	47611	51841	56071	60301	64531	68761	72991
	CAM Data[714](Low)	43382	47612	51842	56072	60302	64532	68762	72992
	CAM Data[714](High)	43383	47613	51843	56073	60303	64533	68763	72993
	CAM Data[715](Low)	43384	47614	51844	56074	60304	64534	68764	72994
	CAM Data[715](High)	43385	47615	51845	56075	60305	64535	68765	72995
	CAM Data[716](Low)	43386	47616	51846	56076	60306	64536	68766	72996
	CAM Data[716](High)	43387	47617	51847	56077	60307	64537	68767	72997
	CAM Data[717](Low)	43388	47618	51848	56078	60308	64538	68768	72998
	CAM Data[717](High)	43389	47619	51849	56079	60309	64539	68769	72999
	CAM Data[718](Low)	43390	47620	51850	56080	60310	64540	68770	73000
	CAM Data[718](High)	43391	47621	51851	56081	60311	64541	68771	73001
	CAM Data[719](Low)	43392	47622	51852	56082	60312	64542	68772	73002
	CAM Data[719](High)	43393	47623	51853	56083	60313	64543	68773	73003
	CAM Data[720](Low)	43394	47624	51854	56084	60314	64544	68774	73004
	CAM Data[720](High)	43395	47625	51855	56085	60315	64545	68775	73005
	CAM Data[721](Low)	43396	47626	51856	56086	60316	64546	68776	73006
	CAM Data[721](High)	43397	47627	51857	56087	60317	64547	68777	73007
	CAM Data[722](Low)	43398	47628	51858	56088	60318	64548	68778	73008
	CAM Data[722](High)	43399	47629	51859	56089	60319	64549	68779	73009
	CAM Data[723](Low)	43400	47630	51860	56090	60320	64550	68780	73010
	CAM Data[723](High)	43401	47631	51861	56091	60321	64551	68781	73011
	CAM Data[724](Low)	43402	47632	51862	56092	60322	64552	68782	73012
	CAM Data[724](High)	43403	47633	51863	56093	60323	64553	68783	73013
	CAM Data[725](Low)	43404	47634	51864	56094	60324	64554	68784	73014
	CAM Data[725](High)	43405	47635	51865	56095	60325	64555	68785	73015
	CAM Data[726](Low)	43406	47636	51866	56096	60326	64556	68786	73016
	CAM Data[726](High)	43407	47637	51867	56097	60327	64557	68787	73017
	CAM Data[727](Low)	43408	47638	51868	56098	60328	64558	68788	73018
	CAM Data[727](High)	43409	47639	51869	56099	60329	64559	68789	73019
	CAM Data[728](Low)	43410	47640	51870	56100	60330	64560	68790	73020
	CAM Data[728](High)	43411	47641	51871	56101	60331	64561	68791	73021
	CAM Data[729](Low)	43412	47642	51872	56102	60332	64562	68792	73022
	CAM Data[729](High)	43413	47643	51873	56103	60333	64563	68793	73023
	CAM Data[730](Low)	43414	47644	51874	56104	60334	64564	68794	73024
	CAM Data[730](High)	43415	47645	51875	56105	60335	64565	68795	73025
	CAM Data[731](Low)	43416	47646	51876	56106	60336	64566	68796	73026
	CAM Data[731](High)	43417	47647	51877	56107	60337	64567	68797	73027
	CAM Data[732](Low)	43418	47648	51878	56108	60338	64568	68798	73028
	CAM Data[732](High)	43419	47649	51879	56109	60339	64569	68799	73029
	CAM Data[733](Low)	43420	47650	51880	56110	60340	64570	68800	73030
	CAM Data[733](High)	43421	47651	51881	56111	60341	64571	68801	73031
	CAM Data[734](Low)	43422	47652	51882	56112	60342	64572	68802	73032
	CAM Data[734](High)	43423	47653	51883	56113	60343	64573	68803	73033
	CAM Data[735](Low)	43424	47654	51884	56114	60344	64574	68804	73034

Chapter 11 Internal Memory Address of “Read/Write Variable Data” command

	CAM Data[735](High)	43425	47655	51885	56115	60345	64575	68805	73035
	CAM Data[736](Low)	43426	47656	51886	56116	60346	64576	68806	73036
	CAM Data[736](High)	43427	47657	51887	56117	60347	64577	68807	73037
	CAM Data[737](Low)	43428	47658	51888	56118	60348	64578	68808	73038
	CAM Data[737](High)	43429	47659	51889	56119	60349	64579	68809	73039
	CAM Data[738](Low)	43430	47660	51890	56120	60350	64580	68810	73040
	CAM Data[738](High)	43431	47661	51891	56121	60351	64581	68811	73041
	CAM Data[739](Low)	43432	47662	51892	56122	60352	64582	68812	73042
	CAM Data[739](High)	43433	47663	51893	56123	60353	64583	68813	73043
	CAM Data[740](Low)	43434	47664	51894	56124	60354	64584	68814	73044
	CAM Data[740](High)	43435	47665	51895	56125	60355	64585	68815	73045
	CAM Data[741](Low)	43436	47666	51896	56126	60356	64586	68816	73046
	CAM Data[741](High)	43437	47667	51897	56127	60357	64587	68817	73047
	CAM Data[742](Low)	43438	47668	51898	56128	60358	64588	68818	73048
	CAM Data[742](High)	43439	47669	51899	56129	60359	64589	68819	73049
	CAM Data[743](Low)	43440	47670	51900	56130	60360	64590	68820	73050
	CAM Data[743](High)	43441	47671	51901	56131	60361	64591	68821	73051
	CAM Data[744](Low)	43442	47672	51902	56132	60362	64592	68822	73052
	CAM Data[744](High)	43443	47673	51903	56133	60363	64593	68823	73053
	CAM Data[745](Low)	43444	47674	51904	56134	60364	64594	68824	73054
	CAM Data[745](High)	43445	47675	51905	56135	60365	64595	68825	73055
	CAM Data[746](Low)	43446	47676	51906	56136	60366	64596	68826	73056
	CAM Data[746](High)	43447	47677	51907	56137	60367	64597	68827	73057
	CAM Data[747](Low)	43448	47678	51908	56138	60368	64598	68828	73058
	CAM Data[747](High)	43449	47679	51909	56139	60369	64599	68829	73059
	CAM Data[748](Low)	43450	47680	51910	56140	60370	64600	68830	73060
	CAM Data[748](High)	43451	47681	51911	56141	60371	64601	68831	73061
	CAM Data[749](Low)	43452	47682	51912	56142	60372	64602	68832	73062
	CAM Data[749](High)	43453	47683	51913	56143	60373	64603	68833	73063
	CAM Data[750](Low)	43454	47684	51914	56144	60374	64604	68834	73064
	CAM Data[750](High)	43455	47685	51915	56145	60375	64605	68835	73065
	CAM Data[751](Low)	43456	47686	51916	56146	60376	64606	68836	73066
	CAM Data[751](High)	43457	47687	51917	56147	60377	64607	68837	73067
	CAM Data[752](Low)	43458	47688	51918	56148	60378	64608	68838	73068
	CAM Data[752](High)	43459	47689	51919	56149	60379	64609	68839	73069
	CAM Data[753](Low)	43460	47690	51920	56150	60380	64610	68840	73070
	CAM Data[753](High)	43461	47691	51921	56151	60381	64611	68841	73071
	CAM Data[754](Low)	43462	47692	51922	56152	60382	64612	68842	73072
	CAM Data[754](High)	43463	47693	51923	56153	60383	64613	68843	73073
	CAM Data[755](Low)	43464	47694	51924	56154	60384	64614	68844	73074
	CAM Data[755](High)	43465	47695	51925	56155	60385	64615	68845	73075
	CAM Data[756](Low)	43466	47696	51926	56156	60386	64616	68846	73076
	CAM Data[756](High)	43467	47697	51927	56157	60387	64617	68847	73077
	CAM Data[757](Low)	43468	47698	51928	56158	60388	64618	68848	73078
	CAM Data[757](High)	43469	47699	51929	56159	60389	64619	68849	73079
	CAM Data[758](Low)	43470	47700	51930	56160	60390	64620	68850	73080

Chapter 11 Internal Memory Address of “Read/Write Variable Data” command

	CAM Data[758](High)	43471	47701	51931	56161	60391	64621	68851	73081
	CAM Data[759](Low)	43472	47702	51932	56162	60392	64622	68852	73082
	CAM Data[759](High)	43473	47703	51933	56163	60393	64623	68853	73083
	CAM Data[760](Low)	43474	47704	51934	56164	60394	64624	68854	73084
	CAM Data[760](High)	43475	47705	51935	56165	60395	64625	68855	73085
	CAM Data[761](Low)	43476	47706	51936	56166	60396	64626	68856	73086
	CAM Data[761](High)	43477	47707	51937	56167	60397	64627	68857	73087
	CAM Data[762](Low)	43478	47708	51938	56168	60398	64628	68858	73088
	CAM Data[762](High)	43479	47709	51939	56169	60399	64629	68859	73089
	CAM Data[763](Low)	43480	47710	51940	56170	60400	64630	68860	73090
	CAM Data[763](High)	43481	47711	51941	56171	60401	64631	68861	73091
	CAM Data[764](Low)	43482	47712	51942	56172	60402	64632	68862	73092
	CAM Data[764](High)	43483	47713	51943	56173	60403	64633	68863	73093
	CAM Data[765](Low)	43484	47714	51944	56174	60404	64634	68864	73094
	CAM Data[765](High)	43485	47715	51945	56175	60405	64635	68865	73095
	CAM Data[766](Low)	43486	47716	51946	56176	60406	64636	68866	73096
	CAM Data[766](High)	43487	47717	51947	56177	60407	64637	68867	73097
	CAM Data[767](Low)	43488	47718	51948	56178	60408	64638	68868	73098
	CAM Data[767](High)	43489	47719	51949	56179	60409	64639	68869	73099
	CAM Data[768](Low)	43490	47720	51950	56180	60410	64640	68870	73100
	CAM Data[768](High)	43491	47721	51951	56181	60411	64641	68871	73101
	CAM Data[769](Low)	43492	47722	51952	56182	60412	64642	68872	73102
	CAM Data[769](High)	43493	47723	51953	56183	60413	64643	68873	73103
	CAM Data[770](Low)	43494	47724	51954	56184	60414	64644	68874	73104
	CAM Data[770](High)	43495	47725	51955	56185	60415	64645	68875	73105
	CAM Data[771](Low)	43496	47726	51956	56186	60416	64646	68876	73106
	CAM Data[771](High)	43497	47727	51957	56187	60417	64647	68877	73107
	CAM Data[772](Low)	43498	47728	51958	56188	60418	64648	68878	73108
	CAM Data[772](High)	43499	47729	51959	56189	60419	64649	68879	73109
	CAM Data[773](Low)	43500	47730	51960	56190	60420	64650	68880	73110
	CAM Data[773](High)	43501	47731	51961	56191	60421	64651	68881	73111
	CAM Data[774](Low)	43502	47732	51962	56192	60422	64652	68882	73112
	CAM Data[774](High)	43503	47733	51963	56193	60423	64653	68883	73113
	CAM Data[775](Low)	43504	47734	51964	56194	60424	64654	68884	73114
	CAM Data[775](High)	43505	47735	51965	56195	60425	64655	68885	73115
	CAM Data[776](Low)	43506	47736	51966	56196	60426	64656	68886	73116
	CAM Data[776](High)	43507	47737	51967	56197	60427	64657	68887	73117
	CAM Data[777](Low)	43508	47738	51968	56198	60428	64658	68888	73118
	CAM Data[777](High)	43509	47739	51969	56199	60429	64659	68889	73119
	CAM Data[778](Low)	43510	47740	51970	56200	60430	64660	68890	73120
	CAM Data[778](High)	43511	47741	51971	56201	60431	64661	68891	73121
	CAM Data[779](Low)	43512	47742	51972	56202	60432	64662	68892	73122
	CAM Data[779](High)	43513	47743	51973	56203	60433	64663	68893	73123
	CAM Data[780](Low)	43514	47744	51974	56204	60434	64664	68894	73124
	CAM Data[780](High)	43515	47745	51975	56205	60435	64665	68895	73125
	CAM Data[781](Low)	43516	47746	51976	56206	60436	64666	68896	73126

Chapter 11 Internal Memory Address of “Read/Write Variable Data” command

	CAM Data[781](High)	43517	47747	51977	56207	60437	64667	68897	73127
	CAM Data[782](Low)	43518	47748	51978	56208	60438	64668	68898	73128
	CAM Data[782](High)	43519	47749	51979	56209	60439	64669	68899	73129
	CAM Data[783](Low)	43520	47750	51980	56210	60440	64670	68900	73130
	CAM Data[783](High)	43521	47751	51981	56211	60441	64671	68901	73131
	CAM Data[784](Low)	43522	47752	51982	56212	60442	64672	68902	73132
	CAM Data[784](High)	43523	47753	51983	56213	60443	64673	68903	73133
	CAM Data[785](Low)	43524	47754	51984	56214	60444	64674	68904	73134
	CAM Data[785](High)	43525	47755	51985	56215	60445	64675	68905	73135
	CAM Data[786](Low)	43526	47756	51986	56216	60446	64676	68906	73136
	CAM Data[786](High)	43527	47757	51987	56217	60447	64677	68907	73137
	CAM Data[787](Low)	43528	47758	51988	56218	60448	64678	68908	73138
	CAM Data[787](High)	43529	47759	51989	56219	60449	64679	68909	73139
	CAM Data[788](Low)	43530	47760	51990	56220	60450	64680	68910	73140
	CAM Data[788](High)	43531	47761	51991	56221	60451	64681	68911	73141
	CAM Data[789](Low)	43532	47762	51992	56222	60452	64682	68912	73142
	CAM Data[789](High)	43533	47763	51993	56223	60453	64683	68913	73143
	CAM Data[790](Low)	43534	47764	51994	56224	60454	64684	68914	73144
	CAM Data[790](High)	43535	47765	51995	56225	60455	64685	68915	73145
	CAM Data[791](Low)	43536	47766	51996	56226	60456	64686	68916	73146
	CAM Data[791](High)	43537	47767	51997	56227	60457	64687	68917	73147
	CAM Data[792](Low)	43538	47768	51998	56228	60458	64688	68918	73148
	CAM Data[792](High)	43539	47769	51999	56229	60459	64689	68919	73149
	CAM Data[793](Low)	43540	47770	52000	56230	60460	64690	68920	73150
	CAM Data[793](High)	43541	47771	52001	56231	60461	64691	68921	73151
	CAM Data[794](Low)	43542	47772	52002	56232	60462	64692	68922	73152
	CAM Data[794](High)	43543	47773	52003	56233	60463	64693	68923	73153
	CAM Data[795](Low)	43544	47774	52004	56234	60464	64694	68924	73154
	CAM Data[795](High)	43545	47775	52005	56235	60465	64695	68925	73155
	CAM Data[796](Low)	43546	47776	52006	56236	60466	64696	68926	73156
	CAM Data[796](High)	43547	47777	52007	56237	60467	64697	68927	73157
	CAM Data[797](Low)	43548	47778	52008	56238	60468	64698	68928	73158
	CAM Data[797](High)	43549	47779	52009	56239	60469	64699	68929	73159
	CAM Data[798](Low)	43550	47780	52010	56240	60470	64700	68930	73160
	CAM Data[798](High)	43551	47781	52011	56241	60471	64701	68931	73161
	CAM Data[799](Low)	43552	47782	52012	56242	60472	64702	68932	73162
	CAM Data[799](High)	43553	47783	52013	56243	60473	64703	68933	73163
	CAM Data[800](Low)	43554	47784	52014	56244	60474	64704	68934	73164
	CAM Data[800](High)	43555	47785	52015	56245	60475	64705	68935	73165
	CAM Data[801](Low)	43556	47786	52016	56246	60476	64706	68936	73166
	CAM Data[801](High)	43557	47787	52017	56247	60477	64707	68937	73167
	CAM Data[802](Low)	43558	47788	52018	56248	60478	64708	68938	73168
	CAM Data[802](High)	43559	47789	52019	56249	60479	64709	68939	73169
	CAM Data[803](Low)	43560	47790	52020	56250	60480	64710	68940	73170
	CAM Data[803](High)	43561	47791	52021	56251	60481	64711	68941	73171
	CAM Data[804](Low)	43562	47792	52022	56252	60482	64712	68942	73172

Chapter 11 Internal Memory Address of “Read/Write Variable Data” command

	CAM Data[804](High)	43563	47793	52023	56253	60483	64713	68943	73173
	CAM Data[805](Low)	43564	47794	52024	56254	60484	64714	68944	73174
	CAM Data[805](High)	43565	47795	52025	56255	60485	64715	68945	73175
	CAM Data[806](Low)	43566	47796	52026	56256	60486	64716	68946	73176
	CAM Data[806](High)	43567	47797	52027	56257	60487	64717	68947	73177
	CAM Data[807](Low)	43568	47798	52028	56258	60488	64718	68948	73178
	CAM Data[807](High)	43569	47799	52029	56259	60489	64719	68949	73179
	CAM Data[808](Low)	43570	47800	52030	56260	60490	64720	68950	73180
	CAM Data[808](High)	43571	47801	52031	56261	60491	64721	68951	73181
	CAM Data[809](Low)	43572	47802	52032	56262	60492	64722	68952	73182
	CAM Data[809](High)	43573	47803	52033	56263	60493	64723	68953	73183
	CAM Data[810](Low)	43574	47804	52034	56264	60494	64724	68954	73184
	CAM Data[810](High)	43575	47805	52035	56265	60495	64725	68955	73185
	CAM Data[811](Low)	43576	47806	52036	56266	60496	64726	68956	73186
	CAM Data[811](High)	43577	47807	52037	56267	60497	64727	68957	73187
	CAM Data[812](Low)	43578	47808	52038	56268	60498	64728	68958	73188
	CAM Data[812](High)	43579	47809	52039	56269	60499	64729	68959	73189
	CAM Data[813](Low)	43580	47810	52040	56270	60500	64730	68960	73190
	CAM Data[813](High)	43581	47811	52041	56271	60501	64731	68961	73191
	CAM Data[814](Low)	43582	47812	52042	56272	60502	64732	68962	73192
	CAM Data[814](High)	43583	47813	52043	56273	60503	64733	68963	73193
	CAM Data[815](Low)	43584	47814	52044	56274	60504	64734	68964	73194
	CAM Data[815](High)	43585	47815	52045	56275	60505	64735	68965	73195
	CAM Data[816](Low)	43586	47816	52046	56276	60506	64736	68966	73196
	CAM Data[816](High)	43587	47817	52047	56277	60507	64737	68967	73197
	CAM Data[817](Low)	43588	47818	52048	56278	60508	64738	68968	73198
	CAM Data[817](High)	43589	47819	52049	56279	60509	64739	68969	73199
	CAM Data[818](Low)	43590	47820	52050	56280	60510	64740	68970	73200
	CAM Data[818](High)	43591	47821	52051	56281	60511	64741	68971	73201
	CAM Data[819](Low)	43592	47822	52052	56282	60512	64742	68972	73202
	CAM Data[819](High)	43593	47823	52053	56283	60513	64743	68973	73203
	CAM Data[820](Low)	43594	47824	52054	56284	60514	64744	68974	73204
	CAM Data[820](High)	43595	47825	52055	56285	60515	64745	68975	73205
	CAM Data[821](Low)	43596	47826	52056	56286	60516	64746	68976	73206
	CAM Data[821](High)	43597	47827	52057	56287	60517	64747	68977	73207
	CAM Data[822](Low)	43598	47828	52058	56288	60518	64748	68978	73208
	CAM Data[822](High)	43599	47829	52059	56289	60519	64749	68979	73209
	CAM Data[823](Low)	43600	47830	52060	56290	60520	64750	68980	73210
	CAM Data[823](High)	43601	47831	52061	56291	60521	64751	68981	73211
	CAM Data[824](Low)	43602	47832	52062	56292	60522	64752	68982	73212
	CAM Data[824](High)	43603	47833	52063	56293	60523	64753	68983	73213
	CAM Data[825](Low)	43604	47834	52064	56294	60524	64754	68984	73214
	CAM Data[825](High)	43605	47835	52065	56295	60525	64755	68985	73215
	CAM Data[826](Low)	43606	47836	52066	56296	60526	64756	68986	73216
	CAM Data[826](High)	43607	47837	52067	56297	60527	64757	68987	73217
	CAM Data[827](Low)	43608	47838	52068	56298	60528	64758	68988	73218

Chapter 11 Internal Memory Address of “Read/Write Variable Data” command

	CAM Data[827](High)	43609	47839	52069	56299	60529	64759	68989	73219
	CAM Data[828](Low)	43610	47840	52070	56300	60530	64760	68990	73220
	CAM Data[828](High)	43611	47841	52071	56301	60531	64761	68991	73221
	CAM Data[829](Low)	43612	47842	52072	56302	60532	64762	68992	73222
	CAM Data[829](High)	43613	47843	52073	56303	60533	64763	68993	73223
	CAM Data[830](Low)	43614	47844	52074	56304	60534	64764	68994	73224
	CAM Data[830](High)	43615	47845	52075	56305	60535	64765	68995	73225
	CAM Data[831](Low)	43616	47846	52076	56306	60536	64766	68996	73226
	CAM Data[831](High)	43617	47847	52077	56307	60537	64767	68997	73227
	CAM Data[832](Low)	43618	47848	52078	56308	60538	64768	68998	73228
	CAM Data[832](High)	43619	47849	52079	56309	60539	64769	68999	73229
	CAM Data[833](Low)	43620	47850	52080	56310	60540	64770	69000	73230
	CAM Data[833](High)	43621	47851	52081	56311	60541	64771	69001	73231
	CAM Data[834](Low)	43622	47852	52082	56312	60542	64772	69002	73232
	CAM Data[834](High)	43623	47853	52083	56313	60543	64773	69003	73233
	CAM Data[835](Low)	43624	47854	52084	56314	60544	64774	69004	73234
	CAM Data[835](High)	43625	47855	52085	56315	60545	64775	69005	73235
	CAM Data[836](Low)	43626	47856	52086	56316	60546	64776	69006	73236
	CAM Data[836](High)	43627	47857	52087	56317	60547	64777	69007	73237
	CAM Data[837](Low)	43628	47858	52088	56318	60548	64778	69008	73238
	CAM Data[837](High)	43629	47859	52089	56319	60549	64779	69009	73239
	CAM Data[838](Low)	43630	47860	52090	56320	60550	64780	69010	73240
	CAM Data[838](High)	43631	47861	52091	56321	60551	64781	69011	73241
	CAM Data[839](Low)	43632	47862	52092	56322	60552	64782	69012	73242
	CAM Data[839](High)	43633	47863	52093	56323	60553	64783	69013	73243
	CAM Data[840](Low)	43634	47864	52094	56324	60554	64784	69014	73244
	CAM Data[840](High)	43635	47865	52095	56325	60555	64785	69015	73245
	CAM Data[841](Low)	43636	47866	52096	56326	60556	64786	69016	73246
	CAM Data[841](High)	43637	47867	52097	56327	60557	64787	69017	73247
	CAM Data[842](Low)	43638	47868	52098	56328	60558	64788	69018	73248
	CAM Data[842](High)	43639	47869	52099	56329	60559	64789	69019	73249
	CAM Data[843](Low)	43640	47870	52100	56330	60560	64790	69020	73250
	CAM Data[843](High)	43641	47871	52101	56331	60561	64791	69021	73251
	CAM Data[844](Low)	43642	47872	52102	56332	60562	64792	69022	73252
	CAM Data[844](High)	43643	47873	52103	56333	60563	64793	69023	73253
	CAM Data[845](Low)	43644	47874	52104	56334	60564	64794	69024	73254
	CAM Data[845](High)	43645	47875	52105	56335	60565	64795	69025	73255
	CAM Data[846](Low)	43646	47876	52106	56336	60566	64796	69026	73256
	CAM Data[846](High)	43647	47877	52107	56337	60567	64797	69027	73257
	CAM Data[847](Low)	43648	47878	52108	56338	60568	64798	69028	73258
	CAM Data[847](High)	43649	47879	52109	56339	60569	64799	69029	73259
	CAM Data[848](Low)	43650	47880	52110	56340	60570	64800	69030	73260
	CAM Data[848](High)	43651	47881	52111	56341	60571	64801	69031	73261
	CAM Data[849](Low)	43652	47882	52112	56342	60572	64802	69032	73262
	CAM Data[849](High)	43653	47883	52113	56343	60573	64803	69033	73263
	CAM Data[850](Low)	43654	47884	52114	56344	60574	64804	69034	73264

Chapter 11 Internal Memory Address of “Read/Write Variable Data” command

	CAM Data[850](High)	43655	47885	52115	56345	60575	64805	69035	73265
	CAM Data[851](Low)	43656	47886	52116	56346	60576	64806	69036	73266
	CAM Data[851](High)	43657	47887	52117	56347	60577	64807	69037	73267
	CAM Data[852](Low)	43658	47888	52118	56348	60578	64808	69038	73268
	CAM Data[852](High)	43659	47889	52119	56349	60579	64809	69039	73269
	CAM Data[853](Low)	43660	47890	52120	56350	60580	64810	69040	73270
	CAM Data[853](High)	43661	47891	52121	56351	60581	64811	69041	73271
	CAM Data[854](Low)	43662	47892	52122	56352	60582	64812	69042	73272
	CAM Data[854](High)	43663	47893	52123	56353	60583	64813	69043	73273
	CAM Data[855](Low)	43664	47894	52124	56354	60584	64814	69044	73274
	CAM Data[855](High)	43665	47895	52125	56355	60585	64815	69045	73275
	CAM Data[856](Low)	43666	47896	52126	56356	60586	64816	69046	73276
	CAM Data[856](High)	43667	47897	52127	56357	60587	64817	69047	73277
	CAM Data[857](Low)	43668	47898	52128	56358	60588	64818	69048	73278
	CAM Data[857](High)	43669	47899	52129	56359	60589	64819	69049	73279
	CAM Data[858](Low)	43670	47900	52130	56360	60590	64820	69050	73280
	CAM Data[858](High)	43671	47901	52131	56361	60591	64821	69051	73281
	CAM Data[859](Low)	43672	47902	52132	56362	60592	64822	69052	73282
	CAM Data[859](High)	43673	47903	52133	56363	60593	64823	69053	73283
	CAM Data[860](Low)	43674	47904	52134	56364	60594	64824	69054	73284
	CAM Data[860](High)	43675	47905	52135	56365	60595	64825	69055	73285
	CAM Data[861](Low)	43676	47906	52136	56366	60596	64826	69056	73286
	CAM Data[861](High)	43677	47907	52137	56367	60597	64827	69057	73287
	CAM Data[862](Low)	43678	47908	52138	56368	60598	64828	69058	73288
	CAM Data[862](High)	43679	47909	52139	56369	60599	64829	69059	73289
	CAM Data[863](Low)	43680	47910	52140	56370	60600	64830	69060	73290
	CAM Data[863](High)	43681	47911	52141	56371	60601	64831	69061	73291
	CAM Data[864](Low)	43682	47912	52142	56372	60602	64832	69062	73292
	CAM Data[864](High)	43683	47913	52143	56373	60603	64833	69063	73293
	CAM Data[865](Low)	43684	47914	52144	56374	60604	64834	69064	73294
	CAM Data[865](High)	43685	47915	52145	56375	60605	64835	69065	73295
	CAM Data[866](Low)	43686	47916	52146	56376	60606	64836	69066	73296
	CAM Data[866](High)	43687	47917	52147	56377	60607	64837	69067	73297
	CAM Data[867](Low)	43688	47918	52148	56378	60608	64838	69068	73298
	CAM Data[867](High)	43689	47919	52149	56379	60609	64839	69069	73299
	CAM Data[868](Low)	43690	47920	52150	56380	60610	64840	69070	73300
	CAM Data[868](High)	43691	47921	52151	56381	60611	64841	69071	73301
	CAM Data[869](Low)	43692	47922	52152	56382	60612	64842	69072	73302
	CAM Data[869](High)	43693	47923	52153	56383	60613	64843	69073	73303
	CAM Data[870](Low)	43694	47924	52154	56384	60614	64844	69074	73304
	CAM Data[870](High)	43695	47925	52155	56385	60615	64845	69075	73305
	CAM Data[871](Low)	43696	47926	52156	56386	60616	64846	69076	73306
	CAM Data[871](High)	43697	47927	52157	56387	60617	64847	69077	73307
	CAM Data[872](Low)	43698	47928	52158	56388	60618	64848	69078	73308
	CAM Data[872](High)	43699	47929	52159	56389	60619	64849	69079	73309
	CAM Data[873](Low)	43700	47930	52160	56390	60620	64850	69080	73310

Chapter 11 Internal Memory Address of “Read/Write Variable Data” command

	CAM Data[873](High)	43701	47931	52161	56391	60621	64851	69081	73311
	CAM Data[874](Low)	43702	47932	52162	56392	60622	64852	69082	73312
	CAM Data[874](High)	43703	47933	52163	56393	60623	64853	69083	73313
	CAM Data[875](Low)	43704	47934	52164	56394	60624	64854	69084	73314
	CAM Data[875](High)	43705	47935	52165	56395	60625	64855	69085	73315
	CAM Data[876](Low)	43706	47936	52166	56396	60626	64856	69086	73316
	CAM Data[876](High)	43707	47937	52167	56397	60627	64857	69087	73317
	CAM Data[877](Low)	43708	47938	52168	56398	60628	64858	69088	73318
	CAM Data[877](High)	43709	47939	52169	56399	60629	64859	69089	73319
	CAM Data[878](Low)	43710	47940	52170	56400	60630	64860	69090	73320
	CAM Data[878](High)	43711	47941	52171	56401	60631	64861	69091	73321
	CAM Data[879](Low)	43712	47942	52172	56402	60632	64862	69092	73322
	CAM Data[879](High)	43713	47943	52173	56403	60633	64863	69093	73323
	CAM Data[880](Low)	43714	47944	52174	56404	60634	64864	69094	73324
	CAM Data[880](High)	43715	47945	52175	56405	60635	64865	69095	73325
	CAM Data[881](Low)	43716	47946	52176	56406	60636	64866	69096	73326
	CAM Data[881](High)	43717	47947	52177	56407	60637	64867	69097	73327
	CAM Data[882](Low)	43718	47948	52178	56408	60638	64868	69098	73328
	CAM Data[882](High)	43719	47949	52179	56409	60639	64869	69099	73329
	CAM Data[883](Low)	43720	47950	52180	56410	60640	64870	69100	73330
	CAM Data[883](High)	43721	47951	52181	56411	60641	64871	69101	73331
	CAM Data[884](Low)	43722	47952	52182	56412	60642	64872	69102	73332
	CAM Data[884](High)	43723	47953	52183	56413	60643	64873	69103	73333
	CAM Data[885](Low)	43724	47954	52184	56414	60644	64874	69104	73334
	CAM Data[885](High)	43725	47955	52185	56415	60645	64875	69105	73335
	CAM Data[886](Low)	43726	47956	52186	56416	60646	64876	69106	73336
	CAM Data[886](High)	43727	47957	52187	56417	60647	64877	69107	73337
	CAM Data[887](Low)	43728	47958	52188	56418	60648	64878	69108	73338
	CAM Data[887](High)	43729	47959	52189	56419	60649	64879	69109	73339
	CAM Data[888](Low)	43730	47960	52190	56420	60650	64880	69110	73340
	CAM Data[888](High)	43731	47961	52191	56421	60651	64881	69111	73341
	CAM Data[889](Low)	43732	47962	52192	56422	60652	64882	69112	73342
	CAM Data[889](High)	43733	47963	52193	56423	60653	64883	69113	73343
	CAM Data[890](Low)	43734	47964	52194	56424	60654	64884	69114	73344
	CAM Data[890](High)	43735	47965	52195	56425	60655	64885	69115	73345
	CAM Data[891](Low)	43736	47966	52196	56426	60656	64886	69116	73346
	CAM Data[891](High)	43737	47967	52197	56427	60657	64887	69117	73347
	CAM Data[892](Low)	43738	47968	52198	56428	60658	64888	69118	73348
	CAM Data[892](High)	43739	47969	52199	56429	60659	64889	69119	73349
	CAM Data[893](Low)	43740	47970	52200	56430	60660	64890	69120	73350
	CAM Data[893](High)	43741	47971	52201	56431	60661	64891	69121	73351
	CAM Data[894](Low)	43742	47972	52202	56432	60662	64892	69122	73352
	CAM Data[894](High)	43743	47973	52203	56433	60663	64893	69123	73353
	CAM Data[895](Low)	43744	47974	52204	56434	60664	64894	69124	73354
	CAM Data[895](High)	43745	47975	52205	56435	60665	64895	69125	73355
	CAM Data[896](Low)	43746	47976	52206	56436	60666	64896	69126	73356

Chapter 11 Internal Memory Address of “Read/Write Variable Data” command

	CAM Data[896](High)	43747	47977	52207	56437	60667	64897	69127	73357
	CAM Data[897](Low)	43748	47978	52208	56438	60668	64898	69128	73358
	CAM Data[897](High)	43749	47979	52209	56439	60669	64899	69129	73359
	CAM Data[898](Low)	43750	47980	52210	56440	60670	64900	69130	73360
	CAM Data[898](High)	43751	47981	52211	56441	60671	64901	69131	73361
	CAM Data[899](Low)	43752	47982	52212	56442	60672	64902	69132	73362
	CAM Data[899](High)	43753	47983	52213	56443	60673	64903	69133	73363
	CAM Data[900](Low)	43754	47984	52214	56444	60674	64904	69134	73364
	CAM Data[900](High)	43755	47985	52215	56445	60675	64905	69135	73365
	CAM Data[901](Low)	43756	47986	52216	56446	60676	64906	69136	73366
	CAM Data[901](High)	43757	47987	52217	56447	60677	64907	69137	73367
	CAM Data[902](Low)	43758	47988	52218	56448	60678	64908	69138	73368
	CAM Data[902](High)	43759	47989	52219	56449	60679	64909	69139	73369
	CAM Data[903](Low)	43760	47990	52220	56450	60680	64910	69140	73370
	CAM Data[903](High)	43761	47991	52221	56451	60681	64911	69141	73371
	CAM Data[904](Low)	43762	47992	52222	56452	60682	64912	69142	73372
	CAM Data[904](High)	43763	47993	52223	56453	60683	64913	69143	73373
	CAM Data[905](Low)	43764	47994	52224	56454	60684	64914	69144	73374
	CAM Data[905](High)	43765	47995	52225	56455	60685	64915	69145	73375
	CAM Data[906](Low)	43766	47996	52226	56456	60686	64916	69146	73376
	CAM Data[906](High)	43767	47997	52227	56457	60687	64917	69147	73377
	CAM Data[907](Low)	43768	47998	52228	56458	60688	64918	69148	73378
	CAM Data[907](High)	43769	47999	52229	56459	60689	64919	69149	73379
	CAM Data[908](Low)	43770	48000	52230	56460	60690	64920	69150	73380
	CAM Data[908](High)	43771	48001	52231	56461	60691	64921	69151	73381
	CAM Data[909](Low)	43772	48002	52232	56462	60692	64922	69152	73382
	CAM Data[909](High)	43773	48003	52233	56463	60693	64923	69153	73383
	CAM Data[910](Low)	43774	48004	52234	56464	60694	64924	69154	73384
	CAM Data[910](High)	43775	48005	52235	56465	60695	64925	69155	73385
	CAM Data[911](Low)	43776	48006	52236	56466	60696	64926	69156	73386
	CAM Data[911](High)	43777	48007	52237	56467	60697	64927	69157	73387
	CAM Data[912](Low)	43778	48008	52238	56468	60698	64928	69158	73388
	CAM Data[912](High)	43779	48009	52239	56469	60699	64929	69159	73389
	CAM Data[913](Low)	43780	48010	52240	56470	60700	64930	69160	73390
	CAM Data[913](High)	43781	48011	52241	56471	60701	64931	69161	73391
	CAM Data[914](Low)	43782	48012	52242	56472	60702	64932	69162	73392
	CAM Data[914](High)	43783	48013	52243	56473	60703	64933	69163	73393
	CAM Data[915](Low)	43784	48014	52244	56474	60704	64934	69164	73394
	CAM Data[915](High)	43785	48015	52245	56475	60705	64935	69165	73395
	CAM Data[916](Low)	43786	48016	52246	56476	60706	64936	69166	73396
	CAM Data[916](High)	43787	48017	52247	56477	60707	64937	69167	73397
	CAM Data[917](Low)	43788	48018	52248	56478	60708	64938	69168	73398
	CAM Data[917](High)	43789	48019	52249	56479	60709	64939	69169	73399
	CAM Data[918](Low)	43790	48020	52250	56480	60710	64940	69170	73400
	CAM Data[918](High)	43791	48021	52251	56481	60711	64941	69171	73401
	CAM Data[919](Low)	43792	48022	52252	56482	60712	64942	69172	73402

Chapter 11 Internal Memory Address of “Read/Write Variable Data” command

	CAM Data[919](High)	43793	48023	52253	56483	60713	64943	69173	73403
	CAM Data[920](Low)	43794	48024	52254	56484	60714	64944	69174	73404
	CAM Data[920](High)	43795	48025	52255	56485	60715	64945	69175	73405
	CAM Data[921](Low)	43796	48026	52256	56486	60716	64946	69176	73406
	CAM Data[921](High)	43797	48027	52257	56487	60717	64947	69177	73407
	CAM Data[922](Low)	43798	48028	52258	56488	60718	64948	69178	73408
	CAM Data[922](High)	43799	48029	52259	56489	60719	64949	69179	73409
	CAM Data[923](Low)	43800	48030	52260	56490	60720	64950	69180	73410
	CAM Data[923](High)	43801	48031	52261	56491	60721	64951	69181	73411
	CAM Data[924](Low)	43802	48032	52262	56492	60722	64952	69182	73412
	CAM Data[924](High)	43803	48033	52263	56493	60723	64953	69183	73413
	CAM Data[925](Low)	43804	48034	52264	56494	60724	64954	69184	73414
	CAM Data[925](High)	43805	48035	52265	56495	60725	64955	69185	73415
	CAM Data[926](Low)	43806	48036	52266	56496	60726	64956	69186	73416
	CAM Data[926](High)	43807	48037	52267	56497	60727	64957	69187	73417
	CAM Data[927](Low)	43808	48038	52268	56498	60728	64958	69188	73418
	CAM Data[927](High)	43809	48039	52269	56499	60729	64959	69189	73419
	CAM Data[928](Low)	43810	48040	52270	56500	60730	64960	69190	73420
	CAM Data[928](High)	43811	48041	52271	56501	60731	64961	69191	73421
	CAM Data[929](Low)	43812	48042	52272	56502	60732	64962	69192	73422
	CAM Data[929](High)	43813	48043	52273	56503	60733	64963	69193	73423
	CAM Data[930](Low)	43814	48044	52274	56504	60734	64964	69194	73424
	CAM Data[930](High)	43815	48045	52275	56505	60735	64965	69195	73425
	CAM Data[931](Low)	43816	48046	52276	56506	60736	64966	69196	73426
	CAM Data[931](High)	43817	48047	52277	56507	60737	64967	69197	73427
	CAM Data[932](Low)	43818	48048	52278	56508	60738	64968	69198	73428
	CAM Data[932](High)	43819	48049	52279	56509	60739	64969	69199	73429
	CAM Data[933](Low)	43820	48050	52280	56510	60740	64970	69200	73430
	CAM Data[933](High)	43821	48051	52281	56511	60741	64971	69201	73431
	CAM Data[934](Low)	43822	48052	52282	56512	60742	64972	69202	73432
	CAM Data[934](High)	43823	48053	52283	56513	60743	64973	69203	73433
	CAM Data[935](Low)	43824	48054	52284	56514	60744	64974	69204	73434
	CAM Data[935](High)	43825	48055	52285	56515	60745	64975	69205	73435
	CAM Data[936](Low)	43826	48056	52286	56516	60746	64976	69206	73436
	CAM Data[936](High)	43827	48057	52287	56517	60747	64977	69207	73437
	CAM Data[937](Low)	43828	48058	52288	56518	60748	64978	69208	73438
	CAM Data[937](High)	43829	48059	52289	56519	60749	64979	69209	73439
	CAM Data[938](Low)	43830	48060	52290	56520	60750	64980	69210	73440
	CAM Data[938](High)	43831	48061	52291	56521	60751	64981	69211	73441
	CAM Data[939](Low)	43832	48062	52292	56522	60752	64982	69212	73442
	CAM Data[939](High)	43833	48063	52293	56523	60753	64983	69213	73443
	CAM Data[940](Low)	43834	48064	52294	56524	60754	64984	69214	73444
	CAM Data[940](High)	43835	48065	52295	56525	60755	64985	69215	73445
	CAM Data[941](Low)	43836	48066	52296	56526	60756	64986	69216	73446
	CAM Data[941](High)	43837	48067	52297	56527	60757	64987	69217	73447
	CAM Data[942](Low)	43838	48068	52298	56528	60758	64988	69218	73448

Chapter 11 Internal Memory Address of “Read/Write Variable Data” command

	CAM Data[942](High)	43839	48069	52299	56529	60759	64989	69219	73449
	CAM Data[943](Low)	43840	48070	52300	56530	60760	64990	69220	73450
	CAM Data[943](High)	43841	48071	52301	56531	60761	64991	69221	73451
	CAM Data[944](Low)	43842	48072	52302	56532	60762	64992	69222	73452
	CAM Data[944](High)	43843	48073	52303	56533	60763	64993	69223	73453
	CAM Data[945](Low)	43844	48074	52304	56534	60764	64994	69224	73454
	CAM Data[945](High)	43845	48075	52305	56535	60765	64995	69225	73455
	CAM Data[946](Low)	43846	48076	52306	56536	60766	64996	69226	73456
	CAM Data[946](High)	43847	48077	52307	56537	60767	64997	69227	73457
	CAM Data[947](Low)	43848	48078	52308	56538	60768	64998	69228	73458
	CAM Data[947](High)	43849	48079	52309	56539	60769	64999	69229	73459
	CAM Data[948](Low)	43850	48080	52310	56540	60770	65000	69230	73460
	CAM Data[948](High)	43851	48081	52311	56541	60771	65001	69231	73461
	CAM Data[949](Low)	43852	48082	52312	56542	60772	65002	69232	73462
	CAM Data[949](High)	43853	48083	52313	56543	60773	65003	69233	73463
	CAM Data[950](Low)	43854	48084	52314	56544	60774	65004	69234	73464
	CAM Data[950](High)	43855	48085	52315	56545	60775	65005	69235	73465
	CAM Data[951](Low)	43856	48086	52316	56546	60776	65006	69236	73466
	CAM Data[951](High)	43857	48087	52317	56547	60777	65007	69237	73467
	CAM Data[952](Low)	43858	48088	52318	56548	60778	65008	69238	73468
	CAM Data[952](High)	43859	48089	52319	56549	60779	65009	69239	73469
	CAM Data[953](Low)	43860	48090	52320	56550	60780	65010	69240	73470
	CAM Data[953](High)	43861	48091	52321	56551	60781	65011	69241	73471
	CAM Data[954](Low)	43862	48092	52322	56552	60782	65012	69242	73472
	CAM Data[954](High)	43863	48093	52323	56553	60783	65013	69243	73473
	CAM Data[955](Low)	43864	48094	52324	56554	60784	65014	69244	73474
	CAM Data[955](High)	43865	48095	52325	56555	60785	65015	69245	73475
	CAM Data[956](Low)	43866	48096	52326	56556	60786	65016	69246	73476
	CAM Data[956](High)	43867	48097	52327	56557	60787	65017	69247	73477
	CAM Data[957](Low)	43868	48098	52328	56558	60788	65018	69248	73478
	CAM Data[957](High)	43869	48099	52329	56559	60789	65019	69249	73479
	CAM Data[958](Low)	43870	48100	52330	56560	60790	65020	69250	73480
	CAM Data[958](High)	43871	48101	52331	56561	60791	65021	69251	73481
	CAM Data[959](Low)	43872	48102	52332	56562	60792	65022	69252	73482
	CAM Data[959](High)	43873	48103	52333	56563	60793	65023	69253	73483
	CAM Data[960](Low)	43874	48104	52334	56564	60794	65024	69254	73484
	CAM Data[960](High)	43875	48105	52335	56565	60795	65025	69255	73485
	CAM Data[961](Low)	43876	48106	52336	56566	60796	65026	69256	73486
	CAM Data[961](High)	43877	48107	52337	56567	60797	65027	69257	73487
	CAM Data[962](Low)	43878	48108	52338	56568	60798	65028	69258	73488
	CAM Data[962](High)	43879	48109	52339	56569	60799	65029	69259	73489
	CAM Data[963](Low)	43880	48110	52340	56570	60800	65030	69260	73490
	CAM Data[963](High)	43881	48111	52341	56571	60801	65031	69261	73491
	CAM Data[964](Low)	43882	48112	52342	56572	60802	65032	69262	73492
	CAM Data[964](High)	43883	48113	52343	56573	60803	65033	69263	73493
	CAM Data[965](Low)	43884	48114	52344	56574	60804	65034	69264	73494

Chapter 11 Internal Memory Address of “Read/Write Variable Data” command

	CAM Data[965](High)	43885	48115	52345	56575	60805	65035	69265	73495
	CAM Data[966](Low)	43886	48116	52346	56576	60806	65036	69266	73496
	CAM Data[966](High)	43887	48117	52347	56577	60807	65037	69267	73497
	CAM Data[967](Low)	43888	48118	52348	56578	60808	65038	69268	73498
	CAM Data[967](High)	43889	48119	52349	56579	60809	65039	69269	73499
	CAM Data[968](Low)	43890	48120	52350	56580	60810	65040	69270	73500
	CAM Data[968](High)	43891	48121	52351	56581	60811	65041	69271	73501
	CAM Data[969](Low)	43892	48122	52352	56582	60812	65042	69272	73502
	CAM Data[969](High)	43893	48123	52353	56583	60813	65043	69273	73503
	CAM Data[970](Low)	43894	48124	52354	56584	60814	65044	69274	73504
	CAM Data[970](High)	43895	48125	52355	56585	60815	65045	69275	73505
	CAM Data[971](Low)	43896	48126	52356	56586	60816	65046	69276	73506
	CAM Data[971](High)	43897	48127	52357	56587	60817	65047	69277	73507
	CAM Data[972](Low)	43898	48128	52358	56588	60818	65048	69278	73508
	CAM Data[972](High)	43899	48129	52359	56589	60819	65049	69279	73509
	CAM Data[973](Low)	43900	48130	52360	56590	60820	65050	69280	73510
	CAM Data[973](High)	43901	48131	52361	56591	60821	65051	69281	73511
	CAM Data[974](Low)	43902	48132	52362	56592	60822	65052	69282	73512
	CAM Data[974](High)	43903	48133	52363	56593	60823	65053	69283	73513
	CAM Data[975](Low)	43904	48134	52364	56594	60824	65054	69284	73514
	CAM Data[975](High)	43905	48135	52365	56595	60825	65055	69285	73515
	CAM Data[976](Low)	43906	48136	52366	56596	60826	65056	69286	73516
	CAM Data[976](High)	43907	48137	52367	56597	60827	65057	69287	73517
	CAM Data[977](Low)	43908	48138	52368	56598	60828	65058	69288	73518
	CAM Data[977](High)	43909	48139	52369	56599	60829	65059	69289	73519
	CAM Data[978](Low)	43910	48140	52370	56600	60830	65060	69290	73520
	CAM Data[978](High)	43911	48141	52371	56601	60831	65061	69291	73521
	CAM Data[979](Low)	43912	48142	52372	56602	60832	65062	69292	73522
	CAM Data[979](High)	43913	48143	52373	56603	60833	65063	69293	73523
	CAM Data[980](Low)	43914	48144	52374	56604	60834	65064	69294	73524
	CAM Data[980](High)	43915	48145	52375	56605	60835	65065	69295	73525
	CAM Data[981](Low)	43916	48146	52376	56606	60836	65066	69296	73526
	CAM Data[981](High)	43917	48147	52377	56607	60837	65067	69297	73527
	CAM Data[982](Low)	43918	48148	52378	56608	60838	65068	69298	73528
	CAM Data[982](High)	43919	48149	52379	56609	60839	65069	69299	73529
	CAM Data[983](Low)	43920	48150	52380	56610	60840	65070	69300	73530
	CAM Data[983](High)	43921	48151	52381	56611	60841	65071	69301	73531
	CAM Data[984](Low)	43922	48152	52382	56612	60842	65072	69302	73532
	CAM Data[984](High)	43923	48153	52383	56613	60843	65073	69303	73533
	CAM Data[985](Low)	43924	48154	52384	56614	60844	65074	69304	73534
	CAM Data[985](High)	43925	48155	52385	56615	60845	65075	69305	73535
	CAM Data[986](Low)	43926	48156	52386	56616	60846	65076	69306	73536
	CAM Data[986](High)	43927	48157	52387	56617	60847	65077	69307	73537
	CAM Data[987](Low)	43928	48158	52388	56618	60848	65078	69308	73538
	CAM Data[987](High)	43929	48159	52389	56619	60849	65079	69309	73539
	CAM Data[988](Low)	43930	48160	52390	56620	60850	65080	69310	73540

Chapter 11 Internal Memory Address of “Read/Write Variable Data” command

	CAM Data[988](High)	43931	48161	52391	56621	60851	65081	69311	73541
	CAM Data[989](Low)	43932	48162	52392	56622	60852	65082	69312	73542
	CAM Data[989](High)	43933	48163	52393	56623	60853	65083	69313	73543
	CAM Data[990](Low)	43934	48164	52394	56624	60854	65084	69314	73544
	CAM Data[990](High)	43935	48165	52395	56625	60855	65085	69315	73545
	CAM Data[991](Low)	43936	48166	52396	56626	60856	65086	69316	73546
	CAM Data[991](High)	43937	48167	52397	56627	60857	65087	69317	73547
	CAM Data[992](Low)	43938	48168	52398	56628	60858	65088	69318	73548
	CAM Data[992](High)	43939	48169	52399	56629	60859	65089	69319	73549
	CAM Data[993](Low)	43940	48170	52400	56630	60860	65090	69320	73550
	CAM Data[993](High)	43941	48171	52401	56631	60861	65091	69321	73551
	CAM Data[994](Low)	43942	48172	52402	56632	60862	65092	69322	73552
	CAM Data[994](High)	43943	48173	52403	56633	60863	65093	69323	73553
	CAM Data[995](Low)	43944	48174	52404	56634	60864	65094	69324	73554
	CAM Data[995](High)	43945	48175	52405	56635	60865	65095	69325	73555
	CAM Data[996](Low)	43946	48176	52406	56636	60866	65096	69326	73556
	CAM Data[996](High)	43947	48177	52407	56637	60867	65097	69327	73557
	CAM Data[997](Low)	43948	48178	52408	56638	60868	65098	69328	73558
	CAM Data[997](High)	43949	48179	52409	56639	60869	65099	69329	73559
	CAM Data[998](Low)	43950	48180	52410	56640	60870	65100	69330	73560
	CAM Data[998](High)	43951	48181	52411	56641	60871	65101	69331	73561
	CAM Data[999](Low)	43952	48182	52412	56642	60872	65102	69332	73562
	CAM Data[999](High)	43953	48183	52413	56643	60873	65103	69333	73563
	CAM Data[1000](Low)	43954	48184	52414	56644	60874	65104	69334	73564
	CAM Data[1000](High)	43955	48185	52415	56645	60875	65105	69335	73565
	CAM Data[1001](Low)	43956	48186	52416	56646	60876	65106	69336	73566
	CAM Data[1001](High)	43957	48187	52417	56647	60877	65107	69337	73567
	CAM Data[1002](Low)	43958	48188	52418	56648	60878	65108	69338	73568
	CAM Data[1002](High)	43959	48189	52419	56649	60879	65109	69339	73569
	CAM Data[1003](Low)	43960	48190	52420	56650	60880	65110	69340	73570
	CAM Data[1003](High)	43961	48191	52421	56651	60881	65111	69341	73571
	CAM Data[1004](Low)	43962	48192	52422	56652	60882	65112	69342	73572
	CAM Data[1004](High)	43963	48193	52423	56653	60883	65113	69343	73573
	CAM Data[1005](Low)	43964	48194	52424	56654	60884	65114	69344	73574
	CAM Data[1005](High)	43965	48195	52425	56655	60885	65115	69345	73575
	CAM Data[1006](Low)	43966	48196	52426	56656	60886	65116	69346	73576
	CAM Data[1006](High)	43967	48197	52427	56657	60887	65117	69347	73577
	CAM Data[1007](Low)	43968	48198	52428	56658	60888	65118	69348	73578
	CAM Data[1007](High)	43969	48199	52429	56659	60889	65119	69349	73579
	CAM Data[1008](Low)	43970	48200	52430	56660	60890	65120	69350	73580
	CAM Data[1008](High)	43971	48201	52431	56661	60891	65121	69351	73581
	CAM Data[1009](Low)	43972	48202	52432	56662	60892	65122	69352	73582
	CAM Data[1009](High)	43973	48203	52433	56663	60893	65123	69353	73583
	CAM Data[1010](Low)	43974	48204	52434	56664	60894	65124	69354	73584
	CAM Data[1010](High)	43975	48205	52435	56665	60895	65125	69355	73585
	CAM Data[1011](Low)	43976	48206	52436	56666	60896	65126	69356	73586

Chapter 11 Internal Memory Address of “Read/Write Variable Data” command

	CAM Data[1011](High)	43977	48207	52437	56667	60897	65127	69357	73587
	CAM Data[1012](Low)	43978	48208	52438	56668	60898	65128	69358	73588
	CAM Data[1012](High)	43979	48209	52439	56669	60899	65129	69359	73589
	CAM Data[1013](Low)	43980	48210	52440	56670	60900	65130	69360	73590
	CAM Data[1013](High)	43981	48211	52441	56671	60901	65131	69361	73591
	CAM Data[1014](Low)	43982	48212	52442	56672	60902	65132	69362	73592
	CAM Data[1014](High)	43983	48213	52443	56673	60903	65133	69363	73593
	CAM Data[1015](Low)	43984	48214	52444	56674	60904	65134	69364	73594
	CAM Data[1015](High)	43985	48215	52445	56675	60905	65135	69365	73595
	CAM Data[1016](Low)	43986	48216	52446	56676	60906	65136	69366	73596
	CAM Data[1016](High)	43987	48217	52447	56677	60907	65137	69367	73597
	CAM Data[1017](Low)	43988	48218	52448	56678	60908	65138	69368	73598
	CAM Data[1017](High)	43989	48219	52449	56679	60909	65139	69369	73599
	CAM Data[1018](Low)	43990	48220	52450	56680	60910	65140	69370	73600
	CAM Data[1018](High)	43991	48221	52451	56681	60911	65141	69371	73601
	CAM Data[1019](Low)	43992	48222	52452	56682	60912	65142	69372	73602
	CAM Data[1019](High)	43993	48223	52453	56683	60913	65143	69373	73603
	CAM Data[1020](Low)	43994	48224	52454	56684	60914	65144	69374	73604
	CAM Data[1020](High)	43995	48225	52455	56685	60915	65145	69375	73605
	CAM Data[1021](Low)	43996	48226	52456	56686	60916	65146	69376	73606
	CAM Data[1021](High)	43997	48227	52457	56687	60917	65147	69377	73607
	CAM Data[1022](Low)	43998	48228	52458	56688	60918	65148	69378	73608
	CAM Data[1022](High)	43999	48229	52459	56689	60919	65149	69379	73609
	CAM Data[1023](Low)	44000	48230	52460	56690	60920	65150	69380	73610
	CAM Data[1023](High)	44001	48231	52461	56691	60921	65151	69381	73611
	CAM Data[1024](Low)	44002	48232	52462	56692	60922	65152	69382	73612
	CAM Data[1024](High)	44003	48233	52463	56693	60923	65153	69383	73613
	CAM Data[1025](Low)	44004	48234	52464	56694	60924	65154	69384	73614
	CAM Data[1025](High)	44005	48235	52465	56695	60925	65155	69385	73615
	CAM Data[1026](Low)	44006	48236	52466	56696	60926	65156	69386	73616
	CAM Data[1026](High)	44007	48237	52467	56697	60927	65157	69387	73617
	CAM Data[1027](Low)	44008	48238	52468	56698	60928	65158	69388	73618
	CAM Data[1027](High)	44009	48239	52469	56699	60929	65159	69389	73619
	CAM Data[1028](Low)	44010	48240	52470	56700	60930	65160	69390	73620
	CAM Data[1028](High)	44011	48241	52471	56701	60931	65161	69391	73621
	CAM Data[1029](Low)	44012	48242	52472	56702	60932	65162	69392	73622
	CAM Data[1029](High)	44013	48243	52473	56703	60933	65163	69393	73623
	CAM Data[1030](Low)	44014	48244	52474	56704	60934	65164	69394	73624
	CAM Data[1030](High)	44015	48245	52475	56705	60935	65165	69395	73625
	CAM Data[1031](Low)	44016	48246	52476	56706	60936	65166	69396	73626
	CAM Data[1031](High)	44017	48247	52477	56707	60937	65167	69397	73627
	CAM Data[1032](Low)	44018	48248	52478	56708	60938	65168	69398	73628
	CAM Data[1032](High)	44019	48249	52479	56709	60939	65169	69399	73629
	CAM Data[1033](Low)	44020	48250	52480	56710	60940	65170	69400	73630
	CAM Data[1033](High)	44021	48251	52481	56711	60941	65171	69401	73631
	CAM Data[1034](Low)	44022	48252	52482	56712	60942	65172	69402	73632

Chapter 11 Internal Memory Address of “Read/Write Variable Data” command

	CAM Data[1034](High)	44023	48253	52483	56713	60943	65173	69403	73633
	CAM Data[1035](Low)	44024	48254	52484	56714	60944	65174	69404	73634
	CAM Data[1035](High)	44025	48255	52485	56715	60945	65175	69405	73635
	CAM Data[1036](Low)	44026	48256	52486	56716	60946	65176	69406	73636
	CAM Data[1036](High)	44027	48257	52487	56717	60947	65177	69407	73637
	CAM Data[1037](Low)	44028	48258	52488	56718	60948	65178	69408	73638
	CAM Data[1037](High)	44029	48259	52489	56719	60949	65179	69409	73639
	CAM Data[1038](Low)	44030	48260	52490	56720	60950	65180	69410	73640
	CAM Data[1038](High)	44031	48261	52491	56721	60951	65181	69411	73641
	CAM Data[1039](Low)	44032	48262	52492	56722	60952	65182	69412	73642
	CAM Data[1039](High)	44033	48263	52493	56723	60953	65183	69413	73643
	CAM Data[1040](Low)	44034	48264	52494	56724	60954	65184	69414	73644
	CAM Data[1040](High)	44035	48265	52495	56725	60955	65185	69415	73645
	CAM Data[1041](Low)	44036	48266	52496	56726	60956	65186	69416	73646
	CAM Data[1041](High)	44037	48267	52497	56727	60957	65187	69417	73647
	CAM Data[1042](Low)	44038	48268	52498	56728	60958	65188	69418	73648
	CAM Data[1042](High)	44039	48269	52499	56729	60959	65189	69419	73649
	CAM Data[1043](Low)	44040	48270	52500	56730	60960	65190	69420	73650
	CAM Data[1043](High)	44041	48271	52501	56731	60961	65191	69421	73651
	CAM Data[1044](Low)	44042	48272	52502	56732	60962	65192	69422	73652
	CAM Data[1044](High)	44043	48273	52503	56733	60963	65193	69423	73653
	CAM Data[1045](Low)	44044	48274	52504	56734	60964	65194	69424	73654
	CAM Data[1045](High)	44045	48275	52505	56735	60965	65195	69425	73655
	CAM Data[1046](Low)	44046	48276	52506	56736	60966	65196	69426	73656
	CAM Data[1046](High)	44047	48277	52507	56737	60967	65197	69427	73657
	CAM Data[1047](Low)	44048	48278	52508	56738	60968	65198	69428	73658
	CAM Data[1047](High)	44049	48279	52509	56739	60969	65199	69429	73659
	CAM Data[1048](Low)	44050	48280	52510	56740	60970	65200	69430	73660
	CAM Data[1048](High)	44051	48281	52511	56741	60971	65201	69431	73661
	CAM Data[1049](Low)	44052	48282	52512	56742	60972	65202	69432	73662
	CAM Data[1049](High)	44053	48283	52513	56743	60973	65203	69433	73663
	CAM Data[1050](Low)	44054	48284	52514	56744	60974	65204	69434	73664
	CAM Data[1050](High)	44055	48285	52515	56745	60975	65205	69435	73665
	CAM Data[1051](Low)	44056	48286	52516	56746	60976	65206	69436	73666
	CAM Data[1051](High)	44057	48287	52517	56747	60977	65207	69437	73667
	CAM Data[1052](Low)	44058	48288	52518	56748	60978	65208	69438	73668
	CAM Data[1052](High)	44059	48289	52519	56749	60979	65209	69439	73669
	CAM Data[1053](Low)	44060	48290	52520	56750	60980	65210	69440	73670
	CAM Data[1053](High)	44061	48291	52521	56751	60981	65211	69441	73671
	CAM Data[1054](Low)	44062	48292	52522	56752	60982	65212	69442	73672
	CAM Data[1054](High)	44063	48293	52523	56753	60983	65213	69443	73673
	CAM Data[1055](Low)	44064	48294	52524	56754	60984	65214	69444	73674
	CAM Data[1055](High)	44065	48295	52525	56755	60985	65215	69445	73675
	CAM Data[1056](Low)	44066	48296	52526	56756	60986	65216	69446	73676
	CAM Data[1056](High)	44067	48297	52527	56757	60987	65217	69447	73677
	CAM Data[1057](Low)	44068	48298	52528	56758	60988	65218	69448	73678

Chapter 11 Internal Memory Address of “Read/Write Variable Data” command

	CAM Data[1057](High)	44069	48299	52529	56759	60989	65219	69449	73679
	CAM Data[1058](Low)	44070	48300	52530	56760	60990	65220	69450	73680
	CAM Data[1058](High)	44071	48301	52531	56761	60991	65221	69451	73681
	CAM Data[1059](Low)	44072	48302	52532	56762	60992	65222	69452	73682
	CAM Data[1059](High)	44073	48303	52533	56763	60993	65223	69453	73683
	CAM Data[1060](Low)	44074	48304	52534	56764	60994	65224	69454	73684
	CAM Data[1060](High)	44075	48305	52535	56765	60995	65225	69455	73685
	CAM Data[1061](Low)	44076	48306	52536	56766	60996	65226	69456	73686
	CAM Data[1061](High)	44077	48307	52537	56767	60997	65227	69457	73687
	CAM Data[1062](Low)	44078	48308	52538	56768	60998	65228	69458	73688
	CAM Data[1062](High)	44079	48309	52539	56769	60999	65229	69459	73689
	CAM Data[1063](Low)	44080	48310	52540	56770	61000	65230	69460	73690
	CAM Data[1063](High)	44081	48311	52541	56771	61001	65231	69461	73691
	CAM Data[1064](Low)	44082	48312	52542	56772	61002	65232	69462	73692
	CAM Data[1064](High)	44083	48313	52543	56773	61003	65233	69463	73693
	CAM Data[1065](Low)	44084	48314	52544	56774	61004	65234	69464	73694
	CAM Data[1065](High)	44085	48315	52545	56775	61005	65235	69465	73695
	CAM Data[1066](Low)	44086	48316	52546	56776	61006	65236	69466	73696
	CAM Data[1066](High)	44087	48317	52547	56777	61007	65237	69467	73697
	CAM Data[1067](Low)	44088	48318	52548	56778	61008	65238	69468	73698
	CAM Data[1067](High)	44089	48319	52549	56779	61009	65239	69469	73699
	CAM Data[1068](Low)	44090	48320	52550	56780	61010	65240	69470	73700
	CAM Data[1068](High)	44091	48321	52551	56781	61011	65241	69471	73701
	CAM Data[1069](Low)	44092	48322	52552	56782	61012	65242	69472	73702
	CAM Data[1069](High)	44093	48323	52553	56783	61013	65243	69473	73703
	CAM Data[1070](Low)	44094	48324	52554	56784	61014	65244	69474	73704
	CAM Data[1070](High)	44095	48325	52555	56785	61015	65245	69475	73705
	CAM Data[1071](Low)	44096	48326	52556	56786	61016	65246	69476	73706
	CAM Data[1071](High)	44097	48327	52557	56787	61017	65247	69477	73707
	CAM Data[1072](Low)	44098	48328	52558	56788	61018	65248	69478	73708
	CAM Data[1072](High)	44099	48329	52559	56789	61019	65249	69479	73709
	CAM Data[1073](Low)	44100	48330	52560	56790	61020	65250	69480	73710
	CAM Data[1073](High)	44101	48331	52561	56791	61021	65251	69481	73711
	CAM Data[1074](Low)	44102	48332	52562	56792	61022	65252	69482	73712
	CAM Data[1074](High)	44103	48333	52563	56793	61023	65253	69483	73713
	CAM Data[1075](Low)	44104	48334	52564	56794	61024	65254	69484	73714
	CAM Data[1075](High)	44105	48335	52565	56795	61025	65255	69485	73715
	CAM Data[1076](Low)	44106	48336	52566	56796	61026	65256	69486	73716
	CAM Data[1076](High)	44107	48337	52567	56797	61027	65257	69487	73717
	CAM Data[1077](Low)	44108	48338	52568	56798	61028	65258	69488	73718
	CAM Data[1077](High)	44109	48339	52569	56799	61029	65259	69489	73719
	CAM Data[1078](Low)	44110	48340	52570	56800	61030	65260	69490	73720
	CAM Data[1078](High)	44111	48341	52571	56801	61031	65261	69491	73721
	CAM Data[1079](Low)	44112	48342	52572	56802	61032	65262	69492	73722
	CAM Data[1079](High)	44113	48343	52573	56803	61033	65263	69493	73723
	CAM Data[1080](Low)	44114	48344	52574	56804	61034	65264	69494	73724

Chapter 11 Internal Memory Address of “Read/Write Variable Data” command

	CAM Data[1080](High)	44115	48345	52575	56805	61035	65265	69495	73725
	CAM Data[1081](Low)	44116	48346	52576	56806	61036	65266	69496	73726
	CAM Data[1081](High)	44117	48347	52577	56807	61037	65267	69497	73727
	CAM Data[1082](Low)	44118	48348	52578	56808	61038	65268	69498	73728
	CAM Data[1082](High)	44119	48349	52579	56809	61039	65269	69499	73729
	CAM Data[1083](Low)	44120	48350	52580	56810	61040	65270	69500	73730
	CAM Data[1083](High)	44121	48351	52581	56811	61041	65271	69501	73731
	CAM Data[1084](Low)	44122	48352	52582	56812	61042	65272	69502	73732
	CAM Data[1084](High)	44123	48353	52583	56813	61043	65273	69503	73733
	CAM Data[1085](Low)	44124	48354	52584	56814	61044	65274	69504	73734
	CAM Data[1085](High)	44125	48355	52585	56815	61045	65275	69505	73735
	CAM Data[1086](Low)	44126	48356	52586	56816	61046	65276	69506	73736
	CAM Data[1086](High)	44127	48357	52587	56817	61047	65277	69507	73737
	CAM Data[1087](Low)	44128	48358	52588	56818	61048	65278	69508	73738
	CAM Data[1087](High)	44129	48359	52589	56819	61049	65279	69509	73739
	CAM Data[1088](Low)	44130	48360	52590	56820	61050	65280	69510	73740
	CAM Data[1088](High)	44131	48361	52591	56821	61051	65281	69511	73741
	CAM Data[1089](Low)	44132	48362	52592	56822	61052	65282	69512	73742
	CAM Data[1089](High)	44133	48363	52593	56823	61053	65283	69513	73743
	CAM Data[1090](Low)	44134	48364	52594	56824	61054	65284	69514	73744
	CAM Data[1090](High)	44135	48365	52595	56825	61055	65285	69515	73745
	CAM Data[1091](Low)	44136	48366	52596	56826	61056	65286	69516	73746
	CAM Data[1091](High)	44137	48367	52597	56827	61057	65287	69517	73747
	CAM Data[1092](Low)	44138	48368	52598	56828	61058	65288	69518	73748
	CAM Data[1092](High)	44139	48369	52599	56829	61059	65289	69519	73749
	CAM Data[1093](Low)	44140	48370	52600	56830	61060	65290	69520	73750
	CAM Data[1093](High)	44141	48371	52601	56831	61061	65291	69521	73751
	CAM Data[1094](Low)	44142	48372	52602	56832	61062	65292	69522	73752
	CAM Data[1094](High)	44143	48373	52603	56833	61063	65293	69523	73753
	CAM Data[1095](Low)	44144	48374	52604	56834	61064	65294	69524	73754
	CAM Data[1095](High)	44145	48375	52605	56835	61065	65295	69525	73755
	CAM Data[1096](Low)	44146	48376	52606	56836	61066	65296	69526	73756
	CAM Data[1096](High)	44147	48377	52607	56837	61067	65297	69527	73757
	CAM Data[1097](Low)	44148	48378	52608	56838	61068	65298	69528	73758
	CAM Data[1097](High)	44149	48379	52609	56839	61069	65299	69529	73759
	CAM Data[1098](Low)	44150	48380	52610	56840	61070	65300	69530	73760
	CAM Data[1098](High)	44151	48381	52611	56841	61071	65301	69531	73761
	CAM Data[1099](Low)	44152	48382	52612	56842	61072	65302	69532	73762
	CAM Data[1099](High)	44153	48383	52613	56843	61073	65303	69533	73763
	CAM Data[1100](Low)	44154	48384	52614	56844	61074	65304	69534	73764
	CAM Data[1100](High)	44155	48385	52615	56845	61075	65305	69535	73765
	CAM Data[1101](Low)	44156	48386	52616	56846	61076	65306	69536	73766
	CAM Data[1101](High)	44157	48387	52617	56847	61077	65307	69537	73767
	CAM Data[1102](Low)	44158	48388	52618	56848	61078	65308	69538	73768
	CAM Data[1102](High)	44159	48389	52619	56849	61079	65309	69539	73769
	CAM Data[1103](Low)	44160	48390	52620	56850	61080	65310	69540	73770

Chapter 11 Internal Memory Address of “Read/Write Variable Data” command

	CAM Data[1103](High)	44161	48391	52621	56851	61081	65311	69541	73771
	CAM Data[1104](Low)	44162	48392	52622	56852	61082	65312	69542	73772
	CAM Data[1104](High)	44163	48393	52623	56853	61083	65313	69543	73773
	CAM Data[1105](Low)	44164	48394	52624	56854	61084	65314	69544	73774
	CAM Data[1105](High)	44165	48395	52625	56855	61085	65315	69545	73775
	CAM Data[1106](Low)	44166	48396	52626	56856	61086	65316	69546	73776
	CAM Data[1106](High)	44167	48397	52627	56857	61087	65317	69547	73777
	CAM Data[1107](Low)	44168	48398	52628	56858	61088	65318	69548	73778
	CAM Data[1107](High)	44169	48399	52629	56859	61089	65319	69549	73779
	CAM Data[1108](Low)	44170	48400	52630	56860	61090	65320	69550	73780
	CAM Data[1108](High)	44171	48401	52631	56861	61091	65321	69551	73781
	CAM Data[1109](Low)	44172	48402	52632	56862	61092	65322	69552	73782
	CAM Data[1109](High)	44173	48403	52633	56863	61093	65323	69553	73783
	CAM Data[1110](Low)	44174	48404	52634	56864	61094	65324	69554	73784
	CAM Data[1110](High)	44175	48405	52635	56865	61095	65325	69555	73785
	CAM Data[1111](Low)	44176	48406	52636	56866	61096	65326	69556	73786
	CAM Data[1111](High)	44177	48407	52637	56867	61097	65327	69557	73787
	CAM Data[1112](Low)	44178	48408	52638	56868	61098	65328	69558	73788
	CAM Data[1112](High)	44179	48409	52639	56869	61099	65329	69559	73789
	CAM Data[1113](Low)	44180	48410	52640	56870	61100	65330	69560	73790
	CAM Data[1113](High)	44181	48411	52641	56871	61101	65331	69561	73791
	CAM Data[1114](Low)	44182	48412	52642	56872	61102	65332	69562	73792
	CAM Data[1114](High)	44183	48413	52643	56873	61103	65333	69563	73793
	CAM Data[1115](Low)	44184	48414	52644	56874	61104	65334	69564	73794
	CAM Data[1115](High)	44185	48415	52645	56875	61105	65335	69565	73795
	CAM Data[1116](Low)	44186	48416	52646	56876	61106	65336	69566	73796
	CAM Data[1116](High)	44187	48417	52647	56877	61107	65337	69567	73797
	CAM Data[1117](Low)	44188	48418	52648	56878	61108	65338	69568	73798
	CAM Data[1117](High)	44189	48419	52649	56879	61109	65339	69569	73799
	CAM Data[1118](Low)	44190	48420	52650	56880	61110	65340	69570	73800
	CAM Data[1118](High)	44191	48421	52651	56881	61111	65341	69571	73801
	CAM Data[1119](Low)	44192	48422	52652	56882	61112	65342	69572	73802
	CAM Data[1119](High)	44193	48423	52653	56883	61113	65343	69573	73803
	CAM Data[1120](Low)	44194	48424	52654	56884	61114	65344	69574	73804
	CAM Data[1120](High)	44195	48425	52655	56885	61115	65345	69575	73805
	CAM Data[1121](Low)	44196	48426	52656	56886	61116	65346	69576	73806
	CAM Data[1121](High)	44197	48427	52657	56887	61117	65347	69577	73807
	CAM Data[1122](Low)	44198	48428	52658	56888	61118	65348	69578	73808
	CAM Data[1122](High)	44199	48429	52659	56889	61119	65349	69579	73809
	CAM Data[1123](Low)	44200	48430	52660	56890	61120	65350	69580	73810
	CAM Data[1123](High)	44201	48431	52661	56891	61121	65351	69581	73811
	CAM Data[1124](Low)	44202	48432	52662	56892	61122	65352	69582	73812
	CAM Data[1124](High)	44203	48433	52663	56893	61123	65353	69583	73813
	CAM Data[1125](Low)	44204	48434	52664	56894	61124	65354	69584	73814
	CAM Data[1125](High)	44205	48435	52665	56895	61125	65355	69585	73815
	CAM Data[1126](Low)	44206	48436	52666	56896	61126	65356	69586	73816

Chapter 11 Internal Memory Address of “Read/Write Variable Data” command

	CAM Data[1126](High)	44207	48437	52667	56897	61127	65357	69587	73817
	CAM Data[1127](Low)	44208	48438	52668	56898	61128	65358	69588	73818
	CAM Data[1127](High)	44209	48439	52669	56899	61129	65359	69589	73819
	CAM Data[1128](Low)	44210	48440	52670	56900	61130	65360	69590	73820
	CAM Data[1128](High)	44211	48441	52671	56901	61131	65361	69591	73821
	CAM Data[1129](Low)	44212	48442	52672	56902	61132	65362	69592	73822
	CAM Data[1129](High)	44213	48443	52673	56903	61133	65363	69593	73823
	CAM Data[1130](Low)	44214	48444	52674	56904	61134	65364	69594	73824
	CAM Data[1130](High)	44215	48445	52675	56905	61135	65365	69595	73825
	CAM Data[1131](Low)	44216	48446	52676	56906	61136	65366	69596	73826
	CAM Data[1131](High)	44217	48447	52677	56907	61137	65367	69597	73827
	CAM Data[1132](Low)	44218	48448	52678	56908	61138	65368	69598	73828
	CAM Data[1132](High)	44219	48449	52679	56909	61139	65369	69599	73829
	CAM Data[1133](Low)	44220	48450	52680	56910	61140	65370	69600	73830
	CAM Data[1133](High)	44221	48451	52681	56911	61141	65371	69601	73831
	CAM Data[1134](Low)	44222	48452	52682	56912	61142	65372	69602	73832
	CAM Data[1134](High)	44223	48453	52683	56913	61143	65373	69603	73833
	CAM Data[1135](Low)	44224	48454	52684	56914	61144	65374	69604	73834
	CAM Data[1135](High)	44225	48455	52685	56915	61145	65375	69605	73835
	CAM Data[1136](Low)	44226	48456	52686	56916	61146	65376	69606	73836
	CAM Data[1136](High)	44227	48457	52687	56917	61147	65377	69607	73837
	CAM Data[1137](Low)	44228	48458	52688	56918	61148	65378	69608	73838
	CAM Data[1137](High)	44229	48459	52689	56919	61149	65379	69609	73839
	CAM Data[1138](Low)	44230	48460	52690	56920	61150	65380	69610	73840
	CAM Data[1138](High)	44231	48461	52691	56921	61151	65381	69611	73841
	CAM Data[1139](Low)	44232	48462	52692	56922	61152	65382	69612	73842
	CAM Data[1139](High)	44233	48463	52693	56923	61153	65383	69613	73843
	CAM Data[1140](Low)	44234	48464	52694	56924	61154	65384	69614	73844
	CAM Data[1140](High)	44235	48465	52695	56925	61155	65385	69615	73845
	CAM Data[1141](Low)	44236	48466	52696	56926	61156	65386	69616	73846
	CAM Data[1141](High)	44237	48467	52697	56927	61157	65387	69617	73847
	CAM Data[1142](Low)	44238	48468	52698	56928	61158	65388	69618	73848
	CAM Data[1142](High)	44239	48469	52699	56929	61159	65389	69619	73849
	CAM Data[1143](Low)	44240	48470	52700	56930	61160	65390	69620	73850
	CAM Data[1143](High)	44241	48471	52701	56931	61161	65391	69621	73851
	CAM Data[1144](Low)	44242	48472	52702	56932	61162	65392	69622	73852
	CAM Data[1144](High)	44243	48473	52703	56933	61163	65393	69623	73853
	CAM Data[1145](Low)	44244	48474	52704	56934	61164	65394	69624	73854
	CAM Data[1145](High)	44245	48475	52705	56935	61165	65395	69625	73855
	CAM Data[1146](Low)	44246	48476	52706	56936	61166	65396	69626	73856
	CAM Data[1146](High)	44247	48477	52707	56937	61167	65397	69627	73857
	CAM Data[1147](Low)	44248	48478	52708	56938	61168	65398	69628	73858
	CAM Data[1147](High)	44249	48479	52709	56939	61169	65399	69629	73859
	CAM Data[1148](Low)	44250	48480	52710	56940	61170	65400	69630	73860
	CAM Data[1148](High)	44251	48481	52711	56941	61171	65401	69631	73861
	CAM Data[1149](Low)	44252	48482	52712	56942	61172	65402	69632	73862

Chapter 11 Internal Memory Address of “Read/Write Variable Data” command

	CAM Data[1149](High)	44253	48483	52713	56943	61173	65403	69633	73863
	CAM Data[1150](Low)	44254	48484	52714	56944	61174	65404	69634	73864
	CAM Data[1150](High)	44255	48485	52715	56945	61175	65405	69635	73865
	CAM Data[1151](Low)	44256	48486	52716	56946	61176	65406	69636	73866
	CAM Data[1151](High)	44257	48487	52717	56947	61177	65407	69637	73867
	CAM Data[1152](Low)	44258	48488	52718	56948	61178	65408	69638	73868
	CAM Data[1152](High)	44259	48489	52719	56949	61179	65409	69639	73869
	CAM Data[1153](Low)	44260	48490	52720	56950	61180	65410	69640	73870
	CAM Data[1153](High)	44261	48491	52721	56951	61181	65411	69641	73871
	CAM Data[1154](Low)	44262	48492	52722	56952	61182	65412	69642	73872
	CAM Data[1154](High)	44263	48493	52723	56953	61183	65413	69643	73873
	CAM Data[1155](Low)	44264	48494	52724	56954	61184	65414	69644	73874
	CAM Data[1155](High)	44265	48495	52725	56955	61185	65415	69645	73875
	CAM Data[1156](Low)	44266	48496	52726	56956	61186	65416	69646	73876
	CAM Data[1156](High)	44267	48497	52727	56957	61187	65417	69647	73877
	CAM Data[1157](Low)	44268	48498	52728	56958	61188	65418	69648	73878
	CAM Data[1157](High)	44269	48499	52729	56959	61189	65419	69649	73879
	CAM Data[1158](Low)	44270	48500	52730	56960	61190	65420	69650	73880
	CAM Data[1158](High)	44271	48501	52731	56961	61191	65421	69651	73881
	CAM Data[1159](Low)	44272	48502	52732	56962	61192	65422	69652	73882
	CAM Data[1159](High)	44273	48503	52733	56963	61193	65423	69653	73883
	CAM Data[1160](Low)	44274	48504	52734	56964	61194	65424	69654	73884
	CAM Data[1160](High)	44275	48505	52735	56965	61195	65425	69655	73885
	CAM Data[1161](Low)	44276	48506	52736	56966	61196	65426	69656	73886
	CAM Data[1161](High)	44277	48507	52737	56967	61197	65427	69657	73887
	CAM Data[1162](Low)	44278	48508	52738	56968	61198	65428	69658	73888
	CAM Data[1162](High)	44279	48509	52739	56969	61199	65429	69659	73889
	CAM Data[1163](Low)	44280	48510	52740	56970	61200	65430	69660	73890
	CAM Data[1163](High)	44281	48511	52741	56971	61201	65431	69661	73891
	CAM Data[1164](Low)	44282	48512	52742	56972	61202	65432	69662	73892
	CAM Data[1164](High)	44283	48513	52743	56973	61203	65433	69663	73893
	CAM Data[1165](Low)	44284	48514	52744	56974	61204	65434	69664	73894
	CAM Data[1165](High)	44285	48515	52745	56975	61205	65435	69665	73895
	CAM Data[1166](Low)	44286	48516	52746	56976	61206	65436	69666	73896
	CAM Data[1166](High)	44287	48517	52747	56977	61207	65437	69667	73897
	CAM Data[1167](Low)	44288	48518	52748	56978	61208	65438	69668	73898
	CAM Data[1167](High)	44289	48519	52749	56979	61209	65439	69669	73899
	CAM Data[1168](Low)	44290	48520	52750	56980	61210	65440	69670	73900
	CAM Data[1168](High)	44291	48521	52751	56981	61211	65441	69671	73901
	CAM Data[1169](Low)	44292	48522	52752	56982	61212	65442	69672	73902
	CAM Data[1169](High)	44293	48523	52753	56983	61213	65443	69673	73903
	CAM Data[1170](Low)	44294	48524	52754	56984	61214	65444	69674	73904
	CAM Data[1170](High)	44295	48525	52755	56985	61215	65445	69675	73905
	CAM Data[1171](Low)	44296	48526	52756	56986	61216	65446	69676	73906
	CAM Data[1171](High)	44297	48527	52757	56987	61217	65447	69677	73907
	CAM Data[1172](Low)	44298	48528	52758	56988	61218	65448	69678	73908

Chapter 11 Internal Memory Address of “Read/Write Variable Data” command

	CAM Data[1172](High)	44299	48529	52759	56989	61219	65449	69679	73909
	CAM Data[1173](Low)	44300	48530	52760	56990	61220	65450	69680	73910
	CAM Data[1173](High)	44301	48531	52761	56991	61221	65451	69681	73911
	CAM Data[1174](Low)	44302	48532	52762	56992	61222	65452	69682	73912
	CAM Data[1174](High)	44303	48533	52763	56993	61223	65453	69683	73913
	CAM Data[1175](Low)	44304	48534	52764	56994	61224	65454	69684	73914
	CAM Data[1175](High)	44305	48535	52765	56995	61225	65455	69685	73915
	CAM Data[1176](Low)	44306	48536	52766	56996	61226	65456	69686	73916
	CAM Data[1176](High)	44307	48537	52767	56997	61227	65457	69687	73917
	CAM Data[1177](Low)	44308	48538	52768	56998	61228	65458	69688	73918
	CAM Data[1177](High)	44309	48539	52769	56999	61229	65459	69689	73919
	CAM Data[1178](Low)	44310	48540	52770	57000	61230	65460	69690	73920
	CAM Data[1178](High)	44311	48541	52771	57001	61231	65461	69691	73921
	CAM Data[1179](Low)	44312	48542	52772	57002	61232	65462	69692	73922
	CAM Data[1179](High)	44313	48543	52773	57003	61233	65463	69693	73923
	CAM Data[1180](Low)	44314	48544	52774	57004	61234	65464	69694	73924
	CAM Data[1180](High)	44315	48545	52775	57005	61235	65465	69695	73925
	CAM Data[1181](Low)	44316	48546	52776	57006	61236	65466	69696	73926
	CAM Data[1181](High)	44317	48547	52777	57007	61237	65467	69697	73927
	CAM Data[1182](Low)	44318	48548	52778	57008	61238	65468	69698	73928
	CAM Data[1182](High)	44319	48549	52779	57009	61239	65469	69699	73929
	CAM Data[1183](Low)	44320	48550	52780	57010	61240	65470	69700	73930
	CAM Data[1183](High)	44321	48551	52781	57011	61241	65471	69701	73931
	CAM Data[1184](Low)	44322	48552	52782	57012	61242	65472	69702	73932
	CAM Data[1184](High)	44323	48553	52783	57013	61243	65473	69703	73933
	CAM Data[1185](Low)	44324	48554	52784	57014	61244	65474	69704	73934
	CAM Data[1185](High)	44325	48555	52785	57015	61245	65475	69705	73935
	CAM Data[1186](Low)	44326	48556	52786	57016	61246	65476	69706	73936
	CAM Data[1186](High)	44327	48557	52787	57017	61247	65477	69707	73937
	CAM Data[1187](Low)	44328	48558	52788	57018	61248	65478	69708	73938
	CAM Data[1187](High)	44329	48559	52789	57019	61249	65479	69709	73939
	CAM Data[1188](Low)	44330	48560	52790	57020	61250	65480	69710	73940
	CAM Data[1188](High)	44331	48561	52791	57021	61251	65481	69711	73941
	CAM Data[1189](Low)	44332	48562	52792	57022	61252	65482	69712	73942
	CAM Data[1189](High)	44333	48563	52793	57023	61253	65483	69713	73943
	CAM Data[1190](Low)	44334	48564	52794	57024	61254	65484	69714	73944
	CAM Data[1190](High)	44335	48565	52795	57025	61255	65485	69715	73945
	CAM Data[1191](Low)	44336	48566	52796	57026	61256	65486	69716	73946
	CAM Data[1191](High)	44337	48567	52797	57027	61257	65487	69717	73947
	CAM Data[1192](Low)	44338	48568	52798	57028	61258	65488	69718	73948
	CAM Data[1192](High)	44339	48569	52799	57029	61259	65489	69719	73949
	CAM Data[1193](Low)	44340	48570	52800	57030	61260	65490	69720	73950
	CAM Data[1193](High)	44341	48571	52801	57031	61261	65491	69721	73951
	CAM Data[1194](Low)	44342	48572	52802	57032	61262	65492	69722	73952
	CAM Data[1194](High)	44343	48573	52803	57033	61263	65493	69723	73953
	CAM Data[1195](Low)	44344	48574	52804	57034	61264	65494	69724	73954

Chapter 11 Internal Memory Address of “Read/Write Variable Data” command

	CAM Data[1195](High)	44345	48575	52805	57035	61265	65495	69725	73955
	CAM Data[1196](Low)	44346	48576	52806	57036	61266	65496	69726	73956
	CAM Data[1196](High)	44347	48577	52807	57037	61267	65497	69727	73957
	CAM Data[1197](Low)	44348	48578	52808	57038	61268	65498	69728	73958
	CAM Data[1197](High)	44349	48579	52809	57039	61269	65499	69729	73959
	CAM Data[1198](Low)	44350	48580	52810	57040	61270	65500	69730	73960
	CAM Data[1198](High)	44351	48581	52811	57041	61271	65501	69731	73961
	CAM Data[1199](Low)	44352	48582	52812	57042	61272	65502	69732	73962
	CAM Data[1199](High)	44353	48583	52813	57043	61273	65503	69733	73963
	CAM Data[1200](Low)	44354	48584	52814	57044	61274	65504	69734	73964
	CAM Data[1200](High)	44355	48585	52815	57045	61275	65505	69735	73965
	CAM Data[1201](Low)	44356	48586	52816	57046	61276	65506	69736	73966
	CAM Data[1201](High)	44357	48587	52817	57047	61277	65507	69737	73967
	CAM Data[1202](Low)	44358	48588	52818	57048	61278	65508	69738	73968
	CAM Data[1202](High)	44359	48589	52819	57049	61279	65509	69739	73969
	CAM Data[1203](Low)	44360	48590	52820	57050	61280	65510	69740	73970
	CAM Data[1203](High)	44361	48591	52821	57051	61281	65511	69741	73971
	CAM Data[1204](Low)	44362	48592	52822	57052	61282	65512	69742	73972
	CAM Data[1204](High)	44363	48593	52823	57053	61283	65513	69743	73973
	CAM Data[1205](Low)	44364	48594	52824	57054	61284	65514	69744	73974
	CAM Data[1205](High)	44365	48595	52825	57055	61285	65515	69745	73975
	CAM Data[1206](Low)	44366	48596	52826	57056	61286	65516	69746	73976
	CAM Data[1206](High)	44367	48597	52827	57057	61287	65517	69747	73977
	CAM Data[1207](Low)	44368	48598	52828	57058	61288	65518	69748	73978
	CAM Data[1207](High)	44369	48599	52829	57059	61289	65519	69749	73979
	CAM Data[1208](Low)	44370	48600	52830	57060	61290	65520	69750	73980
	CAM Data[1208](High)	44371	48601	52831	57061	61291	65521	69751	73981
	CAM Data[1209](Low)	44372	48602	52832	57062	61292	65522	69752	73982
	CAM Data[1209](High)	44373	48603	52833	57063	61293	65523	69753	73983
	CAM Data[1210](Low)	44374	48604	52834	57064	61294	65524	69754	73984
	CAM Data[1210](High)	44375	48605	52835	57065	61295	65525	69755	73985
	CAM Data[1211](Low)	44376	48606	52836	57066	61296	65526	69756	73986
	CAM Data[1211](High)	44377	48607	52837	57067	61297	65527	69757	73987
	CAM Data[1212](Low)	44378	48608	52838	57068	61298	65528	69758	73988
	CAM Data[1212](High)	44379	48609	52839	57069	61299	65529	69759	73989
	CAM Data[1213](Low)	44380	48610	52840	57070	61300	65530	69760	73990
	CAM Data[1213](High)	44381	48611	52841	57071	61301	65531	69761	73991
	CAM Data[1214](Low)	44382	48612	52842	57072	61302	65532	69762	73992
	CAM Data[1214](High)	44383	48613	52843	57073	61303	65533	69763	73993
	CAM Data[1215](Low)	44384	48614	52844	57074	61304	65534	69764	73994
	CAM Data[1215](High)	44385	48615	52845	57075	61305	65535	69765	73995
	CAM Data[1216](Low)	44386	48616	52846	57076	61306	65536	69766	73996
	CAM Data[1216](High)	44387	48617	52847	57077	61307	65537	69767	73997
	CAM Data[1217](Low)	44388	48618	52848	57078	61308	65538	69768	73998
	CAM Data[1217](High)	44389	48619	52849	57079	61309	65539	69769	73999
	CAM Data[1218](Low)	44390	48620	52850	57080	61310	65540	69770	74000

Chapter 11 Internal Memory Address of “Read/Write Variable Data” command

	CAM Data[1218](High)	44391	48621	52851	57081	61311	65541	69771	74001
	CAM Data[1219](Low)	44392	48622	52852	57082	61312	65542	69772	74002
	CAM Data[1219](High)	44393	48623	52853	57083	61313	65543	69773	74003
	CAM Data[1220](Low)	44394	48624	52854	57084	61314	65544	69774	74004
	CAM Data[1220](High)	44395	48625	52855	57085	61315	65545	69775	74005
	CAM Data[1221](Low)	44396	48626	52856	57086	61316	65546	69776	74006
	CAM Data[1221](High)	44397	48627	52857	57087	61317	65547	69777	74007
	CAM Data[1222](Low)	44398	48628	52858	57088	61318	65548	69778	74008
	CAM Data[1222](High)	44399	48629	52859	57089	61319	65549	69779	74009
	CAM Data[1223](Low)	44400	48630	52860	57090	61320	65550	69780	74010
	CAM Data[1223](High)	44401	48631	52861	57091	61321	65551	69781	74011
	CAM Data[1224](Low)	44402	48632	52862	57092	61322	65552	69782	74012
	CAM Data[1224](High)	44403	48633	52863	57093	61323	65553	69783	74013
	CAM Data[1225](Low)	44404	48634	52864	57094	61324	65554	69784	74014
	CAM Data[1225](High)	44405	48635	52865	57095	61325	65555	69785	74015
	CAM Data[1226](Low)	44406	48636	52866	57096	61326	65556	69786	74016
	CAM Data[1226](High)	44407	48637	52867	57097	61327	65557	69787	74017
	CAM Data[1227](Low)	44408	48638	52868	57098	61328	65558	69788	74018
	CAM Data[1227](High)	44409	48639	52869	57099	61329	65559	69789	74019
	CAM Data[1228](Low)	44410	48640	52870	57100	61330	65560	69790	74020
	CAM Data[1228](High)	44411	48641	52871	57101	61331	65561	69791	74021
	CAM Data[1229](Low)	44412	48642	52872	57102	61332	65562	69792	74022
	CAM Data[1229](High)	44413	48643	52873	57103	61333	65563	69793	74023
	CAM Data[1230](Low)	44414	48644	52874	57104	61334	65564	69794	74024
	CAM Data[1230](High)	44415	48645	52875	57105	61335	65565	69795	74025
	CAM Data[1231](Low)	44416	48646	52876	57106	61336	65566	69796	74026
	CAM Data[1231](High)	44417	48647	52877	57107	61337	65567	69797	74027
	CAM Data[1232](Low)	44418	48648	52878	57108	61338	65568	69798	74028
	CAM Data[1232](High)	44419	48649	52879	57109	61339	65569	69799	74029
	CAM Data[1233](Low)	44420	48650	52880	57110	61340	65570	69800	74030
	CAM Data[1233](High)	44421	48651	52881	57111	61341	65571	69801	74031
	CAM Data[1234](Low)	44422	48652	52882	57112	61342	65572	69802	74032
	CAM Data[1234](High)	44423	48653	52883	57113	61343	65573	69803	74033
	CAM Data[1235](Low)	44424	48654	52884	57114	61344	65574	69804	74034
	CAM Data[1235](High)	44425	48655	52885	57115	61345	65575	69805	74035
	CAM Data[1236](Low)	44426	48656	52886	57116	61346	65576	69806	74036
	CAM Data[1236](High)	44427	48657	52887	57117	61347	65577	69807	74037
	CAM Data[1237](Low)	44428	48658	52888	57118	61348	65578	69808	74038
	CAM Data[1237](High)	44429	48659	52889	57119	61349	65579	69809	74039
	CAM Data[1238](Low)	44430	48660	52890	57120	61350	65580	69810	74040
	CAM Data[1238](High)	44431	48661	52891	57121	61351	65581	69811	74041
	CAM Data[1239](Low)	44432	48662	52892	57122	61352	65582	69812	74042
	CAM Data[1239](High)	44433	48663	52893	57123	61353	65583	69813	74043
	CAM Data[1240](Low)	44434	48664	52894	57124	61354	65584	69814	74044
	CAM Data[1240](High)	44435	48665	52895	57125	61355	65585	69815	74045
	CAM Data[1241](Low)	44436	48666	52896	57126	61356	65586	69816	74046

Chapter 11 Internal Memory Address of “Read/Write Variable Data” command

	CAM Data[1241](High)	44437	48667	52897	57127	61357	65587	69817	74047
	CAM Data[1242](Low)	44438	48668	52898	57128	61358	65588	69818	74048
	CAM Data[1242](High)	44439	48669	52899	57129	61359	65589	69819	74049
	CAM Data[1243](Low)	44440	48670	52900	57130	61360	65590	69820	74050
	CAM Data[1243](High)	44441	48671	52901	57131	61361	65591	69821	74051
	CAM Data[1244](Low)	44442	48672	52902	57132	61362	65592	69822	74052
	CAM Data[1244](High)	44443	48673	52903	57133	61363	65593	69823	74053
	CAM Data[1245](Low)	44444	48674	52904	57134	61364	65594	69824	74054
	CAM Data[1245](High)	44445	48675	52905	57135	61365	65595	69825	74055
	CAM Data[1246](Low)	44446	48676	52906	57136	61366	65596	69826	74056
	CAM Data[1246](High)	44447	48677	52907	57137	61367	65597	69827	74057
	CAM Data[1247](Low)	44448	48678	52908	57138	61368	65598	69828	74058
	CAM Data[1247](High)	44449	48679	52909	57139	61369	65599	69829	74059
	CAM Data[1248](Low)	44450	48680	52910	57140	61370	65600	69830	74060
	CAM Data[1248](High)	44451	48681	52911	57141	61371	65601	69831	74061
	CAM Data[1249](Low)	44452	48682	52912	57142	61372	65602	69832	74062
	CAM Data[1249](High)	44453	48683	52913	57143	61373	65603	69833	74063
	CAM Data[1250](Low)	44454	48684	52914	57144	61374	65604	69834	74064
	CAM Data[1250](High)	44455	48685	52915	57145	61375	65605	69835	74065
	CAM Data[1251](Low)	44456	48686	52916	57146	61376	65606	69836	74066
	CAM Data[1251](High)	44457	48687	52917	57147	61377	65607	69837	74067
	CAM Data[1252](Low)	44458	48688	52918	57148	61378	65608	69838	74068
	CAM Data[1252](High)	44459	48689	52919	57149	61379	65609	69839	74069
	CAM Data[1253](Low)	44460	48690	52920	57150	61380	65610	69840	74070
	CAM Data[1253](High)	44461	48691	52921	57151	61381	65611	69841	74071
	CAM Data[1254](Low)	44462	48692	52922	57152	61382	65612	69842	74072
	CAM Data[1254](High)	44463	48693	52923	57153	61383	65613	69843	74073
	CAM Data[1255](Low)	44464	48694	52924	57154	61384	65614	69844	74074
	CAM Data[1255](High)	44465	48695	52925	57155	61385	65615	69845	74075
	CAM Data[1256](Low)	44466	48696	52926	57156	61386	65616	69846	74076
	CAM Data[1256](High)	44467	48697	52927	57157	61387	65617	69847	74077
	CAM Data[1257](Low)	44468	48698	52928	57158	61388	65618	69848	74078
	CAM Data[1257](High)	44469	48699	52929	57159	61389	65619	69849	74079
	CAM Data[1258](Low)	44470	48700	52930	57160	61390	65620	69850	74080
	CAM Data[1258](High)	44471	48701	52931	57161	61391	65621	69851	74081
	CAM Data[1259](Low)	44472	48702	52932	57162	61392	65622	69852	74082
	CAM Data[1259](High)	44473	48703	52933	57163	61393	65623	69853	74083
	CAM Data[1260](Low)	44474	48704	52934	57164	61394	65624	69854	74084
	CAM Data[1260](High)	44475	48705	52935	57165	61395	65625	69855	74085
	CAM Data[1261](Low)	44476	48706	52936	57166	61396	65626	69856	74086
	CAM Data[1261](High)	44477	48707	52937	57167	61397	65627	69857	74087
	CAM Data[1262](Low)	44478	48708	52938	57168	61398	65628	69858	74088
	CAM Data[1262](High)	44479	48709	52939	57169	61399	65629	69859	74089
	CAM Data[1263](Low)	44480	48710	52940	57170	61400	65630	69860	74090
	CAM Data[1263](High)	44481	48711	52941	57171	61401	65631	69861	74091
	CAM Data[1264](Low)	44482	48712	52942	57172	61402	65632	69862	74092

Chapter 11 Internal Memory Address of “Read/Write Variable Data” command

	CAM Data[1264](High)	44483	48713	52943	57173	61403	65633	69863	74093
	CAM Data[1265](Low)	44484	48714	52944	57174	61404	65634	69864	74094
	CAM Data[1265](High)	44485	48715	52945	57175	61405	65635	69865	74095
	CAM Data[1266](Low)	44486	48716	52946	57176	61406	65636	69866	74096
	CAM Data[1266](High)	44487	48717	52947	57177	61407	65637	69867	74097
	CAM Data[1267](Low)	44488	48718	52948	57178	61408	65638	69868	74098
	CAM Data[1267](High)	44489	48719	52949	57179	61409	65639	69869	74099
	CAM Data[1268](Low)	44490	48720	52950	57180	61410	65640	69870	74100
	CAM Data[1268](High)	44491	48721	52951	57181	61411	65641	69871	74101
	CAM Data[1269](Low)	44492	48722	52952	57182	61412	65642	69872	74102
	CAM Data[1269](High)	44493	48723	52953	57183	61413	65643	69873	74103
	CAM Data[1270](Low)	44494	48724	52954	57184	61414	65644	69874	74104
	CAM Data[1270](High)	44495	48725	52955	57185	61415	65645	69875	74105
	CAM Data[1271](Low)	44496	48726	52956	57186	61416	65646	69876	74106
	CAM Data[1271](High)	44497	48727	52957	57187	61417	65647	69877	74107
	CAM Data[1272](Low)	44498	48728	52958	57188	61418	65648	69878	74108
	CAM Data[1272](High)	44499	48729	52959	57189	61419	65649	69879	74109
	CAM Data[1273](Low)	44500	48730	52960	57190	61420	65650	69880	74110
	CAM Data[1273](High)	44501	48731	52961	57191	61421	65651	69881	74111
	CAM Data[1274](Low)	44502	48732	52962	57192	61422	65652	69882	74112
	CAM Data[1274](High)	44503	48733	52963	57193	61423	65653	69883	74113
	CAM Data[1275](Low)	44504	48734	52964	57194	61424	65654	69884	74114
	CAM Data[1275](High)	44505	48735	52965	57195	61425	65655	69885	74115
	CAM Data[1276](Low)	44506	48736	52966	57196	61426	65656	69886	74116
	CAM Data[1276](High)	44507	48737	52967	57197	61427	65657	69887	74117
	CAM Data[1277](Low)	44508	48738	52968	57198	61428	65658	69888	74118
	CAM Data[1277](High)	44509	48739	52969	57199	61429	65659	69889	74119
	CAM Data[1278](Low)	44510	48740	52970	57200	61430	65660	69890	74120
	CAM Data[1278](High)	44511	48741	52971	57201	61431	65661	69891	74121
	CAM Data[1279](Low)	44512	48742	52972	57202	61432	65662	69892	74122
	CAM Data[1279](High)	44513	48743	52973	57203	61433	65663	69893	74123
	CAM Data[1280](Low)	44514	48744	52974	57204	61434	65664	69894	74124
	CAM Data[1280](High)	44515	48745	52975	57205	61435	65665	69895	74125
	CAM Data[1281](Low)	44516	48746	52976	57206	61436	65666	69896	74126
	CAM Data[1281](High)	44517	48747	52977	57207	61437	65667	69897	74127
	CAM Data[1282](Low)	44518	48748	52978	57208	61438	65668	69898	74128
	CAM Data[1282](High)	44519	48749	52979	57209	61439	65669	69899	74129
	CAM Data[1283](Low)	44520	48750	52980	57210	61440	65670	69900	74130
	CAM Data[1283](High)	44521	48751	52981	57211	61441	65671	69901	74131
	CAM Data[1284](Low)	44522	48752	52982	57212	61442	65672	69902	74132
	CAM Data[1284](High)	44523	48753	52983	57213	61443	65673	69903	74133
	CAM Data[1285](Low)	44524	48754	52984	57214	61444	65674	69904	74134
	CAM Data[1285](High)	44525	48755	52985	57215	61445	65675	69905	74135
	CAM Data[1286](Low)	44526	48756	52986	57216	61446	65676	69906	74136
	CAM Data[1286](High)	44527	48757	52987	57217	61447	65677	69907	74137
	CAM Data[1287](Low)	44528	48758	52988	57218	61448	65678	69908	74138

Chapter 11 Internal Memory Address of “Read/Write Variable Data” command

	CAM Data[1287](High)	44529	48759	52989	57219	61449	65679	69909	74139
	CAM Data[1288](Low)	44530	48760	52990	57220	61450	65680	69910	74140
	CAM Data[1288](High)	44531	48761	52991	57221	61451	65681	69911	74141
	CAM Data[1289](Low)	44532	48762	52992	57222	61452	65682	69912	74142
	CAM Data[1289](High)	44533	48763	52993	57223	61453	65683	69913	74143
	CAM Data[1290](Low)	44534	48764	52994	57224	61454	65684	69914	74144
	CAM Data[1290](High)	44535	48765	52995	57225	61455	65685	69915	74145
	CAM Data[1291](Low)	44536	48766	52996	57226	61456	65686	69916	74146
	CAM Data[1291](High)	44537	48767	52997	57227	61457	65687	69917	74147
	CAM Data[1292](Low)	44538	48768	52998	57228	61458	65688	69918	74148
	CAM Data[1292](High)	44539	48769	52999	57229	61459	65689	69919	74149
	CAM Data[1293](Low)	44540	48770	53000	57230	61460	65690	69920	74150
	CAM Data[1293](High)	44541	48771	53001	57231	61461	65691	69921	74151
	CAM Data[1294](Low)	44542	48772	53002	57232	61462	65692	69922	74152
	CAM Data[1294](High)	44543	48773	53003	57233	61463	65693	69923	74153
	CAM Data[1295](Low)	44544	48774	53004	57234	61464	65694	69924	74154
	CAM Data[1295](High)	44545	48775	53005	57235	61465	65695	69925	74155
	CAM Data[1296](Low)	44546	48776	53006	57236	61466	65696	69926	74156
	CAM Data[1296](High)	44547	48777	53007	57237	61467	65697	69927	74157
	CAM Data[1297](Low)	44548	48778	53008	57238	61468	65698	69928	74158
	CAM Data[1297](High)	44549	48779	53009	57239	61469	65699	69929	74159
	CAM Data[1298](Low)	44550	48780	53010	57240	61470	65700	69930	74160
	CAM Data[1298](High)	44551	48781	53011	57241	61471	65701	69931	74161
	CAM Data[1299](Low)	44552	48782	53012	57242	61472	65702	69932	74162
	CAM Data[1299](High)	44553	48783	53013	57243	61473	65703	69933	74163
	CAM Data[1300](Low)	44554	48784	53014	57244	61474	65704	69934	74164
	CAM Data[1300](High)	44555	48785	53015	57245	61475	65705	69935	74165
	CAM Data[1301](Low)	44556	48786	53016	57246	61476	65706	69936	74166
	CAM Data[1301](High)	44557	48787	53017	57247	61477	65707	69937	74167
	CAM Data[1302](Low)	44558	48788	53018	57248	61478	65708	69938	74168
	CAM Data[1302](High)	44559	48789	53019	57249	61479	65709	69939	74169
	CAM Data[1303](Low)	44560	48790	53020	57250	61480	65710	69940	74170
	CAM Data[1303](High)	44561	48791	53021	57251	61481	65711	69941	74171
	CAM Data[1304](Low)	44562	48792	53022	57252	61482	65712	69942	74172
	CAM Data[1304](High)	44563	48793	53023	57253	61483	65713	69943	74173
	CAM Data[1305](Low)	44564	48794	53024	57254	61484	65714	69944	74174
	CAM Data[1305](High)	44565	48795	53025	57255	61485	65715	69945	74175
	CAM Data[1306](Low)	44566	48796	53026	57256	61486	65716	69946	74176
	CAM Data[1306](High)	44567	48797	53027	57257	61487	65717	69947	74177
	CAM Data[1307](Low)	44568	48798	53028	57258	61488	65718	69948	74178
	CAM Data[1307](High)	44569	48799	53029	57259	61489	65719	69949	74179
	CAM Data[1308](Low)	44570	48800	53030	57260	61490	65720	69950	74180
	CAM Data[1308](High)	44571	48801	53031	57261	61491	65721	69951	74181
	CAM Data[1309](Low)	44572	48802	53032	57262	61492	65722	69952	74182
	CAM Data[1309](High)	44573	48803	53033	57263	61493	65723	69953	74183
	CAM Data[1310](Low)	44574	48804	53034	57264	61494	65724	69954	74184

Chapter 11 Internal Memory Address of “Read/Write Variable Data” command

	CAM Data[1310](High)	44575	48805	53035	57265	61495	65725	69955	74185
	CAM Data[1311](Low)	44576	48806	53036	57266	61496	65726	69956	74186
	CAM Data[1311](High)	44577	48807	53037	57267	61497	65727	69957	74187
	CAM Data[1312](Low)	44578	48808	53038	57268	61498	65728	69958	74188
	CAM Data[1312](High)	44579	48809	53039	57269	61499	65729	69959	74189
	CAM Data[1313](Low)	44580	48810	53040	57270	61500	65730	69960	74190
	CAM Data[1313](High)	44581	48811	53041	57271	61501	65731	69961	74191
	CAM Data[1314](Low)	44582	48812	53042	57272	61502	65732	69962	74192
	CAM Data[1314](High)	44583	48813	53043	57273	61503	65733	69963	74193
	CAM Data[1315](Low)	44584	48814	53044	57274	61504	65734	69964	74194
	CAM Data[1315](High)	44585	48815	53045	57275	61505	65735	69965	74195
	CAM Data[1316](Low)	44586	48816	53046	57276	61506	65736	69966	74196
	CAM Data[1316](High)	44587	48817	53047	57277	61507	65737	69967	74197
	CAM Data[1317](Low)	44588	48818	53048	57278	61508	65738	69968	74198
	CAM Data[1317](High)	44589	48819	53049	57279	61509	65739	69969	74199
	CAM Data[1318](Low)	44590	48820	53050	57280	61510	65740	69970	74200
	CAM Data[1318](High)	44591	48821	53051	57281	61511	65741	69971	74201
	CAM Data[1319](Low)	44592	48822	53052	57282	61512	65742	69972	74202
	CAM Data[1319](High)	44593	48823	53053	57283	61513	65743	69973	74203
	CAM Data[1320](Low)	44594	48824	53054	57284	61514	65744	69974	74204
	CAM Data[1320](High)	44595	48825	53055	57285	61515	65745	69975	74205
	CAM Data[1321](Low)	44596	48826	53056	57286	61516	65746	69976	74206
	CAM Data[1321](High)	44597	48827	53057	57287	61517	65747	69977	74207
	CAM Data[1322](Low)	44598	48828	53058	57288	61518	65748	69978	74208
	CAM Data[1322](High)	44599	48829	53059	57289	61519	65749	69979	74209
	CAM Data[1323](Low)	44600	48830	53060	57290	61520	65750	69980	74210
	CAM Data[1323](High)	44601	48831	53061	57291	61521	65751	69981	74211
	CAM Data[1324](Low)	44602	48832	53062	57292	61522	65752	69982	74212
	CAM Data[1324](High)	44603	48833	53063	57293	61523	65753	69983	74213
	CAM Data[1325](Low)	44604	48834	53064	57294	61524	65754	69984	74214
	CAM Data[1325](High)	44605	48835	53065	57295	61525	65755	69985	74215
	CAM Data[1326](Low)	44606	48836	53066	57296	61526	65756	69986	74216
	CAM Data[1326](High)	44607	48837	53067	57297	61527	65757	69987	74217
	CAM Data[1327](Low)	44608	48838	53068	57298	61528	65758	69988	74218
	CAM Data[1327](High)	44609	48839	53069	57299	61529	65759	69989	74219
	CAM Data[1328](Low)	44610	48840	53070	57300	61530	65760	69990	74220
	CAM Data[1328](High)	44611	48841	53071	57301	61531	65761	69991	74221
	CAM Data[1329](Low)	44612	48842	53072	57302	61532	65762	69992	74222
	CAM Data[1329](High)	44613	48843	53073	57303	61533	65763	69993	74223
	CAM Data[1330](Low)	44614	48844	53074	57304	61534	65764	69994	74224
	CAM Data[1330](High)	44615	48845	53075	57305	61535	65765	69995	74225
	CAM Data[1331](Low)	44616	48846	53076	57306	61536	65766	69996	74226
	CAM Data[1331](High)	44617	48847	53077	57307	61537	65767	69997	74227
	CAM Data[1332](Low)	44618	48848	53078	57308	61538	65768	69998	74228
	CAM Data[1332](High)	44619	48849	53079	57309	61539	65769	69999	74229
	CAM Data[1333](Low)	44620	48850	53080	57310	61540	65770	70000	74230

Chapter 11 Internal Memory Address of “Read/Write Variable Data” command

	CAM Data[1333](High)	44621	48851	53081	57311	61541	65771	70001	74231
	CAM Data[1334](Low)	44622	48852	53082	57312	61542	65772	70002	74232
	CAM Data[1334](High)	44623	48853	53083	57313	61543	65773	70003	74233
	CAM Data[1335](Low)	44624	48854	53084	57314	61544	65774	70004	74234
	CAM Data[1335](High)	44625	48855	53085	57315	61545	65775	70005	74235
	CAM Data[1336](Low)	44626	48856	53086	57316	61546	65776	70006	74236
	CAM Data[1336](High)	44627	48857	53087	57317	61547	65777	70007	74237
	CAM Data[1337](Low)	44628	48858	53088	57318	61548	65778	70008	74238
	CAM Data[1337](High)	44629	48859	53089	57319	61549	65779	70009	74239
	CAM Data[1338](Low)	44630	48860	53090	57320	61550	65780	70010	74240
	CAM Data[1338](High)	44631	48861	53091	57321	61551	65781	70011	74241
	CAM Data[1339](Low)	44632	48862	53092	57322	61552	65782	70012	74242
	CAM Data[1339](High)	44633	48863	53093	57323	61553	65783	70013	74243
	CAM Data[1340](Low)	44634	48864	53094	57324	61554	65784	70014	74244
	CAM Data[1340](High)	44635	48865	53095	57325	61555	65785	70015	74245
	CAM Data[1341](Low)	44636	48866	53096	57326	61556	65786	70016	74246
	CAM Data[1341](High)	44637	48867	53097	57327	61557	65787	70017	74247
	CAM Data[1342](Low)	44638	48868	53098	57328	61558	65788	70018	74248
	CAM Data[1342](High)	44639	48869	53099	57329	61559	65789	70019	74249
	CAM Data[1343](Low)	44640	48870	53100	57330	61560	65790	70020	74250
	CAM Data[1343](High)	44641	48871	53101	57331	61561	65791	70021	74251
	CAM Data[1344](Low)	44642	48872	53102	57332	61562	65792	70022	74252
	CAM Data[1344](High)	44643	48873	53103	57333	61563	65793	70023	74253
	CAM Data[1345](Low)	44644	48874	53104	57334	61564	65794	70024	74254
	CAM Data[1345](High)	44645	48875	53105	57335	61565	65795	70025	74255
	CAM Data[1346](Low)	44646	48876	53106	57336	61566	65796	70026	74256
	CAM Data[1346](High)	44647	48877	53107	57337	61567	65797	70027	74257
	CAM Data[1347](Low)	44648	48878	53108	57338	61568	65798	70028	74258
	CAM Data[1347](High)	44649	48879	53109	57339	61569	65799	70029	74259
	CAM Data[1348](Low)	44650	48880	53110	57340	61570	65800	70030	74260
	CAM Data[1348](High)	44651	48881	53111	57341	61571	65801	70031	74261
	CAM Data[1349](Low)	44652	48882	53112	57342	61572	65802	70032	74262
	CAM Data[1349](High)	44653	48883	53113	57343	61573	65803	70033	74263
	CAM Data[1350](Low)	44654	48884	53114	57344	61574	65804	70034	74264
	CAM Data[1350](High)	44655	48885	53115	57345	61575	65805	70035	74265
	CAM Data[1351](Low)	44656	48886	53116	57346	61576	65806	70036	74266
	CAM Data[1351](High)	44657	48887	53117	57347	61577	65807	70037	74267
	CAM Data[1352](Low)	44658	48888	53118	57348	61578	65808	70038	74268
	CAM Data[1352](High)	44659	48889	53119	57349	61579	65809	70039	74269
	CAM Data[1353](Low)	44660	48890	53120	57350	61580	65810	70040	74270
	CAM Data[1353](High)	44661	48891	53121	57351	61581	65811	70041	74271
	CAM Data[1354](Low)	44662	48892	53122	57352	61582	65812	70042	74272
	CAM Data[1354](High)	44663	48893	53123	57353	61583	65813	70043	74273
	CAM Data[1355](Low)	44664	48894	53124	57354	61584	65814	70044	74274
	CAM Data[1355](High)	44665	48895	53125	57355	61585	65815	70045	74275
	CAM Data[1356](Low)	44666	48896	53126	57356	61586	65816	70046	74276

Chapter 11 Internal Memory Address of “Read/Write Variable Data” command

	CAM Data[1356](High)	44667	48897	53127	57357	61587	65817	70047	74277
	CAM Data[1357](Low)	44668	48898	53128	57358	61588	65818	70048	74278
	CAM Data[1357](High)	44669	48899	53129	57359	61589	65819	70049	74279
	CAM Data[1358](Low)	44670	48900	53130	57360	61590	65820	70050	74280
	CAM Data[1358](High)	44671	48901	53131	57361	61591	65821	70051	74281
	CAM Data[1359](Low)	44672	48902	53132	57362	61592	65822	70052	74282
	CAM Data[1359](High)	44673	48903	53133	57363	61593	65823	70053	74283
	CAM Data[1360](Low)	44674	48904	53134	57364	61594	65824	70054	74284
	CAM Data[1360](High)	44675	48905	53135	57365	61595	65825	70055	74285
	CAM Data[1361](Low)	44676	48906	53136	57366	61596	65826	70056	74286
	CAM Data[1361](High)	44677	48907	53137	57367	61597	65827	70057	74287
	CAM Data[1362](Low)	44678	48908	53138	57368	61598	65828	70058	74288
	CAM Data[1362](High)	44679	48909	53139	57369	61599	65829	70059	74289
	CAM Data[1363](Low)	44680	48910	53140	57370	61600	65830	70060	74290
	CAM Data[1363](High)	44681	48911	53141	57371	61601	65831	70061	74291
	CAM Data[1364](Low)	44682	48912	53142	57372	61602	65832	70062	74292
	CAM Data[1364](High)	44683	48913	53143	57373	61603	65833	70063	74293
	CAM Data[1365](Low)	44684	48914	53144	57374	61604	65834	70064	74294
	CAM Data[1365](High)	44685	48915	53145	57375	61605	65835	70065	74295
	CAM Data[1366](Low)	44686	48916	53146	57376	61606	65836	70066	74296
	CAM Data[1366](High)	44687	48917	53147	57377	61607	65837	70067	74297
	CAM Data[1367](Low)	44688	48918	53148	57378	61608	65838	70068	74298
	CAM Data[1367](High)	44689	48919	53149	57379	61609	65839	70069	74299
	CAM Data[1368](Low)	44690	48920	53150	57380	61610	65840	70070	74300
	CAM Data[1368](High)	44691	48921	53151	57381	61611	65841	70071	74301
	CAM Data[1369](Low)	44692	48922	53152	57382	61612	65842	70072	74302
	CAM Data[1369](High)	44693	48923	53153	57383	61613	65843	70073	74303
	CAM Data[1370](Low)	44694	48924	53154	57384	61614	65844	70074	74304
	CAM Data[1370](High)	44695	48925	53155	57385	61615	65845	70075	74305
	CAM Data[1371](Low)	44696	48926	53156	57386	61616	65846	70076	74306
	CAM Data[1371](High)	44697	48927	53157	57387	61617	65847	70077	74307
	CAM Data[1372](Low)	44698	48928	53158	57388	61618	65848	70078	74308
	CAM Data[1372](High)	44699	48929	53159	57389	61619	65849	70079	74309
	CAM Data[1373](Low)	44700	48930	53160	57390	61620	65850	70080	74310
	CAM Data[1373](High)	44701	48931	53161	57391	61621	65851	70081	74311
	CAM Data[1374](Low)	44702	48932	53162	57392	61622	65852	70082	74312
	CAM Data[1374](High)	44703	48933	53163	57393	61623	65853	70083	74313
	CAM Data[1375](Low)	44704	48934	53164	57394	61624	65854	70084	74314
	CAM Data[1375](High)	44705	48935	53165	57395	61625	65855	70085	74315
	CAM Data[1376](Low)	44706	48936	53166	57396	61626	65856	70086	74316
	CAM Data[1376](High)	44707	48937	53167	57397	61627	65857	70087	74317
	CAM Data[1377](Low)	44708	48938	53168	57398	61628	65858	70088	74318
	CAM Data[1377](High)	44709	48939	53169	57399	61629	65859	70089	74319
	CAM Data[1378](Low)	44710	48940	53170	57400	61630	65860	70090	74320
	CAM Data[1378](High)	44711	48941	53171	57401	61631	65861	70091	74321
	CAM Data[1379](Low)	44712	48942	53172	57402	61632	65862	70092	74322

Chapter 11 Internal Memory Address of “Read/Write Variable Data” command

	CAM Data[1379](High)	44713	48943	53173	57403	61633	65863	70093	74323
	CAM Data[1380](Low)	44714	48944	53174	57404	61634	65864	70094	74324
	CAM Data[1380](High)	44715	48945	53175	57405	61635	65865	70095	74325
	CAM Data[1381](Low)	44716	48946	53176	57406	61636	65866	70096	74326
	CAM Data[1381](High)	44717	48947	53177	57407	61637	65867	70097	74327
	CAM Data[1382](Low)	44718	48948	53178	57408	61638	65868	70098	74328
	CAM Data[1382](High)	44719	48949	53179	57409	61639	65869	70099	74329
	CAM Data[1383](Low)	44720	48950	53180	57410	61640	65870	70100	74330
	CAM Data[1383](High)	44721	48951	53181	57411	61641	65871	70101	74331
	CAM Data[1384](Low)	44722	48952	53182	57412	61642	65872	70102	74332
	CAM Data[1384](High)	44723	48953	53183	57413	61643	65873	70103	74333
	CAM Data[1385](Low)	44724	48954	53184	57414	61644	65874	70104	74334
	CAM Data[1385](High)	44725	48955	53185	57415	61645	65875	70105	74335
	CAM Data[1386](Low)	44726	48956	53186	57416	61646	65876	70106	74336
	CAM Data[1386](High)	44727	48957	53187	57417	61647	65877	70107	74337
	CAM Data[1387](Low)	44728	48958	53188	57418	61648	65878	70108	74338
	CAM Data[1387](High)	44729	48959	53189	57419	61649	65879	70109	74339
	CAM Data[1388](Low)	44730	48960	53190	57420	61650	65880	70110	74340
	CAM Data[1388](High)	44731	48961	53191	57421	61651	65881	70111	74341
	CAM Data[1389](Low)	44732	48962	53192	57422	61652	65882	70112	74342
	CAM Data[1389](High)	44733	48963	53193	57423	61653	65883	70113	74343
	CAM Data[1390](Low)	44734	48964	53194	57424	61654	65884	70114	74344
	CAM Data[1390](High)	44735	48965	53195	57425	61655	65885	70115	74345
	CAM Data[1391](Low)	44736	48966	53196	57426	61656	65886	70116	74346
	CAM Data[1391](High)	44737	48967	53197	57427	61657	65887	70117	74347
	CAM Data[1392](Low)	44738	48968	53198	57428	61658	65888	70118	74348
	CAM Data[1392](High)	44739	48969	53199	57429	61659	65889	70119	74349
	CAM Data[1393](Low)	44740	48970	53200	57430	61660	65890	70120	74350
	CAM Data[1393](High)	44741	48971	53201	57431	61661	65891	70121	74351
	CAM Data[1394](Low)	44742	48972	53202	57432	61662	65892	70122	74352
	CAM Data[1394](High)	44743	48973	53203	57433	61663	65893	70123	74353
	CAM Data[1395](Low)	44744	48974	53204	57434	61664	65894	70124	74354
	CAM Data[1395](High)	44745	48975	53205	57435	61665	65895	70125	74355
	CAM Data[1396](Low)	44746	48976	53206	57436	61666	65896	70126	74356
	CAM Data[1396](High)	44747	48977	53207	57437	61667	65897	70127	74357
	CAM Data[1397](Low)	44748	48978	53208	57438	61668	65898	70128	74358
	CAM Data[1397](High)	44749	48979	53209	57439	61669	65899	70129	74359
	CAM Data[1398](Low)	44750	48980	53210	57440	61670	65900	70130	74360
	CAM Data[1398](High)	44751	48981	53211	57441	61671	65901	70131	74361
	CAM Data[1399](Low)	44752	48982	53212	57442	61672	65902	70132	74362
	CAM Data[1399](High)	44753	48983	53213	57443	61673	65903	70133	74363
	CAM Data[1400](Low)	44754	48984	53214	57444	61674	65904	70134	74364
	CAM Data[1400](High)	44755	48985	53215	57445	61675	65905	70135	74365
	CAM Data[1401](Low)	44756	48986	53216	57446	61676	65906	70136	74366
	CAM Data[1401](High)	44757	48987	53217	57447	61677	65907	70137	74367
	CAM Data[1402](Low)	44758	48988	53218	57448	61678	65908	70138	74368

Chapter 11 Internal Memory Address of “Read/Write Variable Data” command

	CAM Data[1402](High)	44759	48989	53219	57449	61679	65909	70139	74369
	CAM Data[1403](Low)	44760	48990	53220	57450	61680	65910	70140	74370
	CAM Data[1403](High)	44761	48991	53221	57451	61681	65911	70141	74371
	CAM Data[1404](Low)	44762	48992	53222	57452	61682	65912	70142	74372
	CAM Data[1404](High)	44763	48993	53223	57453	61683	65913	70143	74373
	CAM Data[1405](Low)	44764	48994	53224	57454	61684	65914	70144	74374
	CAM Data[1405](High)	44765	48995	53225	57455	61685	65915	70145	74375
	CAM Data[1406](Low)	44766	48996	53226	57456	61686	65916	70146	74376
	CAM Data[1406](High)	44767	48997	53227	57457	61687	65917	70147	74377
	CAM Data[1407](Low)	44768	48998	53228	57458	61688	65918	70148	74378
	CAM Data[1407](High)	44769	48999	53229	57459	61689	65919	70149	74379
	CAM Data[1408](Low)	44770	49000	53230	57460	61690	65920	70150	74380
	CAM Data[1408](High)	44771	49001	53231	57461	61691	65921	70151	74381
	CAM Data[1409](Low)	44772	49002	53232	57462	61692	65922	70152	74382
	CAM Data[1409](High)	44773	49003	53233	57463	61693	65923	70153	74383
	CAM Data[1410](Low)	44774	49004	53234	57464	61694	65924	70154	74384
	CAM Data[1410](High)	44775	49005	53235	57465	61695	65925	70155	74385
	CAM Data[1411](Low)	44776	49006	53236	57466	61696	65926	70156	74386
	CAM Data[1411](High)	44777	49007	53237	57467	61697	65927	70157	74387
	CAM Data[1412](Low)	44778	49008	53238	57468	61698	65928	70158	74388
	CAM Data[1412](High)	44779	49009	53239	57469	61699	65929	70159	74389
	CAM Data[1413](Low)	44780	49010	53240	57470	61700	65930	70160	74390
	CAM Data[1413](High)	44781	49011	53241	57471	61701	65931	70161	74391
	CAM Data[1414](Low)	44782	49012	53242	57472	61702	65932	70162	74392
	CAM Data[1414](High)	44783	49013	53243	57473	61703	65933	70163	74393
	CAM Data[1415](Low)	44784	49014	53244	57474	61704	65934	70164	74394
	CAM Data[1415](High)	44785	49015	53245	57475	61705	65935	70165	74395
	CAM Data[1416](Low)	44786	49016	53246	57476	61706	65936	70166	74396
	CAM Data[1416](High)	44787	49017	53247	57477	61707	65937	70167	74397
	CAM Data[1417](Low)	44788	49018	53248	57478	61708	65938	70168	74398
	CAM Data[1417](High)	44789	49019	53249	57479	61709	65939	70169	74399
	CAM Data[1418](Low)	44790	49020	53250	57480	61710	65940	70170	74400
	CAM Data[1418](High)	44791	49021	53251	57481	61711	65941	70171	74401
	CAM Data[1419](Low)	44792	49022	53252	57482	61712	65942	70172	74402
	CAM Data[1419](High)	44793	49023	53253	57483	61713	65943	70173	74403
	CAM Data[1420](Low)	44794	49024	53254	57484	61714	65944	70174	74404
	CAM Data[1420](High)	44795	49025	53255	57485	61715	65945	70175	74405
	CAM Data[1421](Low)	44796	49026	53256	57486	61716	65946	70176	74406
	CAM Data[1421](High)	44797	49027	53257	57487	61717	65947	70177	74407
	CAM Data[1422](Low)	44798	49028	53258	57488	61718	65948	70178	74408
	CAM Data[1422](High)	44799	49029	53259	57489	61719	65949	70179	74409
	CAM Data[1423](Low)	44800	49030	53260	57490	61720	65950	70180	74410
	CAM Data[1423](High)	44801	49031	53261	57491	61721	65951	70181	74411
	CAM Data[1424](Low)	44802	49032	53262	57492	61722	65952	70182	74412
	CAM Data[1424](High)	44803	49033	53263	57493	61723	65953	70183	74413
	CAM Data[1425](Low)	44804	49034	53264	57494	61724	65954	70184	74414

Chapter 11 Internal Memory Address of “Read/Write Variable Data” command

	CAM Data[1425](High)	44805	49035	53265	57495	61725	65955	70185	74415
	CAM Data[1426](Low)	44806	49036	53266	57496	61726	65956	70186	74416
	CAM Data[1426](High)	44807	49037	53267	57497	61727	65957	70187	74417
	CAM Data[1427](Low)	44808	49038	53268	57498	61728	65958	70188	74418
	CAM Data[1427](High)	44809	49039	53269	57499	61729	65959	70189	74419
	CAM Data[1428](Low)	44810	49040	53270	57500	61730	65960	70190	74420
	CAM Data[1428](High)	44811	49041	53271	57501	61731	65961	70191	74421
	CAM Data[1429](Low)	44812	49042	53272	57502	61732	65962	70192	74422
	CAM Data[1429](High)	44813	49043	53273	57503	61733	65963	70193	74423
	CAM Data[1430](Low)	44814	49044	53274	57504	61734	65964	70194	74424
	CAM Data[1430](High)	44815	49045	53275	57505	61735	65965	70195	74425
	CAM Data[1431](Low)	44816	49046	53276	57506	61736	65966	70196	74426
	CAM Data[1431](High)	44817	49047	53277	57507	61737	65967	70197	74427
	CAM Data[1432](Low)	44818	49048	53278	57508	61738	65968	70198	74428
	CAM Data[1432](High)	44819	49049	53279	57509	61739	65969	70199	74429
	CAM Data[1433](Low)	44820	49050	53280	57510	61740	65970	70200	74430
	CAM Data[1433](High)	44821	49051	53281	57511	61741	65971	70201	74431
	CAM Data[1434](Low)	44822	49052	53282	57512	61742	65972	70202	74432
	CAM Data[1434](High)	44823	49053	53283	57513	61743	65973	70203	74433
	CAM Data[1435](Low)	44824	49054	53284	57514	61744	65974	70204	74434
	CAM Data[1435](High)	44825	49055	53285	57515	61745	65975	70205	74435
	CAM Data[1436](Low)	44826	49056	53286	57516	61746	65976	70206	74436
	CAM Data[1436](High)	44827	49057	53287	57517	61747	65977	70207	74437
	CAM Data[1437](Low)	44828	49058	53288	57518	61748	65978	70208	74438
	CAM Data[1437](High)	44829	49059	53289	57519	61749	65979	70209	74439
	CAM Data[1438](Low)	44830	49060	53290	57520	61750	65980	70210	74440
	CAM Data[1438](High)	44831	49061	53291	57521	61751	65981	70211	74441
	CAM Data[1439](Low)	44832	49062	53292	57522	61752	65982	70212	74442
	CAM Data[1439](High)	44833	49063	53293	57523	61753	65983	70213	74443
	CAM Data[1440](Low)	44834	49064	53294	57524	61754	65984	70214	74444
	CAM Data[1440](High)	44835	49065	53295	57525	61755	65985	70215	74445
	CAM Data[1441](Low)	44836	49066	53296	57526	61756	65986	70216	74446
	CAM Data[1441](High)	44837	49067	53297	57527	61757	65987	70217	74447
	CAM Data[1442](Low)	44838	49068	53298	57528	61758	65988	70218	74448
	CAM Data[1442](High)	44839	49069	53299	57529	61759	65989	70219	74449
	CAM Data[1443](Low)	44840	49070	53300	57530	61760	65990	70220	74450
	CAM Data[1443](High)	44841	49071	53301	57531	61761	65991	70221	74451
	CAM Data[1444](Low)	44842	49072	53302	57532	61762	65992	70222	74452
	CAM Data[1444](High)	44843	49073	53303	57533	61763	65993	70223	74453
	CAM Data[1445](Low)	44844	49074	53304	57534	61764	65994	70224	74454
	CAM Data[1445](High)	44845	49075	53305	57535	61765	65995	70225	74455
	CAM Data[1446](Low)	44846	49076	53306	57536	61766	65996	70226	74456
	CAM Data[1446](High)	44847	49077	53307	57537	61767	65997	70227	74457
	CAM Data[1447](Low)	44848	49078	53308	57538	61768	65998	70228	74458
	CAM Data[1447](High)	44849	49079	53309	57539	61769	65999	70229	74459
	CAM Data[1448](Low)	44850	49080	53310	57540	61770	66000	70230	74460

Chapter 11 Internal Memory Address of “Read/Write Variable Data” command

	CAM Data[1448](High)	44851	49081	53311	57541	61771	66001	70231	74461
	CAM Data[1449](Low)	44852	49082	53312	57542	61772	66002	70232	74462
	CAM Data[1449](High)	44853	49083	53313	57543	61773	66003	70233	74463
	CAM Data[1450](Low)	44854	49084	53314	57544	61774	66004	70234	74464
	CAM Data[1450](High)	44855	49085	53315	57545	61775	66005	70235	74465
	CAM Data[1451](Low)	44856	49086	53316	57546	61776	66006	70236	74466
	CAM Data[1451](High)	44857	49087	53317	57547	61777	66007	70237	74467
	CAM Data[1452](Low)	44858	49088	53318	57548	61778	66008	70238	74468
	CAM Data[1452](High)	44859	49089	53319	57549	61779	66009	70239	74469
	CAM Data[1453](Low)	44860	49090	53320	57550	61780	66010	70240	74470
	CAM Data[1453](High)	44861	49091	53321	57551	61781	66011	70241	74471
	CAM Data[1454](Low)	44862	49092	53322	57552	61782	66012	70242	74472
	CAM Data[1454](High)	44863	49093	53323	57553	61783	66013	70243	74473
	CAM Data[1455](Low)	44864	49094	53324	57554	61784	66014	70244	74474
	CAM Data[1455](High)	44865	49095	53325	57555	61785	66015	70245	74475
	CAM Data[1456](Low)	44866	49096	53326	57556	61786	66016	70246	74476
	CAM Data[1456](High)	44867	49097	53327	57557	61787	66017	70247	74477
	CAM Data[1457](Low)	44868	49098	53328	57558	61788	66018	70248	74478
	CAM Data[1457](High)	44869	49099	53329	57559	61789	66019	70249	74479
	CAM Data[1458](Low)	44870	49100	53330	57560	61790	66020	70250	74480
	CAM Data[1458](High)	44871	49101	53331	57561	61791	66021	70251	74481
	CAM Data[1459](Low)	44872	49102	53332	57562	61792	66022	70252	74482
	CAM Data[1459](High)	44873	49103	53333	57563	61793	66023	70253	74483
	CAM Data[1460](Low)	44874	49104	53334	57564	61794	66024	70254	74484
	CAM Data[1460](High)	44875	49105	53335	57565	61795	66025	70255	74485
	CAM Data[1461](Low)	44876	49106	53336	57566	61796	66026	70256	74486
	CAM Data[1461](High)	44877	49107	53337	57567	61797	66027	70257	74487
	CAM Data[1462](Low)	44878	49108	53338	57568	61798	66028	70258	74488
	CAM Data[1462](High)	44879	49109	53339	57569	61799	66029	70259	74489
	CAM Data[1463](Low)	44880	49110	53340	57570	61800	66030	70260	74490
	CAM Data[1463](High)	44881	49111	53341	57571	61801	66031	70261	74491
	CAM Data[1464](Low)	44882	49112	53342	57572	61802	66032	70262	74492
	CAM Data[1464](High)	44883	49113	53343	57573	61803	66033	70263	74493
	CAM Data[1465](Low)	44884	49114	53344	57574	61804	66034	70264	74494
	CAM Data[1465](High)	44885	49115	53345	57575	61805	66035	70265	74495
	CAM Data[1466](Low)	44886	49116	53346	57576	61806	66036	70266	74496
	CAM Data[1466](High)	44887	49117	53347	57577	61807	66037	70267	74497
	CAM Data[1467](Low)	44888	49118	53348	57578	61808	66038	70268	74498
	CAM Data[1467](High)	44889	49119	53349	57579	61809	66039	70269	74499
	CAM Data[1468](Low)	44890	49120	53350	57580	61810	66040	70270	74500
	CAM Data[1468](High)	44891	49121	53351	57581	61811	66041	70271	74501
	CAM Data[1469](Low)	44892	49122	53352	57582	61812	66042	70272	74502
	CAM Data[1469](High)	44893	49123	53353	57583	61813	66043	70273	74503
	CAM Data[1470](Low)	44894	49124	53354	57584	61814	66044	70274	74504
	CAM Data[1470](High)	44895	49125	53355	57585	61815	66045	70275	74505
	CAM Data[1471](Low)	44896	49126	53356	57586	61816	66046	70276	74506

Chapter 11 Internal Memory Address of “Read/Write Variable Data” command

	CAM Data[1471](High)	44897	49127	53357	57587	61817	66047	70277	74507
	CAM Data[1472](Low)	44898	49128	53358	57588	61818	66048	70278	74508
	CAM Data[1472](High)	44899	49129	53359	57589	61819	66049	70279	74509
	CAM Data[1473](Low)	44900	49130	53360	57590	61820	66050	70280	74510
	CAM Data[1473](High)	44901	49131	53361	57591	61821	66051	70281	74511
	CAM Data[1474](Low)	44902	49132	53362	57592	61822	66052	70282	74512
	CAM Data[1474](High)	44903	49133	53363	57593	61823	66053	70283	74513
	CAM Data[1475](Low)	44904	49134	53364	57594	61824	66054	70284	74514
	CAM Data[1475](High)	44905	49135	53365	57595	61825	66055	70285	74515
	CAM Data[1476](Low)	44906	49136	53366	57596	61826	66056	70286	74516
	CAM Data[1476](High)	44907	49137	53367	57597	61827	66057	70287	74517
	CAM Data[1477](Low)	44908	49138	53368	57598	61828	66058	70288	74518
	CAM Data[1477](High)	44909	49139	53369	57599	61829	66059	70289	74519
	CAM Data[1478](Low)	44910	49140	53370	57600	61830	66060	70290	74520
	CAM Data[1478](High)	44911	49141	53371	57601	61831	66061	70291	74521
	CAM Data[1479](Low)	44912	49142	53372	57602	61832	66062	70292	74522
	CAM Data[1479](High)	44913	49143	53373	57603	61833	66063	70293	74523
	CAM Data[1480](Low)	44914	49144	53374	57604	61834	66064	70294	74524
	CAM Data[1480](High)	44915	49145	53375	57605	61835	66065	70295	74525
	CAM Data[1481](Low)	44916	49146	53376	57606	61836	66066	70296	74526
	CAM Data[1481](High)	44917	49147	53377	57607	61837	66067	70297	74527
	CAM Data[1482](Low)	44918	49148	53378	57608	61838	66068	70298	74528
	CAM Data[1482](High)	44919	49149	53379	57609	61839	66069	70299	74529
	CAM Data[1483](Low)	44920	49150	53380	57610	61840	66070	70300	74530
	CAM Data[1483](High)	44921	49151	53381	57611	61841	66071	70301	74531
	CAM Data[1484](Low)	44922	49152	53382	57612	61842	66072	70302	74532
	CAM Data[1484](High)	44923	49153	53383	57613	61843	66073	70303	74533
	CAM Data[1485](Low)	44924	49154	53384	57614	61844	66074	70304	74534
	CAM Data[1485](High)	44925	49155	53385	57615	61845	66075	70305	74535
	CAM Data[1486](Low)	44926	49156	53386	57616	61846	66076	70306	74536
	CAM Data[1486](High)	44927	49157	53387	57617	61847	66077	70307	74537
	CAM Data[1487](Low)	44928	49158	53388	57618	61848	66078	70308	74538
	CAM Data[1487](High)	44929	49159	53389	57619	61849	66079	70309	74539
	CAM Data[1488](Low)	44930	49160	53390	57620	61850	66080	70310	74540
	CAM Data[1488](High)	44931	49161	53391	57621	61851	66081	70311	74541
	CAM Data[1489](Low)	44932	49162	53392	57622	61852	66082	70312	74542
	CAM Data[1489](High)	44933	49163	53393	57623	61853	66083	70313	74543
	CAM Data[1490](Low)	44934	49164	53394	57624	61854	66084	70314	74544
	CAM Data[1490](High)	44935	49165	53395	57625	61855	66085	70315	74545
	CAM Data[1491](Low)	44936	49166	53396	57626	61856	66086	70316	74546
	CAM Data[1491](High)	44937	49167	53397	57627	61857	66087	70317	74547
	CAM Data[1492](Low)	44938	49168	53398	57628	61858	66088	70318	74548
	CAM Data[1492](High)	44939	49169	53399	57629	61859	66089	70319	74549
	CAM Data[1493](Low)	44940	49170	53400	57630	61860	66090	70320	74550
	CAM Data[1493](High)	44941	49171	53401	57631	61861	66091	70321	74551
	CAM Data[1494](Low)	44942	49172	53402	57632	61862	66092	70322	74552

Chapter 11 Internal Memory Address of “Read/Write Variable Data” command

	CAM Data[1494](High)	44943	49173	53403	57633	61863	66093	70323	74553
	CAM Data[1495](Low)	44944	49174	53404	57634	61864	66094	70324	74554
	CAM Data[1495](High)	44945	49175	53405	57635	61865	66095	70325	74555
	CAM Data[1496](Low)	44946	49176	53406	57636	61866	66096	70326	74556
	CAM Data[1496](High)	44947	49177	53407	57637	61867	66097	70327	74557
	CAM Data[1497](Low)	44948	49178	53408	57638	61868	66098	70328	74558
	CAM Data[1497](High)	44949	49179	53409	57639	61869	66099	70329	74559
	CAM Data[1498](Low)	44950	49180	53410	57640	61870	66100	70330	74560
	CAM Data[1498](High)	44951	49181	53411	57641	61871	66101	70331	74561
	CAM Data[1499](Low)	44952	49182	53412	57642	61872	66102	70332	74562
	CAM Data[1499](High)	44953	49183	53413	57643	61873	66103	70333	74563
	CAM Data[1500](Low)	44954	49184	53414	57644	61874	66104	70334	74564
	CAM Data[1500](High)	44955	49185	53415	57645	61875	66105	70335	74565
	CAM Data[1501](Low)	44956	49186	53416	57646	61876	66106	70336	74566
	CAM Data[1501](High)	44957	49187	53417	57647	61877	66107	70337	74567
	CAM Data[1502](Low)	44958	49188	53418	57648	61878	66108	70338	74568
	CAM Data[1502](High)	44959	49189	53419	57649	61879	66109	70339	74569
	CAM Data[1503](Low)	44960	49190	53420	57650	61880	66110	70340	74570
	CAM Data[1503](High)	44961	49191	53421	57651	61881	66111	70341	74571
	CAM Data[1504](Low)	44962	49192	53422	57652	61882	66112	70342	74572
	CAM Data[1504](High)	44963	49193	53423	57653	61883	66113	70343	74573
	CAM Data[1505](Low)	44964	49194	53424	57654	61884	66114	70344	74574
	CAM Data[1505](High)	44965	49195	53425	57655	61885	66115	70345	74575
	CAM Data[1506](Low)	44966	49196	53426	57656	61886	66116	70346	74576
	CAM Data[1506](High)	44967	49197	53427	57657	61887	66117	70347	74577
	CAM Data[1507](Low)	44968	49198	53428	57658	61888	66118	70348	74578
	CAM Data[1507](High)	44969	49199	53429	57659	61889	66119	70349	74579
	CAM Data[1508](Low)	44970	49200	53430	57660	61890	66120	70350	74580
	CAM Data[1508](High)	44971	49201	53431	57661	61891	66121	70351	74581
	CAM Data[1509](Low)	44972	49202	53432	57662	61892	66122	70352	74582
	CAM Data[1509](High)	44973	49203	53433	57663	61893	66123	70353	74583
	CAM Data[1510](Low)	44974	49204	53434	57664	61894	66124	70354	74584
	CAM Data[1510](High)	44975	49205	53435	57665	61895	66125	70355	74585
	CAM Data[1511](Low)	44976	49206	53436	57666	61896	66126	70356	74586
	CAM Data[1511](High)	44977	49207	53437	57667	61897	66127	70357	74587
	CAM Data[1512](Low)	44978	49208	53438	57668	61898	66128	70358	74588
	CAM Data[1512](High)	44979	49209	53439	57669	61899	66129	70359	74589
	CAM Data[1513](Low)	44980	49210	53440	57670	61900	66130	70360	74590
	CAM Data[1513](High)	44981	49211	53441	57671	61901	66131	70361	74591
	CAM Data[1514](Low)	44982	49212	53442	57672	61902	66132	70362	74592
	CAM Data[1514](High)	44983	49213	53443	57673	61903	66133	70363	74593
	CAM Data[1515](Low)	44984	49214	53444	57674	61904	66134	70364	74594
	CAM Data[1515](High)	44985	49215	53445	57675	61905	66135	70365	74595
	CAM Data[1516](Low)	44986	49216	53446	57676	61906	66136	70366	74596
	CAM Data[1516](High)	44987	49217	53447	57677	61907	66137	70367	74597
	CAM Data[1517](Low)	44988	49218	53448	57678	61908	66138	70368	74598

Chapter 11 Internal Memory Address of “Read/Write Variable Data” command

	CAM Data[1517](High)	44989	49219	53449	57679	61909	66139	70369	74599
	CAM Data[1518](Low)	44990	49220	53450	57680	61910	66140	70370	74600
	CAM Data[1518](High)	44991	49221	53451	57681	61911	66141	70371	74601
	CAM Data[1519](Low)	44992	49222	53452	57682	61912	66142	70372	74602
	CAM Data[1519](High)	44993	49223	53453	57683	61913	66143	70373	74603
	CAM Data[1520](Low)	44994	49224	53454	57684	61914	66144	70374	74604
	CAM Data[1520](High)	44995	49225	53455	57685	61915	66145	70375	74605
	CAM Data[1521](Low)	44996	49226	53456	57686	61916	66146	70376	74606
	CAM Data[1521](High)	44997	49227	53457	57687	61917	66147	70377	74607
	CAM Data[1522](Low)	44998	49228	53458	57688	61918	66148	70378	74608
	CAM Data[1522](High)	44999	49229	53459	57689	61919	66149	70379	74609
	CAM Data[1523](Low)	45000	49230	53460	57690	61920	66150	70380	74610
	CAM Data[1523](High)	45001	49231	53461	57691	61921	66151	70381	74611
	CAM Data[1524](Low)	45002	49232	53462	57692	61922	66152	70382	74612
	CAM Data[1524](High)	45003	49233	53463	57693	61923	66153	70383	74613
	CAM Data[1525](Low)	45004	49234	53464	57694	61924	66154	70384	74614
	CAM Data[1525](High)	45005	49235	53465	57695	61925	66155	70385	74615
	CAM Data[1526](Low)	45006	49236	53466	57696	61926	66156	70386	74616
	CAM Data[1526](High)	45007	49237	53467	57697	61927	66157	70387	74617
	CAM Data[1527](Low)	45008	49238	53468	57698	61928	66158	70388	74618
	CAM Data[1527](High)	45009	49239	53469	57699	61929	66159	70389	74619
	CAM Data[1528](Low)	45010	49240	53470	57700	61930	66160	70390	74620
	CAM Data[1528](High)	45011	49241	53471	57701	61931	66161	70391	74621
	CAM Data[1529](Low)	45012	49242	53472	57702	61932	66162	70392	74622
	CAM Data[1529](High)	45013	49243	53473	57703	61933	66163	70393	74623
	CAM Data[1530](Low)	45014	49244	53474	57704	61934	66164	70394	74624
	CAM Data[1530](High)	45015	49245	53475	57705	61935	66165	70395	74625
	CAM Data[1531](Low)	45016	49246	53476	57706	61936	66166	70396	74626
	CAM Data[1531](High)	45017	49247	53477	57707	61937	66167	70397	74627
	CAM Data[1532](Low)	45018	49248	53478	57708	61938	66168	70398	74628
	CAM Data[1532](High)	45019	49249	53479	57709	61939	66169	70399	74629
	CAM Data[1533](Low)	45020	49250	53480	57710	61940	66170	70400	74630
	CAM Data[1533](High)	45021	49251	53481	57711	61941	66171	70401	74631
	CAM Data[1534](Low)	45022	49252	53482	57712	61942	66172	70402	74632
	CAM Data[1534](High)	45023	49253	53483	57713	61943	66173	70403	74633
	CAM Data[1535](Low)	45024	49254	53484	57714	61944	66174	70404	74634
	CAM Data[1535](High)	45025	49255	53485	57715	61945	66175	70405	74635
	CAM Data[1536](Low)	45026	49256	53486	57716	61946	66176	70406	74636
	CAM Data[1536](High)	45027	49257	53487	57717	61947	66177	70407	74637
	CAM Data[1537](Low)	45028	49258	53488	57718	61948	66178	70408	74638
	CAM Data[1537](High)	45029	49259	53489	57719	61949	66179	70409	74639
	CAM Data[1538](Low)	45030	49260	53490	57720	61950	66180	70410	74640
	CAM Data[1538](High)	45031	49261	53491	57721	61951	66181	70411	74641
	CAM Data[1539](Low)	45032	49262	53492	57722	61952	66182	70412	74642
	CAM Data[1539](High)	45033	49263	53493	57723	61953	66183	70413	74643
	CAM Data[1540](Low)	45034	49264	53494	57724	61954	66184	70414	74644

Chapter 11 Internal Memory Address of “Read/Write Variable Data” command

	CAM Data[1540](High)	45035	49265	53495	57725	61955	66185	70415	74645
	CAM Data[1541](Low)	45036	49266	53496	57726	61956	66186	70416	74646
	CAM Data[1541](High)	45037	49267	53497	57727	61957	66187	70417	74647
	CAM Data[1542](Low)	45038	49268	53498	57728	61958	66188	70418	74648
	CAM Data[1542](High)	45039	49269	53499	57729	61959	66189	70419	74649
	CAM Data[1543](Low)	45040	49270	53500	57730	61960	66190	70420	74650
	CAM Data[1543](High)	45041	49271	53501	57731	61961	66191	70421	74651
	CAM Data[1544](Low)	45042	49272	53502	57732	61962	66192	70422	74652
	CAM Data[1544](High)	45043	49273	53503	57733	61963	66193	70423	74653
	CAM Data[1545](Low)	45044	49274	53504	57734	61964	66194	70424	74654
	CAM Data[1545](High)	45045	49275	53505	57735	61965	66195	70425	74655
	CAM Data[1546](Low)	45046	49276	53506	57736	61966	66196	70426	74656
	CAM Data[1546](High)	45047	49277	53507	57737	61967	66197	70427	74657
	CAM Data[1547](Low)	45048	49278	53508	57738	61968	66198	70428	74658
	CAM Data[1547](High)	45049	49279	53509	57739	61969	66199	70429	74659
	CAM Data[1548](Low)	45050	49280	53510	57740	61970	66200	70430	74660
	CAM Data[1548](High)	45051	49281	53511	57741	61971	66201	70431	74661
	CAM Data[1549](Low)	45052	49282	53512	57742	61972	66202	70432	74662
	CAM Data[1549](High)	45053	49283	53513	57743	61973	66203	70433	74663
	CAM Data[1550](Low)	45054	49284	53514	57744	61974	66204	70434	74664
	CAM Data[1550](High)	45055	49285	53515	57745	61975	66205	70435	74665
	CAM Data[1551](Low)	45056	49286	53516	57746	61976	66206	70436	74666
	CAM Data[1551](High)	45057	49287	53517	57747	61977	66207	70437	74667
	CAM Data[1552](Low)	45058	49288	53518	57748	61978	66208	70438	74668
	CAM Data[1552](High)	45059	49289	53519	57749	61979	66209	70439	74669
	CAM Data[1553](Low)	45060	49290	53520	57750	61980	66210	70440	74670
	CAM Data[1553](High)	45061	49291	53521	57751	61981	66211	70441	74671
	CAM Data[1554](Low)	45062	49292	53522	57752	61982	66212	70442	74672
	CAM Data[1554](High)	45063	49293	53523	57753	61983	66213	70443	74673
	CAM Data[1555](Low)	45064	49294	53524	57754	61984	66214	70444	74674
	CAM Data[1555](High)	45065	49295	53525	57755	61985	66215	70445	74675
	CAM Data[1556](Low)	45066	49296	53526	57756	61986	66216	70446	74676
	CAM Data[1556](High)	45067	49297	53527	57757	61987	66217	70447	74677
	CAM Data[1557](Low)	45068	49298	53528	57758	61988	66218	70448	74678
	CAM Data[1557](High)	45069	49299	53529	57759	61989	66219	70449	74679
	CAM Data[1558](Low)	45070	49300	53530	57760	61990	66220	70450	74680
	CAM Data[1558](High)	45071	49301	53531	57761	61991	66221	70451	74681
	CAM Data[1559](Low)	45072	49302	53532	57762	61992	66222	70452	74682
	CAM Data[1559](High)	45073	49303	53533	57763	61993	66223	70453	74683
	CAM Data[1560](Low)	45074	49304	53534	57764	61994	66224	70454	74684
	CAM Data[1560](High)	45075	49305	53535	57765	61995	66225	70455	74685
	CAM Data[1561](Low)	45076	49306	53536	57766	61996	66226	70456	74686
	CAM Data[1561](High)	45077	49307	53537	57767	61997	66227	70457	74687
	CAM Data[1562](Low)	45078	49308	53538	57768	61998	66228	70458	74688
	CAM Data[1562](High)	45079	49309	53539	57769	61999	66229	70459	74689
	CAM Data[1563](Low)	45080	49310	53540	57770	62000	66230	70460	74690

Chapter 11 Internal Memory Address of “Read/Write Variable Data” command

	CAM Data[1563](High)	45081	49311	53541	57771	62001	66231	70461	74691
	CAM Data[1564](Low)	45082	49312	53542	57772	62002	66232	70462	74692
	CAM Data[1564](High)	45083	49313	53543	57773	62003	66233	70463	74693
	CAM Data[1565](Low)	45084	49314	53544	57774	62004	66234	70464	74694
	CAM Data[1565](High)	45085	49315	53545	57775	62005	66235	70465	74695
	CAM Data[1566](Low)	45086	49316	53546	57776	62006	66236	70466	74696
	CAM Data[1566](High)	45087	49317	53547	57777	62007	66237	70467	74697
	CAM Data[1567](Low)	45088	49318	53548	57778	62008	66238	70468	74698
	CAM Data[1567](High)	45089	49319	53549	57779	62009	66239	70469	74699
	CAM Data[1568](Low)	45090	49320	53550	57780	62010	66240	70470	74700
	CAM Data[1568](High)	45091	49321	53551	57781	62011	66241	70471	74701
	CAM Data[1569](Low)	45092	49322	53552	57782	62012	66242	70472	74702
	CAM Data[1569](High)	45093	49323	53553	57783	62013	66243	70473	74703
	CAM Data[1570](Low)	45094	49324	53554	57784	62014	66244	70474	74704
	CAM Data[1570](High)	45095	49325	53555	57785	62015	66245	70475	74705
	CAM Data[1571](Low)	45096	49326	53556	57786	62016	66246	70476	74706
	CAM Data[1571](High)	45097	49327	53557	57787	62017	66247	70477	74707
	CAM Data[1572](Low)	45098	49328	53558	57788	62018	66248	70478	74708
	CAM Data[1572](High)	45099	49329	53559	57789	62019	66249	70479	74709
	CAM Data[1573](Low)	45100	49330	53560	57790	62020	66250	70480	74710
	CAM Data[1573](High)	45101	49331	53561	57791	62021	66251	70481	74711
	CAM Data[1574](Low)	45102	49332	53562	57792	62022	66252	70482	74712
	CAM Data[1574](High)	45103	49333	53563	57793	62023	66253	70483	74713
	CAM Data[1575](Low)	45104	49334	53564	57794	62024	66254	70484	74714
	CAM Data[1575](High)	45105	49335	53565	57795	62025	66255	70485	74715
	CAM Data[1576](Low)	45106	49336	53566	57796	62026	66256	70486	74716
	CAM Data[1576](High)	45107	49337	53567	57797	62027	66257	70487	74717
	CAM Data[1577](Low)	45108	49338	53568	57798	62028	66258	70488	74718
	CAM Data[1577](High)	45109	49339	53569	57799	62029	66259	70489	74719
	CAM Data[1578](Low)	45110	49340	53570	57800	62030	66260	70490	74720
	CAM Data[1578](High)	45111	49341	53571	57801	62031	66261	70491	74721
	CAM Data[1579](Low)	45112	49342	53572	57802	62032	66262	70492	74722
	CAM Data[1579](High)	45113	49343	53573	57803	62033	66263	70493	74723
	CAM Data[1580](Low)	45114	49344	53574	57804	62034	66264	70494	74724
	CAM Data[1580](High)	45115	49345	53575	57805	62035	66265	70495	74725
	CAM Data[1581](Low)	45116	49346	53576	57806	62036	66266	70496	74726
	CAM Data[1581](High)	45117	49347	53577	57807	62037	66267	70497	74727
	CAM Data[1582](Low)	45118	49348	53578	57808	62038	66268	70498	74728
	CAM Data[1582](High)	45119	49349	53579	57809	62039	66269	70499	74729
	CAM Data[1583](Low)	45120	49350	53580	57810	62040	66270	70500	74730
	CAM Data[1583](High)	45121	49351	53581	57811	62041	66271	70501	74731
	CAM Data[1584](Low)	45122	49352	53582	57812	62042	66272	70502	74732
	CAM Data[1584](High)	45123	49353	53583	57813	62043	66273	70503	74733
	CAM Data[1585](Low)	45124	49354	53584	57814	62044	66274	70504	74734
	CAM Data[1585](High)	45125	49355	53585	57815	62045	66275	70505	74735
	CAM Data[1586](Low)	45126	49356	53586	57816	62046	66276	70506	74736

Chapter 11 Internal Memory Address of “Read/Write Variable Data” command

	CAM Data[1586](High)	45127	49357	53587	57817	62047	66277	70507	74737
	CAM Data[1587](Low)	45128	49358	53588	57818	62048	66278	70508	74738
	CAM Data[1587](High)	45129	49359	53589	57819	62049	66279	70509	74739
	CAM Data[1588](Low)	45130	49360	53590	57820	62050	66280	70510	74740
	CAM Data[1588](High)	45131	49361	53591	57821	62051	66281	70511	74741
	CAM Data[1589](Low)	45132	49362	53592	57822	62052	66282	70512	74742
	CAM Data[1589](High)	45133	49363	53593	57823	62053	66283	70513	74743
	CAM Data[1590](Low)	45134	49364	53594	57824	62054	66284	70514	74744
	CAM Data[1590](High)	45135	49365	53595	57825	62055	66285	70515	74745
	CAM Data[1591](Low)	45136	49366	53596	57826	62056	66286	70516	74746
	CAM Data[1591](High)	45137	49367	53597	57827	62057	66287	70517	74747
	CAM Data[1592](Low)	45138	49368	53598	57828	62058	66288	70518	74748
	CAM Data[1592](High)	45139	49369	53599	57829	62059	66289	70519	74749
	CAM Data[1593](Low)	45140	49370	53600	57830	62060	66290	70520	74750
	CAM Data[1593](High)	45141	49371	53601	57831	62061	66291	70521	74751
	CAM Data[1594](Low)	45142	49372	53602	57832	62062	66292	70522	74752
	CAM Data[1594](High)	45143	49373	53603	57833	62063	66293	70523	74753
	CAM Data[1595](Low)	45144	49374	53604	57834	62064	66294	70524	74754
	CAM Data[1595](High)	45145	49375	53605	57835	62065	66295	70525	74755
	CAM Data[1596](Low)	45146	49376	53606	57836	62066	66296	70526	74756
	CAM Data[1596](High)	45147	49377	53607	57837	62067	66297	70527	74757
	CAM Data[1597](Low)	45148	49378	53608	57838	62068	66298	70528	74758
	CAM Data[1597](High)	45149	49379	53609	57839	62069	66299	70529	74759
	CAM Data[1598](Low)	45150	49380	53610	57840	62070	66300	70530	74760
	CAM Data[1598](High)	45151	49381	53611	57841	62071	66301	70531	74761
	CAM Data[1599](Low)	45152	49382	53612	57842	62072	66302	70532	74762
	CAM Data[1599](High)	45153	49383	53613	57843	62073	66303	70533	74763
	CAM Data[1600](Low)	45154	49384	53614	57844	62074	66304	70534	74764
	CAM Data[1600](High)	45155	49385	53615	57845	62075	66305	70535	74765
	CAM Data[1601](Low)	45156	49386	53616	57846	62076	66306	70536	74766
	CAM Data[1601](High)	45157	49387	53617	57847	62077	66307	70537	74767
	CAM Data[1602](Low)	45158	49388	53618	57848	62078	66308	70538	74768
	CAM Data[1602](High)	45159	49389	53619	57849	62079	66309	70539	74769
	CAM Data[1603](Low)	45160	49390	53620	57850	62080	66310	70540	74770
	CAM Data[1603](High)	45161	49391	53621	57851	62081	66311	70541	74771
	CAM Data[1604](Low)	45162	49392	53622	57852	62082	66312	70542	74772
	CAM Data[1604](High)	45163	49393	53623	57853	62083	66313	70543	74773
	CAM Data[1605](Low)	45164	49394	53624	57854	62084	66314	70544	74774
	CAM Data[1605](High)	45165	49395	53625	57855	62085	66315	70545	74775
	CAM Data[1606](Low)	45166	49396	53626	57856	62086	66316	70546	74776
	CAM Data[1606](High)	45167	49397	53627	57857	62087	66317	70547	74777
	CAM Data[1607](Low)	45168	49398	53628	57858	62088	66318	70548	74778
	CAM Data[1607](High)	45169	49399	53629	57859	62089	66319	70549	74779
	CAM Data[1608](Low)	45170	49400	53630	57860	62090	66320	70550	74780
	CAM Data[1608](High)	45171	49401	53631	57861	62091	66321	70551	74781
	CAM Data[1609](Low)	45172	49402	53632	57862	62092	66322	70552	74782

Chapter 11 Internal Memory Address of “Read/Write Variable Data” command

	CAM Data[1609](High)	45173	49403	53633	57863	62093	66323	70553	74783
	CAM Data[1610](Low)	45174	49404	53634	57864	62094	66324	70554	74784
	CAM Data[1610](High)	45175	49405	53635	57865	62095	66325	70555	74785
	CAM Data[1611](Low)	45176	49406	53636	57866	62096	66326	70556	74786
	CAM Data[1611](High)	45177	49407	53637	57867	62097	66327	70557	74787
	CAM Data[1612](Low)	45178	49408	53638	57868	62098	66328	70558	74788
	CAM Data[1612](High)	45179	49409	53639	57869	62099	66329	70559	74789
	CAM Data[1613](Low)	45180	49410	53640	57870	62100	66330	70560	74790
	CAM Data[1613](High)	45181	49411	53641	57871	62101	66331	70561	74791
	CAM Data[1614](Low)	45182	49412	53642	57872	62102	66332	70562	74792
	CAM Data[1614](High)	45183	49413	53643	57873	62103	66333	70563	74793
	CAM Data[1615](Low)	45184	49414	53644	57874	62104	66334	70564	74794
	CAM Data[1615](High)	45185	49415	53645	57875	62105	66335	70565	74795
	CAM Data[1616](Low)	45186	49416	53646	57876	62106	66336	70566	74796
	CAM Data[1616](High)	45187	49417	53647	57877	62107	66337	70567	74797
	CAM Data[1617](Low)	45188	49418	53648	57878	62108	66338	70568	74798
	CAM Data[1617](High)	45189	49419	53649	57879	62109	66339	70569	74799
	CAM Data[1618](Low)	45190	49420	53650	57880	62110	66340	70570	74800
	CAM Data[1618](High)	45191	49421	53651	57881	62111	66341	70571	74801
	CAM Data[1619](Low)	45192	49422	53652	57882	62112	66342	70572	74802
	CAM Data[1619](High)	45193	49423	53653	57883	62113	66343	70573	74803
	CAM Data[1620](Low)	45194	49424	53654	57884	62114	66344	70574	74804
	CAM Data[1620](High)	45195	49425	53655	57885	62115	66345	70575	74805
	CAM Data[1621](Low)	45196	49426	53656	57886	62116	66346	70576	74806
	CAM Data[1621](High)	45197	49427	53657	57887	62117	66347	70577	74807
	CAM Data[1622](Low)	45198	49428	53658	57888	62118	66348	70578	74808
	CAM Data[1622](High)	45199	49429	53659	57889	62119	66349	70579	74809
	CAM Data[1623](Low)	45200	49430	53660	57890	62120	66350	70580	74810
	CAM Data[1623](High)	45201	49431	53661	57891	62121	66351	70581	74811
	CAM Data[1624](Low)	45202	49432	53662	57892	62122	66352	70582	74812
	CAM Data[1624](High)	45203	49433	53663	57893	62123	66353	70583	74813
	CAM Data[1625](Low)	45204	49434	53664	57894	62124	66354	70584	74814
	CAM Data[1625](High)	45205	49435	53665	57895	62125	66355	70585	74815
	CAM Data[1626](Low)	45206	49436	53666	57896	62126	66356	70586	74816
	CAM Data[1626](High)	45207	49437	53667	57897	62127	66357	70587	74817
	CAM Data[1627](Low)	45208	49438	53668	57898	62128	66358	70588	74818
	CAM Data[1627](High)	45209	49439	53669	57899	62129	66359	70589	74819
	CAM Data[1628](Low)	45210	49440	53670	57900	62130	66360	70590	74820
	CAM Data[1628](High)	45211	49441	53671	57901	62131	66361	70591	74821
	CAM Data[1629](Low)	45212	49442	53672	57902	62132	66362	70592	74822
	CAM Data[1629](High)	45213	49443	53673	57903	62133	66363	70593	74823
	CAM Data[1630](Low)	45214	49444	53674	57904	62134	66364	70594	74824
	CAM Data[1630](High)	45215	49445	53675	57905	62135	66365	70595	74825
	CAM Data[1631](Low)	45216	49446	53676	57906	62136	66366	70596	74826
	CAM Data[1631](High)	45217	49447	53677	57907	62137	66367	70597	74827
	CAM Data[1632](Low)	45218	49448	53678	57908	62138	66368	70598	74828

Chapter 11 Internal Memory Address of “Read/Write Variable Data” command

	CAM Data[1632](High)	45219	49449	53679	57909	62139	66369	70599	74829
	CAM Data[1633](Low)	45220	49450	53680	57910	62140	66370	70600	74830
	CAM Data[1633](High)	45221	49451	53681	57911	62141	66371	70601	74831
	CAM Data[1634](Low)	45222	49452	53682	57912	62142	66372	70602	74832
	CAM Data[1634](High)	45223	49453	53683	57913	62143	66373	70603	74833
	CAM Data[1635](Low)	45224	49454	53684	57914	62144	66374	70604	74834
	CAM Data[1635](High)	45225	49455	53685	57915	62145	66375	70605	74835
	CAM Data[1636](Low)	45226	49456	53686	57916	62146	66376	70606	74836
	CAM Data[1636](High)	45227	49457	53687	57917	62147	66377	70607	74837
	CAM Data[1637](Low)	45228	49458	53688	57918	62148	66378	70608	74838
	CAM Data[1637](High)	45229	49459	53689	57919	62149	66379	70609	74839
	CAM Data[1638](Low)	45230	49460	53690	57920	62150	66380	70610	74840
	CAM Data[1638](High)	45231	49461	53691	57921	62151	66381	70611	74841
	CAM Data[1639](Low)	45232	49462	53692	57922	62152	66382	70612	74842
	CAM Data[1639](High)	45233	49463	53693	57923	62153	66383	70613	74843
	CAM Data[1640](Low)	45234	49464	53694	57924	62154	66384	70614	74844
	CAM Data[1640](High)	45235	49465	53695	57925	62155	66385	70615	74845
	CAM Data[1641](Low)	45236	49466	53696	57926	62156	66386	70616	74846
	CAM Data[1641](High)	45237	49467	53697	57927	62157	66387	70617	74847
	CAM Data[1642](Low)	45238	49468	53698	57928	62158	66388	70618	74848
	CAM Data[1642](High)	45239	49469	53699	57929	62159	66389	70619	74849
	CAM Data[1643](Low)	45240	49470	53700	57930	62160	66390	70620	74850
	CAM Data[1643](High)	45241	49471	53701	57931	62161	66391	70621	74851
	CAM Data[1644](Low)	45242	49472	53702	57932	62162	66392	70622	74852
	CAM Data[1644](High)	45243	49473	53703	57933	62163	66393	70623	74853
	CAM Data[1645](Low)	45244	49474	53704	57934	62164	66394	70624	74854
	CAM Data[1645](High)	45245	49475	53705	57935	62165	66395	70625	74855
	CAM Data[1646](Low)	45246	49476	53706	57936	62166	66396	70626	74856
	CAM Data[1646](High)	45247	49477	53707	57937	62167	66397	70627	74857
	CAM Data[1647](Low)	45248	49478	53708	57938	62168	66398	70628	74858
	CAM Data[1647](High)	45249	49479	53709	57939	62169	66399	70629	74859
	CAM Data[1648](Low)	45250	49480	53710	57940	62170	66400	70630	74860
	CAM Data[1648](High)	45251	49481	53711	57941	62171	66401	70631	74861
	CAM Data[1649](Low)	45252	49482	53712	57942	62172	66402	70632	74862
	CAM Data[1649](High)	45253	49483	53713	57943	62173	66403	70633	74863
	CAM Data[1650](Low)	45254	49484	53714	57944	62174	66404	70634	74864
	CAM Data[1650](High)	45255	49485	53715	57945	62175	66405	70635	74865
	CAM Data[1651](Low)	45256	49486	53716	57946	62176	66406	70636	74866
	CAM Data[1651](High)	45257	49487	53717	57947	62177	66407	70637	74867
	CAM Data[1652](Low)	45258	49488	53718	57948	62178	66408	70638	74868
	CAM Data[1652](High)	45259	49489	53719	57949	62179	66409	70639	74869
	CAM Data[1653](Low)	45260	49490	53720	57950	62180	66410	70640	74870
	CAM Data[1653](High)	45261	49491	53721	57951	62181	66411	70641	74871
	CAM Data[1654](Low)	45262	49492	53722	57952	62182	66412	70642	74872
	CAM Data[1654](High)	45263	49493	53723	57953	62183	66413	70643	74873
	CAM Data[1655](Low)	45264	49494	53724	57954	62184	66414	70644	74874

Chapter 11 Internal Memory Address of “Read/Write Variable Data” command

	CAM Data[1655](High)	45265	49495	53725	57955	62185	66415	70645	74875
	CAM Data[1656](Low)	45266	49496	53726	57956	62186	66416	70646	74876
	CAM Data[1656](High)	45267	49497	53727	57957	62187	66417	70647	74877
	CAM Data[1657](Low)	45268	49498	53728	57958	62188	66418	70648	74878
	CAM Data[1657](High)	45269	49499	53729	57959	62189	66419	70649	74879
	CAM Data[1658](Low)	45270	49500	53730	57960	62190	66420	70650	74880
	CAM Data[1658](High)	45271	49501	53731	57961	62191	66421	70651	74881
	CAM Data[1659](Low)	45272	49502	53732	57962	62192	66422	70652	74882
	CAM Data[1659](High)	45273	49503	53733	57963	62193	66423	70653	74883
	CAM Data[1660](Low)	45274	49504	53734	57964	62194	66424	70654	74884
	CAM Data[1660](High)	45275	49505	53735	57965	62195	66425	70655	74885
	CAM Data[1661](Low)	45276	49506	53736	57966	62196	66426	70656	74886
	CAM Data[1661](High)	45277	49507	53737	57967	62197	66427	70657	74887
	CAM Data[1662](Low)	45278	49508	53738	57968	62198	66428	70658	74888
	CAM Data[1662](High)	45279	49509	53739	57969	62199	66429	70659	74889
	CAM Data[1663](Low)	45280	49510	53740	57970	62200	66430	70660	74890
	CAM Data[1663](High)	45281	49511	53741	57971	62201	66431	70661	74891
	CAM Data[1664](Low)	45282	49512	53742	57972	62202	66432	70662	74892
	CAM Data[1664](High)	45283	49513	53743	57973	62203	66433	70663	74893
	CAM Data[1665](Low)	45284	49514	53744	57974	62204	66434	70664	74894
	CAM Data[1665](High)	45285	49515	53745	57975	62205	66435	70665	74895
	CAM Data[1666](Low)	45286	49516	53746	57976	62206	66436	70666	74896
	CAM Data[1666](High)	45287	49517	53747	57977	62207	66437	70667	74897
	CAM Data[1667](Low)	45288	49518	53748	57978	62208	66438	70668	74898
	CAM Data[1667](High)	45289	49519	53749	57979	62209	66439	70669	74899
	CAM Data[1668](Low)	45290	49520	53750	57980	62210	66440	70670	74900
	CAM Data[1668](High)	45291	49521	53751	57981	62211	66441	70671	74901
	CAM Data[1669](Low)	45292	49522	53752	57982	62212	66442	70672	74902
	CAM Data[1669](High)	45293	49523	53753	57983	62213	66443	70673	74903
	CAM Data[1670](Low)	45294	49524	53754	57984	62214	66444	70674	74904
	CAM Data[1670](High)	45295	49525	53755	57985	62215	66445	70675	74905
	CAM Data[1671](Low)	45296	49526	53756	57986	62216	66446	70676	74906
	CAM Data[1671](High)	45297	49527	53757	57987	62217	66447	70677	74907
	CAM Data[1672](Low)	45298	49528	53758	57988	62218	66448	70678	74908
	CAM Data[1672](High)	45299	49529	53759	57989	62219	66449	70679	74909
	CAM Data[1673](Low)	45300	49530	53760	57990	62220	66450	70680	74910
	CAM Data[1673](High)	45301	49531	53761	57991	62221	66451	70681	74911
	CAM Data[1674](Low)	45302	49532	53762	57992	62222	66452	70682	74912
	CAM Data[1674](High)	45303	49533	53763	57993	62223	66453	70683	74913
	CAM Data[1675](Low)	45304	49534	53764	57994	62224	66454	70684	74914
	CAM Data[1675](High)	45305	49535	53765	57995	62225	66455	70685	74915
	CAM Data[1676](Low)	45306	49536	53766	57996	62226	66456	70686	74916
	CAM Data[1676](High)	45307	49537	53767	57997	62227	66457	70687	74917
	CAM Data[1677](Low)	45308	49538	53768	57998	62228	66458	70688	74918
	CAM Data[1677](High)	45309	49539	53769	57999	62229	66459	70689	74919
	CAM Data[1678](Low)	45310	49540	53770	58000	62230	66460	70690	74920

Chapter 11 Internal Memory Address of “Read/Write Variable Data” command

	CAM Data[1678](High)	45311	49541	53771	58001	62231	66461	70691	74921
	CAM Data[1679](Low)	45312	49542	53772	58002	62232	66462	70692	74922
	CAM Data[1679](High)	45313	49543	53773	58003	62233	66463	70693	74923
	CAM Data[1680](Low)	45314	49544	53774	58004	62234	66464	70694	74924
	CAM Data[1680](High)	45315	49545	53775	58005	62235	66465	70695	74925
	CAM Data[1681](Low)	45316	49546	53776	58006	62236	66466	70696	74926
	CAM Data[1681](High)	45317	49547	53777	58007	62237	66467	70697	74927
	CAM Data[1682](Low)	45318	49548	53778	58008	62238	66468	70698	74928
	CAM Data[1682](High)	45319	49549	53779	58009	62239	66469	70699	74929
	CAM Data[1683](Low)	45320	49550	53780	58010	62240	66470	70700	74930
	CAM Data[1683](High)	45321	49551	53781	58011	62241	66471	70701	74931
	CAM Data[1684](Low)	45322	49552	53782	58012	62242	66472	70702	74932
	CAM Data[1684](High)	45323	49553	53783	58013	62243	66473	70703	74933
	CAM Data[1685](Low)	45324	49554	53784	58014	62244	66474	70704	74934
	CAM Data[1685](High)	45325	49555	53785	58015	62245	66475	70705	74935
	CAM Data[1686](Low)	45326	49556	53786	58016	62246	66476	70706	74936
	CAM Data[1686](High)	45327	49557	53787	58017	62247	66477	70707	74937
	CAM Data[1687](Low)	45328	49558	53788	58018	62248	66478	70708	74938
	CAM Data[1687](High)	45329	49559	53789	58019	62249	66479	70709	74939
	CAM Data[1688](Low)	45330	49560	53790	58020	62250	66480	70710	74940
	CAM Data[1688](High)	45331	49561	53791	58021	62251	66481	70711	74941
	CAM Data[1689](Low)	45332	49562	53792	58022	62252	66482	70712	74942
	CAM Data[1689](High)	45333	49563	53793	58023	62253	66483	70713	74943
	CAM Data[1690](Low)	45334	49564	53794	58024	62254	66484	70714	74944
	CAM Data[1690](High)	45335	49565	53795	58025	62255	66485	70715	74945
	CAM Data[1691](Low)	45336	49566	53796	58026	62256	66486	70716	74946
	CAM Data[1691](High)	45337	49567	53797	58027	62257	66487	70717	74947
	CAM Data[1692](Low)	45338	49568	53798	58028	62258	66488	70718	74948
	CAM Data[1692](High)	45339	49569	53799	58029	62259	66489	70719	74949
	CAM Data[1693](Low)	45340	49570	53800	58030	62260	66490	70720	74950
	CAM Data[1693](High)	45341	49571	53801	58031	62261	66491	70721	74951
	CAM Data[1694](Low)	45342	49572	53802	58032	62262	66492	70722	74952
	CAM Data[1694](High)	45343	49573	53803	58033	62263	66493	70723	74953
	CAM Data[1695](Low)	45344	49574	53804	58034	62264	66494	70724	74954
	CAM Data[1695](High)	45345	49575	53805	58035	62265	66495	70725	74955
	CAM Data[1696](Low)	45346	49576	53806	58036	62266	66496	70726	74956
	CAM Data[1696](High)	45347	49577	53807	58037	62267	66497	70727	74957
	CAM Data[1697](Low)	45348	49578	53808	58038	62268	66498	70728	74958
	CAM Data[1697](High)	45349	49579	53809	58039	62269	66499	70729	74959
	CAM Data[1698](Low)	45350	49580	53810	58040	62270	66500	70730	74960
	CAM Data[1698](High)	45351	49581	53811	58041	62271	66501	70731	74961
	CAM Data[1699](Low)	45352	49582	53812	58042	62272	66502	70732	74962
	CAM Data[1699](High)	45353	49583	53813	58043	62273	66503	70733	74963
	CAM Data[1700](Low)	45354	49584	53814	58044	62274	66504	70734	74964
	CAM Data[1700](High)	45355	49585	53815	58045	62275	66505	70735	74965
	CAM Data[1701](Low)	45356	49586	53816	58046	62276	66506	70736	74966

Chapter 11 Internal Memory Address of “Read/Write Variable Data” command

	CAM Data[1701](High)	45357	49587	53817	58047	62277	66507	70737	74967
	CAM Data[1702](Low)	45358	49588	53818	58048	62278	66508	70738	74968
	CAM Data[1702](High)	45359	49589	53819	58049	62279	66509	70739	74969
	CAM Data[1703](Low)	45360	49590	53820	58050	62280	66510	70740	74970
	CAM Data[1703](High)	45361	49591	53821	58051	62281	66511	70741	74971
	CAM Data[1704](Low)	45362	49592	53822	58052	62282	66512	70742	74972
	CAM Data[1704](High)	45363	49593	53823	58053	62283	66513	70743	74973
	CAM Data[1705](Low)	45364	49594	53824	58054	62284	66514	70744	74974
	CAM Data[1705](High)	45365	49595	53825	58055	62285	66515	70745	74975
	CAM Data[1706](Low)	45366	49596	53826	58056	62286	66516	70746	74976
	CAM Data[1706](High)	45367	49597	53827	58057	62287	66517	70747	74977
	CAM Data[1707](Low)	45368	49598	53828	58058	62288	66518	70748	74978
	CAM Data[1707](High)	45369	49599	53829	58059	62289	66519	70749	74979
	CAM Data[1708](Low)	45370	49600	53830	58060	62290	66520	70750	74980
	CAM Data[1708](High)	45371	49601	53831	58061	62291	66521	70751	74981
	CAM Data[1709](Low)	45372	49602	53832	58062	62292	66522	70752	74982
	CAM Data[1709](High)	45373	49603	53833	58063	62293	66523	70753	74983
	CAM Data[1710](Low)	45374	49604	53834	58064	62294	66524	70754	74984
	CAM Data[1710](High)	45375	49605	53835	58065	62295	66525	70755	74985
	CAM Data[1711](Low)	45376	49606	53836	58066	62296	66526	70756	74986
	CAM Data[1711](High)	45377	49607	53837	58067	62297	66527	70757	74987
	CAM Data[1712](Low)	45378	49608	53838	58068	62298	66528	70758	74988
	CAM Data[1712](High)	45379	49609	53839	58069	62299	66529	70759	74989
	CAM Data[1713](Low)	45380	49610	53840	58070	62300	66530	70760	74990
	CAM Data[1713](High)	45381	49611	53841	58071	62301	66531	70761	74991
	CAM Data[1714](Low)	45382	49612	53842	58072	62302	66532	70762	74992
	CAM Data[1714](High)	45383	49613	53843	58073	62303	66533	70763	74993
	CAM Data[1715](Low)	45384	49614	53844	58074	62304	66534	70764	74994
	CAM Data[1715](High)	45385	49615	53845	58075	62305	66535	70765	74995
	CAM Data[1716](Low)	45386	49616	53846	58076	62306	66536	70766	74996
	CAM Data[1716](High)	45387	49617	53847	58077	62307	66537	70767	74997
	CAM Data[1717](Low)	45388	49618	53848	58078	62308	66538	70768	74998
	CAM Data[1717](High)	45389	49619	53849	58079	62309	66539	70769	74999
	CAM Data[1718](Low)	45390	49620	53850	58080	62310	66540	70770	75000
	CAM Data[1718](High)	45391	49621	53851	58081	62311	66541	70771	75001
	CAM Data[1719](Low)	45392	49622	53852	58082	62312	66542	70772	75002
	CAM Data[1719](High)	45393	49623	53853	58083	62313	66543	70773	75003
	CAM Data[1720](Low)	45394	49624	53854	58084	62314	66544	70774	75004
	CAM Data[1720](High)	45395	49625	53855	58085	62315	66545	70775	75005
	CAM Data[1721](Low)	45396	49626	53856	58086	62316	66546	70776	75006
	CAM Data[1721](High)	45397	49627	53857	58087	62317	66547	70777	75007
	CAM Data[1722](Low)	45398	49628	53858	58088	62318	66548	70778	75008
	CAM Data[1722](High)	45399	49629	53859	58089	62319	66549	70779	75009
	CAM Data[1723](Low)	45400	49630	53860	58090	62320	66550	70780	75010
	CAM Data[1723](High)	45401	49631	53861	58091	62321	66551	70781	75011
	CAM Data[1724](Low)	45402	49632	53862	58092	62322	66552	70782	75012

Chapter 11 Internal Memory Address of “Read/Write Variable Data” command

	CAM Data[1724](High)	45403	49633	53863	58093	62323	66553	70783	75013
	CAM Data[1725](Low)	45404	49634	53864	58094	62324	66554	70784	75014
	CAM Data[1725](High)	45405	49635	53865	58095	62325	66555	70785	75015
	CAM Data[1726](Low)	45406	49636	53866	58096	62326	66556	70786	75016
	CAM Data[1726](High)	45407	49637	53867	58097	62327	66557	70787	75017
	CAM Data[1727](Low)	45408	49638	53868	58098	62328	66558	70788	75018
	CAM Data[1727](High)	45409	49639	53869	58099	62329	66559	70789	75019
	CAM Data[1728](Low)	45410	49640	53870	58100	62330	66560	70790	75020
	CAM Data[1728](High)	45411	49641	53871	58101	62331	66561	70791	75021
	CAM Data[1729](Low)	45412	49642	53872	58102	62332	66562	70792	75022
	CAM Data[1729](High)	45413	49643	53873	58103	62333	66563	70793	75023
	CAM Data[1730](Low)	45414	49644	53874	58104	62334	66564	70794	75024
	CAM Data[1730](High)	45415	49645	53875	58105	62335	66565	70795	75025
	CAM Data[1731](Low)	45416	49646	53876	58106	62336	66566	70796	75026
	CAM Data[1731](High)	45417	49647	53877	58107	62337	66567	70797	75027
	CAM Data[1732](Low)	45418	49648	53878	58108	62338	66568	70798	75028
	CAM Data[1732](High)	45419	49649	53879	58109	62339	66569	70799	75029
	CAM Data[1733](Low)	45420	49650	53880	58110	62340	66570	70800	75030
	CAM Data[1733](High)	45421	49651	53881	58111	62341	66571	70801	75031
	CAM Data[1734](Low)	45422	49652	53882	58112	62342	66572	70802	75032
	CAM Data[1734](High)	45423	49653	53883	58113	62343	66573	70803	75033
	CAM Data[1735](Low)	45424	49654	53884	58114	62344	66574	70804	75034
	CAM Data[1735](High)	45425	49655	53885	58115	62345	66575	70805	75035
	CAM Data[1736](Low)	45426	49656	53886	58116	62346	66576	70806	75036
	CAM Data[1736](High)	45427	49657	53887	58117	62347	66577	70807	75037
	CAM Data[1737](Low)	45428	49658	53888	58118	62348	66578	70808	75038
	CAM Data[1737](High)	45429	49659	53889	58119	62349	66579	70809	75039
	CAM Data[1738](Low)	45430	49660	53890	58120	62350	66580	70810	75040
	CAM Data[1738](High)	45431	49661	53891	58121	62351	66581	70811	75041
	CAM Data[1739](Low)	45432	49662	53892	58122	62352	66582	70812	75042
	CAM Data[1739](High)	45433	49663	53893	58123	62353	66583	70813	75043
	CAM Data[1740](Low)	45434	49664	53894	58124	62354	66584	70814	75044
	CAM Data[1740](High)	45435	49665	53895	58125	62355	66585	70815	75045
	CAM Data[1741](Low)	45436	49666	53896	58126	62356	66586	70816	75046
	CAM Data[1741](High)	45437	49667	53897	58127	62357	66587	70817	75047
	CAM Data[1742](Low)	45438	49668	53898	58128	62358	66588	70818	75048
	CAM Data[1742](High)	45439	49669	53899	58129	62359	66589	70819	75049
	CAM Data[1743](Low)	45440	49670	53900	58130	62360	66590	70820	75050
	CAM Data[1743](High)	45441	49671	53901	58131	62361	66591	70821	75051
	CAM Data[1744](Low)	45442	49672	53902	58132	62362	66592	70822	75052
	CAM Data[1744](High)	45443	49673	53903	58133	62363	66593	70823	75053
	CAM Data[1745](Low)	45444	49674	53904	58134	62364	66594	70824	75054
	CAM Data[1745](High)	45445	49675	53905	58135	62365	66595	70825	75055
	CAM Data[1746](Low)	45446	49676	53906	58136	62366	66596	70826	75056
	CAM Data[1746](High)	45447	49677	53907	58137	62367	66597	70827	75057
	CAM Data[1747](Low)	45448	49678	53908	58138	62368	66598	70828	75058

Chapter 11 Internal Memory Address of “Read/Write Variable Data” command

	CAM Data[1747](High)	45449	49679	53909	58139	62369	66599	70829	75059
	CAM Data[1748](Low)	45450	49680	53910	58140	62370	66600	70830	75060
	CAM Data[1748](High)	45451	49681	53911	58141	62371	66601	70831	75061
	CAM Data[1749](Low)	45452	49682	53912	58142	62372	66602	70832	75062
	CAM Data[1749](High)	45453	49683	53913	58143	62373	66603	70833	75063
	CAM Data[1750](Low)	45454	49684	53914	58144	62374	66604	70834	75064
	CAM Data[1750](High)	45455	49685	53915	58145	62375	66605	70835	75065
	CAM Data[1751](Low)	45456	49686	53916	58146	62376	66606	70836	75066
	CAM Data[1751](High)	45457	49687	53917	58147	62377	66607	70837	75067
	CAM Data[1752](Low)	45458	49688	53918	58148	62378	66608	70838	75068
	CAM Data[1752](High)	45459	49689	53919	58149	62379	66609	70839	75069
	CAM Data[1753](Low)	45460	49690	53920	58150	62380	66610	70840	75070
	CAM Data[1753](High)	45461	49691	53921	58151	62381	66611	70841	75071
	CAM Data[1754](Low)	45462	49692	53922	58152	62382	66612	70842	75072
	CAM Data[1754](High)	45463	49693	53923	58153	62383	66613	70843	75073
	CAM Data[1755](Low)	45464	49694	53924	58154	62384	66614	70844	75074
	CAM Data[1755](High)	45465	49695	53925	58155	62385	66615	70845	75075
	CAM Data[1756](Low)	45466	49696	53926	58156	62386	66616	70846	75076
	CAM Data[1756](High)	45467	49697	53927	58157	62387	66617	70847	75077
	CAM Data[1757](Low)	45468	49698	53928	58158	62388	66618	70848	75078
	CAM Data[1757](High)	45469	49699	53929	58159	62389	66619	70849	75079
	CAM Data[1758](Low)	45470	49700	53930	58160	62390	66620	70850	75080
	CAM Data[1758](High)	45471	49701	53931	58161	62391	66621	70851	75081
	CAM Data[1759](Low)	45472	49702	53932	58162	62392	66622	70852	75082
	CAM Data[1759](High)	45473	49703	53933	58163	62393	66623	70853	75083
	CAM Data[1760](Low)	45474	49704	53934	58164	62394	66624	70854	75084
	CAM Data[1760](High)	45475	49705	53935	58165	62395	66625	70855	75085
	CAM Data[1761](Low)	45476	49706	53936	58166	62396	66626	70856	75086
	CAM Data[1761](High)	45477	49707	53937	58167	62397	66627	70857	75087
	CAM Data[1762](Low)	45478	49708	53938	58168	62398	66628	70858	75088
	CAM Data[1762](High)	45479	49709	53939	58169	62399	66629	70859	75089
	CAM Data[1763](Low)	45480	49710	53940	58170	62400	66630	70860	75090
	CAM Data[1763](High)	45481	49711	53941	58171	62401	66631	70861	75091
	CAM Data[1764](Low)	45482	49712	53942	58172	62402	66632	70862	75092
	CAM Data[1764](High)	45483	49713	53943	58173	62403	66633	70863	75093
	CAM Data[1765](Low)	45484	49714	53944	58174	62404	66634	70864	75094
	CAM Data[1765](High)	45485	49715	53945	58175	62405	66635	70865	75095
	CAM Data[1766](Low)	45486	49716	53946	58176	62406	66636	70866	75096
	CAM Data[1766](High)	45487	49717	53947	58177	62407	66637	70867	75097
	CAM Data[1767](Low)	45488	49718	53948	58178	62408	66638	70868	75098
	CAM Data[1767](High)	45489	49719	53949	58179	62409	66639	70869	75099
	CAM Data[1768](Low)	45490	49720	53950	58180	62410	66640	70870	75100
	CAM Data[1768](High)	45491	49721	53951	58181	62411	66641	70871	75101
	CAM Data[1769](Low)	45492	49722	53952	58182	62412	66642	70872	75102
	CAM Data[1769](High)	45493	49723	53953	58183	62413	66643	70873	75103
	CAM Data[1770](Low)	45494	49724	53954	58184	62414	66644	70874	75104

Chapter 11 Internal Memory Address of “Read/Write Variable Data” command

	CAM Data[1770](High)	45495	49725	53955	58185	62415	66645	70875	75105
	CAM Data[1771](Low)	45496	49726	53956	58186	62416	66646	70876	75106
	CAM Data[1771](High)	45497	49727	53957	58187	62417	66647	70877	75107
	CAM Data[1772](Low)	45498	49728	53958	58188	62418	66648	70878	75108
	CAM Data[1772](High)	45499	49729	53959	58189	62419	66649	70879	75109
	CAM Data[1773](Low)	45500	49730	53960	58190	62420	66650	70880	75110
	CAM Data[1773](High)	45501	49731	53961	58191	62421	66651	70881	75111
	CAM Data[1774](Low)	45502	49732	53962	58192	62422	66652	70882	75112
	CAM Data[1774](High)	45503	49733	53963	58193	62423	66653	70883	75113
	CAM Data[1775](Low)	45504	49734	53964	58194	62424	66654	70884	75114
	CAM Data[1775](High)	45505	49735	53965	58195	62425	66655	70885	75115
	CAM Data[1776](Low)	45506	49736	53966	58196	62426	66656	70886	75116
	CAM Data[1776](High)	45507	49737	53967	58197	62427	66657	70887	75117
	CAM Data[1777](Low)	45508	49738	53968	58198	62428	66658	70888	75118
	CAM Data[1777](High)	45509	49739	53969	58199	62429	66659	70889	75119
	CAM Data[1778](Low)	45510	49740	53970	58200	62430	66660	70890	75120
	CAM Data[1778](High)	45511	49741	53971	58201	62431	66661	70891	75121
	CAM Data[1779](Low)	45512	49742	53972	58202	62432	66662	70892	75122
	CAM Data[1779](High)	45513	49743	53973	58203	62433	66663	70893	75123
	CAM Data[1780](Low)	45514	49744	53974	58204	62434	66664	70894	75124
	CAM Data[1780](High)	45515	49745	53975	58205	62435	66665	70895	75125
	CAM Data[1781](Low)	45516	49746	53976	58206	62436	66666	70896	75126
	CAM Data[1781](High)	45517	49747	53977	58207	62437	66667	70897	75127
	CAM Data[1782](Low)	45518	49748	53978	58208	62438	66668	70898	75128
	CAM Data[1782](High)	45519	49749	53979	58209	62439	66669	70899	75129
	CAM Data[1783](Low)	45520	49750	53980	58210	62440	66670	70900	75130
	CAM Data[1783](High)	45521	49751	53981	58211	62441	66671	70901	75131
	CAM Data[1784](Low)	45522	49752	53982	58212	62442	66672	70902	75132
	CAM Data[1784](High)	45523	49753	53983	58213	62443	66673	70903	75133
	CAM Data[1785](Low)	45524	49754	53984	58214	62444	66674	70904	75134
	CAM Data[1785](High)	45525	49755	53985	58215	62445	66675	70905	75135
	CAM Data[1786](Low)	45526	49756	53986	58216	62446	66676	70906	75136
	CAM Data[1786](High)	45527	49757	53987	58217	62447	66677	70907	75137
	CAM Data[1787](Low)	45528	49758	53988	58218	62448	66678	70908	75138
	CAM Data[1787](High)	45529	49759	53989	58219	62449	66679	70909	75139
	CAM Data[1788](Low)	45530	49760	53990	58220	62450	66680	70910	75140
	CAM Data[1788](High)	45531	49761	53991	58221	62451	66681	70911	75141
	CAM Data[1789](Low)	45532	49762	53992	58222	62452	66682	70912	75142
	CAM Data[1789](High)	45533	49763	53993	58223	62453	66683	70913	75143
	CAM Data[1790](Low)	45534	49764	53994	58224	62454	66684	70914	75144
	CAM Data[1790](High)	45535	49765	53995	58225	62455	66685	70915	75145
	CAM Data[1791](Low)	45536	49766	53996	58226	62456	66686	70916	75146
	CAM Data[1791](High)	45537	49767	53997	58227	62457	66687	70917	75147
	CAM Data[1792](Low)	45538	49768	53998	58228	62458	66688	70918	75148
	CAM Data[1792](High)	45539	49769	53999	58229	62459	66689	70919	75149
	CAM Data[1793](Low)	45540	49770	54000	58230	62460	66690	70920	75150

Chapter 11 Internal Memory Address of “Read/Write Variable Data” command

	CAM Data[1793](High)	45541	49771	54001	58231	62461	66691	70921	75151
	CAM Data[1794](Low)	45542	49772	54002	58232	62462	66692	70922	75152
	CAM Data[1794](High)	45543	49773	54003	58233	62463	66693	70923	75153
	CAM Data[1795](Low)	45544	49774	54004	58234	62464	66694	70924	75154
	CAM Data[1795](High)	45545	49775	54005	58235	62465	66695	70925	75155
	CAM Data[1796](Low)	45546	49776	54006	58236	62466	66696	70926	75156
	CAM Data[1796](High)	45547	49777	54007	58237	62467	66697	70927	75157
	CAM Data[1797](Low)	45548	49778	54008	58238	62468	66698	70928	75158
	CAM Data[1797](High)	45549	49779	54009	58239	62469	66699	70929	75159
	CAM Data[1798](Low)	45550	49780	54010	58240	62470	66700	70930	75160
	CAM Data[1798](High)	45551	49781	54011	58241	62471	66701	70931	75161
	CAM Data[1799](Low)	45552	49782	54012	58242	62472	66702	70932	75162
	CAM Data[1799](High)	45553	49783	54013	58243	62473	66703	70933	75163
	CAM Data[1800](Low)	45554	49784	54014	58244	62474	66704	70934	75164
	CAM Data[1800](High)	45555	49785	54015	58245	62475	66705	70935	75165
	CAM Data[1801](Low)	45556	49786	54016	58246	62476	66706	70936	75166
	CAM Data[1801](High)	45557	49787	54017	58247	62477	66707	70937	75167
	CAM Data[1802](Low)	45558	49788	54018	58248	62478	66708	70938	75168
	CAM Data[1802](High)	45559	49789	54019	58249	62479	66709	70939	75169
	CAM Data[1803](Low)	45560	49790	54020	58250	62480	66710	70940	75170
	CAM Data[1803](High)	45561	49791	54021	58251	62481	66711	70941	75171
	CAM Data[1804](Low)	45562	49792	54022	58252	62482	66712	70942	75172
	CAM Data[1804](High)	45563	49793	54023	58253	62483	66713	70943	75173
	CAM Data[1805](Low)	45564	49794	54024	58254	62484	66714	70944	75174
	CAM Data[1805](High)	45565	49795	54025	58255	62485	66715	70945	75175
	CAM Data[1806](Low)	45566	49796	54026	58256	62486	66716	70946	75176
	CAM Data[1806](High)	45567	49797	54027	58257	62487	66717	70947	75177
	CAM Data[1807](Low)	45568	49798	54028	58258	62488	66718	70948	75178
	CAM Data[1807](High)	45569	49799	54029	58259	62489	66719	70949	75179
	CAM Data[1808](Low)	45570	49800	54030	58260	62490	66720	70950	75180
	CAM Data[1808](High)	45571	49801	54031	58261	62491	66721	70951	75181
	CAM Data[1809](Low)	45572	49802	54032	58262	62492	66722	70952	75182
	CAM Data[1809](High)	45573	49803	54033	58263	62493	66723	70953	75183
	CAM Data[1810](Low)	45574	49804	54034	58264	62494	66724	70954	75184
	CAM Data[1810](High)	45575	49805	54035	58265	62495	66725	70955	75185
	CAM Data[1811](Low)	45576	49806	54036	58266	62496	66726	70956	75186
	CAM Data[1811](High)	45577	49807	54037	58267	62497	66727	70957	75187
	CAM Data[1812](Low)	45578	49808	54038	58268	62498	66728	70958	75188
	CAM Data[1812](High)	45579	49809	54039	58269	62499	66729	70959	75189
	CAM Data[1813](Low)	45580	49810	54040	58270	62500	66730	70960	75190
	CAM Data[1813](High)	45581	49811	54041	58271	62501	66731	70961	75191
	CAM Data[1814](Low)	45582	49812	54042	58272	62502	66732	70962	75192
	CAM Data[1814](High)	45583	49813	54043	58273	62503	66733	70963	75193
	CAM Data[1815](Low)	45584	49814	54044	58274	62504	66734	70964	75194
	CAM Data[1815](High)	45585	49815	54045	58275	62505	66735	70965	75195
	CAM Data[1816](Low)	45586	49816	54046	58276	62506	66736	70966	75196

Chapter 11 Internal Memory Address of “Read/Write Variable Data” command

	CAM Data[1816](High)	45587	49817	54047	58277	62507	66737	70967	75197
	CAM Data[1817](Low)	45588	49818	54048	58278	62508	66738	70968	75198
	CAM Data[1817](High)	45589	49819	54049	58279	62509	66739	70969	75199
	CAM Data[1818](Low)	45590	49820	54050	58280	62510	66740	70970	75200
	CAM Data[1818](High)	45591	49821	54051	58281	62511	66741	70971	75201
	CAM Data[1819](Low)	45592	49822	54052	58282	62512	66742	70972	75202
	CAM Data[1819](High)	45593	49823	54053	58283	62513	66743	70973	75203
	CAM Data[1820](Low)	45594	49824	54054	58284	62514	66744	70974	75204
	CAM Data[1820](High)	45595	49825	54055	58285	62515	66745	70975	75205
	CAM Data[1821](Low)	45596	49826	54056	58286	62516	66746	70976	75206
	CAM Data[1821](High)	45597	49827	54057	58287	62517	66747	70977	75207
	CAM Data[1822](Low)	45598	49828	54058	58288	62518	66748	70978	75208
	CAM Data[1822](High)	45599	49829	54059	58289	62519	66749	70979	75209
	CAM Data[1823](Low)	45600	49830	54060	58290	62520	66750	70980	75210
	CAM Data[1823](High)	45601	49831	54061	58291	62521	66751	70981	75211
	CAM Data[1824](Low)	45602	49832	54062	58292	62522	66752	70982	75212
	CAM Data[1824](High)	45603	49833	54063	58293	62523	66753	70983	75213
	CAM Data[1825](Low)	45604	49834	54064	58294	62524	66754	70984	75214
	CAM Data[1825](High)	45605	49835	54065	58295	62525	66755	70985	75215
	CAM Data[1826](Low)	45606	49836	54066	58296	62526	66756	70986	75216
	CAM Data[1826](High)	45607	49837	54067	58297	62527	66757	70987	75217
	CAM Data[1827](Low)	45608	49838	54068	58298	62528	66758	70988	75218
	CAM Data[1827](High)	45609	49839	54069	58299	62529	66759	70989	75219
	CAM Data[1828](Low)	45610	49840	54070	58300	62530	66760	70990	75220
	CAM Data[1828](High)	45611	49841	54071	58301	62531	66761	70991	75221
	CAM Data[1829](Low)	45612	49842	54072	58302	62532	66762	70992	75222
	CAM Data[1829](High)	45613	49843	54073	58303	62533	66763	70993	75223
	CAM Data[1830](Low)	45614	49844	54074	58304	62534	66764	70994	75224
	CAM Data[1830](High)	45615	49845	54075	58305	62535	66765	70995	75225
	CAM Data[1831](Low)	45616	49846	54076	58306	62536	66766	70996	75226
	CAM Data[1831](High)	45617	49847	54077	58307	62537	66767	70997	75227
	CAM Data[1832](Low)	45618	49848	54078	58308	62538	66768	70998	75228
	CAM Data[1832](High)	45619	49849	54079	58309	62539	66769	70999	75229
	CAM Data[1833](Low)	45620	49850	54080	58310	62540	66770	71000	75230
	CAM Data[1833](High)	45621	49851	54081	58311	62541	66771	71001	75231
	CAM Data[1834](Low)	45622	49852	54082	58312	62542	66772	71002	75232
	CAM Data[1834](High)	45623	49853	54083	58313	62543	66773	71003	75233
	CAM Data[1835](Low)	45624	49854	54084	58314	62544	66774	71004	75234
	CAM Data[1835](High)	45625	49855	54085	58315	62545	66775	71005	75235
	CAM Data[1836](Low)	45626	49856	54086	58316	62546	66776	71006	75236
	CAM Data[1836](High)	45627	49857	54087	58317	62547	66777	71007	75237
	CAM Data[1837](Low)	45628	49858	54088	58318	62548	66778	71008	75238
	CAM Data[1837](High)	45629	49859	54089	58319	62549	66779	71009	75239
	CAM Data[1838](Low)	45630	49860	54090	58320	62550	66780	71010	75240
	CAM Data[1838](High)	45631	49861	54091	58321	62551	66781	71011	75241
	CAM Data[1839](Low)	45632	49862	54092	58322	62552	66782	71012	75242

Chapter 11 Internal Memory Address of “Read/Write Variable Data” command

	CAM Data[1839](High)	45633	49863	54093	58323	62553	66783	71013	75243
	CAM Data[1840](Low)	45634	49864	54094	58324	62554	66784	71014	75244
	CAM Data[1840](High)	45635	49865	54095	58325	62555	66785	71015	75245
	CAM Data[1841](Low)	45636	49866	54096	58326	62556	66786	71016	75246
	CAM Data[1841](High)	45637	49867	54097	58327	62557	66787	71017	75247
	CAM Data[1842](Low)	45638	49868	54098	58328	62558	66788	71018	75248
	CAM Data[1842](High)	45639	49869	54099	58329	62559	66789	71019	75249
	CAM Data[1843](Low)	45640	49870	54100	58330	62560	66790	71020	75250
	CAM Data[1843](High)	45641	49871	54101	58331	62561	66791	71021	75251
	CAM Data[1844](Low)	45642	49872	54102	58332	62562	66792	71022	75252
	CAM Data[1844](High)	45643	49873	54103	58333	62563	66793	71023	75253
	CAM Data[1845](Low)	45644	49874	54104	58334	62564	66794	71024	75254
	CAM Data[1845](High)	45645	49875	54105	58335	62565	66795	71025	75255
	CAM Data[1846](Low)	45646	49876	54106	58336	62566	66796	71026	75256
	CAM Data[1846](High)	45647	49877	54107	58337	62567	66797	71027	75257
	CAM Data[1847](Low)	45648	49878	54108	58338	62568	66798	71028	75258
	CAM Data[1847](High)	45649	49879	54109	58339	62569	66799	71029	75259
	CAM Data[1848](Low)	45650	49880	54110	58340	62570	66800	71030	75260
	CAM Data[1848](High)	45651	49881	54111	58341	62571	66801	71031	75261
	CAM Data[1849](Low)	45652	49882	54112	58342	62572	66802	71032	75262
	CAM Data[1849](High)	45653	49883	54113	58343	62573	66803	71033	75263
	CAM Data[1850](Low)	45654	49884	54114	58344	62574	66804	71034	75264
	CAM Data[1850](High)	45655	49885	54115	58345	62575	66805	71035	75265
	CAM Data[1851](Low)	45656	49886	54116	58346	62576	66806	71036	75266
	CAM Data[1851](High)	45657	49887	54117	58347	62577	66807	71037	75267
	CAM Data[1852](Low)	45658	49888	54118	58348	62578	66808	71038	75268
	CAM Data[1852](High)	45659	49889	54119	58349	62579	66809	71039	75269
	CAM Data[1853](Low)	45660	49890	54120	58350	62580	66810	71040	75270
	CAM Data[1853](High)	45661	49891	54121	58351	62581	66811	71041	75271
	CAM Data[1854](Low)	45662	49892	54122	58352	62582	66812	71042	75272
	CAM Data[1854](High)	45663	49893	54123	58353	62583	66813	71043	75273
	CAM Data[1855](Low)	45664	49894	54124	58354	62584	66814	71044	75274
	CAM Data[1855](High)	45665	49895	54125	58355	62585	66815	71045	75275
	CAM Data[1856](Low)	45666	49896	54126	58356	62586	66816	71046	75276
	CAM Data[1856](High)	45667	49897	54127	58357	62587	66817	71047	75277
	CAM Data[1857](Low)	45668	49898	54128	58358	62588	66818	71048	75278
	CAM Data[1857](High)	45669	49899	54129	58359	62589	66819	71049	75279
	CAM Data[1858](Low)	45670	49900	54130	58360	62590	66820	71050	75280
	CAM Data[1858](High)	45671	49901	54131	58361	62591	66821	71051	75281
	CAM Data[1859](Low)	45672	49902	54132	58362	62592	66822	71052	75282
	CAM Data[1859](High)	45673	49903	54133	58363	62593	66823	71053	75283
	CAM Data[1860](Low)	45674	49904	54134	58364	62594	66824	71054	75284
	CAM Data[1860](High)	45675	49905	54135	58365	62595	66825	71055	75285
	CAM Data[1861](Low)	45676	49906	54136	58366	62596	66826	71056	75286
	CAM Data[1861](High)	45677	49907	54137	58367	62597	66827	71057	75287
	CAM Data[1862](Low)	45678	49908	54138	58368	62598	66828	71058	75288

Chapter 11 Internal Memory Address of “Read/Write Variable Data” command

	CAM Data[1862](High)	45679	49909	54139	58369	62599	66829	71059	75289
	CAM Data[1863](Low)	45680	49910	54140	58370	62600	66830	71060	75290
	CAM Data[1863](High)	45681	49911	54141	58371	62601	66831	71061	75291
	CAM Data[1864](Low)	45682	49912	54142	58372	62602	66832	71062	75292
	CAM Data[1864](High)	45683	49913	54143	58373	62603	66833	71063	75293
	CAM Data[1865](Low)	45684	49914	54144	58374	62604	66834	71064	75294
	CAM Data[1865](High)	45685	49915	54145	58375	62605	66835	71065	75295
	CAM Data[1866](Low)	45686	49916	54146	58376	62606	66836	71066	75296
	CAM Data[1866](High)	45687	49917	54147	58377	62607	66837	71067	75297
	CAM Data[1867](Low)	45688	49918	54148	58378	62608	66838	71068	75298
	CAM Data[1867](High)	45689	49919	54149	58379	62609	66839	71069	75299
	CAM Data[1868](Low)	45690	49920	54150	58380	62610	66840	71070	75300
	CAM Data[1868](High)	45691	49921	54151	58381	62611	66841	71071	75301
	CAM Data[1869](Low)	45692	49922	54152	58382	62612	66842	71072	75302
	CAM Data[1869](High)	45693	49923	54153	58383	62613	66843	71073	75303
	CAM Data[1870](Low)	45694	49924	54154	58384	62614	66844	71074	75304
	CAM Data[1870](High)	45695	49925	54155	58385	62615	66845	71075	75305
	CAM Data[1871](Low)	45696	49926	54156	58386	62616	66846	71076	75306
	CAM Data[1871](High)	45697	49927	54157	58387	62617	66847	71077	75307
	CAM Data[1872](Low)	45698	49928	54158	58388	62618	66848	71078	75308
	CAM Data[1872](High)	45699	49929	54159	58389	62619	66849	71079	75309
	CAM Data[1873](Low)	45700	49930	54160	58390	62620	66850	71080	75310
	CAM Data[1873](High)	45701	49931	54161	58391	62621	66851	71081	75311
	CAM Data[1874](Low)	45702	49932	54162	58392	62622	66852	71082	75312
	CAM Data[1874](High)	45703	49933	54163	58393	62623	66853	71083	75313
	CAM Data[1875](Low)	45704	49934	54164	58394	62624	66854	71084	75314
	CAM Data[1875](High)	45705	49935	54165	58395	62625	66855	71085	75315
	CAM Data[1876](Low)	45706	49936	54166	58396	62626	66856	71086	75316
	CAM Data[1876](High)	45707	49937	54167	58397	62627	66857	71087	75317
	CAM Data[1877](Low)	45708	49938	54168	58398	62628	66858	71088	75318
	CAM Data[1877](High)	45709	49939	54169	58399	62629	66859	71089	75319
	CAM Data[1878](Low)	45710	49940	54170	58400	62630	66860	71090	75320
	CAM Data[1878](High)	45711	49941	54171	58401	62631	66861	71091	75321
	CAM Data[1879](Low)	45712	49942	54172	58402	62632	66862	71092	75322
	CAM Data[1879](High)	45713	49943	54173	58403	62633	66863	71093	75323
	CAM Data[1880](Low)	45714	49944	54174	58404	62634	66864	71094	75324
	CAM Data[1880](High)	45715	49945	54175	58405	62635	66865	71095	75325
	CAM Data[1881](Low)	45716	49946	54176	58406	62636	66866	71096	75326
	CAM Data[1881](High)	45717	49947	54177	58407	62637	66867	71097	75327
	CAM Data[1882](Low)	45718	49948	54178	58408	62638	66868	71098	75328
	CAM Data[1882](High)	45719	49949	54179	58409	62639	66869	71099	75329
	CAM Data[1883](Low)	45720	49950	54180	58410	62640	66870	71100	75330
	CAM Data[1883](High)	45721	49951	54181	58411	62641	66871	71101	75331
	CAM Data[1884](Low)	45722	49952	54182	58412	62642	66872	71102	75332
	CAM Data[1884](High)	45723	49953	54183	58413	62643	66873	71103	75333
	CAM Data[1885](Low)	45724	49954	54184	58414	62644	66874	71104	75334

Chapter 11 Internal Memory Address of “Read/Write Variable Data” command

	CAM Data[1885](High)	45725	49955	54185	58415	62645	66875	71105	75335
	CAM Data[1886](Low)	45726	49956	54186	58416	62646	66876	71106	75336
	CAM Data[1886](High)	45727	49957	54187	58417	62647	66877	71107	75337
	CAM Data[1887](Low)	45728	49958	54188	58418	62648	66878	71108	75338
	CAM Data[1887](High)	45729	49959	54189	58419	62649	66879	71109	75339
	CAM Data[1888](Low)	45730	49960	54190	58420	62650	66880	71110	75340
	CAM Data[1888](High)	45731	49961	54191	58421	62651	66881	71111	75341
	CAM Data[1889](Low)	45732	49962	54192	58422	62652	66882	71112	75342
	CAM Data[1889](High)	45733	49963	54193	58423	62653	66883	71113	75343
	CAM Data[1890](Low)	45734	49964	54194	58424	62654	66884	71114	75344
	CAM Data[1890](High)	45735	49965	54195	58425	62655	66885	71115	75345
	CAM Data[1891](Low)	45736	49966	54196	58426	62656	66886	71116	75346
	CAM Data[1891](High)	45737	49967	54197	58427	62657	66887	71117	75347
	CAM Data[1892](Low)	45738	49968	54198	58428	62658	66888	71118	75348
	CAM Data[1892](High)	45739	49969	54199	58429	62659	66889	71119	75349
	CAM Data[1893](Low)	45740	49970	54200	58430	62660	66890	71120	75350
	CAM Data[1893](High)	45741	49971	54201	58431	62661	66891	71121	75351
	CAM Data[1894](Low)	45742	49972	54202	58432	62662	66892	71122	75352
	CAM Data[1894](High)	45743	49973	54203	58433	62663	66893	71123	75353
	CAM Data[1895](Low)	45744	49974	54204	58434	62664	66894	71124	75354
	CAM Data[1895](High)	45745	49975	54205	58435	62665	66895	71125	75355
	CAM Data[1896](Low)	45746	49976	54206	58436	62666	66896	71126	75356
	CAM Data[1896](High)	45747	49977	54207	58437	62667	66897	71127	75357
	CAM Data[1897](Low)	45748	49978	54208	58438	62668	66898	71128	75358
	CAM Data[1897](High)	45749	49979	54209	58439	62669	66899	71129	75359
	CAM Data[1898](Low)	45750	49980	54210	58440	62670	66900	71130	75360
	CAM Data[1898](High)	45751	49981	54211	58441	62671	66901	71131	75361
	CAM Data[1899](Low)	45752	49982	54212	58442	62672	66902	71132	75362
	CAM Data[1899](High)	45753	49983	54213	58443	62673	66903	71133	75363
	CAM Data[1900](Low)	45754	49984	54214	58444	62674	66904	71134	75364
	CAM Data[1900](High)	45755	49985	54215	58445	62675	66905	71135	75365
	CAM Data[1901](Low)	45756	49986	54216	58446	62676	66906	71136	75366
	CAM Data[1901](High)	45757	49987	54217	58447	62677	66907	71137	75367
	CAM Data[1902](Low)	45758	49988	54218	58448	62678	66908	71138	75368
	CAM Data[1902](High)	45759	49989	54219	58449	62679	66909	71139	75369
	CAM Data[1903](Low)	45760	49990	54220	58450	62680	66910	71140	75370
	CAM Data[1903](High)	45761	49991	54221	58451	62681	66911	71141	75371
	CAM Data[1904](Low)	45762	49992	54222	58452	62682	66912	71142	75372
	CAM Data[1904](High)	45763	49993	54223	58453	62683	66913	71143	75373
	CAM Data[1905](Low)	45764	49994	54224	58454	62684	66914	71144	75374
	CAM Data[1905](High)	45765	49995	54225	58455	62685	66915	71145	75375
	CAM Data[1906](Low)	45766	49996	54226	58456	62686	66916	71146	75376
	CAM Data[1906](High)	45767	49997	54227	58457	62687	66917	71147	75377
	CAM Data[1907](Low)	45768	49998	54228	58458	62688	66918	71148	75378
	CAM Data[1907](High)	45769	49999	54229	58459	62689	66919	71149	75379
	CAM Data[1908](Low)	45770	50000	54230	58460	62690	66920	71150	75380

Chapter 11 Internal Memory Address of “Read/Write Variable Data” command

	CAM Data[1908](High)	45771	50001	54231	58461	62691	66921	71151	75381
	CAM Data[1909](Low)	45772	50002	54232	58462	62692	66922	71152	75382
	CAM Data[1909](High)	45773	50003	54233	58463	62693	66923	71153	75383
	CAM Data[1910](Low)	45774	50004	54234	58464	62694	66924	71154	75384
	CAM Data[1910](High)	45775	50005	54235	58465	62695	66925	71155	75385
	CAM Data[1911](Low)	45776	50006	54236	58466	62696	66926	71156	75386
	CAM Data[1911](High)	45777	50007	54237	58467	62697	66927	71157	75387
	CAM Data[1912](Low)	45778	50008	54238	58468	62698	66928	71158	75388
	CAM Data[1912](High)	45779	50009	54239	58469	62699	66929	71159	75389
	CAM Data[1913](Low)	45780	50010	54240	58470	62700	66930	71160	75390
	CAM Data[1913](High)	45781	50011	54241	58471	62701	66931	71161	75391
	CAM Data[1914](Low)	45782	50012	54242	58472	62702	66932	71162	75392
	CAM Data[1914](High)	45783	50013	54243	58473	62703	66933	71163	75393
	CAM Data[1915](Low)	45784	50014	54244	58474	62704	66934	71164	75394
	CAM Data[1915](High)	45785	50015	54245	58475	62705	66935	71165	75395
	CAM Data[1916](Low)	45786	50016	54246	58476	62706	66936	71166	75396
	CAM Data[1916](High)	45787	50017	54247	58477	62707	66937	71167	75397
	CAM Data[1917](Low)	45788	50018	54248	58478	62708	66938	71168	75398
	CAM Data[1917](High)	45789	50019	54249	58479	62709	66939	71169	75399
	CAM Data[1918](Low)	45790	50020	54250	58480	62710	66940	71170	75400
	CAM Data[1918](High)	45791	50021	54251	58481	62711	66941	71171	75401
	CAM Data[1919](Low)	45792	50022	54252	58482	62712	66942	71172	75402
	CAM Data[1919](High)	45793	50023	54253	58483	62713	66943	71173	75403
	CAM Data[1920](Low)	45794	50024	54254	58484	62714	66944	71174	75404
	CAM Data[1920](High)	45795	50025	54255	58485	62715	66945	71175	75405
	CAM Data[1921](Low)	45796	50026	54256	58486	62716	66946	71176	75406
	CAM Data[1921](High)	45797	50027	54257	58487	62717	66947	71177	75407
	CAM Data[1922](Low)	45798	50028	54258	58488	62718	66948	71178	75408
	CAM Data[1922](High)	45799	50029	54259	58489	62719	66949	71179	75409
	CAM Data[1923](Low)	45800	50030	54260	58490	62720	66950	71180	75410
	CAM Data[1923](High)	45801	50031	54261	58491	62721	66951	71181	75411
	CAM Data[1924](Low)	45802	50032	54262	58492	62722	66952	71182	75412
	CAM Data[1924](High)	45803	50033	54263	58493	62723	66953	71183	75413
	CAM Data[1925](Low)	45804	50034	54264	58494	62724	66954	71184	75414
	CAM Data[1925](High)	45805	50035	54265	58495	62725	66955	71185	75415
	CAM Data[1926](Low)	45806	50036	54266	58496	62726	66956	71186	75416
	CAM Data[1926](High)	45807	50037	54267	58497	62727	66957	71187	75417
	CAM Data[1927](Low)	45808	50038	54268	58498	62728	66958	71188	75418
	CAM Data[1927](High)	45809	50039	54269	58499	62729	66959	71189	75419
	CAM Data[1928](Low)	45810	50040	54270	58500	62730	66960	71190	75420
	CAM Data[1928](High)	45811	50041	54271	58501	62731	66961	71191	75421
	CAM Data[1929](Low)	45812	50042	54272	58502	62732	66962	71192	75422
	CAM Data[1929](High)	45813	50043	54273	58503	62733	66963	71193	75423
	CAM Data[1930](Low)	45814	50044	54274	58504	62734	66964	71194	75424
	CAM Data[1930](High)	45815	50045	54275	58505	62735	66965	71195	75425
	CAM Data[1931](Low)	45816	50046	54276	58506	62736	66966	71196	75426

Chapter 11 Internal Memory Address of “Read/Write Variable Data” command

	CAM Data[1931](High)	45817	50047	54277	58507	62737	66967	71197	75427
	CAM Data[1932](Low)	45818	50048	54278	58508	62738	66968	71198	75428
	CAM Data[1932](High)	45819	50049	54279	58509	62739	66969	71199	75429
	CAM Data[1933](Low)	45820	50050	54280	58510	62740	66970	71200	75430
	CAM Data[1933](High)	45821	50051	54281	58511	62741	66971	71201	75431
	CAM Data[1934](Low)	45822	50052	54282	58512	62742	66972	71202	75432
	CAM Data[1934](High)	45823	50053	54283	58513	62743	66973	71203	75433
	CAM Data[1935](Low)	45824	50054	54284	58514	62744	66974	71204	75434
	CAM Data[1935](High)	45825	50055	54285	58515	62745	66975	71205	75435
	CAM Data[1936](Low)	45826	50056	54286	58516	62746	66976	71206	75436
	CAM Data[1936](High)	45827	50057	54287	58517	62747	66977	71207	75437
	CAM Data[1937](Low)	45828	50058	54288	58518	62748	66978	71208	75438
	CAM Data[1937](High)	45829	50059	54289	58519	62749	66979	71209	75439
	CAM Data[1938](Low)	45830	50060	54290	58520	62750	66980	71210	75440
	CAM Data[1938](High)	45831	50061	54291	58521	62751	66981	71211	75441
	CAM Data[1939](Low)	45832	50062	54292	58522	62752	66982	71212	75442
	CAM Data[1939](High)	45833	50063	54293	58523	62753	66983	71213	75443
	CAM Data[1940](Low)	45834	50064	54294	58524	62754	66984	71214	75444
	CAM Data[1940](High)	45835	50065	54295	58525	62755	66985	71215	75445
	CAM Data[1941](Low)	45836	50066	54296	58526	62756	66986	71216	75446
	CAM Data[1941](High)	45837	50067	54297	58527	62757	66987	71217	75447
	CAM Data[1942](Low)	45838	50068	54298	58528	62758	66988	71218	75448
	CAM Data[1942](High)	45839	50069	54299	58529	62759	66989	71219	75449
	CAM Data[1943](Low)	45840	50070	54300	58530	62760	66990	71220	75450
	CAM Data[1943](High)	45841	50071	54301	58531	62761	66991	71221	75451
	CAM Data[1944](Low)	45842	50072	54302	58532	62762	66992	71222	75452
	CAM Data[1944](High)	45843	50073	54303	58533	62763	66993	71223	75453
	CAM Data[1945](Low)	45844	50074	54304	58534	62764	66994	71224	75454
	CAM Data[1945](High)	45845	50075	54305	58535	62765	66995	71225	75455
	CAM Data[1946](Low)	45846	50076	54306	58536	62766	66996	71226	75456
	CAM Data[1946](High)	45847	50077	54307	58537	62767	66997	71227	75457
	CAM Data[1947](Low)	45848	50078	54308	58538	62768	66998	71228	75458
	CAM Data[1947](High)	45849	50079	54309	58539	62769	66999	71229	75459
	CAM Data[1948](Low)	45850	50080	54310	58540	62770	67000	71230	75460
	CAM Data[1948](High)	45851	50081	54311	58541	62771	67001	71231	75461
	CAM Data[1949](Low)	45852	50082	54312	58542	62772	67002	71232	75462
	CAM Data[1949](High)	45853	50083	54313	58543	62773	67003	71233	75463
	CAM Data[1950](Low)	45854	50084	54314	58544	62774	67004	71234	75464
	CAM Data[1950](High)	45855	50085	54315	58545	62775	67005	71235	75465
	CAM Data[1951](Low)	45856	50086	54316	58546	62776	67006	71236	75466
	CAM Data[1951](High)	45857	50087	54317	58547	62777	67007	71237	75467
	CAM Data[1952](Low)	45858	50088	54318	58548	62778	67008	71238	75468
	CAM Data[1952](High)	45859	50089	54319	58549	62779	67009	71239	75469
	CAM Data[1953](Low)	45860	50090	54320	58550	62780	67010	71240	75470
	CAM Data[1953](High)	45861	50091	54321	58551	62781	67011	71241	75471
	CAM Data[1954](Low)	45862	50092	54322	58552	62782	67012	71242	75472

Chapter 11 Internal Memory Address of “Read/Write Variable Data” command

	CAM Data[1954](High)	45863	50093	54323	58553	62783	67013	71243	75473
	CAM Data[1955](Low)	45864	50094	54324	58554	62784	67014	71244	75474
	CAM Data[1955](High)	45865	50095	54325	58555	62785	67015	71245	75475
	CAM Data[1956](Low)	45866	50096	54326	58556	62786	67016	71246	75476
	CAM Data[1956](High)	45867	50097	54327	58557	62787	67017	71247	75477
	CAM Data[1957](Low)	45868	50098	54328	58558	62788	67018	71248	75478
	CAM Data[1957](High)	45869	50099	54329	58559	62789	67019	71249	75479
	CAM Data[1958](Low)	45870	50100	54330	58560	62790	67020	71250	75480
	CAM Data[1958](High)	45871	50101	54331	58561	62791	67021	71251	75481
	CAM Data[1959](Low)	45872	50102	54332	58562	62792	67022	71252	75482
	CAM Data[1959](High)	45873	50103	54333	58563	62793	67023	71253	75483
	CAM Data[1960](Low)	45874	50104	54334	58564	62794	67024	71254	75484
	CAM Data[1960](High)	45875	50105	54335	58565	62795	67025	71255	75485
	CAM Data[1961](Low)	45876	50106	54336	58566	62796	67026	71256	75486
	CAM Data[1961](High)	45877	50107	54337	58567	62797	67027	71257	75487
	CAM Data[1962](Low)	45878	50108	54338	58568	62798	67028	71258	75488
	CAM Data[1962](High)	45879	50109	54339	58569	62799	67029	71259	75489
	CAM Data[1963](Low)	45880	50110	54340	58570	62800	67030	71260	75490
	CAM Data[1963](High)	45881	50111	54341	58571	62801	67031	71261	75491
	CAM Data[1964](Low)	45882	50112	54342	58572	62802	67032	71262	75492
	CAM Data[1964](High)	45883	50113	54343	58573	62803	67033	71263	75493
	CAM Data[1965](Low)	45884	50114	54344	58574	62804	67034	71264	75494
	CAM Data[1965](High)	45885	50115	54345	58575	62805	67035	71265	75495
	CAM Data[1966](Low)	45886	50116	54346	58576	62806	67036	71266	75496
	CAM Data[1966](High)	45887	50117	54347	58577	62807	67037	71267	75497
	CAM Data[1967](Low)	45888	50118	54348	58578	62808	67038	71268	75498
	CAM Data[1967](High)	45889	50119	54349	58579	62809	67039	71269	75499
	CAM Data[1968](Low)	45890	50120	54350	58580	62810	67040	71270	75500
	CAM Data[1968](High)	45891	50121	54351	58581	62811	67041	71271	75501
	CAM Data[1969](Low)	45892	50122	54352	58582	62812	67042	71272	75502
	CAM Data[1969](High)	45893	50123	54353	58583	62813	67043	71273	75503
	CAM Data[1970](Low)	45894	50124	54354	58584	62814	67044	71274	75504
	CAM Data[1970](High)	45895	50125	54355	58585	62815	67045	71275	75505
	CAM Data[1971](Low)	45896	50126	54356	58586	62816	67046	71276	75506
	CAM Data[1971](High)	45897	50127	54357	58587	62817	67047	71277	75507
	CAM Data[1972](Low)	45898	50128	54358	58588	62818	67048	71278	75508
	CAM Data[1972](High)	45899	50129	54359	58589	62819	67049	71279	75509
	CAM Data[1973](Low)	45900	50130	54360	58590	62820	67050	71280	75510
	CAM Data[1973](High)	45901	50131	54361	58591	62821	67051	71281	75511
	CAM Data[1974](Low)	45902	50132	54362	58592	62822	67052	71282	75512
	CAM Data[1974](High)	45903	50133	54363	58593	62823	67053	71283	75513
	CAM Data[1975](Low)	45904	50134	54364	58594	62824	67054	71284	75514
	CAM Data[1975](High)	45905	50135	54365	58595	62825	67055	71285	75515
	CAM Data[1976](Low)	45906	50136	54366	58596	62826	67056	71286	75516
	CAM Data[1976](High)	45907	50137	54367	58597	62827	67057	71287	75517
	CAM Data[1977](Low)	45908	50138	54368	58598	62828	67058	71288	75518

Chapter 11 Internal Memory Address of “Read/Write Variable Data” command

	CAM Data[1977](High)	45909	50139	54369	58599	62829	67059	71289	75519
	CAM Data[1978](Low)	45910	50140	54370	58600	62830	67060	71290	75520
	CAM Data[1978](High)	45911	50141	54371	58601	62831	67061	71291	75521
	CAM Data[1979](Low)	45912	50142	54372	58602	62832	67062	71292	75522
	CAM Data[1979](High)	45913	50143	54373	58603	62833	67063	71293	75523
	CAM Data[1980](Low)	45914	50144	54374	58604	62834	67064	71294	75524
	CAM Data[1980](High)	45915	50145	54375	58605	62835	67065	71295	75525
	CAM Data[1981](Low)	45916	50146	54376	58606	62836	67066	71296	75526
	CAM Data[1981](High)	45917	50147	54377	58607	62837	67067	71297	75527
	CAM Data[1982](Low)	45918	50148	54378	58608	62838	67068	71298	75528
	CAM Data[1982](High)	45919	50149	54379	58609	62839	67069	71299	75529
	CAM Data[1983](Low)	45920	50150	54380	58610	62840	67070	71300	75530
	CAM Data[1983](High)	45921	50151	54381	58611	62841	67071	71301	75531
	CAM Data[1984](Low)	45922	50152	54382	58612	62842	67072	71302	75532
	CAM Data[1984](High)	45923	50153	54383	58613	62843	67073	71303	75533
	CAM Data[1985](Low)	45924	50154	54384	58614	62844	67074	71304	75534
	CAM Data[1985](High)	45925	50155	54385	58615	62845	67075	71305	75535
	CAM Data[1986](Low)	45926	50156	54386	58616	62846	67076	71306	75536
	CAM Data[1986](High)	45927	50157	54387	58617	62847	67077	71307	75537
	CAM Data[1987](Low)	45928	50158	54388	58618	62848	67078	71308	75538
	CAM Data[1987](High)	45929	50159	54389	58619	62849	67079	71309	75539
	CAM Data[1988](Low)	45930	50160	54390	58620	62850	67080	71310	75540
	CAM Data[1988](High)	45931	50161	54391	58621	62851	67081	71311	75541
	CAM Data[1989](Low)	45932	50162	54392	58622	62852	67082	71312	75542
	CAM Data[1989](High)	45933	50163	54393	58623	62853	67083	71313	75543
	CAM Data[1990](Low)	45934	50164	54394	58624	62854	67084	71314	75544
	CAM Data[1990](High)	45935	50165	54395	58625	62855	67085	71315	75545
	CAM Data[1991](Low)	45936	50166	54396	58626	62856	67086	71316	75546
	CAM Data[1991](High)	45937	50167	54397	58627	62857	67087	71317	75547
	CAM Data[1992](Low)	45938	50168	54398	58628	62858	67088	71318	75548
	CAM Data[1992](High)	45939	50169	54399	58629	62859	67089	71319	75549
	CAM Data[1993](Low)	45940	50170	54400	58630	62860	67090	71320	75550
	CAM Data[1993](High)	45941	50171	54401	58631	62861	67091	71321	75551
	CAM Data[1994](Low)	45942	50172	54402	58632	62862	67092	71322	75552
	CAM Data[1994](High)	45943	50173	54403	58633	62863	67093	71323	75553
	CAM Data[1995](Low)	45944	50174	54404	58634	62864	67094	71324	75554
	CAM Data[1995](High)	45945	50175	54405	58635	62865	67095	71325	75555
	CAM Data[1996](Low)	45946	50176	54406	58636	62866	67096	71326	75556
	CAM Data[1996](High)	45947	50177	54407	58637	62867	67097	71327	75557
	CAM Data[1997](Low)	45948	50178	54408	58638	62868	67098	71328	75558
	CAM Data[1997](High)	45949	50179	54409	58639	62869	67099	71329	75559
	CAM Data[1998](Low)	45950	50180	54410	58640	62870	67100	71330	75560
	CAM Data[1998](High)	45951	50181	54411	58641	62871	67101	71331	75561
	CAM Data[1999](Low)	45952	50182	54412	58642	62872	67102	71332	75562
	CAM Data[1999](High)	45953	50183	54413	58643	62873	67103	71333	75563
	CAM Data[2000](Low)	45954	50184	54414	58644	62874	67104	71334	75564

Chapter 11 Internal Memory Address of “Read/Write Variable Data” command

	CAM Data[2000](High)	45955	50185	54415	58645	62875	67105	71335	75565
	CAM Data[2001](Low)	45956	50186	54416	58646	62876	67106	71336	75566
	CAM Data[2001](High)	45957	50187	54417	58647	62877	67107	71337	75567
	CAM Data[2002](Low)	45958	50188	54418	58648	62878	67108	71338	75568
	CAM Data[2002](High)	45959	50189	54419	58649	62879	67109	71339	75569
	CAM Data[2003](Low)	45960	50190	54420	58650	62880	67110	71340	75570
	CAM Data[2003](High)	45961	50191	54421	58651	62881	67111	71341	75571
	CAM Data[2004](Low)	45962	50192	54422	58652	62882	67112	71342	75572
	CAM Data[2004](High)	45963	50193	54423	58653	62883	67113	71343	75573
	CAM Data[2005](Low)	45964	50194	54424	58654	62884	67114	71344	75574
	CAM Data[2005](High)	45965	50195	54425	58655	62885	67115	71345	75575
	CAM Data[2006](Low)	45966	50196	54426	58656	62886	67116	71346	75576
	CAM Data[2006](High)	45967	50197	54427	58657	62887	67117	71347	75577
	CAM Data[2007](Low)	45968	50198	54428	58658	62888	67118	71348	75578
	CAM Data[2007](High)	45969	50199	54429	58659	62889	67119	71349	75579
	CAM Data[2008](Low)	45970	50200	54430	58660	62890	67120	71350	75580
	CAM Data[2008](High)	45971	50201	54431	58661	62891	67121	71351	75581
	CAM Data[2009](Low)	45972	50202	54432	58662	62892	67122	71352	75582
	CAM Data[2009](High)	45973	50203	54433	58663	62893	67123	71353	75583
	CAM Data[2010](Low)	45974	50204	54434	58664	62894	67124	71354	75584
	CAM Data[2010](High)	45975	50205	54435	58665	62895	67125	71355	75585
	CAM Data[2011](Low)	45976	50206	54436	58666	62896	67126	71356	75586
	CAM Data[2011](High)	45977	50207	54437	58667	62897	67127	71357	75587
	CAM Data[2012](Low)	45978	50208	54438	58668	62898	67128	71358	75588
	CAM Data[2012](High)	45979	50209	54439	58669	62899	67129	71359	75589
	CAM Data[2013](Low)	45980	50210	54440	58670	62900	67130	71360	75590
	CAM Data[2013](High)	45981	50211	54441	58671	62901	67131	71361	75591
	CAM Data[2014](Low)	45982	50212	54442	58672	62902	67132	71362	75592
	CAM Data[2014](High)	45983	50213	54443	58673	62903	67133	71363	75593
	CAM Data[2015](Low)	45984	50214	54444	58674	62904	67134	71364	75594
	CAM Data[2015](High)	45985	50215	54445	58675	62905	67135	71365	75595
	CAM Data[2016](Low)	45986	50216	54446	58676	62906	67136	71366	75596
	CAM Data[2016](High)	45987	50217	54447	58677	62907	67137	71367	75597
	CAM Data[2017](Low)	45988	50218	54448	58678	62908	67138	71368	75598
	CAM Data[2017](High)	45989	50219	54449	58679	62909	67139	71369	75599
	CAM Data[2018](Low)	45990	50220	54450	58680	62910	67140	71370	75600
	CAM Data[2018](High)	45991	50221	54451	58681	62911	67141	71371	75601
	CAM Data[2019](Low)	45992	50222	54452	58682	62912	67142	71372	75602
	CAM Data[2019](High)	45993	50223	54453	58683	62913	67143	71373	75603
	CAM Data[2020](Low)	45994	50224	54454	58684	62914	67144	71374	75604
	CAM Data[2020](High)	45995	50225	54455	58685	62915	67145	71375	75605
	CAM Data[2021](Low)	45996	50226	54456	58686	62916	67146	71376	75606
	CAM Data[2021](High)	45997	50227	54457	58687	62917	67147	71377	75607
	CAM Data[2022](Low)	45998	50228	54458	58688	62918	67148	71378	75608
	CAM Data[2022](High)	45999	50229	54459	58689	62919	67149	71379	75609
	CAM Data[2023](Low)	46000	50230	54460	58690	62920	67150	71380	75610

Chapter 11 Internal Memory Address of “Read/Write Variable Data” command

	CAM Data[2023](High)	46001	50231	54461	58691	62921	67151	71381	75611
	CAM Data[2024](Low)	46002	50232	54462	58692	62922	67152	71382	75612
	CAM Data[2024](High)	46003	50233	54463	58693	62923	67153	71383	75613
	CAM Data[2025](Low)	46004	50234	54464	58694	62924	67154	71384	75614
	CAM Data[2025](High)	46005	50235	54465	58695	62925	67155	71385	75615
	CAM Data[2026](Low)	46006	50236	54466	58696	62926	67156	71386	75616
	CAM Data[2026](High)	46007	50237	54467	58697	62927	67157	71387	75617
	CAM Data[2027](Low)	46008	50238	54468	58698	62928	67158	71388	75618
	CAM Data[2027](High)	46009	50239	54469	58699	62929	67159	71389	75619
	CAM Data[2028](Low)	46010	50240	54470	58700	62930	67160	71390	75620
	CAM Data[2028](High)	46011	50241	54471	58701	62931	67161	71391	75621
	CAM Data[2029](Low)	46012	50242	54472	58702	62932	67162	71392	75622
	CAM Data[2029](High)	46013	50243	54473	58703	62933	67163	71393	75623
	CAM Data[2030](Low)	46014	50244	54474	58704	62934	67164	71394	75624
	CAM Data[2030](High)	46015	50245	54475	58705	62935	67165	71395	75625
	CAM Data[2031](Low)	46016	50246	54476	58706	62936	67166	71396	75626
	CAM Data[2031](High)	46017	50247	54477	58707	62937	67167	71397	75627
	CAM Data[2032](Low)	46018	50248	54478	58708	62938	67168	71398	75628
	CAM Data[2032](High)	46019	50249	54479	58709	62939	67169	71399	75629
	CAM Data[2033](Low)	46020	50250	54480	58710	62940	67170	71400	75630
	CAM Data[2033](High)	46021	50251	54481	58711	62941	67171	71401	75631
	CAM Data[2034](Low)	46022	50252	54482	58712	62942	67172	71402	75632
	CAM Data[2034](High)	46023	50253	54483	58713	62943	67173	71403	75633
	CAM Data[2035](Low)	46024	50254	54484	58714	62944	67174	71404	75634
	CAM Data[2035](High)	46025	50255	54485	58715	62945	67175	71405	75635
	CAM Data[2036](Low)	46026	50256	54486	58716	62946	67176	71406	75636
	CAM Data[2036](High)	46027	50257	54487	58717	62947	67177	71407	75637
	CAM Data[2037](Low)	46028	50258	54488	58718	62948	67178	71408	75638
	CAM Data[2037](High)	46029	50259	54489	58719	62949	67179	71409	75639
	CAM Data[2038](Low)	46030	50260	54490	58720	62950	67180	71410	75640
	CAM Data[2038](High)	46031	50261	54491	58721	62951	67181	71411	75641
	CAM Data[2039](Low)	46032	50262	54492	58722	62952	67182	71412	75642
	CAM Data[2039](High)	46033	50263	54493	58723	62953	67183	71413	75643
	CAM Data[2040](Low)	46034	50264	54494	58724	62954	67184	71414	75644
	CAM Data[2040](High)	46035	50265	54495	58725	62955	67185	71415	75645
	CAM Data[2041](Low)	46036	50266	54496	58726	62956	67186	71416	75646
	CAM Data[2041](High)	46037	50267	54497	58727	62957	67187	71417	75647
	CAM Data[2042](Low)	46038	50268	54498	58728	62958	67188	71418	75648
	CAM Data[2042](High)	46039	50269	54499	58729	62959	67189	71419	75649
	CAM Data[2043](Low)	46040	50270	54500	58730	62960	67190	71420	75650
	CAM Data[2043](High)	46041	50271	54501	58731	62961	67191	71421	75651
	CAM Data[2044](Low)	46042	50272	54502	58732	62962	67192	71422	75652
	CAM Data[2044](High)	46043	50273	54503	58733	62963	67193	71423	75653
	CAM Data[2045](Low)	46044	50274	54504	58734	62964	67194	71424	75654
	CAM Data[2045](High)	46045	50275	54505	58735	62965	67195	71425	75655
	CAM Data[2046](Low)	46046	50276	54506	58736	62966	67196	71426	75656

Chapter 11 Internal Memory Address of “Read/Write Variable Data” command

	CAM Data[2046](High)	46047	50277	54507	58737	62967	67197	71427	75657
	CAM Data[2047](Low)	46048	50278	54508	58738	62968	67198	71428	75658
	CAM Data[2047](High)	46049	50279	54509	58739	62969	67199	71429	75659

11.9 User CAM data memory address

	Axis 1	Axis 2	Axis 3	Axis 4	Axis 5	Axis 6
user CAM data	142636	142758	142880	143002	143124	143246
-	142637	142759	142881	143003	143125	143247
Main axis position 1 Low	142638	142760	142882	143004	143126	143248
Main axis position 1 High	142639	142761	142883	143005	143127	143249
Sub axis position 1 Low	142640	142762	142884	143006	143128	143250
Sub axis position 1 High	142641	142763	142885	143007	143129	143251
Main axis position 2 Low	142642	142764	142886	143008	143130	143252
Main axis position 2 High	142643	142765	142887	143009	143131	143253
Sub axis position 2 Low	142644	142766	142888	143010	143132	143254
Sub axis position 2 High	142645	142767	142889	143011	143133	143255
Main axis position 3 Low	142646	142768	142890	143012	143134	143256
Main axis position 3 High	142647	142769	142891	143013	143135	143257
Sub axis position 3 Low	142648	142770	142892	143014	143136	143258
Sub axis position 3 High	142649	142771	142893	143015	143137	143259
Main axis position 4 Low	142650	142772	142894	143016	143138	143260
Main axis position 4 High	142651	142773	142895	143017	143139	143261
Sub axis position 4 Low	142652	142774	142896	143018	143140	143262
Sub axis position 4 High	142653	142775	142897	143019	143141	143263
Main axis position 5 Low	142654	142776	142898	143020	143142	143264
Main axis position 5 High	142655	142777	142899	143021	143143	143265
Sub axis position 5 Low	142656	142778	142900	143022	143144	143266
Sub axis position 5 High	142657	142779	142901	143023	143145	143267
Main axis position 6 Low	142658	142780	142902	143024	143146	143268
Main axis position 6 High	142659	142781	142903	143025	143147	143269
Sub axis position 6 Low	142660	142782	142904	143026	143148	143270
Sub axis position 6 High	142661	142783	142905	143027	143149	143271
Main axis position 7 Low	142662	142784	142906	143028	143150	143272
Main axis position 7 High	142663	142785	142907	143029	143151	143273
Sub axis position 7 Low	142664	142786	142908	143030	143152	143274
Sub axis position 7 High	142665	142787	142909	143031	143153	143275
Main axis position 8 Low	142666	142788	142910	143032	143154	143276
Main axis position 8 High	142667	142789	142911	143033	143155	143277
Sub axis position 8 Low	142668	142790	142912	143034	143156	143278
Sub axis position 8 High	142669	142791	142913	143035	143157	143279
Main axis position 9 Low	142670	142792	142914	143036	143158	143280
Main axis position 9 High	142671	142793	142915	143037	143159	143281
Sub axis position 9 Low	142672	142794	142916	143038	143160	143282
Sub axis position 9 High	142673	142795	142917	143039	143161	143283
Main axis position 10 Low	142674	142796	142918	143040	143162	143284
Main axis position 10 High	142675	142797	142919	143041	143163	143285
Sub axis position 10 Low	142676	142798	142920	143042	143164	143286
Sub axis position 10 High	142677	142799	142921	143043	143165	143287
Main axis position 11 Low	142678	142800	142922	143044	143166	143288

Chapter 11 Internal Memory Address of “Read/Write Variable Data” command

Main axis position 11 High	142679	142801	142923	143045	143167	143289
Sub axis position 11 Low	142680	142802	142924	143046	143168	143290
Sub axis position 11 High	142681	142803	142925	143047	143169	143291
Main axis position 12 Low	142682	142804	142926	143048	143170	143292
Main axis position 12 High	142683	142805	142927	143049	143171	143293
Sub axis position 12 Low	142684	142806	142928	143050	143172	143294
Sub axis position 12 High	142685	142807	142929	143051	143173	143295
Main axis position 13 Low	142686	142808	142930	143052	143174	143296
Main axis position 13 High	142687	142809	142931	143053	143175	143297
Sub axis position 13 Low	142688	142810	142932	143054	143176	143298
Sub axis position 13 High	142689	142811	142933	143055	143177	143299
Main axis position 14 Low	142690	142812	142934	143056	143178	143300
Main axis position 14 High	142691	142813	142935	143057	143179	143301
Sub axis position 14 Low	142692	142814	142936	143058	143180	143302
Sub axis position 14 High	142693	142815	142937	143059	143181	143303
Main axis position 15 Low	142694	142816	142938	143060	143182	143304
Main axis position 15 High	142695	142817	142939	143061	143183	143305
Sub axis position 15 Low	142696	142818	142940	143062	143184	143306
Sub axis position 15 High	142697	142819	142941	143063	143185	143307
Main axis position 16 Low	142698	142820	142942	143064	143186	143308
Main axis position 16 High	142699	142821	142943	143065	143187	143309
Sub axis position 16 Low	142700	142822	142944	143066	143188	143310
Sub axis position 16 High	142701	142823	142945	143067	143189	143311
Main axis position 17 Low	142702	142824	142946	143068	143190	143312
Main axis position 17 High	142703	142825	142947	143069	143191	143313
Sub axis position 17 Low	142704	142826	142948	143070	143192	143314
Sub axis position 17 High	142705	142827	142949	143071	143193	143315
Main axis position 18 Low	142706	142828	142950	143072	143194	143316
Main axis position 18 High	142707	142829	142951	143073	143195	143317
Sub axis position 18 Low	142708	142830	142952	143074	143196	143318
Sub axis position 18 High	142709	142831	142953	143075	143197	143319
Main axis position 19 Low	142710	142832	142954	143076	143198	143320
Main axis position 19 High	142711	142833	142955	143077	143199	143321
Sub axis position 19 Low	142712	142834	142956	143078	143200	143322
Sub axis position 19 High	142713	142835	142957	143079	143201	143323
Main axis position 20 Low	142714	142836	142958	143080	143202	143324
Main axis position 20 High	142715	142837	142959	143081	143203	143325
Sub axis position 20 Low	142716	142838	142960	143082	143204	143326
Sub axis position 20 High	142717	142839	142961	143083	143205	143327
Main axis position 21 Low	142718	142840	142962	143084	143206	143328
Main axis position 21 High	142719	142841	142963	143085	143207	143329
Sub axis position 21 Low	142720	142842	142964	143086	143208	143330
Sub axis position 21 High	142721	142843	142965	143087	143209	143331
Main axis position 22 Low	142722	142844	142966	143088	143210	143332
Main axis position 22 High	142723	142845	142967	143089	143211	143333
Sub axis position 22 Low	142724	142846	142968	143090	143212	143334

Chapter 11 Internal Memory Address of “Read/Write Variable Data” command

Sub axis position 22 High	142725	142847	142969	143091	143213	143335
Main axis position 23 Low	142726	142848	142970	143092	143214	143336
Main axis position 23 High	142727	142849	142971	143093	143215	143337
Sub axis position 23 Low	142728	142850	142972	143094	143216	143338
Sub axis position 23 High	142729	142851	142973	143095	143217	143339
Main axis position 24 Low	142730	142852	142974	143096	143218	143340
Main axis position 24 High	142731	142853	142975	143097	143219	143341
Sub axis position 24 Low	142732	142854	142976	143098	143220	143342
Sub axis position 24 High	142733	142855	142977	143099	143221	143343
Main axis position 25 Low	142734	142856	142978	143100	143222	143344
Main axis position 25 High	142735	142857	142979	143101	143223	143345
Sub axis position 25 Low	142736	142858	142980	143102	143224	143346
Sub axis position 25 High	142737	142859	142981	143103	143225	143347
Main axis position 26 Low	142738	142860	142982	143104	143226	143348
Main axis position 26 High	142739	142861	142983	143105	143227	143349
Sub axis position 26 Low	142740	142862	142984	143106	143228	143350
Sub axis position 26 High	142741	142863	142985	143107	143229	143351
Main axis position 27 Low	142742	142864	142986	143108	143230	143352
Main axis position 27 High	142743	142865	142987	143109	143231	143353
Sub axis position 27 Low	142744	142866	142988	143110	143232	143354
Sub axis position 27 High	142745	142867	142989	143111	143233	143355
Main axis position 28 Low	142746	142868	142990	143112	143234	143356
Main axis position 28 High	142747	142869	142991	143113	143235	143357
Sub axis position 28 Low	142748	142870	142992	143114	143236	143358
Sub axis position 28 High	142749	142871	142993	143115	143237	143359
Main axis position 29 Low	142750	142872	142994	143116	143238	143360
Main axis position 29 High	142751	142873	142995	143117	143239	143361
Sub axis position 29 Low	142752	142874	142996	143118	143240	143362
Sub axis position 29 High	142753	142875	142997	143119	143241	143363
Main axis position 30 Low	142754	142876	142998	143120	143242	143364
Main axis position 30 High	142755	142877	142999	143121	143243	143365
Sub axis position 30 Low	142756	142878	143000	143122	143244	143366
Sub axis position 30 High	142757	142879	143001	143123	143245	143367

Chapter 11 Internal Memory Address of “Read/Write Variable Data” command

Part 4 Communication

Part 4. Built-in communication functions describes the specifications, performance and operation methods of 2port FEnet and RS-232C, RS-485 communication.

Chapter 1 Built-in FEnet communication

1.1 Outline

Ethernet is the international standard registered to IEEE (Institute of Electrical and Electronics Engineers), which controls data transfer through CSMA/CD (Carrier Sense Multiple Access/Collision Detection).

Ethernet can transmit data at the speed of 10 Mbps and 100 Mbps and it is stated as 'Fast Ethernet' in the standard. The speed of Fast Ethernet can be expressed as 10 BASE-T, 100 BASE-T. 'T' means the twisted pair wire. In the case of 100 BASE-T, for stable communication with high speed, the specification of the cable to be used is defined and standardized cables are recommended.

The built-in FEnet of XEM-H2/HP small-sized PLC basic unit has various applications based on the standard so it provides excellent functions and performance for a user.

Notice

XEM-H2/HP operate at 10/100 BASE, but only supports Auto-Negotiation setting, and the user cannot select the speed directly. When auto-negotiation is used, the network speed is set Automatically.

1.1.1 Characteristics

Built-in FEnet supports ARP, ICMP, TCP, UDP, IP, SMTP and SNTP protocols and has the following features.

- 1) Supporting IEEE 802.3u standard
- 2) Supporting high speed link for high-speed data communication between LS ELECTRIC modules
 - Providing the parameter setting program (XG5000)
 - Transmission of the maximum 32 blocks X 200 words, reception of the maximum 32 blocks X 200 words, transmission reception of maximum 64 blocks X 200 words)
- 3) Communication with up to 16 modules except HS link (maximum 16 channels when using dedicated communication and P2P communication)
- 4) Supporting the loader service (XG5000) through Ethernet
 - Dedicated TCP/IP PORT: 2002 allocations
- 5) Easy connection with other companies' systems through P2P communication and XG5000
 - Variable READ/WRITE service is available: Using the Dynamic Connection functions
- 6) Auto Negotiation
 - Supporting 10/100BASE-TX media auto setting

- 7) Auto-MDIX (Using HP Auto-MDIX)
 - Function to assort the cross cable and straight cable automatically
- 8) Supporting various communication functions
 - System access through public network
 - Supporting LS ELECTRIC protocol (XGT) and other companies' protocols (Modbus TCP/IP) (dedicated service)
 - Supporting the simple and convenient client function for communication between LS ELECTRIC communication modules and communication with other companies' modules
 - XGT, Modbus TCP, user-defined P2P client function
 - Providing the host Enable table for upper PC (MMI) and communication security
 - Supporting Dynamic Connection/Disconnection through P2P service
- 9) Providing various diagnosis functions, status information of modules and network
 - Status of the CPU module
 - Status of communication modules
 - Status of communication services (high speed link, dedicated service, P2P)
 - Providing the PING function to verify the presence of other modules
 - Providing packet types received by LS ELECTRIC communication modules and packet reception rate per minute (network load can be estimated)
 - Providing the diagnosis function of communication modules through the network
 - Auto scan(Shows network connected device of LS ELECTRIC product) provided (Except for XBL-EMTA)
 - IP search function provided in XG5000(Except for XBL-EMTA)
- 10) Providing commercial service
 - Providing E-mail transmission service through SMTP.
 - Providing PL C time synchronization service though SNTP protocol.

1.2 Specifications

1.2.1 Performance Specifications

1) Transmission Specifications

Items		Specifications	Remarks
Transmission specifications	Transfer rate	Auto	
	Transfer mode	Base band	
	Flow control	HALF/FULL	
	Modulation method	NRZI	4B/5B coding
	Transformer CT	1:1	node-hub
	Maximum distance between nodes	100 m	
	Minimum distance between nodes	1m or more ^(Note1)	
	Maximum protocol size	Data 512 bytes	
	Communication zone access method	CSMA/CD	
	Frame error check	CRC 32	
	Communication channel	1 Channel	

*Note1) When using a cable of less than 1 m, the SNR (Signal to Noise Ratio) decreases due to the influence of reflected waves, which may cause Link Down or packet loss.

2) Maximum number of channels

Items	Specifications	Remarks
Maximum server access channel	25 channels	XGT dedicated or Modbus: 16 channels UDP dedicated server: 1channel(UDP) High speed link: 1channel(UDP) Remote 1,2: each 2channel(TCP) Auto Scan: 2channels(UDP) SMTP: 2channels (including relay server 1channel)(TCP) SNTP: 1channel(UDP)

3) Performance specifications by communication service

Items		Specifications			Remarks
		Driver	Comm. method	Port No.	
FUNCTION	Dedicated	XGT server	TCP/IP	2004	<ul style="list-style-type: none"> ▪ Up to 16 channels ▪ Up to 512 bytes
			UDP/IP	2005	
		Modbus TCP server	TCP/IP	502	
	High speed link	-	UDP/IP	2006	<ul style="list-style-type: none"> ▪ Up to 64 blocks ▪ 200 words per block
	P2P	XGT client	TCP/IP	2004	<ul style="list-style-type: none"> ▪ Up to 15 channels ▪ Up to 512 bytes
			UDP/IP	2005	
		Modbus TCP client	TCP/IP	502	
		User-defined frame	TCP/IP	Customized	
	Remote	Server	TCP/IP	2002	<ul style="list-style-type: none"> ▪ Up to 1channel
		Client	TCP/IP	2002	<ul style="list-style-type: none"> ▪ Up to 1channel
Auto Scan	-	UDP/IP	2007(list), 2008(inforamtion0)	<ul style="list-style-type: none"> ▪ Up to 2channel 	

	SNTP	Client	UDP/IP	Customized	▪Up to 1channel
	SMTP	Client	TCP/IP	25(relay) Customized	▪Up to 2channel

4) Performance specifications of diagnosis function

Items		Specifications	
Diagnosis function	Information of built-in communication functions	high speed link exchange number/whether using DHCP IP address/MAC address module status/presence of system parameters Group status/media setting value hardware/software version	
	Status by service	Dedicated service	Number of transmitted packets/ Number of received packets / Number of error packets / status drive setting
		High speed link	Number of transmitted/received packets high speed link flag (RUN, link, Mode, Status, TRX, Error)
		P2Pservice	Connection status / service status service count / error count
	Media information	Total number of received packets	BROAD, MULTI, UNI, UDP, ARP, packet drop
		Packet rate per second	
	Ping Test		IP Address / Number of settings / Timeout
Auto-Scan		available	

5) Available PLC Area

(1) XEM-DN32HP/H2 (IEC type)

AREA	Device Type	Size(Word)	Remark
I	%IW0.0.0 ~ %IW15.15.3	1024	Read, Write Enable
Q	%QW0.0.0 ~ %QW15.15.3	1024	Read, Write Enable
M	%MW0 ~ %MW16383	16384	Read, Write Enable
W	%WW0 ~ %WW32767	32768	Read, Write Enable
R	%RW0 ~ %RW16383	16384	Read, Write Enable

1.2.2 Names and roles of built-in FENet parts

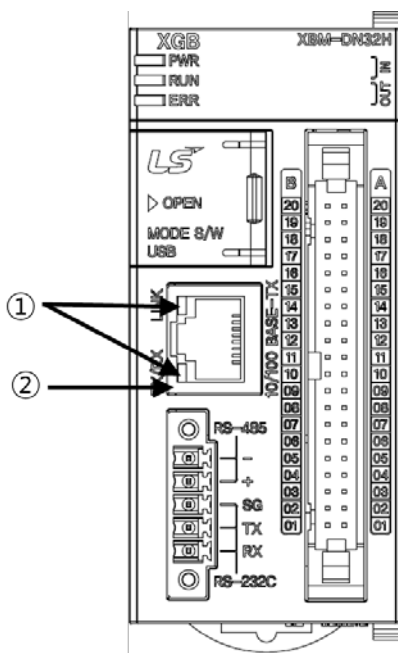

No.	Name	Details																					
①	LED display part	<p>Displays the status of modules and communication.</p> <table border="1"> <thead> <tr> <th>Item</th> <th>Color</th> <th colspan="3">Operation details of each status</th> </tr> </thead> <tbody> <tr> <td rowspan="2">RX/TX</td> <td rowspan="2">Yellow</td> <td>OFF</td> <td>Connection error</td> <td>No connected device</td> </tr> <tr> <td>Flickering</td> <td>During communication</td> <td>Flickering in case RX, TX occur</td> </tr> <tr> <td rowspan="2">SPEED</td> <td rowspan="2">Green</td> <td>ON</td> <td>100BASE-T</td> <td>In progress at 100Mbps</td> </tr> <tr> <td>OFF</td> <td>10BASE-T</td> <td>In progress at 10Mbps</td> </tr> </tbody> </table>	Item	Color	Operation details of each status			RX/TX	Yellow	OFF	Connection error	No connected device	Flickering	During communication	Flickering in case RX, TX occur	SPEED	Green	ON	100BASE-T	In progress at 100Mbps	OFF	10BASE-T	In progress at 10Mbps
Item	Color	Operation details of each status																					
RX/TX	Yellow	OFF	Connection error	No connected device																			
		Flickering	During communication	Flickering in case RX, TX occur																			
SPEED	Green	ON	100BASE-T	In progress at 100Mbps																			
		OFF	10BASE-T	In progress at 10Mbps																			
②	FENet communication connector	FENet communication connector (RJ 45)																					

1.2.3 Cable Specifications

1) Classification of cables

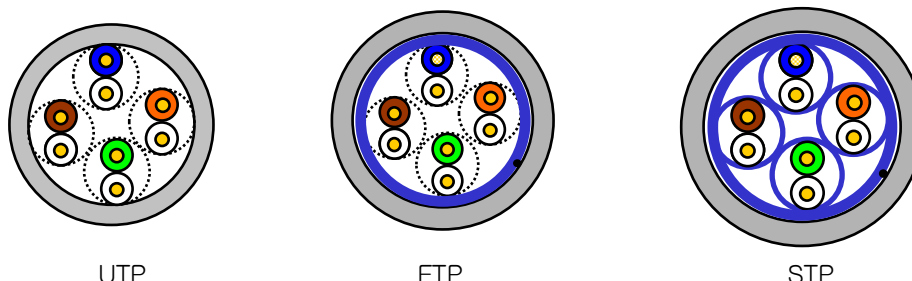

Items	Names	Remarks
UTP (or U.UTP)	Cable for unshielded high speed signal	Up to 200MHz Sound + information (Data)+low-grade video signal
FTP (or S.UTP)	Cable with shielded core only	Up to 100MHz Considering electromagnetic interference (EMI) and electronic stability Sound + information (Data)+low-grade video signal
STP (or S.STP)	Dual Shielded, pair individual twisted and cable with shield core only	Up to 500MHz Sound + information (Data)+Video signal Substitute for the coaxial cable of 75Ω

- UTP(Unshielded Twisted Pair): A cable made by twisting an insulated copper wire to reduce electromagnetic induction.
- FTP(Foil Screened Pair): Aluminum silver foil wrapped around four strands of cable, insulation is higher than UTP cable
- STP(Shielded Twisted Pair): By adding a shielding material that can serve as a ground, it prevents external noise from entering or is resistant to signal interference.

For 100 BASE-TX, 'T' indicates 'a twisted wire is applied' and 'X' indicates the kinds of twisted wires for classification. 'TX' uses an unshielded twisted pair wire 5 (UTP 5) or shielded twisted pair wire ; 'T2' uses an unshielded twisted pair wire 3 (UTP 3); 'T4' uses the unshielded twisted pair wire 3, 4, 5 (UTP 3, 4, 5). The built-in FEnet specifies 100 BASE-TX and adopts the UTP cables of more than Category 5. The cables can be classified as below.

Notice

XGB FEnet does not support AUI (10BASE-5).

- (1) In the case of twisted pair cable unit (more than Category 5) adopts the hub of 100Mbps and it can be used with the zone of 10Mbps (less than Category3) but at this time, the network speed is limited to 10Mbps so be careful for system installation.
- (2) Both twisted cables and straight cables can be applied.
- (3) UTP : Unshielded Twisted Paired Copper Cable
 - FTP : (Overall) Foiled Twisted Paired Copper Cable
 - STP : (Overall) Shielded (and Shielded Individually Pair)Twisted Paired Copper Cable
- (4) Patch Cable (or Patch Cord)

In order to enhance the UTP 4-paired cable's flexibility, the conductor with twisted wire can be used instead of a solid conductor; used standard specification and material is Un-coated AWG 24 (7/0203A). Namely, the diameter of an element wire is 0.203mm and the element wire is standardized with the structure of 1+6 and it is made of annealed copper wire.

2) Classification by using frequency

Classification	Using frequency (MHz)	Transfer rate (Mbps)	Use
Category 1	Sound frequency	1	▪Telephone network (2Pair)
Category 2	4	4	▪Multi-Pair communication cable
Category 3	16	16	▪Telephone network + computer network
Category 4	20	20	▪Computer network transfer rate Up ▪Low-loss communication cable
Category 5 and expanded category 5	100	100	▪Digital telephone network +computer network ▪Low-loss, broadband cable ▪Gigabit Ethernet (1000 BASE-T)
Category 6,6a	250 ~ 500	10G	▪10G BASE-T Cable
Category 7	600~	10G	▪appropriate for STP

Notice

Now, Category 3, 5, En-Category 5 and Category 6 are widely used domestically and internationally. Category 4 disappeared due to emergence of Category 5 and Category 7 that is the STP structure is still at a development stage worldwide.

3) Example of Category 5e cable(LS cable, UTP-E-C5G-E1VN-M 0.5X004P/GY)

Items	Unit		Value
Conductor resistance (Max.)	$\Omega/100m$		9.38/100m
Insulation resistance (Min.)	$\Omega(1\sim100MHz)$		100 ± 15
Attenuation	Less than dB/100m	10MHz	7.1 dB/100m
		25MHz	11.4 dB/100m
		100MHz	24.0 dB/100m
Near-end crosstalk attenuation	Less than dB/100m	10MHz	47.0 dB
		25MHz	40.3 dB
		100MHz	30.1 dB

<UTP cable specifications>

1.3 Specifications of installation and a trial run

1.3.1 Example of FNet installation

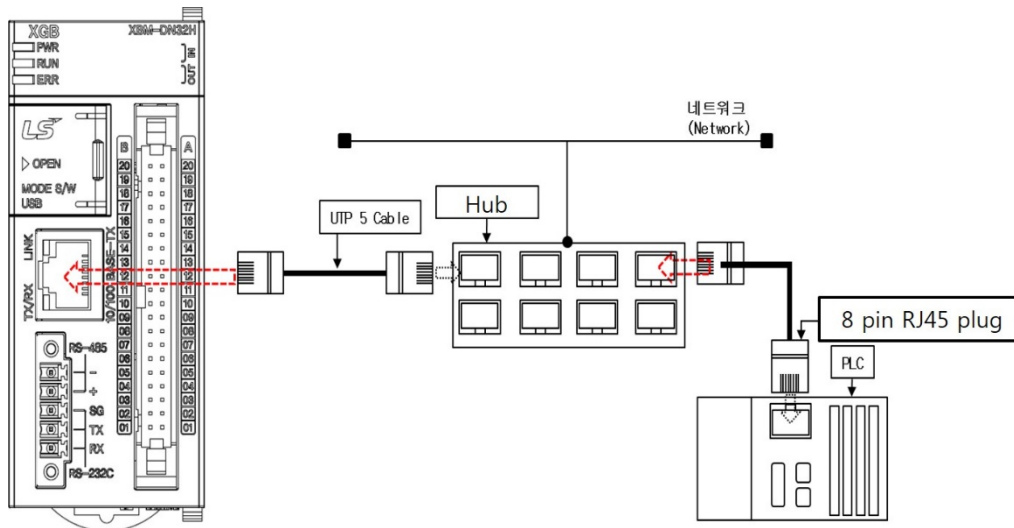

1.3.2 Instructions to install cables

In the case of 10/100 BASE-TX, the maximum length between nodes is 100m (distance between this module and the hub). Generally, a hub uses the straight cable made of twisted transmission (TD) and reception (RD) internally. If you connect these 2 basic units, they can be used regardless of cable types since the built-in FNet interface supports Auto-MDIX.

You can connect the signal lines of straight cables and cross cables as below.

(1) Straight cable

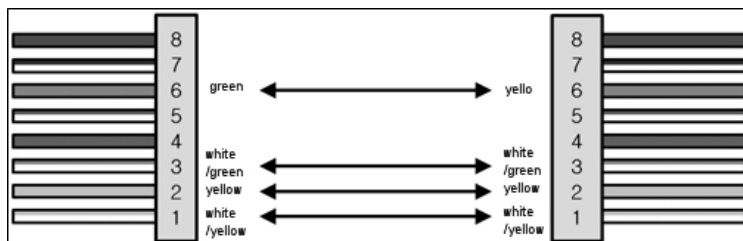

(2) Cross cable

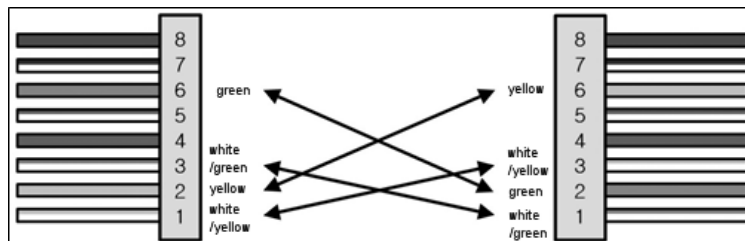

Notice

- (1) Separate the hub's power supply from the PLC's power supply.
- (2) For termination and manufacture, installation of cables, contact the professional manufacturers.

1.3.3 Instructions to install the UTP

Use the UTP cable that meets the characteristics of Category-5. Be careful not to exceed the cable's tensile force by constraint during wiring. When stripping the cable's sheath, strip it by the length to be connected and be careful not to damage the insulator.

When installing the UTP cable, keep the proper distance between the EMI source and the UTP cable.

Conditions	Minimum separation distance		
	Less than 2.0 kVA	2.5 kVA	More than 5.0 kVA
In case the unshielded power line or electric equipments are open or close to the non-metallic pipes.	127 mm	305 mm	610 mm
In case the unshielded power line or electric equipments are open or close to the buried metallic pipes.	64 mm	152 mm	305 mm
In case the power line of the buried metallic pipes (or equivalent shielded ones) is close to the buried metallic pipes.	-	76 mm	152 mm
Transformer /electric motor fluorescent light	1,016 mm / 305 mm		

< Separation distance by conditions when installing the UTP cable >

Items	Color	Operation details of each status		
		LINK/ACT	Yellow	ON
OFF	Connection error			No connected device
Flickering	During communication			Flickering in case RX, TX occur
SPEED	Green	ON	100BASE-T	In progress at 100Mbps
		OFF	10BASE-T	In progress at 10Mbps

1.3.4 How to make a trial run

1) Setting procedures of the product before operation

It describes the installation of the product and procedures before operation. If the installation of the product is completed, install and set up the system based on the below procedures.

Refer to the following items to be checked before operating the system with the built-in FEnet.

2) Communication interface

Items to be checked
Installation and execution, operation of XG5000
Access Status of communication cables (Only when the cable is accessed)

3) Trial run sequence

Startup
<p>Apply the power:</p> <ul style="list-style-type: none"> (1) Check input power. (2) Check the communication cable access. (3) Apply the power. (4) Check whether the power LED is turned on. (5) Check the LED status of the basic unit <p>→ In case of abnormal status, refer to 'Troubleshooting' of the basic unit manual.</p> <ul style="list-style-type: none"> (6) Check whether the status of the LINK LED is normal. <p>→ In case the LED is turned off despite connecting the line to the cable, refer to 'Troubleshooting' of the basic unit manual.</p> <ul style="list-style-type: none"> (7) After setting the system parameters correctly, download them.

4) Instructions for system configuration

When you configure the system with XGB's built-in FEnet, refer to the below for installation.

(1) Check the basic factors required for system configuration and select the proper communication interface.

(2) Choose the dedicated cable for communication modules.

(3) When installing communication cables, check whether the connector pins are damaged or not.

(4) For expansion communication modules besides built-in communication, the maximum of 4 stages can be equipped within the number of stages as below.

(2EA of existing communication expansion modules, 2 EA of high speed communication interfaces for XBM 'H(P)' unit can be equipped)

The following table shows the number of expansion stages for each basic unit type.

Type	XBC			XEC			XBM	XEM
	U-type	H-type	SU-type	U-type	H-type	SU-type	S,H,H2,HP	H2,HP
Maximum number of expansion stages	10-stage	10-stage	7-stage	10-stage	10-stage	7-stage	7-stage	7-stage

(5) When installing modules, lock the modules after equipping the relevant slot without accessing the communication cable. In case the device is not locked up, interface error with the basic unit may occur.

5) Instructions for network configuration

- (1) The IP addresses of devices should be different. If the IP addresses are overlapped, communication will not work normally.
- (2) Set up the different exchange numbers for each station to use the high speed link service.
- (3) Use the specified communication cables. Otherwise, communication problems may occur.
- (4) Check whether the cables are disconnected or shorted before installing the communication cables.
- (5) Fix them tightly until the communication cable connector clicks
- (6) In case the cable access is unstable, it may cause serious communicable problems.
- (7) For wiring, separate the communication cables from the power line or inductive noise.

1.4 Configuration of FEnet communication system

FEnet supports open Ethernet so you can configure the network by connecting with LS ELECTRIC and other companies' PLCs, PCs. Some examples of network system configurations are represented as below.

1.4.1 Mixed network configuration

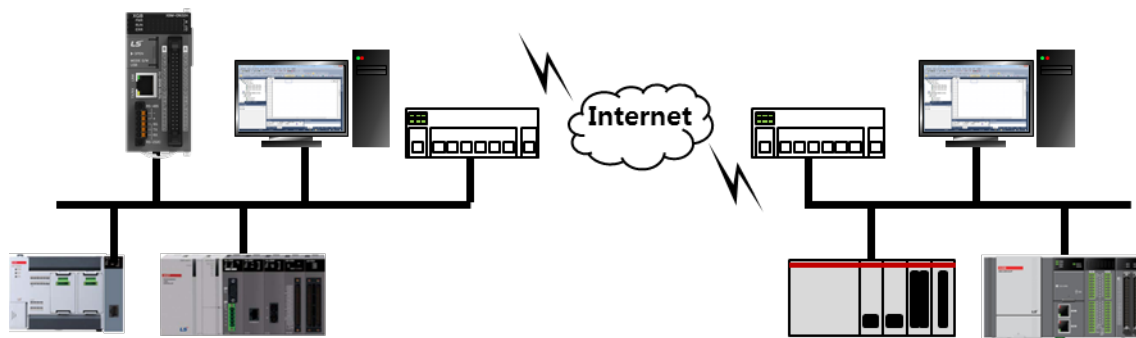

[Fig.1.4.1] System configuration diagram

Built-in FEnet accesses LS ELECTRIC PLC, other companies' PLCs, PCs, etc. through the network. You can configure the system by using dedicated communication, Modbus TCP/IP, user-defined frame, high speed link communication.

1.4.2 Network configuration through XGB PLC

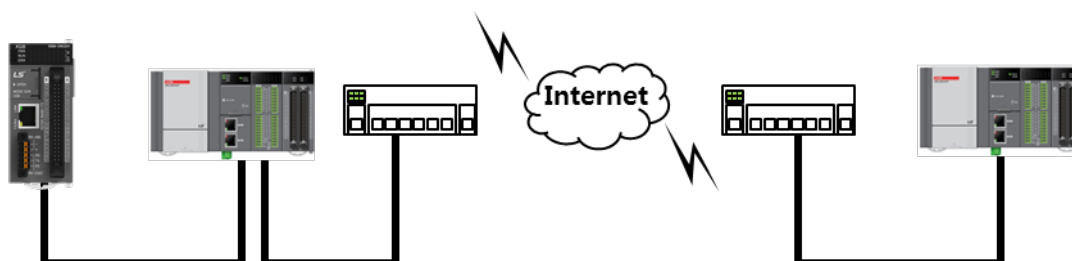

[Fig. 1.4.2] System configuration diagram

XGB's built-in FEnet can access to 1:1 communication or network and perform 1:N communication by using cross cables or straight cables. You can transmit and receive the data through the dedicated services, Modbus TCP/IP, user-defined frame and high speed link communication.

1.4.3 Network configuration through XGB PLC and MMI

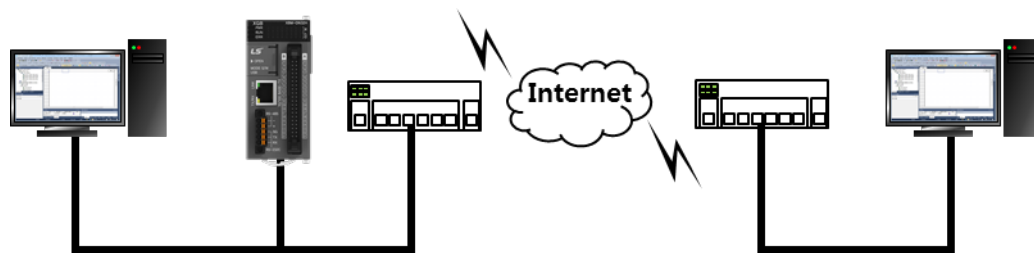

[Fig.1.4.3] System configuration diagram

For communication between XGB's built-in FENet and the PC, 1:N communication is available by accessing to 1:1 communication or the network using cross cables or straight cables. You can transmit and receive data in the PC by using XG5000 or MMI. In addition, through XG5000, you can make, download, upload the program and parameters and transmit/receive data through dedicated services, Modbus TCP/IP, user-defined frame.

1.4.4 Network configuration between LS ELECTRIC modules

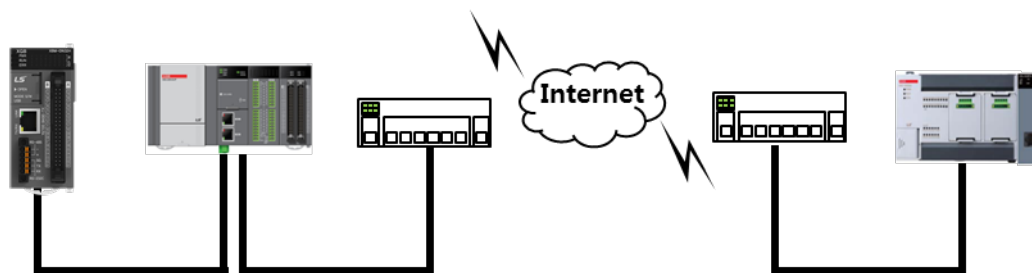

[Fig.1.4.4] System configuration diagram

You can configure the system by using XGB's built-in FENet and XGK PLC's FENet I/F expansion modules. 1:N communication is available through 1:1 communication using cross cables or accessing to network. You can transmit and receive the data through the dedicated services, Modbus TCP/IP, user-defined frame and high speed link communication.

1.4.5 Network configuration using XGB PLC and other companies' PLCs

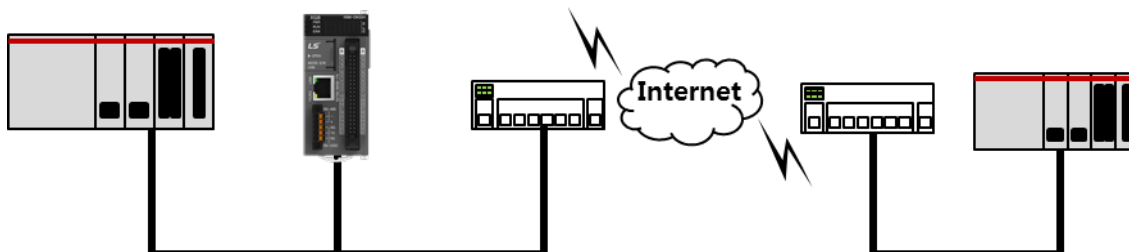

[Fig.1.4.5] System configuration diagram

XGB's built-in FENet can communicate with other companies' PLCs, HMIs, MMIs. 1:N communication is available through 1:1 communication using cross cables or accessing to network. For communication, the PLCs should have the same protocol.

1.5 Protocols for each service

Built-in FEnet interface supports Ethernet(open Ethernet), so you can configure the network by connecting with LS ELECTRIC and other companies' PLCs, PCs.

For communication after network configuration, make sure to set up IP, parameters of each PLC, protocols. The protocols supported by the built-in FEnet are XGT dedicated, Modbus TCP/IP, user-defined frame, File Transfer Protocol (FTP).

Each protocol is operated by the server or client and dedicated server, P2P functions communicate based on designated protocols.

Items		Specifications			
		Driver	Communication method	Port No.	Remarks
Communication function	Dedicated	XGT server	TCP/IP	2004	Up to 16channels Up to 512 bytes
			UDP/IP	2005	
		Modbus TCP server	TCP/IP	502	
	P2P	XGT client	TCP/IP	2004	Up to 15channels Up to 512 bytes
			UDP/IP	2005	
		Modbus TCP client	TCP/IP	502	
		User-defined frame	TCP/IP	Customized	
	UDP/IP		Customized		
	Remote	Server	TCP/IP	2002	Up to 1channels
		Client	UDP/IP	2002	Up to 1channels
	Auto Scan	-	UDP/IP	2007(list) 2008(Information)	Up to 2channels
	SNTP	Client	UDP/IP	Customized	Up to 1channels
SMTP	Client	TCP/IP	25(Relay) Customized	Up to 2channels	

[Table 1.5.1] Protocols by communication functions

1.5.1 XGT dedicated protocol

1) Protocol outline

Dedicated protocols for XGT are the communication protocols for LS ELECTRIC PLC only for communication between LS ELECTRIC modules. You can Read/Write data with commands and communication is available in PC, HMI by using dedicated protocols for XGT. Two communication methods of TCP and UDP can be applied to the dedicated protocols for XGT.

Protocol	Communication Method	Port No.
For XGT only	TCP/IP	2004
	UDP/IP	2005

[Table 1.5.2] Classification of dedicated protocols for XGT

2) Frame structure

(1) XGT dedicated packet's structure through Ethernet

When communicating with dedicated protocols for XGT, MAC, IP header (IP Header), TCP Header and LS frames containing data are included for Ethernet communication. [Fig. 1.5.1] shows the frame structure for Ethernet communication.

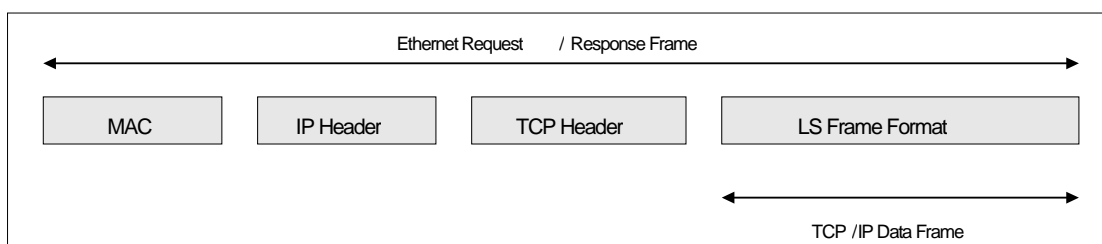

[Fig. 1.5.1] XGT dedicated packet structure through Ethernet

3) Structure of XGT dedicated frame

The LS frames for data communication include LS ELECTRIC's own data (Company ID), command (Command), data type (Data Type), data (Data). [Fig. 1.5.2] shows the frame form.

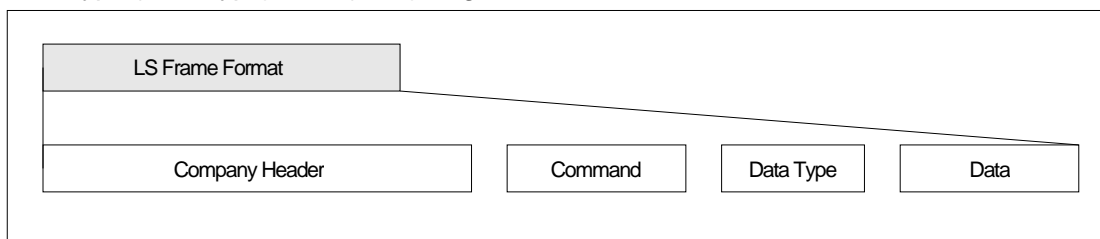

[Fig. 1.5.2] Structure of dedicated frames for XGT

4) Data type of XGT dedicated protocols

(1) Device type

The data types of [Table 1.5.3] are available in the dedicated protocols for XGT. When you designate the devices, '%' (25H) should be attached to the front of string.

('%' is the character indicating the startup of devices)

Data type	Type code value	Flag	Example of application
Bit	h0000	X (58h)	%PX000, %MX000, %LX000, %KX000, %CX000, %TX000, %FX000, %IX0.0.0, %QX0.0.0, %UX00.00.0, etc.
Byte	h0100	B (42h)	PB000, %MB000, %LB000, %KB000, %CB000, %TB000, %FB000, %IB0.0.0, %QB0.0.0, etc.
Word	h0200	W (57h)	%PW000, %MW000, %LW000, %KW000, %CW000, %TW000, %FW000, %DW000, %IW0.0.0, %QW0.0.0, %MW0, %RW0, %WW0, %UW00.00, etc.
D word	h0300	D (44h)	%PD000, %MD000, %LD000, %KD000, %CD000, %TD000, %FD000, %DD000, %ID0.0.0, %QD0.0.0, %MD0, %RD0, %WD0, etc.
L word	h0400	L (4Ch)	%PL000, %ML000, %LL000, %KL000, %CL000, %TL000, %FL000, %DL000, %IL0.0.0, %QL0.0.0, %ML0, %RL0, %WL0, etc.

[Table 1.5.3] Data types of dedicated protocols for XGT

Notice

- (1) In the timer/counter, designating bit means the contact values; designating byte, word values means the current values.
- (2) The data register (D) can be designated as Byte, Word only.
- (3) In the case of byte type command, the address value is doubled compared to the value at the time of designating word. Namely, in the case of %MW1234, %MW1234 should be applied for word designation but %MB2468 should be applied for byte designation.

5) Commands of XGT dedicated protocols

4 commands are used for XGT dedicated protocols and each command processes Read/Write, Request/Response.

For available data types for each command, individual one can apply bit, byte, word, double word, long word; continuous one can adopt byte only.

Command	Command code	Data format	Processing details	
Read	Request: h0000	Individual	h0000	Request on reading data depending on each data type
			h0100	
			h0200	
			h0300	
			h0400	
	Continuous	h1400	Request on reading byte type of variables by block	
	Response: h5500	Individual	h0000	Response to the request on reading data
			h0100	
h0200				
h0300				
h0400				
Continuous		h1400	Response to the request on reading by block	
Write	Request: h5800	Individual	h0000	Request on writing data depending on each data type
			h0100	
			h0200	
			h0300	
			h0400	
	Continuous	h1400	Request on writing byte type of variables by block	
	Response: h5900	Individual	h0000	Response to the request on writing data
			h0100	
h0200				
h0300				
Continuous	h1400	Response to the request on writing by block		

[Table 1.5.4] Command types of XGT dedicated protocols

6) Headers and data structures of XGT dedicated protocols

Items	Client (request frame)			Server (response frame)				
	Classification	Details	Size	Classification	Details	Size		
Company header	LS'S OWN	Company ID 1	10	LS'S OWN	Company ID 1 Company ID 2	10		
	PLC information	h00~hFF	2	PLC information	h00 ~ hFF	2		
	CPU information	hA0	1	CPU information	hA0	1		
	Frame direction	h33	1	Frame direction	h11	1		
	Frame sequence number	h0000~hFFFF	2	Frame sequence number	h0000~hFFFF	2		
	Length	h0000~h0100	2	Length	h0000~h0100	2		
	Position information	h00~hFF	1	Position information	h00~hFF	1		
	Check Sum	h00~hFF	1	Check Sum	h00~hFF	1		
Command	Command	h5400	Read	2	Command	h5500	Read	2
		h5800	Write	2		h5900	Write	2
Data Type	Data type	h0000	bit	2	Data type	h0000	bit	2
		h0100	byte			h0100	byte	
		h0200	word			h0200	word	
		h0300	Double word			h0300	Double word	
		h0400	long word			h0400	Long word	
		h1400	Continuous			h1400	Continuous	
Data	Reserved area	-		2	Reserved area	-		2
	Number of blocks	h0100~h1000		2	Error status	h0000~hFFFF		2
	Variable length (N)	h0400~h1000		2	Data			2
	Data address	-		N				
	Number of data	h0 (M)00		M				

[Table 1.5.5] Headers and data structures of XGT dedicated protocols

(1) Company ID (LS ELECTRIC'S own number)

The LS's own number has two types; XGK and XGB PLC use Company ID 1 when they are operated as the client; the Company ID requested by the client is used when they are operated as server. For client, Company ID 1 or Company ID 2 should be used.

Type	Mode	Frame										Remarks
Company ID 1	ASCII	L	S	I	S	-	X	G	T	/n	/n	XGT
	HEX	h4C	h53	h49	h53	h2D	h58	h47	h54	h00	h00	
Company ID 2	ASCII	L	G	I	S	-	G	L	O	F	A	GM,MK
	HEX	h4C	h47	h49	h53	h2D	h47	h4C	h4F	h46	h41	

[Table 1.5.6] LS's Own Number

7) Example of transmission/reception frames

(1) Request frame for reading variables individually

Items	Type	Frame										Size
Company ID	ASCII	L	S	I	S	-	X	G	T	/n	/n	10
	HEX	0x4C	0x53	0x49	0x53	0x2D	0x58	0x47	0x54	0x00	0x00	
	ASCII	L	G	I	S	-	G	L	O	F	A	
	HEX	0x4C	0x47	0x49	0x53	0x2D	0x47	0x4C	0x4F	0x46	0x41	
PLC Info	HEX	0x00	0x00									2
CPU Info		0xA0										1
Source of Frame		0x33										1
Invoked ID		0x00	0x01									2
Length		0x10	0x00									2
Position		0x00										1
Check Sum		0x09										1
Command		0x54	0x00									2
Data Type		0x14	0x00									2
Reserved		0x00	0x00									2
Block No.		0x01	0x00									2
Variable Length		0x04	0x00									2
Data Address	ASCII	%	M	B	0							4
	HEX	0x25	0x4D	0x42	0x30							
Data Count	HEX	0x02	0x00									2

[Table 1.5.7] Request frame for reading variables individually

(2) Response frame for reading variables individually

Items	Type	Frame										Size
Company ID	ASCII	L	S	I	S	-	X	G	T	/n	/n	10
	HEX	0x4C	0x53	0x49	0x53	0x2D	0x58	0x47	0x54	0x00	0x00	
	ASCII	L	G	I	S	-	G	L	O	F	A	
	HEX	0x4C	0x47	0x49	0x53	0x2D	0x47	0x4C	0x4F	0x46	0x41	
PLC Info	HEX	0x02	0x08									2
CPU Info		0xA0										1
Source of Frame		0x11										1
Invoked ID		0x00	0x01									2
Length		0x0E	0x00									2
Position		0x01										1
Check Sum		0x25										1
Command		0x55	0x00									2
Data Type		0x14	0x00									2
Reserved		0x00	0x00									2
Error State		0x00	0x00									2
Block No.		0x10	0x00									2
Data Count		0x02	0x00									2
Data		0x00	0x00									2

[Table 1.5.8] Response frame for reading variables individually

(3) Request frame for reading variables sequentially

Items	Type	Frame										Size
Company ID	ASCII	L	S	I	S	-	X	G	T	/n	/n	10
	HEX	0x4C	0x53	0x49	0x53	0x2D	0x58	0x47	0x54	0x00	0x00	
	ASCII	L	G	I	S	-	G	L	O	F	A	
	HEX	0x4C	0x47	0x49	0x53	0x2D	0x47	0x4C	0x4F	0x46	0x41	
PLC Info	HEX	0x00	0x00									2
CPU Info		0xA0										1
Source of Frame		0x33										1
Invoked ID		0x00	0x01									2
Length		0x10	0x00									2
Position		0x00										1
Check Sum		0x09										1
Command		0x54	0x00									2
Data Type		0x14	0x00									2
Reserved		0x00	0x00									2
Block No.		0x01	0x00									2
Variable Length		0x04	0x00									2
Data Address	ASCII	%	M	B	0							4
	HEX	0x25	0x4D	0x42	0x30							
Data Count	HEX	0x02	0x00									2

[Table 1.5.9] Frame for reading variables sequentially

(4) Response frame for reading variables sequentially

Items	Type	Frame										Size
Company ID	ASCII	L	S	I	S	-	X	G	T	/n	/n	10
	HEX	0x4C	0x53	0x49	0x53	0x2D	0x58	0x47	0x54	0x00	0x00	
	ASCII	L	G	I	S	-	G	L	O	F	A	
	HEX	0x4C	0x47	0x49	0x53	0x2D	0x47	0x4C	0x4F	0x46	0x41	
PLC Info	HEX	0x02	0x08									2
CPU Info		0xA0										1
Source of Frame		0x11										1
Invoked ID		0x00	0x01									2
Length		0x0E	0x00									2
Position		0x01										1
Check Sum		0x25										1
Command		0x55	0x00									2
Data Type		0x14	0x00									2
Reserved		0x00	0x00									2
Error State		0x00	0x00									2
Block No.		0x10	0x00									2
Data Count		0x02	0x00									2
Data		0x00	0x00									2

[Table 1.5.10] Response frame for reading variables sequentially

1.5.2 Modbus TCP/IP protocol

The Modbus TCP/IP protocol is the function to Read/Write data by using the function codes. The Modbus TCP/IP frame is composed of MAC for Ethernet communication, IP header, TCP header, Modbus ADU.

- 1) ADU: Application Data Unit
- 2) MBAP: Modbus Application Protocol
- 3) PDU: Protocol Data Unit

1) Frame structure of Modbus TCP/IP

(1) Modbus TCP/IP's frame structure through Ethernet

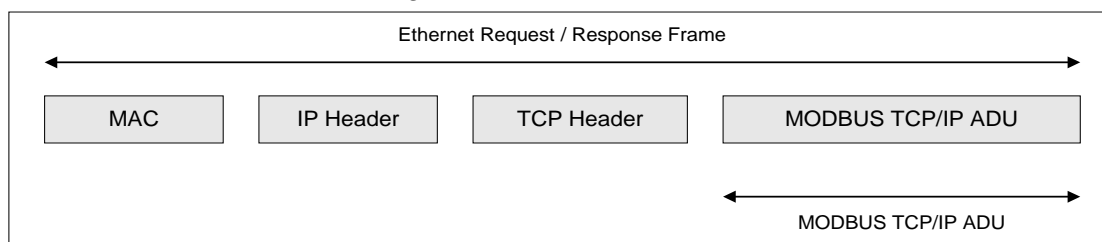

[Table 1.5.1] Modbus TCP/IP's frame structure through Ethernet

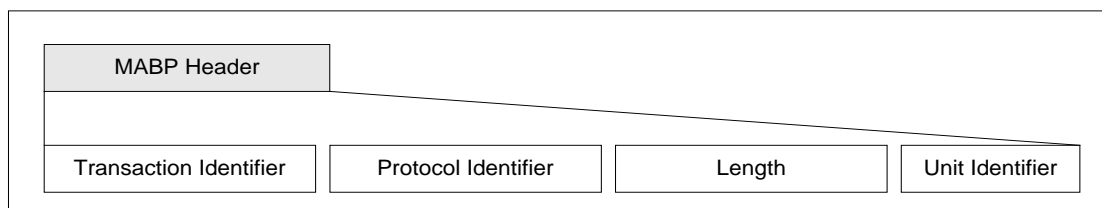

[Table 1.5.2] Modbus MABP structure

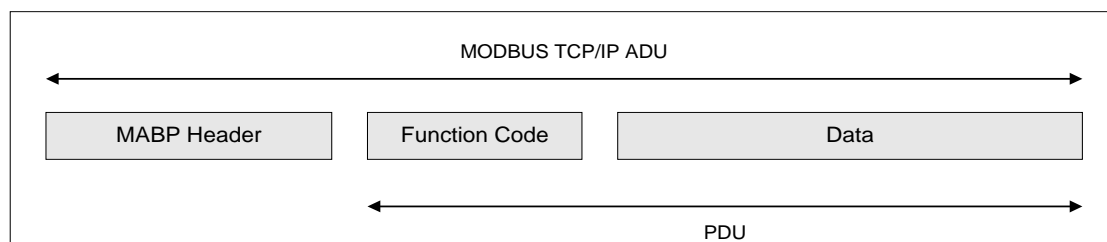

[Table 1.5.3] Modbus ADU structure

(2) MBAP Header structure

Type	Size	Description	Client	Server
Transaction Identifier	2byte	Separation of MODBUS request/response processing	Initialized by the client	When the server responds, it is copied and responded.
Protocol Identifier	2byte	0 = MODBUS protocol	Initialized by the client	When the server responds, it is copied from the request frame.
	2byte	Frame size except MBAP	Created by the client (On request)	Created by the server (In case of response)
Unit Identifier	1byte	Separation of units connected to the serial line	Initialized by the client	When the server responds, it is copied from the request frame

(3) Available function codes

Function codes	Function	Modbus transcription
Function Code 01 (h01)	Reading output bit	Read Coils
Function Code 02 (h02)	Reading input bit	Read Discrete Inputs
Function Code 03 (h03)	Reading output word	Read Holding Registers
Function Code 04 (h04)	Reading input word	Write Input Register
Function Code 05 (h05)	Writing output bit	Write single Coil
Function Code 06 (h06)	Writing output word	Write single Register
Function Code 15 (h0F)	Writing output bit sequentially	Write Multiple Coils
Function Code 16 (h10)	Writing output word sequentially	Write Multiple Registers

2) Frame structures by function codes

(1) Function code h01 : Reading output bit (Read Coils)

• Request

Items	Size	Range
Function code	1 byte	h01
Initial address	2 bytes	h0000 ~ hFFFF
Number of coils	2 bytes	h0001 ~ h07D0 (2000 bit)

• Response

Items	Size	Range
Function code	1 byte	h01
Number of bytes	2 bytes	N
Coil status	n byte	n = N or N + 1

• Error

Items	Size	Range
Function code	1 byte	h81 (function code+ h80)
Exceptional code	1 byte	h01,h02,h03,h04

•Example of Application

Request frame		Response frame	
Items	HEX	Items	HEX
Function code	h01	Function code	h01
Initial address (upper byte)	h00	Number of bytes	h03
Initial address (lower byte)	h13	Coil status (27-20)	hCD
Number of coils (upper byte)	h00	Coil status (36-28)	h6B
Number of coils (lower byte)	h13	Coil status (38-36)	h05

(2) Function code h02 : Reading input bit (Read Discrete Inputs)

• Request

Items	Size	Range
Function code	1 byte	h02
Initial address	2 bytes	h0000 ~ hFFFF
Number of inputs	2 bytes	h0001 ~ h07D0 (2000 bit)

• Response

Items	Size	Range
Function code	1 byte	h01
Number of bytes	2 bytes	N
Input status	N x 1 byte	-

• Error

Items	Size	Range
Function code	1 byte	h82 (Function code + h80)
Exceptional code	1 byte	h01,h02,h03,h04

• Example of application

Request frame		Response frame	
Items	HEX	Items	HEX
Function code	h02	Function code	h02
Initial address (upper byte)	h00	Initial address (upper byte)	h00
Initial address (lower byte)	hC4	Initial address (lower byte)	hC4
Input status (upper byte)	h00	Input status (upper byte)	h00
Number of coils (lower byte)	h16	Number of coils (lower byte)	h16

(3) Function code h03 : Reading output word (Read Holding Registers)

• Request

Items	Size	Range
Function code	1 byte	h03
Initial address	2 bytes	h0000 ~ hFFFF
Number of inputs	2 bytes	h0001 ~ h007D (125word)

• Response

Items	Size	Range
Function code	1 byte	h01
Number of bytes	2 bytes	2 x N
Input status	N x 2 bytes	-

• Error

Items	Size	Range
Function code	1 byte	h83 (Function code + h80)
Exceptional code	1 byte	h01,h02,h03,h04

• Example of application

Request frame		Response frame	
Items	HEX	Items	HEX
Function code	h03	Function code	h03
Initial address (upper byte)	h00	Number of bytes	h06
Initial address (lower byte)	h6B	Word status (108)	h02
Number of words (upper byte)	h00	Word status (108)	h2B
Number of words (lower byte)	h03	Word status (109)	h00
		Word status (109)	h00
		Word status (110)	h00
		Word status (110)	h64

(4) Function code h04 : Writing input word (Read Input Registers)

• Request

Items	Size	Range
Function code	1 byte	h04
Initial address	2 bytes	h0000 ~ hFFFF
Number of inputs	2 bytes	h0001 ~ h007D (125word)

• Response

Items	Size	Range
Function code	1 byte	h04
Number of bytes	2 bytes	2 x N
Input status	N x 2 bytes	-

• Error

Items	Size	Range
Function code	1 byte	h84 (Function code + h80)
Exceptional code	1 byte	h01,h02,h03,h04

• Example of application

Request frame		Response frame	
Items	HEX	Items	HEX
Function code	h04	Function code	h04
Initial address (upper byte)	h00	Number of bytes	h02
Initial address (lower byte)	h08	Word status (108)	h00
Number of words (upper byte)	h00	Word status (108)	h0A
Number of words (lower byte)	h01		

(5) Function code h05 : Writing output bit (Write Single Coil)

• Request

Items	Size	Range
Function code	1 byte	h05
Initial address	2 bytes	h0000 ~ hFFFF
Input value	2 bytes	h0000 or hFF0D

• Response

Items	Size	Range
Function code	1 byte	h05
Number of bytes	2 bytes	h0000 ~ hFFFF
Input status	2 bytes	h0000 or hFF00

• Error

Items	Size	Range
Function code	1 byte	h85 (function code+h80)
Exceptional code	1 byte	h01,h02,h03,h04

• Example of application

Request frame		Response frame	
Items	HEX	Items	HEX
Function code	h02	Function code	h01
Initial address (upper byte)	h00	Number of bytes	h03
Initial address (lower byte)	hC4	Coil status (27-20)	hCD
Input status (upper byte)	h00	Coil status (36-28)	h6B
Number of coils (lower byte)	h16	Coil status (38-36)	h05

(6) Function code h 0F : Writing output word sequentially (Write Multiple Registers)

• Request

Items	Size	Range
Function code	1 byte	h0F
Initial address	2 bytes	h0000 ~ hFFFF
Number of outputs	2 bytes	h0001 ~ h07BD
Number of bytes	1 byte	N
Output value	N x 1 byte	

• Response

Items	Size	Range
Function code	1 byte	h0F
Number of bytes	2 bytes	h0000 ~ hFFFF
Input status	2 bytes	h0001 ~ h07B0

• Error

Items	Size	Range
Function code	1 byte	h8F (function code+ h80)
Exceptional code	1 byte	h01,h02,h03,h04

• Example of application

Request frame		Response frame	
Items	HEX	Items	HEX
Function code	h0F	Function code	h0F
Initial address(upper byte)	h00	Initial address (upper byte)	h00
Initial address(lower byte)	h13	Initial address (lower byte)	h13
Number of outputs (upper byte)	h00	Number of outputs (upper byte)	h00
Number of outputs (lower byte)	h0A	Number of outputs (lower byte)	h0A
Number of bytes	h02		
Output value (upper byte)	hCD		
Output value (lower byte)	h01		

(7) function codeh06 : output word (Write Single Register)

• Request

Items	Size	Range
Function code	1 byte	h06
Initial address	2 bytes	h0000 ~ hFFFF
Output value	2 bytes	h0000 or hFFFF

• Response

Items	Size	Range
Function code	1 byte	h06
Initial address	2 bytes	h0000 ~ hFFFF
Output value	2 bytes	h0000 or hFFFF

• Error

Items	Size	Range
Function code	1 byte	h86 (function code+ h80)
Exceptional code	1 byte	h01,h02,h03,h04

• Example of application

Request frame		Response frame	
Items	HEX	Items	HEX
Function code	h06	Function code	h06
Initial address (upper byte)	h00	Number of bytes	h00
Initial address (lower byte)	h01	Coil status (27-20)	h01
Input status (upper byte)	h00	Coil status (36-28)	h00
Number of coils (lower byte)	h03	Coil status (38-36)	h03

(8) Function code h10 : Writing output sequentially (Write Multiple Registers)

• Request

Items	Size	Range
Function code	1 byte	h10
Initial address	2 bytes	h0000 ~ hFFFF
Number of outputs	2 bytes	h0001 or h07D8
Number of bytes	1 byte	2 x N
Output value	N x 2 bytes	value

• Response

Items	Size	Range
Function code	1 byte	h10
Number of bytes	2 bytes	h0000 ~ hFFFF
Number of outputs	2 bytes	h0001 ~ h007B

• Error

Items	Size	Range
Function code	1 byte	h90 (function code+ h80)
Exceptional code	1 byte	h01,h02,h03,h04

• Example of application

Request frame		Response frame	
Items	HEX	Items	HEX
Function code	h10	Function code	h01
Initial address (upper byte)	h00	Initial address (upper byte)	h00
Initial address (lower byte)	h01	Initial address (lower byte)	h01
Number of outputs (upper byte)	h00	Number of outputs (upper byte)	h00
Number of outputs (lower byte)	h02	Number of outputs (lower byte)	h02
Number of bytes	h04		
Output value(upper byte)	h00		
Output value(lower byte)	h0A		
Output value(upper byte)	h01		
Output value(lower byte)	h02		

1.6 Dedicated services

1.6.1 Outline

1) Server model

The dedicated services mean the server functions in the below client/server model of [Fig. 1.6.1]. It Reads/Writes data based on the protocols assessed and set by the client.

(1) Client/server model

The server performs the functions; ② detection of reception ③ transmission of response.

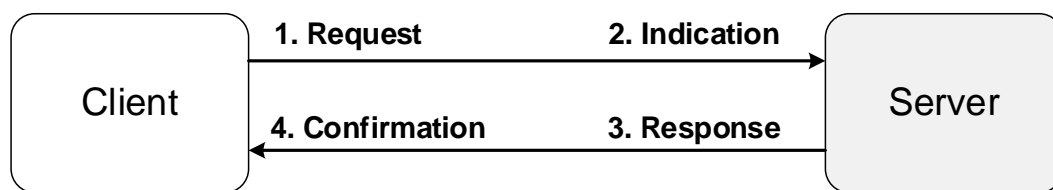

[Fig.1.6.1] Server/client model

(2) System configuration

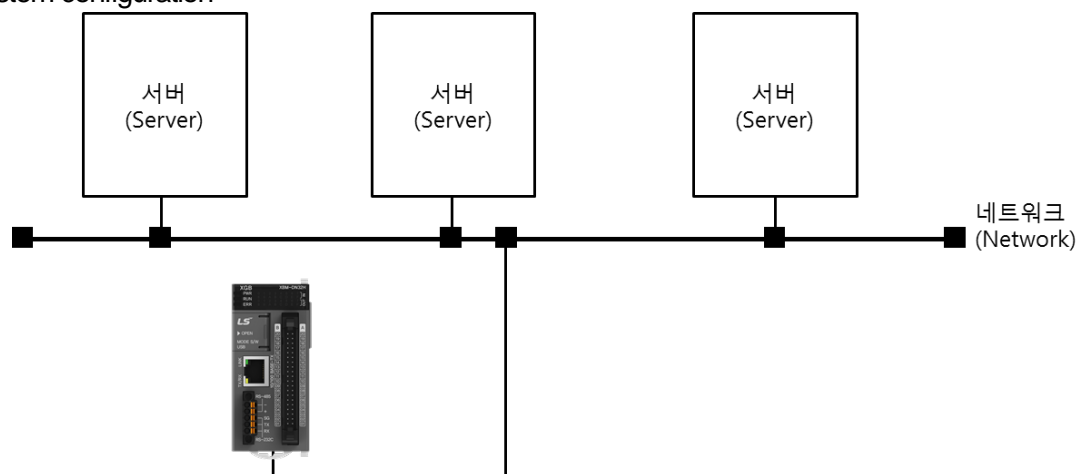

(3) Classification of dedicated services

Dedicated services		Port No.	Protocol	Max./Min. number of accesses
XGT server	TCP XGT server	2004	TCP	1/16
	UDP XGT server	2005	UDP	1/16
Modbus TCP/IP server		502	TCP	1/16

1.6.2 Setting the basic parameters

- 1) Confirming registration of built-in communication
- (1) Setting the basic parameters for XG5000 communication

If you create a project after executing XG5000, only the basic network will be displayed in the network configuration. After accessing to the PLC, if you execute I/O synchronization in [Online] → [Diagnosis] → [I/O information], the built-in communication modules will be updated. Then, if you choose the built-in FEnet, the window for setting communication modules will be executed. The built-in FEnet is automatically set so you cannot change the type, base, slot.

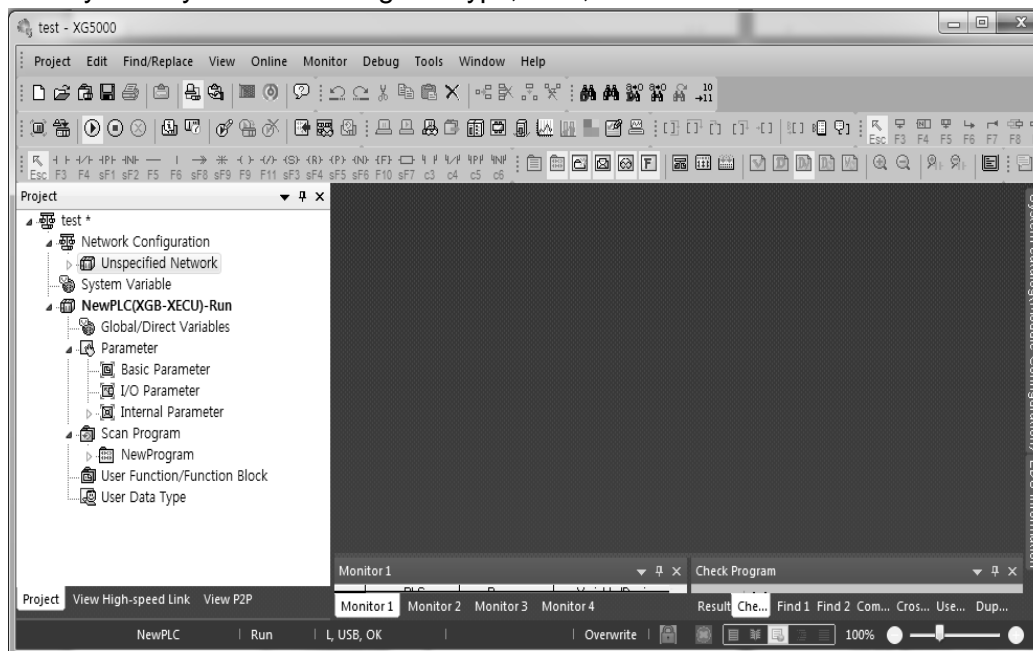

[Fig. 1.6.2] Creation of new project in XG5000

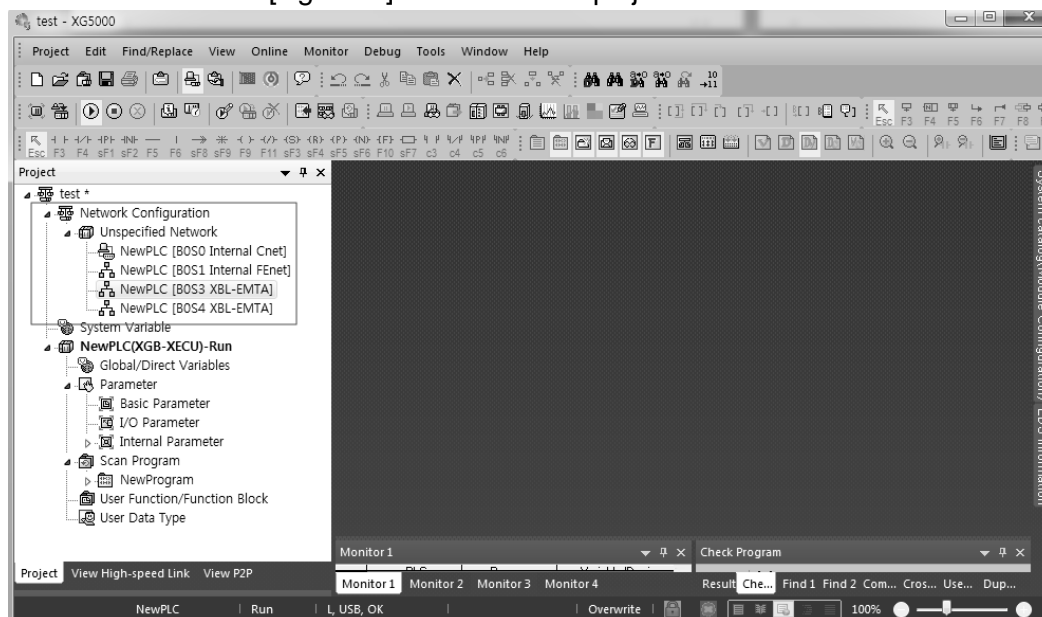

[Fig. 1.6.3] Changes of the network configuration after I/O synchronization

(2) Basic setting

If you double-click the FENet, the window for the basic setting will be created as below [Fig. 1.6.4].

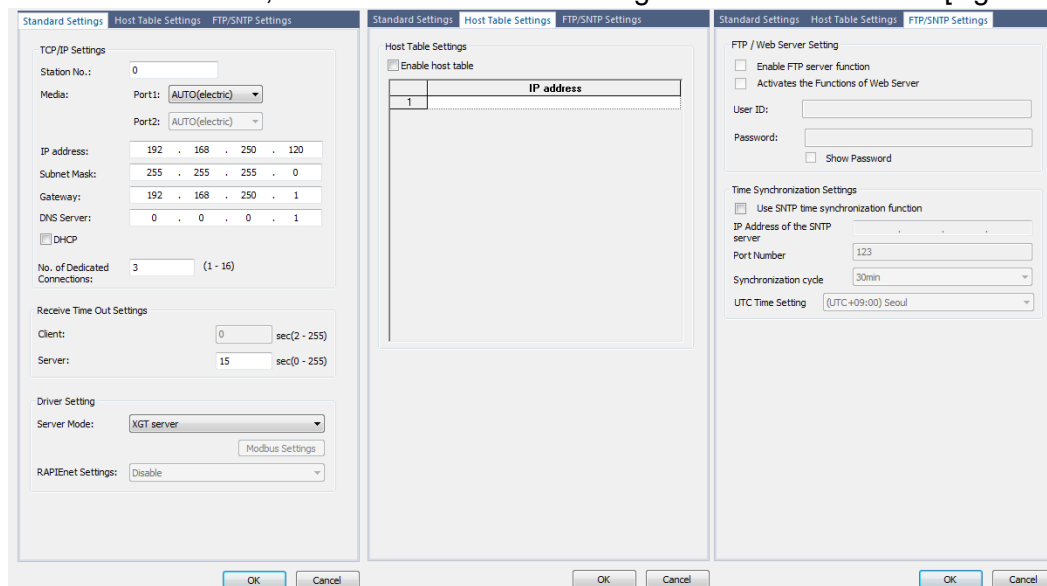

[Fig.1.6.4] Window for the basic settings of communication

The descriptions on each item are as below.

a) TCP/IP setting

Item	Description
High speed link exchange number	For high speed link communication between XGT PLC's FENet I/F modules, the FENet I/F module to set exchange number should not overlapped with the exchange numbers of other FENet I/F modules that are accessible in the network.
Media	Select the media to be used. ▷ AUTO (electricity): It sets the media of the currently equipped module automatically. ▷ 10M/HALF: Half Duplex electricity of 10Mbps ▷ 10M/FULL: Full Duplex electricity of 10Mbps ▷ 100M/HALF: Half Duplex electricity of 100Mbps ▷ 100M/FULL: Full Duplex electricity of 10Mbps Optical(FX) cable is not supported in built-in FENet
IP address	You can set the IP address of the FENet I/F module.
Subnet Mask	Value to determine whether the opposing station exists in the same network as its own.
Gateway	Gateway module address (router address) to transmit and receive data through the station using different network from its own or public network.
DNS server	You can designate domain name server.
DHCP	For using the flexible IP instead of the static IP.
Reception standby time (second)	During dedicated communication, if there is not any RUN request for the set time from the upper system on condition that it is assessed to the upper PC or MMI, the connection with the dedicated service will end regardless of normal termination on the assumption that there are some problems with the upper system. The standby time is used for dedicated services to reset the channels when there are some errors in the opposing station or cables are disconnected.
Number of dedicated accesses	It means the maximum number of TCP dedicated services that are assessable at the same time. Setting of 1~16 is available. (In the case of P2P channel, the number of 16-dedicated accesses)

b) Driver (server) setting

Item	Description
XGT server	For operation with the dedicated communication server
Modbus TCP/IP server	For operation with the Modbus server driver
Smart server	Provide both XGT and Modbus TCP/IP server

c) Host table setting

Item	Description
Enable host table	In case of Enable host table, it allows access for the client who has the IP address registered to the host table.

d) Setting the time synchronization function

Item	Description
SNTP time synchronization function	Setting SNTP time synchronization operations
IP Address of the SNTP	SNTP server's IP address
Port Number	SNTP server's port No.
Synchronization cycle	Time synchronization cycle between the SNTP server and the PLC
UTC Time setting	Setting SNTP time according to UTC

1.6.3 XGT server

The TCP XGT server works in sequence as shown in the operating sequence of the below [Fig. 1.6.5].

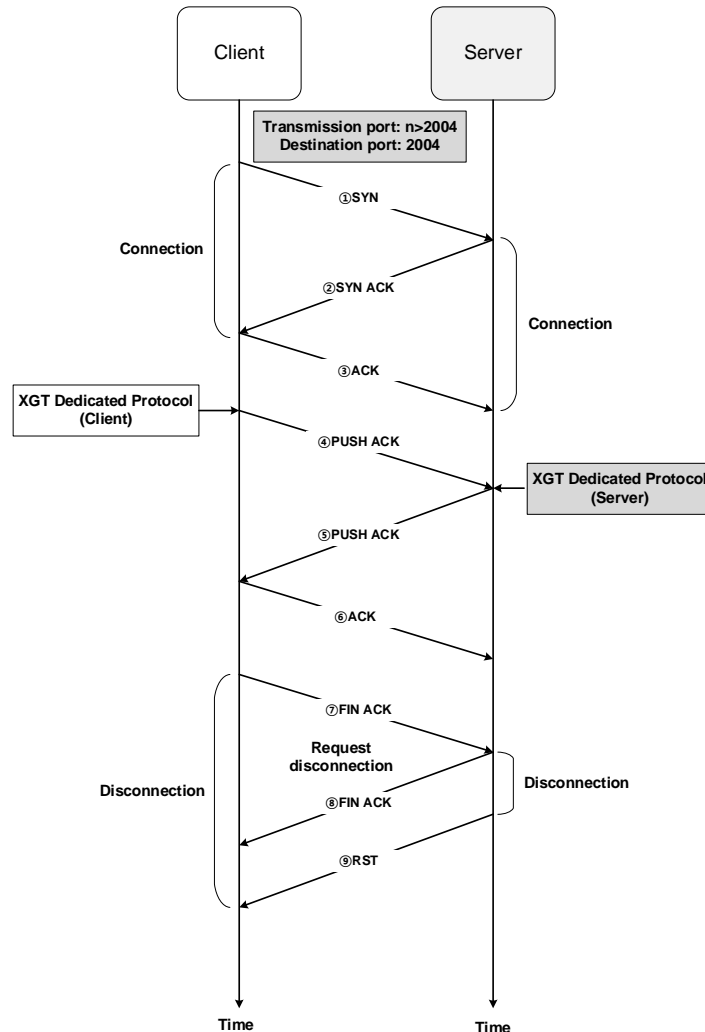

[Fig.1.6.5] Operating sequence of the TCP XGT server

1) Connection

The client sends the ① connection request to the server and then, the server transmits the ② response to connection request. The connection port number is Port No. 2004 of the XGT dedicated protocols. Then, the client sends the ③ response to confirmation of connection. After the stages of ①~ ③ are completed, connection between client/server is made.

2) TCP XGT server

After connection, the client transmits the ④ request frame based on the XGT dedicated protocols. Then, the server transmits the ⑤ response to the request frame and the client transmits the ⑥ confirmation of response.

3) Disconnection

The client transmits ⑦ disconnection request and the server transmits ⑧ confirmation of disconnection and ⑨ terminates the connection.

Notes

UDP XGT server uses a non-connection-oriented communication method.
 Therefore, the number of dedicated server connections is not affected.
 XGT server diagnostic information unable to verify, because the UDP XGT server uses a non-connection-oriented UDP protocol,

1.6.4 Modbus TCP/IP server

The Modbus TCP/IP server works in sequence as shown in the operating sequence of the below [Fig. 1.6.6].

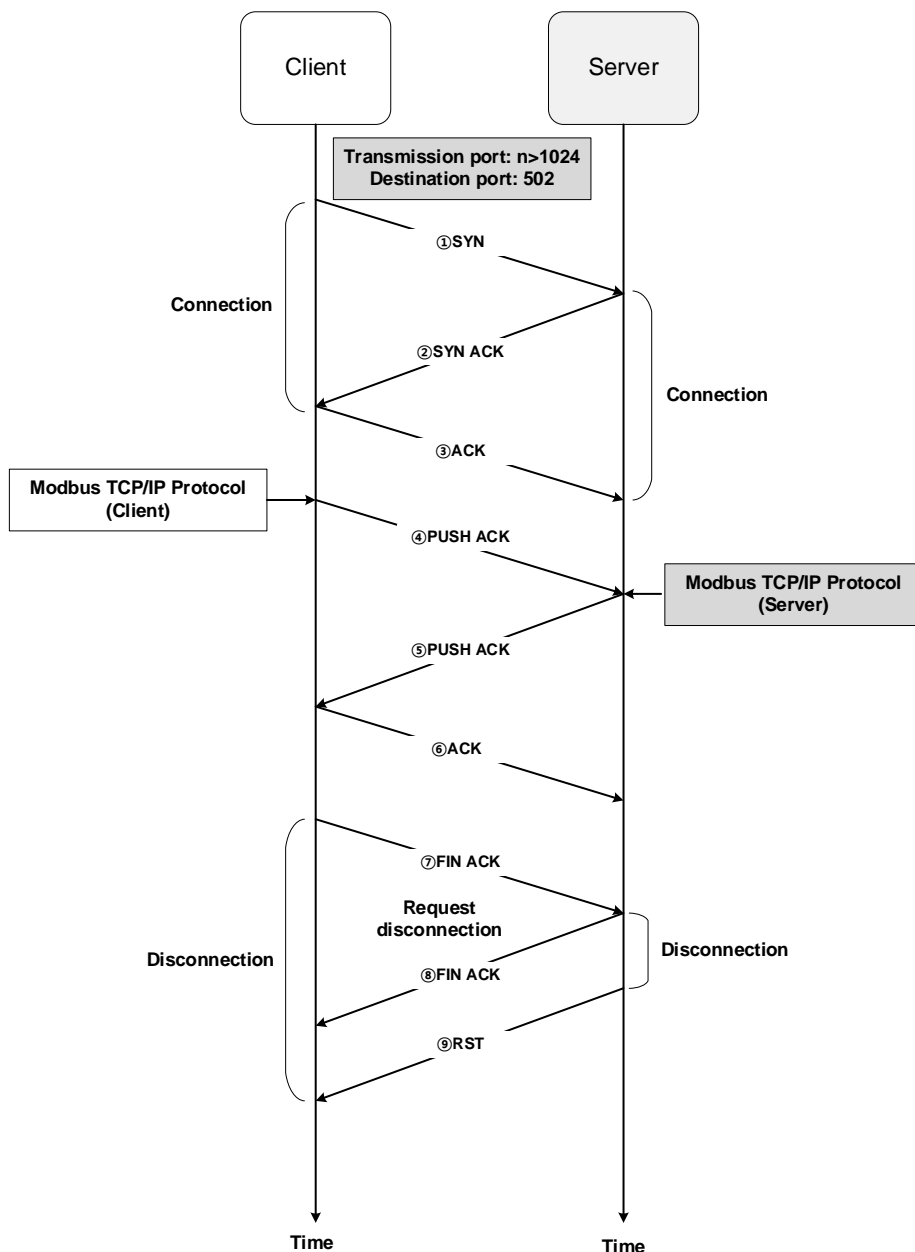

[Fig.1.6.6] Operating sequence of the Modbus TCP/IP server

1.7 P2P service

1.7.1 Outline

The P2P service means the client function in the below client/server model of [Fig. 1.7.1]. It is the function to request Read/Write Data to the server. If the startup conditions of each block are On, it creates the request frames and receives responses for processing with the protocols that are designated as the relevant channel. XGB's built-in FEnet can realize the function through up to 7 channels and you can use other protocols for each channel.

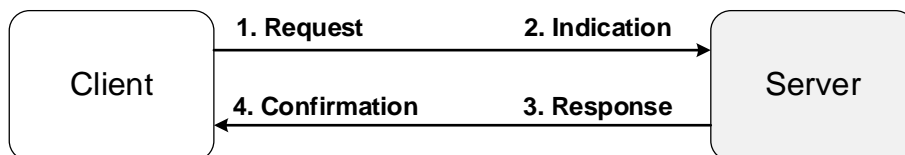

[Fig. 1.7.1] Server/client model

The Client performs the functions of ① transmission of request ④ confirmation.

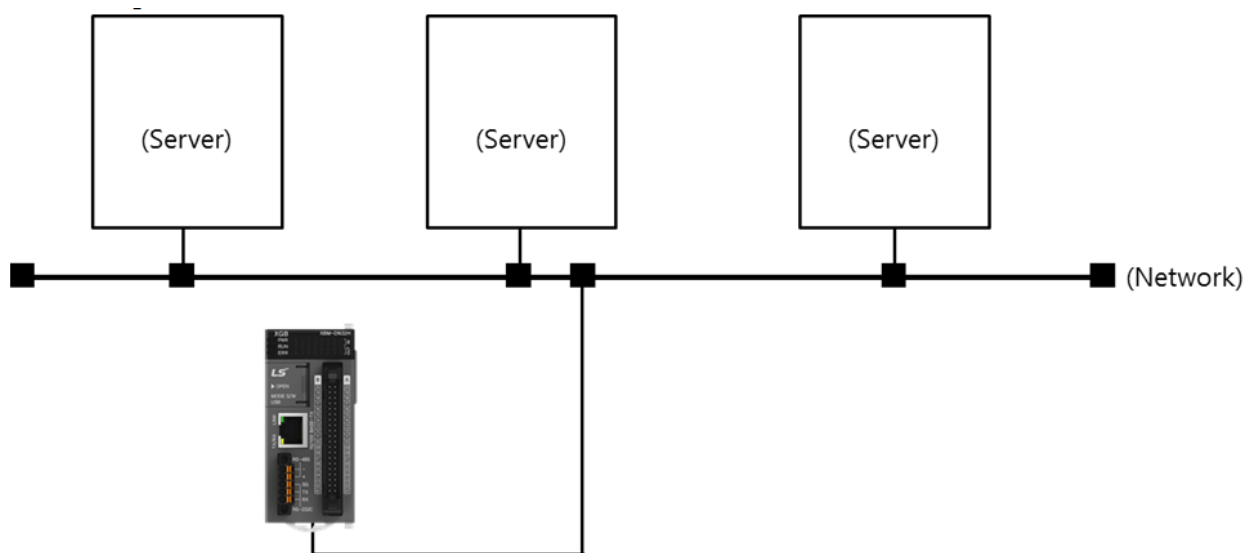

[Fig. 1.7.2] Server/client configuration

1.7.2 Setting P2P parameters

[Fig. 1.7.3] shows the example of setting P2P parameters of XG5000.

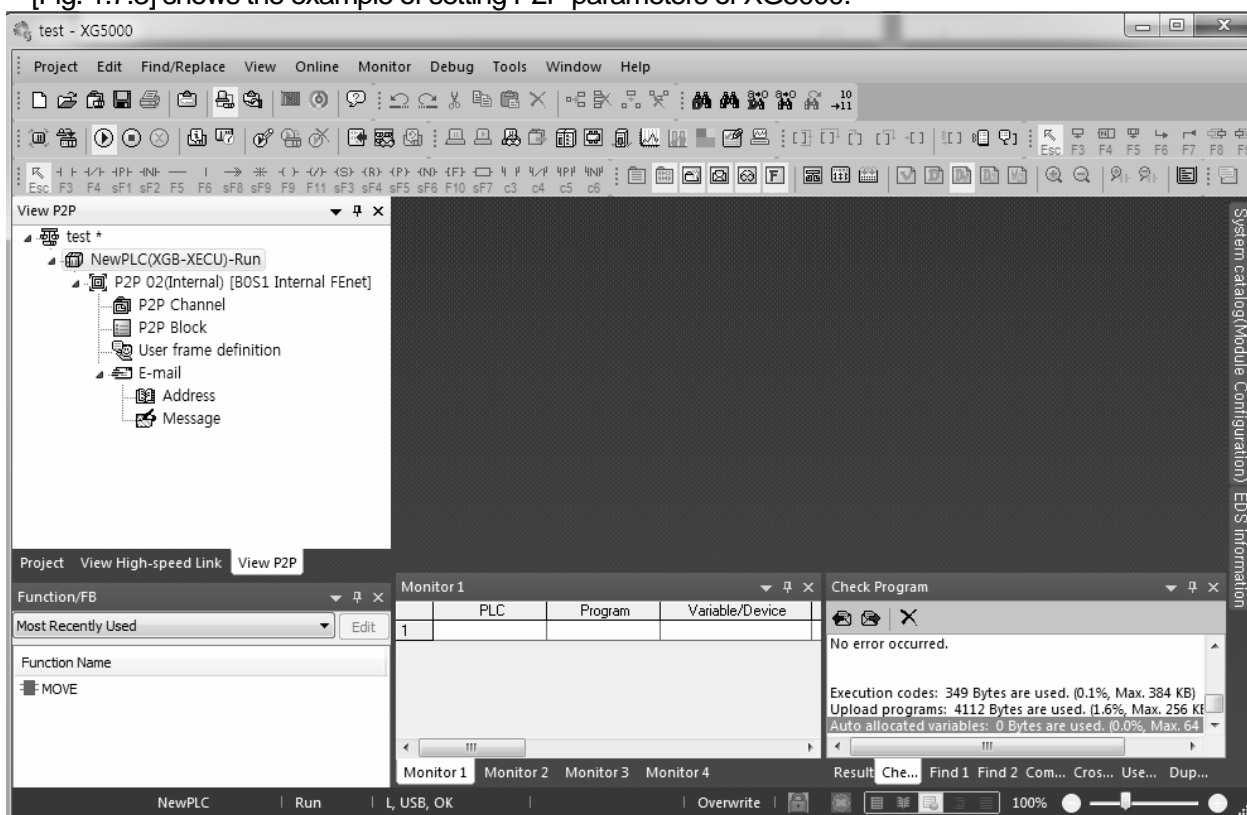

[Fig. 1.7.3] Window for P2P setting of XG5000

- Window for registering P2P parameters
 - You can set the P2P parameters up to 6.
 - Each P2P is composed of P2P channel, P2P block, user-defined frame, E-mail.
- Window for editing P2P
 - You can register and edit P2P block up to 32.
 - You can separately register frames by driver.

1) Setting FENet communication

You need to set P2P parameters to use P2P services.

- (1) Click the PLC module with the right mouse button on the P2P tab and choose P2P communication.

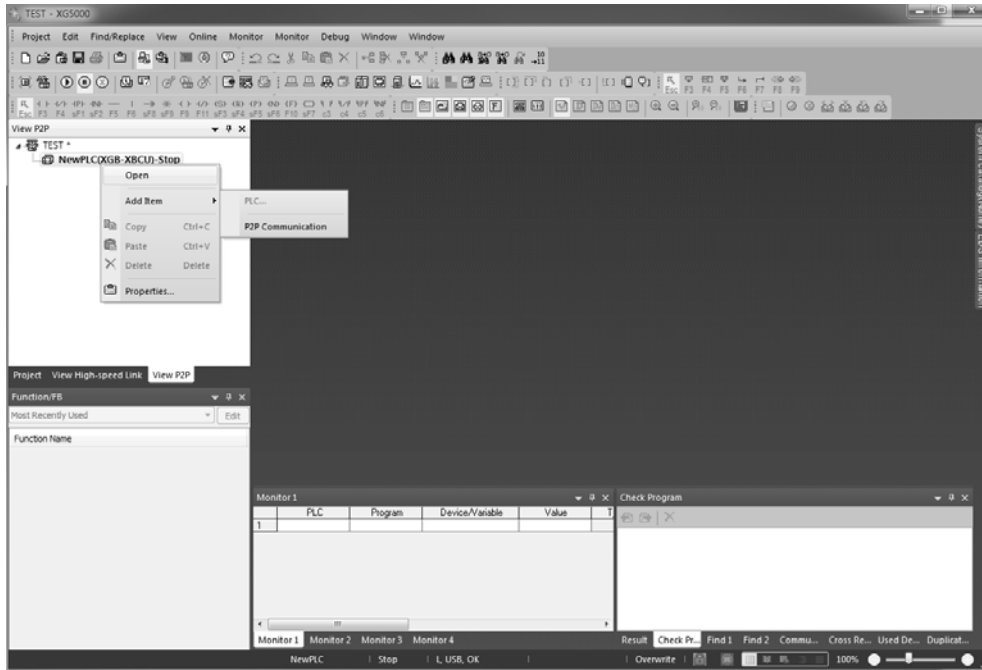

- (2) Choose the P2P number to create the P2P module to be used.

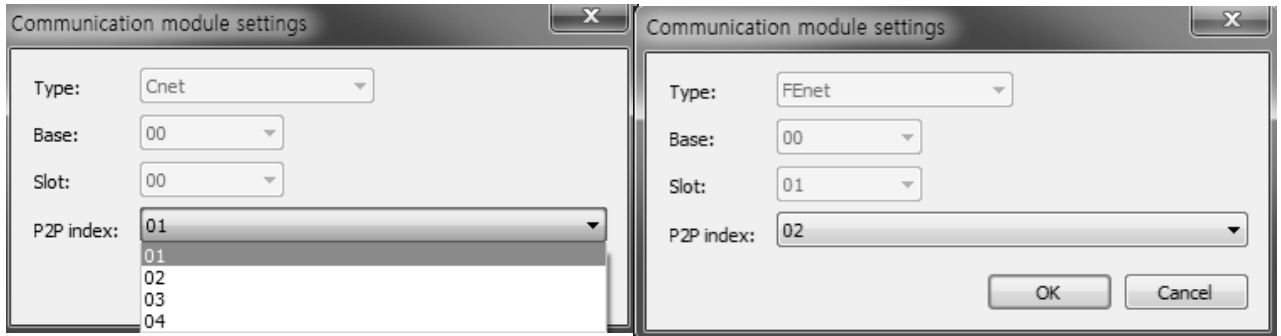

- (3) P2P 01 that XGB basic unit's built-in communication setting is fixed as Cnet.
- (4) P2P 02 that XGB basic unit's built-in communication setting is fixed as FENet.
- (5) Double-click to confirm the communication settings.
- (6) The base is fixed as 0.
- (7) The slot is automatically designated as slot 2 that has the built-in FENet.
- (8) If communication settings are completed, click the 'OK' button.
- (9) If you click the 'OK' button, the detailed items of P2P will be created in the project window as the figure of the

2) Configuration of P2P parameters

If you set the communication modules in the P2p screen, the window for setting P2P parameters will be displayed as the below figure. P2P is composed of 4 data.

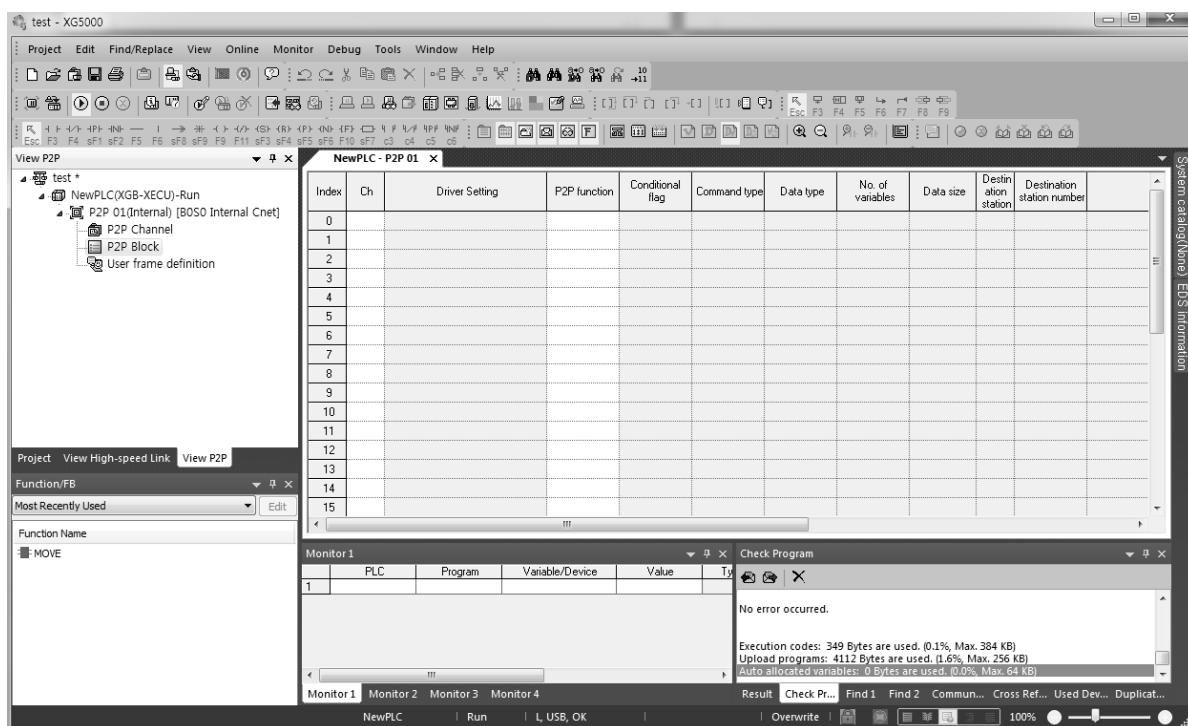

(1) P2P channel

- Setting logical channels (IP, PORT, dedicated driver) of P2P services.
- Setting user-defined frame, XGT client, MODBUS TCP client
- Setting communication equipments using the protocols other than XGT/MODBUS TCP.

(2) P2P block

- Setting 32 P2P blocks that are operated independently.

(3) User-defined frames

- Registration of user-defined frames

(4) E-mail

- Registration of frames to transmit and receive E-mail frames

1.7.3 Kinds of P2P services

1) Kinds of P2P commands

The P2P that a user applies for programming can be divided into 6 commands.

The commands should be different depending on the service types so refer to the below table for proper application.

Items	Commands	Purposes
XGT client	Read	Reads the designated area of the opposing station.
	Write	Transmits its own station's area data to the opposing station.
User-defined frame	Send	Sends its own station's area data to the opposing station.
	Receive	Receives the transferred data from the opposing station and saves it.
Modbus TCP	Read	Reads the designated area of the opposing station.
	Write	Transmits its own station's area data to the opposing station.
E-mail	ESend	Transmits the message in case of occurrence of events.

2) Kinds of P2P services

(1) XGT client

The XGT client service is used to define transmission and reception of data of XGB's built-in FEnet. For simple communication, a user only needs to designate the basic settings such as channels and data type (BIT, BYTE, WORD, etc.) and memory areas, etc. No. 2004 port is used for TCP and No. 2005 port is used for UDP.

(2) User-defined frame

It is the service that makes a user define other companies' protocols in XGB FEnet for communication between XGB's built-in FEnet and other XGT's FEnet I/F modules or communication with other models. The communication protocols may be different depending on the manufacturers. Through the function of user-defined frame, a user can apply and edit the frames according to the characteristics of the relevant communication modules. The basic structure of user-defined frame is composed of HEAD, BODY, TAIL.

(3) Modbus TCP

XGB FEnet supports the Modbus protocol that is the industrial standards. The Port No. is fixed as 502.

1.7.4 How to set up P2P services

1) Ethernet Driver

(1) Driver setting

The Ethernet Driver means the protocols that will work when the built-in FENet is operated by the server. There are the XGT server and Modbus TCP/IP server for the built-in protocols. You can set the Ethernet Driver based on the protocols to be used when the opposing station reads the basic unit's data through the built-in FENet or writes the data to the basic unit. In the majority of cases, the communication opposing station is usually MMI (or HMI). In this case, a user can communicate with the opposing devices by setting parameters without separate communication programming. The below figure shows the typical example of using the Ethernet Driver; communication with MMI PC. When the MMI PC requests the data, FENet will respond.

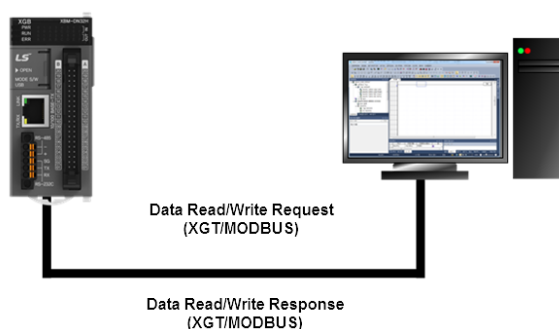

• Types of Ethernet (server) Drivers

The available driver types are as below.

Types	Descriptions
XGT server	LS ELECTRIC's XGT FENet dedicated protocol
Modbus TCP/IP server	Modicon's open protocol

Notice

- (1) The number of drivers varies depending on the set Ethernet channels and if you set the Ethernet channels, the number of available drivers will be as small as the number of set channels. Accordingly, be careful of this.
- (2) The Ethernet (server) Driver can realize 1:N communication so several client devices can connect the one set port to obtain data.

2) P2P channel

The Ethernet P2P channel is used When the PLC is operated as Master by using XGT FENet's built-in protocols or when the PLC should communicate through user-defined protocols

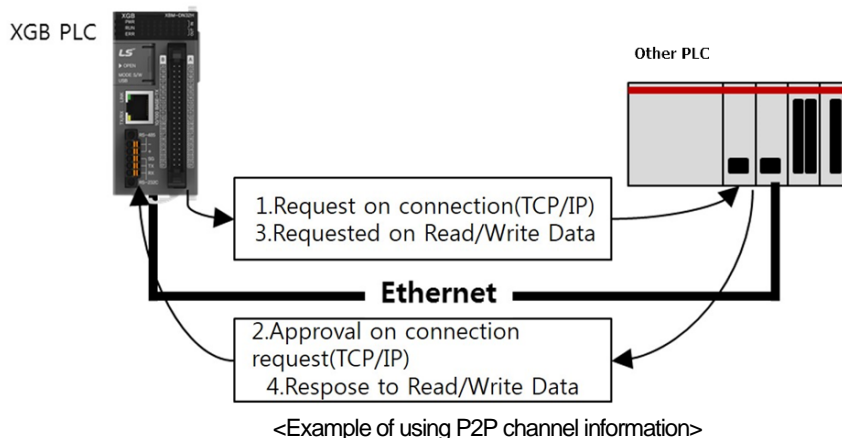

(1) P2P channel setting

The built-in FENet can transmit and receive the data by using the maximum of 16 channels and the channel is composed of the IP address and port number of the communication device.

The number of available channels in P2P is the number that subtracts the number of dedicated accesses in the basic parameter from the total number of channels (16). (Number of P2P channels=16–number of dedicated accesses)

For user convenience, P2P allows the communication with the devices using XGT, Modbus TCP protocols by setting simple parameters. For communication with other devices, it provides the function of user-defined frames. In addition, a user can register the message and mail address to transmit and receive the E-mail frame. (It supports ASCII)

However, you do not need to set the channels for E-mail communication. If you choose the P2P channel in the window for P2P setting, the below window will pop up.

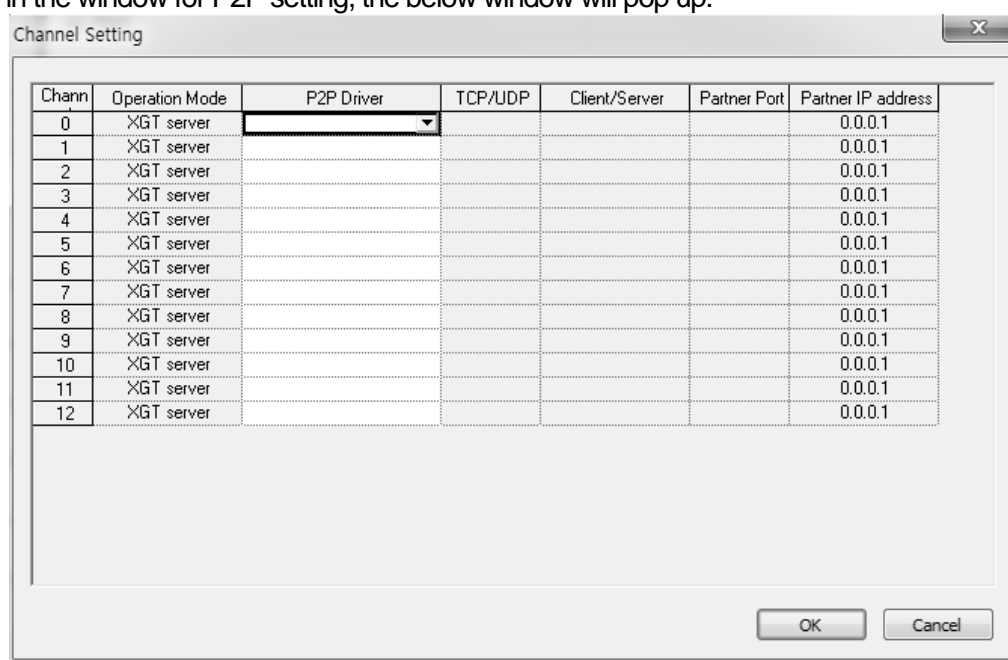

You can define the P2P driver type by selecting the 'P2P Driver' of the desired channel.

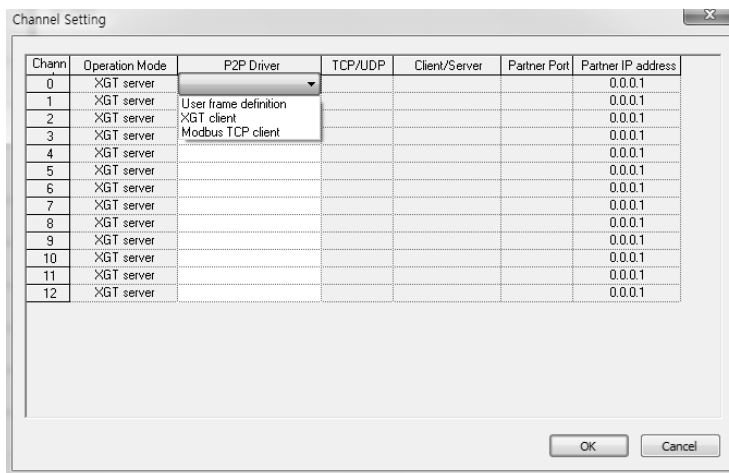

<Selection of P2P Driver client >

The below table shows the available driver types for the built-in FEnet interface and the descriptions

Items		Descriptions
P2P Driver	User defined frame	It is the protocol defined by a user for communication with the opposing device.
	XGT client	XGT dedicated protocol. (No user-defined frame)
	Modbus TCP client	Defines the operations with MODICON's Modbus TCP protocols.
TCP/UDP		You can select between the TCP/UDP. If you select the Modbus TCP, it will be fixed as TCP.
Client/Server		You can select between the Client/Server. If you select the XGT dedicated protocol OR Modbus TCP, it will be fixed as Client.
Partner Port		You can input the opposing device's port number. It is the user-defined frame so when defining the protocols, the random port is designated and you can set the ports at the range of 1~65535. However, the XGT dedicated protocol is fixed as 2004 and the TCP is fixed as 502.
Partner IP Address		You can input the opposing device's IP address.

If you choose the XGT client or Modbus TCP client for the P2P Driver, you cannot apply the user-defined frame

Notice

(1) Opposing station's IP address

In case XGT is client, make sure to set the server device's IP address. If the server is dynamically allocated the IP through DHCP, the IP address may be changed so you need to check the IP address before use.

3) How to use the Modbus Driver

The below table shows the commands and addresses of the Modbus devices.

Code	Names of function codes	Modicon PLC's data address	Remarks
01	Read output contact status (Read Coil Status)	0XXXX (bit-output)	Bit Read
02	Read input contact status(Read Input Status)	1XXXX (bit-input)	Bit Read
03	Read output register (Read Holding Registers)	4XXXX (word-output)	Word Read
04	Read input register (Read Input Registers)	3XXXX (word-input)	Word Read
05	Write output contact 1 bit (Force Single Coil)	0XXXX (bit-output)	Bit Write
06	Write output register 1 word (Preset Single Register)	4XXXX (word-output)	Word Write
15	Sequential Write output contact(Force Multiple Coils)	0XXXX (bit-output)	Bit Write
16	Sequential Write output register (Preset Multiple Register)	4XXXX (word-output)	Word Write

4) P2P block

If you choose the P2P block of the relevant parameter, the window for setting P2P parameters will be displayed.

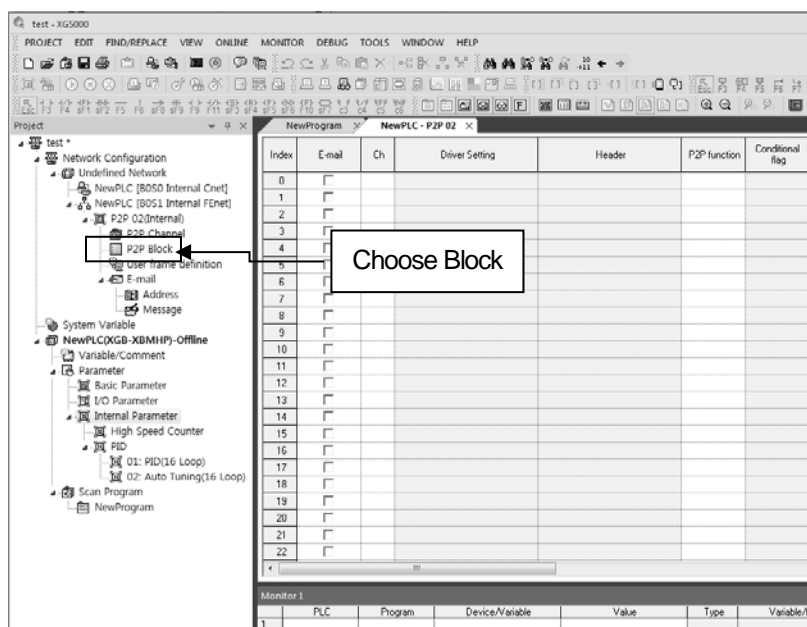

You can set up the independent blocks up to 32. If you choose the random block in XG5000, you can designate the operations of the relevant block by selecting functions as below.

Index	E-mail	Ch	Driver Setting	Header	P2P function	Conditional flag	Command type	Data type
0	<input type="checkbox"/>	0	XGT client	LSIS-XGT				
1	<input type="checkbox"/>							

The setting items by functions and the descriptions are as below.

(1) E-mail

It is used to set up the E-mail service.

(2) Channel

You can select the communication port to be used for the relevant block. The communication port of each block is determined at the time of setting parameter and it cannot be changed during RUN. The maximum number of configurable channels is the number that subtracts the number of set dedicated accesses from total 16 communication modules 'basic settings' of XG5000.

(3) Driver Setting

It means the communication driver designated by P2P setting. When designating channels, the driver for the relevant channel is automatically loaded. In case of arbitrary deletion of P2P channel setting, the set driver will be deleted. For more details, refer to 1.7.2 P2P channel.

(4) P2P functions

You can choose the P2P functions depending on the set channel drivers. Read/Write data can be performed from the opposing station with the set drivers.

- For the XGT client, choose READ/WRITE.
- For the Modbus TCP client, choose READ/WRITE.
- For the user-defined frame, choose SEND/RECEIVE

a) READ

It is the function to read and save the random area of the opposing station. It can be used for both the XGT client and the Modbus TCP client driver.

b) WRITE

It is the function to write data in the desired area of the opposing station. It can be used for both the XGT client and the Modbus TCP client driver. It supports Sequential Write and Individual Write and it is possible to write data for the maximum of 4 individual areas.

c) Send

It is the function to transmit the random frame to the external device to be accessed through unspecified communication not XGT client/Modbus TCP client protocol. It is applied to the user-defined frame.

You can select and use just one frame per one Frame Send. Through this function, you need to designate the fixed /variable sized variables of the relevant frames. Before using this function, you need to define the frame to be transmitted.

d) Receive

It is the function to receive some frames among the frames that are sent to the opposing station. You cannot choose the same frame for each P2P Frame Receive function block. You can choose just one reception function block for the reception frame.

(5) Conditional flag

It defines when the P2P block works and you can choose fixed cycle and memory set trigger conditions. Startup conditions are the internal contacts of XGB basic unit.

(6) Command Type

You can determine the detailed operations of Read; you can choose between Individual Read and Sequential Read. Individual Read covers the maximum of 4 memory areas (XGT protocol) and Sequential Read covers the defined size at the designated position.

(7) Data type

It defines the data type that will be processed by the blocks. In the case of XGT, it is possible to process data of bit, byte, 2 bytes (1 word), 4 bytes (double word), 8 bytes (long word).

(8) Number of variables

It can be defined only when you choose Individual Read. It determines the number of areas to be read individually and in the case of XGT, you can choose them up to 4. In the case of Modbus, it is fixed as 1.

(9) Data size

It defines the size of the data to be read when you choose Sequential Read and the data size is different depending on the data type.

(10) Frame

You can select the relevant frame (group) setting that will perform communication when defining the user frame.

(11) Setting

You can designate the memory area to be transmitted/received when setting XGT client or user definition. For transmission, as shown in the below figure, designate the area that will save the area (%MW0) to be transmitted and the received data from the opposing station.

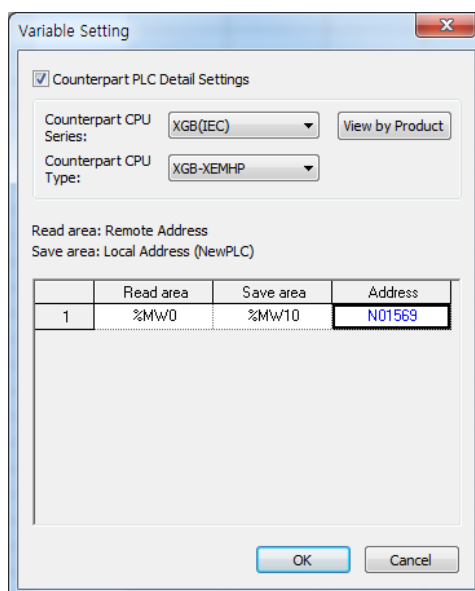

1.7.5 XGT client

XGT client is the function to Read/Write Data, which transmits the request frame to the server through XGT dedicated protocols. It transmits the frame when the startup conditions of each block set in parameters are On. In the case of XBL-EMTA, you can use the XGT client function in two ways; TCP and UDP.

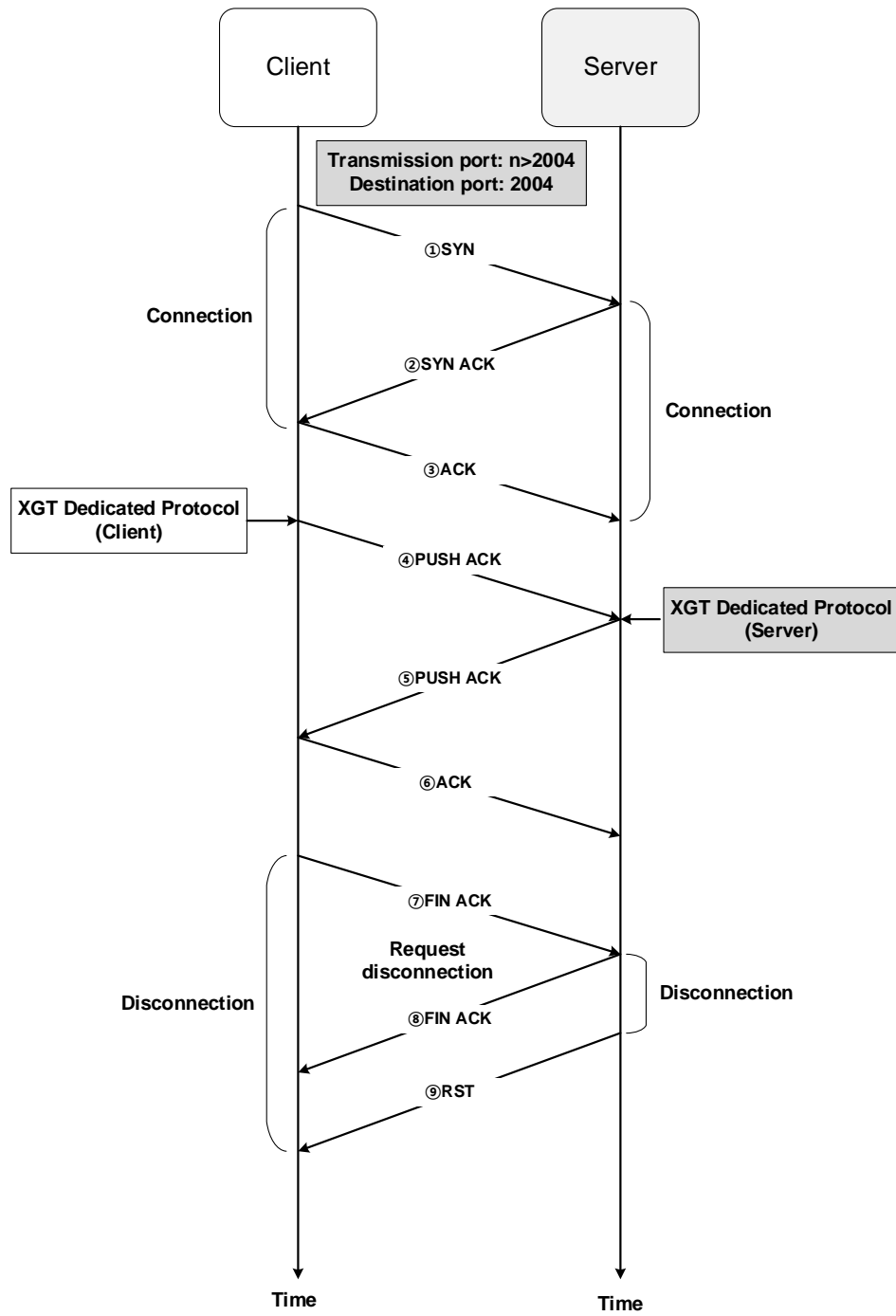

<Setting TCP XGT client channel>

1.7.6 Modbus TCP client

It is the function to Read/Write Data, which transmits the request frame to the server by using function code based on Modbus TCP/IP protocol. It transmits the frame when the startup conditions of each block set in parameters are On.

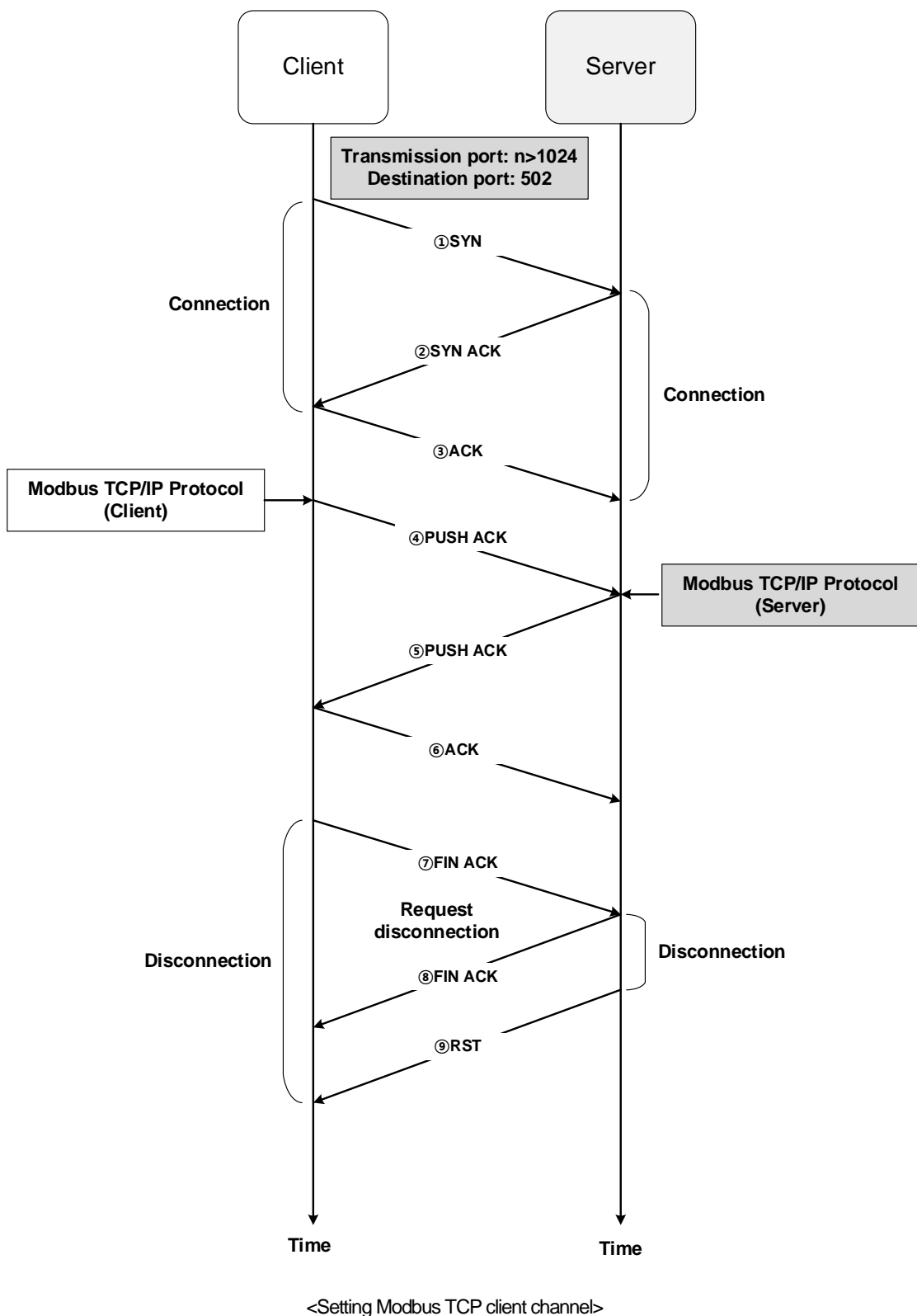

1.7.7 User-defined frame

If you want to transmit the user's desirable frame or receive one among the frames of the network, you need to define the relevant transmission/reception frame. The function is available in the P2P service only. All frames are composed of Header, Data, Tail and each element can be omitted.

The user-defined frame is expressed as the group name and frame name. Each meaning is as below.

1) Group

It is the set of frames having the same Headers and Tails. To register frames, you need to register groups.

(1) Adding groups of user-defined frame

After choosing the user-defined frame as below, click the right mouse button. Select "Add a Group" in the popup menu for adding items.

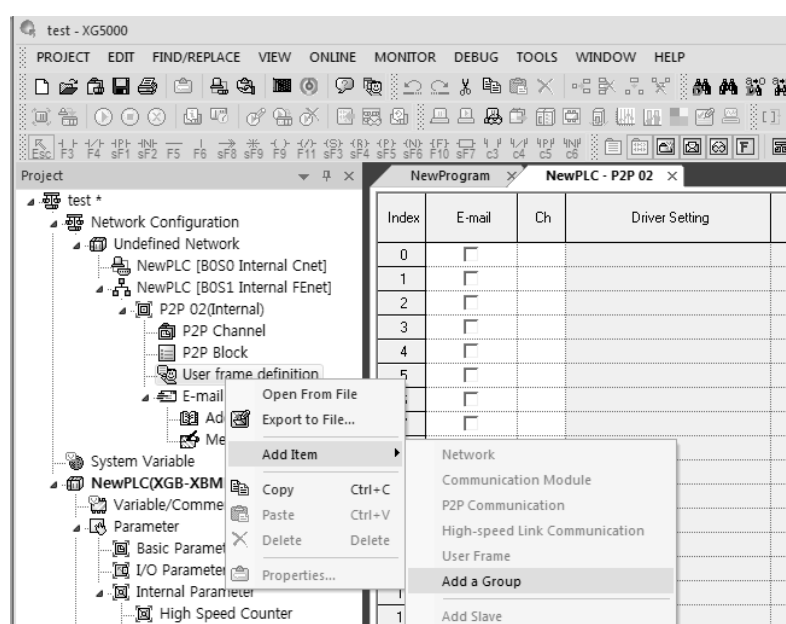

(2) Selecting group names and frame types of the user-defined frame

Enter the group name in the group edition menu and select the frame type. You can input the group name discretionally.

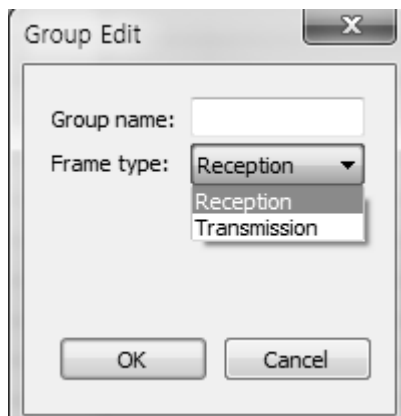

< Selecting group names and frame types of the user-defined frame >

The below figure shows the results of the project window when selecting “SEND” of the group name, transmission frame.

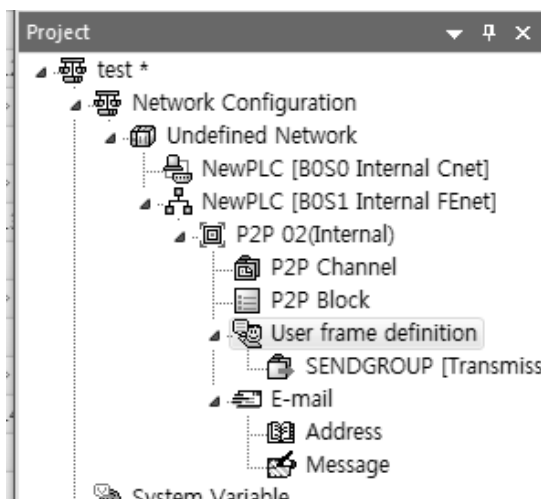

< Completion of adding groups of the user-defined frame >

2) Frame

- It is composed of the Head, Body, Tail.
- It defines the transmission · reception frames.
- You can add the fixed-variable sized variables to the Body.
- The frame is composed of multiple segments and you can register the maximum of 4 variable segments to one Body.

(1) Adding frames to the groups

If you click the right mouse button on the added group as below, the popup menu will come on. Choose 'Add Frames' and choose the frame types. The below figure represents the added frames to the group when you select HEAD, TAIL, BODY respectively.

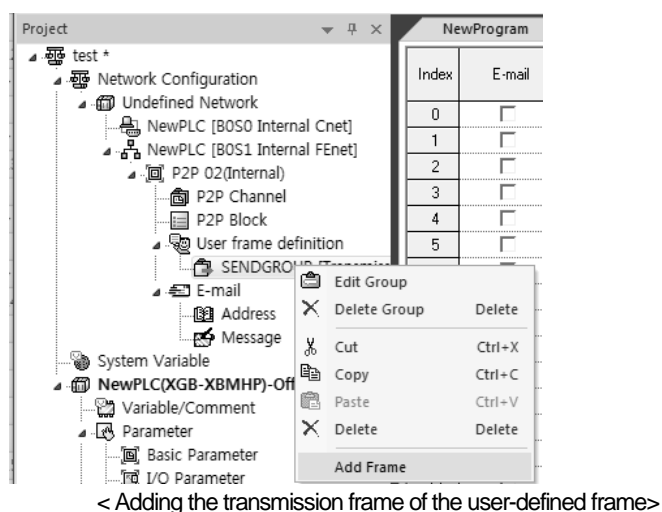

a) Adding the user-defined frame's HEAD

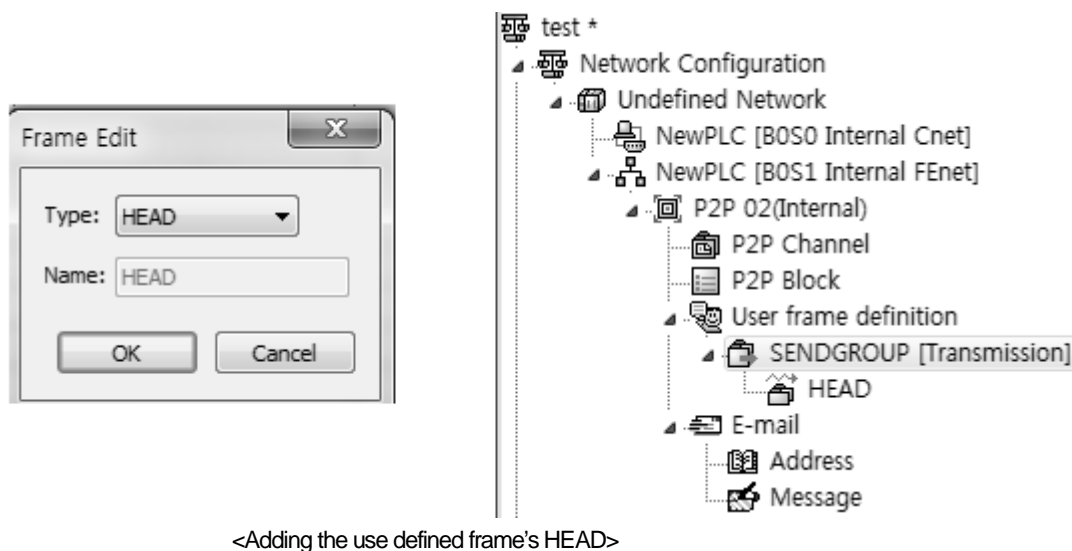

(2) Adding the user-defined frame's TAIL

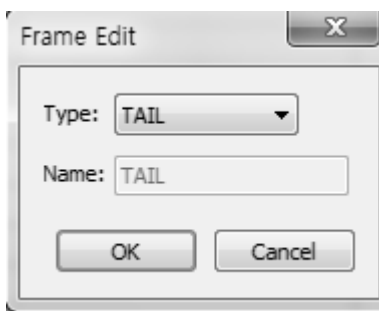

(3) Adding the user-defined frame's BODY

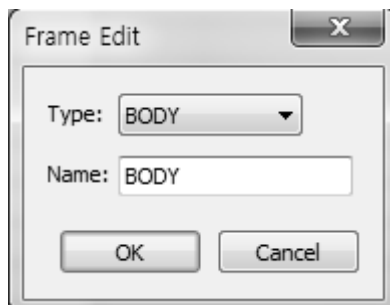

3) Segments

(1) Kind of segments

The frame's Headers, Bodies, Tails are composed of multiple segments. You can add segments by clicking the right mouse button.

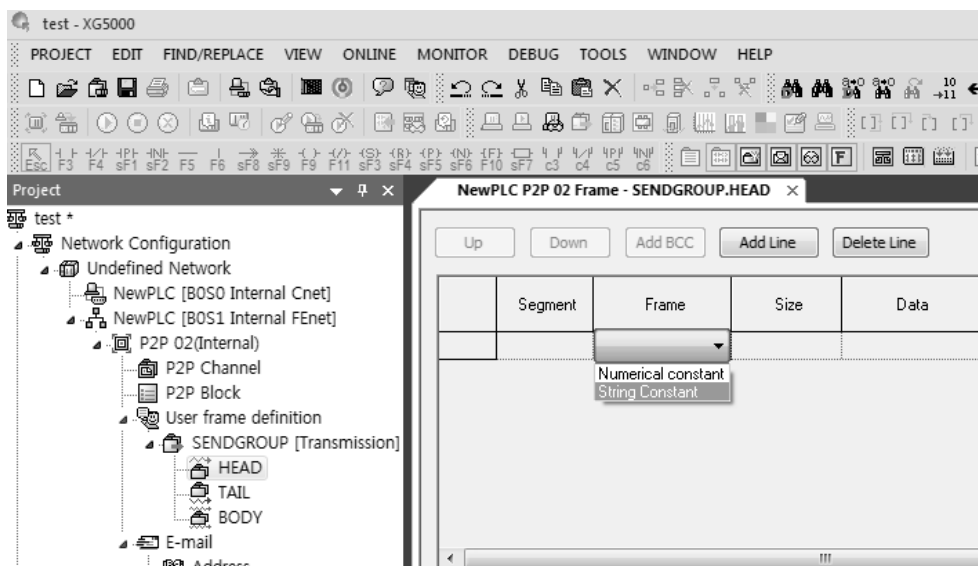

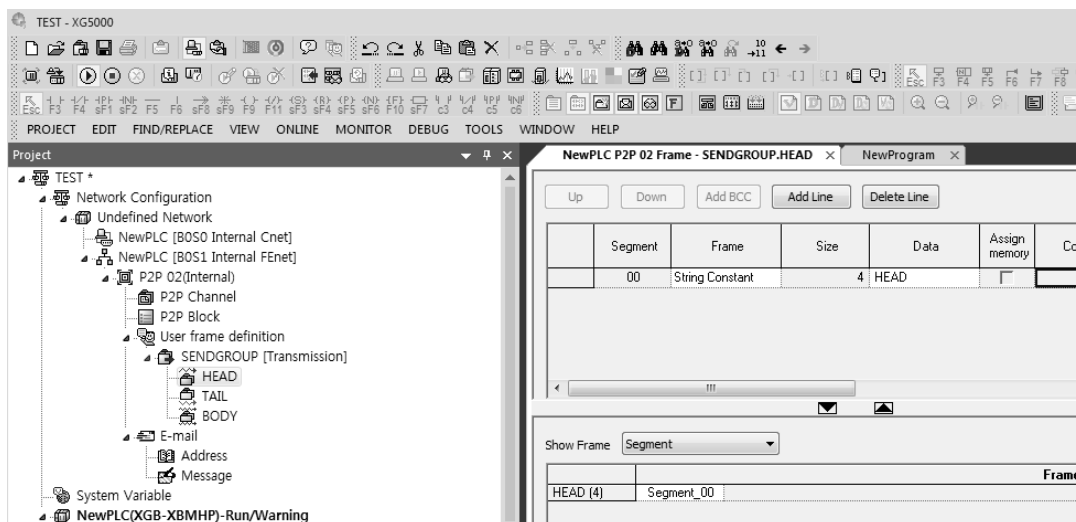

< Example of the window where the segment is registered >

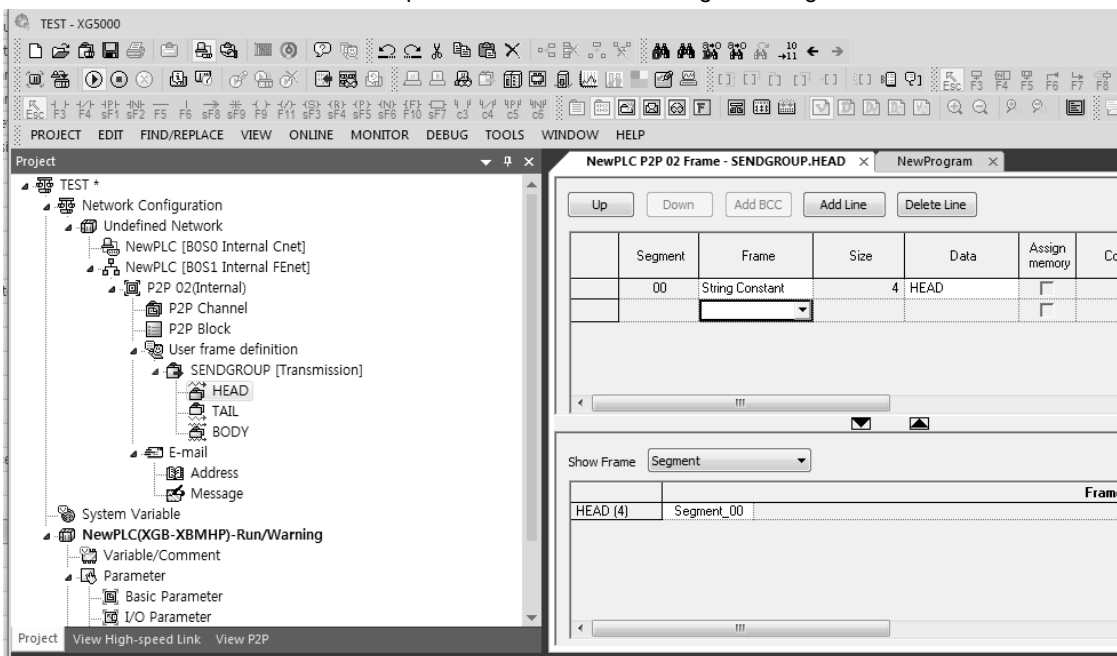

< Example of add line >

There are the numerical constant, string constant, fixed · variable sized variables for the segments forming the frames.

a) Numerical constant

It defines the part that is fixed as the constant among frames and the value of data term should be designated as Hex.

b) String constant

Register the string constant among frames and designate the value of data term as ASCII.

c) Variable size variables

- They can be used for the frame's Body area.
- Transmission frame: It is used to change the frame length. If you check memory specification, the transmission frame will be composed of the data read from the PLC memory.
- Reception frame

It is used to process variable sized data among received frames.

It can be registered to the last segment among the Body areas. If you check memory specification, the data for the corresponding segment will be saved among received frames (it also can be swapped and changed)

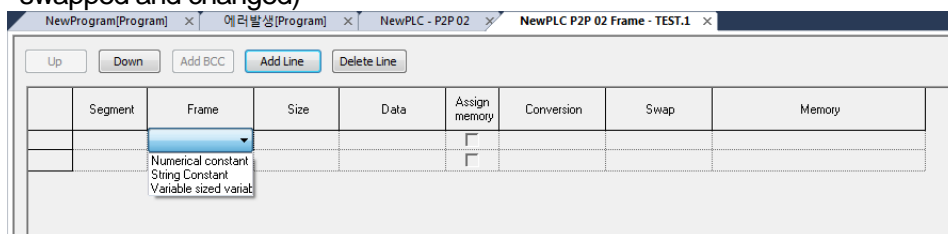

(2) Data conversion processing

In case you need to convert the data into ASCII from Hex during transmission-reception of frames or execute Byte Swap, it can be defined in the frame editing frame.

a) Hex To ASCII

- Transmission: Converts the data read from the PLC memory into ASCII and composes the transmission frame
- Reception: Converts the received data into ASCII and saves it.

b) ASCII To Hex

- Transmission: Converts the data read from the PLC memory into Hex and composes the transmission frame.
- Reception: Converts the received data into Hex and saves it.

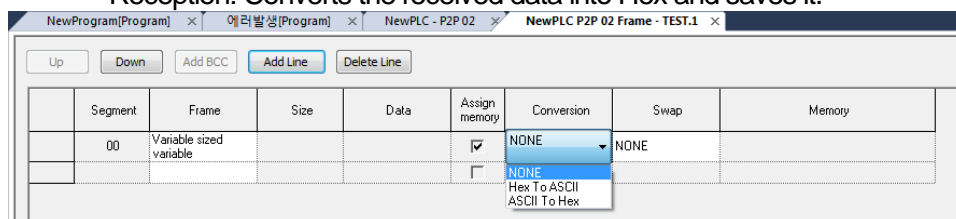

For configuring the transmission frame, in CASE you use the PLC memory MW100's 2word and convert it into Hex to ASCII or in case h34353637 is saved in MW100, the corresponding segment of the transmission frame will be made of "4567".

In addition, when you convert the part of the received frames into Hex and save it, if the value of the corresponding area is "4567", h34353637 will be saved to the PLC memory.

c) Swap

(a) 2byte

- Swapping the corresponding part of transmission · reception frames by 2 bytes

(b) 4byte

- Swapping the corresponding part of transmission · reception frames by 4 bytes

(c) 8byte

- Swapping the corresponding part of transmission · reception frames by 8 bytes

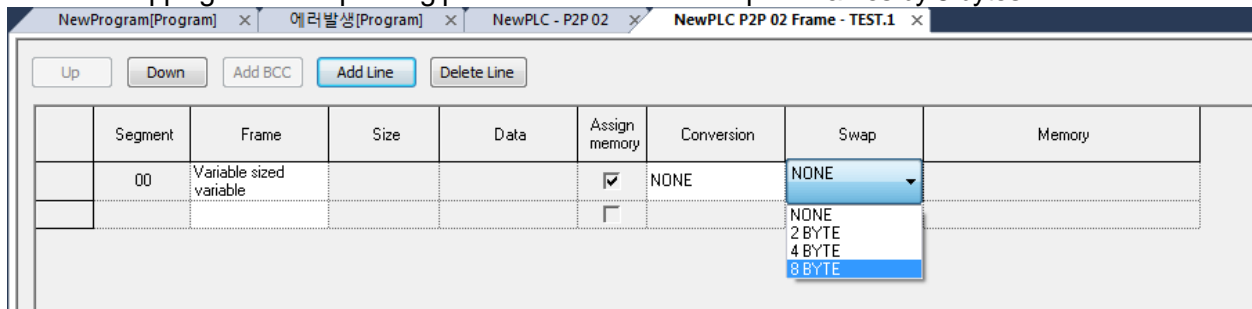

* h1234567811223344 can be converted by each method as below.

- 2byte Swap: h3412785622114433

- 4byte Swap: h7856341244332211

- 8byte Swap: h4433221178563412

4) TCP/UDP user-defined frame server

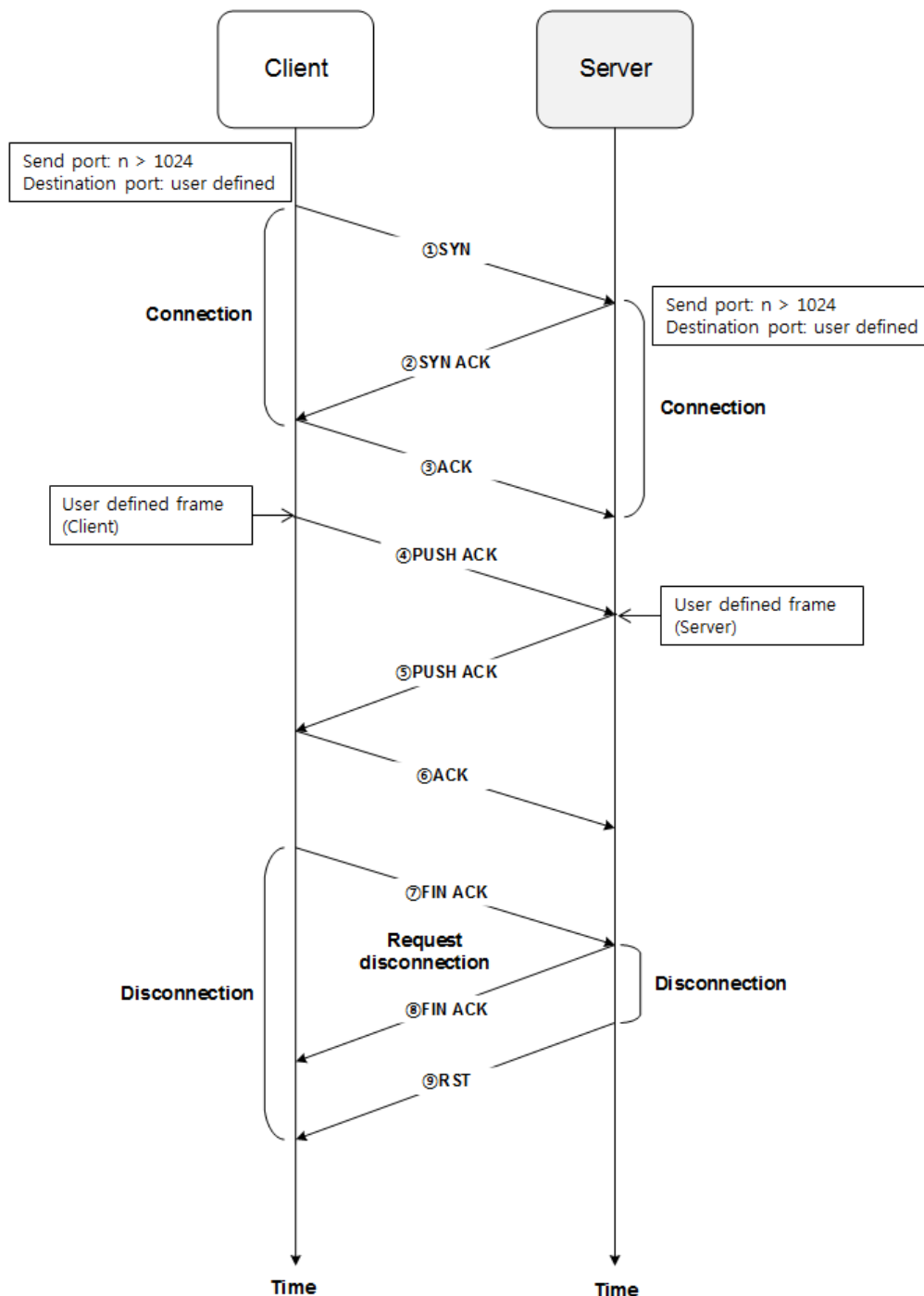

▪<TCP user-defined frame server>

- (1) It is the function to receive the frame registered in the transmission block to the port designated by a user.
- (2) After the access request is received from the client and connection is completed, when the frame registered in the reception block is received from the client, the corresponding block will be processed.
- (3) In case the ports or frame forms are different, reception process is not available.
- (4) In the case of UDP user frame server, when the frame registered in the reception block is received to the port, it will be processed.

5) TCP/UDP user-defined frame client

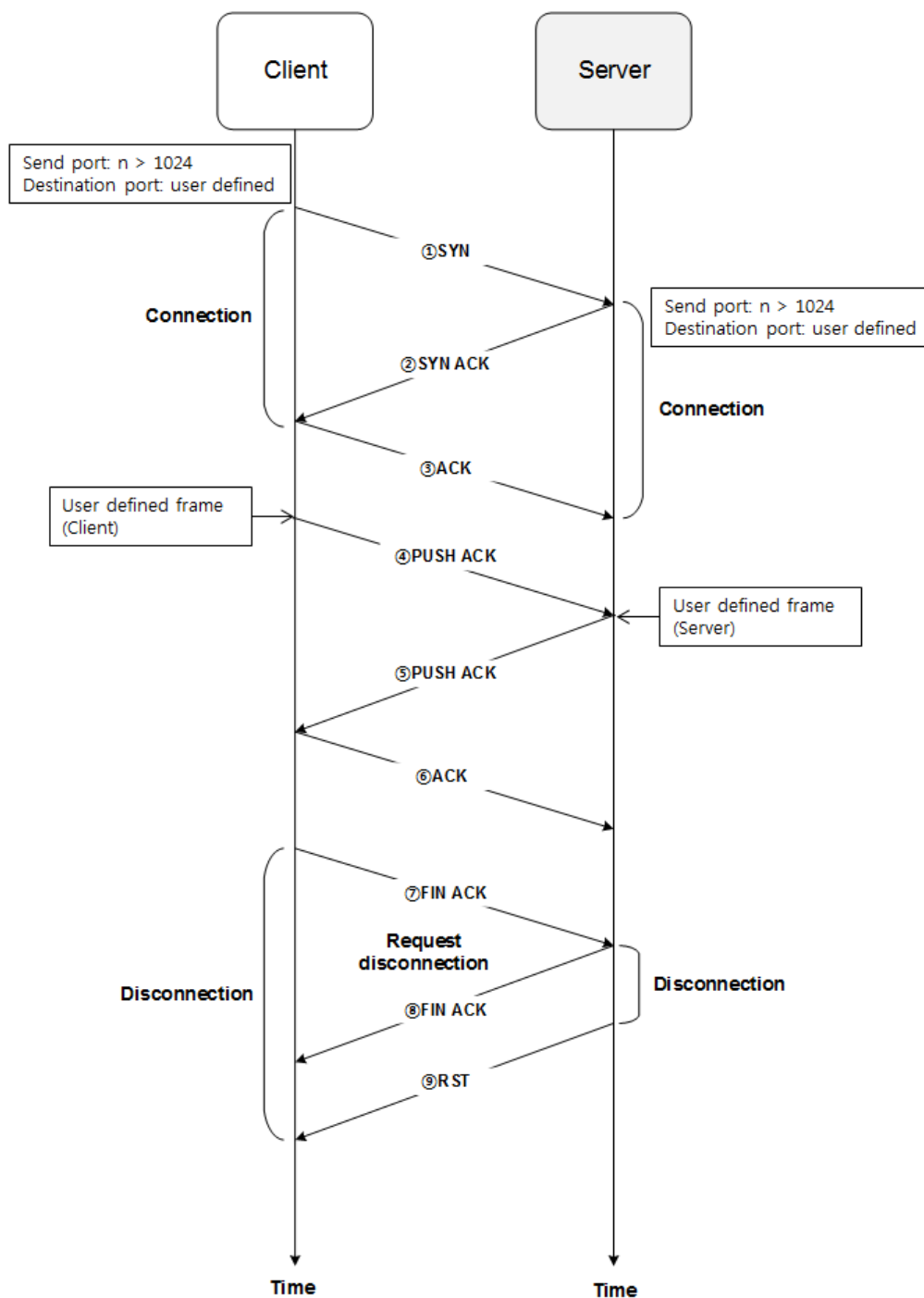

<TCP user-defined frame client>

- 1) It is the function to transmit the frame that is registered in the transmission block to the port designated by a user.
- 2) If the startup conditions of the block are On, the connection request will be sent to the server and the frame registered in the transmission block will be sent to the corresponding port.
- 3) In the case of UDP, when the startup conditions are On to the corresponding port without connection request, the frame will be transmitted.

1.7.8 Operation of P2P service

After setting P2P parameters, you need to download the parameters to the PLC's CPU and start up the P2P service. Assume that the P2P parameters to be downloaded are already made and accesses to the PLC's CPU.

1) P2P parameter download

If you choose [Online] -> [Write] in the XG5000 menu to download the completed P2P parameters, the window for parameters download will pop up. If you click the 'OK' button, the communication parameters will be downloaded to the CPU. if you check 'Set up with Link Enable', Link Enable can be applied with writing P2P/HS parameters at the same time.

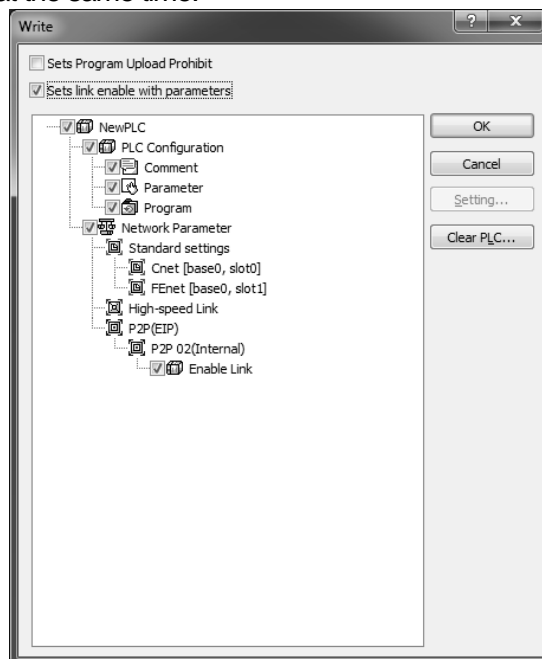

(1) Startup of P2Pservice

After downloading P2P parameters, you need to start up P2P for P2P service. To achieve this, choose [Online] → [Communication Module Setting] → [Link Enable (high speed link, P2P)] in the menu.

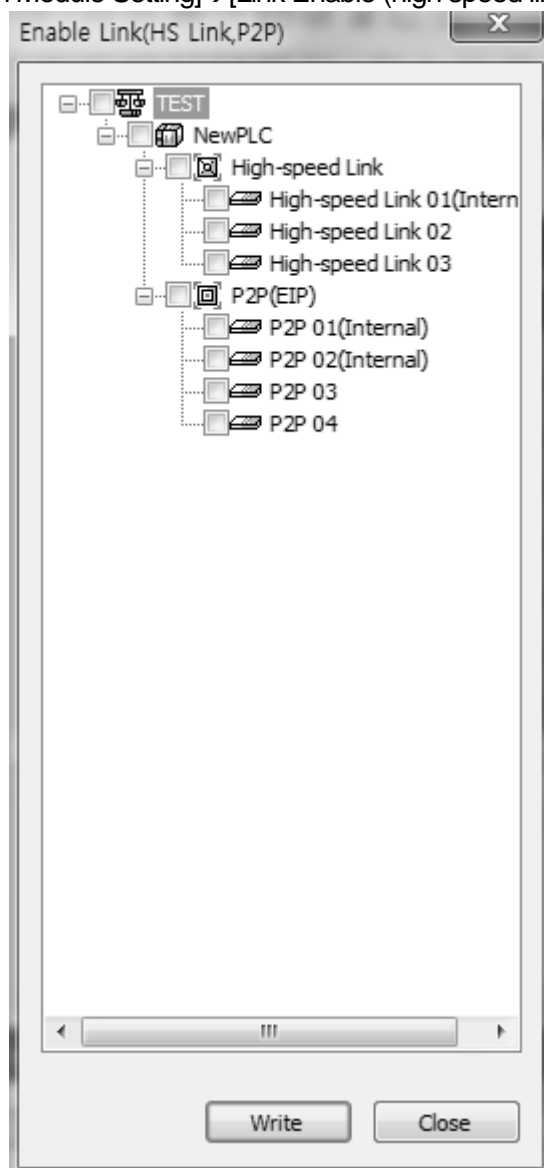

Choose the P2P parameters to be started in the [link Enable (high speed link, P2P)] window. If you cancel the already checked P2P parameter, the relevant P2P service will stop.

1.7.9 P2P diagnosis function

- 1) Click the System Diagnosis as shown in the left figure after access through XG5000.
- 2) Then, the current system is displayed as shown in the right figure.

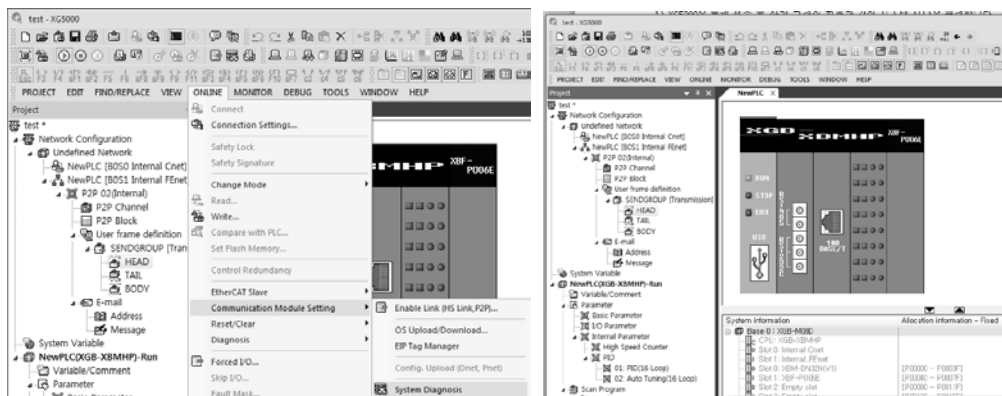

- 3) Put the mouse on the figure of the module and click the right mouse button as shown in the left side of the below figure.
- 4) Choose the status by services and click them.

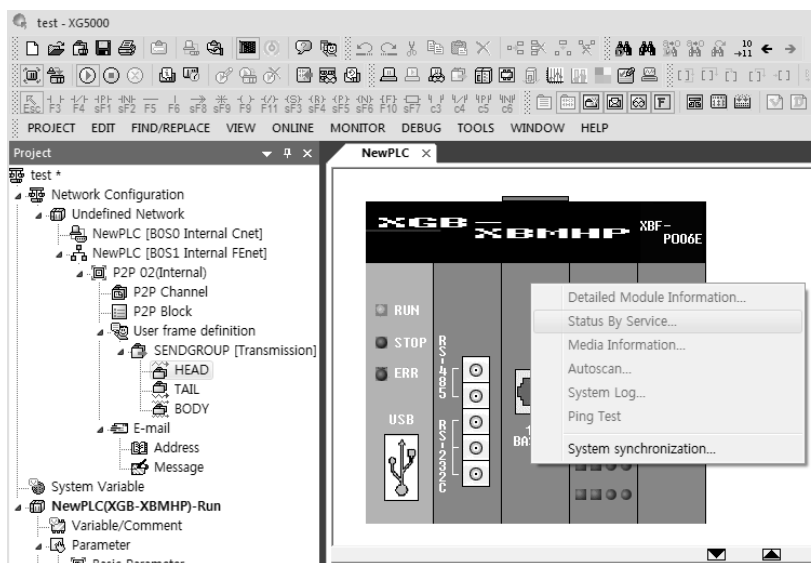

- 5) Then, the status window by service is displayed.
- 6) If you select the P2P service tab, you can check the status of P2P service as below.

The screenshot shows a window titled "Status by service" with three tabs: "Dedicated Service", "P2P Service", and "HS Link Service". The "P2P Service" tab is selected. The window is divided into several sections:

- Standard Information:** Base No.: 0, Slot No.: 1
- Service information:** Parameter existence: exist, No. of blocks in service: 4, Parameter task status: IDLE
- Communication Diagnostics:** A table with 7 columns: Block number, Channel number, Block status, Connection status, Service status, Service count, and Error count. The table contains 4 rows of data.

At the bottom right of the window, there are buttons for "Multiple Reading", "Refresh", and "Close".

Block number	Channel number	Block status	Connection status	Service status	Service count	Error count
0	0	0	IDLE	0	0	0
1	0	0	IDLE	0	0	0
2	0	0	IDLE	0	0	0
3	0	0	IDLE	0	0	0

Remaks

We support Dedicated Service in case of Only TCP client which Connected to XGT server
Dedicated Service not available in XGT Server(UDP)
However, the XGT client (UDP) can check diagnosis history from P2P service.

1.8 High speed link

1.8.1 Outline

The high speed link that is the communicate method between XGB PLC and XGK PLC's communication module is the function to transmit and receive data regularly by setting high speed link parameters. The high speed link service transmits the frame to Subnet Broadcast by using UDP protocols.

The device that is in the same subnet receives the Broadcast frame and if the relevant frame is registered in the reception list, the data will be processed. The functions of the high speed link are as below.

- 1) Function for setting the high speed link block
If there are several transmission · reception areas, you can set the blocks up to 64. It is possible to set 200 words per one block.
- 2) Function for setting the transmission cycle
A user can set the transmission cycle by parameters. It is possible for a user to set the transmission · reception cycle from 20ms to 10 seconds.
- 3) Function for setting transmission · reception areas
You can set the transmission · reception areas by data blocks. It is possible to use the maximum of 64 blocks without distinction of transmission·reception.
- 4) Function for providing the high speed link information
You can check the operating status of the high speed link through flags.
You also can use the convenient diagnosis function through XG5000.

1.8.2 Parameters setting

1) Basic parameters

- (1) When creating the XG5000 project, any RUN communication modules are not registered in the basic network.

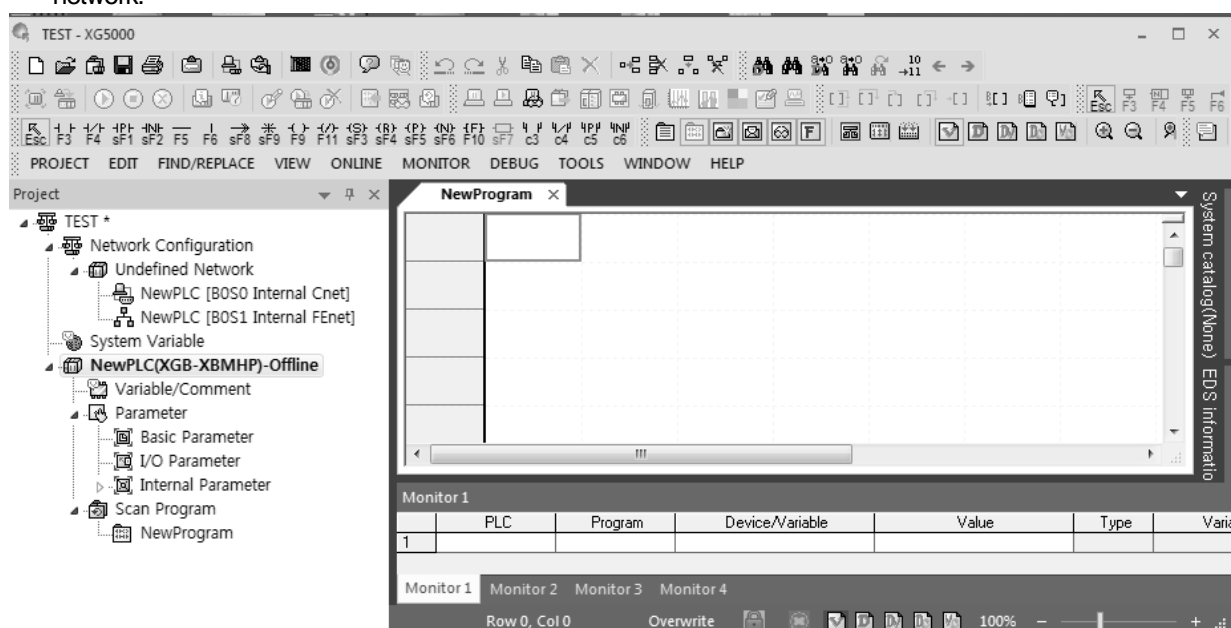

[Fig. 1.8.1] Creation of XG5000 project

- (2) If you execute I/O synchronization in [online]→[diagnosis]→[I/O information] after accessing to the PLC, even the currently installed expansion communication module including built-in communication will be registered.

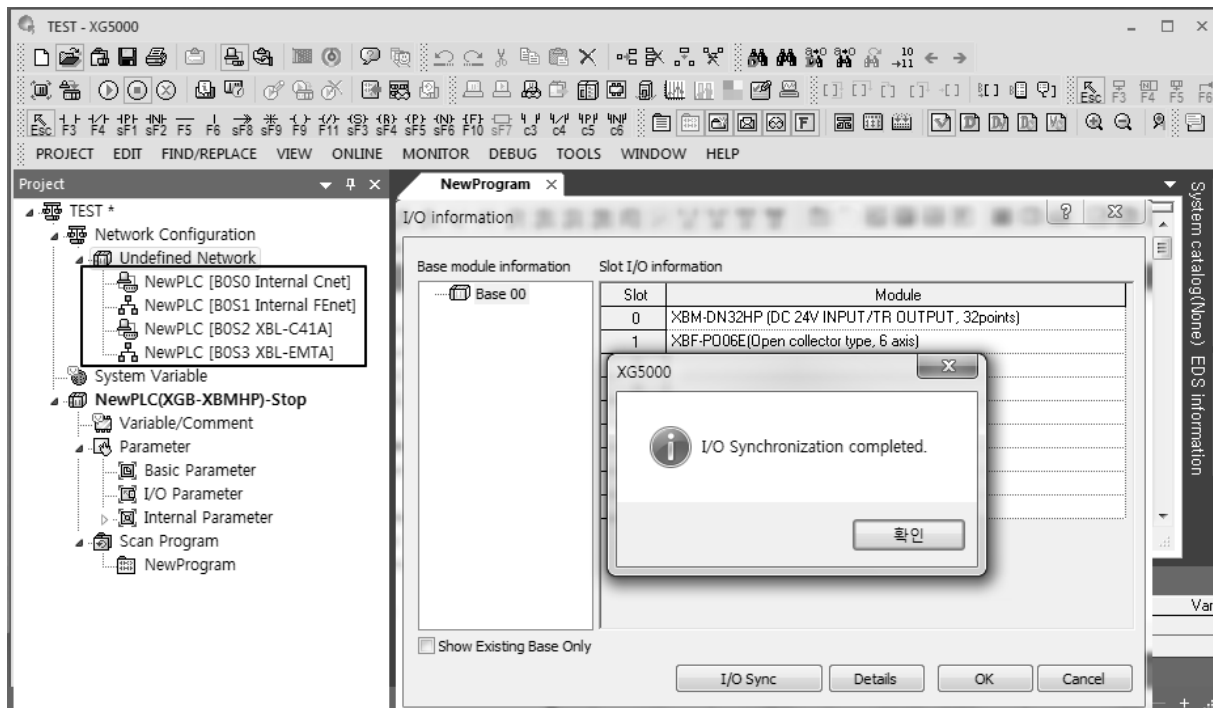

[Fig. 1.8.2] Registration of XG5000 project communication module

- (3) Double-click the built-in Fenet and input high speed link's exchange number and network parameter information.

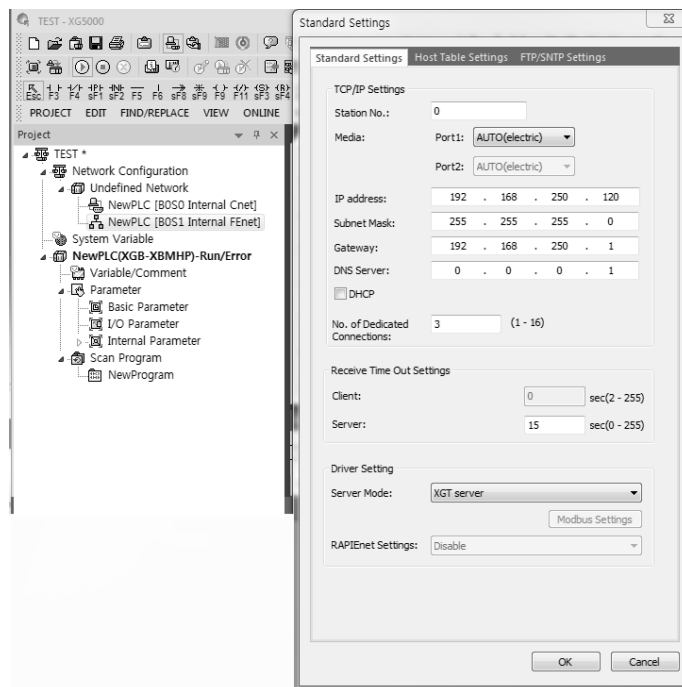

[Fig. 1.8.3] Setting the basic communication module

2) High speed link parameter

(1) Communication setting

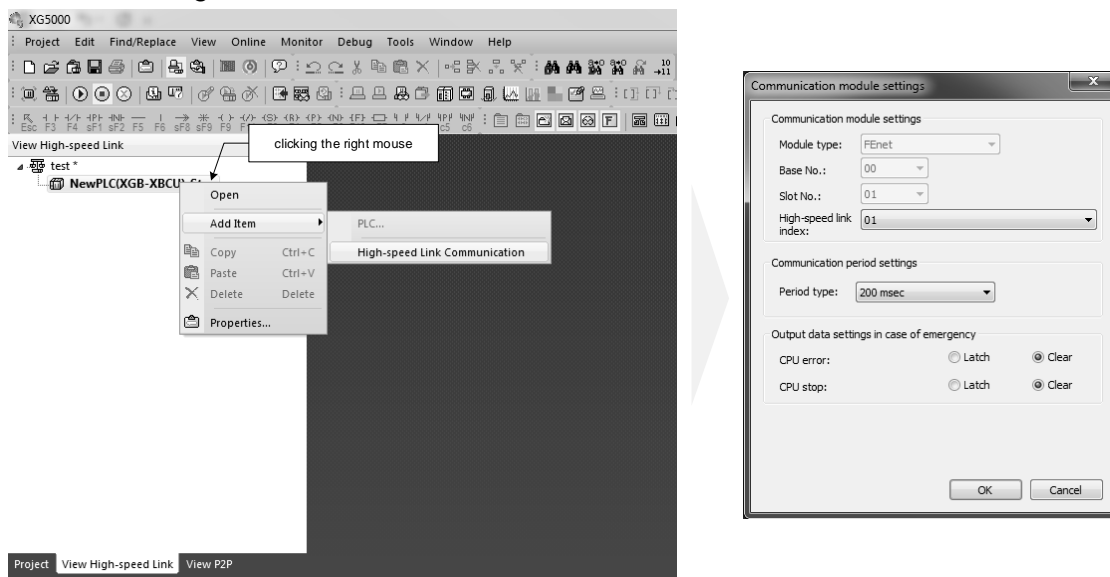

[Fig. 1.8.4] Basic setting of high speed link

- a) After clicking the right mouse on the high speed link tab, add high speed link module communication items as shown in the left side of the figure[1.8.4].
- b) Then, the window for setting communication modules is activated as shown in the right side of the figure[1.8.4] and you can set the basic high speed link. No.01 high speed link is the built-in FENet and No. 02 and 03 .high speed links can be used for expansion communication modules as before.

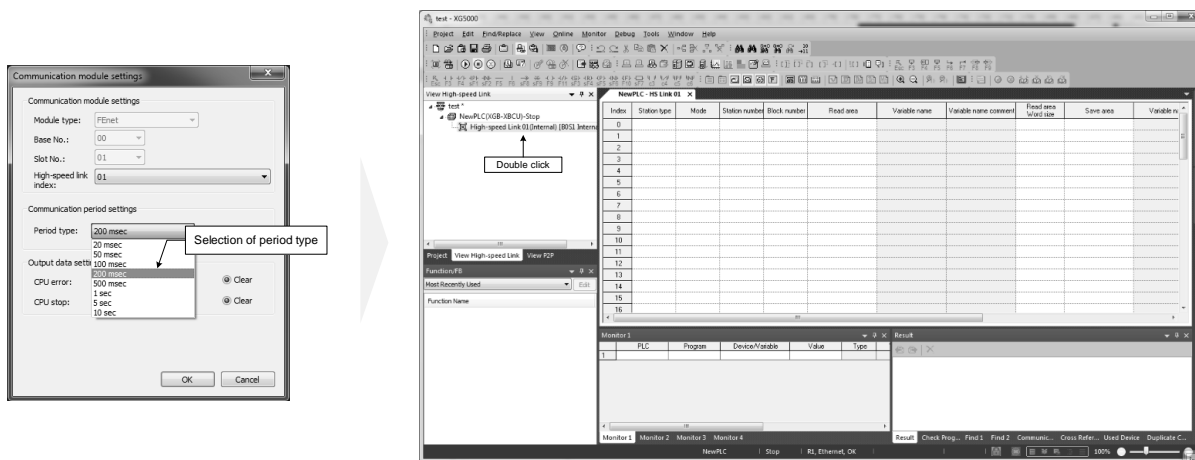

[Fig. 1.8.5] Completion of setting high speed link communication module

- c) Select the cycle to be communicated in communication cycle setting as shown in the left side of [Fig. 1.8.5]. Choose the cycle and click 'OK' button. Then, if you double-click the No.1 module of high speed link, the window for setting block will be displayed as shown in the right side of [Fig. 1.8.5].

(2) Setting the high speed link transmission block

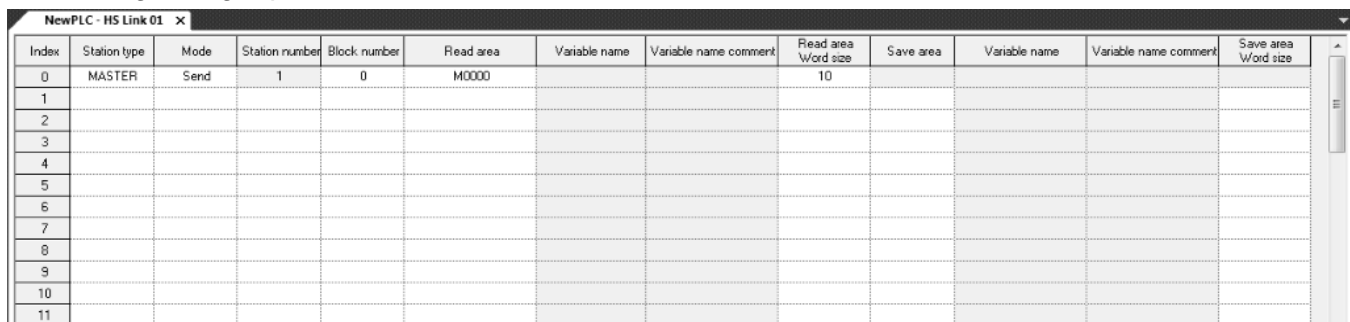

Index	Station type	Mode	Station number	Block number	Read area	Variable name	Variable name comment	Read area Word size	Save area	Variable name	Variable name comment	Save area Word size
0	MASTER	Send	1	0	M0000			10				
1												
2												
3												
4												
5												
6												
7												
8												
9												
10												
11												

[Fig. 1.8.6]Setting high speed link transmission block

- Set the station type as MASTER
- Choose the transmission mode
- If you choose transmission, it will be automatically set as the exchange number set in the basic parameters.
- Input the block number(range: 0~31).
- Input the area to be read. The area to be read is the each area of XGB's CPU modules.
- If you input the word size of the area to be read, setting transmission blocks is completed.

(3) Setting high speed link reception block

Index	Station type	Mode	Station number	Block number	Read area	Variable name	Variable name comment	Read area Word size	Save area	Variable name	Variable name comment	Save area Word size
0	MASTER	Receive	10	1					M0020			10
1												
2												
3												
4												
5												
6												
7												
8												
9												
10												

[Fig. 1.8.7] Setting high speed link reception block

- a) Set the station type as MASTER as show in [Fig. 1.8.7].
- b) Choose the mode as reception.
- c) Input the exchange number. This one is the exchange number of the opposing device transmitting the relevant block.
- d) Input the block number. When the received frame is the same as the relevant block number, reception is processed.
- e) Input the storage area. The storage area is the area saving data when the frames of the relevant block
- f) Numbers are received to each area of XGB CPU modules.
- g) If you input the word size of the data to be read, setting reception block is completed.

(4) HS parameter download

If you choose [Online] -> [Write] in the XG5000 menu to download the completed HS parameters, the window for parameters download will pop up. If you click the 'OK' button, the communication parameters will be downloaded to the CPU. If you check 'Set up with Link Enable', Link Enable can be applied with writing P2P/HS parameters at the same time.

(5) High speed link Enable

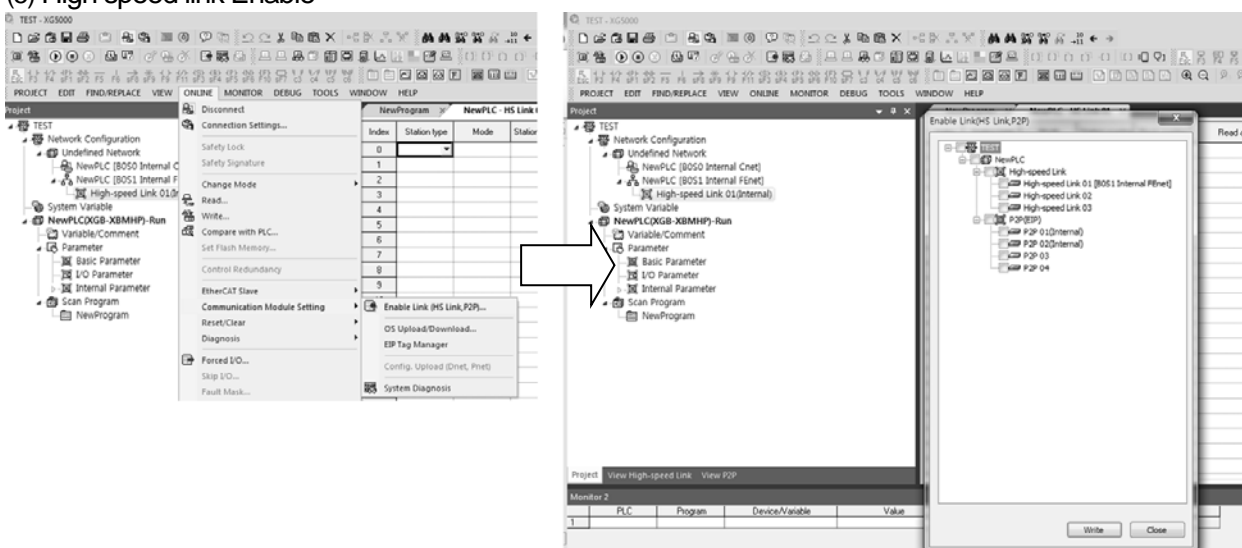

[Fig. 1.8.8] High speed link Enable

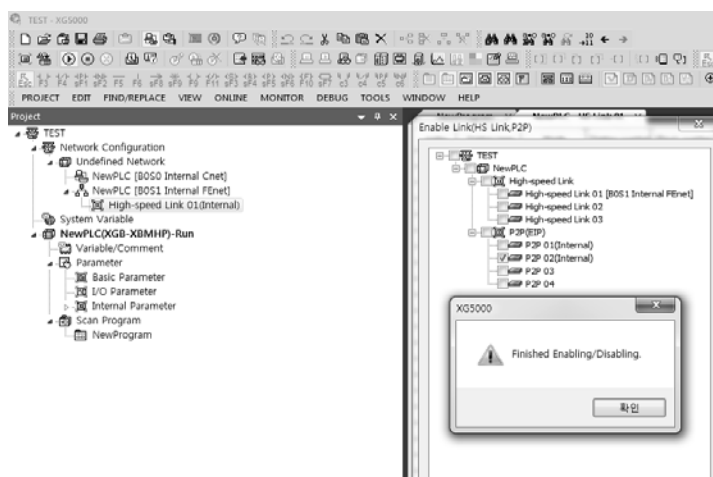

- a) Choose [Online]→[Communication module setting]→[Link Enable] after accessing to the PLC through XG5000.
- b) Choose high speed link 01 that built-in FENet is designated as the base.
- c) After clicking the checkbox, click 'Write' button.
- d) If you click the 'OK' button after the message is output, high speed link communication will start.

3) High speed link flag

The high speed link service is the function for data exchange between communication modules of more than two stations. For a user's information, it provides the way how to check the status of the high speed link service aiming to verify the reliability of the data read from the opposing station through the high speed link.

For the high speed link information, the communication module inform a user whether the high speed link is operated based on the parameters set by the user by synthesizing received data every a certain time.

The high speed link information can be divided into RUN-link (_HSxRLINK) showing the information of the whole communication network; Link-Trouble (_HSxLTRBL)'s whole information; _HSxSTATUS, _HSxTRX, _HSxMOD, _HSxERR's individual information showing the communication status by 64 registered items of the parameters.

A user can use the above information during programming in the format of keywords and monitor the status of the high speed link by using the monitoring function. When operating several PLCs with the high speed link, you need to verify the reliability of the transmitted/received data by using the high speed link information such as RUN-link, link-Trouble, etc.

[Table 1.8.1] shows the functions and definitions of the high speed link information.

Items	RUN-Link	Link-Trouble	Transmission · reception status	Operation mode	Error	Status of high speed link
Information type	General information	General information	Individual information	Individual information	Individual information	Individual information
Keyword name (x=high speed link No.)	_HSxRLINK	_HSxLTRBL	_HSxTRX[n] (n=0..64)	_HSxMOD[n] (n=0..64)	_HSxERR[n] (n=0..64)	_HSxSTATUS [n] (n=0..64)
Data type	Bit	Bit	Bit-Array	Bit-Array	Bit-Array	Bit-Array
Monitoring	Available	Available	Available	Available	Available	Available
Use of programs	Available	Available	Available	Available	Available	Available

[Table 1.8.1] High speed link flag

(1) RUN link flag

It is the whole information showing whether the high speed link works normally based on the parameters set by the user. It is the contact that maintains the status of 'On' until Link Enable is 'Off' once it is 'On'. It is 'On' under the following conditions.

- In case Link Enable is 'On'.
- In case all parameter registering lists are set normally
- In case all relevant data is transmitted and received to the parameter registering list based on the set cycle.
- In case the status of all opposing stations set in the parameters is RUN with no error.

(2) Trouble link flag

It is the information showing whether the high speed link works normally based on the parameters set by the user. Under the situation of RUN-link On, when the conditions of RUN-link On are violated, it will be 'On'; when the conditions are recovered, it will be 'off'.

(3) Flag displaying the general status of the blocks

It is the individual information showing the operating status of the resisted lists of the high speed link parameters. It displays the status of high speed link by registered lists up to 64 like the maximum number of registrations. It displays the general information for the registered lists by synthesizing individual information of each item. When the transmission · reception status of the relevant list is normal and the operation mode is RUN with no error, it will be 'On'; when the above items are violated, it will be 'Off'.

(4) RUN operating mode flag of the block station

It is the individual information showing the operating status of the resisted lists of the high speed link parameters. It displays the operating mode information by registered lists up to 64 like the maximum number of registrations. When the station of the registered items is under Run mode, the relevant bit will be 'On'; when the station is under Stop/Pause/Debug mode, it will be 'Off'.

(5) Flag displaying the block station and normal communication

It is the individual information showing the operating status of the resisted lists of the high speed link parameters. It displays the transmission · reception information of the registered list up to 64. When the transmission · reception operation works based on the cycle, the relevant bit will be 'On'; when the operation does not work normally, it will be 'Off'.

(6) Operation error mode flag of the block station

It is the individual information showing the operating status of the resisted lists of the high speed link parameters. It displays the error information of the registered list up to 64 the maximum number of registrations. The error synthetically indicates the situation that the PLC cannot execute the user programs normally. When it is Off, it means the opposing station's PLC works normally; when it is On, it means the opposing station is abnormal.

4) Limitation of the high speed link's transfer rate

The below table indicates the limitation guaranteeing the high speed link's transmission speed. When you set the high speed link, refer to the below table to determine the communication load. In case of going out of the limitation, the data may be transferred, exceeding the transmission cycle.

(Communication speed: 100Mbps)

Based on 200 words per block			Based on 100 words per block			Based on 50 words per block		
Cycle	Scan time	Blocks No.	Cycle	Scan time	Blocks No.	Cycle	Scan time	Blocks No.
20 ms	Less than 1 ms	12 blocks	20 ms	Less than 1 ms	24 blocks	20 ms	Less than 1 ms	32 blocks
	Less than 2 ms	8 blocks		Less than 2 ms	16 blocks		Less than 2 ms	32 blocks
	Less than 5 ms	4 blocks		Less than 5 ms	8 blocks		Less than 5 ms	16 blocks
	Less than 10 ms	1 block		Less than 10 ms	4 blocks		Less than 10 ms	8 blocks
50 ms	Less than 1 ms	32 blocks	50 ms	Less than 1 ms	32 blocks	50 ms	Less than 1 ms	32 blocks
	Less than 2 ms	24 blocks		Less than 2 ms	32 blocks		Less than 2 ms	32 blocks
	Less than 5 ms	12 blocks		Less than 5 ms	24 blocks		Less than 5 ms	32 blocks
	Less than 10 ms	8 blocks		Less than 10 ms	12 blocks		Less than 10 ms	24 blocks
100 ms	Less than 1 ms	32 blocks	100 ms	Less than 1 ms	32 blocks	100 ms	Less than 1 ms	32 blocks
	Less than 2 ms	32 blocks		Less than 2 ms	32 blocks		Less than 2 ms	32 blocks
	Less than 5 ms	24 blocks		Less than 5 ms	32 blocks		Less than 5 ms	32 blocks
	Less than 10 ms	12 blocks		Less than 10 ms	32 blocks		Less than 10 ms	32 blocks
200 ms	Less than 1 ms	32 Blocks	200 ms	Less than 1 ms	32 Blocks	200 ms	Less than 1 ms	32 Blocks
	Less than 2 ms	32 Blocks		Less than 2 ms	32 Blocks		Less than 2 ms	32 Blocks
	Less than 5 ms	32 Blocks		Less than 5 ms	32 Blocks		Less than 5 ms	32 Blocks
	Less than 10 ms	32 Blocks		Less than 10 ms	32 Blocks		Less than 10 ms	32 Blocks
500 ms	Less than 1 ms	32 Blocks	500 ms	Less than 1 ms	32 Blocks	500 ms	Less than 1 ms	32 Blocks
	Less than 2 ms	32 Blocks		Less than 2 ms	32 Blocks		Less than 2 ms	32 Blocks
	Less than 5 ms	32 Blocks		Less than 5 ms	32 Blocks		Less than 5 ms	32 Blocks
	Less than 10 ms	32 Blocks		Less than 10 ms	32 Blocks		Less than 10 ms	32 Blocks
1s	Less than 1 ms	32 blocks	1s	Less than 1 ms	32 blocks	1s	Less than 1 ms	32 blocks
	Less than 2 ms	32 blocks		Less than 2 ms	32 blocks		Less than 2 ms	32 blocks
	Less than 5 ms	32 blocks		Less than 5 ms	32 blocks		Less than 5 ms	32 blocks
	Less than 10 ms	32 blocks		Less than 10 ms	32 blocks		Less than 10 ms	32 blocks
5s	Less than 1 ms	32 blocks	5s	Less than 1 ms	32 blocks	5s	Less than 1 ms	32 blocks
	Less than 2 ms	32 blocks		Less than 2 ms	32 blocks		Less than 2 ms	32 blocks
	Less than 5 ms	32 blocks		Less than 5 ms	32 blocks		Less than 5 ms	32 blocks
	Less than 10 ms	32 blocks		Less than 10 ms	32 blocks		Less than 10 ms	32 blocks
10s	Less than 1 ms	32 blocks	10s	Less than 1 ms	32 blocks	10s	Less than 1 ms	32 blocks
	Less than 2 ms	32 blocks		Less than 2 ms	32 blocks		Less than 2 ms	32 blocks
	Less than 5 ms	32 blocks		Less than 5 ms	32 blocks		Less than 5 ms	32 blocks
	Less than 10 ms	32 blocks		Less than 10 ms	32 blocks		Less than 10 ms	32 blocks

※ The above values are based on using high speed link only.

1.9 Remote communication

1.9.1 Outline

It is the function to realize remotely programming, user program download, program debugging, monitor, etc. in the network system where the PLCs are connected with each other through Ethernet without moving physical connection of XG5000.

For the devices that are far from the network, it is the convenient function to access to each device in one place without translocation. You can execute XG5000's remote communication service by creating the logical path as below.

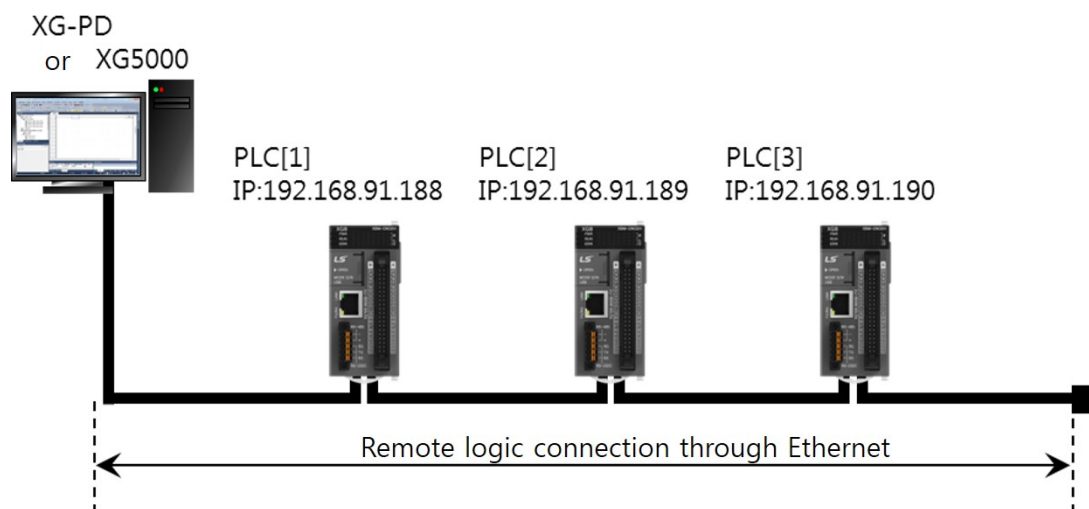

If the Ethernet module is installed in the PC where XG5000 is running and it is connected to the same network with the PLC in the above figure, you can perform the remote 1-stage access through Ethernet. Assume that the Ethernet cables are connected to the PLC #1 station in XG5000 and PLC #1, PLC #2, PLC #N are connected with each other through Ethernet.

To access the details of the PLC #N station in the above figure, set the access method as Ethernet in access setting of XG5000's online menu and input the relevant PLC #N station's IP and remote stage. In this status, you can realize all functions in the PLC #1 such as programming, download, debugging and monitor, etc.

If you use XG5000's remote communication service, you can access easily without moving to the distant PLC. In addition, although the PLC is located in the inaccessible position, it is possible to access from the other PLC so easy access can be realized after installation.

1.9.2 Setup and Access of XG5000

You can access all PLCs that access to the XGT network through XG5000 communication service. The XG5000 remote access is composed of 1-stage access and 2-stage access.

The below figure describes the remote 1-stage and 2-stage access methods.

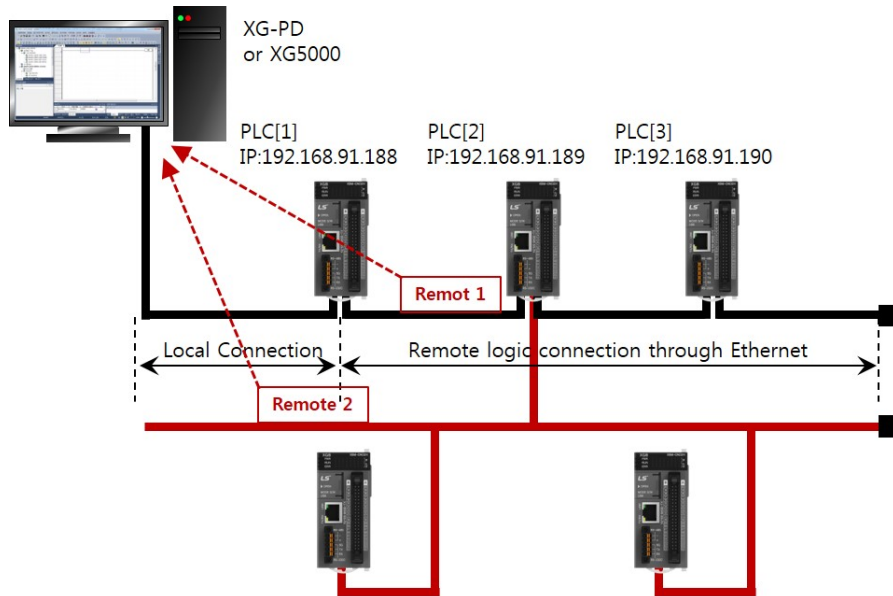

The above figure shows the example of 1-stage (PLC B) and 2-stage (PLC E) access in the system composed of two networks.

1) Direct and remote 1-stage access in the PC connected to Ethernet

If the PC where XG5000 is running is connected to the PLC through network, you can perform the remote 1-stage access through Ethernet without connecting RS-232C to the PLC's CPU.

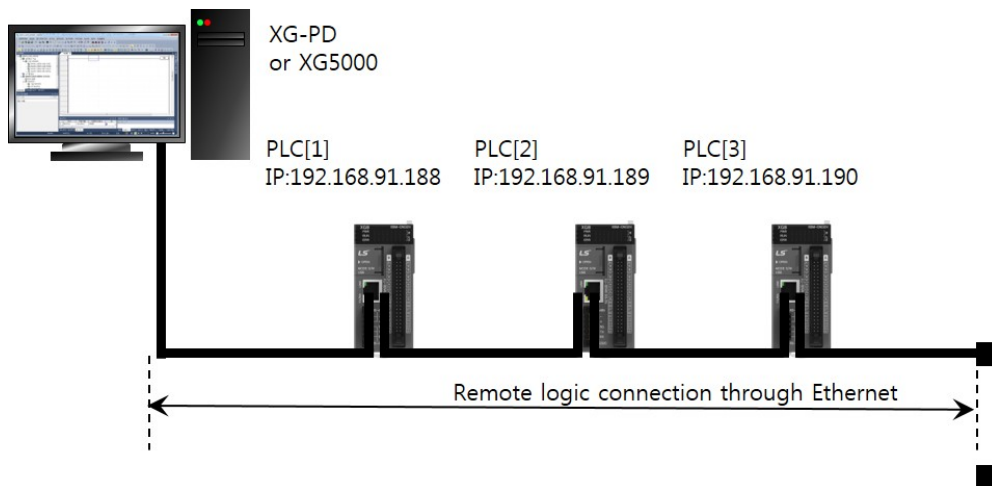

[Fig. 1.9.1] Remote 1-stage access system through the PC

[Fig. 1.9.1] shows the case that the PC and the PLC are connected through Ethernet. In this case, you can access to all PLCs in the network. The local access is omitted and the remote 1-stage access is performed for all PLCs. You need to choose the connection options and change settings as shown in the below dialog box in order to the direct and remote 1-stage access through Ethernet.

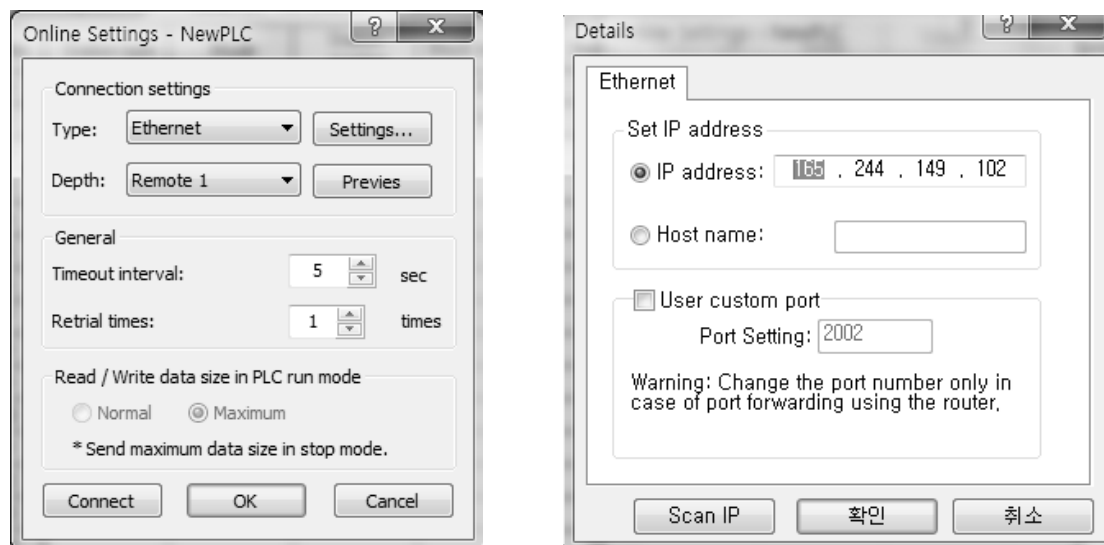

[Fig. 1.9.2] Direct and remote 1-stage access in the PC

(1) Access Method

You can select the access methods. In [Fig. 9.2.6], Ethernet is used for access instead of RS-232C so choose Ethernet.

(2) Access stage

You can determine to connect with the PLC through remote 1-stage or 2-stage. In this case, you need to choose 1-stage.

(3) IP address

Record the IP address of the FEnet I/F module to be accessed.

(4) All further processes are the same as the case using RS-232C.

Click the OK button and choose 'Access' in the online menu

2) Direct and remote 2-stage access in the PC connected Ethernet

It is possible to realize the remote 2-stage access through Ethernet. The method is the same as the remote 1-stage and the example of setting access options is as below.

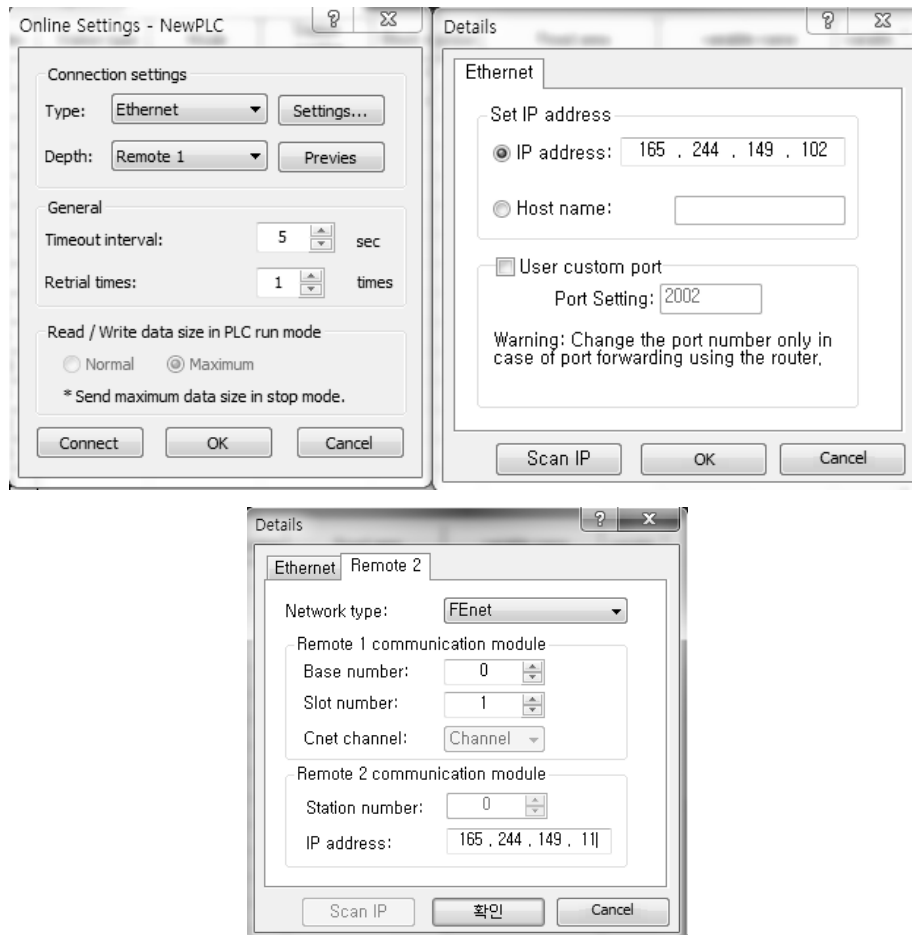

[Fig. 1.9.3] Direct and remote 2-stage access in the PC

Notice

Instructions for remote 1-stage/2-stage access

- (1) In case the currently open project in XG5000 is not matched with the accessed 1-stage and 2-stage CPU types, the following menu items are not available.
 - a) Write program and each parameter
 - b) Read program and each parameter
 - c) Monitor
 - d) Link Enable setting
 - e) I/O information
 - f) Forced I/O information
- (2) Open the project to be accessed and execute remote access when programming XG5000 through remote 1-stage and 2-stage access.
- (3) The remote access is supported up to 2-stage only and further remote access is not allowable.
- (4) In case of writing parameters after modifying communication parameters through remote access, the modified parameters will be applied only after disconnecting remote access.
- (5) IP Scan is not supported in Remote 1 (Only supported in Local connection)

1.9.3 XG5000 Local Ethernet

It is possible to read and write the program faster than previous remote connection.

Remote 1,2 are not provide by Ethernet local connection.

1) Local Ethernet connection from PC connected to Ethernet

-If PC with XG5000 is connected and PLC is connected, you can connect Ethernet locally to PLC without connecting USB.

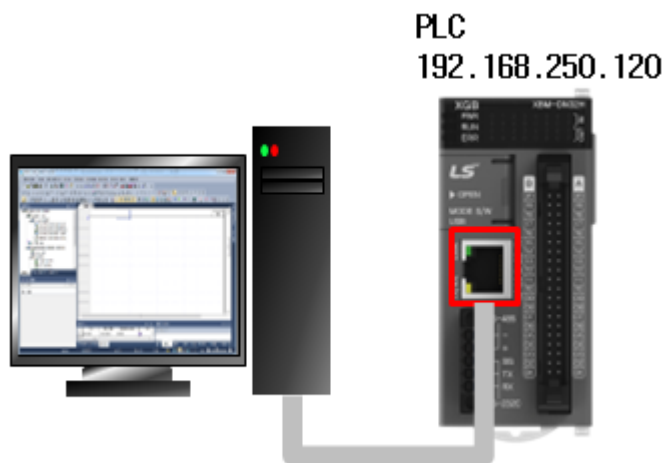

Local connection by Ethernet

2) Local Ethernet connection

XG5000-[ONLINE]-[Connection setting] and choose local

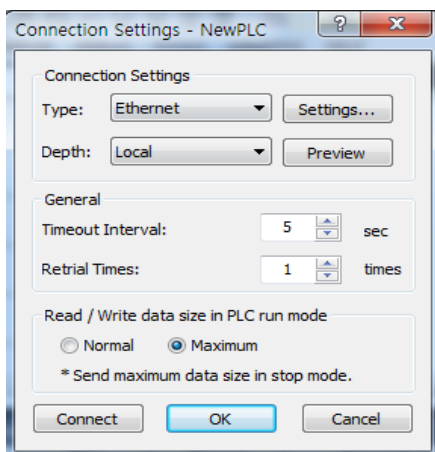

Click [Setting] and input IP Address. Initial IP address is 192.168.250.120 .

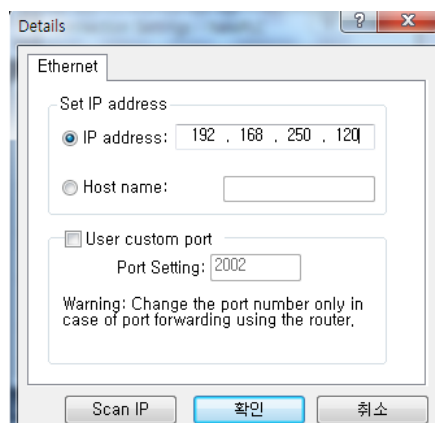

Scan IP Address make it possible to search the IP set information.

If you select Scan IP, the IP of the PLC connected to the current PC or network is displayed as shown below.

Select the IP of PLC you want to connect and press OK.

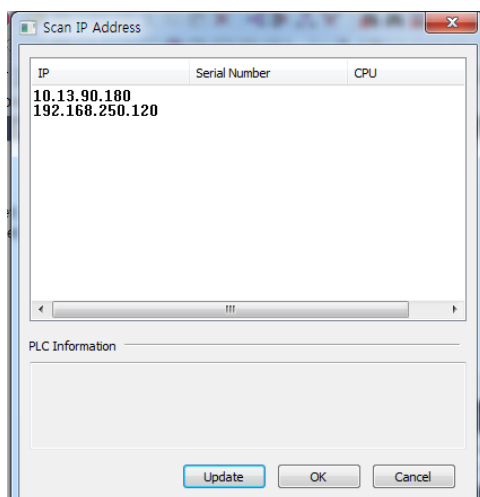

After setting, You can connect PLC

Notes

1. Local Ethernet provided ver
 - (1) XBM-DN32H/H2/HP
 - (2) XEM-DN32H2/HP
 - (3) XBC-DN32Ux (O/S V1.6 or above)
 - (4) XEC-DN32Ux (O/S V1.6 or above)
2. host name is not provided
3. XBL-EMTA do not provide Auto scan and IP Scan
4. You can access PLC only by remote connection or local connection
In case of use connection, multi-connection is available.

1.10 E-mail Transfer(SMTP)

1.10.1 Outline of the Simple Mail Transfer Protocol(SMTP)

XGB high-performance module PLC supports the Simple Mail Transfer Protocol (SMTP). The SMTP is the protocol to send the E-mail on the Internet. The using TCP Port is No.25. In the SMTP that is the text-based protocol, not only request/response messages but also all characters should be 7 bit ACSII.

1) E-mail service

If the system has some problems, E-mail service is required to inform the administrator of the state remotely through the mail. When the CPU's state changes during operation or events occur, you can inform the administrator of the state through the mail server. The E-mail service is also available in common mails and you need to configure the separate relay server to send a common mail.

2) Configuration of the E-mail system

To use the common E-mail service, the configuration for using E-mail is needed. To transfer a common mail, you need to encrypt the mail for security but it is not easy for the PLC to treat this process so that is why you have to use the SMTP relay server. The SMTP relay server accesses to the common E-mail server by using the mail information transferred by the PLC and send the mail in place of the PLC. Therefore, as shown in [Fig. 11.1.1.1] E-mail transfer process, you can send the mail through the SMTP relay server.

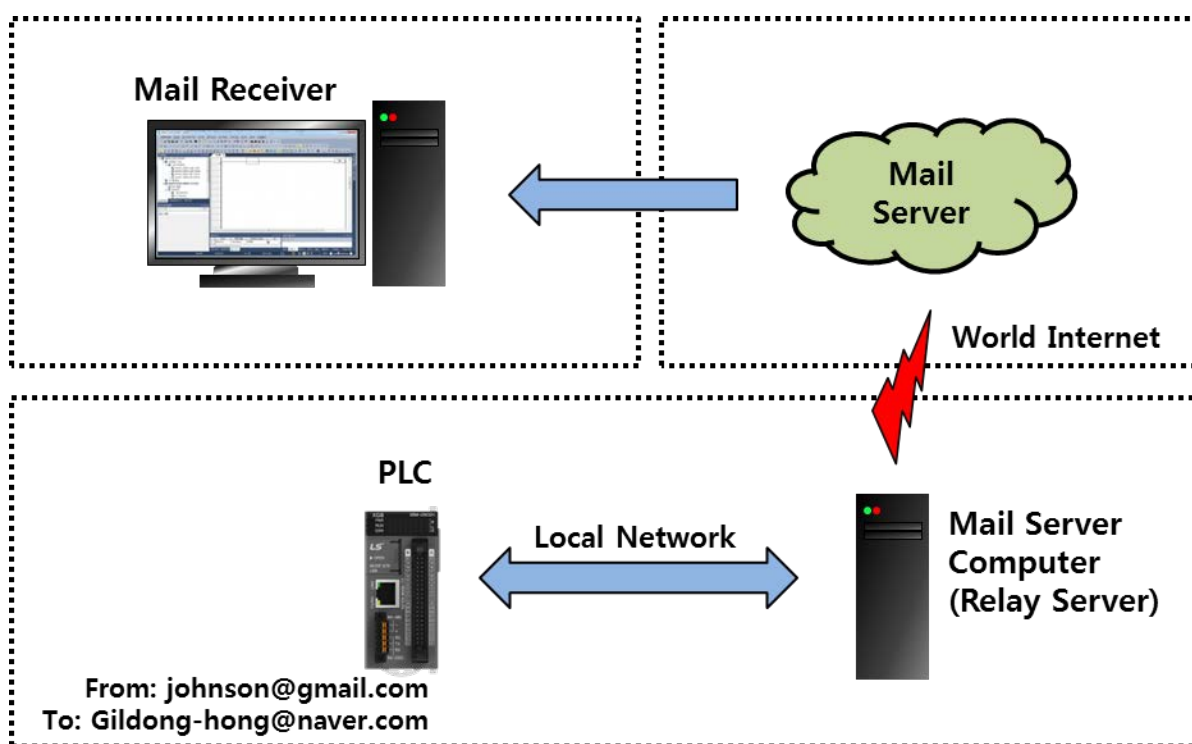

[Fig. 11.1.1.1] E-mail transfer process

3) Specifications of SMTP Realy server

Items	Specifications	Remarks
Maximum concurrent connection number	8	For some email account, because it limits the mail sent through the multi-connection, some mail(occurred simultaneously by the PLC using the same account server) may not be transmitted.

4) Flow Chart of E-mail transfer

The following is the flow chart of E-mail transfer. As shown in [Fig. 11.1.1.2] Flow chart of E-mail **transfer**, in order to transfer a mail, you need to install the SMTP relay server and set up E-mail parameters through XG5000 and meet the start-up conditions to send the mail. If the start-up conditions are met, the mail information is sent to the SMTP relay server and then, the SMTP relay server substitungly goes through authentication process and sends the final mail to a recipient. The mail recipient can see the ID and title, details of the E-mail set in XG5000.

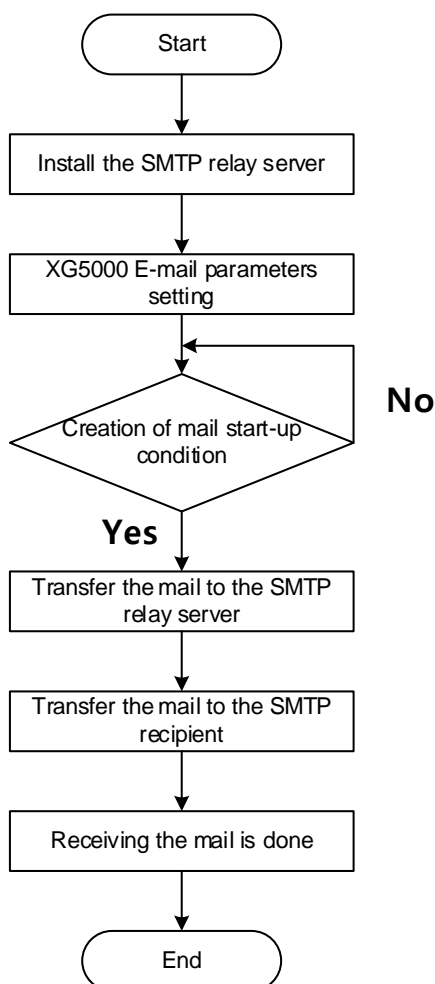

[Fig. 11.1.1.2] Flow Chart of E-mail transfer

Notice

- (1) The SMTP relay server and PLC should be connected to the Ethernet network. The SMTP relay server sends the mail to a recipient in place of the PLC.
- (2) For more details on setting, refer to 1.11.2 E-mail Setting.

1.10.2 E-mail Setting

In order to use the common E-mail function, you need to set up the E-mail parameters and relay server.

1) Relay server setting



You need to set up the SMTP relay server to use the common E-mail as shown below.

2) Relay server program download

In order to set up the relay server, first of all, you need to download the relay server program. You can download the relay server program from LS ELECTRIC Solution Square (SMTP relay server.zip).

-website: <https://sol.ls-electric.com/ww/en/main>

(1) Installation of the relay server

Procedures	Description	
1	Program execution	 <ol style="list-style-type: none"> 1) After downloading the program to set up the SMTP relay to the PC where you want to configure the relay server, double-click SMTPRelay.msi. 2) After clicking the Next button in the SMTP Relay window, if you select the remaining processes properly and click the Finish button, installation will be done.
2	SMTP relay server operations	 <ol style="list-style-type: none"> 1) If you double-click the 'SMTPRelayServer' icon on the desktop, the program will run as shown in the SMTP Relay server window.

(2) Setting to use the relay server

After installing the relay server, you need to register the relay server program in Windows as show below.

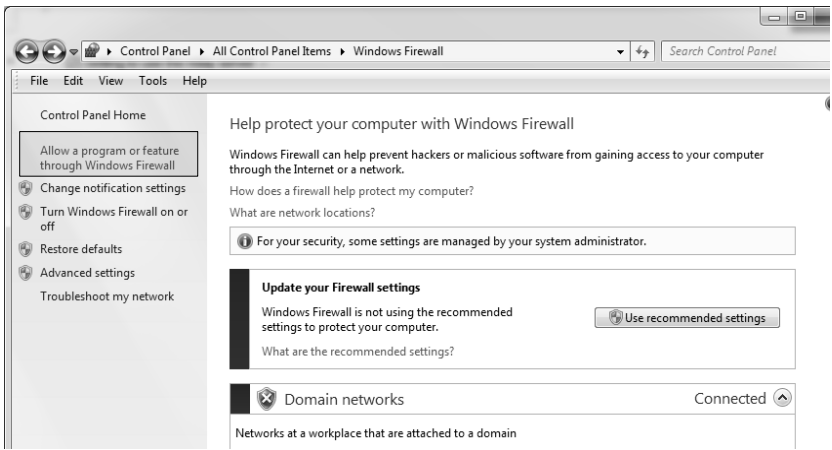
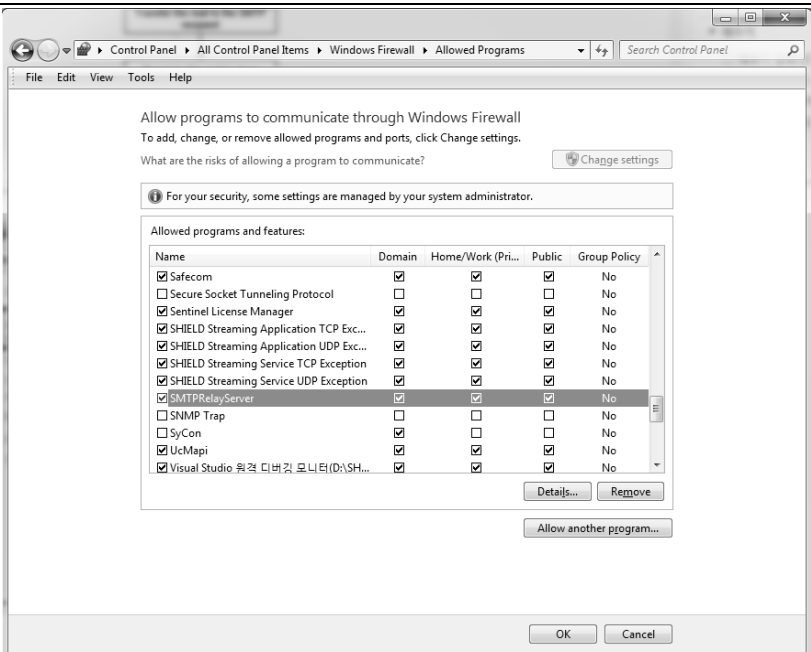
Procedures	Description
1	<div style="display: flex;"> <div style="flex: 1; padding-right: 10px;"> <p style="text-align: center;">Firewall setting</p> </div> <div style="flex: 2;">  </div> </div> <p>1) Click Windows – Control Panel – Windows firewall. 2) Through 'Windows Firewall' in the upper-left of the Windows firewall setting screen, click the Program or Firewall Enable.</p>
2	<div style="display: flex;"> <div style="flex: 1; padding-right: 10px;"> <p style="text-align: center;">Firewall Enable</p> </div> <div style="flex: 2;">  </div> </div> <p>Find the program called 'SMTPRelayServer' and check all items of domain, home/company(individual), common areas and then, click the 'OK' button.</p>

Notice

(1) After the SMTP relay server setting is completed, in the E-mail setting window of 1.11.2 E-mail Setting, you need to input the IP address of the current PC for the IP address of the SMTP relay server information.

3) E-mail setting of the P2P service

You can use the E-mail function of the P2P service as shown below.

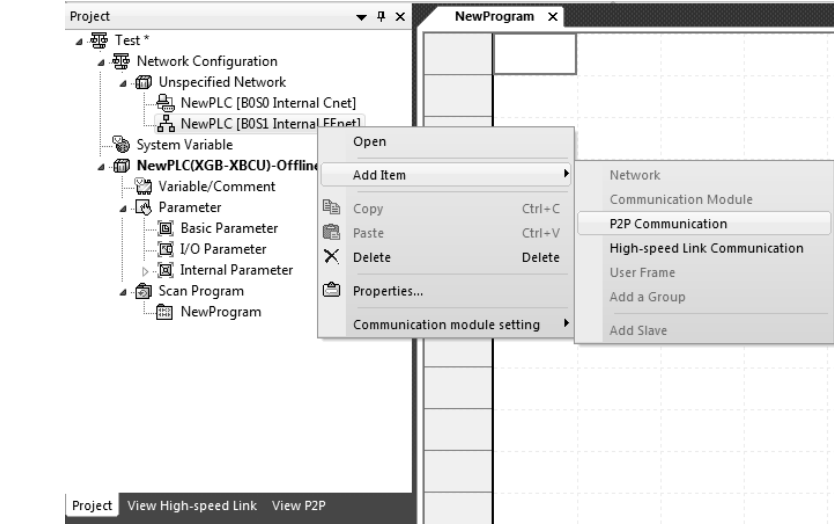
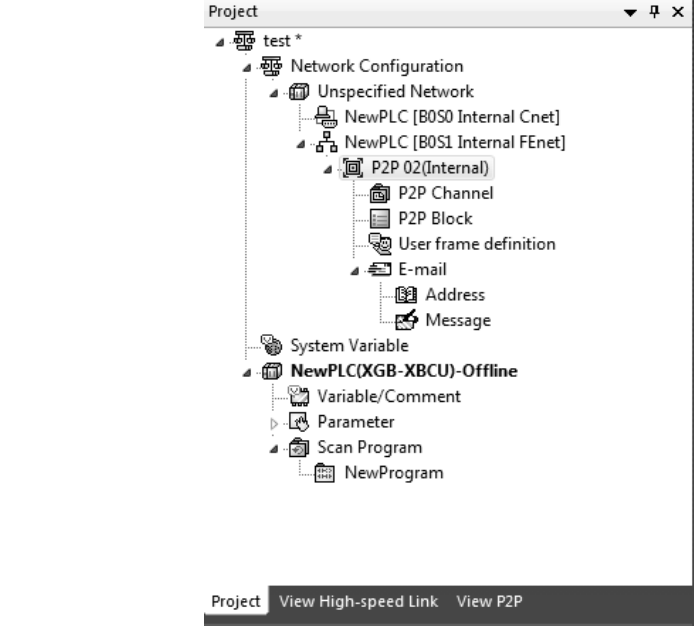
Procedures	Description	
<p style="text-align: center;">1</p> <p style="text-align: center;">Add P2P</p>		
<p>After selecting [Embedded FEnet] in XG5000's project window, click on the right mouse button and then, select [Add Items] → [P2P communication].</p>		
<p style="text-align: center;">2</p> <p style="text-align: center;">Creation of P2P</p>		
<p>When the P2P selection window is created, after selecting No.2 slot, click the 'OK' button.</p>		

Notice

(1) In the P2P view tab, E-mail can be set up in the same way.

Procedures	Description	
3	E-mail setting	
		<ol style="list-style-type: none"> 1) Double-click 'E-mail' in the P2P setting project window. 2) Set up the values referring to each E-mail's set value. 3) After setting parameters in the E-mail setting window, click the 'OK' button.

E-mail setting values

Item	Description	
Using E-mail	It determines whether using the E-mail service or now. To start the E-mail service, you need to check this item.	
Using SMTP relay server	To send the mail to the common mail server, you need to check the SMTP relay server item.	
User information	User name	It sets up the user name displayed when the other part received the mail. If you set up the user name with the PLC, the sender name will be displayed as the PLC.
	Mail address	It is the recipient's mail address when pressing 'Reply'. It indicates the transmitting mail server composed of the user name and mail server. You can also set up that the PLC sends data and a normal PC receives the reply.
SMTP relay server information	IP address	When checking the SMTP relay server item, you can fill in this. Enter the IP address to relay.
	Port Number	You can input the port No. of the relay server. The port is No.25.
SMTP server information	SMTP server address	It means the SMTP server's address. For example, Gmail's SMTP server address is 'smtp.gmail.com'.
	Port number	It means the SMTP server's port No. Gmail uses No.465.
	Account name	You can input the registered account name to the SMTP server.
	Password	You can input the password of the registered account to the SMTP server.

The below table provides the address and port No of the common SMTP server. Input the address and port No. of the desired server to the SMTP server information.

SMTP server	SMTP server address	Port No.
Google	smtp.gmail.com	465
Yahoo	smtp.mail.yahoo.com	25
Naver	smtp.naver.com	465

The event information monitors the CPU's state periodically and keeps track of the state information. In case the PLC stops or errors occur, communication parameter does not work so in preparation for such a situation, the optional service is provided.

Item		Description
Event information	Message monitoring cycle	It should be set as 10 seconds or more. It is the time to check whether the PLC's mode has been changed.
	RUN => STOP	It is the option that the embedded Ethernet sends the E-mail by itself when the PLC's mode changes from RUN into STOP.
	STOP => RUN	It is the option that the embedded Ethernet sends the E-mail by itself when the PLC's mode changes from STOP into RUN.
	ERROR	It is the option that the embedded Ethernet sends the E-mail by itself when some errors occur in the PLC.

Notice

(1) When sending the mail through the SMTP relay server, there may be the common E-mail server that can send the mail only when the SMTP server information's 'SMTP server address' and 'account name' are matched with the user information's 'mail address'. Accordingly, check the mail server's policy and input the user information's 'mail address' based on the policy.

(2) The account name and password of the SMTP server information should be registered in the SMTP server. If you do not have any account, please register the account in the mail server for use.

(3) For more details on the address and message No. of the event information, refer to (1) Writing an address book and (3) Writing message.

(4) You may need to enable SMTP at the server site where you want to use SMTP, or you may need additional settings such as allowing less secure applications

(3) Writing an address book

You can write the recipient's mail address used for the E-mail service as shown below.

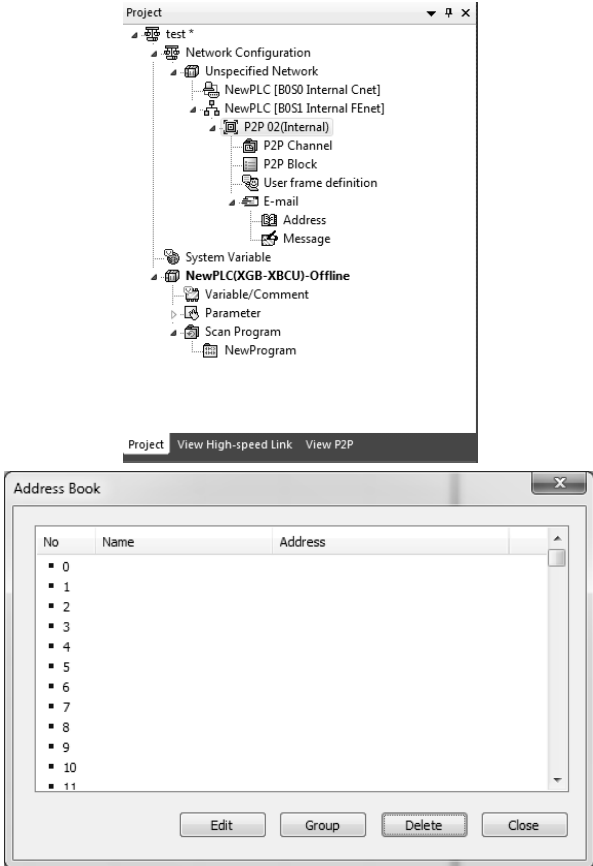
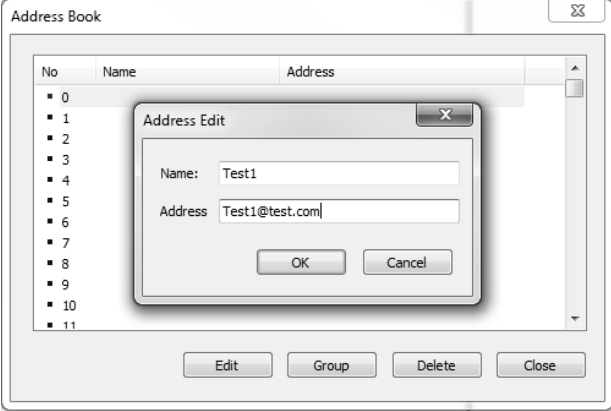
Procedures	Description	
1	Create the address book	
<p>After selecting [Embedded FEnet] in XG5000's project window, double-click the address of [P2P 02(embedded)] or double-click the address of P2P No.2 in [P2P View].</p>		
2	Register the address	
<p>In the window for setting E-mail address book, register the address to which you want to send the mail. If you select 'Edit'. The address edition window will pop up. If you enter the name and mail address in this screen and select the OK button, registration of the address will be done.</p>		

(4) Registration of group address

If you want to send the mail not to individual but to the group, you can set up the group address as shown below.

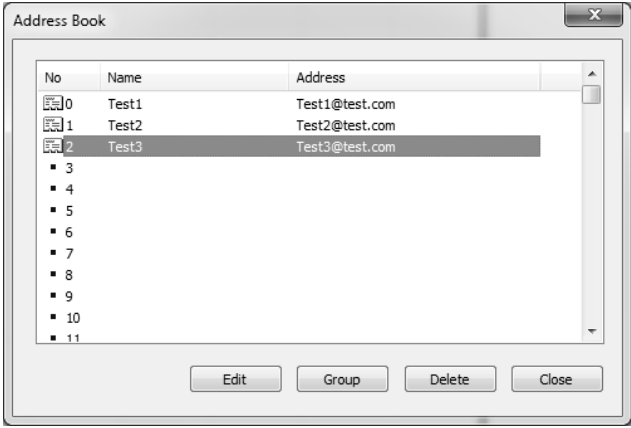
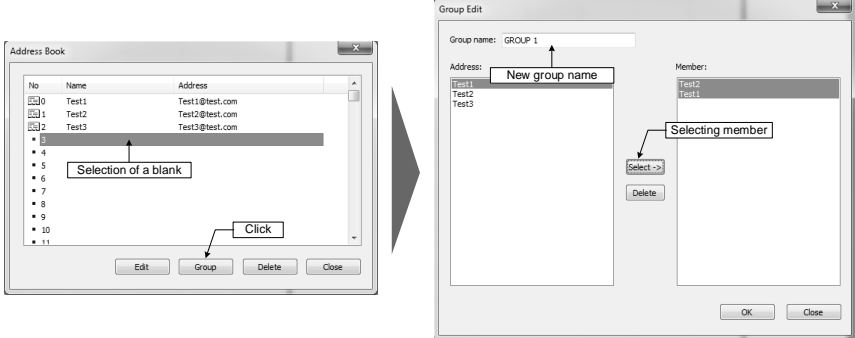
Procedures	Description	
1	Create group	 <p style="text-align: center;"><Address book></p>
1) Double-click the address of P2P No.2.		
2	Register group	
<p>After selecting to a blank of [Address book], select [Address book]- [group], the edition window for E-mail address book's group will be created. The details of the group edition window are as shown below.</p> <ol style="list-style-type: none"> 1) Group name: Name of the group to create newly 2) Contact information: Currently registered addresses 3) Members: Addresses to be included to the group 4) Select: It adds the addresses selected from the Contact Information to the Members. 5) Delete: It deletes the addresses selected in the Members from the Group. <p>After selecting the addresses to add to the group in the Contact Information, if you click [Select], you can see the addresses are added to the Members.</p>		

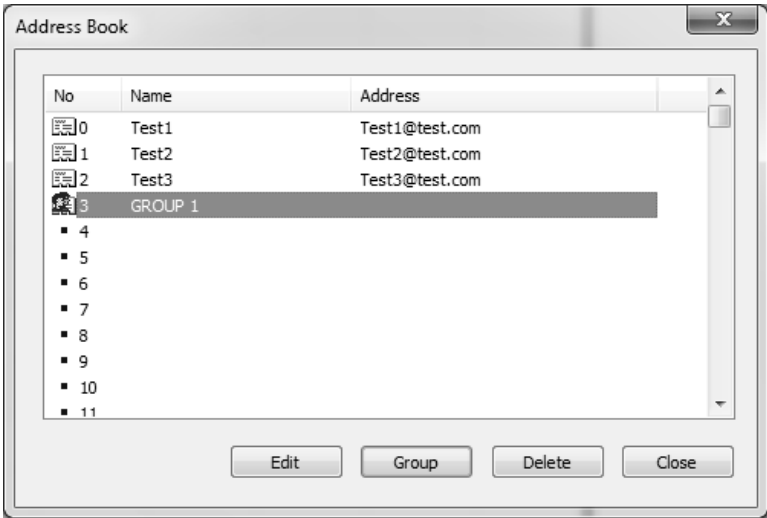
Procedures	Description	
3	Confirm creation of the group	
<p>If you click the OK button in [Group Edition], the group list added newly to the address book will be displayed with the individual addresses.</p>		

(5)Writing the message

You can write the mail message used for the E-mail service as shown below.

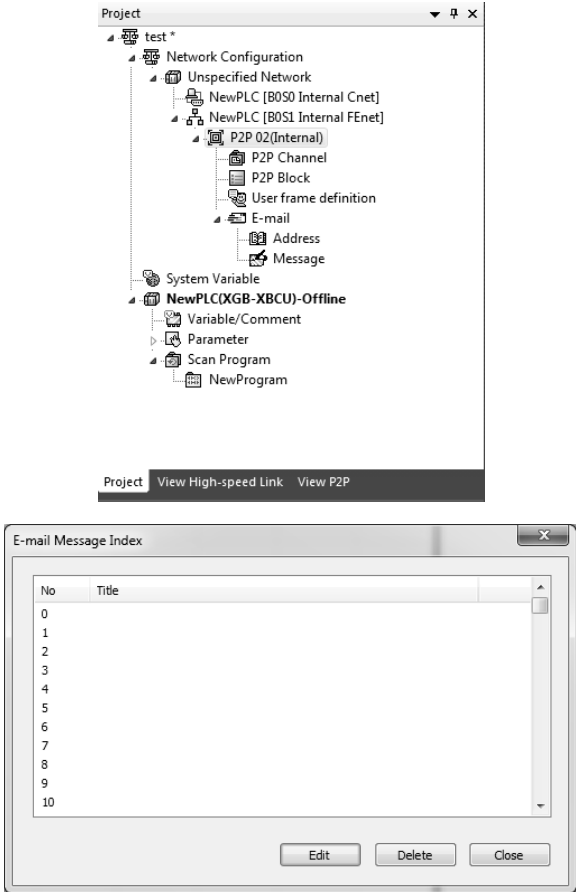
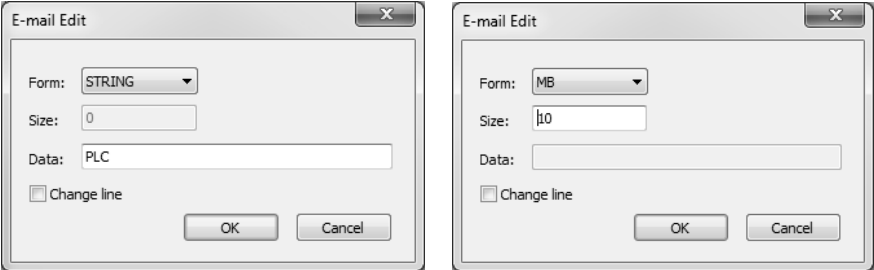
Procedures	Description	
1	<p>Create the message list</p>	
	<p>1) After selecting [Embedded FNet] in XG5000's project window, double-click the message of [P2P 02(embedded)] or double-click the message of P2P No.2 in [P2P View].</p>	
2	<p>Write messages</p>	
2	<p>Click the 'Add' button in the E-mail message editing window and input the details to send. The configuration and details of E-mail edition are as shown below.</p> <ol style="list-style-type: none"> 1) Format: Selection of the message type <ul style="list-style-type: none"> - STRING: Selected when the transferred message is a string type - MB: Selected when the transferred message is a device type 2) Size: It is activated only when the format is [MB]. It means the size of Byte. 3) Data: It is activated only when the format is [STRING]. You can input the test to send. 4) Line break: Means the break of a message line. 	

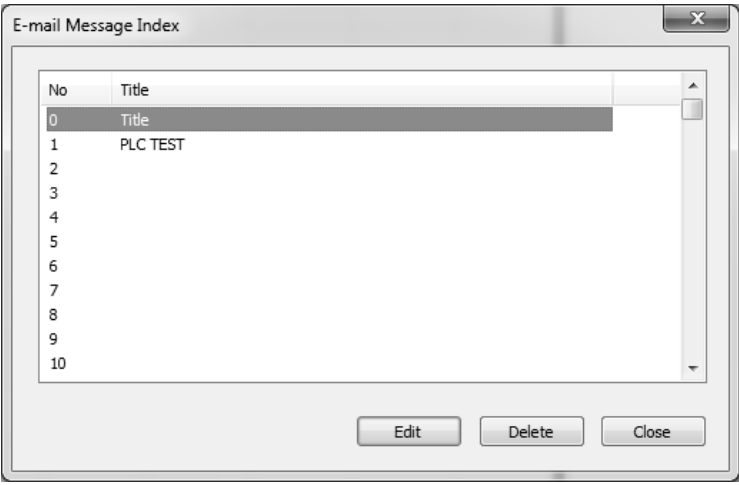
Procedures	Description																									
3	Confirm creation of messages	 <p>The screenshot shows a window titled "E-mail Message Index" with a close button (X) in the top right corner. Inside the window is a table with two columns: "No" and "Title". The table contains the following data:</p> <table border="1"> <thead> <tr> <th>No</th> <th>Title</th> </tr> </thead> <tbody> <tr> <td>0</td> <td>Title</td> </tr> <tr> <td>1</td> <td>PLC TEST</td> </tr> <tr> <td>2</td> <td></td> </tr> <tr> <td>3</td> <td></td> </tr> <tr> <td>4</td> <td></td> </tr> <tr> <td>5</td> <td></td> </tr> <tr> <td>6</td> <td></td> </tr> <tr> <td>7</td> <td></td> </tr> <tr> <td>8</td> <td></td> </tr> <tr> <td>9</td> <td></td> </tr> <tr> <td>10</td> <td></td> </tr> </tbody> </table> <p>At the bottom of the window, there are three buttons: "Edit", "Delete", and "Close".</p>	No	Title	0	Title	1	PLC TEST	2		3		4		5		6		7		8		9		10	
No	Title																									
0	Title																									
1	PLC TEST																									
2																										
3																										
4																										
5																										
6																										
7																										
8																										
9																										
10																										
<p>When the creation of the message is complete, the title will be added to the list of e-mail messages index.</p>																										

Notice

- (1) The format of an E-mail message can be divided into String and Byte data received from the CPU. The MB type is used to send the P2P ESend parameter's message data as many as the number of bytes set in the Size.
- (2) The line break includes the command to write on the next line when outputting the message in the received screen.

(1) P2P block setting

For the actual E-mail service, you can create the mail address book and message written above in the P2P block as shown below.

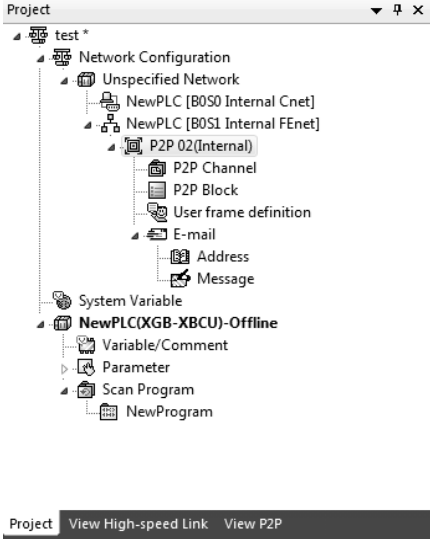
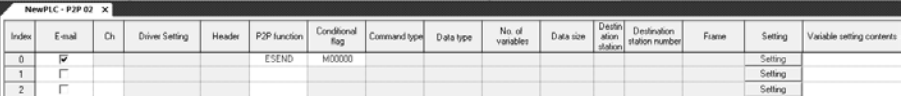
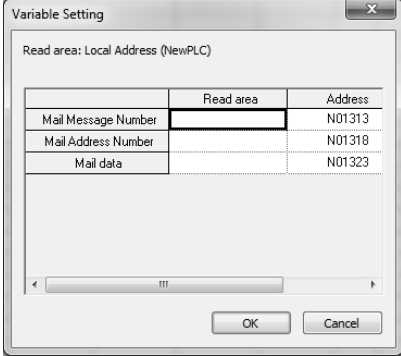
Procedures	Description	
1	P2P block	
<p>After selecting [Embedded FENet] in XG5000's project window, double-click [P2P block] of [P2P 02(embedded)] or double-click [P2P block] of P2P No.2 in [P2P View].</p>		
2	Make P2P block	
<p>1) In the P2P parameter setting window, tick the [E-mail] checkbox. 2) Select [ESEND] in P2P functions. 3) Set up the start-up conditions to transfer E-mail.</p>		
3	Setting	
<p>Click the setting button to set up each variable. For more details, refer to 'E-mail variables'</p>		
4	<p>If you click the [OK] button, the parameter settings to transfer E-mail will be done.</p>	

The details of E-mail variables are as shown below.

Item		Description	
E-mail		It enables you to use the E-mail service.	
P2P function	ESEND	It sends the E-mail.	
	ERECEIVE	It receives the E-mail.	
Setting	Transmission	Mail message No.	Enter the index No. of the message list among E-mail settings of P2P and determine the mail tile and data.
		Mail address No.	Establish the registration No. set in the address book and decide to whom. * If you want to send the mail to several people, you can set up grouping. In this case, the recipient's mail address should be input in advance before grouping. The maximum number of groupings is limited to 10EA or less.
		Mail data	It means the start address of the data to send. In terms of the size of the transmitted data, starting with the first part, the mail is transmitted as many as the number of arrays corresponding to MB[10] among E-mail message settings.
	Reception	Mail information	It is the area where the mail information is saved.
		Mail message	It saves the received mail message to the PLC memory.

Notice

(1) The receiving pare is not supported in settings.

(2) Writing parameters

After parameter setting for the E-mail service is completed, you can apply the parameters to the PLC as show below.

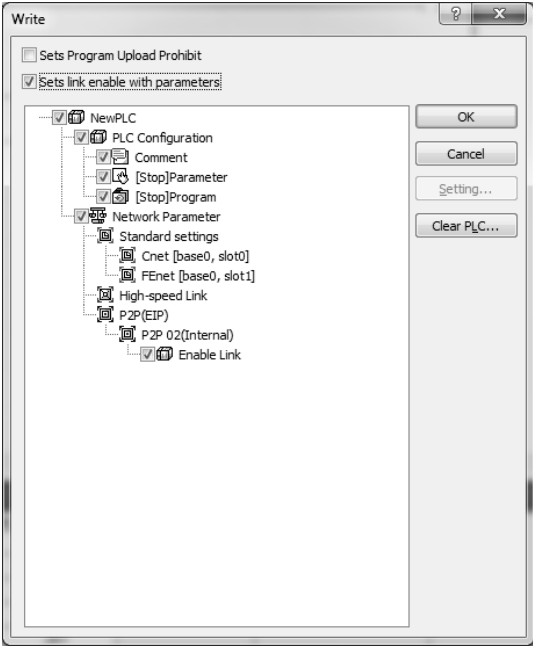
Procedures	Description	
1	Write parameters and Link Enable	
<p>Select [Online] → [Write] in XG5000's project window. After checking [Set together with Link Enable] in the [Write] window, check 'Link Enable' in P2P 02(embedded).</p>		
2	<p>If you click the [OK] button, 'Write Parameters' and 'Link Enable' will be done.</p>	

Notice

- (1) If you set up the parameters for the SMTP relay server to use common E-mails (Gmail, yahoo, etc.), you need to set up for SMTP relay server.
 - Refer to (2) Setting to use the relay server of 1.11.2 E-mail Setting



1.11 Time synchronization(SNTP)

1.11.1 Outline of the time synchronization protocol

The XGB high-performance PLC supports the NTP(Network Time Protocol) that obtains the time information by accessing to the SNTP(Simple Network Time Protocol)server and synchronizes time. The NTP is the protocol to synchronize the time of the PLC connected to the network.

1.11.2 SNTP server parameter setting

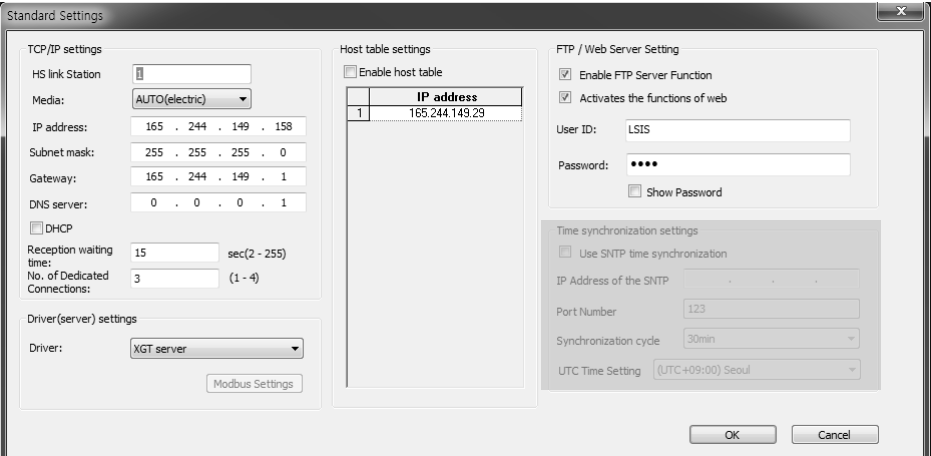
You can set up the parameters to use the SNTP server function as shown below.

Procedures	Description	
1	Setting for SNTP	
2	Write parameters and Link Enable	
	<p>1) Input the [TCP/IP setting] parameters in the FEnet basic setting window. - Enter the IP address, subnet mask, gateway, DNS server address. - This address is commonly used for P2P service, high speed link service, remote service, FTP, SNTP service, etc. 2) Check [SNTP Time Synchronization Enable]. 3) Then, set up the SNTP server's IP address and Port No., synchronization cycle, UTC time setting.</p>	
3	If you click the [OK] button, 'Write Parameters' will be done.	

Notice

- (1) When parameter setting is done, the PLC reads periodically the time value from the SNTP server.
- (2) In the SNTP server's IP address, the initial '203.248.240.140' port is set as '123'.
This is the open SNTP server called 'Time.bora.net'.
- (3) If you want to use other SMTP servers, change the IP address and port No. of the SNTP server before input. Below is an example of public NTP server and port..

Server address	IP	Port	Support
time.apple.com	17.253.6.243	123	Apple
time.asia.apple.com	17.83.253.7	123	Apple
time.euro.apple.com	17.72.148.52	123	Apple
ntp.komet.net	168.126.3.6	123	KT(Korea)
time.kriss.re.kr	210.98.16.100	123	KRISS(Korea)
time.nuri.net	211.115.194.21	123	inethosting(Korea)
time.nist.gov	132.163.4.102	123	NIST(Korea)
time.windows.com	191.233.81.105	123	MS
1.kr.pool.ntp.org	211.233.40.78	123	Navyism(Korea)
1.asia.pool.ntp.org	125.62.193.121	123	Navyism(Korea)
2.asia.pool.ntp.org	82.200.209.236	123	Navyism(Korea)
3.asia.pool.ntp.org	218.189.210.4	123	Navyism(Korea)

- (4) If you cannot use a public NTP server, Please setup a local NTP server refer to '**1.12.3 How to setup a local NTP server**'.

1.11.3 How to setup a local NTP server

If you cannot use a public NTP server, Please setup a local NTP server as follows:

- 1) Select the [Start] button of Windows for execution.(Shortcut key /Windows key + R)
- 2) Input 'regedit' to the execution window and run the process.

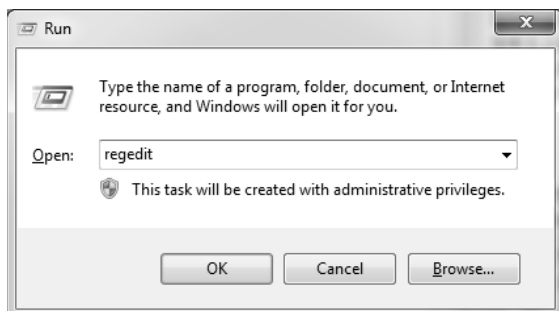

- 3) Check the below path.
HKEY_LOCAL_MACHINE\SYSTEM\CurrentControlSet\Services\W32Time\TimeProviders\NtpServer
- 4) Change the value of 'Enabled' to '1' in the folder.

 Enabled	REG_DWORD	0x00000001 (1)
--	-----------	----------------

- 5) Check the below path.
HKEY_LOCAL_MACHINE\SYSTEM\CurrentControlSet\Services\W32Time\Config
- 6) Change the value of 'AnnounceFlags' to '5' in the folder.

 AnnounceFlags	REG_DWORD	0x00000005 (5)
---	-----------	----------------

- 7) Reboot the computer.
- 8) Setup inbound firewall rules.
 - (1) Run the Control Panel.
 - (2) Run the Window Firewall
 - (3) When you run the Advanced Settings. screen will pop up as shown below.

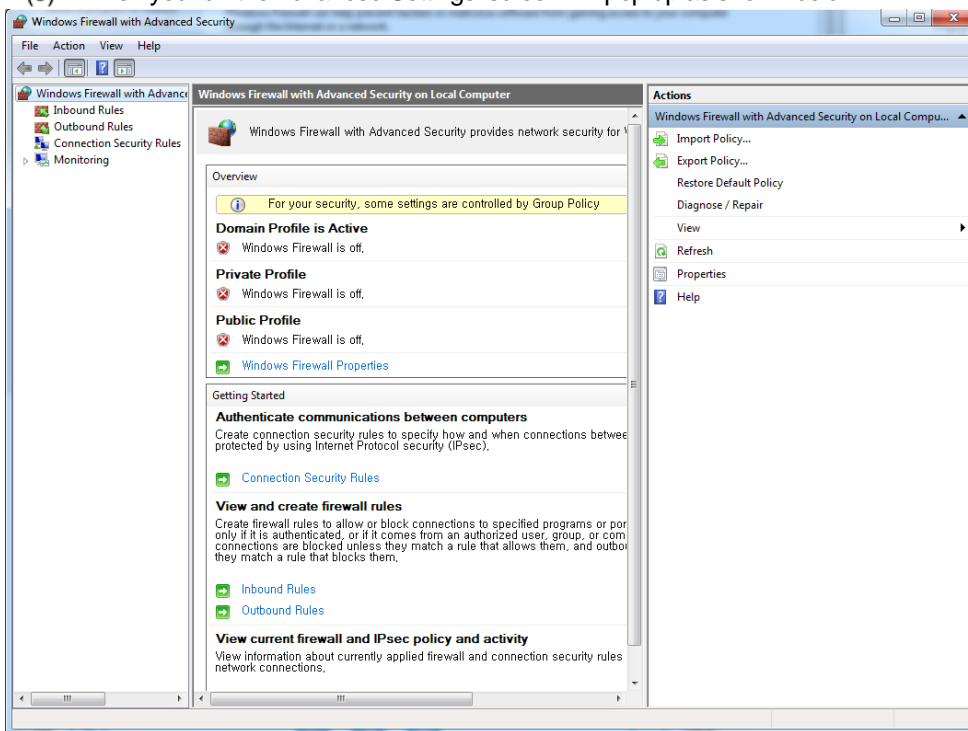

- (4) Select inbound rules.

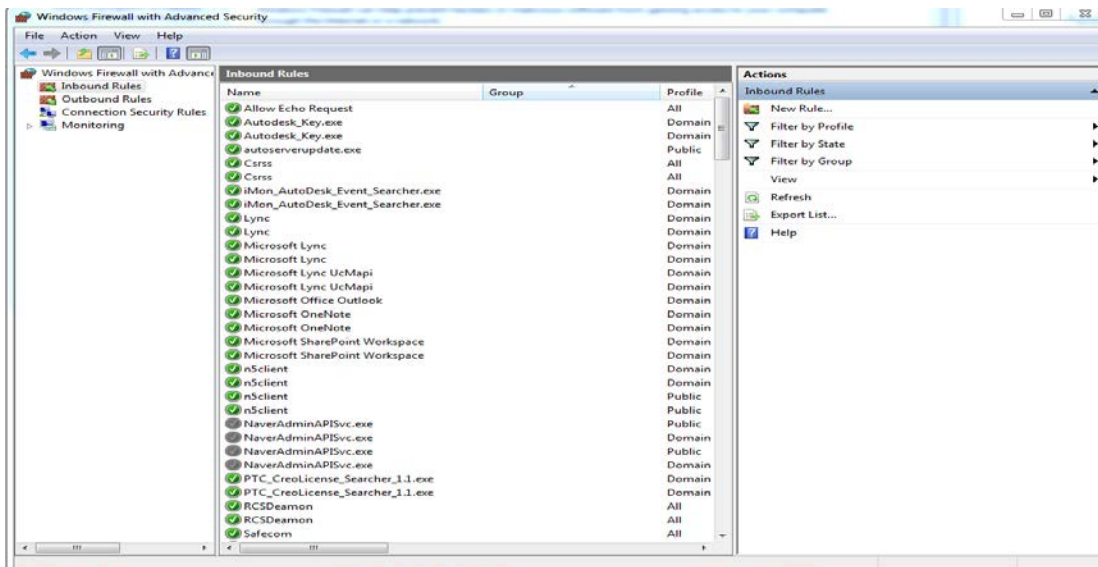

- (5) Select the new rule in the top right.(New Rules)

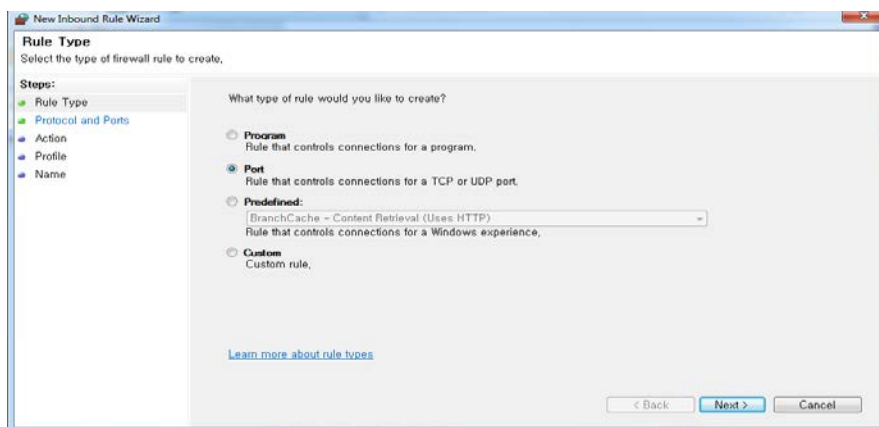

(6) Select the port and click Next button.

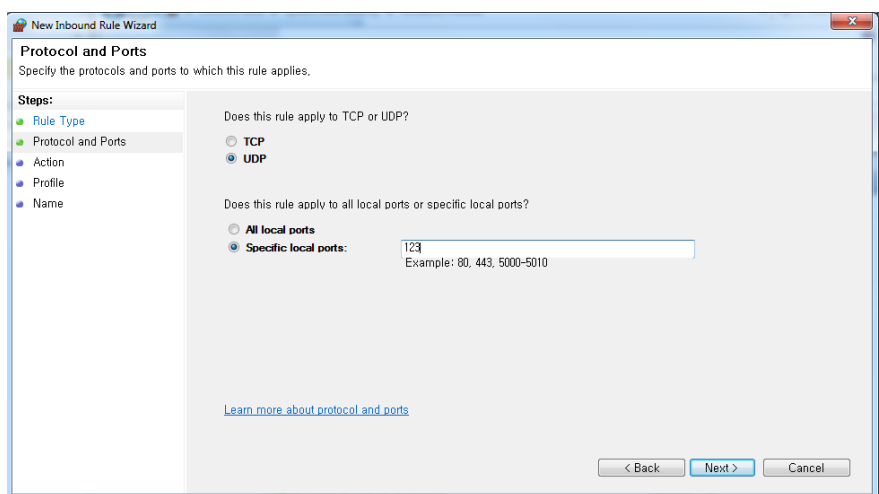

(7) Select **UDP(U)** and **Special local port(S)**. Input '123' and click Next button.

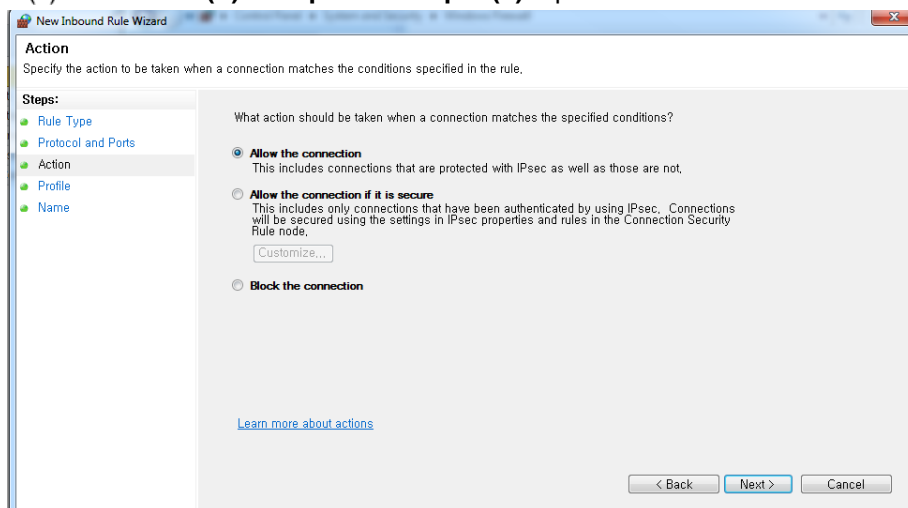

(8) Select **Allow connections(A)** and click Next button.

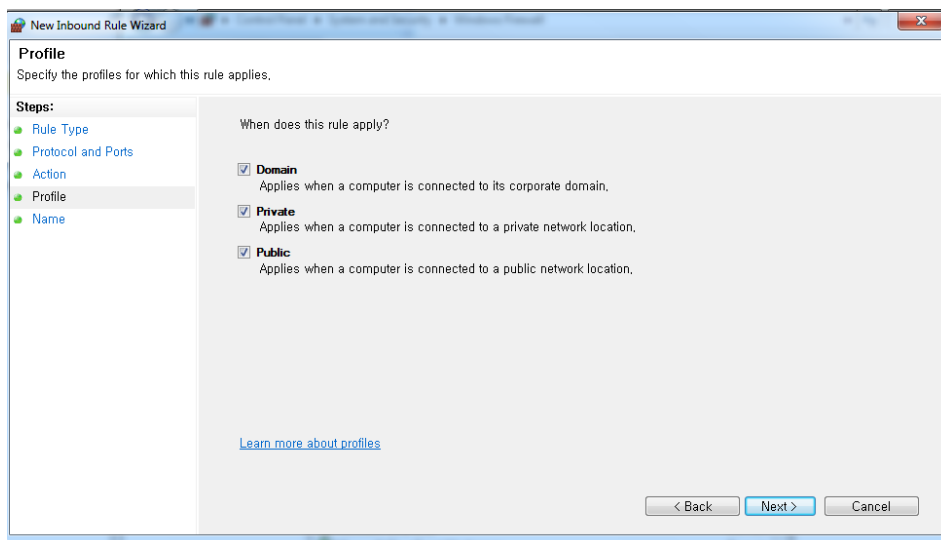

(9) Please select the checkbox to meet your security policy, and click Next button.

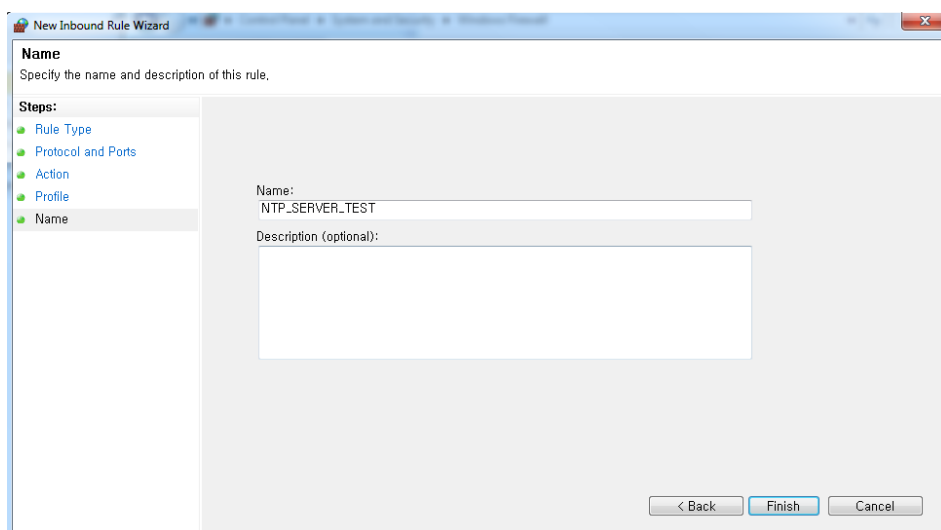

(10) Input the server name(anything) and description and click Finish button.

- 9) Select the [Start] button of Windows for execution(Shortcut Key /Windowskey + R)
- 10) Enter '**CMD**' and click Confirm.(Administrator)
- 11) In the command window, Input '**net stop w32time**'and press Enter key. And then, also input '**net start w32time**'and press Enter key.
- 12) Input '**ipconfig**' and press Enter key in the command window to find out the IP address of NTP server.
- 13) Setting the parameters using IP address of NTP server.(refer to '**1.12.2 SNTP server parameter setting**')

1.12 Trouble Shooting

It describes errors that may occur during system operation and provides the causes of errors, corrective measures. You can check whether there are some problems with the XGB embedded Fenet and the details through the below procedures. Please note that we do not provide after-sales service for discretionary repair or disassembly based on the Quality Policy.

Problem	Corrective Measures
In case LINK/ACT LED flickers or is not turned on after connecting to network.	1. Check whether the cables clicked inserted.
	2. Check whether the XG-PD parameters are already downloaded. ☞ In case XG-PD's communication basic parameters are not downloaded, you cannot set up Full Duplex /Half Duplex communication.
In case the LINK/ACT, SPEED LED are still turned Off, although you download parameters after supplying power and connecting network	Module defect is suspected so follow-up service may be required.
In case Read/Write Data do not work during dedicated services	1. Check the communication speed(Auto/10/100M-TX) . It should have the same communication speed with the opposing device to be communicated. ☞ In case the device with Auto Negotiation and the device with manual speed are mixed in the network, the former recognizes the latter as Half Duplex(standard specification of IEC 802.3u)
	2. Check the IP address settings. The IP should be valid in the network. ☞ In case the set IP addresses are overlapped in the network or invalid IP exists, communication is impossible.
	3. Check the driver(dedicated, Modbus TCP/IP) settings. ☞ You should apply the same protocols with the opposing device.
	4. Check whether the opposing device's IP is registered in the host table. ☞ When the opposing device's IP address is not registered under host table Enable, communication does not work.
	5. Check the MAC Address ☞ In case the MAC Address is abnormal, communication does not work.

Problem	Corrective Measures
<p>In case transmission-reception is impossible during high speed link service</p>	<p>1. Check the communication speed(Auto/10/100M-TX). It should have the same communication speed with the opposing device to be communicated. ☞ The communication speed in the network should be same or set as Auto for communication.</p>
	<p>2. Check the IP address settings. The IP should be valid in the network. ☞ In case the set IP addresses are overlapped in the network or invalid IP exists, communication is impossible.</p>
	<p>3. Check whether the high speed link's parameters are set. ☞ In case the parameters are not set; or the set exchange numbers are overlapped in the network; or you have wrong block setting or block number, communication is impossible.</p>
	<p>4. Check the Link Enable ☞ The frame can be transmitted only when the Link Enable is set.</p>
<p>In case of P2P service, Not working</p>	<p>1. Confirm communication speed (Auto / 10 / 100M-TX) ☞ Communication is possible if the communication speed on the network is the same or set to Auto.</p>
	<p>2. Verify IP address settings ☞ Communication is not possible if the IP address is duplicated on the network or is invalid.</p>
	<p>3. Confirm whether P2P parameter setting ☞ Communication is possible only when P2P parameter channel and block are set.</p>
	<p>4. Checking the other party's IP address in the P2P channel setting ☞ Communication is not possible if the IP address of the other device is not valid</p>
	<p>5. Check Driver Settings ☞ The communication protocol must be set the same as that of the other device of the corresponding channel.</p>
	<p>6. Check Link Enable Settings Send frame when link enable is set</p>
	<p>7. Confirm whether operation condition is working ☞ If the activation condition set in the block is ON,</p>
	<p>8. Check base unit operation mode ☞ Basic unit operation mode should be RUN</p>

Chapter 2 Built-in Cnet Communication

2.1 General

2.1.1 Characteristic

Ultimate performance XEM Main Unit has built-in RS-232C 1 channel and RS-485 1 channel.

Main characteristic of built-in Cnet is as shown below.

- (1) By using XG5000 operated in window environment, since the user can write communication speed, communication mode (protocol), connection with external device is easy.
- (2) RS-232C 1 port, RS-485 1 port as main unit built-in Cnet is supported.
- (3) It operates independently according to channel. Since protocol data written by user is managed by main unit, in case communication module is changed, additional setting/download is not necessary.
- (4) Device read/write by using XGT dedicated/modbus/user defined protocol is available.
- (5) It provides communication function in which multidrop, up to 32 connection is available in case of using RS-485.
- (6) Setting of diverse communication speed is available. (1200,2400,4800,9600,19200,38400,57600,115200bps)
- (7) 1:1 and 1:N communication are available.
- (8) With abundant self-diagnosis, trouble diagnosis is simple.
- (9) It supports dedicated server/client, modbus server/client, user defined communication function.

2.2 Specification

2.2.1 Performance Specification

Item		Specification	
		Channel 1	Channel 2
Serial communication method		RS-232C	RS-485
Modem connection function		-	-
Operation mode (Operation define by channel)	P2P	Act as communication client - XGT dedicated protocol client - Modbus ASCII/RTU client - User defined communication - LS Bus Client ^{Notes 1)}	
	Server	- XGT dedicated protocol server - Modbus ASCII/RTU server	
Data type	Data bit	7 or 8	
	Stop bit	1 or 2	
	Parity	Even/Odd/None	
Synchronization type		Asynchronous type	
Transmission speed (bps)		1200/2400/4800/9600/19200/38400/57600/115200 bps available	
Station No. setting		Setting range: 0~255 ^{Notes2)} Max. station No. available: 32 stations	
Transmission distance		Max. 15m	Max. 500m
Diagnosis function		Check available by XG5000 diagnosis service	

Notes

Notes1) It indicates LS inverter dedicated protocol.

Notes2) When consisting Client and server, max. 32 stations is possible. Station No. can be set up 0 to 255.

2.2.2 Name and Function of Built-in Cnet Part

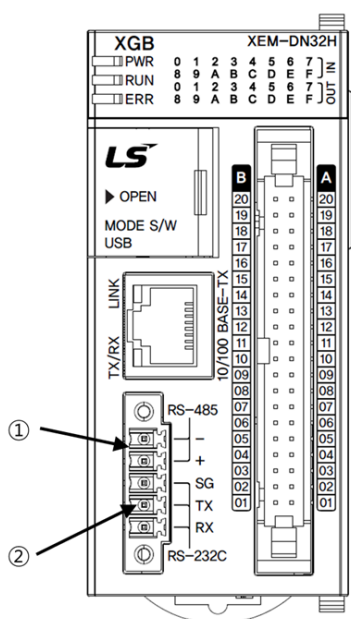

No.	Item	Description
①	RS-485 connection terminal	Built-in RS-485 connection connector
②	RS-232C connection terminal	Built-in RS-232C connection connector

Pin No.	Name	Description	Signal direction (XGBU ↔ External Device)	Function Description
1	485-	485 - Signal	←→	Built-in RS-485- Signal
2	485+	485 + Signal	←→	Built-in RS-485+ Signal
3	SG	Signal Ground	—	Signal ground
4	TX	Transmitted Data	→	Built-in RS-232C transmitted data signal
5	RX	Received Data	←	Built-in RS-232C received data signal

1) Wiring method when using built-in RS-232C

When connecting in null modem mode, connect 3-wire system as follow.

Cnet(9-PIN)		Connection number and signal direction	Computer/ communication device
Pin No.	Name		Name
3	SG		SG
4	TX		TXD
5	RX		RXD

2) Wiring method when using built-in RS-485

Pin No.	Name	Signal direction	External communication device
1	485-	←→	485-
2	485+	←→	485+

2.2.3 Cable Specifications

When using communication channel, RS-485, twisted pair cable for RS-422 shall be used in consideration of communication distance and speed. RS-485.

[Table 2.2.1] describes recommended specifications of cable. Also when using other cable than recommended, the cable conforming to characteristics in [Table 2.2.1] shall be used.

- Product : Low Capacitance LAN Interface Cable
- Type : LIREV-AMESB
- Size : 2P X 22AWG(D/0.254 TA)
- Manufacturer: LS Cable

1) Cable specification

(1) Electrical characteristic

Item	Standard	Test conditions
Withstanding voltage	No destruction	500V/1min
Insulation resistance	1,000 MΩ.km or above	20 °C
Static electricity capacity	45 pF/M or less	1 kHz
Characteristics impedance	120 ± 5 Ω	10 MHz

(2) External characteristic

Item	Unit	Standard
Conductor	Cores	Pair
	Size	AWG
	Composition	No./mm
	Outer dia.	mm
Insulator	Thickness	mm
	Outer dia.	mm

[Table 2.2.1] Cnet twisted pair cable specification

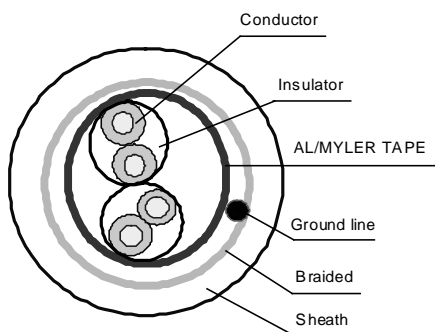

[Figure 2.2.1] Structure

2.2.4 Channel Operation of Built-in Communication

In case of built-in Cnet, each communication port operates independently to allow simultaneous Tx/Rx in separate transmission specifications. Transmission specifications can be set per RS-232C and RS-485 channel, and the operation is started and stopped according to channels. Data flow of each channel is as below.

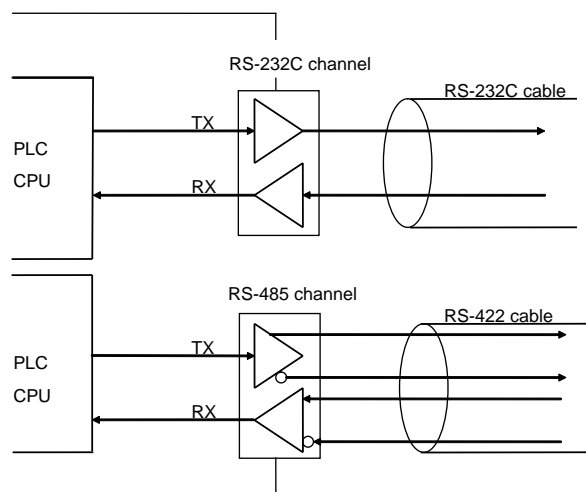

Note

- (1) For mode change during RUN, download parameter by using XG5000.
- (2) Though you don't reset the PLC, if download is complete, changed mode is applied.

2.2.5 Termination Resistor

For communication via PLC built-in RS-485 channel, termination resistor from external must be connected. Termination resistor has the function to prevent distortion of signal by reflected wave of cable for long-distance communication, and the same resistance ($1/2W$) as characteristic impedance of cable must be connected to terminal of network. When using the recommended cable in 2.2.3 connect termination resistor of 120 to both ends of cable. Also when using other cable than recommended, the same resistance ($1/2W$) as characteristic impedance of cable must be connected to both ends of cable

- Recommended termination resistor: $1/2W$, 120Ω , 5% tolerance

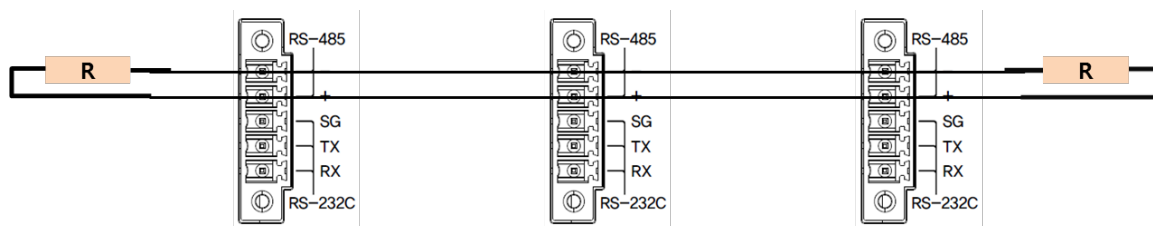

[Termination resistor connection diagram for RS-485]

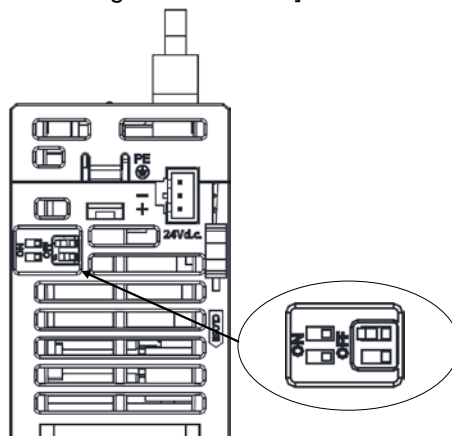

[Termination resistor Switch]

2.3 Cnet Communication System Configuration

Communication system by using XGB built-in communication function is diverse. In this chapter, it describes system configuration example.



2.3.1 1:1 Connection to PC (HMI) (No Modem)

PC (HMI) and main unit are connected by RS-232C or RS-485 channel, PC (HMI) and PLC is connected by 1:1 without modem. In most case, PC (HMI) acts as client and Cnet I/F module acts as server which respond request of PC (HMI). Since there is no modem, in case of using RS-232C channel, communication distance is max 15m, in case of using RS-422 channel, communication distance is max 500m. Operation mode of Cnet I/F is set according to PC (HMI)'s communication method.

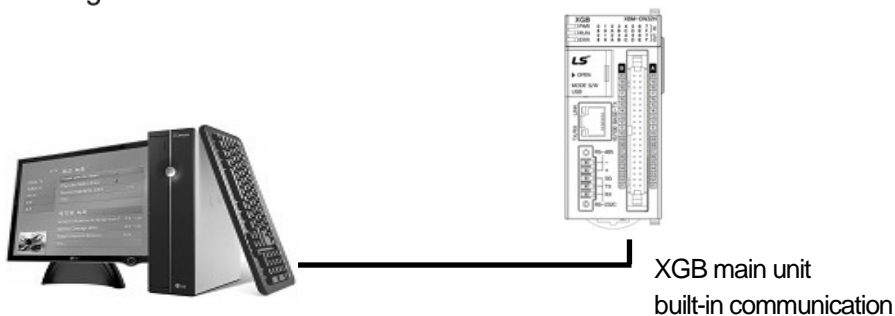
1) In case of using 1:1 connection with normal PC

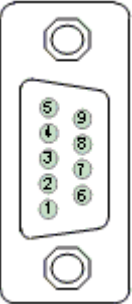
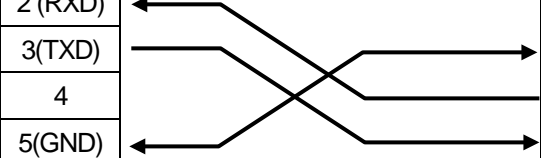

• Wiring method

External form of PC	PC	Connection number and signal direction	XGB main unit		XGB external form
	Pin no.		Pin no.	Signal name	
 <p>Female Type</p>	1		1	485-	
	2 (RXD)		2	485+	
	3(TXD)		3	SG	
	4		4	TX	
	5(GND)		5	RX	
	6				
	7				
	8				
	9				

In case of using channel 2, connect 485+ and 485- of RS485 terminal.

2) In case of using 1:1 connection with monitoring device such as XGT Panel

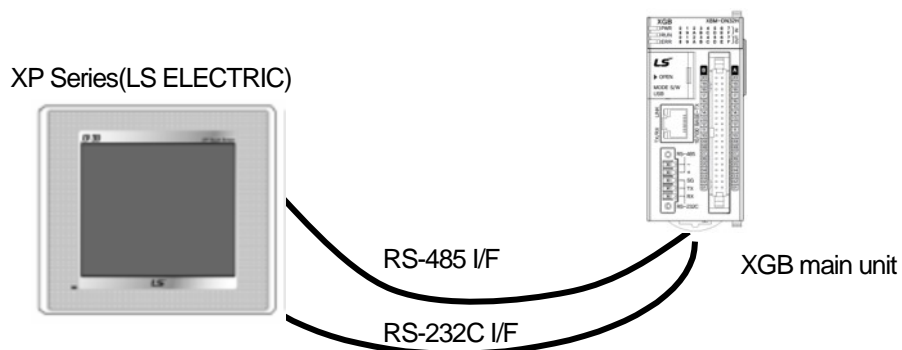

• Wiring method (RS-232C)

XP external form	XP	Connection number and signal direction	XGB main unit		XGB external form
	Pin No.		Pin No.	Signal Name	
<p>Female Type</p>	1		1	485-	
	2(RXD)		2	485+	
	3(TXD)		3	SG	
	4		4	TX	
	5(GND)		5	RX	
	6				
	7				
	8				
	9				

Note) In case of PMU, short no.4 and no.6, short no.7 and no.8.

• Wiring method (RS-485)

PMU	Connection no. and signal direction	XGB main unit
485+	←→	485+
485-	←→	485-

3) In case of using 1:1 connection with XGB main unit

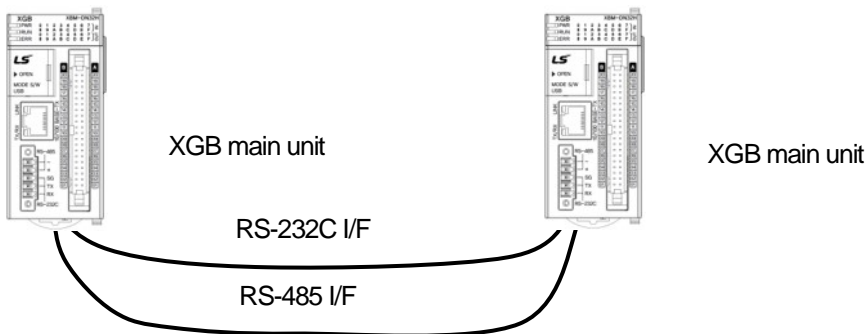

• Wiring method

XGB external form	XGB main unit	Connection no. and signal direction	XGB main unit	
	Pin No.		Pin No.	Signal name
	1	↔	1	485-
	2	↔	2	485+
	3	—	3	SG
	4	↔	4	TX
	5	↔	5	RX

2.3.2 Dedicated Modem Connection with PC(HMI)

It is 1:1 communication system connected through dedicated modem through RS-232C channel with PC (HMI). Normally, PC (HMI) acts as client station, Cnet I/F module acts as server station which respond request of PC (HMI). Since it uses modem, RS-232C channel should be set as dedicated modem and long distance communication is available. Operation mode of this module should be set according to communication method of PC (HMI).

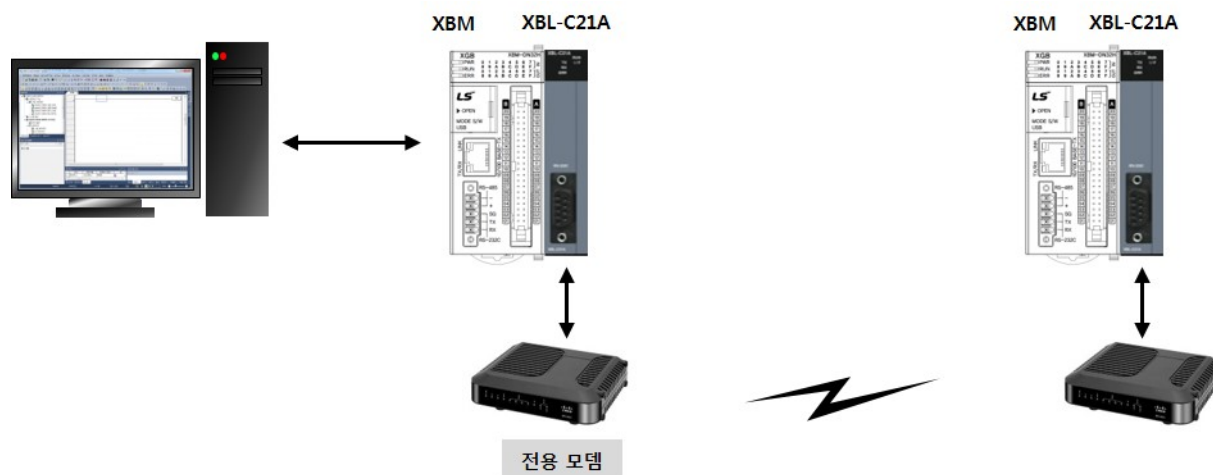

2.3.3 Modem Connection with PC and Communication between Cnet I/F Modules

- PC and Cnet #1 station is connected by modem through RS-232C channel
- Cnet #1 station ~ N station is communication between Cnet I/F module through RS-422 channel
- Cnet #1 station ~ N station is Communication between Cnet I/F modules through RS-422 channel
- PC acts as client station of Cnet #1 station
- Up to max 32 station connection is available in case of Cnet I/F module (RS-422/485 communication)
- It sets station 1 among Cnet I/F module as server station
- Dedicate modem or dial-up modem available

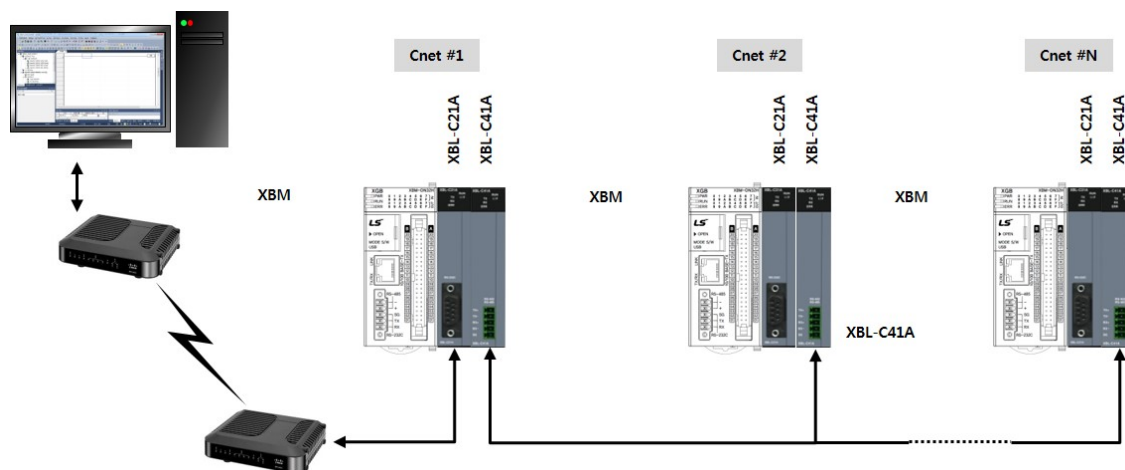

Type	Module setting	
	XBL-C41A	Station no.
PLC Cnet #1	P2P	1
	XGT client	
Cnet #2 ~ #N	XGT server	2~N

2.3.4 Dedicated Communication with PC(HMI) and Different type RS-422 Communication

- Null-modem communication by using PC (HMI) and RS-232C channel
- PC (HMI) acts as client station, Cnet I/F module acts as server, at this time, module setting acts as RS-232C XGT server
- Cnet I/F module RS-422 channel acts as P2P mode.
- It transmits indication data to display module of mosaic panel through RS-422 channel
- Reading display transmission data from PC

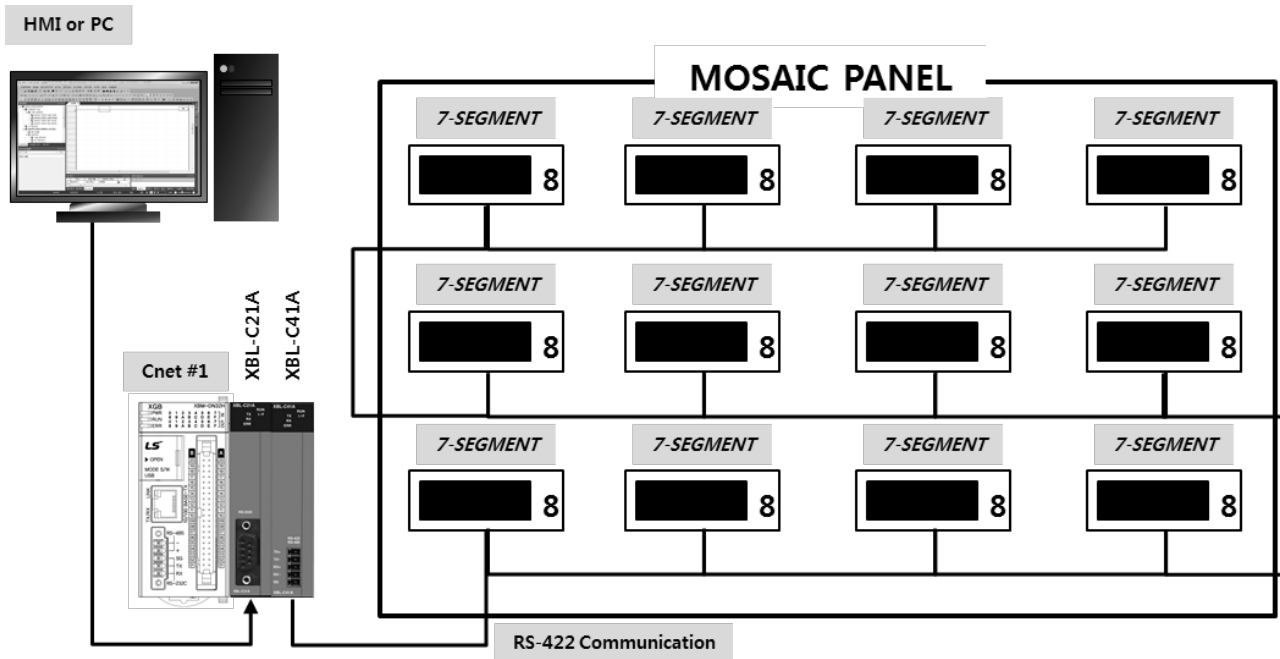

Type	Module setting		
	XBL-C21A	XBL-C41A	Station no.
PLC Cnet #1	XGT server	P2P	1

2.3.5 Optical Modem Communication for Moving Material Communication

- Optical modem communication system for Cnet communication on material above moving linearly
- P2P communication or dedicated mode communication with monitoring device
- RS-232C/RS-422 communication with optical modem
- Communication between Cnet I/F module is dedicated server/client communication
- Optical modem connected with Cnet I/F module on mobile body can communicate with the other optical modem only when positioned in communication available
- Main application: Parking tower

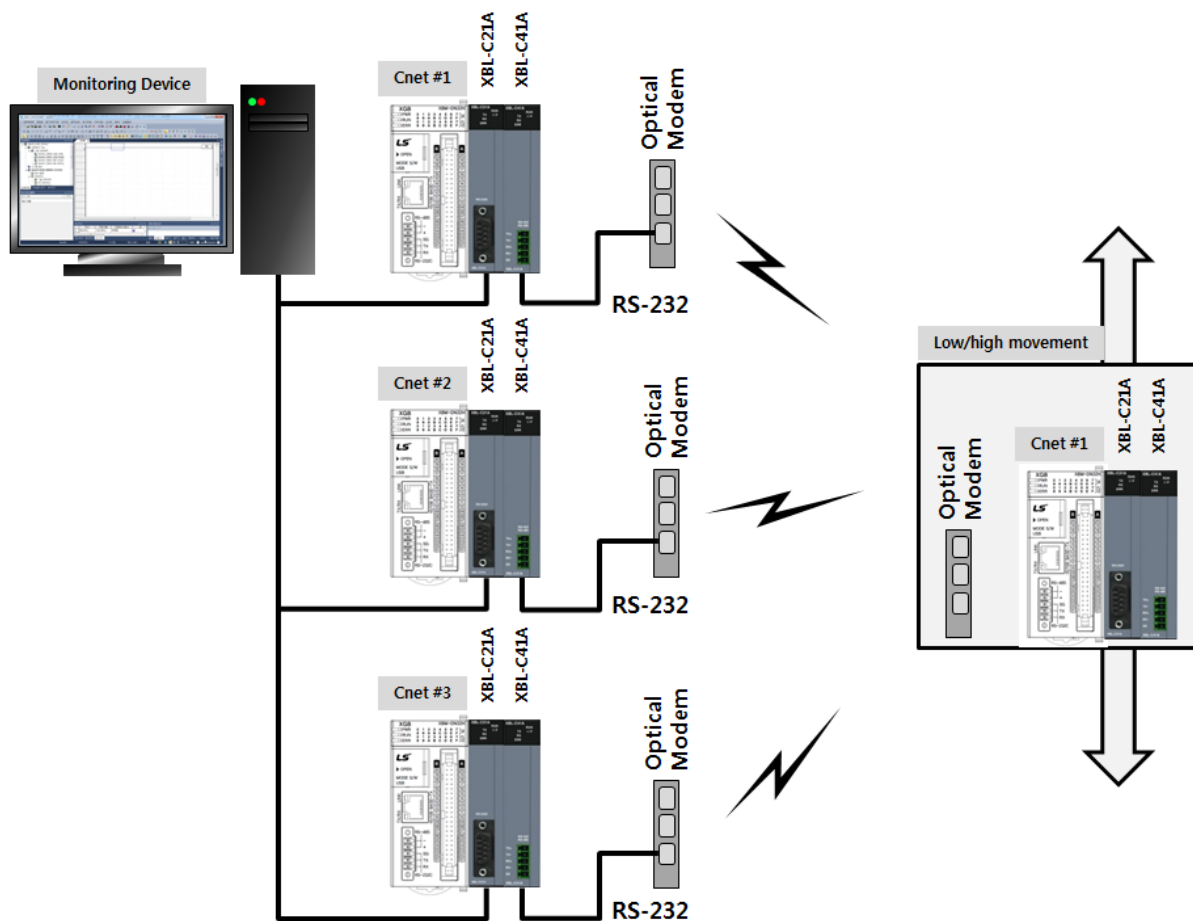

2.1.3 Wireless Modem Communication for Communication between Revolution Bodies

- Wireless modem communication system for Cnet communication on the revolution bodies
- RS-232C communication with wireless modem
- Communication between Cnet I/F module is dedicated/client communication
- RS-232C channel of Cnet I/F module is dedicated modem mode

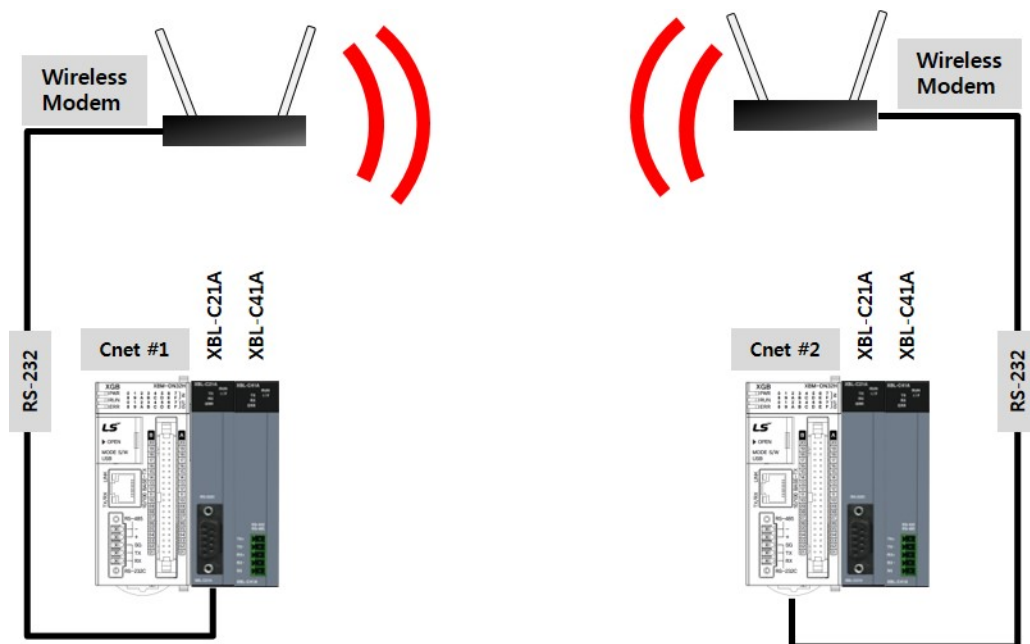

Type	Module setting		
	RS-232C	RS-422	Station
XBL-C21A	Dedicated mode	Not used	2 station
	User mode		

2.4 Basic Setting for Communication

2.4.1 PLC Type Setting and Communication Module Registration

To use Cnet I/F function, communication parameter should be written by XG5000 and the module should be registered in XG5000. Method on register Cnet I/F module is as follows according to On/Off line status.

1) Making new project

First, after click Project-New Project and input project name, select XGB as CPU series.

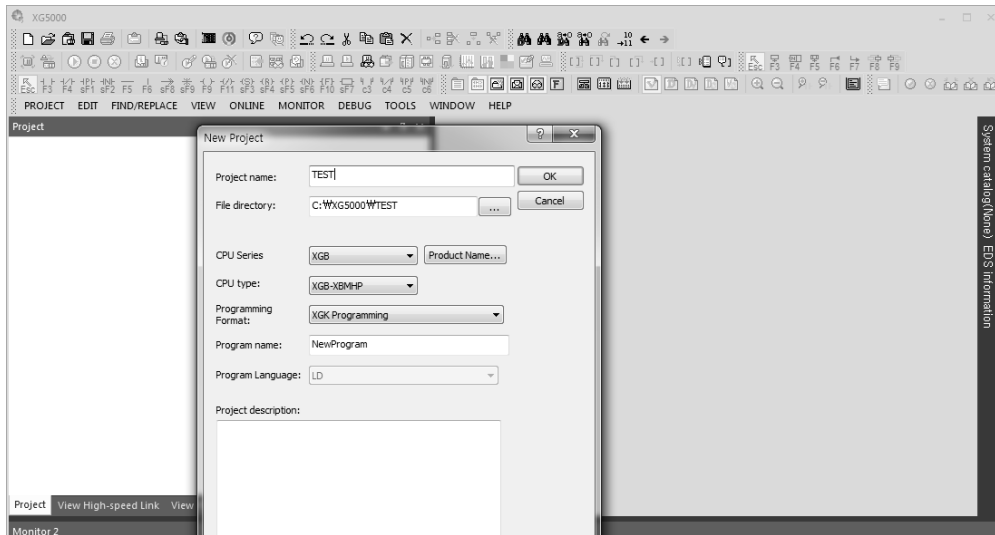

2) In case of off-line, method on Cnet I/F module registration

In the status PLC is not connected, in case the user set about communication module and write parameter related with communication. In the “project” window, select “Undefined Network” and then click mouse right button. Select “Add item – Communication module”. In the window, click “Add Module...” to register Communication module.

At this time, slot 0 is set as built-in Cnet. (Slot 0 : Cnet, Slot 1: Enet) Expansion module starts from slot 2.

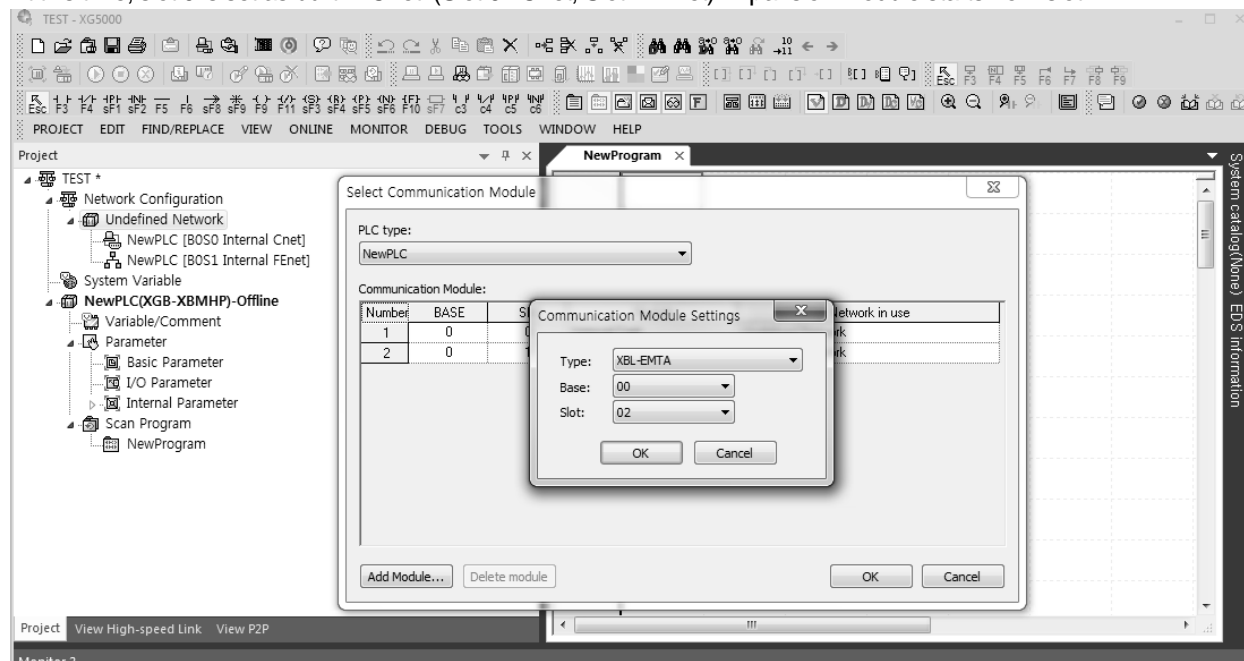

[Cnet module registration]

Chapter 2 Built-in Cnet communication

3) In case of on-line, method on Cnet I/F module registration

If you register communication module at online status by using XG5000, you should connect basic unit. After [Online]-> [Connect] after doing communication setting by using "Online -> Connection settings" and doing local connection. After setting PLC to STOP status, select [Online] → [Diagnosis] → [I / O Information] and perform I / O synchronization.

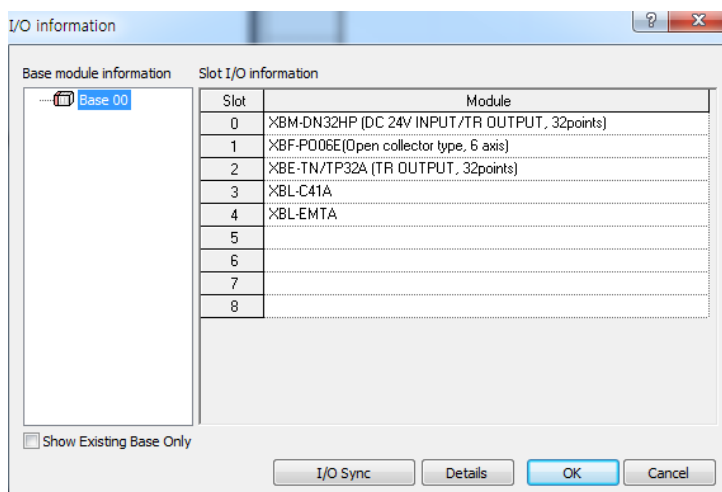
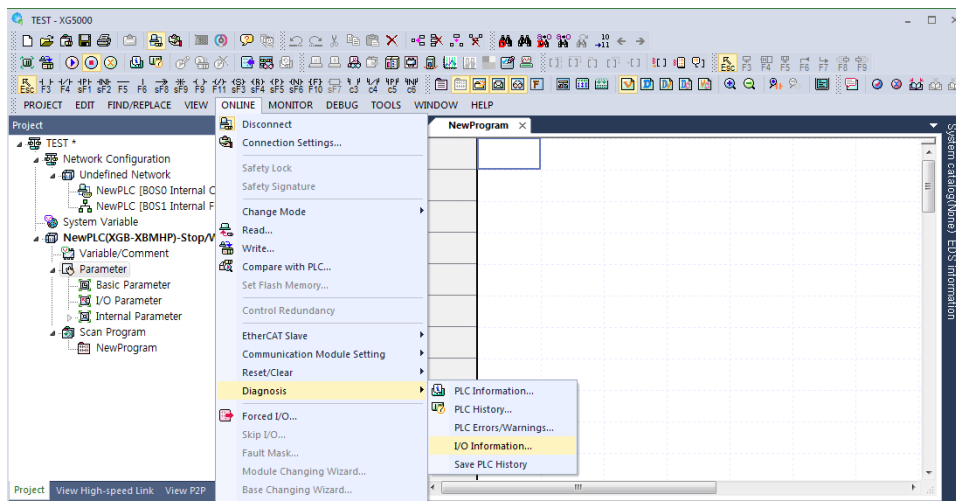

[I/O information change message]

If you Synchronize I/O, communication module will be registered.

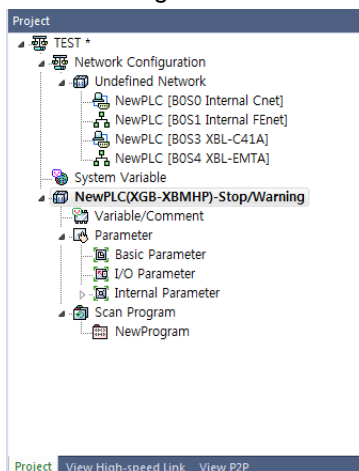

[Communication module registration complete screen]

4) How to read the parameter saved in PLC

The method to read basic setting value and P2P setting value of communication module saved in PLC is as follow. While connecting to main unit, select [Project] -> [Open from PLC]. After setting "Online Settings", click "OK" and then the saved parameter and project in PLC is opened as follow.

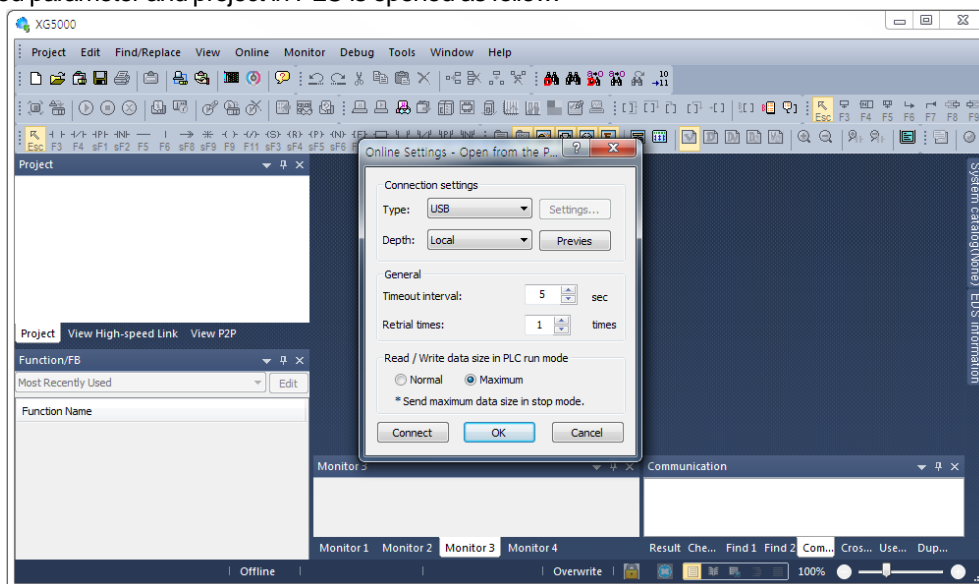

[Open from PLC]

2.4.2 Basic Parameter Setting

Communication function used in Cnet I/F module is classified as followings.

1) Server mode service

Without other program at PLC, you can read or write information in PLC and data.

- It can act as XGT server providing XGT dedicated protocol and Modbus server providing RTU/ASCII protocol.

2) Client (P2P) service

Cnet I/F module acts as client in network.

- In case designated event occurs, you can read or write memory of other station.
- It can act as XGT client and Modbus client.
- In case of sending/receiving user wanted frame and communicating with other device.
- You can define P2P block with max. 32 per one channel acting independently.

3) Loader service

By using remote 1/2, you can monitor/download program about remote PLC.

To use Cnet I/F module, you should set transmission specification such as data type like transmission speed and data/stop bit.

You should select transmission specification of system to be same with specification of system.

Written standard setting value is saved main unit of PLC and this value keeps though power goes off and this value is not changed before writing. Also though Cnet I/F module is changed and new module is installed, the standard setting value saved at main unit previously written is applied to new module automatically. Standard communication setting parameter and P2P, all parameter is applied if download is complete.

4) Setting Item

When setting Cnet communication parameter, the user should define as follows.

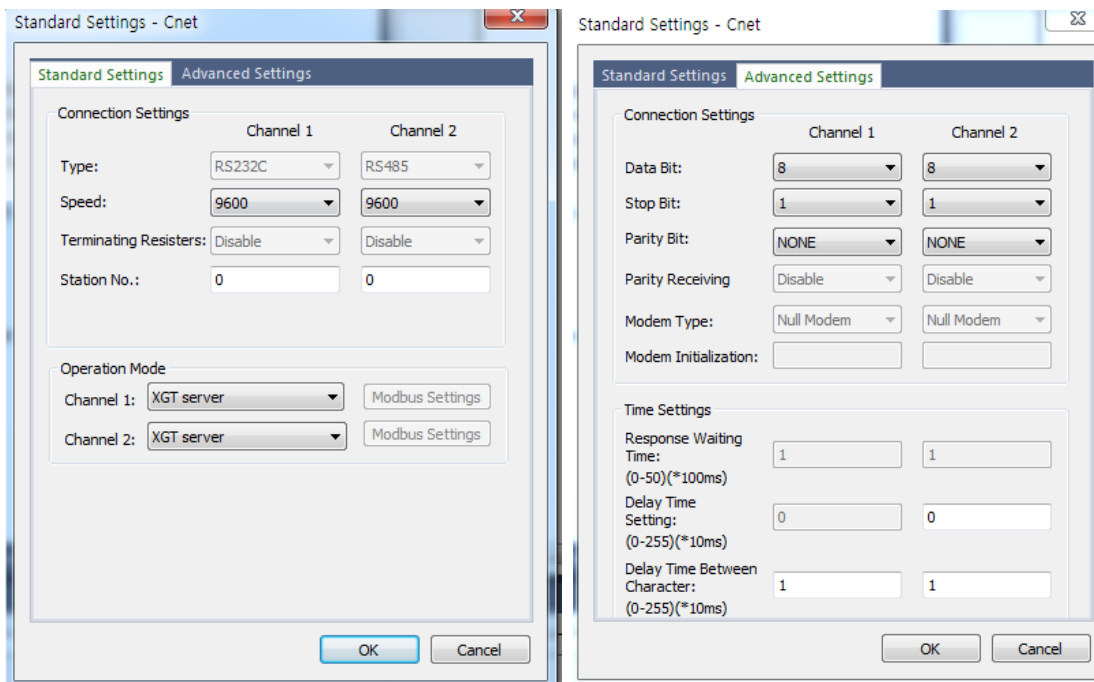

[Built-in communication standard setting screen]

Item	Setting content		
Station no.	• set from station 0 to station 255.		
Speed	• 1200, 2400, 4800, 9600, 19200, 38400, 57600, 76800, 115200 bps available		
Data bit	• 7 or 8 bit available		
Parity bit	• None, Even, Odd available.		
	Kinds	Meaning	NO
	None	Do not use parity bits	
	Even	If the number of 1s in one byte is an even number, "0" is transmitted to the parity bit	
Odd	If the number of 1s in one byte is odd, "0" is sent to the parity bit		
Stop bit	• 1 or 2 bit available		
Modem initialization	• When using dialup modem, the function is available. In case of modem communication, input the initialization instruction of applied modem.		
Type	• It is fixed as follows according to Cnet type 1) Built-in communication → channel 1 : RS-232C , channel 2 : RS-485 2) XBL-C41A → channel 1 : not used, channel 2: RS-422/RS-485 3) XBL-C21A → channel 1 : not used, channel 2: RS-232C		
Response waiting time	• It means the time from sending frame to receiving. 1) operation setting : it is available when active mode is set to "Use P2P". 2) waiting time : 100ms+(setting value × 100ms)		
Delay time Setting	• It means that frame is sent at user-defined frame send timing with delay as setting delay time. 1) operation setting : it is available when communication type is RS-422/485.		

Chapter 2 Built-in Cnet communication

Delay time between characters	<ul style="list-style-type: none"> • It means interval between characters in one frame. 1) operation setting : it is always available regardless of active mode. 2) In case of that waiting time is set to 0, it is applied 3.5 character time¹⁾ as communication speed..
-------------------------------	---

*Operation mode setting

- Sets operation mode

Driver type	Meaning	Reference
P2P	Each port acts as client and executes the communication by setting P2P parameter.	P2P setting reference
XGT server	It acts as XGT server supporting XGT dedicated communication.	Dedicated service
Modbus ASCII server	It acts as Modbus ASCII server	Modbus communication
Modbus RTU server	It acts as Modbus RTU server	Modbus communication

[communication parameter setting item]

Note

Character Time: It means the required time to send 1 character and it is variable depends on communication speed.

1) In case of that communication speed is 9600bps, how to calculate 3.5 Character Time

$$\begin{aligned}
 \text{Character time} &= (\text{number of bits of 1 character}(11)/\text{communication time}) * 3.5 \\
 &= (11/9600)*3.5 \\
 &= 4.01\text{ms}
 \end{aligned}$$

5) Parameter download

You should do like following to operate Cnet I/F module according to communication specification defined by user. In case of setting like the followings about XBL-C41A (RS-422/485 1 port) installed slot 3, setting method is as follows.

(1) Communication specification

- Channel 2: RS-485, 115200Bps, 8/1/Odd, Null modem, P2P, station 0, Response waiting time 100ms, Delay time 10ms,

Waiting time between characters 0ms, XGT server

(2) Executing XG5000, you register communication module Cnet for setting at each slot position.

(3) After Cnet module is registered, if you double-click Cnet module, the following standard setting window shows.

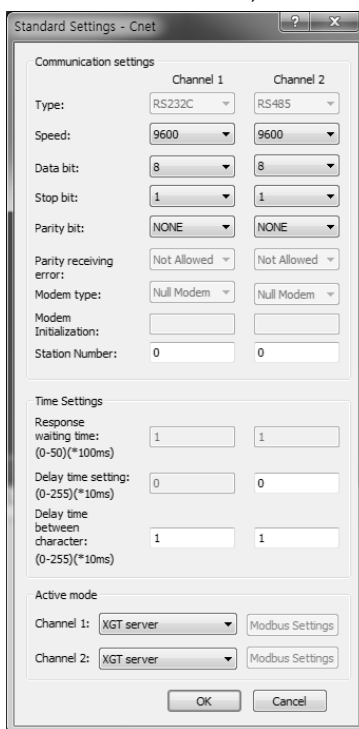

[Communication module setting screen]

(4) If standard communication parameter setting ends, download Cnet module.

If you select [Online -> connection -> Write], download is executed. After downloading, parameter is applied shortly.

If you check 'Set up with Link Enable', Link Enable can be applied with writing P2P/HS parameters at the same time.

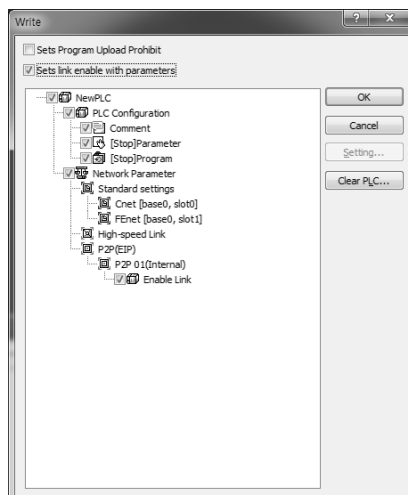

2.5 Remote Connection

In case PC executing XG5000 is far from XGB PLC, if you use remote connection function of Cnet I/F module, you can control remote PLC such as program download, upload, program debugging and monitor. Especially, in case XG5000 is far from PLC, if you use XG5000 remote connection function and modem connection function of Cnet I/F module, you can access easily by remote connection through air line. Remote connection is supported at XGB communication module, FENet I/F module and Cnet I/F module. Connection between networks is available and you can control remote PLC through multiple connections. There are two methods for remote connection by using Cnet I/F module, first, XG5000 is connected with Cnet I/F module of remote PLC through modem, second, XG5000 and local PLC are connected into CPU through RS-232C, Cnet I/F module of local PLC communicates with Cent I/F module of remote PLC.

2.5.1 XG5000 remote connection

[Figure 2.5.1] is figure indicating remote connection example where XG5000 and PLC are connected through modem. Like figure, it is necessary configuration in case PC executing XG5000 is far from PLC and telephone line and connected by dedicated modem or wireless modem. At this case, you should connect Cnet I/F module by modem from XG5000 and you should select modem as connection method at connection option. There are two methods, dedicated modem connection using dedicated line and dial-up modem connection using public line.

(1) Dial-up modem connection

You can establish remote connection by connecting dial-up modem to PC and Cnet I/F module (RS-232C). In PC side, you can use external modem or internal dial-up modem and in Cnet I/F side (RS-232C), you should use external modem.

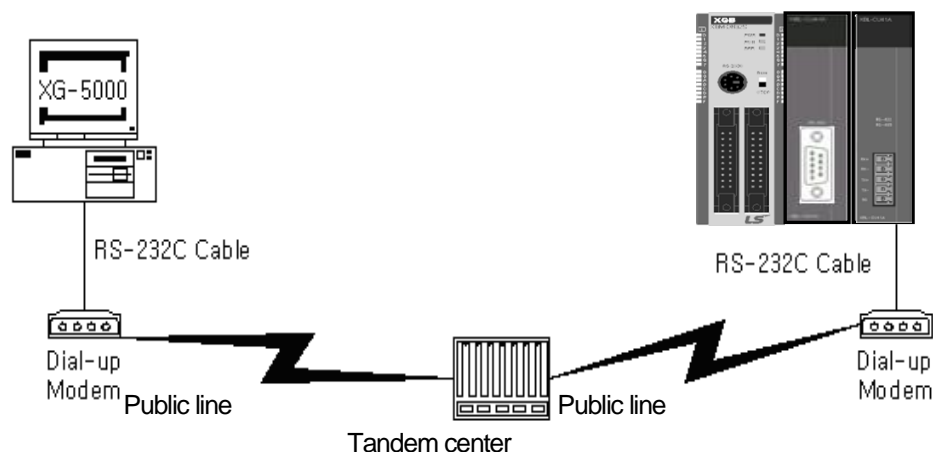

[Figure 2.5.1] XG5000 remote connection example by dial-up modem

Remote connection sequence by using dial-up modem is as follows.

- (1) Cnet I/F module connected with PLC setting
 - a) Sets active mode of RS-232C channel of Cnet I/F as XGT server at XG5000.
 - b) Sets Modem type of Cnet I/F module (RS-232C) as Dial-up modem and inputs atz in Modem Initialization.

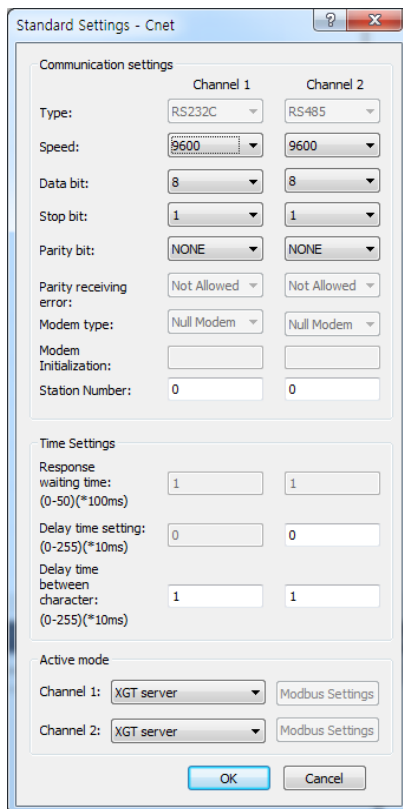

[Figure 2.5.2] XG5000 setting example

(2) XG5000 setting

a) Execute XG5000 and pop up online settings window by selecting "Online -> Connection settings".

Here selects "Connection settings -> Type" as Modem.

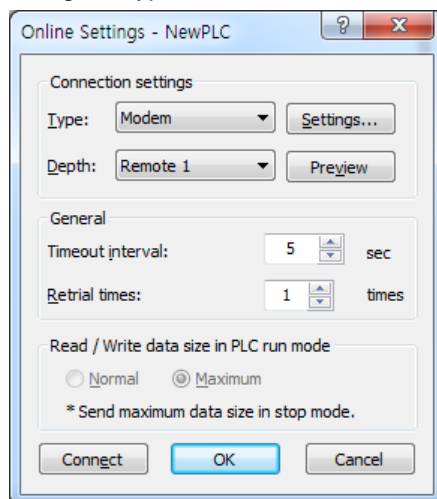

(3) Dial up modem setting

- a) Select settings of "Connection settings" and set detail of modem

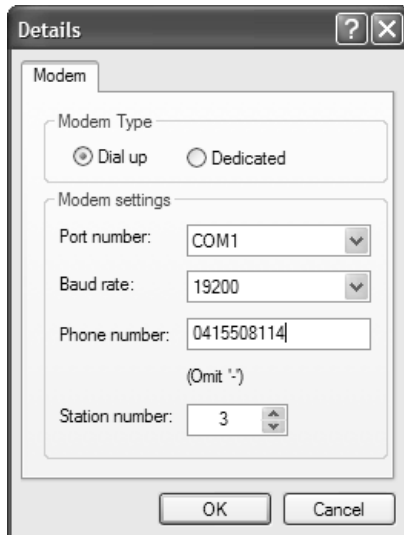

- b) Phone number means phone number of modem side connected with Cnet I/F module, in case of going out from local through extension line, you can use extension number and ',' symbol.

(Ex) In case extension number is '9': set as 9, 0343-398-xxxx

Note

Baud rate in modem settings means communication speed between PC and modem, not communication speed of modem. Baud rate of modem means communication speed between modem and modem, it is set automatically according to quality of public line and destination modem's speed.

For XG5000 remote connection at XGB PLC, you should use RS-232C channel. At communication standard setting, set "RS-232C dial-up modem" and write it to XGB Cnet I/F module.

Chapter 2 Built-in Cnet communication

In case of selecting connection step as remote 2, like the following, select base and slot number of remote 1 communication module in detail and communication module station number of remote 2. Inputs station number set in Cnet I/F module, In case of Cnet channel, selects communication channel of remote 2.

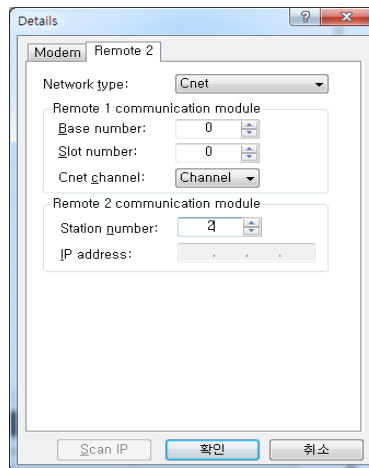
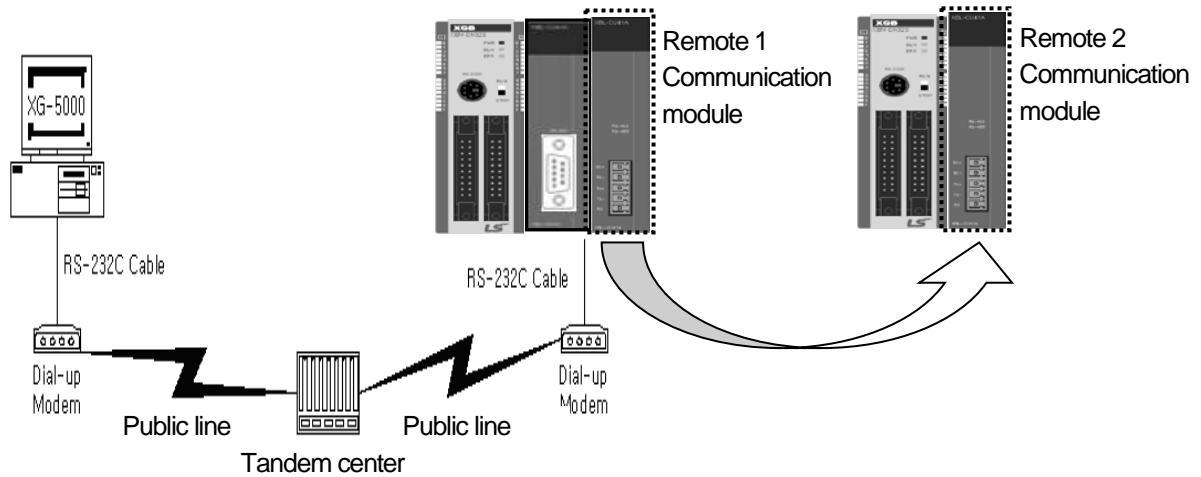

c) Select connection on online after setting connection option, modem initialization dialog box shows and modem is initialized.

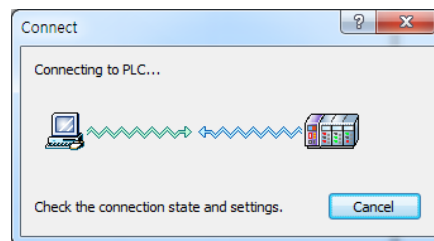

- d) In case setting of COM channel of modem or connection with modem is wrong or, the error message shows. At this time, check COM channel or modem connection.

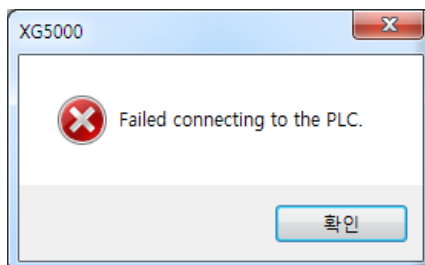

- e) If making phone call is complete, XG5000 tries remote connection. In case remote connection is complete, "Online" menu is activated.
- f) This case is same with connection status where connection is established through RS-232C cable. Here you can use all function of online menu.
- g) In case you want to disconnect remote connection, select disconnect at online menu. Then disconnection menu box shows and remote connection is disconnected.
- h) If connection is disconnected, XG5000 quit call automatically and disconnection telephone connection.
- i) If it is success to quit call normally, local and remote modems return to initialization status. You can establish remote connection through making phone call.

Note

After remote connection, you can use online menu of XG5000 like local connection. You can use program download/upload/monitor function etc. PLC control through modem is affected by capability of modem and status of telephone line. In case telephone line is bad, connection may be canceled. At this time, don't try reconnection instantly, wait for 30s and retry again from step 1)

Chapter 2 Built-in Cnet communication

2) Dedicated modem connection

The following figure indicates that PC and Cent module is connected by dedicated modem through dedicated line.

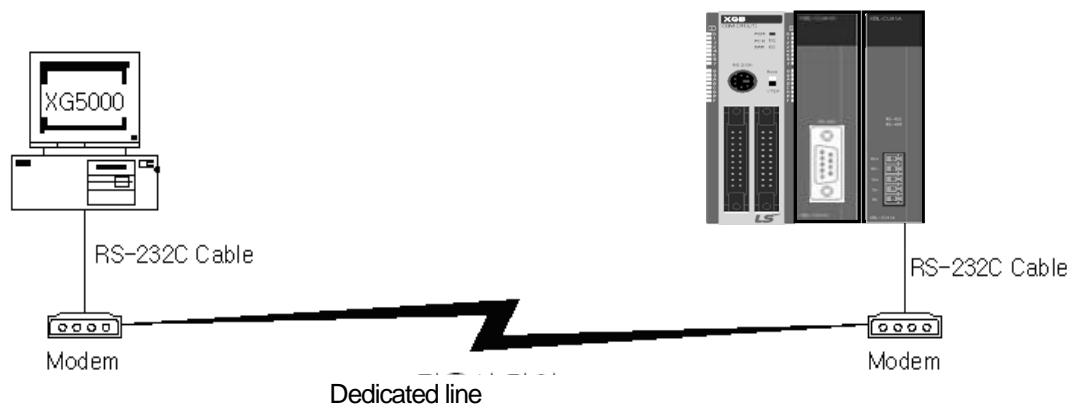

[XG5000 remote connection example by dedicated modem]

This is example of dedicated modem connection by dedicated line. You can use wireless modem, optical modem other than dedicated modem. For setting method of modem not using public line, it is same with case of dedicated modem and refer to the followings.

Remote connection sequence by dedicated modem is as follows.

- (1) Connects PC with dedicated modem at Cnet I/F module
- (2) Cnet I/F module setting connected at remote PLC
 - a) Sets RS-232C channel of Cnet I/F module as XGT server.
 - b) Sets RS-232C channel operation of Cnet I/F module as dedicated modem.
- (3) XG5000 setting
 - a) Execute XG5000 and select "Online -> connection settings" and pop up online settings window. Here set "Connection settings -> Type" as Modem. Press the "Settings" button and set communication channel and baud rate set in dedicated modem connected with PC. Baud rate should be same with communication speed of dedicated modem.

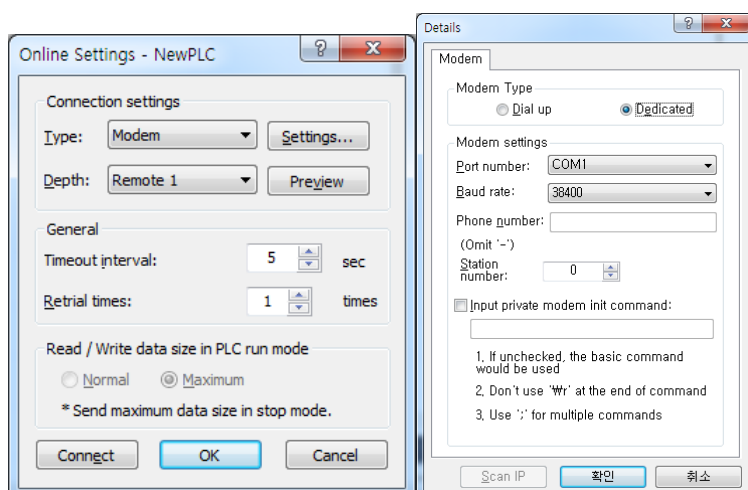

b) In case of setting depth as remote 2, set settings related with remote 1, 2 at the "Detail" window like the followings.

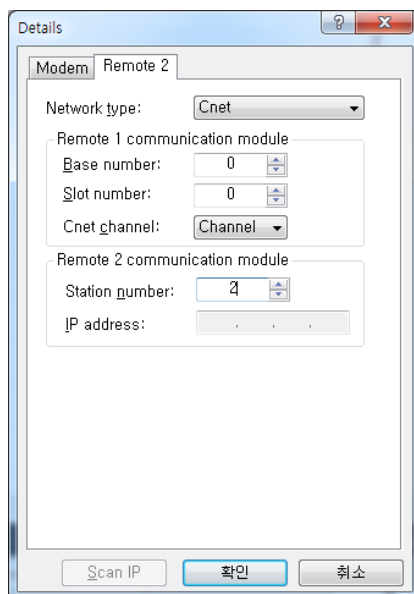

[Figure 5.1.10] dedicated modem remote 2 setting screen

- e) After completing setting, if you click connection of connection setting, XG5000 tried remote connection. In case remote connection is complete, it is same when connection is established by RS-232C cable. Here you can use all functions of "Online" menu.
- d) In case you want to disconnect remote connection, select disconnect at online menu. Disconnection menu box shows and remote connection is disconnected.
- e) If disconnection is done normally, Cnet I/F module and XG5000 are switch into initial mode. In case of reconnection, retry from 2) item to reconnect.
- f) Since for optical modem, wireless modem, only media between modems is different. Connection method is same.

Note

After remote connection, you can use online menu of XG5000 like local connection. You can use program download/upload/monitor etc. PLC control through modem is affected by capability of modem and status of telephone line. In case telephone line is bad, connection may be canceled. At this time, don't try reconnection instantly, wait for 30s and retry again from step 1)

2.5.2 Remote connection between Cnet I/F modules

1) Remote connection through dedicated modem

[Figure 5.1.11] indicates that XG5000 and local PLC is connected through RS-232C cable and in case RS-232C channel of Cnet I/F module equipped at local PLC communicates with Cnet I/F module of remote PLC through dedicated modem. Figure is example indicating remote connection with remote PLC. Like figure, XG5000 uses modem communication function between Cnet I/F modules and control remote PLC by using remote connection.

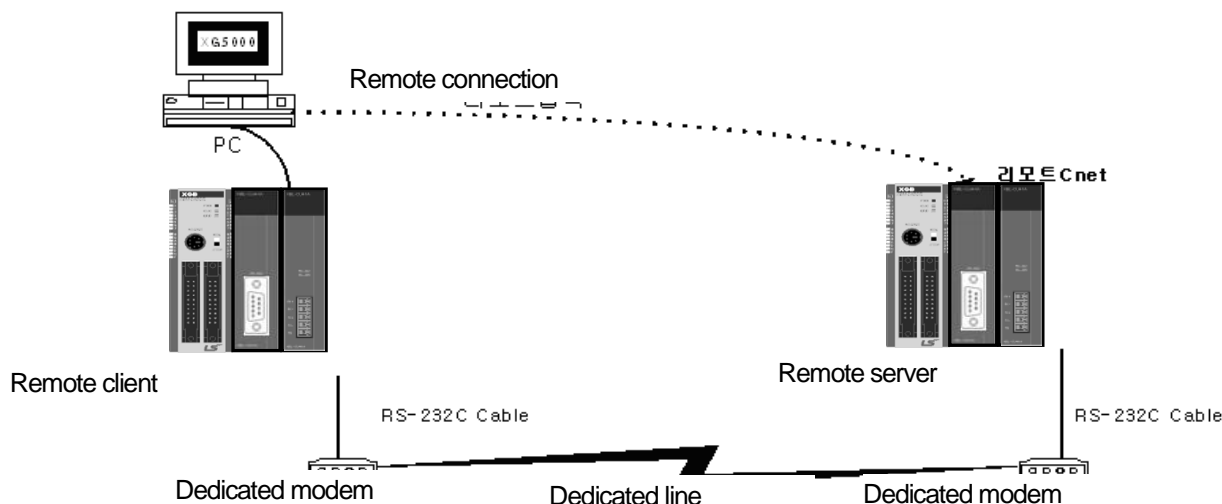

[Figure 5.1.11] remote connection between Cnet I/F modules

Remote connection sequence by dedicated modem is as follows.

(1) Cnet I/F module setting connected at remote PLC

- a) Set RS-232C channel operation of Cnet I/F module at XG5000 as dedicated modem and have it operate as XGT server.

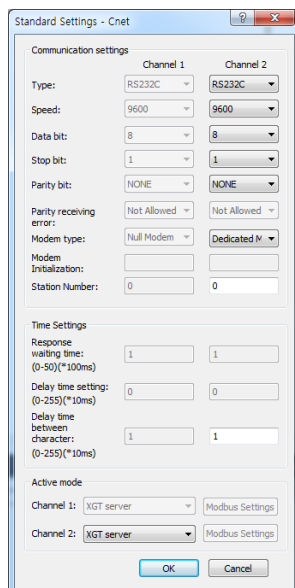

(b) Cnet I/F module setting connected at local PLC

1) Converts local connected PLC to Stop mode

Note

Basic parameter of remote server connected through XG5000 should be set as server. In case of remote client, it should be set as P2P client.

In case there are many communications, if you try to remote connection, you may fail. Be sure to convert local PLC to stop mode and stop communication before remote connection.

Chapter 2 Built-in Cnet communication

(2) XG5000 setting

- a) Set active mode of RS-232C of Cnet I/F module at XG5000 as Use P2P settings.
- b) Set modem type of Cnet I/F module (RS-232C) as dedicated modem.

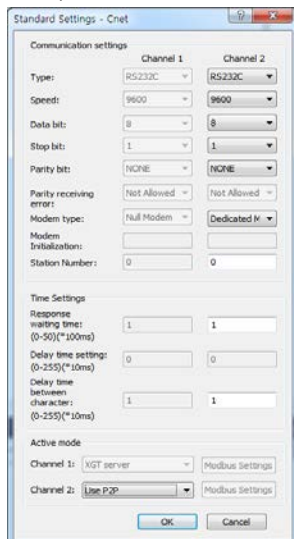

(3) XG5000

- a) Execute XG5000 and select "Online – Connection Settings" and set connection method.

Select Type as RS-232C and communication channel. This is same in case of local connection.

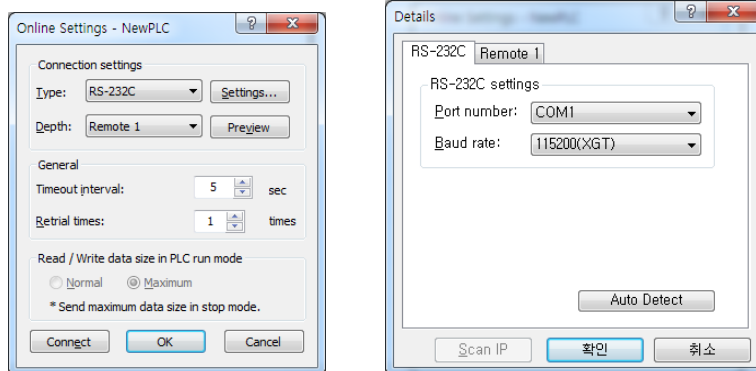

- b) Select depth as remote 1 and click "Settings" for detail setting. In the detail window, set station number. AS for station number, input station number set in Cnet I/F module to execute remote connection. Figure is case Cnet station number is set as 1.

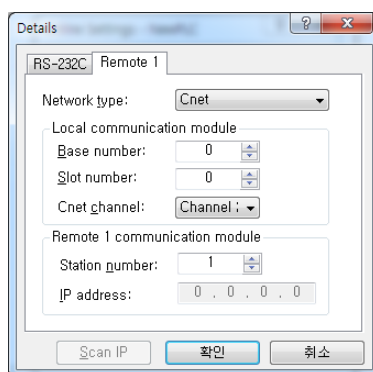

- c) XG5000 tries remote connection and in case remote connection is complete, online related function is activated.
- d) In this case, remote 1 connection is complete, it is same status with where it is connected by RS-232C cable. Here you can use all functions of online menu.
- e) In case you want to disconnect remote connection, select disconnect at online menu. Disconnection menu box shows and remote connection is disconnected.
In case disconnection is done normally, Cnet I/F module and XG5000 are converted into initial mode. In case of reconnection, retry from (a) for reconnection.
- f) In case of optical modem, wireless modem other than dedicated modem, communication media is only different, method of remote connection is same.
- g) [Figure 5.1.16] indicates remote connection by wireless modem. As for connection method, it is same with method of remote connection between Cnet I/F module by using communication. In case of using wireless modem, 1:N remote connection where there are many Cnet I/F module is also available.

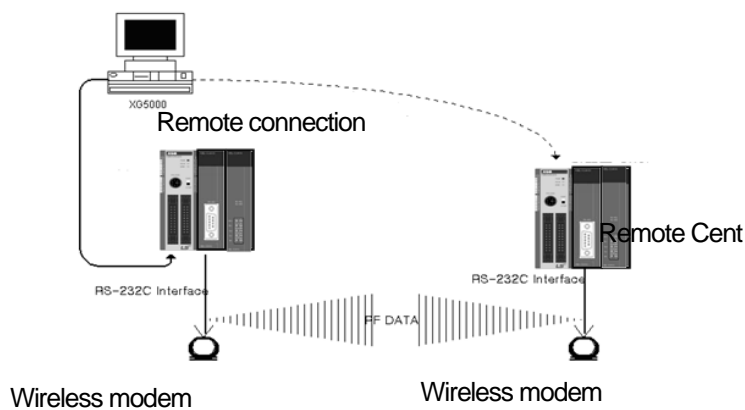

Chapter 2 Built-in Cnet communication

2) Remote connection by RS-422/485

[Figure 5.1.17] indicates XG5000 and local PLC is connected into CPU module by RS-232C cable, in case RS-422/485 channel of Cnet I/F module connected at local PLC communicates, it is figure indicating remote connection example to remote PLC. Like figure, XG5000 can control program of remote PLC by remote connection through remote connection function between Cnet I/F modules.

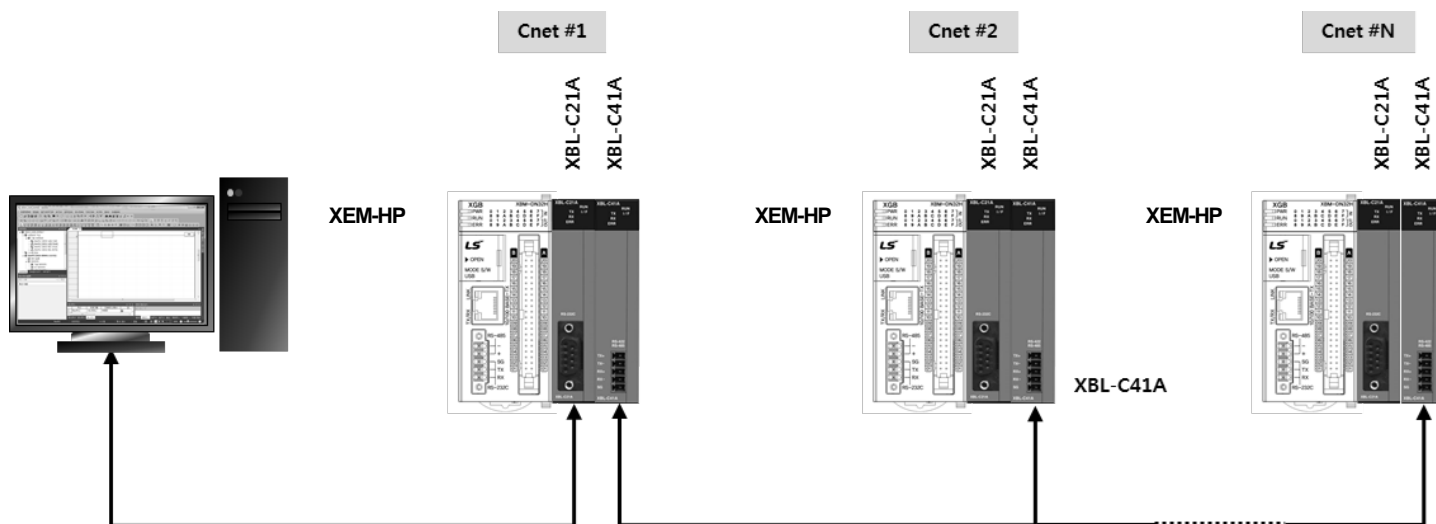

[Remote connection in case of RS-422/485 communication]

Note

Basic parameter of remote server connected through XG5000 should be set as server, in case of remote client, it should be set P2P client.

If you try remote connection when there is many communications, connection may fail. You should convert PLC as Stop mode and stop communication before remote connection.

2.6 Server Function and P2P service

2.6.1 Server Function

Dedicated service is built-in service in Cnet I/F module. Without specific program at PLC, you can read or write information and data from PC and other device. It acts as server at communication network and if read, write request conforming XGT dedicated protocol or Modbus protocol come, it responds.

1) XGT dedicated server

It is used in case of communication between our products by our dedicated service, all characters are configured as ASCII code. In case of using multi drop, up to 32 stations can be connected. In case of setting station number, duplicated station number should not be set. In case of using multi drop, communication speed/stop bit/parity bit/data bit of all Cnet I/F module in network should be same. For more detail protocol, refer to "chapter 2.7 XGT dedicated protocol".

2) Modbus server

It is used in case partner device acts as Modbus client.

ASCII mode and RTU mode of Modbus are all supported. You can define in standard settings active mode. For more detail protocol, refer to "chapter 2.9 Modbus protocol".

Modbus instruction and response data max. number which is supported by Modbus RTU/ASCII driver are as follows. Other client device should request in the range of the following table.

Code	Purpose	Address	Max. no. of response data
01	Read Coil Status	0XXXX	2000 Coils
02	Read Input Status	1XXXX	2000 Coils
03	Read Holding Registers	4XXXX	125 Registers
04	Read Input Registers	3XXXX	125 Registers
05	Force Single Coil	0XXXX	1 Coil
06	Preset Single Register	4XXXX	1 Register
15	Force Multiple Coils	0XXXX	1968 Coils
16	Preset Multiple Registers	4XXXX	120 registers

2.6.2 P2P Service

P2P service means acting client operation of communication module. P2P instructions available at Cnet I/F module are 4 (Read/Write/Send/Receive).

Registration and edit of P2P service is executed in XG5000, each P2P parameter consists of max. 32 P2P block.

The following figure is example of P2P parameter setting window of XG5000.

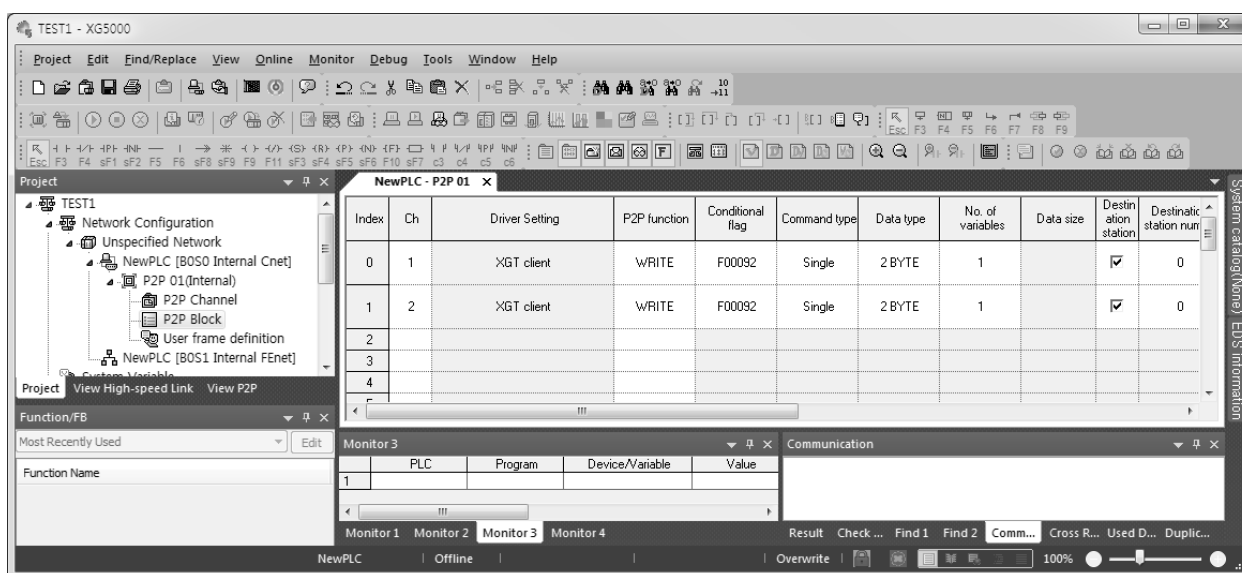

Note

P2P 01 is fixed allocated at built-in Cnet, and P2P 02 is fixed allocated at built-in FEnet. Therefore, it will operate normally with appropriate slot number.

1) P2P parameter configuration

To use P2P service, the user executes the setting for the wanted operation at the P2P parameter window. Like the following figure, P2P parameter consists of three informations.

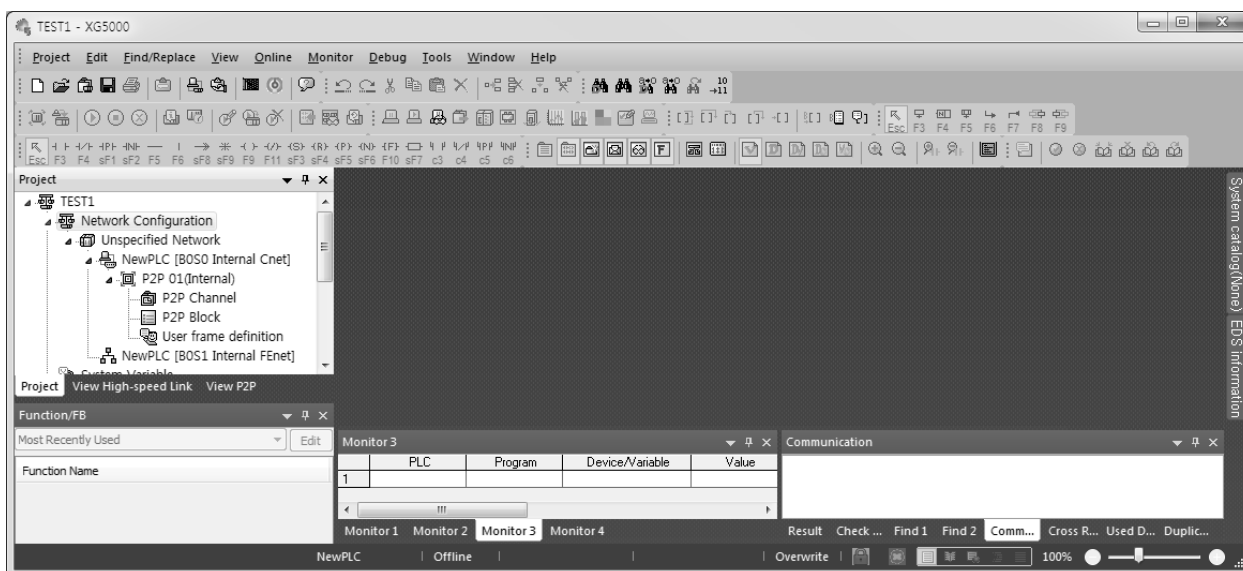

Types	Descriptions	Remark
P2P channel	<ul style="list-style-type: none"> - P2P channel setting defining communication protocol of P2P service to execute - XGT/Modbus available - Each channel is independent. It is applied when active mode is "Use P2P settings" 	
P2P Block	Setting P2P block of 32 acting independently	
User frame definition	User frame definition registration	

Chapter 2 Built-in Cnet communication

2) Channel Setting

Built-in Cnet I/F function provides two fixed communication channel as fixed P2P 1.

Cnet I/F module are allocated P2P 2 and P2P 3 according to equipment sequence and communication channel supports only one channel. At Built-in Cnet I/F, you can define driver type for P2P service about each.

If you select P2P channel at P2P setting window, like the following, P2P channel setting window shows. If you select P2P driver to use, setting is complete.

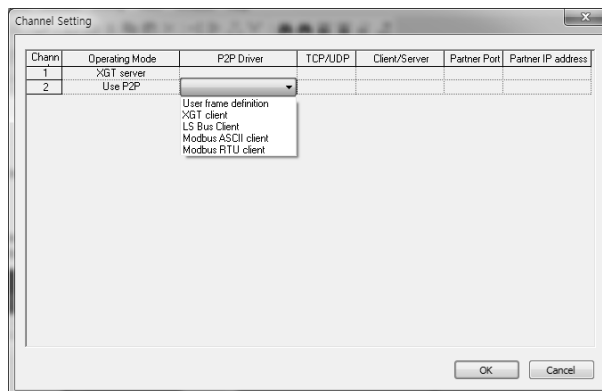

Driver	Meaning
None	Not using P2P service
User frame definition	In case of transmitting/receiving user frame definition
XGT client	Select in case of executing read, write of XGT memory.
Modbus ASCII client	Select in case of acting as Modbus client, using ASCII mode
Modbus RTU client	Select in case of acting as Modbus client, using RTU mode.

About communication channel, in case of selecting P2P driver as XGT or Modbus, user frame definition cannot be used.

3) Block information

If you select P2P block of each parameter at P2P parameter setting window, P2P block setting window shows. Setting value of P2P block will be displayed differently as user sets the P2P Driver of channel.

P2P Channel			P2P Block Setting												
Chann	Operation Mode	P2P Driver	NewPLC - P2P 01												
1	Use P2P	XGT client	Index	Ch	Driver Setting	P2P function	Conditional flag	Command type	Data type	No. of variables	Data size	Destination station	Destination station number	Frame	Setting
			0	1	XGT client							<input checked="" type="checkbox"/>	0		Setting
Chann	Operation Mode	P2P Driver	NewPLC - P2P 01												
1	Use P2P		Index	Ch	Driver Setting	P2P function	Conditional flag	Command type	Data type	No. of variables	Data size	Destination station	Destination station number	Frame	Setting
2	Use P2P	LS Bus Client	0	2	LS BUS Client			2. Continuous	wGRD	1		<input checked="" type="checkbox"/>	0		Setting
Channel	Operating Mode	P2P Driver	NewPLC - P2P 01												
1	Use P2P	Modbus ASCII client	Index	Ch	Driver Setting	P2P function	Conditional flag	Command type	Data type	No. of variables	Data size	Destination station	Destination station number	Frame	Setting
			0	1	Modbus ASCII client					1		<input checked="" type="checkbox"/>	0		Setting
Channel	Operating Mode	P2P Driver	NewPLC - P2P 01												
2	Use P2P	Modbus RTU client	Index	Ch	Driver Setting	P2P function	Conditional flag	Command type	Data type	No. of variables	Data size	Destination station	Destination station number	Frame	Setting
			0	2	Modbus RTU client					1		<input checked="" type="checkbox"/>	0		Setting
Channel	Operating Mode	P2P Driver	NewPLC - P2P 01												
2	Use P2P	User frame definition	Index	Ch	Driver Setting	P2P function	Conditional flag	Command type	Data type	No. of variables	Data size	Destination station	Destination station number	Frame	Setting
			0	2	User frame definition										Setting

[P2P block setting screen]

You can set up to 32 independent blocks. If you select temporary block, you can designate each block operation by selecting instruction.

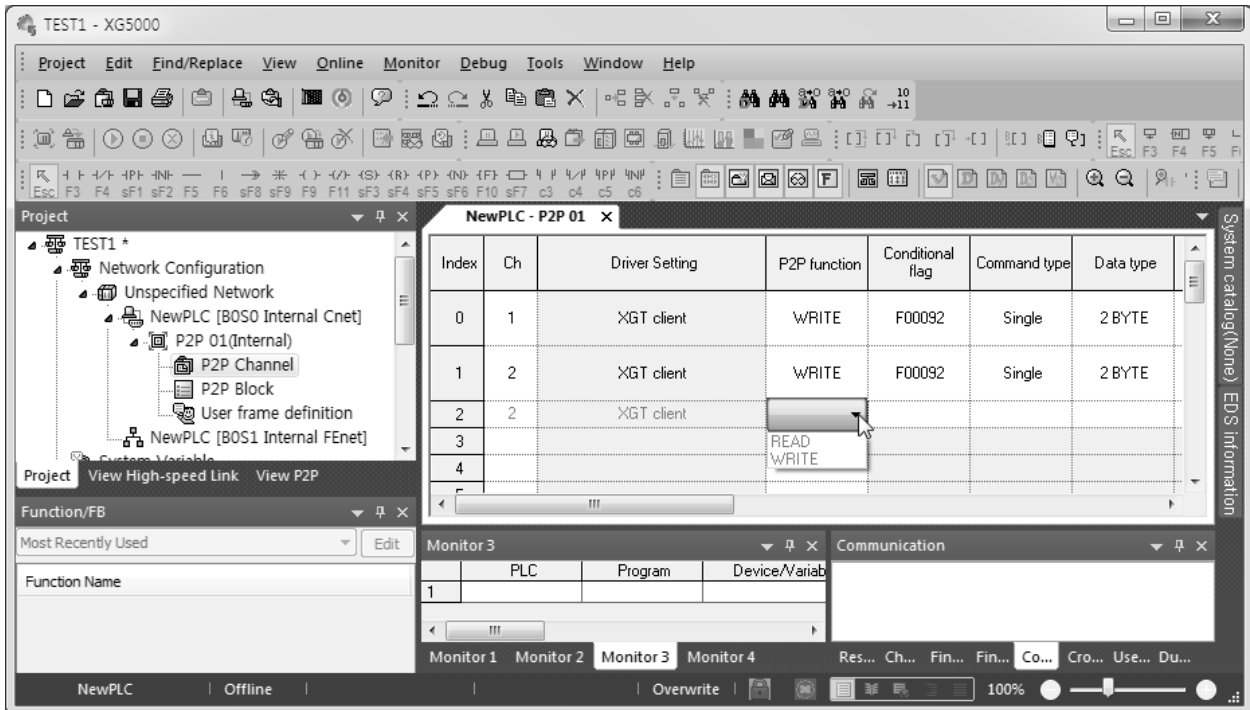

[P2P instruction screen]

2.6.3 XGT Client Service

When using the XGT protocol, XGT client requests writing/reading the data. XGT server analyzes the received data. In case of normal frame, XGT server deals with the received data with ACK response and in case of abnormal frame, XGT transmits the NAK response including error code to XGT client.

1) Channel setting

Cnet I/F module is available to define driver type for P2P service about each channel. However, active mode in the standard settings should be set as "Use P2P settings". P2P setting according to active mode is as follows.

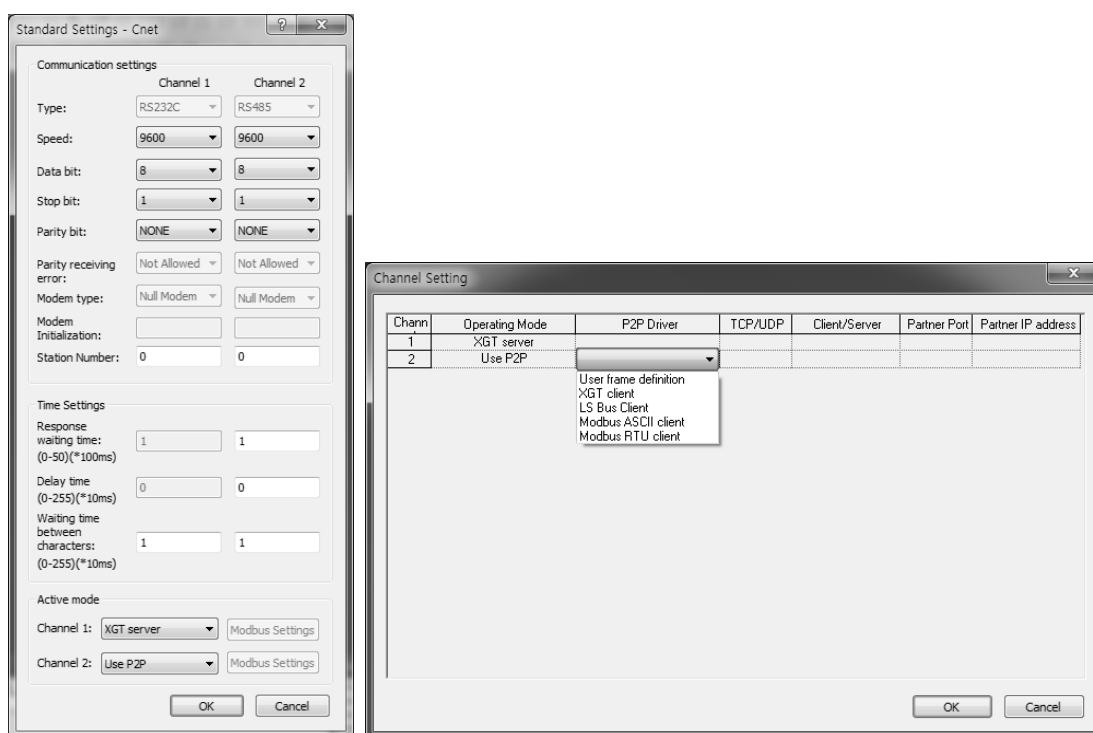





2) P2P block setting

If selecting P2P block in the P2P parameter setting window, P2P block setting window shows.

Block setting window is same according to protocol and activated area is different P2P. Each of items means as follow.

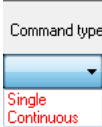
Index	Ch	Driver Setting	P2P function	Conditional flag	Command type	Data type	No. of variables	Data size	Destination station	Destination station number	Frame	Setting
0	2	XGT client							<input checked="" type="checkbox"/>	0		Setting
	①		②	③	④	⑤	⑥	⑦	⑧	⑨		⑩

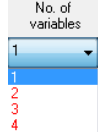
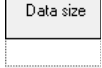
No.	Type	Block form	Contents
1	Channel		Driver name changes according to driver set in the P2P Driver.
2	P2P function		1. Read : when reading the destination station's memory 2. Write: when writing self-station's memory to destination station's memory.
3	Conditional flag		1. Determines when Cnet sends request frame 2. In case of XBC type Ex. : F90(20ms flag), M01 3. In case of XEC type Ex. : _T20MS(20ms flag), %MX01

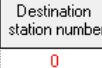
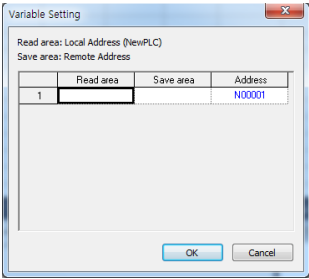
No.	Type	Block form	Contents
4	Command type		<ol style="list-style-type: none"> Single: When reading/writing max. 4 memory areas. (Ex. : M01, M10, M20, M30) Continuous: When reading/writing continuous memory areas. (Ex. : M01~M10)
5	Data type		<ol style="list-style-type: none"> In case that command type is single: bit, 1 byte, 2byte, 4 byte, 8 byte available In case that command type is continuous: 1 byte, 2byte, 4 byte, 8 byte
6	No. of variable		<ol style="list-style-type: none"> This is activated when command type is single and available max. no. is 4. When command type is continuous, it is fixed as 1.
7	Data size		<ol style="list-style-type: none"> This is activated when command type is continuous. When data type is 1 byte, available max. no. is 120 byte
8	Destination station		<ol style="list-style-type: none"> Check: Specify the destination station Uncheck: In case of using P2PSN command, communicate with previously designated (P2PSN)destination station
9	Destination station number		<ol style="list-style-type: none"> Destination station number, setting range is 0~63.
10	Setting		<ol style="list-style-type: none"> When P2P function is Read <ol style="list-style-type: none"> Read area : device area of server Save area : client's device to save the data from server When P2P function is Write <ol style="list-style-type: none"> Read area : device area of client Save area : Server's device area to save client's data

3) Writing parameter

After P2P block setting is completed, download setting parameter to CPU.

Select [Online] – [Connect] – [Write], and click OK in parameter download window, and then it will be downloaded.

After download, the parameter is applied immediately. If you check 'Set up with Link Enable', Link Enable can be applied with writing P2P/HS parameters at the same time.

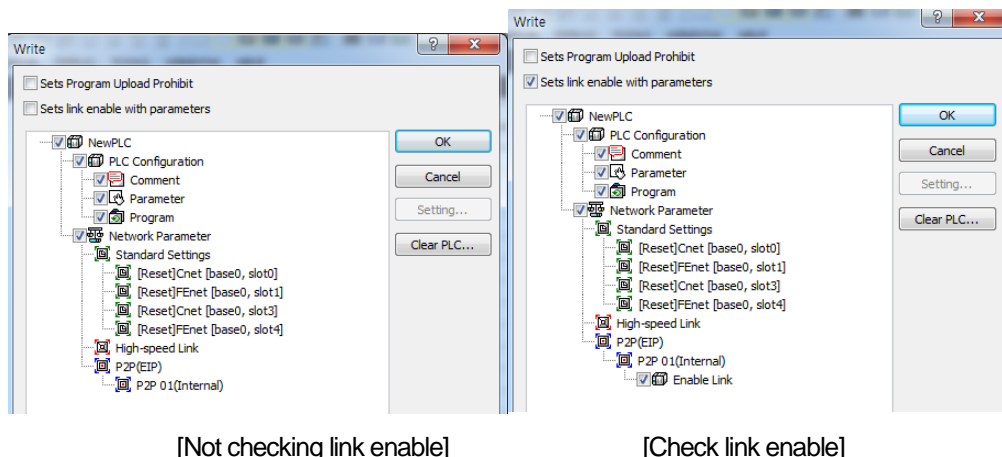

[Not checking link enable]

[Check link enable]

4) Enabling link

After setting P2P parameter and downloading the parameter to PLC CPU, enable P2P service. If parameter is downloaded but P2P(EIP) is not enabled, the P2P block is not operated. In order to enable P2P(EIP), Select [Online] – [Communication module setting] – [Enable Link], and click P2P(EIP) number which you want to operate and then click Write button. The P2P(EIP) is enabled.

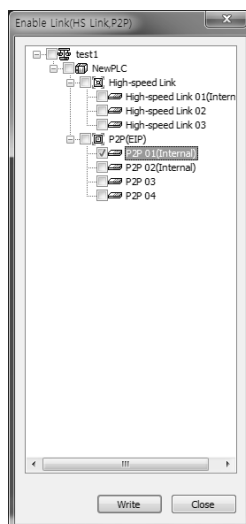

5) Diagnosis service

In order to check the setting parameter operates normally, diagnosis service is available.

Select [Online] – [Communication module setting] – [System Diagnosis]. Click the module and then click mouse right-button. If you select Frame Monitor or Status by Service, it can be checked whether the communication is normal or not. For more detail, refer to chapter 2.9 Diagnosis Function.

2.6.4 Modbus Client Service

Modbus protocol is specified open protocol used between client-server, which executes reading/writing data according to function code. Communication between devices that use Modbus protocol uses Client-server function in which only one client processes the data.

1) Channel setting

Cnet I/F module is available to define driver type for P2P service about each channel. However, active mode in the standard settings should be set as "Use P2P settings".

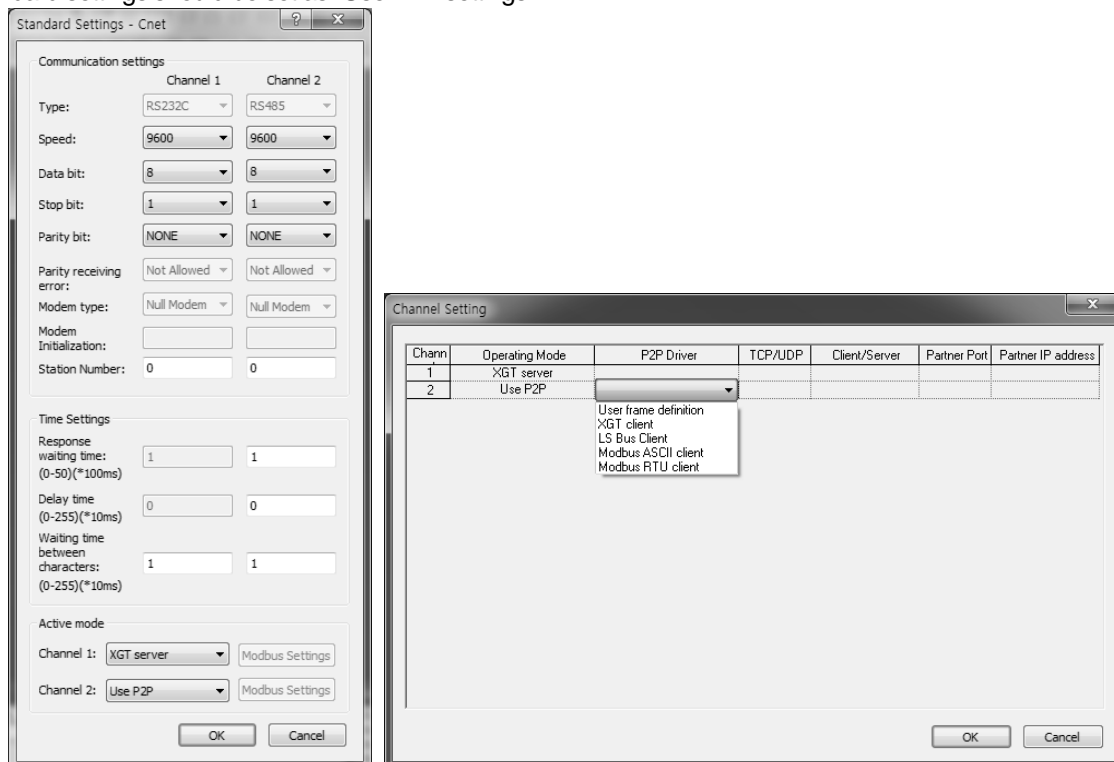





2) P2P block setting

There are two commands; Write (writes memory of self station to destination station's memory area) and Read (reads memory of destination memory and saves it in the memory area of self station)

Setting methods of both RTU and ASCII clients are same.

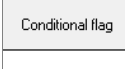
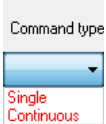
Index	Ch	Driver Setting	P2P function	Conditional flag	Command type	Data type	No. of variables	Data size	Destination station	Destination station number	Frame	Setting
0	2	Modbus RTU client					1		<input checked="" type="checkbox"/>	0		Setting
	①		②	③	④	⑤	⑥	⑦	⑧			⑨

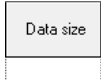
No.	Type	Block type	Meaning
1	Channel		Driver name changes according to driver set in the P2P Driver.
2	P2P function		1. Read : when reading the destination station's memory 2. Write: when writing self-station's memory to destination station's memory.

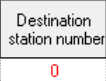
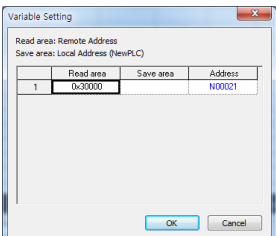
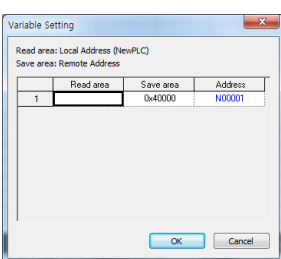
No.	Type	Block type	Meaning
3	Conditional flag		<ol style="list-style-type: none"> 1. Determines when Cent sends frame 2. In case of XBC type Ex. : F90(20ms flag), M01 3. In case of XEC type Ex. : _T20MS(20ms flag), %MX01
4	Command type		<ol style="list-style-type: none"> 1. single: When reading/writing max. 4 memory areas. (Ex. : M01, M10, M20, M30) 2. continuous: When reading/writing continuous memory areas. (Ex. : M01~M10)
5	Data type		Data type can be bit or word.
6	Data size		<p>▷ Determines size of data to communicate and it is activated when command type is continuous.</p> <ol style="list-style-type: none"> 1. when P2P function is Read <ol style="list-style-type: none"> 1) Modbus RTU client <ol style="list-style-type: none"> (1)Bit type : 1~2000 (2)Word type : 1~125 2) Modbus ASCII client <ol style="list-style-type: none"> (1)Bit type : 1~976 (2)Word type : 1~61 2. when P2P function is Write <ol style="list-style-type: none"> 1) Modbus RTU client <ol style="list-style-type: none"> (1)Bit type : 1~1968 (2)Word type : 1~123 2) Modbus ASCII client <ol style="list-style-type: none"> (1)Bit type : 1~944 (2)Word type : 1~125
7	Destination station		<ol style="list-style-type: none"> 1. It is checked automatically. 2. In case that the user doesn't want to use relevant block, remove the check indication. Then that block doesn't work.
8	Destination station number		1. Destination station number, setting range is 0~31.
9	Setting		<p>▶ When P2P function is Read</p> <ol style="list-style-type: none"> 1. Read area: device area of server <ol style="list-style-type: none"> 1) Bit: bit input (0x10000), bit output (0x00000) 2) Word: word input (0x30000), word output (0x40000) 2. Save area: client's device to save the data
			<p>▶ When P2P function is Write</p> <ol style="list-style-type: none"> 1. Read area: device area of self station 2. Save area: server's device area to save the data <ol style="list-style-type: none"> 1) Bit: bit input (0x10000), bit output (0x00000) 2) Word: word input (0x30000), word output (0x40000)

3) Writing parameter

After P2P block setting is completed, download setting parameter to CPU.

Select [Online] – [Connect] – [Write], and click OK in parameter download window, and then it will be downloaded.

After download, the parameter is applied immediately. If you check 'Set up with Link Enable', Link Enable can be applied with writing P2P/HS parameters at the same time.

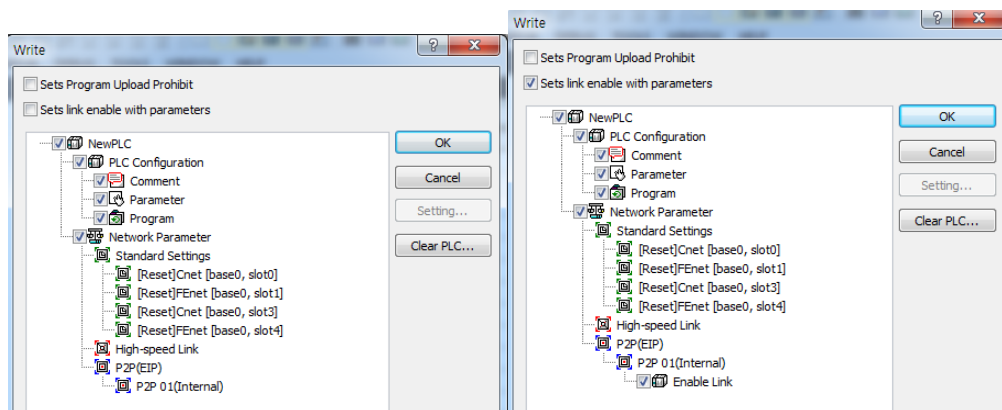

[Not checking link enable]

[Check link enable]

4) Enabling link

After setting P2P parameter and downloading the parameter to PLC CPU, enable P2P service. If parameter is downloaded but P2P(EIP) is not enabled, the P2P block is not operated. In order to enable P2P(EIP), Select [Online] – [Communication module setting] – [Enable Link], and click P2P(EIP) number which you want to operate and then click Write button. The P2P(EIP) is enabled.

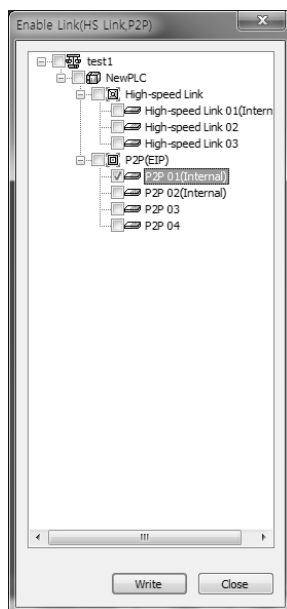

5) Diagnosis service

In order to check the setting parameter operates normally, diagnosis service is available.

Select [Online] – [Communication module setting] – [System Diagnosis]. Click the module and then click mouse right-button. If you select Frame Monitor or Status by Service, it can be checked whether the communication is normal or not. For more detail, refer to chapter 2.9 Diagnosis Function.

2.6.5 User-defined Communication Service

There are many protocols according to producer of communication device and it is impossible to supports diverse protocols. So if the user defines protocols and writes program, Cnet I/F module allows the communication between different devices according to defined protocol. In order to communicate with device which doesn't use specific protocols (XGT protocol, Modbus protocol), the user can directly define protocol used in the device the user want to communicate and communicate. At this time, the user should define TX and RX frame so that it meets partner device's protocol.

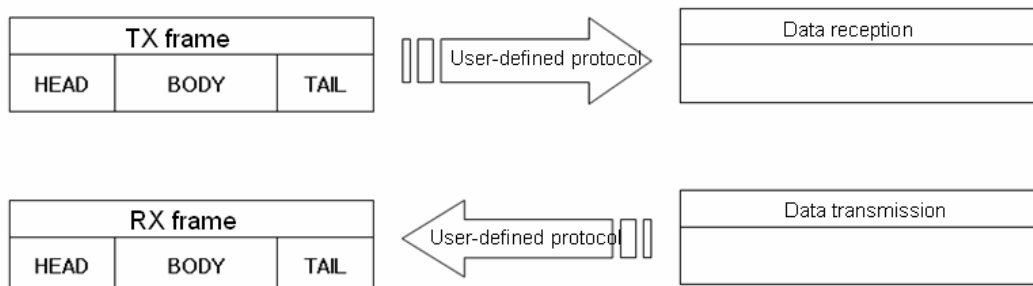

1) Structure of user-defined frame

When writing frame by user definition frame, frame is divided into HEAD, TAIL and BODY generally and each HEAD, TAIL and BODY is divided into segment. Total size of one frame should be less than 1024 byte.

Frame		
HEAD	BODY	TAIL
Segment 1	Segment 1	Segment 1
Segment 2	Segment 2	Segment 2
Segment 3	Segment 3	Segment 3
Segment N	Segment N	Segment N

(1) Structure of HEAD

Input type of segment for HEAD is divided into numerical constant and string constant. In case of numerical constant, it means HEX value and in case of string constant, it means ASCII value.

(2) Structure of TAIL

Input type of segment for HEAD is divided into numerical constant, string constant and BCC which check frame error. Meaning of numerical constant and string constant is same with HEAD's. BCC is segment used for checking TRX frame error, only one can be set in the TAIL.

a) BCC error check

When BCC is applied, calculation about TRX frame is executed and if calculation is different, relevant frame is ignored to improve the reliability of communication. Calculation methods about each BCC are as follows.

Classification	BCC method	Contents description
General method checking error	Byte SUM	Adds designated data as 1 byte unit and uses lower byte value
	Word SUM	Adds designated data as 1 word unit and uses lower word value
	Byte XOR	Executes Exclusive OR calculation about designated data as 1 byte unit and uses lower byte
	7bit SUM	Uses result value of byte sum except the most significant bit
	7bit XOR	Uses result value of byte XOR except the most significant bit
	7bit SUM#1	If result of 7 bit SUM is less than 20 _H , it adds 20 _H .
	Byte SUM 2'S COMP	Takes 2's complement about byte sum result
	Byte SUM 1'S COMP	Takes 1's complement about byte sum result
	CRC 16	16 bit error detection method
	CRC 16 IBM	16 bit IBM CRC error detection method
	CRC 16 CCITT	16 bit CCITT CRC error detection method
MODBUS LRC	MODBUS LRC error detection method	
Method checking error for dedicated communication	LS CRC	Error detection method used for LS PLC
	DLE AB	Error detection method used for DF1 Protocol of Allen Bradley
	DLE SIEMENS	Error detection method used for Siemens 3964R communication

When setting BCC, in case of general method, the user need not set BCC setting range and indication method and in case of dedicated method, the user should set BCC setting range and indication method.

Item	Contents	
Start position	Start area	Determines where BCC calculation starts from among HEAD/BODY/TAIL
	Segment	Determines segment location to start BCC calculation in HEAD/BODY/TAIL. 0 means first segment will be included in the BCC calculation
End position	Before BCC	Included from start position to before BCC
	End of area	Included from start position to end of designated area
	Settings	Included from start position to designated area segment
ASCII conversion	Converts result value, its size will be double	
Initial value 0	Designates BCC initial value as 0. If there is no designation, initial value is FF _H .	

Chapter 2 Built-in Cnet communication

(3) Structure of BODY

Input type of segment which composes BODY is different according to reception and transmission.

In case of transmission, they are divided into string constant, numerical constant and fix sized variable. Meaning of string constant and numerical constant is same with HEAD's.

a) Variable sized variable (in RX frame)

Part where size and contents changes are defined as variable sized variable. Variable sized variable can be set in the BODY and after variable sized variable, the user can't add segment. When using variable sized variable, there should be one among HEAD, TAIL. If the user registers variable sized variable without HEAD, TAIL, when receiving frame, there may be error according to communication status. For reliability of communication, register one among HEAD, TAIL. (In case of Variable sized variable of TX frame, the size is designated in P2P Block setting, so the function and characteristic is same with Fix sized variable of RX frame.)

b) Fix sized variable (in RX frame)

Frame part where size is fixed but contents changes are defined as Fix sized variable. It can be set in the BODY. In case of Fix sized variable, the user can register up to 4.

TRX frame standard for user - defined communication of XGB Cnet I/F module is as follows.

Group	Frame	Segment	Reference
TX frame	HEAD	Numerical constant	Max. 10 byte
		String constant	Max. 10 byte
	TAIL	Numerical constant	Max. 10 byte
		String constant	Max. 10 byte
		BCC	Only one BCC applicable
	BODY	Numerical constant	Max. 10 byte
		String constant	Max. 10 byte
Variable sized variable		Available up to 4	
RX frame	HEAD	Numerical constant	Max. 10 byte
		String constant	Max. 10 byte
	TAIL	Numerical constant	Max. 10 byte
		String constant	Max. 10 byte
		BCC	Only one BCC applicable
	BODY	Numerical constant	Max. 10 byte
		String constant	Max. 10 byte
		Fix sized variable	Available up to 4 Fix sized variable 3, variable sized variable 1 are available
		Variable sized variable	Only one variable sized variable available After variable sized variable, adding segment is impossible

2) Channel setting

Cnet I/F module is available to define driver type for P2P service about each channel. However, active mode in the standard settings should be set as "Use P2P settings".

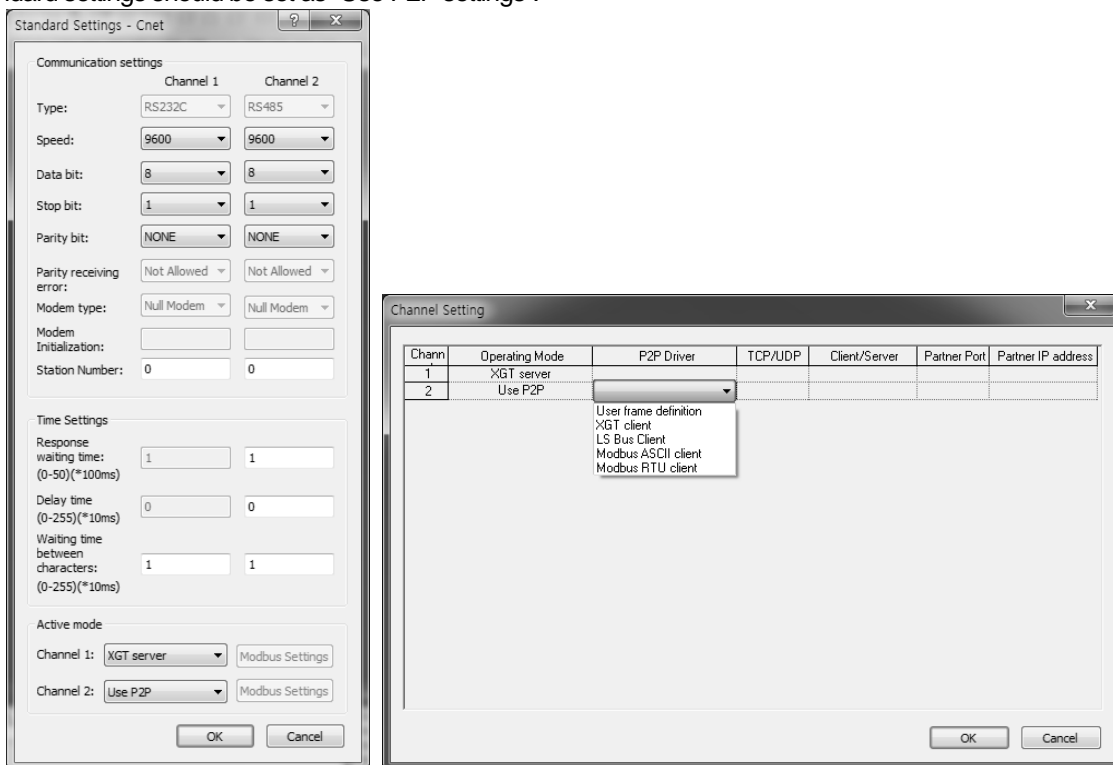

3) Set-up transmission frame

Frame is composed of HEAD indicating start, TAIL indicating end and BODY which is data area. How to write transmission frame is as follows.

Sequence	Setting contents	Setting method
1	Writing user frame definition	
		<ol style="list-style-type: none"> 1. Select User frame definition. 2. Click right button of mouse and click Add Group
2	Creating frame	
		<ol style="list-style-type: none"> 1. Group name is name of frame for user to write. 2. Select Transmission as frame type.

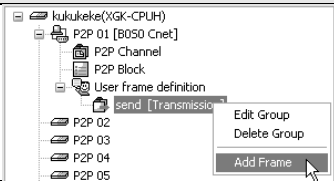
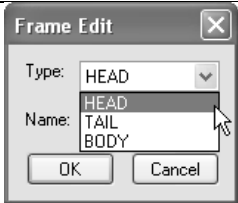
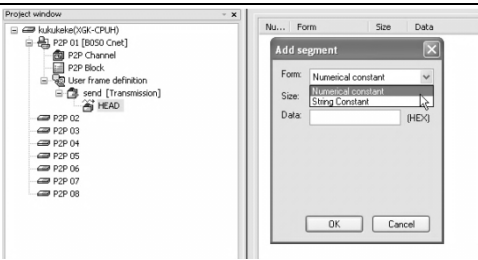
Sequence	Setting contents	Setting method
3	Creating frame	
4	Creating HEAD, TAIL, BODY	
5	HEAD registration	

1. Check creation of frame.
2. Select frame name and click right button of mouse.
3. Click Add Frame to create HEAD, TAIL and BODY.
4. Group Edit: when changing frame name.
5. Delete Group: when deleting frame.



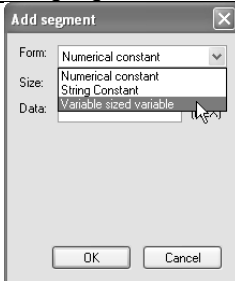

1. After clicking Add Frame, select type of frame.
2. type: HEAD, TAIL, BODY
3. Select HEAD.
4. To create TAIL, BODY, repeat step 3.
5. Name of frame edit window is activated when frame type is BODY.
6. Available to creating many BODYs with different name.

1. Double-click HEAD. Then edit window is created.
 2. Double-click edit window or click right button and select Add segment.
 3. Select Form.
 - 1) Numerical constant
 - (1) Defines numerical constant among frame
 - (2) Data value is always Hex (Hexadecimal)
 - 2) String constant
 - (1) Registers string constant among frame
 - (2) Data value is always ASCII
 4. Input value into Data.

Ex.) Form: Numerical constant
Data: 5(ENQ)
- * When clicking the right button on the created segment, edit, deletion, insertion, copy, etc. are available.

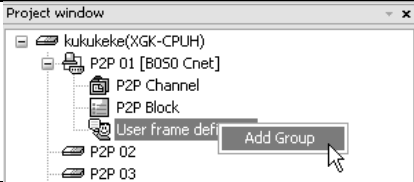
Sequence	Setting contents	Setting method
6	TAIL registration	1. If double-click TAIL, edit window shows. 2. Setting method is same with step 5. 3. Add BCC is activated after inserting segment.
7	BODY registration	
		1. Double-click BODY and select data form. 1) Numerical constant and string constant are same as described above. 2) Variable sized variable (1) used when frame length change (2) available to insert up to 4 for one body (3) 'Assign memory' is checked automatically (4) Control by byte unit 3) Conversion ▶ Hex To ASCII: converts the data red from PLC into ASCII and configures transmission frame ▶ ASCII To Hex: converts the data red from PLC into Hex and configures transmission frame 4) Swap ▶ 2 Byte swap: 2 byte swap of data (ex.: 0x1234->0x3412) ▶ 4 Byte swap: 4 byte swap of data (ex.: 0x12345678->0x78564321) ▶ 8 Byte swap: 8 byte swap of data

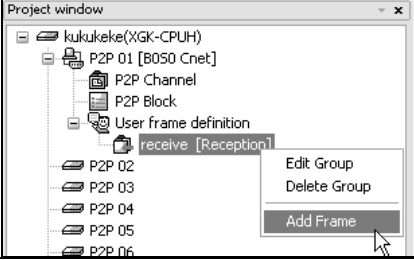
4) Set-up reception frame

Sequence	Setting method	Setting method
1	Writing user-defined frame	
	<p>1. Select User frame definition. 2. Click the right button of mouse and select Add Group.</p>	
2	Creating frame	
	<p>1. Group name is name of frame for user to write. 2. Select Reception as frame type.</p>	
3	Creating frame	
	<p>1. Check creation of frame. 2. Select frame name and click right button of mouse. 3. Click Add Frame to create HEAD, TAIL and BODY. 4. Group Edit: when changing frame name. 5. Delete Group: when deleting frame.</p>	
4	Creating HEAD, TAIL, BODY	
	<p>1. After clicking Add Frame, select type of frame. 2. type: HEAD, TAIL, BODY 3. Select HEAD. 4. To create TAIL, BODY, repeat step 3. 5. Name of frame edit window is activated when frame type is BODY. 6. Available to creating many BODYs with different name.</p>	

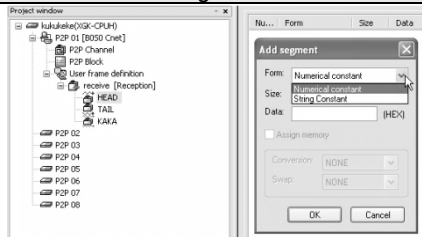
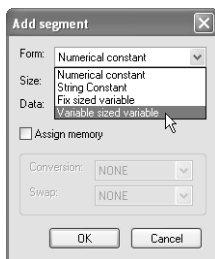

Sequence	Setting method	Setting method
5	HEAD registration	
		<ol style="list-style-type: none"> 1. Double-click HEAD. Then edit window is created. 2. Double-click edit window or click right button and select Add segment. 3. Select Form. <ol style="list-style-type: none"> 1) Meaning of each form is same as described in the transmission. 4. Input value into Data.
6	TAIL registration	<ol style="list-style-type: none"> 1. If double-click TAIL, edit window shows. 2. Setting method is same with step 5. 3. Add BCC is activated after inserting segment.
7	BODY registration	
		<ol style="list-style-type: none"> 1. Double-click BODY and select data form. <ol style="list-style-type: none"> 1) Numerical constant and string constant are same as described above. 2) Variable sized variable <ol style="list-style-type: none"> (1) used when frame length changes (2) Available to insert only one variable sized variable and it is impossible to add segment after variable sized variable (3) When checking [Assign memory], it is available to save in the PLC memory (4) Control by byte unit 3) Fix sized variable <ol style="list-style-type: none"> (1) Used when frame size is fixed. (2) available to insert up to 4 for one body (3) When checking [Assign memory], it is available to save in the PLC memory 4) Assign memory: when setting the device area of PLC to save data. 5) Conversion <ol style="list-style-type: none"> ▶ Hex To ASCII: converts the data received into ASCII and configures reception frame ▶ ASCII To Hex: converts the data received into Hex and configures reception frame 6) Swap <ol style="list-style-type: none"> ▶ 2 Byte swap: 2 byte swap of data (ex.: 0x1234->0x3412) ▶ 4 Byte swap: 4 byte swap of data (ex.: 0x12345678->0x78564321) ▶ 8 Byte swap: 8 byte swap of data

Chapter 2 Built-in Cnet communication

5) Setting parameter

To send and receive the user definition frame of XG5000, the user should set the parameter by P2P block. How to set the P2P block is as follows.

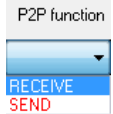
Index	Ch	Driver Setting	P2P function	Conditional flag	Command type	Data type	No. of variables	Data size	Destination station	Destination station number	Frame	Setting
0	2	User frame definition										Setting
	①		②	③							④	⑤

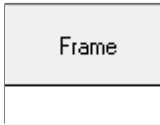
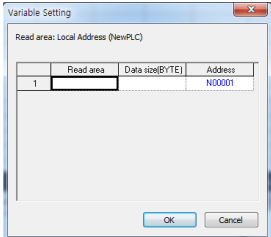
No.	Type	Block type	Meaning
1	Channel		Driver name changes according to driver set in the P2P Driver.
2	P2P Function		<ol style="list-style-type: none"> 1. Receive: used when receiving the frame written according to partner's protocol 2. Send: used when sending the frame written according to partner's protocol
3	Conditional flag		<ol style="list-style-type: none"> 1. Determines when Cent sends frame 2. It is activated when P2P function is [Send]. 3. In case of XBC type Ex.: F90(20ms flag), M01 4. In case of XEC type Ex.: _T20MS(20ms flag), %MX01
4	Frame		1. In case of selecting [SEND] in the P2P function, select body of transmission frame written in the user definition frame.
			1. In case of selecting [RECEIVE] in the P2P function, select body of reception frame written in the user definition frame.
5	Setting		<ol style="list-style-type: none"> 1. Setting is available when [Assign memory] of Fix sized variable and variable sized variable is checked. 2. Save area: start address to save the data received from destination station.

6) Writing parameter

After P2P block setting is completed, download setting parameter to CPU.

Select [Online] – [Connect] – [Write], and click OK in parameter download window, and then it will be downloaded.

After download, the parameter is applied immediately. If you check 'Set up with Link Enable', Link Enable can be applied with writing P2P/HS parameters at the same time.

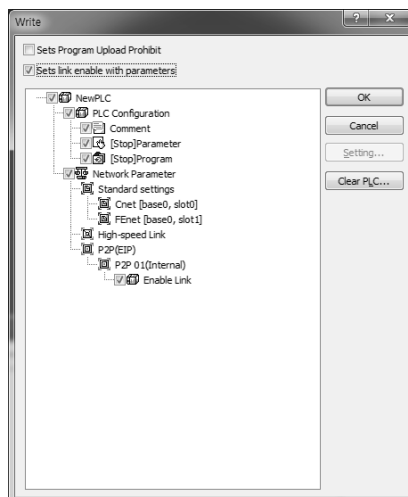

7) Enabling link

After setting P2P parameter and downloading the parameter to PLC CPU, enable P2P service. If parameter is downloaded but P2P(EIP) is not enabled, the P2P block is not operated.

In order to enable P2P(EIP), Select [Online] – [Communication module setting] – [Enable Link], and click P2P(EIP) number which you want to operate and then click Write button. The P2P(EIP) is enabled.

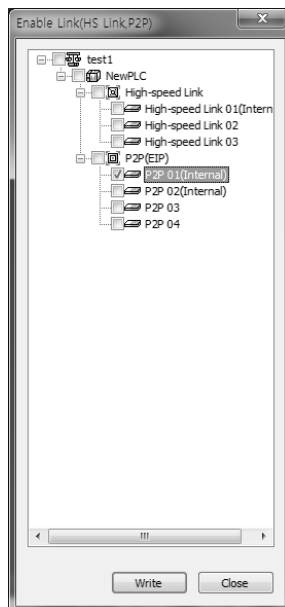

8) Diagnosis service

In order to check the setting parameter operates normally, diagnosis service is available.

Select [Online] – [Communication module setting] – [System Diagnosis]. Click the module and then click mouse right-button. If you select Frame Monitor or Status by Service, it can be checked whether the communication is normal or not. For more detail, refer to chapter 2.9 Diagnosis Function.

2.6.6 LS Bus Client

LS Bus Protocol communication is function executing communication between XGB Cnet and LS Inverter. User can configure LS Bus communication system between our products without special setting by using reading/writing data of internal device area and monitoring function

1) Channel setting

Cnet I/F module is available to define driver type for P2P service about each channel. However, active mode in the standard settings should be set as "Use P2P settings". P2P setting according to active mode is as follows.

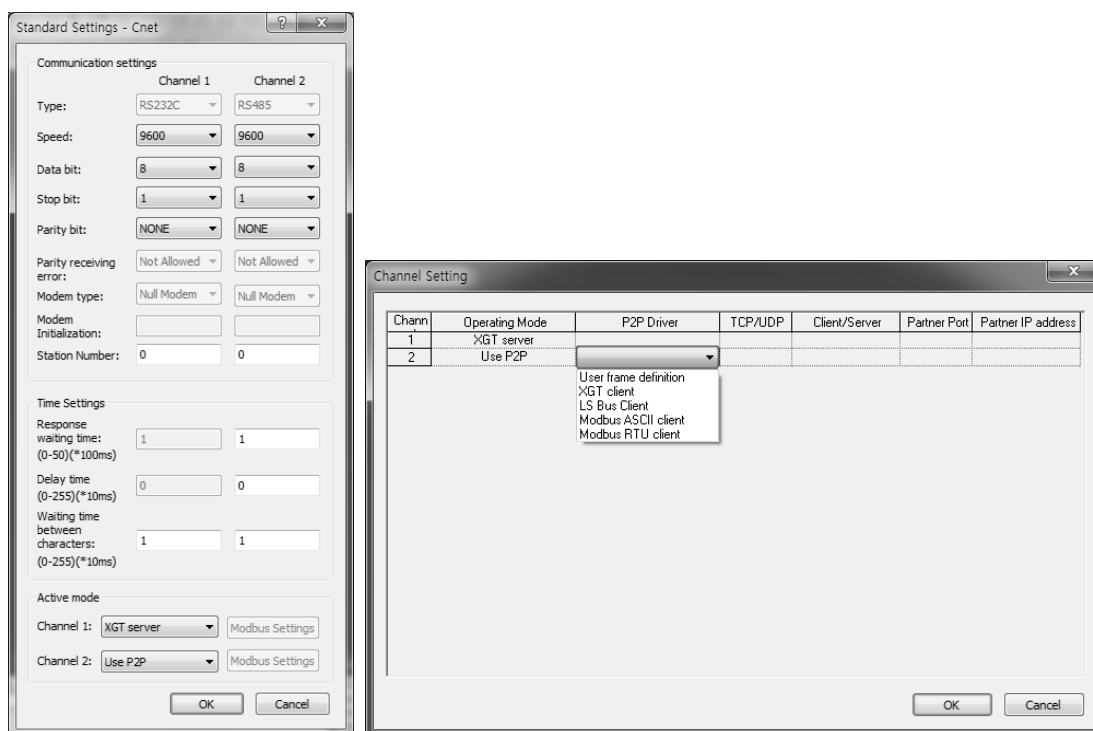

2) P2P block setting



If selecting P2P block in the P2P parameter setting window, P2P block setting window shows.

Block setting window is same according to protocol and activated area is different P2P. Each of items means as follow.

Index	Ch	Driver Setting	P2P function	Conditional flag	Command type	Data type	No. of variables	Data size	Destination station	Destination station number	Frame	Setting
0	2	LS Bus Client			Continuous	wDRD	1		<input checked="" type="checkbox"/>	0		Setting
	①		②	③				④	⑤	⑥		⑦

No.	Type	Block form	Contents
1	Channel		Driver name changes according to driver set in the P2P Driver.
2	P2P function		1. Read : when reading the destination station's memory 2. Write: when writing self-station's memory to destination station's memory.
3	Conditional flag		1. Determines when Cnet sends request frame 2. In case of XBC type Ex. : F90(20ms flag), M01 3. In case of XEC type Ex. : _T20MS(20ms flag), %MX01

Chapter 2 Built-in Cnet communication

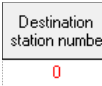
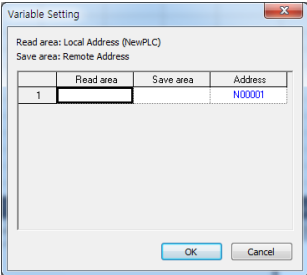
No.	Type	Block form	Contents
4	Data size		<ol style="list-style-type: none"> 1. This is activated when command type is continuous. 2. When data type is 1 word, available max. no. is 8 word
5	Destination station		<ol style="list-style-type: none"> 1. Check: Specify the destination station
6	Destination station number		<ol style="list-style-type: none"> 1. Destination station number, setting range is 0~63.
7	Setting		<ol style="list-style-type: none"> 1. When P2P function is Read <ol style="list-style-type: none"> 1)Read area : device area of server 2)Save area : client's device to save the data from server 2. When P2P function is Write <ol style="list-style-type: none"> 1)Read area : device area of client 2)Save area : Server's device area to save client's data

3) Writing parameter

After P2P block setting is completed, download setting parameter to CPU.

Select [Online] – [Connect] – [Write], and click OK in parameter download window, and then it will be downloaded.

After download, the parameter is applied immediately. If you check 'Set up with Link Enable', Link Enable can be applied with writing P2P/HS parameters at the same time.

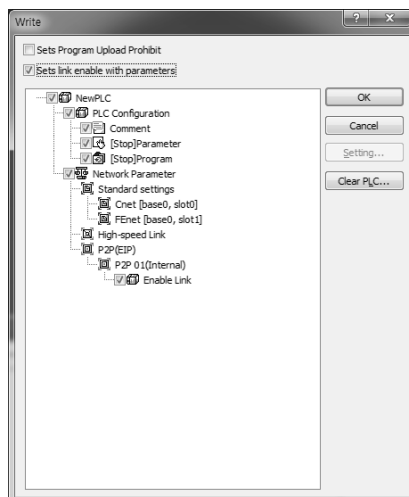

4) Enabling link

After setting P2P parameter and downloading the parameter to PLC CPU, enable P2P service. If parameter is downloaded but P2P(EIP) is not enabled, the P2P block is not operated. In order to enable P2P(EIP), Select [Online] – [Communication module setting] – [Enable Link], and click P2P(EIP) number which you want to operate and then click Write button. The P2P(EIP) is enabled.

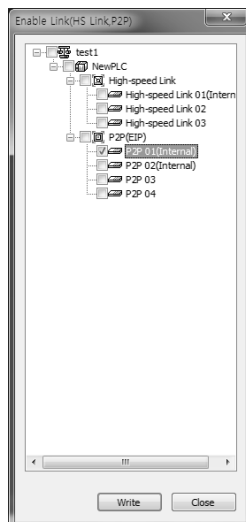

5) Diagnosis service

In order to check the setting parameter operates normally, diagnosis service is available.

Select [Online] – [Communication module setting] – [System Diagnosis]. Click the module and then click mouse right-button. If you select Frame Monitor or Status by Service, it can be checked whether the communication is normal or not. For more detail, refer to chapter 2.9 Diagnosis Function.

2.7 XGT Dedicated Protocol

XGT series dedicated protocol communication is function executing communication by our dedicated protocol. User can configure the intended communication system between our products without special setting by using reading/writing data of internal device area and monitoring function.

Dedicated protocol function supported by XGB is as follows.

- Device individual/continuous read
- Device individual/continuous write
- Monitor variable registration
- Monitor execution
- 1:1 connection (Our link) system configuration

Note

- XGB's built-in communication function supports Cnet communication without any separate Cnet I/F module. It must be used under the following instructions.
- Channel 1 of XGB's main unit supports 1:1 communication only. For 1:N system having master-slave Format, use RS-485 communication in channel 2 or XGB's main unit with XGL-C41A module connected. XGL-C41A module supports RS-422/485 protocol.
- RS-232C communication cable for XGB's main unit is different from RS-232C cable for XG5000 (XG-PD) in pin arrangement and from the cable for Cnet I/F module, too. The cable can't be used without any treatment. For the detailed wiring method, refer to configuration of respective communication.
- It's possible to set baud rate type and station No. in XG5000 (XG-PD).

2.7.1 XGT Dedicated Protocol

1) Frame structure

(1) Basic format

a) Request frame (external communication device → XGB)

Header (ENQ)	Station number	Command	Command type	Structurized data area	Tail (EOT)	Frame check (BCC)
-----------------	-------------------	---------	-----------------	------------------------	---------------	----------------------

b) ACK response frame (XGB → external communication device, when receiving data normally)

Header (ACK)	Station number	Command	Command type	Structurized data area or Null code	Tail (ETX)	Frame check (BCC)
-----------------	-------------------	---------	-----------------	--	---------------	----------------------

c) NAK response frame (XGB → Cnet I/F module → external communication device when receiving data abnormally)

Header (NAK)	Station number	Command	Command type	Error code (ASCII 4 Byte)	Tail (ETX)	Frame check (BCC)
-----------------	-------------------	---------	-----------------	-----------------------------	---------------	----------------------

Note

- 1) The numerical data of all frames are ASCII codes equal to hexadecimal value, if there's no clear statement. The terms in hexadecimal are as follows.
 - Station No.
 - When the main command is R(r) or W (w) and the command type is numerical (means a data type)
 - All of the terms indicating size of all data in the Formatted data area.
 - Monitoring registration and command registration number of execution commands.
 - All contents of data
- 2) If it is hexadecimal, H is attached in front of the number of frames like H01, H12345, H34, H12, and H89AB.
- 3) Available frame length is maximum 256 bytes.
- 4) Used control codes are as follows.

Codes	Hex value	Name	Contents
ENQ	H05	Enquire	Request frame initial code
ACK	H06	Acknowledge	ACK response frame initial code
NAK	H15	Not Acknowledge	NAK response frame initial code
EOT	H04	End of Text	Request frame ending ASCII code
ETX	H03	End Text	Response frame ending ASCII code

- 5) If the command is small letter (r), BCC value is added in check frame. The other side capital letter (R), BCC value is not added in check frame.

(2) Command frame sequence

a) Sequence of command request frame

ENQ	Station No.	Command	Formatted data	EOT	BCC
-----	-------------	---------	----------------	-----	-----

ACK	Station No.	Command	Formatted data	ETX	BCC
-----	-------------	---------	----------------	-----	-----

(PLC ACK response)

NAK	Station No.	Command	Formatted data	ETX	BCC
-----	-------------	---------	----------------	-----	-----

(PLC NAK response)

b) List of commands

List of commands used in dedication communication is as shown below.

Items	Classification	Command				Treatment
		Main command		Command type		
		Code	ASCII code	Code	ASCII code	
Reading device	Individual	r(R)	H72 (H52)	SS	5353	Reads direct variable of Bit, Byte, Word, Dword, Lword type.
	Continuous	r(R)	H72 (H52)	SB	5342	Read direct variable of Byte, Word, Dword, Lword with block unit (Bit continuous read is not allowed)
Writing device	Individual	w(W)	H77 (H57)	SS	5353	Write data of Bit, Byte, Word, Dword, Lword at direct variable
	Continuous	w(W)	H77 (H57)	SB	5342	Write data of Byte, Word, Dword, Lword at direct variable with block unit (Bit continuous read is not allowed)

Item	Classification	Command			Treatment
		Main command		Register No	
		Code	ASCII code		
Monitoring variable register		x(X)	H78 (H58)	H00~H0F	Register device to monitor.
Execution of monitoring		y(Y)	H79 (H59)	H00~H0F	Execute registered device to monitor.

Note

- It identifies capitals or small letters for main commands, but not for the others.

Chapter 2 Built-in Cnet communication

(3) Data type

It's possible to read and write device in built-in communication. When device is used, be aware of data type.

a) Available types of device (XBC type)

Device	Range	Size (Word)	Remark
I	%IW0.0.0 ~ %IW15.15.3	1024	Read/Write/Monitor available
Q	%QW0.0.0 ~ %QW15.15.3	1024	Read/Write/Monitor available
M	%MW0 ~ %MW16383	16384	Read/Write/Monitor available
W	%WW0 ~ %WW32767	32768	Read/Write/Monitor available
R	%RW0 ~ %RW16383	16384	Read/Write/Monitor available

Note

- In case of U device, it will be available only for operation as server.
- Timer/Counter used in bit command means contact point values.
(word command means current values.)
- Data register (D) can use only word or byte commands.
- In byte type commands, address is doubled. For example, D1234 is addressed to '%DW1234' in word type, and is addressed to '%DB2468' in byte type.

(4) Error codes

Error code is displayed as hex 2 byte (4 byte as ASCII code). The user can see error by frame monitor and in case of viewing by ASCII, the user can see the following error code.

Error code	Error type	Error details and causes	Example
0003	Number of blocks exceeded	Number of blocks exceeds 16 at Individual Read/Write Request	01rSS1105%MW10...
0004	Variable length error	Variable Length exceeds the max. size of 16	01rSS010D%MW1000000000 ..
0007	Data type error	Other data type than X,B,W,D,L received	01rSS0105%MK10
0011	Data error	Data length area information incorrect	01rSB05%MW10%4
		In case % is unavailable to start with	01rSS0105\$MW10
		Variable's area value wrong	01rSS0105%MW^&
		Other value is written for Bit Write than 00 or 01	01wSS0105%MX1011
0090	Monitor execution error	Unregistered monitor execution requested	
0190	Monitor execution error	Reg. No. range exceeded	
0290	Monitor reg. Error	Reg. No. range exceeded	
1132	Device memory error	Other letter than applicable device is input	
1232	Data size error	Request exceeds the max range of 60 Words to read or write at a time.	01wSB05%MW1040AA5512,..
1234	Extra frame error	Unnecessary details exist as added.	01rSS0105%MW10000
1332	Data type discordant	All the blocks shall be requested of the identical data type in the case of Individual Read/Write	01rSS0205%MW1005%MB10
1432	Data value error	Data value unavailable to convert to Hex	01wSS0105%MW10AA%5
7132	Variable request	Request exceeds the area each device	01rSS0108%MWFFFFFF

	area exceeded	supports.	
--	---------------	-----------	--

2.7.2 Detail of instruction

1) Individual reading of device (R(r)SS)

This is a function that reads PLC device specified in accord with memory data type. Separate device memory can be read up to 16 at a time.

(1)PC request format

Format name	Header	Station No.	Command	Command type	Number of blocks	Device length	Device name	Tail	Frame check
Ex. of frame	ENQ	H20	R(r)	SS	H01	H06	%MW100		EOT	BCC
ASCII value	H05	H3230	H52(72)	H5353	H3031	H3036	H254D57313030		H04	

1 block (setting can be repeated up to max. 16 blocks)

Item	Description
BCC	When command is lowercase(r), only one lower byte of the value resulted by adding 1 Byte each to ASCII values from ENQ to EOT is converted into ASCII and added to BCC. For example, the BCC of the above frame is gotten as below: $H05+H32+H30+H72+H53+H53+H30+H31+H30+H36+H25+H4D+H57+H31+H30+H30+H04 = H03A4$ Therefore BCC value is A4 (ASCII value : H4134).
Number of Blocks	This specifies how much of the blocks composed of "[device length][device name]" are in this request format. This can be set up to 16. Therefore, the value of [Number of blocks] must be set between H01(ASCII value:3031)-H10(ASCII value:3030).
Device length (Length of device name)	This indicates the number of name's characters that means device, which is allowable up to 16 characters. This value is one of ASCII converted from hex type, and the range is from H01(ASCII value:3031) to H10(ASCII value:3130). For example, if the device name is %MW0, it has 4 characters to be H04 as its length. If %MW000 characters to be H06.
Device name	Address to be actually read is entered. This must be ASCII value within 16 characters, and in this name, digits, upper/lower case, '%' is only allowable to be entered.

Note

- BCC values convert ASCII values to ASCII values and lower values to ASCII values.
- In case of making actual frame, 'H' is not attached. Because the number data of frame indicates hexadecimal.

(2) XGB response format (ACK response)

Format name	Header	Station No.	Command	Command type	Number of blocks	Number of data	data	Tail	Frame check
Ex. of frame	ACK	H20	R(r)	SS	H01	H02	HA9F3		ETX	BCC
ASCII value	H06	H3230	H52(72)	H5353	H3031	H3032	H41394633		H04	

1 block (max. 16 blocks possible)

Item	Description												
BCC	When command is lowercase(r), only one lower byte of the value resulted by adding 1 Byte each to ASCII values from ACK to ETX is converted into ASCII and added to BCC, and sent.												
Number of data	<p>Number of data means byte number of hex type, and is converted into ASCII. This number is determined according to data type (X,B,W) included in device name of computer request Format.</p> <ul style="list-style-type: none"> Number of data in accordance with its data type is as follows: <table border="1" style="margin-left: 40px;"> <thead> <tr> <th>Data type</th> <th>Available variable</th> <th>Number of data</th> </tr> </thead> <tbody> <tr> <td>Bit(X)</td> <td>%(P,M,L,K,F,T,C,D,R,I,Q,W)X</td> <td>1</td> </tr> <tr> <td>Byte(B)</td> <td>%(P,M,L,K,F,T,C,D,R,I,Q,W)B</td> <td>1</td> </tr> <tr> <td>Word(W)</td> <td>%(P,M,L,K,F,T,C,D,R,I,Q,W)W</td> <td>2</td> </tr> </tbody> </table> <p>※R area is supported at XBC-DXXXU</p>	Data type	Available variable	Number of data	Bit(X)	%(P,M,L,K,F,T,C,D,R,I,Q,W)X	1	Byte(B)	%(P,M,L,K,F,T,C,D,R,I,Q,W)B	1	Word(W)	%(P,M,L,K,F,T,C,D,R,I,Q,W)W	2
Data type	Available variable	Number of data											
Bit(X)	%(P,M,L,K,F,T,C,D,R,I,Q,W)X	1											
Byte(B)	%(P,M,L,K,F,T,C,D,R,I,Q,W)B	1											
Word(W)	%(P,M,L,K,F,T,C,D,R,I,Q,W)W	2											
Data	<ul style="list-style-type: none"> In data area, there are the values of hex data converted to ASCII code saved. 												

▪Example 1

The fact that number of data is H04 (ASCII code value:H3034) means that there is hex data of 4 bytes in data. Hex data of 4 bytes is converted into ASCII code in data.

▪Example 2

If number of data is H04 and the data is H12345678, ASCII code converted value of this is "31 32 33 34 35 36 37 38," and this contents is entered in data area. Name directly, highest value is entered first, lowest value last.

Chapter 2 Built-in Cnet communication

(3) XGB response format (NCK response)

Format name	Header	Station No.	Command	Command type	Error code (Hex 2 Byte)	Tail	Frame check
Ex. of frame	NAK	H20	R(r)	SS	H1132	ETX	BCC
ASCII value	H15	H3230	H52(72)	H5353	H31313332	H03	

Item	Explanation
BCC	When command is lowercase(r), only one lower byte of the value resulted by adding 1 Byte each to ASCII values from NAK to ETX is converted into ASCII and added to BCC.
Error code	Hex and 2 bytes (ASCII code, 4 bytes) indicate error type. For the details, Refer to 2.7.1 XGT dedicated communication error codes and countermeasures.

(4) Example

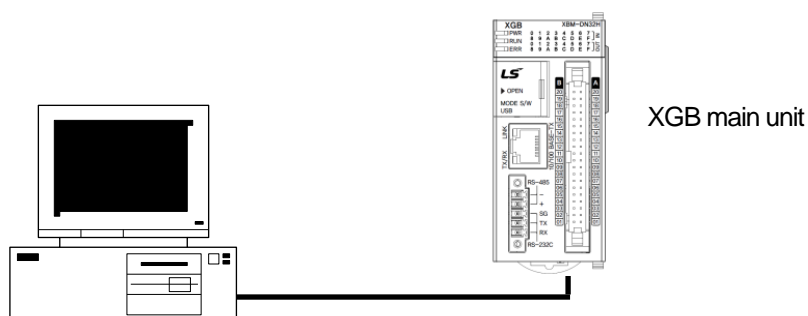

This example supposes when 1 WORD from M20 and 1 WORD from P001 address of station No.1 are read (At this time, it is supposed that H1234 is entered in M20, and data of H5678 is entered in P001.)

a) PC request format (PC → XGB)

Format name	Header	Station No.	Command	Command type	Number of blocks	Variable length	Variable name	Device length	Variable name	Tail	Frame check
Ex. of frame	ENQ	H01	R(r)	SS	H02	H06	%MW020	H06	%PW001	EOT	BCC
ASCII value	H05	H3031	H52(72)	H5353	H3032	H3036	H254D57303230	H3036	H25505730303031	H04	

b) For ACK response after execution of command (PC ← XGB)

Format name	Header	Station No.	Command	Command type	Number of blocks	Number of data	Data	Number of data	Data	Tail	Frame check
Ex. of frame	ACK	H01	R(r)	SS	H02	H02	H1234	H02	H5678	ETX	BCC
ASCII value	H06	H303 1	H52(72)	H5353	H3032	H3032	H31323334	H3032	H35363738	H03	

c) For NAK response after execution of command (PC ← XGB)

Format name	Header	Station No.	Command	Command type	Error code	Tail	Frame check
Ex. of frame	NAK	H01	R(r)	SS	Error code (2 Byte)	ETX	BCC
ASCII value	H15	H3031	H52(72)	H5353	Error code (4 Byte)	H03	

2) Direct variable continuous reading (R(r)SB)

This is a function that reads the PLC device memory directly specified in accord with memory data type. With this, data is read from specified address as much as specified continuously.

(1) PC request format

Format name	Header	Station No.	Command	Command type	Device length	Device	Number of data	Tail	Frame check
Ex. of frame	ENQ	H10	R(r)	SB	H06	%MW100	H05	EOT	BCC
ASCII value	H05	H3130	H52(72)	H5342	H3036	H254D5731 3030	H3035	H04	

Item	Description
BCC	When command is lowercase(r), only one lower byte of the value resulted by adding 1 Byte each to ASCII values from ENQ to EOT is converted into ASCII and added to BCC.
Device length (Length of device name)	This indicates the number of name's characters that means device, which is allowable up to 16 characters. This value is one of ASCII converted from hex type, and the range is from H01 (ASCII value:3031) to H10 (ASCII value:3130).
Device name	Address to be actually read is entered. This must be ASCII value within 16 characters, and in this name, digits, upper/lowercase, and '%' only are allowable to be entered.

Note

- Number of data specifies the number to read according to the type of data. Namely, if the data type of device is word and number is 5, it means that 5 words should be read.
- In the number of data, you can use up to 60 words (120Byte).
- Protocol of continuous reading of direct variable doesn't have number of blocks.
- Bit device continuous reading is not supported.

(2) XGB response format (ACK response)

Format name	Header	Station No.	Command	Command type	Number of blocks	Number of data	data	Tail	Frame check
Ex. of frame	ACK	H10	R(r)	SB	H01	H02	H1122	ETX	BCC
ASCII value	H06	H3130	H52(72)	H5342	H3031	H3134	H31313232	H03	

Item	Description															
Number of data	It means byte number of hex type, and is converted into ASCII															
	<table border="1"> <thead> <tr> <th>Data type</th> <th>Available device</th> <th>Data size (Byte)</th> </tr> </thead> <tbody> <tr> <td>BYTE(B)</td> <td>%(P,M,L,K,F,T,C,D,R,I,Q,W)B</td> <td>1</td> </tr> <tr> <td>WORD(W)</td> <td>%(P,M,L,K,F,T,C,D,R,I,Q,W)W</td> <td>2</td> </tr> <tr> <td>DWord(D)</td> <td>%(P,M,L,K,F,T,C,D,R,I,Q,W)D</td> <td>4</td> </tr> <tr> <td>LWord(L)</td> <td>%(P,M,L,K,F,T,C,D,I,Q,W)L</td> <td>8</td> </tr> </tbody> </table>	Data type	Available device	Data size (Byte)	BYTE(B)	%(P,M,L,K,F,T,C,D,R,I,Q,W)B	1	WORD(W)	%(P,M,L,K,F,T,C,D,R,I,Q,W)W	2	DWord(D)	%(P,M,L,K,F,T,C,D,R,I,Q,W)D	4	LWord(L)	%(P,M,L,K,F,T,C,D,I,Q,W)L	8
	Data type	Available device	Data size (Byte)													
	BYTE(B)	%(P,M,L,K,F,T,C,D,R,I,Q,W)B	1													
	WORD(W)	%(P,M,L,K,F,T,C,D,R,I,Q,W)W	2													
DWord(D)	%(P,M,L,K,F,T,C,D,R,I,Q,W)D	4														
LWord(L)	%(P,M,L,K,F,T,C,D,I,Q,W)L	8														
※R area is supported at XBC-DXXXU																

▪Example 1

When memory type included in variable name of computer request Format is W (Word), and data number of computer request Format is 03, data number of PLC ACK response after execution of command is indicated by H06 (2*03 = 06 bytes)Byte and ASCII code value 3036 is entered in data area.

▪Example 2

In just above example, when data contents of 3 words are 1234, 5678, and 9ABC in order, actual ASCII code converted values are 31323334 35363738 39414243, and the contents are entered in data area.

(3) XGB response format (NAK response)

Format name	Header	Station No.	Command	Command type	Error code (Hex 2 Byte)	Tail	Frame check
Ex. of frame	NAK	H10	R(r)	SB	H1132	ETX	BCC
ASCII value	H15	H3130	H52(72)	H5342	H31313332	H03	

Item	Description
BCC	When command is lowercase(r), only one lower byte of the value resulted by adding 1 Byte each to ASCII values from NAK to ETX is converted into ASCII and added to BCC, and sent.
Error code	Hex and 2 bytes (ASCII code, 4 bytes) indicate error type. For the details, Refer to 2.7.1 XGT dedicated communication error codes and countermeasures.

Chapter 2 Built-in Cnet communication

(4) Example

This example supposes that 2 WORDs from M000 of station No. 10 is read
(It supposes that M000 = H1234, M001 = H5678.)

a) PC request format (PC → XGB)

Format name	Header	Station No.	Command	Command type	Device length	Device name	Number of data	Tail	Frame check
Frame (Example)	ENQ	H0A	R(r)	SB	H06	%MW000	H02	EOT	BCC
ASCII value	H05	H3041	H52(72)	H5342	H3036	H254D3030 30	H3032	H04	

b) For ACK response after execution of command (PC ← XGB)

Format name	Header	Station No.	Command	Command type	Number of block	Number of data	Data	Tail	Frame check
Frame (Example)	ACK	H0A	R(r)	SB	H01	H04	12345678	ETX	BCC
ASCII value	H06	H3041	H52(72)	H5342	H3031	H3034	H3132333435363738	03	

c) For NAK response after execution of command (PC ← XGB)

Format name	Header	Station No.	Command	Command type	Error code	Tail	BCC
Frame (Example)	NAK	H0A	R(r)	SB	Error code (2 Byte)	ETX	BCC
ASCII value	H15	H3041	H52(72)	H5342	Error code (4 Byte)	H03	

3) Individual writing of device (W(w)SS)

This is a function that writes the PLC device memory directly specified in accord with memory data type.

(1) PC request format

Format name	Header	Station No.	Command	Command type	Number of blocks	Device Length	Device Name	Data	Tail	Frame check
Frame(Example)	ENQ	H20	W(w)	SS	H01	H06	%MW100	H00E2		EOT	BCC
ASCII value	H05	H3230	H57(77)	H5353	H3031	H3036	H254D573130 30	H30304532		H04	

1 block (setting can be repeated up to max. 16 blocks)

Item	Description
BCC	When command is lowercase(r), only one lower byte of the value resulted by adding 1 Byte each to ASCII values from ENQ to EOT is converted into ASCII and added to BCC.
Number of blocks	This specifies how much of the blocks composed of "[device length][device name]" are in this request Format. This can be set up to 16. Therefore, the value of [Number of blocks] must be set between H01(ASCII value:3031)-H10 (ASCII value:3030).
Device Length (Name length of device)	This indicates the number of name's characters that means device, which is allowable up to 16 characters. This value is one of ASCII converted from hex type, and the range is from H01 (ASCII value: 3031) to H10 (ASCII value:3130).
device	Address to be actually read is entered. This must be ASCII value within 16 characters, and in this name, digits, upper/lower case, and '%' only is allowable to be entered.
Data	If the value to be written in %MW100 area is H A, the data Format must be H000A. If the value to be written in %MW100 area is H A, the data Format must be H000A. In data area, the ASCII value converted from hex data is entered.

Example 1

If type of data to be currently written is WORD, the data is H1234, ASCII code converted value of this is "31323334" and this content must be entered in data area. Namely, most significant value must be sent first, least significant value last.

Note

- Device data types of each block must be the same
- If data type is Bit, the data to be written is indicated by bytes of hex. Namely, if Bit value is 0, it must be indicated by H00 (3030), and if 1, by H01 (3031).

Chapter 2 Built-in Cnet communication

(2) XGB Response format (ACK response)

Format name	Header	Station No.	Command	Command type	Tail	Frame check
Frame(Example)	ACK	H20	W(w)	SS	ETX	BCC
ASCII value	H06	H3230	H57(77)	H5353	H03	

Item	Description
BCC	When command is lowercase (r), only one lower byte of the value resulted by adding 1 Byte each to ASCII values from ACK to ETX is converted into ASCII and added to BCC, and sent.

(3) XGB Response format (NAK response)

Format name	Header	Station No.	Command	Command type	Error code (Hex 2 Byte)	Tail	Frame check
Frame(Example)	NAK	H20	W(w)	SS	H4252	ETX	BCC
ASCII value	H15	H3230	H57(77)	H5353	H34323532	H03	

Item	Description
BCC	When command is lowercase(r), only one lower byte of the value resulted by adding 1 Byte each to ASCII values from NAK to ETX is converted into ASCII and added to BCC, and sent.
Error code	Hex and 2 bytes (ASCII code, 4 bytes) indicate error type. For the details, Refer to 2.7.1 XGT dedicated communication error codes and countermeasures.

(4) Example

This example supposes that "HFF" is written in M230 of station No. 1.

1) PC request format (PC → XGB)

Format name	Header	Station No.	Command	Command type	Number of blocks	Device Length	Device Name	Data	Tail	Frame check
Frame(Example)	ENQ	H01	W(w)	SS	H01	H06	%MW230	H00FF	EOT	BCC
ASCII value	H05	H3031	H57(77)	H5353	H3031	H3036	H254D573233 30	H30304646	H04	

2) For ACK response after execution of command (PC ← XGB)

Format name	Header	Station No.	Command	Command type	Tail	Frame check
Frame(Example)	ACK	H01	W(w)	SS	ETX	BCC
ASCII value	H06	H3031	H57(77)	H5353	H03	

3) For NAK response after execution of command (PC ← XGB)

Format name	Header	Station No.	Command	Command type	Error code	Tail	Frame check
Frame(Example)	NAK	H01	W(w)	SS	Error code (2 Byte)	ETX	BCC
ASCII value	H15	H3031	H57(77)	H5353	Error code (4 Byte)	H03	

4) Continuous writing of device (W(w)SB)

This is a function that directly specifies PLC device memory and continuously writes data from specified address as much as specified length.

(1) Request format

Format name	Header	Station No.	Command	Command type	Device Length	Device name	Number of data	Data	Tail	Frame check
Frame (Example)	ENQ	H10	W(w)	SB	H06	%MW100	H02	H11112222	EOT	BCC
ASCII value	H05	H3130	H57(77)	H5342	H3036	H254D57313030	H3032	H3131313132323232	H04	

Item	Description
BCC	When command is lowercase(r), only one lower byte of the value resulted by adding 1 Byte each to ASCII values from ENQ to EOT is converted into ASCII and added to BCC.
Device Length (Name length of variable)	This indicates the number of name's characters that means device, which is allowable up to 16 characters. This value is one of ASCII converted from hex type, and the range is from H01 (ASCII value: 3031) to H10 (ASCII value: 3130).
Device	Address to be actually read. This must be ASCII value within 16 characters, and in this name, digits, upper/lower case, and '%' only are allowable to be entered.

Note
<ul style="list-style-type: none"> • Number of data specifies the number according to the type of device. Namely, if the data type of device is WORD, and number of data is 5, it means that 5 WORDs should be written. • Number of data can be used up to 120Bytes (60 Words).

(2) XGB Response format (ACK response)

Format name	Header	Station No.	Command	Command type	Tail	Frame check
Frame (Example)	ACK	H10	W(w)	SB	ETX	BCC
ASCII value	H06	H3130	H57(77)	H5342	H03	

Item	Description
BCC	When command is lowercase(r), only one lower byte of the value resulted by adding 1 Byte each to ASCII values from ACK to ETX is converted into ASCII and added to BCC, and sent.

Chapter 2 Built-in Cnet communication

(3) XGB Response format (NAK response)

Format name	Header	Station No.	Command	Command type	Error code (Hex 2 Byte)	Tail	Frame check
Frame (Example)	ENQ	H10	W(w)	SB	H1132	EOT	BCC
ASCII value	H05	H3130	H57(77)	H5342	H31313332	H03	

Item	Description
BCC	When command is lowercase(r), only one lower byte of the value resulted by adding 1 Byte each to ASCII values from NAK to ETX is converted into ASCII and added to BCC, and sent.
Error code	Hex and 2 bytes (ASCII code, 4 bytes) indicate error type. For the details, Refer to 2.7.1 XGT dedicated communication error codes and countermeasures.

(4) Example

This example supposes that 2 byte H'AA15 is written in D000 of station No. 1.

(a) PC request format (PC → XGB)

Format name	Header	Station No.	Command	Command type	Device Length	Device	Number of data	Data	Tail	Frame check
Frame (Example)	ENQ	H01	W(w)	SB	H06	%DW000	H01	HAA15	EOT	BCC
ASCII value	H05	H3031	H57(77)	H5342	H3036	H254457303030	H3031	H41413135	H04	

(b) For ACK response after execution of command (PC ← XGB)

Format name	Header	Station No.	Command	Command type	Tail	Frame check
Frame (Example)	ACK	H01	W(w)	SB	ETX	BCC
ASCII value	H06	H3031	H57(77)	H5342	H03	

(c) For NAK response after execution of command (PC ← XGB)

Format name	Header	Station No.	Command	Command type	Error code	Tail	Frame check
Frame (Example)	NAK	01	W(w)	SB	Error code (2)	ETX	BCC
ASCII value	H15	H3031	H57(77)	H5342	Error code (4)	H03	

5) Monitor variable register (X##)

Monitor register can separately register up to 16 (from 0 to 15) in combination with actual variable reading command, and carries out the registered one through monitor command after registration.

(1) PC request format

Format name	Header	Station No.	Command	Registration No.	Registration format	Tail	Frame check
Frame (Example)	ENQ	H10	X(x)	H09	Refer to registration format	EOT	BCC
ASCII value	H05	H3130	H58(78)	H3039	Refer to *1	H04	

Item	Description
BCC	When command is lowercase(x), only one lower byte of the value resulted by adding 1 byte each to ASCII values from ENQ to EOT is converted into ASCII, added to BCC.
Register No.	This can be registered up to 16 (0 to 15, H00-H0F), and if an already registered No. is registered again, the one currently being executed is registered.
Register Format	This is used to before EOT in command of Formats of separate reading of variable, continuous reading, and named variable reading.

*1 : Register Format of request Formats must select and use only one of the followings.

(a) Individual reading of device

RSS	Number of blocks (2 Byte)	Device length (2 Byte)	Device name (16 Byte)	...
	1 block (max. 16 blocks)			

(b) Continuous reading of device

RSB	Device length (2 Byte)	Device name (16 Byte)	Number of data
-----	------------------------	-----------------------	----------------

(2) XGB Response format (ACK response)

Format name	Header	Station No.	Command	Registration no.	Tail	Frame check
Frame (Example)	ACK	H10	X(x)	H09	ETX	BCC
ASCII value	H06	H3130	H58(78)	H3039	H03	

Item	Description
BCC	When command is lowercase(x), only one lower byte of the value resulted by adding 1 Byte each to ASCII values from ACK to ETX is converted into ASCII and added to BCC, and sent.

Chapter 2 Built-in Cnet communication

(3) XGB Response format (NAK response)

Format name	Header	Station No.	Command	Registration No.	Error code (Hex 2Byte)	Tail	Frame check
Frame(Example)	NAK	H10	X(x)	H09	H1132	ETX	BCC
ASCII value	H15	H3130	H58(78)	H3039	H31313332	H03	

Item	Description
BCC	When command is one of lower case(x), only one lower byte of the value resulted by adding 1 Byte each to ASCII values from NAK to ETX is converted into ASCII and added to BCC, and sent.
Error code	Hex and 2 bytes (ASCII code, 4 bytes) indicate error type. For the details, Refer to 2.7.1 XGT dedicated communication error codes and countermeasures.

(4) Example

This example supposes that device M000 of station NO. 1 is monitor registered.

(a) PC request format (PC → XGB)

Format name	Header	Station No.	Command	Registration No.	Registration Format				Tail	Frame check
					R##	Number of blocks	Device length	Device name		
Frame(Example)	ENQ	H01	X(x)	H01	RSS	H01	H06	%MW000	EOT	BCC
ASCII value	H05	H3031	H58(78)	H3031	H5253 53	H3031	H3036	H2554573030 30	H04	

(b) For ACK response after execution of command (PC ← XGB)

Format name	Header	Station No.	Command	Registration No.	Tail	Frame check
Frame(Example)	ACK	H01	X(x)	H01	ETX	BCC
ASCII value	H06	H3031	H58(78)	H3031	H03	

(c) For NAK response after execution of command (PC ← XGB)

Format name	Header	Station No.	Command	Registration No.	Error code	Tail	Frame check
Frame(Example)	NAK	H01	X(x)	H01	Error code (2)	ETX	BCC
ASCII value	H15	H3031	H58(78)	H3031	Error code (4)	H03	

6) Monitor execution (Y##)

This is a function that carries out the reading of the variable registered by monitor register. This also specifies a registered number and carries out reading of the variable registered by the number.

(1) PC request format

Format name	Header	Station No.	Command	Registration No.	Tail	Frame check
Frame (Example)	ENQ	H10	Y(y)	H09	EOT	BCC
ASCII value	H05	H3130	H59(79)	H3039	H03	

Item	Description
Register No.	Register No. uses the same number registered during monitor register for monitor execution. It is possible to set from 00-09 (H00-H09).
BCC	When command is lower case(y), only one lower byte of the value resulted by adding 1 byte each to ASCII values from ENQ to EOT is converted into ASCII, added to BCC.

(2) XGB Response format (ACK response)

1) In case that the register Format of register No. is the Individual reading of device

Format name	Header	Station No.	Command	Registration No.	Number of Blocks	Number of data	Data	Tail	Frame check
Frame (Example)	ACK	H10	Y(y)	H09	H01	H02	H9183	ETX	BCC
ASCII value	H06	H3130	H59(79)	H3039	H3031	H3032	H39313833	H03	

2) In case that the register Format of register No. is the continuous reading of device

Format name	Header	Station No.	Command	Registration No.	Number of data	Data	Tail	Frame check
Frame (Example)	ACK	H10	Y(y)	H09	H04	H9183AABB	ETX	BCC
ASCII value	H06	H3130	H59(79)	H3039	H3034	H393138334141424 2	H03	

(3) XGB Response Format (NAK response)

Format name	Header	Station No.	Command	Registration No.	Error code (Hex 2Byte)	Tail	Frame check
Frame (Example)	NAK	H10	Y(y)	H09	H1132	ETX	BCC
ASCII value	H15	H3130	H59(79)	H3039	H31313332	H03	

Item	Description
BCC	When command is lowercase(y), only one lower byte of the value resulted by adding 1 Byte each to ASCII values from NAK to ETX is converted into ASCII and added to BCC, and sent.
Error code	Hex and 2 bytes (ASCII code, 4 bytes) indicate error type. For the details, Refer to 2.7.1 XGT dedicated communication error codes and countermeasures..

(4) Example

This example supposes that registered device No. 1 of station No. 1 is read, and BCC value is checked. And it is supposed that device M000 is registered and the number of blocks is 1.

(a) PC request format (PC → XGB)

Format name	Header	Station No.	Command	Registration No.	Tail	Frame check
Frame (Example)	ENQ	H01	Y(y)	H01	EOT	BCC
ASCII value	H05	H3031	H59(79)	H3031	H04	

(b) For ACK response after execution of command (PC → XGB)

Format name	Header	Station No.	Command	Registration No.	Number of Blocks	Number of data	Data	Tail	Frame check
Frame (Example)	ACK	H01	Y(y)	H01	H01	H02	H2342	ETX	BCC
ASCII value	H06	H3031	H59(79)	H3031	H3031	H3032	H32333432	H03	

(c) For NAK response after execution of command (PC → XGB)

Format name	Header	Station No.	Command	Registration No.	Error code	Tail	Frame check
Frame (Example)	NAK	H01	Y(y)	H01	Error code(2)	ETX	BCC
ASCII value	H15	H3031	H59(79)	H3031	Error code(4)	H03	

2.8 LS Bus Protocol

LS Bus Protocol communication is function executing communication between XGB Cnet and LS Inverter. User can configure LS Bus communication system between our products without special setting by using reading/writing data of internal device area and monitoring function

2.8.1 LS Bus Protocol

LS Bus Protocol communication is function executing communication between XGB Cnet and LS Inverter. User can configure LS Bus communication system between our products without special setting by using reading/writing data of internal device area and monitoring function.

The function of LS Bus Protocol supported by XGB is as follows.

- ◆ Device continuous reading
- ◆ Device continuous writing

1) Frame structure

(1) Base format

(a) Request frame (External communication → XGB)

Header (ENQ)	Station number	Command	Structurized data area	Frame check (BCC)	Tail (EOT)
--------------	----------------	---------	------------------------	-------------------	------------

(b) ACK response frame (XGB → External communication, when receiving data normally)

Header (ACK)	Station number	Command	Structurized data area	Frame check (BCC)	Tail (EOT)
--------------	----------------	---------	------------------------	-------------------	------------

(c) NAK response frame (XGB → External communication, when receiving data abnormally)

Header (NAK)	Station number	Command	Error code (ASCII 4 Byte)	Frame check (BCC)	Tail (EOT)
--------------	----------------	---------	-----------------------------	-------------------	------------

Note

- 1) The numerical data of all frames are ASCII codes equal to hexadecimal value, if there's no clear statement. The terms in hexadecimal are as follows.
 - Station No.
 - Command type is supported R (read) and W (write).
 - All contents of data
- 2) If it is hexadecimal, H is attached in front of the number of frames like H01, H12345, H34, H12, and H89AB.
- 3) Available frame length is maximum 44 bytes.
- 4) Used control codes are as follows.

Code	Hex value	Name	Contents
ENQ	H05	Enquire	Request frame initial code
ACK	H06	Acknowledge	ACK response frame initial code
NAK	H15	Not Acknowledge	NAK response frame initial code
EOT	H04	End of Text	Request frame ending ASCII code

Chapter 2 Built-in Cnet communication

2) Command frame sequence

(1) Sequence of command request frame

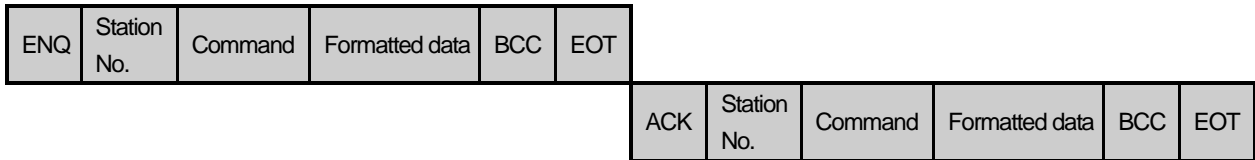

(Inverter ACK response)

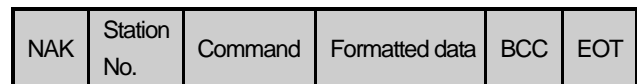

(Inverter NAK response)

(2) List of commands

List of commands used in LS Bus communication is as shown below.

Classification Items	Command		Treatment
	Command type		
	Code	ASCII code	
Continuous read	R	H52	Read inverter variable of Word.
Continuous write	W	H57	Write inverter variable of Word.

2.8.2 Detail of instruction

1) Continuous writing to inverter (W)

This command is to write PLC data in specified address of inverter.

- LS Bus Client Request format

Format name	Header	Station No.	Command	Device Length	Address of inverter	Data	Frame check	Tail
Frame (Example)	ENQ	H20	W	H6	0100	H00E2	-	BCC	EOT
ASCII value	H05	H3230	H57	H36	H30313030	H30304532	-	-	H04

Item	Description
BCC	When ASCII value of each 1byte except ENQ and EOT is summed, the lowest 1byte of the result value is BCC.
Device Length	This specifies how many Words you will write. As converted value to ASCII, the range is from H01 (ASCII value: 3031) to H08 (ASCII value: 3038).
Address of inverter	Enter the address that you want to read. ASCII value above 4 characters and non-numeric is not allowed.
Data	When you write data H'A to inverter address 0100 area, the data format has to be H000A.

- Example)

If you want to write H1234, 31323334 (Converted value to ASCII) should be included in the data area. So, the highest value has to be sent first and the lowest value has to be sent last.

Note

- Device data of Word type is only supported.

Chapter 2 Built-in Cnet communication

● Inverter Response format(ACK response)

Format name	Header	Station No.	Command	Data		Frame check	Tail
Frame (Example)	ACK	H20	W	H00E2	...	BCC	EOT
ASCII value	H06	H3230	H57	H30304532	-	-	H04

Item	Description
BCC	When ASCII value of each 1byte except ENQ and EOT is summed, the lowest 1byte of the result value is BCC.

● Inverter Response format(NAK response)

Format name	Header	Station No.	Command	Error code (ASC 2 Byte)	Frame check	Tail
Frame (Example)	NAK	H20	W	H12	BCC	EOT
ASCII value	H15	H3230	H57	H3132	-	H04

Item	Description
BCC	When ASCII value of each 1byte except ENQ and EOT is summed, the lowest 1byte of the result value is BCC.
Error code	Error information is shown as hex 1byte (2bytes of ASCII code). For more information, please refer to the error code of the inverter user manual.

● Example

This describes if the user want to write "H00FF" to address number 1230 of station number 1 of inverter.

● XGB request format (XGB → Inverter)

Format name	Header	Station No.	Command	Device length	Address of inverter	Data	Frame check	Tail
Frame (Example)	ENQ	H01	W	H1	1230	H00FF	BCC	EOT
ASCII value	H05	H3031	H57	H3031	H31323330	H30304646	-	H04

● For ACK response after execution of command (XGB ← Inverter)

Format name	Header	Station No.	Command	Data	Frame check	Tail
Frame (Example)	ACK	H01	W	H00FF	BCC	EOT
ASCII value	H06	H3031	H57	H30304646	-	H04

● For NAK response after execution of command (XGB ← Inverter)

Format name	Header	Station No.	Command	Error code	Frame check	Tail
Frame (Example)	NAK	H01	W	H12	BCC	EOT
ASCII value	H15	H3031	H57	Error code (2 Byte)	-	H04

2) Continuous reading from inverter (R)

This is a function of continuous reading of designated amount of PLC data from designated address number.

- PC Request format

Format name	Header	Station No.	Command	Address of inverter	Number of data	Frame check	Tail
Frame (Example)	ENQ	H10	R	0100	H5	BCC	EOT
ASCII value	H05	H3130	H52	H30313030	H35	-	H04

Item	Description
BCC	When ASCII value of each 1byte except ENQ and EOT is summed, the lowest 1byte of the result value is BCC.
Device length	This specifies how many Words you will write. As converted value to ASCII, the range is from H01 (ASCII value: 3031) to H08 (ASCII value: 3038).
Address of inverter	Enter the address that you want to read. ASCII value above 4 characters and non-numeric is not allowed.

Note

- Device data of Word type is only supported.

Chapter 2 Built-in Cnet communication

- Inverter response format (ACK response)

Format name	Header	Station No.	Command	Data		Frame check	Tail
Frame (Example)	ACK	H20	R	H00E2	...	BCC	EOT
ASCII value	H06	H3230	H52	H30304532	-	-	H04

Item	Description
BCC	When ASCII value of each 1byte except ENQ and EOT is summed, the lowest 1byte of the result value is BCC.

- Inverter response format (NAK response)

Format name	Header	Station No.	Command	Error code (ASC 2 Byte)	Frame check	Tail
Frame (Example)	NAK	H20	R	H12	BCC	EOT
ASCII value	H15	H3230	H52	H3132	-	H04

Item	Description
BCC	When ASCII value of each 1byte except ENQ and EOT is summed, the lowest 1byte of the result value is BCC.
Error code	Error information is shown as hex 1byte (2bytes of ASCII code). For more information, please refer to the error code of the inverter user manual.

- Example

This describes if the user want to read 1Word data from address number 1230 of station number 1 of inverter..

- XGB request format (XGB → Inverter)

Format name	Header	Station No.	Command	Address of inverter	Device length	Frame check	Tail
Frame (Example)	ENQ	H01	R	1230	H1	BCC	EOT
ASCII value	H05	H3031	H52	H31323330	H31	-	H04

- For ACK response after execution of command (XGB ← Inverter)

Format name	Header	Station No.	Command	Data	Frame check	Tail
Frame (Example)	ACK	H01	R	H1234	BCC	EOT
ASCII value	H06	H3031	H52	H31323334	-	H04

- For NAK response after execution of command (XGB ← Inverter)

Format name	Header	Station No.	Command	Error code	Frame check	Tail
Frame (Example)	NAK	H01	R	H12	BCC	EOT
ASCII value	H15	H3031	H52	H3132	-	H04

2.9 Modbus Protocol

Modbus protocol is specified open protocol used between client-server, which executes reading/writing data according to function code. Communication between devices that use Modbus protocol uses Client-server function in which only one client processes the data.

2.9.1 Modbus Protocol

There are two communication modes of Modbus, ASCII and RTU.

Characteristic		ASCII mode	RTU mode
Coding method		ASCII code	8 bit binary code
No. of data per one character	Start bit	1	1
	Data bit	7	8
	Parity bit	Even,Odd,None	Even,Odd,None
	Stop bit	1 or 2	1 or 2
Error check		LRC(Longitudinal Redundancy Check)	CRC (Cyclical Redundancy Check)
Start of frame		Colon (:)	3.5 Character no response time

1) Structure of Modbus protocol

Modbus protocol's structure is as follows.

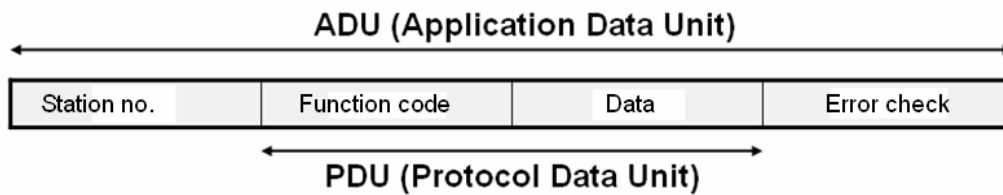

In case of normal communication, process step is as follows.

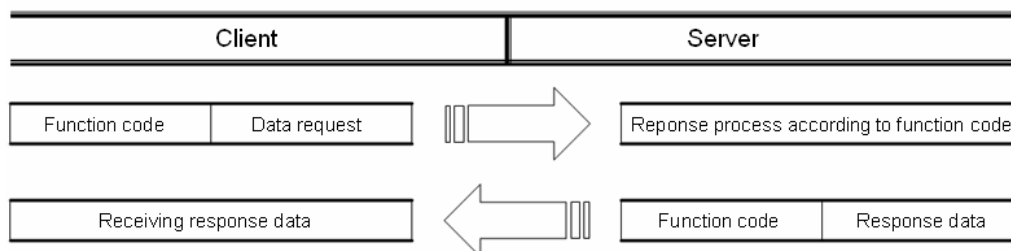

In case of abnormal communication, process step is as follows.

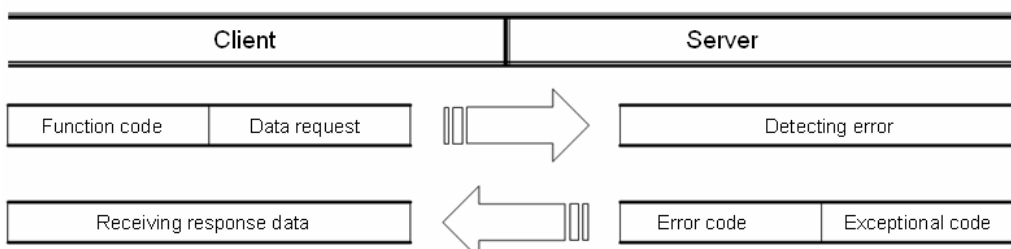

Chapter 2 Built-in Cnet communication

When receiving the abnormal frame from client, server transmits error code and exceptional code. Error code is function code adding 80(Hex) and exceptional code indicate the specific error content. Each code has following content.

Code	Code name	Meaning
01	Function code error	Function code error
02	Address error	Exceeds allowed address range
03	Data setting error	Not allowed data value
04	Server error	Server(slave) is error
05	Server requesting re-transmission	Now server is too busy to process and requests re-transmission later
06	Server process time delay	Server takes time to process. Master should request again.

2.9.2 Frame Structure

1) Frame structure in ASCII mode

Frame structure in the ASCII mode is as follows.

Classification	Start	Station no.	Function code	Data	Error check	End
Size (byte)	1	2	2	N	2	2

(1) Characteristic of ASCII mode

- a) In the ASCII mode, start of frame is indicated with colon (:), which is ASCII code, and end of frame is indicated with 'CRLF'.
- b) Each character allows maximum 1s interval.
- c) How to check the error uses LRC, it takes 2's complement except frame of start and end and converts it as ASCII conversion.

(2) Address area

- a) It consists of 2 byte.
- b) When using the XGT Cnet I/F module, range of station is 0~31.
- c) Station number 0 is used for client.
- d) When server responds, it contains self address to response frame to know client's response.

(3) Data area

- a) Transmits the data by using the ASCII data, data structure changes according to function code.
- b) In case of receiving normal frame, it responds as normal response.
- c) In case of receiving abnormal frame, it responds by using error code.

(4) Error check area

How to check error of frame takes 2's complement except start and end of frame and converts it as ASCII.

2) Frame structure in RTU mode

Frame structure in the RTU mode is as follows.

Classification	Start	Station number	Function code	Data	Error check	End
size(byte)	Idle time	1	1	N	2	Idle time

(1) Characteristic of RTU mode

- a) It uses hexadecimal.
- b) Start character is station number and frame is classified by CRC error check.
- c) Start and end of frame is classified by adding idle time of 1 bit.
- d) Between frames, there is interval of 3.5 character time. When exceeding 1.5 character time, it is acknowledged as independent frame.

(2) Address area

- a) It consists of 1 byte.
- b) When using the XGT Cnet I/F module, range of station is 0~31.
- c) Station number 0 is used for client.
- d) When server responds, it contains self address to response frame to know client's response.

(3) Data area

- a) Transmits the data by using the Hex. data, data structure changes according to function code.
- b) In case of receiving normal frame, it responds as normal response.
- c) In case of receiving abnormal frame, it responds by using error code.

(4) Error check area

It determines if frame is normal or not by using CRC check of 2 byte.

3) Modbus address rules

The address in the data starts from 0 and is equal to the value obtained by subtracting 1 from the modbus memory. That is, Modbus address 2 is the same as address 1 in the data.

4) Expression of data and address

To express data and address of modbus protocol, the characteristic is as follows.

- 1) It used hexadecimal as basic form.
- 2) In the ASCII mode, Hex data is converted into ASCII code.
- 3) RTU mode uses Hex data.
- 4) Each function code has following meaning.

Code(Hex)	Purpose	Used area	address	Max. response data
01	Read Coil Status	Bit output	0XXXX	2000bit
02	Read Input Status	Bit input	1XXXX	2000bit
03	Read Holding Registers	Word output	4XXXX	125word
04	Read Input Registers	Word input	3XXXX	125word
05	Force Single Coil	Bit output	0XXXX	1bit
06	Preset Single Register	Word output	4XXXX	1word
0F	Force Multiple Coils	Bit output	0XXXX	1968bit
10	Preset Multiple Registers	Word output	4XXXX	120word

2.9.3 Modbus Instruction

1) Reading data of bit type at the bit output (01)

(1) Reading bit of output area (function code: 01)

In case of reading data of bit type, request and response frame is as follows.

Detail of frame is applied in case of ASCII mode.

(a) Request frame

Frame	Station no.	Function code (01)	Address	Data size	Frame error check	Tail (CRLF)
Size (byte)	1	1	2	2	2	2

(b) Response frame (In case of receiving normal frame)

Frame	Station no.	Function code (01)	No. of byte	Data	Frame error check	Tail (CRLF)
Size (byte)	1	1	2	N	2	2

(c) In case of response frame (In case of receiving abnormal frame)

Frame	Station no.	Error code	Exceptional code	Tail (CRLF)
Size (byte)	1	1	1	2

(2) Details of frame

(a) Station no.: indicates the station no. of slave to read bit of output area.

(b) Function code: '01' indicating Read Coil Status

(c) Address: start address of data to read and it consists of 2 byte. At this time, start address conforms to modbus address regulation.

(d) Data size: size of data to read and it consists of 2 byte.

(e) Frame error check: in case of ASCII mode, it uses LRC and in case of STU mode, it uses CRC. It consists of 2 byte.

(f) Tail: it is applies in case of ASCII mode, CRLF is added after LRC.

(g) No. of byte: no. of byte of response data

(h) Data: makes address of request frame as start address and transmits data with byte unit

(i) Error code: error code is expressed by adding 80(Hex) to function code and in case of reading bit of output area, it is expressed as 81(Hex).

(j) Exceptional code: indicates detail of error and consists of 1 byte

(3) Frame example

Example that requests reading bit of 20~28 to station number 1 server acting as modbus RTU mode

(a) Request frame

Classification	Station no.	Function code	Address		Data size		Error check
			Upper byte	Lower byte	Upper byte	Lower byte	
Frame	01	01	00	13	00	13	CRC

(b) Response frame (In case receiving normal frame)

Classification	Station no.	Function code	No. of byte	Data			Error check
Frame	01	01	03	12	31	05	CRC

(c) Response frame (In case of receiving abnormal frame)

Classification	Station no.	Function code	Exceptional code	Error check
Frame	01	81	02	CRC

Chapter 2 Built-in Cnet communication

2) Reading data of bit type at the bit input (02)

(1) Reading bit of input area

In case of reading data of bit type of input area, request and response frame is as follows.

Tail of frame is applied in case of ASCII mode.

(a) Request frame

Classification	Station no.	Function code (02)	Address	Data size	Frame error check	Tail (CRLF)
Size (byte)	1	1	2	2	2	2

(b) Response frame (In case of receiving normal frame)

Classification	Station no.	Function code (02)	No. of byte	Data	Frame error check	Tail (CRLF)
Size (byte)	1	1	2	N	2	2

(c) Response frame (In case of receiving abnormal frame)

Classification	Station no.	Error code	Exceptional code	Tail (CRLF)
Size (byte)	1	1	1	2

(2) Details of frame

(a) Station no.: indicates station no. of slave to read bit of input area

(b) Function code: '02' indicating Read Input Status

(c) Address: indicating start address of data to read. It consists of 2 byte. At this time, start address conforms to modbus address regulation.

(d) Data size: size of data to read, consists of 2 byte

(e) Frame error check: in case of ASCII mode, it uses LRC and in case of STU mode, it uses CRC for error check. It consists of 2 byte.

(f) Tail: it is applied in case of ASCII mode, CRLF is added after LRC.

(g) No. of byte: no. of byte of data responding

(h) Data: address of request frame is start address and transmits data with byte unit.

(i) Error code: Error code is expressed by adding 80(Hex) and in case of reading bit of output area, it is expressed 82(Hex).

(j) Exceptional code: details of error, consists of 1 byte.

(3) Frame example

Example that reads bit (20~38) from station number 1 server acting as modbus RTU

(a) Request frame

Classification	Station no.	Function code	Address		Data size		Error check
			Upper byte	Lower byte	Upper byte	Lower byte	
Frame	01	02	00	13	00	13	CRC

(b) Response frame (When receiving normal frame)

Classification	Station no.	Function code	No. of byte	Data			Error check
Frame	01	02	03	12	31	05	CRC

(c) Response frame (When receiving abnormal frame)

Classification	Station no.	Function code	Exceptional code	Error check
Frame	1	82	2	CRC

3) Reading data of word type at the word output (03)

(1) Reading word of output area

When reading data of word type of output area, request and response frame is as follows.

Tail of frame is applied in case of ASCII mode.

(a) Request frame

Classification	Station no.	Function code (03)	Address	Data size	Frame error check	Tail (CRLF)
Size (byte)	1	1	2	2	2	2

(b) Response frame (When receiving normal frame)

Classification	Station no.	Function code (03)	No. of byte	Data	Frame error check	Tail (CRLF)
Size (Byte)	1	1	2	N*2	2	2

(c) Response frame (When receiving abnormal frame)

Classification	Station no.	Error code	Exceptional code	Tail (CRLF)
Size (byte)	1	1	1	2

(2) Details of frame

- (a) Station no.: indicates the station no. of slave to read word data of output area.
- (b) Function code: '03' indicating Read Holding Registers
- (c) Address: indicating start address of data to read. It consists of 2 byte. At this time, start address conforms to modbus address regulation.
- (d) Data size: size of data to read, consists of 2 byte
- (e) Frame error check: in case of ASCII mode, it uses LRC and in case of STU mode, it uses CRC for error check. It consists of 2 byte.
- (f) Tail: it is applied in case of ASCII mode, CRLF is added after LRC.
- (g) No. of byte: no. of byte of data responding
- (h) Data: address of request frame is start address and transmits data with byte unit. At this time, since data is word type, it is double of no. of byte.
- (i) Error code: error code is expressed by adding 80(Hex) and in case of reading word of output area, it is expressed 83(Hex).
- (j) Exceptional code: details of error, consists of 1 byte.

(3) Frame example

Example that reads word (108~110) from station number 1 server acting as modbus RTU

(a) Request frame

Classification	Station no.	Function code	Address		Data size		Error check
			Upper byte	Lower byte	Upper byte	Lower byte	
Frame	01	03	00	6B	00	03	CRC

(b) Response frame (receiving normal frame)

Classification	Station no.	Function code	No. of byte	Data				Error check		
Frame	01	03	06	13	12	3D	12	40	4F	CRC

(c) Response frame (receiving abnormal frame)

Classification	Station no.	Function code	Exceptional code	Error check
Frame	01	83	04	CRC

Chapter 2 Built-in Cnet communication

4) Reading data of word type at the word input (04)

(1) Reading word of input area

In case of reading word of input area, request and response frame is as follows.

Tail of frame is applied in case of ASCII mode.

(a) Request frame

Classification	Station no.	Function code (04)	Address	Data size	Frame error check	Tail (CRLF)
Size (byte)	1	1	2	2	2	2

(b) Response frame (In case of receiving normal frame)

Classification	Station no.	Function code (04)	No. of byte	Data	Frame error check	Tail (CRLF)
Size (byte)	1	1	2	N*2	2	2

(c) In case of response frame (In case of receiving abnormal frame)

Classification	Station no.	Error code	Exceptional code	Tail (CRLF)
Size (byte)	1	1	1	2

(2) Details of frame

(a) Station no.: indicates the station no. of slave to read word of input area.

(b) Function code: '04' indicating Read Input Registers

(c) Address: start address of data to read and it consists of 2 byte. At this time, start address conforms to modbus address regulation.

(d) Data size: size of data to read and it consists of 2 byte.

(e) Frame error check: in case of ASCII mode, it uses LRC and in case of STU mode, it uses CRC. It consists of 2 byte.

(f) Tail: it is applies in case of ASCII mode, CRLF is added after LRC.

(g) No. of byte: no. of byte of response data

(h) Data: makes address of request frame as start address and transmits data with byte unit. At this time, since data is word type, it is double of no. of byte.

(i) Error code: error code is expressed by adding 80(Hex) to function code and in case of reading word of input area, it is expressed as 84(Hex).

(j) Exceptional code: indicates detail of error and consists of 1 byte

(3) Frame example

Example that requests reading word of 9 to station number 1 server acting as modbus RTU mode

(a) Request frame

Classification	Station no.	Function code	Address		Data size		Error check
			Upper byte	Lower byte	Upper byte	Lower byte	
Frame	01	04	00	08	00	01	CRC

(b) Response frame (In case receiving normal frame)

Classification	Station no.	Function code	No. of byte	Data	Error check
Frame	01	04	02	00 0A	CRC

(c) Response frame (In case of receiving abnormal frame)

Classification	Station no.	Function code	Exceptional code	Error check
Frame	01	84	04	CRC

5) Individual writing data of bit type at the bit output (05)

(1) Individual writing bit of output area

When writing single bit of output area, request and response frame is as follows.

Tail of frame is applied in case of ASCII mode.

(a) Request frame

Classification	Station no.	Function code (05)	Address	Output	Frame error check	Tail (CRLF)
Size (byte)	1	1	2	2	2	2

(b) Response frame (In case of receiving normal frame)

Classification	Station no.	Function code (05)	Address	Output	Frame error check	Tail (CRLF)
Size (byte)	1	1	2	2	2	2

(c) In case of response frame (In case of receiving abnormal frame)

Classification	Station no.	Error code	Exceptional code	Tail (CRLF)
Size (byte)	1	1	1	2

(2) Details of frame

(a) Station no.: indicates the station no. of slave to write single bit of output area.

(b) Function code: '05' indicating Force Single Coil

(c) Address: start address of data to write and it consists of 2 byte. At this time, start address conforms to modbus address regulation.

(d) Output: in case of turning on address set in the Address, FF00(Hex) is indicated and in case of turning off address set in the Address, it is indicated 0000(Hex).

(e) Frame error check: in case of ASCII mode, it uses LRC and in case of STU mode, it uses CRC. It consists of 2 byte.

(f) Tail: it is applies in case of ASCII mode, CRLF is added after LRC.

(g) No. of byte: no. of byte of response data

(h) Error code: error code is expressed by adding 80(Hex) to function code and in case of Force Single Coil, it is expressed as 85(Hex).

(i) Exceptional code: indicates detail of error and consists of 1 byte

(3) Frame example

Example that turning on 9th bit to station number 1 server acting as Modbus RTU mode

(a) Request frame

Classification	Station no.	Function code	Address		Output		Error check
			Upper byte	Lower byte	Upper byte	Lower byte	
Frame	01	05	00	08	FF	00	CRC

(b) Response frame (In case receiving normal frame)

Classification	Station no.	Function code	Address		Output		Error check
			Upper byte	Lower byte	Upper byte	Lower byte	
Frame	01	05	00	08	FF	00	CRC

(c) Response frame (In case of receiving abnormal frame)

Classification	Station no.	Function code	Exceptional code	Error check
Frame	01	85	04	CRC

6) Individual writing data of word type at the word output (06)

(1) Individual writing word of output area

In case of writing single word to output area, request and response frame is as follows.
Detail of frame is applied in case of ASCII mode.

a) Request frame

Classification	Station no.	Function code (06)	Address	Output	Frame error check	Tail (CRLF)
Size (byte)	1	1	2	2	2	2

b) Response frame (In case of receiving normal frame)

Classification	Station no.	Function code (06)	Address	Output	Frame error check	Tail (CRLF)
Size (byte)	1	1	2	2	2	2

c) In case of response frame (In case of receiving abnormal frame)

Classification	Station no.	Error code	Exceptional code	Tail (CRLF)
Size (byte)	1	1	1	2

(2) Details of frame

- (a) Station no.: indicates the station no. of slave to write single word of output area.
- (b) Function code: '06' indicating Preset Single Register
- (c) Address: start address of data to write and it consists of 2 byte. At this time, start address conforms to modbus address regulation.
- (d) Output: data value to write in the address set in the Address.
- (e) Frame error check: in case of ASCII mode, it uses LRC and in case of STU mode, it uses CRC. It consists of 2 byte.
- (f) Tail: it is applies in case of ASCII mode, CRLF is added after LRC.
- (g) No. of byte: no. of byte of response data
- (h) Error code: error code is expressed by adding 80(Hex) to function code and in case of writing single word of output area, it is expressed as 86(Hex).
- (i) Exceptional code: indicates detail of error and consists of 1 byte

(3) Frame example

Example writing 0003(Hex) to 9th word of station number 1 server acting as modbus RTU mode

(a) Request frame

Classification	Station no.	Function code	Address		Output		Error check
			Upper byte	Lower byte	Upper byte	Lower byte	
Frame	01	06	00	08	00	03	CRC

(b) Response frame (In case receiving normal frame)

Classification	Station no.	Function code	Address		Output		Error check
			Upper byte	Lower byte	Upper byte	Lower byte	
Frame	01	06	00	08	00	03	CRC

(c) Response frame (In case of receiving abnormal frame)

Classification	Station no.	Function code	Exceptional code	Error check
Frame	01	86	02	CRC

7) Continuous writing data of bit type at the bit output (0F)

(1) Continuous writing bit of output area

In case of writing continuous bit to output area, request and response frame is as follows.
Tail of frame is applied in case of ASCII mode.

(a) Request frame

Classification	Station no.	Function code (0F)	Address	No. of output	Data size	Output	Frame error check	Tail (CRLF)
Size (byte)	1	1	2	2	1	N	2	2

(b) Response frame (In case of receiving normal frame)

Classification	Station no.	Function code (0F)	Address	No. of output	Frame error check	Tail (CRLF)
Size (byte)	1	1	2	2	2	2

(c) In case of response frame (In case of receiving abnormal frame)

Classification	Station no.	Error code	Exceptional code	Tail (CRLF)
Size (byte)	1	1	1	2

(2) Details of frame

- (a) Station no.: indicates the station no. of slave to write continuous bit of output area.
- (b) Function code: '06' indicating Force Multiple Coils
- (c) Address: start address of data to read and it consists of 2 byte. At this time, start address conforms to Modbus address regulation.
- (d) No. of output: no. of output to write and it consists of 2 byte
Ex.) When writing 10 continuous data from address number 20, no. of output is 000A(Hex)
- (e) Data size: indicates no. of output as byte. Namely, in case data size is 1, no. of data is 9.
Ex.) In case of writing 10 continuous bits, data size is 2.
- (f) Output: data value to write in the address set in the Address.
- (g) Frame error check: in case of ASCII mode, it uses LRC and in case of STU mode, it uses CRC. It consists of 2 byte.
- (h) Tail: it is applies in case of ASCII mode, CRLF is added after LRC.
- (i) No. of byte: no. of byte of response data
- (j) Error code: error code is expressed by adding 80(Hex) to function code and in case of writing continuous bit of output area, it is expressed as 8F(Hex).
- (k) Exceptional code: indicates detail of error and consists of 1 byte.

(3) Frame example

Example writing 10 continuous bits starting 20th address of 1 server acting as Modbus RTU mode

Ex.) Data value to write continuously

Bit value	1	1	0	0	1	1	0	1	0	0	0	0	0	0	0	1
Hex	C				D				0				1			
Address	27	26	25	24	23	22	21	20	-	-	-	-	-	-	29	28

(a) Request frame

Classification	Station no.	Function code	Address		No. of output		Data size	Output		Error check
			Upper byte	Lower byte	Upper byte	Lower byte		Upper byte	Lower byte	
Frame	01	0F	00	13	00	0A	02	CD	01	CRC

(b) Response frame (In case receiving normal frame)

Classification	Station no.	Function code	Address		No. of output		Error check
			Upper byte	Lower byte	Upper byte	Lower byte	
Frame	01	04	00	13	00	0A	CRC

(c) Response frame (In case of receiving abnormal frame)

Classification	Station no.	Function code	Exceptional code	Error check
Frame	01	8F	01	CRC

Chapter 2 Built-in Cnet communication

8) Continuous writing data of word type at the word output (10)

(1) Continuous writing word of output area

In case of writing word continuously to output area, request and response frame is as follows.

Tail of frame is applied in case of ASCII mode.

(a) Request frame

Classification	Station no.	Function code (10)	Address	No. of output	Data size	Output	Frame error check	Tail (CRLF)
Size (byte)	1	1	2	2	1	N*2	2	2

(b) Response frame (In case of receiving normal frame)

Classification	Station no.	Function code (10)	Address	No. of output	Frame error check	Tail (CRLF)
Size (byte)	1	1	2	2	2	2

(c) In case of response frame (In case of receiving abnormal frame)

Classification	Station no.	Error code	Exceptional code	Tail (CRLF)
Size (byte)	1	1	1	2

(2) Details of frame

(a) Station no.: indicates the station no. of slave to write continuous word of output area.

(b) Function code: '10' indicating Preset Multiple Registers

(c) Address: start address of data to read and it consists of 2 byte. At this time, start address conforms to modbus address regulation.

(d) No. of output: no. of output to write and it consists of 2 byte

Ex.) When writing 10 continuous data from address number 20, no. of output is 000A(Hex)

(e) Data size: indicates no. of output as byte. Since data type is word, in case of writing data of 1 word, data size is 2.

(f) Output: data value to write in the address set in the Address.

(g) Frame error check: in case of ASCII mode, it uses LRC and in case of STU mode, it uses CRC. It consists of 2 byte.

(h) Tail: it is applied in case of ASCII mode, CRLF is added after LRC.

(i) No. of byte: no. of byte of response data

(j) Error code: error code is expressed by adding 80(Hex) to function code and in case of writing continuous word of output area, it is expressed as 90(Hex).

(k) Exceptional code: indicates detail of error and consists of 1 byte.

(3) Frame example

Example writing continuous 2 words starting 20th address of server 1 acting as Modbus RTU mode

Ex.) value to write continuously

Hex	C	D	0	1	0	0	0	0	A
Address	20				21				

(a) Request frame

Classification	Station no.	Function code	Address		No. of output		Data size	Output				Error check
			Upper byte	Lower byte	Upper byte	Lower byte						
Frame	01	10	00	13	00	02	04	CD	01	00	0A	CRC

(b) Response frame (In case receiving normal frame)

Classification	Station no.	Function code	Address		No. of output		Error check
			Upper byte	Lower byte	Upper byte	Lower byte	
Frame	01	10	00	13	00	02	CRC

(c) Response frame (In case of receiving abnormal frame)

Classification	Station no.	Function code	Exceptional code	Error check
Frame	01	90	01	CRC

2.10 Diagnosis Function

With XG5000 used, the status of the system and the network can be checked and diagnosed. Diagnosis function is composed as described below

- ▶ CPU module information
- ▶ Communication module information
- ▶ Frame monitor
- ▶ Status by service

2.10.1 Diagnosis Function of XG5000

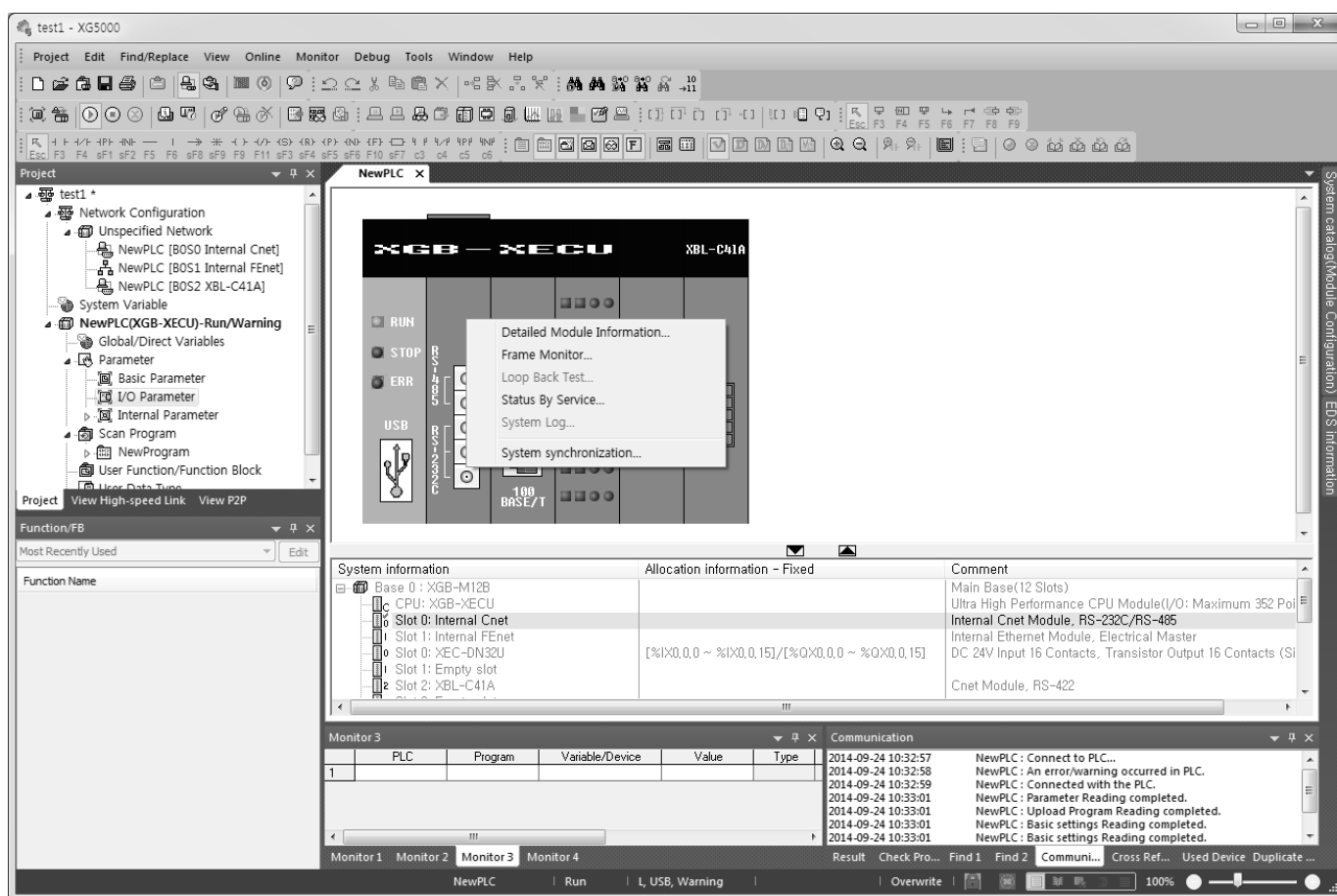

How to diagnosis system and network status by XG5000 system diagnosis are described below.

Connect XG5000 to loader port of main unit and if you select “Online -> Communication module setting -> System Diagnosis”, the following window is created.





- Select [Online] – [Communication module setting] – [System Diagnosis] and click the icon ().
- Click the right button on the the relevant module and click Frame Monitor or Status By Service to check.

1) Checking status of main unit

Check list	Detail result
CPU Module information	
<p>1. Select [Online] – [Communication module setting] – [System Diagnosis] or click the icon ().</p> <p>2. You can check the status of main unit by clicking CPU module information after clicking main unit.</p>	

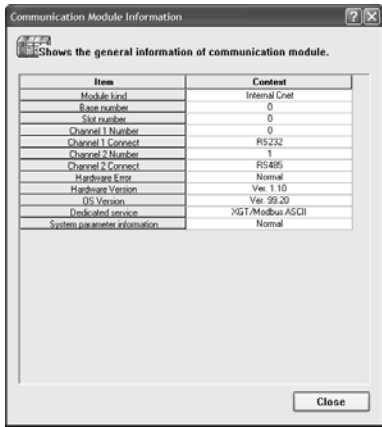
2) Communication module information

Check list	Detail result
Communication module information	
<p>1. Select [Online] – [Communication module setting] – [System Diagnosis] or click the icon ().</p> <p>2. You can check communication module status by clicking communication module information and click the right button after clicking Cnet I/F module and built-in communication.</p> <p>3. Meaning of each item of communication module information is as follows.</p>	

Item	Content	Remark
Module kind	Information of module kind under diagnosis	
Base number	Base information of communication module under diagnosis. It is fixed as 0 at XGB PLC.	
Slot number	Slot no. of communication module under diagnosis In case of built-in communication, it is fixed as 0.	
Station number	Station no. of relevant channel used at dedicated service, P2P	
Connection method	Information of communication type (RS-232C, RS-422) of relevant channel	
Hardware error	Indicates whether hardware of communication module is normal or not.	
Hardware version	Version of communication module hardware	
OS version	Indicates version of communication module OS	
P2P	Indicates whether P2P communication is activated or not	
System parameter information	Whether standard communication parameter is downloaded or not Standard communication parameter error information expression	

Chapter 2 Built-in Cnet communication

3) Frame monitor

The user can check whether frame is normal or not by monitoring TRX frame through Cnet I/F module by XG-PD's frame monitor.

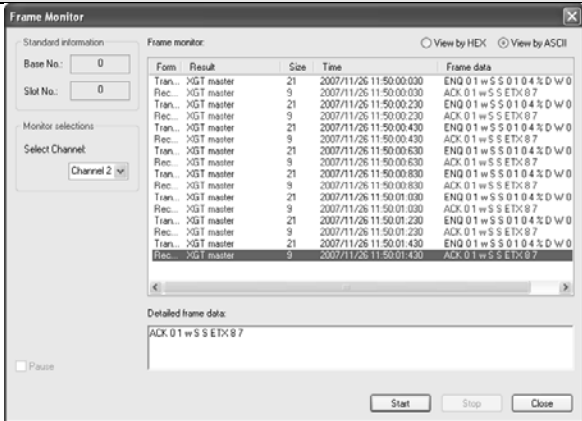
Check list	Detail result
Frame monitor	

1. Select [Online] – [Communication module setting] – [System Diagnosis] or click the icon ().
2. If you click right button after clicking Cnet I/F module and click frame monitor, you can monitor current communication data.
3. If you use frame monitor function, you can check frame of TRX data between Cnet I/F module and external communication device easily.
4. Detailed content of information indicated frame monitor window is as follows.

Item		Content	Remark
Standard information	Base No.	Information of base number under diagnosis	
	Slot No.	Information of slot number under diagnosis	
Monitor selections	Select Channel	Select channel to monitor	
Frame monitor window	Form	Indicates whether it is TX or RX frame.	
	Result	Indicates the protocol type 1) XGT server 2) XGT client 3) Modbus server 4) Modbus client 5) User definition frame 6) Unknown: frame that Cnet can't deal with	
	Size	Size of frame	
	Time	Time when sending/receiving the frame In case main unit is standard type (XBM-D***S), it indicates elapsed time from start.	
	Frame data	Indicates the frame data	
View by HEX		Indicates the frame data as HEX	
View by ASCII		Indicates the frame data as ASCII	
Start		Starts the frame monitor	
Stop		Stops the frame monitor	
Close		Closes the frame monitor window	

4) Status by service(Dedicated Service)



Check list	Detail result
Dedicated service	

1. Select [Online] – [Communication module setting] – [System Diagnosis] or click the icon ().
2. Click the right button on the the Cnet I/F module and click Status By Service.
3. Click Dedicated Service tap.
4. Check the status by service by clicking Multiple Reading and Refresh
5. Detailed content of information indicated in dedicated service window is as follows.

Classification	Item	Content	
Multiple reading/Refresh	Multiple reading	Checks the dedicated service status every second.	
	Refresh	Checks the dedicated service status information at started time	
Dedicated Service	Standard information	Base Number	Information of base number under diagnosis
		Slot Number	Information of slot number under diagnosis
		Link type	Type of communication module under diagnosis
	Dedicated service information		Drive type by service
	Detailed information window	Port number	Channel number
		Service count	Indicates how many dedicated service communication is done
		Error count	Indicates how many error occurs during dedicated service communication
Status		Indicates status of dedicated service communication	

Chapter 2 Built-in Cnet communication

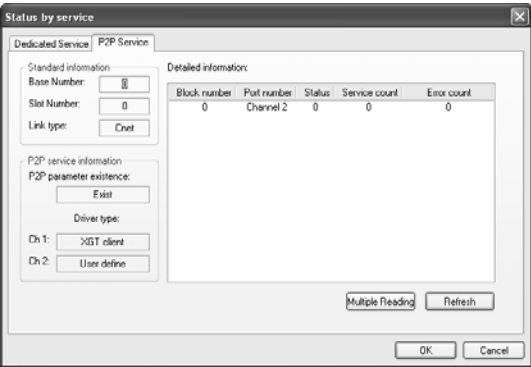
5) Status by service(P2P Service)

Check list	Detail result
P2P service	
<ol style="list-style-type: none"> 1. Select [Online] – [Communication module setting] - [System diagnosis] or click the icon (). 2. Click the right button on the the Cnet I/F module and click Status By Service. 3. Click P2P service of Status by Service 4. Click mutiple reading and check Status by Service. 	

Classification	Item	Contents	
P2P service	Standard information	Base number	Information of base number under diagnosis
		Slot number	Information of slot number under diagnosis
		Link type	Type of communication module under diagnosis
	P2P service information	P2P parameter existence	Indicates whether P2P parameter exists or not
		Driver type	Indicates the P2P driver by port XGT/Modbus/User definition frame
	Detailed information	Block number	Available range:0~63 Only block under operation is indicated.
		Port number	Indicates the channel number
		Status	Indicates the status by service
		Service count	Indicates how many P2P service is done.
Error count		Indicates how many error occurs during service	
Multiple reading/Refresh	Multiple reading	Checks the P2P service status every second.	
	Refresh	Check the P2P service status when refresh is done.	

6) Service status code

It is used to check whether Cnet I/F module is normal or not.

Dedicated service		P2P service	
Status	Meaning	Status	Meaning
0	Normal	0	Normal
1	Error of RX frame head (There is no ACK/NAK.)	4	Error of max. station number (Available range: 0~255)
2	Error of RX frame tail (There is no tail.)	5	Time out
3	BCC error of RX frame	FFFE	1. Modbus address error 2. Commands except Read/Write are used.
9	Station number of RX frame is different with self station number (Self station number = 0)		
0A	In case of not get response from CPU		
0B	RX frame size exceeds the modbus max. frame size		
0C	RX frame is not Modbus ASCII/RTU.		
0D	HEX conversion error in Modbus		

2.10.2 Trouble Shooting by Error

1) Trouble shooting when P2P parameter setting error occurs in case of XG5000 connection

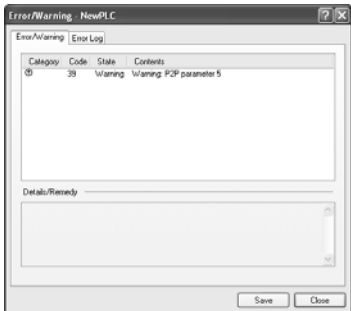
Phenomenon	Reason	Trouble shooting
<p>P2P setting error warning in case of XG5000 connection</p> 	<p>In case of enabling link, the user enabled the link where P2P is not set</p>	<ol style="list-style-type: none"> 1. In Enable Link menu of XG5000, check P2P setting number and delete P2P number not selected properly. 2. After disconnecting XG-PD, connect XG5000 again and check

2) Trouble shooting when communication is not done after P2P client setting

Phenomenon	Reason	Trouble shooting
<p>Tough communication setting is completed, Tx/Rx LED of Cnet I/F doesn't flicker</p>	<p>In case CPU is stop mode</p>	<p>Connect XG5000 and check CPU mode. If CPU mode is stop, change mode into RUN.</p>
	<p>Non-coincidence of communication standard parameter between client and server</p>	<p>Connect XG-PD and click [File] – [Open from PLC]. Check standard settings of module acting as client and server.</p>
	<p>Enable Link setting error</p>	<p>After executing P2P parameter, enable right P2P link</p>

3) Trouble shooting when response frame is missed in case of acting as client and using RS-485

Phenomenon	Reason	Trouble shooting
<p>After setting diverse P2P parameter in P2P block, if frame monitor is executed, response frame is missed.</p>	<p>In case P2P conditional flag is faster than communication time</p>	<ol style="list-style-type: none"> 1. Consider communication time and change P2P conditional flag. 2. Communication time: transmission time + reception time - transmission time: conditional flag+CPU Scan Time+reaction time of communication module+data transmission time - reception time: CPU Scan Time + reaction time of communication module+data transmission time
	<p>In case that response time of partner is slow.</p>	<ol style="list-style-type: none"> 1. Increase Delay time in standard settings of XG-PD.

4) Two response frame are dealt with as unknown when executing frame monitor

Phenomenon					Reason	Trouble shooting
Two response frame are dealt with as unknown when executing frame monitor					Communication type in XG-PD is set as RS-422 but output wiring method is RS-485	Change communication type as RS-485 and write it to PLC.
Transmission	XGT master	17	2007/12/4 ...	ENQ 01rS S 01 04 %M W 0 EOT 4 0		
Reception	Unknown	17	2007/12/4 ...	ENQ 01rS S 01 04 %M W 0 EOT 4 0		
Reception	Unknown	17	2007/12/4 ...	ACK 01rS S 01 02 00 0 0 ETX 0 5		
Transmission	XGT master	17	2007/12/4 ...	ENQ 01rS S 01 04 %M W 0 EOT 4 0		

5) Unable to analyze TRX frame

Phenomenon	Reason	Trouble shooting
Unable to analyze TRX frame	More than one server sends frame	1. Execute 1:1 communication with server and check if it works properly. 2. Take interlock for servers not to sends frame simultaneously.
	In case parity bit setting is not coincident	Set the parity bit to be same each other
	In case stop bit setting is not coincident	Set the stop bit to be same each other
	In case communication speed setting is not coincident	Set the communication speed to be same each other
	In case of multi drop, terminal resistance is not installed	Install terminal resistance

6) Unable to know which one is reason of error, client or server

Phenomenon	Reason	Trouble shooting
Unable to know which one is reason of error, client or server	-	1. Check Cnet I/F module - Check module's equipment status - Check wiring 2. Check main unit status

Chapter 2 Built-in Cnet communication

7) Communication is not normal or communication is not executed repeatedly

Phenomenon	Reason	Trouble shooting
Communication is not normal or communication is not executed repeatedly	In case of multi drop, More than one server sends frame	1. Execute 1:1 communication with server and check if it works properly. 2. Take interlock for servers to sends frame simultaneously.
	Connection error of wiring communication line	Change cable or check connection of cable
	In case of RS-485 (Half duplex), non-coincidence of timing of TRX signal	Increase delay time of client and server
	1. When transmission is not complete, it requests next process of transmission 2. When reception is not complete, it requests next process of reception	Use handshake in program thoroughly



2.11 Example Program

2.11.1 Setting of Cnet I/F Module in the XG5000



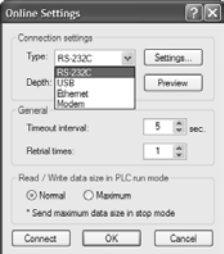

Operation of XGT Cnet I/F is divided into P2P service and Server.

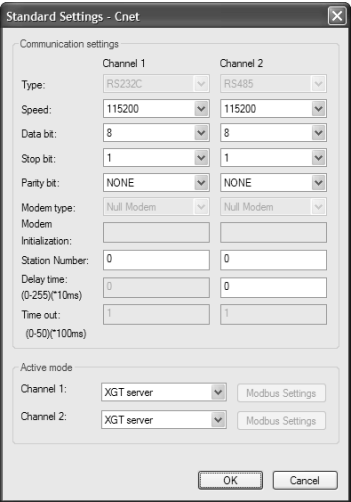
- P2P service: acts as client (master) and request reading/writing.
 - XGT client
 - Modbus RTU/ASCII client
 - User frame definition
- Server: acts as server (slave) and acts according to request
 - XGT server
 - Modbus RTU server
 - Modbus ASCII server

1) In case of acting as server

Sequence	Procedure	Setting method
1	Connection setting	
		1. Select [Online]-[Connection Settings] or click icon () 2. Click [Connect] after setting.
2	Read I/O information	Select [Online] – [Read I/O Information] or click icon () Reads the information about currently equipped module.
3	Standard Settings	
		1. Double-click Cnet I/F module and execute standard setting window. Set Type, Speed, Data bit, Stop bit, station no. of connection menu. 2. Modem initialization is available in case of dial modem, not null modem. 3. Delay time setting: when sending frame, it sends frame after specific delay time. (a) Operation setting: Available when type is RS-422/485. * When using as Modbus ASCII server, data bit should be 7.

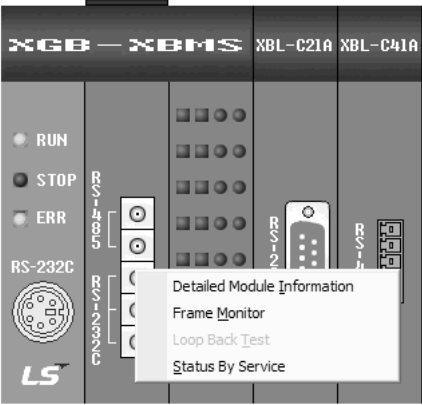



Chapter 2 Built-in Cnet communication

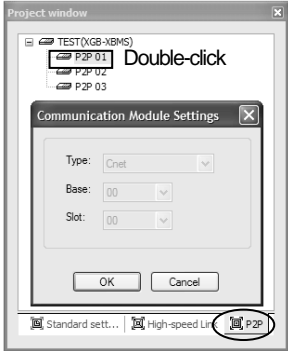
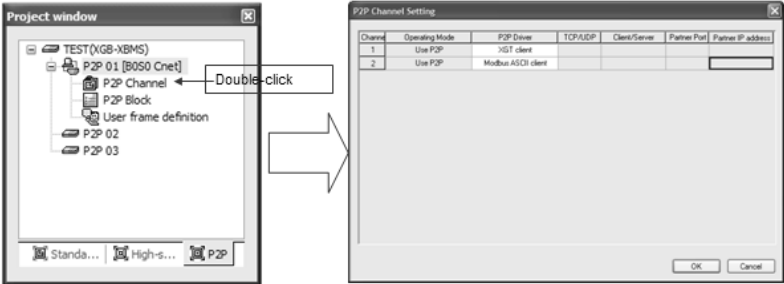

Sequence	Procedure	Setting method
4	Selecting the active mode	<ol style="list-style-type: none"> 1. Select active mode of server for user to use. 2. XGB Cnet I/F module supports XGT server, Modbus ASCII server, Modbus RTU server.
5	Writing parameter	
		<ol style="list-style-type: none"> 1. Select [Online] – [Write Parameter] or click icon () 2. Click [OK]. 3. If you click [OK] button, parameter is sent to PLC. If you don't reset relevant module, XGB Cnet I/F module acts as changed parameter.
6	Checking the operation	
		<ol style="list-style-type: none"> 1. Select [Online] – [System Diagnosis] or click icon (). 2. Click the right button on the relevant module and click Frame Monitor or Status By Service to check

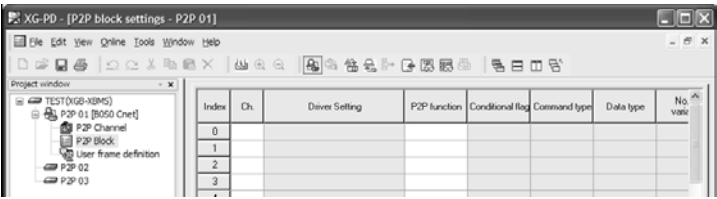
2) In case of acting as P2P service (client)

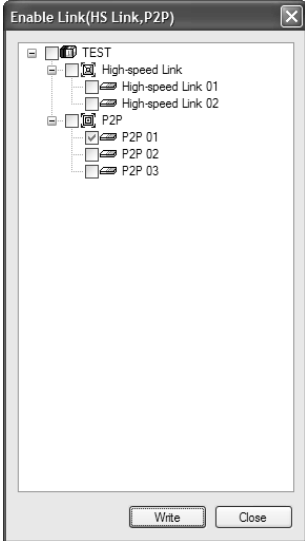
Sequence	Procedure	Setting method
1	Standard settings	1. Step 1~3 is same as described above. *In case of ASCII client, data bit should be 7.
2	Active mode	 <p>1. Select Use P2P settings as active mode.</p>
3	P2P settings	 <p>1. After selecting P2P setting window, double-click P2P block address and input base and slot no. of communication module. 2. P2P 01 is fixed as built-in Cnet and base and slot is fixed as 0 and you can't change that.</p>
4	P2P channel setting	 <p>1. Double-click P2P driver and select protocol according to each channel. 2. P2P driver supports user definition frame, XGT client, Modbus RTU/ASCII client.</p>

Chapter 2 Built-in Cnet communication

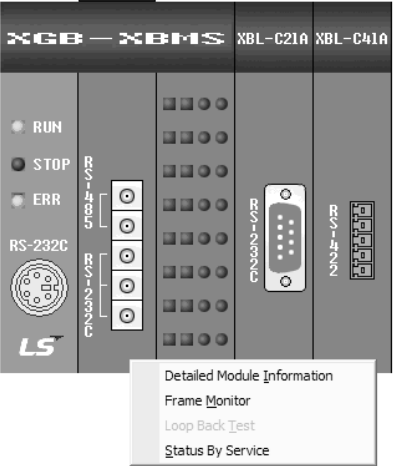
Sequence	Procedure	Setting method
5	P2P block setting	 <p>1. P2P items are activated differently according to type of client set in the channel. 2. Write shell according to protocol * In case of user definition frame, P2P block can be set when user definition frame is written.</p>
6	Writing parameter	 <p>1. Select [Online] – [Write Parameter] or click icon (). 2. Click [OK]. 3. If you press [OK], parameter is sent to PLC. If you don't reset relevant module, XGB Cnet I/F module acts as changed parameter.</p>
7	Enabling the link	 <p>1. Select [Online] – [Enable Link] or click icon (). 2. Click the P2P to enable and click Write.</p>

Sequence	Procedure	Setting method
8	Checking the operation	 <p>The screenshot shows the control panel for XGB-XBMS units, including models XBL-C21A and XBL-C41A. On the left, there are status indicators for RUN, STOP, and ERR, along with RS-232C ports. A context menu is open over the panel, listing the following options: Detailed Module Information, Frame Monitor, Loop Back Test, and Status By Service.</p>
<ol style="list-style-type: none"> 1. Select [Online] – [System Diagnosis] or click icon (). 2. Click the right button on the relevant module and click Frame Monitor or Status By Service to check. 		

Chapter 2 Built-in Cnet communication

2.11.2 Dedicated Communication Example

About Dedicated communication

- As defined protocol by LS ELECTRIC, it is classified XGT client and XGT server
- XGT client: requests reading/writing of data to server
- XGT server: responds according to request of client

We assume that system configuration of dedicated service example is as [Figure 2.11.1] and communication setting is as following table.

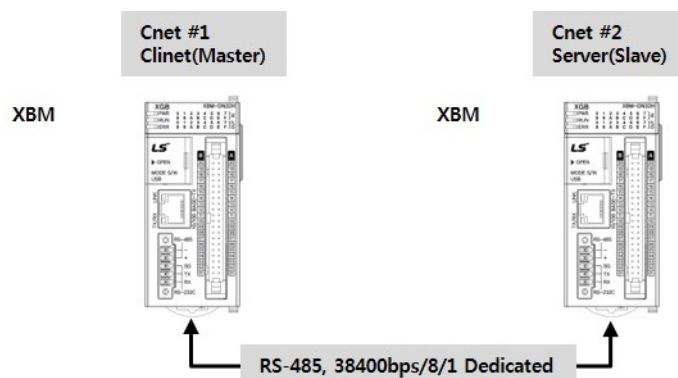

[Figure 2.11.1] Example of dedicated service system configuration

1) Client setting

Type	Setting content
Main unit	XBM-DN32H
Communication module	Main unit built-in (RS-232C)
Communication type	RS-232C
Communication speed	38,400
Data bit	8
Stop bit	1
Parity bit	-
Modem type	Null modem
Operation cycle	1s

[Table 2.11.1] client setting



2) Server setting

Type	Setting content
Main unit	XBM-DN32H
Communication module	Main unit built-in (RS-232C)
Communication type	RS-232C
Communication speed	38,400
Data bit	8
Stop bit	1
Parity bit	-
Modem type	Null modem
Station no.	1

[Table 2.11.2] Server setting

3) Settings of XGT server

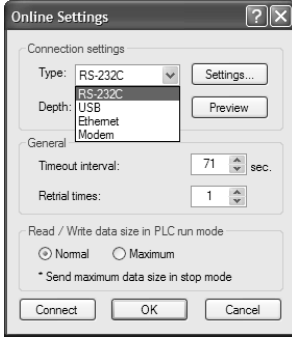

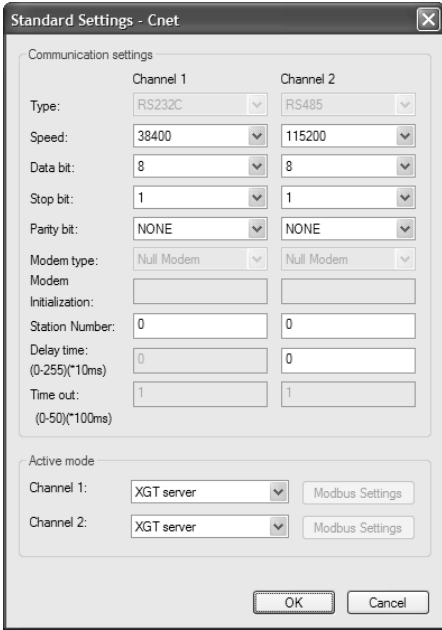
Setting method to operate built-in RS-232C communication channel of Built-in Cnet as server is as follows.

Sequence	Procedure	Setting method
1	Connection settings	
		<ol style="list-style-type: none"> 1. Select [Online]-[Connection settings] and click (). 2. After setting the connection option according to user, click the 'connection'.
2	Reading IO information	Select [Online]-[Read IO Information] and click icon (). IO information of currently mounted is shown on the project window.
3	Standard settings	
		<ol style="list-style-type: none"> 1. Set standard settings at built-in communication channel to be same with [Table 10.2.2]'s standard settings. 2. Since active mode acts as dedicated communication server, set as XGT server.





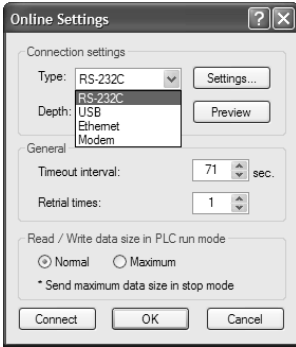

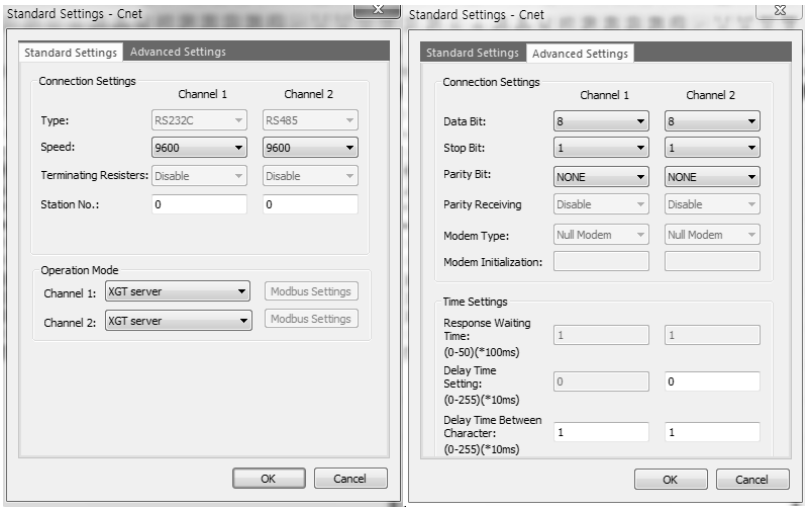
Chapter 2 Built-in Cnet communication

4) Settings of XGT client

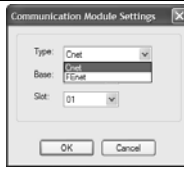

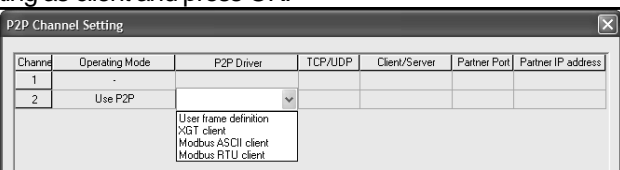

To operate XBL-C21A of client as XGT client, set Cent I/F module as follows.

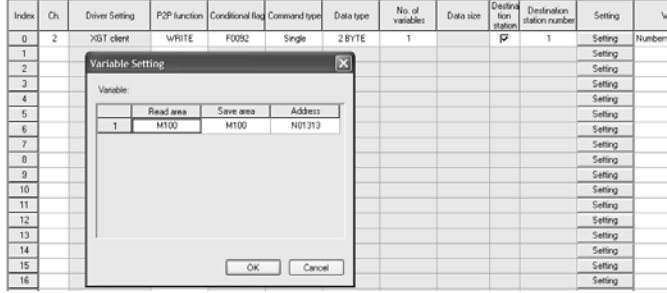
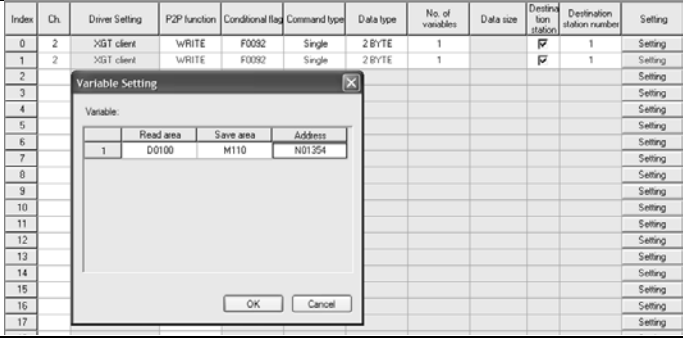
Sequence	Procedure	Setting method
1	Connection settings	
		<ol style="list-style-type: none"> 1. Select [Online]-[Connection settings] or click icon (). 2. After setting the connection option according to user, click the 'connection'.
2	Reading IO information	Select [Online]-[Read IO Information] and click icon (). IO information of currently mounted is shown on the project window.
3	Standard settings	
		<ol style="list-style-type: none"> 1. Select Cnet described in [Table 2.11.1]. 2. In case of acting as client, station setting doesn't have the meaning so set temporary station (0~255). 3. When acting as client, active mode should be [Use P2P settings].

After standard settings, P2P channel and P2P block should be set. Setting methods are as follows.

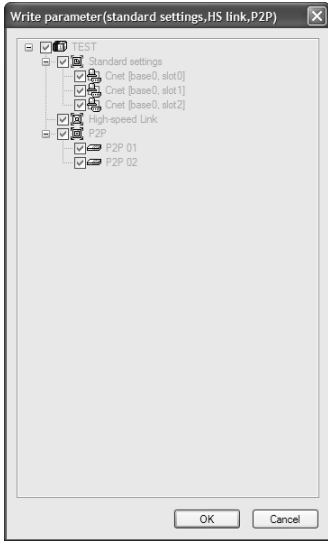

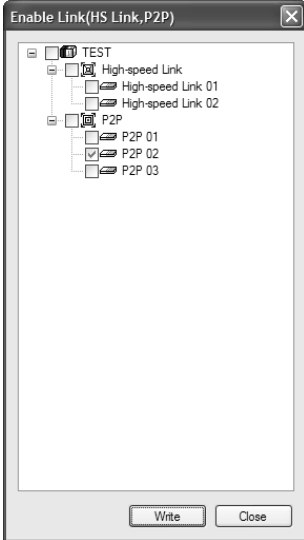
Sequence	Procedure	Setting method
1	P2P setting	Click  P2P bottom of project window.
2	Communication module settings	
		1. Double-click  of project window. (P2P 01 is fixed as built-in communication module) 2. Select slot number (no. 1) acting as client and press OK.
3	P2P channel setting	
		1. Double-click  of P2P 02 and set P2P driver of channel 2 as 
4	1. Double-click  of P2P 02.	
5	Setting of writing operation	
		1. Channel: Select ch.2 set as XGT client set in P2P channel. 2. Since it executes write operation, select WRITE. 3. Conditional flag: to send frame every 200ms, use flag F92. 4. Command type, Data type: to write 1 word, select single and 2 byte. 5. No. of variable: since no. of word is 1, select 1. 6. Destination station number: input 1 as station number of server. 7. Setting: after setting Read area and Save area, click OK. 1) Read area: device address of data saved in the client 2) Save area: device address of server to save data * If all settings are completed, color of index of channel becomes black.
6	Setting of reading operation	
		1. Channel, conditional flag, command type, data type, No. of variable, destination station no.: Same as described in setting is writing. 2. P2P function: select READ. 3. Setting: after setting Read area and Save area, click [OK]. 1) Read area: device address of data saved in server 2) Save area: device address of client to save

Chapter 2 Built-in Cnet communication

Sequence	Procedure	Setting method
7	Writing parameter	
<p>1. Select [Online] – [Write Parameter] or click icon ().</p> <p>2. Click [OK].</p> <p>3. If writing parameter is complete After clicking [OK], changed parameter is applied automatically.</p>		
8	Enabling the link	
<p>1. Select [Online] – [Enable Link] or click icon ()</p> <p>2. Click the P2P to enable and click Write.</p>		

5) Checking the operation

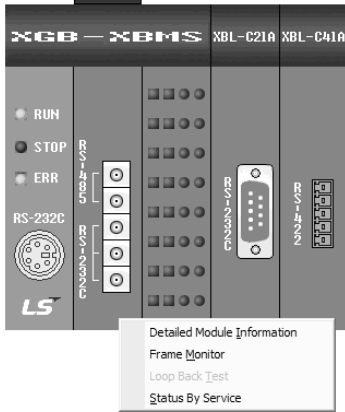
The user can analyze frame by using the frame monitor of XG-PD to check it communication is normal or not. Method of frame monitor of Cnet I/F module is same regardless of protocol.

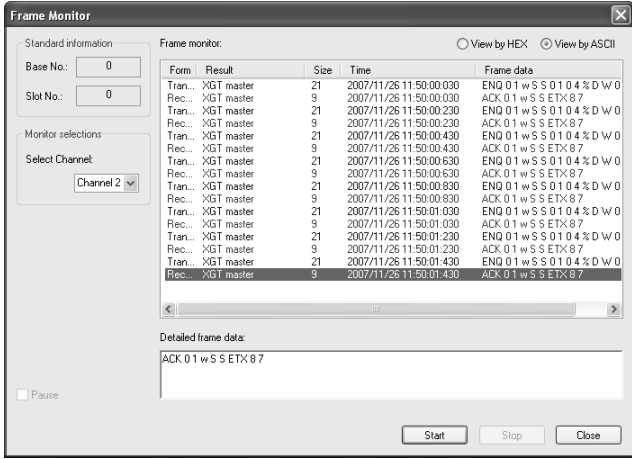
Sequence	Procedure	Setting method
1	System Diagnosis	 <p>Detailed Module Information Frame Monitor Loop Back Test Status By Service</p> <p>1. Connect with client by XG-PD and select [Online] – [System Diagnosis] or click (). 2. Click the right button on the relevant module and click Frame Monitor or Status By Service.</p>
2	Frame monitor	 <p>1. Select channel 2 and click Start. 2. Since dedicated service is ASCII communication, select View by ASCII. * In case of Modbus RTU, select View by HEX and in case of Modbus ASCII, select View by ASCII.</p>

2.11.3 Modbus Communication Example

We assume that system configuration of Modbus communication (Modbus RTU mode) example is as [Figure 10.3.1] and communication setting is as following table.

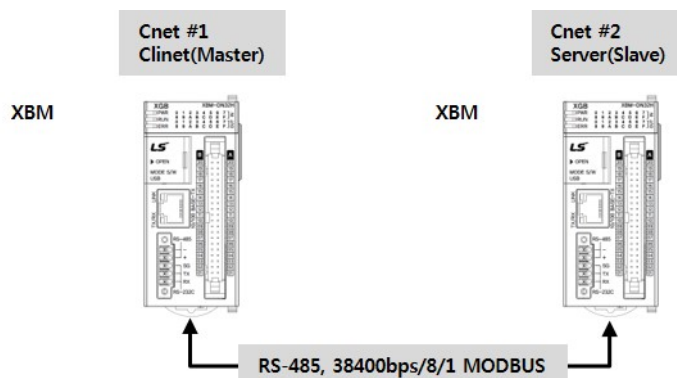

[Figure 2.11.2] XGT Modbus communication system configuration example

- Mount XBL-C41A on no. 1 slot of client PLC

1) Client setting

Main unit		XBM-DN32S
Communication module		XBL-C41A(no.1 Slot)
Communication type		RS-485
Communication speed		38,400
Data bit		8
Stop bit		1
Parity bit		None
Operation cycle		200ms
Operation status	Write	<ul style="list-style-type: none"> ▶ Write 1 word of M100 of client to M1 of server ▶ Write 4 words from D0 of client to M2~M5 of server ▶ Write 15th bit of M2 to 2nd bit of M20 of server ▶ Write 0~15th bit of M2 to 0~15th bit of M21 of server
	Read	<ul style="list-style-type: none"> ▶ Read 1 word of M2 of server and save it at M160 of client ▶ Read 4 words from P0 of server and save it at M150~M153 ▶ Read 1st bit of P2 of server and save it at 1st bit of M170. ▶ Read 0th ~ 15th bit of M10 of server and save it at 0th ~ 15th of M180 of client.

[client setting]



2) Server setting

Main unit		XBC-DN32H
Communication type		Built-in RS-485
Communication speed		38,400
Data bit		8
Stop bit		1
Parity bit		None
Station no.		1
Start address	Bit read area Address	P0
	Bit write area Address	M0
	Word write area Address	P0
	Word write area Address	M0

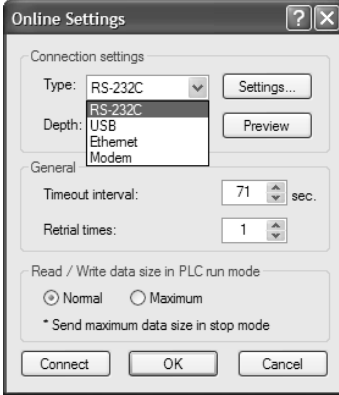

[server setting]

3) Modbus RTU server setting

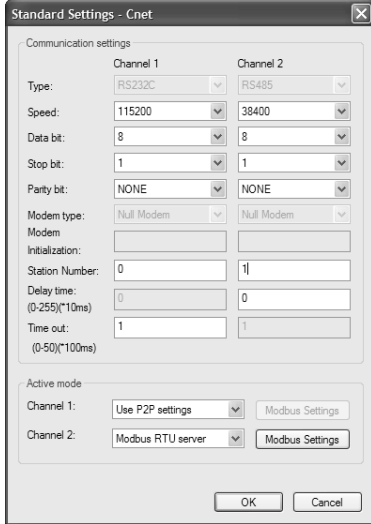
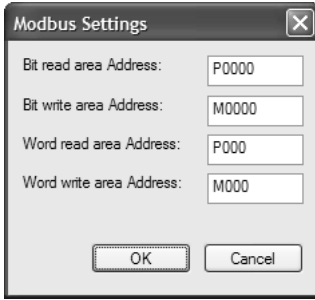
Standard settings are as follows to act built-in RS-485 communication channel of XBC-DN32H as Modbus RTU server.



Sequence	Procedure	Setting method
1	Connection setting	
		<p>1. Select [Online]-[Connection settings] or click icon ()</p> <p>2. After setting the connection option according to user, click the 'connection'.</p>
2	Reading IO information	<p>Select [Online]-[Read IO Information] and click icon ().</p> <p>IO information of currently mounted is shown on the project window.</p>
3	Standard settings	
		<p>1. Write setting value as same with [Table 2.11.2] at built-in communication channel 1.</p> <p>2. Set active mode as Modbus RTU server.</p>
4	Modbus setting	
		<p>1. Bit read area Address: P0000 2. Bit write area Address: M0000</p> <p>3. Word read area Address: P0000 4. Word write area Address: M0000</p> <p>* In the Bit read/write area Address, upper 4 digit is word address and the last digit is bit address (P00110: 0th bit of P11th word)</p>

Chapter 2 Built-in Cnet communication

Sequence	Procedure	Setting method
5	Writing parameter	
		<ol style="list-style-type: none"> 1. Select [Online] – [Write Parameter] or click icon (). 2. Click [OK] 3. If writing parameter is complete after clicking [OK] button, changed parameter is applied automatically.

4) Setting of Modbus RTU client

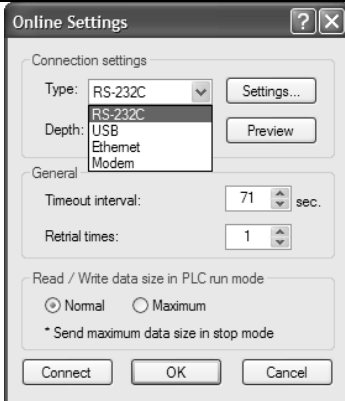



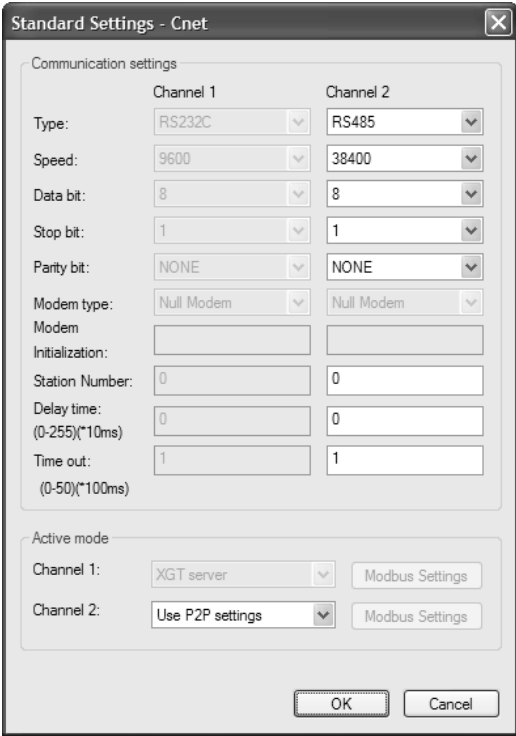

Standard settings are as follows to act XBL-C41A of client as Modbus RTU client.

Sequence	Procedure	Setting method
1	Connection setting	
		<ol style="list-style-type: none"> 1. Select [Online]-[Connection settings] or click icon (). 2. After setting the connection option according to user, click the 'connection'.
2	Reading IO information	Select [Online]-[Read IO Information] and click icon (). IO information of currently mounted is shown on the project window.

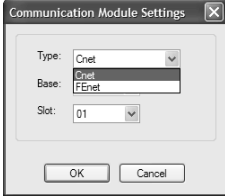

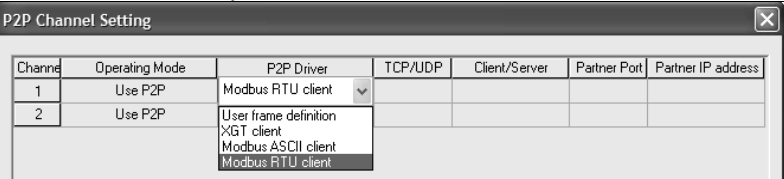

<p>3</p>	<p>Standard settings</p>	
<ol style="list-style-type: none"> 1. Select XBL-C41A and write standard settings to be same with [Table 2.11.1] at channel 2. Since station setting doesn't have meaning when acting as client, set as temporary station number (0~255). 3. When acting as client mode, active mode should be Use P2P settings. 		

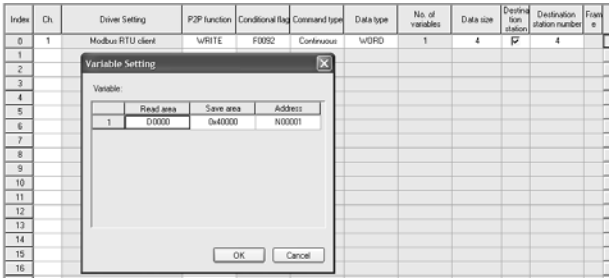
Chapter 2 Built-in Cnet communication

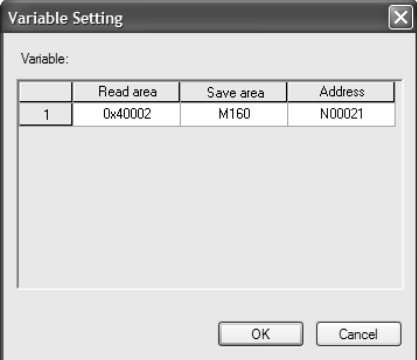
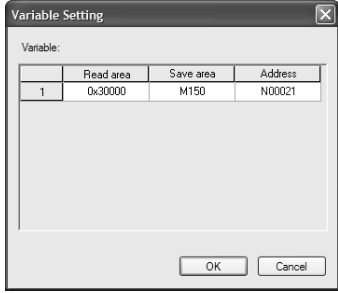
After standard settings, P2P channel and P2P block should be set. Setting methods are as follows.

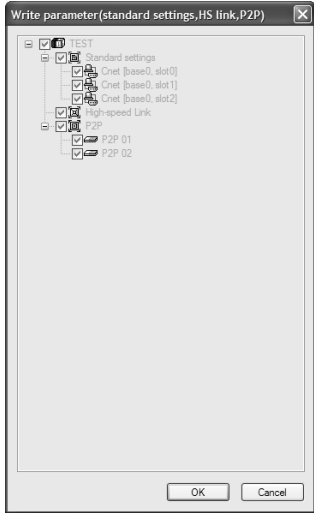
Sequence	Procedure	Setting method
1	P2P setting	Click  P2P bottom of project window.
2	Communication module setting	
	1. Double-click  of project window. (P2P 01 is fixed as built-in communication) 2. Select slot no. (No. 1) of client module and press OK.	
3	P2P channel setting	
	1. Double-click  of P2P 01 and set P2P driver of channel 1 as Modbus RTU client and click [OK].	
4	1. Double-click  of P2P 02.	
5	Setting of writing operation (1)	
	<p>► Write 1 word of M100 of client to M1 of server</p> <ol style="list-style-type: none"> Ch.: Select ch.2 set as Modbus RTU client set in P2P channel. P2P function: select WRITE. Conditional flag: to send frame every 200ms, use flag F92. Command type, Data type: to write 1 word, select single and 2 byte. Destination station number: select station number of server. Setting: after setting Read area and Save area, click OK. <ol style="list-style-type: none"> Read area: device address saved in the client (M100) Save area: device address of server to save (0x40001: M1) <p>* If all settings are completed, color of index of channel becomes black.</p>	
6	Setting of writing operation (2)	
	<p>► Write 4 words from D0 of client to M2~M5 of server</p> <ol style="list-style-type: none"> Ch., P2P function, conditional flag, destination station no.: same with step 5 Command type, Data type: because of writing continuous 4words, select Continuous, WORD Data size: because of 4 words, input 4. Setting: after setting Read area and Save area, click OK. <ol style="list-style-type: none"> Read area: device address saved in the client (D0) Save area: device address of server to save (0x40002 : M2) 	

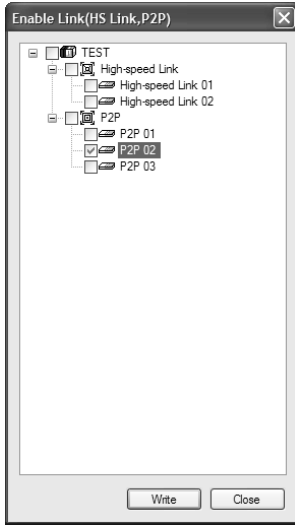
Sequence	Procedure	Setting method
7	Setting of reading operation (1)	
		<p>► Read 1 word of M2 of server and save it at M160 of client</p> <ol style="list-style-type: none"> 1. Ch., Conditional flag, Command type, Data type, Destination station no.: same with step 5 2. P2P function: select READ 3. Setting: after setting Read area and Save area, click OK. <ul style="list-style-type: none"> (1) Read area: device address saved in server (0x40002) (2) Save area: device address of client to save (M0160)
8	Setting of reading operation (2)	
		<p>► Read 4 words from P0 of server and save it at M150~M153</p> <ol style="list-style-type: none"> 1. Ch., Conditional flag, Command type, Data type, Destination station no.: same with step 6 2. P2P function: select READ. 3. Setting: after setting Read area and Save area, click OK. <ul style="list-style-type: none"> (1) Read area: device address saved in server (0x30000) (2) Save area: device address of client to save (M0150)

Sequence	Procedure	Setting method
9	Writing parameter	
<ol style="list-style-type: none"> 1. Select [Online] – [Write Parameter] or click icon (). 2. Click [OK]. 3. If writing parameter is complete after click OK, changed parameter is applied automatically. 		
10	Enabling the link	
<ol style="list-style-type: none"> 1. Select [Online] – [Enable Link] or click icon () 2. Click the P2P to enable and click Write. 		

2.11.4 User-defined Communication Example

When communication with device of which protocol is not supported by Cnet I/F module client, how to use user-defined communication is described in the system like [Figure 2.11.3] below

- System configuration

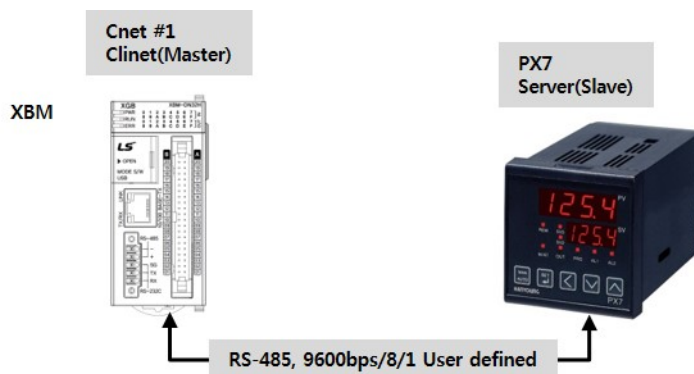

[Figure 2.11.3] User defined communication system configuration

At this example, Cnet I/F module and partner device to communicate through user defined communication system configuration are as Table below.

Device name	Main unit	XBC-DN32H	Han-Young temperature controller PX7 ^{Note2)}
	Communication module	Built-in RS-485	
Operation mode	Client		Server
Protocol	User frame definition		PC Link
Communication type	RS-485		RS-485
Communication speed	9,600		9,600
Data bit	8		8
Stop bit	1		1
Parity bit	None		None
Station no.	0		1
Delay time ^{note1)}	100ms		-
Operation	Reads present value and setting value from temperature controller every second and saves present value at MB200 and setting value at MB210.		

[User defined communication system configuration]

Note1) Delay time is set to prevent from frame error when communication with device of which response is slow in case of RS-422/485 communication. It varies according to partner device and it has 50~100ms value generally.

Chapter 2 Built-in Cnet communication

1) User definition communication frame structure

Frame structure of PC Link, communication protocol of Han-Young used in this example, is as follows.

- Frame of temperature controller is executed as ASCII character string, it can read/write defined D, I Register. There are two protocols, STD standard protocol and SUM protocol adding Check Sum to standard type and protocol is selected by parameter of temperature controller. Standard protocol is STD". It starts with first character STX (0x02) and ends with last character CR(0x0D) LF(0x0A).

The following [Table 2.11.3] and [Table 2.11.4] indicates structure of standard protocol and Sum protocol.

STX	Station no.	Command	Data	CR	LF
0x02	1~99			0x0D	0x0A

[Table 2.11.3] standard protocol structure

STX	Station no.	Command	Data	Error code	CR	LF
0x02	1~99			Check Sum	0x0D	0x0A

[Table 2.11.4] SUM protocol structure

2) Writing example frame

In this example, present value and setting value is saved in M device area of PLC. [Table 2.11.5] is frame requesting continuous data and [Table 2.11.6] is frame responding to request.

Frame	STX	Station no.	DRS	,	No. of data	Start address of D register	CR	LF
(Byte)	1	2	3	1	2	4	1	1

[Table 2.11.5] request frame

- **DRS:** command that request reading continuous D register value. No of data and start address of D register is necessary.
- In the example, no. of data is 2 and start address is 01.

Frame	STX	Station no.	DRS	,	OK	,	Data 1	,	Data N	CR	LF
Size (Byte)	1	2	3	1	2	1	4	1	4	1	1

[Table 2.11.6] response frame

3) User definition communication parameter setting

(1) Communication standard parameter setting

For standard setting, refer to setting method when acting as P2P service of 2.10.2 and configure above system [Table 2.11.1].

Chapter 2 Built-in Cnet communication

(2) Writing frame that requests reading data

Describes how to write frame at XG-PD for user definition communication

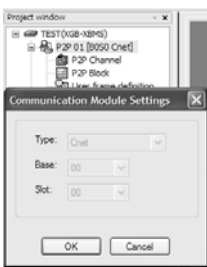
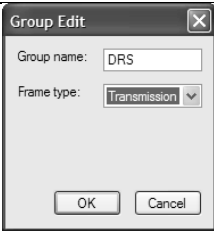
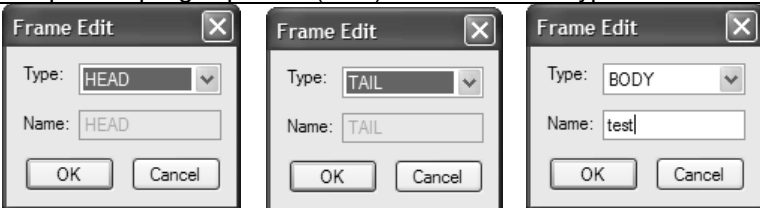
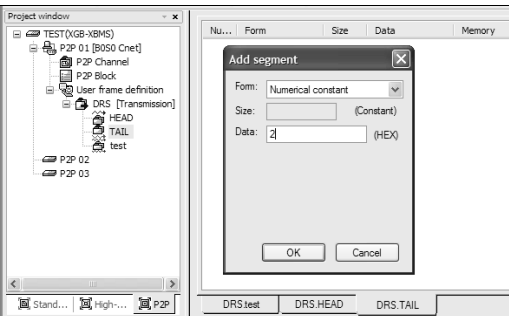
frame that requests reading data (Transmission frame)	
Sequence	Setting method
1	 <p>1. After standard settings, double-click P2P 01 in the P2P window. 2. As for built-in communication, base and slot is fixed as 0. Click OK. 3. Double-click P2P Channel and select User frame definition in Channel 2.</p>
2	 <p>1. Click user definition frame and click right button of mouse. 2. Click 'Add Group' and input group name (DRS) and select frame type as transmission.</p>
3	 <p>1. Click 'Add Frame' and select type HEAD, TAIL, BODY and input BODY name 2. BODY's name is test here.</p>
4	 <p>1. If you double-click editor window after selecting DRS.HEAD tap at right screen, segment setting screen is created. 2. Select Numerical constant which indicates Hex as ASCII code as Form. Input Hex value 2 which indicates STX.</p>
Sequence	Setting method

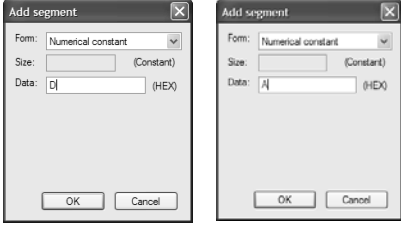
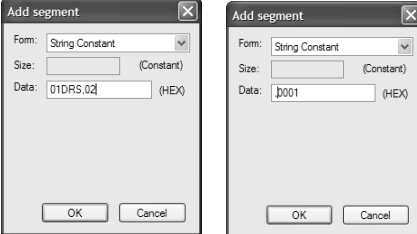
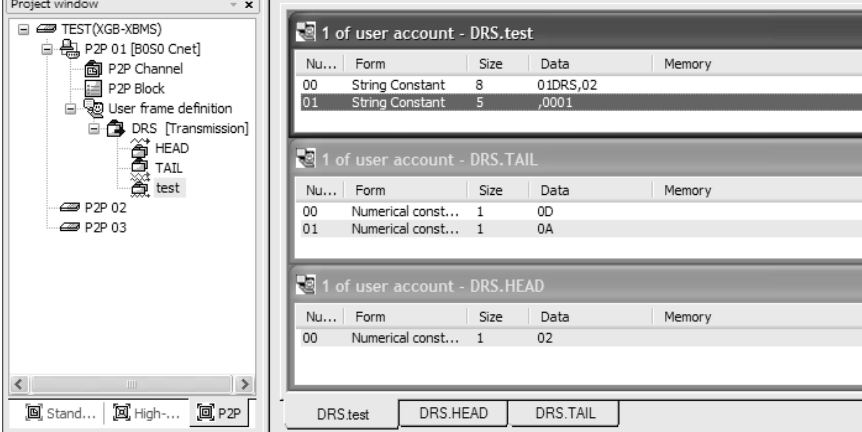
<p>5</p>	
	<p>1. Select Numerical constant which indicates Hex as ASCII code as Form. Input Hex value D, A which indicates CR and LF.</p>
<p>6</p>	
	<p>1. Double-click DRS.test tap and edit segment like the following. 2. Write frame requesting reading data of continuous 2 areas starting first of D register of station no.1. 3. When double-clicking editor screen and writing frame through segment edition, size of one segment is less than 10.</p>
<p>7</p>	 <p>1. Result writing entire frame of data reading request frame.</p>

4) Writing frame to receive response frame of temperature controller

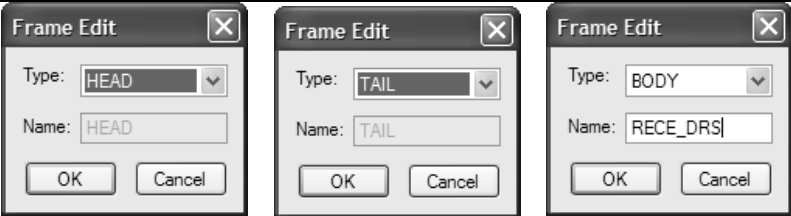
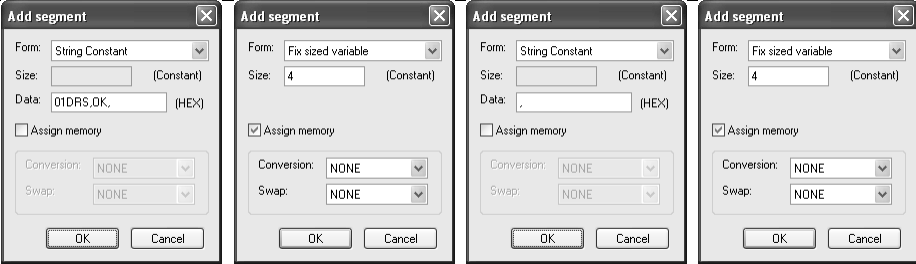
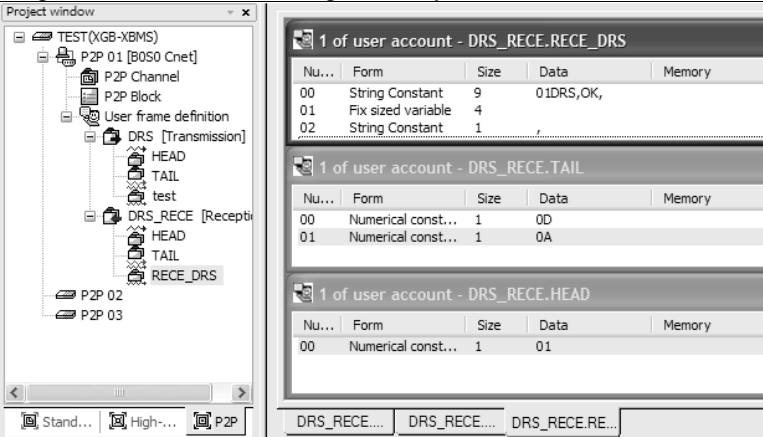
Writing response frame (Reception frame)	
Sequence	Setting method
1	 <p>1. Write like step 2 of frame that request reading data. At this time, set Frame type as reception. 2. Frame name is DRS_RECE.</p>
2	 <p>1. Click 'Add Frame' and select HEAD, TAIL, BODY as type and input BODY name. 2. BODY's name is RECE_DRS here.</p>
3	<p>1. Method writing HEAD, TAIL is same with step 4~5 of method writing frame that request reading data.</p>
4	 <p>1. To save present temperature value in MB200 and setting value in MB210, set the storage area of 1st and 2nd data as set in [Table 10.4.1]. 2. Since data size of data 1 and 2 is 4 byte, select Fix sized variable and input 4 in Size 3. To select storage area of data, check Assign memory.</p>
5	 <p>1. This is entire frame to receive response data of temperature controller.</p>

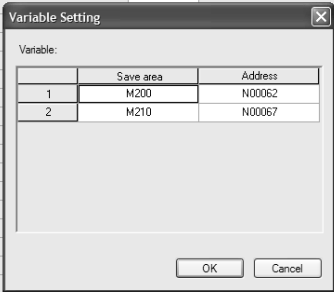

5) Writing P2P transmission/reception block

Write P2P TX/RX block as follows by using user definition communication segment written ahead.

Sequence	Setting method
1	
	<ol style="list-style-type: none"> 1. Double-click P2P block of P2P 01. 2. Input channel selected at P2P channel (user frame definition). 3. In case P2P function is TX frame, select SEND. In case P2P function is RX, select RECEIVE. 4. Conditional flag is activated when P2P function is SEND. 5. Since it reads data every 1 second, use F93 as conditional flag. 6. Click Setting of RX frame and set save area of current temperature and setting value.
2	Execute Write Parameter and Enable Link.

6) Checking TRX data

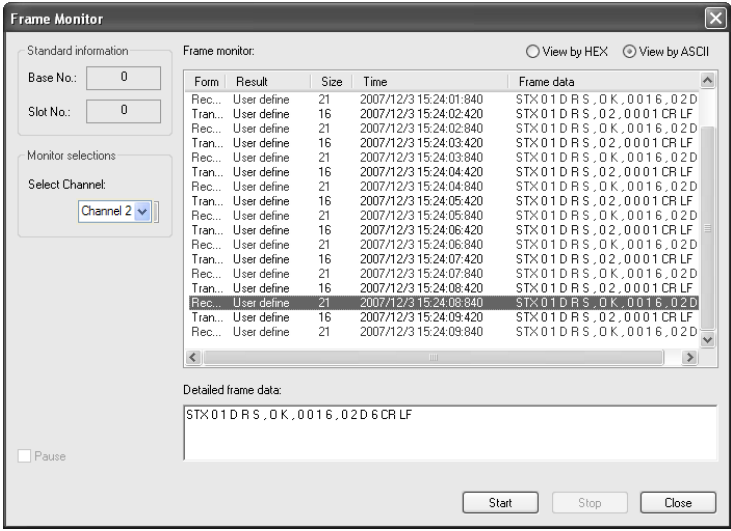
Check whether written frame is transmitted/received properly

Sequence	Setting method
1	
	<ol style="list-style-type: none"> 1. Select [Online]-[System Diagnosis] or click icon () 2. After clicking relevant module and click right button of mouse, select Status by service or frame monitor. 3. When frame is not dealt with properly, unknown message is displayed.
2	Check device area by device monitor of XG-5000.

2.12 Error Code

2.12.1 XGT Server Error Code

Error code is displayed as hex 2 byte (4 byte as ASCII code). The user can see error by frame monitor and in case of viewing by ASCII, the user can see the following error code.

Error code	Error type	Error details and causes	Example
0003	Number of blocks exceeded	Number of blocks exceeds 16 at Individual Read/Write Request	01rSS1105%MW10...
0004	Variable length error	Variable Length exceeds the max. size of 16	01rSS010D%MW100000000000 ..
0007	Data type error	Other data type than X,B,W,D,L received	01rSS0105%MK10
0011	Data error	Data length area information incorrect	01rSB05%MW10%4
		In case % is unavailable to start with	01rSS0105\$MW10
		Variable's area value wrong	01rSS0105%MW^&
		Other value is written for Bit Write than 00 or 01	01wSS0105%MX1011
0090	Monitor execution error	Unregistered monitor execution requested	
0190	Monitor execution error	Reg. No. range exceeded	
0290	Monitor reg. Error	Reg. No. range exceeded	
1132	Device memory error	Other letter than applicable device is input	
1232	Data size error	Request exceeds the max range of 60 Words to read or write at a time.	01wSB05%MW1040AA5512,..
1234	Extra frame error	Unnecessary details exist as added.	01rSS0105%MW10000
1332	Data type discordant	All the blocks shall be requested of the identical data type in the case of Individual Read/Write	01rSS0205%MW1005%MB10
1432	Data value error	Data value unavailable to convert to Hex	01wSS0105%MW10AA%5
7132	Variable request area exceeded	Request exceeds the area each device supports.	01rSS0108%MWFFFFFF

2.12.2 Modbus Server Error Code

Error code is displayed as hex 1 byte (2 byte as ASCII code) and indicates type of error.

Code	Error type	Error details and causes
01	Illegal Function	Function code error
02	Illegal Address	Address range exceeded
03	Illegal Data Value	Data value not allowed

2.12.3 P2P Client Error Code

Code	Error type	Error details and causes
01	ERR_NO_HEAD	There is no head of reception frame
02	ERR_NO_TAIL	There is no tail of reception frame
03	ERR_WRONG_BCC	BCC is not correct
04	ERR_STATION_NO	Station number of reception frame is not correct
05	ERR_WRONG_DRV_TYPE	Driver type is not correct
07	ERR_FRAME_SND	Can't send TX frame
09	ERR_NO_USE_LINKID	There is no communication module
0A	ERR_PLC_RESP_TIMEOUT	Reception frame is not received during time out setting time
0B	ERR_FRM_LENGTH	Length of reception frame is not correct
0D	ERR_ASCII_HEX_ERR	ASC-HEX conversion of reception frame is not correct
0E	ERR_RANGE_OVER	Area of device is exceeded
0F	ERR_NAK_ERR	Response of reception frame is NAK

Appendix1 Flag List

Appendix 1 Flag List

Appendix 1.1 Special Relay (F) List

Word	Bit	Variables	Function	Description	
%FW0-1	%FD0	_SYS_STATE	Mode and state	Indicates PLC mode and operation State.	
	%FX0	_RUN	Run	Run state.	
	%FX1	_STOP	Stop	Stop state.	
	%FX2	_ERROR	Error	Error state.	
	%FX3	_DEBUG	Debug	Debug state.	
	%FX4	_LOCAL_CON	Local control	Local control mode.	
	%FX8	_RUN_EDIT_ST	Online editing	Editing program download during RUN.	
	%FX9	_RUN_EDIT_CHK		Internal edit processing during RUN.	
	%FX10	_RUN_EDIT_DONE		Edit is done during RUN.	
	%FX11	_RUN_EDIT_NG		Edit is ended abnormally during RUN.	
	%FX12	_CMOD_KEY	Operation Mode	Operation mode changed by key.	
	%FX13	_CMOD_LPADT		Operation mode changed by local PADT.	
	%FX14	_CMOD_RPADT		Operation mode changed by Remote PADT.	
	%FX16	_FORCE_IN	Forced input	Forced input state.	
	%FX17	_FORCE_OUT	Forced output	Forced output state.	
	%FX20	_MON_On	Monitor	Monitor on execution.	
	%FX21	_USTOP_On	Stop by STOP function	PLC stops by STOP function after finishing current scan	
	%FX22	_ESTOP_On	Stop by Estop function	PLC stops by ESTOP function promptly	
	%FX24	_INIT_RUN	Initialize	Initialization task on execution.	
	%FX28	_PB1	Program Code 1	Program Code 1 selected.	
%FX29	_PB2	Program Code 2	Program Code 2 selected.		
%FW2-3	%FD1	_CNF_ER	System error	Reports heavy error state of system.	
	%FX33	_IO_TYER	Module Type error	Module Type does not match.	
	%FX34	_IO_DEER	Module detachment error	Module is detached.	
	%FX36	_IO_RWER	Module I/O error	Module I/O error.	
	%FX37	_IP_IFER	Module interface error	Special/communication module interface error.	
	%FX38	_ANNUM_ER	External device error	Detected heavy error in external Device.	

Word	Bit	Variable	Function	Description
%FW2-3	%FX40	_BPRM_ER	Basic parameter	Basic parameter error.
	%FX41	_IOPRM_ER	IO parameter	I/O configuration parameter error.

	%FX42	_SPPRM_ER	Special module parameter	Special module parameter is Abnormal.
	%FX43	_CPPRM_ER	Communication module parameter	Communication module parameter is abnormal.
	%FX44	_PGM_ER	Program error	There is error in Check Sum of user program
	%FX45	_CODE_ER	Program code error	Meets instruction can not be interpreted
	%FX46	_SWDT_ER	CPU abnormal stop Or malfunction	The saved program is damaged because of CPU abnormal end or program can not be executed.
	%FX48	_WDT_ER	Scan watchdog	Scan watchdog operated.
	%FX53	_IO_OVER_ER	Expansion module exceed	Exceed available number of expansion module
%FW4-5	%FD2	_CNF_WAR	System warning	Reports light error state of system.
	%FX64	_RTC_ER	RTC data error	RTC data Error occurred
	%FX65	_DBCK_ER	Backup error	Data backup error.
	%FX66	_HBCK_ER	Restart error	Hot Restart is not available
	%FX67	_ABSD_ER	Operation shutdown error	Stop by abnormal operation.
	%FX68	_TASK_ER	Task collision	Tasks are under collision
	%FX69	_BAT_ER	Battery error	There is error in battery status
	%FX70	_ANNUM_WAR	External device error	Detected light error of external device.
	%FX72	_HS_WAR1	High speed link 1	High speed link – parameter 1 error.
	%FX73	_HS_WAR2	High speed link 2	High speed link – parameter 2 error.
	%FX84	_P2P_WAR1	P2P parameter 1	P2P – parameter 1 error.
	%FX85	_P2P_WAR2	P2P parameter 2	P2P – parameter 2 error.
	%FX86	_P2P_WAR3	P2P parameter 3	P2P – parameter 3 error.
	%FX92	_CONSTANT_ER	Constant error	Constant error.
%FX95	_EIP_TAG_WAR	Abnormal EIP TAG information	Ethernet/IP TAG information incorrect	
%FW8	%FX128	_CONTANT_RUN	Constant run	Constant running
%FW9	%FW9	_USER_F	User contact	Timer used by user.
	%FX144	_T20MS	20ms	20ms cycle clock
	%FX145	_T100MS	100ms	100ms cycle clock
	%FX146	_T200MS	200ms	200ms cycle clock
	%FX147	_T1S	1s Clock	1s cycle clock
	%FX148	_T2S	2 s Clock	2s cycle clock
	%FX149	_T10S	10 s Clock	10s cycle clock
	%FX150	_T20S	20 s Clock	20s cycle clock
	%FX151	_T60S	60 s Clock	60s cycle clock
	%FX153	_On	Ordinary time On	Always On state Bit.
	%FX154	_Off	Ordinary time Off	Always Off state Bit.
	%FX155	_10n	1scan On	First scan On Bit.
	%FX156	_10ff	1scan Off	First scan OFF bit.
	%FX157	_STOG	Reversal	Reversal every scan.

Appendix1 Flag List

Word	Bit	Variable	Function	Description
%FW11	%FW11	_LOGIC_RESULT	Logic result	Indicates logic results.
	%FX176	_ERR	operation error	On during 1 scan in case of operation error.
	%FX181	_LER	Operation error latch	Continuously On in case of operation error
%FW13	-	_AC_F_CNT	Power shutdown times	Saves the times of power shutdown
%FW14	-	_FALS_NUM	FALS no.	Indicates FALS no.
%FW15	-	_PUTGET_ERR0	PUT/GET error 0	Main base Put / Get error.
%FW23	-	_PUTGET_NDR0	PUT/GET end 0	Main base Put/Get end.
%FW44	-	_CPU_TYPE	CPU Type	Indicates information for CPU Type.
%FW45	-	_CPU_VER	CPU version	Indicates CPU version.
%FD23	-	_OS_VER	OS version	Indicates OS version.
%FD24	-	_OS_DATE	OS date	Indicates OS distribution date.
%FW50	-	_SCAN_MAX	Max. scan time	Indicates max. scan time.
%FW51	-	_SCAN_MIN	Min. scan time	Indicates min. scan time.
%FW52	-	_SCAN_CUR	Current scan time	Current scan time.
%FW53	-	_MON_YEAR	Month/year	Clock data (month/year)
%FW54	-	_TIME_DAY	Hour/date	Clock data (hour/date)
%FW55	-	_SEC_MIN	Second/minute	Clock data (Second/minute)
%FW56	-	_HUND_WK	Hundred year/week	Clock data (Hundred year/week)
%FD30	-	_REF_COUNT	Refresh count	Increase when module Refresh.
%FD31	-	_REF_OK_CNT	Refresh OK	Increase when module Refresh is normal.
%FD32	-	_REF_NG_CNT	Refresh NG	Increase when module Refresh is Abnormal.
%FD40	-	_BUF_FULL_CNT	Buffer Full	Increase when CPU internal buffer is full.
%FD41	-	_PUT_CNT	Put count	Increase when Put count.
%FD42	-	_GET_CNT	Get count	Increase when Get count.
%FD43	-	_KEY	Current key	indicates the current state of local key.
%FD44	-	_KEY_PREV	Previous key	indicates the previous state of local key
Word	Bit	Variable	Function	Description
%FW90	-	_IO_TYER_N	Mismatch slot	Module Type mismatched slot no.
%FW91	-	_IO_DEER_N	Detach slot	Module detached slot no.
%FW93	-	_IO_RWER_N	RW error slot	Module read/write error slot no.
%FW95	-	_IP_IFER_N	IF error slot	Module interface error slot no.
%FW96	-	_IO_TYER0	Module Type 0 error	Main base module Type error.
%FW104	-	_IO_DEER0	Module Detach 0 error	Main base module Detach error.
%FW120	-	_IO_RWER0	Module RW 0 error	Main base module read/write error.
%FW128	-	_IO_IFER_0	Module IF 0 error	Main base module interface error.
%FW136		_RTC_DATE	RTC current date	RTC current date
%FW137		_RTC_WEEK	RTC current day	RTC current day
%FD69		_RTC_TOD	Current time of RTC (unit:	As time data based on 00:00:00 within one day,

Appendix1 Flag List

			ms)	unit is ms
%FD70	-	_AC_FAIL_CNT	Power shutdown times	Saves the times of power shutdown.
%FD71	-	_ERR_HIS_CNT	Error occur times	Saves the times of error occur.
%FD72	-	_MOD_HIS_CNT	Mode conversion times	Saves the times of mode conversion.
%FD73	-	_SYS_HIS_CNT	History occur times	Saves the times of system history.
%FD74	-	_LOG_ROTATE	Log Rotate	Saves log rotate information.
%FW150	-	_BASE_INFO0	Slot information 0	Main base slot information.
%FW158		_RBANK_NUM	Currently used block No.	Indicates currently used block no.
%FW173		_PLS_CATCH[0..15]	Pulse Catch Result	Maintain pulse catch result for 1scan
%FD89		_OS_VER_PATCH	OS Version Patch	OS Version Patch
%FW200	-	_USER_WRITE_F	Available contact point	Contact point available in program.
	%FX3200	_RTC_WR	RTC RW	Data write and read in RTC.
	%FX3201	_SCAN_WR	Scan WR	Initializing the value of scan.
	%FX3202	_CHK_ANC_ERR	Request detection of external serious error	Request detection of external error.
	%FX3216	_CHK_ANC_WAR	Request detection of external slight error(warning)	Request detection of external slight error (warning).
%FW201	-	_USER_STAUS_F	User contact point	User contact point.
	%FX3216	_INIT_DONE	Initialization completed	Initialization complete displayed.
%FW202	-	_ANC_ERR	Display information of external serious error	Display information of external serious error
%FW203	-	_ANC_WAR	Display information of external slight error(warning)	Display information of external slight error(warning)
%FW210	-	_MON_YEAR_DT	Month/year	Clock data (month/year)
%FW211	-	_TIME_DAY_DT	Hour/date	Clock data (hour/date)
%FW212	-	_SEC_MIN_DT	Second/minute	Clock data (Second/minute)
%FW213	-	_HUND_WK_DT	Hundred year/week	Clock data (Hundred year/week)
%FW272	%FX4352	_ARY_IDX_ERR	Array -index- range exceeded- error flag	Error flag is indicated when exceeding the no. of array
%FW274	%FX4384	_ARY_IDX_LER	Array -index- range exceeded- latch-error flag	Error latch flag is indicated when exceeding the no. of array

Appendix1 Flag List

Appendix 1.2 Communication Relay (L) List

(1) High-speed Link Flag(L)

High-speed link no. 1~ 5

Device	Keyword	Type	Description
%LX0	_HS1_RLINK	Bit	High speed link parameter 1 normal operation of all station
			Indicates normal operation of all station according to parameter set in High speed link, and On under the condition as below. 1. In case that all station set in parameter is RUN mode and no error, 2. All data block set in parameter is communicated normally, and 3. The parameter set in each station itself is communicated normally. Once RUN_LINK is On, it keeps On unless stopped by LINK_DISABLE.
%LX1	_HS1_LTRBL	Bit	Abnormal state after _HS1RLINK On
			In the state of _HS1RLINK flag On, if communication state of the station set in the parameter and data block is as follows, this flag shall be On. 1. In case that the station set in the parameter is not RUN mode, or 2. There is an error in the station set in the parameter, or 3. The communication state of data block set in the parameter is not good. LINK TROUBLE shall be On if the above 1, 2 & 3 conditions occur, and if the condition return to the normal state, it shall be OFF again.
%LX32 ~ %LX95	_HS1_STATE*** (*** = 000~063)	Bit Array	Indicates total status of High Speed Link no.1 ***th block
			Indicates total status of communication information about each data block of parameter _HS1_STATE*** = HS1MOD*** & _HS1TRX*** & (~_HS1_ERR***)
%LX96 ~ %LX159	_HS1_MOD*** (*** = 000~063)	Bit Array	RUN operation mode of High Speed Link parameter no.1 ***th block station
			Indicates operation mode of station set in *** data block of parameter
%LX160 ~ %LX223	_HS1_TRX*** (*** = 000~063)	Bit Array	Indicates normal communication with High Speed Link no.1 ***th block station
			Indicates whether communication status of *** data block of parameter is normal or not.
%LX224 ~ %LX287	_HS1_ERR*** (*** = 000~063)	Bit Array	Operation error mode of High Speed Link parameter no.1 ***th block station
			Indicates whether there is error at communication status of *** data block of parameter
%LX288 ~ %LX767	_HS1_SETBLOCK***	Bit Array	Indicates High Speed Link parameter no.1 ***th block setting
			Indicates whether *** data block of parameter is set or not.

Block Number	Address	Note
2	%LX416~%LX767	For each block flags, refer to the table on the preceding page.
3	%LX928~%LX1279	
4	%LX1344~%LX1679	
5	%LX1744~%LX2079	

k that is the block number indicates the information of 64 blocks in the range of 00~63 through 4 words; 16 per 1 word. For example, the mode information(_HS1MOD) indicates the information of the block 0~15 in L0006; the information of block 16~31, 32~47, 48~63 in %LW0007, %LW0008, %LW0009. Accordingly, the mode information of block No. 55 is indicated in %LW00097.

(2) P2P Flag(L)

P2P parameter: 1~3, P2P block: 0~31

Device	Keyword	Type	Description
%LX8192	_P2P1_NDR00	Bit	Indicates P2P parameter 1, 0 Block service normal end.
%LX8193	_P2P1_ERR00	Bit	Indicates P2P parameter 1, 0 Block service abnormal end.
%LW513	_P2P1_STATUS00	Word	Indicates error code in case of P2P parameter 1, 0 Block service abnormal end.
%LD257	_P2P1_SVCCNT00	DWord	Indicates P2P parameter 1, 0 Block service normal count.
%LD261	_P2P1_ERRCNT00	DWord	Indicates P2P parameter 1, 0 Block service abnormal count.
%LX8288	_P2P1_NDR01	Bit	P2P parameter 1, 1 Block service normal end.
%LX8289	_P2P1_ERR01	Bit	P2P parameter 1, 1 Block service abnormal end.
%LW519	_P2P1_STATUS01	Word	Indicates error code in case of P2P parameter 1, 1 Block service abnormal end.
%LD260	_P2P1_SVCCNT01	DWord	Indicates P2P parameter 1, 1 Block service normal count.
%LD261	_P2P1_ERRCNT01	DWord	Indicates P2P parameter 1, 1 Block service abnormal count.

In terms of P2P parameter No.1 block, a total of 32 blocks from No.0 to No.31 exist. The parameters of each block have the same size and display function as the above table.

P2P Number	L Address	Note
1	%LW512~%LW703	각각의 블록 플래그는 위의 표 참조
2	%LW704~%LW895	
3	%LW896~%LW1087	
4	%LW1088~%LW1279	
5	%LW1280~%LW1471	
6	%LW1472~%LW1663	

Appendix1 Flag List

(3) Network Resistor(N)

P2P parameter: 1~6, P2P block: 0~31

Device	Keyword	Type	Description
%NW0000	_P1B00SN	Word	Saves another station no. of P2P parameter 1, 00 block.
%NW0001~ %NW0004	_P1B00RD1	Device Structure	Saves area device 1 to read P2P parameter 1, 00 block.
%NW0005	_P1B00RS1	Word	Saves area size 1 to read P2P parameter 1, 00block.
%NW0006~ %NW0009	_P1B00RD2	Device Structure	Saves area device 2 to read P2P parameter 1, 00 block.
%NW0010	_P1B00RS2	Word	Saves area size 2 to read P2P parameter 1, 00 block.
%NW0011~ %NW0014	_P1B00RD3	Device Structure	Saves area device 3 to read P2P parameter 1, 00 block.
%NW0015	_P1B00RS3	Word	Saves area size 3 to read P2P parameter 1, 00 block.
%NW0016~ %NW0019	_P1B00RD4	Device Structure	Saves area device 4 to read P2P parameter 1, 00 block.
%NW0020	_P1B00RS4	Word	Saves area size 4 to read P2P parameter 1, 00 block.
%NW0021~ %NW0024	_P1B00WD1	Device Structure	Saves area device 1 to save P2P parameter 1, 00 block..
%NW0025	_P1B00WS1	Word	Saves area size 1 to save P2P parameter 1, 00 block
%NW0026~ %NW0029	_P1B00WD2	Device Structure	Saves area device 2 to save P2P parameter 1, 00 block..
%NW0030	_P1B00WS2	Word	Saves area size 2 to save P2P parameter 1, 00 block.
%NW0031~ %NW0034	_P1B00WD3	Device Structure	Saves area device 3 to save P2P parameter 1, 00 block.
%NW0035	_P1B00WS3	Word	Saves area size 3 to save P2P parameter 1, 00block.
%NW0036~ %NW0039	_P1B00WD4	Device Structure	Saves area device 4 to save P2P parameter 1, 00 block.
%NW0040	_P1B00WS4	Word	Saves area size 4 to save P2P parameter 1, 00 block
%NW0041	_P1B01SN	Word	Saves another station no. of P2P parameter 1, 01 block.
%NW0042~ %NW0045	_P1B01RD1	Device Structure	Saves area device 1 to read P2P parameter 1, 01 block.
%NW0046	_P1B01RS1	Word	Saves area size 1 to read P2P parameter 1, 01 block.
%NW0047~ %NW0050	_P1B01RD2	Device Structure	Saves area device 2 to read P2P parameter 1, 01 block.
%NW0051	_P1B01RS2	Word	Saves area size 2 to read P2P parameter 1, 01 block.
%NW0052~ %NW0055	_P1B01RD3	Device Structure	Saves area device 3 to read P2P parameter 1, 01 block.
%NW0056	_P1B01RS3	Word	Saves area size 3 to read P2P parameter 1, 01 block.
%NW0057~ %NW0060	_P1B01RD4	Device Structure	Saves area device 4 to read P2P parameter 1, 01 block.
%NW0061	_P1B01RS4	Word	Saves area size 4 to read P2P parameter 1, 01 block.
%NW0062~ %NW0065	_P1B01WD1	Device Structure	Saves area device 1 to save P2P parameter 1, 01 block.
%NW0066	_P1B01WS1	Word	Saves area size 1 to save P2P parameter 1, 01 block.
%NW0067~ %NW0070	_P1B01WD2	Device Structure	Saves area device 2 to save P2P parameter 1, 01 block.
%NW0071	_P1B01WS2	Word	Saves area size 2 to save P2P parameter 1, 01 block

%NW0072~ %NW0075	_P1B01WD3	Device Structure	Saves area device 3 to save P2P parameter 1, 01 block.
%NW0076	_P1B01WS3	Word	Saves area size 3 to save P2P parameter 1, 01 block
%NW0077~ %NW0080	_P1B01WD4	Device Structure	Saves area device 4 to save P2P parameter 1, 01 block.
%NW0081	_P1B01WS4	Word	Saves area size 4 to save P2P parameter 1, 01 block.

P2P Number	L 영역 번지수	비 고
1	%NW0000~%NW1311(CNet)	For the saving area parameters of each block, refer to the above table.
2	%NW1312~%NW2623(ENet)	
3	%NW2624~%NW3935(Expansion)	
4	%NW3936~%NW5247(Expansion)	
5	%NW5248~%NW6559(High Speed Expansion)	
6	%NW6560~%NW7872(High Speed Expansion)	

Note

- (1) When you set P2P parameters through XG5000, N area is automatically set up.
- (2) The N area is the flash area so it cannot be used as the internal device. (Cannot write)

Appendix1 Flag List

(4) ASCII(American National Standard Code for Information Interchange) Code table

ASCII		Value	ASCII		Value	ASCII		Value	ASCII		Value
HEX	DEC		HEX	DEC		HEX	DEC		HEX	DEC	
00	000	NULL	40	064	@	20	032	(space)	60	096	`
01	001	SOH	41	065	A	21	033	!	61	097	a
02	002	STX	42	066	B	22	034	"	62	098	b
03	003	ETX	43	067	C	23	035	#	63	099	c
04	004	EQT	44	068	D	24	036	\$	64	100	d
05	005	ENQ	45	069	E	25	037	%	65	101	e
06	006	ACK	46	070	F	26	038	&	66	102	f
07	007	BEL	47	071	G	27	039	'	67	103	g
08	008	BS	48	072	H	28	040	(68	104	h
09	009	HT	49	073	I	29	041)	69	105	i
0A	010	LF	4A	074	J	2A	042	*	6A	106	j
0B	011	VT	4B	075	K	2B	043	+	6B	107	k
0C	012	FF	4C	076	L	2C	044	`	6C	108	l
0D	013	CR	4D	077	M	2D	045	-	6D	109	m
0E	014	SO	4E	078	N	2E	046	.	6E	110	n
0F	015	SI	4F	079	O	2F	047	/	6F	111	o
10	016	DLE	50	080	P	30	048	0	70	112	p
11	017	DC1	51	081	Q	31	049	1	71	113	q
12	018	DC2	52	082	R	32	050	2	72	114	r
13	019	DC3	53	083	S	33	051	3	73	115	s
14	020	DC4	54	084	T	34	052	4	74	116	t
15	021	NAK	55	085	U	35	053	5	75	117	u
16	022	SYN	56	086	V	36	054	6	76	118	v
17	023	ETB	57	087	W	37	055	7	77	119	w
18	024	CAN	58	088	X	38	056	8	78	120	x
19	025	EM	59	089	Y	39	057	9	79	121	y
1A	026	SUB	5A	090	Z	3A	058	:	7A	122	z
1B	027	ESC	5B	091	[3B	059	;	7B	123	{
1C	028	FS	5C	092	\	3C	060	<	7C	124	
1D	029	GS	5D	093]	3D	061	=	7D	125	}
1E	030	RS	5E	094	^	3E	062	>	7E	126	~
1F	031	US	5F	095	_	3F	063	?	7F	127	□

Appendix 2 Dimension (Unit: mm)

(1) CPU Type

- XEM-DN32H2/HP, XEM-DP32H2/HP

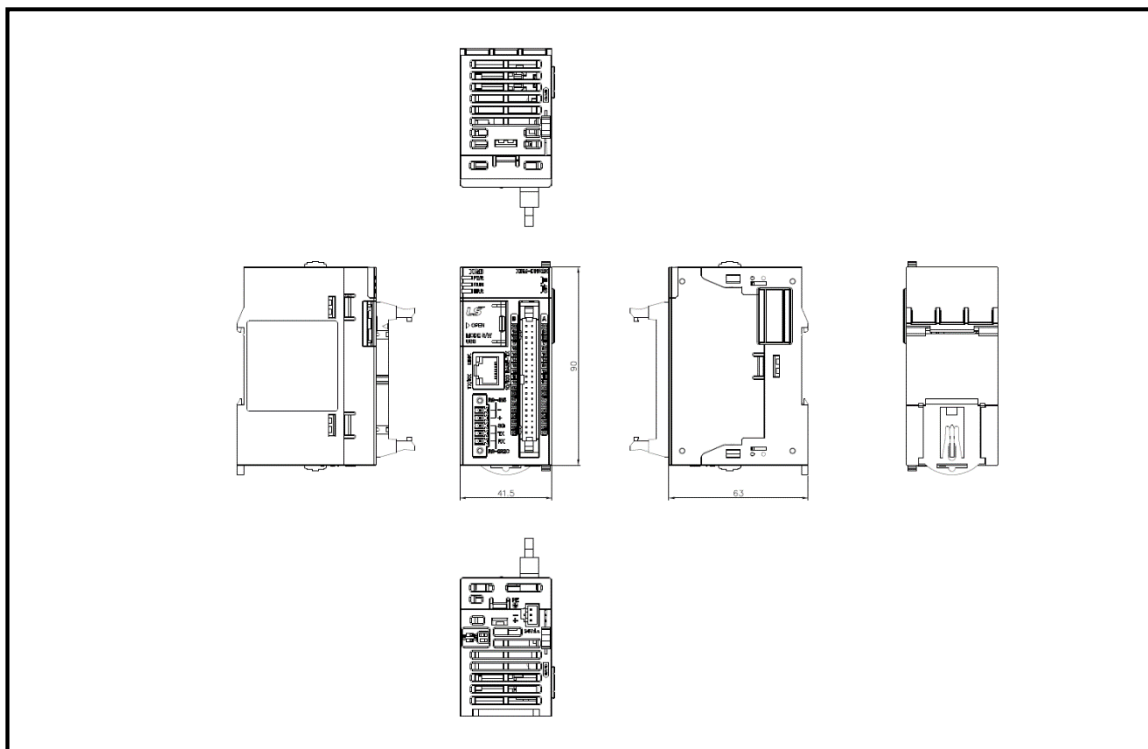

- XEM-DN16H2, XEM-DP16H2, XEM-DR14H2

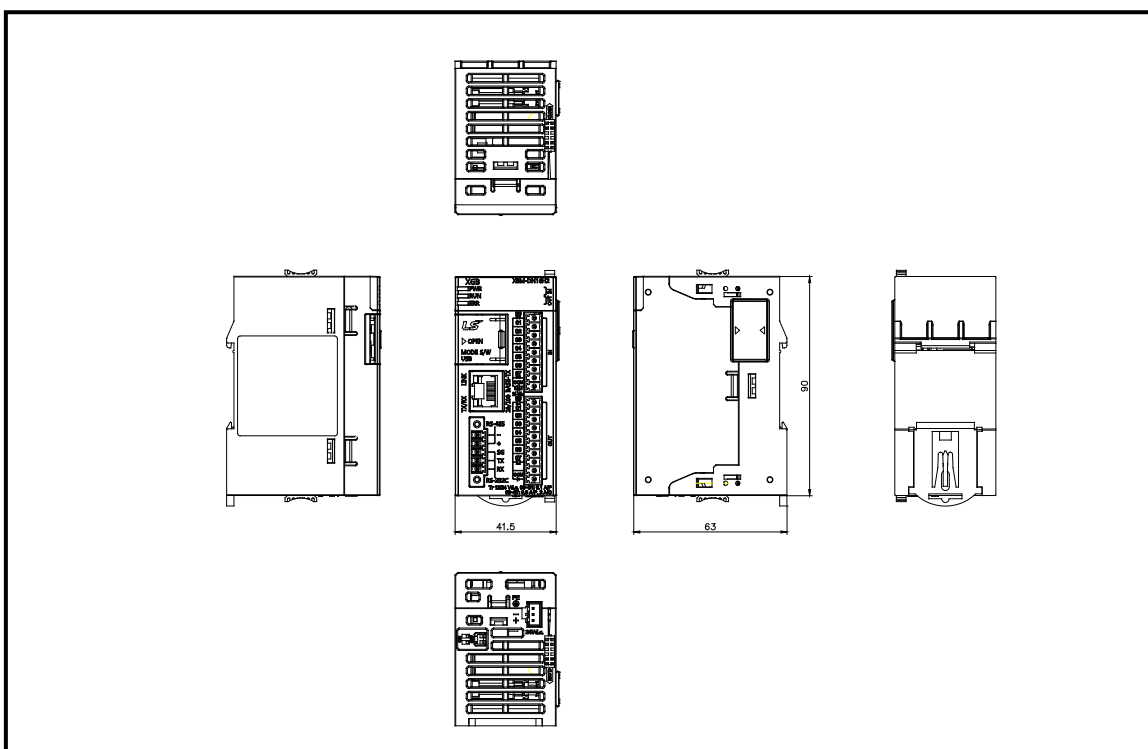

(2) Extension I/O module

- XBE-DC32A, XBE-TN32A, XBE-TP32A, XBE-DN32A

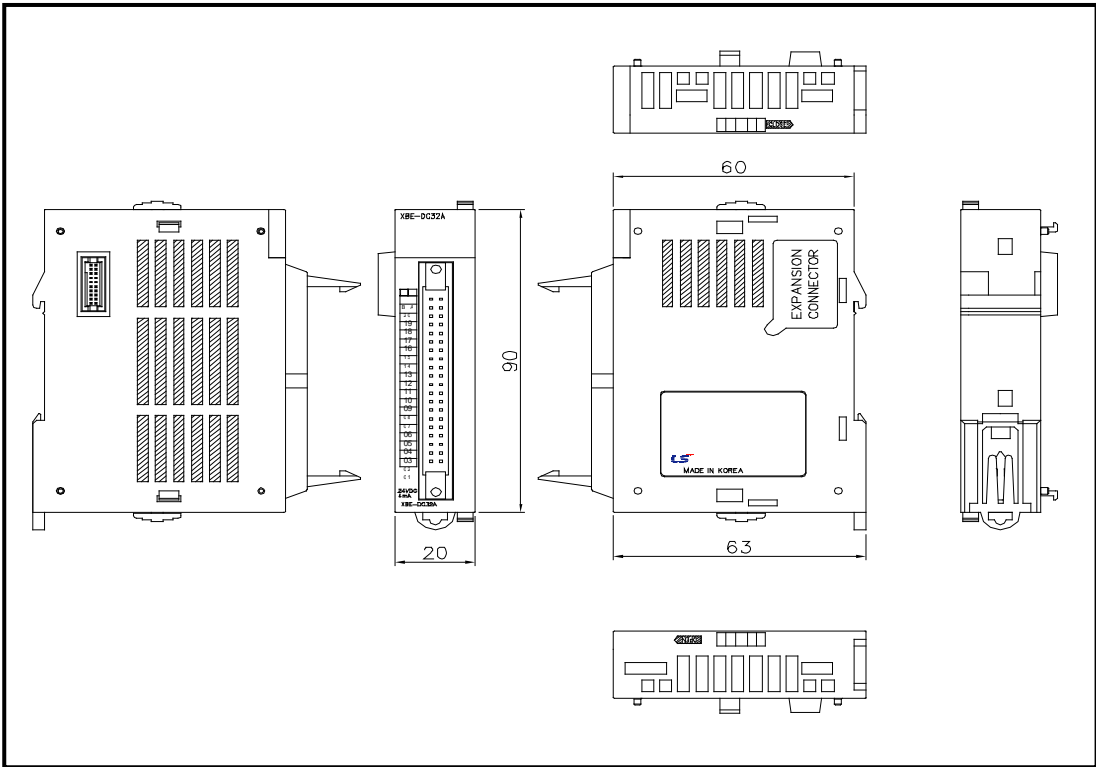

- XBE-RY16A

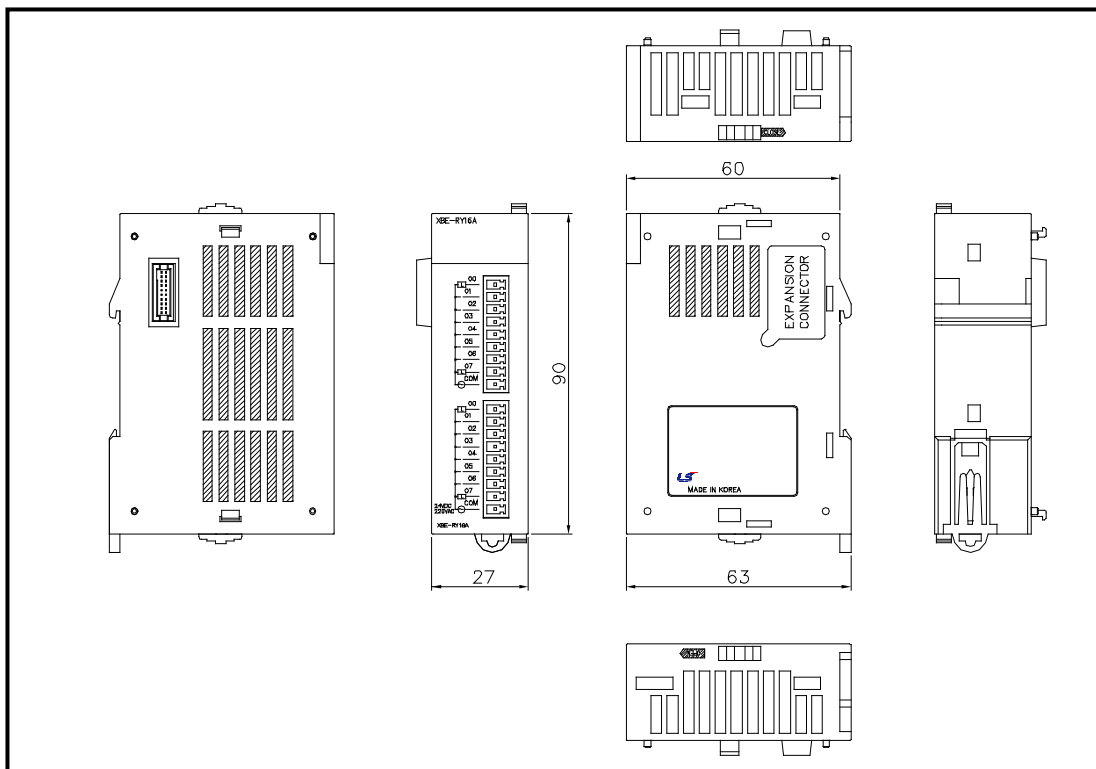

Appendix2 Dimension

- XBE-DC08A, XBE-DC16A, XBE-TN08A, XBE-TP08A, XBE-TN16A, XBE-TP16A, XBE-AC08A

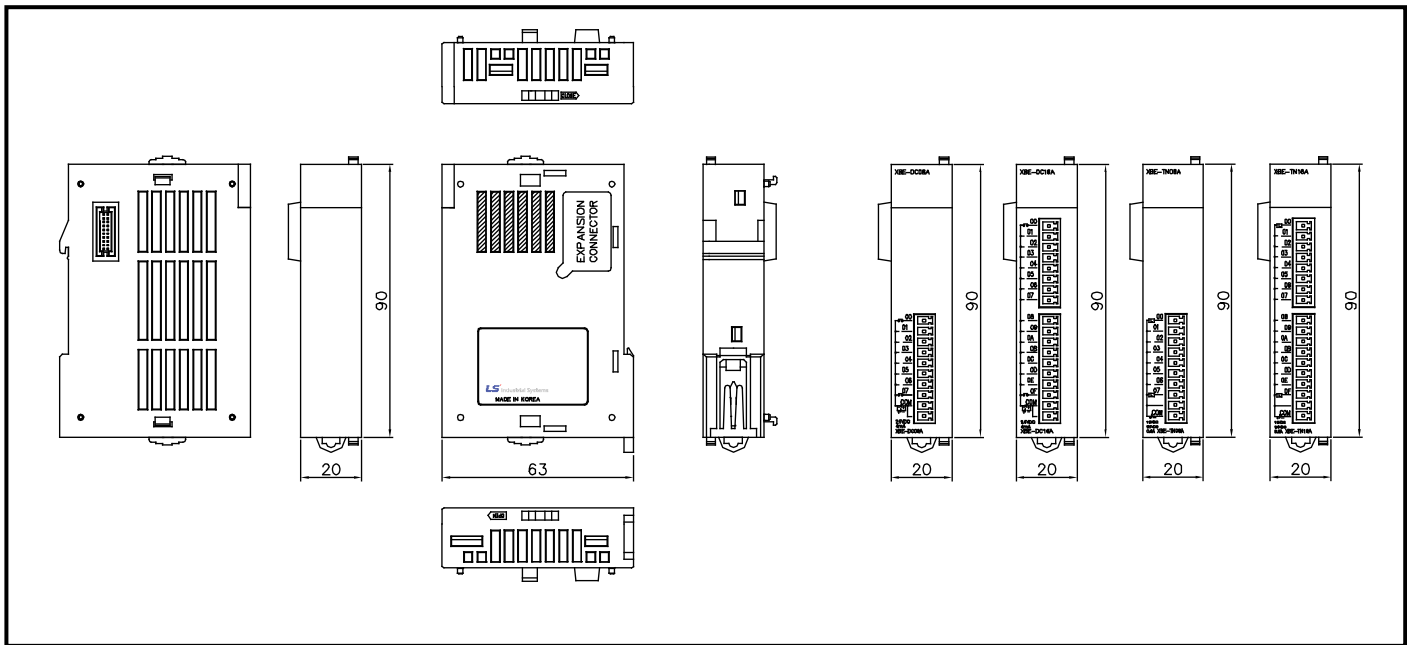

- XBE-DR16A, XBE-RY08A

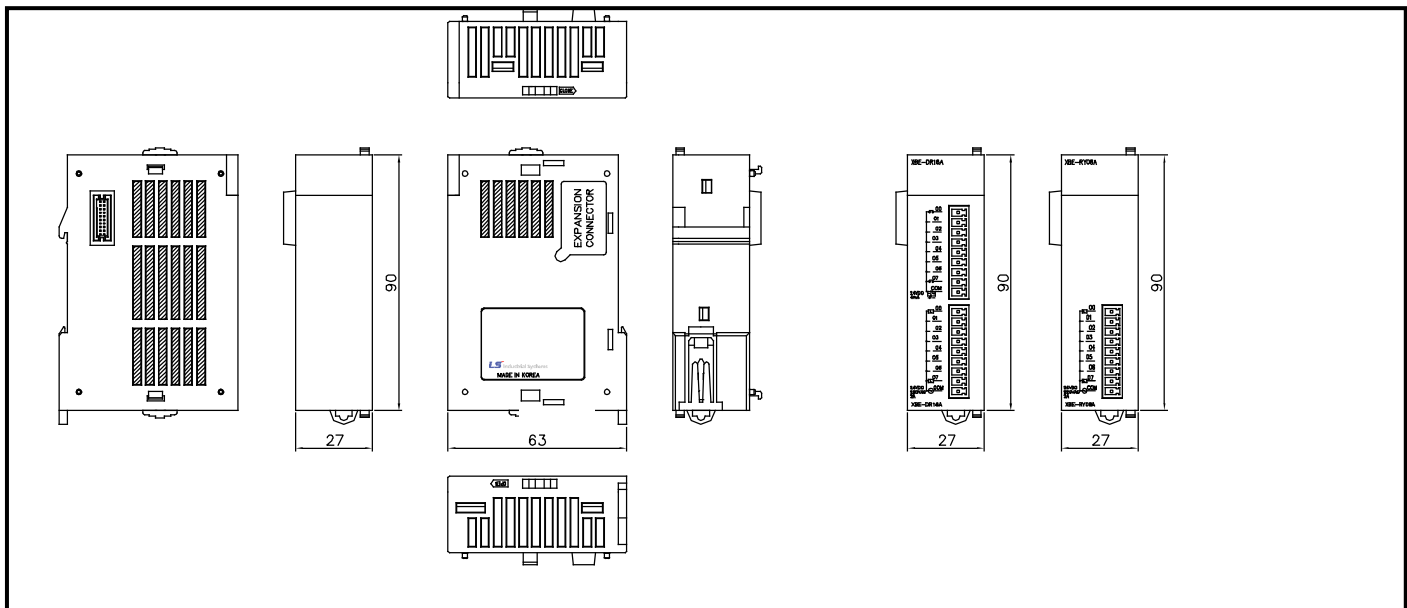

(4) Extension Cnet I/F Module

. XBL-C41A, XBL-C21A

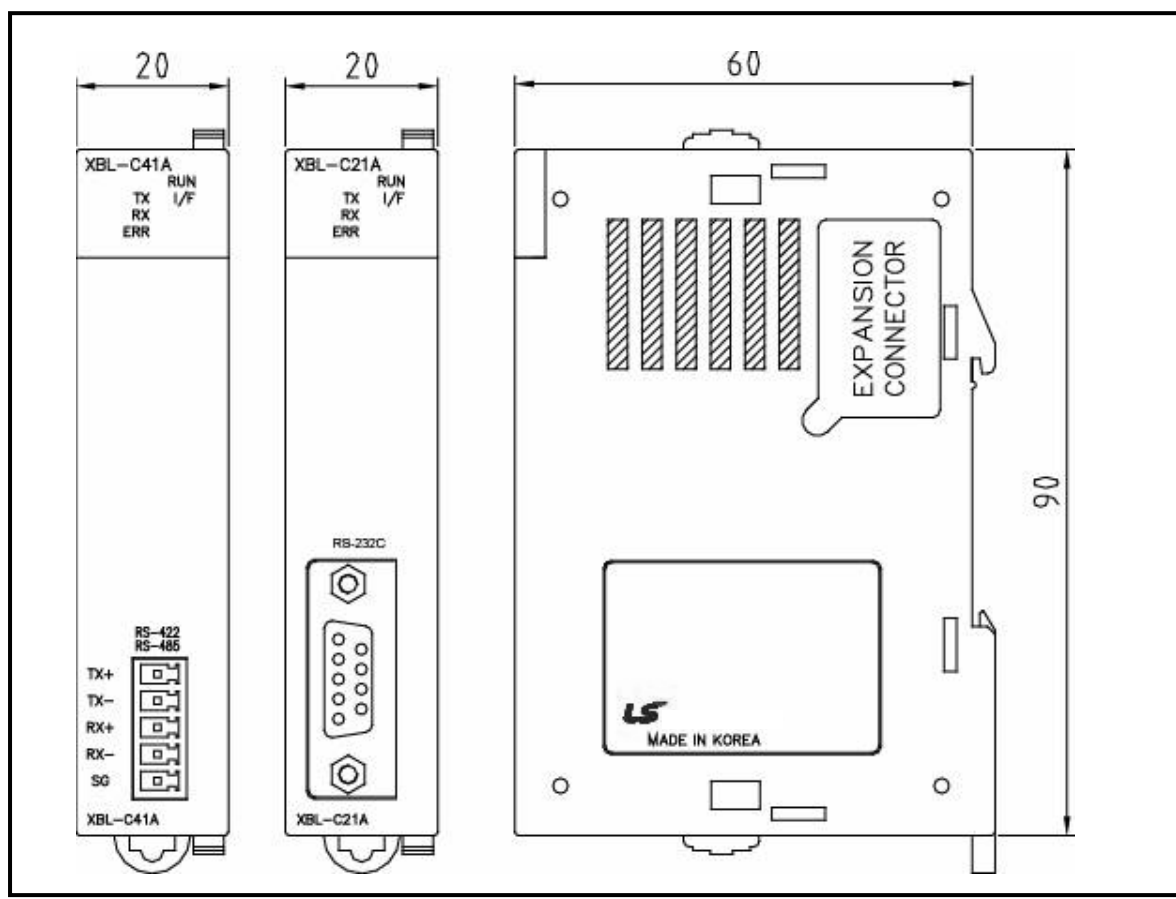

Appendix 3 Instruction List

The list of function and function block. For each function and function block, please refer to XGI/XGR/XEC user's manuals for Instruction

Appendix 3.1 Basic Function

Appendix 3.1.1 Type Conversion Function

It converts each input data type into an output data type.

Function Group	Function	Input data type	Output data type	Remarks
ARY_ASC_TO_***	ARY_ASC_TO_BYTE	WORD(ASCII)	BYTE	
	ARY_ASC_TO_BCD	WORD(ASCII)	BYTE(BCD)	
ARY_BYTE_TO_***	ARY_BYTE_TO_ASC	BYTE	WORD(ASCII)	
ARY_BCD_TO_***	ARY_BCD_TO_ASC	BYTE(BCD)	WORD(ASCII)	
ASC_TO_***	ASC_TO_BCD	BYTE(BCD)	USINT	
	ASC_TO_BYTE	WORD(BCD)	UINT	
BCD_TO_***	BYTE_BCD_TO_SINT	BYTE(BCD)	SINT	
	WORD_BCD_TO_INT	WORD(BCD)	INT	
	DWORD_BCD_TO_DINT	DWORD(BCD)	DINT	
	LWORD_BCD_TO_LINT	LWORD(BCD)	LINT	
	BYTE_BCD_TO_USINT	BYTE(BCD)	USINT	
	WORD_BCD_TO_UINT	WORD(BCD)	UINT	
	DWORD_BCD_TO_UDINT	DWORD(BCD)	UDINT	
	LWORD_BCD_TO_ULINT	LWORD(BCD)	ULINT	
BCD_TO_ASC	BCD_TO_ASC	BYTE(BCD)	WORD	
BYTE_TO_ASC	BYTE_TO_ASC	BYTE	ASC(BYTE)	
TRUNC	TRUNC_REAL	REAL	DINT	
	TRUNC_LREAL	LREAL	LINT	
REAL_TO_***	REAL_TO_SINT	REAL	SINT	
	REAL_TO_INT	REAL	INT	
	REAL_TO_DINT	REAL	DINT	
	REAL_TO_LINT	REAL	LINT	
	REAL_TO_USINT	REAL	USINT	
	REAL_TO_UINT	REAL	UINT	
	REAL_TO_UDINT	REAL	UDINT	
	REAL_TO_ULINT	REAL	ULINT	
	REAL_TO_DWORD	REAL	DWORD	
	REAL_TO_LREAL	REAL	LREAL	
REAL_TO_STRING	REAL	STRING		
LREAL_TO_***	LREAL_TO_SINT	LREAL	SINT	
	LREAL_TO_INT	LREAL	INT	
	LREAL_TO_DINT	LREAL	DINT	
	LREAL_TO_LINT	LREAL	LINT	
	LREAL_TO_USINT	LREAL	USINT	
LREAL_TO_***	LREAL_TO_UINT	LREAL	UINT	
	LREAL_TO_UDINT	LREAL	UDINT	
	LREAL_TO_ULINT	LREAL	ULINT	
	LREAL_TO_LWORD	LREAL	LWORD	
	LREAL_TO_REAL	LREAL	REAL	
	LREAL_TO_STRING	LREAL	STRING	
SINT_TO_***	SINT_TO_INT	SINT	INT	
	SINT_TO_DINT	SINT	DINT	

Function Group	Function	Input data type	Output data type	Remarks
	SINT_TO_LINT	SINT	LINT	
	SINT_TO_USINT	SINT	USINT	
	SINT_TO_UINT	SINT	UINT	
	SINT_TO_UDINT	SINT	UDINT	
	SINT_TO_ULINT	SINT	ULINT	
	SINT_TO_BOOL	SINT	BOOL	
	SINT_TO_BYTE	SINT	BYTE	
	SINT_TO_WORD	SINT	WORD	
	SINT_TO_DWORD	SINT	DWORD	
	SINT_TO_LWORD	SINT	LWORD	
	SINT_TO_REAL	SINT	REAL	
	SINT_TO_LREAL	SINT	LREAL	
	SINT_TO_STRING	SINT	STRING	
INT_TO_***	INT_TO_SINT	INT	SINT	
	INT_TO_DINT	INT	DINT	
	INT_TO_LINT	INT	LINT	
	INT_TO_USINT	INT	USINT	
	INT_TO_UINT	INT	UINT	
	INT_TO_UDINT	INT	UDINT	
	INT_TO_ULINT	INT	ULINT	
	INT_TO_BOOL	INT	BOOL	
	INT_TO_BYTE	INT	BYTE	
	INT_TO_WORD	INT	WORD	
	INT_TO_DWORD	INT	DWORD	
	INT_TO_LWORD	INT	LWORD	
	INT_TO_REAL	INT	REAL	
INT_TO_LREAL	INT	LREAL		
INT_TO_STRING	INT	STRING		
DINT_TO_***	DINT_TO_SINT	DINT	SINT	
	DINT_TO_INT	DINT	INT	
	DINT_TO_LINT	DINT	LINT	
	DINT_TO_USINT	DINT	USINT	
	DINT_TO_UINT	DINT	UINT	
	DINT_TO_UDINT	DINT	UDINT	
	DINT_TO_ULINT	DINT	ULINT	
	DINT_TO_BOOL	DINT	BOOL	
	DINT_TO_BYTE	DINT	BYTE	
DINT_TO_WORD	DINT	WORD		
DINT_TO_***	DINT_TO_DWORD	DINT	DWORD	
	DINT_TO_LWORD	DINT	LWORD	
	DINT_TO_REAL	DINT	REAL	
	DINT_TO_LREAL	DINT	LREAL	
	DINT_TO_STRING	DINT	STRING	
LINT_TO_***	LINT_TO_SINT	LINT	SINT	
	LINT_TO_INT	LINT	INT	
	LINT_TO_DINT	LINT	DINT	
	LINT_TO_USINT	LINT	USINT	
	LINT_TO_UINT	LINT	UINT	
	LINT_TO_UDINT	LINT	UDINT	
	LINT_TO_ULINT	LINT	ULINT	
	LINT_TO_BOOL	LINT	BOOL	
	LINT_TO_BYTE	LINT	BYTE	
	LINT_TO_WORD	LINT	WORD	
LINT_TO_DWORD	LINT	DWORD		

Appendix3 Instruction List

Function Group	Function	Input data type	Output data type	Remarks
	LINT_TO_LWORD	LINT	LWORD	
	LINT_TO_REAL	LINT	REAL	
	LINT_TO_LREAL	LINT	LREAL	
	LINT_TO_STRING	LINT	STRING	
USINT_TO_***	USINT_TO_SINT	USINT	SINT	
	USINT_TO_INT	USINT	INT	
	USINT_TO_DINT	USINT	DINT	
	USINT_TO_LINT	USINT	LINT	
	USINT_TO_UINT	USINT	UINT	
	USINT_TO_UDINT	USINT	UDINT	
	USINT_TO_ULINT	USINT	ULINT	
	USINT_TO_BOOL	USINT	BOOL	
	USINT_TO_BYTE	USINT	BYTE	
	USINT_TO_WORD	USINT	WORD	
	USINT_TO_DWORD	USINT	DWORD	
	USINT_TO_LWORD	USINT	LWORD	
	USINT_TO_REAL	USINT	REAL	
	USINT_TO_LREAL	USINT	LREAL	
USINT_TO_STRING	USINT	STRING		
UINT_TO_***	UINT_TO_SINT	UINT	SINT	
	UINT_TO_INT	UINT	INT	
	UINT_TO_DINT	UINT	DINT	
	UINT_TO_LINT	UINT	LINT	
	UINT_TO_USINT	UINT	USINT	
	UINT_TO_UDINT	UINT	UDINT	
	UINT_TO_ULINT	UINT	ULINT	
	UINT_TO_BOOL	UINT	BOOL	
	UINT_TO_BYTE	UINT	BYTE	
	UINT_TO_WORD	UINT	WORD	
	UINT_TO_DWORD	UINT	DWORD	
UINT_TO_***	UINT_TO_LWORD	UINT	LWORD	
	UINT_TO_REAL	UINT	REAL	
	UINT_TO_STRING	UINT	STRING	
	UINT_TO_LREAL	UINT	LREAL	
	UINT_TO_DATE	UINT	DATE	
UDINT_TO_***	UDINT_TO_SINT	UDINT	SINT	
	UDINT_TO_INT	UDINT	INT	
	UDINT_TO_DINT	UDINT	DINT	
	UDINT_TO_LINT	UDINT	LINT	
	UDINT_TO_USINT	UDINT	USINT	
	UDINT_TO_UINT	UDINT	UINT	
	UDINT_TO_ULINT	UDINT	ULINT	
	UDINT_TO_BOOL	UDINT	BOOL	
	UDINT_TO_BYTE	UDINT	BYTE	
	UDINT_TO_WORD	UDINT	WORD	
	UDINT_TO_DWORD	UDINT	DWORD	
	UDINT_TO_LWORD	UDINT	LWORD	
	UDINT_TO_REAL	UDINT	REAL	
	UDINT_TO_LREAL	UDINT	LREAL	-
	UDINT_TO_TOD	UDINT	TOD	-
UDINT_TO_TIME	UDINT	TIME	-	
UDINT_TO_STRING	UDINT	STRING	-	
ULINT_TO_***	ULINT_TO_SINT	ULINT	SINT	-
	ULINT_TO_INT	ULINT	INT	-

Function Group	Function	Input data type	Output data type	Remarks
	ULINT_TO_DINT	ULINT	DINT	-
	ULINT_TO_LINT	ULINT	LINT	-
	ULINT_TO_USINT	ULINT	USINT	-
	ULINT_TO_UINT	ULINT	UINT	-
	ULINT_TO_UDINT	ULINT	UDINT	-
	ULINT_TO_BOOL	ULINT	BOOL	-
	ULINT_TO_BYTE	ULINT	BYTE	-
	ULINT_TO_WORD	ULINT	WORD	-
	ULINT_TO_DWORD	ULINT	DWORD	-
	ULINT_TO_LWORD	ULINT	LWORD	-
	ULINT_TO_REAL	ULINT	REAL	-
	ULINT_TO_LREAL	ULINT	LREAL	-
	ULINT_TO_STRING	ULINT	STRING	-
BOOL_TO_***	BOOL_TO_SINT	BOOL	SINT	-
	BOOL_TO_INT	BOOL	INT	-
	BOOL_TO_DINT	BOOL	DINT	-
	BOOL_TO_LINT	BOOL	LINT	-
	BOOL_TO_USINT	BOOL	USINT	-
	BOOL_TO_UINT	BOOL	UINT	-
	BOOL_TO_UDINT	BOOL	UDINT	-
	BOOL_TO_ULINT	BOOL	ULINT	-
BOOL_TO_***	BOOL_TO_BYTE	BOOL	BYTE	-
	BOOL_TO_WORD	BOOL	WORD	-
	BOOL_TO_DWORD	BOOL	DWORD	-
	BOOL_TO_LWORD	BOOL	LWORD	-
BYTE_TO_***	BYTE_TO_STRING	BOOL	STRING	-
	BYTE_TO_SINT	BYTE	SINT	-
	BYTE_TO_INT	BYTE	INT	-
	BYTE_TO_DINT	BYTE	DINT	-
	BYTE_TO_LINT	BYTE	LINT	-
	BYTE_TO_USINT	BYTE	USINT	-
	BYTE_TO_UINT	BYTE	UINT	-
	BYTE_TO_UDINT	BYTE	UDINT	-
	BYTE_TO_ULINT	BYTE	ULINT	-
	BYTE_TO_BOOL	BYTE	BOOL	-
	BYTE_TO_WORD	BYTE	WORD	-
	BYTE_TO_DWORD	BYTE	DWORD	-
BYTE_TO_LWORD	BYTE	LWORD	-	
WORD_TO_***	WORD_TO_STRING	BYTE	STRING	-
	WORD_TO_SINT	WORD	SINT	-
	WORD_TO_INT	WORD	INT	-
	WORD_TO_DINT	WORD	DINT	-
	WORD_TO_LINT	WORD	LINT	-
	WORD_TO_USINT	WORD	USINT	-
	WORD_TO_UINT	WORD	UINT	-
	WORD_TO_UDINT	WORD	UDINT	-
	WORD_TO_ULINT	WORD	ULINT	-
	WORD_TO_BOOL	WORD	BOOL	-
	WORD_TO_BYTE	WORD	BYTE	-
	WORD_TO_DWORD	WORD	DWORD	-
	WORD_TO_LWORD	WORD	LWORD	-
WORD_TO_DATE	WORD	DATE	-	
WORD_TO_STRING	WORD	STRING	-	
DWORD_TO_***	DWORD_TO_SINT	DWORD	SINT	-

Appendix3 Instruction List

Function Group	Function	Input data type	Output data type	Remarks
	DWORD_TO_INT	DWORD	INT	
	DWORD_TO_DINT	DWORD	DINT	
	DWORD_TO_LINT	DWORD	LINT	
	DWORD_TO_USINT	DWORD	USINT	
	DWORD_TO_UINT	DWORD	UINT	
	DWORD_TO_UDINT	DWORD	UDINT	
	DWORD_TO_ULINT	DWORD	ULINT	
	DWORD_TO_BOOL	DWORD	BOOL	
	DWORD_TO_BYTE	DWORD	BYTE	
	DWORD_TO_WORD	DWORD	WORD	
	DWORD_TO_LWORD	DWORD	LWORD	
	DWORD_TO_REAL	DWORD	REAL	
	DWORD_TO_TIME	DWORD	TIME	
	DWORD_TO_TOD	DWORD	TOD	
DWORD_TO_***	DWORD_TO_STRING	DWORD	STRING	
LWORD_TO_***	LWORD_TO_SINT	LWORD	SINT	
	LWORD_TO_INT	LWORD	INT	
	LWORD_TO_DINT	LWORD	DINT	
	LWORD_TO_LINT	LWORD	LINT	
	LWORD_TO_USINT	LWORD	USINT	
	LWORD_TO_UINT	LWORD	UINT	
	LWORD_TO_UDINT	LWORD	UDINT	
	LWORD_TO_ULINT	LWORD	ULINT	
	LWORD_TO_BOOL	LWORD	BOOL	
	LWORD_TO_BYTE	LWORD	BYTE	
	LWORD_TO_WORD	LWORD	WORD	
	LWORD_TO_DWORD	LWORD	DWORD	
	LWORD_TO_LREAL	LWORD	LREAL	
	LWORD_TO_DT	LWORD	DT	
LWORD_TO_STRING	LWORD	STRING		
STRING_TO_***	STRING_TO_SINT	STRING	SINT	
	STRING_TO_INT	STRING	INT	
	STRING_TO_DINT	STRING	DINT	
	STRING_TO_LINT	STRING	LINT	
	STRING_TO_USINT	STRING	USINT	
	STRING_TO_UINT	STRING	UINT	
	STRING_TO_UDINT	STRING	UDINT	
	STRING_TO_ULINT	STRING	ULINT	
	STRING_TO_BOOL	STRING	BOOL	
	STRING_TO_BYTE	STRING	BYTE	
	STRING_TO_WORD	STRING	WORD	
	STRING_TO_DWORD	STRING	DWORD	
	STRING_TO_LWORD	STRING	LWORD	
	STRING_TO_REAL	STRING	REAL	
	STRING_TO_LREAL	STRING	LREAL	
	STRING_TO_DT	STRING	DT	
STRING_TO_DATE	STRING	DATE		
STRING_TO_TOD	STRING	TOD		
STRING_TO_TIME	STRING	TIME		
TIME_TO_***	TIME_TO_UDINT	TIME	UDINT	
	TIME_TO_DWORD	TIME	DWORD	
	TIME_TO_STRING	TIME	STRING	
DATE_TO_***	DATE_TO_UINT	DATE	UINT	
	DATE_TO_WORD	DATE	WORD	

Appendix3 Instruction List

Function Group	Function	Input data type	Output data type	Remarks
	DATE_TO_STRING	DATE	STRING	
TOD_TO_***	TOD_TO_UDINT	TOD	UDINT	
	TOD_TO_DWORD	TOD	DWORD	
	TOD_TO_STRING	TOD	STRING	
DT_TO_***	DT_TO_LWORD	DT	LWORD	
	DT_TO_DATE	DT	DATE	
	DT_TO_TOD	DT	TOD	
	DT_TO_STRING	DT	STRING	
***_TO_BCD	SINT_TO_BCD_BYTE	SINT	BYTE(BCD)	
	INT_TO_BCD_WORD	INT	WORD(BCD)	
	DINT_TO_BCD_DWORD	DINT	DWORD(BCD)	
	LINT_TO_BCD_LWORD	LINT	LWORD(BCD)	
	USINT_TO_BCD_BYTE	USINT	BYTE(BCD)	
	UINT_TO_BCD_WORD	UINT	WORD(BCD)	
	UDINT_TO_BCD_DWORD	UDINT	DWORD(BCD)	
	ULINT_TO_BCD_LWORD	ULINT	LWORD(BCD)	

Appendix 3.1.2 Numerical Operation Function

(1) Numerical Operation Function with One Input

No.	Function name	Description	Remarks
General Function			
1	ABS	Absolute value operation	
2	SQRT	Square root operation	
Log function			
3	LN	Natural logarithm operation	
4	LOG	Common logarithm Base to 10 operation	
5	EXP	Natural exponential operation	
Trigonometric function			
6	SIN	Sine operation	
7	COS	Cosine operation	
8	TAN	Tangent operation	
9	ASIN	Arc sine operation	
10	ACOS	Arc Cosine operation	
11	ATAN	Arc Tangent operation	
Angle function			
12	RAD_REAL	Convert degree into radian	
13	RAD_LREAL		
14	DEG_REAL	Convert radian into degree	
15	DEG_LREAL		

(2) Basic Arithmetic Function

No.	Function name	Description	Remarks
Operation function of which input number (n) can be extended up to 8.			
1	ADD	Addition ($OUT \leq IN1 + IN2 + \dots + INn$)	
2	MUL	Multiplication ($OUT \leq IN1 * IN2 * \dots * INn$)	
Operation function of which input number is fixed.			
3	SUB	Subtraction ($OUT \leq IN1 - IN2$)	
4	DIV	Division ($OUT \leq IN1 / IN2$)	
5	MOD	Calculate remainder ($OUT \leq IN1 \text{ Modulo } IN2$)	
6	EXPT	Exponential operation ($OUT \leq IN1^{IN2}$)	
7	MOVE	Copy data ($OUT \leq IN$)	
Input data exchange			
8	XCHG_***	Exchanges two input data	

Appendix 3.1.3 Bit Array Function

(1) Bit-shift Function

No.	Function name	Description	Remarks
1	SHL	Shift input to the left of N bit(the right is filled with 0)	
2	SHR	Shift input to the right of N bit (the left is filled with 0)	
3	SHIFT_C_***	Shift input to designated direction as much as N bit (carry)	
4	ROL	Rotate input to the left of N bit	
5	ROR	Rotate input to the right of N bit	
6	ROTATE_C_***	Rotate input to the direction as much as N bit (carry)	

(2) Bit Operation Function

No.	Function name	Description (n can be extended up to 8)	Remarks
1	AND	Logical AND (OUT <= IN1 AND IN2 AND ... AND INn)	
2	OR	Logical OR (OUT <= IN1 OR IN2 OR ... OR INn)	
3	XOR	Exclusive OR (OUT <= IN1 XOR IN2 XOR ... XOR INn)	
4	NOT	Reverse logic (OUT <= NOT IN1)	
5	XNR	Exclusive logic AND (OUT <= IN1 XNR IN2 XNR ... XNR INn)	

Appendix 3.1.4 Selection Function

No.	Function name	Description(n can be extended up to 8)	Remarks
1	SEL	Selects from two inputs (IN0 or IN1)	
2	MAX	Produces the maximum value among input IN1,...INn	
3	MIN	Produces the minimum value among input IN1,...INn	
4	LIMIT	Limits upper and lower boundaries	
5	MUX	Outputs the K-th input among input IN1,...INn	

Appendix 3.1.5 Data Exchange Function

No.	Function name	Description	Remarks
1	SWAP_BYTE	Swaps upper NIBBLE for lower NIBBLE data of BYTE.	
	SWAP_WORD	Swaps upper BYTE for lower BYTE data of WORD.	
	SWAP_DWORD	Swaps upper WORD for lower WORD data DWORD.	
	SWAP_LWORD	Swaps upper DWORD for lower DWORD data of LWORD.	
2	ARY_SWAP_BYTE	Swaps upper/lower NIBBLE of BYTE elements in array.	
	ARY_SWAP_WORD	Swaps upper/lower BYTE of WORD elements in array.	
	ARY_SWAP_DWORD	Swaps upper/lower WORD of DWORD elements in array.	
	ARY_SWAP_LWORD	Swaps upper/lower DWORD of LWORD elements in array.	

Appendix 3.1.6 Comparison Function

No.	Function name	Description (n can be extended up to 8)	Remarks
1	GT	'Greater than' comparison OUT <= (IN1>IN2) & (IN2>IN3) & ... & (INn-1 > INn)	
2	GE	'Greater than or equal to' comparison OUT <= (IN1>=IN2) & (IN2>=IN3) & ... & (INn-1 >= INn)	
3	EQ	'Equal to' comparison OUT <= (IN1=IN2) & (IN2=IN3) & ... & (INn-1 = INn)	
4	LE	'Less than or equal to' comparison OUT <= (IN1<=IN2) & (IN2<=IN3) & ... & (INn-1 <= INn)	
5	LT	'Less than' comparison OUT <= (IN1<IN2) & (IN2<IN3) & ... & (INn-1 < INn)	
6	NE	'Not equal to' comparison OUT <= (IN1<>IN2) & (IN2<>IN3) & ... & (INn-1 <> INn)	

Appendix 3.1.7 Character String Function

No.	Function name	Description	Remarks
1	LEN	Find a length of a character string	
2	LEFT	Take a left side of a string (size of L) and output it	
3	RIGHT	Take a right side of a string (size of L) and output it	
4	MID	Take a middle side of a string (size of L from the P-th character)	
5	CONCAT	Concatenate the input character string in order	
6	INSERT	Insert the second string after the P-th character of the first string	
7	DELETE	Delete a string (size of L from the P-th character)	
8	REPLACE	Replace a size of L from the P-th character of the first string by the second string	
9	FIND	Find a starting point of the first string which has a same pattern of the second string.	

Appendix 3.1.8 Date and Time of Day Function

No.	Function name	Description	Remarks
1	ADD_TIME	Add time (Time/time of day/date and time addition)	
2	SUB_TIME	Subtract time (Time/time of day/date and time subtraction)	
	SUB_DATE	Calculate time by subtracting date from date	
	SUB_TOD	Calculate time by subtracting TOD from TOD	
	SUB_DT	Calculate time by subtracting DT from DT	
3	MUL_TIME	Multiply number to time	
4	DIV_TIME	Divide time by number	
5	CONCAT_TIME	Concatenate date to make TOD	

Appendix 3.1.9 System Control Function

No.	Function name	Description	Remarks
1	DI	Invalidates interrupt (Not to permit task program starting)	
2	EI	Permits running for a task program	
3	STOP	Stop running by a task program	
4	ESTOP	Emergency running stop by a program	
5	DIREC_IN	Update input data	
6	DIREC_O	Updates output data	
7	WDT_RST	Initialize a timer of watchdog	
8	MCS	Master Control	
9	MCCLR	Master Control Clear	
10	FALS	Self check(error display)	
11	OUTOFF	Output Off	

Appendix 3.1.10 File Function

No.	Function block name	Description	Remarks
1	RSET	Setting file register block number	

Appendix 3.1.11 Data Manipulation Function

No.	Function name	Description	Remarks
1	MEQ_***	Compare whether two inputs are equal after masking	
2	DIS_***	Data distribution	
3	UNI_***	Unite data	
4	BIT_BYTE	Combine 8 bits into one BYTE	
5	BYTE_BIT	Divide one BYTE into 8 bits	
6	BYTE_WORD	Combine two bytes into one WORD	
7	WORD_BYTE	Divide one WORD into two bytes	
8	WORD_DWORD	Combine two WORD data into DWORD	
9	DWORD_WORD	Divide DWORD into 2 WORD data	
10	DWORD_LWORD	Combine two DWORD data into LWORD	
11	LWORD_DWORD	Divide LWORD into two DWORD data	
12	GET_CHAR	Get one character from a character string	
13	PUT_CHAR	Puts a character in a string	
14	STRING_BYTE	Convert a string into a byte array	
15	BYTE_STRING	Convert a byte array into a string	

Appendix 3.1.12 Stack Operation Function

No.	Function name	Description	Remarks
1	FIFO_***	First In First Out	
2	LIFO_***	Last In First Out	

Appendix 3.2 GLOFA Function

No.	Function name	Description(n can be extended up to 8)	Remarks
1	ENCO_B,W,D,L	Output a position of On bit by number	
2	DECO_B,W,D,L	Turn a selected bit on	
3	BSUM_B,W,D,L	Output a number of On bit	
4	SEG_WORD	Convert BCD/HEX into 7-segment code	
5	BMOV_B,W,D,L	Move part of a bit string	
6	INC_B,W,D,L	Increase IN data	
7	DEC_B,W,D,L	Decrease IN data	

Appendix 3.3 Array Operation Function

No.	Function name	Description	Remarks
1	ARY_MOVE	Copy array-typed data (OUT <= IN)	
2	ARY_CMP_***	Array comparison	
3	ARY_SCH_***	Array search	
4	ARY_FLL_***	Filling an array with data	
5	ARY_AVE_***	Find an average of an array	
6	ARY_SFT_C_***	Array bit shift left with carry	
7	ARY_ROT_C_***	Bit rotation of array with carry	
8	SHIFT_A_***	Shift array elements	
9	ROTATE_A_***	Rotates array elements	

Appendix 3.4 Basic Function Block

Appendix 3.4.1 Bistable Function Block

No.	Function block name	Description	Remarks
1	SR	Set preference bistable	
2	RS	Reset preference bistable	
3	SEMA	Semaphore	

Appendix 3.4.2 Edge Detection Function Block

No.	Function block name	Description	Remarks
1	R_TRIG	Rising edge detector	
2	F_TRIG	Falling edge detector	
3	FF	Reverse output if input condition rises	

Appendix 3.4.3 Counter

No.	Function block name	Description	Remarks
1	CTU_***	Up Counter INT,DINT,LINT,UINT,UDINT,ULINT	
2	CTD_***	Down Counter INT,DINT,LINT,UINT,UDINT,ULINT	
3	CTUD_***	Up Down Counter INT,DINT,LINT,UINT,UDINT,ULINT	
4	CTR	Ring Counter	

Appendix 3.4.4 Timer

No.	Function block name	Description	Remarks
1	TP	Pulse Timer	
2	TON	On-Delay Timer	
3	TOF	Off-Delay Timer	
4	TMR	Integrating Timer	
5	TP_RST	TP with reset	
6	TRTG	Retriggerable Timer	
7	TOF_RST	TOF with reset	
8	TON_UINT	TON with integer setting	
9	TOF_UINT	TOF with integer setting	
10	TP_UINT	TP with integer setting	
11	TMR_UINT	TMR with integer setting	
12	TMR_FLK	Blink timer	
13	TRTG_UINT	Integer setting retriggerable timer	

Appendix 3.4.5 File Function Block

No.	Function block name	Description	Remarks
1	EBREAD	Read R area data from flash area	
2	EBWRITE	Write R area data to flash area	

Appendix 3.4.6 Other Function Block

No.	Function block name	Description	Remarks
1	SCON	Sequence Step and Step Jump	
2	DUTY	Scan setting On/Off	
3	RTC_SET	Write time data	

Appendix 3.4.7 Special Function Block

No.	Function block name	Description	Remarks
1	GET	Read special module data	
2	PUT	Write special module data	
3	ARY_GET	Read special module data(array)	
4	ARY_PUT	Write special module data(array)	

Appendix 3.4.8 Positioning Function Block

No.	Function block name	Description	Remarks
1	XPM_ORG	Homing Start	
2	XPM_FLT	Floating Origin Setting	
3	XPM_DST	Direct Start	
4	XPM_IST	Indirect Start	
5	XPM_SST	Simultaneous Start	
6	XPM_VTP	Speed/Position Switching Control	
7	XPM_VTPP	Position specified Speed/Position Switching Control	
8	XPM_PTV	Position/Speed Switching Control	
9	XPM_STP	Deceleration Stop	
10	XPM_SKP	Skip Operation	
11	XPM_SSP	Position Synchronization	
12	XPM_SSS	Speed Synchronization	
13	XPM_SSSP	Position Assigned Speed Synchronization	
14	XPM_POR	Position Override	
15	XPM_SOR	Speed Override	
16	XPM_PSO	Position Assigned Speed Override	
17	XPM_NMV	Continuous Operation	
18	XPM_INC	Inching Operation	
19	XPM_RTP	Repeat Step Number Change	
20	XPM_SNS	Start Step Change	
21	XPM_SRS	Repeat operation step no. change	
22	XPM_MOF	M Code Release	
23	XPM_PRS	Current Position Change	
24	XPM_EPRES	Encoder value preset	
25	XPM_ATEA	Teaching array	
26	XPM_SBP	Basic parameter teaching	
27	XPM_SEP	Extended parameter teaching	
28	XPM_SHP	Homing parameter teaching	
29	XPM_SMP	Manual operation parameter teaching	
30	XPM_SIP	I/O signal parameter teaching	
31	XPM_SCP	Common Parameter Teaching	
32	XPM_SMD	Operation Data Teaching	

Appendix3 Instruction List

No.	Function block name	Description	Remarks
33	XPM_VRD	Read Variable Data	
34	XPM_VWR	Write Variable Data	
35	XPM_EMG	Emergency Stop	
36	XPM_RST	Error Reset	
37	XPM_HRST	Error History Reset	
38	XPM_PST	Point Start	
39	XPM_WRT	Parameter/operation data save	
40	XPM_CRD	Operation Information Read	
41	XPM_SRD	Operation State Read	
42	XPM_ENCRD	Encoder Value Read	
43	XPM_JOG	JOG Operation	
44	XPM_CAM	CAM Operation	
45	XPM_CAMO	Main Axis Offset CAM Operation	
46	XPM_ELIN	Ellipse Interpolation	
47	XPM_RSTR	Restart	
48	XPM_SVON	Servo On	
49	XPM_SVOFF	Servo Off	
50	XPM_SRST	Servo Error Reset	
51	XPM_EPRESB	Encoder Value Preset (XEMH2, XEMHP Internal Position Only)	
52	XPM_ENCRDB	Encoder Value Read(XEMH2, XEMHP Internal Position Only)	

Appendix 3.5 Expanded Function

No.	Function name	Description	Remarks
1	FOR	Repeat a block of FOR ~ NEXT n times	
2	NEXT		
3	BREAK	Escape a block of FOR ~ NEXT	
4	CALL	Call a SBRT routine	
5	SBRT	Assign a routine to be called by the CALL function	
6	RET	RETURN	
7	JMP	Jump to a place of LABEL	
8	INIT_DONE	Terminate an initial task	
9	END	Terminate a program	

Warranty

1. Warranty Period

The product you purchased is guaranteed for 36 months from the date of manufacture.

2. Scope of Warranty

- (1) The initial diagnosis of faults is basically conducted by your company. However, upon your request, our company or our service network can undertake this task for a fee. If the cause of the fault lies with our company, this service will be provided free of charge.
- (2) This warranty only applies if the product is used under normal conditions according to the specifications and precautions described in the handling instructions, user manuals, catalogs, and caution labels.
- (3) Even within the free warranty period, the following cases will be subject to paid repairs:
 - 1) Replacement of consumable and life-limited parts (e.g., relays, fuses, electrolytic capacitors, fans, LCDs, batteries, etc.)
 - 2) Failures or damages caused by improper storage, handling, negligence, or accidents by the customer
 - 3) Failures resulting from the customer's hardware or software design
 - 4) Failures due to modifications without our consent
(Repairs will be refused, even for a fee, if recognized as modified or repaired outside our company)
 - 5) Failures that could have been avoided if the customer's equipment, in which our product is incorporated, had safety devices required by legal regulations or common industry standards
 - 6) Failures that could have been prevented if maintenance and replacement of consumable parts were performed normally according to the handling instructions or user manuals
 - 7) Failures and damages to the product caused by using connected equipment or inappropriate consumables
 - 8) Failures caused by external factors such as fire, abnormal voltage, force majeure, and natural disasters such as earthquakes, lightning, salt damage, wind, and flood damage
 - 9) Failures due to reasons that could not be predicted with the scientific and technical standards at the time of our shipment
 - 10) Other failures, damages, or defects recognized as the responsibility of your company

Environmental Policy

LS ELECTRIC Co., Ltd supports and observes the environmental policy as below.

Environmental Management

LS ELECTRIC considers the environmental preservation as the preferential management subject and every staff of LS ELECTRIC use the reasonable endeavors for the pleasurable environmental preservation of the earth.

About Disposal

LS ELECTRIC' PLC unit is designed to protect the environment. For the disposal, separate aluminum, iron and synthetic resin (cover) from the product as they are reusable.



www.ls-electric.com

LS ELECTRIC Co., Ltd.

■ Headquarter

LS-ro 127(Hogye-dong) Dongan-gu, Anyang-si, Gyeonggi-Do, 14119, Korea

■ Seoul Office

LS Yongsan Tower, 92, Hangang-daero, Yongsan-gu, Seoul, 04386, Korea

Tel: 82-2-2034-4033, 4888, 4703 Fax: 82-2-2034-4588

E-mail: automation@ls-electric.com

■ Overseas Subsidiaries

• LS ELECTRIC Japan Co., Ltd. (Tokyo, Japan)

Tel: 81-3-6268-8241 E-Mail: japan@ls-electric.com

• LS ELECTRIC (Dalian) Co., Ltd. (Dalian, China)

Tel: 86-411-8730-6495 E-Mail: china.dalian@lselectric.com.cn

• LS ELECTRIC (Wuxi) Co., Ltd. (Wuxi, China)

Tel: 86-510-6851-6666 E-Mail: china.wuxi@lselectric.com.cn

• LS ELECTRIC Middle East FZE (Dubai, U.A.E.)

Tel: 971-4-886-5360 E-Mail: middleeast@ls-electric.com

• LS ELECTRIC Europe B.V. (Hoofddorp, Netherlands)

Tel: 31-20-654-1424 E-Mail: europartner@ls-electric.com

• LS ELECTRIC America Inc. (Chicago, USA)

Tel: 1-800-891-2941 E-Mail: sales.us@lselectricamerica.com

• LS ELECTRIC Turkey Co., Ltd.

Tel: 90-212-806-1225 E-Mail: turkey@ls-electric.com

■ Overseas Branches

• LS ELECTRIC Tokyo Office (Japan)

Tel: 81-3-6268-8241 E-Mail: tokyo@ls-electric.com

• LS ELECTRIC Beijing Office (China)

Tel: 86-10-5095-1631 E-Mail: china.auto@lselectric.com.cn

• LS ELECTRIC Shanghai Office (China)

Tel: 86-21-5237-9977 E-Mail: china.auto@lselectric.com.cn

• LS ELECTRIC Guangzhou Office (China)

Tel: 86-20-3818-2883 E-Mail: china.auto@lselectric.com.cn

• LS ELECTRIC Chengdu Office (China)

Tel: 86-28-8670-3201 E-Mail: china.auto@lselectric.com.cn

• LS ELECTRIC Qingdao Office (China)

Tel: 86-532-8501-2065 E-Mail: china.auto@lselectric.com.cn

• LS ELECTRIC Nanjing Office (China)

Tel: 86-25-8467-0005 E-Mail: china.auto@lselectric.com.cn

• LS ELECTRIC Bangkok Office (Thailand)

Tel: 66-90-950-9683 E-Mail: thailand@ls-electric.com

• LS ELECTRIC Jakarta Office (Indonesia)

Tel: 62-21-2933-7614 E-Mail: indonesia@ls-electric.com

• LS ELECTRIC Moscow Office (Russia)

Tel: 7-499-682-6130 E-Mail: info@lselectric-ru.com

• LS ELECTRIC America Western Office (Irvine, USA)

Tel: 1-949-333-3140 E-Mail: america@ls-electric.com

Disclaimer of Liability

LS ELECTRIC has reviewed the information in this publication to ensure consistency with the hardware and software described. However, LS ELECTRIC cannot guarantee full consistency, nor be responsible for any damages or compensation, since variance cannot be precluded entirely. Please check again the version of this publication before you use the product.

© LS ELECTRIC Co., Ltd 2015 All Right Reserved.

2024.06