

The right choice for the ultimate yield!

LS ELECTRIC strives to maximize your profits in gratitude for choosing us as your partner.

## HUMAN MACHINE INTERFACE

# XGT PANEL

eXP2 Series

User Manual

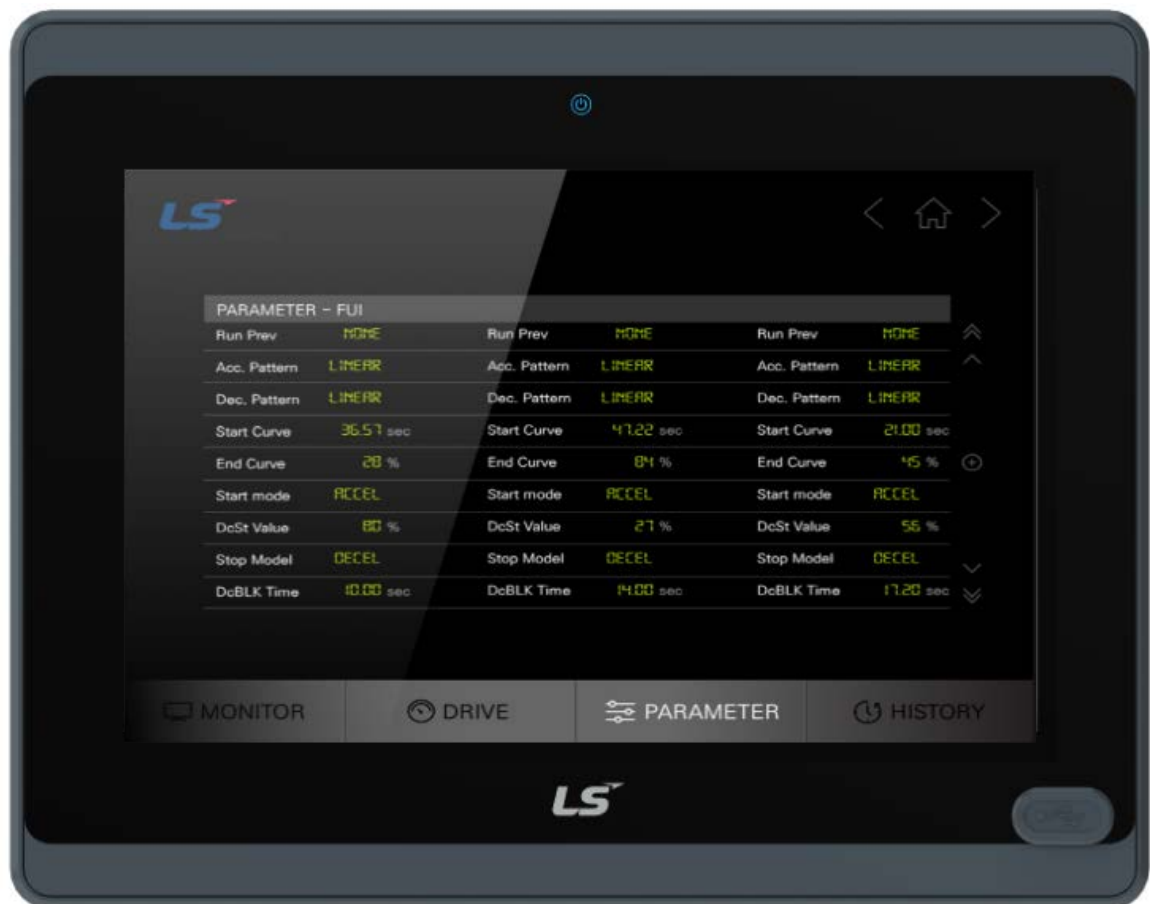

### Safety Instructions

- Read this manual carefully before installing, wiring, operating, servicing or inspecting this equipment.
- Keep this manual within easy reach for quick reference.

**LS**ELECTRIC

## Before using the product...

To use the product safely and effectively, please read this instruction manual thoroughly before use.

- ▶ Please keep to the safety precaution, for it to prevent accidents and potential danger from occurring.
- ▶ Safety precaution is classified into 'Warning' and 'Caution' and their meanings are as follows.

 **Warning** Violating the instruction may result in serious personal injury or death.

 **Caution** Violating the instruction may result in slight personal injury or product damage.

- ▶ The indicated illustrations on the product and in the manual have the following meanings.

 Be cautious, for danger may be present.

 Be cautious, for there is a possibility of an electric shock.

- ▶ After reading the instruction manual, keep it handy for quick reference.

## Design Precautions



### Warning

- ▶ **Install a safety circuit external to the HMI to protect the whole control system in case of external power supply trouble.**

Serious trouble may occur to the entire system due to erroneous output/operation of the HMI.

## Design Precautions



### Caution

- ▶ **In/output signal or communication cable should be at least 100mm apart from High-voltage/power wires.**

Otherwise, it may cause erroneous output/operation.

## Installation Precautions



### Caution

- ▶ **Use the HMI in an environment that meets the general specification contained in this manual or datasheet.**

Otherwise, it could result in electric shock, fire, erroneous operation or deterioration.

- ▶ **In case of much vibration in the installed environment, be sure to insulate the HMI from direct vibration.**

Otherwise, it could result in electric shock, fire, erroneous operation.

- ▶ **Be sure not to let foreign substances such as conductive debris inside the product.**

Otherwise, it could result in electric shock, fire, erroneous operation.

## Wiring Precautions



### Warning

- ▶ **Be sure to turn off the HMI and external power before wiring.**  
Otherwise, it may result in an electric shock or damage to the product.



### Caution

- ▶ **Wire correctly by checking each of the product's rated voltage and terminal layout.**  
Otherwise, it may result in fire, electric shock or erroneous operation.
- ▶ **Tighten terminal screws with specified torque when wiring.**  
If terminal screws are loose, it may result in short circuits, fire or erroneous operation.
- ▶ **Use the exclusive HMI 3-type grounding for the FG terminal.**  
If not grounded, it may result in erroneous operation.
- ▶ **Be sure not to let any foreign substances such as wiring debris inside the module.**  
Such debris may cause fire, damage or erroneous operation.

## Startup and Maintenance Precautions



### Warning

- ▶ **Do not touch the terminals while power is on.**  
Otherwise, it may cause electric shock or erroneous operation.
- ▶ **Turn off the HMI and external power when cleaning or tightening the terminal.**  
Otherwise, it may cause electric shock or erroneous operation.
- ▶ **Do not charge, disassemble, heat, short circuit, solder, etc. other battery.**  
Mishandling the battery may cause overheating, crack, fire and may result in injury or fire.



### Caution

- ▶ **Do not disassemble PCB from the product case or modify the product.**  
Otherwise, it may result in fire, electric shock or erroneous operation.
- ▶ **Use cellular phone or walky-talky at least 30cm away from the HMI.**  
Otherwise, it may result in erroneous operation.
- ▶ **When replacing the battery, correct polarity must be maintained.**  
Otherwise, battery may cause overheating, crack, fire and may result in injury or fire.

## Disposal Precaution



### Caution

- ▶ **When disposing of this product or battery, treat it as industrial waste.**  
Otherwise, it may cause poisonous pollution or explosion.

# Revision History

Version	Date	Contents	Revised location
V1.0	'20.12	First Edition	-
V1.1	'21.07	Added RTC settings content	2-8
V1.2	'22.05	BK image content changed	4-9

※ The number of User's manual is indicated the right side of the back cover.

© LS ELECTRIC Co., Ltd 2020 All Rights Reserved.

**Chapter 1 General Introduction..... 1-1~1-6**

1.1 How to use the Instruction Manual..... 1-1  
 1.2 Feature ..... 1-2  
 1.3 Terminology..... 1-6  
 1.3 Standard of product name..... 1-6

**Chapter 2 System Configuration..... 2-1~2-9**

2.1 Part Names ..... 2-1  
 2.2 System Configuration ..... 2-9

**Chapter 3 Standard Specification ..... 3-1~3-5**

3.1 General Standards ..... 3-1  
 3.2 Function Standards ..... 3-3

**Chapter 4 System Configuration..... 4-1~4-16**

4.1 Backlight Setting ..... 4-2  
 4.2 Touch Calibration ..... 4-3  
 4.3 Date Time Setting ..... 4-4  
 4.4 Environment Setting ..... 4-5  
 4.5 Ethernet Setting ..... 4-13  
 4.6 Buzzer Setting ..... 4-14  
 4.7 XP-Remote Setting ..... 4-15

**Chapter 5 Diagnostics..... 5-1~5-9**

5.1 Screen Diagnosis ..... 5-2  
 5.2 Touch Diagnosis ..... 5-3  
 5.3 Backup Memory Diagnosis ..... 5-4  
 5.4 Flash Memory Diagnosis..... 5-5  
 5.5 USB Memory Diagnosis ..... 5-6  
 5.6 Serial Communication Diagnosis ..... 5-7  
 5.6 SD Card Diagnosis..... 5-9

**Chapter 6 Viewing Information of PLC Connection Status .....6-1~6-8**

6.1 PLC Communication Configuration Settings.....6-2  
 6.2 Connection Information .....6-3  
 6.3 PLC Information .....6-4  
 6.4 History of PLC Error .....6-4  
 6.5 History of PLC Mode Conversion .....6-5  
 6.6 History of PLC Power .....6-5  
 6.7 History of PLC System .....6-6  
 6.8 N:1 Settings .....6-7  
 6.9 Program Monitor .....6-8

**Chapter 7 Storage Function .....7-1~7-6**

7.1 General Introduction .....7-1  
 7.2 Project Download [Project (USB/SD -> HMI)].....7-3  
 7.3 Project Upload [Project (HMI -> USB/SD)] .....7-4  
 7.4. Project Upload Project File(.XPD) (HMI -> USB/SD) .....7-5  
 7.4 Updating the device using a storage device .....7-6

**Chapter 8 XGT Panel S/W Update .....8-1**

8.1 General Introduction .....8-1

**Chapter 9 File Backup through External Storage Equipment .....9-1~9-7**

9.1 Path Structure in case of File Backup.....9-1  
 9.2 Operation setting when there is no space for backup.....9-5  
 9.3 Structure of path of video file and video capture files .....9-6



**Chapter 10 Installation and Wiring..... 10-1~10-10**

10.1 Installation ..... 10-1  
 10.1.1 Installation environment..... 10-1  
 10.1.2 Notice in handling ..... 10-3  
 10.1.3 Notice in installing the panel..... 10-3  
 10.2 Wiring ..... 10-7  
 10.2.1 Power wiring ..... 10-7  
 10.2.2 Ground wiring ..... 10-10

**Chapter 11 Maintenance ..... 11-1~11-3**

11.1 Maintenance..... 11-1  
 11.2 Daily Maintenance..... 11-1  
 11.3 Periodical Maintenance..... 11-2

**Chapter. 12 EMC Standard Certification ..... 12-1~12-2**

12.1 Requirement for EMC Standard Certification ..... 12-1  
 12.1.1 CE standard certification ..... 12-1  
 12.1.2 KC standard certification ..... 12-2  
 12.2 Requirement for Low Voltage Command Suitability ..... 12-2  
 12.2.1 Standard certification for XGT Panel ..... 12-2  
 12.2.2 Selection of XGT Panel ..... 12-2

**Appendix 1 Troubleshooting..... App1-1~App1-25**

1. Type of Problem ..... App 1-1  
 2. Problem when Starting..... App 1-2  
 3. Problem after the Monitor on..... App 1-4  
 4. Display Problem of Figure and Object ..... App 1-6  
 5. Communication Problem..... App 1-9  
 6. USB Memory Problem ..... App 1-10  
 7. Error Message during Execution of Program..... App 1-12

**Appendix 2 Dimension..... App 2-1~ App 2-3**

**Appendix 3 Warranty and Environmental Policy..... App 3-1**

# Chapter 1 General Introduction

## 1.1 How to use the Instruction Manual

This instruction manual provides information such as specification, how to use, etc., of the product needed to operate eXP2 series of XGT Panel.

The user manual's configuration is as follows.

Sequence	Category	Contents
Chapter1	General Introduction	It describes this manual's configuration, product's feature and term.
Chapter2	System Configuration	It describes feature and system configuration of each XGT Panel.
Chapter3	Standard Specification	It describes XGT Panel's general and function specification.
Chapter4	System Configuration	It describes XGT Panel's system configuration.
Chapter5	Diagnostics	It describes XGT Panel's self-diagnosis.
Chapter6	Viewing information of PLC Connection Status	It describes the way on connection status information of PLC which is connected with XGT Panel.
Chapter7	Transmission of Project from USB Storage Device	It describes the way to execute the project by using USB storage device.
Chapter8	XGT Panel S/W Update	It describes the way to update engine at XGT Panel.
Chapter9	Backup files by using Storage Devices	It describes the way to backup recipe, logging and etc. files by using storage devices.
Chapter10	Installation and Wiring	It describes an installation, wiring and caution for reliability of PLC system.
Chapter11	Maintenance	It describes inspection category and method for long normal operation of PLC system.
Chapter12	EMC Standard	It describes system configuration for EMC standard.
Appendix 1	Troubleshooting	It describes a variety of error contents and measure.
Appendix 2	Dimension	It describes the dimension of XGT Panel.
Appendix 3	Warranty and Environment Policy	-

**Remark**

This manual doesn't describe connection with XP-Builder and PLC. For their own function, Please refer to the related manuals.

## 1.2 Feature

XGT Panel series has the following features.

(1) Various types of external interface

(a) Supporting various device of USB, Ethernet, it maximizes the customer's usability.



(b) Various types of connection with controllers such as PLC and inverter are possible.

- RS-485, RS-232C, RS-422/485, Ethernet (based on 10Base-T/100Base-TX) can be used to connect to the controller.



(2) Based on Windows CE

- (a) Adoption of Microsoft Company's Windows CE
  - Windows CE 7.0
- (b) Advantage
  - It provides stable software capacity by using Microsoft Company's platform.
  - It can process diverse function simultaneously.
  - It provides diverse interface including Ethernet, USB.
  - The user interface including mouse and keyboard can be connected.
  - It has high flexibility like computer software.
  - Fast reaction is available when adding new equipment.
  - Wide data sharing and management with upper system is available (Later).

(3) Improvement of project transmission time

- (a) Project transfer using Ethernet port
- (b) Project transfer using USB Loader cable
- (c) It provides the transmission function from USB storage device.

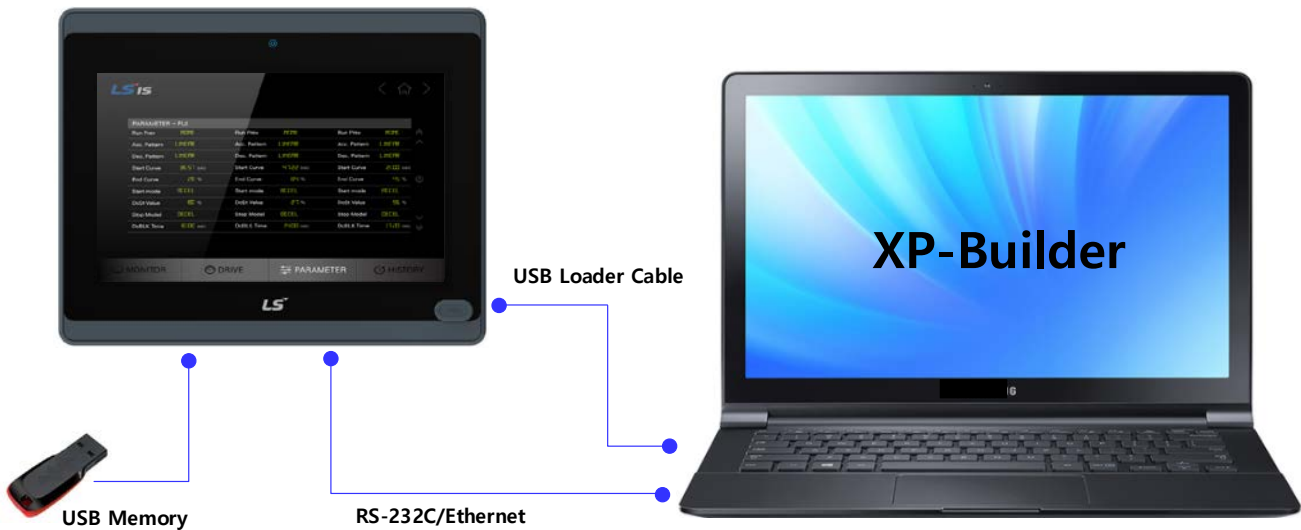

(4) High quality screen

- (a) It provides the high quality screen and clearness by high quality LCD.
  - It adopts TFT LCD which supports the 65,536 Color.
  - ※ eXP2-050xx model supports up to 262,144 colors
- (b) It provides diverse graphic type.
  - It is available to express precisely and actually.
  - It provides the simple moving function with GIF support.

(5) Analog touch Panel

- (a) It adopts analog (resistive) Touch Panel.
  - Visibility is improved without the grids.
- (b) It provides high touch resolution.
  - It can control Touch Panel precisely.

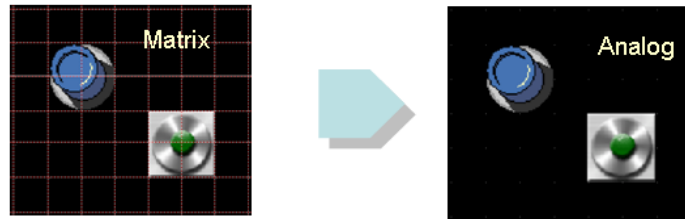

(6) Multilingual and diverse font

- (a) It supports the multilingual function.
  - It transmits the Windows/User font used in computer to XGT Panel.
  - Additional language development is not necessary.
  - Multilingual language is an advantage of Windows CE.
- (b) It can express twelve kinds of language simultaneously.
  - It can express 12 kinds of language simultaneously.
  - Language switching is available by using special switch during operation.
- (c) It can provide the various fonts.
  - Various expressions are available by using the Windows/User font.
  - Font size and type can be adjusted freely.



### (7) Advanced function

#### (a) Alarm function.

- The History alarm can be classified alarm group and alarm list and selected alarm can be expressed by alarm search.
- The Flow alarm indicates current or the latest alarm at the bottom of screen.
- The System alarm indicates the important problems from operation.

#### (b) Logging function

- It provides conditional logging according to device condition and continuous periodic logging which operates periodically according to time and device status.
- It provides 256Kbyte areas for backup.
- Backup into USB,uSD storage device is available.
- Backup data's type is stored in Excel, it is easy to use.

#### (c) Recipe function.

- It provides READ/WRITE function.
- It provides 128Kbyte areas for backups.  
[General recipe: it set up 10,000 double words for each of one of them.]
- Backup into the USB,uSD storage device is available.
- Backup data's type is stored in Excel, it is easy to use.

#### (d) Scheduler function.

- It can be set up to Max. 32.

#### (e) Print function.

- It provides a Screen/Alarm print function.
- It can be printed by USB printer.

#### (f) Script function.

- It provides more flexible function by user Script.
- It can be diversely applied to such as including Global/Object/Screen indication and so on.

### (8) Stable product suitable for international standards

#### (a) CE, KC standard acquisition

#### (b) UL(cUL) standard acquisition

### 1.3 Terminology

It describes terms used in this manual.

Term	Definition	Remarks
Module	A standard element that has a specified function which configures the system. Devices such as I/O board, which inserted onto the mother board or base unit..	Ex) CPU module, Power Module, I/O module
Unit	A single module or group of modules that perform an independent operation as a part of PLC system.	Ex) Basic unit, Extension unit
PLC system	System consisted of PLC and peripheral device which can be controlled by user program.	-
XP-Builder	Software used to write and edit the project.	-
XP-Manager	It is the software for edition, download, monitoring to realize data communication between XGT Panels through XP Link with online control function.	
XP-Remote	Software used to remote monitor and control the XGT Panel	
Cnet module	Computer Link	-
FENet module	Fast Ethernet Network	-
RTC	Abbreviation of 'Real Time Clock'. It is used to call general IC that contains clock function.	-

### 1.4 Standard of product name

It describes terms used in this product names.

Term	Sign	Contents	Remark
(A) Generation	2	2nd generation	-
(B) LCD Size	04	10.9cm (4.3" )	-
	05	14.2cm (5.6" )	-
	07	17.8cm (7" )	-
	10	25.54cm (10.2" )	-
(C) OS type	0	WinCE 7.0(Core)	-
	1	WinCE 7.0(Pro)	-
(D) Communication/ uSD memory	0	Standard type	RS-232C/RS-485/RS-422/Ethernet
	1	Advanced type	RS-232C/RS-485/RS-422/Ethernet/Micro-SD
	2	Economy Type	RS-232C/RS-485/RS-422
(E) Power type,	D	DC Power	DC24V
(F) Option	EX	UL Type 4X	

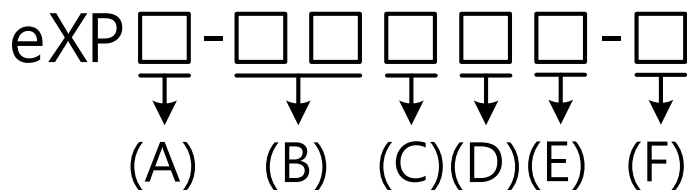

## Chapter 2 System Configuration

Characteristic of each eXP2 series and its system configuration are as follow;

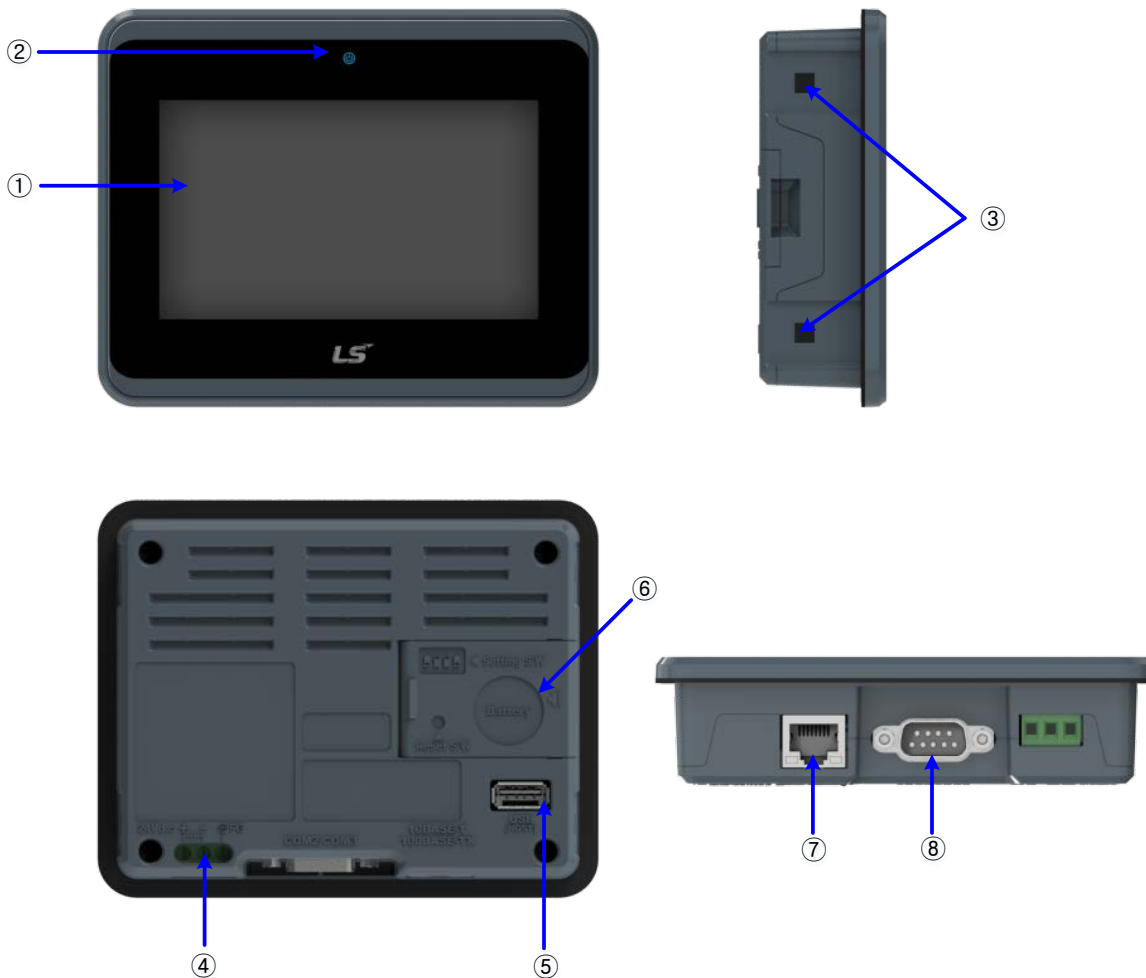

### 2.1 Part Names

#### 1. eXP2-04X0



Items	Part Names	Descriptions
①	Front Part	1) Analog Touch Panel: Input by user's touch 2) LCD: Screen indication ※ Refer to the drawing for details on the front part (color, design, etc.)
②	Power LED	Indicating the state of device (On: BLUE) ※ High Luminance Blue LED
③	Panel Mounting Panel	Fixing XGT Panel on the panel using bracket

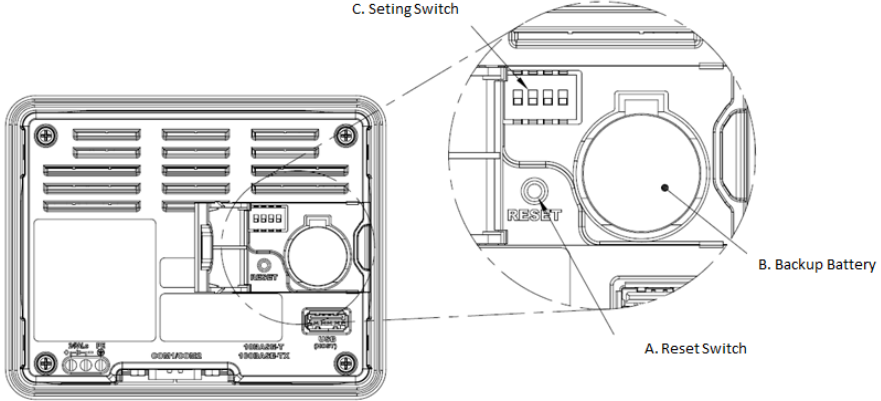

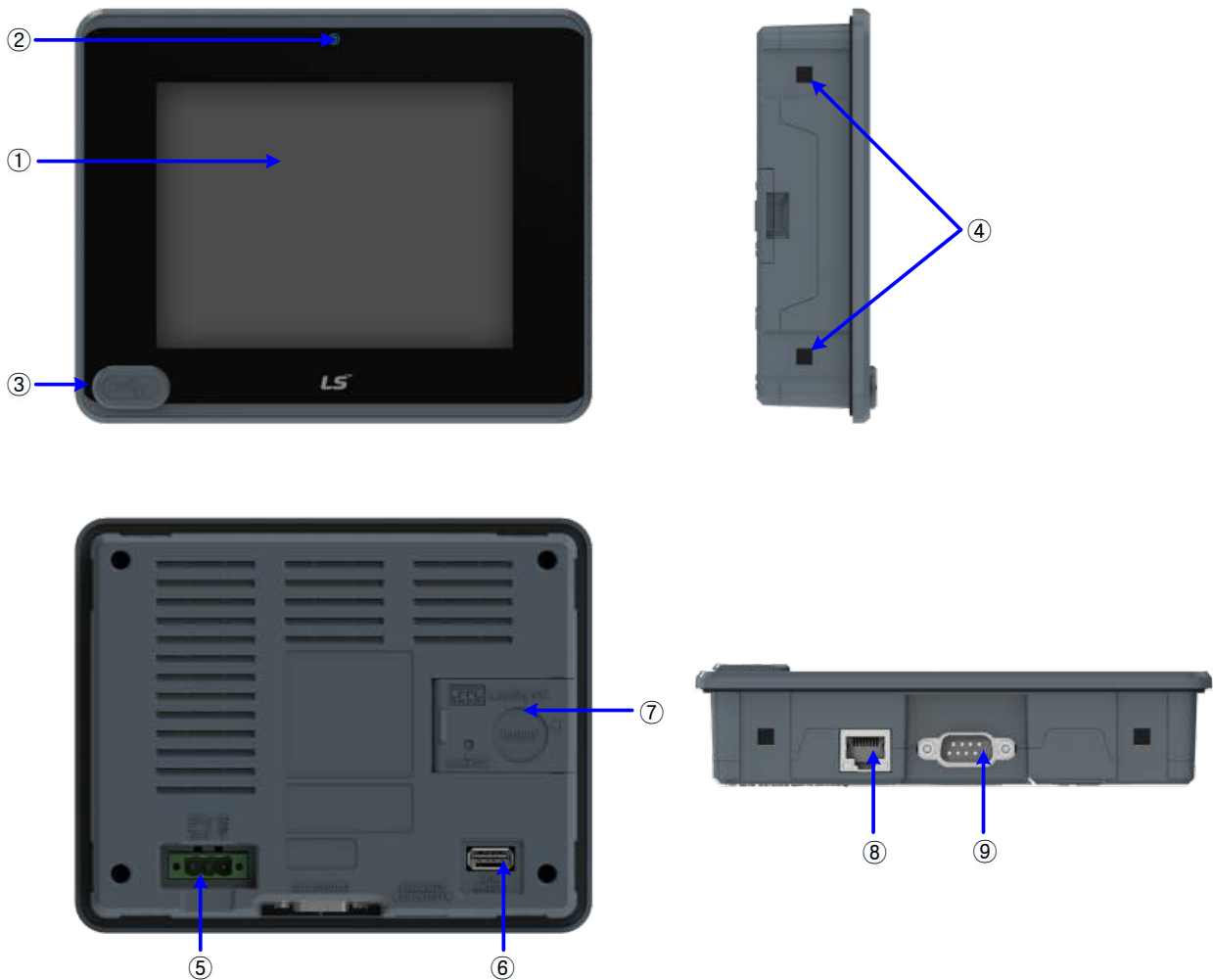

Items	Part Names	Descriptions																		
④	Power Terminal	Composed of Power Input(DC24V) and PE Terminal																		
⑤	USB Interface	1) USB Memory Connection: Backup of data such as alarm/logging/recipe and storage of screen data 2) USB Memory Connection: Send/Receive project data, Send XP-Runtime 3) User's Interface Connection: Using mouse/keyboard 4) Printer connection: Printing function																		
⑥	Battery Cover Reset Switch Backup Battery Setting Switch	 <p data-bbox="563 1115 766 1144">&lt;Setting Switch&gt;</p>  <table border="1" data-bbox="563 1364 1422 1682"> <tbody> <tr> <td data-bbox="563 1364 699 1413">No.1</td> <td data-bbox="699 1364 834 1413">A Side.</td> <td data-bbox="834 1364 1422 1413">Backup Battery On</td> </tr> <tr> <td></td> <td data-bbox="699 1413 834 1462">B Side.</td> <td data-bbox="834 1413 1422 1462">Backup Battery Off(Default)</td> </tr> <tr> <td data-bbox="563 1462 699 1541">No.2 / 3</td> <td data-bbox="699 1462 834 1541">A Side.</td> <td data-bbox="834 1462 1422 1541">RS-422/485 Terminating Resistance On (Default)</td> </tr> <tr> <td></td> <td data-bbox="699 1541 834 1590">B Side.</td> <td data-bbox="834 1541 1422 1590">RS-422/485 Terminating Resistance Off</td> </tr> <tr> <td data-bbox="563 1590 699 1639">No. 4</td> <td data-bbox="699 1590 834 1639">A Side.</td> <td data-bbox="834 1590 1422 1639">O/S Download Mode</td> </tr> <tr> <td></td> <td data-bbox="699 1639 834 1688">B Side.</td> <td data-bbox="834 1639 1422 1688">Operating Mode(Default)</td> </tr> </tbody> </table>	No.1	A Side.	Backup Battery On		B Side.	Backup Battery Off(Default)	No.2 / 3	A Side.	RS-422/485 Terminating Resistance On (Default)		B Side.	RS-422/485 Terminating Resistance Off	No. 4	A Side.	O/S Download Mode		B Side.	Operating Mode(Default)
No.1	A Side.	Backup Battery On																		
	B Side.	Backup Battery Off(Default)																		
No.2 / 3	A Side.	RS-422/485 Terminating Resistance On (Default)																		
	B Side.	RS-422/485 Terminating Resistance Off																		
No. 4	A Side.	O/S Download Mode																		
	B Side.	Operating Mode(Default)																		
⑦	Ethernet Terminal	Ethernet: 10Base-T/ 100Base-TX 1) Send Project Data 2) Receive backup data and project file 3) Send XP-Runtime 4) PLC/Control Device Communication																		
⑧	RS-232C, RS-422/485 Connector	RS-232C (COM2): PLC/ Control Device Communication RS-422/485 (COM3): PLC/ Control Device Communication ※ COM1 is not used.																		

2. eXP2-05X0D/05X2D

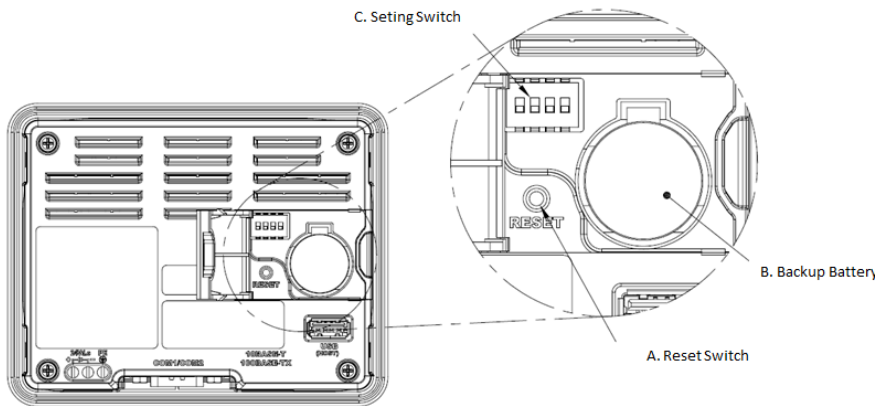

Items	Part Names	Descriptions
①	Front Part	1) Analog Touch Panel: Input by user's touch 2) LCD: Screen indication
②	Power LED	Indicating the state of device (On: BLUE) ※ High Luminance Blue LED
③	USB Device	1) Logging/Recipe/Screen Data Backup 2) Send project data and XP-Run time 3) Receive back data and project file
④	Panel Mounting Panel	Fixing XGT Panel on the panel using bracket
⑤	Power Terminal	Composed of Power Input(DC24V) and PE Terminal
⑥	USB Interface	1) USB Memory Connection: Backup of data such as alarm/logging/recipe and storage of screen data 2) USB Memory Connection: Send/Receive project data, Send XP-Runtime 3) User's Interface Connection: Using mouse/keyboard 4) Printer connection: Printing function

Items	Part Names	Descriptions															
<p>⑦</p>	<p>Battery Cover Reset Switch Backup Battery Setting Switch</p>	<div style="text-align: right; margin-bottom: 10px;">  </div> <p>&lt;Setting Switch&gt;</p> <div style="text-align: center; margin-bottom: 10px;">  </div> <table border="1" style="width: 100%; border-collapse: collapse;"> <tbody> <tr> <td rowspan="2" style="text-align: center; vertical-align: middle;">No.1</td> <td style="text-align: center;">A Side.</td> <td>Backup Battery On</td> </tr> <tr> <td style="text-align: center;">B Side.</td> <td>Backup Battery Off(Default)</td> </tr> <tr> <td rowspan="2" style="text-align: center; vertical-align: middle;">No.2 / 3</td> <td style="text-align: center;">A Side.</td> <td>RS-422/485 Terminating Resistance On (Default)</td> </tr> <tr> <td style="text-align: center;">B Side.</td> <td>RS-422/485 Terminating Resistance Off</td> </tr> <tr> <td rowspan="2" style="text-align: center; vertical-align: middle;">No. 4</td> <td style="text-align: center;">A Side.</td> <td>O/S Download Mode</td> </tr> <tr> <td style="text-align: center;">B Side.</td> <td>Operating Mode(Default)</td> </tr> </tbody> </table>	No.1	A Side.	Backup Battery On	B Side.	Backup Battery Off(Default)	No.2 / 3	A Side.	RS-422/485 Terminating Resistance On (Default)	B Side.	RS-422/485 Terminating Resistance Off	No. 4	A Side.	O/S Download Mode	B Side.	Operating Mode(Default)
No.1	A Side.	Backup Battery On															
	B Side.	Backup Battery Off(Default)															
No.2 / 3	A Side.	RS-422/485 Terminating Resistance On (Default)															
	B Side.	RS-422/485 Terminating Resistance Off															
No. 4	A Side.	O/S Download Mode															
	B Side.	Operating Mode(Default)															
<p>⑧</p>	<p>Ethernet Terminal</p>	<p>Ethernet: 10Base-T/ 100Base-TX                      1) Send Project Data                      2) Receive backup data and project file                      3) Send XP-Runtime                      4) PLC/Control Device Communication</p>															
<p>⑨</p>	<p>RS-232C, RS-422/485 Connector</p>	<p>RS-232C (COM2): PLC/ Control Device Communication                      RS-422/485 (COM3): PLC/ Control Device Communication                      ※ COM1 is not used.</p>															

3. eXP2-07X0D/07X1D/07X2D

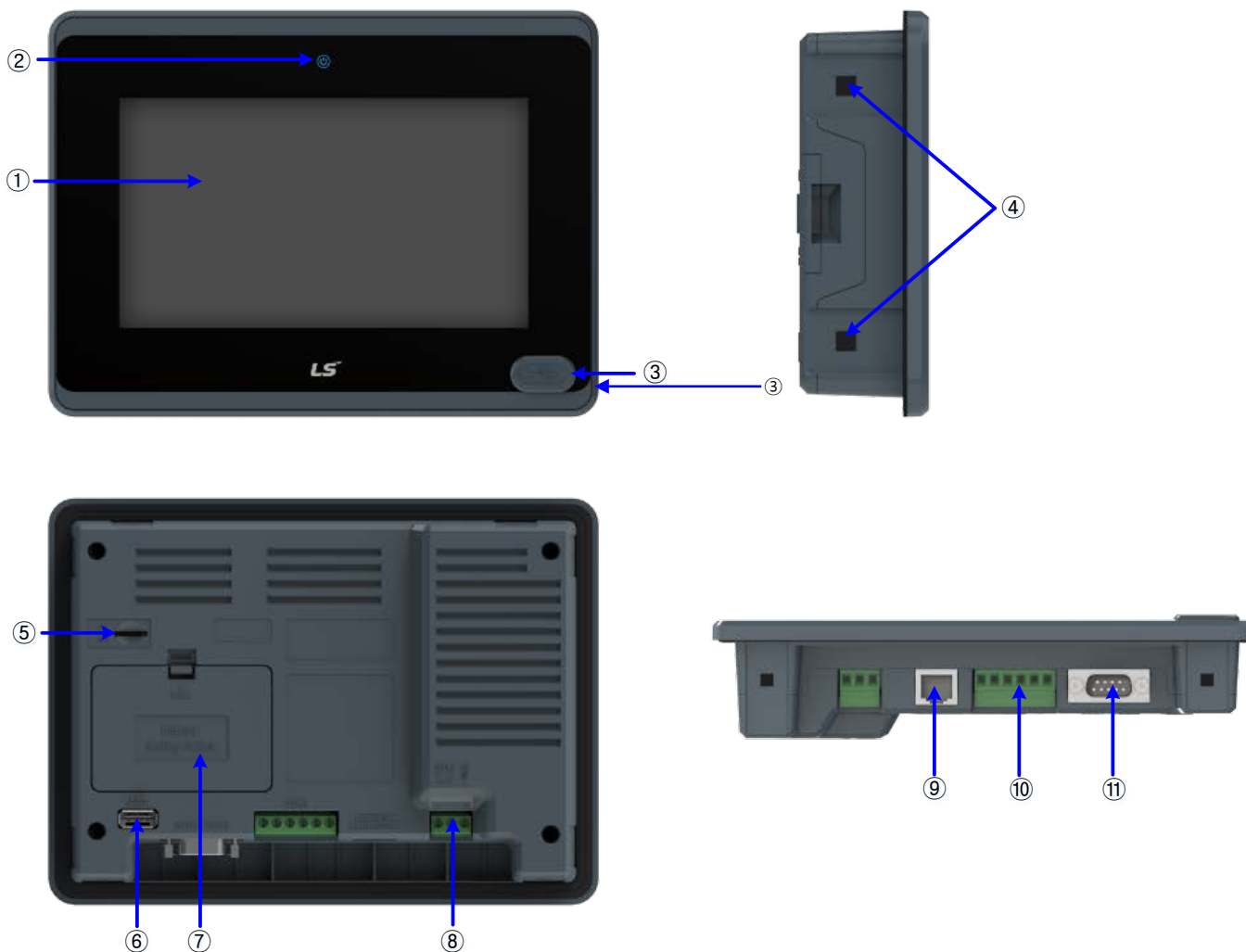

Items	Items	Items
①	Front Part	1) Analog Touch Panel: Input by user's touch 2) LCD: Screen indication
②	Power status LED	Indicating the state of device (On: BLUE)
③	USB Device	1) Logging/Recipe/Screen Data Backup 2) Send project data and XP-Run time 3) Receive back data and project file * Front USB is not available for CERTI products
④	Panel Mounting Part	Fixing XGT Panel on the panel using bracket
⑤	Micro SD Card	1) Backup of data such as alarm/logging/recipe and storage of screen data 2) Send/Receive project data, Send XP-Runtime

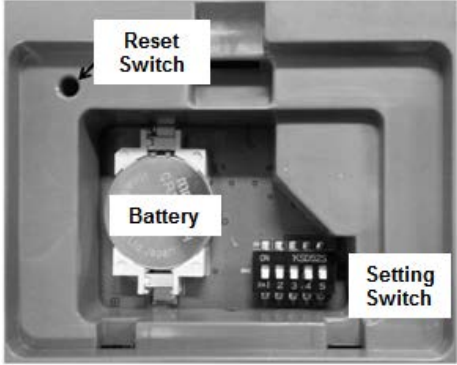
Items	Items	Items																																	
⑥	USB Host	1) USB Memory Connection: Backup of data such as alarm/logging/recipe and storage of screen data, Send/Receive project data, Send XP-Runtime 2) User's Interface Connection: Using mouse/keyboard 3) Printer connection: Printing function * Rated 5 VDC, Typical 100mA																																	
⑦	Battery Cover Reset Switch Backup Battery Setting Switch	 <p>A. Reset Switch B. Coin Battery C. Setting Switch</p> <p>&lt;Setting Switch Configuration &gt;</p> <table border="1" data-bbox="564 965 983 1137"> <tr> <td>A</td> <td><input checked="" type="checkbox"/></td> <td><input checked="" type="checkbox"/></td> <td><input checked="" type="checkbox"/></td> <td><input checked="" type="checkbox"/></td> <td><input checked="" type="checkbox"/></td> </tr> <tr> <td>B</td> <td><input type="checkbox"/></td> <td><input type="checkbox"/></td> <td><input type="checkbox"/></td> <td><input type="checkbox"/></td> <td><input type="checkbox"/></td> </tr> <tr> <td></td> <td>1</td> <td>2</td> <td>3</td> <td>4</td> <td>5</td> </tr> </table> <table border="1" data-bbox="564 1144 1442 1442"> <tr> <td rowspan="2">NO.1</td> <td>A Side.</td> <td>Backup Battery On</td> </tr> <tr> <td>B Side.</td> <td>Backup Battery Off(Default)</td> </tr> <tr> <td rowspan="2">NO.2/3</td> <td>A Side.</td> <td>COM1 RS-485 Terminating Resistance On (Default)</td> </tr> <tr> <td>B Side.</td> <td>COM1 RS-485 Terminating Resistance Off</td> </tr> <tr> <td rowspan="2">NO.4/5</td> <td>A Side.</td> <td>COM3 RS-422 Terminating Resistance On (Default)</td> </tr> <tr> <td>B Side.</td> <td>COM3 RS-422 Terminating Resistance Off</td> </tr> </table>	A	<input checked="" type="checkbox"/>	<input checked="" type="checkbox"/>	<input checked="" type="checkbox"/>	<input checked="" type="checkbox"/>	<input checked="" type="checkbox"/>	B	<input type="checkbox"/>	<input type="checkbox"/>	<input type="checkbox"/>	<input type="checkbox"/>	<input type="checkbox"/>		1	2	3	4	5	NO.1	A Side.	Backup Battery On	B Side.	Backup Battery Off(Default)	NO.2/3	A Side.	COM1 RS-485 Terminating Resistance On (Default)	B Side.	COM1 RS-485 Terminating Resistance Off	NO.4/5	A Side.	COM3 RS-422 Terminating Resistance On (Default)	B Side.	COM3 RS-422 Terminating Resistance Off
A	<input checked="" type="checkbox"/>	<input checked="" type="checkbox"/>	<input checked="" type="checkbox"/>	<input checked="" type="checkbox"/>	<input checked="" type="checkbox"/>																														
B	<input type="checkbox"/>	<input type="checkbox"/>	<input type="checkbox"/>	<input type="checkbox"/>	<input type="checkbox"/>																														
	1	2	3	4	5																														
NO.1	A Side.	Backup Battery On																																	
	B Side.	Backup Battery Off(Default)																																	
NO.2/3	A Side.	COM1 RS-485 Terminating Resistance On (Default)																																	
	B Side.	COM1 RS-485 Terminating Resistance Off																																	
NO.4/5	A Side.	COM3 RS-422 Terminating Resistance On (Default)																																	
	B Side.	COM3 RS-422 Terminating Resistance Off																																	
⑧	Power Terminal	Composed of Power Input(DC24V) and FG Terminal																																	
⑨	Ethernet Terminal	Ethernet: 10Base-T/ 100Base-TX 1) Send Project Data 2) Receive backup data and project file 3) Send XP-Runtime 4) PLC/Control Device Communication																																	
⑩	COM3 Connector	RS-422/485: PLC or Control Device Communication																																	
⑪	COM1, COM2 Connector	RS-485, RS-232C: PLC or Control Device Communication																																	

4. eXP2-10X0D/10X1D

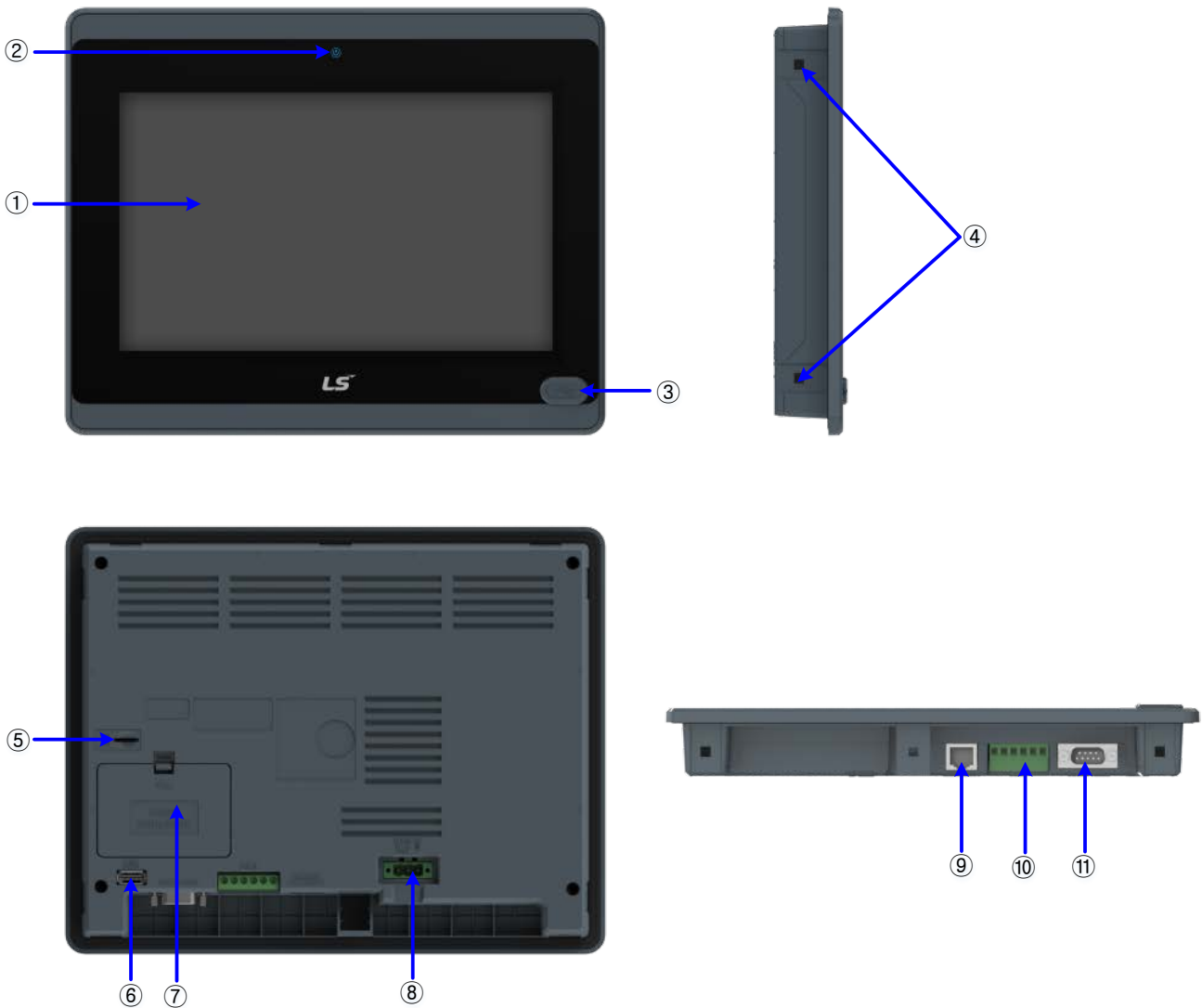

Items	Items	Items
①	Front Part	1) Analog Touch Panel: Input by user's touch 2) LCD: Screen indication
②	Power status LED	Indicating the state of device (On: BLUE)
③	USB Device	1) Logging/Recipe/Screen Data Backup 2) Send project data and XP-Run time 3) Receive back data and project file * Front USB is not available for CERTI products
④	Panel Mounting Part	Fixing XGT Panel on the panel using bracket
⑤	Micro SD Card	1) Backup of data such as alarm/logging/recipe and storage of screen data 2) Send/Receive project data, Send XP-Runtime

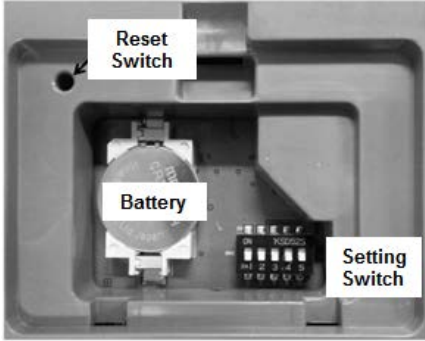
Items	Items	Items																																	
⑥	USB Host	1) USB Memory Connection: Backup of data such as alarm/logging/recipe and storage of screen data, Send/Receive project data, Send XP-Runtime 2) User's Interface Connection: Using mouse/keyboard 3) Printer connection: Printing function * Rated 5 VDC, Typical 100mA																																	
⑦	Battery Cover Reset Switch Backup Battery Setting Switch	 <p>A. Reset Switch B. Coin Battery C. Setting Switch</p> <p>&lt;Setting Switch Configuration &gt;</p> <table border="1" data-bbox="564 927 983 1104"> <tr> <td>A</td> <td><input checked="" type="checkbox"/></td> <td><input checked="" type="checkbox"/></td> <td><input checked="" type="checkbox"/></td> <td><input checked="" type="checkbox"/></td> <td><input checked="" type="checkbox"/></td> </tr> <tr> <td>B</td> <td><input type="checkbox"/></td> <td><input type="checkbox"/></td> <td><input type="checkbox"/></td> <td><input type="checkbox"/></td> <td><input type="checkbox"/></td> </tr> <tr> <td></td> <td>1</td> <td>2</td> <td>3</td> <td>4</td> <td>5</td> </tr> </table> <table border="1" data-bbox="564 1108 1444 1408"> <tr> <td rowspan="2">NO.1</td> <td>A Side.</td> <td>Backup Battery On</td> </tr> <tr> <td>B Side.</td> <td>Backup Battery Off(Default)</td> </tr> <tr> <td rowspan="2">NO.2/3</td> <td>A Side.</td> <td>COM1 RS-485 Terminating Resistance On (Default)</td> </tr> <tr> <td>B Side.</td> <td>COM1 RS-485 Terminating Resistance Off</td> </tr> <tr> <td rowspan="2">NO.4/5</td> <td>A Side.</td> <td>COM3 RS-422 Terminating Resistance On (Default)</td> </tr> <tr> <td>B Side.</td> <td>COM3 RS-422 Terminating Resistance Off</td> </tr> </table>	A	<input checked="" type="checkbox"/>	<input checked="" type="checkbox"/>	<input checked="" type="checkbox"/>	<input checked="" type="checkbox"/>	<input checked="" type="checkbox"/>	B	<input type="checkbox"/>	<input type="checkbox"/>	<input type="checkbox"/>	<input type="checkbox"/>	<input type="checkbox"/>		1	2	3	4	5	NO.1	A Side.	Backup Battery On	B Side.	Backup Battery Off(Default)	NO.2/3	A Side.	COM1 RS-485 Terminating Resistance On (Default)	B Side.	COM1 RS-485 Terminating Resistance Off	NO.4/5	A Side.	COM3 RS-422 Terminating Resistance On (Default)	B Side.	COM3 RS-422 Terminating Resistance Off
A	<input checked="" type="checkbox"/>	<input checked="" type="checkbox"/>	<input checked="" type="checkbox"/>	<input checked="" type="checkbox"/>	<input checked="" type="checkbox"/>																														
B	<input type="checkbox"/>	<input type="checkbox"/>	<input type="checkbox"/>	<input type="checkbox"/>	<input type="checkbox"/>																														
	1	2	3	4	5																														
NO.1	A Side.	Backup Battery On																																	
	B Side.	Backup Battery Off(Default)																																	
NO.2/3	A Side.	COM1 RS-485 Terminating Resistance On (Default)																																	
	B Side.	COM1 RS-485 Terminating Resistance Off																																	
NO.4/5	A Side.	COM3 RS-422 Terminating Resistance On (Default)																																	
	B Side.	COM3 RS-422 Terminating Resistance Off																																	
⑧	Power Terminal	Composed of Power Input(DC24V) and FG Terminal																																	
⑨	Ethernet Terminal	Ethernet: 10Base-T/ 100Base-TX 1) Send Project Data 2) Receive backup data and project file 3) Send XP-Runtime 4) PLC/Control Device Communication																																	
⑩	COM3 Connector	RS-422/485: PLC or Control Device Communication																																	
⑪	COM1, COM2 Connector	RS-485, RS-232C: PLC or Control Device Communication																																	

**Remark**

- (1) For further details on connection of communication, please refer to Communication Instruction Manual.
- (2) For further details on installation, please refer to the Chapter 10.
- (3) In order to use RTC(Date/Time) normally, it is necessary to set the date and time after the backup battery on setting at first.  
For setting method, refer to 4.3 Date/Time Adjustment.

## 2.2 System Configuration

In order to use XGT Panel, it is necessary for XP-Builder to prepare project data and transmit it to XGT Panel.

With Ethernet in use, you can transfer project data more quickly.

With LAN environment built in the following configuration, you may use it more easily and effectively

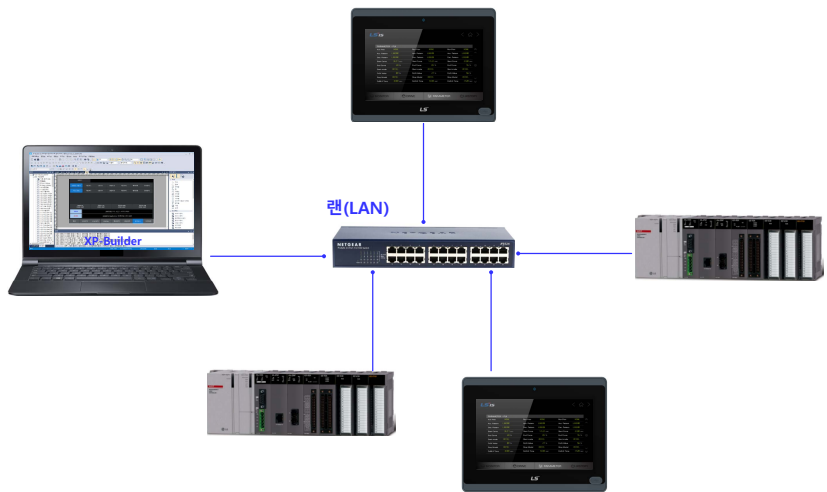

1:1 connection will be supported just in case LAN environment is not built.



If it is impossible to transfer project data using Communication, you can use USB storage device. For how to use in details, please see the Chapter 7 and XP-Builder User's Manual.



**Remark**

- (1) For how to make Ethernet cable, please see the Communication User's Manual.
- (2) For how to transfer project, please see XP-Builder User's Manual.
- (3) eXP2-0502 and eXP2-0702 are not support Ethernet.



## Chapter 3 Standard Specification

### 3.1 General Standards

XGT Panel general standard is as follows.

No.	Category	Standard			Related standard	
1	Ambient operating temperature	0°C~+50°C			-	
2	Storage temperature	-20°C~+60°C			-	
3	Operating humidity	10~85%RH, non-condensing.			-	
4	Storage humidity	10~85%RH, non-condensing.			-	
5	Vibration resistance	Occasional vibration			10 times each in X, Y and Z direction	IEC 61131-2
		Frequency	Acceleration	Amplitude		
		5≤f< 9 Hz	-	3.5mm		
		9≤f≤150 Hz	9.8m/s <sup>2</sup>	-		
		Continuous vibration				
		Frequency	Acceleration	Amplitude		
		5≤f< 9 Hz	-	1.75mm		
9≤f≤150 Hz	4.9m/s <sup>2</sup>	-				
6	Shock endurance	* Maximum shock acceleration: 147m/s <sup>2</sup> (15G) * Duration time: 11ms * Pulse wave: half sine pulse (3 times each in X, Y and Z directions)			IEC 61131-2	
7	Noise Immunity	Square wave Impulse noise	DC: ±1,200V		LS ELECTRIC Standard	
		Electrostatic Discharge Immunity	±6 kV(Contact Discharge), ±8 kV(Air Discharge)		IEC 61131-2 IEC 61000-4-2	
		Electromagnetic Radiated Emissions	80 ~ 1,000 MHz, 10 V/m		IEC 61131-2 IEC 61000-4-3	
		Electrical Fast Transient & Burst Immunity	Category	Power module	Communication Interface	IEC 61131-2
Voltage	2.4 kV		1.2 kV	IEC 61000-4-4		
8	Environment	Free from corrosive gases and excessive dust			-	
9	Operating height	Up to 2,000m(6,562ft)			-	
10	Pollution degree	2 or less			-	
11	Cooling method	Natural Air-Cooling			-	

**Remark**

## (1) IEC(International Electro technical Commission)

- International private group facilitating international cooperation of electric/electronic standardization, issuing international standards and operating the compliance evaluation systems.

## (2) Pollution degree

- As an index representing the pollution degree of an environment to determine the insulation of a device, pollution degree 2 generally means the status generating non-conductive contamination. However, it also contains the status generating temporarily conduction due to condensation.

## (3) Definition of Overvoltage Categories

- Equipment of overvoltage category II is energy-consuming equipment to be supplied from the fixed installation.
- Examples of such equipment are appliances, portable tools and other household and similar loads.

### 3.2 Function Standards

eXP2 Series function standard is as follows.

Item	eXP2-04X0D	eXP2-05X0D	eXP2-05X2D
Display type	TFT color LCD		
Screen size	10.9cm(4.3")	14.2cm(5.6")	
Display Resolution	480 x 272 pixel	640 x 480 pixel	
Color indication	24Bit Color (16.7M)	18Bit Color (65,536)	
Indication degree	Left/Right:60 deg. Upper:40 deg. Lower:50 deg.	Left/Right:60 deg. Upper:40 deg. Lower:60 deg.	
Backlight	LED Type (Supports backlight auto-off function)		
Backlight duration	50,000 hours	20,000 hours	
Touch panel	4-Wire Resistive, analog		
Audio Output	Magnetic buzzer (85dB)		
Process	800MHz		
Memory	Drawing Memory	64MB	
	Operating RAM	512MB	
	Backup RAM	128KB	
Backup data	Date/Hour data, Logging/Alarm/Recipe data and nonvolatile device		
Battery duration	Approx. 3 years (Operating ambient temperature of 50℃)		
RTC	Time error Approx. 3 sec/1day(Operating ambient temperature of 25℃)		
Ethernet	1 channel, IEEE802.1a, 10Base-T/100Base-TX	-	
USB Host	1 channel, USB 2.0 Host (mouse, keyboard, printer and USB memory driver is available)		
USB Device	-	1 channel, USB 2.0 Device (for download and upload project)	
RS-485, RS-232C	1channel, RS-232C (DSUB 9/Male Type)		
RS-422/485	1channel, RS-422/485 (DSUB 9/Male Type)		
Multi-language	Up to 12 language simultaneously		
Animation	GIF format is available		
Recipe	available		
Data logging	available		
Script executor	available		
Certifications	CE, UL(cUL), KC		
Protection standard	IP65		
Dimension (mm)	128x102x32.5	165 x132.5 x 36.1	
Panel cut (mm)	119.0x93	156.0 x 123.5	
Rated voltage	DC24V		
Power consumption (W)	4	5.5	
Weight(Kg)	0.27	0.43	0.43

Item	eXP2-07X0D	eXP2-07X1D	eXP2-07X2D
Display type	TFT color LCD		
Screen size	17.8cm(7")		
Display Resolution	800 x 480		
Color indication	24Bit Color (16.7M)		
Indication degree	Left/Right:70 deg. Upper:50 deg. Lower:70 deg.		
Backlight	LED Type (Supports backlight auto-off function)		
Backlight duration	50,000 hours		
Touch panel	4-Wire Resistive, analog		
Audio Output	Magnetic buzzer (85dB)		
Process	800MHz		
Memory	Drawing Memory	64MB	
	Operating RAM	512MB	
	Backup RAM	128KB	
Backup data	Date/Hour data, Logging/Alarm/Recipe data and nonvolatile device		
Battery duration	Approx. 3 years (Operating ambient temperature of 25℃)		
RTC	Time error Approx. 3 sec/1day(Operating ambient temperature of 25℃)		
Ethernet	1 channel, IEEE802.1a, 10Base-T/100Base-TX		
USB Host	1 channel, USB 2.0 Host (mouse, keyboard, printer and USB memory driver is available)		
USB Device	1 channel, USB 2.0 Device (for download and upload project file)		
Micro SD Card		1 channel SDHC Class10	
RS-485, RS-232C	2channels, RS-485, RS-232C (DSUB 9/Male Type)		
RS-422/485	1channel, RS422/485 mode (Terminal Type)		
Multi-language	Up to 12 language simultaneously		
Animation	GIF format is available		
Recipe	available		
Data logging	available		
Script executor	available		
Certifications	CE, UL(cUL), KC		
Protection standard	IP65		
Dimension (mm)	208 x 154 x 44.4		
Panel cut (mm)	192 x 138		
Rated voltage	DC24V		
Power consumption (W)	6		
Weight(Kg)	0.59	0.59	0.58

Item		eXP2-10X0D	eXP2-10X1D
Display type		TFT color LCD	
Screen size		25.9 cm(10.2")	
Display Resolution		1024 x 600	
Color indication		24Bit Color (16.7M)	
Indication degree		Left/Right:70 deg. Upper:50 deg. Lower:70 deg.	
Backlight		LED Type (Supports backlight auto-off function)	
Backlight duration		30,000 hours	
Touch panel		4-Wire Resistive, analog	
Audio Output		Magnetic buzzer (85dB)	
Process		800MHz	
Memory	Drawing Memory	64MB	
	Operating RAM	512MB	
	Backup RAM	128KB	
Backup data		Date/Hour data, Logging/Alarm/Recipe data and nonvolatile device	
Battery duration		Approx. 3 years (Operating ambient temperature of 50℃)	
RTC		Time error Approx. 3 sec/1day(Operating ambient temperature of 25℃)	
Ethernet		1 channel, IEEE802.1a, 10Base-T/100Base-TX	
USB Host		1 channel, USB 2.0 Host (mouse, keyboard, printer and USB memory driver is available)	
USB Device		1 channel, USB 2.0 Device (for download and upload project file)	
Micro SD Card			1 channel SDHC Class10
RS-485, RS-232C		2channels, RS-485, RS-232C (DSUB 9/Male Type)	
RS-422/485		1channel, RS422/485 mode (Terminal Type)	
Multi-language		Up to 12 language simultaneously	
Animation		GIF format is available	
Recipe		available	
Data logging		available	
Script executor		available	
Certifications		CE, UL(cUL), KC	
Protection standard		IP65	
Dimension (mm)		276 x 218 x 35.1	
Panel cut (mm)		260.0 x 202	
Rated voltage		DC24V	
Power consumption (W)		6	
Weight(Kg)		1.0	1.0

**Note**

## (1) Caution in power connection

: With AC power applied to DC power device, it may cause product damage or fire.

Please pay a special attention to connection.

## (2) PE Connection

: For the device PE, please use ⑦ PE terminal in the Chapter 2.1.

## (3) Battery discharge-prevention DIP switch

: In order to prevent the battery discharge, turn off the DIP switch No.1.

To use backup function, please turn on DIP switch No. 1.

## (4) Battery Operation and Life

: Battery is used for RTC (date/time) when the power of device is off.

Battery is not consumed with power applied.

## (5) Battery Replacement

: The battery must be replaced with CR 2032H.

## (6) LCD Backlight Replacement

: Please replace LCD if you want to replace LCD backlight.

## (7) Protection standard

: XGT Panel is designed by IP65 Standard in front parts. Ingress Protection (IP) is based on the IEC 60529 Standard for degrees of protection provided by enclosures. But XGT Panel does not guarantee from all installation environment.(Indoor use only) When installing panels, make sure that dust and moisture are not brought in. For more details on installation, See Chapter 10.installation and Wiring.

## (8) USB does not recommend using an extension cable. If it is inevitable to use an extension cable, the length of the cable should be within 2 meters and should be used in an environment where there is no noise interference.

## (9) Maximum supported capacity of USB memory and Micro SD card

: USB memory 32GB (Format -> FAT32)

※ For stable USB memory use, it is recommended to use USB 2.0 driver.

Micro SD card 32GB (Format -> FAT32).

## Chapter 4 System Configuration

It describes the system configuration including XGT Panel's time setting, Ethernet connection setting, and Backlight settings.

If you press [Settings] button in XGT Panel's Main screen, you can set XGT Panel's environment as follows.

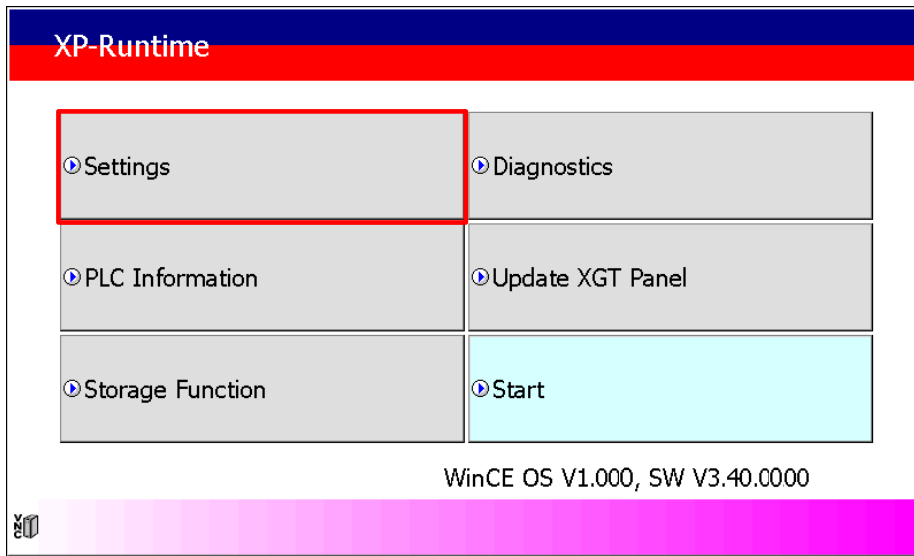

[XGT Panel main screen]

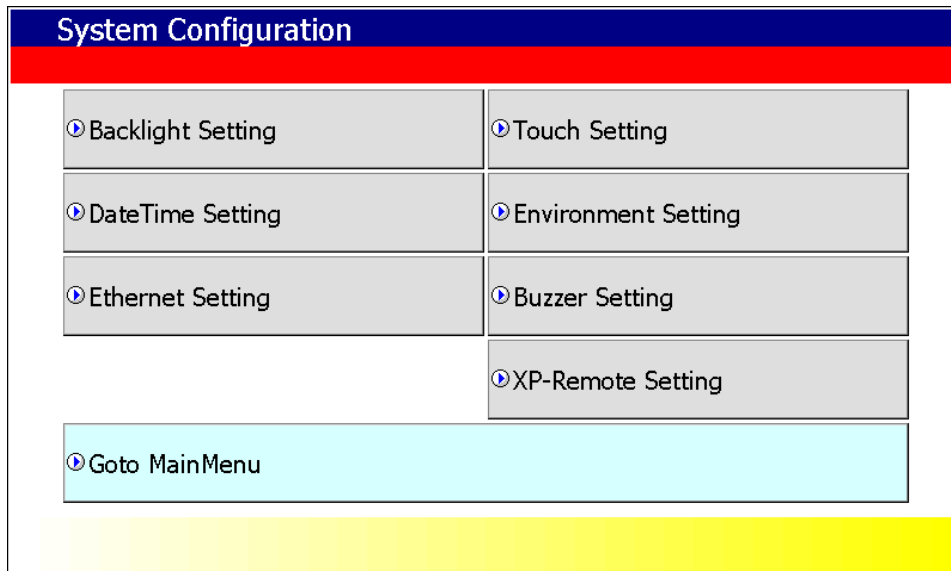

[System Configuration screen]

## 4.1 Backlight Setting

If you press [Backlight Setting] button in [System Configuration] screen as follows, setting screen shows up.

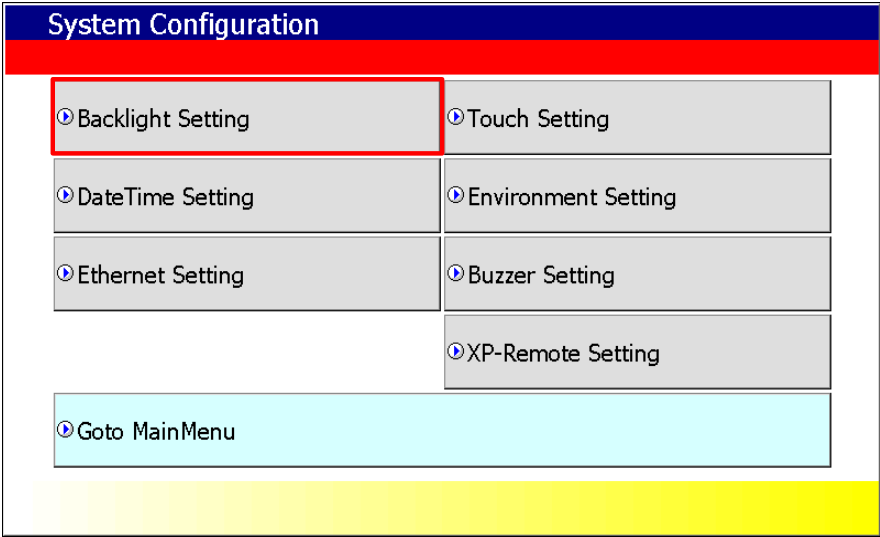

[XGT Panel setting screen]

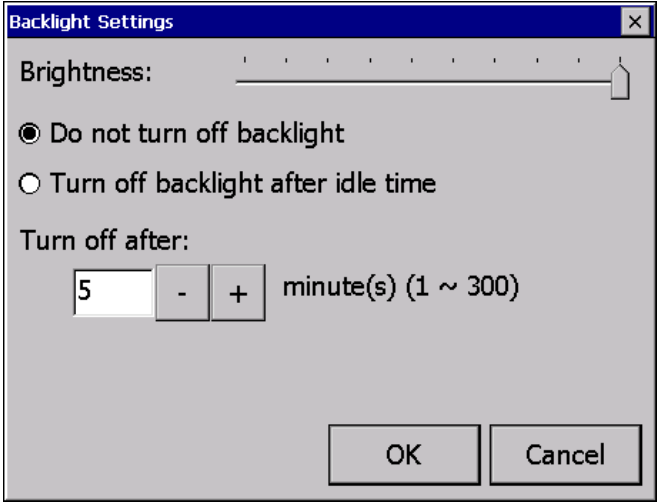

[Backlight setting screen]

[Dialog box setting option]

Name	Description
Brightness	It may adjust brightness of backlight.
Do not turn off backlight	It doesn't turn off backlight power.
Turn off backlight after idle time	It automatically turns off backlight if not in touch for a certain period of time.
Turn off ~ minutes	It turns off backlight after a designated time (unit of minute).



## 4.2 Touch Calibration

When the location is not recognized in XGT Panel, Touch's scale can be adjusted in XGT Panel. If you press [Touch Calibration] button in System Configuration, the setting screen shows up. If you press five '+' marks, XGT Panel's touch location adjustment is completed.

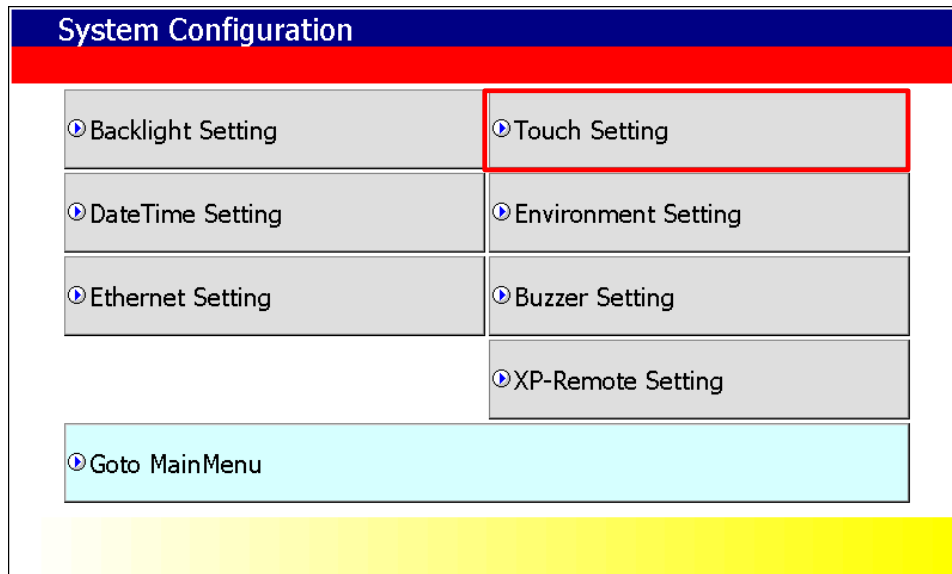

[XGT Panel setting screen]

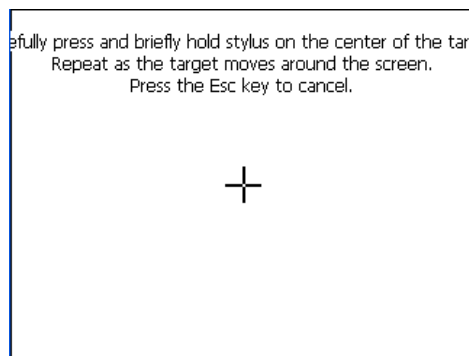

[Touch setting screen]

### Remark

- (1) XGT Panel's Touch Calibration setting is basically set. If Touch location is way off, adjusting menu with touch can be hard through touch. In that case, You can select the Touch Calibration setting menu by USB mouse or simply touch 5 times at the empty space on the main screen.
- (2) When touch location changes in using, redo touch setting.

### 4.3 Date Time Setting

If you press [Date Time Setting] button in [System Configuration] as follows, you can set XGT Panel's data and time.

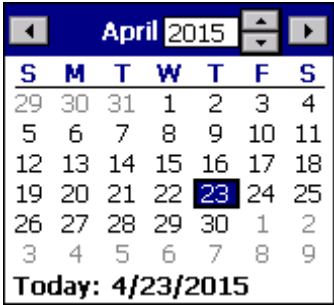
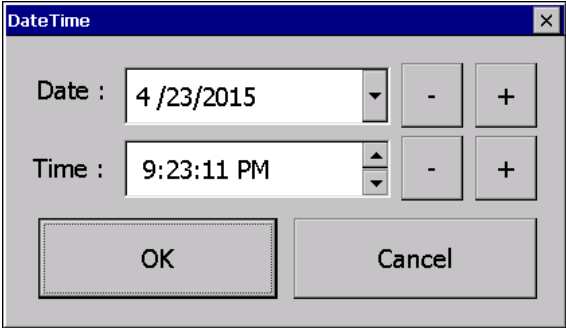
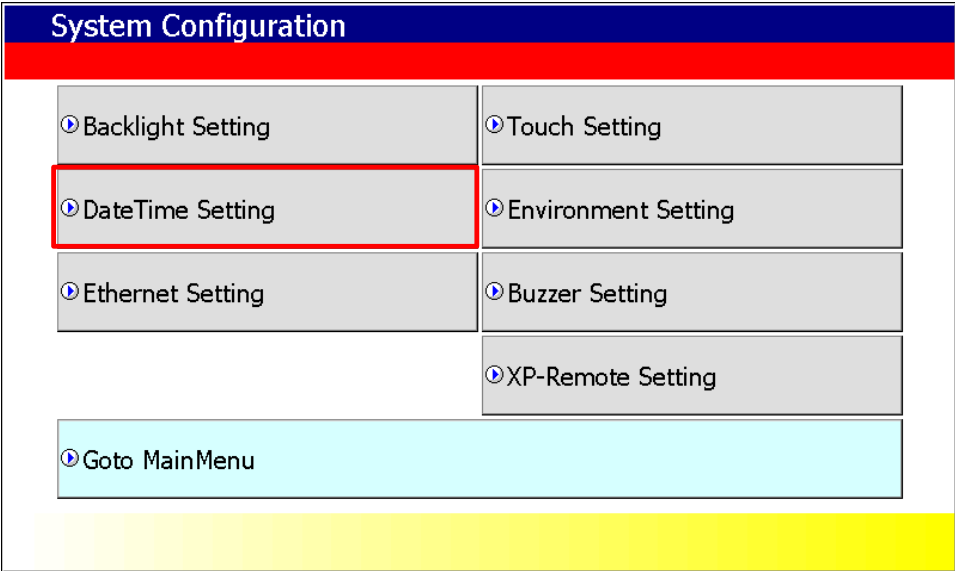

**Remark**  
You can set data/time at device information of communication dialog at the XP-Builder.  
For details, please refer to the XP-Builder's manual.

## 4.4 Environment Setting

If you press [Environment Setting] button in [System Configuration] screen as follows, you can set 'Auto Goto Screen' and 'Buzzer On/Off'.

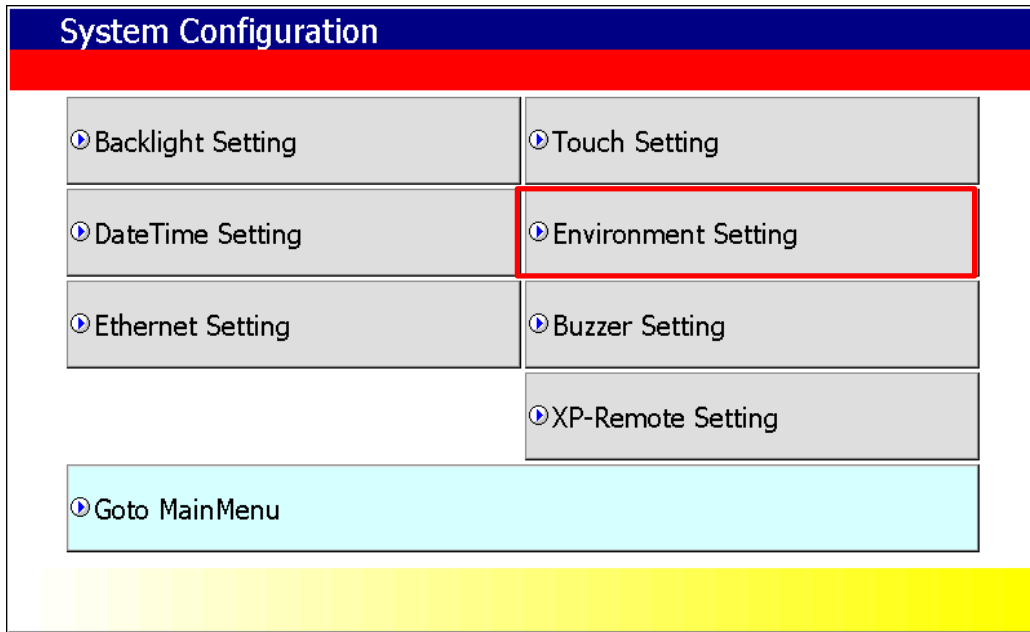

[XGT Panel setting]

(1) Screen

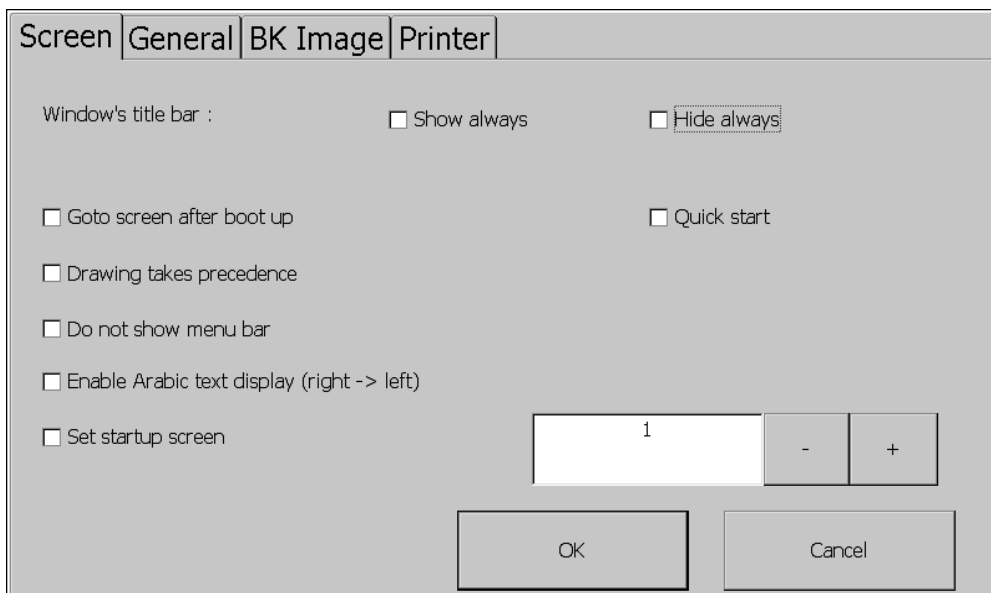

Menu	Explanation
Window's title bar : Show always /Hide always	<p>If you select [Show always], the title bar displays when a pop-up window is displayed on the screen. You can select and move the title bar of the pop-up window. If you select [Hide always] the title bar will not be displayed when a pop-up window is displayed on the screen, and you will not see it when you click the window screen blank.</p> <p>If you uncheck [Show always], [Hide always], the title bar will not be displayed when the pop-up window is displayed on the screen, and the title bar will appear when you click the window screen blank.</p>
Goto screen after boot up	<p>After rebooting XGT Panel or downloading edit data, You will switch. If you disable this setting, Button to move to the screen.</p>
Quick start	<p>When I start the screen, I do not cache the image in advance, It does not appear. However, if you select this option, the initial screen may appear somewhat late.</p> <p>There is. In particular, if the screen contains animation objects, It may take a few seconds. The next screen transition is fast.</p>
Drawing takes precedence	<p>If you choose [Drawing takes precedence], the screen that you have already entered when switching the screen will display the image/value based on the data that was last displayed at that time. Then read the actual device value and display the image/value again. If the screen is entering for the first time, it will behave the same as when [Drawing takes precedence] is deselected.</p> <p>If you deselect [Drawing takes precedence] when switching the screen, read the actual device value and display the image/value. This may take some time to switch screens depending on the network situation or PLC response rate.</p>
Do not show menu bar	<p>In order to exit to the standby screen during screen monitoring, The window (menu bar) does not appear. If this is the case, You need to configure and use a special switch to exit the screen.</p>
Enable Arabic text Display (right-> left)	<p>Enables the right-to-left language.</p>
Set startup screen	<p>The screen corresponding to the number entered at the start of monitoring is displayed.</p>

(2) General

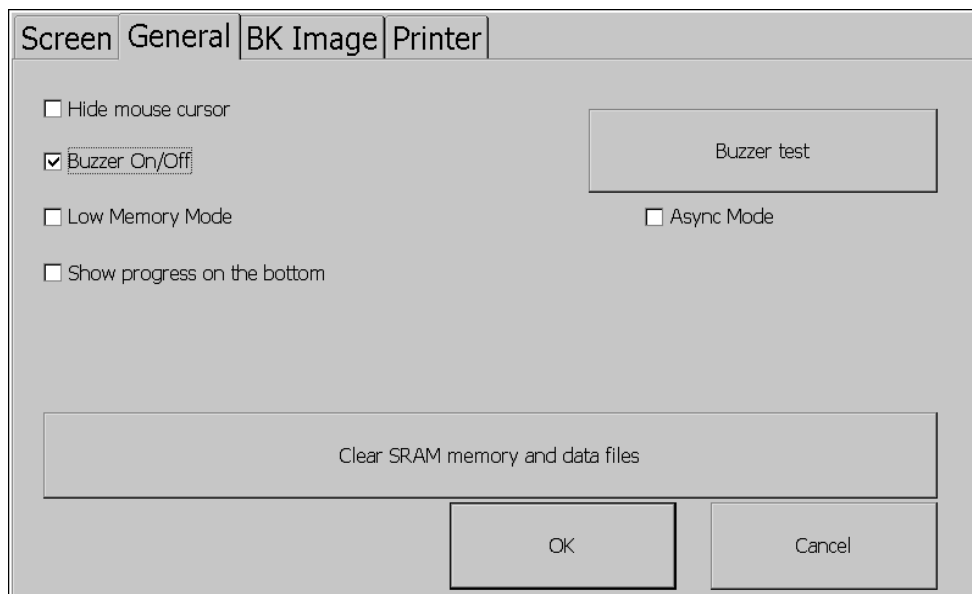

Menu	Explanation
Hide mouse cursor	Mouse cursor does not appear after scrolling.
Buzzer On / Off	You can set whether buzzer is used or not.
Buzzer test	You can test the buzzer.
Low Memory Mode	<p>XGT Panel starts monitoring the images used on the screen to speed up the screen operation.</p> <p>It will be loaded into memory before use. By the way,</p> <p>If a positive image is used, due to memory space constraints, all</p> <p>The image will not load. In this case, if the screen is not yet loaded</p> <p>Images are loaded, and there is not enough space, so unused images are retrieved from memory</p> <p>The operation to delete may be repeated, and the screen switching operation may be slowed down. In this situation</p> <p>Low Memory Mode "is recommended. In Low Memory Mode, you do not load the image before monitoring, but use only the original source of the image used in the project, which results in less memory usage and less load to load and delete images into memory.</p>
Async mode	<p>Ensures the order of operation when entering values by bit switch, word switch, multi-switch, etc. when [Async mode] is deselected. In other words, when 1, 2, 3 actions are performed by multiple switches or overlapped switches, 2 is performed when 1 action is completed, and 3 is performed only when 2 is completed. Therefore, if there is no response from the target controller in Operation 1, the actions 2 and 3 are also delayed even if the controller is different.</p> <p>When [Async mode] is selected, the value is entered by bit switch, word switch, multi-switch, etc. without ensuring order. In other words, when 1, 2, 3 actions are performed by multiple switches or overlaid switches, each action can be completed in the order of 2, 1 and 3 depending on the network situation or controller response speed. Although the order is not followed, it has the advantage of operating quickly for the rest of the controllers even if some of them do not respond.</p>
Show progress on the bottom	<p>When you start monitoring by selecting [Start] menu on the XGT Panel main screen, It buffers the used image and shows the progress of the operation. (fast</p> <p>Do not show progress if you make a start setting). At this time,</p> <p>If you check the [Show Lower] check box, this progress will be simplified and displayed at the bottom of the screen.</p> <p>Is displayed. This option can be applied when using the default screen image.</p>
Clear SRAM memory And data files	<p>Delete all files you've downloaded on your device. However, connecting to the device</p> <p>If a password is set, you must enter the password before you can delete it. The password is the device connection password that you enter when downloading a project, This can be set in XP-Builder on the Device Information View tab of the Communication dialog box.</p> <p>The files to be deleted include user project data, web server, VNC startup module, option card Driver, RAPIEnet communication setting data, XP-Manager setting data etc. from user PC All downloaded data is included. Set using the configuration menu of the machine. The contents are kept uninitialized. If the menu language is not English,</p> <p>A device reboot is required to delete files.</p>

(3) BK Image

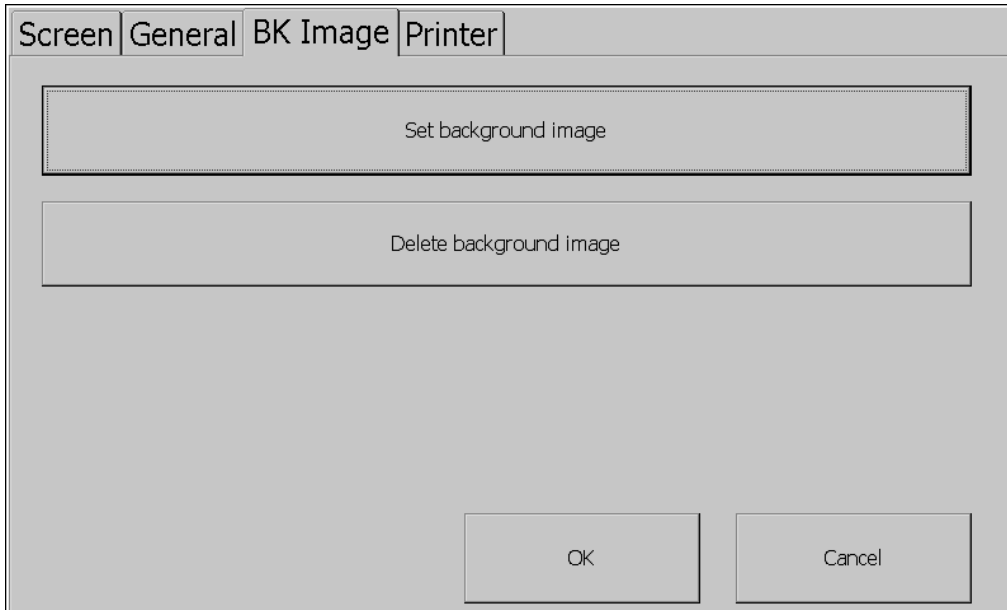

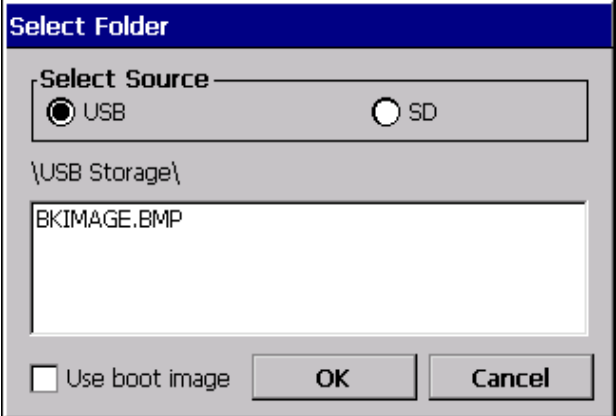
Menu	Explanation
Set background image	<p>If you select an image, the standby screen and desktop are selected after the XGT Panel is powered on.</p>  <p>If [Use boot image] option is selected, images with resolutions other than XGT Panel, it can not be used unless it is a 32bit BMP image.</p>
Delete background image	<p>When you select an image, the XGT Panel is powered on and the standby screen and desktop are selected.</p> <p>Set to image. To turn off background settings, click the Clear Background button. Just press it.</p> <p>If you select the Use boot image option, you cannot use it unless it is an image with a resolution different from the XGT Panel or a 32bit BMP image.</p>

(4) Printer

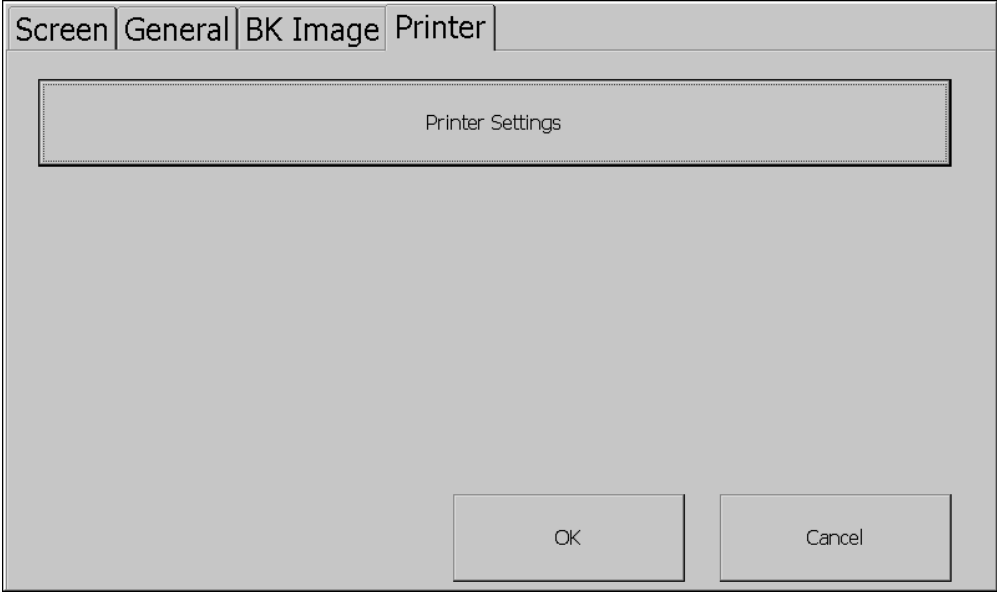

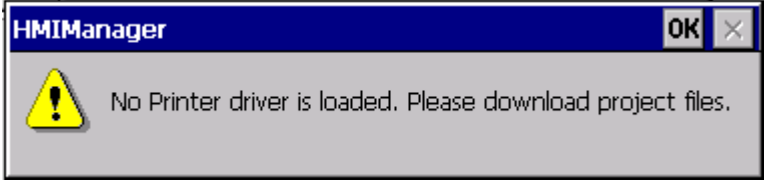
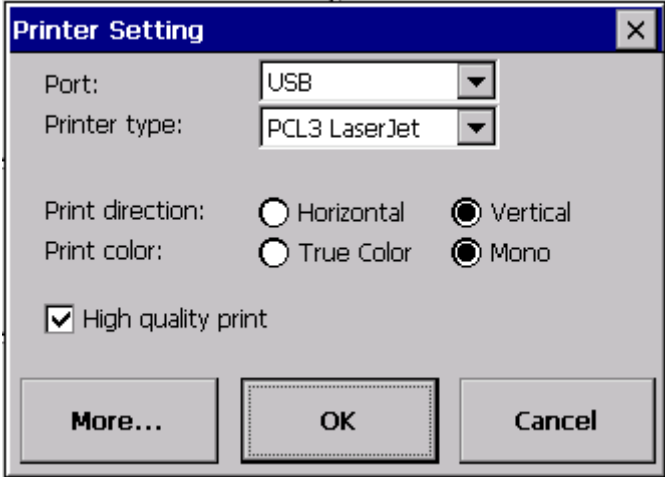
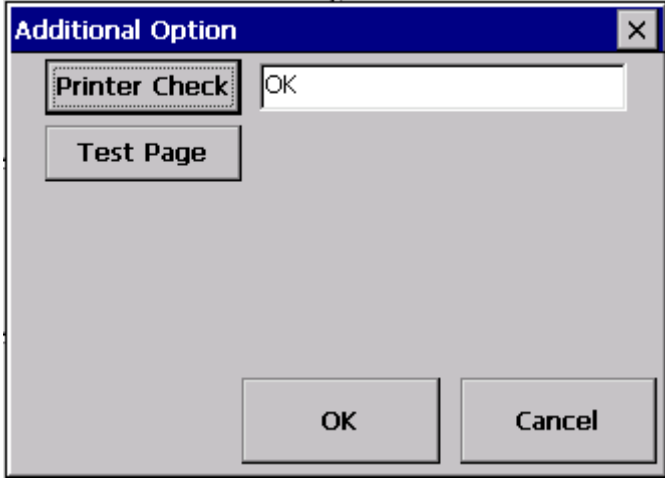

Menu	Explanation
<p>Printer Settings</p>	<p>Displays additional printer print settings dialogs. If there is no printer information You should download from XP-Builder with the following message.                      From XP-Runtime, go to Start menu and prepare for downloading.                      After using the printer, you can use the menu.</p>  <p>&lt;No printer driver and information → Download Required&gt;</p>   <p>&lt;Printer Driver and Information Available&gt;</p>



## 4.5 Ethernet Setting

If you press [Ethernet Setting] button in [System Configuration] screen as follows, you can change IP to use Ethernet.

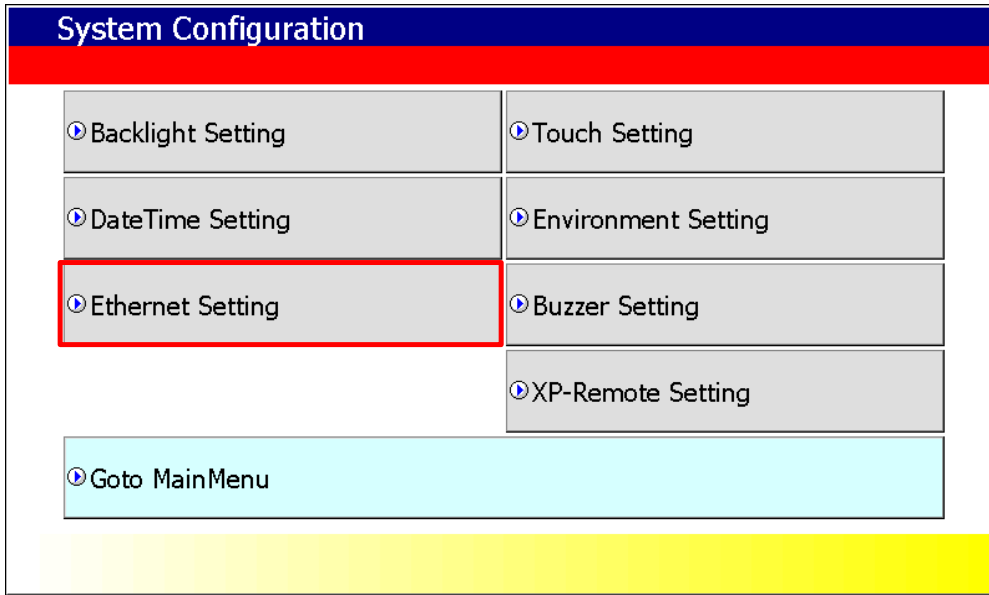

[XGT Panel Setting]

You can change IP address by pressing [Set] button of each IP address, Subnet Mask and Gateway. By pressing OK button, changed IP information is reserved.

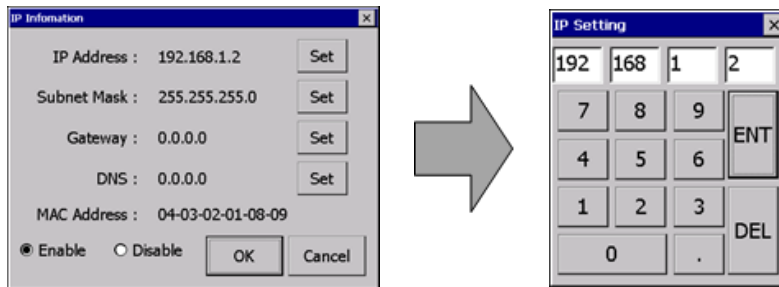

### Remark

We recommend the following method, when connecting with PC solely.

- |  |   |
|--|---|
| <p>1) XGT Panel setting</p> <ul style="list-style-type: none"> <li>- IP Address : 192.168.0.10</li> <li>- Subnet Mask: 255.255.255.0</li> <li>- Gateway : 192.168.0.1</li> </ul> | <p>2) PC setting</p> <ul style="list-style-type: none"> <li>- IP Address : 192.168.0.11</li> <li>- Subnet Mask: 255.255.255.0</li> <li>- Gateway : 192.168.0.1</li> </ul> |
|--|---|

If you reboot after pressing [Disable] button, the device will not use Ethernet. In this case, booting speed gets faster.

If you use Ethernet again, reboot after pressing [Enable].

## 4.6 Buzzer Setting

It may adjust volume and height of XGT Panel Buzzer.

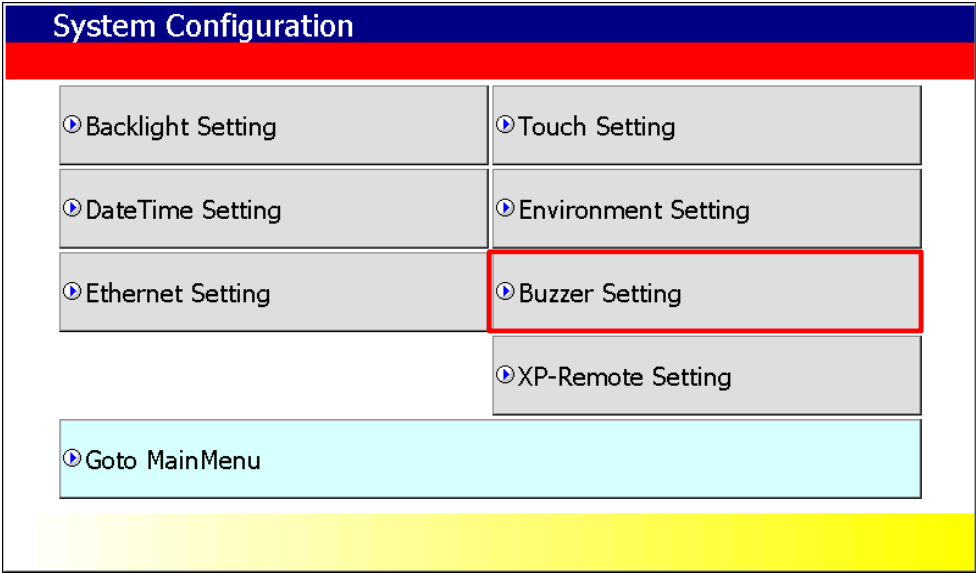

[XGT Panel Setting]

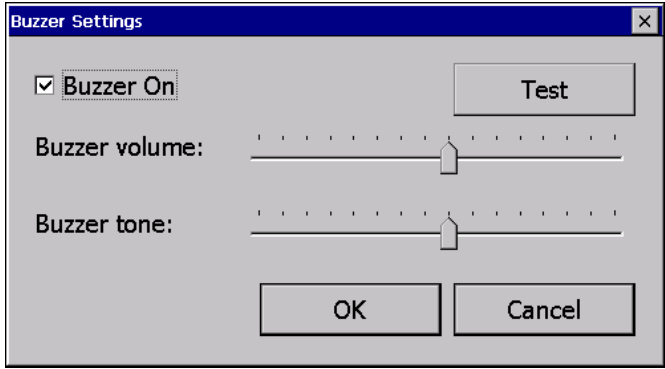

[Buzzer Settings Screen]

[Dialog box setting option]

Name	Description
Buzzer On	It may turn on or off the buzzer that occurs when in touch mode
Buzzer volume	It may adjust the volume of Buzzer
Buzzer tone	It may adjust the tone of Buzzer.
Test	Click the Test button to check the buzzer volume and buzzer tone settings.

## 4.7 XP-Remote Setting

Settings of XP-Remote that can remotely adjust XGT Panel can be changed.

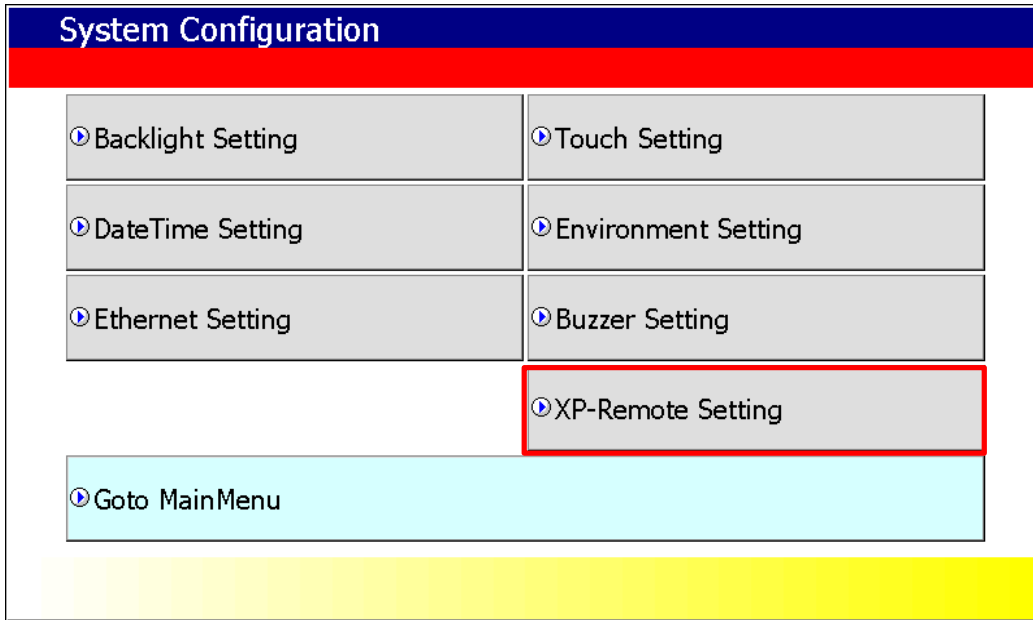

[XGT Panel Setting]

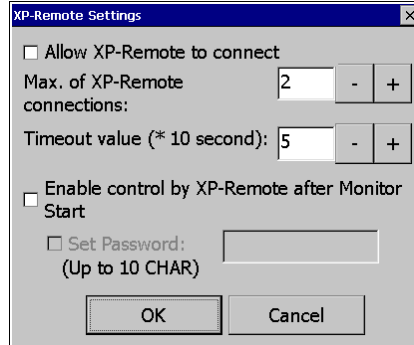

[XP-Remote Setting Screen]

[Dialog box setting options]

Name	Description
Allow XP-Remote to connect	It allows connecting remote XP-Remote.
Max. of XP-Remote connections	It designates the maximum number of XP-Remote connected with XGT Panel.
Timeout value	It stops communication when there is no request of communication from XP-Remote within the designated time. In case XP-Remote is entitled to manipulation, it withdraws the right to manipulation (10 ~ 300 seconds)
Enable control by XP-Remote after Monitor Start	XGT Panel, will automatically allow state control after the monitor was started.
Set Password	You can set it to enter a password when you request a connection from XP-Remote. If a password is set here, remote monitoring will only begin if the UI enters the password when connecting to XP-Remote.

**Note**

For the function of XP-Remote in detail, please refer to XP-Remote user's manual.

## Chapter 5 Diagnostics

It describes the diagnosis function for XGT Panel's communication terminal, screen and touch function. If you press [Diagnostics] button on the XGT Panel's basic screen, the menu for diagnosis shows up.

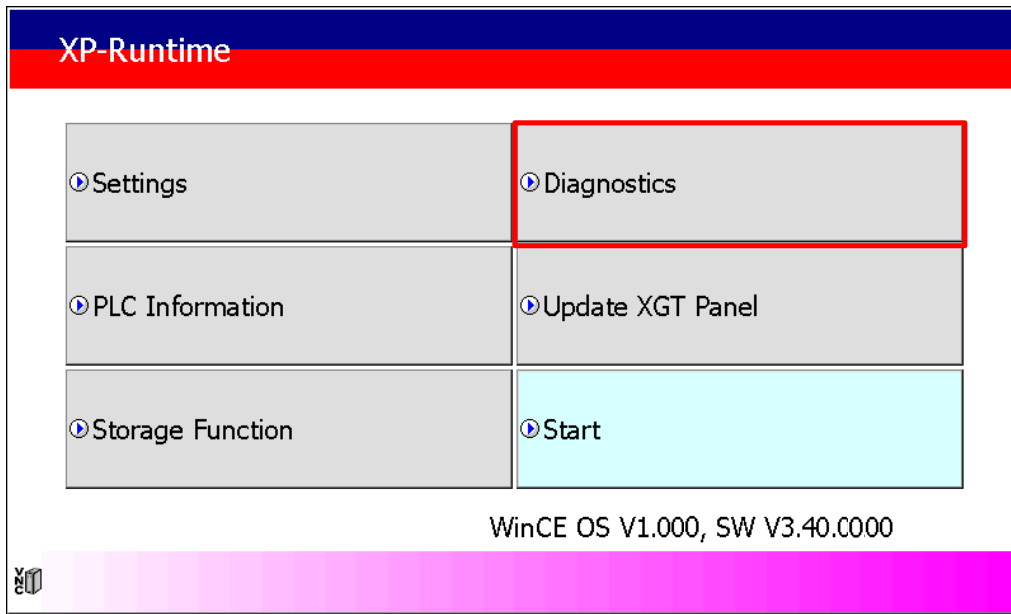

[Main Screen]

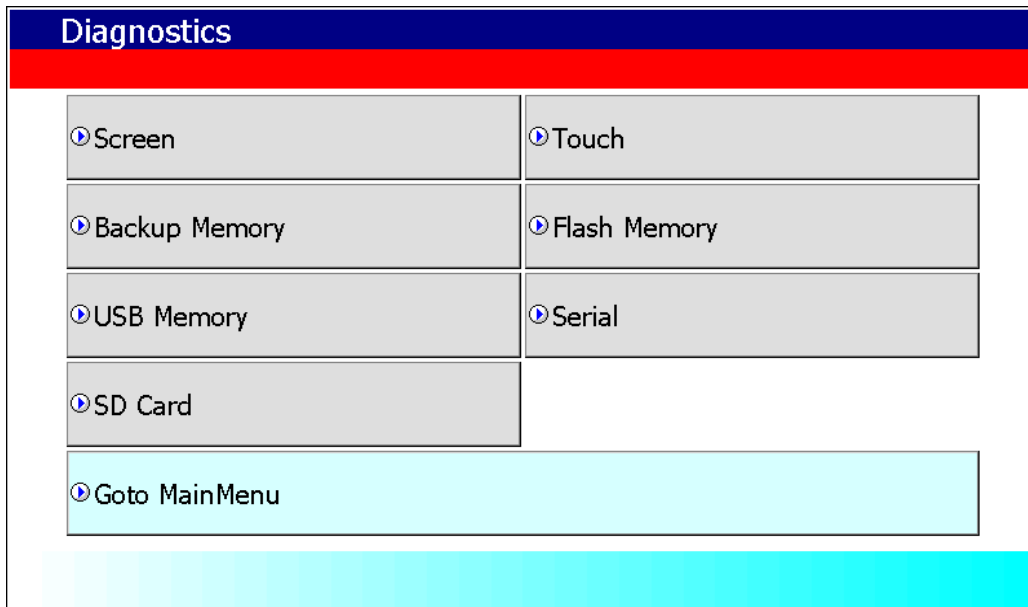

[Diagnostics setting screen]

## 5.1 Screen Diagnosis

If you press [Screen] button, screens continuously change into diverse color with buzzer. After all screen for diagnosis pass. Then, Close button shows up with white ground.

If you press Close button, the initial screen shows up.

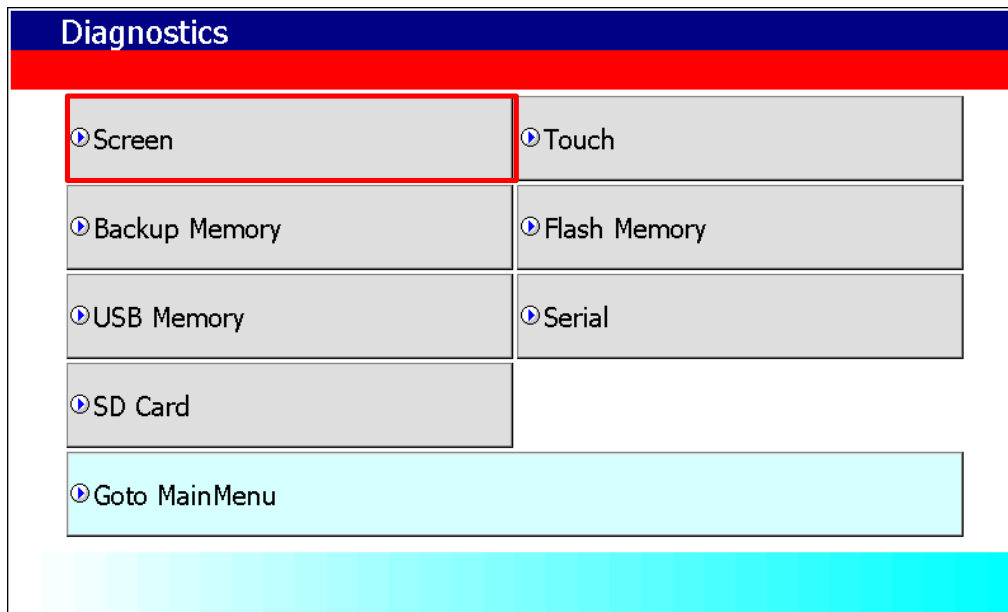

[Diagnosis screen]

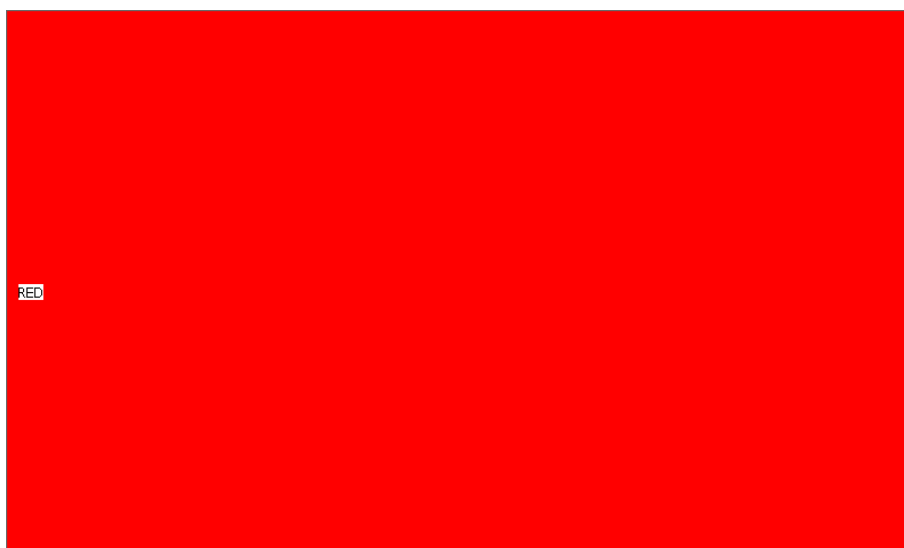

[Screen diagnosis]

<b>Display Sequence</b>	RED > GREEN > BLUE > BLACK > WHITE>GRAPH
-------------------------	--



## 5.2 Touch Diagnosis

If you touch the screen, the touched location is displayed as follows. If pressing the [OK] button, you can quit the screen.

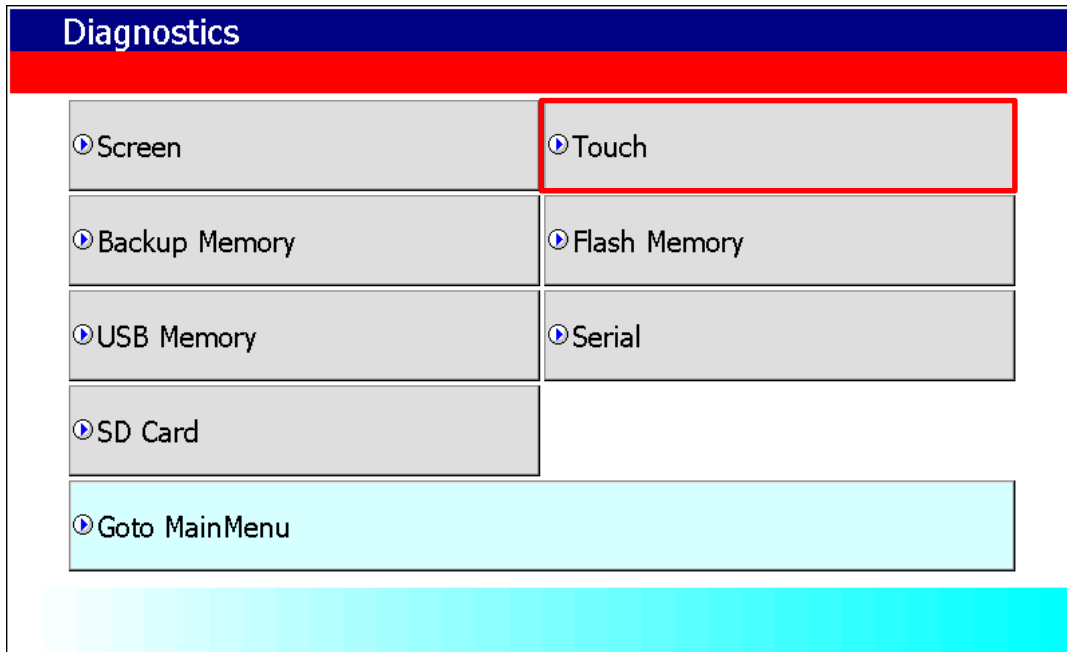

[Diagnosis screen]

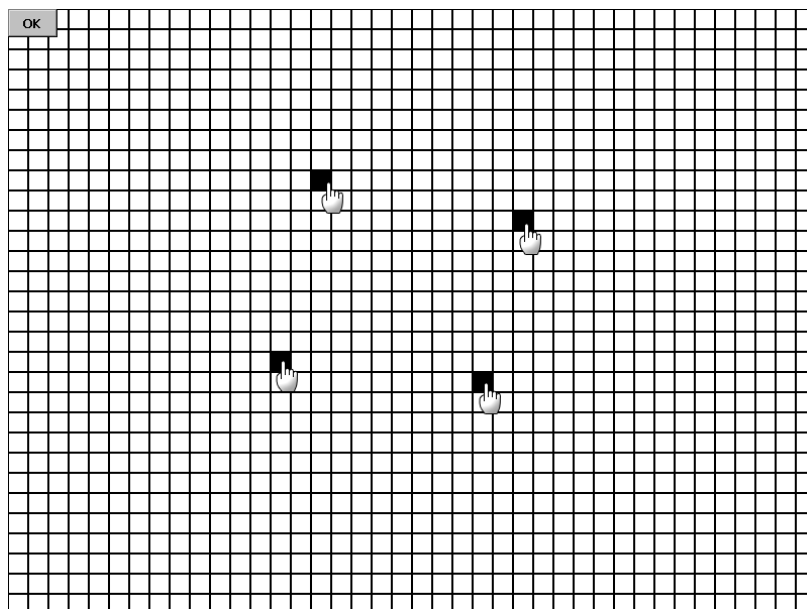

Touch diagnosis

If the touched location is not correct, reset the Touch setting. For detailed information, please refer to the Chapter 4.2 Touch Calibration.

## 5.3 Backup Memory Diagnosis

If you press [Backup Memory] button, you can see the result of diagnosis in the result windows.

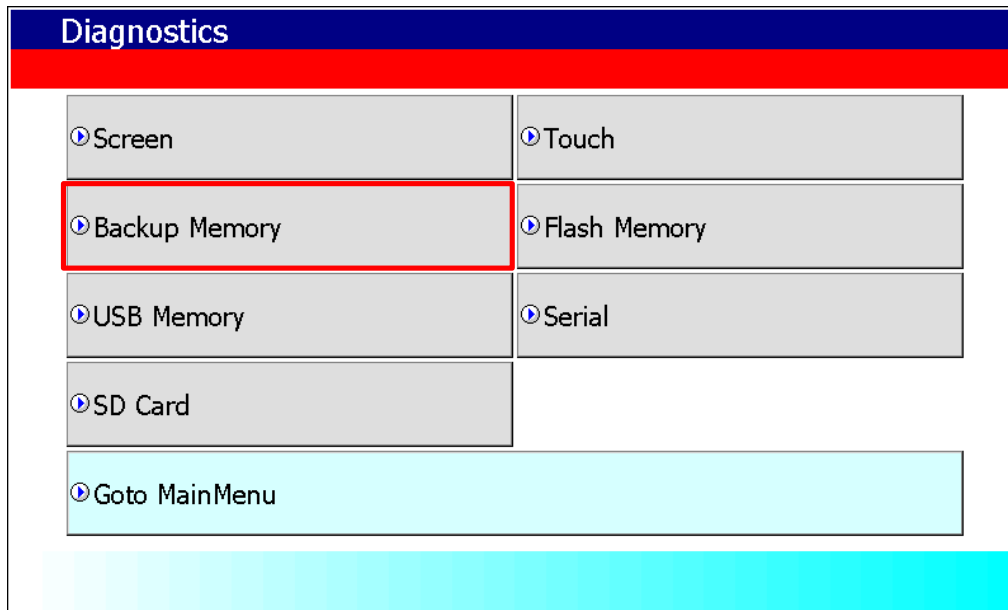

[Diagnosis screen]

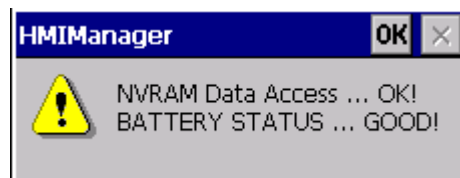

[Completion of Backup Memory diagnosis]

### Remark

- (1) If 'NVRAM Data Access ... Fail' error is occurred, please contact with customer service center.
  - (2) If 'BATTERY STATUS ... BAD' error is occurred, battery should be changed. Please contact with Customer service center.
- If the DIP switch No.1 is set up as B, please set it up as A. The 'B' is the mode in which the backup battery is not used.

## 5.4 Flash Memory Diagnosis

If you press [Flash Memory] button, you can see the result of diagnosis in the result widows.

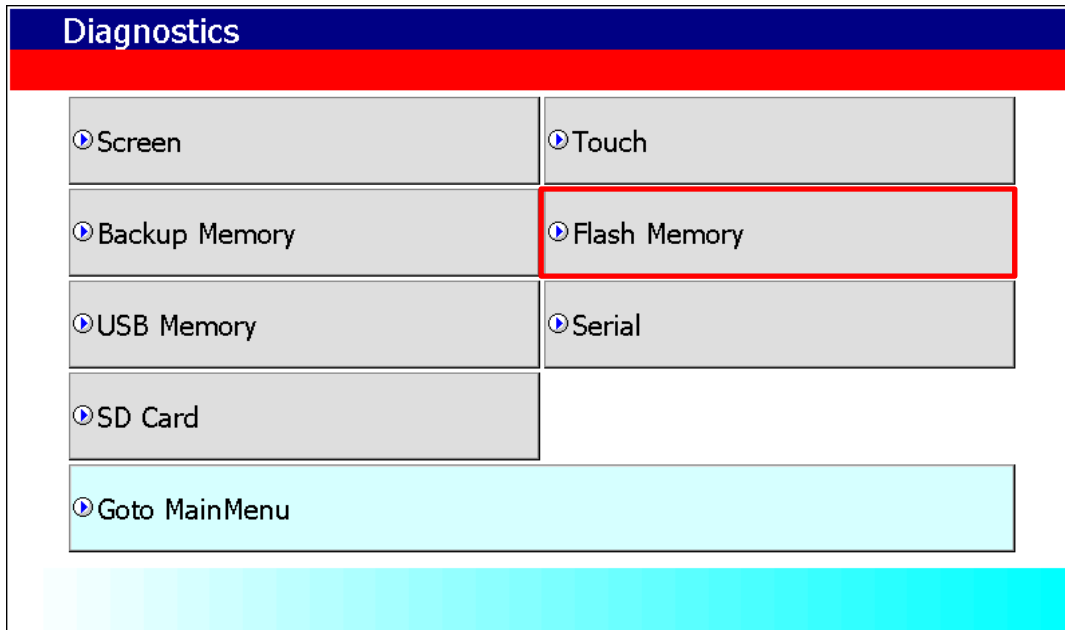

[Diagnosis screen]

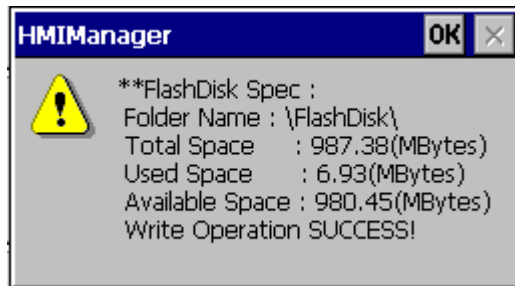

### Remark

If 'Read Disk Information Error!' occurs, please contact with Customer service center.

## 5.5 USB Memory Diagnosis

If you press [USB Memory] button, the result of diagnosis shows up in the result windows.

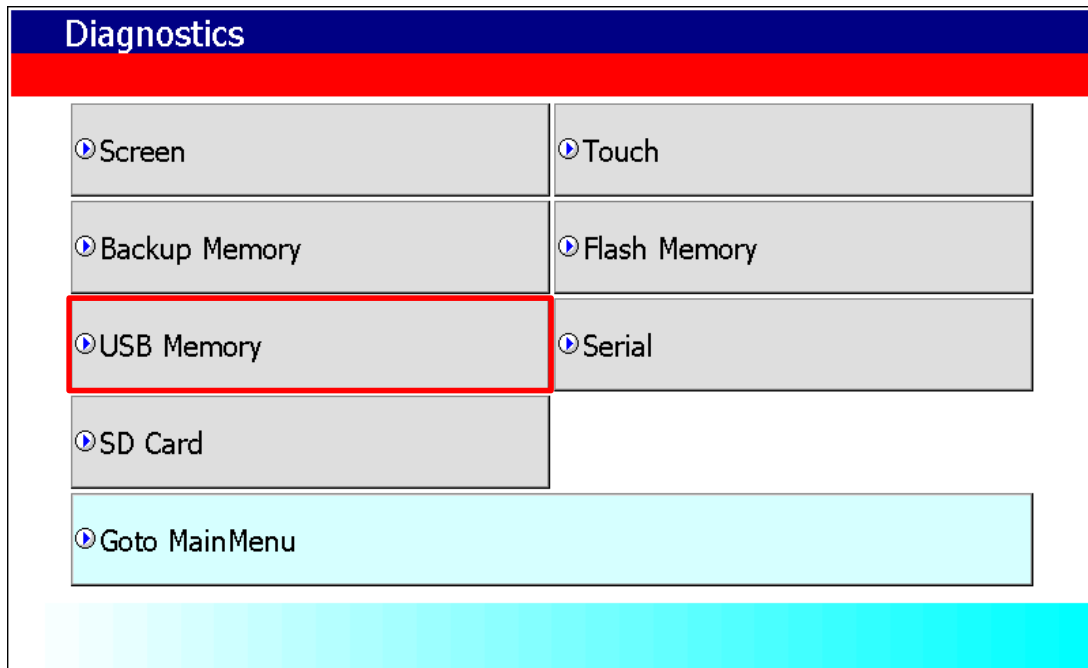

[Diagnosis screen]

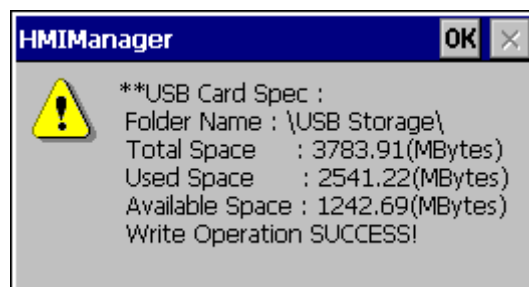

[Completion of USB Memory diagnosis]

### Remark

If 'Read Disk Information Error!' occurs, remove it first and test it after inserting it again.  
If the error message shows up repeatedly, please contact with customer service center.

## 5.6 Serial Communication Diagnosis

If you press [Serial] button, you can diagnose Serial ports which is equipped at XGT Panel.  
(In case of diagnosis purpose, you have to connect the loop-back terminal at each port.)

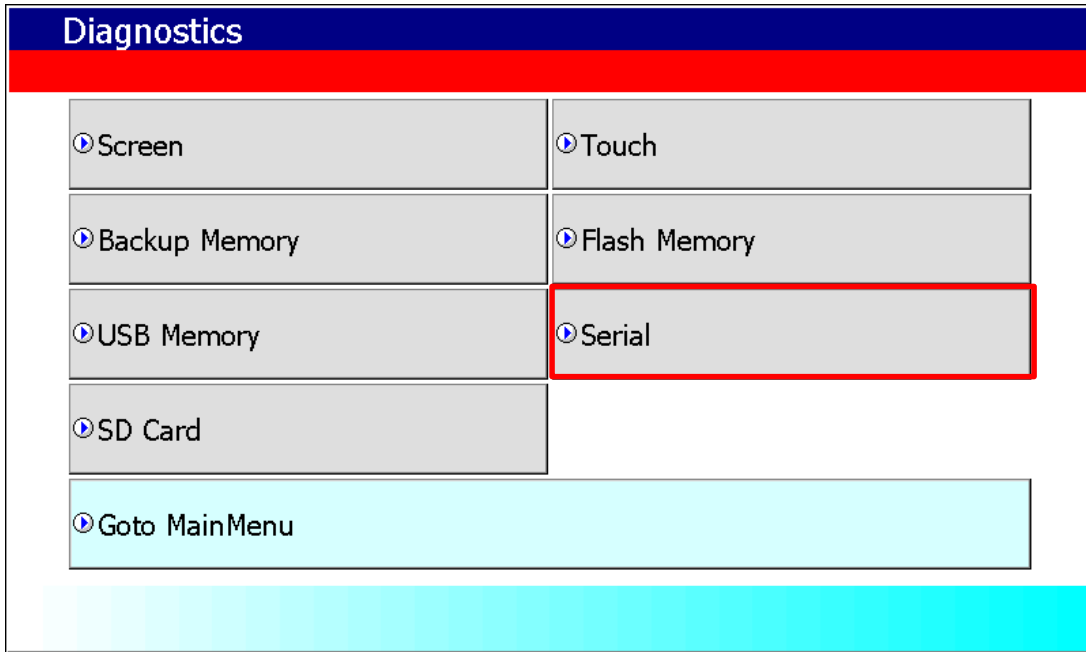

[Diagnosis screen]

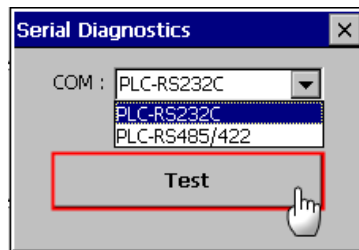

[Serial port selection]

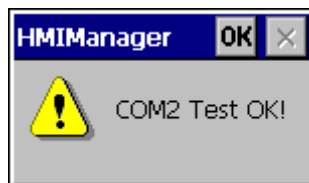

[Completion of serial port diagnosis]

The RS-232C port terminal should be made as follows. (Connect the No.2 and 3 pin)

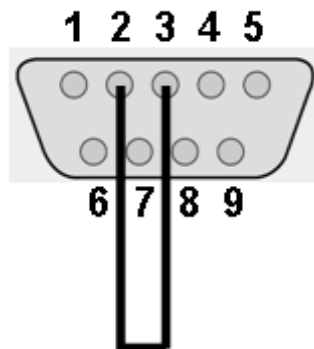

The RS-485 and RS-422/485 port terminal should be made as follows. (Only eXP2-07xx/10xx)

- Connect the RS-485 No.1 with RS-422/485 No.2 and No.4
- Connect the RS-485 No.6 with RS-422/485 No.1 and No.3

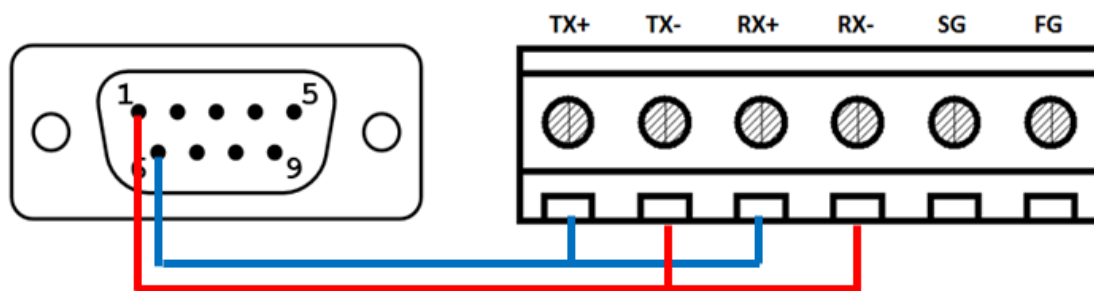

- eXP2-0400/050x does not provide for the communication diagnostics of RS-485/422 communication.

## 5.7 SD Card Diagnosis

It displays the information of SD Card memory inserted in XGT Panel. If you press the [SD Card] button, you can diagnose the SD memory installed in the XGT Panel.

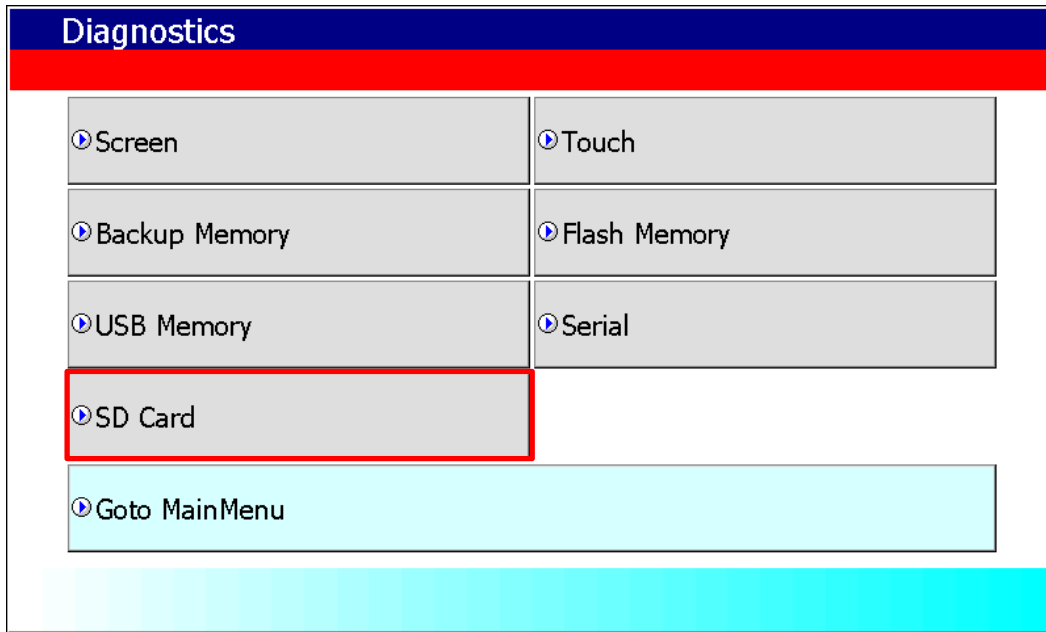

[Diagnosis screen]

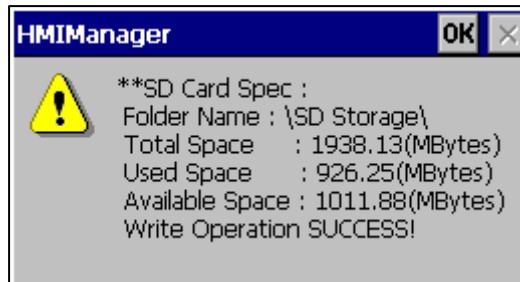

[SD card diagnosis completion screen]

### Remark

If an SD card is installed and 'Read Disk Information Error!' occurs, remove it, insert it again, and test.  
If an error message occurs repeatedly, take A/S action.

## Chapter 6 Viewing Information of PLC Connection Status

PLC Information, it shows XGT Panel configuration, PLC CPU status and various records.

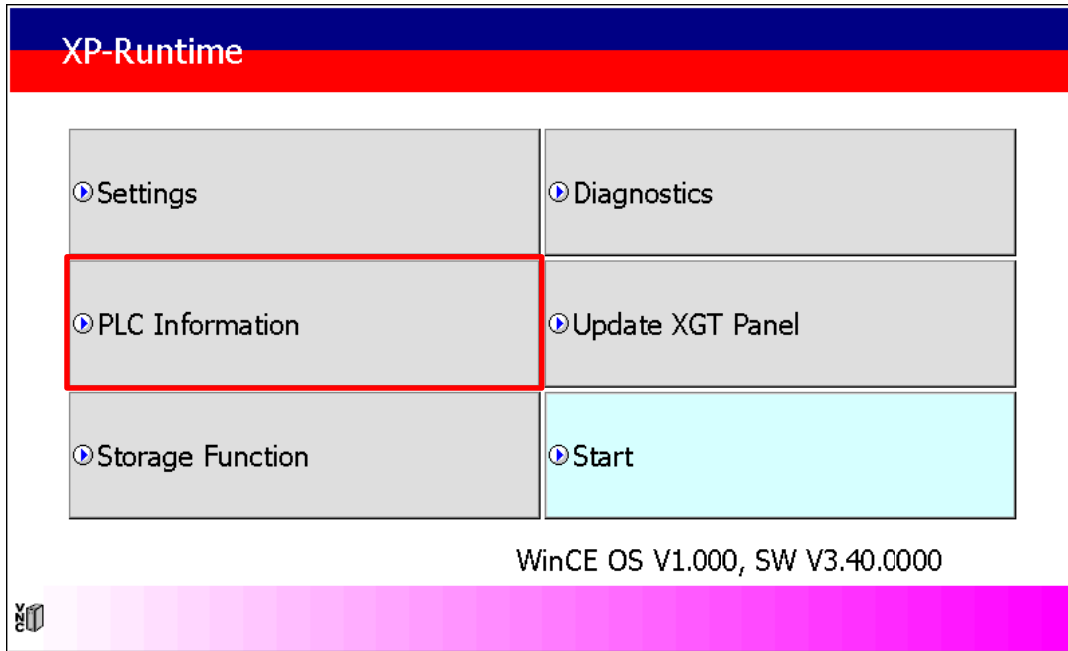

**Remark**

You can check the status of PLC connection after project data is transmitted into XGT Panel.



## 6.1 PLC Communication Configuration Settings

You can select [Settings] button to change PLC communication settings

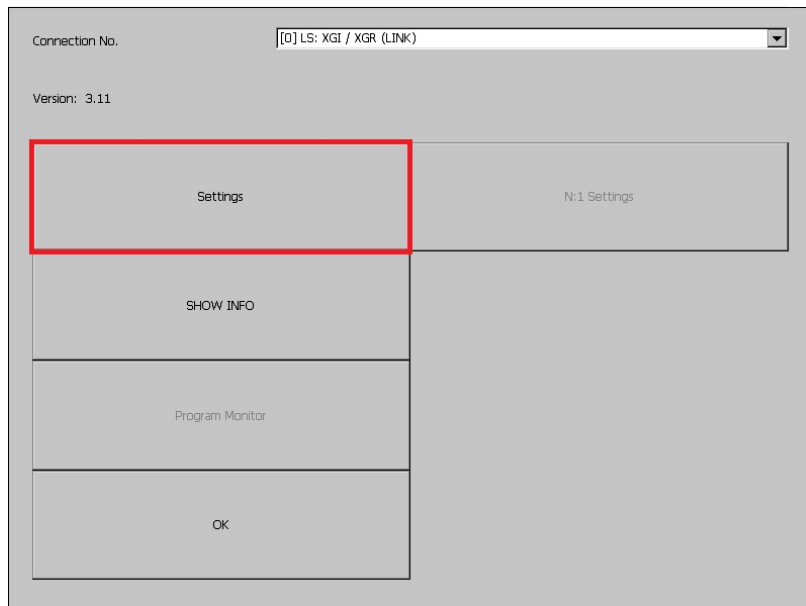

[PLC information screen]

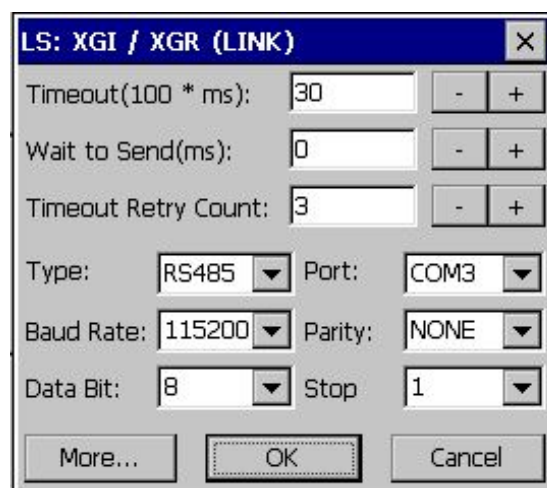

[PLC Communication Configuration setting]

### Remark

- PLC Communication Configuration setting dialog box may look different depending on drivers.
- For further information about the settings, please refer to the PLC user manual.

## 6.2 Connection Information

You can check the setting items for the connection with PLC such as vender of PLC, target device, connection type, ip address, connection information and timeout value in the XP-Builder.

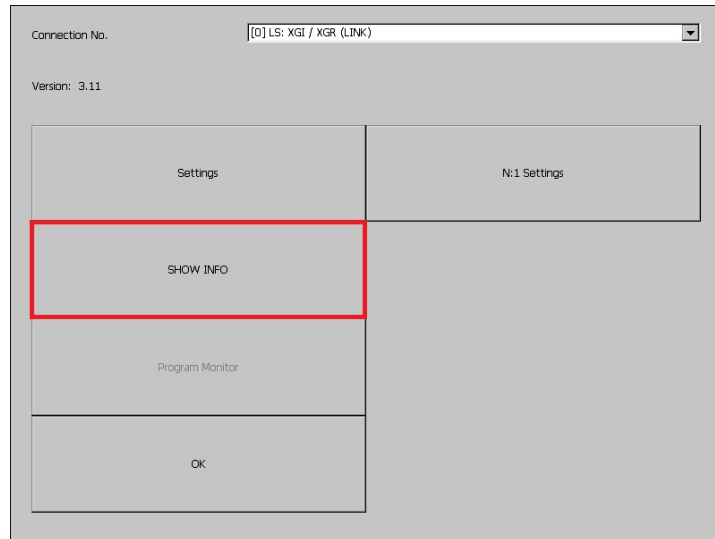

[PLC information screen]

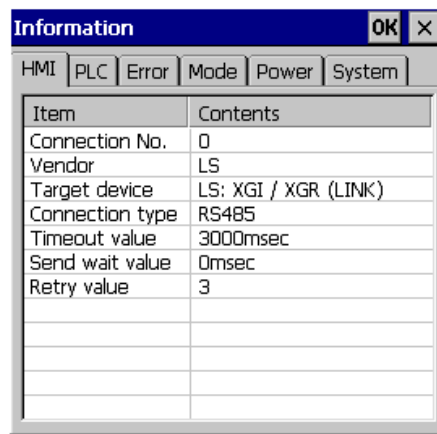

[PLC connection information]

[Dialog box Description]

Name	Description
Connection No.	The communication connection No. is displayed from No.0-15.
Vendor	The vendor of the communication target device is displayed.
Target device	The communication target device is displayed.
Connection type	The connection type is displayed
Timeout value	The set-up timeout value is displayed.
Send wait value	The transmission wait value is displayed.
Retry value	In case when timeout occurs during communication, the retry value is displayed.

## 6.3 PLC Information

You can check CPU type of PLC, operation mode, state, version, and scan time.

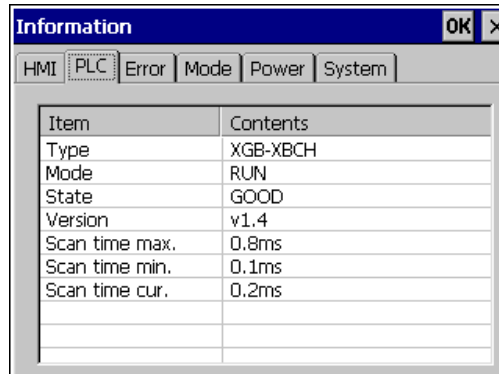

The screenshot shows a dialog box titled 'Information' with tabs for HMI, PLC, Error, Mode, Power, and System. The 'PLC' tab is selected, displaying a table with the following data:

Item	Contents
Type	XGB-XBCH
Mode	RUN
State	GOOD
Version	v1.4
Scan time max.	0.8ms
Scan time min.	0.1ms
Scan time cur.	0.2ms

### Remark

The following PLC is available for view of PLC information.

- MASTER-K CPU, FEnet, Cnet
- GLOFA-GM CPU, FEnet, Cnet
- XGK/XGB/XGI/XGR CPU, FEnet, Cnet

## 6.4 History of PLC Error

You can check the PLC Error History.

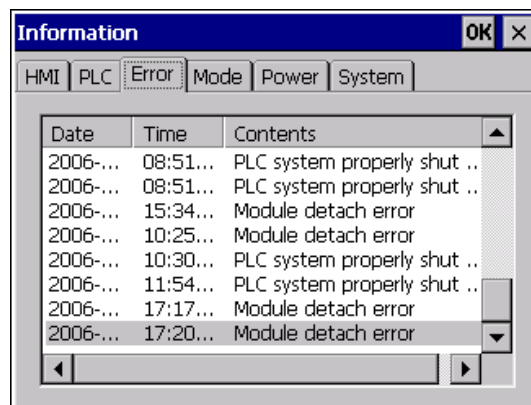

The screenshot shows the 'Information' dialog box with the 'Error' tab selected. It displays a list of error events with columns for Date, Time, and Contents. The data is as follows:

Date	Time	Contents
2006-...	08:51...	PLC system properly shut ..
2006-...	08:51...	PLC system properly shut ..
2006-...	15:34...	Module detach error
2006-...	10:25...	Module detach error
2006-...	10:30...	PLC system properly shut ..
2006-...	11:54...	PLC system properly shut ..
2006-...	17:17...	Module detach error
2006-...	17:20...	Module detach error

### Remark

The following PLC is available for viewing Error History.

- MASTER-K CPU doesn't have the Error History.
- GLOFA-GM CPU, FEnet, Cnet
- XGK/XGB/XGI/XGR CPU, FEnet, Cnet

## 6.5 History of PLC Mode Conversion

You can check the history about our PLC's RUN/STOP operation mode.

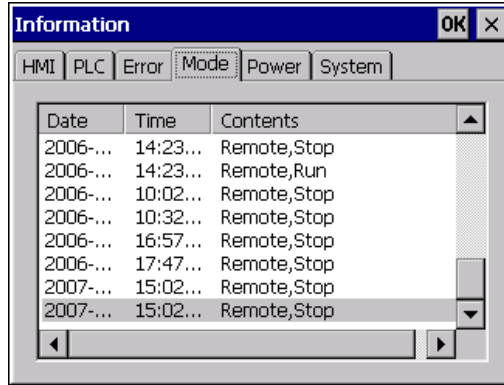

### Remark

The following PLC is available for viewing PLC operation mode conversion history.

- MASTER-K CPU doesn't have the history about operation mode conversion.
- GLOFA-GM CPU, FEnet, Cnet
- XGK/XGB/XGI/XGR CPU, FEnet, Cnet

## 6.6 History of PLC Power

You can check the history about when PLC was turned on and off

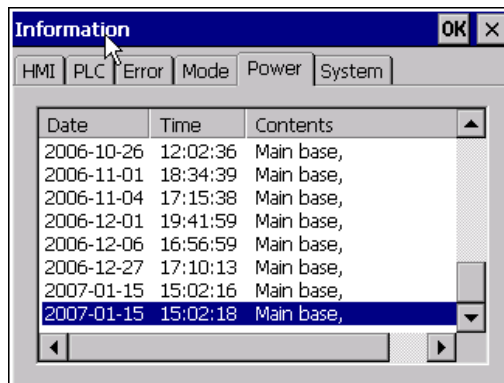

### Remark

The following PLC is available for viewing the history of when our PLC was turned off and on.

- MASTER-K CPU doesn't have the history about when our PLC was turned on and off.
- GLOFA-GM CPU, FEnet, Cnet
- XGK/XGB/XGI/XGR CPU, FEnet, Cnet

## 6.7 History of PLC System

You can check history about PLC system.

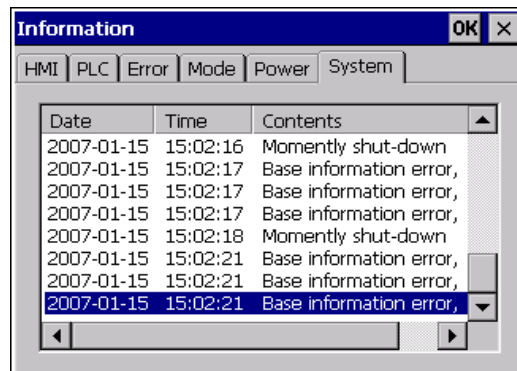

### Remark

The following PLC is available for viewing history about system.

- MASTER-K CPU doesn't have the history about system.
- Only GLOFA-GM CPU (GM4C) has the history about system. Other CPUs don't have the history about system.
- XGK/XGB/XGI/XGR CPU, FEnet, Cnet

## 6.8 N:1 Settings

Using N:1 communication, it means communicate number of XGT Panel with single PLC.

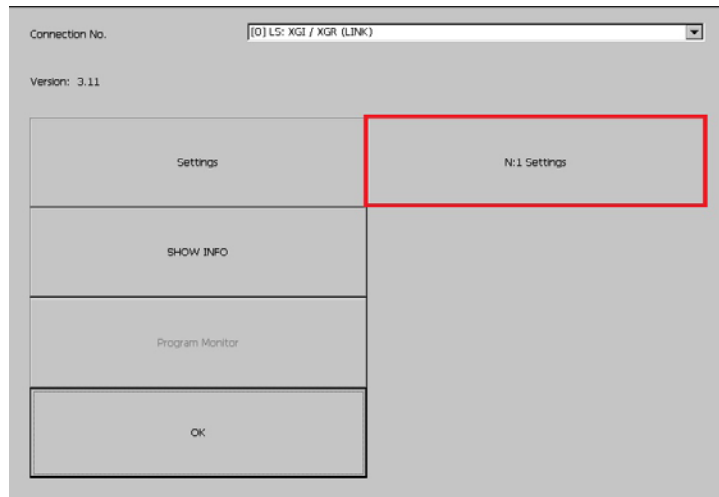

[PLC information screen]

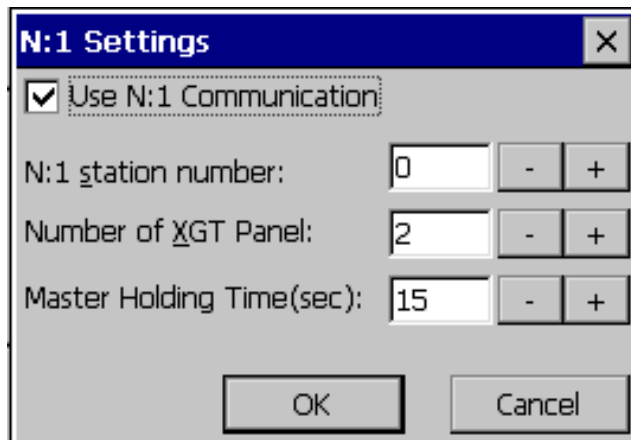

[N:1 settings dialog box]

[Dialog box setting options]

Name	Description
Use N:1 Communication	The matter of performing N:1 communication is designated.
N:1 station number	The station number of N:1 communication is input.
Number of XGT Panel	The number of XGT Panel in N:1 communication is input.
Master Holding Time	The master holding time of N:1 communication is input.

### Remark

For detail information about the N:1 communication, please refer to the XP-Builder manual.

## 6.9 Program Monitor

The programs that adopt Ladder language of XGK series can be monitored.

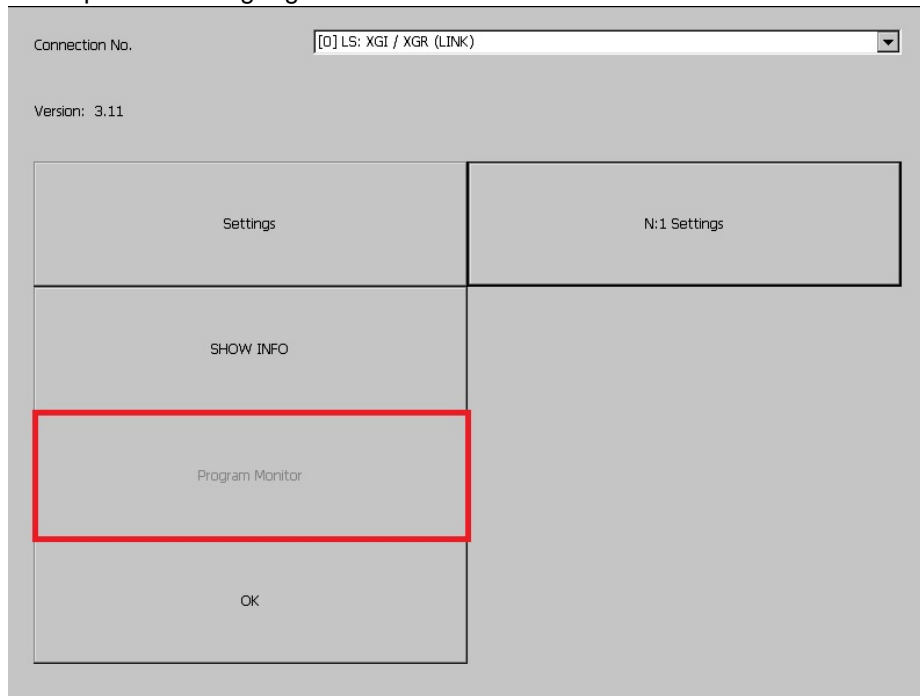

### Remark

- Program Monitor driver can be downloaded from XP-Manager.
- Only support for XGK/XGB CPU, Cnet, Enet communication
- To enable the [Program Monitor] button, program monitor should be checked in which locates in the XP-Builder project property menu.

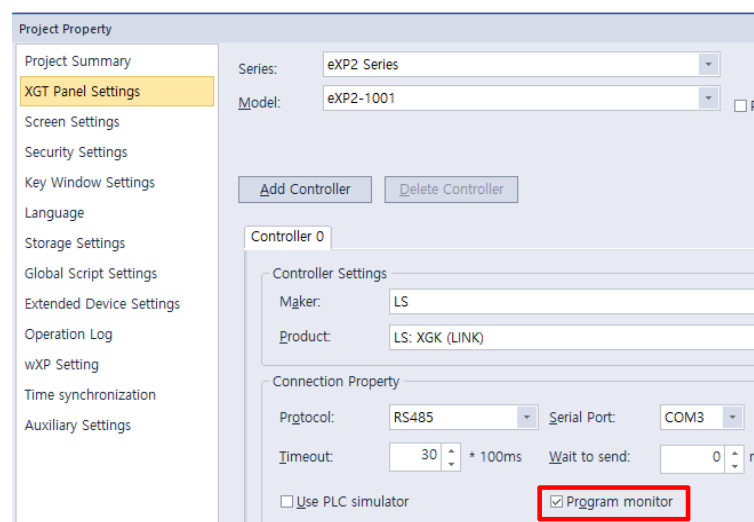

## Chapter 7 Storage Function

### 7.1 General Introduction

Downloading the user project made in XP-Builder from PC, uploading the project stored in the device to PC, updating the device and etc are available through connection with XGT Panel with Serial cable or Ethernet cable generally. However, when those connections are not available, you can use USB storage equipment

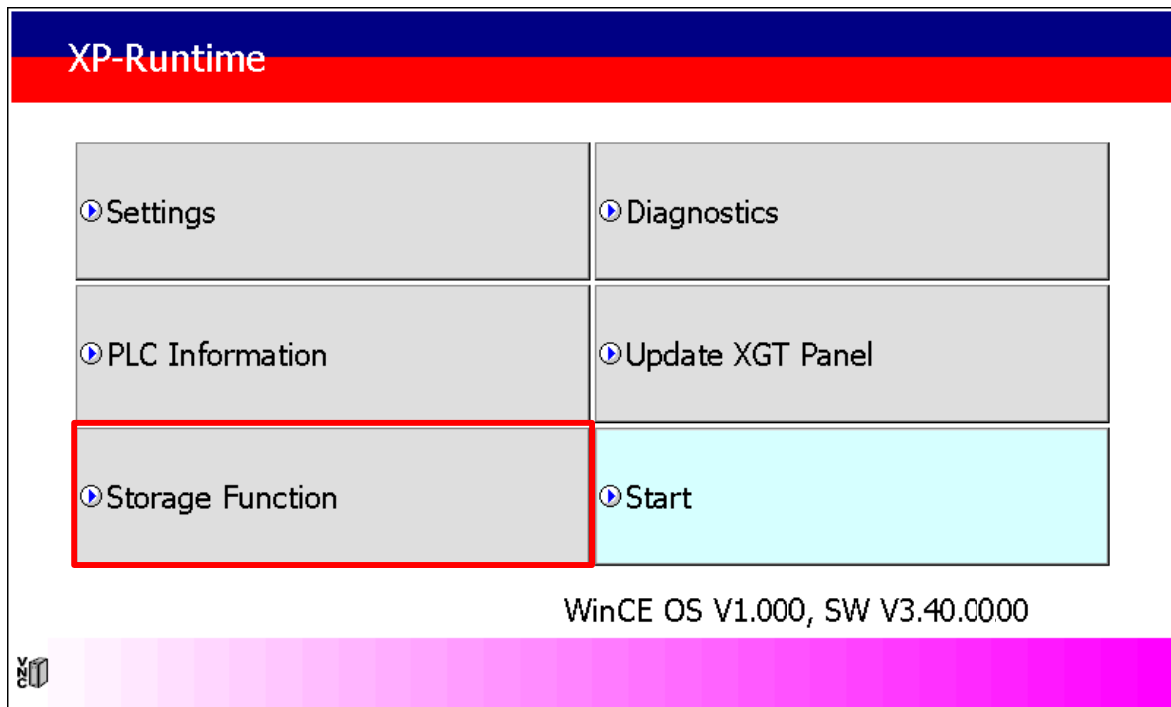

[XGT Panel main screen]



1. If you touch [Storage Function], the following dialog box shows.

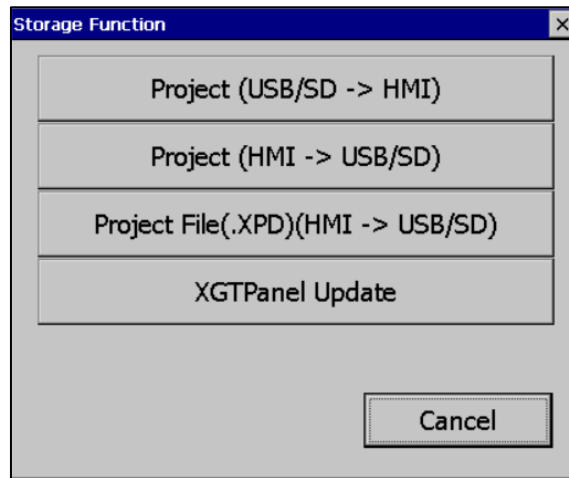

Menu	Description
Project (USB/SD -> HMI)	To download a project from an external storage device to the XGT Panel
Project (HMI -> USB/SD)	Save project from device to external storage device
Project File(.XPD) (HMI -> USB/SD)	To transfer project data backed up to an external storage device from XGT Panel
XGTPanel Update	To update the XGT Panel Software from an external storage device

## 7.2 Project Download [Project (USB/SD -> HMI)]

1. When you touch [Project (USB/SD -> HMI)] in the storage function menu, the following dialog box is displayed.

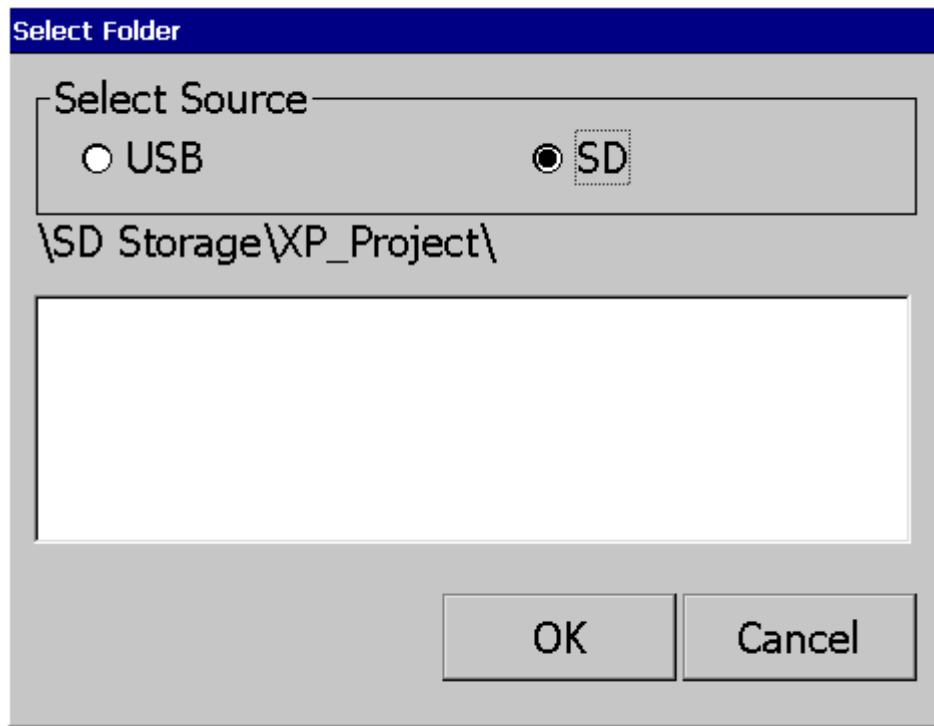

2. Project storage path of USB memory is displayed as below.

- USB: \USB Storage\XP\_Project\
- SD: \SD Storage\XP\_Project\ (SD card only supports eXP2-07/10xx models)

If you want to download a project using a storage device, it must be stored in the directory in the above path.

3. Select one of the directory listings

4. Touch the [OK] button to start the download.

### 7.3 Project Upload [Project (HMI -> USB/SD)]

- When you touch [Project (HMI -> USB/SD)] in the storage function menu, the following dialog box is displayed.

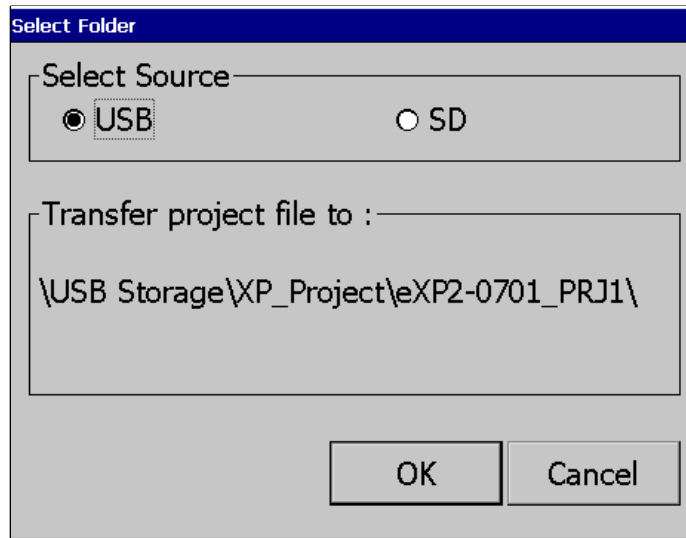

- Project storage path of USB/SD memory is displayed as below

※ The folder name under USB Storage\XP\_Project\ is automatically set to PRJ1 after the device type name

(The project to be saved afterwards automatically increases by 1 in the order of PRJ2, PRJ3.)

EX)

- \\USB Storage\XP\_Project\eXP2-0701\_PRJ1\

- \\SD Storage\XP\_Project\XP2-0701\_PRJ1\

- Touch the [OK] button to transfer the project backup file in the machine to the path of the selected storage device.
- It is possible to transfer directly between the same devices by using the project saved in the storage device.  
(This function is applied only to the same model and is not downloaded to a different model than the uploaded project.)

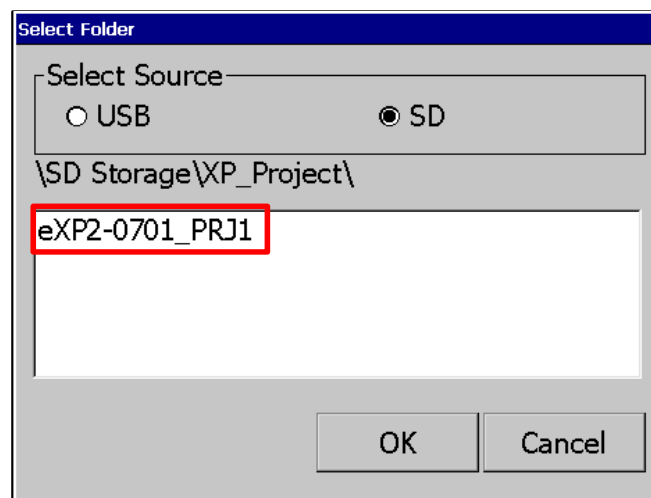

### 7.4 Project Upload Project File(.XPD) (HMI -> USB/SD)

1. If you touch [Project File (.XPD) (HMI -> USB/SD)] in the storage function menu, the following dialog box is displayed.

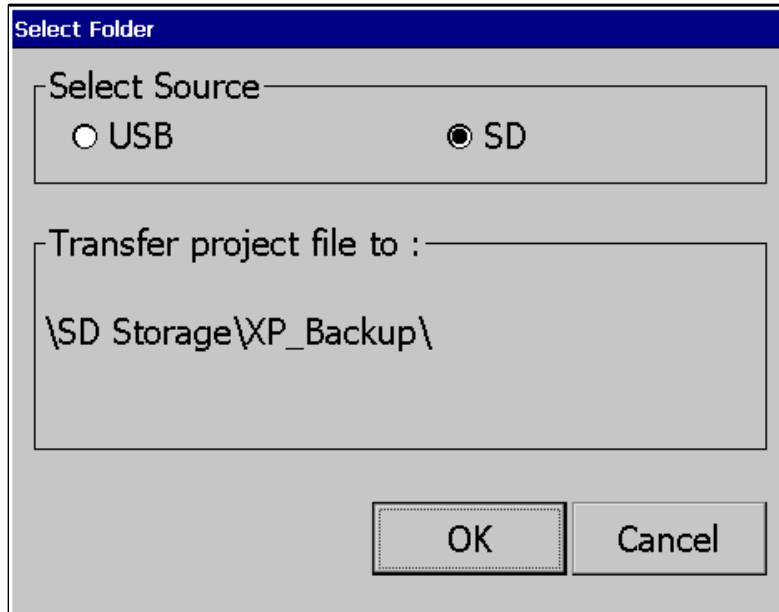

2. The upload path of USB memory is displayed as below

- USB: \\USB Storage\\XP\_Backup\\
- SD: \\SD Storage\\XP\_Backup\\

3. Touch the [OK] button to transfer the project backup file in the machine to the path of the selected storage device.

4. The project backup file must be downloaded to download the project backup file when downloading the project.

If not selected, the project backup file is not stored in the device and therefore cannot be transferred to the storage device.

## 7.5 Updating the device using a storage device

1. If you touch [Update XGT Panel] in the storage function menu, the following dialog box will be displayed.

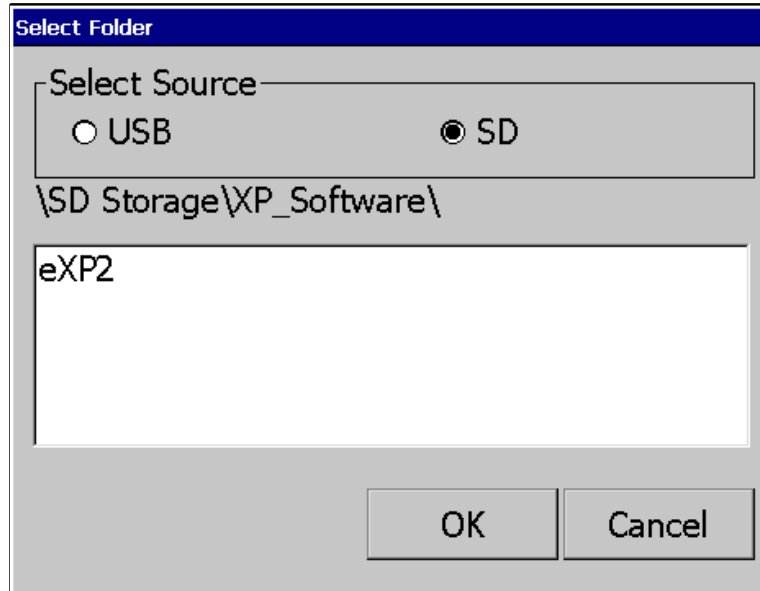

2. Please select the targeted external memory in "Select Source". Following path is indicated depending on the selected external memory

- USB: \\USB Storage\\XP\_Software\\
- SD: \\SD Storage\\XP\_Software\\

If you want to update the device using an external storage device, the XGT Panel Software file is in the directory in the above path  
It must be saved.

3. Touch the [OK] button to update the device with the XGT Panel Software stored in the specified path.

## Chapter 8 XGT Panel S/W Update

### 8.1 General Introduction

It describes the function for updating the XGT Panel software.

Basically you can optimize XGT Panel when you download the project file in XP-Builder. Please use this function only in case of updating XGT Panel specially.

New function is added to XGT software, you need to update a version of XGT Panel.  
Please refer to the following.

[Method]

Select [Upgrade -> Update XGT Panel] on the XGT Panel's main screen. Then XGT Panel becomes update mode.  
In order to return to the main screen, touch a "MENU" button or touch the screen for 3 seconds

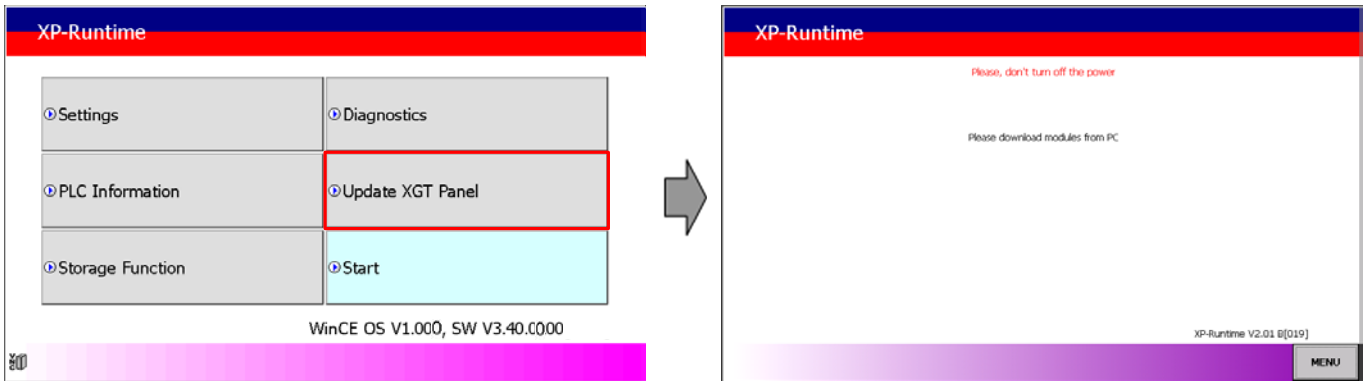

After downloading XGT Panel software from LS ELECTRIC website, make a temporary folder and save it.

Designate the folder where the software will be saved in the XP-Builder's [XGT Panel Update] windows and update XGT Panel by [Send] menu. For more detailed information about XP-Builder, please refer to the XP-Builder user manual.

#### Remark

Do not remove communication cable or turn off the device during updating.  
It may cause the abnormal operation.

## Chapter 9 File Backup through External Storage Equipment

Describes on management function about external storage equipment saving backup data of logging, recipe, and screen image

- (1) XGT Panel can back up the logging, recipe, and screen image data at USB storage equipment according to setting in XP-Builder.
- (2) In case there is no space for backup in the designated storage equipment, it continues backup deleting previous data or stops backup according to setting in XP-Builder
- (3) Monitors attachment status of backup equipment at XP-Builder.

### 9.1 Path Structure in case of File Backup

Backup path structure of logging, recipe, and screen image is as follows.

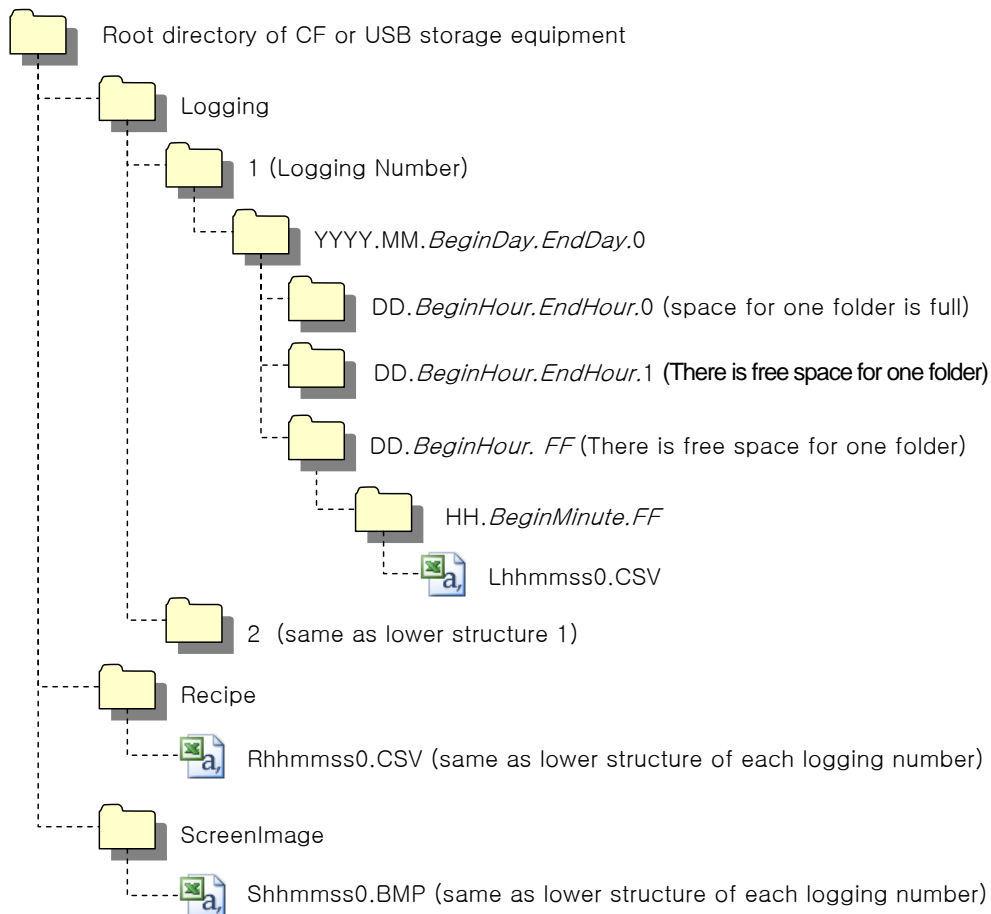

1. Path structure in case of logging backup

- (1) Directory named 'Logging' is created under the root directory of USB equipment
- (2) The directory whose name is logging number is created under Logging directory.
- (3) The directory whose name is year, month is created under Logging number directory.
  - (a) Includes day directory under
  - (b) Up to 500 day directories can be created.
  - (c) Name of year, month directory includes the firstly created day information under its directory
 

Ex) In case directory is created in 2010, October and includes directory since 15th under, directory's name is

: 2010.10.15.FF

FF at end means the directory can save more data created in 2010, October (currently, the number of lower directory is 500 or less)
  - (d) In case month is changed, changes directory name to day information of last created day directory.
 

Ex) In case month becomes November from October and directory from 15th directory to 30th have been created in 2010, October directory.

: 2010.10.15.30.0
  - (e) Though month is not changed, in case the number of day directory under year, month directory is 500 or above, directory name is changed into name including day information of last created day directory.
 

Ex) In case the number of directory from first to 15th is 500 or above in the directory created in 2010, October.

: 2010.10.01.15.0
  - (f) In case there is the year, month directory having same start day and end day when changing directory's name due to over 500 day directories or change of month, last digit index number increases.
 

Ex) In case there are three year, month directories that are having over 500 day directories created in October first and 2010 year October directory

: 2010.10.01.01.0

: 2010.10.01.01.1

: 2010.10.01.01.2
- (4) Day directory is created under year, month directory
  - (a) Hour directory is created under day directory
  - (b) Day directory can have up to 500 hour directory
  - (c) Name of day directory includes not day information but also hour information of first created hour directory
  - (d) Relation between day directory and hour directory is same as relation between year month directory and day directory.
- (5) Directory whose name includes hour information is created under day directory.
  - (a) Hour directory includes backup file under
  - (b) Hour directory can include up to 500 backup file
  - (c) Name of time directory include not only hour information but also minute information of first created file under
  - (d) Relation between hour directory and backup file is same as relation between year, month directory and day directory.
- (6) Name of logging backup file includes the created hour, minute, second information.
  - (a) Backup file is created in CSV format.
  - (b) File name start with 'L' meaning logging and includes hour, minute, second, index information
  - (c) In case backup file is created at the same time in terms of second, index information at the end of file name increases.

2. Path structure in case of recipe backup



- (1) Directory named 'Recipe' is created under USB storage equipment root directory.
- (2) Year, month directory is created under Recipe directory
- (3) The lower directory structure is same as that of logging backup path structure.
- (4) Name of recipe backup file includes the created hour, minute, second information.
  - (a) Backup file is created in CSV format.
  - (b) File name start with 'R' indicating recipe and includes hour, minute, second, index information.
  - (c) In case backup file is created at the same time in terms of second, index information at the end of file name increases.

### 3. Path structure in case of screen backup

- (1) Directory named 'Screen Image' is created under USB storage equipment root directory.
- (2) Directory whose name is year; month is created under Screen Image directory.
- (3) The lower directory structure is same as that of logging.
- (4) Name of screen image backup file includes hour, minute, second information.
  - (a) Backup file is created in bitmap format.
  - (b) File name starts with 'S' and includes hour, minute, second, index information.
  - (c) In case backup file is created at the same time in terms of second, index information at the end of file name increases.

### 4. Structure of path at memo backup

- (1) 'Memo' directory will be formed at the sub route directory of USB storage device.
- (2) Directory in the name of Year and Month will be formed below the Memo Directory.
- (3) Structure of directory thereafter is same as that of logging backup route.
- (4) Memo backup file has the name made of hour/minute/second when it was created.
  - (a) Backup file is created in the type of bitmap.
  - (b) File name starts with 'M' that represents the screen image, which includes the index information of hour, minute, and second thereafter.
  - (c) In case backup file is created at the same time up to second, it increases the far end index information.

### 5. Structure of path at live image recording

- (1) 'Movie' directory will be formed at the sub route directory of USB storage device.
- (2) Recorded live image is stored below the Movie Directory.
- (3) Live image file has the name made of year/month/date/hour/minute/second information when it was created.
  - (a) Backup file will be created in AVI type. H.264 and MP3 were used for Video CODEC and Audio CODEC respectively.
  - (b) File name starts with 'MOV' that represents screen image, which includes data and hour information thereafter.
  - (c) Live image can be stored up to the number 1,000 files. This number can be designated at the special device settings of XP-Builder.

### 6. Structure of path when Blue Screen of camera image and live image is created

- (1) 'MovieStill' directory will be formed at the sub route directory of USB storage device.
- (2) Recorded live image will be stored below MovieStill directory.
- (3) Blue screen image file has the name made of year/month/date/hour/minute/second information when it was created.
  - (a) Backup file will be created in JPG type.
  - (b) File name starts with 'STL' that represents screen image, which includes data and hour information thereafter.

- (c) Live image can be stored up to 1,000 files. This number can be designated at the special device settings of XP-Builder.

### Remark

- (1) When changing device time, in case of changing current time into after time, we guarantee the normal operation. But in case of changing current time into early time, we don't guarantee the normal operation. In this case, you have to delete directory including the changed hour and its lower directory for normal operation. For example, if you change time from December 10<sup>th</sup> to December 5<sup>th</sup>, you have to delete year, month directory created in December 10<sup>th</sup> and restart the device
- (2) Sorting by project is not supported for each logging, recipe, screen image. For example, there are no.1, 2, and 3 logging groups in the project A. And in case each logging group backups the file, 1, 2, 3 directories are created and each data is saved under each directory. Then, in case file backup occurs in the project B having no.1, 2 logging group, backup file is created in same directory of project A. In this case, you have to sort the backup files of project A and B based on the created time.

## 9.2 Operation setting when there is no space for backup

You can designate in the XP-Builder whether to cancel the backup or delete the oldest backup file and execute backup when there is no space in the storage equipment.

[Project Property Setting -> Storage Settings -> Backup Storage -> Delete old file if disk full]

### 1. In case of backup, deleting the oldest data

- (1) In case there is no space for backup, searches the oldest year, month directory under Logging, Recipe, Screen Image. (But in case of Logging, finds under Logging number directory. That is, when executing backup about Logging number 2, in case there is no backup data in Logging number 2 directory and there is data only in logging number 1, data of logging number 1 is not searched/deleted.)
- (2) Searches the oldest day directory under the oldest year, month directory.
- (3) Searches the oldest hour directory under the oldest day directory.
- (4) Deletes the oldest backup file under the oldest hour directory.
- (5) Checks the space and if more space is necessary, the above steps of (1) ~ (4) are repeated and checks the space.
- (6) When deleting file, in case all data in time directory are deleted, relevant hour directory is deleted.
- (7) When deleting hour directory, in case all hour directories in day directory are deleted, relevant hour directory is deleted.
- (8) When deleting day directory, in case all day directories in year, month directory are deleted, relevant year, month directory is deleted.

### Remark

- (1) In unknown directory or file (user file or directory), searches the oldest thing among normal backup files except unknown directory or file.
- (2) In case there is nothing except user data in now searched directory, backup operation fails. XGT Panel can't delete user data, at this point, operation stops.

### 9.3 Monitoring Connection Status of External Storage Equipment

XGT Panels monitors connection status about external storage equipment designated when setting backup path in XP-Builder.

The following figure is backup path specified in XP-Builder.

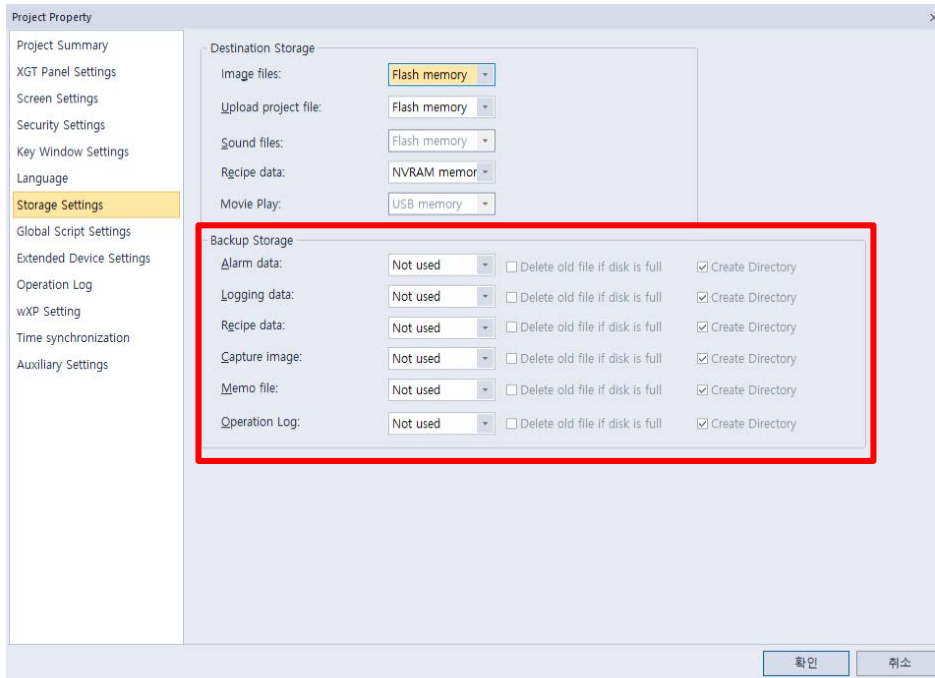

In order to use this monitoring function, you have to set about system alarm window, and then the project should be downloaded.

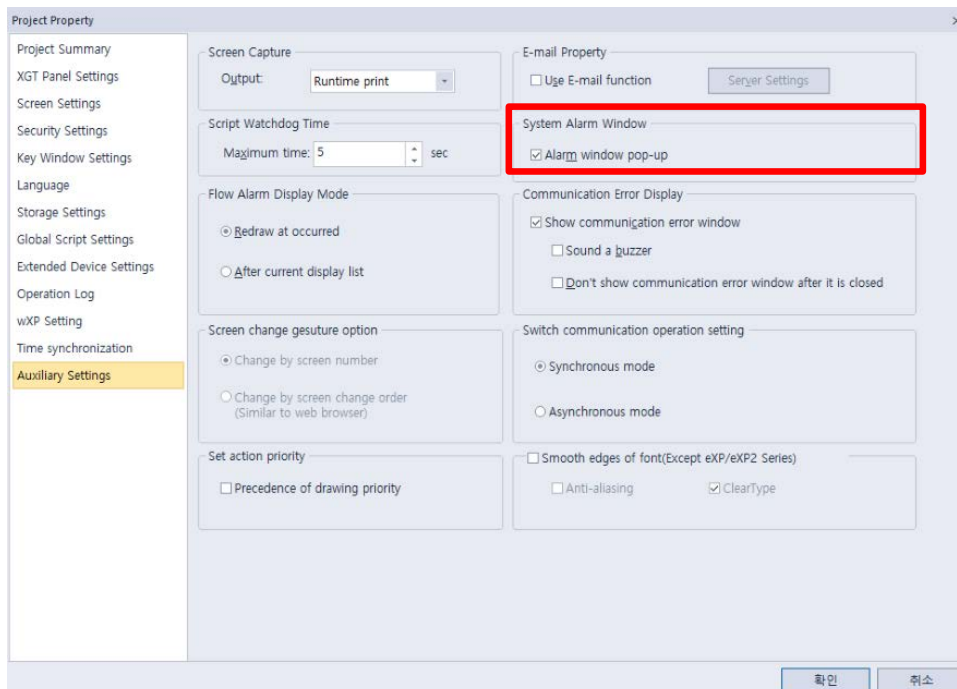

In case USB storage equipment is removed during operation after setting the path for saving Logging backup file as USB storage equipment and downloading the project into device, the designated system alarm (HS951.0) is set. In case storage equipment is equipped again, alarm is reset.

In case USB storage equipment is removed during operation after setting the path for saving Recipe backup file as USB storage equipment and downloading the project into device, the designated system alarm (HS951.1) is set. In case storage equipment is equipped again, alarm is reset.

In case USB storage equipment is removed during operation after setting the path for saving Screen Image backup file as USB storage equipment and downloading the project into device, the designated system alarm (HS951.2) is set. In case storage equipment is equipped again, alarm is reset.

Internal address of the designated system alarm can be checked in XP-Builder as follows.

System Alarm			
	Device	Data Type	Description
1	HS950.0	BIT	NVRAM Low Battery Warning
2	HS950.1	BIT	NVRAM Invalid Data Warning
3	HS951.0	BIT	No Logging Backup Storage
4	HS951.1	BIT	No Recipe Backup Storage
5	HS951.2	BIT	No Screen Backup Storage
6	HS951.4	BIT	No Printer
7	HS950.8	BIT	USB Over Current Warning
8	HS951.3	BIT	No Alarm Backup Storage
9	HS951.5	BIT	No Memo Backup Storage
10	HS100.2	BIT	Failed to load XPLink parameter
11	HS950.9	BIT	RS232C Over Current Warning
12	HS950.A	BIT	VM Module Over Current Warning
13	HS950.B	BIT	Extended Module Over Current Warning
14	HS951.6	BIT	No Movie Backup Storage
15	HS951.7	BIT	No Movie Still Image Backup Storage
16	HS951.8	BIT	No Sound File Storage
17	HS951.9	BIT	No Recipe Storage
18	HS950.6	BIT	SD card has been incorrectly recognized
19	HS950.7	BIT	CF card has been incorrectly recognized
20	HS950.5	BIT	Storage device has been incorrectly recognized
21	HS950.C	BIT	Out of System Memory
22	HS950.F	BIT	Thread Pool is full
23	HS951.A	BIT	No Operation Log Backup Storage
24	HS032.2	BIT	Number of alarms in SRAM has reached limits.

## Chapter 10 Installation and Wiring

### 10.1 Installation

#### 10.1.1 Installation environment

This machine has high reliability regardless environment. But for reliability and stability, be careful the followings

- (1) Environment condition
  - (a) Install at the panel which can protect this machine from water and dust. XGT Panel is designed by IP65 Standard in front parts and IP20 Standard in rear parts.
  - (b) Install at the place where impact and vibration is not continuously applied. XGT Panel is designed to meet IEC standard (IEC 61131-2).
  - (c) Do not expose this machine to direct light.  
Indoor use only
  - (d) Do not install at the place where rapid temperature change can occur. Moisture by rapid temperature change can cause malfunction and damage.
  - (e) This machine should be installed within 0 ~ 50°C, otherwise the screen may be changed or cause malfunction
  - (f) This machine should be installed within 10~85% relative-humidity. Moisture by rapid temperature change can cause malfunction and damage.
  - (g) Avoid corrosive gas and burnable gas.
  - (h) Dry location use only.
- (2) Installation construction
  - (a) When doing screw's processing or wiring construction, be careful that the remains do not enter the XGT Panel inside.
  - (b) Install at the place where you can easily control.
  - (c) Do not install with high voltage machine within same Panel.
  - (d) Keep distance of more than 100mm from duct for wiring and peripheral machine.
  - (e) Ground at the place where few noises develop.
- (3) Anti-heat design of control panel
  - (a) In case of installing XGT Panel in the airtight panel, consider the heat by other machine as well as own heat. In case that the air circulates through a ventilating opening or a general pan, XGT Panel system can be influenced by in-draft of dust or gas.
  - (b) We recommend you to install a filter or to use an airtight heat exchanger.

**Remark**

(1) Waterproof & dustproof standards

(a) IP65 Standards

1) The protection standards of XGT Panel have been designed to meet the IP65 test conditions, in accordance with the degrees of protection provided by enclosures of IEC60529.

As this machine installed at the panel, it is not guaranteed with all installation environment even though its protection standards for the front parts are satisfied.

2) IP65 rating guarantees the enclosure is dust proof (6) and protected against jets of water (5).

3) IP20 rating guarantees protection from solid foreign objects of 12mm diameter and greater (2), but it does not guarantee protection from water ingress.

Elemento <i>Element</i>	Cifre o lettere <i>Numerals or letters</i>	Significato per la protezione dell'apparecchiatura <i>Meaning for the protection of equipment</i>	Significato per la protezione delle persone <i>Meaning for the protection of persons</i>	Rif. <i>Ref.</i>
Lettere caratteristiche <i>Code letters</i>	IP	—	—	—
Prima cifra caratteristica <i>First characteristic numeral</i>	0 1 2 3 4 5 6	Contro la penetrazione di corpi solidi estranei: <i>Against ingress of solid foreign objects:</i> (non protetto) <i>(non-protected)</i> ≥ 50 mm di diametro <i>≥ 50 mm diameter</i> ≥ 12,5 mm di diametro <i>≥ 12,5 mm diameter</i> ≥ 2,5 mm di diametro <i>≥ 2,5 mm diameter</i> ≥ 1,0 mm di diametro <i>≥ 1,0 mm diameter</i> protetto contro la polvere <i>dust-protected</i> totalmente protetto contro la polvere <i>dust-tight</i>	Contro l'accesso a parti pericolose con: <i>Against access to hazardous parts with:</i> (non protetto) <i>(non-protected)</i> dorso della mano <i>back of hand</i> dito <i>finger</i> attrezzo <i>tool</i> filo <i>wire</i> filo <i>wire</i> filo <i>wire</i>	Art. 5 <i>Cl. 5</i>
Seconda cifra caratteristica <i>Second characteristic numeral</i>	0 1 2 3 4 5 6 7 8	Contro la penetrazione di acqua con effetti dannosi: <i>Against ingress of water harmful effects:</i> (non protetto) <i>(non-protected)</i> caduta verticale <i>vertically dripping</i> caduta di gocce d'acqua (inclinazione 15°) <i>dripping (15° tilted)</i> pioggia <i>spraying</i> spruzzi d'acqua <i>splashing</i> getti d'acqua <i>jetting</i> getti potenti <i>powerful jetting</i> immersione temporanea <i>temporary immersion</i> immersione continua <i>continuous immersion</i>	—	Art. 6 <i>Cl. 6</i>
Lettera addizionale (opzionale) <i>Additional letter (optional)</i>	A B C D	—	Contro l'accesso a parti pericolose con: <i>Against access to hazardous parts with:</i> dorso della mano <i>back of hand</i> dito <i>finger</i> attrezzo <i>tool</i> filo <i>wire</i>	Art. 7 <i>Cl. 7</i>
Lettera supplementare (opzionale) <i>Supplementary letter (optional)</i>	H M S W	Informazioni supplementari relative a: <i>Supplementary information specific to:</i> Apparecchiatura ad alta tensione <i>High-voltage apparatus</i> Prova con acqua con apparecchiatura in moto <i>Motion during water test</i> Prova con acqua con apparecchiatura non in moto <i>Stationary during water test</i> Condizioni atmosferiche <i>Weather conditions</i>	—	Art. 8 <i>Cl. 8</i>

(b) Notices

1) In the environment where the protection grade of XGT Panel is exceeded or not satisfied, the damage of the device or malfunction can occur due to the failure of protecting the product.

2) Since the protection grade of XGT Panel is the waterproof/dustproof standards, it cannot be protected from oil, corrosive gas and metal particles.

3) In case when Gasket is damaged by chemicals and continuous vibration, its waterproof/dustproof effect can be weakened.

4) In case when installing the panel, make sure that dust and water are not brought in panels.

### 10.1.2 Notice in handling

It describes the notice from opening to installation.

- Do not drop or cause heavy impact.
- Do not disassemble voluntarily. When doing this, we are not responsible for the product.
- When wiring, be careful that the remains do not enter into XGT Panel.

### 10.1.3 Notice in installing the panel

Here describes how to install XGT Panel in panel and notice.

(1) Panel cut

- Before installing the XGT Panel in panel, panel should be made with the following dimension.

Unit: [mm]

Classification	X(Wide)		Y(Height)		Z(Thickness)	
eXP2-0400D	119	+1	93	+1	1.6~9.5	
		-0				-0
eXP2-0500D eXP2-0502D	156	+1	123.5	+1		
		-0				-0
eXP2-0700D eXP2-0701D eXP2-0702D	192	+1	138	+1		
		-0				-0
eXP2-1000D eXP2-1001D	260	+1	202	+1		
		-0				-0

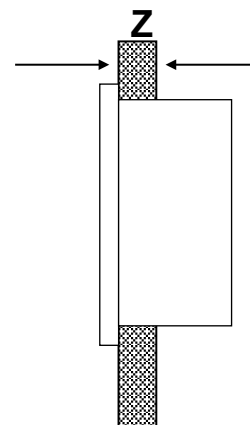
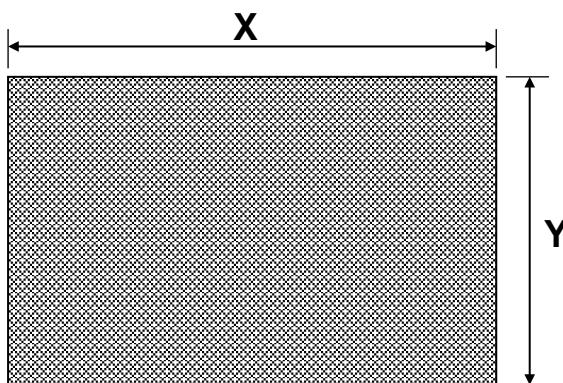



(2) XGT Panel installation

- Keep the distance of 100 mm between XGT Panel and panel per each direction.

Unit: [mm]

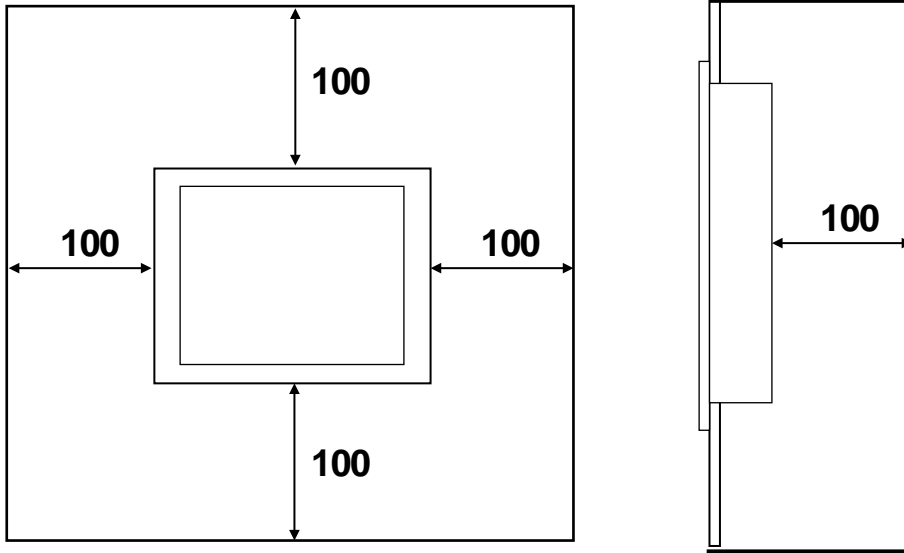

**Remark**

- (1) To be affected at a minimum by the electromagnetic waves (radial noise) or heat from other controllers, it needs to keep its distance as the above explanation.
- (2) When installing, consider the power and communication cable wiring.
- (3) In case when the size of the panel cut exceeds the range of the standard allowance(0 ~ +1mm) when producing panels, the contact area between Gasket and the panel can get small, which can weaken the waterproof/dustproof effect.

- When mounting the XGT Panel inside a panel, ensure that you use the gasket to protect against dust or water ingress.

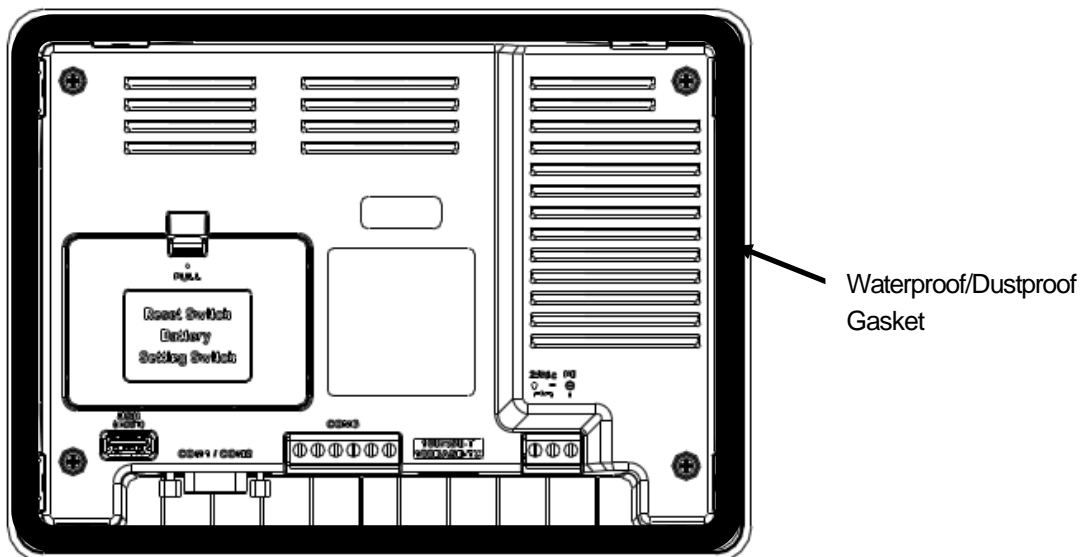

**Remark**

- (1) Must be used the gasket to prevent dust or other contaminant ingress.
- (2) When mounting at the panel, if the surface of panel is uneven, water or dust can enter the machine through the gaps. As such problems can occur depending on the thickness and material (steel, aluminum, acrylic and etc.) of the panel, it is required to review the installation environment. Also it is necessary to check if Gasket and the panel are closely contacted together.
- (3) When Gasket is contaminated or damaged by the deterioration after the use for a certain period of time, the waterproof/dustproof effect can be noticeably weakened. In case when Gasket should be replaced, contact the agency or a sales office close by.

(3) Installation location

- When installing the XGT Panel, consider screen and use of touch.
- When you don't see within the following angle, you may not see clearly. When installing, consider angle.

Item	Left and Right	Upper	Lower
eXP2-0400D	60 deg.	40 deg.	50 deg.
eXP2-0500D eXP2-0502D	60 deg.	40 deg.	60 deg.
eXP2-0700D eXP2-0701D eXP2-0702D	70 deg.	50 deg.	70 deg.
eXP2-1000D eXP2-1001D			

(4) Fixing

- Fix XGT Panel to the panel using the supplied brackets provided in the packaging.

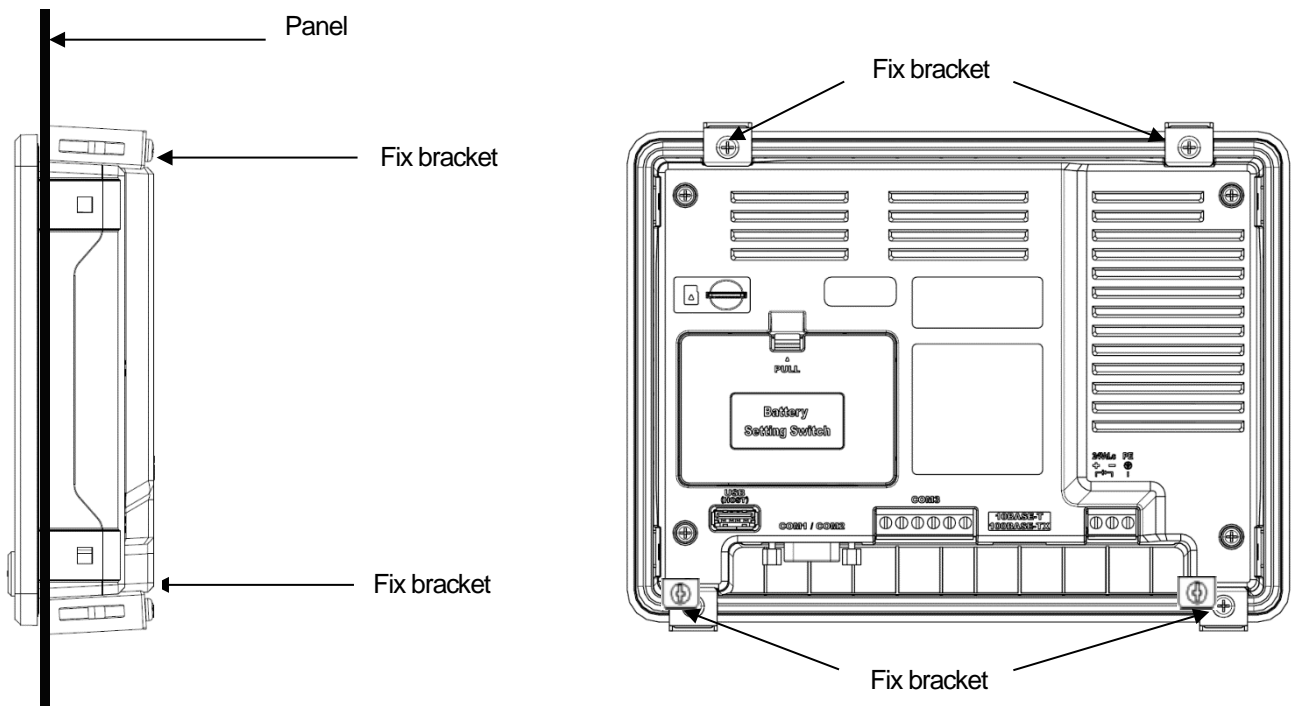

**Remark**

(1) Remove the protection film attached to the front of this machine. Due to the deformation of the protection film, the touch malfunction or wrong input can occur. It is recommended to use a special protection sheet to protect the front sheet. In case of purchasing the protection sheet, contact the agency or a sales office close by.

(5) Removal of protection film

- The film attached to protect the front sheet when this machine has been released, should be removed after it is installed in the panel.

**Remark**

- (1) During installation, XGT Panel should be closely contacted to the panel not to have any gap. In the environment requiring waterproof/dustproof effect, install and fix a bracket on a slope.
- (2) The bracket should be fixed symmetrically(up-down, left-right). In case when it is not fixed symmetrically, there could be a gap between the panel and XGT Panel.
- (3) When fixing the bracket, it should be installed perpendicularly to the panel, and the required bracket screw torque is  $6.7 \pm 0.3 \text{kgf} \cdot \text{cm}$ . Depending on the material type of the panel, the torque value can be different. The standard screw torque for each bolt size is followed. If it is fixed with the power more than the required screw torque, the touch malfunction or weakening of waterproof/dustproof can happen due to the deformation of XGT Panel.

## 10.2 Wiring

It describes the wiring that you should know when installing the XGT Panel.

### 10.2.1 Power wiring

eXP2 Panel is the DC product.

Power	Name
DC 24V	eXP2-0400D, eXP2-0500D, eXP2-0502D, eXP2-0700D, eXP2-0701D, eXP2-0702D, eXP2-1000D, eXP2-1001D,



### Warning

- ▶ If AC power is applied into the product for DC power, It may cause damage or fire. Be careful of connection.
- ▶ 'DC' is the product which use DC 24V. When using the product, Please check the label in the back of the product.
- ▶ Power supply should be insulated and limited voltage/current or Class 2, SELV power supply device.

The power terminal should have the following specification.

Type	Cable specification (Unit: mm <sup>2</sup> )	Wire Type	Thermal Resistance	Screw Torque
Power and protection ground	1.5(AWG16) ~ 2.5(AWG12)	Copper	60°C	0.51N•m

**Remark**

- (1) For installations where there is voltage drop, it is recommended to use stranded wire with a cross sectional area greater than 2 mm<sup>2</sup>.
- (2) It is recommended that cable connections are twisted and secure. Short cable runs are also recommended between the point of supply and the XGT panel.
- (3) For safety reasons it is recommended that you use color coded outer sheaths on the conductors to aid safe terminations.

Wiring of power is as follows.

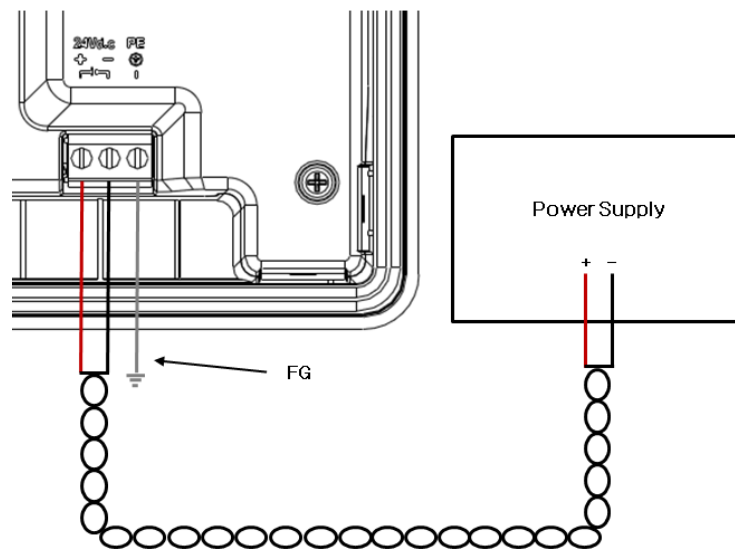

[DC Power connection]

**Remark**

- (1) Use a regulated power supply transformer when the power fluctuation is bigger than the standard.
- (2) If electromagnetic interference is experienced or expected use an insulation transformer to protect the XGT panel from interference.
- (3) Power supply should be insulated and limited voltage/current or Class 2, SELV power supply device.

Separate the XGT Panel power from the I/O device and main circuit device.

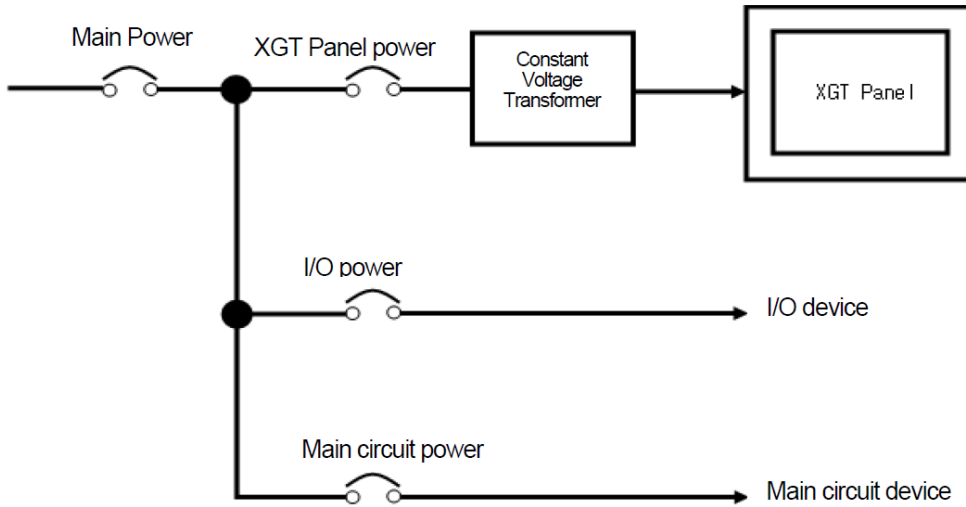

**Remark**

Separate the XGT Panel power supply cable from the main circuit cable (high voltage and current) and input/output cable. Maintain a minimum separation of 100mm between cables.

Use a lightning surge protector to prevent damage from lightning strikes.

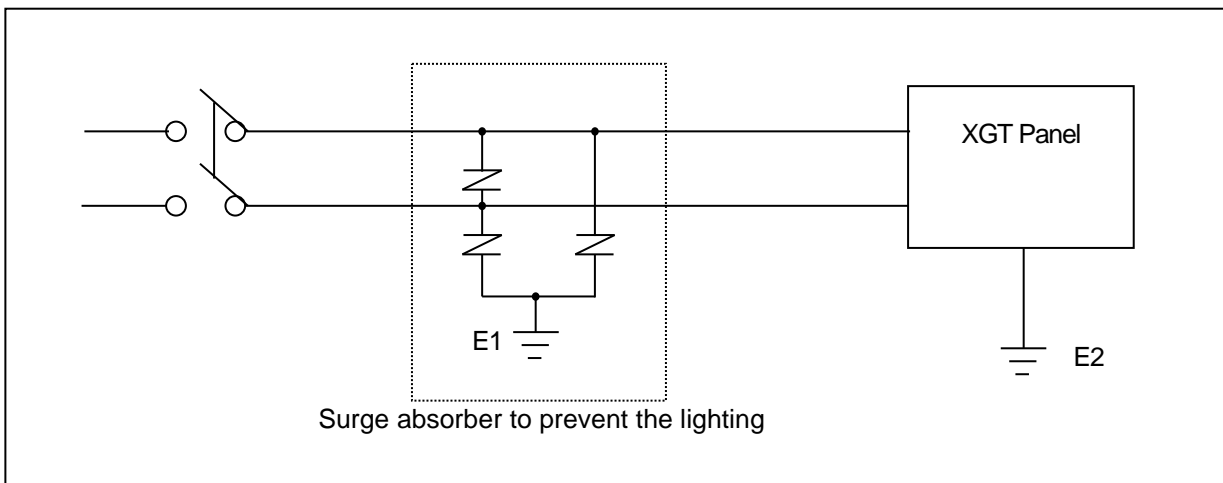

**Remark**

- (1) Separate E1, the ground connection for lightning surge protector, and E2, the ground connection for XGT Panel.
- (2) Set lightning surge protector to below the allowable surge voltage to provide protection if the voltage increases to its maximum.

Use an insulation shielding transformer or noise filter when the electromagnetic interference occurs.

Keep the stripped ends of the terminated cables twisted and as short as possible. When running the wiring avoid running the cables for the insulation shielding transformer or noise filter pass through the cable duct.

When you use the magnetic lighting contactor (MC) for AC/DC, it is recommended to use a ferrite core close to the power terminals as shown below.

Ex) Apply Ferrite Core to the power terminal as shown in the picture.

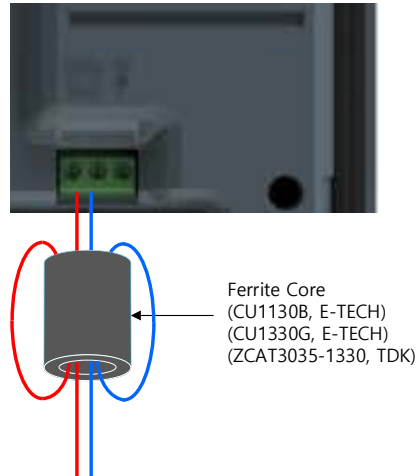

### 10.2.2 Ground wiring

- (1) Our XGT Panel has enough anti-noise measure, so except that there are many noises specially, the ground is not needed. When you use the ground connection, refer to the following information.
- (2) Use the exclusive ground connection. When you install the ground connection, use the third grounding resistance (less than  $100\Omega$ ).
- (3) If you cannot use the exclusive ground connection, use the common ground connection like below.

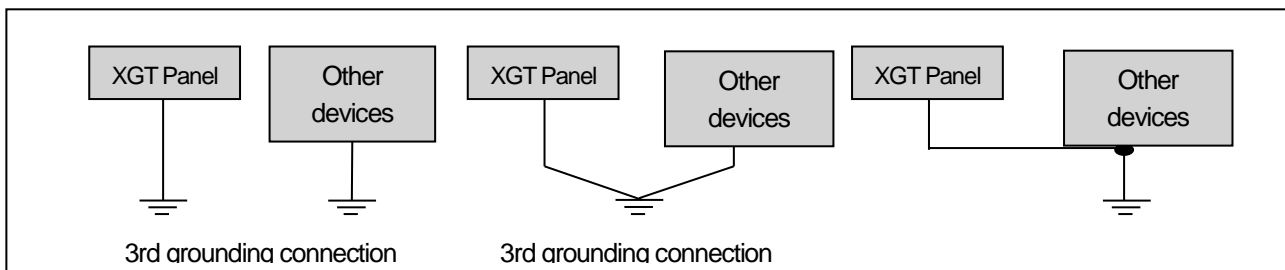

A) Exclusive ground: Best

B) Common ground: Good

C) Common ground: Poor

- (4) Use cables for grounding/earth connections by using cable with a cross sectional area greater than  $2.0 \text{ mm}^2$ . Install the ground connection as close as possible to the XGT Panel.

#### Remark

Check and test the grounding connection. If the connection is bad or in case of (B) above, the XGT Panel may malfunction or the communication signals may fail.

## Chapter 11 Maintenance

To keep the XGT Panel best, examine the XGT Panel.

### 11.1 Maintenance

Because an error may be developed by environment, the periodic maintenance is needed. You should check the following categories once or twice every 6 months.

Maintenance category		Criterion	Action
Power		Within the power change range (Within -15% / +10%)	Modify the source of electric power in order to be in the fluctuation range of a permissible voltage.
Environment	Operating temperature	0 ~ + 50 °C	Modify the operating temperature and humidity to be proper.
	Operating humidity	10 ~ 85%RH	
	Vibration	No vibration	Use the anti-vibration rubber and make a count measure.
Getting loose of power terminal		There is no unwinding	Screw the unwound terminal.
Getting loose of communication connector		There is no unwinding	Screw the unwound terminal.
Reserved part		Amount of reserved part and reservation Check the status	Refill the insufficiency and improve the reservation.
Gasket installation status		No gap between the gasket and panel.	Replace gasket or affix brackets firmly
Gasket status		No damage or deterioration	Replace gasket

### 11.2 Daily Maintenance

Check the followings daily.

Maintenance category	Maintenance contents	Criterion	Action
Mounting status	Check the brackets	Should be mounted firmly	Retighten screws
Power terminal status	Loose terminal screws	Not loose	Retighten screws
	Reduce the distance between compressed terminals.	Keep the proper distance.	Correction
Communication connector status	Unwinding of fixed screw	Not loose	Retighten screws
Indication LED	Check the lighting	Blue LED should be turned on	Refer to the appendix 1.



### 11.3 Periodical Maintenance

Check the followings once or twice every six months and take measure.

Maintenance category		Maintenance method	Criterion	Action
Environment	Surrounding Temperature	Measure through Temperature /Hygrometer Measure of corrosive gas	0 ~ 50 °C	Modify it to meet the general standard. (Environment standard in the panel)
	Surrounding Humidity		10 ~ 85%RH	
	Surrounding pollution degree		No corrosive gas.	
XGT Panel Status	Unwinding, swing	Move XGT Panel	Fixed firmly	Retighten screws
	Dust, foreign matter adhesion	Visual check	Not loose	-
Connection status	Looseness	Retighten screw with Screwdriver	Not loose	Retighten screws
	Reduce the distance between compressed terminals.	Visual check	Keep the proper distance.	Correction
	Loose connectors	Visual check	Not loose	Wind the fixed screw of connector
	Loose brackets	Retighten screw with Screwdriver	Not loose	Retighten screws
Power voltage maintenance		Check the power voltage of input terminal of power by test	AC100~240V: AC85~264V DC24V: DC19.2 ~ 28.8V	Supply power modification
Battery		Check when battery is exchanged and voltage drop is indicated. (It is expressed by system alarm)	<ul style="list-style-type: none"> <li>• Check the total of power stoppage time and guarantee duration</li> <li>• There is no battery voltage drop indication</li> </ul>	If guarantee duration is exceeded even though there is no battery voltage drop indication, change the battery.
LCD Backlight maintenance		Visual check	Check the guarantee duration	When error occurs, change the backlight.
Touch status	Touch location error	Check at the Diagnostics of XGT Panel	Appropriate touch location	Reset at the setting of XGT Panel.
	Damage of Touch	Visual check	There is no damage or deterioration	When error occurs, change touch
	Damage or Deterioration of protection sheet	Visual check	There is no damage or deterioration	When error occurs, Change protection sheet

**Remark**

(1) Battery exchange time is expressed by alarm. System alarm is expressed when system alarm category is set at the XP-Builder as follows.

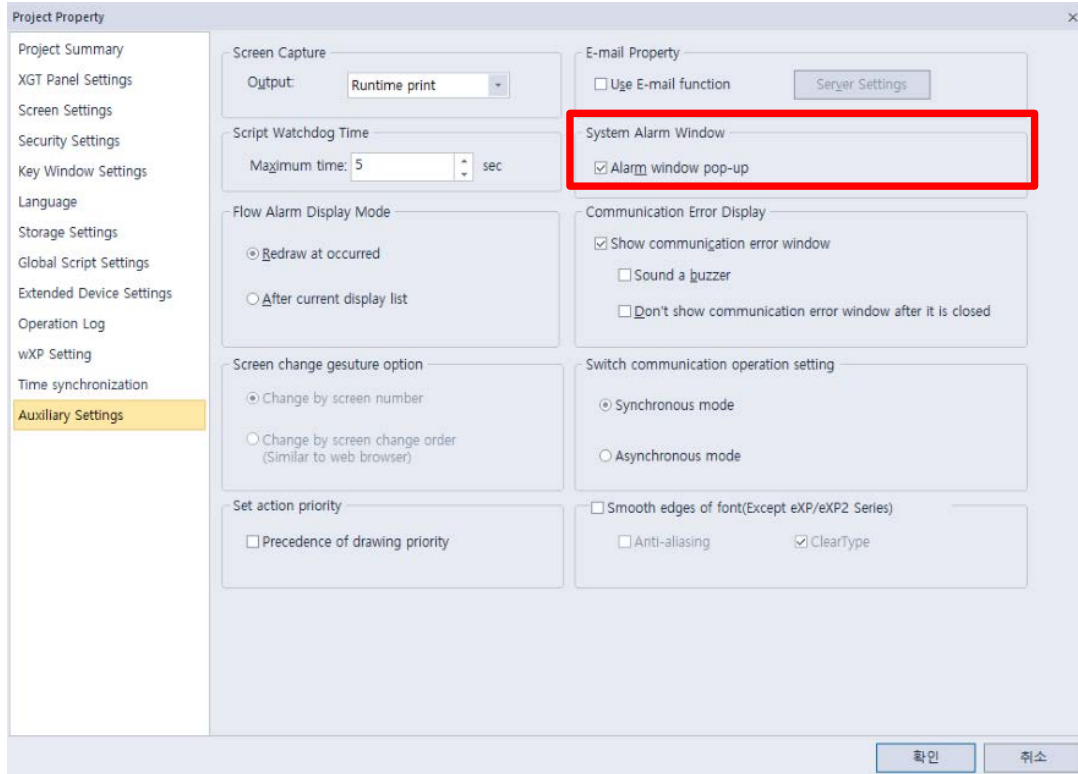

(2) Replace Battery With Hitachi Maxell, Part No. CR2032 Only. Use of Another Battery May Present A Risk Of Fire or Explosion. See Owner's Manual For Safety Instructions.

 **WARNING:** Battery may explode if mistreated. Do not recharge, disassemble or dispose of in fire.

(3) As the eXP model has the integrated LCD and backlight, the LCD should be replaced when the life is over or it is out of order.

## Chapter 12 EMC Standard Certification

### 12.1 Requirement for EMC Standard Certification

EMC command is regulated on “It doesn’t produce the Strong electromagnetic waves: Emission” and “It is not affected by electromagnetic wave from external: Immunity”. The following is describing the contents to meet the EMC command when configuring the system by using the XGT Panel. This is a summary document for the request and standard which our company has obtained from EMC but we don’t assure that all devices manufactured according to these contents are not suitable for the below standards. The final manufacturer needs to finally judge about the fitness method or fitness judgment of EMC command.

#### 12.1.1 CE standard certification

In case of XGT Panel, the EN61000-6-4, EN61000-6-2, EN61000-3-2, and EN61000-3-3 of CE standards were applied.

Applied Standards		Results
1. Emission		
Conducted Disturbance	EN61000-6-4:2007 / A1 : 2011	C
Radiated Disturbance	EN61000-6-4:2007 / A1 : 2011	C
Harmonic Current Emission	EN61000-3-2:2014	N/T
Voltage Change, Fluctuations and Flicker	EN61000-3-3:2013	N/T
2. Immunity		
Electrostatic Discharge	EN61000-6-2:2005 / AC : 2005	C
	EN61000-4-2:2009	
Radio-Frequency Electromagnetic Field	EN61000-6-2:2005 / AC : 2005	C
	EN61000-4-3:2006 / A1 : 2008 / A2 : 2010	
Fast Transient	EN61000-6-2:2005 / AC : 2005	C
	EN61000-4-4:2004 / A1 : 2010	
Radio-Frequency Continuous Conducted	EN61000-6-2:2005 / AC : 2005	C
	EN61000-4-6:2009	
Power-Frequency Magnetic Fields	EN61000-6-2:2005 / AC : 2005	N/T
	EN61000-4-8:2010	
Surges	EN61000-6-2:2005 / AC : 2005	C
	EN61000-4-5:2006	
Voltage Dips and Interruptions	EN61000-6-2:2005 / AC : 2005	N/T
	EN61000-4-11:2004	
C=Comply    NC=Not Comply    N/T=Not Tested    N/A=Not Applicable		

Directive:

Electromagnetic Compatibility Directive 2004/108/EC



### 12.1.2 KC standard certification

The XGT Panel acquires the electromagnetic fitness registration (KC specification) certified by wave laboratory under information-communication part.

A grade device

This device acquires KC for industrial use.

If device is not purchased properly, exchange it to device for home use.



## 12.2 Requirement for Low Voltage Command Suitability

It is required to get the needed Stability for the device operated at AC50~1000V, DC75~1500V's power. The following describes attention about installation and wiring for the suitability when using the XGT Panel. Though the following data is made by requirement of regulation and standard, we don't guarantee that all devices are suitable for the above command. The method to be suitable for the EMC command and judgment of suitability should be finally made by device manufacturer himself.

### 12.2.1 Standard certification for XGT Panel

XGT Panel is according to the EN61131-2:2007 (stability of device used in the measure, control laboratory).

### 12.2.2 Selection of XGT Panel

- (1) eXP2-0400D, eXP2-0500D, eXP2-0502D, eXP2-0700D, eXP2-0701D, eXP2-0702D, eXP2-1000D, eXP2-1001D The I/O module under DC24V exceeds the range of low voltage command target.

## Appendix 1 Troubleshooting

### 1. Type of Problem

It classifies problems from XGT Panel including an indicated figure, indication of the object, and problems appeared when downloading. Refer to the following chart.

Classification of problem	Description
Problem when starting	Malfunction when starting. ☞ <b>Please refer to the 2. Problem when starting.</b>
Problem after the monitor on	In case that there is no reaction when touching. ☞ <b>Please refer to the 3. Problem after the Monitor on.</b>
Display problem of figure and object.	In case that the figure or object is different from when editing. ☞ <b>Please refer to the 4. Indication problem of figure and object.</b>
Communication problem	In case that communication is not executed properly. ☞ <b>Please refer to the 5. Communication problem.</b>
USB Memory Problem	In case that USB memory is not recognized or malfunctioned. ☞ <b>Please refer to the 6. USB Memory Problem</b>
Error message when executing program	In case that an error message occurs when operating the XGT Panel. ☞ <b>Please refer to the 7. Error message when executing program.</b>

## 2. Problem when Starting

<b>Question</b>	Why does black screen show up when turning on the device?
<b>Phenomenon</b>	When turning on the device, black screen shows up and the booting is impossible.

### < Cause >

- (1) Because the device is not set as a booting mode.
- (2) Black screen may appear because of malfunction of backlight.

### <Solution>

- (1) Because the device is not set as a booting mode, the above problem can occur.  
Check whether No. 5 switch at DIP switch in the back of the device is in B direction or not.  
B direction is a booting mode.

When is the color of LED changed?  
Please check the followings.

Display color	Contents
BLUE	Power is supplied to XGT Panel

<b>Question</b>	When applying the option, 'Go to Screen after boot up', it displays "Failed to load image files" as the monitoring has not been started.
<b>Phenomenon</b>	After storing images in the USB storage device and then selecting the option "Go to Screen after boot up" in the start menu, in case when re-permitting the power of the equipment, the message like "Failed to load image files" is displayed and the monitoring is not started.

### <Cause>

- (1) In case when it is connected with the USB storage device, the recognition of the USB is delayed.

### <Solution>

- (1) In case when the recognition speed is delayed due to the characteristics of the USB storage device, remove the USB storage device and then reinstall it.

<b>Question</b>	When the power is re-permitted, the USB storage device (or USB mouse) is not recognized.
<b>Phenomenon</b>	When the USB storage device was initially installed, it was normally recognized. However, it is not recognized after the power is re-permitted.

### <Causes>

- (1) Due to the option of the 'Reset USB Power' of the equipment, there could problems in the recognition process.
- (2) Depending on the USB storage device, it may not be smoothly recognized.

### <Solution>

- (1) If the power initialization option("Reset USB Power") of the equipment is selected, cancel the selection and then permit the power again. The "Reset USB Power" option is an additional function to improve the initialization of the storage device with slow recognition speed or low recognition ratio. Depending on the characteristics of the storage device, however, the power initialization can be an obstacle to the initialization work. Thus, depending on Phenomenon, select what has higher recognition ratio by properly using the power initialization option.
- (2) Depending on the characteristics of the storage device, it may not be recognized. Use another USB storage device showing higher recognition ratio.

### 3. Problem after the Monitor on

<b>Question</b>	When touching the screen it reacts in a different area or it may not react at all?
<b>Phenomenon</b>	When touching the screen it reacts in a different area or it may not react at all.

**< Cause >**

- (1) Touch's Calibration setting is not proper.
- (2) Touch panel may be a break down.

**<Solution>**

- (1) Redo Calibration setting about touch. Refer to the [Device manual Ch.4.1 Touch Calibration].
- (2) If you can't go to setting menu, connect mouse to USB port and use mouse.

<b>Question</b>	Buzzer does not sound.
<b>Phenomenon</b>	When pressing buzzer, buzzer does not sound.

**< Cause >**

- (1) When that the switch operates but the buzzer doesn't sound, the buzzer is set as no sound.
- (2) If the switch doesn't work too, it seems that some error occurs in the touch function.

**<Solution>**

- (1) Redo environment setting for buzzer to sound. Refer to the [device manual Ch.4.7 Environment Setting].
- (2) After setting to use buzzer, check whether the buzzer sounds or not in the 1)'s setting windows.

<b>Question</b>	Lack of system memory system alarm occurs.
<b>Phenomenon</b>	After the system alarm about the lack of system memory occurs, XGT Panel itself closes the monitoring and then moves to the start menu in unspecific time without user's operation.

**<Causes>**

- (1) The memory usage could be exceeding 95%.
- (2) The memory usage can be a bit increased when floating pop-up windows or moving to several screens during monitoring. In case when the number of image used for project is a lot, the memory usage can more easily reach the limit. In this case, XGT Panel closes the monitoring by itself and then takes an action to secure the memory again.

**<Solution>**

- (1) In case of using vector image instead of raster image, the memory share can be reduced. In the graphic library of XP-Builder, the image group marked as OOO\_R is the raster image group while the image group marked as OOO\_V is the vector image group.



- (2) In case when the monitoring is closed down due to the increase of the memory share in spite of the image change operation, contact the A/S center close by.

<b>Question</b>	After continuously adding projects to the screen, and adding/editing objects, the operation speed has been slowed down.
<b>Phenomenon</b>	After adding projects to the screen and also adding/editing objects, it feels like the operation speed of XGT Panel gets slowed down.

### <Causes>

- (1) The amount of image used for projects is big.
- (2) In order to increase the screen operation speed, XGT Panel maintains the used images in the memory in advance. Since the memory resource has limitation, they cannot be maintained in the memory once the amount of image exceeds a certain limit. Whenever they are needed, thus, they are read from the file system and then expressed on the screen. This could be the reason why the screen operation speed gets slowed down.

### <Solution>

- (1) In case of using vector image instead of raster image, the memory share can be reduced. In the graphic library of XP-Builder, the image group marked as OOO\_R is the raster image group while the image group marked as OOO\_V is the vector image group.
- (2) In case when there is no proper vector image, the desired image can be composed by using various functions of figures (circle, square, straight line and etc.).
- (3) Removing unnecessary background screen, the screen is composed by applying the background colors.

## 4. Display Problem of Figure and Object

<b>Question</b>	The shape of object is not shown or the number or character value which has to be shown is not shown
<b>Phenomenon</b>	The shape of object is not shown or the number or character value which has to be shown is not shown.

### <Cause>

- (1) The connection with PLC connected with each project is disconnected or NAK occurs.

### <Solution>

- (1) When the communication is executed at first, Check the cable connected with PLC is OK or not.
- (2) If object where the offset is set is not shown, check whether address range is exceeded or not.
- (3) In case that communication is not OK, when communication is abnormal, the following message shows up in the XGT Panel.

Object type	Phenomenon
Bit Switch	The switch is expressed but it doesn't work.
Word Switch	The switch is expressed but it doesn't work.
Change Screen Switch	The switch is expressed but it doesn't work.
Special Switch	The switch is expressed but it doesn't work.
Multi Switch	The switch is expressed but it doesn't work.
Bit Lamp	Image is not shown.
Word Lamp	Image is not shown.
N-State Lamp	Image is not shown.
Clock	Present time is shown.
Bit Message	Message is not shown. When designating the background image, image is shown as it is.
Word Message	Message is not shown. When designating the background image, image is shown as it is.
Numeric Display	The value is not shown. When designating the background image, image is shown as it is.
Numeric input	The value is not shown. When designating the background image, image is shown as it is.
Text Display	Character string is not shown. When designating the background image, image is shown as it is.
Text Input	Character string is not shown. When designating the background image, image is shown as it is.
Bit Window	The window screen set in the object is not shown. But if communication is set with other object in the same window screen, it can be shown by that object.
Word Window	The window screen set in the object is not shown. But if communication is set with other object in the same window screen, it can be shown by that object.
Bit Part	The part screen set in the object is not shown. But if communication is set with other object in the same part screen, it can be shown by that object.

Object type	Phenomenon
Word Part	The part screen set in the object is not shown. But if communication is set with other object in the same part screen, it can be shown by that object.
Animation	Animation is not shown.
Bar Graph	Graph is not shown. When designating the background image, image is shown as it is.
Pie Graph	Graph is not shown. When designating the background image, image is shown as it is.
Meter Graph	Graph is not shown. When designating the background image, image is shown as it is.
Closed Graph	Graph is not shown. When designating the background image, image is shown as it is.
Trend Graph	X, Y axis is shown normally but trend axis is not normally shown. When designating the background image, image is shown as it is.
History Alarm Viewer	Change doesn't occur. When communication is abnormal, alarm occurs because it can't know the status of alarm target device. But previous alarm data shows up as it is.
Data list	Value is not shown. Lattice of viewing data list of object is shown as it is.
Logging Viewer	Change doesn't occur. When communication is normal, the recorded log data is shown normally. But, log data is shown as # when communication is abnormal.
Navigator	Change doesn't occur. Because it shows the group of alarm already developed, though communication is abnormal, if it has alarm data already developed, it shows the name of group where each alarm is included.

<b>Question</b>	The number indication object value is shown as # or ~
<b>Phenomenon</b>	The number indication object value is shown as # or ~. (Same phenomenon occurs at the number input device, viewing data list, and viewing logging)

**<Cause>**

- (1) This happens when digit is not correct or type is not BCD.

**<Solution>**

- (1) When the number to be expressed exceeds the number set in the object, # is expressed. In case of this, set the digit largely and after download again, execute program again.
- (2) When the numeric display object is expressed as BCD type, the data whose type is not BCD is expressed as ~. In case of this, adjust device value as BCD type.
- (3) This phenomenon occurs at the data list object, numeric input, numeric display device, and logging viewer.

<b>Question</b>	After switching the screen, the previous screen remains for a few minute
<b>Phenomenon</b>	After switching the screen, when there is no background or image in the part or number indication device, the previous screen remains for a few minute because of change of part

**< Cause >**

(1) After switching the screen, when connection is set up multiply or communication time-out occurs, the screen of previous part remains in some object.

**<Solution>**

(1) It is normal status. In case that multiple connection or communication is not good, when switching the screen, the remains of previous screen can occur during the time-out hour.

<b>Question</b>	The folded object doesn't sequentially show up
<b>Phenomenon</b>	The number under the data list shows up above data list.

**< Cause >**

(1) The device value is expressed at the top of object screen.

**<Solution>**

(1) It is normal status. The folded window or part object is not included in screen, regardless of sequence of drawing, the object changed recently is expressed at top of screen. So if possible, do not fold the object in screen.

<b>Question</b>	The object always shows up above the figure
<b>Phenomenon</b>	I downloaded the figure above the object in XP-Builder, but the object always shows up above the figure.

**< Cause >**

(1) In XGT Panel, The object always shows up above the figure.

**<Solution>**

(1) It is normal status. The object always shows up above figure in the XGT Panel.

## 5. Communication Problem

<b>Question</b>	It seems that communication does not work
<b>Phenomenon</b>	On the screen where the object is not many, communication works but when you move the screen where the object is many, timeout occurs.

**< Cause >**

- (1) In the device setting, the communication time-out is set to be too short.

**<Solution>**

- (1) It occurs because timeout is set much smaller than sum of request time of communication data and response time from PLC. In the device setting at the XP-Builder, after setting communication time out to be big, download program and execute again.

<b>Question</b>	It seems that communication doesn't work.
<b>Phenomenon</b>	Communication doesn't work.

**< Cause >**

- (1) Communication setting or cable may be not normal.

**<Solution>**

- (1) In case of RS-232C, check whether connection setting is normal or not in XP-Builder.
- (2) In case of RS-422/485, check whether station and communication connection setting is normal or not.
- (3) If 1), 2) is normal, do diagnosis about PLC-RS232C, PLC-RS485/422 at the Serial diagnosis screen of device menu. Refer to the [Device manual ch.5.6 Serial Communication Diagnosis]
- (4) If 3) is normal, check whether connection cable has error or not.
- (5) In case of Ethernet, check the port and IP setting about relative PLC.



### Caution

- ▶ Before trial operation of the product, be sure to check if a normal communication is available between XGT Panel and the subject device of control

## 6. USB Memory Problem

<b>Question</b>	When removing the USB memory equipment, device is stopped for some times.
<b>Phenomenon</b>	This happens when doing data backup including logging, recipe.

### < Cause >

- (1) This happens because memory card is removed when doing data backup.

### <Solution>

- (1) If possible, when monitoring XGT Panel, do not remove the memory card and after going out to the waiting screen, execute the removing.
- (2) Inescapably you have to remove it during the operation, remove when backup does not occur. If the above phenomenon occurs, it works normally after about 10 seconds.
- (3) In case of USB memory, please remove it when the LED of USB external memory is not flickering.

<b>Question</b>	After the repeated attachment/detachment of the USB storage device, it is not recognized
<b>Phenomenon</b>	It can happen when the attachment/detachment of the USB device is repeated for a short period of time.

### <Cause>

- (1) When the USB device is recognized or removed, it takes a certain period of time(maximum a few seconds) to recognize it. When the storage device is quickly installed/removed, however, it cannot be normally recognized.
- (2) There may be compatibility issues with the USB hub when using USB HUB.
- (3) Compatibility issues may occur when using USB versions 3.0 and later hubs.

### <Solution>

- (1) It is recognized again after waiting for about a minute. Install it again after waiting for more than a minute.
- (2) When removing/reinstalling the USB device, reinstall it after waiting for around 2-3 seconds.
- (3) Use version 2.0 of the USB hub as much as possible. Also, please use external power for the HUB.
- (4) If USB is not recognized when using the HUB, please remove the HUB and connect the USB memory.

<b>Question</b>	Window Pop up "USB Device malfunctioned, and system does not recognize it."
<b>Phenomenon</b>	It can happen when the USB device is not recognized.

### <Cause>

- (1) This occurs when the device is not recognized due to a malfunction of a USB device, etc.

### <Solution>

- (1) Removing/reinstalling the USB device, reinstall it after waiting for around 2-3 seconds.
- (2) If used a USB extension cable, please use USB memory without an extension cable.

**Question**

It is not recognized when connecting to a USB device using a USB extension cable.

**Phenomenon**

This issue occurs when the USB extension cable is incompatible.

**<Cause>**

- (1) This problem occurs because the USB extension cable is too long.

**<Solution>**

- (1) Please refrain from using USB extension cables as this may cause compatibility problems.
- (2) If it is inevitable to use the USB extension cable, please use the cable less than 2m long.

**Caution**

- ▶ If you force to remove the data during the storage of data in the external memory, file may not be stored in a normal condition or external memory may suffer from damage.

## 7. Error Message during Execution of Program

In case that problems occur during execution of XGT Panel including the start of device, diagnosis of device and environment setting, project download, monitoring of control device, and error messages occur as type of box. At this time the message indicates the code made by 4 digit number. The front 2 number indicate code of object and work, the rear 2 number is message number. In case that the present error message is indicated as [0101], an error message occurs when doing diagnosis about the status of NVRAM. When an error message occurs, refer to the row's number and sequence and find the category of reason and measure.

Object	Error code		Occurrence location	Error message	Reason and measure
	Type	Address			
Device diagnosis	0x01	0x01	XGT Panel	NVRAM Data Access ... FAILED!	Failed to check whether backup memory is normal or not. If this symptom is repeated, contact the near Customer Service Center.
		0x02	XGT Panel	BATTERY STATUS ... NOT GOOD!	Backup data is not valid. If this symptom is repeated when turning power off and on, remove XGT Panel's power and exchange the battery.
		0x03	XGT Panel	Write Operation FAILURE!	The built-in Flash disk has an error. Contact the near Customer Service Center.
		0x04	XGT Panel	Read Disk Information Error!	The built-in Flash disk has an error. Contact the near Customer Service Center.
		0x05	XGT Panel	Write Operation FAILURE!	Check that CF card is empty, and equip CF card and test again. If same symptom is repeated, CF card or CF card slot of XGT Panel may have a problem.
		0x06	XGT Panel	Read Disk Information Error!	Check that CF card is empty, and equip CF card and test again. If same symptom is repeated, CF card or CF card slot of XGT Panel may have a problem.
Device setting	0x02	0x01	XGT Panel	Invalid timeout value.	You inputted the wrong time which is not within backlight setting time range. Input the effective time.
		0x02	XGT Panel	Not found XGT Panel configuration file.	There is no setting information data of XGT Panel. If this symptom is repeated when turning power off and on, contact the near Customer Service Center.
		0x03	XGT Panel	Please enter an integer between 0 and 255.	When setting IP, the values within 0~255 are effective. Input the value within the above range.



Object	Error code		Occurrence location	Error message	Reason and measure
	Type	Address			
Viewing device information	0x03	0x01	XGT Panel	No project in XGT Panel.	Now, there is no downloaded project so you can't see connection information. Download the project from XP-Builder.
XGT Panel Update	0x04	0x01	XGT Panel	Failed to Start engine. Please update engine again.	Because of update error or Flash disk error, program can't be executed. If you can update, redo the above procedure. If you can't, contact the near Customer Service Center.
Switch	h05	h01	XGT Panel	Invalid password.	There is password in the each object. When editing the project downloaded in the present device, input the designated password at the project property information.
Number indication device/ Number input device	0x06	h01	XGT Panel	Can't write Data.	Because of communication error, the value can't be inputted. Check the communication status and input again.
		h02	XGT Panel	No input Data.	You tried to input with no value. Input the value
		0x03	XGT Panel	Exceeded the max length.	You exceed the maximum length to input.
		0x04	XGT Panel	Exceeded the minimum Value.	You exceed the maximum value to input.
		0x05	XGT Panel	Exceeded the maximum Value.	You exceed the minimum value to input.
		0x06	XGT Panel	Invalid at Input Case.	When you input the value, input can't be done because of wrong input. Check the input condition of each object in the Builder and input again.
Lamp	0x07			None	
Character indication device/ Character input device	0x08			None	
Message	0x09			None	
Clock	0x0A			None	
Animation	0x0B			None	
Graph	0x0C			None	
Window	0x0D			None	
Part	0x0E			None	
History alarm	0x0F			None	
Flow alarm	0x20			None	
System alarm	0x21			None	

Object	Error code		Occurrence location	Error message	Reason and measure
	Type	Address			
Scheduler related	0x22			None	
Recipe related	0x23			None	
Logging related	0x24			None	
Data list	0x25			None	
Project download	0x26	0x00	XGT Panel	Abnormal send-payload. Please download project again.	Communication status is abnormal. Check the connection of communication cable.
		0x01	XP Builder	There's not Password File.	This message shows up when making it newly because there is no password setting file in the device. When making it newly, it is initialized with no password.
		0x02	XP Builder	Failed to Create Password File.	It make new password setting file when there is no password setting file. But downloading is stopped when it fails to make this file because of device error. If this problem is repeated, Contact the near Customer Service Center.
		0x03	XP Builder	Invalid Backup Media.	Communication status is abnormal. Route information is not correct to save project data. If this problem is repeated, Contact the near Customer Service Center.
		0x04	XP Builder	Failed to Create version File.	In case that the version information file doesn't exist in the device, that file is made newly. In case that the device has error and fails to make that file, download is stopped. If this problem is repeated, Contact the near Customer Service Center.
		0x05	XP Builder	File Size Error.	There is version information file. In case that because of error of device, it fails to read version information, because the device doesn't know version, download is stopped. If this problem is repeated, Contact the near Customer Service Center.

Object	Error code		Occurrence location	Error message	Reason and measure
	Type	Address			
		0x06	XP Builder	Failed to get Project ID.	In case of not reading file where project property is included, download is stopped. If this problem is repeated, Contact the near Customer Service Center.
		0x07	XP Builder	Failed to read history alarm data.	In case of not reading information about alarm history because of error of NVRAM, download is stopped. If this problem is repeated, Contact the near Customer Service Center.
		0x08	XP Builder	Failed to read CF Card information.	Project is set to store data at CF card equipped at device. By the way, now it can't read information about CF card. Check the installation status of CF card and if it is normal, check the CF card. If this problem is repeated, contact Customer Service Center.
Project download	0x26	0x09	XP Builder	Failed to read USB information.	Project is set to store data at USB storage device equipped at device. By the way, now it can't read information about USB storage device. Check the installation status of USB storage device and if it is normal, check USB storage device. If this problem is repeated, contact Customer Service Center.
		0x0A	XP Builder	Failed to read Flash memory information.	In case that it can't know information about memory status, download is stopped. If this problem is repeated, contact Customer Service Center.
		0x0B	XP Builder	Failed to clear Temp Directory.	In case that because of error of Flash Disk, it can't delete the directory made temporarily for download because of error of Flash Disk, download is stopped. If this problem is repeated, contact Customer Service Center.
		0x0C	XGT Panel	Failed to delete Font File. Please reboot XGT Panel.	In case that it fail to delete the font file of previous project because of error of XGT Panel, download is stopped. If this problem is repeated, contact Customer Service Center.
		0x0D	XGT Panel	Failed to delete Image File. Please reboot XGT Panel.	In case that it fail to delete the image file of previous project because of error of XGT Panel, download is stopped. If

Object	Error code		Occurrence location	Error message	Reason and measure
	Type	Address			
					this problem is repeated, contact Customer Service Center.
		0x0E	XGT Panel	Failed to delete Sound File. Please reboot XGT Panel.	In case that it fail to delete the sound file of previous project because of error of XGT Panel, download is stopped. If this problem is repeated, contact Customer Service Center.
		0x0F	XGT Panel	There's no downloaded project. It needs to download whole project	It can't download part or fixed part in case there is no downloaded project. In case of this, download again. If this problem is repeated, contact Customer Service Center.
		0x10	XP Builder	Backup path is invalid. Please check the path that project is downloaded.	When user change the storage location of project data including image and font, if there is not respective routine, it make newly. By the way, download is stopped in case it fails to make newly. When it is designated as CF card, it can occur in case CF card is not installed. If this problem is repeated and not referred in the above, contact Customer Service Center.
		0x11	XGT Panel	Failed to delete previous project archive. Please reboot XGT Panel.	The project backup file downloaded already can be deleted because of error of XGT Panel. Reboot XGT Panel. If this problem is repeated, contact Customer Service Center.
Project download	0x26	0x12	XGT Panel	Failed to delete past project data files. Please download project again.	When downloading, the log data area in the NV-RAM is initialized in case of selecting previous project's the monitor data deletion option. By the way, in case of failing this, downloading is stopped. If this problem is repeated, contact Customer Service Center.
		0x15	XGT Panel	Failed to initialize LOGGING area in NV RAM. Please download project again.	When downloading, the log data area in the NV-RAM is initialized in case of selecting previous project's the monitor data deletion option. By the way, in case of failing this, downloading is stopped. If this problem is repeated, contact Customer Service Center.

Object	Error code		Occurrence location	Error message	Reason and measure
	Type	Address			
		0x16	XGT Panel	Failed to initialize RECIPE area in NV RAM. Please download project again.	When downloading, the alarm history in the NV-RAM is initialized in case of selecting the previous project's monitor data deletion option. By the way, in case of failing this, downloading is stopped. If this problem is repeated, contact Customer Service Center.
		0x17	XGT Panel	Failed to initialize ALARM area in NV RAM. Please download project again.	The downloaded font file is moved into original storage location but when this fails, downloading is stopped. If this symptom is repeated, contact Customer Service Center.
		0x18	XGT Panel	Failed to install font files. Please download project again.	The project data is divided into several files according to the contents but when this fails, downloading is stopped. If this symptom is repeated, contact Customer Service Center.
		0x19	XGT Panel	Failed to unmarshall download file. Please download project again.	The data divided according to the contents is moved to the original storage location but when this fails, downloading is stopped. If this symptom is repeated, contact Customer Service Center.
		0x1A	XGT Panel	Failed to install new project data files. Please download project again.	The downloaded project is not installed normally because of error of the Flash Disk. Download the project again. If this symptom is repeated, contact Customer Service Center.
		0x1B	XGT Panel	Failed to merge data files. Please download project again.	The downloaded project zip file is moved to the original storage location but when it fails, downloading is stopped. If this symptom is repeated, contact Customer Service Center.
		0x1C	XGT Panel	Failed to save new project archive. Please download project again.	There is a program to reboot engine program after downloading in the device but when it fails, this message shows up. But because the downloading is completed if you reboot engine directly, it works normally. The program name to reboot is startup.exe and it can be installed by engine upgrade function.

Object	Error code		Occurrence location	Error message	Reason and measure
	Type	Address			
Project download	0x26	0x1D	XGT Panel	Failed to XGP Panel startup program. Please update XGT Panel Software.	It can't find software to reboot XGT Panel. Update the XGT Panel.
		0x1E	XGT Panel	Project data is not downloaded. Please download project again.	The project data was not downloaded normally because of communication error. Check the connection status of communication cable and If this symptom is repeated, contact Customer Service Center.
		0x1F	XGT Panel/ XP-Builder	Failed to read Version information file. Please download project again.	There is version information file but when it can't read file normally because of the device error, downloading is stopped because it doesn't know version. If this symptom is repeated, contact Custom Service Center
Project download from USB storage device	0x27	0x51	XGT Panel	Cannot find project data in USB Storage	There is no USB or device status of USB is not good or project is not saved properly.
		0x52	XGT Panel	Project information file is not in USB Storage.	The project is not saved normally in the USB. Check whether there is XP_Project folder and [project name].inf in the USB or not.
		0x53	XGT Panel	Failed to read project information file.	It can't read project information file because the project is not saved in the USB normally. Save the project again from XP-Builder to the USB.
		0x54	XGT Panel	Device type is not matched.	The connected device type is not same as the device type set in the project in the USB. In case of this, project can't be downloaded into the device. Edit the project again or download according to the connected device.
		0x55	XGT Panel	Cannot read user password.	Information about the password can't be red because of the device error. If this symptom is repeated, contact Customer Service Center.
		0x56	XGT Panel	Password is not matched.	When saving the project, the password inputted by user is not same as present connection password. Input correct password and save the project.

Object	Error code		Occurrence location	Error message	Reason and measure
	Type	Address			
Project download from USB storage device	0x27	0x57	XGT Panel	Cannot read XGT Panel software version.	There is version information file but when it can't read file normally because of the device error, downloading is stopped because it doesn't know version. If this symptom is repeated, contact Customer Service Center.
		0x58	XGT Panel	XGT Panel software is old version. Please update XGT Panel.	The version of XP-Builder where project is saved is not compatible with present XGT Panel. Update the XGT Panel.
		0x58	XGT Panel	XP-Builder is old version. Please update XP-Builder.	The version of XP-Builder where project is saved is not compatible with present XGT Panel. Update the XGT Panel.
		0x59	XGT Panel	Cannot read download data format version.	There is storage structure version information file. But when it can't read this file because of the device error, downloading is stopped because it doesn't know the version. If this symptom is repeated, contact Customer Service Center.
		0x5A	XGT Panel	Download data format version is not matched. Please update XGT Panel.	Data storage type is not correct. Update XGT Panel.
		0x5A	XGT Panel	Download data format version is not matched. Please update XP-Builder.	Data storage type is not correct. Update the XP-Builder.
		0x5B	XGT Panel	Data file path is invalid.	There is no project data file at designated location. Check the connection status of USB and if there is no error, save the project to USB again.
		0x5C	XGT Panel	Download file name length is invalid.	The name of project data file is not saved correctly. Save the project at the USB again. If this symptom is repeated, contact Customer Service Center.
		0x5D	XGT Panel	Cannot find download file.	The project data file can't be found. Save the project data file at the USB again. When this symptom is repeated, check the USB. If there is no error, contact Customer Service Center.

Object	Error code		Occurrence location	Error message	Reason and measure
	Type	Address			
		0x5E	XGT Panel	Download file size is invalid.	The project data file is not saved correctly. Save the project data file at the USB again. When this symptom is repeated, check the USB. If there is no error, contact Customer Service Center.
Project download from USB storage device	0x27	0x5F	XGT Panel	Cannot find project backup file.	The project backup file which should be downloaded is not downloaded because of communication error. Download again.
		0x60	XGT Panel	Project backup file size is invalid.	The project backup file is saved incorrectly. Save the project at the USB storage equipment again. When this symptom is repeated, check the USB storage equipment and if the USB is normal, contact Customer Service Center.
		0x61	XGT Panel	Font file name length is invalid.	The font file's name is saved incorrectly. Save the project in the USB again. If this symptom is repeated, contact Customer Service Center.
		0x62	XGT Panel	Font file is not downloaded.	The font file which is needed for project is not saved in the USB storage equipment. Save the project in the USB. If this symptom is repeated, contact Customer Service Center.
		0x63	XGT Panel	Font file size is invalid.	The font file is not saved correctly. Save the project at the USB. Save the project at the USB. If this symptom is repeated, check the USB and if the USB is normal, contact Customer Service Center.
		0x64	XGT Panel	Cannot unmarshall download file.	The data can't be analyzed because the project data file is not saved correctly. Save the project at the USB again. If this symptom is repeated, check the USB and if the USB is normal, contact Customer Service Center.
		0x65	XGT Panel	Cannot delete previous project data.	The data of the project can't be deleted because of device error. If this symptom is repeated, check the USB and if the USB is normal, contact Customer Service Center.



Object	Error code		Occurrence location	Error message	Reason and measure
	Type	Address			
		0x66	XGT Panel	Cannot move new font files.	Downloaded font file is moved to the original storage location. But when it fails, the downloading is stopped. If this symptom is repeated, contact Customer Service Center.
		0x67	XGT Panel	Cannot move new project data files.	The project data classified according to the content is moved to the original storage location. But when it fails, the downloading is stopped. If this symptom is repeated, contact Customer Service Center.
		0x68	XGT Panel	Cannot move project backup file.	The downloaded project zip data is moved to the original storage location. But when it fails, the downloading is stopped. If this symptom is repeated, contact Customer Service Center.
XGT Panel booting	0x28	0x01	XGT Panel	Previous instance is not terminated.	XGT Panel software was already started. Reboot the device. If this symptom is repeated, contact Customer Service Center.
		0x02	XGT Panel	Start Server Fail. Restart XGT Panel	The XGT Panel software can't initialize the communication status normally. Check the communication status again. If this symptom is repeated when communication is normal, contact Customer Service Center.
		0x03	XGT Panel	Failed to Start Echo Server.	The XGT Panel software can't initialize the communication status normally. Check the communication status again. If this symptom is repeated when communication is normal, contact Customer Service Center.
		0x04	XGT Panel	Failed to accept connection.	The XGT Panel software can't initialize the communication with the XP-Builder normally. Check the communication status again. If this symptom is repeated when communication is normal, contact Customer Service Center.

Object	Error code		Occurrence location	Error message	Reason and measure
	Type	Address			
		0x05	XGT Panel	Failed to rename UpdateNew.exe	In the present XGT Panel the new updated XGT Panel software's name can not be changed. After rebooting the XGT Panel, update again. When rebooting, if you can't start engine, delete \\FlashDisk\LSISProduct\UpdateNew.exe in the XGT Panel. Then if you touch Update.exe and execute the XGT Panel, it can be update mode. Try update again. If this symptom is repeated, contact Customer Service Center
		0x06	XGT Panel	Failed to Delete Update.exe.	The new module is downloaded by the XGT Panel update but the previous module is not deleted. Reboot the device. If the XGT Panel software is not started normally, touch \\FlashDisk\LSISProduct\Update.exe in the XGT Panel. At this time, if XGT is set as update mode, update again. If this symptom is repeated, contact Customer Service Center.
Communication between other XP Builder-XGT Panel	0x29	0x30	XGT Panel	Failed to modify password file.	The device connection password can't be modified because of error of Flash Disk of XGT Panel. Reboot the device. If this symptom is repeated, contact Customer Service Center.
		0x31	XGT Panel	Password-related command transmission payload error	It failed to set and modify password because of communication status error. If this symptom is repeated, contact Customer Service Center.
		0x32	XGT Panel	There is no XGT Panel connection setting file.	The connection setting file of XGT Panel can't be found.
		0x33	XGT Panel	Modified content can't be saved in the XGT Panel connection setting file.	The modified information can't be saved at the connection setting file of XGT Panel. If this symptom is repeated, contact Customer Service Center.
		0x34	XGT Panel	Failed to set the time	The XGT Panel's time can't be set. If this symptom is repeated, contact Customer Service Center.

Object	Error code		Occurrence location	Error message	Reason and measure
	Type	Address			
XGT panel S/W update	0x30	0x21	XGT Panel/ XP-Builder	Failed to Create Initialized Module Version File.	Because the each module version information can't be read because of XGT Panel's error, it failed to initialize. If this symptom is repeated, contact Customer Service Center.
		0x22	XGT Panel/ XP-Builder	Module version file size is invalid.	The each module version information can't be read because of XGT Panel's error. If this symptom is repeated, contact Customer Service Center.
		0x23	XGT Panel/ XP-Builder	Can't Read module version file.	The each module version information can't be read because of XGT Panel's error. If this symptom is repeated, contact Customer Service Center.
		0x24	XP-Builder	There's no file to download.	The version information list to update is empty. Check the module folder newly designated at XP-Builder and if there is no error, download XGT Panel module and try update again. If this symptom is repeated, contact Customer Service Center.
		0x25	XP-Builder	Downloaded file is not Module to download.	The wrong file which is not in the new module list of XGT Panel is downloaded. Try update of XGT Panel again. If this symptom is repeated, contact Customer Service Center.
XGT panel S/W update	0x30	0x26	XGT Panel	Not enough space in flash memory.	The space to copy new module in XGT Panel is not enough. After deleting the unnecessary file or backing up the previous file to the movable storage equipment, try update again. If this symptom is repeated after deleting, contact Customer Service Center.
		0x27	XGT Panel	Failed to Copy module ~.dll	The new module is not installed because of XGT Panel's error. After rebooting the device, touch \\FlashDisk\LSISProduct\Update.exe and set the device as update mode. Then update again. If this symptom is repeated, contact Customer Service Center.

Object	Error code		Occurrence location	Error message	Reason and measure
	Type	Address			
		0x28	XGT Panel	Failed to Start Engine. Please update engine again.	To reboot the engine is not available because of wrong file which is developed by downloading wrong module or communication error. Touch \\FlashDisk\LSISProduct\Update.exe and set the device as update mode. Then update again. If this symptom is repeated, contact Customer Service Center.
		0x2A	XGT Panel	Failed to write Data to Module version File.	It is failed to record the version information during update of XGT Panel. If this symptom is repeated, contact Customer Service Center.
		0x2B	XGT Panel	There's no downloaded file.	To reboot the engine is not available because of wrong file which is developed by downloading wrong module or communication error. Touch \\FlashDisk\LSISProduct\Update.exe and set the device as update mode. Then update again. If this symptom is repeated, contact Customer Service Center.
		0x2C	XGT Panel	(improper communication command) Current state is not authorized.	To reboot the engine is not available because of wrong file which is developed by downloading wrong module or communication error. Touch \\FlashDisk\LSISProduct\Update.exe and set the device as update mode. Then update again. If this symptom is repeated, contact Customer Service Center.
XGT panel S/W update	0x30	0x2D	XGT Panel	(improper communication command) A module to download is not listed up yet.	To reboot the engine is not available because of wrong file which is developed by downloading wrong module or communication error. Touch \\FlashDisk\LSISProduct\Update.exe and set the device as update mode. Then update again. If this symptom is repeated, contact Customer Service Center.

Object	Error code		Occurrence location	Error message	Reason and measure
	Type	Address			
		0x2E	XGT Panel	Failed to Initialize Update program.	XGT can't be set as update mode because of XGT Panel error. After downloading new XGT Panel module through homepage, etc., copy UpdateNew.exe file among new module to the \\FlashDisk\LSISProduct\ directory of XGT Panel through the movable storage equipment. Then reboot the XGT Panel and go update mode and update again. If this symptom is repeated, contact Customer Service Center.

## Appendix 2. Dimension (Unit: mm)

### 1. eXP2-04X0D

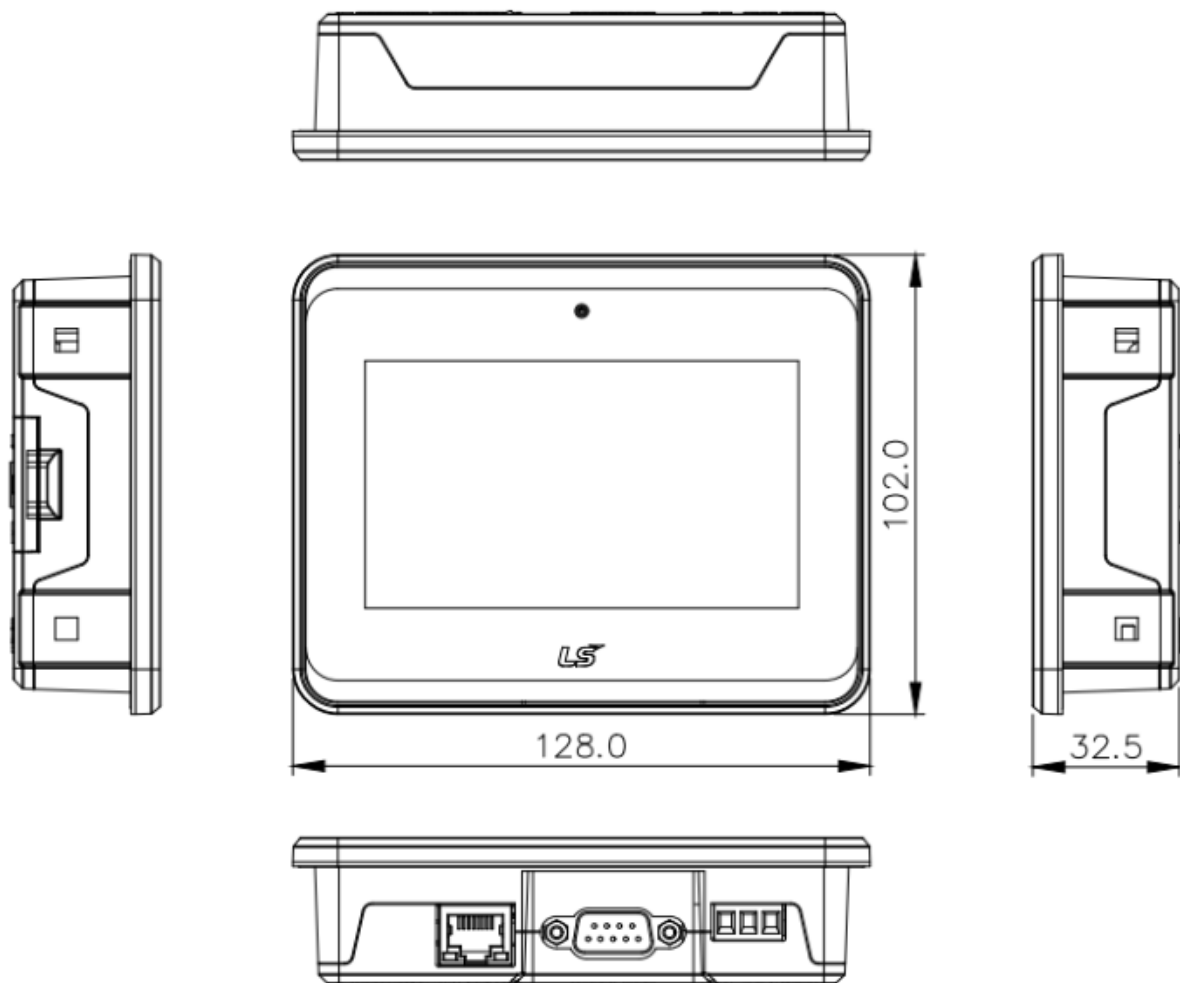

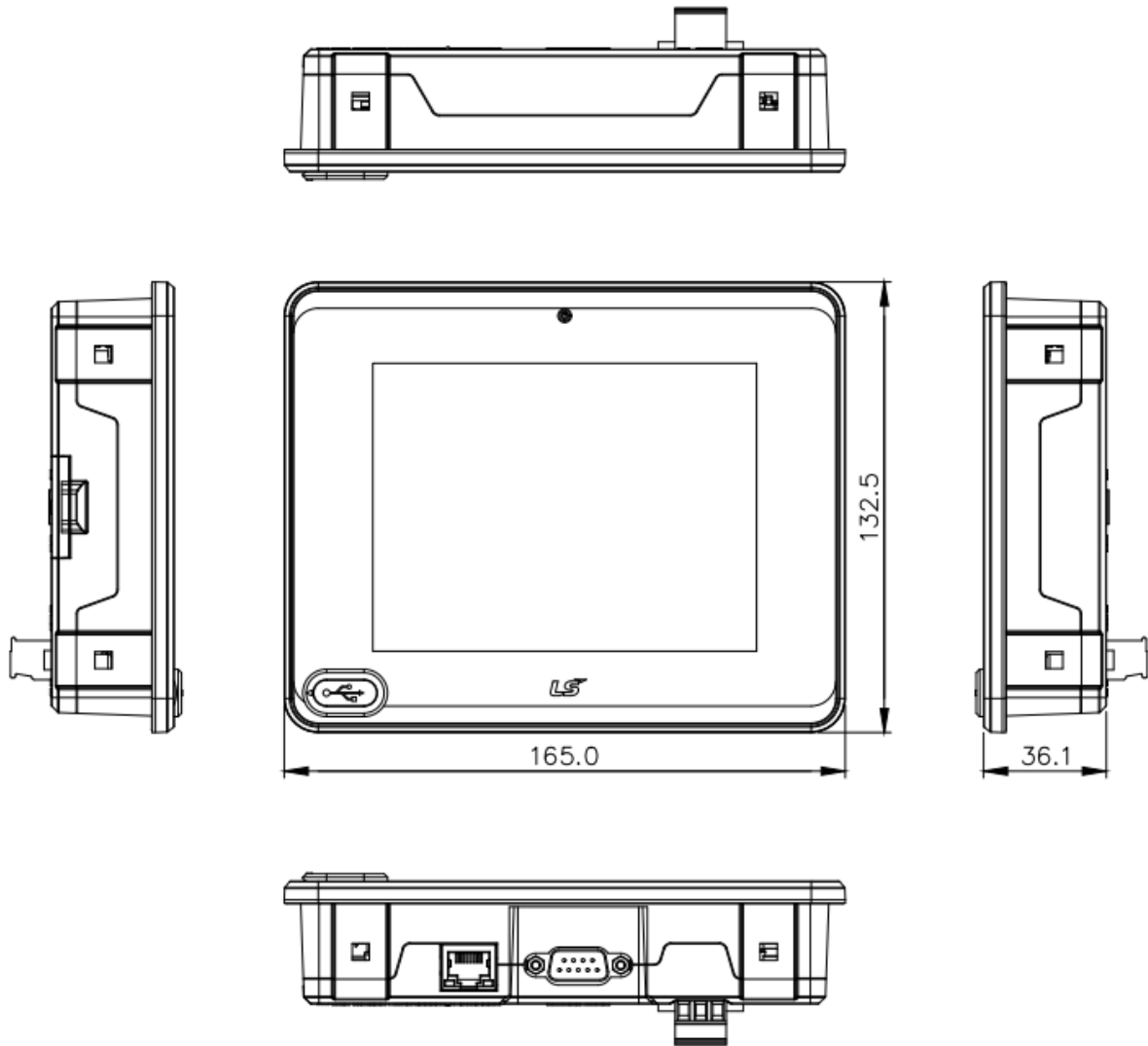
**2. eXP2-05X0D, eXP2-05X2D****Remark**

- (1) The eXP2-05X2D product does not support Ethernet Port.

### 3. eXP2-07X0D, eXP2-07X1D, eXP2-07X2D

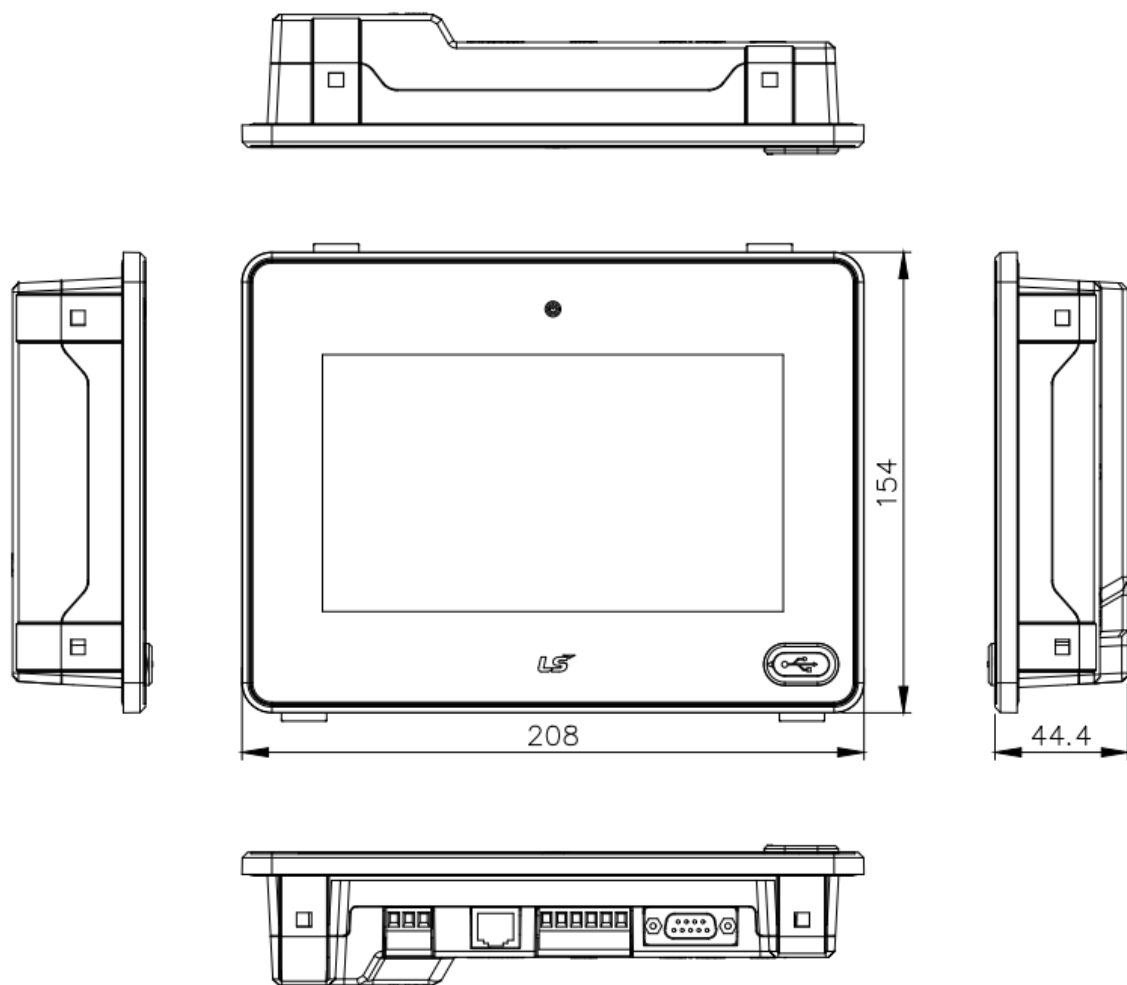

#### Remark

- (1) Only eXP2-07X1D products support Micro SD card.
- (2) The eXP2-07X2D product does not support Ethernet Port.

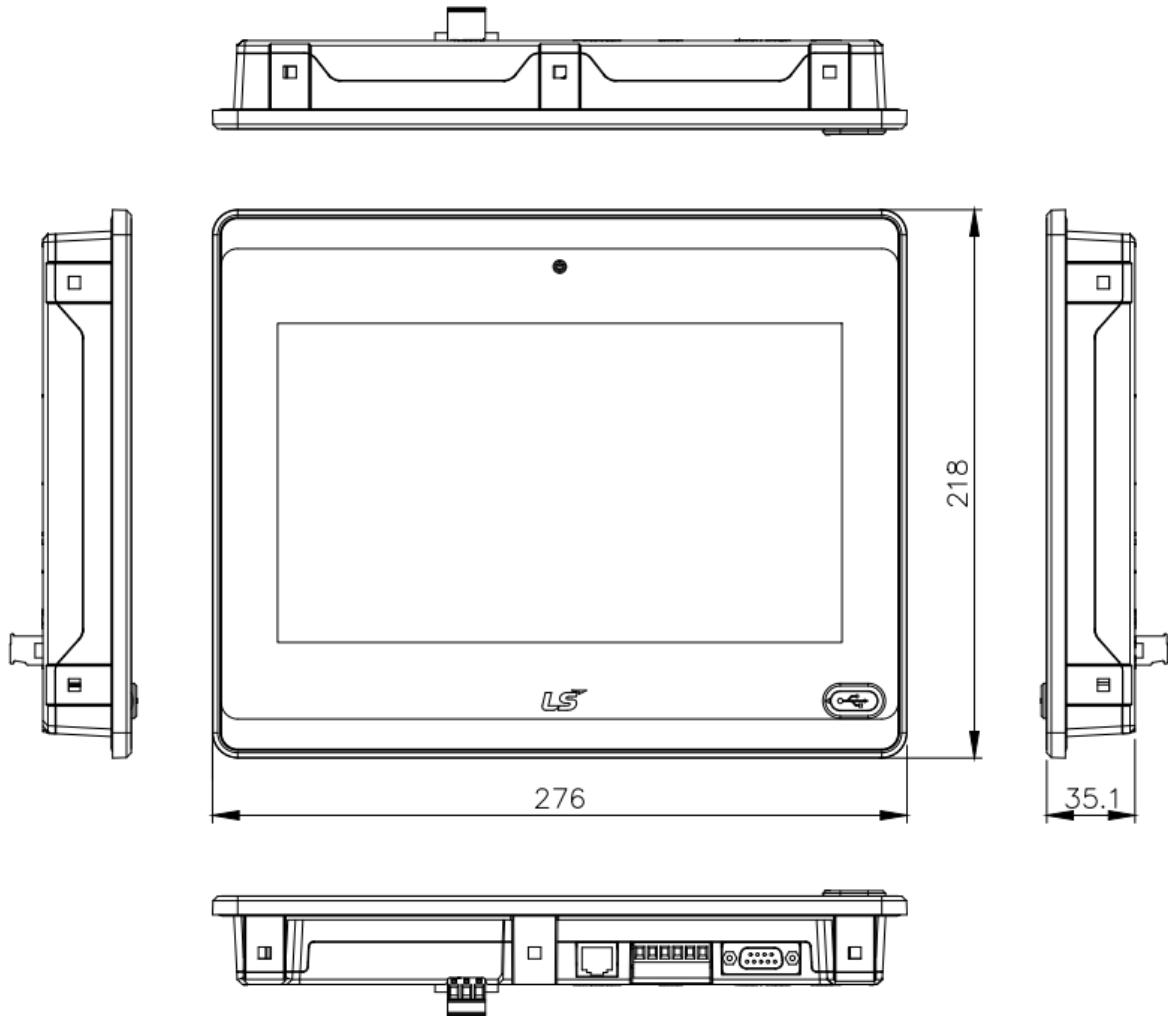

**4. eXP2-10X0D, eXP2-10X1D****Remark**

- (1) Only eXP2-10X1D products support Micro SD card.

## Appendix 3 Warranty and Environmental Policy

### Warranty

#### 1. Warranty Period

The product you purchased will be guaranteed for 18 months from the date of manufacturing.

#### 2. Scope of Warranty

Any trouble or defect occurring for the above-mentioned period will be partially replaced or repaired. However, please note the following cases will be excluded from the scope of warranty.

- (1) Any trouble attributable to unreasonable condition, environment or handling otherwise specified in the manual
- (2) Any trouble attributable to others' products
- (3) If the product is modified or repaired in any other place not designated by the company
- (4) Due to unintended purposes
- (5) Owing to the reasons unexpected at the level of the contemporary science and technology when delivered
- (6) Not attributable to the company; for instance, natural disasters or fire

#### 3. Since the above warranty is limited to HMI unit only, make sure to use the product considering the safety for system configuration or applications.

### Environmental Policy

LS ELECTRIC Co., Ltd supports and observes the environmental policy as below.

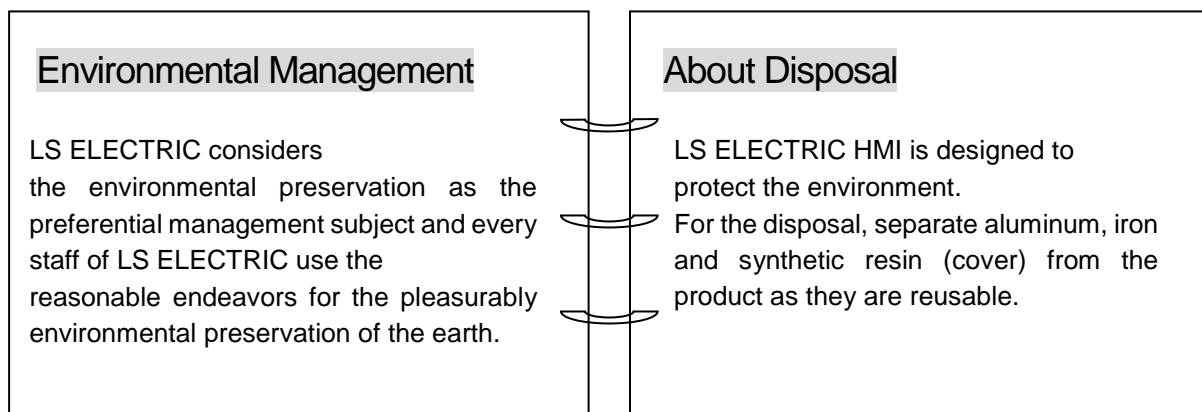



[www.ls-electric.com](http://www.ls-electric.com)

## LS ELECTRIC Co., Ltd.

### ■ Headquarter

LS-ro 127(Hogye-dong) Dongan-gu, Anyang-si, Gyeonggi-Do, 14119, Korea

### ■ Seoul Office

LS Yongsan Tower, 92, Hangang-daero, Yongsan-gu, Seoul, 04386, Korea

Tel: 82-2-2034-4033, 4888, 4703 Fax: 82-2-2034-4588

E-mail: [automation@ls-electric.com](mailto:automation@ls-electric.com)

### ■ Overseas Subsidiaries

#### • LS ELECTRIC Japan Co., Ltd. (Tokyo, Japan)

Tel: 81-3-6268-8241 E-Mail: [japan@ls-electric.com](mailto:japan@ls-electric.com)

#### • LS ELECTRIC (Dalian) Co., Ltd. (Dalian, China)

Tel: 86-411-8730-6495 E-Mail: [china.dalian@lselectric.com.cn](mailto:china.dalian@lselectric.com.cn)

#### • LS ELECTRIC (Wuxi) Co., Ltd. (Wuxi, China)

Tel: 86-510-6851-6666 E-Mail: [china.wuxi@lselectric.com.cn](mailto:china.wuxi@lselectric.com.cn)

#### • LS ELECTRIC Middle East FZE (Dubai, U.A.E.)

Tel: 971-4-886-5360 E-Mail: [middleeast@ls-electric.com](mailto:middleeast@ls-electric.com)

#### • LS ELECTRIC Europe B.V. (Hoofddorp, Netherlands)

Tel: 31-20-654-1424 E-Mail: [europartner@ls-electric.com](mailto:europartner@ls-electric.com)

#### • LS ELECTRIC America Inc. (Chicago, USA)

Tel: 1-800-891-2941 E-Mail: [sales.us@lselectricamerica.com](mailto:sales.us@lselectricamerica.com)

#### • LS ELECTRIC Turkey Co., Ltd.

Tel: 90-212-806-1225 E-Mail: [turkey@ls-electric.com](mailto:turkey@ls-electric.com)

### ■ Overseas Branches

#### • LS ELECTRIC Tokyo Office (Japan)

Tel: 81-3-6268-8241 E-Mail: [tokyo@ls-electric.com](mailto:tokyo@ls-electric.com)

#### • LS ELECTRIC Beijing Office (China)

Tel: 86-10-5095-1631 E-Mail: [china.auto@lselectric.com.cn](mailto:china.auto@lselectric.com.cn)

#### • LS ELECTRIC Shanghai Office (China)

Tel: 86-21-5237-9977 E-Mail: [china.auto@lselectric.com.cn](mailto:china.auto@lselectric.com.cn)

#### • LS ELECTRIC Guangzhou Office (China)

Tel: 86-20-3818-2883 E-Mail: [china.auto@lselectric.com.cn](mailto:china.auto@lselectric.com.cn)

#### • LS ELECTRIC Chengdu Office (China)

Tel: 86-28-8670-3201 E-Mail: [china.auto@lselectric.com.cn](mailto:china.auto@lselectric.com.cn)

#### • LS ELECTRIC Qingdao Office (China)

Tel: 86-532-8501-2065 E-Mail: [china.auto@lselectric.com.cn](mailto:china.auto@lselectric.com.cn)

#### • LS ELECTRIC Nanjing Office (China)

Tel: 86-25-8467-0005 E-Mail: [china.auto@lselectric.com.cn](mailto:china.auto@lselectric.com.cn)

#### • LS ELECTRIC Bangkok Office (Thailand)

Tel: 66-90-950-9683 E-Mail: [thailand@ls-electric.com](mailto:thailand@ls-electric.com)

#### • LS ELECTRIC Jakarta Office (Indonesia)

Tel: 62-21-2933-7614 E-Mail: [indonesia@ls-electric.com](mailto:indonesia@ls-electric.com)

#### • LS ELECTRIC Moscow Office (Russia)

Tel: 7-499-682-6130 E-Mail: [info@lselectric-ru.com](mailto:info@lselectric-ru.com)

#### • LS ELECTRIC America Western Office (Irvine, USA)

Tel: 1-949-333-3140 E-Mail: [america@ls-electric.com](mailto:america@ls-electric.com)

### Disclaimer of Liability

LS ELECTRIC has reviewed the information in this publication to ensure consistency with the hardware and software described. However, LS ELECTRIC cannot guarantee full consistency, nor be responsible for any damages or compensation, since variance cannot be precluded entirely. Please check again the version of this publication before you use the product.

© LS ELECTRIC Co., Ltd 2015 All Right Reserved.

2022.05