

The Best Choice for the Most Benefit!

We are committed to providing premium benefits to all of our customers.

AC Servo Drive

Xmotion

iX7NH Series



Safety Precautions

- Read all safety precautions before using this product.
- After reading this manual, store it in a readily accessible location for future reference.

LSELECTRIC

Introduction



Greetings! Thank you for choosing iX7NH Series product.

The user manual describes how to correctly use this product and matters for which to exercise caution.

Failure to comply with the guidelines outlined in this manual may cause personal injury or damage to the product. Be sure to read this manual carefully before using this product and follow all guidelines contained therein.

- The contents of this manual are subject to change according to software versions without notice.
- Reproduction of part or all of the contents of this manual in any form, by any means or for any purpose is strictly prohibited without the explicit written consent of our company.
- Our company retains all patents, trademarks, copyrights and other intellectual property rights to the materials in this manual. Therefore, the information contained in this manual is only intended for use with our company products, and using it for any other purposes is prohibited.

Safety precautions are categorized as either **Warning** or **Caution**, depending on the severity of the consequences.

Precautions	Descriptions
 Danger	Failure to comply with the guidelines may cause serious injury or death.
 Caution	Failure to comply with the guidelines may cause personal injury or property damage.

- Depending on the situation, ignoring a caution may also result in serious injury. So, be mindful of this.

■ Electric Safety Precautions

 Danger
<ul style="list-style-type: none"> ▪ Before wiring or inspection, turn off the power, wait 15 minutes, make sure that the charge lamp has gone off, and check the voltage. ▪ Ground both the servo drive and the servo motor faultlessly. ▪ Only qualified and trained technicians may perform wiring on this product. ▪ Install both the servo drive and the servo motor before performing any wiring. ▪ Do not operate the device with wet hands. ▪ Do not open the servo drive cover during operation. ▪ Do not operate the device with the servo drive cover removed. ▪ Even if the power is off, do not remove the servo drive cover.

■ Fire Safety Precautions

 Caution
<ul style="list-style-type: none"> ▪ Install the servo drive, the servo motor, and the regeneration brake resistor on non-combustible materials. ▪ Disconnect the input power if the servo drive malfunctions.

■ Installation Precautions

Store and operate this product under the following environmental conditions.

Environment	Conditions	
	Servo drive	Servo motor
Operating temp.	0 ~ 50 °C	0 ~ 40 °C
Storage temp.	-20 ~ 65 °C	-10 ~ 60 °C
Operating humidity	90% RH or lower (no condensation)	20 ~ 80% RH (no condensation)
Storage humidity		
Altitude	1000 m or lower	
Spacing	<ul style="list-style-type: none"> ▪ When installing 1 unit: <ul style="list-style-type: none"> • 40mm or more from the top or bottom of the control panel • 10mm or more from the left or right side of the control panel ▪ When installing 2 or more units: <ul style="list-style-type: none"> • 100mm or more from the top of the control panel • 40mm or more from the bottom of the control panel • 30mm or more from the left and right sides of the control panel • 10mm or more between units • Refer to Section 3.2.2, "Installation with the Control Panel." 	
Others	<ul style="list-style-type: none"> ▪ Ensure the installation location is free from dust, iron, corrosive gas, and combustible gas. ▪ Ensure the installation location is free from abnormal vibrations or potential for hard impacts. 	

Caution

- Make sure to install the product with the correct orientations.
- Do not drop the product or expose it to a hard impact.
- Install this product in a location that is free from water, corrosive gas, combustible gas, or flammable materials.
- Install this product in a location capable of supporting the weight of this product.
- Do not stand or place heavy objects on top of the product.
- Always maintain the specified spacing when installing the servo drive.
- Ensure that there are no conductive or flammable debris inside the servo drive or the servo motor.
- Firmly attach the servo motor to the machine.
- Make sure to install a gearbox-attached servo motor with the correct orientation.
- Do not accidentally touch the rotating unit of the servo motor during operation.
- Do not apply excessive force when connecting couplings to the servo motor shaft.
- Do not place loads on the servo motor shaft that exceed the permitted amount.

■ Wiring Precautions

Caution

- Make sure to use AC power for input power of the servo drive.
- Use a voltage source that is suitable for 110[V](AC 100~120[V]) and 200[V] (AC 200~230[V]).
- Do not connect a commercial power supply directly to the servo motor.
- Do not connect commercial power supply directly to U, V and W output terminals of the servo drive.
- Connect U, V and W output terminals of the servo drive directly to the U, V, W power input terminals of the servo motor, but do not install magnetic contactors between the wires.
- Always use pressurized terminals with insulation tubes when wiring the servo drive power terminal.
- When wiring, be sure to separate U, V and W power cables for the servo motor and the encoder cable.
- Always use the robot cable if the motor is of a moving structure.
- Before performing power wiring, turn off the input power of the servo drive and wait until the charge lamp goes off completely.
- When using single-phase main power, connect it to any two of L1, L2 and L3 terminals.
- Use the (-) terminal for connecting an external capacitor. The product may get burn damage if power supply is connected to the (-) terminal to the product. Always contact the customer center or agency when it is necessary to connect an external capacitor.

■ Startup Precautions

Caution

- Check the input voltage and power unit wiring before supplying power to the device.
- The servo must be in OFF mode when you turn on the power.
- Before supplying power, check the motor ID, encoder type and encoder pulse. After supplying power, first set and check motor ID of [0x2000], encoder type of [0x2001] and encoder pulse of [0x2002].
- After completing the above settings, set the drive mode for the servo drive connected to the upper level controller in [0x6060].
- Refer to Section 3.5 “Wiring for Input/Output Signals” to perform I/O wiring for the servo drive according to each drive mode.
- You can check the on/off status of each I/O contact point from the digital input of [0x60FD].

■ Handling and Operating Precautions

⚠ Caution

- Check and adjust each parameter before operation.
- Do not touch the rotating unit of the motor during operation.
- Do not touch the heat sink during operation.
- Be sure to attach or remove I/O, ENC connectors only when the power is off.
- Extreme changes of parameters may cause system instability.

■ Usage Precautions

⚠ Caution

- Install an emergency cut-off circuit which can immediately stop operation in an emergency.
- Reset the alarm only when the servo is off. Be warned that the system restarts immediately if the alarm is reset while the servo is on.
- Use a noise filter or DC reactor to minimize electromagnetic interference. This prevents nearby electrical devices from malfunctioning due to interference.
- Only use approved servo drive and servo motor combinations.
- The electric brake on the servo motor is for maintaining paused operation. Do not use it for ordinary braking.
- The electric brake may malfunction if the brake degrades or if the mechanical structure is improper (for example, if the ball screw and servo motor are combined via the timing belt). Install an emergency stop device to ensure mechanical safety.

■ Malfunction Precautions

⚠ Caution

- Use a servo motor with an electric brake or install a separate brake system for use if there is potential for a dangerous situation during emergencies or device malfunctions.
- If an alarm occurs, eliminate the underlying cause of the problem and ensure safety in operation. Then, deactivate the alarm and resume operation.
- Do not approach the machine until the problem is solved.

■ Repair/Inspection Precautions

Caution

- Before performing repair or inspection, turn off the power, wait at least 15 minutes, make sure that the charge lamp has gone off, and check the voltage. Enough voltage may remain in the electrolytic condenser after the power is off to cause an electric shock.
- Only authorized personnel may repair and inspect the device or replace its parts.
- Never modify this device in any way.

■ General Precautions

Caution

- This user manual is subject to change due to product modification or changes in standards. If such changes occur, we issue a new user manual with a new product number.

■ Product Application

Caution

- This product is not designed or manufactured for machines or systems intended to sustain human life.
- This product is manufactured under strict quality control conditions. Nevertheless, install safety devices if installing the product in a facility where product malfunctions may result in a major accident or a significant loss.

■ EEPROM Lifespan

Caution

- EEPROM is rewritable up to 4 million times for the purpose of recording parameter settings and other information. The servo drive may malfunction if the total number of the following tasks exceeds 4 million, due to the lifespan of the EEPROM.
 - EEPROM recording as a result of a parameter change
 - EEPROM recording as a result of an alarm

Table of Contents

1.	Product Configuration.....	1-1
1.1	Product Verification.....	1-1
1.2	Product Specifications.....	1-2
1.3	Component Names.....	1-4
1.3.1	Servo Drive Component Names	1-4
1.3.2	Servo Motor Part Names.....	1-7
1.4	Example of System Configuration	1-8
2.	Product Specifications.....	2-1
2.1	Servo Motor.....	2-1
2.1.1	Product Features.....	2-1
2.1.2	External View.....	2-17
2.1.3	Motor Types and IDs.....	2-22
2.2	Servo Drive	2-24
2.2.1	Product Features.....	2-24
2.2.2	External View.....	2-26
2.3	Options and Peripheral Devices.....	2-28
3.	Wiring and Connection	3-1
3.1	Servo Motor Installation	3-1
3.1.1	Operating Environment.....	3-1
3.1.2	Preventing Over-impact.....	3-1
3.1.3	Motor Connection.....	3-1
3.1.4	Load Device Connection	3-2
3.1.5	Cable Installation.....	3-2
3.2	Servo Drive Installation.....	3-3
3.2.1	Installation and Usage Environment.....	3-3
3.2.2	Installation with the Control Panel.....	3-4
3.3	Internal Block Diagram of the Servo Drive	3-6
3.3.1	Internal Block Diagram of the Servo Drive (100-400W / 200[V]).....	3-6

3.3.2	Drive Block Diagram (800W to 3.5kW / 200[V]).....	3-7
3.4	Power Supply Wiring.....	3-8
3.4.1	Power Supply Wiring Diagram.....	3-9
3.4.2	Power Circuit Electrical Component Standards.....	3-11
3.4.3	Power Input Sequence.....	3-16
3.4.4	Regeneration Brake Resistor Options.....	3-17
3.5	Wiring for Input/Output Signals.....	3-18
3.5.1	Names and Functions of Digital Input/Output Signals.....	3-19
3.5.2	Names and Functions of Analog Input/Output Signals.....	3-21
3.5.3	Names and Functions of Encoder Output Signals.....	3-22
3.5.4	Examples of Input/Output Signal Connection.....	3-23
3.5.5	Input/Output Signals Configuration Diagram.....	3-28
3.6	Wiring of Encoder Signal (ENCODER).....	3-29
3.6.1	Quadrature Encoder Signaling Unit Wiring.....	3-29
3.6.2	Serial Encoder Signaling Unit Wiring.....	3-31
3.6.3	Multi-Turn Encoder Signaling Unit Wiring.....	3-32
3.6.4	Tamagawa Encoder Signaling Unit Wiring.....	3-34
3.6.5	EnDat 2.2 Encoder Signaling Unit Wiring.....	3-34
3.6.6	Precautions when Making Encoder Cable.....	3-35
3.7	Wiring for Safety Function Signals (STO).....	3-36
3.7.1	Names and Functions of Safety Function Signals.....	3-36
3.7.2	Example of Connecting Safety Function Signals.....	3-37
3.7.3	Bypass Wiring of Safety Function Signals.....	3-38
3.8	Wiring for EtherCAT Communication Signals.....	3-39
3.8.1	Names and Functions of EtherCAT Communication Signals.....	3-39
3.8.2	Example of Drive Connection.....	3-40
4.	EtherCAT communication.....	4-1
4.1	Structure of CANopen over EtherCAT.....	4-1
4.1.1	EtherCAT State Machine.....	4-2
4.2	Status LED.....	4-3
4.3	Data Type.....	4-5
4.4	PDO-Mapping.....	4-5

4.5	Synchronization Using the DC (Distributed Clock)	4-8
4.6	Emergency Messages.....	4-9
5.	CiA402 Drive Profile.....	5-1
5.1	State Machine.....	5-1
5.2	Operation Modes.....	5-4
5.3	Position Control Modes.....	5-5
5.3.1	Cyclic Synchronous Position Mode	5-5
5.3.2	Profile Position Mode.....	5-8
5.4	Velocity Control Modes	5-13
5.4.1	Cyclic Synchronous Velocity Mode.....	5-13
5.4.2	Profile Velocity Mode	5-16
5.5	Torque Control Modes	5-19
5.5.1	Cyclic Synchronous Torque Mode.....	5-19
5.5.2	Profile Torque Mode.....	5-21
5.6	Homing	5-23
5.6.1	Homing Method	5-23
5.7	Touch Probe Function.....	5-37
6.	Drive Application Functions.....	6-1
6.1	Drive Front Panel	6-1
6.1.1	7-Segment for Indicating the Servo Status	6-1
6.1.2	OTG Function.....	6-4
6.2	Input/Output Signals Setting	6-6
6.2.1	Assignment of Digital Input Signals	6-6
6.2.2	Digital Output Signal Assignment	6-8
6.2.3	Assignment of Analog Output Signals.....	6-10
6.2.4	Use of User I/O	6-13
6.3	Electric Gear Setup	6-17
6.3.1	Electric Gear	6-17
6.3.2	Example of Electric Gear Setup.....	6-19

6.3.3	Calculating Velocity and Acceleration/Deceleration When Using the Electronic Gear 6-20	
6.4	Velocity Control Settings	6-22
6.4.1	Smooth Acceleration and Deceleration.....	6-22
6.4.2	Servo-lock Function.....	6-22
6.4.3	Velocity Control Signals.....	6-23
6.5	Position Control Settings	6-24
6.5.1	Position Command Filter.....	6-24
6.5.2	Position Control Signals.....	6-26
6.6	Settings Related to Torque Control	6-27
6.6.1	Speed Limit Function	6-27
6.7	Positive/Negative Limit Setting	6-28
6.8	Brake Output Signal Function Setting	6-29
6.9	Torque Limit Function	6-31
6.10	Gain Conversion Function	6-34
6.10.1	Gain Group Conversion.....	6-34
6.10.2	P/PI Control Switch.....	6-36
6.11	Motor Overload Prevention Function	6-38
6.11.1	I²T Prevention by Algorithm.....	6-38
6.11.2	Prevention by Motor Thermal Time Constant	6-39
6.12	Dynamic Brake	6-40
6.13	Regeneration Brake Resistor Configuration	6-41
6.13.1	Use of Internal Regeneration Brake Resistor	6-42
6.13.2	Use of External Regeneration Brake Resistor.....	6-44
6.13.3	Other Considerations	6-45
6.14	Drive Node Address Setting (ADDR)	6-46
6.15	Encoder Signal Output	6-46
6.16	Absolute Encoder Data Transmission (ABS_RQ)	6-47
6.17	One Parameter Mode	6-48
7.	Safety Functions	7-1

7.1	Safe Torque Off (STO) Function.....	7-1
7.2	External Device Monitor (EDM).....	7-3
7.3	Example of Using the Safety Function.....	7-4
7.4	How to Verify the Safety Function.....	7-4
7.5	Precautions for Using the Safety Function.....	7-4
8.	Tuning	8-1
8.1	Auto Gain Tuning (Offline Auto Tuning).....	8-1
8.2	Automatic Gain Adjustment (On-line Auto Tuning).....	8-2
8.3	Manual Gain Tuning	8-4
8.3.1	Gain Tuning Sequence.....	8-4
8.4	Vibration Control.....	8-5
8.4.1	Notch Filter.....	8-5
8.4.2	Adaptive Filter	8-8
8.4.3	Vibration Suppression Filter	8-10
9.	Procedure Function	9-1
9.1	Manual Jog Operation.....	9-1
9.2	Program Jog Operation.....	9-2
9.3	Deleting Alarm History.....	9-4
9.4	Automatic Gain Tuning.....	9-6
9.5	Index Pulse Search	9-6
9.6	Absolute Encoder Reset.....	9-7
9.7	Instantaneous Maximum Torque Reset.....	9-7
9.8	Phase Current Offset Tuning	9-8
9.9	Software Reset.....	9-9
9.10	Commutation.....	9-9
9.11	Encoder Reset.....	9-9

10. Object Dictionary	10-1
10.1 General Objects	10-1
10.2 Manufacturer Specific Objects.....	10-18
10.3 CiA402 Objects.....	10-99
11. Maintenance and Inspection	11-1
11.1 Maintenance and Inspection	11-1
11.1.1 Precautions.....	11-1
11.1.2 What to Inspect	11-1
11.1.3 Parts Replacement Cycle.....	11-2
11.2 Diagnosing Abnormalities and Troubleshooting	11-4
11.2.1 Servo Motor	11-4
11.2.2 Servo Drive	11-5
11.3 Overload Graph.....	11-15
11.3.1 Servo Motor	11-15
11.3.2 Servo Drive	11-19
12. Webserver Features.....	12-1
12.1 Webserver Screen Layout.....	12-2
12.2 Webserver Main Features	12-4
12.3 Example of Webserver Access.....	12-6
13. Modbus TCP.....	13-1
13.1 Overview and Communication Specifications	13-1
13.2 Status LED	13-2
13.3 Operation Modes	13-3
13.4 Basic Structure of Communication Protocol.....	13-4
13.4.1 Sending/Receiving Packet Structure	13-4
13.4.2 Protocol Command Codes	13-6
13.5 Parameter Saving & Reset	13-24

13.6	Servo Drive Communication Address Table	13-25
13.6.1	General Objects.....	13-25
13.6.2	System Configuration Parameters	13-25
13.6.3	Control Parameters	13-27
13.6.4	Input and Output Parameters	13-29
13.6.5	Velocity Operation Parameters.....	13-30
13.6.6	Miscellaneous Parameters	13-31
13.6.7	Advanced Control Parameters	13-32
13.6.8	Monitoring Parameters.....	13-33
13.6.9	Procedures and Alarm History.....	13-34
13.6.10	3rd Party Motor Parameters.....	13-35
13.6.11	CiA402 parameters	13-35
14.	Test Drive	14-1
14.1	Preparation for Operation.....	14-2
14.2	Test Drive Using TwinCAT System Manager.....	14-3
14.3	Test Drive Using LS ELECTRIC PLC (XGT + PN8B)	14-11
15.	Appendix i (Update)	15-1
15.1	Firmware Update.....	15-1
15.1.1	Use of USB OTG.....	15-1
15.1.2	Use of FoE (File access over EtherCAT).....	15-3
15.1.3	Using Drive CM.....	15-7
15.1.4	Use of Webserver	15-11
16.	Appendix ii (L7NH → iX7NH exchange).....	16-1
16.1	Precautions When Selecting Capacity.....	16-1
16.1.1	When Selecting a Product	16-1
16.1.2	Comparison Based on Servo Drive Types	16-1
16.2	I/O Pin Map Comparison	16-2
16.3	Control Details	16-3
16.3.1	Input Contact (CN1)	16-3
16.3.2	Output Contact (CN1).....	16-4
16.3.3	Analog Input Signal (CN1).....	16-5

16.3.4	Analog Output Signal (analog monitoring connector)	16-5
16.3.5	Safety Features (STO, Safety Torque Off).....	16-5
16.4	Main Parameter Setting	16-6

1. Product Configuration

1.1 Product Verification

1. Check the name plate to verify that the product received matches the model ordered.
 - Does the servo drive's name plate match?
 - Does the servo motor's name plate match?
2. Check the product components and options.
 - Are the types and lengths of cables correct?
 - Does the regeneration brake resistor conform to the required standard?
 - ◆ Is the shape of the shaft correct?
 - ◆ Are there any abnormalities after mounting the oil seal or the brake?
 - ◆ Are the gearbox and the gear ratios correct?
 - ◆ Is the encoder format correct?
3. Check the exterior of the product.
 - Are there any foreign substances or humidity in the product?
 - Is there any discoloration, contaminant, damage or disconnected wire?
 - Are the bolts tightly fastened to the joints?
 - Is there any abnormal sound or excessive friction during rotation?

1.2 Product Specifications

■ iX7NH Series Product Type

iX7 NH A 035 U AA

Series Name	Series Name		Input voltage	Capacity		Encoder		Option	
iX7series	NH	Network High-performance	A : 200[Vac]	001	100[W]	U	Universal	Blank	Standard
				002	200[W]			Marking	Exclusive
				004	400[W]				
				008	800[W]				
				010	1[kW]				
				020	2[kW]				
				035	3.5[kW]				

■ Servo Motor Product Type

APM – F E 35 D M K 1

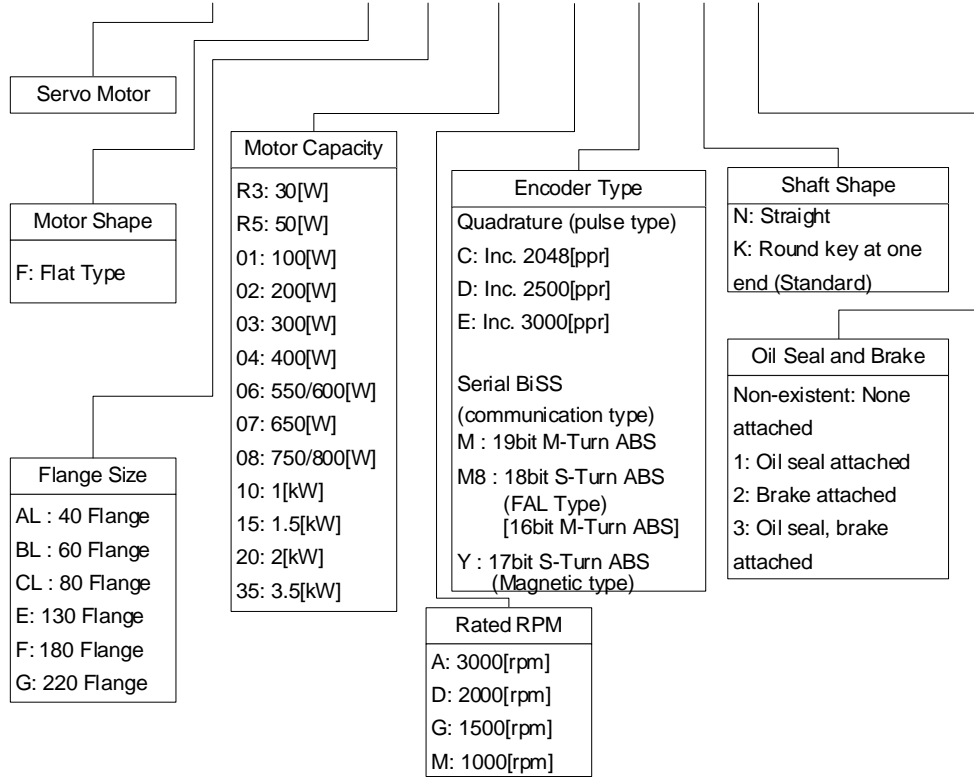

1.3 Component Names

1.3.1 Servo Drive Component Names

■ 100W, 200W, 400W

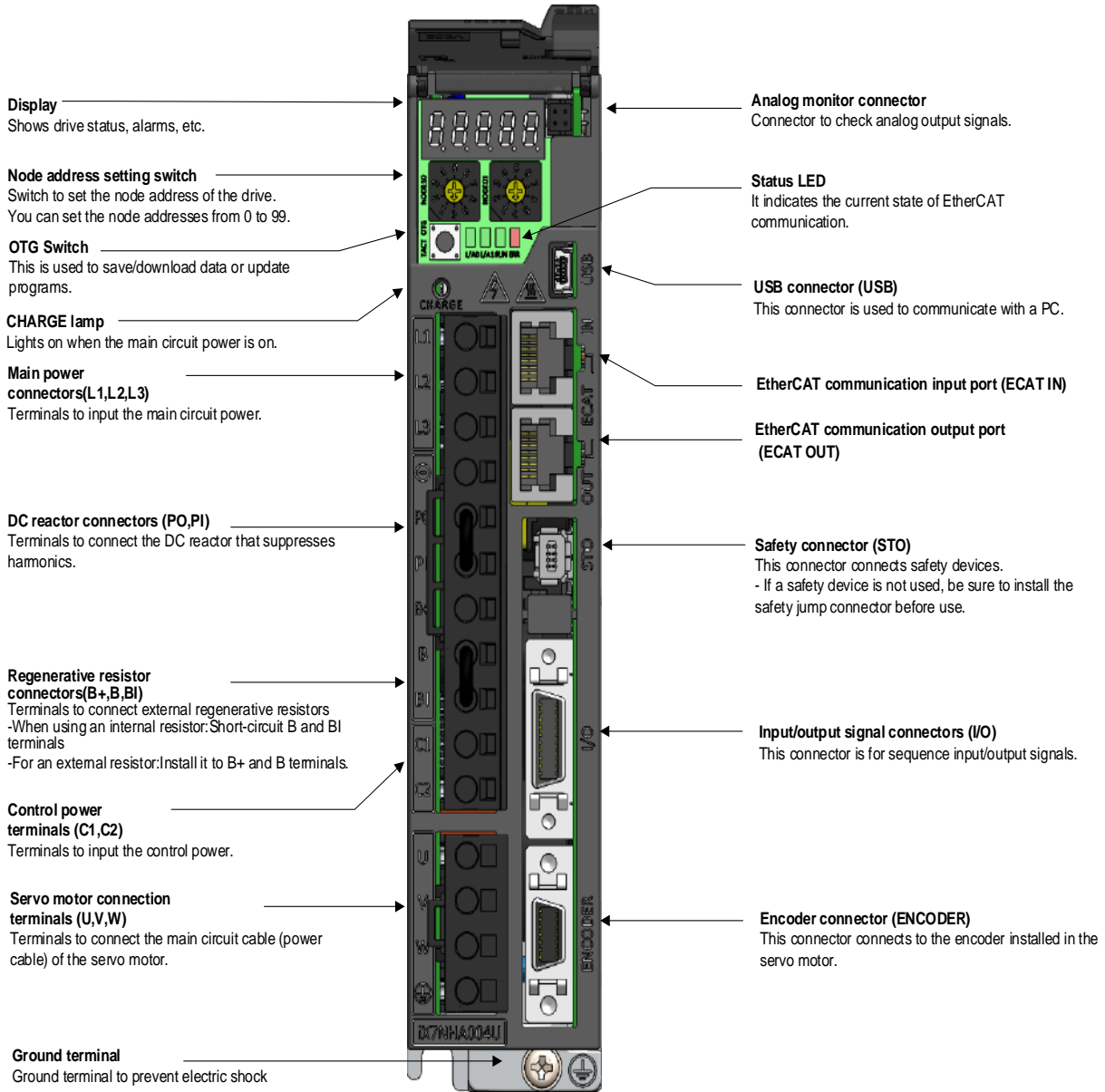

■ 750W, 1kW

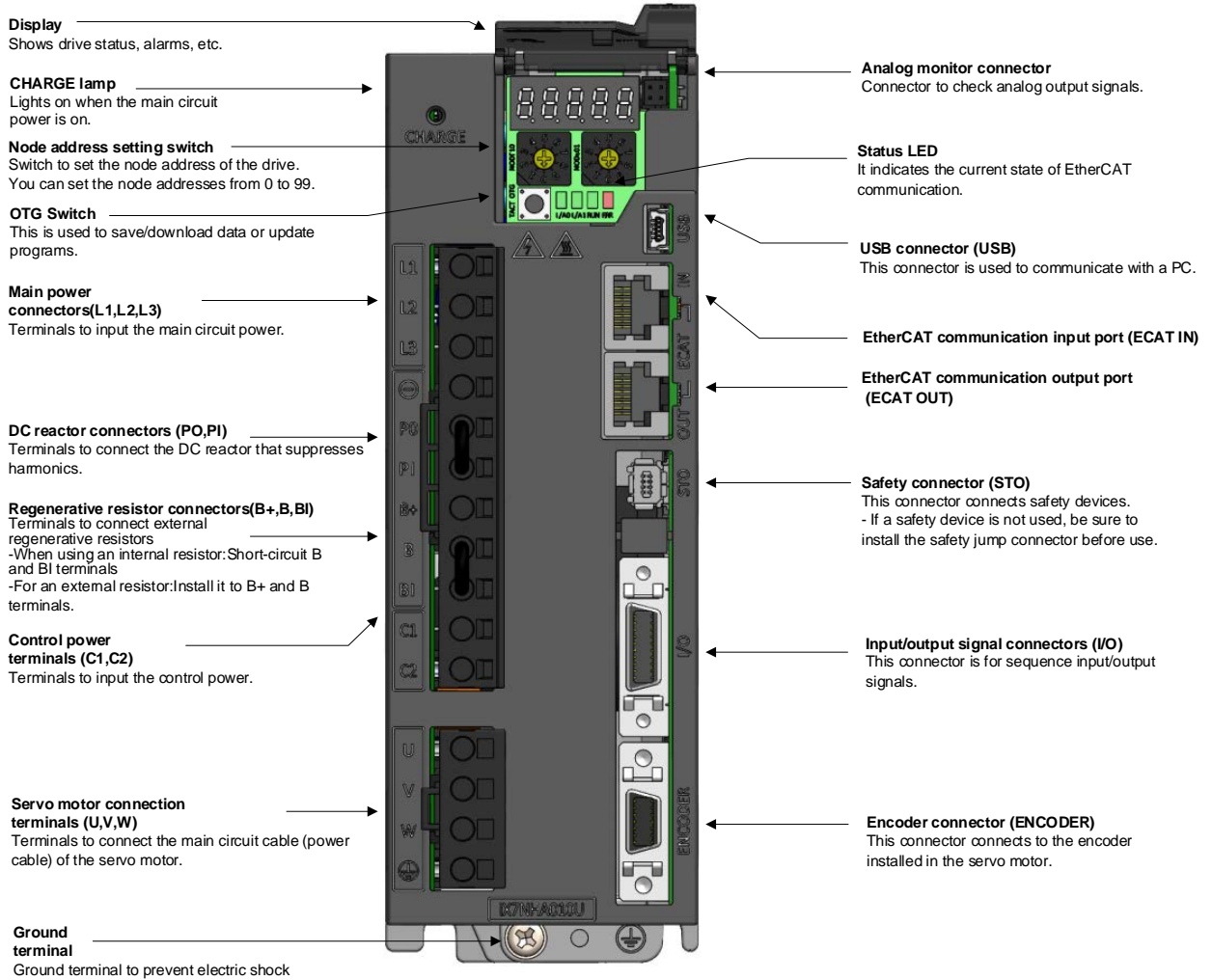

■ 2kW, 3.5kW

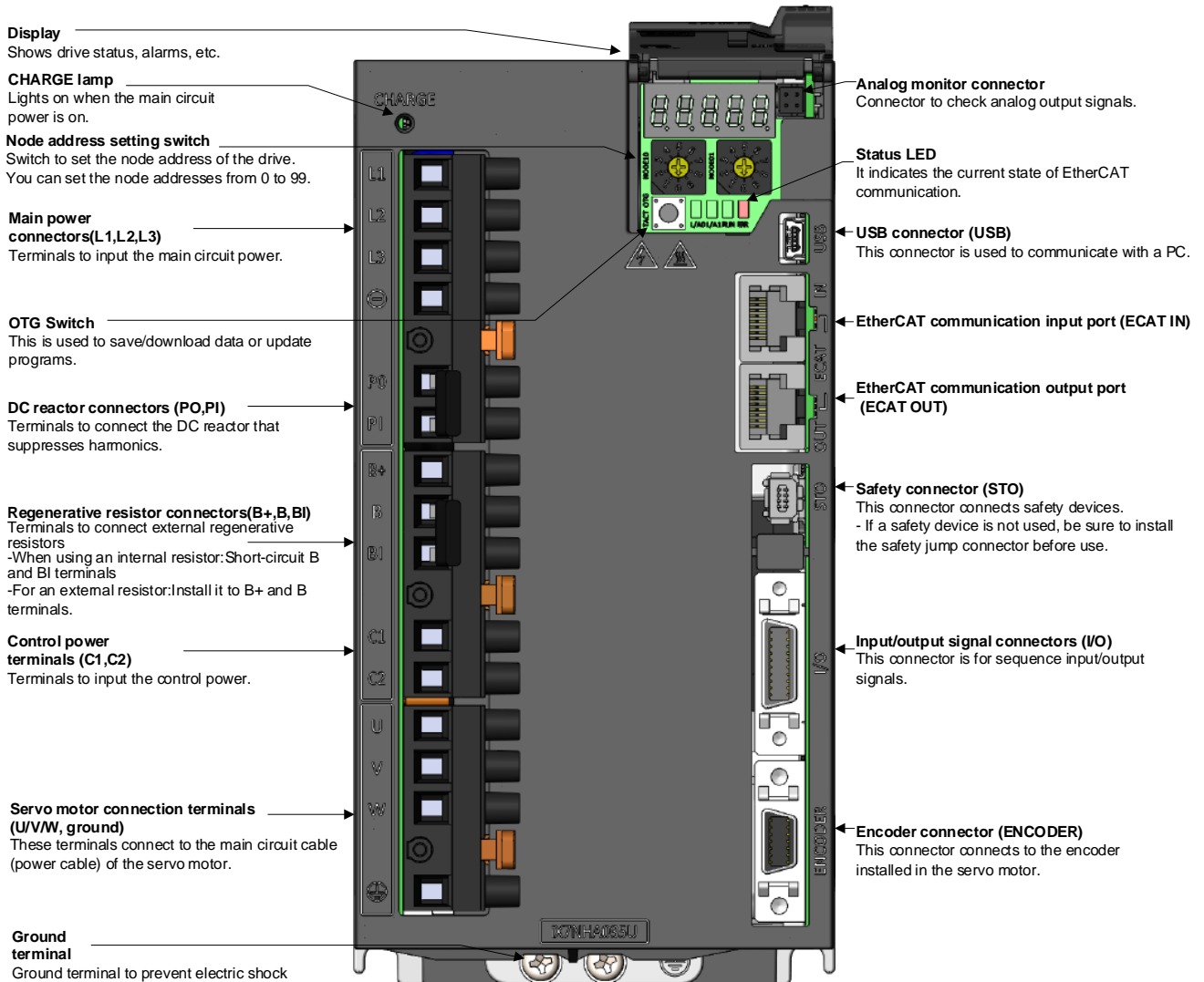

1.3.2 Servo Motor Part Names

■ 80 Flange or Lower

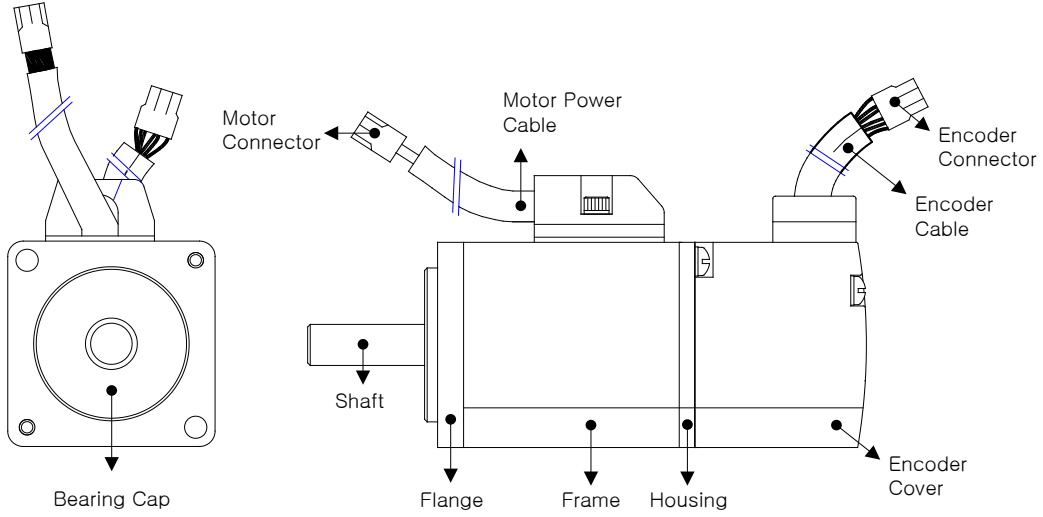

■ 130 Flange or Higher

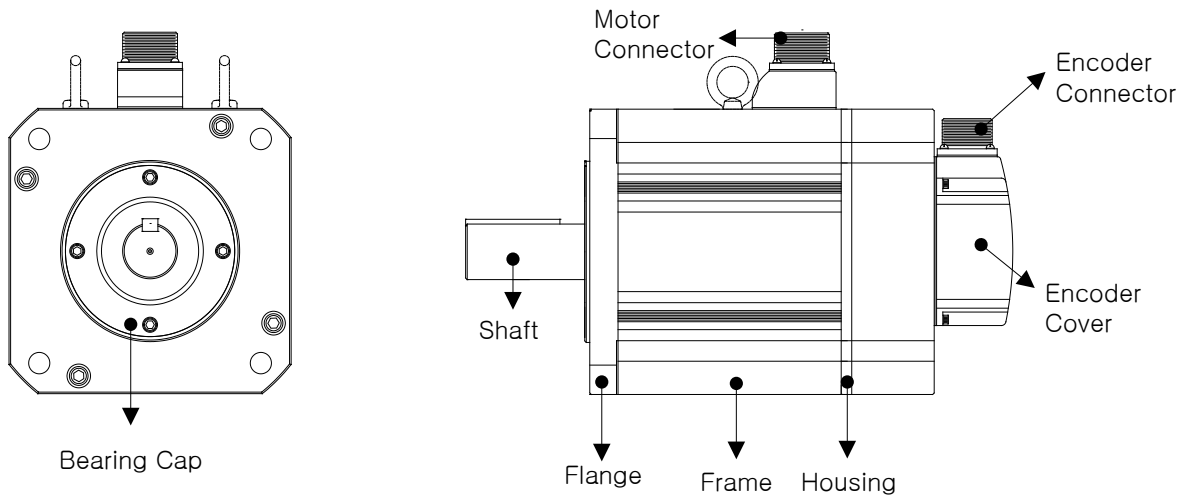

1.4 Example of System Configuration

The figure below shows an example of system configuration using this drive.

- Example of a 200V/400W drive

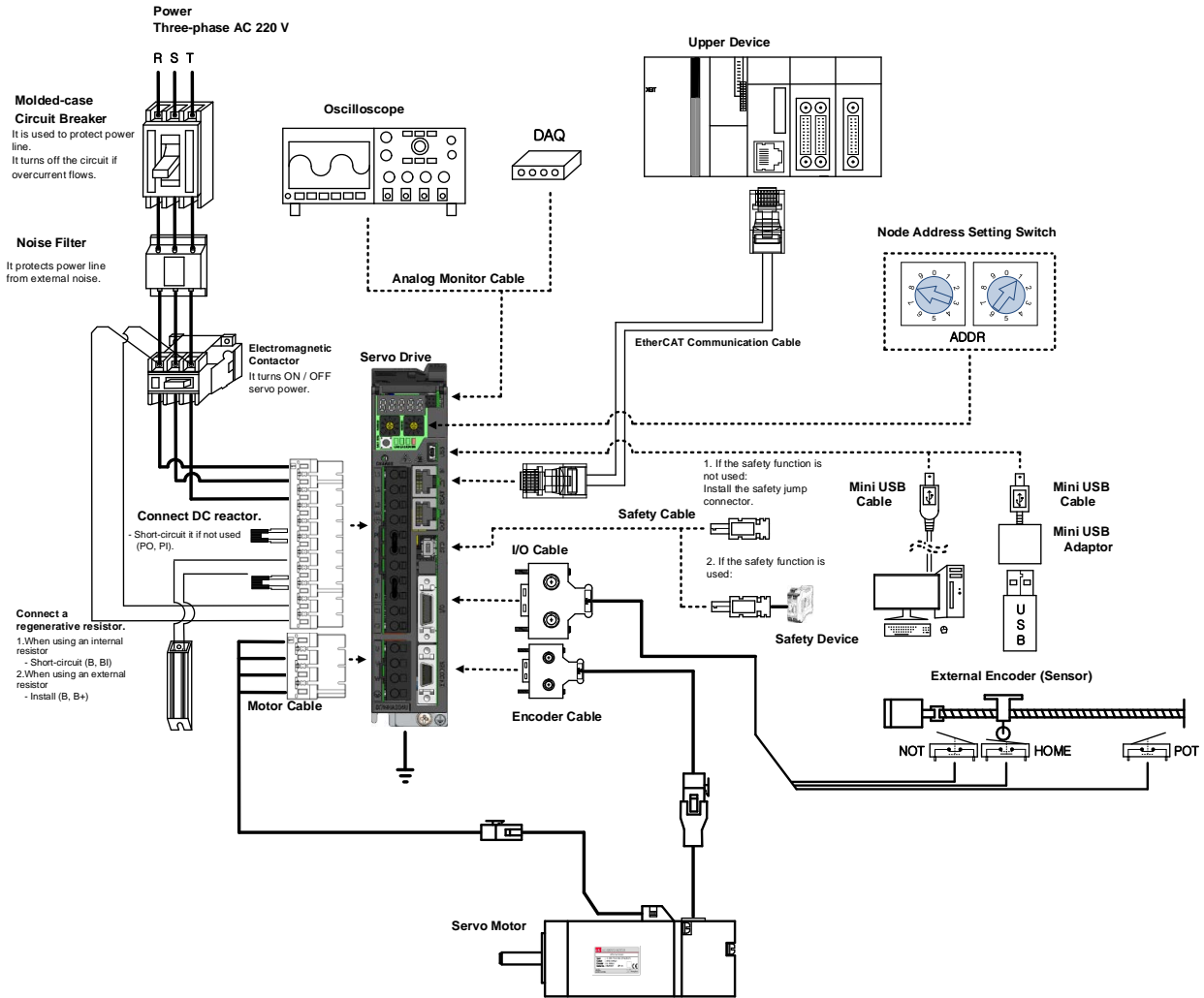

⚠ Caution

- Use the (-) terminal for connecting an external capacitor. The product may get burn damage if power supply is connected to the (-) terminal to the product. Always contact the customer center or agency when it is necessary to connect an external capacitor.
- There must be PE connection between the servo motor and the servo and between the servo and the device.

2. Product Specifications

2.1 Servo Motor

2.1.1 Product Features

■ Heat Sink Specifications

Item	Dimensions (mm)	Item
AP04	250x250x6	Aluminum
AP06	250x250x6	
AP08	250x250x12	
AP13	350x350x20	
AP18	550x550x30	
AP22	650x650x35	

- ※ The product specifications are based on the measurement data obtained after mounting the heat sink.
- ※ IP grade products do not include the shaft penetration part.
- ※ IP grade is not guaranteed for any gearbox attached.
- ※ When a cable is bent by more than the specified bending rate, it may not qualify for the specified IP grade.
- ※ Use only the dedicated heat sink cables to satisfy the specified IP grade conditions.

2. Product Specifications

■ Product Features [200V]

Servo Motor Type (APM-□□□□□)		FALR5A	FAL01A	FAL015A	FBL01A	FBL02A	FBL04A
Applicable Drive (iX7□A□□)		iX7□A001		iX7□A002	iX7□A001	iX7□A002	iX7□A004
Rated Output	[kW]	0.05	0.10	0.15	0.10	0.20	0.40
Rated Torque	[N·m]	0.16	0.32	0.48	0.32	0.64	1.27
	[kgf·cm]	1.62	3.25	4.87	3.25	6.49	12.99
Maximum Instantaneous Torque	[N·m]	0.48	0.96	1.43	0.96	1.91	3.82
	[kgf·cm]	4.87	9.74	14.62	9.74	19.48	38.96
Rated Current	[A] _{φ.ac.rms}	0.95	1.25	1.60	0.95	1.45	2.60
Peak Current	[A] _{φ.ac.rms}	2.85	3.75	4.80	2.85	4.35	7.80
Rated Rotation Velocity	[r/min]	3000					
Maximum Rotation Velocity	[r/min]	5000					
Moment of Inertia	[kg·m ² ×10 ⁻⁴]	0.023	0.042	0.063	0.091	0.147	0.248
	[gf·cm·s ²]	0.024	0.043	0.065	0.093	0.150	0.253
Permitted Load Inertia		Motor inertia x 30			Motor inertia x 20		
Rated Power Rate	[kW/s]	10.55	23.78	36.19	11.09	27.60	27.07
Velocity, Position Detector	Standard	Serial Multi-Turn Built-in Type(18bit)			Serial Multi-Turn Built-in Type(19bit)		
	Option	x					
Specifications and Features	Protection Method	Fully enclosed self-cooling IP67 (excluding shaft penetration part)					
	Time Rating	Continuous					
	Ambient Temperature	Use temperature: 0~40 [°C], maintenance temperature: -10~60 [°C]					
	Ambient Humidity	Use humidity: 80[%] RH, maintenance humidity: 90[%] RH or lower (no condensation)					
	Atmosphere	No direct sunlight or corrosive or combustible gas					
	Anti-vibration	Vibration acceleration 49 [m/s ²] (5G)					
Weight	[kg]	0.31	0.45	0.61	0.56	0.74	1.06

◆ Rotation velocity - Torque characteristics [■: 3-phase AC200V, ▨: 3-phase AC230V]

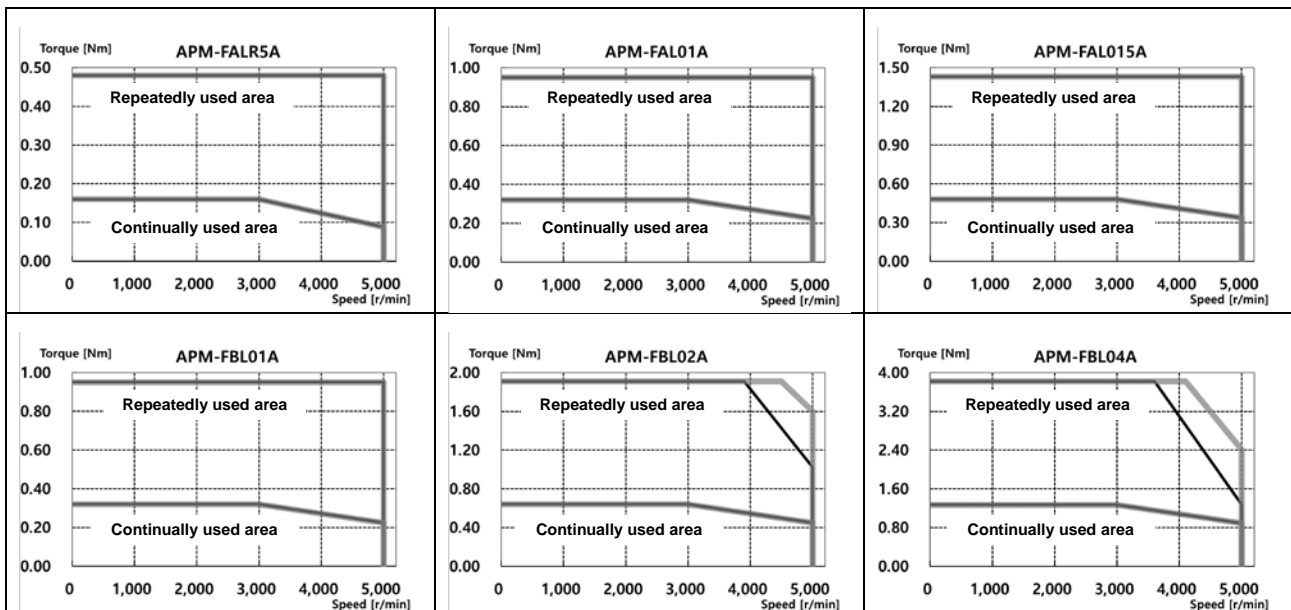

■ Product Features [200V]

Servo Motor Type (APM-□□□□□)		FCL04A	FCL06A	FCL08A	FCL10A			
Applicable Drive (iX7□A□□)		iX7□A004	iX7□A008		iX7□A010			
Rated Output	[kW]	0.40	0.60	0.75	1.00			
Rated Torque	[N·m]	1.27	1.91	2.39	3.18			
	[kgf·cm]	12.99	19.49	24.36	32.48			
Maximum Instantaneous Torque	[N·m]	3.82	5.73	7.16	9.55			
	[kgf·cm]	38.98	58.47	73.08	97.44			
Rated Current	[A] _{φ.ac.rms}	2.58	3.81	5.02	5.83			
Peak Current	[A] _{φ.ac.rms}	7.75	11.42	15.07	17.50			
Rated Rotation Velocity	[r/min]	3000						
Maximum Rotation Velocity	[r/min]	5000						
Moment of Inertia	[kg·m ² ×10 ⁻⁴]	0.530	0.897	1.264	1.632			
	[gf·cm·s ²]	0.541	0.915	1.290	1.665			
Permitted Load Inertia		Motor inertia x 15						
Rated Power Rate	[kW/s]	30.60	40.66	45.09	62.08			
Velocity, Position Detector	Standard	Serial Multi-Turn Built-in Type(19bit)						
	Option	x						
Specifications and Features	Protection Method	Fully enclosed self-cooling IP67 (excluding shaft penetration part)						
	Time Rating	Continuous						
	Ambient Temperature	Use temperature: 0~40 [°C], maintenance temperature: -10~60 [°C]						
	Ambient Humidity	Use humidity: 80[%] RH, maintenance humidity: 90[%] RH or lower (no condensation)						
	Atmosphere	No direct sunlight or corrosive or combustible gas						
	Anti-vibration	Vibration acceleration 49 [m/s ²] (5G)						
Weight	[kg]	1.52	2.14	2.68	3.30			

◆ Rotation velocity - Torque characteristics [■: 3-phase AC200V, □: 3-phase AC230V]

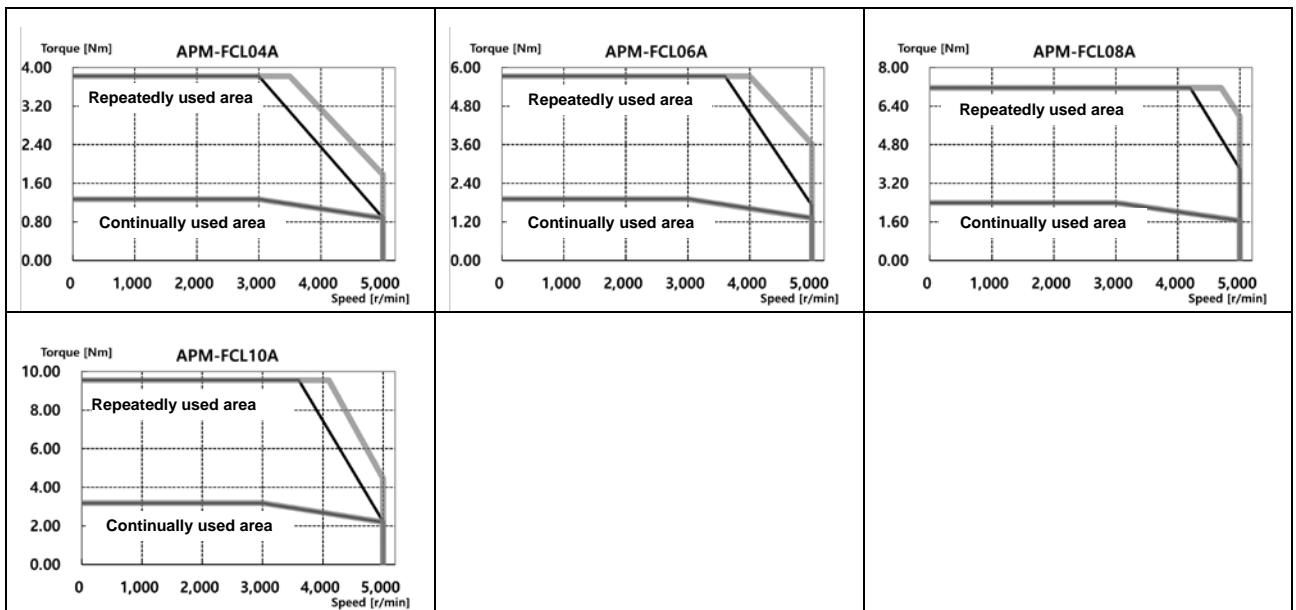

2. Product Specifications

■ Product Features [200V]

Servo Motor Type (APM-□□□□□)		FCL03D	FCL05D	FCL06D	FCL07D			
Applicable Drive (iX7□A□□)		iX7□A004	iX7□A008					
Rated Output	[kW]	0.30	0.45	0.55	0.65			
Rated Torque	[N·m]	1.43	2.15	2.63	3.10			
	[kgf·cm]	14.62	21.92	26.80	31.67			
Maximum Instantaneous Torque	[N·m]	4.30	6.45	7.88	9.31			
	[kgf·cm]	43.85	65.77	80.39	95.01			
Rated Current	[A] _{φ.ac.rms}	2.50	3.05	3.06	3.83			
Peak Current	[A] _{φ.ac.rms}	7.51	9.16	9.18	11.50			
Rated Rotation Velocity	[r/min]	2000						
Maximum Rotation Velocity	[r/min]	3000						
Moment of Inertia	[kg·m ² ×10 ⁻⁴]	0.530	0.897	1.264	1.63			
	[gf·cm·s ²]	0.541	0.915	1.290	1.66			
Permitted Load Inertia		Motor inertia x 15						
Rated Power Rate	[kW/s]	38.73	51.47	54.56	59.03			
Velocity, Position Detector	Standard	Serial Multi-Turn Built-in Type(19bit)						
	Option	x						
Specifications and Features	Protection Method	Fully enclosed self-cooling IP67 (excluding shaft penetration part)						
	Time Rating	Continuous						
	Ambient Temperature	Use temperature: 0~40 [°C], maintenance temperature: -10~60 [°C]						
	Ambient Humidity	Use humidity: 80[%] RH, maintenance humidity: 90[%] RH or lower (no condensation)						
	Atmosphere	No direct sunlight or corrosive or combustible gas						
	Anti-vibration	Vibration acceleration 49 [m/s ²] (5G)						
Weight	[kg]	1.26	2.12	2.66	2.78			

◆ Rotation velocity - Torque characteristics [■: 3-phase AC200V, □: 3-phase AC230V]

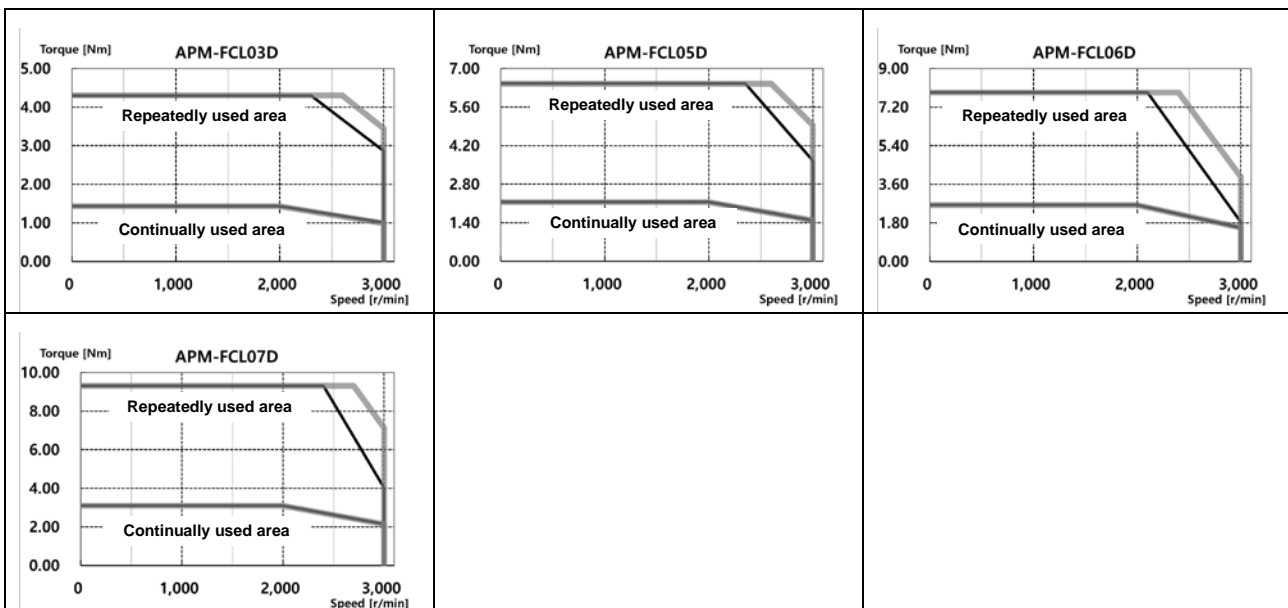

■ Product Features [200V]

Servo Motor Type (APM-□□□□□)		HB01A	HB02A	HB04A	HE09A	HE15A	HE30A
Applicable Drive (iX7□A□□)		iX7□A002		iX7□A004	iX7□A008	iX7□A020	iX7□A035
Rated Output	[kW]	0.1	0.2	0.4	0.9	1.5	3
Rated Torque	[N·m]	0.32	0.64	1.27	2.86	4.77	9.55
	[kgf·cm]	3.25	6.50	12.99	29.23	48.72	97.44
Maximum Instantaneous Torque	[N·m]	0.95	1.91	3.82	8.59	14.32	28.65
	[kgf·cm]	9.74	19.49	38.97	87.69	146.15	292.33
Rated Current	A	1.65	1.63	2.89	4.95	8.23	16.30
Peak Current	A	4.95	4.89	8.67	14.85	24.69	51.48
Rated Rotation Velocity	[r/min]	3000					
Maximum Rotation Velocity	[r/min]	3500					
Moment of Inertia	[kg·m ² ×10 ⁻⁴]	0.27	0.33	0.46	19.56	22.27	31.81
	[gf·cm·s ²]	0.27	0.34	0.47	19.96	22.72	32.46
Permitted Load Inertia		Motor inertia x 20			Motor inertia x 10		
Rated Power Rate	[kW/s]	3.34	11.98	34.47	4.10	10.01	22.03
Velocity, Position Detector	Standard	Quadrature type incremental 1024P/R			Quadrature Type Incremental 2048P/R		
	Option	X					
Specifications and Features	Protection Method	Fully enclosed self-cooling IP55 (excluding shaft penetration part)					
	Time Rating	Continuous					
	Ambient Temperature	Operating temperature: 0 - 40°C, Storage temperature: -10 - 60°C					
	Ambient Humidity	Use humidity: 80[%] RH, maintenance humidity: 90[%] RH or lower (no condensation)					
	Atmosphere	No direct sunlight, corrosive gas, or combustible gas					
	Anti-vibration	Vibration acceleration 49 [m/s ²] (5G)					
Weight	[kg]	0.9	1.2	1.7	5.8	7.4	10.83

◆ Rotation velocity - Torque characteristics [■: 3-phase AC200V, ▨: 3-phase AC230V]

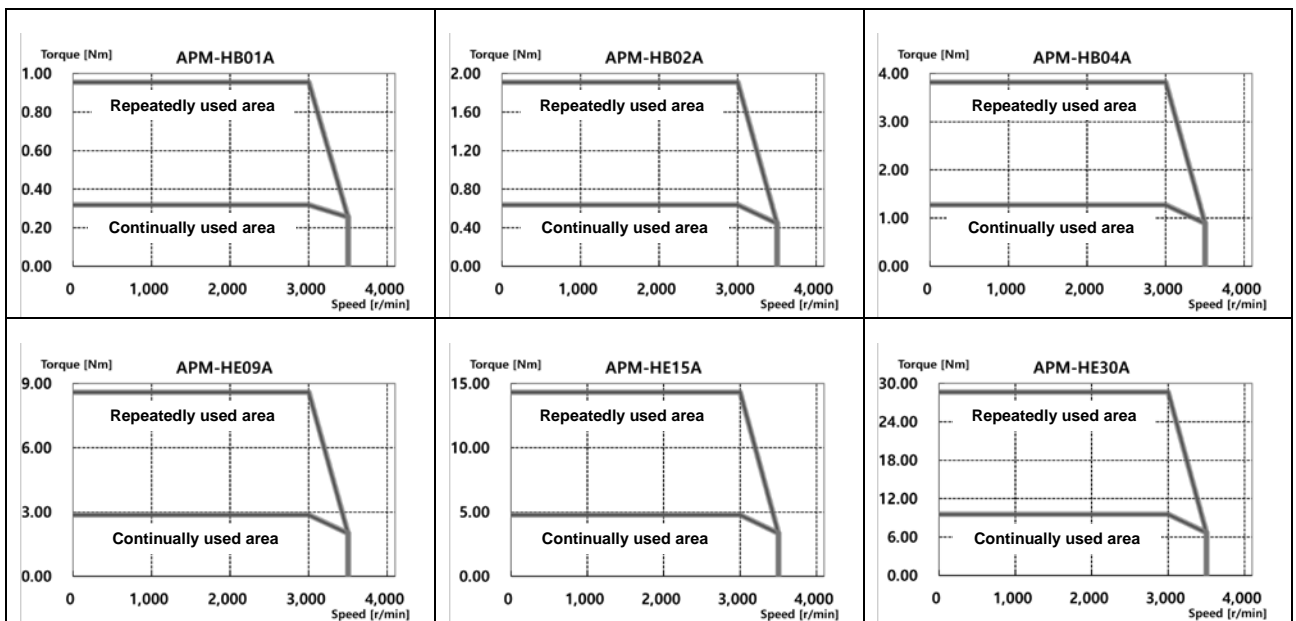

2. Product Specifications

■ Product Features [200V]

Servo Motor Type (APM-□□□□□)		FE09A	FE15A	FE22A	FE30A			
Applicable Drive (iX7□A□□)		iX7□A010	iX7□A020		iX7□A035			
Rated Output	[kW]	0.9	1.5	2.2	3.0			
Rated Torque	[N·m]	2.87	4.78	7.00	9.55			
	[kgf·cm]	29.20	48.70	71.50	97.40			
Maximum Instantaneous Torque	[N·m]	8.59	14.32	21.01	28.65			
	[kgf·cm]	87.70	146.10	214.40	292.30			
Rated Current	A	6.45	9.15	13.24	16.09			
Peak Current	A	19.35	27.45	39.72	48.27			
Rated Rotation Velocity	[r/min]	3000						
Maximum Rotation Velocity	[r/min]	5000						
Moment of Inertia	[kg·m ² ×10 ⁻⁴]	5.66	10.18	14.62	19.04			
	[gf·cm·s ²]	5.77	10.39	14.92	19.43			
Permitted Load Inertia		Motor inertia x 10						
Rated Power Rate	[kW/s]	14.47	22.38	33.59	47.85			
Velocity, Position Detector	Standard	Serial type 19-bit						
	Option	X						
Specifications and Features	Protection Method	Fully enclosed self-cooling IP65 (excluding shaft penetration part)						
	Time Rating	Continuous						
	Ambient Temperature	Operating temperature: 0 - 40°C, Storage temperature: -10 - 60°C						
	Ambient Humidity	Use humidity: 80[%] RH, maintenance humidity: 90[%] RH or lower (no condensation)						
	Atmosphere	No direct sunlight, corrosive gas, or combustible gas						
	Anti-vibration	Vibration acceleration 49 [m/s ²] (5G)						
Weight	[kg]	5.0	6.7	8.5	10.1			

◆ Rotation velocity - Torque characteristics [■: 3-phase AC200V, ▨: 3-phase AC230V]

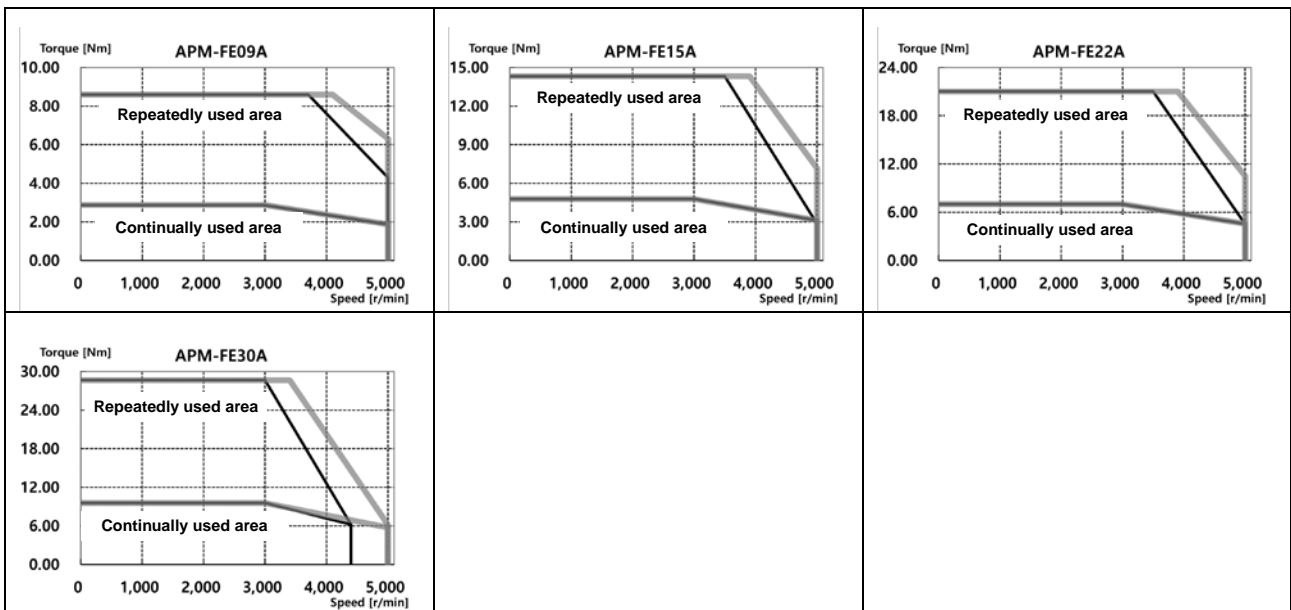

■ Product Features [200V]

Servo Motor Type (APM-□□□□□)		FE06D	FE11D	FE16D	FE22D			
Applicable Drive (iX7□A□□)		iX7□A008	iX7□A010	iX7□A020				
Rated Output	[kW]	0.6	1.1	1.6	2.2			
Rated Torque	[N·m]	2.86	5.25	7.63	10.50			
	[kgf·cm]	29.22	53.57	77.92	107.14			
Maximum Instantaneous Torque	[N·m]	8.59	15.75	22.92	31.51			
	[kgf·cm]	87.66	160.71	233.76	321.42			
Rated Current	A	4.56	6.47	10.98	12.97			
Peak Current	A	13.68	19.41	32.94	38.91			
Rated Rotation Velocity	[r/min]	2000						
Maximum Rotation Velocity	[r/min]	3000						
Moment of Inertia	[kg·m ² ×10 ⁻⁴]	5.66	10.18	14.62	19.04			
	[gf·cm·s ²]	5.77	10.39	14.92	19.43			
Permitted Load Inertia		Motor inertia x 10						
Rated Power Rate	[kW/s]	14.49	27.08	39.89	57.90			
Velocity, Position Detector	Standard	Serial type 19-bit						
	Option	X						
Specifications and Features	Protection Method	Fully enclosed self-cooling IP65 (excluding shaft penetration part)						
	Time Rating	Continuous						
	Ambient Temperature	Operating temperature: 0 - 40°C, Storage temperature: -10 - 60°C						
	Ambient Humidity	Use humidity: 80[%] RH, maintenance humidity: 90[%] RH or lower (no condensation)						
	Atmosphere	No direct sunlight, corrosive gas, or combustible gas						
	Anti-vibration	Vibration acceleration 49 [m/s ²] (5G)						
Weight	[kg]	5.0	6.7	8.5	10.1			

◆ Rotation velocity - Torque characteristics [■: 3-phase AC200V, □: 3-phase AC230V]

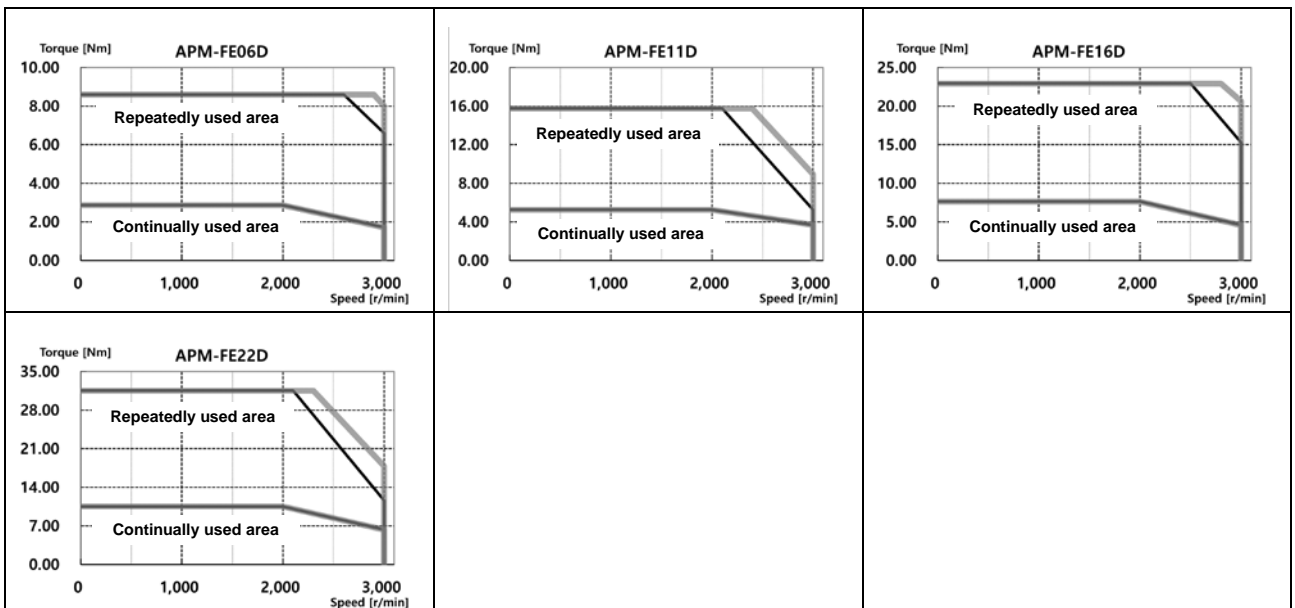

2. Product Specifications

■ Product Features [200V]

Servo Motor Type (APM-□□□□□)		FE05G	FE09G	FE13G	FE17G		
Applicable Drive (iX7□A□□)		iX7□A008	iX7□A010	iX7□A020			
Rated Output	[kW]	0.45	0.85	1.3	1.7		
Rated Torque	[N·m]	2.86	5.41	8.27	10.82		
	[kgf·cm]	29.22	55.19	84.41	110.38		
Maximum Instantaneous Torque	[N·m]	8.59	16.23	24.82	32.46		
	[kgf·cm]	87.66	165.57	253.23	331.14		
Rated Current	A	4.56	6.67	11.90	13.36		
Peak Current	A	13.68	20.01	35.7	40.08		
Rated Rotation Velocity	[r/min]	1500					
Maximum Rotation Velocity	[r/min]	3000					
Moment of Inertia	[kg·m ² ×10 ⁻⁴]	5.66	10.18	14.62	19.04		
	[gf·cm·s ²]	5.77	10.39	14.92	19.43		
Permitted Load Inertia		Motor inertia x 10					
Rated Power Rate	[kW/s]	14.49	28.74	46.81	61.46		
Velocity, Position Detector	Standard	Serial type 19-bit					
	Option	X					
Specifications and Features	Protection Method	Fully enclosed self-cooling IP65 (excluding shaft penetration part)					
	Time Rating	Continuous					
	Ambient Temperature	Operating temperature: 0 - 40°C, Storage temperature: -10 - 60°C					
	Ambient Humidity	Use humidity: 80[%] RH, maintenance humidity: 90[%] RH or lower (no condensation)					
	Atmosphere	No direct sunlight, corrosive gas, or combustible gas					
	Anti-vibration	Vibration acceleration 49 [m/s ²] (5G)					
Weight	[kg]	5.0	6.7	8.5	10.1		

◆ Rotation velocity - Torque characteristics [■: 3-phase AC200V, ▨: 3-phase AC230V]

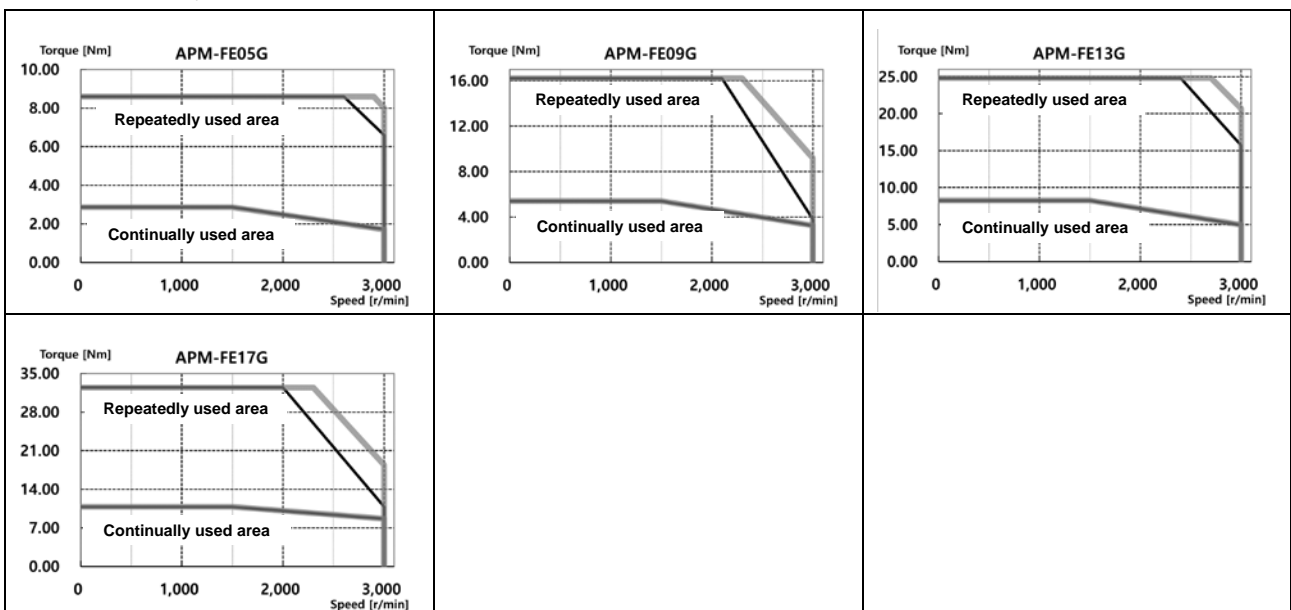

■ Product Features [200V]

Servo Motor Type (APM-□□□□□)		FE03M	FE06M	FE09M	FE12M			
Applicable Drive (iX7□A□□)		iX7□A004	iX7□A008	iX7□A010	iX7□A020			
Rated Output	[kW]	0.3	0.6	0.9	1.2			
Rated Torque	[N·m]	2.86	5.72	8.59	11.46			
	[kgf·cm]	29.22	58.4	87.7	116.9			
Maximum Instantaneous Torque	[N·m]	8.59	17.18	25.77	34.22			
	[kgf·cm]	87.66	175.3	262.9	349.1			
Rated Current	A	2.73	4.56	6.18	10.67			
Peak Current	A	8.19	13.68	18.54	32.01			
Rated Rotation Velocity	[r/min]	1000						
Maximum Rotation Velocity	[r/min]	2000						
Moment of Inertia	[kg·m ² ×10 ⁻⁴]	5.66	10.18	14.62	19.04			
	[gf·cm·s ²]	5.77	10.39	14.92	19.43			
Permitted Load Inertia		Motor inertia x 10						
Rated Power Rate	[kW/s]	14.49	32.22	50.48	68.91			
Velocity, Position Detector	Standard	Serial type 19-bit						
	Option	X						
Specifications and Features	Protection Method	Fully enclosed self-cooling IP65 (excluding shaft penetration part)						
	Time Rating	Continuous						
	Ambient Temperature	Operating temperature: 0 - 40°C, Storage temperature: -10 - 60°C						
	Ambient Humidity	Use humidity: 80[%] RH, maintenance humidity: 90[%] RH or lower (no condensation)						
	Atmosphere	No direct sunlight, corrosive gas, or combustible gas						
	Anti-vibration	Vibration acceleration 49 [m/s ²] (5G)						
Weight	[kg]	5.0	6.7	8.5	10.1			

◆ Rotation velocity - Torque characteristics [■: 3-phase AC200V, □: 3-phase AC230V]

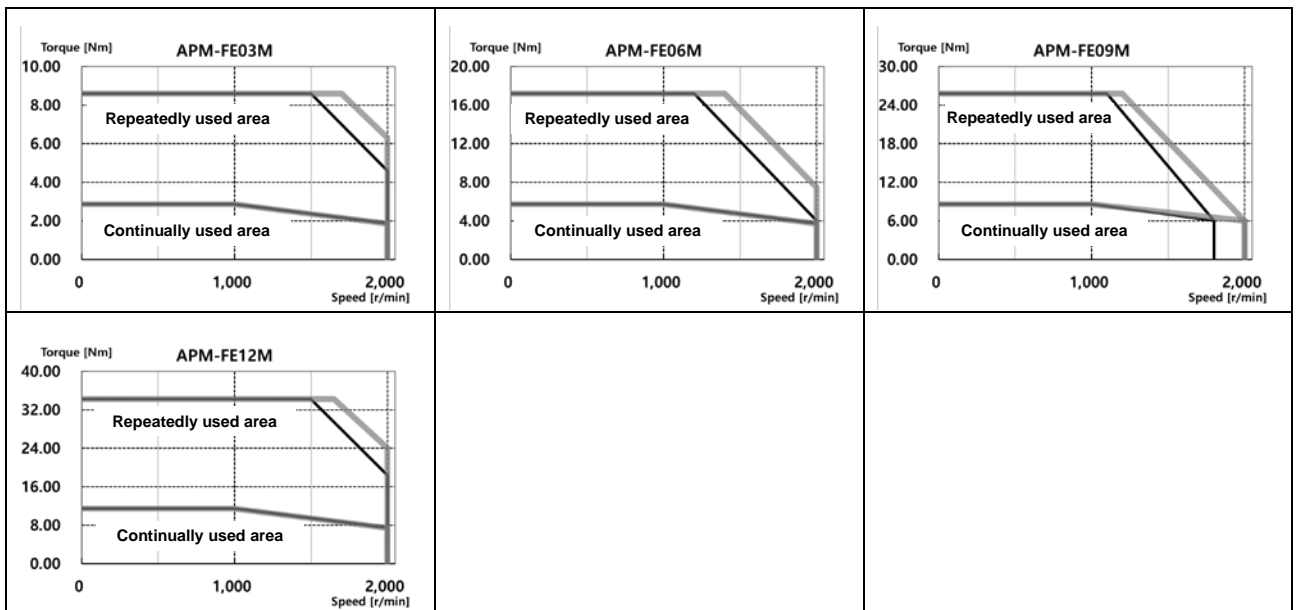

2. Product Specifications

■ Product Features [200V]

Servo Motor Type (APM-□□□□□)		FF30A	FF22D	FF35D				
Applicable Drive (iX7□A□□)		iX7□A035	iX7□A020	iX7□A035				
Rated Output	[kW]	3.0	2.2	3.5				
	[N·m]	9.55	10.50	16.70				
Rated Torque	[kgf·cm]	97.40	107.14	170.40				
	[N·m]	28.65	31.50	50.10				
Maximum Instantaneous Torque	[kgf·cm]	292.30	321.30	511.35				
	[N·m]	15.26	12.76	16.48				
Rated Current	A	45.78	38.28	49.44				
Peak Current	A							
Rated Rotation Velocity	[r/min]	3000	2000					
Maximum Rotation Velocity	[r/min]	5000	3000					
Moment of Inertia	[kg·m ² ×10 ⁻⁴]	27.96	27.96	46.56				
	[gf·cm·s ²]	28.53	28.53	47.51				
Permitted Load Inertia		Motor inertia x 5						
Rated Power Rate	[kW/s]	32.59	39.43	59.89				
Velocity, Position Detector	Standard	Serial type 19-bit						
	Option	X						
Specifications and Features	Protection Method	Fully enclosed self-cooling IP65 (excluding shaft penetration part)						
	Time Rating	Continuous						
	Ambient Temperature	Operating temperature: 0 - 40°C, Storage temperature: -10 - 60°C						
	Ambient Humidity	Use humidity: 80[%] RH, maintenance humidity: 90[%] RH or lower (no condensation)						
	Atmosphere	No direct sunlight, corrosive gas, or combustible gas						
	Anti-vibration	Vibration acceleration 49 [m/s ²] (5G)						
Weight	[kg]	12.5	12.5	17.4				

◆ Rotation velocity - Torque characteristics [■: 3-phase AC200V, ▨: 3-phase AC230V]

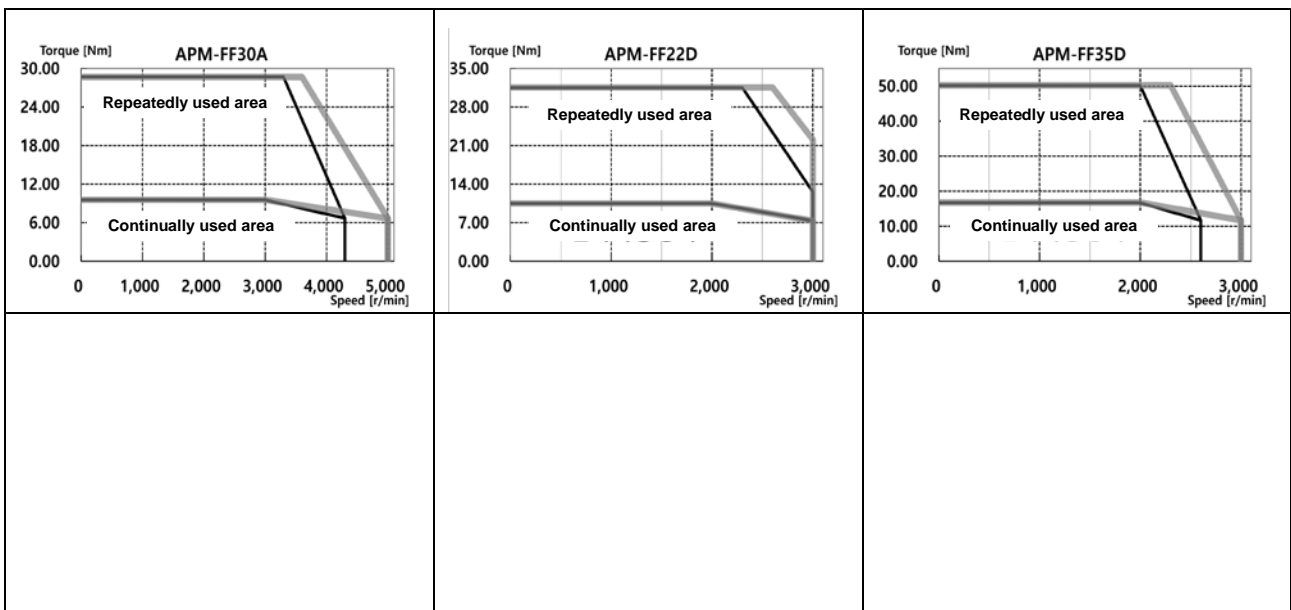

■ Product Features [200V]

Servo Motor Type (APM-□□□□□)		FF20G	FF30G			
Applicable Drive (iX7□A□□)		iX7□A020	iX7□A035			
Rated Output	[kW]	1.8	2.9			
Rated Torque	[N·m]	11.45	18.46			
	[kgf·cm]	116.88	188.30			
Maximum Instantaneous Torque	[N·m]	34.35	55.38			
	[kgf·cm]	350.64	564.90			
Rated Current	A	12.16	15.98			
Peak Current	A	36.48	47.94			
Rated Rotation Velocity	[r/min]	1500				
Maximum Rotation Velocity	[r/min]	3000	2700			
Moment of Inertia	[kg·m ² ×10 ⁻⁴]	27.96	46.56			
	[gf·cm·s ²]	28.53	47.51			
Permitted Load Inertia		Motor inertia x 5				
Rated Power Rate	[kW/s]	46.92	73.14			
Velocity, Position Detector	Standard	Serial type 19-bit				
	Option	X				
Specifications and Features	Protection Method	Fully enclosed self-cooling IP65 (excluding shaft penetration part)				
	Time Rating	Continuous				
	Ambient Temperature	Operating temperature: 0 - 40°C, Storage temperature: -10 - 60°C				
	Ambient Humidity	Use humidity: 80[%] RH, maintenance humidity: 90[%] RH or lower (no condensation)				
	Atmosphere	No direct sunlight, corrosive gas, or combustible gas				
	Anti-vibration	Vibration acceleration 49 [m/s ²] (5G)				
Weight	[kg]	12.5	17.4			

◆ Rotation velocity - Torque characteristics [■: 3-phase AC200V, ▨: 3-phase AC230V]

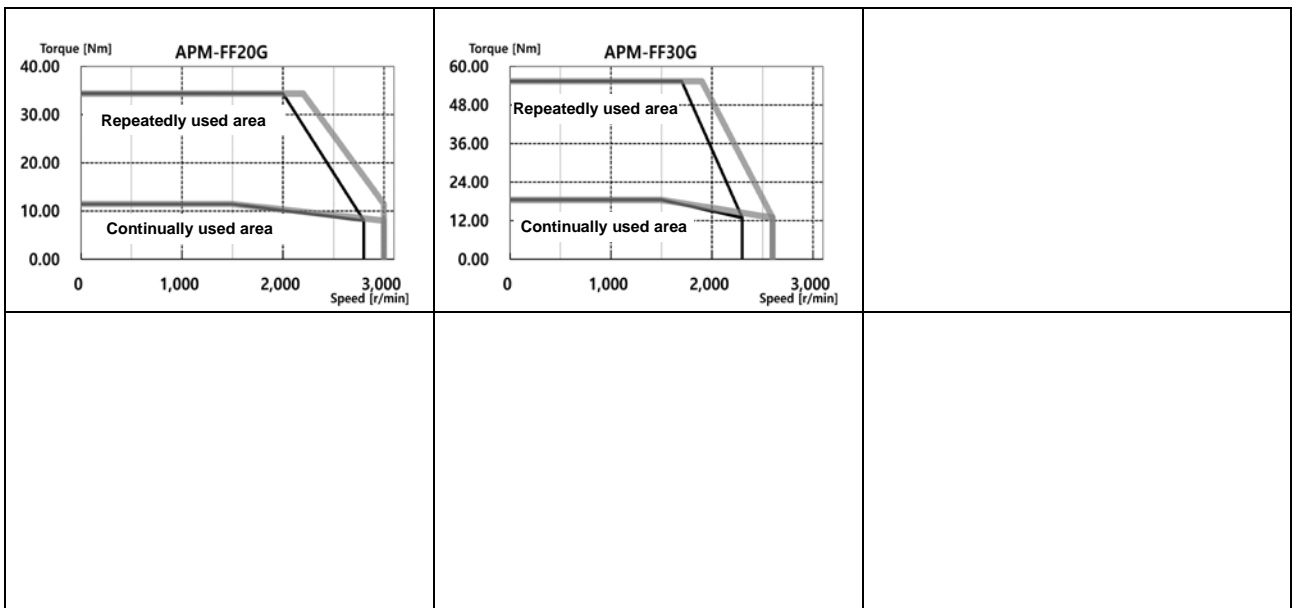

2. Product Specifications

■ Product Features [200V]

Servo Motor Type (APM-□□□□□)		FF12M	FF20M	FF30M			
Applicable Drive (iX7□A□□)		iX7□A020		iX7□A035			
Rated Output	[kW]	1.2	2.0	3.0			
Rated Torque	[N·m]	11.46	19.09	28.64			
	[kgf·cm]	116.90	194.80	292.20			
Maximum Instantaneous Torque	[N·m]	34.38	57.29	85.94			
	[kgf·cm]	350.70	584.40	876.60			
Rated Current	A	11.01	12.96	16.58			
Peak Current	A	33.03	38.88	49.74			
Rated Rotation Velocity	[r/min]	1000					
Maximum Rotation Velocity	[r/min]	2000		1700			
Moment of Inertia	[kg·m ² ×10 ⁻⁴]	27.96	46.56	73.85			
	[gf·cm·s ²]	28.53	47.51	75.36			
Permitted Load Inertia		Motor inertia x 5					
Rated Power Rate	[kW/s]	46.94	78.27	111.04			
Velocity, Position Detector	Standard	Serial type 19-bit					
	Option	X					
Specifications and Features	Protection Method	Fully enclosed self-cooling IP65 (excluding shaft penetration part)					
	Time Rating	Continuous					
	Ambient Temperature	Operating temperature: 0 - 40°C, Storage temperature: -10 - 60°C					
	Ambient Humidity	Use humidity: 80[%] RH, maintenance humidity: 90[%] RH or lower (no condensation)					
	Atmosphere	No direct sunlight, corrosive gas, or combustible gas					
	Anti-vibration	Vibration acceleration 49 [m/s ²] (5G)					
Weight	[kg]	12.5	17.4	25.2			

◆ Rotation velocity - Torque characteristics [■: 3-phase AC200V, ▣: 3-phase AC230V]

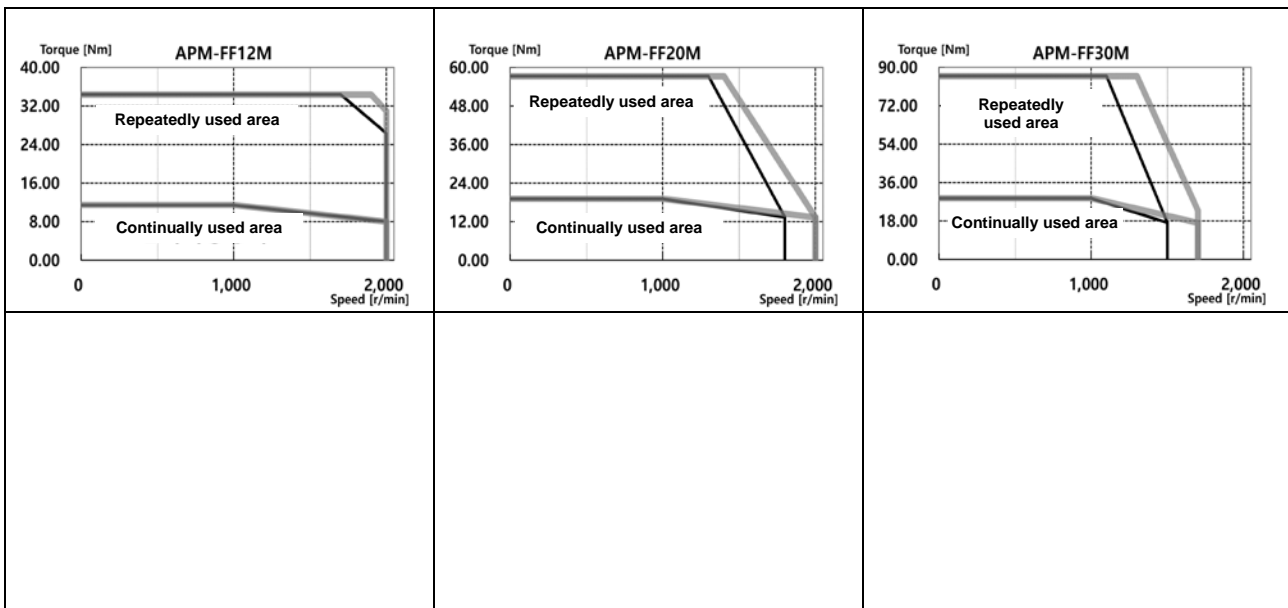

■ Product Features [200V]

Servo Motor Type (APM-□□□□□)		FG22D	FG35D				
Applicable Drive (iX7□A□□)		iX7□A020	iX7□A035				
Rated Output	[kW]	2.2	3.5				
Rated Torque	[N·m]	10.50	16.71				
	[kgf·cm]	107.10	170.40				
Maximum Instantaneous Torque	[N·m]	31.51	50.12				
	[kgf·cm]	321.30	511.30				
Rated Current	A	10.25	14.67				
Peak Current	A	30.75	44.01				
Rated Rotation Velocity	[r/min]	2000					
Maximum Rotation Velocity	[r/min]	3000	2700				
Moment of Inertia	[kg·m ² ×10 ⁻⁴]	41.13	71.53				
	[gf·cm·s ²]	41.97	72.99				
Permitted Load Inertia		Motor inertia x 5					
Rated Power Rate	[kW/s]	26.78	38.99				
Velocity, Position Detector	Standard	Serial type 19-bit					
	Option	Quadrature type incremental 3000 [P/R]					
Specifications and Features	Protection Method	Fully enclosed self-cooling IP65 (excluding shaft penetration part)					
	Time Rating	Continuous					
	Ambient Temperature	Operating temperature: 0 - 40°C, Storage temperature: -10 - 60°C					
	Ambient Humidity	Use humidity: 80[%] RH, maintenance humidity: 90[%] RH or lower (no condensation)					
	Atmosphere	No direct sunlight, corrosive gas, or combustible gas					
	Anti-vibration	Vibration acceleration 49 [m/s ²] (5G)					
Weight	[kg]	15.4	20.2				

◆ Rotation velocity - Torque characteristics [■: 3-phase AC200V, □: 3-phase AC230V]

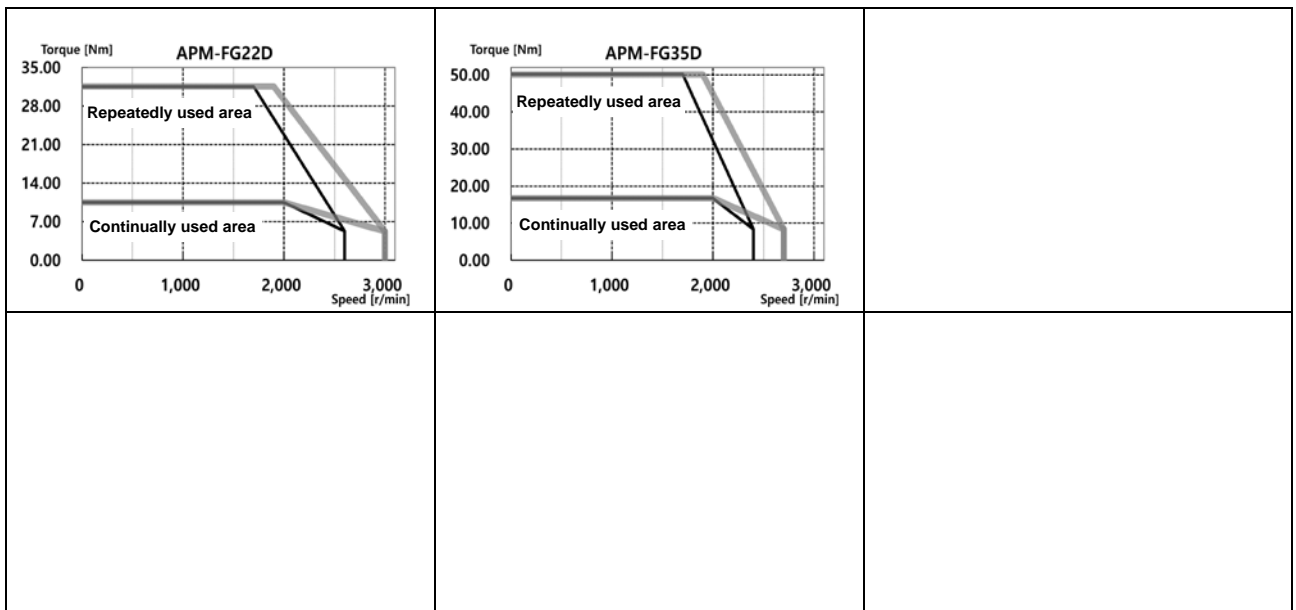

2. Product Specifications

■ Product Features [200V]

Servo Motor Type (APM-□□□□□)		FG20G	FG30G				
Applicable Drive (iX7□A□□)		iX7□A020	iX7□A035				
Rated Output	[kW]	1.8	2.9				
Rated Torque	[N·m]	11.50	18.50				
	[kgf·cm]	116.90	188.40				
Maximum Instantaneous Torque	[N·m]	34.40	55.50				
	[kgf·cm]	350.80	565.2				
Rated Current	A	11.18	16.21				
Peak Current	A	33.54	48.63				
Rated Rotation Velocity	[r/min]	1500					
Maximum Rotation Velocity	[r/min]	2700	2700				
Moment of Inertia	[kg·m ² ×10 ⁻⁴]	14.13	71.53				
	[gf·cm·s ²]	41.97	72.99				
Permitted Load Inertia		Motor inertia x 5					
Rated Power Rate	[kW/s]	31.91	47.66				
Velocity, Position Detector	Standard	Serial type 19-bit					
	Option	Quadrature type incremental 3000 [P/R]					
Specifications and Features	Protection Method	Fully enclosed self-cooling IP65 (excluding shaft penetration part)					
	Time Rating	Continuous					
	Ambient Temperature	Operating temperature: 0 - 40°C, Storage temperature: -10 - 60°C					
	Ambient Humidity	Use humidity: 80[%] RH, maintenance humidity: 90[%] RH or lower (no condensation)					
	Atmosphere	No direct sunlight, corrosive gas, or combustible gas					
	Anti-vibration	Vibration acceleration 49 [m/s ²] (5G)					
Weight	[kg]	15.4	20.2				

◆ Rotation velocity - Torque characteristics [■: 3-phase AC200V, ▨: 3-phase AC230V]

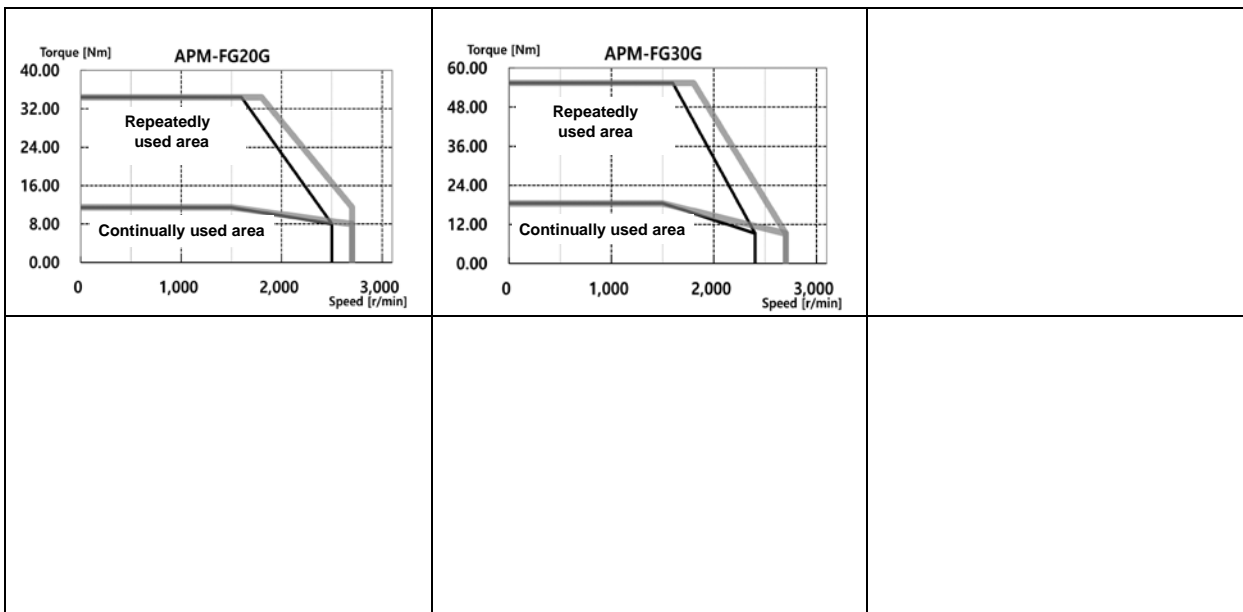

■ Product Features [200V]

Servo Motor Type (APM-□□□□□)		FG12M	FG20M	FG30M			
Applicable Drive (iX7□A□□)		iX7□A020		iX7□A035			
Rated Output	[kW]	1.2	2.0	3.0			
Rated Torque	[N·m]	11.50	19.10	28.60			
	[kgf·cm]	116.90	194.90	292.30			
Maximum Instantaneous Torque	[N·m]	34.40	57.30	85.90			
	[kgf·cm]	350.80	584.60	876.90			
Rated Current	A	11.28	13.10	15.52			
Peak Current	A	33.84	39.3	46.56			
Rated Rotation Velocity	[r/min]	1000					
Maximum Rotation Velocity	[r/min]	2000		1600			
Moment of Inertia	[kg·m ² ×10 ⁻⁴]	41.13	71.53	117.72			
	[gf·cm·s ²]	41.97	72.99	120.12			
Permitted Load Inertia		Motor inertia x 5					
Rated Power Rate	[kW/s]	31.91	51.00	69.70			
Velocity, Position Detector	Standard	Serial type 19-bit					
	Option	X					
Specifications and Features	Protection Method	Fully enclosed self-cooling IP65 (excluding shaft penetration part)					
	Time Rating	Continuous					
	Ambient Temperature	Operating temperature: 0 - 40°C, Storage temperature: -10 - 60°C					
	Ambient Humidity	Use humidity: 80[%] RH, maintenance humidity: 90[%] RH or lower (no condensation)					
	Atmosphere	No direct sunlight, corrosive gas, or combustible gas					
	Anti-vibration	Vibration acceleration 49 [m/s ²] (5G)					
Weight	[kg]	15.4	20.2	28.0			

◆ Rotation velocity - Torque characteristics [■: 3-phase AC200V, □: 3-phase AC230V]

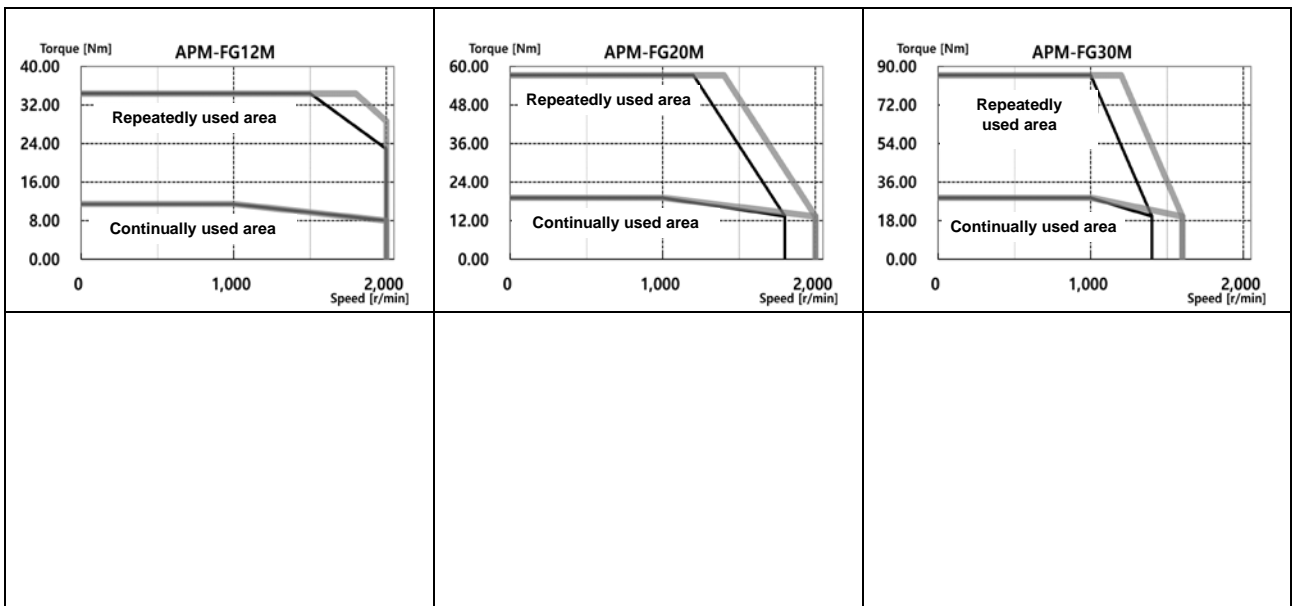

■ Electronic Brake Specifications

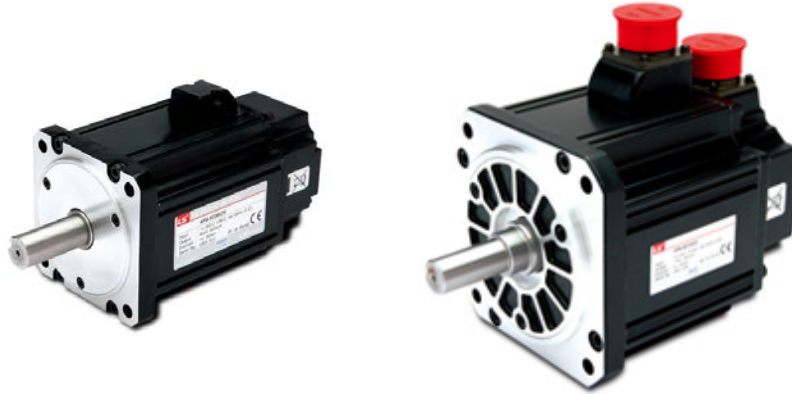

Applicable Motor Series	FAL	FBL	FCL	FE(P)	FF(P)	FG(P)	FG(P)110G FG(P)150G
Purpose	Maintenance	Maintenance	Maintenance	Maintenance	Maintenance	Maintenance	Maintenance
Input voltage [V]	DC 24V	DC 24V	DC 24V	DC 24V	DC 24V	DC 90V	DC 24V
Static Friction Torque [N·m]	0.32	1.47	3.23	10.4	40	74	120
Capacity [W]	6	6.5	9	19.4	25	32	26
Coil resistance [Ω]	96	89	64	29.6	23	327	22.2
Rated Current [A]	0.25	0.27	0.38	0.81	1.04	0.28	1.08
Braking method	Spring brake	Spring brake	Spring brake	Spring brake	Spring brake	Spring brake	Spring brake
Insulation grade	Grade F	Grade F	Grade F	Grade F	Grade F	Grade F	Grade F

Note 1) The same specifications apply to all electric brakes installed in our servo motors.

Note 2) Electric brakes are designed to maintain a stop. Never use them for absolute braking.

Note 3) The characteristics of the electric brakes were measured at 20°C.

Note 4) These brake specifications are subject to change. Check the voltage specifications shown on your specific motor.

Note 5) FAL, FBL, FCL and FE(P) Series brakes satisfy UL specification class 2.

Note 6) Do not apply **DC24V** power (for interface only) to electronic brakes.

You **MUST** use power source only for electronic brake.

2.1.2 External View

■ FAL Series | APM – FALR5A, FAL01A, FAL015A

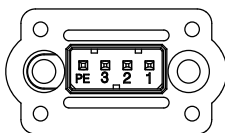
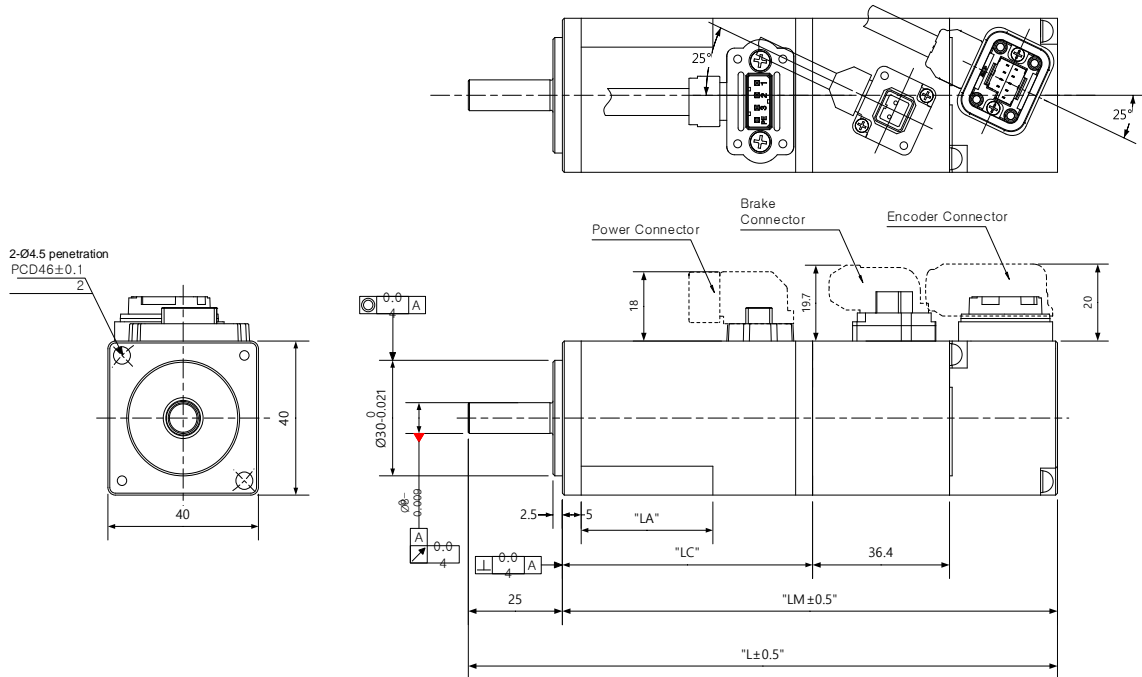

Pin No.	Signal Names
1	U
2	V
3	W
PE	FG

<Power connector pin arrangement>

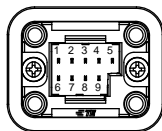

Multi Turn (M)			
Pin No.	Signal Names	Pin No.	Signal Names
1	MA	6	/MA
2	SLO	7	/SLO
3	GND_B	8	Vdd_B
4	0V	9	+5V
5	Shield		

<Encoder connector pin arrangement>

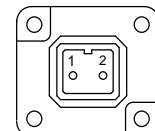

Pin No.	Signal Names
1	BK+
2	BK-

<Brake connector pin arrangement>

Model Name	External Dimensions				Weight (kg)
	L	LM	LC	LA	
FALR5A	103.2 (139.6)	78.2 (114.6)	49.5	23	0.31 (0.66)
FAL01A	120.2 (156.6)	95.2 (131.6)	66.5	35	0.45 (0.80)
FAL015A	140.2	115.2	86.5	35	0.61

Note 1) Use DC 24 [V] for the power to open the brake.

Note 2) The size in parentheses is of an attachable brake.

Note 3) Connect the power cable first when connecting an FAL product.

■ FBL Series | APM – FBL01A, FBL02A, FBL04A

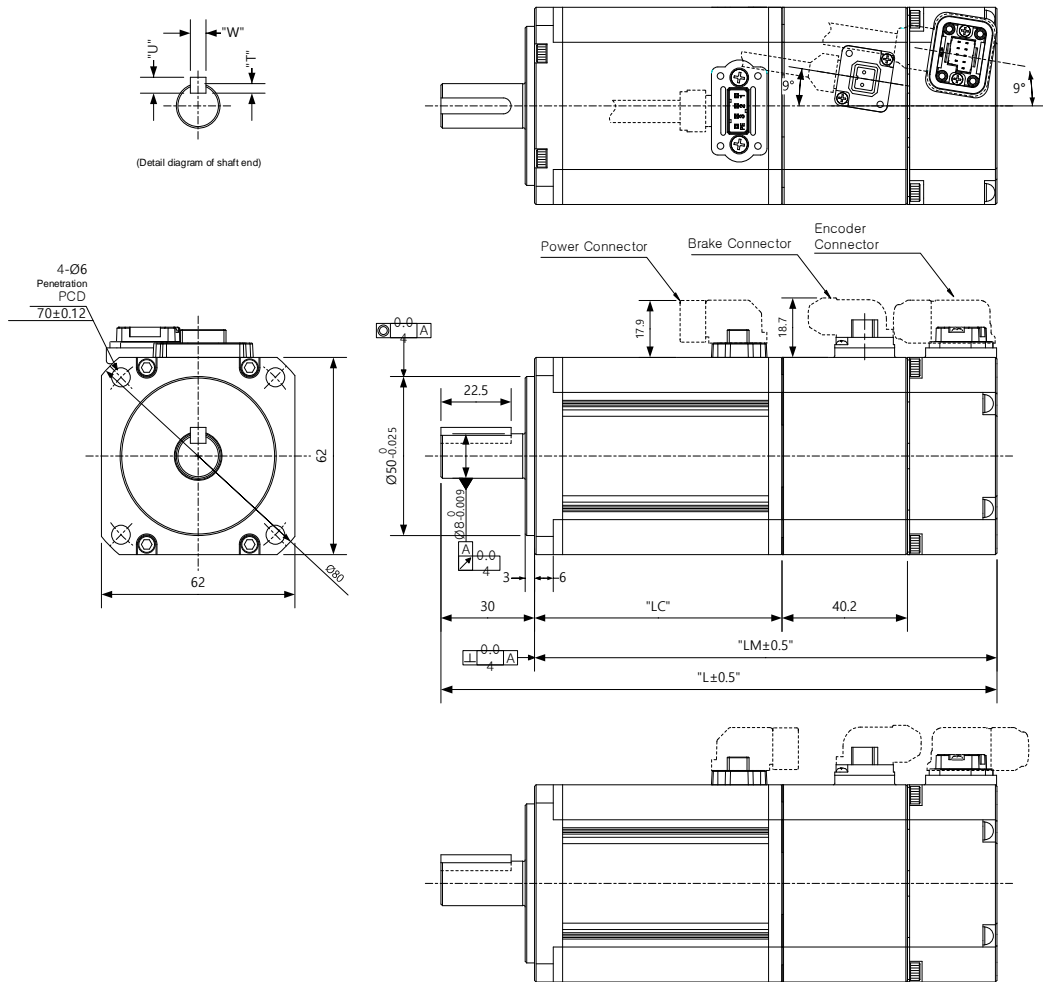

<When the cable withdraw direction is the opposite of the shaft>

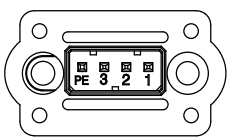

Pin No.	Signal Names
1	U
2	V
3	W
PE	FG

<Power connector pin arrangement>

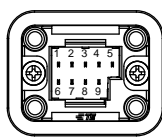

Multi Turn (M)			
Pin No.	Signal Names	Pin No.	Signal Names
1	MA	6	/MA
2	SLO	7	/SLO
3	GND_B	8	VDD_B
4	0V	9	+5V
5	Shield		

<Encoder connector pin arrangement>

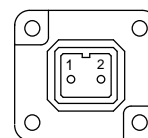

Pin No.	Signal Names
1	BK+
2	BK-

<Brake connector pin arrangement>

Model Name	External Dimensions					Key Dimensions			Weight (kg)
	L	LM	LC	S	H	T	W	U	
FBL01A	107.2 (147.2)	77.2 (117.2)	48.5 (48.3)	14	-0.018	5	5	3	0.56 (1.3)
FBL02A	118.2 (158.2)	88.2 (128.2)	59.5 (59.3)	14	-0.018	5	5	3	0.74 (1.48)
FBL04A	138.2 (178.2)	108.2 (148.2)	79.5 (79.3)	14	-0.018	5	5	3	1.06 (1.8)

Note 1) Use DC 24 [V] for the power to open the brake.

Note 2) The size in parentheses is of an attachable brake.

■ **FCL Series** | APM - FCL04A, FCL03D, FCL06A, FCL05D, FCL08A, FCL06D, FCL10A, FCL07D

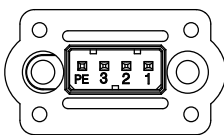
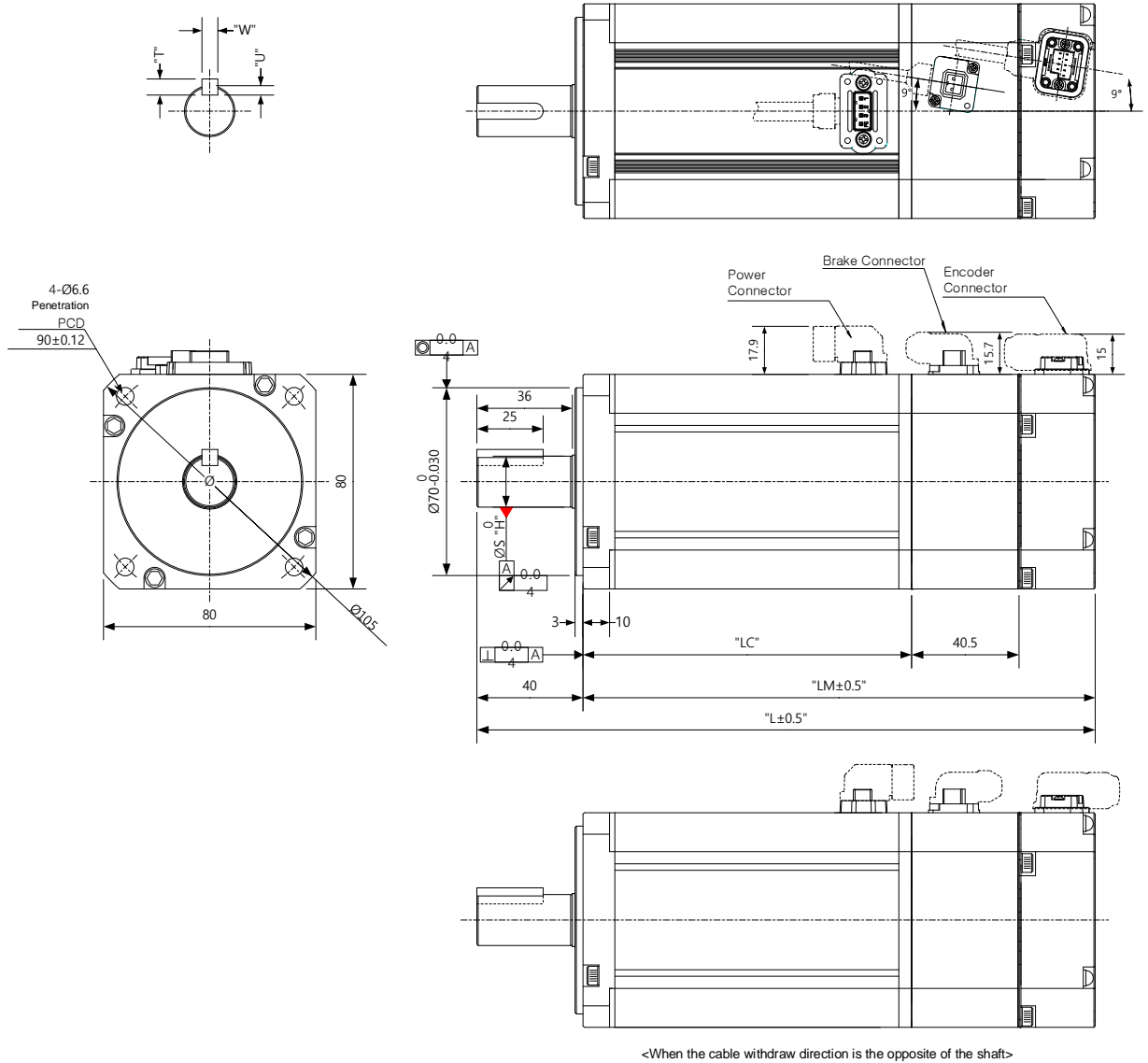

Pin No.	Signal Names
1	U
2	V
3	W
PE	FG

<Power connector pin arrangement>

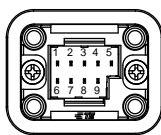

Multi Turn (M)			
Pin No.	Signal Names	Pin No.	Signal Names
1	MA	6	/MA
2	SLO	7	/SLO
3	GND_B	8	VDD_B
4	0V	9	+5V
5	Shield		

<Encoder connector pin arrangement>

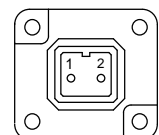

Pin No.	Signal Names
1	BK+
2	BK-

<Brake connector pin arrangement>

■ HE Series | APM-HE09A (Hollow Shaft), HE15A (Hollow Shaft), HE30A (Hollow Shaft)

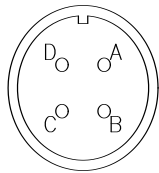
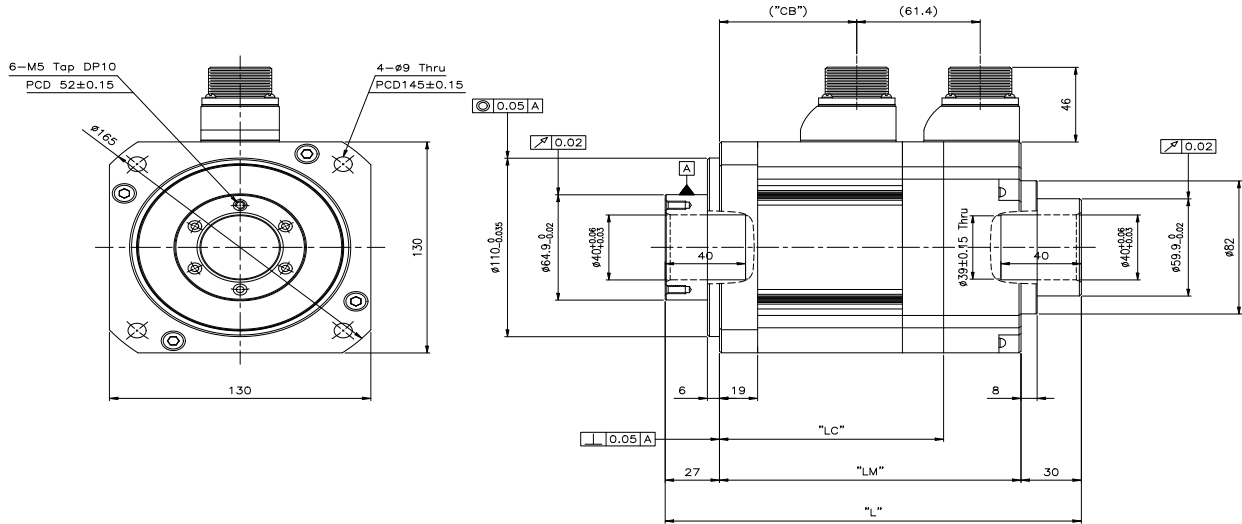

MS3102A20-4P
(4 pole plug)

<Power connector pin arrangement>

Pin No.	Phase
A	U
B	V
C	W
D	FG

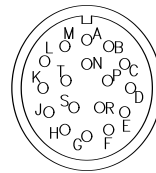

MS3102A20-29P
(17 pole plug)

<Encoder connector pin arrangement>

Pin No.	Encoder Phase	Pin No.	Encoder Phase
A	A	M	V
B	A	N	V
C	B	P	W
D	B	R	W
E	Z	H	+5V
F	Z	G	0V
K	U	J	SHIELD
L	U		

Model	External Dimensions			Hollow Shaft Diameter	Weight (kg)
	L	LM	LC		
HE09A	207	150	111.5	40	5.8
HE15A	231	174	135.5	40	7.4
HE30A	279	222	183.5	40	10.83

Model Name	ID	Watts	Notes
FALR5A	702	50	
FAL01A	703	100	
*FAL015A	706	150	Mass-produced since March 2018
FBL01A	714	100	
FBL02A	715	200	
FBL04A	716	400	
FCL04A	729	400	
FCL06A	730	600	
FCL08A	731	750	
FCL10A	732	1000	
FCL03D	733	300	
FCL05D	734	450	
FCL06D	735	550	
FCL07D	736	650	
FE09A	761	900	
FE15A	762	1500	
FE22A	763	2200	
FE30A	764	3000	
FE06D	765	600	
FE11D	766	1100	
FE16D	767	1600	
FE22D	768	2200	
FE03M	769	300	
FE06M	770	600	
FE09M	771	900	
FE12M	772	1200	
FE05G	773	450	
FE09G	774	850	
FE13G	775	1300	
FE17G	776	1700	

Model Name	ID	Watts	Notes
FF30A	781	3000	
FF50A	782	5000	
FF22D	785	2200	
FF35D	786	3500	
FF55D	787	5500	
FF75D	788	7500	
FF12M	789	1200	
FF20M	790	2000	
FF30M	791	3000	
FF44M	792	4000	
FF20G	793	1800	
FF30G	794	2900	
FF44G	795	4400	
FF60G	796	6000	
FF75G	804	7500	
FG22D	811	2200	
FG35D	812	3500	
FG55D	813	5500	
FG75D	814	7500	
FG12M	821	1200	
FG20M	822	2000	
FG30M	823	3000	
FG44M	824	4400	
FG60M	825	6000	
FG20G	831	1800	
FG30G	832	2900	
FG44G	833	4400	
FG60G	834	6000	
FG85G	835	8500	
FG110G	836	11000	
FG150G	837	15000	

*FAL015A: Use ID 704 for models produced before March 2018.

2.2 Servo Drive

2.2.1 Product Features

200[V]

Items		Model Name		iX7NH A004U	iX7NH A008U	iX7NH A010U	iX7NH A020U	iX7NH A035U
		iX7NH A001U	iX7NH A002U					
Input Power	Main Power	Single-phase AC100-120[V], Single-phase AC200-240[V], 3-phase AC200-240[V], (-15 ~ +10[%]), 50 ~ 60[Hz]			Single-phase AC200-240[V], 3-phase AC200-240[V], (-15 ~ +10[%]), 50 ~ 60[Hz]	3-phase AC200-240[V], (-15 ~ +10[%]), 50 ~ 60[Hz]		
	Control Power	Single-phase AC100-120[V] Single-phase AC200-240[V] (-15 ~ +10[%]), 50 ~ 60[Hz]			Single-phase AC200 ~ 240[V](-15 ~ +10[%]), 50 ~ 60[Hz]			
Rated Current [A]		1.4	1.7	3.0	5.2	6.75	13.5	16
Peak Current [A]		4.9	5.95	10.5	18.2	20.25	40.5	48
Encoder Type		Quadrature (Incremental) , BiSS-B, BiSS-C(Absolute, Incremental) Tamagawa Serial(Absolute, Incremental), EnDat 2.2, Sinusoidal, Analog Hall, SSI, Nikon, Panasonic						
Control Performance	Velocity Control Range	1:5000 Maximum						
	Velocity Variation	±0.01[%] or lower (when the load changes between 0~100[%]) ±0.1[%] or lower (temperature 25±10[°C])						
	Torque Control Repeat Accuracy	Within ±1%						
EtherCAT Communication Specifications	Communication Standard	FoE (Firmware download) EoE (Parameter settings, adjustment and auxiliary functions, and parameter copy through UDP) CoE (IEC 61158 Type12, IEC 61800-7 CiA 402 drive profile)						
	Physical Layer	100BASE-TX (IEEE802.3)						
	Connector	RJ45 x 2						
	Distance	Within 100 m between nodes						
	DC (Distributed Clock)	Synchronization by DC (Distributed Clock) mode Minimum DC cycle: 250 us						
	LED Display	Link Act IN, Link Act OUT, RUN, ERR						
	CiA402 Drive Profile	Profile Position Mode Profile Velocity Mode Profile Torque Mode Cyclic Synchronous Position Mode Cyclic Synchronous Velocity Mode Cyclic Synchronous Torque Mode						

		Homing Mode
Digital Input/Output	Digital Input	<p>Input voltage range: DC 12[V] ~ DC 24 [V]</p> <p>6 input channels in total (assignable)</p> <p>Possible to selectively assign up to 15 functions</p> <p>(*POT, *NOT, *HOME, *STOP, *PCON, *GAIN2, P_CL, N_CL, PROBE1, PROBE2, EMG, A_RST, SV_ON, LVSF1, LVSF2)</p> <p>Note) * Indicates signals assigned by default.</p>
	Digital Output	<p>Rated voltage and current: DC 24[V] ±10%, 120[mA]</p> <p>A total of 3 output channels (allocable)</p> <p>Possible to selectively assign up to 11 outputs</p> <p>(*BRAKE, *ALARM, *READY, ZSPD, INPOS, TLMT, ,VLMT, INSPD, WARN, TGON, INPOS2)</p> <p>Note) * Indicates signals assigned by default</p>
Encoder pulse output		Differential 3-channel (Diff. Line Driver) AO, /AO, BO, /BO, ZO, /ZO Supports up to 6.5[Mpps] (x4 type)
Analog Input/Output	Analog Input	<p>Input voltage range: -10 - +10[V],</p> <p>Function: Analog Torque Limit (1 channel, not assignable)</p>
	Analog Output	<p>A total of 2 channels (allocable)</p> <p>Possible to selectively assign up to 25 outputs</p>
Safety Functions		2 input channels (STO1 and STO2) and 1 output channel (EDM)
USB Communication	Function	Firmware download, parameter setting, test drive, monitoring, parameter copy function
	Communication Standard	Compliant with the USB 2.0 Full Speed and OTG 2.0 Standard
	Connecting Device	PC or USB storage medium
Built-in Function	Dynamic Braking	Standard built-in (activated when the servo alarm goes off or when the servo is off)
	Regenerative Braking	Both the default built-in brake and an externally installed brake are possible.
	Display Function	7 segments (5 DIGITS)
	Self-setting Function	Possible to set the drive node address by using the rotary switch
	Add-on Functions	Gain adjustment, alarm history, jog operation, home search
	Protection Function	Overcurrent, overload, overheat, overvoltage, undervoltage, overspeed, encoder error, position following error, current sensing error, etc.
Use Environment	Operating Temperature /Maintenance Temperature	0 ~ +50[°C] / -20~ +65[°C]
	Operating Humidity /Maintenance Humidity	90[%] RH or lower (No condensation)
	Others	Indoors, areas free of corrosive or combustible gases, areas free of liquids, areas free of conductive dust

2.2.2 External View

■ iX7NHA001U ~ iX7NHA002U

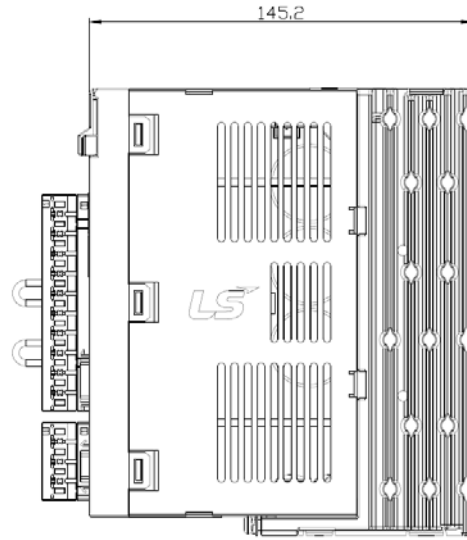
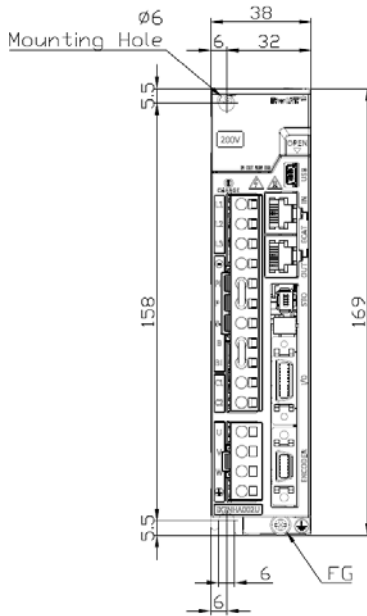

* Weight: 0.8[kg]

■ iX7NHA004U

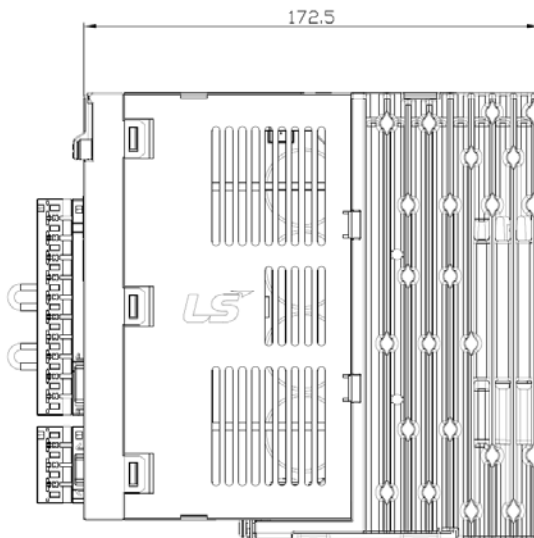
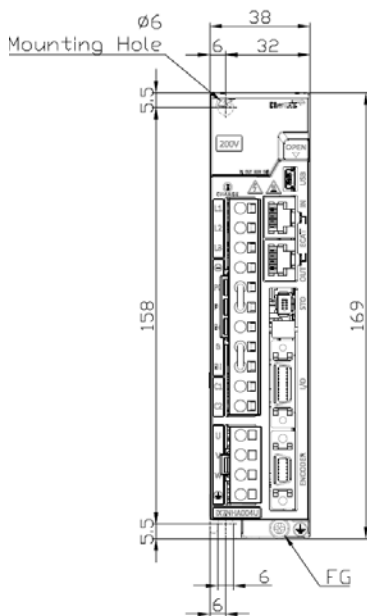

* Weight: 1.0[kg]

■ iX7NHA008U ~ iX7NHA010U

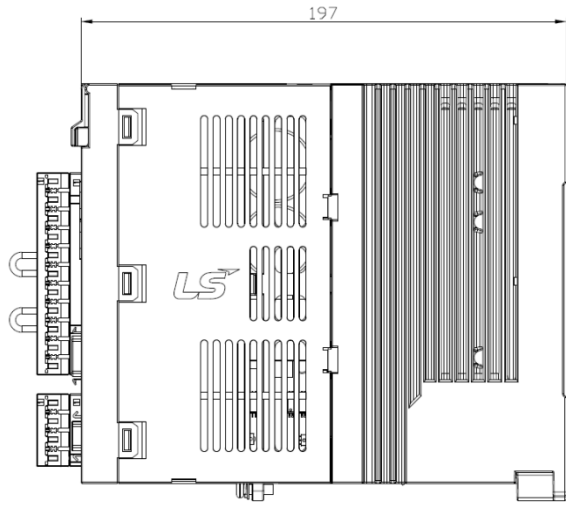
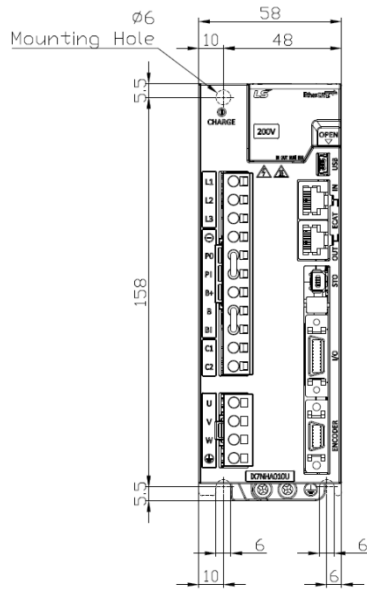

* Weight: 1.6[kg] (including the cooling fan)

■ iX7NHA020U ~ iX7NHA035U

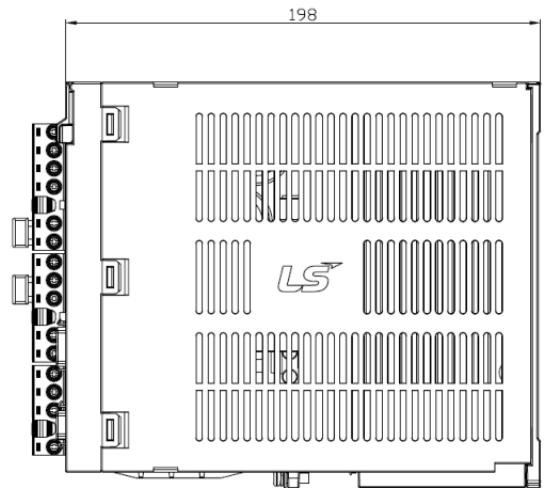
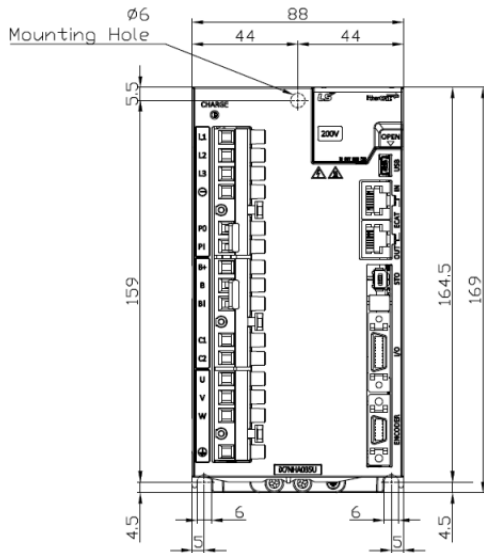

* Weight: 2.4[kg] (including the cooling fan)

2.3 Options and Peripheral Devices

■ Options (incremental encoder cable)

Classification	For signals	Product Name	Medium-capacity flat motor INC encoder cable																																																																							
Model Name (Note 1)	APCS- E□□□BS	Applicable Motor	All FE(P)/FF(P)/FG(P)/HE SERIES INC models																																																																							
Specifications																																																																										
	<table border="1"> <thead> <tr> <th>PIN No.</th> <th>Encoder Signal</th> <th>PIN No.</th> <th>Encoder Signal</th> <th>PIN No.</th> <th>Encoder Signal</th> </tr> </thead> <tbody> <tr> <td>A</td> <td>A</td> <td>F</td> <td>Z</td> <td>P</td> <td>W</td> </tr> <tr> <td>B</td> <td>A</td> <td>K</td> <td>U</td> <td>R</td> <td>W</td> </tr> <tr> <td>C</td> <td>B</td> <td>L</td> <td>U</td> <td>H</td> <td>+5V</td> </tr> <tr> <td>D</td> <td>B</td> <td>M</td> <td>V</td> <td>G</td> <td>0V</td> </tr> <tr> <td>E</td> <td>Z</td> <td>N</td> <td>V</td> <td>J</td> <td>SHIELD</td> </tr> </tbody> </table> <table border="1"> <thead> <tr> <th>PIN No.</th> <th>Encoder Signal</th> <th>PIN No.</th> <th>Encoder Signal</th> <th>PIN No.</th> <th>Encoder Signal</th> </tr> </thead> <tbody> <tr> <td>1</td> <td>W</td> <td>6</td> <td>U</td> <td>11</td> <td>B</td> </tr> <tr> <td>2</td> <td>W</td> <td>7</td> <td>0V</td> <td>12</td> <td>A</td> </tr> <tr> <td>3</td> <td>V</td> <td>8</td> <td>Z</td> <td>13</td> <td>A</td> </tr> <tr> <td>4</td> <td>V</td> <td>9</td> <td>Z</td> <td>14</td> <td>+5V</td> </tr> <tr> <td>5</td> <td>U</td> <td>10</td> <td>B</td> <td>Plate</td> <td>SHIELD</td> </tr> </tbody> </table> <p>1. Motor connection a. Plug specifications: MS3108A 20-29S 2. Drive connection (CN2) a. CASE Model: 10314-52A0-008 (3M) or SM-14J (Suntone) b. CONNECTOR Model: 10114-3000VE (3M) or SM-14J (Suntone) 3. Cable specifications: 7Px0.2SQ or 7Px24AWG</p>			PIN No.	Encoder Signal	PIN No.	Encoder Signal	PIN No.	Encoder Signal	A	A	F	Z	P	W	B	A	K	U	R	W	C	B	L	U	H	+5V	D	B	M	V	G	0V	E	Z	N	V	J	SHIELD	PIN No.	Encoder Signal	PIN No.	Encoder Signal	PIN No.	Encoder Signal	1	W	6	U	11	B	2	W	7	0V	12	A	3	V	8	Z	13	A	4	V	9	Z	14	+5V	5	U	10	B	Plate
PIN No.	Encoder Signal	PIN No.	Encoder Signal	PIN No.	Encoder Signal																																																																					
A	A	F	Z	P	W																																																																					
B	A	K	U	R	W																																																																					
C	B	L	U	H	+5V																																																																					
D	B	M	V	G	0V																																																																					
E	Z	N	V	J	SHIELD																																																																					
PIN No.	Encoder Signal	PIN No.	Encoder Signal	PIN No.	Encoder Signal																																																																					
1	W	6	U	11	B																																																																					
2	W	7	0V	12	A																																																																					
3	V	8	Z	13	A																																																																					
4	V	9	Z	14	+5V																																																																					
5	U	10	B	Plate	SHIELD																																																																					

Note 1) The □□□ in the Model Name indicates the type and length of each cable. Refer to the following table for the marking information.

Cable Length (m)	1	2	...	19	20
Robot Cable	F01	F02		F19	F20
Regular Cable	N01	N02		N19	N20

■ Option (Serial Encoder Cable)

Classification	For signals	Product Name	Medium capacity serial encoder cable for flat motor (single-turn)																																																																																	
Model Name (Note 1)	APCS- E□□□DS	Applicable Motor	All FE(P), APM-FF(P), APM-FG(P) SERIES models																																																																																	
Specifications	<p>Motor Side Connector</p> <table border="1"> <thead> <tr> <th>PIN No.</th> <th>Encoder Phase</th> <th>PIN No.</th> <th>Encoder Phase</th> </tr> </thead> <tbody> <tr><td>A</td><td>MA</td><td>M</td><td>—</td></tr> <tr><td>B</td><td>MA</td><td>N</td><td>—</td></tr> <tr><td>C</td><td>SLO</td><td>P</td><td>—</td></tr> <tr><td>D</td><td>SLO</td><td>R</td><td>—</td></tr> <tr><td>E</td><td>—</td><td>H</td><td>+5V</td></tr> <tr><td>F</td><td>—</td><td>G</td><td>0V</td></tr> <tr><td>K</td><td>—</td><td>J</td><td>SHIELD</td></tr> <tr><td>L</td><td>—</td><td></td><td></td></tr> </tbody> </table> <p>Drive Side Connector</p> <table border="1"> <thead> <tr> <th>PIN No.</th> <th>Encoder Phase</th> <th>PIN No.</th> <th>Encoder Phase</th> </tr> </thead> <tbody> <tr><td>1</td><td>—</td><td>8</td><td>—</td></tr> <tr><td>2</td><td>—</td><td>9</td><td>—</td></tr> <tr><td>3</td><td>MA</td><td>10</td><td>—</td></tr> <tr><td>4</td><td>MA</td><td>11</td><td>—</td></tr> <tr><td>5</td><td>SLO</td><td>12</td><td>—</td></tr> <tr><td>6</td><td>SLO</td><td>13</td><td>—</td></tr> <tr><td>7</td><td>0V</td><td>14</td><td>+5V</td></tr> <tr><td>Plate</td><td></td><td></td><td>SHIELD</td></tr> </tbody> </table> <p>1. Motor connection a. Plug specifications: MS3108A 20-29S 2. Drive connection (CN2) a. Case specifications: 10314-52A0-008 (3M) or SM-14J (Suntone) b. Connector specifications: 10114-3000VE (3M) or SM-14J (Suntone) 3. Cable Model: 3Px0.2SQ or 3Px24AWG</p>			PIN No.	Encoder Phase	PIN No.	Encoder Phase	A	MA	M	—	B	MA	N	—	C	SLO	P	—	D	SLO	R	—	E	—	H	+5V	F	—	G	0V	K	—	J	SHIELD	L	—			PIN No.	Encoder Phase	PIN No.	Encoder Phase	1	—	8	—	2	—	9	—	3	MA	10	—	4	MA	11	—	5	SLO	12	—	6	SLO	13	—	7	0V	14	+5V	Plate			SHIELD									
PIN No.	Encoder Phase	PIN No.	Encoder Phase																																																																																	
A	MA	M	—																																																																																	
B	MA	N	—																																																																																	
C	SLO	P	—																																																																																	
D	SLO	R	—																																																																																	
E	—	H	+5V																																																																																	
F	—	G	0V																																																																																	
K	—	J	SHIELD																																																																																	
L	—																																																																																			
PIN No.	Encoder Phase	PIN No.	Encoder Phase																																																																																	
1	—	8	—																																																																																	
2	—	9	—																																																																																	
3	MA	10	—																																																																																	
4	MA	11	—																																																																																	
5	SLO	12	—																																																																																	
6	SLO	13	—																																																																																	
7	0V	14	+5V																																																																																	
Plate			SHIELD																																																																																	
Classification	For signals	Product Name	Medium capacity serial encoder cable for flat motor (multi-turn)																																																																																	
Model Name (Note 1)	APCS- E□□□DS1	Applicable Motor	All FE(P), APM-FF(P), APM-FG(P) SERIES models																																																																																	
Specifications	<p>Motor Side Connector</p> <table border="1"> <thead> <tr> <th>PIN No.</th> <th>Encoder Phase</th> <th>PIN No.</th> <th>Encoder Phase</th> </tr> </thead> <tbody> <tr><td>A</td><td>MA</td><td>M</td><td>—</td></tr> <tr><td>B</td><td>MA</td><td>N</td><td>—</td></tr> <tr><td>C</td><td>SLO</td><td>P</td><td>—</td></tr> <tr><td>D</td><td>SLO</td><td>R</td><td>—</td></tr> <tr><td>E</td><td>VDD_B</td><td>H</td><td>+5V</td></tr> <tr><td>F</td><td>GND_B</td><td>G</td><td>0V</td></tr> <tr><td>K</td><td>—</td><td>J</td><td>SHIELD</td></tr> <tr><td>L</td><td>—</td><td></td><td></td></tr> </tbody> </table> <p>Drive Side Connector</p> <table border="1"> <thead> <tr> <th>PIN No.</th> <th>Encoder Phase</th> <th>PIN No.</th> <th>Encoder Phase</th> </tr> </thead> <tbody> <tr><td>1</td><td>—</td><td>8</td><td>—</td></tr> <tr><td>2</td><td>—</td><td>9</td><td>—</td></tr> <tr><td>3</td><td>MA</td><td>10</td><td>—</td></tr> <tr><td>4</td><td>MA</td><td>11</td><td>—</td></tr> <tr><td>5</td><td>SLO</td><td>12</td><td>—</td></tr> <tr><td>6</td><td>SLO</td><td>13</td><td>—</td></tr> <tr><td>7</td><td>0V</td><td>14</td><td>+5V</td></tr> <tr><td>Plate</td><td></td><td></td><td>SHIELD</td></tr> </tbody> </table> <p>Battery Connector</p> <table border="1"> <thead> <tr> <th>PIN Number</th> <th>Encoder Signal</th> <th>Color</th> </tr> </thead> <tbody> <tr><td>1</td><td>BATTERY(VDD_B)</td><td>Red</td></tr> <tr><td>2</td><td>BATTERY 0V(GND_B)</td><td>Black</td></tr> </tbody> </table> <p>1. Motor connection a. Plug specifications: MS3108A 20-29S 2. Drive connection (CN2) a. Case specifications: 10314-52A0-008 (3M) or SM-14J (Suntone) b. Connector specifications: 10114-3000VE (3M) or SM-14J (Suntone) 3. Cable specifications: 4Px0.2SQ or 4Px24AWG 4. Battery connection a. Connector specifications: 5267-02A (Molex) b. Battery specifications: ER6V (TOSHIBA, 3.6V, 2000mAh)</p>			PIN No.	Encoder Phase	PIN No.	Encoder Phase	A	MA	M	—	B	MA	N	—	C	SLO	P	—	D	SLO	R	—	E	VDD_B	H	+5V	F	GND_B	G	0V	K	—	J	SHIELD	L	—			PIN No.	Encoder Phase	PIN No.	Encoder Phase	1	—	8	—	2	—	9	—	3	MA	10	—	4	MA	11	—	5	SLO	12	—	6	SLO	13	—	7	0V	14	+5V	Plate			SHIELD	PIN Number	Encoder Signal	Color	1	BATTERY(VDD_B)	Red	2	BATTERY 0V(GND_B)	Black
PIN No.	Encoder Phase	PIN No.	Encoder Phase																																																																																	
A	MA	M	—																																																																																	
B	MA	N	—																																																																																	
C	SLO	P	—																																																																																	
D	SLO	R	—																																																																																	
E	VDD_B	H	+5V																																																																																	
F	GND_B	G	0V																																																																																	
K	—	J	SHIELD																																																																																	
L	—																																																																																			
PIN No.	Encoder Phase	PIN No.	Encoder Phase																																																																																	
1	—	8	—																																																																																	
2	—	9	—																																																																																	
3	MA	10	—																																																																																	
4	MA	11	—																																																																																	
5	SLO	12	—																																																																																	
6	SLO	13	—																																																																																	
7	0V	14	+5V																																																																																	
Plate			SHIELD																																																																																	
PIN Number	Encoder Signal	Color																																																																																		
1	BATTERY(VDD_B)	Red																																																																																		
2	BATTERY 0V(GND_B)	Black																																																																																		

2. Product Specifications

Cable Length (m)	1	2	...	19	20
Robot Cable	F01	F02		F19	F20
Regular Cable	N01	N02		N19	N20

*If you are using a serial or multi-turn cable with a length of 20m or longer, refer to 「3.6.6 Precautions When Making Encoder Cable」.

Classification	For signals	Product Name	Low capacity serial encoder cable for flat motor (single-turn)																																																																					
Model Name (Note 1)	APCS- E□□□ES (Front Direction)/ APCS- E□□□ES-R (Rear Direction)	Applicable Motor	All FAL/FBL/FCL SERIES S-turn models																																																																					
Specifications																																																																								
	<table border="1" style="display: inline-table; margin-right: 20px;"> <thead> <tr> <th>PIN No.</th> <th>Encoder Signal</th> <th>PIN No.</th> <th>Encoder Signal</th> </tr> </thead> <tbody> <tr><td>1</td><td>MA</td><td>6</td><td>MA</td></tr> <tr><td>2</td><td>SLO</td><td>7</td><td>SLO</td></tr> <tr><td>3</td><td>-</td><td>8</td><td>-</td></tr> <tr><td>4</td><td>0V</td><td>9</td><td>+5V</td></tr> <tr><td>5</td><td>SHIELD</td><td></td><td></td></tr> </tbody> </table> <table border="1" style="display: inline-table; margin-right: 20px;"> <thead> <tr> <th>PIN No.</th> <th>Encoder Signal</th> <th>PIN No.</th> <th>Encoder Signal</th> <th>PIN No.</th> <th>Encoder Signal</th> </tr> </thead> <tbody> <tr><td>1</td><td>-</td><td>6</td><td>SLO</td><td>11</td><td>-</td></tr> <tr><td>2</td><td>-</td><td>7</td><td>0V</td><td>12</td><td>-</td></tr> <tr><td>3</td><td>MA</td><td>8</td><td>-</td><td>13</td><td>-</td></tr> <tr><td>4</td><td>MA</td><td>9</td><td>-</td><td>14</td><td>+5V</td></tr> <tr><td>5</td><td>SLO</td><td>10</td><td>-</td><td>Plate</td><td>SHIELD</td></tr> </tbody> </table> <p>1. Motor connection a. CAP Model: 2201825-1 (Tyco) b. SOCKET Model: 2174065-4 (Tyco) 2. Drive connection (CN2) a. CASE Model: 10314-52A0-008 (3M) or SM-14J (Suntone) b. CONNECTOR Model: 10114-3000VE (3M) or SM-14J (Suntone) 3. Cable Model: 3Px0.2SQ or 3Px24AWG</p>				PIN No.	Encoder Signal	PIN No.	Encoder Signal	1	MA	6	MA	2	SLO	7	SLO	3	-	8	-	4	0V	9	+5V	5	SHIELD			PIN No.	Encoder Signal	PIN No.	Encoder Signal	PIN No.	Encoder Signal	1	-	6	SLO	11	-	2	-	7	0V	12	-	3	MA	8	-	13	-	4	MA	9	-	14	+5V	5	SLO	10	-	Plate	SHIELD								
PIN No.	Encoder Signal	PIN No.	Encoder Signal																																																																					
1	MA	6	MA																																																																					
2	SLO	7	SLO																																																																					
3	-	8	-																																																																					
4	0V	9	+5V																																																																					
5	SHIELD																																																																							
PIN No.	Encoder Signal	PIN No.	Encoder Signal	PIN No.	Encoder Signal																																																																			
1	-	6	SLO	11	-																																																																			
2	-	7	0V	12	-																																																																			
3	MA	8	-	13	-																																																																			
4	MA	9	-	14	+5V																																																																			
5	SLO	10	-	Plate	SHIELD																																																																			
Classification	For signals	Product Name	Low capacity serial encoder cable for flat motor (multi-turn)																																																																					
Model Name (Note 1)	APCS- E□□□ES1(Front Direction)/ APCS- E□□□ES1-R(Rear Direction)	Applicable Motor	All FAL/FBL/FCL SERIES M-turn models																																																																					
Specifications																																																																								
	<table border="1" style="display: inline-table; margin-right: 20px;"> <thead> <tr> <th>PIN Number</th> <th>Encoder Signal</th> <th>PIN Number</th> <th>Encoder Signal</th> </tr> </thead> <tbody> <tr><td>1</td><td>MA</td><td>6</td><td>MA</td></tr> <tr><td>2</td><td>SLO</td><td>7</td><td>SLO</td></tr> <tr><td>3</td><td>GND_E</td><td>8</td><td>VDD_E</td></tr> <tr><td>4</td><td>0V</td><td>9</td><td>+5V</td></tr> <tr><td>5</td><td>Shield</td><td></td><td></td></tr> </tbody> </table> <table border="1" style="display: inline-table; margin-right: 20px;"> <thead> <tr> <th>PIN Number</th> <th>Encoder Signal</th> <th>PIN Number</th> <th>Encoder Signal</th> <th>PIN Number</th> <th>Encoder Signal</th> </tr> </thead> <tbody> <tr><td>1</td><td>-</td><td>6</td><td>SLO</td><td>11</td><td>-</td></tr> <tr><td>2</td><td>-</td><td>7</td><td>0V</td><td>12</td><td>-</td></tr> <tr><td>3</td><td>MA</td><td>8</td><td>-</td><td>13</td><td>-</td></tr> <tr><td>4</td><td>MA</td><td>9</td><td>-</td><td>14</td><td>+5V</td></tr> <tr><td>5</td><td>SLO</td><td>10</td><td>-</td><td>Plate</td><td>SHIELD</td></tr> </tbody> </table> <p>1. Motor connection a. Cap specifications (9 positions): 2201825-1 (Tyco) b. Socket specifications: 2174065-4 (Tyco) 2. Drive connection (CN2) a. CASE Model: 10314-52A0-008 (3M) or SM-14J (Suntone) b. CONNECTOR Model: 10114-3000VE (3M) or SM-14J (Suntone) 3. Cable specifications: 4Px0.2SQ or 4Px24AWG 4. Battery connection a. Connector specifications: 5267-02A (Molex) b. Battery specifications: ER6V (TOSHIBA, AA, 3.6V, 2000 mAh)</p> <table border="1" style="display: inline-table;"> <thead> <tr> <th>PIN Number</th> <th>Encoder Signal</th> <th>Color</th> </tr> </thead> <tbody> <tr><td>1</td><td>BATTERY(VDD_B)</td><td>Red</td></tr> <tr><td>2</td><td>BATTERY 0V(GND_B)</td><td>Black</td></tr> </tbody> </table>				PIN Number	Encoder Signal	PIN Number	Encoder Signal	1	MA	6	MA	2	SLO	7	SLO	3	GND_E	8	VDD_E	4	0V	9	+5V	5	Shield			PIN Number	Encoder Signal	PIN Number	Encoder Signal	PIN Number	Encoder Signal	1	-	6	SLO	11	-	2	-	7	0V	12	-	3	MA	8	-	13	-	4	MA	9	-	14	+5V	5	SLO	10	-	Plate	SHIELD	PIN Number	Encoder Signal	Color	1	BATTERY(VDD_B)	Red	2	BATTERY 0V(GND_B)
PIN Number	Encoder Signal	PIN Number	Encoder Signal																																																																					
1	MA	6	MA																																																																					
2	SLO	7	SLO																																																																					
3	GND_E	8	VDD_E																																																																					
4	0V	9	+5V																																																																					
5	Shield																																																																							
PIN Number	Encoder Signal	PIN Number	Encoder Signal	PIN Number	Encoder Signal																																																																			
1	-	6	SLO	11	-																																																																			
2	-	7	0V	12	-																																																																			
3	MA	8	-	13	-																																																																			
4	MA	9	-	14	+5V																																																																			
5	SLO	10	-	Plate	SHIELD																																																																			
PIN Number	Encoder Signal	Color																																																																						
1	BATTERY(VDD_B)	Red																																																																						
2	BATTERY 0V(GND_B)	Black																																																																						

Note 1) □□□ in the model name indicates the type and length of the cable. Please refer to the following table.

Cable Length (m)	1	2	...	19	20
Robot Cable	F01	F02		F19	F20
Regular Cable	N01	N02		N19	N20

*If you are using a serial or multi-turn cable with a length of 20m or longer, refer to 「3.6.6 Precautions When Making Encoder Cable」.

■ Option (Small Capacity L Series Power Cable)

Classification	For main power	Product Name	Low capacity L Series power cable																									
Model Name (Note 1)	APCS- P□□□LSX(Front Direction)/ APCS- P□□□LSX-R(Rear Direction)	Applicable Motor	All FAL/FBL/FCL Series models (with IX7 applied)																									
Specifications	<table border="1" style="margin-left: auto; margin-right: auto;"> <thead> <tr> <th rowspan="2">Item</th> <th rowspan="2">Motor Signal</th> <th rowspan="2">Pin No.</th> <th colspan="2">Line Color</th> </tr> <tr> <th>Line Color 1</th> <th>Line Color 2</th> </tr> </thead> <tbody> <tr> <td rowspan="3">LEAD WIRE</td> <td>U</td> <td>1</td> <td>Light blue</td> <td>Red</td> </tr> <tr> <td>V</td> <td>2</td> <td>Brown</td> <td>White</td> </tr> <tr> <td>W</td> <td>3</td> <td>Black</td> <td>Black</td> </tr> <tr> <td>FG</td> <td>FG</td> <td>PE</td> <td>Green</td> <td>Green</td> </tr> </tbody> </table> <p>1. Motor connection a. PLUG model: SM-JN8FT04 (Suntone) b. Socket model: SMS-201 (Suntone) 2. Drive connection (U, V, W, FG) a. U, V, W, PE pin specifications: 1508 3. CABLE Model: 4Cx0.75SQ or 4Cx18AWG 4. Other: FAL products require encoder cable installation after power cable installation. ※ The specifications are subject to change without notice.</p>			Item	Motor Signal	Pin No.	Line Color		Line Color 1	Line Color 2	LEAD WIRE	U	1	Light blue	Red	V	2	Brown	White	W	3	Black	Black	FG	FG	PE	Green	Green
Item	Motor Signal	Pin No.	Line Color																									
			Line Color 1	Line Color 2																								
LEAD WIRE	U	1	Light blue	Red																								
	V	2	Brown	White																								
	W	3	Black	Black																								
FG	FG	PE	Green	Green																								
Classification	For brake	Product Name	Low capacity L Series brake cable																									
Model Name (Note 1)	APCS- B□□□QS(Front Direction)/ APCS- B□□□QS-R(Rear Direction)	Applicable Motor	All FAL/FBL/FCL Series models																									
Specifications	<table border="1" style="margin-left: auto; margin-right: auto;"> <thead> <tr> <th>Details</th> <th>Phase</th> <th>PIN No.</th> </tr> </thead> <tbody> <tr> <td rowspan="2">BRAKE WIRE</td> <td>+</td> <td>1</td> </tr> <tr> <td>-</td> <td>2</td> </tr> </tbody> </table> <p>1. Motor connection a. PLUG specifications: KN5FT02SJ1 (JAE) b. SOCKET specifications: ST-KN-S-C1B-3500 (JAE) 2. For braking power a. Connection terminal specifications: 1.5x3 (ring terminal) 3. Cable specifications: 2Cx0.5SQ or 2Cx20AWG</p>			Details	Phase	PIN No.	BRAKE WIRE	+	1	-	2																	
Details	Phase	PIN No.																										
BRAKE WIRE	+	1																										
	-	2																										

Note 1) □□□ in the model name indicates the type and length of the cable. Please refer to the following table.

Cable Length (m)	1	2	...	19	20
Robot Cable	F01	F02		F19	F20
Regular Cable	N01	N02		N19	N20

■ Option (Medium Capacity Flat/L Series Power Cable)

Classification	For main power	Product Name	Medium capacity FE/HE Series power cable																					
Model Name (Note 1)	APCS- P□□□ HSX1	Applicable Motor	FE09A, FE15A, FE06D, FE11D, FE05G, FE09G, FE03M, FE06M																					
Specifications	<p>1. Motor connection a. Plug specifications: MS3108A 20-4S 2. Drive connection (U, V, W, PE) a. U, V, W, PE pin specifications: 1508 3. Cable specifications: 4Cx1.5SQ or 4Cx15AWG ※ The specifications are subject to change without notice.</p> <table border="1"> <thead> <tr> <th>Item</th> <th>Motor Signal</th> <th>Pin No.</th> </tr> </thead> <tbody> <tr> <td rowspan="3">LEAD WIRE</td> <td>U</td> <td>A</td> </tr> <tr> <td>V</td> <td>B</td> </tr> <tr> <td>W</td> <td>C</td> </tr> <tr> <td>FG</td> <td>FG</td> <td>D</td> </tr> </tbody> </table>			Item	Motor Signal	Pin No.	LEAD WIRE	U	A	V	B	W	C	FG	FG	D								
Item	Motor Signal	Pin No.																						
LEAD WIRE	U	A																						
	V	B																						
	W	C																						
FG	FG	D																						
Classification	For power and brake	Product Name	Medium capacity FE Series power/brake cable																					
Model Name (Note 1)	APCS- P□□□ NBX1	Applicable Motor	FE09A, FE15A, FE06D, FE11D, FE05G, FE09G, FE03M, FE06M																					
Specifications	<p>1. Motor connection a. Plug specifications: MS3108A 20-15S 2. Drive connection a. U, V, W, PE pin specifications: 1508 3. Cable specifications: 4Cx1.5SQ or 4Cx15AWG 4. Brake power connection a. Connection terminal specifications: 1.5 x 3 (ring terminal) 5. Brake cable specifications: 2Cx0.75SQ or 2Cx18AWG ※ The specifications are subject to change without notice.</p> <table border="1"> <thead> <tr> <th>Item</th> <th>Motor Signal</th> <th>Pin No.</th> </tr> </thead> <tbody> <tr> <td rowspan="3">Brake WIRE</td> <td>U</td> <td>A</td> </tr> <tr> <td>V</td> <td>B</td> </tr> <tr> <td>W</td> <td>C</td> </tr> <tr> <td>FG</td> <td>FG</td> <td>D</td> </tr> </tbody> </table> <table border="1"> <thead> <tr> <th>Item</th> <th>Signal</th> <th>Pin No.</th> </tr> </thead> <tbody> <tr> <td rowspan="2">LEAD WIRE</td> <td>+</td> <td>E</td> </tr> <tr> <td>-</td> <td>F</td> </tr> </tbody> </table>			Item	Motor Signal	Pin No.	Brake WIRE	U	A	V	B	W	C	FG	FG	D	Item	Signal	Pin No.	LEAD WIRE	+	E	-	F
Item	Motor Signal	Pin No.																						
Brake WIRE	U	A																						
	V	B																						
	W	C																						
FG	FG	D																						
Item	Signal	Pin No.																						
LEAD WIRE	+	E																						
	-	F																						

Note 1) □□□ in the model name indicates the type and length of the cable. Please refer to the following table.

Cable Length (m)	1	2	...	19	20
Robot Cable	F01	F02		F19	F20
Regular Cable	N01	N02		N19	N20

2. Product Specifications

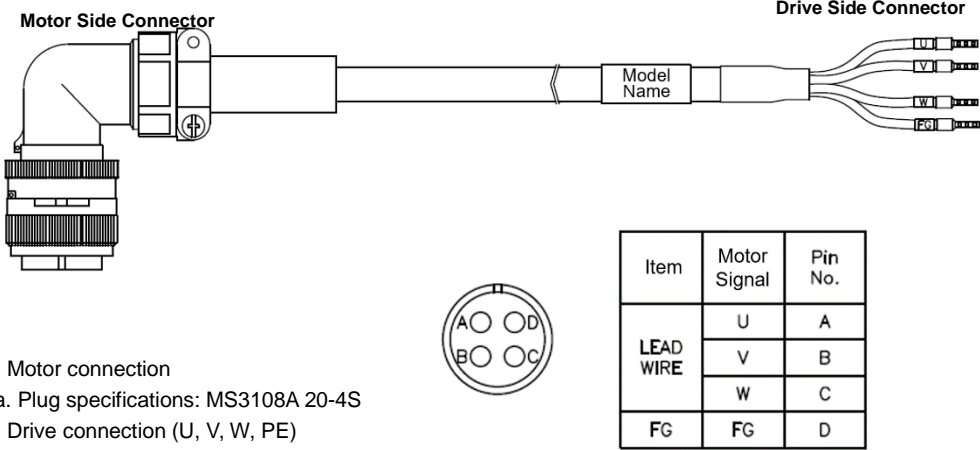
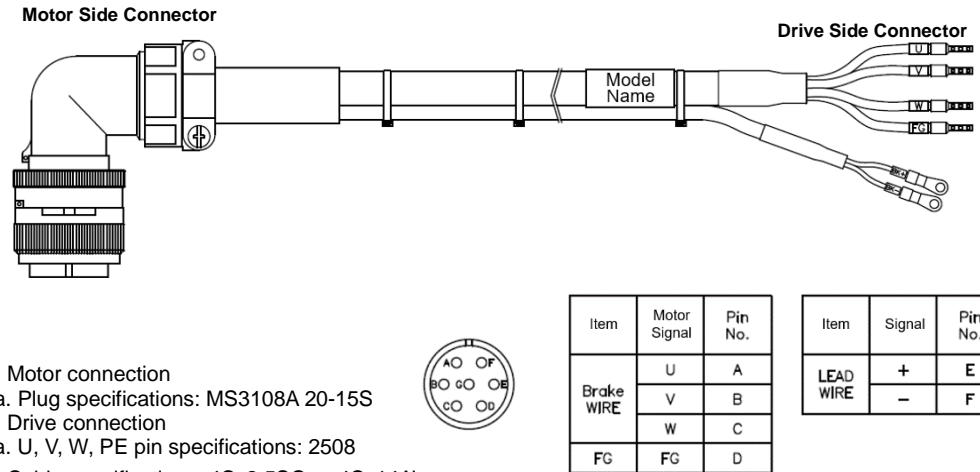
Classification	For main power	Product Name	Medium capacity FE/HE Series power cable																					
Model Name (Note 1)	APCS- P□□□ HSX	Applicable Motor	FE22A, FE30A, FE16D, FE22D, FE13G, FE17G, FE09M, FE12M																					
Specifications	 <p>1. Motor connection a. Plug specifications: MS3108A 20-4S</p> <p>2. Drive connection (U, V, W, PE) a. U, V, W, PE pin specifications: 2508</p> <p>3. Cable specifications: 4Cx2.5SQ or 4Cx14AWG</p> <p>※ The specifications are subject to change without notice.</p> <table border="1" data-bbox="965 667 1216 884"> <thead> <tr> <th>Item</th> <th>Motor Signal</th> <th>Pin No.</th> </tr> </thead> <tbody> <tr> <td rowspan="3">LEAD WIRE</td> <td>U</td> <td>A</td> </tr> <tr> <td>V</td> <td>B</td> </tr> <tr> <td>W</td> <td>C</td> </tr> <tr> <td>FG</td> <td>FG</td> <td>D</td> </tr> </tbody> </table>			Item	Motor Signal	Pin No.	LEAD WIRE	U	A	V	B	W	C	FG	FG	D								
Item	Motor Signal	Pin No.																						
LEAD WIRE	U	A																						
	V	B																						
	W	C																						
FG	FG	D																						
Classification	For power and brake	Product Name	Medium capacity FE Series power/brake cable																					
Model Name (Note 1)	APCS- P□□□ NBX	Applicable Motor	FE22A, FE30A, FE16D, FE22D, FE13G, FE17G, FE09M, FE12M																					
Specifications	 <p>1. Motor connection a. Plug specifications: MS3108A 20-15S</p> <p>2. Drive connection a. U, V, W, PE pin specifications: 2508</p> <p>3. Cable specifications: 4Cx2.5SQ or 4Cx14A_{VV}</p> <p>4. Brake power connection a. Connection terminal specifications: 1.5 x 3 (ring terminal)</p> <p>5. Brake cable specifications: 2Cx0.75SQ or 2Cx18AWG</p> <p>※ The specifications are subject to change without notice.</p> <table border="1" data-bbox="917 1496 1120 1675"> <thead> <tr> <th>Item</th> <th>Motor Signal</th> <th>Pin No.</th> </tr> </thead> <tbody> <tr> <td rowspan="3">Brake WIRE</td> <td>U</td> <td>A</td> </tr> <tr> <td>V</td> <td>B</td> </tr> <tr> <td>W</td> <td>C</td> </tr> <tr> <td>FG</td> <td>FG</td> <td>D</td> </tr> </tbody> </table> <table border="1" data-bbox="1152 1496 1355 1617"> <thead> <tr> <th>Item</th> <th>Signal</th> <th>Pin No.</th> </tr> </thead> <tbody> <tr> <td rowspan="2">LEAD WIRE</td> <td>+</td> <td>E</td> </tr> <tr> <td>-</td> <td>F</td> </tr> </tbody> </table>			Item	Motor Signal	Pin No.	Brake WIRE	U	A	V	B	W	C	FG	FG	D	Item	Signal	Pin No.	LEAD WIRE	+	E	-	F
Item	Motor Signal	Pin No.																						
Brake WIRE	U	A																						
	V	B																						
	W	C																						
FG	FG	D																						
Item	Signal	Pin No.																						
LEAD WIRE	+	E																						
	-	F																						

Note 1) □□□ in the model name indicates the type and length of the cable. Please refer to the following table.



Cable Length (m)	1	2	...	19	20
Robot Cable	F01	F02		F19	F20
Regular Cable	N01	N02		N19	N20

※ More to be added for cables with other specifications than the above

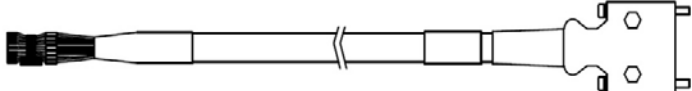
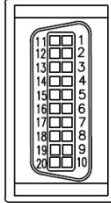
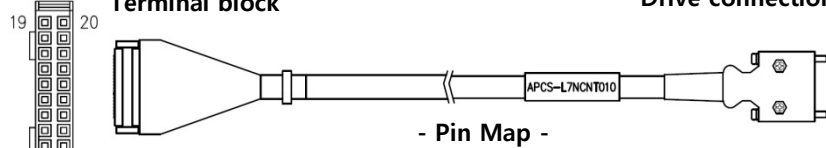
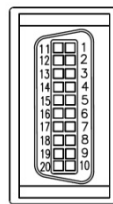
■ Option (Drive Cable)

Classification	For signal	Product Name	CN1 Cable																																																
Model Name (Note 1)	APCS-CN1□□A	Applicable Drive	iX7NH, L7NH SERIES																																																
Specifications	<p>Upper level controller Drive connection CN1</p>  <p style="text-align: center;">- Pin Map -</p> <table border="1" data-bbox="454 638 1061 851"> <thead> <tr> <th>PIN Number</th> <th>I/O signal</th> <th>PIN Number</th> <th>I/O signal</th> <th>PIN Number</th> <th>I/O signal</th> <th>PIN Number</th> <th>I/O signal</th> </tr> </thead> <tbody> <tr> <td>1</td> <td>BREAK+</td> <td>6</td> <td>24V</td> <td>11</td> <td>HOME</td> <td>16</td> <td>NC</td> </tr> <tr> <td>2</td> <td>BREAK-</td> <td>7</td> <td>CWL</td> <td>12</td> <td>ALMRST</td> <td>17</td> <td>RDY+</td> </tr> <tr> <td>3</td> <td>ALARM+</td> <td>8</td> <td>CCWL</td> <td>13</td> <td>DI1</td> <td>18</td> <td>RDY-</td> </tr> <tr> <td>4</td> <td>ALARM-</td> <td>9</td> <td>PROBE1</td> <td>14</td> <td>DI2</td> <td>19</td> <td>DO1+</td> </tr> <tr> <td>5</td> <td>NC</td> <td>10</td> <td>PROBE2</td> <td>15</td> <td>NC</td> <td>20</td> <td>DO1-</td> </tr> </tbody> </table>		PIN Number	I/O signal	PIN Number	I/O signal	PIN Number	I/O signal	PIN Number	I/O signal	1	BREAK+	6	24V	11	HOME	16	NC	2	BREAK-	7	CWL	12	ALMRST	17	RDY+	3	ALARM+	8	CCWL	13	DI1	18	RDY-	4	ALARM-	9	PROBE1	14	DI2	19	DO1+	5	NC	10	PROBE2	15	NC	20	DO1-	
	PIN Number	I/O signal	PIN Number	I/O signal	PIN Number	I/O signal	PIN Number	I/O signal																																											
1	BREAK+	6	24V	11	HOME	16	NC																																												
2	BREAK-	7	CWL	12	ALMRST	17	RDY+																																												
3	ALARM+	8	CCWL	13	DI1	18	RDY-																																												
4	ALARM-	9	PROBE1	14	DI2	19	DO1+																																												
5	NC	10	PROBE2	15	NC	20	DO1-																																												
<p>1. Drive connection (CN1)</p> <p>a. Case specifications: 10320-52A0-008 (3M)</p> <p>b. CONNECTOR specifications: 10120-3000PE (3M)</p> <p>c. CABLE specifications: ROW-SB0.1 x 20C (AWG 28)</p>																																																			
Classification	T/B	Product Name	T/B for CN1																																																
Model Name (Note 1)	APCS-7NCN1T□□□	Applicable Drive	iX7NH, L7NH SERIES																																																
Specifications	<p>Terminal block Drive connection CN1</p>  <p style="text-align: center;">- Pin Map -</p> <table border="1" data-bbox="566 1366 1117 1556"> <thead> <tr> <th>PIN Number</th> <th>I/O signal</th> <th>PIN Number</th> <th>I/O signal</th> <th>PIN Number</th> <th>I/O signal</th> <th>PIN Number</th> <th>I/O signal</th> </tr> </thead> <tbody> <tr> <td>1</td> <td>BREAK+</td> <td>6</td> <td>24V</td> <td>11</td> <td>HOME</td> <td>16</td> <td>NC</td> </tr> <tr> <td>2</td> <td>BREAK-</td> <td>7</td> <td>CWL</td> <td>12</td> <td>ALMRST</td> <td>17</td> <td>RDY+</td> </tr> <tr> <td>3</td> <td>ALARM+</td> <td>8</td> <td>CCWL</td> <td>13</td> <td>DI1</td> <td>18</td> <td>RDY-</td> </tr> <tr> <td>4</td> <td>ALARM-</td> <td>9</td> <td>PROBE1</td> <td>14</td> <td>DI2</td> <td>19</td> <td>DO1+</td> </tr> <tr> <td>5</td> <td>NC</td> <td>10</td> <td>PROBE2</td> <td>15</td> <td>NC</td> <td>20</td> <td>DO1-</td> </tr> </tbody> </table>		PIN Number	I/O signal	PIN Number	I/O signal	PIN Number	I/O signal	PIN Number	I/O signal	1	BREAK+	6	24V	11	HOME	16	NC	2	BREAK-	7	CWL	12	ALMRST	17	RDY+	3	ALARM+	8	CCWL	13	DI1	18	RDY-	4	ALARM-	9	PROBE1	14	DI2	19	DO1+	5	NC	10	PROBE2	15	NC	20	DO1-	
	PIN Number	I/O signal	PIN Number	I/O signal	PIN Number	I/O signal	PIN Number	I/O signal																																											
1	BREAK+	6	24V	11	HOME	16	NC																																												
2	BREAK-	7	CWL	12	ALMRST	17	RDY+																																												
3	ALARM+	8	CCWL	13	DI1	18	RDY-																																												
4	ALARM-	9	PROBE1	14	DI2	19	DO1+																																												
5	NC	10	PROBE2	15	NC	20	DO1-																																												
<p>1. Drive connection (CN1)</p> <p>a. Case specifications: 10320-52A0-008 (3M)</p> <p>b. CONNECTOR specifications: 10120-3000PE (3M)</p> <p>c. CABLE specifications: AWG28 x 10P</p> <p>2. Terminal block connection</p> <p>a. Connector specifications: HIF3BA-20D-2.54R (Hirose)</p> <p>b. Terminal block specifications: XTB-20H (Samwon Act)</p> <p>3. Cable length</p> <table border="1" data-bbox="406 1825 957 1904"> <thead> <tr> <th>Serial Number</th> <th>H01</th> <th>H02</th> <th>H03</th> <th>H04</th> </tr> </thead> <tbody> <tr> <td>Length</td> <td>0.5 Meter</td> <td>1 Meter</td> <td>1.5 Meter</td> <td>2 Meter</td> </tr> </tbody> </table>					Serial Number	H01	H02	H03	H04	Length	0.5 Meter	1 Meter	1.5 Meter	2 Meter																																					
Serial Number	H01	H02	H03	H04																																															
Length	0.5 Meter	1 Meter	1.5 Meter	2 Meter																																															

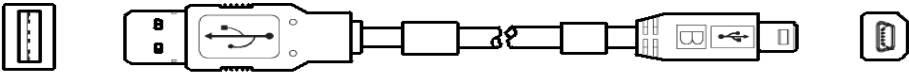
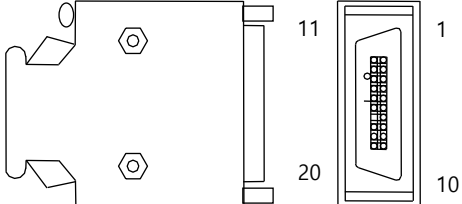
2. Product Specifications

Classification	For signal	Product Name	Communication Cable (CN5)
Model Name (Note 1)	APCS-CN5L7U	Applicable Drive	iX7NH, L7NH SERIES
Specifications	<p>Host controller connection (USB) Drive connection CN1</p>  <ol style="list-style-type: none"> 1. PC connection: USB A plug 2. Drive connection (CN5): Mini USB 5P Plug 3. Electrical requirements: Double shield, twisted pair, attachable EMI filter (Product for reference: SANWA's KU-AMB518) 		
Classification	CN	Product Name	CN1 Connector
Model Name (Note 1)	APC-CN2NNA	Applicable Drive	iX7NH, L7NH SERIES
Specifications	 <ol style="list-style-type: none"> 1. CASE Model: 10320-52A0-008 (3M) 2. CONNECTOR Model: 10120-3000PE (3M) 		
Classification	CN	Product Name	STO Connector
Model Name (Note 1)	APCS-CN6K	Applicable Drive	iX7NH, L7NH SERIES
Specifications	 <ol style="list-style-type: none"> 1. MINI I/O By-Pass Connector: 1971153 (TE) 		

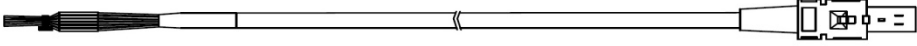
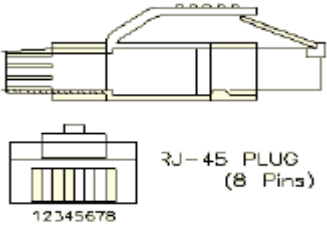
Classification	CN	Product Name	CN6 Connector																														
Model Name (Note 1)	APCS-STO□□A	Applicable Drive	iX7NH, L7NH SERIES																														
Specifications	<p style="text-align: right;">Drive connection</p>  <p style="text-align: center;">-Pin Map -</p> <table border="1"> <thead> <tr> <th>PIN Number</th> <th>IO signal</th> <th>Color</th> </tr> </thead> <tbody> <tr> <td>1</td> <td>NC</td> <td>—</td> </tr> <tr> <td>2</td> <td>NC</td> <td>—</td> </tr> <tr> <td>3</td> <td>HWBB1 Minus</td> <td>Orange</td> </tr> <tr> <td>4</td> <td>HWBB1 Plus</td> <td>Orange/Stripe</td> </tr> <tr> <td>5</td> <td>HWBB2 Minus</td> <td>Yellow</td> </tr> <tr> <td>6</td> <td>HWBB2 Plus</td> <td>Yellow/Stripe</td> </tr> <tr> <td>7</td> <td>EDM Plus</td> <td>White</td> </tr> <tr> <td>8</td> <td>EDM Minus</td> <td>White/Stripe</td> </tr> </tbody> </table> <p>1. Plug Connector Kit a. 2069577-1 (TE) 2. Cable a. 4P x 26AWG 3. Product Marking a. APCS - STO03A (0.3m) b. APCS - STO10A (1m) c. APCS - STO30A (3m)</p>			PIN Number	IO signal	Color	1	NC	—	2	NC	—	3	HWBB1 Minus	Orange	4	HWBB1 Plus	Orange/Stripe	5	HWBB2 Minus	Yellow	6	HWBB2 Plus	Yellow/Stripe	7	EDM Plus	White	8	EDM Minus	White/Stripe			
PIN Number	IO signal	Color																															
1	NC	—																															
2	NC	—																															
3	HWBB1 Minus	Orange																															
4	HWBB1 Plus	Orange/Stripe																															
5	HWBB2 Minus	Yellow																															
6	HWBB2 Plus	Yellow/Stripe																															
7	EDM Plus	White																															
8	EDM Minus	White/Stripe																															
Classification	CN	Product Name	CN6 Cable																														
Model Name (Note 1)	APCS-CN4NNA	Applicable Drive	iX7NH, L7NH SERIES																														
Specifications	 <p style="text-align: center;">3J-45 PLUG (8 Pins)</p> <p style="text-align: center;">12345678</p> <table border="1"> <thead> <tr> <th>PIN Number</th> <th>Signal Names</th> <th>Line color</th> </tr> </thead> <tbody> <tr> <td>1</td> <td>Tx/Rx0+</td> <td>White/Orange</td> </tr> <tr> <td>2</td> <td>Tx/Rx0-</td> <td>Orange</td> </tr> <tr> <td>3</td> <td>Tx/Rx1+</td> <td>White/Green</td> </tr> <tr> <td>4</td> <td>Tx/Rx2+</td> <td>Blue</td> </tr> <tr> <td>5</td> <td>Tx/Rx2-</td> <td>White/Blue</td> </tr> <tr> <td>6</td> <td>Tx/Rx1-</td> <td>Green</td> </tr> <tr> <td>7</td> <td>Tx/Rx3+</td> <td>White/Brown</td> </tr> <tr> <td>8</td> <td>Tx/Rx3-</td> <td>Brown</td> </tr> <tr> <td></td> <td>Plate</td> <td>Shield</td> </tr> </tbody> </table>			PIN Number	Signal Names	Line color	1	Tx/Rx0+	White/Orange	2	Tx/Rx0-	Orange	3	Tx/Rx1+	White/Green	4	Tx/Rx2+	Blue	5	Tx/Rx2-	White/Blue	6	Tx/Rx1-	Green	7	Tx/Rx3+	White/Brown	8	Tx/Rx3-	Brown		Plate	Shield
PIN Number	Signal Names	Line color																															
1	Tx/Rx0+	White/Orange																															
2	Tx/Rx0-	Orange																															
3	Tx/Rx1+	White/Green																															
4	Tx/Rx2+	Blue																															
5	Tx/Rx2-	White/Blue																															
6	Tx/Rx1-	Green																															
7	Tx/Rx3+	White/Brown																															
8	Tx/Rx3-	Brown																															
	Plate	Shield																															

1. □□□ in the model name indicates the cable length. Refer to the table below for how the lengths are represented.

Cable Length (m)	1	2	3	5
Designation	01	02	03	05

■ Option (Braking Resistance)/200[V]

Item	Product Name	Model Name	Applicable Drive	Specifications
Resistance	Braking Resistance	APCS-140R50 (50Ω/140W)	iX7□A001□ iX7□A002□ iX7□A004□	
Resistance	Braking Resistance	APCS-300R30 (30Ω/300W)	iX7□A008□ iX7□A010□	
Resistance	Braking Resistance	APC-600R30 x3P (Parallel) (30Ω/600W x3P (Parallel) =10Ω/1800W)	iX7□A020□ iX7□A035□	

■ Option (Noise Filter)

Item	Product Name	Model Name	Applicable Drive	Specifications
Resistance	Noise Filter	APCS-TB6-B010LBEI	iX7□A 001□ iX7□A 002□ iX7□A 004□ iX7□A 008□ iX7□A 010□	
		APCS-TB6-B030NBDC	iX7□A 020□ iX7□A 035□	

3. Wiring and Connection

3.1 Servo Motor Installation

3.1.1 Operating Environment

Items	Environmental conditions	Precautions
Ambient Temperature	0 ~ 40[°C]	Consult our technical support team to customize the product if the temperatures in the installation environment are outside this range.
Ambient Humidity	80[%] RH or lower	Do not operate this device in an environment with steam.
External vibration	Vibration acceleration 19.6[m/s ²] or below on X and Y axes	Excessive vibrations reduce the lifespan of the bearings.

3.1.2 Preventing Over-impact

Impact to the motor during installation or handling may damage the encoder.



3.1.3 Motor Connection

- Directly connecting the motor to a commercial power supply may burn the motor. Make sure to connect it with the specified drive before using it.
- Connect the motor's ground terminals to the U, V, W and PE connectors of the drive and connect the end of heat sink to the type 3 ground.

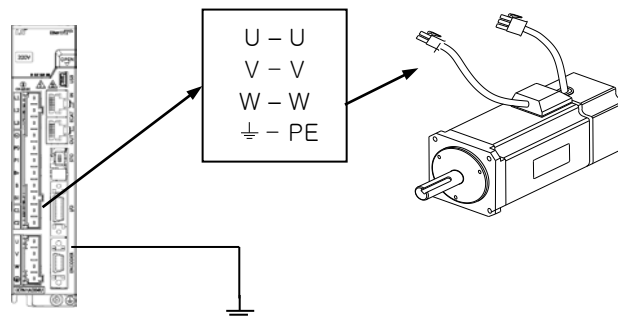

- Connect the U, V, W and PE terminals of the motor to match the U, V, W and PE terminals of the drive.
- Ensure that no pin on the motor connector is fallen off or inadequately connected.
- If there is moisture or condensation on the motor, make sure that insulation resistance is 10[MΩ] (500[V]) or higher and install only if there is no abnormality.

3.1.4 Load Device Connection

For coupling connections: Ensure that the motor shaft and load shaft are aligned within the tolerance range.

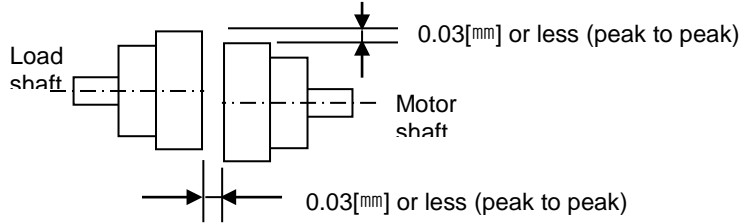

■ For Pulley Connections:

Flange	Radial Load		Axial Load		Notes
	N	kgf	N	kgf	
40	148	15	39	4	
60	206	21	69	7	
80	255	26	98	10	
130	725	74	362	37	
180	1548	158	519	53	
220	1850	189	781	90	

3.1.5 Cable Installation

- For vertical installations, make sure that no oil or water flows into the connecting parts.

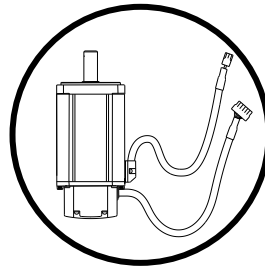
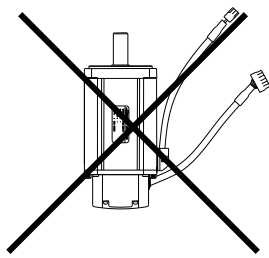

- Do not pressurize or damage the cables. Make sure to use robot cables for a moving motor and prevent the cables from swaying.

3.2 Servo Drive Installation

3.2.1 Installation and Usage Environment

Items	Environmental conditions	Precautions
Ambient Temperature	0 ~ 50[°C]	<p>⚠ Caution</p> <p>Install a cooling fan on the control panel for ventilation and to maintain the temperature within the range.</p>
Ambient Humidity	90% RH or lower	<p>⚠ Caution</p> <p>Moisture developed inside the drive due to ice formation or condensation during a prolonged period of inactivity may damage the drive. Remove all moisture before operating the drive after a prolonged period of inactivity.</p>
External vibration	Vibration acceleration 4.9[m/s ²] or lower	Excessive vibration reduces the lifespan of the product, and it may cause malfunctions.
Ambient conditions		<ul style="list-style-type: none"> ▪ Do not expose the device to direct sunlight. ▪ Do not expose the device to corrosive or combustible gases. ▪ Do not expose the device to oil or dust. ▪ Ensure that the device receives sufficient ventilation even if installed in a confined space.

3.2.2 Installation with the Control Panel

Comply with the spacing standard specified in the following figures when installing with the control panel.

■ When installing 1 unit:

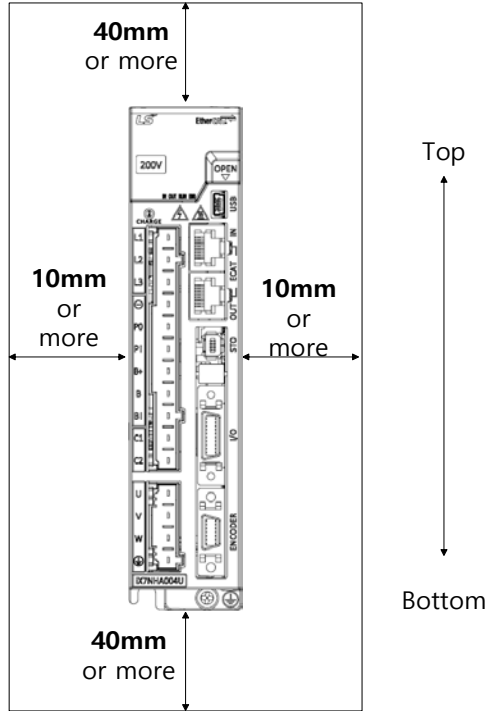

■ When installing 2 or more units:

To prevent the temperature inside the control panel from exceeding the servo drive environmental conditions, install a cooling fan on the top of the servo drive. Also, refer to the picture below and leave sufficient space to allow for cooling by heat convection within the fan and control panel.

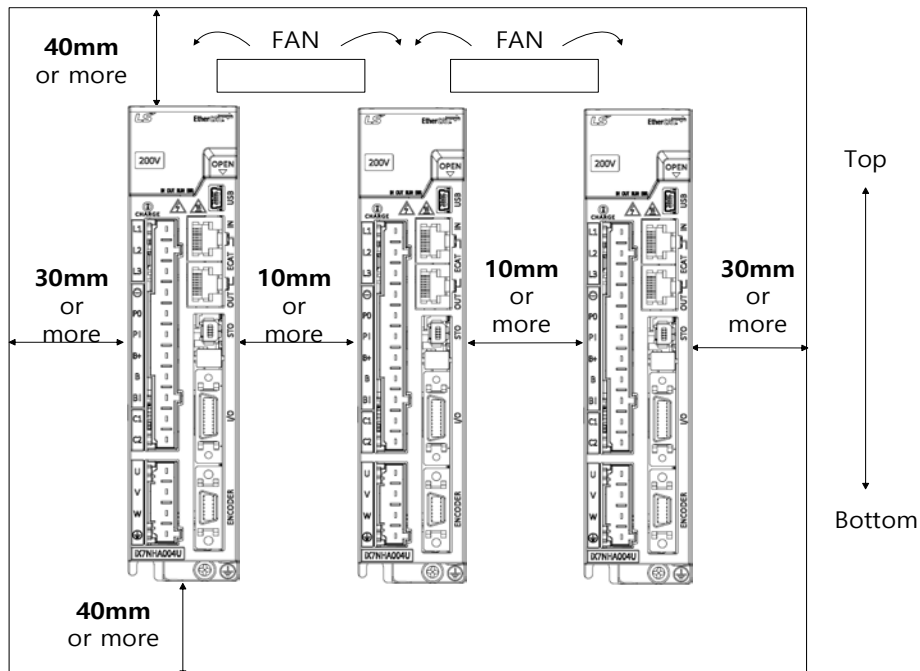

 Caution

- Install the external regeneration brake resistor properly so that generated heat does not affect the drive.
- Assemble the servo drive control panel so it is flat against the wall.
- Do not let any metal debris generated from drilling, etc. fall into the drive when assembling the control panel.
- Make sure that oil, water, or metal dust does not enter the drive through the gaps or roof of the control panel.
- Protect the control panel by using air purge system when using it in an area where there are high amounts of harmful gases or dust.
- Make sure to keep the internal temperature of the control panel below the environmental conditions by allowing a wide space between the surface of the servo drive and the internal surface of the control panel, or installing a cooling fan.
- If the servo drive must be installed closely to one another, mount the 1.0kW (or lower) servo drive 1mm apart considering the mounting tolerance. Also, maintain the ambient temperature at 45°C or lower and operate the device at a load factor under 100%. For the models of the servo drive. higher, installing the drive closely can cause an increase in the internal temperature of the drive and lower the continuous overload range during operation. Therefore, make sure to install them at least 10mm apart.

3.3 Internal Block Diagram of the Servo Drive

3.3.1 Internal Block Diagram of the Servo Drive (100-400W / 200[V])

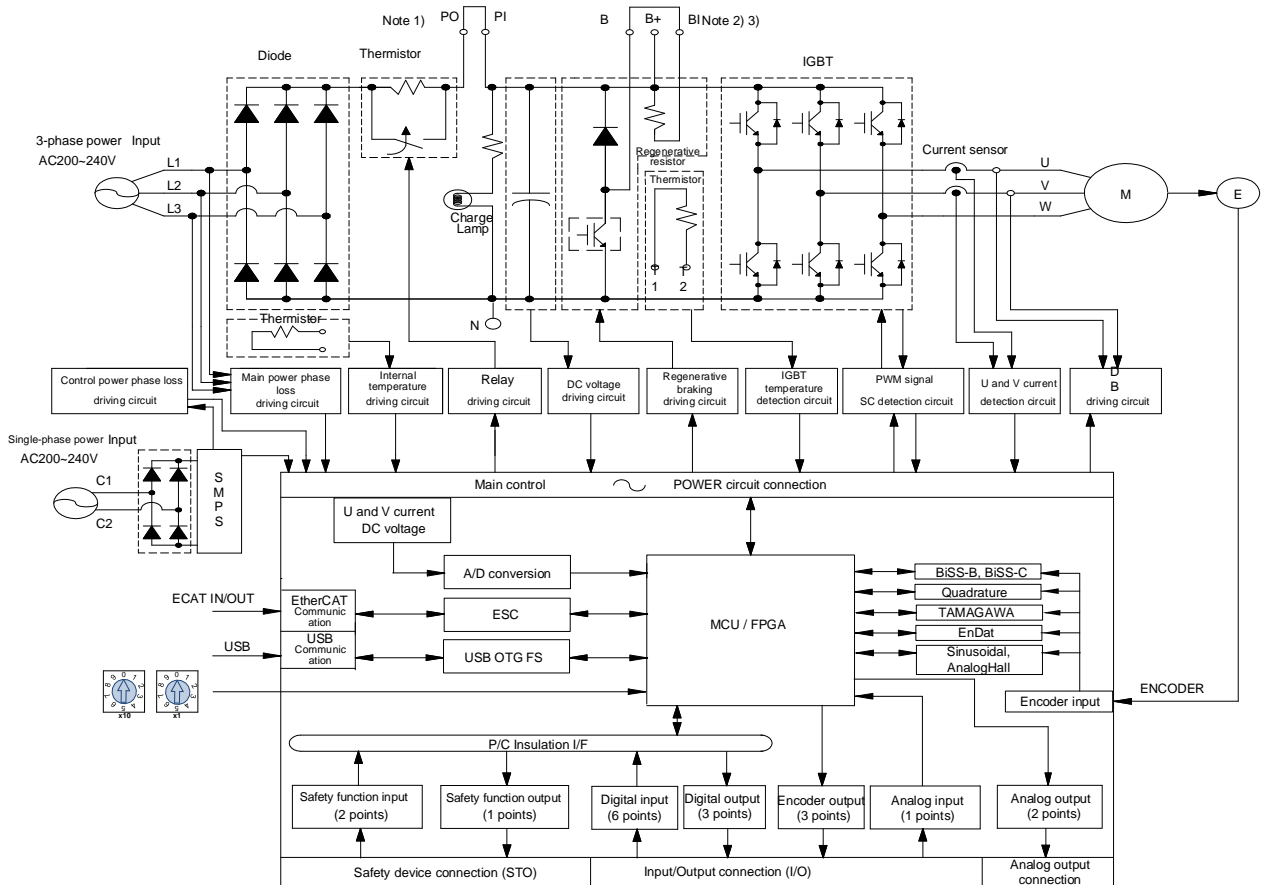

Note 1) To use a DC reactor, connect it to the PO and PI pins.

Note 2) To use an external regeneration brake resistor, remove the B and BI short-circuit pins and connect the resistor to the B+ and B pins.

Note 3) 200[W] or lower models do not include internal regenerative resistors.

Note 4) For main power, 200[V]/100[W]-400[W] models support single-phase 100-120[V] and 200-240[V], and 200[V]/750[W] models support 200-240[V]. When using single-phase main power, connect it to any two of L1, L2 and L3 terminals.

Note 5) Use the N[(-)] terminal for connecting an external capacitor. Connecting power supply to the [(-)] terminal will cause burn damage to the product. Always contact the customer center or agency when it is necessary to connect an external capacitor.

3.3.2 Drive Block Diagram (800W to 3.5kW / 200[V])

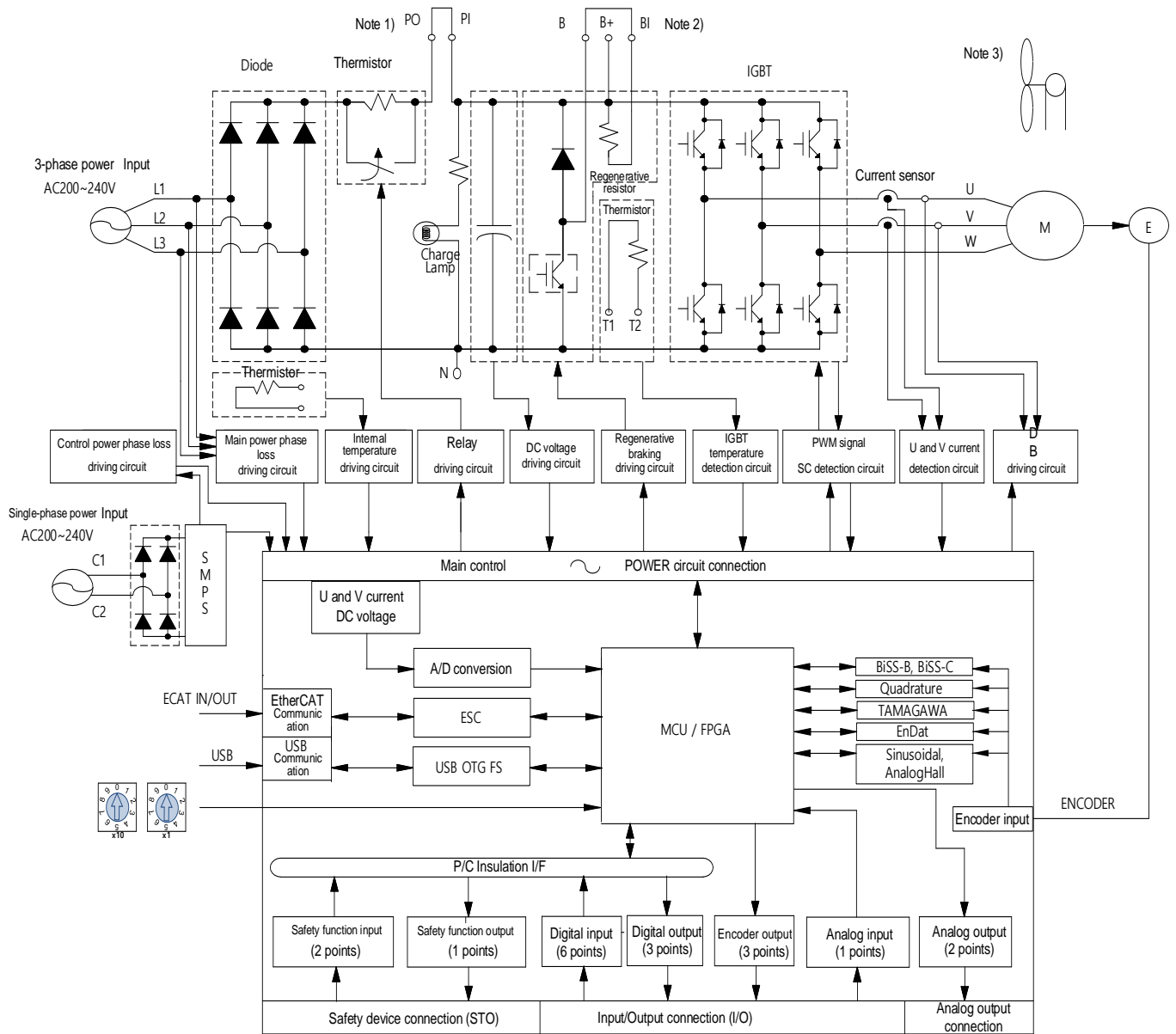

Note 1) To use a DC reactor, connect it to the PO and PI pins.

Note 2) To use an external regeneration brake resistor, remove the B and BI short-circuit pins and connect the resistor to the B+ and B pins.

Note 3) 800 [W] to 3.5 [kW] drive models are cooled by 24 [V] DC cooling fans.

Note 4) Use the N[(-)] terminal for connecting an external capacitor. Connecting power supply to the [(-)] terminal will cause burn damage to the product. Always contact the customer center or agency when it is necessary to connect an external capacitor.

3.4 Power Supply Wiring

- Ensure that the input power voltage is within the acceptable range.

⚠ Caution
Excessive voltage damages the drive.

- If a commercial power supply is connected to U, V and W terminals of the drive, the drive may be damaged. Be sure to connect power to L1, L2, L3 terminals.
- Connect short-circuit pins to the B and BI terminals. For external regeneration brake resistors, remove the short-circuit pins and use standard resistors for the B+ and B terminals.

Operating Voltage	Models	Resistance Values	Standard Capacity	* Notes
220[V]	iX7NHA001U iX7NHA002U	-	-	⚠ Caution For resistance values to use during regenerative capacity expansion, refer to Section 2.3, "Optional and Peripheral Devices."
	iX7NHA004U	100[Ω]	Built-in 50 W	
	iX7NHA008U iX7NHA010U	40[Ω]	Built-in 100 W	
	iX7NHA020U iX7NHA035U	12.6[Ω]	Built-in 150 W	

- Configure the system so that the main power (L1, L2, L3) is supplied after the control power (C1, C2). (Refer to section 3.4.1, "Power Supply Wiring Diagram.")
- High voltages may remain in the device for sometime even after the main power is disconnected. Be careful.

⚡ Danger
Before resuming wiring, make sure to disconnect the main power and that the charge lamp is completely turned off. Failure to do so may result in electric shock.

- Always ground the device using the shortest possible ground wire. Long ground wires are easily influenced by noise, which causes malfunctions.

3.4.1 Power Supply Wiring Diagram

100[W] ~ 3.5[kW]

Phase 3 AC 200~240 [V] Note 2)

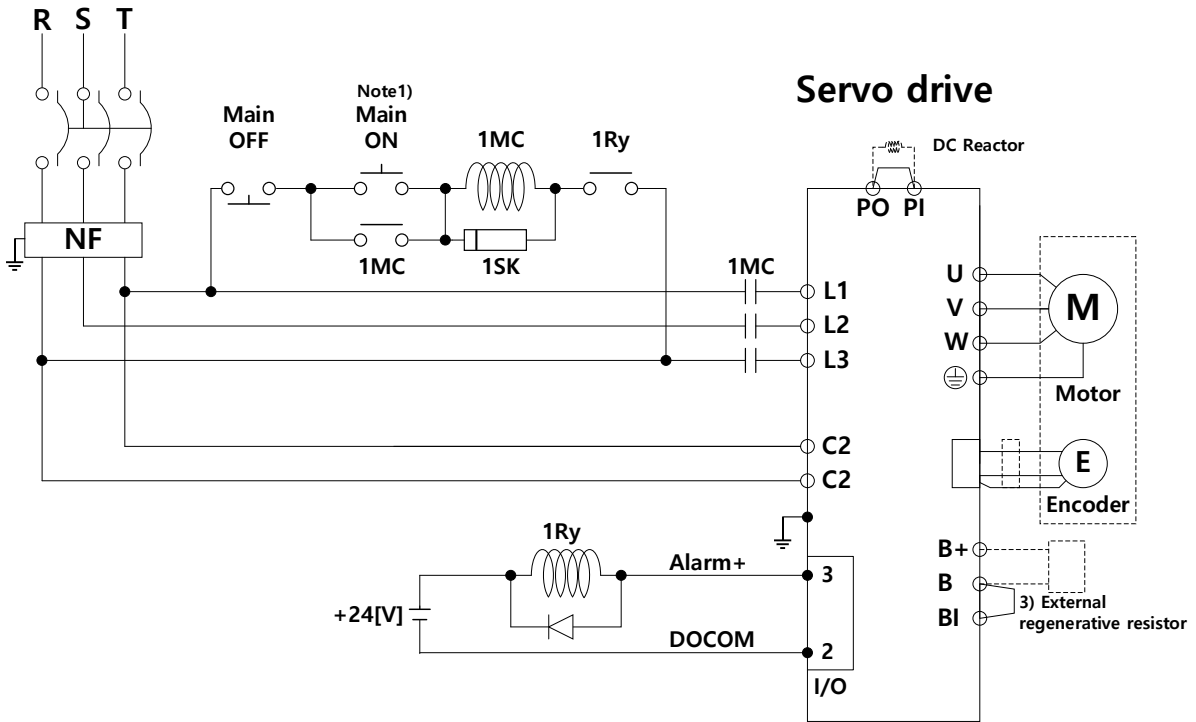

Single phase AC 100~240 [V] Note2)

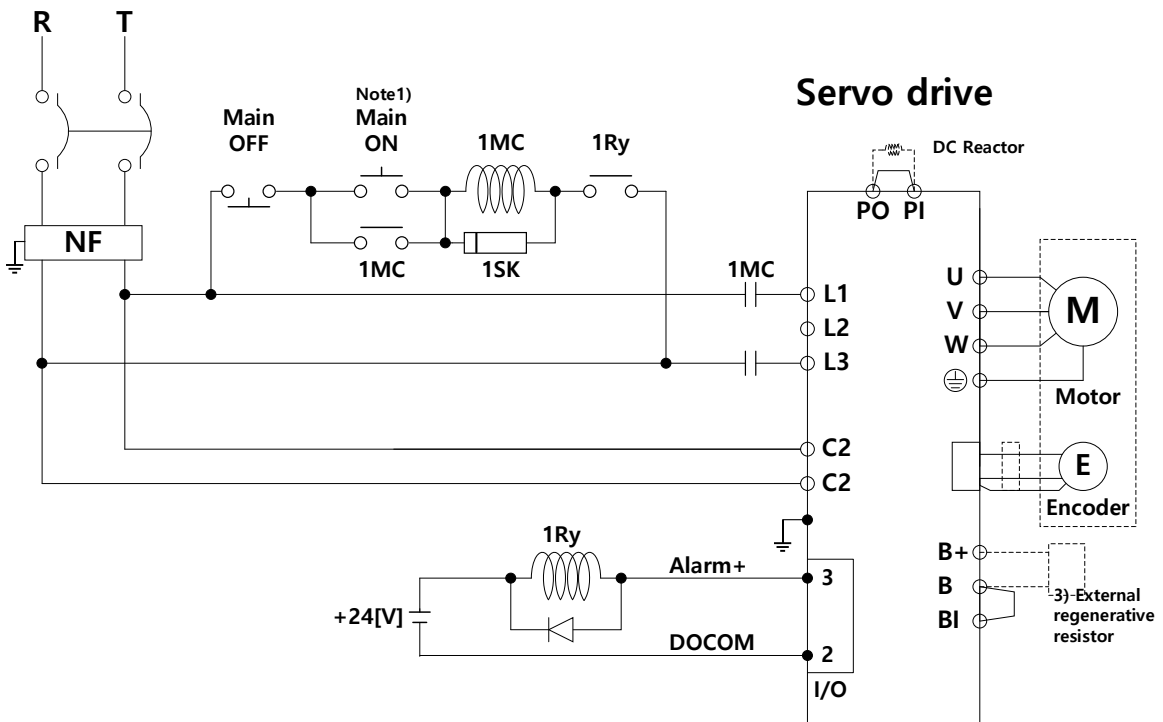

Note 1) It takes approximately 2.5 to 3 seconds until an alarm signal is output after you turn on the main power. Press and hold the main power ON switch for at least 3 seconds.

Note 2) For main power, 200[V]/100[W]-400[W] models support single-phase 100-120[V] and 200-240[V], and 200[V]/750[W] models support 200-240[V]. When using single-phase main power, connect it to any two of L1, L2 and L3 terminals.

Note 3) Since the 200V/400W-3.5kW models include a built-in regeneration brake resistor, short-circuit B and BI terminals before use. If the regenerative capacity is high because of frequent acceleration and deceleration, open the short-circuit pins (B and BI) and connect an external regeneration brake resistor to B and B+.

Note 4) Remove approximately 8 to 9 [mm] of the sheathing from the cables for the main circuit power and use the dedicated pressurized terminals. (Refer to Section 3.4.2, "Power Circuit Electrical Component Standards.")

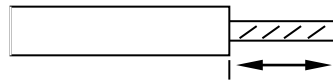

Note 5) Use Spring Opener (TE) to connect or remove the main circuit power wiring of a 200[V]/100[W]-1[kW] drive.

Note 6) Use the (-) terminal for connecting an external capacitor. Connecting power supply to the (-) terminal will cause burn damage to the product. Always contact the customer center or agency when it is necessary to connect an external capacitor.

3.4.2 Power Circuit Electrical Component Standards

Model Name		iX7NHA001U ~iX7NHA004U	iX7NHA008U ~ iX7NHA010U	iX7NHA020U ~ iX7NHA035U
MCCB (NFB)		30A Frame 15A (ABE33C/15)		30A Frame 30A (ABE33C/30)
Noise filter (NF)		TB6-B010LBEI(10A)		TB6-B030NBDC(30A)
DC reactor		10 A	15[A]	30 A
MC		11A / 240V (GM□-9)	18A / 240V (GM□-18)	32A / 240V (GM□-32)
Wire Note 1)	L1,L2, L3,PO,PI,N B+,B,BI U,V,W	AWG16 (1.5 mm ²)	AWG14 (2.5 mm ²)	AWG 12 (4.0 mm ²)
	C1, C2	AWG16 (1.5 mm ²)	AWG16 (1.5 mm ²)	AWG 16 (1.5 mm ²)
Pressurized terminal		AL 1,5-8 BK 3200043, Phoenix Contact AI 0,75- 8 GY - 3200519, Phoenix Contact (8.5±0.5mm Strip & Twist)		UA-F4010, SEOIL (10 mm Strip & Twist)
Regeneration brake resistor (Default)		50[W] 100Ω	100[W] 40Ω	150[W] 13Ω
Connector		<ul style="list-style-type: none"> • 1-2289080-1 • 1-2331743-4 • 1981045-1 (Spring Opener) 		<ul style="list-style-type: none"> • 0183-1105T04 • 0183-1106T04 • 0183-1107T05

Note 1) Select and use 600V, PVC-insulated wires.

Note 2) To comply with UL (CSA) standards, use UL-certified wires that have a heat resistant temperature of 75°C or above.

Note 3) To comply with other standards, use proper wires that meet the applicable standards.

Note 4) For other special specifications, use wires equivalent or superior to those specified in this Section.

Note 5) For pressurized terminals, it is recommended to use the products specified in this section or other products of equivalent specifications.

■ Connector Wiring

The following is how to connect power or motor connectors to iX7NHA010U or lower servo drive models.

To connect a power or motor connector, use a spring opener or flat-head screwdriver to clear the opening as shown below. Insert the core wire into the hole and pull out the spring opener or flat-head screwdriver to complete connection.

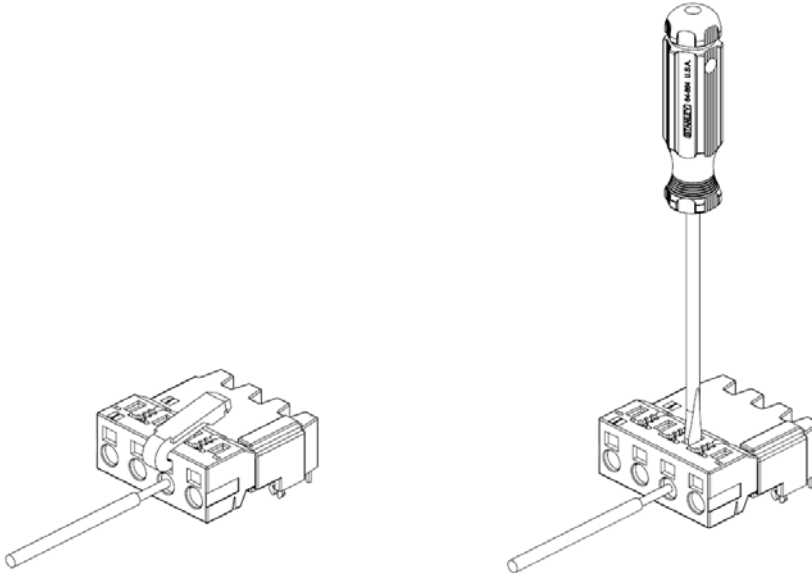

Do the same for each part of the servo drive that needs a connector, and after connection is completed, connect the connector to the servo drive.

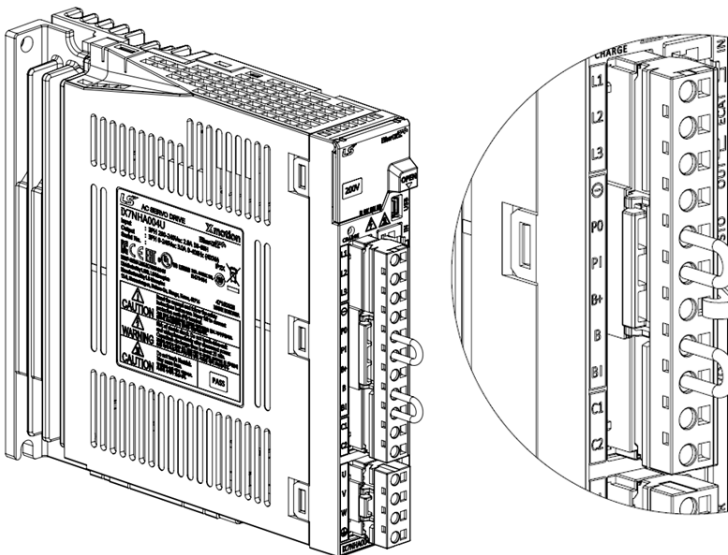

■ iX7NHA004U or lower

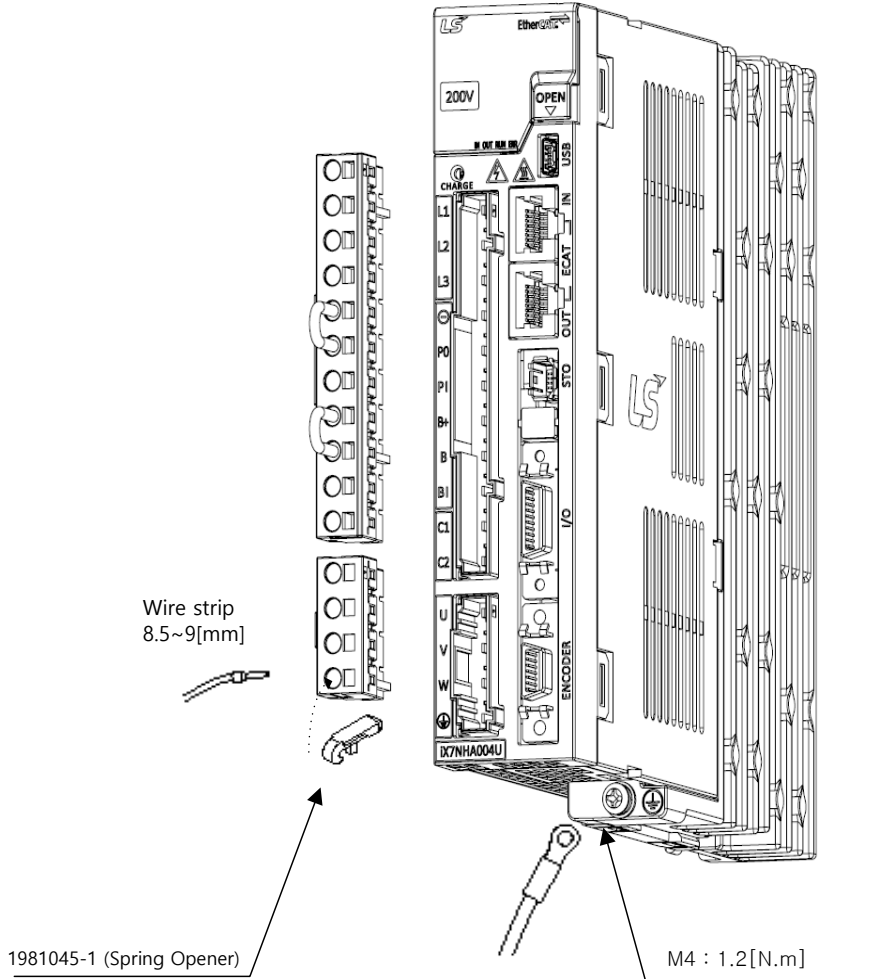

■ iX7NHA008U ~ iX7NHA010U

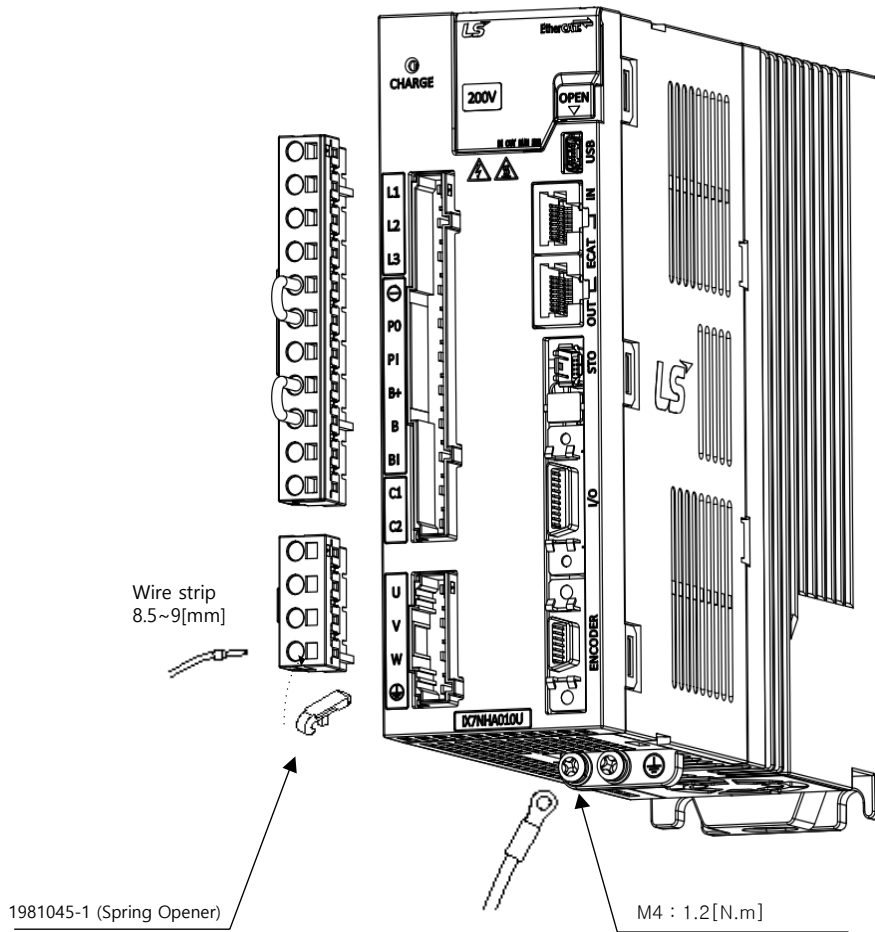

■ iX7NHA020U ~ iX7NHA035U

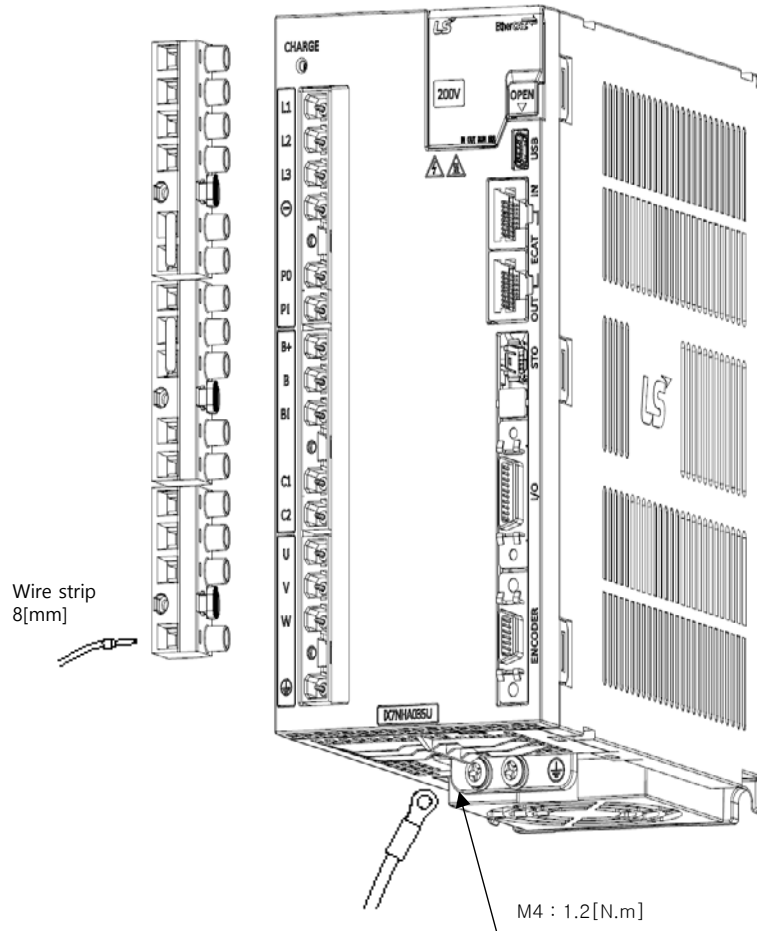

3.4.3 Power Input Sequence

■ Power Input Sequence

- For wiring of the main power, use a magnetic contactor for the main circuit power as shown in Section 3.4.1, "Power Supply Wiring Diagram." Set the magnetic contactor to be turned off simultaneously with an alarm occurrence in the external sequence.
- The control power (C1 and C2) should be applied simultaneously with or before the main power (L1, L2, and L3). Also, when the power is off, shut off the control power simultaneously or after the main power is cut off.
- 2.5 - 3 seconds after the power input, the alarm signal turns on (normal), and the Servo On command signal is recognized. Therefore, when the Servo On command signal is on at the same time as the power is input, the actual Servo On is activated 2.5 - 3 seconds later. Keep this in mind when designing the power input sequence.

■ Timing Chart

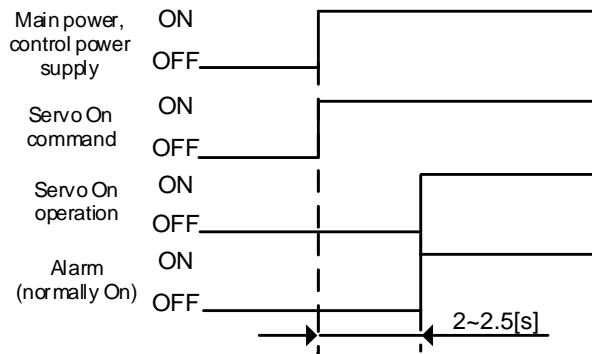

3.4.4 Regeneration Brake Resistor Options

Option Specifications (Braking Resistance)

Item	Product Name	Model Name	Applicable Drive	Specifications
Resistance	Braking Resistance	APCS-140R50	iX7□A001□ iX7□A002□ iX7□A004□	<p>Technical drawing of the APCS-140R50 resistor. It shows a side view with dimensions 188.35 (total length), 172 (resistor length), and 300 (total length including terminals). A detail shows a terminal with a diameter of 4.3 and a height of 41. A top view shows a width of 144.36 and a mounting tab height of 22.</p>
Resistance	Braking Resistance	APCS-300R30	iX7□A008□ iX7□A010□	<p>Technical drawing of the APCS-300R30 resistor. It shows a side view with dimensions 5.3 (terminal diameter), 198 (resistor length), 17 (terminal height), 13 (terminal width), 30 (resistor width), and 500 (total length including terminals). A top view shows a width of 175 and a mounting tab height of 60. The resistor body width is 215.</p>
Resistance	Braking Resistance	APC-600R30	iX7□A020□ (2P) iX7□A035□ (3P)	<p>Technical drawing of the APC-600R30 resistor. It shows two views: a side view for the 2P version with dimensions 5.3 (terminal diameter), 61 (terminal height), and 218 (resistor length); and a top view for the 3P version with dimensions 10 (terminal height), 235 (total width), and 59 (resistor body width). The resistor length is 195.</p>

3.5 Wiring for Input/Output Signals

- I/O Connector Model: 10120-3000PE (3M)

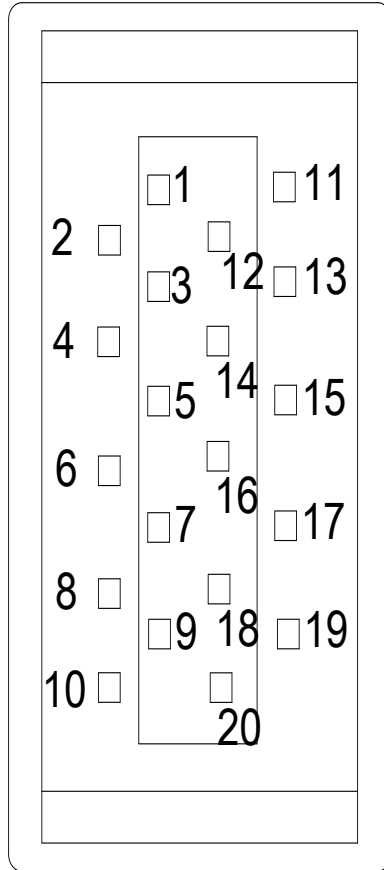

- Analog Monitoring Connector Model: DF-11-4DS-2C (HIROSE)

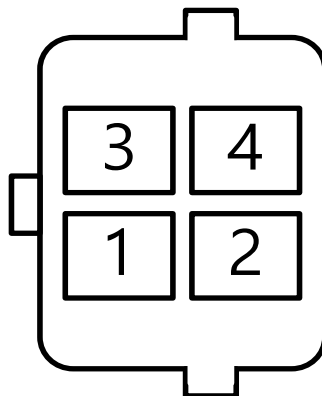

3.5.1 Names and Functions of Digital Input/Output Signals

■ Names and Functions of Digital Input Signals (I/O Connector)

Pin Number	Name	Assignment	Details	Function
6	+24V	DC 24V	DC 24V INPUT	Common
11	DI1	POT	Positive (CCW) Rotation Prohibited	Stops the servo motor to prevent the actuator from allowing positive motion out of the range.
12	DI2	NOT	Negative (CW) Rotation Prohibited	Stops the servo motor to prevent the actuator from allowing negative motion out of the range.
7	DI3	HOME	Home Position Sensor	Connects the home position sensor for homing.
8	DI4	STOP	Servo Stop	Stops the servo motor when the contact is on.
13	DI5	PCON	P Control Action	When the contact is on, it converts the mode from PI control to P control.
14	DI6	GAIN2	Switching Gain 1 to Gain 2	When the contact is on, it switches the velocity control from Gain 1 → Gain 2.
	** PCL		Positive Torque Limit	When the contact is on, the positive torque limit function is activated.
	** NCL		Negative Torque Limit	When the contact is on, the negative torque limit function is activated.
	** PROBE1		Touch Probe 1	The probe signal to rapidly store the position value (1)
	** PROBE2		Touch Probe 2	The probe signal to rapidly store the position value (2)
	** EMG		Emergency Stop	Emergency stop when the contact is on.
	** ARST		Alarm Reset	Resets the servo alarm.
	** LVSF1		Vibration Suppression Filter 1	Signal to use the vibration suppression filter 1 according to the vibration suppression filter function configuration (0x2515)
	** LVSF2		Vibration Suppression Filter 2	Signal to use the vibration suppression filter 2 according to the vibration suppression filter function configuration (0x2515)
	** SVON		Servo ON	Servo ON
	** ABS_Reset		Absolute Encoder Reset	Initializes the multi-turn and single turn values.

** ABS_RQ	Absolute Position Data Request	Upon request of the absolute data of the absolute encoder, the data of the absolute encoder is transmitted to a upper level controller in quadrature pulse format through AO, BO output .
-----------	--------------------------------	---

Note 1)**A signal not assigned by default in the factory setting. The assignment may be changed by parameter settings. For more information, refer to Section 6.2, "Input/Output Signals Setting."

Note 2)Wiring can be also done by using COMMON (DC 24V) of the input signal as GND.

■ Names and Functions of Digital Output Signals

Pin Number	Name	Assignment	Details	Function
1	DO1	BRAKE	Brake	Outputs brake control signal.
3	DO2	ALARM	Servo Alarm	Outputs signal when alarm occurs.
4	DO3	RDY	Servo ready	Output when main power supply is connected and preparation for servo operation is completed.
2	DOCOM		DC 24V GND	DOCOM
	** ZSPD		Zero Speed Achieved	Outputs a signal when the current speed drops below the zero speed.
	** INPOS1		Position Reached 1	Outputs signal when having reached the command position (1)
	** TLMT		Torque Limit	Outputs signal when the torque is limited.
	** VLMT		Speed Limit	Outputs signal when the speed is limited.
	** INSPD		Velocity Reached	Outputs signal when the command velocity is reached.
	** WARN		Servo Warning	Outputs signal when a warning occurs.
	** TGON		Rotation Detection	Outputs signal when the servo motor is rotating above the set value.
	** INPOS2		Position Reached 2	Outputs signal when having reached the command position (2)

** Unassigned signal. The assignment may be changed by parameter settings. For more information, refer to Section 6.2, "Input/Output Signals Setting."

3.5.2 Names and Functions of Analog Input/Output Signals

■ Names and Functions of Analog Input Signals (I/O Connector)

Pin Number	Name	Details	Function
15	A-TLMT	Analog torque limit	It applies -10~+10V between A-TMLT(AI1) and AGND to limit motor output torque. Relationship between input voltage and limit torque depends on the value of [0x221C].
5	AGND	AGND(0V)	Analog ground

■ Names and Functions of Analog Output Signals (Analog Monitoring Connector)

Pin Number	Name	Details	Function
1	AMON1	Analog Monitor 1	Analog monitor output (-10V ~ +10V)
2	AMON2	Analog Monitor 2	Analog monitor output (-10V ~ +10V)
3	AGND	AGND(0V)	Analog ground
4	AGND	AGND(0V)	Analog ground

Note 1) You can change the output variables to be monitored with analog monitor output through parameter settings.

For more information, refer to Section 6.2.3 "Assignment of Analog Output Signals."

3.5.3 Names and Functions of Encoder Output Signals

■ Encoder Output Signal (I/O Connector)

Pin Number	Names	Details	Function
9	AO	Encoder Signal A	Outputs de-multiplied encoder signals in A, B, and Z phases by the line drive method.
10	/AO		
19	BO	Encoder Signal B	
20	/BO		
17	ZO	Encoder Signal Z	
18	/ZO		
16	GND	GND	Digital ground

Note 1) You can set the number of output pulses at [0x2422] and set the lead reference values in phase A and phase B for CCW rotation of the motor at [0x2423].

Up to 6.5[Mpps] of encoder output is supported in multiples of 4. For an output of 6.5[Mpps] or greater, AL-57 is generated. Consider the speed when you set the number of pulses for demultiplied output.

3.5.4 Examples of Input/Output Signal Connection

■ Examples of Digital Input Signal Connection

⚠ Caution

1. You can set the output contact to contact A or contact B, based on the characteristics of individual signals.
2. You can assign each input contact to one of 17 functions.
3. For more information on signal assignment and contact change of the input contact, refer to 6.2 Input/Output Signals Setting.
4. The rated voltage is DC 12V to DC 24V.

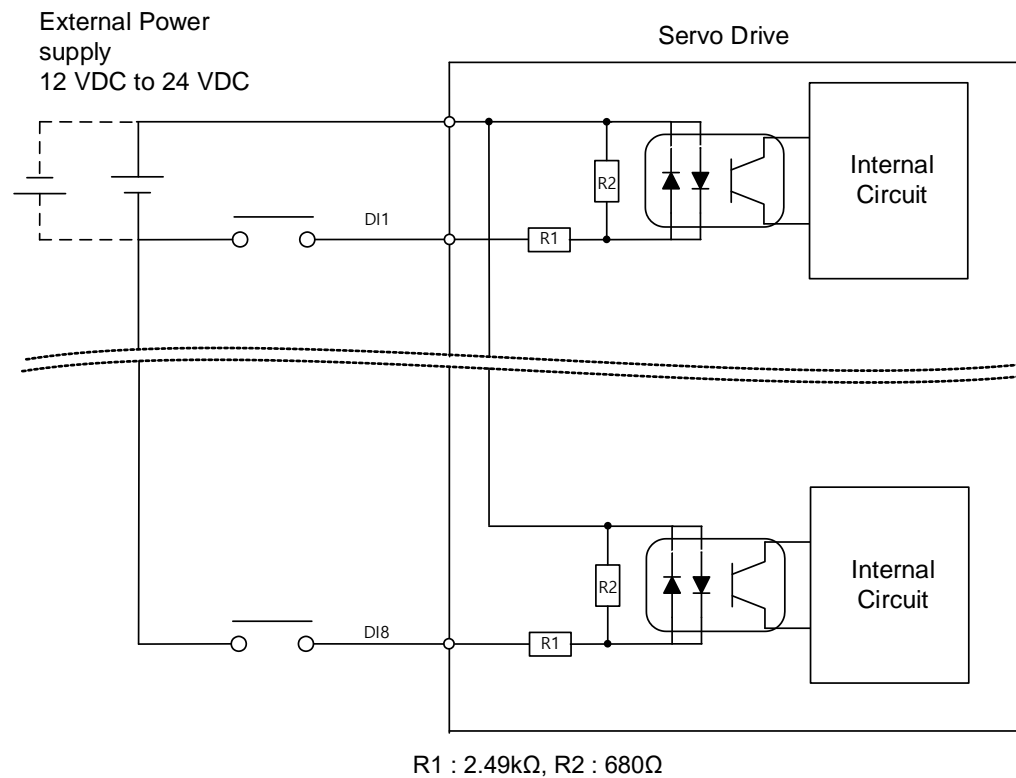

■ Example of Connecting Digital Output Signals

⚠ Caution

1. You can set the output contact to contact A or contact B, based on the characteristics of individual signals.
2. You can assign each output contact to one of 11 output functions.
3. For more information on signal assignment and contact change of the output contact, refer to 6.2 Input/Output Signals Setting.
4. Excessive voltage or overcurrent may damage the device because it uses an internal transistor switch. Be cautious.
5. The rated voltage and current are DC 24V ± 10% and 120[mA].

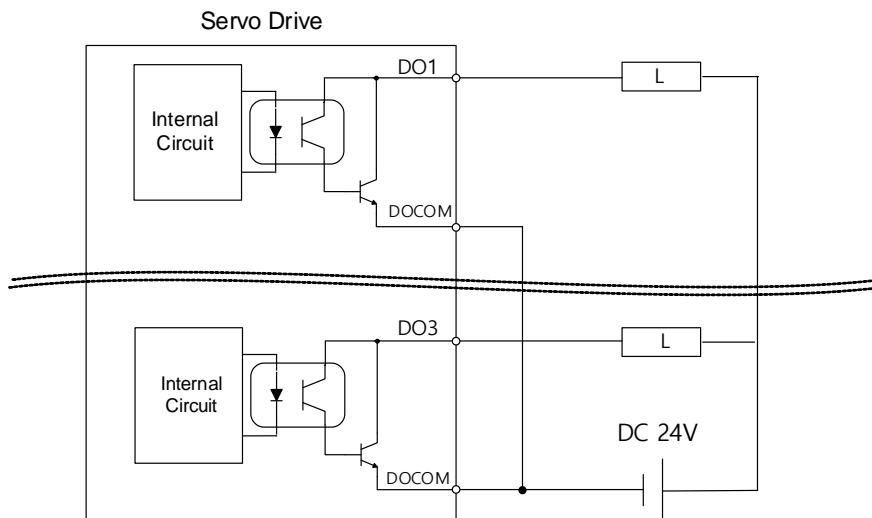

6. When using an electronic brake, refer to the wiring diagram below for configuration.

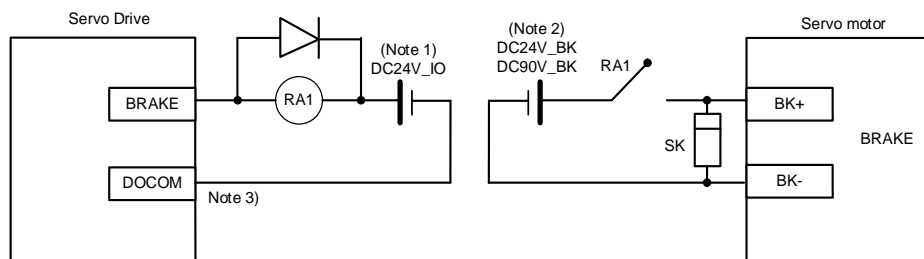

- Note 1) Use separate power sources for the control and the main power of the electronic brake.
 Note 2) Use an appropriate voltage for the electronic brake specifications. (Refer to Section 2. "Product Specifications.")
 Note 3) For DO1-DO3 output, use a common GND24 for DOCOM.

■ Examples of Connecting Analog Input Signals

⚠ Caution

1. For how to operate analog input signals, refer to 「6.9 Torque Limit Functions」.
2. The range of analog output signals is -10V~10V.
3. The impedance for input signals is approximately 10K Ω .

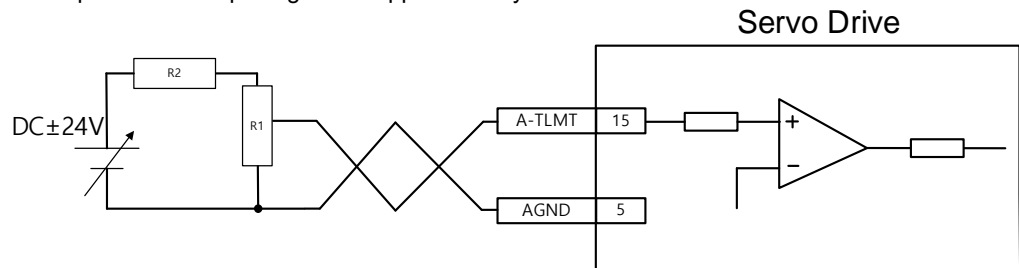

4. Example of resistance selection for use of 24V for input voltage

No	R1	R2
1	5K Ω	6K Ω
2	10K Ω	12K Ω

■ Examples of Connecting Analog Output Signals

⚠ Caution

1. Refer to "6.2.3 Assignment of Analog Output Signals" for signal settings and scale adjustment.
2. The range of analog output signals is -10V to 10V.
3. The resolution of analog output signal is 12 bits.
4. The maximum load current allowed is 2.5 mA.
5. The stabilization time is 15 μ s.

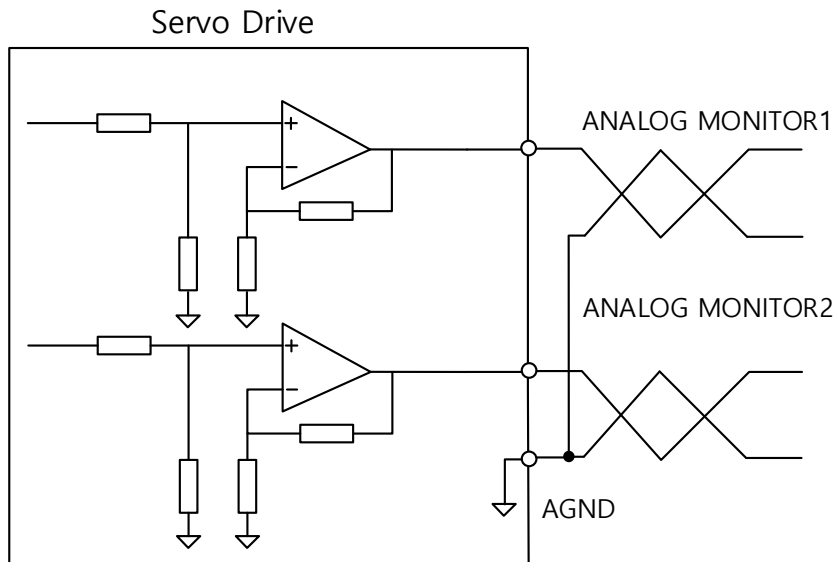

■ Example of Connecting Encoder Output Signals

⚠ Caution

1. Since encoder signals are output for the control power of 0[V] (GND), connect the 0[V] terminal of the upper level controller and the I/O GND terminal.
2. You can set the encoder output pulse at [0x2422] and set the lead reference values in phase A and phase B for CCW rotation of the motor at [0x2423].
3. Up to 6.5[Mpps] of encoder output is supported in multiples of 4.
4. You must change the connection according to the circuit configuration of the upper level controller.

<If the upper level controller is composed of line receivers>

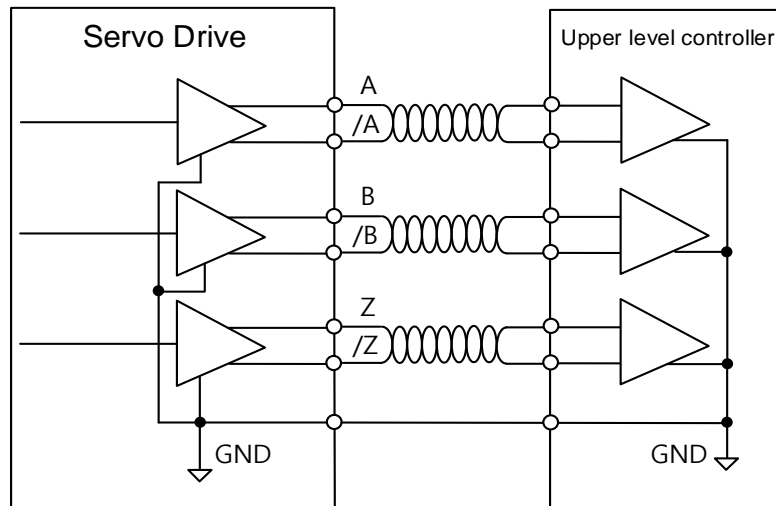

<If the upper level controller is composed of photocouplers>

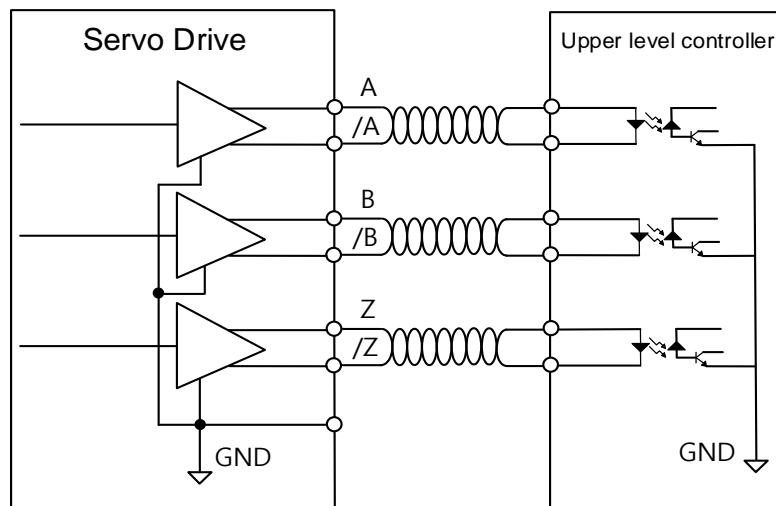

3.5.5 Input/Output Signals Configuration Diagram

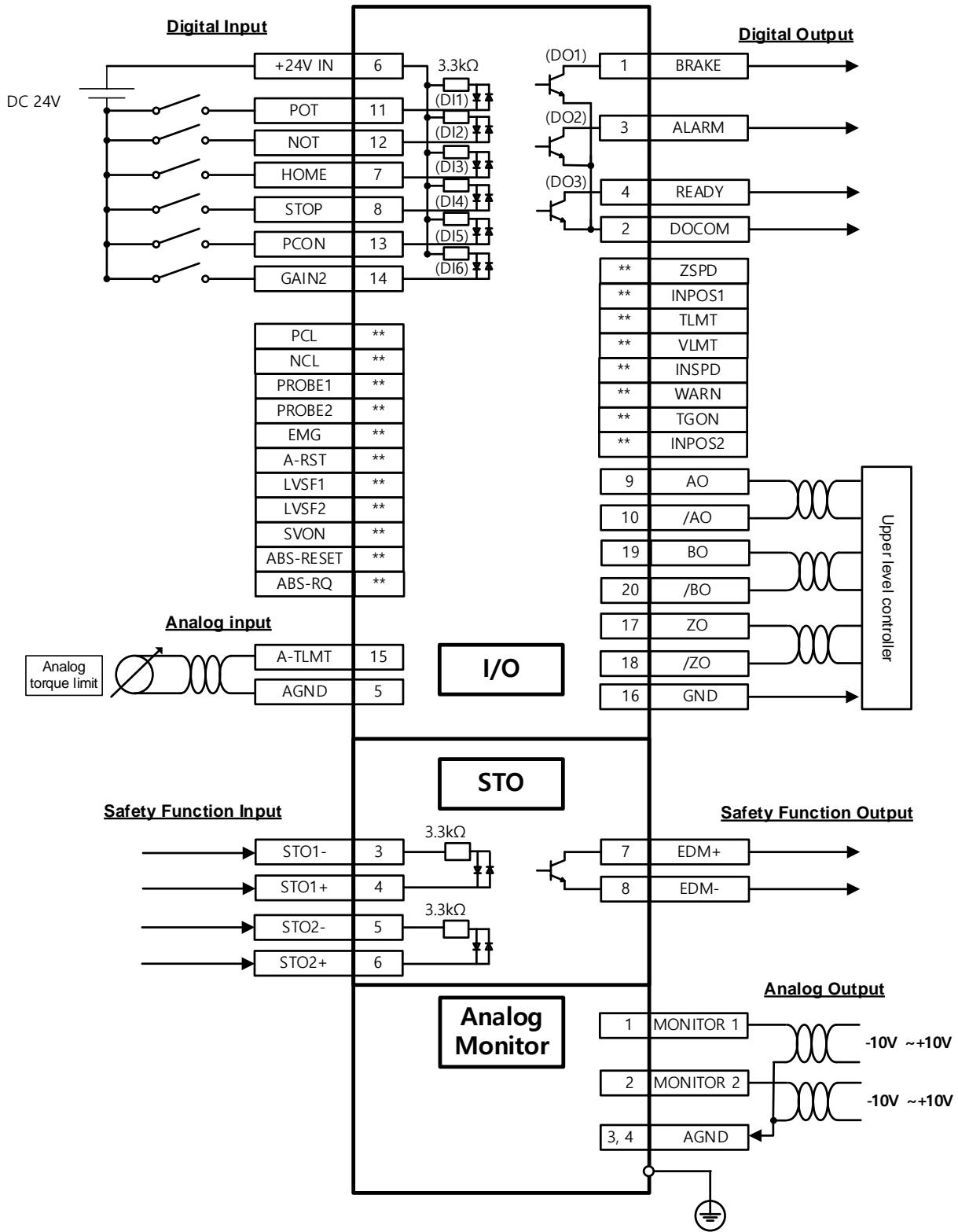

Note 1) Input signals DI1 - DI6 and output signals DO1 - DO3 are factory default signals.

3.6 Wiring of Encoder Signal (ENCODER)

■ ENCODER Connector Model: 10114-3000VE (3M)

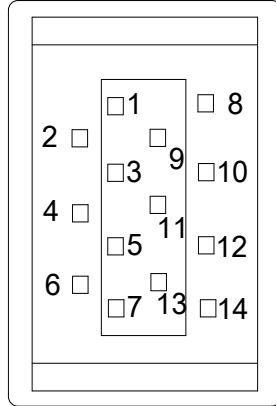

3.6.1 Quadrature Encoder Signaling Unit Wiring

■ APCS-E□□□AS Cable

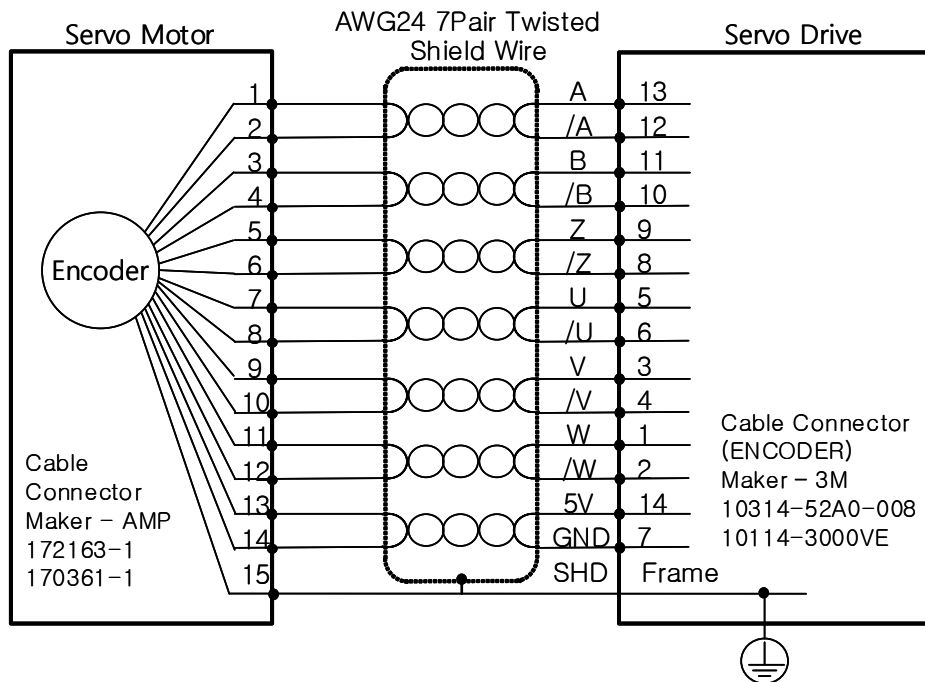

■ APCS-E□□□BS Cable

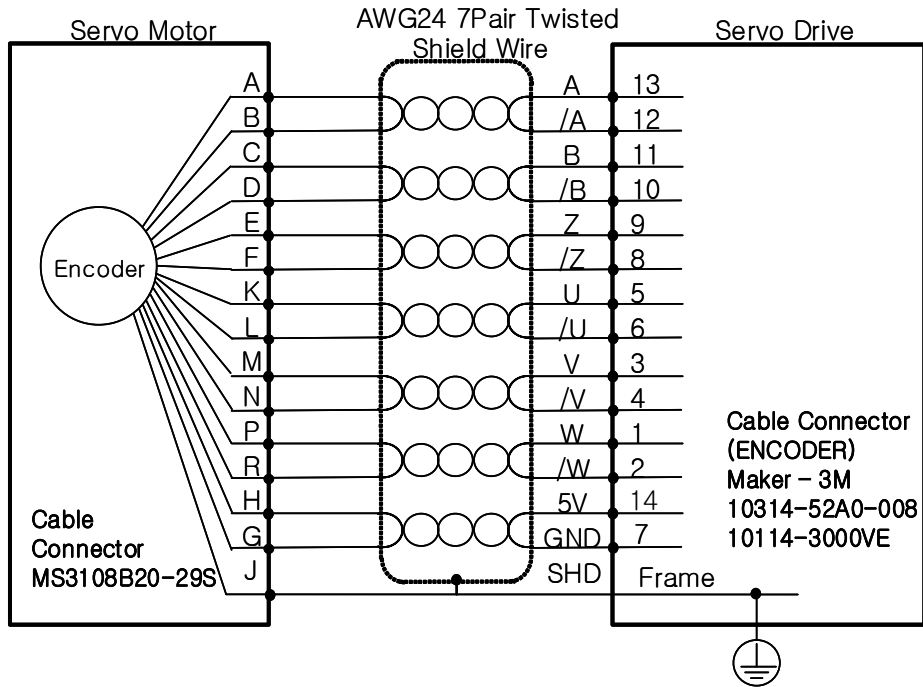

■ Without Quadrature Type Hall Sensor

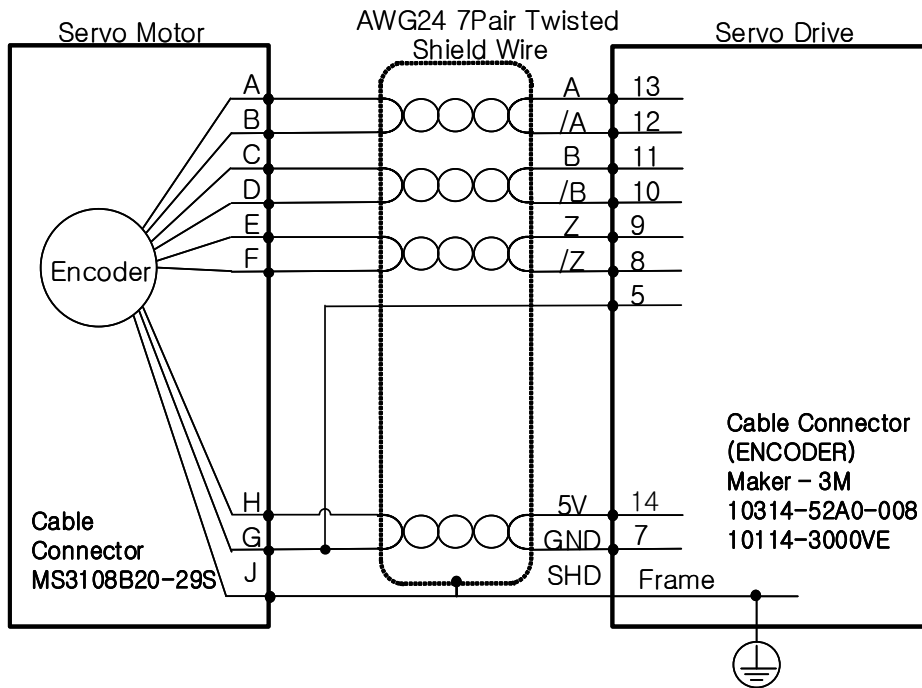

3.6.2 Serial Encoder Signaling Unit Wiring

■ **APCS-E□□□DS Cable**

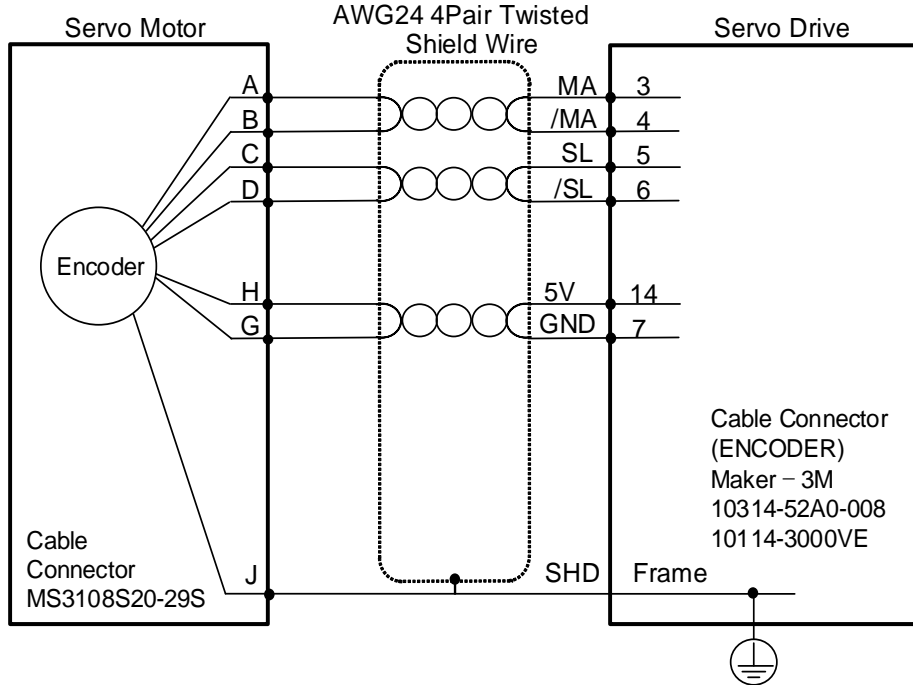

■ **APCS-E□□□ES Cable**

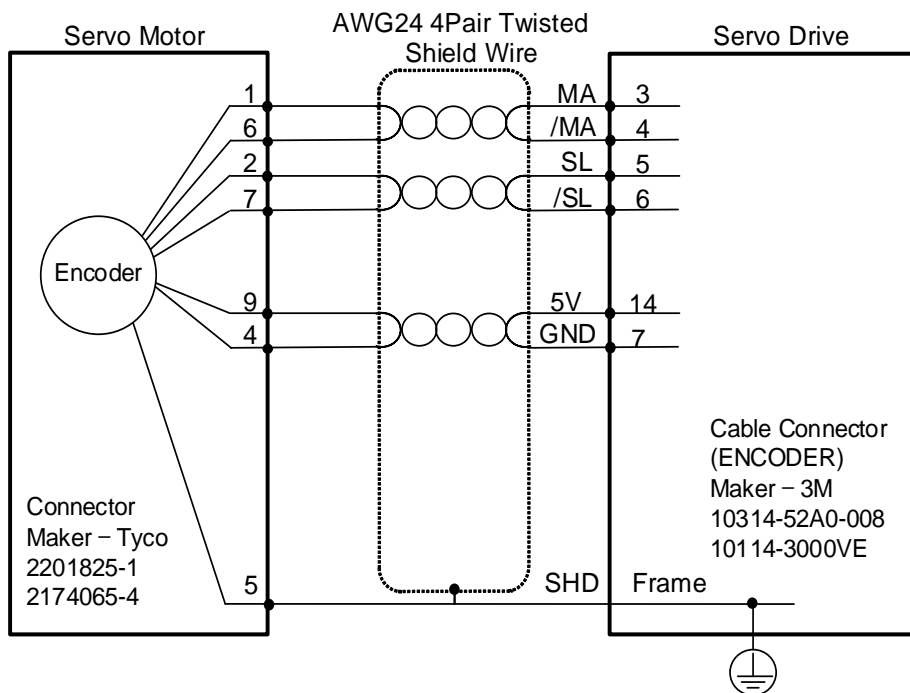

3.6.3 Multi-Turn Encoder Signaling Unit Wiring

■ APCS-E□□□CS1 Cable

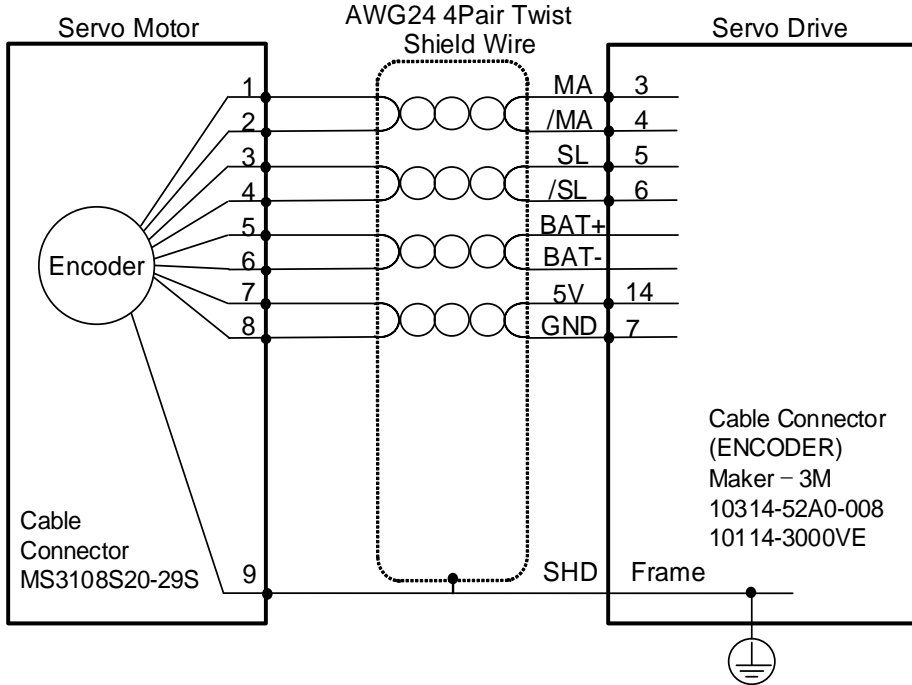

■ APCS-E□□□DS1 Cable

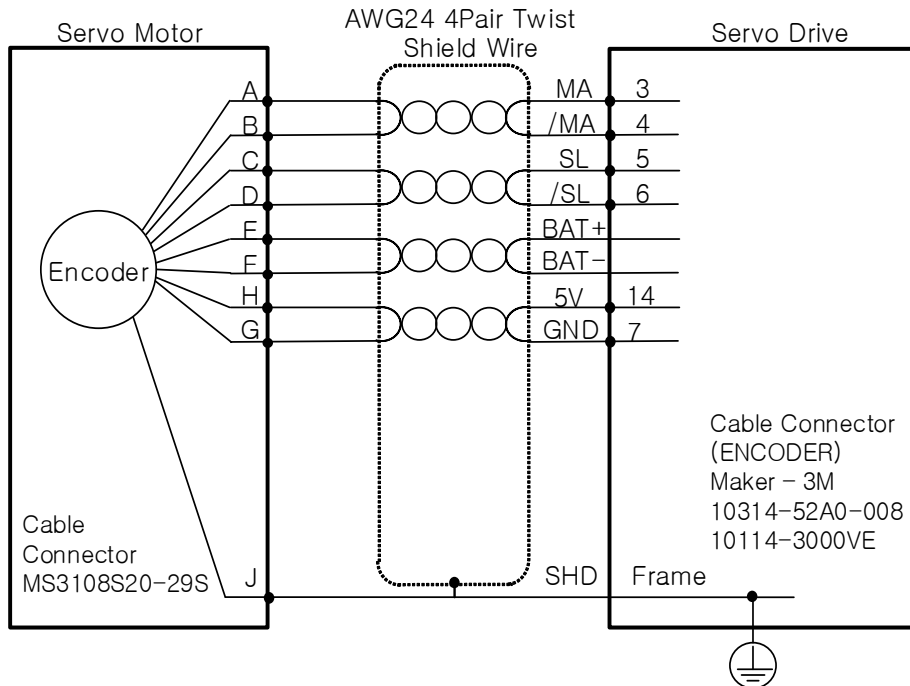

■ APCS-E□□□ES1 Cable

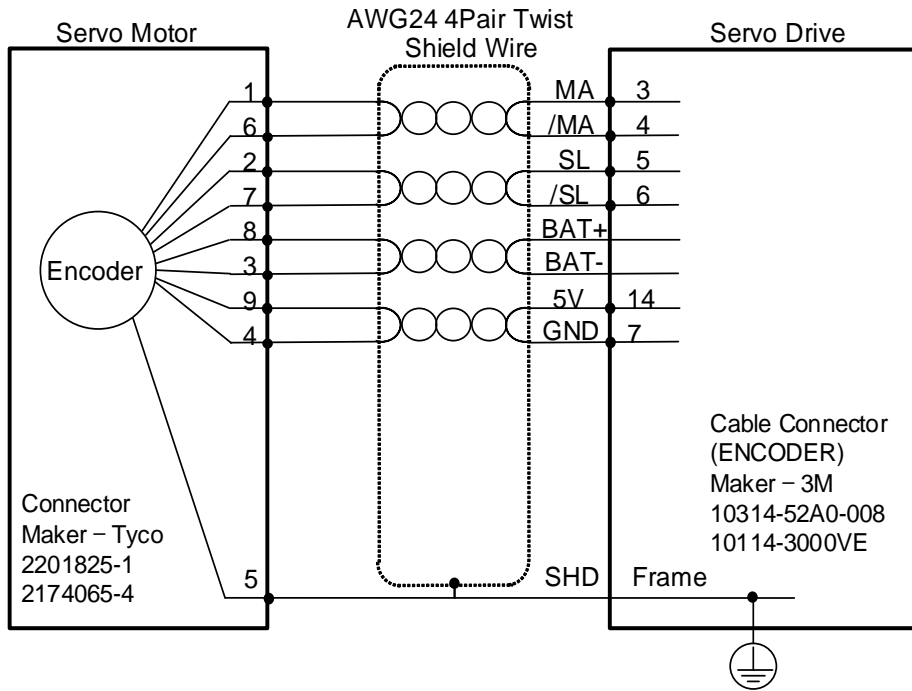

3.6.4 Tamagawa Encoder Signaling Unit Wiring

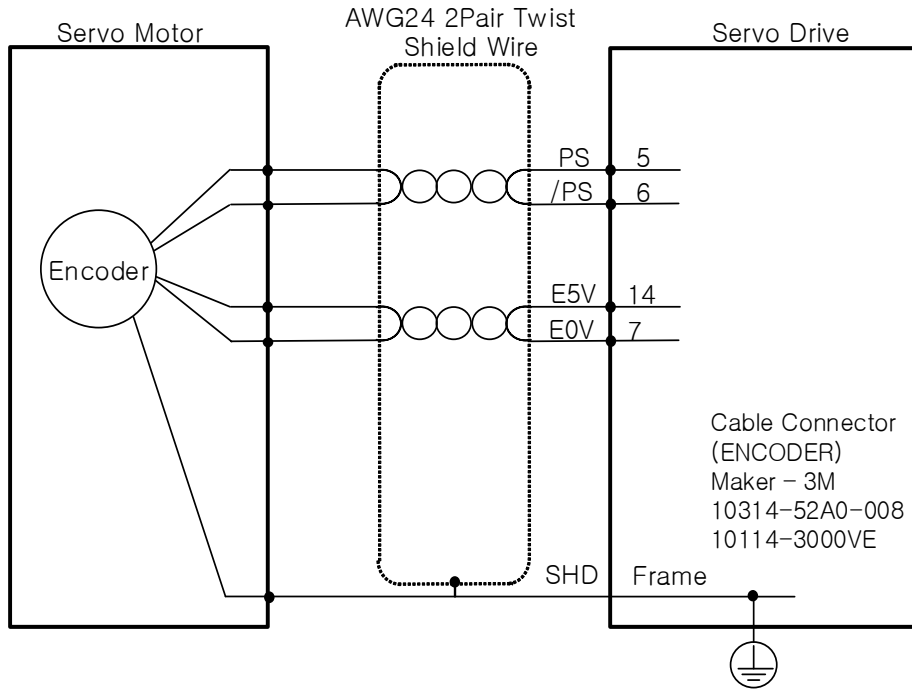

3.6.5 EnDat 2.2 Encoder Signaling Unit Wiring

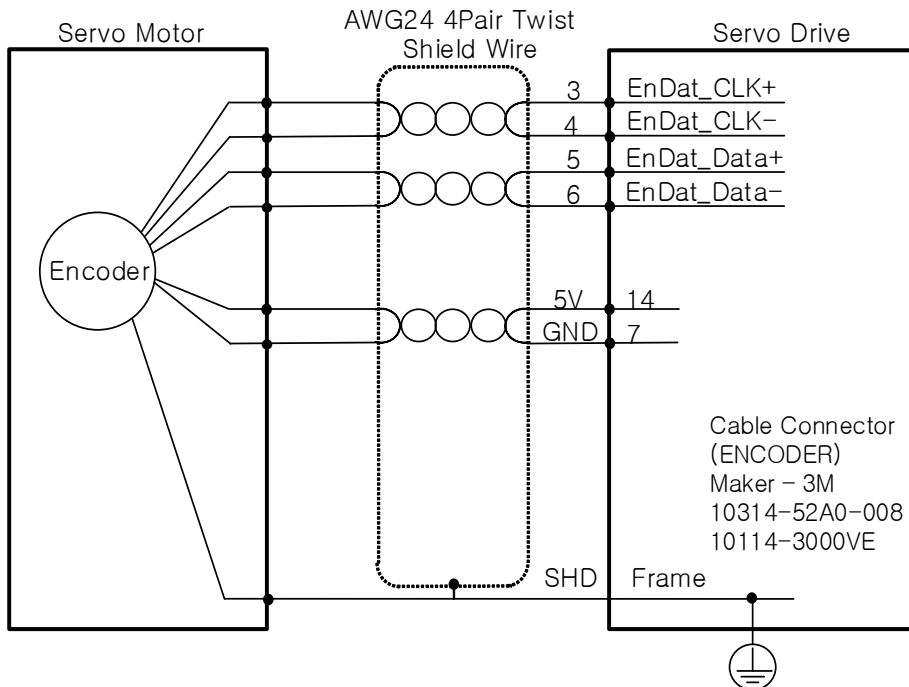

3.6.6 Precautions when Making Encoder Cable

If you need to use a serial or multi-turn encoder cable that is 20m or longer, it is recommended to refer to the below example to make one.

Connection example) APCS-E□□□ES cable

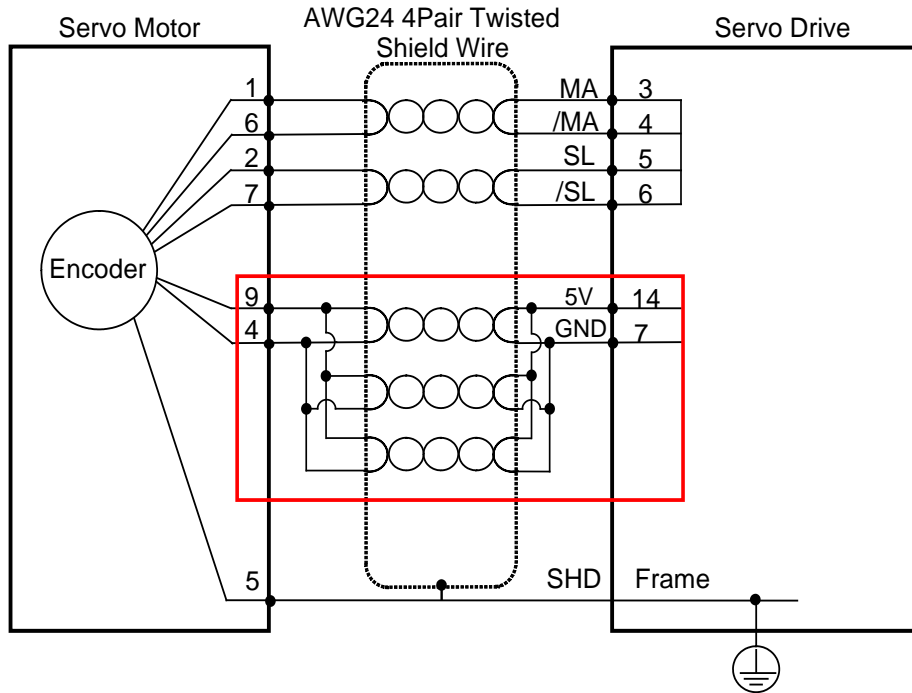

Length	Core wire specifications	Recommended wiring makers	Notes
35m or lower	24AWG 2wire	LS, Ilsan, Shinhwa wires	
55m or lower	24AWG 3wire	LS, Ilsan, Shinhwa wires	

Also, if you are making main power cables for motors 20m or longer, it is recommended to make them to one-level higher specifications than the recommended.

For example, if the recommended specification is 18AWG, use a 14AWG product. If 11AWG is recommended, use a 7AWG product.

With main power cables for motors that are 20m or longer, increase in the voltage drop causes the repeated range of use of "rotation torque-torque characteristics" to get narrower. So, be cautious while in use.

3.7 Wiring for Safety Function Signals (STO)

■ 2069577-1(Tyco Electronics)

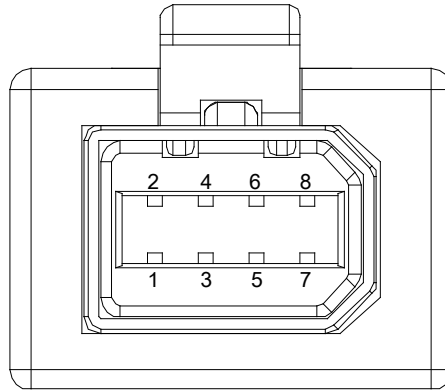

3.7.1 Names and Functions of Safety Function Signals

Pin Number	Names	Function
1	+12V	For bypass wiring
2	-12V	
3	STO1-	DC 24 V GND
4	STO1+	Blocks the current (torque) applied to the motor when the signal is off.
5	STO2-	DC 24 V GND
6	STO2+	Blocks the current (torque) applied to the motor when the signal is off.
7	EDM+	Monitor output signal for checking the status of safety function input signal
8	EDM-	

3.7.2 Example of Connecting Safety Function Signals

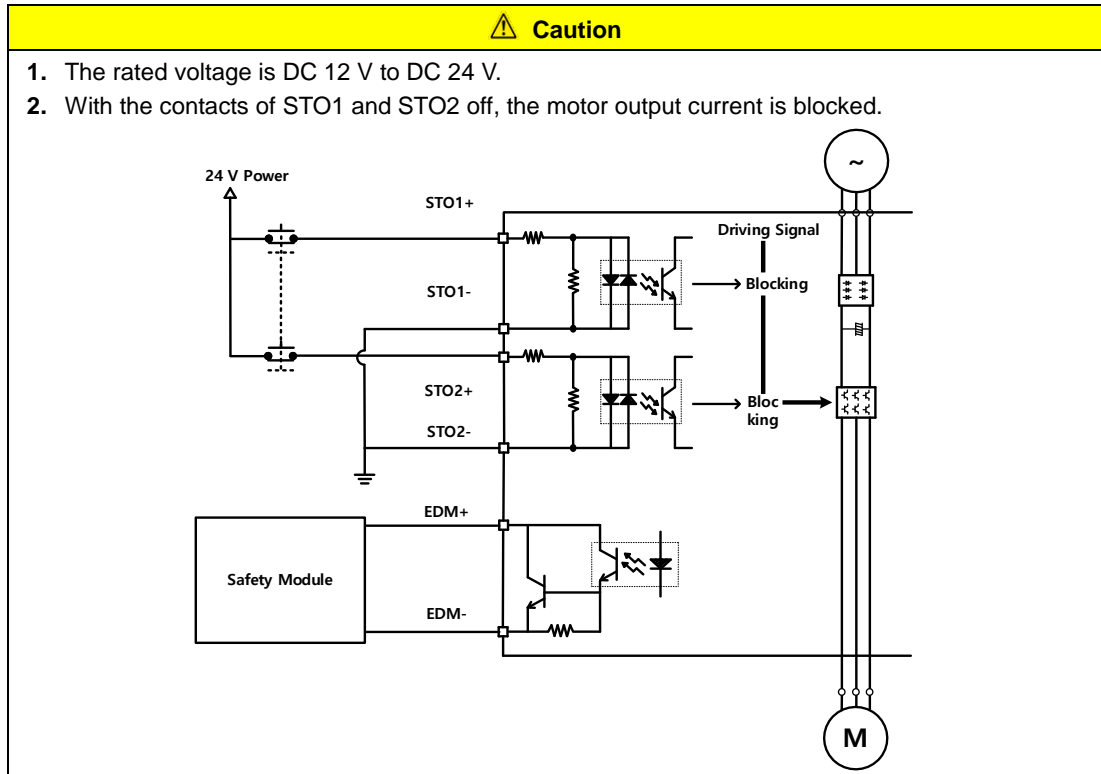

3.7.3 Bypass Wiring of Safety Function Signals

This drive provides the Mini I/O Bypass connector which has Bypass wiring to be used for the convenience of the user when the STO function is not used. To use the Bypass function, connect the Mini I/O Plug connector as follows.

If you connect +12V to STO2-, -12V to STO1+ and STO1- to STO2+ for wiring of the Mini I/O Plug connector, you can bypass the safety function signal. Never use this power (+12 V and -12 V) except for this purpose.

■ Mini I/O By-pass Connector

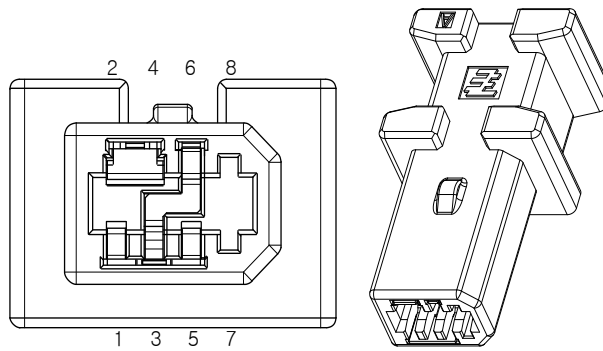

1971153-1(Tyco Electronics)

■ Mini I/O Plug Connector

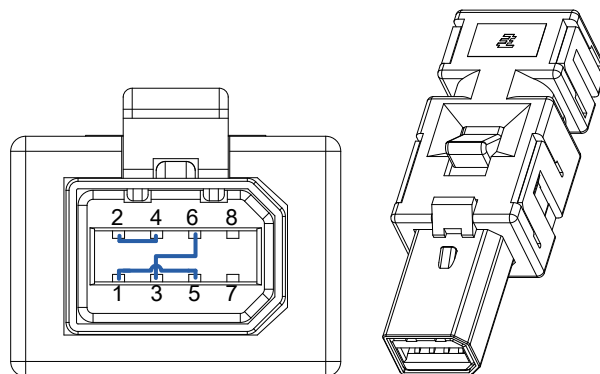







2069577-1(Tyco Electronics)

3.8 Wiring for EtherCAT Communication Signals

3.8.1 Names and Functions of EtherCAT Communication Signals

■ EtherCAT IN and EtherCAT OUT Connector

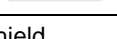
Pin Number	Signal Names	Line color
1	TX/RX0 +	White/Orange 
2	TX/RX0 -	Orange 
3	TX/RX1+	White/Green 
4	TX/RX2 -	Blue 
5	TX/RX2 +	White/Blue 
6	TX/RX1 -	Green 
7	TX/RX3 +	White/Brown 
8	TX/RX3 -	Brown 
Plate		Shield

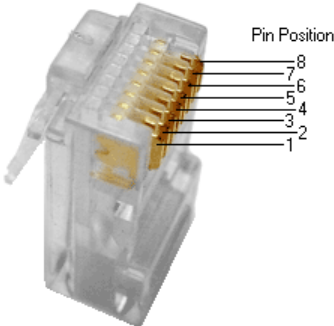

- EtherCAT only uses signals from 1, 2, 3 or 6.

3.8.2 Example of Drive Connection

The following figure shows the connection between a master and slave using EtherCAT communication. This is an example of a connection by topology of the basic line type.

⚠ For an environment with much noise, install ferrite core at both ends of the EtherCAT cable.

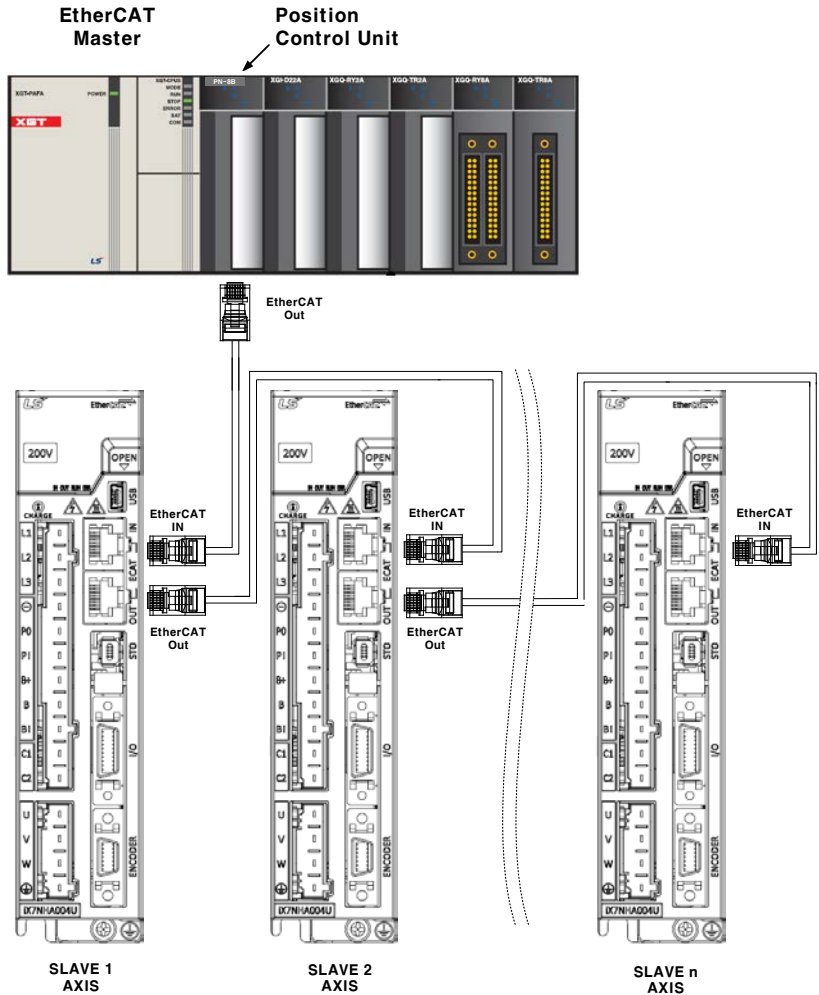

4. EtherCAT communication

EtherCAT stands for Ethernet for Control Automation Technology. It is a communication method for masters and slaves that uses Real-Time Ethernet, developed by the German company BECKHOFF and managed by the EtherCAT Technology Group (ETG).

The basic concept of EtherCAT communication is that, when a DataFrame sent from a master passes through a slave, the slave inputs the received data to the DataFrame as soon as it receives the data.

EtherCAT uses a standard Ethernet frame compliant with IEEE802.3. Therefore, based on the Ethernet 100BASE-TX, the cable can be extended up to 100 m, and up to 65,535 nodes can be connected. In addition to this, when using a separate Ethernet switch, you can interconnect with the commonly used TCP/IP.

4.1 Structure of CANopen over EtherCAT

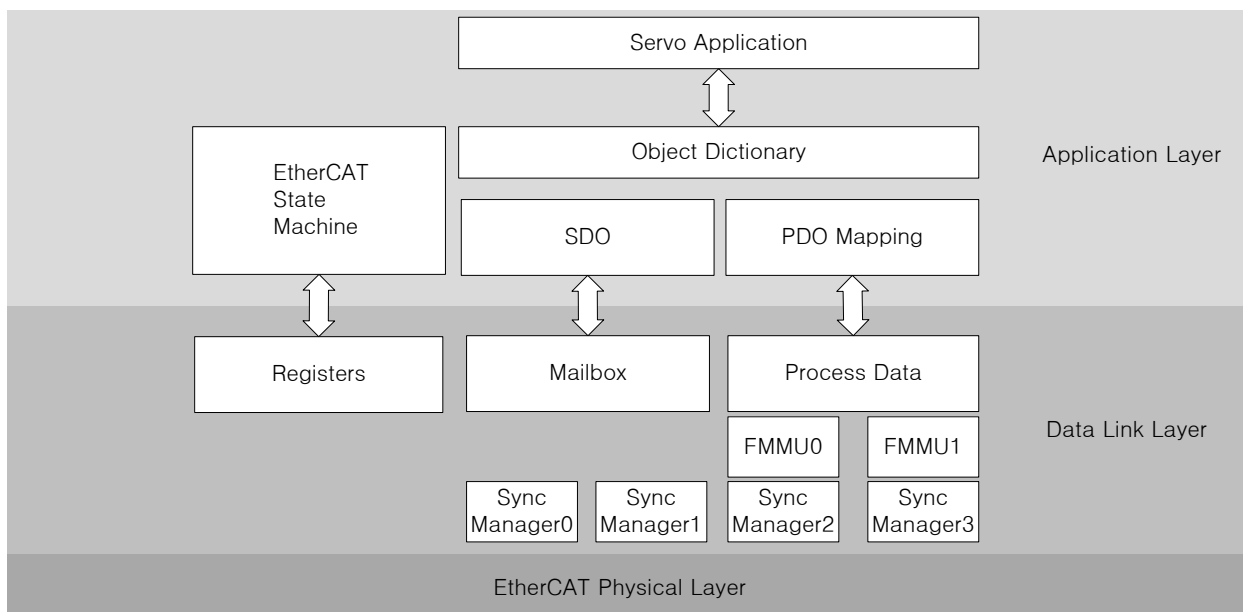

This drive supports a CiA 402 drive profile. The Object Dictionary in the application layer includes the application data and PDO (Process Data Object) mapping information from the process data interface and application data.

The PDO can be freely mapped, and the content of the process data is defined by PDO mapping.

The data mapped to the PDO is periodically exchanged (read and written) between an upper level controller and a slave by process data communication; the mailbox communication is performed aperiodically; and all of the parameters defined in the Object Dictionary are accessible.

4.1.1 EtherCAT State Machine

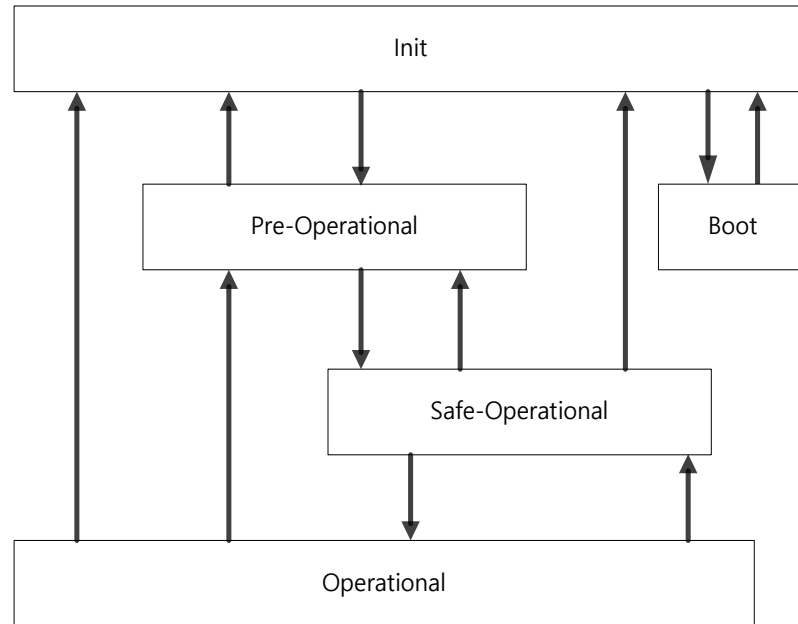

The EtherCAT drive has 5 states as shown above, and a state transition is achieved by an upper level controller (master).

State	Description
Boot	A state for firmware updates. Only mailbox communication using the FoE (File access over EtherCAT) protocol is available. The drive can transit to the Boot state only when in the Init state.
Init	Initializes the communication state. Unable to perform mailbox or process data communication.
Pre-Operational	Mailbox communication is possible.
Safe-Operational	Mailbox communication is possible and PDO can be transmitted. PDO cannot be received. The process data of the drive can be passed to an upper level controller.
Operational	Mailbox communication is possible and PDO can be transmitted and received. The process data can be properly exchanged between the drive and the upper level controller, so the drive can be normally operated.

4.2 Status LED

The LEDs on the EtherCAT ports of this drive indicate the states of the EtherCAT communications and errors, as shown in the following figure. There are 3 green LEDs, L/A0, L/A1, and RUN, and 1 red LED, ERR.

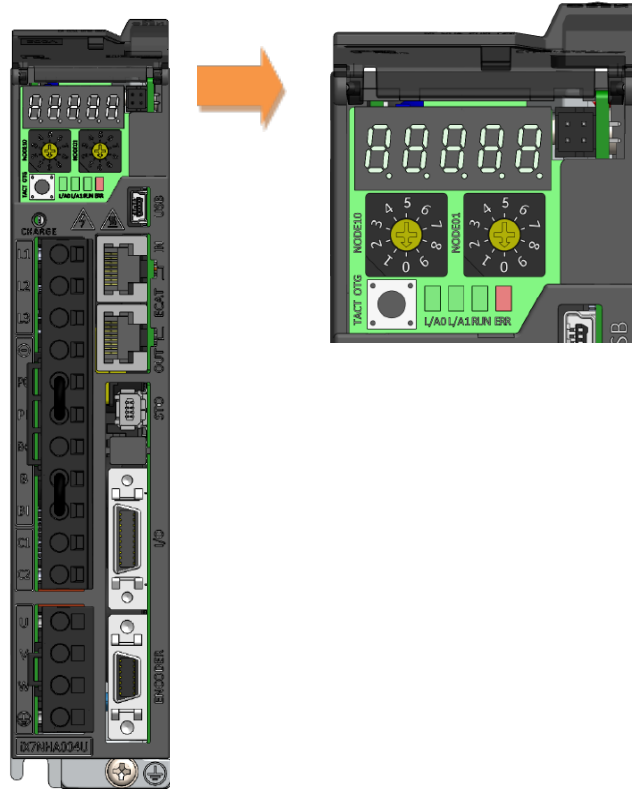



■ L/A0, L/A1 (Link Activity) LED

The L/A0 LED and L/A1 LED indicate the status of the EtherCAT IN and EtherCAT OUT communication ports, respectively. The following table outlines what each LED state indicates.

LED Status	Description
OFF	Not connected for communication.
Flickering	 Connected, and communication is enabled.
ON	Connected, but communication is disabled.

■ RUN LED

The RUN LED indicates in which state the drive is in the EtherCAT State Machine.

LED Status	Description
OFF	The drive is in the Init state.
Blinking	The drive is in the Pre-Operational state. 
Single Flash	The drive is in the Safe-Operational state. 
ON	The drive is in the Operational state.

■ ERR LED

The ERR LED indicates the error status of the EtherCAT communication. The following table outlines what each LED state indicates.

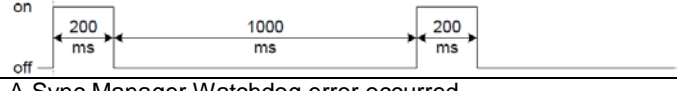
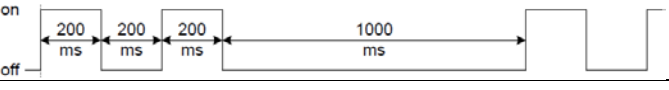
LED Status	Description
OFF	Indicates the EtherCAT communication is in a normal state without any error.
Blinking	Indicates that the drive has received a command from the EtherCAT master instructing it to perform a setting, which is not feasible in its present state, or to perform an impossible state transition. 
Single Flash	A DC PLL Sync error occurred. 
Double Flash	A Sync Manager Watchdog error occurred. 
ON	A servo alarm of the drive occurred.

4.3 Data Type

The following table outlines the data types and ranges used in this manual.

Codes	Description	Ranges
SINT	Signed 8-bit	-128~127
USINT	Unsigned 8-bit	0~255
INT	Signed 16-bit	-32768~32767
UINT	Unsigned 16-bit	0~65535
DINT	Signed 32-bit	-2147483648~2147483647
UDINT	Unsigned 32-bit	0~4294967295
FP32	Float 32-bit	Single precision floating point
STRING	String Value	

4.4 PDO-Mapping

The EtherCAT uses the Process Data Object (PDO) to perform real-time data transfers. There are two types of PDOs: RxPDO receives data transferred from the upper level controller, and TxPDO sends the data from the drive to the upper level controller.

This drive uses the objects of 0x1600 to 0x1603 and 0x1A00 to 0x1A03 to assign the RxPDO and the TxPDO, respectively. It supports the maximum communication cycle of 125us and allows assignment of up to 10 objects to each PDO. The diagram below shows the maximum allowed number of assigned objects and their size.

Communication	Maximum Allowed Number of Assigned PDO Mapping	Maximum Allowed Size of Assigned PDO Mapping	PDO Mapping Object
Rx_PDO	10	28Byte	0x1600 ~ 0x1603
Tx_PDO	10	28Byte	0x1A00 ~ 0x1A03

You can check the PDO assignment attribute of each object to see if it can be assigned to the PDO. The diagram below shows the PDO assignment:

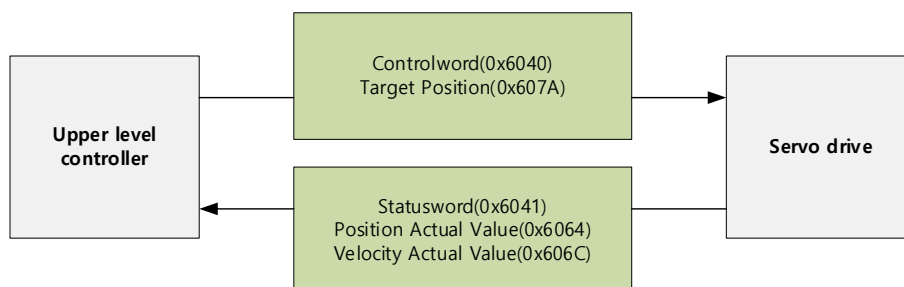

This is an example when assigning the Controlword and the Target Position with the RxPDO (0x1600).

Index	SubIndex	Name	Data Type
0x6040	0x00	Controlword	UINT
0x607A	0x00	Target Position	DINT

The setting values of the RxPDO (0x1600) are as follows:



SubIndex	Setting Value		
0	0x02 (2 values assigned)		
	Bit 31 - 16 (Index)	Bit 15 - 8 (Sub index)	Bit 7 - 0 (Bit size)
1	0x6040	0x00	0x10
2	0x607A	0x00	0x20

This is an example when assigning the Statusword, the Position Actual Value, and the Actual Velocity Value with the TxPDO (0x1A00).

Index	SubIndex	Name	Data Type
0x6041	0x00	Statusword	UINT
0x6064	0x00	Position Actual Value	DINT
0x606C	0x00	Velocity Actual Value	DINT

The TxPDO (0x1A00) settings are as follows:



SubIndex	Setting Value		
0	0x03 (3 values assigned)		
	Bit 31 - 16 (Index)	Bit 15 - 8 (Sub index)	Bit 7 - 0 (Bit size)
1	0x6041	0x00	0x10
2	0x6064	0x00	0x20
3	0x606C	0x00	0x20

The Sync Manager can be composed of multiple PDOs. The Sync Manager PDO Assign Object (RxPDO:0x1C12, TxPDO:0x1C13) indicates the relationship between the SyncManager and the PDO.

The following figure shows an example of SyncManager PDO mapping:

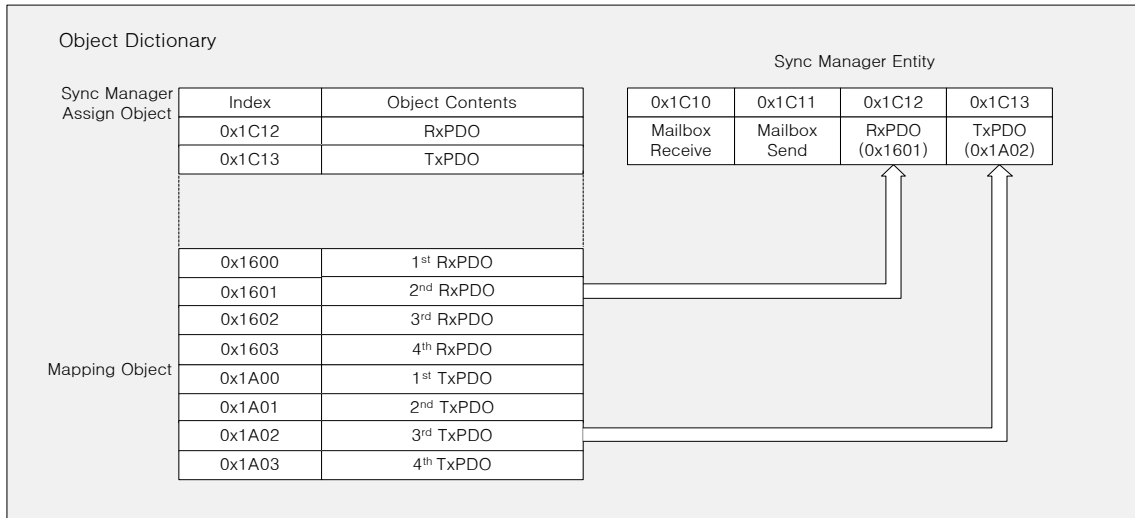

■ PDO Mapping

The following tables list the PDO mappings set by default. These settings are defined in the EtherCAT Slave Information file (XML file).

1st PDO Mapping:

RxPDO (0x1600)	Controlword (0x6040)	Target Torque (0x6071)	Target Position (0x607A)	Operation Mode (0x6060)	Touch Probe Function (0x60B8)						
TxPDO (0x1A00)	Statusword (0x6041)	Actual Torque Value (0x6077)	Actual Position Value (0x6064)	Actual Positional Error (0x60F4)	Digital Input (0x60FD)	Operation Mode Display (0x6061)	Command Speed (0x2601)	Operation Speed (0x2600)	Touch Probe Status (0x60B9)	Touch Probe 1 Forward Position Value (0x60BA)	

2nd PDO Mapping:

RxPDO (0x1601)	Controlword (0x6040)	Target Position (0x607A)	Touch Probe Function (0x60B8)	Digital Output (0x60FE)		
TxPDO (0x1A01)	Statusword (0x6041)	Actual Position Value (0x6064)	Actual Positional Error (0x60F4)	Touch Probe Status (0x60B9)	Touch Probe 1 Forward Position Value (0x60BA)	Digital Input (0x60FD)

3rd PDO Mapping:

RxPDO (0x1602)	Controlword (0x6040)	Target Velocity (0x60FF)	Touch Probe Function (0x60B8)	Digital Output (0x60FE)	
TxPDO (0x1A02)	Statusword (0x6041)	Actual Position Value (0x6064)	Touch Probe Status (0x60B9)	Touch Probe 1 Forward Position Value (0x60BA)	Digital Input (0x60FD)

4th PDO Mapping:

RxPDO (0x1603)	Controlword (0x6040)	Target Torque (0x6071)	Touch Probe Function (0x60B8)	Digital Output (0x60FE)	
TxPDO (0x1A03)	Statusword (0x6041)	Actual Position Value (0x6064)	Touch Probe Status (0x60B9)	Touch Probe 1 Forward Position Value (0x60BA)	Digital Input (0x60FD)

4.5 Synchronization Using the DC (Distributed Clock)

The Distributed Clock (DC) synchronizes EtherCAT communication. The master and slave share a reference clock (system time) for synchronization, and the slave synchronizes its applications with the Sync0 event generated by the reference clock.

The following synchronization modes exist in this drive. You can change the mode with the sync control register.

(1) Free-run Mode:

In Free-run mode, it operates each cycle independent of the communication cycle and master cycle. If the transmission cycle of the master is inconsistent, the timing difference makes the servo recalculate the previous incremental value, which may create noise during operation.

For the standard OS Ver0.95 and later versions, the SM Sync function prevents noise generation when there is a change in the master transmission cycle during use of Free-run. However, since transmission cycle errors can accumulate if errors continue to occur, make sure to be cautious about accumulated time error while using Free-run mode.

(2) DC Synchronous Mode:

In DC Synchronous mode, the Sync0 event from the EtherCAT master synchronizes the drive. Please use this mode for more precise synchronous control.

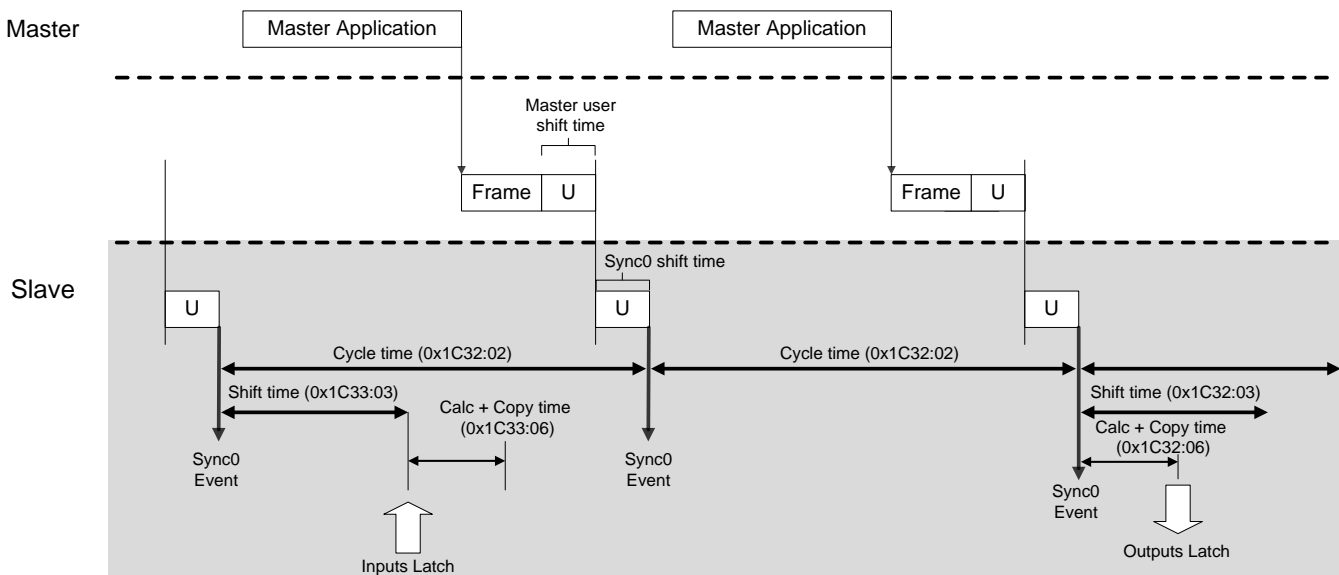

4.6 Emergency Messages

Emergency messages are passed to the master via mailbox communication when a servo alarm occurs in the drive. Emergency messages may not be sent in the event of communication failure.

Emergency messages consist of 8-byte data.

Byte	0	1	2	3	4	5	6	7
Details	Emergency Error Code (0xFF00)		Error Register (0x1001)	Reserved	Unique Field for Each Manufacturer			
					Servo Alarm Code		Reserved	

5. CiA402 Drive Profile

5.1 State Machine

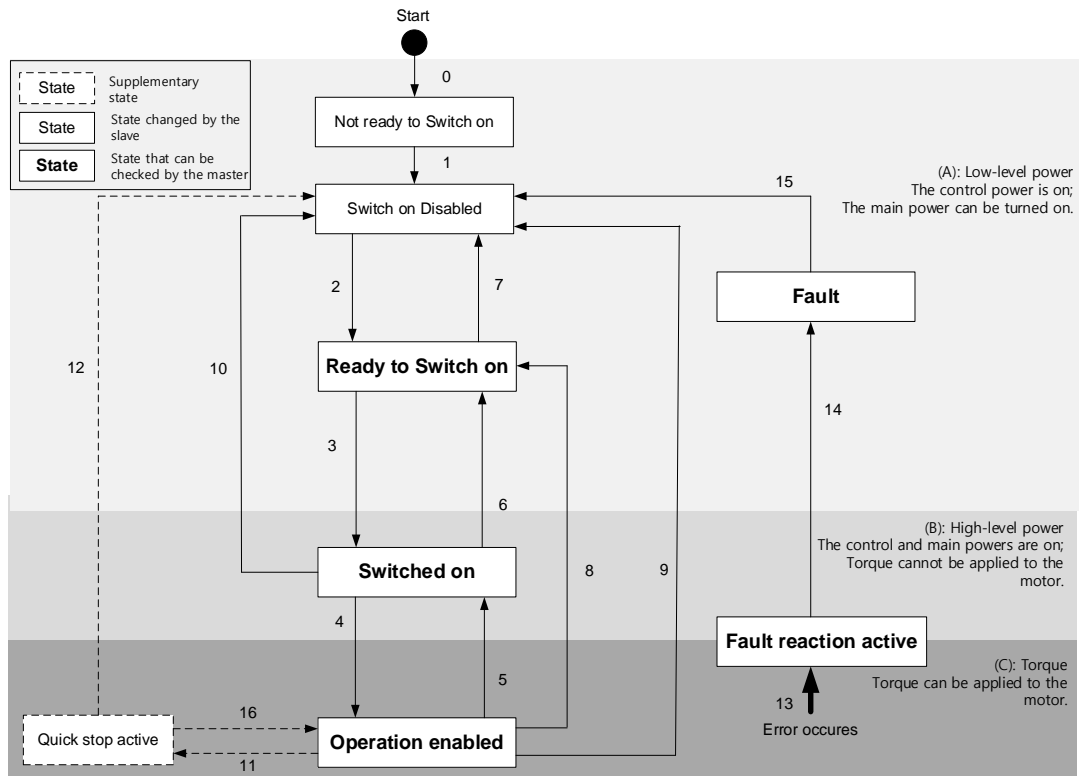

State	Description
Not ready to switch on	Reset is in progress by control power on.
Switch on disabled	Initialization completed, but the main power cannot be turned on.
Ready to switch on	The main power can be turned on and the drive function is disabled.
Switched on	The main power is turned on and the drive function is disabled.
Operation enabled	The drive function is enabled, and the servo is on.
Quick Stop active	Quick stop function is in operation.
Fault reaction active	A servo alarm occurred causing a relevant sequence to be processed.
Fault	Servo alarm is activated.

■ State Machine Control Commands

The state of the State Machine can be switched by bit setting combinations of the Controlword (0x6040), as described in the table below:

Command	Controlword bits (0x6040)					State Machine switching
	Bit 7	Bit 3	Bit 2	Bit 1	Bit 0	
Shutdown	x	x	1	1	0	2, 6, 8
Switch on	x	0	1	1	1	3
Switch on + Enable operation	x	1	1	1	1	3 + 4
Disable voltage	x	x	x	0	x	7, 9, 10,12
Quick stop	x	x	0	1	x	7, 10,11
Disable operation	x	0	1	1	1	5
Enable operation	x	1	1	1	1	4, 16
Fault reset	0 → 1	x	x	x	x	15

■ Statusword Bit Names (0x6041)

You can check the state of the State Machine by bit combinations of the Statusword (0x6041), as described in the table below:

Command	Statusword bits (0x6041)						
	Bit 6	Bit 5	Bit 4	Bit 3	Bit 2	Bit 1	Bit 0
Not ready to switch on	0	0	x	0	0	0	0
Switch on disabled	1	1	x	0	0	0	0
Ready to switch on	0	1	x	0	0	0	1
Switched on	0	1	x	0	0	1	1
Operation enabled	0	1	x	0	1	1	1
Fault reaction active	0	1	x	1	1	1	1
Fault	0	1	x	1	0	0	0

Bit No.	Data Description	Note
0	Ready to switch on	For more information, refer to 10.3 CiA402 Objects.
1	Switched on	
2	Operation enabled	
3	Fault	
4	Voltage enabled	
5	Quick stop	
6	Switched on disabled	
7	Warning	
8	-	
9	Remote	
10	Target reached	
11	Internal limit active	

12	Operation mode specific	
13		
14	ABS position valid	
15	Procedure busy	

5.2 Operation Modes

This drive supports the following operation modes (0x6060):

- Profile Position Mode (PP)
- Homing Mode (HM)
- Profile Velocity Mode (PV)
- Profile Torque Mode (PT)
- Cyclic Synchronous Position Mode (CSP)
- Cyclic Synchronous Velocity Mode (CSV)
- Cyclic Synchronous Torque Mode (CST)

Drive functions supported for each mode are listed in the table below:

Function	Operation Modes			
	CSP PP	CSV PV	CST PT	HM
Electric Gear	O	O	O	O
Velocity Feed-forward	O	X	X	OX
Torque Feed-forward	O	O	X	O
Position Command Filter	O	X	X	OX
Real-time Gain Adjustment	O	O	O	O
Notch Filter	O	O	O	O
Disturbance Observer	O	O	X	O

Note 1) For HM mode, the control mode is internally switched; thus, the function of speed feed-forward and/or position command filter may or may not be applied, depending on the operation condition.

■ Related Objects

Index	Sub Index	Name	Variable Type	Accessibility	PDO Assignment	Unit
0x6060	-	Modes of Operation	SNIT	RW	Yes	-
0x6061	-	Modes of Operation Display	SNIT	RO	Yes	-
0x6502	-	Supported Drive Modes	UDINT	RO	No	-

5.3 Position Control Modes

5.3.1 Cyclic Synchronous Position Mode

Cyclic Synchronous Position (CSP) mode receives the Target Position (0x607A) that is renewed at every PDO update cycle from the upper level controller to control the position.

In this mode, the controller is able to calculate the Velocity Offset (0x60B1) and the Torque Offset (0x60B2) that corresponds to the speed and torque feedforwards respectively, and pass them to the drive.

The block diagram of CSP mode is as follows:

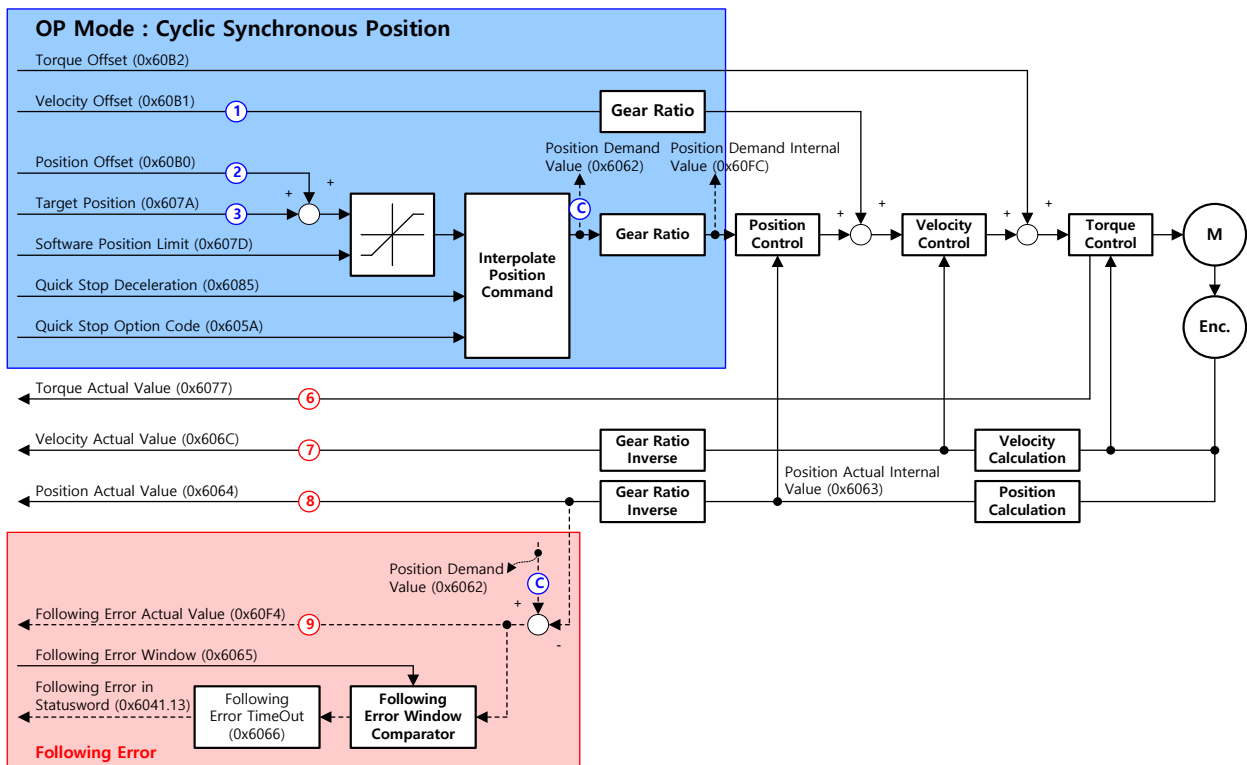

■ Related Objects

Index	Sub Index	Name	Variable Type	Accessibility	PDO Assignment	Unit
0x6040	-	Controlword	UINT	RW	Yes	-
0x6041	-	Statusword	UINT	RO	Yes	-
0x607A	-	Target Position	DINT	RW	Yes	UU
0x607D	-	Software Position Limit	-	-	-	-
	0	Number of Entries	USINT	RO	No	-
	1	Min position limit	DINT	RW	No	UU
	2	Max position limit	DINT	RW	No	UU
0x6084	-	Profile Deceleration	UDINT	RW	No	UU/s ²
0x6085	-	Quick Stop Deceleration	UDINT	RW	No	UU/s ²
0x60B0	-	Position Offset	DINT	RW	Yes	UU
0x60B1	-	Velocity Offset	DINT	RW	Yes	UU/s
0x60B2	-	Torque Offset	INT	RW	Yes	0.1%
0x6062	-	Position Demand Value	DINT	RO	Yes	UU
0x60FC	-	Position Demand Internal Value	DINT	RO	Yes	pulse
0x606C	-	Velocity Actual Value	DINT	RO	Yes	UU/s
0x606D	-	Velocity Window	UINT	RW	No	UU/s
0x606E	-	Velocity Window Time	UINT	RW	No	ms
0x6077	-	Torque Actual Value	INT	RO	Yes	0.1%
0x606C	-	Velocity Actual Value	DINT	RO	Yes	UU/s
0x6064	-	Position Actual Value	DINT	RO	Yes	UU
0x6063	-	Position Actual Internal Value	DINT	RO	Yes	pulse

Internal Block Diagram of CSP Mode

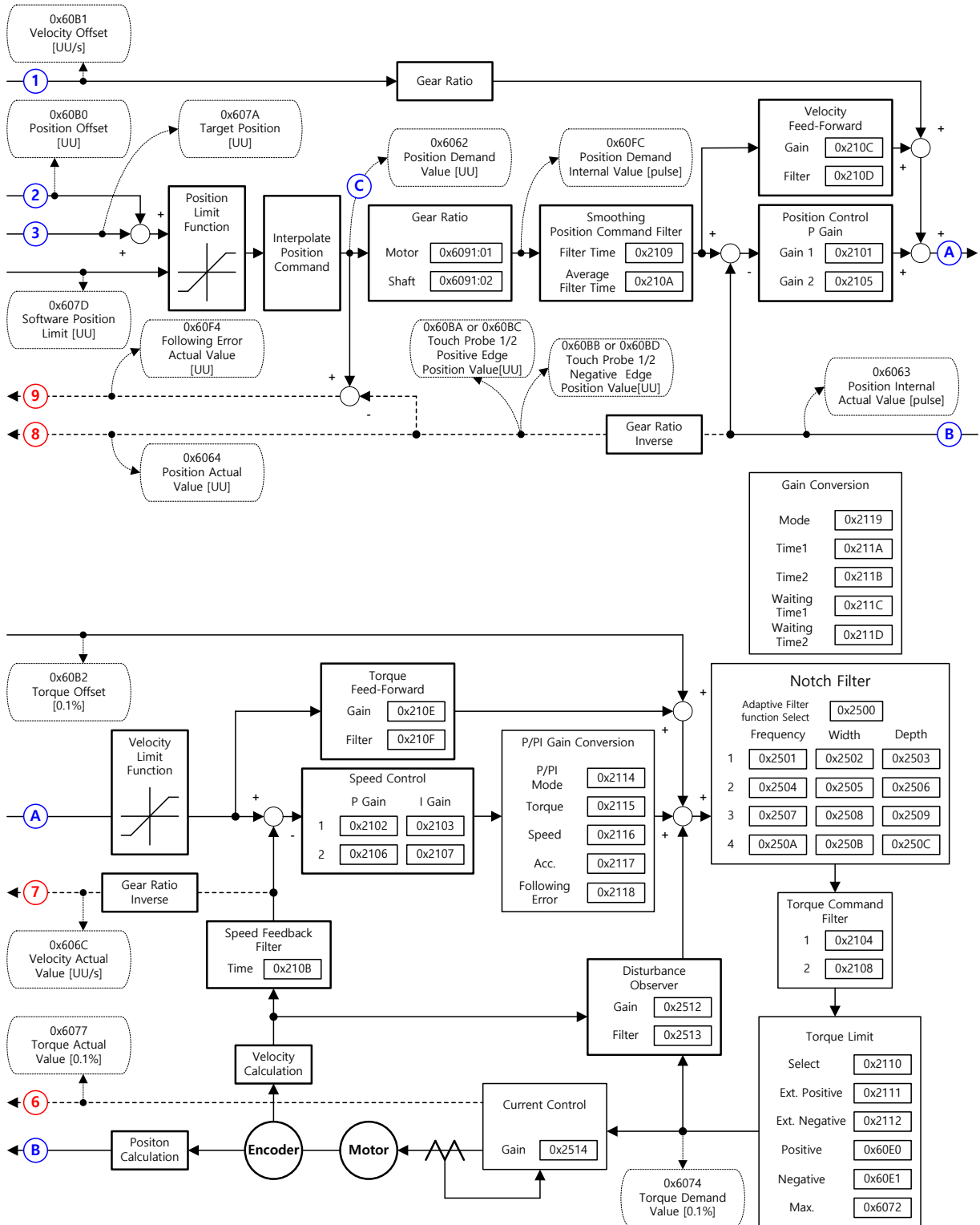

5.3.2 Profile Position Mode

Unlike CSP mode, which receives the target position that is renewed at every PDO update cycle from the upper level controller, in Profile Position (PP) mode, the drive generates a position profile internally to operate up to the target position (0x607A) using the profile velocity (0x6081), acceleration (0x6083), and deceleration (0x6084).

The block diagram of PP mode is as follows:

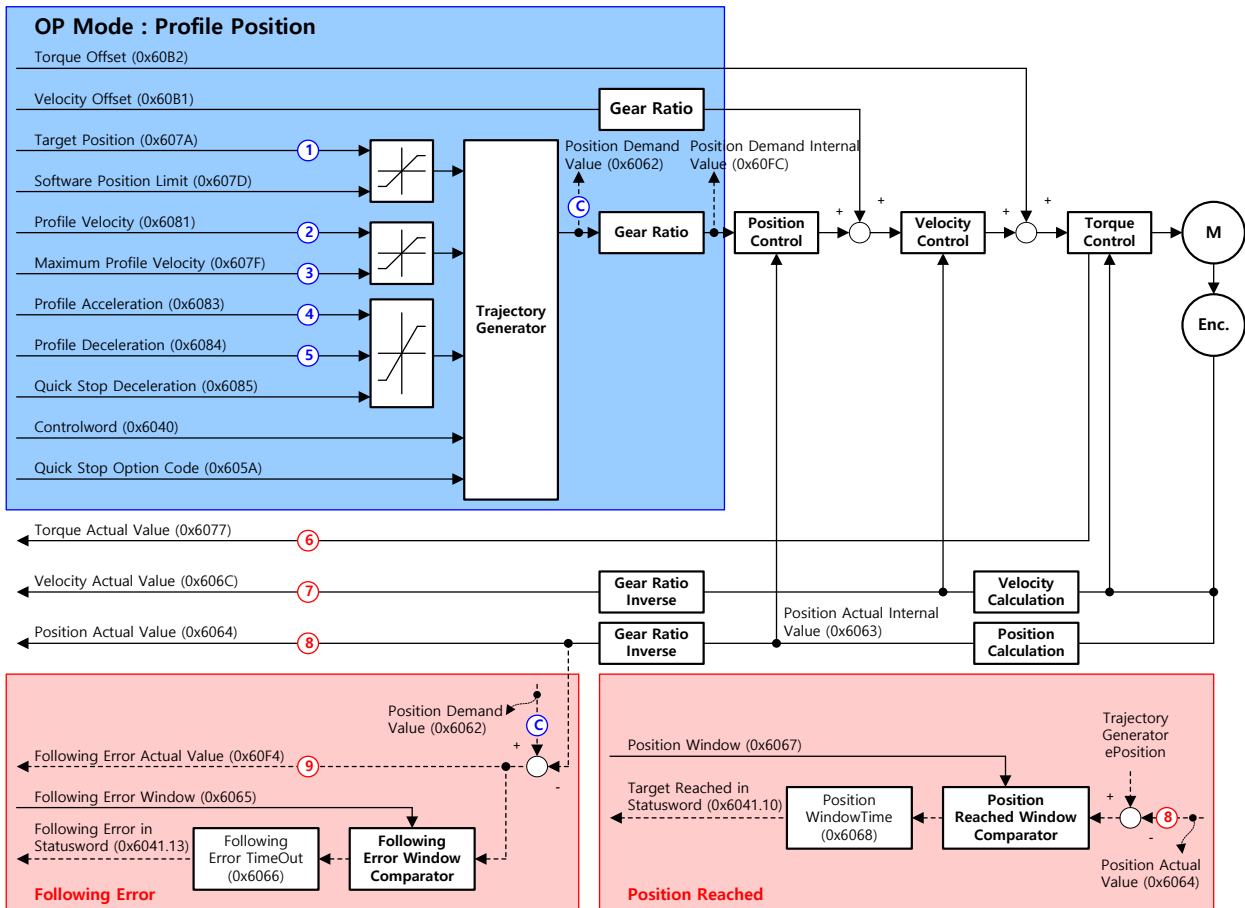

Related Objects

Index	Sub Index	Name	Variable Type	Accessibility	PDO Assignment	Unit
0x6040	-	Controlword	UINT	RW	Yes	-
0x6041	-	Statusword	UINT	RO	Yes	-
0x607A	-	Target Position	DINT	RW	Yes	UU
0x607D	-	Software Position Limit	-	-	-	-
	0	Number of Entries	USINT	RO	No	-
	1	Min position limit	DINT	RW	No	UU
	2	Max position limit	DINT	RW	No	UU

0x607F	-	Maximum Profile Velocity	UDINT	RW	Yes	UU/s
0x6081	-	Profile Velocity	UDINT	RW	No	UU/s
0x6083	-	Profile Acceleration	UDINT	RW	No	UU/s ²
0x6084	-	Profile Deceleration	UDINT	RW	No	UU/s ²
0x6085	-	Quick Stop Deceleration	UDINT	RW	No	UU/s ²
0x60B1	-	Velocity Offset	DINT	RW	Yes	UU/s
0x60B2	-	Torque Offset	INT	RW	Yes	0.1%
0x6062	-	Position Demand Value	DINT	RO	Yes	UU
0x60FC	-	Position Demand Internal Value	DINT	RO	Yes	pulse
0x606C	-	Velocity Actual Value	DINT	RO	Yes	UU/s
0x606D	-	Velocity Window	UINT	RW	No	UU/s
0x606E	-	Velocity Window Time	UINT	RW	No	ms
0x6077	-	Torque Actual Value	INT	RO	Yes	0.1%
0x606C	-	Velocity Actual Value	DINT	RO	Yes	UU/s
0x6064	-	Position Actual Value	DINT	RO	Yes	UU
0x6063	-	Position Actual Internal Value	DINT	RO	Yes	pulse

Internal Block Diagram of PP Mode

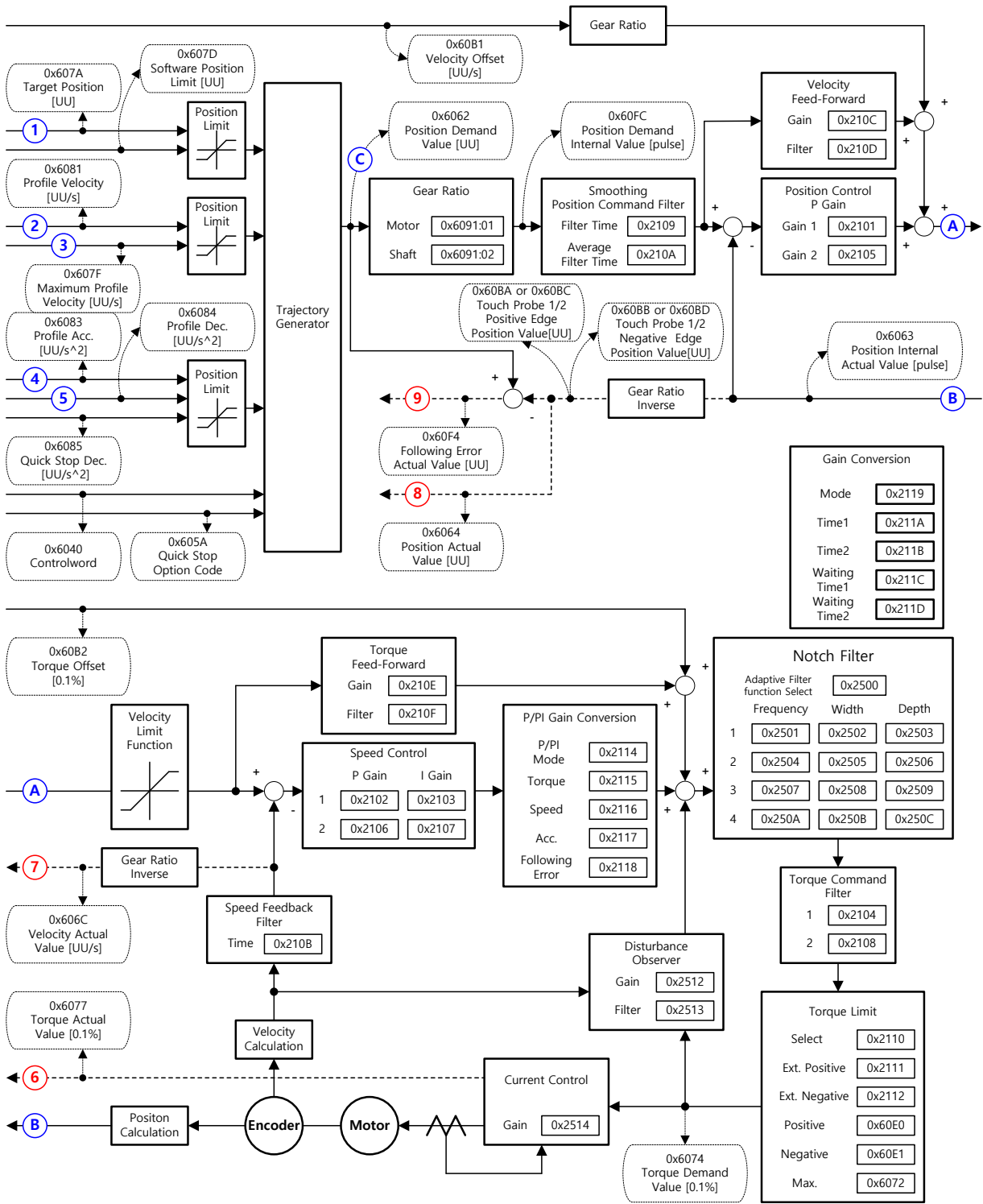

You can use the following three position commands in Profile Position Mode:

- Single set point

After reaching the target position, the drive sends a completion signal to the upper level controller and receives a new command.

- Change immediately

When it receives a new position command while driving to the target position, it drives to the new position regardless of the existing target position.

- Set of Set point

When it receives a new position command while driving to the target position, it subsequently drives to the new target position after driving to the existing target position.

The three methods mentioned above can be set by the combination of the New set point bit (Controlword, 0x6040.4), the Change set immediately bit (Controlword, 0x6040.5), and the Change set point bit (Controlword, 0x6040.9).

■ Single Set Point Driving Procedure

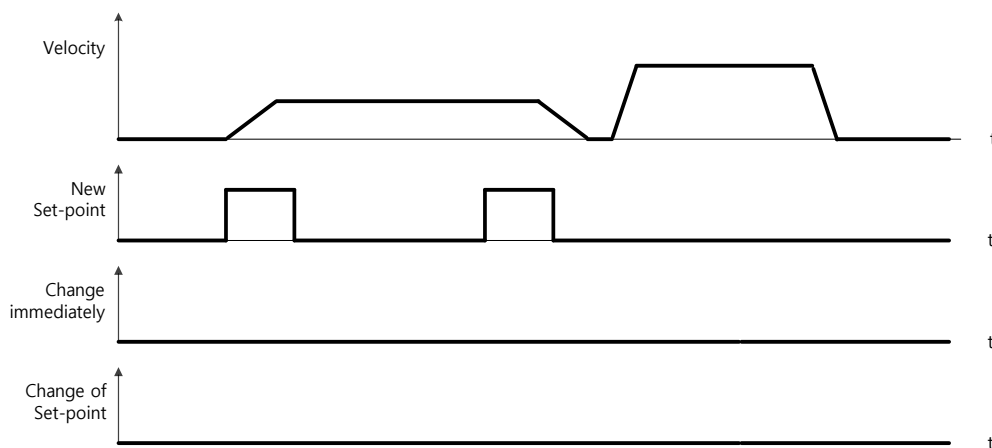

- (1) Specify the target position (0x607A).
- (2) Set the New set point bit to 1 and the Change set immediately bit to 0 to request the position operation.
- (3) The drive notifies the operator of its arrival at the target position with the Target reached bit (Statusword, 0x6041.10). The drive can suspend where it is or perform a new position operation if it receives the New set point bit.

■ Change Immediately Driving Procedure

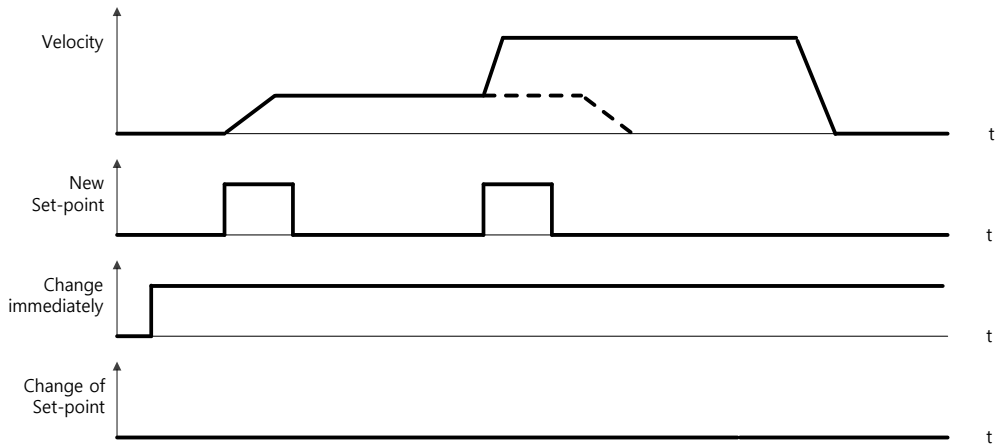

- (1) Specify the target position (0x607A).
- (2) Set the New set point bit to 1 and the Change set immediately bit to 1 to request the position operation.
- (3) You can begin a new position operation (New set point) regardless of the previous target position. The drive immediately moves to the new position.
- (4) The drive notifies the operator of its arrival at the target position with the Target reached bit (Statusword, 0x6041.10).

■ Set of Set Point Driving Procedure

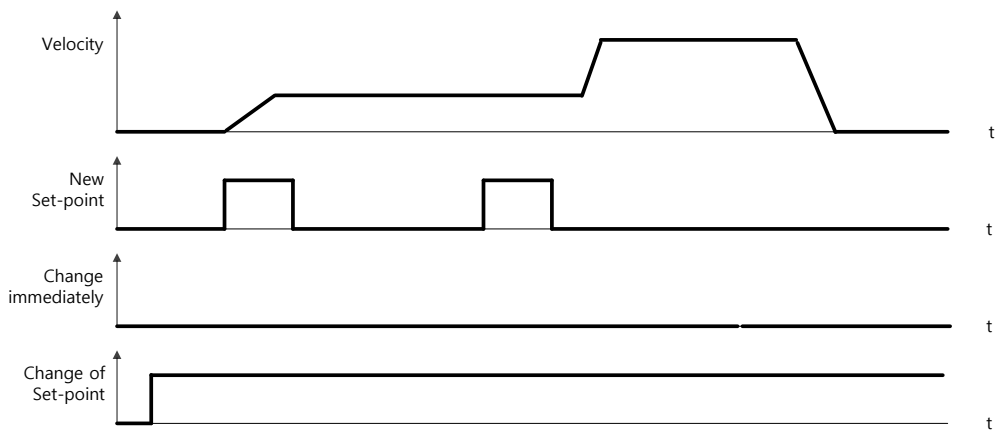

- (1) Specify the target position (0x607A).
- (2) Set the New set point bit to 1 and the Change of set point bit to 1 to request the position operation.
- (3) After reaching the previous target position, the drive begins to move to the new position (New set point).
- (4) The drive notifies the operator of its arrival at the target position with the Target reached bit (Statusword, 0x6041.10).

5.4 Velocity Control Modes

5.4.1 Cyclic Synchronous Velocity Mode

Cyclic Synchronous Velocity (CSV) mode receives the Target Velocity (0x60FF) that is renewed at every PDO update cycle from the upper level controller to control the velocity.

This mode allows the upper level controller to calculate the Torque Offset (0x60B2) that corresponds to the torque feed-forward and pass it to the drive.

The block diagram of the CSV mode is shown below.

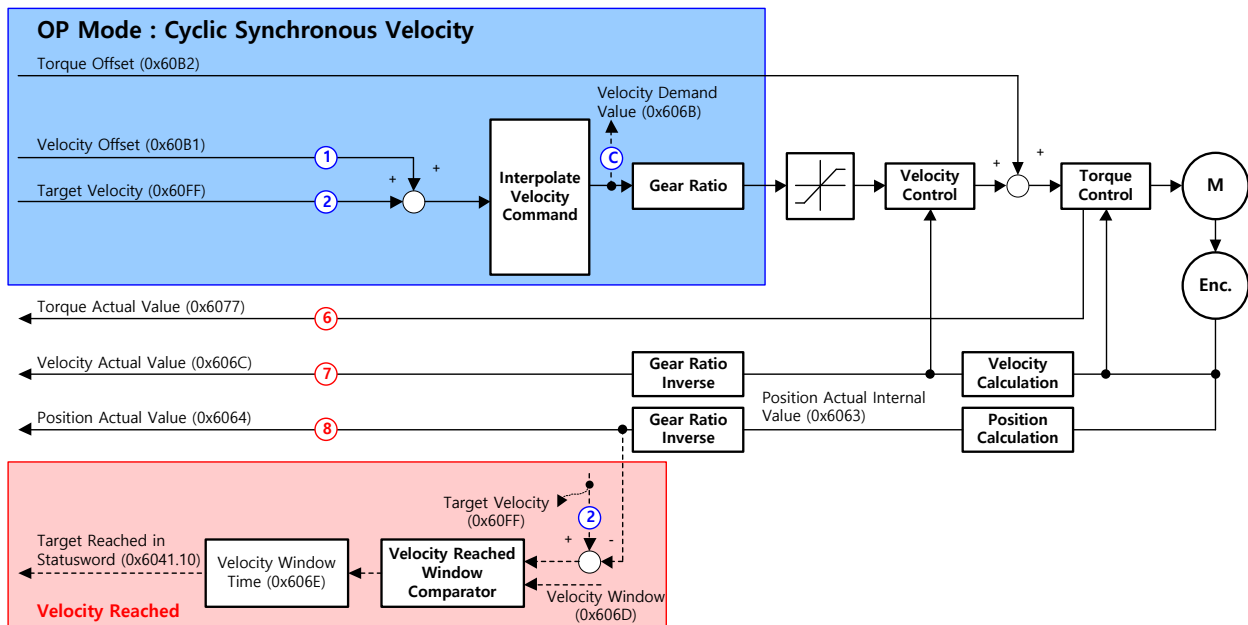

■ Related Objects

Index	Sub Index	Name	Variable Type	Accessibility	PDO Assignment	Unit
0x6040	-	Controlword	UINT	RW	Yes	-
0x6041	-	Statusword	UINT	RO	Yes	-
0x60FF	-	Target Velocity	DINT	RW	Yes	UU/s
0x6084	-	Profile Deceleration	UDINT	RW	No	UU/s ²
0x6085	-	Quick Stop Deceleration	UDINT	RW	No	UU/s ²
0x60B1	-	Velocity Offset	DINT	RW	Yes	UU/s
0x60B2	-	Torque Offset	INT	RW	Yes	0.1%
0x606B	-	Velocity Demand Value	DINT	RO	Yes	UU
0x606C	-	Velocity Actual Value	DINT	RO	Yes	UU/s

0x606D	-	Velocity Window	UINT	RW	No	UU/s
0x606E	-	Velocity Window Time	UINT	RW	No	ms
0x6077	-	Torque Actual Value	INT	RO	Yes	0.1%
0x606C	-	Velocity Actual Value	DINT	RO	Yes	UU/s
0x6064	-	Position Actual Value	DINT	RO	Yes	UU
0x6063	-	Position Actual Internal Value	DINT	RO	Yes	pulse

Internal Block Diagram of CSV Mode

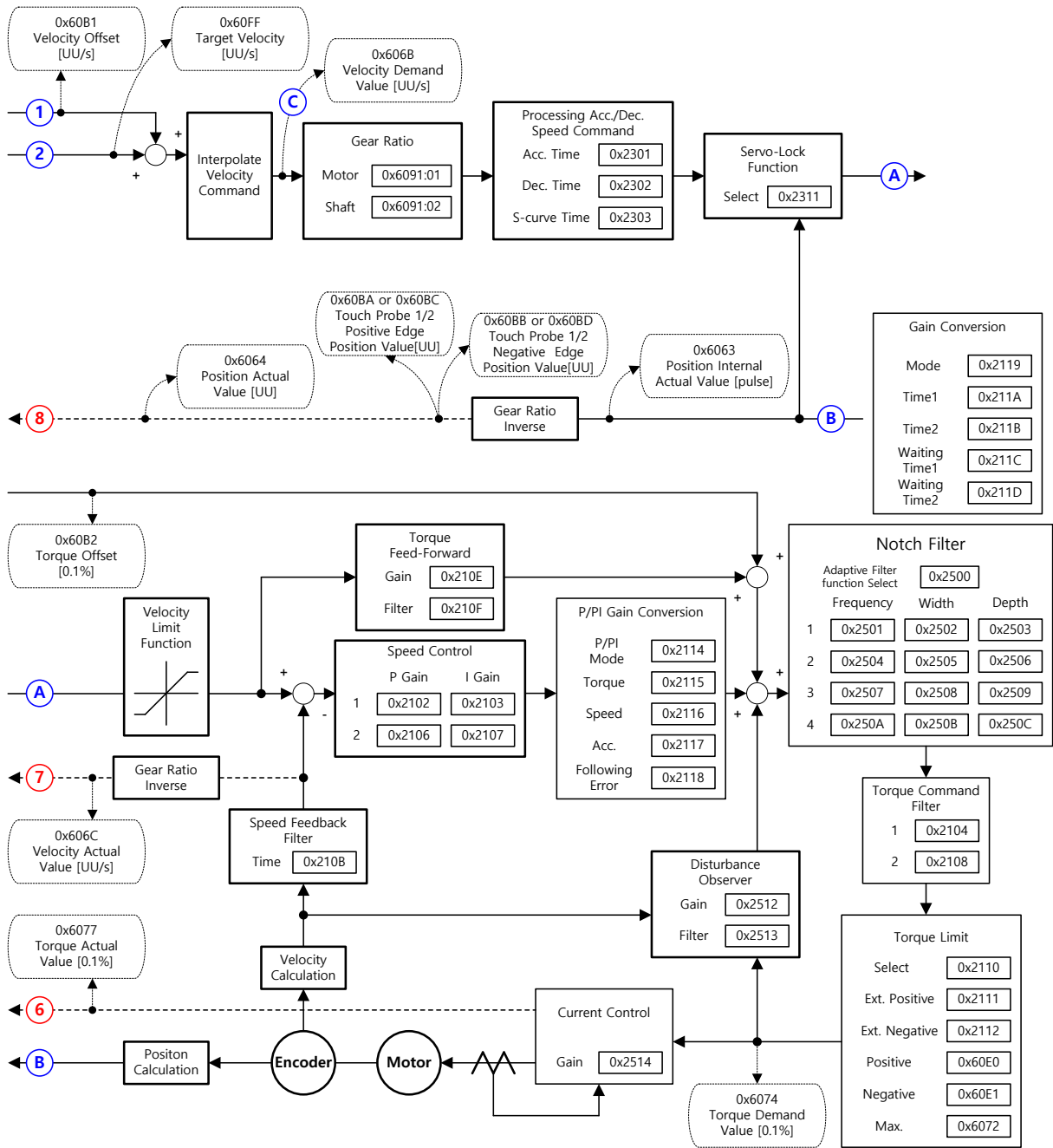

5.4.2 Profile Velocity Mode

Unlike CSV mode, which receives the target velocity that is renewed at every PDO update cycle from the upper level controller, in Profile Velocity (PV) mode, the drive generates a velocity profile internally up to the target velocity (0x60FF) using the profile acceleration (0x6083) and deceleration (0x6084) in order to control its velocity.

At this time, the max. profile velocity (0x607F) limits the maximum velocity.

The block diagram of the PV mode is shown below.

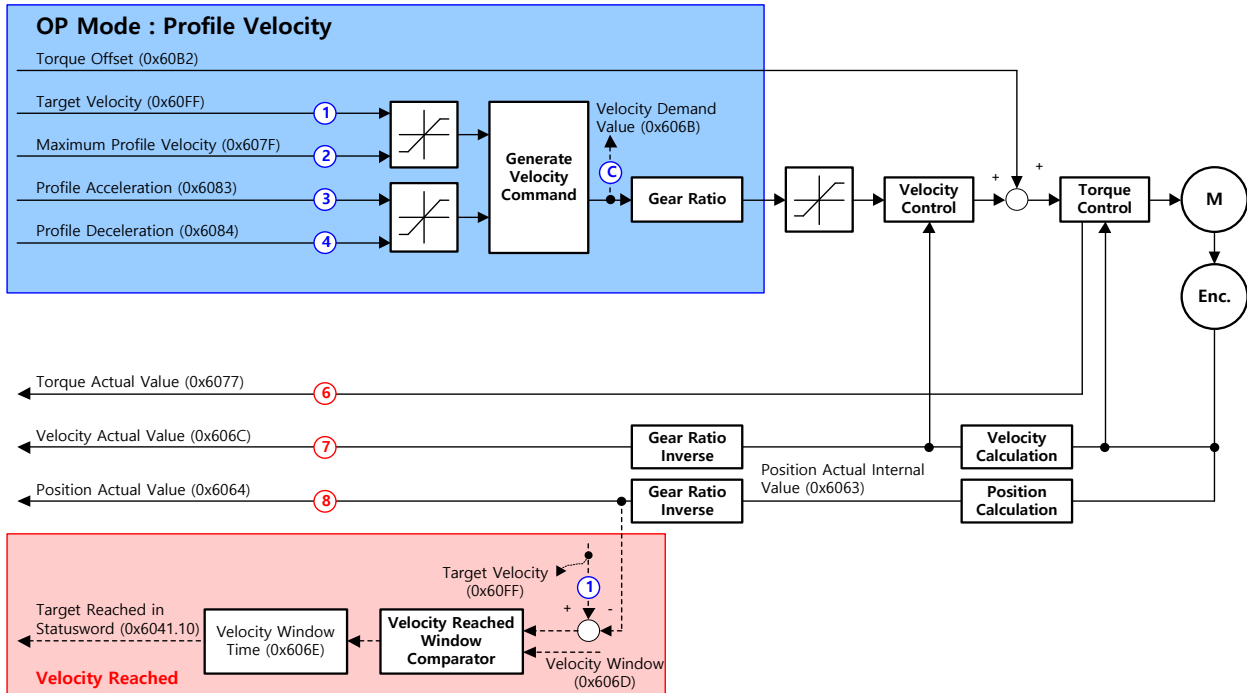

■ Related Objects

Index	Sub Index	Name	Variable Type	Accessibility	PDO Assignment	Unit
0x6040	-	Controlword	UINT	RW	Yes	-
0x6041	-	Statusword	UINT	RO	Yes	-
0x60FF	-	Target Velocity	DINT	RW	Yes	UU/s
0x607F	-	Maximum Profile Velocity	UDINT	RW	Yes	UU/s
0x6083	-	Profile Acceleration	UDINT	RW	No	UU/s ²
0x6084	-	Profile Deceleration	UDINT	RW	No	UU/s ²
0x60B1	-	Velocity Offset	DINT	RW	Yes	UU/s
0x60B2	-	Torque Offset	INT	RW	Yes	0.1%
0x606B	-	Velocity Demand Value	DINT	RO	Yes	UU/s
0x606C	-	Velocity Actual Value	DINT	RO	Yes	UU/s
0x606D	-	Velocity Window	UINT	RW	No	UU/s
0x606E	-	Velocity Window Time	UINT	RW	No	ms
0x6077	-	Torque Actual Value	INT	RO	Yes	0.1%
0x606C	-	Velocity Actual Value	DINT	RO	Yes	UU/s
0x6064	-	Position Actual Value	DINT	RO	Yes	UU
0x6063	-	Position Actual Internal Value	DINT	RO	Yes	pulse

Internal Block Diagram of PV Mode

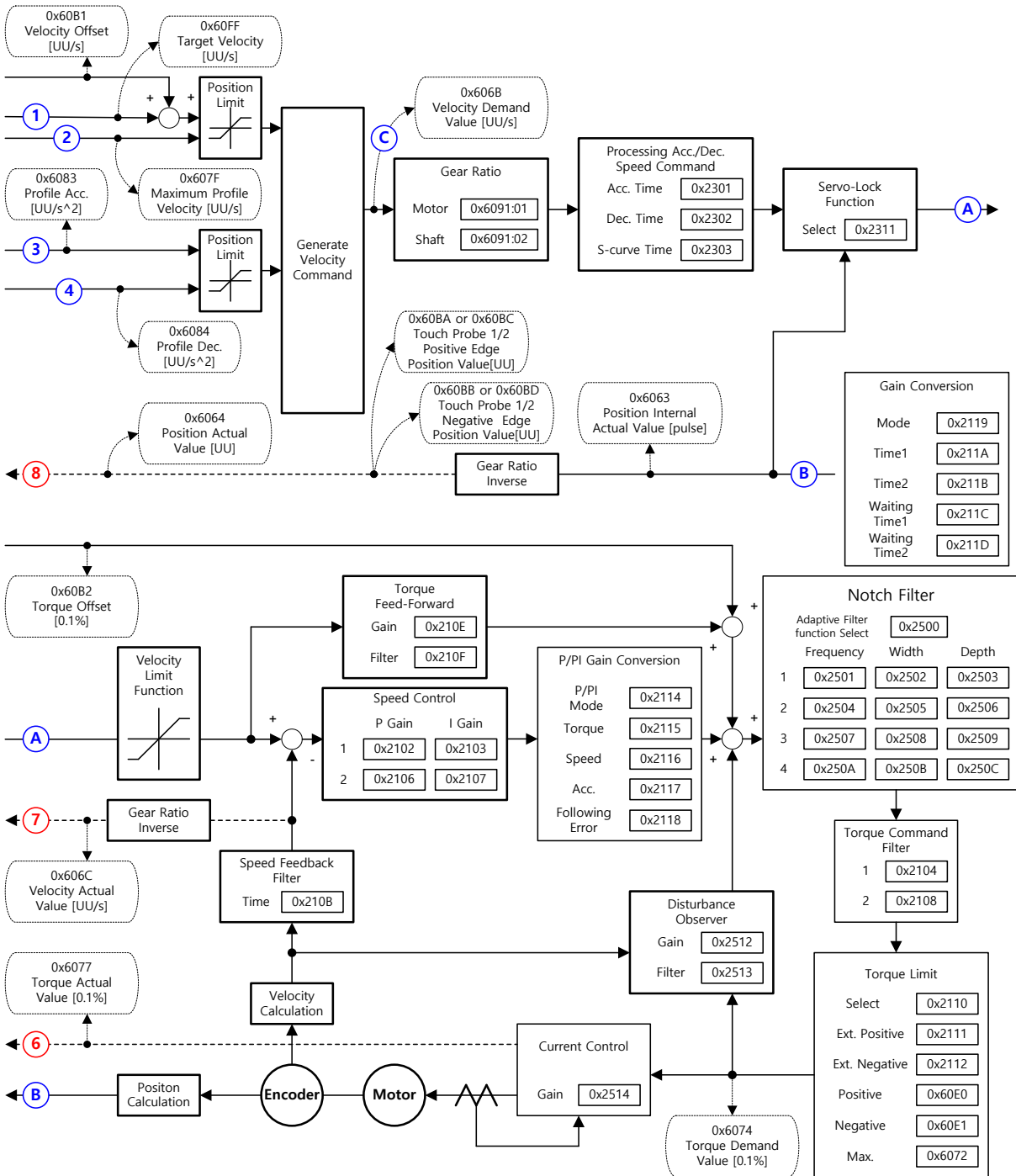

5.5 Torque Control Modes

5.5.1 Cyclic Synchronous Torque Mode

Cyclic Synchronous Torque (CST) mode receives the Target Torque (0x6071) that is renewed at every PDO update cycle from the upper level controller to control the torque.

This mode allows the upper level controller to calculate the Torque Offset (0x60B2) that corresponds to the torque feed-forward and pass it to the drive.

The block diagram of the CST mode is shown below.

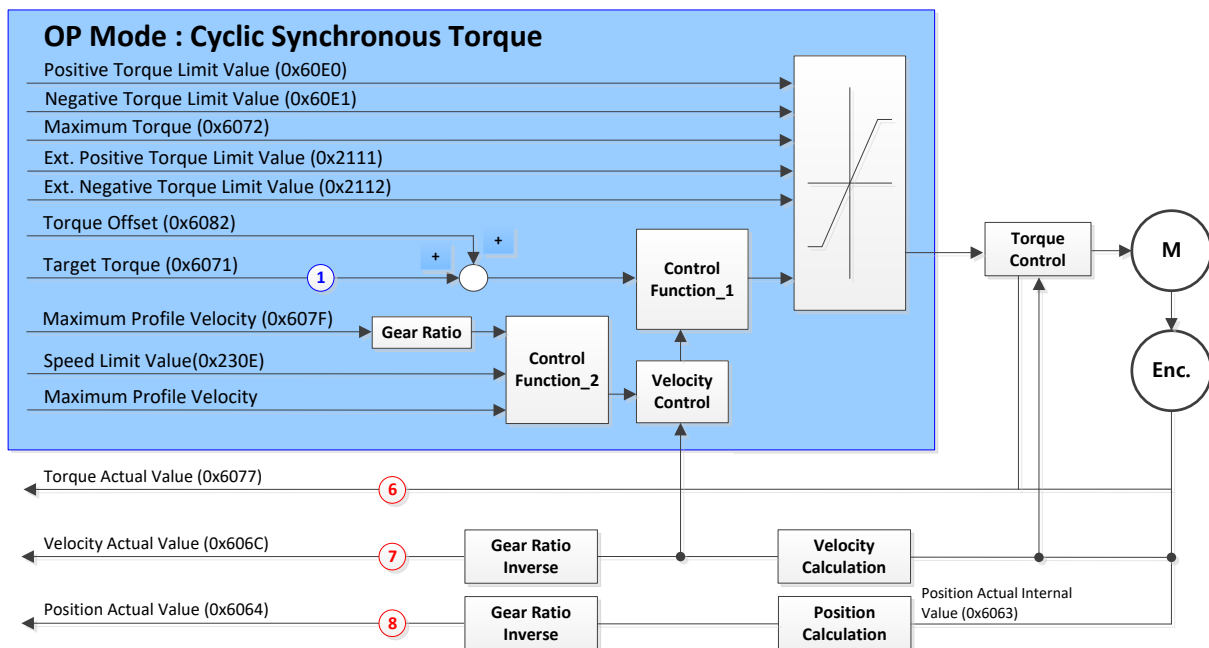

■ Related Objects

Index	Sub Index	Name	Variable Type	Accessibility	PDO Assignment	Unit
0x6040	-	Controlword	UINT	RW	Yes	-
0x6041	-	Statusword	UINT	RO	Yes	-
0x6071	-	Target Torque	INT	RW	Yes	0.1%
0x6072	-	Maximum Torque	UINT	RW	Yes	0.1%
0x607F	-	Maximum Profile Velocity	UDINT	RW	Yes	UU/s
0x60E0	-	Positive Torque Limit Value	UINT	RW	Yes	0.1%
0x60E1	-	Negative Torque Limit Value	UINT	RW	Yes	0.1%
0x60B2	-	Torque Offset	INT	RW	Yes	0.1%
0x6074	-	Torque Demand Value	INT	RO	Yes	0.1%

0x606C	-	Velocity Actual Value	DINT	RO	Yes	UU/s
0x606D	-	Velocity Window	UINT	RW	No	UU/s
0x606E	-	Velocity Window Time	UINT	RW	No	ms
0x6077	-	Torque Actual Value	INT	RO	Yes	0.1%
0x606C	-	Velocity Actual Value	DINT	RO	Yes	UU/s
0x6064	-	Position Actual Value	DINT	RO	Yes	UU
0x6063	-	Position Actual Internal Value	DINT	RO	Yes	pulse

Internal Block Diagram of CST Mode

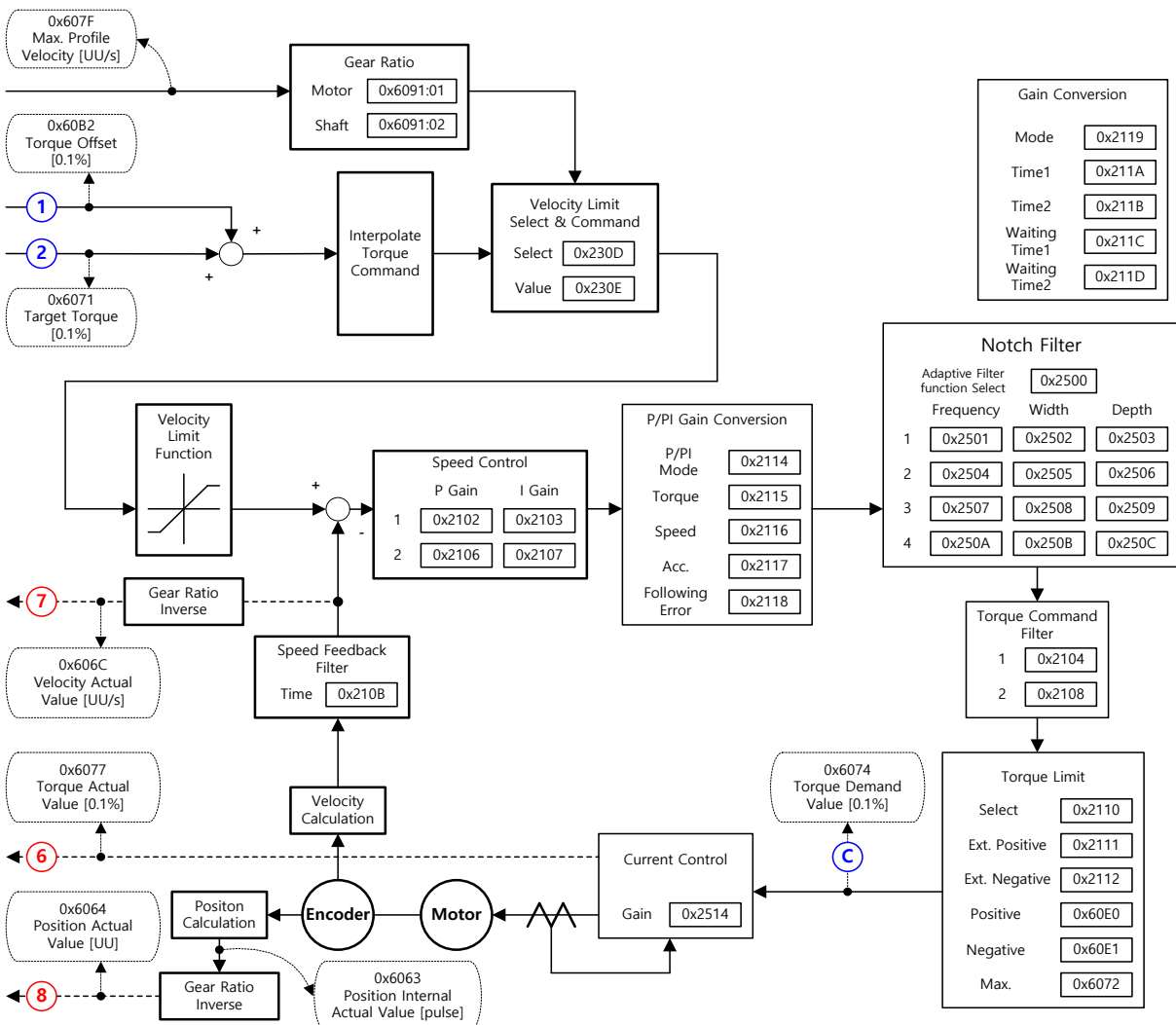

5.5.2 Profile Torque Mode

Unlike CST mode, which receives the target torque that is renewed at every PDO update cycle from the upper level controller, in Profile Torque (PT) mode, the drive generates a torque profile internally up to the target torque (0x6071) by the torque slope (0x6087) in order to control its torque.

At this moment, the torque applied to the motor is limited depending on the Positive/Negative Torque Limit Value (0x60E0 and 0x60E1) and the Maximum Torque (0x6072) based on its driving direction.

The block diagram of the PT mode is shown below.

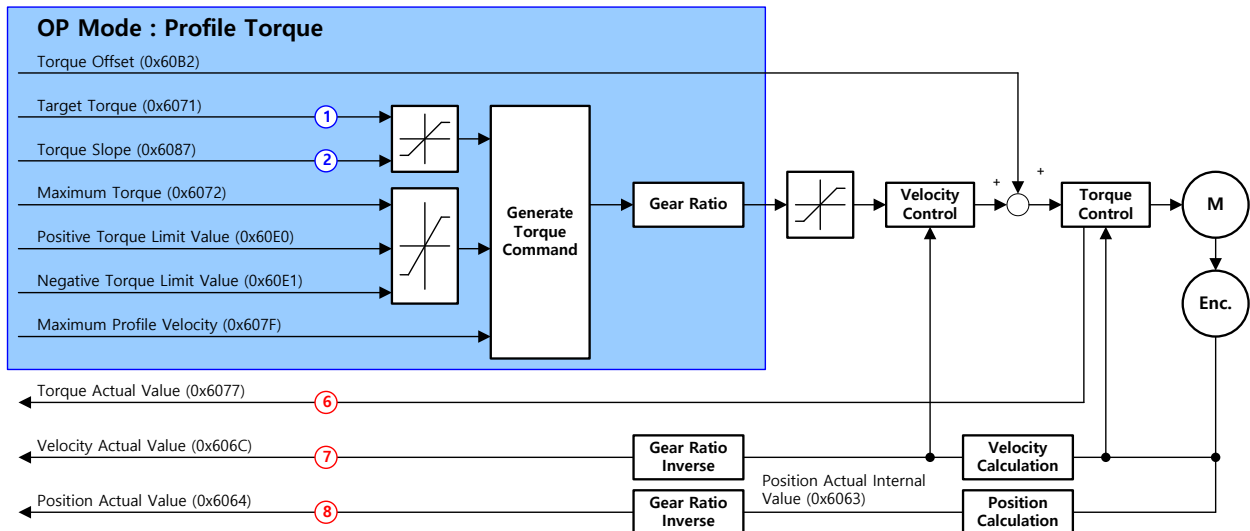

■ Related Objects

Index	Sub Index	Name	Variable Type	Accessibility	PDO Assignment	Unit
0x6040	-	Controlword	UINT	RW	Yes	-
0x6041	-	Statusword	UINT	RO	Yes	-
0x6071	-	Target Torque	INT	RW	Yes	0.1%
0x6072	-	Maximum Torque	UINT	RW	Yes	0.1%
0x607F	-	Maximum Profile Velocity	UDINT	RW	Yes	UU/s
0x6087	-	Torque Slope	UDINT	RW	Yes	0.1%/s
0x60E0	-	Positive Torque Limit Value	UINT	RW	Yes	0.1%
0x60E1	-	Negative Torque Limit Value	UINT	RW	Yes	0.1%
0x60B2	-	Torque Offset	INT	RW	Yes	0.1%
0x6074	-	Torque Demand Value	INT	RO	Yes	0.1%
0x606C	-	Velocity Actual Value	DINT	RO	Yes	UU/s

5.6 Homing

This drive provides its own homing function. The figure below represents the relationship between the input and output parameters for the Homing Mode. You can specify velocity, acceleration, offset, and homing method.

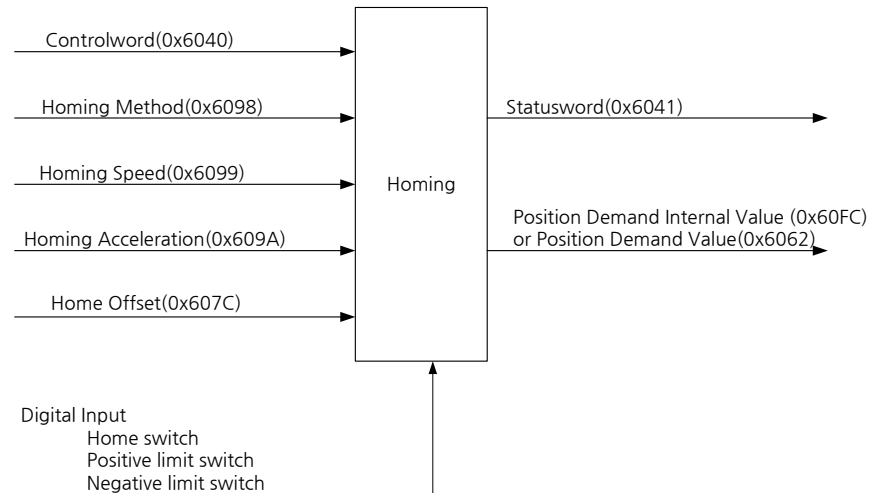

As shown in the figure below, you can set the offset between the home position and the zero position of the machine using the home offset function. The zero position indicates a point whose Position Actual Value (0x6064) is zero (0).

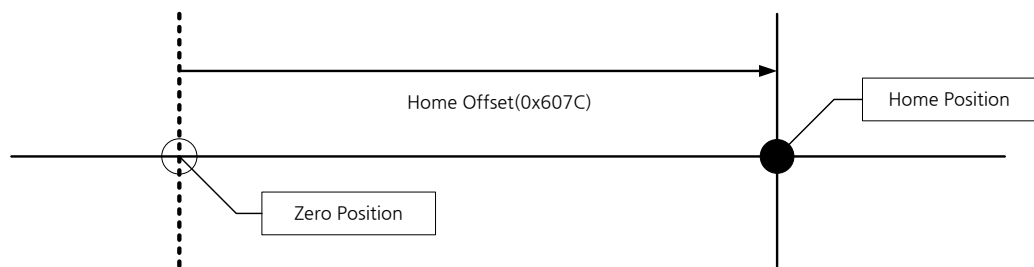

5.6.1 Homing Method

The drive supports the following homing methods (0x6098):

Homing Method (0x6098)	Description
1	The drive returns to the home position by the negative limit switch (NOT) and the Index (Z) pulse while driving in the negative direction.
2	The drive returns to the home position by the positive limit switch (POT) and the Index (Z) pulse while driving in the positive direction.
7,8,9,10	The drive returns to the home position by the home switch (HOME) and the Index (Z) pulse while driving in the positive direction. When the positive limit switch (POT) is input during homing, the drive switches its driving direction.
11,12,13,14	The drive returns to the home position by the home switch (HOME) and the Index (Z) pulse while driving in the negative direction. When the negative limit switch (NOT) is input during homing, the drive switches its driving direction.
24	The drive returns to the home position by the home switch (HOME) while driving in the positive direction. When the positive limit switch (POT) is input during homing, the drive switches its driving direction.

28	The drive returns to the home position by the home switch (HOME) while driving in the negative direction. When the negative limit switch (NOT) is input during homing, the drive switches its driving direction.
33	The drive returns to the home position by the Index (Z) pulse while driving in the negative direction.
34	The drive returns to the home position by the Index (Z) pulse while driving in the positive direction.
35	Sets the current position as the home position.
-1	The drive returns to the home position by the negative stopper and the Index (Z) pulse while driving in the negative direction.
-2	The drive returns to the home position by the positive stopper and the Index (Z) pulse while driving in the positive direction.
-3	The drive returns to the home position only by the negative stopper while driving in the negative direction.
-4	The drive returns to the home position only by the positive stopper while driving in the positive direction.
-5	The drive returns to the home position only with the home switch (HOME) while driving in the negative direction.
-6	The drive returns to the home position only with the home switch (HOME) while driving in the positive direction.

■ Related Objects

Index	Sub Index	Name	Variable Type	Accessibility	PDO Assignment	Unit
0x6040	-	Controlword	UNIT	RW	Yes	-
0x6041	-	Statusword	UINT	RO	Yes	-
0x607C	-	Home Offset	DINT	RW	No	UU
0x6098	-	Homing Method	SINT	RW	Yes	-
0x6099	-	Homing Speed	-	-	-	-
	0	Number of Entries	USINT	RO	No	-
	1	Speed during search for switch	UDINT	RW	Yes	UU/s
	2	Speed during search for zero	UDINT	RW	Yes	UU/s
0x609A	-	Homing Acceleration	UDINT	RW	Yes	UU/s ²

■ Homing Methods 1 and 2

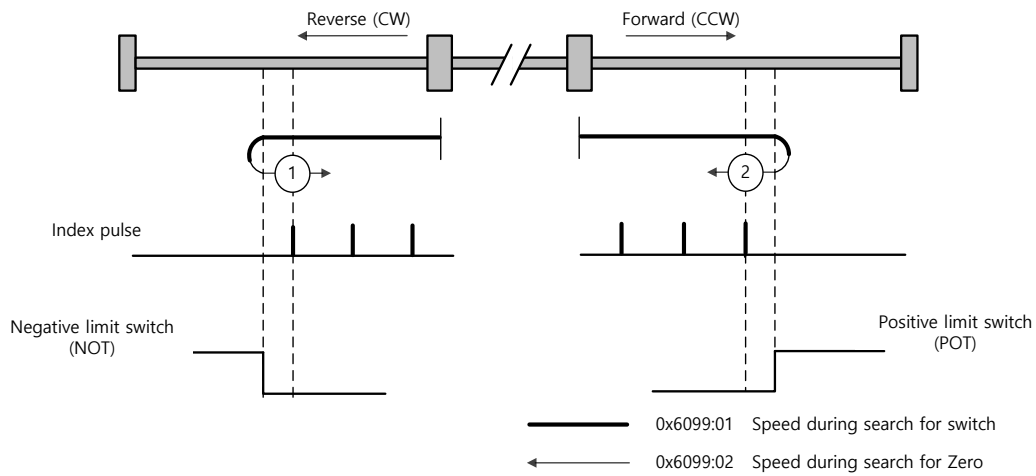

For homing using the homing method 1, the velocity profile according to the sequence is as follows. See the details below:

Homing Method ①

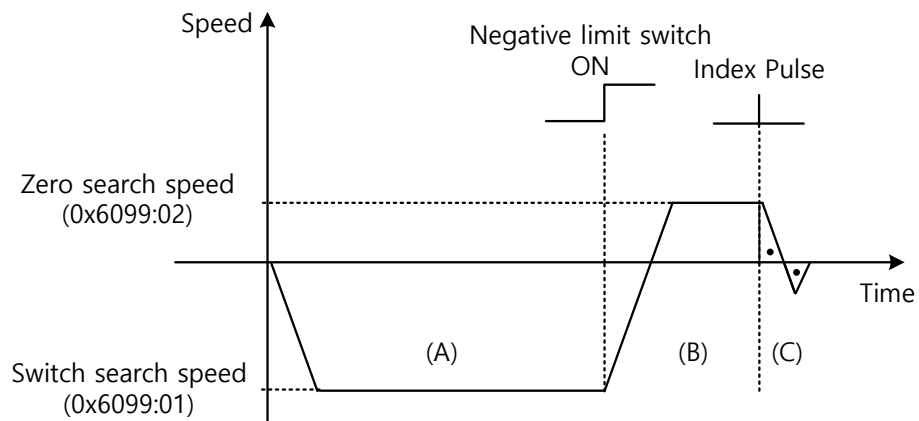

- (A) The initial driving direction is negative (CW), and the drive operates at the switch search speed.
- (B) When the negative limit switch (NOT) is turned on, the drive switches to the positive direction (CCW), decelerating to zero search speed.
- (C) While operating at the zero search speed, the drive detects the first index pulse to move to the index position (Home).

■ **Methods 7, 8, 9, and 10**

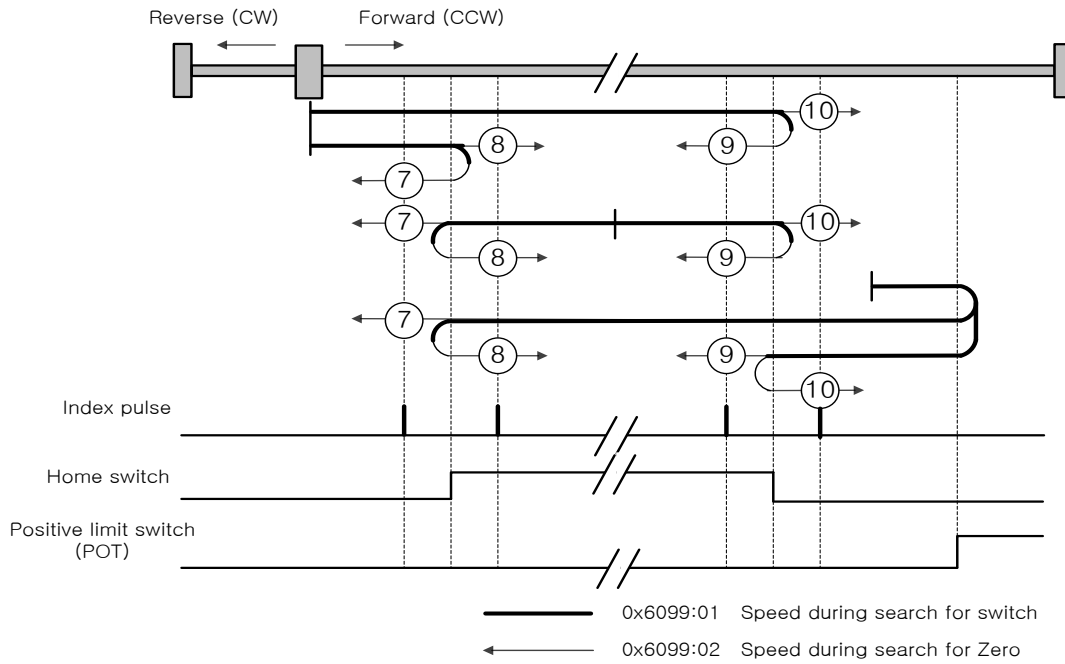

For homing using the homing method 7, the velocity profile according to the sequence is as follows. The sequence varies depending on the relationship between the load position and the home switch during homing, which is categorized into three cases as below. For more information, see the details below:

(1) At the start of homing, when the Home switch is off and the limit is not met during operation

Homing Method ⑦

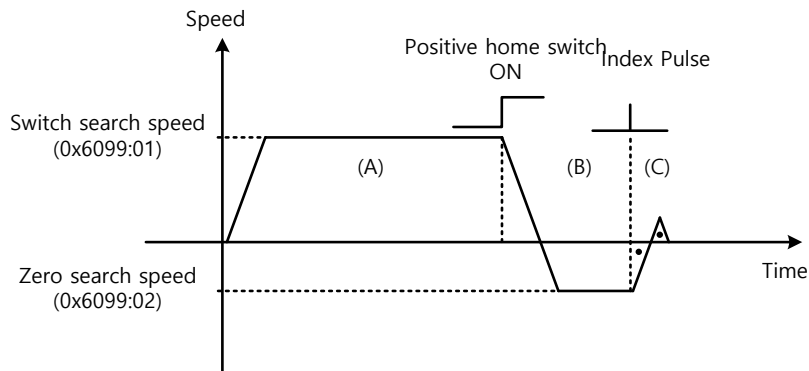

- (A) The initial driving direction is positive (CCW), and the drive operates at the switch search speed.
- (B) When the Positive Home switch is turned on, the drive will decelerate to zero search speed, and then switch to the negative direction (CW).
- (C) While operating at the zero search speed, the drive detects the first index pulse to move to the index position (Home).

(2) At the start of homing, when the Home switch is on

Homing Method ⑦

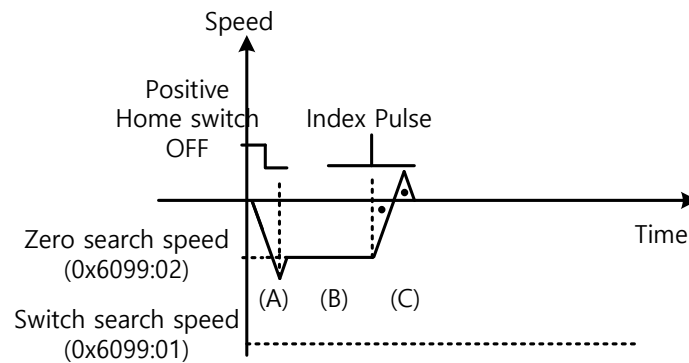

- (A) Since the home signal is on, the drive operates at the switch search speed in the direction of the positive home switch (CCW). It might not reach the Switch Search Speed depending on the start position of homing.
- (B) When the Home switch is turned off, the drive will decelerate to zero search speed, and then continue to operate.
- (C) While operating at the zero search speed, the drive detects the first index pulse to move to the index position (Home).

(3) At the start of homing, when the Home switch is off and the limit is met during operation

Homing Method ⑦

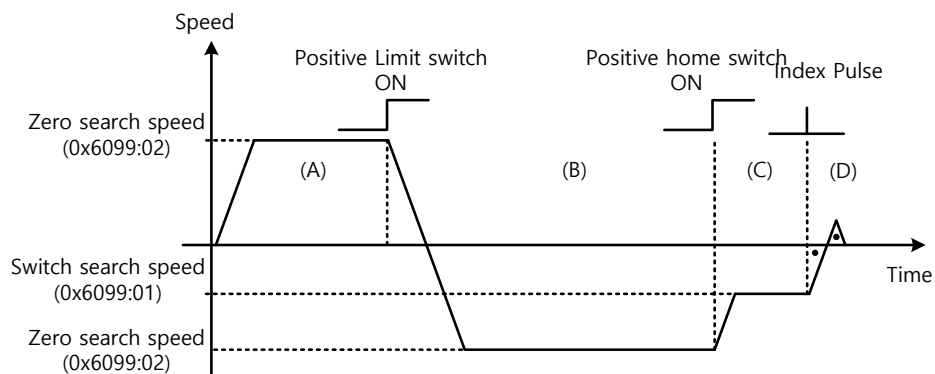

- (A) The initial driving direction is positive (CCW), and the drive operates at the switch search speed.
- (B) When the positive limit switch (POT) is turned on, the drive will decelerate to a stop, and then operate at switch search speed in the negative direction (CW).
- (C) When the positive home switch is turned off, the drive decelerates to the zero search speed, then continues to operate.
- (D) While operating at the zero search speed, the drive detects the first index pulse to move to the index position (Home).

Methods 8, 9, and 10 are nearly identical to method 7 in terms of homing sequence. The only differences are the initial driving direction and the home switch polarity.

The positive home switch is determined by the initial driving direction. The home switch encountered in the initial driving direction becomes the positive home switch.

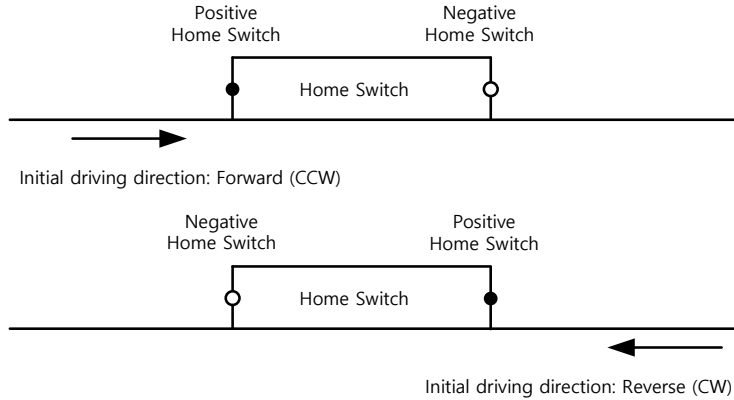

■ **Methods 11, 12, 13, and 14**

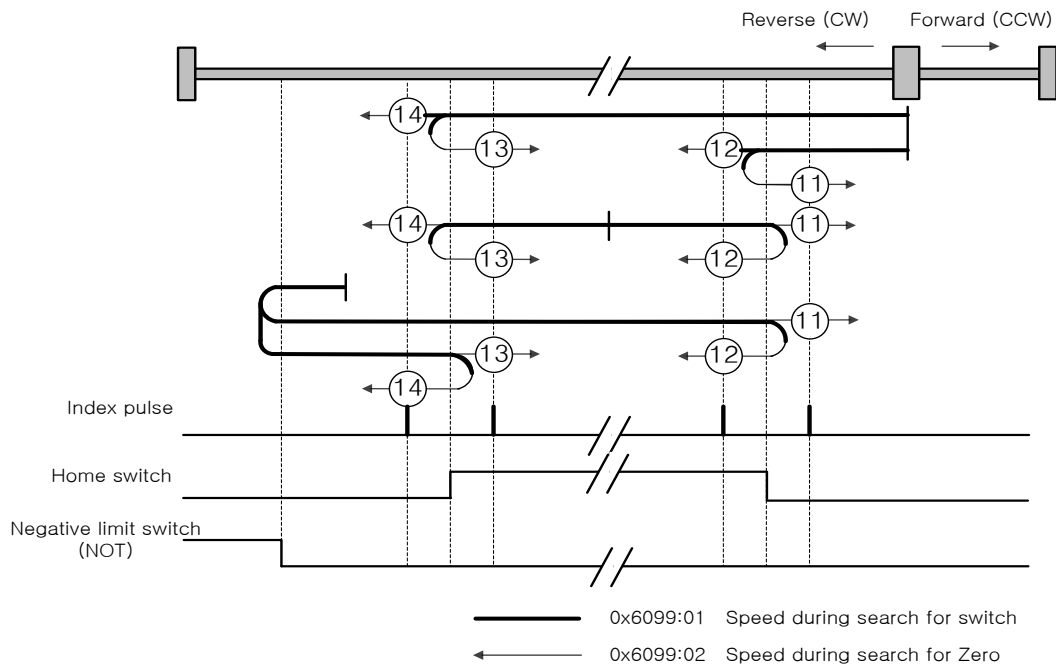

For homing using Homing Method 14, the velocity profile according to the sequence is as follows. The sequence varies depending on the relationship between the load position and the home switch during homing, which is categorized into three cases as below. For more information, see the details below:

(1) At the start of homing, when the Home switch is off and the limit is not met during operation

Homing Method ⑭

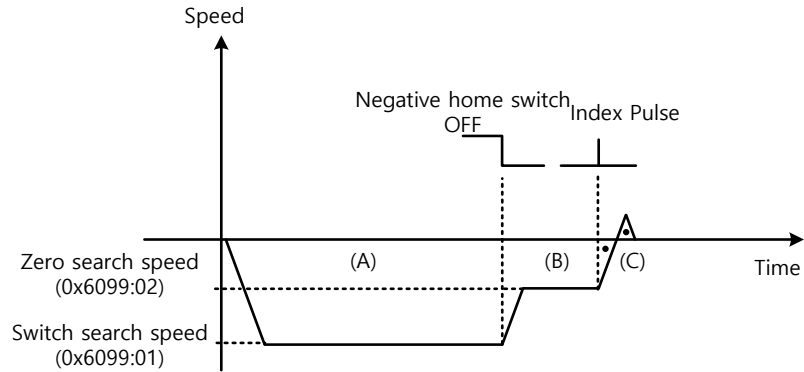

- (A) The initial driving direction is negative (CW), and the drive operates at the switch search speed.
- (B) When the negative home switch is turned off, the drive decelerates to the zero search speed, then continues to operate.
- (C) While operating at the zero search speed, the drive detects the first index pulse to move to the index position (Home).

(2) At the start of homing when the Home switch is on

Homing Method ⑭

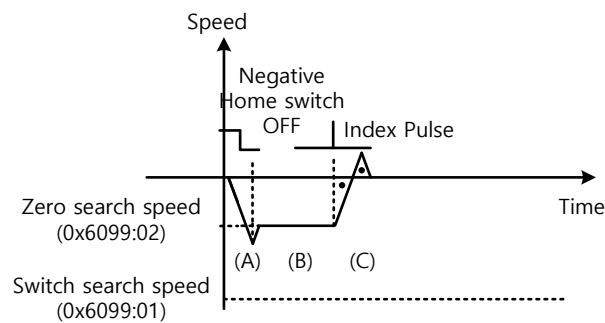

- (A) Since the home signal is on, the drive operates at the switch search speed in the direction of the negative home switch (CW). It might not reach the Switch Search Speed depending on the start position of homing.
- (B) When the home switch is turned off, the drive decelerates to the zero search speed, then continues to operate.
- (C) While operating at zero search speed, the drive detects the first index pulse to move to the index position (Home).

(3) At the start of homing, when the Home switch is off and the limit is met during operation

Homing Method 14

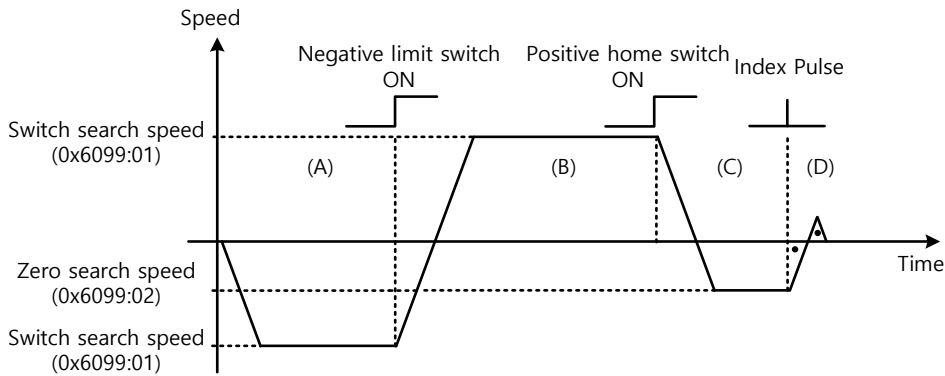

- (A) The initial driving direction is negative (CW), and the drive operates at the switch search speed.
- (B) When the negative limit switch (NOT) is turned on, the drive decelerates to a stop, then operates at the switch search speed in the positive direction (CCW).
- (C) When the negative home switch is turned on, the drive will decelerate to zero search speed, and then switch to the negative direction (CW).
- (D) While operating at zero search speed, the drive detects the first index pulse to move to the index position (Home).

Methods 11, 12, and 13 are nearly identical to method 14 in terms of homing sequence. The only differences are the initial driving direction and home switch polarity.

Method 24

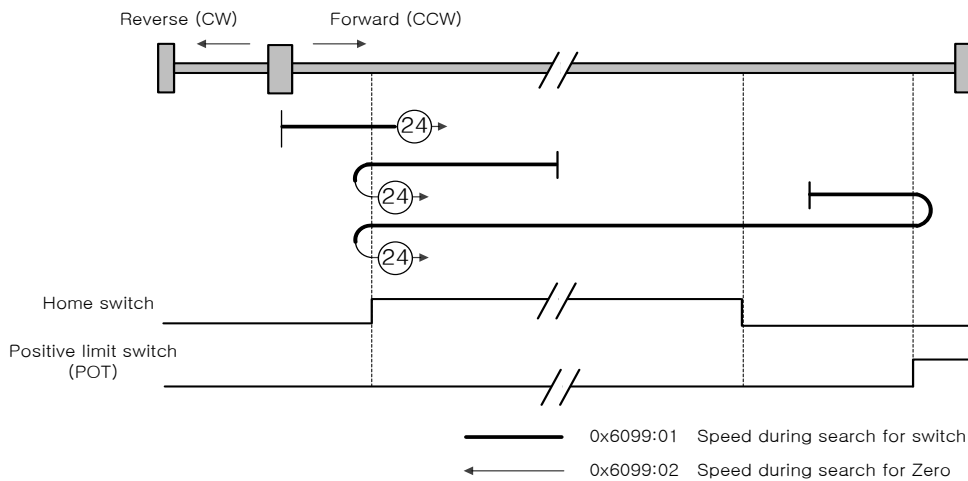

The initial driving direction is positive (CCW), and the point where the positive home switch is turned on becomes the home position.

■ Method 28

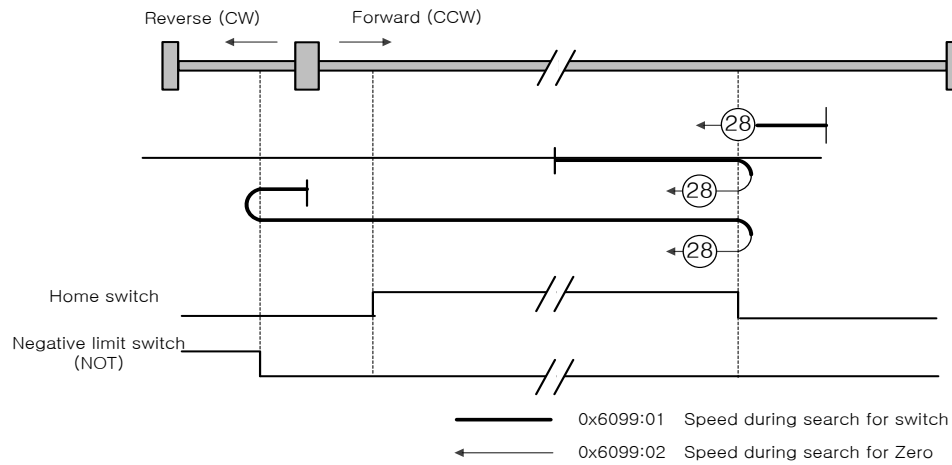

The initial driving direction is negative (CW), and the point where the positive home switch is turned on becomes the home position.

■ Method 33 and 34

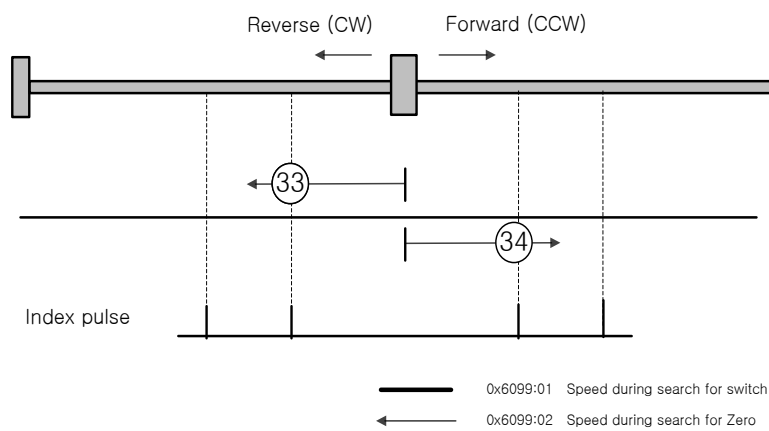

The initial driving direction is negative (CW) for method 33 and positive (CCW) for method 34. The drive detects the index pulse at the zero search speed.

■ Method 35

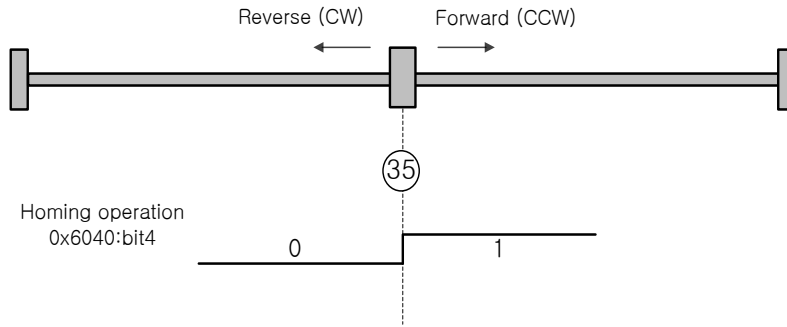

The current position at start of homing operation becomes the home position. This method is used to make the current position the home position according to the demand of the upper level controller.

The drive supports homing methods -1, -2, -3, and -4 apart from the standard ones. These methods can only be used if the home switch is not used separately.

■ Method -1 and -2

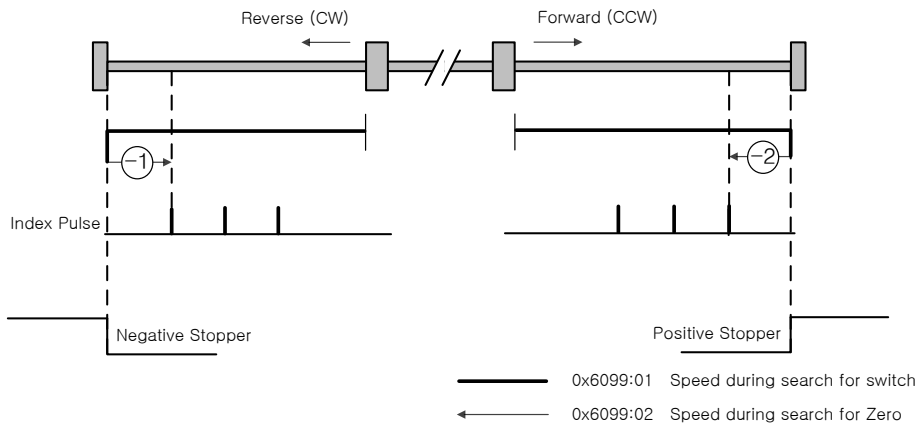

Homing method -1 and -2 use the stopper and index (Z) pulse to perform homing. The velocity profile according to sequence is as follows. For more information, see the details below:

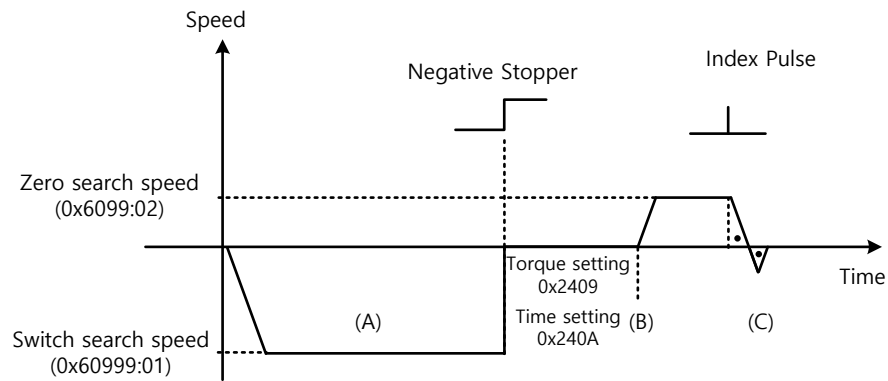
Homing Method ①

- (A) The initial driving direction is negative (CW), and the drive operates at the switch search speed.
- (B) When the drive hits the negative stopper, it stands by according to the torque limit value (0x2409) and the time setting value (0x240A) during homing using the stopper, then switches the direction.
- (C) While operating at the zero search speed, the drive detects the first index pulse to move to the index position (Home).

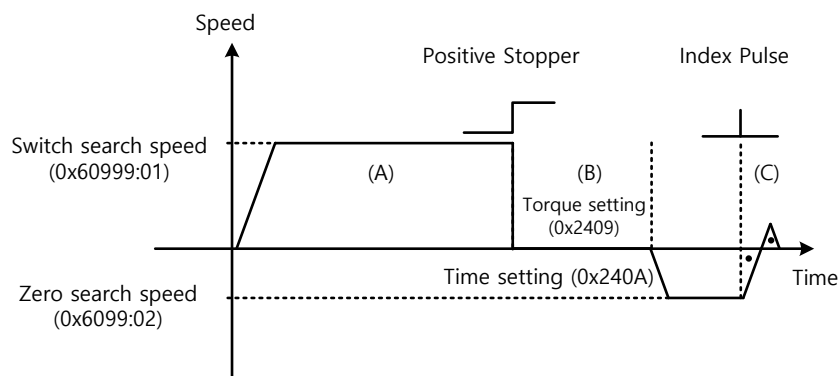
Homing Method ②

- (A) The initial driving direction is positive (CCW), and the drive operates at the switch search speed.
- (B) When the drive hits the positive stopper, it stands by according to the torque limit value (0x2409) and the time setting value (0x240A) during homing using the stopper, then switches the direction.
- (C) While operating at the zero search speed, the drive detects the first index pulse to move to the index position (Home).

■ Method -3 and -4

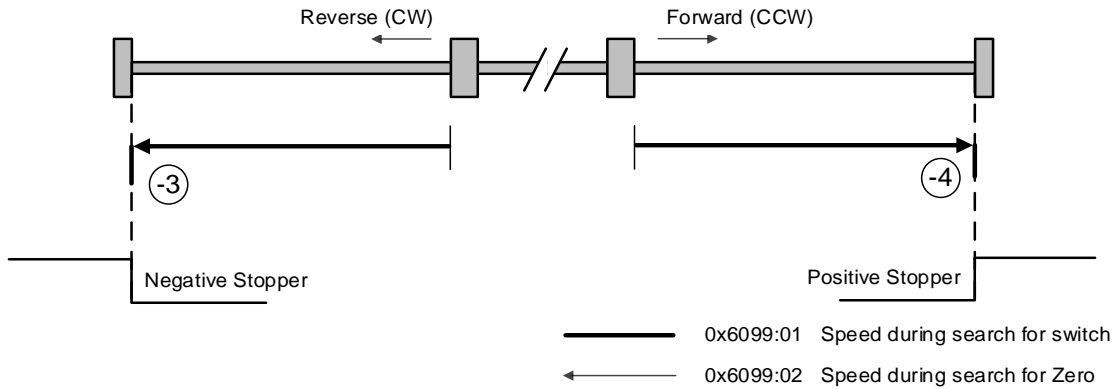

Homing methods -3 and -4 only use the stopper to perform homing. The velocity profile according to sequence is as follows. For more information, see the details below:

Homing Method ⊖

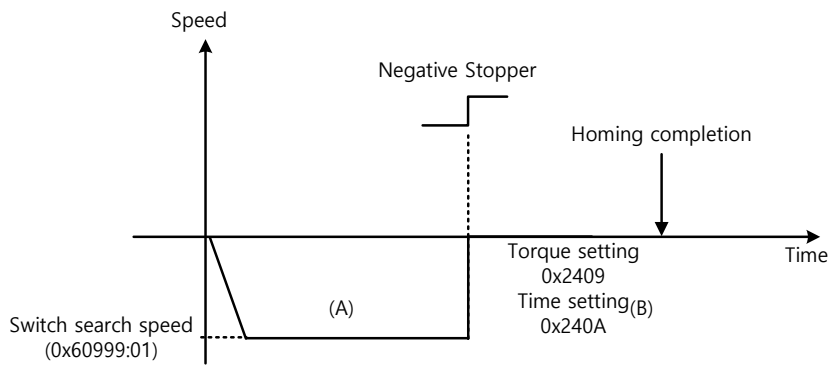

- (A) The initial driving direction is negative (CW), and the drive operates at the switch search speed.
- (B) When the drive hits the negative stopper, it stands by according to the torque limit value (0x2409) and the time setting value (0x240A) at the time of homing using the stopper and finishes homing.

Homing Method ⊕

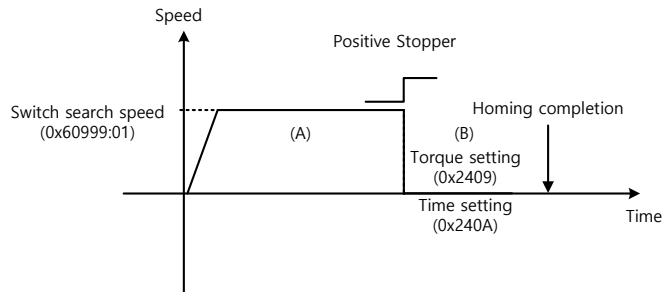

- (A) The initial driving direction is positive (CCW), and the drive operates at the switch search speed.
- (B) When the drive hits the positive stopper, it stands by according to the torque limit value (0x2409) and the time setting value (0x240A) at the time of homing using the stopper and finishes homing.

■ Method -5 and -6

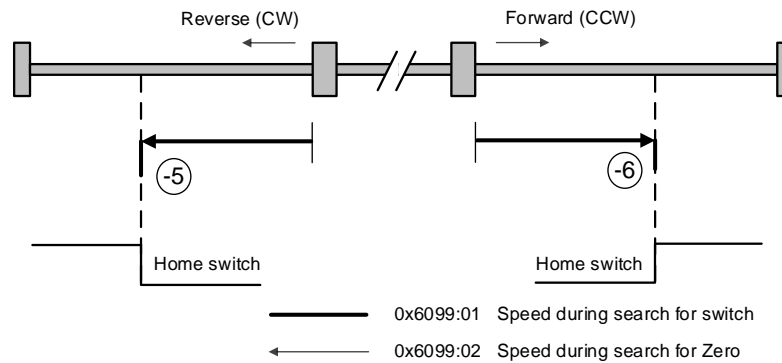

Homing methods -5 and -6 perform homing only by using the stopper. The velocity profile according to sequence is as follows. Homing is stopped when the drive meets the limit switch. For more information, see the details below:

- (1) At the start of homing, when the Home switch is off and the limit is not met during operation

Homing Method ⑤

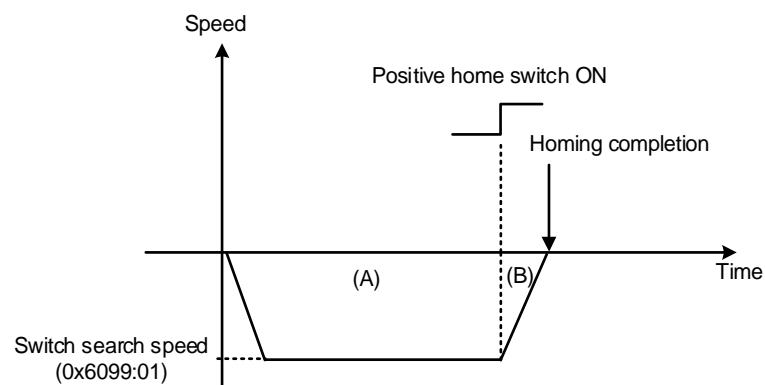

- (A) The initial driving direction is negative (CW), and the drive operates at the switch search speed.
 (B) If the positive home switch is turned on, the drive decelerates to a stop and completes homing.

(2) At the start of homing, when the Home switch is off and the limit is met during operation

Homing Method ⑤

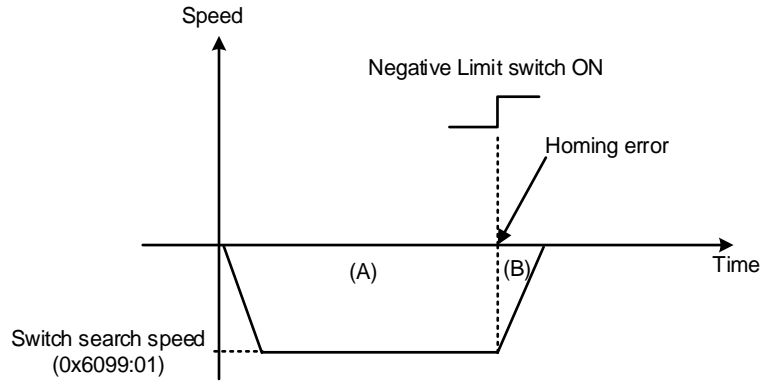

- (A) The initial driving direction is negative (CW), and the drive operates at the switch search speed.
- (B) When the negative limit switch is turned on, the drive issues a homing error and decelerates to a stop.

Homing Method ⑥

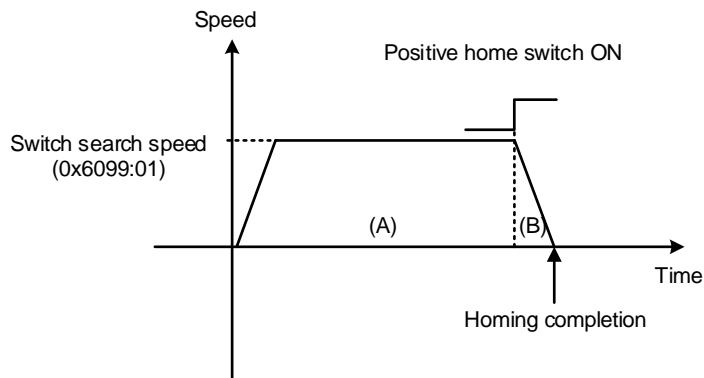

- (A) The initial driving direction is positive (CCW), and the drive operates at the switch search speed.
- (B) If the positive home switch is turned on, the drive decelerates to a stop and completes homing.

5.7 Touch Probe Function

The touch probe is a function that rapidly captures the position value of the encoder with external input (PROBE 1 and 2) signals or the index (Z) pulse of the encoder.

- Example of Touch Probe

Wafer mapper system of wafer transfer robot (WTR)

When wafers are piled up on a wafer stack, the presence of wafers can be determined by scanning the stack once using a mapping sensor. At this time, any unnecessary movement by the robot can be prevented using the value of the wafer loading position, which has been captured rapidly.

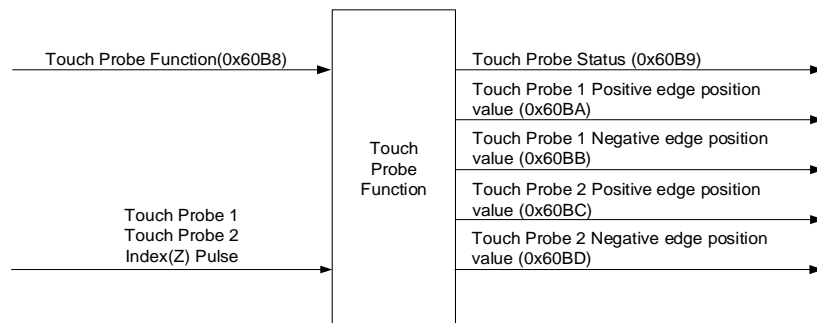
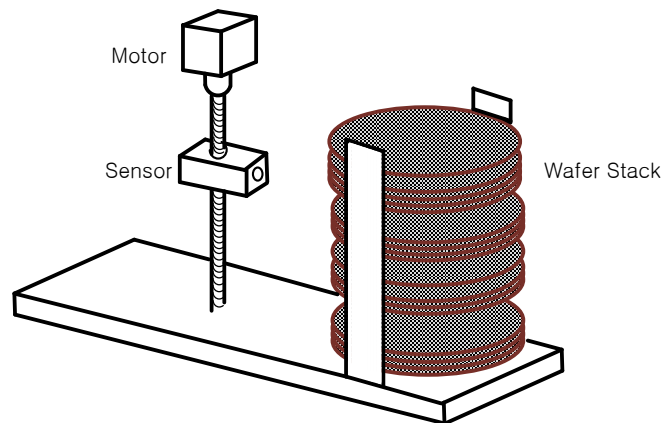

The position value of the encoder (Position Actual Value, 0x6064) is latched by the following trigger events according to the setting value. At the same time, 2 channel inputs can be latched independently at the positive/negative edges.

- Triggered by touch probe 1 (I/O, PROBE1)
- Triggered by touch probe 2 (I/O, PROBE2)
- Triggered by the encoder index (Z) pulse

■ Related Objects

Index	Sub Index	Name	Variable Type	Accessibility	PDO Assignment	Unit
0x60B8	-	Touch Probe Function	UINT	RW	Yes	-

0x60B9	-	Touch Probe Status	UINT	RO	Yes	-
0x60BA	-	Touch Probe 1 Positive Edge Position Value	DINT	RO	Yes	UU
0x60BB	-	Touch Probe 1 Negative Edge Position Value	DINT	RO	Yes	UU
0x60BC	-	Touch Probe 2 Positive Edge Position Value	DINT	RO	Yes	UU
0x60BD	-	Touch Probe 2 Negative Edge Position Value	DINT	RO	Yes	UU

■ Touch Probe Timing Diagram

- Single Trigger Mode (0x60B8.1=0, 0x60B8.9=0):

To reset bits 1, 2, 9, and 10 of the touch probe status (0x60B9) in single trigger mode, set the corresponding bits (4, 5, 12, and 13) of the touch probe function (0x60B8) to 0.

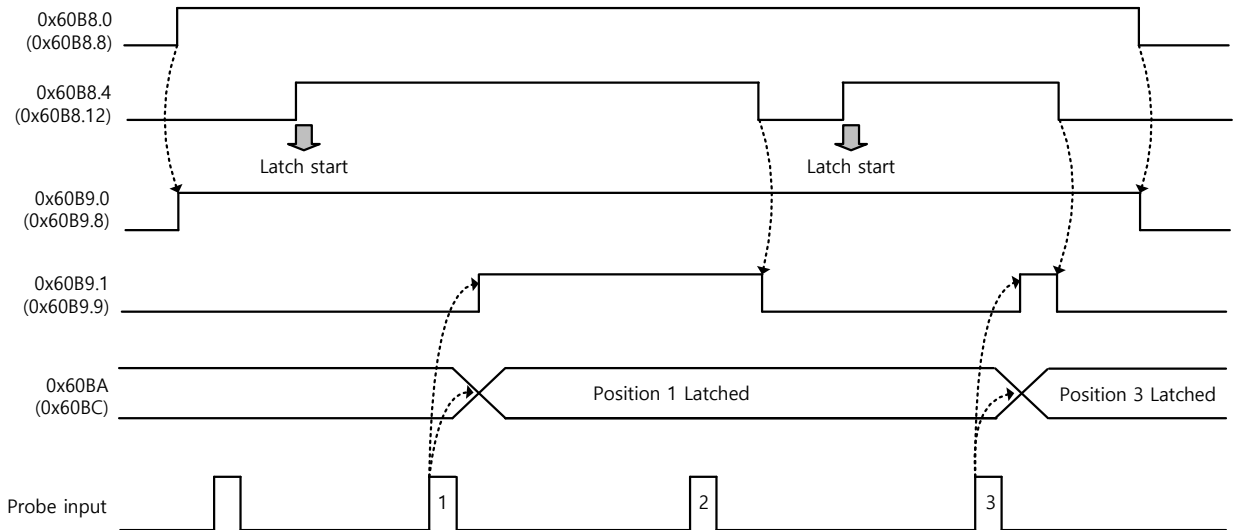

- **Continuous Trigger Mode (0x60B8.1=1, 0x60B8.9=1):**

In continuous trigger mode, bits 6, 7, 14, and 15 of the touch probe status (0x60B9) toggle (0 → 1 or 1 → 0) every time the corresponding input/edge is input.

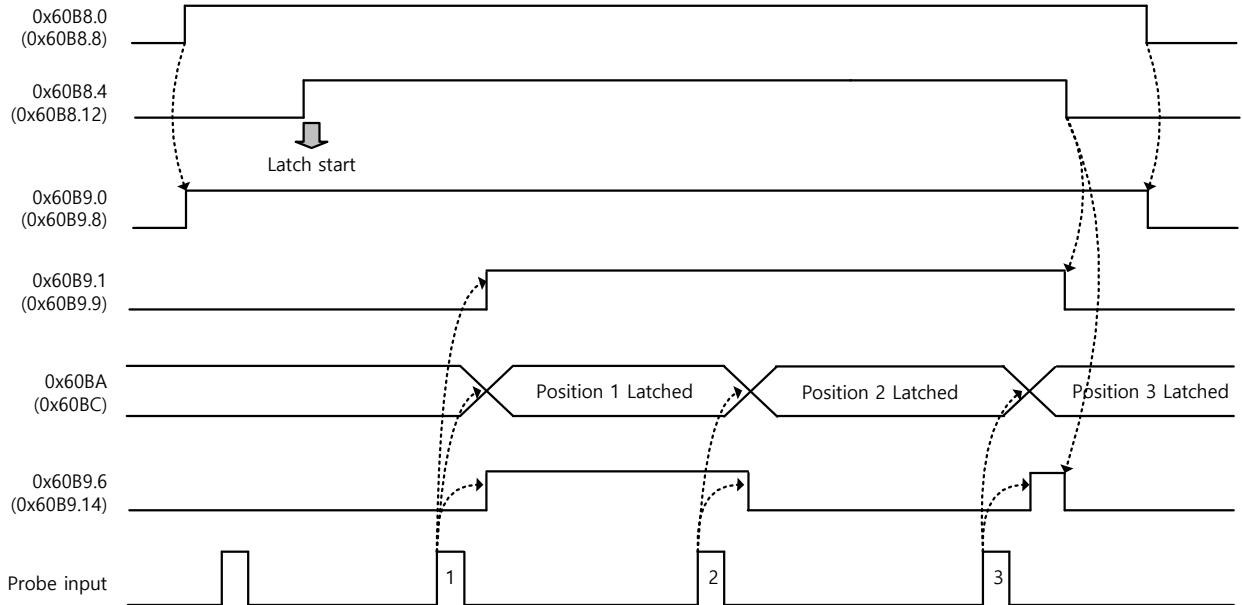

- **Index Pulse Trigger Mode (0x60B8.2=1, 0x60B8.10=1):**

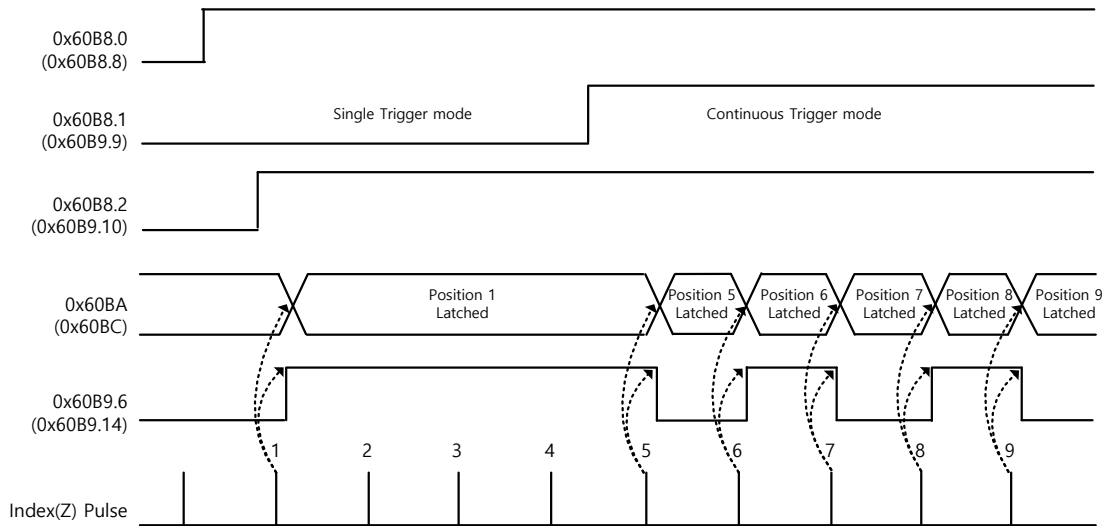

6. Drive Application Functions

6.1 Drive Front Panel

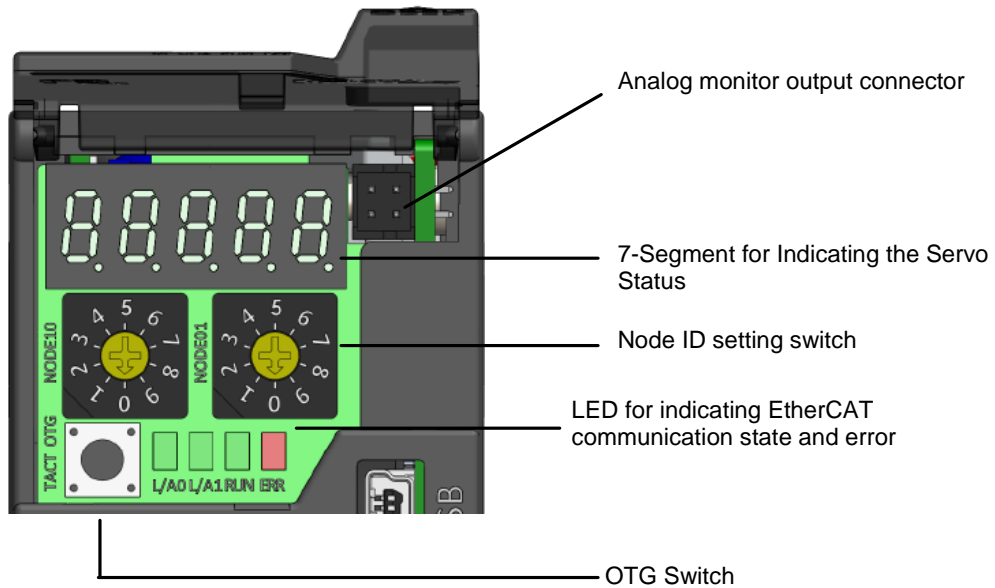

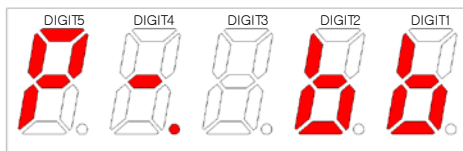

6.1.1 7-Segment for Indicating the Servo Status

7-Segment for indicating the servo status consists of 5 digits as shown below, which are in the order of Digit 1→Digit 5 from right to left.



Three digits from Digit 3~1 of the 7-Segment represent the drive status as described below if no servo alarm occurs. In the event of a servo warning occurrence, the warning status display takes precedence over other status.

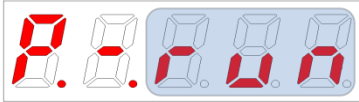

Digit 3~Digit 1 display	Status details
<p>STO connector not connected</p>	<p>Positive limit sensor input</p>

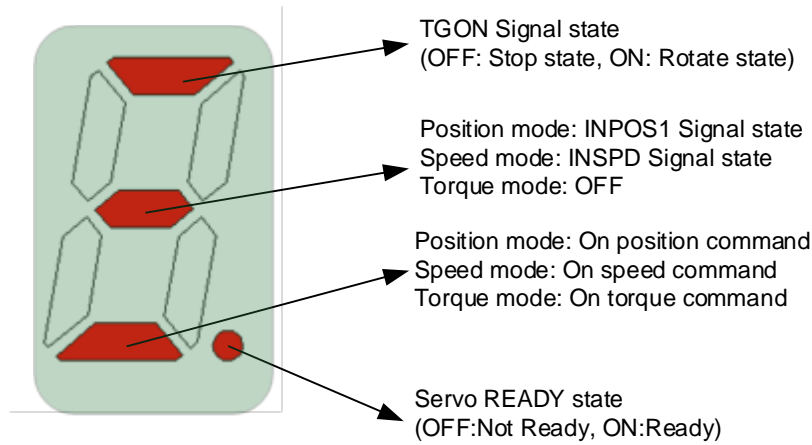

Servo OFF status	Negative limit sensor input
 <p>Servo ON status</p>	 <p>Servo warning W10 occurrence (Code: 10)</p>

Digit 4 displays the current operation status and servo ready status.

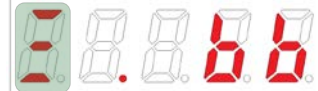

Digit 5 displays the status of the EtherCAT State Machine or of the current control mode and servo ON.

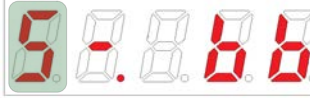

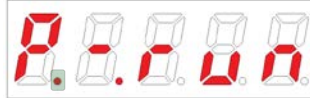
<p>If the status of the EtherCAT State Machine is prior to the operation state (communication setup process):</p> <p>➔ A preparation status, where a servo operation is not available, indicating that the EtherCAT communication is in progress.</p>		
 <p>Init state</p>	 <p>Pre-Operational state</p>	 <p>Safe-Operational state</p>

<p>If the status of the EtherCAT State Machine is the operation state (operation ready):</p> <p>→ A status, where a servo operation is available, indicating the operation mode and status.</p>		
 <p>Position Control Mode: CSP and PP</p>	 <p>Velocity control modes: CSV and PV</p>	 <p>Torque control modes: CST and PT</p>
 <p>Homing Mode</p>	 <p>(ON: Servo ON, OFF: Servo OFF)</p>	

In the event of a servo alarm occurrence, Digit 5~1 blink with the below display. Digit 2 and Digit 1 represent the alarm code. The servo alarm display takes precedence over other status.



Example for Alarm state
AL-10 (IPM Fault)

<p>ex. 1) Limit signal input</p>  <p>DIGIT3~1:CCW direction Limit input</p> <p>DIGIT4 : INPOS1, SERVO READY</p> <p>DIGIT5 : Position mode, SERVO ON</p>	<p>ex. 2) Servo warning occurrence</p>  <p>DIGIT3~1! W01(Main power failure)+W40(Low voltage warning)state</p> <p>DIGIT4 : INSPD, On speed command, SERVO READY</p> <p>DIGIT5 : SPEED CONTROL MODE, SERVO ON</p>
--	--

6.1.2 OTG Function

The OTG USB memory can send and receive data without using a PC. With an OTG cable connected to the USB connector, you can use the Tact switch of the drive loader to back up or restore parameters, save error history or update firmware.

However, use a USB OTG cable, consisting of a USB Female Plug Type A and USB Mini B 5 pins, as the download cable. Also, you must set the format method of the USB drive to FAT32 (default) in order to use the functions below.

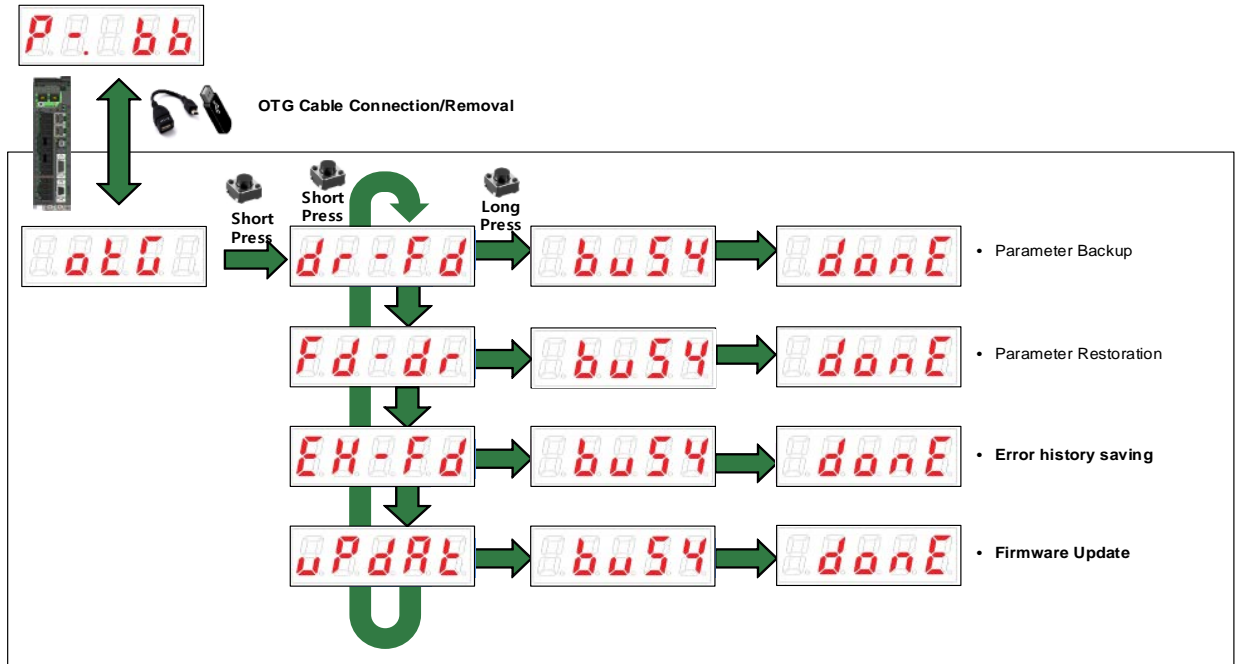

The OTG function operates in the following sequence. See below for the details of each step.

■ Parameter Backup

Use this function to back up parameters without using a setting program (Drive CM). Check the operation of each function in the order below:

- (1) Run parameter backup by following the steps shown in the figure above.
- (2) When parameter backup is complete, connect the USB drive to the PC.
- (3) Check that the iX7NH_PARA_'date'_'time'.text file has been created in the Drive to USB folder of the USB drive.
- (4) Check the parameter information saved in the text file.

Note 1) If the Drive to USB folder does not exist in the USB drive, the folder is automatically created during parameter backup.

■ Parameter Restoration

Use this function to restore parameters without using a setting program (Drive CM). Check the operation of each function in the order below:

- (1) Add the text file containing parameter information to the USB to Drive folder of the USB drive.
- (2) Run parameter restoration by following the steps shown in the figure above.
- (3) Turn on the power again and check the information on the text file and the parameter information saved in the drive.

Note 1) The file must have a name starting with iX7NH_PARA and the file extension .text for parameter restoration to work.

e.g. File name: **iX7NH_PARA_'date'_'time'.text**

Note 2) If the USB to Drive folder does not exist in the USB drive during parameter restoration, the folder is automatically created. After the folder is created, parameter restoration is possible only if the file exists in the folder.

Note 3) You do not need to store parameters but only have to turn on the control power to complete parameter restoration.

■ Saving Error History

All the alarms that occur are saved in the error history of the drive. This function allows you to save alarms listed in the history into a USB drive.

Check the operation of each function in the order below:

- (1) An alarm occurs. e.g. The encoder cable is removed after power is turned on (AL-31).
- (2) Save the alarm in the parameter error history by following the steps shown in the figure above.
- (3) Check the iX7NH_ERROR_'date'_'time'.text file in the Drive to USB folder of the USB drive.
- (4) Check the error history saved in the text file.

Note 1) If the Drive to USB folder does not exist in the USB drive, the folder is automatically created during parameter backup.

Note 2) If fewer than 16 alarms occur, the empty alarm slots show "FF."

■ Firmware Update

Use this function to update firmware without using a setting program (Drive CM). Check the operation of each function in the order below:

- (1) Add the firmware file to the USB to Drive folder of the USB drive.
- (2) Run firmware update by following the steps shown in the figure above.
- (3) When file download is completed, remove the OTG cable, turn on the power again and run upload.
- (4) When upload is completed, check the firmware information.

Note 1) The file must have a name starting with iX7NH_FW_V and the file extension .bin for firmware update to work.

e.g. File name: **iX7NH_FW_V_'date'_'time'.bin**

Note 2) When firmware update is completed, turn the drive off and on again (control power) before use.

6.2 Input/Output Signals Setting

6.2.1 Assignment of Digital Input Signals

You can set the digital input signal function and input signal level of the I/O connector. As shown in the figure below, you can arbitrarily assign up to 6 input functions, out of 17 functions, to digital input signals 1 - 6 for use:

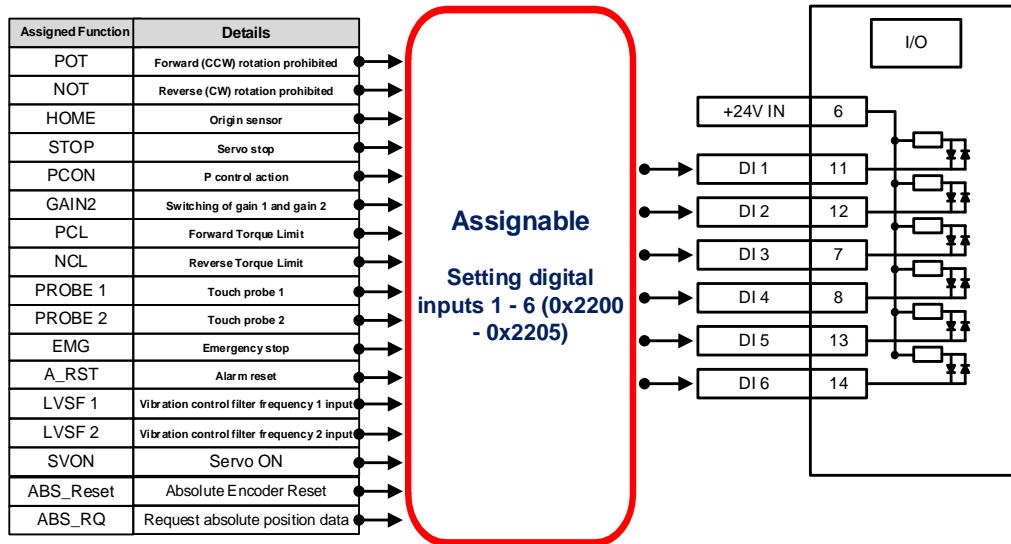

■ Related Objects

Index	Sub Index	Name	Variable Type	Accessibility	PDO Assignment	Unit
0x2200	-	Digital Input Signal 1 Selection	UINT	RW		-
0x2201	-	Digital Input Signal 2 Selection	UINT	RW		-
0x2202	-	Digital Input Signal 3 Selection	UINT	RW		-
0x2203	-	Digital Input Signal 4 Selection	UINT	RW		-
0x2204	-	Digital Input Signal 5 Selection	UINT	RW		-
0x2205	-	Digital Input Signal 6 Selection	UINT	RW		-

Set the digital input signal function and input signal level of the I/O connector. Select signals to assign to bits 7-0, and set the signal level to bit 15.

Bits	Setting Details
15	Signal input level settings (0: Contact A, 1: Contact B)
14~8	Reserved
7~0	Input Signal Assignments

Contact A: The default setting is 0 (Low), and enter 1 (High) to start operation (Active High).

Contact B: The default setting is 1 (High), and enter 0 (Low) to start operation (Active Low).

Setting value	Assignable Input Signals
0x00	Not assigned
0x01	POT
0x02	NOT
0x03	HOME
0x04	STOP
0x05	PCON
0x06	GAIN2
0x07	PCL
0x08	NCL
0x09	PROBE1
0x0A	PROBE2
0x0B	EMG
0x0C	ARST
0x0D	LVSF1
0x0E	LVSF2
0x0F	SVON
0x24	ABS_Reset
0x10	ABS_RQ

■ Example of Digital Input Signal Assignment

The following table shows an example of assigning input signals. See the setting values for parameters 0x2200~0x2209.

DI#1	DI#2	DI#3	DI#4	DI#5	DI#6
POT (Contact B)	NOT (Contact B)	HOME (Contact A)	STOP (Contact A)	PCON (Contact A)	GAIN2 (Contact A)

Assigned Function	Contact	Details	
0x01	POT	B	Forward (CCW) rotation prohibited
0x02	NOT	B	Reverse (CW) rotation prohibited
0x03	HOME	A	Origin sensor
0x04	STOP	A	Servo stop
0x05	PCON	A	P control action
0x06	GAIN2	A	Switching of gain 1 and gain 2
0x07	PCL	-	Forward Torque Limit
0x08	NCL	-	Reverse Torque Limit
0x09	PROBE1	A	Touch probe 1
0x0A	PROBE2	-	Touch probe 2
0x0B	EMG	-	Emergency stop
0x0C	ARST	A	Alarm reset
0x0D	LVSF1	-	Vibration control filter 1
0x0E	LVSF2	-	Vibration control filter 2
0x0F	SVON	-	Servo ON
0x24	ABS_Reset	-	Absolute Value Reset
0x10	ABS_RQ	-	Request absolute position data

I/O (pin number)	Parameter	Bit		Settings	Details
		15	7-0		
DI # 1 (11)	0x2200	1	0x01	0x8001	POT (Contact B)
DI # 2 (12)	0x2201	1	0x02	0x8002	NOT (Contact B)
DI # 3 (7)	0x2202	0	0x03	0x0003	HOME (Contact A)
DI # 4 (8)	0x2203	0	0x04	0x0004	STOP (Contact A)
DI # 5 (13)	0x2204	0	0x05	0x0005	PCON (Contact A)
DI # 6 (14)	0x2205	0	0x06	0x0006	GAIN2 (Contact A)

6.2.2 Digital Output Signal Assignment

You can set the digital output signal function and output signal level of the I/O connector. As shown in the figure below, you can arbitrarily assign up to 3 output functions, out of 11 functions, to the digital output signals 1 - 3 for use:

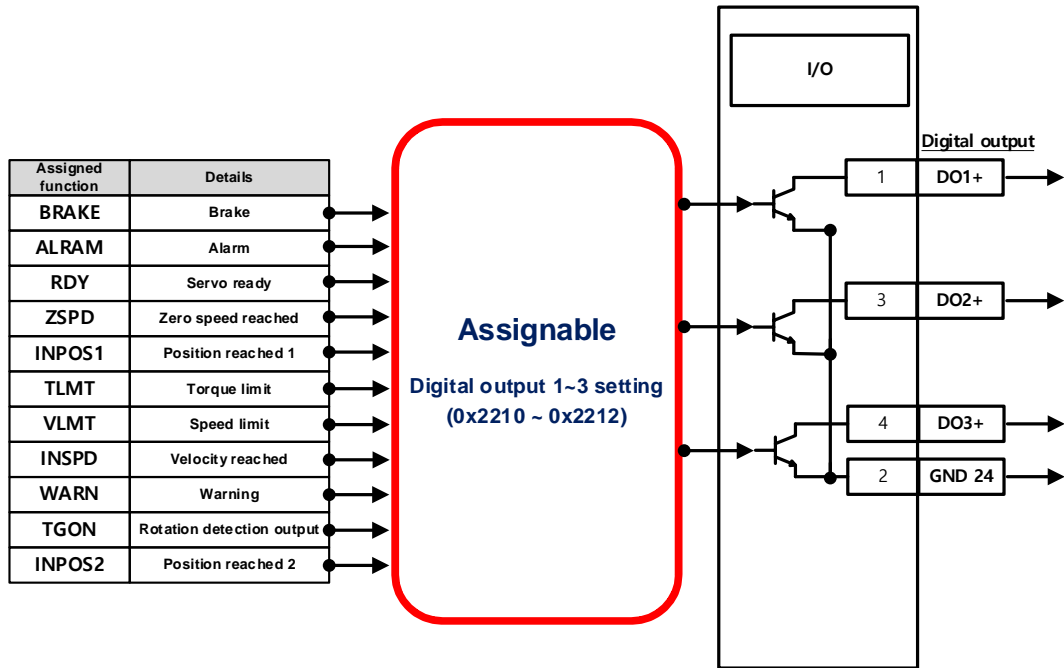

■ Related Objects

Index	Sub Index	Name	Variable Type	Accessibility	PDO Assignment	Unit
0x2210	-	Digital Output Signal 1 Selection	UINT	RW		-
0x2211	-	Digital Output Signal 2 Selection	UINT	RW		-
0x2212	-	Digital Output Signal 3 Selection	UINT	RW		-

Assigns the digital output signal 1 function and set the output signal level of the I/O connector. Select signals to assign to bits 7~0, and set the signal level to bit 15.

Bits	Setting Details
15	Signal output level settings (0: Contact A, 1: Contact B)
14~8	Reserved
7~0	Output Signal Assignment

■ Example Digital Output Signal Assignment

The following table shows an example of assigning output signals. Verify the settings from 0x2210 to 0x2212.

DO#1	DO#2	DO#3
BRAKE (Contact B)	ALARM (Contact B)	RDY (Contact A)

Setting value	Assignable Output Signals
0x00	Not assigned
0x01	BRAKE
0x02	ALARM
0x03	RDY
0x04	ZSPD
0x05	INPOS1
0x06	TLMT
0x07	VLMT
0x08	INSPD
0x09	WARN
0x0A	TGON
0x0B	INPOS2

Assigned Function	Contact	Details
0x01	BRAKE	B Brake
0x02	ALARM	B Alarm
0x03	RDY	A Servo ready
0x04	ZSPD	- Zero speed reached
0x05	INPOS1	A Position reached 1
0x06	TLMT	- torque limit
0x07	VLMT	- Speed limit
0x08	INSPD	- Speed reached
0x09	WARN	- Warning
0x0A	TGON	- Rotation detection output
0x0B	INPOS2	- Position reached 2

CN1 (pin number)	Parameter	Bit		Settings	Details
		15	7~0		
DO # 1 (10)	0x2210	1	0x01	0x8001	BRAKE (Contact B)
DO # 2 (9)	0x2211	1	0x02	0x8002	ALARM (Contact A)
DO # 3 (12)	0x2212	0	0x03	0x0003	RDY (Contact A)

6.2.3 Assignment of Analog Output Signals

Two channels of analog monitor outputs are provided to adjust drive gain or monitor internal status variables.

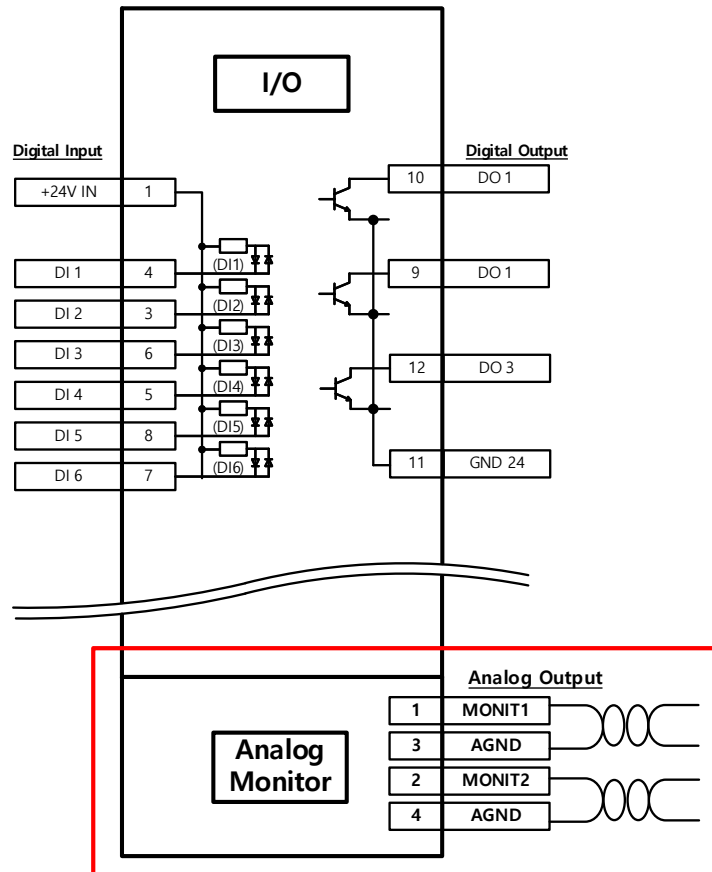

■ Related Objects

Index	Sub Index	Name	Variable Type	Accessibility	PDO Assignment	Unit
0x2220	-	Analog Monitor Output Mode	UINT	RW	No	-
0x2221	-	Analog Monitor Channel 1 Select	UINT	RW	No	-
0x2222	-	Analog Monitor Channel 2 Select	UINT	RW	No	-
0x2223	-	Analog Monitor Channel 1 Offset	DINT	RW	No	-
0x2224	-	Analog Monitor Channel 2 Offset	DINT	RW	No	-
0x2225	-	Analog Monitor Channel 1 Scale	UDINT	RW	No	-
0x2226	-	Analog Monitor Channel 2 Scale	UDINT	RW	No	-

- Analog monitor output mode settings (0x2220)

The output range of the analog monitor is from -10 V to +10 V. If the setting is 1, take the absolute value of the output so the output values is only positive.

Settings	Details	Description
0	Output as negative/positive values	
1	Output only positive values	

- Analog monitor channel 1 select (0x2221)

This sets the monitoring variables to be output to analog monitor output channel 1.

Setting value	Displayed Items	Unit
0x00	Speed feedback	rpm
0x01	Speed command	rpm
0x02	Speed error	rpm
0x03	Torque feedback	%
0x04	Torque command	%
0x05	Following error	pulse
0x06	Accumulated operation overload	%
0x07	DC link voltage	V
0x08	Accumulated regeneration overload	%
0x09	Encoder single-turn data	pulse
0x0A	Inertia ratio	%
0x0B	Reserved	-
0x0C	Drive temperature 1	°C
0x0D	Drive temperature 2	°C
0x0E	Encoder temperature 1	°C
0x0F	Hall signal	-
0x10	U phase current	A
0x11	V phase current	A
0x12	W phase current	A
0x13	Position Actual Value	UU
0x14	Target position value	UU
0x15	Position command speed	rpm, mm/s
0x16	Hall U signal	-
0x17	Hall V signal	-
0x18	Hall W signal	-

The voltage is calculated as shown below during the analog monitor output:

$$\text{Output voltage for channel 1 (V)} = [\text{Monitoring signal value (0x2221)} - \text{Offset (0x2203)}] / \text{Scale (0x2205)}$$

$$\text{Output voltage for channel 2 (V)} = [\text{Monitoring signal value (0x2222)} - \text{Offset (0x2204)}] / \text{Scale (0x2206)}$$

For example, if you are monitoring speed output, enter 100 for scale to get an output of 100[rpm] per 1[V].

■ Setting Example

The following shows an example of monitoring ripples during the 1000 rpm operation of a speed feedback signal:

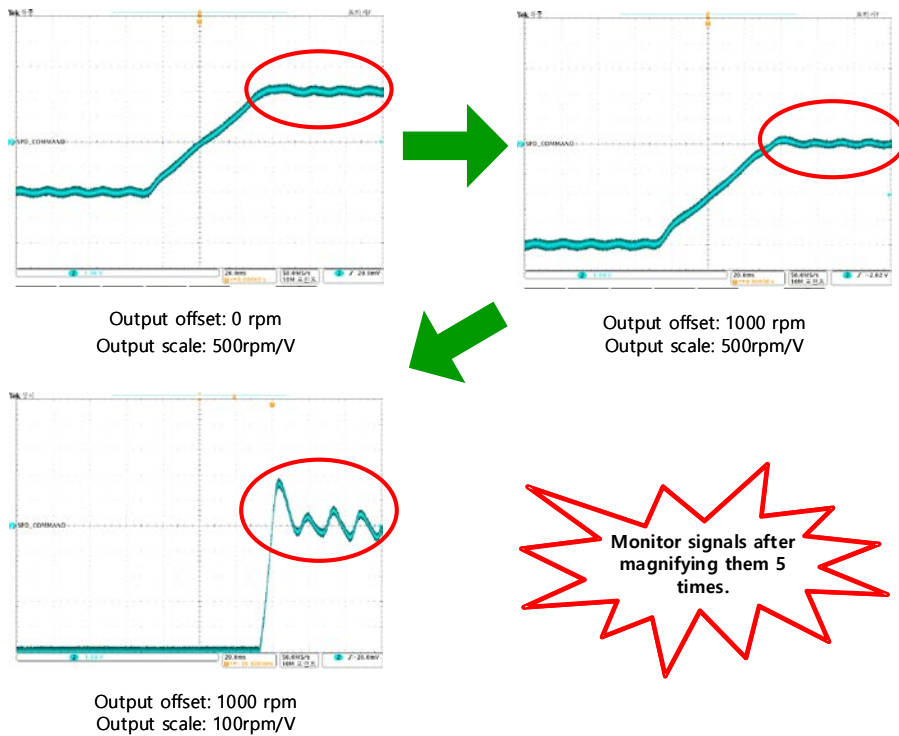

In the first graph, if the servo is driving from -1000[rpm] to 1000[rpm], the 0[rpm] point is at the Zero Crossing (middle dotted line) because the offset is 0[rpm]. Since the scale is 500[rpm], the output is 500[rpm] per 1[V], and driving from -1000 to 1000[rpm] will pass through 4 phases. The second graph shows when the input offset is 1000[rpm], and the Zero Crossing point changes to 1000[rpm]. The third graph illustrates when the output scale is 100[rpm]. It allows you to monitor the point of reaching 1000[rpm] on a more detailed view than when the output is 500[rpm] per 1[V].

6.2.4 Use of User I/O

User I/O means some of the I/Os provided by the drive are used for controlling the drive itself and for the user's individual purposes. All contacts provided by the input/output connector (I/O) can be used as the User I/O.

If only a few user I/Os are needed, you can wire the drive with the I/O connector rather than a separate I/O module, reducing the cost.

This drive can use up to 6 points for input signals and 3 points for output signals as the user I/O.

■ How to Set the User Input

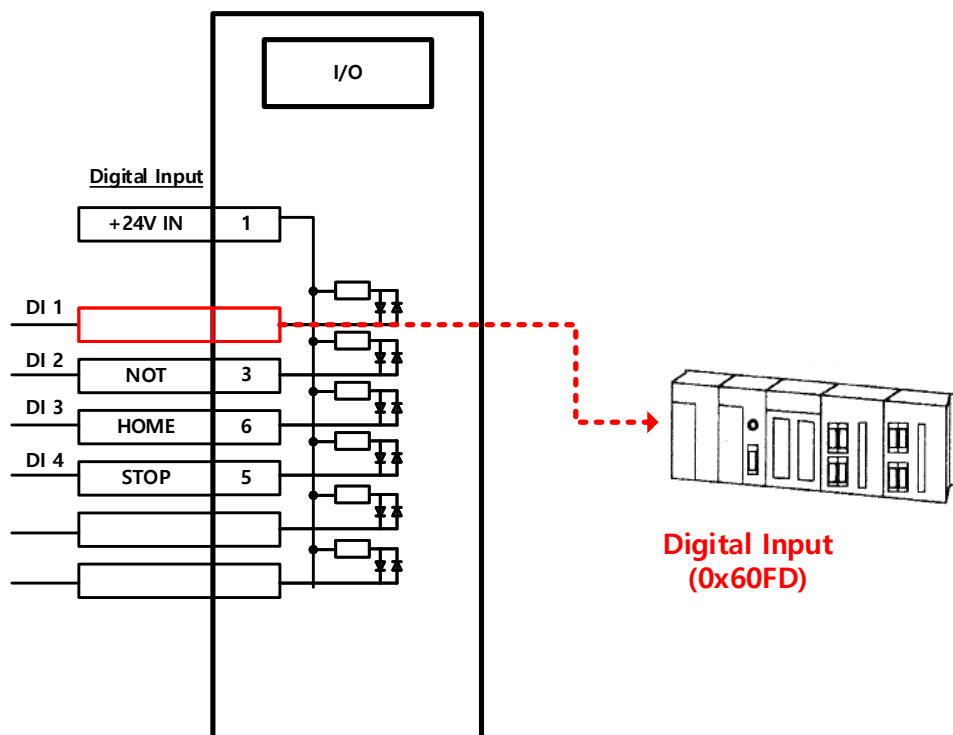

- 1) Set the function of the digital input port to be used as the user input to "Not assigned (setting 0)." (Refer to Input Signal Assignments.)
- 2) Read the values of the corresponding bits (0x60FD.16 - 21) from the digital input (0x60FD) to use them as the user input.

■ Related Objects

Index	Sub Index	Name	Variable Type	Accessibility	PDO Assignment	Unit
0x60FD	-	Digital Inputs	UDINT	RO	Yes	-

Bits	Description
0	NOT (Negative Limit Switch)
1	POT (Positive Limit Switch)
2	HOME (Home Position Sensor Input)
3 to 15	Reserved
16	DI #1(I/O pin 11), 0:Open, 1:Close
17	DI #2(I/O pin 12), 0:Open, 1:Close
18	DI #3(I/O pin 7), 0:Open, 1:Close
19	DI #4(I/O pin 8), 0:Open, 1:Close
20	DI #5(I/O pin 13), 0:Open, 1:Close
21	DI #6(I/O pin 14), 0:Open, 1:Close
22	Reserved
23	Reserved
24-30	Reserved
31	STO(Safe Torque Off), 0:Close, 1:Open

■ How to Set the User Output

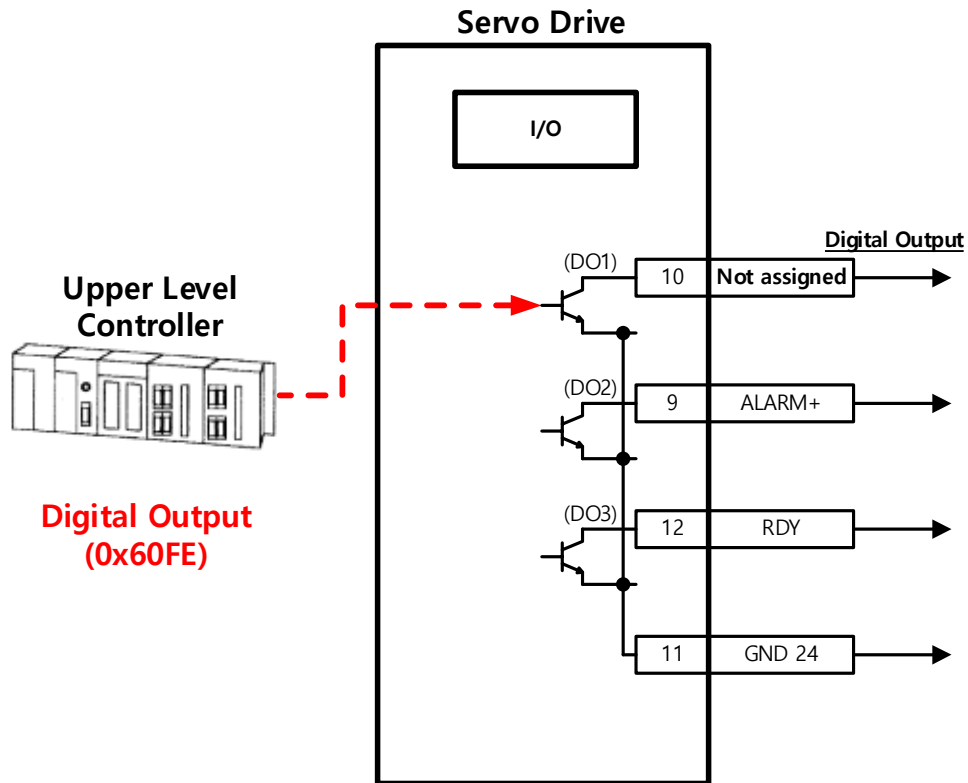

- 1) Set the function of the digital output port to be used as the user output to "Not assigned (setting 0)." (Refer to Output Signal Assignments.)
- 2) Set the bits (bits 16 - 18) corresponding to the port used as the user output for the bit mask (0x60FE:02) to Forced Output Enabled (setting 1).
- 3) Using physical outputs (0x60FE:01), set the value corresponding to the user output for the relevant port (bits 16 - 18) to 0 or 1.

■ Related Objects

Index	Sub Index	Name	Variable Type	Accessibility	PDO Assignment	Unit
0x60FE	-	Digital Outputs	-	-	-	-
	0	Number of Entries	USINT	RO	No	
	1	Physical outputs	UDINT	RW	Yes	-
	2	Bit mask	UDINT	RW	No	-

They indicate the status of digital outputs.

- Description of physical outputs

Bits	Description
0 to 15	Reserved
16	Forced output (0: OFF, 1: ON) of DO #1 (I/O pin 1). Provided that the relevant bit mask (0x60FE:02.16) is set to 1.
17	Forced output (0: OFF, 1: ON) of DO #2 (I/O pin 3). Provided that the relevant bit mask (0x60FE:02.17) is set to 1.
18	Forced output (0: OFF, 1: ON) of DO #3 (I/O pin 4). Provided that the relevant bit mask (0x60FE:02.18) is set to 1.
19	Reserved
20 to 23	Reserved
24	Output status of DO #1 (0: OFF, 1: ON)
25	Output status of DO #2 (0: OFF, 1: ON)
26	Output status of DO #3 (0: OFF, 1: ON)
27 to 31	Reserved

- Bit mask

Bits	Description
0 to 15	Reserved
16	Forced output setting (0: Disable, 1: Enable) of DO #1 (I/O pin 1)
17	Forced output setting (0: Disable, 1: Enable) of DO #2 (I/O pin 3)
18	Forced output setting (0: Disable, 1: Enable) of DO #3 (I/O pin 4)
19 to 31	Reserved

6.3 Electric Gear Setup

6.3.1 Electric Gear

This function allows you to drive the motor by the user unit in which the user intends to give commands.

The electric gear function of the drive does not allow the user to utilize the highest resolution of the encoder. If the upper level controller has the function of electric gear, it is advisable to use it instead.

Set the gear ratio within the range of 1000~1/1000.

Typically, electric gears are used in the following situations.

(1) To drive the load based on user unit

- The electric gear function makes it easy to convert user units [UU] into the user-defined unit.

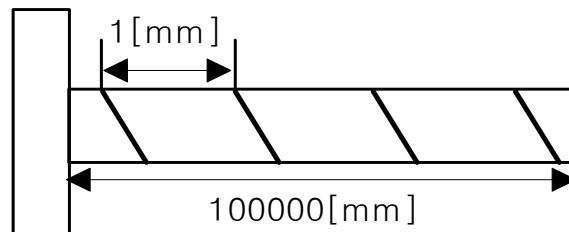

Let's assume that there is a ball screw that moves 1 [mm] per motor rotation. Here, the motor resolution is 524288 [ppr]. Therefore, to move the screw by 1 [mm], you have to input 524288 [Pulses] into the servo. If you wish to move it by 27 [mm], addition calculations are necessary and you have to input the very high value of 14155776 [Pulse].

However, if you use the gear ratio, you can avoid the inconvenience of having to input the command value.

For example, if you want to move the screw by 1 [mm] by inputting 1 [Pulses] into the servo, you can set the gear ratio as follows.

$$\frac{\text{Motor Resolution}[0x6091.1]}{\text{Shaft Resolution}[0x6091.2]} \times \text{User Demand Pulse}[UU]$$

$$= \frac{524288}{1} \times 1[UU] = 524288[UU] = 1[mm]$$

If you input 524288 for motor resolution and 1 for shaft resolution of the electric gear, the movement ratio of the ball screw for a revolution of the motor is set internally. To move the screw by 1 [mm], you only have to input the same value 1 into User Demand Pulse because the unit has been made the same, which provides convenience in entering commands.

As another example, if you want to make the ball screw move by 0.0001 [mm] by inputting 1 [UU], the gear ratio formula is as follows.

$$\frac{\text{Motor Resolution}[0x6091.1]}{\text{Shaft Resolution}[0x6091.2]} \times \text{User Demand Pulse}[UU]$$

$$= \frac{524288}{10000} \times 1[UU] = \frac{1[mm]}{10000} \times 1[UU] = 0.0001[mm]$$

By applying the above gear ratio formula, the ball screw can be moved by 0.0001 [mm]/1 [UU] and by 0.001 [mm] when you input 10 [UU]. You can conveniently input values in the desired unit [UU].

- You can command the driving based on the user unit, regardless of the encoder (motor) type. The following example is for a movement of 12mm for the ball screw type with a 10mm pitch.

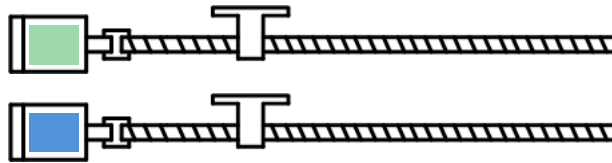

	(A) 5000 ppr encoder	(B) 19-bit (524288 ppr) encoder
Electric gear is not used	5000*12/10= 6000	524288*12/10= 629145.6
	Different commands should be given to the encoders (motor) used for the same distance movement.	
For a command given in the minimum user unit of 1 um (0.001 mm)		
Electric gear setting	Motor Revolutions = 5000 Shaft Revolutions = 10000	Motor Revolutions = 524288 Shaft Revolutions = 10000
If the electric gear is used	Movements can be made under the same command of 12000 (12mm= 12000*1um) regardless of the encoder (motor) used.	

- (2) When the output frequency of the upper level controller or input frequency of the drive is limited for driving a high-resolution encoder at a high speed

- The output frequency of a general high-speed line drive pulse output unit is approximately 500Kpps, and the possible input frequency of the drive is approximately 1Mpps. For this reason, when driving a high-resolution encoder at high speeds, be sure to use an electric gear for proper driving due to the limitations of the output frequency of the upper level controller and the input frequency of the drive.

6.3.2 Example of Electric Gear Setup

■ Ball Screw Load

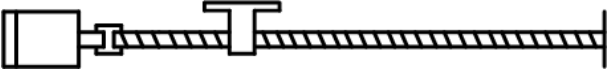
Apparatus specification	 <p>Pitch: 10mm, Deceleration ratio: 1/1</p>
User unit	1μm (0.001mm)
Encoder specification	19-bit (524288 PPR)
Load movement amount/revolution	10 [mm]= 10000 [User Unit]
Electric gear setting	Motor Revolutions : 524288 Shaft Revolutions : 10000

■ Turntable Load

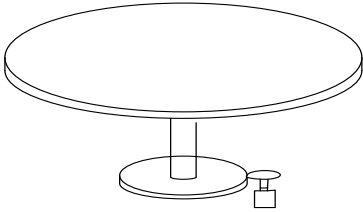
Apparatus specification	 <p>Deceleration ratio: 100/1</p>
User unit	0.001%
Encoder specification	19-bit (524288 PPR)
Load movement amount/revolution	$360/100/0.001 = 3600$
Electric gear setting	Motor Revolutions : 524288 Shaft Revolutions : 3600

■ Belt + Pulley System

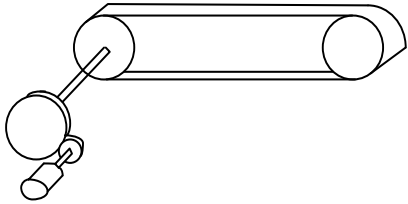
Apparatus specification	 <p>Deceleration ratio: 10/1, Pulley diameter: 100 mm</p>
User unit	1μm (0.001mm)
Encoder specification	19-bit (524288 PPR)
Load movement amount/revolution	$\pi * 100/10/0.001 = 31416$
Electric gear setting	Motor Revolutions : 524288 Shaft Revolutions : 31416

6.3.3 Calculating Velocity and Acceleration/Deceleration When Using the Electronic Gear

- **How to Set Index Velocity**

When the gear ratio is 1:1, the following proportional expression for velocity and acceleration/deceleration applies.

$$\begin{aligned} \text{Encoder Pulse per Resolution}[ppr] : 60[rpm] \\ = \text{Index Velocity}[uu/s] : \text{Demand Speed}[rpm] \end{aligned}$$

To drive a 19-bit motor at 3000 [rpm], you can calculate the index velocity as follows.

$$\begin{aligned} 524288[ppr] : 60[rpm] = \text{Index Velocity}[uu/s] : 3000[rpm] \\ \text{Index Velocity}[uu/s] = 26214400[uu/s] \end{aligned}$$

If the gear ratio is other than 1:1, it affects the velocity. Thus, use the following formula taking the gear ratio into consideration.

$$\begin{aligned} \text{Index Velocity}[UU/sec] \\ = \text{Demand Speed}[rpm] \times \frac{\text{Encoder Pulse per Resolution}}{\text{Motor Resolution}} \times \frac{\text{Shaft Resolution}}{60[rpm]} \end{aligned}$$

* Application example

When applying a gear ratio of motor resolution: 524288/shaft resolution: 20 to the 19 bit motor

Index velocity calculation for driving at 3000 [rpm]

$$\begin{aligned} \text{Index Velocity}[UU/sec] = 3000[rpm] \times \frac{524288}{524288} \times \frac{20}{60[rpm]} \\ \text{Index Velocity}[uu/s] = 1000[UU/sec] \end{aligned}$$

Index 0	
Index Type	Relative
Distance [UU]	524288
Velocity [UU/s]	1000
Acceleration [UU/s ²]	10000
Deceleration [UU/s ²]	10000
Registration Distance [UU]	100000
Registration Velocity [UU/s]	1000000
Repeat Count	1
Dwell Time [ms]	200
Next Index	1
Action	Next Index
	Copy Paste

If you enter 1000 [UU/s] for index velocity, the motor runs at 3000 [rpm].

● **How to Set Index Acceleration/Deceleration**

You can calculate acceleration and deceleration by the following formula using travel time and index velocity.

$$\text{Travel time}[\text{sec}] = \frac{\text{Velocity}[\text{uu/s}]}{\text{Acceleration or Deceleration}[\text{uu/sec}^2]}$$

Travel time is the time required to reach the target, that is, the time required for the feedback speed to reach the registered velocity.

* Application example

When applying a gear ratio of motor resolution: 524288/shaft resolution: 20 to the 19 bit motor

To make the feedback speed to reach 3000 [rpm] in 0.1 seconds

$$0.1[\text{sec}] = \frac{1000[\text{uu/s}]}{\text{Acceleration or Deceleration}[\text{uu/sec}^2]}$$

$$\text{Acceleration or Deceleration}[\text{uu/sec}^2] = 10000[\text{UU/sec}^2]$$

Index 0	
Index Type	Relative
Distance [UU]	524288
Velocity [UU/s]	1000
Acceleration [UU/s ²]	10000
Deceleration [UU/s ²]	10000
Registration Distance [UU]	100000
Registration Velocity [UU/s]	1000000
Repeat Count	1
Dwell Time [ms]	200
Next Index	1
Action	Next Index
<input type="button" value="Copy"/> <input type="button" value="Paste"/>	

You can set acceleration and deceleration as shown above.

6.4 Velocity Control Settings

6.4.1 Smooth Acceleration and Deceleration

For smoother acceleration and deceleration during velocity control, you can generate an acceleration/deceleration profile of a trapezoidal or S-curved shape. Here, You can enable S-curve operation by setting the speed command S-curve time to 1 [ms] or higher.

The speed command acceleration/deceleration time (0x2301, 0x2302) is the time needed to accelerate the drive from the zero speed to the rated speed or to decelerate it from the rated speed to the zero speed.

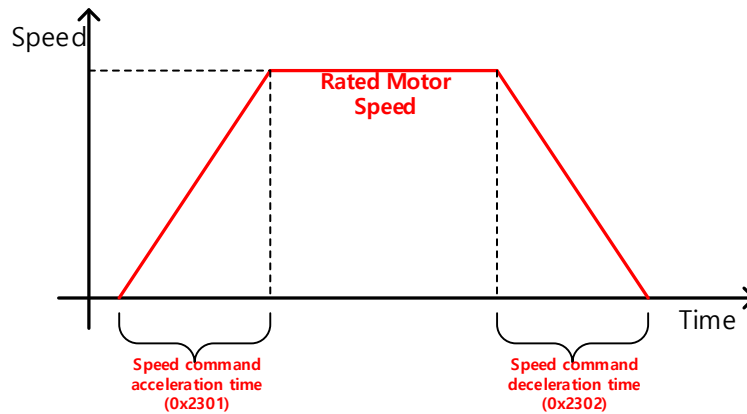

You can calculate the actual acceleration/deceleration time as below.

Acceleration time = speed command/rated speed x speed command acceleration time (0x2301)

Deceleration time = speed command/rated speed x speed command deceleration time (0x2302)

As shown in the figure below, you can generate an S-curve shape acceleration/deceleration profile by setting the speed command S-curve time (0x2303) to 1 or a higher value. Make sure to verify the relationship between the acceleration/deceleration time and S-curve time.

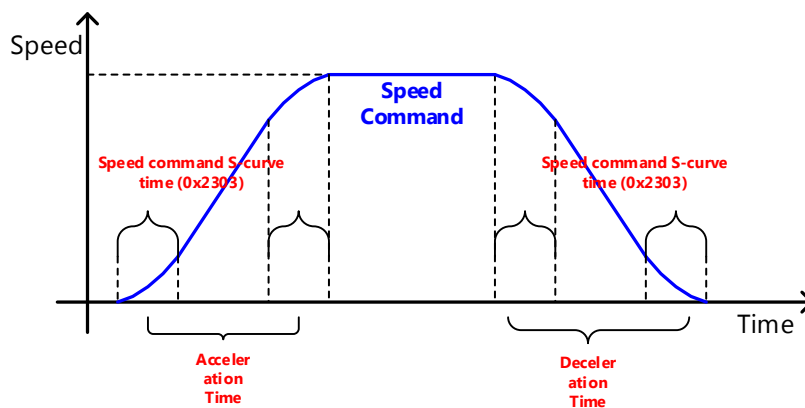

6.4.2 Servo-lock Function

During velocity control operation, the servo position cannot be locked even when 0 is entered for the speed command. This is due to the characteristic of velocity control. Here, you can lock the servo position by enabling the servo-lock function select (0x2311).

Setting value	Setting Details
0	Servo-lock function disabled
1	Servo-lock function enabled

Using the servo-lock function, you can internally control the positions based on the position of 0 speed command input. If you input a speed command other than 0, the mode switches to normal velocity control.

6.4.3 Velocity Control Signals

As shown in the figure below, when the value of speed feedback is below the ZSPD output range (0x2404), a ZSPD (zero speed) signal is output; and when it is above the TGON output range (0x2405), a TGON (motor rotation) signal is output.

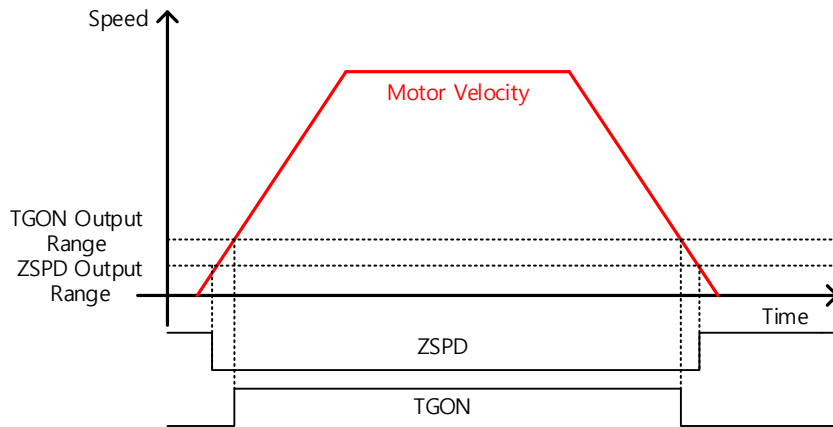

In addition, if the difference between the command and the speed feedback (i.e., velocity error) is below the INSPD output range (0x2406), an INSPD (velocity match) signal is output.

■ Related Objects

Index	Sub Index	Name	Variable Type	Accessibility	PDO Assignment	Unit
0x2404	-	ZSPD Output Range	UINT	RW	Yes	rpm
0x2405	-	TGON Output Range	UINT	RW	Yes	rpm
0x2406	-	INSPD Output Range	UINT	RW	Yes	rpm

6.5 Position Control Settings

6.5.1 Position Command Filter

You can apply filters to position commands to operate the drive more smoothly. Movements with an excessive response can generate a jerk. In such cases, you can enter an appropriate value to enable critical point braking (appropriate response).

You can set position command filter time constant (0x2109) using the primary low pass filter and position command average filter time constant (0x210A) using the movement average. However, if the position command average filter time constant (0x210A) is too high, it may reach the target position slowly. Therefore, it is necessary to be careful when setting the value.

You can use a position command filter in the following cases.

- (1) When the electric gear ratio is x10 or above
- (2) When the acceleration/deceleration profile cannot be generated from the upper level controller

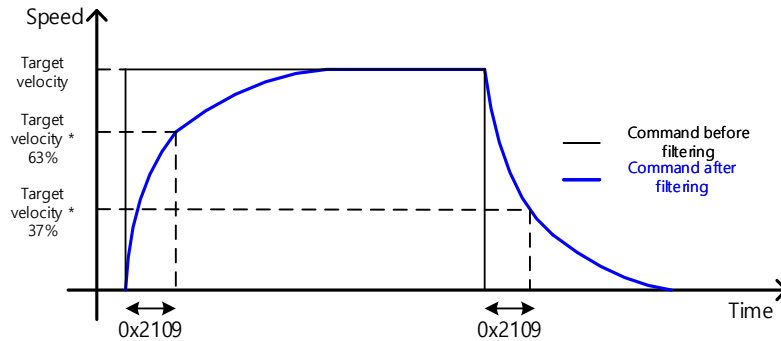

Position command filter using position command filter time constant (0x2109)

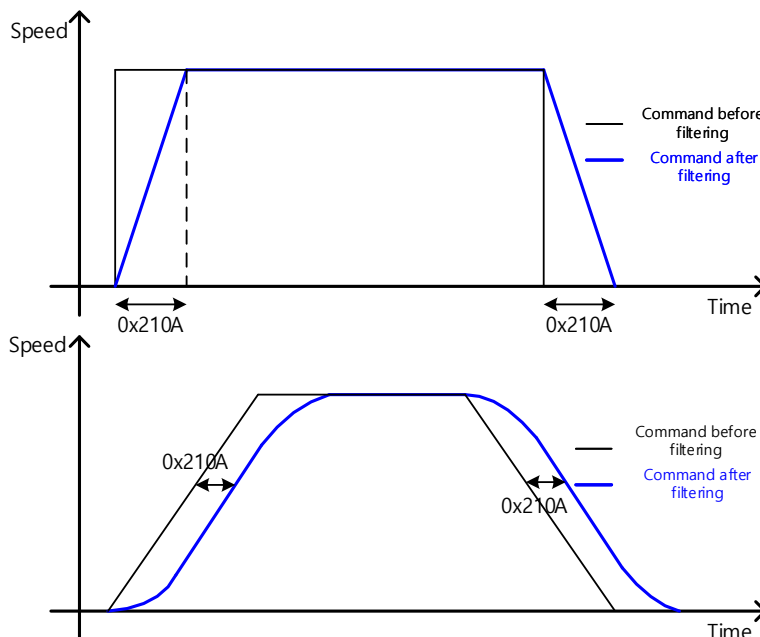

Position command filter using position command average filter time constant (0x210A)

■ Related Objects

Index	Sub Index	Name	Variable Type	Accessibility	PDO Assignment	Unit
0x2109	-	Position Command Filter Time Constant	UINT	RW	Yes	0.1ms
0x210A	-	Position Command Average Filter Time Constant	UINT	RW	Yes	0.1ms

6.5.2 Position Control Signals

As shown in the figure below, if the following error value (i.e., the difference between the position command value input by the upper level controller and the position feedback value) is below the INPOS1 output range (0x2401) and is maintained for the INPOS1 output time (0x2402), the INPOS1 (Positioning completed 1) signal is output. However, the signal is output only when the position command is not renewed.

Here, if the following error value goes below the INPOS2 output range (0x2403), the INPOS2 (Positioning completed 2) signal is output regardless of whether or not the position command has been renewed.

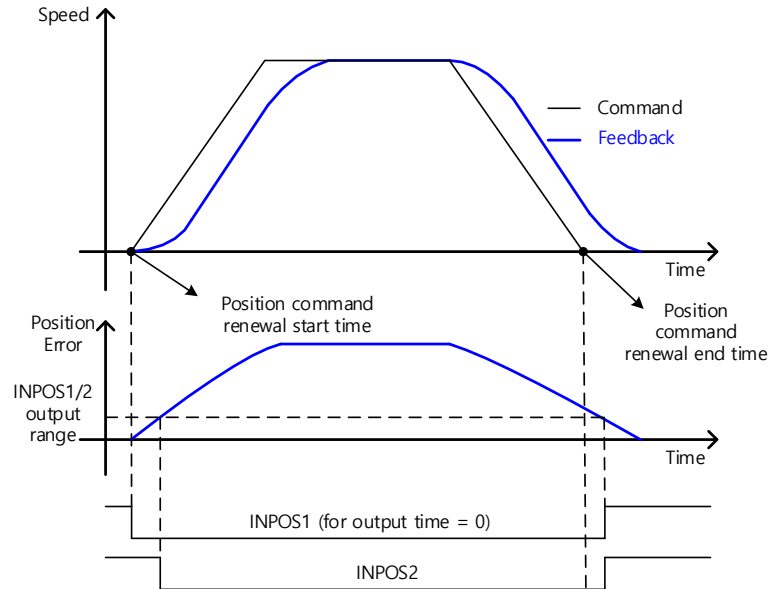

■ Related Objects

Index	Sub Index	Name	Variable Type	Accessibility	PDO Assignment	Unit
0x2401	-	INPOS1 Output Range	UINT	RW	Yes	UU
0x2402	-	INPOS1 Output Time	UINT	RW	Yes	ms
0x2403	-	INPOS2 Output Range	UINT	RW	Yes	UU

6.6 Settings Related to Torque Control

6.6.1 Speed Limit Function

In torque control mode, the torque command input from the upper level controller controls the torque, but does not control the speed; thus, the apparatus might be damaged due to the exceedingly increased speed by an excessive torque command. To address this problem, this drive provides a function that limits motor speed based on the parameters set during torque control.

You can limit the speed using the maximum speed or the speed limit value (0x230E) according to the value of the speed limit function select (0x230D), as described below. With the VLMT (speed limit) output value, you can verify whether the speed is limited.

Setting value	Setting Details
0	Limited by the speed limit value (0x230E)
1	Limited by the maximum motor speed

■ Related Objects

Index	Sub Index	Name	Variable Type	Accessibility	PDO Assignment	Unit
0x230D	-	Speed Limit Function Select	UINT	RW	No	-
0x230E	-	Speed Limit Value	UINT	RW	Yes	rpm

6.7 Positive/Negative Limit Setting

This function is used to safely operate the drive within the movable range of the apparatus using the positive/negative limit signals of the drive. Be sure to connect and set the limit switch for safe operation. For more information about the settings, refer to 6.2.1 Assignment of Digital Input Signals.

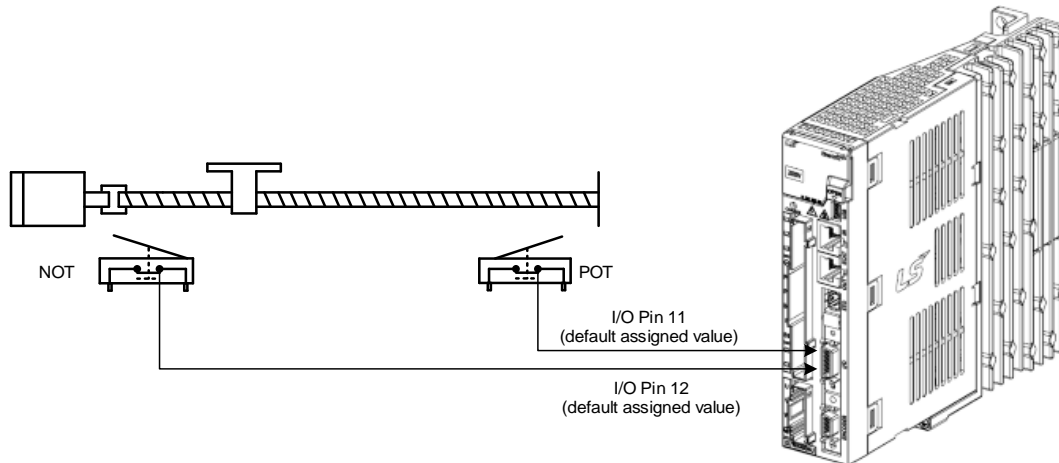

When a positive/negative limit signal is input, the motor stops according to the emergency stop configuration (0x2013).

Setting Value	Description
0	The motor stops according to the method set in Dynamic Brake Control Mode (0x2012). It stops using the dynamic brake and maintains the torque command at 0.
1	The motor decelerates to a stop using the emergency stop torque (0x2113).

■ Related Objects

Index	Sub Index	Name	Variable Type	Accessibility	PDO Assignment	Unit
0x2012	-	Dynamic Brake Control Mode	UINT	RW	No	-
0x2013	-	Emergency Stop Configuration	UINT	RW	No	-
0x2113	-	Emergency Stop Torque	UINT	RW	Yes	-

6.8 Brake Output Signal Function Setting

If the motor stops due to the servo off state or servo alarm during rotation, you can set the velocity (0x2407) and delay time (0x2408) for brake signal output in order to set the output timing.

The brake signal is output if the motor rotation velocity goes below the set value (0x2407) or the output delay time (0x2408) has been reached after the servo off command.

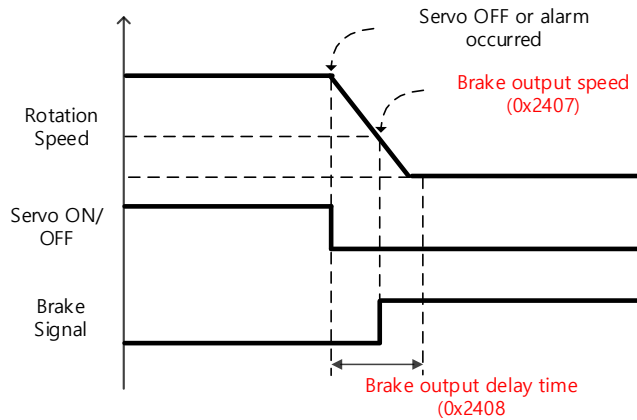

Timing diagram for signal output by the brake output speed (0x2407)

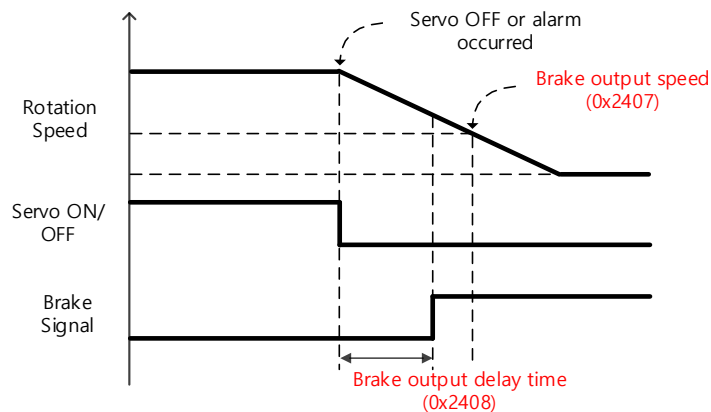

Timing diagram for signal output by the brake output delay time (0x2408)

You can set the delay time until the actual PWM output goes off when the servo is turned off or a servo alarm occurs.

When using a motor with a brake installed on the vertical axis, you can output the brake signal first and turn off PWM after the set time in order to prevent it from running down along the axis.

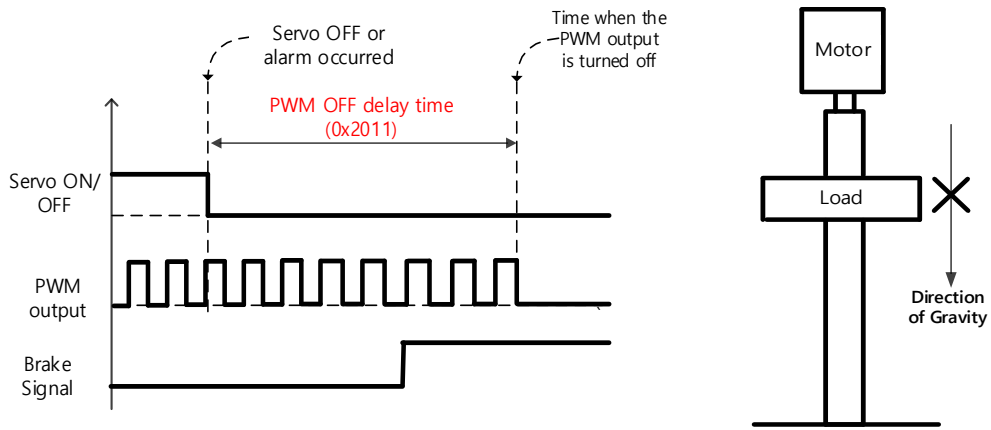

(1) When the brake signal is output before PWM output is turned off

You can output the brake signal first before PWM output is turned off to prevent the drop along the vertical axis due to gravity.

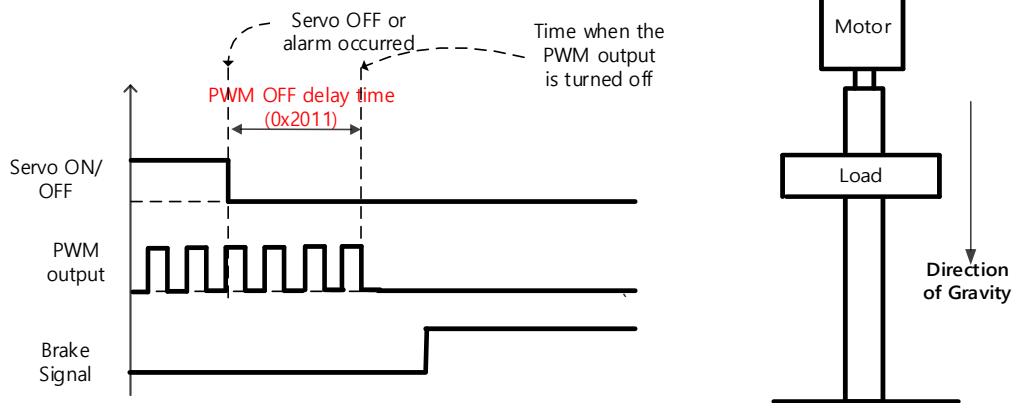

(2) If PWM output is turned off before the brake signal output

PWM output is turned off before the brake signal output, allowing the drop along the vertical axis due to gravity.

6.9 Torque Limit Function

You can limit the drive's output torque to protect the machine. You can set the limit on torque output in torque limit function select (0x2110). The setting unit of torque limit value is [0.1%].

- Description of torque limit function select (0x2110)

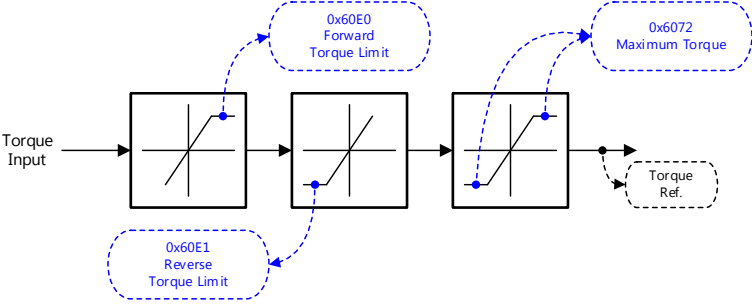
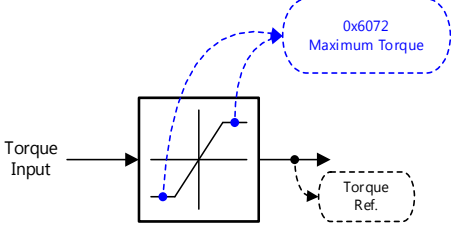
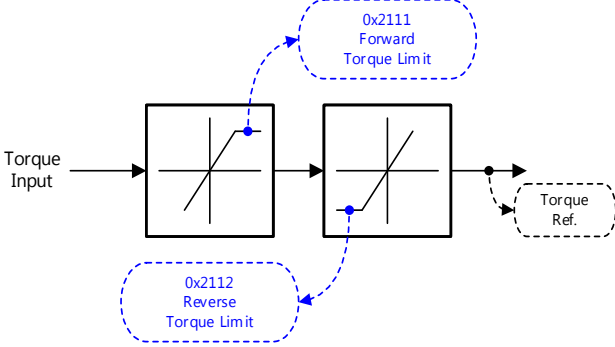
Limit function	Description
<p>Internal torque limit 1 (Setting value 0)</p>	 <p>Limits the torque using positive/negative torque limit values according to the driving direction; the maximum value is limited by the maximum torque (0x6072).</p> <p>- Positive: 0x60E0, Negative: 0x60E1</p>
<p>Internal torque limit 2 (Setting value 1)</p>	 <p>Limits the torque by the maximum torque (0x6072) only regardless of the driving direction.</p>
<p>External torque limit (Setting value 2)</p>	 <p>Limits the torque value using external positive/negative torque limits according to the driving direction</p> <p>- Positive: 0x2111, Negative: 0x2112</p>

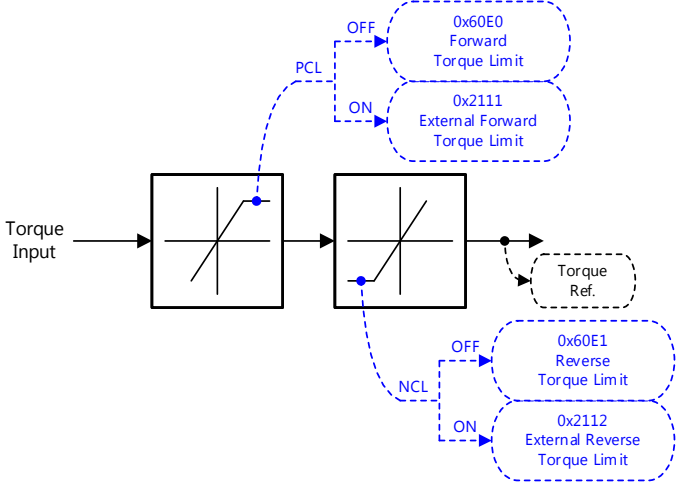
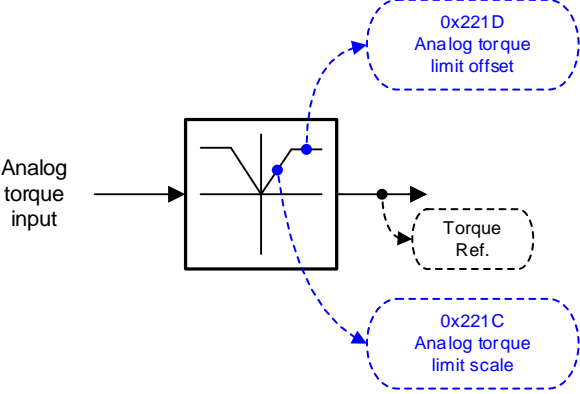
<p>Internal + External Torque Limits (Setting value 3)</p>	 <p>Limits the torque value using internal and external torque limits according to the driving direction and the torque limit signal</p> <ul style="list-style-type: none"> - Positive: 0x60E0 (if PCL signal is not input), 0x2111 (if PCL signal is input) - Negative: 0x60E1 (if NCL signal is not input), 0x2112 (if NCL signal is input)
<p>Analog torque limit (Setting value 4)</p>	 <p>The torque limits are set according to analog input voltage</p> <ul style="list-style-type: none"> - When +/-10V is input, there is a torque limit at 300% in the positive or negative direction regardless of whether the analog input voltage is positive or negative. - The torque limit and the analog input voltage have the following relationship. - If you set Torque Limit Function Select (0x2110) to 4, there is a torque limit according to the analog input voltage. The limit value can be determined by using the following formula. $\text{Torque Limit Value [\%]} = \left(\frac{\text{Input Voltage [mv]} - \text{Torque Input Offset (0x221D)[mV]}}{1000} \right) \times \frac{\text{Torque Command Scale [0x221C]}}{10}$ <p>ex 1) the command scaler is set to 100 and the offset is set to 0</p> <p>When the input voltage is -10[V],</p> $\text{Torque Limit Value [\%]} = \left(\frac{-10000[\text{mv}] - 0[\text{mV}]}{1000} \right) \times \frac{100}{10} = -100[\%]$ <p>The torque limit is -100%. If you enter an input voltage of 10 [V], the torque values are also set up to 100 [%].</p>

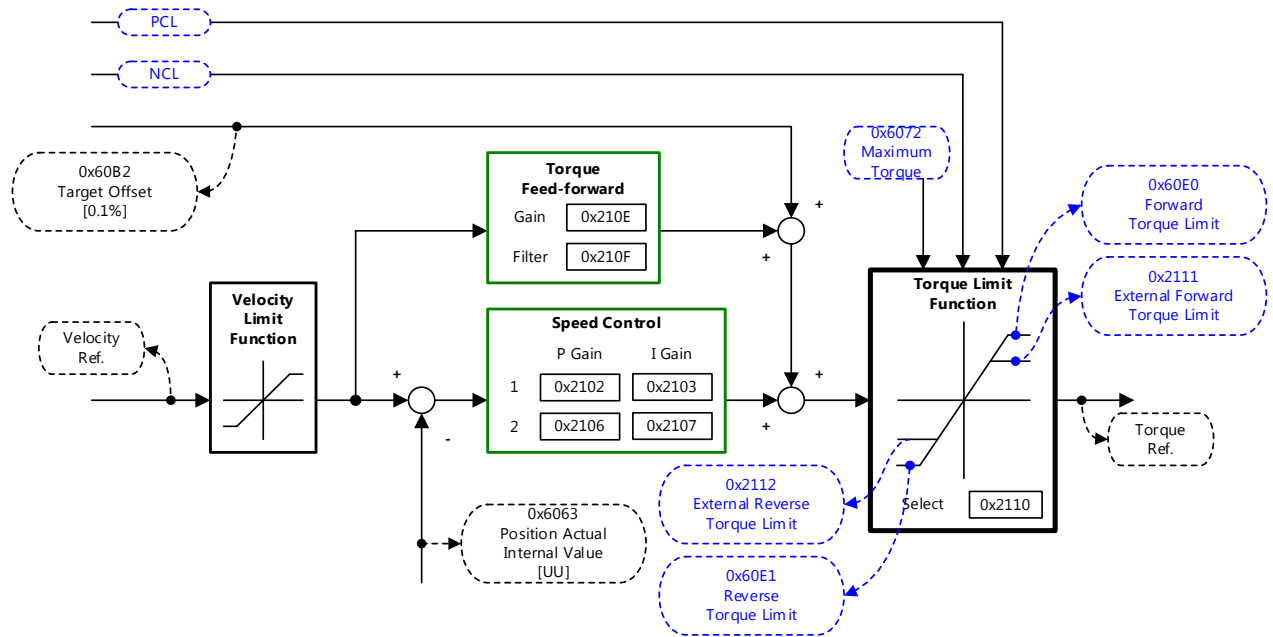

■ Related Objects

Index	Sub Index	Name	Variable Type	Accessibility	PDO Assignment	Unit
0x2110	-	Torque Limit Function Select	UINT	RW	Yes	-
0x2111	-	External Positive Torque Limit Value	UINT	RW	Yes	0.1%
0x2112	-	External Negative Torque Limit Value	UINT	RW	Yes	0.1%
0x6072	-	Maximum Torque	UINT	RW	Yes	0.1%
0x60E0	-	Positive Torque Limit Value	UNIT	RW	Yes	0.1%
0x60E1	-	Negative Torque Limit Value	UINT	RW	Yes	0.1%

6.10 Gain Conversion Function

6.10.1 Gain Group Conversion

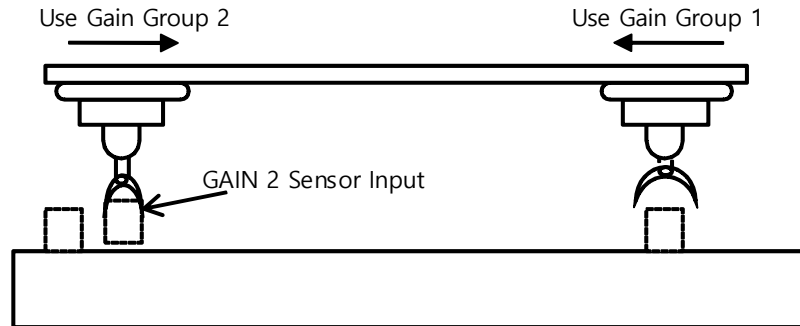

This is one of the gain adjustment functions and is used to switch between Gain Groups 1 and 2. You can reduce the time required for positioning through gain conversion.

A gain group consists of position loop gain, speed loop gain, Speed Loop Integral Time Constant, and torque command filter time constant. You can set the gain conversion function (0x2119) as follows.

- Description of Gain Conversion Function (0x2119)

Setting Value	Setting Details
0	Only gain group 1 is used
1	Only gain group 2 is used
2	Gain is switched according to the GAIN2 input status - 0: Use gain group 1 - 1: Use gain group 2
3	Reserved
4	Reserved
5	Reserved
6	Gain is switched according to the ZSPD output status - 0: Use gain group 1 - 1: Use gain group 2
7	Gain is switched according to the INPOS1 output status - 0: Use gain group 1 - 1: Use gain group 2

Waiting time and switching time for gain conversion are as follows.

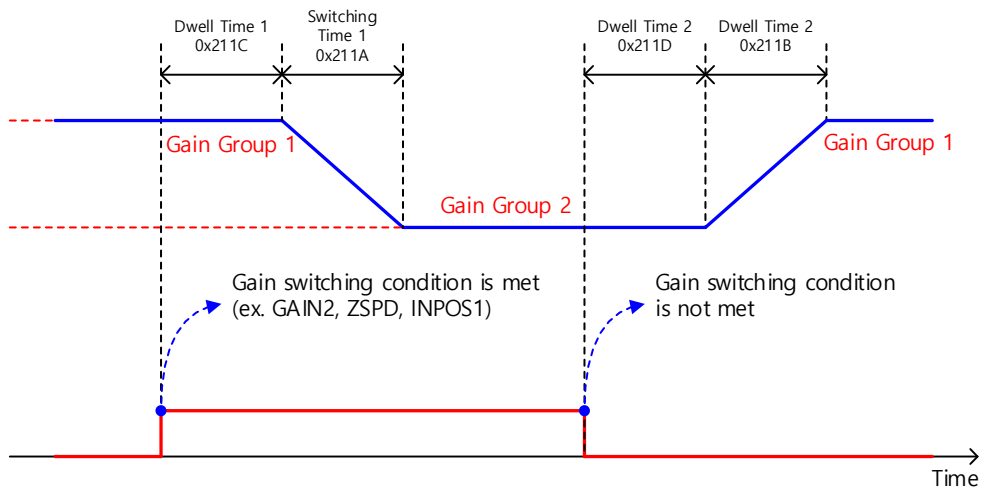
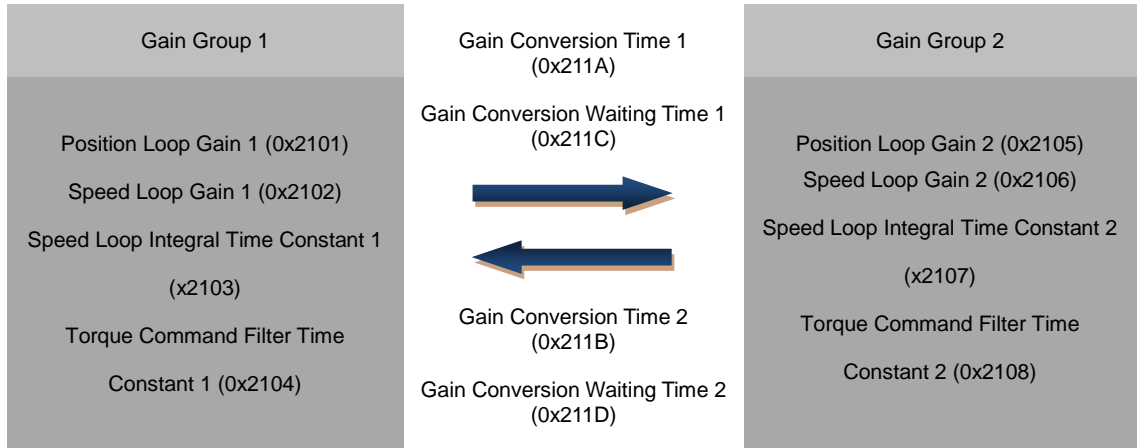

■ Related Objects

Index	Sub Index	Name	Variable Type	Accessibility	PDO Assignment	Unit
0x2119	-	Gain Conversion Mode	UINT	RW	Yes	-
0x211A	-	Gain Conversion Time 1	UINT	RW	Yes	ms
0x211B	-	Gain Conversion Time 2	UINT	RW	Yes	ms
0x211C	-	Gain Conversion Waiting Time 1	UINT	RW	Yes	ms
0x211D	-	Gain Conversion Waiting Time 2	UINT	RW	Yes	ms

6.10.2 P/PI Control Switch

PI control uses both proportional (P) and integral (I) gains of the velocity controller, while P control uses only the proportional gain.

The proportional gain determines the responsiveness of the entire controller, and the integral gain is used to eliminate errors in the steady state. Too high of an integral gain will result in an overshoot during acceleration or deceleration.

The PI/P control switch function is used to switch between the PI and P controls under the condition of the parameters within the servo (torque, velocity, acceleration, position deviation); specifically, they are used in the following situations.

Velocity control: To suppress any overshoot or undershoot during acceleration/deceleration

Position control: To suppress undershoots during positioning in order to reduce the positioning time

You can accomplish similar effects by setting acceleration/deceleration of the upper level controller, soft start of the servo drive, position command filter, etc.

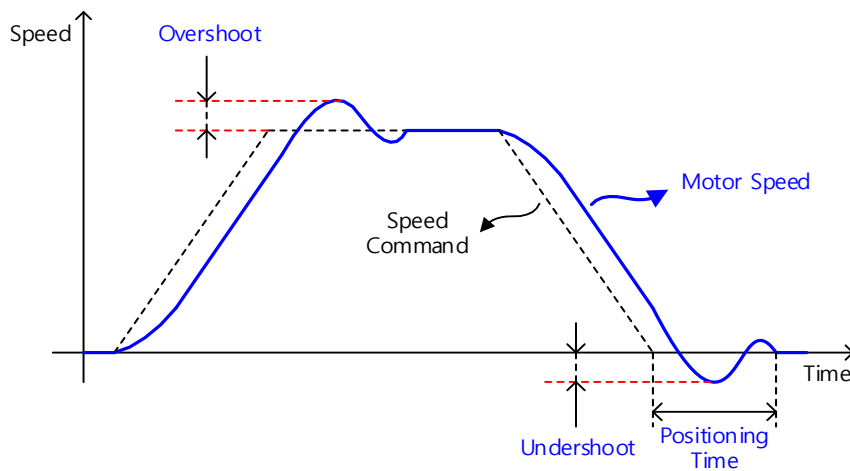

You make these settings in the P/PI Control Conversion Mode (0x2114). See the details below. Switching to P control by PCON input takes precedence over this setting.

Setting Value	Setting Details
0	Always use PI control
1	Switches to P control if the command torque is larger than the P control switch torque (0x2115)
2	Switches to P control if the command speed is larger than the P control switch speed (0x2116)
3	Switches to P control if the acceleration command is larger than the P control switch acceleration (0x2117)
4	Switches to P control if the following error is larger than the P control switch following error (0x2118)

■ Related Objects

Index	Sub Index	Name	Variable Type	Accessibility	PDO Assignment	Unit
0x2114	-	P/PI Control Conversion Mode	UINT	RW	Yes	-
0x2115	-	P Control Switch Torque	UINT	RW	Yes	0.1%
0x2116	-	P Control Switch Speed	UINT	RW	Yes	rpm
0x2117	-	P Control Switch Acceleration	UINT	RW	Yes	rpm/s
0x2118	-	P Control Switch Following Error	UINT	RW	Yes	pulse

■ Example of P/PI Switching by Torque Command

When using PI control for all situations rather than using P/PI control switch for velocity control, the integral term of acceleration/deceleration error is accumulated, which results in an overshoot and an extended positioning time. Here, you can reduce overshoot and positioning time using an appropriate P/PI switching mode. The figure below shows an example of mode switching by torque commands.

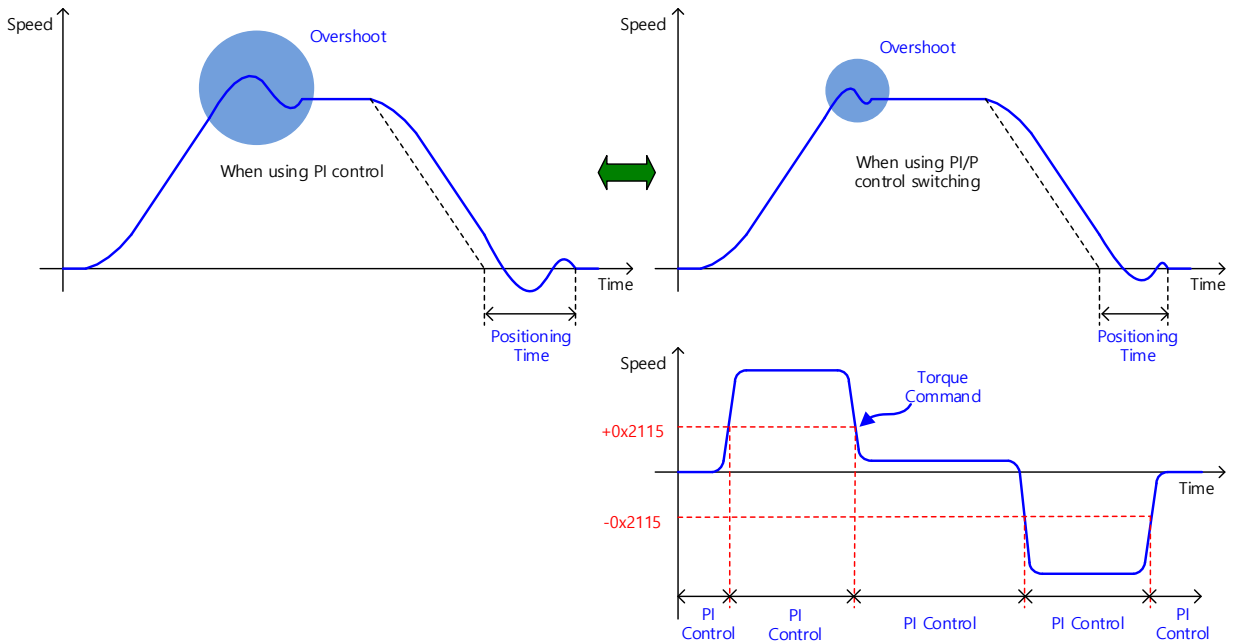

6.11 Motor Overload Prevention Function

In order to prevent motor damage due to overheating, the motor overload prevention function by algorithm or by motor thermal time constant is provided. I^2T

6.11.1 I^2T Prevention by Algorithm

It traces the current flow from the drive and blocks the motor current output when the estimated motor temperature exceeds the standard. This function should be set correctly since it is calculated based on the motor parameter [0x2000] or 3rd party motor parameters [0x2802] and [0x2803], and the operating time at the maximum current [0x2031].

For example, let's assume that the motor specifications are as follows.

Motor rated current: 3A
 Motor maximum current: 9A
 Operation Time at Peak Current: 1000ms

Drive output current (I_{out}): 6A

$$I^2T_{Limit} = ((9A)^2 - (3A)^2) \times 1000ms = 72000A^2ms$$

$$T_{LMT} = \frac{I^2T_{Limit}}{I_{out}^2 - (3A)^2} = \frac{72000A^2ms}{(6A)^2 - (3A)^2} = 2666ms$$

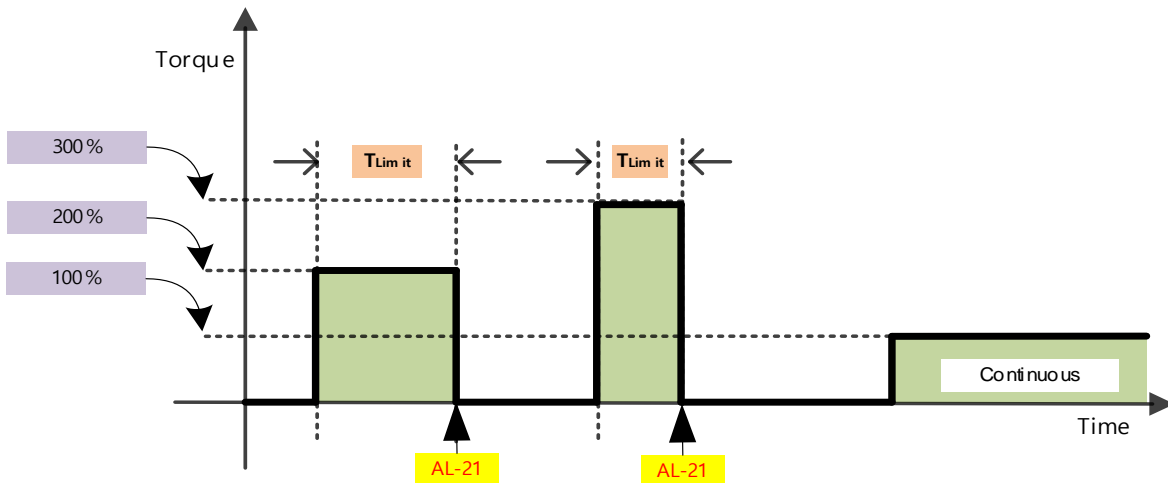

Related Objects

Index	Sub Index	Name	Variable Type	Accessibility	PDO Assignment	Unit
0x2000	-	Motor ID	UINT	RW	No	-
0x2031	-	Operation Time at Peak Current	UINT	RW	No	ms
0x2802	-	Third Party Motor Rated Current	FP32	RW	No	Arms
0x2803	-	Third Party Motor Max Current	FP32	RW	No	Arms

6.11.2 Prevention by Motor Thermal Time Constant

It estimates the motor temperature based on the relationship between motor winding and ambient temperature. If the temperature exceeds the standard, it blocks motor current output. This function is activated when the motor thermal protection enable [0x2034] parameter is set to 1. It should be set correctly since it is calculated based on the motor thermal time constant [0x280D].

The formula for calculating the motor thermal time constant is shown below.

$$\text{Thermal time constant[sec]} = \text{Thermal resistance} \left[\frac{^{\circ}\text{C}}{\text{watt}} \right] \times \text{Thermal capacitance} \left[\text{watt} \times \frac{\text{sec}}{^{\circ}\text{C}} \right]$$

■ **Related Objects**

Index	Sub Index	Name	Variable Type	Accessibility	PDO Assignment	Unit
0x2034	-	Motor Thermal Protection Enable	UINT	RW	No	-
0x280D	-	[3 rd Party Motor]Thermal Time Constant	FP32	RW	No	$\frac{^{\circ}\text{C}}{\text{watt}}$

6.12 Dynamic Brake

What is dynamic brake?

: It is a method of rapidly stopping the motor by causing an electrical short-circuit to the phases of the servo motor.

Circuits of to the dynamic brake are integrated into the drive.

The drive can apply short-circuits to only two phases or to all three phases depending on the model type.

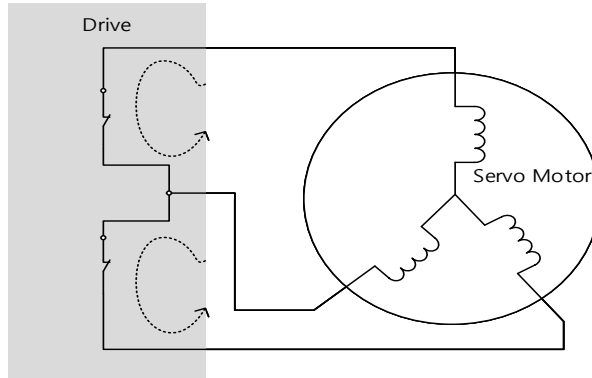

You can set various stop modes as shown below, in dynamic brake control mode (0x2012).

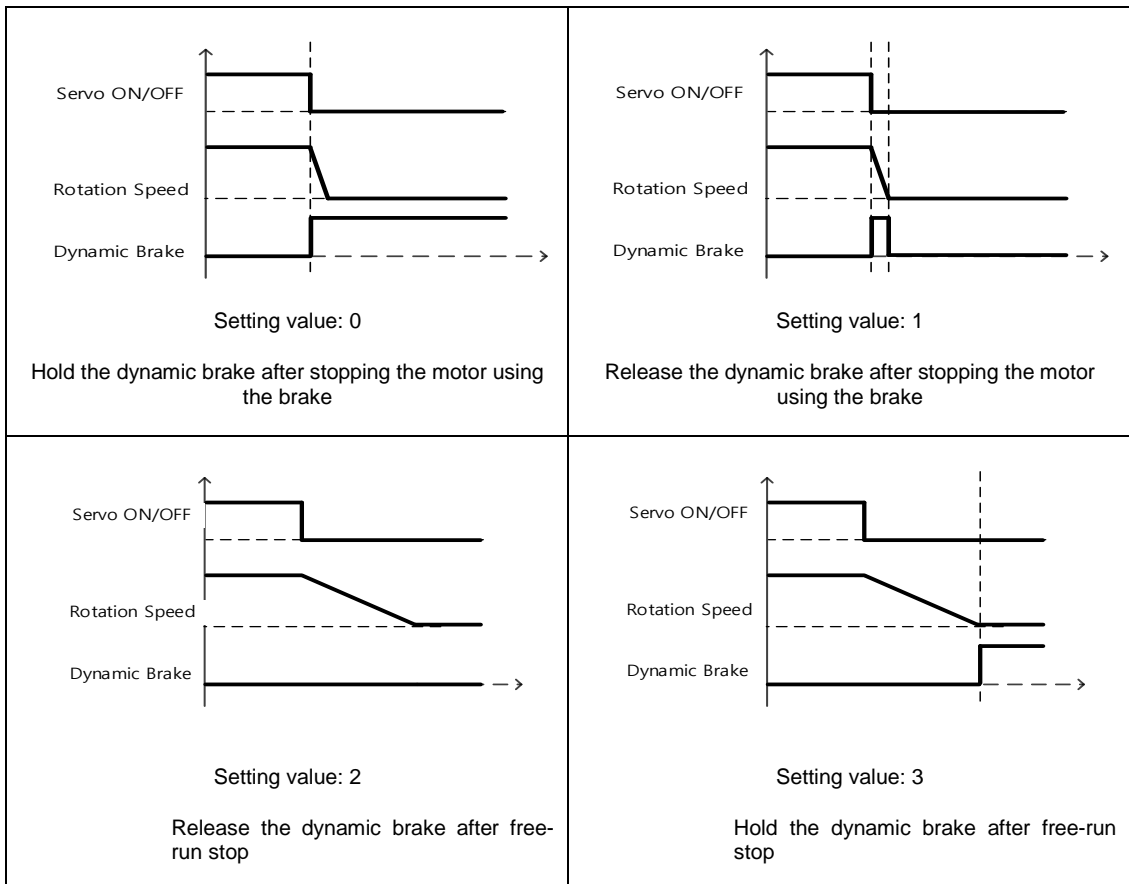

■ Related Objects

Index	Sub Index	Name	Variable Type	Accessibility	PDO Assignment	Unit
0x2012	-	Dynamic Brake Control Mode	UINT	RW	No	-
0x2013	-	Emergency Stop Configuration	UINT	RW	No	-

6.13 Regeneration Brake Resistor Configuration

Regeneration refers to a phenomenon where kinetic energy of the motor is converted to electric energy and input into the drive because of the high inertia or sudden deceleration of the load driven. Here, a regeneration brake resistor is used to suppress the rise of the drive's internal voltage (V_{DC}) caused by regeneration and prevent burnout of the drive.

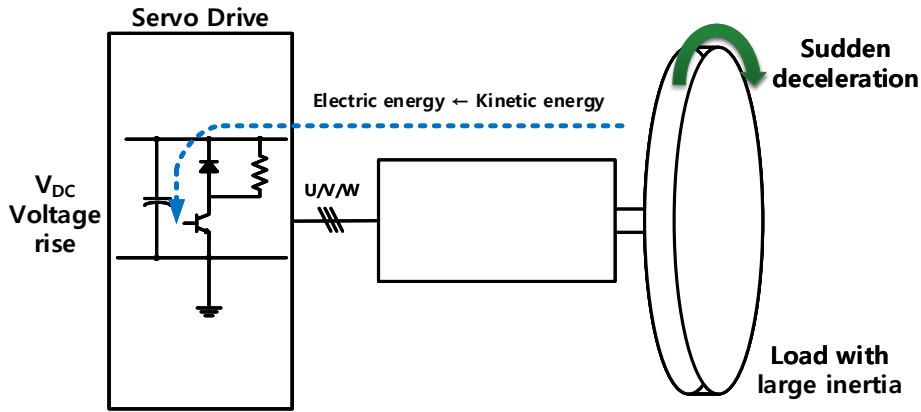

■ Related Objects

Index	Sub Index	Name	Variable Type	Accessibility	PDO Assignment	Unit
0x2009	-	Regeneration Brake Resistor Configuration	UINT	RW	No	-
0x200A	-	Regeneration Brake Resistor Derating Factor	UINT	RW	No	%
0x200B	-	Regeneration Brake Resistor Value	UINT	RW	No	Ω
0x200C	-	Regeneration Brake Resistor Capacity	UINT	RW	No	Watts

6.13.1 Use of Internal Regeneration Brake Resistor

This drive essentially has internal regeneration brake resistor depending on its capacity. The integrated regeneration brake resistors depending on the drive capacity are as follows:

Models	Resistance Values	Standard Capacity
iX7NHA001U~iX7NHA002U	-	-
iX7NHA004U	100[Ω]	Built-in 50 W
iX7NHA008U~iX7NHA010U	40[Ω]	Built-in 100 W
iX7NHA020U~iX7NHA035U	13[Ω]	Built-in 150 W

When using the regeneration brake resistor installed in the drive, make sure to observe the order below for configuration:

1. Wiring regeneration brake resistor.
 - Check to see if the terminals B and BI are short-circuited (short-circuited at factory setup, 1 kW or less).

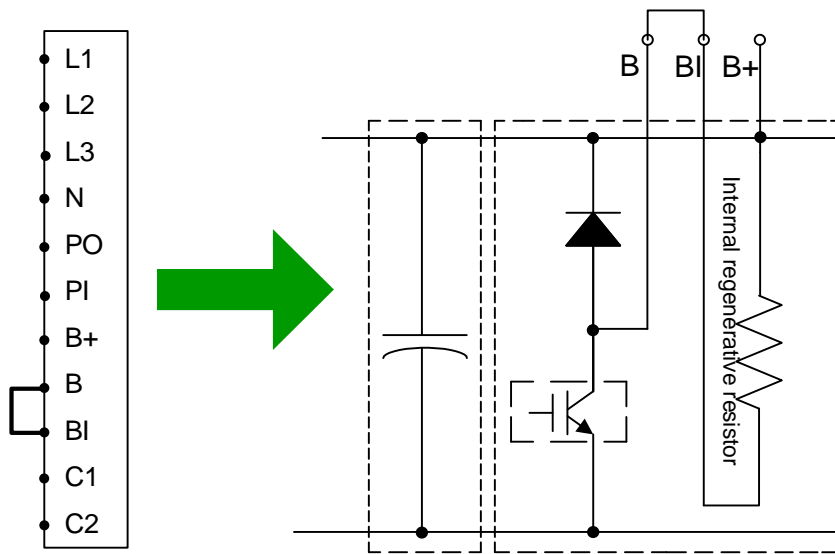

Wiring method when using internal regenerative resistor

2. Regeneration Brake Resistor Configuration (0x2009)
 - Configure to use the regeneration brake resistor integrated into the drive (0x2009 = 0).
 - Basically, the resistor is attached on the rear of the drive heat sink.
 - Initial Value: 0
3. Check the internal regeneration brake resistor value and capacity.
 - Check the internal regeneration brake resistor value (0x200B).
 - Check the regeneration brake resistor capacity (0x200C).

- 1 kW or less: Basically, the resistor is installed on the rear of the drive heat sink (see the figure below).

(For 100W or 200W, no regeneration brake resistor is included.)

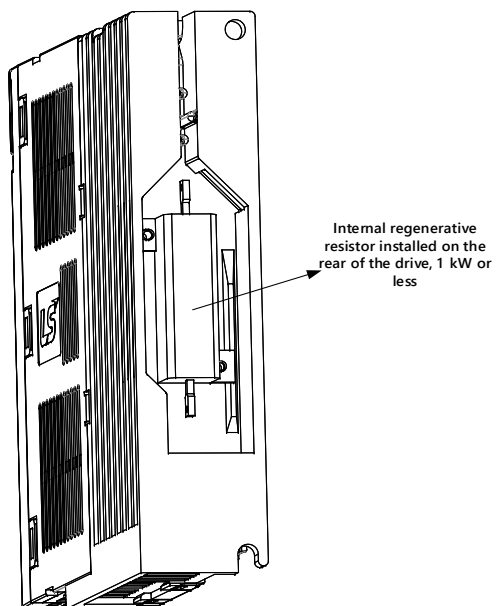

6.13.2 Use of External Regeneration Brake Resistor

When using the external regeneration brake resistor for different driving conditions, make sure to observe the order below for configuration.

1. Wiring external regeneration brake resistor

- Connect the external regeneration brake resistor to the terminals B and B+.
- Remove the short-circuits of the terminals B and BI (short-circuited at factory setup, 1 kW or less).

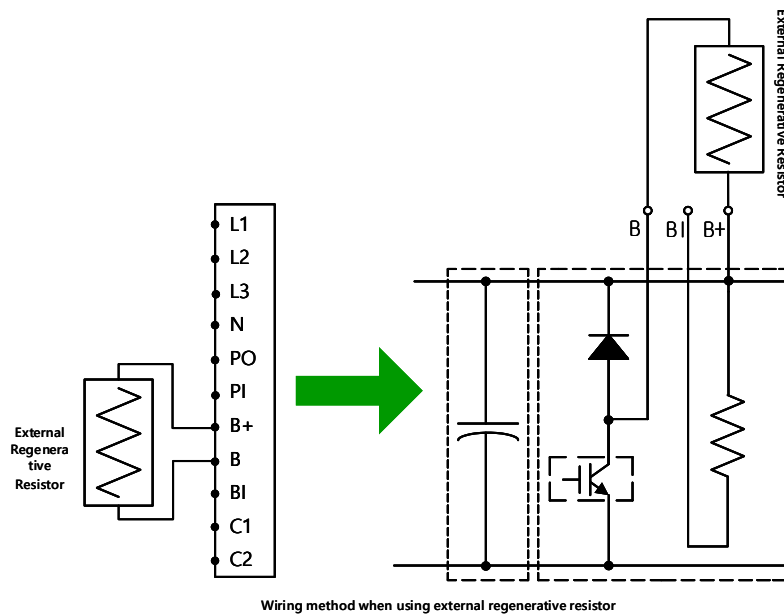

2. Regeneration Brake Resistor Configuration (0x2009)

- Configure the regeneration brake resistor installed separately outside the drive (0x2009=1)
- Set if a regeneration brake resistor is connected of a capacity which is larger than that of the internal regeneration brake resistor.

3. Regeneration Brake Resistor Value (0x200B)

- Set regeneration brake resistor value installed separately outside the drive in the unit of [Ω]
- Be sure to set it when you have set Regeneration Brake Resistor Configuration (0x2009) to 1
- Initial Value: 0

4. Regeneration Brake Resistor Capacity (0x200C).

- Set the capacity of the regeneration brake resistor installed separately outside the drive in the unit of [W]
- Be sure to set it when you have set Regeneration Brake Resistor Configuration (0x2009) to 1
- Initial Value: 0

5. Set the maximum capacity and allowed time of the regeneration brake resistor (0x200D, 0x200E)

- Set the maximum capacity and use time at the capacity by using the data sheet of the externally installed regeneration brake resistor
- If there are no specific values provided, set the maximum capacity to a value 5 times the regeneration brake resistor capacity (0x200C) and the allowed time to 5000[ms](The values may differ according to the general regeneration brake resistor specifications or the regeneration brake resistor value)
- Be sure to set it when you have set regeneration brake resistor configuration (0x2009) to 1

Our company provides the following regeneration brake resistor specifications as options for the use of external regeneration brake resistors.

Service Voltage	Drive Capacity	Resistance Values	Resistor Capacity (Optional)	Model Name
200[V]	100W	50Ω	140W	APCS-140R50
	200W			
	400W			
	750W	30Ω	300W	APCS-300R30
	1KW			
	2KW	15Ω	1200W	APCS-600R30 (2P)
	3.5kW	10Ω	1800W	APCS-600R30 (3P)

6.13.3 Other Considerations

You can set the regeneration brake resistor's Derating Factor (0x200A) by considering the ambient environment and heat radiation conditions for drive installation. If the heat radiation condition is poor, use a derated (with lowered capacity) resistor.

When it is derated for use (value set to 100 or lower), the less the set value of the regeneration overload alarm (AL-23), the faster its trigger.

When you wish to set the derating factor to 100% or higher, be sure to fully consider the heat radiation condition of the drive installed.

6.14 Drive Node Address Setting (ADDR)

Set the drive node address. You can verify the set address in the node ID (0x2003). The value of the node setting switch is read just once when the power is turned on. Any subsequently modified settings will only take effect when the power is turned off and then turned on again.

As this drive consists of two rotary switches configurable to 0~9 as below, 0~98 node addresses can be set. The following example shows an address set to 48:

⚠ Perform the rotary switch operation for the node ID setting only when drive power is not applied.

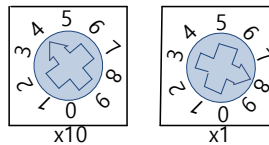

Note: For more information about how the master reads the node address of the EtherCAT drive, refer to 18.4.1 Requesting ID in the document titled "ETG.1020 EtherCAT Protocol Enhancements."

6.15 Encoder Signal Output

The drive processes encoder signals internally and outputs the processed signals in the form of pulses and using the line drive method through the basic pins (1~6) assigned to the I/O connector.

You can set the count of the encoder pulse output per revolution of the motor by the encoder output pulse [0x2422] value.

Also, you can set the phase A and phase B lead for encoder signal output during motor operation by the encoder output logic [0x2423] value.

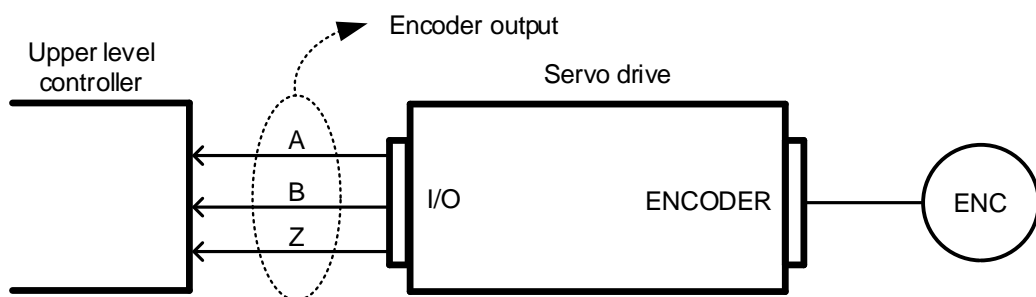

The maximum encoder signal output frequency of the drive is 6.5 [Mpps] for the line drive method (in multiples of 4).

■ Encoder Output Signal for the Line Drive Method

Pin Number	Names	Details	Function
9	AO	Encoder Signal A	Outputs de-multiplied encoder signals in A, B, and Z phases by the line drive method. Output demultiplication can be set in [0x2442].
10	/AO		
19	BO	Encoder Signal B	
20	/BO		
17	ZO	Encoder Signal Z	
18	/ZO		

■ Related Objects

Index	Sub Index	Name	Variable Type	Accessability	PDO-Mapping	Unit
0x2422	-	Encoder Output Pulse	UDINT	RW	No	Pulse/rev.
0x2423	-	Encoder Output Logic	UINT	RW	No	-

6.16 Absolute Encoder Data Transmission (ABS_RQ)

Upon request, the absolute encoder's data are transmitted to the upper level controller in the form of quadrature pulses through AO, BO outputs, which are the encoder's output signals. In this case, pulses are output at the velocity of 500 [Kpps].

The drive transmits multi-turn data first among the absolute data upon ABS_RQ signal input, then transmits single-turn data within a single revolution.

(For assignment of sequence input signal ABS_RQ, refer to Section 6.2, "Input/Output Signals.")

ABS_RQ can be requested in the Servo Off state.

■ Transmission/Reception Sequence of Absolute Data

1) When the upper level controller is ready for data reception, turn on the ABS_RQ signal.

Here, you can input the ABS_RQ signals through the ABS_RQ bits of digital input or drive control input 2 [0x2120].

(For the Modbus TCP communication address, refer to Section 13.6 "Servo Drive Communication Address Table.")

2) When the drive receives an ABS_RQ signal input, it prepares for transmission of the encoder data after a delay time of 100 [ms].

3) The drive transmits multi-turn data for up to 200 [ms]. The drive prepares for transmission of single-turn data for 200 [ms] from the start of multi-turn data transmission.

4) The drive transmits single-turn data within one revolution for up to 1200 [ms]. Here, the output data take into account the encoder output pulse count (demultiplication ratio). The data operate as normal encoder output signals 1200 [ms] after the starting point of data transmission within one revolution.

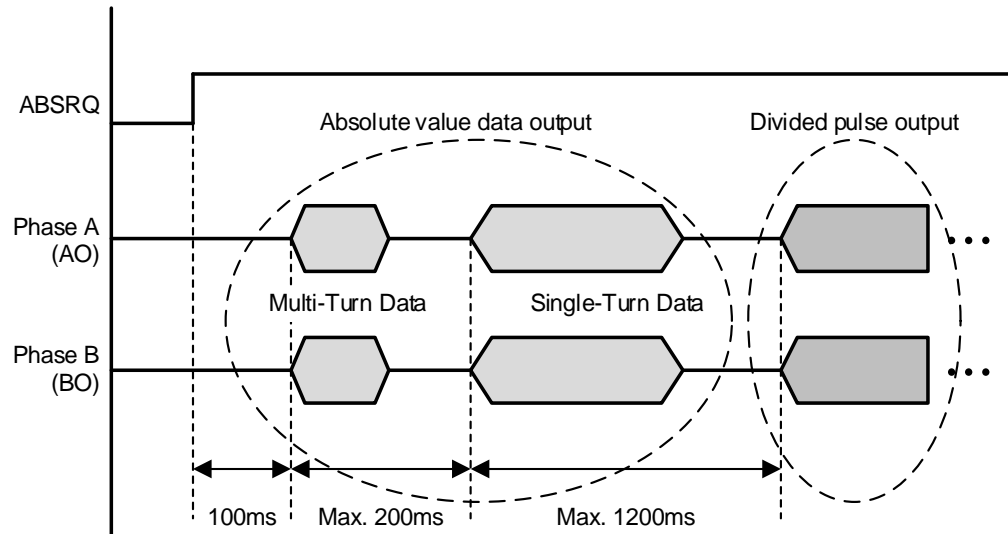

6.17 One Parameter Mode

Although the existing PI control provides the benefit of low calculation load and very fast speed of execution, it has the following shortcomings.

- Allows only approximate differential calculations for the error signals that occur.
- Generates transient responses such as settle time, overshoot, and vibration when gain is inaccurate.
- Proportional, error, and integral terms show a linear structure during output of the final control value.
- Removes static intrinsic error during integral calculation, but does not guarantee control stability.

One Parameter Mode blocks disturbance and can be used through simple parameter setting.

Gain tunings of position gain (0x2101), velocity gain (0x2102), integral time constant (0x2103), torque command filter time constant 1 (0x2104), torque feed-forward gain (0x210E) and torque feed-forward filter time constant (0x210F) are adjusted according to the setting value of system rigidity for gain tuning (0x250E) and can be easily done even when high load inertia is connected.

(At this time, see 10.2 System Rigidity for Gain Tuning of Manufacturer Specific Objects for the gain adjustment table according to the setting value of system rigidity for gain tuning [0x250E].)

You can use One Parameter Mode [0x251A] to turn on/off One Parameter Mode.

■ Example of One Parameter Application for Velocity and Position Control

- If you increase the system rigidity setting value during velocity control, the speed command value is estimated more quickly.

- If you increase the system rigidity setting value during position control, the command position value is estimated more quickly.

⚠ If the setting value is too high, vibration may occur depending on the machine structure, so be sure to set the value within the range that does not cause vibration.

The following figures illustrate changes in driving depending on the control mode when One Parameter Mode is enabled.

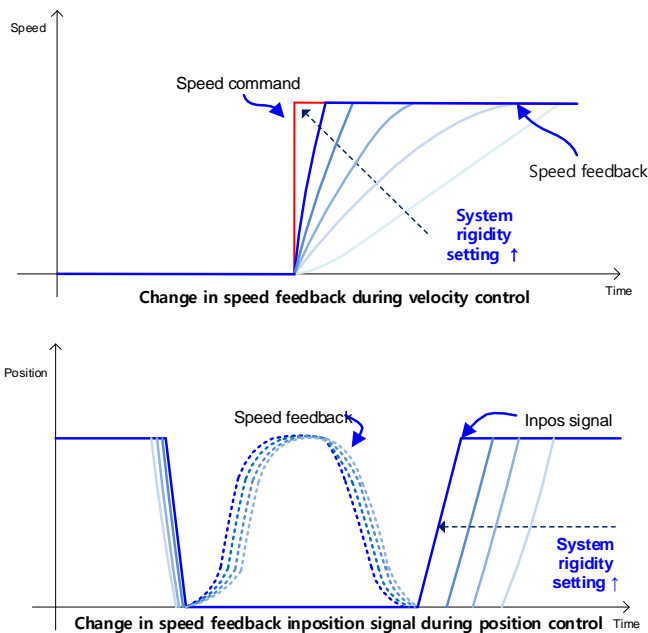

The following are functional benefits of One Parameter Mode in comparison to PI control.

- 1) It generates less overshoot than PI control under the same conditions for velocity control and estimates the speed command value more quickly.
- 2) It responds faster than PI control under the same conditions for position control and thus outputs the completion signal (INPOS) more quickly.
- 3) Gain is adjusted by system rigidity value unlike PI control where position gain, velocity gain, integral time constant and many other objects must be adjusted manually.

■ Related Objects

Index	Sub Index	Name	Variable Type	Accessi- bility	PDO- Mappi- ng	Unit
0x250E	-	System Rigidity for Gain Tuning	UINT	RW	No	-
0x251A	-	One Parameter Mode	UINT	RW	No	-

7. Safety Functions

This servo drive has a built-in safe torque off (STO) function to reduce the risks associated with using the machine by protecting people from the dangerous operation of moveable parts. In particular, this function can be used to prevent the dangerous operation of the machine's moveable parts when you need to perform tasks such as maintenance in a danger zone.

7.1 Safe Torque Off (STO) Function

The safe torque off function blocks motor current according to the input signal transferred from a safety device connected to the connector (STO), such as safety controller and safety sensor, to stop the motor.

■ Safe Torque Off Operation State According to STO Input Contact

Signal Names	Function			
STO1	ON	ON	OFF	OFF
STO2	ON	OFF	ON	OFF
Operation State	Normal State	STO State	STO State	STO State

■ Electric Characteristics

- STO1 and STO2

Items	Characteristic Value
Internal impedance	3.3 k Ω
Voltage input range	DC 12V ~ DC 24V
Maximum Delay Time	1 ms or less

- EDM

Items	Characteristic Value
Maximum Allowed Voltage	DC 30V
Maximum Current	DC 120mA
Maximum Delay Time	1 ms or less

■ Timing diagram for STO operation

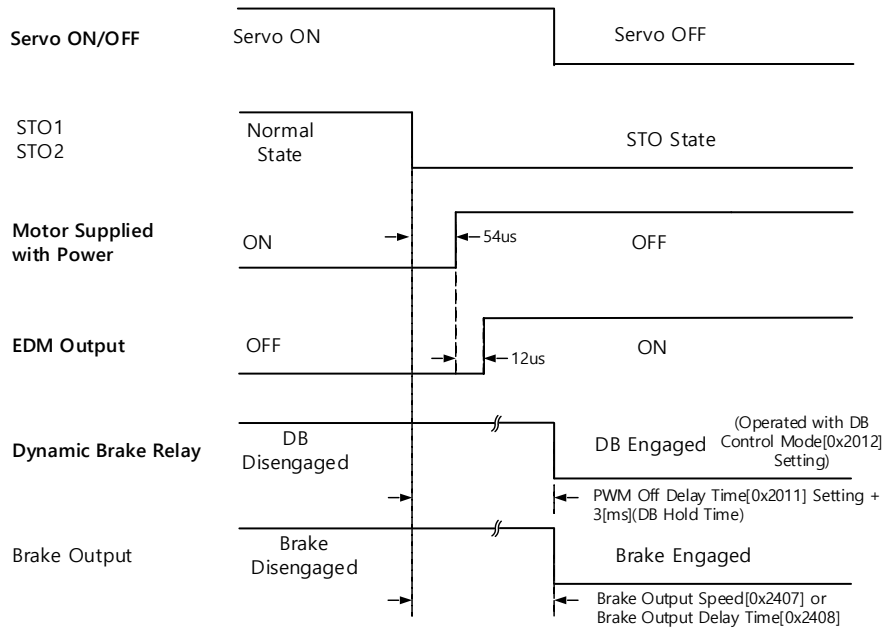

Note 2) If either STO1 or STO2 is turned off, the drive state is switched to the STO state.

Note 3) The dynamic brake operates according to the dynamic brake control mode (0x2012).

Note 4) Whichever is the earlier time, out of the points of time until the value becomes less than the setting value of the brake output delay time (0x2408) or less than the brake output speed (0x2407), will be applied.

■ Timing diagram for STO recovery

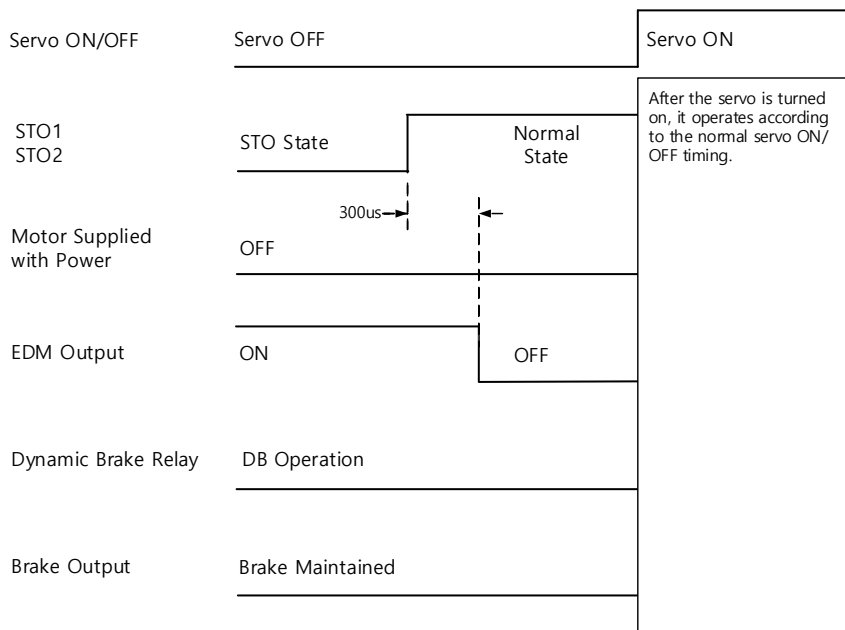

Note 5) Be sure to recover the STO1 and STO 2 input signals to On in the Servo Off state. It is not necessary to reset the alarm separately since the "STO state" is not an alarm state.

Note 6) The dynamic brake operates according to the dynamic brake control mode (0x2012) for the STO state, the alarming state, and the servo OFF state.

7.2 External Device Monitor (EDM)

Monitor output signal is to monitor the state of safety input signal with an external device.

Connect it to the terminal for external device monitor of safety device such as safety controller or safety sensor.

■ Failure detection through EDM signal

You can detect failure of the safety input circuit and the EDM output circuit by monitoring the following 4 signal states from the external device.

In case of failure, there are two possible cases:

- The EDM output signal is not turned on even when both the STO1 and 2 are off.
- The EDM output signal is turned on even when one or both of the STO1 and 2 are on.

Signal Names	Function			
	ON	ON	OFF	OFF
STO1	ON	ON	OFF	OFF
STO2	ON	OFF	ON	OFF
EDM	OFF	OFF	OFF	ON

7.3 Example of Using the Safety Function

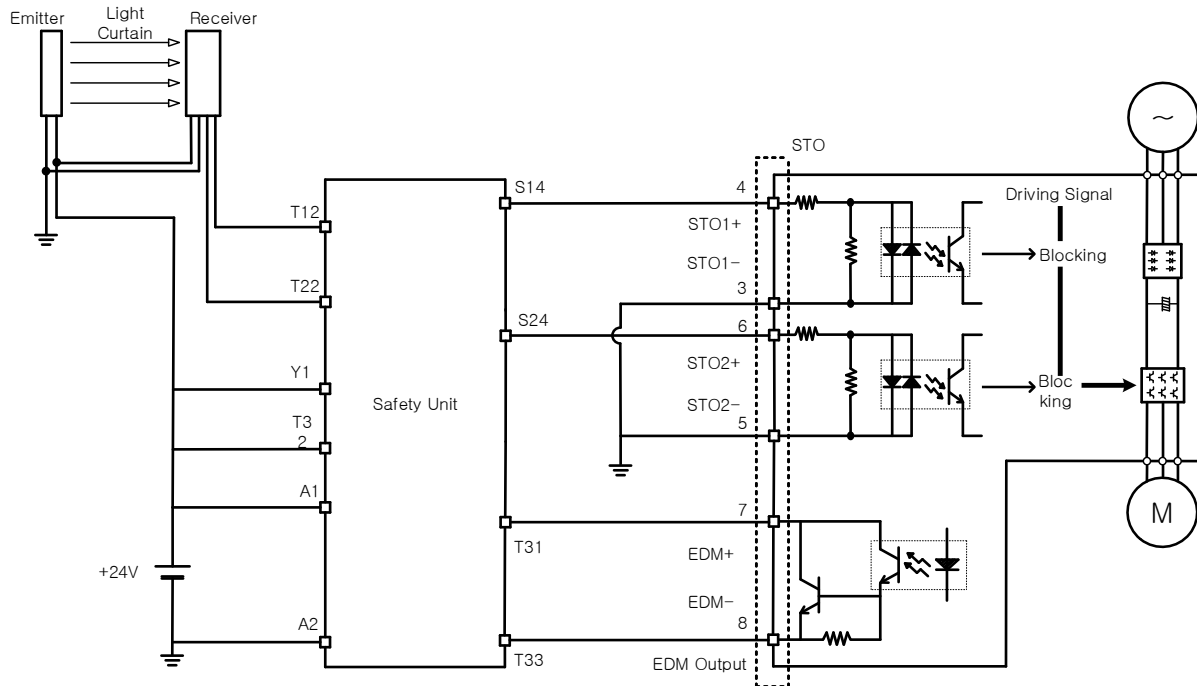

7.4 How to Verify the Safety Function

In case the servo drive was replaced prior to starting up the device or during maintenance, make sure to check the details below:

- When the STO1 and STO2 signals are turned off, check if the drive is in STO status (Bit 31 for digital input (0x60FD) is 1).
- Make sure that the EDM signal is off during general operation by checking the input indicator for feedback circuit of the connected device.

7.5 Precautions for Using the Safety Function

- When using the STO function, be sure to carry out risk assessments for the device to check if the system safety requirements are met.
- There may be risks even if the STO function works.
- In the STO state, the motor is operated by an external force; thus, if the load needs to be maintained, arrange a separate measure such as an external mechanical brake. The brake of the servo system is dedicated for maintaining the load; thus, be careful not to use it to brake the motor.
- If no external force exists and free-run stop is configured in the dynamic brake control mode (0x2012), note that the braking distance of load will be extended.

The purpose of the STO function is not to block the servo drive power or electrically insulate the drive. That is why you have to disconnect the servo drive power before carrying out maintenance of any sub-drive.

8. Tuning

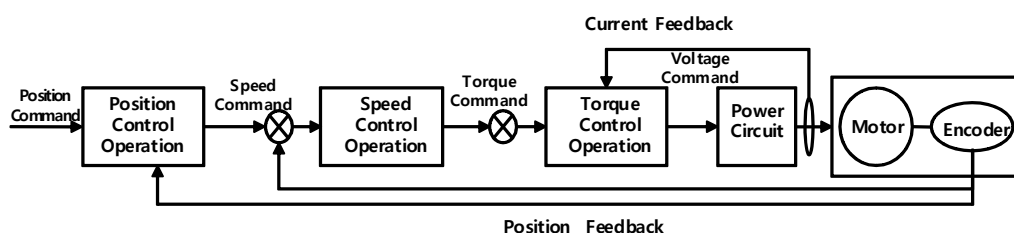

The drive is set to the torque control, velocity control, or position control mode for use, depending on the method of connecting with the upper level controller. This drive has a control structure where position control is located at the outermost part and current control at the innermost, forming a cascade. You can tune the operation according to the purpose by setting gain parameters for the torque controller, velocity controller, and position controller for the drive's operation modes.

8.1 Auto Gain Tuning (Offline Auto Tuning)

You can automatically set gain according to the load conditions by using the commands generated by the drive itself. The following gain parameters are changed.

- Inertia ratio, position loop gain, speed loop gain, speed integral time constant, torque command filter time constant, notch filter 3 frequency, and notch filter 4 frequency

The entire gains are set higher or lower depending on the setting value of the system rigidity for gain tuning (0x250E). Set the appropriate value depending on the rigidity of the load driven.

As shown in the figure below, sinusoidal type commands are generated in the positive or negative direction according to the off-line gain tuning direction (0x2510) setting. You can set the movement distance for tuning by the off-line gain tuning distance (0x2511). The larger the setting value is, the longer the movement distance becomes. Set the distance appropriately for the case. Make sure to secure enough distance (one or more motor revolutions) prior to gain tuning.

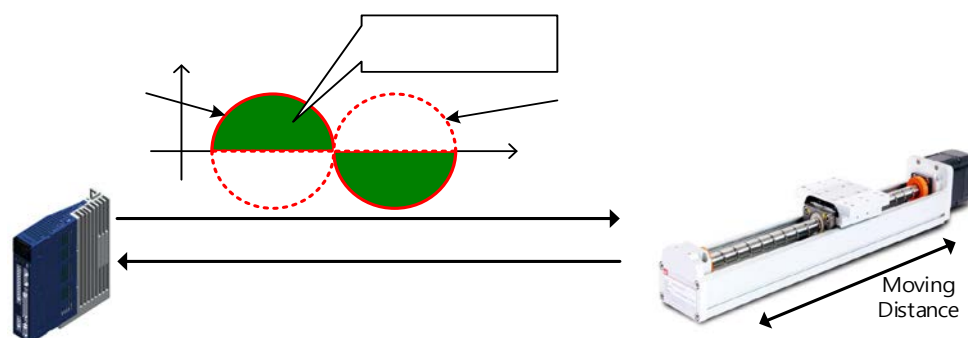

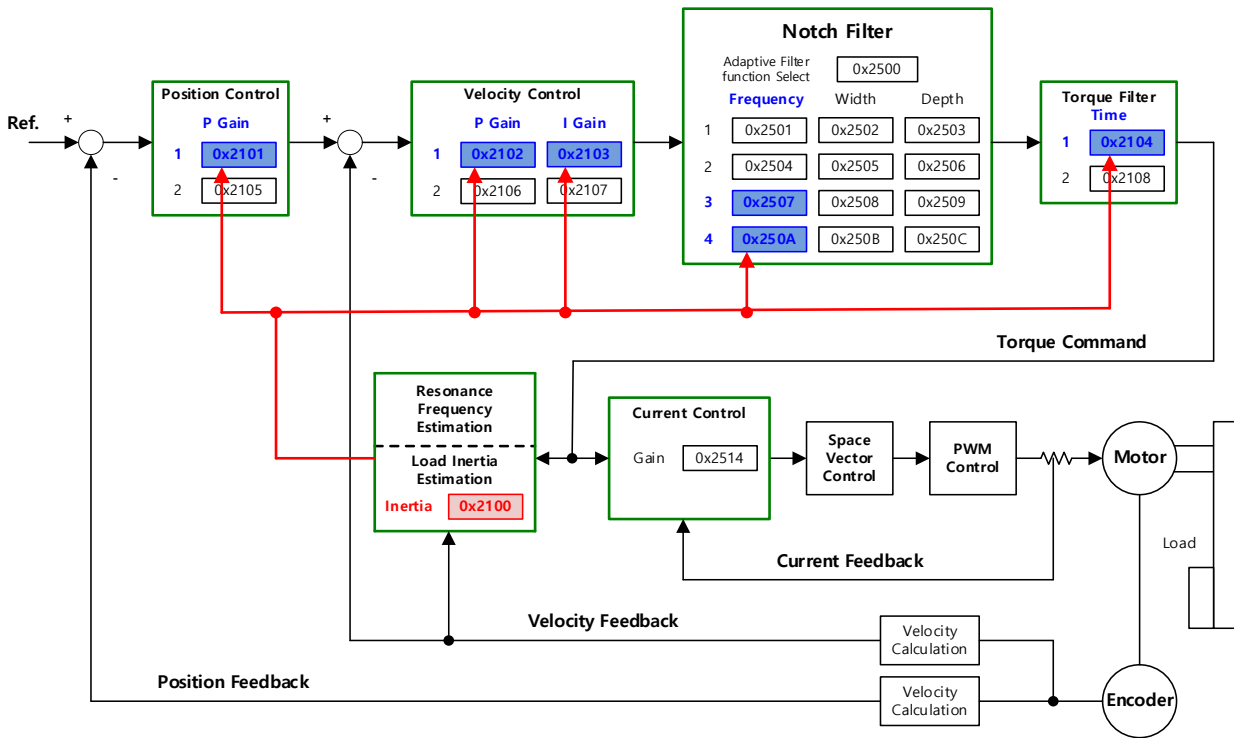

■ Related Objects

Index	Sub Index	Name	Variable Type	Accessibility	PDO Assignment	Unit
0x250E		System Rigidity for Gain Tuning	UINT	RW	No	-
0x2510	-	Off-line Gain Tuning Direction	UINT	RW	No	-
0x2511		Off-line Gain Tuning Distance	UINT	RW	No	-

8.2 Automatic Gain Adjustment (On-line Auto Tuning)

It does not use offline auto tuning that is generated by the drive, but receives a command from an upper level unit to automatically set the parameters related to gains based on system inertia, the rigidity set by the user, and other general rules.

- Inertia ratio, position loop gain, speed loop gain, speed integral time constant, torque command filter time constant

Online tuning is carried out based on the gain table values that are divided into 20 levels based on the rigidity. The tuning results are regularly applied and the changed gains are saved on EEPROM every 2 minutes.

It can reflect the estimation values either slowly or fast according to the adaptation speed setting value and determine the overall responsiveness of the system by using only a single rigidity setting parameter. The inertia is estimated in real time, so the value changes according to the change in load.

In the below cases, inertia ratio estimation may be incorrect by on-line auto tuning.

- Load variation is too high
- Load rigidity is too low or the system's backlash is severe
- Load is too small (lower than x3) or too big (higher than x20)
- Acceleration or deceleration is too low, resulting in insufficient acceleration/deceleration torque (lower than 15% of the rated value)
- Rotation velocity is low (lower than 15% of the rated value)
- Friction torque is high

If normal inertia is not estimated due to the above conditions or during online auto tuning, carry out offline gain tuning.

■ Parameters Changed by Tuning

- Inertia ratio (0x2100), Position Loop Gain 1 (0x2101), Speed Loop Gain 1 (0x2102), Speed Integral Time Constant 1 (0x2103), Torque Command Filter Time Constant 1 (0x2104)
- Notch Filter 3, 4 Frequency (0x2507, 0x250A) → Refer to the auto notch setting function

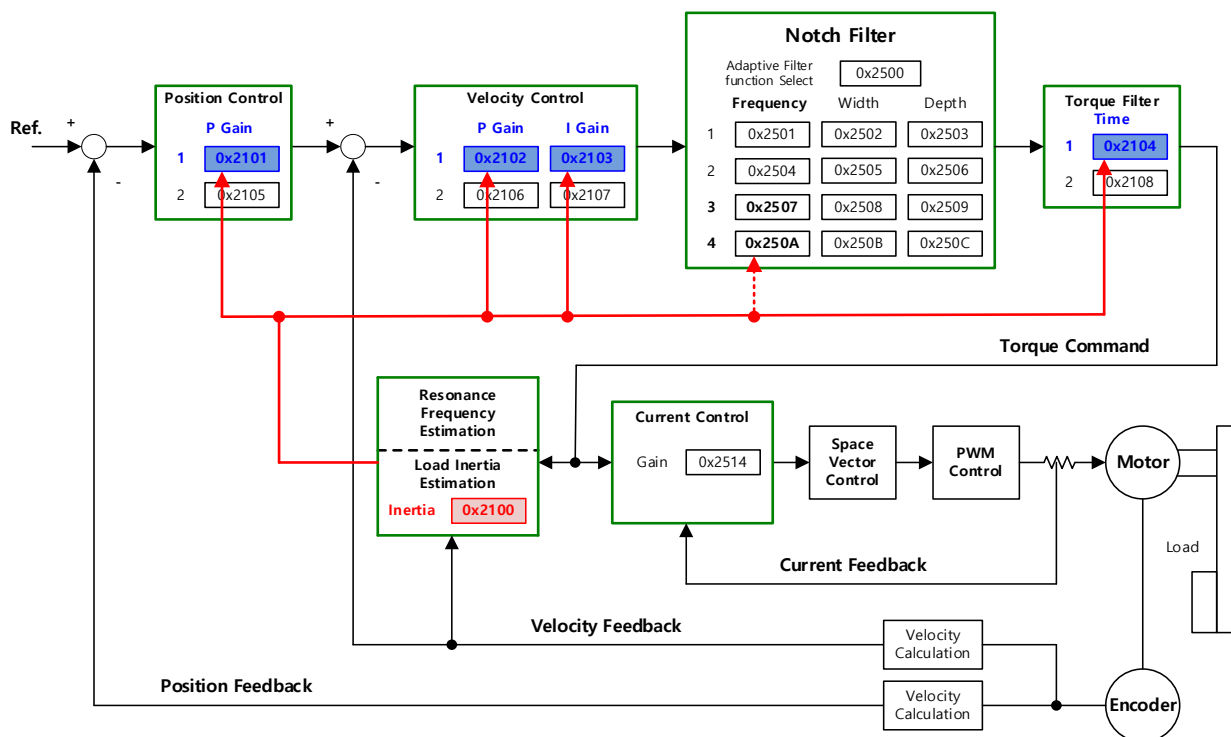

■ Related Objects

Index	Sub Index	Name	Variable Type	Accessibility	PDO Assignment	Unit
0x250D		On-line Gain Tuning Mode	UINT	RW	No	-
0x250E		System Rigidity for Gain Tuning	UINT	RW	No	-
0x250F		On-line Tuning Adaptation Speed	UINT	RW	No	-

8.3 Manual Gain Tuning

8.3.1 Gain Tuning Sequence

For a cascade-type controller, tune the gain of the velocity controller located at an inner position first, then tune the gain of the position controller located at an outer position.

In other words, perform tuning in the order of proportional gain→ integral gain→ feedforward gain.

The role of each individual gain is as follows.

- Proportional gain: Determines controller BW
- Integral gain: Determines error of the steady state and generates an overshoot
- Feedforward gain: Enhances on the system lag characteristic
- Differential gain: Plays the role of a damper for the system (not provided)

■ Velocity Controller Tuning

- (1) Inertia ratio setting
 - Use the automatic inertia estimation function or carry out manual setting
- (2) Proportional gain setting
 - Monitor for torque and noise before any vibration occurs
- (3) Integral gain setting
 - Monitor the speed overshoot and the steady-state error.
 - You can use the P/PI switching mode if you want to increase the integral gain but overshoot occurs.
 - For this drive, the integral gain is set to the integral time constant.
- (4) Speed command filter and speed feedback filter setting

■ Position Controller Tuning

- (1) Proportional gain setting
 - Monitor torque, following error, and noise before any vibration occurs.
- (2) Feedforward setting
 - Following error monitoring
 - Feedforward filter setting possible
 - Set the filter if you want to increase the feedforward value but noise occurs.
 - You can set feedforward to a value from 0% to 100%, which is the deviation ratio of the position command value being entered currently.
- (3) Position command filter setting possible
 - You can smooth out the position command.

8.4 Vibration Control

8.4.1 Notch Filter

The notch filter is a sort of band stop filter that eliminates specific frequency components. You can use a notch filter to eliminate resonant frequency components of an apparatus, which allows vibration avoidance and higher gain setting.

This drive provides notch filters in 4 levels, and you can set frequency, width, and depth for each filter. You can use one or two notch filters as adaptive filters, which set the frequency and width automatically through real-time frequency analysis (FFT).

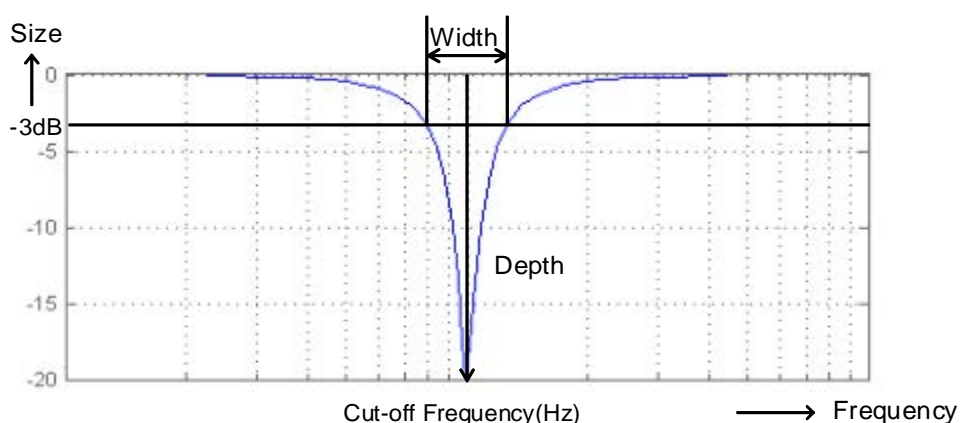

■ Related Objects

Index	Sub Index	Name	Variable Type	Accessibility	PDO Assignment	Unit
0x2501	-	Notch Filter 1 Frequency	UINT	RW	No	Hz
0x2502	-	Notch Filter 1 Width	UINT	RW	No	-
0x2503	-	Notch Filter 1 Depth	UINT	RW	No	-
0x2504	-	Notch Filter 2 Frequency	UINT	RW	No	Hz
0x2505	-	Notch Filter 2 Width	UINT	RW	No	-
0x2506	-	Notch Filter 2 Depth	UINT	RW	No	-
0x2507	-	Notch Filter 3 Frequency	UINT	RW	No	Hz
0x2508	-	Notch Filter 3 Width	UINT	RW	No	-
0x2509	-	Notch Filter 3 Depth	UINT	RW	No	-
0x250A	-	Notch Filter 4 Frequency	UINT	RW	No	Hz
0x250B	-	Notch Filter 4 Width	UINT	RW	No	-
0x250C	-	Notch Filter 4 Depth	UINT	RW	No	-

■ Resonance Frequency Measurement Using Drive CM

- If a resonance frequency occurs in a specific state during motor operation as shown below, you can measure the resonance frequency by using the FFT function in Drive CM.

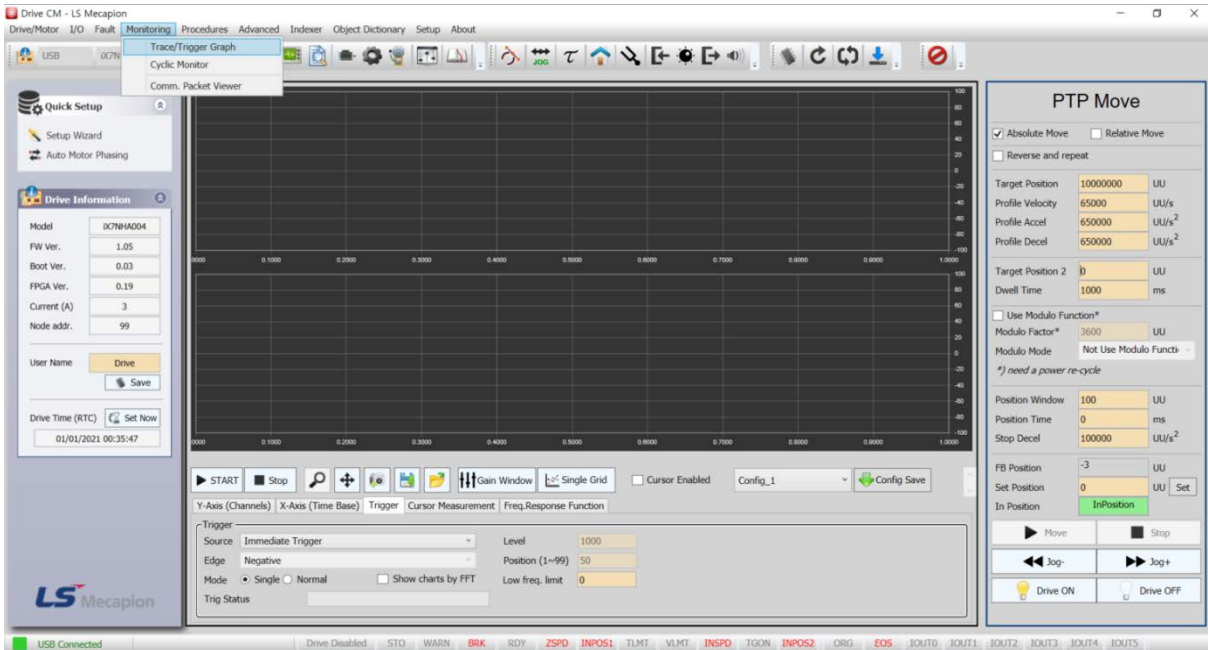
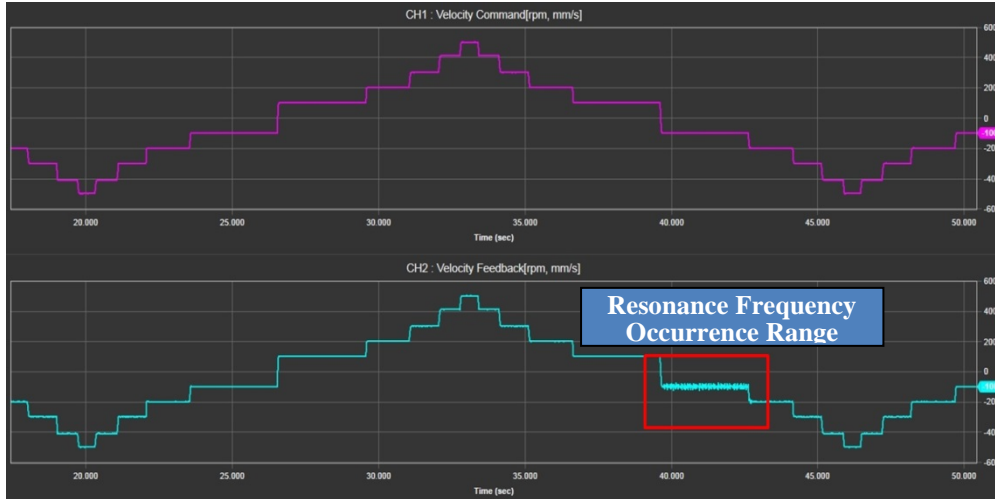

- (1) Run the Drive CM program and connect it to the servo drive.
 - (2) Under the Monitoring tab, select Trace/Trigger Graph.
 - (3) Under the bottom tab, select Y-Axis (Channels).
- Assign Velocity Feedback to the Ch1 channel.

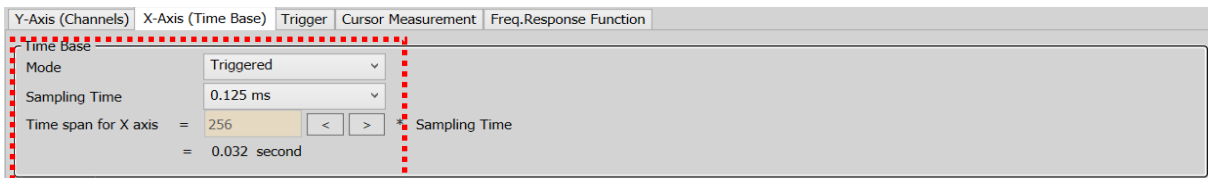

(4) Under the bottom tab, select X-Axes (Time Base).

- Mode: Select Triggered.

- Sampling Time: Set 0.125ms.

- Time span for X-axis: Enter 1024. (If measurement is difficult due to a short movement distance, enter 256.)

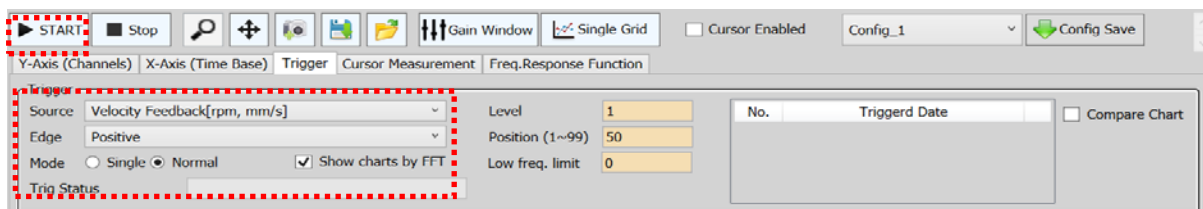

(5) Under the bottom tab, select Trigger.

- Source: Select Velocity Feedback.

- Mode: Select Normal.

- Check Show charts by FFT.

- Set Level and Edge according to the conditions of resonance occurrence.

(6) Click the START button to view the real-time frequency analysis results for the resonance occurrence range (while the motor is operating).

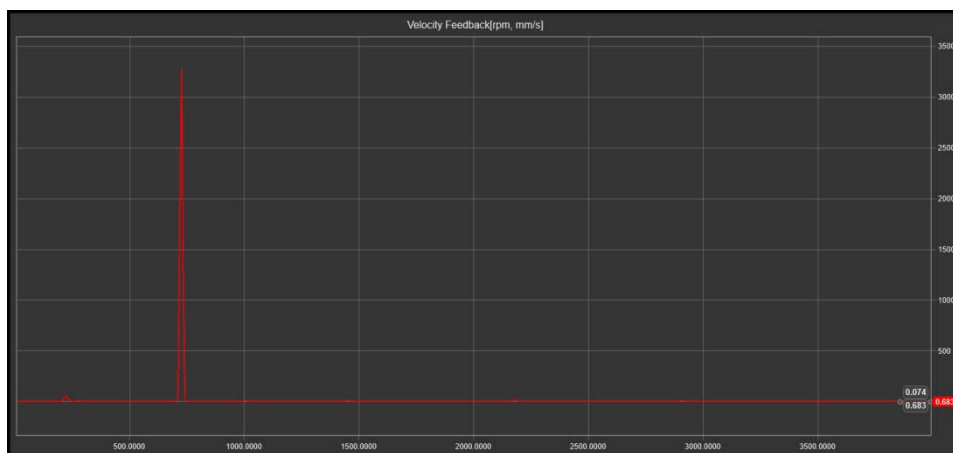

<If resonance frequency is observed>

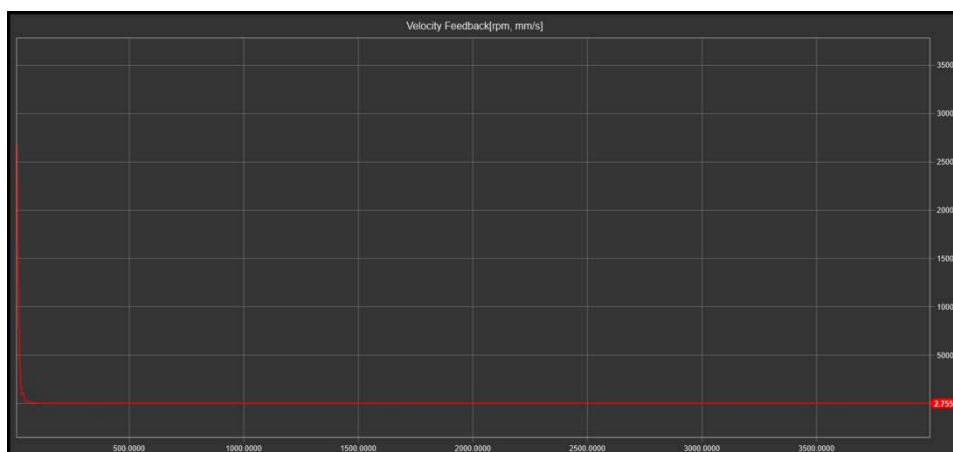

<If resonance frequency is not observed or has been removed>

(7) Check the observed resonance frequency and set notch filter frequency to the same value.

Increase the setting values slowly for width and depth of the notch filter and check that the resonance frequency is removed.

8.4.2 Adaptive Filter

Using speed feedback signals, the adaptive filter provides real-time analyses of the vibration frequency generated from the load during drive operation, and configures the notch filter automatically to reduce vibration.

It can detect vibration frequencies through frequency analysis in order to automatically configure one or two notch filters. At this time, frequency, width, and depth are automatically set.

The adaptive filter only operates above the resonance frequency of 500Hz. When the resonance frequency is below 500Hz, manually enter the notch filter value.

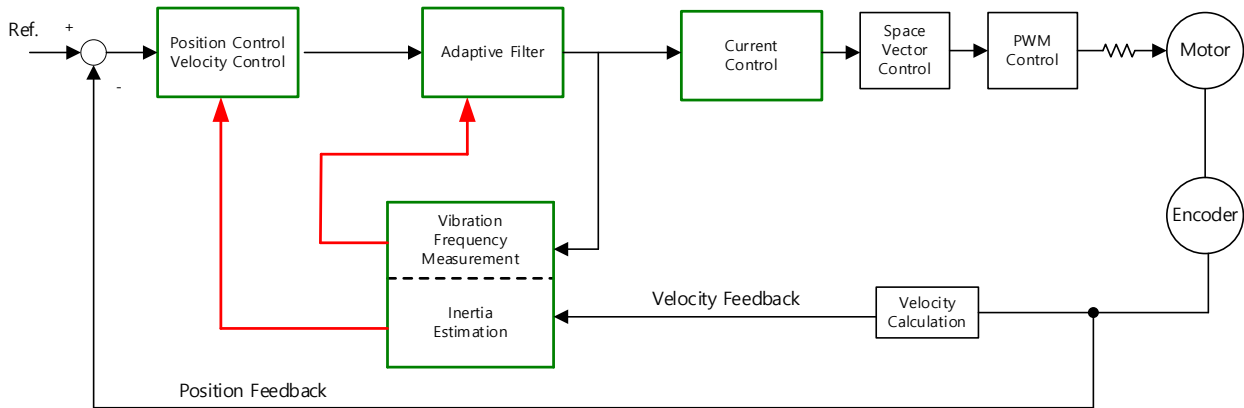

■ Related Objects

Index	Sub Index	Name	Variable Type	Accessibility	PDO Assignment	Unit
0x2500	-	Adaptive Filter Function Select	UINT	RW	No	-

- Adaptive Filter Function Select (0x2500)

Setting value	Setting Details
0	The adaptive filter is not used
1	Only one adaptive filter is used. You can check the settings configured automatically in the notch filter 3 settings (0x2507, 0x2508, 0x2509). If an arbitrary value is set in notch filter 3, auto setting is not available. If you wish to use auto setting, you should initialize notch filter 3 first.
2	Two adaptive filters are used. You can check the settings configured automatically in the Notch Filter 3 (0x2507, 0x2508, 0x2509) and Filter 4 settings (0x250A, 0x250B, 0x250C).

	If an arbitrary value is set for notch filter 3 (or 4), auto setting is applied to notch filter 4 (or 3). If arbitrary values are set for notch filter 3 and 4, the original settings remain unchanged. If notch filter 3 and 4 are initialized, auto setting is available.
3	Reserved
4	Resets the Notch Filter 3 (0x2507, 0x2508, and 0x2509) and Notch Filter 4 (0x250A, 0x250B, and 0x250C) settings.
5	Reserved

8.4.3 Vibration Suppression Filter

The vibration suppression filter is a function used to reduce vibration generated in the load side.

It can measure the vibration frequency occurring in the load side through external sensors or using the response function. This drive provides a vibration suppression filter in two levels, and you can set the frequency and damping amount for each filter.

It controls the lower frequency range, i.e. 1 [Hz]~100 [Hz], from the upper part of the device or the entire system, and operates only in the position control mode.

You need to set the vibration suppression filter after adjusting gain. Also, be sure to stop the servo motor when changing a related object. Attempting to change during motor operation can result in a malfunction.

If the remaining vibration at the end of servo motor is small, estimation may not be performed properly.

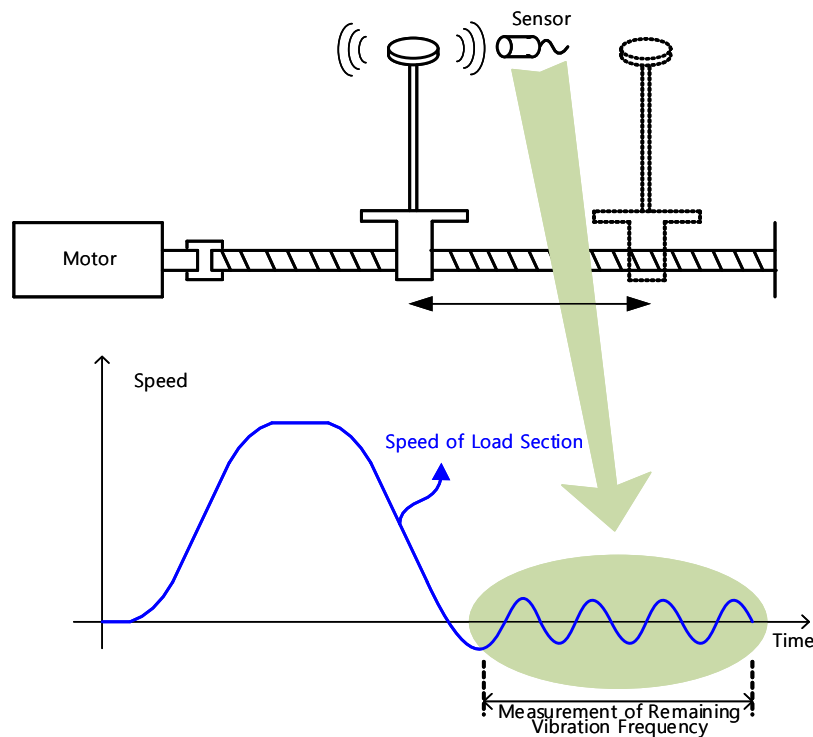

■ Related Objects

Index	Sub Index	Name	Variable Type	Accessibility	PDO Assignment	Unit
0x2515	-	Vibration Suppression Filter Configuration	UINT	RW	No	-
0x2516	-	Vibration Suppression Filter 1 Frequency	UINT	RW	No	0.1[Hz]
0x2517	-	Vibration Suppression Filter 1 Damping	UINT	RW	No	-
0x2518	-	Vibration Suppression Filter 2 Frequency	UINT	RW	No	0.1[Hz]
0x2519	-	Vibration Suppression Filter 2 Damping	UINT	RW	No	-

- Vibration Suppression Filter Function Setting (0x2515)

Setting Value	Setting Details
0	Vibration suppression (damping) filter is not used.
1	Vibration suppression (damping) filter 1 is applied
2	Vibration suppression (damping) filter 2 is applied
3	Vibration suppression (damping) filters 1 and 2 are used.
4	Vibration suppression (damping) filters 1 and 2 are used according to LVSF1 and LVSF2 inputs.

■ Vibration Frequency Measurement Using Drive CM

- This function must only be used when the device is not in operation. If the function is used while the device is operating, the motor will malfunction.

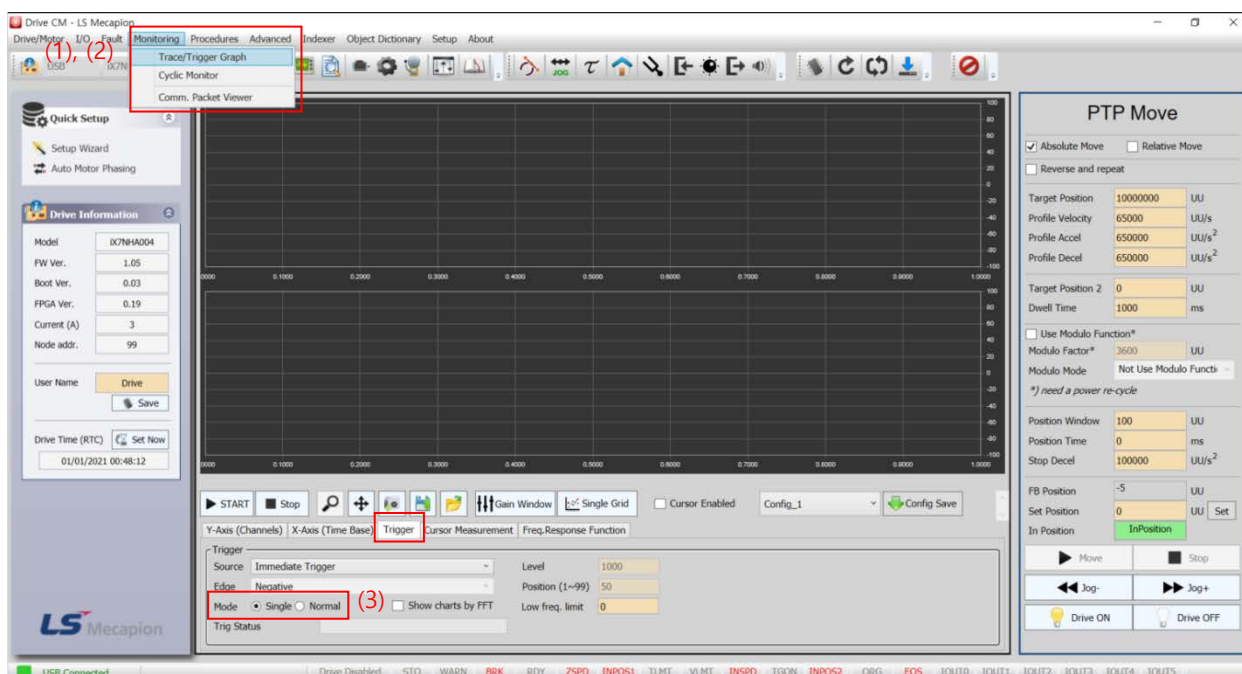

(1) Run the Drive CM program and connect it to the servo drive.

(2) Under the Monitoring tab, select Trace/Trigger Graph.

(3) Under the bottom tab, select Trigger.

- Set Mode to Single.

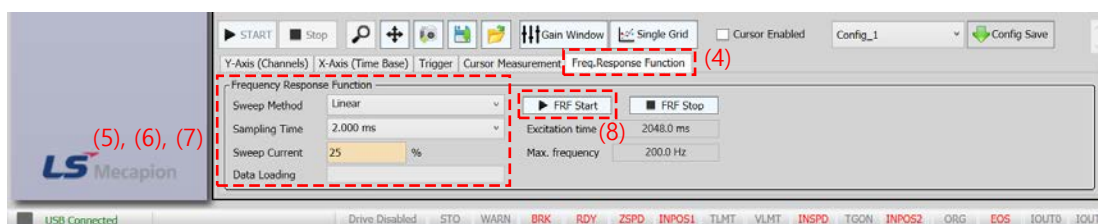

(4) Under the bottom tab, select Freq.Response Function.

(5) Sweep Method: Select Linear.

- (6) Sampling Time: Select 2.000ms.
- (7) Sweep Current: Set to 25%.
- (8) Click the FRF Start button.

- When you click the FRF Start button, a current is applied to the motor and initiates a movement. Before you press the FRF Start button, make sure to clear both ends of the device.

- After clicking the FRF Start button, check that the names of CH1-CH4 on the graph have changed.

- After clicking the FRF Start button, check if the color of the data loading bar has changed, which means that data triggering was successful.

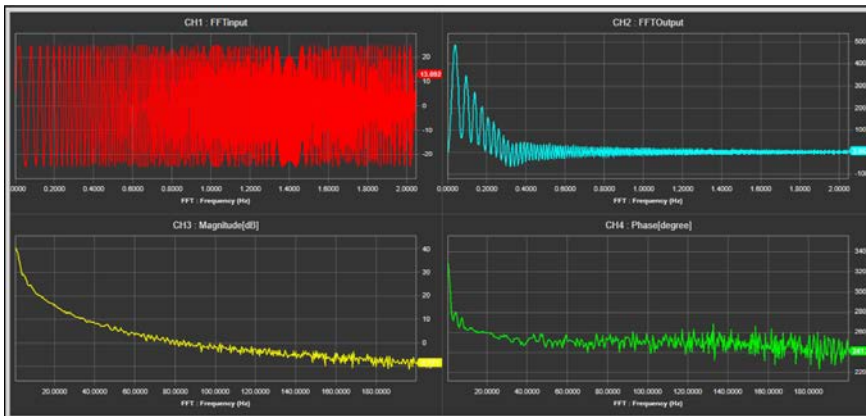

<If no vibration frequency is observed>

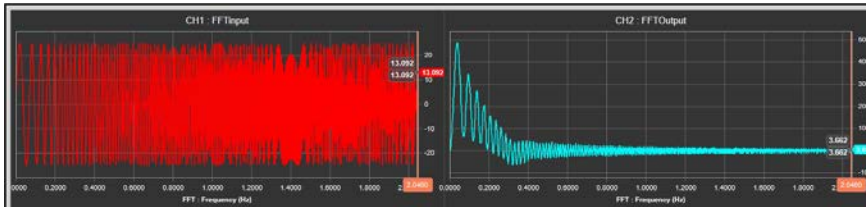

<If vibration frequency is observed>

- (9) Set the vibration suppression (damping) filter as desired and enter the observed vibration frequency value as the vibration suppression (damping) filter frequency. Increase the vibration suppression (damping) filter coefficient slowly from 1 and select an appropriate value.

If vibration frequency cannot be properly measured while using Drive CM, you need to measure vibration frequency occurring on the load side through external sensors and set the value in the object.

9. Procedure Function

Procedure function is an auxiliary function provided by the drive as described below. It can be executed by the procedure command code (0x2700) and procedure command factor (0x2701). It can be activated by using the servo setting tool.

Procedure commands	Codes	Details
Manual JOG	0x0001	Operates manual JOG
Program JOG	0x0002	Operates program JOG
Alarm History Reset	0x0003	Deletes alarm history
Off-Line Auto-Tuning	0x0004	Performs off-line auto-tuning
Index Pulse Search	0x0005	Searches for Phase Z position
Absolute Encoder Reset	0x0006	Resets the absolute encoder
Max. Load Torque Clear	0x0007	Resets the instantaneous maximum operation overload (0x2604) value
Calibrate Phase Current Offset	0x0008	Tunes the phase current offset
Software Reset	0x0009	Resets the software
Commutation	0x000A	Commutation
Tamagawa Encoder Reset	0x000B	Resets Tamagawa encoder
GB Preset	0x000D	Resets GB encoder

9.1 Manual Jog Operation

Jog operation is a function that verifies servo motor operation by velocity control without an upper level controller.

Before you start jog operation, confirm the following.

- The main power is turned on
- The STO (Safe Torque Off) connector is connected;
- No alarm is active
- The servo is turned off
- The operation velocity is set in consideration of the state of the apparatus

■ Related Objects

Index	Sub Index	Name	Variable Type	Accessibility	PDO Assignment	Unit
0x2300	-	Jog Operation Speed	INT	RW	No	rpm
0x2301	-	Speed Command Acceleration Time	UINT	RW	No	ms
0x2302	-	Speed Command Deceleration Time	UINT	RW	No	ms
0x2303	-	Speed Command S-curve Time	UINT	RW	No	ms

9.2 Program Jog Operation

Program jog operation is a function that verifies servo motor operation by velocity control at predefined operation velocity and time without an upper level controller.

Before you start jog operation, confirm the following.

- The main power is turned on
- The STO (Safe Torque Off) connector is connected;
- No alarm is active
- The servo is turned off
- Velocity and time are set in consideration of the state and operation range of the apparatus

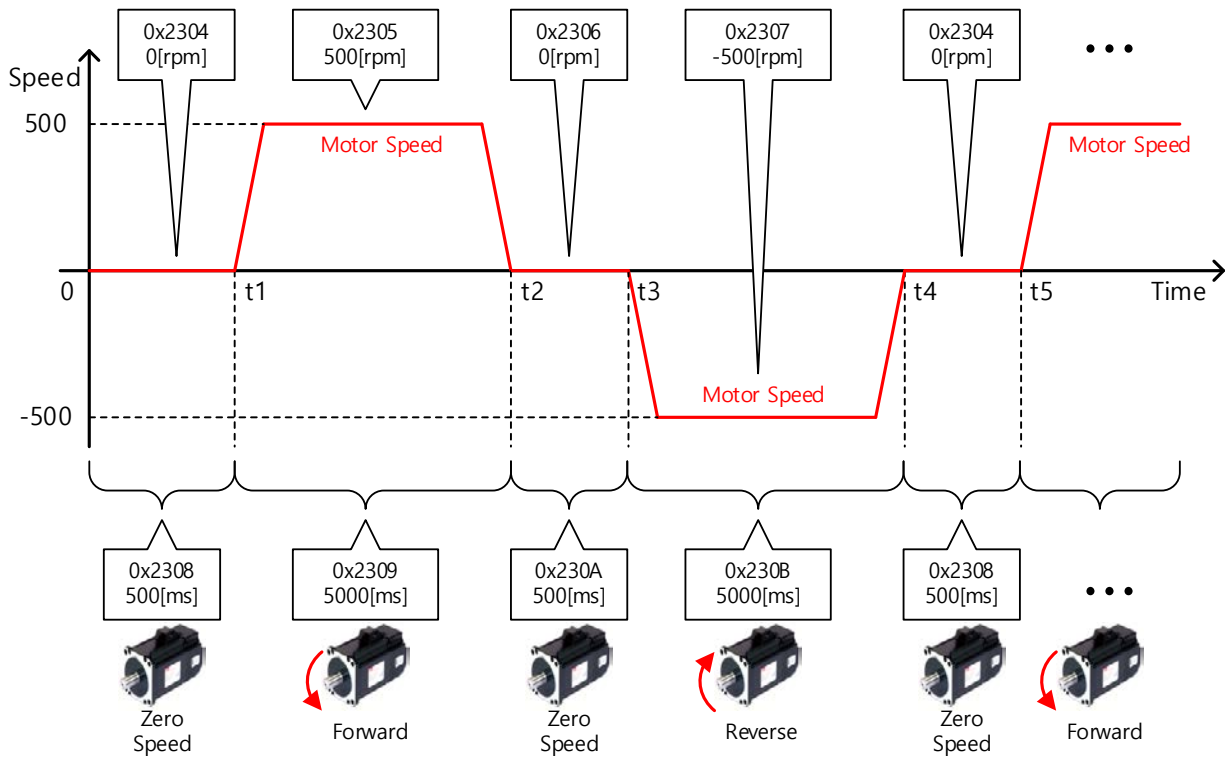

■ Related Objects

Index	Sub Index	Name	Variable Type	Accessibility	PDO Assignment	Unit
0x2304	-	Program Jog Operation Speed 1	INT	RW	No	rpm
0x2305	-	Program Jog Operation Speed 2	INT	RW	No	rpm
0x2306	-	Program Jog Operation Speed 3	INT	RW	No	rpm
0x2307	-	Program Jog Operation Speed 4	INT	RW	No	rpm
0x2308	-	Program Jog Operation Time 1	UINT	RW	No	ms
0x2309	-	Program Jog Operation Time 2	UINT	RW	No	ms
0x230A	-	Program Jog Operation Time 3	UINT	RW	No	ms
0x230B	-	Program Jog Operation Time 4	UINT	RW	No	ms

9.3 Deleting Alarm History

This function deletes all the alarm code histories stored in the drive. Alarm histories including the latest alarm history up to the 16th previous alarm are stored.

You can check the histories as shown below (0x2702:01~16). The latest alarm is listed in 0x2702:01.

2702:0	Servo Alarm History	RO	> 16 <
2702:01	Alarm code 1(Newest)	RO	[51]POS following
2702:02	Alarm code 2	RO	[51]POS following
2702:03	Alarm code 3	RO	[51]POS following
2702:04	Alarm code 4	RO	[51]POS following
2702:05	Alarm code 5	RO	[51]POS following
2702:06	Alarm code 6	RO	[51]POS following
2702:07	Alarm code 7	RO	[51]POS following
2702:08	Alarm code 8	RO	[51]POS following
2702:09	Alarm code 9	RO	[51]POS following
2702:0A	Alarm code 10	RO	[51]POS following
2702:0B	Alarm code 11	RO	[51]POS following
2702:0C	Alarm code 12	RO	[51]POS following
2702:0D	Alarm code 13	RO	[51]POS following
2702:0E	Alarm code 14	RO	[51]POS following
2702:0F	Alarm code 15	RO	[51]POS following
2702:10	Alarm code 16(Oldest)	RO	[51]POS following

■ Related Objects

Index	Sub Index	Name	Variable Type	Accessibility	PDO Assignment	Unit
0x2702	-	Servo Alarm History	-	-	-	-
	1	Alarm code 1(newest)	STRING	RO	No	-
	2	Alarm code 2	STRING	RO	No	-
	3	Alarm code 3	STRING	RO	No	-
	4	Alarm code 4	STRING	RO	No	-
	5	Alarm code 5	STRING	RO	No	-
	6	Alarm code 6	STRING	RO	No	-
	7	Alarm code 7	STRING	RO	No	-
	8	Alarm code 8	STRING	RO	No	-
	9	Alarm code 9	STRING	RO	No	-
	10	Alarm code 10	STRING	RO	No	-
	11	Alarm code 11	STRING	RO	No	-
	12	Alarm code 12	STRING	RO	No	-
	13	Alarm code 13	STRING	RO	No	-
	14	Alarm code 14	STRING	RO	No	-
	15	Alarm code 15	STRING	RO	No	-
16	Alarm code 16(oldest)	STRING	RO	No	-	

9.4 Automatic Gain Tuning

For more information, refer to Section 8.1 Auto Gain Tuning.

9.5 Index Pulse Search

Index pulse search is a function used to find the index (Z) pulse position of the encoder and bring the index to a stop. You can use this function to roughly locate a position since it searches for a position using the Velocity Mode. You can locate the exact position of the index pulse using the homing operation.

You can set the velocity used to search for index pulses in 0x230C [rpm].

Before you start index pulse search, confirm the following.

- The main power is turned on
- No alarm is active
- The servo is turned off
- the Safe Torque Off (STO) connector is installed; and
- Operation velocity is set in consideration of the operation range of the machine.

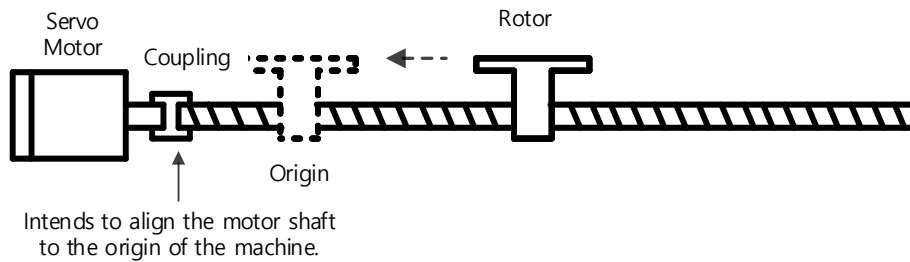

■ Related Objects

Index	Sub Index	Name	Variable Type	Accessibility	PDO Assignment	Unit
0x230C	-	Index Pulse Search Speed	INT	RW	No	rpm

9.6 Absolute Encoder Reset

This function resets the absolute encoder. The following are the situations where you need to reset the absolute encoder.

- To set up the apparatus for the first time
- When an alarm occurs for low voltage of the encoder
- To set multi-turn data of the absolute encoder to 0

When the absolute encoder reset is complete, the multi-turn data (0x260A) is reset to 0.

When the power is turned on again, the Position Actual Value (0x6064) is displayed by reading the position of the absolute encoder and applying the home offset (0x607C).

At the time, even if you change the home offset (0x607C) while driving, the position actual value (0x6064) does not change.

■ Related Objects

Index	Sub Index	Name	Variable Type	Accessibility	PDO Assignment	Unit
0x2005	-	Absolute Encoder Configuration	UINT	RW	No	-
0x260A		Multi-turn data	DINT	RO	Yes	rev

9.7 Instantaneous Maximum Torque Reset

This function resets the instantaneous maximum overload rate (0x2604) to 0. The instantaneous maximum operation overload rate represents the maximum value of the operation overload rate output instantaneously from the drive for the last 15 seconds.

It displays the peak load for the last 15 seconds as a percentage of the rated output. The unit is [0.1%]. Turning on the power again resets the value to 0.

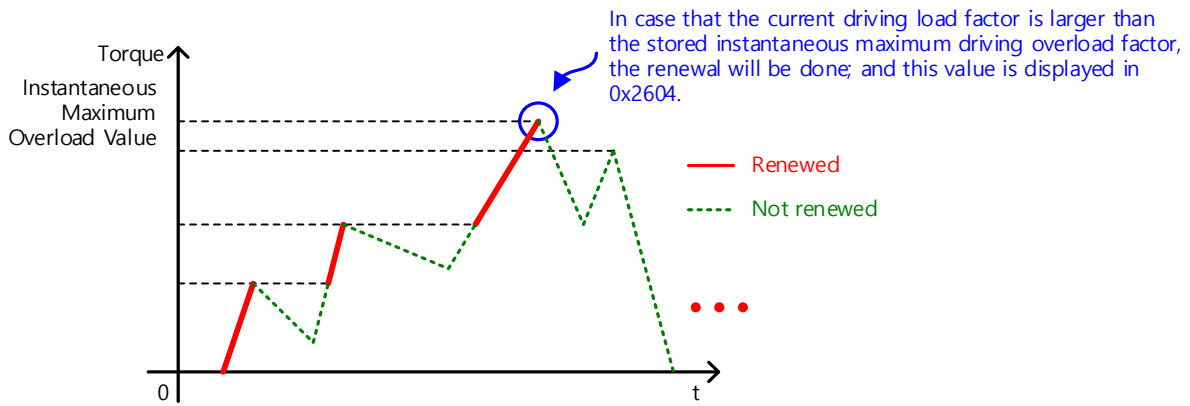

■ Related Objects

Index	Sub Index	Name	Variable Type	Accessibility	PDO Assignment	Unit
0x2604	-	Instantaneous Maximum Operation Overload	INT	RO	Yes	0.1%

9.8 Phase Current Offset Tuning

This function automatically tunes the current offset of the U/V/W phases. You can tune the phase current offset according to the environmental condition for use. The device is shipped with its factory default setting.

The measured U/V/W phase offsets are individually stored in 0x2015, 0x2016, and 0x2017. If an offset value is abnormally large, AL-15 is generated.

■ Related Objects

Index	Sub Index	Name	Variable Type	Accessibility	PDO Assignment	Unit
0x2015	-	U Phase Current Offset	INT	RW	No	0.1%
0x2016	-	V Phase Current Offset	INT	RW	No	0.1%
0x2017	-	W Phase Current Offset	INT	RW	No	0.1%

9.9 Software Reset

This function is used to reset the servo drive by means of software. Software reset means a restart of the drive program, which results in an effect similar to re-applying the power.

You can use this function in the following cases.

- Parameter settings which require re-application of the power have been changed
- The drive needs a re-start due to an alarm which cannot be reset

9.10 Commutation

The commutation function is used to get the information of the initial angle of the motor. When you use a motor with the hall sensor not installed, you have to get the information on the initial angle through commutation prior to operation, in order to carry out normal operation.

■ Related Objects

Index	Sub Index	Name	Variable Type	Accessibility	PDO Assignment	Unit
0x2019	-	Linear Scale Resolution	UINT	RW	No	nm
0x201A	-	Commutation Method	UINT	RW	No	-
0x201B	-	Commutation Current	UINT	RW	No	0.1%
0x201C	-	Commutation Time	UINT	RW	No	ms

9.11 Encoder Reset

This is the function to reset the 19bit Multiturn encoder among our servo motor products.

It is used when the encoder position loss alarm occurs. If this function is executed normally, you can perform software reset.

If you have used this function, make sure to perform homing operation.

10. Object Dictionary

Object is a data structure which includes parameters, state variables, run commands (procedures), etc. of the drive.

Object can be mainly divided into general object (from 0x1000) for EtherCAT communication, CiA402 object (from 0x6000) for CAN application over EtherCAT (CoE), and manufacturer specific object (from 0x2000) exclusively provided by this drive.

10.1 General Objects

0x1000		Device Type					
Variable Type	Setting Range	Initial Value	Unit	Accessibility	PDO Assignment	Variable Attribute	Saving
UDINT	-	0x00020192	-	RO	No	-	No

The following table lists device types and their functions.

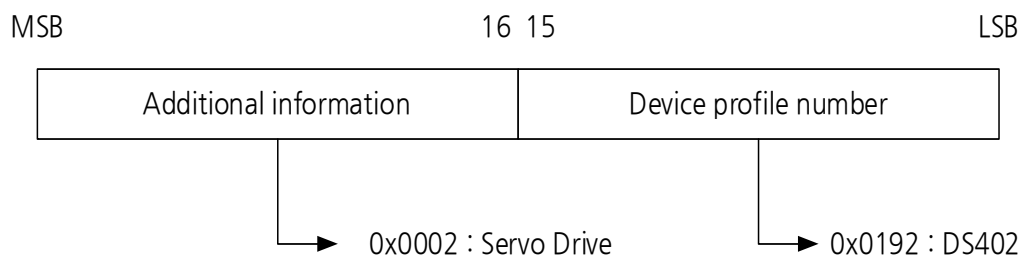

0x1001		Error Register					
Variable Type	Setting Range	Initial Value	Unit	Accessibility	PDO Assignment	Variable Attribute	Saving
USINT	-	0x00	-	RO	No	-	No

The following table shows the error register values for each device. This value is stored in the emergency message.

Bits	Setting Details
0	0: No error
	1: Error occurs
1 to 7	Reserved

0x1008		Device Name					
Variable Type	Setting Range	Initial Value	Unit	Accessibility	PDO Assignment	Variable Attribute	Saving
STRING	-	-	-	RO	No	-	No

Represents the device name.

0x1009		Hardware Version					
Variable Type	Setting Range	Initial Value	Unit	Accessibility	PDO Assignment	Variable Attribute	Saving
STRING	-	-	-	RO	No	-	No

Represents the hardware version of the device.

0x100A		Software Version					
Variable Type	Setting Range	Initial Value	Unit	Accessibility	PDO Assignment	Variable Attribute	Saving
STRING	-	-	-	RO	No	-	No

This parameter represents the software version of the device.

0x1010		Store Parameters					
SubIndex 0		Number of Entries					
Variable Type	Setting Range	Initial Value	Unit	Accessibility	PDO Assignment	Variable Attribute	Saving
USINT	-	4	-	RO	No	-	No
SubIndex 1		Store all parameters					
Variable Type	Setting Range	Initial Value	Unit	Accessibility	PDO Assignment	Variable Attribute	Saving
UDINT	0 to 0xFFFFFFFF	0	-	RW	No	-	No
SubIndex 2		Store communication parameters					
Variable Type	Setting Range	Initial Value	Unit	Accessibility	PDO Assignment	Variable Attribute	Saving
UDINT	0 to 0xFFFFFFFF	0	-	RW	No	-	No
SubIndex 3		Store CiA402 parameters					
Variable Type	Setting Range	Initial Value	Unit	Accessibility	PDO Assignment	Variable Attribute	Saving
UDINT	0 to 0xFFFFFFFF	0	-	RW	No	-	No
SubIndex 4		Store drive-specific parameters					
Variable Type	Setting Range	Initial Value	Unit	Accessibility	PDO Assignment	Variable Attribute	Saving
UDINT	0 to 0xFFFFFFFF	0	-	RW	No	-	No

Store the drive's parameters in the memory. To avoid any mistake, store the parameters if the ASCII code value corresponding to 'save' is written to the relevant SubIndex value.

	MSB	16	15	LSB
	e	v	a	s
ASCII Code	0x65	0x76	0x61	0x73

All parameters within the drive are stored when "save" is written to SubIndex 1.

Only communication parameters (from 0x1000) are stored when "save" is written to SubIndex 2.

Only CiA402 parameters (from 0x6000) are stored when "save" is written to SubIndex 3.

Only drive-specific parameters (from 0x2000) are stored when "save" is written to SubIndex 4.

0x1011		Restore Default Parameters					
SubIndex 0		Number of Entries					
Variable Type	Setting Range	Initial Value	Unit	Accessibility	PDO Assignment	Variable Attribute	Saving
USINT	-	4	-	RO	No	-	No
SubIndex 1		Restore all parameters					
Variable Type	Setting Range	Initial Value	Unit	Accessibility	PDO Assignment	Variable Attribute	Saving
UDINT	0 to 0xFFFFFFFF	0	-	RW	No	-	No
SubIndex 2		Restore communication parameters					
Variable Type	Setting Range	Initial Value	Unit	Accessibility	PDO Assignment	Variable Attribute	Saving
UDINT	0 to 0xFFFFFFFF	0	-	RW	No	-	No
SubIndex 3		Restore CiA402 parameters					
Variable Type	Setting Range	Initial Value	Unit	Accessibility	PDO Assignment	Variable Attribute	Saving
UDINT	0 to 0xFFFFFFFF	0	-	RW	No	-	No
SubIndex 4		Restore drive-specific parameters					
Variable Type	Setting Range	Initial Value	Unit	Accessibility	PDO Assignment	Variable Attribute	Saving
UDINT	0 to 0xFFFFFFFF	0	-	RW	No	-	No

Initialize the drive's parameters. To avoid any mistake, initialize the parameters if the ASCII code value corresponding to 'load' is written to the relevant SubIndex value.

	MSB	16	15	LSB
	d	a	o	l
ASCII Code	0x64	0x61	0x6F	0x6C

All parameters within the drive are initialized when "load" is written to SubIndex 1.

Only communication parameters (from 0x1000) are initialized when "load" is written to SubIndex 2.

Only CiA402 parameters (from 0x6000) are initialized when "load" is written to SubIndex 3.

Only drive-specific parameters (from 0x2000) are initialized when "load" is written to SubIndex 4.

To apply the initialized value, you need to cycle the power of the drive.

0x1018		Identity Object					
SubIndex 0		Number of Entries					
Variable Type	Setting Range	Initial Value	Unit	Accessibility	PDO Assignment	Variable Attribute	Saving
USINT	-	4	-	RO	No	-	No
SubIndex 1		Vendor ID					
Variable Type	Setting Range	Initial Value	Unit	Accessibility	PDO Assignment	Variable Attribute	Saving
UDINT	-	0x00007595	-	RO	No	-	No
SubIndex 2		Product code					
Variable Type	Setting Range	Initial Value	Unit	Accessibility	PDO Assignment	Variable Attribute	Saving
UDINT	-	0x00010001	-	RO	No	-	No
SubIndex 3		Revision number					
Variable Type	Setting Range	Initial Value	Unit	Accessibility	PDO Assignment	Variable Attribute	Saving
UDINT	-	-	-	RO	No	-	No
SubIndex 4		Serial number					
Variable Type	Setting Range	Initial Value	Unit	Accessibility	PDO Assignment	Variable Attribute	Saving
UDINT	-	-	-	RO	No	-	No

Represents the device information.

0x1600		1 st Receive PDO Mapping						
SubIndex 0		Number of entries						
Variable Type	Setting Range	Initial Value	Unit	Accessibility	PDO Assignment	Variable Attribute	Saving	
USINT	0 to 10	5	-	RW	No	PREOP	Yes	
SubIndex 1		Mapping entry 1						
Variable Type	Setting Range	Initial Value	Unit	Accessibility	PDO Assignment	Variable Attribute	Saving	
UDINT	0 to 0xFFFFFFFF	0x60400010	-	RW	No	PREOP	Yes	
SubIndex 2		Mapping entry 2						
Variable Type	Setting Range	Initial Value	Unit	Accessibility	PDO Assignment	Variable Attribute	Saving	
UDINT	0 to 0xFFFFFFFF	0x60710010	-	RW	No	PREOP	Yes	
SubIndex 3		Mapping entry 3						
Variable Type	Setting Range	Initial Value	Unit	Accessibility	PDO Assignment	Variable Attribute	Saving	
UDINT	0 to 0xFFFFFFFF	0x607A0020	-	RW	No	PREOP	Yes	
SubIndex 4		Mapping entry 4						
Variable Type	Setting Range	Initial Value	Unit	Accessibility	PDO Assignment	Variable Attribute	Saving	
UDINT	0 to 0xFFFFFFFF	0x60600008	-	RW	No	PREOP	Yes	
SubIndex 5		Mapping entry 5						
Variable Type	Setting Range	Initial Value	Unit	Accessibility	PDO Assignment	Variable Attribute	Saving	
UDINT	0 to 0xFFFFFFFF	0x60B80010	-	RW	No	PREOP	Yes	
SubIndex 6		Mapping entry 6						
Variable Type	Setting Range	Initial Value	Unit	Accessibility	PDO Assignment	Variable Attribute	Saving	
UDINT	0 to 0xFFFFFFFF	-	-	RW	No	PREOP	Yes	
SubIndex 7		Mapping entry 7						
Variable Type	Setting Range	Initial Value	Unit	Accessibility	PDO Assignment	Variable Attribute	Saving	
UDINT	0 to 0xFFFFFFFF	-	-	RW	No	PREOP	Yes	
SubIndex 8		Mapping entry 8						
Variable Type	Setting Range	Initial Value	Unit	Accessibility	PDO Assignment	Variable Attribute	Saving	
UDINT	0 to 0xFFFFFFFF	-	-	RW	No	PREOP	Yes	
SubIndex 9		Mapping entry 9						
Variable Type	Setting Range	Initial Value	Unit	Accessibility	PDO Assignment	Variable Attribute	Saving	
UDINT	0 to 0xFFFFFFFF	-	-	RW	No	PREOP	Yes	
SubIndex 10		Mapping entry 10						
Variable Type	Setting Range	Initial Value	Unit	Accessibility	PDO Assignment	Variable Attribute	Saving	
UDINT	0 to 0xFFFFFFFF	-	-	RW	No	PREOP	Yes	

PDO Mapping :

Set the Process Data Objects (PDO) to perform real-time data transfer through the CANopen over EtherCAT protocol. This drive can freely map up to 10 objects of PDOs for transmission/reception, respectively.

Use 0x1600 - 0x1603 to set the receive PDO mapping, and 0x1A00 - 0x1A03 to set the transmit PDO mapping. Set information about the objects below that you want to assign to entries 1 to 10 (SubIndex 1 - 10). You have to set the number of the objects to be assigned for the number of entries (SubIndex 0).

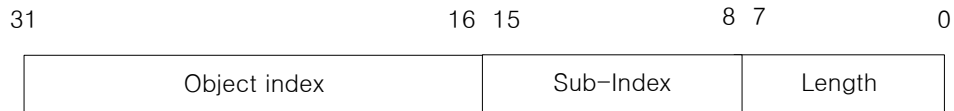

Bit 0-7: Bit lengths of objects to be mapped (e.g. displayed as 0x20 for 32-bit data)

Bits 8-15: SubIndex of objects to be mapped

Bits 16-31: Index of objects to be mapped

0x1601	2nd Receive PDO Mapping						
SubIndex 0		Number of entries					
Variable Type	Setting Range	Initial Value	Unit	Accessibility	PDO Assignment	Variable Attribute	Saving
USINT	0 to 10	4	-	RW	No	PREOP	Yes
SubIndex 1		Mapping entry 1					
Variable Type	Setting Range	Initial Value	Unit	Accessibility	PDO Assignment	Variable Attribute	Saving
UDINT	0 to 0xFFFFFFFF	0x60400010	-	RW	No	PREOP	Yes
SubIndex 2		Mapping entry 2					
Variable Type	Setting Range	Initial Value	Unit	Accessibility	PDO Assignment	Variable Attribute	Saving
UDINT	0 to 0xFFFFFFFF	0x607A0020	-	RW	No	PREOP	Yes
SubIndex 3		Mapping entry 3					
Variable Type	Setting Range	Initial Value	Unit	Accessibility	PDO Assignment	Variable Attribute	Saving
UDINT	0 to 0xFFFFFFFF	0x60B80010	-	RW	No	PREOP	Yes
SubIndex 4		Mapping entry 4					
Variable Type	Setting Range	Initial Value	Unit	Accessibility	PDO Assignment	Variable Attribute	Saving
UDINT	0 to 0xFFFFFFFF	0x60FE0120	-	RW	No	PREOP	Yes
SubIndex 5		Mapping entry 5					
Variable Type	Setting Range	Initial Value	Unit	Accessibility	PDO Assignment	Variable Attribute	Saving
UDINT	0 to 0xFFFFFFFF	-	-	RW	No	PREOP	Yes
SubIndex 6		Mapping entry 6					
Variable Type	Setting Range	Initial Value	Unit	Accessibility	PDO Assignment	Variable Attribute	Saving
UDINT	0 to 0xFFFFFFFF	-	-	RW	No	PREOP	Yes
SubIndex 7		Mapping entry 7					
Variable Type	Setting Range	Initial Value	Unit	Accessibility	PDO Assignment	Variable Attribute	Saving

UDINT	0 to 0xFFFFFFFF	-	-	RW	No	PREOP	Yes
SubIndex 8		Mapping entry 8					
Variable Type	Setting Range	Initial Value	Unit	Accessibility	PDO Assignment	Variable Attribute	Saving
UDINT	0 to 0xFFFFFFFF	-	-	RW	No	PREOP	Yes
SubIndex 9		Mapping entry 9					
Variable Type	Setting Range	Initial Value	Unit	Accessibility	PDO Assignment	Variable Attribute	Saving
UDINT	0 to 0xFFFFFFFF	-	-	RW	No	PREOP	Yes
SubIndex 10		Mapping entry 10					
Variable Type	Setting Range	Initial Value	Unit	Accessibility	PDO Assignment	Variable Attribute	Saving
UDINT	0 to 0xFFFFFFFF	-	-	RW	No	PREOP	Yes

Refer to the description of 0x1600.

0x1602	3rd Receive PDO Mapping						
SubIndex 0		Number of entries					
Variable Type	Setting Range	Initial Value	Unit	Accessibility	PDO Assignment	Variable Attribute	Saving
USINT	0 to 10	4	-	RW	No	PREOP	Yes
SubIndex 1		Mapping entry 1					
Variable Type	Setting Range	Initial Value	Unit	Accessibility	PDO Assignment	Variable Attribute	Saving
UDINT	0 to 0xFFFFFFFF	0x60400010	-	RW	No	PREOP	Yes
SubIndex 2		Mapping entry 2					
Variable Type	Setting Range	Initial Value	Unit	Accessibility	PDO Assignment	Variable Attribute	Saving
UDINT	0 to 0xFFFFFFFF	0x60FF0020	-	RW	No	PREOP	Yes
SubIndex 3		Mapping entry 3					
Variable Type	Setting Range	Initial Value	Unit	Accessibility	PDO Assignment	Variable Attribute	Saving
UDINT	0 to 0xFFFFFFFF	0x60B80010	-	RW	No	PREOP	Yes
SubIndex 4		Mapping entry 4					
Variable Type	Setting Range	Initial Value	Unit	Accessibility	PDO Assignment	Variable Attribute	Saving
UDINT	0 to 0xFFFFFFFF	0x60FE0120	-	RW	No	PREOP	Yes
SubIndex 5		Mapping entry 5					
Variable Type	Setting Range	Initial Value	Unit	Accessibility	PDO Assignment	Variable Attribute	Saving
UDINT	0 to 0xFFFFFFFF	-	-	RW	No	PREOP	Yes
SubIndex 6		Mapping entry 6					
Variable Type	Setting Range	Initial Value	Unit	Accessibility	PDO Assignment	Variable Attribute	Saving
UDINT	0 to 0xFFFFFFFF	-	-	RW	No	PREOP	Yes

SubIndex 7		Mapping entry 7					
Variable Type	Setting Range	Initial Value	Unit	Accessibility	PDO Assignment	Variable Attribute	Saving
UDINT	0 to 0xFFFFFFFF	-	-	RW	No	PREOP	Yes
SubIndex 8		Mapping entry 8					
Variable Type	Setting Range	Initial Value	Unit	Accessibility	PDO Assignment	Variable Attribute	Saving
UDINT	0 to 0xFFFFFFFF	-	-	RW	No	PREOP	Yes
SubIndex 9		Mapping entry 9					
Variable Type	Setting Range	Initial Value	Unit	Accessibility	PDO Assignment	Variable Attribute	Saving
UDINT	0 to 0xFFFFFFFF	-	-	RW	No	PREOP	Yes
SubIndex 10		Mapping entry 10					
Variable Type	Setting Range	Initial Value	Unit	Accessibility	PDO Assignment	Variable Attribute	Saving
UDINT	0 to 0xFFFFFFFF	-	-	RW	No	PREOP	Yes

Refer to the description of 0x1600.

0x1603		4th Receive PDO Mapping					
SubIndex 0		Number of entries					
Variable Type	Setting Range	Initial Value	Unit	Accessibility	PDO Assignment	Variable Attribute	Saving
USINT	0 to 10	4	-	RW	No	PREOP	Yes
SubIndex 1		Mapping entry 1					
Variable Type	Setting Range	Initial Value	Unit	Accessibility	PDO Assignment	Variable Attribute	Saving
UDINT	0 to 0xFFFFFFFF	0x60400010	-	RW	No	PREOP	Yes
SubIndex 2		Mapping entry 2					
Variable Type	Setting Range	Initial Value	Unit	Accessibility	PDO Assignment	Variable Attribute	Saving
UDINT	0 to 0xFFFFFFFF	0x60710010	-	RW	No	PREOP	Yes
SubIndex 3		Mapping entry 3					
Variable Type	Setting Range	Initial Value	Unit	Accessibility	PDO Assignment	Variable Attribute	Saving
UDINT	0 to 0xFFFFFFFF	0x60B80010	-	RW	No	PREOP	Yes
SubIndex 4		Mapping entry 4					
Variable Type	Setting Range	Initial Value	Unit	Accessibility	PDO Assignment	Variable Attribute	Saving
UDINT	0 to 0xFFFFFFFF	0x60FE0120	-	RW	No	PREOP	Yes
SubIndex 5		Mapping entry 5					
Variable Type	Setting Range	Initial Value	Unit	Accessibility	PDO Assignment	Variable Attribute	Saving
UDINT	0 to 0xFFFFFFFF	-	-	RW	No	PREOP	Yes

SubIndex 6		Mapping entry 6					
Variable Type	Setting Range	Initial Value	Unit	Accessibility	PDO Assignment	Variable Attribute	Saving
UDINT	0 to 0xFFFFFFFF	-	-	RW	No	PREOP	Yes
SubIndex 7		Mapping entry 7					
Variable Type	Setting Range	Initial Value	Unit	Accessibility	PDO Assignment	Variable Attribute	Saving
UDINT	0 to 0xFFFFFFFF	-	-	RW	No	PREOP	Yes
SubIndex 8		Mapping entry 8					
Variable Type	Setting Range	Initial Value	Unit	Accessibility	PDO Assignment	Variable Attribute	Saving
UDINT	0 to 0xFFFFFFFF	-	-	RW	No	PREOP	Yes
SubIndex 9		Mapping entry 9					
Variable Type	Setting Range	Initial Value	Unit	Accessibility	PDO Assignment	Variable Attribute	Saving
UDINT	0 to 0xFFFFFFFF	-	-	RW	No	PREOP	Yes
SubIndex 10		Mapping entry 10					
Variable Type	Setting Range	Initial Value	Unit	Accessibility	PDO Assignment	Variable Attribute	Saving
UDINT	0 to 0xFFFFFFFF	-	-	RW	No	PREOP	Yes

Refer to the description of 0x1600.

0x1A00		1 st Transmit PDO Mapping					
SubIndex 0		Number of entries					
Variable Type	Setting Range	Initial Value	Unit	Accessibility	PDO Assignment	Variable Attribute	Saving
USINT	0 to 10	10	-	RW	No	PREOP	Yes
SubIndex 1		Mapping entry 1					
Variable Type	Setting Range	Initial Value	Unit	Accessibility	PDO Assignment	Variable Attribute	Saving
UDINT	0 to 0xFFFFFFFF	0x60410010	-	RW	No	PREOP	Yes
SubIndex 2		Mapping entry 2					
Variable Type	Setting Range	Initial Value	Unit	Accessibility	PDO Assignment	Variable Attribute	Saving
UDINT	0 to 0xFFFFFFFF	0x60770010	-	RW	No	PREOP	Yes
SubIndex 3		Mapping entry 3					
Variable Type	Setting Range	Initial Value	Unit	Accessibility	PDO Assignment	Variable Attribute	Saving
UDINT	0 to 0xFFFFFFFF	0x60640020	-	RW	No	PREOP	Yes
SubIndex 4		Mapping entry 4					
Variable Type	Setting Range	Initial Value	Unit	Accessibility	PDO Assignment	Variable Attribute	Saving
UDINT	0 to 0xFFFFFFFF	0x60F40020	-	RW	No	PREOP	Yes

SubIndex 5		Mapping entry 5					
Variable Type	Setting Range	Initial Value	Unit	Accessibility	PDO Assignment	Variable Attribute	Saving
UDINT	0 to 0xFFFFFFFF	0x60FD0020	-	RW	No	PREOP	Yes
SubIndex 6		Mapping entry 6					
Variable Type	Setting Range	Initial Value	Unit	Accessibility	PDO Assignment	Variable Attribute	Saving
UDINT	0 to 0xFFFFFFFF	0x60610008	-	RW	No	PREOP	Yes
SubIndex 7		Mapping entry 7					
Variable Type	Setting Range	Initial Value	Unit	Accessibility	PDO Assignment	Variable Attribute	Saving
UDINT	0 to 0xFFFFFFFF	0x26010010	-	RW	No	PREOP	Yes
SubIndex 8		Mapping entry 8					
Variable Type	Setting Range	Initial Value	Unit	Accessibility	PDO Assignment	Variable Attribute	Saving
UDINT	0 to 0xFFFFFFFF	0x26000010	-	RW	No	PREOP	Yes
SubIndex 9		Mapping entry 9					
Variable Type	Setting Range	Initial Value	Unit	Accessibility	PDO Assignment	Variable Attribute	Saving
UDINT	0 to 0xFFFFFFFF	0x60B90010	-	RW	No	PREOP	Yes
SubIndex 10		Mapping entry 10					
Variable Type	Setting Range	Initial Value	Unit	Accessibility	PDO Assignment	Variable Attribute	Saving
UDINT	0 to 0xFFFFFFFF	0x60BA0020	-	RW	No	PREOP	Yes

Refer to the description of 0x1600.

0x1A01		2nd Transmit PDO Mapping					
SubIndex 0		Number of entries					
Variable Type	Setting Range	Initial Value	Unit	Accessibility	PDO Assignment	Variable Attribute	Saving
USINT	0 to 10	6	-	RW	No	PREOP	Yes
SubIndex 1		Mapping entry 1					
Variable Type	Setting Range	Initial Value	Unit	Accessibility	PDO Assignment	Variable Attribute	Saving
UDINT	0 to 0xFFFFFFFF	0x60410010	-	RW	No	PREOP	Yes
SubIndex 2		Mapping entry 2					
Variable Type	Setting Range	Initial Value	Unit	Accessibility	PDO Assignment	Variable Attribute	Saving
UDINT	0 to 0xFFFFFFFF	0x60640020	-	RW	No	PREOP	Yes
SubIndex 3		Mapping entry 3					
Variable Type	Setting Range	Initial Value	Unit	Accessibility	PDO Assignment	Variable Attribute	Saving
UDINT	0 to 0xFFFFFFFF	0x60F40020	-	RW	No	PREOP	Yes

SubIndex 4		Mapping entry 4					
Variable Type	Setting Range	Initial Value	Unit	Accessibility	PDO Assignment	Variable Attribute	Saving
UDINT	0 to 0xFFFFFFFF	0x60B90010	-	RW	No	PREOP	Yes
SubIndex 5		Mapping entry 5					
Variable Type	Setting Range	Initial Value	Unit	Accessibility	PDO Assignment	Variable Attribute	Saving
UDINT	0 to 0xFFFFFFFF	0x60BA0020	-	RW	No	PREOP	Yes
SubIndex 6		Mapping entry 6					
Variable Type	Setting Range	Initial Value	Unit	Accessibility	PDO Assignment	Variable Attribute	Saving
UDINT	0 to 0xFFFFFFFF	0x60FD0020	-	RW	No	PREOP	Yes
SubIndex 7		Mapping entry 7					
Variable Type	Setting Range	Initial Value	Unit	Accessibility	PDO Assignment	Variable Attribute	Saving
UDINT	0 to 0xFFFFFFFF	-	-	RW	No	PREOP	Yes
SubIndex 8		Mapping entry 8					
Variable Type	Setting Range	Initial Value	Unit	Accessibility	PDO Assignment	Variable Attribute	Saving
UDINT	0 to 0xFFFFFFFF	-	-	RW	No	PREOP	Yes
SubIndex 9		Mapping entry 9					
Variable Type	Setting Range	Initial Value	Unit	Accessibility	PDO Assignment	Variable Attribute	Saving
UDINT	0 to 0xFFFFFFFF	-	-	RW	No	PREOP	Yes
SubIndex 10		Mapping entry 10					
Variable Type	Setting Range	Initial Value	Unit	Accessibility	PDO Assignment	Variable Attribute	Saving
UDINT	0 to 0xFFFFFFFF	-	-	RW	No	PREOP	Yes

Refer to the description of 0x1600.

0x1A02		3rd Transmit PDO Mapping					
SubIndex 0		Number of entries					
Variable Type	Setting Range	Initial Value	Unit	Accessibility	PDO Assignment	Variable Attribute	Saving
USINT	0 to 10	5	-	RW	No	PREOP	Yes
SubIndex 1		Mapping entry 1					
Variable Type	Setting Range	Initial Value	Unit	Accessibility	PDO Assignment	Variable Attribute	Saving
UDINT	0 to 0xFFFFFFFF	0x60410010	-	RW	No	PREOP	Yes
SubIndex 2		Mapping entry 2					
Variable Type	Setting Range	Initial Value	Unit	Accessibility	PDO Assignment	Variable Attribute	Saving
UDINT	0 to 0xFFFFFFFF	0x60640020	-	RW	No	PREOP	Yes
SubIndex 3		Mapping entry 3					
Variable Type	Setting Range	Initial Value	Unit	Accessibility	PDO Assignment	Variable Attribute	Saving

UDINT	0 to 0xFFFFFFFF	0x60B90010	-	RW	No	PREOP	Yes
SubIndex 4		Mapping entry 4					
Variable Type	Setting Range	Initial Value	Unit	Accessibility	PDO Assignment	Variable Attribute	Saving
UDINT	0 to 0xFFFFFFFF	0x60BA0020	-	RW	No	PREOP	Yes
SubIndex 5		Mapping entry 5					
Variable Type	Setting Range	Initial Value	Unit	Accessibility	PDO Assignment	Variable Attribute	Saving
UDINT	0 to 0xFFFFFFFF	0x60FD0020	-	RW	No	PREOP	Yes
SubIndex 6		Mapping entry 6					
Variable Type	Setting Range	Initial Value	Unit	Accessibility	PDO Assignment	Variable Attribute	Saving
UDINT	0 to 0xFFFFFFFF	-	-	RW	No	PREOP	Yes
SubIndex 7		Mapping entry 7					
Variable Type	Setting Range	Initial Value	Unit	Accessibility	PDO Assignment	Variable Attribute	Saving
UDINT	0 to 0xFFFFFFFF	-	-	RW	No	PREOP	Yes
SubIndex 8		Mapping entry 8					
Variable Type	Setting Range	Initial Value	Unit	Accessibility	PDO Assignment	Variable Attribute	Saving
UDINT	0 to 0xFFFFFFFF	-	-	RW	No	PREOP	Yes
SubIndex 9		Mapping entry 9					
Variable Type	Setting Range	Initial Value	Unit	Accessibility	PDO Assignment	Variable Attribute	Saving
UDINT	0 to 0xFFFFFFFF	-	-	RW	No	PREOP	Yes
SubIndex 10		Mapping entry 10					
Variable Type	Setting Range	Initial Value	Unit	Accessibility	PDO Assignment	Variable Attribute	Saving
UDINT	0 to 0xFFFFFFFF	-	-	RW	No	PREOP	Yes

Refer to the description of 0x1600.

0x1A03	4th Transmit PDO Mapping						
SubIndex 0		Number of entries					
Variable Type	Setting Range	Initial Value	Unit	Accessibility	PDO Assignment	Variable Attribute	Saving
USINT	0 to 10	5	-	RW	No	PREOP	Yes
SubIndex 1		Mapping entry 1					
Variable Type	Setting Range	Initial Value	Unit	Accessibility	PDO Assignment	Variable Attribute	Saving
UDINT	0 to 0xFFFFFFFF	0x60410010	-	RW	No	PREOP	Yes
SubIndex 2		Mapping entry 2					
Variable Type	Setting Range	Initial Value	Unit	Accessibility	PDO Assignment	Variable Attribute	Saving
UDINT	0 to 0xFFFFFFFF	0x60640020	-	RW	No	PREOP	Yes

SubIndex 3		Mapping entry 3					
Variable Type	Setting Range	Initial Value	Unit	Accessibility	PDO Assignment	Variable Attribute	Saving
UDINT	0 to 0xFFFFFFFF	0x60B90010	-	RW	No	PREOP	Yes
SubIndex 4		Mapping entry 4					
Variable Type	Setting Range	Initial Value	Unit	Accessibility	PDO Assignment	Variable Attribute	Saving
UDINT	0 to 0xFFFFFFFF	0x60BA0020	-	RW	No	PREOP	Yes
SubIndex 5		Mapping entry 5					
Variable Type	Setting Range	Initial Value	Unit	Accessibility	PDO Assignment	Variable Attribute	Saving
UDINT	0 to 0xFFFFFFFF	0x60FD0020	-	RW	No	PREOP	Yes
SubIndex 6		Mapping entry 6					
Variable Type	Setting Range	Initial Value	Unit	Accessibility	PDO Assignment	Variable Attribute	Saving
UDINT	0 to 0xFFFFFFFF	-	-	RW	No	PREOP	Yes
SubIndex 7		Mapping entry 7					
Variable Type	Setting Range	Initial Value	Unit	Accessibility	PDO Assignment	Variable Attribute	Saving
UDINT	0 to 0xFFFFFFFF	-	-	RW	No	PREOP	Yes
SubIndex 8		Mapping entry 8					
Variable Type	Setting Range	Initial Value	Unit	Accessibility	PDO Assignment	Variable Attribute	Saving
UDINT	0 to 0xFFFFFFFF	-	-	RW	No	PREOP	Yes
SubIndex 9		Mapping entry 9					
Variable Type	Setting Range	Initial Value	Unit	Accessibility	PDO Assignment	Variable Attribute	Saving
UDINT	0 to 0xFFFFFFFF	-	-	RW	No	PREOP	Yes
SubIndex 10		Mapping entry 10					
Variable Type	Setting Range	Initial Value	Unit	Accessibility	PDO Assignment	Variable Attribute	Saving
UDINT	0 to 0xFFFFFFFF	-	-	RW	No	PREOP	Yes

Refer to the description of 0x1600.

0x1C00		Sync Manager Communication Type					
SubIndex 0		Number of Entries					
Variable Type	Setting Range	Initial Value	Unit	Accessibility	PDO Assignment	Variable Attribute	Saving
USINT	-	4	-	RO	No	-	No
SubIndex 1		Communication Type SM0					
Variable Type	Setting Range	Initial Value	Unit	Accessibility	PDO Assignment	Variable Attribute	Saving
USINT	-	1	-	RO	No	-	No
SubIndex 2		Communication Type SM1					
Variable Type	Setting Range	Initial Value	Unit	Accessibility	PDO Assignment	Variable Attribute	Saving

USINT	-	2	-	RO	No	-	No
SubIndex 3		Communication Type SM2					
Variable Type	Setting Range	Initial Value	Unit	Accessibility	PDO Assignment	Variable Attribute	Saving
USINT	-	3	-	RO	No	-	No
SubIndex 4		Communication Type SM3					
Variable Type	Setting Range	Initial Value	Unit	Accessibility	PDO Assignment	Variable Attribute	Saving
USINT	-	4	-	RO	No	-	No

It represents the Sync Manager Communication Type assigned by default.

0x1C10	Sync Manager 0 PDO Assignment						
Variable Type	Setting Range	Initial Value	Unit	Accessibility	PDO Assignment	Variable Attribute	Saving
USINT	-	0	-	RO	No	-	No

0x1C11	Sync Manager 1 PDO Assignment						
Variable Type	Setting Range	Initial Value	Unit	Accessibility	PDO Assignment	Variable Attribute	Saving
USINT	-	0	-	RO	No	-	No

0x1C12	Sync Manager 2 PDO Assignment						
SubIndex 0		Number of Entries					
Variable Type	Setting Range	Initial Value	Unit	Accessibility	PDO Assignment	Variable Attribute	Saving
USINT	-	1	-	RW	No	PREOP	No
SubIndex 1		Index of objects assigned to PDO					
Variable Type	Setting Range	Initial Value	Unit	Accessibility	PDO Assignment	Variable Attribute	Saving
UINT	0x1600 to 0x1603	0x1601	-	RW	No	PREOP	No

0x1C13	Sync Manager 3 PDO Assignment						
SubIndex 0		Number of Entries					
Variable Type	Setting Range	Initial Value	Unit	Accessibility	PDO Assignment	Variable Attribute	Saving
USINT	-	1	-	RW	No	PREOP	No
SubIndex 1		Index of objects assigned to PDO					
Variable Type	Setting Range	Initial Value	Unit	Accessibility	PDO Assignment	Variable Attribute	Saving
UINT	0x1A00 to 0x1A03	0x1A01	-	RW	No	PREOP	No

0x1C32		Output Sync Manager Parameter					
SubIndex 0		Number of entries					
Variable Type	Setting Range	Initial Value	Unit	Accessibility	PDO Assignment	Variable Attribute	Saving
USINT	-	32	-	RO	No	-	No
SubIndex 1		Sync mode					
Variable Type	Setting Range	Initial Value	Unit	Accessibility	PDO Assignment	Variable Attribute	Saving
UINT	-	-	-	RW	No	-	No
SubIndex 2		Cycle time					
Variable Type	Setting Range	Initial Value	Unit	Accessibility	PDO Assignment	Variable Attribute	Saving
UDINT	-	-	ns	RW	No	-	No
SubIndex 3		Shift time					
Variable Type	Setting Range	Initial Value	Unit	Accessibility	PDO Assignment	Variable Attribute	Saving
UDINT	-	0	ns	RO	No	-	No
SubIndex 4		Sync modes supported					
Variable Type	Setting Range	Initial Value	Unit	Accessibility	PDO Assignment	Variable Attribute	Saving
UINT	-	0x4007	-	RO	No	-	No
SubIndex 5		Minimum cycle time					
Variable Type	Setting Range	Initial Value	Unit	Accessibility	PDO Assignment	Variable Attribute	Saving
UDINT	-	250000	ns	RO	No	-	No
SubIndex 6		Calc and copy time					
Variable Type	Setting Range	Initial Value	Unit	Accessibility	PDO Assignment	Variable Attribute	Saving
UDINT	-	0	ns	RO	No	-	No
SubIndex 8		Get Cycle Time					
Variable Type	Setting Range	Initial Value	Unit	Accessibility	PDO Assignment	Variable Attribute	Saving
UDINT	-	0	ns	RO	No	-	No
SubIndex 9		Delay time					
Variable Type	Setting Range	Initial Value	Unit	Accessibility	PDO Assignment	Variable Attribute	Saving
UDINT	-	0	ns	RO	No	-	No
SubIndex 10		Sync0 time					
Variable Type	Setting Range	Initial Value	Unit	Accessibility	PDO Assignment	Variable Attribute	Saving
UDINT	-	0	ns	RO	No	-	No
SubIndex 11		Cycle exceeded counter					
Variable Type	Setting Range	Initial Value	Unit	Accessibility	PDO Assignment	Variable Attribute	Saving
UDINT	-	0	-	RO	No	-	No

SubIndex 12		SM event missed counter					
Variable Type	Setting Range	Initial Value	Unit	Accessibility	PDO Assignment	Variable Attribute	Saving
UDINT	-	0	-	RO	No	-	No
SubIndex 13		Shift too short counter					
Variable Type	Setting Range	Initial Value	Unit	Accessibility	PDO Assignment	Variable Attribute	Saving
UDINT	-	0	-	RO	No	-	No
SubIndex 32		Sync error					
Variable Type	Setting Range	Initial Value	Unit	Accessibility	PDO Assignment	Variable Attribute	Saving
BOOL	-	0	-	RO	No	-	No

0x1C33		Input Sync Manager Parameter					
SubIndex 0		Number of entries					
Variable Type	Setting Range	Initial Value	Unit	Accessibility	PDO Assignment	Variable Attribute	Saving
USINT	-	32	-	RO	No	-	No
SubIndex 1		Sync mode					
Variable Type	Setting Range	Initial Value	Unit	Accessibility	PDO Assignment	Variable Attribute	Saving
UINT	-	-	-	RO	No	-	No
SubIndex 2		Cycle time					
Variable Type	Setting Range	Initial Value	Unit	Accessibility	PDO Assignment	Variable Attribute	Saving
UDINT	-	-	ns	RO	No	-	No
SubIndex 3		Shift time					
Variable Type	Setting Range	Initial Value	Unit	Accessibility	PDO Assignment	Variable Attribute	Saving
UDINT	-	0	ns	RO	No	-	No
SubIndex 4		Sync modes supported					
Variable Type	Setting Range	Initial Value	Unit	Accessibility	PDO Assignment	Variable Attribute	Saving
UINT	-	0x4007	-	RO	No	-	No
SubIndex 5		Minimum cycle time					
Variable Type	Setting Range	Initial Value	Unit	Accessibility	PDO Assignment	Variable Attribute	Saving
UDINT	-	250000	ns	RO	No	-	No
SubIndex 6		Calc and copy time					
Variable Type	Setting Range	Initial Value	Unit	Accessibility	PDO Assignment	Variable Attribute	Saving
UDINT	-	0	ns	RO	No	-	No
SubIndex 8		Get Cycle Time					
Variable Type	Setting Range	Initial Value	Unit	Accessibility	PDO Assignment	Variable Attribute	Saving
UDINT	-	0	ns	RO	No	-	No

SubIndex 9		Delay time					
Variable Type	Setting Range	Initial Value	Unit	Accessibil ity	PDO Assignment	Variable Attribute	Saving
UDINT	-	0	ns	RO	No	-	No
SubIndex 10		Sync0 time					
Variable Type	Setting Range	Initial Value	Unit	Accessibil ity	PDO Assignment	Variable Attribute	Saving
UDINT	-	0	ns	RO	No	-	No
Subindex 11		Cycle exceeded counter					
Variable Type	Setting Range	Initial Value	Unit	Accessibil ity	PDO Assignment	Variable Attribute	Saving
UDINT	-	0	-	RO	No	-	No
SubIndex 12		SM event missed counter					
Variable Type	Setting Range	Initial Value	Unit	Accessibil ity	PDO Assignment	Variable Attribute	Saving
UDINT	-	0	-	RO	No	-	No
SubIndex 13		Shift too short counter					
Variable Type	Setting Range	Initial Value	Unit	Accessibil ity	PDO Assignment	Variable Attribute	Saving
UDINT	-	0	-	RO	No	-	No
SubIndex 32		Sync error					
Variable Type	Setting Range	Initial Value	Unit	Accessibil ity	PDO Assignment	Variable Attribute	Saving
BOOL	-	0	-	RO	No	-	No

10.2 Manufacturer Specific Objects

● Basic Setting (from 0x2000)

0x2000		Motor ID					ALL
Variable Type	Setting Range	Initial Value	Unit	Accessibility	PDO Assignment	Variable Attribute	Saving
UINT	1 to 9999	13	-	RW	No	Power cycling	Yes

This is a parameter for resetting the motor ID. The company supplies a motor with a default ID and ID input is also possible.

Encoder Types	Motor ID Input Method
Incremental	Direct Input
Absolute Singleturn	Direct Input
Absolute Multiturn	Automatic Recognition

For a motor supplied by the company, you can enable automatic recognition or input a motor ID into the parameter. Motor IDs are provided on the sticker attached on a side of the motor.

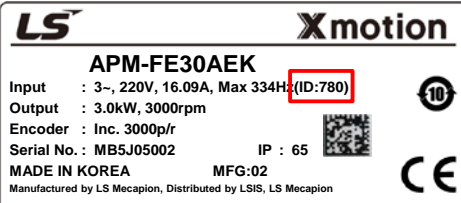
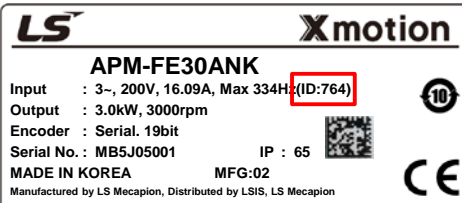
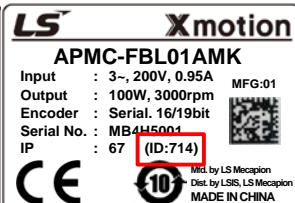
 <p>APM-FE30AEK Input : 3~, 220V, 16.09A, Max 334Hz (ID:780) Output : 3.0kW, 3000rpm Encoder : Inc. 3000p/r Serial No. : MB5J05002 IP : 65 MADE IN KOREA MFG:02 Manufactured by LS Mecapion, Distributed by LSIS, LS Mecapion</p>	 <p>APM-FE30ANK Input : 3~, 200V, 16.09A, Max 334Hz (ID:764) Output : 3.0kW, 3000rpm Encoder : Serial. 19bit Serial No. : MB5J05001 IP : 65 MADE IN KOREA MFG:02 Manufactured by LS Mecapion, Distributed by LSIS, LS Mecapion</p>	 <p>APMC-FBL01AMK Input : 3~, 200V, 0.95A MFG:01 Output : 100W, 3000rpm Encoder : Serial. 16/19bit Serial No. : MB4H5001 (ID:714) IP : 67 MADE IN CHINA Mfg. by LS Mecapion Dist. by LSIS, LS Mecapion</p>
Incremental	Absolute Singleturn	Absolute Multiturn

Keep in mind that you need power cycling after ID registration. When connecting a motor of another brand, you have to input 9999 and make the setting to 3rd party.

0x2001		Encoder Type					ALL
Variable Type	Setting Range	Initial Value	Unit	Accessibility	PDO Assignment	Variable Attribute	Saving
UINT	0 to 99	2	-	RW	No	Power cycling	Yes

This is a parameter for setting the encoder type. Set it correctly by referencing the table below. Here, the serial encoder provided by our company is automatically recognized and configured regardless of these settings. You can view the type of the encoder automatically recognized.

When the multiturn encoders 3 and 4 are used, the parameter is automatically recognized and does not need to be set.

Setting value	Encoder Types	Setting value	Encoder Types
0	Quadrature (incremental, A lead B)	9	-
1	Quadrature (incremental, B lead A)	10	BiSS_General
2	BiSS Serial (Absolute Single-turn only)	11	PANASONIC Single-turn
3	-	12	PANASONIC Multi-turn
4	BiSS Serial Absolute (Absolute Multi-turn 16-bit)	13	-
5	-	14	PANASONIC A6
6	TAMAGAWA Multi-turn	15	Nikon
7	Sinusoidal to BiSS	16	SSI
8	Analog Hall to BiSS	17	-

When using an incremental encoder or absolute singleturn encoder, you need to enter a value directly. You can view the encoder type on the name plate attached on the motor. Refer to Section 1.2, "Product Specifications" for the product type of the servo motor.

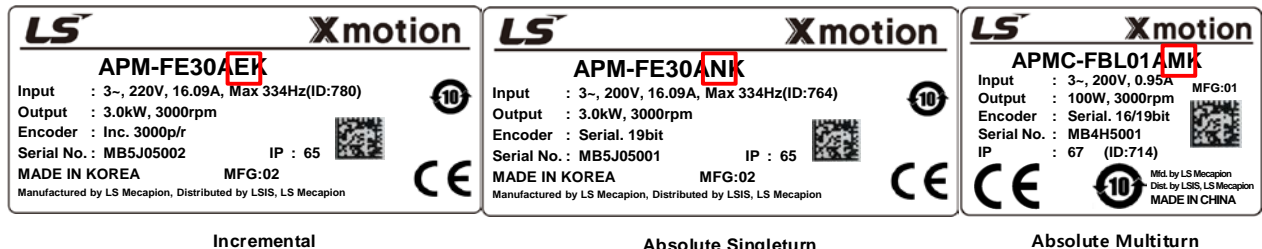

For example, C refers to an incremental encoder. In this case, enter 0. If N is input, enter 2, which is the absolute singleturn. Since M is the absolute multi-turn, 4 is automatically input.

If you are using a BiSS_General, SSI, or Nikon encoder, set the 0x202A parameter separately.

If you are using a Sinusoidal to BiSS or Analog Hall to BiSS type encoder, connect an Analog to BiSS Converter before use. When connecting an Analog to BiSS Converter, you need to set the encoder as the converter-connected type and also set the encoder resolution separately. For details on how to set encoder resolution, refer to the description of the encoder resolution setting parameter [0x2002].

0x2002	Encoder Pulse per Revolution						ALL
Variable Type	Setting Range	Initial Value	Unit	Accessibility	PDO Assignment	Variable Attribute	Saving
UDINT	0 to 1073741824	524288	pulse	RW	No	Power cycling	Yes

This is a parameter for setting the resolution of the encoder. Set the encoder resolution in the unit of pulse (count) and in multiples of 4. The absolute encoder provided by the company recognize the values automatically. However, for incremental and absolute singleturn encoders, values need to be manually entered.

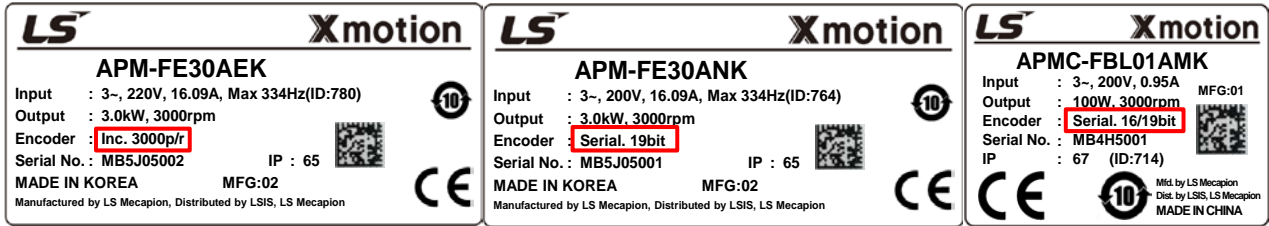

Incremental

Absolute Singleturn

Absolute Multiturn

The encoder resolution values are provided on the sticker on a side of the motor. Refer to the figures above.

Encoder Types	Input Methods	Input Examples
Incremental	Direct Input	Input 8192 if it shows 2048p/r on the sticker on the motor's side
Absolute Singleturn	Direct Input	Input 524288 if it shows 19[bit] on the sticker on the motor's side
Absolute Multiturn	Automatic Recognition	No input necessary for automatic recognition Possible to view the automatic input of 524288

If you are using an Analog to BiSS converter, an encoder output per 1pulse has the encoder resolution of an Analog to BiSS converter. In other words, if the resolution of an Analog to BiSS converter is 8192p/r, the output per 1pulse of analog input has the resolution of 8192p/r, and encoder resolution for one turn needs a separate setting.

For example, consider an analog input encoder that has a resolution of 2048p/r and uses an Analog to BiSS converter. Since the output from an input of 1pulse has a resolution of 8192p/r and the encoder's resolution is 2048pulse, it is necessary to set the value to '16777216' for normal operation.

0x2003	Node ID						ALL
Variable Type	Setting Range	Initial Value	Unit	Accessibility	PDO Assignment	Variable Attribute	Saving
UINT	0 to 99	-	-	RO	No	Power cycling	No

Display the node ID configured for the node setting switch of the drive. The value of the node setting switch is read just once when the power is turned on. Any set value modified subsequently will be in effect only when the power is turned on again.

E.g. When the node ID is set to 29

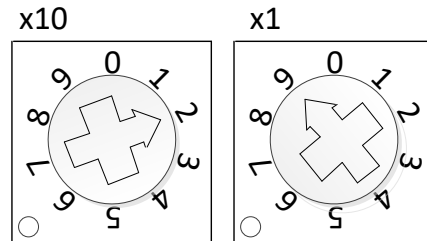

0x2004	Rotation Direction Select						ALL
Variable Type	Setting Range	Initial Value	Unit	Accessibility	PDO Assignment	Variable Attribute	Saving
UINT	0 to 1	0	-	RW	No	Power cycling	Yes

You can set the rotation direction of the motor. You can change the rotation direction with this setting between the positive and negative relative to the user in the final apparatus section.

Setting Value	Description
0	With a command for the positive direction, the motor rotates counterclockwise. Here, the position feedback value increases.
1	With a command for the positive direction, the motor rotates clockwise. Here, the position feedback value increases.

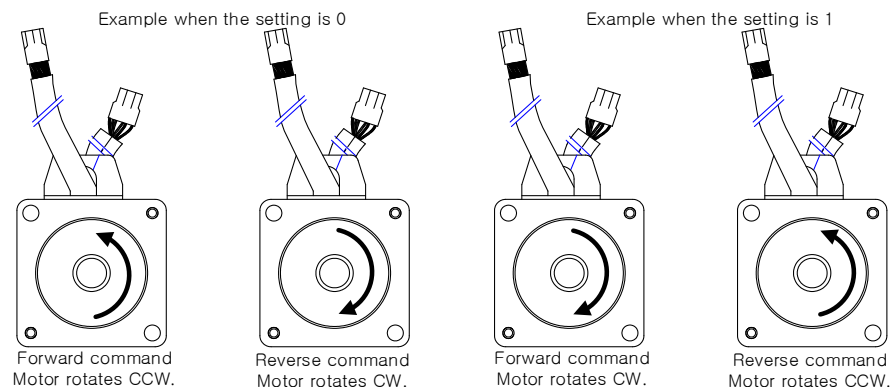

0x2005	Absolute Encoder Configuration0						ALL
Variable Type	Setting Range	Initial Value	Unit	Accessibility	PDO Assignment	Variable Attribute	Saving
UINT	0 to 2	1	-	RW	No	Power cycling	Yes

This is parameter for deciding whether or not to use multi-turn data when using the absolute multi-turn encoder.

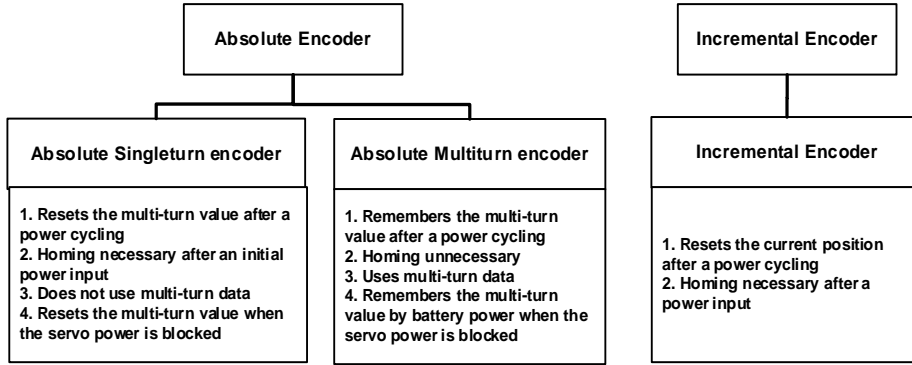

Setting value	Description
0	Uses multi-turn data of the absolute multi-turn encoder.
1	Does not use multi-turn data of the absolute multi-turn encoder.
2	When power is turned on, use the single-turn value of the encoder as the current position value.

When you set the parameter to 0, the values of multiturn and the current position are maintained even when the power is turned off and on. However, if you set it to 1, the values of multiturn and the current position are all reset during power cycling.

For Absolute Single-Turn Encoder setting 1

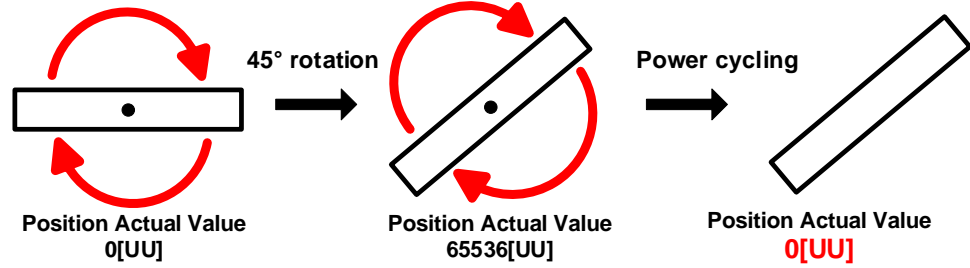

For Absolute Single-Turn Encoder setting 0

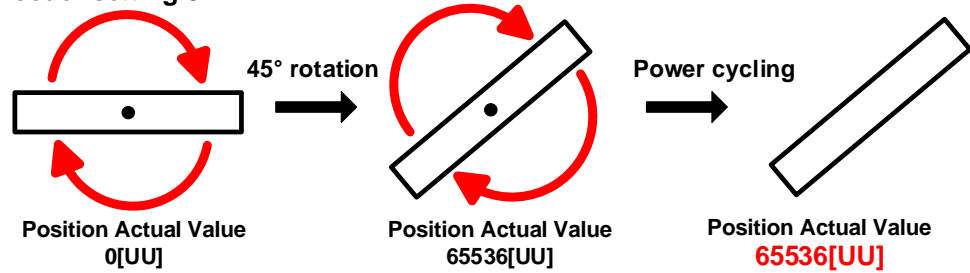

If you set the value to 1 in an absolute single-turn encoder, turning power off and on initializes both multi-turn and current position values. When you set the value to 0 or 2, power cycling resets the multiturn value to 0[revolution] but brings the encoder's singleturn value for the current position and displays it.

0x2006		Main Power Fail Check Mode					ALL
Variable Type	Setting Range	Initial Value	Unit	Accessibility	PDO Assignment	Variable Attribute	Saving
UINT	0 to 255	0	-	RW	No	Always	Yes

You can set the main power input mode and the processing method for phase loss.

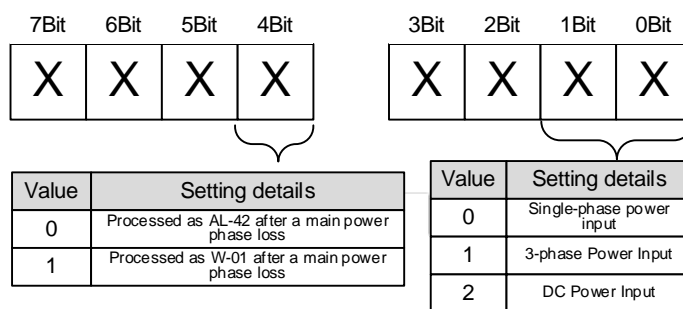

The upper 4 bits determine the servo's state in the event of a phase loss of the main power. The lower 4 bits set the power input method to use.

Main Power Fail Check Mode[0x2006]	Single-phase Input	3-phase Input
0x00	Servo On	AL-42
0x01	AL-42	Servo On
0x10	Servo On	W-01
0x11	W-01	Servo On

<State of Servo right after Servo On>

For example, let's assume that you have entered '0x01' and single-phase power. If you give a Servo on command, the servo will immediately issue the AL-42 alarm. During Servo off, no alarm will occur.

Main Power Fail Check Mode[0x2006]	When the main power is blocked during operation after servo on
0x00	AL-42
0x01	
0x10	Although W-01 occurs, the motor keeps operating and AL-40 (under-voltage) occurs.
0x11	

<State of Servo right after main power disconnection after Servo On>

If the main power is blocked during Servo on operation, a warning or alarm occurs according to the setting values in the table above.

0x2007		Main Power Fail Check Time					ALL
Variable Type	Setting Range	Initial Value	Unit	Accessibility	PDO Assignment	Variable Attribute	Saving
UINT	0 to 5000	40	ms	RW	No	Always	Yes

You can set the checking time for main power fail check time. This function detects instantaneous voltage drop or voltage sag, which may occur in a short period of time depending on the condition of external power input, to check the main power phase loss. Set this function properly according to the condition of external power input.

0x2008		7SEG Display Selection					ALL
Variable Type	Setting Range	Initial Value	Unit	Accessibility	PDO Assignment	Variable Attribute	Saving
UINT	0 to 100	0	-	RW	Yes	Always	Yes

You can set items to display in the 7SEG window.

Setting value	Displayed Items	Unit	Description
0	Operation status	-	
1	Speed feedback	rpm, mm/s	
2	Speed command	rpm, mm/s	
3	Torque feedback	0.1%	
4	Torque command	0.1%	
5	Accumulated operation overload	0.1%	
6	DC link voltage	V	
7	Accumulated regeneration overload	0.1%	
8	Mechanical angle	0.1deg	
9	Electrical angle	0.1deg	
10	Inertia ratio	%	
11	Drive temperature 1	°C	Temperature near drive power element
12	Drive temperature 2	°C	Internal temperature of the drive
13	Encoder temperature 1	°C	Internal temperature of the encoder
14	Node ID	-	
15	Instantaneous maximum load factor	0.1%	Instantaneous maximum load factor for 15 seconds
16	Root mean square (RMS) load factor	0.1%	Root mean square (RMS) load factor for 15 seconds

0x2009		Regeneration Brake Resistor Configuration					ALL
Variable Type	Setting Range	Initial Value	Unit	Accessibility	PDO Assignment	Variable Attribute	Saving
UINT	0 to 1	0	-	RW	No	Always	Yes

You can make settings related to regeneration brake resistor.

Setting value	Description
0	Use the regeneration brake resistor installed in the drive.
1	Use the regeneration brake resistor separately installed outside the drive. Set the regeneration resistor value (0x200B) and capacity (0x200C) correctly. * Notes Power supply wiring (3.4)

0x200A		Regeneration Brake Resistor Derating Factor					ALL
Variable Type	Setting Range	Initial Value	Unit	Accessibility	PDO Assignment	Variable Attribute	Saving
UINT	0 to 200	100	%	RW	No	Always	Yes

You can set the derating factor for regeneration brake resistor overload checkups. When the derating factor is set to a value of 100 [%] or lower, the regeneration overload alarm (AL-23) is triggered quickly. When it is set to a value higher than 100 [%], the alarm is triggered slowly. Change the setting values according to the heat radiation condition of the regeneration brake resistor used. You must consider the heat radiation condition with more care when you set the derating factor to a value higher than 100%.

0x200B		Regeneration Brake Resistor Value					ALL
Variable Type	Setting Range	Initial Value	Unit	Accessibility	PDO Assignment	Variable Attribute	Saving
UINT	0 to 1000	0	ohm	RW	No	Always	Yes

When you use an external regeneration brake resistor (0x2009=1), set the regeneration brake resistor value in the unit of ohm. When you use an internal regeneration brake resistor (0x2009= 0), the setting value does not apply.

0x200C		Regeneration Brake Resistor Power					ALL
Variable Type	Setting Range	Initial Value	Unit	Accessibility	PDO Assignment	Variable Attribute	Saving
UINT	0 to 30000	0	watt	RW	No	Always	Yes

When you use an external regeneration brake resistor (0x2009=1), set the regeneration brake resistor capacity in the unit of watt. When you use an internal regeneration brake resistor (0x2009= 0), the setting value does not apply.

0x200D		Peak Power of Regeneration Brake Resistor					ALL
Variable Type	Setting Range	Initial Value	Unit	Accessibility	PDO Assignment	Variable Attribute	Saving
UINT	1 to 50000	100	watt	RW	No	Always	Yes

When you use an external regeneration brake resistor (0x2009=1), set the maximum allowable capacity of the regeneration brake resistor in the unit of watt. When you use an internal regeneration brake resistor (0x2009= 0), the setting value does not apply.

0x200E		Duration Time @ Peak Power of Regeneration Brake Resistor					ALL
Variable Type	Setting Range	Initial Value	Unit	Accessibility	PDO Assignment	Variable Attribute	Saving
UINT	1 to 50000	5000	ms	RW	No	Always	Yes

When you use an external regeneration brake resistor (0x2009=1), set the allowed time at the maximum regeneration brake resistor capacity (0x200D) in watt. When you use an internal regeneration brake resistor (0x2009= 0), the setting value does not apply.

0x200F		Overload Check Base					ALL
Variable Type	Setting Range	Initial Value	Unit	Accessibility	PDO Assignment	Variable Attribute	Saving
UINT	10 to 120	100	%	RW	No	Always	Yes

This is a parameter for adjusting the load factor for accumulation of continuous accumulated overload.

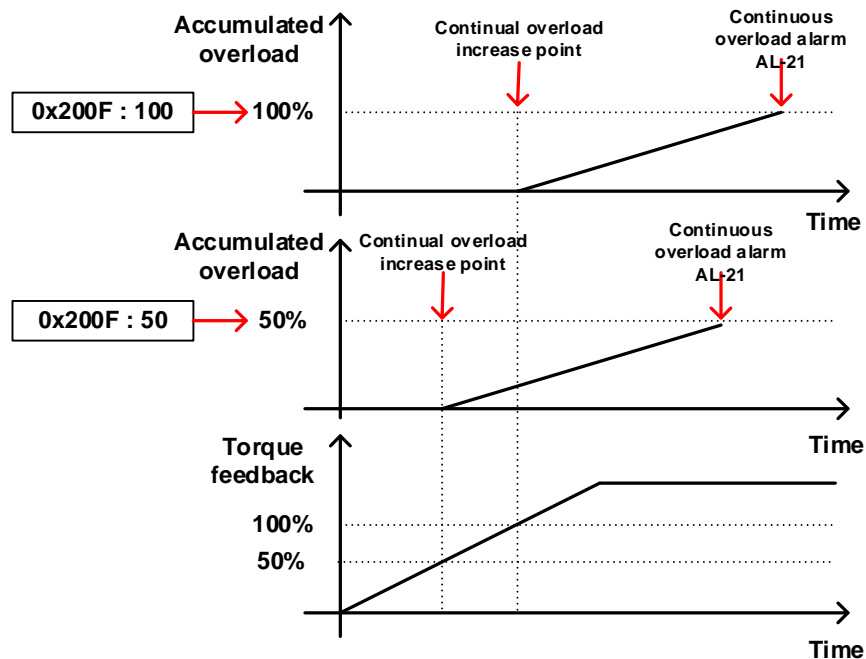

The default value is 100. If torque feedback exceeds 100 [%], accumulated overload keeps accumulating, causing an occurrence of the continuous overload alarm (AL-21). If you set the parameter value to 50 and 100, accumulated overload is activated when torque feedback exceeds 50 [%] and 100 [%], respectively. Therefore, for any given time period, the setting with 50 causes accumulation quicker than one with 100, causing AL-21 to occur earlier.

If the heat radiation condition of the drive is poor, set the value to be 100% or lower to trigger an overload alarm more quickly.

0x2010	Overload Warning Level						ALL
Variable Type	Setting Range	Initial Value	Unit	Accessibility	PDO Assignment	Variable Attribute	Saving
UINT	10 to 100	50	%	RW	No	Always	Yes

This is a parameter for adjusting the output level of the accumulated operation overload warning (W10). When the accumulated operation overload rate (0x2603) reaches the set value, a warning is output. With this setting, you can find out the time point when you need to take an appropriate action before an accumulated operation overload alarm occurs.

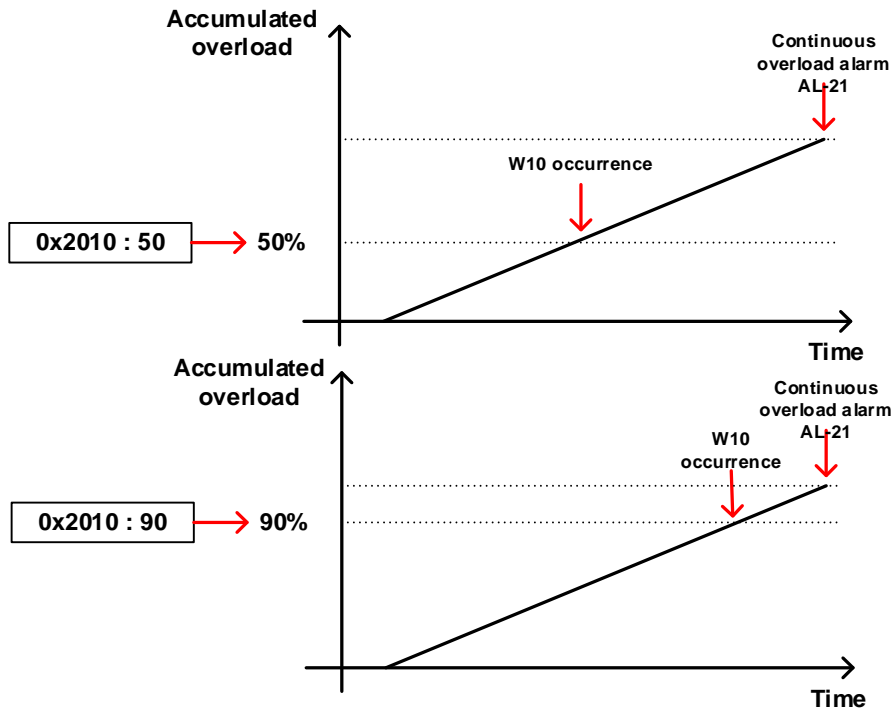

For example, when you input 50, W10 starts to occur at the point when accumulated overload becomes 50 [%]. If you input 90, it starts to occur at the 90 [%] mark. If accumulated overload becomes 100%, W10 is changed into AL-21.

0x2011		PWM Off Delay Time					ALL
Variable Type	Setting Range	Initial Value	Unit	Accessibility	PDO Assignment	Variable Attribute	Saving
UINT	0 to 1000	10	ms	RW	No	Always	Yes

You can set the delay time until PWM is actually turned off after the servo off command. When you use a motor with a brake installed on the vertical axis, you can make the brake signal output to come out first then PWM be turned off after the set time, in order to prevent the axis from flowing down vertically.

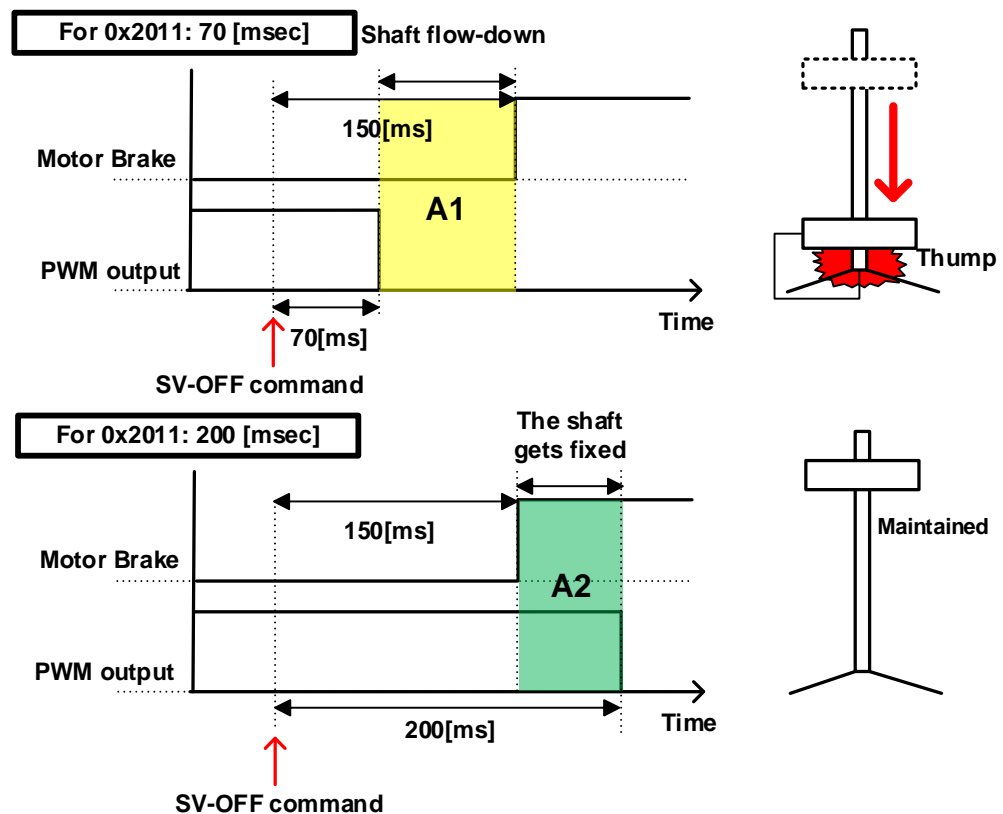

For example, assume that you have set the brake to operate 150 [msec] after a servo off command during operation of a motor with a brake installed on its vertical axis. If you set the parameter to 50 [msec], PWM is turned off in 50 [msec] after a servo off command, causing A1 to occur in which the brake cannot be held. In this case, the axis flows down because of gravity. However, if you set the parameter to 200 [msec], an overlapped section (green) appears in which PWM is output for 50 [msec] and the brake can be held, which can maintain the vertical axis.

0x2012		Dynamic Brake Control Mode					ALL
Variable Type	Setting Range	Initial Value	Unit	Accessibility	PDO Assignment	Variable Attribute	Saving
UINT	0 to 3	0	-	RW	No	Always	Yes

You can set the control mode of the dynamic brake in servo off.

Setting Value	Description
0	Hold the dynamic brake after stopping the motor using the brake
1	Release the dynamic brake after stopping the motor using the brake
2	Release the dynamic brake after free-run stop
3	Hold the dynamic brake after free-run stop

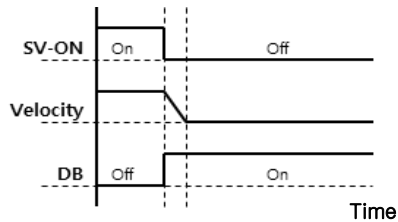

Hold after a DB stop

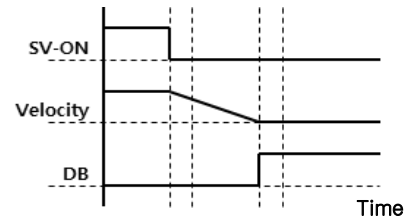

Hold after a free run stop

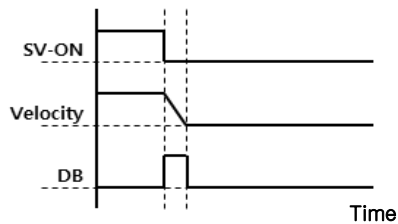

Release after a DB stop

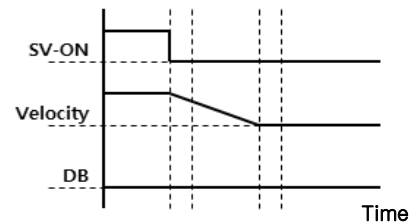

Release after a free run stop

When POT/NOT is input in torque control mode, only the release function after stopping and the release function after free-run stop are provided using the dynamic brake. The default setting value of 0 is to use a dynamic brake to stop and then release.

0x2013		Emergency Stop Configuration					ALL
Variable Type	Setting Range	Initial Value	Unit	Accessibility	PDO Assignment	Variable Attribute	Saving
UINT	0 to 1	1	-	RW	No	Always	Yes

You can set the method of emergency stop (for POT, NOT, or ESTOP input). In torque control mode, the deceleration stop mode which uses emergency stop torque is not applied.

Setting Value	Description
0	The motor stops according to the method set in Dynamic Brake Control Mode (0x2012). It stops using the dynamic brake and maintains the torque command at 0.
1	The motor decelerates to a stop using the emergency stop torque (0x2113).

0x2014		Warning Mask Configuration					ALL
Variable Type	Setting Range	Initial Value	Unit	Accessibility	PDO Assignment	Variable Attribute	Saving
UINT	0 to FFFF _{hex}	0	-	RW	Yes	Always	Yes

Warnings (alarms) masked by this setting are not triggered.

Bits	Warning Codes	Warning Names
0	W01	Main power phase loss
1	W02	Low voltage of encoder battery
2	W04	Software position limit
3	W08	DB overcurrent
4	W10	Operation overload
5	W20	Abnormal combination of drive and motor
6	W40	Low voltage
7	W80	Emergency signal input
Bits	Alarm Code	Alarm Name
14	AL-34	Encoder Z-phase loss

0x2015		U Phase Current Offset					ALL
Variable Type	Setting Range	Initial Value	Unit	Accessibility	PDO Assignment	Variable Attribute	Saving
INT	-1000 to 1000	0	0.1%	RW	No	Always	Yes

0x2016		V Phase Current Offset					ALL
Variable Type	Setting Range	Initial Value	Unit	Accessibility	PDO Assignment	Variable Attribute	Saving
INT	-1000 to 1000	0	0.1%	RW	No	Always	Yes

0x2017		W Phase Current Offset					ALL
Variable Type	Setting Range	Initial Value	Unit	Accessibility	PDO Assignment	Variable Attribute	Saving
INT	-1000 to 1000	0	0.1%	RW	No	Always	Yes

You can manually set the current offset for each phase. The set offset value is subtracted from the measured current value, then applied as an actual current value. Do not manually set the offset if you do not know the exact setting value. You can view the automatically-tuned value if you tune the current offset through the procedure function (Refer to the description of 0x2700).

For a drive with a small to medium capacity (7.5KW or lower), this parameter is not used since the W phase current is not separately measured.

0x2018		Magnetic Pole Pitch					ALL
Variable Type	Setting Range	Initial Value	Unit	Accessibility	PDO Assignment	Variable Attribute	Saving
UINT	1 to 65535	2400	.01 mm	RW	No	Power cycling	Yes

You can set the pitch between the magnetic poles of the linear motor. Pole pitch refers to the distance between the north poles or the south poles of magnets, which corresponds to an electrical angle of 360°.

0x2019		Linear Scale Resolution					ALL
Variable Type	Setting Range	Initial Value	Unit	Accessibility	PDO Assignment	Variable Attribute	Saving
UINT	1 to 65535	1000	nm	RW	No	Power cycling	Yes

You can set linear scale resolution in the unit of nm. For a linear scale with a resolution of 1µm, set it to 1000 (= 1µm/1nm).

0x201A		Commutation Method					ALL
Variable Type	Setting Range	Initial Value	Unit	Accessibility	PDO Assignment	Variable Attribute	Saving
UINT	0 to 4	0	-	RW	No	Power cycling	Yes

This specifies the commutation method to get information on the initial angle of the motor.

Setting Value	Description
0	Separate commutation is unnecessary or it carries out commutation using a hall sensor
1	Performs commutation by a minimum distance movement after the initial servo on.
2	Performs commutation after angle alignment after the initial servo on.
3	Performs commutation by a minimum distance movement after servo on.
4	Performs commutation after angle alignment after servo on.

0x201B		Commutation Current					ALL
Variable Type	Setting Range	Initial Value	Unit	Accessibility	PDO Assignment	Variable Attribute	Saving
UINT	0 to 1000	500	0.1%	RW	No	Always	Yes

You can set the commutation current used to get information on the initial angle of the motor.

0x201C		Commutation Time					ALL
Variable Type	Setting Range	Initial Value	Unit	Accessibility	PDO Assignment	Variable Attribute	Saving
UINT	500 to 5000	1000	ms	RW	No	Always	Yes

You can set the commutation time used to get information on the initial angle of the motor.

0x201D		Grating Period of Sinusoidal Encoder					ALL
Variable Type	Setting Range	Initial Value	Unit	Accessibility	PDO Assignment	Variable Attribute	Saving
UINT	1 to 65535	40	um	RW	No	Power cycling	Yes

You can set the grating period of sinusoidal encoder.

0x201E		Homing Done Behavior					ALL
Variable Type	Setting Range	Initial Value	Unit	Accessibility	PDO Assignment	Variable Attribute	Saving
UINT	0 to 1	0	-	RW	No	Always	Yes

This specifies whether to move to the zero position by Home Offset[0x607C] after homing is completed.

Setting Value	Description
0	After homing with Homing Method [0x6098] is completed, the motor does not rotate, and the Home Offset [0x607C] value changes to the zero position.
1	After homing with Homing Method [0x6098] is completed, the motor rotates as much as the amount of Home Offset [0x607C] and the zero position becomes 0.

0x201F		Velocity Function Select					ALL
Variable Type	Setting Range	Initial Value	Unit	Accessibility	PDO Assignment	Variable Attribute	Saving
UINT	0 to 2	0	-	RW	No	Always	Yes

You can select the calculation method of feedback speed when the encoder type is Quadrature.

Setting Value	Description
0	MT Method + Speed Observer
1	MT Method
2	M Method

0x2020		Motor and Hall Phase Correction					ALL
Variable Type	Setting Range	Initial Value	Unit	Accessibility	PDO Assignment	Variable Attribute	Saving
UINT	0 to 65535	0	-	RW	No	Power cycling	Yes

For a 3rd party motor, you can set the motor's rotation direction, the polarity of the hall sensor signal, and the sequence of the hall sensor's UVW by examining wiring of the motor and the hall sensor.

Bits	Description
0	Sets the motor's rotation direction (computation of the 0x2004 setting value and Exclusive OR possible)
1~7	Reserved
8	Reverses Hall U polarity
9	Reverses Hall V polarity
10	Reverses Hall W polarity
11	Reserved
12	Replaces Hall U, Hall V
13	Replaces Hall V, Hall W
14	Replaces Hall W, Hall U
15	Reserved

0x202A		Motor Encoder Configuration					ALL
Variable Type	Setting Range	Initial Value	Unit	Accessibility	PDO Assignment	Variable Attribute	Saving
UDINT	0x0 to 0xFFFFFFFF	0	-	RW	No	Power cycling	Yes

Set when the encoder attached to the motor is Biss_General, SSI, Nikon or Tamagawa.

Bits	Description (if encoder type is BISS)
5~0	Number of bits for single-turn data
12~8	Number of bits for multi-turn data
16	Mode B setting (0: mode C, 1: mode B)
20	Error and warning bit polarity setting (0: active high, 1:active low)
21	Position of status bit (0: behind the position data, 1: in front of the position data, reserved)
22	Position relationship between error and warning bit (0: error at the front, 1: error is at the back)
26~24	Alignment bit number setting
28	Reserved
30	Baud rate setting (reserved)

Setting Example)

Bits	BiSS-B single-turn	BiSS-C multi-turn
5~0	19	19
12~8	0	16
16	1	0
20	0	0
21	0	0
22	0	0
26~24	2	2
28	-	-
30	-	-
Setting Value (hex)	0x02010013	0x02001013

Bits	Description (if encoder type is SSI)
0-7	Number of data bits
8-15	Number of bits for rotary multi-turn data (For a linear encoder, the setting value is irrelevant.)
16	Whether to ignore the first bit (0: one start bit, 1: two start bits)
17	Coding(0:binary, 1:gray)
20-23	Number of align bits
24-27	Clock rate (0:20Mhz, 1:10Mhz, 2:5Mhz, 3:2.5Mhz, 4:1.25Mhz, 5:625Khz, 6:312.5Khz, 7:156.25Khz)
28	Whether error bit exists (0: No, 1: Yes)
29	Error bit logic(0:active high, 1:active low)
31~30	Reserved

Setting Example)

Bits	Description (if encoder type is SSI)
5~0	13
12~8	10
16	0(one start bit)
17	0(binary)
18	0
19	-
22~20	2 align bit
23	0
27-24	2
28	0
29	0
31~30	-

Bits	Description (if encoder type is Nikon)
0-5	Number of bits for single-turn data
8-12	Number of bits for multi-turn data
16-19	Reserved
20-22	CRC error value (reserved)
24-27	Protocol (Reserved)
30	Set baud rate (reserved)
31	Use PPR (Reserved)

Setting example)

Bits	Description (if encoder type is Nikon)
0-5	20
8-12	16
16-19	0
20-22	0
24-27	0
30	0
31	0
Setting value (hex)	0x00001014

Bits	Description (if encoder type is Tamagawa)
0-5	Number of bits for single-turn data
8-12	Number of bits for multi-turn data
16-19	Reserved
20-22	CRC error value (Reserved)
24-27	Protocol (Reserved)
30	Battery Error (Reserved)
31	Use PPR (Reserved)

Setting example)

Bits	Description (if encoder type is Tamagawa)
0-5	20
8-12	16
16-19	0
20-22	0
24-27	0
30	0
31	0
Setting value (hex)	0x00001014

0x202C		Lines per Revolution of Sinusoidal Encoder					ALL
Variable Type	Setting Range	Initial Value	Unit	Accessibility	PDO Assignment	Variable Attribute	Saving
UINT	0 to 65535	1000	-	RW	No	Power cycling	Yes

This sets the CPR or line count (number of grids per revolution) on a sinusoidal encoder

0x202D		FIR Filter Window of Speed Feedback					ALL
Variable Type	Setting Range	Initial Value	Unit	Accessibility	PDO Assignment	Variable Attribute	Saving
UINT	0 to 8	0	-	RW	No	Always	Yes

This sets the degree of FIR filter for speed feedback.

In order to apply a FIR filter on a speed feedback signal, set the value to 2 or more. In this case, the speed feedback filter time constant [0x201B] does not apply. In order to use the speed feedback filter time constant, set the value to 0.

0x2031		Operation Time at Peak Current					ALL
Variable Type	Setting Range	Initial Value	Unit	Accessibility	PDO Assignment	Variable Attribute	Saving
UINT	1 to 65535	1000	ms	RW	No	Power cycling	Yes

This sets the maximum operation time at the maximum motor current. The setting protects the motor with an I²T algorithm, so it should be set correctly. (Figure to be added for further explanation)

0x2034		Motor Thermal Protection Enable					ALL
Variable Type	Setting Range	Initial Value	Unit	Accessibility	PDO Assignment	Variable Attribute	Saving
UINT	0 to 1	0	-	RW	No	Always	Yes

This activates the protective function using the motor's thermal parameter (thermal resistance/capacitance).

Setting Value	Description
0	Disable
1	Enable

● Gain Adjustment (0x2100~)

0x2100	Inertia Ratio						ALL
Variable Type	Setting Range	Initial Value	Unit	Accessibility	PDO Assignment	Variable Attribute	Saving
UINT	0 to 3000	100	%	RW	No	Always	Yes

You can set the ratio of load inertia to the motor's rotor inertia in %.

Inertia ratio= load inertia/motor's rotor inertia x 100

This inertia ratio setting is an important control parameter for operation of the servo. Therefore it is crucial to set the inertia ratio accurately for optimal servo operation. You can estimate the inertia ratio value by automatic gain tuning. The ratio is continuously estimated during operation if you carry out On-line gain tuning.

0x2101	Position Loop Gain 1						ALL
Variable Type	Setting Range	Initial Value	Unit	Accessibility	PDO Assignment	Variable Attribute	Saving
UINT	1 to 500	50	1/s	RW	Yes	Always	Yes

You can set the overall responsiveness of the position controller. The larger the setting value is, the higher the responsiveness is. Too large setting value may cause vibration depending on the load.

0x2102	Speed Loop Gain 1						ALL
Variable Type	Setting Range	Initial Value	Unit	Accessibility	PDO Assignment	Variable Attribute	Saving
UINT	1 to 2000	75	Hz	RW	Yes	Always	Yes

This specifies the overall responsiveness of the velocity controller. To make the whole responsiveness of the system higher, you have to set the speed loop gain large as well, along with the position loop gain. Too large setting value may cause vibration depending on the load.

0x2103		Speed Loop Integral Time Constant 1					ALL
Variable Type	Setting Range	Initial Value	Unit	Accessibility	PDO Assignment	Variable Attribute	Saving
UINT	1 to 1000	50	ms	RW	Yes	Always	Yes

You can set integral time constant of the velocity controller. If you set it to a large value, error is reduced in the steady state (stopped or driving at a constant velocity), but vibration may occur at a transitional state (while accelerating or decelerating).

0x2104		Torque Command Filter Time Constant 1					ALL
Variable Type	Setting Range	Initial Value	Unit	Accessibility	PDO Assignment	Variable Attribute	Saving
UINT	0 to 1000	5	0.1ms	RW	Yes	Always	Yes

You can apply a low pass filter for torque command. You can improve the system's stability by setting an appropriate value to smoothen the torque command. If you set the value to be too large, the delay for the torque command is extended, reducing the system responsiveness.

0x2105		Position Loop Gain 2					ALL
Variable Type	Setting Range	Initial Value	Unit	Accessibility	PDO Assignment	Variable Attribute	Saving
UINT	1 to 500	30	/s	RW	Yes	Always	Yes

You can set position loop gain used as Gain Group 2 for gain conversion. For more information, refer to the description of position loop gain 1 (0x2101).

0x2106		Speed Loop Gain 2					ALL
Variable Type	Setting Range	Initial Value	Unit	Accessibility	PDO Assignment	Variable Attribute	Saving
UINT	1 to 2000	50	Hz	RW	Yes	Always	Yes

You can set Speed Loop Gain used as Gain Group 2 for gain conversion. For more information, refer to the description of the Speed Loop Gain 1 (0x2102).

0x2107		Speed Loop Integral Time Constant 2					ALL
Variable Type	Setting Range	Initial Value	Unit	Accessibility	PDO Assignment	Variable Attribute	Saving
UINT	1 to 1000	50	ms	RW	Yes	Always	Yes

You can set the Speed Loop Integral Time Constant used as Gain Group 2 for gain conversion. For more information, refer to the description of Speed Loop Integral Time Constant 1 (0x2103).

0x2108		Torque Command Filter Time Constant 2					ALL
Variable Type	Setting Range	Initial Value	Unit	Accessibility	PDO Assignment	Variable Attribute	Saving
UINT	0 to 1000	5	0.1ms	RW	Yes	Always	Yes

You can set time constant of the torque command filter time constant used as Gain Group 2 for gain conversion. For more information, refer to the description of torque command filter time constant 1 (0x2104).

0x2109		Position Command Filter Time Constant					ALL
Variable Type	Setting Range	Initial Value	Unit	Accessibility	PDO Assignment	Variable Attribute	Saving
UINT	0 to 10000	0	0.1ms	RW	Yes	Always	Yes

You can apply a low pass filter for position command to smoothen the position command. Especially, this can be used for setting a higher gear ratio.

0x210A		Position Command Average Filter Time Constant					ALL
Variable Type	Setting Range	Initial Value	Unit	Accessibility	PDO Assignment	Variable Attribute	Saving
UINT	0 to 10000	0	0.1ms	RW	Yes	Always	Yes

You can apply a movement average filter for position command to smoothen the position command. The value of Position Command Filter Time Constant (0x2109) is first applied. Position Command Average Filter Time Constant (0x210A) is only applied if the value is 0.

0x210B		Speed Feedback Filter Time Constant					ALL
Variable Type	Setting Range	Initial Value	Unit	Accessibility	PDO Assignment	Variable Attribute	Saving
UINT	0 to 1000	5	0.1ms	RW	Yes	Always	Yes

You can apply a low pass filter to the speed feedback signal calculated in the encoder. When system vibration occurs or vibration occurs due to a gain load with an excessive inertia is applied, you can suppress vibration by setting an appropriate value.

0x210C		Velocity Feed-Forward Gain					ALL
Variable Type	Setting Range	Initial Value	Unit	Accessibility	PDO Assignment	Variable Attribute	Saving
UINT	0 to 100	0	%	RW	Yes	Always	Yes

You can set feedforward gain for the speed command during position control. The larger the setting value is, the lower the following error is. If you set too large a value for the load, vibration or an overshoot may occur. For gain tuning, increase the setting value gradually.

0x210D		Velocity Feed-forward Filter Time Constant					ALL
Variable Type	Setting Range	Initial Value	Unit	Accessibility	PDO Assignment	Variable Attribute	Saving
UINT	0 to 1000	10	0.1ms	RW	Yes	Always	Yes

You can apply a low pass filter to the compensation amount added to the speed command by velocity feed-forward gain. You can enhance the system's stability by using it when you have set a large speed feed-forward gain or when there is an excessive change in position command.

0x210E		Torque Feed-forward Gain					ALL
Variable Type	Setting Range	Initial Value	Unit	Accessibility	PDO Assignment	Variable Attribute	Saving
UINT	0 to 100	0	%	RW	Yes	Always	Yes

You can set feed-forward gain for the torque command during velocity control.

0x210F		Torque Feed-forward Filter Time Constant					ALL
Variable Type	Setting Range	Initial Value	Unit	Accessibility	PDO Assignment	Variable Attribute	Saving
UINT	0 to 1000	10	0.1ms	RW	Yes	Always	Yes

You can apply a low pass filter to the compensation amount added to the torque command by torque feed-forward gain.

0x2110		Torque Limit Function Select					ALL
Variable Type	Setting Range	Initial Value	Unit	Accessibility	PDO Assignment	Variable Attribute	Saving
UINT	0 to 4	2	-	RW	Yes	Always	Yes

You can set the function used to limit output torque of the drive.

Setting Value	Description
0	Limits the torque using positive/negative torque limit values according to the driving direction; the maximum value is limited by the maximum torque (0x6072). - Positive: 0x60E0, Negative: 0x60E1
1	Limits the torque by the maximum torque (0x6072) only regardless of the driving direction.
2	Limits the torque value using external positive/negative torque limits according to the driving direction - Positive: 0x2111, Negative: 0x2112
3	Limits the torque value using internal and external torque limits according to the driving direction and the torque limit signal - Positive: 0x60E0 (if P_CL signal is not input), 0x2111 (if P_CL signal is input) - Negative: 0x60E1 (if N_CL signal is not input), 0x2112 (if N_CL signal is input)
4	Limits applied by analog input torque limit values. - Refer to the analog torque limit scale (0x221C) and offset (0x221D).

0x2111		External Positive Torque Limit Value					ALL
Variable Type	Setting Range	Initial Value	Unit	Accessibility	PDO Assignment	Variable Attribute	Saving
UINT	0 to 5000	3000	0.1%	RW	Yes	Always	Yes

You can set the external positive torque limit value according to the torque limit function select (0x2110).

0x2112		External Negative Torque Limit Value					ALL
Variable Type	Setting Range	Initial Value	Unit	Accessibility	PDO Assignment	Variable Attribute	Saving
UINT	0 to 5000	3000	0.1%	RW	Yes	Always	Yes

You can set the external negative torque limit value according to the torque limit function select (0x2110).

0x2113		Emergency Stop Torque					ALL
Variable Type	Setting Range	Initial Value	Unit	Accessibility	PDO Assignment	Variable Attribute	Saving
UINT	0 to 5000	1000	0.1%	RW	Yes	Always	Yes

You can set torque stop during emergency stop (POT, NOT, ESTOP input).

0x2114		P/PI Control Conversion Mode					ALL
Variable Type	Setting Range	Initial Value	Unit	Accessibility	PDO Assignment	Variable Attribute	Saving
UINT	0 to 4	0	-	RW	Yes	Always	Yes

You can set the switch mode between PI control and P control. Using this function, you can improve the velocity control characteristic to reduce overshoot during velocity operation and positioning time during position operation.

Setting Value	Setting Details
0	Always use PI control
1	Switches to P control if the command torque is larger than the P control switch torque (0x2115)
2	Switches to P control if the command speed is larger than the P control switch speed (0x2116)
3	Switches to P control if the acceleration command is larger than the P control switch acceleration (0x2117)
4	Switches to P control if the following error is larger than the P control switch following error (0x2118)

0x2115		P Control Switch Torque					ALL
Variable Type	Setting Range	Initial Value	Unit	Accessibility	PDO Assignment	Variable Attribute	Saving
UINT	0 to 5000	500	0.1%	RW	Yes	Always	Yes

Refer to the description of P/PI Control Conversion Mode (0x2114).

0x2116		P Control Switch Speed					ALL
Variable Type	Setting Range	Initial Value	Unit	Accessibility	PDO Assignment	Variable Attribute	Saving
UINT	0 to 6000	100	rpm	RW	Yes	Always	Yes

Refer to the description of P/PI Control Conversion Mode (0x2114).

0x2117		P Control Switch Acceleration					ALL
Variable Type	Setting Range	Initial Value	Unit	Accessibility	PDO Assignment	Variable Attribute	Saving
UINT	0 to 60000	1000	rpm/s	RW	Yes	Always	Yes

Refer to the description of P/PI Control Conversion Mode (0x2114).

0x2118		P Control Switch Following Error					ALL
Variable Type	Setting Range	Initial Value	Unit	Accessibility	PDO Assignment	Variable Attribute	Saving
UINT	0 to 60000	100	pulse	RW	Yes	Always	Yes

Refer to the description of P/PI Control Conversion Mode (0x2114).

0x2119		Gain Conversion Mode					ALL
Variable Type	Setting Range	Initial Value	Unit	Accessibility	PDO Assignment	Variable Attribute	Saving
UINT	0 to 7	0	-	RW	Yes	Always	Yes

You can enhance the performance of the entire system by switching between two gain groups. According to the switching mode, manual switch or automatic switch can be done depending on the external input or output signal, respectively.

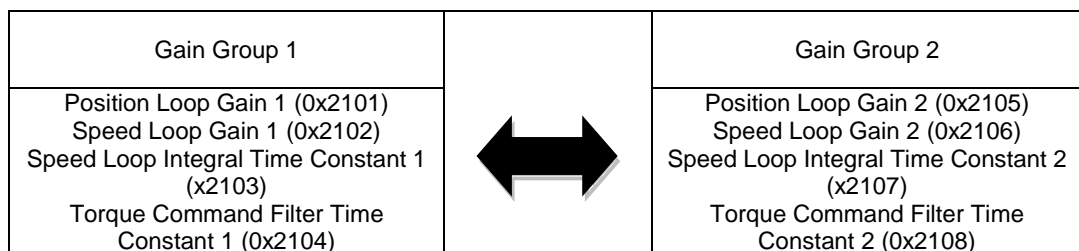

Setting Value	Setting Details
0	Only gain group 1 is used
1	Only gain group 2 is used
2	Gain is switched according to the GAIN2 input status - 0: Use gain group 1 - 1: Use gain group 2
3	Reserved
4	Reserved
5	Reserved
6	Gain is switched according to the ZSPD output status - 0: Use gain group 1 - 1: Use gain group 2
7	Gain is switched according to the INPOS1 output status - 0: Use gain group 1 - 1: Use gain group 2

0x211A	Gain Conversion Time 1						ALL
Variable Type	Setting Range	Initial Value	Unit	Accessibility	PDO Assignment	Variable Attribute	Saving
UINT	0 to 1000	2	ms	RW	Yes	Always	Yes

This specifies the time to switch from gain group 1 to gain group 2.

0x211B	Gain Conversion Time 2						ALL
Variable Type	Setting Range	Initial Value	Unit	Accessibility	PDO Assignment	Variable Attribute	Saving
UINT	0 to 1000	2	ms	RW	Yes	Always	Yes

This specifies the time to switch from gain group 2 to gain group 1.

0x211C	Gain Conversion Waiting Time 1						ALL
Variable Type	Setting Range	Initial Value	Unit	Accessibility	PDO Assignment	Variable Attribute	Saving
UINT	0 to 1000	0	ms	RW	Yes	Always	Yes

This specifies the waiting time before switching from gain group 1 to gain group 2.

0x211D		Gain Conversion Waiting Time 2					ALL
Variable Type	Setting Range	Initial Value	Unit	Accessibility	PDO Assignment	Variable Attribute	Saving
UINT	0 to 1000	0	ms	RW	Yes	Always	Yes

This specifies the waiting time before switching from gain group 2 to gain group 1.

0x211E		Dead Band for Position Control					ALL
Variable Type	Setting Range	Initial Value	Unit	Accessibility	PDO Assignment	Variable Attribute	Saving
UINT	0 to 1000	0	UU	RW	Yes	Always	Yes

The position controller output is 0 if the following error for position control is below the setting.

0x211F		Drive Control Input 1					ALL
Variable Type	Setting Range	Initial Value	Unit	Accessibility	PDO Assignment	Variable Attribute	Saving
UINT	0 to FFFF _{hex}	0	-	RW	Yes	Always	No

You can input the signal required for drive control via the I/O. Using a remote I/O, you can indirectly input the control input signal, inputted to the upper level controller, to the drive through this setting.

An applicable function will be performed by logical OR operation of the signal received through the I/O and the bit value of this setting.

Bits	Setting Details
0	POT
1	NOT
2	HOME
3	STOP
4	PCON
5	GAIN2
6	P_CL
7	N_CL
8	PROBE1
9	PROBE2
10	EMG
11	A_RST
12	SV_ON
13	LVSF1
14	LVSF2
15	Reserved

0x2120		Drive Control Input 2					ALL
Variable Type	Setting Range	Initial Value	Unit	Accessibility	PDO Assignment	Variable Attribute	Saving
UINT	0 to FFFF _{hex}	0	-	RW	Yes	-	No

Bits	Setting Details
15-0	Reserved

0x2121		Drive Status Output 1					ALL
Variable Type	Setting Range	Initial Value	Unit	Accessibility	PDO Assignment	Variable Attribute	Saving
UINT	0 to FFFF _{hex}	0	-	RO	Yes	-	No

You can assign the state of the drive output signal to the output signal of the I/O in order to verify the applicable bit of this output value, in addition to the actual output.

Bits	Setting Details
0	BRAKE
1	ALARM
2	READY
3	ZSPD
4	INPOS1
5	TLMT
6	VLMT
7	INSPD
8	WARN
9	TGON
10	INPOS2
15-11	Reserved

0x2122		Drive Status Output 2					ALL
Variable Type	Setting Range	Initial Value	Unit	Accessibility	PDO Assignment	Variable Attribute	Saving
UINT	0 to FFFF _{hex}	0	-	RO	Yes	-	No

Bits	Setting Details
15-0	Reserved

● I/O Configuration (0x2200~)

0x2200	Digital Input Signal 1 Selection						ALL
Variable Type	Setting Range	Initial Value	Unit	Accessibility	PDO Assignment	Variable Attribute	Saving
UINT	0 to 0xFFFF	0x0001	-	RW	No	Always	Yes

This specifies the functions of digital input signal 1 of the I/O connector and the input signal level. The debounce filter function will be supported in future.

15Bit 14Bit 13Bit 12Bit 11Bit 10Bit 9Bit 8Bit

0	0	0	0	0	0	0	0
---	---	---	---	---	---	---	---

Signal input level settings

Setting value	Status
0	Contact A
1	Contact B

7Bit 6Bit 5Bit 4Bit 3Bit 2Bit 1Bit 0Bit

0	0	0	0	0	0	0	0
---	---	---	---	---	---	---	---

Debounce filter settings

Setting value	Valid signal filtering recognized time[msec]
0	Reserved
1	Reserved
2	Reserved
3	Reserved
4	Reserved
5	Reserved
6	Reserved
7	Reserved
8	Reserved
9	Reserved
10	Reserved
11	Reserved
12	Reserved
13	Reserved
14	Reserved
15	Reserved

Input Signal Allocation

Setting value	Assigned signals
0x00	Not assigned
0x01	POT
0x02	NOT
0x03	HOME
0x04	STOP
0x05	PCON
0x06	GAIN2
0x07	PCL
0x08	NCL
0x09	PROBE1
0x0A	PROBE2
0x0B	EMG
0x0C	ARST(Alarm Reset)
0x0D	LVSF1
0x0E	LVSF2
0x0F	SV_ON
0x10	ABS_RQ
0x24	ABS_RESET

The setting method is the same up to the digital input signal 6 [0x2205].

ex) When Gain 2 is set for contact A

15Bit 14Bit 13Bit 12Bit 11Bit 10Bit 9Bit 8Bit

0	0	0	0	0	0	0	0
---	---	---	---	---	---	---	---

0

7Bit 6Bit 5Bit 4Bit 3Bit 2Bit 1Bit 0Bit

0	0	0	0	0	1	1	0
---	---	---	---	---	---	---	---

6

→ 0x0006

0x2201	Digital Input Signal 2 Selection						ALL
Variable Type	Setting Range	Initial Value	Unit	Accessibility	PDO Assignment	Variable Attribute	Saving
UINT	0 to 0xFFFF	0x0002	-	RW	No	Always	Yes

This specifies the functions of digital input signal 2 of the I/O and the input signal level. For more information, refer to the description of 0x2200.

0x2202		Digital Input Signal 3 Selection					ALL
Variable Type	Setting Range	Initial Value	Unit	Accessibility	PDO Assignment	Variable Attribute	Saving
UINT	0 to 0xFFFF	0x0003	-	RW	No	Always	Yes

This specifies the functions of digital input signal 3 of the I/O and the input signal level. For more information, refer to the description of 0x2200.

0x2203		Digital Input Signal 4 Selection					ALL
Variable Type	Setting Range	Initial Value	Unit	Accessibility	PDO Assignment	Variable Attribute	Saving
UINT	0 to 0xFFFF	0x0004	-	RW	No	Always	Yes

This specifies the functions of digital input signal 4 of the I/O and the input signal level. For more information, refer to the description of 0x2200.

0x2204		Digital Input Signal 5 Selection					ALL
Variable Type	Setting Range	Initial Value	Unit	Accessibility	PDO Assignment	Variable Attribute	Saving
UINT	0 to 0xFFFF	0x0005	-	RW	No	Always	Yes

This specifies the functions of digital input signal 5 of the I/O and the input signal level. For more information, refer to the description of 0x2200.

0x2205		Digital Input Signal 6 Selection					ALL
Variable Type	Setting Range	Initial Value	Unit	Accessibility	PDO Assignment	Variable Attribute	Saving
UINT	0 to 0xFFFF	0x0006	-	RW	No	Always	Yes

This specifies the functions of digital input signal 6 of the I/O and the input signal level. For more information, refer to the description of 0x2200.

0x2210	Digital Output Signal 1 Selection						ALL
Variable Type	Setting Range	Initial Value	Unit	Accessibility	PDO Assignment	Variable Attribute	Saving
UINT	0 to 0xFFFF	0x8001	-	RW	No	Always	Yes

This assigns the digital output signal 1 function and sets the output signal level of the I/O connector. Output signal setting does not provide the debounce filter function.

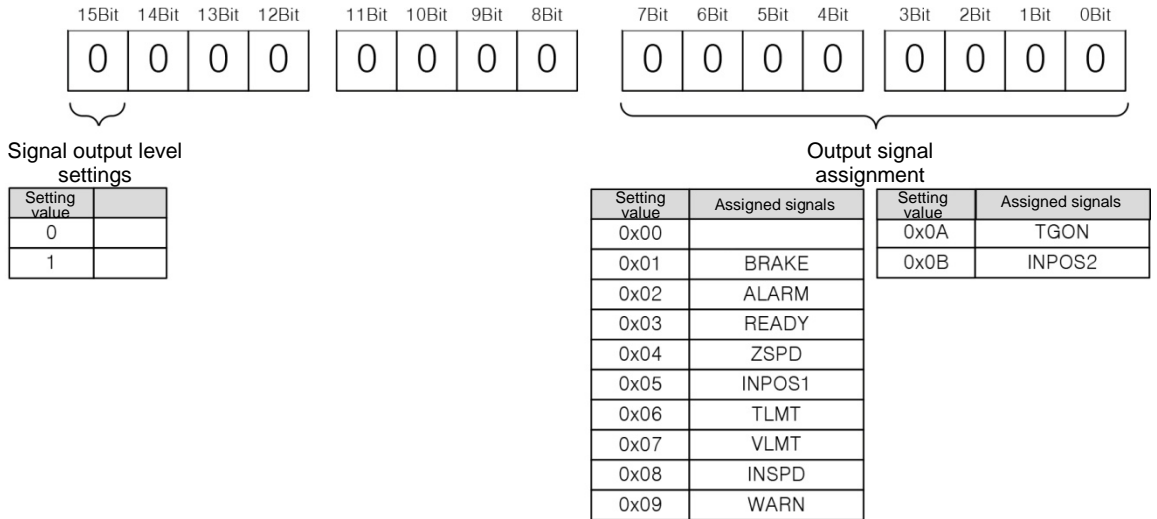

The method is the same up to digital output signal 3 [0x2212].

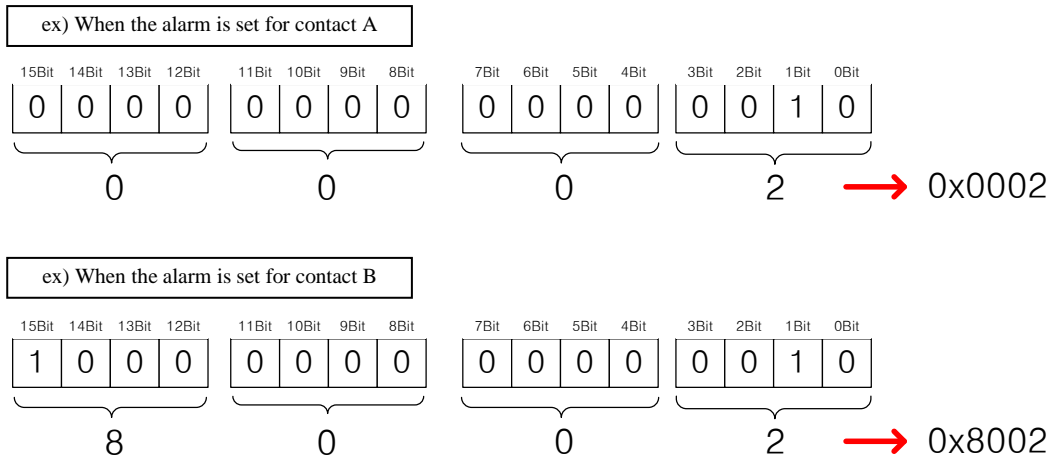

0x2211	Digital Output Signal 2 Selection						ALL
Variable Type	Setting Range	Initial Value	Unit	Accessibility	PDO Assignment	Variable Attribute	Saving
UINT	0 to 0xFFFF	0x8002	-	RW	No	Always	Yes

This sets the digital output signal 2 function and output signal level of the I/O. For more information, refer to the description of 0x2210.

0x2212		Digital Output Signal 3 Selection					ALL
Variable Type	Setting Range	Initial Value	Unit	Accessibility	PDO Assignment	Variable Attribute	Saving
UINT	0 to 0xFFFF	0x0003	-	RW	No	Always	Yes

This sets the functions and level of digital output signal 3 of I/O. For more information, refer to the description of 0x2210.

0x221C		Analog Torque Limit Scale					ALL
Variable Type	Setting Range	Initial Value	Unit	Accessibility	PDO Assignment	Variable Attribute	Saving
INT	-1000 to 1000	100	0.1 %/V	RW	No	Always	Yes

For non-torque operation, if the setting value of the torque limit function select (0x2110) is 4 (analog torque limit), torque is limited by the analog input torque limit. At this time, this parameter sets the scale of analog input value, and below is the formula for calculation.

$$\text{Torque Limit Value [\%]} = \left(\frac{\text{Input Voltage [mv]} - \text{Torque Input Offset (0x221D)[mV]}}{1000} \right) \times \frac{\text{Torque Command Scale [0x221C]}}{10}$$

Refer to 6.9, "Torque Limit Function."

0x221D		Analog Torque Limit Offset					ALL
Variable Type	Setting Range	Initial Value	Unit	Accessibility	PDO Assignment	Variable Attribute	Saving
INT	-1000 to 1000	0	mV	RW	No	Always	Yes

This specifies the analog voltage offset controlled by the analog torque limit.

0x2220		Analog Monitor Output Mode					ALL
Variable Type	Setting Range	Initial Value	Unit	Accessibility	PDO Assignment	Variable Attribute	Saving
UINT	0 to 1	0	-	RW	No	Always	Yes

The output range of the analog monitor is from -10 V to +10 V. If the setting is 1, take the absolute value of the output so the output values is only positive.

Setting Value	Setting Details
0	Output as negative/positive values
1	Output as positive values only

0x2221		Analog Monitor Channel 1 Select					ALL
Variable Type	Setting Range	Initial Value	Unit	Accessibility	PDO Assignment	Variable Attribute	Saving
UINT	0 to 65535	0	-	RW	No	Always	Yes

This sets the monitoring variables to be output to analog monitor output channel 1.

Setting Value	Displayed Items	Unit
0x00	Speed feedback	rpm
0x01	Speed command	rpm
0x02	Speed error	rpm
0x03	Torque feedback	%
0x04	Torque command	%
0x05	Following error	pulse
0x06	Accumulated operation overload	%
0x07	DC link voltage	V
0x08	Accumulated regeneration overload	%
0x09	Encoder single-turn data	pulse
0x0A	Inertia ratio	%
0x0B	Reserved	-
0x0C	Drive temperature 1	°C
0x0D	Drive temperature 2	°C
0x0E	Encoder temperature 1	°C
0x0F	Hall signal	-
0x10	U phase current	A
0x11	V phase current	A
0x12	W phase current	A
0x13	Current position value	UU
0x14	Target position value	UU
0x15	Position command speed	rpm, mm/s
0x16	Hall U signal	-
0x17	Hall V signal	-
0x18	Hall W signal	-

0x2222		Analog Monitor Channel 2 Select					ALL
Variable Type	Setting Range	Initial Value	Unit	Accessibility	PDO Assignment	Variable Attribute	Saving
UINT	0 to 65535	1	-	RW	No	Always	Yes

This sets the monitoring variables to be output to analog monitor output channel 2.

0x2223		Analog Monitor Channel 1 Offset					ALL
Variable Type	Setting Range	Initial Value	Unit	Accessibility	PDO Assignment	Variable Attribute	Saving
DINT	0 to 0x40000000	0	-	RW	No	Always	Yes

Subtract the offset value from the monitoring variable of analog monitor output channel 1 to determine the final output. The unit will be that of the variable configured in the Analog Monitor Channel 1 Select (0x2221).

0x2224		Analog Monitor Channel 2 Offset					ALL
Variable Type	Setting Range	Initial Value	Unit	Accessibility	PDO Assignment	Variable Attribute	Saving
DINT	0 to 0x40000000	0	-	RW	No	Always	Yes

Subtract the offset value from the monitoring variable of analog monitor output channel 2 to determine the final output. The unit will be that of the variable configured in the Analog Monitor Channel 2 Select (0x2222).

0x2225		Analog Monitor Channel 1 Scale					ALL
Variable Type	Setting Range	Initial Value	Unit	Accessibility	PDO Assignment	Variable Attribute	Saving
UDINT	0 to 0x40000000	500	-	RW	No	Always	Yes

This sets the scaling of the variable to be output per 1 V when outputting the monitoring variable set as analog output channel 1. The unit will be that of the variable configured in the Analog Monitor Channel 1 Select (0x2221) per 1 V.

For example, if you set the speed feedback to channel 1 and the scale to 500, up to ± 5000 rpm can be output as ± 10 V.

0x2226		Analog Monitor Channel 2 Scale					ALL
Variable Type	Setting Range	Initial Value	Unit	Accessibility	PDO Assignment	Variable Attribute	Saving
UDINT	0 to 0x40000000	500	-	RW	No	Always	Yes

This sets the scaling of the variable to be output per 1 V when outputting the monitoring variable set as analog output channel 2. The unit will be that of the variable configured in the Analog Monitor Channel 2 Select (0x2222) per 1 V.

● Velocity Control (0x2300~)

0x2300	Jog Operation Speed						ALL
Variable Type	Setting Range	Initial Value	Unit	Accessibility	PDO Assignment	Variable Attribute	Saving
INT	-6000 to 6000	500	rpm	RW	No	Always	Yes

You can set the Jog operation speed.

0x2301	Speed Command Acceleration Time						ALL
Variable Type	Setting Range	Initial Value	Unit	Accessibility	PDO Assignment	Variable Attribute	Saving
UINT	0 to 10000	200	ms	RW	No	Always	Yes

You can set the time required for the motor to reach the rated motor speed from a stop in the unit of ms.

0x2302	Speed Command Deceleration Time						ALL
Variable Type	Setting Range	Initial Value	Unit	Accessibility	PDO Assignment	Variable Attribute	Saving
UINT	0 to 10000	200	ms	RW	No	Always	Yes

You can set the time required for the motor to decelerate from the rated motor speed to a stop in the unit of ms.

0x2303	Speed Command S-curve Time						ALL
Variable Type	Setting Range	Initial Value	Unit	Accessibility	PDO Assignment	Variable Attribute	Saving
UINT	0 to 1000	0	ms	RW	No	Always	Yes

You can set the speed command to operate in an S-curve pattern for smooth acceleration/deceleration. If it is set to 0, the drive operates in a trapezoidal pattern by default.

0x2304		Program Jog Operation Speed 1					ALL
Variable Type	Setting Range	Initial Value	Unit	Accessibility	PDO Assignment	Variable Attribute	Saving
INT	-6000 to 6000	0	rpm	RW	No	Always	Yes

For program jog operation, you can set operation velocity 1 to 4 and operation time 1 to 4 as follows.

0x2305		Program Jog Operation Speed 2					ALL
Variable Type	Setting Range	Initial Value	Unit	Accessibility	PDO Assignment	Variable Attribute	Saving
INT	-6000 to 6000	500	rpm	RW	No	Always	Yes

Refer to the description of Program Jog Operation Speed 1 (0x2304).

0x2306		Program Jog Operation Speed 3					ALL
Variable Type	Setting Range	Initial Value	Unit	Accessibility	PDO Assignment	Variable Attribute	Saving
INT	-6000 to 6000	0	rpm	RW	No	Always	Yes

Refer to the description of Program Jog Operation Speed 1 (0x2304).

0x2307		Program Jog Operation Speed 4					ALL
Variable Type	Setting Range	Initial Value	Unit	Accessibility	PDO Assignment	Variable Attribute	Saving
INT	-6000 to 6000	-500	rpm	RW	No	Always	Yes

Refer to the description of Program Jog Operation Speed 1 (0x2304).

0x2308		Program Jog Operation Time 1					ALL
Variable Type	Setting Range	Initial Value	Unit	Accessibility	PDO Assignment	Variable Attribute	Saving
UINT	0 to 10000	500	ms	RW	No	Always	Yes

Refer to the description of Program Jog Operation Speed 1 (0x2304).

0x2309		Program Jog Operation Time 2					ALL
Variable Type	Setting Range	Initial Value	Unit	Accessibility	PDO Assignment	Variable Attribute	Saving
UINT	0 to 10000	5000	ms	RW	No	Always	Yes

Refer to the description of Program Jog Operation Speed 1 (0x2304).

0x230A		Program Jog Operation Time 3					ALL
Variable Type	Setting Range	Initial Value	Unit	Accessibility	PDO Assignment	Variable Attribute	Saving
UINT	0 to 10000	500	ms	RW	No	Always	Yes

Refer to the description of Program Jog Operation Speed 1 (0x2304).

0x230B		Program Jog Operation Time 4					ALL
Variable Type	Setting Range	Initial Value	Unit	Accessibility	PDO Assignment	Variable Attribute	Saving
UINT	0 to 10000	5000	ms	RW	No	Always	Yes

Refer to the description of Program Jog Operation Speed 1 (0x2304).

0x230C		Index Pulse Search Speed					ALL
Variable Type	Setting Range	Initial Value	Unit	Accessibility	PDO Assignment	Variable Attribute	Saving
INT	-1000 to 1000	20	rpm	RW	No	Always	Yes

You can set the velocity for index pulse search.

0x230D		Speed Limit Function Select					ALL
Variable Type	Setting Range	Initial Value	Unit	Accessibility	PDO Assignment	Variable Attribute	Saving
UINT	0 to 3	0	-	RW	Yes	Always	Yes

You can set the speed limit function for torque control.

Setting Value	Setting Details
0	Limited by the speed limit value (0x230E)
1	Limited by the maximum motor speed
2	Sets the analog speed command as the maximum torque speed limit
3	Applies the lower value between 0x230E and analog speed command value

0x230E		Speed Limit Value at Torque Control Mode					ALL
Variable Type	Setting Range	Initial Value	Unit	Accessibility	PDO Assignment	Variable Attribute	Saving
UINT	0 to 6000	1000	rpm	RW	Yes	Always	Yes

You can set the speed limit value at torque control mode. This setting is applied only when the Speed Limit Function Select (0x230D) is set to 0.

0x230F		Over Speed Detection Level					ALL
Variable Type	Setting Range	Initial Value	Unit	Accessibility	PDO Assignment	Variable Attribute	Saving
UINT	0 to 10000	6000	rpm	RW	No	Always	Yes

You can set the level of detecting overspeed alarms (AL-50). If the setting value is larger than the maximum motor speed, the detection level is set by the maximum motor speed.

0x2310		Excessive Speed Error Detection Level					ALL
Variable Type	Setting Range	Initial Value	Unit	Accessibility	PDO Assignment	Variable Attribute	Saving
UINT	0 to 10000	5000	rpm	RW	No	Always	Yes

You can set the level of detecting excessive speed error alarms (AL-53). If the difference between the speed command and the speed feedback exceeds the setting value, an excessive speed error alarm is generated.

0x2311	Servo-Lock Function Select						ALL
Variable Type	Setting Range	Initial Value	Unit	Accessibility	PDO Assignment	Variable Attribute	Saving
UINT	0 to 1	0	-	RW	No	Always	Yes

You can set the servo-lock function to fix the motor position with a position value when the speed command of 0 is for velocity control.

Setting Value	Setting Details
0	Servo-lock function disabled
1	Servo-lock function enabled

● Miscellaneous Setting (0x2400~)

0x2400		Software Position Limit Function Select					P
Variable Type	Setting Range	Initial Value	Unit	Accessibility	PDO Assignment	Variable Attribute	Saving
UINT	0 to 3	0	-	RW	No	Always	Yes

You can set the software position limit function for position control. When you use the position limit function, the upper and the lower limits in (0x607D:02) and (0x607D:01) are used.

Encoder specification	Necessary conditions for function use
Incremental encoder	1. Homing must be performed once after a power input. 2. Functions can be used after homing is completed.
Absolute single-turn encoder (BissB)	
Absolute multi-turn encoder (BissC)	1. External batteries must be connected. 2. Absolute Encoder Configuration [0x2005] must be set to 0. 3. There is no need for another homing after the power input. 4. Functions can immediately be used.

The software position limit function can be used in the incremental and singleturn encoders only when the main power is applied and homing is completed. In multiturn encoders, homing is unnecessary when using a multiturn that has a 0 Absolute Encoder Configuration [0x2005]. Also, be aware that this function does not operate when the upper limit is smaller than the lower limit. .

Setting Value	Setting Details
0	None of the positive and negative direction software position limits are used
1	Only the positive direction software position limit value is used It is not limited for the negative direction
2	Only the negative direction software position limit value is used It is not limited for the positive direction
3	Both the positive and the negative direction software position limits are used

0x2401		INPOS1 Output Range					P
Variable Type	Setting Range	Initial Value	Unit	Accessibility	PDO Assignment	Variable Attribute	Saving
UINT	0 to 60000	100	UU	RW	Yes	Always	Yes

With the position command not newly updated, if the following error is retained within the INPOS1 output range for the INPOS1 output time, the INPOS1 signal is output.

0x2402		INPOS1 Output Time					P
Variable Type	Setting Range	Initial Value	Unit	Accessibility	PDO Assignment	Variable Attribute	Saving
UINT	0 to 1000	0	ms	RW	Yes	Always	Yes

Refer to the description of 0x2401.

0x2403		INPOS2 Output Range					P
Variable Type	Setting Range	Initial Value	Unit	Accessibility	PDO Assignment	Variable Attribute	Saving
UINT	0 to 60000	100	UU	RW	Yes	Always	Yes

This parameter outputs the INPOS2 signal when the following error is lower than the setting value. Unlike INPOS1, the INPOS2 signal is output by calculating only the following error value.

0x2404		ZSPD Output Range					P
Variable Type	Setting Range	Initial Value	Unit	Accessibility	PDO Assignment	Variable Attribute	Saving
UINT	0 to 6000	10	rpm	RW	Yes	Always	Yes

When the current velocity is lower than the setting value, the parameter outputs the ZSPD signal.

0x2405		TGON Output Range					P
Variable Type	Setting Range	Initial Value	Unit	Accessibility	PDO Assignment	Variable Attribute	Saving
UINT	0 to 6000	100	rpm	RW	Yes	Always	Yes

When the current velocity is higher than the setting value, the parameter outputs the TGON signal.

0x2406		INSPD Output Range					P
Variable Type	Setting Range	Initial Value	Unit	Accessibility	PDO Assignment	Variable Attribute	Saving
UINT	0 to 6000	100	rpm	RW	Yes	Always	Yes

When the velocity error is lower than the setting value, the parameter outputs the INSPD signal.

0x2407		BRAKE Output Speed					P
Variable Type	Setting Range	Initial Value	Unit	Accessibility	PDO Assignment	Variable Attribute	Saving
UINT	0 to 6000	100	rpm	RW	No	Always	Yes

If the motor stops due to the servo off state or servo alarm during rotation, you can set the velocity (0x2407) and delay time (0x2408) for brake signal output in order to set the output timing. The brake signal is output if the motor rotation velocity goes below the set value (0x2407) or the output delay time (0x2408) has been reached after the servo off command.

0x2408		BRAKE Output Delay Time					P
Variable Type	Setting Range	Initial Value	Unit	Accessibility	PDO Assignment	Variable Attribute	Saving
UINT	0 to 1000	100	ms	RW	No	Always	Yes

Refer to the description of 0x2407.

0x2409		Torque Limit for Homing Using Stopper					ALL
Variable Type	Setting Range	Initial Value	Unit	Accessibility	PDO Assignment	Variable Attribute	Saving
UINT	0 to 2000	250	0.1%	RW	No	Always	Yes

You can set torque limits for homing using the stopper. With too large of a value configured, the machine may collide with the stopper. So be careful.

0x240A		Duration Time for Homing Using Stopper					ALL
Variable Type	Setting Range	Initial Value	Unit	Accessibility	PDO Assignment	Variable Attribute	Saving
UINT	0 to 1000	50	ms	RW	No	Always	Yes

You can set the time to detect the stopper during homing. Set an appropriate value for the machine.

0x240B		Modulo Mode					ALL
Variable Type	Setting Range	Initial Value	Unit	Accessibility	PDO Assignment	Variable Attribute	Saving
UINT	0 to 5	0	-	RW	No	Power cycling	Yes

This specifies whether to use the Modulo function. The setting is applied only in the Profile Position Mode.

Setting Value	Function
0	Does not use the modulo function.
1	Uses the modulo function to move in the positive direction.
2	Uses the modulo function to move in the negative direction.
3	Uses the modulo function to move via the possible shortest distance.
4	Uses the modulo function to move to the absolute position.
5	Uses the modulo function to move to the relative position.

■ **Setting Value 1: Use the modulo function to move in the positive direction.**

The index always moves in the positive (+) direction regardless of the starting position and command position (Distance).

Rotation runs only within a revolution (Value set in Modulo Factor: 0x240C). The Distance value is treated as an absolute value.

The following figure shows an example of positive rotation from 300° to 30° and from 30° to 180°.

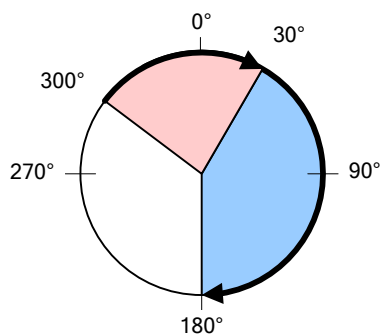

■ **Setting Value 2: Use the modulo function to move in the negative direction.**

The index always moves in the negative (-) direction regardless of the starting position and command position (Distance).

Rotation runs only within a revolution (Value set in Modulo Factor: 0x240C). The Distance value is treated as an absolute value.

The following figure shows an example of negative rotation from 60° to 340° and from 340° to 180°.

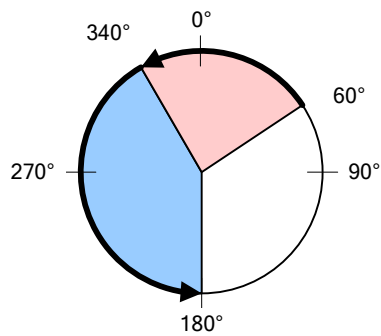

■ **Setting Value 3: Use the modulo function to move via the possible shortest distance.**

The shorter of the positive and negative directions becomes the movement direction.

Rotation runs only within a revolution (Value set in Modulo Factor: 0x240C). The Distance value is treated as an absolute value.

The following figure shows an example of movements in the shorter direction in a negative rotation from 30° to 310° and in a positive rotation from 30° to 180°.

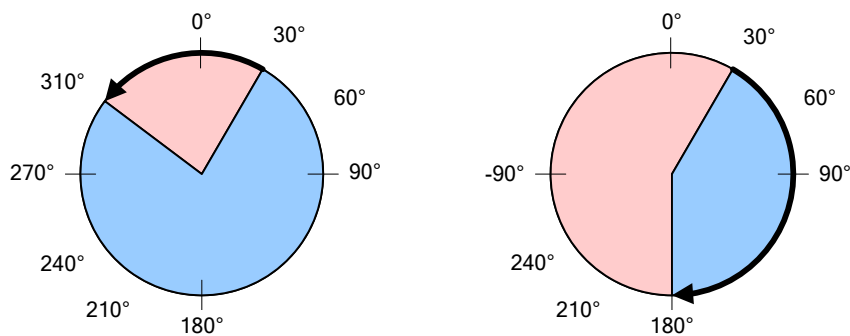

■ **Setting Value 4: Use the modulo function to move to the absolute position.**

The direction of rotation is determined by the relationship between the starting position and the command position. If the starting position value is smaller than the command position value, the rotation runs in the positive direction, and for the opposite case, it runs in the negative direction. Here, the movement is not necessarily made by the shortest distance.

You can input a value greater than a revolution (Value set in Modulo Factor: 0x240C) or a negative value (-90° equals 270° when Modulo Factor is 360°). In this case, the final position is set in consideration of Modulo Factor. Putting in a negative value in such a case is useful because the index can pass the 0 point in its negative rotation.

Depending on the command value, rotation can exceed a revolution.

The following figure shows an example of a positive rotation from 30° to 240° and a negative rotation from 300° to 240°.

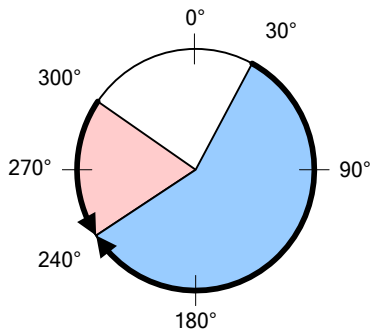

■ **Setting Value 5: Use the modulo function to move to the relative position.**

If the command Distance value is positive (+), the index moves in the positive direction, and if the value is negative (-), it moves in the negative direction. You can input a value greater than a revolution (Value set in Modulo Factor: 0x240C) and rotation can exceed a revolution depending on the command value.

The following figure shows an example of a +180° movement from 30° to 210° and a -120° movement from 30° to -90°.

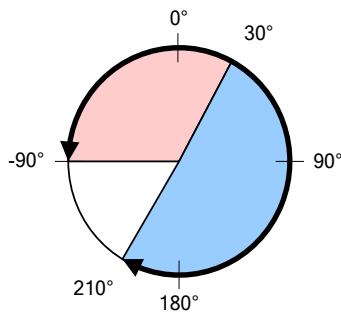

0x240C		Modulo Factor					ALL
Variable Type	Setting Range	Initial Value	Unit	Accessibility	PDO Assignment	Variable Attribute	Saving
DINT	1 to 0x3FFFFFFF	3600	UU	RW	No	Power cycling	Yes

You can set the factor for using the Modulo function. You can set the position value that corresponds to one revolution when a user drives the motor.

* Modulo factor concept

The default formula is as follows.

$$\text{Position Actual Value using Modulo factor} = \text{Position Actual Value} - (\text{Position Actual Value} \div \text{Modulo Factor})$$

$$\times \text{Encoder Pulse per Revolution}$$

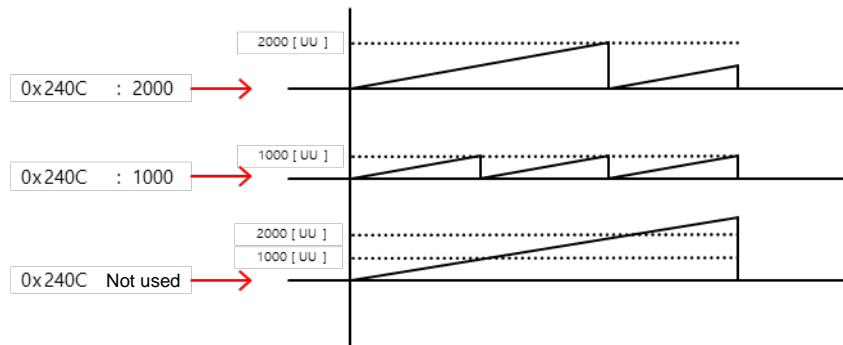

In general, when you do not use the Modulo factor, the current position keeps increasing when the motor rotates in one direction. If you are using modulo factor and input 1000, the current position (Position Actual Value) increases only up to 1000 [UU] and then gets reset to 0 [UU]. Similarly, when you input 2000, it increases only up to 2000 [UU] and is reset. In other words, the remainder value from dividing Position Actual Value by Modulo factor is applied.

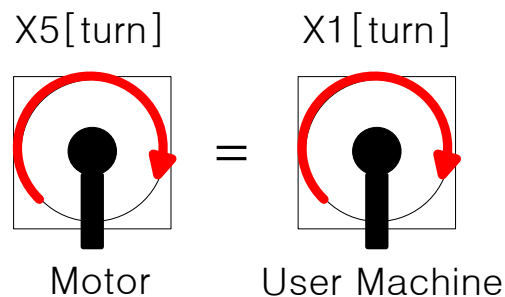

When the machine's apparatus makes 1 [turn], the total pulse required for the machine's 1 [turn] for the installed 19 [bit] motor's 5 [turn] is as follows.

$$524288 \times 5[\text{turn}] = 2621440[\text{UU}]$$

To control the machine so it makes 1 [turn] within 0 to 2621440 [UU], set the modulo factor to 2621440 [UU]. In this case, Position Actual Value ranges from 1 to 2621440 [UU] for 1 [turn] and restarts from 1 [UU] for the next turn.

* Modulo factor application example

For L7P, the modulo factor can be applied when the address 0x3000 is set to the index mode 0 and the address 0x3001 is set to the rotary coordinate system 1.

To rotate the axis of the machine to the 30 degree mark in Index Operation Mode,

$$2621440[\text{UU}] \times \frac{30^\circ}{360^\circ} = 218453[\text{UU}]$$

Set the index distance to 218453 [UU]. To rotate the axis of the machine to 210 degrees, set the index distance to 1529173 [UU].

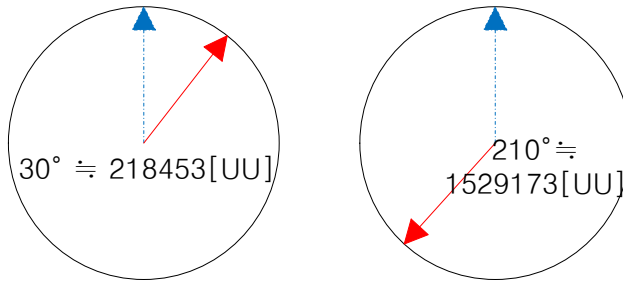

0x240D	User Drive Name						ALL
Variable Type	Setting Range	Initial Value	Unit	Accessibility	PDO Assignment	Variable Attribute	Saving
STRING	-	'Drive'	UU	RW	No	Always	Yes

You can customize the drive name. You can use up to 16 characters to set the name.

0x240E	Individual Parameter Save						ALL
Variable Type	Setting Range	Initial Value	Unit	Accessibility	PDO Assignment	Variable Attribute	Saving
UINT	0 to 1	0	-	RW	No	Always	No

You can set whether or not to immediately save individual parameters. This parameter is not saved and reset to 0 during power turn-on.

Setting Value	Setting Details
0	Does not save parameters individually. For details on saving parameters, refer to Store Parameter (0x1010)
1	Saves parameters individually. When a parameter is written, it is immediately saved in the memory

0x240F	RMS Overload Calculation Time						ALL
Variable Type	Setting Range	Initial Value	Unit	Accessibility	PDO Assignment	Variable Attribute	Saving
UINT	100 to 60000	15000	ms	RW	No	Power cycling	Yes

You can set the time to calculate RMS operation overload (0x2619).

0x2410	RTC Time Set						ALL
Variable Type	Setting Range	Initial Value	Unit	Accessibility	PDO Assignment	Variable Attribute	Saving
UDINT	0 to 0xFFFFFFFF		-	RW	No	Always	Yes

You can set the time for RTC.

0x2411		RTC Date Set					ALL
Variable Type	Setting Range	Initial Value	Unit	Accessibility	PDO Assignment	Variable Attribute	Saving
UDINT	0 to 0xFFFFFFFF		-	RW	No	Always	Yes

You can set the date for RTC.

0x2412		General Object Monitor 1 Config					ALL
Variable Type	Setting Range	Initial Value	Unit	Accessibility	PDO Assignment	Variable Attribute	Saving
UDINT	0 to 0xFFFFFFFF		-	RW	No	Always	No

0x2413		General Object Monitor 2 Config					ALL
Variable Type	Setting Range	Initial Value	Unit	Accessibility	PDO Assignment	Variable Attribute	Saving
UDINT	0 to 0xFFFFFFFF		-	RW	No	Always	No

0x2414		General Object Monitor 3 Config					ALL
Variable Type	Setting Range	Initial Value	Unit	Accessibility	PDO Assignment	Variable Attribute	Saving
UDINT	0 to 0xFFFFFFFF		-	RW	No	Always	No

0x2415		General Object Monitor 4 Config					ALL
Variable Type	Setting Range	Initial Value	Unit	Accessibility	PDO Assignment	Variable Attribute	Saving
UDINT	0 to 0xFFFFFFFF		-	RW	No	Always	No

You can set the object monitor value used in Drive CM.

0x2416		Position tracking error level at zero speed					ALL
Variable Type	Setting Range	Initial Value	Unit	Accessibility	PDO Assignment	Variable Attribute	Saving
UINT	0 to 0xFFFF	500	-	RW	No	Always	Yes

You can set the position tracking error level in the zero speed state. However, a zero speed position tracking error can be detected only in the SV_ON state.

0x2417		Position tracking error level at max. speed					ALL
Variable Type	Setting Range	Initial Value	Unit	Accessibility	PDO Assignment	Variable Attribute	Saving
UINT	0 to 0xFFFF	3000	-	RW	No	Always	Yes

You can set the position tracking error level in the maximum speed operation.

0x2418		Following Error Window at Standstill					P
Variable Type	Setting Range	Initial Value	Unit	Accessibility	PDO Assignment	Variable Attribute	Saving
UDINT	0 to 0xFFFF	2621440	-	RW	No	Always	Yes

This specifies the following error window to check the Following Error (Statusword, 0x6041.13) at a stop.

0x2419		Industrial Ethernet Select					ALL
Variable Type	Setting Range	Initial Value	Unit	Accessibility	PDO Assignment	Variable Attribute	Saving
UINT	-	-	-	RO	No	-	No

You can show the Ethernet setting for Ethernet connection of the servo drive. If the output is 1, Ethernet connection is enabled.

0x241A		Ethernet TCP Port					ALL
Variable Type	Setting Range	Initial Value	Unit	Accessibility	PDO Assignment	Variable Attribute	Saving
UINT	0 to 0xFFFF	502	-	RW	No	Always	Yes

You can set the Ethernet port for Ethernet connection. Connection can be made only if the Ethernet port set in the upper level controller and the servo drive port are the same.

0x241B		Ethernet TCP IP Address					ALL
Variable Type	Setting Range	Initial Value	Unit	Accessibility	PDO Assignment	Variable Attribute	Saving
UDINT	0 to 0xFFFFFFFF	0x0505A8C0	-	RW	No	Always	Yes

You can set the Ethernet IP address for Ethernet connection. If you access the network from the upper-level controller, you can enter the IP address set in the servo drive to make connection.

Ethernet IP setting can be set as follows.

Setting example) IP address: 192.168.5.5

Bits	31~24	23~16	15~8	7~0
DATA	05	05	A8	C0
Setting value (hex)	0x0505A8C0			
Setting value (address)	192.168.5.5			

The following figure illustrates conversion from a HEX value to an address value.

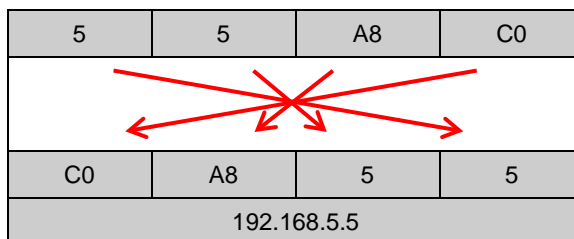

0x241C	Ethernet Subnet Mask						ALL
Variable Type	Setting Range	Initial Value	Unit	Accessibility	PDO Assignment	Variable Attribute	Saving
UDINT	0 to 0xFFFFFFFF	0x00FF FFFF	-	RW	No	Always	Yes

You can set the Ethernet subnet mask for Ethernet connection.

Ethernet subnet mask setting can be set as follows.

Setting Example) Subnet mask: 255.255.255.0

Bits	31~24	23~16	15~8	7~0
DATA	00	FF	FF	FF
Setting value (HEX)	0x00FFFFFF			
Setting value (address)	255.255.255.0			

For details on converting a HEX value to an address value, refer to the description of Ethernet TCP IP [0x241B].

0x241D	Ethernet Gateway						ALL
Variable Type	Setting Range	Initial Value	Unit	Accessibility	PDO Assignment	Variable Attribute	Saving
UDINT	0 to 0xFFFFFFFF	0x0201 A8C0	-	RW	No	Always	Yes

You can set the Ethernet gateway address for Ethernet connection.

Ethernet gateway setting can be set as follows.

Setting example) IP address: 192.168.1.2

Bits	31~24	23~16	15~8	7~0
DATA	02	01	A8	C0
Setting value (HEX)	0x0201A8C0			
Setting value (address)	192.168.1.2			

For details on converting a HEX value to an address value, refer to the description of Ethernet TCP IP [0x241B].

0x241E		MAC Address - Vendor					ALL
Variable Type	Setting Range	Initial Value	Unit	Accessibility	PDO Assignment	Variable Attribute	Saving
UDINT	0 to 0xFFFFFFFF	0x000080E1	-	RW	No	Power cycling	Yes

You can set the vendor for the MAC address.

Vendor setting for the Ethernet MAC address can be set as follows. If the MAC address is '00 – 80 – E1 – 12 – 34 – 56,' enter 0x000080E1 to set its vendor.

0x241F		MAC Address - NIC					ALL
Variable Type	Setting Range	Initial Value	Unit	Accessibility	PDO Assignment	Variable Attribute	Saving
UDINT	0 to 0xFFFFFFFF	0x00000000	-	RW	No	Power cycling	Yes

You can set the network interface controller (NIC) for the Ethernet MAC address.

NIC setting for the Ethernet MAC address can be set as follows. If the MAC address is '00 – 80 – E1 – 12 – 34 – 56,' enter 0x00123456 to set its NIC.

0x2420		Webserver ID					ALL
Variable Type	Setting Range	Initial Value	Unit	Accessibility	PDO Assignment	Variable Attribute	Saving
STRING	-	'ID'	-	RW	No	Always	Yes

You can set the ID for logging into the Webserver.

0x2421		Webserver Password					ALL
Variable Type	Setting Range	Initial Value	Unit	Accessibility	PDO Assignment	Variable Attribute	Saving
STRING	-	'PASS WORD'	-	RW	No	Always	Yes

You can set the password for logging into the Webserver.









0x2422	Encoder Output Pulse						ALL
Variable Type	Setting Range	Initial Value	Unit	Accessibility	PDO Assignment	Variable Attribute	Saving
UDINT	0 to 4294967295	10000	pulse	RW	No	Power cycling	Yes

Specify the count of pulses to be output per motor rotation when the encoder signal is sent from the drive to the outside.

Up to 6.5Mpps of demultiplied output is supported (in multiples of 4). Consider the motor operation speed while setting the parameter.

0x2423	Encoder Output Logic						ALL
Variable Type	Setting Range	Initial Value	Unit	Accessibility	PDO Assignment	Variable Attribute	Saving
UINT	0 to 1	0	-	RW	No	Power cycling	Yes

You can set the phase A/B lead for encoder signal output during positive driving of the motor.

Setting value	Forward rotation	Reverse rotation
0	Phase A  Phase B 	Phase A  Phase B 
1	Phase A  Phase B 	Phase A  Phase B 

● Enhanced Control (0x2500~)

0x2500		Adaptive Filter Function Select					ALL
Variable Type	Setting Range	Initial Value	Unit	Accessibility	PDO Assignment	Variable Attribute	Saving
UINT	0 to 5	0	-	RW	No	Always	Yes

You can set the adaptive filter function.

Setting Value	Setting Details
0	The adaptive filter is not used
1	Only one adaptive filter is used. You can check the settings configured automatically in the notch filter 3 settings (0x2507, 0x2508, 0x2509). If an arbitrary value is set in notch filter 3, auto setting is not available. If you wish to use auto setting, you should initialize notch filter 3 first.
2	Two adaptive filters are used. You can check the settings configured automatically in the notch filter 3 (0x2507, 0x2508, 0x2509) and filter 4 settings (0x250A, 0x250B, 0x250C). If an arbitrary value is set for notch filter 3 (or 4), auto setting is applied to notch filter 4 (or 3). If arbitrary values are set for notch filter 3 and 4, the original settings remain unchanged. If notch filter 3 and 4 are initialized, auto setting is available.
3	Reserved
4	Resets the notch filter 3 (0x2507, 0x2508, and 0x2509) and notch filter 4 (0x250A, 0x250B, and 0x250C) settings.
5	Reserved

0x2501		Notch Filter 1 Frequency					ALL
Variable Type	Setting Range	Initial Value	Unit	Accessibility	PDO Assignment	Variable Attribute	Saving
UINT	50 to 5000	5000	Hz	RW	No	Always	Yes

You can set the frequency of Notch Filter 1.

0x2502		Notch Filter 1 Width					ALL
Variable Type	Setting Range	Initial Value	Unit	Accessibility	PDO Assignment	Variable Attribute	Saving
UINT	1 to 100	1	-	RW	No	Always	Yes

You can set the width of Notch Filter 1.

0x2503		Notch Filter 1 Depth					ALL
Variable Type	Setting Range	Initial Value	Unit	Accessibility	PDO Assignment	Variable Attribute	Saving
UINT	1 to 5	1	-	RW	No	Always	Yes

You can set the depth of Notch Filter 1.

0x2504		Notch Filter 2 Frequency					ALL
Variable Type	Setting Range	Initial Value	Unit	Accessibility	PDO Assignment	Variable Attribute	Saving
UINT	50 to 5000	5000	Hz	RW	No	Always	Yes

0x2505		Notch Filter 2 Width					ALL
Variable Type	Setting Range	Initial Value	Unit	Accessibility	PDO Assignment	Variable Attribute	Saving
UINT	1 to 100	1	-	RW	No	Always	Yes

0x2506		Notch Filter 2 Depth					ALL
Variable Type	Setting Range	Initial Value	Unit	Accessibility	PDO Assignment	Variable Attribute	Saving
UINT	1 to 5	1	-	RW	No	Always	Yes

0x2507		Notch Filter 3 Frequency					ALL
Variable Type	Setting Range	Initial Value	Unit	Accessibility	PDO Assignment	Variable Attribute	Saving
UINT	50 to 5000	5000	Hz	RW	No	Always	Yes

0x2508		Notch Filter 3 Width					ALL
Variable Type	Setting Range	Initial Value	Unit	Accessibility	PDO Assignment	Variable Attribute	Saving
UINT	1 to 100	1	-	RW	No	Always	Yes

0x2509		Notch Filter 3 Depth					ALL
Variable Type	Setting Range	Initial Value	Unit	Accessibility	PDO Assignment	Variable Attribute	Saving
UINT	1 to 5	1	-	RW	No	Always	Yes

0x250A		Notch Filter 4 Frequency					ALL
Variable Type	Setting Range	Initial Value	Unit	Accessibility	PDO Assignment	Variable Attribute	Saving
UINT	50 to 5000	5000	Hz	RW	No	Always	Yes

0x250B		Notch Filter 4 Width					ALL
Variable Type	Setting Range	Initial Value	Unit	Accessibility	PDO Assignment	Variable Attribute	Saving
UINT	1 to 100	1	-	RW	No	Always	Yes

0x250C		Notch Filter 4 Depth					ALL
Variable Type	Setting Range	Initial Value	Unit	Accessibility	PDO Assignment	Variable Attribute	Saving
UINT	1 to 5	1	-	RW	No	Always	Yes

0x250D		On-line Gain Tuning Mode					ALL
Variable Type	Setting Range	Initial Value	Unit	Accessibility	PDO Assignment	Variable Attribute	Saving
UINT	0 to 1	0	-	RW	No	Always	Yes

It determines whether real-time gain is adjusted during operation. The factory setting is 1 (Use). The estimated gain at online tuning is reflected every 64 ms, and the changed gain is stored in EEPROM about every 2 minutes.

Setting Value	Setting Details
0	On-line gain tuning not used
1	On-line gain tuning used

0x250E		System Rigidity for Gain Tuning					ALL
Variable Type	Setting Range	Initial Value	Unit	Accessibility	PDO Assignment	Variable Attribute	Saving
UINT	1 to 20	8	-	RW	No	Always	Yes

This specifies the system rigidity applied for gain tuning. After the gain tuning according to the setting, the overall gain will be set higher or lower. If the gain of the maximum setting value is not enough, carry out the tuning manually.

Increasing the system rigidity setting will increase the gain and shorten the positioning time. However, if the setting is too high, vibration may occur depending on the machine configuration. Adjust the system rigidity setting from low to high values within a range that does not cause vibration.

After the gain tuning, the following gains will be automatically changed:

Inertia Ratio (0x2100), Position Loop Gain 1 (0x2001), Speed Loop Gain 1 (0x2102), Speed Integral Time Constant 1 (0x2103), Torque Command Filter Time Constant 1 (0x2104), Notch Filter 3 Frequency (0x2507), and Notch Filter 4 Frequency (0x250A).

The gain values (position loop gain, speed loop gain, speed integration time constant and torque command filter time constant) according to the system rigidity settings are determined by the values in the table below.

System Rigidity	1	2	3	4	5	6	7	8	9	10
Position Loop Gain 1	2	5	10	15	22	25	30	35	40	45
Speed Loop Gain 1	3	8	15	23	33	36	45	52	60	68
Speed Integral Time Constant 1	190	70	50	40	30	28	22	18	15	14
Torque Command Filter Time Constant 1	80	30	20	10	8	7	6	5	4	3
System Rigidity	11	12	13	14	15	16	17	18	19	20
Position Loop Gain 1	50	55	60	65	73	87	100	110	117	120
Speed Loop Gain 1	75	83	90	100	110	130	150	160	175	185
Speed Integral Time Constant 1	13	12	10	9	9	8	7	6	6	6
Torque Command Filter Time Constant 1	3	3	3	2	2	2	2	2	2	2

0x250F	On-line Gain Tuning Adaptation Speed						ALL
Variable Type	Setting Range	Initial Value	Unit	Accessibility	PDO Assignment	Variable Attribute	Saving
UINT	1 to 5	1	-	RW	No	Always	Yes

You can the speed of reflecting the change in gain when performing On-line gain tuning. The larger the setting value is, the faster the gain changes are reflected. Depending on the condition of the load, the system may become unstable if it is reflected too quickly.

0x2510	Off-line Gain Tuning Direction						ALL
Variable Type	Setting Range	Initial Value	Unit	Accessibility	PDO Assignment	Variable Attribute	Saving
UINT	0 to 1	0	-	RW	No	Always	Yes

You can set the movement direction when performing offline gain tuning. Set the function properly according to the conditions of the apparatus.

Setting Value	Setting Details
0	Drives in the positive direction
1	Drives in the negative direction

0x2511	Off-line Gain Tuning Distance						ALL
Variable Type	Setting Range	Initial Value	Unit	Accessibility	PDO Assignment	Variable Attribute	Saving
UINT	1 to 10	5	-	RW	No	Always	Yes

You can set the distance when performing off-line gain tuning. The larger the setting value is, the longer the movement distance becomes. Set the distance properly according to the condition of the apparatus. Make sure to secure an enough distance(more than one revolution of the motor) prior to gain tuning.

0x2512		Disturbance Observer Gain					ALL
Variable Type	Setting Range	Initial Value	Unit	Accessibility	PDO Assignment	Variable Attribute	Saving
UINT	0 to 100	0	%	RW	No	Always	Yes

This function suppresses torque disturbance by compensating torque through load model. If the disturbance observer gain setting is large, the disturbance suppression works well. However, since noise occurs during operation, it is necessary to set the gain and filter time constant appropriately.

0x2513		Disturbance Observer Filter Time Constant					ALL
Variable Type	Setting Range	Initial Value	Unit	Accessibility	PDO Assignment	Variable Attribute	Saving
UINT	0 to 1000	10	0.1ms	RW	No	Always	Yes

This applies a low pass filter for the disturbance observer reference. By setting the disturbance observer gain and filter time constant appropriately, disturbance can be suppressed.

0x2514		Current Controller Gain					ALL
Variable Type	Setting Range	Initial Value	Unit	Accessibility	PDO Assignment	Variable Attribute	Saving
UINT	1 to 150	100	%	RW	No	Always	Yes

You can set gain of the current controller. Lowering the setting value can reduce the noise, but the drive's responsiveness decreases at the same time.

0x2515		Vibration Suppression Filter Configuration					ALL
Variable Type	Setting Range	Initial Value	Unit	Accessibility	PDO Assignment	Variable Attribute	Saving
UINT	0 to 4	0	-	RW	No	Always	Yes

Set whether to use a filter to suppress vibration generated at the load end.

Setting Value	Setting Details
0	Vibration Suppression (Damping) Filter is not used.
1	Vibration Suppression (Damping) Filter 1 is used.
2	Vibration Suppression (Damping) Filter 2 is used.
3	Vibration Suppression (Damping) Filters 1 and 2 are used.
4	Vibration Suppression (Damping) Filters 1 and 2 are used according to LVSF1 and LVSF2 inputs.

0x2516		Vibration Suppression Filter 1 Frequency					ALL
Variable Type	Setting Range	Initial Value	Unit	Accessibility	PDO Assignment	Variable Attribute	Saving
UINT	0 to 2000	10	0.1Hz	RW	No	Always	Yes

Set the Vibration Suppression (Damping) Filter 1 frequency.

0x2517		Vibration Suppression Filter 1 Damping					ALL
Variable Type	Setting Range	Initial Value	Unit	Accessibility	PDO Assignment	Variable Attribute	Saving
UINT	0 to 5	0	-	RW	No	Always	Yes

Set the coefficient of Vibration Suppression (Damping) Filter 1. The lower the setting value, the higher the damping width.

0x2518		Vibration Suppression Filter 2 Frequency					ALL
Variable Type	Setting Range	Initial Value	Unit	Accessibility	PDO Assignment	Variable Attribute	Saving
UINT	0 to 2000	10	0.1Hz	RW	No	Always	Yes

Set the Vibration Suppression (Damping) Filter 2 frequency.

0x2519		Vibration Suppression Filter 2 Damping					ALL
Variable Type	Setting Range	Initial Value	Unit	Accessibility	PDO Assignment	Variable Attribute	Saving
UINT	0 to 5	0	-	RW	No	Always	Yes

Set the coefficient of Vibration Suppression (Damping) Filter 2. The lower the setting value, the higher the damping width.

0x251A	ONE Parameter Mode						ALL
Variable Type	Setting Range	Initial Value	Unit	Accessibility	PDO Assignment	Variable Attribute	Saving
UINT	0 to 1	1	-	RW	No	Always	Yes

This decides whether or not to use the One Parameter function. If you set this to 1, the values of Position Loop Gain (0x2101), Velocity Loop Gain (0x2102), Velocity Integral Time Constant (0x2103), Torque Command Filter Time Constant (0x2104), Velocity Feed-forward Gain (0x210C) and Velocity Feed-forward Filter Time Constant (0x210D) are readjusted according to the Setting Value for System Rigidity for Gain Tuning (0x250E).

(For detailed gain setting, see the description of System Rigidity for Gain Tuning (0x250E).)

Setting Value	Setting Details
0	Do not use One Parameter Mode
1	Use One Parameter Mode

● Monitoring (0x2600~)

0x2600		Feedback Velocity					ALL
Variable Type	Setting Range	Initial Value	Unit	Accessibility	PDO Assignment	Variable Attribute	Saving
INT	-	-	rpm	RO	Yes	-	No

This parameter represents the current rotation velocity of the motor.

0x2601		Command Speed					ALL
Variable Type	Setting Range	Initial Value	Unit	Accessibility	PDO Assignment	Variable Attribute	Saving
INT	-	-	rpm	RO	Yes	-	No

This parameter represents the speed command input to the velocity control loop of the drive.

0x2602		Following Error					ALL
Variable Type	Setting Range	Initial Value	Unit	Accessibility	PDO Assignment	Variable Attribute	Saving
DINT	-	-	pulse	RO	Yes	-	No

This parameter represents the following error of position control.

0x2603		Accumulated Operation Overload					ALL
Variable Type	Setting Range	Initial Value	Unit	Accessibility	PDO Assignment	Variable Attribute	Saving
INT	-	-	0.1%	RO	No	-	No

This parameter represents the accumulated operation overload rate. When the accumulated operation overload rate reaches the Overload Warning Level (0x2010), an operation overload warning (W10) occurs; when it reaches 100%, an operation overload alarm (AL-21) occurs.

0x2604		Instantaneous Maximum Operation Overload					ALL
Variable Type	Setting Range	Initial Value	Unit	Accessibility	PDO Assignment	Variable Attribute	Saving
INT	-	-	0.1%	RO	Yes	-	No

This represents the maximum value of the operation overload rate output instantaneously from the drive for the last 15 seconds. This value can be initialized by instantaneous maximum operation overload reset.

0x2605		DC-Link Voltage					ALL
Variable Type	Setting Range	Initial Value	Unit	Accessibility	PDO Assignment	Variable Attribute	Saving
UINT	-	-	Volt	RO	Yes	-	No

This parameter represents DC link voltage by a main power input.

0x2606		Accumulated Regeneration Overload					ALL
Variable Type	Setting Range	Initial Value	Unit	Accessibility	PDO Assignment	Variable Attribute	Saving
INT	-	-	0.1%	RO	No	-	No

This parameter represents the accumulated overload rate of the regeneration brake resistor from regenerative operation. When the accumulated regeneration overload rate reaches 100%, a regeneration overload alarm (AL-23) is generated.

0x2607		Single-turn Data					ALL
Variable Type	Setting Range	Initial Value	Unit	Accessibility	PDO Assignment	Variable Attribute	Saving
UDINT	-	-	pulse	RO	Yes	-	No

This parameter represents the data for one revolution of the motor. A value ranging from 0 to (encoder resolution-1) is displayed.

0x2608		Mechanical Angle					ALL
Variable Type	Setting Range	Initial Value	Unit	Accessibility	PDO Assignment	Variable Attribute	Saving
UINT	-	-	0.1 deg	RO	Yes	-	No

This parameter represents the single-turn data of the motor in the range of 0.0~359.9.

0x2609		Electrical Angle					ALL
Variable Type	Setting Range	Initial Value	Unit	Accessibility	PDO Assignment	Variable Attribute	Saving
INT	-	-	0.1 deg	RO	Yes	-	No

This parameter represents the electrical angle of the motor in the range of -180.0~180.0.

0x260A		Multi-turn data					ALL
Variable Type	Setting Range	Initial Value	Unit	Accessibility	PDO Assignment	Variable Attribute	Saving
DINT	-	-	rev.	RO	Yes	-	No

This parameter represents multi-turn data of the multi-turn encoder.

0x260B		Drive Temperature 1					ALL
Variable Type	Setting Range	Initial Value	Unit	Accessibility	PDO Assignment	Variable Attribute	Saving
INT	-	-	°C	RO	No	-	No

This is the temperature measured by the temperature sensor integrated into the drive power board. If the measurement is higher than 105°C, the drive overheat alarm 1 (AL-22) will be generated.

0x260C		Drive Temperature 2					ALL
Variable Type	Setting Range	Initial Value	Unit	Accessibility	PDO Assignment	Variable Attribute	Saving
INT	-	-	°C	RO	No	-	No

This parameter represents the temperature measured by the temperature sensor integrated into the drive control board. If the measured temperature is higher than 100°C, the drive overheat alarm 2 (AL-25) will be generated.

0x260D		Encoder Temperature					ALL
Variable Type	Setting Range	Initial Value	Unit	Accessibility	PDO Assignment	Variable Attribute	Saving
INT	-	-	°C	RO	No	-	No

This parameter represents the temperature measured by the temperature sensor integrated into the serial encoder provided by our company (if the setting value of the encoder type (0x2001) are 3, 4, 5, and 6). If the measured temperature 90°C or higher, an encoder overheat alarm (AL-26) is generated.

0x260E		Motor Rated Speed					ALL
Variable Type	Setting Range	Initial Value	Unit	Accessibility	PDO Assignment	Variable Attribute	Saving
UINT	-	-	rpm	RO	No	-	No

This parameter represents the rated speed of a driving motor.

0x260F		Motor Maximum Speed					ALL
Variable Type	Setting Range	Initial Value	Unit	Accessibility	PDO Assignment	Variable Attribute	Saving
UINT	-	-	rpm	RO	No	-	No

This parameter represents the maximum velocity of a driving motor.

0x2610		Drive Rated Current					ALL
Variable Type	Setting Range	Initial Value	Unit	Accessibility	PDO Assignment	Variable Attribute	Saving
UINT	-	-	0.1A	RO	No	-	No

This parameter represents the rated current of the drive.

0x2611		FPGA Version					ALL
Variable Type	Setting Range	Initial Value	Unit	Accessibility	PDO Assignment	Variable Attribute	Saving
STRING	-	-	-	RO	No	-	No

This parameter represents the version of FPGA within the drive.

0x2612		Hall Signal Display					ALL
Variable Type	Setting Range	Initial Value	Unit	Accessibility	PDO Assignment	Variable Attribute	Saving
UINT	-	-	-	RO	No	-	No

This parameter represents the signal of the hall sensor installed in the encoder (or motor). You can use this to verify the connection status of the hall sensor signal or compare the U/V/W phases of the motor with the direction of the hall sensor signal.

The signal value is repeated in the order of 5→4→6→2→3→1 for a positive movement, and it is repeated in the order of 1→3→2→6→4→5 for a negative movement.

Bits	Setting Details
0	W phase hall sensor signal
1	V phase hall sensor signal
2	U phase hall sensor signal

0x2613		Bootloader Version					ALL
Variable Type	Setting Range	Initial Value	Unit	Accessibility	PDO Assignment	Variable Attribute	Saving
STRING	-	-	-	RO	No	-	No

This parameter represents the bootloader version of the drive.

0x2614		Warning Code					ALL
Variable Type	Setting Range	Initial Value	Unit	Accessibility	PDO Assignment	Variable Attribute	Saving
UINT	-	-	-	RO	Yes	-	No

This represents a warning code which has occurred in the drive.

0x2615		Analog Input Channel 1 Value					ALL
Variable Type	Setting Range	Initial Value	Unit	Accessibility	PDO Assignment	Variable Attribute	Saving
INT	-	-	mV	RO	No	-	No

This indicates the voltage in mV which is inputted to the analog input channel 1.

0x2619		RMS Operation Overload					ALL
Variable Type	Setting Range	Initial Value	Unit	Accessibility	PDO Assignment	Variable Attribute	Saving
UINT	-	-	0.1 %	RO	No	-	No

This displays the Root Mean Square (RMS) load factor for the last 15 seconds in 0.1% increments.

Compare the RMS load factor with the rated torque in a 15-second driving cycle to ensure that the RMS load factor is within the drive rated torque. If the RMS load factor is higher than the rated torque, check the drive and motor selection again.

0x261D		Motor Temperature in Per Unit					ALL
Variable Type	Setting Range	Initial Value	Unit	Accessibility	PDO Assignment	Variable Attribute	Saving
UINT	-	-	PU	R	Yes	-	No

This displays the motor temperature per unit. When it exceeds 100, the motor overheat (AL-27) alarm occurs.

The alarm generation time is calculated using the following formula:

$$T = \tau * \ln(I^2/(I^2-1)), \tau: \text{Thermal time constant of the motor, } I: \text{Motor load factor}$$

The alarm generation time for the motor load factor when T is 30 seconds is shown below.

Motor load factor (%)	Alarm generation time
110%	$1.75 * \tau = 52.54$
125%	$1.02 * \tau = 30.65$
150%	$0.59 * \tau = 17.63$
200%	$0.29 * \tau = 8.63$
250%	$0.17 * \tau = 5.23$
300%	$0.12 * \tau = 3.53$

0x2622		Current RTC Time					ALL
Variable Type	Setting Range	Initial Value	Unit	Accessibility	PDO Assignment	Variable Attribute	Saving
UDINT	-	-	-	RO	No	-	No

This parameter displays the current time of RTC.

0x2623		Current RTC Date					ALL
Variable Type	Setting Range	Initial Value	Unit	Accessibility	PDO Assignment	Variable Attribute	Saving
UDINT	-	-	-	RO	No	-	No

This parameter displays the current date of RTC.

0x2626		Cumulative Hours of Use					ALL
Variable Type	Setting Range	Initial Value	Unit	Accessibility	PDO Assignment	Variable Attribute	Saving
DINT	-	-	S	RO	Yes	-	No

This parameter displays the power input time of the drive.

0x2627		Number of Inrush Current Switching					ALL
Variable Type	Setting Range	Initial Value	Unit	Accessibility	PDO Assignment	Variable Attribute	Saving
DINT	-	-	-	RO	Yes	-	No

This parameter represents the relay switch operation counts of the charge relay that operates after the main power is turned on.

0x2628		Number of Dynamic Brake Switching					ALL
Variable Type	Setting Range	Initial Value	Unit	Accessibility	PDO Assignment	Variable Attribute	Saving
DINT	-	-	-	RO	Yes	-	No

This parameter represents the relay switch operation counts of the dynamic brake relay.

0x262A		Fan Life Time					ALL
Variable Type	Setting Range	Initial Value	Unit	Accessibility	PDO Assignment	Variable Attribute	Saving
DINT	-	-	%	RO	Yes	-	No

This parameter represents the lifetime of the fan.

0x2634	Estimated Position Value						ALL
Variable Type	Setting Range	Initial Value	Unit	Accessibility	PDO Assignment	Variable Attribute	Saving
DINT	-	-	Hour	RO	Yes	-	No

This parameter represents the position value estimated using the integral of the command speed.

0x2635	Estimated Following Error						ALL
Variable Type	Setting Range	Initial Value	Unit	Accessibility	PDO Assignment	Variable Attribute	Saving
DINT	-	-	Hour	RO	Yes	-	No

This parameter represents the difference between the position actual value and the estimated position value.

0x2636	General Object Monitor 1 Value						ALL
Variable Type	Setting Range	Initial Value	Unit	Accessibility	PDO Assignment	Variable Attribute	Saving
	-	-	Hour	RO	Yes	-	No

This parameter represents the object data value assigned to object monitor 1.

0x2637	General Object Monitor 2 Value						ALL
Variable Type	Setting Range	Initial Value	Unit	Accessibility	PDO Assignment	Variable Attribute	Saving
	-	-	Hour	RO	Yes	-	No

This parameter represents the object data value assigned to object monitor 2.

0x2638	General Object Monitor 3 Value						ALL
Variable Type	Setting Range	Initial Value	Unit	Accessibility	PDO Assignment	Variable Attribute	Saving
	-	-	Hour	RO	Yes	-	No

This parameter represents the object data value assigned to object monitor 3.

0x2639		General Object Monitor 4 Value					ALL
Variable Type	Setting Range	Initial Value	Unit	Accessibility	PDO Assignment	Variable Attribute	Saving
	-	-	Hour	RO	Yes	-	No

This parameter represents the object data value assigned to object monitor 4.

● Procedure and Alarm History (0x2700~)

0x2700		Procedure Command Code					ALL
Variable Type	Setting Range	Initial Value	Unit	Accessibility	PDO Assignment	Variable Attribute	Saving
UINT	0 to 0xFFFF	0	-	RW	No	-	No

You can run various procedures with the following procedure command codes and command arguments. Make sure to enter correct a command argument value prior to entering a command code because the drive refers to the command argument for the command code input.

Command Codes	Command Arguments	Run Procedures
Manual Jog (0x0001)	1	Servo ON
	2	Servo OFF
	3	Positive (+) Operation (0x2300)
	4	Negative (-) Operation (0x2300)
	5	Zero Speed Stop
Program Jog (0x0002)	1	Servo ON
	2	Servo OFF
	3	Start Operation
	4	Zero Speed Stop (Server ON Maintained)
Servo Alarm History Reset (0x0003)	1	
Off-line Auto Tuning (0x0004)	1	Start Auto Tuning
Index Pulse Search (0x0005)	1	Servo ON
	2	Servo OFF
	3	Positive (+) Search (0x230C)
	4	Negative (-) Search (0x230C)
	5	Zero Speed Stop
Resets the absolute encoder (0x0006)	1	Resets the absolute encoder
Instantaneous Maximum Operation Overload Reset (0x0007)	1	Resets the instantaneous maximum operation overload (0x2604) value
Tunes the phase current offset (0x0008)	1	Tunes the phase current offset (U/V/W phase offsets are stored in 0x2015~0x2017, respectively. If an offset is abnormally large, AL-15 is generated)
Resets the software (0x0009)	1	Resets the software
Commutation (0x000A)	1	Performs commutation
Resets Tamagawa	1	Resets alarm

encoder (0x000B)	2	Resets Tamagawa multiturn
	3	Resets Panasonic warning
GB Preset (0x000D)	1	Resets GB encoder

0x2701	Procedure Command Argument						ALL
Variable Type	Setting Range	Initial Value	Unit	Accessibility	PDO Assignment	Variable Attribute	Saving
UINT	0 to FFFF _{hex}	0	-	RW	No	-	No

0x2702	Servo Alarm History						ALL
SubIndex 0		Number of Entries					
Variable Type	Setting Range	Initial Value	Unit	Accessibility	PDO Assignment	Variable Attribute	Saving
USINT	-	16	-	RO	No	-	No
SubIndex 1		Alarm Code 1 (newest)					
Variable Type	Setting Range	Initial Value	Unit	Accessibility	PDO Assignment	Variable Attribute	Saving
STRING	-	-	-	RO	No	-	No
SubIndex 2		Alarm Code 2					
Variable Type	Setting Range	Initial Value	Unit	Accessibility	PDO Assignment	Variable Attribute	Saving
STRING	-	-	-	RO	No	-	No
SubIndex 3		Alarm Code 3					
Variable Type	Setting Range	Initial Value	Unit	Accessibility	PDO Assignment	Variable Attribute	Saving
STRING	-	-	-	RO	No	-	No
SubIndex 4		Alarm Code 4					
Variable Type	Setting Range	Initial Value	Unit	Accessibility	PDO Assignment	Variable Attribute	Saving
STRING	-	-	-	RO	No	-	No
SubIndex 5		Alarm Code 5					
Variable Type	Setting Range	Initial Value	Unit	Accessibility	PDO Assignment	Variable Attribute	Saving
STRING	-	-	-	RO	No	-	No
SubIndex 6		Alarm Code 6					
Variable Type	Setting Range	Initial Value	Unit	Accessibility	PDO Assignment	Variable Attribute	Saving
STRING	-	-	-	RO	No	-	No
SubIndex 7		Alarm Code 7					
Variable Type	Setting Range	Initial Value	Unit	Accessibility	PDO Assignment	Variable Attribute	Saving
STRING	-	-	-	RO	No	-	No
SubIndex 8		Alarm Code 8					
Variable Type	Setting Range	Initial Value	Unit	Accessibility	PDO Assignment	Variable Attribute	Saving
STRING	-	-	-	RO	No	-	No
SubIndex 9		Alarm Code 9					
Variable Type	Setting Range	Initial Value	Unit	Accessibility	PDO Assignment	Variable Attribute	Saving
STRING	-	-	-	RO	No	-	No
SubIndex 10		Alarm Code 10					
Variable Type	Setting Range	Initial Value	Unit	Accessibility	PDO Assignment	Variable Attribute	Saving
STRING	-	-	-	RO	No	-	No

SubIndex 11		Alarm Code 11					
Variable Type	Setting Range	Initial Value	Unit	Accessibility	PDO Assignment	Variable Attribute	Saving
STRING	-	-	-	RO	No	-	No
SubIndex 12		Alarm Code 12					
Variable Type	Setting Range	Initial Value	Unit	Accessibility	PDO Assignment	Variable Attribute	Saving
STRING	-	-	-	RO	No	-	No
SubIndex 13		Alarm Code 13					
Variable Type	Setting Range	Initial Value	Unit	Accessibility	PDO Assignment	Variable Attribute	Saving
STRING	-	-	-	RO	No	-	No
SubIndex 14		Alarm Code 14					
Variable Type	Setting Range	Initial Value	Unit	Accessibility	PDO Assignment	Variable Attribute	Saving
STRING	-	-	-	RO	No	-	No
SubIndex 15		Alarm Code 15					
Variable Type	Setting Range	Initial Value	Unit	Accessibility	PDO Assignment	Variable Attribute	Saving
STRING	-	-	-	RO	No	-	No
SubIndex 16		Alarm Code 16(oldest)					
Variable Type	Setting Range	Initial Value	Unit	Accessibility	PDO Assignment	Variable Attribute	Saving
STRING	-	-	-	RO	No	-	No

This parameter represents the history of servo alarms generated in the drive. You can store up to 16 recently generated servo alarms. Sub-Index 1 is the latest alarm while the Sub-Index 16 is the oldest of the recently generated alarms. You can reset the servo alarm history by procedure commands.

0x2703		Servo Alarm History(Time, Date)						ALL
SubIndex 0		Number of Entries						
Variable Type	Setting Range	Initial Value	Unit	Accessibility	PDO Assignment	Variable Attribute	Saving	
USINT	-	16	-	RO	No	-	No	
SubIndex 1		Alarm 1 (Newest)						
Variable Type	Setting Range	Initial Value	Unit	Accessibility	PDO Assignment	Variable Attribute	Saving	
ULINT	-	-	-	RO	No	-	No	
SubIndex 2		Alarm 2						
Variable Type	Setting Range	Initial Value	Unit	Accessibility	PDO Assignment	Variable Attribute	Saving	
ULINT	-	-	-	RO	No	-	No	
SubIndex 3		Alarm 3						
Variable Type	Setting Range	Initial Value	Unit	Accessibility	PDO Assignment	Variable Attribute	Saving	
ULINT	-	-	-	RO	No	-	No	
SubIndex 4		Alarm 4						
Variable Type	Setting Range	Initial Value	Unit	Accessibility	PDO Assignment	Variable Attribute	Saving	
ULINT	-	-	-	RO	No	-	No	
SubIndex 5		Alarm 5						
Variable Type	Setting Range	Initial Value	Unit	Accessibility	PDO Assignment	Variable Attribute	Saving	
ULINT	-	-	-	RO	No	-	No	
SubIndex 6		Alarm 6						
Variable Type	Setting Range	Initial Value	Unit	Accessibility	PDO Assignment	Variable Attribute	Saving	
ULINT	-	-	-	RO	No	-	No	
SubIndex 7		Alarm 7						
Variable Type	Setting Range	Initial Value	Unit	Accessibility	PDO Assignment	Variable Attribute	Saving	
ULINT	-	-	-	RO	No	-	No	
SubIndex 8		Alarm 8						
Variable Type	Setting Range	Initial Value	Unit	Accessibility	PDO Assignment	Variable Attribute	Saving	
ULINT	-	-	-	RO	No	-	No	
SubIndex 9		Alarm 9						
Variable Type	Setting Range	Initial Value	Unit	Accessibility	PDO Assignment	Variable Attribute	Saving	
ULINT	-	-	-	RO	No	-	No	
SubIndex 10		Alarm 10						
Variable Type	Setting Range	Initial Value	Unit	Accessibility	PDO Assignment	Variable Attribute	Saving	
ULINT	-	-	-	RO	No	-	No	
SubIndex 11		Alarm 11						
Variable Type	Setting Range	Initial Value	Unit	Accessibility	PDO Assignment	Variable Attribute	Saving	
ULINT	-	-	-	RO	No	-	No	
SubIndex 12		Alarm 12						
Variable Type	Setting Range	Initial Value	Unit	Accessibility	PDO Assignment	Variable Attribute	Saving	
ULINT	-	-	-	RO	No	-	No	
SubIndex 13		Alarm 13						
Variable Type	Setting Range	Initial Value	Unit	Accessibility	PDO Assignment	Variable Attribute	Saving	
ULINT	-	-	-	RO	No	-	No	
SubIndex 14		Alarm 14						
Variable Type	Setting Range	Initial Value	Unit	Accessibility	PDO Assignment	Variable Attribute	Saving	
ULINT	-	-	-	RO	No	-	No	
SubIndex 15		Alarm 15						
Variable Type	Setting Range	Initial Value	Unit	Accessibility	PDO Assignment	Variable Attribute	Saving	

ULINT	-	-	-	RO	No	-	No
SubIndex 16		Alarm 16 (oldest)					
Variable Type	Setting Range	Initial Value	Unit	Accessibility	PDO Assignment	Variable Attribute	Saving
ULINT	-	-	-	RO	No	-	No

This displays the time and date that a servo alarm was generated on the drive. Similarly to Servo Alarm History [0x2702], it can store up to 16 most recent servo alarms. The SubIndex 1 is the latest alarm while the SubIndex 16 is the oldest one out of the recently generated alarms. You can reset the servo alarm history by procedure commands.

0x2704	Alarm History Configuration						ALL
SubIndex 0		Number of Entries					
Variable Type	Setting Range	Initial Value	Unit	Accessibility	PDO Assignment	Variable Attribute	Saving
USINT	-	6	-	RO	No	-	No
SubIndex 1		Sampling Time					
Variable Type	Setting Range	Initial Value	Unit	Accessibility	PDO Assignment	Variable Attribute	Saving
UDINT	-	2	ms	RW	No	-	Yes
SubIndex 2		Position					
Variable Type	Setting Range	Initial Value	Unit	Accessibility	PDO Assignment	Variable Attribute	Saving
UDINT	-	75	%	RW	No	-	Yes
SubIndex 3		Monitor Ch1. Setting					
Variable Type	Setting Range	Initial Value	Unit	Accessibility	PDO Assignment	Variable Attribute	Saving
UDINT	-	0x00	-	RW	No	-	Yes
SubIndex 4		Monitor Ch2. Setting					
Variable Type	Setting Range	Initial Value	Unit	Accessibility	PDO Assignment	Variable Attribute	Saving
UDINT	-	0x03	-	RW	No	-	Yes
SubIndex 5		Monitor Ch3. Setting					
Variable Type	Setting Range	Initial Value	Unit	Accessibility	PDO Assignment	Variable Attribute	Saving
UDINT	-	0x07	-	RW	No	-	Yes
SubIndex 6		Monitor Ch4. Setting					
Variable Type	Setting Range	Initial Value	Unit	Accessibility	PDO Assignment	Variable Attribute	Saving
UDINT	-	0x0B	-	RW	No	-	Yes

It is a setting-related object used to upload the servo alarm history data in the servo drive into Drive CM. You can set the data sampling time, position, and monitor channels in each Subindex.

● Third Party Motor Support (0x2800~)

The following motor parameters are provided for driving motors manufactured by a third party in addition to our motor. To drive a third party's motor with our drive, you have to enter correct parameters. In this case, however, our company neither has performed any test for combinations of our drive and a third party motor nor provides any warranty for the motors' characteristics.

0x2800		[Third Party Motor] Type					ALL
Variable Type	Setting Range	Initial Value	Unit	Accessibility	PDO Assignment	Variable Attribute	Saving
UINT	0 to 1	0	-	RW	No	Power cycling	Yes

You can set the motor type.

Setting Value	Setting Details
0	Rotary motor
1	Linear motor

0x2801		[Third Party Motor] Number of Poles					ALL
Variable Type	Setting Range	Initial Value	Unit	Accessibility	PDO Assignment	Variable Attribute	Saving
UINT	2 to 1000	8	-	RW	No	Power cycling	Yes

You can set the number of motor poles. For a linear motor, set the value to 2.

0x2802		[Third Party Motor] Rated Current					ALL
Variable Type	Setting Range	Initial Value	Unit	Accessibility	PDO Assignment	Variable Attribute	Saving
FP32	-	2.89	Arms	RW	No	Power cycling	Yes

You can set the rated current of the motor.

0x2803		[Third Party Motor] Maximum Current					ALL
Variable Type	Setting Range	Initial Value	Unit	Accessibility	PDO Assignment	Variable Attribute	Saving
FP32	-	8.67	Arms	RW	No	Power cycling	Yes

You can set the maximum current of the motor.

0x2804		[Third Party Motor] Rated Speed					ALL
Variable Type	Setting Range	Initial Value	Unit	Accessibility	PDO Assignment	Variable Attribute	Saving
UINT	1 to 60000	3000	rpm	RW	No	Power cycling	Yes

You can set the rated speed of the motor. For a linear motor, the unit is mm/s.

0x2805		[Third Party Motor] Maximum Speed					ALL
Variable Type	Setting Range	Initial Value	Unit	Accessibility	PDO Assignment	Variable Attribute	Saving
UINT	1 to 60000	5000	rpm	RW	No	Power cycling	Yes

You can set the maximum speed of the motor. For a linear motor, the unit is mm/s.

0x2806		[Third Party Motor] Inertia					ALL
Variable Type	Setting Range	Initial Value	Unit	Accessibility	PDO Assignment	Variable Attribute	Saving
FP32	-	0.321	Kg.m ² . 10 ⁻⁴	RW	No	Power cycling	Yes

You can set the motor inertia. For a linear motor, set the weight of the rotor. The unit is kg.

0x2807		[Third Party Motor] Torque Constant					ALL
Variable Type	Setting Range	Initial Value	Unit	Accessibility	PDO Assignment	Variable Attribute	Saving
FP32	-	0.46	Nm/A	RW	No	Power cycling	Yes

You can set the torque constant of the motor. For a linear motor, set a force constant. The unit is N/A.

0x2808		[Third Party Motor] Phase Resistance					ALL
Variable Type	Setting Range	Initial Value	Unit	Accessibility	PDO Assignment	Variable Attribute	Saving
FP32	-	0.82	ohm	RW	No	Power cycling	Yes

You can set the phase resistance (= resistance between lines ÷ 2) of the motor.

0x2809		[Third Party Motor] Phase Inductance					ALL
Variable Type	Setting Range	Initial Value	Unit	Accessibility	PDO Assignment	Variable Attribute	Saving
FP32	0 to 1000	3.66	mH	RW	No	Power cycling	Yes

You can set the phase inductance (= inductance between lines ÷ 2) of the motor.

0x280A	[Third Party Motor] TN Curve Data 1						ALL
Variable Type	Setting Range	Initial Value	Unit	Accessibility	PDO Assignment	Variable Attribute	Saving
UINT	1 to 60000	3000	rpm	RW	No	Power cycling	Yes

You can set the data of the motor speed/torque curve. Enter the maximum speed for when the maximum torque(for a linear motor, the maximum thrust) is output. For a linear motor, the unit is mm/s.

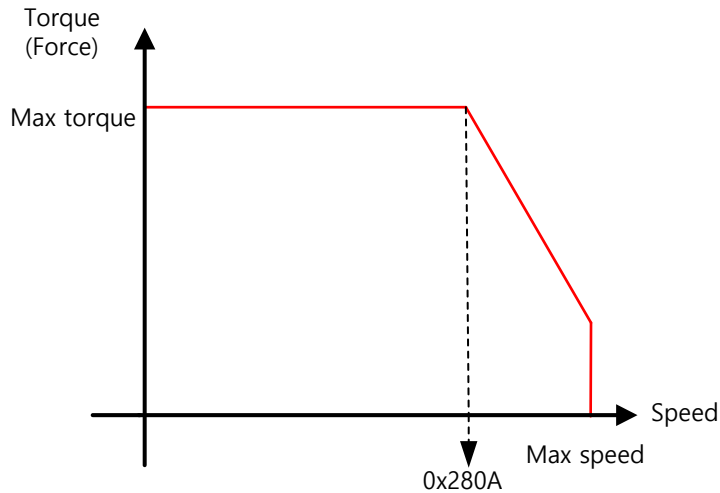

0x280B	[Third Party Motor] TN Curve Data 2						ALL
Variable Type	Setting Range	Initial Value	Unit	Accessibility	PDO Assignment	Variable Attribute	Saving
FP32	-	100.0	%	RW	No	Power cycling	Yes

You can set the data of the motor speed/torque curve. Enter a torque (thrust for a linear motor) which can be output at the maximum speed in percentage (%) relative to the maximum torque.

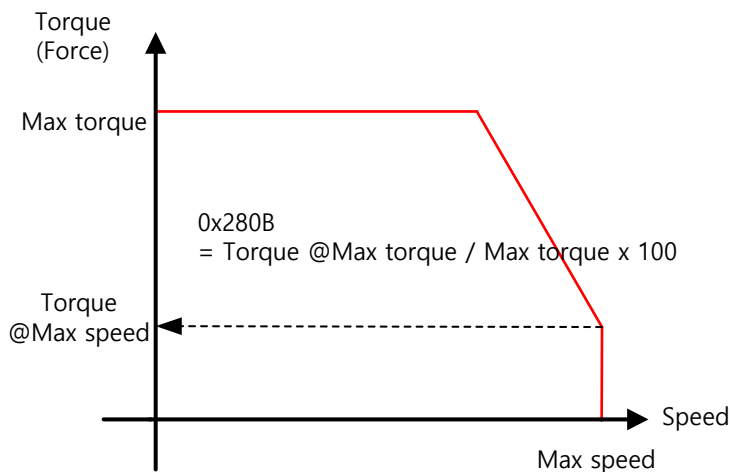

0x280C		[Third Party Motor] Hall Offset					ALL
Variable Type	Setting Range	Initial Value	Unit	Accessibility	PDO Assignment	Variable Attribute	Saving
UINT	0 to 360	0	deg	RW	No	Power cycling	Yes

The offset of the hall sensor set for the initial angle of a 3rd party motor may vary depending on manufacturer. For this, you must check the hall sensor offset and make a correct setting.

0x280D		[3rd Party Motor] Thermal Time Constant					ALL
Variable Type	Setting Range	Initial Value	Unit	Accessibility	PDO Assignment	Variable Attribute	Saving
FP32	-	32.77	°C /watt	RW	No	Power cycling	Yes

This sets the thermal time constant between motor winding and ambient temperature. If the motor thermal protection function is activated (0x2034 = 1), it estimates the motor temperature to generate a motor overheat (AL-27) alarm.

Thermal time constant[sec] = Thermal resistance[°C/watt] * Thermal capacitance[watt-sec/°C]

0x2810		[3rd Party Motor] D Axis Inductance					ALL
Variable Type	Setting Range	Initial Value	Unit	Accessibility	PDO Assignment	Variable Attribute	Saving
FP32	-	0	mH	RW	No	Power cycling	Yes

Set the D-axis inductance when using an IPMSM motor.

0x2811		[3rd Party Motor] Q Axis Inductance					ALL
Variable Type	Setting Range	Initial Value	Unit	Accessibility	PDO Assignment	Variable Attribute	Saving
FP32	-	0	mH	RW	No	Power cycling	Yes

Set the Q-axis inductance when using an IPMSM motor.

10.3 CiA402 Objects

0x603F	Error Code						ALL
Variable Type	Setting Range	Initial Value	Unit	Accessibility	PDO Assignment	Variable Attribute	Saving
UINT	-	0	-	RO	Yes	-	No

The last alarm code (HEX value) that occurred in the servo drive is displayed.

0x6040	Controlword						ALL
Variable Type	Setting Range	Initial Value	Unit	Accessibility	PDO Assignment	Variable Attribute	Saving
UINT	0 to 0xFFFF	0	-	RW	Yes	Always	No

This is composed of bits that control the drive state, the operation mode, and manufacturer-specific options.

Bits	Function	Description
0	Switch on	Refer to the description below of bits 0 to 3.
1	Enable Voltage	
2	Quick stop	
3	Enable operation	
4 to 6	Settings by Operation Mode	Refer to the description below of bits 4 to 9.
7	Fault Reset	0→1: Alarm/warning reset
8	Halt	Refer to the description below of bits 4 to 9.
9	Settings by Operation Mode	
10	-	-
11 to 15	-	-

< Description of bits 0 to 3 >

- Bits 0 to 3: Drive state control

Command	Controlword bit			
	Bit 3	Bit 2	Bit 1	Bit 0
Shutdown	-	1	1	0
Switch on	0	1	1	1
Switch on + Enable operation	1	1	1	1
Disable voltage	-	-	0	-
Quick stop	-	0	1	-
Disable operation	0	1	1	1
Enable operation	1	1	1	1

< Description of bits 4 to 9 >

- Bits 4, 5, 6, 8 and 9: For CSP, CSV, or CST mode operation

Bits	Function	Value	Details
4	–	0	-
5	–	0	-
6	–	0	-
8	Halt	0	Continues to perform the operation.
		1	Halts the operation according to the Halt Option code (0x605D).
9	–	0	-

- Bits 4, 5 and 9: For PP mode operation

Bit 9	Bit 5	Bit 4	Details
0	0	0 → 1	Proceeds to the next position when the operation at the current position is complete.
–	1	0 → 1	Drives to the next position immediately.
1	0	0 → 1	Drives from the current position to the profile position at the profile velocity before it applies the next position.

- Bits 6 and 8: For PP mode operation

Bits	Function	Value	Details
6	Abs/rel	0	Sets the target position to an absolute value.
		1	Sets the target position to a relative value.
8	Halt	0	Runs an operation or continues an operation.
		1	Halts the operation according to the Halt Option code (0x605D).

- Bits 4, 5, 6, 8 and 9: For PV and PT mode operation

Bits	Function	Value	Details
4	–	0	Reserved
5	–	0	Reserved
6	–	0	Reserved
8	Halt	0	Continues to perform the operation.
		1	Halts the operation according to the Halt Option code (0x605D).
9	–	0	Reserved

- Bits 4, 5, 6, 8 and 9: For HM mode operation

Bits	Function	Value	Details
4	Homing Start	0	Does not perform the homing operation.
		1	Performs or is performing the homing operation.
5	–	0	-
6	–	0	-
8	Halt	0	Runs the bit 4 command.
		1	Halts the operation according to the Halt Option code (0x605D).
9	–	0	Reserved

0x6041		Statusword					ALL
Variable Type	Setting Range	Initial Value	Unit	Accessibility	PDO Assignment	Variable Attribute	Saving
UINT	-	-	-	RO	Yes	-	No

Statusword indicates the current state of the drive. It consists of bits that indicate the state according to the drive and operation mode.

Bits	Function	Description
0	Ready to switch on	Refer to the description below of bits 0 to 7.
1	Switched on	
2	Operation enabled	
3	Fault	
4	Voltage enabled	
5	Quick stop	
6	Switch on disabled	
7	Warning	
8	–	Reserved
9	Remote	Processed as a Controlword (0x6040)
10	Operation mode specific	Refer to the description below of bits 10, 12 and 13.
11	Internal limit active	Refer to the description below of bit 11.
12 to 13	Operation mode specific	Refer to the description below of bits 10, 12 and 13.
14	ABS position valid	Refer to the description below of bit 14.
15	-	Reserved

<Description of bits 0 to 7>

- Bits 0 to 7: For the current state of the drive

Bit 7	Bit 6	Bit 5	Bit 4	Bit 3	Bit 2	Bit 1	Bit 0	Drive State
–	0	–	–	0	0	0	0	Not ready to switch on
–	1	–	–	0	0	0	0	Switch on disabled
–	0	1	–	0	0	0	1	Ready to switch on
–	0	1	–	0	0	1	1	Switched on
–	0	1	–	0	1	1	1	Operation enabled
–	0	0	–	0	1	1	1	Quick stop active
–	0	–	–	1	1	1	1	Fault reaction active
–	0	–	–	1	0	0	0	Fault
–	–	–	1	–	–	–	–	Main Power On
1	–	–	–	–	–	–	–	Warning is occurred

- Bits 10, 12 and 13: For CSP and CSV mode operation

Bits	State	Value	Details
10	Target reached	0	Unable to reach the target (position/velocity)
		1	Reached the target (position/velocity)
12	-	0	-
13	Following Error	0	No following error (always 0 in Csv/Torque mode)
		1	Following Error

- Bits 10, 12 and 13: For PP mode operation

Bits	State	Value	Details
10	Target reached	0	Halt (0x6040.8) = 0: Unable to reach the target position Halt (0x6040.8) = 1: Deceleration
		1	Halt (0x6040.8) = 0: Reached the target position Halt (0x6040.8) = 1: Speed: 0
12	Set-point acknowledge	0	Prepares the previous set point and waits for a new set point.
		1	Changed from the previous set point to the new set point.
13	Following Error	0	No following error
		1	Following Error

- Bits 10, 12 and 13: For PV mode operation

Bits	State	Value	Details
10	Target reached	0	Halt (0x6040.8) = 0: Unable to reach the target velocity Halt (0x6040.8) = 1: Deceleration
		1	Halt (0x6040.8) = 0: Reached the target velocity Halt (0x6040.8) = 1: Speed: 0
12	ZeroSpeed	0	Not in a zero speed state
		1	In a zero speed state
13	-	0	-

- Bits 10, 12 and 13: For homing mode operation

Bit 13	Bit 12	Bit 10	Details
Homing error	Homing attained	Target reached	
0	0	0	Homing in progress
0	0	1	Homing stopped or not started
0	1	0	Performed homing operation, but did not reach the target
0	1	1	Homing completed
1	0	0	Homing error; speed not equal to 0
1	0	1	Homing error; speed equal to 0

Description of bit 11

- Bit 11: Indicates whether to use an internal limit

Bits	State	Value	Details
11	Internal Limit Active	0	Not in software position limit status or does not use the software position limit function (0x2400).
		1	Software position limit status

Description of bit 14

- Bit 14: Absolute position valid

Bits	State	Value	Details
14	ABS Position Valid	0	Homing is not complete or an alarm related to the encoder has occurred.
		1	Homing is complete (applied when the drive is connected to EtherCAT communication).

0x605A		Quick Stop Option Code					P
Variable Type	Setting Range	Initial Value	Unit	Accessibility	PDO Assignment	Variable Attribute	Saving
INT	0 to 4	2	-	RW	No	Always	Yes

This parameter sets the Quick Stop option code when the drive is operating in CSP or PP modes.

Setting Value	Description
0	Not used (transits into Switch On Disabled).
1 or 2	Slowly decelerates and stops according to the quick stop deceleration (0x6085) setting. (Switch On Disabled).

0x605B		Shutdown Option Code					ALL
Variable Type	Setting Range	Initial Value	Unit	Accessibility	PDO Assignment	Variable Attribute	Saving
INT	0 to 1	0	-	RW	No	Always	Yes

This sets the operation to shut down the servo drive (Operation Enabled state -> Ready to Switch On state).

Setting Value	Description
0	Not used
1	Decelerates to a stop; enters the Switch On Disabled state; enters the Ready state

0x605C		Disable Operation Option Code					ALL
Variable Type	Setting Range	Initial Value	Unit	Accessibility	PDO Assignment	Variable Attribute	Saving
INT	0 to 1	1	-	RW	No	Always	Yes

This sets the Disable Operation state (Operation Enabled state → Switched On state) option code.

Setting Value	Description
0	Does not use the drive function.
1	Decelerates to a stop; moves to the Switch On Disabled state; moves to the Not Ready state

0x605D		Halt Option Code					ALL
Variable Type	Setting Range	Initial Value	Unit	Accessibility	PDO Assignment	Variable Attribute	Saving
INT	0 to 4	0	-	RW	No	Always	Yes

The Halt option code sets the operation method used to move from the Operation Enabled state to the Switched On state.

Setting Value	Description
1	Decelerates to a stop; moves to the Operation Enabled state
2	Decelerates to a stop based on the quick stop deceleration time; move to the Operation Enabled state

0x605E		Fault Reaction Option Code					ALL
Variable Type	Setting Range	Initial Value	Unit	Accessibility	PDO Assignment	Variable Attribute	Saving
INT	0	0	-	RW	No	Always	Yes

This sets the operation method that protects the drive system during fault reactions.

Setting Value	Description
0	Does not use the servo drive function. The motor will retain the free-run state.

0x6060		Modes of Operation					ALL
Variable Type	Setting Range	Initial Value	Unit	Accessibility	PDO Assignment	Variable Attribute	Saving
SINT	0 to 10	0	-	RW	Yes	Always	No

This sets the servo drive operation mode. The master sets the operation mode when the power is turned on.

This drive provides the following operation modes:

Setting Value	Names	Details
0	-	Mode not assigned
1	PP	Profile Position Mode
2	-	Reserved
3	PV	Profile Velocity mode
4	PT	Profile Torque mode
6	HM	Homing mode
7	-	Reserved
8	CSP	Cyclic Synchronous Position mode
9	CSV	Cyclic Synchronous Velocity mode
10	CST	Cyclic Synchronous Torque mode
Other	-	Reserved

0x6061		Modes of Operation Display					ALL
Variable Type	Setting Range	Initial Value	Unit	Accessibility	PDO Assignment	Variable Attribute	Saving
SINT	-	-	-	RO	Yes	-	No

This displays the operation mode of the current drive.

0x6062		Position Demand Value					ALL
Variable Type	Setting Range	Initial Value	Unit	Accessibility	PDO Assignment	Variable Attribute	Saving
DINT	-	-	UU	RO	Yes	-	No

This displays the position demand value in the position units (UU) specified by the user.

0x6063		Position Actual Internal Value					ALL
Variable Type	Setting Range	Initial Value	Unit	Accessibility	PDO Assignment	Variable Attribute	Saving
DINT	-	-	pulse	RO	Yes	-	No

This parameter displays the position actual internal value in the unit of encoder pulse.

0x6064		Position Actual Value					ALL
Variable Type	Setting Range	Initial Value	Unit	Accessibility	PDO Assignment	Variable Attribute	Saving
DINT	-	-	UU	RO	Yes	-	No

This parameter displays the position actual value in a user-defined position unit (UU).

0x6065		Following Error Window					ALL
Variable Type	Setting Range	Initial Value	Unit	Accessibility	PDO Assignment	Variable Attribute	Saving
UDINT	0 to 0x3FFFFFFF	5242880	UU	RW	No	Always	Yes

This sets the following error window to check the Following Error (Statusword, 0x6041.13).

0x6066		Following Error Timeout					ALL
Variable Type	Setting Range	Initial Value	Unit	Accessibility	PDO Assignment	Variable Attribute	Saving
UINT	0 to 65535	0	ms	RW	No	Always	Yes

This sets the timeout for when checking the Following Error (Statusword, 0x6041.13).

0x6067		Position Window					ALL
Variable Type	Setting Range	Initial Value	Unit	Accessibility	PDO Assignment	Variable Attribute	Saving
UDINT	0 to 0x3FFFFFFF	100	UU	RW	No	Always	Yes

This sets the position window for the target. If the drive remains within the position window (0x6067) for the position window time (0x6068), then it sets bit 10 of the Statusword (0x6041.10) to 1.

0x6068		Position Window Time					ALL
Variable Type	Setting Range	Initial Value	Unit	Accessibility	PDO Assignment	Variable Attribute	Saving
UINT	0 to 65535	0	ms	RW	No	Always	Yes

This sets the time it takes to reach the target position. If the drive remains within the position window (0x6067) for the position window time (0x6068), then it sets bit 10 of the Statusword (0x6041.10) to 1.

0x606B		Velocity Demand Value					ALL
Variable Type	Setting Range	Initial Value	Unit	Accessibility	PDO Assignment	Variable Attribute	Saving
DINT	-	-	UU/s	RO	Yes	-	No

This displays the output speed of the position controller or the command speed input to the velocity controller.

0x606C		Velocity Actual Value					ALL
Variable Type	Setting Range	Initial Value	Unit	Accessibility	PDO Assignment	Variable Attribute	Saving
DINT	-	-	UU/s	RO	Yes	-	No

This displays the velocity actual value in user-defined position units.

0x606D		Velocity Window					ALL
Variable Type	Setting Range	Initial Value	Unit	Accessibility	PDO Assignment	Variable Attribute	Saving
UINT	0 to 65535	20000	UU/s	RW	No	Always	Yes

This sets the velocity window. If the difference between the target velocity and the actual velocity remains within the velocity window (0x606D) for the amount of velocity window time (0x606E), it sets bit 10 of Statusword (0x6041.10) to 1.

0x606E		Velocity Window Time					ALL
Variable Type	Setting Range	Initial Value	Unit	Accessibility	PDO Assignment	Variable Attribute	Saving
UINT	0 to 65535	0	ms	RW	No	Always	Yes

You can set the velocity window time. If the difference between the target velocity and the actual velocity remains within the velocity window (0x606D) for the amount of velocity window time (0x606E), it sets bit 10 of Statusword (0x6041.10) to 1.

0x6071		Target Torque					ALL
Variable Type	Setting Range	Initial Value	Unit	Accessibility	PDO Assignment	Variable Attribute	Saving
INT	-5000 to 5000	0	0.1%	RW	Yes	Always	No

This sets the target torque for the motor in 0.1% increments of the rated torque during torque control.

0x6072		Maximum Torque					ALL
Variable Type	Setting Range	Initial Value	Unit	Accessibility	PDO Assignment	Variable Attribute	Saving
UINT	0 to 5000	3000	0.1%	RW	Yes	Always	No

This sets the maximum torque that the motor can output in 0.1% increments of the rated torque.

0x6074		Torque Demand Value					ALL
Variable Type	Setting Range	Initial Value	Unit	Accessibility	PDO Assignment	Variable Attribute	Saving
INT	-	-	0.1%	RO	Yes	-	No

This parameter displays the current torque demand value in the unit of 0.1% of the motor's rated torque.

0x6076		Motor Rated Torque					ALL
Variable Type	Setting Range	Initial Value	Unit	Accessibility	PDO Assignment	Variable Attribute	Saving
UDINT	-	-	mNm	RO	No	-	No

This displays the rated torque of the motor in mNm.

0x6077		Torque Actual Value					ALL
Variable Type	Setting Range	Initial Value	Unit	Accessibility	PDO Assignment	Variable Attribute	Saving
INT	-	-	0.1%	RO	Yes	-	No

This displays the torque actual value generated by the drive in 0.1% increments of the rated torque.

0x6078		Current Actual Value					ALL
Variable Type	Setting Range	Initial Value	Unit	Accessibility	PDO Assignment	Variable Attribute	Saving
INT	-	-	0.1%	RO	Yes	-	No

This displays the torque actual value generated by the drive in 0.1% increments of the rated torque. A value that is the same as the torque actual value [0x6077] is displayed.

0x6079		DC Link Circuit Voltage					ALL
Variable Type	Setting Range	Initial Value	Unit	Accessibility	PDO Assignment	Variable Attribute	Saving
UDINT	-	-	0.1V	RO	Yes	-	No

This displays the DC-link voltage supplied by the main power in 0.1 V units.

0x607A		Target Position					p
Variable Type	Setting Range	Initial Value	Unit	Accessibility	PDO Assignment	Variable Attribute	Saving
DINT	-2147483648 to 2147483647	0	UU	RW	Yes	Always	No

This sets the target position in the PP (Profile Position) mode or CSP (Cyclic Synchronous Position) mode.

In the PP mode, it is used as an absolute or relative coordinate according to the Bit4 (0x6040.4) setting of Controlword. In CSP mode, it is always used as an absolute coordinate.

0x607C		Home Offset					ALL
Variable Type	Setting Range	Initial Value	Unit	Accessibility	PDO Assignment	Variable Attribute	Saving
DINT	-2147483648 to 2147483647	0	UU	RW	No	Always	Yes

This sets the offset value for the home position of the absolute encoder or absolute external scale and the zero position of the position actual value (0x6064).

- Incremental Encoder

If the home position is found or at the home position, the position reached by the home offset value becomes the zero position.

- Absolute Encoder

If the absolute encoder is connected, the home offset value is added to the absolute position (position actual value).

0x607D		Software Position Limit					P
SubIndex 0		Number of Entries					
Variable Type	Setting Range	Initial Value	Unit	Accessibility	PDO Assignment	Variable Attribute	Saving
USINT	-	2	-	RO	No	-	No
SubIndex 1		Min. position limit					
Variable Type	Setting Range	Initial Value	Unit	Accessibility	PDO Assignment	Variable Attribute	Saving
DINT	-1073741824 to 1073741823	-2000000000	UU	RW	No	Always	Yes
SubIndex 2		Max. position limit					
Variable Type	Setting Range	Initial Value	Unit	Accessibility	PDO Assignment	Variable Attribute	Saving
DINT	-1073741824 to 1073741823	2000000000	UU	RW	No	Always	Yes

You can set the software position limit. It limits the range of the position demand value (0x6062) and position actual value (0x6064) and checks the new target positions for the setting value at every cycle.

The minimum software limit value is the negative rotation limit. The maximum software limit value is the positive rotation limit.

0x607F		Max Profile Velocity					P
Variable Type	Setting Range	Initial Value	Unit	Accessibility	PDO Assignment	Variable Attribute	Saving
UDINT	0 to 0x7FFFFFFF	0x7FFF FFFF	UU/s	RW	Yes	Always	Yes

This sets the maximum profile velocity for the PP mode operation.

0x6080		Max Motor Speed					ALL
Variable Type	Setting Range	Initial Value	Unit	Accessibility	PDO Assignment	Variable Attribute	Saving
UDINT	-	-	RPM	RO	No	Always	Yes

This represents the maximum speed of the motor.

0x6081		Profile Velocity					P
Variable Type	Setting Range	Initial Value	Unit	Accessibility	PDO Assignment	Variable Attribute	Saving
UDINT	0 to 0x7FFFFFFF	200000	UU/s	RW	Yes	Always	Yes

This sets the profile velocity for the PP mode operation.

0x6083		Profile Acceleration					P
Variable Type	Setting Range	Initial Value	Unit	Accessibility	PDO Assignment	Variable Attribute	Saving
UDINT	0 to 0x7FFFFFFF	200000	UU/s ²	RW	Yes	Always	Yes

This sets the profile acceleration for the PP mode operation.

0x6084		Profile Deceleration					P
Variable Type	Setting Range	Initial Value	Unit	Accessibility	PDO Assignment	Variable Attribute	Saving
UDINT	0 to 0x7FFFFFFF	200000	UU/s ²	RW	Yes	Always	Yes

This sets the profile deceleration for the PP mode operation.

0x6085		Quick Stop Deceleration					ALL
Variable Type	Setting Range	Initial Value	Unit	Accessibility	PDO Assignment	Variable Attribute	Saving
UDINT	0 to 0x7FFFFFFF	2000	UU/s ²	RW	No	Always	Yes

The value of Quick Stop Deceleration is applied if Quick Stop Option Code (0x605A) is set to 2.

The following formula is used to calculate the target position of Quick Stop Deceleration.

$$Target\ Position[UU] = \frac{Velocity^2[UU^2/sec^2]}{2 \times Quick\ Stop\ Deceleration[UU/sec^2]}$$

The following is the formula for the target position value when you run index 0 at 300 [rpm] and input 2000000 [UU/sec²] for the 0x6085 value and input a STOP signal.

$$Target\ Position[UU] = \frac{2621440^2}{2 \times 2000000} = 1717986[UU]$$

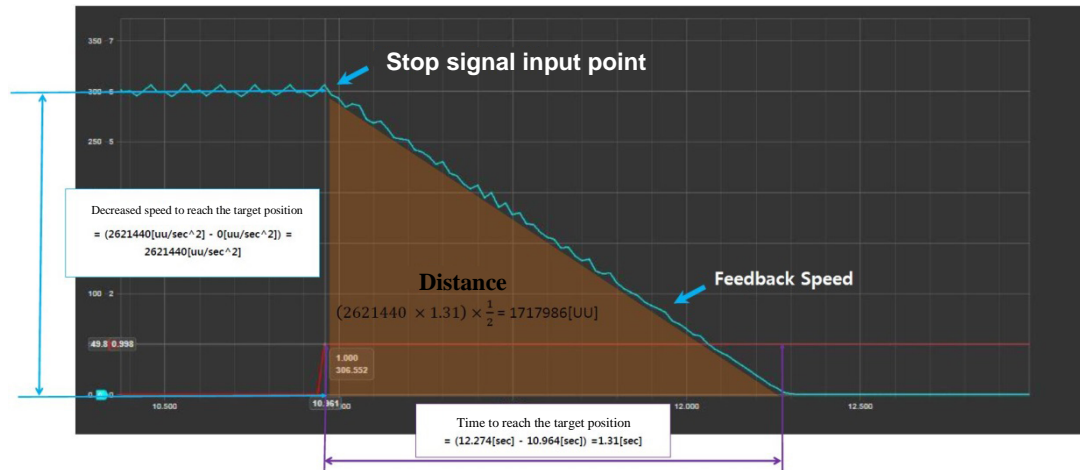

The target position is equal to the area of the distance shown in the figure above. If you want to stop the motor for approximately 2 seconds after inputting STOP signal while the motor is running at 300 rpm in index mode, you can calculate Quick Stop Deceleration as follows.

$$Target\ Position = (2621440[UU/sec] \times 2[sec]) \times \frac{1}{2} = 2621440[UU]$$

$$\frac{2621440^2[UU^2/sec^2]}{2 \times 2621440[UU]} = 1310720[UU/sec^2]$$

In other words, Quick Stop Deceleration function enables you to stop the motor exactly at the specified position or time when you input the STOP signal.

0x6087		Torque Slope					T
Variable Type	Setting Range	Initial Value	Unit	Accessibility	PDO Assignment	Variable Attribute	Saving
UDINT	0 to 0x7FFFFFFF	1000	0.1%/s	RW	Yes	Always	Yes

This sets the torque slope for the PT mode operation.

0x6091		Gear Ratio					
SubIndex 0		Number of Entries					
Variable Type	Setting Range	Initial Value	Unit	Accessibility	PDO Assignment	Variable Attribute	Saving
USINT	-	2	-	RO	No	-	No
SubIndex 1		Motor revolutions					
Variable Type	Setting Range	Initial Value	Unit	Accessibility	PDO Assignment	Variable Attribute	Saving
UDINT	0 to 0x40000000	1	-	RW	No	Power cycling	Yes
SubIndex 2		Shaft revolutions					
Variable Type	Setting Range	Initial Value	Unit	Accessibility	PDO Assignment	Variable Attribute	Saving
UDINT	0 to 0x40000000	1	-	RW	No	Power cycling	Yes

For more information, refer to Section 6.3 Electric Gear Setup.

0x6098		Homing Method					ALL
Variable Type	Setting Range	Initial Value	Unit	Accessibility	PDO Assignment	Variable Attribute	Saving
SINT	-128 to 127	34	-	RW	No	Always	Yes

You can set the homing method. For more information, refer to 5.6 Homing.

Setting Value	Details
0	Disabled
1	Homing using index pulse and negative limit contact
2	Homing using index pulse and positive limit contact
7 to 14	Homing using index pulse and home contact
24	Same as method 8 (does not use index pulse)
28	Same as method 12 (does not use index pulse)
33, 34	Homing by index pulse
35	Homing to the current position
-1	Homing using the negative stopper and index pulse
-2	Homing using the positive stopper and index pulse
-3	Homing using the negative stopper only
-4	Homing using the positive stopper only
-5	The drive returns to the home position only with the home switch (HOME) while driving in the negative direction.
-6	The drive returns to the home position only with the home switch (HOME) while driving in the positive direction.

0x6099		Homing Speeds					
SubIndex 0		Number of Entries					
Variable Type	Setting Range	Initial Value	Unit	Accessibility	PDO Assignment	Variable Attribute	Saving
USINT	-	2	-	RO	No	-	No
SubIndex 1		Switch search speed (Speed during search for switch)					
Variable Type	Setting Range	Initial Value	Unit	Accessibility	PDO Assignment	Variable Attribute	Saving
UDINT	0 to 0x40000000	500000	UU/s	RW	No	Always	Yes
SubIndex 2		Zero search speed (Speed during search for zero)					
Variable Type	Setting Range	Initial Value	Unit	Accessibility	PDO Assignment	Variable Attribute	Saving
UDINT	0 to 0x40000000	100000	UU/s	RW	No	Always	Yes

You can set the operation velocity for homing.

0x609A		Homing Acceleration					ALL
Variable Type	Setting Range	Initial Value	Unit	Accessibility	PDO Assignment	Variable Attribute	Saving
UDINT	0 to 0x40000000	200000	UU/ s ²	RW	No	Always	Yes

You can set the operation acceleration for homing.

0x60B0		Position Offset					P
Variable Type	Setting Range	Initial Value	Unit	Accessibility	PDO Assignment	Variable Attribute	Saving
DINT	-2147483648 to 2147483647	0	UU	RW	Yes	Always	No

In CSP mode, this sets the offset value added to the position command.

0x60B1		Velocity Offset					ALL
Variable Type	Setting Range	Initial Value	Unit	Accessibility	PDO Assignment	Variable Attribute	Saving
DINT	-2147483648 to 2147483647	0	UU/s	RW	Yes	Always	No

In CSP mode, this corresponds to the speed feed-forward value.

In CSV mode, this sets the offset value added to the speed command value.

0x60B2		Torque Offset					ALL
Variable Type	Setting Range	Initial Value	Unit	Accessibility	PDO Assignment	Variable Attribute	Saving
INT	-5000 to 5000	0	0.1%	RW	Yes	Always	No

In CSP and CSV modes, this corresponds to the torque feed-forward value.

In CST mode, this sets the offset value added to the torque command value.

0x60B8		Touch Probe Function					ALL
Variable Type	Setting Range	Initial Value	Unit	Accessibility	PDO Assignment	Variable Attribute	Saving
UINT	0 to 0xFFFF	0x0033	-	RW	Yes	Always	No

This sets the touch probe function.

Bits	Value	Description
0	0	Does not use touch probe 1.
	1	Uses touch probe 1.
1	0	Single trigger mode
	1	Continuous trigger mode
2	0	Triggered by the input of touch probe 1.
	1	Triggered by the index pulse signal.
3	–	Reserved
4	0	Does not capture the positive edge position value of touch probe 1.
	1	Captures the positive edge position value of touch probe 1.
5	0	Does not capture the negative edge position value of touch probe 1.
	1	Captures the negative edge position value of touch probe 1.
6 to 7	–	Reserved
8	0	Does not use touch probe 2.
	1	Uses touch probe 2.
9	0	Single trigger mode
	1	Continuous trigger mode
10	0	Triggered by the input of touch probe 2.
	1	Triggered by the index pulse signal.
11	–	Reserved
12	0	Does not capture the positive edge position value of touch probe 2.
	1	Captures the positive edge position value of touch probe 2.
13	0	Does not capture the negative edge position value of touch probe 2.
	1	Captures the negative edge position value of touch probe 2.
14 to 15	–	Reserved

0x60B9		Touch Probe Status					ALL
Variable Type	Setting Range	Initial Value	Unit	Accessibility	PDO Assignment	Variable Attribute	Saving
UINT	-	-	-	RO	Yes	-	No

This displays the status of the touch probe.

Bits	Value	Description
0	0	Does not use touch probe 1.
	1	Uses touch probe 1.
1	0	Does not store the positive edge position value of touch probe 1.
	1	Stores the positive edge position value of touch probe 1.
2	0	Does not store the negative edge position value of touch probe 1.
	1	Stores the negative edge position value of touch probe 1.
3 to 5	-	Reserved
6	0, 1	Toggles when the positive edge position value of touch probe 1 is updated.
7	0, 1	Toggles when the negative edge position value of touch probe 1 is updated.
8	0	Does not use touch probe 2.
	1	Uses touch probe 2.
9	0	Does not store the positive edge position value of touch probe 2.
	1	Stores the positive edge position value of touch probe 2.
10	0	Does not store the negative edge position value of touch probe 2.
	1	Stores the negative edge position value of touch probe 2.
11 to 13	-	Reserved
14	0, 1	Toggles when the positive edge position value of touch probe 2 is updated.
15	0, 1	Toggles when the negative edge position value of touch probe 2 is updated.

In continuous trigger mode, you can toggle to save all update values for 6, 7, 14 and 15 bits on the positive/negative edge of the touch probe.

To disable bits 1, 2, 9 and 10 (saving the position values on the positive/negative edges of touch probes 1 and 2) of the touch probe state (0x60B8), disable bits 4, 5, 12 and 13 (using sampling on the positive/negative edges of touch probes 1 and 2) of the touch probe function (0x60B8) and enable them.

0x60BA		Touch Probe 1 Positive Edge Position Value					ALL
Variable Type	Setting Range	Initial Value	Unit	Accessibility	PDO Assignment	Variable Attribute	Saving
DINT	-	-	UU	RO	Yes	-	No

This represents the positive edge position value of touch probe 1.

0x60BB		Touch Probe 1 Negative Edge Position Value					ALL
Variable Type	Setting Range	Initial Value	Unit	Accessibility	PDO Assignment	Variable Attribute	Saving
DINT	-	-	UU	RO	Yes	-	No

This represents the negative edge position value of touch probe 1.

0x60BC		Touch Probe 2 Positive Edge Position Value					ALL
Variable Type	Setting Range	Initial Value	Unit	Accessibility	PDO Assignment	Variable Attribute	Saving
DINT	-	-	UU	RO	Yes	-	No

This represents the positive edge position value of touch probe 2.

0x60BD		Touch Probe 2 Negative Edge Position Value					ALL
Variable Type	Setting Range	Initial Value	Unit	Accessibility	PDO Assignment	Variable Attribute	Saving
DINT	-	-	UU	RO	Yes	-	No

This represents the negative edge position value of touch probe 2.

0x60E0		Positive Torque Limit Value					ALL
Variable Type	Setting Range	Initial Value	Unit	Accessibility	PDO Assignment	Variable Attribute	Saving
UINT	0 to 5000	3000	0.1%	RW	Yes	Always	Yes

You can set the positive torque value limit.

0x60E1		Negative Torque Limit Value					ALL
Variable Type	Setting Range	Initial Value	Unit	Accessibility	PDO Assignment	Variable Attribute	Saving
UINT	0 to 5000	3000	0.1%	RW	Yes	Always	Yes

You can set the negative torque value limit.

0x60F4		Following Error Actual Value					ALL
Variable Type	Setting Range	Initial Value	Unit	Accessibility	PDO Assignment	Variable Attribute	Saving
DINT	-	-	UU	RO	Yes	-	No

This parameter displays the following error actual value during position control.

0x60FC		Position Demand Internal Value					ALL
Variable Type	Setting Range	Initial Value	Unit	Accessibility	PDO Assignment	Variable Attribute	Saving
DINT	-	-	pulse	RO	Yes	-	No

This represents the value entered as the command during position control.

0x60FD		Digital Inputs					ALL
Variable Type	Setting Range	Initial Value	Unit	Accessibility	PDO Assignment	Variable Attribute	Saving
UDINT	-	-	-	RO	Yes	-	No

They indicate the status of digital inputs.

Bits	Description
0	NOT (Negative Limit Switch)
1	POT (Positive Limit Switch)
2	HOME (Home Position Sensor Input)
3 to 15	Reserved
16	DI #1(I/O pin 11), 0:Open, 1:Close
17	DI #2(I/O pin 12), 0:Open, 1:Close
18	DI #3(I/O pin 7), 0:Open, 1:Close
19	DI #4(I/O pin 8), 0:Open, 1:Close
20	DI #5(I/O pin 13), 0:Open, 1:Close
21	DI #6(I/O pin 14), 0:Open, 1:Close
22~30	Reserved
31	STO(Safe Torque Off), 0:Close, 1:Open

0x60FE		Digital Outputs						
SubIndex 0		Number of Entries						
Variable Type	Setting Range	Initial Value	Unit	Accessibility	PDO Assignment	Variable Attribute	Saving	
USINT	-	2	-	RO	No	-	No	
SubIndex 1		Physical outputs						
Variable Type	Setting Range	Initial Value	Unit	Accessibility	PDO Assignment	Variable Attribute	Saving	
UDINT	0 to 0xFFFFFFFF	0	-	RW	Yes	Always	No	
SubIndex 2		Bit mask						
Variable Type	Setting Range	Initial Value	Unit	Accessibility	PDO Assignment	Variable Attribute	Saving	
UDINT	0 to 0xFFFFFFFF	0	-	RW	Yes	Always	Yes	

- Description of physical outputs

Bits	Description
0 to 15	Reserved
16	Forced output (0: OFF, 1: ON) of DO #1 (I/O pin 1). Provided that the relevant bit mask (0x60FE:02.16) is set to 1.
17	Forced output (0: OFF, 1: ON) of DO #2 (I/O pin 3). Provided that the relevant bit mask (0x60FE:02.17) is set to 1.
18	Forced output (0: OFF, 1: ON) of DO #3 (I/O pin 4). Provided that the relevant bit mask (0x60FE:02.18) is set to 1.
19 to 23	Reserved
24	Output status of DO #1 (0: OFF, 1: ON)
25	Output status of DO #2 (0: OFF, 1: ON)
26	Output status of DO #3 (0: OFF, 1: ON)
27 to 31	Reserved

- Bit mask

Bits	Description
0 to 15	Reserved
16	Forced output setting (0: Disable, 1: Enable) of DO #1 (I/O pin 1)
17	Forced output setting (0: Disable, 1: Enable) of DO #2 (I/O pin 3)
18	Forced output setting (0: Disable, 1: Enable) of DO #3 (I/O pin 4)
19 to 31	Reserved

0x60FF		Target Velocity					V
Variable Type	Setting Range	Initial Value	Unit	Accessibility	PDO Assignment	Variable Attribute	Saving
DINT	-2147483648 to 2147483647	0	UU/s	RW	Yes	Always	No

This sets the target velocity in PV mode and CSV mode.

0x6502		Supported Drive Modes					ALL
Variable Type	Setting Range	Initial Value	Unit	Accessibility	PDO Assignment	Variable Attribute	Saving
UDINT	-	0x000003AD	-	RO	No	-	No

This displays the mode(s) supported by the drive.

Bits	Supported modes	Details
0	PP (Profile Position)	1: Supported
1	VI (Velocity)	0: Not supported
2	PV (Profile Velocity)	1: Supported
3	PT (Torque Profile)	1: Supported
4	Reserved	0
5	HM (Homing)	1: Supported
6	IP (Interpolated Position)	0: Not Supported
7	CSP (Cyclic Synchronous Position)	1: Supported
8	CSV (Cyclic Synchronous Velocity)	1: Supported
9	CST (Cyclic Synchronous Torque)	1: Supported
10 to 31	Reserved	0

11. Maintenance and Inspection

This chapter explains how to perform basic maintenance and inspection tasks as well as diagnose and troubleshoot the servo motor and drive.

11.1 Maintenance and Inspection

11.1.1 Precautions

1. When measuring the motor voltage: The PWM controls the voltage output from the servo amp to the motor. Because of this, the waves take the form of pulses. Use a rectifier voltmeter for accurate measurements because different meters may produce largely different results.
2. When measuring the motor current: Connect and use a moving-iron-type ampere meter because the motor's reactance smooths the pulse waveform to produce partial sine waves.
3. When measuring the electric power: Use an electro-dynamo-meter and measure based on the 3 power meter method.
4. Other gauges: When using an oscilloscope or digital voltmeter, do not allow them to touch the ground. Use an input current gauge of 1mA or lower.

11.1.2 What to Inspect

Wait at least 10 minutes after turning off the power before beginning the inspection because the condenser can hold enough voltage to cause an electrical accident.

(1) Servo Motor Inspection

⚠ Caution

Wait at least 10 minutes after turning off the power before beginning the inspection because the condenser can hold enough voltage to cause an electrical accident.

Inspection Items	Inspection Time	Inspection and Handling	Notes
Vibration and sound check	Monthly	Touch the module and listen to sounds.	The feel and sounds must be the same as usual.
Exterior check	Depends on the level of contamination or damage.	Clean the module with a cloth or air.	-
Insulation resistance measurement	At least once a year	Disconnect the module from the drive and measure insulation resistance. A normal resistance level is 10[MΩ] or higher. ^{Note 1)}	Contact our service center if resistance is lower than 10[MΩ].
Oil seal replacement	At least once every 5,000 hours	Remove the oil seal from the motor and replace it.	Only applies to motors with an oil seal.
General inspection	At least once every 20,000 hours or 5 years.	Contact our service center.	Do not disassemble the servo motor by yourself for cleaning.

Note 1) Measure the resistance between PE and one of the U, V and W power cables in the servo motor.

(2) Servo Drive Inspection

Inspection Items	Inspection Time	Inspection Method	What to do for Abnormalities
Main body and boards cleaning	At least once a year	Check if there is any dust or oil on the components.	Clean it with air or a cloth.
Loose screws	At least once a year	Screws on the terminal board or connector must not be loose.	Tighten the screws.
Defective parts of the main body or control board	At least once a year	Check for discoloration, damage or disconnection caused by heat.	Contact our company.

11.1.3 Parts Replacement Cycle

Mechanical friction or aging of objects with certain characteristics may deteriorate performance of the following parts or cause them to malfunction. Therefore it is important to conduct regular maintenance checks and regular replacement.

1. Smoothing condenser: Degrees of product deterioration vary greatly depending on ripple current levels and use environments. Lifespans of the smoothing condenser depend greatly on use conditions and surrounding environment, but for continuous use in a general use environment (30°C), five years of lifespan is guaranteed.

Inspect the condenser at least once each year because it can rapidly age over certain short periods of time (inspect at least once half a year as it approaches its end of life).

※ Visual inspection criteria

- a. The condition of the case: Check for enlargement of the sides and bottom.
 - b. The condition of the lid: Check for notable enlargement, severe cracks, or broken parts.
 - c. The condition of the explosion valve: Check for notable valve enlargement and check the operation status.
 - d. Also, regularly check whether the exterior is cracked, discolored, or leaking and whether there are any broken parts. The condenser is obsolete when its rated capacity degrades to 85% or lower.
2. Relays: Check for bad connection and wear and tear of the contacts caused by switching currents. A relay is obsolete when its accumulated number of switches reaches around 100,000 times, depending on the power capacity.
 3. Motor bearings: Replace the bearings after 20,000 to 30,000 hours of operation at the rated velocity under the rated load. Replace the bearings if abnormal sounds or vibrations are detected during inspection, depending on the operating conditions.
 4. Electrolytic condenser: For electrolytic condensers, degrees of product deterioration vary greatly depending on ripple current levels and use environments. Lifespans of the electrolytic condensers depend greatly on use conditions and surrounding environment, but for continuous use in a general use environment (30°C), five years of lifespan is guaranteed.

[Standard Part Replacement Cycles]

Part Names	Standard Replacement Cycle	Replacement Method
Smoothing Condenser	5 years	Replace
Relays	-	Determine after inspection
Fuses	10 years	Replace
Aluminum Electrolytic Condensers on Printed Boards	5 years	Replace with a new board
Cooling Fans	4~5 years	Replace
Motor Bearings	-	Determine after inspection
Motor Oil Seal	5,000 hours	Replace

11.2 Diagnosing Abnormalities and Troubleshooting

An alarm or warning is generated if a problem occurs during operation. If this happens, find the applicable code and take a proper action. If the problem persists after taking such a measure, contact our service center.

11.2.1 Servo Motor





[Cause of abnormalities, inspection procedure, and troubleshooting methods]





Symptoms	Cause	Inspection Method	Remedies
The motor does not move.	The P-OT and N-OT inputs are off.	Refer to "3. Wiring and Connection" or "3.5. Wiring for Input/Output Signals."	Turn on the P-OT and N-OT inputs.
	The motor is defective.	Use a resistance tester to measure the resistance to the motor lead terminal (resistance between phases: several ohms).	Replace the motor.
	The locking screws are loose.	Check the locking screws.	Tighten any loose screws.
	External wiring is abnormal or there is a disconnected cable.	Check the wires to the motor and the encoder.	Redo the wiring. Replace the cables.
	Encoder failure.	Check the output waves.	Replace the encoder. (Contact our service center.)
Motor rotation is unstable.	The connection is bad.	Check the connection of the motor lead terminal.	Fix any bad connections.
	The input voltage is low.	Check the input voltage of the drive.	Change the power source.
	Overloads occur.	Check the condition of the machine.	Remove any foreign substances from the rotating unit and grease or lubricate it.
The motor overheats.	The ambient temperature is too high.	Check the temperature around the motor. (40°C or lower)	Change heat transfer structure. Install a cooling fan.
	The surface of the motor is contaminated.	Check whether there are any foreign substances on the surface of the motor.	Clean the surface of the motor.
	Overloads occur.	Check the load on the drive. Check the acceleration/deceleration time.	Reduce the load. Increase the acceleration/deceleration time. Replace with a motor with a greater capacity.
	The magnetic power of the magnets is reduced.	Check the counter voltage and voltage waveforms.	Replace the motor.
The device is making a strange sound.	Coupling is bad.	Tighten the coupling screws and measure the concentricity of the connection.	Readjust the coupling.
	The bearings are abnormal.	Check the bearings for vibrations and sounds.	Contact us.
	The parameters are set incorrectly. (the inertia, gain, and time constants).	Check the parameters.	Refer to Chapter 10 Object Dictionary.

11.2.2 Servo Drive





■ Servo Alarms







If the drive detects a problem, it triggers a servo alarm and transition to the servo off state for a stop. In this case, the setting value of emergency stop configuration (0x2013) is used to stop the drive.



Alarm Code Names	Causes	Inspection Items	Measures to Take
 IPM fault (Overcurrent (H/W)) AL-10  Over current (Overcurrent (S/W)) AL-14  Current limit exceeded (Overcurrent (H/W)) AL-16	Motor cable abnormality.	Check for abnormal wiring or short circuit.	Replace the motor cable.
	Encoder cable abnormality.	Check for abnormal wiring or short circuit.	Replace the encoder cable.
	Parameter setting abnormality.	Make sure that the setting values for motor ID [0x2000], encoder type [0x2001] and encoder format [0x2002] match the applied information on the motor label.	Modify the parameters so that they match the information on the motor label.
	Motor phase resistance inspection.	Inspect resistance between motor lines. (U-V, V-W, W-U below several Ω)	Replace the motor.
	Apparatus abnormality.	Determine whether there are conflicts or binding among the apparatuses.	Inspect the apparatus.
	Drive abnormality.	-	If the alarm occurs continually after power cycling, replace the drive since there may be abnormalities in the drive.
	Noise-related abnormalities.	Find a way to resolve the noise problem by checking the wiring and installation.	Check the wiring of the PE. Adjust the PE wiring size so that it matches the size of the drive main circuit wiring.
 IPM temperature (IPM Overheat) AL-11	Ambient temperature.	Check if the ambient temperature exceeds 50[°C].	Lower the temperature around the drive.
	Continual overload alarm.	Check if the load is lower than 100% by the accumulated operation overload ratio value [0x2603].	Change the capacity of the drive and motor. Adjust gain.
	Highly frequent regenerative operation or continual regenerative operation.	Check accumulated regeneration overload ratio [0x2606].	Adjust the regeneration brake resistor [0x2009] setting values. Use an external regeneration brake resistor.
	Drive installation direction.	Check the installation status of the drive.	Refer to Section 3. "Wiring and Connection."
	Drive abnormality.	-	If the alarm occurs continually after power cycling, replace the drive since there may be abnormalities in the drive.
 Current offset (Current offset)	Motor U, V phase current offset set excessively.	Check whether the U/V/W-phase current offsets [0x2015]~[0x2017] are 5% or higher of the rated current.	Adjust the phase current offset again.



Alarm Code Names	Causes	Inspection Items	Measures to Take
abnormality) AL-15	Drive abnormality	-	If alarms occur continually after phase current offset adjustment, replace the drive since there may be abnormalities in the drive.
 Continuous overload AL-21	Continuous operation with a load exceeding the rated value.	Accumulated operation during constant velocity periods and pauses Check whether the load is below 100% with the load rate [0x2603].	Change the capacity of the motor and drive. Adjust gain.
	Motor brake abnormality.	Check for opening of the motor brake during SVON.	Supply power to the motor brake.
	Parameter setting abnormality.	Check the setting values for motor ID [0x2000], encoder type [0x2001] and encoder format [0x2002] with the applied information on the motor label.	Modify the parameters so that they match the information on the motor label.
		Check the setting value of overload check base [0x200F].	Set an appropriate value.
	Apparatus abnormality.	Check for any abnormality during operation.	Inspect the apparatus.
	Motor cable abnormality.	Check for abnormal wiring or short circuit.	Replace the motor cable.
	Encoder cable abnormality.	Check for abnormal wiring or short circuit.	Replace the encoder cable.
 Drive temperature 1 (Drive overheat 1) AL-22	Ambient temperature.	Check if the ambient temperature exceeds 50[°C].	Lower the temperature around the drive.
	Drive abnormality.	Check if the displayed drive temperature 1 value [0x260B] is highly different than the ambient temperature in the normal state.	Replace the drive.
 Regenerative overload AL-23	Capacity exceeded due to highly frequent operation or continual regenerative operation.	Check the accumulated regeneration overload rate [0x2606] setting.	Adjust the regeneration brake resistor configuration [0x2009] after connecting the external regeneration brake resistor and use the external regeneration brake resistor.
	Parameter setting abnormality.	Check the regeneration brake resistor parameters [0x2009] - [0x200E] settings.	Set an appropriate value.
	Main power input voltage abnormality.	Check whether the main power voltage is 544 Vac or higher.	Re-inspect the main power source.
	Drive abnormality.	Check if the regeneration brake resistor generates any heat when not in operation.	Replace the drive.
 Motor cable open (Motor disconnection) AL-24	Parameter setting abnormality.	Check the settings at [0x2015], [0x2016] and [0x2017] for U, V and W phase current offsets.	Execute the command for the current offset adjustment procedure.
	Motor cable abnormality.	Check for cable disconnection.	Replace the motor cable.
	Motor abnormality	Check for U, V, W short circuit inside the motor. (U-V, V-W, W-U)	Replace the motor.
	Drive abnormality.	-	If an alarm occurs continuously after SV-ON, there may be a problem with the drive. Replace the drive.

Alarm Code Names	Causes	Inspection Items	Measures to Take
AL-25 Drive temperature 2 (Drive overheat 2) AL-25	Ambient temperature.	Check if the ambient temperature exceeds 50[°C].	Lower the temperature around the drive.
	Drive abnormality.	Check if the displayed drive temperature 2 value [0x260C] is highly different than the ambient temperature in the normal state.	Replace the drive.
AL-26 Encoder temperature (Encoder Overheat) AL-26	Reserved.	-	-
AL-28 Fan trip (DC cooling fan abnormality) AL-28	DC cooling fan abnormality.	Check for disconnection, abnormal connection and short circuit.	Connect the DC cooling fan to the drive. If alarms occur continually after power cycling, there may be a problem with the DC cooling fan. Replace the DC cooling fan.
AL-29 Regeneration brake fault (Regeneration brake abnormality) AL-29	Regeneration resistor abnormality.	Check for disconnection and short-circuit.	Connect the regeneration brake resistor to the drive. If alarms occur continually after power cycling, there may be a problem with the regenerative resistor. Replace the regenerative resistor.
AL-30 Encoder communication (Serial Encoder Communication Error) AL-30 AL-31 Encoder cable open (Encoder cable disconnection) AL-31 AL-32 Encoder data (Encoder Data Error) AL-32	Encoder cable abnormality.	Check for disconnection, abnormal connection and short circuit.	Replace the encoder cable.
	Parameter setting abnormality.	Encoder type [0x2001] and encoder resolution [0x2002] settings should be the same as the motor label information.	Modify the parameter so it matches the motor label information. If the modified values are not applied after saving the parameters, replace the motor because there may be a problem with the motor.
	Encoder abnormality.	-	If the alarm occurs continually after power cycling, replace the motor since there may be abnormalities in the motor.
	Drive abnormality.	-	If alarms occur continually after power cycling, replace the drive since there may be abnormalities in the drive.
AL-33 Motor setting (Motor ID Setting Error) AL-33	Motor ID setting.	Motor ID [0x2000] setting should be the same as the motor label information.	Modify the parameters so that they match the information on the motor label. This alarm can be canceled after parameter modification when the power is on/off.
	Drive abnormality.	-	If alarms occur continually after power cycling, replace the drive since there may be abnormalities in the drive.
AL-34 Z Phase open (Encoder Z-phase Loss) AL-34	Parameter setting abnormality.	Check the setting of the warning mask [0x2014].	If the motor does not use the Z phase (e.g. step motor), set the 14th bit in the warning mask settings to mask the AL-34.
	Encoder cable abnormality.	Check for abnormal wiring or short circuit.	Replace the encoder cable.

Alarm Code Names	Causes	Inspection Items	Measures to Take
	Encoder abnormality.	-	If alarms occur continually after power cycling, replace the motor since there may be abnormalities in the motor.
	Drive abnormality.	-	If alarms occur continually after power cycling, replace the drive since there may be abnormalities in the drive.
 Low battery (Low voltage of encoder battery) AL-35	Parameter setting abnormality.	Check the setting value of the absolute encoder configuration [0x2005].	If you want to use an absolute encoder as an incremental encoder, set it to 1 so the alarm does not occur.
	Defective battery connection, unconnected.	Check the battery connection.	Connect the battery accurately.
	Low battery voltage.	Check if the battery voltage is 3.3V or higher.	Replace the battery.
 Sinusoidal ENC amplitude (Encoder Sine Wave Amplitude Error) AL-36  Sinusoidal ENC frequency (Encoder Sine Wave Frequency Error) AL-37	Encoder cable abnormality.	Check for disconnection, abnormal connection and short circuit. Check for shield and PE disconnection.	Replace the encoder cable.
	Parameter setting abnormality.	Check the encoder type [0x2001] setting.	Check the encoder type setting. Check the speed command. (Maximum: 250kHz)
	Drive abnormality.	-	If alarms occur continually after power cycling, replace the drive since there may be abnormalities in the drive.
	Converter failure.	-	If alarms occur continually after power cycling, there may be a problem with the converter. Replace the converter.
	Encoder abnormality.	-	If alarms occur continually after power cycling, there may be a problem with the encoder. Replace the encoder.
 Encoder setting error AL-38	Abnormal combination of drive and motor.	Check the brand label codes of the drive and motor.	Use a drive and a motor that have the same brand label.
	Encoder cable abnormality.	Check for abnormal wiring and short circuit.	Replace the encoder cable.
	Encoder abnormality.	-	If the alarm occurs continually after power cycling, replace the motor since there may be abnormalities in the motor.
	Drive abnormality.	-	If the alarm occurs continually after power cycling, replace the drive since there may be abnormalities in the drive.

Alarm Code Names	Causes	Inspection Items	Measures to Take
 Encoder position error (Encoder position loss alarm) AL-3b	Defective battery connection, unconnected.	Check the battery connection.	Check if the battery is correctly connected, then execute the GB preset procedure command.
	Low battery voltage.	Check if the battery voltage is 3.3V or higher.	Replace the battery, then execute the GB preset procedure command.
 Under voltage (Low Voltage) AL-40	Main power input voltage abnormality.	Check whether the main power voltage is about 134 Vac or higher.	Re-inspect the main power source.
		Check whether the DC link voltage [0x2605] is above 190 Vdc while the main power is being supplied.	Replace the drive.
	Lowered power voltage during operation.	Check the wiring status of the main power.	Use 3-phase voltage supply.
 Over voltage AL-41	Main power input voltage abnormality.	Check whether the main power voltage is about 286 Vac or lower.	Re-inspect the main power source.
		Check whether the DC link voltage [0x2605] is below 405 Vdc while the main power is being supplied.	Replace the drive.
	In case of too large an external regeneration resistor value.	Check the operation conditions and the regeneration brake resistor value.	Please recheck the regeneration brake resistor value considering the operation condition and load.
	Acceleration/deceleration setting values.	Check whether a rapid increase/decrease occurs frequently.	Set a high value for acceleration/deceleration time.
	Drive abnormality.	-	If the alarm occurs continually after power cycling, replace the drive since there may be abnormalities in the drive.
 Main power fail AL-42	Main power input voltage abnormality.	Check the voltage range of 200-240 Vac between L1, L2 and L3 phases.	Re-check power.
	Parameter setting abnormality.	Check the main power fail check mode setting [0x2006] according to the main power input status.	Make parameter settings and wiring with a 3-phase input power if possible.
	Momentary power outage.	Check the main power fail check time [0x2007] setting.	Increase the monitoring interval of the main power fail check time [0x2007] or check the power supply.
	Drive abnormality.	-	If the alarm occurs continually after power cycling, replace the drive since there may be abnormalities in the drive.
 Control power fail AL-43	A voltage failure between C1 and C2 phases.	The voltage between C1 and C2 phases should be within 200-240 Vac.	Re-inspect the control power.
	Drive abnormality.	-	If the alarm occurs continually after power cycling, replace the drive since there may be abnormalities in the drive.
 Over speed limit AL-50	Motor cable abnormality.	Check for abnormal wiring or short circuit.	Replace the motor cable.
	Encoder cable abnormality.	Check for abnormal wiring or short circuit.	Replace the encoder cable.
	Parameter setting abnormality.	Make sure that the settings of motor ID [0x2000], encoder type [0x2001] and encoder resolution [0x2002] match the information on the motor label.	Modify the parameters so that they match the information on the motor label.

Alarm Code Names	Causes	Inspection Items	Measures to Take
		Check the gear ratio [0x6091] setting.	Lower the electric gear ratio setting.
		Check the gain adjustment parameters [0x2100]~[0x211F].	Re-adjust gain according to the operation conditions.
	Encoder abnormality.	-	If the alarm occurs continually after power cycling, replace the motor since there may be abnormalities in the motor.
	Drive abnormality.	-	If the alarm occurs continually after power cycling, replace the drive since there may be abnormalities in the drive.
 POS following (Excessive Position Error) AL-51	Parameter setting abnormality.	Check the gear ratio [0x6091] setting.	Lower the gear ratio setting .
		Check the settings for following error window [0x6065] and following error timeout [0x6066].	Re-adjust the parameter according to the operation conditions.
	Apparatus abnormality.	Check for binding of the apparatuses.	Inspect the apparatus.
	Drive abnormality.	-	If the alarm occurs continually after power cycling, replace the drive since there may be abnormalities in the drive.
 Excessive SPD deviation AL-53	Motor cable abnormality.	Check for disconnection, abnormal wiring or short circuit.	Replace the motor cable.
	Encoder cable abnormality.	Check for disconnection, abnormal wiring or short circuit.	Replace the encoder cable.
	Parameter setting abnormality.	Make sure that the settings of motor ID [0x2000], encoder type [0x2001] and encoder resolution [0x2002] match the applied information on the motor label.	Modify the parameters so that they match the information on the motor label.
		Check the gear ratio [0x6091] setting.	Lower the electric gear ratio setting.
	Apparatus abnormality.	Check for binding of the apparatuses. Operation status of the limit contact sensor	Inspect the apparatus.
	Encoder abnormality.	-	If the alarm occurs continually after power cycling, replace the motor since there may be abnormalities in the motor.
	Drive abnormality.	-	If the alarm occurs continually after power cycling, replace the drive since there may be abnormalities in the drive.
 excessive position command AL-56	Motor cable abnormality.	Check for disconnection, abnormal wiring or short circuit.	Replace the motor cable.
	Encoder cable abnormality.	Check for disconnection, abnormal wiring or short circuit.	Replace the encoder cable.
	Parameter setting abnormality.	Make sure that the settings of motor ID [0x2000], encoder type [0x2001] and encoder resolution [0x2002] match the applied information on the motor label.	Modify the parameters so that they match the information on the motor label.
		Check the gear ratio [0x6091] setting.	Lower the gear ratio setting .
	Apparatus abnormality.	Check for binding of the apparatuses.	Inspect the apparatus.

Alarm Code Names	Causes	Inspection Items	Measures to Take
	Encoder abnormality.	-	If the alarm occurs continually after power cycling, replace the motor since there may be abnormalities in the motor.
	Drive abnormality.	-	If the alarm occurs continually after power cycling, replace the drive since there may be abnormalities in the drive.
 excessive pulse output speed (Encoder Output abnormality) AL-57	Parameter setting abnormality.	Check the encoder output pulse [0x2422] setting.	Lower the encoder output pulse setting considering the motor's driving velocity.
		Check the gear ratio [0x6091] setting.	Lower the electric gear ratio setting.
 Parameter checksum (Parameter abnormality) AL-63	O/S replacement.	Check the variable parameters set to the maximum.	Restore the default parameters (0x1011). The parameter setting values are initialized after restoration. For this reason, it is necessary to set the parameters before operation.
	Drive abnormality.	-	If the alarm occurs continually after power cycling, replace the drive since there may be abnormalities in the drive.
 Factory setting (Factory settings abnormality) AL-71	Parameter setting abnormality.	Contact our service center. Check the drive capacity at the device name setting [0x1008].	Reset the drive capacity and download the OS again. If alarms occur continually after power cycling, replace the drive since there may be abnormalities in the drive.





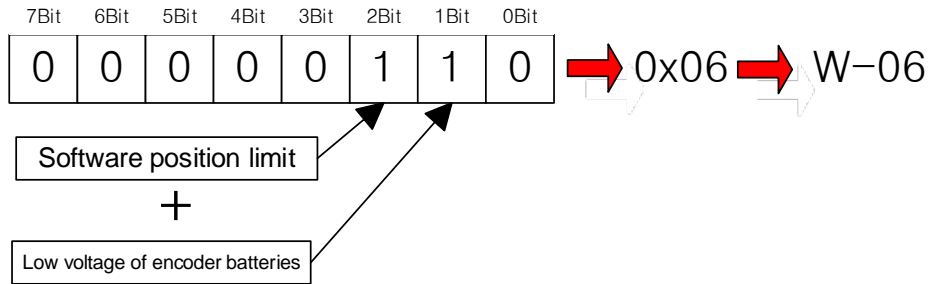

■ **Servo Warnings**

If the drive detects an abnormality classified as a servo warning, it triggers a warning. In this case, the drive maintains its normal operation condition. After the cause of the warning is eliminated, the warning is automatically cleared. In case of a warning, take an appropriate action. You can set the check status of each warning with warning mask configuration (0x2014).

Bits	Warning Codes	Warning Names
0	W01	Main power phase loss
1	W02	Low voltage of encoder battery
2	W04	Software position limit
3	-	-
4	W10	Operation overload
5	W20	An abnormal combination of drive and motor, or an I/O setting error.
6	W40	Low voltage
7	W80	Emergency signal input



If two warnings occur at the same time, each corresponding bit is set to 1. For example, when a software position limit warning is triggered, the second bit is set. Also, when an encoder battery low voltage warning is triggered, the first bit is set. The two warnings are combined into '0x06,' and you can view the alarm in the display of 'W06' on the segment window.

Warning Status (Code) Names	Causes	Inspection Items	Measures to Take
 PWR_FAIL (Main Power Phase Loss) W01	Main power input voltage failure.	Check the voltage range of 200-240 Vac between L1, L2 and L3 phases.	Re-inspect the main power source.
	Parameter setting abnormality.	Check the main power fail check mode setting [0x2006] according to the main power input status.	Make parameter settings and wiring with a 3-phase input power if possible.
	Momentary power outage.	Check the main power fail check time setting [0x2007].	Increase the main power fail check time setting [0x2007] or check the power supply.
	Drive abnormality.	-	If alarms occur continually after power cycling, replace the drive since there may be abnormalities in the drive.
 LOW_BATT (Low Voltage of Encoder Battery) W02	Parameter setting abnormality.	Check the setting value of the absolute encoder configuration [0x2005].	To use an incremental type absolute encoder, set the value to 1 to disable alarms.
	Defective battery connection, unconnected.	Check the battery connection.	Connect the battery accurately.
	Low battery voltage.	Check if the battery voltage is 3.3V or higher.	Replace the battery.
 SW_POS_LMT (Software Position Limit) W03	Parameter setting abnormality.	Check the software position limit function select [0x2400] and setting [0x607D] of the software position limit.	Change the settings of the software position limit function select [0x2400] or change the minimum and maximum setting values of the software position limit [0x607D].
 OV_LOAD (Operation Overload) W10	Continuous operation with a load exceeding the rated value.	Check the accumulated operation overload rate [0x2603] and overload warning level setting [0x2010] in the constant speed area or in the stopped state.	Change the capacity of the motor and drive. Adjust gain. Adjust the overload warning level setting [0x2010].
	Motor brake abnormality.	Check for opening of the motor brake during SVON.	Supply power to the motor brake.
	Parameter setting abnormality.	Make sure that the setting values for motor ID [0x2000], encoder type [0x2001] and encoder format [0x2002] match the applied information on the motor label.	Modify the parameters so that they match the information on the motor label.
		Check the setting value of overload check base [0x200F].	Set an appropriate value.
	Apparatus abnormality.	Check for any abnormality during operation.	Inspect the apparatuses.
	Motor cable abnormality.	Check for abnormal wiring or short circuit.	Replace the motor cable.
	Encoder cable abnormality.	Check for abnormal wiring or short circuit.	Replace the encoder cable.
 SETUP (Setting abnormality) W20	Abnormal combination of drive and motor.	Check if the current capacity of the applied motor exceeds that of the drive.	Lower the torque limit value or replace the motor with one that has a lower current capacity than that of the drive.
	IO setting abnormality.	Check whether the signal allocation has overlapped in the digital input signal selection [0x2200] - [0x2205] and the digital output signal selection [0x2210] - [0x2212].	Set the parameter appropriately for the operation conditions.
 UD_VTG (Low Voltage) W40	Main power input voltage abnormality.	Check whether the main power voltage is 134 Vac or higher.	Re-inspect the main power source.
		Check whether the DC link voltage [0x2605] is between 190 - 405 Vdc while the main power is being supplied.	Replace the drive.

Warning Status (Code) Names	Causes	Inspection Items	Measures to Take
	Lowered power voltage during operation.	Check the wiring status of the main power.	Use a 3-phase voltage supply.
 EMG (Emergency Signal Input) W80	EMG contact abnormality.	This represents the state of emergency pause by EMG contacts. Check the settings of the wiring and drive parameters (drive control input 1 [0x211F], digital input signal 1 setting [0x2200] - digital input signal 6 setting [0x2205]).	Set the wiring and parameter for the operation conditions.
	Drive abnormality.		If alarms occur continually after power cycling, replace the drive since there may be abnormalities in the drive.

11.3 Overload Graph

Overload check level refers to the level that detects an overload warning or overload alarm when there is a continuous overload exceeding the rating of the servo drive or servo motor.

Lower overload check levels must be prioritized between the servo drive and servo motor. You can change the detection timing through the overload check base [0x200F] and overload warning level [0x2010]. Overload check base can be set up to 120%, but this does not mean that a continuous output is guaranteed when the load is over 100%.

When using a combination of the servo drive and servo motor, limit the torque actual values to stay within the continuous use range specified in 「Rotation velocity - Torque Characteristics」 in 「2.1 Servo Motor」.

11.3.1 Servo Motor

■ FA Type Servo Motor Capacity - 150W or Lower

Load Factor (%)	AL-21 duration (sec)		Load Factor (%)	AL-21 duration (sec)	
	Turn	Stop		Turn	Stop
100 or lower	Infinite	Infinite			
110	1696.0	152.0	210	5.2	3.9
120	424.0	92.2	220	4.4	3.4
130	188.4	46.5	230	3.8	3.0
140	106.0	26.0	240	3.3	2.6
150	70.4	20.0	250	2.9	2.3
160	26.8	15.0	260	2.6	2.0
170	20.6	13.0	270	2.3	1.8
180	16.2	10.5	280	2.0	1.6
190	13.0	8.7	290	1.8	1.5
200	10.5	7.2	300	1.6	1.3

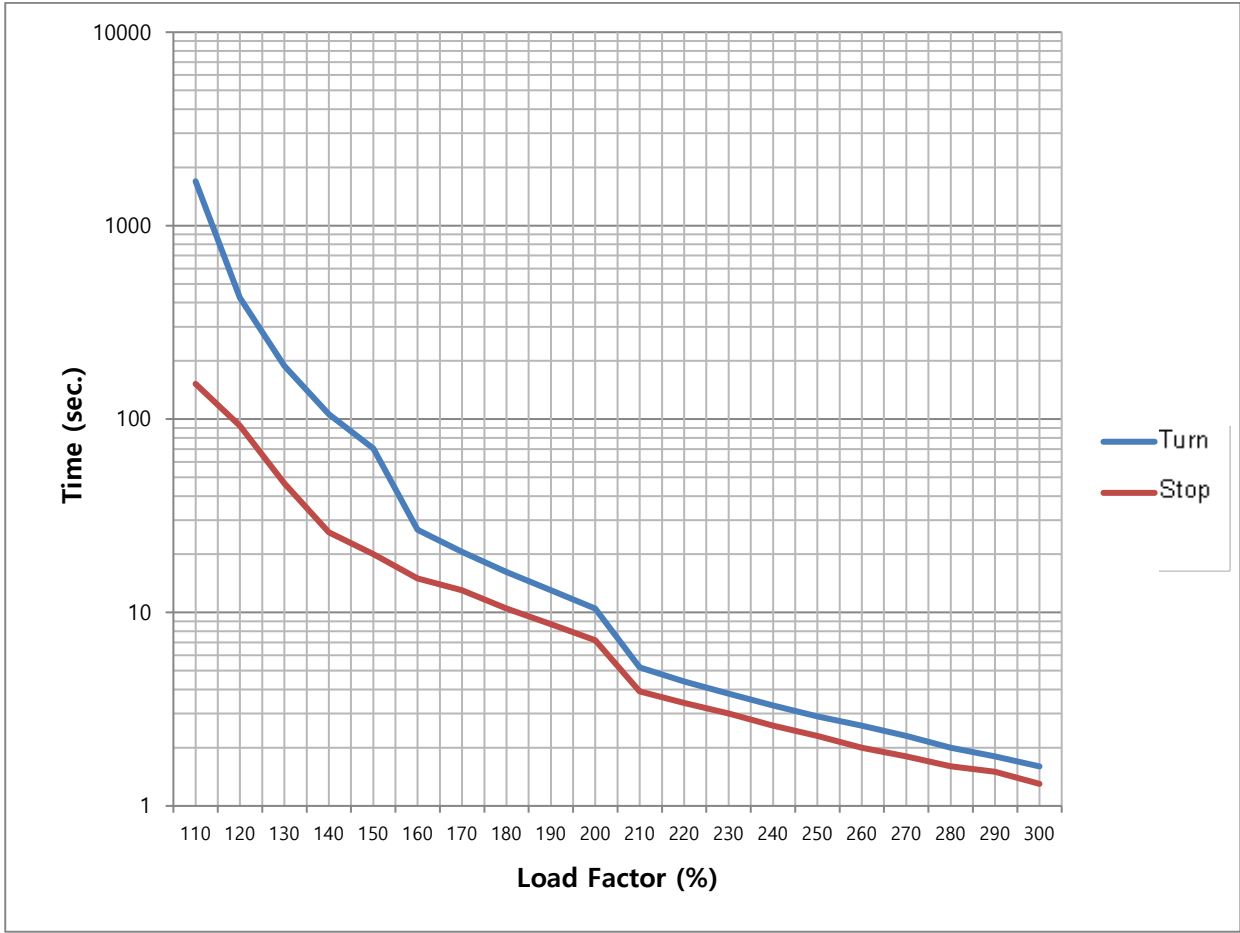

■ **FB Type Servo Motor Capacity - 200W**

Load Factor (%)	AL-21 duration (sec)		Load Factor (%)	AL-21 duration (sec)	
	Turn	Stop		Turn	Stop
100 or lower	Infinite	Infinite			
110	55776.0	267.0	210	66.8	29.0
120	1500.0	161.0	220	50.1	26.0
130	702.0	110.0	230	38.5	24.0
140	455.0	81.0	240	30.3	9.7
150	308.0	65.0	250	24.2	8.3
160	223.0	53.0	260	4.2	3.8
170	170.0	50.0	270	3.8	3.4
180	142.0	41.0	280	3.4	3.1
190	108.0	35.0	290	3.0	2.7
200	91.0	31.0	300	2.7	2.5

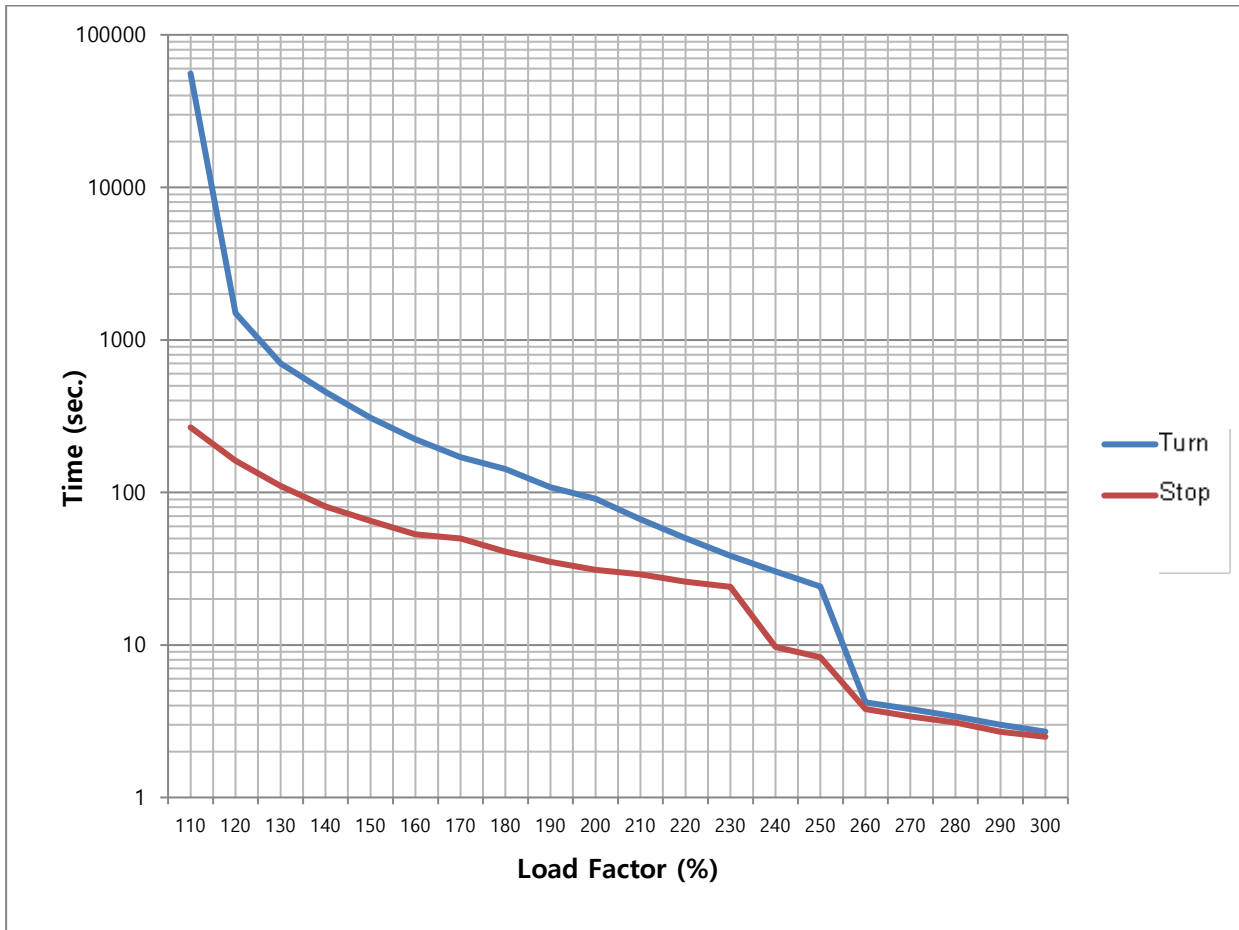

■ **FB Type Servo Motor Capacity - 400W**

Load Factor (%)	AL-21 duration (sec)		Load Factor (%)	AL-21 duration (sec)	
	Turn	Stop		Turn	Stop
100 or lower	Infinite	Infinite			
110	2494.0	738.0	210	66.8	40.0
120	950.0	422.0	220	50.1	37.0
130	603.0	251.0	230	38.5	30.3
140	419.0	196.0	240	30.3	9.7
150	303.0	125.0	250	24.2	8.3
160	270.0	78.0	260	4.2	3.8
170	193.0	66.0	270	3.8	3.4
180	147.0	57.0	280	3.4	3.1
190	126.0	53.0	290	3.0	2.7
200	92.0	44.0	300	2.7	2.5

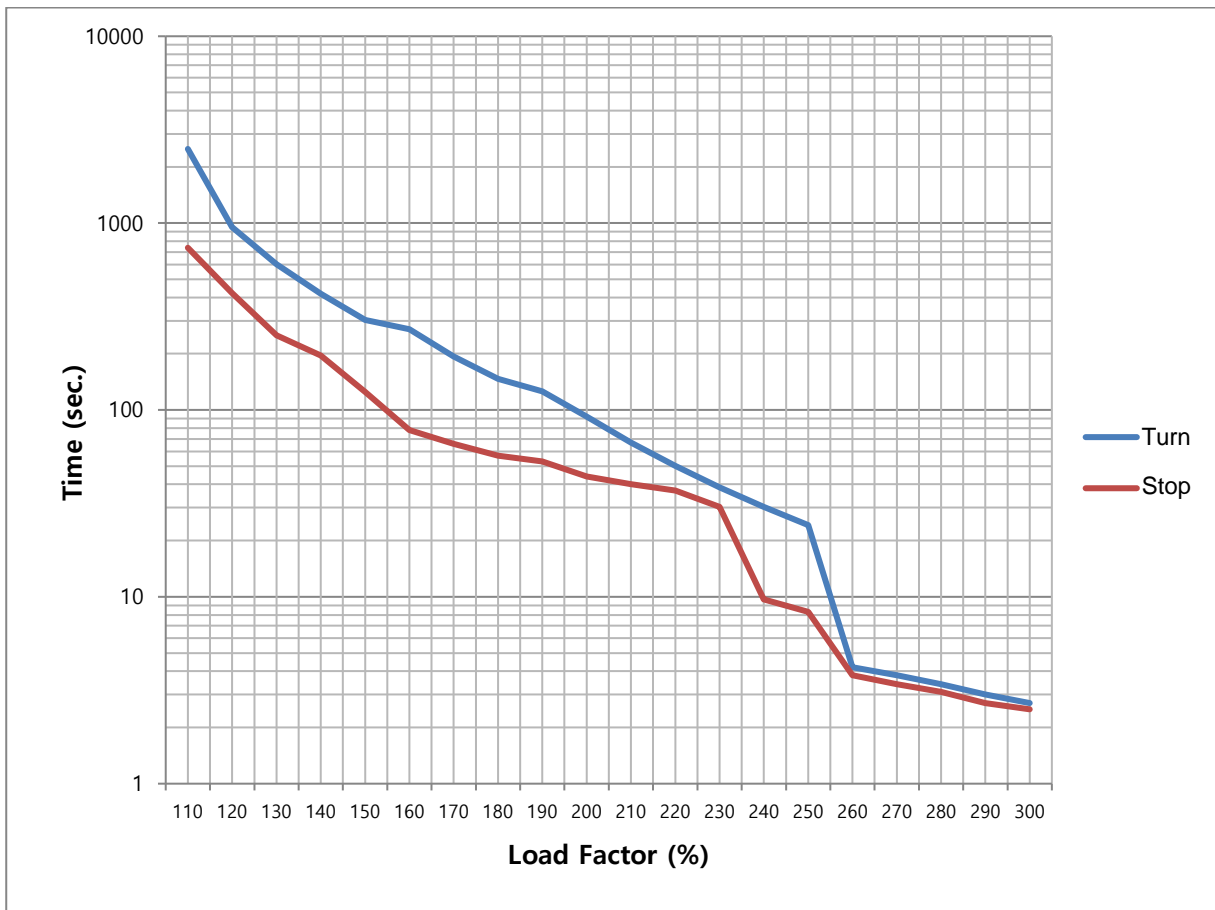

11.3.2 Servo Drive

■ Servo Drive Capacity - 400W

Load Factor (%)	AL-21 duration (sec)		Load Factor (%)	AL-21 duration (sec)	
	Turn	Stop		Turn	Stop
100 or lower	Infinite	Infinite	230	38.5	30.3
110	55776.0	37935.0	240	30.3	9.7
120	13944.0	9483.0	250	24.2	8.3
130	6197.0	4215.0	260	5.0	5.0
140	3486.0	2371.0	270	4.8	4.7
150	1183.0	926.0	280	4.5	4.4
160	566.0	470.0	290	4.3	4.1
170	318.0	273.0	300	4.0	3.8
180	198.0	173.0	310	3.8	3.5
190	131.0	117.0	320	3.5	3.2
200	92.0	66.0	330	3.3	2.9
210	66.8	50.1	340	3.0	2.6
220	50.1	38.5	350	2.7	2.5

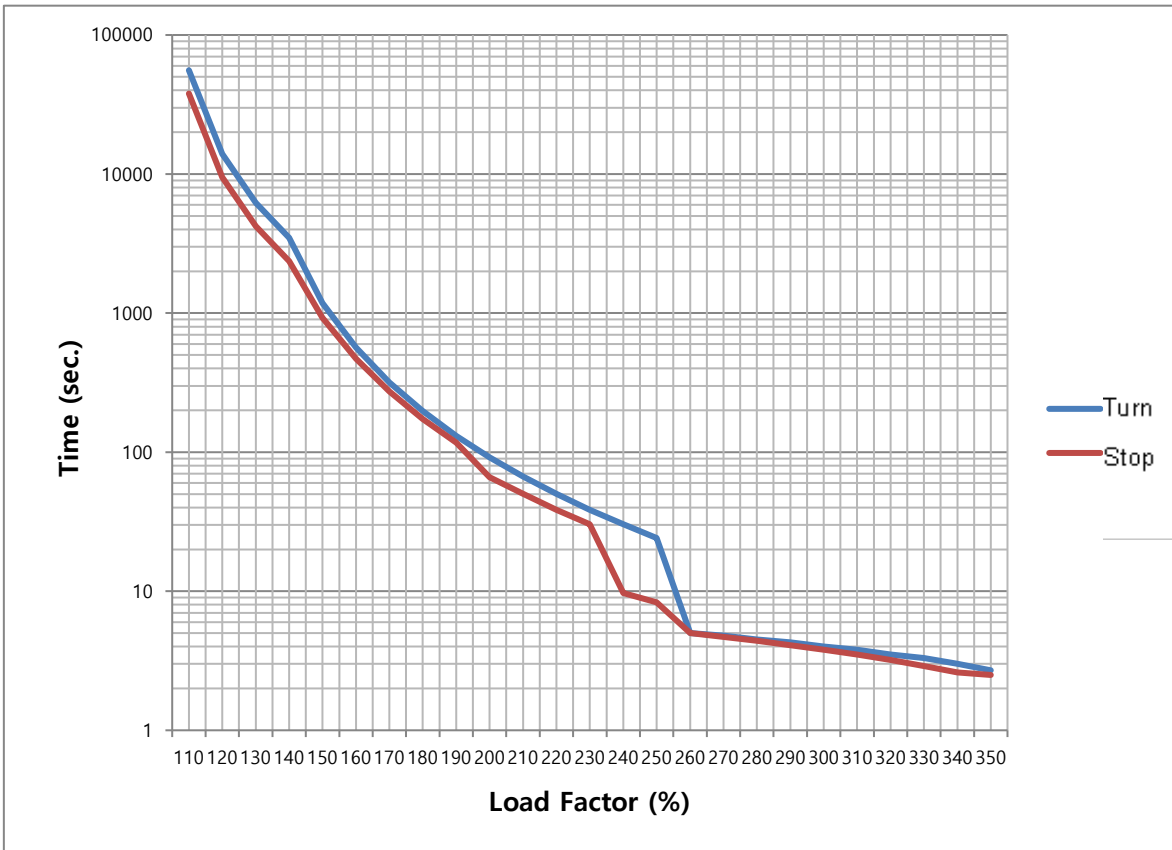

■ Servo Drive Capacity - 750W

Load Factor (%)	AL-21 duration (sec)		Load Factor (%)	AL-21 duration (sec)	
	Turn	Stop		Turn	Stop
100 or lower	Infinite	Infinite	230	49.3	30.3
110	105800.0	37935.0	240	38.8	9.7
120	26450.0	9483.0	250	31.0	8.3
130	11755.5	4215.0	260	7.0	3.8
140	6612.5	2371.0	270	6.7	3.4
150	2244.0	926.0	280	6.4	2.9
160	1073.6	470.0	290	6.2	2.7
170	603.2	273.0	300	5.9	2.5
180	413.6	173.0	310	5.6	2.3
190	273.6	117.0	320	5.3	2.1
200	201.0	66.0	330	5.0	1.9
210	119.0	50.1	340	4.8	1.8
220	89.2	38.5	350	4.6	1.7

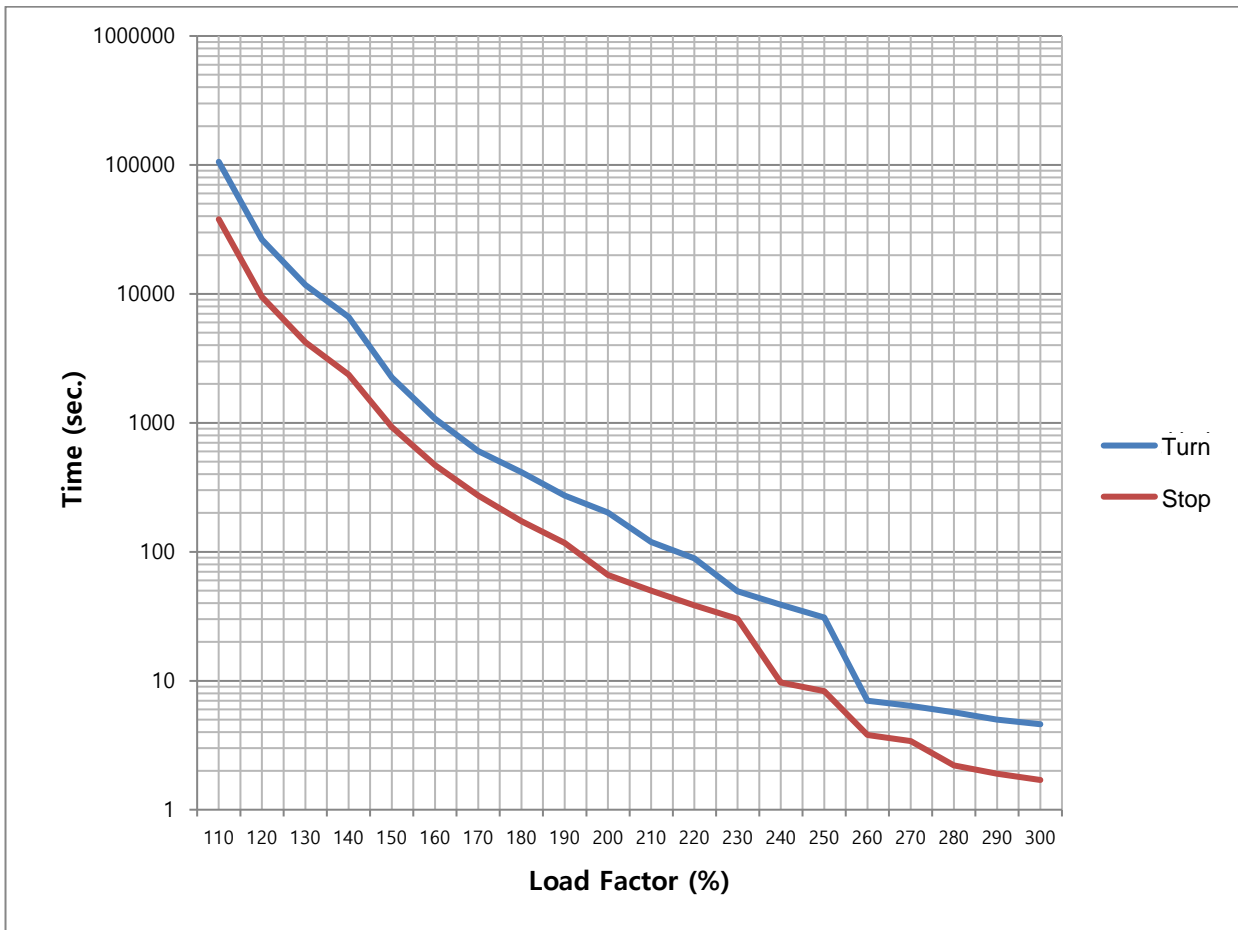

■ Servo Drive Capacity - 1kW

Load Factor (%)	AL-21 duration (sec)		Load Factor (%)	AL-21 duration (sec)	
	Turn	Stop		Turn	Stop
100 or lower	Infinite	Infinite			
110	105800.0	37935.0	210	119.0	50.1
120	26450.0	9483.0	220	89.2	38.5
130	11755.5	4215.0	230	49.3	30.3
140	6612.5	2371.0	240	38.8	9.7
150	2244.0	926.0	250	31.0	8.3
160	1073.6	470.0	260	7.0	3.8
170	603.2	273.0	270	6.4	3.4
180	413.6	173.0	280	5.7	2.2
190	273.6	117.0	290	5	1.9
200	201.0	66.0	300	4.6	1.7

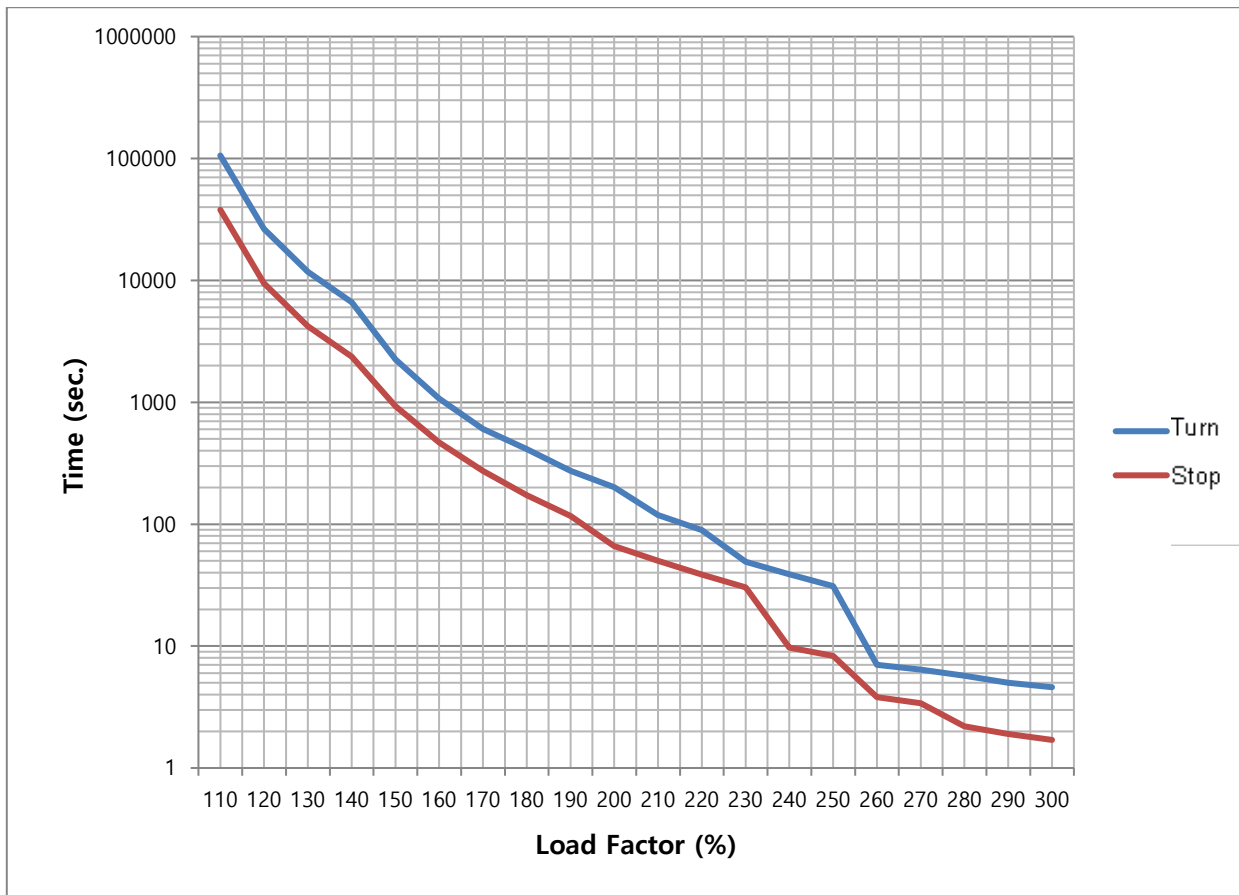

■ Servo Drive Capacity– 2.0W, 3.5kW

Load Factor (%)	AL-21 duration (sec)		Load Factor (%)	AL-21 duration (sec)	
	Turn	Stop		Turn	Stop
100 or lower	Infinite	Infinite			
110	4832	4832	210	66.8	44
120	1208	1208	220	50.1	36
130	536	536	230	38.5	30.3
140	302	302	240	30.3	9.7
150	257	154	250	24.2	8.3
160	229	100	260	4.2	3.8
170	200	85	270	3.8	3.4
180	165	70	280	3.4	3.1
190	131	61	290	3.0	2.7
200	103	52	300	2.7	2.5

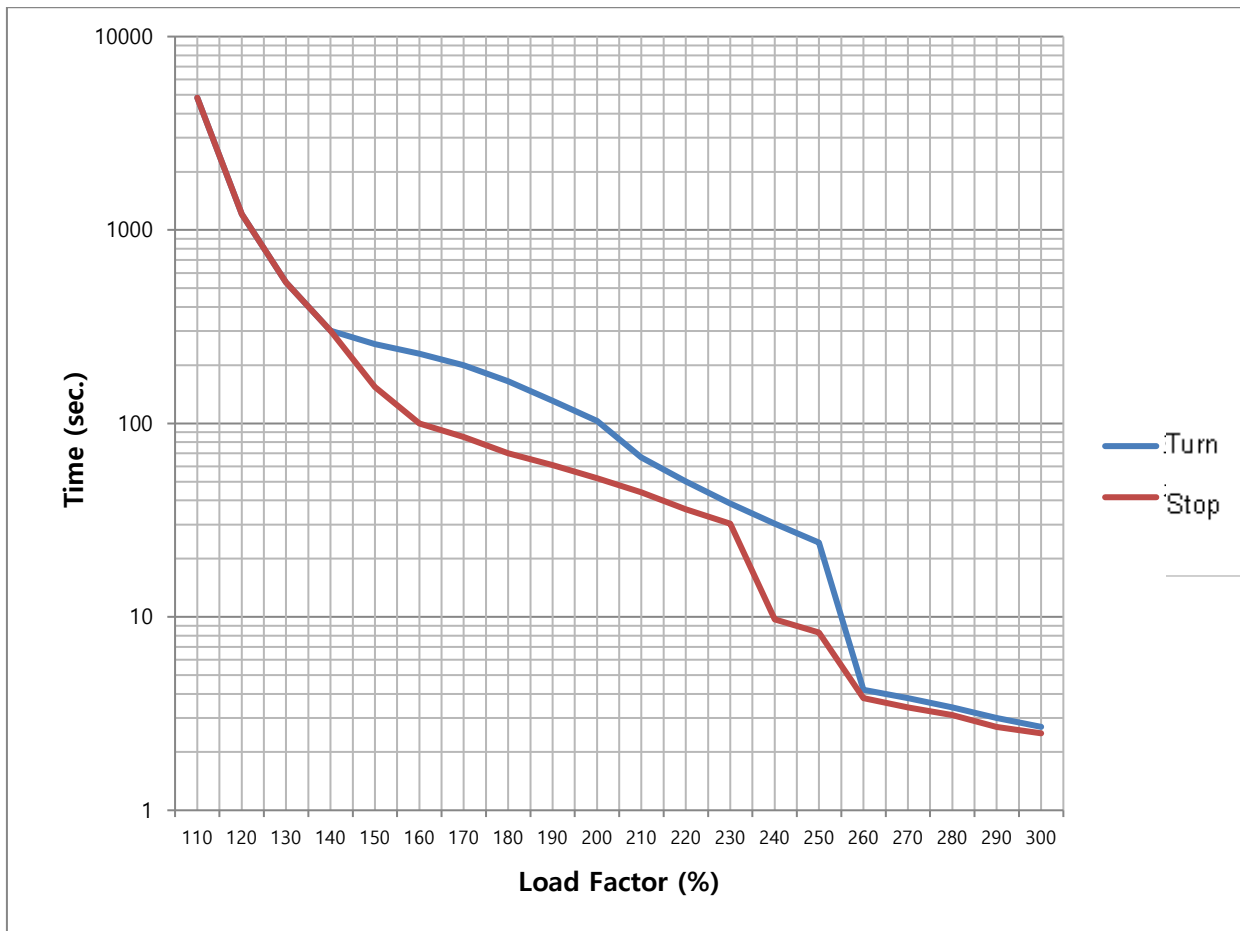

12. Webserver Features

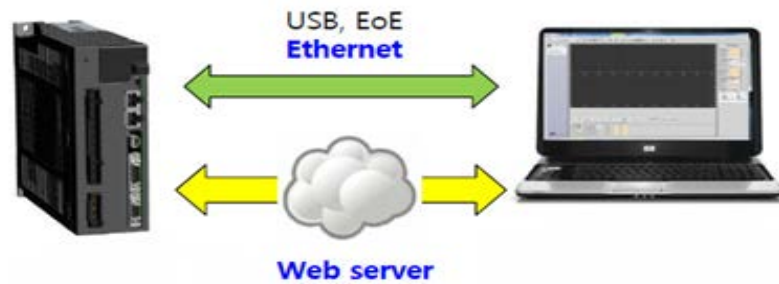

The Webserver interface can be accessed through Ethernet connection between the drive and the user's PC. This servo drive has a built-in Webserver function, which enables you to set up and control the drive in a web browser environment without having to use a separate setup program (Drive CM).

iX7NH Drive supports the Webserver function through the EtherCAT communication input port (IN) and allows you to use the following features in a web browser:

- Drive information monitoring available
- Motor/encoder configuration available
- Alarm history monitoring/reset available
- Supports Cyclic Monitor
- Supports Program Jog Operation Modes
- Supports Manual Jog Operation Modes
- Supports PTP Operation Modes
- Supports other functions (absolute encoder reset, current offset, software reset)
- Supports Object Dictionary reading/writing

■ Related Objects

Index	Sub Index	Name	Variable Type	Accessibility	PDO Assignment	Unit
0x241A	-	Ethernet TCP Port	UINT	RW	No	-
0x241B	-	Ethernet TCP IP Address	UDINT	RW	No	-
0x241C	-	Ethernet Subnet Mask	UDINT	RW	No	-
0x241D	-	Ethernet Gateway	UDINT	RW	No	-
0x241E	-	MAC Address - Vendor	UDINT	RW	No	-
0x241F	-	MAC Address - NIC	UDINT	RW	No	-
0x2420	-	Webserver ID	STRING	RW	No	-
0x2421	-	Webserver Password	STRING	RW	No	-

■ Communication Access Method

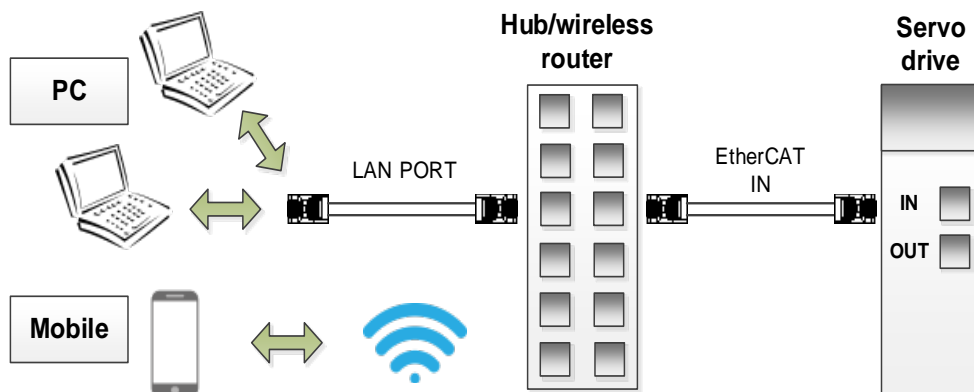

Note 1) Communication is available if your device is connected to the server via the EtherCAT communication input port (IN).

Note 2) A mobile device can be connected to the Webserver for communication only if wireless network sharing is available.

Note 3) Webserver access address: Setting IP [0x241B] - e.g. 192.168.5.5

12.1 Webserver Screen Layout

Below are descriptions of the Webserver homepage layout.

■ Login Page Layout

To access the Webserver, you need to log in.

The screenshot shows the login page of the 'iX7NH Built-in Webserver'. At the top left is the 'LS' logo, and at the top right is the 'LSpartnership' logo. The main title is 'iX7NH Built-in Webserver'. Below the title, there is a 'Please Log-in' section. This section contains two input fields: 'ID' and 'Password'. Arrows point to these fields with circled numbers 1 and 2.

② ID: Enter the ID [0x2420] saved in the drive.

② Password: Enter the password [0x2421] saved in the drive to access Webserver.

Control Page Layout

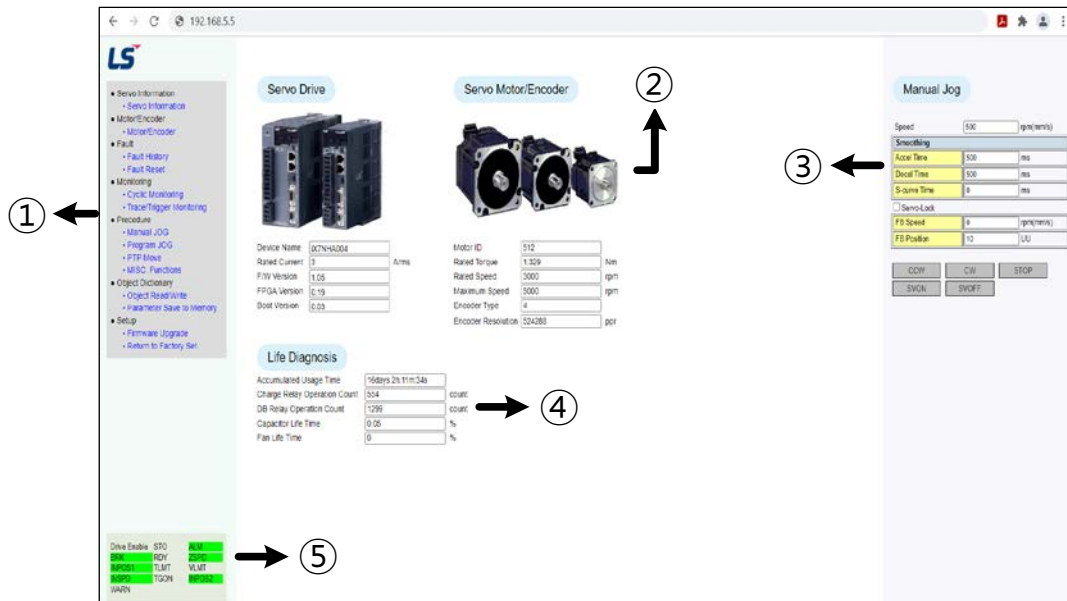

- ① Categories: Provides a menu of all the options for controlling and monitoring the servo drive.
- ② Drive Information: Displays information of the drive and motor connected to the Webserver.
- ③ Procedure Mode: You can set the drive procedure function provided by the Webserver.
- ④ Lifetime diagnosis: Displays information of the drive use time and lifetime.
- ⑤ Status: Displays information of the drive connection and input/output status.

Alarm History Pop-up Layout

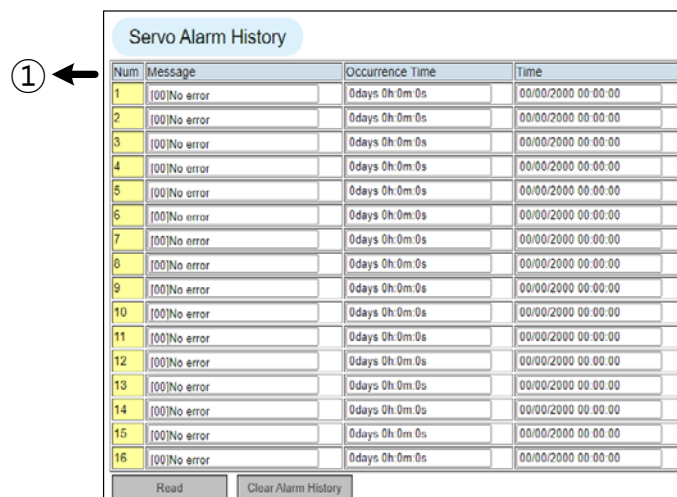

- ① Alarm History: Select Fault History in Categories to open the above pop-up window. You can view or reset the alarm history.

12.2 Webserver Main Features

The following are the main features to control the servo drive on the Webserver:

■ Servo Drive Object Setting

1) Object Dictionary

- Modifies and saves objects in Object Dictionary.
(For details, refer to Section 10 "Object Dictionary.")

■ Procedure Features on Webserver

1) Manual Jog Operation

- Control speed without a host controller.
(For details, refer to Section 9.1 "Manual Jog.")

2) Program Jog Operation

- Control speed without a host controller through driving speed and time settings.
(For details, refer to Section 9.2 "Program Jog.")

3) PTP Move

- The drive generates a position profile internally to drive up to the target position.

4) Other functions

- Absolute encoder reset: This function resets the absolute encoder.
(For details, refer to Section 9.6 "Absolute Encoder Reset.")
- Phase current offset tuning: This function performs automatic phase current offset tuning in U/V/W phases.
(For details, refer to Section 9.8 "Phase Current Offset Tuning.")
- Software reset: This function resets the servo drive using software.
(For details, refer to Section 9.9 "Software Reset.")

■ Viewing Drive Status and Operation Status Using Cyclic Monitor

Cyclic Monitor

Velocity		
Feedback Speed	0	rpm or mm/s
Command Speed	0	rpm or mm/s
Velocity Actual Value	0	UU/s
Velocity Demand Value	0	UU/s

Position		
Following Error	0	pulse
Position Actual Value	113	UU
Position Demand Value	113	UU
Following Error Actual Value	0	UU
Position Actual Internal Value	113	pulse

Torque(Force)		
Torque Actual Value	0.0	%
Torque Demand Value	0.0	%

Overload		
Accumulated Operation Overload	0.0	%
Instantaneous Max. Operation Overload	0.0	%
RMS Operation Overload	0.0	%
Accumulated Regeneration Overload	0.0	%

Encoder		
SingleTurn Data	203292	pulse
Mechanical Angle	139.5	degree
Electrical Angle	18.3	degree
MultiTurn Data	0	revolutions

General		
Drive Temperature 1	60	°C
Drive Temperature 2	61	°C
Encoder Temperature	0	°C
Hall Signal Value	0	(1-6)
DC-Link Voltage	291	Volt

- You can check motor driving and drive status in real time.

■ Viewing Drive Operation Status on Graph Through Trace/Trigger Monitoring



- You can check the drive operation status on graphs. (Note: Internet Explorer does not support this function.)

- Viewing and Deleting Alarm History
- Drive Set-up

1) Firmware Update

- Update the firmware.
(For details, refer to Section 15.1.4 "Using Webserver.")

2) Reset to Factory Default Settings

12.3 Example of Webserver Access

To connect to the Webserver on your PC, separate settings need to be made on the PC and the servo drive.

You can make those settings as follows.

■ PC Settings

1) Network IP Settings

To connect to the Webserver, your PC needs the same network IP address setting as in the servo drive. Go to Ethernet Attributes [Control Panel\All Items\Network Connection] and set the network IP address and subnet mask as follows:

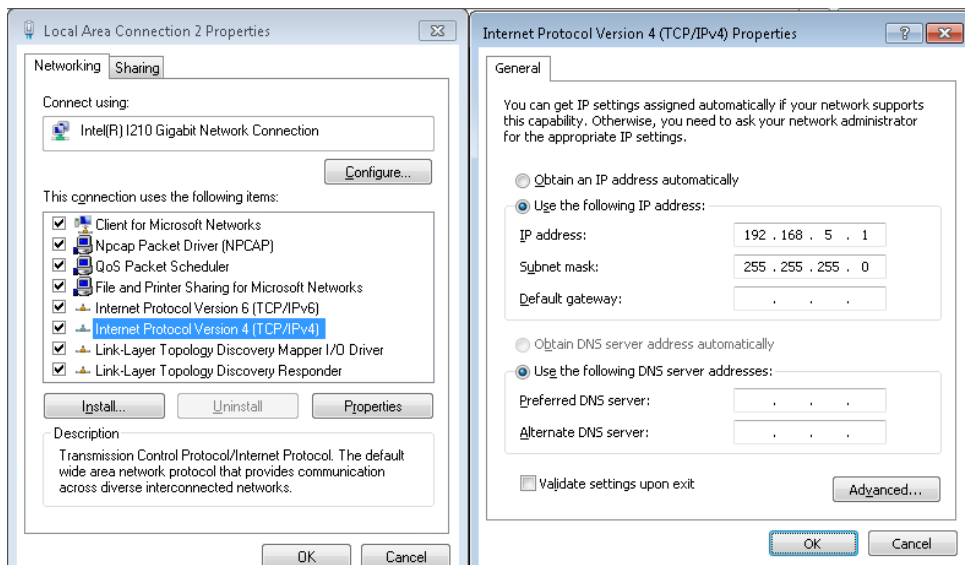

Note 1) You can access the Webserver only if the IP addresses set in the servo drive and PC are the same.

Note 2) If the Host IP addresses set in the PC and the servo drive are the same, you cannot access the Webserver. Therefore, the Host IP address must be set differently.

■ Servo Drive Settings

1) Changing Node ID

You need to change the node ID to connect to the Webserver. Node ID can be changed by using the node address setting switch in Loader. Use the switch to set the value to 99.

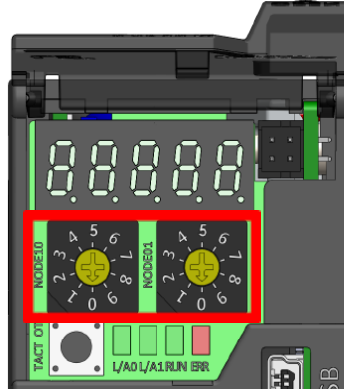

Note 1) You need to power-cycle the device after changing the node ID.

2) Object Settings

Set the below objects to connect to the Webserver.

- ✓ Webserver IP setting

0x241B	IP Address						ALL
Variable Type	Setting Range	Initial Value	Unit	Accessibility	PDO Assignment	Variable Attribute	Saving
UDINT	0 to 0xFFFFFFFF	0x0505A8C0	-	RW	-	-	Yes

Setting example) IP address: 192.168.05.05

Note 1) If you enter an IP address already in use, access will be denied.

Bits	31~24	23~16	15~8	7~0
DATA	05	05	A8	C0
Setting Value (hex)	0x0505A8C0			
Setting Value (IP address)	192.168.5.5			

- ✓ Webserver ID setting

0x2420	Webserver ID						ALL
Variable Type	Setting Range	Initial Value	Unit	Accessibility	PDO Assignment	Variable Attribute	Saving
STRING	-	'ID'	-	RW	No	Always	Yes

✓ Webserver password setting

0x2421	Webserver Password						ALL
Variable Type	Setting Range	Initial Value	Unit	Accessibility	PDO Assignment	Variable Attribute	Saving
STRING	-	'PASSWORD'	-	RW	No	Always	Yes

1) Webserver Access and Logging in

Do the following to access the Webserver.



Open Microsoft Edge or Chrome and enter the previously set Webserver IP address (e.g. 192.168.5.5) in the address bar.

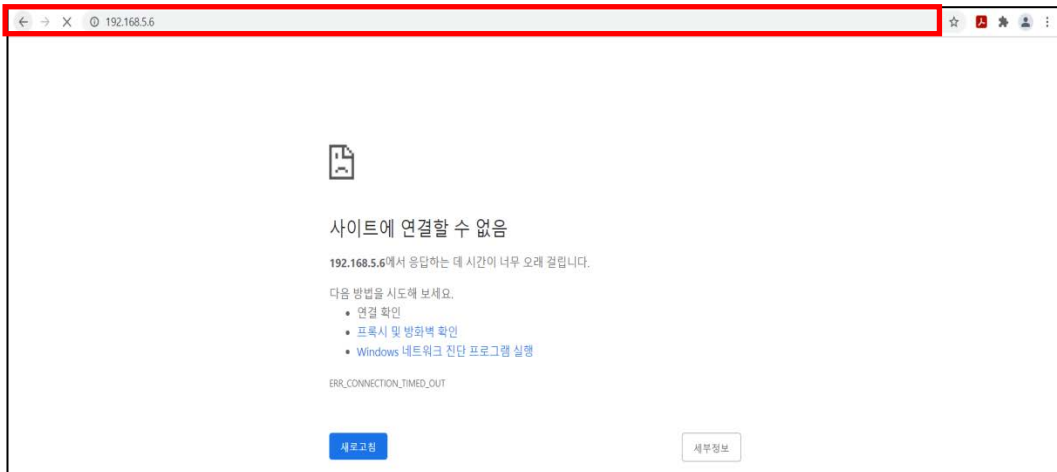

Note 1) If you enter a different IP address than the previously set one, access will be denied.

On the login screen that appears below, enter the Webserver ID and password set in the objects. Press the Enter key on the keyboard to log in.

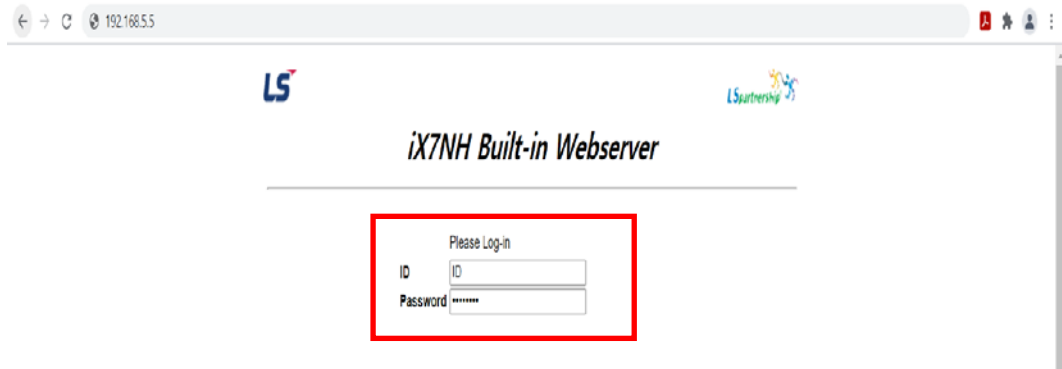

Note 2) ID and password are case-sensitive.

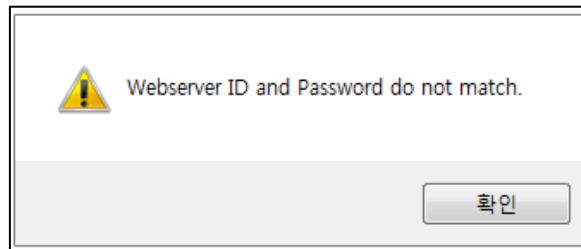

Note 3) If you enter the ID or password incorrectly, the following error message will appear.

2) After Logging in

Once logged in, you are directed to the main screen shown below and can start using the various features provided by the Webserver.

The screenshot displays the LS webserver interface with the following sections:

- Navigation Menu (Left):**
 - Servo Information
 - Servo Information
 - Motor/Encoder
 - Motor/Encoder
 - Fault
 - Fault History
 - Fault Reset
 - Monitoring
 - Cyclic Monitoring
 - Trace/Tagger Monitoring
 - Procedure
 - Manual JOG
 - Program JOG
 - PTP Move
 - MISC. Functions
 - Object Dictionary
 - Object ReadWrite
 - Parameter Save to Memory
 - Setup
 - Firmware Upgrade
 - Return to Factory Set
- Servo Drive:** Includes an image of the drive and a table of parameters:

Device Name	BC2H-A004
Rated Current	0 A rms
FW Version	1.05
FPQA Version	0.19
Boot Version	0.03
- Servo Motor/Encoder:** Includes an image of the motor and a table of parameters:

Motor ID	315
Rated Torque	1.329 Nm
Rated Speed	3000 rpm
Maximum Speed	5000 rpm
Encoder Type	4
Encoder Resolution	524288 ppr
- Life Diagnosis:** Includes a table of usage metrics:

Accumulated Usage Time	168hrs 24m 34s
Charge Relay Operation Count	304 count
DB Relay Operation Count	1299 count
Capacitor Life Time	0.05 %
Fan Life Time	0 %
- Manual Jog:** Includes a speed control section:

Speed	(500) (rpm/min)
Smoothing	
Accel Time	500 ms
Decel Time	500 ms
S-ramp Time	0 ms
Servo-Lock	<input type="checkbox"/>
FD Speed	0 (rpm/min)
FD Position	10 LU

 Control buttons: [COW] [C/W] [STOP] [SVCN] [SVOP].
- Status (Bottom Left):**
 - Drive Enable: STO (OK)
 - DRK: RDN (OK)
 - SRVON: TLUT (N.LST)
 - SRVSI: TIGON (N.LST)
 - WARN

13. Modbus TCP

13.1 Overview and Communication Specifications

■ Overview

iX7NH Drive supports the Modbus-TCP Server among the modbus protocols through the EtherCAT communication input port (IN). To use this feature, you need to set the node address setting switch to 99.

■ Serial Communication Access

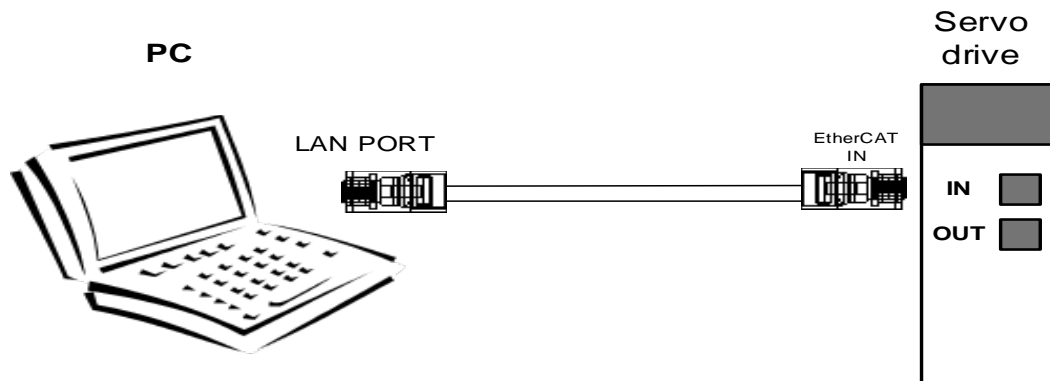

Note 1) Communication is possible through the EtherCAT communication input port (IN) only.

Note 2) IP Address : 192.168.5.5 / Port : 502

■ Connecting Connector Pin for Communication

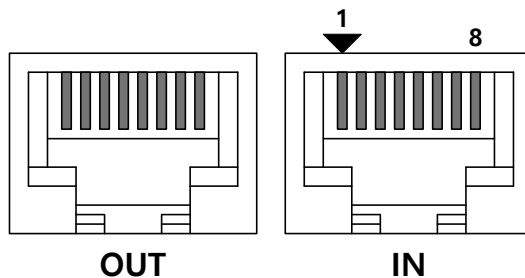

Pin arrangement seen from the drive's front

Pin arrangement seen from the connector

For better stability in using the product, it is recommended to use an STP cable and connector.

Pin Number	Pin Function	Pin Number	Pin Function
1	Transmit data (TXD)+	5	-
2	Transmit data (TXD) -	6	Receive data (RXD)-
3	Receive data (RXD)+	7	-
4	-	8	-

Note 1) Connect TXD+ and TXD-, and RXD+ and RXD- in twisted pairs.

Note 2) The TXD and RXD in the above table are based on the servo drive.

13.2 Status LED

The LEDs on the loader of this drive indicate the states of the EtherCAT communications and errors, as shown in the following figure. There are two LED lamps for indicating the Ethernet communication status: L/A0 and L/A1.

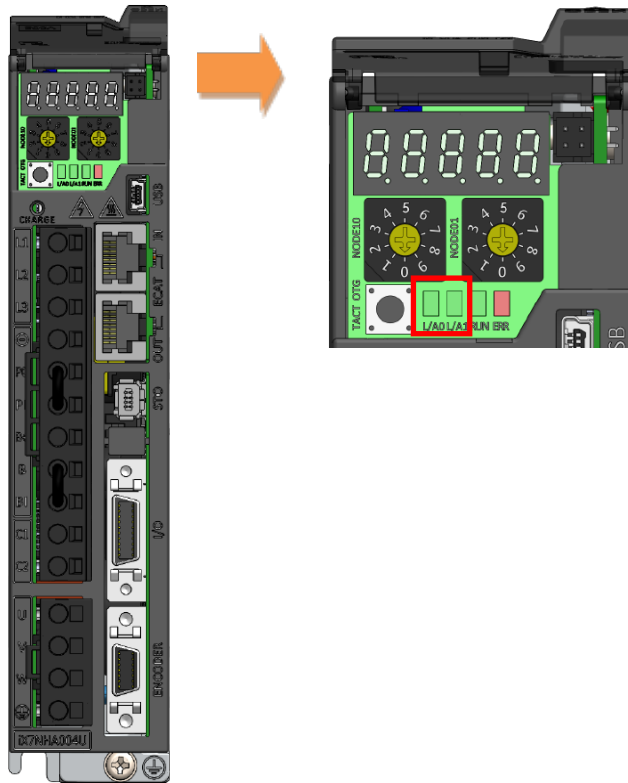

■ Link, Activity LED

L/A0 LED indicates the connection status of the Ethernet communication port, and L/A1 LED indicates the data transmission/reception status. The following table outlines what each LED state indicates.

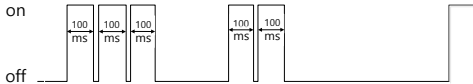
LED	LED Status	Description
Link (L/A0)	OFF	No communication cable is connected.
	ON	Communication cable is connected.
Activity (L/A1)	OFF	Data transmission/reception are inactive.
	ON	Communication is enabled and data transmission/reception are active. 

13.3 Operation Modes

This drive supports the following operation modes (0x6060) when connected to the Modbus-TCP server.

- Profile Position Mode (PP): Refer to Section 5.3.2 (Profile Position Mode).
- Homing Mode (HM): Refer to Section 5.6 (Homing).
- Profile Velocity Mode (PV): Refer to Section 5.4.2 (Profile Velocity Mode).
- Profile Torque Mode (PT): Refer to Section 5.5.2 (Profile Torque Mode).

■ Related Objects

Index	Sub Index	Name	Variable Type	Accessibility	PDO Assignment	Unit
0x6060	-	Modes of Operation	SINT	RW	Yes	-
0x6061	-	Modes of Operation Display	SINT	RO	Yes	-
0x6502	-	Supported Drive Modes	UDINT	RO	No	-

13.4 Basic Structure of Communication Protocol

Also, the concepts of sending (Tx) and receiving (Rx) are for the Host in this manual.

13.4.1 Sending/Receiving Packet Structure

For data communication to be possible between the master (Client) and slave (Server), data packets need to be suitable for the Modbus-TCP frame structure. The Modbus-TCP frame structure is very similar to the frame structure of general Modbus (RTU, ASCII).

■ Frame Structure of General Modbus (RTU, ASCII)



■ Modbus-TCP Frame Structure

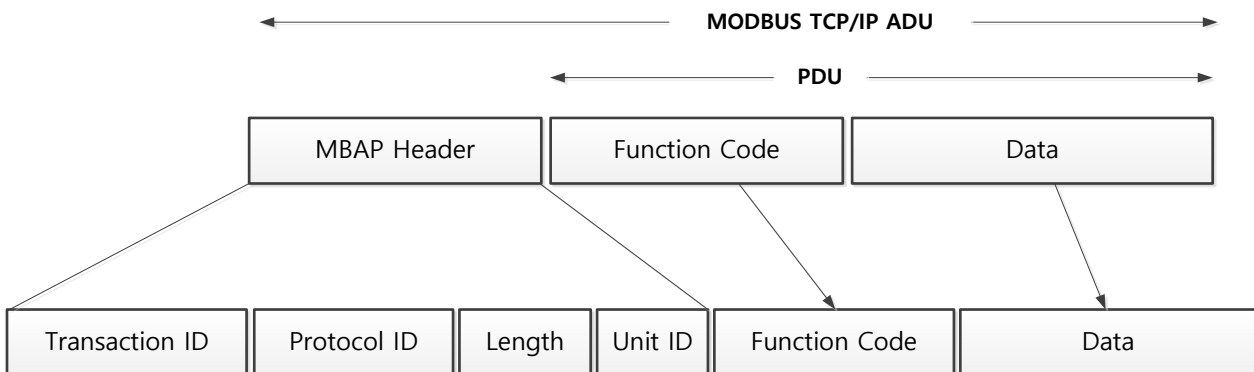

Transaction ID [2Bytes]: The master (Client) increases each value by 1 starting with 0x0000, and the slave (Server) copies and uses the values. This checks if each query has been paired with a response.

Protocol ID [2Bytes]: This is the ID of the protocol. Modbus-TCP uses a fixed value set in 0x0000.

Length [2Bytes]: This indicates the distance between the length field position and the frame end. In other words, it is the number of bytes from the unit ID and end of data.

Unit ID [1 Byte]: This is information that distinguishes slaves connected to a communication line other than TCP/IP.

Function Code: This is a command group code provided by the Modbus protocol. You can use a function code to read and write values from and to the slave memory (coil, register). Function Code uses values in the range of 1~127, but TCPSPORT supports the values of 1, 2, 3, 4, 5, 6, 15 and 16. This is because this service is frequently used.

Data

[Sending]: For a read register command, it is necessary to set the Modbus address and numbers of registers. For a write register, it is necessary to set the Modbus address, number of bytes and setting value.

[Receiving]: For a normal response of a read register, the function code in receiving have the same number as in sending. Data are received with register values according to the register order during sending.

For the write single register command, the transmitted data are received without change. For the write multi registers command, the start address of the register for which to write data using the command as well as the number of registers are received.

Exception Code: The following are the exception codes for all abnormal responses to function codes.

Exception Code	Descriptions
0x01	Unsupported function code
0x02	Invalid register address
0x03	Invalid data
0x04	Device malfunction, parameter setting value abnormality <small>Note 1)</small>
0x05	Data unprepared
0x06	Parameter locked

Note1) If the setting range of the parameter is the same as that of the data type and a value out of the range is input, no response is made using the exception code, but the maximum and minimum values are set.

■ Sending Packet Structure

Bytes	Transaction ID		Protocol ID		Length		Unit ID	Function Code	Data			
	0	1	2	3	4	5	6	7	8	9	10	11
Details	0x00	0x01	0x00	0x00	0x00	0x06	0x01	0x04	0x20	0x00	0x00	0x01

- Request to read the motor ID setting value at 0x2000

■ Receiving Packet Structure

Bytes	Transaction ID		Protocol ID		Length		Unit ID	Function Code	Data			
	0	1	2	3	4	5	6	7	8	9	10	11
Details	0x00	0x01	0x00	0x00	0x00	0x05	0x01	0x04	0x02	0x00	0x0D	

- Response with 13, the motor ID setting value at 0x2000

13.4.2 Protocol Command Codes

(1) Read Coils (0x01)

It reads individual bit outputs as well as continual bit output block values.

■ Request

Function Code	1Byte	0x01
Starting Address	2Byte	0x0000 to 0x003E
Quantity of Coils	2Bytes	1 to 64 (0x003F)

■ Request OK

Function Code	1Byte	0x01
Byte Count	1Byte	N*
Coil Status	n Bytes	n= N or N+1

*N= Quantity of Outputs/8

■ Response not OK

Error Code	1Byte	0x81
Exception Code	1Byte	0x01~0x04

The command code Read Coils can read the status of contacts that correspond to drive status input 1, 2 and drive status output 1, 2. The following are the addresses that correspond to drive status input 1, 2 and drive status output 1, 2.

■ Drive Status Input 1 Communication Addresses

Communication Address		Input Contacts	Accessib ility
Decimal Number	Hexadecimal Number		
0	0x0000	POT	RW
1	0x0001	NOT	RW
2	0x0002	HOME	RW
3	0x0003	STOP	RW
4	0x0004	PCON	RW
5	0x0005	GAIN2	RW
6	0x0006	P_CL	RW
7	0x0007	N_CL	RW
8	0x0008	PROBE1	RW
9	0x0009	PROB2	RW
10	0x000A	EMG	RW
11	0x000B	A_RST	RW
12	0x000C	SV_ON	RW
13	0x000D	LVSF1	RW
14	0x000E	LVSF2	RW
15	0x000F	Reserved	RW

■ Drive Status Output 1 Communication Addresses

Communication Address		Output Contacts	Accessib ility	Communication Address		Output Contacts	Accessib ility
Decimal Number	Hexadecimal Number			Decimal Number	Hexadecimal Number		
32	0x0020	BRAKE	RO	40	0x0028	WARN	RO
33	0x0021	ALARM	RO	41	0x0029	TGON	RO
34	0x0022	READY	RO	42	0x002A	INPOS2	RO
35	0x0023	ZSPD	RO	43	0x002B	Reserved	RO
36	0x0024	INPOS1	RO	44	0x002C	Reserved	RO
37	0x0025	TLMT	RO	45	0x002D	Reserved	RO
38	0x0026	VLMT	RO	46	0x002E	Reserved	RO
39	0x0027	INSPD	RO	47	0x002F	Reserved	RO

ex 1) Reading brake output contact status

■ Request

	Transaction ID		Protocol ID		Length		Unit ID	Function Code	Data			
									Starting Address		Quantity of Coils	
Bytes	0	1	2	3	4	5	6	7	8	9	10	11
Details	0x00	0x01	0x00	0x00	0x00	0x06	0x01	0x01	0x00	0x20	0x00	0x01

■ Request OK

	Transaction ID		Protocol ID		Length		Unit ID	Function Code	Data	
									Byte Count	Coil Status
Bytes	0	1	2	3	4	5	6	7	8	9
Details	0x00	0x01	0x00	0x00	0x00	0x04	0x01	0x01	0x01	0x01

- The BRAKE output contact status is High (1).

■ Response not OK

	Transaction ID		Protocol ID		Length		Unit ID	Error Code	Exception Code
Bytes	0	1	2	3	4	5	6	7	8
Details	0x00	0x01	0x00	0x00	0x00	0x04	0x01	0x81	0x01~0x04

(2) Read Discrete Inputs (0x02)

It reads individual bit outputs as well as continual bit input block values.

■ Request

Function Code	1Byte	0x02
Starting Address	2Byte	0x0000 to 0x003E
Quantity of Inputs	2Bytes	1 to 64 (0x003F)

■ Request OK

Function Code	1Byte	0x02
Byte Count	1Byte	N*
Input Status	N* x 1Byte	

*N= Quantity of Inputs/8

■ Response not OK

Error Code	1Byte	0x82
Exception Code	1Byte	0x01~0x04

The command code Read Discrete Inputs can read the status of contacts that correspond to drive status input 1, 2 and drive status output 1, 2. The following are the addresses that correspond to drive status input 1, 2 and drive status output 1, 2.

■ Drive Status Input 1, 2 Communication Addresses

Communication Address		Output Contacts	Accessib ility	Communication Address		Output Contacts	Accessib ility
Decimal Number	Hexadecimal Number			Decimal Number	Hexadecimal Number		
0	0x0000	POT	RW	16	0x0010	START	RW
1	0x0001	NOT	RW	17	0x0011	PAUSE	RW
2	0x0002	HOME	RW	18	0x0012	REGT	RW
3	0x0003	STOP	RW	19	0x0013	HSTART	RW
4	0x0004	PCON	RW	20	0x0014	ISEL0	RW
5	0x0005	GAIN2	RW	21	0x0015	ISEL1	RW
6	0x0006	P_CL	RW	22	0x0016	ISEL2	RW
7	0x0007	N_CL	RW	23	0x0017	ISEL3	RW
8	0x0008	MODE	RW	24	0x0018	ISEL4	RW
9	0x0009	Reserved	RW	25	0x0019	ISEL5	RW
10	0x000A	EMG	RW	26	0x001A	ABSRQ	RW
11	0x000B	A_RST	RW	27	0x001B	JSTART	RW
12	0x000C	SV_ON	RW	28	0x001C	JDIR	RW
13	0x000D	SPD1/LV SF1	RW	29	0x001D	PCLEAR	RW
14	0x000E	SPD2/LV SF2	RW	30	0x001E	AOVR	RW
15	0x000F	SPD3	RW	31	0x001F	Reserved	RW

Note1) iX7NH does not support input contacts assigned to communication addresses 16~31.

■ Drive Status Output 1, 2 Communication Addresses

Communication Address		Output Contacts	Accessib ility	Communication Address		Output Contacts	Accessib ility
Decimal Number	Hexadecimal Number			Decimal Number	Hexadecimal Number		
32	0x0020	BRAKE	RO	48	0x0030	ORG	RO
33	0x0021	ALARM	RO	49	0x0031	EOS	RO
34	0x0022	READY	RO	50	0x0032	IOUT0	RO
35	0x0023	ZSPD	RO	51	0x0033	IOUT1	RO
36	0x0024	INPOS1	RO	52	0x0034	IOUT2	RO
37	0x0025	TLMT	RO	53	0x0035	IOUT3	RO
38	0x0026	VLMT	RO	54	0x0036	IOUT4	RO
39	0x0027	INSPD	RO	55	0x0037	IOUT5	RO
40	0x0028	WARN	RO	56	0x0038	Reserved	RO
41	0x0029	TGON	RO	57	0x0039	Reserved	RO
42	0x002A	Reserved	RO	58	0x003A	Reserved	RO
43	0x002B	Reserved	RO	59	0x003B	Reserved	RO
44	0x002C	Reserved	RO	60	0x003C	Reserved	RO
45	0x002D	Reserved	RO	61	0x003D	Reserved	RO
46	0x002E	Reserved	RO	62	0x003E	Reserved	RO
47	0x002F	Reserved	RO	63	0x003F	Reserved	RO

Note1) iX7NH does not support output contacts assigned to communication addresses 48~63.

ex 1) Reading POT input contact status

■ Request

	Transaction ID		Protocol ID		Length		Unit ID	Function Code	Data			
									Starting Address		Quantity of Inputs	
Bytes	0	1	2	3	4	5	6	7	8	9	10	11
Details	0x00	0x01	0x00	0x00	0x00	0x06	0x01	0x02	0x00	0x00	0x00	0x01

■ Request OK

	Transaction ID		Protocol ID		Length		Unit ID	Function Code	Data	
									Byte Count	Input Status
Bytes	0	1	2	3	4	5	6	7	8	9
Details	0x00	0x01	0x00	0x00	0x00	0x04	0x01	0x02	0x01	0x01

- The POT input contact status is Low (0).

■ Response not OK

	Transaction ID		Protocol ID		Length		Unit ID	Error Code	Exception Code
Bytes	0	1	2	3	4	5	6	7	8
Details	0x00	0x01	0x00	0x00	0x00	0x04	0x01	0x82	0x01~0x04

(3) Read Holding Register (0x03)

It reads single registers (16-bit data) and continuous register block (16 bit data) values.

■ Request

Function Code	1Byte	0x03
Starting Address	2Byte	0x0000 to 0xFFFF
Quantity(Num) of Registers	2Bytes	1 to 125 (0x7D)

■ Request OK

Function Code	1Byte	0x03
Byte Count	1Byte	2 x N*
Register Values	N* x 2Bytes	

*N= Quantity of Registers

■ Response not OK

Error Code	1Byte	0x83
Exception Code	1Byte	0x01~0x06

ex 1) When reading only the parameter for the current velocity (Address: 0x2600)

■ Request

	Transaction ID		Protocol ID		Length		Unit ID	Function Code	Data			
									Starting Address		Quantity(Num) of Registers	
Bytes	0	1	2	3	4	5	6	7	8	9	10	11
Details	0x00	0x01	0x00	0x00	0x00	0x06	0x01	0x03	0x26	0x00	0x00	0x01

■ Request OK

	Transaction ID		Protocol ID		Length		Unit ID	Function Code	Data		
									Byte Count	Register Value	
Bytes	0	1	2	3	4	5	6	7	8	9	10
Details	0x00	0x01	0x00	0x00	0x00	0x05	0x01	0x03	0x02	0x00	0x00

- The current speed is 0 (or 0x0000).

■ Response not OK

	Transaction ID		Protocol ID		Length		Unit ID	Error Code	Exception Code
Bytes	0	1	2	3	4	5	6	7	8
Details	0x00	0x01	0x00	0x00	0x00	0x04	0x01	0x83	0x01~0x04

ex 2) when reading several parameters including motor ID (Address: 0x2000), encoder type (Address: 0x2000) encoder pulse per revolution (Address: 0x2002~0x2003)

■ Request

	Transaction ID		Protocol ID		Length		Unit ID	Function Code	Data			
									Starting Address		Quantity(Num) of Registers	
Bytes	0	1	2	3	4	5	6	7	8	9	10	11
Details	0x00	0x01	0x00	0x00	0x00	0x06	0x01	0x03	0x20	0x00	0x00	0x04

■ Request OK

	Transaction ID		Protocol ID		Length		Unit ID	Function Code	Data		
									Byte Count	Register Value1	
Bytes	0	1	2	3	4	5	6	7	8	9	10
Details	0x00	0x01	0x00	0x00	0x00	0x0B	0x01	0x03	0x08	0x02	0xDC

	Data										
	Register Value 2		Register Value3		Register Value 4						
Bytes	11	12	13	14	15	16					
Details	0x00	0x04	0x00	0x00	0x00	0x08					

- The motor ID (Address: 0x2000) value is 732 (or 0x02DC) and the encoder type (Address: 0x2001) value is 4 (or 0x0004). Since the encoder pulse per revolution (Address: 0x2002~0x2003) is 32-bit data, the data that has been read must be swapped. The currently displayed value is 524288 (or 0x00080000).

■ Response not OK

	Transaction ID		Protocol ID		Length		Unit ID	Error Code	Exception Code
	0	1	2	3	4	5	6	7	8
Details	0x00	0x01	0x00	0x00	0x00	0x04	0x01	0x83	0x01~0x04

(4) Read Input Register (0x04)

It reads single registers (16-bit data) and continuous register binary (16 bit data) values.

■ Request

Function Code	1Byte	0x04
Starting Address	2Byte	0x0000 to 0xFFFF
Quantity(Num) of Registers	2Bytes	0x0000 to 0x007D

■ Request OK

Function Code	1Byte	0x04
Byte Count	1Byte	2 x N*
Register Value	N* x 2Bytes	

*N= Quantity of Input Registers

■ Response not OK

Error Code	1Byte	0x84
Exception Code	1Byte	0x01~0x06

ex1) When reading the parameter value of drive status output 1 (Address: 0x2121)

■ Request

	Transaction ID		Protocol ID		Length		Unit ID	Function Code	Data			
	0	1	2	3	4	5	6	7	Starting Address		Quantity(Num) of Registers	
Bytes	0	1	2	3	4	5	6	7	8	9	10	11
Details	0x00	0x01	0x00	0x00	0x00	0x06	0x01	0x04	0x21	0x21	0x00	0x01

■ Request OK

	Transaction ID		Protocol ID		Length		Unit ID	Function Code	Data		
	0	1	2	3	4	5	6	7	Byte Count	Register Value	
Bytes	0	1	2	3	4	5	6	7	8	9	10
Details	0x00	0x01	0x00	0x00	0x00	0x05	0x01	0x04	0x02	0x01	0x09

- Drive status output 1 (Address: 0x2121) is 0b100001001 (0x0109), BRAKE, ZSPD and WARN contacts are output as High (Status 1).

■ Response not OK

	Transaction ID		Protocol ID		Length		Unit ID	Error Code	Exception Code
Bytes	0	1	2	3	4	5	6	7	8
Details	0x00	0x01	0x00	0x00	0x00	0x04	0x01	0x84	0x01~0x04

(5) Write Single Coil (0x05)

It turns on or off individual bit input vales

■ **Request**

Function Code	1Byte	0x05
Output Address	2Byte	0x0000 to 0x003E
Output Value	2Bytes	0x0000 or 0xFF00

■ **Request OK**

Function Code	1Byte	0x05
Output Address	2Byte	0x0000 to 0x003E
Output Value	2Byte	0x0000 or 0xFF00

■ **Response not OK**

Error Code	1Byte	0x85
Exception Code	1Byte	0x01~0x04

The command code Write Single Coil can control input of individual bits that correspond to drive status input 1, 2. The following are the addresses that correspond to drive status input 1, 2.

■ Drive Status Input 1, 2 Communication Addresses

Communication Address		Output Contacts	Accessib ility	Communication Address		Output Contacts	Accessib ility
Decimal Number	Hexadecimal Number			Decimal Number	Hexadecimal Number		
0	0x0000	POT	RW	16	0x0010	START	RW
1	0x0001	NOT	RW	17	0x0011	PAUSE	RW
2	0x0002	HOME	RW	18	0x0012	REGT	RW
3	0x0003	STOP	RW	19	0x0013	HSTART	RW
4	0x0004	PCON	RW	20	0x0014	ISEL0	RW
5	0x0005	GAIN2	RW	21	0x0015	ISEL1	RW
6	0x0006	P_CL	RW	22	0x0016	ISEL2	RW
7	0x0007	N_CL	RW	23	0x0017	ISEL3	RW
8	0x0008	MODE	RW	24	0x0018	ISEL4	RW
9	0x0009	Reserved	RW	25	0x0019	ISEL5	RW
10	0x000A	EMG	RW	26	0x001A	ABSRQ	RW
11	0x000B	A_RST	RW	27	0x001B	JSTART	RW
12	0x000C	SV_ON	RW	28	0x001C	JDIR	RW
13	0x000D	SPD1/LVSF1	RW	29	0x001D	PCLEAR	RW
14	0x000E	SPD2/LVSF2	RW	30	0x001E	AOVR	RW
15	0x000F	SPD3	RW	31	0x001F	Reserved	RW

Note1) iX7NH does not support input contacts assigned to communication addresses 16~31.

ex 1) Writing POT Input State of Contact ON (0xFF00)

■ Request

	Transaction ID		Protocol ID		Length		Unit ID	Function Code	Data			
									Starting Address		Output Value	
Bytes	0	1	2	3	4	5	6	7	8	9	10	11
Details	0x00	0x01	0x00	0x00	0x00	0x06	0x01	0x05	0x00	0x00	0xFF	0x00

■ Request OK

	Transaction ID		Protocol ID		Length		Unit ID	Function Code	Data			
									Output Address		Output Value	
Bytes	0	1	2	3	4	5	6	7	8	9	10	11
Details	0x00	0x01	0x00	0x00	0x00	0x06	0x01	0x05	0x00	0x00	0xFF	0x00

■ Response not OK

	Transaction ID		Protocol ID		Length		Unit ID	Error Code	Exception Code
Bytes	0	1	2	3	4	5	6	7	8
Details	0x00	0x01	0x00	0x00	0x00	0x04	0x01	0x85	0x01~0x04

ex) Writing POT input contact status OFF

■ Request

	Transaction ID		Protocol ID		Length		Unit ID	Function Code	Data			
									Starting Address		Output Value	
Bytes	0	1	2	3	4	5	6	7	8	9	10	11
Details	0x00	0x01	0x00	0x00	0x00	0x06	0x01	0x05	0x00	0x00	0x00	0x00

■ Request OK

	Transaction ID		Protocol ID		Length		Unit ID	Function Code	Data			
									Output Address		Output Value	
Bytes	0	1	2	3	4	5	6	7	8	9	10	11
Details	0x00	0x01	0x00	0x00	0x00	0x06	0x01	0x05	0x00	0x00	0x00	0x00

■ Response not OK

	Transaction ID		Protocol ID		Length		Unit ID	Error Code	Exception Code
Bytes	0	1	2	3	4	5	6	7	8
Details	0x00	0x01	0x00	0x00	0x00	0x04	0x01	0x85	0x01~0x04

(6) Write Single Register (0x06)

It writes values on the single register (16-bit data).

■ Request

Function Code	1Byte	0x06
Register Address	2Bytes	0x0000 to 0xFFFF
Register Value	2Bytes	0x0000 to 0xFFFF

■ Request OK

Function Code	1Byte	0x06
Register Address	2Bytes	0x0000 to 0xFFFF
Register Value	2Bytes	0x0000 to 0xFFFF

■ Response not OK

Error Code	1Byte	0x86
Exception Code	1Byte	0x01~0x06

ex 1) When changing inertia ratio (Address: 0x2100) to 200

■ Request

	Transaction ID		Protocol ID		Length		Unit ID	Function Code	Data			
									Register Address		Register Value	
Bytes	0	1	2	3	4	5	6	7	8	9	10	11
Details	0x00	0x01	0x00	0x00	0x00	0x06	0x01	0x06	0x21	0x00	0x00	0xC8

■ Request OK

	Transaction ID		Protocol ID		Length		Unit ID	Function Code	Data			
									Register Address		Register Value	
Bytes	0	1	2	3	4	5	6	7	8	9	10	11
Details	0x00	0x01	0x00	0x00	0x00	0x06	0x01	0x06	0x21	0x00	0x00	0xC8

- It changes the inertia ratio value (Address: 0x2100) to 200 (or 0x00C8).

■ Response not OK

	Transaction ID		Protocol ID		Length		Unit ID	Error Code	Exception Code
Bytes	0	1	2	3	4	5	6	7	8
Details	0x00	0x01	0x00	0x00	0x00	0x03	0x01	0x86	0x01~0x04

(7) Write Multiple Coils (0x0F)

It turns on or off continual bit input values.

Request

Function Code	1Byte	0x0F
Starting Address	2Byte	0x0000 to 0x003E
Quantity of Outputs	2Bytes	0x0000 to 0x003F
Byte Count	1Bytes	N*
Output Value	N* x 1Byte	-

*N= Quantity of Outputs/8

Request OK

Function Code	1Byte	0x0F
Starting Address	2Byte	0x0000 to 0x003E
Quantity of Outputs	2Byte	0x0000 or 0x003F

Response not OK

Error Code	1Byte	0x8F
Exception Code	1Byte	0x01~0x04

The command code Write Multiple Coil can control continual input of bits that correspond to drive status input 1, 2. The following are the addresses that correspond to drive status input 1, 2.

Drive Control Input [0x211F]

ex1) Writing NOT and EMG input contacts ON

Bits	Setting Details	Bits	Setting Details
0	POT	8	PROBE1
1	NOT	9	PROBE2
2	HOME	10	EMG
3	STOP	11	A_RST
4	PCON	12	SV_ON
5	GAIN2	13	LVSF1
6	P_CL	14	LVSF2
7	N_CL	15	Reserved

- This allows you to input below commands by entering the corresponding bit of the Drive Control Input [0x211F] parameter rather than the communication address of the contact. ex) To input POT, enter 0x01.

■ Request

	Transaction ID		Protocol ID		Length		Unit ID	Function Code	Data			
	0	1	2	3	4	5	6	7	Starting Address		Quantity of Outputs	
Bytes	0	1	2	3	4	5	6	7	8	9	10	11
Details	0x00	0x01	0x00	0x00	0x00	0x09	0x01	0x0F	0x00	0x00	0x00	0x0F

	Data			
	Byte Count	Data 1	Data 2	-
Bytes	12	13	14	-
Details	0x02	0x02	0x04	-

■ Request OK

	Transaction ID		Protocol ID		Length		Unit ID	Function Code	Data			
	0	1	2	3	4	5	6	7	Starting Address		Quantity of Outputs	
Bytes	0	1	2	3	4	5	6	7	8	9	10	11
Details	0x00	0x01	0x00	0x00	0x00	0x09	0x01	0x0F	0x00	0x00	0x00	0x0F

■ Response not OK

	Transaction ID		Protocol ID		Length		Unit ID	Error Code	Exception Code
	0	1	2	3	4	5	6	7	8
Details	0x00	0x01	0x00	0x00	0x00	0x03	0x01	0x8F	0x01~0x04

(8) Write Multi Register (0x10)

Writes values on the continuous register block (16-bit data).

■ Request

Function Code	1Byte	0x10
Starting Address	2Bytes	0x0000 to 0xFFFF
Quantity(Num) of Registers	2Bytes	0x0001 to 0x007B
Byte Count	1Byte	2 x N*
Registers Value	N* x 2Bytes	value

*N= Quantity of Registers

■ Request OK

Function Code	1Byte	0x10
Starting Address	2Byte	0x0000 to 0xFFFF
Quantity(Num) of Registers	2Byte	1 to 123(0x7B)

■ Response not OK

Error Code	1Byte	0x90
Exception Code	1Byte	0x01~0x06

ex 1) When using multiple parameters including jog speed (Address: 0x2300), speed command acceleration time (Address: 0x2301), speed command deceleration time (Address: 0x2302)

■ Request

	Transaction ID		Protocol ID		Length		Unit ID	Function Code	Data			
	0	1	2	3	4	5	6	7	Starting Address		Quantity (Num) of Registers	
Bytes	0	1	2	3	4	5	6	7	8	9	10	11
Details	0x00	0x01	0x00	0x00	0x00	0x0D	0x01	0x10	0x23	0x00	0x00	0x03

	Data							
	Byte Count	Register Value 1		Register Value 2		Register Value 3		-
Bytes	12	13	14	15	16	17	18	-
Details	0x06	0x0B	0xB8	0x00	0x64	0x00	0x64	-

■ Request OK

	Transaction ID		Protocol ID		Length		Unit ID	Function Code	Data			
	0	1	2	3	4	5	6	7	Starting Address		Quantity (Num) of Registers	
Bytes	0	1	2	3	4	5	6	7	8	9	10	11
Details	0x00	0x01	0x00	0x00	0x00	0x06	0x01	0x10	0x23	0x00	0x00	0x03

- Jog speed (Address: 0x2300) is changed to 3000 (or 0x0BB8) and speed command acceleration time (Address: 0x2301) and speed command deceleration time (Address: 0x2302) is changed to 100 (or 0x0064).

■ Response not OK

	Transaction ID		Protocol ID		Length		Unit ID	Error Code	Exception Code
	0	1	2	3	4	5	6	7	8
Details	0x00	0x01	0x00	0x00	0x00	0x04	0x01	0x90	0x01~0x04

13.5 Parameter Saving & Reset

Apart from individual parameter save [0x240E], you can save or reset parameters using below commands.

- Store Parameters

■ Request

	Transaction ID		Protocol ID		Length		Unit ID	Function Code	Data			
									Starting Address		Quantity (Num) of Registers	
Bytes	0	1	2	3	4	5	6	7	8	9	10	11
Details	0x00	0x01	0x00	0x00	0x00	0x0B	0x01	0x10	0x10	0x0F	0x00	0x02

	Data					
	Byte Count	Register Value 1		Register Value 2		-
Bytes	12	13	14	15	16	-
Details	0x04	0x61	0x73	0x65	0x76	-

■ Request OK

	Transaction ID		Protocol ID		Length		Unit ID	Function Code	Data			
									Starting Address		Quantity (Num) of Registers	
Bytes	0	1	2	3	4	5	6	7	8	9	10	11
Details	0x00	0x01	0x00	0x00	0x00	0x06	0x01	0x10	0x10	0x0F	0x00	0x02

- Parameter Restoration

■ Request

	Transaction ID		Protocol ID		Length		Unit ID	Function Code	Data			
									Starting Address		Quantity (Num) of Registers	
Bytes	0	1	2	3	4	5	6	7	8	9	10	11
Details	0x00	0x01	0x00	0x00	0x00	0x0B	0x01	0x10	0x10	0x11	0x00	0x02

	Data					
	Byte Count	Register Value 1		Register Value 2		-
Bytes	12	13	14	15	16	-
Details	0x04	0x6F	0x6C	0x64	0x61	-

■ Request OK

	Transaction ID		Protocol ID		Length		Unit ID	Function Code	Data			
									Starting Address		Quantity (Num) of Registers	
Bytes	0	1	2	3	4	5	6	7	8	9	10	11
Details	0x00	0x01	0x00	0x00	0x00	0x06	0x01	0x10	0x10	0x11	0x00	0x02

13.6 Servo Drive Communication Address Table

13.6.1 General Objects

Communication Address		Parameter Name	Parameter Number	Variable Type	Initial Value	Minimum Value	Maximum Value	Unit	Accessibility
Decimal Number	Hexadecimal Number								
4096	0x1000	Device Type	0x1000	UDINT	0x0020192	0	0xFFFFFFFF	-	RO
4098	0x1002	Error Register	0x1001	USINT	0x00	0	0xFFFF	-	RO
4099	0x1003	Device Name	0x1008	STRING	-	-	-	-	RO
4105	0x1009	Hardware Version	0x1009	STRING	-	-	-	-	RO
4108	0x100C	Software Version	0x100A	STRING	-	-	-	-	RO
4111	0x100F	Store Parameters	0x1010:1	UDINT	0	0	0xFFFFFFFF	-	RO
4113	0x1011	Restore Default Parameters	0x1011:1	UDINT	0	0	0xFFFFFFFF	-	RO
4115	0x1013	Identity Object	0x1018:1	UDINT	0	0	0xFFFFFFFF	-	RO
4117	0x1015	Identity Object	0x1018:2	UDINT	0	0	0xFFFFFFFF	-	RO
4119	0x1017	Identity Object	0x1018:3	UDINT	0	0	0xFFFFFFFF	-	RO
4121	0x1019	Identity Object	0x1018:4	UDINT	0	0	0xFFFFFFFF	-	RO

13.6.2 System Configuration Parameters

Communication Address		Parameter Name	Parameter Number	Variable Type	Initial Value	Minimum Value	Maximum Value	Unit	Accessibility
Decimal Number	Hexadecimal Number								
8192	0x2000	Motor ID	0x2000	UINT	13	1	9999	-	RW
8193	0x2001	Encoder Type	0x2001	UINT	2	0	99	-	RW
8194	0x2002	Encoder Pulse per Revolution	0x2002	UDINT	524288	0	1073741824	pulse	RW
8196	0x2004	Node ID	0x2003	UINT	-	0	0xFFFF	-	RO
8197	0x2005	Rotation Direction Select	0x2004	UINT	0	0	1	-	RW
8198	0x2006	Absolute Encoder Configuration	0x2005	UINT	1	0	2	-	RW
8199	0x2007	Main Power Fail Check Mode	0x2006	UINT	0	0	255	-	RW
8200	0x2008	Main Power Fail Check Time	0x2007	UINT	40	0	5000	ms	RW
8201	0x2009	7SEG Display Selection	0x2008	UINT	0	0	100	-	RW
8202	0x200A	Regeneration Brake Resistor Configuration	0x2009	UINT	0	0	1	-	RW
8203	0x200B	Regeneration Brake Resistor Derating Factor	0x200A	UINT	100	0	200	%	RW

13. Modbus TCP

8204	0x200C	Regeneration Brake Resistor Value	0x200B	UINT	0	0	1000	ohm	RW
8205	0x200D	Regeneration Brake Resistor Power	0x200C	UINT	0	0	30000	watt	RW
8206	0x200E	Peak Power of Regeneration Brake Resistor	0x200D	UINT	100	1	50000	watt	RW
8207	0x200F	Duration Time @ Peak Power of Regeneration Brake Resistor	0x200E	UINT	5000	1	50000	ms	RW
8208	0x2010	Overload Check Base	0x200F	UINT	100	10	120	%	RW
8209	0x2011	Overload Warning Level	0x2010	UINT	50	10	100	%	RW
8210	0x2012	PWM Off Delay Time	0x2011	UINT	10	0	1000	ms	RW
8211	0x2013	Dynamic Brake Control Mode	0x2012	UINT	0	0	3	-	RW
8212	0x2014	Emergency Stop Configuration	0x2013	UINT	1	0	1	-	RW
8213	0x2015	Warning Mask Configuration	0x2014	UINT	0	0	0xFFFF	-	RW
8214	0x2016	U Phase Current Offset	0x2015	INT	0	-1000	1000	0.10%	RW
8215	0x2017	V Phase Current Offset	0x2016	INT	0	-1000	1000	0.10%	RW
8216	0x2018	W Phase Current Offset	0x2017	INT	0	-1000	1000	0.10%	RW
8217	0x2019	Magnetic Pole Pitch	0x2018	UINT	2400	1	65535	0.01mm	RW
8218	0x201A	Linear Scale Resolution	0x2019	UINT	1000	1	65535	nm	RW
8219	0x201B	Commutation Method	0x201A	UINT	0	0	4	-	RW
8220	0x201C	Commutation Current	0x201B	UINT	500	0	1000	0.10%	RW
8221	0x201D	Commutation Time	0x201C	UINT	1000	500	5000	ms	RW
8222	0x201E	Grating Period of Sinusoidal Encoder	0x201D	UINT	40	1	65535	Um	RW
8223	0x201F	Homing Done Behavior	0x201E	UINT	0	0	1	-	RW
8224	0x2020	Velocity Function Select	0x201F	UINT	0	0	2	-	RW
8225	0x2021	Motor Hall Phase Config.	0x2020	UINT	0	0	0xFFFF	-	RW
8226	0x2022	Reserved	0x2021	UINT	-	-	-	-	RW
8227	0x2023	Reserved	0x2022	UINT	-	-	-	-	RW
8228	0x2024	Reserved	0x2023	UINT	-	-	-	-	RW
8229	0x2025	Reserved	0x2024	UINT	-	-	-	-	RW
8230	0x2026	Reserved	0x2025	UDINT	-	-	-	-	RW
8232	0x2028	Reserved	0x2026	UDINT	-	-	-	-	RW
8234	0x202A	Reserved	0x2027	UDINT	-	-	-	-	RW
8236	0x202C	Reserved	0x2028	UINT	-	-	-	-	RW
8237	0x202D	Reserved	0x2029	UINT	-	-	-	-	RW
8238	0x202E	Reserved	0x202A	UDINT	-	-	-	-	RW

8240	0x2030	Reserved	0x202B	UDINT	-	-	-	-	RW
8242	0x2032	Lines per Revolution of Sinusoidal Encoder	0x202C	UINT	1000	0	65535	pulse	RW
8243	0x2033	FIR Filter Window of Speed Feedback	0x202D	UINT	0	0	8	-	RW
8244	0x2034	Reserved	0x202E	UINT	-	-	-	-	-
8245	0x2035	Reserved	0x202F	UINT	-	-	-	-	-
8246	0x2036	Reserved	0x2030	UINT	-	-	-	-	RW
8247	0x2037	Operation Time at Peak Current	0x2031	UINT	-	-	-	-	RW
8248	0x2038	Reserved	0x2032	UINT	-	-	-	-	RW
8249	0x2039	Reserved	0x2033	UINT	-	-	-	-	RW
8250	0x203A	Motor Thermal Protection Enable	0x2034	UINT	-	-	-	-	RW
8251	0x203B	Reserved	0x2035	UINT	-	-	-	-	RW
8252	0x203C	Reserved	0x2036	UINT	-	-	-	-	RW
8253	0x203D	Reserved	0x2037	UINT	-	-	-	-	RW
8254	0x203E	Reserved	0x2038	UINT	-	-	-	-	RW

13.6.3 Control Parameters

Communication Address		Parameter Name	Parameter Number	Variable Type	Initial Value	Minimum Value	Maximum Value	Unit	Accessibility
Decimal Number	Hexadecimal Number								
8448	0x2100	Inertia Ratio	0x2100	UINT	100	0	3000	%	RW
8449	0x2101	Position Loop Gain 1	0x2101	UINT	50	1	500	1/s	RW
8450	0x2102	Speed Loop Gain 1	0x2102	UINT	75	1	2000	Hz	RW
8451	0x2103	Speed Loop Integral Time Constant 1	0x2103	UINT	50	1	1000	ms	RW
8452	0x2104	Torque Command Filter Time Constant 1	0x2104	UINT	5	0	1000	0.1ms	RW
8453	0x2105	Position Loop Gain 2	0x2105	UINT	30	1	500	1/s	RW
8454	0x2106	Speed Loop Gain 2	0x2106	UINT	50	1	2000	Hz	RW
8455	0x2107	Speed Loop Integral Time Constant 2	0x2107	UINT	50	1	1000	ms	RW
8456	0x2108	Torque Command Filter Time Constant 2	0x2108	UINT	5	0	1000	0.1ms	RW
8457	0x2109	Position Command Filter Time Constant	0x2109	UINT	0	0	10000	0.1ms	RW
8458	0x210A	Position Command Average	0x210A	UINT	0	0	10000	0.1ms	RW

13. Modbus TCP

		Filter Time Constant							
8459	0x210B	Speed Feedback Filter Time Constant	0x210B	UINT	5	0	1000	0.1ms	RW
8460	0x210C	Velocity Feed-Forward Gain	0x210C	UINT	0	0	100	%	RW
8461	0x210D	Velocity Feed-forward Filter Time Constant	0x210D	UINT	10	0	1000	0.1ms	RW
8462	0x210E	Torque Feed-forward Gain	0x210E	UINT	0	0	100	%	RW
8463	0x210F	Torque Feed-forward Filter Time Constant	0x210F	UINT	10	0	1000	0.1ms	RW
8464	0x2110	Torque Limit Function Select	0x2110	UINT	2	0	4	-	RW
8465	0x2111	External Positive Torque Limit Value	0x2111	UINT	3000	0	5000	0.1%	RW
8466	0x2112	External Negative Torque Limit Value	0x2112	UINT	3000	0	5000	0.1%	RW
8467	0x2113	Emergency Stop Torque	0x2113	UINT	1000	0	5000	0.1%	RW
8468	0x2114	P/PI Control Conversion Mode	0x2114	UINT	0	0	4	-	RW
8469	0x2115	P Control Switch Torque	0x2115	UINT	500	0	5000	0.1%	RW
8470	0x2116	P Control Switch Speed	0x2116	UINT	100	0	6000	rpm	RW
8471	0x2117	P Control Switch Acceleration	0x2117	UINT	1000	0	60000	rpm/s	RW
8472	0x2118	P Control Switch Following Error	0x2118	UINT	100	0	60000	pulse	RW
8473	0x2119	Gain Conversion Mode	0x2119	UINT	0	0	7	-	RW
8474	0x211A	Gain Conversion Time 1	0x211A	UINT	2	0	1000	ms	RW
8475	0x211B	Gain Conversion Time 2	0x211B	UINT	2	0	1000	ms	RW
8476	0x211C	Gain Conversion Waiting Time 1	0x211C	UINT	0	0	1000	ms	RW
8477	0x211D	Gain Conversion Waiting Time 2	0x211D	UINT	0	0	1000	ms	RW
8478	0x211E	Dead Band for Position Control	0x211E	UINT	0	0	1000	UU	RW
8479	0x211F	Drive Control Input 1	0x211F	UINT	0	0	0xFFFF	-	RW
8480	0x2120	Reserved	0x2120	UINT	-	-	-	-	RW
8481	0x2121	Drive Status Output 1	0x2121	UINT	0	0	0xFFFF	-	RO
8482	0x2122	Reserved	0x2122	UINT	-	-	-	-	RO

13.6.4 Input and Output Parameters

Communication Address		Parameter Name	Parameter Number	Variable Type	Initial Value	Minimum Value	Maximum Value	Unit	Accessibility
Decimal Number	Hexadecimal Number								
8704	0x2200	Digital Input Signal 1 Selection	0x2200	UINT	0x0001	0	0xFFFF	-	RW
8705	0x2201	Digital Input Signal 2 Selection	0x2201	UINT	0x0002	0	0xFFFF	-	RW
8706	0x2202	Digital Input Signal 3 Selection	0x2202	UINT	0x0003	0	0xFFFF	-	RW
8707	0x2203	Digital Input Signal 4 Selection	0x2203	UINT	0x0004	0	0xFFFF	-	RW
8708	0x2204	Digital Input Signal 5 Selection	0x2204	UINT	0x0005	0	0xFFFF	-	RW
8709	0x2205	Digital Input Signal 6 Selection	0x2205	UINT	0x0006	0	0xFFFF	-	RW
8710	0x2206	Reserved	0x2206	UINT	0x0007	-	-	-	RW
8711	0x2207	Reserved	0x2207	UINT	0x0008	-	-	-	RW
8712	0x2208	Reserved	0x2208	UINT	0x0003	-	-	-	RW
8713	0x2209	Reserved	0x2209	UINT	0x0013	-	-	-	RW
8714	0x220A	Reserved	0x220A	UINT	0x0014	-	-	-	RW
8715	0x220B	Reserved	0x220B	UINT	0x0015	-	-	-	RW
8716	0x220C	Reserved	0x220C	UINT	0x0016	-	-	-	RW
8717	0x220D	Reserved	0x220D	UINT	0x0017	-	-	-	RW
8718	0x220E	Reserved	0x220E	UINT	0x0018	-	-	-	RW
8719	0x220F	Reserved	0x220F	UINT	0x0019	-	-	-	RW
8720	0x2210	Digital Output Signal 1 Selection	0x2210	UINT	0x8001	0	0xFFFF	-	RW
8721	0x2211	Digital Output Signal 2 Selection	0x2211	UINT	0x8002	0	0xFFFF	-	RW
8722	0x2212	Digital Output Signal 3 Selection	0x2212	UINT	0x0003	0	0xFFFF	-	RW
8723	0x2213	Reserved	0x2213	UINT	0x0004	-	-	-	RW
8724	0x2214	Reserved	0x2214	UINT	0x0010	-	-	-	RW
8725	0x2215	Reserved	0x2215	UINT	0x0011	-	-	-	RW
8726	0x2216	Reserved	0x2216	UINT	0x000A	-	-	-	RW
8727	0x2217	Reserved	0x2217	UINT	0x0006	-	-	-	RW
8728	0x2218	Analog Torque Input (command/limit) Scale	0x221C	INT	100	-1000	1000	0.1%/V	RW
8729	0x2219	Analog Torque Input (command/limit) Offset	0x221D	INT	0	-1000	1000	mV	RW
8730	0x221A	Reserved	0x221E	UINT	0	-	-	-	RW
8731	0x221B	Reserved	0x221F	INT	0	-	-	-	RW
8732	0x221C	Analog Monitor Output Mode	0x2220	UINT	0	0	1	-	RW
8733	0x221D	Analog Monitor Channel 1 Select	0x2221	UINT	0	0	65535	-	RW
8734	0x221E	Analog Monitor Channel 2 Select	0x2222	UINT	1	0	65535	-	RW

8736	0x2220	Analog Monitor Channel 1 Offset	0x2223	DINT	0	0	0x40000000	Unit	RW
8738	0x2222	Analog Monitor Channel 2 Offset	0x2224	DINT	0	0	0x40000000	Unit	RW
8740	0x2224	Analog Monitor Channel 1 Scale	0x2225	UDINT	500	0	0x40000000	Unit	RW
8742	0x2226	Analog Monitor Channel 2 Scale	0x2226	UDINT	500	0	0x40000000	Unit	RW

13.6.5 Velocity Operation Parameters

Communication Address		Parameter Name	Parameter Number	Variable Type	Initial Value	Minimum Value	Maximum Value	Unit	Accessibility
Decimal Number	Hexadecimal Number								
8960	0x2300	Jog Operation Speed	0x2300	INT	500	-6000	6000	rpm	RW
8961	0x2301	Speed Command Acceleration Time	0x2301	UINT	200	0	10000	ms	RW
8962	0x2302	Speed Command Deceleration Time	0x2302	UINT	200	0	10000	ms	RW
8963	0x2303	Speed Command S-curve Time	0x2303	UINT	0	0	1000	ms	RW
8964	0x2304	Program Jog Operation Speed 1	0x2304	INT	0	-6000	6000	rpm	RW
8965	0x2305	Program Jog Operation Speed 2	0x2305	INT	500	-6000	6000	rpm	RW
8966	0x2306	Program Jog Operation Speed 3	0x2306	INT	0	-6000	6000	rpm	RW
8967	0x2307	Program Jog Operation Speed 4	0x2307	INT	-500	-6000	6000	rpm	RW
8968	0x2308	Program Jog Operation Time 1	0x2308	UINT	500	0	10000	ms	RW
8969	0x2309	Program Jog Operation Time 2	0x2309	UINT	5000	0	10000	ms	RW
8970	0x230A	Program Jog Operation Time 3	0x230A	UINT	500	0	10000	ms	RW
8971	0x230B	Program Jog Operation Time 4	0x230B	UINT	5000	0	10000	ms	RW
8972	0x230C	Index Pulse Search Speed	0x230C	INT	20	-1000	1000	rpm	RW
8973	0x230D	Speed Limit Function Select	0x230D	UINT	0	0	3	-	RW
8974	0x230E	Speed Limit Value at Torque Control Mode	0x230E	UINT	1000	0	6000	rpm	RW
8975	0x230F	Over Speed Detection Level	0x230F	UINT	6000	0	10000	rpm	RW
8976	0x2310	Excessive Speed Error Detection Level	0x2310	UINT	5000	0	10000	rpm	RW
8977	0x2311	Servo-Lock Function Select	0x2311	UINT	0	0	1	-	RW

13.6.6 Miscellaneous Parameters

Communication Address		Parameter Name	Parameter Number	Variable Type	Initial Value	Minimum Value	Maximum Value	Unit	Accessibility
Decimal Number	Hexadecimal Number								
9216	0x2400	Software Position Limit Function Select	0x2400	UINT	0	0	3	-	RW
9217	0x2401	INPOS1 Output Range	0x2401	UINT	100	0	60000	pulse	RW
9218	0x2402	INPOS1 Output Time	0x2402	UINT	0	0	1000	ms	RW
9219	0x2403	INPOS2 Output Range	0x2403	UINT	100	0	60000	pulse	RW
9220	0x2404	ZSPD Output Range	0x2404	UINT	10	0	6000	rpm	RW
9221	0x2405	TGON Output Range	0x2405	UINT	100	0	6000	rpm	RW
9222	0x2406	INSPD Output Range	0x2406	UINT	100	0	6000	rpm	RW
9223	0x2407	BRAKE Output Speed	0x2407	UINT	100	0	6000	rpm	RW
9224	0x2408	BRAKE Output Delay Time	0x2408	UINT	100	0	1000	ms	RW
9225	0x2409	Torque Limit at Homing Using Stopper	0x2409	UINT	250	0	2000	0.10%	RW
9226	0x240A	Duration Time at Homing Using Stopper	0x240A	UINT	50	0	1000	ms	RW
9227	0x240B	Modulo Mode	0x240B	UINT	0	0	5	-	RW
9228	0x240C	Modulo Factor	0x240C	DINT	3600	1	1073741823	UU	RW
9230	0x240E	User Drive Name	0x240D	STRING	Drive	-	-	-	RW
9238	0x2416	Individual Parameter Save	0x240E	UINT	0	0	1	-	RW
9239	0x2417	RMS Overload Call Time	0x240F	UINT	15000	100	60000	ms	RW
9240	0x2418	RTC Time Set	0x2410	UDINT	0	0	0xFFFFFFFF		RW
9242	0x241A	RTC Date Set	0x2411	UDINT	0x00180101	0	0xFFFFFFFF		RW
9244	0x241C	General Object Config[0]	0x2412	UDINT	0x00260000	0	0xFFFFFFFF		RW
9246	0x241E	General Object Config[1]	0x2413	UDINT	0x00260200	0	0xFFFFFFFF		RW
9248	0x2420	General Object Config[2]	0x2414	UDINT	0x00260500	0	0xFFFFFFFF		RW
9250	0x2422	General Object Config[3]	0x2415	UDINT	0x00260700	0	0xFFFFFFFF		RW
9252	0x2424	Position Tracking Error Level at Zero	0x2416	UINT	500	0	65535	pulse	RW
9253	0x2425	Position Tracking Error Level at Max	0x2417	UINT	3000	0	65535	pulse	RW
9254	0x2426	Following Error Window at Stop	0x2418	UDINT	2621440	0	1073741823	pulse	RW
9256	0x2428	Industrial Ethernet Select	0x2419	UINT	1	0	1	-	RO
9257	0x2429	Ethernet TCP Port	0x241A	UINT	502	0	0xFFFF	-	RW
9258	0x242A	Ethernet TCP IP Address	0x241B	UDINT	0x0505A8C0	0	0xFFFFFFFF	-	RW
9260	0x242C	Ethernet Subnet Mask	0x241C	UDINT	0x00FFFFFF	0	0xFFFFFFFF	-	RW
9262	0x242E	Ethernet Gateway	0x241D	UDINT	0x0201A8C0	0	0xFFFFFFFF	-	RW
9264	0x2430	MAC Address - Vendor	0x241E	UDINT	0x000080E1	0	0xFFFFFFFF	-	RW
9266	0x2432	MAC Address - NIC	0x241F	UDINT	0x00000000	0	0xFFFFFFFF	-	RW
9268	0x2434	Webserver ID	0x2420	STRING	ID	-	-	-	RW

9276	0x243C	Webserver Password	0x2421	STRING	PASSWORD	-	-	-	RW
9284	0x2444	Encoder Output Pulse	0x2422	UDINT	10000	0	2147483647	Pulse	RW
9286	0x2446	Encoder Output Logic	0x2423	UINT	0	0	1	-	RW

13.6.7 Advanced Control Parameters

Communication Address		Parameter Name	Parameter Number	Variable Type	Initial Value	Minimum Value	Maximum Value	Unit	Accessibility
Decimal Number	Hexadecimal Number								
9472	0x2500	Adaptive Filter Function Select	0x2500	UINT	0	0	5	-	RW
9473	0x2501	Notch Filter 1 Frequency	0x2501	UINT	5000	50	5000	Hz	RW
9474	0x2502	Notch Filter 1 Width	0x2502	UINT	1	1	100		RW
9475	0x2503	Notch Filter 1 Depth	0x2503	UINT	1	1	5	-	RW
9476	0x2504	Notch Filter 2 Frequency	0x2504	UINT	5000	50	5000	Hz	RW
9477	0x2505	Notch Filter 2 Width	0x2505	UINT	1	1	100		RW
9478	0x2506	Notch Filter 2 Depth	0x2506	UINT	1	1	5	-	RW
9479	0x2507	Notch Filter 3 Frequency	0x2507	UINT	5000	50	5000	Hz	RW
9480	0x2508	Notch Filter 3 Width	0x2508	UINT	1	1	100		RW
9481	0x2509	Notch Filter 3 Depth	0x2509	UINT	1	1	5	-	RW
9482	0x250A	Notch Filter 4 Frequency	0x250A	UINT	5000	50	5000	Hz	RW
9483	0x250B	Notch Filter 4 Width	0x250B	UINT	1	1	100		RW
9484	0x250C	Notch Filter 4 Depth	0x250C	UINT	1	1	5	-	RW
9485	0x250D	On-line Gain Tuning Mode	0x250D	UINT	0	0	1	-	RW
9486	0x250E	System Rigidity for Gain Tuning	0x250E	UINT	8	1	20	-	RW
9487	0x250F	On-line Gain Tuning Adaptation Speed	0x250F	UINT	1	1	5	-	RW
9488	0x2510	Off-line Gain Tuning Direction	0x2510	UINT	0	0	1	-	RW
9489	0x2511	Off-line Gain Tuning Distance	0x2511	UINT	5	1	10	-	RW
9490	0x2512	Disturbance Observer Gain	0x2512	UINT	0	0	100	%	RW
9491	0x2513	Disturbance Observer Filter Time Constant	0x2513	UINT	10	0	1000	0.1ms	RW
9492	0x2514	Current Controller Gain	0x2514	UINT	100	1	150	%	RW
9493	0x2515	Vibration Suppression Filter Configuration	0x2515	UINT	0	0	5	-	RW
9494	0x2516	Vibration Suppression Filter 1 Frequency	0x2516	UINT	0	0	2000	0.1Hz	RW
9495	0x2517	Vibration Suppression Filter 1 Damping	0x2517	UINT	0	0	5	-	RW
9496	0x2518	Vibration Suppression Filter 2 Frequency	0x2518	UINT	0	0	2000	0.1Hz	RW

9497	0x2519	Vibration Suppression Filter 2 Damping	0x2519	UINT	0	0	5	-	RW
9498	0x251A	ONE Parameter Mode	0x251A	UINT	1	0	1	-	RW

13.6.8 Monitoring Parameters

Communication Address		Parameter Name	Parameter Number	Variable Type	Initial Value	Minimum Value	Maximum Value	Unit	Accessibility
Decimal Number	Hexadecimal Number								
9728	0x2600	Feedback Velocity	0x2600	INT	-	-32768	32767	rpm	RO
9729	0x2601	Command Speed	0x2601	INT	-	-32768	32767	rpm	RO
9730	0x2602	Following Error	0x2602	DINT	-	-2147483648	2147483647	pulse	RO
9732	0x2604	Accumulated Operation Overload	0x2603	INT	-	-32768	32767	0.10%	RO
9733	0x2605	Instantaneous Maximum Operation Overload	0x2604	INT	-	-32768	32767	0.10%	RO
9734	0x2606	DC-Link Voltage	0x2605	UINT	-	0	65535	Volt	RO
9735	0x2607	Accumulated Regeneration Overload	0x2606	INT	-	-32768	32767	0.10%	RO
9736	0x2608	Single-turn Data	0x2607	UDINT	-	0	4294967295	pulse	RO
9738	0x260A	Mechanical Angle	0x2608	UINT	-	0	65535	0.1deg	RO
9739	0x260B	Electrical Angle	0x2609	INT	-	-32768	32767	0.1deg	RO
9740	0x260C	Multi-turn data	0x260A	DINT	-	-2147483648	2147483647	rev	RO
9742	0x260E	Drive Temperature 1	0x260B	INT	-	-32768	32767	°C	RO
9743	0x260F	Drive Temperature 2	0x260C	INT	-	-32768	32767	°C	RO
9744	0x2610	Encoder Temperature	0x260D	INT	-	-32768	32767	°C	RO
9745	0x2611	Motor Rated Speed	0x260E	UINT	-	0	65535	rpm	RO
9746	0x2612	Motor Maximum Speed	0x260F	UINT	-	0	65535	rpm	RO
9747	0x2613	Drive Rated Current	0x2610	UINT	-	0	65535	0.1A	RO
9748	0x2614	FPGA Version	0x2611	STRING	-	-	-	-	RO
9751	0x2617	Hall Signal Display	0x2612	UINT	-	0	65535	-	RO
9752	0x2618	Bootloader Version	0x2613	STRING	-	-	-	-	RO
9755	0x261B	Warning Code	0x2614	UINT	-	0	65535	-	RO
9756	0x261C	Analog Input 1 Value	0x2615	INT	-	-32768	32767	mV	RO
9757	0x261D	Reserved	0x2616	INT	-	-	-	-	RO
9758	0x261E	Reserved	0x2617	STRING	-	-	-	-	RO
9763	0x2623	RMS Operation Overload	0x2619	INT	-	-32768	32767	0.1%	RO
9764	0x2624	Reserved	0x261A	INT	-	-	-	-	RO
9765	0x2625	Reserved	0x261B	INT	-	-	-	-	RO
9766	0x2626	Reserved	0x261C	INT	-	-	-	-	RO

9767	0x2627	Motor Temperature in Per Unit	0x261D	UINT	-	0	65535	°C/UU	RO
9768	0x2628	Reserved	0x261E	UDINT	-	-	-	-	RO
9770	0x262A	Reserved	0x261F	DINT	-	-	-	-	RO
9772	0x262C	Reserved	0x2620	DINT	-	-	-	-	RO
9774	0x262E	Reserved	0x2621	DINT	-	-	-	-	RO
9776	0x2630	Current RTC Time	0x2622	UDINT	-	0	4294967295	-	RO
9778	0x2632	Current RTC Date	0x2623	UDINT	-	0	4294967295	-	RO
9780	0x2634	Reserved	0x2624	UINT	-	-	-	-	RO
9781	0x2635	Reserved	0x2625	UINT	-	-	-	-	RO
9782	0x2636	Cumulative Hours of Use	0x2626	DINT	-	-2147483648	2147483647	S	RO
9784	0x2638	Number of Inrush Current Switching	0x2627	DINT	-	-2147483648	2147483647	-	RO
9786	0x263A	Number of Dynamic Brake Switching	0x2628	DINT	-	-2147483648	2147483647	-	RO
9788	0x263C	Reserved	0x2629	DINT	-	-	-	-	RO
9790	0x263E	Fan Life Time	0x262A	DINT	-	-	-	%	RO
9792	0x2640	Reserved	0x262B	DINT	-	-	-	-	RO
9794	0x2642	Reserved	0x262C	DINT	-	-	-	-	RO
9796	0x2644	Reserved	0x262D	DINT	-	-	-	-	RO
9798	0x2646	Reserved	0x262E	DINT	-	-	-	-	RO
9800	0x2648	Reserved	0x262F	DINT	-	-	-	-	RO
9802	0x264A	Reserved	0x2630	DINT	-	-	-	-	RO
9804	0x264C	Reserved	0x2631	DINT	-	-	-	-	RO
9806	0x264E	Reserved	0x2632	DINT	-	-	-	-	RO
9808	0x2650	Reserved	0x2633	DINT	-	-	-	-	RO
9810	0x2652	Estimated Position Value	0x2634	DINT	-	-2147483648	2147483647	pulse	RO
9812	0x2654	Estimated Following Error	0x2635	DINT	-	-2147483648	2147483647	pulse	RO
9814	0x2656	Gen Object Value 0	0x2636	FP32	-			-	RO
9816	0x2658	Gen Object Value 1	0x2637	FP32	-			-	RO
9818	0x265A	Gen Object Value 2	0x2638	FP32	-			-	RO
9820	0x265C	Gen Object Value 3	0x2639	FP32	-			-	RO

13.6.9 Procedures and Alarm History

Communication Address		Parameter Name	Parameter Number	Variable Type	Initial Value	Minimum Value	Maximum Value	Unit	Accessibility
Decimal Number	Hexadecimal Number								
9984	0x2700	Procedure Command Code	0x2700	UINT	0	0	0xFFFF	-	RW
9985	0x2701	Procedure Command Argument	0x2701	UINT	0	0	0xFFFF	-	RW

13.6.10 3rd Party Motor Parameters

Communication Address		Parameter Name	Parameter Number	Variable Type	Initial Value	Minimum Value	Maximum Value	Unit	Accessibility
Decimal Number	Hexadecimal Number								
10240	0x2800	[Third Party Motor] Type	0x2800	UINT	0	0	1	-	RW
10241	0x2801	[Third Party Motor] Number of Poles	0x2801	UINT	8	2	1000	-	RW
10242	0x2802	[Third Party Motor] Rated Current	0x2802	FP32	2.89			Arms	RW
10244	0x2804	[Third Party Motor] Maximum Current	0x2803	FP32	8.67			Arms	RW
10246	0x2806	[Third Party Motor] Rated Speed	0x2804	UINT	3000	1	60000	rpm	RW
10247	0x2807	[Third Party Motor] Maximum Speed	0x2805	UINT	5000	1	60000	rpm	RW
10248	0x2808	[Third Party Motor] Inertia	0x2806	FP32	0.321			Kg	RW
10250	0x280A	[Third Party Motor] Torque Constant	0x2807	FP32	0.46			Kg.m2.10 ⁻⁴	RW
10252	0x280C	[Third Party Motor] Phase Resistance	0x2808	FP32	0.82			ohm	RW
10254	0x280E	[Third Party Motor] Phase Inductance	0x2809	FP32	3.66			mH	RW
10256	0x2810	[Third Party Motor] TN Curve Data 1	0x280A	UINT	3000	1	60000	rpm	RW
10258	0x2812	[Third Party Motor] TN Curve Data 2	0x280B	FP32	100			%	RW
10260	0x2814	[Third Party Motor] Hall Offset	0x280C	UINT	0	0	360	deg	RW
10262	0x2816	[Third Party Motor] Thermal Time Constant	0x280D	FP32	32.77				RW

13.6.11 CiA402 parameters

Communication Address		Parameter Name	Parameter Number	Variable Type	Initial Value	Minimum Value	Maximum Value	Unit	Accessibility
Decimal Number	Hexadecimal Number								
24576	0x6000	Error Code	0x603F	UINT	0	0	0xFFFF	-	RO
24577	0x6001	Controlword	0x6040	UINT	0	0	0xFFFF	-	RW
24578	0x6002	Statusword	0x6041	UINT	0	0	0xFFFF	-	RO
24579	0x6003	Quick Stop Option Code	0x605A	INT	2	0	4	-	RW
24580	0x6004	Shutdown Option Code	0x605B	INT	0	0	1	-	RW
24581	0x6005	Disable Operation Option Code	0x605C	INT	1	0	1	-	RW
24582	0x6006	Halt Option Code	0x605D	INT	0	0	4	-	RW
24583	0x6007	Fault Reaction Option Code	0x605E	INT	0	0	0	-	RW
24584	0x6008	Modes of Operation	0x6060	SINT	0	0	10	-	RW

13. Modbus TCP

24585	0x6009	Modes of Operation Display	0x6061	SINT	0	0	10	-	RO
24586	0x600A	Position Demand Value	0x6062	DINT	0	-2147483648	2147483647	UU	RO
24588	0x600C	Position Actual Internal Value	0x6063	DINT	0	-2147483648	2147483647	Pulse	RO
24590	0x600E	Position Actual Value	0x6064	DINT	0	-2147483648	2147483647	UU	RO
24592	0x6010	Following Error Window	0x6065	UDINT	5242880	0	1073741823	UU	RW
24594	0x6012	Following Error Timeout	0x6066	UINT	0	0	65535	ms	RW
24595	0x6013	Position Window	0x6067	UDINT	100	0	1073741823	UU	RW
24597	0x6015	Position Window Time	0x6068	UINT	0	0-	65535	ms	RW
24598	0x6016	Velocity Demand Value	0x606B	DINT	0	-2147483648	2147483647	UU/s	RO
24600	0x6018	Velocity Actual Value	0x606C	DINT	0	-2147483648	2147483647	UU/s	RO
24602	0x601A	Velocity Window	0x606D	UINT	20000	0	65535	UU/s	RW
24603	0x601B	Velocity Window Time	0x606E	UINT	0	0	65535	ms	RW
24604	0x601C	Target Torque	0x6071	INT	0	-5000	5000	0.1%	RW
24605	0x601D	Maximum Torque	0x6072	UINT	3000	0	5000	0.1%	RW
24606	0x601E	Torque Demand Value	0x6074	INT	0	-32767	32767	0.1%	RO
24607	0x601F	Motor Rated Torque	0x6076	UDINT	0	0	4294967295	mNm	RO
24609	0x6021	Torque Actual Value	0x6077	INT	0	-32767	32767	0.1%	RO
24610	0x6022	Current Actual Value	0x6078	INT	0	-32767	32767	0.1%	RO
24611	0x6023	DC Link Circuit Voltage	0x6079	UDINT	0	0	4294967295	0.1V	RO
24613	0x6025	Target Position	0x607A	DINT	0	-2147483648	2147483647	UU	RW
24615	0x6027	Home Offset	0x607C	DINT	0	-2147483648	2147483647	UU	RW
24619	0x602B	Software Position Limit (Min)	0x607D:01	DINT	-10000000000	-1073741824	1073741823	UU	RW
24621	0x602D	Software Position Limit (Max)	0x607D:02	DINT	10000000000	-1073741824	1073741823	UU	RW
24623	0x602F	Reserved	0x607E	USINT	-	-	-	-	RW
24624	0x6030	Max Profile Velocity	0x607F	UDINT	2147483648	0	2147483647	UU/s	RW
24626	0x6032	Max Motor Speed	0x6080	UDINT	0	0	4294967295	rpm	RO
24628	0x6034	Profile Velocity	0x6081	UDINT	100000	0	2147483647	UU/s	RW
24630	0x6036	Profile Acceleration	0x6083	UDINT	200000	0	2147483647	UU/s ²	RW
24632	0x6038	Profile Deceleration	0x6084	UDINT	200000	0	2147483647	UU/s ²	RW
24634	0x603A	Quick Stop Deceleration	0x6085	UDINT	200000	0	2147483647	UU/s ²	RW
24636	0x603C	Torque Slope	0x6087	UDINT	1000	0	2147483647	0.1% ^s	RW
24640	0x6040	Reserved	0x608F:1	UDINT	-	-	-	-	RW
24642	0x6042	Reserved	0x608F:2	UDINT	-	-	-	-	RW
24646	0x6046	Reserved	0x6090:1	UDINT	-	-	-	-	RW
24648	0x6048	Reserved	0x6090:2	UDINT	-	-	-	-	RW
24652	0x604C	Gear Ratio (Motor revolutions)	0x6091:01	UDINT	1	0	0x40000000	-	RW
24654	0x604E	Gear Ratio (Shaft revolutions)	0x6091:02	UDINT	1	0	0x40000000	-	RW

24658	0x6052	Reserved	0x6092:1	UDINT	-	-	-	-	RW
24660	0x6054	Reserved	0x6092:2	UDINT	-	-	-	-	RW
24662	0x6056	Homing Method	0x6098	SINT	34	-128	127	-	RW
24665	0x6059	Homing Speed (switch)	0x6099:01	UDINT	500000	0	0x40000000	UU/s	RW
24667	0x605B	Homing Speed (zero)	0x6099:02	UDINT	100000	0	0x40000000	UU/s	RW
24669	0x605D	Homing Acceleration	0x609A	UDINT	200000	0	0x40000000	UU/s ²	RW
24671	0x605F	Position Offset	0x60B0	DINT	0	-2147483648	2147483647	UU	RW
24673	0x6061	Velocity Offset	0x60B1	DINT	0	-2147483648	2147483647	UU/s	RW
24675	0x6063	Torque Offset	0x60B2	INT	0	-5000	5000	0.1%	RW
24676	0x6064	Touch Probe Function	0x60B8	UINT	0x0033	0	0xFFFF	-	RW
24677	0x6065	Touch Probe Status	0x60B9	UINT	0	0	0xFFFF	-	RO
24678	0x6066	Touch Prove 1 Positive Edge Position Value	0x60BA	DINT	0	-2147483648	2147483647	UU	RO
24680	0x6068	Touch Prove 1 Negative Edge Position Value	0x60BB	DINT	0	-2147483648	2147483647	UU	RO
24682	0x606A	Touch Prove 2 Positive Edge Position Value	0x60BC	DINT	0	-2147483648	2147483647	UU	RO
24684	0x606C	Touch Prove 2 Negative Edge Position Value	0x60BD	DINT	0	-2147483648	2147483647	UU	RO
24692	0x6074	Positive Torque Limit Value	0x60E0	UINT	3000	0	5000	0.1%	RW
24693	0x6075	Negative Torque Limit Value	0x60E1	UINT	3000	0	5000	0.1%	RW
24694	0x6076	Following Error Actual Value	0x60F4	DINT	0	-2147483648	2147483647	UU	RO
24696	0x6078	Position Demand Internal Value	0x60FC	DINT	0	-2147483648	2147483647	Pulse	RO
24798	0x607A	Digital Inputs	0x60FD	UDINT	0	0	0xFFFFFFFF	-	RO
24702	0x607E	Digital Outputs (Physical)	0x60FE:01	UDINT	0	0	0xFFFFFFFF	-	RW
24704	0x6080	Digital Outputs (Bit mask)	0x60FE:02	UDINT	0	0	0xFFFFFFFF	-	RW
24706	0x6082	Target Velocity	0x60FF	DINT	0	-2147483648	2147483647	UU/s	RW
24708	0x6084	Supported Drive Modes	0x6502	UDINT	0x000003ED	0	0xFFFFFFFF	-	RO

14. Test Drive

For a safe and proper test drive, make sure to check the following prior to a test drive. If there is a problem, take appropriate measures before the test drive.

■ Servo Motor State

Is the module correctly installed and wired?

Is each connecting part correctly tightened without looseness?

For motors with oil seal, is there any damage on the oil seal?

Is oil properly applied?

To perform a test drive of a servo motor that has been stored for an extended period, make sure to check the motor according to the maintenance and inspection method for the motor. For more information on maintenance and inspection, refer to Section 11. **Maintenance and Inspection.**

■ Servo Drive State

Is the drive correctly installed, wired and connected?

Is the power supply voltage for the servo drive correct?

14.1 Preparation for Operation

Carry out a test drive in the following order.

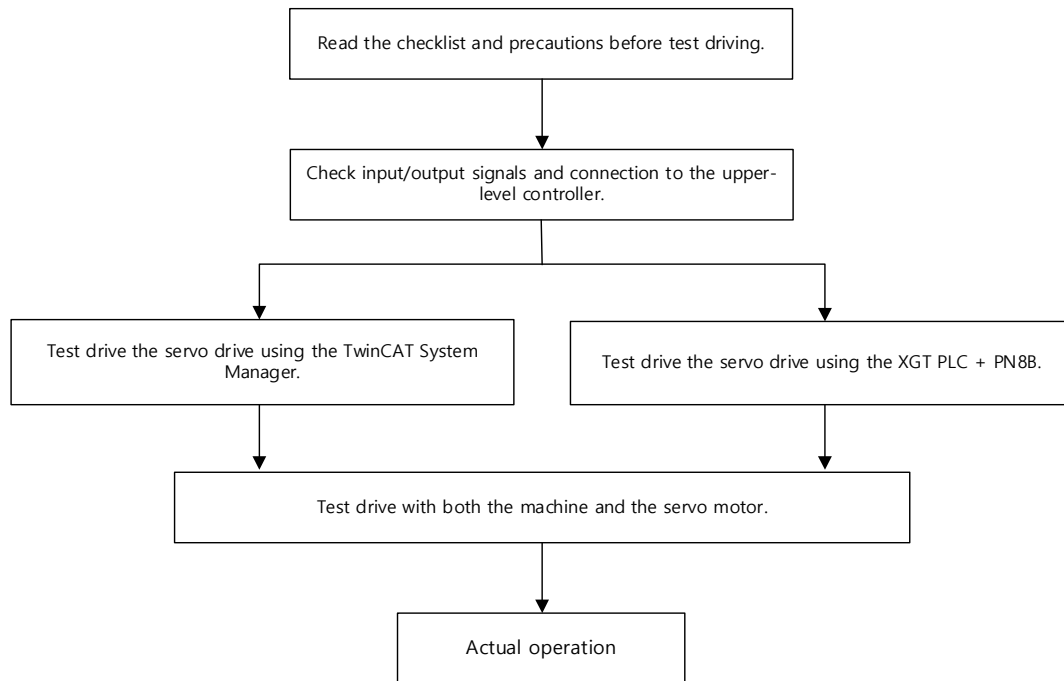

Before the test drive, check that the upper level controller and the servo drive are correctly wired, and the objects of the servo drive are correctly configured.

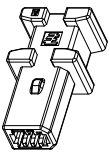
Order	Handling	Notes
1	Connect the power connector and safety function connector of Servo Drive.	Refer to Section 3.5 Wiring for Input/Output Signals.
2	Connect motor and encoder cables to the servo drive.	Refer to Section 3.5 Wiring for Input/Output Signals.
3	<p>If you use the safety function, connect the STO safety device connector.</p>  <p>(Note) If you do not use the safety function, insert safety jumper connector, an accessory of the servo drive, into the STO. If you do not install the connector, motor current will be not supplied and the torque will not output from the motor. In this case, the panel monitor state at the power ON will be "Sto."</p> <p>(Note) When removing the safety jumper connector attached to the STO, pull out the motor main circuit connector first, and then the connector body while pressing the lock ejector on the jumper connector side towards the servo drive side. The connector may be damaged if you pull it out when the lock has not been released. Please be careful.</p>	Refer to Section 3.5 Wiring for Input/Output Signals.
4	<p>Connect ECAT IN and OUT of the EtherCAT communication connector between the upper level device and Servo Drive.</p> <p>(Note) Please use the CAT5 and SFTP cables.</p>	Refer to Section 3.5 Wiring for Input/Output Signals.

5	<p>Turn on the servo drive. The servo drive communication is in the Safe OP state. Make sure that the state of the servo drive panel monitor is as the figure below:</p>  <p>The Link/Activity LED is flickering. The RUN LED is in "Single Flash."</p> <p>(Note) If the Error LED is flickering or on, and the monitor panel state is AL-xx, refer to Manual Maintenance and Inspection.</p> <p>(Note) If the Link/Activity LED is not flickering, the communication is not established.</p>	Refer to Section 11 Maintenance and Inspection.
6	Now, we have finished checking the connection and state of input signal circuits to prepare for the test drive.	Refer to Section 11 Maintenance and Inspection.

14.2 Test Drive Using TwinCAT System Manager

■ Test Drive Procedure

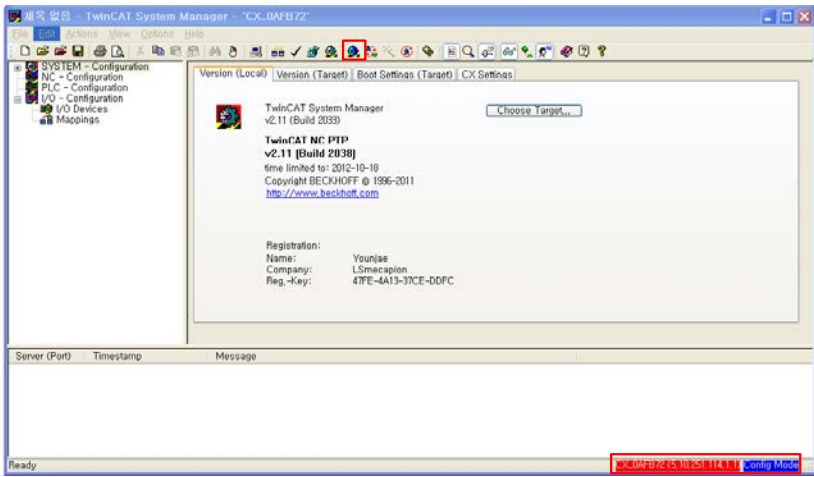
Order	Handling	Notes
1	Before launching the TwinCAT System Manager, copy the servo drive XML file into the schema folder (C:\TwinCAT\Io\EtherCAT).	
2	Launch the TwinCAT System Manager.	
3	<p>Select a target system.</p> <p>When performing the test drive using a remote system, select the device.</p>	
4	<p>Restart the TwinCAT System with Config Mode.</p> <ul style="list-style-type: none"> Using the Set/Reset TwinCAT to Config Mode icon under the TwinCAT System Manager, you can restart the system with Config Mode. 	
5	<p>Search for EtherCAT communication-based devices connected to the system.</p> <ul style="list-style-type: none"> Right-click I/O Devices in the Work Space pane of the TwinCAT system, and then click Scan Devices. 	

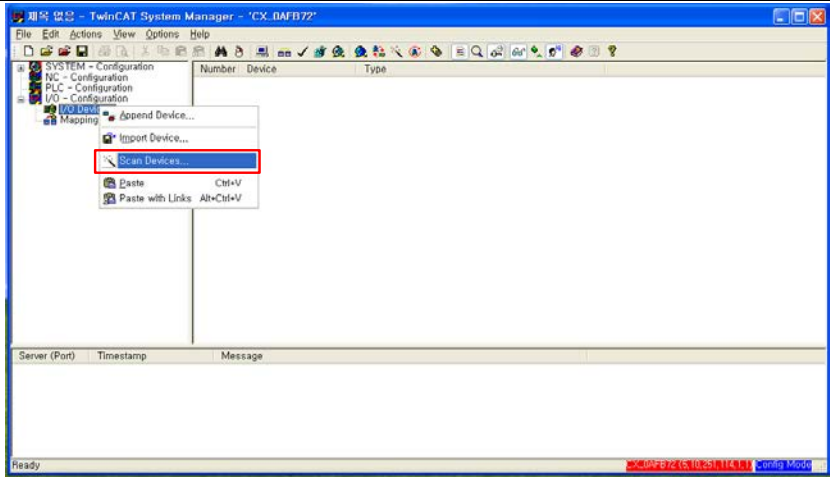

- If the dialog window below appears in the TwinCAT System Manager, click OK.

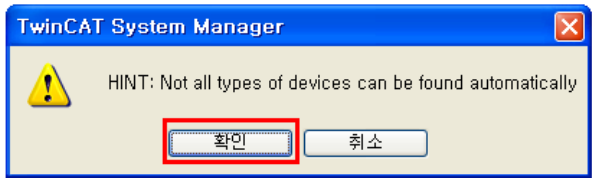

- If the New I/O devices found dialog window appears, select the device or servo drive that needs to be test driven and click OK.

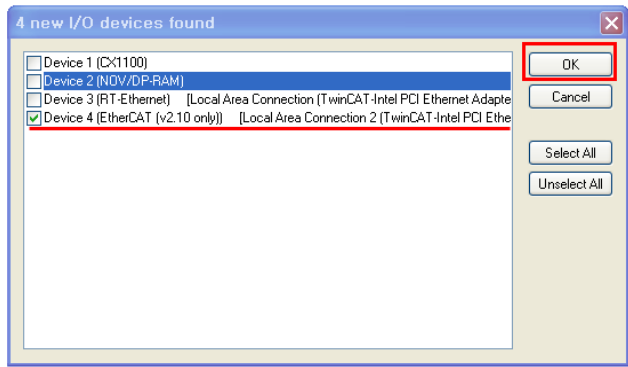

- If the dialog window below appears, click Yes.

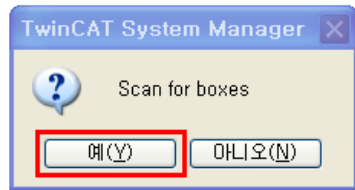

6

Add the servo drive's NC Task to the NC-Configuration.

- If the dialog window below appears, click Yes.

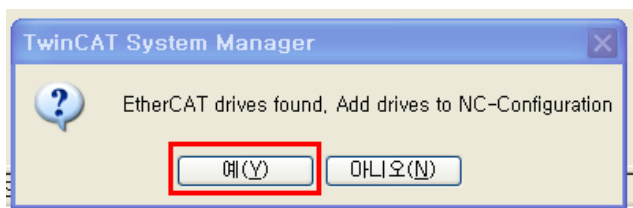

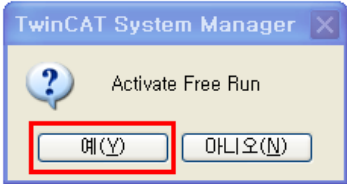
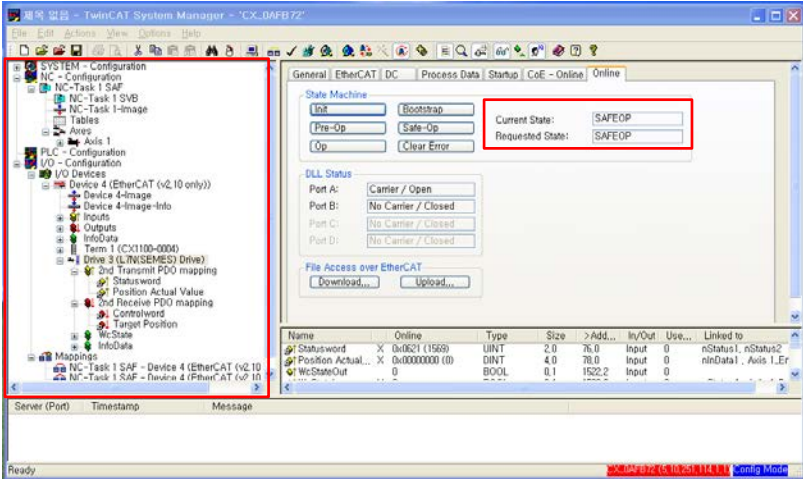
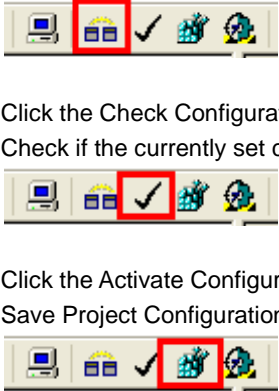
<p>7</p>	<p>Switch the TwinCAT System Manager to a free run state to allow it to control devices independently of the TwinCAT PLC and so on.</p> <ul style="list-style-type: none"> If the dialog window below appears, click Yes. 	
<p>8</p>	<p>Make sure NC Task is added to the NC-Configuration tree in the workspace on the left, and the servo drive is registered to the I/O-Configuration tree.</p> <ul style="list-style-type: none"> If the connected servo drive is registered, select it. Click the Online tab on the right side to verify that Current State and Requested State are in the SAFEOP state.  <p>**Drive X(L7xx Drive)** may differ depending on the drive type.</p>	
<p>9</p>	<p>Switch the EtherCAT communication state from SafeOP to OP, enabling MailBox Communication and Process Data Communication.</p> <ul style="list-style-type: none"> Click the Generate Mappings icon on the menu bar. Map the images defined in NC Task and I/O Device. Click the Check Configuration icon on the menu bar. Check if the currently set configuration is valid. Click the Activate Configuration icon on the menu bar. Save Project Configuration in Windows Registry. 	
<p>10</p>	<p>Verify if the EtherCAT communication state has switched from SafeOP to OP.</p> <ul style="list-style-type: none"> Verify if the states of the servo drive panel monitor and the I/O device (servo drive) of the TwinCAT system are in the online state as shown in the figure below. Check the panel monitor status. 	



- Check the communication LED.
The Link/Activity LED is flickering.
The RUN LED is on.
- Check the online state of the I/O device of the TwinCAT system.
In the I/O-Configuration tree of the workspace, click the servo drive, and then click the Online tab to check if Current State and Requested State are in the OP state.

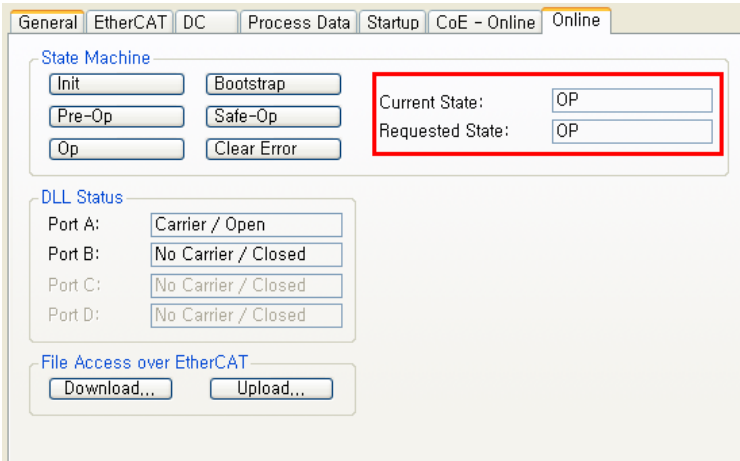

- Verify if the state displayed at the bottom-right of the TwinCAT System Manager menu window is in the Run state.



11

We have finished adding NC-Task and I/O Devices (servo drive) to the TwinCAT System Manager.

Setting NC-Task Axis Parameters

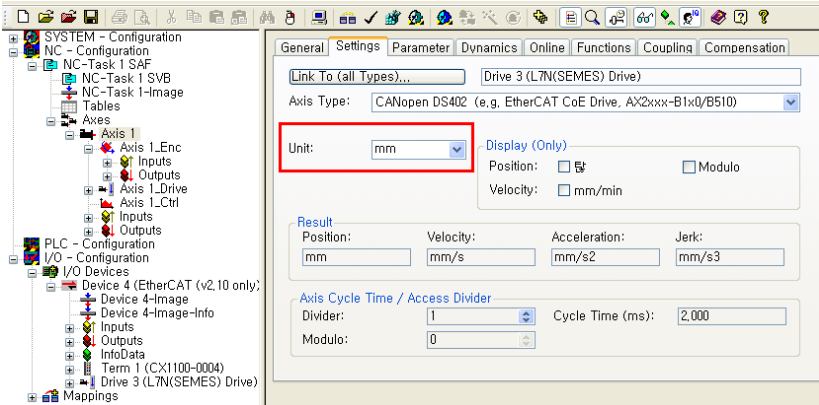
Order	Handling	Notes
1	<p>Set the display units for the relevant axis.</p> <ul style="list-style-type: none"> Select Axis1. Click the Settings tab. Click the display units for position and speed. 	

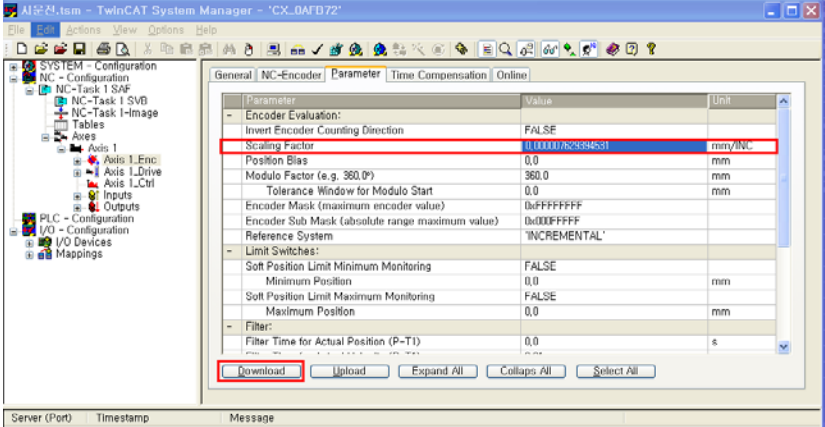
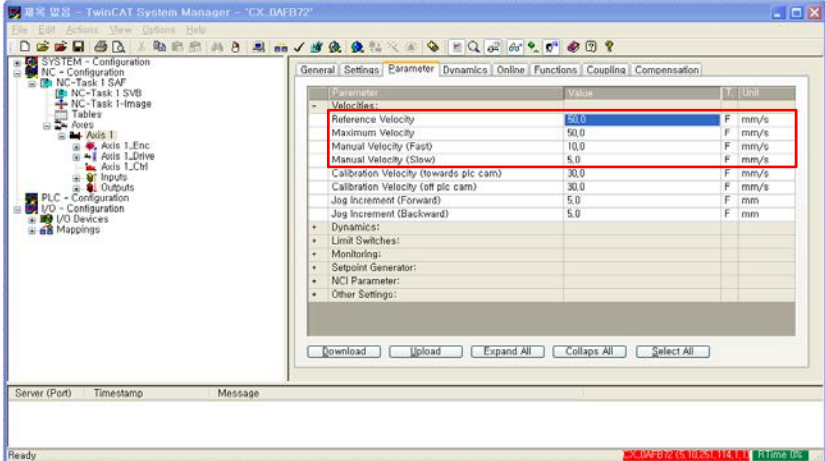
	<p>Note: Remember the actual units will not be converted even if the units shown in the figure above was converted to mm or degrees.</p> <p>Note: Change the units and tune the Axis Scaling Factor below.</p>	
<p>2</p>	<p>Set the Axis Scaling Factor. The Axis Scaling Factor determines the distance of the axial load movement while the motor shaft makes one revolution.</p> <ul style="list-style-type: none"> ▪ Select Axis 1. ▪ Select the Parameter tab. ▪ Set the Scaling Factor. ▪ Then, download the settings.  <p>Note: The default is 0.0001 if the scaling factor is not set.</p> <p>Note: After configuring the settings, download them.</p>	
<p>3</p>	<p>Set the speed parameter of the test drive axis.</p> <ul style="list-style-type: none"> ▪ Select Axis 1. ▪ Select the Parameter tab. ▪ Set Maximum Velocity, Manual Velocity (Fast), and Manual Velocity (Slow). Then, download the settings. 	
<p>4</p>	<p>Set the velocity, acceleration, and jerk of the test drive axis.</p> <p>Set the acceleration, deceleration, and jerk directly for the test drive axis; the TwinCAT NC can calculate the acceleration based on the configured profile timing.</p> <ul style="list-style-type: none"> ▪ Select Axis 1. ▪ Click the Dynamics tab. ▪ Set the acceleration, deceleration, and jerk directly. <ul style="list-style-type: none"> • Select the Direct button. 	

- Set the acceleration, deceleration, and jerk.
- Download the settings.

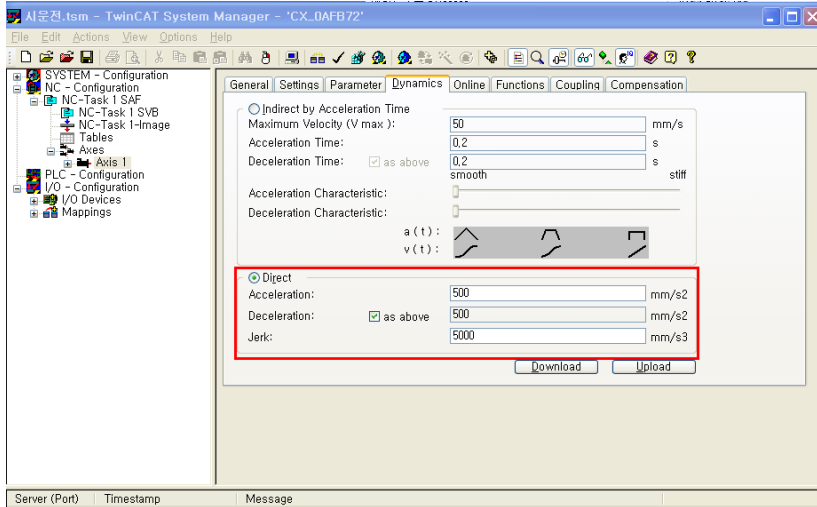

- Set the acceleration, deceleration, and jerk indirectly.
- Set the acceleration, deceleration, and jerk indirectly by setting the acceleration time. If you change the acceleration time, the acceleration value will be automatically changed.

- Select the Indirect by Acceleration Time button.
- Set the acceleration, deceleration, and jerk.
- Download the settings.

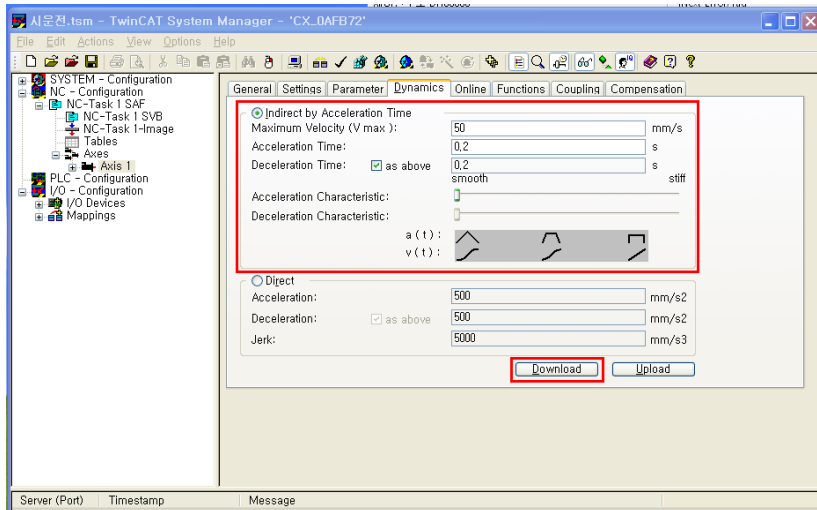

5

Set the Position Lag Monitoring (Following Error).



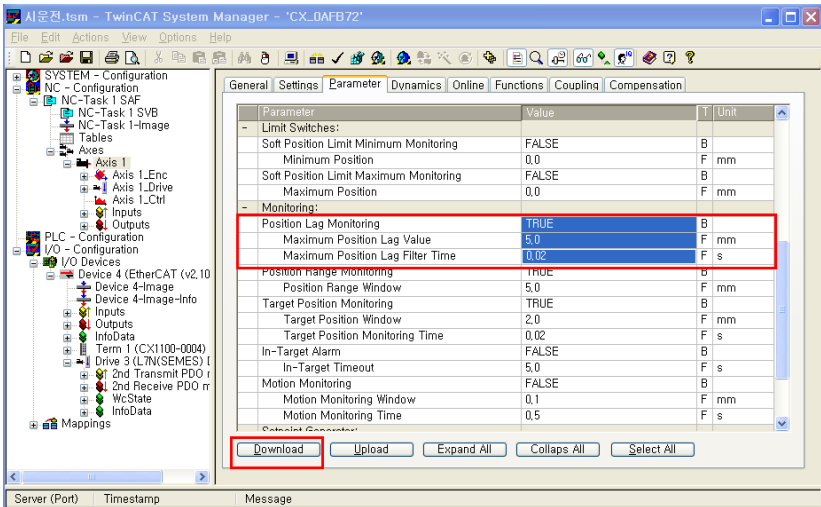





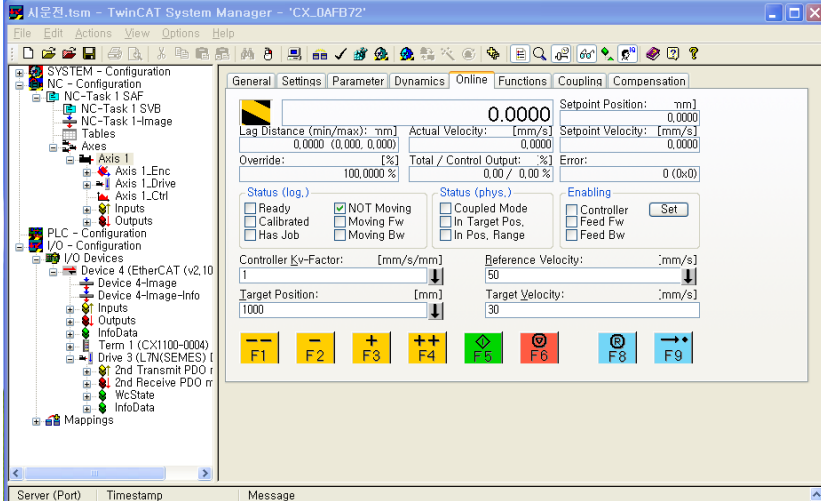
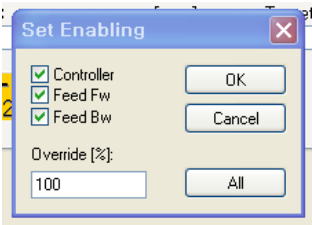

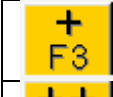

- Select Axis 1.
- Select the Parameter tab.
- Set the Position Lag Monitoring.
- Set the Position Lag Filter Time.
- Download the settings.

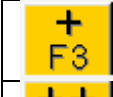

Note: The Position Lag Monitoring is the difference between the position reference and the actual position at a given cycle time. When the Position Lag Monitoring is enabled, the TwinCAT NC generates an alarm if the following error exceeds the settings.

■ Test Drive the Servo Drive Using TwinCAT NC Axis

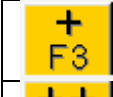
Order	Handling	Notes
	<p>Make sure that TwinCAT NC axis is "Servo On."</p> <ul style="list-style-type: none"> ▪ Select Axis 1. ▪ Click the Online tab. 	
1	<p>Click the Set button.</p>  <ul style="list-style-type: none"> ▪ Select Controller, Feed Fw, and Feed Bw in the Set Enabling pop-up. ▪ Set the Override to 100%. 	

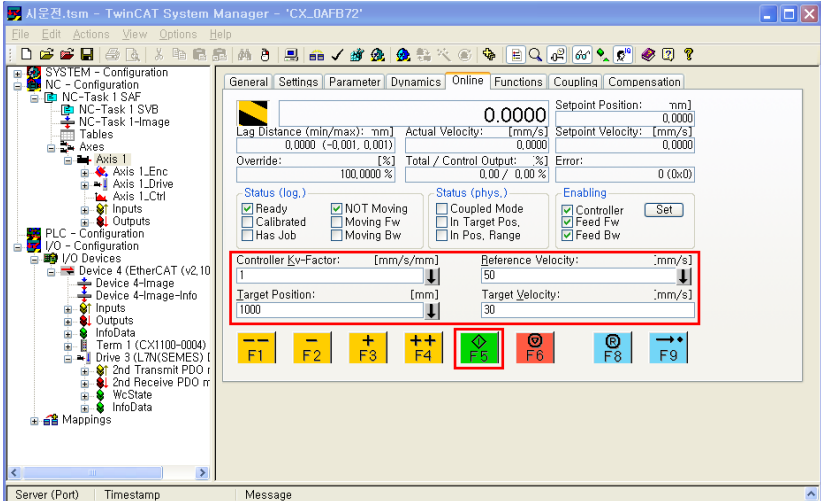
	<ul style="list-style-type: none"> Click OK. Make sure that the state of the servo drive panel monitor is as the figure below: 									
<p>2</p>	<p>Use the buttons shown below to manually perform the test drive (JOG).</p> <table border="1" data-bbox="271 443 1096 792"> <tr> <td data-bbox="271 443 384 539">  </td> <td data-bbox="384 443 1096 539">Perform a negative rotation at the specified Manual Velocity (Fast).</td> </tr> <tr> <td data-bbox="271 539 384 636">  </td> <td data-bbox="384 539 1096 636">Perform a negative rotation at the specified Manual Velocity (Slow).</td> </tr> <tr> <td data-bbox="271 636 384 732">  </td> <td data-bbox="384 636 1096 732">Perform a positive rotation at the specified Manual Velocity (Slow).</td> </tr> <tr> <td data-bbox="271 732 384 792">  </td> <td data-bbox="384 732 1096 792">Perform a positive rotation at the specified Manual Velocity (Fast).</td> </tr> </table>		Perform a negative rotation at the specified Manual Velocity (Fast).		Perform a negative rotation at the specified Manual Velocity (Slow).		Perform a positive rotation at the specified Manual Velocity (Slow).		Perform a positive rotation at the specified Manual Velocity (Fast).	
	Perform a negative rotation at the specified Manual Velocity (Fast).									
	Perform a negative rotation at the specified Manual Velocity (Slow).									
	Perform a positive rotation at the specified Manual Velocity (Slow).									
	Perform a positive rotation at the specified Manual Velocity (Fast).									
<p>3</p>	<p>Perform the test drive with relative coordinates.</p> <ul style="list-style-type: none"> Set the Target Position. Set the Target Velocity. Click the F5 button.  <ul style="list-style-type: none"> Move it to the Target Position from the current position, decelerating to a stop. After moving it to the Target Position, verify if the Set Position is the same as the Target Position. Click the F6 button to stop driving with relative coordinates. When the alarm goes off, click the F8 button to reset the alarm. <p>Note: If the position limit is enabled, set the Target Position within the limit.</p>									
<p>4</p>	<p>Make sure the TwinCAT NC axis is "Servo Off."</p> <ul style="list-style-type: none"> Click Set. Click to clear Controller, Feed Fw, and Feed Bw in Enabling. Click OK. 									

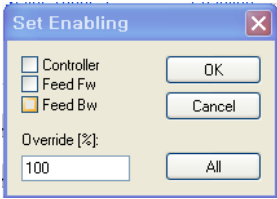
		
5	Test driving the drive using the TwinCAT NC axis is completed.	

14.3 Test Drive Using LS ELECTRIC PLC (XGT + PN8B)

■ Test Drive Procedure

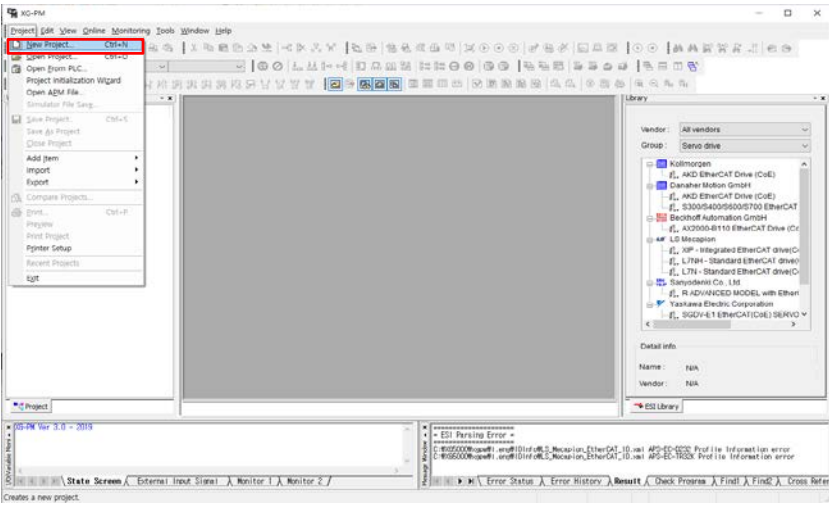
Order	Handling	Notes
1	Launch the XG-PM.	
2	<p>Create a new project.</p> <ul style="list-style-type: none"> On the menu bar, click Project → New Project. 	
3	<p>Name the new project.</p> <ul style="list-style-type: none"> Select the PLC series and the CPU type. Select the module type (XGF-PN8B), and click OK. 	

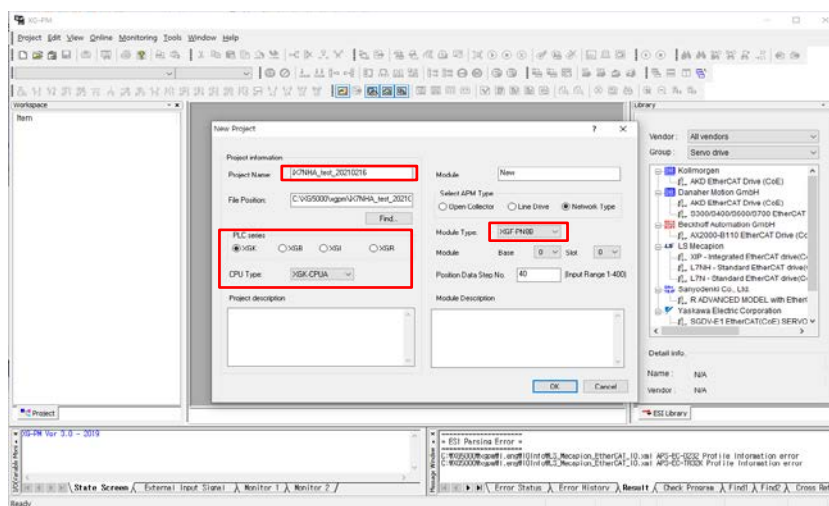

The PC and the PLC are connected for communication.

- On the menu bar, click Online → Connection.

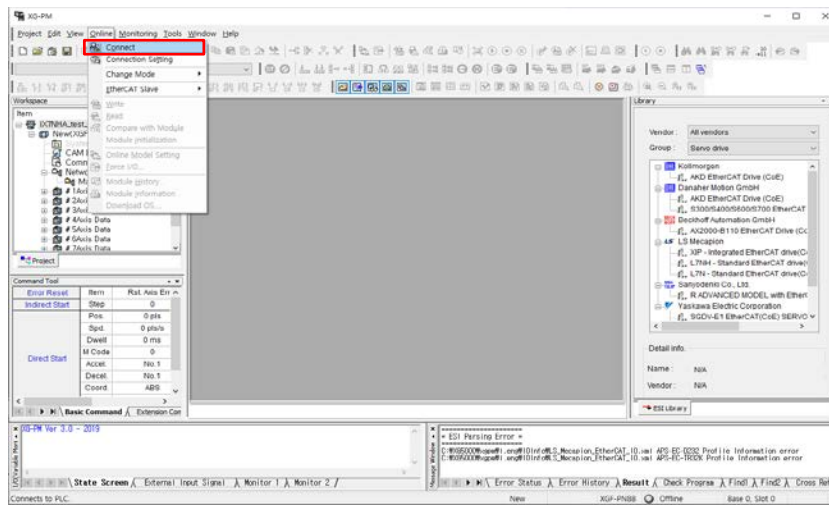

4

- When the PC and the PLC are connected, the connection between the PLC and the servo drive will be enabled as shown in the figure below.

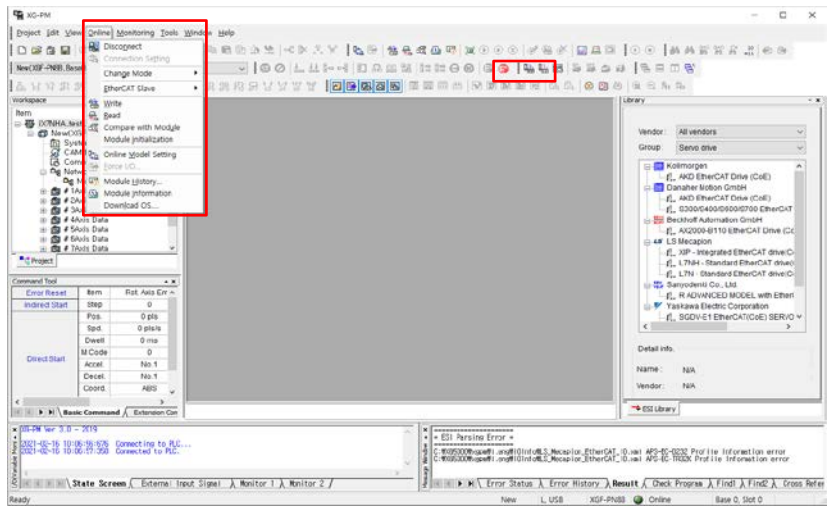

Connect the PLC with the servo drive.

- For the first connection, enable the network parameters and servo parameters in the workspace on the left through Connect Network Servo Automatically.
- After the servo drive and the PLC are connected, the servo parameters and the motor test drive function will be enabled.
- Connecting multiple shafts enables as many servo parameters as the number of connected shafts.

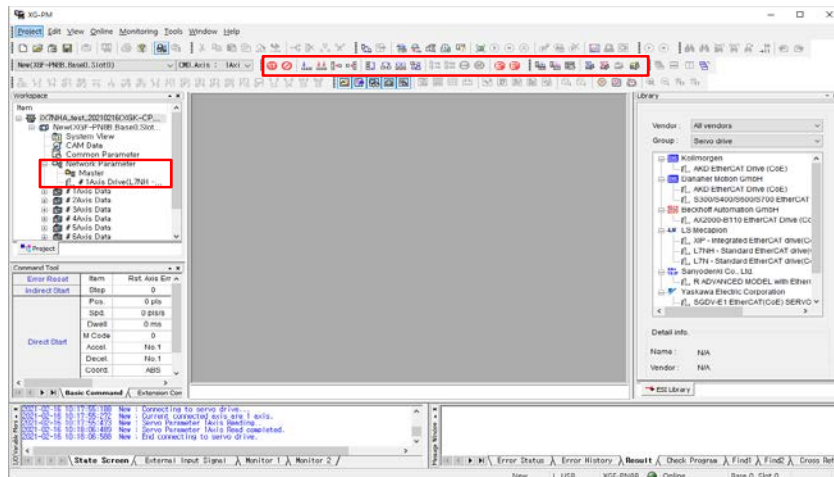

5

****Axis 1 Drive(L7xx)** may differ depending on the drive type.**

- Make sure that the state of the servo drive panel monitor is as the figure below:



- Check the state of the status LEDs.

The Link/Activity LED is flickering.

The RUN LED is on.

Note: Automatic connection of the network servo registers the device connected to the XGT, and initializes the parameters of the connected device.

Note: For subsequent connections, connect or disconnect the XGT and the servo drive by connecting the entire servo or disconnecting them respectively, since the device has been registered and its parameters initialized through automatic servo connection.

Note: In case there is any change in the XGT-connected device, initialize the parameters of the device connected by the automatic servo connection.

- 6 Set the Driving Parameters of Test Drive Axis → Basic Parameters.
- Enter the number of encoder pulses per motor revolution.
 - Encoder resolution of 19 bits = 524288
 - Check the motor specifications, and then configure the appropriate settings.
 - Set the units for the speed command.
 - It can be set as rpm or mm/s.
 - Set the speed limit.
 - Check the motor specifications, and then configure the appropriate settings.

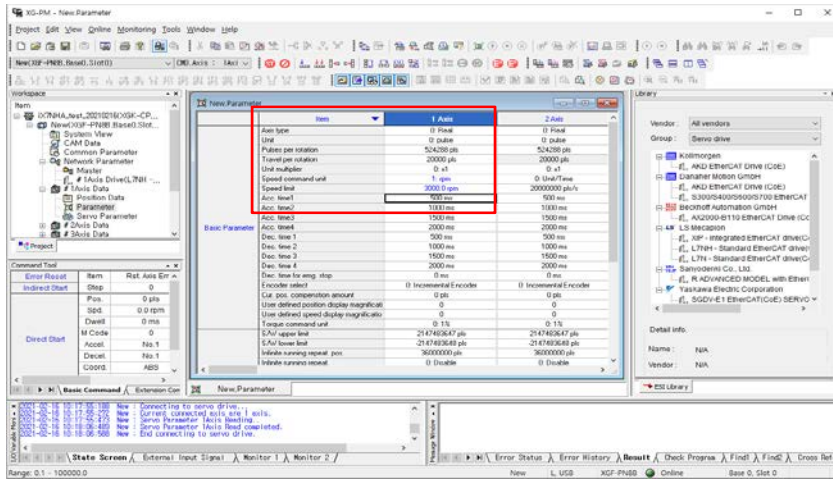

- 8 Set the Driving Parameters of Test Drive Axis → Manual Operation (Jog) Parameters.

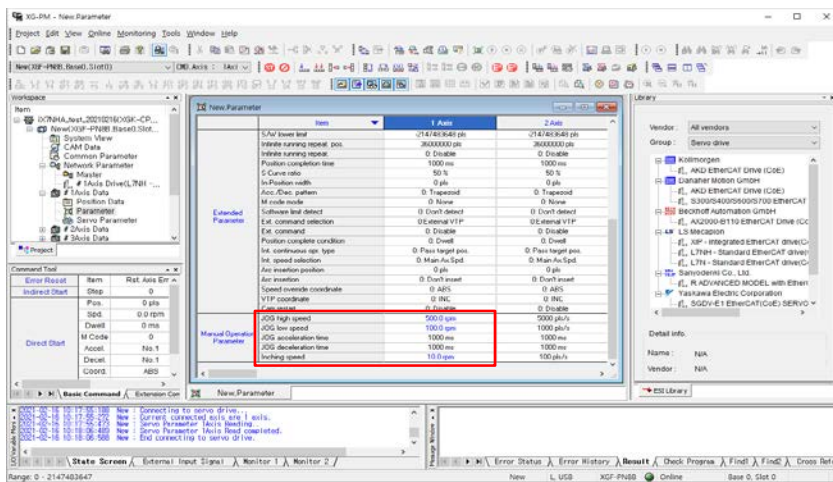

- 9 Set the servo parameters of the test drive axis.

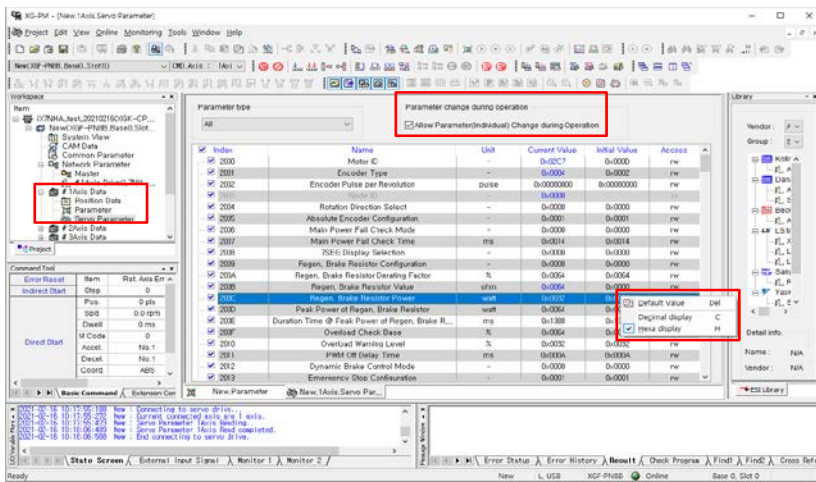

- Select parameters that you want to change, and then change them.
- To change the parameters during operation, click to select the Allow to Modify Servo Parameters During Operation checkbox at the top of the pane.
- You can display parameter values as decimals or hexadecimals.

Save the configured parameters.

- On the menu bar, click →Online → Write.
- With the Write Project dialog window enabled, click to select the Operation Data of Test Drive Axis, the Operation Parameters, and the Servo Parameters checkboxes, and then click OK to save the configured parameters.

11

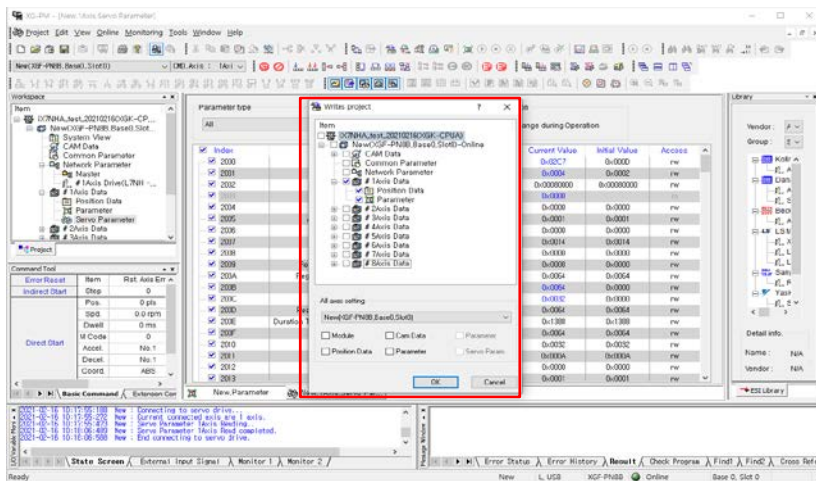

Turn on the servo.

12

- On the menu bar, click the Servo ON icon to turn on the servo of the servo drive of the test drive axis.

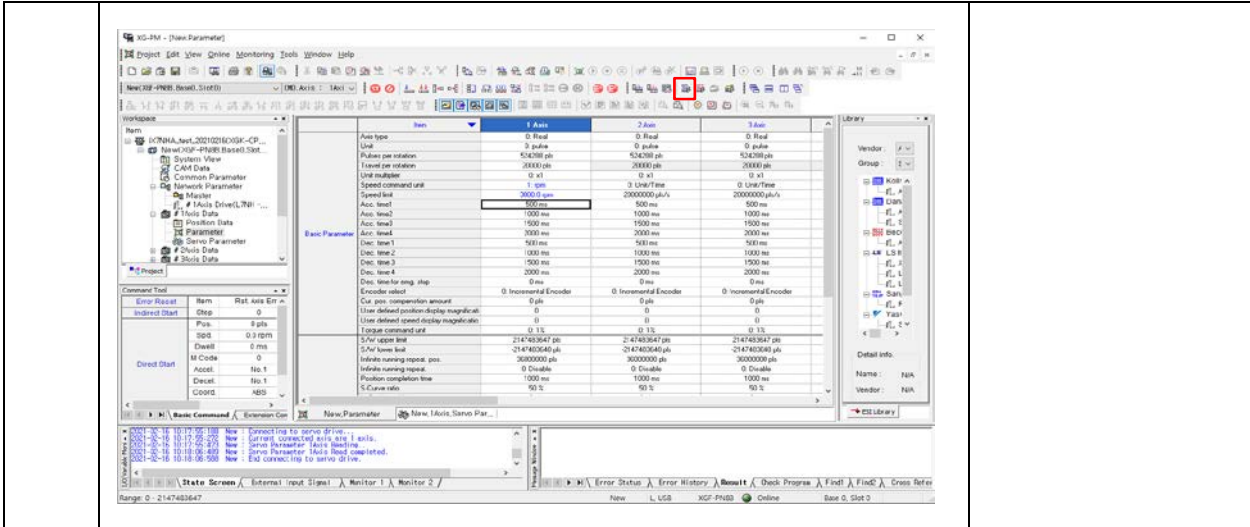

Save the configured parameters.

- Click the System View tab and the Basic Command tab in the workspace to check the state of the servo drive as shown in the figure below.

13

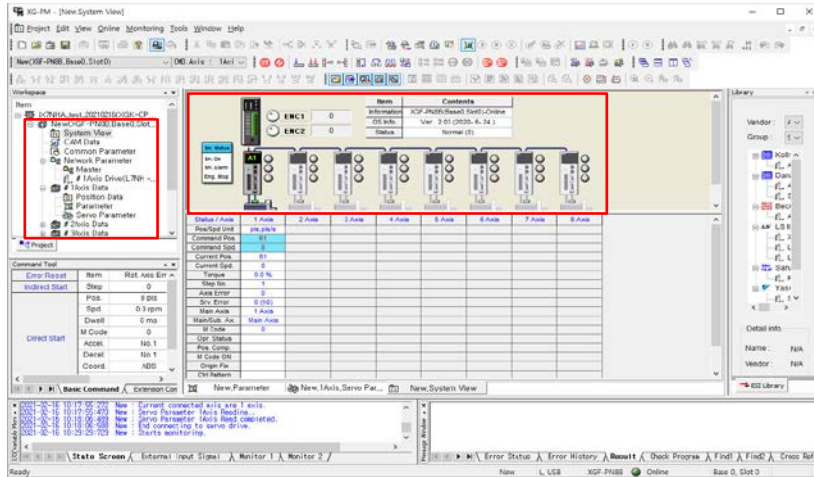

- Make sure that the state of the servo drive panel monitor is as the figure below:



- Check the state of the status LEDs.
The Link/Activity LED is flickering.
The RUN LED is on.

14

Test drive using jog operation and inching operation

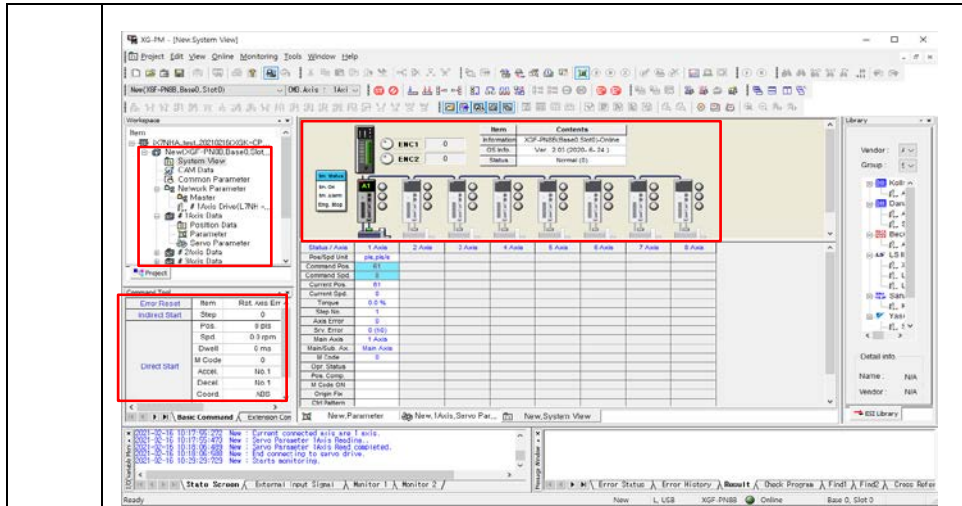

- For the jog operation, the motor is driven with the settings of the operation parameters.
- For the inching operation, the motor moves to the entered position.
- After entering the position value, click the Run button to perform the test drive.

15 Point to Point Test Drive

- Select Workspace → Command Tool → Point Command tab.
- Set the operation data.
- On the Point Command tab in the workspace, specify the number of point operations and the order.
- On the menu bar, click Online → Write to store the operation data.
- On the Point Command tab, click the Run button to perform the test drive.

16 Test driving the drive using the XGT is completed.

15. Appendix i (Update)

15.1 Firmware Update

15.1.1 Use of USB OTG

The drive performs a USB host function to search for firmware files in the USB memory and download them to the flash memory inside the drive. You can easily update the firmware using the USB memory and OTG cable without a PC. The update procedure is as follows:

- 1) Prepare a download cable (USB OTG cable) and a USB memory.

Use a USB OTG cable, consisting of a USB Female Plug Type A and USB Mini B 5 pins, as the download cable.



- 2) Copy the firmware file (iX7NH_FW.bin) to update to the USB memory.

***Caution**

1. In order to perform firmware update, the file must be located in the “USB to Drive” folder in the USB memory and have a name starting the same with ‘iX7NH_FW_V’ and a file extension of ‘bin.’

e.g. File name: iX7NH_FW_V_‘date’_‘time’.bin

2. The formatting type of the USB memory has to be set to FAT32 (default).

- 3) After you input power of the drive, connect the USB memory to the USB OTG cable, then connect the cable to the USB port of the drive. Edge bars of the 7-segment display for servo status will be lit in the clockwise order. If the display shows ‘otG,’ it means that connection is successful.

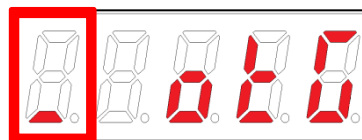

(Displays 7-segment when an OTG cable is connected)
- The first edge bars of the loader are lit in the clockwise order.

- 4) Press the Loader Tact switch on the drive briefly four times to select the firmware update option. If the 7-segment display for servo status shows ‘uPdAt,’ the firmware download option is selected.

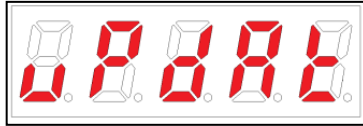

(7-Segment display appears when selecting firmware download using OTG)

- 5) Press and hold the Loader Tact switch on the drive once to perform firmware update. If the 7-segment display for servo status shows 'buSY,' firmware download has started.

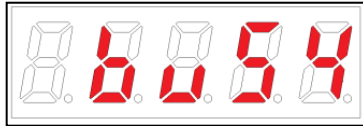

(7-Segment display appears at the start of firmware download using OTG)

- 6) If the 7-segment display for servo status displays from '0.0' to '100.0' sequentially, it means that firmware download is in progress. If it shows 'Done' on the 7-Segment for the servo status display, it means download is complete. At this time, you can turn off the power and remove the USB OTG cable and USB memory.

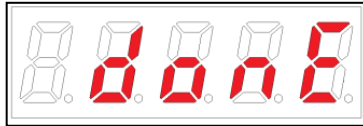

(7-Segment display appears at the completion of firmware download using OTG)

- 7) After power cycling, if the 7-segment display displays 'FLASH' and then from '0.0' to '100.0' sequentially, it means firmware upload is in progress. Once upload is complete and the display outputs a Drive Ready message, you can check if firmware update has been successful.

15.1.2 Use of FoE (File access over EtherCAT)

FoE is a simple file transfer protocol using the EtherCAT, enabling firmware update. When the drive and the upper level controller (e.g.: TwinCAT) are connected, you can simply update the firmware remotely via FoE. The update procedure is as follows:

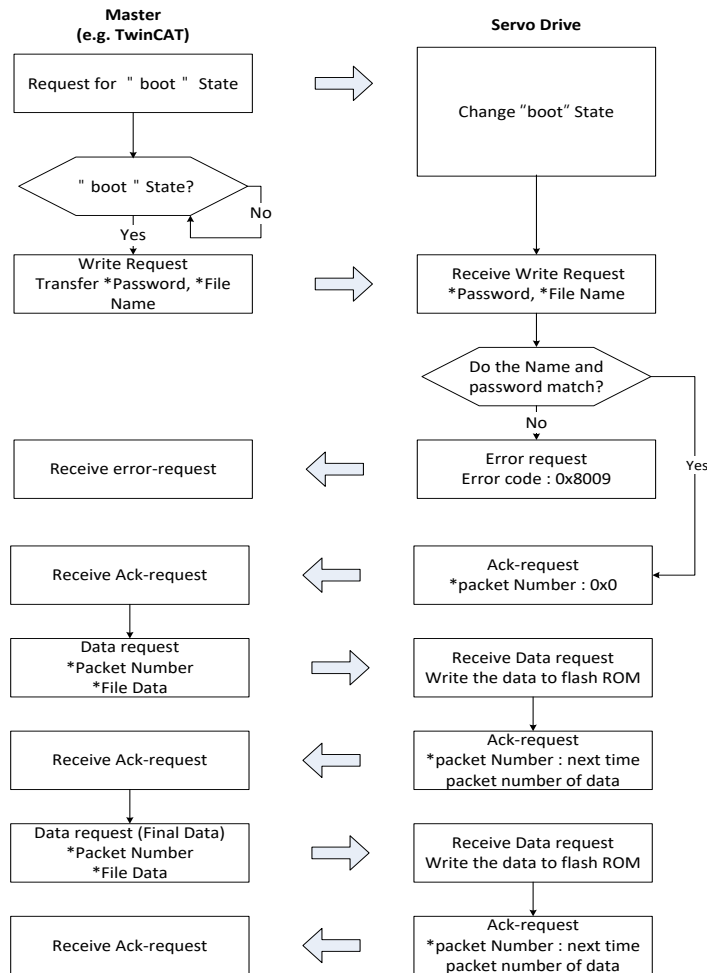

- 1) Establish communication between the drive and the TwinCAT.
- 2) I/O Configuration of TwinCAT - On the Online tab of the drive connected to the I/O, click Bootstrap in the State Machine menu.

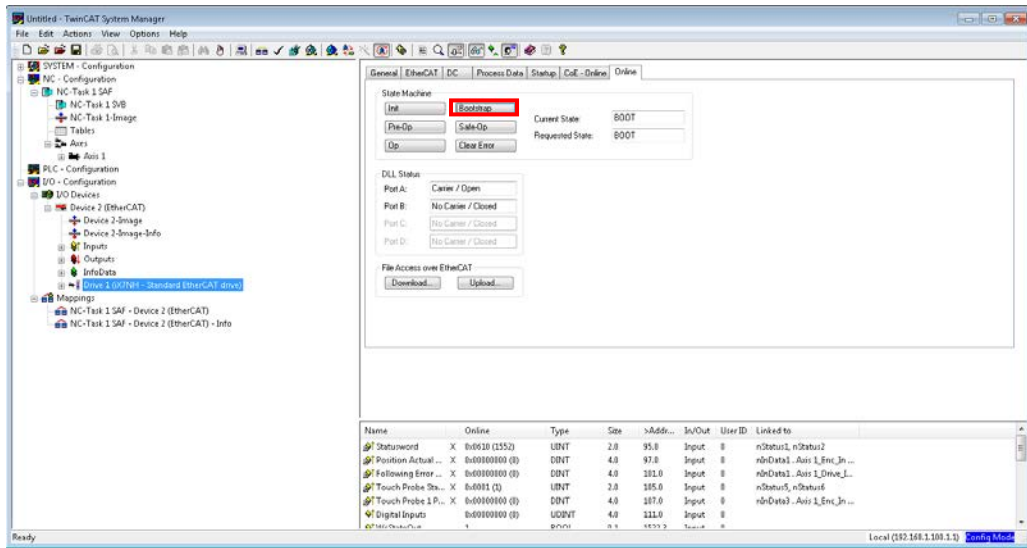

**Drive X(L7xx Drive)" may differ depending on the drive type.

- After the current state is changed to BOOT and you check the drive status (7-segment displays boot), wait for approx. 10 seconds until the internal flash memory of the drive is cleared.

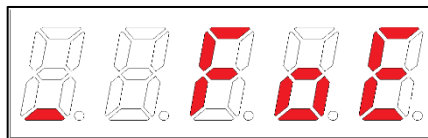
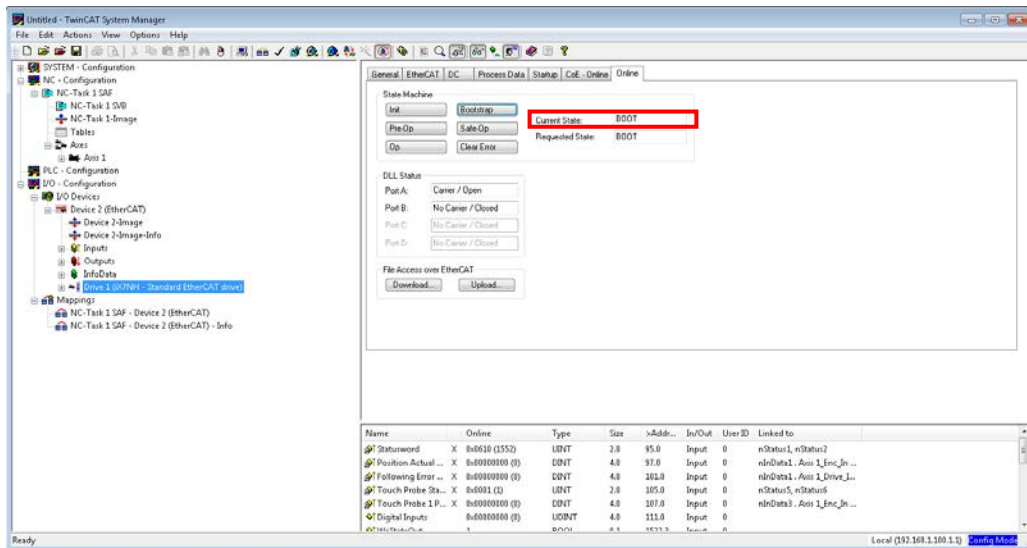

(7-Segment display appears at the start of firmware download using FoE)

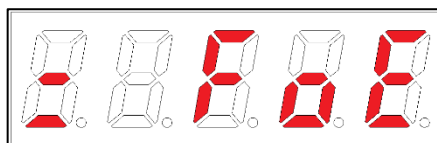

(7-Segment display appears at the completion of firmware download deletion using FoE)

***Caution**

The following error occurs if you try to download before the required 10 seconds pass for the flash memory to be cleared. Two error windows shown below may indicate that the flash memory is not deleted completely, or the file name does not match. Check the file name, wait for 10 seconds until the flash memory is cleared, and then try it again.

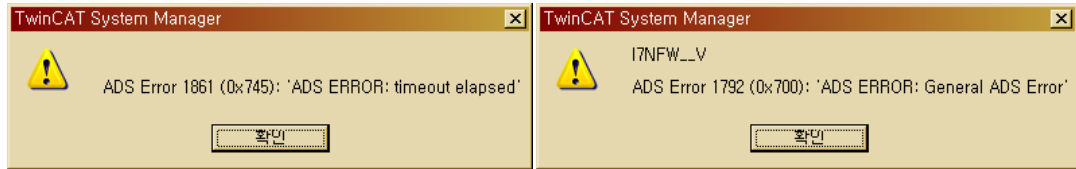

- 4) Click Download in the File Access over EtherCAT menu at the bottom of the Online tab.

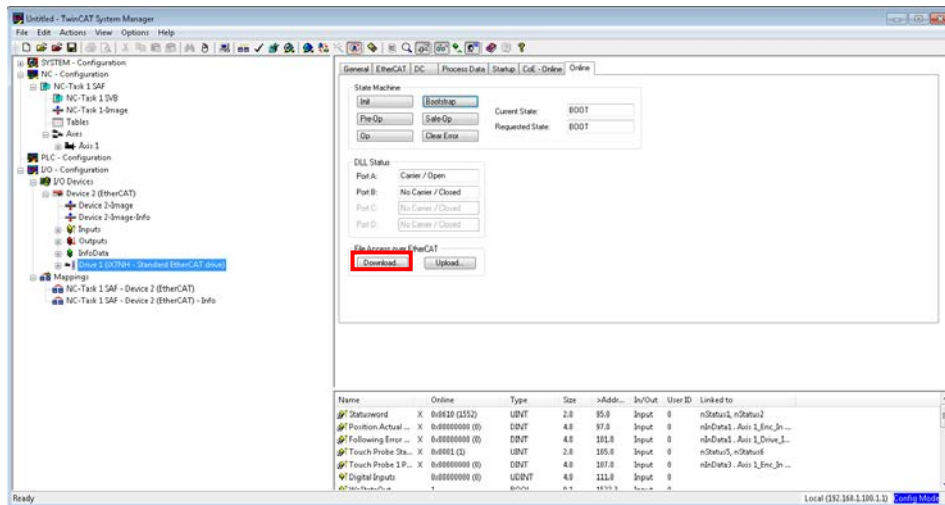

- 5) Select the path of the file to be downloaded (iX7NH_fw_bin) and the file. If capitalization of the entered file name or the name itself is incorrect, download will not proceed and the following error will occur.

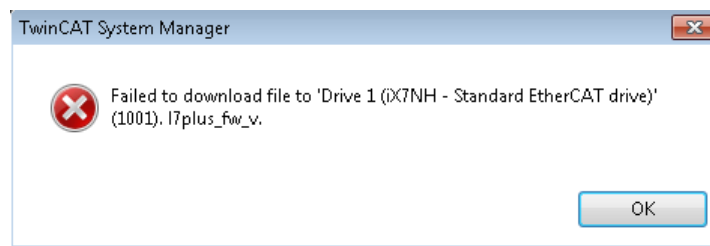

- 6) Enter the password for file download and click OK to start the download. (Password: 00000000)

- 7) If "Downloading..." is displayed as shown in the following figure, the download is in progress. If the progress bar at the bottom is full, it indicates the download is completed.

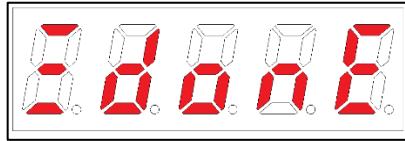

(7-Segment display appears at the completion of firmware download using FoE)

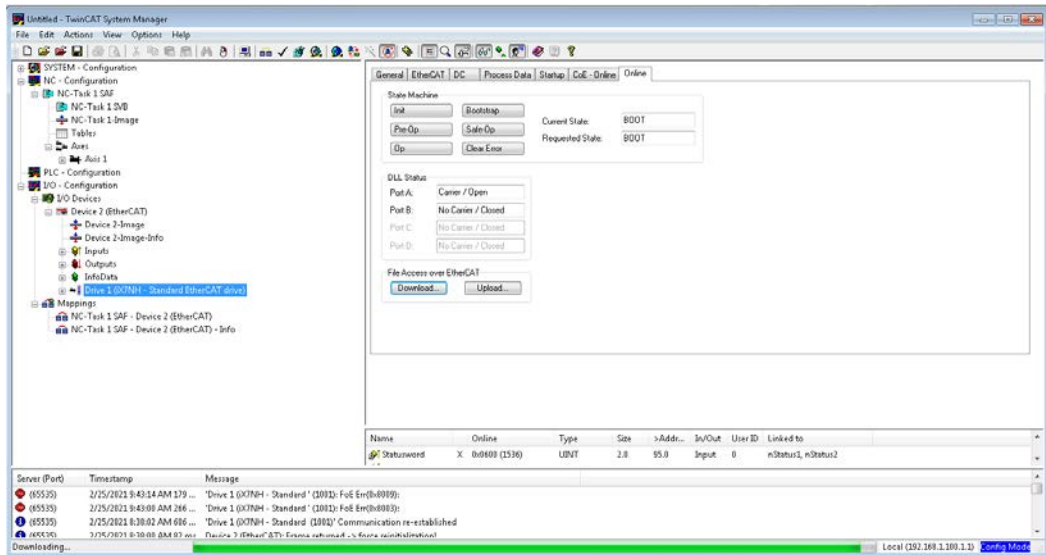

- 8) After power cycling, if the 7-segment display displays 'FLASH' and then from '0.0' to '100.0' sequentially, it means firmware upload is in progress. Once upload is complete and the display outputs a Drive Ready message, you can check if firmware update has been successful.

15.1.3 Using Drive CM

Drive CM allows you to upgrade the OS for the drive to the newest through the PC's USB port. The transmission time depends on the PC performance, but it usually takes from tens of seconds to several minutes.



Click "Setup" and "Firmware Update" from the top menu of DriveCM.

■ Precautions for Firmware Upgrade

- 1) Do not turn off the PC or drive during transmission.
- 2) Do not unplug the USB cable or close the firmware program during transmission.
- 3) Do not run other applications on the PC during transmission.
- 4) Since the parameter (object) setting values in the drive may be reset, save the drive parameter (object) setting values before upgrade.

■ OS Download

- 1) Click the "Open Firmware Downloader" button.

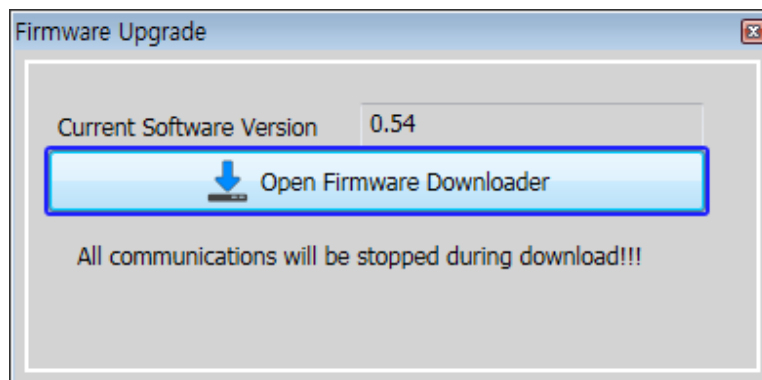

- 2) To load the appropriate OS file, click the "Load" button.

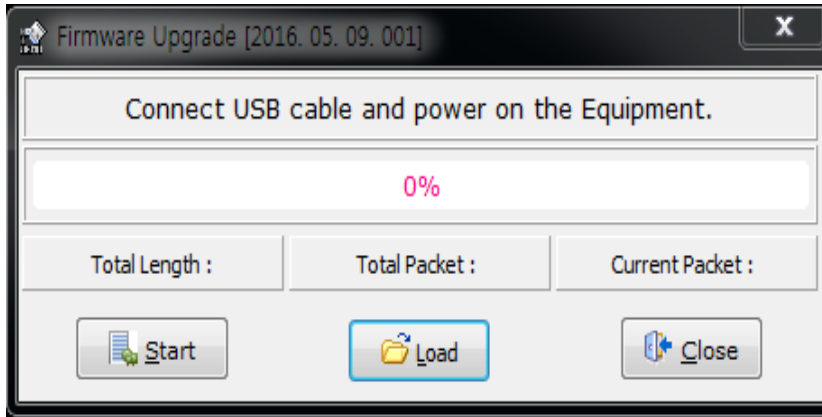

- 3) Select the OS file to transfer and click the Open button.

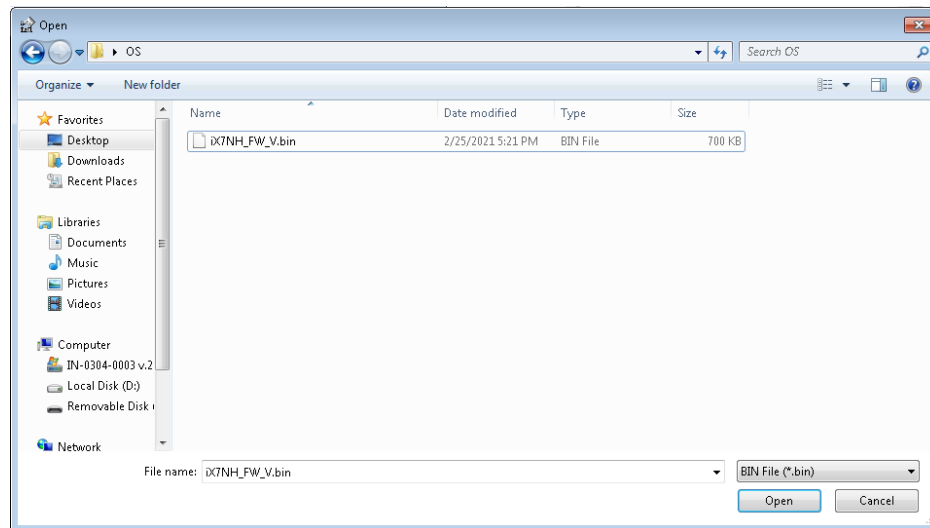

- 4) "Total Length" and "Total Packet" of the loaded OS are displayed.

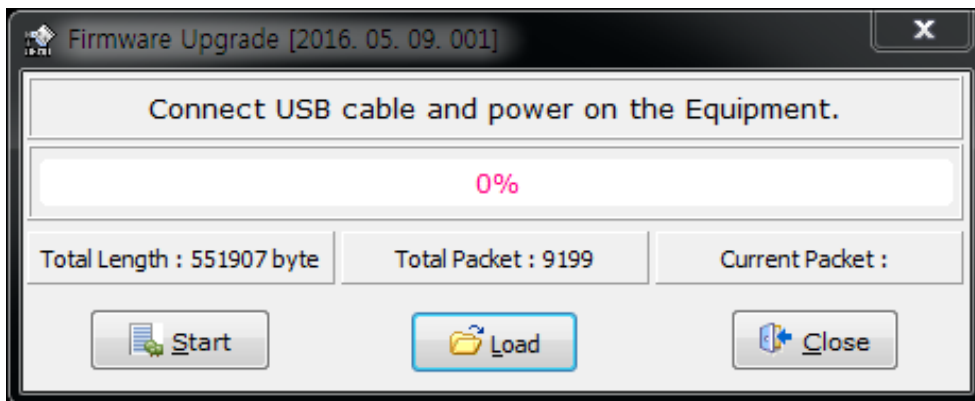

- 5) Press the "Start" button to start transmission. A count-down of 10 seconds is activated to clear the internal memory in the drive. (For L7NH and L7P, the segment 7 should display "USB". For PEGASUS, a red "ERR" LED should be illuminated.)
- 6) After clearing, the OS is transmitted automatically and the progress bar and "Current Packet" display the current transmission status. (The transmission time depends on the PC performance, but it usually takes from tens of seconds to several minutes.)

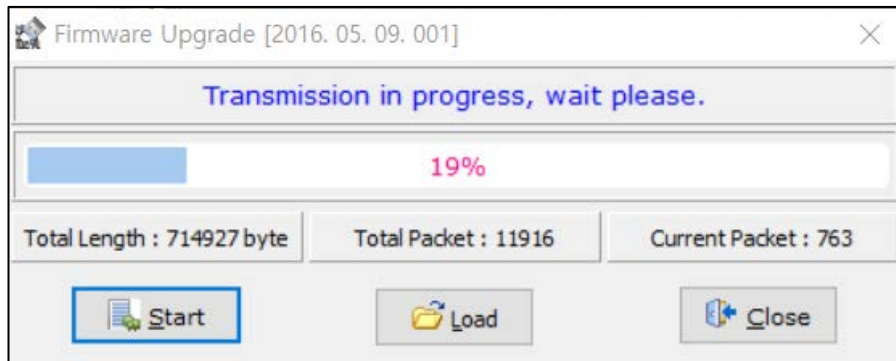

- 7) When transmission is completed, a popup saying "Transmission completed" is displayed. (When transmission to the PC is completed, turn the drive off and on to restart.)

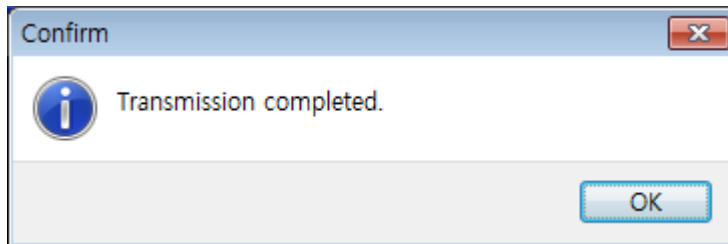

- 8) After power cycling, if the 7-segment display displays 'FLASH' and then from '0.0' to '100.0' sequentially, it means firmware upload is in progress. Once upload is complete and the display outputs a Drive Ready message, you can check if firmware update has been successful.

■ **When an Error Occurs During Transmission**

- Turn off and on the drive and repeat the above process from (2) to (7).

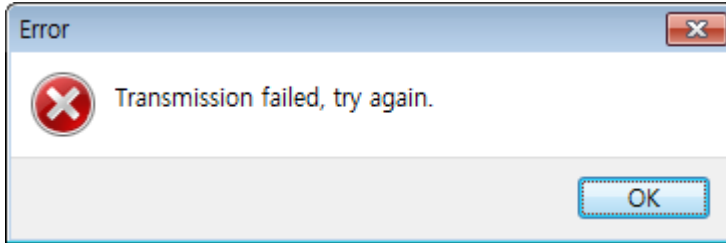

15.1.4 Use of Webserver

Webserver allows you to upgrade the drive OS to the newest version through the Ethernet port of the PC or the EtherCAT In port of the servo drive. The transmission time depends on the PC performance, but it usually takes from tens of seconds to several minutes.

■ Precautions for Firmware Upgrade

- 1) Do not turn off the PC or drive during transmission.
- 2) Do not remove the Ethernet cable during transmission.
- 3) Do not run other applications on the PC during transmission.
- 4) Since the parameter (object) setting values in the drive may be reset, save the drive parameter (object) setting values before upgrade.
- 5) Do not close the "Firmware Upgrade" window during upgrade since doing so aborts firmware upgrade and data download.
- 6) When you download a firmware, the "Firmware Upgrade" window does not provide download progress information. You can check the progress on the 7-segment display for servo status.

■ OS Download

- 1) Access the Webserver (Refer to Section 12.3 "Example of Webserver Access.") and click "Setup->Firmware" on the top menu.

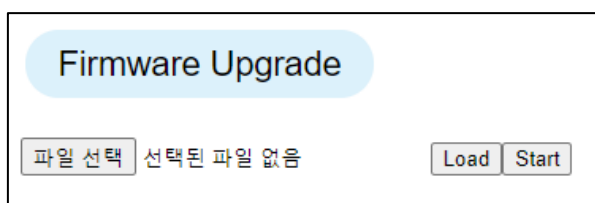

- 2) On the Firmware Upgrade window, click “Select File.”

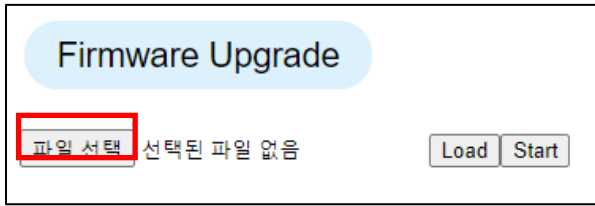

- 3) Select the OS file to transfer and click the Open button.

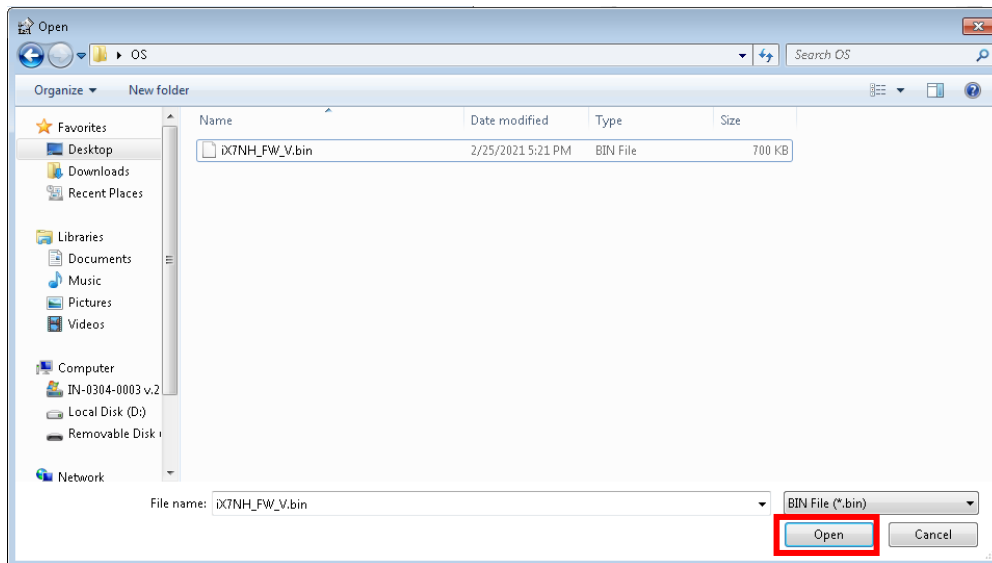

- 4) Check that the OS file has been uploaded and click the “Load” button.

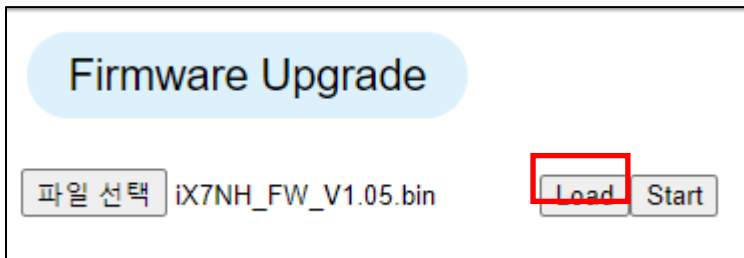

- 5) Once the OS file to transfer is uploaded, the phrase in the image below will appear. Click the “Start” button to start download.



- 6) When you execute download, the “Firmware Upgrade” window does not provide download progress information. You can check the progress on the 7-segment display for servo status. If the 7-segment display displays from '0.0' to '100.0' sequentially, it means that firmware download is in progress. Once upload is complete, the below highlighted message will appear on the “Firmware Upgrade” window.

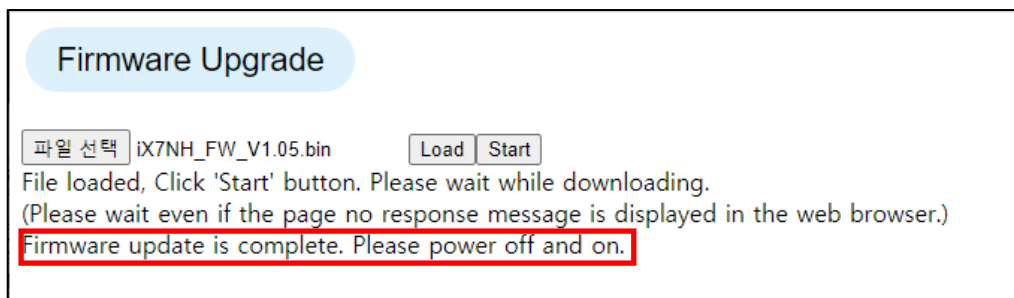

Note 1) A pause of the sequential number display on the 7-segment display means that an error occurred during firmware download. In this case, turn the power off and on and start over the download process.

- 7) After power cycling, if the 7-segment display displays 'FLASH' and then from '0.0' to '100.0' sequentially, it means firmware upload is in progress. Once upload is complete and the display outputs a Drive Ready message, you can check if firmware update has been successful.



16. Appendix ii (L7NH → iX7NH exchange)

16.1 Precautions When Selecting Capacity

16.1.1 When Selecting a Product

- 1) When selecting a product, be sure to refer to Section 2 “Product Specifications” in the manual and the product combination table in the catalog.

16.1.2 Comparison Based on Servo Drive Types

L7NH						iX7NH					
L7 NH A 004 U AA						iX7 NH A 035 U AA					
Series Name	Communication / Drive Type	Input Voltage	Capacity	Encoder Type	Option	Series Name	Series Name	Input voltage	Capacity	Encoder	Option
L7 Series	NH : Network / All-in-One Type	A : 200Vac B : 400Vac	001 : 100W 002 : 200W 004 : 400W 008 : 750W 010 : 1kW 020 : 2kW 035 : 3.5kW 075 : 7.5kW 110 : 11.0kW 150 : 15kW	U : Universal	Blank : Standard Marked : Exclusive	iX7series	NH Network High-performance	A : 200[Vac]	001 100[W] 002 200[W] 004 400[W] 008 800[W] 010 1[kW] 020 2[kW] 035 3.5[kW]	U Universal	Blank Standard Mark <small>Dedicated use</small>

※ For details, refer to Section 2 “Product Characteristics” in the manual and the product characteristics in the catalog.

16.2 I/O Pin Map Comparison

- You can see that the I/O Pin Maps of the two models are different. Please refer to this for wiring.

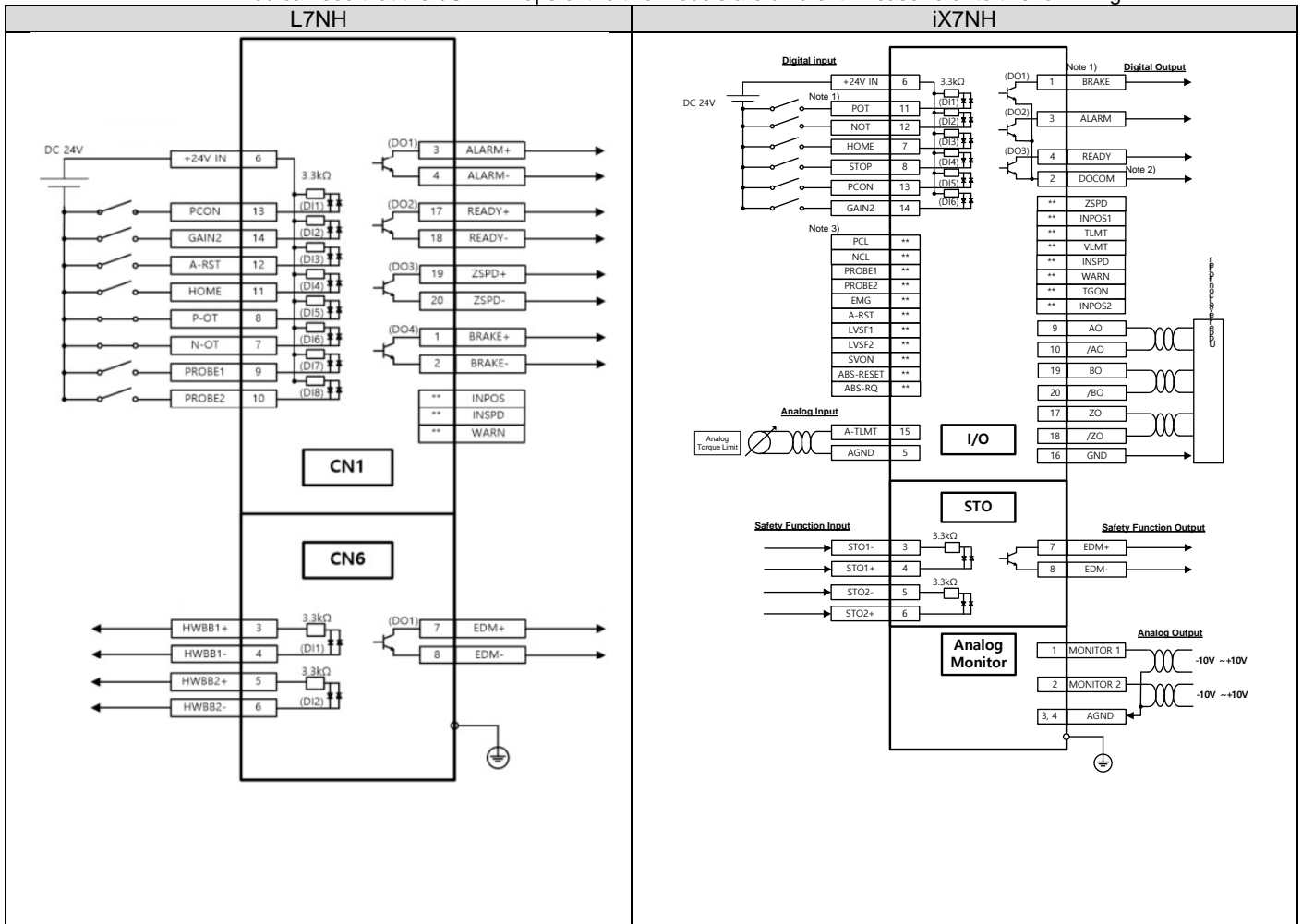

< Precautions >

Note 1) Input signals DI1 - DI6 and output signals DO1 - DO3 are factory default signals. While L7NH provides 8 channels for input contacts and 4 channels for output contacts, iX7NH provides 6 channels for input contacts, 3 channels for output contacts and 3 channels for encoder output.

Note 2) L7NH has the Common Open Type output contacts, while iX7NH has the Open Collector Type. Please keep this in mind for wiring.

Note 3) ** indicates unassigned signals. The assignment may be changed by parameter settings.

16.3 Control Details

16.3.1 Input Contact (CN1)

- 1) The PROBE signal assignment may be changed by parameter settings.
- 2) The ALARM RESET signal assignment may be changed by parameter settings.
- 3) Contact points are applied with a bidirectional photocoupler, and you can change the polarity as desired.
- 4) Check the changed Pin Map before use.

L7NH		iX7NH		Notes
PIN	Names	PIN	Names	
7	/N-OT	12	NOT	
8	/P-OT	11	POT	
9	/PROBE1 (Note 1)	Assignment	**PROBE1	Mappable
10	/PROBE2 (Note 1)	Assignment	**PROBE2	Mappable
11	HOME	7	HOME	
12	ALM RST	Assignment	**ARST	Mappable
13	PCON	13	PCON	
14	GAIN2	14	GAIN2	
6	+24V IN	6	+24V IN	
		8	STOP	
		Assignment	**PCL	
		Assignment	**NCL	
		Assignment	**EMG	
		Assignment	**LVSF1	
		Assignment	**LVSF2	
		Assignment	**SVON	
		Assignment	**ABS_RESET	
		Assignment	**ABS_RQ	

(Note 1) You cannot map touch probe signals.

Note) ** indicates unassigned signals. The assignment may be changed by parameter settings.

16.3.2 Output Contact (CN1)

- 1) While L7NH uses a single contact to use two functions, iX7NH splits a contact to assign L7P separately. (Refer to the following table.)
- 2) As for the signal output type, L7NH uses the Common Open Type, while iX7NH uses the Open Collector Type.

L7NH		iX7NH		Notes
PIN	Names	PIN	Names	
1	BRAKE+	1	BRAKE	
2	BRAKE-			
3	ALARM+	3	ALARM	
4	ALARM-			
17	/READY+	4	READY	
18	/READY-			
19	/ZSPD+	Assignment	**ZSPD	
20	/ZSPD-			
Assignment	INPOS	Assignment	**INPOS1	
Assignment	INSPD	Assignment	**INSPD	
Assignment	WARN	Assignment	**WARN	
		Assignment	**TLMT	
		Assignment	**VLMT	
		Assignment	**TGON	
		Assignment	**INPOS2	
		2	DOCOM (Note 1)	

Note) ** indicates unassigned signals. The assignment may be changed by parameter settings.

(Note 1) Common GND24 is used as DOCOM.

16.3.3 Analog Input Signal (CN1)

- 1) This signal applies a voltage between -10V and +10V between A-TMLT (AI1) and AGND to limit motor output torque. Relationship between input voltage and limit torque depends on the value of [0x221C].

iX7NH	
PIN	Names
15	A-TLMT
5	AGND

16.3.4 Analog Output Signal (analog monitoring connector)

Pin Number	Names	Details	Function
1	AMON1	Analog monitor 1	Analog monitor output (-10V ~ +10V)
2	AMON2	Analog monitor 2	Analog monitor output (-10V ~ +10V)
3	AGND	AGND (0V)	Analog ground
4	AGND	AGND (0V)	Analog ground

16.3.5 Safety Features (STO, Safety Torque Off)

- 1) For details on how to use the safety features, refer to Section 7 "Safety Features."

L7NH		iX7NH		Function
Pin Number	Names	Pin Number	Names	
1		1	+12V	For bypass wiring
2		2	-12V	For bypass wiring
3	/HWBB1+	3	STO1-	
4	/HWBB1-	4	STO1+	
5	/HWBB2+	5	STO2-	
6	/HWBB2-	6	STO2+	
7	EDM+	7	EDM+	
8	EDM-	8	EDM-	

16.4 Main Parameter Setting

- 1) iX7NH automatically sets Motor ID (0x2000), Encoder Type (0x2001) and Encoder Resolution (0x2002) for serial encoders provided by our company.
- 2) If necessary, use the front rotary switch to set the node ID. You can check the set ID at 0x2003.
- 3) If you are using an absolute encoder, refer to the following table to change the 0x2005 value.

Setting Value	Description
0	Uses the absolute encoder as the absolute encoder. Uses the multi-turn data.
1	Uses the absolute encoder as the incremental encoder. Does not use the multi-turn data. Does not display any battery-related alarm/warning.

Note) For details, refer to Section 10.2 "Manufacturer Specific Objects" in the manual.

- 4) Main parameters comparison

Details	L7NH	iX7NH
Motor ID	0x2000	0x2000
Encoder Type	0x2001	0x2001
Encoder Resolution	0x2002	0x2002
Node ID	0x2003	0x2003
Rotation Direction Select	0x200D	0x2004
Absolute Encoder Configuration	0x200D	0x2005
Main Power Fail Check Mode	0x2003	0x2006
7SEG Display Selection	0x2005	0x2008
Regeneration Brake Resistor Configuration	-	0x2009
Regeneration Brake Resistor Derating Factor	0x2006	0x200A
Regeneration Brake Resistor Value	0x2007	0x200B
Regeneration Brake Resistor Capacity	0x2008	0x200C
Peak Power of Regeneration Brake Resistor	-	0x200D
Inertia ratio setting	0x2100	0x2100
Position Gain 1	0x2101	0x2101
Speed Gain 1	0x2106	0x2102
Speed Feedback Filter Time Constant	0x210B	0x210B

Define input signal	0x2200, 0x2201, 0x2204	0x2200 ~ 0x2207
Define output signal	0x2202, 0x2203, 0x2205	0x2210 ~ 0x2213
Analog monitor output		0x2220 ~ 0x2226

Product Warranty

This product was produced using the strict quality control guidelines and testing procedures developed by technicians of our company.

The warranty applies for 12 months after the date of installation. If the installation date is not specified, the warranty is valid for 18 months after the date of manufacture. However, the terms of this warranty may change depending on the terms of the contract. Be aware during purchase that the products in this manual are subject to discontinuation or modifications without notice.

Free Technical Support

If the drive malfunctions under proper usage conditions and the product warranty is still valid, contact one of our agencies or the designated service center. We will repair the product free of charge.

Paid Technical Support

We provide product repair at a cost in the following cases.

- The malfunction is a result of negligence on the part of the consumer.
- The malfunction is a result of inappropriate voltage or defects in the machines connected to the product.
- The malfunction is a result of an act of God (fire, flood, gas, earthquake, etc.)
- The product was modified or repaired by someone other than our agency or service center worker.
- The name tag of our company is not attached on the product.
- The warranty has expired.

※ After installing the servo, fill out this quality assurance form and send it to our quality assurance department (technical support).

Environmental Guidelines

Our company complies with the following environmental guidelines.

Green Management

Our company puts the highest priority for its business on environmental protection.
All employees of LS ELECTRIC shall do their best to preserve the environment of the earth.

Guidelines on the disposal of the product

All of our company's servo products are designed to protect the environment. When you dispose of the product, you should recycle the product by sorting its parts into aluminum, iron, and synthetic resin (cover).

User Manual Revision History

Number	Date issued	Revised content	Version number	Notes
1	2021.02.15	New Distrubution	1.0	
2	2023.16.15	Functions added, figures inserted Add Installation with the control panel Add Power Supply Wiring Diagram	1.1	
3				
4				
5				
6				
7				



www.ls-electric.com

LS ELECTRIC Co., Ltd.

■ Headquarter

LS-ro 127(Hogye-dong) Dongan-gu, Anyang-si, Gyeonggi-Do, 14119, Korea

■ Seoul Office

LS Yongsan Tower, 92, Hangang-daero, Yongsan-gu, Seoul, 04386, Korea

Tel: 82-2-2034-4033, 4888, 4703 Fax: 82-2-2034-4588

E-mail: automation@ls-electric.com

■ Overseas Subsidiaries

• LS ELECTRIC Japan Co., Ltd. (Tokyo, Japan)

Tel: 81-3-6268-8241 E-Mail: japan@ls-electric.com

• LS ELECTRIC (Dalian) Co., Ltd. (Dalian, China)

Tel: 86-411-8730-6495 E-Mail: china.dalian@ls-electric.com.cn

• LS ELECTRIC (Wuxi) Co., Ltd. (Wuxi, China)

Tel: 86-510-6851-6666 E-Mail: china.wuxi@ls-electric.com.cn

• LS ELECTRIC Middle East FZE (Dubai, U.A.E.)

Tel: 971-4-886-5360 E-Mail: middleeast@ls-electric.com

• LS ELECTRIC Europe B.V. (Hoofddorp, Netherlands)

Tel: 31-20-654-1424 E-Mail: europartner@ls-electric.com

• LS ELECTRIC America Inc. (Chicago, USA)

Tel: 1-800-891-2941 E-Mail: sales.us@lselectricamerica.com

• LS ELECTRIC Turkey Co., Ltd.

Tel: 90-212-806-1225 E-Mail: turkey@ls-electric.com

■ Overseas Branches

• LS ELECTRIC Tokyo Office (Japan)

Tel: 81-3-6268-8241 E-Mail: tokyo@ls-electric.com

• LS ELECTRIC Beijing Office (China)

Tel: 86-10-5095-1631 E-Mail: china.auto@lselectric.com.cn

• LS ELECTRIC Shanghai Office (China)

Tel: 86-21-5237-9977 E-Mail: china.auto@lselectric.com.cn

• LS ELECTRIC Guangzhou Office (China)

Tel: 86-20-3818-2883 E-Mail: china.auto@lselectric.com.cn

• LS ELECTRIC Chengdu Office (China)

Tel: 86-28-8670-3201 E-Mail: china.auto@lselectric.com.cn

• LS ELECTRIC Qingdao Office (China)

Tel: 86-532-8501-2065 E-Mail: china.auto@lselectric.com.cn

• LS ELECTRIC Nanjing Office (China)

Tel: 86-25-8467-0005 E-Mail: china.auto@lselectric.com.cn

• LS ELECTRIC Bangkok Office (Thailand)

Tel: 66-90-950-9683 E-Mail: thailand@ls-electric.com

• LS ELECTRIC Jakarta Office (Indonesia)

Tel: 62-21-2933-7614 E-Mail: indonesia@ls-electric.com

• LS ELECTRIC Moscow Office (Russia)

Tel: 7-499-682-6130 E-Mail: info@lselectric-ru.com

• LS ELECTRIC America Western Office (Irvine, USA)

Tel: 1-949-333-3140 E-Mail: america@ls-electric.com

Disclaimer of Liability

LS ELECTRIC has reviewed the information in this publication to ensure consistency with the hardware and software described. However, LS ELECTRIC cannot guarantee full consistency, nor be responsible for any damages or compensation, since variance cannot be precluded entirely. Please check again the version of this publication before you use the product.

© LS ELECTRIC Co., Ltd 2021 All Right Reserved.

2023.11