

# USER MANUAL

# CSX

RIGHT FROM  
THE START

**AuCom**  
MOTOR CONTROL SPECIALISTS

## Contents

1. Caution Statements.....	2
2. System Design.....	4
3. Electrical Installation .....	10
4. Adjustments .....	13
5. Troubleshooting .....	15

The examples and diagrams in this manual are included solely for illustrative purposes. The information contained in this manual is subject to change at any time and without prior notice. In no event will responsibility or liability be accepted for direct, indirect or consequential damages resulting from the use or application of this equipment.

- FR** Ce manuel est également disponible en français à partir de [www.aucom.com](http://www.aucom.com).
- DE** Dieses Handbuch ist auch in deutscher Sprache aus [www.aucom.com](http://www.aucom.com).
- IT** Questo manuale è disponibile anche in italiano da [www.aucom.com](http://www.aucom.com).
- PT** Este manual também está disponível em Português no site [www.aucom.com](http://www.aucom.com).
- ES** Este manual también está disponible en español a partir de [www.aucom.com](http://www.aucom.com).
- ZH** 该手册也可在中国从 [www.aucom.com](http://www.aucom.com).

© 2017 AuCom Electronics Ltd. All Rights Reserved.

# 1. Caution Statements

Caution Statements cannot cover every potential cause of equipment damage but can highlight common causes of damage. It is the installer's responsibility to read and understand all instructions in this manual prior to installing, operating or maintaining the equipment, to follow good electrical practice including applying appropriate personal protective equipment and to seek advice before operating this equipment in a manner other than as described in this manual.

- Isolate the CSX completely from the power supply before attempting any work on the CSX or motor.
- Cables to the control inputs must be segregated from mains voltage and motor cabling.
- Some electronic contactor coils are not suitable for direct switching with PCB mount relays. Consult the contactor manufacturer/supplier to confirm suitability.
- Do not apply incorrect voltages to the control input terminals.
- Power factor correction capacitors must be connected to the input side of the soft starter. Connecting power factor correction capacitors to the output side will damage the soft starter.



## **WARNING - ELECTRICAL SHOCK HAZARD**

The CSX contains dangerous voltages when connected to mains voltage. Only a qualified electrician should carry out the electrical installation. Improper installation of the motor or the CSX may cause equipment failure, serious injury or death. Follow this manual and local electrical safety codes.



## **GROUNDING AND BRANCH CIRCUIT PROTECTION**

It is the responsibility of the user or person installing the CSX to provide proper grounding and branch circuit protection according to local electrical safety codes.



## **SHORT CIRCUIT**

The CSX is not short circuit proof. After severe overload or short circuit, the operation of the CSX should be fully tested by an authorised service agent.

## 1.2 Avertissements à l'attention des clients canadiens



### AVERTISSEMENT

L'icône AVERTISSEMENT ci-contre signale les informations concernant des risques pouvant entraîner des blessures graves, voire mortelles. Pour votre sécurité, veuillez consulter les avertissements sur cette page ou demander une copie du présent manuel en français auprès de votre distributeur local.



### AVERTISSEMENT

Isoler complètement le CSX de l'alimentation secteur avant de tenter toute intervention sur le CSX ou sur le moteur. Les bornes de commande peuvent être au potentiel de la tension de phase.



### AVERTISSEMENT - DANGER D'ÉLECTROCUTION

Le CSX contient des tensions dangereuses lorsqu'il est raccordé à l'alimentation secteur. Seul un électricien compétent peut effectuer l'installation électrique. Une mauvaise installation du moteur ou du CSX peut déclencher une panne d'équipement, provoquer de graves blessures ou même la mort. Suivre les instructions de ce manuel et des codes locaux concernant la sécurité électrique.



### AVERTISSEMENT

Toujours appliquer la tension de commande avant (ou en même temps que) la tension secteur.

## 2. System Design

### 2.1 Model Code

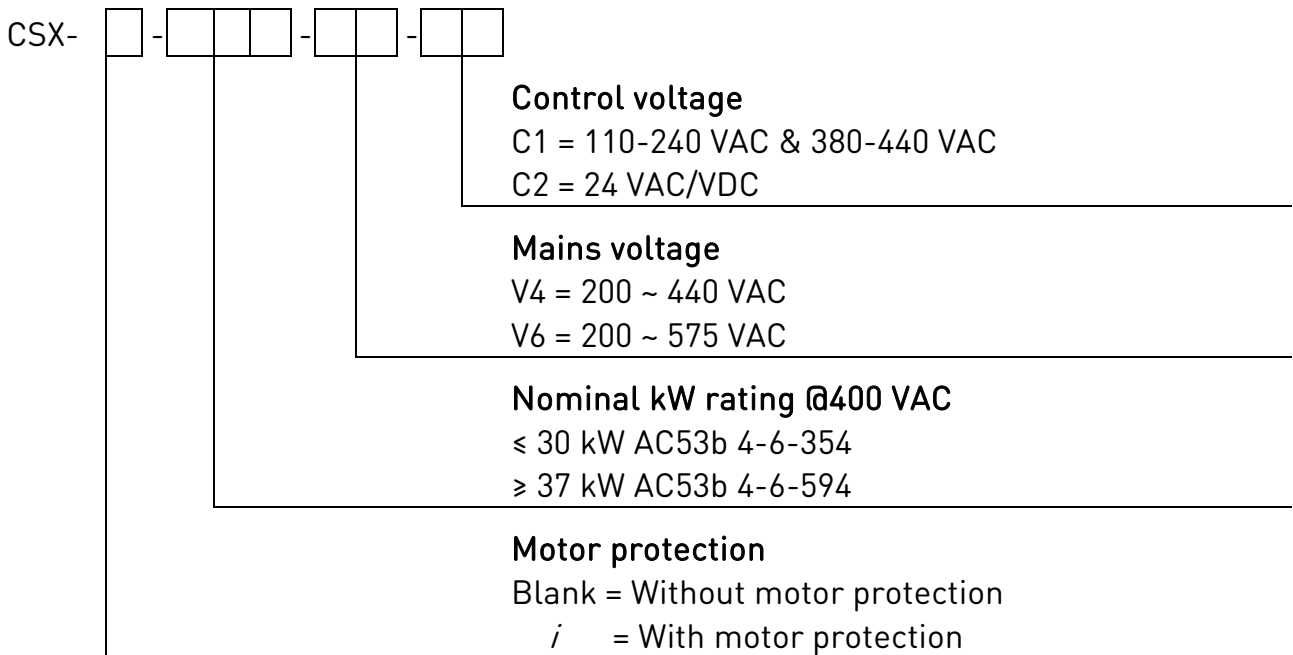

### 2.2 Current Ratings

	AC53b 4-6:354 < 1000 metres		AC53b 4-20:340 < 1000 metres	
	40 °C	50 °C	40 °C	50 °C
	CSX-007	18 A	17 A	17 A
CSX-015	34 A	32 A	30 A	28 A
CSX-018	42 A	40 A	36 A	33 A
CSX-022	48 A	44 A	40 A	36 A
CSX-030	60 A	55 A	49 A	45 A
	AC53b 4-6:594 < 1000 metres		AC53b 4-20 580 < 1000 metres	
	40 °C	50 °C	40 °C	50 °C
	CSX-037	75 A	68 A	65 A
CSX-045	85 A	78 A	73 A	67 A
CSX-055	100 A	100 A	96 A	87 A
CSX-075	140 A	133 A	120 A	110 A
CSX-090	170 A	157 A	142 A	130 A
CSX-110	200 A	186 A	165 A	152 A

## 2.3 Dimensions and Weights

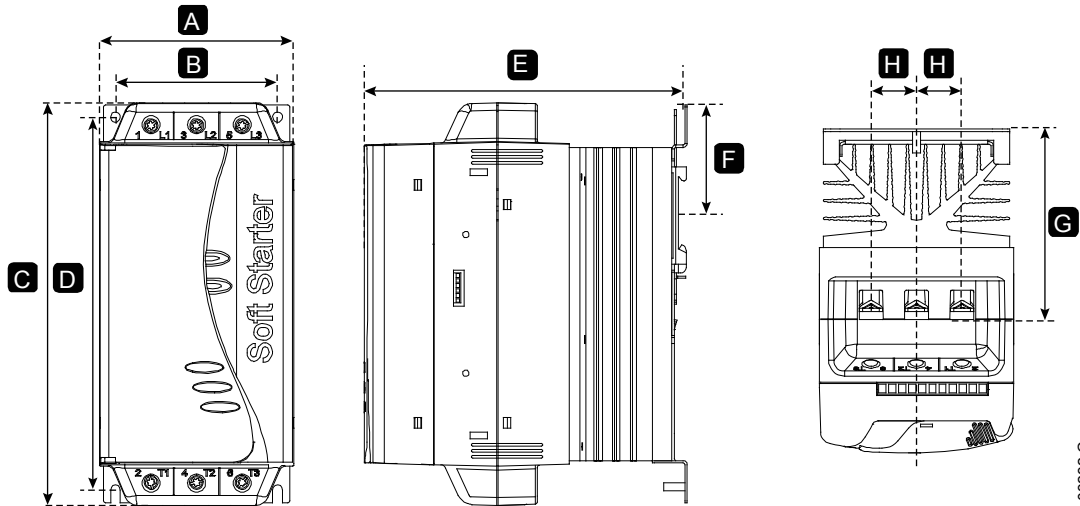

Model	Width		Height		Depth		Weight		
	mm (inch)	mm (inch)	mm (inch)	mm (inch)	mm (inch)	mm (inch)	mm (inch)	kg (lb)	
CSX-007									
CSX-015									
CSX-018	98	82	201	188	165	55	90.5	23	2.1
CSX-022	(3.85)	(3.22)	(7.91)	(7.40)	(6.49)	(2.16)	(3.6)	(0.9)	(4.6)
CSX-030									
CSX-037									
CSX-045	145	124	215	196	193	-	110.5	37	3.8
CSX-055	(5.70)	(4.88)	(8.46)	(7.71)	(7.59)		(4.4)	(1.5)	(8.4)
CSX-075									
CSX-090	200	160	240	216	214	-	114.5	51	6.1
CSX-110	(7.87)	(6.30)	(9.44)	(8.50)	(8.43)		(4.5)	(2.0)	(13.5)

## 2.4 Physical Installation

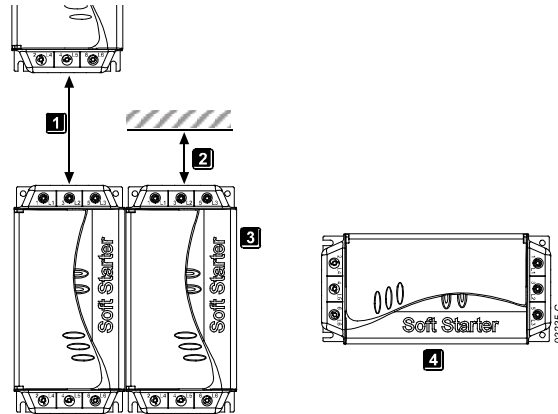

- |   |   |
|---|---|
| 1 | CSX-007 ~ CSX-055: Allow 100 mm (3.9 inch) between soft starters.<br>CSX-075 ~ CSX-110: Allow 200 mm (7.9 inch) between soft starters.  |
| 2 | CSX-007 ~ CSX-055: Allow 50 mm (2.0 inch) between the soft starter and solid surfaces.<br>CSX-075 ~ CSX-110: Allow 200 mm (7.9 inch) between the soft starter and solid surfaces. |
| 3 | Soft starters may be mounted side by side with no clearance (that is, if mounted without communications modules).   |
| 4 | The soft starter may be mounted on its side. Derate the soft starter's rated current by 15%.  |

## 2.5 Accessories

### Finger Guard Kit

Finger guards may be specified for personnel safety. Finger guards fit over the soft starter terminals to prevent accidental contact with live terminals. Finger guards provide IP20 protection when used with cable of diameter 22 mm or greater.

### Remote Operator

The Remote Operator can control and monitor the soft starter's performance. Functionality includes:

- Operational control (Start, Stop, Reset, Quick Stop)
- Starter status monitoring (Ready, Starting, Running, Stopping, Tripped)
- Trip code display

### Communication Interfaces

CSX soft starters support network communication via easy-to-install communications interfaces. Each soft starter can support one communications interface at a time.

Available protocols:

Ethernet (Profinet, Modbus TCP, Ethernet/IP), Profibus, DeviceNet, Modbus RTU, and USB.



#### NOTE

Ethernet communication modules are not suitable for use with CSX starters using 380/440 VAC control voltage.

## PC Software

The PC software is a fully functional program for controlling, monitoring and programming soft starters. It provides the following functionality:

- Operation of soft starter networks containing up to 254 individual soft starters
- Operational control (Start, Stop, Reset, Quick Stop)
- Starter status monitoring (Ready, Starting, Running, Stopping, Tripped)

To use WinMaster with the CSX, the soft starter must be fitted with a USB Module, Modbus Module or a Remote Operator.

## 2.6 Semiconductor Fuses

Semiconductor fuses can be used with CSX soft starters to reduce the potential for damage to SCRs from transient overload currents and for Type 2 coordination. CSX soft starters have been tested to achieve Type 2 coordination with semiconductor fuses. Suitable Bussmann and Ferraz/Mersen semiconductor fuses are detailed below.

Model	SCR I <sup>2</sup> t (A <sup>2</sup> s)	Ferraz/Mersen Fuse European/IEC Style (North American Style)	Bussmann Fuse Square Body (170M)	Bussmann Fuse British Style (BS88)
CSX-007	1150	6.6URD30xxxA0063 (A070URD30xxx0063)	170M-1314	63 FE
CSX-015	8000	6.6URD30xxxA0125 (A070URD30xxx0125)	170M-1317	160 FEE
CSX-018	10500	6.6URD30xxxA0160 (A070URD30xxx0160)	170M-1318	160 FEE
CSX-022	15000	6.6URD30xxxA0160 (A070URD30xxx0160)	170M-1318	180 FM
CSX-030	18000	6.6URD30xxxA0160 (A070URD30xxx0160)	170M-1319	180 FM
CSX-037	51200	6.6URD30xxxA0250 (A070URD30xxx0250)	170M-1321	250 FM
CSX-045	80000	6.6URD30xxxA0315 (A070URD30xxx0315)	170M-1321	250 FM
CSX-055	97000	6.6URD30xxxA0315 (A070URD30xxx0315)	170M-1321	250 FM
CSX-075	168000	6.6URD31xxxA0450 (A070URD31xxx0450)	170M-1322	500 FMM
CSX-090	245000	6.6URD31xxxA0450 (A070URD31xxx0450)	170M-3022	500 FMM
CSX-110	320000	6.6URD31xxxA0450 (A070URD31xxx0450)	170M-3022	500 FMM

xxx = Blade Type. Contact Ferraz/Mersen for options.

## 2.7 General Technical Data

### Mains Supply

Mains voltage (L1, L2, L3)	
V4 .....	3 x 200 VAC ~ 440 VAC (+ 10% / - 15%)
V6 .....	3 x 200 VAC ~ 575 VAC (+ 10% / - 15%)
Mains frequency (at start) .....	45 Hz to 66 Hz
Rated insulation voltage .....	600 VAC
Form designation .....	Bypassed semiconductor motor starter form 1

### Control Voltage (A1, A2, A3)

CSX-xxx-xx-C1 .....	110-240 VAC (+ 10% / - 15%)
.....	or 380-440 VAC (+ 10% / - 15%)
CSX-xxx-xx-C2 .....	24 VAC/VDC (± 20%)
Current consumption (during run) .....	< 100 mA
Current consumption (inrush)	
CSX-xxx-xx-C1 .....	10 A
CSX-xxx-xx-C2 .....	2 A

### Inputs

Start (terminal 01) .....	Normally open
.....	150 kΩ @ 300 VAC and 5.6 kΩ @ 24 VAC/VDC
Stop (terminal 02) .....	Normally closed
.....	150 kΩ @ 300 VAC and 5.6 kΩ @ 24 VAC/VDC

### Outputs

Main contactor (terminals 13, 14) .....	Normally open
.....	6 A, 30 VDC / 6 A, 250 VAC resistive
Run relay (terminals 23, 24) .....	Normally open
.....	6 A, 30 VDC / 6 A, 250 VAC resistive

### Environmental

Degree of Protection CSX-007 to CSX-055 .....	IP20
Degree of Protection CSX-075 to CSX-110 .....	IP00
Operating temperature .....	- 10 °C to + 60 °C
Storage temperature .....	-25 °C~+ 60 °C (to +70 °C for less than 24 hours)
Humidity .....	5%~95% Relative Humidity
Pollution degree .....	Pollution Degree 3
Vibration .....	IEC 60068 Test Fc Sinusoidal
.....	4 Hz to 13.2 Hz: ± 1 mm displacement
.....	13.2 Hz to 200 Hz: ± 0.7 g

### EMC Emission

Equipment class (EMC) .....	Class B
Conducted radio frequency emission .....	0.15 MHz to 0.5 MHz: < 56-46 dB (µV)
.....	0.5 MHz to 5 MHz: < 46 dB (µV)
.....	5 MHz to 30 MHz: < 50 dB (µV)



Radiated radio frequency emission .....	30 MHz to 230 MHz: < 30 dB (µV/m)
.....	230 MHz to 1000 MHz: < 37 dB (µV/m)

**EMC Immunity**

Electrostatic discharge .....	4 kV contact discharge, 8 kV air discharge
Radio frequency electromagnetic field ....	0.15 MHz to 1000 MHz: 140 dB (µV)
Rated impulse withstand voltage (Fast transients 5/50 ns)	
.....	2 kV line to earth, 1 kV line to line
Voltage dip and short time interruption .....	100 ms (at 40% nominal voltage)
Harmonics and distortion .....	IEC61000-2-4 (Class 3), EN/IEC61800-3

**Short Circuit**

Rated short-circuit current CSX-007 to CSX-022 .....	5 kA <sup>1</sup>
Rated short-circuit current CSX-030 to CSX-110 .....	10 kA <sup>1</sup>

<sup>1</sup> These short circuit ratings are with fuses used as given in the table under *Semiconductor Fuses* on page 7.

**Heat Dissipation**

During Start .....	3 watts / ampere
During Run .....	10 watts typical

**Standards Approvals**



RCM .....	IEC 60947-4-2
CE .....	EN 60947-4-2
CCC .....	GB 14048.6
EAC .....	TP TC 004/2011, TP TC 020/2011
Marine .....	Lloyds Marine No 1 Specification
UL / C-UL .....	UL 508

**Operational Life**

CSX-007~055 .....	1,000,000 operations
CSX-075~110 .....	30,000 operations

### 3. Electrical Installation

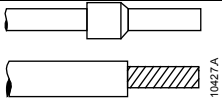
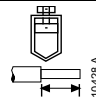
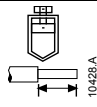
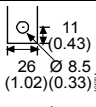
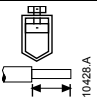
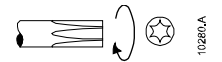
#### 3.1 Power Terminations

	1/L1, 3/L2, 5/L3, 2/T1, 4/T2, 6/T3 mm <sup>2</sup> (AWG)			A1, A2, A3, 01, 02, 13, 14, 23, 24 mm <sup>2</sup> (AWG)	
	007 - 030	037 - 055	075 - 110	007 - 110	
			N.A.		
	10 - 35 (8 - 2)	25 - 50 (4 - 1/10)		mm (inch)	0.14 - 1.5 (26 - 16) 6 mm (0.24 inch)
	Torx (T20) 3 Nm 2.2 ft-lb	Torx (T20) 4 Nm 2.9 ft-lb	n/a	n/a	
	7 mm 3 Nm 2.2 ft-lb	7 mm 4 Nm 2.9 ft-lb	n/a	3.5 mm 0.5 Nm max 4.4 in-lb max	

#### 3.2 Control Voltages

CSX soft starters can be supplied in either of two control voltage configurations:

CSX-xxx-xx-C1 ..... 110-240 VAC (+ 10% / - 15%) or 380-440 VAC (+ 10% / - 15%)

CSX-xxx-xx-C2 ..... 24 VAC/VDC (± 20%)



**WARNING**

Always apply control voltage before (or with) mains voltage.



**CAUTION**

With 24 VAC/VDC use contacts rated for low voltage and low current (gold flash or similar).

### 3.3 Control Circuits



**WARNING**

Isolate the CSX completely from the power supply before attempting any work on the CSX or motor. Control terminals may be at phase voltage potential.



**CAUTION**

For CSX-xxx-xx-C2 (24 VAC/VDC control voltage) units you can connect an external 24 VDC supply into the control input terminals 01, 02.

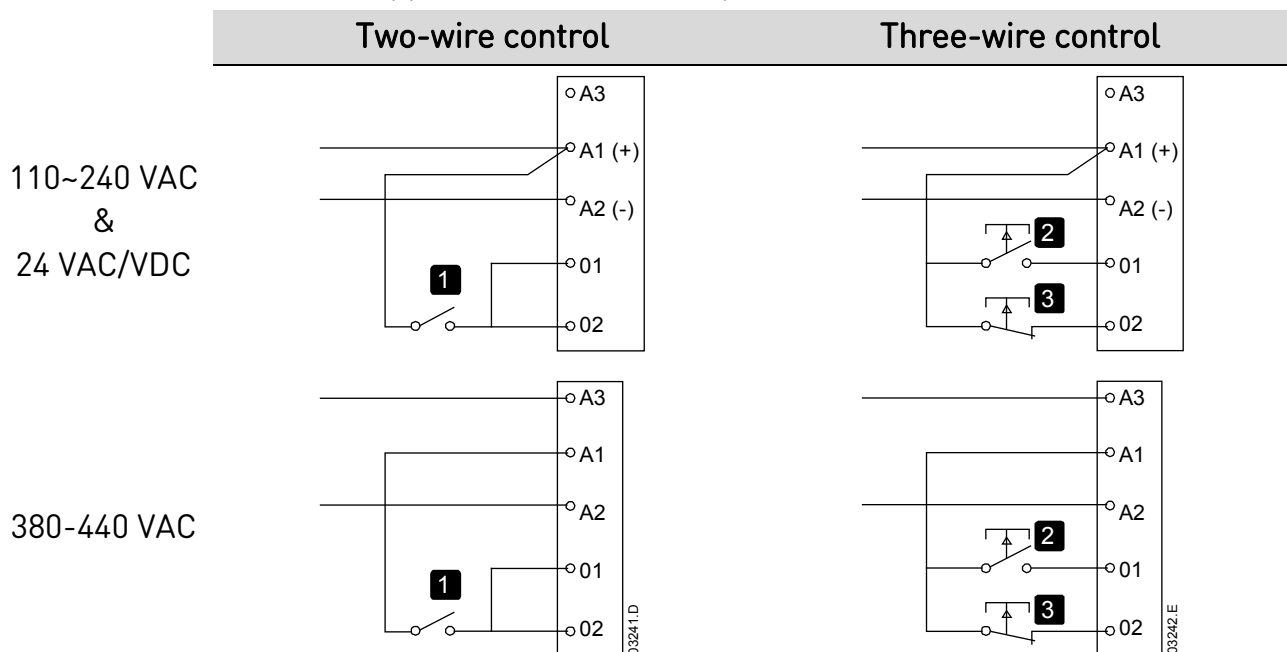

- |   |  |
|---|--|
| 1 | Start/stop. To reset a trip, open then close 02. |
| 2 | Start.   |
| 3 | Stop. To reset a trip, open then close 02.       |

### 3.4 Outputs

#### Main Contactor Output

The Main Contactor output (terminals 13, 14) closes as soon as the soft starter receives a start command and remains closed while the soft starter is controlling the motor (until the motor starts a coast to stop, or until the end of a soft stop). The Main Contactor output will also open if the soft starter trips.

The Main Contactor output can be used to directly control a main contactor coil.

#### Run Contactor Output

The relay (terminals 23, 24) operates four seconds after the set start ramp time is complete. The relay can be used to operate a contactor for power factor correction capacitors, or to signal soft starter run status to an automation system.

### 3.5 Electrical Schematics

Soft starter installed with a motor protection circuit breaker

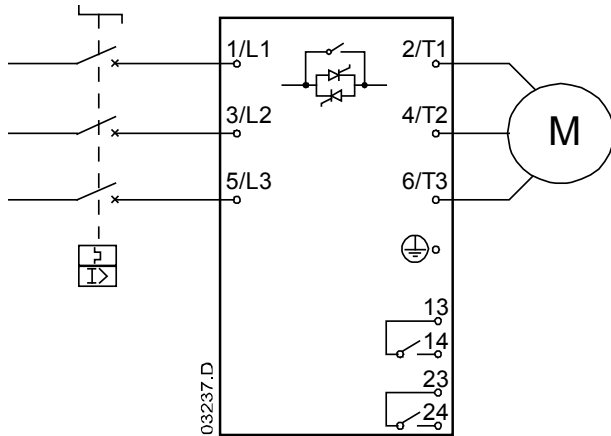

Soft starter installed with a motor protection circuit breaker and main contactor

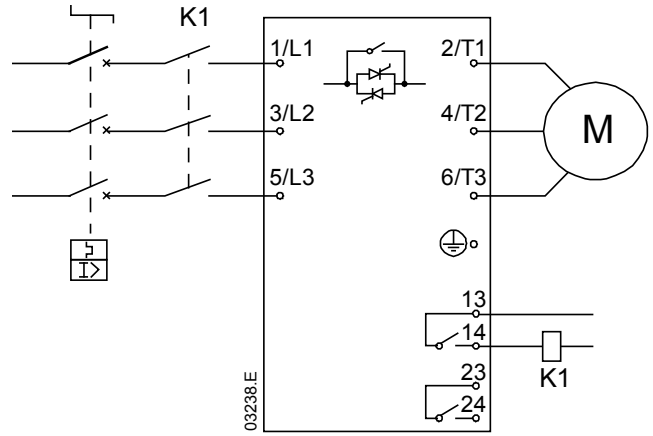

<b>M</b>	Motor (three phase)
<b>K1</b>	Main contactor
<b>13, 14</b>	Main contactor output
<b>23, 24</b>	Run contactor output

# 4. Adjustments

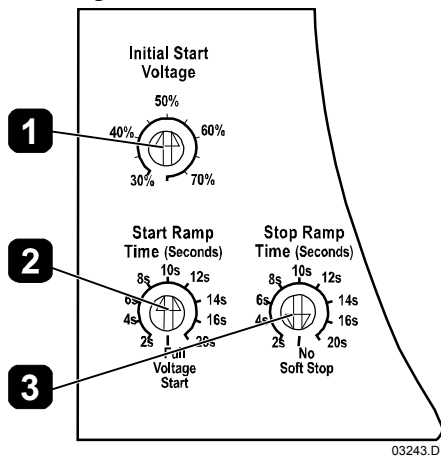

- 1 Initial Start Voltage
- 2 Start Ramp Time
- 3 Stop Ramp Time

## 1 Initial Start Voltage



Select the initial start voltage (A).

Application	Initial Start Voltage - Suggested setting
Centrifugal Pump	50%
Submersible Pump	60%
Screw Compressor	
Conveyor	
Crusher	70%
Fan	
Other applications	

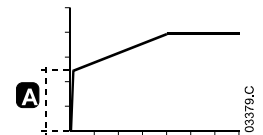

## 2 Start Ramp Time

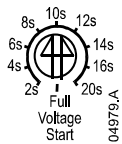

Select the start ramp time (B).

The start ramp defines how long the soft starter will take to increase voltage from the initial start voltage to full voltage.

The start ramp time does not control the time the motor will take to reach full speed.

1. Set the start ramp time to 20 seconds.
2. Set the initial start voltage as required for the application.
3. Attach a current monitoring device to output T1.
4. Start the motor under normal load conditions. Record the time required for the measured current to fall to (or below) the motor's rated full load current ( $t_1$ ) then stop the motor.
5. Set start ramp time =  $t_1$ .



### NOTE

The start ramp time must be long enough for the motor to reach full speed before the soft starter enters bypass mode.

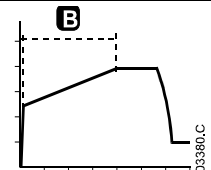

### 3 Stop Ramp Time

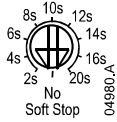

Select the soft stop ramp time (C).  
Soft stop extends the time soft starter takes to reduce voltage to zero.  
The ramp time does not control the time the motor will take to stop completely.

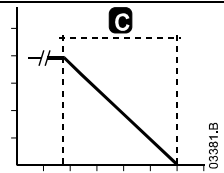

## 5. Troubleshooting



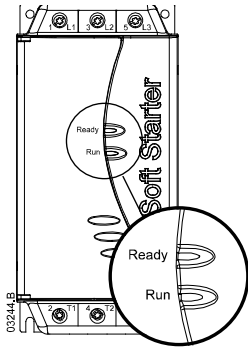

### 5.1 LEDs



LED Status	Ready	Run
Off	No control power	Motor not running
On	Ready	Motor running at full speed
Flash	Starter tripped	Motor starting or stopping

### 5.2 Trip Codes

The Ready LED will flash a different number of times to indicate the cause of the trip.

Ready LED	Description
 x 1	Power Circuit: Check mains supply (L1, L2, L3), motor circuit (T1, T2, T3), soft starter SCRs and bypass relays.
 x 6	Supply Frequency: Check mains voltage is available and supply frequency is in range.
 x 8	Network Communication Failure (between module and network): Check network connections, settings and configuration.
 x 9	Starter Communication Failure (between starter and module): Remove and refit accessory module.

### Supply Frequency Protection

The soft starter will trip on supply frequency if the frequency rises above 72 Hz or falls below 40 Hz for more than five seconds while the soft starter is running. These trip points are not adjustable.

In pre-start, starting and stopping modes the high and low frequency limits both apply with no time delay.

A supply frequency trip will also occur if:

- all three input phases are lost while the soft starter is running
- all three input phases fall below 120 VAC at start or while the soft starter is running
- the line contactor opens while running

## **5.3 Reset**

Trips can be cleared by pressing the Reset button on the soft starter, sending a Reset command from the serial communications network, or by switching the control inputs.

To clear a trip via the control inputs, the soft starter requires a closed to open transition on the stop input (O2).

- In three-wire control, use the external stop button to momentarily open the stop input (open A1-O2).
- In two-wire control, if the soft starter tripped with a start signal present, remove the start signal (open A1 to O1, O2).

The Reset button is located on the front of the unit, above the adjustment switches.

The soft starter will trip again immediately if the cause of the trip still exists.

