

Controller



Parameter setting and programming -----

Reference Manual

EN

Contents

1	About this documentation	6
1.1	Document history	9
1.2	Conventions used	10
1.3	Terminology used	11
1.4	Definition of the notes used	12
2	Safety instructions	13
2.1	General safety instructions	15
2.2	Product-specific safety instructions	19
2.2.1	Controller c300 and p300	19
2.2.2	Panel Controller/HMI p300 and p500	19
2.2.3	Heatsink and GapPad strips for Controller 3200 C	20
2.2.4	I/O system 1000	20
2.2.5	Voltage supply (24 V DC) of the Controllers	21
2.2.6	RJ45 plug connections	21
2.2.7	Optional capacitor pack (CAPS pack)	21
2.3	Notes on wiring according to EMC	22
3	Controller-based Automation: Central motion control	23
4	System structure	26
4.1	Engineering tools	27
4.2	Controller: The control centre of the Controller-based Automation	29
4.3	Lenze FAST application software	30
4.4	"Visualisation" application software	31
4.4.1	Sample topology 1: External monitor panel/display for cabinet controllers	32
4.4.2	Sample topology 2: Separate control and visualisation	33
4.4.3	Sample topology 3: Independent control and visualisation (CANopen)	34
5	Commissioning the controller	35
5.1	Identification	35
5.2	Control elements of the controllers	35
5.3	Starting the controller	36
5.4	Error case: Controller does not start	37
5.5	Configuring the controller	38
5.5.1	Establishing an automatic dial-up connection	38
5.5.2	Entering the IP address of the controller	38
5.5.2.1	Cabinet Controller with external monitor panel (3231 C/3241 C)	39
5.5.2.2	Cabinet Controller without an external monitor panel (c300/3221 C/3251 C)	40
5.5.3	Specifying the IP address of the controller via file (optional)	41
5.5.4	Establishing Windows® CE access rights	42
5.5.4.1	Setting up Windows® CE users in »WebConfig«	42
5.5.5	Use your own background image (Windows® CE)	43
5.6	Reset Controller / Load Lenze standard setting	44
5.7	I/O system 1000 at the backplane bus of the Cabinet Controller	46
5.7.1	Limits on the backplane bus	47
5.7.2	Configuring I/O modules at the backplane bus	48
5.7.3	Determining the topology of the I/O modules automatically	50
5.8	Tabs of the I/O modules at the backplane bus	51
5.9	Error messages (backplane bus)	52

Contents

6	Parameter setting using the »WebConfig«	56
6.1	System structure	56
6.2	Parameter setting of the Controller	56
6.3	Online connection from the Engineering PC to the controller	57
6.3.1	Setting IP addresses on the Engineering PC (example: Windows® XP)	57
6.4	Start »WebConfig«	58
6.5	User interface of »WebConfig«	59
6.5.1	Device parameters of the controller	61
6.5.2	Diagnostic/device commands	62
6.5.3	Logbook	63
6.5.3.1	Structure of a logbook entry: example	63
6.5.3.2	Filter options	64
6.5.3.3	Time filter for the display of logbook entries	64
6.5.3.4	Saving log files with mains failure protection	65
6.5.3.5	Exporting logbook entries	65
6.5.4	Device commands	66
6.5.5	User management	66
6.5.6	General parameters	66
6.5.7	Parameters of the communication cards (MC cards)	67
6.5.8	Polling	67
6.5.9	Language selection	67
6.5.10	Parameter list buttons	67
7	Programming with the »PLC Designer«	68
7.1	System structure	69
7.2	Function blocks	70
7.3	Configuring and parameterising the controller using the control application	72
7.4	Controller c300/p300: Access to odd Controller addresses	73
7.5	Creating remanent variables (retain/persistent)	75
7.6	Storing retain data on the SD card (only Controllers 3221 C/3231 C/3251 C)	76
8	»Backup & Restore« (data backup/restore)	77
9	»EASY Starter - Application Loader« (data transfer)	78
10	UPS function (backup in case of voltage failure)	79
10.1	Internal UPS (for Controllers without UPS connection)	79
10.2	External UPS (for Controllers 3241 C with UPS connection)	80
10.3	Storage of »VisiWinNET® Smart« visualisation data	81
10.4	Storage of retain/persistent variables of the PLC	82
11	RTC function (Real Time Clock)	83
12	Replacing the Controller (in the event of service)	84
12.1	Removing the connected (defective) Controller	85
12.2	Connecting the new Controller/replacement device	86
12.3	Device replacement against an incompatible replacement device (exceptional case)	87
12.4	Undo update of data (exceptional case)	88
12.5	Subsequent use of retain data on the new Controller	89
12.6	Error messages after a device replacement	90

Contents

13	Remote maintenance and diagnostics	91
13.1	Status LEDs of the Controllers	92
13.1.1	Status LEDs of the Controller 3200 C	93
13.1.2	Status LEDs of the Controllers c300/p300	94
13.1.3	Status LEDs of the Controllers p500	95
13.2	Diagnostics via Telnet	96
13.3	Data transfer via FTP	98
13.3.1	FTP settings with the »WebConfig«	98
13.3.2	FTP and web settings in the Internet Explorer	99
13.4	Diagnostics with the logbook	101
13.4.1	Logbook query via »WebConfig«	102
13.4.2	Logbook parameters	103
13.5	Activate Windows® CE interface	104
13.5.1	Remote Display: Remote control of Controller via Internet or LAN	106
13.5.2	Virtual Network Computing (VNC)	107
13.5.3	Script commands in PreStart.txt/PostStart.txt	108
13.5.3.1	"Script control" functions	109
13.5.3.2	System functions	110
14	Visualisation with »VisiWinNET®«	111
14.1	Visualisation on the Controller: Local and remote	112
14.2	System structure	113
14.3	Using the visualisation to access data of the control/parameters	114
14.4	Local visualisation with the "LogicAndMotionV3" direct driver	116
14.4.1	Selecting the target device using the Windows® CE operating system (example 3200 C/p500)	117
14.4.2	Project Explorer	119
14.4.3	Using the variables browser to access variables	120
14.4.4	Accept variable definitions to project	122
14.4.5	Creating control elements/linking them to variables	123
14.4.6	Transferring an application to the target device	124
14.4.7	Start the »VisiWinNET®«	125
14.5	Remote access with the "LogicAndMotionV3" direct driver	126
14.6	OPC tunnel for local visualisation (integrated control system)	127
14.6.1	Integrating the OPC tunnel in »VisiWinNET®«	128
14.6.2	Browsing variable definitions	129
14.6.3	Manual integration of variables (experts only - background knowledge required!)	131
14.6.4	Configure OPC tunnel	134
14.7	OPC tunnel for external visualisation (remote access)	135
14.7.1	Windows® CE operating system	135
14.7.1.1	Configure OPC tunnel for remote access (Windows® CE)	136
14.7.2	Windows® XP/XP Embedded operating system	137
14.7.2.1	Configure OPC tunnel for remote access (Windows® XP/XP Embedded)	138
14.7.3	Browsing variable definitions	139
14.8	Lenze specifications	141
14.8.1	Install additional fonts	141
14.8.2	Timeout (waiting position) of the CAN OPC server influences the time response of the visualisation	141

Contents

15	Parameter reference	142
15.1	Structure of the parameter description	143
15.1.1	Data types	143
15.1.2	Parameters with read access	144
15.1.3	Parameters with write access	144
15.1.3.1	Parameters with setting range	144
15.1.3.2	Parameters with selection list	144
15.1.3.3	Parameters with bit-coded setting	145
15.1.4	Parameter attributes	145
15.2	Basic parameters of the Controllers	146
15.3	Voltage buffering by external UPS (optional for Controller 3241 C)	174
15.4	Monitor panel (integrated/external)	177
15.5	PLC (Logic/Motion)	181
15.6	Backup & Restore	183
15.7	Ethernet	187
15.8	EtherCAT	189
15.9	CAN	194
15.9.1	Parameters of the first CAN interface	195
15.9.2	Parameters of the second CAN interface	197
15.10	PROFIBUS / PROFINET / Serial interfaces	200
	Index	202
	Your opinion is important to us	211

1 About this documentation

1 About this documentation

This documentation ...

- contains general information on how to parameterise, configure and diagnose the Lenze Controllers.
- is part of the "Controller-based Automation" manual collection. It consists of the following sets of documentation:

Documentation type	Subject
Product catalogue	Controller-based Automation (system overview, sample topologies) Lenze Controller (product information, technical data)
System manuals	Visualisation (system overview/sample topologies)
Communication manuals Online helps	Bus systems <ul style="list-style-type: none">• Controller-based Automation EtherCAT®• Controller-based Automation CANopen®• Controller-based Automation PROFIBUS®• Controller-based Automation PROFINET®
Reference manuals Online helps	Lenze Controllers: <ul style="list-style-type: none">• Controller 3200 C• Controller c300• Controller p300• Controller p500
software manuals Online helps	Lenze Engineering Tools: <ul style="list-style-type: none">• »PLC Designer« (programming)• »Engineer« (parameter setting, configuration, diagnostics)• »VisiWinNET® Smart« (visualisation)• »Backup & Restore« (data backup, recovery, update)

1 About this documentation

More technical documentation for Lenze components

Further information on Lenze products which can be used in conjunction with Controller-based Automation can be found in the following sets of documentation:

Design / configuration / technical data	
<input type="checkbox"/>	Product catalogues <ul style="list-style-type: none">• Controller-based Automation• Controllers• Inverter Drives/Servo Drives
Installation and wiring	
<input type="checkbox"/>	Mounting instructions <ul style="list-style-type: none">• Controllers• Communication cards (MC-xxx)• I/O system 1000 (EPM-Sxxx)• Inverter Drives/Servo Drives• Communication modules
<input type="checkbox"/>	Hardware manuals <ul style="list-style-type: none">• Inverter Drives/Servo Drives
Parameterisation / configuration / commissioning	
<input type="checkbox"/>	Online help/reference manuals <ul style="list-style-type: none">• Controllers• Inverter Drives/Servo Drives• I/O system 1000 (EPM-Sxxx)
<input type="checkbox"/>	Online help/communication manuals <ul style="list-style-type: none">• Bus systems• Communication modules
Sample applications and templates	
<input type="checkbox"/>	Online help / software manuals and reference manuals <ul style="list-style-type: none">• i700 application sample• Application Samples 8400/9400• FAST application template• FAST technology modules

Symbols:

-  Printed documentation
- PDF file / online help in the Lenze engineering tool



Tip!

Current documentation and software updates with regard to Lenze products can be found in the download area at:

www.lenze.com

Target group

This documentation is intended for persons who commission and maintain a Controller-based automation system by means of a Lenze Controller and the »PLC Designer« engineering tool.



Screenshots/application examples

All screenshots in this documentation are application examples. Depending on the firmware version of the field devices and the software version of the Engineering tools installed (e.g. »PLC Designer«), screenshots in this documentation may differ from the representation on the screen.

1 About this documentation

Information regarding the validity

The information provided in this documentation is valid for the following Lenze Controllers:

Controllers	Versions
Cabinet Controller	
 <p>Example: Controller 3241 C with connected I/O system 1000</p>	<ul style="list-style-type: none"> • Controller 3221 C • Controller 3231 C • Controller 3241 C • Controller 3251 C
 <p>Example: Controller c300 with connected I/O system 1000</p>	<ul style="list-style-type: none"> • Controller c300
Panel Controller/HMI	
 <p>Example: Controller p500</p>	<ul style="list-style-type: none"> • Controller p300 • Controller p500

1 About this documentation

1.1 Document history



1.1 Document history

Version			Description
4.0	11/2020	TD06	<ul style="list-style-type: none">• Status LEDs of the Controllers (☞ 92) corrected: Test mode (insufficient application credits).• Chapter Parameter reference (☞ 143) extended:<ul style="list-style-type: none">• C0189 ... C0195, C0619 / C0620, C0660 / C0661• Functionality for activating the field device firmware update extended (C0640).
3.2	05/2017	TD17	<ul style="list-style-type: none">• Error messages (backplane bus) (☞ 52) updated.• Corrected: maximum electronic supply 650 mA for the Controller c300<ul style="list-style-type: none">▶ Limits on the backplane bus (☞ 47)
3.1	11/2016	TD17	Update for the Lenze automation system "Controller-based Automation" 3.14 <ul style="list-style-type: none">• Neu: PROFINET option for Controller c300 and p300• New: Chapter Limits on the backplane bus (☞ 47)• New: Chapter Script commands in PreStart.txt/PostStart.txt (☞ 108)• General corrections
3.0	04/2016	TD17	Update for the Lenze automation system "Controller-based Automation" 3.13 <ul style="list-style-type: none">• New: Controller 3251 C• New: EtherNet/IP™ for Controllers 3200 C and p500• General corrections
2.0	10/2015	TD17	Update for the Lenze automation system "Controller-based Automation" 3.11 <ul style="list-style-type: none">• General corrections• Chapter Safety instructions (☞ 13) extended• Chapter RTC function (Real Time Clock) (☞ 83) new• Chapter Parameter reference (☞ 142) extended
1.7	05/2015	TD17	Update for the "Controller-based Automation" 3.10 Lenze automation system <ul style="list-style-type: none">• General corrections• Chapter Lenze FAST application software (☞ 30)• Chapter "Visualisation" application software (☞ 31)
1.6	01/2015	TD17	Update for the Lenze automation system "Controller-based Automation" 3.9 <ul style="list-style-type: none">• Controller p300: C0427• Chapter »Backup & Restore« (data backup/restore) (☞ 77)• Chapter »EASY Starter - Application Loader« (data transfer) (☞ 78)• Chapter Visualisation with »VisiWinNET®« (☞ 111)
1.5	04/2014	TD17	Update for the "Controller-based Automation" 3.8 Lenze automation system <ul style="list-style-type: none">• Controller c300/p300
1.4	11/2012	TD11	Update for the Lenze automation system "Controller-based Automation" 3.6 <ul style="list-style-type: none">• Controller c300/p300 added (in preparation)
1.3	05/2012	TD11	Update for the Lenze automation system "Controller-based Automation" 3.3 <ul style="list-style-type: none">• Amended by Controllers p500 (panel controllers)
1.2	12/2011	TD11	Update for the Lenze automation system "Controller-based Automation" 3.2
1.1	04/2011	TD11	Update for the "Controller-based Automation" 3.1 Lenze automation system
1.0	10/2010	TD11	First edition on the Lenze automation system "Controller-based Automation" 3.x

1 About this documentation

1.2 Conventions used







This documentation uses the following conventions to distinguish between different types of information:

Type of information	Highlighting	Examples/notes
Spelling of numbers		
Decimal separator	Point	The decimal point is always used. For example: 1234.56
Text		
Program name	» «	»PLC Designer«...
Window	<i>italics</i>	The <i>message window</i> ... / The <i>Options</i> dialog box ...
Variable names		Setting <i>bEnable</i> to TRUE...
Control element	bold	The OK button... / The Copy command... / The Properties tab... / The Name input field...
Sequence of menu commands		If several commands must be used in sequence to carry out a function, the individual commands are separated by an arrow. Select File→Open to...
Shortcut	< bold >	Use < F1 > to open the online help. If a key combination is required for a command, a "+" is placed between the key identifiers: With < Shift >+< ESC >...
Hyperlink	<u>underlined</u>	Reference to further information: Hyperlink to further information .
Icons		
Page reference	 10	Reference to further information: Page number in PDF file.
Step-by-step instructions		Step-by-step instructions are indicated by a pictograph.

1 About this documentation

1.3 Terminology used

1.3 Terminology used

Term	Meaning
Controllers	The Controller is the central component of the Lenze automation system which control the motion sequences by means of the application software. The Controller communicates with the field devices (inverters) via the fieldbus.
Engineering PC	The Engineering PC and the Engineering tools installed serve to configure and parameterise the system "Controller-based Automation". The Engineering PC communicates with the controller via Ethernet.
Engineering tools	Software solutions for easy engineering in all phases which serve to commission, configure, parameterise and diagnose the Lenze automation system. ▶ Engineering tools (□ 27)
FAST	Lenze FAST application software (□ 30)
Fieldbus node	Devices integrated in the bus system as, for instance, Controller and inverter
Field device	
Inverters	Generic term for Lenze frequency inverters, servo inverters
PLC	Programmable Logic Controller (German designation: SPS - Speicherprogrammierbare Steuerung)
RTC	RTC function (Real Time Clock)
UPS	Uninterruptible power system (UPS)
Bus systems	
CAN	CAN (Controller Area Network) is an asynchronous, serial fieldbus system.
	CANopen® is a communication protocol based on CAN. The Lenze system bus (CAN on board) operates with a subset of this communication protocol. CANopen® is a registered community trademark of the CAN user organisation CiA® (CAN in Automation e. V.).
	EtherCAT® (Ethernet for Controller and Automation Technology) is an Ethernet-based fieldbus system which fulfils the application profile for industrial real-time systems. EtherCAT® is a registered trademark and patented technology, licenced by Beckhoff Automation GmbH, Germany.
	Ethernet specifies the software (protocols) and hardware (cables, plugs, etc.) for wired data networks. In the form of "Industrial Ethernet", the Ethernet standard is used in industrial production systems. On the basis of IEEE 802.3, standard Ethernet is specified by the Institute of Electrical and Electronics Engineers (IEEE), USA.
	EtherNet/IP™ (EtherNet Industrial Protocol) is an Ethernet-based fieldbus system that uses Common Industrial Protocol™ (CIP™) to exchange data. EtherNet/IP™ and Common Industrial Protocol™ (CIP™) are brand labels and patented technologies, licensed by the ODVA user organisation (Open DeviceNet Vendor Association), USA.
	PROFIBUS® (Process Field Bus) is a widely used fieldbus system for the automation of machines and production lines. PROFIBUS® is a registered trademark and patented technology licensed by the PROFIBUS & PROFINET International (PI) user organisation.
	PROFINET® (Process Field Network) is a real-time capable fieldbus system based on Ethernet. PROFINET® is a registered trademark and patented technology licensed by the PROFIBUS & PROFINET International user organisation (PI).

1 About this documentation

1.4 Definition of the notes used

1.4 Definition of the notes used

The following signal words and symbols are used in this documentation to indicate dangers and important information:

Safety instructions

Layout of the safety instructions:



Pictograph and signal word!

(characterise the type and severity of danger)

Note

(describes the danger and gives information about how to prevent dangerous situations)

Pictograph	Signal word	Meaning
	Danger!	Danger of personal injury through dangerous electrical voltage Reference to an imminent danger that may result in death or serious personal injury if the corresponding measures are not taken.
	Danger!	Danger of personal injury through a general source of danger Reference to an imminent danger that may result in death or serious personal injury if the corresponding measures are not taken.
	Stop!	Danger of property damage Reference to a possible danger that may result in property damage if the corresponding measures are not taken.

Application notes

Pictograph	Signal word	Meaning
	Note!	Important note to ensure trouble-free operation
	Tip!	Useful tip for easy handling
		Reference to another document

2 Safety instructions

Please observe the safety instructions in this documentation when you want to commission an automation system or a plant with a Lenze Controller.



The device documentation contains safety instructions which must be observed!

Read the documentation supplied with the components of the automation system carefully before you start commissioning the Controller and the connected devices.

In particular, please observe the [Product-specific safety instructions \(19\)](#) in this documentation!



Danger!

High electrical voltage

Injury to persons caused by dangerous electrical voltage

Possible consequences

Death or severe injuries

Protective measures

Switch off the voltage supply before working on the components of the automation system.

After switching off the voltage supply, do not touch live device parts and power terminals immediately because capacitors may be charged.

Observe the corresponding information plates on the device.



Danger!

Injury to persons

Risk of injury is caused by ...

- unpredictable motor movements (e.g. unintended direction of rotation, too high velocities or jerky movement);
- impermissible operating states during the parameterisation while there is an active online connection to the device.

Possible consequences

Death or severe injuries

Protective measures

- If required, provide systems with installed inverters with additional monitoring and protective devices according to the safety regulations valid in each case (e.g. law on technical equipment, regulations for the prevention of accidents).
- During commissioning, maintain an adequate safety distance to the motor or the machine parts driven by the motor.



Stop!

Damage or destruction of machine parts

Damage or destruction of machine parts can be caused by ...

- Short circuit or static discharges (ESD);
- unpredictable motor movements (e.g. unintended direction of rotation, too high velocities or jerky movement);
- impermissible operating states during the parameterisation while there is an active online connection to the device.

Protective measures

- Always switch off the voltage supply before working on the components of the automation system.
- Do not touch electronic components and contacts unless ESD measures were taken beforehand.
- If required, provide systems with installed inverters with additional monitoring and protective devices according to the safety regulations valid in each case (e.g. law on technical equipment, regulations for the prevention of accidents).

2 Safety instructions

2.1 General safety instructions

2.1 General safety instructions



Stop!

Controller c300 and p300

Depending on the system, sporadic cycle time extensions beyond the set cycle time or jitters may occur.

Especially the use of the »EASY Starter«, »Engineer«, »WebConfig« engineering tools, and an online change or data access may cause such an extension of the cycle time and must only be carried out in a machine-safe state.

Scope

The following general safety instructions apply to the Lenze drive and automation components.

In particular, please observe the [Product-specific safety instructions](#) (19) in this documentation!

Also for your own safety



Danger!

If the following basic safety measures are disregarded, severe injuries to persons and damage to material assets may result.

- Lenze drive and automation components ...
 - ... must only be used as directed;
 - ... must never be commissioned if they display signs of damage;
 - ... must never be technically modified;
 - ... must never be commissioned if they are not fully mounted;
 - ... must never be operated without the required covers;
 - ... can have live, moving and rotating parts during and after operation, depending on their degree of protection. Surfaces can be hot.
- Lenze drive and automation components ...
 - ... only use the accessories approved;
 - ... only use original manufacturer spare parts.
- Observe all specifications contained in the enclosed documentation and related documentation.

This is the condition for safe and troublefree operation and the achievement of the specified product features.

The specifications, processes, and circuitry described in this document are for guidance only and must be adapted to your own specific application. Lenze does not take responsibility for the suitability of the process and circuit proposals.

-
- Only qualified personnel may work with and on Lenze drive and automation components. According to IEC 60364 or CENELEC HD 384 these are persons who ...
 - ... are familiar with installing, mounting, commissioning, and operating the device;
 - ... have the corresponding qualifications for their work;
 - ... know and can apply all regulations for the prevention of accidents, directives, and laws applicable on site.

Transport, storage

Transport and storage of the Lenze drive and automation components in a dry, low-vibration environment without aggressive atmosphere, preferably in the packaging provided by the manufacturer. If required, use carrying aids for transport.

- Protect devices against dust and impacts.
- Observe climatic conditions according to the "Operating conditions" section in the "Technical data" chapter of the product catalogue.
- Printed-circuit boards, such as communication cards (MC-Cards), ...
 - ... may only be transported and stored in ESD packaging;
 - ... may only be touched at contact-free positions;
 - ... may only be positioned on suitable underlays (e.g. on ESD packaging or conductive foamed material).

Mechanical installation

- Install the Lenze drive and automation components according to the instructions given in the corresponding documentation.

Select the mounting location so that the "Operating conditions" in the "Technical data" chapter of the product catalogue are guaranteed.
- In the installation space, continuous and sufficient air circulation is absolutely required to dissipate the heat of the device. The ventilation slots must not be covered.
- Provide for careful handling and avoid mechanical overload. During handling neither bend components, nor change the insulation distances.
- The devices contain electrostatic sensitive devices that can be easily damaged by short circuit or static discharge (ESD). Thus, only touch electronic components and contacts if ESD measures were taken before.
- The fixing rail and the mounting plate in the control cabinet have to be conductive and free of lacquer. The mechanical connections have to be ensured.

Electrical installation

- The electrical installation must be carried out according to the appropriate regulations (e.g. cable cross-sections, fuses, PE connection).
Additional information can be obtained from the documentation.
- When working on live components, applicable national regulations (e.g. BGV 3) must be observed.
- The documentation includes notes about wiring according to EMC regulations (shielding, earthing, filters and cable routing). The compliance with limit values required in conjunction with the EMC legislation is the responsibility of the manufacturer of the machine or system.
Warning: The Lenze drive and automation components can be used in industrial environments according to EN 61000-6-4. These devices can cause radio interferences in residential areas. In this case, protective measures may be required.
 - ▶ [Notes on wiring according to EMC](#) (□ 22)
- If specified in the technical data, the components must be installed in housings (e.g. control cabinets) to meet the limit values for radio interferences valid at the site of installation. The housings must enable an EMC-compliant installation. Observe in particular that e.g. the control cabinet doors should have a circumferential metal connection to the housing.
Reduce housing openings and cutouts to a minimum.
- All pluggable connection terminals must only be connected or disconnected when no voltage is applied.

Commissioning

If required, provide systems with additional monitoring and protective devices according to the safety regulations (e.g. law on technical equipment, regulations for the prevention of accidents).

Maintenance and servicing

- The Lenze drive and automation components are maintenance-free. Nonetheless, you have to carry out a visual inspection at regular and sufficiently short intervals considering the ambient conditions.
Check the following:
 - Does the environment still meet the operating conditions specified in the "Technical data" chapter of the product catalogue?
 - Is the heat dissipation impeded by dust or dirt?
 - Are the mechanical and electrical connections still okay?
- If the ambient air is polluted, the cooling surfaces may become dirty or the air vents may be obstructed. Therefore, clean the cooling surfaces and air vents periodically under these operating conditions. Do not use sharp or pointed tools for this purpose!
- Heatsinks get very hot during operation.
Before working on the devices, check the heatsink temperature.
Flammable material or substances must not be placed near the heatsink or get to it.
- After disconnecting the system from the supply voltage, do not touch live device parts and power terminals immediately because capacitors may be charged.
Observe the corresponding information plates on the device.

Cleaning

- Deenergise the complete system before cleaning.
- Heatsinks get very hot during operation.
Before working on the devices, check the heatsink temperature.
- The Lenze drive and automation components can be damaged if they are not appropriately cleaned.
Housings will get scratched or dull if cleaning agents containing alcohol, solvents or abrasives are used.
Electrical components will be damaged if humidity enters in the housing.
- Wipe the housing using a clean, lintfree, soft cloth.
- For stubborn dirt, only use water and an ordinary household cleaning agent or a detergent declared especially for flat screens.
Do not spray the detergent directly on the device. Moisten the cloth only slightly with the detergent.

Disposal

Recycle or dispose of the Lenze drive and automation components according to the applicable regulations.

2.2 Product-specific safety instructions

2.2.1 Controller c300 and p300



Stop!

Depending on the system, sporadic cycle time extensions beyond the set cycle time or jitters may occur.

Especially the use of the »EASY Starter«, »Engineer«, »WebConfig« engineering tools, and an online change or data access may cause such an extension of the cycle time and must only be carried out in a machine-safe state.

2.2.2 Panel Controller/HMI p300 and p500

- When selecting the installation site, be sure to observe an ergonomic position of the screen and pay regard to the incidence of light, which may cause reflections on the screen. Protect the device from direct sunlight since the housing may heat up strongly.
- During installation, there is a danger that the controller will fall out of the mounting cutout. You should therefore secure it to prevent this happening until all screw clamps have been fitted.
- During mounting, the gasket of the front frame is exposed and can be damaged. Check the gasket to make sure it is undamaged before you install the device. Handle the gasket with care during mounting. Protect the gasket from UV radiation.
- The device must be securely seated in the mounting cutout and the front panel seal must be correctly fitted. Otherwise, class of protection IP65 will not be achieved on the front side of the device! (IP rating is not UL-approved.)
- A touchscreen does not comply with the Ergonomics Directive ZH 1/618. This is why it is only designed for shorttime inputs and control functions. For longer inputs, connect an external keyboard.

2.2.3 Heatsink and GapPad strips for Controller 3200 C

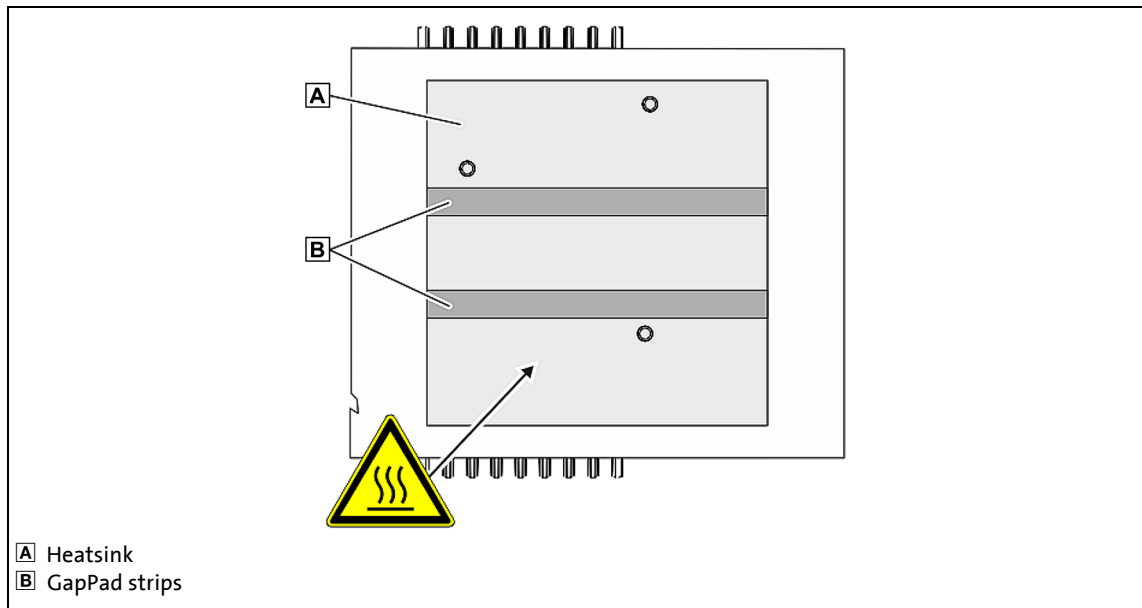

[2-1] Heatsink and GapPad strips on the rear side of the Controller 3200 C

- The heatsink on the rear side of the Controller gets very hot during operation. Before working on the device, check the heatsink temperature. Flammable material or substances must not be placed near the heatsink or get to it.
- On the rear side of the Controller, there are two GapPad strips. These strips serve to thermally connect the device to the DIN rail. If the strips are defective, they must be replaced. Mounting of the device on the DIN rail is limited to 20 plug cycles. Afterwards, you have to exchange the GapPad strips (Lenze order number: EPCZMEG).

2.2.4 I/O system 1000

- Attach and detach Controllers and modules of the I/O system 1000 only when the supply voltage is switched off. Otherwise, they could be damaged by short circuits.
- Always arrange the modules from left to right starting with the Controller directly followed by a power supply module EMPS701 on the right side.
- The module must always be installed directly next to each other. Free slots between the modules are not permissible because otherwise the backplane bus would be interrupted.
- The side contacts of the last module always must be covered with the supplied contact cover. Otherwise, the modules may be damaged by short circuit or static discharge.
- In connection with the EPM-S130 bus coupler module (EtherCAT), only EPM-Sxxx I/O compound modules from hardware version 1B onwards are supported.

2.2.5 Voltage supply (24 V DC) of the Controllers

- The voltage input is not fused internally. The Controller can be destroyed when the input voltage is too high.
Observe the maximum possible input voltage.
Professionally fuse the device on the input side against voltage fluctuations and voltage peaks.
- The Controller starts as soon as the supply voltage is applied. After the operating system has been shut down, the controller switches off automatically. For restarting, the supply voltage has to be disconnected for a short time.
- In the event of an error, the device must be switched to a deenergised state immediately. For this, disconnect the supply connector and a possibly available UPS pack. Afterwards, send the device to the manufacturer. The address can be found on the back cover of this documentation. Please use the original packaging for the return!

2.2.6 RJ45 plug connections

If the RJ45 plug connection is exposed to oscillating or vibrating stress:

- Use a strain relief in the immediate vicinity of the RJ45 socket.
- Select the contact surface on which the device is mounted as fixing point of the strain relief.
- Comply with the related minimum bending radius of the cable used.

2.2.7 Optional capacitor pack (CAPS pack)

- Connect the capacitor pack before switching on the Controller.
- The Controller is only deenergised if the supply cable and the capacitor pack connecting cable have been disconnected.
- The capacitor pack is only deenergised if its capacitors are discharged.
- The capacitor pack must not be charged by means of external battery chargers.

2.3 Notes on wiring according to EMC

General information

- The electromagnetic compatibility of the system depends on the type of installation and care taken. Especially consider the following:
 - Setup
 - Shielding
 - Earthing
- For diverging installations, the conformity to the CE EMC Directive requires a check of the system regarding the EMC limit values.
This is valid, for instance, when unshielded cables are used.
- The compliance of the EMC Directive is in the responsibility of the user.
If you observe the following measures, you can assume that the machine will operate without any EMC problems and that compliance with the EMC Directive and the EMC law is achieved.
If devices which do not comply with the CE requirement concerning noise immunity EN 61000-6-2 are operated close to the system, these devices may be electromagnetically affected by the system.

Setup

- Provide electrical contact between the DIN rail and the earthed mounting plate:
Mounting plates with conductive surfaces (zinc-coated, stainless steel) allow permanent contact.
Painted plates are not suitable for an EMC-compliant installation.
- If you use several mounting plates:
Connect as much surface of the mounting plates as possible (e.g. with copper strips).
- Install data cables separately from the mains cables.
- Lay the cables as close as possible to the reference potential; freely suspended cables act like aerials.

Shielding

- If possible, only use cables with braided shield.
- The overlap rate of the shield should be higher than 80%.
- For data cables for serial connection, always use metal or metallised connectors. Connect the shield of the data cable to the connector shell.

Earthing

- Earth all metallically conductive components using suitable cables connected to a central earthing point (PE bar).
- Maintain the minimum cross-sections prescribed in the safety regulations:
For EMC not the cable cross-section is important, but the surface of the cable and the contact with a cross-section as large as possible, i.e. large surface.

3 Controller-based Automation: Central motion control

3 Controller-based Automation: Central motion control

The Lenze automation system "Controller-based Automation" serves to create complex automation solutions with central motion control. Here, the Controller is the control centre of the system.

System structure of the Controller-based Automation

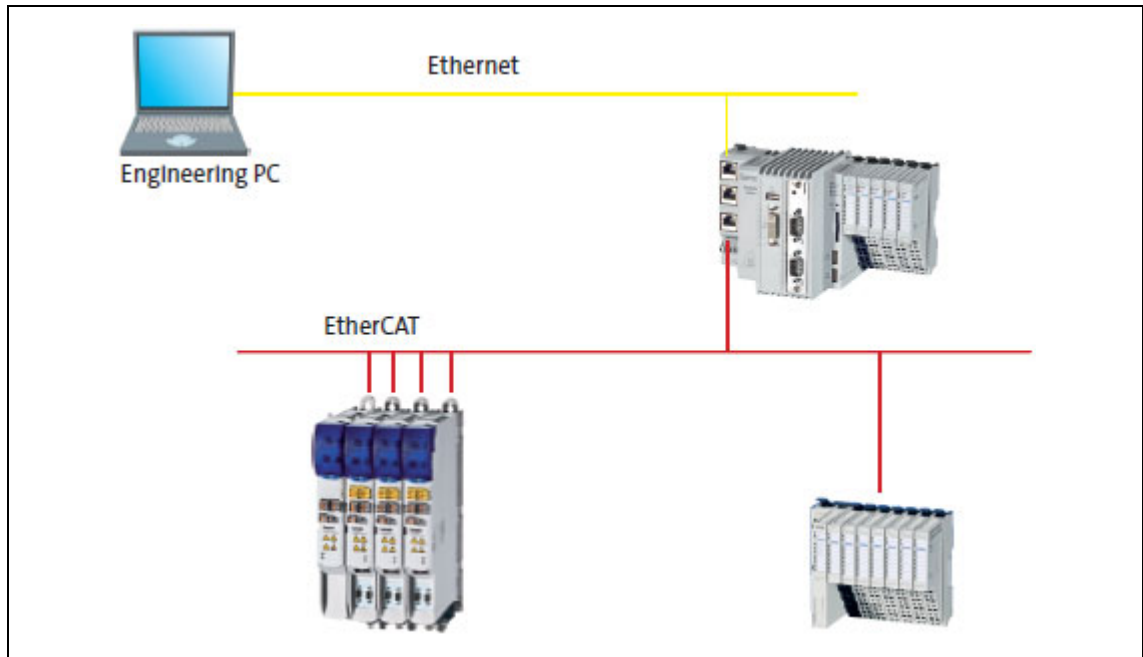

[3-1] **Example:** EtherCAT with Controller 3231 C, I/O system 1000 and Servo-Inverter i700

Lenze provides especially coordinated system components:

- **Engineering software**
The Lenze [Engineering tools](#) (☞ 27) on your Engineering PC (Windows® operating system) serve to parameterise, configure and diagnose the system. The Engineering PC communicates with the Controller via Ethernet.
The Lenze engineering tools are available for download at:
www.lenze.com → **Download** → **Software Downloads**
- **Controllers**
The Lenze Controller is available as Panel Controller with integrated touch display and as Cabinet Controller in control cabinet design.
Cabinet Controllers provide a direct coupling of the I/O system 1000 via the integrated backplane bus.
- **Bus systems**
EtherCAT is the standard "on-board" bus system of the Controller-based Automation. EtherCAT enables the control of all nodes on one common fieldbus.
Optionally, CANopen, PROFIBUS and PROFINET (Slave) can be used as extended topologies.
With Controllers 3200 C and p500 it is also possible to use EtherNet/IP via the Ethernet interfaces. The controller provides the Ethernet/IP adapter (slave).
Controllers c300 and p300 are provided with an "on board" CANopen interface (in addition to EtherCAT).
- **Inverter (e.g. Servo-Inverter i700)**

"Application software" of the Lenze Controllers

The "application software" of the Lenze Controllers enables the control and/or visualisation of motion sequences.

FAST technology modules allow for the easy development of a modular machine control in the »PLC Designer«.

The following "Application Software" versions are available:

- "FAST Runtime"
The sequence control takes place (by logically combined control signals) in the Controller.
The motion control takes place in the inverter.
- "FAST Motion"
The sequence control and the motion control take place in the controller.
The inverter merely serves as actuating drive.
Motion applications make special demands on the cycle time and real-time capability of the bus system between the Controller and the subordinate fieldbus nodes. This is the case, for instance, if the nodes are to be traversed in a synchronised way or position setpoints are to be transferred.
- "Visualisation"
The optional visualisation of the automation system can be used separately or additionally to "FAST Runtime" or "FAST Motion".
For this purpose, an external monitor panel/display can be connected to the Cabinet Controller 3231 C/3241 C/3251 C.

3 Controller-based Automation: Central motion control

Fieldbus communication

The Lenze controllers have different interfaces for fieldbus communication:

Range	Cabinet Controller		Panel Controller	
	c300	3200 C series	p300	p500
Interfaces (on board)				
Ethernet	1	2	1	2
EtherNet/IP	-		-	
EtherCAT	1 ¹⁾	1	1 ¹⁾	1
CANopen	1	-	1 ²⁾	-
Optional interfaces (communication cards)				
CANopen MC-CAN2	-	●	-	● ²⁾
PROFIBUS master MC-PBM	-	●	-	●
PROFIBUS slave MC-PBS	-	●	-	●
PROFINET device MC-PND	●	●	●	●
Ethernet MC-ETH	-	●	-	●
Serial interfaces MC-ISI	-	●	-	●

1) Only the master functionality is supported.

2) Up to release 3.9: "EL 100 CAN" driver / from release 3.10: "Lenze CAN driver"

Ethernet interface

The Ethernet interface serves to connect the Engineering PC or to create line topologies (no integrated switch for Controller c300/p300).

With Controllers 3200 C and p500, the Ethernet interfaces also provide for EtherNet/IP communication.

4 System structure

This chapter provides you with an overview of the basic system structure of the Lenze "Controller-based Automation" system. The system consists of an **Engineering PC**, a **Controller** and the devices communicating with the Controller via the **fieldbus**.

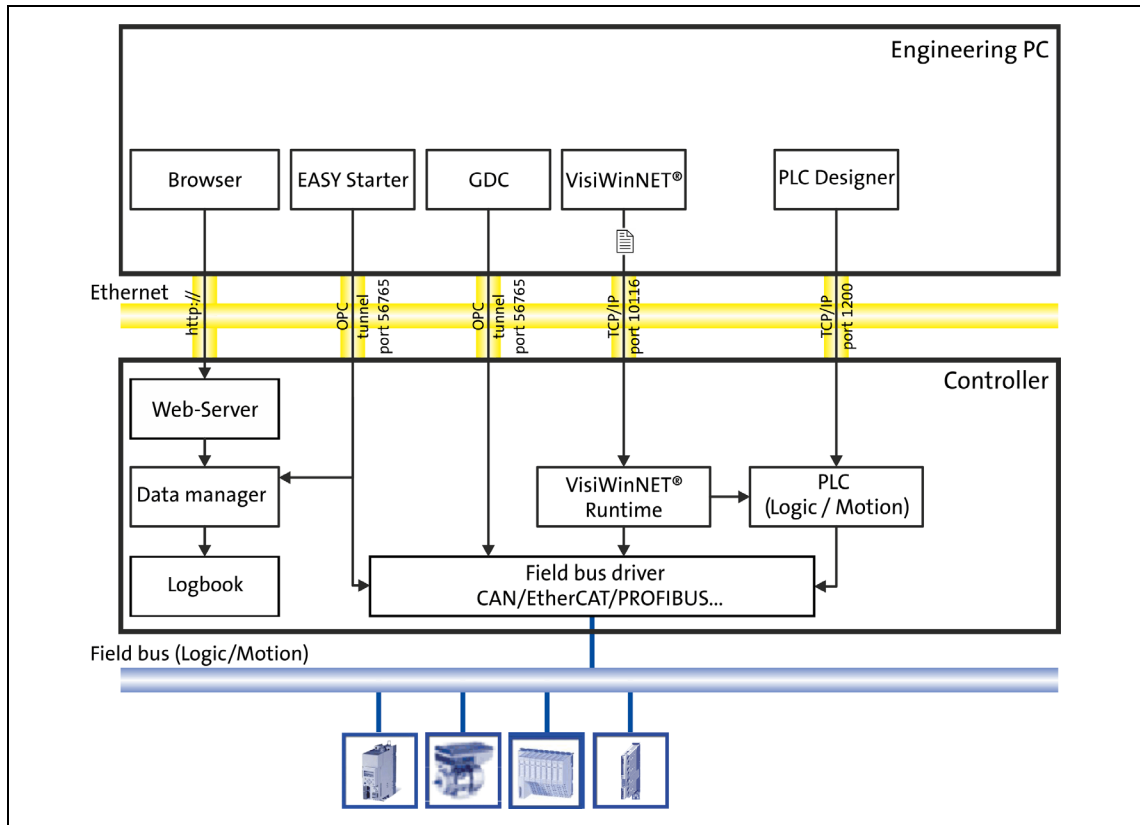

[4-1] System structure of the "Controller-based Automation" Lenze automation system

Controllers and field devices form the automation system to be commissioned via the Engineering PC. The Engineering PC is a PC/Laptop with Windows® operating system and network connection. The Engineering PC comes installed with the Lenze [Engineering tools](#) (□ 27) for parameter setting, configuration, programming and diagnostics.

The Controller with the PLC (Logic/Motion) is the central control unit, consisting of the [Lenze FAST application software](#) (□ 30) with the running PLC application.

Device-internally, the Controller comes with a data manager for configuring and managing the data of the automation system. The data manager and the fieldbus driver enable the PLC (Logic/Motion) to access the system components and the field devices (inverter).

The fieldbus enables the Controller to read and write the parameters of the connected field devices.



Note!

There is no OPC server available for **PROFIBUS** and **PROFINET**.

The **PROFIBUS** fieldbus driver can only be accessed via the PLC (Logic/Motion). Access via »EASY Starter« and »VisiWinNET®« is not provided.

4 System structure

4.1 Engineering tools

4.1 Engineering tools

The Engineering PC is a PC/Laptop with Windows® operating system and network connection.

The Engineering PC comes installed with the Lenze Engineering tools which enable the desired automation solution to be ...

- parameterised/configured,
- programmed,
- diagnosed.

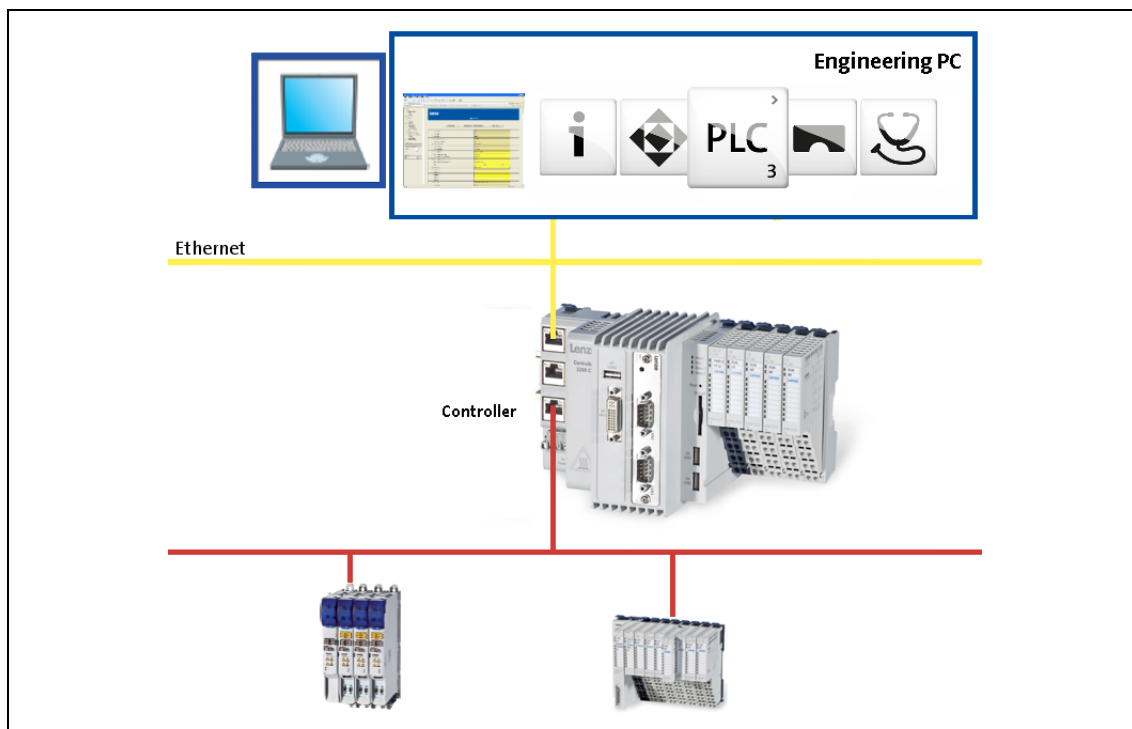

[4-2] Engineering tools for the "Controller-based Automation" Lenze automation system

The Lenze engineering tools are available for download at:

www.lenze.com → Download → Software Downloads



»EASY Navigator«: Starting the suitable Engineering tool

The Lenze Engineering software consists of the Engineering tools optimised for the respective Engineering stage.

The »EASY Navigator« represents the Lenze Engineering tools installed on the Engineering PC. Start the desired Engineering tool via the corresponding button:



The »EASY Navigator« ...

- simplifies the selection of the Engineering tool, depending on the Engineering phase.
- simplifies starting the desired Engineering tool (depending on the application case).
- makes it possible to select the Engineering tool suitable for the Engineering phase.

The overview displays the respective function of the Engineering tools:

What would you like to do?	Button	Engineering tool
Programming <ul style="list-style-type: none"> • Program the controller • Parameterise/commission the Servo-Inverter i700 • Parameterise the I/O system 1000 		»PLC Designer«
Parameterising/configuring the inverter <ul style="list-style-type: none"> • Parameterising and configuring the automation/drive system • Parameterising Inverter Drives 8400/Servo Drives 9400 		»Engineer«
Visualisation <ul style="list-style-type: none"> • Visualising the applications of the automation system • Creating the visualisation/user interfaces 		»VisiWinNET®«
Online diagnostics <ul style="list-style-type: none"> • Easy online diagnostics of the controllers (from »EASY Starter« V1.2) and other Lenze devices 		»EASY Starter« (reading parameters)
Online parameterisation <ul style="list-style-type: none"> • Online parameterisation/commissioning of Lenze devices • Direct online parameterisation when the online connection to the Lenze devices is active. 		»EASY Starter« (reading/writing parameters)
Loading data into the Controller <ul style="list-style-type: none"> • Load PLC programs, parameter sets and application data (LFL file) into the Controller. 		»EASY Starter« Application Loader
Engineering tools that are not included in the »EASY Navigator«:		
Controller parameterisation/diagnostics <ul style="list-style-type: none"> • »WebConfig« can be used on the controller without commissioning (integrated web server). • By the use of »WebConfig«, the parameters of the controller can be accessed via web browser. • »WebConfig« can also be started in the »PLC Designer«. 		»WebConfig«
Backup of controller data <ul style="list-style-type: none"> • Create data backups • Restore data after device replacement • Carry out software update of the Controller 		»Backup & Restore«

4.2

Controller: The control centre of the Controller-based Automation**Cabinet controllers: Compact control cabinet design**

Cabinet controllers are designed for the demanding continuous use in industrial applications. Compared to panel controllers, they are not equipped with an integrated display. The Controllers 3231 C and 3241 C are provided with a DVI interface for the connection of an external monitor panel.

Mounting is carried out in a control cabinet or a corresponding built-in housing on a standard DIN rail (35 mm).

The device-internal backplane bus provides for a direct connection of the I/O system 1000.

Panel controllers: controlling and visualising

Panel controllers are designed for the installation into control cabinets, machine panels, or other mounting cutouts. They are equipped with rear bolts and clamping screws which provide for easy mounting and reliable sealing (front panel enclosure IP65/rear panel IP20) in rough industrial environments. They can be operated easily by directly touching the screen.

From Lenze control technology release 3.10 onwards, the Panel Controllers are provided with PDF viewer, WordPad text editor, Microsoft® Office viewer and web browser. These tools can be executed from the desktop.

**Product catalogue for the Controller**

Here, further information on the device-specific features and technical data can be found.

4.3 Lenze FAST application software

The **Lenze FAST** is installed on the Lenze Controller by default, in the "**FAST Runtime**" version with "**FAST Motion**" for the central control of PLC applications.

"**FAST Motion**" enables an extensive motion control of motion functions. Then inverter then only acts as an actuating drive.

For Panel Controllers, the "**Visualisation**" mode is available in addition, enabling a central visualisation with the Controller.

The application software consists of:

- Windows® CE operating system
- Application Software "FAST Runtime" with "FAST Motion" for controlling motion sequences via standardised "FAST technology modules"
- Optional visualisation software (»VisiWinNET®« Compact CE).

Differences between "FAST Runtime" and "FAST Motion"

FAST Runtime (formerly "L-force Logic" (LPC 1000))	FAST Motion (formerly "L-force Motion" (MPC 1000))
The Controller controls simple motion sequences by <u>logically</u> combined control signals.	The controller controls extensive motion sequences. The "FAST Motion" application software... <ul style="list-style-type: none"> • contains the PLCopen library; • supports "SoftMotion" applications
Logic applications are suitable for the control of inverters <u>without</u> a Motion functionality which ... <ul style="list-style-type: none"> • execute simple motion sequences; • can only be controlled via PLC functionality. 	Motion applications are suitable... <ul style="list-style-type: none"> • for the control of inverters executing complex motion sequences of multi-axes in several dimensions; • ...for the control of devices that are to traverse synchronously; • for the transfer of setpoints.



Note!

Lenze FAST in case of Controller c300 and p300

- The Motion Control libraries are not loaded by default into the library manager.
- FAST Motion for "Coordinated Motion" (robot kinematics) and axes groups are not supported.
- Technology modules "Pick & Place" and "Track Pick & Place" are not supported.

Fieldbus communication

Depending on the application software used (FAST Runtime/Motion), it may be the case that a fieldbus can only be used to a limited extent for a Lenze device series.

Details can be found in the **communication manuals**:

- Controller-based Automation EtherCAT®
- Controller-based Automation CANopen®
- Controller-based Automation PROFIBUS®
- Controller-based Automation PROFINET®

4.4 "Visualisation" application software

Engineering tool required: »VisiWinNET®«

The "Visualisation" application software extends the Controller to be a visualisation device and thus provides for a central visualisation of the system.

The visualisation can either run on a separate Controller or monitor panel or parallel to the "Runtime" or "Motion" application software on the Controller.

Various options described in the following sections are available for the communication link.



Note!

There is no OPC server available for **PROFIBUS** and **PROFINET**.

4.4.1 Sample topology 1: External monitor panel/display for cabinet controllers

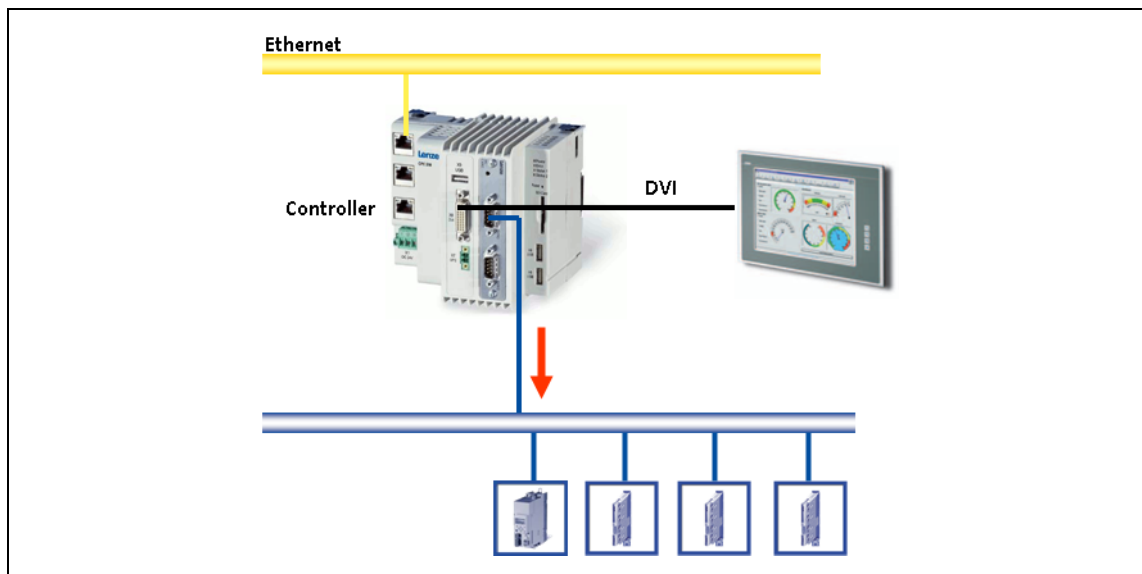

[4-3] **Sample topology:** Controller 3231 C with an external monitor panel (connected to the DVI interface)

This topology with regard to its performance corresponds to the implemented solution (control/visualisation on the same controller). The external monitor panel/display shows the visualisation.

Advantages

- Small amount of cabling
- Protected operating conditions
- Extensible topology

4.4.2 Sample topology 2: Separate control and visualisation

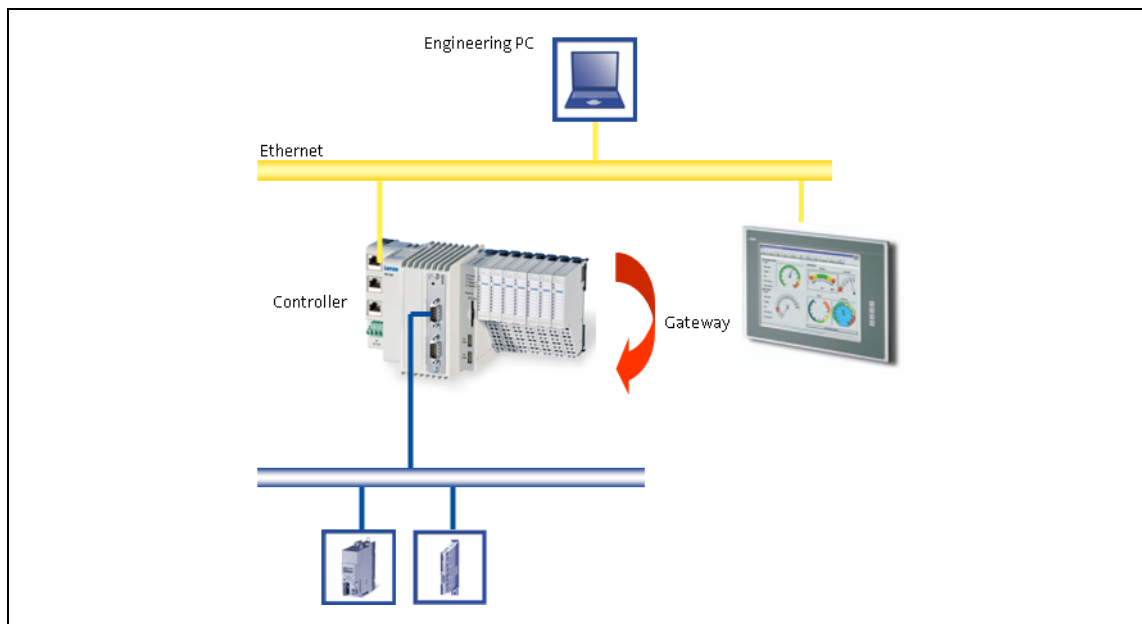

[4-4] **Sample topology:** Controller 3200 C as gateway for the Visualisation Controller (IPC)

The Visualisation Controller (IPC) accesses the field devices via the Controller 3200 C as gateway. In order to separate the control and visualisation, the integrated gateway function of the controller can be used.

The use of this topology is advisable...

- to achieve a higher performance;
- for the use of different operating systems within one automation system.

Engineering tools required: »EASY Starter«, »Engineer«

Advantages

- Several visualisations can access the controller.
- Most suitable for extensive visualisation processes.

4.4.3 Sample topology 3: Independent control and visualisation (CANopen)

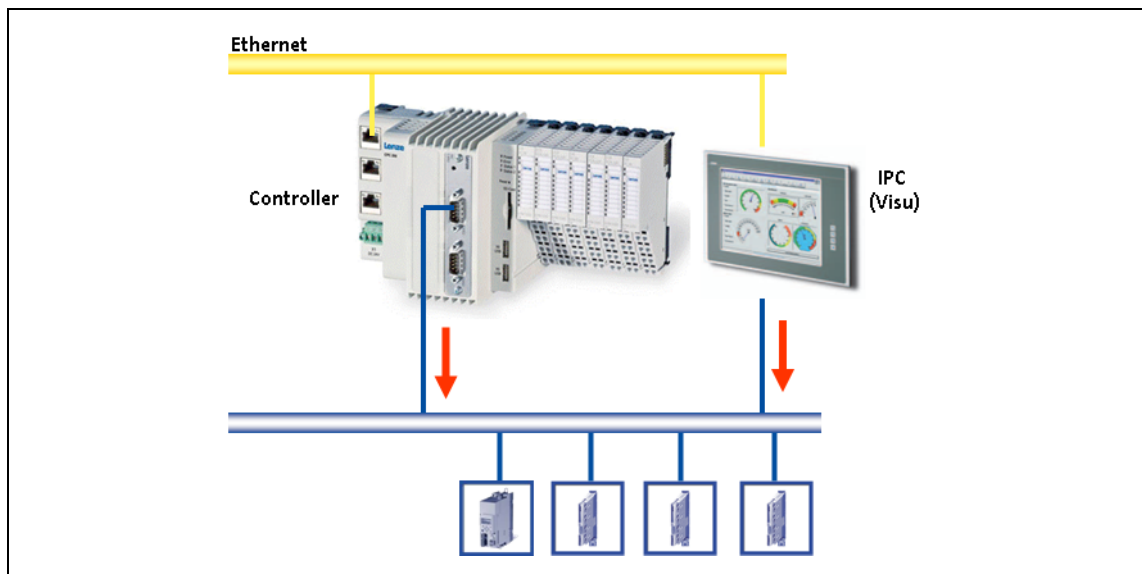

[4-5] **Sample configuration:** Parallel access of Controller 3200 C and Visualisation Controller (IPC)

If this topology is used, the Controller 3200 C and the Visualisation Controller (IPC) access the fieldbus independently of each other.



Note!

The configuration with a control and configuration independent of each other is only available for the **CANopen** bus system!

- CANopen enables (several) fieldbus master independent of each other.
- In connection with EtherCAT, no configuration with two fieldbus masters is possible.

Advantages

- Spatially separate control and visualisation.
- The visualisation has access to the parameters of the field devices.

Disadvantage

- The visualisation may disrupt the real-time capability of the fieldbus. This topology therefore is only suitable for Motion systems to a limited extent (depending on the bus system used).

5 Commissioning the controller

5.1 Identification

5 Commissioning the controller

This chapter provides some general information on the commissioning of a controller. Depending on the actual hardware installed, different settings are required for integrating the controller into a network.



Note!

Please observe the predefined IP address of the controller for the initial commissioning: **192.168.5.99** (Lenze setting).

Further information on how to set the IP address of the Controller can be found here:

▶ [Entering the IP address of the controller](#) (□ 38)

5.1 Identification

Every controller is provided with a nameplate containing the device data. The device data are helpful for identifying the technical equipment of the controller. Detailed information relating to the nameplate data can be found in the product catalogue for the Controller.

Web-based diagnostics/parameter setting

Via »WebConfig« the configuration of the controller can be identified. The parameter values of the controller can be represented using the web browser.

▶ [Online connection from the Engineering PC to the controller](#) (□ 57)

Assigning a unique name to the controller

In order to be able to clearly identify a Controller, the desired name has to be assigned to parameter 13 "System identification: Name" [C0013](#). The name assigned can then be used in the corresponding engineering tool (e.g. »PLC Designer«) to identify the Controller.

5.2 Control elements of the controllers

Depending on the type and equipment, the Lenze Controllers are provided with various control elements (e.g. function keys for external monitor panels) and status LEDs for diagnostic purposes.

▶ [Status LEDs of the Controllers](#) (□ 92)

The controllers can be operated via external input devices (keyboard/mouse). This makes it possible to carry out comprehensive diagnostics and configuration tasks directly on the controller.

5.3

Starting the controller

**Note!**

All Controllers only work with a plugged-in SD card!

The SD card must not be provided with an additional sticker!

During the starting process of the controller

If a non-bootable USB flash drive is connected during the starting sequence, it will be stopped!

- Remove the USB stick and restart the Controller.
- Alternatively, the USB stick can be prepared using the »Backup & Restore« software. Further information can be found in the online help of the »Backup & Restore« software.

When the controller is running

Removal of the SD card will lead to a system failure!

- The SD card must not be removed while the controller is running (no "Hot Plugging" of the SD card possible).
- The SD card is required for the system start since it contains the system files for the starting process.

The internal flash memory and the SD card are the storage media of the controller.

The operating system of the Controller and the [Lenze FAST application software \(□ 30\)](#) are stored in the internal flash memory.

The SD card is used as memory for the following application data:

- PLC boot project
- "Application Credit" for the [Lenze FAST application software \(□ 30\)](#)
- Visualisation
- Databases of the data manager
- prestart.txt/poststart.txt
- Retain and logbook data
- User data (projects and individual data)

The combination of control technology software and application data on the SD card ensures that the data match the prevailing application in the present version.

The SD card serves to easily exchange data in a different device. This serves to avoid automatic, possibly unwanted and difficult-to-master update/downgrade processes.

**How to change the SD card:**

1. For unlocking the SD card, push in lightly and then release.
2. Carefully pull out the SD card.
3. Gently push another SD card into the slot until it clicks into place.

5 Commissioning the controller

5.4 Error case: Controller does not start

IP configuration

The Controller has the preset standard IP address **192.168.5.99**.

The preset IP configuration can be changed in the »WebConfig«.

▶ [Setting IP addresses on the Engineering PC \(example: Windows® XP\)](#) (📖 57)

▶ [Entering the IP address of the controller](#) (📖 38)

After 15 seconds, the network configuration dialog box will close automatically; the controller continues with the starting process.

5.4 Error case: Controller does not start

If the Controller does not start, you can load the Lenze standard settings with the **Reset button**.

▶ [Reset Controller / Load Lenze standard setting](#) (📖 44)

5 Commissioning the controller

5.5 Configuring the controller

5.5 Configuring the controller

This chapter provides information on how to configure the Controller during initial commissioning. The IP address setting is preserved after a restart of the system.

5.5.1 Establishing an automatic dial-up connection

Further information on how to establish an automatic dial-up connection, remote maintenance and diagnostics options can be found under:

- ▶ [Remote maintenance and diagnostics](#) (📖 91)

In order to carry out a remote maintenance on the controller different mechanisms are provided:

- ▶ [Diagnostics via Telnet](#) (📖 96)
- ▶ [Data transfer via FTP](#) (📖 98)
- ▶ [Activate Windows® CE interface](#) (📖 104)
- ▶ [Diagnostics with the logbook](#) (📖 101)

5.5.2 Entering the IP address of the controller

The controller has the following network settings by default:

Address	Lenze setting
IP address	192.168.5.99
Subnetwork	255.255.255.0
Default gateway	192.168.5.1

During initial commissioning of the Controller, the desired IP address has to be entered.

Optionally, the network settings can be selected via a file:

- ▶ [Specifying the IP address of the controller via file \(optional\)](#) (📖 41)

5.5.2.1 Cabinet Controller with external monitor panel (3231 C/3241 C)



Note!

If an external display (monitor panel) is used, the switch-on sequence of display/controller must be observed so that it can be correctly controlled by the controller:

- Connect the external display to the DVI output of the controller and switch it on before switching on the controller.

After connection of a monitor panel/an external display to a running controller, the display resolution is VGA .

- Calibrate the monitor panel/ display connected, so that the screen content can be displayed correctly.



Tip!

Connect a keyboard to the Controller to be able to enter the IP address.

Then you can make the entries:

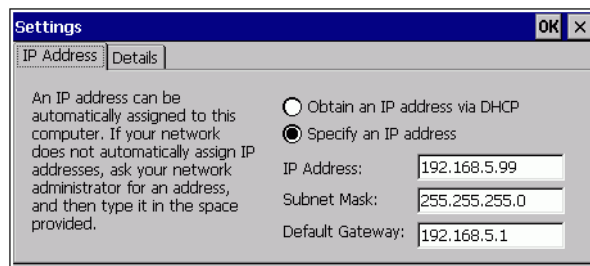

[5-1] IP settings of the controller by default

- Start the control panel with **<Shift>+<F4>**.
- Start the network connections by double-click and enter the IP address, subnet mask, and the default gateway.
- After clicking the **OK** button the IP address is saved and need not be entered again when the system is restarted.

5.5.2.2 Cabinet Controller without an external monitor panel (c300/3221 C/3251 C)

The configuration of a Cabinet Controller without a connected monitor panel requires a PC/laptop with the relevant addresses (IP address, subnet mask, default gateway).

- Connect the PC/laptop to the controller by means of a "crossed" network cable.
- Change the settings on an HTML compliant browser:
 - ▶ [Setting IP addresses on the Engineering PC \(example: Windows® XP\)](#) (📖 57)
- Connection establishment: enter the IP address of the controller in the browser: **192.168.5.99** (Lenze default setting).
- In »WebConfig«, click the **Ethernet** button.
- Enter the desired IP address, subnet mask and default gateway of the Controller.
- Click **Accept & Save all**.
- Set **Use IP configuration** to the value "**Activate device**".
- Click again **Accept & Save all** in order to save the network settings permanently.

5.5.3 Specifying the IP address of the controller via file (optional)



How to proceed:

1. Create file "ip.txt" on the Engineering PC.
2. Save file "ip.txt" to the SD card of the controller by connecting the SD card to the Engineering PC using a memory card reader.

File "ip.txt"

```
172.31.207.88  
255.255.255.0  
172.31.201.1
```

[5-2] Example of an "ip.txt" file for selecting the IP address

In ASCII file "ip.txt" an IP address is defined which can be selected for the controller.

- Copy file "ip.txt" to the root directory of the SD card.
- Insert the SD card into the controller. Then start the controller.
 - ▶ [Starting the controller](#) (36)
- When the system is started ...
 - the controller reads in the IP address file "ip.txt" from the SD card;
 - the controller writes the result (Result) to the ip.txt file:

```
172.31.207.88  
255.255.255.0  
172.31.201.1
```

```
Result: 2010-9-24 14:42:23 :Success: IP Settings taken from file.
```

[5-3] Example of an "ip.txt" file for IP address selection with result entry

- Then, the Controller renames the file: "ip_old.txt".
- To select the IP address once again using the file, the file must be renamed to "ip.txt".



Tip!

The "ip.txt" file can be used to select the use of the DHCP. For this, write "DHCP" into the first line of the file. Then, the following lines will no longer be considered.

5 Commissioning the controller

5.5 Configuring the controller

5.5.4 Establishing Windows® CE access rights

In order to be able to establish a connection to the controller, each user has to be assigned access rights. For this the respective user has to be set up as a Windows® CE user with a user name and a password. Windows® CE users can be set up via »WebConfig« and the »EASY Starter«:

▶ [Setting up Windows® CE users in »WebConfig«](#) (📖 42)

The representation for user 1 is displayed. The users 2 to 10 are displayed analogously.

5.5.4.1 Setting up Windows® CE users in »WebConfig«



Note!

You have to be set up as Windows® CE user to have authorisations for further services like FTP, telnet, or web server access.

- Up to ten Windows® CE users can be set up in »WebConfig« the **User management 10** area.
- Use parameters 101 to 169 to set up the user name, password, and various authorisations for a maximum of ten users.

User 1		
101	WinCe users: user name 1	admin
102	WinCe users: password 1
107	WinCE users: RAS is allowed user 1	<input checked="" type="checkbox"/>
103	WinCE users: FTP is allowed user 1	<input checked="" type="checkbox"/>
104	FTP: permissions user 1	Allow Read <input checked="" type="checkbox"/>
		Allow Write <input checked="" type="checkbox"/>
		Allow Virtual Roots <input checked="" type="checkbox"/>
		Allow Hidden Files <input checked="" type="checkbox"/>
105	FTP: home user 1	\
106	WinCE users: TELNET is allowed user 1	<input checked="" type="checkbox"/>

The representation for user 1 is displayed. The users 2 to 10 are displayed analogously.

Detailed information on the parameters can be found here:

▶ [Basic parameters of the Controllers](#) (📖 146)

5 Commissioning the controller

5.5 Configuring the controller

5.5.5 Use your own background image (Windows® CE)

The standard wallpaper of the panel controller can be replaced by your own wallpaper.

The wallpaper must meet the following conditions:

- File format:
 - p500, 3231 C, 3241 C, 3251 C: Bitmap (*.bmp)
 - p300: Bitmap ([Width]_[Height]_*.bmp, z. B. 480_272_Roboter.bmp)
- The resolution of the image must correspond to the resolution of the monitor panel to achieve a correct representation:

Screen sizes	Panel Controller					
	p300			p500 / Monitor panel for 3231 C/3241 C/3251 C		
Diagonal measurement	10.9 cm (4.3")	17.8 cm (7.0")	26.4 cm (10.4")	17.8 cm (7.0")	26.4 cm (10.4")	38.1 cm (15.0")
Resolution [pixel]	480 x 272 (PSP)	800 x 480 (WVGA)	800 x 600 (SVGA)	800 x 480 (WVGA)	800 x 600 (SVGA)	1024 x 768 (XGA)

- The display of the panel controller p300 can be rotated in 90° steps.
Setting via code: [C0427](#) (📖 178)



How to proceed:

Copy the desired bitmap file to the SD card of the controller, directory: \CustomBitmap.

Directory name on the controller if the SD card has been inserted into the controller:

- **3200 C/p500:** \USBStorage\CustomBitmap
- **p300:** \sdcard\CustomBitmap

5 Commissioning the controller

5.6 Reset Controller / Load Lenze standard setting

5.6 Reset Controller / Load Lenze standard setting

In order to reset the Controller, press the reset pushbutton.

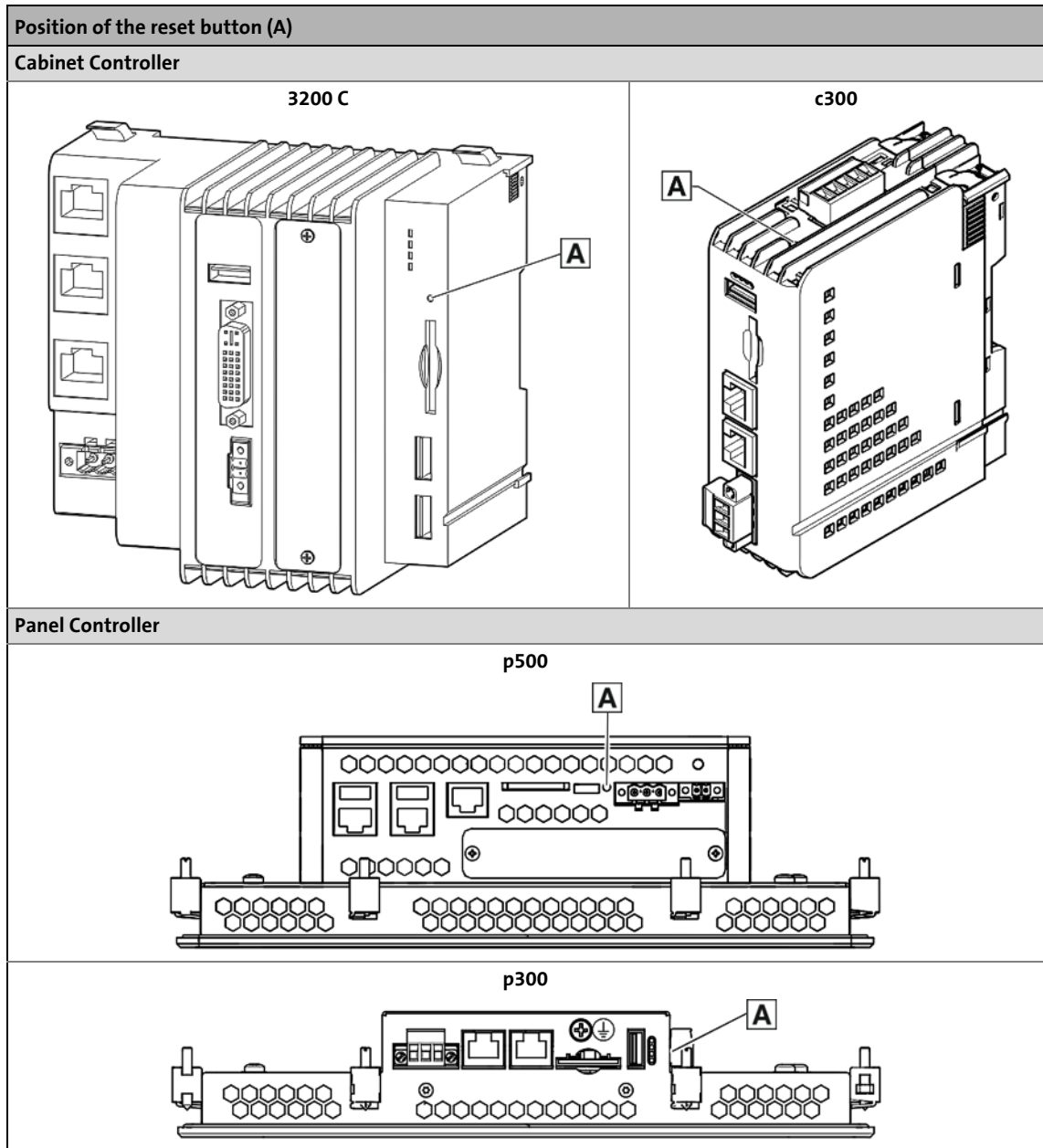

Resetting the Controller:

- Press the reset pushbutton for 4 ... 10 s.
- All LEDs are off during the reset.
- When reset has been executed successfully, the Power LED is lit, depending on the Controller, in green or in blue.
 - ▶ [Status LEDs of the Controllers](#) (92)

Loading the last internally saved firmware of the controller:

- Switch off voltage supply.
- Press Reset button.
- Switch on the voltage supply while the Reset button is pressed and keep the Reset button pressed for at least 10 s.

If the Error-LED is blinking (green/red) after this action, switch off the voltage supply again. The Controller must be disconnected from the mains until all LEDs have gone off.

Then switch on the voltage supply again.

**Note!****EPM-S130 (EtherCAT) bus coupler module**

Only EPM-Sxxx I/O compound modules from hardware version 1B onwards are supported.

The Cabinet Controllers 3200 C and c300 allow for a direct connection of the I/O system 1000 to the integrated backplane bus.

The modules of the I/O system connected to the backplane bus of the Controller can be parameterised in the »PLC Designer«.

**Reference manual for the I/O system 1000**

Here, further information on the parameter setting/configuration can be found.

5.7.1 Limits on the backplane bus

- 3 different update tasks can be executed at a maximum.
- Memory area for the I/O process image: 1792 bytes
- Electronic supply
 - for the Controller c300 maximum 650 mA
 - for the Controller 3200 C maximum 1.7 A

If the power of the bus coupler main supply is not sufficient for supplying the I/O level and/or the electronics, power supply modules (EPM-S701, EPM-S702) can be used.



System manual for the I/O system 1000

Here you'll find more information regarding the system structure with power supply modules (EPM-S701, EPM-S702).

5 Commissioning the controller

5.7 I/O system 1000 at the backplane bus of the Cabinet Controller

5.7.2 Configuring I/O modules at the backplane bus

The following illustration is a schematic representation of the controller hardware structure including I/O modules.

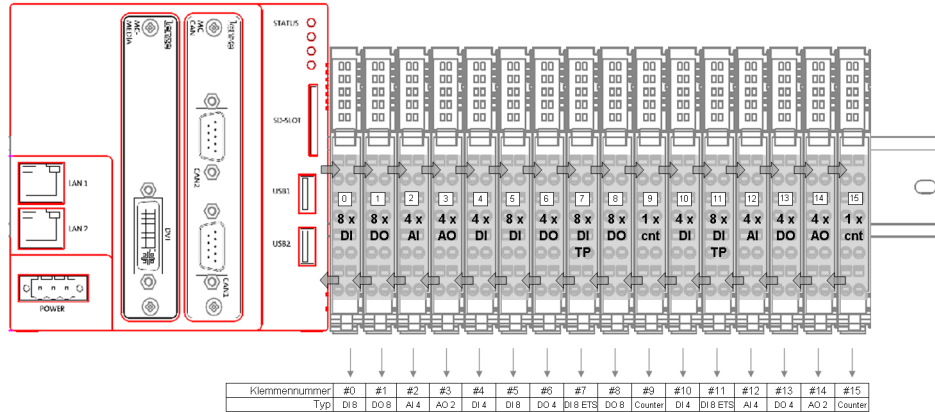

The I/O system 1000 includes the following components:

- I/O module coupler for voltage supply of the I/O compound modules
- I/O compound modules:
Up to 64 modules are possible which are connected to the Controller 3200 C via the Lenze backplane bus.

In order to be able to access the modules by means of a PLC program (read input signals/write output signals), the modules have to be configured in the »PLC Designer«. For this, map the physical arrangement of the I/O modules in the »PLC Designer«.

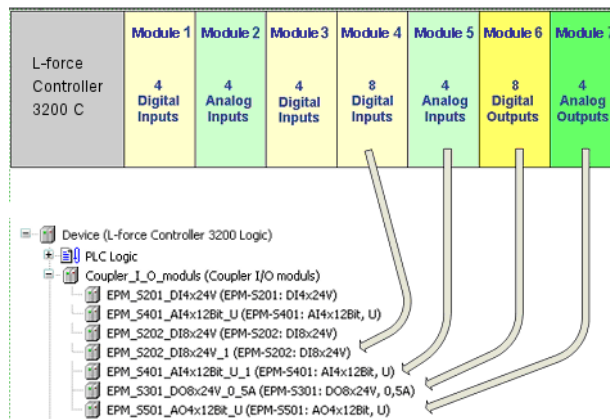

[5-4] Example: mapping the physical arrangement of modules 1...7 in the »PLC Designer«



How to configure the I/O modules in the »PLC Designer«:

1. Go to the context menu of the I/O module coupler and add the used I/O modules with the **Device Add** menu command.

Note: The sequence of the I/O modules in the device tree must comply with the physical arrangement.

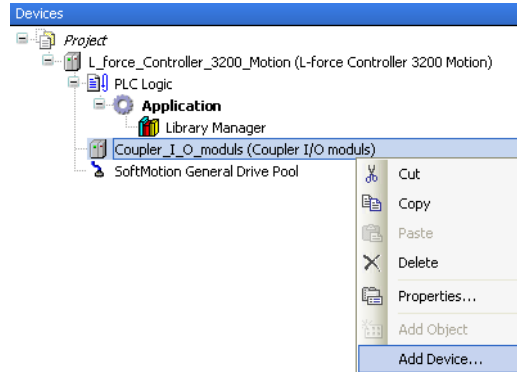

2. View in the device tree/*Device view*:

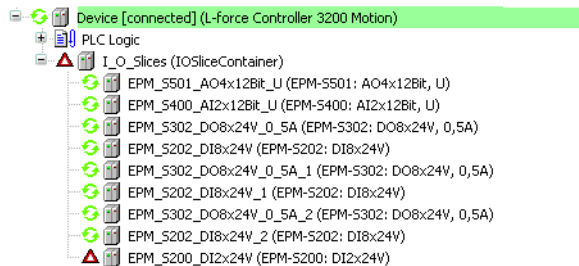

- If everything is configured correctly, all modules are marked with the symbol in the device tree after going online and starting the PLC.
- In the event of an error, i.e. if the configuration deviates from the physical arrangement, the modules are marked with the .

Use the **I/O module coupler** tab for diagnostics purposes using the PLC application.

Example: Insert the `b_myError` variable in this tab. The variable is globally declared and the PLC application is able to evaluate it.

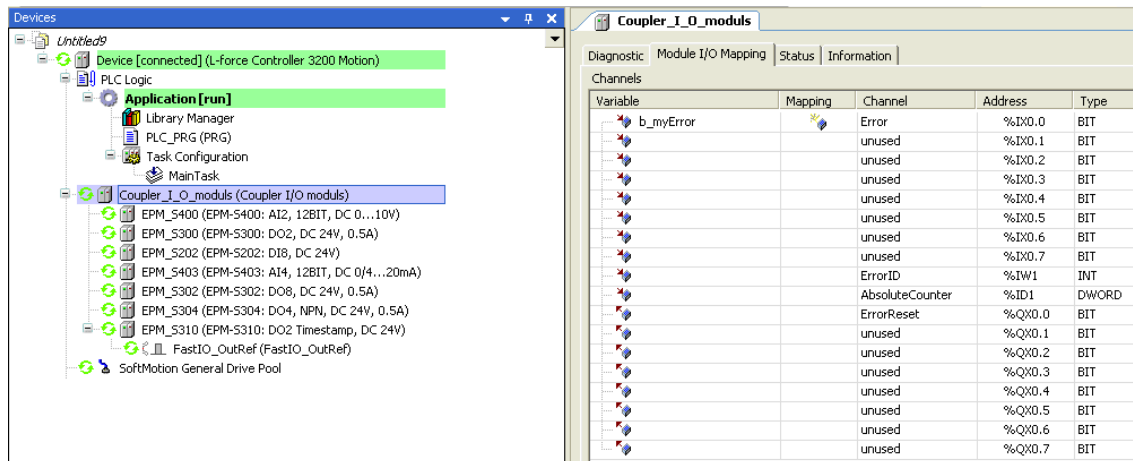

5.7.3 Determining the topology of the I/O modules automatically

In addition to appending devices manually, the »PLC Designer« allows for the automatic recognition of I/O modules connected (fieldbus scan).

For this purpose, execute the **Start Search** command in the context menu of the *I/O module coupler*:

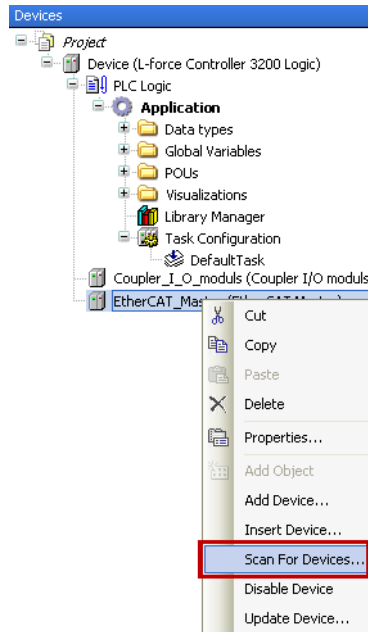

5.8 Tabs of the I/O modules at the backplane bus

The *Workspace* ...

- uses various tabs to display the properties and settings of the module selected from the *Device view*.
- serves to edit the parameters of the individual I/O compound modules.

Depending on the module selected from the *Device view*, different tabs are available in the *Workspace*.

I/O module coupler (backplane bus)

Tab	Contents
Diagnostics	Error status of the modules. ▶ Error messages (backplane bus) (📖 52)
Module I/O coupler	List of all objects available for the parameterisation of the I/O compound modules - digital I/O.
Status	Status information of the module coupler.
Information	Project information and catalogue information of the module coupler.

Each I/O module on the backplane bus is represented by the following tab:

I/O compound modules

Tab	Contents
Parameter	<ul style="list-style-type: none"> • Offline configuration of the I/O module • All parameters of the I/O compound module <ul style="list-style-type: none"> • Parameterising digital modules: <ul style="list-style-type: none"> • Polarity of the control signals, status in the event of an error for digital output modules. • Parameterising analog modules: <ul style="list-style-type: none"> • Signal functions, status in the event of an error. <p>Depending on the type of I/O module, specific settings are possible. More information regarding the I/O system 1000 can be found in the online help.</p>
Module I/O image	Process image of the I/O module
Status	Status information of the I/O compound module.
Information	Designation and layout plan of the I/O compound module

5 Commissioning the controller

5.9 Error messages (backplane bus)

5.9 Error messages (backplane bus)

Error messages are shown under the **Diagnostics** tab of the I/O module coupler.

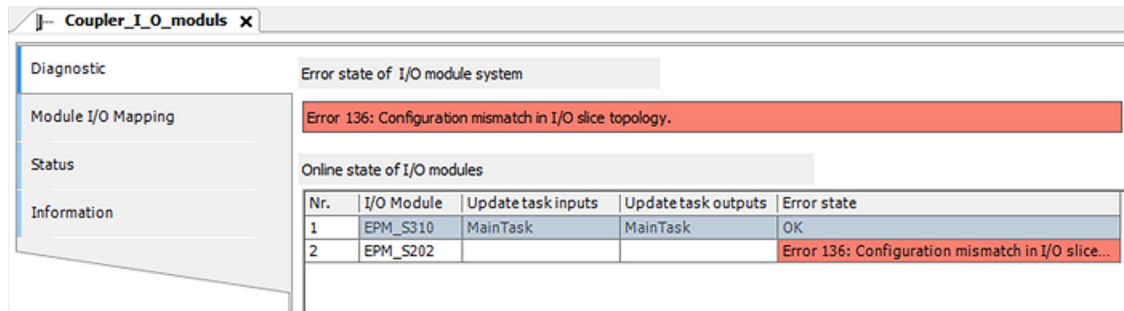

[5-5] Example: Topology error '136', the EPM-S202 module cannot be reached at the backplane bus.

Error description and remedy

If the remedies described do not manage to eliminate the error causes and you have to contact Lenze, provide the following information:

- PLC project («PLC Designer«)
- Bus structure at the backplane bus of the Controller (number and type of all modules connected including the passive modules EPM-S7xx/EPM-S9xx)
- Status of the RUN and MF-LEDs of all modules connected

Error number	Description and remedy
11	Too many I/O modules for the task cycle time selected. • Remedy: Increase the cycle time.
12	FIFO response full. • The Controller could not access all parameters of the I/O modules. The process data communication (PDO) is not limited. • This warning occurs if ... <ul style="list-style-type: none">• the task utilisation at the start of the Controller is near the cycle time and a great many configurable I/O modules are connected to the backplane bus of the Controller;• the task utilisation during operation is near the cycle time and, at the same time, the tabs of configurable I/O modules are shown in the "PLC Designer". • Remedy: increase cycle time of the bus cycle tasks. • The warning can be acknowledged in the «PLC Designer« using the "Reset error" button.
32	Timeout reset • Contact Lenze.
33	Timeout reset error • Contact Lenze.
96 ... 98	Too many I/O modules for the task cycle time selected. • These errors occur at the start of the PLC application. Possible causes and remedies: Too many tasks for the processing of I/O modules. • Remedy: check device tree. A maximum of 3 different tasks must be assigned to the individual I/O modules at the backplane bus as update task. After having updated the Controller firmware: the firmware has not been fully updated. • Remedy: update or restore the Controller again. Controller is defective. • Remedy: replace the Controller.

Error number	Description and remedy
99	<p>Too many I/O modules for the task cycle time selected.</p> <ul style="list-style-type: none"> • The error occurs at the start of the PLC application. • Error when creating the task assigned to the backplane bus. • The number of I/O modules or the size of the process image cannot be processed by the Controller. • Remedy: reduce the number of I/O modules.
100 ... 103	<p>Too many I/O modules for the task cycle time selected.</p> <ul style="list-style-type: none"> • These errors occur during ongoing operation. • Error in the processing of the backplane bus telegrams. <p>Possible causes and remedies:</p> <p>Error in the PLC application (Monitoring the task configuration):</p> <ul style="list-style-type: none"> • The task runtime is exceeded. The runtime of the task is longer than the set task interval. • The jitter of the backplane bus task is too high (>120 µs). <p>Remedy: Die SPS-Applikation auf mögliche Ursachen der Laufzeitverlängerung oder des Jitter prüfen und ggf. korrigieren. Check the PLC application for possible causes of the runtime extension or the jitter and correct it if necessary.</p> <p>EMC impacts (transmission failures):</p> <ul style="list-style-type: none"> • The telegram transmission quality is poor. • Remedy: <ul style="list-style-type: none"> • check the shielding. • Check whether the error is connected to specific events (e.g. starting torque of the drives). <p>Mechanical impact:</p> <ul style="list-style-type: none"> • short circuits of the signal cables by canted sockets. • The telegram transmission quality is poor due to missing or soiled contacts. • Remedy: check and clean the contacts between the I/O modules and the sockets. <p>I/O module is defective.</p> <ul style="list-style-type: none"> • Remedy: replace the I/O modules separately in order to find the defective module. <p>The number of I/O modules or the size of the process image cannot be processed by the Controller.</p> <ul style="list-style-type: none"> • Remedy: reduce the number of I/O modules. <p>Controller is defective.</p> <ul style="list-style-type: none"> • The MF-LEDs of all modules are lit. • Measure voltage at the 5V contacts of the last backplane bus module (pins 3 and 5). • Remedy: replace the Controller.
104 ... 106 116 ... 117	<p>Read semaphore time-out</p> <ul style="list-style-type: none"> • The data exchange between the backplane bus and the PLC application cannot be implemented within the time specified. <p>Possible causes and remedies:</p> <p>Subsequent error of errors 100 ... 103:</p> <ul style="list-style-type: none"> • Check the error sequence in the logbook. • Remedy: eliminate errors 100 ... 103. <p>Error in the PLC application:</p> <ul style="list-style-type: none"> • The task runtime is violated. • Remedy: correct the PLC application. <p>Backplane bus structure:</p> <ul style="list-style-type: none"> • many passive modules (EPM-S7xx/EPM-S9xx) are plugged between the I/O modules • Remedy: remove passive I/O modules, change structure.

Error number	Description and remedy
107 ... 109 119 ... 121	Write semaphore time-out <ul style="list-style-type: none"> The data exchange between the backplane bus and the PLC application cannot be implemented within the time specified. Possible causes and remedies: <ul style="list-style-type: none"> Subsequent error of errors 100 ... 103: <ul style="list-style-type: none"> Check the error sequence in the logbook. Remedy: eliminate errors 100 ... 103. Error in the PLC application: <ul style="list-style-type: none"> The program processing duration is longer than the task cycle time set (task overrun). Remedy: increase the task cycle time set, optimise the program code. Backplane bus structure: <ul style="list-style-type: none"> many passive modules (EPM-S7xx/EPM-S9xx) are plugged between the I/O modules Remedy: remove passive I/O modules, change structure.
110	Internal hardware error at the backplane bus <ul style="list-style-type: none"> Contact Lenze.
136	Configuration error in the I/O module topology <ul style="list-style-type: none"> The I/O modules configured in the PLC application were not found at the backplane bus. Possible causes and remedies: <ul style="list-style-type: none"> The bus structure in the PLC application do not comply with the actual bus structure. <ul style="list-style-type: none"> Remedy: adapt the PLC application to the actual bus structure. There is no contact between the electronic module and the base module of the I/O module. <ul style="list-style-type: none"> Remedy: plug the electronic module tightly onto the base module. There is no contact between two adjacent base modules of the I/O system. <ul style="list-style-type: none"> Remedy: plug in the base modules correctly. An I/O module is defective. <ul style="list-style-type: none"> The MF-LEDs of the module affected are lit. Remedy: replace the I/O module. The voltage supply of the I/O modules has been interrupted. <ul style="list-style-type: none"> When using EPM-S702 modules, check the voltage supply of the modules. Remedy: restore the voltage supply of the EPM-S702 modules. Controller is defective. <ul style="list-style-type: none"> The MF-LEDs of all modules are lit. Measure voltage at the 5V contacts of the last backplane bus module (pins 3 and 5). Remedy: replace the Controller.
137	Too many tasks for the processing of I/O modules. <ul style="list-style-type: none"> Maximum: 3 tasks
138	The device description does not contain any device type. <ul style="list-style-type: none"> Contact Lenze
139	Error while writing the initialisation parameters. <ul style="list-style-type: none"> Contact Lenze.
140	No definition for the number of channels in the device description. <ul style="list-style-type: none"> Contact Lenze
181	The synchronisation of the I/O system is incorrect. <ul style="list-style-type: none"> Contact Lenze.
200	SDO timeout <ul style="list-style-type: none"> Contact Lenze.
220	SDO communication error <ul style="list-style-type: none"> Contact Lenze.
221	The physical I/O module topology could not be read. <ul style="list-style-type: none"> Contact Lenze.

Error number	Description and remedy
222	The I/O system driver (backplane bus driver) could not be started. Possible causes and remedies:
	After having updated the Controller firmware: <ul style="list-style-type: none">• Remedy: update or restore the Controller again.
	Controller is defective. <ul style="list-style-type: none">• Remedy: replace the Controller.

6 Parameter setting using the »WebConfig«

6.1 System structure

6 Parameter setting using the »WebConfig«

This chapter contains information on how to parameterise the Controller via »WebConfig«.

6.1 System structure

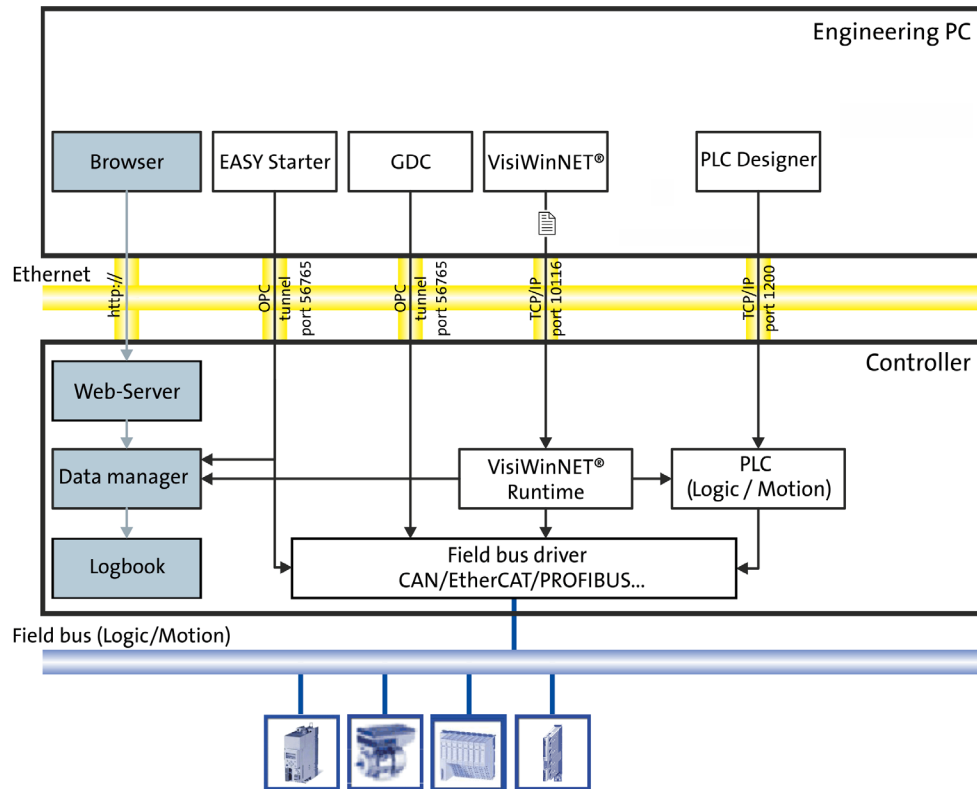

6.2 Parameter setting of the Controller

All settings that can be used for parameterising the controller are included in a numbered parameter list.

»WebConfig« can be remotely called via http by an external Engineering PC which can be reached via network. The Engineering PC is a desktop computer with a Windows® (XP/7) operating system.

▶ [Basic parameters of the Controllers](#) (146)

6.3 Online connection from the Engineering PC to the controller

Connect the Engineering PC to the Controller using a network cable or connect the Controller to the network which is accessed to the Engineering PC.



Note!

In the case of a direct connection between the Engineering PC and the controller, a **crossed** network cable is required.

The settings of the static IP address of the Engineering PC are only to be carried out for the direct connection between the Engineering PC and controller.

6.3.1 Setting IP addresses on the Engineering PC (example: Windows® XP)



Note!

Recommended setting for the Engineering PC:

IP address: <192.168.5.100>

Default settings of the controller:

IP address: <192.168.5.99>, subnetwork <255.255.255.0>.

Setting for the direct connection between Engineering PC and controller:



How to set the static IP address of the Engineering PC:

1. Open the *Network connections* dialog box.
Start → Settings → Network connections
2. Select the network interface which is connected to the Controller.
Right-click **Properties**.
3. Select **Internet protocol (TCP/IP)**.
4. Click the **Properties** button.
5. Select the **Alternate configuration** tab.
6. Select the **User configured** option.
 - Enter the IP address. The subnet range of this IP address and the one of the IP address of the controller must be the same, example: <192.168.5.100> (Lenze setting of the controller: <192.168.5.99>).
 - Enter the subnet mask of the Engineering PC (standard setting: <255.255.255.0>)
7. Close the individual dialog boxes with **OK/Close**.

The Properties of internet protocol (TCP/IP) dialog window

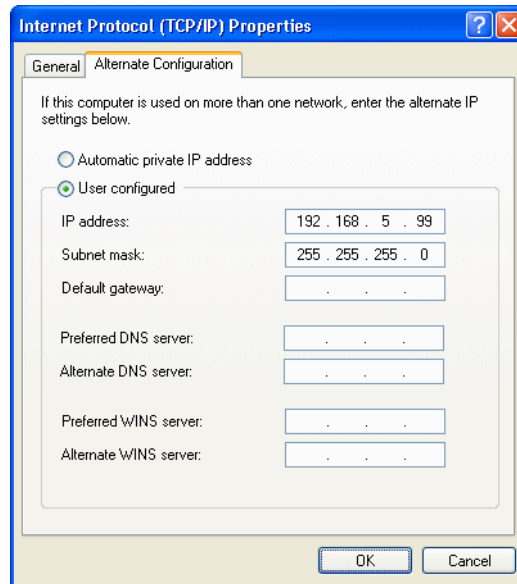

How to set the browser:

1. Open the browser at the Engineering PC.
(This setting refers to the Microsoft Internet Explorer.)
2. Select the *Proxy settings* dialog window:
Tools → Internet Options → Connections → Settings → Advanced
3. Position the cursor in the **Exceptions** field at the end of the entries available.
4. Enter the IP address of the controller: <;192.168.5*> (Lenze setting)
5. Close the individual dialog windows with **OK**.

6.4

Start »WebConfig«

Start a browser at the Engineering PC and enter the IP address of the controller.

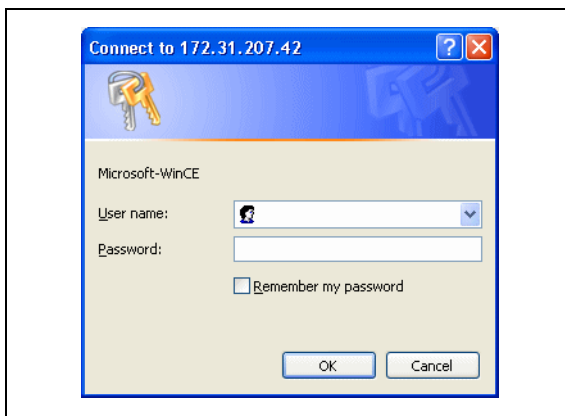

1. Enter <User name:password>. As default setting, **admin:admin** is preselected. Any user set up on the controller can log in.
▶ [User management](#) (66)
2. Confirm with **OK**.
3. Afterwards, »WebConfig« is visible.
▶ [User interface of »WebConfig«](#) (59)

6 Parameter setting using the »WebConfig«

6.5 User interface of »WebConfig«

6.5 User interface of »WebConfig«

The user interface of »WebConfig« is divided into the following areas A - J:

The screenshot shows the Lenze WebConfig interface. On the left is a navigation tree with callouts A through H. On the right, callout I points to a button bar and callout J points to a data table.

Navigation Tree (Callouts A-H):

- A: Parameter list 1, Parameter list 2, PLC, Ethernet, EtherCAT
- B: Diagnostics, LogViewer, Device commands
- C: User management
- D: Clock, UPS settings, Monitoring functions, Memory, Identification
- E: Backup Restore
- F: MC-CAN2
- F: MC-PBM
- G: Polling (Interval: 5 sec, Active:)
- H: Language (English)

Buttons (Callout I): Submit, Submit & Persist All, Refresh

Data Table (Callout J):

L-force Controller		
13	System identification: name	WindowsCE
15	System identification: user name	guest
16	System identification: description	WindowsCE Device
3	Device: name	CPC210
4	Device: software revision	3.0.0.972
5	Device: hardware revision	3.0.0.0
6	Device: serial number	PROTO007
7	Device: manufacturer	Lenze
8	Device: manufacturing date	30.03.2010
CPU		
20	CPU: name	Intel Atom Z5xx



Note!

The representation of the user interface in area F depends on the respective system configuration!

Range	Information
Menu buttons	A Device parameters of the controller (61) <ul style="list-style-type: none"> • Parameter list 1: All parameters of the standard device • Parameter list 2: All parameters of the installed communication cards • PLC parameters • Ethernet (on board) parameters • EtherCAT parameters
	B Diagnostic/device commands (62) <ul style="list-style-type: none"> • Logbook parameters • Logbook of the controller • Device commands
	C User management (66) ... for settings of the users 1 - 10
	D General parameters (66) <ul style="list-style-type: none"> • Time • UPS settings • Monitoring functions • Memory • Diagnostics
	E »Backup & Restore« ... for carrying out a backup, restore or software updates Detailed information regarding the parameters of the »Backup & Restore« can be found here: ▶ Backup & Restore (183) Further information on how to carry out a backup, restore or software updates can be found in the »Backup & Restore« software manual.
	F Parameters of the communication cards (MC cards) (67) <p>Note:</p> <ul style="list-style-type: none"> • The represented parameters of slots 1 and 2 depend on the corresponding communication cards that are installed! • The additional buttons for the actually installed communication cards are automatically added to the menu buttons. • The top-down order of the buttons corresponds to the order in which the communication cards have been installed (slot 1, slot 2). Detailed information regarding the parameters of the communication cards can be found here: ▶ Parameter reference (142)
	G Polling (67)
	H Language selection (67)
Buttons	I Parameter list buttons (67)
Display range	J Parameter display Depending on the selected menu button, the parameters can be viewed in this area. <ul style="list-style-type: none"> • Parameter numbers • Name of the parameter • Representation of the display, entry, selection, control and list fields.



Depending on the equipment of the controller, deviating components are shown by use of the menu control fields.

Detailed information on the parameters of the Controller can be found here:

▶ [Basic parameters of the Controllers \(146\)](#)









Representation of parameter values

In the display area of »WebConfig«, settings of device parameters are represented with different background colours which have the following meaning:



Colour	Example	Meaning
Pale yellow		Parameter (read only) • Display of status information and actual values.
yellow		Parameter (read and write) • The current parameter value of the device is displayed. Changes with regard to a parameter have to be transmitted to the device with Accept or Accept & Save All .
red		Entry of a value beyond the valid range • Via Refresh the original value is shown again. • A correct value can be entered in the red input field and transmitted to the device with Accept or Accept & Save All .

In the following the individual menus of the web-based parameterisation »WebConfig« are described.

6.5.1 Device parameters of the controller

Button	Function
 Parameter list 1	Displays all parameters of the standard device of the controller in numerically ascending order. This user interface helps you to e.g. ... • find system properties and version numbers (read-only parameters); • set the system time; • Activate the USB connection at the front of the monitor panel. ▶ Basic parameters of the Controllers (□ 146) The other menu buttons of the areas  ,  and  are a filtered view of parameter list 1.
 Parameter list 2	Displays all parameters of the installed communication cards in numerically ascending order. The top-down order of the parameters corresponds to the order in which the communication cards have been installed (slot 1, slot 2). Detailed information on the parameters of the communication cards can be found here: ▶ Parameter reference (□ 142) The other menu buttons of area  are a filtered view of parameter list 2.
 PLC	Displays the PLC parameters in numerically ascending order. From this user interface can e.g. be seen: • PLC status • Information on a PLC project Detailed information on the parameters of the PLC can be found here: ▶ PLC (Logic/Motion) (□ 181)
 Ethernet	Displays the Ethernet parameters in numerically ascending order. On this user interface, the network settings of the network connection are displayed/set. Detailed information on the Ethernet parameters can be found here: ▶ Ethernet (□ 187)
 EtherCAT	Displays the EtherCAT parameters (information on EtherCAT master and EtherCAT slaves). Detailed information on the EtherCAT parameters can be found here: ▶ EtherCAT (□ 189)

6.5.2 Diagnostic/device commands

Button	Function
 Diagnostics	Displays parameters of the following areas: <ul style="list-style-type: none"> • Diagnostics • Logbook In the <i>Logbook</i> area you can configure settings regarding the Logbook . Further information on remote maintenance options of the Controller can be found here: ▶ Remote maintenance and diagnostics (📖 91)
 Logbook	Displays logbook contents. <ul style="list-style-type: none"> • Different filter settings display, for instance, only the oldest or only the most recent logbook entries. ▶ Logbook (📖 63)
 Device commands	Displays the commands of the Controller to be executed. The available commands can be found in the following section under 18 (C0018) ▶ Basic parameters of the Controllers (📖 146)

6 Parameter setting using the »WebConfig«

6.5 User interface of »WebConfig«

6.5.3 Logbook

This user interface displays the logbook information of the Controller.

The logbook offers various filter options to systematically display specific logbook contents.



Note!

If the **ClearLog** button is clicked, the entire logbook contents of the controller are deleted without further query!

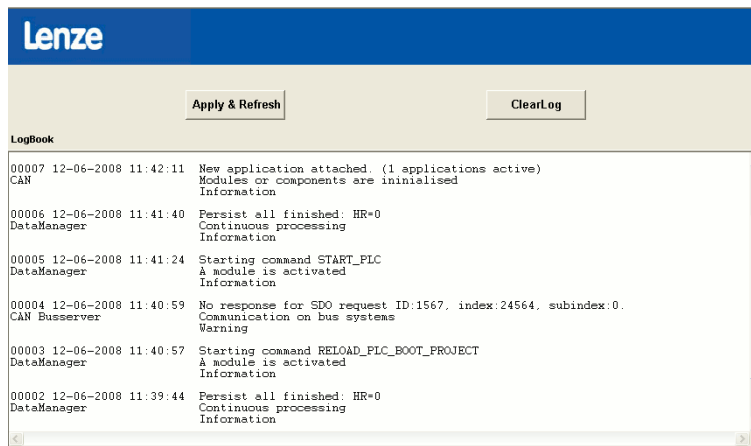

6.5.3.1 Structure of a logbook entry: example

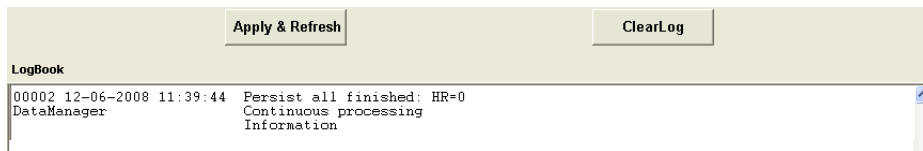

Logbook entry, example	Meaning
00001	Consecutive number of the entry
2009-03-24 14:45:26	Date (year/month/day) and time (hour/minute/second) on the Controller when the logbook entry was made
Log service	Application that has triggered the entry (application)
Logbook deleted	Description of the event
Continuous processing.	Event origin within the application (area)
Warning	Severity of the event

6.5.3.2 Filter options

Section	Information
Logbook	Display logbook entries ▶ Structure of a logbook entry: example (📄 63)
Time period	Select filter for the time period of the logbook entries shown <ul style="list-style-type: none"> The logbook will only display entries which are in the selected time period.
Application	Set filter for the application <ul style="list-style-type: none"> The logbook will only display entries for the selected applications.
Severity	Set filter for the severity of the error messages displayed <ul style="list-style-type: none"> The logbook will only display entries that correspond to the severity selected. The "Information" severity is deactivated by default. In order to show all logbook entries, the "Information" option is to be activated
Range	Set filter for the origin of the event <ul style="list-style-type: none"> The logbook will only display entries that correspond to the selected area.

6.5.3.3 Time filter for the display of logbook entries

Time Period	All
- From	2009 03 10 15 05 11
- To	2009 03 10 15 05 11
- Last	Days

Range	Filter option	Function
Time period	1: All	Display all entries
	2: From - to	Filter entries according to date specified
	3: Last	Display last entries only. Possible filter options: <ul style="list-style-type: none"> 1: Days 2: Weeks 3: Months 4: Years
-from	Time zone: <ul style="list-style-type: none"> Date (year/month/day) Time (hour/minute/second) Example: 10th March 2009, 15.05 hours, 11 seconds: UTC 2009 03 10 15 05 11	Date specification for filtering the entries to be displayed <ul style="list-style-type: none"> Starting date from which the entries are to be displayed
-to	Time zone: <ul style="list-style-type: none"> Date (year/month/day) Time (hour/minute/second) 	Date specification for filtering the entries to be displayed <ul style="list-style-type: none"> Target date up to which the entries are to be displayed
-last	1: Days 2: Weeks 3: Months 4: Years	Display entries according to filter options. <ul style="list-style-type: none"> To activate this filter option, in the Time period area of the selection list the last item must be selected!

6.5.3.4 Saving log files with mains failure protection

The log files are persisted automatically at certain events.

▶ [Diagnostics with the logbook](#) (📖 101)

You can also persist the log files manually by means of the »EASY Starter« and »WebConfig«.



How to proceed:

1. Click the **Device commands** button.
2. Select the entry "1282: Persist logbook" from the **Commands** list field.
3. Click the **Accept** button.
OK appears in the "Status" field.

6.5.3.5 Exporting logbook entries



How to export the logbook entries to a text file (without using the »EASY Starter«):

1. Establish online connection to the controller.
▶ [Entering the IP address of the controller](#) (📖 38)
2. Available logbook entries can be seen on the **Logbook** tab.
3. Click the **ExportLog** button in the header of the logbook to export the logbook entries to a file.

The contents of the logbook is exported to a German (*_de) and English file (*_en) to the memory card in the directory \USBStorage\export\log (with 3200 C/p500) or \sdcard\export\log (with c300/p300).

The directory is already preinstalled on the SD card by default.

Notes:

- The contents of the logbook can also be exported to a USB stick (connected to the Controller). To be able to export the contents of the logbook to the USB stick, create the \export\log subdirectory manually on the USB stick prior to export.
- The execution of an **ExportLog** is entered into the logbook as "information". Entries of the "information" type can only be seen in the logbook if the corresponding filter options are set in the **logbook**.

Export logbook entries via device command

The logbook export can also be started by writing to command parameter **18** ([C0018](#)) via PLC or »VisiWinNET®«.

In the section **Device commands** (parameter 18), execute the **304: Export complete logbook** command to export the logbook entries.

6.5.4 Device commands

In this area, the available device commands of parameter **18** ([C0018](#)) can be executed.

Parameter **19** ([C0019](#)) shows status information relating to the executed command.

▶ [Basic parameters of the Controllers](#) (📖 146)

Saving parameters of the controller

The parameters of the controller can be saved with the **Persist all data** device command.



How to proceed:





1. Click the **Device commands** button.
2. Select the entry "279: Persist all data" from **Commands** list field.
3. Click the **Accept** button.
OK appears in the "Status" field.

6.5.5 User management

This section sets up the Windows® CE users (users 1-10) and defines their access authorisations.

Button	Function
 User management	Set up Windows® CE user, enter user-specific data <ul style="list-style-type: none"> • Enter user name and password, and the home directory. • Enter access authorisation of the user. Standard value for user 1: admin:admin

6.5.6 General parameters

Button	Function
 Clock	Displays the parameters for setting the time, date, system time, and time zone.
 UPS settings	Shows the UPS settings for the parameterisation of the UPS (provided depending on the device/with UPS option).
 Monitoring functions	Displays hardware/temperature data.
 Memory	Displays information on program/Flash memories.
 Diagnostics	Displays information on system diagnostics.

6 Parameter setting using the »WebConfig«

6.5 User interface of »WebConfig«

6.5.7 Parameters of the communication cards (MC cards)

Basically we distinguish between parameters of the on-board interfaces and parameters of the communication cards.

This area of »WebConfig« displays the parameters of the installed communication cards. The following communication cards can be used:

- MC-ETH (Ethernet)
- MC-ETC (EtherCAT)
- MC-CAN2 (CAN)
- MC-PBM (PROFIBUS master)
- MC-PBS (PROFIBUS slave)
- MC-PND (PROFINET device)
- MC-ISI (serial interfaces RS-232/422/485)

A communication card can be equipped with several interfaces, such as the MC-CAN2 communication card.

Detailed information regarding the parameters of the communication cards can be found here:

▶ [Parameter reference](#) (📖 142)

6.5.8 Polling

This menu can be used to activate the automatic, interval-controlled update of the screen contents:

Polling	
Interval	<input type="text" value="5"/> sec
Active	<input type="checkbox"/>

Interval:

Specify period of time in seconds, defining the intervals in which the screen content is automatically updated.

Sample value '5': Update is carried out every 5 seconds.

Activation:

Tick the checkmark (☑) to activate the automatic update.

6.5.9 Language selection

The desired language settings can be selected in the *Language* section.

The language settings take immediate effect.

6.5.10 Parameter list buttons

Button	Function
Apply	Accept data. After a system restart changed data is lost, as it is not persisted automatically.
Accept & Save all	Accept and save all changed data. The data will remain on your PC after a system restart.
Build	Reload data and update screen content.

7 Programming with the »PLC Designer«



This chapter provides you with general information on the programming of the control function of the controller.

The »PLC Designer« is a Lenze Engineering tool for the creation of PLC programs according to IEC 61131.

The following programming languages can be used:

- Instruction list (IL),
- Ladder diagram (LD),
- Function block diagram (FBD),
- Structured text (ST),
- Sequential function chart (SFC),
- Function block diagram (CFC).

The completely created and compiled PLC program can be transferred to the controller by means of the »PLC Designer«.

The PLC program can then be executed on the Controller using the "Runtime" or "Motion" [Lenze FAST application software](#) (☞ 30).

7 Programming with the »PLC Designer«

7.1 System structure

7.1 System structure

Install the »PLC Designer« on the Engineering PC. Via Ethernet, the »PLC Designer« accesses the Controller:

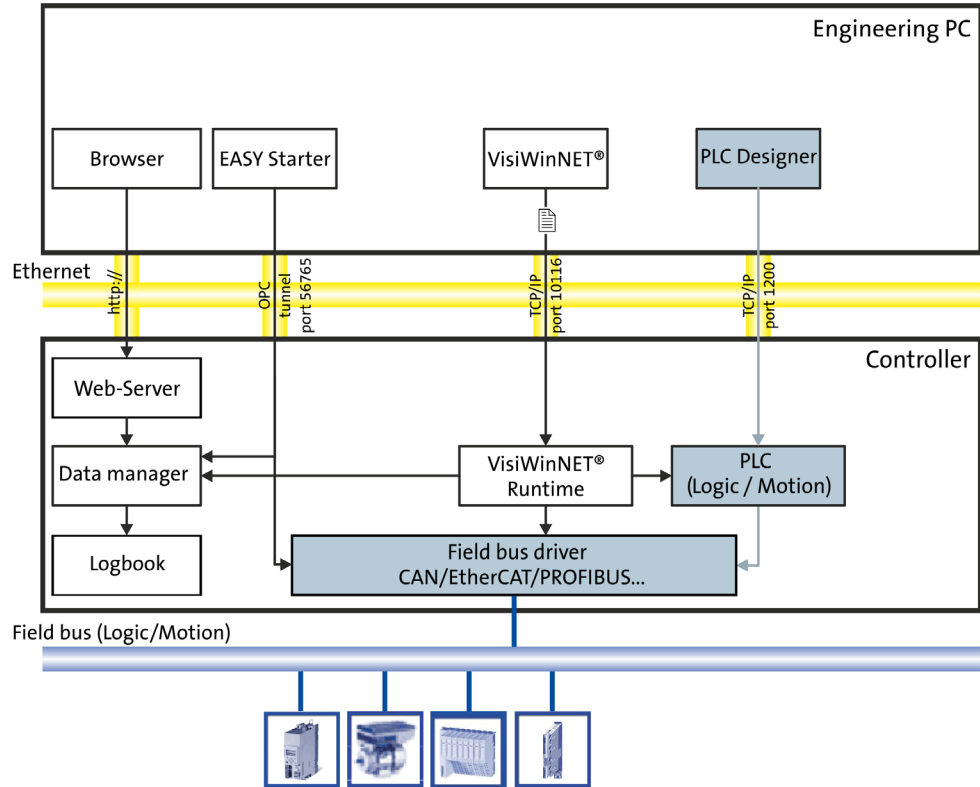

7.2 Function blocks

The »PLC Designer« contains function blocks which enable the PLC program to directly access the parameters of the Controller and the connected field devices.

Parameters which can be accessed are ...

- device parameters or logbook entries of the Controller;
- device parameters of the field devices (example: Servo Inverter i700).

Memory sizes of the Lenze Controllers

Memory area/data	Controllers	Value
Total RAM memory (Program memory/data memory)	3221 C 3231 C 3251 C	2 GB DDR3-RAM
	3241 C	1 GB DDR2-RAM
	c300	512 MB DDR3-RAM
	p300	
	p500	2 GB DDR3-RAM
Retain and persistent data	3221 C 3231 C 3251 C	60 kB
	3241 C	1 MB (with external battery pack/capacitor pack)
	c300	128 kB
	p300	
	p500	1 MB
Fixed memory (flash)	4 GB	
Flag	4 kB	
Maximum number of tasks	32	
Shortest task time	3221 C 3231 C 3241 C 3251 C	1 ms (default setting: 4 ms)
	c300	EtherCAT: 4 ms (a 2 ms reserve of which cannot be used.) CAN: 10 ms (a 5 ms reserve of which cannot be used.)
	p300	
	p500	1 ms (default setting: 4 ms)
Watchdog monitoring time (Lenze standard setting)	3221 C 3231 C 3241 C 3251 C	3.2 ms
	c300	10 ms
	p300	
	p500	3.2 ms
Maximum input / output area	8 kB	

Windows® operating systems of the Lenze Controllers

Operating systems					
Cabinet Controller	c300	3221 C	3231 C	3251 C	3241 C
	Windows® Embedded Compact 7	Windows® CE 6.0			Windows® Embedded Standard 2009
Panel Controller	p300		p500		
	Windows® Embedded Compact 7		Windows® CE 6.0		

The operating systems and the PLC applications use the available RAM memory area of the Controller together (see above).

7.3 Configuring and parameterising the controller using the control application

For the creation of a control application, Lenze provides function blocks in standardised libraries (e.g.: motion functions according to PLCopen). Further function blocks can for instance be used to access controller parameters.

By means of the »PLC Designer«, the compiled PLC program has to be loaded to the controller via Ethernet, where it processes the operating system.



Information regarding the commissioning, configuration, and diagnostics

More information regarding the commissioning, configuration, and diagnostics of the Controller can be found in these **communication manuals**:

- Controller-based Automation EtherCAT®
- Controller-based Automation CANopen®
- Controller-based Automation PROFIBUS®
- Controller-based Automation PROFINET®

7.4

Controller c300/p300: Access to odd Controller addresses

**Note!**

Due to the processor type (Cortex™-A8), write/read access of variables is only possible to memory addresses that are divisible by the variable size.

Examples:

- When variables of the DWORD/DINT data type are accessed (read/write), the memory address must be divisible by 4.
- When variables of the WORD-/INT data type are accessed (read/write), the memory address must be divisible by 2.

Access to other memory addresses causes exception handling of the runtime (exception).

Different response of the PLC program (3200 C/p500 and c300/p300)

1. In the case of the Controllers 3200 C/p500 with x86 processors, unlimited access to the memory addresses is possible. Due to the different processor (Cortex™-A8), PLC programs cause exception handling of the runtime on the Controllers A8c300/p300, although they run without fault on the Controllers 3200 C/p500.

```

PROGRAM PLC_PRG
VAR
  aByteArray : ARRAY [0..20] OF BYTE;
  dwDword    : DWORD;
  wWord      : WORD;
  pDwordPtr  : POINTER TO DWORD;
  pWordPtr   : POINTER TO WORD;
END_VAR

// Prerequisite: pDwordPtr is divisible by 4
// DWORD-access to an address which is not divisible by 4 => crash on ARM
// processor
pDwordPtr := ADR(aByteArray[2]);
dwDword := pDwordPtr^;

// WORD-access to an address which is not divisible by 2 => crash on ARM
// processor
pWordPtr := ADR(aByteArray[1]);
pWordPtr^ := wWord;

```

2. In the case of many functions/function blocks, a pointer is transferred to a byte array and then the content of the byte array is for instance interpreted as DWORD. This requires manual conversion before the data are used:

```

PROGRAM PLC_PRG
PROGRAM PRG_Logic
VAR
  mySDO_READ : CIA405.SDO_READ4;
  aReadData  : ARRAY [1..4] OF BYTE;
  dwDword    : DWORD;
END_VAR

mySDO_READ(NETWORK:= 1,
           ENABLE:= TRUE,
           TIMEOUT:= 10000,
           CONFIRM=>,
           ERROR=> ,
           DEVICE:= 1001,
           CHANNEL:= 1,
           INDEX:= 16#5FE7,
           SUBINDEX:= 0,
           DATA=> aReadData,
           DATALENGTH=>,
           ERRORINFO=>);

// Manually create a DWORD from a Byte array
dwDword := aReadData[1]
          + 256 * aReadData[2]
          + 65536 * aReadData[3]
          + 16777216 * aReadData[4];

```

General information on how to use pointers can be found in the "Pointer" section.

7 Programming with the »PLC Designer«

7.5 Creating remanent variables (retain/persistent)

7.5 Creating remanent variables (retain/persistent)

Retain variables ...

- are variables of the PLC which are automatically saved by the controller in the case of a voltage failure.
- are variables which are necessary to restart the production process.

The values of a drive system which cannot be read out from the machine due to the lack of a sensor system should be persistent. These values should also be persistent if the corresponding value only changes through the influence of the PLC.

Examples

Temperature: Changes, requires a sensor system

Position: Selection preferably via absolute value encoder

Number of parts within buffer inventory: Reasonable for RETAIN.

```
VAR RETAIN
  remvar1: INT; (* 1st remanent variable*)
END_VAR
```

Persistent variables ...

can be created in the device tree in the »PLC Designer«:

Right-click **Application** → **New object** → **Persistent variables**.

```
VAR_GLOBAL PERSISTENT RETAIN
  uiPerRetain : ARRAY[0..1000] OF UNIT; (* declaration of the persistent variable*)
END_VAR
```

7.6 Storing retain data on the SD card (only Controllers 3221 C/3231 C/3251 C)

In the case of Controllers 3221 C, 3231 C, and 3251 C, by default, the values of the retain variables are only stored in the device.

In order to avoid a loss of the retain data, or in order to provide for further use of the data (e.g. if the device is replaced), save the retain data on the SD card of the Controller. For this purpose, use the **L_Util_Retain** function from the **L_Util.lib** library.



Note!

- The SD card is only suitable for storing retain data if the RETAIN values do not change very often.
- It is not possible to save the RETAIN values to the SD card during every PLC cycle.
- SD cards only have a limited number of write/read cycles. Thus, the retain variables should not be saved at very short time intervals.
- Please avoid calling the **L_Util_Retain()** function in a motion task. The creation of the RETAIN file prolongs the current PLC cycle of the calling task by several 100 ms.
- The **SysSaveRetains()** and **SysRestoreRetain()** functions included in the **SysPlcCtrl23.lib** library are not supported and must not be used.

Program example for the use of the L_Util_Retain() function

```
PROGRAM PLC_PRG

VAR
    FB_LUtilRetain: L_Util_Retain;
    xRetainsIntoFile_LUtilRetain: BOOL;
    instSetRetainValues: SetRetainValues;
    xSetRetain: BOOL;
    xStoreRetains_LUtilRetain: BOOL;
END_VAR
```

When being called, the **L_Util_Retain()** function saves the retain/persistent variables to the SD card to the **retains.ret** file (directory: IPC\PLC).

Re-use of the retain data after a device replacement

- Plug the SD card of the Controller that has been replaced into the new device.
- The boot application starts with the retain values saved last by the **L_Util_Retain()** function.
- When the PLC is started, the retain file is generated once. In order to generate the retain file again or to generate it manually, the **xStoreRetains** input must be set to TRUE.

▶ [Subsequent use of retain data on the new Controller](#) (89)

8 »Backup & Restore« (data backup/restore)

8 »Backup & Restore« (data backup/restore)



The Lenze »Backup & Restore« software makes it possible to ...

- create backups (data backup);
- restore backups (data recovery);
- the installation of updates.

The Lenze software »Backup & Restore« is only available for the Lenze control technology.



Documentation for the Lenze »Backup & Restore« software

More information can be found in the software manual (PDF) or in the online help of the Lenze »Backup & Restore« software.

9 »EASY Starter - Application Loader« (data transfer)

9 »EASY Starter - Application Loader« (data transfer)



The Lenze software »EASY Starter - Application Loader« makes standard set-up easier.

This software serves to transmit PLC programs, parameter sets, and application data (LFL file) to the Lenze Controller from the PC.



Note!

When the application data is downloaded, the retain data gets lost.

Export PLC programs/application data in the »PLC Designer«

In the »PLC Designer«, you can export the PLC program or the application into an LFL file using the **Project → Export L-force Loader file** menu command.

10

UPS function (backup in case of voltage failure)

10.1

Internal UPS (for Controllers without UPS connection)

10 UPS function (backup in case of voltage failure)

Thanks to the UPS function (uninterrupted current supply), the Controller is provided with a backup function. If the supply voltage fails, the user data (retain variables, logbook data) is saved before the device is switched off.

In order to minimise the power input during the buffer time and increase the safety in the buffer times, circuit sections that are not required can be switched off in case of a supply voltage failure (e.g. supply of the backplane bus, supply of the devices connected to the USB ports).

Controllers	UPS functionality via ...	Memory for backup files
3221 C	Internal capacitor for the short-time buffering of data	MRAM (Magnetoresistive Random Access Memory)
3231 C		
3251 C		
3241 C	External capacitor pack (CAPS-PACK)	Memory card
c300	Internal capacitor	
p300		
p500		

10.1 Internal UPS (for Controllers without UPS connection)

In case of a voltage failure, retain/persistent variables, logbook data and visualisation data (e.g. trends alarms) are saved.

Controllers **3221 C**, **3231 C**, and **3251 C** are provided with an internal buffer capacitor for short-time buffering of the data.

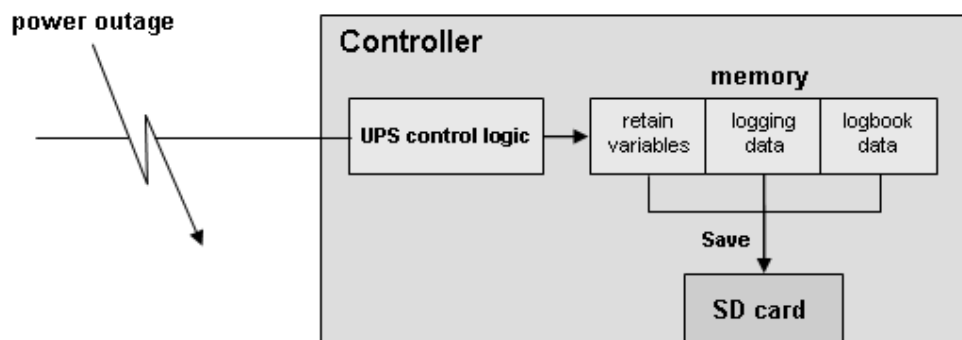

Controllers **c300**, **p300**, and **p500** are equipped with a high-capacity, internal UPS for the storage of data in the event of a voltage failure. This makes external energy storage dispensable. Voltage fluctuations cannot be compensated for.

The UPS behaviour of the internal UPS is preset. Parameter setting is not possible or required.

10.2 External UPS (for Controllers 3241 C with UPS connection)

The Controllers 3241 C provide for the connection of an external capacitor pack (CAPS-PACK) to the X9 socket. Like this, voltage fluctuations of up to five seconds can be compensated.

In the case of a voltage failure, the external UPS saves the following content to the memory card of the Controller 3241 C:

- Retain/persistent variables of the PLC
- Logbook data
- Visualisation data (e.g. trends, alarms)

When the data have been saved, the PLC stops. The log service does not accept any further log messages and deactivates itself.

The UPS behaviour of the external UPS can be parameterised via »WebConfig«:

▶ [Parameter setting using the »WebConfig«](#) (□ 56)

Detailed information on the parameters of the UPS can be found here:

▶ [Voltage buffering by external UPS \(optional for Controller 3241 C\)](#) (□ 174)

10.3 Storage of »VisiWinNET® Smart« visualisation data

Controllers **3221 C**, **3231 C**, and **3251 C** cyclically save »VisiWinNET® Smart« visualisation data (user-specific trends, alarms, recipes) every 60 seconds. After a voltage failure, the visualisation data saved are not exactly up to date.

In the event of a voltage failure, the Controllers **3241 C** store the »VisiWinNET® Smart« visualisation data (user-specific trends, alarms, recipes) exactly isochronously to the SD card.

In the event of a voltage failure, Controllers **c300**, **p300**, and **p500** store the »VisiWinNET® Smart« visualisation data (user-specific trends, alarms, recipes) exactly isochronously to the memory card. This is made possible by the high-capacity UPS that is integrated.

10.4 Storage of retain/persistent variables of the PLC

For the storage of retain/persistent variables, a defined storage capacity is available:

Controllers	Storage capacity
3221 C 3231 C 3251 C	60 kB
3241 C	1 MB (with external capacitor pack (CAPS-Pack))
c300	128 kB
p300	128 kB
p500	1 MB



Tip!

You can create retain variables in the »PLC Designer« by marking the variables with the keyword `RETAIN`.

Further information on how to create retain variables in the »PLC Designer« can be found here:

▶ [Creating remanent variables \(retain/persistent\)](#) (📖 75)

11 RTC function (Real Time Clock)

11 RTC function (Real Time Clock)

The operating system receives the CMOS-RTC time via a maintenance-free clock chip.
In case of the Controller 3200 C, the CMOS-RTC time is stored internally for at least 14 days.
In case of the Controllers c300, p300 and p500, the internal storage lasts for at least 28 days.
Afterwards, the time needs to be reset manually via the »WebConfig« (parameter 91).
A battery is not required.

12 Replacing the Controller (in the event of service)

12 Replacing the Controller (in the event of service)

Which replacement device is suitable for the Controller?

Principally, a defective Controller can only be replaced by a device of the same product type.

Panel Controllers of the same product type but with different screen diagonals can be exchanged against each other. If the mounting dimension is to be identical, use a Panel Controller with identical screen diagonal.

The replacement device has to be provided with the same features such as integrated communication cards and connections.

Defective Controller	Replacement device						
	3221 C	3231 C	3241 C	3251 C	c300	p300	p500
3221 C	●	●	-	●	-	-	-
3231 C	-	●	-	-	-	-	-
3241 C	-	-	●	-	-	-	-
3251 C	-	-	-	●	-	-	-
c300	-	-	-	-	●	-	-
p300	-	-	-	-	-	●	-
p500	-	-	-	-	-	-	●

●: compatible
-: incompatible

12.1 Removing the connected (defective) Controller



Danger!

High electrical voltage

Injury to persons caused by dangerous electrical voltage

Possible consequences

Death or severe injuries

Protective measures

Switch off the voltage supply before working on the components of the automation system.

After switching off the voltage supply, do not touch live device parts and power terminals immediately because capacitors may be charged.

Observe the corresponding information plates on the device.



Mounting instructions for the Controller and I/O system 1000 (EPM-Sxxx)

Please observe ...

- the safety instructions contained therein;
- the information provided on mounting/dismounting.



How to remove the connected controller:

1. Switch off the voltage supply of the entire system and the Controller.
2. Remove the supply connections, bus connections and all other connections from the Controller.
3. When an I/O system 1000 (EPM-Sxxx) is connected to the Controller:
Remove the first electronic module of the I/O system.
4. Dismount the Controller.
5. Remove the SD card from the card slot.

12.2 Connecting the new Controller/replacement device



How to connect a new Controller:

1. Insert the SD card of the removed Controller into the new one.
2. Mount the new Controller.
3. Optional: Mount and connect the electronic module of the I/O system 1000 (EPM-Sxxx).
4. Connect supply connections, bus connections and all other connections to the Controller.
5. Switch on voltage supply.

The Controller starts the **automatic update**:

- The data of the SD card of the defective Controller such as an executable boot project and a visualisation are reused in the replacement device. Thus, a quick commissioning is possible.
- The progress of the update process can be followed in the logbook of the Controller and is also indicated by the [Status LEDs of the Controllers](#) (□ 92).



Note!

Prevent voltage failure

A voltage failure during the update aborts the process.

During the next system start the update process will automatically restart.

Free memory location is required on the memory card

The controllers require an SD card for operation.

- For a successful data update, the memory card of the Controllers must be provided with a sufficient amount of free memory space.
- Guide value for the size of a backup file:
size of the data to be updated + **1 MB**

12.3 Device replacement against an incompatible replacement device (exceptional case)

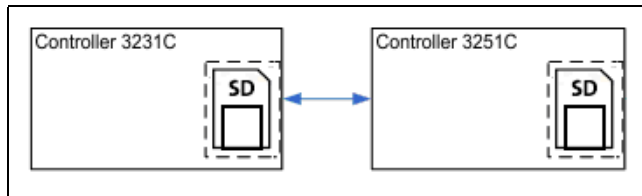

[12-1] Example: Incompatible replacement device

If a device replacement involves an incompatible replacement device, an error message will be entered into the logbook of the Controller.

Scenario (version of replacement device/SD card)	Description
<p>The firmware version of the replacement device is <u>higher</u> than the software version on the SD card. Example:</p>	<p>This is the standard case.</p> <ul style="list-style-type: none"> • The controller's version is more up-to-date than the software version on the SD card of the replaced/defective controller. • Automatic data update is started.
<p>The firmware version of the replacement device is <u>identical</u> with the software version on the SD card. Example:</p>	<p>The data remains unchanged since a data update is not required.</p>
<p>The firmware version of the replacement device is <u>lower</u> than the software version on the SD card. Example:</p>	<p>This is <u>no</u> case of application for an automatic data update.</p> <ul style="list-style-type: none"> • An automatic update is only possible if the software version is identical or more up-to-date. • Remedy: Update the Controller firmware. Use a USB stick to update the Controller. Further information on the update is provided in the documentation on the Lenze »Backup & Restore« software.

12.4 Undo update of data (exceptional case)

In the event of an accidental update, the initial state (version before the update) can be restored manually if a suitable backup is available.

An "accidental" update takes place if an SD card has been plugged into a Controller which is not scheduled for replacement.

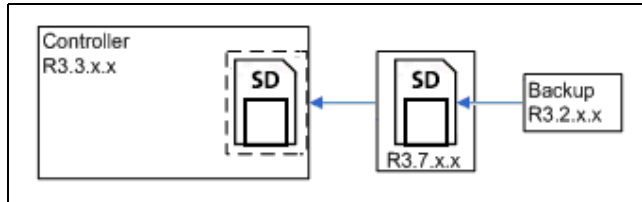

Copy the contents of the backup directory to the basic directory of the SD card:

- 3200 C/p500: \USBSTORAGE
- c300/p300: \sdcard).

[12-2] **Example:** Undo update manually (exceptional case).

**Note!**

Depending on the used controller, the retain data may no longer be available after a voltage failure/device replacement.

- Controllers **3221 C**, **3231 C** and **3251 C** save the retain data internally (in the device, i.e. not on the SD card). The retain data of the replacement device therefore correspond to the output values (default values).
- Controllers **3241 C**, **c300**, **p300**, and **p500** save the retain data on the SD card.

**How to proceed with Controllers 3221 C, 3231 C, and 3251 C:**

In order to be able to use the retain data after a device replacement, ...

- save the desired data to the SD card from the application;
- restore the desired data from the application.

Further information on the use of retain variables.

▶ [Creating remanent variables \(retain/persistent\)](#) (📖 75)

▶ [Storing retain data on the SD card \(only Controllers 3221 C/3231 C/3251 C\)](#) (📖 75)

12.6 Error messages after a device replacement

Message	Information / remedy
Backup/restore cannot be copied. Not enough free memory on the data medium.	The installed SD card has not enough free memory space to execute a safety backup. Delete non-required data from the SD card and try it again.
The replacement device is not compatible with the original device. Device migration was not successful.	In order to replace a device, the devices have to be compatible. ▶ Replacing the Controller (in the event of service) (📖 84)
Inserted SD card has higher version than the system. Please update the controller first.	Update the Controller firmware. Afterwards, you can replace the device. ▶ Device replacement against an incompatible replacement device (exceptional case) (📖 87)
Error while creating the backup for device replacement. Please try again.	An error has occurred while creating a backup. Please try again.
Migration failed. Please check your configuration.	The migration of the databases failed. Please contact your manufacturer.

13 Remote maintenance and diagnostics

This chapter contains information regarding the [Status LEDs of the Controllers](#) (📖 92) and the various diagnostics options for remote maintenance:

- ▶ [Diagnostics via Telnet](#) (📖 96)
- ▶ [Data transfer via FTP](#) (📖 98)
- ▶ [Activate Windows® CE interface](#) (📖 104)
- ▶ [Diagnostics with the logbook](#) (📖 101)



Note!

Error case: Controller does not start

Information on error correction can be found here:

- ▶ [Error case: Controller does not start](#) (📖 37)



Tip!

Lenze Controllers can be diagnosed with »WebConfig« via web browser and by means of the »EASY Starter«.

13.1 Status LEDs of the Controllers

The Controllers are provided with LEDs which indicate the current operating status. Depending on the Controller used, the colouring of the LEDs may vary.



[13-1] Example: Cabinet Controller 3200 C

- **Power:** green/blue*, yellow
 - **Error:** green, red
 - **Status 1:** green, yellow
 - **Status 2:** no function
- * Device-dependent LED colour: either green or blue

Depending on the running software application, different control modes of the LEDs are possible.



Online help for »Backup & Restore«

Here, further information on the »Backup & Restore« specific LED signals can be found.

13.1.1 Status LEDs of the Controller 3200 C

LED Colour 1 / colour 2		Interval	Meaning
Power			
green		is lit constant	Starting sequence completed successfully. <ul style="list-style-type: none"> Controller is switched on and is ready for operation. Supply voltage OK. System clock is synchronised. No error pending.
yellow		is lit constant	The supply voltage has fallen below the minimum value. ▶ UPS function (backup in case of voltage failure) (☞ 79) ▶ Voltage buffering by external UPS (optional for Controller 3241 C) (☞ 174)
		blinking (2.0 Hz)	State after switch-on/restart or reset
green	yellow	blinking (5.0 Hz)	System clock is not synchronised" (missing time information). Note: If the Controller is switched off for more than two weeks, the time information set will be lost. <ul style="list-style-type: none"> The next starting process generates a logbook entry (power LED blinking green/blue). Set the current time manually via the »WebConfig« (parameter 91).
Only for Controller 3241 C:			
green		blinking (5.0 Hz)	Capacitor pack (CAPS-PACK) not fully charged. The length of the dark bar indicates the charge condition: <ul style="list-style-type: none"> CAPS-PACK almost empty: long dark phase CAPS-PACK almost full: short dark phase
green	yellow	blinking (5.0 Hz)	Error status of the capacitor pack (CAPS-PACK) UPS function not available, possible cause: <ul style="list-style-type: none"> Connection to the CAPS-PACK interrupted. CAPS-PACK not connected, cable break/short circuit.
Error			
red		blinking (5.0 Hz)	Error <ul style="list-style-type: none"> Fatal error (Abort) SD card not available/not inserted correctly. No operating system licence available.
green	red	blinking (5.0 Hz)	Mains switching required. LED "Error" and "Status 1" flash simultaneously: <ul style="list-style-type: none"> Controller in test mode SD licence card with higher "Application Credit" required.
Status 1			
green		is lit constant	Operating status: <ul style="list-style-type: none"> Controller is running. PLC project is running.
		blinking (0.5 Hz)	Starting sequence of the Controller active.
green	yellow	blinking (0.5 Hz)	PLC project (e.g. the boot project) is loaded. After being loaded successfully, the LED is lit constantly green. Or user action required: <ul style="list-style-type: none"> Load PLC project: PLC started, project is not running Remove USB device. LED "Error" and "Status 1" flash simultaneously: <ul style="list-style-type: none"> Controller in test mode SD licence card with higher "Application Credit" required.

13

Remote maintenance and diagnostics

13.1

Status LEDs of the Controllers

LED Colour 1 / colour 2	Interval	Meaning
Status 2		
-	-	No function

13.1.2

Status LEDs of the Controllers c300/p300

LED				Meaning
Power	Error	Status 1	Status 2	
is lit blue	Off	Off	Off	Starting sequence completed successfully. <ul style="list-style-type: none"> • Controller is switched on and is ready for operation. • Supply voltage OK. • System clock is synchronised. • No error pending.
is lit blue	Off	blinking yellow	Off	Operating system is running and the control technology (PLC project) is started.
is lit blue	blinking red	blinking yellow	Off	SD card not available/not inserted correctly.
is lit yellow	Off	Off	Off	Input voltage has fallen below a minimum value (voltage failure). The UPS function is triggered. ▶ UPS function (backup in case of voltage failure) (□ 79)
blinking yellow	Off	Off	Off	State after switch-on/restart or reset
blinking blue/ yellow	Off	Off	Off	System clock not synchronised.
Off	Off	Off	Off	Reset has been triggered.
Off	blinking red/green	Off	Off	LED "Error" and "Status 1" flash simultaneously: <ul style="list-style-type: none"> • Controller in test mode • SD licence card with higher "Application Credit" required.
Off	Off	blinking green/ yellow	Off	PLC project (e.g. the boot project) is loaded. After being loaded successfully, the LED is lit constantly green. <u>Or user action required:</u> <ul style="list-style-type: none"> • Load PLC project: PLC started, project is not running • Remove USB device.

13.1.3 Status LEDs of the Controllers p500

LED				Meaning
Power	Error	Status 1	Status 2	
is lit blue	Off	Off	Off	Starting sequence completed successfully. <ul style="list-style-type: none"> • Controller is switched on and is ready for operation. • Supply voltage OK. • System clock is synchronised. • No error pending.
is lit yellow	Off	Off	Off	Input voltage has fallen below a minimum value (voltage failure). The UPS function is triggered. ▶ UPS function (backup in case of voltage failure) (☰ 79)
blinking yellow	Off	Off	Off	State after switch-on/restart or reset
blinking blue/ yellow	Off	Off	Off	System clock not synchronised.
Off	Off	Off	Off	Reset has been triggered.
Off	blinking red/green	Off	Off	LED "Error" and "Status 1" flash simultaneously: <ul style="list-style-type: none"> • Controller in test mode • SD licence card with higher "Application Credit" required.
Off	Off	blinking green/ yellow	Off	PLC project (e.g. the boot project) is loaded. After being loaded successfully, the LED is lit constantly green. <u>Or</u> user action required: <ul style="list-style-type: none"> • Load PLC project: PLC started, project is not running • Remove USB device.

13.2 Diagnostics via Telnet

Telnet is a standard mechanism for experts to change system settings.

Telnet ...

- enables the access to the Controller data (example: Contents of the SD card);
- requires an existing local connection or remote connection.

Settings in the »WebConfig«

Telnet settings		
180	Telnet: use authentication	<input checked="" type="checkbox"/>
181	Telnet: enabled	<input checked="" type="checkbox"/>

The telnet settings can be configured via telnet parameters 180 and 181 by clicking the **Remote maintenance** button of the web-based parameterisation function.

- Parameter 180 activates authentication of the telnet user.
- Parameter 181 activates the telnet access to the controller.



Note!

Access via telnet must only be used for diagnostic purposes. Changing system data may result in controller faults.

The corresponding Windows® CE user must have a telnet authorisation.

▶ [Setting up Windows® CE users in »WebConfig«](#) (42)

Standard access data:

- Login: **admin**
- Password: **admin**

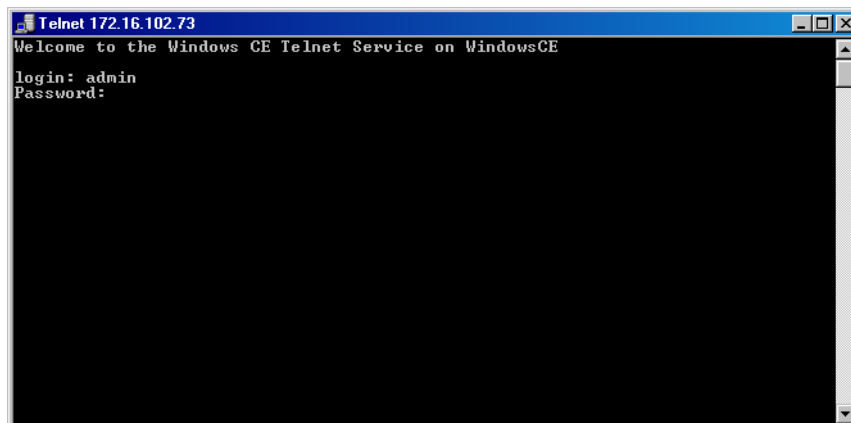

**How to establish a telnet connection to the controller:**

1. Start the command line on the PC with which you want to log in:
Start button → Execute
2. Establish telnet connection to the Controller:
Start **telnet <IP address>** of the Controller.
3. The user name and password for the authentication must correspond to the data stored in the user management (parameters 101 to 170).

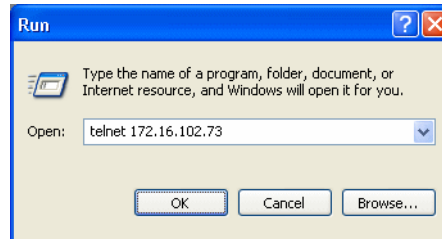

13.3 Data transfer via FTP

The File Transfer Protocol (FTP) is a network protocol for the transmission of data within networks.

- FTP makes it possible to exchange files between the controller and other PCs.
- The controller data can be accessed via FTP connection.
- FTP requires an existing connection or a remote connection.
- In order to be able to transfer files with Windows® via FTP, the Windows® Explorer can be used which comes with an integrated FTP support.



Note!

FTP must be used for system-diagnostic purposes only. Deleting or changing system files causes malfunctions of the controller!

13.3.1 FTP settings with the »WebConfig«

The settings of the FTP connection can be managed via the web-based parameterisation. From parameters 171 to 174 the FTP access for the controller can be activated and user rights can be specified. Click the **Remote control** button to call the FTP settings:

FTP settings		
171	FTP: use authentication	<input checked="" type="checkbox"/>
172	FTP: allow anonymous	<input type="checkbox"/>
173	FTP: allow anonymous upload	<input checked="" type="checkbox"/>
174	FTP: enabled	<input checked="" type="checkbox"/>

- Parameter 171 activates authentication of the FTP user,
- Parameter 172 enables log-on of the anonymous FTP user "Anonymous",
- Parameter 173 activates the upload of files by anonymous FTP users,
- Parameter 174 activates the FTP service.

The user management, the **User management** button, specifies the following:

- The Windows® CE users who may use the FTP access.
- Which authorisations the Windows® CE users have.

The access rights are required to establish a connection to the Controller via FTP.



Note!

Restart the FTP server to accept the changed settings: click the **Device commands** button.

- Send the "Stop FTP server" command. The FTP server is stopped.
- Send the "Start FTP server" command. The FTP server is started with the changed settings.
- Send the "Update FTP server" command to update information to the FTP server.

13.3.2 FTP and web settings in the Internet Explorer



Note!

- You must change your browser settings to be able to establish an FTP / web connection to the controller.
- Your firewall settings may be blocking your access via FTP and HTTP. Change your firewall settings or deactivate your firewall.
- You need administrator rights to be able to change your firewall settings.

- Open browser settings via **Extras→Internet Options→Advanced**.
- Activate **folder view for FTP and passive FTP**.

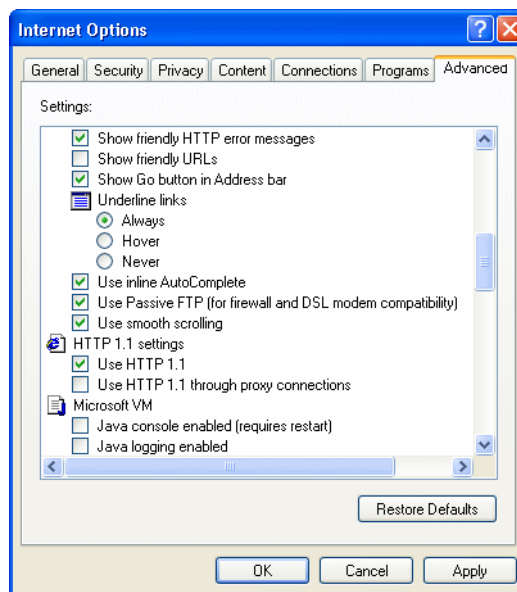

- Open the settings for the local area network via **Extras→Internet Options→Connections→Settings**.
- Switch off proxy server or delete the Controller from the proxy settings.

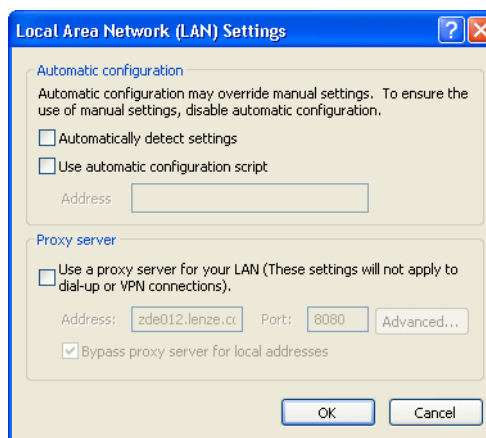



Note!

The settings for the local area network and the proxy settings depend on your own network settings on site.



How to start an FTP connection to the controller:

1. Select the file transfer protocol in the input line of the web browser or in the command line via **Start→Execute...**:
2. Enter **FTP://<user name>:<password>@<IP address>**.
 - The standard setting is **FTP://admin:admin@<IP address>**.
 - As an alternative, the IP address can also be entered directly: **FTP://<IP address>**
3. Enter the user name and password in the input window opening now.
4. When the entry is correct, click the **Log in** button.

The Controller can now be accessed by the Engineering PC.

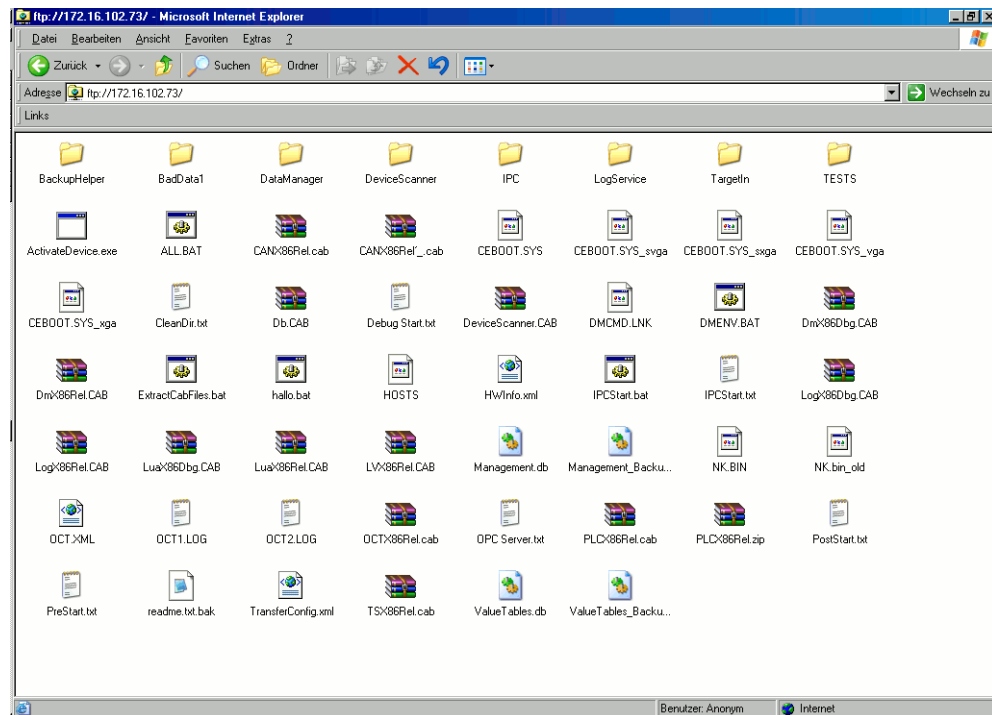

13.4 Diagnostics with the logbook

Lenze controllers are equipped with a logbook function which records system events and error messages. The entries in the logbook of the controller make it easier to diagnose the automation system if malfunctions occur.

The logbook of the controller...

- displays error messages and events of the applications;
- automatically stores the information on the SD card.

Structure of a logbook entry

Each logbook entry contains the following information:

- Numbering in ascending order
- Date / time
- Application triggering the logbook entry
- Severity of the event in four categories
 - Information
 - Warning
 - Error
 - Fatal error
- Area as the event origin of the error message triggered

The logbook of the controller can be called via »WebConfig« and the »EASY Starter«:

▶ [Logbook query via »WebConfig«](#) (📖 102)

13.4.1 Logbook query via »WebConfig«

The logbook entries can be called via »WebConfig«.

- The browser of the Engineering PC accesses the web server of the controller via Ethernet connection (<http://>).
- The data manager of the Controller ensures the access to the logbook contents.

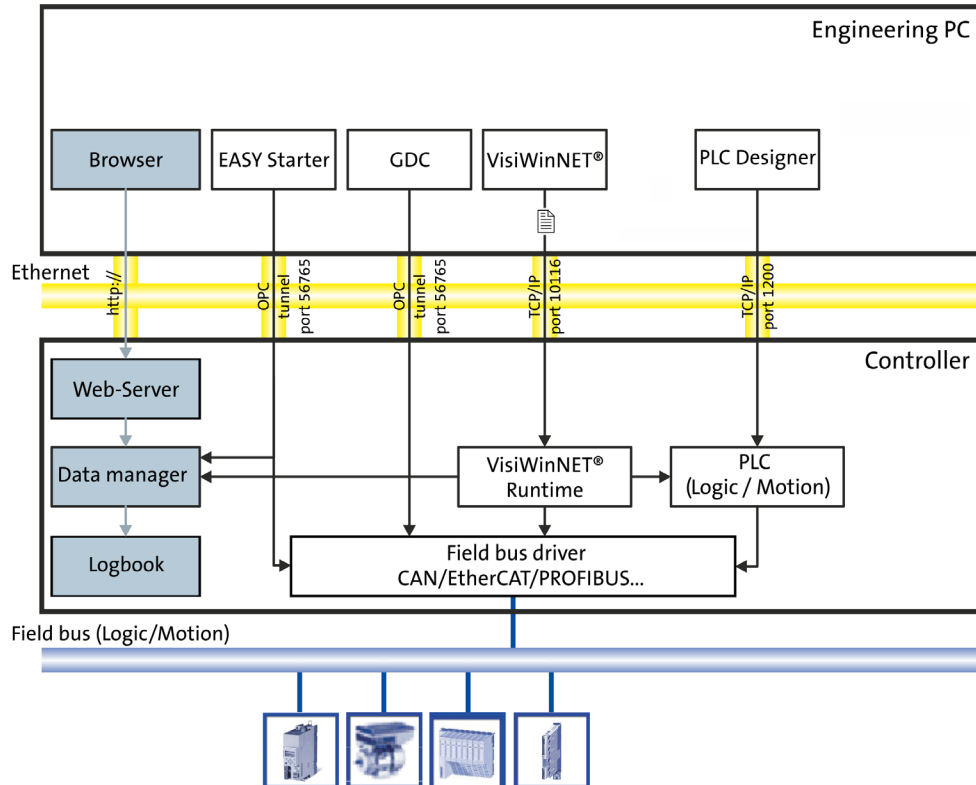

How to call the logbook in »WebConfig«:

1. Start your browser on the Engineering PC,
2. Enter the IP address of the controller: <http://<IP address>>,
3. Enter your user name and password,
4. Click the **logbook** button.

The logbook of the controller can be displayed via the **Logbook** button in »WebConfig«.



Note!

The **ClearLog** command deletes all logbook entries on your controller without further query!



Tip!

The display of the logbook entries can be filtered according to the period, application, severity, and area.

More information on how to use the logbook function in the »WebConfig« can be found here:

▶ [Logbook](#) (📖 63)

13.4.2 Logbook parameters

The logbook settings can be called in »WebConfig« via the **Diagnostics** button.

Further information on the parameters of the logbook (from parameter [C0048](#)) can be found here:

▶ [Basic parameters of the Controllers](#) (📖 146)

13.5 Activate Windows® CE interface

During normal operation the Windows® CE functions are hidden on the controller. All controller functions can be controlled via the Engineering PC.

For diagnostic purposes and maintenance activities you can use the standard functions of the controller operating system Windows® CE.

You can access the Windows® CE functions ...

- via the service mode if the Controller is operated directly, or ...
- via a telnet connection with the corresponding administrator rights.



How to activate the user interface of Windows® CE on the controller:

1. Start the control panel with **<Shift>+<F4>**.
 - The entry can be made via the on-screen keyboard or a keyboard that is optionally connected.
 - When the green LED is blinking, you can start the Control panel with function key **<F1>** on the monitor panel.
2. Start the **Service command** by double-click.
3. Activate the task bar by entering `explorer` in the command line box.

```
Pocket CMD v 5.0
\> explorer
```

The taskbar facilitates the navigation by providing the basic functions of Windows® CE:

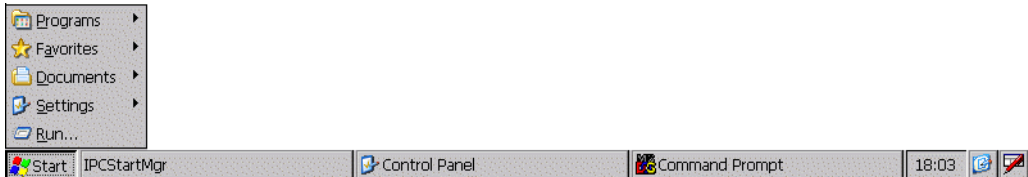

Note!

In order to be able to use a telnet connection, you have to provide a telnet authorisation to the corresponding Windows® CE user.



How to activate the user interface of Windows® CE via telnet:

Log in on the controller which requires a diagnostics via [Diagnostics via Telnet](#).

- The standard settings of the Windows® CE User 1 are: User name: admin, password
- `explorer` activates the Windows® CE interface on the controller



13.5.1 Remote Display: Remote control of Controller via Internet or LAN

Remote Display Control for Windows® CE (cerhost/cerdisp)

The Engineering PC requires the "Remote Display Control" software (Cerhost.exe). It can be procured from the download area of the Lenze homepage:

www.lenze.com → Download → Application Knowledge Base



How to establish a remote display connection to the controller:

1. Identify the IP address of the Engineering PC, e.g. by means of the **IPConfig** command.
2. Start "Remote Display Control" (cerhost.exe) on the Engineering PC.
3. Start Cerdisp.exe on the Controller with the previously established IP address of the Engineering PC: **cerdisp <IP address>**

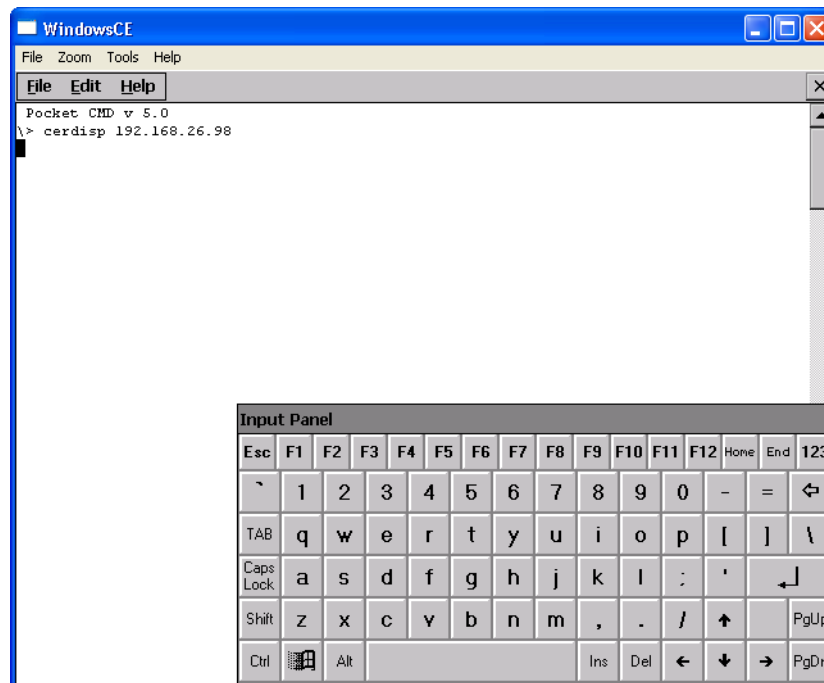

13.5.2 Virtual Network Computing (VNC)

For the Engineering PC, you need the "Virtual Network Computing" (VNC) software.

- VNC is preinstalled on the Controller. (directory: \windows\VNC.exe)
- VNC allows you to operate the controller by remote control from the Engineering PC. In this way, you will work on a remote PC as if you were sitting directly in front of the controller.

Conditions

- The controller is switched on and connected to the network/Internet.
- The VNC server is started on the controller.
- A VNC client (e.g. VNCviewer) is installed on the Engineering PC.



Note!

The VNC server is not protected by a password. To protect data from unauthorised access, the server should be deactivated whenever the connection is not needed.



How to establish a remote display connection to the controller:

1. Start the VNC server on the controller
 - In the »WebConfig«, set the "Activate VNC server" (CS 95) or
 - Execute the \windows\VNC.exe file
2. Start VNC client on the Engineering PC.
3. Enter the IP address of the controller.

Tip: To display the IP address of the controller, go to the **Control Panel** (**Start**→**Settings**→**Control Panel**) of the controller and select "Network Connections".

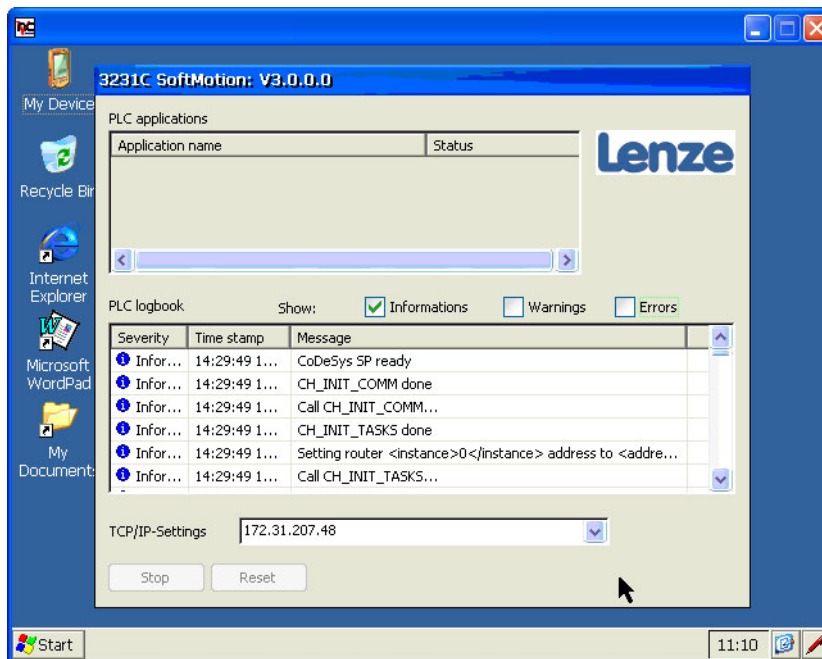

13.5.3 Script commands in PreStart.txt/PostStart.txt

The script files **prestart.txt** and **poststart.txt** are automatically started by the system. The **prestart.txt** file is executed before the Soft PLC is started and the **poststart.txt** file is executed after the Soft PLC is started.

Automation Panel Script Control

This tool is a script engine for Windows® CE. In the following sections, the following functions and commands will be described in detail:

- Starting programs by the "Open" command
- Copying files and/or directories
- Starting the "Script control"
- System functions

The **IpcScriptCtrl.exe** program (with parameters) is started via the prompt.

Script files are text files in Unicode format. All Unicode files can be used as script by adding the path in the command line.

Example: `\Windows\IpcScriptCtrl.exe \storage\IpcScript.txt`

The first line of the script file must be a comment. Comments are marked by a preceding ";".

Example: `; This is a comment`

13.5.3.1 "Script control" functions



Note!

When using the functions, please note that entered text is case-sensitive.

Function/command	Description
Open	<p>The open command is used like an ordinary instruction in the prompt.</p> <p>Syntax: <code>open "<source path\file>" "<parameter>"</code></p> <p>Example: <code>open "\Storage\VWOPC\VWOPCDemoCE.exe" "/regserver"</code></p> <ul style="list-style-type: none"> • The VWOPCDemoCE.exe program in the VWOPC directory is executed with the "/regserver" parameter. • Directory path and parameter must be given in quotation marks.
mkdir	<p>This command serves to create subdirectories in the main directory.</p> <p>Syntax: <code>mkdir <path></code></p> <p>Example: <code>mkdir "\VWOPCDemo"</code></p>
copy	<p>This command is used to copy a file from a source directory to a target directory. The total source and target directory path must be given in quotation marks. The source file name does not need to be identical to the target file name.</p> <p>Syntax: <code>copy "<source path\file>" "<target path\file>"</code></p> <p>Example: <code>copy "\VWOPC\VWOPCDemoCE.exe"</code> <code>"\VWOPCDemo\VWOPCDemoCE.exe"</code> <code>copy "\VWOPC\VWOPCDemoCE.exe" "\VWOPCDemo\Demo.exe"</code></p>
copypath	<p>All files of a source directory are copied to a target directory. The total source and target directory path must be given in quotation marks.</p> <p>Syntax: <code>copypath "<source path>" "<target path>"</code></p> <p>Example: <code>copypath "\Storage\VWOPC" "\VWOPCDemo"</code></p>

13.5.3.2 System functions

**Note!**

When using the functions, please note that entered text is case-sensitive.

Function/command	Description
SILENT	No output signals are sent to the console.
ENDMESSAGE	A message box is displayed at the end.
WAITFORRUNNINGPROCESS	<p>This command causes a waiting until all programs are completed. The time is given in milliseconds. If no time is given, the script waits for a standard time of 30 seconds.</p> <p>Syntax: <code>WAITFORRUNNINGPROCESS <Time> <Program file></code></p> <p>Examples: <code>WAITFORRUNNINGPROCESS 7000 Test01.exe</code> <ul style="list-style-type: none"> Maximally 7 seconds must pass until the "Test01.exe" program is completed. <code>WAITFORRUNNINGPROCESS Test02.exe</code> <ul style="list-style-type: none"> Maximally 30 seconds must pass until the "Test02.exe" program is completed. </p>
NOWAITFORPROCESS	<p>This command does <u>not</u> cause a waiting for started programs to be completed.</p> <p>Syntax: <code>NOWAITFORPROCESS <Program file></code></p> <p>Example: <code>NOWAITFORPROCESS Test03.exe</code> <ul style="list-style-type: none"> The script starts the "Test03.exe" program and proceeds the processing of the following commands without any waiting time. </p>
WAIT	<p>The script is interrupted for a certain time in ms.</p> <p>Syntax: <code>WAIT <time></code></p> <p>Example: <code>WAIT 1000</code> <ul style="list-style-type: none"> The waiting time is 1000 ms. </p>
BOOTSCREEN	<p>Shows a blue overlaying message screen with a hidden mouse pointer. The message screen can only be closed with <code>BOOTSCREEN OFF</code>.</p> <p>Syntax: <code>BOOTSCREEN <Text></code></p> <p>Example: <code>BOOTSCREEN Loading Application...</code> <ul style="list-style-type: none"> The "Loading Application..." message is displayed on the screen. </p>
WAITFOREVENT	<p>Waiting for an event signalled by an application.</p> <p>Syntax: <code>WAITFOREVENT <Event name></code></p> <p>Example: <code>WAITFOREVENT MYEVENT</code> <ul style="list-style-type: none"> Waiting for an event with the "MYEVENT" name. The maximum waiting time is 30 seconds. </p>
ENDEVENT	After script processing, an "APSCRIPTEND" event signals that the script can be used in applications.

14 Visualisation with »VisiWinNET®«

This chapter provides you with some basic information regarding the use of »VisiWinNET®« in connection with the "Controller-based Automation" Lenze automation system.

»VisiWinNET®« ...

- is a visualisation software for mechanical and systems engineering.
- can be used to create complex visualisation applications, the possibilities range from classical operate and monitor functions through to sophisticated SCADA systems.



Online help for »VisiWinNET®«

Here, further information on the use can be found.

Licensing

The Controllers can be ordered with a factory-set licence which enables the use of »VisiWinNET®«.

The licence level installed can be found in »WebConfig« under: **Diagnostics → Licence**

14.1 Visualisation on the Controller: Local and remote



Note!

Controllers 3221 C, 3251 C, and c300

Controllers 3221 C, 3251 C, and c300 can only be accessed by a remote connection via »VisiWinNET®« as these devices do not have a display interface (DVI).

Controller 3231/3241 C and p500

During the DHCP configuration with an unplugged Ethernet cable, the local visualisation cannot be operated for approx. 20 s.

A visualisation can either run **locally** on a controller, or via **remote** connection on an additional controller.

The following cases are distinguished:

- **Local visualisation - integrated control system**

Controlling and visualising on the same Controller.

The following runs on the Controller: »VisiWinNET®«-Runtime, PLC (Logic/Motion), the data manager and the fieldbus driver.

Local visualisation can be carried out...

- on a panel controller.
- on a cabinet controller with a connection facility for a monitor panel.

- **Remote access - external visualisation**

Control and visualisation on separate controllers.

The »VisiWinNET®« runtime runs on a separate visualisation controller. This controller solely undertakes visualisation tasks. The external visualisation controller accesses the process data of an additional controller which controls the system.

The control program runs on the first controller. The »VisiWinNET®« runtime runs on the second controller.

- External "Visu" on the controller
- External "Visu" on a Windows® XP or Windows® Embedded XP PC.

14.2 System structure

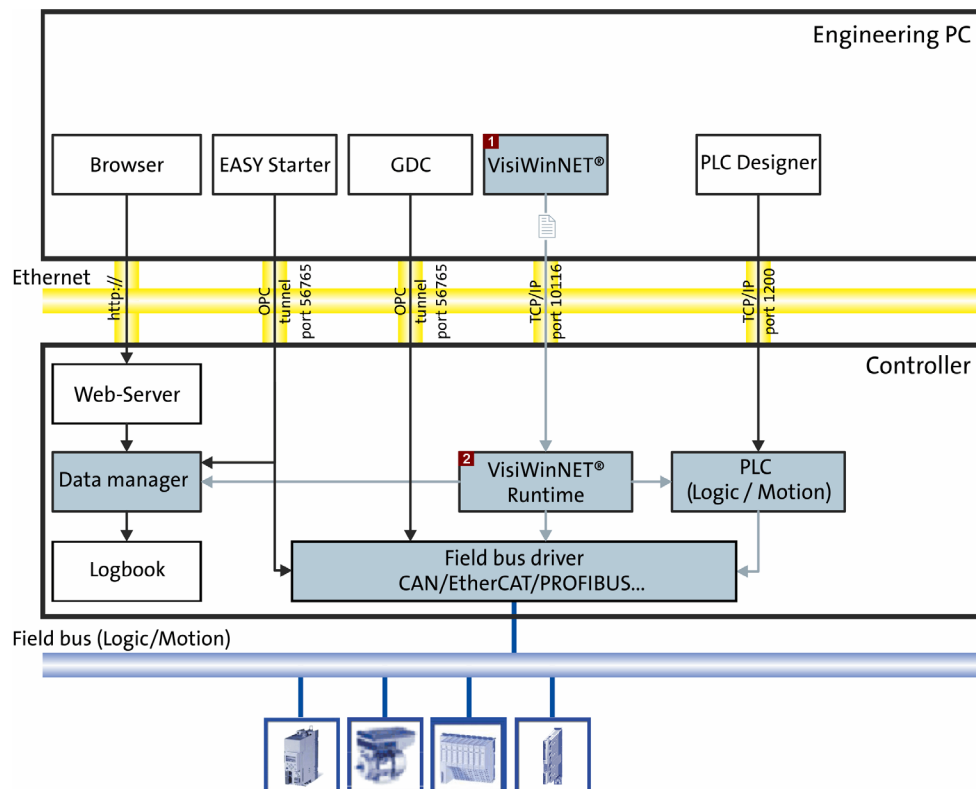

»VisiWinNET®« consists of...

- the »VisiWinNET®« engineering tool on the Engineering PC **1** and
- the »VisiWinNET®« runtime on the Controller **2**.

By means of the »VisiWinNET®« engineering tool, you create the visualisations on the Engineering PC.

- »VisiWinNET®« executes the corresponding »VisiWinNET®« runtime of the Controller.
- By means of the »VisiWinNET®« **Remote Access Manager**, you transfer the visualisations to the controller.
 - Activate parameter 97 "Activate VisiWinNET Remote Access
 - **Remote Access Manager**.
 - TCP/IP serves as a standard for data transmission.
- The »VisiWinNET®« Runtime is able to access the following variables:
 - PLC variables (Logic/Motion),
 - parameters of the Controller (data manager)
 - Parameters of the devices (via the fieldbus driver).

14.3 Using the visualisation to access data of the control/parameters

Variables of the PLC (Logic/Motion) can be accessed with the "LogicAndMotionV3". Here, the »VisiWinNET®« Runtime may be on a local controller or on an external controller.



Note!

We recommend the use of the "LogicAndMotionV3" direct driver for easy commissioning.

▶ [Local visualisation with the "LogicAndMotionV3" direct driver](#) (116)

There is no OPC server available for PROFIBUS and PROFINET.

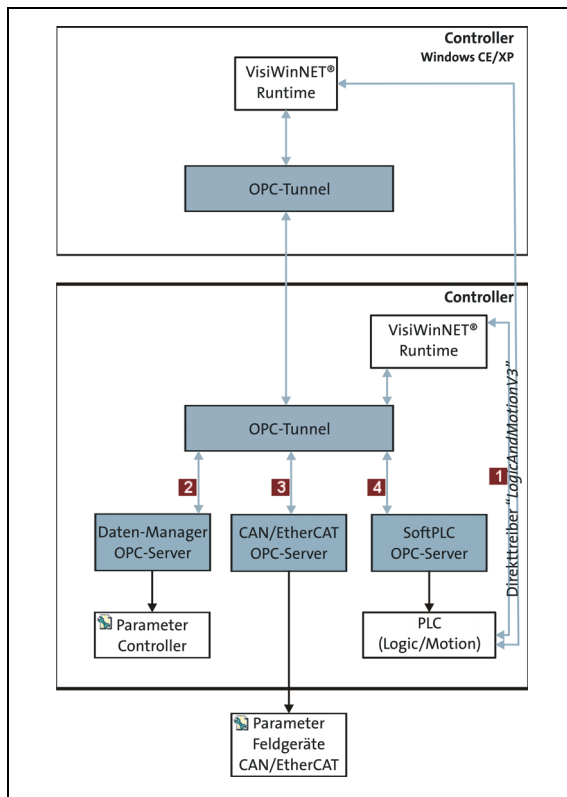

Use the "LogicAndMotionV3" direct driver to access the following parameters:

- PLC (Logic/Motion) data
- Lenze recommends the use of the "LogicAndMotionV3" direct driver.
- Alternatively, you can access the following data via the OPC tunnel:
 - **Data Manager OPC-Server**
→ Controller parameters
 - **CAN/EtherCAT OPC server**
→ Field device parameters (CAN/ EtherCAT)
 - **SoftPLC OPC server**
→ Variables of the PLC (Logic/Motion)

Communication type / description	Access to ...
<p>1 Direct driver "LogicAndMotionV3" (Recommended connection type!) ▶ Local visualisation with the "LogicAndMotionV3" direct driver (116)</p>	PLC (Logic/Motion) data
<p>2 • Data Manager OPC tunnel • Data Manager Remote OPC tunnel (remote access)</p>	Parameters of the Controller

	Communication type / description	Access to ...
3	<ul style="list-style-type: none"> • CAN OPC tunnel • CAN Remote OPC tunnel (remote access) • EtherCAT OPC tunnel • EtherCAT Remote OPC tunnel (remote access) 	Field device parameters at the CAN bus Field device parameters at the EtherCAT bus
4	<p>Note: The (Remote) SoftPLC OPC Tunnel communication type requires a separate configuration of the controller (experts only - please contact Lenze if required!).</p> <ul style="list-style-type: none"> • SoftPLC OPC tunnel • SoftPLC Remote OPC tunnel (remote access) 	PLC (Logic/Motion) data

14.4 Local visualisation with the "LogicAndMotionV3" direct driver

We recommend the use of the "LogicAndMotionV3" direct driver for easy commissioning.

Start »VisiWinNET®«



Start the EASY »Navigator«

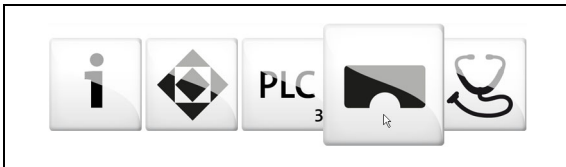

Start »VisiWinNET® Smart« by clicking the **Visualisation** button.



Note!

There is no OPC server available for **PROFIBUS** and **PROFINET**.

14.4.1 Selecting the target device using the Windows® CE operating system (example 3200 C/p500)



How to use the "LogicAndMotionV3" direct driver:

1. Execute the **File** → **New project** menu command to create a new project in »VisiWinNET®«.
2. Select the desired target device.

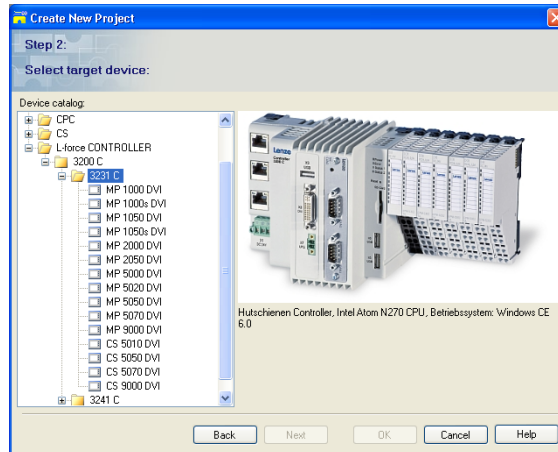

- Example: Controller 3231 C
- For cabinet controllers: select connected monitor panel.

3. Add the "LogicAndMotionV3" direct driver as communication channel.

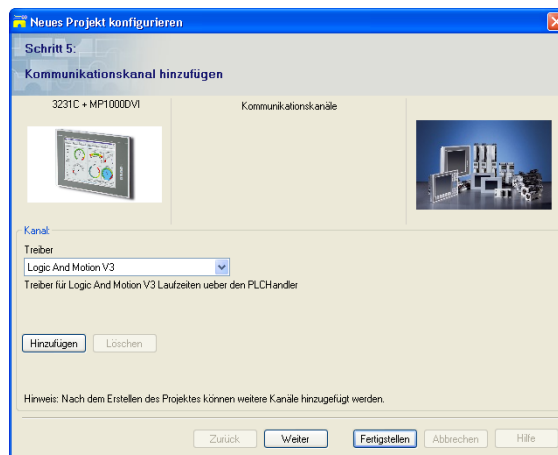

4. Configure the communication channel added.

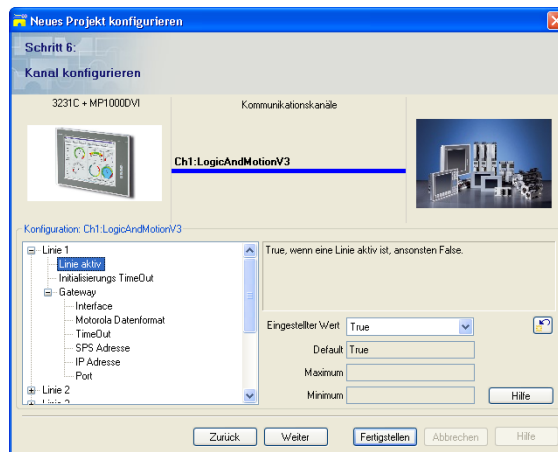

- Activate a **Line**.
- Specify the PLC address (node address) and IP address of the Controller. (Default IP address: 192.168.5.99)

Note: The PLC address can be found in the »PLC Designer« in the context menu of the device: **Device** → **Communication settings** → **IPC:Node address**

Further information on the configuration of the communication channel can be found in the »VisiWinNET®« online help. Click the **Help** button to call the online help.

- In a next step you can do the following: [Using the variables browser to access variables \(120\)](#).
- After completion of the project configuration, the Project Explorer is provided with a new channel: "**LogicAndMotionV3**".

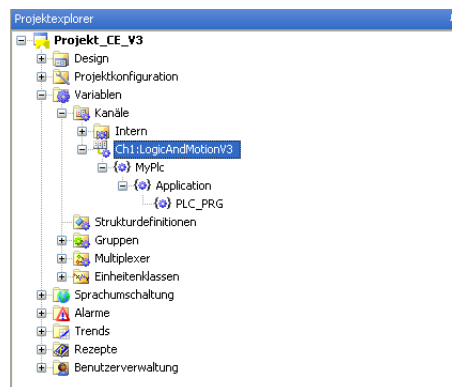

14.4.2 Project Explorer

The project Explorer enables central access to controller data in »VisiWinNET®«.

With the **View → Project Explorer** menu command, you open the project explorer.

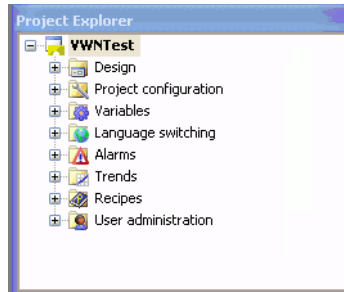

14.4.3 Using the variables browser to access variables

The variables browser can be used to browse for variables on the devices connected to the controller and to transfer them to a project subsequently. For this purpose, a connection between the integrated »VisiWinNET®« development environment and the controller is not required. The data is read from the locally available symbol description files, which have been exported from the »EASY Starter« in advance.



»PLC Designer« Online help

More information about this topic can be found in the "Icon configuration editor" section.



How to call up the variables browser:

1. Open the **Variables** → **Channels** folder in the Project Explorer.
2. Execute the **Browse variables** command in the context menu of the intended communication channel.

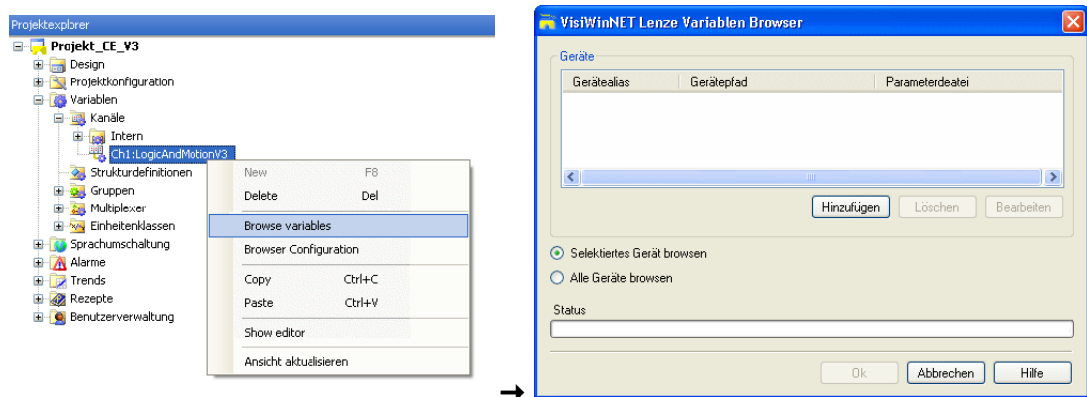

In the **VisiWinNET Lenze Variablen Browser** dialog box, all available devices for reading variable definitions can be seen in the **Devices** selection list.

3. Click the **Add** button to select the desired communication type.

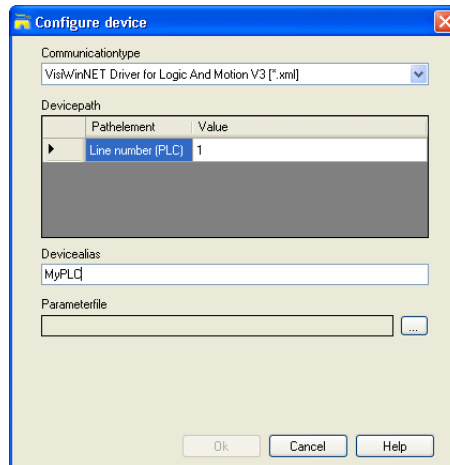

Required information:

- Line number set
 - Device alias (freely selectable)
 - Parameter file (XML icon configuration file exported from the »PLC Designer«)
- ▶ [Browsing variable definitions](#) (📖 129)

14.4.4 Accept variable definitions to project

You can transfer one or more "browsed" variable definitions to your »VisiWinNET®« project.



How to transfer the variable definitions to the project:

1. Highlight the desired device in the **Devices** selection list of the variables browser.
2. Click the **OK** button.

A tree view of the read variable definitions appears.

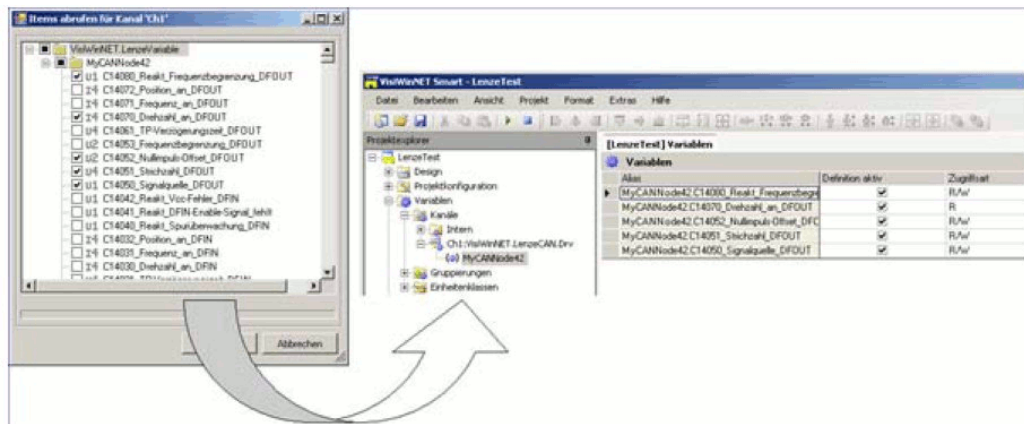

3. Select the variable definitions required.
4. Click the **OK** button.

The variable definitions are transferred to the project database.

14.4.5 Creating control elements/linking them to variables

A user /visualisation interface created with »VisiWinNET®« consists of different control elements (e.g. buttons, checkboxes and selection fields).

To be able to use control elements, the desired control elements must be linked to the available variables of the target device.



How to create control elements:

1. In the Project Explorer double-click an existing form in the **Design** folder.
The "FCentral" form is created for a new project.
2. Open the tool box using the **View → Tool box** menu command or via the tab on the right of the screen.
3. Move the desired control elements using the **Tool box** via drag&drop to the desired position in the workspace.



How to link control elements with variables:

1. Highlight the desired control element (example: VarIn1).
Click the arrow icon .

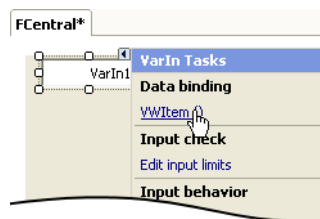

2. Click the **VWItem()** process variable to open the **ItemDialog**.
3. Select the desired variable from the tree structure.

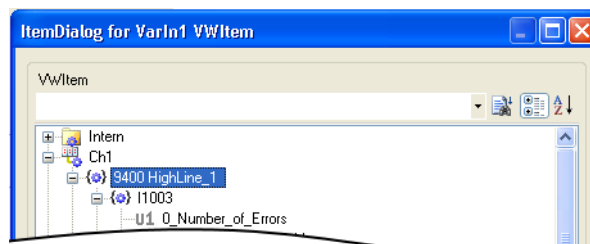

4. Click **OK** to assign the variable to the control element.
5. Repeat steps 1 to 4 for all control elements.

14.4.6 Transferring an application to the target device

In order to be able to transfer an application to the target device, you have to start the »VisiWinNET®« Remote Access Manager.

For this purpose, activate parameter 97, "Activate VisiWinNET Remote Access

 in »WebConfig«.

Alternatively, the »VisiWinNET®« Remote Access Manager can be started via the user interface of an optional monitor panel:

1. Change to the service mode.
Start the control panel: **F1** key on the monitor panel or key combination: **<Shift>+<F4>**
2. Double-click the »VisiWinNET®« Remote Access icon to start the Remote Access Manager.



How to transfer an application to the target device:

1. Go to the »VisiWinNET®« menu bar and select **Project → Transmit to target device**.

The **Connect device** window appears.

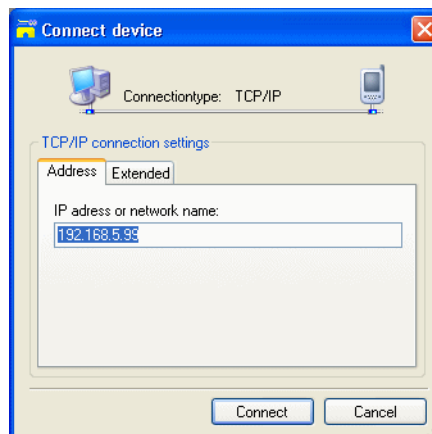

2. Enter the **IP address or network name**.
You can view and alter the IP address of the controller in the "Network Connections" program.
▶ [Configuring the controller](#) (38)
3. Click the **Connect** button.
The application is transferred to the target device.



Note!

If the firewall of Windows®XP/7 is active, you have to enable a port for »VisiWinNET®«. In the standard setting this is port 10116.

14.4.7 Start the »VisiWinNET®«

The »VisiWinNET®« project manager manages the »VisiWinNET®« project data of the visualisation Controller (IPC).

Click the  »VisiWinNET®« **Project Manager** icon to start the Project Manager.

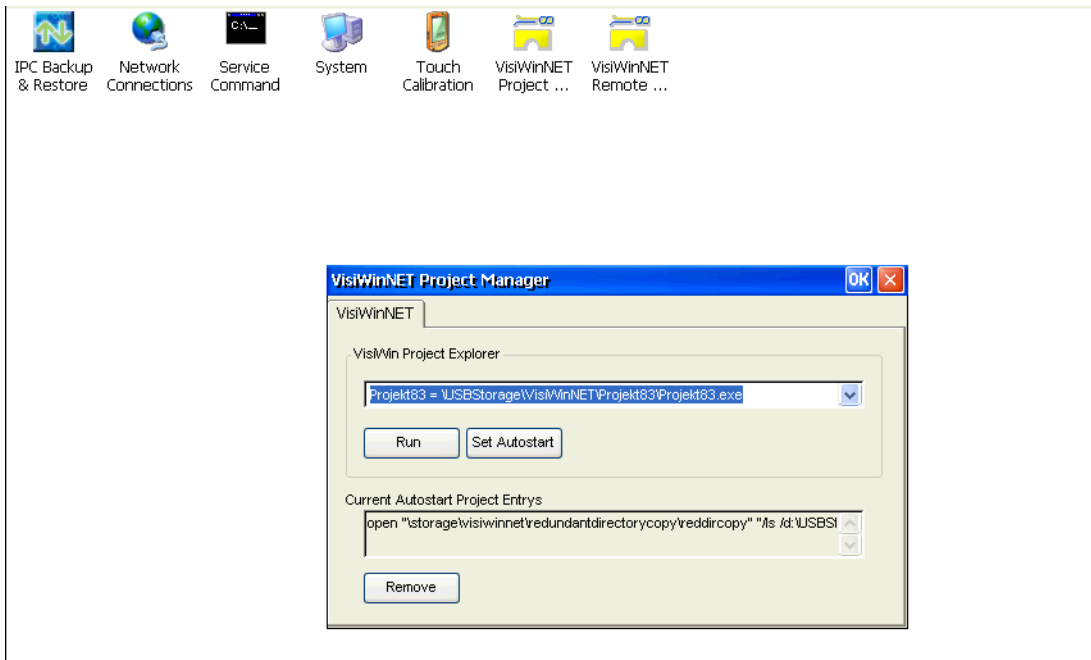

[14-1] »VisiWinNET®« Project Manager on the controller (Windows® CE)

- Click the **Run** button to start the selected project. (Corresponds to the **Start project** command in »VisiWinNET®«)
- The **Set AutoStart** button sets the project as start project in »VisiWinNET®«. This will cause the controller to load this project automatically when the system is started.

14.5 Remote access with the "LogicAndMotionV3" direct driver

Select the target device (Windows® XP operating system)

Use of the "LogicAndMotionV3" direct driver under »VisiWinNET® Smart«.



Note!

The access of external visualisations is limited to a maximum of 10 by the Controller.



How to use the direct driver:

1. Select new project with the desired target device, example: **Controller 3241C**.

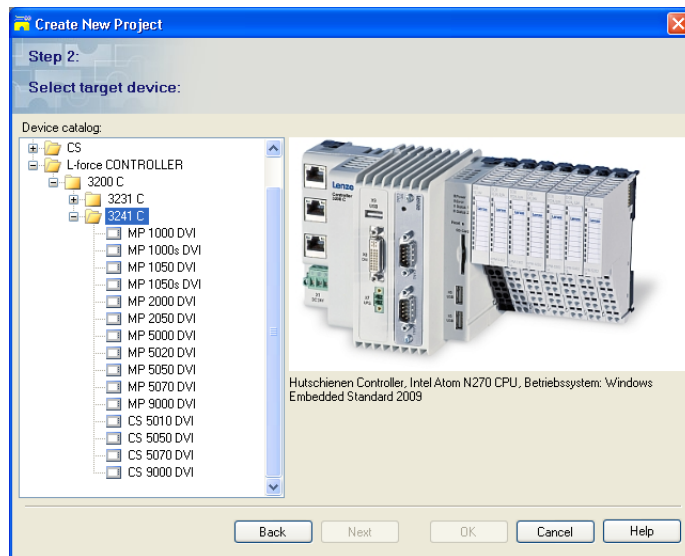

For cabinet controllers: select connected monitor panel.

2. For the configuration of the "LogicAndMotionV3" channel, the address of the target device (Controller - control PC) has to be specified.
3. The further procedure is identical to steps 2 to 5 of the "LogicAndMotionV3" direct driver under Windows® CE:

▶ [Selecting the target device using the Windows® CE operating system \(example 3200 C/p500\)](#) (□ 117)

14.6 OPC tunnel for local visualisation (integrated control system)

**Note!**

There is no OPC server available for **PROFIBUS** and **PROFINET**.

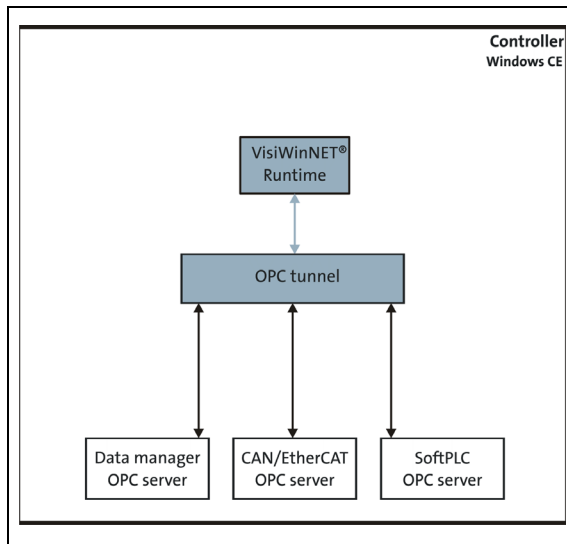

[14-2] Local visualisation on a controller

- The local »VisiWinNET®« Runtime on the Controller uses the local **OPC tunnel** to access the respective **OPC server (Data Manager, CAN/EtherCAT, SoftPLC)**.
- For a local visualisation, the **OPCServer.ini** configuration file has to be adapted. The configuration file is on the memory card of the Controller in the directory `\USBStorage` (in case of 3200 C/p500) or `\sdcard` (in case of c300/p300).
 ▶ [Configure OPC tunnel](#) (□ 134)

14.6.1 Integrating the OPC tunnel in »VisiWinNET®«

The OPC tunnel is the communication channel between »VisiWinNET®« and the OPC servers of the controller. The desired OPC tunnel must be integrated into the project.



Note!

The OPC tunnel cannot be integrated by means of the menu navigation (during the creation of a new project).

Integrate the OPC tunnel by means of the Project Explorer. Then the OPC tunnel can be configured.



How to integrate the OPC server into the project:

1. Open the Project Explorer.
2. Select the **New** entry in the context menu of the **Variables → Channels** node.

- Select "OPC server" as **Channel type**.
 - Select the **OPC server/driver** by clicking the button.
 - Select the Lenze OPC tunnel (**Lenze.Digitec.OPCTunnel.DA**).
3. Confirm your selection by clicking the **OK** button.

The OPC tunnel can be selected in the Project Explorer.

14.6.2 Browsing variable definitions

When you have started the variables browser, you can configure one or more devices and then import the variable definitions.



How to browse for variable definitions:

1. Click the **Add** button in the Lenze variables browser:



2. Select the communication type from the **Configure device** dialog box depending on the variables you want to access.

▶ [Communication types](#) (130)

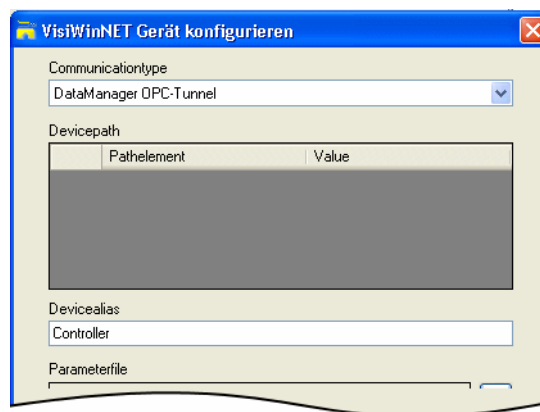

- Select the desired **Communicationtype**.
 - Select the desired **Parameterfile** (variable definition file).
 - Click the ... button to search for a parameter file on a data carrier.
3. Enter the name into the **Devicealias** text field (freely selectable).
The device alias is a »VisiWinNET®«-internal name for the device.
 4. Click the **OK** button.

Communication types

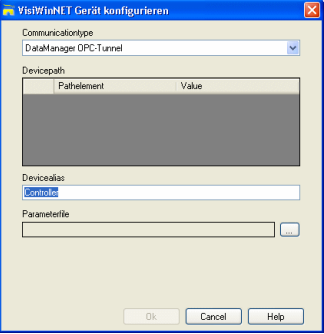
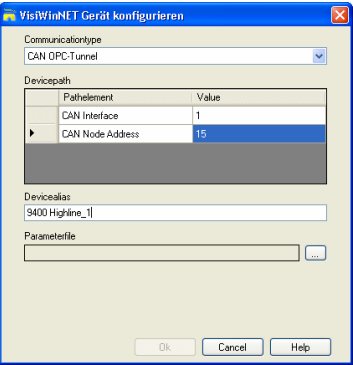
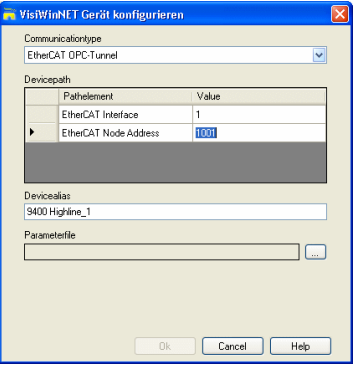
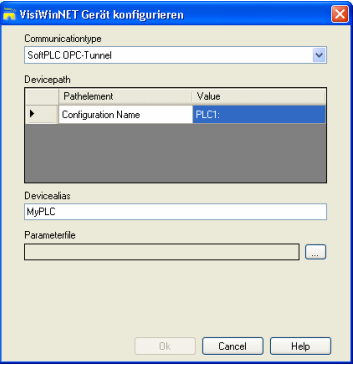
Communication type	Description
<p>Data Manager OPC tunnel</p> 	<p>Required information:</p> <ul style="list-style-type: none"> • Devicealias • Parameterfile <p>Supported file formats:</p> <ul style="list-style-type: none"> • Device description files (*.dcf, *.eds) <p>Suitable device description files (*.eds) for the Controller 32xx can be found in the Lenze Application Knowledge Base (AKB) under: www.Lenze.com</p>
<p>CAN OPC tunnel</p> 	<p>Required information:</p> <ul style="list-style-type: none"> • CAN interface (CAN Interface) • CAN node address (CAN Node Address) • Devicealias • Parameterfile <p>Supported file formats:</p> <ul style="list-style-type: none"> • Device description files (*.dcf, *.eds) • Parameter description (*.pdb) • »Global Drive Control« file(*.gdc)
<p>EtherCAT OPC tunnel</p> 	<p>Required information:</p> <ul style="list-style-type: none"> • EtherCAT interface (EtherCAT Interface) • EtherCAT address (EtherCAT Node Address) • Devicealias • Parameterfile <p>Supported file format:</p> <ul style="list-style-type: none"> • Device description files (*.dcf, *.eds) • Parameter file (*.pdb) • »Global Drive Control« file (*.gdc) <p>Note: EtherCAT device description files (*.xml) are <u>not</u> supported!</p>
<p>SoftPLC OPC tunnel</p> 	<p>Required information:</p> <ul style="list-style-type: none"> • The configuration name (Configuration Name) must be entered manually. Default value of the Controller: PLC1 . Note: The configuration name must be identical to the specification in the OPCServer.ini file! • The OPCServer.ini file is on the memory card of the Controller (directory \USBStorage (in case of 3200 C/p500) or \sdcard (in case of c300/p300)). <p>Supported file format:</p> <ul style="list-style-type: none"> • Symbol file (*.sym) <p>Note: XML symbol configuration files exported from the »PLC Designer« V3.x are <u>not</u> supported!</p> <p>▶ Configure OPC tunnel (134)</p> <p>▶ Manual integration of variables (experts only - background knowledge required!) (131)</p>

14.6.3 Manual integration of variables (experts only - background knowledge required!)

If no suitable parameter file is available, the Item ID can also be entered manually (as an alternative to the variables browser).

Depending on the server and type of connection (local or remote), a defined syntax must be observed (see below).



How to enter a variable manually:

1. Open the Project Explorer.
2. Activate the variable editor by double-clicking the desired channel in the **Variables → Channels** node.
3. Select the **New** entry from the context menu.
4. Enter the ItemID in the **ItemID/address** input field. Alternatively, enter the variable name in the variable editor.

The given syntax of the Item ID must be observed!

The screenshot shows a dialog box with three input fields:

- Alias:** `__CURRENT_USER.NAME`
- ItemID/Address:** (empty)
- Text:** `User logged on`

Syntax of the Item ID

The ItemID must be used according to the table, depending on the desired OPC tunnel.

Data types used: [▶ Data types \(133\)](#)

Access to ...	Syntax of the ItemID
Data Manager OPC tunnel	<ol style="list-style-type: none"> 1. Put the prefix, <DM>, in front. DM = "Data Manager". 2. The index results from 0x5FFF minus <Code> of the Data Manager. Example: (code = 5): 0x5FFF - 5 = 0x5FFA = 24570 3. Specify the variable as follows: DM.pari<0x5FFF "minus" Code>d<Data type>. 4. If an additional reference to a subindex is provided, supplement the following entry: <ul style="list-style-type: none"> • Example with subindex "1": DM.pari24572s1d8
Data Manager Remote OPC tunnel	<ol style="list-style-type: none"> 1. In the ItemID, put the prefix, <RemoteIPC>, in front. 2. Specify the variable as follows: .pari<0x5FFF "minus" <Code>d<Data type>. • Example: RemoteIPC.DM.pari24572d8 3. If an additional reference to a subindex is provided, supplement the following entry: <ul style="list-style-type: none"> • Example with subindex "1": RemoteIPC.DM.pari24572s1d8
CAN OPC tunnel	<ul style="list-style-type: none"> • Put the prefix, CAN, in front of the variable: CAN.can<Number of the CAN interface>.dev<Device CAN address>.pari<0x5FFF "minus" Code>d<Data type> • Example (CAN interface 2, CAN address 18, code 1, subcode 2, data type unsigned INT): CAN.can2.dev18.pari24576s2d17

Access to ...	Syntax of the ItemID
CAN Remote OPC tunnel	<ol style="list-style-type: none"> In the ItemID, put the prefix, <RemoteIPC>, in front. Specify the variable as follows: CAN.can<Number of the CAN interface>.dev<Device CAN address>.pari<0x5FFF "minus" Code>d<Data type>. <ul style="list-style-type: none"> Example (CAN interface 2, CAN address 18, code 1, subcode 2, data type unsigned INT): RemoteIPC.CAN.can2.dev18.pari24576s2d17
EtherCAT OPC tunnel	<ol style="list-style-type: none"> Put the prefix, ECAT, in front of the variable. Specify the variable as follows: ECAT.ecat1.dev<Device address>.pari<0x5FFF "minus" Code>d<Data type> <ul style="list-style-type: none"> Example (EtherCAT address 1001, code 1, subcode 2, data type unsigned INT):RemoteIPC.ECAT.ecat1.dev1001.pari24576s2d17
EtherCAT Remote OPC tunnel	<ol style="list-style-type: none"> In the ItemID, put the prefix, <RemoteIPC>, in front. Specify the variable as follows: .ecat1.dev<Device address>.pari<0x5FFF "minus" Code>d<Data type>. <ul style="list-style-type: none"> Example (EtherCAT address 1001, code 1, subcode 2, data type unsigned INT):RemoteIPC.ECAT.ecat1.dev1001.pari24576s2d17
SoftPLC OPC tunnel	<ol style="list-style-type: none"> Put the prefix, <PLC . PLC1 . >, in front of the variable. <p>Note: The prefix, PLC1, must be identical to the specification in the OPCServer.ini file!</p> <ul style="list-style-type: none"> The OPCServer.ini file is on the memory card of the Controller (directory \USBStorage (in case of 3200 C/p500) or \sdcard (in case of c300/p300)). <ol style="list-style-type: none"> Specify the variable as follows: <Application>.<POU>.<Symbol name>. <ul style="list-style-type: none"> Example: PLC.PLC1.Application.PLC_Prg.My_Variable
SoftPLC Remote OPC tunnel	<ol style="list-style-type: none"> In the ItemID, put the prefix, <RemoteIPC>, in front. Specify the variable as follows: <RemoteIPC> <PLC . PLC1 . > + <Application>.<POU>.<Symbol name>. <ul style="list-style-type: none"> Example: RemoteIPC.PLC.PLC1.Application.GVL.byGlobalByte

Data types

The following data types are available for query:

Data type »VisiWinNET®«	OPC tunnel	Description
VT_BOOL	d11	Truth value (TRUE/FALSE)
VT_BSTR	d8	String STRING
VT_DATE	d7	Date / time format
VT_EMPTY	d0	The data type is not specified. • This data type is e.g. returned if no process variable has been specified.
VT_I1	d16	Integer 1-byte value; signed (-128 ... 127)
VT_I2	d2	Integer 2-byte value; signed (-32768 ... 32767)
VT_I4	d3	Integer 4-byte value; signed (-2147483648 ... 2147483647)
VT_INT	d22	Integer value; signed; machine type-dependent
VT_R4	d4	Floating-point number simple accuracy (4 bytes)
VT_R8	d5	Floating-point number double accuracy (8 bytes)
VT_UI1	d17	Integer 1-byte value; unsigned (0 ... 255)
VT_UI2	d18	Integer 2-byte value; unsigned (0 ... 65535)
VT_UI4	d19	Integer 4-byte value; unsigned (0 ... 4294967295)
VT_UINT	d23	Integer value; unsigned; machine type-dependent

14.6.4 Configure OPC tunnel

The OPC tunnel ...

- permits »VisiWinNET®« access to the OPC servers of the Controller
- "tunnels" all accesses via a special Ethernet port and hence offers the possibility of remote access by security systems.



Note!

If the Windows® XP firewall is activated, the port (standard setting: port 56765) needs to be activated for the OPC tunnel!

The OPCServer.ini configuration file



Note!

- The **OPCServer.ini** configuration file contains parameters which must be observed/edited if the SoftPLC OPC server is to be used for communication.
- After edition of the configuration file, the Controller must be restarted for the changes to take effect.

To be able to access the SoftPLC OPC server, the ...

- ... configuration name (standard value: `PLC1`) specified in the **OPCServer.ini** file must be used.
- ... respective node address of the device must be entered into the **OPCServer.ini** file (`value0=<Node address>`).

```
PLC0=PLC1 <-- Configuration name (standard value: PLC1)
...
[PLC:PLC1]
...
value0=0731 <-- Node address (example: 731)
```

The **OPCServer.ini** file is on the memory card of the Controller in the directory `\USBStorage` (in case of 3200 C/p500) or `\sdcard` (in case of c300/p300)

14 Visualisation with »VisiWinNET®«

14.7 OPC tunnel for external visualisation (remote access)

14.7 OPC tunnel for external visualisation (remote access)

14.7.1 Windows® CE operating system

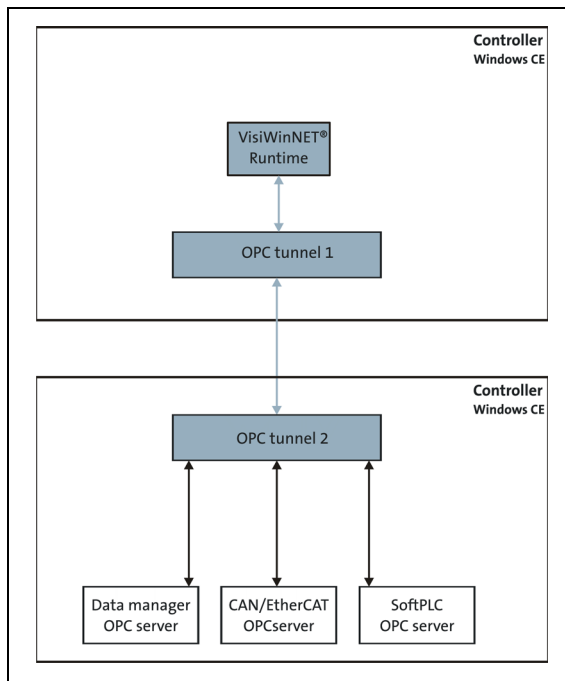

The »VisiWinNET®« Runtime of the external Controller **Controller(Visu)** accesses the OPC servers of the control system Controller via the OPC tunnels (1, 2).

[14-3] Remote access with one visualisation controller ("Visu") and one controller



Note!

There is no OPC server available for **PROFIBUS** and **PROFINET**.

14.7.1.1 Configure OPC tunnel for remote access (Windows® CE)

For the configuration of the OPC tunnel, the **oct.xml** configuration file must be edited.

In our example, the IP address of the **Controller** controller is: 192.168.5.99

- For configuring **OPC tunnel 1**, use the **oct.xml** configuration file in the directory `\USBStorage\OCT` (in case of 3200 C/p500) or `\sdcard\OCT` (in case of c300/p300). Enter the corresponding IP address of the control system Controller in the configuration file (as described in the following section).
- For configuring **OPC tunnel 2**, standard settings need **not** be changed (configuration file: **oct.xml**).

Preparation

Import the SD card of the visualisation Controller (IPC) on your PC using a card reader.

or

Establish an FTP connection between your PC and the visualisation Controller (IPC).

▶ [FTP settings with the »WebConfig«](#) (98)



How to set up an external visualisation on the controller:

1. Change to the directory `\USBStorage\OCT` (in case of 3200 C/p500) or `\sdcard\OCT` (in case of c300/p300).
2. Rename the `oct.xml` file to `oct_save.xml`
3. Rename the `octvisu.xml` file to `oct.xml`
4. Open the **oct.xml** file using an editor.
This is a text file. Use the Software Microsoft Editor, for instance, for edition.
5. Go to the following section:

```
<Server ID="RemoteIPC" URL="tpda://172.31.207.56:56765" ProvideItems="dynamic"
ItemPre-fix="RemoteIPC" EstablishConnection="on demand"/>
```

6. Enter the IP address of the controller (with the control function).
7. Line contents (example):

```
<Server ID="RemoteIPC" URL="tpda://192.168.5.99:56765" ProvideItems="dynamic" ItemPre-
fix="RemoteIPC" EstablishConnection="on demand"/>
```

8. Save changed file on the SD card.
9. Restart the controller (with the visualisation function).

The OPC servers of the control controller can now be accessed.



Tip!

To undo faulty changes in the configuration files, the original state of the configuration files can be restored. For this purpose, delete all configuration files from the directory `\USBStorage\OCT` (in case of 3200 C/p500) or `\sdcard\OCT` (in case of c300/p300) and restart the Controller.

14.7.2 Windows® XP/XP Embedded operating system

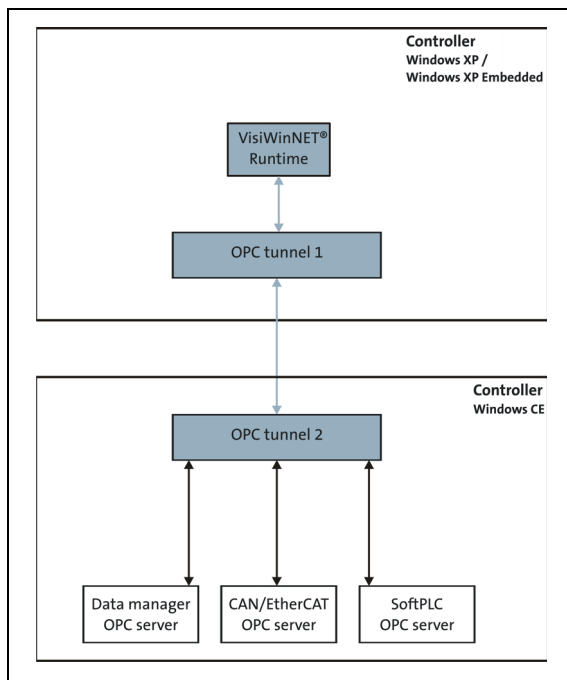

The »VisiWinNET®« runtime of the external Windows® XP/XP Embedded controller accesses (via **OPC tunnel 1**) the OPC servers of the **Controller**.



Note!

There is no OPC server available for **PROFIBUS** and **PROFINET**.

14.7.2.1 Configure OPC tunnel for remote access (Windows® XP/XP Embedded)

In our example, the IP address of the Controller is: 192 . 168 . 5 . 99

- For the configuration of **OPC tunnel 1** (external Controller), the `oct.xml` configuration file is used which can be found in the `\Programs\Lenze\Lenze Digitec OPC Tunnel` directory.
- The suitable IP address of the control system Controller must be entered into the configuration file as described in the following section.

Preparation



Install the OPC tunnel on the Windows® XP PC.

1. The required installation files are provided on the Lenze installation CD in the following directory:

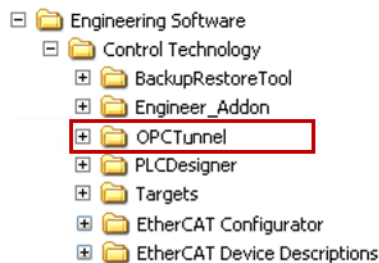

2. Execute the installation file: `Lenze_L-force OPC_Tunnel_x.x.x.x_setup.exe`.



How to set up the external visualisation:

1. Open the Windows® Explorer on the visualisation IPC
2. Go to the following directory: `... \Programs\Lenze\Lenze Digitec OPC Tunnel`
3. Open the `oct.xml` file using an editor.

The file can for instance be edited using the Microsoft Editor.

4. Go to the following file section:

```
<!-- <Server ID="RemoteIPC" URL="tpda://172.31.207.16:56765" ProvideItems="dynamic"
ItemPre-fix="RemoteIPC" EstablishConnection="on demand"> <FilterFile Path="" />
</Server-->
```

Remove the "`<!--`" and "`-->`" comment characters at the beginning and at the end of the section.

5. Enter the IP address of the Lenze controller (with the control function).

In the example, the line contents is now as follows:

```
<Server ID="RemoteIPC" URL="tpda://192.168.5.99:56765" ProvideItems="dynamic" ItemPre-
fix="RemoteIPC" EstablishConnection="on demand"> <FilterFile Path="" />
</Server>
```

6. Save the changed file.
7. Restart visualisation IPC.

The OPC servers of the controller can now be accessed.

14.7.3 Browsing variable definitions



How to browse for variable definitions:

1. Click the **Add** button to import the variable definition file which has been previously exported from the »PLC Designer«.
2. Select the communication type (Remote OPC server) from the **Configure device** dialog box depending on the variables you want to access.

Possible communication types

Communication type	Description
<p>Remote Data Manager OPC tunnel</p>	<p>Required information:</p> <ul style="list-style-type: none"> • Remote name of the target device (standard value: RemotePC) • Note: The Remote name must be identical to the value specified in the oct.xml file. • The oct.xml file is on the SD memory card of the Controller (directory: \USBStorage\OCT (in case of 3200 C/p500) or \sdcard\OCT (in case of c300/p300)). • Devicealias • Parameterfile <p>Supported file formats:</p> <ul style="list-style-type: none"> • Device description files (*.dcf, *.eds) <p>EDS device description files can be found in the Lenze Application Knowledge Base (AKB): http://www.Lenze.com</p>
<p>CAN Remote OPC tunnel</p>	<p>Required information:</p> <ul style="list-style-type: none"> • Remote name of the target device (example: "RemoteIPC") • CAN interface (CAN Interface) • CAN node address (CAN Node Address) • Devicealias • Parameterfile <p>Supported file formats:</p> <ul style="list-style-type: none"> • Device description files (*.dcf, *.eds) • »Global Drive Control« file (*.gdc) • Parameter file (*.pdb)

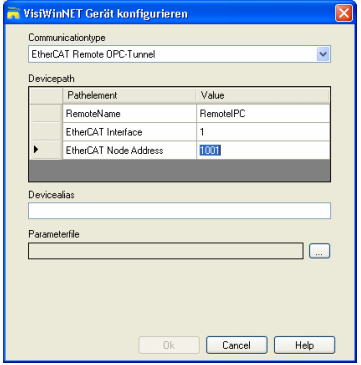
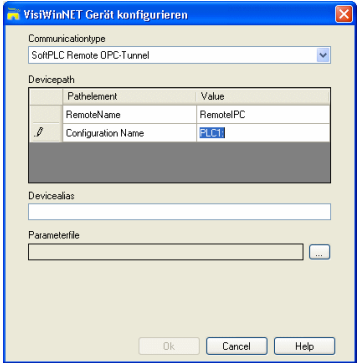
Communication type	Description
<p>EtherCAT Remote OPC tunnel</p> 	<p>Required information:</p> <ul style="list-style-type: none"> • Remote name of the target device (example: "RemotelPC") • EtherCAT interface (EtherCAT Interface) • EtherCAT address (EtherCAT Node Address) • Devicealias • Parameterfile <p>Supported file format:</p> <ul style="list-style-type: none"> • Device description files (*.dcf, *.eds) • »Global Drive Control« file (*.gdc) • Parameter file (*.pdb) <p>Note: EtherCAT device description files (*.xml) are <u>not</u> supported!</p>
<p>SoftPLC Remote OPC tunnel</p> 	<p>Required information:</p> <ul style="list-style-type: none"> • Remote name of the target device (example: "RemotelPC") • The configuration name (Configuration Name) must be entered manually. Default value of the Controller: PLC1 . <p>Note: The configuration name must be identical to the specification in the OPCServer.ini file!</p> <ul style="list-style-type: none"> • The OPCServer.ini file is on the memory card of the Controller (directory \USBStorage (in case of 3200 C/p500) or \sdcard (in case of c300/p300)) <p>Supported file format:</p> <ul style="list-style-type: none"> • Symbol file (*.sym) <p>Note: XML symbol configuration files exported from the »PLC Designer« V3.x are <u>not</u> supported!</p> <p>► Manual integration of variables (experts only - background knowledge required!) (📖 131)</p>

14.8 Lenze specifications

14.8.1 Install additional fonts

Copy additional font files onto the SD card:

- Directory `\USBStorage\Fonts` in case of Controller 3200 C/p500
- Directory `\sdcard\Fonts` in case of Controller c300/p300

14.8.2 Timeout (waiting position) of the CAN OPC server influences the time response of the visualisation

When the visualisation directly accesses the parameters of an inverter and does not get any response afterwards, this will cause a timeout (waiting position) of the CAN OPC server.



Note!

The timeout occurs if...

- `VWGET / VWSET` is used to read / write a variable via the CAN OPC server and the node does not respond to it (SDO);
- alarms or trends are connected to a variable which is retrieved via the CAN OPC server and the node does not respond to it (SDO);
- ...no node is connected and no feedback takes place, a timeout is caused.

The timeout of the CAN OPC server affects the display speed of the visualisation. This may, for instance, cause a time delay for the page changeover in the visualisation.

Remedy

When the timeout is changed in the registry, the visualisation can be operated again. For this purpose you must enter the following data in the `PostStart.txt` file. This sets the timeout to 200 ms.

```
[HKEY_LOCAL_MACHINE\Drivers\BuiltIn\CANXBusY]
"SDOTimeout"=dword:0xc8
"Timeout"=dword:0xc8
```

The designation `CANXBusY` designates the respective CAN interface.

Examples:

- The first CAN interface is called: `CAN2Bus1`
- The second CAN interface is called: `CAN2Bus2`

15 Parameter reference

This chapter provides a list of all parameters of the Lenze Controllers, fieldbus interfaces and optional (fieldbus) communication cards in numerically ascending order.



Note!

Depending on the equipment and configuration of your Controller, the parameter lists may vary.

This chapter describes the following parameters:

- ▶ [Basic parameters of the Controllers](#) (📖 146)
- ▶ [Voltage buffering by external UPS \(optional for Controller 3241 C\)](#) (📖 174)
- ▶ [Monitor panel \(integrated/external\)](#) (📖 177)
- ▶ [PLC \(Logic/Motion\)](#) (📖 181)
- ▶ [Backup & Restore](#) (📖 183)
- ▶ [Ethernet](#) (📖 187)
- ▶ [EtherCAT](#) (📖 189)
- ▶ [CAN](#) (📖 194)
- ▶ [PROFIBUS / PROFINET / Serial interfaces](#) (📖 200)

15 Parameter reference

15.1 Structure of the parameter description

15.1 Structure of the parameter description

Each parameter is described in the parameter list in the form of a table which consists of the following three areas:

Table header

The table header contains the following general information:

- Parameter number (Cxxxxx)
- Name of the parameter
- [Data types](#)
- Decimal and hexadecimal parameter index for access via bus systems

Table contents

The table contains further general explanations and notes on the parameter and the possible settings. The representation depends on the parameter type:

- [Parameters with read access](#) (🔒 144)
- [Parameters with write access](#) (🔒 144)

Table footer

The table footer contains the [Parameter attributes](#).

15.1.1 Data types

The following data types are available for parameters:

Data type	Meaning
INTEGER_8	8-bit value with sign
INTEGER_16	16-bit value with sign
INTEGER_32	32-bit value with sign
INTEGER_64	64-bit value with sign
UNSIGNED_8	8-bit value without sign
UNSIGNED_16	16-bit value without sign
UNSIGNED_32	32-bit value without sign
UNSIGNED_64	64-bit value without sign
FLOAT_32	32-bit floating point number
FLOAT_64	64-bit floating point number
VISIBLE_STRING	String of characters of printable characters
OCTET_STRING	String of characters of any characters
BITFIELD_8	8-bit value bit-coded
BITFIELD_16	16-bit value bit coded
BITFIELD_32	32-bit value bit coded
DATE	Date

15 Parameter reference

15.1 Structure of the parameter description

15.1.2 Parameters with read access

Parameters without the "Write access" attribute are read only/not editable.

Description structure

Parameter Name: Cxxxxx _____	Data type: _____ Index: _____
Description	
Display range (min. value unit max. value)	
<input checked="" type="checkbox"/> Read access <input type="checkbox"/> Write access <input type="checkbox"/> CINH <input type="checkbox"/> PLC-STOP <input type="checkbox"/> No transfer	

15.1.3 Parameters with write access

Parameters with a checkmark (☑) in front of the "Write access" attribute are editable. The preset Lenze setting for these parameters is **printed in bold**.

- The settings can either be changed ...
 - ... via a selection list or
 - ... by entering a value directly.

15.1.3.1 Parameters with setting range

Description structure

Parameter Name: Cxxxxx _____	Data type: _____ Index: _____
Description	
Setting range (min. value unit max. value)	Lenze setting
<input checked="" type="checkbox"/> Read access <input checked="" type="checkbox"/> Write access <input type="checkbox"/> CINH <input type="checkbox"/> PLC-STOP <input type="checkbox"/> no transfer	

15.1.3.2 Parameters with selection list

Description structure

Parameter Name: Cxxxxx _____	Data type: _____ Index: _____
Description	
Selection list (Lenze setting printed in bold)	
1	
2	
3	
<input checked="" type="checkbox"/> Read access <input checked="" type="checkbox"/> Write access <input type="checkbox"/> CINH <input type="checkbox"/> PLC-STOP <input type="checkbox"/> no transfer	

15.1.3.3 Parameters with bit-coded setting

Description structure

Parameter Name: Cxxxxx _____	Data type: _____ Index: _____
Description	
Value is bit-coded:	
Bit 0	
...	
Bit 31	
<input checked="" type="checkbox"/> Read access <input checked="" type="checkbox"/> Write access <input type="checkbox"/> CINH <input type="checkbox"/> PLC-STOP <input type="checkbox"/> no transfer	

15.1.4 Parameter attributes

Attribute	Meaning
<input checked="" type="checkbox"/> Read access	Read access to parameter possible.
<input checked="" type="checkbox"/> Write access	Write access to parameter possible.
	<input checked="" type="checkbox"/> CINH This attribute is not required for the parameter setting of the controllers!
	<input checked="" type="checkbox"/> PLC STOP This attribute is not required for the parameter setting of the controllers!
<input checked="" type="checkbox"/> No transfer	This attribute is not required for the parameter setting of the controllers!

15.2 Basic parameters of the Controllers

In this chapter all parameters of the controller standard devices (Cabinet Controller/Panel Controller) are listed in numerically ascending order.

C0001

Parameter Name: C0001 Device: Type key	Data type: VISIBLE_STRING Index: 24574 _d = 5FFE _h
Device identification of the Controller	
<input checked="" type="checkbox"/> Read access <input type="checkbox"/> Write access <input type="checkbox"/> CINH <input type="checkbox"/> PLC-STOP <input type="checkbox"/> No transfer	

C0002

Parameter Name: C0002 Device: Type version	Data type: VISIBLE_STRING Index: 24573 _d = 5FFD _h
Version of the Controller	
<input checked="" type="checkbox"/> Read access <input type="checkbox"/> Write access <input type="checkbox"/> CINH <input type="checkbox"/> PLC-STOP <input type="checkbox"/> No transfer	

C0003

Parameter Name: C0003 Device: Name	Data type: VISIBLE_STRING Index: 24572 _d = 5FFC _h
Device name of the controller	
<input checked="" type="checkbox"/> Read access <input type="checkbox"/> Write access <input type="checkbox"/> CINH <input type="checkbox"/> PLC-STOP <input type="checkbox"/> No transfer	

C0004

Parameter Name: C0004 Device: Software	Data type: VISIBLE_STRING Index: 24571 _d = 5FFB _h
Software version of the controller	
<input checked="" type="checkbox"/> Read access <input type="checkbox"/> Write access <input type="checkbox"/> CINH <input type="checkbox"/> PLC-STOP <input type="checkbox"/> No transfer	

C0005

Parameter Name: C0005 Device: Hardware	Data type: VISIBLE_STRING Index: 24570 _d = 5FFA _h
Hardware version of the controller	
<input checked="" type="checkbox"/> Read access <input type="checkbox"/> Write access <input type="checkbox"/> CINH <input type="checkbox"/> PLC-STOP <input type="checkbox"/> No transfer	

C0006

Parameter Name: C0006 Device: Serial number	Data type: VISIBLE_STRING Index: 24569 _d = 5FF9 _h
Serial number of the controller	
<input checked="" type="checkbox"/> Read access <input type="checkbox"/> Write access <input type="checkbox"/> CINH <input type="checkbox"/> PLC-STOP <input type="checkbox"/> No transfer	

C0007

Parameter Name: C0007 Device: Manufacturer	Data type: VISIBLE_STRING Index: 24568 _d = 5FF8 _h
Manufacturer of the controller	
<input checked="" type="checkbox"/> Read access <input type="checkbox"/> Write access <input type="checkbox"/> CINH <input type="checkbox"/> PLC-STOP <input type="checkbox"/> No transfer	

C0008

Parameter Name: C0008 Device: Manufacturing date	Data type: VISIBLE_STRING Index: 24567 _d = 5FF7 _h
Manufacturing date of the controller	
<input checked="" type="checkbox"/> Read access <input type="checkbox"/> Write access <input type="checkbox"/> CINH <input type="checkbox"/> PLC-STOP <input type="checkbox"/> No transfer	

C0013

Parameter Name: C0013 System identification: Name	Data type: VISIBLE_STRING Index: 24562 _d = 5FF2 _h
Assign device names to the controller, in order to be able to identify it in the Engineering tool more easily.	
<input checked="" type="checkbox"/> Read access <input checked="" type="checkbox"/> Write access <input type="checkbox"/> CINH <input type="checkbox"/> PLC-STOP <input type="checkbox"/> no transfer	

C0015

Parameter Name: C0015 System identification: User name	Data type: VISIBLE_STRING Index: 24560 _d = 5FF0 _h
User name for the identification on the system	
<input checked="" type="checkbox"/> Read access <input checked="" type="checkbox"/> Write access <input type="checkbox"/> CINH <input type="checkbox"/> PLC-STOP <input type="checkbox"/> no transfer	

C0016

Parameter Name: C0016 System identification: Description	Data type: VISIBLE_STRING Index: 24559 _d = 5FEF _h
Description for the identification on the system	
<input checked="" type="checkbox"/> Read access <input checked="" type="checkbox"/> Write access <input type="checkbox"/> CINH <input type="checkbox"/> PLC-STOP <input type="checkbox"/> no transfer	

C0018

Parameter Name: C0018 Command		Data type: UNSIGNED_16 Index: 24557 _d = 5FED _h
Load PLC program command. Here the PLC boot project is reloaded.		
Selection list(Lenze setting printed in bold)		Info
0	No command	
279	Persist all	Save the data from the following tables to the management data base: <ul style="list-style-type: none"> • Data of the object table • Data of all address tables • Data of the file table
302	Delete logbook	
304	Export complete logbook	
512	Start PLC	
513	Stop PLC	
515	PLC: Reload boot project	
1282	Persist logbook	Save the logbook including all entries to a logbook file.
1538	Start FTP server	
1539	Stop FTP server	
1560	Update FTP server	
1540	Start telnet server	
1541	Stop telnet server	
1561	Update telnet server	
1542	Start web server	
1543	Stop web server	
1562	Update web server	
<input checked="" type="checkbox"/> Read access <input checked="" type="checkbox"/> Write access <input type="checkbox"/> CINH <input type="checkbox"/> PLC-STOP <input checked="" type="checkbox"/> no transfer		

C0019

Parameter Name: C0019 Command status		Data type: UNSIGNED_16 Index: 24556 _d = 5FEC _h
Parameter with the status of the running command		
<input checked="" type="checkbox"/> Read access <input type="checkbox"/> Write access <input type="checkbox"/> CINH <input type="checkbox"/> PLC-STOP <input type="checkbox"/> No transfer		

C0020

Parameter Name: C0020 CPU: Name		Data type: VISIBLE_STRING Index: 24555 _d = 5FEB _h
CPU type designation		
<input checked="" type="checkbox"/> Read access <input type="checkbox"/> Write access <input type="checkbox"/> CINH <input type="checkbox"/> PLC-STOP <input type="checkbox"/> No transfer		

C0025

Parameter Name: C0025 CPU: Firmware version		Data type: VISIBLE_STRING Index: 24550 _d = 5FE6 _h
CPU firmware version		
<input checked="" type="checkbox"/> Read access <input type="checkbox"/> Write access <input type="checkbox"/> CINH <input type="checkbox"/> PLC-STOP <input type="checkbox"/> No transfer		

C0030

Parameter Name: C0030 CPU: Temperature		Data type: UNSIGNED_8 Index: 24545 _d = 5FE1 _h
Processor temperature [°C]		
Display range (min. value unit max. value)		
0	°C	255
<input checked="" type="checkbox"/> Read access <input type="checkbox"/> Write access <input type="checkbox"/> CINH <input type="checkbox"/> PLC-STOP <input type="checkbox"/> No transfer		

C0036

Parameter Name: C0036 Bootloader: Type version		Data type: VISIBLE_STRING Index: 24539 _d = 5FDB _h
<input checked="" type="checkbox"/> Read access <input type="checkbox"/> Write access <input type="checkbox"/> CINH <input type="checkbox"/> PLC-STOP <input type="checkbox"/> No transfer		

C0040

Parameter Name: C0040 Activate front USB		Data type: UNSIGNED_8 Index: 24534 _d = 5FD7 _h
Activation of the front USB socket at the monitor panel <ul style="list-style-type: none"> • 0: USB socket not activated. • 1: USB socket activated. • Applies to the Controllers 3200 C with external monitor panels (optionally available) 		
Setting range (min. value unit max. value)		Lenze setting
0		1 0
<input checked="" type="checkbox"/> Read access <input checked="" type="checkbox"/> Write access <input type="checkbox"/> CINH <input type="checkbox"/> PLC-STOP <input type="checkbox"/> no transfer		

C0041

Parameter Name: C0041 Operating time		Data type: UNSIGNED_32 Index: 24534 _d = 5FD6 _h
Total operating time since the device has been switched on [s]		
Display range (min. value unit max. value)		
0	H	16777215
<input checked="" type="checkbox"/> Read access <input type="checkbox"/> Write access <input type="checkbox"/> CINH <input type="checkbox"/> PLC-STOP <input type="checkbox"/> No transfer		

C0042

Parameter Name: C0042 Number of reboots		Data type: UNSIGNED_32 Index: 24533 _d = 5FD5 _h
Number of boot processes of the device		
Display range (min. value unit max. value)		
0		65535
<input checked="" type="checkbox"/> Read access <input type="checkbox"/> Write access <input type="checkbox"/> CINH <input type="checkbox"/> PLC-STOP <input type="checkbox"/> No transfer		

C0043

Parameter Name: C0043 Activate Explorer		Data type: UNSIGNED_8 Index: 24532 _d = 5FD4 _h
Unhiding/hiding the Windows® CE interface/task bar on the Controller. <ul style="list-style-type: none"> • 0: Windows® CE interface/task bar hidden. • 1: Windows® CE interface/task bar unhidden. • The VisiWinNet Remote Access Manager remains visible. 		
Setting range (min. value unit max. value)		Lenze setting
0		1 1
<input checked="" type="checkbox"/> Read access <input checked="" type="checkbox"/> Write access <input type="checkbox"/> CINH <input type="checkbox"/> PLC-STOP <input type="checkbox"/> no transfer		

C0048

Parameter Name: C0048 Logbook: Time to auto persist		Data type: UNSIGNED_32 Index: 24527 _d = 5FCF _h
The time for the timer is entered in minutes. The timer is restarted when the log service has saved data. If the time has expired and no logbook entries have been saved in the meantime, the saving process will be activated.		
Setting range (min. value unit max. value)		Lenze setting
	min	2 min
<input checked="" type="checkbox"/> Read access <input checked="" type="checkbox"/> Write access <input type="checkbox"/> CINH <input type="checkbox"/> PLC-STOP <input type="checkbox"/> no transfer		

C0049

Parameter Name: C0049 Entry count to auto persist		Data type: UNSIGNED_32 Index: 24526 _d = 5FCE _h
Enter the number of logbook entries after which the saving process is to be activated. Counting starts with the last saving.		
Setting range (min. value unit max. value)		Lenze setting
0		150 150
<input checked="" type="checkbox"/> Read access <input checked="" type="checkbox"/> Write access <input type="checkbox"/> CINH <input type="checkbox"/> PLC-STOP <input type="checkbox"/> no transfer		

C0050

Parameter Name: C0050 Logbook: Max. entries		Data type: UNSIGNED_32 Index: 24525 _d = 5FCD _h
Enter the maximum number of logbook entries. The logbook entries are taken from the main memory and from the SD memory card.		
Setting range (min. value unit max. value)		Lenze setting
100		10000 3000
<input checked="" type="checkbox"/> Read access <input checked="" type="checkbox"/> Write access <input type="checkbox"/> CINH <input type="checkbox"/> PLC-STOP <input type="checkbox"/> no transfer		

C0051

Parameter Name: C0051 Logbook: Size on CF		Data type: UNSIGNED_32 Index: 24524 _d = 5FCC _h
Size of the memory space occupied on the SD memory card		
<input checked="" type="checkbox"/> Read access <input type="checkbox"/> Write access <input type="checkbox"/> CINH <input type="checkbox"/> PLC-STOP <input type="checkbox"/> No transfer		

C0052

Parameter Name: C0052 Logbook: Number of entries in RAM	Data type: UNSIGNED_32 Index: 24523 _d = 5FCB _h
Actual number of entries in the RAM	
<input checked="" type="checkbox"/> Read access <input type="checkbox"/> Write access <input type="checkbox"/> CINH <input type="checkbox"/> PLC-STOP <input type="checkbox"/> No transfer	

C0053

Parameter Name: C0053 Logbook: Time of oldest entry	Data type: DATE Index: 24522 _d = 5FCA _h
Date of the oldest entry in the logbook	
Display range (min. value unit max. value)	
	(Local time)
<input checked="" type="checkbox"/> Read access <input type="checkbox"/> Write access <input type="checkbox"/> CINH <input type="checkbox"/> PLC-STOP <input type="checkbox"/> No transfer	

C0054

Parameter Name: C0054 Logbook: Index of oldest entry	Data type: UNSIGNED_32 Index: 24521 _d = 5FC9 _h
Number of the oldest entry in the logbook	
<input checked="" type="checkbox"/> Read access <input type="checkbox"/> Write access <input type="checkbox"/> CINH <input type="checkbox"/> PLC-STOP <input type="checkbox"/> No transfer	

C0055

Parameter Name: C0055 Logbook: Time of last entry on CF	Data type: DATE Index: 24520 _d = 5FC8 _h
Time of the last entry on the SD card	
Display range (min. value unit max. value)	
	(Local time)
<input checked="" type="checkbox"/> Read access <input type="checkbox"/> Write access <input type="checkbox"/> CINH <input type="checkbox"/> PLC-STOP <input type="checkbox"/> No transfer	

C0056

Parameter Name: C0056 Logbook: Index of last entry on CF	Data type: UNSIGNED_32 Index: 24519 _d = 5FC7 _h
Number of the last entry on the SD memory card	
<input checked="" type="checkbox"/> Read access <input type="checkbox"/> Write access <input type="checkbox"/> CINH <input type="checkbox"/> PLC-STOP <input type="checkbox"/> No transfer	

C0057

Parameter Name: C0057 Logbook: Index of last entry	Data type: UNSIGNED_32 Index: 24518 _d = 5FC6 _h
Number of the last entry in the logbook	
<input checked="" type="checkbox"/> Read access <input type="checkbox"/> Write access <input type="checkbox"/> CINH <input type="checkbox"/> PLC-STOP <input type="checkbox"/> No transfer	

C0058

Parameter Name: C0058 Logbook: Time of last entry		Data type: DATE Index: 24517 _d = 5FC5 _h
Time of the last entry in the logbook		
Display range (min. value unit max. value)		
	(Local time)	
<input checked="" type="checkbox"/> Read access <input type="checkbox"/> Write access <input type="checkbox"/> CINH <input type="checkbox"/> PLC-STOP <input type="checkbox"/> No transfer		

C0064

Parameter Name: C0064 Logbook: Time of last error entry		Data type: DATE Index: 24517 _d = 5FBF _h
Time stamp of the latest error entry in the logbook		
Display range (min. value unit max. value)		
	(Local time)	
<input checked="" type="checkbox"/> Read access <input type="checkbox"/> Write access <input type="checkbox"/> CINH <input type="checkbox"/> PLC-STOP <input type="checkbox"/> No transfer		

C0070

Parameter Name: C0070 Ratio: Data/program memory		Data type: UNSIGNED_32 Index: 24505 _d = 5FB9 _h
<ul style="list-style-type: none"> • A part of the available memory is provided to the current programs as main memory. • The other part is available as object store for saving files in the RAM. • The percentage value indicated shows the ratio between object store (MemoryVirtualFilesAll) and total memory. 		
Setting range (min. value unit max. value)		Lenze setting
0	%	27 27 %
<input checked="" type="checkbox"/> Read access <input checked="" type="checkbox"/> Write access <input type="checkbox"/> CINH <input type="checkbox"/> PLC-STOP <input type="checkbox"/> no transfer		

C0071

Parameter Name: C0071 Allocated program memory		Data type: UNSIGNED_32 Index: 24504 _d = 5FB8 _h
Size of the reserved program memory		
Display range (min. value unit max. value)		
0	Bytes	4294967295
<input checked="" type="checkbox"/> Read access <input type="checkbox"/> Write access <input type="checkbox"/> CINH <input type="checkbox"/> PLC-STOP <input type="checkbox"/> No transfer		

C0072

Parameter Name: C0072 Used program memory		Data type: UNSIGNED_32 Index: 24503 _d = 5FB7 _h
Size of the occupied program memory		
Display range (min. value unit max. value)		
0	Bytes	4294967295
<input checked="" type="checkbox"/> Read access <input type="checkbox"/> Write access <input type="checkbox"/> CINH <input type="checkbox"/> PLC-STOP <input type="checkbox"/> No transfer		

C0075

Parameter Name: C0075 Allocated virtual file memory		Data type: UNSIGNED_32 Index: 24500 _d = 5FB4 _h
Object store reserved for saving of virtual files		
Display range (min. value unit max. value)		
0	Bytes	4294967295
<input checked="" type="checkbox"/> Read access <input type="checkbox"/> Write access <input type="checkbox"/> CINH <input type="checkbox"/> PLC-STOP <input type="checkbox"/> No transfer		

C0076

Parameter Name: C0076 Used virtual file memory		Data type: UNSIGNED_32 Index: 24499 _d = 5FB3 _h
Object store occupied by virtual files		
Display range (min. value unit max. value)		
0	Bytes	4294967295
<input checked="" type="checkbox"/> Read access <input type="checkbox"/> Write access <input type="checkbox"/> CINH <input type="checkbox"/> PLC-STOP <input type="checkbox"/> No transfer		

C0078

Parameter Name: C0078 Allocated flash memory		Data type: UNSIGNED_32 Index: 24497 _d = 5FB1 _h
Flash memory reserved		
Display range (min. value unit max. value)		
0	Bytes	4294967295
<input checked="" type="checkbox"/> Read access <input type="checkbox"/> Write access <input type="checkbox"/> CINH <input type="checkbox"/> PLC-STOP <input type="checkbox"/> No transfer		

C0079

Parameter Name: C0079 Used flash memory		Data type: UNSIGNED_32 Index: 24496 _d = 5FB0 _h
Flash memory occupied		
Display range (min. value unit max. value)		
0	Bytes	4294967295
<input checked="" type="checkbox"/> Read access <input type="checkbox"/> Write access <input type="checkbox"/> CINH <input type="checkbox"/> PLC-STOP <input type="checkbox"/> No transfer		

C0085

Parameter Name: C0085 NTP: Activate network time protocol AutoUpdate		Data type: UNSIGNED_32 Index: 24490 _d = 5FAA _h
Activation of a global time levelling with an NTP server. Internet connection of the Controller is required. <ul style="list-style-type: none"> • 0: Global time levelling not activated. • 1: Global time levelling activated. 		
Setting range (min. value unit max. value)		Lenze setting
0		1 0
<input checked="" type="checkbox"/> Read access <input checked="" type="checkbox"/> Write access <input type="checkbox"/> CINH <input type="checkbox"/> PLC-STOP <input type="checkbox"/> no transfer		

C0086

Parameter Name: C0086 NTP: NTP server	Data type: VISIBLE_STRING Index: 24489 _d = 5FA9 _h
Address of the NTP server to be used by the controller for global system time levelling. Example: 172.10.1.123	
<input checked="" type="checkbox"/> Read access <input checked="" type="checkbox"/> Write access <input type="checkbox"/> CINH <input type="checkbox"/> PLC-STOP <input type="checkbox"/> no transfer	

C0090

Parameter Name: C0090 System: Date and time	Data type: DATE Index: 24485 _d = 5FA5 _h
Date and time	
<input checked="" type="checkbox"/> Read access <input checked="" type="checkbox"/> Write access <input type="checkbox"/> CINH <input type="checkbox"/> PLC-STOP <input checked="" type="checkbox"/> no transfer	

C0091

Parameter Name: C0091 Local date and time	Data type: DATE Index: 24484 _d = 5FA4 _h
Local date and time.	
<input checked="" type="checkbox"/> Read access <input checked="" type="checkbox"/> Write access <input type="checkbox"/> CINH <input type="checkbox"/> PLC-STOP <input checked="" type="checkbox"/> no transfer	

C0092

Parameter Name: C0092 Time zone	Data type: VISIBLE_STRING Index: 24483 _d = 5FA3 _h
Time zone of the device. Possible values: "Central European Standard Time", "North Pacific Standard Time", "GMT Standard Time", ...	
Selection list (Lenze setting printed in bold)	Info
Afghanistan Standard Time	Afghanistan Standard Time
Alaskan Standard Time	Alaska Standard Time
Arab Standard Time	Arab Standard Time
Arabian Standard Time	Arabian Standard Time
Arabic Standard Time	Arabic Standard Time
Atlantic Standard Time	Atlantic Standard Time
AUS Central Standard Time	AUS Central Standard Time
AUS Eastern Standard Time	AUS Eastern Standard Time
Azerbaijan Standard Time	Azores Standard Time
Azores Standard Time	China Standard Time
Canada Central Standard Time	Dateline Standard Time
Cape Verde Standard Time	E. Africa Standard Time
Caucasus Standard Time	E. Australia Standard Time
Cen. Australia Standard Time	E. Europe Standard Time
Central America Standard Time	E. South America Standard Time

Parameter Name: C0092 Time zone		Data type: VISIBLE_STRING Index: 24483 _d = 5FA3 _h
Central Asia Standard Time	Eastern Standard Time	
Central Brazilian Standard Time	Egypt Standard Time	
Central Europe Standard Time	Ekaterinburg Standard Time	
Central European Standard Time	Fiji Standard Time	
Central Pacific Standard Time	Malay Peninsula Standard Time	
Central Standard Time	Mexico Standard Time	
Central Standard Time (Mexico)	Mexico Standard Time 2	
China Standard Time	Mid-Atlantic Standard Time	
Dateline Standard Time	Mountain Standard Time	
E. Africa Standard Time	Myanmar Standard Time	
E. Australia Standard Time	N. Central Asia Standard Time	
E. Europe Standard Time	Nepal Standard Time	
E. South America Standard Time	New Zealand Standard Time	
Eastern Standard Time	Newfoundland Standard Time	
Egypt Standard Time	SE Asia Standard Time	
Ekaterinburg Standard Time	South Africa Standard Time	
Fiji Standard Time	Sri Lanka Standard Time	
FLE Standard Time	Taipei Standard Time	
Georgian Standard Time	Tasmania Standard Time	
GMT Standard Time	Tokyo Standard Time	
Greenland Standard Time	Tonga Standard Time	
Greenwich Standard Time	US Eastern Standard Time	
GTB Standard Time	US Mountain Standard Time	
Hawaiian Standard Time	Vladivostok Standard Time	
India Standard Time	India Standard Time	
Iran Standard Time	Iran Standard Time	
Israel Standard Time	Jerusalem Standard Time	
Jordan Standard Time	Jordan Standard Time	
Korea Standard Time	Korea Standard Time	
Mid-Atlantic Standard Time	Mid-Atlantic Standard Time	
Middle East Standard Time	Middle East Standard Time	
Mountain Standard Time	Mountain Standard Time	
Mountain Standard Time (Mexico)	Mountain Standard Time (Mexico)	
Myanmar Standard Time	Myanmar Standard Time	

Parameter Name: C0092 Time zone		Data type: VISIBLE_STRING Index: 24483 _d = 5FA3 _h
N. Central Asia Standard Time	N. Central Asia Standard Time	
Namibia Standard Time	Namibia Standard Time	
Nepal Standard Time	Nepal Standard Time	
New Zealand Standard Time	New Zealand Standard Time	
Newfoundland Standard Time	Newfoundland Standard Time	
North Asia East Standard Time	North Asia East Standard Time	
North Asia Standard Time	North Asia Standard Time	
Pacific SA Standard Time	Pacific SA Standard Time	
Pacific Standard Time	Pacific Standard Time	
Pacific Standard Time (Mexico)	Pacific Standard Time (Mexico)	
Romance Standard Time	Romance Standard Time	
Russian Standard Time	Russian Standard Time	
SA Eastern Standard Time	SA Eastern Standard Time	
Singapore Standard Time	Malay Peninsula Standard Time	
SA Pacific Standard Time	SA Pacific Standard Time	
SA Western Standard Time	SA Western Standard Time	
Samoa Standard Time	Samoa Standard Time	
SE Asia Standard Time	SE Asia Standard Time	
South Africa Standard Time	South Africa Standard Time	
Sri Lanka Standard Time	Sri Lanka Standard Time	
Taipei Standard Time	Taipei Standard Time	
Tasmania Standard Time	Tasmania Standard Time	
Tokyo Standard Time	Tokyo Standard Time	
Tonga Standard Time	Tonga Standard Time	

Parameter Name: C0092 Time zone		Data type: VISIBLE_STRING Index: 24483 _d = 5FA3 _h
US Eastern Standard Time	US Eastern Standard Time	
US Mountain Standard Time	US Mountain Standard Time	
Vladivostok Standard Time	Vladivostok Standard Time	
W. Australia Standard Time	W. Australia Standard Time	
W. Central Africa Standard Time	W. Central Africa Standard Time	
W. Europe Standard Time	W. Europe Standard Time	
West Asia Standard Time	West Asia Standard Time	
West Pacific Standard Time	West Pacific Standard Time	
Yakutsk Standard Time	Yakutsk Standard Time	
<input checked="" type="checkbox"/> Read access <input checked="" type="checkbox"/> Write access <input type="checkbox"/> CINH <input type="checkbox"/> PLC-STOP <input type="checkbox"/> no transfer		

C0093

Parameter Name: C0093 Locale		Data type: UNSIGNED_32 Index: 24482 _d = 5FA2 _h
Selection of regional and language options		
Selection list (Lenze setting printed in bold)		Info
1030	Danish (Denmark)	
1043	Dutch (Netherlands)	
1033	English (United States)	
2057	English (United Kingdom)	
1036	French (France)	
1031	German (Germany)	
1037	Hebrew (Israel)	
1040	Italian (Italy)	
1044	Norwegian (Norway, Bokmål)	
2070	Portuguese (Portugal)	
3082	Spanish (Spain, International Sort)	
1053	Swedish (Sweden)	
<input checked="" type="checkbox"/> Read access <input checked="" type="checkbox"/> Write access <input type="checkbox"/> CINH <input type="checkbox"/> PLC-STOP <input type="checkbox"/> no transfer		

C0095

Parameter Name: C0095 Activate VNC server		Data type: UNSIGNED_8 Index: 24480 _d = 5FA0 _h
Activation of the parameter to start the VNC server on the Controller. <ul style="list-style-type: none"> • 0: Parameter not activated. • 1: Parameter activated. 		
Setting range (min. value unit max. value)		Lenze setting
0		1 0
<input checked="" type="checkbox"/> Read access <input checked="" type="checkbox"/> Write access <input type="checkbox"/> CINH <input type="checkbox"/> PLC-STOP <input type="checkbox"/> no transfer		

C0097

Parameter Name: C0097 Activate VisiWinNET Remote Access		Data type: UNSIGNED_8 Index: 24478 _d = 5F9E _h
Activation of the parameters to start the VisiWinNET Remote Access Manager on the Controller. <ul style="list-style-type: none"> • 0: Parameter not activated. • 1: Parameter activated. 		
Setting range (min. value unit max. value)		Lenze setting
0		1 1
<input checked="" type="checkbox"/> Read access <input checked="" type="checkbox"/> Write access <input type="checkbox"/> CINH <input type="checkbox"/> PLC-STOP <input type="checkbox"/> no transfer		

C0100

Parameter Name: C0100 WinCE users: Number		Data type: UNSIGNED_8 Index: 24475 _d = 5F9B _h
Number of users registered		
Display range (min. value unit max. value)		
0		10
<input checked="" type="checkbox"/> Read access <input type="checkbox"/> Write access <input type="checkbox"/> CINH <input type="checkbox"/> PLC-STOP <input type="checkbox"/> No transfer		

C0101

Parameter Name: C0101 WinCE users: User name 1		Data type: VISIBLE_STRING Index: 24474 _d = 5F9A _h
Name of the user Default setting: admin		
<input checked="" type="checkbox"/> Read access <input checked="" type="checkbox"/> Write access <input type="checkbox"/> CINH <input type="checkbox"/> PLC-STOP <input type="checkbox"/> no transfer		

C0102

Parameter Name: C0102 WinCE users: Password 1		Data type: VISIBLE_STRING Index: 24473 _d = 5F99 _h
Password of the user Default setting: admin		
<input checked="" type="checkbox"/> Read access <input checked="" type="checkbox"/> Write access <input type="checkbox"/> CINH <input type="checkbox"/> PLC-STOP <input type="checkbox"/> no transfer		

C0103

Parameter Name: C0103 WinCE users: User 1 with FTP permissions		Data type: UNSIGNED_8 Index: 24472 _d = 5F98 _h
Permissions for using the FTP <ul style="list-style-type: none"> • 0: User must not use FTP. • 1: User may use FTP. 		
Setting range (min. value unit max. value)		Lenze setting
0		1 1
<input checked="" type="checkbox"/> Read access <input checked="" type="checkbox"/> Write access <input type="checkbox"/> CINH <input type="checkbox"/> PLC-STOP <input type="checkbox"/> no transfer		

C0104

Parameter Name: C0104 FTP: Permissions user 1		Data type: UNSIGNED_32 Index: 24471 _d = 5F97 _h
FTP rights of the user.		
Value is bit-coded:		
Bit 0	Read	
Bit 1	Write	
Bit 2	Virtual Roots	
Bit 3	Allow Hidden Files	
<input checked="" type="checkbox"/> Read access <input checked="" type="checkbox"/> Write access <input type="checkbox"/> CINH <input type="checkbox"/> PLC-STOP <input type="checkbox"/> no transfer		

C0105

Parameter Name: C0105 FTP: Home user 1		Data type: VISIBLE_STRING Index: 24470 _d = 5F96 _h
Home directory of the user		
<input checked="" type="checkbox"/> Read access <input checked="" type="checkbox"/> Write access <input type="checkbox"/> CINH <input type="checkbox"/> PLC-STOP <input type="checkbox"/> no transfer		

C0106

Parameter Name: C0106 WinCE users: User 1 with telnet permissions		Data type: UNSIGNED_8 Index: 24469 _d = 5F95 _h
Permissions for using the Telnet		
<ul style="list-style-type: none"> • 0: User must not use Telnet. • 1: User may use Telnet. 		
Setting range (min. value unit max. value)		Lenze setting
0		1 1
<input checked="" type="checkbox"/> Read access <input checked="" type="checkbox"/> Write access <input type="checkbox"/> CINH <input type="checkbox"/> PLC-STOP <input type="checkbox"/> no transfer		

C0108

Parameter Name: C0108 WinCE users: User name 2		Data type: VISIBLE_STRING Index: 24467 _d = 5F93 _h
Name of the user		
<input checked="" type="checkbox"/> Read access <input checked="" type="checkbox"/> Write access <input type="checkbox"/> CINH <input type="checkbox"/> PLC-STOP <input type="checkbox"/> no transfer		

C0109

Parameter Name: C0109 WinCE users: Password 2		Data type: VISIBLE_STRING Index: 24466 _d = 5F92 _h
Password of the user		
<input checked="" type="checkbox"/> Read access <input checked="" type="checkbox"/> Write access <input type="checkbox"/> CINH <input type="checkbox"/> PLC-STOP <input type="checkbox"/> no transfer		

C0110

Parameter Name: C0110 WinCE users: User 2 with FTP permissions		Data type: UNSIGNED_8 Index: 24465 _d = 5F91 _h
Permissions for using the FTP <ul style="list-style-type: none"> • 0: User must not use FTP. • 1: User may use FTP. 		
Setting range (min. value unit max. value)		Lenze setting
0		1 0
<input checked="" type="checkbox"/> Read access <input checked="" type="checkbox"/> Write access <input type="checkbox"/> CINH <input type="checkbox"/> PLC-STOP <input type="checkbox"/> no transfer		

C0111

Parameter Name: C0111 FTP: Permissions user 2		Data type: UNSIGNED_32 Index: 24464 _d = 5F90 _h
FTP rights of the user.		
Value is bit-coded:		
Bit 0	Read	
Bit 1	Write	
Bit 2	Virtual Roots	
Bit 3	Allow Hidden Files	
<input checked="" type="checkbox"/> Read access <input checked="" type="checkbox"/> Write access <input type="checkbox"/> CINH <input type="checkbox"/> PLC-STOP <input type="checkbox"/> no transfer		

C0112

Parameter Name: C0112 FTP: Home user 2		Data type: VISIBLE_STRING Index: 24463 _d = 5F8F _h
Home directory of the user		
<input checked="" type="checkbox"/> Read access <input checked="" type="checkbox"/> Write access <input type="checkbox"/> CINH <input type="checkbox"/> PLC-STOP <input type="checkbox"/> no transfer		

C0113

Parameter Name: C0113 WinCE users: User 2 with telnet permissions		Data type: UNSIGNED_8 Index: 24462 _d = 5F8E _h
Permissions for using the Telnet <ul style="list-style-type: none"> • 0: User must not use Telnet. • 1: User may use Telnet. 		
Setting range (min. value unit max. value)		Lenze setting
0		1 0
<input checked="" type="checkbox"/> Read access <input checked="" type="checkbox"/> Write access <input type="checkbox"/> CINH <input type="checkbox"/> PLC-STOP <input type="checkbox"/> no transfer		

C0115

Parameter Name: C0115 WinCE users: User name 3		Data type: VISIBLE_STRING Index: 24460 _d = 5F8C _h
Name of the user		
<input checked="" type="checkbox"/> Read access <input checked="" type="checkbox"/> Write access <input type="checkbox"/> CINH <input type="checkbox"/> PLC-STOP <input type="checkbox"/> no transfer		

C0116

Parameter Name: C0116 WinCE users: Password 3	Data type: VISIBLE_STRING Index: 24459 _d = 5F8B _h
Password of the user	
<input checked="" type="checkbox"/> Read access <input checked="" type="checkbox"/> Write access <input type="checkbox"/> CINH <input type="checkbox"/> PLC-STOP <input type="checkbox"/> no transfer	

C0117

Parameter Name: C0117 WinCE users: User 3 with FTP permissions	Data type: UNSIGNED_8 Index: 24458 _d = 5F8A _h
Permissions for using the FTP	
<ul style="list-style-type: none"> • 0: User must not use FTP. • 1: User may use FTP. 	
Setting range (min. value unit max. value)	Lenze setting
0	1 0
<input checked="" type="checkbox"/> Read access <input checked="" type="checkbox"/> Write access <input type="checkbox"/> CINH <input type="checkbox"/> PLC-STOP <input type="checkbox"/> no transfer	

C0118

Parameter Name: C0118 FTP: Permissions user 3	Data type: UNSIGNED_32 Index: 24457 _d = 5F89 _h
FTP rights of the user.	
Value is bit-coded:	
Bit 0	Read
Bit 1	Write
Bit 2	Virtual Roots
Bit 3	Allow Hidden Files
<input checked="" type="checkbox"/> Read access <input checked="" type="checkbox"/> Write access <input type="checkbox"/> CINH <input type="checkbox"/> PLC-STOP <input type="checkbox"/> no transfer	

C0119

Parameter Name: C0119 FTP: Home user 3	Data type: VISIBLE_STRING Index: 24456 _d = 5F88 _h
Home directory of the user	
<input checked="" type="checkbox"/> Read access <input checked="" type="checkbox"/> Write access <input type="checkbox"/> CINH <input type="checkbox"/> PLC-STOP <input type="checkbox"/> no transfer	

C0120

Parameter Name: C0120 WinCE users: User 3 with telnet permissions	Data type: UNSIGNED_8 Index: 24455 _d = 5F87 _h
Permissions for using the Telnet	
<ul style="list-style-type: none"> • 0: User must not use Telnet. • 1: User may use Telnet. 	
Setting range (min. value unit max. value)	Lenze setting
0	1 0
<input checked="" type="checkbox"/> Read access <input checked="" type="checkbox"/> Write access <input type="checkbox"/> CINH <input type="checkbox"/> PLC-STOP <input type="checkbox"/> no transfer	

C0122

Parameter Name: C0122 WinCE users: User name 4	Data type: VISIBLE_STRING Index: 24453 _d = 5F85 _h
Name of the user	
<input checked="" type="checkbox"/> Read access <input checked="" type="checkbox"/> Write access <input type="checkbox"/> CINH <input type="checkbox"/> PLC-STOP <input type="checkbox"/> no transfer	

C0123

Parameter Name: C0123 WinCE users: Password 4	Data type: VISIBLE_STRING Index: 24452 _d = 5F84 _h
Password of the user	
<input checked="" type="checkbox"/> Read access <input checked="" type="checkbox"/> Write access <input type="checkbox"/> CINH <input type="checkbox"/> PLC-STOP <input type="checkbox"/> no transfer	

C0124

Parameter Name: C0124 WinCE users: User 4 with FTP permissions	Data type: UNSIGNED_8 Index: 24451 _d = 5F83 _h
Permissions for using the FTP	
<ul style="list-style-type: none"> • 0: User must not use FTP. • 1: User may use FTP. 	
Setting range (min. value unit max. value)	Lenze setting
0	1 0
<input checked="" type="checkbox"/> Read access <input checked="" type="checkbox"/> Write access <input type="checkbox"/> CINH <input type="checkbox"/> PLC-STOP <input type="checkbox"/> no transfer	

C0125

Parameter Name: C0125 FTP: Permissions user 4	Data type: UNSIGNED_32 Index: 24450 _d = 5F82 _h
FTP rights of the user.	
Value is bit-coded:	
Bit 0	Read
Bit 1	Write
Bit 2	Virtual Roots
Bit 3	Allow Hidden Files
<input checked="" type="checkbox"/> Read access <input checked="" type="checkbox"/> Write access <input type="checkbox"/> CINH <input type="checkbox"/> PLC-STOP <input type="checkbox"/> no transfer	

C0126

Parameter Name: C0126 FTP: Home user 4	Data type: VISIBLE_STRING Index: 24449 _d = 5F81 _h
Home directory of the user	
<input checked="" type="checkbox"/> Read access <input checked="" type="checkbox"/> Write access <input type="checkbox"/> CINH <input type="checkbox"/> PLC-STOP <input type="checkbox"/> no transfer	

C0127

Parameter Name: C0127 WinCE users: User 4 with telnet permissions		Data type: UNSIGNED_8 Index: 24448 _d = 5F80 _h
Permissions for using the Telnet <ul style="list-style-type: none"> • 0: User must not use Telnet. • 1: User may use Telnet. 		
Setting range (min. value unit max. value)		Lenze setting
0		1 0
<input checked="" type="checkbox"/> Read access <input checked="" type="checkbox"/> Write access <input type="checkbox"/> CINH <input type="checkbox"/> PLC-STOP <input type="checkbox"/> no transfer		

C0129

Parameter Name: C0129 WinCE users: User name 5		Data type: VISIBLE_STRING Index: 24446 _d = 5F7E _h
Name of the user		
<input checked="" type="checkbox"/> Read access <input checked="" type="checkbox"/> Write access <input type="checkbox"/> CINH <input type="checkbox"/> PLC-STOP <input type="checkbox"/> no transfer		

C0130

Parameter Name: C0130 WinCE users: Password 5		Data type: VISIBLE_STRING Index: 24445 _d = 5F7D _h
Password of the user		
<input checked="" type="checkbox"/> Read access <input checked="" type="checkbox"/> Write access <input type="checkbox"/> CINH <input type="checkbox"/> PLC-STOP <input type="checkbox"/> no transfer		

C0131

Parameter Name: C0131 WinCE users: User 5 with FTP permissions		Data type: UNSIGNED_8 Index: 24444 _d = 5F7C _h
Permissions for using the FTP <ul style="list-style-type: none"> • 0: User must not use FTP. • 1: User may use FTP. 		
Setting range (min. value unit max. value)		Lenze setting
0		1 0
<input checked="" type="checkbox"/> Read access <input checked="" type="checkbox"/> Write access <input type="checkbox"/> CINH <input type="checkbox"/> PLC-STOP <input type="checkbox"/> no transfer		

C0132

Parameter Name: C0132 FTP: Permissions user 5		Data type: UNSIGNED_32 Index: 24443 _d = 5F7B _h
FTP rights of the user.		
Value is bit-coded:		
Bit 0	Read	
Bit 1	Write	
Bit 2	Virtual Roots	
Bit 3	Allow Hidden Files	
<input checked="" type="checkbox"/> Read access <input checked="" type="checkbox"/> Write access <input type="checkbox"/> CINH <input type="checkbox"/> PLC-STOP <input type="checkbox"/> no transfer		

C0133

Parameter Name: C0133 FTP: Home user 5	Data type: VISIBLE_STRING Index: 24442 _d = 5F7A _h
Home directory of the user	
<input checked="" type="checkbox"/> Read access <input checked="" type="checkbox"/> Write access <input type="checkbox"/> CINH <input type="checkbox"/> PLC-STOP <input type="checkbox"/> no transfer	

C0134

Parameter Name: C0134 WinCE users: User 5 with telnet permissions	Data type: UNSIGNED_8 Index: 24441 _d = 5F79 _h
Permissions for using the Telnet	
<ul style="list-style-type: none"> • 0: User must not use Telnet. • 1: User may use Telnet. 	
Setting range (min. value unit max. value)	Lenze setting
0	1 0
<input checked="" type="checkbox"/> Read access <input checked="" type="checkbox"/> Write access <input type="checkbox"/> CINH <input type="checkbox"/> PLC-STOP <input type="checkbox"/> no transfer	

C0136

Parameter Name: C0136 WinCE users: User name 6	Data type: VISIBLE_STRING Index: 24439 _d = 5F77 _h
Name of the user	
<input checked="" type="checkbox"/> Read access <input checked="" type="checkbox"/> Write access <input type="checkbox"/> CINH <input type="checkbox"/> PLC-STOP <input type="checkbox"/> no transfer	

C0137

Parameter Name: C0137 WinCE users: Password 6	Data type: VISIBLE_STRING Index: 24438 _d = 5F76 _h
Password of the user	
<input checked="" type="checkbox"/> Read access <input checked="" type="checkbox"/> Write access <input type="checkbox"/> CINH <input type="checkbox"/> PLC-STOP <input type="checkbox"/> no transfer	

C0138

Parameter Name: C0138 WinCE users: User 6 with FTP permissions	Data type: UNSIGNED_8 Index: 24437 _d = 5F75 _h
Permissions for using the FTP	
<ul style="list-style-type: none"> • 0: User must not use FTP. • 1: User may use FTP. 	
Setting range (min. value unit max. value)	Lenze setting
0	1 0
<input checked="" type="checkbox"/> Read access <input checked="" type="checkbox"/> Write access <input type="checkbox"/> CINH <input type="checkbox"/> PLC-STOP <input type="checkbox"/> no transfer	

C0139

Parameter Name: C0139 FTP: Permissions user 6		Data type: UNSIGNED_32 Index: 24436 _d = 5F74 _h
FTP rights of the user.		
Value is bit-coded:		
Bit 0	Read	
Bit 1	Write	
Bit 2	Virtual Roots	
Bit 3	Allow Hidden Files	
<input checked="" type="checkbox"/> Read access <input checked="" type="checkbox"/> Write access <input type="checkbox"/> CINH <input type="checkbox"/> PLC-STOP <input type="checkbox"/> no transfer		

C0140

Parameter Name: C0140 FTP: Home user 6		Data type: VISIBLE_STRING Index: 24435 _d = 5F73 _h
Home directory of the user		
<input checked="" type="checkbox"/> Read access <input checked="" type="checkbox"/> Write access <input type="checkbox"/> CINH <input type="checkbox"/> PLC-STOP <input type="checkbox"/> no transfer		

C0141

Parameter Name: C0141 WinCE users: User 6 with telnet permissions		Data type: UNSIGNED_8 Index: 24434 _d = 5F72 _h
Permissions for using the Telnet		
<ul style="list-style-type: none"> • 0: User must not use Telnet. • 1: User may use Telnet. 		
Setting range (min. value unit max. value)		Lenze setting
0		1 0
<input checked="" type="checkbox"/> Read access <input checked="" type="checkbox"/> Write access <input type="checkbox"/> CINH <input type="checkbox"/> PLC-STOP <input type="checkbox"/> no transfer		

C0143

Parameter Name: C0143 WinCE users: User name 7		Data type: VISIBLE_STRING Index: 24432 _d = 5F70 _h
Name of the user		
<input checked="" type="checkbox"/> Read access <input checked="" type="checkbox"/> Write access <input type="checkbox"/> CINH <input type="checkbox"/> PLC-STOP <input type="checkbox"/> no transfer		

C0144

Parameter Name: C0144 WinCE users: Password 7		Data type: VISIBLE_STRING Index: 24431 _d = 5F6F _h
Password of the user		
<input checked="" type="checkbox"/> Read access <input checked="" type="checkbox"/> Write access <input type="checkbox"/> CINH <input type="checkbox"/> PLC-STOP <input type="checkbox"/> no transfer		

C0145

Parameter Name: C0145 WinCE users: User 7 with FTP permissions		Data type: UNSIGNED_8 Index: 24430 _d = 5F6E _h
Permissions for using the FTP <ul style="list-style-type: none"> • 0: User must not use FTP. • 1: User may use FTP. 		
Setting range (min. value unit max. value)		Lenze setting
0		1 0
<input checked="" type="checkbox"/> Read access <input checked="" type="checkbox"/> Write access <input type="checkbox"/> CINH <input type="checkbox"/> PLC-STOP <input type="checkbox"/> no transfer		

C0146

Parameter Name: C0146 FTP: Permissions user 7		Data type: UNSIGNED_32 Index: 24429 _d = 5F6D _h
FTP rights of the user.		
Value is bit-coded:		
Bit 0	Read	
Bit 1	Write	
Bit 2	Virtual Roots	
Bit 3	Allow Hidden Files	
<input checked="" type="checkbox"/> Read access <input checked="" type="checkbox"/> Write access <input type="checkbox"/> CINH <input type="checkbox"/> PLC-STOP <input type="checkbox"/> no transfer		

C0147

Parameter Name: C0147 FTP: Home user 7		Data type: VISIBLE_STRING Index: 24428 _d = 5F6C _h
Home directory of the user		
<input checked="" type="checkbox"/> Read access <input checked="" type="checkbox"/> Write access <input type="checkbox"/> CINH <input type="checkbox"/> PLC-STOP <input type="checkbox"/> no transfer		

C0148

Parameter Name: C0148 WinCE users: User 7 with telnet permissions		Data type: UNSIGNED_8 Index: 24427 _d = 5F6B _h
Permissions for using the Telnet <ul style="list-style-type: none"> • 0: User must not use Telnet. • 1: User may use Telnet. 		
Setting range (min. value unit max. value)		Lenze setting
0		1 0
<input checked="" type="checkbox"/> Read access <input checked="" type="checkbox"/> Write access <input type="checkbox"/> CINH <input type="checkbox"/> PLC-STOP <input type="checkbox"/> no transfer		

C0150

Parameter Name: C0150 WinCE users: User name 8		Data type: VISIBLE_STRING Index: 24425 _d = 5F69 _h
Name of the user		
<input checked="" type="checkbox"/> Read access <input checked="" type="checkbox"/> Write access <input type="checkbox"/> CINH <input type="checkbox"/> PLC-STOP <input type="checkbox"/> no transfer		

C0151

Parameter Name: C0151 WinCE users: Password 8	Data type: VISIBLE_STRING Index: 24424 _d = 5F68 _h
Password of the user	
<input checked="" type="checkbox"/> Read access <input checked="" type="checkbox"/> Write access <input type="checkbox"/> CINH <input type="checkbox"/> PLC-STOP <input type="checkbox"/> no transfer	

C0152

Parameter Name: C0152 WinCE users: User 8 with FTP permissions	Data type: UNSIGNED_8 Index: 24423 _d = 5F67 _h
Permissions for using the FTP	
<ul style="list-style-type: none"> • 0: User must not use FTP. • 1: User may use FTP. 	
Setting range (min. value unit max. value)	Lenze setting
0	1 0
<input checked="" type="checkbox"/> Read access <input checked="" type="checkbox"/> Write access <input type="checkbox"/> CINH <input type="checkbox"/> PLC-STOP <input type="checkbox"/> no transfer	

C0153

Parameter Name: C0153 FTP: Permissions user 8	Data type: UNSIGNED_32 Index: 24422 _d = 5F66 _h
FTP rights of the user.	
Value is bit-coded:	
Bit 0	Read
Bit 1	Write
Bit 2	Virtual Roots
Bit 3	Allow Hidden Files
<input checked="" type="checkbox"/> Read access <input checked="" type="checkbox"/> Write access <input type="checkbox"/> CINH <input type="checkbox"/> PLC-STOP <input type="checkbox"/> no transfer	

C0154

Parameter Name: C0154 FTP: Home user 8	Data type: VISIBLE_STRING Index: 24421 _d = 5F65 _h
Home directory of the user	
<input checked="" type="checkbox"/> Read access <input checked="" type="checkbox"/> Write access <input type="checkbox"/> CINH <input type="checkbox"/> PLC-STOP <input type="checkbox"/> no transfer	

C0155

Parameter Name: C0155 WinCE users: User 8 with telnet permissions	Data type: UNSIGNED_8 Index: 24420 _d = 5F64 _h
Permissions for using the Telnet	
<ul style="list-style-type: none"> • 0: User must not use Telnet. • 1: User may use Telnet. 	
Setting range (min. value unit max. value)	Lenze setting
0	1 0
<input checked="" type="checkbox"/> Read access <input checked="" type="checkbox"/> Write access <input type="checkbox"/> CINH <input type="checkbox"/> PLC-STOP <input type="checkbox"/> no transfer	

C0157

Parameter Name: C0157 WinCE users: User name 9	Data type: VISIBLE_STRING Index: 24418 _d = 5F62 _h
Name of the user	
<input checked="" type="checkbox"/> Read access <input checked="" type="checkbox"/> Write access <input type="checkbox"/> CINH <input type="checkbox"/> PLC-STOP <input type="checkbox"/> no transfer	

C0158

Parameter Name: C0158 WinCE users: Password 9	Data type: VISIBLE_STRING Index: 24417 _d = 5F61 _h
Password of the user	
<input checked="" type="checkbox"/> Read access <input checked="" type="checkbox"/> Write access <input type="checkbox"/> CINH <input type="checkbox"/> PLC-STOP <input type="checkbox"/> no transfer	

C0159

Parameter Name: C0159 WinCE users: User 9 with FTP permissions	Data type: UNSIGNED_8 Index: 24416 _d = 5F60 _h
Permissions for using the FTP	
<ul style="list-style-type: none"> • 0: User must not use FTP. • 1: User may use FTP. 	
Setting range (min. value unit max. value)	Lenze setting
0	1 0
<input checked="" type="checkbox"/> Read access <input checked="" type="checkbox"/> Write access <input type="checkbox"/> CINH <input type="checkbox"/> PLC-STOP <input type="checkbox"/> no transfer	

C0160

Parameter Name: C0160 FTP: Permissions user 9	Data type: UNSIGNED_32 Index: 24415 _d = 5F5F _h
FTP rights of the user.	
Value is bit-coded:	
Bit 0	Read
Bit 1	Write
Bit 2	Virtual Roots
Bit 3	Allow Hidden Files
<input checked="" type="checkbox"/> Read access <input checked="" type="checkbox"/> Write access <input type="checkbox"/> CINH <input type="checkbox"/> PLC-STOP <input type="checkbox"/> no transfer	

C0161

Parameter Name: C0161 FTP: Home user 9	Data type: VISIBLE_STRING Index: 24414 _d = 5F5E _h
Home directory of the user	
<input checked="" type="checkbox"/> Read access <input checked="" type="checkbox"/> Write access <input type="checkbox"/> CINH <input type="checkbox"/> PLC-STOP <input type="checkbox"/> no transfer	

C0162

Parameter Name: C0162 WinCE users: User 9 with telnet permissions		Data type: UNSIGNED_8 Index: 24413 _d = 5F5D _h
Permissions for using the Telnet <ul style="list-style-type: none"> • 0: User must not use Telnet. • 1: User may use Telnet. 		
Setting range (min. value unit max. value)		Lenze setting
0		1 0
<input checked="" type="checkbox"/> Read access <input checked="" type="checkbox"/> Write access <input type="checkbox"/> CINH <input type="checkbox"/> PLC-STOP <input type="checkbox"/> no transfer		

C0164

Parameter Name: C0164 WinCE users: User name 10		Data type: VISIBLE_STRING Index: 24411 _d = 5F5B _h
Name of the user		
<input checked="" type="checkbox"/> Read access <input checked="" type="checkbox"/> Write access <input type="checkbox"/> CINH <input type="checkbox"/> PLC-STOP <input type="checkbox"/> no transfer		

C0165

Parameter Name: C0165 WinCE users: Password 10		Data type: VISIBLE_STRING Index: 24410 _d = 5F5A _h
Password of the user		
<input checked="" type="checkbox"/> Read access <input checked="" type="checkbox"/> Write access <input type="checkbox"/> CINH <input type="checkbox"/> PLC-STOP <input type="checkbox"/> no transfer		

C0166

Parameter Name: C0166 WinCE users: User 10 with FTP permissions		Data type: UNSIGNED_8 Index: 24409 _d = 5F59 _h
Permissions for using the FTP <ul style="list-style-type: none"> • 0: User must not use FTP. • 1: User may use FTP. 		
Setting range (min. value unit max. value)		Lenze setting
0		1 0
<input checked="" type="checkbox"/> Read access <input checked="" type="checkbox"/> Write access <input type="checkbox"/> CINH <input type="checkbox"/> PLC-STOP <input type="checkbox"/> no transfer		

C0167

Parameter Name: C0167 FTP: Permissions user 10		Data type: UNSIGNED_32 Index: 24408 _d = 5F58 _h
FTP rights of the user.		
Value is bit-coded:		
Bit 0	Read	
Bit 1	Write	
Bit 2	Virtual Roots	
Bit 3	Allow Hidden Files	
<input checked="" type="checkbox"/> Read access <input checked="" type="checkbox"/> Write access <input type="checkbox"/> CINH <input type="checkbox"/> PLC-STOP <input type="checkbox"/> no transfer		

C0168

Parameter Name: C0168 FTP: Home user 10	Data type: VISIBLE_STRING Index: 24407 _d = 5F57 _h
Home directory of the user	
<input checked="" type="checkbox"/> Read access <input checked="" type="checkbox"/> Write access <input type="checkbox"/> CINH <input type="checkbox"/> PLC-STOP <input type="checkbox"/> no transfer	

C0169

Parameter Name: C0169 WinCE users: User 10 with telnet permissions	Data type: UNSIGNED_8 Index: 24406 _d = 5F56 _h
Permissions for using the Telnet <ul style="list-style-type: none"> • 0: User must not use Telnet. • 1: User may use Telnet. 	
Setting range (min. value unit max. value)	Lenze setting
0	1 0
<input checked="" type="checkbox"/> Read access <input checked="" type="checkbox"/> Write access <input type="checkbox"/> CINH <input type="checkbox"/> PLC-STOP <input type="checkbox"/> no transfer	

C0172

Parameter Name: C0172 FTP: Allow anonymous	Data type: UNSIGNED_32 Index: 24403 _d = 5F53 _h
An unregistered user is allowed to log in. The user name is "anonymous" <ul style="list-style-type: none"> • 1: Activates the login. • 0: Deactivates the login. 	
Setting range (min. value unit max. value)	Lenze setting
0	1 0
<input checked="" type="checkbox"/> Read access <input checked="" type="checkbox"/> Write access <input type="checkbox"/> CINH <input type="checkbox"/> PLC-STOP <input type="checkbox"/> no transfer	

C0173

Parameter Name: C0173 FTP: Allow anonymous upload	Data type: UNSIGNED_32 Index: 24402 _d = 5F52 _h
1: An anonymous user is allowed to upload data to the controller if parameter ... <ul style="list-style-type: none"> • FtpAllowAnonymousUpload = TRUE <u>and</u> • FtpAllowAnonymous = true. 0: An anonymous user must not load any data to the Controller.	
Setting range (min. value unit max. value)	Lenze setting
0	1 1
<input checked="" type="checkbox"/> Read access <input checked="" type="checkbox"/> Write access <input type="checkbox"/> CINH <input type="checkbox"/> PLC-STOP <input type="checkbox"/> no transfer	

C0174

Parameter Name: C0174 FTP: Enabled	Data type: UNSIGNED_32 Index: 24401 _d = 5F51 _h
Activation of the FTP service <ul style="list-style-type: none"> • 0: FTP service not activated. • 1: FTP service activated. 	
Setting range (min. value unit max. value)	Lenze setting
0	1 1
<input checked="" type="checkbox"/> Read access <input checked="" type="checkbox"/> Write access <input type="checkbox"/> CINH <input type="checkbox"/> PLC-STOP <input type="checkbox"/> no transfer	

C0180

Parameter Name: C0180 Telnet: Use authentication		Data type: UNSIGNED_32 Index: 24395 _d = 5F4B _h
The telnet user has to identify himself/herself with name and password when connecting. <ul style="list-style-type: none"> • 0: Login not activated. • 1: Login activated. 		
Setting range (min. value unit max. value)		Lenze setting
0		1 1
<input checked="" type="checkbox"/> Read access <input checked="" type="checkbox"/> Write access <input type="checkbox"/> CINH <input type="checkbox"/> PLC-STOP <input type="checkbox"/> no transfer		

C0181

Parameter Name: C0181 Telnet: Enabled		Data type: UNSIGNED_32 Index: 24394 _d = 5F4A _h
Activation of the Telnet service <ul style="list-style-type: none"> • 0: Telnet not activated. • 1: Telnet activated. 		
Setting range (min. value unit max. value)		Lenze setting
0		1 1
<input checked="" type="checkbox"/> Read access <input checked="" type="checkbox"/> Write access <input type="checkbox"/> CINH <input type="checkbox"/> PLC-STOP <input type="checkbox"/> no transfer		

C0182

Parameter Name: C0182 0x100a: Software version		Data type: VISIBLE_STRING Index: 24393 _d = 5F49 _h
Software version of the backplane bus Controller <ul style="list-style-type: none"> • Applies to Controllers 3200 C 		
<input checked="" type="checkbox"/> Read access <input type="checkbox"/> Write access <input type="checkbox"/> CINH <input type="checkbox"/> PLC-STOP <input type="checkbox"/> No transfer		

C0183

Parameter Name: C0183 0x1009: Hardware version/FPGA firmware version		Data type: VISIBLE_STRING Index: 24392 _d = 5F48 _h
Hardware version of the backplane bus Controller <ul style="list-style-type: none"> • Applies to Controllers 3200 C 		
Version of the FPGA (Field Programmable Gate Array) <ul style="list-style-type: none"> • Applies to Controllers p500 		
<input checked="" type="checkbox"/> Read access <input type="checkbox"/> Write access <input type="checkbox"/> CINH <input type="checkbox"/> PLC-STOP <input type="checkbox"/> No transfer		

C0184

Parameter Name: C0184 0x100a: Software version		Data type: VISIBLE_STRING Index: 24391 _d = 5F47 _h
Software version of the backplane bus master <ul style="list-style-type: none"> • Applies to Controllers 3200 C 		
<input checked="" type="checkbox"/> Read access <input type="checkbox"/> Write access <input type="checkbox"/> CINH <input type="checkbox"/> PLC-STOP <input type="checkbox"/> No transfer		

C0185

Parameter Name: C0185 0x1009: Hardware version	Data type: VISIBLE_STRING Index: 24390 _d = 5F46 _h
Hardware version of the backplane bus master • Applies to Controllers 3200 C	
<input checked="" type="checkbox"/> Read access <input type="checkbox"/> Write access <input type="checkbox"/> CINH <input type="checkbox"/> PLC-STOP <input type="checkbox"/> No transfer	

C0186

Parameter Name: C0186 PLC: Licence	Data type: VISIBLE_STRING Index: 24389 _d = 5F45 _h
Licence level of the PLC. Possible licence levels are: • No licence • Logic (LPC1000) • Motion (MPC1200)	
<input checked="" type="checkbox"/> Read access <input type="checkbox"/> Write access <input type="checkbox"/> CINH <input type="checkbox"/> PLC-STOP <input type="checkbox"/> No transfer	

C0187

Parameter Name: C0187 Visualisation licence	Data type: VISIBLE_STRING Index: 24388 _d = 5F44 _h
Visualisation licence (relevant for the visualisation in VisiWinNET). Possible licence levels are: • Compact CE • Compact XP	
<input checked="" type="checkbox"/> Read access <input type="checkbox"/> Write access <input type="checkbox"/> CINH <input type="checkbox"/> PLC-STOP <input type="checkbox"/> No transfer	

C0188

Parameter Name: C0188 Visualisation: Number of power tags	Data type: UNSIGNED_32 Index: 24387 _d = 5F43 _h
Max. number of variables that can be represented in VisiWinNET	
<input checked="" type="checkbox"/> Read access <input type="checkbox"/> Write access <input type="checkbox"/> CINH <input type="checkbox"/> PLC-STOP <input type="checkbox"/> No transfer	

C0189

Parameter Name: C0189 VNC: Password	Datentyp: VISIBLE_STRING Index: 24386 _d = 5F42 _h
Password used for authentication (C0190) via VNC. Note: To activate the code location, the VNC server must be stopped and restarted each time.	
<input checked="" type="checkbox"/> Read access <input checked="" type="checkbox"/> Write access <input type="checkbox"/> CINH <input type="checkbox"/> PLC-STOP <input type="checkbox"/> no transfer	

C0190

Parameter Name: C0190 VNC: Used Authentication	Datentyp: VISIBLE_STRING Index: 24385 _d = 5F41 _h
Enable authentication using a password entered in C0189. Note: To activate the code location, the VNC server must be stopped and restarted.	
Selection list (Lenze setting printed in bold)	Info
0 Authentication not activated	
1 Authentication aktivated	
<input checked="" type="checkbox"/> Read access <input checked="" type="checkbox"/> Write access <input type="checkbox"/> CINH <input type="checkbox"/> PLC-STOP <input type="checkbox"/> no transfer	

C0191

Parameter Name: C0191 VNC: Maximum number of clients		Datentyp: UNSIGNED_32 Index: 24384 _d = 5F40 _h
Definition of the maximum number of simultaneously connected clients Note: To activate the code location, the VNC server must be stopped and restarted.		
Setting range (min. value unit max. value)		Lenze setting
1		3 1
<input checked="" type="checkbox"/> Read access <input checked="" type="checkbox"/> Write access <input type="checkbox"/> CINH <input type="checkbox"/> PLC-STOP <input type="checkbox"/> no transfer		

C0192

Parameter Name: C0192 VNC: Automatic log out		Datentyp: VISIBLE_STRING Index: 24383 _d = 5F3F _h
Automatic disconnection Note: To activate the code location, the VNC server must be stopped and restarted.		
Selection list (Lenze setting printed in bold)		Info
0	Auto switch-off not activated	
1	Auto switch-off activated	
<input checked="" type="checkbox"/> Read access <input checked="" type="checkbox"/> Write access <input type="checkbox"/> CINH <input type="checkbox"/> PLC-STOP <input type="checkbox"/> no transfer		

C0193

Parameter Name: C0193 VNC: Maximum session time [s]		Datentyp: UNSIGNED_32 Index: 24382 _d = 5F3E _h
Lenze setting: 7200 s Note: To activate the code location, the VNC server must be stopped and restarted.		
<input checked="" type="checkbox"/> Read access <input checked="" type="checkbox"/> Write access <input type="checkbox"/> CINH <input type="checkbox"/> PLC-STOP <input type="checkbox"/> no transfer		

C0194

Parameter Name: C0194 VNC: Port		Datentyp: UNSIGNED_32 Index: 24381 _d = 5F3D _h
Free choice of ports Lenze setting: 5900 Note: To activate the code location, the VNC server must be stopped and restarted.		
<input checked="" type="checkbox"/> Read access <input checked="" type="checkbox"/> Write access <input type="checkbox"/> CINH <input type="checkbox"/> PLC-STOP <input type="checkbox"/> no transfer		

C0195

Parameter Name: C0195 VNC: Maximum idle time [s]		Datentyp: UNSIGNED_32 Index: 24380 _d = 5F3C _h
The connection is automatically terminated if the client does not send a request to the VNC server for the set time. The function depends on C0192. Lenze setting: 0 s (the session is not automatically interrupted)		
<input checked="" type="checkbox"/> Read access <input checked="" type="checkbox"/> Write access <input type="checkbox"/> CINH <input type="checkbox"/> PLC-STOP <input type="checkbox"/> no transfer		

15.3

Voltage buffering by external UPS (optional for Controller 3241 C)

This chapter lists all UPS parameters in numerically ascending order.

▶ [UPS function \(backup in case of voltage failure\)](#) (📖 79)

C0203

Parameter Name: C0203 UPS: UPS monitoring		Data type: UNSIGNED_8 Index: 24372 _d = 5F34 _h
Enable monitoring via an external UPS (optional).		
Selection list (Lenze setting printed in bold)		Info
0	Off	
1	On	
<input checked="" type="checkbox"/> Read access <input checked="" type="checkbox"/> Write access <input type="checkbox"/> CINH <input type="checkbox"/> PLC-STOP <input type="checkbox"/> no transfer		

C0204

Parameter Name: C0204 UPS: Status		Data type: UNSIGNED_8 Index: 24371 _d = 5F33 _h
Status of the external UPS		
Selection list (read only)		Info
0	ACU Controller is missing	
85	Battery / capacitor is loaded	
86	Battery / capacitor is being loaded	
87	-	
88	-	
89	UPS is buffering the system	
90	Battery / capacitor short circuit	
91	Battery / capacitor is missing	
92	Battery / capacitor is defective	
93	ACU Controller is defective	
94	-	
95	Undefined status of battery / capacitor	
<input checked="" type="checkbox"/> Read access <input type="checkbox"/> Write access <input type="checkbox"/> CINH <input type="checkbox"/> PLC-STOP <input type="checkbox"/> No transfer		

C0205

Parameter Name: C0205 UPS: Supply voltage		Data type: FLOAT_32 Index: 24370 _d = 5F32 _h
Supply voltage of the external UPS in [V]		
Display range (min. value unit max. value)		
0	V	34
<input checked="" type="checkbox"/> Read access <input type="checkbox"/> Write access <input type="checkbox"/> CINH <input type="checkbox"/> PLC-STOP <input type="checkbox"/> No transfer		

C0207

Parameter Name: C0207 UPS: Battery / capacitor voltage	Data type: FLOAT_32 Index: 24368 _d = 5F30 _h
Voltage of the battery/capacitor in [V]	
<input checked="" type="checkbox"/> Read access <input type="checkbox"/> Write access <input type="checkbox"/> CINH <input type="checkbox"/> PLC-STOP <input type="checkbox"/> No transfer	

C0208

Parameter Name: C0208 UPS: Display lighting after voltage failure	Data type: UNSIGNED_8 Index: 24367 _d = 5F2F _h
Behaviour of the display lighting after a voltage failure.	
Selection list (Lenze setting printed in bold)	Info
0 Off	Display lighting activated.
1 On	Display lighting not activated.
<input checked="" type="checkbox"/> Read access <input checked="" type="checkbox"/> Write access <input type="checkbox"/> CINH <input type="checkbox"/> PLC-STOP <input type="checkbox"/> no transfer	

C0209

Parameter Name: C0209 UPS: Number of voltage dips	Data type: UNSIGNED_8 Index: 24366 _d = 5F2E _h
Indicates the number of voltage failures.	
Display range (min. value unit max. value)	
0	255
<input checked="" type="checkbox"/> Read access <input type="checkbox"/> Write access <input type="checkbox"/> CINH <input type="checkbox"/> PLC-STOP <input type="checkbox"/> No transfer	

C0210

Parameter Name: C0210 UPS: Supply voltage OK	Data type: UNSIGNED_8 Index: 24365 _d = 5F2D _h
Status of supply voltage (present/not present)	
Selection list (read only)	Info
0 No	
1 Yes	
<input checked="" type="checkbox"/> Read access <input type="checkbox"/> Write access <input type="checkbox"/> CINH <input type="checkbox"/> PLC-STOP <input type="checkbox"/> No transfer	

C0211

Parameter Name: C0211 UPS: Voltage failure	Data type: UNSIGNED_8 Index: 24364 _d = 5F2C _h
Status of voltage failure (present/not present)	
Selection list (read only)	
0 No	
1 Yes	
<input checked="" type="checkbox"/> Read access <input type="checkbox"/> Write access <input type="checkbox"/> CINH <input type="checkbox"/> PLC-STOP <input type="checkbox"/> No transfer	

C0212

Parameter Name: C0212 UPS: Firmware version	Data type: VISIBLE_STRING Index: 24363 _d = 5F2B _h
Version of the UPS firmware	
<input checked="" type="checkbox"/> Read access <input type="checkbox"/> Write access <input type="checkbox"/> CINH <input type="checkbox"/> PLC-STOP <input type="checkbox"/> No transfer	

C0213

Parameter Name: C0213 UPS: Buffer time without action		Data type: UNSIGNED_16 Index: 24362 _d = 5F2A _h
The UPS buffers the system without any further action. If the voltage dip lasts longer than the time set here: <ul style="list-style-type: none"> • The PLC is stopped. • The PLC saves the retain variables, logbook entries and visualisation data (trends and alarms). • The timer C00214 is started. 		
Selection list(Lenze setting printed in bold)		Info
0	0	
250	250	
500	500	
750	750	
1000	1000	
1250	1250	
1500	1500	
1750	1750	
2000	2000	
2250	2250	
2500	2500	
2750	2750	
3000	3000	
3250	3250	
3500	3500	
3750	3750	
4000	4000	
4250	4250	
4500	4500	
4750	4750	
5000	5000	
<input checked="" type="checkbox"/> Read access <input checked="" type="checkbox"/> Write access <input type="checkbox"/> CINH <input type="checkbox"/> PLC-STOP <input type="checkbox"/> no transfer		

C0214

Parameter Name: C0214 UPS: Buffer time until shutdown		Data type: UNSIGNED_8 Index: 24361 _d = 5F29 _h
After expiration of the time set here, the system is shut down. If the voltage is applied once again, the system is restarted automatically.		
Setting range (min. value unit max. value)		Lenze setting
0	s	255 10 s
<input checked="" type="checkbox"/> Read access <input checked="" type="checkbox"/> Write access <input type="checkbox"/> CINH <input type="checkbox"/> PLC-STOP <input type="checkbox"/> no transfer		

15.4 Monitor panel (integrated/external)

This chapter lists all parameters of the monitor panel (panel controller) and the parameters of an external, optional panel in numerically ascending order.

The parameters are available depending on the panel variant.

C0420

Parameter Name: C0420 Panel: Width		Data type: UNSIGNED_16 Index: 24153 _d = 5E5B _h
Horizontal resolution of the panel		
Display range (min. value unit max. value)		
160		2400
<input checked="" type="checkbox"/> Read access <input type="checkbox"/> Write access <input type="checkbox"/> CINH <input type="checkbox"/> PLC-STOP <input type="checkbox"/> No transfer		

C0421

Parameter Name: C0421 Panel: Height		Data type: UNSIGNED_16 Index: 24154 _d = 5E5A _h
Vertical resolution of the panel		
Display range (min. value unit max. value)		
100		2000
<input checked="" type="checkbox"/> Read access <input type="checkbox"/> Write access <input type="checkbox"/> CINH <input type="checkbox"/> PLC-STOP <input type="checkbox"/> No transfer		

C0422

Parameter Name: C0422 Dimout: Actual value		Data type: UNSIGNED_8 Index: 24153 _d = 5E59 _h
Enter the actual brightness value of the display. The numerical value ranges from the <ul style="list-style-type: none"> • Maximum = 0 and the • Minimum = 63 Note: In the case of a Cabinet Controller with an external monitor panel, this parameter is saved in the panel. This requires connecting the Controller and the panel to each other using a USB cable.		
Setting range (min. value unit max. value)		Lenze setting
0	63	0
<input checked="" type="checkbox"/> Read access <input checked="" type="checkbox"/> Write access <input type="checkbox"/> CINH <input type="checkbox"/> PLC-STOP <input checked="" type="checkbox"/> no transfer		

C0423

Parameter Name: C0423 Brightness: Upper limit		Data type: UNSIGNED_8 Index: 24152 _d = 5E58 _h
Enter the maximum brightness value of the display. The numerical value ranges from the <ul style="list-style-type: none"> • Maximum = 0 and the • Minimum = 63 Note: In the case of a Cabinet Controller with an external monitor panel, this parameter is saved in the panel. This requires connecting the Controller and the panel to each other using a USB cable.		
Setting range (min. value unit max. value)		Lenze setting
0	63	0
<input checked="" type="checkbox"/> Read access <input checked="" type="checkbox"/> Write access <input type="checkbox"/> CINH <input type="checkbox"/> PLC-STOP <input type="checkbox"/> no transfer		

C0424

Parameter Name: C0424 Automatic dimout: Switch-on after			Data type: UNSIGNED_8 Index: 24151 _d = 5E57 _h
Enter the time until automatic dimout of the display. The values range between ... <ul style="list-style-type: none"> • 0 (maximum value = no dimout of the display) and • 255 (minimum value) Note: <ul style="list-style-type: none"> • To deactivate an active dimout of the display, an entry must be made (by activation of the touch display/mouse-click/shortcut). Then the controller is ready to accept input. • In the case of a Cabinet Controller with an external monitor panel, this parameter is saved in the panel. This requires connecting the Controller and the panel to each other using a USB cable. 			
Setting range (min. value unit max. value)			Lenze setting
0	min	255	0 min
<input checked="" type="checkbox"/> Read access <input checked="" type="checkbox"/> Write access <input type="checkbox"/> CINH <input type="checkbox"/> PLC-STOP <input type="checkbox"/> no transfer			

C0425

Parameter Name: C0425 Automatic dimout: Brightness value			Data type: UNSIGNED_8 Index: 24150 _d = 5E56 _h
Brightness value of the monitor panel in its dimmed state after automatic dimout in [%]. <ul style="list-style-type: none"> • Applies to the integrated monitor panel (panel controller). 			
Setting range (min. value unit max. value)			Lenze setting
10	%	80	10 %
<input checked="" type="checkbox"/> Read access <input checked="" type="checkbox"/> Write access <input type="checkbox"/> CINH <input type="checkbox"/> PLC-STOP <input type="checkbox"/> no transfer			

C0426

Parameter Name: C0426 Brightness: Actual value			Data type: UNSIGNED_8 Index: 24149 _d = 5E55 _h
Actual brightness value of the monitor panel in [%] <ul style="list-style-type: none"> • Applies to the integrated monitor panel (panel controller). 			
Setting range (min. value unit max. value)			Lenze setting
10	%	100	100 %
<input checked="" type="checkbox"/> Read access <input checked="" type="checkbox"/> Write access <input type="checkbox"/> CINH <input type="checkbox"/> PLC-STOP <input checked="" type="checkbox"/> no transfer			

C0427

Parameter Name: C0427 Current rotation of the display			Data type: UNSIGNED_16 Index: 24148 _d = 5E54 _h
The display of the monitor panel (Panel Controller) can be rotated in 90° steps. <ul style="list-style-type: none"> • Valid for Panel Controller p300. Name/format for your own background image: [Width]_[Height]_*.bmp (e.g. 480_272_Roboter.bmp) <ul style="list-style-type: none"> ▶ Use your own background image (Windows® CE) (📖 43) 			
Selection list (Lenze setting printed in bold)			Info
0	0°		
1	90°		
2	180°		
3	270°		
<input checked="" type="checkbox"/> Read access <input checked="" type="checkbox"/> Write access <input type="checkbox"/> CINH <input type="checkbox"/> PLC-STOP <input checked="" type="checkbox"/> no transfer			

C0432

Parameter Name: C0432 F1 key: Function		Data type: UNSIGNED_32 Index: 24143 _d = 5E4F _h
Function assignment of the F1 key. The individual functions are assigned from a selection list. • Applies to external monitor panels with function keys.		
Selection list(Lenze setting printed in bold)		Info
0	None	
1	Start program	
2	Touch keyboard	
3	Right-hand mouse button	
4	Execute AP script	
5	Start control panel	
<input checked="" type="checkbox"/> Read access <input checked="" type="checkbox"/> Write access <input type="checkbox"/> CINH <input type="checkbox"/> PLC-STOP <input type="checkbox"/> no transfer		

C0433

Parameter Name: C0433 F1 key: Parameter		Data type: VISIBLE_STRING Index: 24142 _d = 5E4E _h
Name of the program or script to be executed • Applies to external monitor panels with function keys.		
<input checked="" type="checkbox"/> Read access <input checked="" type="checkbox"/> Write access <input type="checkbox"/> CINH <input type="checkbox"/> PLC-STOP <input type="checkbox"/> no transfer		

C0434

Parameter Name: C0434 F2 key: Function		Data type: UNSIGNED_32 Index: 24141 _d = 5E4D _h
Function assignment of the F2 key. The individual functions are assigned from a selection list. • Applies to external monitor panels with function keys.		
Selection list(Lenze setting printed in bold)		Info
0	None	
1	Start program	
2	Touch keyboard	
3	Right-hand mouse button	
4	Execute AP script	
5	Start control panel	
<input checked="" type="checkbox"/> Read access <input checked="" type="checkbox"/> Write access <input type="checkbox"/> CINH <input type="checkbox"/> PLC-STOP <input type="checkbox"/> no transfer		

C0435

Parameter Name: C0435 F2 key: Parameter		Data type: VISIBLE_STRING Index: 24140 _d = 5E4C _h
Name of the program or script to be executed • Applies to external monitor panels with function keys.		
<input checked="" type="checkbox"/> Read access <input checked="" type="checkbox"/> Write access <input type="checkbox"/> CINH <input type="checkbox"/> PLC-STOP <input type="checkbox"/> no transfer		

C0436

Parameter Name: C0436 F3 key: Function		Data type: UNSIGNED_32 Index: 24139 _d = 5E4B _h
Function assignment of the F3 key. The individual functions are assigned from a selection list. • Applies to external monitor panels with function keys.		
Selection list (Lenze setting printed in bold)		Info
0	None	
1	Start program	
2	Touch keyboard	
3	Right-hand mouse button	
4	Execute AP script	
5	Start control panel	
<input checked="" type="checkbox"/> Read access <input checked="" type="checkbox"/> Write access <input type="checkbox"/> CINH <input type="checkbox"/> PLC-STOP <input type="checkbox"/> no transfer		

C0437

Parameter Name: C0437 F3 key: Parameter		Data type: VISIBLE_STRING Index: 24138 _d = 5E4A _h
Name of the program or script to be executed • Applies to external monitor panels with function keys.		
<input checked="" type="checkbox"/> Read access <input checked="" type="checkbox"/> Write access <input type="checkbox"/> CINH <input type="checkbox"/> PLC-STOP <input type="checkbox"/> no transfer		

C0438

Parameter Name: C0438 F4 key: Function		Data type: UNSIGNED_32 Index: 24137 _d = 5E49 _h
Function assignment of the F4 key. The individual functions are assigned from a selection list. • Applies to external monitor panels with function keys.		
Selection list (Lenze setting printed in bold)		Info
0	None	
1	Start program	
2	Touch keyboard	
3	Right-hand mouse button	
4	Execute AP script	
5	Start control panel	
<input checked="" type="checkbox"/> Read access <input checked="" type="checkbox"/> Write access <input type="checkbox"/> CINH <input type="checkbox"/> PLC-STOP <input type="checkbox"/> no transfer		

C0439

Parameter Name: C0439 F4 key: Parameter		Data type: VISIBLE_STRING Index: 24136 _d = 5E48 _h
Name of the program or script to be executed • Applies to external monitor panels with function keys.		
<input checked="" type="checkbox"/> Read access <input checked="" type="checkbox"/> Write access <input type="checkbox"/> CINH <input type="checkbox"/> PLC-STOP <input type="checkbox"/> no transfer		

15 Parameter reference

15.5 PLC (Logic/Motion)

15.5 PLC (Logic/Motion)

In this chapter the parameters of the PLC (Logic/Motion) are listed in numerically ascending order.

C0619

Parameter Name: C0619 Boot application loaded		Datentyp: UNSIGNED_8 Index: 23956 _d = 5D94 _h	
Display range (min. value unit max. value)			
0			1
<input checked="" type="checkbox"/> Read access <input type="checkbox"/> Write access <input type="checkbox"/> CINH <input type="checkbox"/> PLC-STOP <input type="checkbox"/> No transfer			

C0620

Parameter Name: C0620 PLC: Status		Data type: VISIBLE_STRING Index: 23955 _d = 5D93 _h	
Status of the PLC application			
<input checked="" type="checkbox"/> Read access <input type="checkbox"/> Write access <input type="checkbox"/> CINH <input type="checkbox"/> PLC-STOP <input type="checkbox"/> No transfer			

C0630

Parameter Name: C0630 Display Soft PLC window		Data type: UNSIGNED_8 Index: 23945 _d = 5D89 _h	
Display of the SoftPLC dialog box on the Controller			
<ul style="list-style-type: none">• 0: SoftPLC dialog box is not displayed.• 1: SoftPLC dialog box is displayed.			
Display range (min. value unit max. value)			
0			1
<input checked="" type="checkbox"/> Read access <input type="checkbox"/> Write access <input type="checkbox"/> CINH <input type="checkbox"/> PLC-STOP <input type="checkbox"/> No transfer			

C0640

Parameter Name: C0640 Activate field device firmware update		Data type: UNSIGNED_8 Index: 23935 _d = 5D7F _h	
Activation of the firmware update of the field devices: The Controller writes the parameters to the connected field devices. This function is available depending on the device!			
These settings are valid for devices with a firmware version < 3.20:			
<ul style="list-style-type: none">• 0: Firmware update is not activated.• 1: Firmware update is activated.			
These settings are valid for devices with a firmware version ≥ 3.20:			
<ul style="list-style-type: none">• 0: Deactivated• 1: Activated. Field device: Main version = configured version.• 2: Activated. Field device: Main version > configured version. (Lenze setting)			
Setting range (min. value unit max. value)		Lenze setting	
0		2	2
<input checked="" type="checkbox"/> Read access <input checked="" type="checkbox"/> Write access <input type="checkbox"/> CINH <input type="checkbox"/> PLC-STOP <input type="checkbox"/> no transfer			

C0650

Parameter Name: C0650 Start Field Device parameter storage		Data type: UNSIGNED_16 Index: 23925 _d = 5D75 _h
Storage of the parameters of the connected field devices on the Controller. • This function is available depending on the device!		
Selection list (Lenze setting printed in bold)		Info
0	No Operation	
1	Start parameter storage	
<input checked="" type="checkbox"/> Read access <input checked="" type="checkbox"/> Write access <input type="checkbox"/> CINH <input type="checkbox"/> PLC-STOP <input checked="" type="checkbox"/> no transfer		

C0651

Parameter Name: C0651 Status Field Device parameter storage		Data type: VISIBLE_STRING Index: 23924 _d = 5D74 _h
Current status of the storage of the field device parameters on the Controller. • This function is available depending on the device!		
<input checked="" type="checkbox"/> Read access <input type="checkbox"/> Write access <input type="checkbox"/> CINH <input type="checkbox"/> PLC-STOP <input type="checkbox"/> No transfer		

C0660

Parameter Name: C0660 Available application credits		Data type: UNSIGNED_16 Index: 23915 _d = 5D6B _h
Display of the available application credits		
<input checked="" type="checkbox"/> Read access <input type="checkbox"/> Write access <input type="checkbox"/> CINH <input type="checkbox"/> PLC-STOP <input type="checkbox"/> No transfer		

C0661

Parameter Name: C0661 Application credits used		Data type: UNSIGNED_16 Index: 23914 _d = 5D6A _h
Display of the application credits used		
<input checked="" type="checkbox"/> Read access <input type="checkbox"/> Write access <input type="checkbox"/> CINH <input type="checkbox"/> PLC-STOP <input type="checkbox"/> No transfer		

15 Parameter reference

15.6 Backup & Restore

15.6 Backup & Restore

In this chapter, all parameters for carrying out a »Backup & Restore« (using »WebConfig«) are listed in numerically ascending order.

C0809

Parameter Name: C0809 Select a main action for the Lenze software		Data type: UNSIGNED_16 Index: 23766 _d = 5CD6 _h
Selection list(Lenze setting printed in bold)		Info
0	Backup	
<input checked="" type="checkbox"/> Read access <input checked="" type="checkbox"/> Write access <input type="checkbox"/> CINH <input type="checkbox"/> PLC-STOP <input type="checkbox"/> no transfer		

C0810

Parameter Name: C0810 Select a main action for the Lenze software		Data type: UNSIGNED_16 Index: 23765 _d = 5CD5 _h
Carry out a backup or restore by means of the WebConfig.		
Selection list(Lenze setting printed in bold)		Info
2	Restore	Carry out restore: <ul style="list-style-type: none">• Select this process to restore the data bases of a backup on an individual Controller.
3	Auto-restore	Carry out auto restore: <ul style="list-style-type: none">• Restore (restoring a backup) at any number of Controllers.• If you connect the USB stick to another Controller, the same process is carried out automatically (standard set-up).
4	Update	Carry out update: <ul style="list-style-type: none">• Updates the software of the Controller (the data is transferred from the USB flash drive to the internal flash memory of the Controller).• In the case of a Controller c300/p300, the update takes several minutes, since several restart processes are taking place.
5	Auto update	Carry out auto update: <ul style="list-style-type: none">• Multiple restore of an update at any number of Controllers.• If you connect the USB stick to another Controller, the same process is carried out automatically (standard set-up).• In the case of a Controller c300/p300, the update takes several minutes, since several restart processes are taking place.
<input checked="" type="checkbox"/> Read access <input checked="" type="checkbox"/> Write access <input type="checkbox"/> CINH <input type="checkbox"/> PLC-STOP <input type="checkbox"/> no transfer		

C0811

Parameter Name: C0811 Assign a name for the backup		Data type: VISIBLE_STRING Index: 23764 _d = 5CD4 _h
<input checked="" type="checkbox"/> Read access <input checked="" type="checkbox"/> Write access <input type="checkbox"/> CINH <input type="checkbox"/> PLC-STOP <input type="checkbox"/> no transfer		

C0813

Parameter Name: C0813 Display of the backup or update files		Data type: UNSIGNED_16 Index: 23762 _d = 5CD2 _h
Selection list (Lenze setting printed in bold)		Info
1	Display 1 to 10	
2	Display 11 to 20	
3	Display 21 to 30	
<input checked="" type="checkbox"/> Read access <input checked="" type="checkbox"/> Write access <input type="checkbox"/> CINH <input type="checkbox"/> PLC-STOP <input type="checkbox"/> no transfer		

C0814

Parameter Name: C0814 Backup or update file 1		Data type: VISIBLE_STRING Index: 23761 _d = 5CD1 _h
<input checked="" type="checkbox"/> Read access <input type="checkbox"/> Write access <input type="checkbox"/> CINH <input type="checkbox"/> PLC-STOP <input type="checkbox"/> No transfer		

C0815

Parameter Name: C0815 Backup or update file 2		Data type: VISIBLE_STRING Index: 23760 _d = 5CD0 _h
<input checked="" type="checkbox"/> Read access <input type="checkbox"/> Write access <input type="checkbox"/> CINH <input type="checkbox"/> PLC-STOP <input type="checkbox"/> No transfer		

C0816

Parameter Name: C0816 Backup or update file 3		Data type: VISIBLE_STRING Index: 23759 _d = 5CCF _h
<input checked="" type="checkbox"/> Read access <input type="checkbox"/> Write access <input type="checkbox"/> CINH <input type="checkbox"/> PLC-STOP <input type="checkbox"/> No transfer		

C0817

Parameter Name: C0817 Backup or update file 4		Data type: VISIBLE_STRING Index: 23758 _d = 5CCE _h
<input checked="" type="checkbox"/> Read access <input type="checkbox"/> Write access <input type="checkbox"/> CINH <input type="checkbox"/> PLC-STOP <input type="checkbox"/> No transfer		

C0818

Parameter Name: C0818 Backup or update file 5		Data type: VISIBLE_STRING Index: 23757 _d = 5CCD _h
<input checked="" type="checkbox"/> Read access <input type="checkbox"/> Write access <input type="checkbox"/> CINH <input type="checkbox"/> PLC-STOP <input type="checkbox"/> No transfer		

C0819

Parameter Name: C0819 Backup or update file 6		Data type: VISIBLE_STRING Index: 23756 _d = 5CCC _h
<input checked="" type="checkbox"/> Read access <input type="checkbox"/> Write access <input type="checkbox"/> CINH <input type="checkbox"/> PLC-STOP <input type="checkbox"/> No transfer		

C0820

Parameter Name: C0820 Backup or update file 7		Data type: VISIBLE_STRING Index: 23755 _d = 5CCB _h
<input checked="" type="checkbox"/> Read access <input type="checkbox"/> Write access <input type="checkbox"/> CINH <input type="checkbox"/> PLC-STOP <input type="checkbox"/> No transfer		

C0821

Parameter Name: C0821 Backup or update file 8	Data type: VISIBLE_STRING Index: 23754 _d = 5CCA _h
<input checked="" type="checkbox"/> Read access <input type="checkbox"/> Write access <input type="checkbox"/> CINH <input type="checkbox"/> PLC-STOP <input type="checkbox"/> No transfer	

C0822

Parameter Name: C0822 Backup or update file 9	Data type: VISIBLE_STRING Index: 23753 _d = 5CC9 _h
<input checked="" type="checkbox"/> Read access <input type="checkbox"/> Write access <input type="checkbox"/> CINH <input type="checkbox"/> PLC-STOP <input type="checkbox"/> No transfer	

C0823

Parameter Name: C0823 Backup or update file 10	Data type: VISIBLE_STRING Index: 23752 _d = 5CC8 _h
<input checked="" type="checkbox"/> Read access <input type="checkbox"/> Write access <input type="checkbox"/> CINH <input type="checkbox"/> PLC-STOP <input type="checkbox"/> No transfer	

C0824

Parameter Name: C0824 Select a backup or update	Data type: UNSIGNED_16 Index: 23751 _d = 5CC7 _h
Selection list(Lenze setting printed in bold)	Info
0 Nothing is selected	
1 Backup or update file 1	
2 Backup or update file 2	
3 Backup or update file 3	
4 Backup or update file 4	
5 Backup or update file 5	
6 Backup or update file 6	
7 Backup or update file 7	
8 Backup or update file 8	
9 Backup or update file 9	
10 Backup or update file 10	
<input checked="" type="checkbox"/> Read access <input checked="" type="checkbox"/> Write access <input type="checkbox"/> CINH <input type="checkbox"/> PLC-STOP <input type="checkbox"/> no transfer	

C0830

Parameter Name: C0830 Start backup	Data type: UNSIGNED_16 Index: 23745 _d = 5CC1 _h
Selection list(Lenze setting printed in bold)	Info
0 No action	
1 Start backup	
<input checked="" type="checkbox"/> Read access <input checked="" type="checkbox"/> Write access <input type="checkbox"/> CINH <input type="checkbox"/> PLC-STOP <input type="checkbox"/> no transfer	

C0831

Parameter Name: C0831 Start restore update		Data type: UNSIGNED_16 Index: 23744 _d = 5CC0 _h
Selection list (Lenze setting printed in bold)		Info
0	No action	
2	Start restore update	
<input checked="" type="checkbox"/> Read access <input checked="" type="checkbox"/> Write access <input type="checkbox"/> CINH <input type="checkbox"/> PLC-STOP <input type="checkbox"/> no transfer		

C0832

Parameter Name: C0832 Backup status		Data type: VISIBLE_STRING Index: 23743 _d = 5CBF _h
<input checked="" type="checkbox"/> Read access <input type="checkbox"/> Write access <input type="checkbox"/> CINH <input type="checkbox"/> PLC-STOP <input type="checkbox"/> No transfer		

C0833

Parameter Name: C0833 Restore update status		Data type: VISIBLE_STRING Index: 23742 _d = 5CBE _h
<input checked="" type="checkbox"/> Read access <input type="checkbox"/> Write access <input type="checkbox"/> CINH <input type="checkbox"/> PLC-STOP <input type="checkbox"/> No transfer		

15 Parameter reference

15.7 Ethernet

15.7 Ethernet

This chapter provides a list of all parameters of the Ethernet interface (on board) of the Controllers in numerically ascending order.

The parameters of the MC-ETH communication card (C1078 ... C1086) are not included in this chapter.

C0238

Parameter Name: C0238 Apply IP configuration		Data type: UNSIGNED_16 Index: 24337 _d = 5F11 _h
Parameter for the activation of the set IP configuration.		
Selection list (Lenze setting printed in bold)		Info
1	Activate device	
0	No command	
<input checked="" type="checkbox"/> Read access <input checked="" type="checkbox"/> Write access <input type="checkbox"/> CINH <input type="checkbox"/> PLC-STOP <input checked="" type="checkbox"/> no transfer		

C0240

Parameter Name: C0240 Enable Dhcp		Data type: UNSIGNED_32 Index: 24335 _d = 5F0F _h
Activation of the DHCP • 0: DHCP not activated. • 1: DHCP activated. If DHCP is active, the codes C0241 ... C0245 do not have any function Note regarding the visualisation for Controller 3231/3241 C and p500: During the DHCP configuration with an unplugged Ethernet cable, the local visualisation cannot be operated for approx. 20 s.		
Setting range (min. value unit max. value)		Lenze setting
0		1 0
<input checked="" type="checkbox"/> Read access <input checked="" type="checkbox"/> Write access <input type="checkbox"/> CINH <input type="checkbox"/> PLC-STOP <input type="checkbox"/> no transfer		

C0241

Parameter Name: C0241 IP address		Data type: VISIBLE_STRING Index: 24334 _d = 5F0E _h
IP address of the interface		
<input checked="" type="checkbox"/> Read access <input checked="" type="checkbox"/> Write access <input type="checkbox"/> CINH <input type="checkbox"/> PLC-STOP <input type="checkbox"/> no transfer		

C0242

Parameter Name: C0242 Subnet mask		Data type: VISIBLE_STRING Index: 24333 _d = 5F0D _h
Subnet mask of the interface		
<input checked="" type="checkbox"/> Read access <input checked="" type="checkbox"/> Write access <input type="checkbox"/> CINH <input type="checkbox"/> PLC-STOP <input type="checkbox"/> no transfer		

C0243

Parameter Name: C0243 Default gateway		Data type: VISIBLE_STRING Index: 24332 _d = 5F0C _h
Default gateway of the interface		
<input checked="" type="checkbox"/> Read access <input checked="" type="checkbox"/> Write access <input type="checkbox"/> CINH <input type="checkbox"/> PLC-STOP <input type="checkbox"/> no transfer		

C0244

Parameter Name: C0244 Domain	Data type: VISIBLE_STRING Index: 24331 _d = 5F0B _h
Domain name of the interface	
<input checked="" type="checkbox"/> Read access <input checked="" type="checkbox"/> Write access <input type="checkbox"/> CINH <input type="checkbox"/> PLC-STOP <input type="checkbox"/> no transfer	

C0246

Parameter Name: C0246 MAC address	Data type: VISIBLE_STRING Index: 24329 _d = 5F09 _h
MAC address (6 8-bit hexadecimal numbers) (e.g. 00:af:13:42:01:a8)	
<input checked="" type="checkbox"/> Read access <input type="checkbox"/> Write access <input type="checkbox"/> CINH <input type="checkbox"/> PLC-STOP <input type="checkbox"/> No transfer	

15.8 EtherCAT

EtherCAT is the "on board" standard bus system of the Lenze Controllers.

This chapter provides a list of all parameters of the EtherCAT interface (on board) of the Controllers and the MC-ETC communication card in numerically ascending order.

C280/4

Parameter Name: C280/4 ECAT bus scan result		Data type: UNSIGNED_8 Index: 24295.4 _d = 0x5EE7.0x04 _h
Brief information on whether the master configuration corresponds to the physical bus structure. The master configuration of the stack is compared to the actual bus structure.		
Selection list (Lenze setting printed in bold)		Info
0	No match	The master configuration does not correspond to the bus structure.
1	OK	The master configuration corresponds to the bus structure.
<input checked="" type="checkbox"/> Read access <input type="checkbox"/> Write access <input type="checkbox"/> CINH <input type="checkbox"/> PLC-STOP <input type="checkbox"/> No transfer		

C281/2

Parameter Name: C281/2 ECAT Master: State		Data type: UNSIGNED_8 Index: 24294.2 _d = 0x5EE6.0x02 _h
Display of the current state of the master		
Selection list (read only)		
0	Unknown	
1	Init	
2	Pre-Operational	
3	Bootstrap mode	<i>Bootstrap mode is not supported.</i>
4	Safe-operational	
8	Operational	
<input checked="" type="checkbox"/> Read access <input type="checkbox"/> Write access <input type="checkbox"/> CINH <input type="checkbox"/> PLC-STOP <input type="checkbox"/> No transfer		

C281/5

Parameter Name: C281/5 ECAT master: State information	Data type: UNSIGNED_32 Index: 24294.5 _d = 0x5EE6.0x05 _h
Display of additional information on the current state of the master The bits are set to value 1 if the respective states are reached.	
Value is bit-coded:	
Bit 0	Master ok
Bit 1	Reserved 1
Bit 2	Reserved 2
Bit 3	Reserved 3
Bit 4	Init
Bit 5	Pre-Operational
Bit 6	Safe-operational
Bit 7	Operational
Bit 8	Slaves in requested state
Bit 9	Master in requested state
Bit 10	Bus Scan Match
Bit 11	Reserved 4
Bit 12	DC: Activated
Bit 13	DC: Synchronised
Bit 14	DC: Busy
Bit 15	Reserved 5
Bit 16	Link Up
Bit 17	Reserved 6
...	...
Bit 31	Reserved 20
<input checked="" type="checkbox"/> Read access <input type="checkbox"/> Write access <input type="checkbox"/> CINH <input type="checkbox"/> PLC-STOP <input type="checkbox"/> No transfer	

C281/6

Parameter Name: C281/6 ECAT bus scan	Data type: UNSIGNED_8 Index: 24294.6 _d = 0x5EE6.0x06 _h
Activation of the fieldbus scan The fieldbus scan updates all EtherCAT codes.	
Selection list (Lenze setting printed in bold)	
0	No Operation
1	The bus is scanned
<input checked="" type="checkbox"/> Read access <input checked="" type="checkbox"/> Write access <input type="checkbox"/> CINH <input type="checkbox"/> PLC-STOP <input checked="" type="checkbox"/> no transfer	

C282/2

Parameter Name: C282/2 ECAT DC: Perm. dev. slave sync		Data type: UNSIGNED_32 Index: 24293.2 _d = 0x5EE5.0x02 _h
Permissible deviation of the distributed clocks of all devices in nanoseconds. If the permissible deviation is exceeded, the master will initiate a resynchronisation of the distributed clocks.		
Display range (min. value unit max. value)		
0	ns	4294967295
<input checked="" type="checkbox"/> Read access <input type="checkbox"/> Write access <input type="checkbox"/> CINH <input type="checkbox"/> PLC-STOP <input type="checkbox"/> No transfer		

C282/3

Parameter Name: C282/3 - ECAT DC: Current deviation		Data type: INTEGER_32 Index: 24293.3 _d = 0x5EE5.0x03 _h
Current maximum deviation of the distributed clocks of all devices in nanoseconds.		
Display range (min. value unit max. value)		
-2147483647	ns	2147483647
<input checked="" type="checkbox"/> Read access <input type="checkbox"/> Write access <input type="checkbox"/> CINH <input type="checkbox"/> PLC-STOP <input type="checkbox"/> No transfer		

C286/3

Parameter Name: C286/3 ECAT bus: No. of slaves		Data type: UNSIGNED_32 Index: 24289.3 _d = 0x5EE1.0x03 _h
Number of slaves connected to the fieldbus		
Display range (min. value unit max. value)		
0		4294967295
<input checked="" type="checkbox"/> Read access <input type="checkbox"/> Write access <input type="checkbox"/> CINH <input type="checkbox"/> PLC-STOP <input type="checkbox"/> No transfer		

C286/4

Parameter Name: C286/4 ECATBus: No. of slaves with DC		Data type: UNSIGNED_32 Index: 24289.4 _d = 0x5EE1.0x04 _h
Number of slaves connected to the fieldbus and supported by distributed clocks		
Display range (min. value unit max. value)		
0		4294967295
<input checked="" type="checkbox"/> Read access <input type="checkbox"/> Write access <input type="checkbox"/> CINH <input type="checkbox"/> PLC-STOP <input type="checkbox"/> No transfer		

C286/5

Parameter Name: C286/5 ECAT config.: No. of slaves		Data type: UNSIGNED_32 Index: 24289.5 _d = 0x5EE1.0x05 _h
Number of slaves configured in the master configuration file		
Display range (min. value unit max. value)		
0		4294967295
<input checked="" type="checkbox"/> Read access <input type="checkbox"/> Write access <input type="checkbox"/> CINH <input type="checkbox"/> PLC-STOP <input type="checkbox"/> No transfer		

C286/6

Parameter Name: C286/6 ECAT config.: No. of mailbox slaves		Data type: UNSIGNED_32 Index: 24289.6 _d = 0x5EE1.0x06 _h
Number of mailbox slaves configured in the master configuration file		
Display range (min. value unit max. value)		
0		4294967295
<input checked="" type="checkbox"/> Read access <input type="checkbox"/> Write access <input type="checkbox"/> CINH <input type="checkbox"/> PLC-STOP <input type="checkbox"/> No transfer		

C286/7

Parameter Name: C286/7 ECAT counter: Tx frames		Data type: UNSIGNED_32 Index: 24289.7 _d = 0x5EE1.0x07 _h
Number of sent frames		
Display range (min. value unit max. value)		
0		4294967295
<input checked="" type="checkbox"/> Read access <input type="checkbox"/> Write access <input type="checkbox"/> CINH <input type="checkbox"/> PLC-STOP <input type="checkbox"/> No transfer		

C286/8

Parameter Name: C286/8 ECAT counter: Rx frames		Data type: UNSIGNED_32 Index: 24289.8 _d = 0x5EE1.0x08 _h
Number of received frames		
Display range (min. value unit max. value)		
0		4294967295
<input checked="" type="checkbox"/> Read access <input type="checkbox"/> Write access <input type="checkbox"/> CINH <input type="checkbox"/> PLC-STOP <input type="checkbox"/> No transfer		

C286/9

Parameter Name: C286/9 ECAT counter: Lost frames		Data type: UNSIGNED_32 Index: 24289.9 _d = 0x5EE1.0x09 _h
Number of lost frames		
Display range (min. value unit max. value)		
0		4294967295
<input checked="" type="checkbox"/> Read access <input type="checkbox"/> Write access <input type="checkbox"/> CINH <input type="checkbox"/> PLC-STOP <input type="checkbox"/> No transfer		

C286/10

Parameter Name: C286/10 ECAT counter: Cyclic frames		Data type: UNSIGNED_32 Index: 24289.10 _d = 0x5EE1.0x0A _h
Number of cyclic frames		
Display range (min. value unit max. value)		
0		4294967295
<input checked="" type="checkbox"/> Read access <input type="checkbox"/> Write access <input type="checkbox"/> CINH <input type="checkbox"/> PLC-STOP <input type="checkbox"/> No transfer		

C286/11

Parameter Name: C286/11 ECAT counter: Cyclic datagrams		Data type: UNSIGNED_32 Index: 24289.11 _d = 0x5EE1.0x0B _h
Number of cyclic datagrams		
Display range (min. value unit max. value)		
0		4294967295
<input checked="" type="checkbox"/> Read access <input type="checkbox"/> Write access <input type="checkbox"/> CINH <input type="checkbox"/> PLC-STOP <input type="checkbox"/> No transfer		

C286/12

Parameter Name: C286/12 ECAT counter: Acyclic frames		Data type: UNSIGNED_32 Index: 24289.12 _d = 0x5EE1.0x0C _h
Number of acyclic frames		
Display range (min. value unit max. value)		
0		4294967295
<input checked="" type="checkbox"/> Read access <input type="checkbox"/> Write access <input type="checkbox"/> CINH <input type="checkbox"/> PLC-STOP <input type="checkbox"/> No transfer		

C286/13

Parameter Name: C286/13 ECAT counter: Acyclic datagrams		Data type: UNSIGNED_32 Index: 24289.13 _d = 0x5EE1.0x0D _h
Number of acyclic datagrams		
Display range (min. value unit max. value)		
0		4294967295
<input checked="" type="checkbox"/> Read access <input type="checkbox"/> Write access <input type="checkbox"/> CINH <input type="checkbox"/> PLC-STOP <input type="checkbox"/> No transfer		

C286/14

Parameter Name: C286/14 ECAT: Reset individual counters		Data type: UNSIGNED_32 Index: 24289.14 _d = 0x5EE1.0x0E _h
Reset frame and datagram counters (C1086/7 ... 13)		
Selection list(Lenze setting printed in bold)		
0	No Operation	
1	Reset - All counters	
2	Reset - Tx frame counters	
4	Reset - Rx frame counters	
8	Reset - Lost frame counters	
16	Clear Cyclical Frame Counter	
32	Clear Cyclical Datagram Counter	
64	Reset - Acyclic frame counters	
128	Reset - Acyclic datagram counters	
<input checked="" type="checkbox"/> Read access <input checked="" type="checkbox"/> Write access <input type="checkbox"/> CINH <input type="checkbox"/> PLC-STOP <input checked="" type="checkbox"/> no transfer		

15.9

CAN

This chapter provides a list of all parameters of the CAN interface (on board) of the Controllers c300 and p300 and the MC-CAN2 communication card in numerically ascending order.

The MC-CAN2 communication card ...

- has two CAN interfaces;
- is not supported by Controller c300/p300 (CAN on board).

**Note!**

If an MC-CAN2 card is replaced, the parameters of the card previously used must be checked and deviant settings will have to be adjusted!

C1031

Parameter Name: C1031 Device: Type key	Data type: VISIBLE_STRING Index: 23544 _d = 5BF8 _h
Identification of the card	
<input checked="" type="checkbox"/> Read access <input type="checkbox"/> Write access <input type="checkbox"/> CINH <input type="checkbox"/> PLC-STOP <input type="checkbox"/> No transfer	

C1032

Parameter Name: C1032 Device: Type version	Data type: VISIBLE_STRING Index: 23543 _d = 5BF7 _h
Version number of the card	
<input checked="" type="checkbox"/> Read access <input type="checkbox"/> Write access <input type="checkbox"/> CINH <input type="checkbox"/> PLC-STOP <input type="checkbox"/> No transfer	

C1033

Parameter Name: C1033 Device: Name	Data type: VISIBLE_STRING Index: 23542 _d = 5BF6 _h
Device name of the card	
<input checked="" type="checkbox"/> Read access <input type="checkbox"/> Write access <input type="checkbox"/> CINH <input type="checkbox"/> PLC-STOP <input type="checkbox"/> No transfer	

C1034

Parameter Name: C1034 Device: Software	Data type: VISIBLE_STRING Index: 23541 _d = 5BF5 _h
Software version of the card	
<input checked="" type="checkbox"/> Read access <input type="checkbox"/> Write access <input type="checkbox"/> CINH <input type="checkbox"/> PLC-STOP <input type="checkbox"/> No transfer	

C1035

Parameter Name: C1035 Device: Hardware	Data type: VISIBLE_STRING Index: 23540 _d = 5BF4 _h
Hardware version of the card	
<input checked="" type="checkbox"/> Read access <input type="checkbox"/> Write access <input type="checkbox"/> CINH <input type="checkbox"/> PLC-STOP <input type="checkbox"/> No transfer	

C1036

Parameter Name: C1036 Device: Serial number	Data type: VISIBLE_STRING Index: 23539 _d = 5BF3 _h
Serial number of the card	
<input checked="" type="checkbox"/> Read access <input type="checkbox"/> Write access <input type="checkbox"/> CINH <input type="checkbox"/> PLC-STOP <input type="checkbox"/> No transfer	

C1037

Parameter Name: C1037 Device: Manufacturer	Data type: VISIBLE_STRING Index: 23538 _d = 5BF2 _h
Manufacturer of the card	
<input checked="" type="checkbox"/> Read access <input type="checkbox"/> Write access <input type="checkbox"/> CINH <input type="checkbox"/> PLC-STOP <input type="checkbox"/> No transfer	

C1038

Parameter Name: C1038 Device: Manufacturing date	Data type: VISIBLE_STRING Index: 23537 _d = 5BF1 _h
Manufacturing date of the card	
<input checked="" type="checkbox"/> Read access <input type="checkbox"/> Write access <input type="checkbox"/> CINH <input type="checkbox"/> PLC-STOP <input type="checkbox"/> No transfer	

15.9.1 Parameters of the first CAN interface

C1073

Parameter Name: C1073 Device: Driver index	Data type: UNSIGNED_32 Index: 23502 _d = 5BCE _h
Index of the device driver. Since there can be more than one CAN interface, several instances can be run via the driver.	
<input checked="" type="checkbox"/> Read access <input type="checkbox"/> Write access <input type="checkbox"/> CINH <input type="checkbox"/> PLC-STOP <input type="checkbox"/> No transfer	

C1081

Parameter Name: C1081 Sync master: Interface index	Data type: UNSIGNED_32 Index: 23494 _d = 5BC6 _h
Note: Restart the Controller after changing this parameter!	
Setting range (min. value unit max. value)	Lenze setting
	4294967295
<input checked="" type="checkbox"/> Read access <input checked="" type="checkbox"/> Write access <input type="checkbox"/> CINH <input type="checkbox"/> PLC-STOP <input type="checkbox"/> no transfer	

C1082

Parameter Name: C1082 Baud rate		Data type: UNSIGNED_32 Index: 23493 _d = 5BC5 _h
Baud rate of the CAN interface. The value is assigned from a selection list.		
Selection list (Lenze setting printed in bold)		
7	5	
6	10	
5	20	
3	50	
8	100	
2	125	
1	250	
0	500	
4	1000	
<input checked="" type="checkbox"/> Read access <input checked="" type="checkbox"/> Write access <input type="checkbox"/> CINH <input type="checkbox"/> PLC-STOP <input type="checkbox"/> no transfer		

C1090

Parameter Name: C1090 Tx PDO counter		Data type: UNSIGNED_32 Index: 23485 _d = 5BBD _h
PDO counter for sent CAN messages		
<input checked="" type="checkbox"/> Read access <input type="checkbox"/> Write access <input type="checkbox"/> CINH <input type="checkbox"/> PLC-STOP <input type="checkbox"/> No transfer		

C1091

Parameter Name: C1091 Rx PDO counter		Data type: UNSIGNED_32 Index: 23484 _d = 5BBC _h
PDO counter for received CAN messages		
<input checked="" type="checkbox"/> Read access <input type="checkbox"/> Write access <input type="checkbox"/> CINH <input type="checkbox"/> PLC-STOP <input type="checkbox"/> No transfer		

C1092

Parameter Name: C1092 Bus load		Data type: UNSIGNED_32 Index: 23483 _d = 5BBB _h
Specification of the average bus load. The bus load is calculated as follows: Bus load = Value in percent x 1000		
<input checked="" type="checkbox"/> Read access <input type="checkbox"/> Write access <input type="checkbox"/> CINH <input type="checkbox"/> PLC-STOP <input type="checkbox"/> No transfer		

C1093

Parameter Name: C1093 Error counter		Data type: UNSIGNED_32 Index: 23482 _d = 5BBA _h
Error counter since last initialisation of the CAN interface		
<input checked="" type="checkbox"/> Read access <input type="checkbox"/> Write access <input type="checkbox"/> CINH <input type="checkbox"/> PLC-STOP <input type="checkbox"/> No transfer		

C1094

Parameter Name: C1094 Last error code		Data type: UNSIGNED_32 Index: 23481 _d = 5BB9 _h
Code of the last error that occurred		
<input checked="" type="checkbox"/> Read access <input type="checkbox"/> Write access <input type="checkbox"/> CINH <input type="checkbox"/> PLC-STOP <input type="checkbox"/> No transfer		

C1096

Parameter Name: C1096 CAN node ID		Data type: UNSIGNED_8 Index: 23479 _d = 5BB7 _h	
Setting range (min. value unit max. value)		Lenze setting	
0		128	63
<input checked="" type="checkbox"/> Read access <input checked="" type="checkbox"/> Write access <input type="checkbox"/> CINH <input type="checkbox"/> PLC-STOP <input type="checkbox"/> no transfer			

C1098

Parameter Name: C1098 Channel		Data type: UNSIGNED_32 Index: 23477 _d = 5BB5 _h	
Setting range (min. value unit max. value)		Lenze setting	
			0
<input checked="" type="checkbox"/> Read access <input checked="" type="checkbox"/> Write access <input type="checkbox"/> CINH <input type="checkbox"/> PLC-STOP <input type="checkbox"/> no transfer			

15.9.2 Parameters of the second CAN interface

C1113

Parameter Name: C1113 Device: Driver index		Data type: UNSIGNED_32 Index: 23462 _d = 5BA6 _h	
Index of the device driver. Since there can be more than one CAN interface, several instances can be run via the driver.			
<input checked="" type="checkbox"/> Read access <input type="checkbox"/> Write access <input type="checkbox"/> CINH <input type="checkbox"/> PLC-STOP <input type="checkbox"/> No transfer			

C1121

Parameter Name: C1121 Sync master: Interface index		Data type: UNSIGNED_32 Index: 23454 _d = 5B9E _h	
Note: Restart the Controller after changing this parameter!			
Setting range (min. value unit max. value)		Lenze setting	
			4294967295
<input checked="" type="checkbox"/> Read access <input checked="" type="checkbox"/> Write access <input type="checkbox"/> CINH <input type="checkbox"/> PLC-STOP <input type="checkbox"/> no transfer			

C1122

Parameter Name: C1122 Baud rate		Data type: UNSIGNED_32 Index: 23453 _d = 5B9D _h
Baud rate of the CAN interface. The value is assigned from a selection list.		
Selection list (Lenze setting printed in bold)		
7	5	
6	10	
5	20	
3	50	
8	100	
2	125	
1	250	
0	500	
4	1000	
<input checked="" type="checkbox"/> Read access <input checked="" type="checkbox"/> Write access <input type="checkbox"/> CINH <input type="checkbox"/> PLC-STOP <input type="checkbox"/> no transfer		

C1130

Parameter Name: C1130 Tx PDO counter		Data type: UNSIGNED_32 Index: 23445 _d = 5B95 _h
PDO counter for sent CAN messages		
<input checked="" type="checkbox"/> Read access <input type="checkbox"/> Write access <input type="checkbox"/> CINH <input type="checkbox"/> PLC-STOP <input type="checkbox"/> No transfer		

C1131

Parameter Name: C1131 Rx PDO counter		Data type: UNSIGNED_32 Index: 23444 _d = 5B94 _h
PDO counter for received CAN messages		
<input checked="" type="checkbox"/> Read access <input type="checkbox"/> Write access <input type="checkbox"/> CINH <input type="checkbox"/> PLC-STOP <input type="checkbox"/> No transfer		

C1132

Parameter Name: C1132 Bus load		Data type: UNSIGNED_32 Index: 23443 _d = 5B93 _h
Indication of the mean bus load		
The bus load is calculated as follows: Bus load = value in percent x 1000		
<input checked="" type="checkbox"/> Read access <input type="checkbox"/> Write access <input type="checkbox"/> CINH <input type="checkbox"/> PLC-STOP <input type="checkbox"/> No transfer		

C1133

Parameter Name: C1133 Error counter		Data type: UNSIGNED_32 Index: 23442 _d = 5B92 _h
Error counter since last initialisation of the CAN interface		
<input checked="" type="checkbox"/> Read access <input type="checkbox"/> Write access <input type="checkbox"/> CINH <input type="checkbox"/> PLC-STOP <input type="checkbox"/> No transfer		

C1134

Parameter Name: C1134 Last error code	Data type: UNSIGNED_32 Index: 23441 _d = 5B91 _h
Code of the last error that occurred	
<input checked="" type="checkbox"/> Read access <input type="checkbox"/> Write access <input type="checkbox"/> CINH <input type="checkbox"/> PLC-STOP <input type="checkbox"/> No transfer	

C1136

Parameter Name: C1136 CAN node ID	Data type: UNSIGNED_8 Index: 23439 _d = 5B8F _h
Setting range (min. value unit max. value)	Lenze setting
0	128 63
<input checked="" type="checkbox"/> Read access <input checked="" type="checkbox"/> Write access <input type="checkbox"/> CINH <input type="checkbox"/> PLC-STOP <input type="checkbox"/> no transfer	

C1138

Parameter Name: C1138 Channel	Data type: UNSIGNED_32 Index: 23437 _d = 5B8D _h
Setting range (min. value unit max. value)	Lenze setting
	0
<input checked="" type="checkbox"/> Read access <input checked="" type="checkbox"/> Write access <input type="checkbox"/> CINH <input type="checkbox"/> PLC-STOP <input type="checkbox"/> no transfer	

15.10 PROFIBUS / PROFINET / Serial interfaces

This chapter lists all parameters of the PROFIBUS and PROFINET communication cards and the communication card with serial interfaces in numerically ascending order:

- Communication card MC-PBM (PROFIBUS master)
- Communication card MC-PBS (PROFIBUS slave)
- MC-PND communication card (PROFINET device)
- MC-ISI communication card (serial interfaces RS-232/422/485)

C1031

Parameter Name: C1031 Device: Type key	Data type: VISIBLE_STRING Index: 23544 _d = 5BF8 _h
Identification of the card	
<input checked="" type="checkbox"/> Read access <input type="checkbox"/> Write access <input type="checkbox"/> CINH <input type="checkbox"/> PLC-STOP <input type="checkbox"/> No transfer	

C1032

Parameter Name: C1032 Device: Type version	Data type: VISIBLE_STRING Index: 23543 _d = 5BF7 _h
Version number of the card	
<input checked="" type="checkbox"/> Read access <input type="checkbox"/> Write access <input type="checkbox"/> CINH <input type="checkbox"/> PLC-STOP <input type="checkbox"/> No transfer	

C1033

Parameter Name: C1033 Device: Name	Data type: VISIBLE_STRING Index: 23542 _d = 5BF6 _h
Device name of the card	
<input checked="" type="checkbox"/> Read access <input type="checkbox"/> Write access <input type="checkbox"/> CINH <input type="checkbox"/> PLC-STOP <input type="checkbox"/> No transfer	

C1034

Parameter Name: C1034 Device: Software	Data type: VISIBLE_STRING Index: 23541 _d = 5BF5 _h
Software version of the card	
<input checked="" type="checkbox"/> Read access <input type="checkbox"/> Write access <input type="checkbox"/> CINH <input type="checkbox"/> PLC-STOP <input type="checkbox"/> No transfer	

C1035

Parameter Name: C1035 Device: Hardware	Data type: VISIBLE_STRING Index: 23540 _d = 5BF4 _h
Hardware version of the card	
<input checked="" type="checkbox"/> Read access <input type="checkbox"/> Write access <input type="checkbox"/> CINH <input type="checkbox"/> PLC-STOP <input type="checkbox"/> No transfer	

C1036

Parameter Name: C1036 Device: Serial number	Data type: VISIBLE_STRING Index: 23539 _d = 5BF3 _h
Serial number of the card	
<input checked="" type="checkbox"/> Read access <input type="checkbox"/> Write access <input type="checkbox"/> CINH <input type="checkbox"/> PLC-STOP <input type="checkbox"/> No transfer	

C1037

Parameter Name: C1037 Device: Manufacturer	Data type: VISIBLE_STRING Index: 23538 _d = 5BF2 _h
Manufacturer of the card	
<input checked="" type="checkbox"/> Read access <input type="checkbox"/> Write access <input type="checkbox"/> CINH <input type="checkbox"/> PLC-STOP <input type="checkbox"/> No transfer	

C1038

Parameter Name: C1038 Device: Manufacturing date	Data type: VISIBLE_STRING Index: 23537 _d = 5BF1 _h
Manufacturing date of the card	
<input checked="" type="checkbox"/> Read access <input type="checkbox"/> Write access <input type="checkbox"/> CINH <input type="checkbox"/> PLC-STOP <input type="checkbox"/> No transfer	

Symbols

"LogicAndMotionV3" direct driver for remote access [126](#)

"LogicAndMotionV3" direct driver for visualisation [116](#)

"Visualisation" application software [31](#)

(C0193) [173](#)

(C0195) [173](#)

Figures

0x1009

Hardware version (C0183) [171](#)

Hardware version (C0185) [172](#)

0x100a

Software version (C0182) [171](#)

Software version (C0184) [171](#)

A

Activate Explorer [150](#)

Activate field devices firmware update (C0640) [181](#)

Activate front USB (C0040) [149](#)

Activate VisiWinNET Remote Access (C0097) [158](#)

Activate VNC server (C0095) [157](#)

Activate Windows® CE interface [104](#)

Allocated flash memory (C0078) [153](#)

Allocated program memory (C0071) [152](#)

Allocated virtual file memory (C0075) [153](#)

Application credits used (C0661) [182](#)

Application Loader [78](#)

Application notes [12](#)

Application software of the Lenze Controllers [24](#)

Apply IP configuration (C0238) [187](#)

Assign a name for the backup (C0811) [183](#)

Automatic data update (after device replacement) [86](#)

automatic dimout

brightness value (C0425) [178](#)

Switch-on after (C0424) [178](#)

Automation Panel Script Control [108](#)

Available application credits (C0660) [182](#)

B

Backplane bus error messages [52](#)

Backup & Restore (data backup/restore) [77](#)

Backup & Restore (parameters) [183](#)

Backup or update file 1 (C0814) [184](#)

Backup or update file 10 (C0823) [185](#)

Backup or update file 2 (C0815) [184](#)

Backup or update file 3 (C0816) [184](#)

Backup or update file 4 (C0817) [184](#)

Backup or update file 5 (C0818) [184](#)

Backup or update file 6 (C0819) [184](#)

Backup or update file 7 (C0820) [184](#)

Backup or update file 8 (C0821) [185](#)

Backup or update file 9 (C0822) [185](#)

Backup status (C0832) [186](#)

Basic parameters of the Controllers [146](#)

Baud rate (C1082) [196](#)

Baud rate (C1122) [198](#)

Boot application loaded (C0619) [181](#)

Bootloader

Version (C0036) [149](#)

Brightness

actual value (C0426) [178](#)

Upper limit (C0423) [177](#)

Browsing variable definitions at local visualisation [129](#)

Browsing variable definitions at remote access [139](#)

Bus coupler module, tab [51](#)

Bus load (C1092) [196](#)

Bus load (C1132) [198](#)

C

C0001 | Device

Name [146](#)

C0002 | Device

Software version [146](#)

C0003 | Device

Name [146](#)

C0004 | Device

Software version [146](#)

C0005 | Device

Hardware version [146](#)

C0006 | Device

Serial number [146](#)

C0007 | Device

Manufacturer [146](#)

C0008 | Device

Manufacturing date [147](#)

C0013 | System identification

Name [147](#)

C0015 | System identification

User name [147](#)

C0016 | System identification

Description [147](#)

C0018 | Command [148](#)

C0019 | Command status [148](#)

C0020 | CPU

Name [148](#)

C0025 | CPU

Firmware version [148](#)

C0030 | CPU

Temperature [149](#)

C0036 | Bootloader

Version [149](#)

C0040 | Activate front USB [149](#)

C0041 | Operating time [149](#)

C0042 | Number of reboots [149](#)

C0043 | Activate Explorer [150](#)

C0048 | Logb.

Time to auto persist ... min [150](#)

C0049 | Logb.

Entry count to auto persist [150](#)

Index

- C0050 | Logb.
 - Max. entries [150](#)
- C0051 | Logb.
 - Size on CF [150](#)
- C0052 | Logb.
 - Number of entries in RAM [151](#)
- C0053 | Logb.
 - Time of oldest entry [151](#)
- C0054 | Logb.
 - Index of oldest entry [151](#)
- C0055 | Logb.
 - Time of last entry on CF [151](#)
- C0056 | Logb.
 - Index of last entry on CF [151](#)
- C0057 | Logb.
 - Index of last entry [151](#)
- C0058 | Logb.
 - Time of last entry [152](#)
- C0064 | Logb.
 - Time of last error entry [152](#)
- C0070 | Ratio
 - Data/program memory [152](#)
- C0071 | Allocated program memory [152](#)
- C0072 | Used program memory [152](#)
- C0075 | Allocated virtual file memory [153](#)
- C0076 | Used virtual file memory [153](#)
- C0078 | Allocated flash memory [153](#)
- C0079 | Used flash memory [153](#)
- C0085 | NTP
 - Activate network time protocol AutoUpdate [153](#)
- C0086 | NTP
 - NTP Server [154](#)
- C0090 | System
 - Date and time [154](#)
- C0091 | Local date and time [154](#)
- C0092 | Time zone [154](#)
- C0093 | Locale [157](#)
- C0095 | Activate VNC server [157](#)
- C0097 | Activate VisiWinNET Remote Access [158](#)
- C0100 | WinCE users
 - Number [158](#)
- C0101 | WinCE users
 - User name 1 [158](#)
- C0102 | WinCE users
 - Password 1 [158](#)
- C0103 | WinCE users
 - User 1 with FTP permissions [158](#)
- C0104 | FTP
 - Permissions user 1 [159](#)
- C0105 | FTP
 - Home user 1 [159](#)
- C0106 | WinCE users
 - User 1 with Telnet permissions [159](#)
- C0108 | WinCE users
 - User name 2 [159](#)
- C0109 | WinCE users
 - Password 2 [159](#)
- C0110 | WinCE users
 - User 2 with FTP permissions [160](#)
- C0111 | FTP
 - Permissions user 2 [160](#)
- C0112 | FTP
 - Home user 2 [160](#)
- C0113 | WinCE users
 - User 2 with Telnet permissions [160](#)
- C0115 | WinCE users
 - User name 3 [160](#)
- C0116 | WinCE users
 - Password 3 [161](#)
- C0117 | WinCE users
 - User 3 with FTP permissions [161](#)
- C0118 | FTP
 - Permissions user 3 [161](#)
- C0119 | FTP
 - Home user 3 [161](#)
- C0120 | WinCE users
 - User 3 with Telnet permissions [161](#)
- C0122 | WinCE users
 - User name 4 [162](#)
- C0123 | WinCE users
 - Password 4 [162](#)
- C0124 | WinCE users
 - User 4 with FTP permissions [162](#)
- C0125 | FTP
 - Permissions user 4 [162](#)
- C0126 | FTP
 - Home user 4 [162](#)
- C0127 | WinCE users
 - User 4 with Telnet permissions [163](#)
- C0129 | WinCE users
 - User name 5 [163](#)
- C0130 | WinCE users
 - Password 5 [163](#)
- C0131 | WinCE users
 - User 5 with FTP permissions [163](#)
- C0132 | FTP
 - Permissions user 5 [163](#)
- C0133 | FTP
 - Home user 5 [164](#)
- C0134 | WinCE users
 - User 5 with Telnet permissions [164](#)
- C0136 | WinCE users
 - User name 6 [164](#)
- C0137 | WinCE users
 - Password 6 [164](#)
- C0138 | WinCE users
 - User 6 with FTP permissions [164](#)
- C0139 | FTP
 - Permissions user 6 [165](#)
- C0140 | FTP
 - Home user 6 [165](#)

Index

- C0141 | WinCE users
 - User 6 with Telnet permissions [165](#)
- C0143 | WinCE users
 - User name 7 [165](#)
- C0144 | WinCE users
 - Password 7 [165](#)
- C0145 | WinCE users
 - User 7 with FTP permissions [166](#)
- C0146 | FTP
 - Permissions user 7 [166](#)
- C0147 | FTP
 - Home user 7 [166](#)
- C0148 | WinCE users
 - User 7 with Telnet permissions [166](#)
- C0150 | WinCE users
 - User name 8 [166](#)
- C0151 | WinCE users
 - Password 8 [167](#)
- C0152 | WinCE users
 - User 8 with FTP permissions [167](#)
- C0153 | FTP
 - Permissions user 8 [167](#)
- C0154 | FTP
 - Home user 8 [167](#)
- C0155 | WinCE users
 - User 8 with Telnet permissions [167](#)
- C0157 | WinCE users
 - User name 9 [168](#)
- C0158 | WinCE users
 - Password 9 [168](#)
- C0159 | WinCE users
 - User 9 with FTP permissions [168](#)
- C0160 | FTP
 - Permissions user 9 [168](#)
- C0161 | FTP
 - Home user 9 [168](#)
- C0162 | WinCE users
 - User 9 with Telnet permissions [169](#)
- C0164 | WinCE users
 - User name 10 [169](#)
- C0165 | WinCE users
 - Password 10 [169](#)
- C0166 | WinCE users
 - User 10 with FTP permissions [169](#)
- C0167 | FTP
 - Permissions user 10 [169](#)
- C0168 | FTP
 - Home user 10 [170](#)
- C0169 | WinCE users
 - User 10 with Telnet permissions [170](#)
- C0172 | FTP
 - Allow "Anonymous" [170](#)
- C0173 | FTP
 - Allow "Anonymous" upload [170](#)
- C0174 | FTP
 - enabled [170](#)
- C0180 | Telnet
 - Use authentication [171](#)
- C0181 | Telnet
 - enabled [171](#)
- C0182 | 0x100a
 - Software version [171](#)
- C0183 | 0x1009
 - Hardware version/FPGA firmware version [171](#)
- C0184 | 0x100a
 - Software version [171](#)
- C0185 | 0x1009
 - Hardware version [172](#)
- C0186 | PLC
 - Licence [172](#)
- C0187 | Visualisation licence [172](#)
- C0188 | Visualisation
 - Number of power tags [172](#)
- C0189 | VNC
 - Password [172](#)
- C0190 | VNC
 - Used authentication [172](#)
- C0191 | VNC
 - Maximum number of clients [173](#)
- C0192 | VNC
 - Automatic log out [173](#)
- C0194 | VNC
 - Port [173](#)
- C0203 | UPS
 - UPS monitoring [174](#)
- C0204 | UPS
 - Status [174](#)
- C0205 | UPS
 - Supply voltage [174](#)
- C0207 | UPS
 - Battery / capacitor voltage [175](#)
- C0208 | UPS
 - Display lighting after voltage failure [175](#)
- C0209 | UPS
 - Number of voltage dips [175](#)
- C0210 | UPS
 - Supply voltage OK [175](#)
- C0211 | UPS
 - Voltage failure [175](#)
- C0212 | UPS
 - Firmware version [175](#)
- C0213 | UPS
 - Buffer time without action [176](#)
- C0214 | UPS
 - Buffer time until shutdown [176](#)
- C0238 | Apply IP configuration [187](#)
- C0240 | Enable Dhcp [187](#)
- C0241 | IP address [187](#)
- C0242 | Subnet mask [187](#)
- C0243 | Default gateway [187](#)
- C0244 | Domain [188](#)

Index

- C0246 | MAC address [188](#)
- C0420 | Panel
 - Width [177](#)
- C0421 | Panel
 - Height [177](#)
- C0422 | Dimout
 - Actual value [177](#)
- C0423 | Brightness
 - Upper limit [177](#)
- C0424 | Automatic dimout
 - Switch-on after [178](#)
- C0425 | Automatic dimout
 - Brightness value [178](#)
- C0426 | Brightness
 - Actual value [178](#)
- C0427 | Current rotation of the display [178](#)
- C0432 | Key F1
 - Function [179](#)
- C0433 | Key F1
 - Parameter [179](#)
- C0434 | Key F2
 - Function [179](#)
- C0435 | Key F2
 - Parameter [179](#)
- C0436 | Key F3
 - Function [180](#)
- C0437 | Key F3
 - Parameter [180](#)
- C0438 | Key F4
 - Function [180](#)
- C0439 | Key F4
 - Parameter [180](#)
- C0619 | Boot application loaded [181](#)
- C0620 | PLC
 - Status [181](#)
- C0630 | Display Soft PLC window [181](#)
- C0640 | Activate field device firmware update [181](#)
- C0650 | Start Field Device parameter storage [182](#)
- C0651 | Status Field Device parameter storage [182](#)
- C0660 | Available application credits [182](#)
- C0661 | Application credits used [182](#)
- C0809 | Select a main action for the Lenze software [183](#)
- C0810 | Select a main action for the Lenze software [183](#)
- C0811 | Assign a name for the backup [183](#)
- C0813 | Display of the backup or update files [184](#)
- C0814 | Backup or update file 1 [184](#)
- C0815 | Backup or update file 2 [184](#)
- C0816 | Backup or update file 3 [184](#)
- C0817 | Backup or update file 4 [184](#)
- C0818 | Backup or update file 5 [184](#)
- C0819 | Backup or update file 6 [184](#)
- C0820 | Backup or update file 7 [184](#)
- C0821 | Backup or update file 8 [185](#)
- C0822 | Backup or update file 9 [185](#)
- C0823 | Backup or update file 10 [185](#)
- C0824 | Select a backup or update [185](#)
- C0830 | Start backup [185](#)
- C0831 | Start restore update [186](#)
- C0832 | Backup status [186](#)
- C0833 | Restore update status [186](#)
- C1031 | Device
 - Identification [194](#), [200](#)
- C1032 | Device
 - Version [194](#), [200](#)
- C1033 | Device
 - Name [194](#), [200](#)
- C1034 | Device
 - Software version [194](#), [200](#)
- C1035 | Device
 - Hardware version [194](#), [200](#)
- C1036 | Device
 - Serial number [195](#), [200](#)
- C1037 | Device
 - Manufacturer [195](#), [201](#)
- C1038 | Device
 - Manufacturing date [195](#), [201](#)
- C1073 | Device
 - Driver index [195](#)
- C1081 | Sync-Master
 - Interface Index [195](#)
- C1082 | Baud rate [196](#)
- C1090 | Tx PDO counter [196](#)
- C1091 | Rx PDO counter [196](#)
- C1092 | Bus load [196](#)
- C1093 | Error counter [196](#)
- C1094 | Last error code [196](#)
- C1096 | CAN node ID [197](#)
- C1098 | Channel [197](#)
- C1113 | Device
 - Driver index [197](#)
- C1121 | Sync-Master
 - Interface Index [197](#)
- C1122 | Baud rate [198](#)
- C1130 | Tx PDO counter [198](#)
- C1131 | Rx PDO counter [198](#)
- C1132 | Bus load [198](#)
- C1133 | Error counter [198](#)
- C1134 | Last error code [199](#)
- C1136 | CAN node ID [199](#)
- C1138 | Channel [199](#)
- C280/4 | ECAT bus scan result [189](#)
- C281/2 | ECAT Master
 - State [189](#)
- C281/5 | ECAT master
 - State information [190](#)
- C281/6 | ECAT bus scan [190](#)
- C282/2 | ECAT DC
 - Perm. dev. slave sync [191](#)
- C282/3 | ECAT DC
 - Current deviation [191](#)

- C286/10 | ECAT counter - Cyclic frames [192](#)
- C286/11 | ECAT counter - Cyclic datagrams [193](#)
- C286/12 | ECAT counter - Acyclic frames [193](#)
- C286/13 | ECAT counter - Acyclic datagrams [193](#)
- C286/14 | ECAT Clear specific counters [193](#)
- C286/3 | ECAT bus - No. of slaves [191](#)
- C286/4 | ECATBus - No. of slaves with DC [191](#)
- C286/5 | ECAT config.
 - No. of slaves [191](#)
- C286/6 | ECAT config.
 - No. of mailbox slaves [192](#)
- C286/7 | ECAT counter
 - Tx frames [192](#)
- C286/8 | ECAT counter
 - Rx frames [192](#)
- C286/9 | ECAT counter
 - Lost frames [192](#)
- Cabinet Controller [29](#)
- CAN node ID (C1096) [197](#)
- CAN node ID (C1136) [199](#)
- CAN parameters [194](#)
- Capacitor pack CAPS pack (notes) [21](#)
- CAPS pack (notes) [21](#)
- Channel (C1098) [197](#)
- Channel (C1138) [199](#)
- Cleaning (notes) [18](#)
- Command (C0018) [148](#)
- Command status (C0019) [148](#)
- Commissioning (notes) [17](#)
- Commissioning the controller [35](#)
- Configuration of the Controller [38](#)
- Configuring and parameterising the controller using the control application [72](#)
- Configuring the controller [38](#)
- Connect Controller/replacement device [86](#)
- Control elements of the controllers [35](#)
- Controller basic parameters [146](#)
- Controller c300/p300 (notes) [19](#)
- Controller does not start (error case) [37](#)
- Controller-based Automation
 - Central motion control [23](#)
- Controllers [29](#)
 - Establishing an automatic dial-up connection [38](#)
- Conventions used [10](#)
- CPU
 - Firmware version (C0025) [148](#)
 - Name (C0020) [148](#)
 - Temperature (C0030) [149](#)
- Create LFL file [78](#)
- Creating retain variables [75](#)
- Current rotation of the display (C0427) [178](#)
- D**
- Data backup in case of voltage failure (UPS) [79](#)
- Data backup/restore (»Backup & Restore«) [77](#)
- Data transfer (»EASY Starter - Application Loader«) [78](#)
- Data transfer via FTP [98](#)
- Data types [143](#)
- Default gateway (C0243) [187](#)
- Device
 - Driver index (C1073) [195](#)
 - Driver index (C1113) [197](#)
 - Hardware version (C0005) [146](#)
 - Hardware version (C1035) [194](#), [200](#)
 - Identification (C1031) [194](#), [200](#)
 - Manufacturer (C0007) [146](#)
 - Manufacturer (C1037) [195](#), [201](#)
 - Manufacturing date (C0008) [147](#)
 - Manufacturing date (C1038) [195](#), [201](#)
 - Name (C0001) [146](#)
 - Name (C0003) [146](#)
 - Name (C1033) [194](#), [200](#)
 - Serial number (C0006) [146](#)
 - Serial number (C1036) [195](#), [200](#)
 - Software version (C0002) [146](#)
 - Software version (C0004) [146](#)
 - Software version (C1034) [194](#), [200](#)
 - Version (C1032) [194](#), [200](#)
- Device replacement (error messages) [90](#)
- Device replacement (replacing the Controller) [84](#)
- Device replacement against an incompatible replacement device [87](#)
- Diagnostics [91](#)
- Diagnostics via Telnet [96](#)
- Diagnostics with the logbook [101](#)
- Dimout
 - actual value (C0422) [177](#)
- Display of the backup or update files (C0813) [184](#)
- Display Soft PLC window (C0630) [181](#)
- Disposal (notes) [18](#)
- Domain (C0244) [188](#)
- E**
- EASY Navigator [28](#)
- EASY Starter - Application Loader [78](#)
- ECAT bus - No. of slaves (C286/3) [191](#)
- ECAT bus scan - compliance (C280/4) [189](#)
- ECAT bus scan (C281/6) [190](#)
- ECAT Clear specific counters (C286/14) [193](#)
- ECAT config.
 - No. of mailbox slaves (C286/6) [192](#)
 - No. of slaves (C286/5) [191](#)
- ECAT counter
 - Lost frames (C286/9) [192](#)
 - Rx frames (C286/8) [192](#)
 - Tx frames (C286/7) [192](#)
- ECAT counter - Acyclic datagrams (C286/13) [193](#)
- ECAT counter - Acyclic frames (C286/12) [193](#)
- ECAT counter - Cyclic datagrams (C286/11) [193](#)

ECAT counter - Cyclic frames (C286/10) [192](#)
ECAT DC - Current deviation (C282/3) [191](#)
ECAT DC - Perm. dev. slave sync (C282/2) [191](#)

ECAT Master

State (C281/2) [189](#)

ECAT master

State information (C281/5) [190](#)

ECATBus - No. of slaves with DC (C286/4) [191](#)

Electrical installation (notes) [17](#)

E-mail to Lenze [211](#)

EMC notes [22](#)

Enable Dhcp (C0240) [187](#)

Engineering tools [27](#)

Enter IP Address [38](#)

Error counter (C1093) [196](#)

Error counter (C1133) [198](#)

Error messages after a device replacement [90](#)

Error messages backplane bus [52](#)

EtherCAT parameters [189](#)

Ethernet parameters [187](#)

Export (LFL file) [78](#)

Export application data (LFL file) [78](#)

Export file for »EASY Starter - Application Loader« [78](#)

Export PLC program (LFL file) [78](#)

External voltage buffering (UPS parameter) [174](#)

F

F1 key

Function (C0432) [179](#)

Parameter (C0433) [179](#)

F2 key

Function (C0434) [179](#)

Parameter (C0435) [179](#)

F3 key

Function (C0436) [180](#)

Parameter (C0437) [180](#)

F4 key

Function (C0438) [180](#)

Parameter (C0439) [180](#)

FAST application software [30](#)

Fault

Controller does not start [37](#)

Feedback to Lenze [211](#)

Fieldbus communication (interfaces) [25](#)

FPGA firmware version (C0183) [171](#)

FTP

Allow "Anonymous" (C0172) [170](#)

Allow "Anonymous" upload (C0173) [170](#)

enabled (C0174) [170](#)

Home user 1 (C0105) [159](#)

Home user 10 (C0168) [170](#)

Home user 2 (C0112) [160](#)

Home user 3 (C0119) [161](#)

Home user 4 (C0126) [162](#)

Home user 5 (C0133) [164](#)

Home user 6 (C0140) [165](#)

Home user 7 (C0147) [166](#)

Home user 8 (C0154) [167](#)

Home user 9 (C0161) [168](#)

Permissions user 1 (C0104) [159](#)

Permissions user 10 (C0167) [169](#)

Permissions user 2 (C0111) [160](#)

Permissions user 3 (C0118) [161](#)

Permissions user 4 (C0125) [162](#)

Permissions user 5 (C0132) [163](#)

Permissions user 6 (C0139) [165](#)

Permissions user 7 (C0146) [166](#)

Permissions user 8 (C0153) [167](#)

Permissions user 9 (C0160) [168](#)

FTP and web settings in the Internet Explorer [99](#)

FTP settings with the »WebConfig« [98](#)

Function blocks [70](#)

G

GapPad strips for Controller 3200 C (notes) [20](#)

H

Heatsink for Controller 3200 C (notes) [20](#)

I

I/O compound modules, tab [51](#)

I/O modules on the backplane bus [46](#)

I/O system 1000 (notes) [20](#)

Identification of the Controller [35](#)

Identification of the controller [35](#)

Interfaces for fieldbus communication [25](#)

IP address (C0241) [187](#)

IP configuration of the Controller [37](#)

L

Last error code (C1094) [196](#)

Last error code (C1134) [199](#)

Layout of the safety instructions [12](#)

LEDs of the Controller 3200 C [93](#)

LEDs of the Controllers [92](#)

LEDs of the Controllers c300/p300 [94](#)

LEDs of the Controllers p500 [95](#)

Lenze FAST application software [30](#)

Limits on the backplane bus [47](#)

Load standard setting [44](#)

Load the application data (LFL file) into the Controller [78](#)

Load the LFL file into the Controller [78](#)

Load the PLC program (LFL file) into the Controller [78](#)

Local date and time (C0091) [154](#)

logbook

Entry count to auto persist (C0049) [150](#)

Index of last entry (C0057) [151](#)

Index of last entry on CF (C0056) [151](#)

Index of oldest entry (C0054) [151](#)

Max. entries (C0050) [150](#)

Number of entries in RAM (C0052) [151](#)
Size on CF (C0051) [150](#)
Time of last entry (C0058) [152](#)
Time of last entry on CF (C0055) [151](#)
Time of last error entry (C0064) [152](#)
Time of oldest entry (C0053) [151](#)
Time to auto persist (C0048) [150](#)
Logbook parameters [103](#)
Logbook query via the »WebConfig« [102](#)
LogicAndMotionV3 (direct driver for remote access) [126](#)
LogicAndMotionV3 (direct driver for visualisation) [116](#)

M

MAC address (C0246) [188](#)
Maintenance (notes) [17](#)
MC-CAN2 (CAN parameters) [194](#)
MC-ETC (EtherCAT parameter) [189](#)
MC-ETH (Ethernet parameter) [187](#)
MC-ISI (parameter of the serial interfaces) [200](#)
MC-PBM (PROFIBUS master parameter) [200](#)
MC-PBS (PROFIBUS slave parameter) [200](#)
MC-PND (PROFINET device parameter) [200](#)
Mechanical installation (notes) [16](#)
Memory sizes of the Lenze Controllers [70](#)
Monitor Panel (parameters) [177](#)

N

Navigator [28](#)
Notes on wiring according to EMC [22](#)
NTP
 Activate network time protocol AutoUpdate (C0085) [153](#)
 NTP Server (C0086) [154](#)
Number of reboots (C0042) [149](#)

O

OPC tunnel for external visualisation [135](#)
OPC tunnel for local visualisation (integrated control system) [127](#)
Operating system of the Lenze Controllers
 Windows® [71](#)

P

Panel
 Height (C0421) [177](#)
 Width (C0420) [177](#)
Panel Controller [29](#)
Panel Controller/HMI (notes) [19](#)
Parameter (external voltage buffering UPS) [174](#)
Parameter attributes [145](#)
Parameter description (structure) [143](#)
Parameter of the serial interfaces (MC-ISI) [200](#)
Parameter reference [142](#)
Parameters (Backup & Restore) [183](#)
Parameters (EtherCAT) [189](#)
Parameters (Ethernet) [187](#)

Parameters (Monitor Panel) [177](#)
Parameters (PLC Logic/Motion) [181](#)
Parameters of the Controllers (basic parameters) [146](#)
PLC
 Status (C0620) [181](#)
PLC (Logic/Motion) parameters [181](#)
PLC licence (C0186) [172](#)
Pointer - c300/p300 [73](#)
PostStart.txt Script commands [108](#)
PreStart.txt Script commands [108](#)
Product-specific safety instructions [19](#)
PROFIBUS master parameter (MC-PBM) [200](#)
PROFIBUS parameters [200](#)
PROFIBUS slave parameter (MC-PBS) [200](#)
PROFINET device parameter (MC-PND) [200](#)
PROFINET parameters [200](#)
Programming with the »PLC Designer« [68](#)

PROFIBUS master parameter (MC-PBM) [200](#)
PROFIBUS parameters [200](#)
PROFIBUS slave parameter (MC-PBS) [200](#)
PROFINET device parameter (MC-PND) [200](#)
PROFINET parameters [200](#)
Programming with the »PLC Designer« [68](#)

R

Ratio
 Data/program memory (C0070) [152](#)
Real Time Clock (RTC) [83](#)
Regional and language options (C0093) [157](#)
Remote access with the "LogicAndMotionV3" direct driver [126](#)
Remote Display
 Remote control of Controller via Internet or LAN [106](#)
Remote maintenance and diagnostics [91](#)
Remove Controller [85](#)
Replacement devices for the Controller [84](#)
Replacing the Controller [84](#)
Reset [44](#)
Reset Controller [44](#)
Restore update status (C0833) [186](#)
Re-use of the retain data [76](#)
RJ45 plug connections (notes) [21](#)
RTC function (Real Time Clock) [83](#)
Running time (C0041) [149](#)
Rx PDO counter (C1091) [196](#)
Rx PDO counter (C1131) [198](#)

S

C0193 | VNC
 Maximum session time [173](#)
C0195 | VNC
 Maximum idle time [173](#)
VNC
 Maximum idle time [173](#)
 Maximum session time [173](#)
Safety instructions [12](#), [13](#)
Screenshots [7](#)
Script commands in PreStart.txt/PostStart.txt [108](#)
Script control functions (Windows CE) [109](#)
SD card [36](#)
Select a backup or update (C0824) [185](#)

Index

Select a main action for the Lenze software (C0809) [183](#)
Select a main action for the Lenze software (C0810) [183](#)
Selecting the IP address of the controller
 With file [41](#)
Serial interfaces - parameter [200](#)
Servicing (notes) [17](#)
Settings in the »WebConfig« [96](#)
Software (Engineering tools) [27](#)
Start backup (C0830) [185](#)
Start Field Device parameter storage (C0650) [182](#)
Start restore update (C0831) [186](#)
Status Field Device parameter storage (C0651) [182](#)
Status LEDs of the Controller 3200 C [93](#)
Status LEDs of the Controllers [92](#)
Status LEDs of the Controllers c300/p300 [94](#)
Storage [16](#)
Storing retain data [76](#)
Structure of the parameter description [143](#)
Subnet mask (C0242) [187](#)
Subsequent use of retain data after device replacement [89](#)
Sync master
 Interface index (C1081) [195](#)
 Interface index (C1121) [197](#)
System
 Date and time (C0090) [154](#)
System architecture
 PLC Designer - controller access [69](#)
System functions (Windows CE) [110](#)
System identification
 Description (C0016) [147](#)
 Name (C0013) [147](#)
 User name (C0015) [147](#)
System structure of Controller-based Automation [23](#)

T

Tabs of the I/O modules at the backplane bus [51](#)
Target group [7](#)
telnet
 enabled (C0181) [171](#)
 Use authentication (C0180) [171](#)
Terms [11](#)
Thermal connection to the DIN rail (notes) [20](#)
Time zone (C0092) [154](#)
Transport [16](#)
Tx PDO counter (C1090) [196](#)
Tx PDO counter (C1130) [198](#)

U

Undo update of data [88](#)
UPS
 Battery / capacitor voltage (C0207) [175](#)
 Buffer time until shutdown (C0214) [176](#)
 Buffer time without action (C0213) [176](#)
 Display lighting after voltage failure (C0208) [175](#)
 External UPS (for Controllers 3241 C with UPS connection) [80](#)

Firmware version (C0212) [175](#)
Internal UPS (for Controllers without UPS connection) [79](#)
Number of voltage dips (C0209) [175](#)
Status (C0204) [174](#)
Supply voltage (C0205) [174](#)
Supply voltage OK (C0210) [175](#)
UPS monitoring (C0203) [174](#)
Voltage failure (C0211) [175](#)
UPS (Uninterrupted power supply) [79](#)
UPS parameter [174](#)
Use your own background image (Windows CE) [43](#)
Used flash memory (C0079) [153](#)
Used program memory (C0072) [152](#)
Used virtual file memory (C0076) [153](#)
Using the direct driver for visualisations under Windows CE [117](#)

V

Variable access with the variables browser [120](#)
Virtual Network Computing (VNC) [107](#)
VisiWinNET® [111](#)
Visualisation
 Number of power tags (C0188) [172](#)
Visualisation (application software) [31](#)
Visualisation licence (C0187) [172](#)
Visualisation on the Controller
 Local and remote [112](#)
Visualisation with the "LogicAndMotionV3" direct driver [116](#)
Visualising with »VisiWinNET®« [111](#)
VNC
 Automatic log out (C0192) [173](#)
 Maximum number of clients (C0191) [173](#)
 Password (C0189) [172](#)
 Port (C0194) [173](#)
 Used authentication (C0190) [172](#)
Voltage supply (notes) [21](#)

W

Watchdog monitoring time [70](#)
Web settings in the Internet Explorer [99](#)
Web-based parameterisation [56](#)
WebConfig [56](#)
WebConfig - user interface [59](#)
WinCE users
 Number (C0100) [158](#)
 Password 1 (C0102) [158](#)
 Password 10 (C0165) [169](#)
 Password 2 (C0109) [159](#)
 Password 3 (C0116) [161](#)
 Password 4 (C0123) [162](#)
 Password 5 (C0130) [163](#)
 Password 6 (C0137) [164](#)
 Password 7 (C0144) [165](#)
 Password 8 (C0151) [167](#)
 Password 9 (C0158) [168](#)
 User 1 with FTP permissions (C0103) [158](#)

Index

User 1 with telnet permissions (C0106) [159](#)
User 10 with FTP permissions (C0166) [169](#)
User 10 with telnet permissions (C0169) [170](#)
User 2 with FTP permissions (C0110) [160](#)
User 2 with telnet permissions (C0113) [160](#)
User 3 with FTP permissions (C0117) [161](#)
User 3 with telnet permissions (C0120) [161](#)
User 4 with FTP permissions (C0124) [162](#)
User 4 with telnet permissions (C0127) [163](#)
User 5 with FTP permissions (C0131) [163](#)
User 5 with telnet permissions (C0134) [164](#)
User 6 with FTP permissions (C0138) [164](#)
User 6 with telnet permissions (C0141) [165](#)
User 7 with FTP permissions (C0145) [166](#)
User 7 with telnet permissions (C0148) [166](#)
User 8 with FTP permissions (C0152) [167](#)
User 8 with telnet permissions (C0155) [167](#)
User 9 with FTP permissions (C0159) [168](#)
User 9 with telnet permissions (C0162) [169](#)
User name 1 (C0101) [158](#)
User name 10 (C0164) [169](#)
User name 2 (C0108) [159](#)
User name 3 (C115) [160](#)
User name 4 (C0122) [162](#)
User name 5 (C0129) [163](#)
User name 6 (C0136) [164](#)
User name 7 (C0143) [165](#)
User name 8 (C0150) [166](#)
User name 9 (C0157) [168](#)

FEEDBACK



Your opinion is important to us

These instructions were created to the best of our knowledge and belief to give you the best possible support for handling our product.

Perhaps we have not succeeded in achieving this objective in every respect. If you have suggestions for improvement, please e-mail us to:

feedback-docu@lenze.com

Thank you very much for your support.

Your Lenze documentation team

Lenze SE

Postfach 10 13 52, D-31763 Hameln
Hans-Lenze-Straße 1, D-31855 Aerzen
GERMANY

HR Hannover B 204803

☎ +49 5154 82-0

📠 +49 5154 82-2800

@ sales.de@lenze.com

🌐 www.lenze.com

Service

Lenze Service GmbH
Breslauer Straße 3, 32699 Extertal
GERMANY

☎ 008000 24 46877 (24 h helpline)

📠 +49 5154 82-1112

@ service.de@lenze.com