

EDB82MV752
13206840

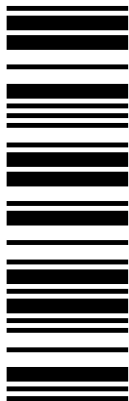

Lenze

Operating Instructions

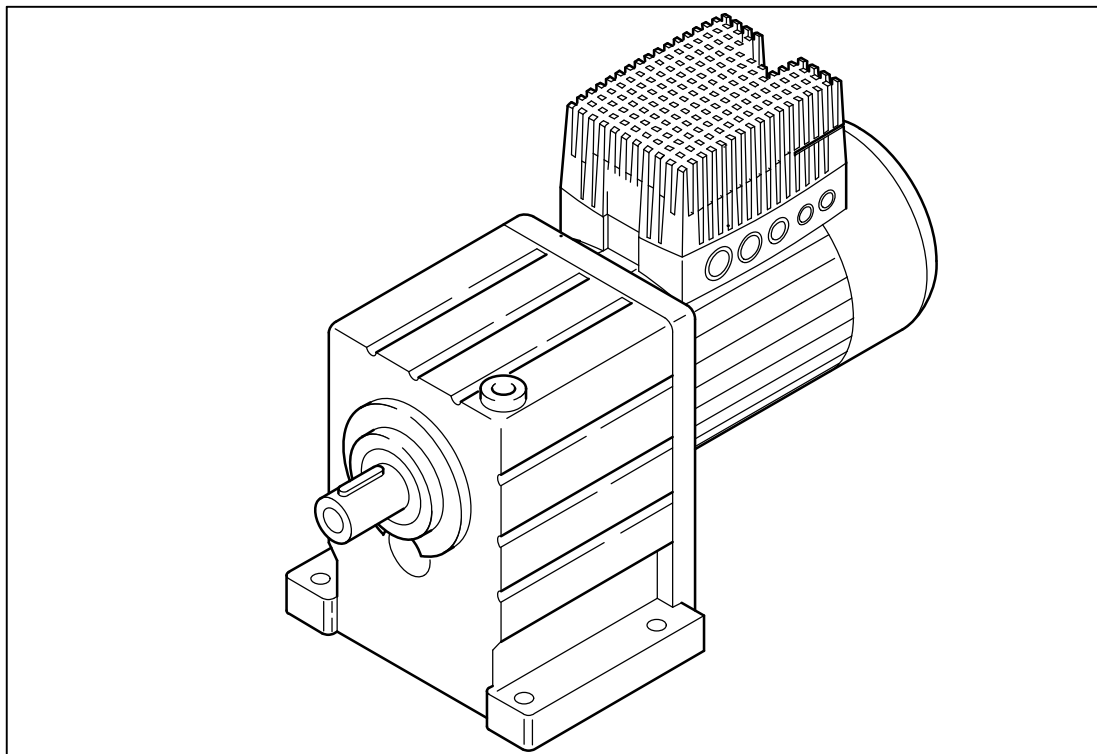

Global Drive

8200 motec frequency inverter

0.25 kW ... 7.5 kW



This documentation is valid for 8200 motec controllers as of version

	E82MV	xxx	_	x	B	xxx	XX	XX	3x
Type									
Power (e.g. 152 = $15 \times 10^2 \text{ W} = 1.5 \text{ kW}$) (e.g. 113 = $11 \times 10^3 \text{ W} = 11 \text{ kW}$)									
Voltage class 2 = 240 V 4 = 400 V/500 V									
Device version									
Hardware version									
Software version									

When 8200 motec controllers are operated together with Lenze motors or Lenze geared motors, these instructions are only valid together with the operating instructions for the motors and geared motors.

In the event of service, please state the exact type designation. The function module used can either be identified through the keypad, the PC, or by means of the nameplate stuck on the carrier housing. Moreover, each function module is clearly designated (e.g. "STANDARD" for standard I/O).

What is new / what has changed in the Operating Instructions?

Material number	Edition	Important	Contents
00402783	1.0 07/98 TD00	1. edition	First edition for pilot series
00404604	2.0 11/98 TD00	2. edition Replaces 402783	Complete revision for series All chapters: error correction and complete editorial revision
00422543	3.0 09/01 TD02	3. edition Replaces 404604	Extended by frequency inverter 0.25 kW/0.37 kW and 3 kW ... 7.5 kW, Chapter 3 "Technical data": extended by powers 0.25/0.37 kW u. 3..7.5 kW Chapter. 5 "Commissioning": extended by step for step commissioning Chapter 12 "Accessories": extended and updated All chapters: update, error correction and complete editorial revision
00459196	4.0 11/02 TD01	4. edition Replaces 422543	Change of company name
	4.1 02/03 TD15	Replaces 459196	Chapter 11 "Braking operation": update
13206840	5.1 07/07 TD14	5. edition	Extended by device version with electronic switching output K1 Chapter 4.2.1.5, 8, 11.2: update Chapter 4.2.2.5: removed; chapter 4.2.4.4: reference to Communication Manual Chapter 5.4 - 5.5: internal reorganisation Chapter 11.3.2 u 11.3.3: update of brake resistor data Chapter 14: signal flow diagrams (without AIF) updated/newly arranged and code table updated according to SW 3.7 Layout corrections: Chapter 13.1: Table of the application-specific configuration: - Correction of mixed up example values in code 412/1 and 412/5 - Supplement of code 0415

© 2006 Lenze Drive Systems GmbH

No part of this documentation may be copied or made available without the explicit written approval of Lenze Drive Systems GmbH.

We have compiled all information in this documentation with great care and have checked them with regard to compliance with the hardware and software described. Nevertheless, we cannot entirely exclude deviations. We do not accept legal responsibility or liability for damage possibly resulting therefrom. We will include necessary amendments in the subsequent editions.

Version 5.2 08/2007

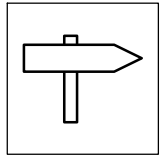

1 Preface and general information	1-1
1.1 The 8200 motec frequency inverter	1-1
1.2 About these Operating Instructions ...	1-1
1.3 Terminology used	1-1
1.4 Legal regulations	1-2
2 Safety information	2-1
2.1 General safety and application instructions for Lenze controllers	2-1
2.2 General safety and application instructions for Lenze motors	2-3
2.3 Residual hazards	2-5
2.4 Layout of the safety information	2-5
3 Technical data	3-1
3.1 General data/operating conditions	3-1
3.2 Rated data at a mains voltage of 230 V	3-5
3.2.1 Operation with rated power (normal operation)	3-5
3.2.2 Operation with increased rated power	3-6
3.3 Rated data at a mains voltage of 400/500 V	3-7
3.3.1 Operation with rated power (normal operation)	3-7
3.3.2 Operation with increased rated power	3-9
4 Installation	4-1
4.1 Mechanical installation	4-1
4.1.1 Important notes	4-1
4.1.2 Mechanical design	4-1
4.1.3 Dimensions	4-2
4.2 Electrical installation	4-3
4.2.1 Important notes	4-3
4.2.1.1 Protection of persons	4-3
4.2.1.2 Motor protection	4-3
4.2.1.3 Mains types/mains conditions	4-4
4.2.1.4 Operation on public supply systems (compliance with EN 61000-3-2)	4-4
4.2.1.5 Operation with earth-leakage circuit breaker	4-5
4.2.1.6 Interaction with compensation equipment	4-5
4.2.1.7 Specification of the cables used	4-6
4.2.2 Installation according to EMC	4-7
4.2.2.1 Assembly	4-7
4.2.2.2 Filters	4-7
4.2.2.3 Shielding	4-7
4.2.2.4 Earthing	4-7
4.2.3 Power connections	4-8
4.2.4 Control connections	4-8
4.2.4.1 Mounting/dismounting the I/O function module	4-8
4.2.4.2 Terminal assignment - standard I/O E82ZAFSC001	4-9
4.2.4.3 Terminal assignment - application I/O E82ZAFAC001	4-12
4.2.4.4 Wiring of bus function modules	4-16

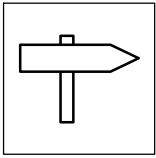

Contents

5	Commissioning	5-1
5.1	Before you start	5-1
5.2	Before switching on	5-1
5.2.1	Menu structure	5-2
5.2.2	Changing and saving parameters	5-3
5.3	Selection of the correct control mode	5-4
5.4	Commissioning - V/f characteristic control	5-6
5.4.1	Commissioning without function module	5-6
5.4.2	Commissioning with standard I/O function module	5-8
5.5	Commissioning - vector control	5-10
5.5.1	Commissioning without function module	5-10
5.5.2	Commissioning with standard I/O function module	5-12
5.5.3	Vector control optimisation	5-14
6	Parameter setting	6-1
6.1	General information	6-1
6.2	Parameter setting via keypad	6-2
6.2.1	Installation/commissioning	6-2
6.2.2	Displays and functions	6-2
6.2.3	Menu structure	6-4
6.2.4	Changing and saving parameters using the keypad	6-5
6.2.5	Change parameter set	6-5
6.2.6	Remote parameterisation of system bus nodes	6-6
6.2.7	Change entries in the user menu	6-6
6.2.8	Activation of password protection	6-7
6.3	Parameter setting using the LECOM-A (RS232) communication module	6-9
6.3.1	Technical data	6-9
6.3.1.1	General data/operating conditions	6-9
6.3.1.2	Communication times	6-10
6.3.2	Wiring to a host (PC or PLC)	6-11
6.3.2.1	Notes on self-made PC system cables	6-11
6.3.3	Parameter setting using LECOM-A (RS232)	6-12
6.3.4	Additional codes for LECOM-A (RS232)	6-12
6.3.5	Troubleshooting and fault elimination LECOM-A (RS232)	6-16
7	Function library	7-1
7.1	Operating mode	7-2
7.1.1	V/f characteristic control	7-4
7.1.2	Vector control	7-8
7.1.3	Sensorless torque control with speed limitation	7-10
7.2	Optimising the operating behaviour	7-13
7.2.1	Slip compensation	7-13
7.2.2	Inverter switching frequency	7-14
7.2.3	Oscillation damping	7-16
7.2.4	Skip frequencies	7-17
7.3	Behaviour in the event of mains switching, mains failure or controller inhibit	7-18

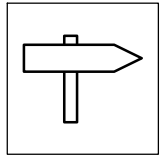

7.3.1	Start conditions/flying-restart circuit	7-18
7.3.2	Controlled deceleration after mains failure/mains disconnection	7-19
7.3.3	Controller inhibit	7-20
7.4	Limit value setting	7-21
7.4.1	Speed range	7-21
7.4.2	Current limits	7-23
7.5	Acceleration, deceleration, braking, stopping	7-24
7.5.1	Setting of acceleration times, deceleration times and S-shaped ramps	7-24
7.5.2	Quick stop	7-27
7.5.3	Change of direction of rotation	7-28
7.5.4	DC braking (DCB)	7-30
7.5.5	AC motor braking	7-31
7.6	Configuration of analog and digital setpoints and actual values	7-32
7.6.1	Setpoint source selection	7-32
7.6.2	Analog setpoints via terminal	7-34
7.6.3	Digital setpoints via frequency input	7-39
7.6.4	Setpoints via function "motor potentiometer"	7-41
7.6.5	Setpoints via fixed setpoints (JOG)	7-43
7.6.6	Setpoints via keypad	7-45
7.6.7	Setpoints via a bus system	7-46
7.6.8	Setpoint changeover (hand/remote changeover)	7-47
7.7	Automatic detection of motor data	7-48
7.8	Process controller	7-50
7.8.1	Setting of control characteristics	7-50
7.8.2	Setpoint selection for the process controller	7-53
7.8.3	Actual value selection for the process controller	7-54
7.8.4	Switching off process controller functions	7-55
7.9	Current-limit controller	7-56
7.10	Free interconnection of analog signals	7-57
7.10.1	Free configuration of analog input signals	7-57
7.10.2	Free configuration of analog outputs	7-59
7.10.3	Free configuration of analog process data output words	7-64
7.11	Free interconnection of digital signals	7-68
7.11.1	Free configuration of digital input signals	7-68
7.11.2	Free configuration of digital outputs	7-73
7.11.3	Free configuration of digital process data output words	7-79
7.12	Thermal motor monitoring	7-82
7.12.1	I ² t monitoring	7-82
7.12.2	Temperature monitoring of the motor with PTC and earth-fault detection	7-84
7.13	External fault evaluation	7-85
7.13.1	External fault detection	7-85
7.13.2	Reset of external faults	7-85
7.14	Display of operating data, diagnostics	7-86
7.14.1	Display of operating data	7-86
7.14.2	Diagnostics	7-89

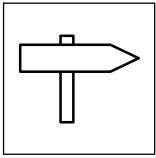

Contents

7.15	Parameter set management	7-91
7.15.1	Saving and copying parameter sets	7-91
7.15.2	Parameter set changeover	7-94
7.16	Individual summary of drive parameters in the user menu	7-95
8	Troubleshooting and fault elimination	8-1
8.1	Troubleshooting	8-1
8.1.1	Status display (LEDs on the controller)	8-1
8.2	LEDs on the drive controller (status display)	8-1
8.2.1	Error analysis with the history buffer	8-1
8.3	Drive performance in case of errors	8-2
8.4	Error elimination	8-3
8.4.1	Maloperation of the drive	8-3
8.4.2	Fault messages on the keypad or in the parameter setting program Global Drive Control	8-4
8.5	Resetting error messages	8-7
9	Automation	9-1
9.1	System bus function module (CAN) E82ZAF C	9-1
10	DC-bus connection	10-1
11	Braking operation	11-1
11.1	Braking operation without additional measures	11-1
11.2	Braking operation with external brake resistor	11-1
11.2.1	Selection of brake resistors	11-1
11.2.2	Rated data of the integrated brake transistor	11-2
11.2.3	Rated data of Lenze brake resistors	11-3
12	Accessories	12-1
13	Application examples	13-1
13.1	Pressure control	13-1
13.1.1	Example 1: Simple pressure control with fixed setpoint selection	13-5
13.1.2	Example 2: Simple pressure control with changeable setpoint selection	13-7
13.2	Operation with mid-frequency motors	13-9
13.3	Speed control	13-10
13.4	Group drive (operation with several motors)	13-13
13.5	Setpoint summation (base and additional load operation)	13-14
13.6	Power control (torque limitation)	13-15
14	Appendix	14-1
14.1	Signal flow diagrams	14-1
14.2	Overview of signal processing of standard I/O	14-2
14.2.1	Controller with standard I/O	14-2

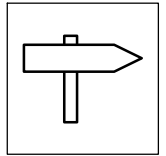

14.3	Signal processing in the standard I/O function blocks	14-3
14.3.1	Speed setpoint conditioning (NSET1)	14-3
14.3.2	Process controller and setpoint processing (PCTRL1)	14-4
14.3.3	Motor control (MCTRL1)	14-5
14.4	Overview of signal processing of the application I/O	14-6
14.4.1	Controller with application I/O	14-6
14.5	Signal processing in the application I/O function blocks	14-7
14.5.1	Speed setpoint conditioning (NSET1)	14-7
14.5.2	Process controller and setpoint processing (PCTRL1) with Application I/O	14-8
14.5.3	Motor control (MCTRL1) with Application I/O	14-9
14.6	Code table	14-10
14.7	Table of attributes	14-51
14.7.1	Standard devices in the power range 0.25 ... 7.5 kW with standard I/O	14-52
14.7.2	Standard devices in the power range 0.25 ... 7.5 kW with application I/O	14-56
15	Table of keywords	15-1



1 Preface and general information

1.1 The 8200 motec frequency inverter

Decentralised drive solutions require a flexible combination of motor/geared motor and frequency inverter.

The concept of the 8200 motec frequency inverter is therefore based on a modular system of matching components. Together with a Lenze geared motor or a Lenze three-phase AC motor the 8200 motec is a highly functional electronic variable speed drive.

As compact drives they can be used for adjusting speeds in different application, such as material handling, HVAC technology, automation, etc. A free combination of input and output signals and parallel operation of two interfaces ensure an individual solution for your drive task.

The 8200 motec frequency inverter is directly mounted onto the motor. Wall mounting of the 8200 motec is also possible.

1.2 About these Operating Instructions ...

- These Operating Instructions are intended for all persons who install, set-up and adjust the 8200 motec frequency inverter.
- A chapter informs entirely about a subject:
 - You therefore only have to read the chapters you are interested in at the moment.
 - The Index helps you to find all information about a certain topic.
- These Instructions are meant as addition to the Mounting Instructions which are part of the delivery package:
 - The features and functions are described in detail.
 - Examples describe how to set the parameters for typical applications.
 - In case of doubt, the Mounting Instructions delivered together with the 8200 motec frequency inverter apply.
- The Mounting Instructions do not inform about the use together with Lenze geared motors and Lenze motors. The most important data are listed on the nameplates. If necessary, Operating Instructions can always be ordered from Lenze.

1.3 Terminology used

Term	In the following text used for
Controller	Any frequency inverter, servo inverter or DC controller
motec	Frequency inverter 8200 motec
Drive	8200 motec in combination with a geared motor, a three-phase AC motor and other Lenze drive components
AIF	AutomationInterF ace: Interface for a communication module. Accessible from the outside at the heatsink of the motec.
FIF	F unction InterF ace: Interface for a function module. Is inside the motec.
Cxxx/y	Subcode y of code Cxxx (e.g. C0517/3 = subcode 3 of code C0517)
Xk/y	Terminal y on terminal strip Xk (e. g. X3/28 = terminal 28 on terminal strip X3)

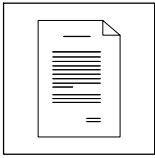

Preface and general information

1.4 Legal regulations

Labelling	Nameplate	CE-identification	Manufacturer
	Lenze controllers are unambiguously designated by the contents of the nameplate.	Conforms to the EC Low Voltage Directive	Lenze Drive Systems GmbH Postfach 10 13 52 D-31763 Hameln
Application as directed	<p>8200 motec frequency inverter and accessories</p> <ul style="list-style-type: none"> • must only be operated under the conditions prescribed in these Operating Instructions. • are components <ul style="list-style-type: none"> – for open and closed loop control of variable speed drives with asynchronous standard motors, reluctance motors, PM synchronous motors with asynchronous damping cage. – for installation into a machine – used for assembly together with other components to form a machine. • comply with the requirements of the EC Low-Voltage Directive. • are not machines for the purpose of the EC Machinery Directive. • are not to be used as domestic appliances, but only for industrial purposes. <p>Drives with 8200 motec frequency inverters</p> <ul style="list-style-type: none"> • meet the EC Electromagnetic Compatibility Directive if they are installed according to the guidelines of CE-typical drive systems. • can be used <ul style="list-style-type: none"> – for operation on public and non-public mains – for operation in industrial premises and residential areas. • The user is responsible for the compliance of his application with the EC directives. <p>Any other use shall be deemed inappropriate!</p>		
Liability	<ul style="list-style-type: none"> • The information, data, and notes in these instructions met the state of the art at the time of printing. Claims referring to drive systems which have already been supplied cannot be derived from the information, illustrations, and descriptions given in these Operating Instructions. • The specifications, processes, and circuitry described in these instructions are for guidance only and must be adapted to your own specific application. Lenze does not take responsibility for the suitability of the process and circuit proposals. • The specifications in these Instructions describe the product features without guaranteeing them. • Lenze does not accept any liability for damage and operating interference caused by: <ul style="list-style-type: none"> – disregarding the operating instructions – unauthorized modifications to the controller – operating errors – improper working on and with the controller 		
Warranty	<ul style="list-style-type: none"> • Warranty conditions: see Sales and Delivery Conditions of Lenze Drive Systems GmbH. • Warranty claims must be made to Lenze immediately after detecting the deficiency or fault. • The warranty is void in all cases where liability claims cannot be made. 		
Disposal	Material	recycle	dispose
	Metal	•	-
	Plastic	•	-
	Assembled PCBs	-	•



2 Safety information

2.1 General safety and application instructions for Lenze controllers

(According to: Low-Voltage Directive 73/23/EEC)

General

Depending on their degree of protection, some parts of Lenze controllers (frequency inverters, servo inverters, DC controllers) and their accessory components can be live, moving and rotating during operation. Surfaces can be hot.

Non-authorized removal of the required cover, inappropriate use, incorrect installation or operation, creates the risk of severe injury to persons or damage to material assets.

For more information please see the documentation.

All operations concerning transport, installation, and commissioning as well as maintenance must be carried out by qualified, skilled personnel (IEC 364 and CENELEC HD 384 or DIN VDE 0100 and IEC report 664 or DIN VDE 0110 and national regulations for the prevention of accidents must be observed).

According to this basic safety information, qualified, skilled personnel are persons who are familiar with the assembly, installation, commissioning, and operation of the product and who have the qualifications necessary for their occupation.

Application as directed

Drive controllers are components which are designed for installation in electrical systems or machinery. They are not to be used as domestic appliances, but only for industrial purposes according to EN 61000-3-2.

When installing drive controllers into machines, commissioning of these controllers (i.e. the starting of operation as directed) is prohibited until it is proven that the machine corresponds to the regulations of the EC Directive 98/37/EC (Machinery Directive); EN 60204 must be observed.

Commissioning (i.e. starting of operation as directed) is only allowed when there is compliance with the EMC Directive (89/336/EEC).

The controllers meet the requirements of the Low-Voltage Directive 73/23/EEC. The harmonised standard EN 61800-5-1 applies to the controllers.

The technical data as well as the connection conditions can be obtained from the nameplate and the documentation. They must be strictly observed.

Warning: The controllers are products which can be installed in drive systems of category C2 according to EN 61800-3. These products can cause radio interference in residential areas. In this case, special measures can be necessary.

Transport, storage

Please observe the notes on transport, storage and appropriate handling.

Observe the climatic conditions according to the technical data.

Installation

The controllers must be installed and cooled according to the instructions given in the corresponding documentation.

Ensure proper handling and avoid mechanical stress. Do not bend any components and do not change any insulation distances during transport or handling. Do not touch any electronic components and contacts.

Controllers contain electrostatically sensitive components, which can easily be damaged by inappropriate handling. Do not damage or destroy any electrical components since this might endanger your health!



Safety instructions

Lenze controllers

Electrical connection

When working on live controllers, the valid national regulations for the prevention of accidents (e.g. VBG 4) must be observed.

Carry out the electrical installation in compliance with the corresponding regulations (e.g. cable cross-sections, fuses, PE connection). More detailed information is given in the corresponding documentation.

Notes about installation according to EMC regulations (shielding, earthing, filters and cable routing) are included in the documentation. These notes also apply to CE-marked controllers. The compliance with limit values required by the EMC legislation is the responsibility of the manufacturer of the machine or system. The controllers must be installed in housings (e.g. control cabinets) to meet the limit values for radio interferences valid at the site of installation. The housings must enable an EMC-compliant installation. Observe in particular that e.g. the control cabinet doors should have a circumferential metal connection to the housing. Reduce housing openings and cutouts to a minimum.

Lenze controllers can cause a DC current in the protective conductor. If a residual current device (RCD) is used as a protective means in the case of direct or indirect contact, only a residual current device (RCD) of type B may be used on the current supply side of the controller. Otherwise, another protective measure, such as separation from the environment through double or reinforced insulation or disconnection from the mains by means of a transformer must be used.

Operation

If necessary, systems including controllers must be equipped with additional monitoring and protection devices according to the valid safety regulations (e.g. law on technical equipment, regulations for the prevention of accidents). The controller can be adapted to your application. Please observe the corresponding information given in the documentation.

After a controller has been disconnected from the voltage supply, all live components and power connections must not be touched immediately because capacitors can still be charged. Please observe the corresponding stickers on the controller.

All protection covers and doors must be shut during operation.

Note for UL approved systems with integrated controllers: UL warnings are notes that only apply to UL systems. The documentation contains special UL notes.

Safety functions

Special controller variants support safety functions (e.g. "safe torque off", formerly "safe standstill") according to the requirements of Annex I No. 1.2.7 of the EC Directive "Machinery" 98/37/EC, EN 954-1 Category 3 and EN 1037. Strictly observe the notes on the safety functions given in the documentation on the respective variants.

Maintenance and servicing

The controllers do not require any maintenance, if the prescribed conditions of operation are observed.

If the ambient air is polluted, the cooling surfaces of the controller may become dirty or the air vents of the controller may be obstructed. Therefore, clean the cooling surfaces and air vents periodically under these operating conditions. Do not use sharp or pointed tools for this purpose!

Waste disposal

Recycle metal and plastic materials. Ensure professional disposal of assembled PCBs.

The product-specific safety and application notes given in these instructions must be observed!



2.2 General safety and application instructions for Lenze motors

(According to: Low-Voltage Directive 73/23/EEC)

General

Low-voltage machines have hazardous live and rotating parts and possibly also hot surfaces.

Synchronous machines induce voltages at open terminals during operation.

All operations concerning transport, connections, commissioning and maintenance must be carried out by qualified, skilled personnel (EN 50110-1 (VDE 0105-100) and IEC 60364 must be observed). Inappropriate use creates the risk of severe injury to persons and damage to material assets.

Low-voltage machines may only be operated under the conditions that are indicated in the section "Application as directed".

The conditions at the place of installation must comply with the data given on the nameplate and in the documentation.

Application as directed

Low-voltage machines are intended for commercial installations. They comply with the harmonised standards of the series EN 60034 (VDE 0530). Their use in potentially explosive atmospheres is prohibited unless they are expressly intended for such use (follow additional instructions).

Low-voltage machines are components for installation into machines as defined in the Machinery Directive 98/37/EC. Commissioning is prohibited until the conformity of the end product with this directive has been established (follow i. a. EN 60204-1).

Low-voltage machines with IP23 protection or less are only intended for outdoor use when applying special protective features.

The integrated brakes must not be used as safety brakes. It cannot be ruled out that factors which cannot be influenced, such as oil ingress due to a defective A-side shaft seal, cause a brake torque reduction.

Transport, storage

Damages must be reported immediately upon receipt to the forwarder; if required, commissioning must be excluded. Tighten screwed-in ring bolts before transport. They are designed for the weight of the low-voltage machines, do not apply extra loads. If necessary, use suitable and adequately dimensioned means of transport (e. g. rope guides).

Remove transport locking devices before commissioning. Reuse them for further transport. When storing low-voltage machines, ensure a dry, dust-free and low-vibration ($v_{\text{eff}} \leq 0.2 \text{ mm/s}$) environment (bearing damage while being stored).

Installation

Ensure an even surface, solid foot/flange mounting and exact alignment if a direct clutch is connected. Avoid resonances with the rotational frequency and double mains frequency which may be caused by the assembly. Turn rotor by hand, listen for unusual slipping noises. Check the direction of rotation when the clutch is not active (observe section "Electrical connection").

Use appropriate means to mount or remove belt pulleys and clutches (heating) and cover them with a touch guard. Avoid impermissible belt tensions.

The machines are half-key balanced. The clutch must be half-key balanced, too. The visible jutting out part of the key must be removed.

If required, provide pipe connections. Designs with shaft end at bottom must be protected with a cover which prevents the ingress of foreign particles into the fan. Free circulation of the cooling air must be ensured. The exhaust air - also the exhaust air of other machines next to the drive system - must not be taken in immediately.



Safety instructions

Lenze low-voltage machinery

Electrical connection

All operations must only be carried out by qualified and skilled personnel on the low-voltage machine at standstill and deenergised and provided with a safe guard to prevent an unintentional restart. This also applies to auxiliary circuits (e. g. brake, encoder, blower).

Check safe isolation from supply!

If the tolerances specified in EN 60034-1; IEC 34 (VDE 0530-1) - voltage $\pm 5\%$, frequency $\pm 2\%$, waveform, symmetry - are exceeded, more heat will be generated and the electromagnetic compatibility will be affected.

Observe the data on the nameplate, operating notes, and the connection diagram in the terminal box.

The connection must ensure a continuous and safe electrical supply (no loose wire ends); use appropriate cable terminals. The connection to the PE conductor must be safe. The plug-in connectors must be bolted tightly (to stop).

The clearances between blank, live parts and to earth must not fall below 8 mm at $U_r \leq 550$ V, 10 mm at $U_r \leq 725$ V, 14 mm at $U_r \leq 1000$ V.

The terminal box must be free of foreign particles, dirt and moisture. All unused cable entries and the box itself must be sealed against dust and water.

Commissioning and operation

Before commissioning after longer storage periods, measure insulation resistance. In case of values ≤ 1 k Ω per volt of rated voltage, dry winding.

For trial run without output elements, lock the featherkey. Do not deactivate the protective devices, not even in a trial run.

Check the correct operation of the brake before commissioning low-voltage machines with brakes.

Integrated thermal detectors do not provide full protection for the machine. If necessary, limit the maximum current. Parameterise the controller so that the motor will be switched off with $I > I_r$ after a few seconds of operation, especially at the risk of blocking.

Vibrational severities $v_{\text{eff}} \leq 3.5$ mm/s ($P_r \leq 15$ kW) or 4.5 mm/s ($P_r > 15$ kW) are acceptable if the clutch is activated.

If deviations from normal operation occur, e.g. increased temperatures, noises, vibrations, find the cause and, if required, contact the manufacturer. In case of doubt, switch off the low-voltage machine.

If the machine is exposed to dirt, clean the air paths regularly.

Shaft sealing rings and roller bearings have a limited service life.

Regrease bearings with relubricating devices while the low-voltage machine is running. Only use the grease recommended by the manufacturer. If the grease drain holes are sealed with a plug, (IP54 drive end; IP23 drive and non-drive end), remove plug before commissioning. Seal bore holes with grease. Replace prelubricated bearings (2Z bearing) after approx. 10,000 h - 20,000 h, at the latest however after 3 - 4 years.

The product-specific safety and application notes given in these instructions must be observed!



2.3 Residual hazards

Protection of persons	<ul style="list-style-type: none"> Deenergise the motec before you start working on it or open the housing. Wait for at least one minute since the power terminals U, V, W; BR0, BR1, BR2 and the pins of the FIF interface remain live after switching off the mains. <ul style="list-style-type: none"> After opening the motec, check if the power terminals L1, L2, L3; U, V, W; BR0, BR1, BR2, the relay outputs K11, K12, K14, and the pins of the FIF interface are dead. Even if the motec is disconnected from the mains, the relay outputs K11, K12, K14 can be live! If you do not use the fail-safe function "selection of direction of rotation" via the digital signal DCTRL1-CW/CCW (C0007 = -0- ... -13-, C0410/3 ≠ 255): <ul style="list-style-type: none"> In case of open circuit or failure of the control voltage, the drive may change the direction of rotation. If you use the "flying restart circuit" function (C0142 = -2-, -3-) for machines with a low moment of inertia and low friction: <ul style="list-style-type: none"> After controller enable has been effected in the standstill status, the motor may temporarily start up, or change direction of rotation. The motec heatsink has an operating temperature > 60 °C: <ul style="list-style-type: none"> Skin contact with the heatsink causes burns.
Device protection	<ul style="list-style-type: none"> 8200 motec 3 ... 7.5 kW (E82MV302_4B, E82MV402_4B, E82MV552_4B, E82MV752_4B): Frequent mains switching (e.g. inching mode via mains contactor) may overload and destroy the input current limitation of the controller: <ul style="list-style-type: none"> Thus, at least three minutes have to pass between two switch-on processes. Depending on the controller settings, the connected motor can be overheated: <ul style="list-style-type: none"> e. g. long-time operation of the DC injection brake. long-time operation of self-ventilated motors at low speeds.
Overspeed	<ul style="list-style-type: none"> Drives can attain dangerous overspeeds (e. g. setting of high output frequencies with regard to motors and machines not qualified for this purpose): <ul style="list-style-type: none"> The drive controllers do not provide protection against such operating conditions. For this purpose, apply additional components.

2.4 Layout of the safety information

All safety information given in these Operating Instructions has the same layout:



Signal word (characterises the severity of danger)

Note (describes the danger and gives information how to avoid it)

	Icons used		Signal words	
Warning of danger to persons		Warning of hazardous electrical voltage	Danger!	Warns of impending danger . Consequences if disregarded: Death or most severe injuries
		Warning of a general danger	Warning!	Warns of potential, very hazardous situations . Possible consequences if disregarded: Death or most severe injuries
Warning of damage to material			Caution!	Warns of potential, hazardous situations . Possible consequences if disregarded: Light or minor injuries
			Stop!	Warns of potential damage to material . Possible consequences if disregarded: Damage of the controller/drive system or its environment
More information			Tip!	Designates a general, useful note. If you observe it, handling of the controller/drive system is made easier.



Safety instructions

Residual hazards, Layout of the safety instructions

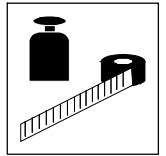

3 Technical data

3.1 General data/operating conditions

Standards and operating conditions			
Conformity	CE	Low-Voltage Directive (73/23/EEC) EMC Directive (93/68/EEC)	
Approvals	UL 508C	Underwriter Laboratories (File-No. E132659) Power Conversion Equipment	
Vibration resistance	Acceleration resistant up to 2g (Germanischer Lloyd, general conditions)		
Climatic conditions			
Storage	IEC/EN 60721-3-1	1K3 (-25 °C...+60 °C)	< 6 months
		1K3 (-25 °C...+40 °C)	> 6 months > 2 years: form the DC bus capacitors
Transport	IEC/EN 60721-3-2	2K3 (-25 °C...+70 °C)	
Operation	IEC/EN 60721-3-3	3K3 (-20 °C...+60 °C) At temperatures above +40 °C, the rated output current should be derated by 2.5 %/ °C	
Permissible installation height	0 ... 4000 m amsl The rated output current should be derated by 5 %/1000 m above 1000 m amsl		
Degree of pollution	VDE 0110 part 2 degree of pollution 2		
Mounting positions	All mounting positions and mounting alignments are permitted		
Free space	above	100 mm	
	to the sides	100 mm	
DC-bus operation	not possible		

Mechanical design		
Housing	Carrier housing: glass-fiber reinforced plastic, heatsink: die-cast aluminium	
Screwed connections	E82MV251K2B, E82MV371K2B	4 x M20/ 2 x M16 (thread length 10 mm, without counternut)
	E82MV551K4B, E82MV751K4B	2 x M25/ 4 x M16 (thread length 10 mm, without counternut) 1 x M20 for motor cable in case of wall mounting (EMC cable gland, thread length 10 mm, with counternut)
	E82MV152K4B, E82MV222K4B	2 x M25/1 x M20/4 x M16 (thread length 10 mm, without counternut) 1 x M20 for motor cable in case of wall mounting (EMC cable gland, thread length 10 mm, with counternut)
	E82MV302K4B, E82MV402K4B, E82MV552K4B, E82MV752K4B	3 x M25/4 x M16 (thread length 10 mm, without counternut)

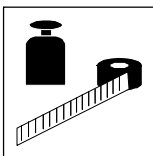

Technical data

General data/operating conditions

General electrical data			
EMC	Complies with requirements according to EN 61800-3/A11		
Noise emission	Motor mounting Complies with the limit classes A and B (for B: at a max. switching frequency of 8 kHz) acc. to EN 61800-3		
	Wall mounting Complies with the limit class A acc. to EN 61800-3 (up to 10 m shielded motor cable) Complies with the limit class B acc. to EN 61800-3 (up to 1 m shielded motor cable; at a max. switching frequency of 8 kHz)		
Noise immunity	Requirements	Standard	Severities
	ESD	EN 61000-4-2	3, i. e. 8 kV with air discharge, 6 kV with contact discharge
	Cable-guided high frequency	EN 61000-4-6	150 kHz ... 80 MHz, 10 V/m 80 % AM (1kHz)
	RF interference (housing)	EN 61000-4-3	80 MHz ... 1000 MHz, 10 V/m 80 % AM (1kHz)
	Burst	EN 61000-4-4	3/4, i. e. 2 kV/5 kHz
Insulation resistance	Surge (Surge voltage on mains cable)	EN 61000-4-5	3, i. e. 1.2/50 µs, 1 kV phase-phase, 2 kV phase-PE
	Overvoltage category III acc. to EN 61800-5-1		
Discharge current to PE (to EN 61800-5-1)	> 3.5 mA	Observe regulations and safety instructions!	
Enclosure	IP54 (NEMA 250 type 12)	when using the fan module	
	IP55 (NEMA 250 type 12)	without fan module and without protective cap on the AIF interface	
	IP65 (NEMA 250 type 4)	without fan module and with protective cap on the AIF interface	
Protective measures against	Short circuit, earth fault, overvoltage, motor stalling, motor overtemperature (input for PTC or thermal contact, I ² t monitoring)		
Protective insulation of control circuits	Safe mains isolation: Double/reinforced insulation to EN 61800-5-1		

Technical data

General data/operating conditions

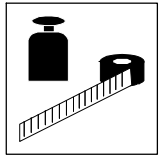

Open and closed loop control		
Open and closed-loop control methods	V/f characteristic control (linear, quadratic), vector control, torque selection	
Switching frequency	optionally 2 kHz, 4 kHz, 8 kHz, 16 kHz	
Torque behaviour	Maximum torque	1.8 x M _N for 60 s if rated motor power = rated controller power
	Setting range	1 : 10 in speed setting range 3 ... 50 Hz, accuracy < 8 %
Torque/speed characteristic	<p>The graph shows the torque/speed characteristic. The vertical axis is labeled M/M_N and has tick marks at 1.0, 1.8, and 2.0. The horizontal axis is labeled n [min⁻¹] and has tick marks at 500, 1000, and 1500. A solid line represents the overall characteristic, which is constant at 1.8 until approximately 1400 min⁻¹, then drops to 1.0 at 1500 min⁻¹. Several dashed lines represent constant torque regions for different speed settings, each starting at 1.8 and ending at a lower speed than the previous one.</p>	
Sensorless speed control	Minimum output frequency	1.0 Hz (0 ... M _N)
	Setting range	1 : 50 related to 50 Hz and M _N
	Accuracy	± 0.5 % in speed setting range 3 ... 50 Hz
	Smooth running	± 0.1 Hz
Output frequency	Range	- 650 Hz ... + 650 Hz
	Absolute resolution	0.02 Hz
	Standardised resolution	Parameter data: 0.01 %, process data: 0.006 % (= 2 ¹⁴)
Digital setpoint selection	Accuracy	± 0.005 Hz (= ±100 ppm)
Analog setpoint selection	Linearity	± 0.5 % Signal level: 5 V or 10 V
	Temperature sensitivity	+ 0.3 % 0 ... 60 °C
	Offset	± 0 %

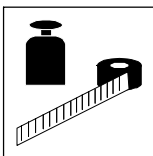

Technical data

General data/operating conditions

Inputs and outputs		
Analog inputs/outputs	with standard I/O	1 input, optionally bipolar 1 output
	with application I/O	2 inputs, optionally bipolar 2 outputs
Digital inputs/outputs	with standard I/O	4 inputs, optionally 1 frequency input, single-track 0 ... 10 kHz / two-track 0...1 kHz; 1 input for controller inhibit 1 output
	with application I/O	6 inputs, optionally 1 frequency input, single-track / two-track 0 ... 102.4 kHz; 1 input for controller inhibit 2 outputs, 1 frequency output 50 Hz ... 10 kHz
Cycle times	digital inputs	1 ms
	digital outputs	4 ms
	analog inputs	2 ms
	analog outputs	4 ms (smoothing time: $\tau = 10$ ms)
Relay output (device version 151)		Changeover contact, AC 250 V/3 A, DC 24 V/2 A ... 240 V/0.22 A
digital switching output (device versions 152 and 153)		DC 24 V ext./50 mA or DC 20 V int./10 mA
Operation in generator mode (monitored internally)		Integrated brake transistor external brake resistors: (📄 11-1)

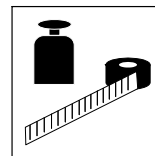

3.2 Rated data at a mains voltage of 230 V

3.2.1 Operation with rated power (normal operation)

Typical motor power		P_N [kW]	0.25	0.37
Three-phase asynchronous motor (4-pole)		P_N [hp]	0.34	0.5
8200 motec		Type	E82MV251_2B	E82MV371_2B
Mains voltage		U_{mains} [V]	1/N/PE AC 180 V - 0 % ... 264 V + 0 % ; 45 Hz - 0 % ... 65 Hz + 0 %	
Data for operation at 1/N/PE AC 230 V				
Rated mains current		I_{mains} [A]	3.4	5.0
Rated output current at switching frequency	2 kHz	I_{N24} [A] ²⁾	2.0	2.9
	4 kHz			
	8 kHz	I_{N8} [A]	1.7	2.4
	16 kHz	I_{N16} [A]	1.1	1.6
Max. permissible output current for 60 s at switching frequency ¹⁾	2 kHz	I_{max24} [A]	2.5	3.6
	4 kHz			
	8 kHz	I_{max8} [A]	2.5	3.6
	16 kHz	I_{max16} [A]	1.6	1.4
Output voltage		U_M [V]	3~ 0 ... U_{mains} / 0 ... 650 Hz	
Power loss (operation with I_{N8})		P_V [W]	30	40
Dimensions		L x W x H [mm]	190 x 138 x 100	
Weight		m [kg]	1.8	1.8

Bold print = data for operation at a switching frequency of 8 kHz (Lenze setting)

- 1) Currents for periodic load change: 1 min overcurrent time with I_{max} and 2 min base load time with 75 % I_{Nx}
- 2) Under different operating conditions possible for some types: Operation with increased rated output current with the same load change cycle (□ 3-6)

Fuses and cable cross-sections

8200 motec			Normal operation					FI
			Installation acc. to EN 60204-1			Installation acc. to UL ¹⁾		
Type	[kW]	System	Fuse	Circuit breaker	L1, L2, L3, PE [mm ²]	Fuse	L1, L2, L3, PE [AWG]	≥ 30 mA ²⁾
E82MV251_2B	0.25	1/N/PE AC 180 ... 264 V; 45 ... 65 Hz	M10 A	C10 A	1.5	10 A	16	
E82MV371_2B	0.37		M10 A	C10 A	1.5	10 A	16	

- 1) Only use UL-approved cables, fuses, and fuse holders.
UL fuse: voltage 240 V, tripping characteristic "H", "K5" or "CC"
- 2) Pulse current sensitive or universal-current sensitive earth-leakage circuit breaker
Observe national and regional regulations

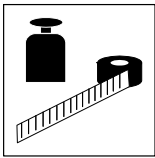

Technical data

Rated data at 230 V mains voltage

3.2.2 Operation with increased rated power

Under the application conditions described here the controller can be operated in continuous operation with a motor of higher performance. The overload capacity is reduced to 120 %.

- Typical applications:
 - Pumps with quadratic load characteristic
 - Fan
- Operation is only permissible
 - in the mains voltage ranges mentioned
 - at a switching frequency of 2 or 4 kHz
 - with the prescribed fuses and cable cross-sections

Typical motor power	P_N [kW]	0.37	0.55
Three-phase asynchronous motor (4-pole)	P_N [hp]	0.5	0.75
8200 motec	Type	E82MV251_2B	E82MV371_2B
Mains voltage	U_{mains} [V]	1/N/PE AC 180 V - 0 % ... 264 V + 0 % ; 45 Hz - 0 % ... 65 Hz + 0 %	
Data for operation on 1/N/PE AC 230 V			
Rated mains current	I_{mains} [A]	4.1	6.0
Rated output current at switching frequency	2 kHz	2.0	2.9
	4 kHz		
Max. permissible output current for 60 s at switching frequency ¹⁾	2 kHz	2.5	3.6
	4 kHz		
Output voltage	U_M [V]	3~ 0 ... U_{mains} / 0 ... 650 Hz	
Power loss (operation with I_{N24})	P_V [W]	30	40
Dimensions	L x W x H [mm]	190 x 138 x 100	
Weight	m [kg]	1.8	1.8

¹⁾ Currents for periodic load change with 1 min overcurrent time with I_{max} and 2 min base load time with 75 % I_{Nx}

Fuses and cable cross-sections

8200 motec			Operation with increased rated power					FI
			Installation acc. to EN 60204-1			Installation acc. to UL ¹⁾		
Type	[kW]	System	Fuse	Circuit breaker	L1, L2, L3, PE [mm ²]	Fuse	L1, L2, L3, PE [AWG]	
E82MV251_2B	0.37	1/N/PE AC 180 ... 264 V; 45 ... 65 Hz	M10 A	C10 A	1.5	10 A	16	≥ 30 mA ²⁾
E82MV371_2B	0.55		M10 A	C10 A	1.5	10 A	16	

¹⁾ Only use UL-approved cables, fuses, and fuse holders.

UL fuse: voltage 240 V, tripping characteristic "H", "K5" or "CC"

²⁾ Pulse current sensitive or universal-current sensitive earth-leakage circuit breaker

Observe national and regional regulations

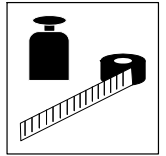

3.3 Rated data at a mains voltage of 400/500 V

3.3.1 Operation with rated power (normal operation)

Typical motor power		P_N [kW]	0.55		0.75		1.5		2.2	
Three-phase asynchronous motor (4-pole)		P_N [hp]	0.75		1.0		2.0		3.0	
8200 motec		Type	E82MV551_4B		E82MV751_4B		E82MV152_4B		E82MV222_4B	
Mains voltage		U_{mains} [V]	3/PE AC 320 V - 0 % ... 550 V + 0 % ; 45 Hz - 0 % ... 65Hz + 0 %							
Data for operation on 3/PE AC			400 V	500 V	400 V	500 V	400 V	500 V	400 V	500 V
Rated mains current		I_{mains} [A]	1.8	1.4	2.4	1.9	3.8	3.0	5.5	4.5
Rated output current at switching frequency	2 kHz	I_{N24} [A] ²⁾	2.1	1.8	2.9	2.4	4.6	3.9	6.7	5.6
	4 kHz									
	8 kHz	I_{N8} [A]	1.8	1.6	2.4	2.1	3.9	3.5	5.6	5.0
	16 kHz	I_{N16} [A]	1.2	1.1	1.6	1.4	2.5	2.3	3.6	3.2
Max. permissible output current for 60 s at switching frequency ¹⁾	2 kHz	I_{max24} [A]	2.7	2.4	3.6	3.2	5.8	5.2	8.4	7.6
	4 kHz									
	8 kHz	I_{max8} [A]	2.7	2.4	3.6	3.2	5.8	5.2	8.4	7.6
	16 kHz	I_{max16} [A]	1.8	1.6	2.4	2.1	3.9	3.5	5.3	4.8
Output voltage		U_M [V]	3~ 0 ... U_{mains} / 0 ... 650 Hz							
Power loss (operation with I_{N8})		P_V [W]	35		45		70		95	
Dimensions		L x W x H [mm]	202 x 156 x 151				230 x 176 x 167			
Weight		m [kg]	2.8		2.8		4.1		4.1	

Typical motor power		P_N [kW]	3.0		4.0		5.5		7.5	
Three-phase asynchronous motor (4-pole)		P_N [hp]	4.1		5.4		7.5		10.2	
8200 motec		Type	E82MV302_4B		E82MV402_4B		E82MV552_4B		E82MV752_4B	
Mains voltage		U_{mains} [V]	3/PE AC 320 V - 0 % ... 550 V + 0 % ; 45 Hz - 0 % ... 65Hz + 0 %							
Data for operation on 3/PE AC			400 V	500 V	400 V	500 V	400 V	500 V	400 V	500 V
Rated mains current		I_{mains} [A]	9.5	7.6	12.3	9.8	16.8	13.4	21.5	17.2
Rated output current at switching frequency	2 kHz	I_{N24} [A] ²⁾	8.8	7.0	11.4	9.2	15.6	12.5	16.5	13.2
	4 kHz									
	8 kHz	I_{N8} [A]	7.3	5.8	9.5	7.6	13.0	10.4	16.5	13.2
	16 kHz	I_{N16} [A]	4.7	4.2	6.1	5.5	8.4	7.6	10.7	9.6
Max. permissible output current for 60 s at switching frequency ¹⁾	2 kHz	I_{max24} [A]	11.0	8.7	14.2	11.4	19.5	15.6	24.8	19.8
	4 kHz									
	8 kHz	I_{max8} [A]	11.0	8.7	14.2	11.4	19.5	15.6	24.8	19.8
	16 kHz	I_{max16} [A]	7.1	6.4	9.1	8.2	12.7	11.4	16.1	14.5
Output voltage		U_M [V]	3~ 0 ... U_{mains} / 0 ... 650 Hz							
Power loss (operation with I_{N8})		P_V [W]	140		180		230		290	
Dimensions		L x W x H [mm]	325 x 211 x 163 (223**)							
Weight		m [kg]	9.7		9.7		9.7		9.7	

Bold print = data for operation at a switching frequency of 8 kHz (Lenze setting)

¹⁾ Currents for periodic load change: 1 min overcurrent time with I_{max} and 2 min base load time with 75 % I_{Nx}

²⁾ Under different operating conditions possible for some types: Operation with increases rated output current with the same load change cycle (□ 3-9)

** for wall mounting or with a supplementary module (E82ZMV)

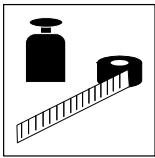

Technical data

Rated data at 400/500 V mains voltage

Fuses and cable cross-sections

8200 motec			Normal operation					FI
Type	[kW]	System	Installation acc. to EN 60204-1			Installation acc. to UL 1)		
			Fuse	Circuit breaker	L1, L2, L3, PE [mm ²]	Fuse	L1, L2, L3, PE [AWG]	
E82MV551_4B	0.55	3/PE AC 320 ... 550 V; 45 ... 65 Hz	M6 A	B6 A	1	5 A	18	≥ 30 mA ²⁾
E82MV751_4B	0.75		M6 A	B6 A	1	5 A	18	
E82MV152_4B	1.5		M6 A	B6 A	1	5 A	18	
E82MV222_4B	2.2		M10 A	B10 A	1.5	10 A	16	≥ 300 mA ²⁾
E82MV302_4B	3.0		M16 A	B16 A	2.5	15 A	14	
E82MV402_4B	4.0		M20 A	B20 A	4.0	20 A	12	
E82MV552_4B	5.5		M25 A	B25 A	4.0	25 A	10	
E82MV752_4B	7.5		M32 A	B32 A	6.0	35 A	8	

- 1) Only use UL-approved cables, fuses, and fuse holders.
UL fuse: voltage 500 ... 600 V, tripping characteristic "H", "K5" or "CC"
- 2) Universal-current sensitive earth-leakage circuit breaker
Observe national and regional regulations

Current derating

Depending on the operating conditions and the use of the 8200 motec, the types E82MV302_4B to EMV752_4B may require a reduction of the rated output current in continuous operation:

8200 motec mounted on...	Current derating
...Lenze motor/forced ventilated geared motor	not required
...Lenze motor/self-ventilated geared motor	see illustration below
...Lenze motor/self-ventilated geared motor with E82ZMV supplementary module	not required
...no Lenze motor/geared motor ⇒ E82ZMV supplementary module is always required	not required
...the wall (wall mounting) ⇒ E82ZMV supplementary module is always required	not required

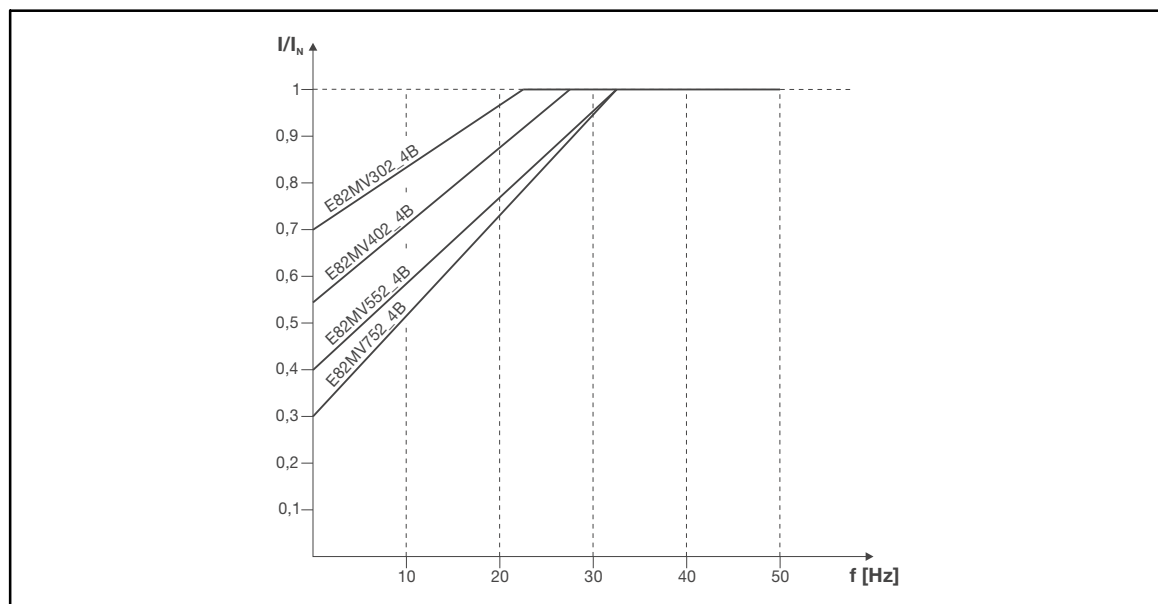
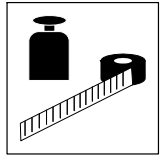

Fig. 3-1

Reduction of the rated output current in continuous operation at 40°C ambient temperature and a switching frequency of 4 kHz or 35°C and 8 kHz

- I** Reduced output current 8200 motec
I_N Rated output current 8200 motec at a switching frequency of 4 kHz or 8 kHz
f Output frequency 8200 motec [Hz]



3.3.2 Operation with increased rated power

Under the application conditions described here the controller can be operated in continuous operation with a motor of higher performance. The overload capacity is reduced to 120 %.

- Typical applications:
 - Pumps with quadratic load characteristic
 - Fan
- Operation is only permissible
 - in the mains voltage ranges mentioned
 - at a switching frequency of 2 or 4 kHz
 - with the prescribed fuses and cable cross-sections

Typical motor power	P_N [kW]	0.75	1.1	2.2	3.0
Three-phase asynchronous motor (4-pole)	P_N [hp]	1.0	1.5	3.0	4.0
8200 motec	Type	E82MV551_4B	E82MV751_4B	E82MV152_4B	E82MV222_4B
Mains voltage	U_{mains} [V]	3/PE AC 320 V - 0 % ... 440 V + 0 % ; 45 Hz - 0 % ... 65Hz + 0 %			
Data for operation on 3/PE AC		400 V	400 V	400 V	400 V
Rated mains current	I_{mains} [A]	2.2	2.8	4.6	6.6
Rated output current at switching frequency	2 kHz	2.1	2.9	4.6	6.7
	4 kHz				
Max. permissible output current for 60 s at switching frequency 1)	2 kHz	2.7	3.6	5.8	8.4
	4 kHz				
Output voltage	U_M [V]	3~ 0 ... U_{mains} / 0 ... 650 Hz			
Power loss (operation with I_{N8})	P_V [W]	35	45	70	95
Dimensions	L x W x H [mm]	202 x 156 x 151		230 x 176 x 167	
Weight	m [kg]	2.8	2.8	4.1	4.1

Typical motor power	P_N [kW]	4	5.5	7.5
Three-phase asynchronous motor (4-pole)	P_N [hp]	5.4	7.5	10.2
8200 motec	Type	E82MV302_4B	E82MV402_4B	E82MV552_4B
Mains voltage	U_{mains} [V]	3/PE AC 320 V - 0 % ... 440 V + 0 % ; 45 Hz - 0 % ... 65Hz + 0 %		
Data for operation on 3/PE AC		400 V	400 V	400 V
Rated mains current	I_{mains} [A]	11.4	14.8	20.2
Rated output current at switching frequency	2 kHz	8.8	11.4	15.6
	4 kHz			
Max. permissible output current for 60 s at switching frequency 1)	2 kHz	11.0	14.2	19.5
	4 kHz			
Output voltage	U_M [V]	3~ 0 ... U_{mains} / 0 ... 650 Hz		
Power loss (operation with I_{N8})	P_V [W]	140	180	230
Dimensions	L x W x H [mm]	325 x 211 x 163 (223**)		
Weight	m [kg]	9.7	9.7	9.7

Bold print = data for operation at a switching frequency of 8 kHz (Lenze setting)

1) Currents for periodic load change with 1 min overcurrent time with I_{max} and 2 min base load time with 75 % I_{Nx}

** for wall mounting or with a supplementary module (E82ZMV)

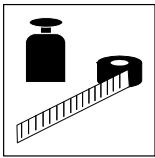

Technical data

Rated data at 400/500 V mains voltage

Fuses and cable cross-sections

8200 motec			Operation with increased rated power					FI
			Installation acc. to EN 60204-1			Installation acc. to UL ¹⁾		
Type	[kW]	System	Fuse	Circuit breaker	L1, L2, L3, PE [mm ²]	Fuse	L1, L2, L3, PE [AWG]	
E82MV551_4B	0.75	3/PE AC 320 ... 440 V; 45 ... 65 Hz	M6 A	B6 A	1	5 A	18	≥ 30 mA ²⁾
E82MV751_4B	1.1		M6 A	B6 A	1	5 A	18	
E82MV152_4B	2.2		M10 A	B10 A	1.5	10 A	16	
E82MV222_4B	3.0		M10 A	B10 A	1.5	10 A	16	
E82MV302_4B	4.0		M16 A	B16 A	2.5	15 A	14	
E82MV402_4B	5.5		M20 A	B20 A	4.0	20 A	12	≥ 300 mA ²⁾
E82MV552_4B	7.5		M32 A	B32 A	6.0	25 A	10	

- 1) Only use UL-approved cables, fuses, and fuse holders.
UL fuse: voltage 500 ... 600 V, tripping characteristic "H", "K5" or "CC"
- 2) Universal-current sensitive earth-leakage circuit breaker
Observe national and regional regulations

Current derating

Depending on the operating conditions and the use of the 8200 motec, the types E82MV302_4B to EMV552_4B may require a reduction of the rated output current in continuous operation:

8200 motec mounted on...	Current derating
...Lenze motor/forced ventilated geared motor	not required
...Lenze motor/self-ventilated geared motor	see illustration below
...Lenze motor/self-ventilated geared motor with E82ZMV supplementary module	not required
...no Lenze motor/geared motor ⇒ E82ZMV supplementary module is always required	not required
...the wall (wall mounting) ⇒ E82ZMV supplementary module is always required	not required

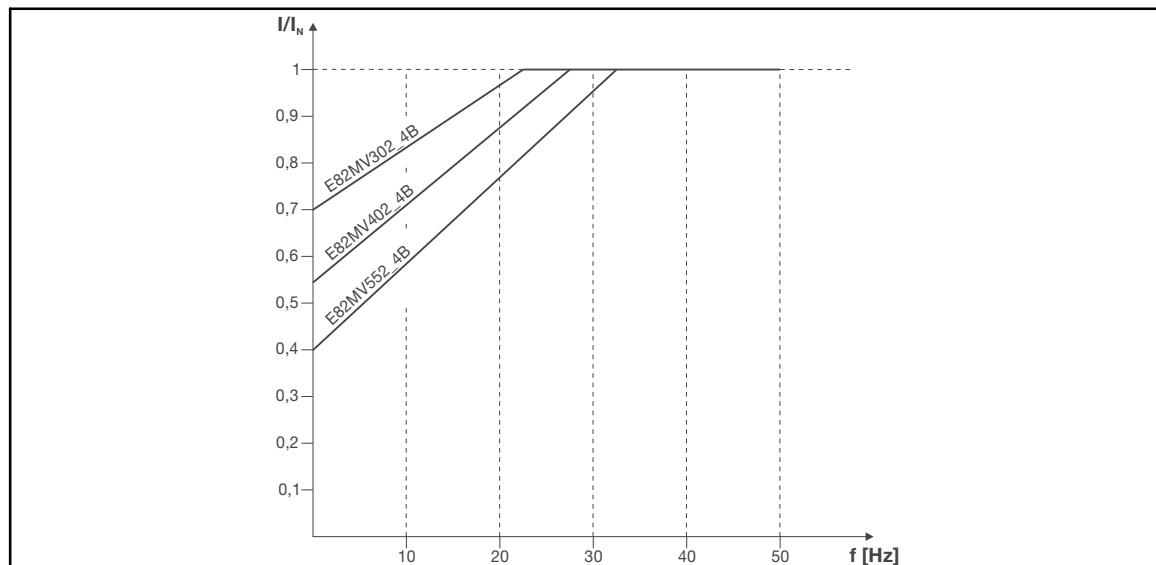
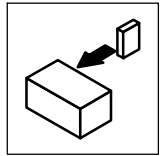

Fig. 3-2

Reduction of the rated output current in continuous operation at 40°C ambient temperature and a switching frequency of 4 kHz

- I** Reduced output current 8200 motec
I_N Rated output current 8200 motec at a switching frequency of 4 kHz
f Output frequency 8200 motec [Hz]



4 Installation

4.1 Mechanical installation

4.1.1 Important notes

- The 8200 motec frequency inverter can be used in all operating positions.
- Free space:
 - Allow a free space of 100 mm above and below the inverter.
 - Ensure unimpeded ventilation of cooling air and outlet of exhaust air.



Tip!

The installation of compact drives, mechanical motor mounting or wall mounting is described in the corresponding Mounting Instructions.

4.1.2 Mechanical design

Type	Cable connections	Weight
E82MV251_2B E82MV371_2B	4 M20 (thread length 10 mm, without counter nut) 2 M16	1.8 kg
E82MV551_4B E82MV751_4B	2 M25 (thread length 10 mm, without counter nut) 4 M16 1 M20 for motor cable used for wall mounting (EMC cable connection) (thread length 10 mm, with counter nut)	2.8 kg
E82MV152_4B E82MV222_4B	1 M20 2 M25 (thread length 10 mm, without counter nut) 4 M16 1 M20 for motor cable used for wall mounting (EMC cable connection) (thread length 10 mm, with counter nut)	4.1 kg
E82MV302_4B E82MV402_4B E82MV552_4B E82MV752_4B	3 M25 4 M16 (thread length 10 mm, without counter nut)	9.7 kg

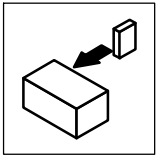

Installation

Mechanical installation - Dimensions

4.1.3 Dimensions

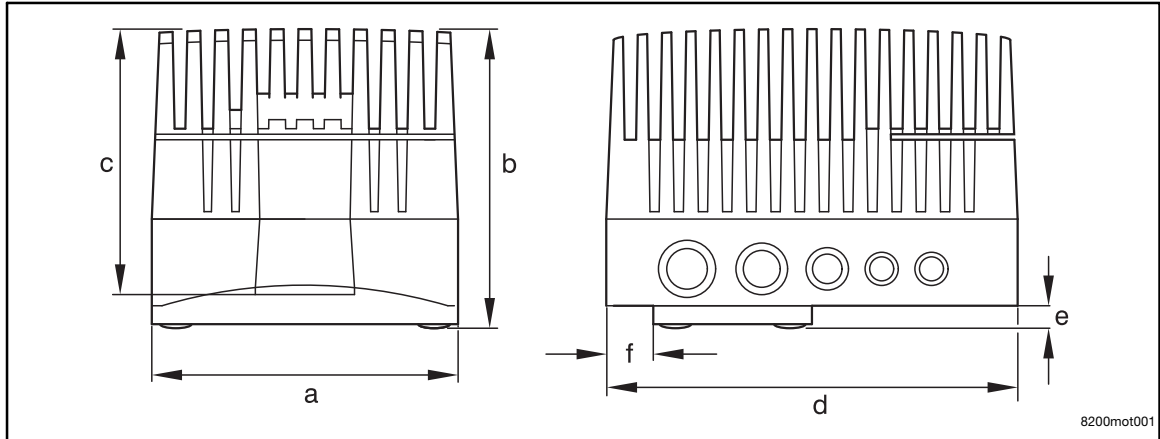

Fig. 4-1 Dimensions 0.25 ... 2.2 kW

	a [mm]	b [mm]	c [mm]	d [mm]	[mm]	f [mm]
E82MV251_2B E82MV371_2B	138	100	90	190	7	12
E82EV551_4B E82EV751_4B	156	151	135	202	15	26
E82EV152_4B E82EV222_4B	176	167	151	230	15	26

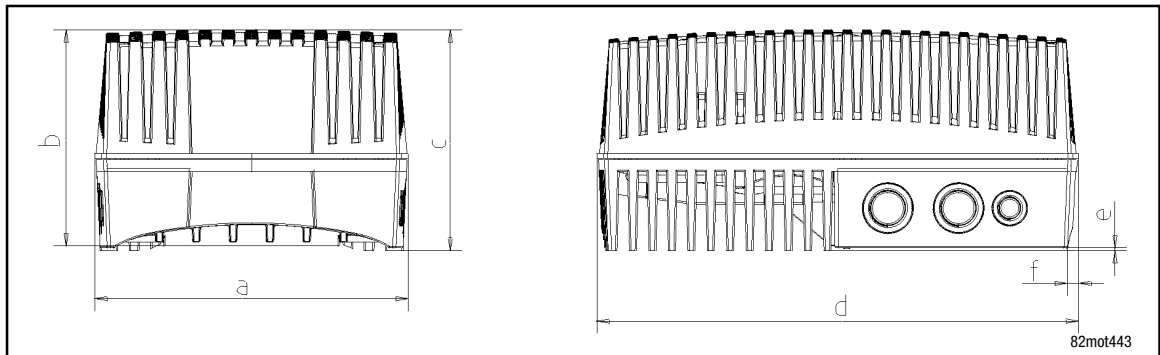
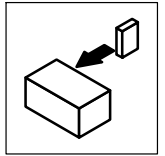

Fig. 4-2 Dimensions 3 ... 7.5 kW

Type	a [mm]	b [mm]	c [mm]	d [mm]	[mm]
E82MV302_4B E82MV402_4B E82MV552_4B E82MV752_4B	211	163 (223 ^{**})	148	325	15

** for wall mounting or with fan module (type E82ZMV, dimensions L x W x H [mm]: 325 x 211 x 60), see also Instructions enclosed in the fan module.



4.2 Electrical installation

4.2.1 Important notes



Stop !

The controller contains electrostatic sensitive devices!

Before working in the connection area, the personnel must be free of electrostatic charges.

4.2.1.1 Protection of persons



Danger!

Before working on the controller, check whether all power terminals (device version 001 or 151) and the pins of the FIF interface are dead, because

- the power terminals U, V, W, BR0, BR1, BR2 and the pins of the FIF interface remain live for at least 1 minute after power-off.
- the power terminals L1, L2, L3; U, V, W, BR0, BR1, BR2 and the pins of the FIF interface remain live when the motor is stopped.
- the relay outputs K11, K12, K14 (device version 001 or 151) can be live if the controller is disconnected from the mains.

Use of earth-leakage circuit breakers (☞ 4-5)

Pluggable terminal strips

Plug in or pull off all pluggable terminals in deenergised state only!

Replacing defective fuses

Replace defective fuses with the prescribed type only when no voltage is applied.

Disconnecting the controller from the mains

The controller can be safely disconnected from the mains only via a contactor on the input side.

4.2.1.2 Motor protection

- Extensive protection against overload:
 - By overcurrent relay or temperature monitoring.
 - We recommend to use PTC thermistors or thermal contacts for motor temperature monitoring. (Lenze three-phase AC motors are equipped with thermal contacts (NC contacts) as standard)
 - PTC thermistors or thermal contacts can be connected to the controller.
- Only use motors the insulation of which is suitable for inverter operation:
 - Insulation resistance: min. $\hat{u} = 1.5 \text{ kV}$, min. $du/dt = 5 \text{ kV}/\mu\text{s}$
 - Lenze three-phase AC motors are designed for inverter operation.
 - When using motors with an unknown insulation resistance, please contact your motor supplier.

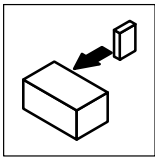

Installation

Electrical installation - Important notes

4.2.1.3 Mains types/mains conditions

Please observe the restrictions of each mains type!

System	Controller operation	Notes
with earthed neutral (TT/TN systems)	No restrictions	Comply with the rated data of the controllers.
with isolated neutral (IT systems)	possible if the controller is protected in the event of an earth fault in the mains supply <ul style="list-style-type: none"> • by suitable equipment which detect the earth fault and • the controller is directly disconnected from the mains 	In the event of an earth fault at the inverter output, a safe operation cannot be ensured.

4.2.1.4 Operation on public supply systems (compliance with EN 61000-3-2)

The European standard EN 61000-3-2 stipulates limit values for harmonic currents in the supply system. Non-linear consumers (e.g. frequency inverters) cause harmonic currents which "interfere" the supplying mains and may disturb other consumers. This standard helps to ensure the high quality of public mains systems and reduce the mains load.



Tip!

The standard only applies to public mains systems. Mains systems with an own transformer station as common in industry are not public. Thus, the standard does not apply to them.

If a device or machine consists of several components, the limit values defined in the standard apply to the entire unit.

If you observe all measures given, the controllers comply with the limit values according to EN 61000-3-2. The machine/system manufacturer is responsible for the compliance with the requirements for the machine/system:

	Supply voltage	Power	Measure
8200 motec	[V]	[kW]	
E82MV251_2B	1/N/PE AC 230 V	0.25	Use ELN1-0900H005 mains choke
E82MV371_2B		0.37	
E82MV551_4B	3/PE AC 400 V	0.55	Use EZN3A1500H003 mains choke
E82MV751_4B		0.75	

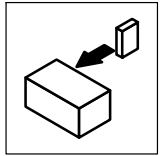

4.2.1.5 Operation with earth-leakage circuit breaker



Danger!

The controllers have an internal mains rectifier. In the event of a short circuit to frame, a DC residual current can prevent the activation of the AC-sensitive or pulse-current sensitive earth-leakage circuit breakers and thus block the protective function for all electrical equipment operated on this earth-leakage circuit breaker.

- We recommend the following to protect persons and animals (DIN VDE 0100):
 - Pulse current sensitive earth-leakage circuit breakers in systems where controllers are connected to a single-phase mains (L1/N).
 - Universal-current sensitive earth-leakage circuit breakers in systems where controllers are connected to a three-phase mains (L1/L2/L3).
- Earth-leakage circuit breakers must only be installed between mains supply and controller.
- Earth-leakage circuit breakers can be misactivated by
 - capacitive compensation currents of the cable shields during operation (especially with long, shielded motor cables),
 - simultaneous connection of several controllers to the mains,
 - use of additional interference filters.

4.2.1.6 Interaction with compensation equipment

- Controllers only consume very little reactive power of the fundamental wave from the AC mains. Therefore, a compensation is not necessary.
- If you operate the controllers on a mains with compensation equipment, the compensation equipment must be provided with chokes.
 - For this purpose please contact the supplier of the compensation equipment.

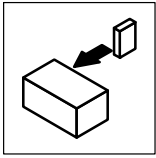

Installation

Electrical installation - Important notes

4.2.1.7 Specification of the cables used

Power terminals

- The cables used must comply with the approvals required for the application (e.g. UL).
- Use low-capacitance motor cables. Capacitance per unit length:
 - Core/core ≤ 75 pF/m
 - Core/shield ≤ 150 pF/m
- Max. permissible motor cable length without external measures:
 - unshielded: 10 m
 - shielded: 10 m

Control connections

- Control cables must always be shielded to prevent interference injections.

Shielded cables

The efficiency of shielded cables is determined by

- a good shield connection
 - a contact surface as large as possible.
- a low shield resistance:
 - only use shields with tin or nickel-plated copper braid!
 - shields made of steel braid are not suitable.
- the overlap rate of the braid:
 - at least 70 to 80 % with an overlap angle of 90°.

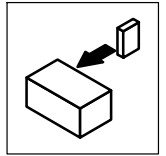

4.2.2 Installation according to EMC

The electromagnetic compatibility (EMC) of a machine depends on the type of installation and the care taken.

If you observe the following measures, you can assume that the machine will operate without any EMC problems caused by the drive system.

4.2.2.1 Assembly

- Ensure the separation of motor cable and signal or mains cables.
- Do not use the same terminal strip for mains input and motor output.
- Rout cables as close as possible to the reference potential. Freely suspended cables have the same effect as aerials.

4.2.2.2 Filters

- Only use RFI filters and mains chokes which are assigned to the controllers:
 - RFI filters reduce impermissible high-frequency interferences to a permissible value.
 - Mains chokes reduce the effective current consumption of the frequency inverter on the mains.

4.2.2.3 Shielding

- Use shielded, low-capacitance motor cable. Capacitance per unit length:
 - Core/core ≤ 75 pF/m
 - Core/shield ≤ 150 pF/m
- Connect the shield to the shield sheets in the motor with a large surface
- Connect the shield with PE in the terminal box of the motor:
 - Metal cable glands at the motor terminal box ensure a large surface connection of the shield to the motor housing.
- If you use a brake resistor:
 - Connect the shield of the brake resistor cable directly at the frequency inverter and the brake resistor to the mounting plate with a large surface.
- Shield control cables:
 - Connect control cable shields at both ends.

4.2.2.4 Earthing

- Earth all components (controllers, RFI filters, motor filters, mains chokes) using suitable cables connected to a central earthing point (PE rail).
- Maintain the defined minimum cross-sections:
 - For EMC, the surface of the cable with a large-surface contact is decisive, i.e. as large cross-sections as possible (large surface).

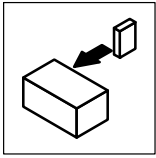

Installation

Electrical installation - Connections

4.2.3 Power connections

See corresponding Mounting Instructions

4.2.4 Control connections

The basic controller version is not provided with control terminals. Different I/O function modules are available for the FIF interface to equip the controllers with control terminals.

4.2.4.1 Mounting/dismounting the I/O function module

See corresponding Mounting Instructions

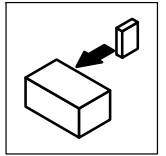





4.2.4.2 Terminal assignment - standard I/O E82ZAFSC001



Stop !

Control cables must always be shielded to prevent interference injections!

Electrical connection	Terminal strip with screw connection
Possible connections	 rigid: 1.5 mm ² (AWG 16)
	flexible:
	 without wire end ferrule 1.0 mm ² (AWG 18)
	 with wire end ferrule, without plastic sleeve 0.5 mm ² (AWG 20)
	 with wire end ferrule, with plastic sleeve 0.5 mm ² (AWG 20)
Tightening torque	0.22 ... 0.25 Nm (1.9 ... 2.2 lb-in)
Bare end	5 mm

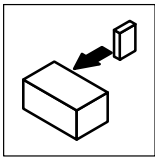

Installation

Electrical installation - Connections

Supply via the internal voltage source (X3/20):

- X3/28, controller inhibit (CINH)
- X3/E1 X3/E4, digital inputs

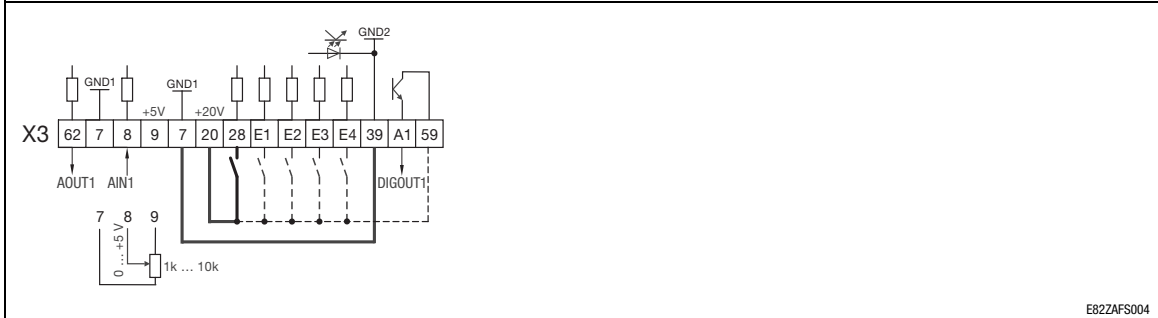

E82ZAFS004

Supply via an external voltage source:

- X3/28, controller inhibit (CINH)
- X3/E1 ... X3/E4, digital inputs

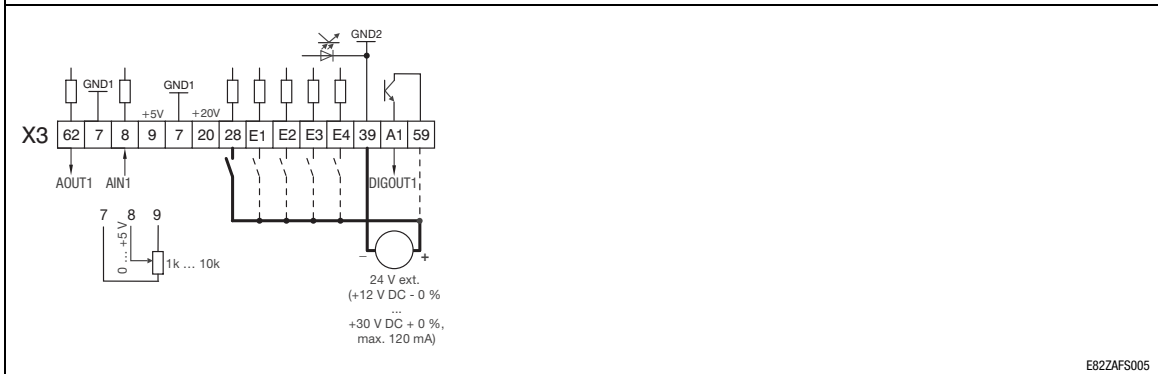

E82ZAFS005

Min. wiring required for operation

Signal type and range selection by DIP switch



Note!

DIP switch and C0034 must be set for the same value range, otherwise the analog input signal at X3/8 will be interpreted incorrectly by the basic unit.

If a setpoint potentiometer is internally supplied through X3/9, the DIP switch must be set for a voltage range of 0 ... 5 V. Otherwise it is not possible to use the whole speed range.

Signal at X3/8	Switch position					C0034
	1	2	3	4	5	
0 ... 5 V	OFF	OFF	ON	OFF	OFF	0
0 ... 10 V (Lenze setting)	OFF	OFF	ON	OFF	ON	0
0 ... 20 mA	OFF	OFF	ON	ON	OFF	0
4 ... 20 mA	OFF	OFF	ON	ON	OFF	1
4 ... 20 mA Open-circuit monitoring	OFF	OFF	ON	ON	OFF	3
-10 V ... +10 V	ON	ON	OFF	OFF	OFF	2

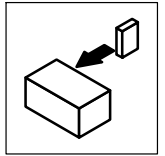

X3/	Signal type	Function	Level		
62	Analog output	Output frequency	0 ... + 6 V 0 ... + 10 V ¹⁾		
7	-	GND1, reference potential for analog signals	-		
8	Analog input	Act. or setpoint input Change range using the DIP switch and C0034			
		<ul style="list-style-type: none"> Master voltage 	0 ... +5 V 0 ... +10 V -10 V ... +10 V ²⁾		
		<ul style="list-style-type: none"> Master current 	0 ... +20 mA +4 ... +20 mA +4 ... +20 mA (open-circuit monitored)		
9	-	Internal, stabilised DC voltage supply for setpoint potentiometer	+5.2 V		
20	-	Internal DC voltage supply for control of digital inputs and outputs	+20 V ± 10 % (ref.: X3/7)		
28	-	Controller inhibit (CINH)	1 = START		
E1 ³⁾	Digital inputs	Activation of JOG frequencies JOG1 = 20 Hz JOG2 = 30 Hz JOG3 = 40 Hz		E1	E2
			JOG1	1	0
E2 ³⁾			JOG2	0	1
			JOG3	1	1
E3		DC-injection brake (DCB)	1 = DCB		
E4		Change of direction of rotation CW/CCW rotation		E4	
			CW	0	
			CCW	1	
39	-	GND2, reference potential for digital signals	-		
A1	Digital output	Ready for operation with – internal supply: – external supply:	0 ... +20 V 0 ... +24 V		
59	-	DC supply for X3/A1 – internal (bridge to X3/20): – external:	+20 V +24 V		

1) Output level 0 ... + 10 V: Adapt offset (C0109/C0422) and gain (C0108/C0420)

2) Adjust offset (C0026) and gain (C0027) separately for each function module:

After replacing the function module or the basic device

After loading the Lenze setting

3) Alternatively frequency input 0 ... 10 kHz single-tracked or 0 ... 1 kHz double-tracked, configuration via C0425

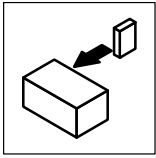

Installation





Electrical installation - Connections

4.2.4.3 Terminal assignment - application I/O E82ZAFAC001



Stop !

Control cables must always be shielded to prevent interference injections!

Electrical connection	Terminal strip with screw connection
Possible connections	 rigid: 1.5 mm ² (AWG 16)
	flexible:
	 without wire end ferrule 1.0 mm ² (AWG 18)
	 with wire end ferrule, without plastic sleeve 0.5 mm ² (AWG 20)
	 with wire end ferrule, with plastic sleeve 0.5 mm ² (AWG 20)
Tightening torque	0.22 ... 0.25 Nm (1.9 ... 2.2 lb-in)
Bare end	5 mm

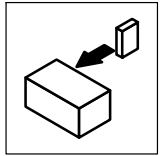

Controller inhibit (CINH) supply via internal voltage source (X3.3/20)

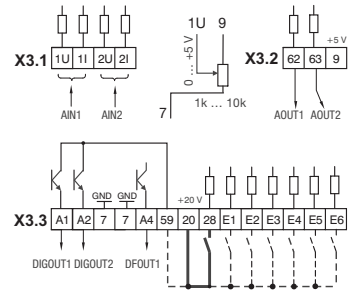

E82ZAF001

Controller inhibit (CINH) supply via external voltage source

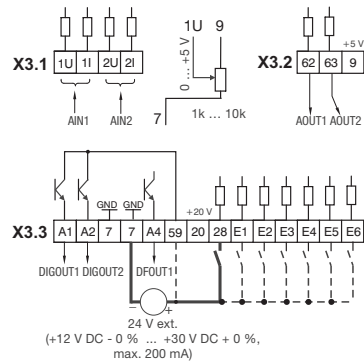

E82ZAF002

Min. wiring required for operation

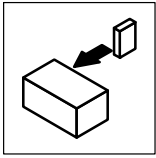

Installation

Electrical installation - Connections

Jumper setting for inputs

	Lenze setting (see bold print in tables) <ul style="list-style-type: none"> • 1 - 3 • 2 - 4 • 7 - 9 • 8 - 10
--	--



Note!

If a setpoint potentiometer is internally supplied via X3.2/9, the jumper must be set to a voltage range between 0 ... 5 V. Otherwise not the whole speed range can be covered.

X3.1/1U Analog input1, AIN1	Possible levels	0 ... 5 V	0 ... 10 V ²⁾	-10 V ... +10 V
	Jumper	7 - 9: free	7 - 9	7 - 9
	Code	C0034/1 = 0	C0034/1 = 0	C0034/1 = 1

X3.1/2U Analog input2, AIN2	Possible levels	0 ... 5 V	0 ... 10 V ²⁾	-10 V ... +10 V
	Jumper	8 - 10: free	8 - 10	8 - 10
	Code	C0034/2 = 0	C0034/2 = 0	C0034/2 = 1

X3.1/1I Analog input1, AIN1	Possible levels	0 ... 20 mA	4 ... 20 mA	4 ... 20 mA ¹⁾
	Jumper	any	any	any
	Code	C0034/1 = 2	C0034/1 = 3	C0034/1 = 4

X3.1/2I Analog input2, AIN2	Possible levels	0 ... 20 mA	4 ... 20 mA	4 ... 20 mA ¹⁾
	Jumper	any	any	any
	Code	C0034/2 = 2	C0034/2 = 3	C0034/2 = 4

¹⁾ open-circuit monitored

²⁾ Lenze setting (delivery status)

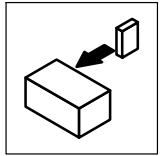

Jumper setting for outputs

	Lenze setting (see bold print in tables) <ul style="list-style-type: none"> • 1 - 3 • 2 - 4 • 7 - 9 • 8 - 10
--	--

X3.1/62 Analog output, AOUT1	Possible levels	0 ... 10 V	0 ... 20 mA	4 ... 20 mA
	Jumper	1 - 3	3 - 5	3 - 5
	Code	C0424/1 = 0	C0424/1 = 0	C0424/1 = 1

X3.1/63 Analog output, AOUT2	Possible levels	0 ... 10 V	0 ... 20 mA	4 ... 20 mA
	Jumper	2 - 4	4 - 6	4 - 6
	Code	C0424/2 = 0	C0424/2 = 0	C0424/2 = 1

X3.1/	Signal type	Function	Level (Lenze setting, in bold print)
1U/2U	Analog inputs	Actual or setpoint inputs (master voltage) Use jumper and C0034 to change range	0 ... +5 V 0 ... +10 V -10 V ... +10 V
1I/2I		Actual or setpoint inputs (master current) Use jumper and C0034 to change range	0 ... +20 mA +4 ... +20 mA +4 ... +20 mA (open-circuit monitored)

X3.2/	Signal type	Function (Lenze setting, in bold print)	Level (Lenze setting, in bold print)
62	Analog outputs	Output frequency	Voltage output: 0 ... +6 V 0 ... +10 V ¹⁾ Current output: (0 ... +12 mA) 0 ... +20 mA ¹⁾ +4 ... +20 mA ¹⁾
63		Motor current	
9	-	Internal, stabilised DC voltage supply for setpoint potentiometer	+5.2 V

¹⁾ Output level 0 ... + 10 V or 0/+4 ... +20 mA: Adapt offset (C0422) and gain (C0420)

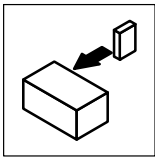

Installation

Electrical installation - Connections

X3.3/	Signal type	Function	Level (Lenze setting, in bold print)		
A1	Digital outputs	Ready for operation	0/+20 V at DC internal 0/+24 V at DC external		
A2		not prefabricated			
7	-	GND, reference potential	-		
A4	Frequency output	DC bus voltage	HIGH: +18 V...+24 V (HTL) LOW: 0 V		
59	-	DC supply for X3/A1 and X3/A2	+20 V (internal, bridge to X3/20) +24 V (external)		
20	-	Internal DC voltage supply for control of digital inputs and output	+20 V \pm 10 %		
28	Digital inputs	Controller inhibit (CINH)	1 = START		
E1 ²⁾		Activation of JOG frequencies JOG1 = 20 Hz JOG2 = 30 Hz JOG3 = 40 Hz		E1	E2
E2 ²⁾			JOG1	1	0
			JOG2	0	1
			JOG3	1	1
E3		DC-injection brake (DCB)	1 = DCB		
E4	Change of direction of rotation CW/CCW rotation		E4		
		CW	0		
		CCW	1		
E5		not prefabricated	-		
E6		not prefabricated	-		

²⁾ Optional frequency input 0 ... 102.4 kHz, single-tracked or double-tracked, configuration via C0425

4.2.4.4 Wiring of bus function modules

- System bus (CAN): see CAN Communication Manual
- For all other bus function modules (e.g. PROFIBUS-DP, INTERBUS, ...) see the accompanying Mounting Instructions or Communication Manual.

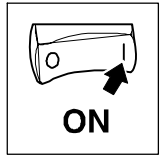

5 Commissioning

5.1 Before you start



Tip!

- The controller is factory-set to drive the following four-pole standard asynchronous motors:
 - 230/400 V, 50 Hz
 - 280/480 V, 60 Hz
 - 400 V, 50 Hz
- Maintain the switch-on sequence. (▢ 5-6)
- In the event of an error during commissioning please see the "Troubleshooting and fault elimination" chapter: (▢ 8-1)

Check ...

... before the mains voltage is connected

- the wiring for completeness, short circuit, and earth fault
- If no function module is used (delivery status):
 - Has the FIF cover been mounted?
- If the internal voltage source X3/20 of the standard I/O is used:
 - Are the terminals X3/7 and X3/39 bridged?

... the most important drive parameters settings before the controller is enabled

- Has the V/f rated frequency been adapted to the motor circuit configuration? (▢ 7-5)
- Have the configuration of the analog inputs and outputs been adapted to the wiring? (▢ 7-57)
- Have the configuration of the digital inputs and outputs been adapted to the wiring? (▢ 7-68)
- Are the drive parameters relevant for your application set correctly?

If required, use the keypad or PC to adapt them. (▢ 6-1 ff)

5.2 Before switching on



STOP!

Special commissioning procedure after long-time storage

If controllers have been stored for more than 2 years, their DC-bus capacitors may have dried out.

Possible consequences:

- The DC-bus capacitors and thus the controller will be damaged at the first switch-on.

Protective measures:

- Anodize the DC-bus capacitors before commissioning. A detailed set of instructions can be downloaded from the Internet (www.Lenze.com).

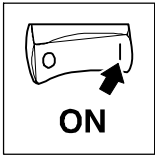

Commissioning

Parameter setting using the keypad

5.2.1 Menu structure

For easy operation the codes are divided in two groups:

- The *uSEr* menu
 - is active after every mains switching or keypad attachment during operation.
 - contains all codes for a standard application with linear V/f characteristic control (Lenze setting).
 - can be modified as required under C0517.
- The *ALL* menu
 - contains all codes.
 - shows a list of all codes in ascending order.

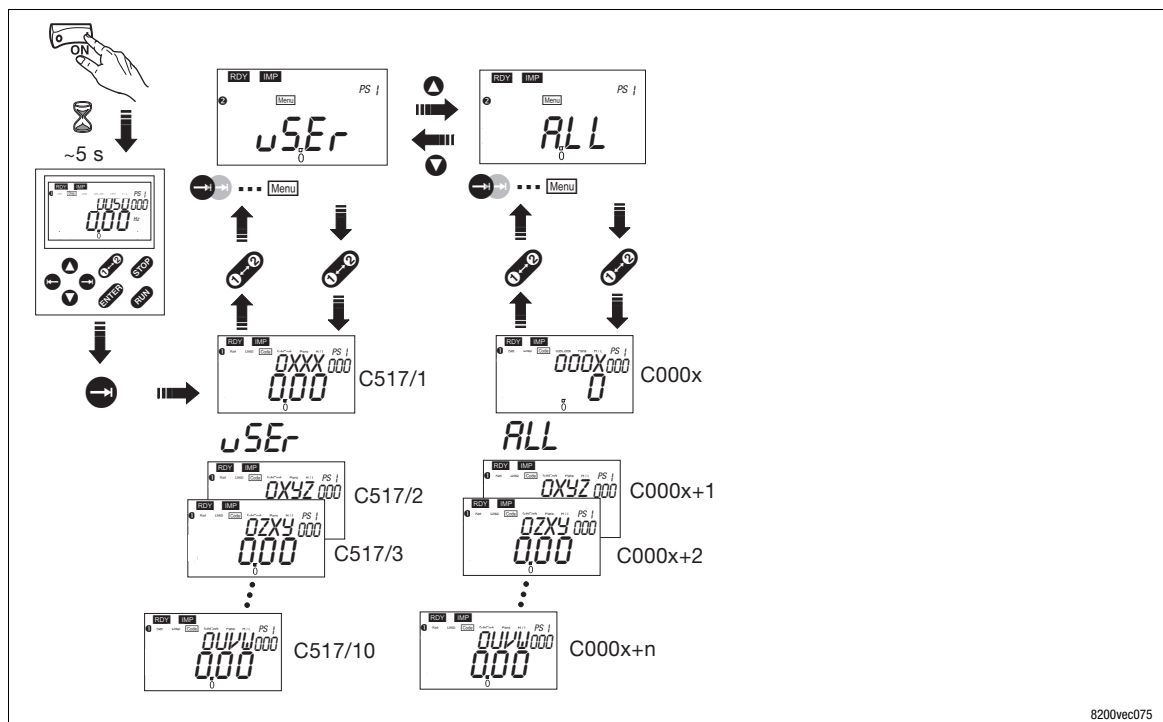
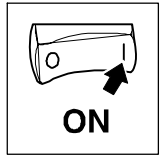

Fig. 5-1 Change between the *uSEr* and *ALL* menus



5.2.2 Changing and saving parameters



Note!

- The user menu *USER* is active after mains switching. Change to the menu *ALL* to address all codes.
- In the different parameter sets only parameter values can be changed with the keypad.
- Digital signals must be used to activate a parameter set for operation (configuration with C0410)!
- In the function **Disp** the display shows the parameter set which is just active during operation.

Step		Keys	Result	Action
1.	Connect keypad		Disp XX.XX Hz	Function Disp is activated. The first code in the user menu will be displayed (C0517/1, Lenze setting: C0050 = output frequency).
2.	If necessary change to the menu "ALL"	1-2	2	Change to function bar 2
3.		←→	Menu	
4.		↕	<i>ALL</i>	Select menu "ALL" (list of all codes)
5.		1-2	1	Confirm selection and change to function bar 1
6.	Select parameter set for change	1-2	2	Change to function bar 2
7.		←→	PS	
8.		↕	<i>1 ... 4</i>	Select parameter set to be changed
9.		1-2	1	Confirm selection and change to function bar 1
10.	Inhibit controller	STOP	RDY IMP	Only necessary if you want to change C0002, C0148, C0174 and/or C0469
11.	Set parameters	←→	Code	
12.		↕	<i>XXXX</i>	Select code
13.		←	SubCode <i>00!</i>	For codes without subcodes: Jump automatically to Para
14.		↕	<i>XXX</i>	Select subcode
15.		←	Para	
16.		↕	<i>XXXXX</i>	Set parameters
17.		ENTER	<i>STO-E</i>	Confirm entry if ↔ is blinking
		←		Confirm entry if ↔ is not blinking; ENTER is not active
18.			Restart the "loop" at 11. or 6. to set other parameters.	

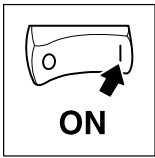

Commissioning

Selection of the correct control mode

5.3 Selection of the correct control mode

The following table helps you to find the correct control mode for standard applications. You can choose between V/f characteristic control, vector control and sensor torque control:

V/f characteristic control is the classic control mode for standard applications.

The vector control provides better control features than the V/f characteristic control because of:

- a higher torque over the whole speed range
- higher speed accuracy and smooth running features
- higher efficiency

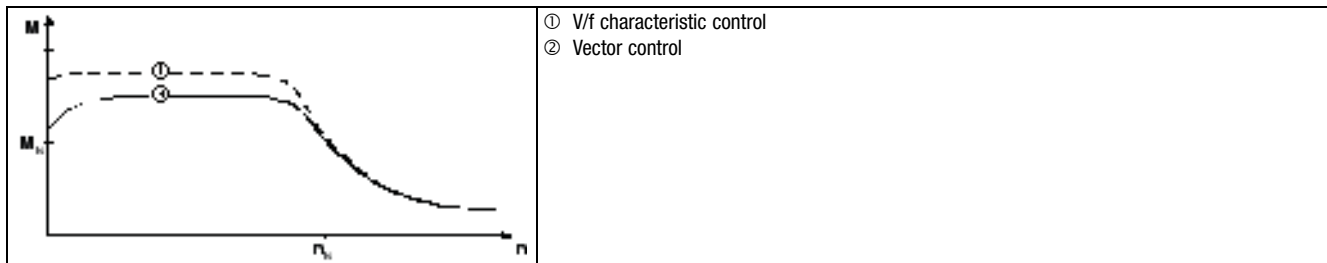

Tip!

The parameters for the corresponding control mode are to be set as follows:

- for linear V/f characteristic control in menu *USEr*
- for square-law V/f characteristic control, vector control or sensorless torque in menu *ALL*

Commissioning

Selection of the correct control mode

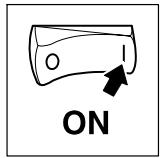

Application	Operating mode	
	C0014	
Stand-alone drives	recommended	alternatively
with extremely alternating loads	-4-	-2-
with heavy start conditions	-4-	-2-
with speed control (speed feedback)	-2-	-4-
with high dynamic response (e. g. positioning and infeed drives)	-2-	-
with torque setpoint	-5-	-
with torque limitation (power control)	-2-	-4-
three-phase AC reluctance motors	-2-	-
three-phase sliding rotor motors	-2-	-
three-phase motors with fixed frequency-voltage characteristic	-2-	-
Pump and fan drives with square-law load characteristic	-3-	-2- / -4-
Group drives (several motors connected to controller)		
identical motors and identical loads	-2-	-
different motors and/or changing loads	-2-	-

- C0014 = -2-: linear V/f characteristic control
- C0014 = -3-: square-law V/f characteristic control
- C0014 = -4-: vector control
- C0014 = -5-: sensorless torque control

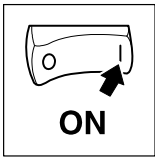

Commissioning

V/f characteristic control

5.4 Commissioning - V/f characteristic control

5.4.1 Commissioning without function module



Stop !

- The controller can only be used when the FIF cover is mounted!
 - If the FIF cover is missing, the green LED is blinking (keypad: **RDY** **IMP**). The controller is inhibited.
 - The FIF cover is mounted when the inverter is delivered.
- Since the controller is not provided with control terminals when the function module is not attached, starting and stopping during operation is also possible by switching the mains.
 - Frequent mains switching (e.g. inching mode via mains contactor) may overload and destroy the input current limitation of the controller: for this reason, at least three minutes have to pass between two starting operations.
- The **Set** function saves the setpoint at the time the operation is interrupted when switching the mains or in case of mains failures. The drive restarts automatically as soon as the mains recovers.
- If the drive does not start after the setpoint has been selected, (**IMP** does not go off), press **RUN** to enable the controller.

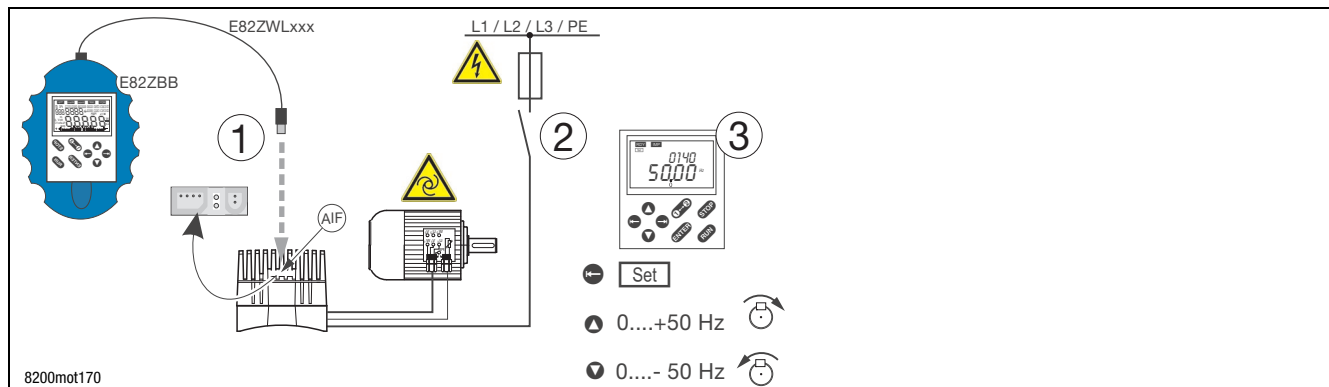



Step	Comment
① Connect diagnosis terminal (contains keypad) with motec. Put the plug of the connecting cable into the AIF interface on the motec.	Diagnosis terminal and connecting cable are not included in the scope of supply.
② Connect mains voltage. Automatic start is possible!	The controller is ready for operation after approx. 1 second. Keypad: RDY IMP
③ Select setpoint via the Set function.	Activate Set Disp Set
	CW rotation IMP goes off. The drive is running now.
	CCW rotation Display indicates output frequency.
Faults during commissioning or operation? chapter 8	

Commissioning

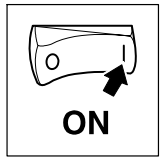
V/f characteristic control

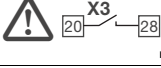

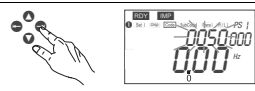
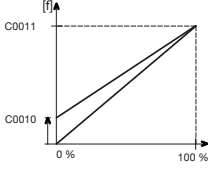
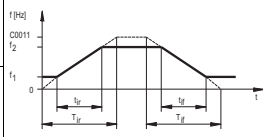
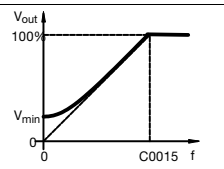
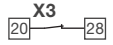
1.	Connect the keypad		
2.	Ensure that controller inhibit is active after mains connection	 misc001	Terminal X3/28 = LOW
3.	Switch on the mains	 misc002	
4.	The keypad is in "Disp" mode after approx. 2 s and indicates the output frequency (C0050)		The <i>USER</i> - menu is active
5.	Change to the <i>Code</i> mode to configure the basic settings for your drive		Blinking on the display: 0050
6.	Set the minimum output frequency (C0010) Lenze setting: 0.00 Hz		
7.	Set the maximum output frequency (C0011) Lenze setting: 50.00 Hz		
8.	Set the acceleration time T_{ir} (C0012) Lenze setting: 5.00 s		$T_{ir} = t_{ir} \cdot \frac{C0011}{f_2 - f_1}$ t_{ir} = acceleration time wanted
9.	Set the deceleration time T_{if} (C0013) Lenze setting: 5.00 s		$T_{if} = t_{if} \cdot \frac{C0011}{f_2 - f_1}$ t_{if} = deceleration time wanted
10.	Set the V/f-rated frequency (C0015) Lenze setting: 50.00 Hz		
11.	Set the V_{min} boost (C0016) Lenze setting: Depends on the controller type		The Lenze setting is suitable for all common applications
12.	If you want to change other settings, please go to the <i>ALL</i> menu	Activate e.g. JOG frequencies (C0037, C0038, C0039) or motor temperature monitoring (C0119)	
13.	Go to the <i>ALL</i> menu A Check the fan monitoring setting under code C0608: – for 8200 motec 0.25...0.37 kW and 0.55...2.2 kW: C0608 = 0! (default setting) – for 8200 motec 3...7.5 kW: C0608 = 1 (recommended) or C0608 = 2! Stop! Function must be activated during commissioning! Otherwise, the controller may be destroyed through overheating! – for all other controllers: C0608 = 0! (default setting) B Select additional functions via codes, if necessary.		
When all settings are complete:			
14.	Select the setpoint	E.g. via potentiometer at terminals 7, 8, 9	
15.	Enable the controller	 misc002	Terminal X3/28 = HIGH
16.	The drive should now be running.		If the drive does not start, press RUN in addition

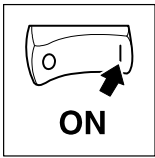





Commissioning

V/f characteristic control

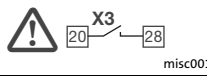
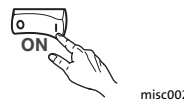
5.4.2 Commissioning with standard I/O function module

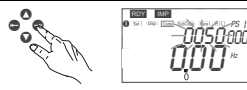
The following instructions apply to controllers equipped with a standard-I/O function module and a three-phase AC motor which has been selected according to a power-based assignment.

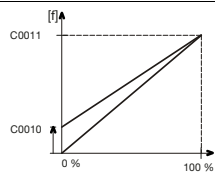
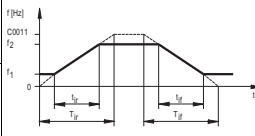
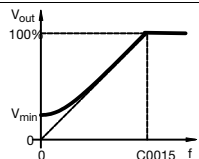
1.	Connect the keypad		
2.	Ensure that controller inhibit is active after mains connection		Terminal X3/28 = LOW
3.	Switch on the mains		
4.	The keypad is in "Disp" mode after approx. 2 s and indicates the output frequency (C0050)		The <i>USER</i> menu is active
5.	Change to the Code mode to configure the basic settings for your drive		Blinking on the display: 0050
6.	Adapt the voltage/current range for the analog setpoint selection (C0034) Lenze setting: -0-, (0 ... 5 V/0 ... 10 V/0 ... 20 mA)		Set the DIP switch on the standard I/O to the same range (see Mounting Instructions for the standard I/O)
7.	Adapt the terminal configuration to the wiring (C0007) Lenze setting: -0-, i. e. E1: JOG1/3 fixed setpoint selection E2: JOG2/3 E3: DCB DC injection brake E4: CW/CCW rotation		
8.	Set the minimum output frequency (C0010) Lenze setting: 0.00 Hz		
9.	Set the maximum output frequency (C0011) Lenze setting: 50.00 Hz		
10.	Set the acceleration time T_{ir} (C0012) Lenze setting: 5.00 s		$T_{ir} = t_{ir} \cdot \frac{C0011}{f_2 - f_1}$ t_{ir} = acceleration time wanted
11.	Set the deceleration time T_{if} (C0013) Lenze setting: 5.00 s		$T_{if} = t_{if} \cdot \frac{C0011}{f_2 - f_1}$ t_{if} = deceleration time wanted
12.	Set the V/f-rated frequency (C0015) Lenze setting: 50.00 Hz		
13.	Set the V_{min} boost (C0016) Lenze setting: Depends on the controller type		The Lenze setting is suitable for all common applications

Commissioning

V/f characteristic control

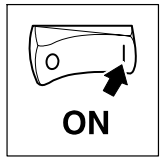

14.	If you want to change other settings, please go to the <i>RLL</i> menu	Activate e.g. JOG frequencies (C0037, C0038, C0039) or motor temperature monitoring (C0119)	
15.	<p>Go to the <i>RLL</i> menu</p> <p>A Check the fan monitoring setting under code C0608:</p> <ul style="list-style-type: none"> – for 8200 motec 0.25...0.37 kW and 0.55...2.2 kW: C0608 = 0! (default setting) – for 8200 motec 3...7.5 kW: C0608 = 1 (recommended) or C0608 = 2! <p>Stop! Function must be activated during commissioning! Otherwise, the controller may be destroyed through overheating!</p> <ul style="list-style-type: none"> – for all other controllers: C0608 = 0 ! (default setting) <p>B Select additional functions via codes, if necessary.</p>		
When all settings are complete:			
16.	Select the setpoint	E.g. via potentiometer at terminals 7, 8, 9	
17.	Enable the controller		Terminal X3/28 = HIGH
18.	The drive should now be running.		If the drive does not start, press RUN in addition

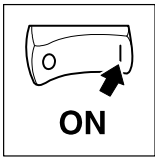

Commissioning

Vector control



5.5 Commissioning - vector control

5.5.1 Commissioning without function module

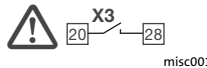

Stop !

- The controller can only be used when the FIF cover is mounted!
 - If the FIF cover is missing, the green LED is blinking (keypad: **RDY** | **IMP**). The controller is inhibited.
 - The FIF cover is mounted when the inverter is delivered.
- Since the controller is not provided with control terminals when the function module is not attached, starting and stopping during operation is also possible by switching the mains.
 - Frequent mains switching (e.g. inching mode via mains contactor) may overload and destroy the input current limitation of the controller: for this reason, at least three minutes have to pass between two starting operations.
- The **[Set]** function saves the setpoint at the time the operation is interrupted when switching the mains or in case of mains failures. The drive restarts automatically as soon as the mains recovers.
- If the drive does not start after the setpoint has been selected, (**IMP** does not go off), press **[RUN]** to enable the controller.

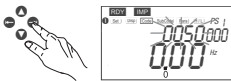
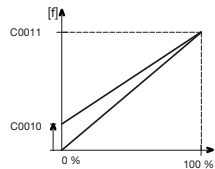
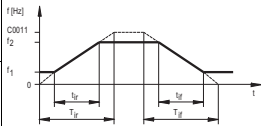
1.	Connect the keypad		
2.	Ensure that controller inhibit is active after mains connection		Terminal X3/28 = LOW
3.	Switch on the mains		
4.	The keypad is in "Disp" mode after approx. 2 s and indicates the output frequency (C0050)		The <i>USER</i> menu is active
5.	Go to the <i>ALL</i> menu		
6.	Change to the [Code] mode to configure the basic settings for your drive		Blinking on the display: 0050
7.	Set the minimum output frequency (C0010) Lenze setting: 0.00 Hz		
8.	Set the maximum output frequency (C0011) Lenze setting: 50.00 Hz		
9.	Set the acceleration time T_{ir} (C0012) Lenze setting: 5.00 s		$T_{ir} = t_{ir} \cdot \frac{C0011}{f_2 - f_1}$ t_{ir} = acceleration time wanted
10.	Set the deceleration time T_{if} (C0013) Lenze setting: 5.00 s		$T_{if} = t_{if} \cdot \frac{C0011}{f_2 - f_1}$ t_{if} = deceleration time wanted

Commissioning

Vector control

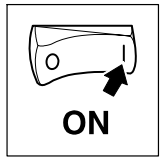

11.	Activate the control mode "vector control" (C0014 = 4) Lenze setting: Linear V/f characteristic control (C0014 = 2)	 E82ZBC014	
12.	Enter the motor data	 Mitsubishi-Strasse 1 · D-31855 Aerzen 3-MOT Typ MDFMA 112-228 IP 54 CI F KTY/TKO Y/Y/Δ 400/480/400 V 50/60/87 Hz 1435/1735/2545 min ⁻¹ 4.00/4.80/7.10 kW 8.30/8.30/14.3 A cosφ 0.82/0.82/0.83 Geber: Bremsen V- A Nm C06: Y90:1022/Δ87:1023 Typ-Nr. Imol.Nr. Auftr.Nr.	See motor nameplate
A	Rated motor speed (C0087) Lenze setting: 1390 rpm		
B	Rated motor current (C0088) Lenze setting: Depends on the controller		Enter the value for the motor connection type (star/delta) selected!
C	Rated motor frequency (C0089) Lenze setting: 50 Hz		
D	Rated motor voltage (C0090) Lenze setting: Depends on the controller		Enter the value for the motor connection type (star/delta) selected!
E	Motor-cosφ (C0091) Lenze setting: Depends on the controller		
13.	Start the motor parameter identification (C0148)		Only when the motor is cold!
A	Ensure that the controller is inhibited		Terminal X3/28 = LOW
B	Set C0148 = 1	Press SHIFT PRG	
C	Enable the controller		<ul style="list-style-type: none"> Terminal X3/28 = HIGH The identification starts: <ul style="list-style-type: none"> The segment IMP is off The motor consumes current and makes a "high-pitched" tone. The motor does not rotate!
D	If the segment IMP becomes active after approx. 30 s, inhibit the controller once again.		<ul style="list-style-type: none"> Terminal X3/28 = LOW Identification is completed. Calculated and stored: <ul style="list-style-type: none"> V/f rated frequency (C0015) Slip compensation (C0021) Motor stator inductance (C0092) Measured and stored: <ul style="list-style-type: none"> Motor stator resistance (C0084) = Total resistance of motor cable and motor
14.	If necessary, change other parameters	Activate e.g. JOG frequencies (C0037, C0038, C0039) or motor temperature monitoring (C0119)	
15.	Go to the <i>ALL</i> menu A Check the fan monitoring setting under code C0608: – for 8200 motec 0.25...0.37 kW and 0.55...2.2 kW: C0608 = 0! (default setting) – for 8200 motec 3...7.5 kW: C0608 = 1 (recommended) or C0608 = 2! Stop! Function must be activated during commissioning! Otherwise, the controller may be destroyed through overheating! – for all other controllers: C0608 = 0 ! (default setting) B Select additional functions via codes, if necessary.		
When all settings are complete:			
16.	Select the setpoint	E.g. via potentiometer at terminals 7, 8, 9	
17.	Enable the controller		Terminal X3/28 = HIGH
18.	The drive should now be running.		If the drive does not start, press RUN in addition

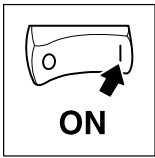

Commissioning

Vector control

5.5.2 Commissioning with standard I/O function module

The following instructions apply to controllers equipped with a standard-I/O function module and a three-phase AC motor which has been selected according to a power-based assignment.

1.	Connect the keypad		
2.	Ensure that controller inhibit is active after mains connection	misc001	Terminal X3/28 = LOW
3.	Switch on the mains	misc002	
4.	The keypad is in "Disp" mode after approx. 2 s and indicates the output frequency (C0050)	misc003	The <i>USER</i> menu is active
5.	Go to the <i>ALL</i> menu		
6.	Change to the <i>Code</i> mode to configure the basic settings for your drive	misc004	Blinking on the display: 0050
7.	Adapt the terminal configuration to the wiring (C0007) Lenze setting: -0-, i. e. E1: JOG1/3 fixed setpoint selection E2: JOG2/3 E3: DCB DC injection brake E4: CW/CCW rotation	misc005	
8.	Set the minimum output frequency (C0010) Lenze setting: 0.00 Hz	C0011 C0010	
9.	Set the maximum output frequency (C0011) Lenze setting: 50.00 Hz		
10.	Set the acceleration time T_{ir} (C0012) Lenze setting: 5.00 s	C0011 f2 f1 Tif Tir	$T_{ir} = t_{ir} \cdot \frac{C0011}{f_2 - f_1}$ t_{ir} = acceleration time wanted
11.	Set the deceleration time T_{if} (C0013) Lenze setting: 5.00 s		$T_{if} = t_{if} \cdot \frac{C0011}{f_2 - f_1}$ t_{if} = deceleration time wanted
12.	Activate the control mode "vector control" (C0014 = 4) Lenze setting: Linear V/f characteristic control (C0014 = 2)	E82ZBC014	
13.	Adapt the voltage/current range for the analog setpoint selection (C0034) Lenze setting: -0-, (0 ... 5 V/0 ... 10 V/0 ... 20 mA)	misc006	Set the DIP switch on the standard I/O to the same range (see Mounting Instructions for the standard I/O)
14.	Enter the motor data	CE 3-MOT Typ MDFMA 112-225 IP 54 CI F KTYTKO Y/Y/Δ 400/480/400 V [50/60/67 Hz] 1435/1725/2545 min ⁻¹ 4.00/4.00/7.10 kW [0.30/0.30/14.3 A] cosφ 0.82/0.82/0.83 Gabel: Bromse V- A Nm CS6: Y50-1022/S7-1023 Typ-Nr. IMot-Nr. Auftr.-Nr.	See motor nameplate
A	Rated motor speed (C0087) Lenze setting: 1390 rpm		
B	Rated motor current (C0088) Lenze setting: Depends on the controller		Enter the value for the motor connection type (star/delta) selected!
C	Rated motor frequency (C0089) Lenze setting: 50 Hz		
D	Rated motor voltage (C0090) Lenze setting: Depends on the controller		Enter the value for the motor connection type (star/delta) selected!
E	Motor-cosφ (C0091) Lenze setting: Depends on the controller		

Commissioning

Vector control

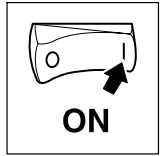

15.	Start the motor parameter identification (C0148)		Only when the motor is cold!
A	Ensure that the controller is inhibited		Terminal X3/28 = LOW
B	Set C0148 = 1	Press SHIFT PRG	
C	Enable the controller		<ul style="list-style-type: none"> Terminal X3/28 = HIGH The identification starts: <ul style="list-style-type: none"> The segment IMP is off The motor consumes current and makes a "high-pitched" tone. The motor does not rotate!
D	If the segment IMP becomes active after approx. 30 s, inhibit the controller once again.		<ul style="list-style-type: none"> Terminal X3/28 = LOW Identification is completed. Calculated and stored: <ul style="list-style-type: none"> V/f rated frequency (C0015) Slip compensation (C0021) Motor stator inductance (C0092) Measured and stored: <ul style="list-style-type: none"> Motor stator resistance (C0084) = Total resistance of motor cable and motor
16.	If necessary, change other parameters	Activate e.g. JOG frequencies (C0037, C0038, C0039) or motor temperature monitoring (C0119)	
17.	<p>Go to the <i>ALL</i> menu</p> <p>A Check the fan monitoring setting under code C0608:</p> <ul style="list-style-type: none"> for 8200 motec 0.25...0.37 kW and 0.55...2.2 kW: C0608 = 0! (default setting) for 8200 motec 3...7.5 kW: C0608 = 1 (recommended) or C0608 = 2! <p>Stop!</p> <p>Function must be activated during commissioning! Otherwise, the controller may be destroyed through overheating!</p> <ul style="list-style-type: none"> for all other controllers: C0608 = 0 ! (default setting) <p>B Select additional functions via codes, if necessary.</p>		
When all settings are complete:			
18.	Select the setpoint	E.g. via potentiometer at terminals 7, 8, 9	
19.	Enable the controller		Terminal X3/28 = HIGH
20.	The drive should now be running.		If the drive does not start, press RUN in addition

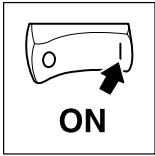

Commissioning

Vector control

5.5.3 Vector control optimisation

In general, the vector control is ready for operation without any further measures after the motor parameters have been identified. The vector control must only be optimised in case of the following drive behaviour:

Drive behaviour	Remedy
Rough motor run and motor current (C0054) > 60 % rated motor current in idle running (steady-state operation)	<ol style="list-style-type: none"> 1. Reduce motor inductance (C0092) by 10 % 2. Check motor current in C0054 3. If the motor current (C0054) is > 50 % of the rated motor current: <ul style="list-style-type: none"> – Reduce C0092 until the motor current amounts to approx. 50 % of the rated motor current – Reduce C0092 by max. 20 %! – Note: If you reduce C0092, the torque will decrease!
Torque too low for frequencies $f < 5$ Hz (starting torque)	Increase motor resistance (C0084) or motor inductance (C0092)
Poor speed stability at high load (setpoint and motor speed are proportional anymore)	Increase slip compensation (C0021) Overcompensation results in drive instability!
Error messages OC1, OC3, OC4 or OC5 at acceleration times (C0012) < 1 s (controller is no longer able to follow the dynamic processes)	Change reset time of the I_{\max} controller (C0078): <ul style="list-style-type: none"> • Reduce C0078 = I_{\max} controller becomes faster (more dynamic) • Increase C0078 = I_{\max} controller becomes slower ("smoother")

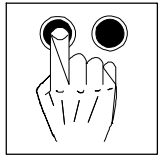

6 Parameter setting

6.1 General information

- The controller can be adapted to your application by means of parameterisation. A detailed description of the functions can be found in the function library. (▣ 7-1 ff.)
- The parameters for the functions are stored in numbered codes:
 - The codes are marked in the text with a "C".
 - The code table provides a quick overview of all codes. The codes are sorted in numerical ascending order. (▣ 14-10)

You can either parameterise via keypad, PC or via the parameter channel of a bus system:

Parameter setting via keypad or PC

- Detailed information about parameter setting via keypad: (▣ 6-2)
- Detailed information about parameter setting via PC: (▣ 6-9)
- In addition to parameter setting the keypad or PC serves to:
 - control your controller (e.g. inhibit and enable)
 - Select the setpoints
 - Display operating data
 - Transfer parameter sets to other controllers

Parameter setting with a bus system

- Detailed information on the "system bus (CAN)" function module. (▣ 9-1)
- Detailed information on other bus modules can be found in the Operating Instructions of the modules.



Tip!

- The signal flow diagrams provide an overview of all configurable signals. (▣ 14-1)
- If you make a mistake during parameter setting, load the Lenze setting with C0002 and start again.

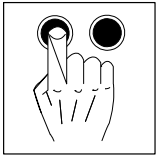

Parameter setting

With keypad

6.2 Parameter setting via keypad

The controller is parameterised via the keyboard of the E82ZBB diagnosis terminal.
The diagnosis terminal can be connected to the AIF via cables with different lengths.



Tip!

The diagnosis terminal can be connected or disconnected and parameterised during operation.

6.2.1 Installation/commissioning

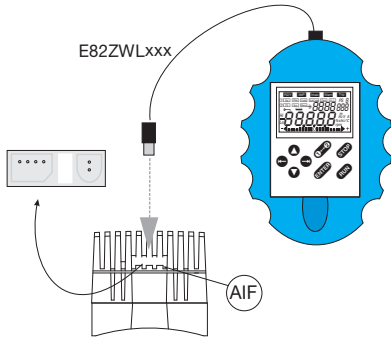
With diagnosis terminal	Basic structure
4. Remove plug from the motec heatsink. 5. Connect diagnosis terminal to the AIF interface using the connecting cable.	
When the mains voltage is switched on, the communication module is ready for operation. You can communicate with the drive.	

6.2.2 Displays and functions

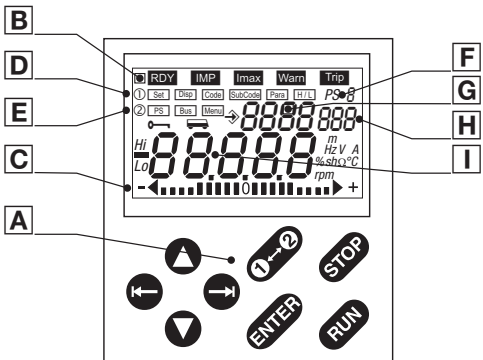
	<table border="1"> <tbody> <tr> <td>A</td> <td>Function keys</td> <td></td> </tr> <tr> <td>B</td> <td>Status displays</td> <td></td> </tr> <tr> <td>C</td> <td>Bar graph display</td> <td></td> </tr> <tr> <td>D</td> <td>Function bar 1</td> <td></td> </tr> <tr> <td>E</td> <td>Function bar 2</td> <td></td> </tr> <tr> <td>F</td> <td>Active parameter set to be changed</td> <td rowspan="4">If the corresponding value is blinking, it can be changed.</td> </tr> <tr> <td>G</td> <td>Code number</td> </tr> <tr> <td>H</td> <td>Subcode number</td> </tr> <tr> <td>I</td> <td>Parameter value with unit</td> </tr> </tbody> </table>	A	Function keys		B	Status displays		C	Bar graph display		D	Function bar 1		E	Function bar 2		F	Active parameter set to be changed	If the corresponding value is blinking, it can be changed.	G	Code number	H	Subcode number	I	Parameter value with unit	
A	Function keys																									
B	Status displays																									
C	Bar graph display																									
D	Function bar 1																									
E	Function bar 2																									
F	Active parameter set to be changed	If the corresponding value is blinking, it can be changed.																								
G	Code number																									
H	Subcode number																									
I	Parameter value with unit																									

Parameter setting

With keypad

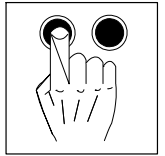

A Function keys		
Key	Function	Explanation
RUN	Enable drive controller	X3/28 must be set to HIGH level.
STOP	Inhibit drive controller (CINH) or quick stop (QSP)	Configuration in C0469.
↔	Change function bar 1 ↔ function bar 2	
←	To the right/left in the active function bar.	The current function is framed.
▲▼	Increase/decrease value. change quickly: keep key pressed	Only blinking values can be changed.
ENTER	Save parameters if → is blinking. confirmation by STOP in the display.	
B Status displays		
Description of the fault messages: (□) 8-1 ff)		
Display	Meaning	Explanation
RDY	Ready for operation	
IMP	Pulse inhibit	Power outputs inhibited
Imax	Set current limit is exceeded	C0022 (in motor mode) or C0023 (in generator mode)
Warn	Warning active	
Trip	Error active	
C Bar graph display		
	Set value in C0004 in %. (Lenze setting: device utilisation C0056).	Display range: - 180 % ... + 180 % (every scale line = 20 %)
D Function bar 1		
Function	Meaning	Explanation
Set	Setpoint selection via ▲▲	Not possible with active password protection (display = "LQc")
Disp	Display function: • User menu, memory location 1 (C0517/1), display • Display active parameter set	Active after every mains connection
Code	Select codes	Active code number shown on four-digit display □
SubCode	Select subcodes	Active subcode number shown on three-digit display □
Para	Change parameter value of a (sub-) code	Current value shown on five-digit display □
H/L	Display values with more than 5 digits	
	H: high-order digits L: low-order digits	"HI" shown on display "LQ" shown on display
E Function bar 2		
Function	Meaning	Explanation
PS	Select parameter set 1 ... parameter set 4 for changing	<ul style="list-style-type: none"> Display e. g. PS 2 (□) Activating parameter sets can be effected via digital signals only (configuration with C0410).
Bus	Select node on system bus (CAN)	The node selected can be parameterised from the current drive. ☐ = function active
Menu	Select menu	<i>uSEr</i> List of the codes in the user menu (C0517)
	The user menu is active after every mains switching. If required, change to ALL.	<i>ALL</i> List of all codes
		<i>Funct</i> Only specific codes for bus function modules, e.g. INTERBUS, PROFIBUS-DP and LECOM-B

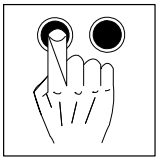

Parameter setting

With keypad

6.2.3 Menu structure

All parameters for parameterising or monitoring the controller are saved in codes in the *USER* and *ALL* menus. The codes are numbered \square and labelled with a "C" in the text. Some codes save the parameters in numbered "subcodes" \square so that a clear parameter setting is ensured (example: C0517 *USER* menu).

- The *USER*
- menu
 - is active after every mains switching or keypad attachment during operation.
 - contains all codes for a standard application with linear V/f characteristic control (Lenze setting).
 - can be compiled as required in C0517.
- The *ALL* menu
 - contains all codes.
 - shows a list of all codes in ascending order.
- The change between *USER* and *ALL* and how to change the parameters in the codes is described on the following pages.

Change between the *USER* and *ALL* menus

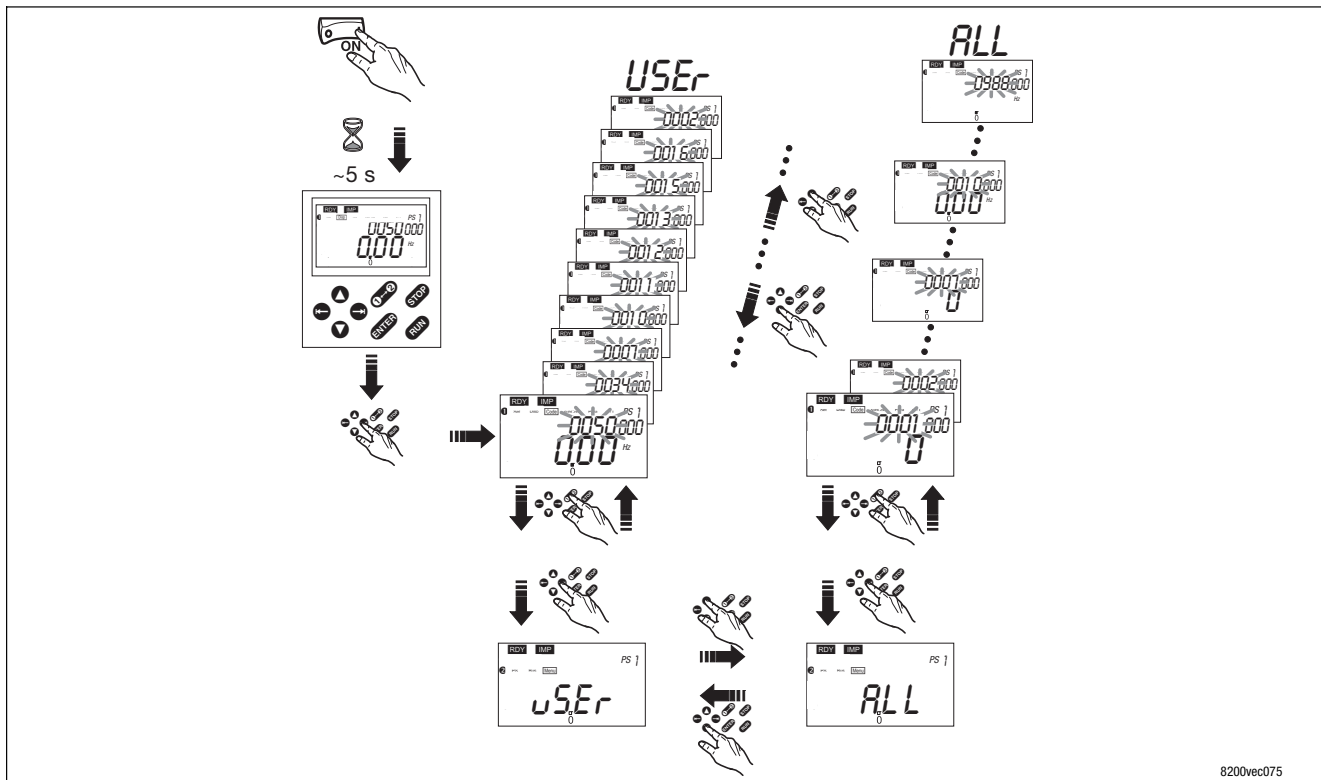

8200vec075

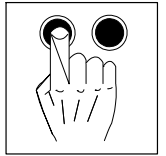

6.2.4 Changing and saving parameters using the keypad



Tip!

After every mains switching, the user menu is active. In order to be able to call up all codes, you have to change to the *ALL* menu.

Action	Key sequence	Result	Comment	Example	
1. Attach keypad		XX.XX Hz	Function is active. The first code in the user menu (C0517/1, Lenze setting: C0050 = output frequency) is displayed.		
2. If required, change to the menu "ALL"		2	Change to function bar 2		
3.		Menu			
4.		<i>ALL</i>	Select menu "ALL" (list of all codes)		
5.		1	Confirm selection and change to function bar 1		
6. Inhibit controller			Only necessary if you alter C0002, C0148, C0174, and/or C0469		
7. Set parameters		Code		C0412, assign subcode 3 to value 3.	
8.		XXXX	Select code		0412
9.		Para 001	For codes without subcodes: automatic skip to		
10.		XXX	Select subcode		003
11.		Para			
12.		XXXXX	Set parameters		3
13.		STD-E	Confirm entry if is blinking		
			Confirm entry if is not blinking; is inactive		
14.			Restart "loop" at 7. again, in order to set further parameters		

6.2.5 Change parameter set



Tip!

The keypad can only be used to change to parameter sets in order to change the parameters. Use digital signals to activate a parameter set for operation (configuration with C0410)!

The function shows the parameter set active in the operation at this moment.

Action	Key sequence	Result	Comment	Example
1. Select function		2	Change to function bar 2	Select parameter set 2.
2.		PS		
3. Select parameter set		1 ... 4	Select parameter set to be changed	
4.		1	Confirm selection and change to function bar 1	
5. Set parameters			As described in chapter 6.2.4	

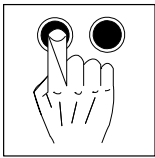

Parameter setting

With keypad

6.2.6 Remote parameterisation of system bus nodes



Tip!

Instead of using the **[Bus]** function, the system bus node can also be selected via C0370.

Action	Key sequence	Result	Comment	Example
1.		2	Change to function bar 2	
2.	[Bus]			Remote parameterisation of system bus node 32.
3.		<i>1 ... 63</i>	Select node address. ([])	<i>32</i>
4.		1 	Confirm address and change to function bar 1 The node can be parameterised remotely now	
5.			As described in chapter 6.2.4 All settings are redirected to the selected node	

6.2.7 Change entries in the user menu



Tip!

Detailed information on the user menu: (**[]** 7-95)

Action	Key sequence	Result	Comment	Example
1.		2	Change to function bar 2	
2.	[Menu]			
3.		<i>ALL</i>	Select menu "ALL" (list of all codes)	
4.		1	Confirm selection and change to function bar 1	
5.		[Code]		
6.		<i>0517</i>	Code for user menu	<i>0517</i>
7.		<i>001</i>	Code saved in C0517/1 is displayed (Lenze setting: output frequency C0050)	
8.		<i>001 ... 010</i>	Select subcode	<i>002</i>
9.		[Para]		
10.		<i>XXXXX</i>	Enter code number It is not checked whether the code number exists! Enter "0" to delete the entry.	<i>14</i>
11.	[ENTER]	<i>ST0rE</i>	Confirm entry	
12.			Restart "loop" at 7. again, in order to change further memory locations	

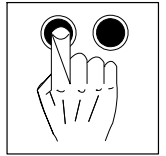

6.2.8 Activation of password protection



Tip!

- If the password protection is activated (C0094 = 1 ... 9999) only the user menu can be freely accessed.
- All other functions require the correct password.
- Please observe that also the password-protected parameters are overwritten when the parameter sets are transferred. The password will not be transferred.
- Do not forget your password! If you have forgotten the password, it can only be reset via PC or a bus system!

6.2.8.1 Activation of password protection

Action	Key sequence	Result	Comment	Example		
1.	Change the "ALL" menu		2	Change to function bar 2		
2.			Menu			
3.			ALL	Select menu "ALL" (list of all codes)		
4.			1	Confirm selection and change to function bar 1		
5.	Enter password				Enter and activate password 123	
6.			0094	Code for password		0094
7.			Para			
8.			XXXX	Set password		123
9.			STO-E	Confirm password		
10.	Activate password by changing to the user menu		2	Change to function bar 2		
11.			Menu			
12.			USER	Select user menu		
13.			1	Confirm selection and change to function bar 1 The key symbol indicates that the password protection is active		

6.2.8.2 Calling a password-protected function

Action	Key sequence	Result	Comment	Example	
1.	Calling a password-protected function	Various	PRSS D 	Deactivating password 123 temporarily	
2.			PRSS XXXX 		123
3.			STO-E 		Confirm password goes off
4.	Free access to all functions	Various		All functions can be freely accessed again	
5.	Reactivating password protection by changing to the user menu		2	Change to function bar 2	
6.			Menu		
7.			USER	Select user menu	
8.			1 	Confirm selection and change to function bar 1 Password protection is active again	

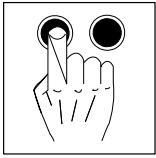

Parameter setting

With keypad

6.2.8.3 Deactivating password protection permanently

Action	Key sequence	Result	Comment	Example	
1. Change the "ALL" menu		<i>PRSS</i> <i>0</i> 	<i>0</i> is blinking	Deactivating password 123 permanently	
2.		<i>PRSS</i> <i>XXXX</i> 	Set password		<i>123</i>
3.		<i>STO-E</i>	Confirm password goes off		
4.		<i>2</i>	Change to function bar 2		
5.		[Menu]			
6.		<i>ALL</i>	Select menu "ALL" (list of all codes)		
7.		<i>1</i>	Confirm selection and change to function bar 1		
8. Deactivate password protection permanently		[Code]			
9.		<i>0094</i>	Code for password	<i>0094</i>	
10.		[Para]			
11.		<i>0</i>	Delete password	<i>0</i>	
12.		<i>STO-E</i>	Confirm entry All functions can be freely accessed again		

Parameter setting

With communication module LECOM-A (RS232)

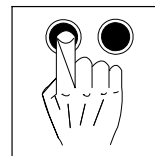

6.3 Parameter setting using the LECOM-A (RS232) communication module

The LECOM-A (RS232) communication module connects the controller to a host (e.g. PC) via the RS232 interface.

You need the following accessory components to use the communication module:

- Parameterisation software “Global Drive Control easy (GDC easy)”
- PC system cable
- Connecting cable

6.3.1 Technical data

6.3.1.1 General data/operating conditions

Communication module type	E82ZBL		
Communication medium	RS232 (LECOM-A)		
Communication protocol	LECOM-A/B V2.0		
Character format	7E1: 7 bits ASCII, 1 stop bit, 1 start bit, 1 parity bit (even)		
Baud rate [Bit/s]	1200, 2400, 4800, 9600, 19200		
LECOM-A node	Slave		
Network topology	Point-to-point		
Max. number of nodes	1		
Max. cable length	15 m		
Communication time	See table		
PC connection	9-pole Sub-D socket		
DC voltage supply	Internal		
Insulation voltage to reference earth/PE	50 V AC		
Type of protection	EN60529	IP20	outside the wire range of the terminals on the motor side
	NEMA 250	Protection against accidental contact to type 1	
Climatic conditions			
Permissible Temperature ranges	Storage	IEC/EN 60721-3-1	1K3 (-25 °C...+60 °C)
	Transport	IEC/EN 60721-3-2	2K3 (-25 °C...+70 °C)
	Operation	IEC/EN 60721-3-3	3K3 (0 °C...+55 °C)
Dimensions (L x B x H)	75 mm x 62 mm x 23 mm		

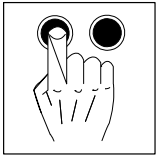

Parameter setting

With communication module LECOM-A (RS232)

6.3.1.2 Communication times

The time required for communication with the drive can be displayed as a sequence of time segments. The communication times depend on the baud rate set in C0125:

Section	Active component	Action
t0	Application program in the host system	Starts request on the controller
t1	Software driver in the host system	Converts request data into the LECOM-A/B protocol and starts the transmission
t2		Communication (= serial transmission) to the controller (telegram run time)
t3	Controller	Processes the request and starts the response
t4		Communication response is transmitted (telegram run time)
t5	Software driver in the host system	Evaluates the response and converts it into the format of the application program
t6	Application program in the host system	Receives the result

Telegram run time (t2 + t4) [ms]		Baud rate [bits/s] (can be set with C0125)				
		1200	2400	4800	9600	19200
SEND telegram type (sends data to the drive)	t2 _{Standard} (parameter value = 9 characters)	150	75	37.5	18.8	9.4
	Addition for extended addressing	41.6	20.8	10.4	5.2	2.6
RECEIVE telegram (reads data from the drive)	t4 _{Standard} (parameter value = 9 characters)	166.7	83.3	41.7	20.8	10.4
	Addition for extended addressing	83.3	41.7	20.8	10.4	5.2
Runtime of single character ¹⁾	per character [ms]	8.4	4.2	2.1	1	0.52
Processing time in the controller (t3)		t3 [ms]				
	Write codes	20				
	Read codes	20				

¹⁾ If the telegram contains less or more than nine characters, the transmission time changes by the values given.

Parameter setting

With communication module LECOM-A (RS232)

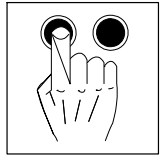

6.3.2 Wiring to a host (PC or PLC)

Pin assignment of 9-pole SubD socket				
Pin	Designation	Input (E) / output (A)	Explanation	
1	-	-	not assigned	
2	RxD	e	"Data reception" cable	
3	TxD	a	"Data transmission" cable	
4	DTR	a	Transmission control	
5	GND	-	Reference potential	
6	DSR	e	not assigned	
7	-	-	not assigned	
8	-	-	not assigned	
9	GND	-	Reference potential for T/R (A), T/R (B) and +5 V	
<p>① = PC system cable ② = connecting cable ③ = plug</p>				<p>The Global Drive Control easy parameterisation software must be installed on your PC.</p> <ol style="list-style-type: none"> 1. Connect communication module to the PC via PC system cable ①. 2. Insert the connecting cable ② into the diagnosis terminal. 3. Remove protective cap ③ from the motec heatsink. 4. Connect connecting cable ② to the interface (AIF) of the controller. <p>When the mains voltage is switched on, the communication module is ready for operation. You can communicate with the drive.</p>



Tip!

- The controller has a double basic insulation to EN 50178. An additional electrical isolation is not required.
- Use the Lenze accessories listed for wiring.

6.3.2.1 Notes on self-made PC system cables

Specification for RS232 interface cable	Cable type	LIYCY 4 x 0.25 mm ² shielded		
	Cable resistance	≤ 100 Ω/km		
	Capacitance per unit length	≤ 140 nF/km		
Specification for SubD connector	Use metallic SubD housing only. Connect the shield on both ends to the housing.			
Pin assignment	at communication module		Must be connected to PC or similar with	
	9-pole SubD plug pin	2 (RxD)	9-pole SubD socket pin 3 (TxD)	25-pole SubD socket pin 2 (TxD)
		3 (TxD)	2 (RxD)	3 (RxD)
		5 (GND)	5 (GND)	7 (GND)

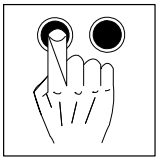

Parameter setting

With communication module LECOM-A (RS232)

6.3.3 Parameter setting using LECOM-A (RS232)

All codes can be accessed using LECOM-A:

- Controller codes (code table: ☐ 14-10 ff.).
 - These codes are automatically saved non-volatilely in the controller.
 - Exception: Process data as e. g. control words or setpoints.
- Module-specific codes (access via communication module only: ☐ 6-12).
- The Online Help of Global Drive Control contains all notes on parameter setting with LECOM-A.

6.3.4 Additional codes for LECOM-A (RS232)

How to read the code table:

Column	Entry	Meaning
Code	No.	Code number (codes marked with “**” are the same in all parameter sets).
	Name	Code name.
	LECOM format	Interpretation of response message: VH = hexadecimal; VD = decimal; VS = ASCII string; VO = octet
Parameter	Settings/options	Contents or meaning of the parameter values (bold print = Lenze setting)
Important		Important additional information

Parameter setting

With communication module LECOM-A (RS232)

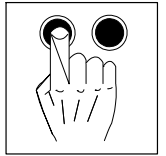

Code			Parameter	Important
No.	Designation	LECOM format	Settings/options	
C0068*	Operating status	VH	Bit Assignment	
			3 2 1 10 TRIP error number	Submission of the 10th digit of the LECOM error number. Example: TRIP 0H (LECOM no. 50) = 0110 (5)
			7 6 5 4 Last communication error	
			0000 No error	
			0001 Checksum error	
			0010 Protocol frame error	
			0011 Reserved	
			0100 Invalid code number	
			0101 Invalid variable value	
			0110 No access authorisation	
0111 Telegram processing interrupted by new telegram				
1111 General error				
8	Controller inhibit (DCTRL1-CINH)			
0	Controller inhibited			
1	Controller enabled			
9	Q _{min} threshold reached (PCTRL1-QMIN)			
0	Not reached			
1	Reached			
10	Direction of rotation (NSET1/CW/CCW)			
0	CW rotation			
1	CCW rotation			
11	Pulse inhibit (DCTRL1-IMP)			
0	Power outputs inhibited			
1	Power outputs enabled			
12	Quick stop (DCTRL1-QSP)			
0	Not active			
1	Active			
13	I _{max} limit reached (MCTRL1-IMAX) (C0014 = -5-: torque setpoint)			
0	Not reached			
1	Reached			
14	Frequency setpoint reached (MCTRL1-RFG1=NOUT)			
0	Wrong			
1	True			
15	TRIP error message (DCTRL1-TRIP)			
0	Not active			
1	Active			
C0248*	LECOM input selection	VD	0 0000 ... 0255	<ul style="list-style-type: none"> For compatibility with LECOM-A/B drivers V1.0 which do not support the direct addressing of subcodes (array parameters). C0248 determines the subcode (array element) which is accessed. The attempt to access codes without subcodes with C0248 > 0, causes an error since the address does not exist. LECOM-A/B drivers from V2.0 on support the direct addressing of subcodes. Do not use C0248 together with these drivers! With every switch-on, C0248 is set to 0.

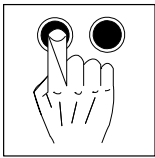

Parameter setting

With communication module LECOM-A (RS232)

Code			Parameter	Important
No.	Designation	LECOM format	Settings/options	
C0249*	LECOM code bank	VD	Code bank Addressable codes 0 0000 ... 0255 1 0250 ... 0505 2 0500 ... 0755 3 0750 ... 1005 4 1000 ... 1255 5 1250 ... 1505 6 1500 ... 1755 7 1750 ... 2005 8 2000 ... 2255 9 2250 ... 2505 10 2500 ... 2755 11 2750 ... 3005 12 3000 ... 3255 13 3250 ... 3505 14 3500 ... 3755 15 3750 ... 4005	<ul style="list-style-type: none"> For compatibility with LECOM-A/B drivers V1.0 (maximum possible code number 255). With the code bank, an offset of 250 is added to the code number. Together with LECOM.A/B drivers from V2.0 on, C0249 is ineffective. With every switch-on, C0249 is set to 0.
C1810*	SW identification	VS	Structure: 33S2102l_xy000	Software identification (x = main version, y = subversion)
C1811*	SW creation	VS		Date of software creation
C1920	Starting status	VD	0 QSP (quick stop)	After mains switching the drive is in "QSP" status.
			1 CINH (controller inhibit)	After mains switching the drive is in "CINH" status. Writing of C0040 =1 ⇒enable
C1921	Reduced response time	VD	0 Not active	C1921 = 1: <ul style="list-style-type: none"> A write telegram (send) is only checked for transmission errors: – A faulty telegram is acknowledged positively (ACK), otherwise negatively (NAK). – Only after this the value is transmitted to the controller. It is not guaranteed that the controller has adopted the value correctly. The communication module can be readdressed after 50 ms.
			1 Active	
C1922	Communication monitoring response	VD	0 Not active	<ul style="list-style-type: none"> Use C1922 and C1923 to monitor the communication connection to the host. If the host does not send a telegram to the communication module during the monitoring time set under C1923, the action set under C1922 will be executed.
			1 CINH (controller inhibit)	
			2 QSP (quick stop)	
C1923	Monitoring time		50 {ms}	65535

Parameter setting

With communication module LECOM-A (RS232)

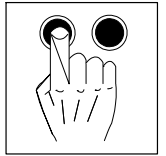

Code			Parameter	Important
No.	Designation	LECOM format	Settings/options	
C1962	Extended error no.		0 No error	
			1 Invalid service identification	Internal error
			2 Invalid call identification	
			3 Invalid data type	User error in the host
			4 Invalid subcode number	
			5 Invalid code number	
			6 Invalid parameter - general	
			7 Operating status, e. g. controller inhibit	Access error
			8 Operating mode C0001 wrong	
			9 Parameter can only be read	
			10 General	
			11 Data block length too long	Limit violation
			12 Collision with other parameter values	
13 Leave value range				
14 General limit violation				
17 General internal error	Internal error			
32 General	Communication error - communication module ↔ controller			
33 Time-out				
34 Frame error				
35 Parity error				
36 Overflow				
37 Handshake				
38 Block memory overflow				
208 Frame error	Communication error - controller ↔ communication module			
209 Overflow error				
210 Checksum error in the communication module				
211 Telegram interruption				
212 Invalid data				
213 Invalid service				
214 Parity error				

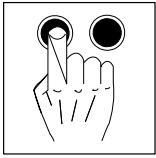

Parameter setting

With communication module LECOM-A (RS232)

6.3.5 Troubleshooting and fault elimination LECOM-A (RS232)

Three LEDs on the LECOM-A (RS232) communication module show the status:

	Green LED (Vcc)	Yellow LED (RxD)	Yellow LED (TxD)
Blinking	Communication module is not initialised yet.	Telegram is received.	Response is transmitted
On	Communication module is supplied with voltage, no trouble	-	-
Off	Communication module is not supplied with voltage.	No telegrams are received.	No responses are transmitted.

Error	Cause	Remedy
No communication with the controller	Controller is switched off: <ul style="list-style-type: none"> No operating status display is lit at the controller. The green LED Vcc is not lit. 	Supply controller with voltage.
	Communication module has no voltage: <ul style="list-style-type: none"> The green LED Vcc is not lit. 	Check connection with the controller.
	Communication module was not initialised with the controller.	
	Controller does not receive any telegrams. Test: Let the host transmit telegrams cyclically (e.g. with GDC in online operation).	If the yellow LED RxD is not blinking: <ul style="list-style-type: none"> Check wiring to host. Check the host if it transmits telegrams and uses the correct interface.
	Controller does not transmit telegrams. Test: Let the host transmit telegrams cyclically. This can be done e.g. with GDC in online operation.	If the yellow LED TxD is not blinking: <ul style="list-style-type: none"> Check LECOM baud rate (C0125) of both nodes and equate them, if required. Do not use device addresses 00, 10, ..., 90. The yellow LED TxD is blinking: <ul style="list-style-type: none"> Check wiring to host.
Controller does not execute write request	<ul style="list-style-type: none"> Controller transmits negative acknowledgement (NAK response): <ul style="list-style-type: none"> No write access on C0044, C0046, since C0412 is set incorrectly. Attempt to write into code of "read only" type. 	Set C0412/1, C0412/2 = 0. Write request is never possible.
	<ul style="list-style-type: none"> Controller transmits positive acknowledgement (ACK response): <ul style="list-style-type: none"> Controller works with another parameter set. 	Change over parameter set.

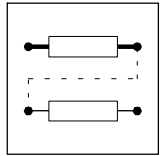

7 Function library

The function library gives all information needed to adapt your controller to your application. The chapter is subdivided into the following sections:

- Select control mode, optimise operating behaviour
- Limit value setting
- Acceleration, deceleration, braking, stopping
- Configuration of analog and digital setpoints
- Motor data entry/automatic detection
- Process controller I_{max} controller
- Free connection of analog signals
- Free connection of digital signals, message output
- Thermal motor monitoring, error detection
- Display of operating data, diagnostics
- Parameter set management
- Individual grouping of drive parameters - The user menu



Tip!

- Signal flow charts show how codes are integrated into signal processing. (☞ 14-1 ff.)
- The code table lists all codes in numerical order and explains them briefly. (☞ 14-10 ff.)

For free signal configuration:

- Select the source from the targets point of view:
 - Ask yourself “Where does the signal come from?”
 - That makes it easy to find the correct entry for a code.
 - A source can have several targets:
 - It is thus possible that double assignments occur when targets are assigned to sources.
 - For instance, the assignment of E1 remains the same even if the frequency input E1 is activated (Lenze setting: ”JOG1 activation!). The previous assignment must be deleted with C0410/1 = 255 to ensure trouble-free operation.
 - Ensure that only the targets wanted are assigned to a source.
 - A target can have one source only.
-

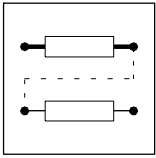

Function library

Selection of control mode, optimisation of operating behaviour

7.1 Operating mode

Description

The control mode of the controller can be selected via the operating mode. You can select between

- V/f characteristic control
- Vector control
- Sensorless torque control

Selection of the correct operating mode

V/f characteristic control is the classic operating mode for standard applications.

The vector control provides a better control performance than the V/f characteristic control due to:

- a higher torque over the whole speed range
- a higher speed accuracy and concentricity factor
- a higher efficiency

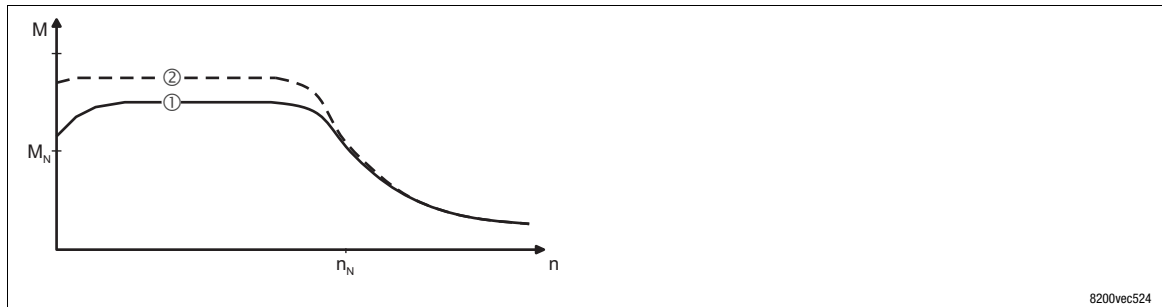
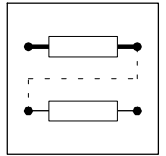

Fig. 7-1 Comparison of V/f characteristic control and vector control

- ① V/f characteristic control
- ② Vector control

Operating modes recommended for standard applications

The following table helps you to find the correct operating mode for standard applications:



Application	Operating mode	
	Setting in C0014	
Single drives	recommended	alternatively
With extremely alternating loads	4	2
With high starting duty	4	2
With speed control (speed feedback)	2	4
With high dynamic response (e. g. positioning and infeed drives)	2	-
With torque setpoint	5	-
With torque limitation (power control)	2	4
Three-phase AC reluctance motors	2	-
Three-phase sliding rotor motors	2	-
Three phase motors with assigned frequency-voltage characteristic	2	-
Pump and fan drives with square-law load characteristic	3	2 or 4
Group drives (several motors connected to one controller)		
Identical motors and identical loads	2	-
Different motors and/or changing loads	2	-

C0014 = 2: linear V/f characteristic control

C0014 = 3: square-law V/F characteristic control

C0014 = 4: vector control

C0014 = 5: sensorless torque control



Note!

- Only change between the operating modes if the controller is inhibited!
- Do not use the operating mode "Torque control" for applications with power control!
- Optimum drive behaviour in process controller applications, e.g. with speed control or dancer position control can be achieved with the control modes "linear V/f characteristic control" or with "vector control".
 - If you need a high torque at low speed we recommend the operating mode "vector control".

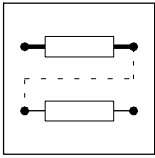

Function library

Selection of control mode, optimisation of operating behaviour

7.1.1 V/f characteristic control

Description

The output voltage of the controller follows a defined characteristic. At low output frequencies, the characteristic can be boosted. It can be adapted to different load profiles.

- Linear characteristic for drives with constant load torque over the speed.
- Quadratic characteristic for drives with quadratic load torque over the speed:
 - Quadratic V/f characteristics are preferably used in centrifugal pump and fan drives. However, it must be checked whether your pump or fan drive can be operated in this operating mode!
 - If your pump or fan drive cannot be used for the operation with a quadratic V/f characteristic, the linear V/f characteristic or vector control mode must be used.

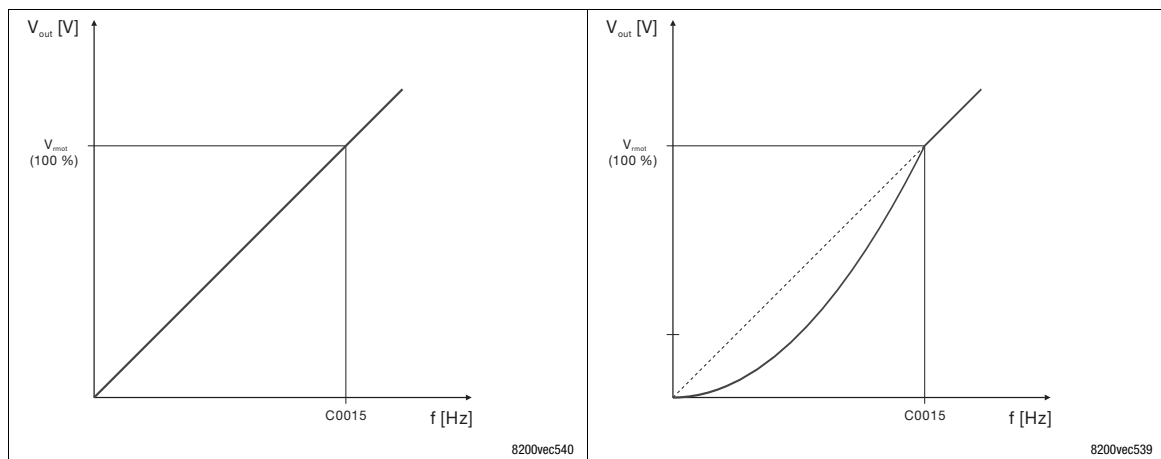
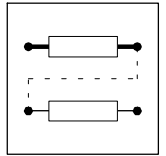

Fig. 7-2 Linear and square-law V/f characteristic

Codes for parameter setting

Code		Possible settings			IMPORTANT		
No.	Name	Lenze	Selection				
C0014 <small>ENTER</small>	Operating mode	2	2	V/f characteristic control $V \sim f$ (linear characteristic with constant V_{min} boost)	<ul style="list-style-type: none"> • Commissioning is possible without identifying motor parameters • Advantage of identification with C0148: <ul style="list-style-type: none"> – Improved smooth running at low speeds – V/f rated frequency (C0015) and slip (C0021) are calculated and saved. They must not be entered 		
			3	V/f characteristic control $V \sim f^2$ (square-law characteristic with constant V_{min} boost)			
			4	Vector control			
			5	Sensorless torque control with speed limitation <ul style="list-style-type: none"> • Torque setpoint via C0412/6 • Speed limitation via setpoint 1 (NSET1-N1) if C0412/1 is assigned, otherwise via maximum frequency (C0011) 			
			<p>In case of the first selection enter the motor data and identify them with C0148 Otherwise, commissioning is not possible When C0014 = 5, C0019 must be set = 0 (automatic DC injection brake is deactivated)</p>		7-2		
C0015 <small>5Er</small>	V/f rated frequency	50.00	7.50	{0.02 Hz}	960.00	<ul style="list-style-type: none"> • C0015 is calculated and stored under C0148 when the motor parameters are identified • Setting applies to all mains voltages permitted 	7-4 7-8
C0016 <small>5Er</small>	V_{min} boost	→	0.00	{0.01 %}	40.00	→ Depending on the controller Setting applies to all mains voltages permitted	7-4



Setting the V/f characteristic

Under C0014 select the V/f characteristic suitable for your application.



Note!

The following must be observed when operating drives with square-law V/f characteristic:

- High moments of inertia reduce the acceleration of the drive.
- This drive behaviour can be avoided by using the linear V/f characteristic via the parameter set changeover during the acceleration.

Setting of V/f rated frequency

The V/f rated frequency determines the slope of the V/f characteristic and has considerable influence on the current, torque and power performance of the motor.

- The setting under C0015 applies to all admitted mains voltages.
- The internal mains voltage compensation compensates deviations in the mains during operation. Therefore, they do not have to be considered for the setting of C0015.
- Depending on the settings under C0015 it can be necessary to adapt the maximum output frequency under C0011 to ensure that the entire speed range will be used.
- The V/f rated frequency depends on the rated controller voltage, the rated motor voltage, and the rated motor frequency:

$$C0015 \text{ [Hz]} = \frac{U \text{ [V]}}{U_r \text{ [V]}} \cdot f_r \text{ [Hz]}$$

V	400 V for E82xVxxxK4C types
V	230 V for E82xVxxxK2C types
U_r	Rated motor voltage depending on type of connection, see nameplate
f_r	Rated motor frequency according to nameplate



Note!

The identification of the motor parameters calculates C0015 and automatically saves the value.

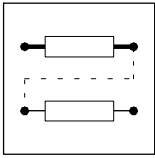

Function library

Selection of control mode, optimisation of operating behaviour

Typical values for C0015

400 V E82xVxxxK4 controller				230 V E82xVxxxK2 controller			
motor			C0015	motor			C0015
Voltage	Frequency	Connection		Voltage	Frequency	Connection	
230/400 V	50 Hz	Y	50 Hz	230/400 V	50 Hz	Δ	50 Hz
220/380 V	50 Hz	Y	52.6 Hz	220/380 V	50 Hz	Δ	52.3 Hz
280/480 V	60 Hz	Y	50 Hz				
400/690 V 400 V	50 Hz 50 Hz	Δ	50 Hz				
230/400 V 280/480 V 400 V	50 Hz 60 Hz 87 Hz	Δ	87 Hz				
220/380 V	50 Hz	Δ	90.9 Hz				



Note!

- 4-pole asynchronous motors which are designed for a rated frequency of 50 Hz in star connection, can be operated in delta connection if the constant excitement does not exceed 87 Hz.
 - The motor current and the motor power increase by the factor $\sqrt{3} = 1.73$.
 - The field-weakening range starts above 87 Hz.
- Advantages:
 - Higher speed-setting range
 - 73 % higher power output with standard motors.
- In principle, this method can also be used for motors with other pole numbers.
 - Observe the mechanical limit speed when using 2-pole asynchronous motors.

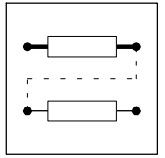

Setting of V_{\min} boost

Load-independent boost of the motor voltage for output frequencies below the V/f rated frequency. This serves to optimise the torque behaviour.

C0016 must always be adapted to the asynchronous motor used. Otherwise, the motor might be destroyed by overtemperature or the controller might be driven with overcurrent:

1. Operate the motor in idle running at slip frequency ($f \approx 5$ Hz):

$f_s = f_r \cdot \frac{n_{r\text{syn}} - n_r}{n_{r\text{syn}}}$	f_s	Slip frequency [Hz]
	f_r	Rated motor frequency according to nameplate [Hz]
$n_{r\text{syn}} = \frac{f_r \cdot 60}{p}$	$r_{r\text{syn}}$	Synchronous motor speed [min^{-1}]
	r_r	Rated motor speed according to nameplate [min^{-1}]
	p	Number of pole pairs

2. V_{\min} until the following motor current is reached:

A Motor in short-term operation at $0 \text{ Hz} \leq f \leq 25 \text{ Hz}$:

- Motor with integrated ventilation: $I_{\text{motor}} \leq I_{r \text{ motor}}$
- Motor with forced ventilation: $I_{\text{motor}} \leq I_{r \text{ motor}}$

B Motor in continuous operation at $0 \text{ Hz} \leq f \leq 25 \text{ Hz}$:

- Motor with integrated ventilation: $I_{\text{motor}} \leq 0,8 \cdot I_{r \text{ motor}}$
- Motor with forced ventilation: $I_{\text{Motor}} \leq I_{r \text{ motor}}$



Note!

For adjustment, observe the thermal performance of the connected asynchronous motor at low output frequencies:

- As experience shows it is possible to operate standard asynchronous motors with insulation class B for a short time with rated current $0 \text{ Hz} \leq f \leq 25 \text{ Hz}$.
- Contact the motor manufacturer for exact setting values for the max. permissible motor current in the lower frequency range of self-ventilated motors.

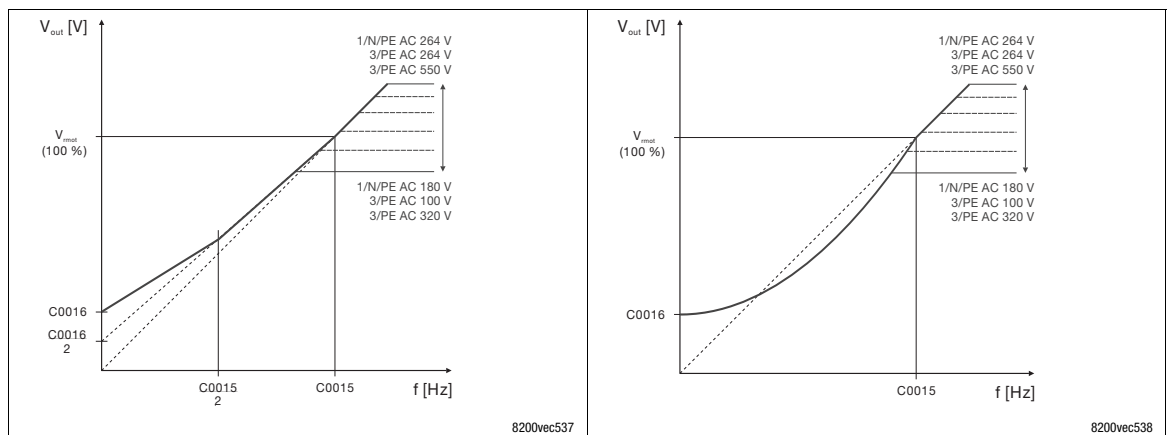
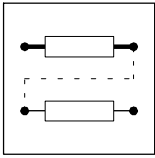

Fig. 7-3

V_{\min} boost at linear and square-law V/f characteristic



Function library

Selection of control mode, optimisation of operating behaviour

7.1.2 Vector control

Description

Compared with the V/f characteristic control the vector control offers considerably higher torque and lower current consumption during idle running. The vector control is an improved motor current control following the Lenze FTC technology. Select vector control for operation of the following drives:

- Single drives with extremely changing loads
- Single drives with heavy start conditions
- Sensorless speed control of standard three-phase AC motors



Note!

- The connected motor should maximally be two power classes lower than the motor assigned to the controller.
- The operation with vector control is not possible if several drives are operated on one controller.
- The motor parameter identification is absolutely vital! Otherwise commissioning is not possible.

Codes for parameter setting

Code		Possible settings			IMPORTANT
No.	Name	Lenze	Selection		
C0014 <small>ENTER</small>	Operating mode	2	2	V/f characteristic control $V \sim f$ (linear characteristic with constant V_{min} boost)	<ul style="list-style-type: none"> • Commissioning is possible without identifying motor parameters • Advantage of identification with C0148: <ul style="list-style-type: none"> – Improved smooth running at low speeds – V/f rated frequency (C0015) and slip (C0021) are calculated and saved. They must not be entered
			3	V/f characteristic control $V \sim f^2$ (square-law characteristic with constant V_{min} boost)	
			4	Vector control	
			5	Sensorless torque control with speed limitation <ul style="list-style-type: none"> • Torque setpoint via C0412/6 • Speed limitation via setpoint 1 (NSET1-N1) if C0412/1 is assigned, otherwise via maximum frequency (C0011) 	
			In case of the first selection enter the motor data and identify them with C0148		
			Otherwise, commissioning is not possible		
			When C0014 = 5, C0019 must be set = 0 (automatic DC injection brake is deactivated)		
C0015 <small>5Er</small>	V/f rated frequency	50.00	7.50	{0.02 Hz} 960.00	<ul style="list-style-type: none"> • C0015 is calculated and stored under C0148 when the motor parameters are identified • Setting applies to all mains voltages permitted
C0021	Slip compensation	0.0	-50.0	{0.1 %} 50.0	C0021 is calculated and stored under C0148 when the motor parameters are identified
C0054*	Apparent motor current (MCTRL1-IMOT)		0.0	{A} 2000.0	Only display
C0087	Rated motor speed	→	300	{1 rpm} 16000	→ Depending on the controller
C0088	Rated motor current	→	0.0	{0.1 A} 650.0	→ Depending on the controller 0.0 ... 2.0 x rated output current of the controller
C0089	Rated motor frequency	50	10	{1 Hz} 960	
C0090	Rated motor voltage	→	50	{1 V} 500	→ 230 V with 230 V controllers, 400 V with 400 V controllers

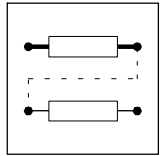

Code		Possible settings			IMPORTANT	
No.	Name	Lenze	Selection			
C0091	Motor cos φ	→	0.40	{0.1}	1.0	→ Depending on the controller 7-48
C0092	Motor stator inductance	0.0	0.000	{0.1 mH}	200.0	7-48
		0.00	0.00	{0.01 mH}	200.00	
C0148* 	Motor parameter identification	0	0	Ready		7-48
			1	Start identification <ul style="list-style-type: none"> V/f-rated frequency (C0015), slip compensation (C0021) and motor stator inductivity (C0092) are calculated and saved. The motor stator resistance (C0084) = total resistance of motor cable and motor is measured and saved 		

Setting of vector control

Use C0014 = 4 to set the operating mode "vector control".

Preparing motor parameter identification

You must enter the motor data of the motor nameplate:

- Rated motor speed (C0087)
- Rated motor current (C0088)
- Rated motor frequency (C0089)
- Rated motor voltage (C0090)
- Motor cos φ (C0091)

Motor parameter identification

Carry out the motor parameter identification. (7-48)

Automatically detected parameters

V/f-rated frequency (C0015), slip compensation (C0021) and motor stator inductivity (C0092) are calculated and saved. The total resistance of motor cable and motor is measured and saved as motor stator resistance (C0084).

Optimising the vector control

In general, the vector control is ready for operation after the motor parameters have been identified. Vector control must only be optimised for the following drive performance:

Drive performance	Remedy
Rough motor run and motor current (C0054) > 60 % rated motor current in idle running (stationary operation)	<ol style="list-style-type: none"> Reduction of motor inductance (C0092) by 10 % Check of motor current under C0054 If the motor current (C0054) > 50 % of the rated motor current: <ul style="list-style-type: none"> – C0092 must be reduced until the motor current amounts to 50 % of the rated motor current – Reduce C0092 by max. 20 %! – Note: If you reduce C0092 the torque will decrease!
Torque too low for frequencies $f < 5$ Hz (starting torque)	Increase of motor resistance (C0084) or increase of motor inductance (C0092)
Poor constant speed at high loads (setpoint and motor speed are not proportional).	Increase of slip compensation (C0021) Overcompensation results in drive instability!
Error messages OC1, OC3, OC4 or OC5 during acceleration times (C0012) < 1 s (drive controller is no longer able to follow the dynamic processes)	Change reset time of the I_{\max} controller (C0078): <ul style="list-style-type: none"> • Reduction of C0078 = I_{\max} controller becomes quicker (more dynamic) • Increase of C0078 = I_{\max} controller becomes slower ("smoother")

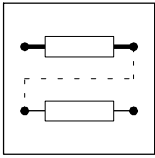

Function library

Selection of control mode, optimisation of operating behaviour

7.1.3 Sensorless torque control with speed limitation

Description

The setpoint linked with C0412/6 is interpreted as torque setpoint. Actual values are not required. The controller varies the speed within the set frequency range in dependence of the load and the torque selected.

The speed is limited via setpoint 1 or the maximum frequency.

Application with, for instance, winding drives.



Note!

- The sensorless torque control only operates in motor mode, not in generator mode.
- The motor parameter identification is absolutely vital! Otherwise commissioning is not possible.

Codes for parameter setting

Code		Possible settings			IMPORTANT	
No.	Name	Lenze	Selection			
C0014 <small>ENTER</small>	Operating mode	2	2	V/f characteristic control $V \sim f$ (linear characteristic with constant V_{min} boost)	<ul style="list-style-type: none"> • Commissioning is possible without identifying motor parameters • Advantage of identification with C0148: <ul style="list-style-type: none"> – Improved smooth running at low speeds – V/f rated frequency (C0015) and slip (C0021) are calculated and saved. They must not be entered 	
			3	V/f characteristic control $V \sim f^2$ (square-law characteristic with constant V_{min} boost)		
			4	Vector control		
			5	Sensorless torque control with speed limitation <ul style="list-style-type: none"> • Torque setpoint via C0412/6 • Speed limitation via setpoint 1 (NSET1-N1) if C0412/1 is assigned, otherwise via maximum frequency (C0011) 		
					<p>In case of the first selection enter the motor data and identify them with C0148</p> <p>Otherwise, commissioning is not possible</p> <p>When C0014 = 5, C0019 must be set = 0 (automatic DC injection brake is deactivated)</p>	
C0047*	Torque setpoint or torque limit value (MCTRL1-MSET)	400	0	{1 %}	400	<p>The value set will be lost when switching the mains!</p> <p>Control mode "Sensorless torque control" (C0014 = 5):</p> <ul style="list-style-type: none"> • Torque setpoint selection if C0412/6 = FIXED-FREE (not assigned) • Torque setpoint display if C0412/6 is linked with a signal source <p>Control mode "V/f characteristic control" or "Vector control" (C0014 = 2, 3, 4):</p> <ul style="list-style-type: none"> • Torque limit value is displayed if C0412/6 is linked with a signal source • C0047 = 400 is displayed if C0412/6 = FIXED-FREE (not assigned)
C0077*	Gain I_{max} controller	0.25	0.00	{0.01}	16.00	<p>= P component not active</p>
C0078*	Integral action time I_{max} controller	65 → 130	12	{1 ms}	9990	<p>= I component not active</p> <p>→ Only 8200 vector 15 ... 90 kW</p>
C0087	Rated motor speed	→	300	{1 rpm}	16000	<p>→ Depending on the controller</p>
C0088	Rated motor current	→	0.0	{0.1 A}	650.0	<p>→ Depending on the controller</p> <p>0.0 ... 2.0 x rated output current of the controller</p>
C0089	Rated motor frequency	50	10	{1 Hz}	960	

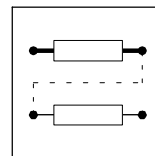

Code		Possible settings			IMPORTANT
No.	Name	Lenze	Selection		
C0090	Rated motor voltage	→	50 {1 V}	500	→ 230 V with 230 V controllers, 400 V with 400 V controllers 📖 7-48
C0091	Motor cos φ	→	0.40 {0.1}	1.0	→ Depending on the controller 📖 7-48
C0092	Motor stator inductance	0.0	0.000 {0.1 mH}	200.0	📖 7-48
		0.00	0.00 {0.01 mH}	200.00	
C0148* STOP	Motor parameter identification	0	0	Ready	Only when the motor is cold! 1. Inhibit controller, wait until drive is at standstill 2. Enter the correct motor data under C0087, C0088, C0089, C0090, C0091 (see motor nameplate). 3. Set C0148 = 1 by ENTER 4. Enable controller The identification – starts, IMP goes off – the motor makes a high-pitched tone, but does not rotate! – takes approx. 30 s – is completed when IMP is on again 5. Inhibit controller 📖 7-48
			1	Start identification <ul style="list-style-type: none"> • V/f-rated frequency (C0015), slip compensation (C0021) and motor stator inductivity (C0092) are calculated and saved. • The motor stator resistance (C0084) = total resistance of motor cable and motor is measured and saved 	

Setting of torque control

Use C0014 = 5 to set the operating mode "sensorless torque control".

Linking setpoint and selecting speed limitation

Link an external setpoint source with the torque setpoint via C0412/6. (📖 7-57)

Select the type of speed limitation. The speed is limited via setpoint 1 or the maximum frequency:

- Setpoint 1, if C0412/1 is linked with a setpoint source.
- Maximum frequency, if C0412/1 is not assigned.

Preparing motor parameter identification

You must enter the motor data of the motor nameplate:

- Rated motor speed (C0087)
- Rated motor current (C0088)
- Rated motor frequency (C0089)
- Rated motor voltage (C0090)
- Motor cos φ (C0091)

Motor parameter identification

Carry out the motor parameter identification. (📖 7-48)

Automatically detected parameters

V/f-rated frequency (C0015), slip compensation (C0021) and motor stator inductivity (C0092) are calculated and saved. The total resistance of motor cable and motor is measured and saved as motor stator resistance (C0084).

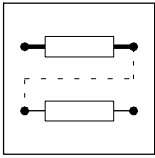

Function library

Selection of control mode, optimisation of operating behaviour

Optimising the sensorless torque control

In general, the sensorless torque control is ready for operation after the motor parameters have been identified. The drive performance can be optimised by manually setting several parameters:

Drive performance	Remedy
Torque is not constant	Reduce motor inductance (C0092) by approx. 10 ... 20 %. Idle current and maximum current decrease.
Drive does not accelerate from standstill	Raise the torque setpoint to 20 ... 25 %.
Controller is not able to follow the quick load changes	Adapt gain C0077) and adjustment time (C0078) of the I_{\max} -controller: <ul style="list-style-type: none">• Reduction of C0078 = I_{\max} controller becomes quicker (more dynamic)• Increase of C0078 = I_{\max} controller becomes slower ("smoother")

Tip

- The minimum torque setpoint must not fall below 10 % (setting range 1 : 10).
- The motor may stall at operation with output frequencies < 3 Hz. If so, reset the internal control by quickly switching the controller inhibit.
- If C0412/6 is combined with an analog signal source it is possible to display the torque setpoint under C0047.
- If C0412/6 is not combined with an analog signal source (FIXED-FREE) it is possible to select the torque setpoint under C0047. Please note:
 - When disconnecting the mains, the value set will be lost!
 - Before enabling the controller it is absolutely necessary at the restart to select the correct setpoint under C0047. Otherwise the drive would start with the maximum torque.



Note!

In the control modes "V/f characteristic control" and "vector control" the signal combined with C0412/6 or C0047 act as a torque limitation.

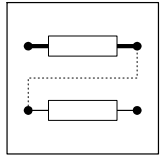

7.2 Optimising the operating behaviour

7.2.1 Slip compensation

Description

Under load, the speed of an asynchronous machine is reduced. This load dependent speed drop is called slip. The slip can be partly compensated by setting C0021 accordingly. The slip compensation is effective for all control modes (C0014).

Codes for parameter setting

Code		Possible settings			IMPORTANT	
No.	Name	Lenze	Selection			
C0021	Slip compensation	0.0	-50.0	{0.1 %}	50.0	C0021 is calculated and stored under C0148 when the motor parameters are identified 7-13

Automatic adjustment

The slip compensation is calculated during the motor parameter identification and entered under C0021.

Preparing motor parameter identification

You must enter the motor data of the motor nameplate:

- Rated motor speed (C0087)
- Rated motor current (C0088)
- Rated motor frequency (C0089)
- Rated motor voltage (C0090)
- Motor $\cos \varphi$ (C0091)

Motor parameter identification

Carry out the motor parameter identification. (7-48)

Automatically detected parameters

V/f-rated frequency (C0015), slip compensation (C0021) and motor stator inductivity (C0092) are calculated and saved. The total resistance of motor cable and motor is measured and saved as motor stator resistance (C0084).

Manual adjustment

The slip compensation must only be set if the motor parameter identification is not carried out. For this purpose the slip compensation initially must be coarsely adjusted on the basis of the motor data. The fine adjustment is made empirically during operation:

Coarse adjustment

1. Coarsely detect slip compensation and enter under C0021:

$s = \frac{n_{rsyn} - n_r}{n_{rsyn}} \cdot 100 \%$ $n_{rsyn} = \frac{f_r \cdot 60}{p}$	s	Slip constant (C0021) [%]
	n_{rsyn}	Synchronous motor speed [min^{-1}]
	n_r	Rated motor speed to motor nameplate [min^{-1}]
	f_r	Rated motor frequency to motor nameplate [Hz]
	p	No. of pole pairs (1, 2, 3, ...) of the motor
$n_{rsyn} = \frac{50\text{Hz} \cdot 60}{2} = 1500 \text{ min}^{-1}$ $s = \frac{1500 \text{ min}^{-1} - 1435 \text{ min}^{-1}}{1500 \text{ min}^{-1}} \cdot 100 \% = 4.33 \%$	Example for 4-pole motor / 1435 min^{-1} / 50 Hz: Preset C0021 = 4.3 %	

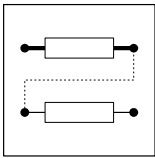

Function library

Selection of control mode, optimisation of operating behaviour

Fine adjustment

2. Correct C0021 during operation until no load-dependent speed drop occurs in the required speed range between idle running and maximum motor load. The following is regarded as the standard value for the correctly adjusted slip compensation:
 - Deviation of the rated speed $\leq 0.5\%$ for an output frequency of 5 ... 50 Hz (87 Hz)
 - Greater deviations are possible in the field weakening range



Note!

If C0021 is set too high, the drive can get instable.

Tip

- Set C0021 = 0.0 for speed control with internal process controller.
- Negative slip (C0021 < 0) at V/f characteristic control causes a “smoother” drive behaviour with high load impacts or multi-motor applications.

7.2.2 Inverter switching frequency

Description

The switching frequency of the inverter influences the smooth running performance, the power loss inside the controller, and the noise generation in the connected motor. The Lenze setting of 8 kHz is the optimum value for standard applications. The following general rule applies:

The lower the switching frequency the

- lower the power loss.
- higher the noise generation.

Moreover you can determine whether the switching frequency is changed over to 4 kHz if the heatsink temperature only amounts to approx. 5 °C below the permissible maximum temperature. This serves to prevent the drive from being inhibited by the “overtemperature” error and the motor from coasting without torque.



Note!

Note that when operating with a switching frequency of 16 kHz the output current must be reduced to prevent the controller from being overheated (derating).

The current limit values (C0022 and C0023) must be adapted so that the currents given in the technical data will not be exceeded.

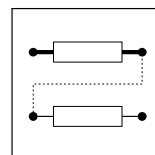

Codes for parameter setting

Code		Possible settings		IMPORTANT
No.	Name	Lenze	Selection	
C0018 <small>ENTER</small>	Switching frequency	2	0 2 kHz sin	General rule: The lower the switching frequency the <ul style="list-style-type: none"> • lower the power loss • higher the noise generation Only operate mid-frequency motors at 8 kHz sin or 16 kHz sin (C0018 = 2 or 3)!
			1 4 kHz sin	
			2 8 kHz sin	
			3 16 kHz sin low noise generation	
C0018 <small>ENTER</small>	Switching frequency (only 8200 vector 15 ... 90 kW)	6	0 2 kHz sin	General rule: The lower the switching frequency the <ul style="list-style-type: none"> • lower the power loss • higher the noise generation Only operate mid-frequency motors at 8 kHz sin or 16 kHz sin (C0018 = 2 or 3)!
			1 4 kHz sin	
			2 8 kHz sin	
			3 16 kHz sin low noise generation	
			4 2 kHz	
			5 4 kHz	
			6 8 kHz low power loss	
			7 16 kHz	
			8 1 kHz sin	
			9 ... 11 Reserved	
			12 1 kHz low power loss	
			C0144 <small>ENTER</small>	
1 Automatic switching frequency derating to 4 kHz, if ϑ_{\max} reaches $-5\text{ }^{\circ}\text{C}$				

Automatic switching frequency reduction

C0144 = 0 (no temperature-dependent switching frequency reduction)

If the maximum heatsink temperature (ϑ_{\max}) is exceeded when using a switching frequency of 8 kHz or 16 kHz the inverter will be inhibited, TRIP "OH" (overtemperature) will be set and the motor will coast to standstill.

C0144 = 1 (temperature-dependent switching frequency reduction is active):

- If the heatsink temperature $\vartheta_{\max} - 5\text{ }^{\circ}\text{C}$ is reached when using a switching frequency of 8 kHz or 16 kHz the controller automatically reduces the switching frequency to 4 kHz thus keeping the operation running.
- After cooling the heatsink the controller automatically changes to the switching frequency set.



Note!

The switching frequency is automatically set to its optimum value depending on the apparent motor current and output frequency to ensure trouble-free operation.

- The noise emission changes.
- The user cannot influence this function.

Tip

Medium-frequency motors are only allowed to be operated on 8 kHz sin or 16 kHz sin.

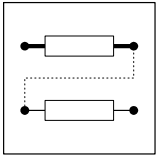

Function library

Selection of control mode, optimisation of operating behaviour

7.2.3 Oscillation damping

Description

Suppression of idling oscillations when:

- the rated power of controller and motor of a drive do not match, e.g. at operation with high switching frequency and the related power derating
- Operation of higher-pole motors
- Operation of special motors

Compensation of resonances in the drive

- Some asynchronous motors can show this behaviour when being operated with an output frequency of approx. 20 ... 40 Hz. As a result, operation can be instable (current and speed fluctuations).

Codes for parameter setting

Code		Possible settings			IMPORTANT
No.	Name	Lenze	Selection		
C0079	Oscillation damping	2	0 {1}	140	7-16

Adjustment

1. Approach with speed oscillations.
2. Reduce the speed oscillations by changing C0079 step by step. Additional indicators for smooth running can be:
 - uniform motor current
 - reduction of mechanical vibrations in the bearing seat



Note!

Compensate the resonances in speed-controlled operation via the parameters of the controller only.

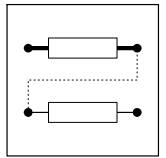

7.2.4 Skip frequencies

Description

With certain output frequencies, mechanical resonances might occur (e. g. fan). The skip frequencies suppress these unwanted output frequencies. The bandwidth (Δf) determines the skip frequency range.

The function is in the block NSET1 before the ramp function generator.

Codes for parameter setting

Code		Possible settings				IMPORTANT
No.	Name	Lenze	Selection			
C0625*	Skip frequency 1	0.00	0.00	{0.02 Hz}	650.00	7-17
C0626*	Skip frequency 2	0.00	0.00	{0.02 Hz}	650.00	
C0627*	Skip frequency 3	0.00	0.00	{0.02 Hz}	650.00	
C0628*	Bandwidth of skip frequencies	0.00	0.00	{0.01 %}	100.00	Applies to C0625, C0626, C0627

Adjustment



Note!

- Skip frequencies only effect main setpoints.
 - C0625, C0626, C0627, C0628 are the same for all parameter sets.
- Set the required skip frequencies under C0625, C0626, C0627.
 - C0628 defines the bandwidth for skip frequencies.
 - Calculation of bandwidth (Δf) for the respective skip frequency:

$$\Delta f \text{ [Hz]} = 2 \cdot f_s \text{ [Hz]} \cdot \frac{C0628 \text{ [\%]}}{100 \%}$$

f_s Skip frequency

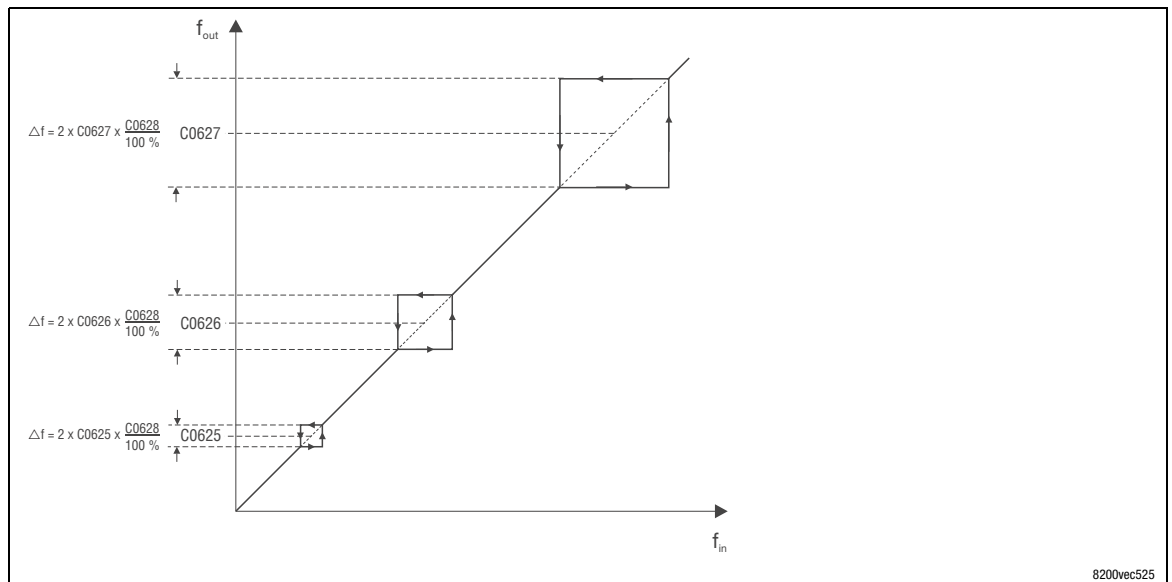
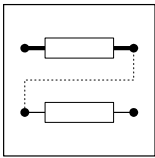

Fig. 7-4

Effect of the skip frequencies

f_{in} Input frequency of the function
 f_{out} Output frequency of the function



Function library

Selection of control mode, optimisation of operating behaviour

7.3 Behaviour in the event of mains switching, mains failure or controller inhibit

7.3.1 Start conditions/flying-restart circuit

Description

Determines the controller behaviour after a restart after controller inhibit, mains switching or a mains failure.

With activated flying-restart circuit the controller automatically synchronises to a coasting motor after mains disconnection or adds a setpoint signal.

Codes for parameter setting

Code		Possible settings		IMPORTANT		
No.	Name	Lenze	Selection			
C0142 <small>ENTER</small>	Start condition	1	0	Automatic restart after mains connection inhibited Flying restart not active	Start after HIGH-LOW-HIGH changes at X3/28	7-18
			1	Automatic start, if X3/28 = HIGH Flying restart circuit not active		
			2	Automatic restart after mains connection inhibited Flying-restart circuit active	Start after HIGH-LOW-HIGH changes at X3/28	
			3	Automatic start, if X3/28 = HIGH Flying restart circuit active		
C0143* <small>ENTER</small>	Selection of flying-restart	0	0	Max. output frequency (C0011) ... 0 Hz	Motor speed selected for the indicated range	7-18
			1	Last output frequency ... 0 Hz		
			2	Frequency setpoint addition (NSET1-NOUT)	The corresponding value is input after controller enable.	
			3	Act. process controller value (C0412/5) addition (PCTRL1-ACT)		

Drive behaviour without flying-restart circuit

Manual start (C0142 = 0):

After mains interruption the drive only restarts after a LOW/HIGH level change at the "Controller inhibit" terminal (X3/28).

Automatic start (C0142 = 1)

After mains interruption the drive only restarts if a HIGH level is applied to the "controller inhibit" terminal (X3/28).

The controller sets all integrators to zero and releases them again.

Drive behaviour with flying-restart circuit

Manual start with flying-restart circuit (C0142 = 2)

After mains interruption the drive only restarts after a LOW/HIGH level change at the "Controller inhibit" terminal (X3/28).

Automatic start with flying-restart circuit (C0142 = 3)

After mains interruption the drive only restarts if a HIGH level is applied to the "controller inhibit" terminal (X3/28).

Flying restart

With the selection of the flying restart (C0143) you define whether the controller searches for the motor speed after the restart or adds a signal.

Searching for the motor speed (C0143 = 0, C0143 = 1)

The drive starts if the momentary motor speed has been found. The acceleration is steady and smooth.

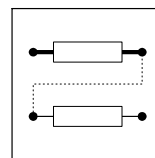

Note!

- The flying-restart circuit must not be used if several motors with different rotating masses are connected to a controller.
- The flying restart method is safe and reliable for drives with great rotating masses.
- With machines with low moments of inertia and small friction, the motor can restart for a short time or reverse after controller enable.

- The controller only searches the given direction of rotation.
- The controller calculates the output frequency required for the current speed of the idling motor, is connected and accelerates the motor until it reaches its setpoint.

Adding a signal (C0143 = 2, C0143 = 3)

The controller adds the output frequency corresponding to the frequency setpoint or the actual process controller value.



Note!

The actual process controller value must only be set if a speed-proportional signal is available in C0412/5!

Tip

If the flying-restart circuit **is not required** for every drive start, but only after mains reconnection:

- Bridge X3/28 with HIGH level and start the controller with the function “QSP” (C0142 = 3 and C0106 = 0 s).
- The flying-restart circuit is now only **activated for** for the first mains connection.

7.3.2 Controlled deceleration after mains failure/mains disconnection



Note!

This function cannot be used with a 8200 motec!

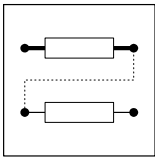

Function library

Selection of control mode, optimisation of operating behaviour

7.3.3 Controller inhibit

Description

If the controller inhibit is active, the power outputs are inhibited.

- The drive idles to standstill without torque.
- Keypad status display: Pulse inhibit **IMP**
- Status display of the controller: The green LED is blinking.



Danger!

Do not use controller inhibit (DCTRL1-CINH) as emergency off. The controller inhibit only inhibits the power outputs and does **not** disconnect the controller from the mains!

The drive could restart any time.

Codes for parameter setting

Code		Possible settings		IMPORTANT
No.	Name	Lenze	Selection	
C0040* ENTER	Controller inhibit (CINH)		-0- Controller inhibited (CINH) -1- Controller enabled (CINH)	Controller can only be enabled if X3/28 = HIGH 7-20

Activation

- Via terminal X3/28:
 - LOW level at the terminal activates the controller inhibit (cannot be inverted)
 - HIGH level enables the controller again
- Via digital signal (linking C0410/10 with a signal source):
 - LOW level at the signal source activates the controller inhibit (level inversion is possible with C0411)
 - HIGH level releases the controller again
- Via keypad (condition: C0469 = 1):
 - **STOP** activates the controller inhibit
 - **RUN** enables the controller again
- Via code C0040:
 - C0040 = 0 activates the controller inhibit
 - C0040 = 1 enables the controller again



Note!

- The sources for controller inhibit are ANDed, i. e. the drive only restarts when the controller inhibit is cancelled at all signal sources.
- The restart begins with an output frequency of 0 Hz, i.e. if the flying-restart circuit is not activated, still rotating masses can lead to generative overload.

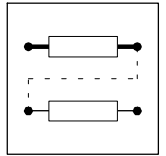

7.4 Limit value setting

7.4.1 Speed range

Description

The speed setting range required for the application can be set via the selection of output frequencies:

- The minimum output frequency (C0010) corresponds to the speed at 0 % speed setpoint selection.
- The maximum output frequency (C0011) corresponds to the speed at 100 % speed setpoint selection.
- The lower frequency limitation (C0239) sets the speed. Independently of the setpoint, the value cannot fall below this speed (e.g. for fans, dancer position control, or dry running protection for pumps).



Fig. 7-5 Relation between setpoint and minimum and maximum output frequency

Codes for parameter setting

Code		Possible settings				IMPORTANT
No.	Name	Lenze	Selection			
C0010 uSEr	Minimum output frequency	0.00	0.00	{0.02 Hz}	650.00	<ul style="list-style-type: none"> • C0010 is not effective with bipolar setpoint selection (-10 V ... + 10 V) • C0010 only defines the analog input 1 • As of software 3.5: If C0010 > C0011, the drive does not start running with controller enable. <p>→ Speed setting range 1 : 6 for Lenze geared motors: Setting absolutely required for operation with Lenze geared motors.</p>
C0011 uSEr	Maximum output frequency	50.00	7.50	{0.02 Hz}	650.00	
C0239	Lowest frequency limit	-650.00	-650.00	{0.02 Hz}	650.00	<ul style="list-style-type: none"> • The value does not fall below limit independently of the setpoint. • If the minimum frequency limitation is active, the automatic DC-injection brake (auto DCB) must be deactivated (C0019 = 0 or C0106 = 0).
C0236 (A)	Acceleration time - minimum frequency limitation	0.00	0.00	{0.02 s}	1300.00	Ref. to C0011 Minimum frequency limitation = C0239

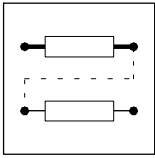

Function library

Limit value setting

Adjustment

Relation between output frequency and synchronous speed of the motor:

$n_{\text{rsyn}} = \frac{C0011 \cdot 60}{p}$	r_{rsyn} Synchronous motor speed [min^{-1}] C0011 Max. output frequency [Hz] p No. of pole pairs (1, 2, 3, ...)
Example: 4-pole asynchronous motor: $p = 2$, $C0011 = 50 \text{ Hz}$	$n_{\text{rsyn}} = \frac{50 \cdot 60}{2} = 1500 \text{ min}^{-1}$

C0010

"Minimum output frequency" characteristics:

- C0010 is approached via the acceleration ramp.
- C0010 has no effect
 - on the analog input 2 of the application I/O.
 - when the setpoint is selected via frequency input.
- $C0010 \geq C0011$:
 - C0011 is approached via the acceleration ramp regardless of the selected analog setpoint.
 - The output frequency is limited to C0011.
 - The analog input gain must be set to zero ($C0027 = 0$), to ensure a trouble-free operation.

C0011

"Maximum output frequency" characteristics:

- When selecting fixed setpoint (JOG) C0011 acts as limitation.
- C0011 is an internal normalisation variable! Bigger changes should only be made when the controller is inhibited!



Stop!

Set C0011 so that the maximum permissible motor speed will not be exceeded. Otherwise the motor can be destroyed.

C0239

"Lower frequency limitation" characteristics:

- When using standard I/O, C0239 is approached without acceleration ramp (jolt!). When using application I/O, C0236 can be used to set an acceleration time for C0239.
- $C0239 = 0.00 \text{ Hz}$ only allows one direction of rotation.

Tip

- For output frequencies $> 300 \text{ Hz}$, switching frequencies $< 8 \text{ kHz}$ must be avoided.
- The display values of C0010 and C0011 can be related to a process variable under C0500 and C0501.

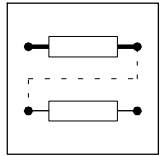

7.4.2 Current limits

Description

The controllers are equipped with a current-limit control which determines the dynamic response under load. The measured load is compared with the limit values set under C0022 for motor load and C0023 for generator load. If the current limit is exceeded, the controller will change its dynamic behaviour:

Controller performance when a limit value is reached

Motor overload during acceleration:

The controller prolongs the acceleration ramp.

Generator overload during deceleration:

The controller prolongs the deceleration ramp.

With increasing load and constant speed:

- When the current limit of the motor mode is reached:
 - The controller reduces the output frequency to 0 Hz.
 - The controller cancels the change of the output frequency if the load falls below the limit value.
- When the current limit in the generator mode is reached:
 - The controller increases the output frequency up to the maximum frequency (C0011).
 - The controller cancels the change of the output frequency if the load falls below the limit value.
- If suddenly a load is applied to the motor shaft (e.g. drive is blocked), the overcurrent switch-off can be activated (error message OCX).

Codes for parameter setting

Code		Possible settings			IMPORTANT
No.	Name	Lenze	Selection		
C0022	I_{\max} limit (motor mode)	150	30 {1 %}	150	Only 8200 vector 15 ... 90 kW: If C0022 = 150 %, 180 % I_r are available for max. 3 s. after controller enable 7-23
C0023	I_{\max} -limit in the generator mode	150	30 {1 %}	150	C0023 = 30 %: function is inactive, if C0014 = 2, 3: 7-23

Adjustment

- Set the acceleration and deceleration times so that the drive can follow the speed profile without reaching I_{\max} of the controller.
- C0022 and C0023 refer to the rated output current at a switching frequency of 8 kHz.
- When operating with a switching frequency of 16 kHz you must adapt C0022 and C0023 to the permissible output currents (derating).
- Correct current control for operation in generator mode is only possible with external brake resistor.

C0023 = 30 %

At V/f characteristic control the current-limit controller is not active for the operation in generator mode with C0023 = 30%:

- Possibly reasonable in applications with medium frequency asynchronous motors if motor and generator mode cannot be detected as fault-free.
- Drive behaviour in case of motor and generator overload (C0054 > C0022):
 - The controller reduces the output frequency to 0 Hz.
 - The controller cancels the change of the output frequency if the load falls below the limit value.

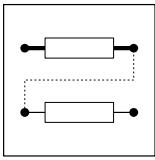

Function library

Acceleration, deceleration, braking, stopping

7.5 Acceleration, deceleration, braking, stopping

7.5.1 Setting of acceleration times, deceleration times and S-shaped ramps

Description

The acceleration times and deceleration times determine the controller response after a setpoint change.

The ramp function generator for the main setpoint can be set linearly or S-shaped. The S-shape selection of the main setpoint enables the drive to start and stop smoothly.

When operating with application I/O three additional deceleration times and acceleration times can be activated via digital signals.

Codes for parameter setting

Code		Possible settings			IMPORTANT
No.	Name	Lenze	Selection		
C0012 uSEr	Acceleration time main setpoint	5.00	0.00	{0.02 s} 1300.00	Reference: frequency change 0 Hz ... C0011 • Additional setpoint ⇒ C0220 • Acceleration times can be activated via digital signals ⇒ C0101
C0013 uSEr	Deceleration time main setpoint	5.00	0.00	{0.02 s} 1300.00	Reference: frequency change C0011 ... 0 Hz • Additional setpoint ⇒ C0221 • Deceleration times can be activated via digital signals ⇒ C0103
C0101 (A)	Acceleration times - main setpoint		0.00	{0.02 s} 1300.00	Binary coding of the digital signal sources assigned to C0410/27 and C0410/28 determine the active time pair
1	C0012	5.00			
2	T _{ir} 1	2.50			
3	T _{ir} 2	0.50			
4	T _{ir} 3	10.00			
C0103 (A)	Deceleration times - main setpoint		0.00	{0.02 s} 1300.00	C0410/27 C0410/28 Active LOW LOW C0012; C0013 HIGH LOW T _{ir} 1; T _{if} 1 LOW HIGH T _{ir} 2; T _{if} 2 HIGH HIGH T _{ir} 3; T _{if} 3
1	C0013	5.00			
2	T _{if} 1	2.50			
3	T _{if} 2	0.50			
4	T _{if} 3	10.00			
C0182*	Integration time S-ramps	0.00	0.00	{0.01 s} 50.00	• C0182 = 0.00: Linear ramp function generator operation • C0182 > 0.00: S-shaped ramp function generator (smooth)
C0220*	Acceleration time - additional setpoint (PCTRL1-NADD)	5.00	0.00	{0.02 s} 1300.00	Main setpoint ⇒ C0012
C0221*	Deceleration time - additional setpoint (PCTRL1-NADD)	5.00	0.00	{0.02 s} 1300.00	Main setpoint ⇒ C0013

Adjustment

- The acceleration and deceleration times refer to an output frequency change from 0 Hz to the max. output frequency set under C0011.
- Calculate the times T_{ir} and T_{if}, which must be set under C0012 and C0013.

$T_{ir} = t_{ir} \cdot \frac{C0011}{f_2 - f_1}$ $T_{if} = t_{if} \cdot \frac{C0011}{f_2 - f_1}$	t_{ir} and t_{if} are the times required for the change between f_1 and f_2 :
---	---

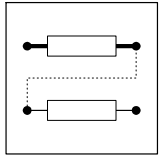

Note!

If the acceleration and deceleration times are set too short the controller may switch off with TRIP OC5 under unfavorable service conditions. In these cases, the acceleration and deceleration times should be set short enough so that the drive can follow the speed profile without reaching I_{max} of the controller.

Linear ramp setting

C0182 = 0.00: Linear ramp function generator operation for the main setpoint.

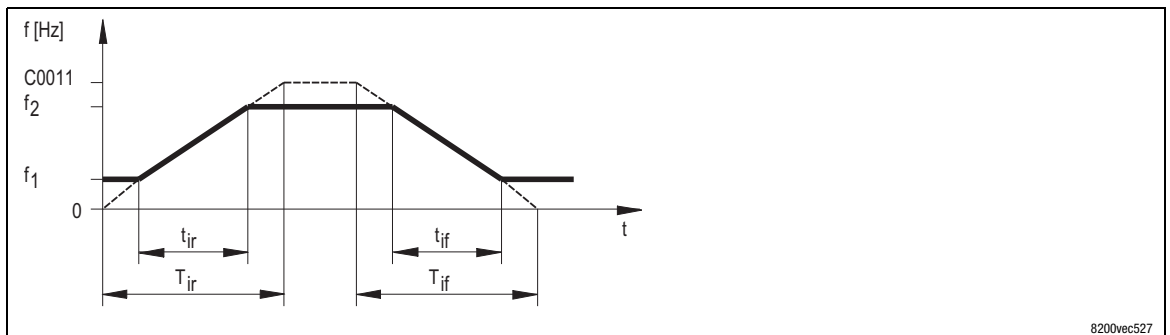

Fig. 7-6

Acceleration times and deceleration times for linear ramp function generator

S-shaped ramp setting

C0182 > 0.00: S-shaped (smooth) ramp function generator operation for the main setpoint.

- The value of C0182 determines the shape of the S-curve.
- C0182 has no effect on the additional setpoint (PCTRL1-NADD).

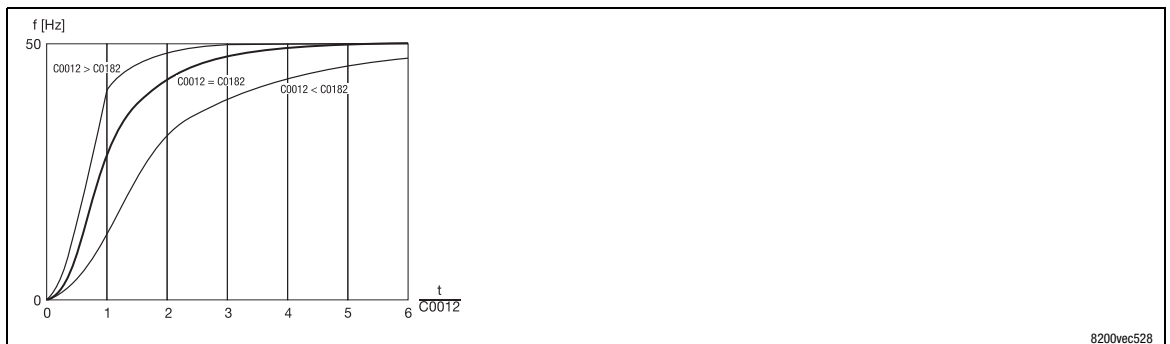

Fig. 7-7

Acceleration times and deceleration times for linear ramp function generator



Note!

- The ramp function generator operation in the parameter sets must not differ as C0182 is the same in all parameter sets.
- The S-shaped ramp also has an effect on the deceleration time for quick stop!

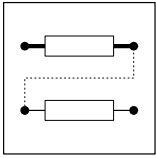

Function library

Acceleration, deceleration, braking, stopping

Special functions for the ramp function generator

Setting the ramp function generator to 0

The ramp function generator input of the main setpoint can be set to 0 under C0410/6:

- The main setpoint decelerates to 0 Hz along the deceleration ramp (C0013) as long as the function is active.
- With setpoint summation or in controlled operation the drive can continue to run.

Stopping the ramp function generator

The ramp function generator of the main setpoint can be stopped under C0410/5 (NSET1-RFG1-STOP).

The ramp function generator output value remains the same as long as the function is active.

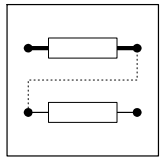

7.5.2 Quick stop

Description

Quick stop decelerates the drive to standstill according to the deceleration time set under C0105, as soon as the signal DCTRL1-QSP is activated.

If the output frequency falls below the threshold C0019, the automatic DC injection brake (DCB) is activated. After the holding time (C0106) the controller sets pulse inhibit (display: **IMP**).

Quick stop acts on

- the main setpoint (NSET1-N1, NSET1-N2).
- the additional setpoint (PCTRL1-NADD).
- the process controller setpoint 1 (PCTRL1-SET1) (only application I/O).



Note!

The S-shaped ramp (C0182) has also an effect on quick stop! Therefore the real deceleration time is longer than set under C0105.

Reduce the time setting under C0105 to reach the desired deceleration time for quick stop.

Codes for parameter setting

Code		Possible settings			IMPORTANT	
No.	Name	Lenze	Selection			
C0105	Deceleration time quick stop (QSP)	5.00	0.00 {0.02 s} 1300.00		<ul style="list-style-type: none"> • Quick stop (QSP) decelerates the drive to standstill according to the ramp set under C0105. • If the output frequency falls below the threshold C0019, the DC-injection brake (DCB) will be activated. • The S-shaped ramp (C0182) has also an effect on quick stop! <ul style="list-style-type: none"> – Reduce the time setting under C0105 to reach the desired deceleration time for quick stop. – The S-shaped ramp for the quick stop can be switched off under C0311 (as of software 3.1). 	7-27
C0019	Operating threshold - automatic DC injection brake (auto DCB)	0.10	0.00 = inactive {0.02 Hz}	650.00	Hold time ⇒ C0106 Deactivate automatic DC injection brake (auto DBC): <ul style="list-style-type: none"> • at active lower frequency limitation (C0239) • at operating mode C0014 = 5 	7-30
C0106	Hold time for automatic DC-injection brake (Auto DCB)	0.50	0.00 = auto DCB not active {0.01 s}	999.00 = ∞	Hold time, if DC-injection brake is activated because the value falls below the setting under C0019.	7-30

Activation

Via digital signal:

C0410/4 must be combined with digital signal source.

- LOW level at the signal source activates quick stop
- Level inversion with C0411 is possible

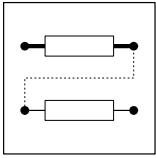

Function library

Acceleration, deceleration, braking, stopping



Note!

Quick stop can also be activated when using the function "fail-safe change of the direction of rotation". (□ 7-28)

In addition to the free configuration under C0410 you can also use the fixed assignment under C0007 to combine the function with a digital input.

Via keypad:

Assign the key with the quick stop function (C0469 = 2):

- **STOP** activates quick stop
- **RUN** restarts the drive

7.5.3

Change of direction of rotation

Description

Change of direction of motor rotation via digital control signals. Only the main setpoint is changed.

The direction of rotation can be changed in a fail-safe or non-fail-safe way. Depending on the type of change-over, the controller brakes the motor to 0 Hz along the deceleration ramp or quick stop ramp in order to accelerate the motor along the acceleration ramp in the other direction of rotation.

The reversing time depends on the ramp times set for the main setpoint or quick stop.

Non-fail-safe change of the direction of rotation

Link C0410/3 with a digital signal source.

If the direction of rotation is changed, the drive brakes along the deceleration ramp (C0013) and accelerates along the acceleration ramp (C0012) in the other direction of rotation.

Direction of rotation with in-phase connection and HIGH active signal:

- LOW = CW rotation
- HIGH = CCW rotation



Note!

In case of open circuit or failure of the external control voltage, the drive may reverse the direction of rotation.

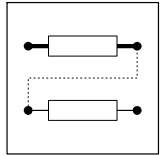

Fail-safe change of the direction of rotation

Link C0410/22 and C0410/23 with one digital signal source each.

If the direction of rotation is changed, the drive brakes along the quick stop ramp (C0105) and accelerates along the acceleration ramp (C0012) in the other direction or rotation.

Direction of rotation with in-phase connection and HIGH active signal:

Direction of rotation	Signal level at		Notes
	C0410/22 (DCTRL1-CW/QSP)	C0410/23 (DCTRL1-CCW/QSP)	
CCW rotation	LOW	HIGH	<ul style="list-style-type: none"> • During operation: The direction of rotation results from the signal which was active first. • When switching on the mains: The controller activates quick stop (QSP).
CW rotation	HIGH	LOW	
Quick stop	LOW	LOW	
Unchanged	HIGH	HIGH	



Note!

In addition to the free configuration in C0410 you can also use the fixed assignment in C0007 to link the "change direction of rotation" function with a digital input.

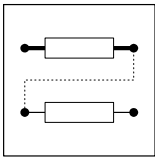

Function library

Acceleration, deceleration, braking, stopping

7.5.4 DC braking (DCB)

Description

The DC-injection brake enables quick deceleration of the drive to standstill without using an external brake resistor. The DC-injection brake can be activated via terminal or automatically.

- The braking torque amounts to approx. 20 ... 30 % of the rated motor torque. It is lower than for braking in generator mode with external brake resistor.
- A brake voltage or a brake current can be selected.
- Automatic DC braking improves the starting performance of the motor e.g. when operating hoists.

Codes for parameter setting

Code		Possible settings			IMPORTANT
No.	Name	Lenze	Selection		
C0019	Operating threshold - automatic DC injection brake (auto DCB)	0.10	0.00 {0.02 Hz} = inactive	650.00	Hold time ⇒ C0106 Deactivate automatic DC injection brake (auto DCB): • at active lower frequency limitation (C0239) • at operating mode C0014 = 5
C0035* ENTER	DC injection brake (DCB) control mode	0	0 Brake voltage selection under C0036 1 Brake current selection under C0036		Hold time ⇒ C0107
C0036	Voltage/current DC injection brake (DCB)	→	0.00 {0.01 %} 150.00 %		→ Depending on the controller • Reference M_r , I_r • Setting applies to all mains voltages permitted
C0106	Hold time for automatic DC-injection brake (Auto DCB)	0.50	0.00 {0.01 s} = auto DCB not active	999.00 = ∞	Hold time, if DC-injection brake is activated because the value falls below the setting under C0019.
C0107	Hold time DC injection brake (DCB)	999.00	1.00 {0.01 s}	999.00 = ∞	Hold time, if DC-injection brakes are activated via an external terminal or control word.
C0196* ENTER	Activation of auto-DCB	0	0 Auto-DCB active, if PCTRL1-SET3 < C0019 1 Auto-DCB active, if PCTRL1-SET3 < C0019 and NSET1-RFG1-IN < C0019		

Adjustment

1. Use C0035 to select whether a brake voltage or a brake current shall be selected.
2. Enter the brake voltage or brake current under C0036 in percent.
 - If C0035 = 0, the data refers to the rated voltage of the controller.
 - If C0035 = 1, the data refers to the rated current of the controller.
3. Select how to activate the DC injection brake:
 - Via digital input signal (configuration with C0410/15)
 - Automatically when the values are fallen below the operating threshold C0019 (condition: C0106 > 0.00 s)

Activate DC-injection braking via input signal (DCB)

Link C0410/15 with a digital signal source.

In case of HIGH-active inputs, the DC-injection braking (DCB) remains active as long as the signal is on HIGH level.

After the hold time (C0107) has elapsed, the controller sets pulse inhibit (keypad display: **IMP**).



Note!

In addition to the free configuration in C0410 you can also use the fixed assignment in C0007 to link the function with a digital input.

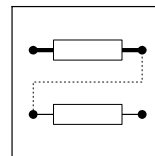

Activate automatic DC-injection braking (auto DCB)

1. Select the hold time >0.00 s under C0106:
 - The automatic DC-injection braking (auto DCB) is active for the set time.
 - Afterwards, the controller sets pulse inhibit (keypad display: **IMP**).
2. Select the condition for activating the automatic DC-injection braking under C0196:
 - C0196 = 0: auto DCB active if the output frequency is lower than the operating threshold ($C0050 < C0019$)
 - C0196 = 1: auto DCB is active if the output frequency is lower than the operating threshold ($C0050 < C0019$) **and** the setpoint is lower than the operating threshold (setpoint $< C0019$)
3. Set the operating threshold under C0019.



Note!

If DC-injection braking is operated too long with high brake current or brake voltage, the connected motor can be overheated!

Setting tips

- Use C0019 to set a dead band in the setpoint. If DC-injection braking is not to be active here, set C0106 = 0.00 s.
- C0019 can be referred to a process variable.

7.5.5

AC motor braking



Note!

This function cannot be used with a 8200 motec!

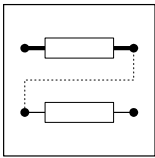

Function library

Configuration of analog and digital setpoints and actual values

7.6 Configuration of analog and digital setpoints and actual values

7.6.1 Setpoint source selection

Description

Fixed setpoint source selection.

- C0001 = 0, 2: Setpoint source as described in the following. Link the setpoint source with the internal analog signal under C0412.
- C0001 = 1: Setpoint source is the parameter channel of AIF. The freely configurable signals are “switched off” (C0412/x = 0 or 255). The setpoint must be written to the codes which are assigned to the signals (see signal flow charts or description of C0412).
- C0001 = 3: Setpoint source is the process data channel of AIF. The setpoint is written to an AIF input word (AIF-IN.W1 or AIF-IN.W2). Link the AIF input word with the internal analog signal under C0412.

Codes for parameter setting

Code		Possible settings		IMPORTANT	
No.	Name	Lenze	Selection		
C0001 <small>ENTER</small>	Selection of setpoint entry (operating mode)	0		<ul style="list-style-type: none"> • Changing C0001 will cause the changes mentioned below under C0412 and C0410, if no free configuration under C0412 was made before. • In the event that a free configuration was made under C0412 (verification = C0005 = 255), C0001 does not influence C0412 and C0410. The signals must be linked manually. • Free configuration under C0412 or C0410 does not change C0001! • The control can be realised via terminals or PC/keypad 	
			0	Setpoint entry via AIN1 (X3/8 or X3/1U, X3/1)	<ul style="list-style-type: none"> • C0412/1 and C0412/2 are linked with the analog input 1 (C0412/1 = 1, C0412/2 = 1). • C0410 is not changed.
			1	Setpoint entry via keypad or parameter channel of an AIF bus module	<ul style="list-style-type: none"> • Under C0412 the linkage with the analog input is separated (C0412/1 = 255, C0412/2 = 255). • Setpoint selection via C0044 or C0046. • C0410 is not changed.
			2	Setpoint selection via AIN1 (X3/8 or X3/1U, X3/1)	<ul style="list-style-type: none"> • C0412/1 and C0412/2 are linked with the analog input 1 (C0412/1 = 1, C0412/2 = 1) • C0410 is not changed.
			3	Setpoint selection via process channel of an AIF bus module	<ul style="list-style-type: none"> • C0001 = 3 must be set to select a setpoint via a process data channel of an AIF bus module (types 210x, 211x, 213x, 217x)! Otherwise the process data will not be evaluated. • C0412/1 and C0412/2 are linked with the analog input words AIF-IN.W1 and AIF-IN.W2 (C0412/1 = 10, C0412/2 = 11). • C0410/1 ... C0410/16 are linked with the single bit of the AIF control word (AIF-CTRL) (C0410/1 = 10 ... C0410/16 = 25)

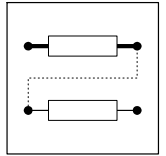

Note!

- With C0001 = 0, 1 or 2 the operation can start after the controller has been released.
- C0001 = 3 must be set to select a setpoint via a process data channel of an AIF bus module! Otherwise the process data will not be evaluated.
- With C0001 = 3 quick stop (QSP) is set after mains switch-on !
 - PC: Deactivate QSP using the control word C0135, bit 3 = 0.
 - Keypad: Set C0469 = -2-. Press **RUN**.

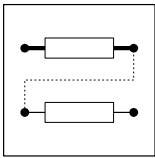

Function library

Configuration of analog and digital setpoints and actual values

7.6.2 Analog setpoints via terminal

Description

Selection and adjustment of analog signals via terminal as setpoint or actual value.

Codes for parameter setting

Code		Possible settings			IMPORTANT	
No.	Name	Lenze	Selection			
C0034* <small>ENTER</small> ↵SEr	Setpoint selection range Standard-I/O (X3/8)	0	0	Unipolar voltage 0 ... 5 V / 0 ... 10 V Current 0 ... 20 mA	Observe the switch position of the function module! Changing the direction of rotation is only possible with a digital signal. • Minimum output frequency (C0010) not effective • Individual adjustment of offset and gain TRIP Sd5, if I < 4 mA Changing the direction of rotation is only possible with a digital signal.	
			1	Current 4 ... 20 mA		
			2	Bipolar voltage -10 V ... +10 V		
			3	Current 4 ... 20 mA open-circuit monitored		
C0034* <small>ENTER</small> (A) ↵SEr	Setpoint selection range Application I/O	0	1	Unipolar voltage 0 ... 5 V / 0 ... 10 V	Observe the jumper setting of the function module! Minimum output frequency (C0010) not effective Changing the direction of rotation is only possible with a digital signal. Changing the direction of rotation is only possible with a digital signal. TRIP Sd5 if I < 4 mA	
			2	Bipolar voltage -10 V ... +10 V		
			3	Current 0 ... 20 mA		
			4	Current 4 ... 20 mA		
			1	X3/1U, X3/1I		
			2	X3/2U, X3/2I		
C0026*	Offset analog input 1 (AIN1-OFFSET)	0.0	-200.0	{0.1 %}	200.0	• Settings for X3/8 and X3/1U, X3/1I • The max. limit of the setpoint value range of C0034 equals 100 % • C0026 and C0413/1 are identical
C0027*	Gain analog input 1 (AIN1-GAIN)	100.0	-1500.0	{0.1 %}	1500.0	• Settings for X3/8 and X3/1U, X3/1I • 100.0 % = Gain 1 • Inverse setpoint selection by negative gain and negative offset • C0027 and C0414/1 are identical
C0413*	Offset - analog inputs	0.0	-200.0	{0.1 %}	200.0	The upper limit of the setpoint range from C0034 corresponds to 100 % Setting for X3/8 or X3/1U, X3/1I C0413/1 and C0026 are the same
C0414*	Gain - analog inputs	100.0	-1500.0	{0.1 %}	1500.0	• 100.0 % = gain 1 • Inverted setpoint selection through negative gain and negative offset Setting for X3/8 or X3/1U, X3/1I C0414/1 and C0027 are the same

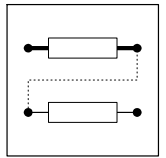

Code		Possible settings		IMPORTANT	
No.	Name	Lenze	Selection		
C0430* (A)	Automatic analog input adjustment	0	0 not active	Gain and offset are calculated by two points from the setpoint characteristic. Choose two points distant from each other to increase the calculation accuracy. 1. Select and input under C0430 which you want to calculate gain and offset for 2. Enter point 1 under C0431 X value (setpoint) and Y value (output frequency) 3. Enter point 2 under C0432 X value (setpoint) and Y value (output frequency) 4. Calculated values are automatically entered under C0413 (offset) and C0414 (gain)	
			1 Input point for X3/1U, X3/1I		
			2 Input points for X3/2U, X3/2I		
C0431* (A)	Coordinates point 1		-100.0 {0.1 %} 100.0		
			1 X (P1)		-100.0 Analog setpoint of P1 100 % = max. input value (5 V, 10 V or 20 mA)
			2 Y (P1)		-100.0 Output frequency of P1 100 % = C0011
C0432* (A)	Coordinates point 2		-100.0 {0.1 %} 100.0		
			1 X (P2)		100.0 Analog setpoint of P2 100 % = max. input value (5 V, 10 V or 20 mA)
			2 Y (P2)		100.0 Output frequency of P2 100 % = C0011

Adjustment

1. Assign the desired setpoint or actual value to an analog input under C0412 (C0412/x = 1 or 4).



Note!

In addition to the free configuration under C0412 it is also possible to select a fixed configuration under C0005.

2. Select the setpoint range under C0034.
3. Set the switch and jumper at the function module for the same range. Otherwise the setpoint signal cannot be interpreted correctly.
 - The setpoint signal is only evaluated in the setpoint range set (C0034), independently of the gain.
 - The minimum output frequency (C0010) corresponds to 0 % setpoint signal.
 - With offset ≠ 0 % and/or inverse setpoint selection the value set under C0010 may not be reached.
4. If necessary, adjust the gain (C0414)
 - The gain always affects setpoint signal and offset.
 - 100 % equals gain factor = 1.
 - Calculate the gain on the basis of two points of the setpoint characteristic and observe the signs of the coordinates:

$$\text{Gain [\%]} = \frac{f(P_2) - f(P_1)}{U(P_2) - U(P_1)} \cdot 100 \%$$

5. If necessary, adjust the offset (C0413).
 - The offset shifts the characteristic.
 - A dead band can be set through the offset and if necessary via C0239 (lower frequency limit).
 - Calculate the offset from the calculated gain and one point of the setpoint characteristic and observe the signs of the coordinates:

$$\text{Offset (P}_2\text{) [\%]} = \frac{f(P_2) [\%]}{\text{Gain [\%]}} \cdot 100 \% - U(P_2) [\%]$$

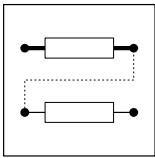

Function library

Configuration of analog and digital setpoints and actual values



Note!

- C0026, C0027, C0413 and C0414 are identical in all parameter sets.
- For operation with application I/O the setpoint inputs can be adjusted automatically via C0430, C0431 and C0432:
 - Select a setpoint input under C0430.
 - Enter the coordinates of two points of the setpoint characteristic under C0431 and C0432.
 - The calculated values are entered automatically as offset (C0413) and gain (C0414).

Unipolar setpoint selection

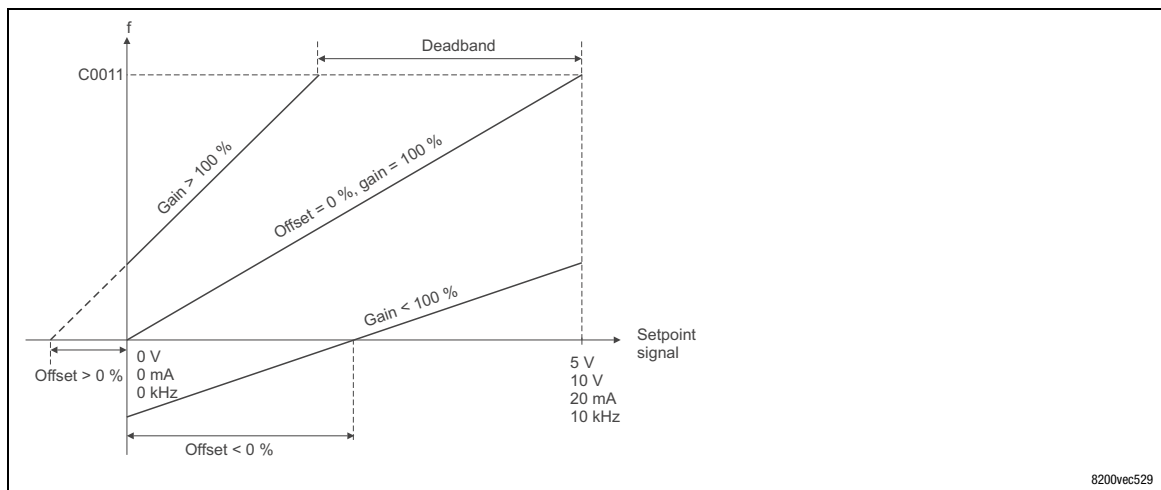

Fig. 7-8

Gain and offset at unipolar setpoint selection

Bipolar setpoint selection

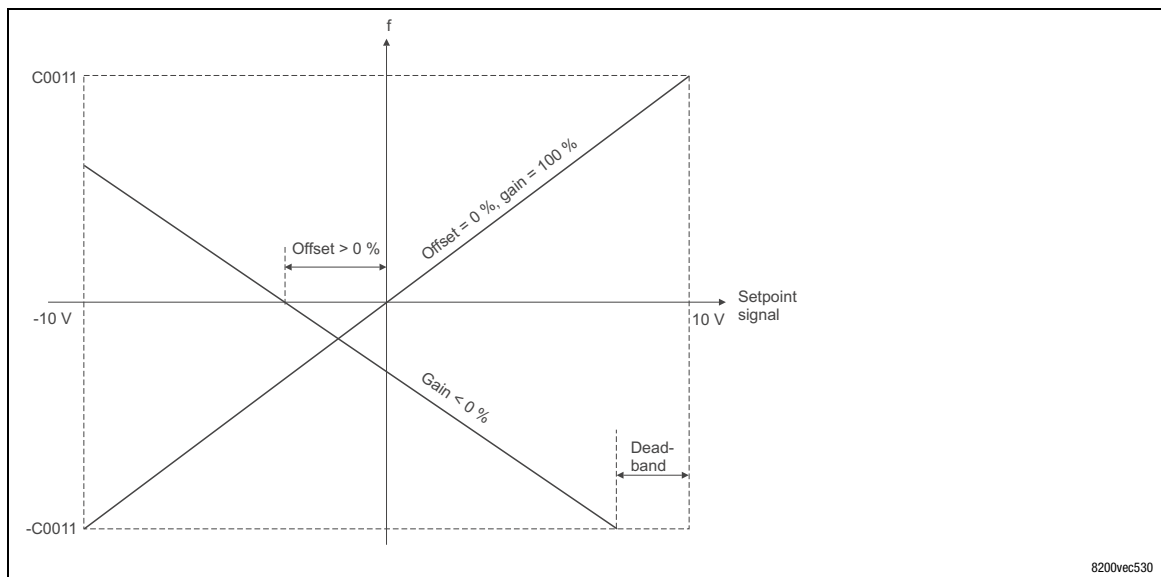
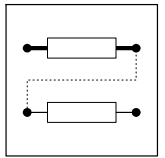

Fig. 7-9

Gain and offset at bipolar setpoint selection



Inverse setpoint selection

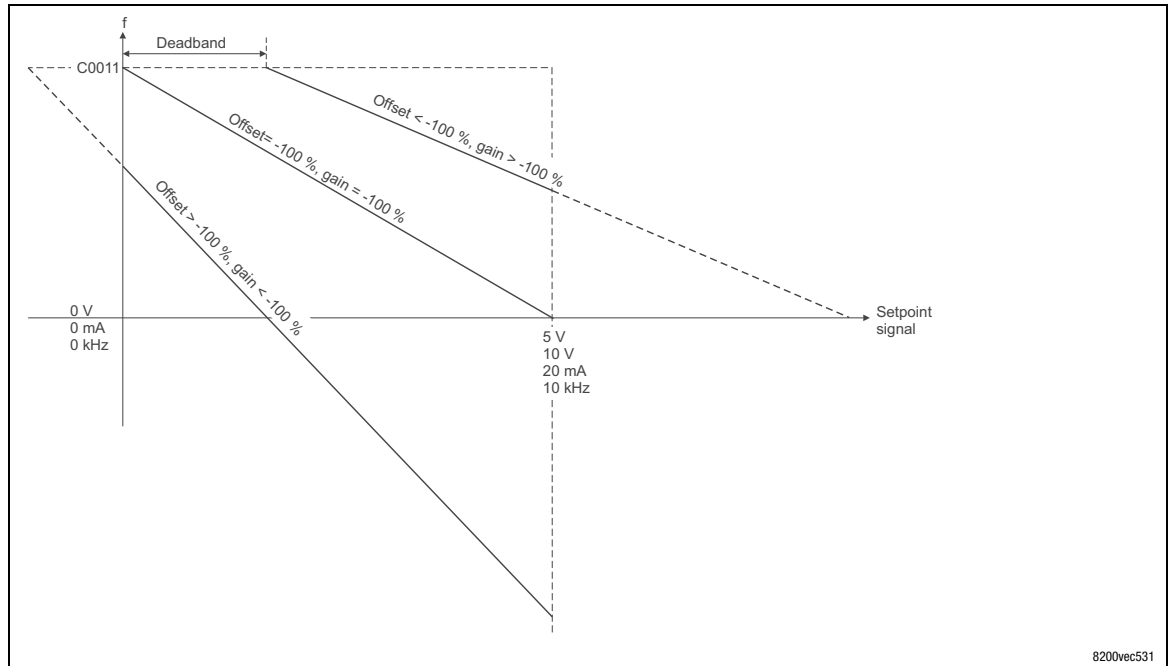

Fig. 7-10

Gain and offset at inverse setpoint selection

Example of inverse setpoint selection

A dead band of +2 V (= 20 %) is to be set for an inverse setpoint selection (0 ... +10 V). The output frequency is to be inverted with an increasing setpoint signal and is to reach -30 % at setpoint +10 V.

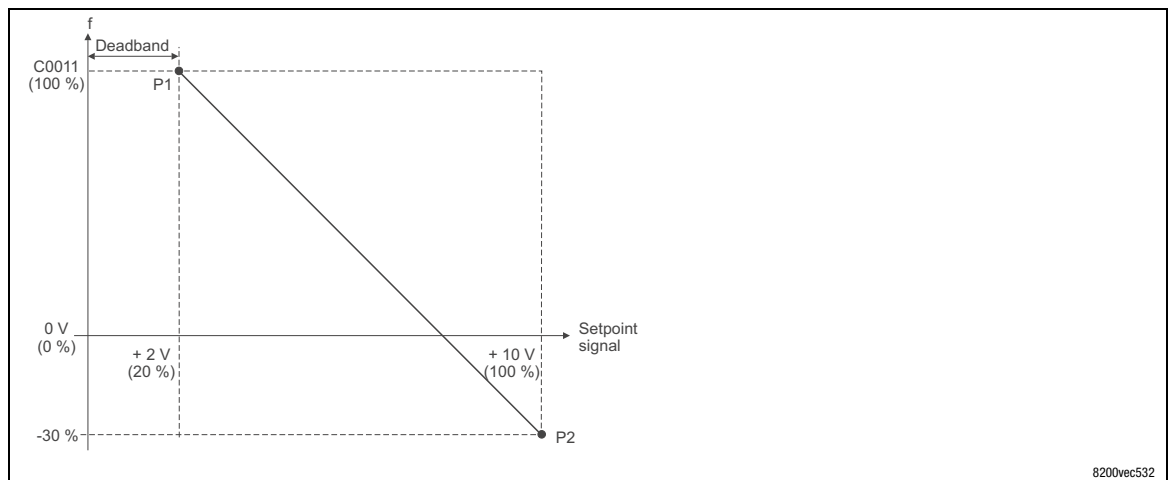

Fig. 7-11

Calculation example for gain and offset

Gain calculation

$$\text{Gain [\%]} = \frac{f(P_2) - f(P_1)}{U(P_2) - U(P_1)} \cdot 100\% = \frac{-30\% - 100\%}{100\% - 20\%} \cdot 100\% = -162.5\%$$

Offset calculation

$$\text{Offset } (P_2) [\%] = \frac{f(P_2) [\%]}{\text{Gain} [\%]} \cdot 100\% - U(P_2) [\%] = \frac{-30\%}{-162.5\%} \cdot 100\% - 100\% = -81.5\%$$

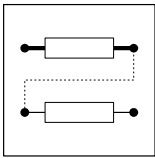

Function library

Configuration of analog and digital setpoints and actual values

Example: Calibration when using a process controller

Example for pressure control

If, for instance, the control range of a pressure control is to be limited to a value lower than the rated sensor value P_r , the effective pressure setpoint can be proportionally reduced through the gain of the analog input (C0027, C0414):

- Actual pressure value via pressure sensor ($P_r = 0 - 200$ mbar) at X3/2U (C0412/5 = 4).
- Analog pressure setpoint via X3/1U (C0412/4 = 1).
- The maximum pressure is to be limited to 120 mbar. Reduce the effective pressure setpoint via the gain of the analog input:

$$C0414/1 = \frac{P_1}{P_N} \cdot 100\% = \frac{120 \text{ mbar}}{200 \text{ mbar}} \cdot 100\% = 60\%$$

Gain calculation

$$\text{Gain [\%]} = \frac{f(P_2) - f(P_1)}{U(P_2) - U(P_1)} \cdot 100\% = \frac{-30\% - 100\%}{100\% - 20\%} \cdot 100\% = -162.5\%$$

Offset calculation

$$\text{Offset (P}_2\text{) [\%]} = \frac{f(P_2) [\%]}{\text{Verstärkung [\%]}} \cdot 100\% - U(P_2) [\%] = \frac{-30\%}{-162.5\%} \cdot 100\% - 100\% = -81.5\%$$

Example: Calibration when using a process controller

Example for pressure control

The control range of a pressure control is to be limited to a value lower than the rated sensor value P_N . For this purpose, the effective pressure setpoint can be proportionally reduced through the gain of the analog input (C0027, C0414):

- Actual pressure value via pressure sensor ($P_N = 0 - 200$ mbar) at X3/2U (C0412/5 = 4).
- Analog pressure setpoint via X3/1U (C0412/4 = 1).
- The maximum pressure is to be limited to 120 mbar. Reduce the effective pressure setpoint via the gain of the analog input.

$$C0414/1 = \frac{P_1}{P_N} \cdot 100\% = \frac{120 \text{ mbar}}{200 \text{ mbar}} \cdot 100\% = 60\%$$

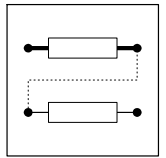

7.6.3 Digital setpoints via frequency input

Description

It is possible to configure the digital inputs E1 and E2 of the standard I/O or application I/O as frequency input. This enables you to select a digital frequency as setpoint or actual value:

- For operation with standard I/O
 - single-tracked: 0 ... 10 kHz at X3/E1
 - two-tracked: 0 ... 1 kHz at X3/E1 and X3/E2
- For operation with application I/O
 - single-tracked: 0 ... 100 kHz at X3/E1
 - two-tracked: 0 ... 100 kHz at X3/E1 and X3/E2

Codes for parameter setting

Code		Possible settings				IMPORTANT		
No.	Name	Lenze	Selection					
C0425* ENTER	Configuration frequency input single track X3/E1 (DFIN1)	2	f_r	Δf_{\min}	t	f_{\max}	<ul style="list-style-type: none"> • f_r = Normalisation frequency <ul style="list-style-type: none"> – f_r corresponds to C0011 • Δf_{\min} = Resolution • t = Scanning rate <ul style="list-style-type: none"> – The lower the scanning rate the higher the dynamic response. • f_{\max} = Maximum frequency which can be processed independently of C0425 <ul style="list-style-type: none"> – Set C0425 that the frequency coming from the encoder is lower than f_{\max} • Activate frequency input with C0410/24 = 1 • Adjust frequency input under C0426 and C0427 	
			0	100 Hz	1/200	1 s		300 Hz
			1	1 kHz	1/200	100 msec		3 kHz
			2	10 kHz	1/200	10 msec		10 kHz
			3	10 kHz	1/1000	50 msec		10 kHz
			4	10 kHz	1/10000	500 ms		10 kHz
			5 (A)	102.4 kHz	1/400	2 msec		102.4 kHz
			6 (A)	102.4 kHz	1/1000	5 msec		102.4 kHz
			7 (A)	102.4 kHz	1/2000	10 msec		102.4 kHz
	Configuration frequency input two tracks X3/E1, X3/E2 (DFIN1)	10	100 Hz	1/200	1 s	300 Hz		
		11	1 kHz	1/200	100 msec	3 kHz		
		12 (A)	10 kHz	1/200	10 msec	10 kHz		
		13 (A)	10 kHz	1/1000	50 msec	10 kHz		
		14 (A)	10 kHz	1/10000	500 ms	10 kHz		
		15 (A)	102.4 kHz	1/400	2 msec	102.4 kHz		
		16 (A)	102.4 kHz	1/1000	5 msec	102.4 kHz		
		17 (A)	102.4 kHz	1/2000	10 msec	102.4 kHz		
		C0426*	Gain frequency input X3/E1, X3/E2 (A) (DFIN1-GAIN)	100	-1500.0	{0.1 %}		1500.0
C0427*	Offset frequency input X3/E1, X3/E2 (A) (DFIN1-OFFSET)	0.0	-100.0	{0.1 %}	100.0			

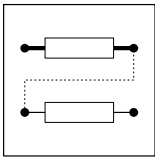

Function library

Configuration of analog and digital setpoints and actual values

Code		Possible settings			IMPORTANT
No.	Name	Lenze	Selection		
C0428* (A)	Gain frequency output (DFOUT1-OUT)	100	0.0 {0.1 %}	1500.0	
C0435* ENTER (A)	Automatic frequency input adjustment	0	0 = not active {1}	4096	<ul style="list-style-type: none"> • Only require for speed control with digital feedback via HTL encoder • Calculates the gain C0426, depending on C0425 and C0011 • C0426 will be recalculated after every change of C0011 or C0425. • Always enter number of increments divided by number of pole pairs of the motor! – Example: Encoder increments = 4096, motor 4-pole ⇒ C0435 = 2048

Activation

1. If you use X3/E1 or X3/E1 and X3/E2 as frequency inputs, you must ensure that the inputs are not connected to other digital signals:
 - These connections must be removed under C0410
 - Otherwise the controller will evaluate the digital setpoint signal in a wrong way! (📖 14-1 ff)
2. Assign the signal source "frequency input" to the required setpoint or actual value under C0412 (C0412/x = 2).
3. Activation of frequency input with C0410/24 = 1.



Note!

- In addition to the free configuration under C0412 you can also use the fixed assignment under C0007 and C0005:
- Use C0007 to link the function with a digital input.
- Use C005 to select a configuration which evaluates the frequency input.

Adjustment

1. Enter frequency, resolution, scanning time and type (single-tracked, two-tracked) of the setpoint signal (C0425).
2. Set the gain and ensure that the input frequency corresponds to the normalisation frequency at maximum process speed of the motor (C0426).
 - The gain always affects setpoint signal and offset.
 - 100 % equals gain factor = 1.

$C0426 = \frac{f_N \cdot p}{z \cdot C0011} \cdot 100 \%$	f_r	Normalisation frequency from C0425
	p	Pole pair number of the motor
	z	Number of increments of the encoder
	C0011	Maximum output frequency (corresponds to maximum process speed of the motor)

3. If necessary, adjust the offset (C0427).
 - The offset shifts the characteristic.

Tip

- For higher accuracy requirements, select a higher resolution under C0425.
- The direction of rotation of the motor can be evaluated with a two-tracked frequency signal.



Note!

The setting for the minimum output frequency (C0010) is not effective.

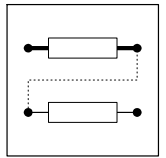

7.6.4 Setpoints via function "motor potentiometer"

Description

Setpoint selection via two digital signals (UP/DOWN), which are controlled by means of, for instance, simple pushbuttons.

The output frequency is changed via the acceleration and deceleration times set for the main setpoint (C0012/C0013) or for the additional setpoint (C0220/C0221).

Codes for parameter setting

Code		Possible settings		IMPORTANT	
No.	Name	Lenze	Selection		
C0265 <small>ENTER</small>	Configuration motor potentiometer	3	0	Start value = power off	<ul style="list-style-type: none"> Start value: output frequency which is approached with Tir (C0012) when the mains is switched on and the motor potentiometer is activated: <ul style="list-style-type: none"> "Power off" = act. value if mains is off "C0010": Minimum output frequency from C0010. The setpoint must have exceeded C0010 before. "0" = output frequency 0 Hz C0265 = 3, 4, 5: <ul style="list-style-type: none"> QSP reduces the motor potentiometer along the QSP ramp (C0105)
			1	Start value = C0010	
			2	Start value = 0	
			3	Start value = power off QSP, if UP/DOWN = LOW	
			4	Start value = C0010 QSP, if UP/DOWN = LOW	
			5	Start value = 0 QSP, if UP/DOWN = LOW	

Activation

1. Link UP and DOWN with external signal sources: C04110/7 UP and C0410/8 DOWN



Note!

In addition to the free configuration under C0410 you can also use the fixed assignment under C0007 to combine the function with digital inputs.

2. Assign the signal source "Motor potentiometer" to the required setpoint under C0412 (C0412/x = 3). (7-57)

Function	UP	DOWN
Decelerate setpoint to 0 Hz along QSP ramp	LOW	LOW
Decelerate the setpoint along the main setpoint ramp (C0013) to minimum output frequency (C0010) (Setpoint must have been higher than value set under C0010)	LOW	HIGH
Accelerate the setpoint along the main setpoint acceleration ramp (C0012) to maximum output frequency (C0011)	HIGH	LOW
Setpoint remains constant	HIGH	HIGH

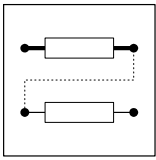

Function library

Configuration of analog and digital setpoints and actual values

Example: Triggering the "motor potentiometer" function via NC contacts.

Configuration

E1 = "UP": C0410/7 = 1

E2 = "DOWN": C0410/8 = 2

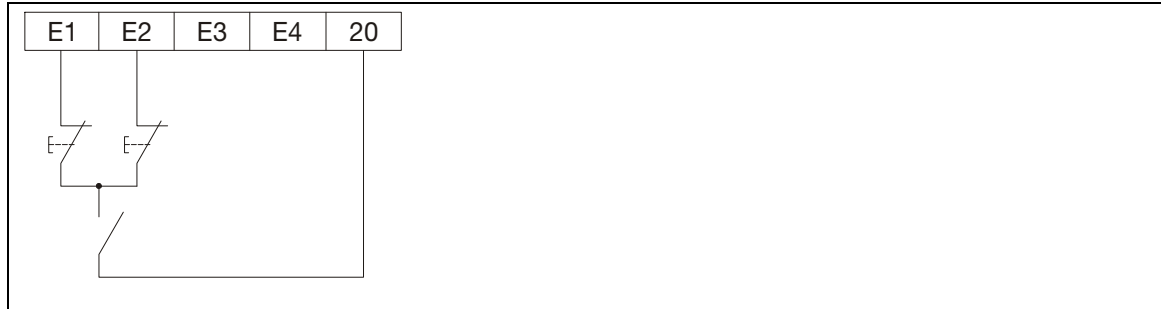

Fig. 7-12

Motor potentiometer with NC contacts

Important



Note!

- Proceed as follows if the setpoint selection via motor potentiometer is used together with the standard I/O function module:
 - Link the output signal MPOT1-OUT only with the signals NSET1-N1, NSET1-N2 or PCTRL1-NADD under C0412.
 - The linkage with other signals results in a step change in the setpoint!
- JOG frequencies have priority over the function "Motor potentiometer".
- The setpoint is saved
 - when switching the mains (see C0265),
 - when the controller is inhibited (CINH),
 - when error messages occur
 - If C0265 = 3, 4, 5:
 - If quick stop is activated, the motor potentiometer will be reset to 0 Hz along the QSP ramp (C0105).
- The additional setpoint is added when using the motor potentiometer function.

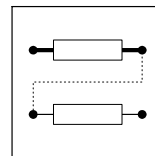

7.6.5 Setpoints via fixed setpoints (JOG)

Description

You can store up to three fixed setpoints per parameter set and retrieve them using digital input signals.

At operation with application I/O 7 fixed setpoints are available per parameter set.

Codes for parameter setting

Code		Possible settings				IMPORTANT	
No.	Name	Lenze	Selection				
C0037	JOG1	20.00	-650.00	{0.02 Hz}	650.00	JOG = fixed setpoint Additional fixed setpoints ⇔ C0440 7-43	
C0038	JOG2	30.00	-650.00	{0.02 Hz}	650.00		
C0039	JOG3	40.00	-650.00	{0.02 Hz}	650.00		
C0440 (A)	Additional JOG values		-650.00	{0.02 Hz}	650.00	JOG = fixed setpoint Activation via configuration in C0410 7-43	
1	JOG 1	20.00					C04401/1 and C0037 are the same
2	JOG 2	30.00					C04401/2 and C0038 are the same
3	JOG 3	40.00					C04401/3 and C0039 are the same
4	JOG 4	15.00					
5	JOG 5	25.00					
6	JOG 6	35.00					
7	JOG 7	45.00					

Activation

Operation without application I/O

- The signal NSET1-JOG1/3 must be combined with a digital input signal under C0410/1.
- The signal NSET1-JOG2/3 must be combined with a digital input signal under C0410/2.

Active setpoint	Level at	
	NSET1-JOG1/3	NSET1-JOG2/3
other setpoint source	LOW	LOW
JOG 1	HIGH	LOW
JOG 2	LOW	HIGH
JOG 3	HIGH	HIGH



Note!

In addition to the free configuration under C0410 you can also use the fixed assignment under C0007 to combine the function with digital inputs.

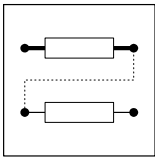

Function library

Configuration of analog and digital setpoints and actual values

Operation with application I/O

- The signal NSET1-JOG1/3/5 must be combined with a digital input signal under C0410/1.
- The signal NSET1-JOG2/3/6/7 must be combined with a digital input signal under C0410/2.
- The signal NSET1-JOG4/5/6/7 must be combined with a digital input signal under C0410/33.

Active setpoint	Level at		
	NSET1-JOG1/3/5/7	NSET1-JOG2/3/6/7	NSET1-JOG4/5/6/7
other setpoint source	LOW	LOW	LOW
JOG 1	HIGH	LOW	LOW
JOG 2	LOW	HIGH	LOW
JOG 3	HIGH	HIGH	LOW
JOG 4	LOW	LOW	HIGH
JOG 5	HIGH	LOW	HIGH
JOG 6	LOW	HIGH	HIGH
JOG 7	HIGH	HIGH	HIGH

Influence on other setpoints

- The maximum output frequency (C0011) also limits the fixed setpoints (JOG).
- The minimum output frequency (C0010) does not limit the fixed setpoints (JOG).
- Fixed setpoints (JOG) have priority over the analog setpoint 1 (NSET1-N1) and over the analog setpoint 2 (NSET1-N2).
- The additional setpoint (PCTRL1-NADD) is added to the fixed setpoints.

Tip

The display of the parameter can be related to a process variable. ( 7-86)

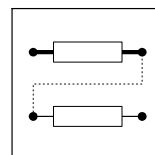

7.6.6 Setpoints via keypad

Description

The setpoint can be selected via the keypad.

The keypad setpoint is added to the main setpoint.



Note!

- Setpoints selected by means of the keypad are stored when the controller is disconnected from the mains or operation is interrupted.
- The drive can start again after controller enable!

Codes for parameter setting

Code		Possible settings			IMPORTANT	
No.	Name	Lenze	Selection			
C0044*	Setpoint 2 (NSET1-N2)		-650.00 {0.02 Hz} 650.00		<p>The value set will be lost when switching the mains!</p> <ul style="list-style-type: none"> • Selection, if C0412/2 = FIXED-FREE (not assigned) • Display if C0412/2 is linked with a signal source 	📖 7-45
C0046*	Setpoint 1 (NSET1-N1)		-650.00 {0.02 Hz} 650.00		<p>The value set will be lost when switching the mains!</p> <ul style="list-style-type: none"> • Selection, if C0412/1 = FIXED-FREE (not assigned) • Display if C0412/1 is linked with a signal source 	📖 7-45
C0140*	Additive frequency setpoint (NSET1-NADD)	0.00	-650.00 {0.02 Hz} 650.00		<ul style="list-style-type: none"> • Selection via function <input type="text" value="Set"/> of the keypad or the parameter channel • Is added to main setpoint • Value is stored when switching the mains or removing the keypad 	📖 7-45

Select setpoint with E82ZBC keypad

You can simply select the setpoint by using the function:

1. Use or to select the function.
2. Set setpoint with or .
 - If the controller is enabled, the changed setpoint has a direct effect on the drive.
 - If the controller is inhibited, the setpoint is saved. After the controller has been enabled, the drive accelerates to the setpoint set last with the adjusted acceleration or deceleration time.



Note!

writes the setpoint into C0140. You can directly select the setpoint in C0140.

Select setpoint with XT EMZ9371BC keypad

You select the setpoint directly in C0140:

1. Select C0140 in the menus.
2. Set setpoint with or .

Drive behaviour when selecting setpoints via keypad

- If the controller is enabled, the changed setpoint has a direct effect on the drive.
- If the controller is inhibited, the setpoint is saved. After the controller has been enabled, the drive accelerates to the value saved last with the adjusted acceleration or deceleration time.

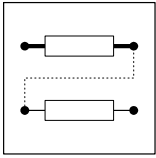

Function library

Configuration of analog and digital setpoints and actual values

Setting tips

- The setpoint via keypad has an effect on setpoint 1 (NSET1-N1) and setpoint 2 (NSET1-N2). If you want to select different setpoints via keypad:
 - Separate the linkage of NSET1-N1 and NSET1-N2 with analog input signals (C0412/1 = 0 and C0412/2 = 0).
 - Now you can set NSET1-N1 in C0046 and NSET-N2 in C0044.
- Set C0140 = 0 if the setpoint is not selected via C0140, otherwise the drive may start immediately when the controller is enabled.

7.6.7 Setpoints via a bus system

Setpoints or actual values can be preselected for FIF by means of a bus function module or AIF by means of a bus module.

A detailed description can be found in the documentation for the modules.

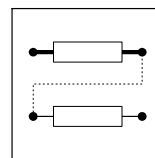

7.6.8 Setpoint changeover (hand/remote changeover)

Description

Changeover between the setpoints NSET1-N1 and NSET1-N2.

- With manual/remote changeover it is possible to e.g. change from remote operation to manual operation in the event of setting or service at the drive.
 - For manual operation the setpoint source for remote operation must not be changed.
 - In manual operation the setpoint is selected via potentiometer, motor potentiometer or keypad/PC.
- Examples for setpoint changeovers:
 - Bus operation ⇔ Keypad or PC
 - Bus operation ⇔ analog setpoint via analog input
 - Keypad or PC ⇔ analog setpoint via analog input
 - Function “Motor potentiometer” ⇔ analog setpoint via analog input
 - Analog setpoint via analog input ⇔ setpoint via frequency input
 - Analog input 1 ⇔ analog input 2 (application I/O only)



Note!

The safety functions controller inhibit and quick stop (QSP) set in remote operation will be reset when manual operation is being activated. Check whether the master system reactivates these functions after a changeover.

Activation

Analog setpoint changeover via analog input

- The setpoint source for remote operation must be linked with NSET1-N1 under C0412/1.
- The setpoint source for manual operation must be linked with NSET1-N2 under C0412/2.
- A digital input signal must be linked with the manual/remote changeover (DCTRL1-H/Re) under C0410/17.
- HIGH active inputs:
 - Manual operation active if signal source for DCTRL1-H/Re = HIGH

Activation of “bus operation ⇔ keypad or PC”

1. Internally invert a digital input (X3/E5 or X3/E6) not used in the Lenze setting under C0411.
2. Assign this input C0410/17 (DCTRL1-H/Re) to activate manual operation.
3. If the inversion of the digital input reset (C0411 = 0), remote operation will be active again.

Example

- Invert X3/E6 with C0411 = 32.
- Assign X3/E6 to the subcode C0410/17 with C0410/17 = 6.
- The setpoint can be selected under C0044 using the keypad or PC.
- If C0411 = 0 is set, the remote operation is active again.

Influence on other setpoints

- JOG frequency are not effected by a manual/remote changeover.
- Function  of the keypad E82ZBC simultaneously acts on NSET1-N1 and NSET1-N2.
 - Use C0046 (NSET1-N1) and C0044 (NSET1-N2) for separated setpoint selection.



Note!

The keypad key  is not active in manual operation!

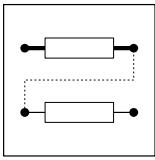

Function library

Motor data entry/automatic detection

7.7 Automatic detection of motor data

Description

This function serves to detect the required motor data and the motor cable influences.

Must be done before the first commissioning of vector control (C0014 = 4) or sensorless torque control (C0014 = 5). Otherwise commissioning is not possible.



Note!

The motor parameter identification influences the smooth running behaviour in the control mode "V/f characteristic control with constant U_{min} boost" (C0014 = 2 or 3). If you identify the motor parameters for this control mode, you can optimise the smooth running behaviour for low speeds.

Codes for parameter setting

Code		Possible settings				IMPORTANT
No.	Name	Lenze	Selection			
C0084	Motor stator resistance	0.000	0.000	{0.001 Ω }	64.000	Only 8200 vector 15 ... 90 kW 7-48
		0.0	0.0	{0.1 m Ω }	6500.0	
C0087	Rated motor speed	→	300	{1 rpm}	16000	→ Depending on the controller 7-48
C0088	Rated motor current	→	0.0	{0.1 A}	650.0	→ Depending on the controller 0.0 ... 2.0 x rated output current of the controller 7-48
C0089	Rated motor frequency	50	10	{1 Hz}	960	7-48
C0090	Rated motor voltage	→	50	{1 V}	500	→ 230 V with 230 V controllers, 400 V with 400 V controllers 7-48
C0091	Motor cos φ	→	0.40	{0.1}	1.0	→ Depending on the controller 7-48
C0092	Motor stator inductance	0.0	0.000	{0.1 mH}	200.0	7-48
		0.00	0.00	{0.01 mH}	200.00	
C0148*	Motor parameter identification	0	0	Ready		Only when the motor is cold! 1. Inhibit controller, wait until drive is at standstill 2. Enter the correct motor data under C0087, C0088, C0089, C0090, C0091 (see motor nameplate). 3. Set C0148 = 1 by ENTER 4. Enable controller The identification – starts, IMP goes off – the motor makes a high-pitched tone, but does not rotate! – takes approx. 30 s – is completed when IMP is on again 5. Inhibit controller 7-48
STOP		1	Start identification	<ul style="list-style-type: none"> V/f-rated frequency (C0015), slip compensation (C0021) and motor stator inductivity (C0092) are calculated and saved. The motor stator resistance (C0084) = total resistance of motor cable and motor is measured and saved 		

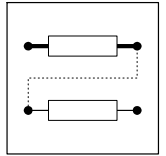

Activation



Note!

Ensure that the motor is cold when the identification is started!

- During identification current flow via the controller outputs U, V.
- The load machine can remain connected. Holding brakes can remain in their braking position.
- With idling motors a small angle shift can occur at the motor shaft.

1. Inhibit the controller. And wait until the drive is in standstill.
2. Enter C0087, C0088, C0089, C0090 and C0091 of your motor (see nameplate):
 - It is absolutely necessary to enter correct data since important parameters such as slip compensation, idle running current and I^2t monitoring are based on these values.
 - Enter rated motor current (C0088) and rated motor voltage (C0090) according to the connection type (star or delta).
3. Select C0148 = 1, confirm with **ENTER**.
4. Enable controller. Identification starts (green controller LED blinking quickly).
 - The motor stator resistance is measured and stored under C0084.
 - The motor stator inductance is calculated from the data entered and stored under C0092.
 - The V/f rated frequency is calculated and stored under C0015.
 - The slip is calculated and stored under C0021.
 - The identification takes approx. 30 s.
 - Identification is completed when the green controller LED comes on (keypad, GDC: **IMP** is active).
5. Inhibit the controller.



Note!

Only the parameter set activated via the digital input signals will be identified.

If you want to detect motor data for any other parameter set, this parameter set must be activated via digital input signals before it can be identified.

Motor data correction during operation

- The motor data are corrected automatically during operation (max. $\pm 25\%$) to compensate for temperature fluctuations.
 - The values under C0084 and C0092 calculated by C0148 become active after mains switching.
- The values under C0084 and C0092 can be manually entered or corrected.

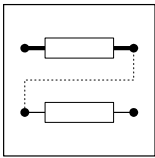

Function library

Process controller, current limitation controller

7.8 Process controller

7.8.1 Setting of control characteristics

Description

The process controller serves to put up control loops for controlling e.g. speed, pressure, temperature, flow rate, humidity, level or dancer position.

The process controller requires a setpoint and an actual value (e.g. from a sensor). If setpoint and actual value are selected as analog values (potentiometer, PLC), the controller must be equipped with an application I/O to build up a control circuit.

Codes for parameter setting

Code		Possible settings			IMPORTANT	
No.	Name	Lenze	Selection			
C0070	Process controller gain	1.00	0.00 = P component not active	{0.01} 300.00	7-50	
C0071	Process controller readjustment time	100	10 = I component not active	{1} 9999	7-50	
C0072	Differential component of process controller	0.0	0.0 = D component not active	{0.1} 5.0	7-50	
C0074	Process controller influence	0.0	0.0	{0.1 %} 100.0	7-50	
C0238 	Frequency precontrol	2	0	No precontrol (only process controller)	Process controller has full influence	7-50
			1	Precontrol (total setpoint + process controller)	Process controller has limited influence	7-53
			2	No precontrol (only total setpoint)	Process controller has no influence (not active)	
				Total setpoint (PCTRL1-SET3) = Main setpoint + additional setpoint		

Adjustment

1. Roughly adjust the control features in the following tables based on the guide values.
2. Fine adjustment:
 - Adjust C0070, C0071 and C0072 so that the target value is reached quickly and with minimum overshoots in case of setpoint and actual value changes.

Scaling C0071

Value in C0071	Resulting reset time T_N
10 ... 5000	10 ms ... 5000 ms
5000 ... 6000	5 s ... 10 s
6000 ... 7000	10 s ... 100 s
7000 ... 8000	100 s ... 1000 s
8000 ... 9998	1000 s ... 9998 s

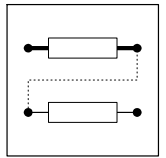

Pressure control and flow control

- The differential component K_D (C0072) is generally not required for pressure and flow control.
- Set the influence (C0074) to 100 %.
- Deactivate the frequency feedforward control (C0238 = 0).

Code	Setting for	
	Gases	Fluids
C0070 (K_P)	0.1	0.02 ... 0.1
C0071 (T_N)	5000 ($T_N = 5$ s)	200 ... 1000 ($T_N = 0.2$ s ... 1 s)
C0072 (K_D)	0	0

Speed control

Code	Setting
C0070 (K_P)	5
C0071 (T_N)	100 ($T_N = 0.1$ s)
C0072 (K_D)	0

Setting of process controller influence

- Activate frequency feedforward control (C0238 = 1). Now the process controller has only limited influence:
 - The control factor determines the influence of the process controller (C0074).
 - Control factor = C0050 (output frequency) - C0051 (actual process controller value)
- C0074 refers to the maximum output frequency C0011.
- C0074 influences the stability of the control loop:
 - Set C0074 as low as possible.
 - If C0074 is set too high, the control loop can become unstable.

Calculation of process controller influence

Calculate C0074	Example
$C0074 [\%] = \frac{C0050 - C0051}{C0011} \cdot 100 \%$	C0011 = 50 Hz, C0050 = 53 Hz, C0051 = 50 Hz:
	$C0074 [\%] = \frac{53 \text{ Hz} - 50 \text{ Hz}}{50 \text{ Hz}} \cdot 100 \% = 6 \%$

Set the influence so that the process controller output covers the calculated value in every working point.

Set C0074 = 10 % as guide value for the example (C0074 = 6 %). The guide value contains tolerances which must always be observed.

Example of additive influence

The effective direction of the process controller output to the main setpoint is additive.

Settings

- C0051 = positive actual value
- C0181 = select positive setpoint
- C0238 = 1 (with frequency feedforward control)
- Potentiometer terminals of the dancer
 - End (E) = +10 V
 - Start (A) = GND

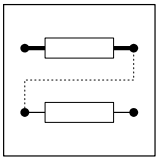

Function library

Process controller, current limitation controller

Function

1. The dancer deflects to the bottom. The dancer control (V_T) decreases.
2. V_2 increases.

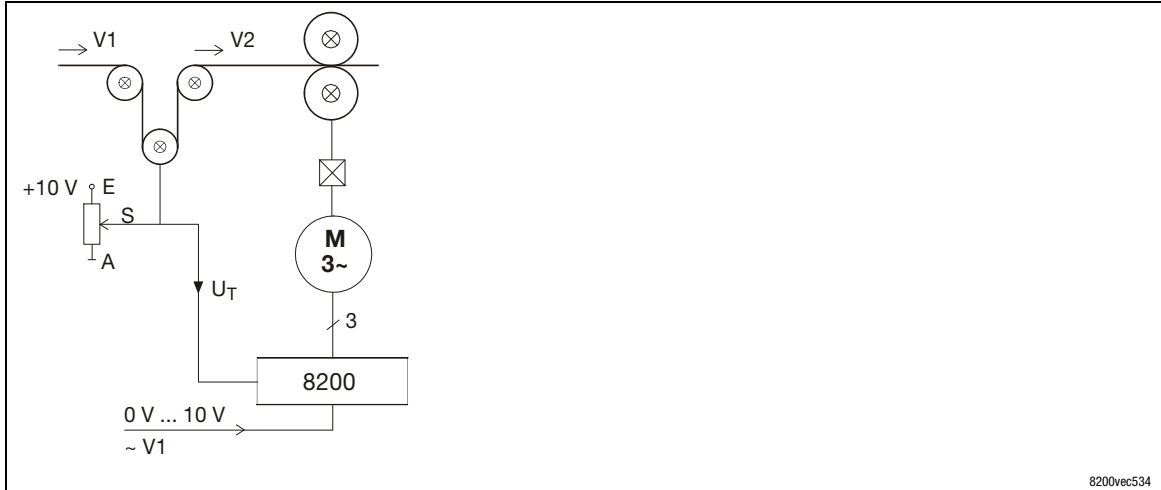

Fig. 7-13

Example: Dancer control with adding influence of the process controller

Example of subtractive influence

The effective direction of the process controller output to the main setpoint is subtractive.

Settings

- C0051 = Positive actual value
- C0181 = select positive setpoint
- C0238 = 1 (with frequency feedforward control)
- Potentiometer terminals of the dancer
 - End (E) = +10 V
 - Start (A) = GND

Function

1. The dancer deflects to the bottom. The dancer control (V_T) increases.
2. V_1 decreases.

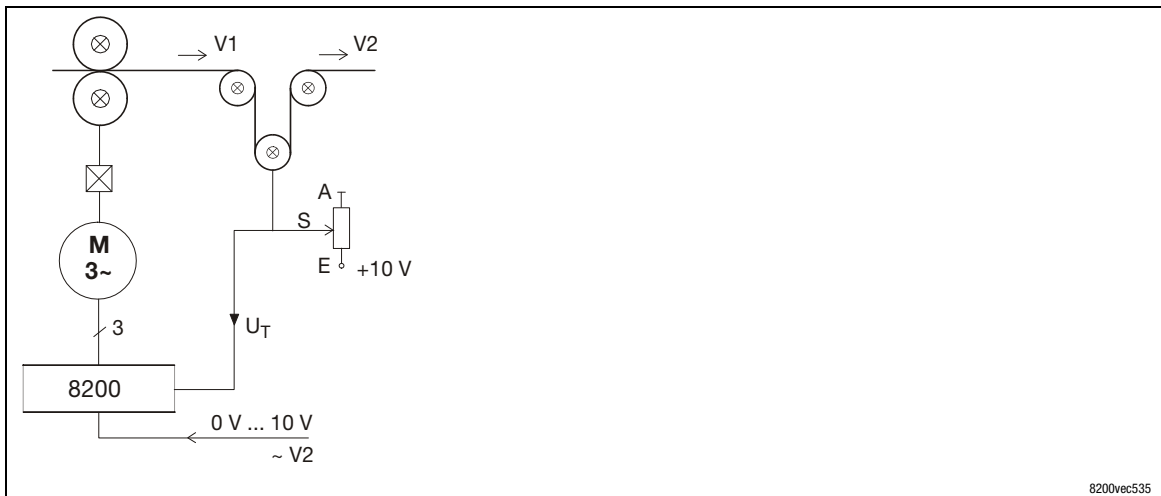
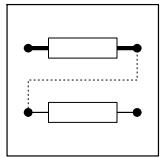

Fig. 7-14

Example: Dancer control with subtractive influence of the process controller





7.8.2 Setpoint selection for the process controller

Description

Selection of a frequency setpoint for the process controller, e.g. for

- the dancer position for a dancer position control in a line drive.
- the pressure setpoint for a pressure control.

Codes for parameter setting

Code		Possible settings			IMPORTANT	
No.	Name	Lenze	Selection			
C0138*	Process controller setpoint 1 (PCTRL1-SET1)	0.00	-650.00	{0.02 Hz} 650.00	The value set will be lost when switching the mains! <ul style="list-style-type: none"> • Selection if C0412/4 = FIXED-FREE • Display if C0412/4 ≠ FIXED-FREE 	7-53
C0181*	Process controller setpoint 2 (PCTRL1-SET2)	0.00	-650.00	{0.02 Hz} 650.00		7-53
C0145* 	Process controller setpoint source	0	0	Total setpoint (PCTRL1-SET3)	Main setpoint + additional setpoint <ul style="list-style-type: none"> • Setpoint selection not possible via <ul style="list-style-type: none"> – JOG values –  function of the keypad – C0044, C0046 and C0049 – in connection with manual/remote changeover, skip frequencies, ramp function generator, additional setpoint • Activate the automatic DC-injection brake (auto DCB) with C0019 = 0 or C0106 = 0 	7-53
			1	C0181 (PCTRL1-SET2)		
			2	C0412/4 (PCTRL1-SET1)		

Selection

Process controller setpoint = Total setpoint

C0145 = 0

Process controller setpoint = Total setpoint (PCTRL1-SET3)

Select C0145 = 0 if the setpoint is to be selected

- via JOG values,
- via keypad (C0140, function ) ,
- for operation with manual/remote changeover, skip frequencies, ramp function generator or additional setpoint,
- via parameter channel (C0044, C0046, C0049).

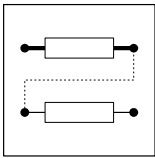

Function library

Process controller, current limitation controller

Process controller setpoint = C0181

C0145 = 1

Process controller setpoint = Value under C0181.

- Applications are e.g. dancer controls, pressure controls and flow rate controls
- Activate the automatic DC-injection brake (auto DCB) with C0019 = 0 or C0106 = 0
- C0181 is the same in all parameter sets.

C0145 = 2

Process controller setpoint = Freely configured signal via C0412/4.

- The process controller setpoint (PCTRL1-SET1) must be linked with an analog input signal under C0412/4.
- Use C0138 to display the current process controller setpoint.
- The setpoint acts directly on the process controller.



Note!

If you do not link an analog input signal with the process controller setpoint under C0412/4, the process controller setpoint can be directly selected under C0138.

7.8.3 Actual value selection for the process controller

Description

The actual value is the process feedback signal (e.g. from a pressure encoder or a speed encoder).

Codes for parameter setting

Code		Possible settings			IMPORTANT
No.	Name	Lenze	Selection		
C0051*	Output frequency with slip compensation (MCTRL1-NOOUT+SLIP) or act. process controller value (PCTRL1-ACT)		-650.00 {0.02 Hz} 650.00		<p>The value set will be lost when switching the mains!</p> <p>Operation without process controller (C0238 = 2):</p> <ul style="list-style-type: none"> • Display only: Output frequency with slip compensation (MCTRL1-NOOUT+SLIP) <p>Operation with process controller (C0238 = 0, 1):</p> <ul style="list-style-type: none"> • Selection, if C0412/5 = FIXED-FREE (not assigned) • Display if C0412/5 is linked with a signal source

Activation

The actual process controller value (PCTRL1-ACT) must be linked with an analog input signal under C0412/5.

Use C0051 to display the current actual process controller value.



Note!

If you do not link an analog input signal with the actual process controller value under C0412/5, the actual process controller value can be directly selected under C0051.

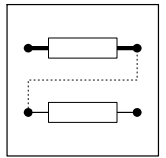

7.8.4 Switching off process controller functions

Process controller switch-off (PCTRL1-OFF)

The process controller output does not send signals as long as this function is active.

Activation

The function must be linked with a digital input signal under C0410/19.

HIGH level at C0410/19 activates the function.



Note!

In addition to the free configuration under C0410 you can also use the fixed assignment under C0007 to combine the function with a digital input.

Process controller stop (PCTRL1-STOP)

The process controller output is frozen on the current value when the function is activated. The value remains unchanged until the function is deactivated.

Activation

The function must be linked with a digital input signal under C0410/21.

HIGH level at C0410/21 activates the function.

Integral action component switch-off (PCTRL1-I-OFF)

The process controller output provides the difference between setpoint and actual value, if necessary with gain V_p

- Thus overcontrolled starting and stopping can be avoided. When the controller operates normally, the integral action component K_I can be connected.
- Application: e.g. dancer position control

Codes for parameter setting

Code		Possible settings			IMPORTANT
No.	Name	Lenze	Selection		
C0184*	Frequency threshold PCTRL1-I-OFF	0.0	0.0	{0.1 Hz} 25.0	<ul style="list-style-type: none"> • If the output frequency < C0184, the I component of the process controller will be switched off • 0.0 Hz = Function not active

Activation

Link the function with a digital input signal in C0410/18.

HIGH level at C0410/18 activates the function.



Note!

In addition to the free configuration under C0410 you can also use the fixed assignment under C0007 to combine the function with a digital input.

Activation via frequency threshold

Use C0184 to set the required frequency.

If the output frequency falls below the value in C0184, the integral-action component will be switched off.

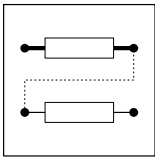

Function library

Process controller, current limitation controller

7.9 Current-limit controller

Description

For controlling high moments of inertia the current limiting controller (I_{\max} controller) can be set.

Codes for parameter setting

Code		Possible settings				IMPORTANT
No.	Name	Lenze	Selection			
C0077*	Gain I_{\max} controller	0.25	0.00 = P component not active	{0.01}	16.00	7-56
C0078*	Integral action time I_{\max} controller	65 → 130	12	{1 ms}	9990 = I component not active	→ Only 8200 vector 15 ... 90 kW 7-56

Adjustment

The current limiting controller is factory-set so that the drive is stable.

Setting notes for power control

The current limiting controller must only be adapted in case of a power control with high moments of inertia:

- V/f characteristic control (C0014 = 2 or 3)
- V_P (C0077): ≈ 0.06
- T_i (C0078): ≈ 750 ms



Note!

C0077 and C0078 are the same for all parameter sets.

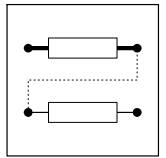

7.10 Free interconnection of analog signals

7.10.1 Free configuration of analog input signals

Description

- Internal analog signals can be freely assigned to external analog signal sources:
 - Analog inputs (X3/8, X3/1U, X3/2U, X3/1I, X3/2I)
 - Frequency input
 - Function “Motor potentiometer”
 - Analog process data input words
- A signal source can be assigned to several targets.



Note!

Use C0005 to configure some of the signal sources for analog inputs. The corresponding subcodes of C0412 will be adapted automatically.

Codes for parameter setting

Code		Possible settings		IMPORTANT	
No.	Name	Lenze	Selection		
C0412 <small>ENTER</small>	Free configuration of analog input signals		Link between analog signal sources and internal analog signals	A selection under C0005 or C0007 will be copied to the corresponding subcode of C0412. A change of C0412 sets C0005 = 255, C0007 = 255! 7-57	
1	Setpoint 1 (NSET1-N1)	1	Analog input 1 (AIN1-OUT): X3/8 (Standard-I/O) X3/1U or X3/1I (Application-I/O)	Either NSET1-N1 or NSET1-N2 active Changeover with C0410/17	Parameter channel: C0046
2	Setpoint 2 (NSET1-N2)	1			Parameter channel: C0044
3	Additional setpoint (PCTRL1-NADD)	255	Not assigned (FIXED-FREE) or selected via keypad or parameter channel of an AIF bus module	Is added to NSET1-N1, NSET1-N2, JOG values and the function $\lfloor \text{Sel} \rfloor$ of the keypad	Parameter channel: C0049
4	Process controller setpoint 1 (PCTRL1-SET1)	255	Not assigned (FIXED-FREE) or selected via keypad or parameter channel of an AIF bus module		
5	Act. process controller value (PCTRL1-ACT)	255	Not assigned (FIXED-FREE) or selected via keypad or parameter channel of an AIF bus module		Parameter channel: C0051, if C0238 = 1, 2
6	Torque setpoint or torque limit value (MCTRL1-MSET)	255	Not assigned (FIXED-FREE) or selected via keypad or parameter channel of an AIF bus module	<ul style="list-style-type: none"> • Observe C0014! • Actual torque values not required. • $16384 \equiv 100\%$ torque setpoint • Condition for selection via terminal (C0412/6 = 1, 2 or 4): <ul style="list-style-type: none"> – The gain of the analog input is set to: $C0414/x, C0426 = 32768/C0011$ [%] 	Parameter channel: C0047
7	Reserved	255	Not assigned (FIXED-FREE) or selected via keypad or parameter channel of an AIF bus module		
8	MCTRL1-VOLT-ADD	255	Not assigned (FIXED-FREE) or selected via keypad or parameter channel of an AIF bus module	Only for special applications. Modifications only when agreed on by Lenze!	
9	MCTRL1-PHI-ADD	255	Not assigned (FIXED-FREE) or selected via keypad or parameter channel of an AIF bus module		

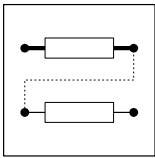

Function library

Free connection of analog signals

Code		Possible settings		IMPORTANT	
No.	Name	Lenze	Selection		
C0412 <small>ENTER</small> (cont.)				7-57	
	Analog signal source possible for C0412				
	0		Not assigned (FIXED-FREE) or selected via keypad or parameter channel of an AIF bus module		
	1		Analog input 1 (AIN1-OUT) X3/8 (Standard-I/O) X3/1U or X3/1I (Application-I/O)		
	2		Frequency input (DFIN1-OUT)		Observe C0410/24, C0425, C0426, C0427
	3		Motor potentiometer (MPOT1-OUT)		
	4 (A)		Analog input 2 (AIN2-OUT) X3/2U or X3/2I		
	5 ... 9		Input signal is constantly 0 (FIXED0)		
	10		AIF input word 1 (AIF-IN.W1)		Only evaluated if C0001 = 3!
	11		AIF input word 2 (AIF-IN.W2)		
	20		CAN-IN1.W1 or FIF-IN.W1		± 24000 ≙ ±480 Hz 2 ¹⁴ ≙ 100 % rated motor torque
	21		CAN-IN1.W2 or FIF-IN.W2		
	22		CAN-IN1.W3 or FIF-IN.W3		
	23		CAN-IN1.W4 or FIF-IN.W4		
	30		CAN-IN2.W1		
	31		CAN-IN2.W2		
	32		CAN-IN2.W3		
	33		CAN-IN2.W4		
	200		Signals are assigned word by word from fieldbus function module to FIF (e.g. INTERBUS or PROFIBUS-DP)		See C0005
	228 (A)		PCTRL1-ACT		
229 (A)		PCTRL1-SET			
230 (A)		PCTRL1-OUT			
231 (A)		NSET1-RFG1-IN			
232 (A)		NSET1-NOUT			
233 (A)		PCTRL1-PID-OUT			
234 (A)		PCTRL1-NOUT			
255		Not assigned (FIXED-FREE) or selected via keypad or parameter channel of an AIF bus module	Either NSET1-N1 or NSET1-N2 active		

Signal linkage

The internal analog signals are linked with an external signal source by entering the selection figure of the external signal in the corresponding subcode of C0412. C0412 can be different for the parameter sets.

Examples

- C0412/1 = 2 ⇒ The frequency input is the signal source for setpoint 1 (NSET1-N1)
- C0412/5 = 23 ⇒ CAN-IN1/word 4 is the signal source for the actual process controller value (PCTRL-ACT)



Note!

The process data input words CAN-IN1.W1, CAN-IN1.W2, CAN-IN2.W1 and CAN-IN2.W2 can be defined as analog word or as digital word (16 bit). If you link them with internal analog signals (C0412/x = 20, 21 or 30, 31), they must be defined as analog input words. Otherwise the controller cannot interpret the signal correctly.

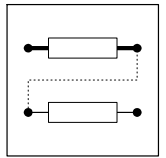

7.10.2 Free configuration of analog outputs

Description

- The analog outputs (X3/62, X3/63) and the frequency output (X3/A4) can be freely assigned to internal analog process signals or monitoring signals. The controller outputs a voltage proportional to the internal signal at the analog outputs.
- Currents can also be output when using the application I/O.
 - Range: 0 ... 20 mA, as of software version 1.1 also 4 ... 20 mA
 - Setting via jumper at module and C0424
- A signal source can be assigned to several targets.



Note!

Use C0111 to permanently assign the analog output X3/62 to some internal signal sources. C0419/1 is automatically adapted.

Codes for parameter setting

Code		Possible settings		IMPORTANT	
No.	Name	Lenze	Selection		
C0419 ENTER	Free configuration of analog outputs		Output of analog signals to terminal	7-59	
1	X3/62 (AOUT1-IN)	0	Output frequency (MCTRL1-NOUT+SLIP)		A selection in C0111 is copied into C0419/1. Change of C0419/1 sets C0111 = 255!
2 (A)	X3/63 (AOUT2-IN)	2	Apparent motor current (MCTRL1-IMOT)		
3 (A)	X3/A4 (DFOUT1-IN)	3	DC-bus voltage (MCTRL1-DCVOLT)		Frequency output: 50 Hz ... 10 kHz
C0419 ENTER (cont.)			Possible analog signals for C0419	7-59	
0	Output frequency (MCTRL1-NOUT+SLIP)		6 V/12 mA/5.85 kHz \equiv C0011		
1	Device utilisation (MCTRL1-MOUT) at V/f characteristic control (C0014 = 2 or 3)		3 V/6 mA/2.925 kHz \equiv Rated active inverter current (active current/C0091)		
	Actual motor torque (MCTRL1-MACT) with vector control (C0014 = 4) or sensorless torque control (C0014 = 5)		3 V/6 mA/2.925 kHz \equiv rated motor torque		
2	Apparent motor current (MCTRL1-IMOT)		3 V/6 mA/2.925 kHz \equiv rated inverter current		
3	DC-bus voltage (MCTRL1-DCVOLT)		6 V/12 mA/5.85 kHz \equiv DC 1000 V (400 V mains) 6 V/12 mA/5.85 kHz \equiv DC 380 V (230 V mains)		
4	Motor power (MCTRL1-PMOT)		3 V/6 mA/2.925 kHz \equiv rated motor power		
5	Motor voltage (MCTRL1-VOLT)		4.8 V/9.6 mA/4.68 kHz \equiv rated motor voltage		
6	1/output frequency (1/C0050) (MCTRL1-1/NOUT)		2 V/4 mA/1.95 kHz \equiv $0.5 \times$ C0011		
7	Output frequency within adjusted limits (DCTRL1-C0010...C0011)		0 V/0 mA/4 mA/0 kHz \equiv $f = f_{\min}$ (C0010) 6 V/12 mA/5.85 kHz \equiv $f = f_{\max}$ (C0011)		
8	Operation with process controller (C0238 = 0, 1): Actual process controller value (PCTRL1-ACT) Operation without process controller (C0238 = 2): Output frequency without slip (MCTRL1-NOUT)		6 V/12 mA/5.85 kHz \equiv C0011		

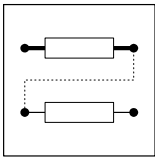

Function library

Free connection of analog signals

Code		Possible settings		IMPORTANT	
No.	Name	Lenze	Selection		
C0419 ENTER (cont.)				Selection 9 ... 25 correspond to the digital functions of the relay output K1 or the digital switching output K1 (C0008) or the digital output A1 (C0117): LOW = 0 V/0 mA/4 mA/ 0 kHz HIGH = 10 V/20 mA/10 kHz	
	Possible analog signals for C0419				
	9		Ready for operation (DCTRL1-RDY)		
	10		TRIP error message (DCTRL1-TRIP)		
	11		Motor is running (DCTRL1-RUN)		
	12		Motor is running / CW rotation (DCTRL1-RUN-CW)		
	13		Motor is running / CCW rotation (DCTRL1-RUN-CCW)		
	14		Output frequency = 0 (DCTRL1-NOOUT=0)		
	15		Frequency setpoint reached (DCTRL1-RFG1=NOOUT)		
	16		Values have fallen below frequency threshold Q_{min} ($f < C0017$) (PCTRL1-QMIN)		LOW active
	17		I_{max} limit reached (MCTRL1-IMAX) C0014 = -5-: Torque setpoint reached		
	18		Overtemperature ($\vartheta_{max} - 5\text{ °C}$) (DCTRL1-OH-WARN)		
	19		TRIP or Q_{min} or pulse inhibit (IMP) active (DCTRL1-TRIP-QMIN-IMP)		
	20		PTC warning (DCTRL1-PTC-WARN)		
	21		Apparent motor current < current threshold (DCTRL1-IMOT<ILIM)		V-belt monitoring Apparent motor current = C0054
22		Apparent motor current < current threshold and output frequency > Frequency threshold Q_{min} (DCTRL1-(IMOT<ILIM)-QMIN)	Current threshold = C0156 Frequency threshold Q_{min} = C0017		
23		Apparent motor current < current threshold and ramp function generator 1: input = output (DCTRL1-(IMOT<ILIM)-RFG-I=0)			
24		Motor phase failure warning (DCTRL1-LP1-WARN)			
25		Minimum output frequency reached ($f \leq C0010$) (PCTRL1-NMIN)	LOW active		

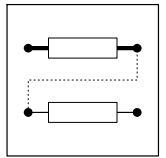

Code		Possible settings			IMPORTANT	
No.	Name	Lenze	Selection			
C0419 ENTER (cont.)			Possible analog signals for C0419		7-59	
			26 Output frequency normalised without slip (MCTRL1-NOUT-NORM)			
			27 Output frequency without slip (MCTRL1-NOUT)	6 V/12 mA/5.85 kHz \equiv C0011		
			28 Actual process controller value (PCTRL1-ACT)			
			29 Process controller setpoint (PCTRL1-SET1)	6 V/12 mA/5.85 kHz \equiv C0011		
			30 Process controller output without feedforward control (PCTRL1-OUT)			
			31 Ramp function generator input (NSET1-RFG1-IN)			
			32 Ramp function generator output (NSET1-NOUT)			
			33 (A) PID controller output (PCTRL1-PID-OUT)			
			34 (A) Process controller output (PCTRL1-NOUT)			
			35 Input signal at X3/8 (standard I/O) or X3/1U or X3/1I (application I/O), assessed with gain (C0414/1 or C0027) and offset (C0413/1 or C0026) (AIN1-OUT)	6 V/12 mA/5.85 kHz \equiv maximum value of analog input signal (5 V, 10 V, 20 mA, 10 kHz) Condition: The gain of the analog input or frequency input is set to: C0414/x, C0426 = 100 %		
			36 Input signal at frequency input X3/E1 and X3/E2, assessed with gain (C0426) and offset (C0427) (DFIN1-OUT)			
			37 Motor potentiometer output (MPOT1-OUT)			
			38 (A) Input signal at X3/2U or X3/2I, assessed with gain (C0414/2) and offset (C0413/2) (AIN2-OUT)			
			40 AIF input word 1 (AIF-IN.W1)	Setpoints to the controller from communication module on AIF		
			41 AIF input word 2 (AIF-IN.W2)	10 V/20 mA/10 kHz \equiv 1000		
			50 CAN-IN1.W1 or FIF-IN.W1	Setpoints to controller from function module on FIF		
			51 CAN-IN1.W2 or FIF-IN.W2	10 V/20 mA/10 kHz \equiv 1000		
			52 CAN-IN1.W3 or FIF-IN.W3			
			53 CAN-IN1.W4 or FIF-IN.W4			
		60 CAN-IN2.W1				
		61 CAN-IN2.W2				
		62 CAN-IN2.W3				
		63 CAN-IN2.W4				
		255 Not assigned (FIXED-FREE)				
C0108*	Gain analog output X3/62 (AOUT1-GAIN)	128	0 {1}	255	Standard I/O: C0108 and C0420 are the same Application I/O: C0108 and C0420/1 are the same	7-59
C0109*	Offset analog output X3/62 (AOUT1-OFFSET)	0.00	-10.00 {0.01 V}	10.00	Standard I/O: C0109 and C0422 are the same Application I/O: C0109 and C0422/1 are the same	7-59
C0420*	Gain analog output X3/62 (AOUT1-GAIN) Standard I/O	128	0 {1}	255	128 \equiv Gain 1 C0420 and C0108 are the same	7-59
C0422*	Offset analog output X3/62 (AOUT1-OFFSET) Standard I/O	0.00	-10.00 {0.01 V}	10.00	C0422 and C0109 are the same	7-59
C0420* (A)	Gain analog outputs Application I/O				128 \equiv Gain 1	7-59
	1 X3/62 (AOUT1-GAIN)	128	0 {1}	255	C0420/1 and C0108 are the same	
	2 X3/63 (AOUT2-GAIN)					

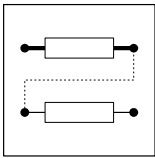

Function library

Free connection of analog signals

Code		Possible settings			IMPORTANT	
No.	Name	Lenze	Selection			
C0422* (A)	Offset of analog outputs Application I/O		-10.00	{0.01 V}	10.00	7-59 C0422/1 and C0109 are the same
1	X3/62 (AOUT1-OFFSET)	0.00				
2	X3/63 (AOUT2-OFFSET)					
C0424* ENTER (A)	Output signal range - analog outputs Application I/O		0	0 ... 10 V / 0 ... 20 mA	1	7-59 Observe jumper position of the function module! (from version: application I/O E82ZAF... Vx11)
1	X3/62 (AOUT1)	0	4 ... 20 mA			
2	X3/63 (AOUT2)	0				

Signal linkage

The analog outputs are linked with internal analog signals by entering the selection figure of the internal signal into the corresponding subcode of C0419. C0419 can be different for the parameter sets.

Examples

- C0419/1 ⇨ 51: The process data word CAN-IN2/word 2 is the signal source for X3/62.
- C0419/2 ⇨ 5: The monitoring signal "Motor voltage" is the signal source for X3/63.



Note!

The process data input words CAN-IN1.W1/FIF-IN.W1, CAN-IN1.W2/FIF-IN.W2, CAN-IN2.W1 and CAN-IN2.W2 can be defined as analog word or digital word (16 bit). If you link them with analog outputs (C0419/x = 50, 51 or 60, 61), they must be defined as analog input words. Otherwise the output signal would be incorrect.

Adjustment

Set gain (C0420) and offset (C0422) to adapt the output signal to the application.

The normalisations of the output signal indicated under C0419 refer to gain 1 (C0420 = 128).

Output signal at selection 7

The output signal at selection 7 is proportional to the output frequency with slip compensation.

$U_{\text{out}} [\text{V}] = 6,00 \text{ V} \cdot \frac{f - C0011}{C0011 - C0010}$	V_{out}	Output signal
	f	Output frequency
	C0010	Minimum output frequency
	C0011	Maximum output frequency

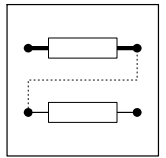

Output signal at selection 8

When using no process controller the output signal at selection 8 is proportional to the output frequency without slip compensation.

Application example for selection 6

The output signal is reciprocal to the output frequency. This signal can be used for the time indication (e.g. machining time of a product).

Example: Output signal = 0 ... 10 V

$U_{out} [V] = 1.00 \text{ V} \cdot \frac{C0011}{f} \cdot \frac{C0420}{128}$	V_{out}	Output signal
	f	Output frequency
	C0011	Maximum output frequency
	C0420	Gain of analog output

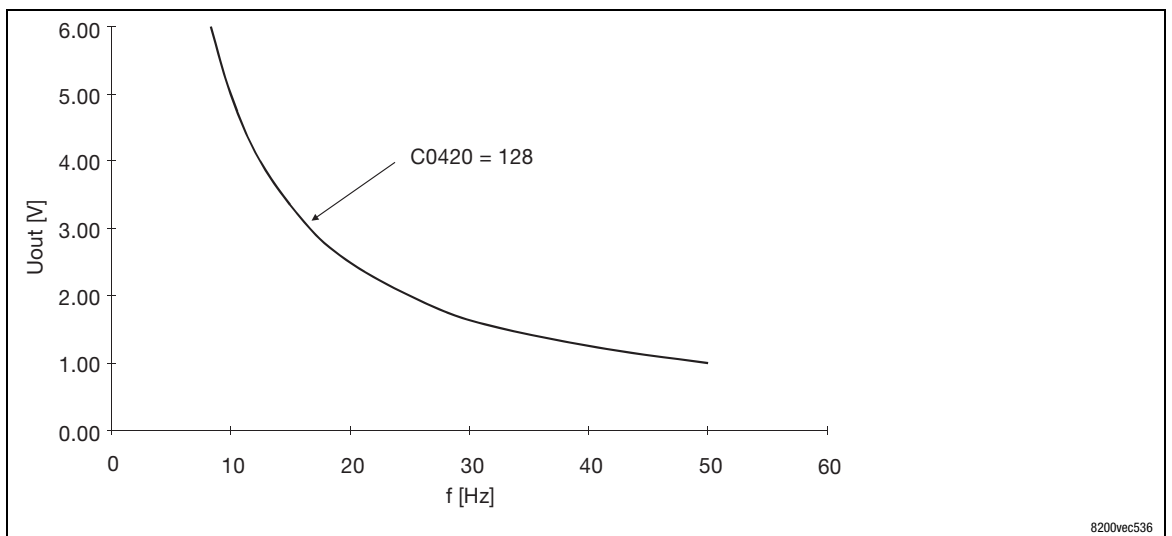
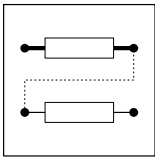

Fig. 7-15

Output signal of the function "1/output frequency"



Function library

Free connection of analog signals

7.10.3 Free configuration of analog process data output words

Description

- The analog process data output words can be freely assigned to internal analog process signals or monitoring signals. The controller outputs a value proportional to the internal signal on the bus. The normalisation is indicated under C0421.
- A signal source can be assigned to several targets.

Codes for parameter setting

Code		Possible settings		IMPORTANT	
No.	Name	Lenze	Selection		
C0421* ENTER	Free configuration of analog process data output words		Output of analog signals to bus	7-64	
1	AIF-OUT.W1	8	Operation with process controller (C0238 = 0, 1): Actual process controller value (PCTRL1-ACT) Operation without process controller (C0238 = 2): Output frequency without slip (MCTRL1-NOUT)		
2	AIF-OUT.W2	0	Output frequency (MCTRL1-NOUT+SLIP)		
3	CAN-OUT1.W1 / FIF-OUT.W1	255	Not assigned (FIXED-FREE)		<ul style="list-style-type: none"> • CAN-OUT1.W1 and FIF-OUT.W1 are digitally defined in the Lenze setting and assigned to the 16 bits of the controller status word 1 (C0417) • Before assigning an analog signal source (C0421/3 ≠ 255), first delete the digital assignment (C0417/x = 255)! Otherwise, the output signal would be wrong
4	CAN-OUT1.W2 / FIF-OUT.W2	255	Not assigned (FIXED-FREE)		
5	CAN-OUT1.W3 / FIF-OUT.W3	255	Not assigned (FIXED-FREE)		
6	CAN-OUT1.W4 / FIF-OUT.W4	255	Not assigned (FIXED-FREE)		
7	CAN-OUT2.W1	255	Not assigned (FIXED-FREE)		
8	CAN-OUT2.W2	255	Not assigned (FIXED-FREE)		
9	CAN-OUT2.W3	255	Not assigned (FIXED-FREE)		
10	CAN-OUT2.W4	255	Not assigned (FIXED-FREE)		
C0421* ENTER (cont.)			Possible analog signals for C0421	7-64	
0	Output frequency (MCTRL1-NOUT+SLIP)	24000	≡ 480 Hz		
1	Device utilisation (MCTRL1-MOUT) at V/f characteristic control (C0014 = 2 or 3)	16383	≡ Rated active inverter current (active current/C0091)		
	Actual motor torque (MCTRL1-MACT) with vector control (C0014 = 4) or sensorless torque control (C0014 = 5)	16383	≡ Rated motor torque		
2	Apparent motor current (MCTRL1-IMOT)	16383	≡ Rated inverter current		
3	DC-bus voltage (MCTRL1-DCVOLT)	16383	≡ 565 VDC at 400 V mains		
		16383	≡ 325 VDC at 230 V mains		
4	Motor power	285	≡ Rated motor power		
5	Motor voltage (MCTRL1-VOLT)	16383	≡ Rated motor voltage		
6	1/output frequency (1/C0050) (MCTRL1-1/NOUT)	195	≡ 0.5 × C0011		
7	Output frequency within adjusted limits (DCTRL1-C0010...C0011)	24000	≡ 480 Hz		
		$0 \equiv f < C0010$ $\frac{24000 \cdot (f - C0010)}{480 \text{ Hz}} \equiv f \geq C0010$			
8	Operation with process controller (C0238 = 0, 1): Actual process controller value (PCTRL1-ACT) Operation without process controller (C0238 = 2): Output frequency without slip (MCTRL1-NOUT)	24000	≡ 480 Hz		

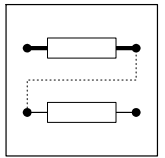

Code		Possible settings		IMPORTANT		
No.	Name	Lenze	Selection			
C0421* ENTER (cont.)				Selection 9 ... 25 correspond to the digital functions of the relay output K1 or the digital switching output K1 (C0008) or the digital output A1 (C0117): LOW = 0 HIGH = 1023		
				Possible analog signals for C0421		
			9	Ready for operation (DCTRL1-RDY)		
			10	TRIP error message (DCTRL1-TRIP)		
			11	Motor is running (DCTRL1-RUN)		
			12	Motor is running / CW rotation (DCTRL1-RUN-CW)		
			13	Motor is running / CCW rotation (DCTRL1-RUN-CCW)		
			14	Output frequency = 0 (DCTRL1-NOU=0)		
			15	Frequency setpoint reached (DCTRL1-RFG1=NOUT)		
			16	Values have fallen below frequency threshold Q_{min} ($f < C0017$) (PCTRL1-QMIN)		
			17	I_{max} limit reached (MCTRL1-IMAX) C0014 = -5: Torque setpoint reached		
			18	Overtemperature ($\vartheta_{max} -5\text{ }^{\circ}\text{C}$) (DCTRL1-OH-WARN)		
			19	TRIP or Q_{min} or pulse inhibit (IMP) (DCTRL1-IMP)		
			20	PTC warning (DCTRL1-PTC-WARN)		
			21	Apparent motor current < current threshold (DCTRL1-IMOT<ILIM)		V-belt monitoring Apparent motor current = C0054 Current threshold = C0156 Frequency threshold Q_{min} = C0017
			22	Apparent motor current < current threshold and output frequency > Frequency threshold Q_{min} (DCTRL1-(IMOT<ILIM)-QMIN)		
			23	Apparent motor current < current threshold and ramp function generator 1: input = output (DCTRL1-(IMOT<ILIM)-RFG-I=0)		
			24	Motor phase failure warning (DCTRL1-LP1-WARN)		
			25	Minimum output frequency reached ($f \leq C0010$) (PCTRL1-NMIN)		

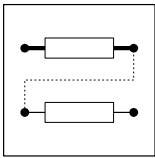

Function library

Free connection of analog signals

Code		Possible settings		IMPORTANT	
No.	Name	Lenze	Selection		
C0421* ENTER (cont.)			Possible analog signals for C0421	7-64	
			26 Output frequency normalised without slip (MCTRL1-NOUT-NORM)		2 ¹⁴ ≙ C0011
			27 Output frequency without slip (MCTRL1-NOUT)		24000 ≙ 480 Hz
			28 Actual process controller value (PCTRL1-ACT)		
			29 Process controller setpoint (PCTRL1-SET1)		
			30 Process controller output without feedforward control (PCTRL1-OUT)		
			31 Ramp function generator input (NSET1-RFG1-IN)		
			32 Ramp function generator output (NSET1-NOUT)		
			33 (A) PID controller output (PCTRL1-PID-OUT)		
			34 (A) Process controller output (PCTRL1-NOUT)		
			35 Input signal at X3/8 (standard I/O) or X3/1U or X3/1I (application I/O), assessed with gain (C0414/1 or C0027) and offset (C0413/1 or C0026) (AIN1-OUT)		1000 ≙ Maximum value of analog input signal (5 V, 10 V, 20 mA, 10 kHz) Condition: The gain of the analog input or frequency input is set to: C0414/x, C0426 = 20/C0011 [%]
			36 Input signal at frequency input X3/E1, assessed with gain (C0426) and offset (C0427) (DFIN1-OUT)		
			37 Motor potentiometer output (MPOT1-OUT)		
			38 (A) Input signal at X3/2U or X3/2I, assessed with gain (C0414/2) and offset (C0413/2) (AIN2-OUT)		
			40 AIF input word 1 (AIF-IN.W1)		Setpoints to the controller from communication module on AIF Normalisation via AIF
			41 AIF input word 2 (AIF-IN.W2)		
			50 CAN-IN1.W1 or FIF-IN.W1		Setpoints to controller from function module on FIF Normalisation via CAN or FIF
			51 CAN-IN1.W2 or FIF-IN.W2		
			52 CAN-IN1.W3 or FIF-IN.W3		
			53 CAN-IN1.W4 or FIF-IN.W4		
		60 CAN-IN2.W1			
		61 CAN-IN2.W2			
		62 CAN-IN2.W3			
		63 CAN-IN2.W4			
		255 Not assigned (FIXED-FREE)			

Signal linkage

The process data output words are linked with internal analog signals by entering the selection figure of the internal signal in the corresponding subcode of C0421. C0421 can be different for the parameter sets.

Examples

- C0421/3 ⇔ 5: The monitoring signal “Motor voltage” is the signal source for CAN-OUT1/word1.
- C0421/8 ⇔ 61: The process data input word CAN-IN2/word2 is the signal source for CAN-OUT2/word 2.

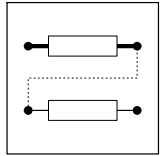

Note!

- The process data output words CAN-OUT1.W1/FIF-OUT.W1, CAN-OUT2.W1 and FIF-OUT.W2 can also be assigned to C0417 and C0418 with 16 bit status information each:
 - With digital configuration under C0417 or C0418 no simultaneous analog assignment with C0421 (C0421/x = 255)!
 - With analog configuration under C0421 no simultaneous digital assignment with C0417 and C0418 (C0417/x = 255, C0418/x = 255)!
 - Otherwise the output signal would be incorrect.
- The process data input words CAN-IN1.W1/FIF-IN.W1, CAN-IN1.W2/FIF-IN.W2, CAN-IN2.W1 and CAN-IN2.W2 can be defined as analog word or digital word (16 bit). If you link them with analog process data output words (C0421/x = 50, 51 or 60, 61), they must be defined as analog input words. Otherwise the output signal would be incorrect.

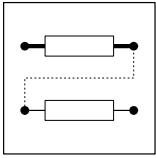

Function library

Free connection of digital signals, message output

7.11 Free interconnection of digital signals

7.11.1 Free configuration of digital input signals

Description

- Internal digital signals can be freely assigned to external digital signal sources. It is thus possible to achieve a freely configured control of the controller
 - Digital inputs X3/E1 ... X3/E6
 - Digital process data input words
- A signal source can be assigned to several targets. Please ensure reasonable assignments. Otherwise it is possible to activate functions which cannot be operated together (e.g. a digital signal linked with quick stop and DC braking at the same time).



Note!

Use C0007 to configure some internal digital signals with the digital inputs X3/E1 ... X3/E4 block by block. The corresponding subcodes of C0410 will be adapted automatically.

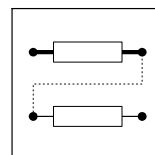

Codes for parameter setting

Code		Possible settings		IMPORTANT
No.	Name	Lenze	Selection	
C0410 ENTER	Free configuration of digital input signals		Link between digital signal sources and internal digital signals	A selection made under C0007 is copied to the corresponding subcode of C0410. A change of C0410 sets C0007 = 255! 7-68
1	NSET1-JOG1/3 NSET1-JOG1/3/5/7 (A)	1	Digital input X3/E1	Selection of fixed setpoints C0410/1 C0410/2 active C0410/33 C0046 LOW LOW LOW JOG1 HIGH LOW LOW JOG2 LOW HIGH LOW JOG7 HIGH HIGH HIGH
2	NSET1-JOG2/3 NSET1-JOG2/3/6/7 (A)	2	Digital input X3/E2	
3	DCTRL1-CW/CCW	4	Digital input X3/E4	CW = CW rotation LOW CCW = CCW rotation HIGH
4	DCTRL1-QSP	255	Not assigned (FIXED-FREE)	Quick stop (via terminal LOW active)
5	NSET1-RFG1-STOP	255	Not assigned (FIXED-FREE)	Ramp function generator main setpoint stop
6	NSET1-RFG1-0	255	Not assigned (FIXED-FREE)	Ramp function generator input must be set to "0" for mains setpoint
7	MPOT1-UP	255	Not assigned (FIXED-FREE)	Motor potentiometer functions
8	MPOT1-DOWN	255	Not assigned (FIXED-FREE)	
9	Reserved	255	Not assigned (FIXED-FREE)	Do not change 255!
10	DCTRL1-CINH	255	Not assigned (FIXED-FREE)	Controller inhibit (via terminal LOW active)
11	DCTRL1-TRIP-SET	255	Not assigned (FIXED-FREE)	External error (via terminal LOW active)
12	DCTRL1-TRIP-RESET	255	Not assigned (FIXED-FREE)	Error reset
13	DCTRL1-PAR2/4	255	Not assigned (FIXED-FREE)	Parameter set changeover (only possible if C0988 = 0) C0410/13 and C0410/14 must have the same source in every parameter sets used. Otherwise it is not possible to change between the parameter sets (error message CE5 or CE7).
14	DCTRL1-PAR3/4	255	Not assigned (FIXED-FREE)	C0410/13 C0410/14 active LOW LOW PAR1 HIGH LOW PAR2 LOW HIGH PAR3 HIGH HIGH PAR4
15	MCTRL1-DCB	3	Digital input X3/E3	DC-injection brake
16	PCTRL1-RFG2-LOADI (A)	255	Not assigned (FIXED-FREE)	Actual process controller value (PCTRL1-ACT) must be connected to process controller ramp function generator (PCTRL1-RFG2)
17	DCTRL1-H/Re	255	Not assigned (FIXED-FREE)	Manual/remote changeover
18	PCTRL1-I-OFF	255	Not assigned (FIXED-FREE)	Switch off I-component of the process controller
19	PCTRL1-OFF	255	Not assigned (FIXED-FREE)	Process controller switch off
20	Reserved	255	Not assigned (FIXED-FREE)	Do not change 255!
21	PCTRL1-STOP	255	Not assigned (FIXED-FREE)	Process controller stop (value "frozen")
22	DCTRL1-CW/QSP	255	Not assigned (FIXED-FREE)	Failsafe change of the direction of rotation
23	DCTRL1-CCW/QSP	255	Not assigned (FIXED-FREE)	
24	DFIN1-ON	255	Not assigned (FIXED-FREE)	0 = Frequency input not active 1 = Frequency input active Frequency input configuration under C0425 and C0426

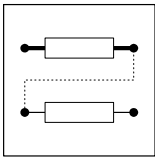



Function library

Free connection of digital signals, message output

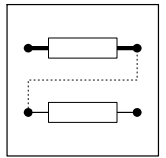
Code		Possible settings		IMPORTANT
No.	Name	Lenze	Selection	
C0410 ENTER (cont.)				7-68
25 (A)	PCTRL1-FOLL1-0	255	Not assigned (FIXED-FREE)	Compensator at reset ramp C0193 to "0"
26 (A)	Reserved	255	Not assigned (FIXED-FREE)	
27 (A)	NSET1-TI1/3	255	Not assigned (FIXED-FREE)	Activate acceleration times
28 (A)	NSET1-TI2/3	255	Not assigned (FIXED-FREE)	C0410/27 C0410/28 active LOW LOW C0012; C0013 HIGH LOW T _{ir} 1; T _{if} 1 LOW HIGH T _{ir} 2; T _{if} 2 HIGH HIGH T _{ir} 3; T _{if} 3
29 (A)	PCTRL1-FADING	255	Not assigned (FIXED-FREE)	Process controller output on (LOW)/ off (HIGH)
30 (A)	PCTRL1-INV-ON	255	Not assigned (FIXED-FREE)	Process controller output inversion
31 (A)	PCTRL1-NADD-OFF	255	Not assigned (FIXED-FREE)	Switch off additional setpoint
32 (A)	PCTRL1-RFG2-0	255	Not assigned (FIXED-FREE)	Decelerate process controller ramp function generator input to "0" along ramp C0226
33 (A)	NSET1-JOG4/5/6/7	255	Not assigned (FIXED-FREE)	



Code		Possible settings		IMPORTANT		
No.	Name	Lenze	Selection			
C0410  (cont.)			Digital signal sources for C0410	 7-68		
			0		Not assigned (FIXED-FREE)	
			1		Digital input X3/E1 (DIGIN1)	
			2		Digital input X3/E2 (DIGIN2)	
			3		Digital input X3/E3 (DIGIN3)	
			4		Digital input X3/E4 (DIGIN4)	
			5 (A)		Digital input X3/E5 (DIGIN5)	
			6 (A)		Digital input X3/E6 (DIGIN6)	
			7		PTC input (X2.2/T1, X2.2/T2)	T1/T2 can only be connected to potential-free switches! T1/T2 is active ("HIGH") when the switch is closed
					AIF control word (AIF-CTRL)	
			10		Bit 0	
			
			25		Bit 15	
					CAN-IN1.W1 or FIF-IN.W1	
			30		Bit 0	
			
			45		Bit 15	
					CAN-IN1.W2 or FIF-IN.W2	
			50		Bit 0	
			
			65		Bit 15	
					CAN-IN2.W1	
			70		Bit 0	
			
			85		Bit 15	
	CAN-IN2.W2					
90	Bit 0					
...	...					
105	Bit 15					
	Status application I/O	Only active when using application I/O				
140	Torque threshold 1 reached (MSET1=MOUT)					
141	Torque threshold 2 reached (MSET2=MOUT)					
142	Process controller output limit reached (PCTRL1-LIM)					
143...172	Reserved					
200	Control words are assigned bit by bit from the fieldbus function module to FIF (e.g. INTERBUS or PROFIBUS-DP)	See C0005				
	Digital output signals					
201	as C0415, selection 1					
...	...					
231	as C0415, selection 31					
255	Not assigned (FIXED-FREE)					

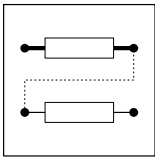

Function library

Free connection of digital signals, message output

Code		Possible settings		IMPORTANT		
No.	Name	Lenze	Selection			
C0411 <small>ENTER</small>	Level inversion of digital inputs	0	0	Level inversion is switched off	<ul style="list-style-type: none"> By entering the sum of the selected values you can invert several inputs C0114 and C0411 are identical The function "Parameter set changeover" cannot be inverted! 	
			1	E1 inverted		
			2	E2 inverted		
			4	E3 inverted		
			8	E4 inverted		
			16	E5 inverted		only application I/O
			32	E6 inverted		only application I/O
			64	T1/T2 inverted		T1/T2 can only be connected to potential-free switches. T1/T2 is active, if the switch is open.

Signal linkage

The internal digital signals are linked with an external signal source by entering the selection figure of the external signal in the corresponding subcode of C0410. C0410 can be different for the parameter sets.

Examples

- C0410/10 = 2 ⇒ Terminal X3/E2 is the signal source for controller inhibit (CINH)
- C0410/15 = 32 ⇒ CAN-IN1/word1, Bit 3 is the signal source for the DC injection brake (DCB)



Note!

The process data input words CAN-IN1.W1, CAN-IN1.W2, CAN-IN2.W1 and CAN-IN2.W2 can be defined as analog word or as digital word (16 bit). If you link internal digital signals (C0410/x = 30 ... 105), they must be defined as digital input words. Otherwise the controller would interpret the bit control information incorrectly.

Signal level

- Terminals (X3/E1 ... X3/E6):
 - HIGH = +12 V ... +30 V
 - LOW = 0 V ... +3 V
- Process data input words:
 - HIGH = bit logic 1
 - LOW = bit logic 0
- Response times: 1.5 ... 2.5 ms

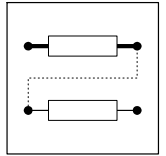

7.11.2 Free configuration of digital outputs

Description

- The digital outputs (X3/A1, X3/A2, relay output K1 ¹ or digital switching output K1 ²) can be linked freely with internal digital signals.
- A signal source can be linked with several targets.



Hinweis!

- C0008 enables the relay output K1 ¹ or the digital switching output K1 ² to be also linked permanently with some internal signal sources. C0415/1 is then adapted automatically.
- C0117 enables the digital output X3/A1 to be also linked permanently with some internal signal sources. C0415/2 is then adapted automatically.

1) for device version 151

2) for device versions 152 and 153

Codes for parameter setting

Code		Possible settings		IMPORTANT
No.	Name	Lenze	Selection	
C0415 <small>ENTER</small>	Free configuration of digital outputs		Output of digital signals to terminals	For configuration of relay output K2 see C0409
1	Relay output K1 (RELAY, motec version 151) Digital switching output K1 (motec version 152, 153)	25	TRIP error message (DCTRL1-TRIP)	A selection in C0008 is copied into C0415/1. Change of C0415/1 sets C0008 = 255!
2	Digital output X3/A1 (DIGOUT1)	16	Ready for operation (DCTRL1-RDY)	A selection in C0117 is copied into C0415/2. Change of C0415/2 sets C0117 = 255!
3 (A)	Digital output X3/A2 (DIGOUT2)	255	Not assigned (FIXED-FREE)	

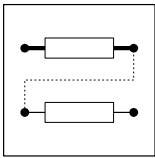

Function library

Free connection of digital signals, message output

Code		Possible settings		IMPORTANT																
No.	Name	Lenze	Selection																	
C0415 ENTER (cont.)			Possible digital signals for C0415	7-73																
	0		Not assigned (FIXED-FREE)																	
	1		Parameter set 2 or parameter set 4 is active (DCTRL1-PAR-B0)		<table border="0"> <tr> <td>PAR-B1</td> <td>PAR-B0</td> <td>Active</td> </tr> <tr> <td>LOW</td> <td>LOW</td> <td>PAR1</td> </tr> <tr> <td>LOW</td> <td>HIGH</td> <td>PAR2</td> </tr> <tr> <td>HIGH</td> <td>LOW</td> <td>PAR3</td> </tr> <tr> <td>HIGH</td> <td>HIGH</td> <td>PAR4</td> </tr> </table>	PAR-B1	PAR-B0	Active	LOW	LOW	PAR1	LOW	HIGH	PAR2	HIGH	LOW	PAR3	HIGH	HIGH	PAR4
	PAR-B1	PAR-B0	Active																	
	LOW	LOW	PAR1																	
	LOW	HIGH	PAR2																	
	HIGH	LOW	PAR3																	
	HIGH	HIGH	PAR4																	
	2		Pulse inhibit active (DCTRL1-IMP)																	
	3		I_{max} limit reached (MCTRL1-IMAX) (C0014 = -5-: torque setpoint reached)																	
	4		Frequency setpoint reached (DCTRL1-RFG1=NOUT)																	
	5		Ramp function generator 1: input = output (NSET1-RFG1-I=0)		RFG1 = ramp function generator - main setpoint															
	6		Values have fallen below frequency threshold Q_{min} ($f < C0017$) (PCTRL1-QMIN)		LOW active															
	7		Output frequency = 0 (DCTRL1-NOUT=0)																	
	8		Controller inhibit active (DCTRL1-CINH)																	
	9 ... 12		Reserved																	
	13		Group signal (DCTRL1-OH-PTC-LP1-FAN1-WARN): Overtemperature warning ($\vartheta_{max} - 5 \text{ }^\circ\text{C}$) (DCTRL1-OH-WARN) or Motor overtemperature warning or Motor phase failure warning (DCTRL1-LP1-WARN) or Fan failure warning (DCTRL1-FAN1-WARN) (only active with 8200 motec and C0608 = 1))		Set C0119 = 2 or C0119 = 5 Set C0597 = 2 With 8200 vector, C0608 must be set to 0															
	14		DC bus overvoltage (DCTRL1-OV)																	
	15		CCW rotation (DCTRL1-CCW)																	
16		Ready for operation (DCTRL1-RDY)																		
17		Parameter set 3 or parameter set 4 active (DCTRL1-PAR-B1)	<table border="0"> <tr> <td>PAR-B1</td> <td>PAR-B0</td> <td>Active</td> </tr> <tr> <td>LOW</td> <td>LOW</td> <td>PAR1</td> </tr> <tr> <td>LOW</td> <td>HIGH</td> <td>PAR2</td> </tr> <tr> <td>HIGH</td> <td>LOW</td> <td>PAR3</td> </tr> <tr> <td>HIGH</td> <td>HIGH</td> <td>PAR4</td> </tr> </table>	PAR-B1	PAR-B0	Active	LOW	LOW	PAR1	LOW	HIGH	PAR2	HIGH	LOW	PAR3	HIGH	HIGH	PAR4		
PAR-B1	PAR-B0	Active																		
LOW	LOW	PAR1																		
LOW	HIGH	PAR2																		
HIGH	LOW	PAR3																		
HIGH	HIGH	PAR4																		
18		Values have fallen below TRIP or Q_{min} or pulse inhibit (IMP) is active (DCTRL1-TRIP-QMIN-IMP)	LOW active																	
19		PTC warning (DCTRL1-PTC-WARN) Status of relay K_{SR}	Set C0119 = 2 or C0119 = 5 Only with 8200 vector 15 ...90 kW, variant "safe standstill": HIGH = pulse inhibit active by "safe standstill" LOW = no pulse inhibit by "safe standstill"																	

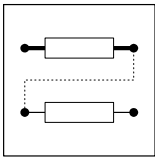

Function library

Free connection of digital signals, message output

Code		Possible settings		IMPORTANT		
No.	Name	Lenze	Selection			
C0415 ENTER (cont.)	Possible digital signals for C0415			Permanently assigned bits of AIF-CTRL: Bit 3: QSP Bit 7: CINH Bit 10: TRIP-SET Bit 11: TRIP-RESET Only active for operation with application I/O		
	40	Bit 0				
				
	55	Bit 15				
	60	Bit 0	CAN-IN1.W1 or FIF-IN.W1			
				
	75	Bit 15				
	80	Bit 0	CAN-IN1.W2 or FIF-IN.W2			
				
	95	Bit 15				
100	Bit 0	CAN-IN2.W1				
...	...					
115	Bit 15					
120	Bit 0	CAN-IN2.W2				
...	...					
135	Bit 15					
140	Torque threshold 1 reached (MSET1=MOUT)		Status application I/O Torque threshold 1 reached (MSET1=MOUT) Torque threshold 2 reached (MSET2=MOUT) Limitation of process controller output reached (PCTRL1-LIM) Reserved			
141	Torque threshold 2 reached (MSET2=MOUT)					
142	Limitation of process controller output reached (PCTRL1-LIM)					
143 ... 172	Reserved					
255	Not assigned (FIXED-FREE)					
C0416 ENTER	Level inversion - digital outputs	0	0	Level inversion switched off	By entering the sum of the selected values you can invert several outputs. 1: applies to version 151 2: applies to version 152 Only application I/O Relay output K2 only with 8200 vector 15 ... 90 kW	
			1	Relay K1 ¹ or digital switching output K1 ²		
			2	X3/A1		
			4	X3/A2		
			8	Relay K2		
C0423* (A)	Delay of digital outputs		0.000	{0.001 s}	65.000	"Debouncing" of the digital outputs (from version: application I/O E82ZAFa ... Vx11) <ul style="list-style-type: none"> Switches the digital output if the linked signal is still active after the time set. The digital output is reset without delay
	1	Device version 151: relay output K1 (RELAY) Device version 152, 153: Digital switching output K1	0.000			
	2	Digital output X3/A1 (DIGOUT1)	0.000			
	3	Digital output X3/A2 (DIGOUT2)	0.000			

Signal linkage

The digital outputs are linked with the internal digital signals by entering the selection figure of the internal signal in the corresponding subcode of C0415. C0415 can be different for the parameter sets.

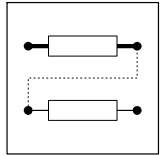

Examples

- C0415/2 ⇒ 15: The status message "CCW rotation" is the signal source for X3/A1
- C0415/1 ⇒ 60: The status of bit 1 of the process data word CAN-IN1/word is the signal source for K1



Note!

The process data input words CAN-IN1.W1/FIF-IN.W1, CAN-IN1.W2/FIF-IN.W2, CAN-IN2.W1 and CAN-IN2.W2 can be defined as analog word or digital word (16 bit). If you link digital outputs (C0415/x = 60 ... 135), they must be defined as digital input words. Otherwise the output signal would be incorrect.

Signal level for V-belt monitoring

Please consider the way the signals are mapped with the current threshold C0156 when monitoring a V-belt (monitoring signals 20, 21, 22):

- The display value (C0054) is smoothed with a ring memory with 500 ms.
- The value set under C0156 corresponds to a percentage of the rated controller current I_r .
- If you use the control mode "V/f characteristic control with square characteristic" (C0014 = 3) C0156 will be internally adapted via the output frequency:

$$C0156_{\text{int}} [\%] = C0156 [\%] \cdot \frac{f^2 [\text{Hz}^2]}{C0011^2 [\text{Hz}^2]}$$

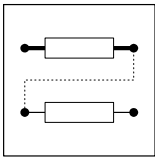

Function library

Free connection of digital signals, message output

Switching conditions

Selection under C0415/x		Relays/digital output (not inverted)
1	Parameter set 2 or parameter set 4 is active (DCTRL1-PAR-B0)	Picks up/HIGH, if parameter set 2 or parameter set 4 is active
2	Pulse inhibit active (DCTRL1-IMP)	Picks up/HIGH if STOP , controller inhibit (CINH), overvoltage or undervoltage
3	I_{max} limit reached (MCTRL1-IMAX) (C0014 = -5-: Torque setpoint reached)	Picks up/HIGH if motor current = C0022 or motor current = C0023
4	Frequency setpoint reached (DCTRL1-RFG1=NOUT)	Picks up/HIGH if output frequency = frequency setpoint
5	Ramp function generator 1: Input = output (NSET1-RFG1-I=0)	Picks up/HIGH, if the condition is met
6	Value has fallen below frequency threshold Q_{min} ($f < C0017$) (PCTRL1-QMIN)	Picks up/HIGH if output frequency > C0017 (related to setpoint)
7	Output frequency = 0 (DCTRL1-NOUT=0)	Picks up/HIGH, because <ul style="list-style-type: none"> • frequency setpoint = 0 Hz, t_{ff} over • DC injection brake (DCB) is active • controller inhibited (CINH)
8	Controller inhibit active (DCTRL1-CINH)	Picks up/HIGH, if controller is inhibited by <ul style="list-style-type: none"> • X3/28 = LOW • C0410/10 = active • STOP
13	Collective message (DCTRL1-OH-PTC-LP1-FAN1-WARN) Overtemperature ($\vartheta_{max} - 5$ °C) (DCTRL1-OH-WARN) or motor overtemperature (DCTRL1-LP1-PTC-WARN) or motor phase failure (DCTRL1-LP1-WARN) or fan failure (only active when using 8200 motec)	Picks up/HIGH, if one message is active
14	DC-bus overvoltage (DCTRL1-OV)	Picks up/HIGH, when the permissible voltage threshold is reached
15	CCW rotation (DCTRL1-CCW)	Picks up/HIGH with CCW rotation
16	Ready for operation (DCTRL1-RDY)	Picks up/HIGH, if the controller is ready for operation Drops out/LOW if <ul style="list-style-type: none"> • TRIP fault message • Undervoltage or overvoltage
17	Parameter set 3 or parameter set 4 is active (DCTRL1-PAR-B1)	Picks up/HIGH, if parameter set 3 or parameter set 4 is active
18	Value has fallen below TRIP or Q_{min} or pulse inhibit (IMP) is active (DCTRL1-TRIP-QMIN-IMP)	Drops out/LOW, if at least one of the three conditions (selection 25 or 6 or 2) is met
19	PTC warning (DCTRL1-PTC-WARN)	Drops out/LOW, if motor overtemperature is indicated by thermostat or PTC
20	Apparent motor current < current threshold (DCTRL1-IMOT<ILIM)	Picks up/HIGH, if the condition is met
21	Apparent motor current < current threshold and output frequency > frequency threshold Q_{min} (DCTRL1-(IMOT<ILIM)-QMIN)	
22	Apparent motor current < current threshold and RFG 1: Input = output (DCTRL1-(IMOT<ILIM)-RFG-I=0)	
23	Motor phase failure warning (DCTRL1-LP1-WARN)	
24	Minimum output frequency reached ($f \leq C0010$) (PCTRL1-NMIN)	Picks up/HIGH if output frequency > C0010
25	TRIP fault message (DCTRL1-TRIP)	Picks up/HIGH with TRIP error message
26	Motor is running (DCTRL1-RUN)	Picks up/HIGH if output frequency \neq 0 Hz
27	Motor is running/CW rotation (DCTRL1-RUN-CW)	Picks up/HIGH if output frequency > 0 Hz
28	Motor is running/CCW rotation (DCTRL1-RUN-CCW)	Picks up/HIGH if output frequency < 0 Hz
29	Process controller input = process controller output (PCTRL1-SET=ACT)	Picks up/HIGH, if the condition is met
31	Apparent motor current > current threshold and ramp function generator 1: Input = output (DCTRL1-(IMOT>ILIM)-RFG-I=0)	

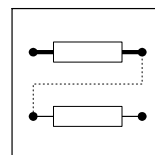

Selection under C0415/x		Relays/digital output (not inverted)
32	Digital input X3/E1	Picks up/HIGH, if HIGH level is applied to the corresponding digital input
33	Digital input X3/E2	
34	Digital input X3/E3	
35	Digital input X3/E4	
36 (A)	Digital input X3/E5	
37 (A)	Digital input X3/E6	
38	PTC input X2.2/T1, X2.2/T2	Picks up/HIGH, if the potential-free switch is connected to X2.2/T1, X2.2/T2
40 ... 55	AIF control word (AIF-CTRL) Bit 0 ... Bit 15	Picks up/HIGH, if the corresponding bit is set
60 ... 75	CAN-IN1.W1 or FIF-IN.W1 bit 0 ... bit 15	
80 ... 95	CAN-IN1.W2 or FIF-IN.W2 bit 0 ... bit 15	
100 ... 115	CAN-IN2.W1 bit 0 ... bit 15	
120 ... 135	CAN-IN2.W2 bit 0 ... bit 15	
140	Torque threshold 1 reached (MSET1=MOUT)	Picks up/HIGH, if the condition is met
141	Torque threshold 2 reached (MSET2=MOUT)	
142	Process controller output limit reached (PCTRL1-LIM)	

7.11.3 Free configuration of digital process data output words

Description

- The digital process data output words can be freely assigned to internal digital signals. With this you can summarise status information which will be automatically assigned to status word bits:
 - The configuration under C0417 is mapped to the AIF status word 1 (C0150), FIF output word 1 (FIF-OUT.W1) and output word 1 of the CAN object 1 (CAN-OUT1.W1).
 - The configuration under C0418 is mapped to the AIF status word 2 (C0151), FIF output word 2 (FIF-OUT.W2) and output word 1 of the CAN object 2 (CAN-OUT2.W1).
- A signal source can be assigned to several targets.

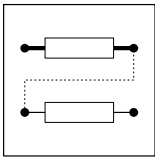

Function library

Free connection of digital signals, message output

Codes for parameter setting

Code		Possible settings		IMPORTANT
No.	Name	Lenze	Selection	
C0417*	Free configuration of controller status messages (1)		Output of digital signals to bus	The assignment is mapped to the <ul style="list-style-type: none"> • Controller status word 1 (C0150) • AIF status word (AIF-STAT) • FIF output word 1 (FIF-OUT.W1) • Output word 1 in CAN object 1 (CAN-OUT1.W1) → Fixed assignment to AIF when operating with communication modules INTERBUS 211x, PROFIBUS-DP 213x or LECOM-A/B/LI 2102. Modifications are not allowed! If you use function modules system bus (CAN), INTERBUS, PROFIBUS-DP to FIF, all bits are freely configurable.
1	Bit 0	1	Active parameter set PAR-B0 active (DCTRL1-PAR-B0)	
2	Bit 1	2	Pulse inhibit active (DCTRL1-IMP)	
3	Bit 2	3	I_{max} limit reached (MCTRL1-IMAX) (C0014 = -5-: Torque setpoint reached)	
4	Bit 3	4	Frequency setpoint reached (DCTRL1-RFG1=NOUT)	
5	Bit 4	5	Ramp function generator 1: Input = output (NSET1-RFG1-I=0)	
6	Bit 5	6	Value below frequency threshold Q_{min} ($f < C0017$) (PCTRL1-QMIN)	
7	Bit 6	7	Output frequency = 0 (DCTRL1-NOUT=0)	
8	Bit 7	8	Controller inhibit active (DCTRL1-CINH)	
9	Bit 8	9	111101918 Controller status 0000 Controller initialization 0001 Mains voltage off (at external supply of the control section of the drive controller)	
10	Bit 9	10	0010 Switch-on inhibit 0011 Operation inhibited	
11	Bit 10	11	0100 Flying restart circuit active 0101 DC-injection brake active 0110 Operation enabled	
12	Bit 11	12	0111 Message active 1000 Active error	
13	Bit 12	13	Collective message: (DCTRL1-OH-PTC-LP1-FAN1-WARN)	
14	Bit 13	14	DC-bus overvoltage (DCTRL1-OV)	
15	Bit 14	15	CCW rotation (DCTRL1-CCW)	
16	Bit 15	16	Ready for operation (DCTRL1-RDY)	
Digital signals possible for C0417 see C0415				
C0418*	Free configuration of controller status messages (2)		Output of digital signals to bus	All bits can be freely configured The assignment is mapped to the <ul style="list-style-type: none"> • Controller status word 2 (C0151) • FIF output word 2 (FIF-OUT.W2) • Output word 1 in the CAN object 2 (CAN-OUT2.W1)
1	Bit 0	255	Not assigned (FIXED-FREE)	
16	Bit 15	255	Not assigned (FIXED-FREE)	
Digital signals possible for C0418 see C0415				

Signal linkage

The process data output words are linked with internal signals by entering the selection figure of the internal signal in the corresponding subcode C0417 and C0418. C0417 and C0418 can be different for the parameter sets.

Examples

- C0417/4 ⇔ 16: The status message “Ready for operation” is the signal source for bit 3.
- C0418/5 ⇔ 101: Bit 2 of CAN-IN2.W1 is the signal source for bit 4.

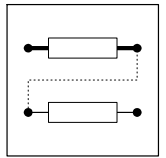

Note!

The process data output words CAN-OUT1.W1/FIF-OUT.W1, CAN-OUT2.W1 and FIF-OUT.W2 can also be assigned as analog word under C0421:

- If digitally configured under C0417 or C0418 no simultaneous analog assignment with C0421 (C0421/x = 255)!
- With analog configuration under C0421 no simultaneous digital assignment with C0417 and C0418 (C0417/x = 255, C0418/x = 255)!
- Otherwise the status information would be incorrect.

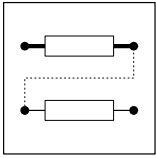

Function library

Thermal motor monitoring, error detection

7.12 Thermal motor monitoring

7.12.1 I²t monitoring

Description

With I²t monitoring, self-ventilated three-phase AC motors can be thermally monitored without using sensor.



Stop!

- I²t monitoring does not fully protect the motor since the calculated motor temperature is reset after every mains disconnection!
- After renewed mains connection the connected motor can be overheated, if
 - it is already hot and is still overloaded.
 - the cooling air supply is interrupted.
 - the air is too hot.
- Full motor protection can be achieved by using a PTC thermistor or thermostat in the motor. (☞ 7-84)

Codes for parameter setting

Code		Possible settings		IMPORTANT
No.	Name	Lenze	Selection	
C0120	I ² t switch-off	0	0 {1 %} = not active	200 Reference: Apparent motor current (C0054) ☞ 7-82 Ref. to active motor current (C0056) possible, see C0310

Adjustment

1. Calculate C0120. This value corresponds to a motor load of 100 % :

$C0120 [\%] = \frac{I_r}{I_N} \cdot 100 \%$	I _r	Rated motor current
	I _r	Rated controller current at a chopper frequency of 8 kHz

2. If you reduce C0120 based on the calculated value, the monitoring already starts at a motor load of < 100 %.
3. If you increase C0120 based on the calculated value, the monitoring only starts at a motor load > 100 %.

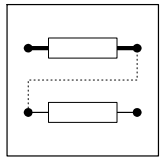

The controller switches off with fault OC6, if the apparent motor current is higher than the rated motor current over a longer period of time.

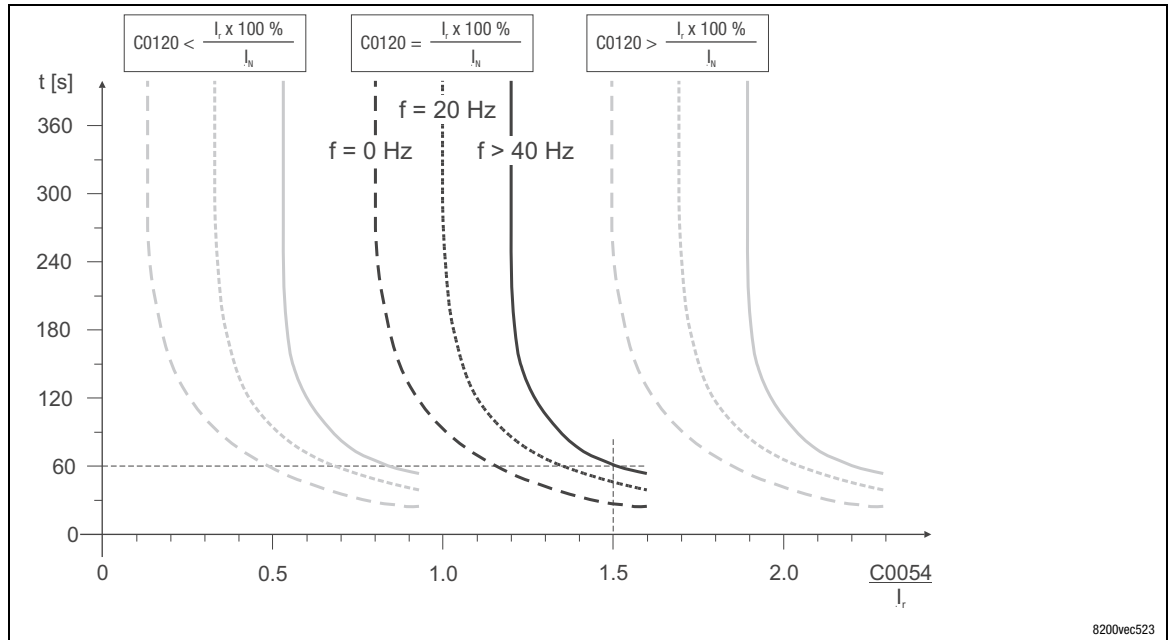

Fig. 7-16

Tripping characteristic of I^2t monitoring

f	Output frequency
t	Time to trip
I_r	Rated controller current at a chopper frequency of 8 kHz
I_r	Rated motor current
C0054	Apparent motor current

Example:

$$C0120 = \frac{I_r}{I_N} \cdot 100 \%$$

$$C0054 = 1.5 \times \text{rated motor current}$$

The controller switches off at output frequencies $f > 40$ Hz after approx. 60 s with fault OC6.

Tip

- To prevent motors with forced ventilation from starting too early, this function can be deactivated.
- The current limits C0022 and C0023 only have indirect influence on the I^2t calculation. It is possible to prevent motor operation with a maximum of possible load with settings under C0022 and C0023.



Note!

If the controller operates at increased rated power, the I^2t monitoring starts if C0120 is set lower than 100 %.

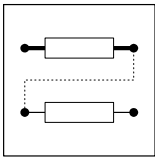

Function library

Thermal motor monitoring, error detection

7.12.2 Temperature monitoring of the motor with PTC and earth-fault detection

Description

You can connect PTC resistors via the inputs X2/T1 and X2/T2 according to DIN 44081 and DIN 44082. The motor temperature is detected and integrated into the drive monitoring.

It is also possible to connect a thermostat (NC contact) to X2/T1 and X2/T2. Lenze AC three-phase motors are equipped with these components as standard.

We recommend to always activate the PTC input for operation with motors equipped with PTC resistors or thermostats. By this you prevent the motor from overheating.



Stop!

- The controller can only detect one PTC resistor! Do not connect several PTC resistors in series or in parallel:
 - The motor temperature would be measured incorrectly.
 - The motors could be destroyed by overheating.
- If you connect several motors to one controller, use thermostats (NC contacts) connected in parallel to monitor the motor temperature.
- To achieve a total motor protection you must install an additional temperature monitoring with a separate evaluation.

Codes for parameter setting

Code		Possible settings			IMPORTANT
No.	Name	Lenze	Selection		
C0119 <small>ENTER</small>	Configuration of motor temperature monitoring (PTC input) / earth fault detection	0	0	PTC input not active	Earth fault detection active
			1	PTC input active, TRIP set	
			2	PTC input active, Warning set	
			3	PTC input not active	Earth fault detection inactive
			4	PTC input active, TRIP set	
5	PTC input active, Warning set				

- Signal output configuration under C0415 7-84
- If several parameter sets are used, the monitoring must be separately adjusted for each parameter set.
- Deactivate the earth fault detection, if it has been activated unintentionally.
- If the earth fault detection is active, the motor starts after controller enable with a delay of approx.40 ms.

Activation



Note!

- In the Lenze setting, the temperature monitoring of the motor is switched off!
- If you are dealing with several parameter sets, you must activate the monitoring in each parameter set!

1. Connect the monitoring circuit of the motor to X2/T1 and X2/T2.
 - If $1.6 \text{ k}\Omega < R < 4 \text{ k}\Omega$ the monitoring is activated.
2. Set the reaction of the controller:
 - C0119 = 0 or 3: Temperature monitoring of the motor is switched off
 - C0119 = 1 or 4: TRIP fault message (keypad display: OH3 Trip)
 - C0119 = 2 or 5: Warning signal (keypad display: OH51 Warn)

Verification

Connect the PTC input to a fixed resistor:

- $R > 4 \text{ k}\Omega$: A fault message OH3 or OH51 must be initiated.
- $R < 1 \text{ k}\Omega$: A fault message must not be initiated.

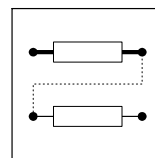

7.13 External fault evaluation

7.13.1 External fault detection

Description

Use the internal digital signal DCTRL1-TRIP-SET to evaluate external disturbances and integrate them into the monitoring of the system. If an external disturbance is recognised, the controller indicates the fault EEr and sets controller inhibit.



Note!

The function is LOW active.

Activation

- C0410/11 (DCTRL1-TRIP-SET) must be combined with digital signal source.
- LOW level at the signal source for DCTRL1-TRIP-SET sets fault message EEr and activates the controller inhibit.



Note!

Use C0007 to carry out a fixed configuration of DCTRL1-TRIP-SET with the digital inputs X3/E1 ... X3/E4. C0410/11 will be automatically adapted.

7.13.2 Reset of external faults

Description

You can reset a fault message with the internal digital signal DCTRL1-TRIP-RESET, when the cause of disturbance has been removed.



Note!

A LOW-HIGH signal resets the fault message.

Activation

- C0410/12 (DCTRL1-TRIP-RESET) must be combined with digital signal source.
- LOW-HIGH signal at the signal source for DCTRL1-TRIP-RESET resets the fault message.



Note!

Further options to reset fault messages: (8-7)

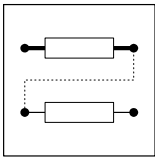

Function library

Display of operating data, diagnostics

7.14 Display of operating data, diagnostics

7.14.1 Display of operating data

Description

Important operating parameters are measured by the controller. They can be displayed with the keypad or PC.

Some operating data can be calibrated to be directly displayed or selected in the process variable unit (e.g. pressure, temperature, speed).



Note!

The calibration always effects all selected codes.

Codes for parameter setting

Code		Possible settings		IMPORTANT
No.	Name	Lenze	Selection	
C0004*	Bar-graph display	56	1 {Code No.} 989 56 = controller load (C0056)	<ul style="list-style-type: none"> Bargraph display indicates the selected value in % after power on Range -180 % ... +180 %
C0044*	Setpoint 2 (NSET1-N2)		-650.00 {0.02 Hz} 650.00	<p>The value set will be lost when switching the mains!</p> <ul style="list-style-type: none"> Selection, if C0412/2 = FIXED-FREE (not assigned) Display if C0412/2 is linked with a signal source
C0046*	Setpoint 1 (NSET1-N1)		-650.00 {0.02 Hz} 650.00	<p>The value set will be lost when switching the mains!</p> <ul style="list-style-type: none"> Selection, if C0412/1 = FIXED-FREE (not assigned) Display if C0412/1 is linked with a signal source
C0047*	Torque setpoint or torque limit value (MCTRL1-MSET)	400	0 {1 %} 400 Ref.: Rated motor torque detected by motor parameter identification	<p>The value set will be lost when switching the mains!</p> <p>Control mode "Sensorless torque control" (C0014 = 5):</p> <ul style="list-style-type: none"> Torque setpoint selection if C0412/6 = FIXED-FREE (not assigned) Torque setpoint display if C0412/6 is linked with a signal source <p>Control mode "V/f characteristic control" or "Vector control" (C0014 = 2, 3, 4):</p> <ul style="list-style-type: none"> Torque limit value is displayed if C0412/6 is linked with a signal source C0047 = 400 is displayed if C0412/6 = FIXED-FREE (not assigned)
C0049*	Additional setpoint (PCTRL1-NADD)		-650.00 {0.02 Hz} 650.00	<p>The value set will be lost when switching the mains!</p> <ul style="list-style-type: none"> Selection, if C0412/3 = FIXED-FREE (not assigned) Display if C0412/3 is linked with a signal source
C0050* u5Er	Output frequency (MCTRL1-NOUT)		-650.00 {Hz} 650.00	Only display: Output frequency without slip compensation

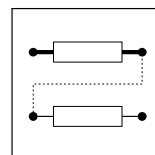

Code		Possible settings			IMPORTANT
No.	Name	Lenze	Selection		
C0051*	Output frequency with slip compensation (MCTRL1-NOUT+SLIP) or act. process controller value (PCTRL1-ACT)		-650.00 {0.02 Hz} 650.00		<p>The value set will be lost when switching the mains!</p> <p>Operation without process controller (C0238 = 2):</p> <ul style="list-style-type: none"> • Display only: Output frequency with slip compensation (MCTRL1-NOUT+SLIP) <p>Operation with process controller (C0238 = 0, 1):</p> <ul style="list-style-type: none"> • Selection, if C0412/5 = FIXED-FREE (not assigned) • Display if C0412/5 is linked with a signal source
C0052*	Motor voltage (MCTRL1-VOLT)		0 {V} 1000		Only display
C0053*	DC-bus voltage (MCTRL1-DCVOLT)		0 {V} 1000		Only display
C0054*	Apparent motor current (MCTRL1-IMOT)		0.0 {A} 2000.0		Only display
C0056*	Controller load (MCTRL1-MOUT)		-255 {=} 255		<p>Only display</p> <p>Under C0311 you can change the display value for the operating modes vector control or sensorless torque control.</p>
C0061*	Heatsink temperature		0 {°C} 255		<p>Only display</p> <ul style="list-style-type: none"> • If the heatsink temperature is $> \vartheta_{\max} - 5 \text{ °C}$: <ul style="list-style-type: none"> – The warning <i>DH</i> will be sent. – The chopper frequency will be reduced to 4 kHz, if C0144 = 1 • If the heatsink temperature is $> \vartheta_{\max}$: <ul style="list-style-type: none"> – Controller sets TRIP <i>DH</i>
C0138*	Process controller setpoint 1 (PCTRL1-SET1)	0.00	-650.00 {0.02 Hz} 650.00		<p>The value set will be lost when switching the mains!</p> <ul style="list-style-type: none"> • Selection if C0412/4 = FIXED-FREE • Display if C0412/4 \neq FIXED-FREE
C0189* (A)	Output signal compensator (PCTRL1-FOLL1-OUT)		-650.00 {0.02 Hz} 650.00		<p>Only display</p> <p>Compensator = PCTRL1-FOLL1</p>
C0320 (A)	Actual process controller value (PCTRL1-ACT)		-650.00 {0.02 Hz} 650.00		Only display
C0321 (A)	Process controller setpoint (PCTRL1-SET)		-650.00 {0.02 Hz} 650.00		Only display
C0322 (A)	Process controller output without precontrol (PCTRL1-OUT)		-650.00 {0.02 Hz} 650.00		Only display
C0323 (A)	Ramp function generator input (NSET1-RFG1-IN)		-650.00 {0.02 Hz} 650.00		Only display
C0324 (A)	Ramp function generator output (NSET1-NOUT)		-650.00 {0.02 Hz} 650.00		Only display
C0325 (A)	PID controller output (PCTRL1-PID-OUT)		-650.00 {0.02 Hz} 650.00		Only display
C0326 (A)	Process controller output (PCTRL1-NOUT)		-650.00 {0.02 Hz} 650.00		Only display

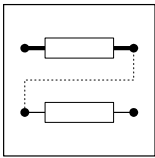

Function library

Display of operating data, diagnostics

Code		Possible settings		IMPORTANT
No.	Name	Lenze	Selection	
C0500*	Calibration of numerator variable	2000	1 {1} 25000	<ul style="list-style-type: none"> The codes C0010, C0011, C0017, C0019, C0037, C0038, C0039, C0044, C0046, C0049, C0050, C0051, C0138, C0139, C0140, C0181, C0239, C0625, C0626, C0627 can be calibrated in a way that the keypad indicates a process variable. If C0500/C0501 remain unchanged, the unit "Hz" will no longer be displayed.
C0501*	Calibration of denominator process variable	10	1 {1} 25000	
C0500* (A)	Calibration of numerator variable	2000	1 {1} 25000	<ul style="list-style-type: none"> The codes C0037, C0038, C0039, C0044, C0046, C0049, C0051, C0138, C0139, C0140, C0181 can be calibrated in a way that the keypad indicates a process variable with the unit selected under C0502.
C0501* (A)	Calibration of denominator process variable	10	1 {1} 25000	
C0502* (A)	Process variable unit	0	0: — 6: rpm 13: % 18: Ω 1: ms 9: °C 14: kW 19: hex 2: s 10: Hz 15: N 34: m 4: A 11: kVA 16: mV 35: h 5: V 12: Nm 17: mΩ 42: mH	<ul style="list-style-type: none"> Frequency-related codes (C0010, C0011, C0017, C0019, C0050, C0239, C0625, C0626, C0627) are always indicated in "Hz".

Calibration

Calibrated values are calculated from:

$$C0_{xxx} = \frac{C0011}{200} \cdot \frac{C0500}{C0501}$$

Calibration example

The pressure setpoint is to be selected in bar.

The maximum pressure of 5 bars (100 %) is reached at C0011 = 50 Hz.

Relative calibration in %

$$100\% = \frac{50}{200} \cdot \frac{C0500}{C0501} = \frac{50}{200} \cdot \frac{4000}{10} \quad \text{E.g. } C0500 = 4000, C0501 = 10$$

Absolute calibration in bar

$$5.00 \text{ bar} = \frac{50}{200} \cdot \frac{C0500}{C0501} = \frac{50}{200} \cdot \frac{200}{10} \quad \text{E.g. } C0500 = 200, C0501 = 10$$



Note!

At standard I/O operation the frequency-related codes C0010, C0011, C0017, C0019, C0050, C0239, C0625, C0626 and C0627 are also displayed in the unit defined by calibration.

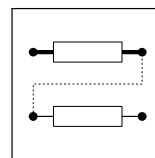

7.14.2 Diagnostics

Description

Display codes for diagnostics

Codes for parameter setting

Code		Possible settings		IMPORTANT		
No.	Name	Lenze	Selection			
C0093*	Controller type		xxx	Only display <ul style="list-style-type: none"> • xxx = Power taken from nameplate (e. g. 551 = 550 W) • y = Voltage class (2 = 240 V, 4 = 400 V) 		
C0099*	Software version		x.y	Only display x = Main version, y = Index		
C0161*	Active error			Display history buffer contents <ul style="list-style-type: none"> • Keypad: three-digit, alpha numerical fault detection • 9371BB keypad: LECOM fault number 		
C0162*	Last fault					
C0163*	Last but one fault					
C0164*	Last but two fault					
C0168*	Actual fault			History buffer displays "active error" <ul style="list-style-type: none"> • Keypad: three-digit, alpha numerical fault detection • 9371BB keypad: LECOM fault number 		
C0179*	Power-on time		{h}	Only display Total time mains on		
C0183*	Diagnostics		0	No fault	Only display	
			102	TRIP active		
			104	Message "Overvoltage (OL)" or "Undervoltage (LL)" active		
			142	Pulse inhibit		
			151	Quick stop active		
			161	DC-injection brake active		
			250	Warning active		
C0200*	Software ID				Read only on PC x = main version, y = subversion	
			82S8212V_xy000		8200 vector 0.25 ... 11 kW	
			82S8212V_xy010		8200 vector 15 ... 90 kW	
C0201*	Software creation date			Read only on PC		
C0202*	Software ID		Output in keypad as string in four parts at four characters each		Read only in keypad	
			1	82S8		
			2	212 V		
			3	_xy0		x = main version, y = subversion
			4	zz		00 = 8200 vector 0.25 ... 11 kW 10 = 8200 vector 15 ... 90 kW
C0304 ... C0309	Service codes			Modifications only by Lenze Service!		
C0372*	Function module identification		0	No function module	Only display	
			1	Standard I/O or AS-i		
			2	System bus (CAN)		
			6	Other function module on FIF e.g. application I/O, INTERBUS, ...		
			10	No valid recognition		
C0518 C0519 C0520	Service codes			Modifications only by Lenze Service!		

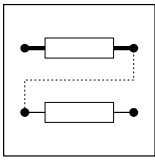

Function library

Display of operating data, diagnostics

Code		Possible settings		IMPORTANT
No.	Name	Lenze	Selection	
C1500* (A)	Software number application I/O		82SAFA0B_xy000	Only PC display x = main version y = subversion
C1501* (A)	Software creation date application I/O			Only PC display
C1502* (A)	Software ID application I/O		Output in keypad as string in four parts at four characters each	Read only in keypad x = main version y = subversion
	1		82SA	
	2		FA0B	
	3		_xy0	
	4		00	
C1504 (A) ... C1507 (A)	Service codes application I/O			Modifications only by Lenze Service!
C1550 (A)	Service code application I/O			Modifications only by Lenze Service!

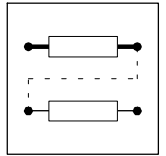

7.15 Parameter set management

7.15.1 Saving and copying parameter sets

Description

Management of the controller parameter sets. It is possible to

- restore the Lenze setting and put the controller into the delivery state again.
- save your own basic setting, e.g. the delivery state of the machine.
- transfer parameter sets from the keypad to the controller or vice versa. The settings can thus be easily copied between controllers.

Codes for parameter setting

Code		Possible settings		IMPORTANT		
No.	Name	Lenze	Selection			
C0002* <i>USER</i>	Parameter set management	0	0 Ready	PAR1 ... PAR4: <ul style="list-style-type: none"> • Parameter sets of the controller • PAR1 ... PAR4 also contain parameters for Standard-I/O, Application-I/O, AS interface or system bus (CAN) FPAR1: <ul style="list-style-type: none"> • Module-specific parameter set of the fieldbus function modules INTERBUS, PROFIBUS-DP, LECOM-B, DeviceNet/CANopen • FPAR1 is saved in the function module 7-91		
	Restorage of default setting	1	Lenze setting ⇒ PAR1		Restorage of default setting in the selected parameter set	
		2	Lenze setting ⇒ PAR2			
		3	Lenze setting ⇒ PAR3			
		4	Lenze setting ⇒ PAR4			
		31	Lenze setting ⇒ FPAR1			Restorage of default setting in the fieldbus function module
		61	Lenze setting ⇒ PAR1 + FPAR1			Restorage of default setting in the selected parameter set of the controller and the fieldbus function module
		62	Lenze setting ⇒ PAR2 + FPAR1			
63	Lenze setting ⇒ PAR3 + FPAR1					
C0002* <i>USER</i> (cont.)	Parameter set transfer using the keypad			Use the keypad to transfer parameter sets to other controllers. During transfer the parameters cannot be accessed via other channels!		
		70	Keypad ⇒ Controller With function module Application-I/O, INTERBUS, PROFIBUS-DP, LECOM-B, DeviceNet/CANopen	All available parameter sets (PAR1 ... PAR4, and FPAR1) are overwritten with the corresponding keypad data		
		10	With all other function modules			

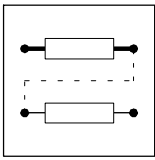

Function library

Parameter set management

Code		Possible settings		IMPORTANT	
No.	Name	Lenze	Selection		
C0002* (cont.)	Parameter set transfer using the keypad		71	Keypad ⇔ PAR1 (+ FPAR1) With function module Application-I/O, INTERBUS, PROFIBUS-DP, LECOM-B, DeviceNet/CANopen	Overwrite selected parameter set and, if necessary, FPAR1 with the corresponding keypad data
			11	With all other function modules	
			72	Keypad ⇔ PAR2 (+ FPAR1) With function module Application-I/O, INTERBUS, PROFIBUS-DP, LECOM-B, DeviceNet/CANopen	
			12	With all other function modules	
			73	Keypad ⇔ PAR3 (+ FPAR1) With function module Application-I/O, INTERBUS, PROFIBUS-DP, LECOM-B, DeviceNet/CANopen	
			13	With all other function modules	
			74	Keypad ⇔ PAR4 (+ FPAR1) With function module Application-I/O, INTERBUS, PROFIBUS-DP, LECOM-B, DeviceNet/CANopen	
			14	With all other function modules	
			80	Controller ⇔ Keypad With function module Application-I/O, INTERBUS, PROFIBUS-DP, LECOM-B, DeviceNet/CANopen	
20	With all other function modules				
40	Keypad ⇔ Function module Only with function module INTERBUS, PROFIBUS-DP, LECOM-B, DeviceNet/CANopen	Overwrite the module-specific parameter set FPAR1 only			
50	Function module ⇔ Keypad Only with function module INTERBUS, PROFIBUS-DP, LECOM-B, DeviceNet/CANopen	Copy the module-specific parameter set FPAR1 only			
C0002* (cont.)	Saving of own settings	9	PAR1 ⇔ Own settings	You can save your own basic settings for a controller (e.g. machine delivery status): 1. Ensure that parameter set 1 is active 2. Controller inhibit 3. Set C0003 = 3, acknowledge with 4. Set C0002 = 9, acknowledge with , to save your own basic settings 5. Set C0003 = 1, acknowledge with 6. Enable the controller.	
C0002* (cont.)	Loading/copying of your own basic settings		5	Own settings ⇔ PAR1	Using this function, PAR1 can be copied to parameter sets PAR2 ... PAR4 Restorage of own basic setting in the selected parameter set
			6	Own settings ⇔ PAR2	
			7	Own settings ⇔ PAR3	
			8	Own settings ⇔ PAR4	
C0003* 	Non-volatile parameter saving	1	0	Parameter not saved in EEPROM	Data loss after mains disconnection
			1	Parameter always saved in EEPROM	<ul style="list-style-type: none"> Active after every mains connection Cyclic parameter changes via bus module are not allowed.
			3	Own settings saved in EEPROM	Subsequently save parameter set 1 as own basic setting with C0002 = 9

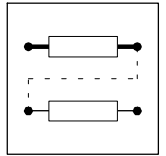

Note!

- Do not remove keypad as long as the parameters are being transmitted! If the keypad is removed during transmission, the controller indicates the errors "Prx" or "PT5".
- A detailed description of the keypads can be found in the "Parameter setting" chapter.

Restoring the delivery status

1. Attach keypad.
2. Inhibit controller with **STOP** or via terminal (X3/28 = LOW).
3. Set the correct selection number in C0002 from the "Restore delivery status" category and confirm with **ENTER**.
 - E.g. C0002 = 1: Parameter set 1 of the controller is overwritten with Lenze setting.

Parameter set transfer from the controller to the keypad

1. Attach keypad.
2. Inhibit controller with **STOP** or via terminal (X3/28 = LOW).
3. Set C0002 = 20 or 50 or 80, confirm with **ENTER**.

Parameter set transfer from the keypad to the controller

1. Attach keypad.
2. Inhibit controller with **STOP** or via terminal (X3/28 = LOW).
3. Set the correct selection number in C0002 from the "Parameter set transfer with keypad" category and confirm with **ENTER**.
 - E.g. C0002 = 10: All parameter sets of the controller are overwritten with the settings in the keypad.
 - E.g. C0002 = 11: Parameter set 1 of the controller is overwritten with the settings in the keypad.

Saving your own basic setting

1. Attach keypad.
2. Parameter set 1 must be active!
3. Inhibit controller with **STOP** or via terminal (X3/28 = LOW).
4. Set parameter in parameter set 1.
5. Set C0003 = 3 and confirm with **ENTER**.
6. Set C0002 = 9 and confirm with **ENTER**. The own basic setting is saved.
7. Set C0003 = 1 and confirm with **ENTER**.

Copying your own basic setting into the parameter sets

1. Attach keypad.
2. Inhibit controller with **STOP** or via terminal (X3/28 = LOW).
3. Set the correct selection number in C0002 from the "Loading/saving you own basic setting" category and confirm with **ENTER**.
 - E.g. C0002 = 5: Parameter set 1 is overwritten with your own basic setting.
 - E.g. C0002 = 8: Parameter set 4 is overwritten with your own basic setting.

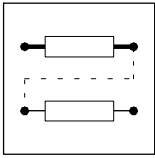

Function library

Parameter set management

7.15.2 Parameter set changeover

Description

During operation you can change between the four parameter sets of the controller via digital signals. Thus 9 additional JOG values or additional acceleration and deceleration times are available.

The parameter set changeover via digital signals is not possible if the automatic changeover via DC-bus voltage is active!

Activation

Link C0410/13 (DCTRL1-PAR2/4) and C0410/14 (DCTRL1-PAR3/4) with a digital signal source.

After being initialised, the controller always operates with parameter set 1. Only when a signal for parameter set changeover is active, the controller changes the parameter set.



Note!

- C0410/13 and C0410/14 must be linked with the same signals in all parameter sets!
- Start the parameter setting with the highest parameter set. Parameterise the parameter set 1 at the end. In this way undefined states can be prevented
- If the control mode (C0014) is different for the parameter sets, you should only switch between the parameter sets when the controller is inhibited (CINH).

Signal source		Active parameter set
Level at C0410/13	Level at C0410/14	
LOW	LOW	Parameter set 1 (PAR1)
HIGH	LOW	Parameter set 2 (PAR2)
LOW	HIGH	Parameter set 3 (PAR3)
HIGH	HIGH	Parameter set 4 (PAR4)



Note!

Use C0007 to link the changeover between parameter set 1 and parameter set 2 with the digital inputs X3/E2 or X3/E3.

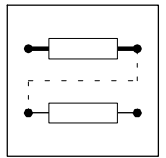

7.16 Individual summary of drive parameters in the user menu

Description

- Fast access to 10 codes
- Individual combination of 10 codes most important for your application.

Codes for parameter setting

Code		Possible settings		IMPORTANT
No.	Name	Lenze	Selection	
C0517*	User menu			<ul style="list-style-type: none"> • After mains switching or when using the function the code from C0517/1 will be displayed. • In Lenze setting, the user menu contains the most important codes for starting-up the control mode "V/f characteristic control with linear characteristic" • When the password protection is activated, only the codes entered under C0517 are freely accessible. • Enter the required code numbers in the subcodes. <p>Codes, which are only active when being used together with an Application-I/O, cannot be entered!</p>
1	Memory 1	50	C0050 Output frequency (MCTRL1-NOUT)	
2	Memory 2	34	C0034 Analog setpoint selection range	
3	Memory 3	7	C0007 Fixed configuration - digital input signals	
4	Memory 4	10	C0010 Minimum output frequency	
5	Memory 5	11	C0011 Maximum output frequency	
6	Memory 6	12	C0012 Acceleration time main setpoint	
7	Memory 7	13	C0013 Deceleration time main setpoint	
8	Memory 8	15	C0015 V/f rated frequency	
9	Memory 9	16	C0016 U _{min} boost	
10	Memory 10	2	C0002 Parameter set transfer	

User menu adaptation

Enter the required code number or subcode number into the subcodes under C0517.



Note!

Use the user menu to select "tailored" codes for your application to be used by your personnel if the password protection is activated additionally. Your personnel can only change codes listed in the user menu.

Example: Select speed via keypad

The personnel operating a transportation system shall be able to change the speed of the conveyor using the keypad. The speed is set and indicated in "rpm":

User menu configuration

1. Assign C0140 to memory 1 of the user menu (C0517/1 = 140)
2. Delete all other entries from the user menu (C0517/2 ... C0517/10 = 0)
3. Convert the value indicated under C0140 into "rpm" using C0500/C0501 ()
4. Activate the password protection (C0094 > 0)
5. The current conveyor speed will be indicated after the keypad has been attached or power on.
6. Use to activate the function and to change the speed during operation using the keys. The speed set last will be stored when the mains is switched off.

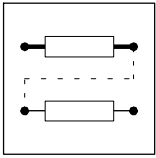

Function library

Individual grouping of drive parameters - The menu USEr



8 Troubleshooting and fault elimination

8.1 Troubleshooting

Detecting failures

The controller LED's and the status information at the keypad immediately indicate errors or operation problems.

Analysing errors

You can analyse an error using the history buffer. The list "Error messages" helps you to eliminate the error. (☞ 8-4)

8.1.1 Status display (LEDs on the controller)

During operation, the operating status of the controller is indicated by means of two LEDs.

8.2 LEDs on the drive controller (status display)

LED		Operating status
red ①	green ②	
off	on	Controller enabled
on	on	Mains switched on and automatic start inhibited
off	slowly blinking	Controller inhibited
off	fast blinking	Motor parameter identification being executed
fast blinking	off	Undervoltage switch-off
slowly blinking	off	Fault active, check under C0161

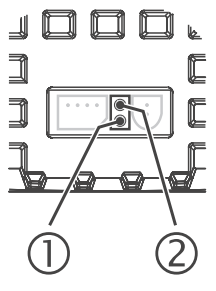

8.2.1 Error analysis with the history buffer

Tracing back failures

Failures can be traced back via the history buffer. Error messages are stored in the history buffer in the order of their occurrence.

The memory locations can be retrieved via the codes.

Structure of the history buffer

Code	Memory unit	Entry	Comment
C0161	History buffer location 1	Active error	If the error is no longer active or has been acknowledged: <ul style="list-style-type: none"> • The contents of the memory locations 1 ... 3 are saved in a "higher" location. • The contents of the memory location 4 will be eliminated from the history buffer and cannot be read any longer. • Memory location 1 will be deleted (= no active fault).
C0162	Memory location 2	Last error	
C0163	Memory location 3	Last but one error	
C0164	Memory location 4	Third last error	



Troubleshooting and fault elimination

Maloperation of the drive

8.3 Drive performance in case of errors

The controller responds differently to the three possible fault types TRIP, message, and warning:

TRIP (keypad display:)

- Switches the power output U, V, W to high resistance until TRIP is reset.
- The fault indication is entered into the history buffer as "current fault" in C0161.
- The drive is coasting (no control)!
- After TRIP reset ( 8-7):
 - The drive accelerates to its setpoint along the set ramps.
 - The fault indication is moved to C0162 as "last fault" and deleted in C0161.

Messages (keypad display:)

- Switches the power outputs U, V, W to high resistance.
- Messages are not entered into the history buffer.
- The drive is coasting without control as long as the message is active!
- If the message is not active anymore, the drive starts automatically.

Warnings

"Heatsink overtemperature" (keypad:)

- The drive operates under control!
- The warning signal goes off if the fault is not active anymore.

"Error in motor phase" (keypad:)

"PTC monitoring" (keypad:)

- The drive operates under control!
- The fault indication is entered into the history buffer as "current fault" in C0161.
- After TRIP reset the fault indication is moved to C0162 as "last fault" and deleted in C0161.



8.4 Error elimination

8.4.1 Maloperation of the drive

Fault	Cause	Remedy
Motor does not rotate	DC-bus voltage too low (Red LED is blinking every 0.4 s; keypad display <i>LL</i>)	Check mains voltage
	Controller inhibited (Green LED is blinking, keypad display: IMP)	Remove the controller inhibit, controller inhibit can be set through several sources
	Automatic start inhibited (C0142 = 0 or 2)	LOW-HIGH edge at X3/28 If necessary, correct start condition (C0142)
	DC injection brake (DCB) active	Deactivate DC injection brake
	Mechanical motor brake is not released	Manual or electrical release of mechanical motor brake
	Quick stop (QSP) active (keypad display: IMP)	Remove quick stop
	Setpoint = 0	Select setpoint
	JOG setpoint activated and JOG frequency = 0	Select JOG setpoint (C0037 ... C0039)
	Active fault	Eliminate fault
	Wrong parameter set active	Change to correct parameter set via terminal
	Operating mode C0014 = -4-, -5-, but no motor parameter identification executed	Motor parameter identification (C0148)
	Under C0410 several functions which exclude each other, are assigned to the same signal source.	Correct configuration in C0410
	Use of internal voltage source X3/20 for function modules Standard I/O, INTERBUS, PROFIBUS-DP or LECOM-B (RS485): Jumper between X3/7 and X3/39 is missing	Jumper terminals
Motor does not rotate smoothly	Defective motor cable	Check motor cable
	Maximum current set too low (C0022, C0023)	Adapt settings to the application
	Motor underexcited or overexcited	Check parameter setting (C0015, C0016, C0014)
	C0084, C0087, C0088, C0089, C0090, C0091 and/or C0092 are not adapted to the motor data	Manual adaptation or identification of motor parameters (C0148)
Current consumption of motor too high	Setting of C0016 too high	Correct setting
	Setting of C0015 too low	Correct setting
	C0084, C0087, C0088, C0089, C0090, C0091 and/or C0092 are not adapted to the motor data	Manual adaptation or identification of motor parameters (C0148)
Motor rotates, setpoints are "0"	With the function [Set] of the keypad a setpoint has been selected.	Set the setpoint to "0" via C0140 = 0
Motor parameter identification stops with error LP1	Motor too small compared with rated device power	
	DC injection brake active via terminal	
Unacceptable drive response with vector control	various	Optimise vector control (☐ 7-9)
Torque dip in the field weakening range	various	Contact Lenze
Stalling of the motor when operating in the field weakening range		



Troubleshooting and fault elimination

Error messages

8.4.2 Fault messages on the keypad or in the parameter setting program Global Drive Control

Keypad	PC 1)	Fault	Cause	Remedy
$nDEr$	0	No fault	-	-
cCr Trip	71	System failure	Strong interference injections on the control cables Earth loops in the wiring	Shield control cable
cEO Trip	61	Communication error on AIF (configurable in C0126)	Faulty transmission of control commands via AIF	Insert the communication module properly into the diagnosis terminal
$cE1$ Trip	62	Communication error on CAN-IN1 with sync control	CAN-IN1 object receives faulty data or communication is interrupted	<ul style="list-style-type: none"> • Check plug connection of bus module ↔ FIF • Check sender • Increase monitoring time in C0357/1, if necessary
$cE2$ Trip	63	Communication error on CAN-IN2	CAN-IN2 object receives faulty data or communication is interrupted	<ul style="list-style-type: none"> • Check plug connection of bus module ↔ FIF • Check sender • Increase monitoring time in C0357/2, if necessary
$cE3$ Trip	64	Communication error on CAN-IN1 in case of event or time control	CAN-IN1 object receives faulty data or communication is interrupted	<ul style="list-style-type: none"> • Check plug connection of bus module ↔ FIF • Check sender • Increase monitoring time in C0357/3, if necessary
$cE4$ Trip	65	BUS-OFF (many communication errors occurred)	Controller has received too many faulty telegrams via the system bus and has been disconnected from the bus	<ul style="list-style-type: none"> • Check whether bus termination is available • Check shielding of the cables • Check PE connection • Check bus load, reduce the baud rate, if necessary
$cE5$ Trip	66	CAN time-out (configurable in C0126)	In case of remote parameterisation via the system bus (C0370): Slave does not respond. Communication monitoring time has been exceeded	<ul style="list-style-type: none"> • Check wiring of the system bus • Check system bus configuration
			When operating with Application I/O: Parameter set change-over has been parameterised incorrectly	In all parameter sets, the "change over parameter set" signal (C0410/13, C0410/14) must be connected with the same source
			When operating with module on FIF: Internal error	Contact Lenze
$cE6$ Trip	67	System bus (CAN) function module on FIF has the "Warning" or "BUS-OFF" status (configurable in C0126)	CAN controller signals "Warning" or "BUS-OFF" status	<ul style="list-style-type: none"> • Check whether bus termination is available • Check shielding of the cables • Check PE connection • Check bus load, reduce the baud rate, if necessary
$cE7$ Trip	68	Communication error in case of remote parameterisation via the system bus (C0370) (configurable in C0126)	Node does not respond or is not available	<ul style="list-style-type: none"> • Check whether bus termination is available • Check shielding of the cables • Check PE connection • Check bus load, reduce the baud rate, if necessary
			When operating with Application I/O: Parameter set change-over has been parameterised incorrectly	In all parameter sets, the "change over parameter set" signal (C0410/13, C0410/14) must be connected with the same source
EEr Trip	91	External fault (TRIP-SET)	A digital signal assigned to the TRIP-set function is activated	Check external encoder
$Er-PD$... $Er-P19$ Trip	-	Communication abort between keypad and standard device	Various	Contact Lenze
$FRn1$ Trip	95	Fan failure (only 8200 motec 3 ... 7.5 kW)	Fan is defective	Replace fan
$FRn1$	-	TRIP or warning configurable in C0608	Fan is not connected	Connect fan Check wiring
$HD5$ Trip	105	Internal fault		Contact Lenze
$Id1$ Trip	140	Faulty parameter identification	Motor is not connected	Connect motor

Troubleshooting and fault elimination

Error messages



Keypad	PC 1)	Fault	Cause	Remedy
LP1 Trip	32	Error in motor phase (Display when C0597 = 1)	<ul style="list-style-type: none"> Failure of one/several motor phases Motor current too low 	<ul style="list-style-type: none"> Check motor supply cables Check U_{min} boost, Connect motor with a corresponding power or adapt motor with C0599
LP1	182	Error in motor phase (Display when C0597 = 2)		
LU IMP	-	DC bus undervoltage	Mains voltage too low Voltage in DC-bus connection too low 400 V controller is connected to 240 V mains	Check mains voltage Check power supply module Connect controller to correct mains voltage
OC1 Trip	11	Short circuit	Short circuit	<ul style="list-style-type: none"> Search for cause of short circuit; check motor cable Check brake resistor and cable to brake resistor
			Capacitive charging current of the motor cable too high	Use shorter/low-capacitance motor cable
OC2 Trip	12	Earth fault	A motor phase has earth contact Capacitive charging current of the motor cable too high	Check motor; check motor cable Use shorter/low-capacitance motor cable Deactivate earth-fault detection for inspection purposes
OC3 Trip	13	Controller overload during acceleration or short circuit	Acceleration time set is too short (C0012) Defective motor cable Interturn fault in the motor	<ul style="list-style-type: none"> Increase acceleration time Check drive dimensioning Check wiring Check motor
OC4 Trip	14	Controller overload during deceleration	Deceleration time set is too short (C0013)	<ul style="list-style-type: none"> Increase deceleration time Check dimensioning of the external brake resistor
OC5 Trip	15	Controller overload during steady-state operation	Frequent and too long overload	Check drive dimensioning
OC6 Trip	16	Motor overload ($I^2 \times t$ overload)	Motor is thermally overload by e.g. <ul style="list-style-type: none"> impermissible continuous current frequent or too long acceleration processes 	<ul style="list-style-type: none"> Check drive dimensioning Check setting of C0120
DH Trip	50	Heatsink temperature > +85 °C	Ambient temperature is too high	Allow controller to cool and provide better ventilation
DH Warn	-	Heatsink temperature > +80 °C	Heatsink is very dirty Impermissibly high currents or frequent and too long acceleration processes	Clean heatsink <ul style="list-style-type: none"> Check drive dimensioning Check load, exchange rough-running, defective bearings if necessary
DH3 Trip	53	PTC monitoring (TRIP) (Display when C0119 = 1 or 4)	Motor too hot due to impermissibly high currents or frequent and too long acceleration processes No PTC connected	Check drive dimensioning Connect PTC or switch off monitoring
DH4 Trip	54	Controller overtemperature	Controller too hot inside	<ul style="list-style-type: none"> Reduce controller load Improve cooling Check fan in the controller
DH51	203	PTC monitoring (Display when C0119 = 2 or 5)	Motor too hot due to impermissibly high currents or frequent and too long acceleration processes No PTC connected	Check drive dimensioning Connect PTC or switch off monitoring
OU IMP	-	DC bus overvoltage (Message or TRIP configurable in C0310)	Mains voltage too high	Check supply voltage
QUE Trip	22		Braking operation	<ul style="list-style-type: none"> Increase deceleration times When operating with an external brake resistor: <ul style="list-style-type: none"> Check dimensioning, connection and supply cable of the brake resistor Increase deceleration times
			Earth leakage on the motor side	Check motor supply cable and motor for earth fault (disconnect motor from the inverter)
Pr Trip	75	Faulty parameter transmission when using the keypad	All parameter sets are defective	Before enabling the controller, repeat the data transfer or load the Lenze setting
Pr1 Trip	72	Faulty PAR1 transfer with keypad	Parameter set 1 is defective	



Troubleshooting and fault elimination

Error messages

Keypad	PC 1)	Fault	Cause	Remedy
<i>P_r2</i> Trip	73	Faulty PAR2 transfer with keypad	Parameter set 2 is defective	
<i>P_r3</i> Trip	77	Faulty PAR3 transfer with keypad	Parameter set 3 is defective	
<i>P_r4</i> Trip	78	Faulty PAR4 transfer with keypad	Parameter set 4 is defective	
<i>P_r5</i> Trip	79	Internal fault	EEPROM is defective	Contact Lenze
<i>P_t5</i> Trip	81	Time error during parameter set transfer	Data flow from keypad or PC interrupted, e.g. because keypad was disconnected during transfer	Before enabling the controller, repeat the data transfer or load the Lenze setting.
<i>r_St</i> Trip	76	Error during auto TRIP reset	More than 8 error messages within 10 minutes	Depends on the error message
<i>S_d5</i> Trip	85	Open circuit - analog input 1	Current at analog input < 4 mA at setpoint range 4 ... 20 mA	Close circuit at analog input
<i>S_d7</i> Trip	87	Open circuit - analog input 2		

1) LECOM error number, display in Global Drive Control (GDC) parameter setting program



8.5 Resetting error messages

Eliminating the cause for TRIP error message

After eliminating the cause for a TRIP error message the error message must be reset with the "TRIP reset" order. Only then the drive will start again.



Note!

A TRIP error message can have several causes. The TRIP reset can only be carried out after all causes for the TRIP have been eliminated.

Manual or automatic TRIP reset

You can select whether errors occurred are to be reset manually or automatically. Mains disconnection always carries out a TRIP reset independent of the settings under C0170.



Note!

If the controller carries out more than eight automatic TRIP resets within ten minutes, the controller will set TRIP *r57* (Counter exceeded).

TRIP reset also resets the auto TRIP counter.

Codes for parameter setting

Code		Possible settings		IMPORTANT
No.	Name	Lenze	Selection	
C0043* <small>ENTER</small>	TRIP reset		0 No current error 1 Active fault	Reset active error with C0043 = 0
C0170 <small>ENTER</small>	Configuration TRIP reset	0	0 TRIP reset by mains switching, <small>STOP</small> , LOW-signal at X3/28, via function module or communication module 1 like 0 and additional auto TRIP reset 2 TRIP reset through mains switching, via function module or communication module 3 TRIP reset by mains switching	<ul style="list-style-type: none"> TRIP reset via function module or communication module with C0043, C0410/12 or C0135 bit 11. Auto TRIP reset after the time set under C0171.
C0171	Delay for auto-TRIP reset	0.00	0.00 {0.01 sec} 60.00	



Troubleshooting and fault elimination

Error message reset

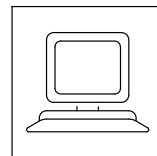

9 Automation

9.1 System bus function module (CAN) E82ZAFC

Automation with the fieldbus function modules system bus (CAN), INTERBUS, PROFIBUS-DP, LECOM-B (RS485) is described in the accompanying Communication Manual for the corresponding fieldbus system.

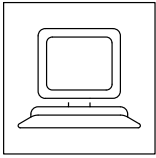

Automation

System bus (CAN)

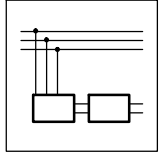

10 DC-bus connection

8200 motec frequency inverters are not suitable for DC-bus connection.

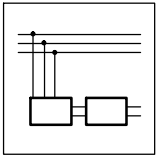

Network of several drives

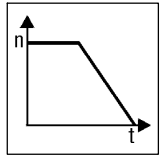

11 Braking operation

11.1 Braking operation without additional measures

In order to brake low masses you can parameterise the "DC injection brake DCB" (☞ 7-30) function.

11.2 Braking operation with external brake resistor

Larger moments of inertia or longer generator-mode operation require an external brake resistor. It converts mechanical energy into heat.

The brake transistor integrated in the controller switches the external brake resistor in addition when the DC-voltage exceeds a threshold. It can thus be avoided that the controller sets "overvoltage" and pulse inhibit and forces the drive to coast to standstill. External brake resistors ensure braking operation at any time.

11.2.1 Selection of brake resistors

The Lenze brake resistors recommended in the tables are matched to the corresponding controller (with regard to 150 % of regenerative power). They are suitable for most of the applications.

For special applications, e.g. centrifuges, the suitable brake resistor must meet the following requirements:

Brake resistor Criterion	Application	
	with active load	with passive load
Continuous braking power [W]	$\geq P_{\max} \cdot \eta_e \cdot \eta_m \cdot \frac{t_1}{t_{\text{cycl}}}$	$\geq \frac{P_{\max} \cdot \eta_e \cdot \eta_m}{2} \cdot \frac{t_1}{t_{\text{cycl}}}$
Thermal capacity [Ws]	$\geq P_{\max} \cdot \eta_e \cdot \eta_m \cdot t_1$	$\geq \frac{P_{\max} \cdot \eta_e \cdot \eta_m}{2} \cdot t_1$
Resistor [Ω]	$R_{\min} \leq R \leq \frac{U_{\text{DC}}^2}{P_{\max} \cdot \eta_e \cdot \eta_m}$	

Active load	Can move by itself without any influence from the drive (e.g. unwinder)
Passive load	Stops by itself without any influence from the drive (e.g. horizontal travelling drives, centrifuges, fans)
U_{DC} [V]	Switching threshold for brake transistor from C0174
P_{\max} [W]	Maximum braking power defined by the application
η_e	Electrical efficiency (controller + motor) Guide values: 0.54 (0.25 kW) ... 0.85 (11 kW)
η_m	Mechanical efficiency (gearbox, machine)
t_1 [s]	Braking time
t_{cycl} [s]	Cycle time = Time between two subsequent braking cycles (= t_1 + dead time)
R_{\min} [Ω]	Lowest permissible brake resistance (see rated data of the integrated brake transistor)

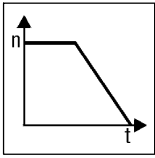

Braking operation

11.2.2 Rated data of the integrated brake transistor

8200 motec, 230 V

Brake transistor		8200 motec, 230 V	
		E82MV251_2B	E82MV371_2B
Switching threshold U_{DC}	[V DC]	380 (fixed)	
Peak braking current \hat{I}	[A DC]	0.85	
Max. continuous current	[A DC]	0.85	
Lowest permissible brake resistance R_{min}	[Ω]	470	
Current derating		At temperatures above 40 °C, the peak braking current should be derated by 2.5 %/°C Above 1000 m amsl, the peak braking current should be derated by 5 %/1000 m	
Switch-on cycle		Max. 60 s with peak braking current, then at least 60 s recovery time	
Recommended Lenze brake resistor	Order no.	ERBS470R150W	

8200 motec, 400 V

Brake transistor		8200 motec, 400 V			
		E82MV551_4B	E82MV751_4B	E82MV152_4B	E82MV222_4B
Switching threshold U_{DC}	[V DC]	790 (fixed)			
Peak braking current \hat{I}	[A DC]	1.8		4.0	
Max. continuous current	[A DC]	1.0		2.5	
Lowest permissible brake resistance ($U_{DC} = 790$ V)	[Ω]	450		200	
Current derating		At temperatures above 40 °C, the peak braking current should be derated by 2.5 %/°C Above 1000 m amsl, the peak braking current should be derated by 5 %/1000 m			
Switch-on cycle		Max. 60 s with peak braking current, then at least 60 s recovery time			
Recommended Lenze brake resistor	Order no.	ERBS470R150W		ERBS240R300W	

Brake transistor		8200 motec, 400 V			
		E82MV302_4B	E82MV402_4B	E82MV552_4B	E82MV752_4B
Switching threshold U_{DC}	[V DC]	790 (fixed)			
Peak braking current \hat{I}	[A DC]	7.8	7.8	11.4	16.5
Max. continuous current	[A DC]	3.9	5.1	7.0	9.6
Lowest permissible brake resistance ($U_{DC} = 790$ V)	[Ω]	100	100	68	47
Current derating		At temperatures above 40 °C, the peak braking current should be derated by 2.5 %/°C Above 1000 m amsl, the peak braking current should be derated by 5 %/1000 m			
Recommended Lenze brake resistor	Order no.	ERBS180R350W	ERBS100R625W	ERBS100R625W	ERBS082R780W

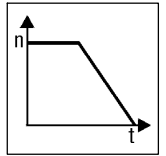

11.2.3 Rated data of Lenze brake resistors

Lenze brake resistors (IP65)							
	r	Continuous power*	Thermal capacity	Switch-on cycle	Cable cross-section		Weight
Order number	[Ω]	[kW]	[kWs]		[mm ²]	AWG	[kg]
ERBS470R150W	470	0.15	22.5	1:10 Brake for a maximum of 15 s, then apply a recovery time of at least 135 s	0.5 ... 10	20 ... 6	1.3
ERBS240R300W	240	0.3	45				2.1
ERBS180R350W	180	0.35	53				2.1
ERBS100R625W	100	0.62	94				3.1
ERBS082R780W	82	0.78	117				3.6

* The continuous power is a reference variable for selecting the brake resistor. Peak brake power is applied during braking (U_{DC}^2/R)
Observe national and regional regulations



Tip!

- The brake resistors are fitted with a thermostat (potential-free NC contact) as standard.
- If required, several brake resistors can be connected in parallel or in series. (Caution: do not fall below the lowest possible value!)

Installation instructions

- Brake resistors may overheat, possibly a brake resistor may burn. Therefore, mount the brake resistors in such a way that the possibly very high temperatures may not cause any damage.
- Provide a safety shutdown when the brake resistor overheats!
- Use temperature contacts of the brake resistor (e.g. T1 / T2) as control contacts to separate the controller from the mains!

Connection to E82MV251_2B, E82MV371_2B

Procedure	Connection diagram
The brake resistor R_B is connected to the terminal strip X1 of the motec. 1. Open the motec. 2. Mount the cable connector for the cable gland. 3. Unscrew the terminal strip X1 and remove it from its support. 4. Connect the brake resistor to BR2 and BR1. 5. Reconnect the terminal strip X1.	

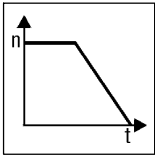

Braking operation

Connection to E82MV551_4B, E82MV751_4B, E82MV152_4B, E82MV152_4B

Procedure	Connection diagram
<p>The brake resistor R_B is connected to the terminal strip X1 of the motec.</p> <ol style="list-style-type: none"> 1. Open the motec. 2. Mount the cable connector for the cable gland. 3. Unscrew the terminal strip X1 and remove it from its support. 4. Remove the bridge between BR1 and BR0. 5. Connect the brake resistor to BR2 and BR1. 6. Reconnect the terminal strip X1. <p>If the external resistor is disconnected, BR1 and BR0 must be bridged again. Otherwise, the motec can be destroyed.</p>	

Connection to E82MV302_4B, E82MV402_4B, E82MV552_4B, E82MV752_4B

Procedure	Connection diagram
<p>The brake resistor R_B is connected to the terminal strip X2 of the motec.</p> <ol style="list-style-type: none"> 1. Open the motec. 2. Mount the cable connector for the cable gland. 3. Connect the brake resistor to BR2 and BR1. 	

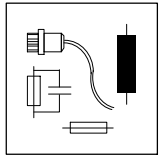

12 Accessories



The accessories can be found in the accompanying product catalogue.

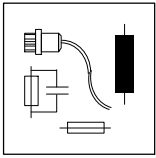

Accessories



13 Application examples

13.1 Pressure control

A centrifugal pump (quadratic load characteristic) is to maintain constant pressure in a pipeline system (e.g. water supply for private households or industrial plants).

Basic conditions

- PLC operation (selection of the pressure setpoint, night-time pressure reduction).
- On-site set-up is possible.
- During the night the pressure is reduced, and the pump then operates at an unregulated, low constant speed.
- Under no operating circumstances must the pump be operated at an output frequency of less than 10 Hz (dry running).
- Avoidance of pressure surges in the water network.
- Avoidance of mechanical resonance at an output frequency of approx. 30 Hz.
- Overtemperature protection for the motor.
- Collective fault messaging to the PLC.
- On-site display of readiness for operation and the actual pressure value.
- On-site facility for stopping the pump.

Functions used

- Internal process controller for pressure control
 - Pressure setpoint from the PLC (4 ... 20 mA)
 - Actual pressure value from the sensor (0 ... 10 V)
- Manual/remote switchover for on-site set-up
 - Manual: Pressure setpoint entered via a pushbutton with motor potentiometer function (UP/DOWN)
 - Remote: Pressure setpoint from the PLC
- Fixed speed (JOG) for night-time pressure reduction (activated via the PLC).
- Protection against dry running (setpoint-independent minimum speed).
- Smooth and jerk-free starting action with S-ramps.
- Masking of mechanical resonances with a cancelling frequency.
- PTC motor monitoring.
- TRIP error message via a digital output.
- Readiness for operation via a relay output.
- Configurable analog outputs for actual pressure value.
- Electric device lock (CINH).



Application examples

Pressure control

Application-specific configuration

- Execute motor parameter identification. (□ 7-48)

Code		Settings		Important
No.	Name	Value	Meaning	
C0014.┘	Operating mode	3	V/f characteristic control V ~ f	square-law characteristic with constant V _{min} boost
C0410			Digital signal source	
8	DOWN	1	E1 Inputs of the "UP" and "DOWN" pushbuttons	
7	UP	2	E2	
1	JOG1/3	3	E3 Fixed speed for night-time pressure reduction	Applying the fixed speed simultaneously deactivates the process controller.
19	PCTRL1-OFF	3	E3 Deactivation of process controller	
17	H/Re	4	E4 Changeover - PLC/on-site set-up	
C0412			Analog signal source	
1	Setpoint 1 (NSET1-N1)	4	X3/2I	Pressure setpoint (manual)
2	Setpoint 2 (NSET1-N2)	3	MPOT1-OUT motor potentiometer function	Pressure setpoint (remote)
5	Actual process controller value (PCTRL1-ACT)	1	X3/1U	Actual pressure value
C0145	Source - process controller setpoint	0	Overall setpoint (PCTRL1-SET3)	Main setpoint + additional setpoint
C0070	Process controller gain	→		Adapt to process, if required. → Further information: □ 7-50 ff.
C0071	Process controller reset time	→		
C0072	Differential component of process controller	→		
C0074	Process controller influence	100.0	0.0 {0.1 %} 100.0	
C0238.┘	Frequency precontrol	-0-	-0- No feedforward control (only process controller)	Process controller has full influence.
C0419	Free configuration of analog outputs		Analog signal source	
1	X3/62 (AOUT1-IN)	8	Actual process controller value	
C0037	JOG1	17		Fixed reduction to approx. 1/3 of the rated motor speed.
C0239o	Lower frequency limitation	10.00		Setpoint-independent minimum speed.
C0182*	Integration time S ramps	0.50 s	Jerk-free starting action	
C0625*	Blocking frequency 1	30.00 Hz		
C0628*	Skipping bandwidth - skip frequency	10.00 %		with regard to C0625
C0119.┘	Configuration of PTC input/earth-fault detection	4	PTC input is active, TRIP is effected	
C0415	Free configuration of digital outputs			
1	Relay output K1 ¹ or digital switching output K1 ²	16	Ready for operation	1: applies to motec version 151 2: applies to motec version 152, 153
2	Digital output X3/A1	25	TRIP error message	



Jumper position at application I/O

- Jumper A in 7-9 position (actual pressure 0 ... 10 V at X3/1U)
- Remove jumper B (setpoint selection via master current at X3/2I), (observe C0034)
- Plug jumper C into 3-5 position (actual pressure value is output as current signal to X3/62)
- Jumper D in 2-4 or 4-6 position since X3/63 is not assigned.



Tip!

- For this example the controller must be equipped with an application I/O since two analog inputs are required.
- If the pressure setpoint is not selected via PLC but via PC, keypad, or fixed setpoint, a standard I/O is sufficient.



The following examples show a simple pressure control with the 8200 vector frequency inverter or 8200 motec using the internal process controller.

The setpoint can either be defined in a fixed way via the code C0181 (example 1) or variably with the motor potentiometer function (example 2).

Application example

A centrifugal pump (quadratic load characteristic) is to maintain constant pressure in a pipeline system (e.g. water supply for private households or industrial plants).



Note!

- For this example, the controller must be equipped with a standard I/O since an analog input for the actual pressure value is required.
- If you want to select the pressure setpoint via an analog source, you need an application I/O since two analog inputs are required. This variant will not be considered in the following.

13.1.1 Example 1: Simple pressure control with fixed setpoint selection

The actual value is supplied via the analog input of the standard I/O **A** and linked to the controller input (PCTRL-ACT). The setpoint is defined via code C0181 **B**.

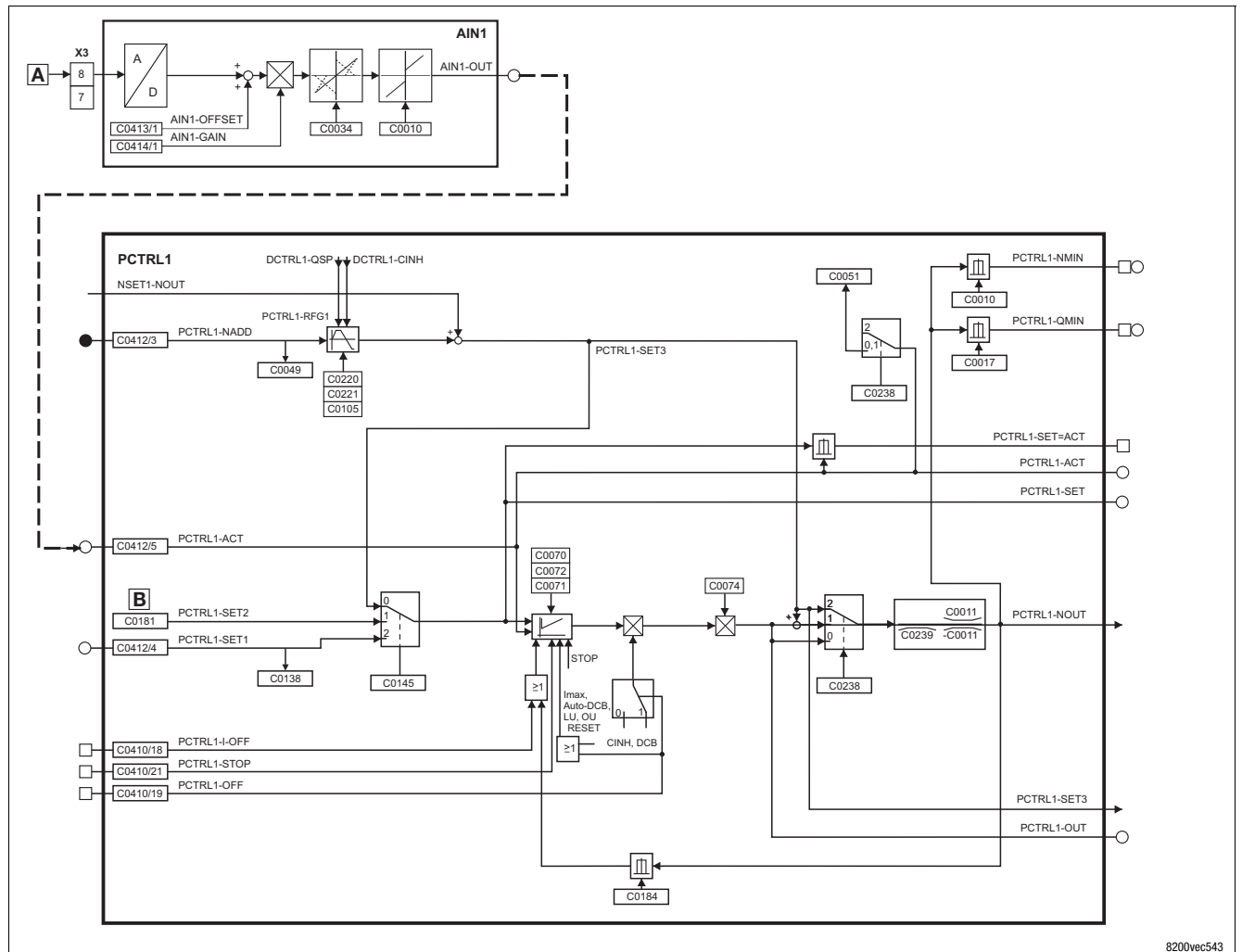

Fig. 13-2 Signal flow - overview

8200vec543



Application examples

Pressure control

Application-specific configuration

Code		Settings		Important
No.	Designation	Value	Meaning	
C0014	Operating mode	3	V/f characteristic control $V \sim f^2$	square-law characteristic with constant V_{\min} boost
C0019	Operating threshold - automatic DC injection brake (auto DCB)	0	Automatic DC injection brake is deactivated	If the lower frequency limitation is activated (C0239) or if C0181 is used as controller setpoint (C0145), the automatic DC injection brake must be deactivated!
C0106	Hold time - automatic DC injection brake (auto DCB)	0	Automatic DC injection brake is deactivated	
C0070	Process controller gain	1.00	Lenze default setting	Adapt to process, if required. → Further information: 7-50 ff.
C0071	Process controller reset time	100	Lenze default setting	
C0074	Process controller influence	100.0	0.0 {0.1 %} 100.0	
C0145	Source of process controller setpoint	1	Setpoint from C0181 (PCTRL1-SET2)	Automatic DC injection brake (auto DCB) must be deactivated with C0019 = 0 or C0106 = 0
C0181	Process controller setpoint 2 (PCTRL1-SET2)		-650.00 {0.02 Hz} 650.0	
C0238	Frequency precontrol	0	No feedforward control (only process controller)	Process controller has full influence.
C0239	Lower frequency limitation	≥ 0	Prevent reversed rotation	The value does not fall below the limit independently of the setpoint. Automatic DC injection brake (auto DCB) must be deactivated with C0019 = 0 or C0106 = 0
C0412			Linking analog signal sources to internal analog signals	
1	Setpoint 1 (NSET1-N1)	255	fixed free (disconnect from analog input)	The analog input of the standard I/O (AIN1) is linked factory-set to the speed feedforward control. This connection must be separated so that the input can be used for the analog actual value (C0412/5).
2	Setpoint 2 (NSET1-N2)	255		
5	Actual process controller value (PCTRL1-ACT)	1	Analog input X3/8 of the standard I/O	Actual pressure value



13.1.2 Example 2: Simple pressure control with changeable setpoint selection

The actual value is supplied via the analog input of the standard I/O **A** and linked to the controller input (PCTRL-ACT).

The setpoint is defined with the motor potentiometer function **B** and supplied to the process controller via the controller input (PCTRL1-NADD). This value is added to the value from the speed feedforward control (NSET1). This requires the output of the speed feedforward control (NSET1-NOU) to be zero.

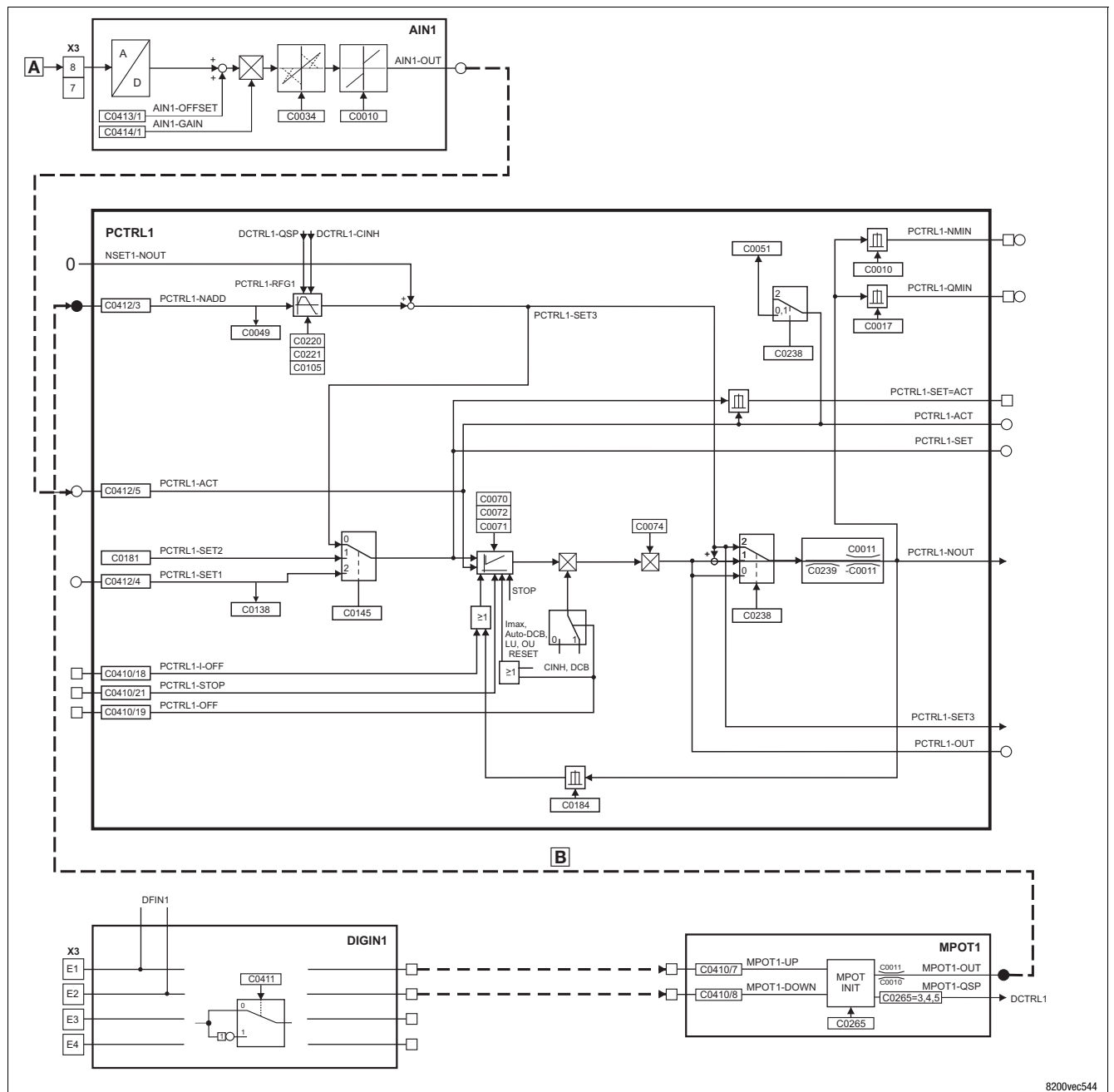

Fig. 13-3 Signal flow - overview



Application examples

Pressure control

Application-specific configuration

Code		Settings		Important
No.	Designation	Value	Meaning	
C0014	Operating mode	3	V/f characteristic control $V \sim f^2$	square-law characteristic with constant V_{min} boost
C0019	Operating threshold - automatic DC injection brake (auto DCB)	0	Automatic DC injection brake is deactivated	If the lower frequency limitation is activated (C0239) or if C0181 is used as controller setpoint (C0145), the automatic DC injection brake must be deactivated!
C0106	Hold time - automatic DC injection brake (auto DCB)	0	Automatic DC injection brake is deactivated	
C0070	Process controller gain	1.00	Lenze default setting	Adapt to process, if required. → Further information: 7-50 ff.
C0071	Process controller reset time	100	Lenze default setting	
C0074	Process controller influence	100.0	0.0 {0.1 %} 100.0	
C0145	Source of process controller setpoint	0	Overall setpoint (PCTRL1-SET3)	Setpoint = NSET1-NOUT + PCTRL1-NADD (Main setpoint + additional setpoint)
C0181	Process controller setpoint 2 (PCTRL1-SET2)		-650.00 {0.02 Hz} 650.0	
C0238	Frequency precontrol	0	No feedforward control (only process controller)	Process controller has full influence.
C0239	Lower frequency limitation	≥ 0	Prevent reversed rotation	The value does not fall below the limit independently of the setpoint. Automatic DC injection brake (auto DCB) must be deactivated with C0019 = 0 or C0106 = 0
C0412			Linking analog signal sources to internal analog signals	
1	Setpoint 1 (NSET1-N1)	255	fixed free (disconnect from analog input)	The analog input of the standard I/O (AIN1) is linked factory-set to the speed feedforward control. This connection must be separated so that the input can be used for the analog actual value (C0412/5).
2	Setpoint 2 (NSET1-N2)	255		
5	Actual process controller value (PCTRL1-ACT)	1	Analog input X3/8 of the standard I/O	Actual pressure value



Note!

- The motor potentiometer in connection with the standard I/O may only be linked with the signals NSET1-N1, NSET1-N2 or PCTRL1-NADD. The linkage with other signals would cause a setpoint step-change.
- When selecting the setpoint via the motor potentiometer, we recommend the acceleration and deceleration times $\geq 5s$ (C0220, C0221).

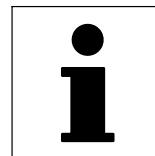

13.2 Operation with mid-frequency motors

Mid-frequency asynchronous motors are used where high and adjustable speeds are required. Possible applications are milling cutters for wood working machines, fans, vacuum pumps, concrete vibrators, grinding and polishing drives.

Dimensioning notes

- If the motor is to be braked shortly, and with high moments of inertia, an external brake resistor must be used. (□ 11-1)
- Set the speed setting range so that motors with integral fan are always cooled sufficiently (setting range as a function of load)

Application-specific configuration

Code	Designation	Setting	Comment
C0011	max. output frequency		Set to the value given on the motor nameplate, not higher than 400 Hz.
C0012	Acceleration time - main setpoint		Set it so that acceleration takes place below the current limitation.
C0013	Deceleration time main setpoint		Set it so that braking is possible with or without external brake without the "overvoltage (OU)" message being displayed.
C0014	Operating mode	-2-	Linear characteristic (best operational performance for mid-frequency motors)
C0015	V/f rated frequency		□ 7-5
C0016	U _{min} boost		Setting depends on the load at low frequencies. Recommendation: 0 %
C0018	Switching frequency	-3-	16 kHz (good concentricity with only 16 kHz) Observe power reduction □ 3-5
C0021	Slip compensation	0 %	Normally not required.
C0022	I _{max} limit in motor mode		Set to rated motor current. At short acceleration times and high moments of inertia to 150 %.
C0023	I _{max} limit in generator mode	150 %	Lenze setting
C0106	Hold time for DCB	0 s	DC injection brake must be deactivated!
C0144	Switching frequency reduction	-0-	No reduction.



Application examples

Speed control

13.3 Speed control



Tip!

Lenze three-phase AC motors and Lenze geared motors can be supplied with the Lenze pulse encoder ITD21 (512/2048 increments, HTL output signals). This makes it possible to set up a two-track speed feedback (tracks A and B) when using the application I/O function module.

Example

Speed control with inductive single-track three-wire sensor

The speed control is designed to correct the deviation between the actual speed and the setpoint speed caused by the effect of the load (motive and generative).

In order to detect the motor speed, the inductive sensor scans e.g. a gear, a metallic fan impeller or cam. Scanning should take place directly on the motor or within the machine.

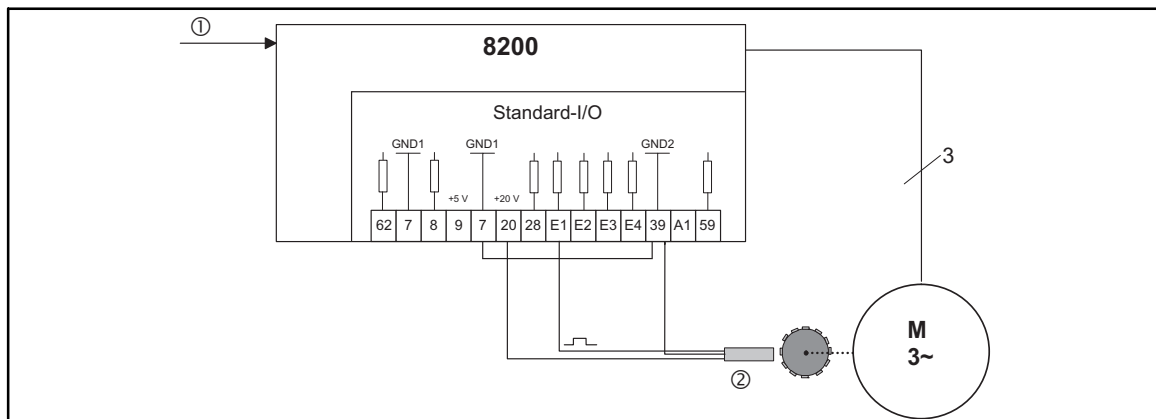

Fig. 13-4 Speed control with three-wire sensor

- ① setpoint
- ② three-wire sensor

8200: 8200 motec or 8200 vector

Speed sensor requirements

- The maximum frequency of inductive sensors generally ranges from 1 ... 6 kHz depending on the type.
- At the detection point, the number of attenuation cams per revolution must ensure an output frequency of the sensor as high as possible.
- The control dynamics will be sufficient if the output frequency (f_{act}) is > 0.5 kHz at rated speed.
- If the current consumption of the sensor is not higher than the value permitted at X3/20, a three-wire sensor can be directly connected to the controller.

Output frequency calculation

$$f_{act} = \frac{z \cdot n}{60}$$

z = number of cams per revolution
 n = speed at the detection point [rpm]
 f_{act} = output frequency of the sensor in [Hz]

Permissible pulse shape at X3/E1

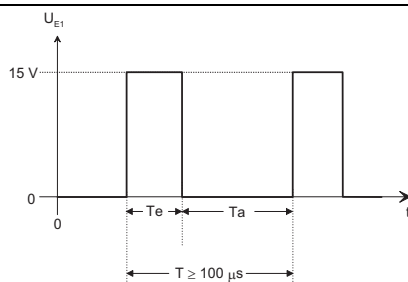

- T_e = on (HIGH)
- T_a = off (LOW)
- Permissible level range:
 - LOW: 0 ... +3 V
 - HIGH: +12 ... +30 V
- Permissible range of the scanning ratio
 - $T_e : T_a = 1 : 1$ to $T_e : T_a = 1 : 5$

Tip!

You can use every speed sensor which meets the level and scanning ratio requirements.

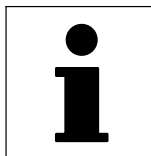

Application-specific configuration

- Basic settings. (▢ 6-2)

Code		Settings		Important
		Value	Meaning	
C0410	Free configuration of digital input signals			Configuration of frequency input X3/E1
24	DFIN1-ON	-1-		
C0412	Free configuration of analog input signals		Analog signal source	
5	Actual process controller value (PCTRL1-ACT)	-2-		
C0011	Maximum output frequency		$(1 + \frac{C0074 [\%]}{100}) \cdot \frac{p}{60} \cdot n_{max}$	p = number of pole pairs n _{max} = required maximum speed [rpm]
C0014.┘	Operating mode	-2	V/f characteristic control	Dynamics in "vector control" mode too low
C0019	Operating threshold auto DCB	approx. 0.5 Hz		Adaptation to the application
C0021	Slip compensation	0 %		No slip compensation with controlled operation
C0035*.┘	DCB selection	-1-	Brake current selection under C0036	
C0036	Voltage/current DCB	50 ... 100 %		Adaptation to the application
C0070	Process controller gain	1 ... 15		5 = typical
C0071	Process controller reset time	50 ... 500 ms		100 ms = typical
C0072	Differential component of process controller	0		Not active
C0074	Process controller influence	2 ... 10 %	$S_N = \frac{n_0 - n_N}{n_0}$ Example $S_N = \frac{1500 - 1400}{1500} = 6.67 \%$	<ul style="list-style-type: none"> • Adaptation to the application • Set 200% rated motor slip (2 * S_N)
C0106	Hold time auto DCB	1 s		<ul style="list-style-type: none"> • Guide value • Afterwards the controller sets controller inhibit
C0181*	Process controller setpoint 2 (PCTRL1-SET2)			<ul style="list-style-type: none"> • Adaptation to the application • Selection with keypad or PC • ▢ 7-53: Further options for selecting the setpoint
C0196*.┘	Activation auto DCB	-1-	DCB active when C0050 < C0019 and setpoint < C0019	
C0238.┘	Frequency precontrol	-1-		With frequency feedforward control
C0239.┘	Lower frequency limitation	0 Hz		unipolar, no reversal of rotation direction
C0425.┘*	Configuration of frequency input X3/E1 (DFIN1)			Set C0425 so that, at maximum motor speed, the frequency supplied by the encoder is lower than f _{max}
C0426*	Frequency input gain X3/E1, X3/E2 (A) (DFIN1-GAIN)	100	-1500.0 {0.1 %} 1500.0	$C0426 = \frac{f_N(C0425)}{\frac{n_{max}}{60 s} \cdot inc/rev} \cdot \frac{C0011 - f_s}{C0011} \cdot 100 \%$ <ul style="list-style-type: none"> • n_{max} = maximum motor process speed in rpm • f_s = slip frequency in Hz



Application examples

Speed control

Adjustment (see example in Fig. 13-4)

Basic conditions

- A four-pole motor is to be operated up to $n_{\max} = 1500$ rpm. The motor has the following data:
 - Rated speed $n_r = 1390$ rpm
 - Rated frequency $f_r = 50$ Hz
 - Slip $s_N = 7.3$ %
 - Slip frequency $f_s = 3.7$ Hz
- The pulse encoder supplies 6 increments/revolution (inc/rev).
 - Thus, the maximum frequency at X3/E1 with maximum speed amounts to:

$$\frac{1500}{60 \text{ s}} \cdot 6 = 150 \text{ Hz}$$

- Set process controller influence (C0074) to 200% rated slip:
 - C0074 = 14.6 %
- Calculate maximum output frequency (C0011):

$$\left(1 + \frac{\text{C0074} [\%]}{100}\right) \cdot \frac{p}{60} \cdot n_{\max} [\text{min}^{-1}] = 1.15 \cdot \frac{2 \cdot 1500}{60} = 57.5 \text{ Hz}$$

Adjustment of frequency input X3/E1

- C0425 = -0-
 - Normalisation frequency = 100 Hz
 - Maximum frequency = 300 Hz
- Activate the frequency input with C0410/24 = 1.
 - Ensure that no other digital signal is linked with E1 (no double assignment)!
- Link the frequency input with the actual process controller value in C0412 (C0412/5 = 2)
- Gain C0426
 - The input frequency at X3/E1 is normalised to the value of the preselected frequency (100 Hz), i.e. 100 Hz correspond internally to the output frequency set in C0011.
 - Every time C0011 is changed, C0426 must be adapted.

$$\text{C0426} = \frac{f_N (\text{C0425})}{\frac{n_{\max}}{60 \text{ s}} \cdot \text{inc/rev}} \cdot \frac{\text{C0011} - f_s}{\text{C0011}} \cdot 100 \% = \frac{100}{150} \cdot \frac{57.5 - 3.7}{57.5} \cdot 100 \% = 62.4 \%$$



Tip!

If the number of increments per revolution of the encoder is not known, the gain to be set must be determined by experiment:

1. Set C0238 = 0 or 1.
2. Accelerate the drive the maximum desired output frequency. The output frequency is now only determined via the frequency feedforward control.
3. Set the gain via C0426 so that the actual value (C0051) corresponds to the setpoint (C0050).



13.4 Group drive (operation with several motors)

Several motors can be connected to the controller in parallel. The sum of the single motor currents must not exceed the rated current of the controller.

Installation instructions

- The motor cable is wired in parallel e.g. in a terminal box.
- Each motor must be equipped with a thermostat (NC contact) the series connection of which must be connected to X2/T1 and X2/T2 using a separate cable.
- Only use shielded cables (▣ 4-6). Connect the shield to PE with a large surface.
- Resulting cable length:

$$l_{\text{res}} = \text{sum of all motor cable lengths} \times \sqrt{\text{number of motor cables}}$$

Application-specific configuration

- Basic settings. (▣ 6-2)
- Operating mode C0014 = -2- possibly -4-. (▣ 7-2)
- PTC input C0119 = -1-. (▣ 7-84)

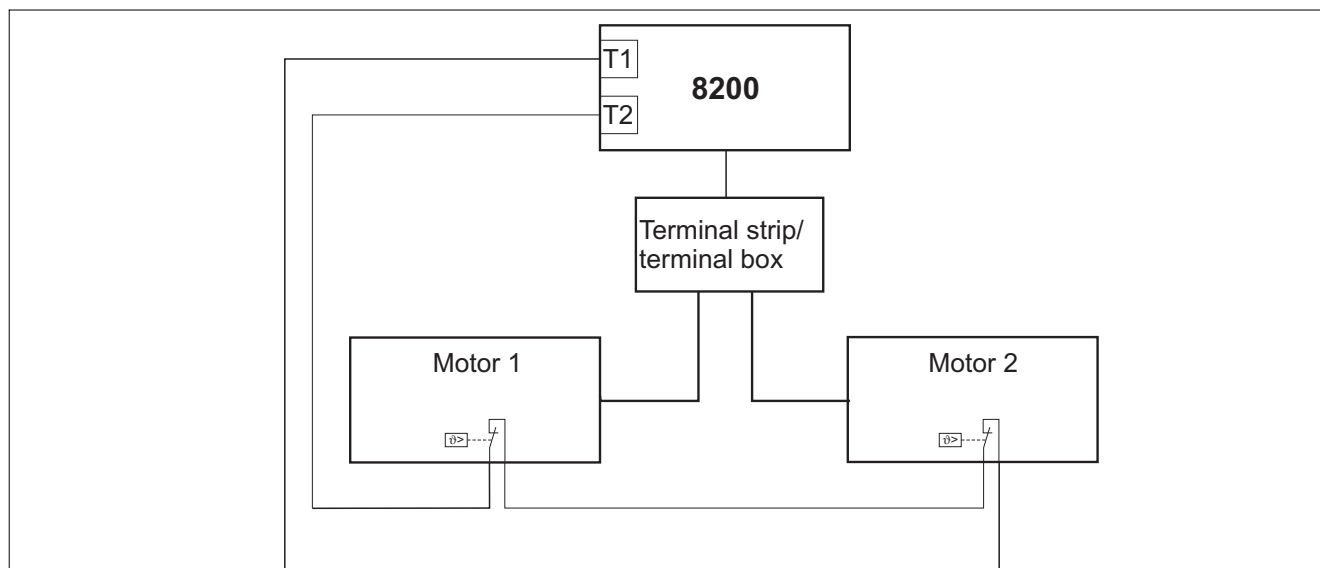

Fig. 13-5 Basic structure of a group drive



Tip!

You can monitor the motor cables and operating elements using the motor phase failure detection. (▣ 14-50, C0597)



Application examples

Setpoint summation

13.5 Setpoint summation (base and additional load operation)

Conveyors, pumps etc. are often operated at a basic speed which can be increased, if required.

The speed is set by selecting a main and additional setpoint at the controller. The setpoints can have different sources (e.g. PLC and setpoint potentiometer). The controller adds both analog setpoints and increases the motor speed accordingly.

For smooth acceleration, acceleration and deceleration ramps of both setpoints can be adjusted variably. Moreover, the main setpoint ramps can have an S-shape.

Application-specific configuration

- Basic settings. (□ 6-2)
- Setpoint summation configuration: assign the setpoints to be added to C0412/1 and C0412/3. (□ 7-57)
- If required, set S-shape main setpoint ramps under C0182. (□ 7-24)



Tip!

- Possible ways to select a setpoint: (□ 7-32 ff)
- The additional setpoint can be displayed under C0049 (alternatively: selection when C0412/3 = 0).
- With controllers with standard I/O, the mains setpoint must be selected via PC, keypad, fixed frequency (JOG) or via the "motor potentiometer" function, since only one analog input is available.
- If you use an application I/O, the additional setpoint can be switched on and off during operation (C0410/31 \neq 0)

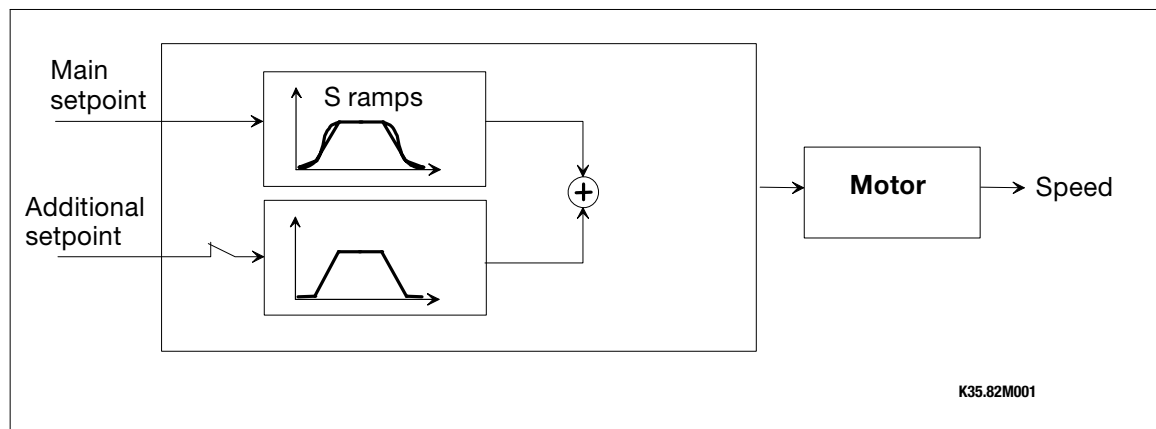
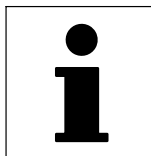

Fig. 13-6

Principle of setpoint summation



13.6 Power control (torque limitation)

The power control (torque limitation) generates a constant mass flow when moving masses which change their specific weight, usually air exposed to different temperatures.

Torque limit and speed setpoint are selected for the controller. The torque limit will not be exceeded because the speed is automatically adapted if the specific weight changes. The speed setpoint must be set in a way that it does not limit the speed adaptation.

”Sensorless torque control” mode (C0014 = 5):

With sensorless torque control, a constant torque is preselected. A defined speed limit is not exceeded (speed limitation).

Application-specific configuration

- Basic settings. (☐ 6-2)
- Operating mode selection: C0014 ≠ 5! (☐ 7-2)
- Torque limit value configuration: Assign C0412/6.
- Speed setpoint configuration: Assign C0412/1.



Tip!

- Set max. output frequency C0011 to the max. permissible speed. Thus, the speed does not have a limiting effect, and the drive is constantly running at the defined torque limit.
- The torque limit value can be displayed under C0047.
- Possible ways to select the speed and torque limit: (☐ 7-32 ff)
- With controllers with standard I/O, the speed setpoint must be selected via PC, keypad, fixed frequency (JOG) or via the ”motor potentiometer” function, since only one analog input is available.
- Acceleration time and moment of inertia require a torque reserve.
- The power control should not be used for group drives.

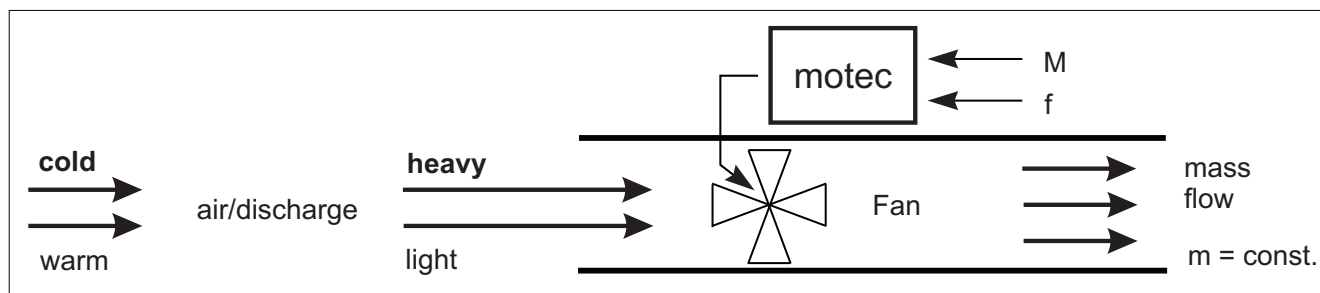

Fig. 13-7 Principle power control example: fan

8200: 8200 motec or 8200 vector



Application examples



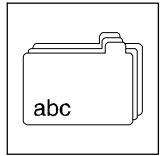









Power control



14 Appendix

14.1 Signal flow diagrams

How to read the signal flow diagrams

Symbol	Meaning
	Signal combination in the Lenze setting
	Fixed signal combination
	Analog input, can be freely connected with an analog output with the same identification
	
	Analog output
	
	Analog input to be used to connect the motor potentiometer output
	Motor potentiometer output
	Digital input, can be freely connected with a digital output with the same identification
	
	Digital output
	

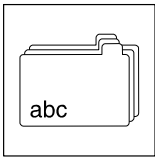

Appendix

Signal flow charts - Standard-I/O

14.2 Overview of signal processing of standard I/O

14.2.1 Controller with standard I/O

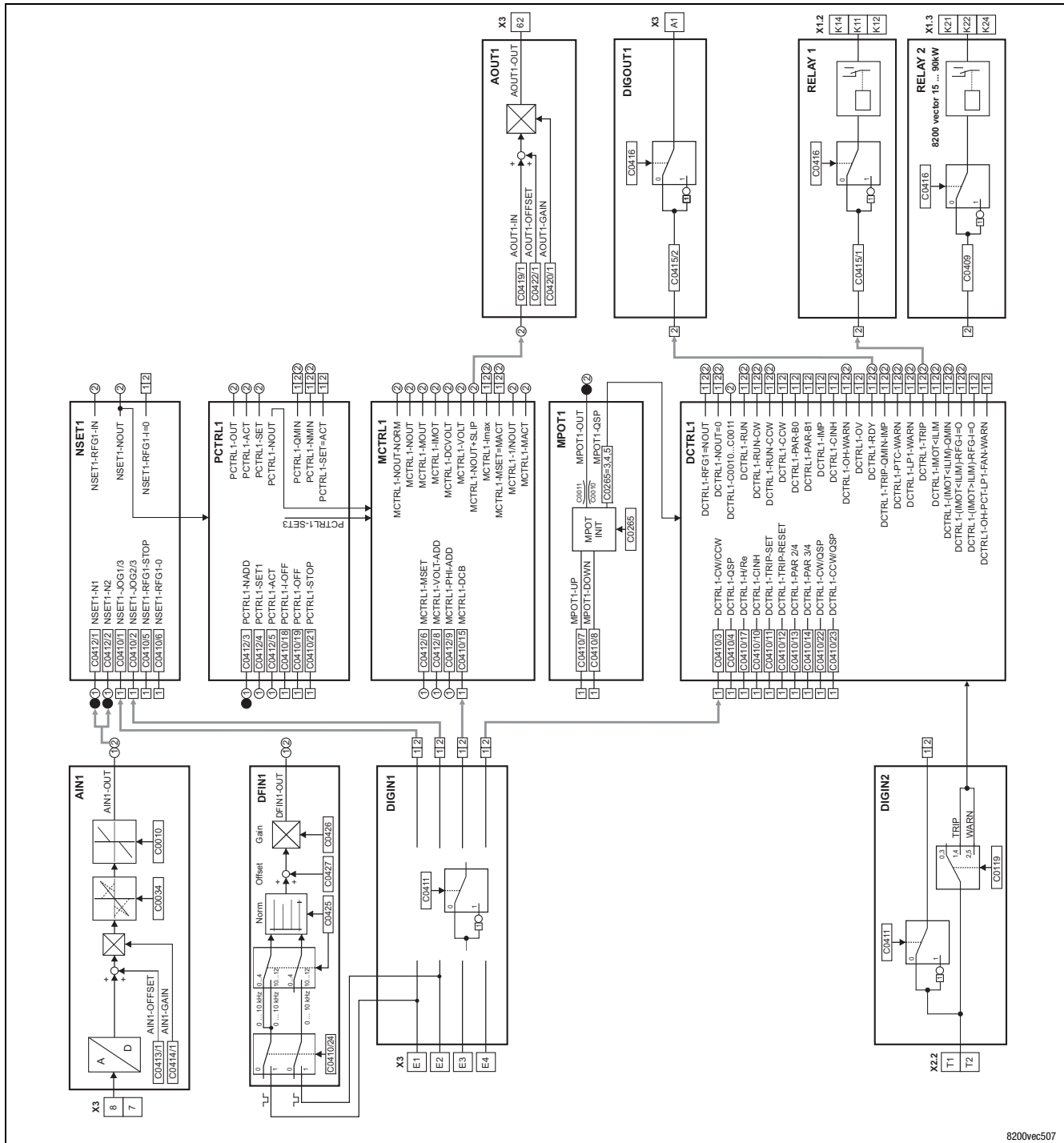

8200vec507

Fig. 14-1 Overview of signal flow with Standard I/O

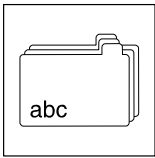

Appendix

Signal flow charts - Standard-I/O

14.3.2 Process controller and setpoint processing (PCTRL1)

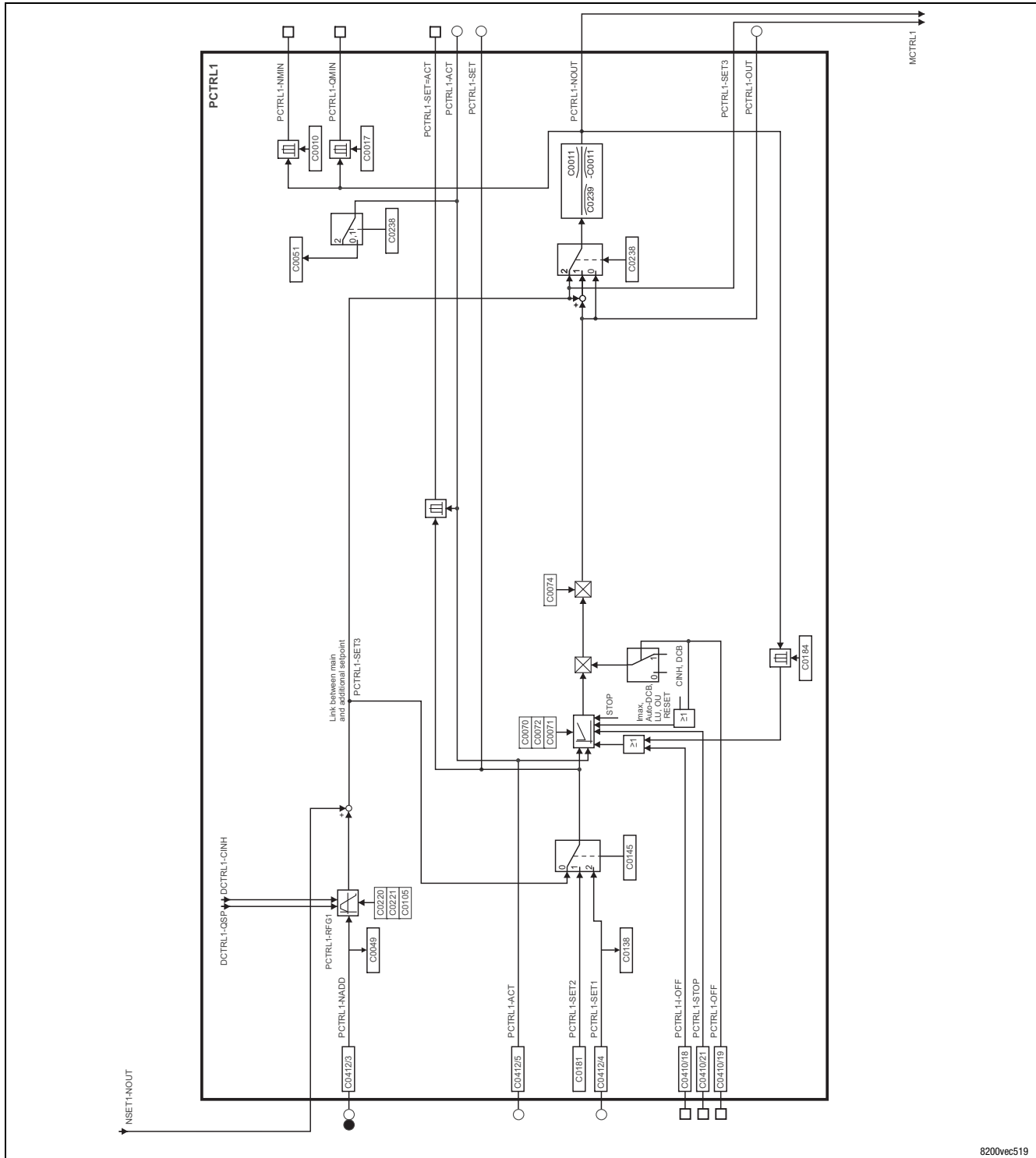
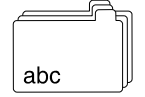
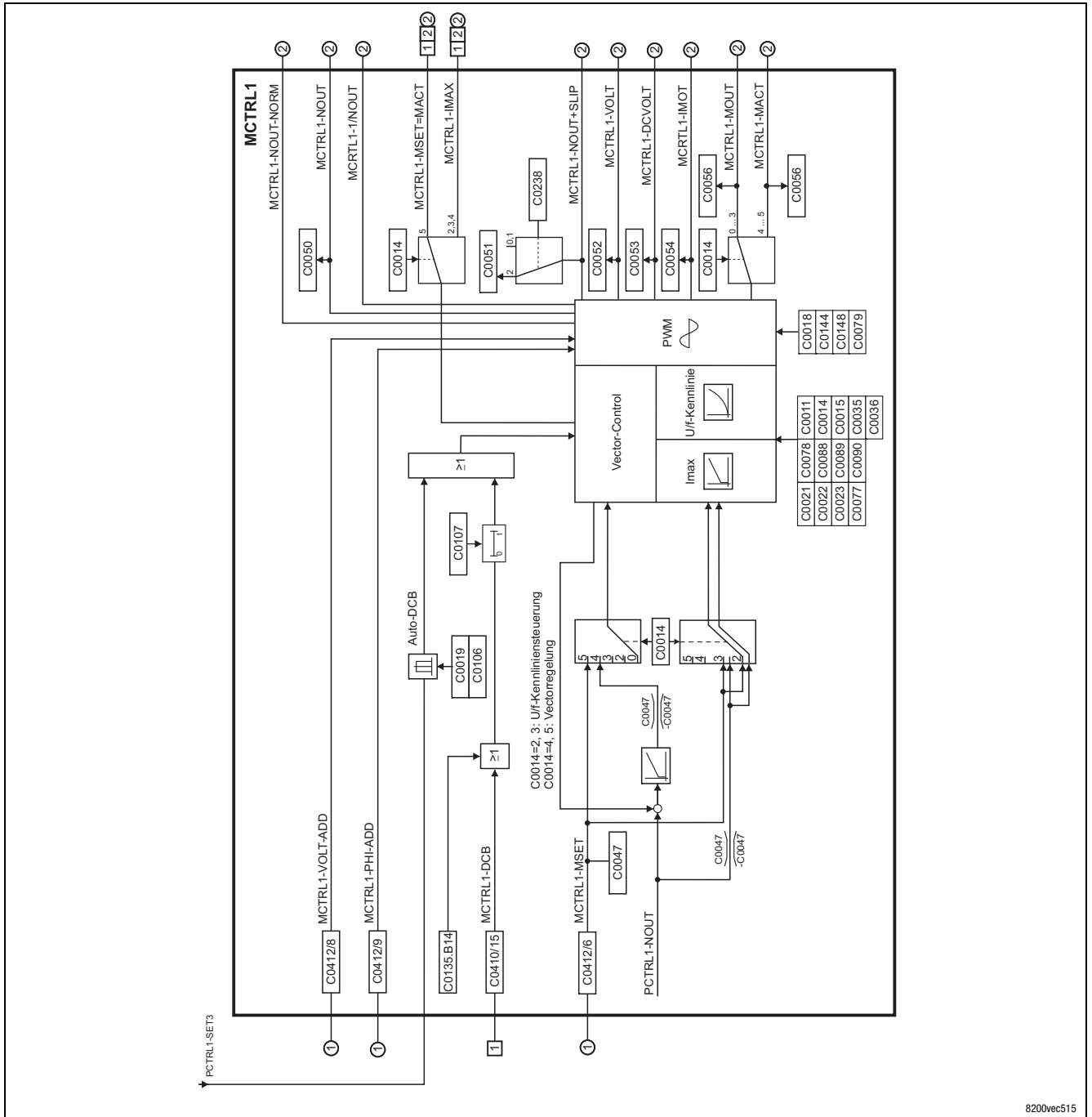

Fig. 14-3 Signal flow in the process controller and setpoint processing



14.3.3 Motor control (MCTRL1)



8200vec515

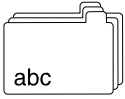

Appendix

Signal flow charts - Application I/O

14.4 Overview of signal processing of the application I/O

14.4.1 Controller with application I/O

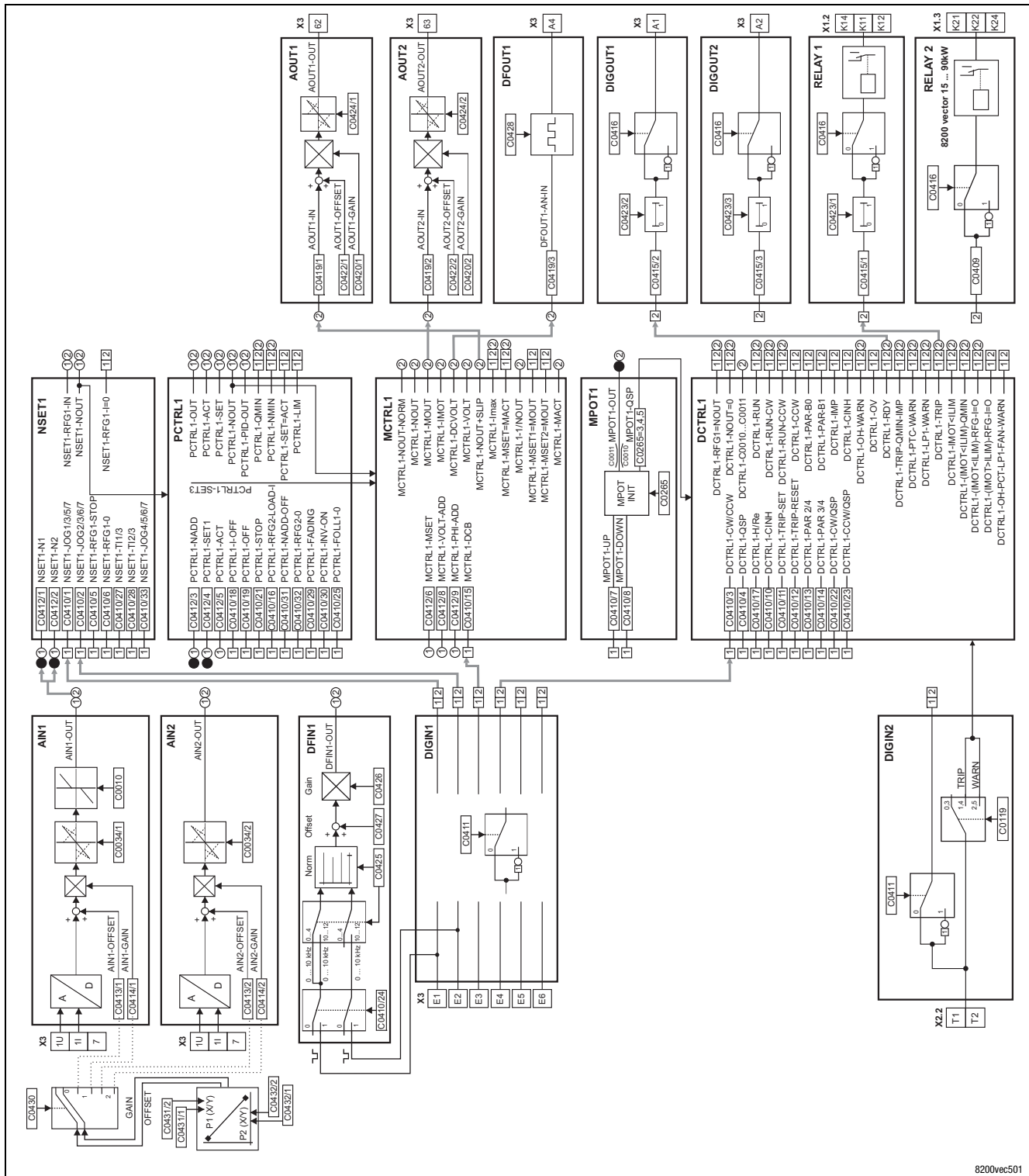

8200vec501

Fig. 14-5 Overview of signal flow with Application I/O

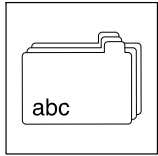

14.5 Signal processing in the application I/O function blocks

14.5.1 Speed setpoint conditioning (NSET1)

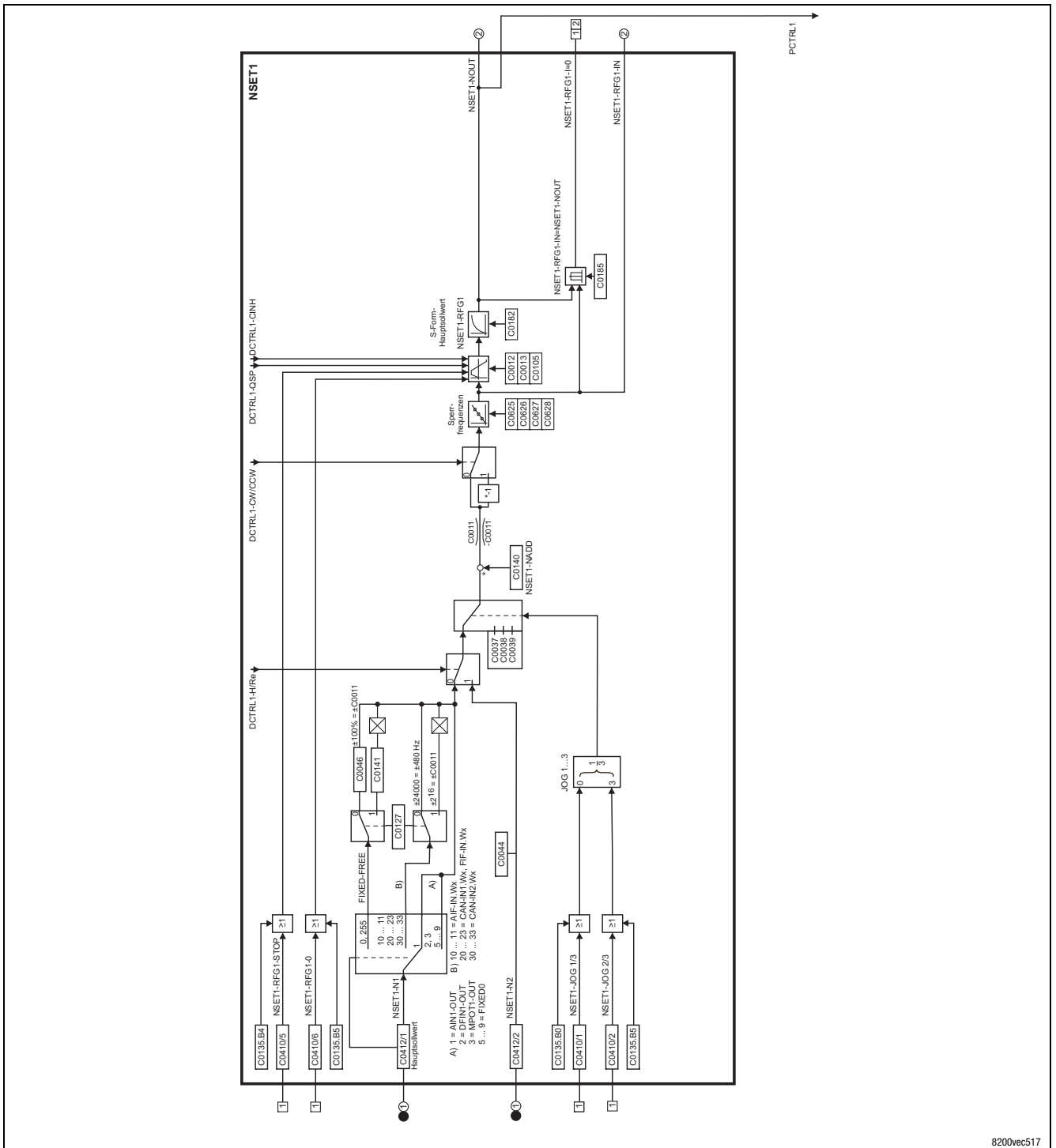
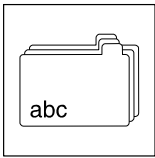

Fig. 14-6 Signal flow of speed setpoint conditioning



Appendix

Signal flow charts - Application I/O

14.5.2 Process controller and setpoint processing (PCTRL1) with Application I/O

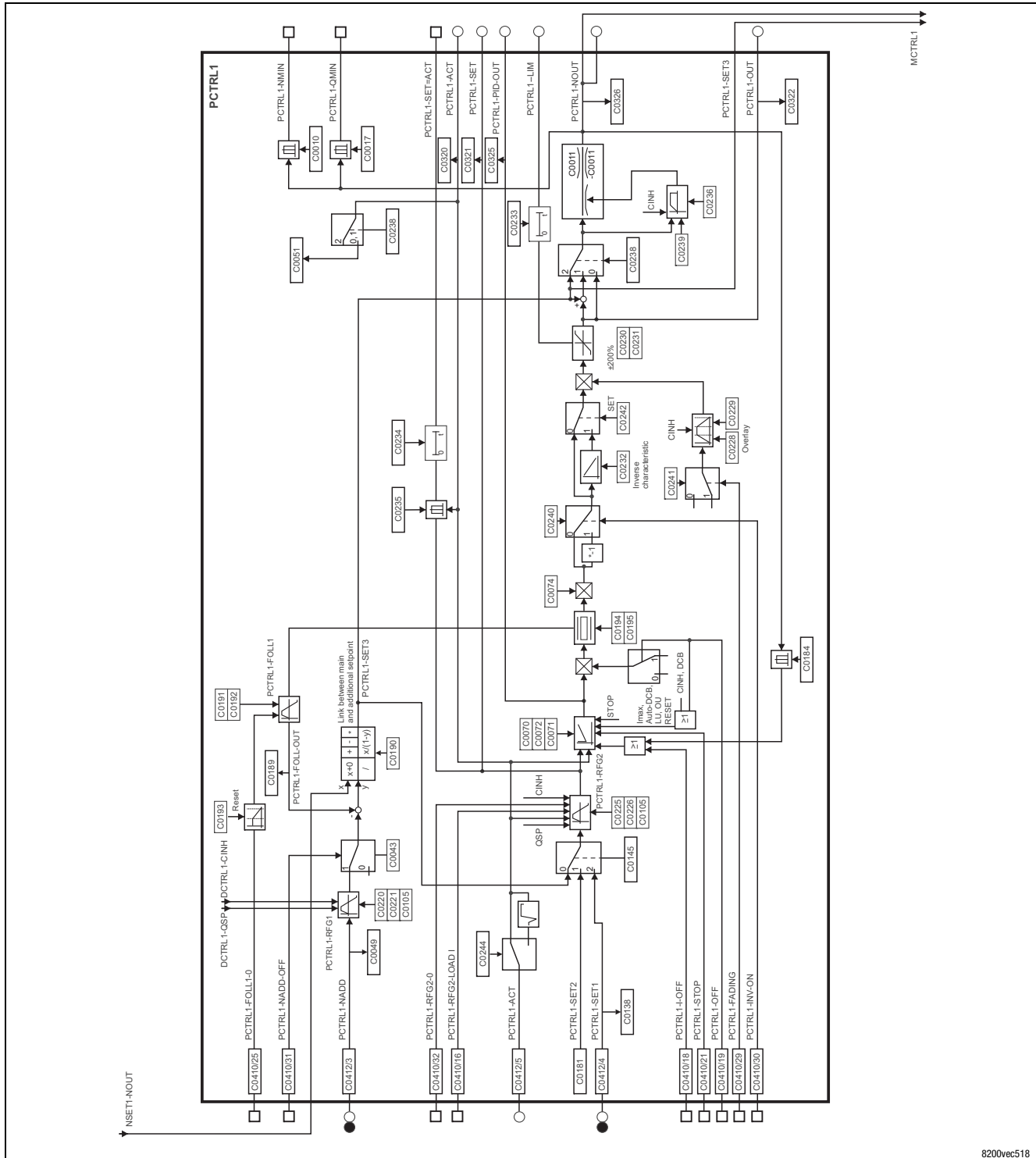

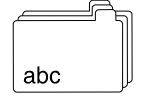

14.5.3 Motor control (MCTRL1) with Application I/O

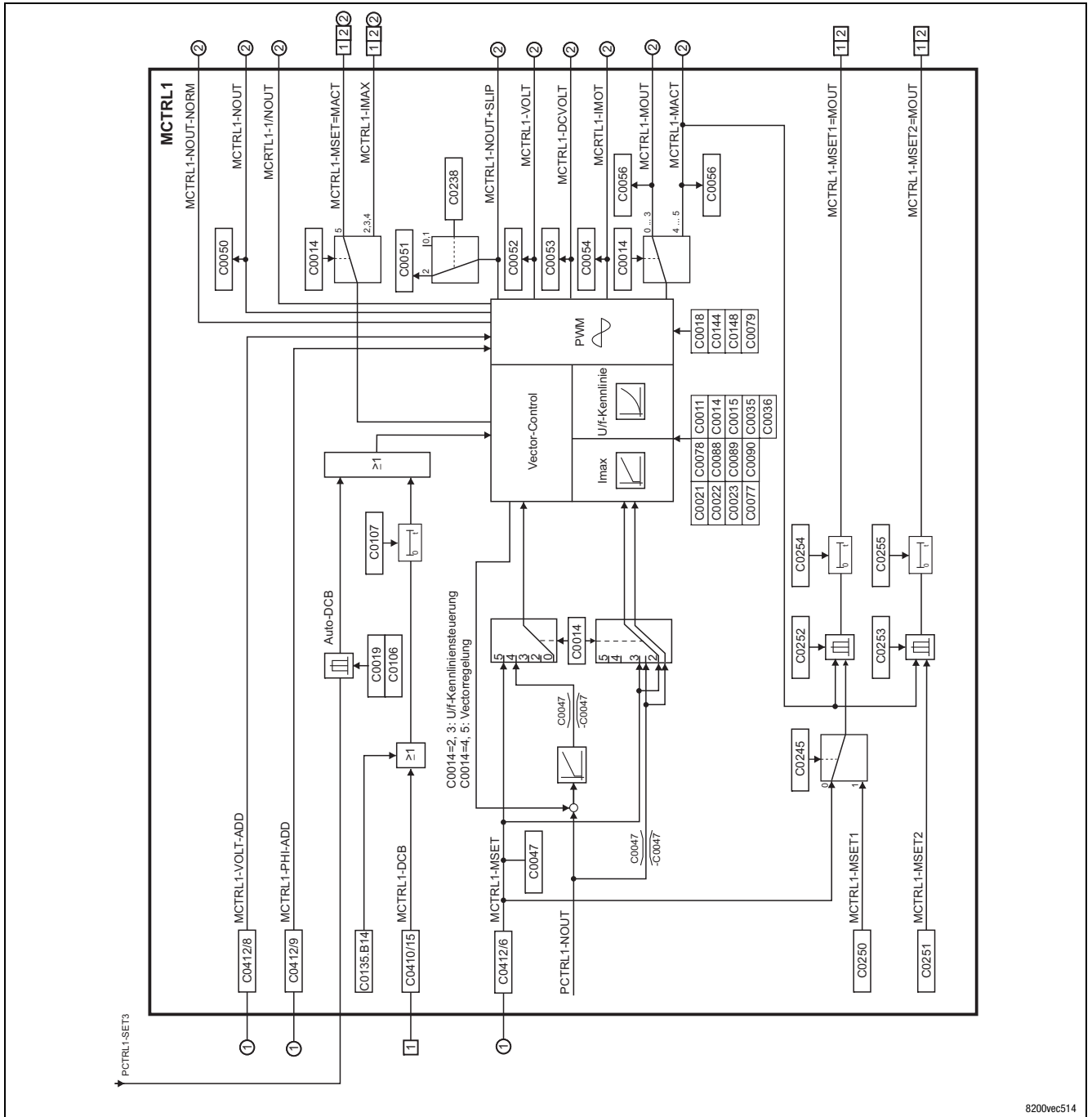
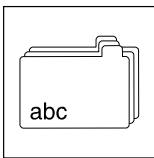

Fig. 14-8 Signal flow in the motor control with Application I/O



Appendix

Code table





14.6 Code table

How to read the code table

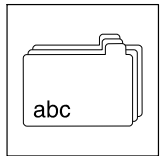
Column	Abbreviation	Meaning	
Code	Cxxxx	Code Cxxxx	
	1	Subcode 1 of Cxxxx	
	2	Subcode 2 of Cxxxx	
	*	Parameter value of the code is the same in all parameter sets	
	ENTER	Keypad E82ZBC Keypad XT EMZ9371BC	Changed parameters will be accepted after pressing ENTER
	STOP	Keypad E82ZBC Keypad XT EMZ9371BC	Changed parameters will be accepted after pressing ENTER if the controller is inhibited Changed parameters will be accepted after pressing SHIFT PRG if the controller is inhibited
	(A)	Code, subcode or selection are only available when using an Application-I/O	
	<i>uSEr</i>	With Lenze setting the code is available in the USER-menu	
Name		Name of the code	
Lenze		Lenze setting (value at delivery or after restoring the delivery state with C0002)	
	→	Further information can be obtained from "IMPORTANT"	
Selection	1 {%	99 Min. value {unit} Max. value	
IMPORTANT	-	Brief, important explanations	

Code		Possible settings		IMPORTANT
No.	Name	Lenze	Selection	
C0001 ENTER	Selection of setpoint entry (operating mode)	0		<ul style="list-style-type: none"> Changing C0001 will cause the changes mentioned below under C0412 and C0410, if no free configuration under C0412 was made before. In the event that a free configuration was made under C0412 (verification = C0005 = 255), C0001 does not influence C0412 and C0410. The signals must be linked manually. Free configuration under C0412 or C0410 does not change C0001! The control can be realised via terminals or PC/keypad
		0	Setpoint entry via AIN1 (X3/8 or X3/1U, X3/1)	<ul style="list-style-type: none"> C0412/1 and C0412/2 are linked with the analog input 1 (C0412/1 = 1, C0412/2 = 1). C0410 is not changed.
		1	Setpoint entry via keypad or parameter channel of an AIF bus module	<ul style="list-style-type: none"> Under C0412 the linkage with the analog input is separated (C0412/1 = 255, C0412/2 = 255). Setpoint selection via C0044 or C0046. C0410 is not changed.
		2	Setpoint selection via AIN1 (X3/8 or X3/1U, X3/1)	<ul style="list-style-type: none"> C0412/1 and C0412/2 are linked with the analog input 1 (C0412/1 = 1, C0412/2 = 1) C0410 is not changed.
		3	Setpoint selection via process channel of an AIF bus module	<ul style="list-style-type: none"> C0001 = 3 must be set to select a setpoint via a process data channel of an AIF bus module (types 210x, 211x, 213x, 217x)! Otherwise the process data will not be evaluated. C0412/1 and C0412/2 are linked with the analog input words AIF-IN.W1 and AIF-IN.W2 (C0412/1 = 10, C0412/2 = 11). C0410/1 ... C0410/16 are linked with the single bit of the AIF control word (AIF-CTRL) (C0410/1 = 10 ... C0410/16 = 25)



Code		Possible settings		IMPORTANT	
No.	Name	Lenze	Selection		
C0002*  ↳ SEr	Parameter set management	0	0 Ready	PAR1 ... PAR4: <ul style="list-style-type: none"> Parameter sets of the controller PAR1 ... PAR4 also contain parameters for Standard-I/O, Application-I/O, AS interface or system bus (CAN) FPAR1: <ul style="list-style-type: none"> Module-specific parameter set of the fieldbus function modules INTERBUS, PROFIBUS-DP, LECOM-B, DeviceNet/CANopen FPAR1 is saved in the function module Restorage of default setting in the selected parameter set Restorage of default setting in the fieldbus function module Restorage of default setting in the selected parameter set of the controller and the fieldbus function module	7-91
	Restorage of default setting	1	Lenze setting ⇒ PAR1		
		2	Lenze setting ⇒ PAR2		
		3	Lenze setting ⇒ PAR3		
		4	Lenze setting ⇒ PAR4		
		31	Lenze setting ⇒ FPAR1		
		61	Lenze setting ⇒ PAR1 + FPAR1		
		62	Lenze setting ⇒ PAR2 + FPAR1		
C0002*  ↳ SEr (cont.)	Parameter set transfer using the keypad		Use the keypad to transfer parameter sets to other controllers. During transfer the parameters cannot be accessed via other channels!		
		70	Keypad ⇒ Controller With function module Application-I/O, INTERBUS, PROFIBUS-DP, LECOM-B, DeviceNet/CANopen	All available parameter sets (PAR1 ... PAR4, and FPAR1) are overwritten with the corresponding keypad data	
		10	With all other function modules		
		C0002*  ↳ SEr (cont.)	Parameter set transfer using the keypad	71	Keypad ⇒ PAR1 (+ FPAR1) With function module Application-I/O, INTERBUS, PROFIBUS-DP, LECOM-B, DeviceNet/CANopen
11	With all other function modules				
72	Keypad ⇒ PAR2 (+ FPAR1) With function module Application-I/O, INTERBUS, PROFIBUS-DP, LECOM-B, DeviceNet/CANopen				
12	With all other function modules				
73	Keypad ⇒ PAR3 (+ FPAR1) With function module Application-I/O, INTERBUS, PROFIBUS-DP, LECOM-B, DeviceNet/CANopen				
13	With all other function modules				
74	Keypad ⇒ PAR4 (+ FPAR1) With function module Application-I/O, INTERBUS, PROFIBUS-DP, LECOM-B, DeviceNet/CANopen				
14	With all other function modules				
80	Controller ⇒ Keypad With function module Application-I/O, INTERBUS, PROFIBUS-DP, LECOM-B, DeviceNet/CANopen			All available parameter sets (PAR1 ... PAR4, and FPAR1) are copied to the keypad	
20	With all other function modules				
C0002*  ↳ SEr (cont.)	Parameter set transfer using the keypad	40	Keypad ⇒ Function module Only with function module INTERBUS, PROFIBUS-DP, LECOM-B, DeviceNet/CANopen	Overwrite the module-specific parameter set FPAR1 only	
		50	Function module ⇒ Keypad Only with function module INTERBUS, PROFIBUS-DP, LECOM-B, DeviceNet/CANopen	Copy the module-specific parameter set FPAR1 only	

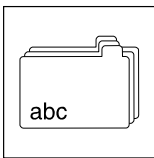

Appendix

Code table

Code		Possible settings		IMPORTANT
No.	Name	Lenze	Selection	
C0002* \downarrow 5Er (cont.)	Saving of own settings		9 PAR1 \Rightarrow Own settings	You can save your own basic settings for a controller (e.g. machine delivery status): 1. Ensure that parameter set 1 is active 2. Controller inhibit 3. Set C0003 = 3, acknowledge with 4. Set C0002 = 9, acknowledge with , to save your own basic settings 5. Set C0003 = 1, acknowledge with 6. Enable the controller.
C0002* \downarrow 5Er (cont.)	Loading/copying of your own basic settings		5 Own settings \Rightarrow PAR1 6 Own settings \Rightarrow PAR2 7 Own settings \Rightarrow PAR3 8 Own settings \Rightarrow PAR4	
C0003* 	Non-volatile parameter saving	1	0 Parameter not saved in EEPROM 1 Parameter always saved in EEPROM 3 Own settings saved in EEPROM	Data loss after mains disconnection <ul style="list-style-type: none"> Active after every mains connection Cyclic parameter changes via bus module are not allowed. Subsequently save parameter set 1 as own basic setting with C0002 = 9
C0004*	Bar-graph display	56	1 {Code No.} 989 56 = controller load (C0056)	<ul style="list-style-type: none"> Bargraph display indicates the selected value in % after power on Range -180 % ... +180 %
C0005 	Fixed configuration of analog input signals	0	0 Setpoint for speed control via X3/8 or X3/1U, X3/11 1 Setpoint for speed control via X3/8 with setpoint summation via frequency input 2 Setpoint for speed control via frequency input with setpoint summation via X3/8 3 Setpoint for speed control via frequency input, torque limitation via X3/8 (power control) 4 Setpoint for sensorless torque control via X3/8, speed limitation via C0011 5 Setpoint for sensorless torque control via X3/8, speed limitation via frequency input 6 Controlled operation; setpoint via X3/8 with digital feedback via frequency input 7 Controlled operation, setpoint via frequency input X3/E1 with analog feedback via X3/8 200 All digital and analog input signals are from the fieldbus function module on FIF (e.g. INTERBUS, PROFIBUS-DP, CANopen or DeviceNet) 255 Free configuration in C0412	Change of C0005 is copied into the corresponding subcode of C0412. Free configuration in C0412 sets C0005 = 255! Observe the following in case of configurations with frequency input: <ul style="list-style-type: none"> Activate the frequency input X3/E1, X3/E2 with C0410/24 = 1. Delete all existing signal connections of the digital inputs in C0410 used by the frequency input. Configure frequency input with C0425 and C0426 Only active if C0014 = -5- (torque selection) Sets C0410/x = 200 and C0412/x = 200 Read only Do not change C0005 since settings in C0412 may get lost

Appendix

Code table

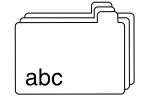

Code		Possible settings				IMPORTANT																	
No.	Name	Lenze	Selection																				
C0007 SEr ⌵SEr	Fixed configuration of digital inputs	0		E4	E3	E2	E1	Change under C0007 will be copied to the corresponding subcode of C0410. Free configuration under C0410 sets C0007 = 255! 7-68 <ul style="list-style-type: none"> • CW/CCW = CW rotation/CCW rotation • DCB = DC-injection brake • QSP = Quick stop • PAR = Parameter set changeover (PAR1 ↔ PAR2) <ul style="list-style-type: none"> – PAR1 = LOW, PAR2 = HIGH – The terminal must be assigned to the function "PAR" in PAR1 and PAR2. – Configurations with "PAR" are only allowed if C0988 = 0 • TRIP set = external fault 															
			0	CW/CCW	DCB	JOG2/3	JOG1/3																
			1	CW/CCW	PAR	JOG2/3	JOG1/3																
			2	CW/CCW	QSP	JOG2/3	JOG1/3																
			3	CW/CCW	PAR	DCB	JOG1/3																
			4	CW/CCW	QSP	PAR	JOG1/3																
			5	CW/CCW	DCB	TRIP set	JOG1/3																
			j6	CW/CCW	PAR	TRIP set	JOG1/3																
			7	CW/CCW	PAR	DCB	TRIP set																
			8	CW/CCW	QSP	PAR	TRIP set																
			9	CW/CCW	QSP	TRIP set	JOG1/3																
10	CW/CCW	TRIP set	UP	DOWN																			
C0007 SEr ⌵SEr (cont.)				E4	E3	E2	E1	<ul style="list-style-type: none"> • Selection of fixed setpoints <table border="0"> <tr> <td>JOG1/3</td> <td>JOG2/3</td> <td>active</td> </tr> <tr> <td>LOW</td> <td>LOW</td> <td>C0046</td> </tr> <tr> <td>HIGH</td> <td>LOW</td> <td>JOG1</td> </tr> <tr> <td>LOW</td> <td>HIGH</td> <td>JOG2</td> </tr> <tr> <td>HIGH</td> <td>HIGH</td> <td>JOG3</td> </tr> </table>	JOG1/3	JOG2/3	active	LOW	LOW	C0046	HIGH	LOW	JOG1	LOW	HIGH	JOG2	HIGH	HIGH	JOG3
			JOG1/3	JOG2/3	active																		
			LOW	LOW	C0046																		
			HIGH	LOW	JOG1																		
			LOW	HIGH	JOG2																		
			HIGH	HIGH	JOG3																		
			11	CW/CCW	DCB	UP	DOWN																
			12	CW/CCW	PAR	UP	DOWN																
			13	CW/CCW	QSP	UP	DOWN																
14	CCW/QSP	CW/QSP	DCB	JOG1/3																			
15	CCW/QSP	CW/QSP	PAR	JOG1/3																			
16	CCW/QSP	CW/QSP	JOG2/3	JOG1/3																			
17	CCW/QSP	CW/QSP	PAR	DCB																			
18	CCW/QSP	CW/QSP	PAR	TRIP set																			
19	CCW/QSP	CW/QSP	DCB	TRIP set																			
C0007 SEr ⌵SEr (cont.)				E4	E3	E2	E1	<ul style="list-style-type: none"> • UP/DOWN = Motor potentiometer functions • H/Re = Manual/remote changeover • PCTRL1-I-OFF = Switch-off process controller I component • DFIN1-ON = Digital frequency input 0 ... 10 kHz • PCTRL1-OFF = Switch off process controller 															
			20	CCW/QSP	CW/QSP	TRIP set	JOG1/3																
			21	CCW/QSP	CW/QSP	UP	DOWN																
			22	CCW/QSP	CW/QSP	UP	JOG1/3																
			23	H/Re	CW/CCW	UP	DOWN																
			24	H/Re	PAR	UP	DOWN																
			25	H/Re	DCB	UP	DOWN																
			26	H/Re	JOG1/3	UP	DOWN																
			27	H/Re	TRIP set	UP	DOWN																
			28	JOG2/3	JOG1/3	PCTRL1-I-OFF	DFIN1-ON																
			29	JOG2/3	DCB	PCTRL1-I-OFF	DFIN1-ON																
30	JOG2/3	QSP	PCTRL1-I-OFF	DFIN1-ON																			
C0007 SEr ⌵SEr (cont.)				E4	E3	E2	E1																
			31	DCB	QSP	PCTRL1-I-OFF	DFIN1-ON																
			32	TRIP set	QSP	PCTRL1-I-OFF	DFIN1-ON																
			33	QSP	PAR	PCTRL1-I-OFF	DFIN1-ON																
			34	CW/QSP	CCW/QSP	PCTRL1-I-OFF	DFIN1-ON																
			35	JOG2/3	JOG1/3	PAR	DFIN1-ON																
			36	DCB	QSP	PAR	DFIN1-ON																
			37	JOG1/3	QSP	PAR	DFIN1-ON																
			38	JOG1/3	PAR	TRIP set	DFIN1-ON																
			39	JOG2/3	JOG1/3	TRIP set	DFIN1-ON																
			40	JOG1/3	QSP	TRIP set	DFIN1-ON																

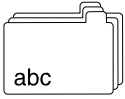

Appendix

Code table

Code		Possible settings				IMPORTANT			
No.	Name	Lenze	Selection						
C0007 <small>ENTER</small> 5Er (cont.)				E4	E3	E2	E1		
			41	JOG1/3	DCB	TRIP set	DFIN1-ON		
			42	QSP	DCB	TRIP set	DFIN1-ON		
			43	CW/CCW	QSP	TRIP set	DFIN1-ON		
			44	UP	DOWN	PAR	DFIN1-ON		
			45	CW/CCW	QSP	PAR	DFIN1-ON		
			46	H/Re	PAR	QSP	JOG1/3		
			47	CW/QSP	CCW/QSP	H/Re	JOG1/3		
			48	PCTRL1- OFF	DCB	PCTRL1-I-OFF	DFIN1-ON		
			49	PCTRL1- OFF	JOG1/3	QSP	DFIN1-ON		
			50	PCTRL1- OFF	JOG1/3	PCTRL1-I-OFF	DFIN1-ON		
			51	DCB	PAR	PCTRL1-I-OFF	DFIN1-ON		
			255	Free configuration under C0410					Only display Do not change C0007 since settings under C0410 can be lost
C0008 <small>ENTER</small>	Fixed configuration - relay output K1 (relay, motec version 151) or Digital switching output K1 (motec versions 152, 153)	1						Change of C0008 is copied into C0415/1. Free configuration in C0415/1 sets C0008 = 255!	7-73
			0	Ready for operation (DCTRL1-RDY)					
			1	TRIP error message (DCTRL1-TRIP)					
			2	Motor is running (DCTRL1-RUN)					
			3	Motor is running / CW rotation (DCTRL1-RUN-CW)					
			4	Motor is running / CCW rotation (DCTRL1-RUN-CCW)					
			5	Output frequency = 0 (DCTRL1-NOUT=0)					
			6	Frequency setpoint reached (DCTRL1-RFG1=NOUT)					
			7	Values have fallen below frequency threshold Q_{min} ($f < C0017$) (PCTRL1-QMIN)				LOW active	
			8	I_{max} limit reached (MCTRL1-IMAX) C0014 = 5: torque setpoint reached					
			9	Overtemperature ($\vartheta_{max} -5$ °C) (DCTRL1-OH-WARN)					
			10	Values have fallen below TRIP or Q_{min} or pulse inhibit (IMP) (DCTRL1-TRIP-QMIN-IMP)					
			11	PTC warning (DCTRL1-PTC-WARN)					
			12	Apparent motor current < current threshold (DCTRL1-IMOT<ILIM)				V-belt monitoring Apparent motor current = C0054 Current threshold = C0156 Frequency threshold Q_{min} = C0017	
			13	Apparent motor current < current threshold and output frequency > Frequency threshold Q_{min} (DCTRL1-(IMOT<ILIM)-QMIN)					
			14	Apparent motor current < current threshold and ramp function generator 1: input = output (DCTRL1-(IMOT<ILIM)-RFG1=0)					
15	Motor phase failure warning (DCTRL1-LP1-WARN)								
16	Minimum output frequency reached ($f \leq C0010$) (PCTRL1-NMIN)				LOW active				
255	Free configuration in C0415/1				Read only Do not change C0008 since settings in C0415/1 may get lost				

Appendix

Code table

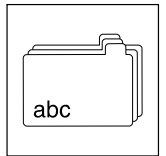

Code		Possible settings			IMPORTANT
No.	Name	Lenze	Selection		
C0009* ENTER	Controller address	1	1 {1}	99	<p>Only for communication modules on the AIF interface:</p> <ul style="list-style-type: none"> • LECOM-A (RS232) E82ZBL • LECOM-A/B/LI 2102 • PROFIBUS-DP 213x, • System bus (CAN) 217x <p>During operation with the E82ZAFCC system bus function module the node address must be set under C0350.</p>
C0010 SEr	Minimum output frequency	0.00	0.00 {0.02 Hz} → 14.5 Hz	650.00	<ul style="list-style-type: none"> • C0010 is not effective with bipolar setpoint selection (-10 V ... +10 V) • C0010 only defines the analog input 1 • As of software 3.5: If C0010 > C0011, the drive does not start running with controller enable. <p>→ Speed setting range 1 : 6 for Lenze geared motors: Setting absolutely required for operation with Lenze geared motors.</p>
C0011 SEr	Maximum output frequency	50.00	7.50 {0.02 Hz} → 87 Hz	650.00	
C0012 SEr	Acceleration time main setpoint	5.00	0.00 {0.02 s}	1300.00	<p>Reference: frequency change 0 Hz ... C0011</p> <ul style="list-style-type: none"> • Additional setpoint ⇔ C0220 • Acceleration times can be activated via digital signals ⇔ C0101
C0013 SEr	Deceleration time main setpoint	5.00	0.00 {0.02 s}	1300.00	<p>Reference: frequency change C0011 ... 0 Hz</p> <ul style="list-style-type: none"> • Additional setpoint ⇔ C0221 • Deceleration times can be activated via digital signals ⇔ C0103
C0014 ENTER	Operating mode	2	<p>2 V/f characteristic control $V \sim f$ (linear characteristic with constant V_{min} boost)</p> <p>3 V/f characteristic control $V \sim f^2$ (square-law characteristic with constant V_{min} boost)</p> <p>4 Vector control</p> <p>5 Sensorless torque control with speed limitation</p> <ul style="list-style-type: none"> • Torque setpoint via C0412/6 • Speed limitation via setpoint 1 (NSET1-N1) if C0412/1 is assigned, otherwise via maximum frequency (C0011) 		<ul style="list-style-type: none"> • Commissioning is possible without identifying motor parameters • Advantage of identification with C0148: <ul style="list-style-type: none"> – Improved smooth running at low speeds – V/f rated frequency (C0015) and slip (C0021) are calculated and saved. They must not be entered <p>In case of the first selection enter the motor data and identify them with C0148</p> <p>Otherwise, commissioning is not possible</p> <p>When C0014 = 5, C0019 must be set = 0 (automatic DC injection brake is deactivated)</p>
C0015 SEr	V/f rated frequency	50.00	7.50 {0.02 Hz}	960.00	<ul style="list-style-type: none"> • C0015 is calculated and stored under C0148 when the motor parameters are identified • Setting applies to all mains voltages permitted
C0016 SEr	V_{min} boost	→	0.00 {0.01 %}	40.00	<p>→ Depending on the controller</p> <p>Setting applies to all mains voltages permitted</p>
C0017	Frequency threshold Q_{min}	0.00	0.00 {0.02 Hz}	650.00	<p>Programmable frequency threshold</p> <ul style="list-style-type: none"> • Reference: Setpoint • Signal output configuration under C0415
C0018 ENTER	Switching frequency	2	<p>0 2 kHz sin</p> <p>1 4 kHz sin</p> <p>2 8 kHz sin</p> <p>3 16 kHz sin</p> <p style="text-align: right;">low noise generation</p>		<p>General rule:</p> <p>The lower the switching frequency the</p> <ul style="list-style-type: none"> • lower the power loss • higher the noise generation <p>Only operate mid-frequency motors at 8 kHz sin or 16 kHz sin (C0018 = 2 or 3)!</p>

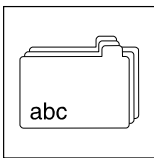

Appendix

Code table

Code		Possible settings			IMPORTANT
No.	Name	Lenze	Selection		
C0019	Operating threshold - automatic DC injection brake (auto DCB)	0.10	0.00 {0.02 Hz} = inactive	650.00	Hold time ⇔ C0106 Deactivate automatic DC injection brake (auto DBC): • at active lower frequency limitation (C0239) • at operating mode C0014 = 5
C0021	Slip compensation	0.0	-50.0 {0.1 %}	50.0	C0021 is calculated and stored under C0148 when the motor parameters are identified
C0022	I_{max} limit (motor mode)	150	30 {1 %}	150	Only 8200 vector 15 ... 90 kW: If C0022 = 150 %, 180 % I_r are available for max. 3 s. after controller enable
C0023	I_{max} limit in the generator mode	150	30 {1 %}	150	C0023 = 30 %: function is inactive, if C0014 = 2, 3:
C0026*	Offset analog input 1 (AIN1-OFFSET)	0.0	-200.0 {0.1 %}	200.0	• Settings for X3/8 and X3/1U, X3/1I • The max. limit of the setpoint value range of C0034 equals 100 % • C0026 and C0413/1 are identical
C0027*	Gain analog input 1 (AIN1-GAIN)	100.0	-1500.0 {0.1 %}	1500.0	• Settings for X3/8 and X3/1U, X3/1I • 100.0 % = Gain 1 • Inverse setpoint selection by negative gain and negative offset • C0027 and C0414/1 are identical
C0034* ENTER uSEr	Setpoint selection range Standard-I/O (X3/8)	0	0	Unipolar voltage 0 ... 5 V / 0 ... 10 V Current 0 ... 20 mA	Observe the switch position of the function module! Changing the direction of rotation is only possible with a digital signal. • Minimum output frequency (C0010) not effective • Individual adjustment of offset and gain TRIP Sd5, if $I < 4$ mA Changing the direction of rotation is only possible with a digital signal.
			1	Current 4 ... 20 mA	
			2	Bipolar voltage -10 V ... +10 V	
			3	Current 4 ... 20 mA open-circuit monitored	
C0034* ENTER (A) uSEr	Setpoint selection range Application I/O	0	0	Unipolar voltage 0 ... 5 V / 0 ... 10 V	Observe the jumper setting of the function module! Minimum output frequency (C0010) not effective Changing the direction of rotation is only possible with a digital signal. Changing the direction of rotation is only possible with a digital signal. TRIP Sd5 if $I < 4$ mA
			1	Bipolar voltage -10 V ... +10 V	
			2	Current 0 ... 20 mA	
			3	Current 4 ... 20 mA	
			4	Current 4 ... 20 mA open-circuit monitored	
C0035* ENTER	DC injection brake (DCB) control mode	0	0	Brake voltage selection under C0036	Hold time ⇔ C0107
			1	Brake current selection under C0036	
C0036	Voltage/current DC injection brake (DCB)	→	0.00 {0.01 %}	150.00 %	→ Depending on the controller • Reference M_r , I_r • Setting applies to all mains voltages permitted
C0037	JOG1	20.00	-650.00 {0.02 Hz}	650.00	JOG = fixed setpoint
C0038	JOG2	30.00	-650.00 {0.02 Hz}	650.00	Additional fixed setpoints ⇔ C0440
C0039	JOG3	40.00	-650.00 {0.02 Hz}	650.00	
C0040* ENTER	Controller inhibit (CINH)		-0-	Controller inhibited (CINH)	Controller can only be enabled if X3/28 = HIGH
			-1-	Controller enabled (CINH)	

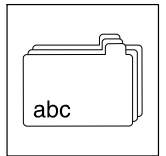

Code		Possible settings		IMPORTANT	
No.	Name	Lenze	Selection		
C0043*	TRIP reset		0 No current error 1 Active fault		Reset active error with C0043 = 0
C0044*	Setpoint 2 (NSET1-N2)		-650.00 {0.02 Hz} 650.00		The value set will be lost when switching the mains! <ul style="list-style-type: none"> • Selection, if C0412/2 = FIXED-FREE (not assigned) • Display if C0412/2 is linked with a signal source
C0046*	Setpoint 1 (NSET1-N1)		-650.00 {0.02 Hz} 650.00		The value set will be lost when switching the mains! <ul style="list-style-type: none"> • Selection, if C0412/1 = FIXED-FREE (not assigned) • Display if C0412/1 is linked with a signal source
C0047*	Torque setpoint or torque limit value (MCTRL1-MSET)	400	0 {1 %} 400 Ref.: Rated motor torque detected by motor parameter identification		The value set will be lost when switching the mains! Control mode "Sensorless torque control" (C0014 = 5): <ul style="list-style-type: none"> • Torque setpoint selection if C0412/6 = FIXED-FREE (not assigned) • Torque setpoint display if C0412/6 is linked with a signal source Control mode "V/f characteristic control" or "Vector control" (C0014 = 2, 3, 4): <ul style="list-style-type: none"> • Torque limit value is displayed if C0412/6 is linked with a signal source • C0047 = 400 is displayed if C0412/6 = FIXED-FREE (not assigned)
C0049*	Additional setpoint (PCTRL1-NADD)		-650.00 {0.02 Hz} 650.00		The value set will be lost when switching the mains! <ul style="list-style-type: none"> • Selection, if C0412/3 = FIXED-FREE (not assigned) • Display if C0412/3 is linked with a signal source
C0050*	Output frequency (MCTRL1-NOUT)		-650.00 {Hz} 650.00		Only display: Output frequency without slip compensation
C0051*	Output frequency with slip compensation (MCTRL1-NOUT+SLIP) or act. process controller value (PCTRL1-ACT)		-650.00 {0.02 Hz} 650.00		The value set will be lost when switching the mains! Operation without process controller (C0238 = 2): <ul style="list-style-type: none"> • Display only: Output frequency with slip compensation (MCTRL1-NOUT+SLIP) Operation with process controller (C0238 = 0, 1): <ul style="list-style-type: none"> • Selection, if C0412/5 = FIXED-FREE (not assigned) • Display if C0412/5 is linked with a signal source
C0052*	Motor voltage (MCTRL1-VOLT)		0 {V} 1000		Only display
C0053*	DC-bus voltage (MCTRL1-DCVOLT)		0 {V} 1000		Only display
C0054*	Apparent motor current (MCTRL1-IMOT)		0.0 {A} 2000.0		Only display
C0056*	Controller load (MCTRL1-MOUT)		-255 {%} 255		Only display Under C0311 you can change the display value for the operating modes vector control or sensorless torque control.

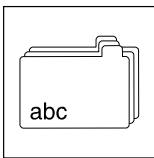

Appendix

Code table

Code		Possible settings			IMPORTANT
No.	Name	Lenze	Selection		
C0061*	Heatsink temperature		0 {°C}	255	Only display <ul style="list-style-type: none"> If the heatsink temperature is $> \vartheta_{\max} - 5$ °C: <ul style="list-style-type: none"> The warning <i>OH</i> will be sent. The chopper frequency will be reduced to 4 kHz, if C0144 = 1 If the heatsink temperature is $> \vartheta_{\max}$: <ul style="list-style-type: none"> Controller sets TRIP <i>OH</i>
C0070	Process controller gain	1.00	0.00 {0.01} = P component not active	300.00	7-50
C0071	Process controller readjustment time	100	10 {1} = I component not active	9999	7-50
C0072	Differential component of process controller	0.0	0.0 {0.1} = D component not active	5.0	7-50
C0074	Process controller influence	0.0	0.0 {0.1 %}	100.0	7-50
C0077*	Gain I_{\max} controller	0.25	0.00 {0.01} = P component not active	16.00	7-56
C0078*	Integral action time I_{\max} controller	65 → 130	12 {1 ms} = I component not active	9990	→ Only 8200 vector 15 ... 90 kW 7-56
C0079	Oscillation damping	2	0 {1}	140	7-16
C0084	Motor stator resistance	0.000	0.000 {0.001 Ω}	64.000	7-48
		0.0	0.0 {0.1 m Ω}	6500.0	
C0087	Rated motor speed	→	300 {1 rpm}	16000	→ Depending on the controller 7-48
C0088	Rated motor current	→	0.0 {0.1 A}	650.0	→ Depending on the controller 0.0 ... 2.0 x rated output current of the controller 7-48
C0089	Rated motor frequency	50	10 {1 Hz}	960	7-48
C0090	Rated motor voltage	→	50 {1 V}	500	→ 230 V with 230 V controllers, 400 V with 400 V controllers 7-48
C0091	Motor cos φ	→	0.40 {0.1}	1.0	→ Depending on the controller 7-48
C0092	Motor stator inductance	0.0	0.000 {0.1 mH}	200.0	7-48
		0.00	0.00 {0.01 mH}	200.00	
C0093*	Controller type		xxxxy		Only display <ul style="list-style-type: none"> xxx = Power taken from nameplate (e. g. 551 = 550 W) y = Voltage class (2 = 240 V, 4 = 400 V)
C0094*	User password		0 {1} = no password protection	9999	1 ... 9999 = Free access to user menu only 6-7
C0099*	Software version		x.y		Only display x = Main version, y = Index

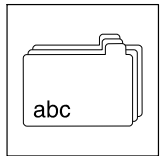

Code		Possible settings			IMPORTANT	
No.	Name	Lenze	Selection			
C0101 (A)	Acceleration times - main setpoint		0.00	{0.02 s}	1300.00	<p>Binary coding of the digital signal sources assigned to C0410/27 and C0410/28 determine the active time pair</p> <p>C0410/27 C0410/28 Active LOW LOW C0012; C0013 HIGH LOW T_{ir} 1; T_{ir} 1 LOW HIGH T_{ir} 2; T_{ir} 2 HIGH HIGH T_{ir} 3; T_{ir} 3</p>
	1 C0012	5.00				
	2 T _{ir} 1	2.50				
	3 T _{ir} 2	0.50				
	4 T _{ir} 3	10.00				
C0103 (A)	Deceleration times - main setpoint		0.00	{0.02 s}	1300.00	<p>• Quick stop (QSP) decelerates the drive to standstill according to the ramp set under C0105.</p> <p>• If the output frequency falls below the threshold C0019, the DC-injection brake (DCB) will be activated.</p> <p>• The S-shaped ramp (C0182) has also an effect on quick stop! – Reduce the time setting under C0105 to reach the desired deceleration time for quick stop. – The S-shaped ramp for the quick stop can be switched off under C0311 (as of software 3.1).</p>
	1 C0013	5.00				
	2 T _{ir} 1	2.50				
	3 T _{ir} 2	0.50				
	4 T _{ir} 3	10.00				
C0105	Deceleration time quick stop (QSP)	5.00	0.00	{0.02 s}	1300.00	<p>• Quick stop (QSP) decelerates the drive to standstill according to the ramp set under C0105.</p> <p>• If the output frequency falls below the threshold C0019, the DC-injection brake (DCB) will be activated.</p> <p>• The S-shaped ramp (C0182) has also an effect on quick stop! – Reduce the time setting under C0105 to reach the desired deceleration time for quick stop. – The S-shaped ramp for the quick stop can be switched off under C0311 (as of software 3.1).</p>
C0106	Hold time for automatic DC-injection brake (Auto DCB)	0.50	0.00 = auto DCB not active	{0.01 s}	999.00 = ∞	Hold time, if DC-injection brake is activated because the value falls below the setting under C0019.
C0107	Hold time DC injection brake (DCB)	999.00	1.00	{0.01 s}	999.00 = ∞	Hold time, if DC-injection brakes are activated via an external terminal or control word.
C0108*	Gain analog output X3/62 (AOUT1-GAIN)	128	0	{1}	255	Standard I/O: C0108 and C0420 are the same Application I/O: C0108 and C0420/1 are the same
C0109*	Offset analog output X3/62 (AOUT1-OFFSET)	0.00	-10.00	{0.01 V}	10.00	Standard I/O: C0109 and C0422 are the same Application I/O: C0109 and C0422/1 are the same

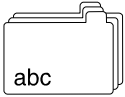

Appendix

Code table

Code		Possible settings		IMPORTANT	
No.	Name	Lenze	Selection		
C0111 <small>ENTER</small>	Configuration of analog output X3/62 (AOUT1-IN)		Output of analog signals to terminal	Change of C0111 is copied into C0419/1. Free configuration in C0419/1 sets C0111 = -255-! 7-59	
		0	0 Output frequency with slip (MCTRL1-NOUT+SLIP)	6 V/12 mA \equiv C0011	
			1 Device utilisation (MCTRL1-MOUT) at V/f characteristic control (C0014 = 2 or 3)	3 V/6 mA \equiv rated active inverter current (active current/C0091)	
			Actual motor torque (MCTRL1-MACT) with vector control (C0014 = 4) or sensorless torque control (C0014 = 5)	3 V/6 mA \equiv rated motor torque	
			2 Apparent motor current (MCTRL1-IMOT)	3 V/6 mA \equiv rated inverter current	
			3 DC-bus voltage (MCTRL1-DCVOLT)	6 V/12 mA \equiv DC 1000 V (400 V mains) 6 V/12 mA \equiv DC 380 V (240 V mains)	
			4 Motor power	3 V/6 mA \equiv rated motor power	
			5 Motor voltage (MCTRL1-VOLT)	4.8 V/9.6 mA \equiv rated motor voltage	
			6 1/output frequency (1/C0050) (MCTRL1-1/NOUT)	2 V/4 mA \equiv $0.5 \times$ C0011	
			7 Output frequency within adjusted limits (DCTRL1-C0010...C0011)	0 V/0 mA/4 mA \equiv $f = f_{\min}$ (C0010) 6 V/12 mA \equiv $f = f_{\max}$ (C0011)	
			8 Operation with process controller (C0238 = 0, 1): Actual process controller value (PCTRL1-ACT) Operation without process controller (C0238 = 2): Output frequency without slip (MCTRL1-NOUT)	6 V/12 mA \equiv C0011	
			9 Ready for operation (DCTRL1-RDY)	Selection 9 ... 25 corresponds to the digital functions of the relay output K1 or the digital switching output K1 (C0008) or the digital output A1 (C0117): LOW = 0 V/0 mA/4 mA HIGH = 10 V/20 mA	
			10 TRIP error message (DCTRL1-TRIP)		
			11 Motor is running (DCTRL1-RUN)		
			12 Motor is running / CW rotation (DCTRL1-RUN-CW)		
			13 Motor is running / CCW rotation (DCTRL1-RUN-CCW)		
			14 Output frequency = 0 (DCTRL1-NOUT=0)		
			15 Frequency setpoint reached (MCTRL1-RFG1=NOUT)		
			16 Values have fallen below frequency threshold Q_{\min} ($f < C0017$) (PCTRL1-QMIN)		LOW active
			17 I_{\max} limit reached (MCTRL1-IMAX) C0014 = -5-: Torque setpoint reached		
			18 Overtemperature ($\vartheta_{\max} - 5^\circ\text{C}$) (DCTRL1-OH-WARN)		
			19 Values have fallen below TRIP or Q_{\min} or pulse inhibit (IMP) is active (DCTRL1-TRIP-QMIN-IMP)		
			20 PTC warning (DCTRL1-PTC-WARN)		
			21 Apparent motor current < current threshold (DCTRL1-IMOT<ILIM)	V-belt monitoring Apparent motor current = C0054 Current threshold = C0156 Frequency threshold Q_{\min} = C0017	
			22 Apparent motor current < current threshold and output frequency > Frequency threshold Q_{\min} (DCTRL1-(IMOT<ILIM)-QMIN)		
	23 Apparent motor current < current threshold and ramp function generator 1: input = output (DCTRL1-(IMOT<ILIM)-RFG-I=0)				
	24 Motor phase failure warning (DCTRL1-LP1-WARN)				
	25 Minimum output frequency reached ($f \leq C0010$) (PCTRL1-NMIN)	LOW active			
	255 Free configuration in C0419/1	Read only Do not change C0111 since settings in C0419/1 may get lost			

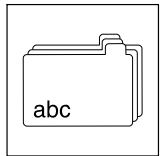

Code		Possible settings		IMPORTANT	
No.	Name	Lenze	Selection		
C0114 	Level inversion - digital inputs	0	0 Level inversion switched off	<ul style="list-style-type: none"> By entering the sum of the selected values you can invert several inputs. C0114 and C0411 are the same The "Change over parameter set" cannot be inverted! 	
			1 E1 inverted		
			2 E2 inverted		
			4 E3 inverted		
			8 E4 inverted		
			16 E5 inverted		Only application I/O
			32 E6 inverted		Only application I/O
64 T1/T2 inverted	Only connect potential-free switches to T1/T2. T1/T2 is active when the switch is open.				
C0117 	Fixed configuration of digital output A1 (DIGOUT1)	0		Changes of C0117 will be copied to C0415/2. Free configuration under C0415/2 sets C0117 =255!	
			0 ... 16 see C0008		
			255 Free configuration under C0415/2	Only display Do not change C0117 since settings under C0415/2 can be lost	
C0119 	Configuration of motor temperature monitoring (PTC input) / earth fault detection	0	0 PTC input not active Earth fault detection active	<ul style="list-style-type: none"> Signal output configuration under C0415 If several parameter sets are used, the monitoring must be separately adjusted for each parameter set. Deactivate the earth fault detection, if it has been activated unintentionally. If the earth fault detection is active, the motor starts after controller enable with a delay of approx.40 ms. 	
			1 PTC input active, TRIP set		
			2 PTC input active, Warning set		
			3 PTC input not active Earth fault detection inactive		
			4 PTC input active, TRIP set		
5 PTC input active, Warning set					
C0120	I ² t switch-off	0	0 {1 %} 200 = not active	Reference: Apparent motor current (C0054) Ref. to active motor current (C0056) possible, see C0310	
C0125* 	Baud rate	0	LECOM System bus (CAN) 217x	Only for communication modules on the AIF interface: <ul style="list-style-type: none"> LECOM-A (RS232) E82ZBL LECOM-A/B/LI 2102 System bus (CAN) 217x During operation with the E82ZAFCC system bus function module the baud rate must be set under C0351.	
			0 9600 baud 500 kbaud		
			1 4800 baud 250 kbaud		
			2 2400 baud 125 kbaud		
			3 1200 baud 50 kbaud		
			4 19200 baud 1000 kbaud		
C0126* 	Response in the event of a communication error	10	Monitored communication channel	By entering the sum of the selected values you can activate a monitoring combination	
			0 All monitoring is deactivated		
			1 Process channel of the AIF interface		Communication abort at active monitoring activates TRIP CE0
			2 Internal communication between function module on FIF and controller		Communication abort at active monitoring activates TRIP CE5
			4 Communication (bus OFF) at operation with system bus function module (CAN) on FIF		Communication abort at active monitoring activates TRIP CE6
8 Remote parameter setting via C0370 at operation with function module system bus (CAN) on FIF	Communication abort at active monitoring activates TRIP CE7				
C0127 	Setpoint selection	0	0 Absolute setpoint selection in Hz via C0046 or process data channel		
			1 Setpoint selection normalised via C0141 (0... 100 %) or process data channel ($\pm 16384 = C0011$)		
C0128	Service code			Modifications only by Lenze Service!	

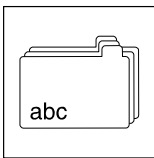

Appendix

Code table

Code		Possible settings		IMPORTANT		
No.	Name	Lenze	Selection			
C0135*	Controller control word (parameter channel)		Bit Assignment	<ul style="list-style-type: none"> Control via parameter channel. The most important control commands are grouped as bit commands. C0135 cannot be changed using the keypad 		
			110 JOG1, JOG2, JOG3 or C0046 (NSET1-JOG1/3, NSET1-JOG2/3)		00 C0046 active 01 JOG1 (C0037) active 10 JOG2 (C0038) active 11 JOG3 (C0039) active	
			2 Current direction of rotation (DCTRL1-CW/CCW)		0 not inverted 1 inverted	
			3 Quick stop (DCTRL1-QSP)		0 not active 1 active	
			4 Stop ramp function generator (NSET1-RFG1-STOP)		0 not active 1 active	
			5 Ramp function generator input = 0 (NSET1-RFG1-0)		0 not active 1 active (deceleration to C0013)	RFG1 = Ramp function generator main setpoint
			6 UP function motor potentiometer (MPOT1-UP)		0 not active 1 active	
			7 DOWN function motor potentiometer (MPOT1-DOWN)		0 not active 1 active	
			8 Reserved			
			9 Controller inhibit (DCTRL1-CINH)		0 Controller enabled 1 Controller inhibited	
			10 TRIP set (DCTRL1-TRIP-SET)			Sets "external error" in the controller (EEr, LECOM No. 91)
			11 TRIP reset (DCTRL1-TRIP-RESET)		0 ⇒ 1 Edge causes TRIP reset	
			13112 Parameter set changeover (DCTRL1-PAR2/4, DCTRL1-PAR3/4)		00 PAR1 01 PAR2 10 PAR3 11 PAR4	
			14 DC injection brake (MTCRL1-DCB)		0 not active 1 active	
			15 Reserved			
C0138*	Process controller setpoint 1 (PCTRL1-SET1)	0.00	-650.00 {0.02 Hz} 650.00	<p>The value set will be lost when switching the mains!</p> <ul style="list-style-type: none"> Selection if C0412/4 = FIXED-FREE Display if C0412/4 ≠ FIXED-FREE 	7-53	
C0140*	Additive frequency setpoint (NSET1-NADD)	0.00	-650.00 {0.02 Hz} 650.00	<ul style="list-style-type: none"> Selection via function <input type="button" value="Set"/> of the keypad or the parameter channel Is added to main setpoint Value is stored when switching the mains or removing the keypad 	7-45	

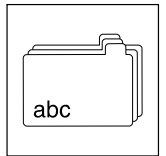

Code		Possible settings			IMPORTANT	
No.	Name	Lenze	Selection			
C0141*	Setpoint normalisation	0.00	-100.00	{0.01 %}	100.00	The value set will be lost when switching the mains! Only effective if C0127 = 1 Reference: C0011
C0142 ENTER	Start condition	1	0	Automatic restart after mains connection inhibited Flying restart not active		Start after HIGH-LOW-HIGH changes at X3/28
			1	Automatic start, if X3/28 = HIGH Flying restart circuit not active		
			2	Automatic restart after mains connection inhibited Flying-restart circuit active		Start after HIGH-LOW-HIGH changes at X3/28
			3	Automatic start, if X3/28 = HIGH Flying restart circuit active		
C0143* ENTER	Selection of flying-restart	0	0	Max. output frequency (C0011) ... 0 Hz		Motor speed selected for the indicated range
			1	Last output frequency ... 0 Hz		
			2	Frequency setpoint addition (NSET1-NOUT)		The corresponding value is input after controller enable.
			3	Act. process controller value (C0412/5) addition (PCTRL1-ACT)		
C0144 ENTER	No temperature depending switching frequency derating	1	0	No temperature-depending switching frequency derating		When operating with a switching frequency of 16 kHz it is also possible to derate it to 4 kHz. The behaviour can be changed under C0310.
			1	Automatic switching frequency derating to 4 kHz, if ϑ_{max} reaches - 5 °C		
C0145* ENTER	Process controller setpoint source	0	0	Total setpoint (PCTRL1-SET3)		Main setpoint + additional setpoint
			1	C0181 (PCTRL1-SET2)		
			2	C0412/4 (PCTRL1-SET1)		
C0148* STOP	Motor parameter identification	0	0	Ready		Only when the motor is cold! 1. Inhibit controller, wait until drive is at standstill 2. Enter the correct motor data under C0087, C0088, C0089, C0090, C0091 (see motor nameplate). 3. Set C0148 = 1 by ENTER 4. Enable controller The identification – starts, IMP goes off – the motor makes a high-pitched tone, but does not rotate! – takes approx. 30 s – is completed when IMP is on again 5. Inhibit controller
			1	Start identification • V/f-rated frequency (C0015), slip compensation (C0021) and motor stator inductivity (C0092) are calculated and saved. • The motor stator resistance (C0084) = total resistance of motor cable and motor is measured and saved		

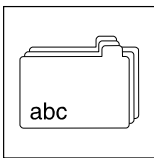

Appendix

Code table

Code		Possible settings		IMPORTANT
No.	Name	Lenze	Selection	
C0150*	Controller status word 1 (parameter channel)		Bit Assignment	<ul style="list-style-type: none"> • Scan of the controller status via parameter channel. The most important status information are grouped as bit pattern. • Some bits can be freely assigned to internal digital signals • Configuration in C0417 • In keypad: display only (hexadecimal)
			0 Mapping of C0417/1	
			1 Pulse inhibit (DCTRL1-IMP) 0 Power outputs enabled 1 Power outputs inhibited	
			2 Mapping of C0417/3	
			3 Mapping of C0417/4	
			4 Mapping of C0417/5	
			5 Mapping of C0417/6	
			6 Output frequency = 0 (DCTRL1-NOUT=0) 0 false 1 true	
			7 Controller inhibit (DCTRL1-CINH) 0 Controller enabled 1 Controller inhibited	
			1110 9 8 Controller status 0000 Controller initialization 0001 Mains voltage off (at external supply of the control section of the drive controller) 0010 Switch-on inhibit 0011 Operation inhibited 0100 Flying-restart circuit active 0101 DC-injection brake active 0110 Operation enabled 0111 Message active 1000 Active error	
			12 Overheat warning (DCTRL1-OH-WARN) 0 No warning 1 $\vartheta_{\max} - 5\text{ °C}$ reached	
			13 DC-bus overvoltage (DCTRL1-OV) 0 No overvoltage 1 Overvoltage	
			14 Mapping of C0417/15	
			15 Mapping of C0417/16	
			C0151*	
0 ... 15 Mapping of C0418/1 ... C0418/16				
C0155*	Extended status word		Bit Assignment	
			0 not ready for operation (NOT DCTRL-RDY)	
			1 not assigned	
			2 I_{\max} (MCTRL1-IMAX)	
			3 Pulse inhibit (DCTRL1-IMP)	
			4 not assigned	
			5 Controller inhibit (DCTRL1-CINH)	
			6 TRIP (DCTRL1-TRIP)	
			7 not assigned	
			8 Collective message (DCTRL1-OH-PTC-LP1-FAN1-WARN)	
			9 PAR B0 (DCTRL1-PAR-B0)	
			10 PAR B1 (DCTRL1-PAR-B1)	
11 ... 15 Reserved				

Appendix

Code table

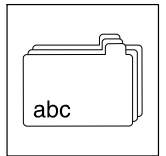

Code		Possible settings			IMPORTANT
No.	Name	Lenze	Selection		
C0156*	Current threshold	0	0 {1 %} 150	Programmable current threshold	
C0161*	Active error			Display history buffer contents	8-1
C0162*	Last fault				
C0163*	Last but one fault				
C0164*	Last but two fault				
C0168*	Actual fault			History buffer displays "active error"	8-1
C0170 ENTER	Configuration TRIP reset	0	0 TRIP reset by mains switching, STOP , LOW-signal at X3/28, via function module or communication module	• TRIP reset via function module or communication module with C0043, C0410/12 or C0135 bit 11. • Auto TRIP reset after the time set under C0171.	8-7
			1 like 0 and additional auto TRIP reset		
			2 TRIP reset through mains switching, via function module or communication module		
			3 TRIP reset by mains switching		
C0171	Delay for auto-TRIP reset	0.00	0.00 {0.01 sec} 60.00		
C0174* STOP	Switching threshold - brake chopper	100	78 {1 %} 110 Required setting	Only active with 8200 motec 3 ... 7.5 kW and 8200 vector 0.55 ... 11 kW, version for 400/500 V mains voltage	11-1
			U _{mains} C0174 U _{DC}		
			[3/PE AC xxx V] [%] [V DC]		
			380 78 618		
			400 81 642		
			415 84 665		
			440 89 704		
			460 93 735		
			480 97 767		
			500 100 790		
C0178*	Operating time		{h}	Only display	
C0179*	Power-on time		{h}	Only display	
C0181*	Process controller setpoint 2 (PCTRL1-SET2)	0.00	-650.00 {0.02 Hz} 650.00	Total duration terminal 28 (CINH) = HIGH	
C0182*	Integration time S-ramps	0.00	0.00 {0.01 s} 50.00	• C0182 = 0.00: Linear ramp function generator operation • C0182 > 0.00: S-shaped ramp function generator (smooth)	7-24
C0183*	Diagnostics		0 No fault	Only display	
			102 TRIP active		
			104 Message "Overvoltage (OL)" or "Undervoltage (LL)" active		
			142 Pulse inhibit		
			151 Quick stop active		
			161 DC-injection brake active		
250 Warning active					
C0184*	Frequency threshold PCTRL1-I-OFF	0.0	0.0 {0.1 Hz} 25.0	• If the output frequency < C0184, the I component of the process controller will be switched off • 0.0 Hz = Function not active	7-53

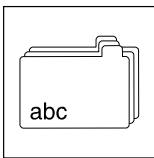

Appendix

Code table

Code		Possible settings			IMPORTANT
No.	Name	Lenze	Selection		
C0185*	Switching window for "Frequency setpoint reached (C0415/x = 4)" and "NSET1-RFG1-I=0 (C0415/x = 5)"	0	0 {1 %}	80	<ul style="list-style-type: none"> C0415/x = 4 and C0415/x = 5 are active within a window around NSET1-RFG1-IN Window in C0185 = 0%: ± 0,5 % ref. to C0011 Window in C0185 > 0%: ± C0185 ref. to NSET1-RFG1-IN
C0189* (A)	Output signal compensator (PCTRL1-FOLL1-OUT)		-650.00 {0.02 Hz}	650.00	Only display Compensator = PCTRL1-FOLL1
C0190* (A)	Main and additional setpoint (PCTRL1-ARITH1)	1	0 X + 0 1 X + Y 2 X - Y 3 $\frac{X \cdot Y}{C0011}$ 4 $\frac{X \cdot C0011}{Y \cdot 100}$ 5 $\frac{X \cdot C0011}{C0011 - Y}$		Mathematical addition of mains setpoint (NSET1-NOUT) and additional setpoint (PCTRL1-NADD) The result is in Hz X = NSET1-NOUT Y = PCTRL1-NADD
C0191 (A)	Compensator acceleration time	5.00	0.00 {0.02 s}	1300.00	Ref. to change 0 Hz ... C0011
C0192 (A)	Compensator deceleration time	5.00	0.00 {0.02 s}	1300.00	Ref. to change C0011 ... 0 Hz
C0193 (A)	Compensator reset	5.00	0.00 {0.02 s}	1300.00	Ref. to change C0011 ... 0 Hz Decelerate compensator to "0"
C0194 (A)	Min. compensator activation threshold	-200.00	-200.00 {0.01 %}	200.00	Ref. to C0011 If the value falls below C0194: Compensator "runs" at C0191 or C0192 direction -C0011
C0195 (A)	Max. compensator activation threshold	200.00	-200.00 {0.01 %}	200.00	Ref. to C0011 If C0195 is exceeded: Compensator "runs" at C0191 or C0192 direction +C0011
C0196* (A)	Activation of auto-DCB	0	0 Auto-DCB active, if PCTRL1-SET3 < C0019 1 Auto-DCB active, if PCTRL1-SET3 < C0019 and NSET1-RFG1-IN < C0019		7-30
C0200*	Software ID				Read only on PC x = main version, y = subversion 82S8212V_xy000 8200 vector 0.25 ... 11 kW 82S8212V_xy010 8200 vector 15 ... 90 kW
C0201*	Software creation date				Read only on PC
C0202*	Software ID		Output in keypad as string in four parts at four characters each		Read only in keypad
	1		82S8		
	2		212 V		
	3		_xy0		x = main version, y = subversion
	4		zz		00 = 8200 vector 0.25 ... 11 kW 10 = 8200 vector 15 ... 90 kW
C0220*	Acceleration time - additional setpoint (PCTRL1-NADD)	5.00	0.00 {0.02 s}	1300.00	Main setpoint ⇒ C0012
C0221*	Deceleration time - additional setpoint (PCTRL1-NADD)	5.00	0.00 {0.02 s}	1300.00	Main setpoint ⇒ C0013

Appendix

Code table

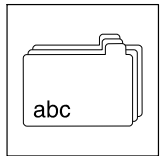

Code		Possible settings				IMPORTANT	
No.	Name	Lenze	Selection				
C0225 (A)	Acceleration time - process controller setpoint (PCTRL1-SET1)	0.00	0.00	{0.02 s}	1300.00	Acceleration encoder for process controller setpoint = PCTRL1-RFG2	
C0226 (A)	Deceleration time - process controller setpoint (PCTRL1-SET1)	0.00	0.00	{0.02 s}	1300.00		
C0228 (A)	Unhide time - process controller	0.000	0.000	{0.001 s}	32.000	0.000 = Process controller output is transferred without unhide	
C0229 (A)	Hide time - process controller	0.000	0.000	{0.001 s}	32.000	0.000 = "Fading-off" switched off (C0241)	
C0230 (A)	Min. limit process controller output	-100.0	-200.0	{0.1 %}	200.0	Asymmetric limit of process controller output ref. to C0011 <ul style="list-style-type: none"> If value falls below C0230 or exceeds C0231: <ul style="list-style-type: none"> Output signal PCTRL1-LIM = HIGH after time set under C0233 Set C0231 > C0230 	
C0231 (A)	Max. limit process controller output	100.0	-200.0	{0.1 %}	200.0		
C0232 (A)	Offset inverse characteristic process controller	0.00	-200.0	{0.1 %}	200.0	Ref. to C0011	
C0233* (A)	Delay PCTRL1-LIM=HIGH	0.000	0.000	{0.001 s}	65.000	"Debouncing" of digital output signal PCTRL1-LIM (limit for process controller output exceeded) <ul style="list-style-type: none"> Sets PCTRL1-LIM = HIGH if the following still applies after time set: <ul style="list-style-type: none"> Value below C0230 or higher than C0231 Transition HIGH ⇔ LOW without delay 	
C0234* (A)	Delay PCTRL1-SET=ACT	0.000	0.000	{0.001 s}	65.000	"Debouncing" of digital output signal PCTRL1-SET=ACT (process controller setpoint = process controller actual value) <ul style="list-style-type: none"> Sets PCTRL1-SET=ACT = HIGH if the following still applies after time set: <ul style="list-style-type: none"> Difference between PCTRL1-SET and PCTRL1-ACT is below threshold under C0235 Transition HIGH ⇔ LOW without delay 	
C0235* (A)	Difference threshold PCTRL1-SET=ACT	0.00	0.00	{0.01 Hz}	650.00	Threshold for the digital output signal PCTRL1-SET=ACT (process controller setpoint = process controller actual value) <ul style="list-style-type: none"> Difference between PCTRL1-SET and PCTRL1-ACT is within limits under C0235: <ul style="list-style-type: none"> PCTRL1-SET=ACT = HIGH after time set under C0234 	
C0236 (A)	Acceleration time - minimum frequency limitation	0.00	0.00	{0.02 s}	1300.00	Ref. to C0011 Minimum frequency limitation = C0239	📖 7-21
C0238 ENTER	Frequency precontrol	2	0	No precontrol (only process controller)	Process controller has full influence	📖 7-50	
			1	Precontrol (total setpoint + process controller)	Process controller has limited influence	📖 7-53	
			2	No precontrol (only total setpoint)	Process controller has no influence (not active)		
					Total setpoint (PCTRL1-SET3) = Main setpoint + additional setpoint		
C0239	Lowest frequency limit	-650.00	-650.00	{0.02 Hz}	650.00	<ul style="list-style-type: none"> The value does not fall below limit independently of the setpoint. If the minimum frequency limitation is active, the automatic DC-injection brake (auto DCB) must be deactivated (C0019 = 0 or C0106 = 0). 	📖 7-21

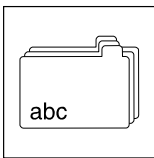

Appendix

Code table

Code		Possible settings		IMPORTANT
No.	Name	Lenze	Selection	
C0240 (A)	Process controller output inversion (PCTRL1-INV-ON) (parameter channel)	0	0 Not inverted	Set digital signal PCTRL1-INV-ON (process controller output inversion) via keypad/PC or parameter channel
			1 Inverted	
C0241 (A)	Process controller not hidden/hidden (PCTRL1-FADING) (parameter channel)	0	0 Process controller unhiding	Set digital signal PCTRL1-FADING (process controller hiding/unhiding) via keypad/PC or parameter channel
			1 Process controller hiding	
C0242 (A)	Activation of process controller inverse control	0	0 Normal control	Act. value increases ⇒ Output frequency increases
			1 Inverse control	Act. value increases ⇒ Output frequency decreases
C0243 (A)	Deactivation of additional setpoint (PCTRL1-NADD-OFF) (parameter channel)	0	0 PCTRL1-NADD active	Set digital signal PCTRL1-NADD-OFF (deactivation of additional setpoint) via keypad/PC or parameter channel
			1 PCTRL1-NADD not active	
C0244 (A)	Root function actual process controller value	0	0 not active	Internal calculation 1. Storing sign of PCTRL1-ACT 2. Extraction of the root of the absolute value 3. Multiply the result with the sign
			1 $\pm \sqrt{ PCTRL1-ACT }$	
C0245* (A)	Comparison value for MSET1=MACT	0	0 MCTRL1-MSET (C0412/6 or C0047)	Selection of a comparison value for setting the digital output signal MSET1=MACT (torque threshold 1 = actual torque value) • If the difference between MCTRL1-MSET1 and MCTRL1-MACT or C0250 is within C0252: – MSET1=MACT = HIGH after time set under C0254
			1 Value under C0250	

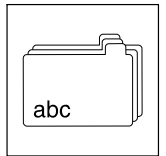

Code		Possible settings				IMPORTANT
No.	Name	Lenze	Selection			
C0250* (A)	Torque threshold 1 (MCTRL1-MSET1)	0.0	-200.0	{0.1 %}	200.0	Related to rated motor torque
C0251* (A)	Torque threshold 2 (MCTRL1-MSET2)	0.0	-200.0	{0.1 %}	200.0	Related to rated motor torque Comparison value for setting the digital output signal MSET2=MACT (torque threshold 2 = actual torque value) <ul style="list-style-type: none"> If the difference between MCTRL1-MSET2 and MCTRL1-MACT is within C0253: <ul style="list-style-type: none"> MSET2=MACT = HIGH after time set under C0255
C0252* (A)	Difference threshold for MSET1=MACT	0.0	0.0	{0.1 %}	100.0	
C0253* (A)	Difference threshold for MSET2=MACT	0.0	0.0	{0.1 %}	100.0	
C0254* (A)	Delay MSET1=MACT	0.000	0.000	{0.001 s}	65.000	"Debouncing" of digital output signals MSET1=MACT <ul style="list-style-type: none"> Sets MSET1=MACT = HIGH if the following still applies after time set: <ul style="list-style-type: none"> Difference between MCTRL1-MSET1 and MCTRL1-MACT or C0250 is within the threshold under C0252 Transition HIGH ⇔ LOW without delay
C0255* (A)	Delay MSET2=MACT	0.000	0.000	{0.001 s}	65.000	"Debouncing" of digital output signals MSET2=MACT <ul style="list-style-type: none"> Sets MSET2=MACT = HIGH if the following still applies after time set: <ul style="list-style-type: none"> Difference between MCTRL1-MSET2 and MCTRL1-MACT is within values set under C0253 Transition HIGH ⇔ LOW without delay
C0265 ENTER	Configuration motor potentiometer	3	0	Start value = power off		<ul style="list-style-type: none"> Start value: output frequency which is approached with Tir (C0012) when the mains is switched on and the motor potentiometer is activated: <ul style="list-style-type: none"> "Power off" = act. value if mains is off "C0010": Minimum output frequency from C0010. The setpoint must have exceeded C0010 before. "0" = output frequency 0 Hz C0265 = 3, 4, 5: <ul style="list-style-type: none"> QSP reduces the motor potentiometer along the QSP ramp (C0105)
1			Start value = C0010			
2			Start value = 0			
3			Start value = power off QSP, if UP/DOWN = LOW			
4			Start value = C0010 QSP, if UP/DOWN = LOW			
5			Start value = 0 QSP, if UP/DOWN = LOW			
C0304 ... C0309	Service codes					Modifications only by Lenze Service!

7-41

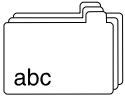

Appendix

Code table

Code		Possible settings		IMPORTANT		
No.	Name	Lenze	Selection			
C0310* <small>ENTER</small>	Functions for special applications 1	0	0	Functions are switched off	By entering the sum of the selected values you can activate a combination of the functions. Behaviour in case of overvoltage in the DC bus Function is active: TRIP "OUE" (Lecom No. 22) in case of overvoltage in the DC bus Function is active: Threshold = 400 VDC Function is active: Reference to controller load (C0056) Function is active: Limitation to maximum frequency (C0011) is inactive Only for applications with parameter set changeover if C0011 is set differently in the parameter sets. Function is active: Chopper frequency is reduced from 16 kHz to 8 kHz, and after one second of operation with 8 kHz it is switched to 4 kHz. Function is active: • When operating with a chopper frequency of 16 kHz and C0144 = 0 no temperature-dependent chopper frequency derating to 4 kHz occurs • When operating with application I/O only the process controller output is reset, but not the integral component Function is active: Up to the power of 2.2 kW = 1000 ms From a power of 3 kW = 250 ms	By entering the sum of the selected values you can activate a combination of the functions. Behaviour in case of overvoltage in the DC bus Function is switched off: Message "OU" Function is switched off: Threshold = 285 VDC Function is switched off: Reference to the apparent current (C0054) Function is switched off: Limitation to maximum frequency (C0011) Function is switched off: Limitation to C0011 is active Function is switched off: Chopper frequency is immediately reduced to 4 kHz. Function is switched off: • When operating with a chopper frequency of 16 kHz it is also possible with C0144 = 0 to derate it to 4 kHz • When operating with application I/O the process controller output and the integral component are reset. Function is switched off: Up to the power of 2.2 kW = 250 ms From a power of 3 kW = 1000 ms
			1			
			2			
			4			
			8			
			32			
			64			
			128			

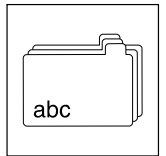

Code		Possible settings		IMPORTANT			
No.	Name	Lenze	Selection				
C0311* <small>ENTER</small>	Functions for special applications 2	1	0	Functions are switched off	By entering the sum of the selected values you can activate a combination of the functions.		
	(C0156 as of software 3.1, C0056 as of software 3.5)		1	<p>Function is active: In the operating mode V/f characteristic control</p> <ul style="list-style-type: none"> • C0156: Rated controller current • C0056: Controller load (MCTRL-MOUT) <p>In the operating mode vector control or sensorless torque control:</p> <ul style="list-style-type: none"> • C0156: Rated controller current • C0056: Controller load (MCTRL-MOUT) 	<p>Selection:</p> <ul style="list-style-type: none"> • Reference value for the current threshold C0156 • Display value in C0056 <p>Function is switched off: In the operating mode V/f characteristic control:</p> <ul style="list-style-type: none"> • C0156: Rated controller current • C0056: Controller load (MCTRL-MOUT) <p>In the operating mode vector control or sensorless torque control: Rated motor torque</p> <ul style="list-style-type: none"> • C0156: Rated motor torque • C0056: Actual torque value (MCTRL-MACT) 		
	(As of software version 3.1)		2	<p>Function is active: The S-shaped ramp (C0182) has no effect on the quick stop ramp (C0105).</p>	<p>Effect of the S-shaped ramp</p> <p>Function is switched off: The S-shaped ramp (C0182) has also an effect on quick stop.</p>		
	(As of software version 3.5)		4	<p>Function is active: Flying restart function optimised for two-pole motors is active</p>	<p>Selection of the flying restart function</p> <p>Function is switched off: Standard flying restart function is active</p>		
C0320 (A)	Actual process controller value (PCTRL1-ACT)		-650.00	{0.02 Hz}	650.00	Only display	
C0321 (A)	Process controller setpoint (PCTRL1-SET)		-650.00	{0.02 Hz}	650.00	Only display	
C0322 (A)	Process controller output without precontrol (PCTRL1-OUT)		-650.00	{0.02 Hz}	650.00	Only display	
C0323 (A)	Ramp function generator input (NSET1-RFG1-IN)		-650.00	{0.02 Hz}	650.00	Only display	
C0324 (A)	Ramp function generator output (NSET1-NOUT)		-650.00	{0.02 Hz}	650.00	Only display	
C0325 (A)	PID controller output (PCTRL1-PID-OUT)		-650.00	{0.02 Hz}	650.00	Only display	
C0326 (A)	Process controller output (PCTRL1-NOUT)		-650.00	{0.02 Hz}	650.00	Only display	
C0350* <small>ENTER</small>	System bus node address	1	1	{1}	63	<ul style="list-style-type: none"> • Only for the E82ZAFCC system bus function module on the FIF interface. • Changes will become effective after the command "reset node" <p>During operation with 217x communication modules the node address must be set under C0009.</p>	

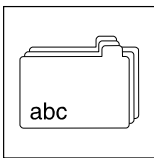

Appendix

Code table

Code		Possible settings			IMPORTANT		
No.	Name	Lenze	Selection				
C0351* <small>ENTER</small>	System bus baud rate	0	0	500 kbit/s	<ul style="list-style-type: none"> Only for the E82ZAFCC system bus function module on the FIF interface. Changes will become effective after the command "reset node" During operation with 217x communication modules the baud rate must be set under C0125.		
			1	250 kbits/s			
			2	125 kbits/s			
			3	50 kbits/s			
			4	1000 kbits/s (only E82ZAFCC100 function module)			
			5	20 kbits/s			
C0352* <small>ENTER</small>	Configuration of system bus devices	0	0	slave	<ul style="list-style-type: none"> Only for the E82ZAFCC system bus function module on the FIF interface. Changes will become effective after the command "reset node" 		
			1	Master			
C0353* <small>PRG</small>	Source of system bus address		0	C0350 is the source	<ul style="list-style-type: none"> Only for E82ZAFCC system bus function module on FIF interface. Source of the address for system bus process data channels 		
			1	C0354 is the source			
	1 CAN1 (Sync)	0				Effective for sync control (C0360 = 1)	
	2 CAN2	0					
	3 CAN1 (time)	0			Effective for event or time control (C0360 = 0)		
C0354* <small>ENTER</small>	Selective system bus address		0	{1}	513	<ul style="list-style-type: none"> Only for the E82ZAFCC system bus function module on the FIF interface. Individual addressing of system bus process data objects 	
	1 CAN-IN1 (sync)	129					Effective with sync control (C0360 = 1)
	2 CAN-OUT1 (sync)	1					
	3 CAN-IN2	257					
	4 CAN-OUT2	258					
	5 CAN-IN1 (time)	385					
	6 CAN-OUT1 (time)	386					Effective with event and time control (C0360 = 0)
C0355* <small>ENTER</small>	System bus identifier		0	{1}	2047	<ul style="list-style-type: none"> Only for the E82ZAFCC system bus function module on the FIF interface. Only display 	
	1 CAN-IN1						Identifier of CAN1 with sync control (C0360 = 1)
	2 CAN-OUT1						
	3 CAN-IN2						
	4 CAN-OUT2						Identifier of CAN1 with event or time control (C0360 = 0)
	5 CAN-IN1						
	6 CAN-OUT1						
C0356* <small>ENTER</small>	System bus time settings		0	{1 ms}	65000	<ul style="list-style-type: none"> Only for E82ZAFCC system bus function module on FIF interface. 	
	1 boot up	3000					Required for CAN system without master
	2 Cycle time CAN-OUT2	0					0 = event-controlled process data transfer > 0 = cyclic process data transfer
	3 Cycle time CAN-OUT1	0					0 and C0360 = 0: event-controlled process data transfer > 0 and C0360 = 1: cyclic process data transfer
	4 CAN delay	20					Waiting time until cyclic transmission starts after boot-up
C0357* <small>ENTER</small>	System bus monitoring times		0 = monitoring inactive	{1 ms}	65000	<ul style="list-style-type: none"> Only for E82ZAFCC system bus function module on FIF interface. 	
	1 CAN-IN1 (Sync)	0					active if C0360 = 1 TRIP CE1 in case of communication fault
	2 CAN-IN2	0					TRIP CE2 in case of communication fault
	3 CAN-IN1 (time)	0					active if C0360 = 0 TRIP CE3 in case of communication fault

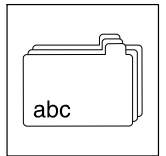

Code		Possible settings		IMPORTANT	
No.	Name	Lenze	Selection		
C0358* 	Reset node	0	0 Without function	<ul style="list-style-type: none"> Only for the E82ZAFCC system bus function module on the FIF interface. System bus reset node set-up 	
			1 System bus reset		
C0359* 	System bus status		0 Operational	<ul style="list-style-type: none"> Only for the E82ZAFCC system bus function module on the FIF interface. Only display 	
			1 Pre-operational		
			2 Warning		
			3 Bus off		
C0360* 	Control of process data channel CAN1	1	0 Event or time control	Only for the E82ZAFCC system bus function module on the FIF interface.	
			1 Sync control		
C0370* 	Activate remote parameter setting via system bus (CAN)		0 Deactivated	<ul style="list-style-type: none"> Only for the E82ZAFCC system bus function module on the FIF interface. Can only be read when using all other bus function modules on FIF. 	
			1 ... 63 Activates corresponding CAN address		1 = CAN address 1 63 = CAN address 63
			255 No system bus (CAN)		Only display
C0372*	Function module identification		0 No function module	Only display	
			1 Standard I/O or AS-i		
			2 System bus (CAN)		
			6 Other function module on FIF e.g. application I/O, INTERBUS, ...		
			10 No valid recognition		
C0395*	LONGWORD process input data		Bit 0..15 Controller word (mapping to C0135)	For bus operation only <ul style="list-style-type: none"> Sending of control word and main setpoint in a telegram to controller In keypad: display only (hexadecimal) 	
			Bit 16..31 Setpoint 1 (NSET1-N1) (mapping to C0046)		
C0396*	LONGWORD process output data		Bit 0...15 Controller status word 1 (mapping of C0150)	For bus operation only <ul style="list-style-type: none"> Reading of status word and output frequency in a telegram from controller In keypad: display only (hexadecimal) 	
			Bit 16...31 Output frequency (MCTRL1-NOU) (mapping of C0050)		
C0409 	Configuration relay output K2	255	Output of digital signals to relay K2	<ul style="list-style-type: none"> Relay output K2 only with 8200 vector 15 ... 90 kW For operation with Application-I/O only active as of version E82ZAF...XXVx2x 	
			255 Not assigned (FIXED-FREE)		
			Digital signals possible for C0409 see C0415		

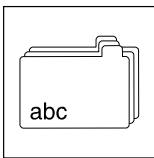

Appendix

Code table

Code		Possible settings		IMPORTANT
No.	Name	Lenze	Selection	
C0410 <small>ENTER</small>	Free configuration of digital input signals		Link between digital signal sources and internal digital signals	A selection made under C0007 is copied to the corresponding subcode of C0410. A change of C0410 sets C0007 = 255! 7-68
1	NSET1-JOG1/3 NSET1-JOG1/3/5/7 (A)	1	Digital input X3/E1	Selection of fixed setpoints C0410/1 C0410/2 active C0410/33 C0046 LOW LOW LOW JOG1 HIGH LOW LOW JOG2 LOW HIGH LOW JOG7 HIGH HIGH HIGH
2	NSET1-JOG2/3 NSET1-JOG2/3/6/7 (A)	2	Digital input X3/E2	
3	DCTRL1-CW/CCW	4	Digital input X3/E4	CW = CW rotation LOW CCW = CCW rotation HIGH
4	DCTRL1-QSP	255	Not assigned (FIXED-FREE)	Quick stop (via terminal LOW active)
5	NSET1-RFG1-STOP	255	Not assigned (FIXED-FREE)	Ramp function generator main setpoint stop
6	NSET1-RFG1-0	255	Not assigned (FIXED-FREE)	Ramp function generator input must be set to "0" for mains setpoint
7	MPOT1-UP	255	Not assigned (FIXED-FREE)	Motor potentiometer functions
8	MPOT1-DOWN	255	Not assigned (FIXED-FREE)	
9	Reserved	255	Not assigned (FIXED-FREE)	Do not change 255!
10	DCTRL1-CINH	255	Not assigned (FIXED-FREE)	Controller inhibit (via terminal LOW active)
11	DCTRL1-TRIP-SET	255	Not assigned (FIXED-FREE)	External error (via terminal LOW active)
12	DCTRL1-TRIP-RESET	255	Not assigned (FIXED-FREE)	Error reset
13	DCTRL1-PAR2/4	255	Not assigned (FIXED-FREE)	Parameter set changeover (only possible if C0988 = 0) C0410/13 and C0410/14 must have the same source in every parameter sets used. Otherwise it is not possible to change between the parameter sets (error message CE5 or CE7).
14	DCTRL1-PAR3/4	255	Not assigned (FIXED-FREE)	C0410/13 C0410/14 active LOW LOW PAR1 HIGH LOW PAR2 LOW HIGH PAR3 HIGH HIGH PAR4
15	MCTRL1-DCB	3	Digital input X3/E3	DC-injection brake
16	PCTRL1-RFG2-LOADI (A)	255	Not assigned (FIXED-FREE)	Actual process controller value (PCTRL1-ACT) must be connected to process controller ramp function generator (PCTRL1-RFG2)
17	DCTRL1-H/Re	255	Not assigned (FIXED-FREE)	Manual/remote changeover
18	PCTRL1-I-OFF	255	Not assigned (FIXED-FREE)	Switch off I-component of the process controller
19	PCTRL1-OFF	255	Not assigned (FIXED-FREE)	Process controller switch off
20	Reserved	255	Not assigned (FIXED-FREE)	Do not change 255!
21	PCTRL1-STOP	255	Not assigned (FIXED-FREE)	Process controller stop (value "frozen")
22	DCTRL1-CW/QSP	255	Not assigned (FIXED-FREE)	Failsafe change of the direction of rotation
23	DCTRL1-CCW/QSP	255	Not assigned (FIXED-FREE)	
24	DFIN1-ON	255	Not assigned (FIXED-FREE)	0 = Frequency input not active 1 = Frequency input active Frequency input configuration under C0425 and C0426

Appendix

Code table

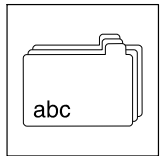

Code		Possible settings		IMPORTANT
No.	Name	Lenze	Selection	
C0410 ENTER (cont.)				
25 (A)	PCTRL1-FOLL1-0	255	Not assigned (FIXED-FREE)	Compensator at reset ramp C0193 to "0"
26 (A)	Reserved	255	Not assigned (FIXED-FREE)	
27 (A)	NSET1-TI1/3	255	Not assigned (FIXED-FREE)	Activate acceleration times
28 (A)	NSET1-TI2/3	255	Not assigned (FIXED-FREE)	C0410/27 C0410/28 active LOW LOW C0012; C0013 HIGH LOW T _{ir} 1; T _{if} 1 LOW HIGH T _{ir} 2; T _{if} 2 HIGH HIGH T _{ir} 3; T _{if} 3
29 (A)	PCTRL1-FADING	255	Not assigned (FIXED-FREE)	Process controller output on (LOW)/ off (HIGH)
30 (A)	PCTRL1-INV-ON	255	Not assigned (FIXED-FREE)	Process controller output inversion
31 (A)	PCTRL1-NADD-OFF	255	Not assigned (FIXED-FREE)	Switch off additional setpoint
32 (A)	PCTRL1-RFG2-0	255	Not assigned (FIXED-FREE)	Decelerate process controller ramp function generator input to "0" along ramp C0226
33 (A)	NSET1-JOG4/5/6/7	255	Not assigned (FIXED-FREE)	

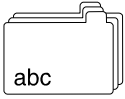

Appendix

Code table

Code		Possible settings		IMPORTANT		
No.	Name	Lenze	Selection			
C0410 ENTER (cont.)			Digital signal sources for C0410	7-68		
			0		Not assigned (FIXED-FREE)	
			1		Digital input X3/E1 (DIGIN1)	
			2		Digital input X3/E2 (DIGIN2)	
			3		Digital input X3/E3 (DIGIN3)	
			4		Digital input X3/E4 (DIGIN4)	
			5 (A)		Digital input X3/E5 (DIGIN5)	
			6 (A)		Digital input X3/E6 (DIGIN6)	
			7		PTC input (X2.2/T1, X2.2/T2)	T1/T2 can only be connected to potential-free switches! T1/T2 is active ("HIGH") when the switch is closed
			10		AIF control word (AIF-CTRL) Bit 0	
			
			25		Bit 15	
			30		CAN-IN1.W1 or FIF-IN.W1 Bit 0	
			
			45		Bit 15	
			50		CAN-IN1.W2 or FIF-IN.W2 Bit 0	
			
			65		Bit 15	
			70		CAN-IN2.W1 Bit 0	
			
85	Bit 15					
90	CAN-IN2.W2 Bit 0					
...	...					
105	Bit 15					
140	Status application I/O Torque threshold 1 reached (MSET1=MOUT)	Only active when using application I/O				
141	Torque threshold 2 reached (MSET2=MOUT)					
142	Process controller output limit reached (PCTRL1-LIM)					
143...172	Reserved					
200	Control words are assigned bit by bit from the fieldbus function module to FIF (e.g. INTERBUS or PROFIBUS-DP)	See C0005				
201	Digital output signals as C0415, selection 1					
...	...					
231	as C0415, selection 31					
255	Not assigned (FIXED-FREE)					

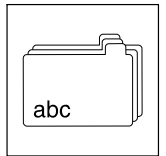

Code		Possible settings		IMPORTANT		
No.	Name	Lenze	Selection			
C0411 <small>ENTER</small>	Level inversion of digital inputs	0	0	Level inversion is switched off	<ul style="list-style-type: none"> By entering the sum of the selected values you can invert several inputs C0114 and C0411 are identical The function "Parameter set changeover" cannot be inverted! 	
			1	E1 inverted		
			2	E2 inverted		
			4	E3 inverted		
			8	E4 inverted		
			16	E5 inverted		only application I/O
			32	E6 inverted		only application I/O
			64	T1/T2 inverted		T1/T2 can only be connected to potential-free switches. T1/T2 is active, if the switch is open.
C0412 <small>ENTER</small>	Free configuration of analog input signals		Link between analog signal sources and internal analog signals	A selection under C0005 or C0007 will be copied to the corresponding subcode of C0412. A change of C0412 sets C0005 = 255, C0007 = 255! 7-57		
1	Setpoint 1 (NSET1-N1)	1	Analog input 1 (AIN1-OUT): X3/8 (Standard-I/O) X3/1U or X3/1I (Application-I/O)	Either NSET1-N1 or NSET1-N2 active Changeover with C0410/17 Parameter channel: C0046		
2	Setpoint 2 (NSET1-N2)	1		Parameter channel: C0044		
3	Additional setpoint (PCTRL1-NADD)	255	Not assigned (FIXED-FREE) or selected via keypad or parameter channel of an AIF bus module	Is added to NSET1-N1, NSET1-N2, JOG values and the function Set of the keypad Parameter channel: C0049		
4	Process controller setpoint 1 (PCTRL1-SET1)	255	Not assigned (FIXED-FREE) or selected via keypad or parameter channel of an AIF bus module			
5	Act. process controller value (PCTRL1-ACT)	255	Not assigned (FIXED-FREE) or selected via keypad or parameter channel of an AIF bus module	Parameter channel: C0051, if C0238 = 1, 2		
6	Torque setpoint or torque limit value (MCTRL1-MSET)	255	Not assigned (FIXED-FREE) or selected via keypad or parameter channel of an AIF bus module	<ul style="list-style-type: none"> Observe C0014! Actual torque values not required. 16384 = 100 % torque setpoint Condition for selection via terminal (C0412/6 = 1, 2 or 4): <ul style="list-style-type: none"> The gain of the analog input is set to: C0414/x, C0426 = 32768/C0011 [%] Parameter channel: C0047		
7	Reserved	255	Not assigned (FIXED-FREE) or selected via keypad or parameter channel of an AIF bus module			
8	MCTRL1-VOLT-ADD	255	Not assigned (FIXED-FREE) or selected via keypad or parameter channel of an AIF bus module	Only for special applications. Modifications only when agreed on by Lenze!		
9	MCTRL1-PHI-ADD	255	Not assigned (FIXED-FREE) or selected via keypad or parameter channel of an AIF bus module			

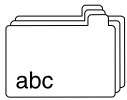

Appendix

Code table

Code		Possible settings		IMPORTANT	
No.	Name	Lenze	Selection		
C0412 <small>ENTER</small> (cont.)				7-57	
	Analog signal source possible for C0412				
	0		Not assigned (FIXED-FREE) or selected via keypad or parameter channel of an AIF bus module		
	1		Analog input 1 (AIN1-OUT) X3/8 (Standard-I/O) X3/1U or X3/1I (Application-I/O)		
	2		Frequency input (DFIN1-OUT)		Observe C0410/24, C0425, C0426, C0427
	3		Motor potentiometer (MPOT1-OUT)		
	4 (A)		Analog input 2 (AIN2-OUT) X3/2U or X3/2I		
	5 ... 9		Input signal is constantly 0 (FIXED0)		
	10		AIF input word 1 (AIF-IN.W1)		Only evaluated if C0001 = 3!
	11		AIF input word 2 (AIF-IN.W2)		
	20		CAN-IN1.W1 or FIF-IN.W1		$\pm 24000 \approx \pm 480 \text{ Hz}$ $2^{14} \approx 100 \% \text{ rated motor torque}$
	21		CAN-IN1.W2 or FIF-IN.W2		
	22		CAN-IN1.W3 or FIF-IN.W3		
	23		CAN-IN1.W4 or FIF-IN.W4		
	30		CAN-IN2.W1		
	31		CAN-IN2.W2		
	32		CAN-IN2.W3		
	33		CAN-IN2.W4		
	200		Signals are assigned word by word from fieldbus function module to FIF (e.g. INTERBUS or PROFIBUS-DP)		See C0005
	228 (A)		PCTRL1-ACT		
229 (A)		PCTRL1-SET			
230 (A)		PCTRL1-OUT			
231 (A)		NSET1-RFG1-IN			
232 (A)		NSET1-NOUT			
233 (A)		PCTRL1-PID-OUT			
234 (A)		PCTRL1-NOUT			
255		Not assigned (FIXED-FREE) or selected via keypad or parameter channel of an AIF bus module	Either NSET1-N1 or NSET1-N2 active		
C0413*	Offset - analog inputs		-200.0 {0.1 %} 200.0	7-34 The upper limit of the setpoint range from C0034 corresponds to 100 % Setting for X3/8 or X3/1U, X3/1I C0413/1 and C0026 are the same Setting for X3/2U, X3/2I (only application I/O)	
1	AIN1-OFFSET	0.0			
2	AIN2-OFFSET	0.0			
C0414*	Gain - analog inputs		-1500.0 {0.1 %} 1500.0	<ul style="list-style-type: none"> • 100.0 % = gain 1 • Inverted setpoint selection through negative gain and negative offset Setting for X3/8 or X3/1U, X3/1I C0414/1 and C0027 are the same Setting for X3/2U, X3/2I (only application I/O)	
1	AIN1-GAIN	100.0			
2	AIN2-GAIN	100.0			

Appendix

Code table

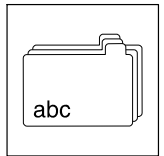

Code		Possible settings		IMPORTANT																
No.	Name	Lenze	Selection																	
C0415 <small>ENTER</small>	Free configuration of digital outputs		Output of digital signals to terminals	For configuration of relay output K2 see C0409 7-73																
	1 Relay output K1 (RELAY, motec version 151) Digital switching output K1 (motec version 152, 153)	25	TRIP error message (DCTRL1-TRIP)	A selection in C0008 is copied into C0415/1. Change of C0415/1 sets C0008 = 255!																
	2 Digital output X3/A1 (DIGOUT1)	16	Ready for operation (DCTRL1-RDY)	A selection in C0117 is copied into C0415/2. Change of C0415/2 sets C0117 = 255!																
	3 (A) Digital output X3/A2 (DIGOUT2)	255	Not assigned (FIXED-FREE)																	
C0415 <small>ENTER</small> (cont.)	Possible digital signals for C0415			7-73																
	0		Not assigned (FIXED-FREE)																	
	1		Parameter set 2 or parameter set 4 is active (DCTRL1-PAR-B0)		<table border="0"> <tr> <td>PAR-B1</td> <td>PAR-B0</td> <td>Active</td> </tr> <tr> <td>LOW</td> <td>LOW</td> <td>PAR1</td> </tr> <tr> <td>LOW</td> <td>HIGH</td> <td>PAR2</td> </tr> <tr> <td>HIGH</td> <td>LOW</td> <td>PAR3</td> </tr> <tr> <td>HIGH</td> <td>HIGH</td> <td>PAR4</td> </tr> </table>	PAR-B1	PAR-B0	Active	LOW	LOW	PAR1	LOW	HIGH	PAR2	HIGH	LOW	PAR3	HIGH	HIGH	PAR4
	PAR-B1	PAR-B0	Active																	
	LOW	LOW	PAR1																	
	LOW	HIGH	PAR2																	
	HIGH	LOW	PAR3																	
	HIGH	HIGH	PAR4																	
	2		Pulse inhibit active (DCTRL1-IMP)																	
	3		I_{max} limit reached (MCTRL1-IMAX) (C0014 = -5-: torque setpoint reached)																	
	4		Frequency setpoint reached (DCTRL1-RFG1=NOUT)																	
	5		Ramp function generator 1: input = output (NSET1-RFG1-I=0)		RFG1 = ramp function generator - main setpoint															
	6		Values have fallen below frequency threshold Q_{min} ($f < C0017$) (PCTRL1-QMIN)		LOW active															
	7		Output frequency = 0 (DCTRL1-NOUT=0)																	
	8		Controller inhibit active (DCTRL1-CINH)																	
	9 ... 12		Reserved																	
	13		Group signal (DCTRL1-OH-PTC-LP1-FAN1-WARN): Overtemperature warning ($\vartheta_{max} - 5$ °C) (DCTRL1-OH-WARN) or Motor overtemperature warning or Motor phase failure warning (DCTRL1-LP1-WARN) or Fan failure warning (DCTRL1-FAN1-WARN) (only active with 8200 motec and C0608 = 1))		Set C0119 = 2 or C0119 = 5 Set C0597 = 2 With 8200 vector, C0608 must be set to 0															
	14		DC bus overvoltage (DCTRL1-OV)																	
	15		CCW rotation (DCTRL1-CCW)																	
	16		Ready for operation (DCTRL1-RDY)																	
17		Parameter set 3 or parameter set 4 active (DCTRL1-PAR-B1)	<table border="0"> <tr> <td>PAR-B1</td> <td>PAR-B0</td> <td>Active</td> </tr> <tr> <td>LOW</td> <td>LOW</td> <td>PAR1</td> </tr> <tr> <td>LOW</td> <td>HIGH</td> <td>PAR2</td> </tr> <tr> <td>HIGH</td> <td>LOW</td> <td>PAR3</td> </tr> <tr> <td>HIGH</td> <td>HIGH</td> <td>PAR4</td> </tr> </table>	PAR-B1	PAR-B0	Active	LOW	LOW	PAR1	LOW	HIGH	PAR2	HIGH	LOW	PAR3	HIGH	HIGH	PAR4		
PAR-B1	PAR-B0	Active																		
LOW	LOW	PAR1																		
LOW	HIGH	PAR2																		
HIGH	LOW	PAR3																		
HIGH	HIGH	PAR4																		
18		Values have fallen below TRIP or Q_{min} or pulse inhibit (IMP) is active (DCTRL1-TRIP-QMIN-IMP)	LOW active																	
19		PTC warning (DCTRL1-PTC-WARN) Status of relay K_{SR}	Set C0119 = 2 or C0119 = 5 Only with 8200 vector 15 ...90 kW, variant "safe standstill": HIGH = pulse inhibit active by "safe standstill" LOW = no pulse inhibit by "safe standstill"																	

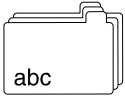



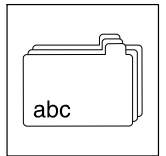

Appendix

Code table

Code		Possible settings		IMPORTANT	
No.	Name	Lenze	Selection		
C0415 ENTER (cont.)			Possible digital signals for C0415	7-73 V-belt monitoring Apparent motor current = C0054 Current threshold = C0156 Frequency threshold Q_{\min} = C0017 Set C0597 = 2 LOW active digital inputs Only connect potential-free switches to T1/T2! T1/T2 is active ("HIGH") when the switch is closed	
			20		Apparent motor current < current threshold (DCTRL1-IMOT<ILIM)
			21		Apparent motor current < current threshold and output frequency > Frequency threshold Q_{\min} (DCTRL1-(IMOT<ILIM)-QMIN)
			22		Apparent motor current < current threshold and ramp function generator 1: input = output (DCTRL1-(IMOT<ILIM)-RFG-I=0)
			23		Motor phase failure warning (DCTRL1-LP1-WARN)
			24		Minimum output frequency reached ($f \leq C0010$) (PCTRL1-NMIN)
			25		TRIP error message (DCTRL1-TRIP)
			26		Motor is running (DCTRL1-RUN)
			27		Motor is running / CW rotation (DCTRL1-RUN-CW)
			28		Motor is running / CCW rotation (DCTRL1-RUN-CCW)
			29		Process controller input = process controller output (PCTRL1-SET=ACT)
			30		Reserved
			31		Apparent motor current > Current threshold and ramp function generator 1: input = output (DCTRL1-(IMOT>ILIM)-RFG-I=0)
			32		Digital input X3/E1
			33		Digital input X3/E2
			34		Digital input X3/E3
			35		Digital input X3/E4
36 (A)	Digital input X3/E5				
37 (A)	Digital input X3/E6				
38	PTC input X2.2/T1, X2.2/T2				



Code		Possible settings		IMPORTANT			
No.	Name	Lenze	Selection				
C0415  (cont.)			Possible digital signals for C0415		 7-68 Permanently assigned bits of AIF-CTRL: Bit 3: QSP Bit 7: CINH Bit 10: TRIP-SET Bit 11: TRIP-RESET		
			40	Bit 0	
			55	Bit 15		CAN-IN1.W1 or FIF-IN.W1	
			60	Bit 0	
			75	Bit 15		CAN-IN1.W2 or FIF-IN.W2	
			80	Bit 0	
			95	Bit 15		CAN-IN2.W1	
			100	Bit 0	
			115	Bit 15		CAN-IN2.W2	
			120	Bit 0	
135	Bit 15	Status application I/O		Only active for operation with application I/O			
140	Torque threshold 1 reached (MSET1=MOUT)		Reserved				
141	Torque threshold 2 reached (MSET2=MOUT)						
142	Limitation of process controller output reached (PCTRL1-LIM)						
143 ...	Reserved						
172	Reserved						
255	Not assigned (FIXED-FREE)						
C0416 	Level inversion of digital outputs	0	0	Level inversion is switched off	 7-73 By entering the sum of the selected values you can invert several outputs		
			1	Relay K1			
			2	X3/A1			
			4	X3/A2		only application I/O	
			8	Relay K2		Relay output K2 only with 8200 vector 15 ... 90 kW	

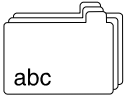

Appendix

Code table

Code		Possible settings		IMPORTANT
No.	Name	Lenze	Selection	
C0417* <small>ENTER</small>	Free configuration of controller status messages (1)		Output of digital signals to bus	<p>The assignment is mapped to the</p> <ul style="list-style-type: none"> • Controller status word 1 (C0150) • AIF status word (AIF-STAT) • FIF output word 1 (FIF-OUT.W1) • Output word 1 in CAN object 1 (CAN-OUT1.W1) <p>→ Fixed assignment to AIF when operating with communication modules INTERBUS 211x, PROFIBUS-DP 213x or LECOM-A/B/LI 2102. Modifications are not allowed!</p> <p>If you use function modules system bus (CAN), INTERBUS, PROFIBUS-DP to FIF, all bits are freely configurable.</p>
1	Bit 0	1	Active parameter set PAR-B0 active (DCTRL1-PAR-B0)	
2	Bit 1	2 →	Pulse inhibit active (DCTRL1-IMP)	
3	Bit 2	3	I_{max} limit reached (MCTRL1-IMAX) (C0014 = -5-: Torque setpoint reached)	
4	Bit 3	4	Frequency setpoint reached (DCTRL1-RFG1=NOUT)	
5	Bit 4	5	Ramp function generator 1: Input = output (NSET1-RFG1-I=0)	
6	Bit 5	6	Value below frequency threshold Q_{min} ($f < C0017$) (PCTRL1-QMIN)	
7	Bit 6	7 →	Output frequency = 0 (DCTRL1-NOUT=0)	
8	Bit 7	8 →	Controller inhibit active (DCTRL1-CINH)	
9	Bit 8	9 →	1110 9 8 Controller status 0000 Controller initialization 0001 Mains voltage off (at external supply of the control section of the drive controller)	
10	Bit 9	10 →	0010 Switch-on inhibit 0011 Operation inhibited	
11	Bit 10	11 →	0100 Flying restart circuit active 0101 DC-injection brake active	
12	Bit 11	12 →	0110 Operation enabled 0111 Message active 1000 Active error	
13	Bit 12	13 →	Collective message: (DCTRL1-OH-PTC-LP1-FAN1-WARN)	
14	Bit 13	14 →	DC-bus overvoltage (DCTRL1-OV)	
15	Bit 14	15	CCW rotation (DCTRL1-CCW)	
16	Bit 15	16	Ready for operation (DCTRL1-RDY)	
Digital signals possible for C0417 see C0415				
C0418* <small>ENTER</small>	Free configuration of controller status messages (2)		Output of digital signals to bus	<p>All bits can be freely configured</p> <p>The assignment is mapped to the</p> <ul style="list-style-type: none"> • Controller status word 2 (C0151) • FIF output word 2 (FIF-OUT.W2) • Output word 1 in the CAN object 2 (CAN-OUT2.W1)
1	Bit 0	255	Not assigned (FIXED-FREE)	
...	
16	Bit 15	255	Not assigned (FIXED-FREE)	
Digital signals possible for C0418 see C0415				
C0419 <small>ENTER</small>	Free configuration of analog outputs		Output of analog signals to terminal	<p>7-59</p> <p>A selection in C0111 is copied into C0419/1. Change of C0419/1 sets C0111 = 255!</p> <p>Frequency output: 50 Hz ... 10 kHz</p>
1	X3/62 (AOUT1-IN)	0	Output frequency (MCTRL1-NOUT+SLIP)	
2 (A)	X3/63 (AOUT2-IN)	2	Apparent motor current (MCTRL1-IMOT)	
3 (A)	X3/A4 (DFOUT1-IN)	3	DC-bus voltage (MCTRL1-DCVOLT)	

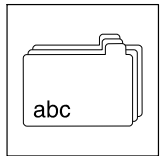

Code		Possible settings		IMPORTANT			
No.	Name	Lenze	Selection				
C0419 (cont.)			Possible analog signals for C0419	7-59			
			0		Output frequency (MCTRL1-NOUT+SLIP)	6 V/12 mA/5.85 kHz \equiv C0011	
			1		Device utilisation (MCTRL1-MOUT) at V/f characteristic control (C0014 = 2 or 3)	3 V/6 mA/2.925 kHz \equiv Rated active inverter current (active current/C0091)	
					Actual motor torque (MCTRL1-MACT) with vector control (C0014 = 4) or sensorless torque control (C0014 = 5)	3 V/6 mA/2.925 kHz \equiv rated motor torque	
			2		Apparent motor current (MCTRL1-IMOT)	3 V/6 mA/2.925 kHz \equiv rated inverter current	
			3		DC-bus voltage (MCTRL1-DCVOLT)	6 V/12 mA/5.85 kHz \equiv DC 1000 V (400 V mains)	
						6 V/12 mA/5.85 kHz \equiv DC 380 V (230 V mains)	
			4		Motor power (MCTRL1-PMOT)	3 V/6 mA/2.925 kHz \equiv rated motor power	
			5		Motor voltage (MCTRL1-VOLT)	4.8 V/9.6 mA/4.68 kHz \equiv rated motor voltage	
			6		1/output frequency (1/C0050) (MCTRL1-1/NOUT)	2 V/4 mA/1.95 kHz \equiv $0.5 \times$ C0011	
7	Output frequency within adjusted limits (DCTRL1-C0010...C0011)	0 V/0 mA/4 mA/0 kHz \equiv $f = f_{\min}$ (C0010) 6 V/12 mA/5.85 kHz \equiv $f = f_{\max}$ (C0011)					
8	Operation with process controller (C0238 = 0, 1): Actual process controller value (PCTRL1-ACT) Operation without process controller (C0238 = 2): Output frequency without slip (MCTRL1-NOUT)	6 V/12 mA/5.85 kHz \equiv C0011					
C0419 (cont.)			Possible analog signals for C0419	7-59			
			9		Ready for operation (DCTRL1-RDY)	Selection 9 ... 25 correspond to the digital functions of the relay output K1 or the digital switching output K1 (C0008) or the digital output A1 (C0117): LOW = 0 V/0 mA/4 mA/ 0 kHz HIGH = 10 V/20 mA/10 kHz	
			10		TRIP error message (DCTRL1-TRIP)		
			11		Motor is running (DCTRL1-RUN)		
			12		Motor is running / CW rotation (DCTRL1-RUN-CW)		
			13		Motor is running / CCW rotation (DCTRL1-RUN-CCW)		
			14		Output frequency = 0 (DCTRL1-NOUT=0)		
			15		Frequency setpoint reached (DCTRL1-RFG1=NOUT)		
			16		Values have fallen below frequency threshold Q_{\min} ($f < C0017$) (PCTRL1-QMIN)		LOW active
			17		I_{\max} limit reached (MCTRL1-IMAX) C0014 = -5: Torque setpoint reached		
			18		Overtemperature ($\vartheta_{\max} - 5^\circ\text{C}$) (DCTRL1-OH-WARN)		
			19		TRIP or Q_{\min} or pulse inhibit (IMP) active (DCTRL1-TRIP-QMIN-IMP)		
			20		PTC warning (DCTRL1-PTC-WARN)		
			21		Apparent motor current < current threshold (DCTRL1-IMOT<ILIM)	V-belt monitoring Apparent motor current = C0054 Current threshold = C0156 Frequency threshold Q_{\min} = C0017	
			22		Apparent motor current < current threshold and output frequency > Frequency threshold Q_{\min} (DCTRL1-(IMOT<ILIM)-QMIN)		
			23		Apparent motor current < current threshold and ramp function generator 1: input = output (DCTRL1-(IMOT<ILIM)-RFG-I=0)		
24	Motor phase failure warning (DCTRL1-LP1-WARN)						
25	Minimum output frequency reached ($f \leq C0010$) (PCTRL1-NMIN)	LOW active					

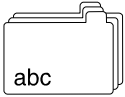

Appendix

Code table

Code		Possible settings		IMPORTANT		
No.	Name	Lenze	Selection			
C0419 ENTER (cont.)			Possible analog signals for C0419	7-59		
			26		Output frequency normalised without slip (MCTRL1-NOUT-NORM)	
			27		Output frequency without slip (MCTRL1-NOUT)	6 V/12 mA/5.85 kHz \equiv C0011
			28		Actual process controller value (PCTRL1-ACT)	6 V/12 mA/5.85 kHz \equiv C0011
			29		Process controller setpoint (PCTRL1-SET1)	
			30		Process controller output without feedforward control (PCTRL1-OUT)	
			31		Ramp function generator input (NSET1-RFG1-IN)	
			32		Ramp function generator output (NSET1-NOUT)	
			33 (A)		PID controller output (PCTRL1-PID-OUT)	
			34 (A)		Process controller output (PCTRL1-NOUT)	
			35		Input signal at X3/8 (standard I/O) or X3/1U or X3/1I (application I/O), assessed with gain (C0414/1 or C0027) and offset (C0413/1 or C0026) (AIN1-OUT)	6 V/12 mA/5.85 kHz \equiv maximum value of analog input signal (5 V, 10 V, 20 mA, 10 kHz) Condition: The gain of the analog input or frequency input is set to: C0414/x, C0426 = 100 %
			36		Input signal at frequency input X3/E1 and X3/E2, assessed with gain (C0426) and offset (C0427) (DFIN1-OUT)	6 V/12 mA/5.85 kHz \equiv maximum value of analog input signal (5 V, 10 V, 20 mA, 10 kHz) Condition: The gain of the analog input or frequency input is set to: C0414/x, C0426 = 100 %
			37		Motor potentiometer output (MPOT1-OUT)	
			38 (A)		Input signal at X3/2U or X3/2I, assessed with gain (C0414/2) and offset (C0413/2) (AIN2-OUT)	6 V/12 mA/5.85 kHz \equiv maximum value of analog input signal (5 V, 10 V, 20 mA, 10 kHz) Condition: The gain of the analog input or frequency input is set to: C0414/x, C0426 = 100 %
			40		AIF input word 1 (AIF-IN.W1)	
			41		AIF input word 2 (AIF-IN.W2)	Setpoints to the controller from communication module on AIF 10 V/20 mA/10 kHz \equiv 1000
			50		CAN-IN1.W1 or FIF-IN.W1	Setpoints to controller from function module on FIF 10 V/20 mA/10 kHz \equiv 1000
			51		CAN-IN1.W2 or FIF-IN.W2	
			52		CAN-IN1.W3 or FIF-IN.W3	
			53		CAN-IN1.W4 or FIF-IN.W4	
60	CAN-IN2.W1					
61	CAN-IN2.W2					
62	CAN-IN2.W3					
63	CAN-IN2.W4					
255	Not assigned (FIXED-FREE)					

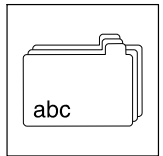

Code		Possible settings		IMPORTANT	
No.	Name	Lenze	Selection		
C0421* ENTER	Free configuration of analog process data output words		Output of analog signals to bus	7-64	
1	AIF-OUT.W1	8	Operation with process controller (C0238 = 0, 1): Actual process controller value (PCTRL1-ACT) Operation without process controller (C0238 = 2): Output frequency without slip (MCTRL1-NOUT)		
2	AIF-OUT.W2	0	Output frequency (MCTRL1-NOUT+SLIP)		
3	CAN-OUT1.W1 / FIF-OUT.W1	255	Not assigned (FIXED-FREE)		<ul style="list-style-type: none"> • CAN-OUT1.W1 and FIF-OUT.W1 are digitally defined in the Lenze setting and assigned to the 16 bits of the controller status word 1 (C0417) • Before assigning an analog signal source (C0421/3 ≠ 255), first delete the digital assignment (C0417/x = 255)! Otherwise, the output signal would be wrong
4	CAN-OUT1.W2 / FIF-OUT.W2	255	Not assigned (FIXED-FREE)		
5	CAN-OUT1.W3 / FIF-OUT.W3	255	Not assigned (FIXED-FREE)		
6	CAN-OUT1.W4 / FIF-OUT.W4	255	Not assigned (FIXED-FREE)		
7	CAN-OUT2.W1	255	Not assigned (FIXED-FREE)		
8	CAN-OUT2.W2	255	Not assigned (FIXED-FREE)		
9	CAN-OUT2.W3	255	Not assigned (FIXED-FREE)		
10	CAN-OUT2.W4	255	Not assigned (FIXED-FREE)		
C0421* ENTER (cont.)			Possible analog signals for C0421	7-64	
0	Output frequency (MCTRL1-NOUT+SLIP)	24000	≡ 480 Hz		
1	Device utilisation (MCTRL1-MOUT) at V/f characteristic control (C0014 = 2 or 3) Actual motor torque (MCTRL1-MACT) with vector control (C0014 = 4) or sensorless torque control (C0014 = 5)	16383	≡ Rated active inverter current (active current/C0091) 16383 ≡ Rated motor torque		
2	Apparent motor current (MCTRL1-IMOT)	16383	≡ Rated inverter current		
3	DC-bus voltage (MCTRL1-DCVOLT)	16383	≡ 565 VDC at 400 V mains 16383 ≡ 325 VDC at 230 V mains		
4	Motor power	285	≡ Rated motor power		
5	Motor voltage (MCTRL1-VOLT)	16383	≡ Rated motor voltage		
6	1/output frequency (1/C0050) (MCTRL1-1/NOUT)	195	≡ 0.5 × C0011		
7	Output frequency within adjusted limits (DCTRL1-C0010...C0011)	24000	≡ 480 Hz $0 \equiv f < C0010$ $\frac{24000 \cdot (f - C0010)}{480 \text{ Hz}} \equiv f \geq C0010$		
8	Operation with process controller (C0238 = 0, 1): Actual process controller value (PCTRL1-ACT) Operation without process controller (C0238 = 2): Output frequency without slip (MCTRL1-NOUT)	24000	≡ 480 Hz		

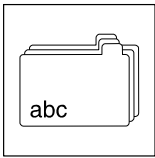

Appendix

Code table

Code		Possible settings		IMPORTANT	
No.	Name	Lenze	Selection		
C0421* ENTER (cont.)				Selection 9 ... 25 correspond to the digital functions of the relay output K1 or the digital switching output K1 (C0008) or the digital output A1 (C0117): LOW = 0 HIGH = 1023	
			Possible analog signals for C0421		
			9		Ready for operation (DCTRL1-RDY)
			10		TRIP error message (DCTRL1-TRIP)
			11		Motor is running (DCTRL1-RUN)
			12		Motor is running / CW rotation (DCTRL1-RUN-CW)
			13		Motor is running / CCW rotation (DCTRL1-RUN-CCW)
			14		Output frequency = 0 (DCTRL1-NOU=0)
			15		Frequency setpoint reached (DCTRL1-RFG1=NOUT)
			16		Values have fallen below frequency threshold Q_{min} ($f < C0017$) (PCTRL1-QMIN)
			17		I_{max} limit reached (MCTRL1-IMAX) C0014 = -5-: Torque setpoint reached
			18		Overtemperature (ϑ_{max} -5 °C) (DCTRL1-OH-WARN)
			19		TRIP or Q_{min} or pulse inhibit (IMP) (DCTRL1-IMP)
			20		PTC warning (DCTRL1-PTC-WARN)
			21		Apparent motor current < current threshold (DCTRL1-IMOT<ILIM)
22	Apparent motor current < current threshold and output frequency > Frequency threshold Q_{min} (DCTRL1-(IMOT<ILIM)-QMIN)				
23	Apparent motor current < current threshold and ramp function generator 1: input = output (DCTRL1-(IMOT<ILIM)-RFG-I=0)				
24	Motor phase failure warning (DCTRL1-LP1-WARN)				
25	Minimum output frequency reached ($f \leq C0010$) (PCTRL1-NMIN)				

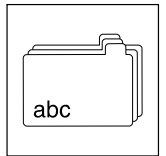

Code		Possible settings			IMPORTANT	
No.	Name	Lenze	Selection			
C0421* ENTER (cont.)					7-64	
				Possible analog signals for C0421		
				26 Output frequency normalised without slip (MCTRL1-NOUT-NORM)		2 ¹⁴ ≙ C0011
				27 Output frequency without slip (MCTRL1-NOUT)		24000 ≙ 480 Hz
				28 Actual process controller value (PCTRL1-ACT)		
				29 Process controller setpoint (PCTRL1-SET1)		
				30 Process controller output without feedforward control (PCTRL1-OUT)		
				31 Ramp function generator input (NSET1-RFG1-IN)		
				32 Ramp function generator output (NSET1-NOUT)		
				33 (A) PID controller output (PCTRL1-PID-OUT)		
				34 (A) Process controller output (PCTRL1-NOUT)		
				35 Input signal at X3/8 (standard I/O) or X3/1U or X3/1I (application I/O), assessed with gain (C0414/1 or C0027) and offset (C0413/1 or C0026) (AIN1-OUT)		1000 ≙ Maximum value of analog input signal (5 V, 10 V, 20 mA, 10 kHz) Condition: The gain of the analog input or frequency input is set to: C0414/x, C0426 = 20/C0011 [%]
				36 Input signal at frequency input X3/E1, assessed with gain (C0426) and offset (C0427) (DFIN1-OUT)		
				37 Motor potentiometer output (MPOT1-OUT)		
				38 (A) Input signal at X3/2U or X3/2I, assessed with gain (C0414/2) and offset (C0413/2) (AIN2-OUT)		
				40 AIF input word 1 (AIF-IN.W1)		Setpoints to the controller from communication module on AIF Normalisation via AIF
				41 AIF input word 2 (AIF-IN.W2)		
				50 CAN-IN1.W1 or FIF-IN.W1		Setpoints to controller from function module on FIF Normalisation via CAN or FIF
				51 CAN-IN1.W2 or FIF-IN.W2		
				52 CAN-IN1.W3 or FIF-IN.W3		
			53 CAN-IN1.W4 or FIF-IN.W4			
			60 CAN-IN2.W1			
			61 CAN-IN2.W2			
			62 CAN-IN2.W3			
			63 CAN-IN2.W4			
			255 Not assigned (FIXED-FREE)			
C0420*	Gain analog output X3/62 (AOUT1-GAIN) Standard I/O	128	0 {1} 255	128 ≙ Gain 1 C0420 and C0108 are the same	7-59	
C0420* (A)	Gain analog outputs Application I/O			128 ≙ Gain 1	7-59	
1	X3/62 (AOUT1-GAIN)	128	0 {1} 255	C0420/1 and C0108 are the same		
2	X3/63 (AOUT2-GAIN)					
C0422*	Offset analog output X3/62 (AOUT1-OFFSET) Standard I/O	0.00	-10.00 {0.01 V} 10.00	C0422 and C0109 are the same	7-59	
C0422* (A)	Offset of analog outputs Application I/O				7-59	
1	X3/62 (AOUT1-OFFSET)	0.00		C0422/1 and C0109 are the same		
2	X3/63 (AOUT2-OFFSET)					

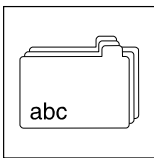

Appendix

Code table

Code		Possible settings			IMPORTANT				
No.	Name	Lenze	Selection						
C0423* (A)	Digital output delay		0.000	{0.001 s}	65.000	"Debouncing" of digital outputs (as of version application-I/O E82ZAF... Vx11) <ul style="list-style-type: none"> Switches the digital output if the linked signal is still active after the time set. Digital output reset without delay 	7-73		
	1 Relay output K1 (RELAY)	0.000							
	2 Digital output X3/A1 (DIGOUT1)	0.000							
	3 Digital output X3/A2 (DIGOUT2)	0.000							
C0424* (A)	Output signal range - analog outputs Application I/O		0	0 ... 10 V / 0 ... 20 mA		Observe jumper position of the function module! (from version: application I/O E82ZAF... Vx11)	7-59		
	1 X3/62 (AOUT1)	0	1	4 ... 20 mA					
	2 X3/63 (AOUT2)	0							
C0425* (A)	Configuration frequency input single track X3/E1 (DFIN1)	2		f_r	Δf_{min}	t	f_{max}	<ul style="list-style-type: none"> f_r = Normalisation frequency - f_r corresponds to C0011 Δf_{min} = Resolution t = Scanning rate - The lower the scanning rate the higher the dynamic response. f_{max} = Maximum frequency which can be processed independently of C0425 - Set C0425 that the frequency coming from the encoder is lower than f_{max} Activate frequency input with C0410/24 = 1 Adjust frequency input under C0426 and C0427 	7-39
			0	100 Hz	1/200	1 s	300 Hz		
			1	1 kHz	1/200	100 msec	3 kHz		
			2	10 kHz	1/200	10 msec	10 kHz		
			3	10 kHz	1/1000	50 msec	10 kHz		
			4	10 kHz	1/10000	500 ms	10 kHz		
			5 (A)	102.4 kHz	1/400	2 msec	102.4 kHz		
			6 (A)	102.4 kHz	1/1000	5 msec	102.4 kHz		
	7 (A)		102.4 kHz	1/2000	10 msec	102.4 kHz			
	Configuration frequency input two tracks X3/E1, X3/E2 (DFIN1)		10	100 Hz	1/200	1 s	300 Hz		
			11	1 kHz	1/200	100 msec	3 kHz		
			12 (A)	10 kHz	1/200	10 msec	10 kHz		
			13 (A)	10 kHz	1/1000	50 msec	10 kHz		
			14 (A)	10 kHz	1/10000	500 ms	10 kHz		
			15 (A)	102.4 kHz	1/400	2 msec	102.4 kHz		
			16 (A)	102.4 kHz	1/1000	5 msec	102.4 kHz		
			17 (A)	102.4 kHz	1/2000	10 msec	102.4 kHz		
C0426*	Gain frequency input X3/E1, X3/E2 (A) (DFIN1-GAIN)	100	-1500.0	{0.1 %}	1500.0	$C0426 = \frac{f_N \cdot p}{z \cdot C0011} \cdot 100 \%$ <ul style="list-style-type: none"> f_r = Normalisation frequency from C0425 p = Number of pole pairs of the motor z = Number of increments per revolution of the encoder C0011 = Maximum output frequency (corresponds to maximum process speed of the motor) 			
C0427*	Offset frequency input X3/E1, X3/E2 (A) (DFIN1-OFFSET)	0.0	-100.0	{0.1 %}	100.0				
C0428* (A)	Gain frequency output (DFOUT1-OUT)	100	0.0	{0.1 %}	1500.0				

Appendix

Code table

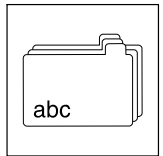

Code		Possible settings		IMPORTANT	
No.	Name	Lenze	Selection		
C0430* (A)	Automatic analog input adjustment	0	0 not active	<p>Gain and offset are calculated by two points from the setpoint characteristic. Choose two points distant from each other to increase the calculation accuracy.</p> <ol style="list-style-type: none"> 1. Select and input under C0430 which you want to calculate gain and offset for 2. Enter point 1 under C0431 X value (setpoint) and Y value (output frequency) 3. Enter point 2 under C0432 X value (setpoint) and Y value (output frequency) 4. Calculated values are automatically entered under C0413 (offset) and C0414 (gain) 	
			1 Input point for X3/1U, X3/1I		7-34
			2 Input points for X3/2U, X3/2I		
C0431* (A)	Coordinates point 1		-100.0 {0.1 %} 100.0		
			1 X (P1)		-100.0 Analog setpoint of P1 100 % = max. input value (5 V, 10 V or 20 mA)
			2 Y (P1)		-100.0 Output frequency of P1 100 % = C0011
C0432* (A)	Coordinates point 2		-100.0 {0.1 %} 100.0		
			1 X (P2)		100.0 Analog setpoint of P2 100 % = max. input value (5 V, 10 V or 20 mA)
			2 Y (P2)		100.0 Output frequency of P2 100 % = C0011
C0435* (A)	Automatic frequency input adjustment	0	0 {1} 4096 = not active		<ul style="list-style-type: none"> • Only require for speed control with digital feedback via HTL encoder • Calculates the gain C0426, depending on C0425 and C0011 • C0426 will be recalculated after every change of C0011 or C0425. • Always enter number of increments divided by number of pole pairs of the motor! – Example: Encoder increments = 4096, motor 4-pole ⇒ C0435 = 2048
C0440 (A)	Additional JOG values		-650.00 {0.02 Hz} 650.00	<p>JOG = fixed setpoint Activation via configuration in C0410</p> <p>7-43</p> <p>C04401/1 and C0037 are the same C04401/2 and C0038 are the same C04401/3 and C0039 are the same</p>	
			1 JOG 1 20.00		
			2 JOG 2 30.00		
			3 JOG 3 40.00		
			4 JOG 4 15.00		
			5 JOG 5 25.00		
			6 JOG 6 35.00		
			7 JOG 7 45.00		
C0469* 	Function of key of the keypad	1	0 not active	<p>Determines the function which is activated when pressing .</p> <p>Changes will only be active after mains switching!</p>	
			1 CINH (controller inhibit)		
			2 QSP (quick stop)		
C0500*	Calibration of numerator variable	2000	1 {1} 25000	<p>7-86</p> <ul style="list-style-type: none"> • The codes C0010, C0011, C0017, C0019, C0037, C0038, C0039, C0044, C0046, C0049, C0050, C0051, C0138, C0139, C0140, C0181, C0239, C0625, C0626, C0627 can be calibrated in a way that the keypad indicates a process variable. • If C0500/C0501 remain unchanged, the unit "Hz" will no longer be displayed. 	
C0501*	Calibration of denominator process variable	10	1 {1} 25000		
C0500* (A)	Calibration of numerator variable	2000	1 {1} 25000	<p>7-86</p> <ul style="list-style-type: none"> • The codes C0037, C0038, C0039, C0044, C0046, C0049, C0051, C0138, C0139, C0140, C0181 can be calibrated in a way that the keypad indicates a process variable with the unit selected under C0502. • Frequency-related codes (C0010, C0011, C0017, C0019, C0050, C0239, C0625, C0626, C0627) are always indicated in "Hz". 	
C0501* (A)	Calibration of denominator process variable	10	1 {1} 25000		
C0502* (A)	Process variable unit	0	0: — 6: rpm 13: % 18: Ω 1: ms 9: °C 14: kW 19: hex 2: s 10: Hz 15: N 34: m 4: A 11: kVA 16: mV 35: h 5: V 12: Nm 17: mΩ 42: mH		

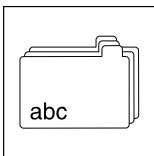

Appendix

Code table

Code		Possible settings		IMPORTANT		
No.	Name	Lenze	Selection			
C0517* <small>ENTER</small>	User menu			<ul style="list-style-type: none"> After mains switching or when using the function <small>[DISP]</small> the code from C0517/1 will be displayed. In Lenze setting, the user menu contains the most important codes for starting-up the control mode "V/f characteristic control with linear characteristic" When the password protection is activated, only the codes entered under C0517 are freely accessible. Enter the required code numbers in the subcodes. <p>Codes, which are only active when being used together with an Application-I/O, cannot be entered!</p> <p>Modifications only by Lenze Service!</p>		
1	Memory 1	50	C0050 Output frequency (MCTRL1-NOUT)			
2	Memory 2	34	C0034 Analog setpoint selection range			
3	Memory 3	7	C0007 Fixed configuration - digital input signals			
4	Memory 4	10	C0010 Minimum output frequency			
5	Memory 5	11	C0011 Maximum output frequency			
6	Memory 6	12	C0012 Acceleration time main setpoint			
7	Memory 7	13	C0013 Deceleration time main setpoint			
8	Memory 8	15	C0015 V/f rated frequency			
9	Memory 9	16	C0016 U _{min} boost			
10	Memory 10	2	C0002 Parameter set transfer			
C0518	Service codes			<p>Modifications only by Lenze Service!</p>		
C0519						
C0520						
C0597* <small>ENTER</small>	Configuration of motor phase failure detection -28-	0	0 not active			
			1 TRIP fault message	Keypad: <i>LPI</i> , bus: 32		
			2 Warning	Keypad: <i>LPI</i> , bus: 182		
C0599* <small>ENTER</small>	Current limit value for motor phase failure detection	5	1 {1 %}	50	<ul style="list-style-type: none"> Threshold for C0597 Reference: Rated controller current 	
C0608*	Fan monitoring	0	0 Not active	<p>8200 motec 3 ... 7.5 kW: Function must be activated during commissioning (recommended: C0608 = 1)! Otherwise, the controller may be destroyed through overheating.</p> <p>For all other controllers: It is essential to set C0608 = 0.</p>		
			1 TRIP error message			
			2 Warning			
C0625*	Skip frequency 1	0.00	0.00 {0.02 Hz}	650.00	<p><small>[DISP]</small> 7-17</p> <p>Applies to C0625, C0626, C0627</p>	
C0626*	Skip frequency 2	0.00	0.00 {0.02 Hz}	650.00		
C0627*	Skip frequency 3	0.00	0.00 {0.02 Hz}	650.00		
C0628*	Bandwidth of skip frequencies	0.00	0.00 {0.01 %}	100.00		
C0988*	DC-bus voltage threshold for DC-bus voltage control	0	0 {1 %}	200	<ul style="list-style-type: none"> Changeover always between PAR1 and PAR2 Parameter set changeover is not possible via terminal, bus or PC if C988 > 0! 	
C1500* (A)	Software number application I/O		82SAFA0B_xy000		Only PC display x = main version y = subversion	
C1501* (A)	Software creation date application I/O				Only PC display	
C1502* (A)	Software ID application I/O		Output in keypad as string in four parts at four characters each		Read only in keypad x = main version y = subversion	
			1	82SA		
			2	FAOB		
			3	_xy0		
			4	00		
C1504 (A) ... C1507 (A)	Service codes application I/O				Modifications only by Lenze Service!	
C1550 (A)	Service code application I/O				Modifications only by Lenze Service!	

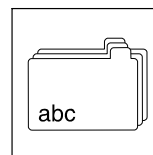

14.7 Table of attributes

The data given in the table of attributes is required to write your own programs. It contains all information for parameter communication with the controller.

How to read the table of attributes:

Column		Meaning	Entry	
Code		Name of the Lenze code	Cxxxx	
Index	dec	Index under which the parameter is addressed. The subindex of array variables corresponds to the Lenze subcode number.		Is only required for control via INTERBUS, PROFIBUS-DP or system bus (CAN).
	hex			
Data	DS	Data structure	e	Single variable (only one parameter element)
			a	Array variable (several parameter elements)
	DT	Data type	B8	1 byte bit-coded
			B16	2 bytes bit-coded
			B32	4 bytes bit-coded
			FIX32	32 bit value with sign; decimal with four decimal positions
			I32	4 bytes with sign
			U32	4 bytes without sign
			VS	ASCII string
			Format	LECOM format
	VH	ASCII hexadecimal format		
	VS	String format		
	VO	Octet string format for data blocks		
DA	Number of array elements (subcodes)	XX		
DL	Data length in bytes			
Access	R/W Remote	Access authorisation for LECOM	Ra	Reading is always permitted
			Wa	Writing is always permitted
			w	Writing is attached to a condition
	R/W CAN	Access authorisation for system bus (CAN)	Ra	Reading is always permitted
			Wa	Writing is always permitted
			w	Writing is attached to a condition
	Condition	Condition for writing	CINH	Writing only permitted when controller is inhibited

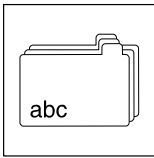

Appendix

Attribute table

14.7.1 Standard devices in the power range 0.25 ... 7.5 kW with standard I/O

Attributes apply to the SW versions 3.5 and 3.7

Code	Index		Data					Access		
	dec	hex	DS	DA	DL	DT	Format	R/W Remote	R/W CAN	Condition
C0001	24574dec	5FFEhex	e	1	4	FIX32	VD	Ra/Wa	Ra/Wa	
C0002	24573dec	5FFDhex	e	1	4	FIX32	VD	Ra/W	Ra/W	CINH
C0003	24572dec	5FFChex	e	1	4	FIX32	VD	Ra/Wa	Ra/Wa	
C0004	24571dec	5FFBhex	e	1	4	FIX32	VD	Ra/Wa	Ra/Wa	
C0005	24570dec	5FFAhex	e	1	4	FIX32	VD	Ra/Wa	Ra/Wa	
C0007	24568dec	5FF8hex	e	1	4	FIX32	VD	Ra/Wa	Ra/Wa	
C0008	24567dec	5FF7hex	e	1	4	FIX32	VD	Ra/Wa	Ra/Wa	
C0009	24566dec	5FF6hex	e	1	4	FIX32	VD	Ra/Wa	Ra/Wa	
C0010	24565dec	5FF5hex	e	1	4	FIX32	VD	Ra/Wa	Ra/Wa	
C0011	24564dec	5FF4hex	e	1	4	FIX32	VD	Ra/Wa	Ra/Wa	
C0012	24563dec	5FF3hex	e	1	4	FIX32	VD	Ra/Wa	Ra/Wa	
C0013	24562dec	5FF2hex	e	1	4	FIX32	VD	Ra/Wa	Ra/Wa	
C0014	24561dec	5FF1hex	e	1	4	FIX32	VD	Ra/Wa	Ra/Wa	
C0015	24560dec	5FF0hex	e	1	4	FIX32	VD	Ra/Wa	Ra/Wa	
C0016	24559dec	5FEFhex	e	1	4	FIX32	VD	Ra/Wa	Ra/Wa	
C0017	24558dec	5FEEhex	e	1	4	FIX32	VD	Ra/Wa	Ra/Wa	
C0018	24557dec	5FEDhex	e	1	4	FIX32	VD	Ra/Wa	Ra/Wa	
C0019	24556dec	5FEChex	e	1	4	FIX32	VD	Ra/Wa	Ra/Wa	
C0021	24554dec	5FEAhex	e	1	4	FIX32	VD	Ra/Wa	Ra/Wa	
C0022	24553dec	5FE9hex	e	1	4	FIX32	VD	Ra/Wa	Ra/Wa	
C0023	24552dec	5FE8hex	e	1	4	FIX32	VD	Ra/Wa	Ra/Wa	
C0026	24549dec	5FE5hex	e	1	4	FIX32	VD	Ra/Wa	Ra/Wa	
C0027	24548dec	5FE4hex	e	1	4	FIX32	VD	Ra/Wa	Ra/Wa	
C0034	24541dec	5FDDhex	e	1	4	FIX32	VD	Ra/Wa	Ra/Wa	
C0035	24540dec	5FDChex	e	1	4	FIX32	VD	Ra/Wa	Ra/Wa	
C0036	24539dec	5FDBhex	e	1	4	FIX32	VD	Ra/Wa	Ra/Wa	
C0037	24538dec	5FDAhex	e	1	4	FIX32	VD	Ra/Wa	Ra/Wa	
C0038	24537dec	5FD9hex	e	1	4	FIX32	VD	Ra/Wa	Ra/Wa	
C0039	24536dec	5FD8hex	e	1	4	FIX32	VD	Ra/Wa	Ra/Wa	
C0040	24535dec	5FD7hex	e	1	4	FIX32	VD	Ra/Wa	Ra/Wa	
C0043	24532dec	5FD4hex	e	1	4	FIX32	VD	Ra/Wa	Ra/Wa	
C0044	24531dec	5FD3hex	e	1	4	FIX32	VD	Ra	Ra	
C0046	24529dec	5FD1hex	e	1	4	FIX32	VD	Ra	Ra	
C0047	24528dec	5FD0hex	e	1	4	FIX32	VD	Ra	Ra	
C0049	24526dec	5FCEhex	e	1	4	FIX32	VD	Ra	Ra	
C0050	24525dec	5FCDhex	e	1	4	FIX32	VD	Ra	Ra	
C0051	24524dec	5FCChex	e	1	4	FIX32	VD	Ra	Ra	
C0052	24523dec	5FCBhex	e	1	4	FIX32	VD	Ra	Ra	
C0053	24522dec	5FCAhex	e	1	4	FIX32	VD	Ra	Ra	
C0054	24521dec	5FC9hex	e	1	4	FIX32	VD	Ra	Ra	
C0056	24519dec	5FC7hex	e	1	4	FIX32	VD	Ra	Ra	
C0061	24514dec	5FC2hex	e	1	4	FIX32	VD	Ra	Ra	
C0070	24505dec	5FB9hex	e	1	4	FIX32	VD	Ra/Wa	Ra/Wa	
C0071	24504dec	5FB8hex	e	1	4	FIX32	VD	Ra/Wa	Ra/Wa	
C0072	24503dec	5FB7hex	e	1	4	FIX32	VD	Ra/Wa	Ra/Wa	
C0074	24501dec	5FB5hex	e	1	4	FIX32	VD	Ra/Wa	Ra/Wa	

Appendix

Attribute table

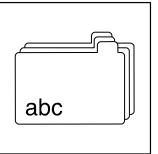

Code	Index		Data					Access		
	dec	hex	DS	DA	DL	DT	Format	R/W Remote	R/W CAN	Condition
C0077	24498dec	5FB2hex	e	1	4	FIX32	VD	Ra/Wa	Ra/Wa	
C0078	24497dec	5FB1hex	e	1	4	FIX32	VD	Ra/Wa	Ra/Wa	
C0079	24496dec	5FB0hex	e	1	4	FIX32	VD	Ra/Wa	Ra/Wa	
C0080	24495dec	5FAFhex	e	1	4	FIX32	VD	Ra/Wa	Ra/Wa	
C0084	24491dec	5FABhex	e	1	4	FIX32	VD	Ra/Wa	Ra/Wa	
C0087	24488dec	5FA8hex	e	1	4	FIX32	VD	Ra/Wa	Ra/Wa	
C0088	24487dec	5FA7hex	e	1	4	FIX32	VD	Ra/Wa	Ra/Wa	
C0089	24486dec	5FA6hex	e	1	4	FIX32	VD	Ra/Wa	Ra/Wa	
C0090	24485dec	5FA5hex	e	1	4	FIX32	VD	Ra/Wa	Ra/Wa	
C0091	24484dec	5FA4hex	e	1	4	FIX32	VD	Ra/Wa	Ra/Wa	
C0092	24483dec	5FA3hex	e	1	4	FIX32	VD	Ra/Wa	Ra/Wa	
C0093	24482dec	5FA2hex	e	1	4	FIX32	VD	Ra	Ra	
C0094	24481dec	5FA1hex	e	1	4	FIX32	VD	Ra/Wa	Ra/Wa	
C0099	24476dec	5F9Chex	e	1	4	FIX32	VD	Ra	Ra	
C0105	24470dec	5F96hex	e	1	4	FIX32	VD	Ra/Wa	Ra/Wa	
C0106	24469dec	5F95hex	e	1	4	FIX32	VD	Ra/Wa	Ra/Wa	
C0107	24468dec	5F94hex	e	1	4	FIX32	VD	Ra/Wa	Ra/Wa	
C0108	24467dec	5F93hex	e	1	4	FIX32	VD	Ra/Wa	Ra/Wa	
C0109	24466dec	5F92hex	e	1	4	FIX32	VD	Ra/Wa	Ra/Wa	
C0111	24464dec	5F90hex	e	1	4	FIX32	VD	Ra/Wa	Ra/Wa	
C0114	24461dec	5F8Dhex	e	1	4	FIX32	VD	Ra/Wa	Ra/Wa	
C0117	24458dec	5F8Ahex	e	1	4	FIX32	VD	Ra/Wa	Ra/Wa	
C0119	24456dec	5F88hex	e	1	4	FIX32	VD	Ra/Wa	Ra/Wa	
C0120	24455dec	5F87hex	e	1	4	FIX32	VD	Ra/Wa	Ra/Wa	
C0125	24450dec	5F82hex	e	1	4	FIX32	VD	Ra/Wa	Ra/Wa	
C0126	24449dec	5F81hex	e	1	4	FIX32	VD	Ra/Wa	Ra/Wa	
C0127	24448dec	5F80hex	e	1	4	FIX32	VD	Ra/Wa	Ra/Wa	
C0128	24447dec	5F7Fhex	e	1	4	FIX32	VD	Ra/Wa	Ra/Wa	
C0135	24440dec	5F78hex	e	1	2	B16	VH	Ra	Ra	
C0138	24437dec	5F75hex	e	1	4	FIX32	VD	Ra	Ra	
C0140	24435dec	5F73hex	e	1	4	FIX32	VD	Ra/Wa	Ra/Wa	
C0141	24434dec	5F72hex	e	1	4	FIX32	VD	Ra/Wa	Ra/Wa	
C0142	24433dec	5F71hex	e	1	4	FIX32	VD	Ra/Wa	Ra/Wa	
C0143	24432dec	5F70hex	e	1	4	FIX32	VD	Ra/Wa	Ra/Wa	
C0144	24431dec	5F6Fhex	e	1	4	FIX32	VD	Ra/Wa	Ra/Wa	
C0145	24430dec	5F6Ehex	e	1	4	FIX32	VD	Ra/Wa	Ra/Wa	
C0148	24427dec	5F6Bhex	e	1	4	FIX32	VD	Ra/W	Ra/W	CINH
C0150	24425dec	5F69hex	e	1	2	B16	VH	Ra	Ra	
C0151	24424dec	5F68hex	e	1	2	B16	VH	Ra	Ra	
C0155	24420dec	5F64hex	e	1	2	B16	VH	Ra	Ra	
C0156	24419dec	5F63hex	e	1	4	FIX32	VD	Ra/Wa	Ra/Wa	
C0161	24414dec	5F5Ehex	e	1	4	FIX32	VD	Ra	Ra	
C0162	24413dec	5F5Dhex	e	1	4	FIX32	VD	Ra	Ra	
C0163	24412dec	5F5Chex	e	1	4	FIX32	VD	Ra	Ra	
C0164	24411dec	5F5Bhex	e	1	4	FIX32	VD	Ra	Ra	
C0165	24410dec	5F5Ahex	e	1	4	FIX32	VD	Ra/Wa	Ra/Wa	
C0168	24407dec	5F57hex	e	1	4	FIX32	VD	Ra	Ra	
C0170	24405dec	5F55hex	e	1	4	FIX32	VD	Ra/Wa	Ra/Wa	
C0171	24404dec	5F54hex	e	1	4	FIX32	VD	Ra/Wa	Ra/Wa	

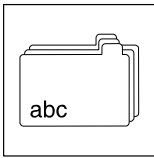

Appendix

Attribute table

Code	Index		Data					Access		
	dec	hex	DS	DA	DL	DT	Format	R/W Remote	R/W CAN	Condition
C0174	24401dec	5F51hex	e	1	4	FIX32	VD	Ra/W	Ra/W	CINH
C0178	24397dec	5F4Dhex	e	1	4	FIX32	VD	Ra	Ra	
C0179	24396dec	5F4Chex	e	1	4	FIX32	VD	Ra	Ra	
C0181	24394dec	5F4Ahex	e	1	4	FIX32	VD	Ra/Wa	Ra/Wa	
C0182	24393dec	5F49hex	e	1	4	FIX32	VD	Ra/Wa	Ra/Wa	
C0183	24392dec	5F48hex	e	1	4	FIX32	VD	Ra	Ra	
C0184	24391dec	5F47hex	e	1	4	FIX32	VD	Ra/Wa	Ra/Wa	
C0185	24390dec	5F46hex	e	1	4	FIX32	VD	Ra/Wa	Ra/Wa	
C0196	24379dec	5F3Bhex	e	1	4	FIX32	VD	Ra/Wa	Ra/Wa	
C0200	24375dec	5F37hex	e	1	14	VS	VS	Ra	Ra	
C0201	24374dec	5F36hex	e	1	17	VS	VS	Ra	Ra	
C0202	24373dec	5F35hex	e	1	4	FIX32	VD	Ra	Ra	
C0220	24355dec	5F23hex	e	1	4	FIX32	VD	Ra/Wa	Ra/Wa	
C0221	24354dec	5F22hex	e	1	4	FIX32	VD	Ra/Wa	Ra/Wa	
C0238	24337dec	5F11hex	e	1	4	FIX32	VD	Ra/Wa	Ra/Wa	
C0239	24336dec	5F10hex	e	1	4	FIX32	VD	Ra/Wa	Ra/Wa	
C0265	24310dec	5EF6hex	e	1	4	FIX32	VD	Ra/Wa	Ra/Wa	
C0304	24271dec	5ECFhex	e	1	4	FIX32	VD	Ra/Wa	Ra/Wa	
C0305	24270dec	5ECEhex	e	1	4	FIX32	VD	Ra/Wa	Ra/Wa	
C0306	24269dec	5ECDhex	e	1	2	U16	VH	Ra/Wa	Ra/Wa	
C0307	24268dec	5ECChex	e	1	2	U16	VH	Ra/Wa	Ra/Wa	
C0308	24267dec	5ECBhex	e	1	4	FIX32	VD	Ra/Wa	Ra/Wa	
C0309	24266dec	5ECAhex	e	1	4	FIX32	VD	Ra/Wa	Ra/Wa	
C0310	24265dec	5EC9hex	e	1	4	FIX32	VD	Ra/Wa	Ra/Wa	
C0311	24264dec	5EC8hex	e	1	4	FIX32	VD	Ra/Wa	Ra/Wa	
C0350	24225dec	5EA1hex	e	1	4	FIX32	VD	Ra/Wa	Ra/Wa	
C0351	24224dec	5EA0hex	e	1	4	FIX32	VD	Ra/Wa	Ra/Wa	
C0352	24223dec	5E9Fhex	e	1	4	FIX32	VD	Ra/Wa	Ra/Wa	
C0353	24222dec	5E9Ehex	a	3	4	FIX32	VD	Ra/Wa	Ra/Wa	
C0354	24221dec	5E9Dhex	a	6	4	FIX32	VD	Ra/Wa	Ra/Wa	
C0355	24220dec	5E9Chex	a	6	4	FIX32	VD	Ra	Ra	
C0356	24219dec	5E9Bhex	a	4	4	FIX32	VD	Ra/Wa	Ra/Wa	
C0357	24218dec	5E9Ahex	a	3	4	FIX32	VD	Ra/Wa	Ra/Wa	
C0358	24217dec	5E99hex	e	1	4	FIX32	VD	Ra/Wa	Ra/Wa	
C0359	24216dec	5E98hex	e	1	4	FIX32	VD	Ra	Ra	
C0360	24215dec	5E97hex	e	1	4	FIX32	VD	Ra/Wa	Ra/Wa	
C0370	24205dec	5E8Dhex	e	1	4	FIX32	VD	Ra/Wa	Ra	
C0372	24203dec	5E8Bhex	e	1	4	FIX32	VD	Ra	Ra	
C0395	24180dec	5E74hex	e	1	4	B32	VH	Ra	Ra	
C0396	24179dec	5E73hex	e	1	4	B32	VH	Ra	Ra	
C0409	24166dec	5E66hex	e	1	4	FIX32	VD	Ra/Wa	Ra/Wa	
C0410	24165dec	5E65hex	a	25	4	FIX32	VD	Ra/Wa	Ra/Wa	
C0411	24164dec	5E64hex	e	1	4	FIX32	VD	Ra/Wa	Ra/Wa	
C0412	24163dec	5E63hex	a	9	4	FIX32	VD	Ra/Wa	Ra/Wa	
C0413	24162dec	5E62hex	a	2	4	FIX32	VD	Ra/Wa	Ra/Wa	
C0414	24161dec	5E61hex	a	2	4	FIX32	VD	Ra/Wa	Ra/Wa	
C0415	24160dec	5E60hex	a	3	4	FIX32	VD	Ra/Wa	Ra/Wa	
C0416	24159dec	5E5Fhex	e	1	4	FIX32	VD	Ra/Wa	Ra/Wa	
C0417	24158dec	5E5Ehex	a	16	4	FIX32	VD	Ra/Wa	Ra/Wa	

Appendix

Attribute table

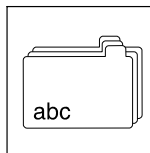

Code	Index		Data					Access		
	dec	hex	DS	DA	DL	DT	Format	R/W Remote	R/W CAN	Condition
C0418	24157dec	5E5Dhex	a	16	4	FIX32	VD	Ra/Wa	Ra/Wa	
C0419	24156dec	5E5Chex	a	3	4	FIX32	VD	Ra/Wa	Ra/Wa	
C0420	24155dec	5E5Bhex	e	1	4	FIX32	VD	Ra/Wa	Ra/Wa	
C0421	24154dec	5E5Ahex	a	10	4	FIX32	VD	Ra/Wa	Ra/Wa	
C0422	24153dec	5E59hex	e	1	4	FIX32	VD	Ra/Wa	Ra/Wa	
C0425	24150dec	5E56hex	e	1	4	FIX32	VD	Ra/Wa	Ra/Wa	
C0426	24149dec	5E55hex	e	1	4	FIX32	VD	Ra/Wa	Ra/Wa	
C0427	24148dec	5E54hex	e	1	4	FIX32	VD	Ra/Wa	Ra/Wa	
C0469	24106dec	5E2Ahex	e	1	4	FIX32	VD	Ra/W	Ra/W	CINH
C0500	24075dec	5E0Bhex	e	1	4	FIX32	VD	Ra/Wa	Ra/Wa	
C0501	24074dec	5E0Ahex	e	1	4	FIX32	VD	Ra/Wa	Ra/Wa	
C0517	24058dec	5DFAhex	a	10	4	FIX32	VD	Ra/Wa	Ra/Wa	
C0518	24057dec	5DF9hex	a	250	4	FIX32	VD	Ra/Wa	Ra/Wa	
C0519	24056dec	5DF8hex	a	250	4	FIX32	VD	Ra	Ra	
C0520	24055dec	5DF7hex	a	1	4	FIX32	VD	Ra/Wa	Ra/Wa	
C0597	23978dec	5DAAhex	e	1	4	FIX32	VD	Ra/Wa	Ra/Wa	
C0599	23976dec	5DA8hex	e	1	4	FIX32	VD	Ra/Wa	Ra/Wa	
C0608	23967dec	5D9Fhex	e	1	4	FIX32	VD	Ra/Wa	Ra/Wa	
C0625	23950dec	5D8Ehex	e	1	4	FIX32	VD	Ra/Wa	Ra/Wa	
C0626	23949dec	5D8Dhex	e	1	4	FIX32	VD	Ra/Wa	Ra/Wa	
C0627	23948dec	5D8Chex	e	1	4	FIX32	VD	Ra/Wa	Ra/Wa	
C0628	23947dec	5D8Bhex	e	1	4	FIX32	VD	Ra/Wa	Ra/Wa	
C0988	23587dec	5C23hex	e	1	4	FIX32	VD	Ra/Wa	Ra/Wa	

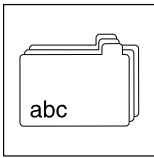

Appendix

Attribute table

14.7.2 Standard devices in the power range 0.25 ... 7.5 kW with application I/O

Attributes apply to the SW versions 3.5 and 3.7

Code	Index		Data					Access		
	dec	hex	DS	DA	DL	DT	Format	R/W Remote	R/W CAN	Condition
C0001	24574dec	5FFEhex	e	1	4	FIX32	VD	Ra/Wa	Ra/Wa	
C0002	24573dec	5FFDhex	e	1	4	FIX32	VD	Ra/W	Ra/W	CINH
C0003	24572dec	5FFChex	e	1	4	FIX32	VD	Ra/Wa	Ra/Wa	
C0004	24571dec	5FFBhex	e	1	4	FIX32	VD	Ra/Wa	Ra/Wa	
C0005	24570dec	5FFAhex	e	1	4	FIX32	VD	Ra/Wa	Ra/Wa	
C0007	24568dec	5FF8hex	e	1	4	FIX32	VD	Ra/Wa	Ra/Wa	
C0008	24567dec	5FF7hex	e	1	4	FIX32	VD	Ra/Wa	Ra/Wa	
C0009	24566dec	5FF6hex	e	1	4	FIX32	VD	Ra/Wa	Ra/Wa	
C0010	24565dec	5FF5hex	e	1	4	FIX32	VD	Ra/Wa	Ra/Wa	
C0011	24564dec	5FF4hex	e	1	4	FIX32	VD	Ra/Wa	Ra/Wa	
C0012	24563dec	5FF3hex	e	1	4	FIX32	VD	Ra/Wa	Ra/Wa	
C0013	24562dec	5FF2hex	e	1	4	FIX32	VD	Ra/Wa	Ra/Wa	
C0014	24561dec	5FF1hex	e	1	4	FIX32	VD	Ra/Wa	Ra/Wa	
C0015	24560dec	5FF0hex	e	1	4	FIX32	VD	Ra/Wa	Ra/Wa	
C0016	24559dec	5FEFhex	e	1	4	FIX32	VD	Ra/Wa	Ra/Wa	
C0017	24558dec	5FEEhex	e	1	4	FIX32	VD	Ra/Wa	Ra/Wa	
C0018	24557dec	5FEDhex	e	1	4	FIX32	VD	Ra/Wa	Ra/Wa	
C0019	24556dec	5FEChex	e	1	4	FIX32	VD	Ra/Wa	Ra/Wa	
C0021	24554dec	5FEAhex	e	1	4	FIX32	VD	Ra/Wa	Ra/Wa	
C0022	24553dec	5FE9hex	e	1	4	FIX32	VD	Ra/Wa	Ra/Wa	
C0023	24552dec	5FE8hex	e	1	4	FIX32	VD	Ra/Wa	Ra/Wa	
C0026	24549dec	5FE5hex	e	1	4	FIX32	VD	Ra/Wa	Ra/Wa	
C0027	24548dec	5FE4hex	e	1	4	FIX32	VD	Ra/Wa	Ra/Wa	
C0034	24541dec	5FDDhex	a	2	4	FIX32	VD	Ra/Wa	Ra/Wa	
C0035	24540dec	5FDChex	e	1	4	FIX32	VD	Ra/Wa	Ra/Wa	
C0036	24539dec	5FDBhex	e	1	4	FIX32	VD	Ra/Wa	Ra/Wa	
C0037	24538dec	5FDAhex	e	1	4	FIX32	VD	Ra/Wa	Ra/Wa	
C0038	24537dec	5FD9hex	e	1	4	FIX32	VD	Ra/Wa	Ra/Wa	
C0039	24536dec	5FD8hex	e	1	4	FIX32	VD	Ra/Wa	Ra/Wa	
C0040	24535dec	5FD7hex	e	1	4	FIX32	VD	Ra/Wa	Ra/Wa	
C0043	24532dec	5FD4hex	e	1	4	FIX32	VD	Ra/Wa	Ra/Wa	
C0044	24531dec	5FD3hex	e	1	4	FIX32	VD	Ra	Ra	
C0046	24529dec	5FD1hex	e	1	4	FIX32	VD	Ra	Ra	
C0047	24528dec	5FD0hex	e	1	4	FIX32	VD	Ra	Ra	
C0049	24526dec	5FCEhex	e	1	4	FIX32	VD	Ra	Ra	
C0050	24525dec	5FCDhex	e	1	4	FIX32	VD	Ra	Ra	
C0051	24524dec	5FCChex	e	1	4	FIX32	VD	Ra	Ra	
C0052	24523dec	5FCBhex	e	1	4	FIX32	VD	Ra	Ra	
C0053	24522dec	5FCAhex	e	1	4	FIX32	VD	Ra	Ra	
C0054	24521dec	5FC9hex	e	1	4	FIX32	VD	Ra	Ra	
C0056	24519dec	5FC7hex	e	1	4	FIX32	VD	Ra	Ra	
C0061	24514dec	5FC2hex	e	1	4	FIX32	VD	Ra	Ra	
C0070	24505dec	5FB9hex	e	1	4	FIX32	VD	Ra/Wa	Ra/Wa	
C0071	24504dec	5FB8hex	e	1	4	FIX32	VD	Ra/Wa	Ra/Wa	
C0072	24503dec	5FB7hex	e	1	4	FIX32	VD	Ra/Wa	Ra/Wa	
C0074	24501dec	5FB5hex	e	1	4	FIX32	VD	Ra/Wa	Ra/Wa	

Appendix

Attribute table

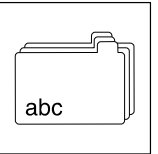

Code	Index		Data					Access		
	dec	hex	DS	DA	DL	DT	Format	R/W Remote	R/W CAN	Condition
C0077	24498dec	5FB2hex	e	1	4	FIX32	VD	Ra/Wa	Ra/Wa	
C0078	24497dec	5FB1hex	e	1	4	FIX32	VD	Ra/Wa	Ra/Wa	
C0079	24496dec	5FB0hex	e	1	4	FIX32	VD	Ra/Wa	Ra/Wa	
C0080	24495dec	5FAFhex	e	1	4	FIX32	VD	Ra/Wa	Ra/Wa	
C0084	24491dec	5FABhex	e	1	4	FIX32	VD	Ra/Wa	Ra/Wa	
C0087	24488dec	5FA8hex	e	1	4	FIX32	VD	Ra/Wa	Ra/Wa	
C0088	24487dec	5FA7hex	e	1	4	FIX32	VD	Ra/Wa	Ra/Wa	
C0089	24486dec	5FA6hex	e	1	4	FIX32	VD	Ra/Wa	Ra/Wa	
C0090	24485dec	5FA5hex	e	1	4	FIX32	VD	Ra/Wa	Ra/Wa	
C0091	24484dec	5FA4hex	e	1	4	FIX32	VD	Ra/Wa	Ra/Wa	
C0092	24483dec	5FA3hex	e	1	4	FIX32	VD	Ra/Wa	Ra/Wa	
C0093	24482dec	5FA2hex	e	1	4	FIX32	VD	Ra	Ra	
C0094	24481dec	5FA1hex	e	1	4	FIX32	VD	Ra/Wa	Ra/Wa	
C0099	24476dec	5F9Chex	e	1	4	FIX32	VD	Ra	Ra	
C0101	24474dec	5F9Ahex	e	1	4	FIX32	VD	Ra/Wa	Ra/Wa	
C0103	24472dec	5F98hex	e	1	4	FIX32	VD	Ra/Wa	Ra/Wa	
C0105	24470dec	5F96hex	e	1	4	FIX32	VD	Ra/Wa	Ra/Wa	
C0106	24469dec	5F95hex	e	1	4	FIX32	VD	Ra/Wa	Ra/Wa	
C0107	24468dec	5F94hex	e	1	4	FIX32	VD	Ra/Wa	Ra/Wa	
C0108	24467dec	5F93hex	e	1	4	FIX32	VD	Ra/Wa	Ra/Wa	
C0109	24466dec	5F92hex	e	1	4	FIX32	VD	Ra/Wa	Ra/Wa	
C0111	24464dec	5F90hex	e	1	4	FIX32	VD	Ra/Wa	Ra/Wa	
C0114	24461dec	5F8Dhex	e	1	4	FIX32	VD	Ra/Wa	Ra/Wa	
C0117	24458dec	5F8Ahex	e	1	4	FIX32	VD	Ra/Wa	Ra/Wa	
C0119	24456dec	5F88hex	e	1	4	FIX32	VD	Ra/Wa	Ra/Wa	
C0120	24455dec	5F87hex	e	1	4	FIX32	VD	Ra/Wa	Ra/Wa	
C0125	24450dec	5F82hex	e	1	4	FIX32	VD	Ra/Wa	Ra/Wa	
C0126	24449dec	5F81hex	e	1	4	FIX32	VD	Ra/Wa	Ra/Wa	
C0127	24448dec	5F80hex	e	1	4	FIX32	VD	Ra/Wa	Ra/Wa	
C0128	24447dec	5F7Fhex	e	1	4	FIX32	VD	Ra/Wa	Ra/Wa	
C0135	24440dec	5F78hex	e	1	2	B16	VH	Ra	Ra	
C0138	24437dec	5F75hex	e	1	4	FIX32	VD	Ra	Ra	
C0140	24435dec	5F73hex	e	1	4	FIX32	VD	Ra/Wa	Ra/Wa	
C0141	24434dec	5F72hex	e	1	4	FIX32	VD	Ra/Wa	Ra/Wa	
C0142	24433dec	5F71hex	e	1	4	FIX32	VD	Ra/Wa	Ra/Wa	
C0143	24432dec	5F70hex	e	1	4	FIX32	VD	Ra/Wa	Ra/Wa	
C0144	24431dec	5F6Fhex	e	1	4	FIX32	VD	Ra/Wa	Ra/Wa	
C0145	24430dec	5F6Ehex	e	1	4	FIX32	VD	Ra/Wa	Ra/Wa	
C0148	24427dec	5F6Bhex	e	1	4	FIX32	VD	Ra/W	Ra/W	CINH
C0150	24425dec	5F69hex	e	1	2	B16	VH	Ra	Ra	
C0151	24424dec	5F68hex	e	1	2	B16	VH	Ra	Ra	
C0152	24423dec	5F67hex	e	1	2	B16	VH	Ra	Ra	
C0155	24420dec	5F64hex	e	1	2	B16	VH	Ra	Ra	
C0156	24419dec	5F63hex	e	1	4	FIX32	VD	Ra/Wa	Ra/Wa	
C0161	24414dec	5F5Ehex	e	1	4	FIX32	VD	Ra	Ra	
C0162	24413dec	5F5Dhex	e	1	4	FIX32	VD	Ra	Ra	
C0163	24412dec	5F5Chex	e	1	4	FIX32	VD	Ra	Ra	
C0164	24411dec	5F5Bhex	e	1	4	FIX32	VD	Ra	Ra	
C0165	24410dec	5F5Ahex	e	1	4	FIX32	VD	Ra/Wa	Ra/Wa	

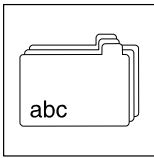

Appendix

Attribute table

Code	Index		Data					Access		
	dec	hex	DS	DA	DL	DT	Format	R/W Remote	R/W CAN	Condition
C0168	24407dec	5F57hex	e	1	4	FIX32	VD	Ra	Ra	
C0170	24405dec	5F55hex	e	1	4	FIX32	VD	Ra/Wa	Ra/Wa	
C0171	24404dec	5F54hex	e	1	4	FIX32	VD	Ra/Wa	Ra/Wa	
C0174	24401dec	5F51hex	e	1	4	FIX32	VD	Ra/W	Ra/W	CINH
C0178	24397dec	5F4Dhex	e	1	4	FIX32	VD	Ra	Ra	
C0179	24396dec	5F4Chex	e	1	4	FIX32	VD	Ra	Ra	
C0181	24394dec	5F4Ahex	e	1	4	FIX32	VD	Ra/Wa	Ra/Wa	
C0182	24393dec	5F49hex	e	1	4	FIX32	VD	Ra/Wa	Ra/Wa	
C0183	24392dec	5F48hex	e	1	4	FIX32	VD	Ra	Ra	
C0184	24391dec	5F47hex	e	1	4	FIX32	VD	Ra/Wa	Ra/Wa	
C0185	24390dec	5F46hex	e	1	4	FIX32	VD	Ra/Wa	Ra/Wa	
C0189	24386dec	5F42hex	e	1	4	FIX32	VD	Ra	Ra	
C0190	24385dec	5F41hex	e	1	4	FIX32	VD	Ra/Wa	Ra/Wa	
C0191	24384dec	5F40hex	e	1	4	FIX32	VD	Ra/Wa	Ra/Wa	
C0192	24383dec	5F3Fhex	e	1	4	FIX32	VD	Ra/Wa	Ra/Wa	
C0193	24382dec	5F3Ehex	e	1	4	FIX32	VD	Ra/Wa	Ra/Wa	
C0194	24381dec	5F3Dhex	e	1	4	FIX32	VD	Ra/Wa	Ra/Wa	
C0195	24380dec	5F3Chex	e	1	4	FIX32	VD	Ra/Wa	Ra/Wa	
C0196	24379dec	5F3Bhex	e	1	4	FIX32	VD	Ra/Wa	Ra/Wa	
C0200	24375dec	5F37hex	e	1	14	VS	VS	Ra	Ra	
C0201	24374dec	5F36hex	e	1	17	VS	VS	Ra	Ra	
C0202	24373dec	5F35hex	e	1	4	FIX32	VD	Ra	Ra	
C0220	24355dec	5F23hex	e	1	4	FIX32	VD	Ra/Wa	Ra/Wa	
C0221	24354dec	5F22hex	e	1	4	FIX32	VD	Ra/Wa	Ra/Wa	
C0225	24350dec	5F1Ehex	e	1	4	FIX32	VD	Ra/Wa	Ra/Wa	
C0226	24349dec	5F1Dhex	e	1	4	FIX32	VD	Ra/Wa	Ra/Wa	
C0228	24347dec	5F1Bhex	e	1	4	FIX32	VD	Ra/Wa	Ra/Wa	
C0229	24346dec	5F1Ahex	e	1	4	FIX32	VD	Ra/Wa	Ra/Wa	
C0230	24345dec	5F19hex	e	1	4	FIX32	VD	Ra/Wa	Ra/Wa	
C0231	24344dec	5F18hex	e	1	4	FIX32	VD	Ra/Wa	Ra/Wa	
C0232	24343dec	5F17hex	e	1	4	FIX32	VD	Ra/Wa	Ra/Wa	
C0233	24342dec	5F16hex	e	1	4	FIX32	VD	Ra/Wa	Ra/Wa	
C0234	24341dec	5F15hex	e	1	4	FIX32	VD	Ra/Wa	Ra/Wa	
C0235	24340dec	5F14hex	e	1	4	FIX32	VD	Ra/Wa	Ra/Wa	
C0236	24339dec	5F13hex	e	1	4	FIX32	VD	Ra/Wa	Ra/Wa	
C0238	24337dec	5F11hex	e	1	4	FIX32	VD	Ra/Wa	Ra/Wa	
C0239	24336dec	5F10hex	e	1	4	FIX32	VD	Ra/Wa	Ra/Wa	
C0240	24335dec	5F0Fhex	e	1	4	FIX32	VD	Ra/Wa	Ra/Wa	
C0241	24334dec	5F0Ehex	e	1	4	FIX32	VD	Ra/Wa	Ra/Wa	
C0242	24333dec	5F0Dhex	e	1	4	FIX32	VD	Ra/Wa	Ra/Wa	
C0243	24332dec	5F0Chex	e	1	4	FIX32	VD	Ra/Wa	Ra/Wa	
C0244	24331dec	5F0Bhex	e	1	4	FIX32	VD	Ra/Wa	Ra/Wa	
C0245	24330dec	5F0Ahex	e	1	4	FIX32	VD	Ra/Wa	Ra/Wa	
C0250	24325dec	5F05hex	e	1	4	FIX32	VD	Ra/Wa	Ra/Wa	
C0251	24324dec	5F04hex	e	1	4	FIX32	VD	Ra/Wa	Ra/Wa	
C0252	24323dec	5F03hex	e	1	4	FIX32	VD	Ra/Wa	Ra/Wa	
C0253	24322dec	5F02hex	e	1	4	FIX32	VD	Ra/Wa	Ra/Wa	
C0254	24321dec	5F01hex	e	1	4	FIX32	VD	Ra/Wa	Ra/Wa	
C0255	24320dec	5F00hex	e	1	4	FIX32	VD	Ra/Wa	Ra/Wa	

Appendix

Attribute table

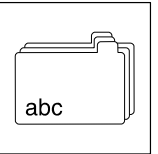

Code	Index		Data					Access		
	dec	hex	DS	DA	DL	DT	Format	R/W Remote	R/W CAN	Condition
C0265	24310dec	5EF6hex	e	1	4	FIX32	VD	Ra/Wa	Ra/Wa	
C0304	24271dec	5ECFhex	e	1	4	FIX32	VD	Ra/Wa	Ra/Wa	
C0305	24270dec	5ECEhex	e	1	4	FIX32	VD	Ra/Wa	Ra/Wa	
C0306	24269dec	5ECDhex	e	1	2	U16	VH	Ra/Wa	Ra/Wa	
C0307	24268dec	5ECChex	e	1	2	U16	VH	Ra/Wa	Ra/Wa	
C0308	24267dec	5ECBhex	e	1	4	FIX32	VD	Ra/Wa	Ra/Wa	
C0309	24266dec	5ECAhex	e	1	4	FIX32	VD	Ra/Wa	Ra/Wa	
C0310	24265dec	5EC9hex	e	1	4	FIX32	VD	Ra/Wa	Ra/Wa	
C0311	24264dec	5EC8hex	e	1	4	FIX32	VD	Ra/Wa	Ra/Wa	
C0320	24255dec	5EBFhex	e	1	4	FIX32	VD	Ra	Ra	
C0321	24254dec	5EBEhex	e	1	4	FIX32	VD	Ra	Ra	
C0322	24253dec	5EBDhex	e	1	4	FIX32	VD	Ra	Ra	
C0323	24252dec	5EBChex	e	1	4	FIX32	VD	Ra	Ra	
C0324	24251dec	5EBBhex	e	1	4	FIX32	VD	Ra	Ra	
C0325	24250dec	5EBAhex	e	1	4	FIX32	VD	Ra	Ra	
C0326	24249dec	5EB9hex	e	1	4	FIX32	VD	Ra	Ra	
C0327	24248dec	5EB8hex	e	1	4	FIX32	VD	Ra	Ra	
C0350	24225dec	5EA1hex	e	1	4	FIX32	VD	Ra/Wa	Ra/Wa	
C0351	24224dec	5EA0hex	e	1	4	FIX32	VD	Ra/Wa	Ra/Wa	
C0352	24223dec	5E9Fhex	e	1	4	FIX32	VD	Ra/Wa	Ra/Wa	
C0353	24222dec	5E9Ehex	a	3	4	FIX32	VD	Ra/Wa	Ra/Wa	
C0354	24221dec	5E9Dhex	a	6	4	FIX32	VD	Ra/Wa	Ra/Wa	
C0355	24220dec	5E9Chex	a	6	4	FIX32	VD	Ra	Ra	
C0356	24219dec	5E9Bhex	a	4	4	FIX32	VD	Ra/Wa	Ra/Wa	
C0357	24218dec	5E9Ahex	a	3	4	FIX32	VD	Ra/Wa	Ra/Wa	
C0358	24217dec	5E99hex	e	1	4	FIX32	VD	Ra/Wa	Ra/Wa	
C0359	24216dec	5E98hex	e	1	4	FIX32	VD	Ra	Ra	
C0360	24215dec	5E97hex	e	1	4	FIX32	VD	Ra/Wa	Ra/Wa	
C0370	24205dec	5E8Dhex	e	1	4	FIX32	VD	Ra/Wa	Ra	
C0372	24203dec	5E8Bhex	e	1	4	FIX32	VD	Ra	Ra	
C0395	24180dec	5E74hex	e	1	4	B32	VH	Ra	Ra	
C0396	24179dec	5E73hex	e	1	4	B32	VH	Ra	Ra	
C0409	24166dec	5E66hex	e	1	4	FIX32	VD	Ra/Wa	Ra/Wa	
C0410	24165dec	5E65hex	a	32	4	FIX32	VD	Ra/Wa	Ra/Wa	
C0411	24164dec	5E64hex	e	1	4	FIX32	VD	Ra/Wa	Ra/Wa	
C0412	24163dec	5E63hex	a	9	4	FIX32	VD	Ra/Wa	Ra/Wa	
C0413	24162dec	5E62hex	a	2	4	FIX32	VD	Ra/Wa	Ra/Wa	
C0414	24161dec	5E61hex	a	2	4	FIX32	VD	Ra/Wa	Ra/Wa	
C0415	24160dec	5E60hex	a	3	4	FIX32	VD	Ra/Wa	Ra/Wa	
C0416	24159dec	5E5Fhex	e	1	4	FIX32	VD	Ra/Wa	Ra/Wa	
C0417	24158dec	5E5Ehex	a	16	4	FIX32	VD	Ra/Wa	Ra/Wa	
C0418	24157dec	5E5Dhex	a	16	4	FIX32	VD	Ra/Wa	Ra/Wa	
C0419	24156dec	5E5Chex	a	3	4	FIX32	VD	Ra/Wa	Ra/Wa	
C0420	24155dec	5E5Bhex	e	1	4	FIX32	VD	Ra/Wa	Ra/Wa	
C0421	24154dec	5E5Ahex	a	10	4	FIX32	VD	Ra/Wa	Ra/Wa	
C0422	24153dec	5E59hex	e	1	4	FIX32	VD	Ra/Wa	Ra/Wa	
C0423	24152dec	5E58hex	a	3	4	FIX32	VD	Ra/Wa	Ra/Wa	
C0424	24151dec	5E57hex	a	2	4	FIX32	VD	Ra/Wa	Ra/Wa	
C0425	24150dec	5E56hex	e	1	4	FIX32	VD	Ra/Wa	Ra/Wa	

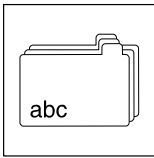

Appendix

Attribute table

Code	Index		Data					Access		
	dec	hex	DS	DA	DL	DT	Format	R/W Remote	R/W CAN	Condition
C0426	24149dec	5E55hex	e	1	4	FIX32	VD	Ra/Wa	Ra/Wa	
C0427	24148dec	5E54hex	e	1	4	FIX32	VD	Ra/Wa	Ra/Wa	
C0428	24147dec	5E53hex	e	1	4	FIX32	VD	Ra/Wa	Ra/Wa	
C0430	24145dec	5E51hex	e	1	4	FIX32	VD	Ra/Wa	Ra/Wa	
C0431	24144dec	5E50hex	e	1	4	FIX32	VD	Ra/Wa	Ra/Wa	
C0432	24143dec	5E4Fhex	e	1	4	FIX32	VD	Ra/Wa	Ra/Wa	
C0435	24140dec	5E4Chex	e	1	4	FIX32	VD	Ra/Wa	Ra/Wa	
C0440	24135dec	5E47hex	e	1	4	FIX32	VD	Ra/Wa	Ra/Wa	
C0469	24106dec	5E2Ahex	e	1	4	FIX32	VD	Ra/W	Ra/W	CINH
C0500	24075dec	5E0Bhex	e	1	4	FIX32	VD	Ra/Wa	Ra/Wa	
C0501	24074dec	5E0Ahex	e	1	4	FIX32	VD	Ra/Wa	Ra/Wa	
C0502	24073dec	5E09hex	e	1	4	FIX32	VD	Ra/Wa	Ra/Wa	
C0517	24058dec	5DFAhex	a	10	4	FIX32	VD	Ra/Wa	Ra/Wa	
C0518	24057dec	5DF9hex	a	250	4	FIX32	VD	Ra/Wa	Ra/Wa	
C0519	24056dec	5DF8hex	a	250	4	FIX32	VD	Ra	Ra	
C0520	24055dec	5DF7hex	a	1	4	FIX32	VD	Ra/Wa	Ra/Wa	
C0597	23978dec	5DAAhex	e	1	4	FIX32	VD	Ra/Wa	Ra/Wa	
C0599	23976dec	5DA8hex	e	1	4	FIX32	VD	Ra/Wa	Ra/Wa	
C0608	23967dec	5D9Fhex	e	1	4	FIX32	VD	Ra/Wa	Ra/Wa	
C0625	23950dec	5D8Ehex	e	1	4	FIX32	VD	Ra/Wa	Ra/Wa	
C0626	23949dec	5D8Dhex	e	1	4	FIX32	VD	Ra/Wa	Ra/Wa	
C0627	23948dec	5D8Chex	e	1	4	FIX32	VD	Ra/Wa	Ra/Wa	
C0628	23947dec	5D8Bhex	e	1	4	FIX32	VD	Ra/Wa	Ra/Wa	
C0988	23587dec	5C23hex	e	1	4	FIX32	VD	Ra/Wa	Ra/Wa	
C 1500	23075dec	5A23hex	e	1	14	VS	VS	Ra	Ra	
C 1501	23074dec	5A22hex	e	1	17	VS	VS	Ra	Ra	
C 1502	23073dec	5A21hex	e	1	4	FIX32	VD	Ra	Ra	
C 1504	23071dec	5A1Fhex	e	1	4	FIX32	VD	Ra/Wa	Ra/Wa	
C 1505	23070dec	5A1Ehex	e	1	4	FIX32	VD	Ra/Wa	Ra/Wa	
C 1506	23069dec	5A1Dhex	e	1	2	U16	VH	Ra/Wa	Ra/Wa	
C 1507	23068dec	5A1Chex	e	1	2	U16	VH	Ra/Wa	Ra/Wa	
C 1550	23025dec	59F1hex	a	1	4	FIX32	VD	Ra/W	Ra/W	CINH
C 1698	22877dec	595Dhex	e	1	4	FIX32	VD	Ra	Ra	

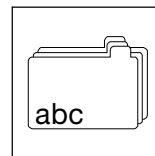

15 Table of keywords

0 ... 9

87 Hz technology, 7-6

A

AC motor braking, 7-31

Acceleration, 7-24

Acceleration time

Additional setpoint, 7-24, 14-26

Minimum frequency limitation, 7-21, 14-27

Process controller setpoint, 14-27

Acceleration times, 7-24

Accessories, 12-1

External brake resistor, 11-1

Acknowledgement

negative, 6-16

positive, 6-16

Actual value, Digital supply, 7-39

Actual value selection, 7-32

PID controller, 7-54

Address settings, by DIP switch, 4-10, 4-14, 4-15

Adjustment

Bipolar setpoint, 7-36

Inverse setpoint, 7-37

Unipolar setpoint, 7-36

AIF, 1-1

Analog input 1

Gain, 7-34, 14-16

Offset, 7-34, 14-16

Analog input signals, 7-57

Analog inputs

Automatic adjustment, 7-35, 14-49

gain, 7-34, 14-38

offset, 7-34, 14-38

Analog output 1

Gain, 7-61, 14-19

Offset, 7-61, 14-19

Analog output signals, 7-59

Analog outputs, Configuration, 7-59

Analog process data output words, Configuration, 7-64

Appendix, 14-1

Application as directed, 1-2

Application datum, Display, 7-86

Application examples, 13-1

group drive, 13-13

operation of mid-frequency motors, 13-9

power control, 13-15

pressure control, 13-1

setpoint summation, 13-14

speed control, 13-10

Application I/O

acceleration times - main setpoint, 7-24, 14-19

additional JOG values, 7-43, 14-49

Automatic analog input adjustment, 7-35, 14-49

Automatic frequency input adjustment, 7-40, 14-49

Calibration of process variable, 7-88, 14-49

deceleration times - main setpoint, 7-24, 14-19

Delay digital outputs, 14-48

delay of digital outputs, 7-76

Main and additional setpoint, 14-26

Offset of analog outputs, 7-62, 14-47

output signal range - analog outputs, 7-62, 14-48

Setpoint selection range, 7-34, 14-16

terminal assignment, 4-12

Approvals, 3-1

Asynchronous standard motors, 1-2

Auto-TRIP reset, 8-7

Automation, 9-1

with INTERBUS, PROFIBUS-DP, LECOM-B (RS485), 9-1

B

Bar graph display, 6-3

Basic settings, Own, 7-92, 14-12

Baud rate, 14-21

LECOM-A (RS232) communication module, 6-10

Bipolar setpoint, Adjustment, 7-36

Brake chopper, switching threshold, 14-25

Brake resistor, 11-3

selection, 11-1

Brake transistor, 11-2

Brakes, 11-1

Braking, 7-24

Braking operation, 11-1

With external brake resistor, 11-1

without additional measures, 11-1

Bus function modules, terminal assignment, 4-16

Bus systems, Setpoint selection, 7-46

C

Cable cross-sections

operation with increased rated power
230 V, 3-6

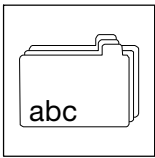
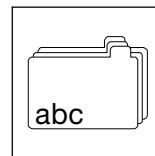

Table of keywords

- 400 V/500 V, 3-10
 - operation with rated power
 - 230 V, 3-5
 - 400 V/500 V, 3-8
- Cable specification, 4-6
- Calibration, Application datum, 7-86
- calling a password-protected function, 6-7
- CAN bus identifier, 14-32
- CAN bus node address, 14-31
- Changeover, Setpoints, 7-47
- Changing and saving parameters, with E82ZBC keypad, 5-3
- Character format, 6-9
- Check, before commissioning, 5-1
- Chopper frequency reduction, 7-15
- Code, 6-1
- Code bank, 6-14
- Code table, LECOM-A (RS232) communication module, 6-12

- Codetabelle, Erläuterungen zur, 14-10
- Codetabelle Antriebsregler, 14-10
- Commissioning, 5-1
 - check before, 5-1
 - V/f characteristic control, 5-6
 - without function module, 5-6 , 5-8 , 5-10 , 5-12
 - Vector control, 5-10
 - Vector control optimisation, 5-14
- Communication error, Reaction to, 14-21
- Communication monitoring, LECOM-A (RS485) function module, 6-14
- Communication times, LECOM-A (RS232) communication times, 6-10
- Compensation equipment, interaction with, 4-5
- Configuration
 - Acceleration times and deceleration times, 7-24
 - Actual value selection, 7-32
 - Analog input signals, 7-57
 - Analog output signals, 7-59
 - Analog outputs, 7-59
 - Analog process data output words, 7-64
 - Change of direction of rotation, 7-28
 - Communication monitoring, 14-21
 - Controller inhibit (DCTRL1-CINH), 7-20
 - Current limits, 7-23
 - Current-limit controller, 7-56
 - DC-injection brake (DCB), 7-30
 - Digital input signals, 7-68
 - Digital output signals, 7-73
 - Digital outputs, 7-73
 - Display functions, 7-86
 - Function library, 7-1
 - Manual / remote operation, 7-47
 - Maximum field frequency, 7-21
 - Minimum field frequency, 7-21
 - Monitoring functions
 - external faults, 7-85
 - Motor temperature, 7-82
 - Motor data detection, 7-48
 - Oscillation damping, 7-16
 - Parameter set changeover, 7-94
 - Process data output words, 7-79
 - Quick stop (QSP), 7-27
 - Relay output, 7-73
 - Setpoint selection, 7-32
 - Setpoint source selection, 7-32
 - Slip compensation, 7-13
 - Speed limit values, 7-21
 - Start conditions/flying-restart circuit, 7-18
 - switching frequency of inverter, 7-14
 - table of attributes, 14-51
 - Thermal motor monitoring, 7-82
 - TRIP reset, 7-85
 - TRIP set, 7-85
 - V/f rated frequency, 7-5
 - Vmin boost, 7-7
- Conformity, 3-1
- Control characteristics, Process controller, 7-50
- Control connections
 - terminal assignment - application I/O, 4-12
 - terminal assignment - bus function modules, 4-16
 - terminal assignment - standard I/O, 4-9
- Control mode, Selection, 5-4
- Control word, 14-22
- Controlled deceleration after mains failure, 7-19
- Controller
 - Application as directed, 1-2
 - Labelling, 1-2
- Controller inhibit, Drive performance, 7-18 , 7-20
- Current derating
 - operation with increased rated power, 400 V/500 V, 3-10
 - operation with rated power, 400 V/500 V, 3-8
- Current limits, 7-23
- Current-limit controller, 7-56
- Cyclic mains switching, 5-6 , 5-10

- D**
- DC-bus connection, 10-1
 - Several drives, 10-1
- DC-bus operation, 3-1
- DC-injection brake, 7-30
- Dead band
 - setting with auto DCB, 7-31
 - With analog setpoint selection, 7-35
- Debouncing
 - Digital output signal "Torque threshold reached", 14-29



Digital output signal PCTRL1-LIM, 14-27
 Digital output signal PCTRL1-SET=ACT, 14-27
 Digital outputs, 14-48
 digital outputs, 7-76

Deceleration, 7-24

Deceleration time
 Additional setpoint, 7-24 , 14-26
 Process controller setpoint, 14-27

Deceleration times, 7-24

Default setting
 load, 7-91 , 14-11
 Restorage, 7-91 , 14-11

Definitions, Terms, 1-1

Degree of pollution, 3-1

Delay digital outputs, Application I/O, 14-48

Delay of digital outputs, application I/O, 7-76

Derating, 7-14 , 7-16 , 7-23

Design, mechanical, 4-1

Device protection, 2-5

Diagnostics, 7-86 , 7-89 , 14-25

Digital input signals, 7-68

Digital inputs
 Level inversion, 7-72 , 14-37
 level inversion, 14-21

Digital output signals, 7-73

Digital outputs
 Configuration, 7-73
 Level inversion, 14-41
 level inversion, 7-76

digital switching output, linking with internal digital signals, 7-73

Dimensions, 4-2

Direction of rotation
 Failsafechange, 7-28
 Nonfail-safe change, 7-28

dismounting, function module, 4-8

Display
 Application datum, 7-86
 bar graph, 6-3
 keypad, 6-2
 Operating status, 8-1
 Software version, 7-89 , 14-18
 status, 6-3
 Type, 7-89 , 14-18

Display functions, 7-86
 Possible values, 7-86

Display of operating data, 7-86

Display values, 7-86
 Calibration, 7-86

Drive performance
 at mains disconnection, 7-18
 at mains failure, 7-18
 Controller inhibit, 7-20
 Controller inhibit/controller release, 7-18
 in case of errors, 8-2

Dry running protection, 7-21

E

E82ZBC keypad, Changing and saving parameters, 5-3

Earth fault, Detection, 7-84

Earth fault detection, 7-84

Earth-leakage circuit breaker, 4-5
 operation with, 4-5

Electrical installation, 4-3
 according to EMC, 4-7
 important notes, 4-3

EMC, 3-2

Emergency off, Controller inhibit, 7-20

EN 61000-3-2, 4-4

Enclosure, 3-2

Error analysis, 8-1

Error elimination, 8-3

Error message, Reset, 8-7

Errors, external fault evaluation, 7-85

F

Fault elimination, 8-1

Fault message, External, 7-85

Fault message reset, , 7-85

Fault messages, 8-4

Field frequency
 maximum, 7-21
 Minimum, 7-21

FIF, 1-1

Fixed frequencies (JOG), additional, 7-43 , 14-49

Fixed setpoint (JOG), 7-43

Flying restart circuit, 2-5

Flying-restart circuit, 7-18

Free space, 3-1

Frequency, Skipping, 7-17

Frequency input
 Automatic adjustment, 7-40 , 14-49
 digital, 7-39

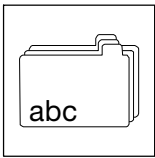

Table of keywords

Frequency precontrol, 7-53
Frequency setpoint reached, Switching window, 14-26
Function keys, keypad, 6-3
Function library, 7-1
Function module, mounting/dismounting, 4-8
Functions, keypad, 6-2

Fuses

operation with increased rated power
230 V, 3-6
400 V/500 V, 3-10
400 V/500V (UL), 3-10
operation with rated power
230 V, 3-5
230 V (UL), 3-5, 3-6
400 V/500 V, 3-8
400 V/500V (UL), 3-8

G

Gain

Analog input 1, 7-34, 14-16
analog inputs, 7-34, 14-38
Analog output 1, 7-61, 14-19
Imax controller, 7-10, 7-56, 14-18

General data, 3-1

Group drive, 13-13

H

Hide time, Process controller, 14-27

History buffer, 8-1

Assembly, 8-1

Humidity class, 3-1

I

I2xt monitoring, 7-82

Imax controller

Gain, 7-10, 7-56, 14-18
Integral action time, 7-10, 7-56, 14-18

Input signals

Analog, Configuration, 7-57
digital, Configuration, 7-68

Inputs

digital, Response times, 7-68
PTC, 7-84

Installation

electrical, 4-3
keypad, 6-2
mechanical, 4-1

Installation according to EMC, 4-7

Installation height, 3-1

Insulation resistance, 3-2

Integral action time, Imax controller, 7-10, 7-56, 14-18

Interaction with compensation equipment, 4-5

Internal digital signals, linking with digital switching output, 7-73

Inverse setpoint, Adjustment, 7-37

J

JOG (fixed frequencies), additional, 7-43, 14-49

JOG (fixed setpoint), 7-43

Jumper, Analog signal selection, 7-34

K

Keypad, 6-2

activation of password protection, 6-7
bar graph display, 6-3
calling a password-protected function, 6-7
change parameter set, 6-5
changing/saving parameters, 6-5
deactivating password protection permanently, 6-8
displays and functions, 6-2
function keys, 6-3
installation, 6-2
menu structure, 6-4
remote parameterisation, 6-6
Setpoint selection, 7-45
status display, 6-3
user menu, 6-6

Keypad E82ZBC, Menu structure, 5-2

Konfiguration, Codetabelle, 14-10

L

Labelling, Controller, 1-2

LECOM code bank. *Siehe* code bank

LECOM format, 6-12

LECOM-A (RS232) communication module, 6-9

baud rate, 6-9
code table, 6-12
communication medium, 6-9
communication monitoring, 6-14
communication time, 6-9
communication times, 6-10
parameter setting, 6-12
reduce response time, 6-14
self-made PC system cables, 6-11
troubleshooting and fault elimination, 6-16
wiring to host, 6-11

LECOM-A (RS232) communication module, technical data, 6-9

LECOM-A (RS232) communication times, baud rate, 6-10

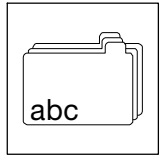

LECOM-B, operating status, 6-13

LED display, 8-1

LED's, 8-1

Legal regulations, 1-2

Level inversion

Digital inputs, 7-72 , 14-37

digital inputs, 14-21

Digital outputs, 14-41

digital outputs, 7-76

Liability, 1-2

Limit value, 7-21

Setting, 7-21

M

Main and additional setpoint, Application I/O, 14-26

Mains conditions, 4-4

Mains disconnection, Drive performance, 7-18

Mains failure, Drive performance, 7-18

Mains switching, cyclic, 5-6 , 5-10

Mains types, 4-4

Mains voltage compensation, 7-5

Maloperation of the drive, 8-3

Manual / remote operation, 7-47

Manufacturer, 1-2

Max. limit process controller output, 14-27

Maximum motor cable length, 4-6

Mechanical design, 4-1

Mechanical installation, 4-1

Menu

"ALL", 6-4

"User", 6-4

structure in the keypad, 6-4

Menu structure, Keypad E82ZBC, 5-2

Min. limit process controller output, 14-27

Minimum frequency limitation, Acceleration time, 7-21 , 14-27

Monitoring functions

external faults, 7-85

Motor temperature, 7-82

motec, Description, 1-1

motor

Phase failure, 14-50

Thermal monitoring

Sensorless, 7-82

With PTC resistor, 7-84

Motor cable length, maximum permissible, 4-6

Motor data detection, 7-48

Motor monitoring, 7-82

Motor parameter identification, , 7-48

Motor potentiometer, 7-41

Motor protection, 4-3

Mounting, function module, 4-8

Mounting positions, 3-1

Multi-motor drive, 13-13

N

Noise emission, 3-2

Noise immunity, 3-2

Noise optimised operation, 7-14

O

Offset

Analog input 1, 7-34 , 14-16

analog inputs, 7-34 , 14-38

Analog output 1, 7-61 , 14-19

analog outputs - application I/O, 7-62 , 14-47

Inverse characteristic process controller, 14-27

Operating behaviour

Optimise, 7-2

Optimising, 7-13

Operating conditions, 3-1

Operating mode, 7-4 , 7-8 , 7-10 , 14-15

for standard applications, 7-2

Select, 7-2

V/f characteristic control, 7-4

Vector control, 7-8

Operating status

Display, 8-1

LECOM-B, 6-13

Operating threshold, auto DCB, 7-27 , 7-30 , 14-16

Operating time, 14-25

Operation, with earth-leakage circuit breaker, 4-5

operation

noise optimised, 7-14

on public systems, 4-4

Operation of mid-frequency motors, 13-9

Oscillation damping, 7-16

Reduction of speed oscillations, 7-16

Output signal - analog outputs, range, 7-62 , 14-48

Output signals

Analog, Configuration, 7-59

digital, Configuration, 7-73

Outputs

Analog, 7-59

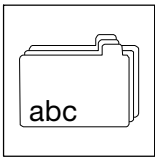
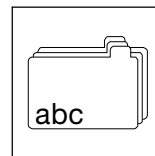

Table of keywords

- digital, 7-73
- Overspeed, 2-5
- P**
- Parameter
 - change/save with LECOM-A (RS232), 6-12
 - Non-volatile saving, 7-92 , 14-12
 - Using the keypad, 7-91 , 7-92 , 14-11
- Parameter set, change using keypad, 6-5
- Parameter set changeover
 - AC motor braking, 7-31
 - Controlled deceleration after mains failure, 7-19
- Parameter set management, 7-91 , 14-11
 - Own settings, 7-92 , 14-12
- Parameter set transfer, 7-91 , 7-92 , 14-11
- Parameter sets
 - changeover, 7-94
 - Management, 7-91
- Parameter setting, 6-1
 - basics, 6-1
 - code, 6-1
 - using the LECOM A (RS232) communication module, 6-9
 - via keypad, 6-2
 - via keypad or PC, 6-1
 - with bus system, 6-1
- Parameters, changing/saving using the keypad, 6-5
- Password
 - delete, 6-8
 - enter, 6-7
- Password protection, 6-7 , 14-18
 - activation, 6-7
 - calling a protected function, 6-7
 - permanent deactivation, 6-8
- PID controller, 7-50
 - Actual value selection, 7-54
 - Setpoint precontrol, 7-53
 - Setpoint selection, 7-53
- PM synchronous motors, 1-2
- Power control, 13-15
- Power-on time, 7-89 , 14-25
- Pressure control, protection against dry running, 13-1
- Process controller, 7-50
 - "Debouncing" of digital output signal PCTRL1-LIM, 14-27
 - "Debouncing" of digital output signal PCTRL1-SET=ACT , 14-27
 - Activation of inverse control, 14-28
 - Actual root function value, 14-28
 - Control characteristics, 7-50
 - Delay PCTRL1-LIM=HIGH, 14-27
 - Delay PCTRL1-SET=ACT, 14-27
 - Difference threshold PCTRL1-SET=ACT, 14-27
 - Hide time, 14-27
 - hiding/unhiding, 14-28
 - Max. limit output, 14-27
 - Min. limit output, 14-27
 - Offset inverse characteristic, 14-27
 - Output inversion, 14-28
 - Unhide time, 14-27
- Process controller setpoint
 - Acceleration time, 14-27
 - Deceleration time, 14-27
- Process data output words, Free configuration, 7-79
- Process variable, Calibration of application I/O, 7-88 , 14-49
- Protection against dry running, 13-1
- Protection of persons, 2-5 , 4-3
 - with earth-leakage circuit breaker, 4-5
- Protective insulation of circuits, 3-2
- Protective measures, 3-2
- PTC motor monitoring, 7-84
- public systems, EN 61000-3-2, 4-4
- Q**
- Quick stop, 7-27
- R**
- Rated data
 - brake resistors, 11-3
 - integrated brake transistor, 11-2
 - rated data 230 V, operation with rated power, 3-5 , 3-6
 - rated data 400/500 V
 - current derating, 3-8 , 3-10
 - operation with increased rated power, 3-9
 - operation with rated power, 3-7
- Reaction times of digital inputs, 7-68
- Reduce response time, LECOM-B (RS485) function module, 6-14
- Relay output, Configuration, 7-73
- Reluctance motors, 1-2
- Remote parameterisation, using keypad, 6-6
- Reset, Error message, 8-7
- Residual hazards, 2-5
- Response in the event of communication errors, 14-21
- Running optimisation, 7-13
- S**
- S-shaped ramps, Smooth acceleration/deceleration, 7-24
- Safety information, 2-1
 - Layout, 2-5
 - Other notes, 2-5



- Warning of damage to material, 2-5
 - Warning of danger to persons, 2-5
 - Saving parameter sets, , 7-91
 - Selection
 - Control mode, 5-4
 - Operating mode, 7-2
 - Sensor compensation
 - Acceleration time, 14-26
 - Deceleration time, 14-26
 - Max. activation threshold, 14-26
 - Min. activation threshold, 14-26
 - Output signal, 7-87 , 14-26
 - Reset, 14-26
 - Setpoint changeover, 7-47
 - Setpoint selection, 7-32 , 14-21
 - Bipolar, 7-36
 - Field, 7-34 , 14-16
 - Inverse, 7-37
 - Normalisation, 14-23
 - PID controller, 7-53
 - Selection, 14-21
 - unipolar, 7-36
 - via bus systems, 7-46
 - via fixed setpoint (JOG), 7-43
 - via motor potentiometer, 7-41
 - with keypad, 7-45
 - Setpoint selection range
 - Application I/O, 7-34 , 14-16
 - Standard I/O, 7-34 , 14-16
 - Setpoint source, Select, 7-32
 - Setpoint source selection, 7-32
 - Setpoint summation, 13-14
 - Setting range, 7-21 , 14-15
 - Signal flow diagram
 - Controller with application I/O, 14-6
 - Controller with standard I/O, 14-2
 - Motor control (MCTRL1), 14-5
 - Motor control (MCTRL1) with Application I/O, 14-9
 - Process controller and setpoint processing (PCTRL1), 14-4
 - Process controller and setpoint processing (PCTRL1) with Application I/O, 14-8
 - Speed setpoint conditioning (NSET1), 14-3 , 14-7
 - Signal flow diagrams, 14-1
 - explanations, 14-1
 - Signal selection, Analog, 7-34
 - Jumper position, 7-34
 - Signal selection , digital, 7-39
 - Skip frequency, 7-17
 - Slip compensation, 7-13
 - Smooth acceleration/deceleration, 7-24
 - Software version, 7-89 , 14-18
 - Special motors, Operation of, 7-16
 - Speed control, 13-10
 - Speed oscillations, 7-16
 - Standard I/O
 - Setpoint selection range, 7-34 , 14-16
 - terminal assignment, 4-9
 - Start options, 7-18
 - Status display, 8-1
 - Status word, 14-24
 - Stopping, 7-24
 - Switching frequency of inverter, 7-14
 - noise optimised, 7-14
 - Switching threshold, brake chopper, 14-25
 - Switching window, Frequency setpoint reached, 14-26
 - System bus, remote parameterisation of node using keypad, 6-6
- ## T
- Table of attributes, 14-51
 - explanations for, 14-51
 - Technical data, 3-1
 - general data/operating conditions, 3-1
 - LECOM-A (RS3232) communication module, 6-9
 - rated data 230 V
 - operation with increased rated power, 3-6
 - operation with rated power, 3-5
 - rated data 400/500 V
 - operation with increased rated power, 3-9
 - operation with rated power, 3-7
 - Temperature ranges, 3-1 , 6-9
 - Terminal assignment
 - application I/O, 4-12
 - bus function modules, 4-16
 - standard I/O, 4-9
 - Terms
 - Controller, 1-1
 - Definitions, 1-1
 - Drive, 1-1
 - motec, 1-1
 - Thermal monitoring, motor
 - Sensorless, 7-82
 - With PTC resistor, 7-84
 - Threshold, Qmin, 14-15
 - Torque control, Sensorless with speed limitation, 7-10
 - Torque limitation, 13-15
 - Torque thresholds
 - Comparison value, 14-28
 - Delay MSET1=MACT, 14-29
 - Delay MSET2=MACT, 14-29
 - Difference threshold for MSET1=MACT, 14-29
 - Difference thresholds MSET2=MACT, 14-29

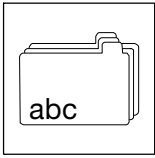

Table of keywords

Threshold 1, 14-29
Threshold 2, 14-29
Torque/speed characteristics, 3-3
Transferring parameter sets, , 7-91
TRIP reset, 7-85 , 8-7
TRIP set, 7-85
Troubleshooting, 8-1
 Drive performance in case of errors, 8-2
 Error analysis with history buffer, 8-1
 Fault messages, 8-4
 LED display, 8-1
 Maloperation of the drive, 8-3
 Resetting error message, 8-7
Troubleshooting and fault elimination, LECOM-A
(RS232)communication module, 6-16
Type, 7-89 , 14-18

U

Unhide time, Process controller, 14-27
Unipolar setpoint, Adjustment, 7-36
Use, as directed, 1-2
User menu, 6-6 , 7-95 , 14-50
 change entries, 6-6

User password, 14-18

V

V/f characteristic, 87 Hz technology, 7-6
V/f characteristic control, 7-4
 commissioning, 5-6
V/f rated frequency, 7-5
Vector control, 7-8
 Commissioning, 5-10
 Optimise, 5-14
Vibration resistance, 3-1
Vmin boost, 7-7

W

Warranty, 1-2
Waste disposal, 1-2 , 2-2
Wiring
 application I/O, 4-12
 bus function modules, 4-16
 LECOM-A (RS232) communication module, 6-11
 standard I/O, 4-9

Table of keywords

