

Inverter



# 8400

E84AVSCxxxxx...

Inverter Drives 8400 StateLine C \_\_\_\_\_

Reference manual

EN



13572910

# Lenze

# Overview of technical documentation for Inverter Drives 8400

---

## Project planning, selection & ordering

- 8400 hardware manual
- Catalogue

## Mounting & wiring

- MA 8400 BaseLine/StateLine/HighLine/TopLine
- MA for the communication module
- MA for the extension module
- MA for the safety module
- MA for the accessories

## Parameter setting

- BA keypad
- SW 8400 BaseLine
- SW 8400 StateLine
- SW 8400 HighLine
- SW 8400 TopLine
- KHB for the communication module

← This documentation

## Drive commissioning

- SW 8400 BaseLine/StateLine/HighLine/TopLine
  - chapter "Commissioning"
  - chapter "Diagnostics & error management"
- Remote maintenance manual

## Networking

- KHB for the communication medium used

### Legend:

- Printed documentation
- Online documentation (PDF/Engineer online help)

### Abbreviations used:

- BA Operating instructions
- KHB Communication manual
- MA Mounting instructions
- SW Software/reference manual

# Contents

---

<b>1</b>	<b>About this documentation</b>	<b>18</b>
1.1	Document history	19
1.2	Conventions used	20
1.3	Terminology used	21
1.4	Definition of the notes used	23
<b>2</b>	<b>Introduction: Parameterising the inverter</b>	<b>24</b>
2.1	Integrated technology applications	26
2.1.1	Purpose of the technology applications	27
2.1.2	Application cases for a technology application	27
2.1.3	Technology application = function block interconnection	28
2.2	Selection of the appropriate commissioning tool	29
2.2.1	Overview: Accessories for commissioning	30
2.3	General notes on parameters	31
2.3.1	Changing the parameterisation with the keypad	32
2.3.2	Change parameter settings with PC and Lenze software	35
2.3.3	Save parameter settings in the memory module safe against mains failure	36
2.3.4	User menu for quick access to frequently used parameters	38
2.4	Device access protection	39
2.4.1	Password protection	40
2.4.2	Individual password protection for single communication channels	42
2.4.3	Device personalisation	44
2.4.4	Unlocking the inverter with a MasterPin	46
2.5	Device identification	47
2.5.1	Automatic acceptance of the device name in the »Engineer«	47
2.5.2	Extended item designation	47

# Contents

---

<b>3</b>	<b>Commissioning</b>	<b>48</b>
3.1	Safety instructions with regard to commissioning	49
3.2	Notes on motor control	50
3.3	Preconditions for commissioning with the »Engineer«	51
3.4	Trouble-shooting during commissioning	52
3.5	Commissioning wizard 8400	52
3.6	Manual motor direction of rotation check (manual control)	54
3.7	Commissioning of the "Actuating drive speed" technology application	55
3.7.1	Prepare inverter for commissioning	56
3.7.2	Creating an »Engineer« project & going online	57
3.7.3	Parameterising the motor control	58
3.7.4	Parameterise application	59
3.7.5	Save parameter settings safe against mains failure	61
3.7.6	Enable inverter and test application	61
3.8	Commissioning of the "Switch-off positioning" technology application	63
3.8.1	Prepare inverter for commissioning	65
3.8.2	Creating an »Engineer« project & going online	66
3.8.3	Parameterising the motor control	67
3.8.4	Parameterise application	68
3.8.5	Save parameter settings safe against mains failure	70
3.8.6	Enable inverter and test application	70
3.9	PC manual control	71
3.9.1	Activate PC manual control	71
3.9.2	Speed control	74

# Contents

---

<b>4</b>	<b>Device control (DCTRL)</b>	<b>76</b>
4.1	Device commands (C00002/x)	78
4.1.1	Load Lenze setting	81
4.1.2	Load all parameter sets	82
4.1.3	Save all parameter sets	83
4.1.4	Enable/inhibit inverter	84
4.1.5	Activate/deactivate quick stop	85
4.1.6	Reset error	86
4.1.7	Delete logbook	86
4.1.8	Device search function	87
4.2	Device state machine and device states	88
4.2.1	FirmwareUpdate	89
4.2.2	Init	90
4.2.3	Ident	91
4.2.4	SafeTorqueOff	92
4.2.5	ReadyToSwitchOn	93
4.2.6	SwitchedOn	94
4.2.7	OperationEnabled	95
4.2.8	TroubleQSP	96
4.2.9	Trouble	97
4.2.10	Fault	98
4.3	Automatic restart after mains connection/fault...	99
4.3.1	"Inhibit at device on" auto-start option	99
4.3.2	Auto-start option "Inhibit at trouble"	101
4.3.3	Auto-start option "Inhibit at fault"	101
4.3.4	Auto-start option "Inhibit at undervoltage"	102
4.3.5	Auto-start option "Inhibit at Lenze setting"	103
4.4	Internal interfaces   "LS_DriveInterface" system block	104
4.4.1	wCANControl/wMCIControl control words	107
4.4.2	wDeviceStatusWord status word	109
4.5	Energy saving mode	110

# Contents

---

<b>5</b>	<b>Motor control (MCTRL)</b>	<b>112</b>
5.1	Motor selection/Motor data	113
5.1.1	Selecting a motor from the motor catalogue in the »Engineer«	117
5.1.2	Automatic motor data identification	119
5.1.3	Application notes for asynchronous motors with high slip speed	125
5.2	Selecting the control mode	126
5.2.1	Selection help	130
5.3	Defining current and speed limits	131
5.4	V/f characteristic control (VFCplus)	134
5.4.1	Parameterisation dialog/signal flow	135
5.4.2	Basic settings	137
5.4.2.1	Define V/f characteristic shape	138
5.4.2.2	Defining current limits (I <sub>max</sub> controller)	139
5.4.3	Optimising the control mode	140
5.4.3.1	Adapting the V/f base frequency	141
5.4.3.2	Adapting the V <sub>min</sub> boost	143
5.4.3.3	Optimising the I <sub>max</sub> controller	144
5.4.3.4	Optimising the stalling behaviour	145
5.4.3.5	Torque limitation	146
5.4.3.6	Defining a user-defined V/f characteristic	148
5.4.4	Remedies for undesired drive behaviour	151
5.5	V/f characteristic control - energy-saving (VFCplusEco)	152
5.5.1	Parameterisation dialog/signal flow	153
5.5.2	Comparison of VFCplusEco - VFCplus	155
5.5.3	Basic settings	156
5.5.4	Optimising the control mode	157
5.5.4.1	Improving the behaviour at high dynamic load changes	158
5.5.4.2	Adapting the slope limitation for lowering the Eco function	159
5.5.4.3	Optimising the cos/phi controller	159
5.5.5	Remedies for undesired drive behaviour	160
5.6	V/f control (VFCplus + encoder)	162
5.6.1	Parameterisation dialog/signal flow	163
5.6.2	Basic settings	165
5.6.2.1	Parameterising the slip regulator	166
5.7	Sensorless vector control (SLVC)	169
5.7.1	Parameterisation dialog/signal flow	170
5.7.2	Types of control	172
5.7.2.1	Speed control with torque limitation	172
5.7.2.2	Torque control with speed limitation	173
5.7.3	Basic settings	174
5.7.4	Optimising the control mode	176
5.7.4.1	Optimising the starting performance after a controller enable	176
5.7.4.2	Optimise speed controller	177
5.7.4.3	Optimising dynamic performance and field weakening behaviour	178
5.7.4.4	Optimising the stalling behaviour	179
5.7.4.5	Optimise response to setpoint changes and determine mass inertia	180
5.7.4.6	Slip calculation from motor equivalent circuit diagram data	183
5.7.4.7	Optimising field feedforward control and torque feedforward control	184
5.7.5	Remedies for undesired drive behaviour	185

# Contents

---

5.8	Sensorless control for synchronous motors (SLPSM)	186
5.8.1	Parameterisation dialog/signal flow	188
5.8.2	Types of control	191
5.8.3	Basic settings	192
5.8.3.1	Reduction of speed overshoot	194
5.8.4	Optimising the control mode	195
5.8.4.1	Optimise current controller	196
5.8.4.2	Optimise speed controller	197
5.8.4.3	Optimise response to setpoint changes and determine mass inertia	200
5.8.4.4	Current-dependent stator leakage inductance $P_{pp}(l)$	203
5.8.4.5	Setting the current setpoint filter (band-stop filter)	205
5.8.4.6	Adapting the max. acceleration change (jerk limitation)	206
5.8.5	Pole position identification without motion	207
5.8.6	Field weakening for synchronous motors	209
5.9	Parameterisable additional functions	212
5.9.1	Selection of switching frequency	212
5.9.2	Operation with increased rated power	216
5.9.3	Flying restart function	218
5.9.4	DC-injection braking	221
5.9.4.1	Manual DC-injection braking (DCB)	222
5.9.4.2	Automatic DC-injection braking (Auto-DCB)	222
5.9.5	Slip compensation	225
5.9.6	Oscillation damping	226
5.9.6.1	Oscillation damping voltage range	227
5.9.6.2	Oscillation damping in the field weakening range	228
5.9.7	Phase sequence reversal for correcting misconnected UVW motor phases	229
5.10	Encoder/feedback system	230
5.10.1	Parameterising digital inputs as encoder inputs	233
5.10.2	Generation of the actual speed value	234
5.10.3	HTL encoder at DI1/DI2	235
5.11	Braking operation/brake energy management	237
5.11.1	Setting the voltage source for braking operation	240
5.11.2	Selecting the response to an increase of the DC-bus voltage	240
5.11.2.1	Inverter motor brake	242
5.11.3	Avoiding thermal overload of the brake resistor	245
5.11.4	Control of multiple internal brake choppers in the DC-bus system	245
5.12	Monitoring	248
5.12.1	Device overload monitoring (I <sub>xt</sub> )	249
5.12.2	Motor overload monitoring (I <sub>2xt</sub> )	250
5.12.3	Motor overcurrent monitoring	252
5.12.4	Motor temperature monitoring (PTC)	253
5.12.5	Brake resistor monitoring (I <sub>2xt</sub> )	254
5.12.6	Motor phase failure monitoring	256
5.12.7	Motor phase error monitoring before operation	257
5.12.8	Mains phase failure monitoring	259
5.12.9	Maximum current monitoring	259
5.12.10	Current monitoring for overload	260
5.12.11	Maximum torque monitoring	261
5.12.12	Motor speed monitoring	261
5.12.13	Encoder open-circuit monitoring	262
5.13	Internal interfaces   System block "LS_MotorInterface"	263
5.14	Internal status signals   System block "LS_DeviceMonitor"	270

# Contents

---

<b>6</b>	<b>I/O terminals</b>	273
6.1	Digital terminals	274
6.1.1	Change function assignment	277
6.1.1.1	Using DI1 and DI2 as digital inputs	278
6.1.1.2	Using DI1 and DI2 as frequency inputs	279
6.1.1.3	Using DI1 as counting input	283
6.1.2	Internal interfaces   System block "LS_DigitalInput"	286
6.1.2.1	Output of the encoder position of the DI1/DI2 frequency input	288
6.1.3	Internal interfaces   System block "LS_DigitalOutput"	292
6.2	Analog terminals	293
6.2.1	Parameterising analog input	295
6.2.1.1	Signal adaptation by means of characteristic	297
6.2.2	Parameterising analog output	299
6.2.3	Internal interfaces   System block "LS_AnalogInput"	300
6.2.4	Internal interfaces   System block "LS_AnalogOutput"	300
6.3	Configuring exception handling of the output terminals	301
6.4	User-defined terminal assignment	302
6.4.1	Source-destination principle	303
6.4.2	Changing the terminal assignment with the keypad	304
6.4.3	Changing the terminal assignment with the »Engineer«	306



# Contents

---

<b>7</b>	<b>Technology applications</b>	<b>309</b>
7.1	Selection of the technology application and the control mode	310
7.2	TA "Actuating drive speed"	311
7.2.1	Basic signal flow	312
7.2.2	Internal interfaces   application block "LA_NCtrl"	314
7.2.3	Terminal assignment of the control modes	322
7.2.3.1	Terminals 0	323
7.2.3.2	Terminals 2	324
7.2.3.3	Terminals 11	325
7.2.3.4	Terminal 16	326
7.2.3.5	Keypad	327
7.2.3.6	PC	328
7.2.3.7	CAN	329
7.2.3.8	MCI	330
7.2.4	Process data assignment for fieldbus communication	331
7.2.5	Setting parameters (short overview)	333
7.2.6	Configuration parameters	335
7.3	TA "actuating drive speed (AC Drive Profile)"	338
7.3.1	I/O assemblies	339
7.3.2	Basic signal flow	340
7.3.3	Internal interfaces   application block "LA_NCtrl"	343
7.3.4	Terminal assignment of the control modes	352
7.3.4.1	Terminals 0	353
7.3.4.2	Terminals 2	354
7.3.4.3	Terminals 11	355
7.3.4.4	Terminal 16	356
7.3.4.5	Keypad	357
7.3.4.6	PC	358
7.3.4.7	CAN	359
7.3.4.8	MCI	360
7.3.5	Process data assignment for fieldbus communication	361
7.3.5.1	Run/Stop event	362
7.3.5.2	Scaling of speed and torque values	363
7.3.6	AC Drive Profile diagnostic parameters	364
7.3.7	Setting parameters (short overview)	364
7.3.8	Configuration parameters	366
7.4	TA "Switch-off positioning"	371
7.4.1	Basic signal flow	373
7.4.2	Internal interfaces   application block "LA_SwitchPos"	374
7.4.2.1	Truth table for activating the pre-switch off	381
7.4.3	Terminal assignment of the control modes	382
7.4.3.1	Terminals 0	383
7.4.3.2	Terminals 2	384
7.4.3.3	Terminals 11	385
7.4.3.4	Terminal 16	386
7.4.3.5	Keypad	387
7.4.3.6	PC	388
7.4.3.7	CAN	389
7.4.3.8	MCI	390
7.4.4	Process data assignment for fieldbus communication	391
7.4.5	Setting parameters (short overview)	393
7.4.6	Configuration parameters	395

# Contents

---

7.5	"GeneralPurpose" functions	398
7.5.1	Analog switch	398
7.5.2	Arithmetic	399
7.5.3	Multiplication/Division	399
7.5.4	Binary delay element	400
7.5.5	Binary logic	400
7.5.6	Analog comparison	401
7.5.7	Binary signal monitor	401
7.5.8	Analog signal monitor	402
7.5.9	D-FlipFlop	402
<b>8</b>	<b>Basic drive functions (MCK)</b>	<b>403</b>
8.1	Basic signal flow	404
8.2	Internal interfaces   System block "LS_MotionControlKernel"	405
8.2.1	MCK status word	410
8.2.2	MCK state machine	411
8.2.2.1	"StandBy" operating mode	411
8.2.2.2	Status bit "bReadyToOperate"	412
8.2.3	Interface to safety system	413
8.3	Speed follower	414
8.3.1	Parameter setting	414
8.3.2	Setpoint selection	415
8.4	Holding brake control	416
8.4.1	Internal interfaces	417
8.4.2	Parameter setting	419
8.4.2.1	Operating mode	420
8.4.2.2	Functional settings	422
8.4.2.3	Switching thresholds	423
8.4.2.4	Application and release time	424
8.4.2.5	Ramp time for approaching the setpoint speed	426
8.4.2.6	Motor magnetising time (only with asynchronous motor)	427
8.4.2.7	Actual value monitoring	427
8.4.3	Process when brake is released	428
8.4.4	Process when brake is closed	429
8.4.5	Behaviour in case of pulse inhibit	431
8.4.6	Feedforward control of the motor before release	432

# Contents

---

<b>9</b>	<b>Diagnostics &amp; error management</b>	434
9.1	Basics on error handling in the inverter	434
9.2	LED status displays	435
9.2.1	LED status displays of the device status	436
9.3	Drive diagnostics with the »Engineer«	437
9.3.1	Display details of the error	439
9.4	Drive diagnostics via keypad/bus system	440
9.5	Logbook	443
9.5.1	Functional description	443
9.5.2	Filtering logbook entries	444
9.5.3	Automatic recording of device-internal signals at the time the error occurs	444
9.5.4	Reading out logbook entries	446
9.5.5	Exporting logbook entries to a file	447
9.5.6	Storing the logbook in the project	448
9.5.7	Reading out the logbook from an external control/visualisation	449
9.6	Monitoring	451
9.6.1	Monitoring configuration	452
9.6.2	Setting the error response	453
9.6.3	AutoFailReset function	454
9.7	Maloperation of the drive	455
9.8	Operation without mains supply	458
9.9	Error messages of the operating system	459
9.9.1	Structure of the 32-bit error number (bit coding)	459
9.9.2	Structure of the 16 bit error number (bit coding)	462
9.9.3	Reset error message	463
9.9.4	Export error texts	464
9.9.5	Short overview (A-Z)	465
9.9.6	Cause & possible remedies	468
9.10	"LS_SetError_1" system block	487
<b>10</b>	<b>Oscilloscope function</b>	488
10.1	Technical data	489
10.2	Operation	490
10.2.1	User interface	491
10.2.2	Selecting the signal sources to be recorded	493
10.2.3	Selecting the recording time/sample rate	494
10.2.4	Defining the trigger condition	495
10.2.5	Starting recording	497
10.2.6	Cyclic recording	497
10.2.7	Adjusting the representation	497
10.2.8	Cursor function: Reading individual measured values	499
10.2.9	Automatic recording directly after mains connection	501
10.2.10	Last settings	502
10.3	Managing oscillograms	503
10.3.1	Commenting the oscillogram	503
10.3.2	Saving the oscillogram in a file	504
10.3.3	Loading the oscillogram file	505
10.3.4	Overlay function	506
10.3.5	Deleting an oscillogram file saved in the project	507

# Contents

---

<b>11</b>	<b>System bus "CAN on board"</b>	<b>508</b>
11.1	General information	509
11.1.1	General data and application conditions	509
11.1.2	Supported protocols	510
11.1.3	Communication time	511
11.2	Possible settings via DIP switch	512
11.2.1	Activating the bus terminating resistor	512
11.2.2	Setting the baud rate	513
11.2.3	Setting the node address	513
11.3	LED status displays for the system bus	514
11.4	Going online via the system bus	515
11.5	Reinitialising the CANopen interface	515
11.6	Structure of the CAN data telegram	516
11.6.1	Identifier	516
11.6.2	User data	518
11.7	Communication phases/network management	519
11.7.1	Status transitions	520
11.7.2	Network management telegram (NMT)	521
11.7.3	Parameterising the inverter as CAN master	522
11.8	Process data transfer	523
11.8.1	Available process data objects	524
11.8.1.1	RPDO1   Port block "LP_CanIn1"	525
11.8.1.2	RPDO2   "LP_CanIn2" port block	527
11.8.1.3	RPDO3   "LP_CanIn3" port block	529
11.8.1.4	RPDO4   "LP_CanIn4" port block	531
11.8.1.5	TPDO1   "LP_CanOut1" port block	533
11.8.1.6	TPDO2   "LP_CanOut2" port block	534
11.8.1.7	TPDO3   "LP_CanOut3" port block	535
11.8.1.8	TPDO4   "LP_CanOut4" port block	536
11.8.2	Identifiers of the process data objects	537
11.8.3	Transmission type	539
11.8.4	Synchronisation of PDOs via sync telegram	541
11.8.5	Monitoring of the RPDOs for data reception	542
11.8.6	Configuring exception handling of the CAN PDOs	542
11.9	Parameter data transfer	544
11.9.1	Identifiers of the parameter data objects	545
11.9.2	User data	545
11.9.2.1	Command	546
11.9.2.2	Addressing by means of index and subindex	547
11.9.2.3	Data 1 ... Data 4	548
11.9.2.4	Error messages	549
11.9.3	Parameter data telegram examples	551
11.9.3.1	Read parameters	551
11.9.3.2	Write parameters	552
11.9.3.3	Read block parameters	553
11.10	Monitoring	556
11.10.1	Integrated error detection	556
11.10.2	Heartbeat protocol	557
11.10.2.1	Telegram structure	557
11.10.2.2	Parameter setting	558
11.10.2.3	Commissioning example	559
11.10.3	Emergency telegram	560
11.11	CANopen objects implemented	561
11.12	Internal interfaces   System block "LS_CANManagement"	587

# Contents

---

<b>12</b>	<b>Fieldbus interface (MCI)</b>	588
12.1	Process data transfer	589
12.2	Control mode "MCI"	591
12.2.1	Port block "LP_MciIn"	592
12.2.2	Port block "LP_MciOut"	593
12.3	CAN gateway	594
<b>13</b>	<b>Synchronisation of the internal time base</b>	595
13.1	Internal interfaces   System block "LS_SyncManagement"	596
<b>14</b>	<b>Parameter change-over</b>	597
14.1	Configuring parameter change-over via the »Engineer« parameterisation dialog	598
14.1.1	Configuring the parameter list(s)	599
14.1.2	Configuring control inputs	602
14.1.3	Functional settings	603
14.1.4	Error message	603
14.2	Configuring the definable parameter list by means of parameterisation	604
14.3	Configuring the motor data parameter list by means of parameterisation	605
14.4	Internal interfaces   System block "LS_WriteParamList"	608
<b>15</b>	<b>Parameter reference</b>	611
15.1	Structure of the parameter descriptions	612
15.1.1	Data type	613
15.1.2	Parameters with read-only access	613
15.1.3	Parameters with write access	614
15.1.3.1	Parameters with setting range	614
15.1.3.2	Parameters with selection list	614
15.1.3.3	Parameters with bit-coded setting	615
15.1.3.4	Parameters with subcodes	616
15.1.4	Parameter attributes	616
15.2	Parameter list	618
15.3	Overview of all parameters with power-related Lenze setting	858
15.4	Selection list - analog signals	860
15.5	Selection list - digital signals	863
15.6	Selection list - angle signals	868
15.7	Table of attributes	869

# Contents

---

<b>16</b>	<b>Working with the FB Editor</b>	<b>882</b>
16.1	Basics	882
16.1.1	Basic components of a drive solution	883
16.1.1.1	What is a function block?	884
16.1.1.2	Parameterisable function blocks	885
16.1.1.3	What is a system block?	885
16.1.1.4	What is a port block?	886
16.1.1.5	What is an application block?	886
16.1.2	Conventions used for input/output identifiers	887
16.1.3	Scaling of physical units	888
16.2	User interface	889
16.2.1	Toolbar	890
16.2.2	Search function	891
16.2.3	Plane selection	892
16.2.4	Editor view/overview	894
16.2.5	Context menu	895
16.2.6	Status bar	895
16.2.7	Overview	896
16.3	Using the FB Editor as "Viewer"	898
16.3.1	Following connections of inputs and outputs	899
16.3.2	Keyboard commands for navigation	900
16.3.3	Change online display format	901
16.4	Reconfiguring the predefined interconnection	903
16.4.1	Inserting/Deleting objects	903
16.4.1.1	Inserting a function block	904
16.4.1.2	Inserting a system block	906
16.4.1.3	Insert port block	908
16.4.1.4	Inserting a comment	910
16.4.1.5	Deleting objects that are no longer required	912
16.4.2	Changing connector visibilities	913
16.4.3	Arranging objects in the drawing area	914
16.4.4	Creating/deleting connections	915
16.4.4.1	Creating a connection using the connection line	917
16.4.4.2	Creating a connection using port identifiers	918
16.4.4.3	Creating a connection via connection dialog	919
16.4.4.4	Deleting connections that are no longer required	920
16.4.5	Changing the processing order	921
16.4.6	Copying interconnection elements (across all devices)	923
16.4.6.1	Insert options for copied elements	925
16.4.7	Resetting changed interconnection	926
16.5	Adjusting online and offline interconnection	927
16.6	Printing the interconnection	928
16.7	Comparing interconnections	929
16.8	Copying an interconnection	932
16.9	Exporting/Importing an interconnection	933

# Contents

---

<b>17</b>	<b>Function library</b>	934
17.1	Function blocks	934
17.1.1	L_Absolut_1	936
17.1.2	L_AddSub_1	937
17.1.3	L_AnalogSwitch_1	938
17.1.4	L_AnalogSwitch_2	939
17.1.5	L_AnalogSwitch_3	940
17.1.6	L_And_1	941
17.1.7	L_And_2	942
17.1.8	L_And_3	943
17.1.9	L_Arithmetik_1	944
17.1.10	L_Arithmetik_2	945
17.1.11	L_Compare_1	946
17.1.11.1	Function 1: $n1n1 = n1n2$	947
17.1.11.2	Function 2: $n1n1 > n1n2$	948
17.1.11.3	Function 3: $n1n1 < n1n2$	949
17.1.11.4	Function 4: $ n1n1  =  n1n2 $	950
17.1.11.5	Function 5: $ n1n1  >  n1n2 $	950
17.1.11.6	Function 6: $ n1n1  <  n1n2 $	950
17.1.12	L_Compare_2	951
17.1.13	L_Compare_3	952
17.1.14	L_DFlipFlop_1	953
17.1.15	L_DigitalDelay_1	955
17.1.16	L_DigitalLogic_1	957
17.1.17	L_DigitalLogic_3	959
17.1.18	L_GainOffset_1	961
17.1.19	L_GainOffset_2	962
17.1.20	L_GainOffset_3	963
17.1.21	L_Interpolator_1	964
17.1.21.1	Signal interpolation	965
17.1.21.2	Signal monitoring	966
17.1.22	L_JogCtrlExtension_1	967
17.1.23	L_MPot_1	969
17.1.23.1	Activate & control motor potentiometer	971
17.1.23.2	Deactivate motor potentiometer	972
17.1.24	L_MulDiv_1	973
17.1.25	L_Negation_1	974
17.1.26	L_Not_1	975
17.1.27	L_Not_2	975
17.1.28	L_Not_3	976
17.1.29	L_NSet_1	977
17.1.29.1	Main setpoint path	981
17.1.29.2	JOG setpoints	981
17.1.29.3	Setpoint inversion	982
17.1.29.4	Value range of the input signal	982
17.1.29.5	Skip frequency function	982
17.1.29.6	Ramp function generator for the main setpoint	984
17.1.29.7	S-ramp	986
17.1.29.8	Additional setpoint	987
17.1.29.9	Application example for the additional load function	987
17.1.30	L_OffsetGain_1	988
17.1.31	L_OffsetGain_2	989
17.1.32	L_OffsetGainP_1	990
17.1.33	L_OffsetGainP_2	991
17.1.34	L_OffsetGainP_3	992

# Contents

---

17.1.35	L_Or_1	993
17.1.36	L_Or_2	994
17.1.37	L_Or_3	995
17.1.38	L_Or_4	996
17.1.39	L_PCTRL_1	997
17.1.39.1	Control characteristic	1001
17.1.39.2	Ramp function generator	1002
17.1.39.3	Operating range of the PID process controller	1002
17.1.39.4	Evaluation of the output signal	1003
17.1.39.5	Comparison function "Actual value = setpoint"	1003
17.1.39.6	Control functions	1004
17.1.40	L_PT1_1	1005
17.1.41	L_RLO_1	1006
17.1.42	L_SignalMonitor_a	1007
17.1.43	L_SignalMonitor_b	1008
17.1.44	L_Transient_1	1009
17.1.44.1	Function 0: Evaluate rising signal edges	1010
17.1.44.2	Function 1: Evaluate falling signal edges	1010
17.1.44.3	Function 2: Evaluate rising and falling signal edges	1011
17.1.45	L_Transient_2	1012
17.1.46	L_Transient_3	1013
17.1.47	L_Transient_4	1014
17.2	System blocks	1015
17.2.1	LS_AnalogInput	1017
17.2.2	LS_CANManagement	1017
17.2.3	LS_DataAccess	1017
17.2.4	LS_DeviceMonitor	1017
17.2.5	LS_DigitalInput	1017
17.2.6	LS_DigitalOutput	1017
17.2.7	LS_DisFree	1018
17.2.8	LS_DisFree_a	1019
17.2.8.1	Display of internal process factors in application units	1020
17.2.9	LS_DisFree_b	1021
17.2.10	LS_DriveInterface	1021
17.2.11	LS_Keypad	1022
17.2.12	LS_MotionControlKernel	1023
17.2.13	LS_MotorInterface	1023
17.2.14	LS_ParFix	1024
17.2.15	LS_ParFree	1025
17.2.16	LS_ParFree_a	1026
17.2.17	LS_ParFree_b	1027
17.2.18	LS_ParFree_p	1028
17.2.19	LS_ParFree_v	1029
17.2.20	LS_ParReadWrite_1-3	1030
17.2.20.1	Arithmetic function	1033
17.2.21	LS_PulseGenerator	1034
17.2.22	LS_SetError_1	1035
17.2.23	LS_SyncManagement	1035
17.2.24	LS_WriteParamList	1035
17.3	Application blocks	1036
17.3.1	Technology application "Actuating drive speed"	1036
17.3.2	Technology application "actuating drive speed (AC Drive profile)"	1036
17.3.3	"Switch-off positioning" technology application	1036



# Contents

---

17.4	Port blocks	1037
17.4.1	Port block "LP_CanIn1"	1037
17.4.2	Port block "LP_CanIn2"	1037
17.4.3	Port block "LP_CanIn3"	1037
17.4.4	Port block "LP_CanIn4"	1037
17.4.5	Port block "LP_CanOut1"	1037
17.4.6	Port block "LP_CanOut2"	1038
17.4.7	Port block "LP_CanOut3"	1038
17.4.8	Port block "LP_CanOut4"	1038
	<b>Index</b>	1039
	Your opinion is important to us	1058

## 1 About this documentation



### Danger!

The inverter is a source of danger which may lead to death or the severe injury of persons.

To protect yourself and others against these dangers, observe the safety instructions before switching on the inverter.

Please read the safety instructions provided in the **8400 mounting instructions** and in the **8400 hardware manual**. Both documents are supplied with the inverter.

### Target group

This documentation is intended for all persons who would like to parameterise, configure and diagnose the 8400 StateLine inverter with the Lenze engineering software »Engineer« and the X400 keypad.

### Information regarding the validity

The information in this documentation are valid for the following standard devices:

Product range	Type designation	From software version
8400 StateLine C	E84AVSCxxxxx	01.00

### Screenshots/application examples

All screenshots provided in this documentation are application examples. Depending on the software version of the inverter and the version of the »Engineer« software installed, the screenshots in this documentation may differ from the representation in the »Engineer«.



### Tip!

Information and tools regarding the Lenze products can be found on the Internet:

<http://www.lenze.com> → Download

# 1 About this documentation

## 1.1 Document history

---

### 1.1 Document history



Version			Description
16.1	10/2019	TD06	Corrected term <a href="#">C00142</a>
16.0	09/2019	TD06	Error corrections & supplements for 8400 StateLine C (FW21.00.00)
15.1	02/2018	TD23	Error corrections & supplements
15.0	01/2018	TD23	Extended by new functions for 8400 StateLine C V18.00.00, error corrections
14.0	06/2017	TD23	Extended by new functions for 8400 StateLine C V17.00.00, error corrections and supplements
13.0	02/2016	TD06	Extended by new functions for 8400 StateLine C V16.00.00
12.0	06/2014	TD05	Extended by new functions for 8400 StateLine C V15.00.00
11.0	11/2013	TD05	Extended by new functions for 8400 StateLine C V14.00.00
10.0	11/2012	TD05	Extended by new functions for 8400 StateLine C V13.00.00 and converted to new layout.
9.1	09/2012	TD05	Error corrections & supplements
9.0	08/2012	TD05	Extended by new functions for 8400 StateLine C V12.00.00
8.0	10/2011	TD05	Extended by new functions for 8400 StateLine C V11.00.00
7.1	02/2011	TD05	Error corrections & supplements
7.0	11/2010	TD05	Extended by new functions for 8400 StateLine C V06.00.00 and V10.00.00

# 1 About this documentation

## 1.2 Conventions used

### 1.2 Conventions used

This documentation uses the following conventions to distinguish between different types of information:

Type of information	Highlighting	Examples/notes
Numeric notation		
Decimal separator	Point	The decimal point is always used. Example: 1234.56
Hexadecimal number	0x	For hexadecimal numbers, the "0x" prefix is used. Example: 0x60F4
Binary number	0b	For binary numbers, the "0b" prefix is used. Example: 0b00010111
Text		
Version information	Blue text colour	All information that only applies to or from a certain software version of the inverter is marked accordingly in this documentation. Example: <a href="#">This function extension is available from software version V3.0!</a>
Program name	» «	The Lenze »Engineer« PC software...
Window	<i>italics</i>	The <i>Message window...</i> / The dialog box <i>Options...</i>
Variable names		By setting <i>bEnable</i> to TRUE...
Control element	<b>Bold</b>	The <b>OK</b> button... / The <b>Copy</b> command... / The Properties tab... / The <b>Name</b> input field...
Sequence of menu commands		If several commands must be used in sequence to carry out a function, the individual commands are separated by an arrow: Select <b>File</b> → <b>Open</b> to...
Shortcut	< <b>bold</b> >	Press < <b>F1</b> > to open the online help. If a command requires a combination of keys, a "+" is placed between the key symbols: Use < <b>Shift</b> >+< <b>ESC</b> > to...
Hyperlink	<u>Underlined</u>	Optically highlighted reference to another topic. It is activated with a mouse-click in this online documentation.
Symbols		
Page reference	 20	Optically highlighted reference to another page. It is activated with a mouse-click in this online documentation.
Step-by-step instructions		Step-by-step instructions are indicated by a pictograph.

---







All information that only applies to or from a certain software version of the inverter is marked accordingly in this documentation.



---

# 1 About this documentation

## 1.3 Terminology used

### 1.3 Terminology used

Term	Meaning
Engineering tools	<p>Software solutions for easy engineering in all project stages</p> <div style="display: flex; border-bottom: 1px solid black;"> <div style="flex: 1; text-align: center; border-right: 1px solid black;">  </div> <div style="flex: 2;"> <p>»EASY Navigator« – ensures easy operator guidance</p> <ul style="list-style-type: none"> <li>• All convenient Lenze engineering tools at a glance</li> <li>• Tools can be quickly selected</li> <li>• The clear structure simplifies the engineering process from the start</li> </ul> </div> </div> <div style="display: flex; border-bottom: 1px solid black;"> <div style="flex: 1; text-align: center; border-right: 1px solid black;">  </div> <div style="flex: 2;"> <p>»EASY Starter« – easy-to-use tool for service technicians</p> <ul style="list-style-type: none"> <li>• Specifically designed for commissioning and maintaining Lenze devices</li> <li>• Graphic user interface with very few icons</li> <li>• Easy to run online diagnostics, set parameters and perform commissioning</li> <li>• No risk of accidentally changing an application</li> <li>• Loading off-the-shelf applications onto the device</li> </ul> </div> </div> <div style="display: flex;"> <div style="flex: 1; text-align: center; border-right: 1px solid black;">  </div> <div style="flex: 2;"> <p>»Engineer« – multi-device engineering</p> <ul style="list-style-type: none"> <li>• For all products in our L-force portfolio</li> <li>• Practical user interface</li> <li>• Graphic interfaces make it easy to navigate</li> <li>• Can be applied in every phase of a project (project planning, commissioning, production)</li> <li>• Parameter setting and configuration</li> </ul> </div> </div>
Application block	<p>Block for a technology application (e.g. actuating drive speed)</p> <p>A technology application is a drive solution based on the experience and know-how of Lenze in which function blocks interconnected to a signal flow form the basis for implementing typical drive tasks.</p>
ASM	Abbreviation for asynchronous motor
Service brake	The service brake serves to shutdown rotary or translatory masses in motion in a controlled manner. The energy to be dissipated in this process is produced in the form of friction energy. Unlike emergency braking, this process is a regular and recurring operating mode.
CAN	Abbreviation for Controller Area Network. CAN is an asynchronous, serial fieldbus system.
	<p>CANopen® is a CAN-based communication protocol. The Lenze system bus (CAN on board) works with a subset of this communication protocol.</p> <p>CANopen® is a registered community trade mark of the CiA® (CAN in Automation e. V.) CAN user organisation.</p> <p>▶ <a href="#">System bus "CAN on board"</a></p>
Code	Parameter used for inverter parameterisation or monitoring. Is usually referred to as "index".
Display code	Parameter that displays the current status or value of an input/output of a system block.
	<p>EtherCAT® is a real-time capable Ethernet system with top performance.</p> <p>EtherCAT® is a registered trademark and patented technology, licensed by Beckhoff Automation GmbH, Germany.</p>
	<p>Ethernet POWERLINK is a real-time capable fieldbus system based on Ethernet. For user data exchange, Ethernet POWERLINK specifies a communication protocol based on CANopen.</p> <p>Ethernet POWERLINK is a patented technology licensed by the Ethernet POWERLINK Standardization Group (EPSP), Germany.</p>
	<p>EtherNet/IP™ (EtherNet Industrial Protocol) is an Ethernet-based fieldbus system that uses Common Industrial Protocol™ (CIP™) to exchange data.</p> <p>EtherNet/IP™ and Common Industrial Protocol™ (CIP™) are brand labels and patented technologies, licensed by the ODVA (Open DeviceNet Vendor Association) user organisation, USA.</p>
FB Editor	<p>Abbreviation for "function block editor". Graphic interconnection tool which is available in the »Engineer« for function block interconnections on the <b>FB Editor</b>.</p> <p>▶ <a href="#">Working with the FB Editor</a></p>

Term	Meaning
Function block	General designation of a function block for free interconnection in the FB Editor. A function block (short: FB) can be compared with an integrated circuit that contains a specific control logic and delivers one or several values when being executed. Example: "L_Arithmetik_1" (FB for arithmetic operations) Many function blocks are available several times (e.g. L_And_1, L_And_2, and L_And_3). ▶ <a href="#">Function blocks</a>
Holding brake	The holding brake serves to statically hold e.g. a position during the downtimes of a robot/travelling/synchronous/hoist drive.
	INTERBUS was developed as sensor/actuator/bus system for transmitting process data. Today, maintenance activities for the INTERBUS technologies are carried out by the user organisation PROFIBUS & PROFINET International (PI).
Keypad	The keypad is an alternative to the PC for the local operation, parameterisation, and diagnostics in a simple manner.
LA	Abbreviation for Lenze Application block Example: "LA_NCtrl" (block for the "Actuating drive speed" application)
Lenze setting	This setting is the default factory setting of the device.
LP	Abbreviation for Lenze Port block Example: "LP_CanIn1" (CAN1 port block)
LS	Abbreviation for Lenze System block Example: "LS_DigitalInput" (system block for digital input signals)
MCI	Abbreviation for <b>M</b> otionbus <b>C</b> ommunication <b>I</b> nterface (fieldbus interface) The Inverter Drives 8400 can accommodate plug-in communication modules and can therefore take part in the data transfer of an existing fieldbus system. ▶ <a href="#">Fieldbus interface (MCI)</a>
Emergency brake	The emergency brake serves to shutdown rotary or translatory masses in motion in emergency situations. Emergency situations are exceptional situations that only occur sporadically.
Port block	Block for implementing the process data transfer via a fieldbus
	PROFIBUS® (Process Field Bus) is fieldbus system used worldwide for automating machines and production plants. PROFIBUS® is a registered trademark and patented technology licensed by the PROFIBUS & PROFINET International (PI) user organisation.
	PROFINET® (Process Field Network) is a real-time capable fieldbus system based on Ethernet. PROFINET® is a registered trademark and patented technology licensed by the PROFIBUS & PROFINET International (PI) user organisation.
PSM	Abbreviation for permanently excited synchronous motor
QSP	Abbreviation for quick stop
SC	Abbreviation for Servo Control
SLPSM	Abbreviation for sensorless control of synchronous motors
SLVC	Abbreviation for SensorLess Vector Control
Subcode	If a code contains several parameters, they are stored in "subcodes". This manual uses a slash "/" as a separator between code and subcode (e.g. "C00118/3"). This term is also referred to as "subindex" in common parlance.
System block	In the function block editor of the »Engineer«, system blocks provide interfaces to basic functions, "free codes", and to the hardware of the inverter (e.g. to the digital inputs). Each system block is available only once. ▶ <a href="#">System blocks</a>
USB diagnostic adapter	The USB diagnostic adapter is used for the operation, parameterisation, and diagnostics of the inverter. Data are exchanged between the PC (USB connection) and the inverter (diagnostic interface on the front) via the diagnostic adapter. Order designation: E94AZCUS
VFCplus	Abbreviation for Voltage Frequency Control

# 1 About this documentation

## 1.4 Definition of the notes used

### 1.4 Definition of the notes used

The following signal words and symbols are used in this documentation to indicate dangers and important information:

#### Safety instructions

Structure of the safety instructions:



#### Pictograph and signal word!

(characterise the type and severity of danger)

#### Note

(describes the danger and gives information about how to prevent dangerous situations)

Pictograph	Signal word	Meaning
	Danger!	<b>Danger of personal injury through dangerous electrical voltage</b> Reference to an imminent danger that may result in death or serious personal injury if the corresponding measures are not taken.
	Danger!	<b>Danger of personal injury through a general source of danger</b> Reference to an imminent danger that may result in death or serious personal injury if the corresponding measures are not taken.
	Stop!	<b>Danger of damage to material assets</b> Reference to a possible danger that may result in property damage if the corresponding measures are not taken.

#### Application notes

Pictograph	Signal word	Meaning
	Note!	Important note to ensure trouble-free operation
	Tip!	Useful tip for easy handling

### 2 Introduction: Parameterising the inverter

Being a component of a machine which includes a speed-variable drive system, the inverter needs to be adjusted to its drive task. The inverter is adjusted by changing parameters which are saved in the memory module. The parameters can be accessed by keypad, by the »EASY Starter« or by the »Engineer«. Access is also possible by a master control via fieldbus communication. For this purpose, the "CAN on board" CAN interface and the MCI interface for using a communication module (e.g. PROFIBUS) are available.



#### **Danger!**

In general, changing a parameter causes an immediate response in the inverter!

An enabled inverter can cause an unwanted behaviour at the motor shaft! For instance, setpoint sources can change over abruptly (e.g. when the signal source is configured for the main setpoint).

Certain device commands or settings which may cause critical states of drive behaviour constitute exceptions. Such parameter changes are only possible if the inverter is inhibited. Otherwise, a corresponding error message will be issued.



## 2 Introduction: Parameterising the inverter

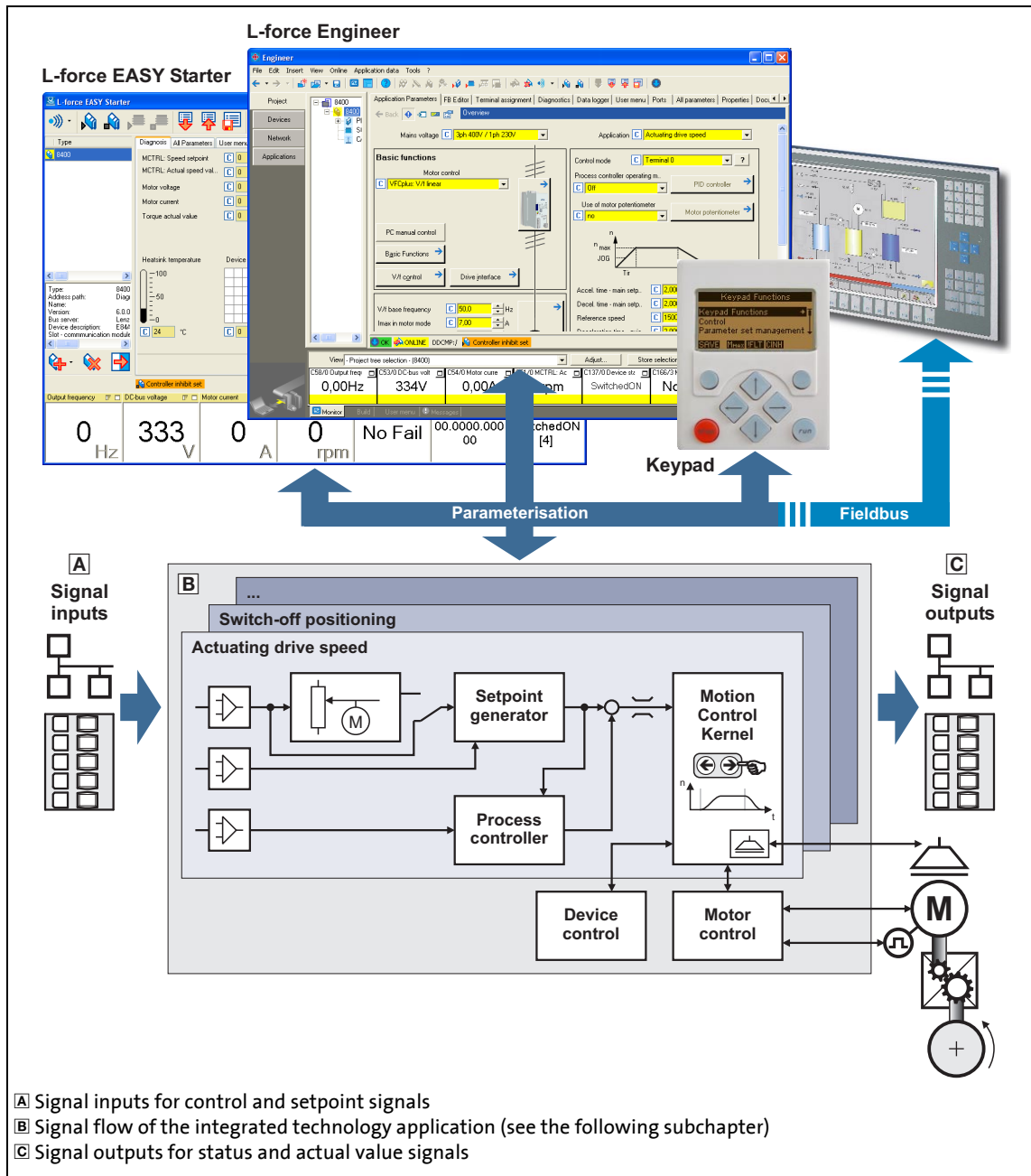

[2-1] Adaptation of the drive solution via parameter setting

## 2 Introduction: Parameterising the inverter

### 2.1 Integrated technology applications

---

#### 2.1 Integrated technology applications

The following technology applications integrated in the inverter 8400 StateLine provide the main signal flow for the implementation of a general or a special drive solution:



##### Technology application "Actuating drive speed"

This preset technology application serves to solve speed-controlled drive tasks, e.g. conveyor drives (interconnected), extruders, test benches, vibrators, travelling drives, presses, machining systems, metering units.



##### Technology application "actuating drive speed (AC Drive profile)"

This technology application available [from version 13.00.00](#) provides a speed and torque control by means of "AC Drive Profile". The fieldbuses EtherNet/IP™ and system bus (CANopen) are supported.



##### "Switch-off positioning" technology application

This technology application available [from version 04.00.00](#) is used to solve speed-controlled drive tasks which require a pre-switch off or stopping at certain positions, e.g. roller conveyors and conveying belts. The pre-switch off is implemented by connecting switch-off sensors.



#### Note!

Please note that the "StateLine", "HighLine" and "TopLine" device types differ with regard to the number, functional range, and flexibility of the technology applications offered.



Detailed information on each technology application can be found in the main chapter entitled "[Technology applications](#)". ([□ 309](#))

---

### 2.1.1 Purpose of the technology applications

The stepped Inverter Drives 8400 series provides solutions for simple to complex applications – depending on the user's experience and knowledge about the handling of drives and drive tasks.

On the one hand, a great scope of standard drive tasks for frequency inverters is covered by the technology applications offered by Lenze, and on the other hand, the user is relieved from time-consuming programming activities. In practice, some drive tasks are alike so that minor modifications of the corresponding technology applications lead to quick results.

Other important features of technology applications are:

- Direct implementation of drive tasks without recreating a function block interconnection inside the device
- Operation via keypad and/or operation via convenient operator dialogs in the «Engineer».
- Commissioning via few operating and diagnosing parameters (local keypad operation).
- Achieving a transparency as high as possible via the integrated functionality of the device by representing signal flow diagrams.
- Provision of a basic functionality suitable and often sufficient for many applications.

### 2.1.2 Application cases for a technology application

You should use a technology application if

- the task can be solved completely or to a great extent by the basic functionality of the technology application.
- the end customer does not want to create the comprehensive core functions of the corresponding technology on his own.
- the creation time for a project is to be reduced by using the ready-made technology application
- the end customer wants to build upon the know-how of Lenze.



#### Tip!

If the end customer of the machine does not want to use ready-made Lenze functions, it is also possible to implement individual drive solutions with the "StateLine C", "HighLine C" and "TopLine C" versions in the form of "free interconnections". (In case of "StateLine C", free interconnection is only possible from version 12.00.00 and »Engineer« V2.17.)

Here, a technology application can be used as starting basis, which has to be adapted to the requirement by a change or extension via function block editor (see the following chapter).

#### 2.1.3 Technology application = function block interconnection

In case of the 8400 device version, each technology application is connected to a "function block interconnection" ("FB interconnection"). This FB interconnections serve to implement signal interconnections. Various FBs are available for digital signal processing, signal conversion and logic modules.

For special drive tasks it has proved of value to use the integrated technology applications as a basis for modifications or extensions of the available FB interconnections.

##### I/O level & application level

The interconnection of the interfaces is shown in the I/O level of the function block editor according to the selected control mode. In the "deeper" application level, the main signal flow is realised in the form of an interconnection of various function and system blocks.

For the device versions "StateLine C", "HighLine C" and "TopLine C" the following applies:

- The preconfigured signal links can be reconfigured in the I/O level if required.
- Moreover, the applications integrated in the inverter can be reconfigured and extended by individual functions.
- Moreover, experienced users are offered the opportunity to implement their own drive solutions independent of the predefined technology applications by using so-called "free interconnections". (In case of "StateLine C", free interconnection is only possible from version 12.00.00 and »Engineer« V2.17.)

##### Motion control kernel

Important basic (drive) functions as well as further basic functionalities are implemented in the firmware of the inverter in the so-called **Motion Control Kernel (MCK)** which can be accessed by the active technology application via defined internal interfaces. By this means the expensive creation of single function block interconnections is omitted so that the expenditure and the complexity for the realisation of standard functions is minimised.

The **Motion Control Kernel** is integrated in the main setpoint path and, depending on the set operating mode, it creates the required control and setpoint signals for the motor control and the drive interface.



##### More information:

- A detailed description of the basic functions implemented in the **Motion Control Kernel** can be found in the main chapter "[Basic drive functions \(MCK\)](#)". (📖 403)
- Detailed information on the creation or change of interconnections by means of the function block editor can be found in the main chapter "[Working with the FB Editor](#)". (📖 882)
- All available function and system blocks are described in the main chapter "[Function library](#)". (📖 934)

---

## 2.2 Selection of the appropriate commissioning tool

There are several possibilities for commissioning the 8400 StateLine inverter:



### Commissioning via keypad X400 (or diagnosis terminal X400)

The keypad is an alternative to the PC for the local operation, parameterisation, and diagnostics in a simple manner. The keypad is especially suited for test and demonstration purposes and for the case that only few parameters have to be adapted.



### Commissioning with PC and »EASY Starter«

The »EASY Starter« is a Lenze tool for easy online diagnostics, parameter setting and commissioning of the inverter.



### Commissioning with PC and »Engineer«

The »Engineer« is a Lenze engineering software for parameter setting across all devices, configuring and diagnosing individual components (as for instance inverters, industrial PCs, motors, I/O systems) and machine control systems.





### Tip!

The Engineering tools »EASY Starter« and »Engineer StateLevel« are provided free of charge in the internet:

<http://www.lenze.com> → Download → Software Downloads

For communication between PC and inverter, the USB diagnostic adapter can be used for instance (see the following subchapter).

### 2.2.1 Overview: Accessories for commissioning

Version	Features	Product key
Keypad X400 	Quick access to parameters and operating data <ul style="list-style-type: none"> <li>• Supports hot plugging</li> <li>• Graphic display with plain texts</li> <li>• Backlighting</li> <li>• Easy user guidance</li> <li>• 4 navigation keys, 2 context-sensitive keys</li> <li>• Adjustable RUN/STOP function</li> <li>• Can be used for L-force Inverter Drives 8400 and Servo Drives 9400</li> </ul>	EZAEBK1001
Diagnosis terminal X400 	Keypad X400 in a robust housing, also suitable for installation into the control cabinet door. <ul style="list-style-type: none"> <li>• Supports hot plugging</li> <li>• Graphic display with plain texts</li> <li>• Backlighting</li> <li>• Easy user guidance</li> <li>• 4 navigation keys, 2 context-sensitive keys</li> <li>• Adjustable RUN/STOP function</li> <li>• Incl. 2.5 m cable</li> <li>• Enclosure IP20; in case of front installation in control cabinet IP65</li> <li>• Can be used for L-force Inverter Drives 8400 and Servo Drives 9400</li> </ul>	EZAEBK2001
USB diagnostic adapter 	For electrical isolation of your PC and the inverter. <ul style="list-style-type: none"> <li>• Supports hot plugging</li> <li>• Diagnostic LED for data transfer display</li> <li>• plug and play</li> <li>• Input-side voltage supply via USB connection from PC</li> <li>• Output-side voltage supply via the diagnostic interface of the inverter</li> <li>• Connecting cables can be selected in various lengths:</li> </ul>	E94AZCUS
Connecting cable for USB diagnostic adapter	2.5 m length	EWL0070
	5 m length	EWL0071
	10 m length	EWL0072

### 2.3 General notes on parameters

All parameters for inverter parameterising or monitoring are saved as so-called "codes".

- The codes are numbered and indicated by the prefix "C" before the code, e.g. "C00002".
- Moreover, each code has a name and specific attributes, as for example access type (reading, writing), data type, limit values and default setting ("Lenze setting").
- For the sake of clarity, some codes contain "subcodes" for saving parameters. This Manual uses a slash "/" as a separator between code and subcode, e.g. C00118/3".
- According to their functionality, the parameters are divided into three groups:
  - Setting parameters: For specifying setpoints and for setting device / monitoring functions.
  - Configuration parameters: For configuring signal connections and terminal assignments.
  - Diagnostic/display parameters: For displaying device-internal process factors, current actual values and status messages. These are read-only parameters.

### 2.3.1 Changing the parameterisation with the keypad



The keypad is simply plugged on the diagnostic interface X6 ("DIAG") at the front of the standard device.





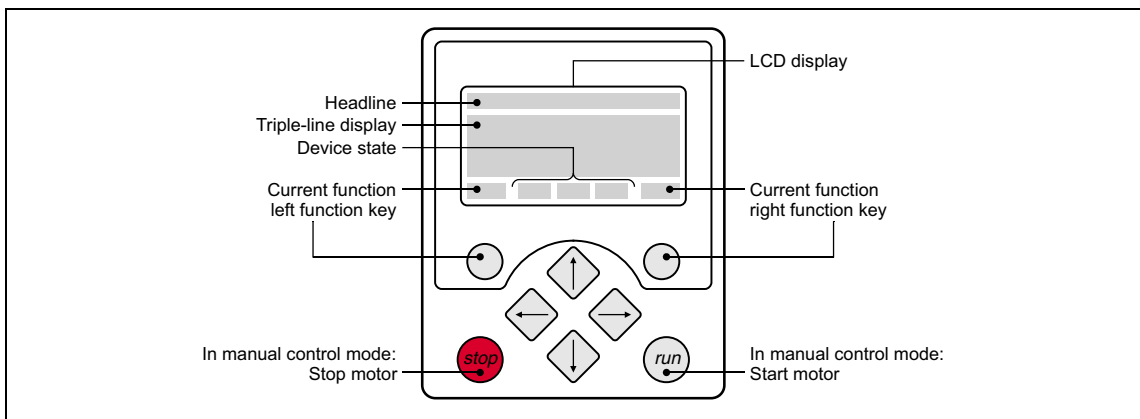

Plugging and unplugging the keypad is possible during operation.







#### Keypad display and control elements



LCD display			
<b>Headline</b>			
In the menu level: Menu name			
In the parameter level: Parameter name			
<b>Three-part display</b>			
In the menu level: List of available menus			
In the parameter level: Code/subcode and setting or actual value			
<b>Device status</b>			
<b>RDY</b>	Inverter is switched on	<b>IMP</b>	Pulse inhibit active
<b>RUN</b>	Inverter is enabled	<b>IFLT</b>	"Fault" device status is active
<b>CINH</b>	Inverter is inhibited	<b>ITRB</b>	"Trouble" device status is active
<b>QSP</b>	Quick stop active	<b>ITQSP</b>	"TroubleQSP" device status is active
<b>Imax</b>	Current limit exceeded	<b>WRN</b>	A warning is indicated
<b>Mmax</b>	Speed controller 1 in the limitation		



LCD display	
Function - left function key	Function - right function key
 Change parameter setting (change to editing mode)	 Accept change in the inverter (no saving with mains failure protection →  )
 Back to main menu	 Abort (discard change)
 Parameter can only be changed when the inverter is inhibited	
 Save all parameter settings in the memory module safe against mains failure	

Control elements	
	Execute the function assigned to the function key (see LCD display)
	Execute the stop function set in <a href="#">C00469</a> (Lenze setting: Inhibit inverter)
	Deactivate stop function again (Lenze setting: Enable inverter again)
	In the menu level: Select menu/submenu In the parameter level: Select parameter
	In the editing mode: Change marked digits or select list entry
	In the menu level: Select submenu/change to parameter level In the editing mode: Cursor to the right
	In the menu level: One menu level higher (if available) In the parameter level: Back to the menu level In the editing mode: Cursor to the left

### Menu structure

In the keypad, the parameters are classified into various menus and submenus.

- The **USER menu** includes a selection of frequently used parameters.
- The **Code list** contains all parameters.
- The **Go to param** function enables you to reach the corresponding parameter directly.
- The **Logbook** logs all errors and their chronological history.
- The **Diagnostics** menu contains diagnostic/display parameters for displaying device-internal process factors, current actual values and status messages.

### User level

From version **12.00.00 onwards**, the extent of menus, submenus and codes shown in the keypad can be adapted by selecting the "Userlevel" in [C00001/1](#):

- **Standard** user level (Lenze setting): Only the most important menus and codes are displayed in the keypad.
- **Expert** user level: All menus and codes are displayed in the keypad.
- **Service** user level: Only for the purpose of service (Lenze Service).

After changing the user level, the menus in the keypad are restructured according to the selected user level. The parameters of plugged-in communication module are always shown completely independent of the set user level.

## General operation

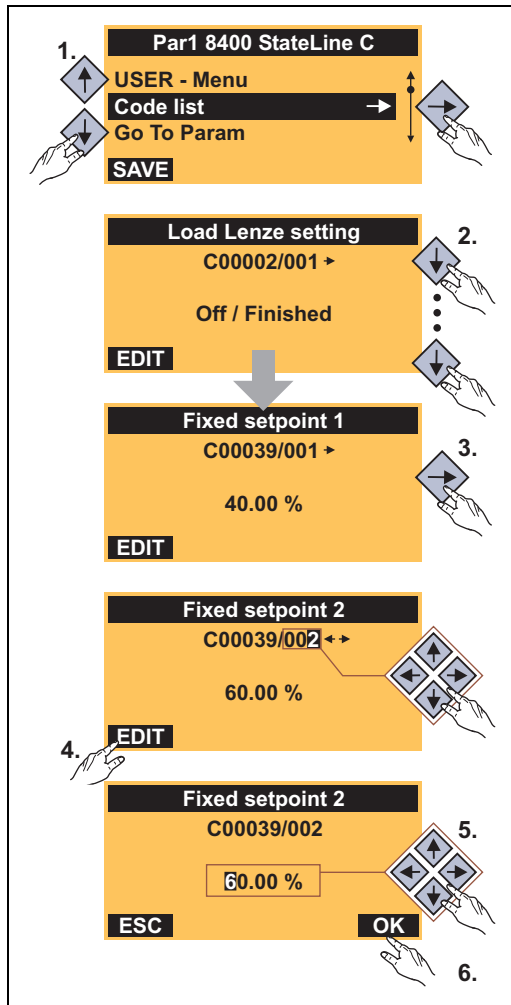

[2-2] Example: Changing parameters with the keypad

1. Use the  $\uparrow/\downarrow$  navigation keys to select the desired menu.
  - Use the  $\uparrow/\downarrow$  navigation keys to reach a higher/lower menu level.
  - Use the  $\text{ESC}$  function key to return to the main menu.
2. Use the  $\uparrow/\downarrow$  navigation keys to select the parameter to be set within a submenu.
3. In order to select another subcode in case of a parameter with subcodes:
  - Press the navigation key  $\rightleftarrows$  to change to the editing mode for the subcode.
  - Use the navigation keys to set the desired subcode.
4. Use the **EDIT** function key to switch over to the editing mode.
5. Use the navigation keys to set the desired value.
6. Use the **OK** function key to accept the change and to leave the editing mode.
  - Use the **ESC** function key to leave the editing mode without accepting the change.

## Multilingualism

All texts displayed in the keypad are in English.

From version 11.00.00 onwards, the most important menus as well as diagnostic and configuration parameters can be also available in German and French. To set a different language, select the **Language selection** menu item in the main menu of the keypad.

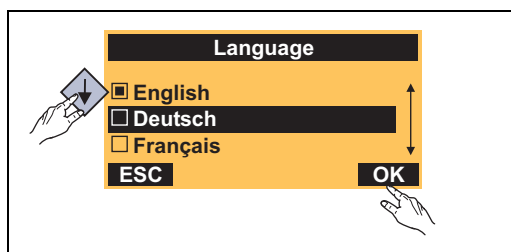

- The multilingual texts are stored in the inverter and do not have to be loaded into the device.
- For reasons of disc space, only the most important menus and parameters as well as the error messages are available in several languages.

## 2 Introduction: Parameterising the inverter

### 2.3 General notes on parameters

#### 2.3.2 Change parameter settings with PC and Lenze software

The USB diagnostic adapter, for instance, can be used for the communication between the PC (including the »EASY Starter« or »Engineer« software) and the inverter, see the following illustration. The USB diagnostic adapter is the connection between the PC (free USB port) and the inverter (X6 diagnostic interface).

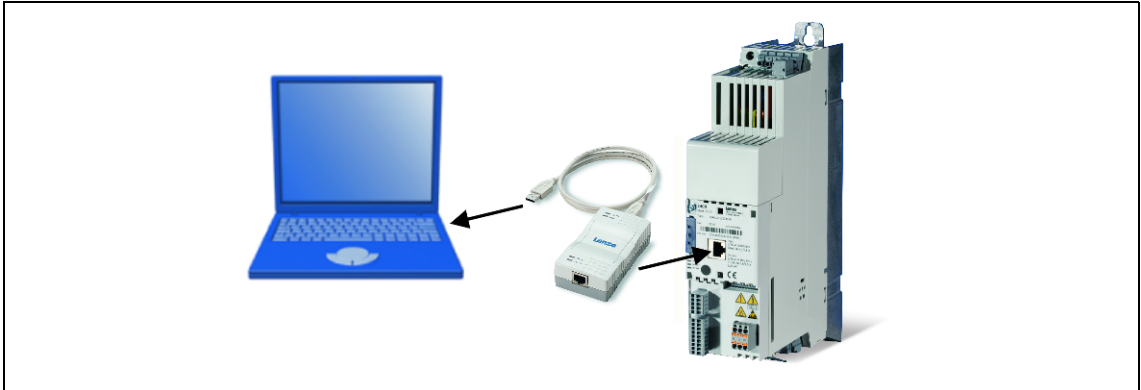

[2-3] Exemplary constellation for parameterising the inverter

The **All parameters** tab in the »EASY Starter« and the »Engineer« provides a quick access to all parameters of the inverter.

The given categories and subcategories correspond 1:1 to the menus and submenus of the keypad:

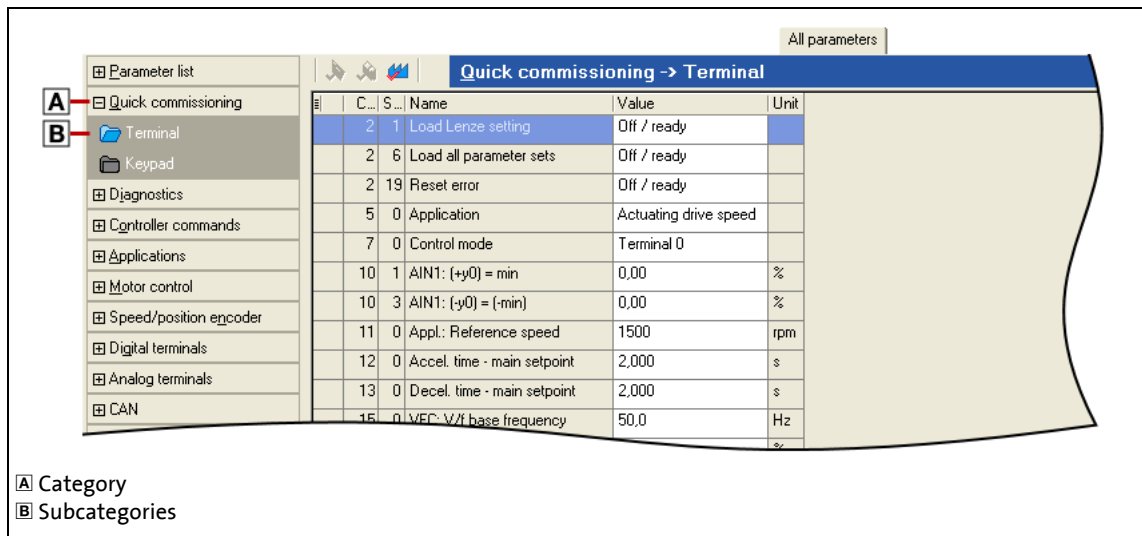

C...	S...	Name	Value	Unit
2	1	Load Lenze setting	Off / ready	
2	6	Load all parameter sets	Off / ready	
2	19	Reset error	Off / ready	
5	0	Application	Actuating drive speed	
7	0	Control mode	Terminal 0	
10	1	AIN1: (+y0) = min	0.00	%
10	3	AIN1: (-y0) = (-min)	0.00	%
11	0	Appl.: Reference speed	1500	rpm
12	0	Accel. time - main setpoint	2,000	s
13	0	Decel. time - main setpoint	2,000	s
15	0	VFC: V/f base frequency	50.0	Hz

**A** Category  
**B** Subcategories

[2-4] All parameters tab in the »Engineer«

Moreover, the »Engineer« provides a commissioning interface on the **Application parameters** tab where you can commission the application in a few steps.



Detailed information on how to handle the »Engineer« can be found in the integrated online help that you can call with the **[F1]** function key.

### 2.3.3 Save parameter settings in the memory module safe against mains failure

Inverter parameter changes via the EASY Starter /»Engineer«, the keypad, or a master control via fieldbus communication will be lost after mains switching of the controller unless the settings have been explicitly saved to the integrated memory module.

#### General information

- In the delivery state, the Lenze setting of the parameters has been saved to the integrated memory module. These parameters are
  - the parameters of the inverter
  - the parameters of the communication module plugged into the MCI interface
  - the parameters of the possibly existing safety module (device variant)
- When the device or the external 24 V voltage supply is switched on, all parameters are automatically loaded from the memory module into the main memory of the inverter.
- Full functionality of the memory module is even provided if the power supply has been switched off and only the electronic components of the inverter are externally supplied by a 24 V DC voltage, e.g. via the X4/24E terminal.
- The memory module can be preconfigured with customised data.
- The memory module is available as a spare part - without any data.

#### During operation

- Parameter sets can be saved and loaded manually.
- Using the keypad, you can press function key **SAVE** to save the parameter settings.
- The »EASY Starter«/»Engineer« serves to execute the saving via the icon  in the *toolbar* or via the device command "Save all parameter sets" ([C00002/11](#) = "1: On / start").
  - The storage process may take a couple of seconds. After the device command has been called in [C00002/11](#), dynamic status information ("Work in progress 20%" → "Work in progress 40%" → "Work in progress 60%", etc.) is returned.



#### Note!

In order to prevent data inconsistencies during the saving process:

- Do not switch off the supply voltage!
- Do not remove the memory module from the device!

Automatic saving of changed parameter settings is explicitly not supported because this significantly reduces the service life of the memory module.

### Unplugging the memory module

The memory module is hot-pluggable. A removal during operation causes a warning "[PS01: No memory module](#)" and should thus be avoided. The behaviour of the device, however, remains unchanged as all parameters are available in the RAM memory after the device has been started. The device can also be parameterised when the memory module has been unplugged. In this case, the parameter sets cannot be saved in the memory module.

### Replacement of the inverter

In the event of a device replacement, the entire parameter data of an axis can be copied to the replacement device by "taking along" the memory module, so that additional PC or keypad operations are not required.

When replacing the inverter, the versions of the old and new device are of importance. Before data are actually transferred, the versions are checked internally. As a general principle, the following applies:

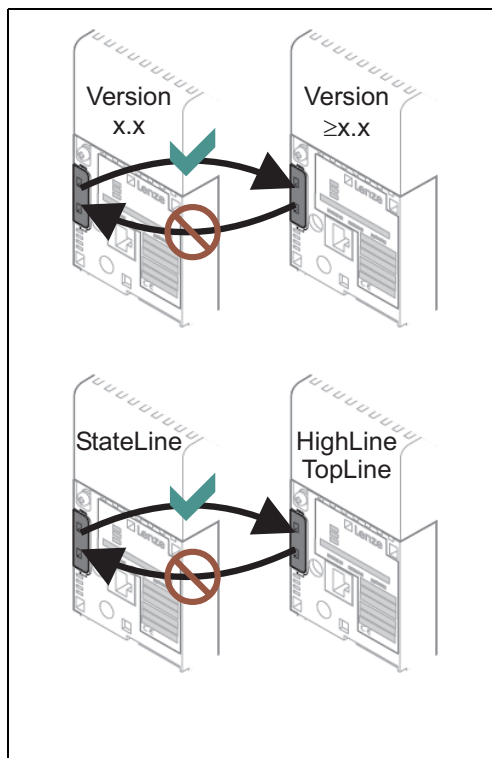

- Parameter sets of old devices can only be processed on new devices with the same or higher device version (downward compatibility).
- Parameter sets of devices with versions that have less functions (e.g. 8400 StateLine) can be loaded into and executed on devices with versions that have more functions (e.g. 8400 HighLine). The reverse is not possible!
- If the parameter set stored in the memory module is incompatible with the standard device, the "[PS03: Par.set device invalid](#)" error message is output and the inverter changes to the "[Fault](#)" device state.
- If the parameter set stored in the memory module is compatible with the standard device but has a different (lower) version, the "[PS03: Par.set device invalid](#)" message is only output as "Information". The message can be eliminated by storing the parameter set again.  
**Note:** If you save the parameter set in a higher device version, you can no longer load this parameter set to a lower device version.

Example of parameter set compatibilities:

Parameter version on memory module	Device version			
	StateLine V12	HighLine V12	HighLine V13	TopLine V12
StateLine V12				
HighLine V12				
HighLine V13				
TopLine V12				

### 2.3.4 User menu for quick access to frequently used parameters

When a system is installed, parameters must be changed time and again until the system runs satisfactorily. The user menu of the inverter contains a selection of frequently used parameters to be able to access and change these parameters quickly:

Parameters	Name	Lenze setting
<a href="#">C00051</a>	MCTRL: Actual speed value	-
<a href="#">C00053</a>	DC-bus voltage	-
<a href="#">C00054</a>	Motor current	-
<a href="#">C00061</a>	Heatsink temperature	-
<a href="#">C00137</a>	Device status	-
<a href="#">C00166/3</a>	Mess. - status det. error	-
<a href="#">C00011</a>	Appl.: Reference speed	1500 rpm
<a href="#">C00039/1</a>	Preset setpoint 1	40.00 %
<a href="#">C00039/2</a>	Preset setpoint 2	60.00 %
<a href="#">C00012</a>	Acceleration time - main setpoint	2.000 s
<a href="#">C00013</a>	Deceleration time - main setpoint	2.000 s
<a href="#">C00015</a>	VFC: V/f base frequency	50 Hz
<a href="#">C00016</a>	VFC: Vmin boost	1.60 %
<a href="#">C00022</a>	I <sub>max</sub> in motor mode	depending on the device power
<a href="#">C00120</a>	Setting of motor overload (I <sup>2</sup> xt)	100.00 %
<a href="#">C00087</a>	Rated motor speed	1460 rpm
<a href="#">C00099</a>	Firmware version	-
<a href="#">C00200</a>	Firmware product type	-
<a href="#">C00105</a>	Decel. time - quick stop	2.000 s
<a href="#">C00173</a>	Mains voltage	0: "3ph 400V / 1ph 230V"
Greyed out = display parameter		



#### Tip!

The user menu can be freely configured in [C00517](#).

In the »Engineer«, you can configure the user menu comfortably via the **User menu** tab (see »Engineer« online help).

The [password protection](#) serves to restrict the access to parameters of the user menu. Then, all other parameters cannot be accessed without knowing the password and are thus protected against unwanted changes.

---

## 2.4 Device access protection

This function extension is available from version 06.00.00!

---

Various tasks can be executed via the functions of the device access protection:

- [Password protection](#)
  - Only authorised persons (with password knowledge) may read/change all parameters of the inverter.
  - Non-authorised persons (without password knowledge) can only access the max. 32 parameters of the user menu.
- [Device personalisation](#)
  - Only inverters and memory modules personalised with a specific binding ID can be used in the system.



### Note!

If password protection/device personalisation is used:

- Inform the end customer that Lenze can only provide restricted service for the devices with access protection.
- It is not possible for Lenze to modify a replacement device via special accesses in such a way that it cooperates with a personalised memory module.
- The keypad does not support the alpha-numeric entry of a password, thus the keypad cannot be used for entry.

### 2.4.1 Password protection

When the password protection is active, only write/read access to the parameters of the user menu is possible.

- From version 15.00.00, the password protection can be configured individually for every single communication channel. ▶ [Individual password protection for single communication channels](#) (□ 42)
- The following describes how to set/check/delete a password by means of the parameters relevant for these functions.
- From »Engineer« V2.14 onwards, these functions can also be executed via dialog (menu command **Online** → **Set/check/delete password**).



#### Note!

The password protection serves to only limit the access to parameters of the standard device. The access to parameters of a plugged-in communication module is not concerned.

#### Short overview of the relevant parameters for password protection:

Parameters	Info	Lenze setting
<a href="#">C00505/3</a>	Password <ul style="list-style-type: none"> <li>• The password must have a length of 4 ... 16 characters.</li> <li>• The password may consist of any character. However, this is not sensible. Recommended characters are: lower case letters (a - z), upper case letters (A - Z) and digits (0 - 9).</li> </ul> <b>Note:</b> After the execution of one of the device commands listed below, this parameter provides the current password status:	
	off No password is set, password protection is not active (Lenze delivery status).	
	on Password is set, password protection is active. <ul style="list-style-type: none"> <li>• This status is also displayed if checking/deleting the password has not been successful due to an invalid entry.</li> </ul>	
	ok Password is set, password protection is not active. <ul style="list-style-type: none"> <li>• The password protection is temporarily deactivated.</li> </ul>	
<b>Device commands</b>		
Before the following device commands are executed, enter the corresponding password in <a href="#">C00505/3</a> .		
<a href="#">C00002/31</a>	Set password ▶ <a href="#">Activate the password protection</a>	0: Off / ready
<a href="#">C00002/32</a>	Check password ▶ <a href="#">Temporarily deactivate the password protection</a>	0: Off / ready
<a href="#">C00002/33</a>	Delete password ▶ <a href="#">Deactivate password protection/change password</a>	0: Off / ready
Greyed out = display parameter		



Parameters	Info	Lenze setting
<b>Status displays</b>		
<a href="#">C00003</a>	Status of the last device command	-
<a href="#">C00507/1</a>	Password protection - all communication channels • Bit coded display of the active protective functions:	-
	Bit 0 Only access to user menu	
	Bit 1 Parameter write protection	
	Bit 2 Parameter read protection	
	Bit 3 ... 14 Reserved	
	Bit 15 Memory module binding on	
	<b>Note:</b> As the password protection can be configured individually for each single communication channel from version 15.00.00 bit 1 and bit 2 indicate the active protection always with regard to the communication channel <u>used</u> .	
Greyed out = display parameter		

### Activate the password protection

The password protection is activated by setting a password.



#### How to set a password:

- Enter the desired password in [C00505/3](#).
  - The password must have a length of 4 ... 16 characters.
  - The password may consist of any character. However, this is not sensible. Recommended characters are: lower case letters (a - z), upper case letters (A - Z) and digits (0 - 9).
- Execute "Set password" device command: [C00002/31](#) = "1: On / start"
  - After successful execution, password status ON is displayed in [C00505/3](#) and password protection takes immediate effect.

### Temporarily deactivate the password protection

The "Check password" device command serves to temporarily deactivate the password protection in order to execute password-protected functions.

- The password protection remains deactivated until
  - an invalid password will be entered and checked
  - or -
  - the external 24-V supply of the control electronics is switched off (< 19 V).



#### How to temporarily deactivate the active password protection:

- Enter the set password in [C00505/3](#).
- Execute "Check password" device command [C00002/32](#) = "1: On / start"
  - After a successful check, password status OK is displayed in [C00505/3](#).

### Deactivate password protection/change password

The password protection is simply activated by deleting the set password. If you want to change the set password, first delete the set password as well. Then set the new password.



#### How to delete the set password:

1. Enter the set password in [C00505/3](#).
2. Execute "Delete password" device command [C00002/33](#) = "1: On / start"
  - After a successful deletion, password status OFF is displayed in [C00505/3](#).

## 2.4.2 Individual password protection for single communication channels

This function extension is available from version 15.00.00!

The 8400 StateLine can be parameterised via the following "communication channels":

- Internally via system blocks ([LS\\_ParReadWrite1-6](#) and [LS\\_WriteParamList](#))
- externally via
  - Diagnostics interface X6 ("DIAG")
  - CANopen interface X1 ("CAN on board")
  - Fieldbus interface (MCI)

As in some applications, only certain communication channels have to be protected, the parameters described in the following serve to configure individual access restrictions for each communication channel.

In the Lenze setting, all access restrictions are active for all communication channels when the password is set. This corresponds to the previous behaviour with a set password, i.e. only one write/read access to the parameters of the user menu is possible.



### Note!

The configuration can only be changed if no password has been set!

- This means that even if the password has been deactivated temporarily by the "check password" device command, the configuration cannot be changed.
- As long as a password is set, the "Load Lenze setting" device command does not change the configuration either.

The password protection is activated by setting a password.

▶ [Activate the password protection](#) (📖 41)

▶ [Deactivate password protection/change password](#) (📖 42)

**Short overview of the relevant parameters for configuring the password protection:**

When the password is set, the respective restriction is active if the corresponding bit has been set:

Parameters	Info	Lenze setting	
<a href="#">C00506/1</a>	PW protection internal config	0x0007	
	Bit 0		Only access to user menu <ul style="list-style-type: none"> <li>• The menus in the keypad are reduced.</li> <li>• Only the user menu can be used to change parameters.</li> </ul>
	Bit 1		Parameter write protection <ul style="list-style-type: none"> <li>• System blocks cannot be used to write into write/read parameters.</li> </ul>
	Bit 2		Parameter read protection <ul style="list-style-type: none"> <li>• System blocks cannot be used to read write/read parameters.</li> </ul>
	Bit 3 ... 15		Reserved
<a href="#">C00508/1</a>	PW protection config. X6 (DIAG)	0x0006	
	Bit 0		Reserved
	Bit 1		Parameter write protection <ul style="list-style-type: none"> <li>• The diagnostics interface X6 cannot be used to write into write/read parameters.</li> </ul>
	Bit 2		Parameter read protection <ul style="list-style-type: none"> <li>• The diagnostics interface X6 cannot be used to read write/read parameters.</li> </ul>
	Bit 3 ... 15		Reserved
<a href="#">C00509/1</a>	PW protection config. X1 (CAN)	0x0006	
	Bit 0		Reserved
	Bit 1		Parameter write protection <ul style="list-style-type: none"> <li>• The CANopen interface X1 cannot be used to write into write/read parameters.</li> </ul>
	Bit 2		Parameter read protection <ul style="list-style-type: none"> <li>• The CANopen interface X1 cannot be used to read write/read parameters.</li> </ul>
	Bit 3 ... 15		Reserved
<a href="#">C00510/1</a>	PW protection config. MCI	0x0006	
	Bit 0		Reserved
	Bit 1		Parameter write protection <ul style="list-style-type: none"> <li>• The fieldbus interface (MCI) cannot be used to write into write/read parameters.</li> </ul>
	Bit 2		Parameter read protection <ul style="list-style-type: none"> <li>• The fieldbus interface (MCI) cannot be used to read write/read parameters.</li> </ul>
	Bit 3 ... 15		Reserved

The parameter set must be saved to the device safe against mains failure to prevent password protection configured in the device from getting lost due to mains switching.



▶ [Save parameter settings in the memory module safe against mains failure](#) (36)

**2.4.3 Device personalisation**

The inverter and the memory module are married via the device personalisation by means of a binding ID. When the device personalisation is active, all write/read actions between inverter and memory module are only executed if both components have the same binding ID.

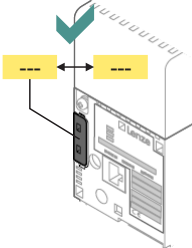
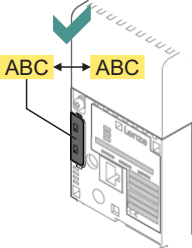
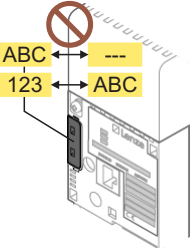
Lenze delivery status:	Procedure carried out by the customer:	Impermissible replacement by the end user:
		
No binding ID is set.	Customer sets binding ID for device personalisation.	When device personalisation is active: The replacement of the inverter or memory module causes an error message if the binding ID is incorrect or not available.

If, for instance, a parameter set has been loaded from the memory module with an active device personalisation, saving of this parameter set on another memory module with a different or non-existent binding ID is not possible.

- Thus, copying the parameter set from a personalised memory module to a non-personalised memory module is not possible!

Two types of checks are distinguished:

- If a differing binding ID is detected when the inverter is switched on (during device initialisation):
  - the "Fault" error response is returned.
  - The "[PS10: Invalid memory module binding](#)" error message is entered into the logbook.
- If a differing binding ID is detected while a device command for loading/saving the parameter set is executed:
  - Loading/saving is not executed.
  - A corresponding status for the device command is output in [C00003](#).

**Short overview of the relevant parameters for device personalisation:**

Parameters	Info	Lenze setting				
<a href="#">C00505/2</a>	Binding ID <ul style="list-style-type: none"> <li>• The binding ID must have a length of 4 ... 16 characters.</li> <li>• The binding ID may consist of any character. However, this is not sensible. Recommended characters are: lower case letters (a - z), upper case letters (A - Z) and digits (0 - 9).</li> </ul> <b>Note:</b> After the execution of one of the device commands listed below, this parameter provides the current binding ID status:					
	<table border="1" style="width: 100%; border-collapse: collapse;"> <tr> <td style="text-align: center;">off</td> <td>No binding ID is set.</td> </tr> <tr> <td style="text-align: center;">on</td> <td>Binding ID is set.</td> </tr> </table>	off	No binding ID is set.	on	Binding ID is set.	
off	No binding ID is set.					
on	Binding ID is set.					
Greyed out = display parameter						

Parameters	Info	Lenze setting
<b>Device commands</b>		
Before the following device commands are executed, enter the corresponding binding ID in <a href="#">C00505/2</a> .		
<a href="#">C00002/29</a>	Set binding ID ▶ <a href="#">Activate device personalisation</a>	0: Off / ready
<a href="#">C00002/30</a>	Delete binding ID ▶ <a href="#">Deactivate device personalisation/change binding ID</a>	0: Off / ready
<b>Status displays</b>		
<a href="#">C00003</a>	Status of the last device command	-
<a href="#">C00507/1</a>	Password protection - all communication channels • Bit coded display of the active protective functions:	-
	Bit 0 Only access to user menu	
	Bit 1 Parameter write protection	
	Bit 2 Parameter read protection	
	Bit 3 ... 14 Reserved	
Bit 16 Memory module binding on		
Greyed out = display parameter		

### Activate device personalisation

The device personalisation is activated by setting a binding ID.



#### How to set the binding ID:

- Enter the desired binding ID in [C00505/2](#).
  - The binding ID must have a length of 4 ... 16 characters.
  - The binding ID may consist of any character. However, this is not sensible. Recommended characters are: lower case letters (a - z), upper case letters (A - Z) and digits (0 - 9).
- Execute "Set binding ID" device command [C00002/29](#) = "1: On / start"
  - After successful execution, status ON is displayed in [C00505/2](#).

### Deactivate device personalisation/change binding ID

The device personalisation is simply deactivated by deleting the set binding ID. If you want to change the set binding ID, first delete the set binding ID as well. Then set the new binding ID.



#### How to delete the binding ID:

- Enter the set binding ID in [C00505/2](#).
  - If inverter and memory module do not have the same binding ID, enter the binding ID of the memory module to delete the binding ID of both components.
- Execute "Delete binding ID" device command [C00002/30](#) = "1: On / start"
  - After a successful deletion, status OFF is displayed in [C00505/2](#).

#### 2.4.4 Unlocking the inverter with a MasterPin

Every inverter has an individual master password called "MasterPin". By entering the MasterPin, an inverter inhibited by the password mechanisms can be reset to the delivery status.



### Stop!

When the MasterPin is used, the parameter set is reset to the Lenze setting both in the inverter and in the memory module!

- This results in a permanent loss of the customised parameterisation that must be recreated!
- A reset to the Lenze setting can result in unforeseen level changes at the I/O terminals (e.g. brake control)!



### How to restore the delivery status:

1. Inhibit the inverter if it is enabled, e.g. via the [C00002/16](#) device command.
2. Enter the MasterPin in [C00505/1](#).
  - The MasterPin comprises the last 6 digits of the serial number of the memory module.
3. Execute "Check MasterPin" device command [C00002/28](#) = "1: On / start"

## 2 Introduction: Parameterising the inverter

### 2.5 Device identification

#### 2.5 Device identification

For device identification, any device name (e.g. wheel drive) with max 32 characters can be set in [C00199/1](#) for the inverter and saved in the memory module with mains failure protection.

##### 2.5.1 Automatic acceptance of the device name in the »Engineer«

If a device name is assigned in [C00199/1](#) and the inverter in the »Engineer« is added to the project via the **Insert** → **Insert device detected online...** function, the device name stored in [C00199/1](#) (here: wheel drive) is used as device designation in the *Project view* instead of the type (8400 Stateline):

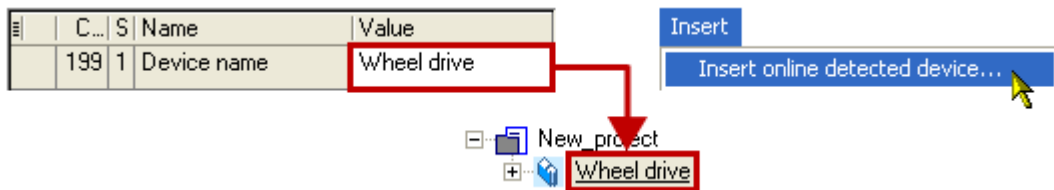

This mechanism also functions in reverse direction:

If you rename the inverter in the *project view* via <F2>, you will be asked afterwards if you want to take over the changed name in [C00199/1](#):

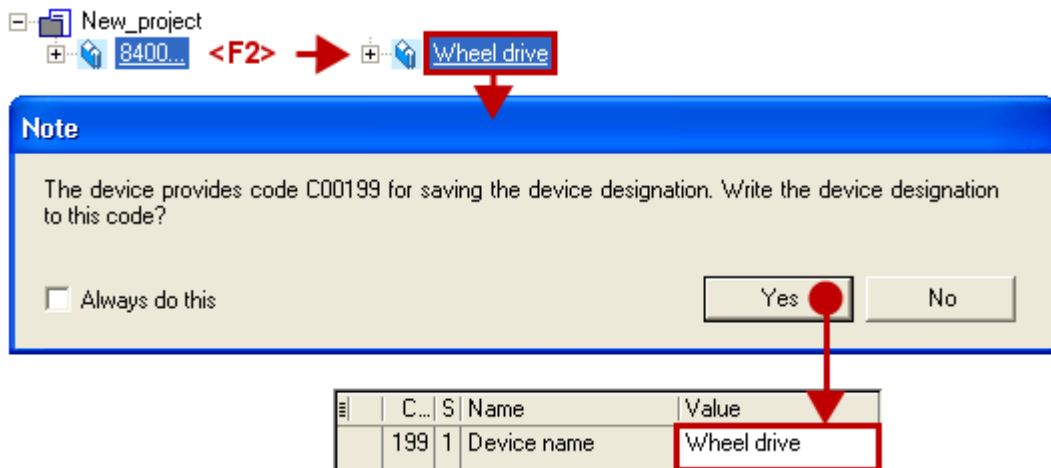

##### 2.5.2 Extended item designation

This function extension is available from version 12.00.00!

In [C00199/2...5](#), four texts à max. 32 characters can be set for item designation and saved in the memory module safe against mains failure. These additional subcodes are not dependent on the previously described text acceptance mechanism in the »Engineer« for the device name ([C00199/1](#)).

### 3 Commissioning



#### Danger!

##### Unexpected motor movements can occur

Under certain conditions the motor may rotate after mains connection.

##### Possible consequences:

- Persons in the vicinity of the machine or plant risk getting hurt.
- Unexpected starting action may damage the machine or plant.

##### Protective measures:

- Commissioning with external 24 V supply and without mains voltage. In this case, the inverter can only be parameterised and diagnosed during commissioning.
- Ensure that setpoints are not active.



#### Tip!

- Information on some of the operating statuses can quickly be obtained via the [LED status displays](#) on the front of the inverter. ([📖 435](#))
- **Check firmware:** Particularly with regard to the use of an older inverter (e.g. if the customer is using one from stock) it makes sense to check the software (firmware) version. The software version of the inverter can be seen on the nameplate in the "SW" line and can be determined by reading out code [C00099](#).
- **Restore delivery status:** Set code [C00002/1](#) to "1: On / start" to reset all parameter settings of the device to the Lenze setting. This leaves you with a defined device configuration. ▶ [Load Lenze setting](#) ([📖 81](#))



The following chapters describe the commissioning of the available technology applications with the »Engineer«.

Information on how to commission using the keypad (or diagnosis terminal) can be found in the **8400 hardware manual**. The hardware manual has been stored in electronic form on the data carrier supplied with the 8400 inverter.



---

### 3.1 Safety instructions with regard to commissioning

#### General safety instructions

In order to prevent injury to persons or damage to material assets

- check before connecting the mains voltage
  - the wiring for completeness, short circuit, and earth fault
  - the "emergency stop" function of the entire system
  - that the motor circuit configuration (star/delta) is adapted to the output voltage of the inverter
  - the in-phase connection of the motor
- check the setting of the most important drive parameters before enabling the controller:
  - the V/f rated frequency must be adapted to the motor circuit configuration!
  - the drive parameters relevant for your application must be set correctly!
  - the configuration of the I/O terminals must be adapted to the wiring!
- ensure that there are no active speed setpoints before enabling the controller.

#### Safety instructions with regard to motor operation



#### Danger!

- For thermal reasons, continuous operation of self-ventilated motors at a low field frequency and rated motor current is not permissible!
  - In the Lenze setting, the [Motor temperature monitoring \(PTC\)](#) is activated. (☞ 253)
  - Activate the [Brake resistor monitoring \(I2xt\)](#) if necessary. (☞ 254)
- [C00015](#) must be used to select 87 Hz operation if a delta-connected asynchronous motor (nameplate data: 400 V  $\lambda$  / 230 V  $\Delta$ ) is to be operated in conjunction with an inverter for a mains voltage of 400 V.

### 3.2 Notes on motor control

In the Lenze setting, the V/f characteristic control (VFCplus) as motor control is set in [C00006](#) with a linear characteristic.

- V/f characteristic control (VFCplus) is a motor control mode for classic frequency inverter applications on the basis of a simple and robust control procedure for the operation of machines with a linear or quadratic load torque characteristic (e.g. fans).
- The presettings of the parameters ensure that the inverter is immediately ready for operation and the motor works adequately without further parameterisation if an inverter and a 50 Hz asynchronous machine with matching performances are assigned to each other.



#### Note!

Check the nameplate data against the motor data set in the inverter. Further information is provided in the chapter "[Motor selection/Motor data](#)". (📖 113)

#### Recommendations for the following application cases:

- If the inverter and motor differ greatly in terms of performance:  
Set the I<sub>max</sub> limit (in motor mode) in [C00022](#) to 2x rated motor current.
- If a high starting torque is required:  
When the motor is idling, set a value for V<sub>min</sub> boost in [C00016](#) which ensures that the rated motor current flows at a field frequency of f = 3 Hz (display in [C00058](#)).
- For noise optimisation:  
In [C00018](#), set a switching frequency of "16 kHz var./drive-opt."
- If a high torque must be provided at small speeds without feedback:  
Select "Sensorless vector control (SLVC) as motor control mode in [C00006](#).

#### Related topics:

- ▶ [Motor control \(MCTRL\)](#) (📖 112)

## 3.3

**Preconditions for commissioning with the »Engineer«**

For commissioning, you need

- a PC that meets the following system requirements:
  - a processor with 1.4 GHz or higher
  - at least 512 MB RAM and 650 MB free hard disc space
  - Microsoft® Windows® 2000 operating system (from service pack 2 onwards) or Windows® XP
- the Lenze »Engineer« PC software
- a connection to the inverter, e.g. via a USB diagnostic adapter:
  - connect the USB diagnostic adapter to the X6 diagnostic interface.
  - establish a connection between the USB diagnostic adapter and the PC via a free USB port.

**Tip!**

How to obtain/update the »Engineer« software:

- **Download from the internet:** The full version of the »Engineer StateLevel« is provided free of charge in the internet:  
<http://www.Lenze.com> → Download → Software downloads
- **Requesting the CD** You can also request the »Engineer« separately on CD free of charge at your Lenze representative. See the "About Lenze" area on our homepage for e.g. the corresponding German address.

---

### 3.4 Trouble-shooting during commissioning

When the »Engineer« is used, trouble during commissioning can be detected and eliminated conveniently. Proceed as follows:

- Check whether error messages appear in the »Engineer«.
  - On the **Diagnostics** tab, relevant actual states of the inverter and pending error messages are displayed in a well-arranged visualisation.
- Check the input terminals for their corresponding setpoints.
  - The **Terminal assignment** tab displays the current input/output signals.
- Check the signal flow of the application.
  - For this purpose, click the **Signal flow** button on the **Application parameter** tab. The displayed signal flow shows active setpoints and their further processing.

#### Related topics:

- ▶ [Diagnostics & error management](#) (📖 434)
- ▶ [LED status displays](#) (📖 435)
- ▶ [Error messages of the operating system](#) (📖 459)

### 3.5 Commissioning wizard 8400

This function extension is supported by the »Engineer« from version 2.15 onwards!

---

The **commissioning wizard 8400** serves to carry out a guided commissioning of the inverter based on the Lenze setting of the parameters. The set parameters can then be saved in the inverter with mains failure protection.



#### Note!

Take all the necessary safety precautions before you carry out the following commissioning steps and switch the device on!

- ▶ [Safety instructions with regard to commissioning](#) (📖 49)

**How to carry out a guided commissioning using the »Engineer«:**

1. Go to the *Project view* and select the 8400 StateLine inverter.
2.  Go online.

After a connection to the inverter has been established, the following status is displayed in the *Status line*:

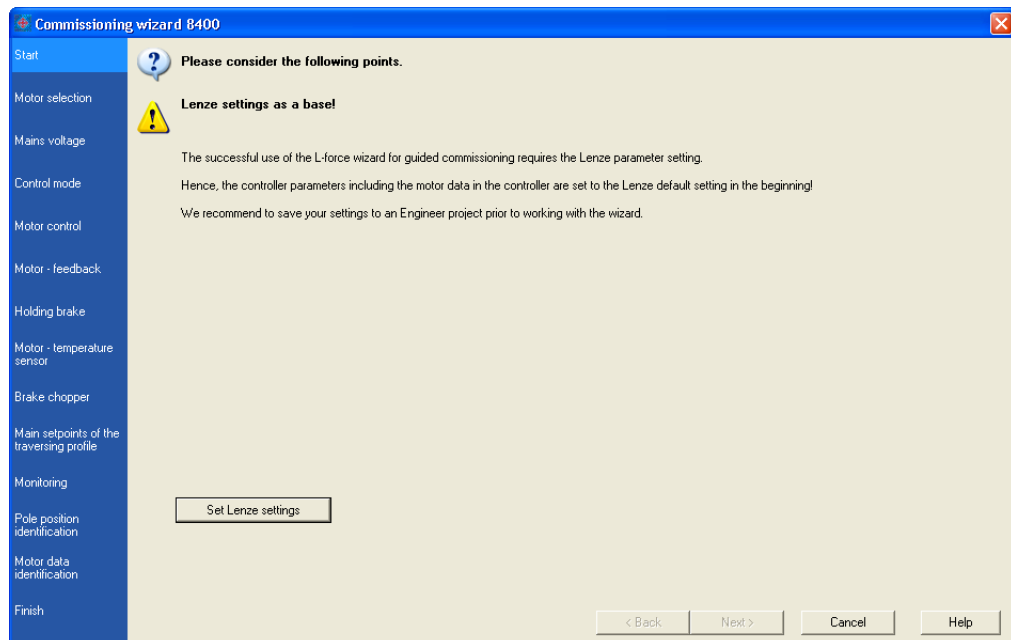

3. Click the  icon to open the *commissioning wizard 8400* dialog box.
  - Now the commissioning wizard guides you step by step through the setting of the important parameters for a quick commissioning.
  - The **Next** button can only be activated again after all parameter settings in the device have been reset via the **Load Lenze setting** button.

**Related topics:**

- ▶ [Commissioning of the "Actuating drive speed" technology application](#) (55)

### 3.6 Manual motor direction of rotation check (manual control)

The »Engineer« function "Manual control" easily allows for controlling the direction of rotation of the motor. The manual control serves to let the motor connected to the inverter with an adjustable speed for an adjustable time.



#### Note!

Take all the necessary safety precautions before you carry out the following commissioning steps and switch the device on!

▶ [Safety instructions with regard to commissioning](#) (49)





#### How to carry out a manual motor direction of rotation check using the »Engineer«:

1. Go to the *Project view* and select the 8400 Stateline inverter.

2.  Go online.

After a connection to the inverter has been established, the following status is displayed in the *Status line*:



3. Click the  symbol to inhibit the inverter via device command.
4. Ensure that the following conditions are met:
  - The mains voltage is switched on.
  - No trouble is active.
  - Safe torque off (STO) is not active.
5. Enable inverter via terminal: Set terminal X5/RFR to HIGH level.
6. Click the  icon to open the *Manual motor rotation indication* dialog box.

**Note:** If the "not ready for operation" status is displayed, check whether all conditions mentioned before (see steps 3 ... 5) have been met.

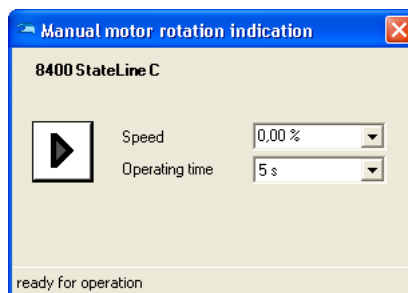

7. Set the desired speed and runtime.  
(The speed refers to the reference speed set in [C00011](#).)
8. Click the  button to let the motor rotate with the set speed for the set runtime.

By clicking the  button, the function can be aborted.

**Note!**

Take all the necessary safety precautions before you carry out the following commissioning steps and switch the device on!

▶ [Safety instructions with regard to commissioning](#) (49)

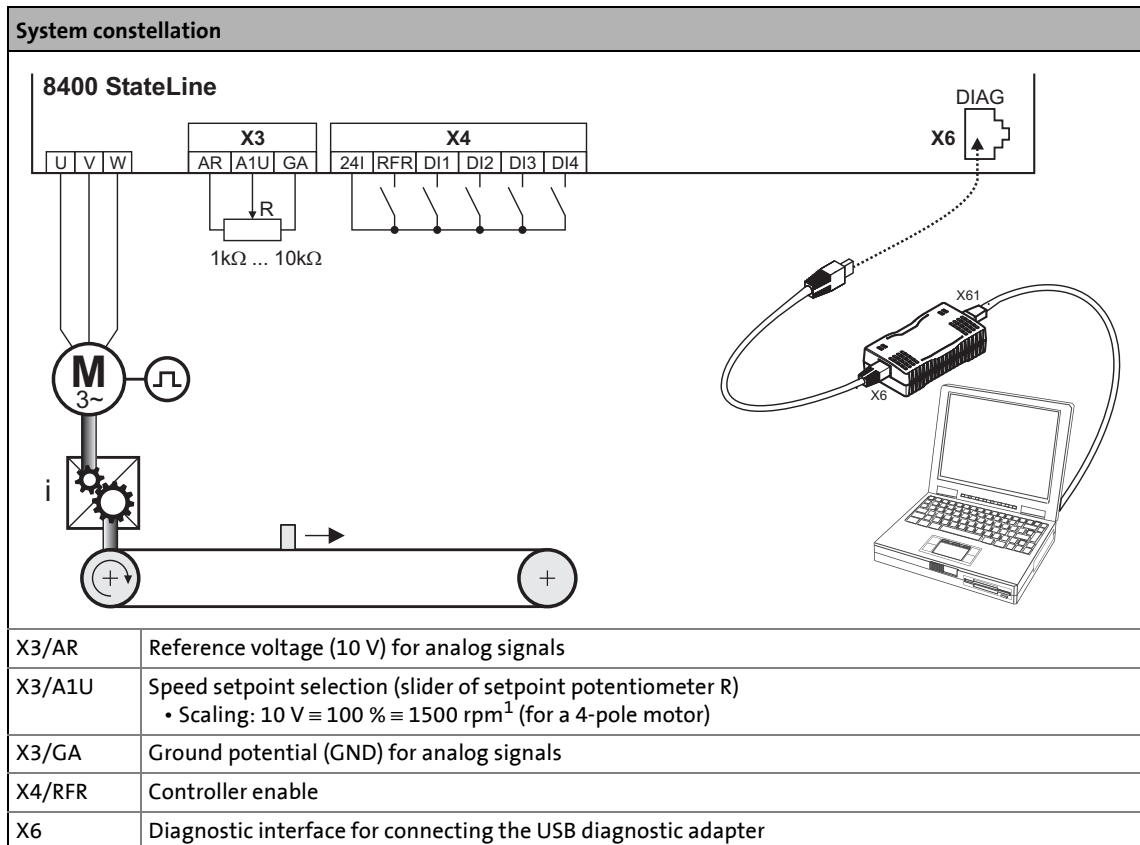

[3-1] Block diagram for wiring the commissioning example for the "Actuating drive speed" application

**Commissioning steps**

Find a description of the commissioning steps of the "Actuating drive speed" technology application below.

Please observe the sequence of the steps in the following chapters and follow them through carefully. This will help you to commission your inverter quickly and as safely as possible:

- ▶ [Prepare inverter for commissioning](#) (56)
- ▶ [Creating an »Engineer« project & going online](#) (57)
- ▶ [Parameterising the motor control](#) (58)
- ▶ [Parameterise application](#) (59)

▶ [Save parameter settings safe against mains failure](#) (📖 61)

▶ [Enable inverter and test application](#) (📖 61)

### 3.7.1 Prepare inverter for commissioning

#### 1. Power terminal wiring.

Refer to the mounting instructions supplied with the inverter to find help on how to correctly design the power connections to match the requirements of your device.

#### 2. Wire the control terminals.

The assignment for your digital inputs should correspond to one of the preconfigured control modes ([C00007](#)) for terminal control:

Control mode	Assignment of the digital terminals			
	DI1	DI2	DI3	DI4
Terminals 0	JOG 1/3	JOG 2/3	DCB	Cw/Ccw
Terminals 2	JOG 1/3	JOG 2/3	QSP	Cw/Ccw
Terminals 11	Cw/Ccw	DCB	MPotUp	MPotDown
Terminal 16	JOG 1/3	JOG 2/3	Cw/QSP	Ccw/QSP
<b>Abbreviations used:</b>				
JOG	Selection of fixed setpoints 1 ... 3 parameterised in <a href="#">C00039/1...3</a>			
DCB	Manual DC-injection braking			
Cw/Ccw	CW/CCW rotation			
QSP	Quick stop			
MPotUp	Motor potentiometer: Increase speed			
MPotDown	Motor potentiometer: Reduce speed			
Cw/QSP	Fail-safe selection of the direction of rotation in connection with quick stop			
Ccw/QSP				

#### 3. Inhibit inverter: Set terminal X4/RFR to LOW level or open contact.

#### 4. Connect USB diagnostic adapter.

#### 5. Switch on voltage supply of the inverter.

- Without motor operation: Connect external 24 V supply.
- With motor operation: Connect mains voltage.

If the green "DRV-RDY" LED is blinking and the red "DRV-ERR" LED is off, the inverter is ready for operation and commissioning can proceed.

#### Related topics:

▶ [Automatic restart after mains connection/fault...](#) (📖 99)

▶ [LED status displays](#) (📖 435)



### 3.7.2 Creating an »Engineer« project & going online



You can find detailed information on the general use of the »Engineer« in the online help which you can call with **[F1]**.

- The chapter "Working with projects" describes, among other things, all options of the *Start-up wizard* which are available to create a new »Engineer« project.

The following steps serve to describe a general method for creating a project with the **Select component from catalogue** option. For this purpose, individual components ( inverter, motor, etc.) are selected from selection lists.

1. Start »Engineer«.
2. Create a new project with the *Start-up wizard* and the **Select component from catalogue** option:
  - In the **Component** step, select the 8400 StateLine inverter.
  - In the **Device modules** step, select the available communication module.
  - In the **Application** step, select the "Actuating drive speed" application. (The application can also be selected any time afterwards via the **Application parameter** tab or [C00005](#).)
  - Select the other components (motor/gearbox) to be added to the project in the **Other components** dialog step.

3. Go to the *Project view* and select the 8400 StateLine inverter.

4. Go online.

After a connection to the inverter has been established, the following status is displayed in the *Status line*:



5. Transfer parameter set to the device.

This command serves to overwrite the current parameter settings in the inverter by parameter settings of the »Engineer« project.

### 3.7.3 Parameterising the motor control

1. Select the **Application parameters** tab from the *Workspace*.

The motor control parameters, among other things, can be found on the left:

2. In the **1** **Motor control** list field (**C00006**), select the desired motor control.
3. Adapt the motor control parameters:

Parameters	Lenze setting		Info
	Value	Unit	
<b>2</b> V/f base frequency ( <a href="#">C00015</a> )	50.0	Hz	▶ <a href="#">Adapting the V/f base frequency</a> (📖 141)
<b>3</b> Imax in motor mode ( <a href="#">C00022</a> )	47.00	A	▶ <a href="#">Optimising the Imax controller</a> (📖 144)
<b>4</b> Vmin boost ( <a href="#">C00016</a> )	1.60	%	▶ <a href="#">Adapting the Vmin boost</a> (📖 143)

#### Related topics:

- ▶ [Notes on motor control](#) (📖 50)
- ▶ [Motor control \(MCTRL\)](#) (📖 112)

### 3.7.4 Parameterise application

The application parameters can be found on the right side of the **Application parameter** tab:

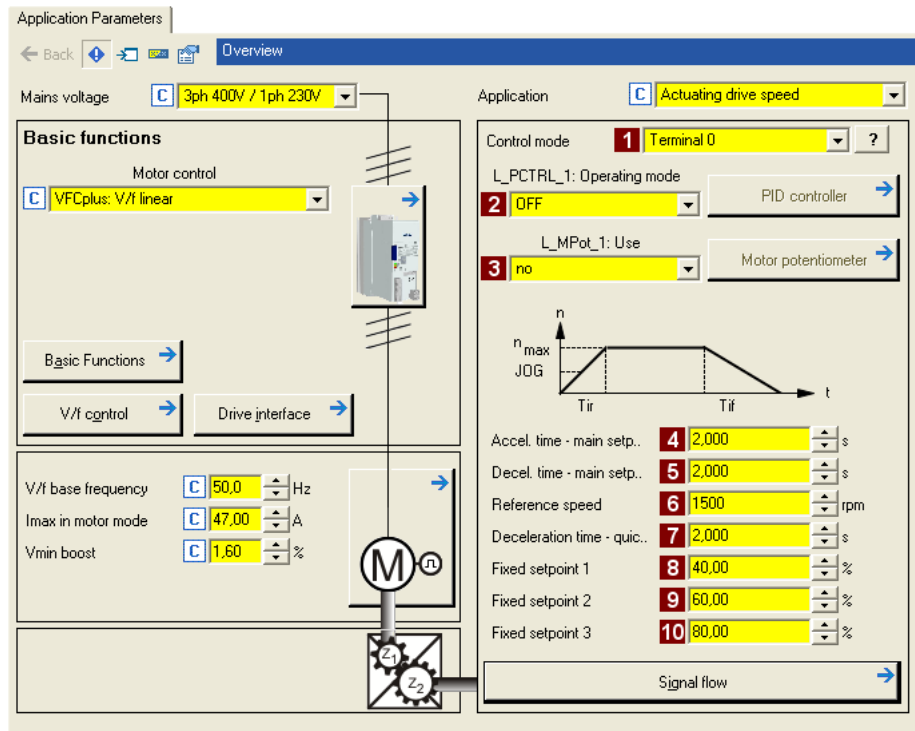

1. In the **1 Control mode** list field ([C00007](#)), select the control mode suitable for the wiring of the terminals.
  - The corresponding wiring diagram is displayed in a pop-up window if you click the **?** button right to the list field.
  - For a detailed description, see the chapter "[Terminal assignment of the control modes](#)". ([□ 322](#))
2. Optional: Use process controller.
  - For this purpose, select the desired operating mode in the **2 L\_PCTRL\_1: Operating mode** list field ([C00242](#)).
  - For a detailed description see the [L\\_PCTRL\\_1](#) function block. ([□ 997](#))
  - Go to the parameterisation dialog of the process controller via the **Process controller** button.
3. Optional: Use motor potentiometer.
  - For this purpose, select "1: On" in the **3 L\_MPot\_1: Use** list field ([C00806](#)).
  - For a detailed description see the [L\\_MPot\\_1](#) function block. ([□ 969](#))
  - Go to the parameterisation dialog of the motor potentiometer via the **Motor potentiometer** button.

## 4. Adapt the application parameters:

Parameters	Lenze setting		Info
	Value	Unit	
<b>4</b> Accel. time - main setpoint (C00012)	2.000	s	The setpoint is led via a ramp function generator with linear characteristic. The ramp function generator converts setpoint step-changes at the input into a ramp. ▶ <a href="#">L_NSet_1</a> (☰ 977)
<b>5</b> Decel. time - main setpoint (C00013)	2.000	s	
<b>6</b> Reference speed (C00011)	1500	rpm	All speed setpoint selections are provided in % and always refer to the reference speed set in <a href="#">C00011</a> . The motor reference speed is indicated on the motor nameplate.
<b>7</b> Decel. time - quick stop (C00105)	2.000	s	If quick stop is requested, motor control is decoupled from the setpoint selection and, within the deceleration time parameterised in <a href="#">C00105</a> , the motor is brought to a standstill ( $n_{act} = 0$ ). ▶ <a href="#">Activate/deactivate quick stop</a> (☰ 85)
<b>8</b> Preset setpoint 1 (C00039/1)	40.00	%	A fixed setpoint for the setpoint generator can be activated instead of the main setpoint via the digital DI1 and DI2 inputs. • Fixed setpoints are selected in [%] based on the reference speed ( <a href="#">C00011</a> ). ▶ <a href="#">L_NSet_1</a> (☰ 977)
<b>9</b> Preset setpoint 2 (C00039/2)	60.00	%	
<b>10</b> Preset setpoint 3 (C00039/3)	80.00	%	

**Tip!**

- Click the **Signal flow** button to go down one dialog level to the signal flow of the application with further possible parameter settings. See chapter "[Basic signal flow](#)". (☰ 312)
- The preconfigured I/O connection in the selected control mode can be changed via configuration parameters. See chapter "[User-defined terminal assignment](#)". (☰ 302)

**More detailed information on the technology application:**

- ▶ [TA "Actuating drive speed"](#) (☰ 311)
- ▶ [Internal interfaces | application block "LA\\_NCtrl"](#) (☰ 314)
- ▶ [Process data assignment for fieldbus communication](#) (☰ 331)
- ▶ [Terminal assignment of the control modes](#) (☰ 322)
- ▶ [Setting parameters \(short overview\)](#) (☰ 333)
- ▶ [Configuration parameters](#) (☰ 335)

### 3.7.5 Save parameter settings safe against mains failure

In order to prevent parameter settings carried out in the device from being lost by mains switching, you have to explicitly save the parameter set with mains failure protection in the device.

 Save parameter set.

### 3.7.6 Enable inverter and test application



#### Stop!

Before stipulating a speed setpoint, check whether the brake in the form of a holding brake on the motor shaft has been released!



#### Note!

If the controller is enabled at mains connection and [C00142](#) has activated the "Inhibit at device on" auto-start option (Lenze setting), the inverter remains in the "[ReadyToSwitchOn](#)" state.

To be able to change to the "[SwitchedOn](#)" status, the controller enable must be deactivated first: set terminal X4/RFR to LOW level.

If the inverter is in the "[SwitchedOn](#)" state:

1. Enable inverter: Set terminal X4/RFR to HIGH level or close contact.
  - If there is no other active source for the controller inhibit, the inverter changes from the "[SwitchedOn](#)" status to the "[OperationEnabled](#)" status.
  - The **Diagnostics** tab and [C00158](#) display all active sources for the controller inhibit.
2. Select the speed setpoint.

In the "Terminal 0" control mode by selecting a voltage at the analog input via the setpoint potentiometer or by selecting a fixed setpoint via the digital DI1/DI2 inputs:

DI1	DI2	Speed selection
LOW	LOW	The setpoint speed is selected via analog input 1 <ul style="list-style-type: none"> <li>• Scaling: 10 V <math>\equiv</math> 100 % <math>\equiv</math> reference speed (<a href="#">C00011</a>)</li> </ul>
HIGH	LOW	Fixed setpoint 1 ( <a href="#">C00039/1</a> ) is used as setpoint speed. <ul style="list-style-type: none"> <li>• Lenze setting: 40 % of the reference speed (<a href="#">C00011</a>)</li> </ul>
LOW	HIGH	Fixed setpoint 2 ( <a href="#">C00039/2</a> ) is used as setpoint speed. <ul style="list-style-type: none"> <li>• Lenze setting: 60 % of the reference speed (<a href="#">C00011</a>)</li> </ul>
HIGH	HIGH	Fixed setpoint 3 ( <a href="#">C00039/3</a> ) is used as setpoint speed. <ul style="list-style-type: none"> <li>• Lenze setting: 80 % of the reference speed (<a href="#">C00011</a>)</li> </ul>



#### Note!

Observe the actual speed value (display in [C00051](#)) as well as the [LED status displays](#).  
([435](#))

**Tip!**

Other control functions in the "Terminal 0" control mode:

- DI3: HIGH level  $\equiv$  Request DC-injection braking
- DI4: HIGH level  $\equiv$  Request a change of direction of rotation

**Related topics:**

- ▶ ["Inhibit at device on" auto-start option](#) (📖 99)
- ▶ [Trouble-shooting during commissioning](#) (📖 52)
- ▶ [Diagnostics & error management](#) (📖 434)

**Note!**

Take all the necessary safety precautions before you carry out the following commissioning steps and switch the device on!

► [Safety instructions with regard to commissioning](#) (49)

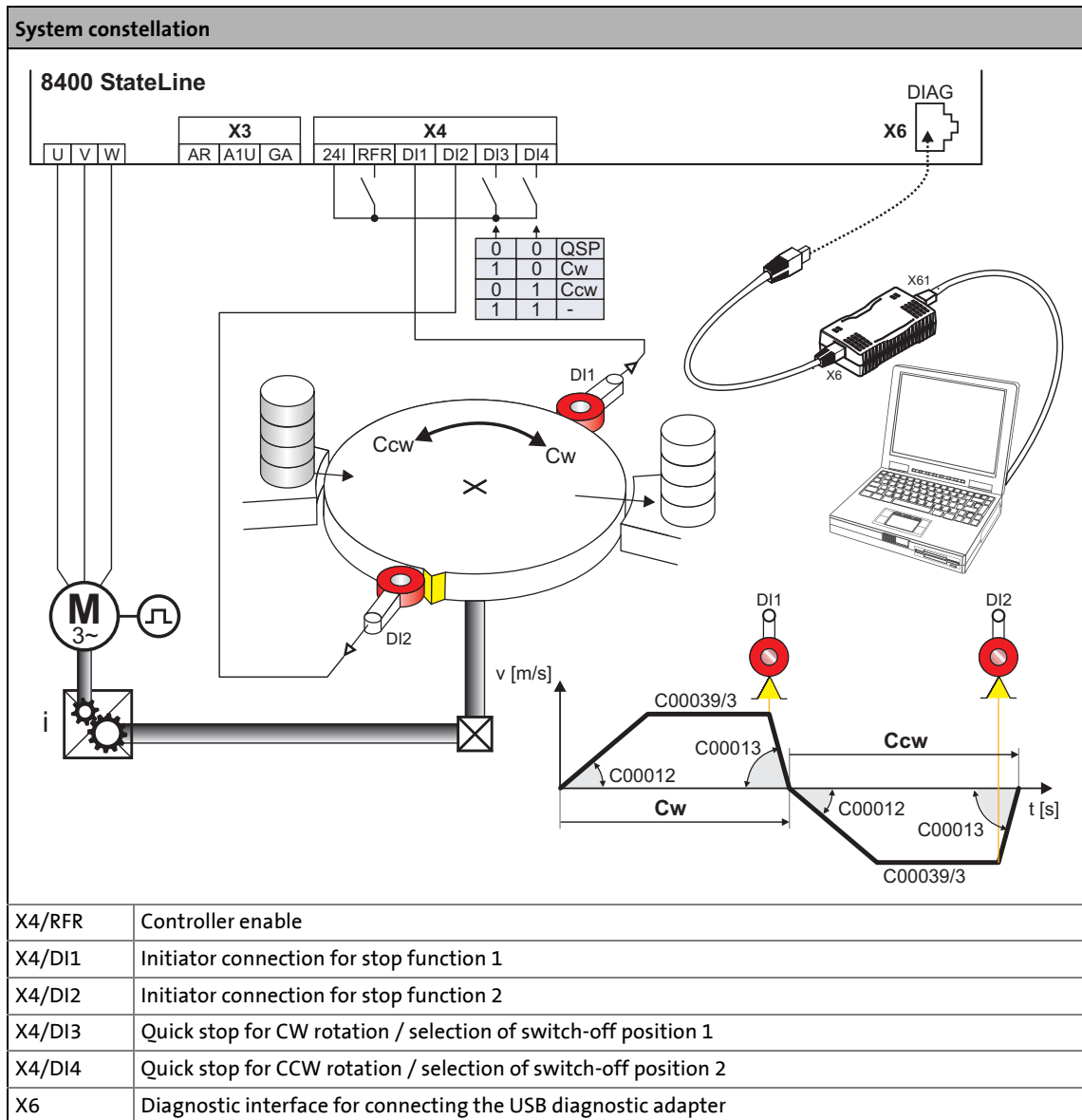

[3-2] Block diagram for wiring of the commissioning example for the "Switch-off positioning" application

### Functional principle of a switch-off positioning without pre-switch off

In case of the switch-off positioning without pre-switch off shown above, it makes sense to use the "[Terminals 2](#)" control mode:

1. Set DI3 to HIGH level to activate CW rotation.
2. The drive accelerates along the acceleration ramp ([C00012](#)) up to the traversing speed set in [C00039/3](#).
3. After reaching the DI1 contact, the drive comes to a stop with quick stop (QSP) in the target position.
4. Reset DI3 to LOW level and set DI4 to HIGH level to activate CCW rotation now.
5. The drive is accelerated along the acceleration ramp ([C00012](#)) up to the traversing speed set in [C00039/3](#).
6. After the DI2 contact has been reached, the drive is braked to standstill with quick stop (QSP) in the initial position.



#### Tip!

- In order to avoid positioning inaccuracy due to signal propagation delays, the initiators can be directly evaluated by the inverter. Limit switch evaluation can be configured in the inverter. In code [C00488/x](#) you can change the method of detecting position signals from level evaluation to edge evaluation.
- In order to prevent unintended movements of the load in the target position, the use of a holding brake is recommended as an alternative to DC-injection braking (limited torque).
- The device terminals and their function assignment do not appear in the FB Editor. The assignment of (hardware) terminals to (software) functions is explained in the chapter "[Terminal assignment of the control modes](#)". ([□ 382](#))

### Commissioning steps

As shown in illustration [\[3-2\]](#), below find a description of the commissioning steps of the "Switch-off positioning" application without pre-switch off.

Please observe the sequence of the steps in the following chapters and follow them through carefully. This will help you to commission your inverter quickly and as safely as possible:

- ▶ [Prepare inverter for commissioning](#) ([□ 65](#))
- ▶ [Creating an »Engineer« project & going online](#) ([□ 66](#))
- ▶ [Parameterising the motor control](#) ([□ 67](#))
- ▶ [Parameterise application](#) ([□ 68](#))
- ▶ [Save parameter settings safe against mains failure](#) ([□ 70](#))
- ▶ [Enable inverter and test application](#) ([□ 70](#))



### 3.8.1 Prepare inverter for commissioning

#### 1. Power terminal wiring.

Refer to the mounting instructions supplied with the inverter to find help on how to correctly design the power connections to match the requirements of your device.

#### 2. Wire the control terminals.

In case of the application shown in illustration [3-2], switch-off positioning without pre-switch off, wiring according to the "[Terminals 2](#)" control mode makes sense:

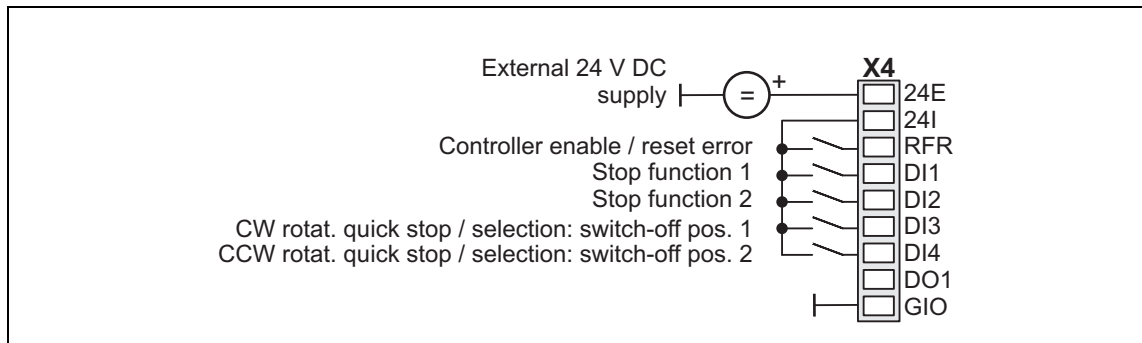

#### 3. Inhibit inverter: Set terminal X4/RFR to LOW level or open contact.

#### 4. Connect USB diagnostic adapter.

#### 5. Switch on voltage supply of the inverter.

- Without motor operation: Connect external 24 V supply.
- With motor operation: Connect mains voltage.

If the green "DRV-RDY" LED is blinking and the red "DRV-ERR" LED is off, the inverter is ready for operation and commissioning can proceed.

#### Related topics:

- ▶ [Automatic restart after mains connection/fault...](#) (📖 99)
- ▶ [LED status displays](#) (📖 435)

### 3.8.2 Creating an »Engineer« project & going online



You can find detailed information on the general use of the »Engineer« in the online help which you can call with **[F1]**.

- The chapter "Working with projects" describes, among other things, all options of the *Start-up wizard* which are available to create a new »Engineer« project.

The following steps serve to describe a general method for creating a project with the **Select component from catalogue** option. For this purpose, individual components ( inverter, motor, etc.) are selected from selection lists.

1. Start »Engineer«.
2. Create a new project with the *Start-up wizard* and the **Select component from catalogue** option:
  - In the **Component** step, select the 8400 StateLine inverter.
  - In the **Device modules** step, select the available communication module.
  - In the **Application** step, select the "Switch-off positioning" application. (The application can also be selected any time afterwards via the **Application parameter** tab or [C00005](#).)
  - Select the other components (motor/gearbox) to be added to the project in the **Other components** dialog step.

3. Go to the *Project view* and select the 8400 StateLine inverter.

4.  Go online.

After a connection to the inverter has been established, the following status is displayed in the *Status line*:



5.  Transfer parameter set to the device.

This command serves to overwrite the current parameter settings in the inverter by parameter settings of the »Engineer« project.

### 3.8.3 Parameterising the motor control

1. Select the **Application parameters** tab from the *Workspace*.

The motor control parameters, among other things, can be found on the left:

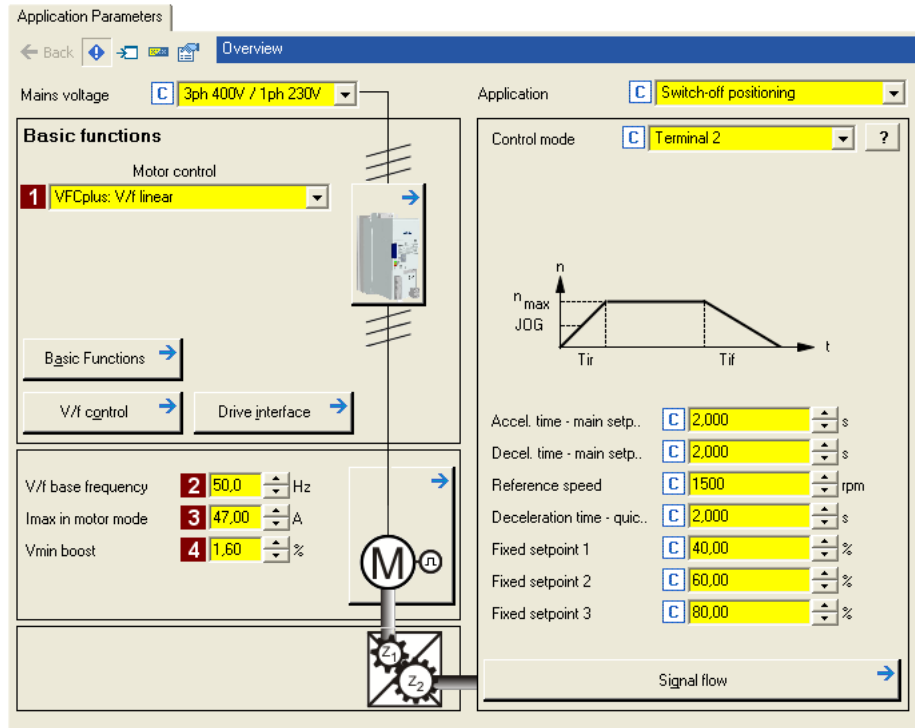

2. In the **1 Motor control** list field ([C00006](#)), select the desired motor control.
3. Adapt the motor control parameters:

Parameters	Lenze setting		Info
	Value	Unit	
<b>2</b> V/f base frequency ( <a href="#">C00015</a> )	50.0	Hz	▶ <a href="#">Adapting the V/f base frequency</a> (📖 141)
<b>3</b> Imax in motor mode ( <a href="#">C00022</a> )	47.00	A	▶ <a href="#">Optimising the Imax controller</a> (📖 144)
<b>4</b> Vmin boost ( <a href="#">C00016</a> )	1.60	%	▶ <a href="#">Adapting the Vmin boost</a> (📖 143)

#### Related topics:

- ▶ [Notes on motor control](#) (📖 50)
- ▶ [Motor control \(MCTRL\)](#) (📖 112)

### 3.8.4 Parameterise application

The application parameters can be found on the right side of the **Application parameter** tab:

The screenshot shows the 'Application Parameters' software interface. The 'Application' dropdown is set to '1 Switch-off positioning'. The 'Control mode' dropdown is set to '2 Terminal 2'. The 'Basic functions' section shows 'VFCplus: V/f linear' selected. The 'V/f control' section shows 'V/f base frequency' at 50.0 Hz, 'Imax in motor mode' at 47.00 A, and 'Vmin boost' at 1.60%. The 'Application' section shows a speed-time diagram with parameters: Accel. time - main setp. (3) 2.000 s, Decel. time - main setp. (4) 2.000 s, Reference speed (5) 1500 rpm, Deceleration time - quic. (6) 2.000 s, Fixed setpoint 1 (7) 40.00%, Fixed setpoint 2 (8) 60.00%, and Fixed setpoint 3 (9) 80.00%.

- In the **1 Application** list field ([C00005](#)), select the "switch-off positioning".  
After the "Switch-off positioning" application is selected, the contents of the tab change, e.g. the **Process controller** and **Motor potentiometer** buttons are not shown any more.
- In the **2 Control mode** list field ([C00007](#)) and in case of illustration [\[3-2\]](#), for the shown switch-off positioning without pre-switch off the "[Terminals 2](#)" control mode must be selected.
  - The corresponding wiring diagram is displayed in a pop-up window if you click the **?** button right to the list field.
  - For a detailed description, see the chapter "[Terminal assignment of the control modes](#)". ([322](#))

## 3. Adapt the application parameters:

Parameters	Lenze setting		Info
	Value	Unit	
<b>3</b> Accel. time - main setpoint (C00012)	2.000	s	The setpoint is led via a ramp function generator with linear characteristic. The ramp function generator converts setpoint step-changes at the input into a ramp. Note: These settings only apply if no other ramp times have been selected at the <a href="#">L_NSet</a> FB!
<b>4</b> Decel. time - main setpoint (C00013)	2.000	s	
<b>5</b> Reference speed (C00011)	1500	rpm	All speed setpoint selections are provided in % and always refer to the reference speed set in <a href="#">C00011</a> . The motor reference speed is indicated on the motor nameplate.
<b>6</b> Decel. time - quick stop (C00105)	2.000	s	If quick stop is requested, motor control is decoupled from the setpoint selection and, within the deceleration time parameterised in <a href="#">C00105</a> , the motor is brought to a standstill ( $n_{act} = 0$ ). ▶ <a href="#">Activate/deactivate quick stop</a> (☞ 85)
<b>7</b> Preset setpoint 1 (C00039/1)	40.00	%	Fixed setpoints are selected in [%] based on the reference speed ( <a href="#">C00011</a> ). <b>Fixed setpoint 2 must be smaller than fixed setpoint 3!</b> Otherwise, the drive will be started with a low speed and accelerated after the pre-switch off.
<b>8</b> Preset setpoint 2 (C00039/2)	60.00	%	
<b>9</b> Preset setpoint 3 (C00039/3)	80.00	%	

**Tip!**

- Click the **Signal flow** button to go down one dialog level to the signal flow of the application with further possible parameter settings. See chapter "[Basic signal flow](#)". (☞ 373)
- The preconfigured I/O connection in the selected control mode can be changed via configuration parameters. See chapter "[User-defined terminal assignment](#)". (☞ 302)
- Low-jerk traversing profiles can be implemented by means of S-shaped ramps.
- In the case of high breakaway torques combined with horizontal motion sequences, "Sensorless vector control (SLVC)" can be used as motor control ([C00006](#)).
- For reversal of rotation direction (bidirectional motion), comprehensive configuration options are available in the inverter (e.g. by means of the [L\\_DFlipFlop](#) function block).

**More detailed information on the technology application:**

- ▶ [TA "Switch-off positioning"](#) (☞ 371)
- ▶ [Internal interfaces | application block "LA\\_SwitchPos"](#) (☞ 374)
- ▶ [Process data assignment for fieldbus communication](#) (☞ 391)
- ▶ [Terminal assignment of the control modes](#) (☞ 382)
- ▶ [Setting parameters \(short overview\)](#) (☞ 393)
- ▶ [Configuration parameters](#) (☞ 395)

### 3.8.5 Save parameter settings safe against mains failure

In order to prevent parameter settings carried out in the device from being lost by mains switching, you have to explicitly save the parameter set with mains failure protection in the device.

 Save parameter set.

### 3.8.6 Enable inverter and test application



#### Stop!

Before stipulating a speed setpoint, check whether the brake in the form of a holding brake on the motor shaft has been released!



#### Note!

If the controller is enabled at mains connection and [C00142](#) has activated the "Inhibit at device on" auto-start option (Lenze setting), the inverter remains in the "[ReadyToSwitchOn](#)" state.

To be able to change to the "[SwitchedOn](#)" status, the controller enable must be deactivated first: set terminal X4/RFR to LOW level.

If the inverter is in the "[SwitchedOn](#)" state:

1. Enable inverter: Set terminal X4/RFR to HIGH level or close contact.
  - If there is no other active source for the controller inhibit, the inverter changes from the "[SwitchedOn](#)" status to the "[OperationEnabled](#)" status.
  - The **Diagnostics** tab and [C00158](#) display all active sources for the controller inhibit.
2. Select the respective control signals via the digital inputs.



#### Note!

Observe the actual speed value (display in [C00051](#)) as well as the [LED status displays](#).  
([435](#))

#### Related topics:

- ▶ ["Inhibit at device on" auto-start option](#) ([499](#))
- ▶ [Trouble-shooting during commissioning](#) ([52](#))
- ▶ [Diagnostics & error management](#) ([434](#))

---

### 3.9 PC manual control

This function extension is available from version 06.00.00 onwards and is supported by the »Engineer« from version 2.13 onwards!

For the purpose of testing and demonstration and when an online connection has been established, the PC manual control enables the manual control of various drive functions from the »Engineer«.

**Supported drive functions:**

- Speed control (follow speed setpoint)
- Activate/deactivate quick stop

**More control functions:**

- Reset error message
- Set digital/analog outputs (in preparation)

**Diagnostic functions:**

- Display of the actual speed value and motor current (as time characteristic)
- Display of the current device status
- Display of the status determining error
- Display of the status of the digital/analog inputs (in preparation)

#### 3.9.1 Activate PC manual control

**Stop!**

PC manual control must be explicitly activated by the user.

If PC manual control is activated, the inverter is inhibited via device command ([C00002/16](#)) first.



### Note!

#### With active PC manual control:

The online connection between PC and controller is monitored by the inverter.

- If the online connection is interrupted longer than the timeout time set (Lenze setting: 2 s):
  - The error response "Fault" takes place, i.e. the motor becomes torqueless and coasts, if it has not yet been in standstill.
  - The "[Ck16: Time overflow manual control](#)" error message is entered into the logbook.

PC manual control provides the **Motion Control Kernel** and the motor interface with all required control signals and setpoint signals.

- The available application (function block interconnection) is now decoupled from these interfaces, but is continued to be processed and remains unchanged.
- It does not matter what type of motor control is set in [C00006](#).



#### How to activate the PC manual control:

1. If an online connection to the inverter has not been established yet:
  - Go online.
2. Select the **Application parameters** tab from the *Workspace*.
3. Go to the *Overview* dialog level and click the "PC manual control" button.
  - First, the following safety note is displayed:

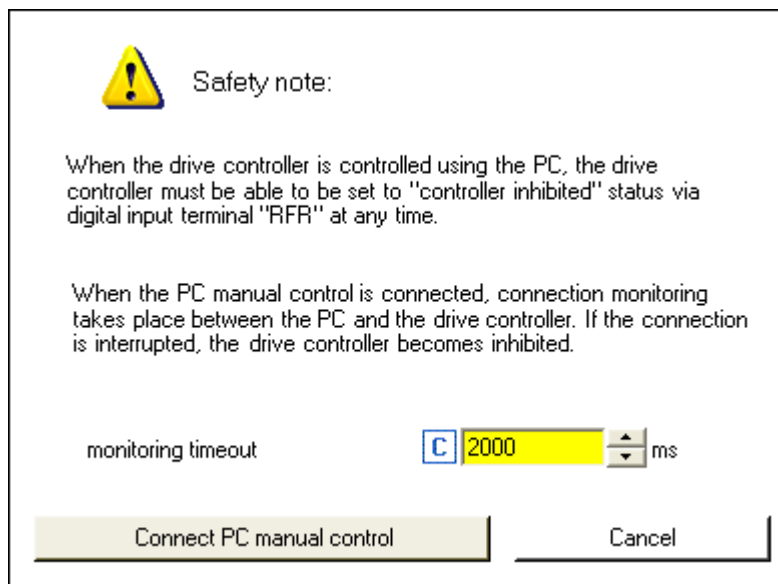

- Click the **Cancel** button to abort the action and close the dialog box.
  - The **Timeout monitoring** input field serves to adapt the timeout time for the connection monitoring between PC and inverter.
4. To acknowledge the note and activate PC manual control:
    - Click the **Activate PC manual control** button.
    - The inverter is inhibited via device command ([C00002/16](#)).
    - The *PC manual control* operator dialog is displayed.



### PC manual control - operator dialog

On the left-hand side, the *PC manual control* operator dialog includes control elements which serve to select various control functions. On the right-hand side, setpoint and status displays are provided for diagnostic purposes:

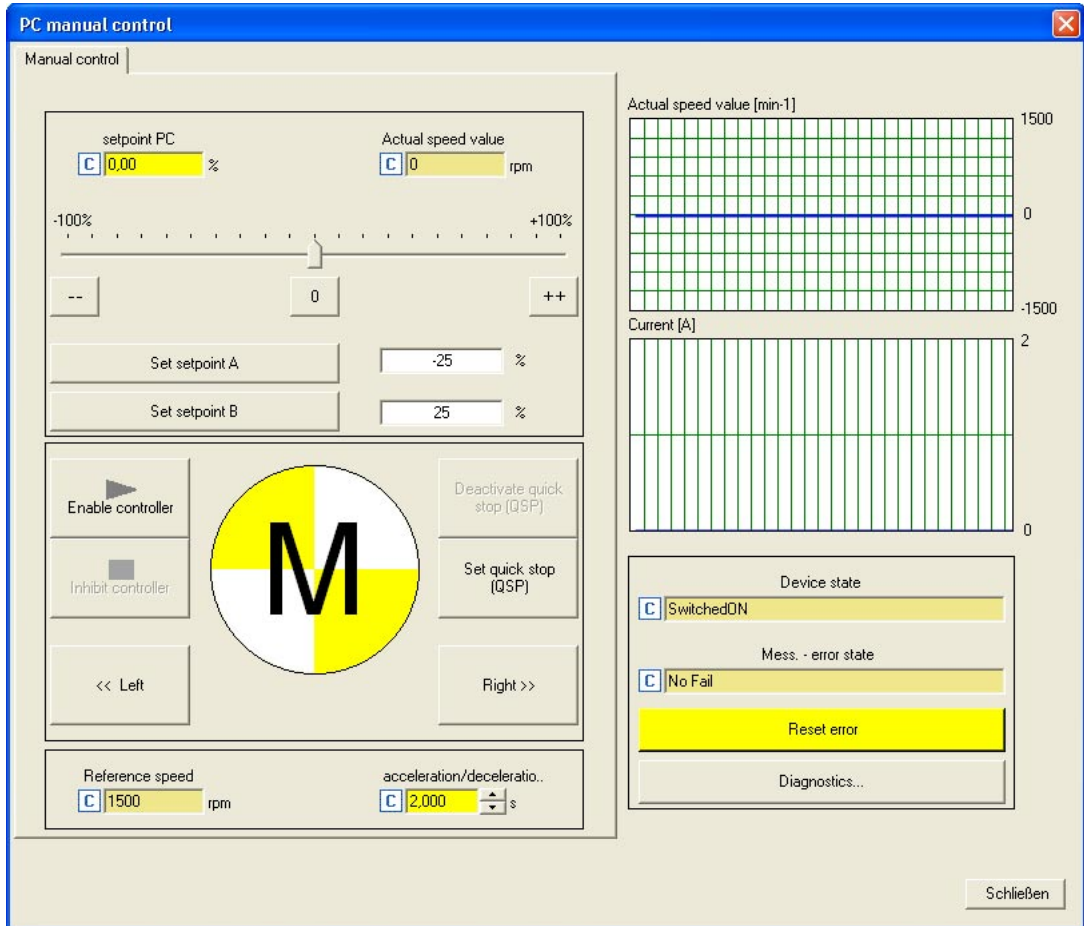

### Note!

PC manual control can be exited any time by clicking the **Close** button.

If you exit PC manual control or change to another tab, the inverter is inhibited via device command ([C00002/16](#)), i.e. the motor becomes torqueless and is coasting unless it already is at standstill.

The different versions are described in the following chapters.

### 3.9.2 Speed control

The **Speed control** serves to easily rotate the drive without setting control parameters or feedback systems in the "Speed follower" mode:

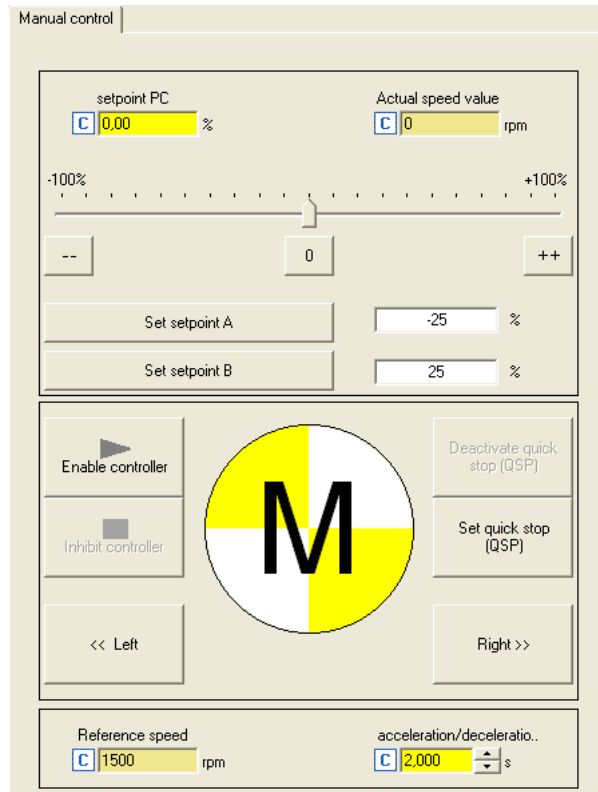

#### How to easily rotate the motor:

1. Set the desired speed setpoint in [%] based on the reference speed, e.g. directly in the **Setpoint PC** input field or via the slider.
  - Via the -- / 0 / ++ buttons, the currently set speed setpoint can be reduced/increased in steps of 10 percent or set to zero.
  - Via the **Set setpoint A/B** buttons, the speed setpoint can be set to a previously set constant value A/B.
2. To start the speed follower:
 

Enable the inverter via the **Enable controller** button.

  - Please observe that the inverter will not be enabled if other sources of controller inhibit (e.g. RFR terminal) are active.
  - The enabled drive now follows the defined speed setpoint.
  - In order to prevent shocks or overload at higher setpoint changes, the speed setpoint is lead via a linear ramp generator with adjustable acceleration/deceleration time.
  - Via the **Inhibit controller** button, the inverter can be inhibited again, i.e. the motor becomes torqueless and is coasting unless it already is at standstill.

**Further functions:**

- If the **Set quick stop (QSP)** button is clicked, the motor is braked to a standstill within the deceleration time parameterised in [C00105](#).
  - Via the **Deactivate quick stop (QSP)** button, the quick stop can be deactivated.
- Via the << **CCW** and **CW** >> buttons, the direction of rotation can be changed.

### 4 Device control (DCTRL)

This chapter provides information on internal device control as well as the device commands which can be executed via the subcodes of [C00002](#).

- The device control causes the inverter to take defined device statuses.
- The device control provides a multitude of status information in many ways:
  - Visually via the [LED status displays](#) on the front of the inverter. ([📖 436](#))
  - As text messages in the [Logbook](#). ([📖 443](#))
  - As process signals via the outputs of the [LS\\_DriveInterface](#) system block. ([📖 104](#))
  - Via diagnostic / display parameters which are included in the »Engineer« parameter list as well as in the **Diagnostics** category in the keypad.



#### Note!

The device states of the inverter are based on the operating states of the CiA402 standard. ▶ [Device state machine and device states](#) ([📖 88](#))



## How to get to the parameterisation dialog of the device control:

1. »Engineer« Go to the *Project view* and select the 8400 StateLine inverter.
2. Select the **Application parameters** tab from the *Workspace*.
3. Go to the *Overview* dialog level and click the **Drive interface** button.

## Parameterisation dialog in the »Engineer«

The parameterisation dialog shows the input / output signals and the internal signal flow of the [LS\\_DriveInterface](#) system block which displays the device control in the function block editor:

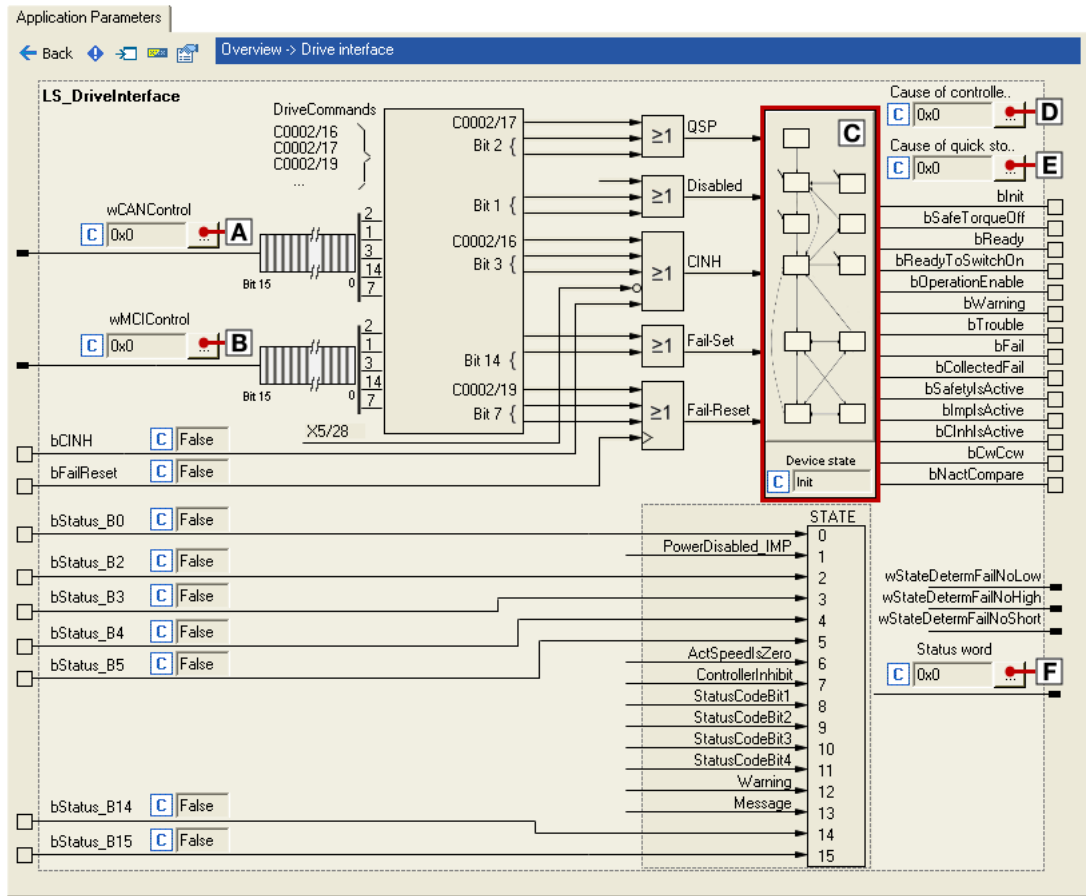

Range / Meaning	Display parameter
<b>A</b> Display of the control word via system bus (CAN)	<a href="#">C00136/2</a>
<b>B</b> Display of the control word via communication module (e.g. PROFIBUS)	<a href="#">C00136/1</a>
<b>C</b> Display of the internal state machine and the current device status	<a href="#">C00137</a>
<b>D</b> Display of all active sources of a controller inhibit	<a href="#">C00158</a>
<b>E</b> Display of all active sources of a quick stop	<a href="#">C00159</a>
<b>F</b> Display of the status word of the device control	<a href="#">C00150</a>

## 4 Device control (DCTRL)

### 4.1 Device commands (C00002/x)

---

#### 4.1 Device commands (C00002/x)

This chapter describes the device commands of the inverter which are provided in the subcodes of [C00002](#) and can be carried out using the keypad or, alternatively, the »Engineer« when an online connection has been established.

The device commands serve, among other things, to directly control the inverter to organise parameter sets, and to call diagnostic services.

Regarding the execution of the device commands, a distinction is drawn between:

- Device commands which have an immediate effect on control (e.g. "Activate quick stop")
  - After being called in [C00002/x](#), these device commands provide static status information ("On" or "Off").
- Device commands with longer execution duration (several seconds)
  - After being called in [C00002/x](#), these device commands provide dynamic status information ("Work in progress 20%" → "Work in progress 40%", etc.).
  - The execution of the device command has not finished successfully until the "Off / ready" status information is provided in [C00002/x](#).
  - In the event of an error, the "Action cancelled" status information is provided in [C00002/x](#). In this case, further details can be obtained from the status of the device command executed last which is displayed in [C00003](#).



#### Stop!

Before the supply voltage is switched off after a device command has been transmitted via [C00002/x](#), the device command must be checked for successful completion on the basis of the status information provided in [C00002/x](#)!

- This is of particular importance for device commands which save data to the memory module of the device. Incomplete storage processes may lead to data inconsistencies in the memory module.





#### Note!

- Before activating device commands by a master control, wait for the "Ready" signal of the inverter.
- The device will reject a write process to [C00002/x](#) if the value is >1 and issue an error message.
- [C00003](#) displays the status of the device command that was executed last.

### Activate device command

When an online connection has been established, simply use the »Engineer« to activate a device command by selecting the corresponding option from the **Parameters** tab in [C00002/x](#) ("0: off" or "1: On / start").

- Alternatively, the device command can also be activated via e.g. keypad or through a master control by writing to [C00002/x](#).
- Some of the frequently used device commands (such as "Save parameter set") can also be executed via the *Toolbar* icons of the »Engineer« when an online connection has been established:

Symbol	Function
	Enable inverter
	Inhibit inverter
	Save parameter set (for 8400: Save all parameter sets)



### Note!

Device commands that can be executed via the *Toolbar* of the »Engineer« always affect the element currently selected in the *Project view* including all subelements!

- If no inverter but a system module is selected in the *Project view*, the corresponding device command will be activated in all lower-level inverters having an online connection with the »Engineer«.

Before the desired action is carried out, a confirmation prompt appears first, asking whether the action is really to be carried out.

### Short overview of device commands

Device commands described in this chapter:

C00002 Subcode:	Device command	Controller inhibit required	Status information
1	<a href="#">Load Lenze setting</a>	●	dynamic
6	<a href="#">Load all parameter sets</a>	●	dynamic
11	<a href="#">Save all parameter sets</a>		dynamic
16	<a href="#">Enable/inhibit inverter</a>		static
17	<a href="#">Activate/deactivate quick stop</a>		static
19	<a href="#">Reset error</a>		static
21	<a href="#">Delete logbook</a>		static
27	<a href="#">Device search function</a> (from version 06.00.00)		static

Device commands described in other chapters:

C00002 Subcode:	Device command	Controller inhibit required	Status information
23	Identify motor parameters ▶ <a href="#">Automatic motor data identification</a>	●	dynamic
26	CAN reset node ▶ <a href="#">Reinitialising the CANopen interface</a>		static
28	Check MasterPin (from version 06.00.00) ▶ <a href="#">Unlocking the inverter with a MasterPin</a>	●	static
29	Set binding ID (from version 06.00.00) ▶ <a href="#">Device personalisation</a>		static
30	Delete binding ID (from version 06.00.00) ▶ <a href="#">Device personalisation</a>		static
31	Set password (from version 06.00.00) ▶ <a href="#">Password protection</a>		static
32	Check password (from version 06.00.00) ▶ <a href="#">Password protection</a>		static
33	Delete password (from version 06.00.00) ▶ <a href="#">Password protection</a>		static



## 4 Device control (DCTRL)

### 4.1 Device commands (C00002/x)

---

#### 4.1.1 Load Lenze setting

The [C00002/1](#) = "1: On / start" device command resets the parameters to the Lenze setting which are saved in the inverter firmware.

- Can only be executed if the controller is inhibited; otherwise, the feedback [C00002/1](#) = "6: No access - controller inhibit" will be returned.
- All parameter changes made since the last saving of the parameter set will get lost!
- This device command has an effect on the settings of the parameters of the operating system, application and module.



#### Note!

When the Lenze setting [C00002/1](#) is loaded, all communication parameters are reset as well. After the mains is switched on, the Lenze setting is accepted and the inverter might not be accessible anymore via the communication module.

From **version 18.00.00** onwards, [C01004](#) (Load Lenze setting without:) serves to prevent all communication parameters from being reset when the Lenze setting [C00002/1](#) is loaded.

In order that the communication parameters are not reset while loading the Lenze setting, you must parameterise [C01004](#) before mains switching:

- When using a communication module: [C01004](#):set bit 0 = 1.
- When using CAN OnBoard: [C01004](#):set bit 1 = 1.



#### How to load the Lenze setting:

1. If the inverter is enabled, it must be inhibited, e.g. by executing the "Enable/Inhibit inverter" device command "[C00002/16](#) = "0: Off / ready".
2. Execute the "Load Lenze setting" device command:  
[C00002/1](#) = "1: On / start"

The loading process may take a couple of seconds. After the device command has been called, [C00002/1](#) returns dynamic status information ("Work in progress 20 %" → "Work in progress 40 %" → "Work in progress 60 %", etc.).

#### Notes on execution time

The execution time of this device command usually is 2.5 s, independent of the communication module used.

If - in addition to the device-internal time monitoring - a monitoring of the execution time is to be implemented for this device command in a higher-level control, the monitoring time has to be 2 ... 3 times higher.

# 4 Device control (DCTRL)

## 4.1 Device commands (C00002/x)

### 4.1.2 Load all parameter sets

The [C00002/6](#) = "1: On / start" device command reloads all parameter settings from the memory module to the inverter.

- Can only be executed if the controller is inhibited; otherwise, the feedback [C00002/6](#) = "6: No access - controller inhibit" will be returned.
- All parameter changes made since the last saving of the parameter set will get lost!
- This device command has an effect on the settings of the parameters of the operating system, application and module.



#### Note!

The inverter is currently provided with one data record for all parameters, i.e. every parameter has a value. Several data records per inverter are in preparation.

From version 04.00.00 onwards, the basic function [Parameter change-over](#) provides a change-over between four sets with different parameter values for up to 32 freely selectable parameters. ([□ 597](#))



#### How to load the parameter settings from the memory module:

1. If the inverter is enabled, it must be inhibited, e.g. by executing the "Enable/Inhibit inverter" device command "([C00002/16](#) = "0: Off / ready").
2. Execute the "Load all parameter sets" device command:  
[C00002/6](#) = "1: On / start"

The loading process may take a couple of seconds. After the device command has been called, [C00002/6](#) returns dynamic status information ("Work in progress 20 %" → "Work in progress 40 %" → "Work in progress 60 %", etc.).

#### Notes on execution time

The execution time of this device command depends on the communication module used. If - in addition to the device-internal time monitoring - a monitoring of the execution time is to be implemented for this device command in a higher-level control, the monitoring time has to be 2 ... 3 times higher than the times specified in the following table:

Communication module used	Typical execution time		
	StateLine C	HighLine C	TopLine C
Without communication module	3.5 s	3.5 s	3.5 s
PROFIBUS® or INTERBUS	3.5 s	3.5 s	3.5 s
EtherCAT®, PROFINET® or EtherNet/IP™	4.0 s	3.5 s	4.0 s
Ethernet POWERLINK	15.0 s	15.0 s	15.0 s

### 4.1.3 Save all parameter sets

If parameter settings are changed in the inverter, those changes will be lost after mains switching of the inverter unless the settings have been saved explicitly.

The [C00002/11](#) = "1: On / start" device command saves the current parameter settings safe against mains failure to the memory module of the inverter.



#### Note!

When the device is switched on, all parameters are automatically loaded from the memory module to the main memory of the inverter.

Observe the following to avoid data inconsistencies which cause errors when the parameters are loaded from the memory module:

During the storage process:

- Do not switch off the supply voltage!
- Do not remove the memory module from the device!

The inverter is currently provided with one data record for all parameters, i.e. every parameter has a value. Several data records per inverter are in preparation.



#### How to save the parameter settings to the memory module:

Execute the "Save all parameter sets" device command:

[C00002/11](#) = "1: On / start"

The storage process may take a couple of seconds. After the device command has been called in [C00002/11](#), dynamic status information ("Work in progress 20%" → "Work in progress 40%" → "Work in progress 60%", etc.) is returned.



#### Tip!

- This device command can also be activated via the  icon in the *Toolbar*.
- The "[Load Lenze setting](#)" device command ([C00002/1](#) = "1: On / start") resets the parameter settings to the delivery status of the device.

#### Notes on execution time

The execution time of this device command depends on the communication module used. If - in addition to the device-internal time monitoring - a monitoring of the execution time is to be implemented for this device command in a higher-level control, the monitoring time has to be 2 ... 3 times higher than the times specified in the following table:

Communication module used	Typical execution time		
	StateLine C	HighLine C	TopLine C
Without communication module	2.0 s	2.5 s	2.5 s
PROFIBUS® or INTERBUS	3.5 s	3.5 s	4.0 s
EtherCAT®, PROFINET® or EtherNet/IP™	4.5 s	4.5 s	4.5 s
Ethernet POWERLINK	11.0 s	11.0 s	11.0 s

# 4 Device control (DCTRL)

## 4.1 Device commands (C00002/x)

### 4.1.4 Enable/inhibit inverter

The [C00002/16](#) = "1: On / start" device command enables the inverter, provided that no other source of an inverter inhibit is active.

The [C00002/16](#) = "0: Off / ready" device command inhibits the inverter again, i.e. the power output stages in the inverter are inhibited and the speed/current controllers of the motor control are reset.

- The motor becomes torqueless and coasts, if it has not yet been in standstill.
- When the controller is inhibited, the status output *bCInhActive* of the [LS\\_DriveInterface](#) system block is set to TRUE.
- When the controller inhibit request is reset, the drive synchronises to the actual speed. For this purpose,
  - If the flying restart circuit is activated in [C00990](#), the flying restart function parameterised in [C00991](#) is used for the synchronisation to the rotary or standing drive. ▶ [Flying restart function](#) (□ 218)
  - In the case of an operation with feedback, the actual speed is read out by the encoder system.
  - In the case of a sensorless vector control (SLVC), the actual speed from the motor model of the motor control is used for the synchronisation.
- [C00158](#) provides a bit coded representation of all active sources/triggers of a controller inhibit:

Bit	Cause/Source of controller inhibit
Bit 0	Terminal controller enable
Bit 1	CAN control word
Bit 2	MCI control word
Bit 3	SwitchOn
Bit 4	Application ( <a href="#">LS_DriveInterface</a> system block: <i>bCInh</i> input)
<b>Bit 5</b>	<b>Device command (<a href="#">C00002/16</a>)</b>
Bit 6	Error with error response "Fault" or "Trouble"
Bit 7	Internal signal
Bit 8	Reserved
Bit 9	Reserved
Bit 10	AutoStartLock
Bit 11	Motor parameter identification
Bit 12	Automatic brake operation
Bit 13	DCB-IMP
Bit 14	Reserved
Bit 15	Reserved



**Tip!**

The inverter can also be enabled or inhibited via the  and  toolbar icons.

## 4 Device control (DCTRL)

### 4.1 Device commands (C00002/x)

#### 4.1.5 Activate/deactivate quick stop

The [C00002/17](#) = "1: On / start" device command activates the quick stop function, i.e. the motor control is separated from the setpoint selection, and within the deceleration time parameterised in [C00105](#) the motor is brought to a standstill ( $n_{act} = 0$ ).

Parameters	Info	Lenze setting	
		Value	Unit
<a href="#">C00105</a>	Decel. time - quick stop	2.000	s

- The motor is kept at a standstill during closed-loop operation.
- A pulse inhibit is set if the auto-DCB function has been activated via [C00019](#).
- [C00159](#) provides a bit coded representation of all active sources/triggers of a quick stop:

Bit	Cause/source for quick stop
Bit 0	Reserved
Bit 1	CAN control word (bit 2)
Bit 2	MCI control word (bit 2)
Bit 3	Reserved
Bit 4	Application ( <a href="#">LS_MotorInterface</a> system block: <i>bQspOn</i> input)
<b>Bit 5</b>	<b>Device command (<a href="#">C00002/17</a>)</b>
Bit 6	Device error with "TroubleQSP" error response
Bit 7	Internal signal
Bit 8	Reserved
Bit 9	Reserved
Bit 10	Operating system
Bit 11	Reserved
Bit 12	MCK (System block <a href="#">LS_MotionControlKernel</a> : Input <i>bQspOn</i> )
Bit 13	Reserved
Bit 14	Reserved
Bit 15	Reserved

#### Deactivate quick stop again

The [C00002/17](#) = "0: Off / ready" device command deactivates the quick stop again, provided that no other source of a quick stop is active.

## 4 Device control (DCTRL)

### 4.1 Device commands (C00002/x)

---

#### 4.1.6 Reset error

The [C00002/19](#) = "1: On / start" device command acknowledges an existing error message if the error cause has been eliminated and thus the error is no longer pending.

- After the reset (acknowledgement) of the current error, further errors may be pending which must also be reset.
- The status determining error is displayed in [C00168](#).
- The current error is displayed in [C00170](#).



#### Tip!

An error message can also be acknowledged by activating the **Reset error** button in the **Diagnostics** tab.

Detailed information on error messages can be found in the "[Diagnostics & error management](#)" chapter. (□ 434)

#### 4.1.7 Delete logbook

The [C00002/21](#) = "1: On / start" device command deletes all logbook entries.



#### Tip!

To display the logbook in the »Engineer«, click the **Logbook** button on the **Diagnostics** tab. In the *Logbook* dialog box, it is also possible to delete all logbook entries by clicking the **Delete** button.

Detailed information on the logbook can be found in the "[Diagnostics & error management](#)" chapter. (□ 434)

## 4 Device control (DCTRL)

### 4.1 Device commands (C00002/x)

---

#### 4.1.8 Device search function

This function extension is available from version 06.00.00!

---

In some applications where inverters are installed in control cabinets or are positioned in a spacious plant, it is often difficult to locate a device connected online for e.g. maintenance work. There is an established online connection with the device but you do not know where the inverter is located physically.

The [C00002/27](#) = "1: On / start" device command serves to carry out an "optical location":

- For the time set in [C00181/1](#), all four status LEDs at the front of the inverter flash. Afterwards, the function is turned off automatically.
- If the device command is executed again within the set time period, the duration is extended accordingly.
- The setting [C00002/27](#) = "0: Off / ready" serves to abort or switch off the function.
- Adjustable time period: 0 ... 6000 s (Lenze setting: 5 s)



The device search function can also be activated via the  *toolbar* icon.

### 4.2 Device state machine and device states

The behaviour of the inverter is mainly determined by the current device status within the device state machine. Which device status is active and which device status is next depends on certain control signals (e.g. for controller inhibit and quick stop) and status parameters.

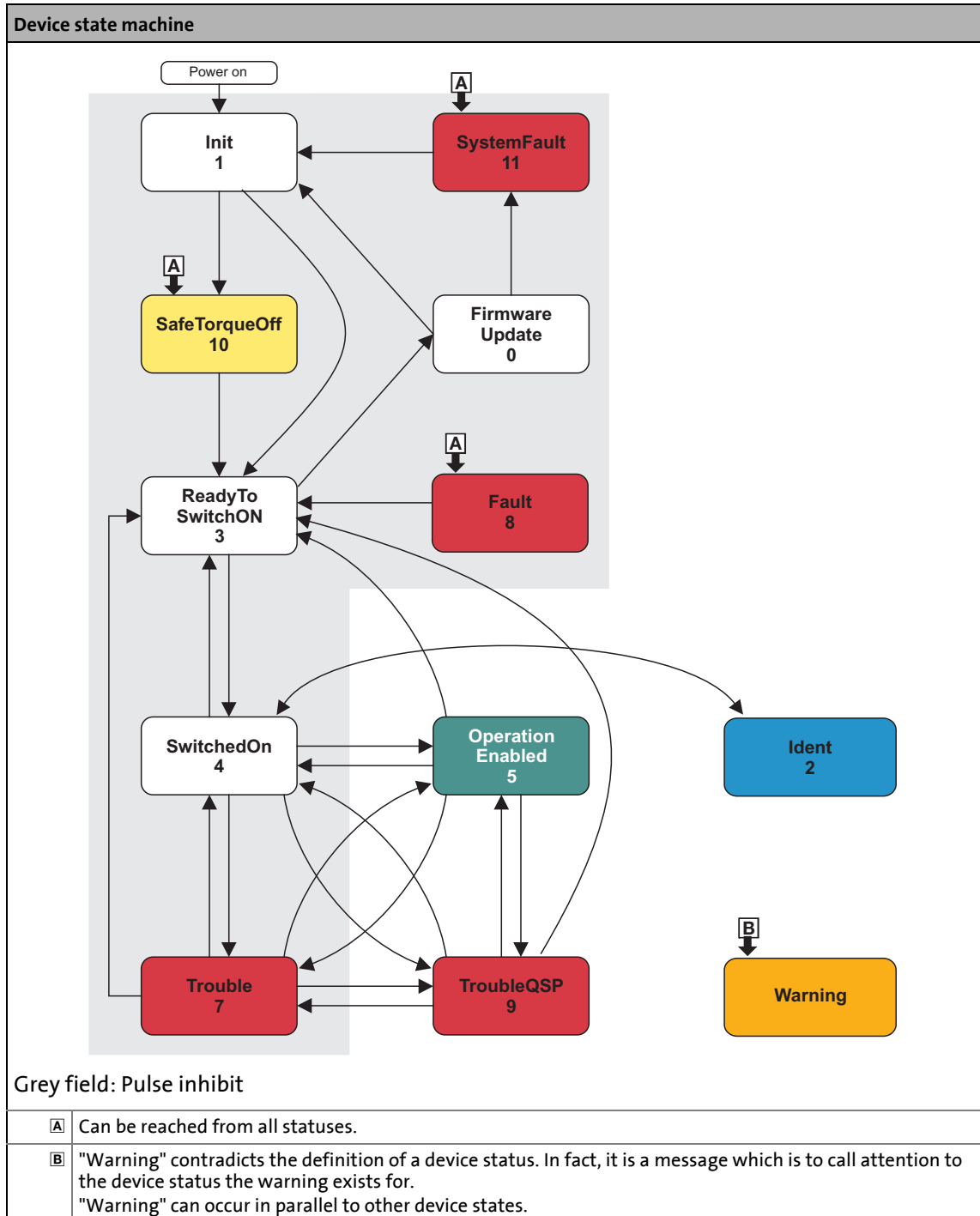

- The arrows between the device states mark possible state changes.
- The digits stand for the status ID (see table below).



- The change from one status to the other is carried out within a 1-ms cycle. If within this time there are several requests for status changes, the status with the higher priority is processed first (see table below).
- The [C00137](#) displays the current device status.
- [C00150](#) (status word) provides a bit coded representation of the current device status via bits 8 ... 11 (see table below).

ID	Device status (Display in <a href="#">C00137</a> )	Priority	Status bits (Display in <a href="#">C00150</a> )				Meaning
			Bit 11	Bit 10	Bit 9	Bit 8	
0	<a href="#">FirmwareUpdate</a>	-	0	0	0	0	Firmware update function is active
1	<a href="#">Init</a>	-	0	0	0	1	Initialisation active
2	<a href="#">Ident</a>	-	0	0	1	0	Identification active
3	<a href="#">ReadyToSwitchOn</a>	Prio 5	0	0	1	1	Device is ready to start
4	<a href="#">SwitchedOn</a>	Prio 4	0	1	0	0	Device is switched on
5	<a href="#">OperationEnabled</a>	Prio 1	0	1	0	1	Operation
6	-	-	0	1	1	0	-
7	<a href="#">Trouble</a>	Prio 3	0	1	1	1	Trouble active
8	<a href="#">Fault</a>	Prio 7	1	0	0	0	Error active
9	<a href="#">TroubleQSP</a>	Prio 2	1	0	0	1	TroubleQSP is active
10	<a href="#">SafeTorqueOff</a>	Prio 6	1	0	1	0	Safe torque off is active
11	SystemFault	Prio 8	1	0	1	1	System fault active • This device state is not used since the inverter lacks the activating event.

[4-1] Device statuses, priorities, and meaning of the status bits in the status word

### 4.2.1 FirmwareUpdate



#### Note!

This function may only be executed by qualified Lenze personnel!

### 4.2.2 Init

"DRV-RDY" LED	LED "DRV-ERR"	Display in <a href="#">C00137</a>	Display in status word 1 ( <a href="#">C00150</a> )			
			Bit 11	Bit 10	Bit 9	Bit 8
OFF	OFF	Init	0	0	0	1

The inverter is in this status immediately after switching on its 24 V supply voltage.

In the "Init" status, the operating system is initialised and all device components (communication module, memory module, power section, etc.) are identified. When identifying the power section, it is checked first if it is switched on or if the required voltage lies within the tolerance zone, respectively.

- The inverter is inhibited, i.e. the motor terminals (U, V, W) of the inverter are deenergised.
- The digital and analog inputs are not yet evaluated at this time.
- The bus systems (CAN, PROFIBUS etc.) do not work yet, i.e. communication is not possible.
- The application is not yet processed.
- The monitoring functions are not active yet.
- The inverter cannot be parameterised yet and no device commands can be carried out yet.



#### Note!

If the 24V voltage supply is in the valid range (>19V) and the initialisation is finished, the device changes automatically to the "[ReadyToSwitchOn](#)" status.

If only the 24V voltage supply is available during the mains connection, the error message "[LU: Undervoltage in the DC bus](#)" is also entered into the logbook of the inverter.

4.2.3 Ident

"DRV-RDY" LED	LED "DRV-ERR"	Display in <a href="#">C00137</a>	Display in status word 1 ( <a href="#">C00150</a> )			
			Bit 11	Bit 10	Bit 9	Bit 8
	OFF	Ident	0	0	1	0

The inverter has been provided with the "Motor parameter identification" function for automatic identification of the motor parameters. If the motor parameter identification is active, the inverter is in the "Ident" device status.

The "Ident" device status can only be reached from the "[SwitchedOn](#)" device status, i.e. the inverter must be inhibited first so that identification can be started afterwards via the corresponding device command:

Device command	Function	Detailed information
<a href="#">C00002/23</a>	Identify motor parameters	▶ <a href="#">Automatic motor parameter identification</a>



**Stop!**

During the identification of the motor parameters

- the inverter does not respond to setpoint changes or control processes, (e.g. speed setpoints, quick stop, torque limitations),
- the application remains active,
- all system interfaces (IO, bus systems, etc.) remain active,
- error monitoring remains active,
- the inverter is controlled independently of the setpoint sources.

After the motor parameter identification is completed, the status changes back to "[SwitchedOn](#)".

4.2.4 SafeTorqueOff

"DRV-RDY" LED	LED "DRV-ERR"	Display in <a href="#">C00137</a>	Display in status word 1 ( <a href="#">C00150</a> )			
			Bit 11	Bit 10	Bit 9	Bit 8
	OFF	SafeTorqueOff	1	0	1	0



**Note!**

Up to and including version 13.xx.xx the following applies:

This device status is only possible in connection with an integrated safety system and if a power section supply is available!

From version 14.00.00 the following applies:

This device status is only possible in connection with an integrated safety system!

**Integrated safety systems with Inverter Drives 8400**

Inverters of the 8400 series can be equipped with the integrated "Safe torque off (STO)" safety system.

The integrated safety system can be used on machines for the protection of persons.

The drive function is still carried out by the inverter. The safety system provides safe inputs. If the safety system is activated, it executes control functions according to EN 60204-1 directly in the inverter in case of errors.

**Safety state**

If the inverter is switched off by the safety system, the device changes to the "SafeTorqueOff" status.

If the safety system deactivates the "Safe torque off (STO)" request, the device changes to the "[ReadyToSwitchOn](#)" status.



Detailed information on the integrated safety system can be found in the hardware manual!

**The hardware manual contains important notes on the safety system which must be observed!**

The hardware manual has been stored in electronic form on the data carrier supplied with the 8400 inverter.

### 4.2.5 ReadyToSwitchOn

"DRV-RDY" LED	LED "DRV-ERR"	Display in <a href="#">C00137</a>	Display in status word 1 ( <a href="#">C00150</a> )			
			Bit 11	Bit 10	Bit 9	Bit 8
	OFF	ReadyToSwitchOn	0	0	1	1

The inverter is in this device status directly after the initialisation has been completed!

- The bus systems are running and the terminals and encoders are evaluated.
- The monitoring functions are active.
- The inverter can be parameterised.
- The application is basically executable.



#### Note!

- The "ReadyToSwitchOn" state is not only activated after the mains connection, but also after the deactivation of "[Trouble](#)", "[Fault](#)" or "[SafeTorqueOff](#)".
- If [C00142](#) activates the autostart option "Inhibit at device on" (Lenze setting), explicit deactivation of the controller inhibit after mains connection is always required for the inverter to change from the "ReadyToSwitchOn" status to the "[SwitchedOn](#)" status.
- If only the 24V voltage supply is available during the mains connection, the error message "[LU: Undervoltage in the DC bus](#)" is entered into the logbook of the inverter and the inverter remains in the "ReadyToSwitchOn" status.



#### Danger!

If the "Inhibit at device on" auto-start option has been deactivated in [C00142](#), the "ReadyToSwitchOn" status switches directly to the "[SwitchedOn](#)" status after mains connection.

▶ [Automatic restart after mains connection/fault...](#) (📖 99)

### 4.2.6 SwitchedOn

"DRV-RDY" LED	LED "DRV-ERR"	Display in <a href="#">C00137</a>	Display in status word 1 ( <a href="#">C00150</a> )			
			Bit 11	Bit 10	Bit 9	Bit 8
	OFF	SwitchedON	0	1	0	0

The drive is in this device status if the DC bus voltage is applied and the inverter is still inhibited by the user (controller inhibit).

- The bus systems are running and the terminals and encoders are evaluated.
- The monitoring functions are active.
- The application is basically executable.

If the controller inhibit is deactivated, the device changes to the "[OperationEnabled](#)" status and the motor follows the setpoint defined by the active application.



#### Tip!

[C00158](#) provides a bit coded representation of all active sources/triggers of a controller inhibit.

Depending on certain conditions, a status change takes place based on the "SwitchedOn" device status:

Change condition	Changeover to the device status
Control bit "EnableOperation" of all control channels = "1" <b>AND</b> terminal RFR = HIGH level (controller enable)	<a href="#">OperationEnabled</a>
Control bit "SwitchOn" of a control channel = "0".	<a href="#">ReadyToSwitchOn</a>
Motor parameter identification requested.	<a href="#">Ident</a>
Undervoltage in the DC bus.	<a href="#">Trouble/Fault</a> (depending on <a href="#">C00600/1</a> )
Error with error response "Trouble" occurs.	<a href="#">Trouble</a>
Error with error response "TroubleQSP" occurs.	<a href="#">TroubleQSP</a>

#### Related topics:

- ▶ [wCANControl/wMCIControl control words](#) (□ 107)

### 4.2.7 OperationEnabled

"DRV-RDY" LED	LED "DRV-ERR"	Display in <a href="#">C00137</a>	Display in status word 1 ( <a href="#">C00150</a> )			
			Bit 11	Bit 10	Bit 9	Bit 8
	OFF	OperationEnabled	0	1	0	1

The inverter is in this device status if the controller inhibit is deactivated and no error ("Trouble" or "TroubleQSP") has occurred.

If the operation is enabled and the magnetisation in case of sensorless vector control (SLVC) has been completed, the motor follows the setpoint determined by the active application.



Depending on certain conditions, a status change takes place based on the "OperationEnabled" device status.

Change condition	Changeover to the device status
Control bit "EnableOperation" of a control channel = "0" <b>OR</b> terminal RFR = LOW level (controller inhibit).	<a href="#">SwitchedOn</a>
Control bit "SwitchOn" of a control channel = "0".	<a href="#">ReadyToSwitchOn</a>
Undervoltage in the DC bus.	<a href="#">Trouble/Fault</a> (depending on <a href="#">C00600/1</a> )
Error with error response "Trouble" occurs.	<a href="#">Trouble</a>
Error with error response "TroubleQSP" occurs.	<a href="#">TroubleQSP</a>

#### Related topics:

▶ [wCANControl/wMCIControl control words](#) (□ 107)

### 4.2.8 TroubleQSP

"DRV-RDY" LED	LED "DRV-ERR"	Display in <a href="#">C00137</a>	Display in status word 1 ( <a href="#">C00150</a> )			
			Bit 11	Bit 10	Bit 9	Bit 8
		TroubleQSP	1	0	0	1

This device status will be active as soon as a monitoring mode responds the error response "TroubleQSP" has been parameterised for.

- The drive is decelerated to standstill with torque within the deceleration time parameterised for quick stop independently of the defined setpoint and can be kept there.
- The device status can only be abandoned by acknowledging the error if the error cause is removed.
- When the controller is inhibited, it is possible to jump to the "[SwitchedOn](#)" status even during the error status since the controller inhibit function has a higher priority. As long as the error is pending and has not been acknowledged, the status is changed back to the "TroubleQSP" status when the controller is enabled afterwards.

Depending on certain conditions a status change takes place based on the "TroubleQSP" device status.

Change condition	Changeover to the device status
Control bit "SwitchOn" of a control channel = "0".	<a href="#">ReadyToSwitchOn</a>
Control bit "EnableOperation" of all control channels = "1" <b>AND</b> terminal RFR = HIGH level (controller enable) <b>AND</b> error is reset by the control bit "ResetFault" <b>AND</b> no more errors are pending.	<a href="#">OperationEnabled</a>
Control bit "EnableOperation" of a control channel = "0" <b>OR</b> terminal RFR = LOW level (controller inhibit) <b>AND</b> error is reset by the control bit "ResetFault" <b>AND</b> no more errors are pending.	<a href="#">SwitchedOn</a>
A message is active in the system.	<a href="#">Trouble</a>

#### Related topics:

- ▶ [wCANControl/wMCIControl control words](#) (📖 107)
- ▶ [Basics on error handling in the inverter](#) (📖 434)
- ▶ [Error messages of the operating system](#) (📖 459)



### 4.2.9 Trouble

"DRV-RDY" LED	LED "DRV-ERR"	Display in <a href="#">C00137</a>	Display in status word 1 ( <a href="#">C00150</a> )			
			Bit 11	Bit 10	Bit 9	Bit 8
OFF		Trouble	0	1	1	1

This device status becomes active as soon as a monitoring mode responds for which the error response "Trouble" has been parameterised.

- The motor has no torque (is coasting) when the inverter is inhibited.
- The "Trouble" device status is automatically exited if the error cause has been removed.



#### Note!

If in [C00142](#) the "Inhibit at trouble" is activated, explicit deactivation of the controller inhibit is required before this status can be abandoned.

Depending on certain conditions a status change takes place based on the "Trouble" device status.

Change condition	Changeover to the device status
The error cause is no longer active.	<a href="#">ReadyToSwitchOn</a>
Control bit "EnableOperation" of all control channels = "1" AND terminal RFR = HIGH level (controller enable) AND the message has been cancelled.	<a href="#">OperationEnabled</a>
Control bit "EnableOperation" of a control channel = "0" OR terminal RFR = LOW level (controller inhibit) AND the message has been cancelled.	<a href="#">SwitchedOn</a>
In the system, there is an error configured on "TroubleQSP". AND the message has been cancelled.	<a href="#">TroubleQSP</a>

#### Related topics:

- ▶ [wCANControl/wMCIControl control words](#) (📖 107)
- ▶ [Basics on error handling in the inverter](#) (📖 434)
- ▶ [Error messages of the operating system](#) (📖 459)

4.2.10 Fault

"DRV-RDY" LED	LED "DRV-ERR"	Display in <a href="#">C00137</a>	Display in status word 1 ( <a href="#">C00150</a> )			
			Bit 11	Bit 10	Bit 9	Bit 8
OFF		Fault	1	0	0	0

This device status will be active as soon as a monitoring mode responds the error response "Fault" has been parameterised for.

- The motor has no torque (is coasting) when the inverter is inhibited.
- The error must explicitly be reset ("acknowledged") in order to exit the device status, e.g. by the device command "[Reset error](#)" or via the control bit "ResetFault" in the control word *wCanControl* or *wMCIControl*.



**Note!**

If an undervoltage in the DC bus of the inverter occurs (error message "LU"), the device changes to the "[Trouble](#)" status.

An additional error of higher priority leads the device into the "[Fault](#)" status.

According to the [Device state machine](#), the device changes to the "[ReadyToSwitchOn](#)" status after acknowledging the error although the undervoltage is still available!

If the "Inhibit at fault" auto-start option has been activated in [C00142](#), explicit deactivation of the controller inhibit is required before the status can be abandoned.

**Related topics:**

- ▶ [wCANControl/wMCIControl control words](#) (📖 107)
- ▶ [Basics on error handling in the inverter](#) (📖 434)
- ▶ [Error messages of the operating system](#) (📖 459)

## 4 Device control (DCTRL)

### 4.3 Automatic restart after mains connection/fault...

#### 4.3 Automatic restart after mains connection/fault...

##### .../Error/undervoltage/loading of the Lenze setting

In [C00142](#), the starting performance of the inverter after mains connection, undervoltage, loading of the Lenze setting as well as a "[Trouble](#)" or a "[Fault](#)" reset can be parameterised individually:

Auto-start option ( <a href="#">C00142</a> )	Lenze setting
Bit 0 <a href="#">"Inhibit at device on" auto-start option</a>	1 ≙ Inhibit is active
Bit 1 <a href="#">Auto-start option "Inhibit at trouble"</a>	0 ≙ Inhibit is not active
Bit 2 <a href="#">Auto-start option "Inhibit at fault"</a>	0 ≙ Inhibit is not active
Bit 3 <a href="#">Auto-start option "Inhibit at undervoltage"</a>	1 ≙ Inhibit is active
Bit 4 <a href="#">Auto-start option "Inhibit at Lenze setting"</a> <small>(from version 06.00.00)</small>	1 ≙ Inhibit is active
Bit 5 Reserved	0
Bit 6	
Bit 7	



#### Note!

In the Lenze setting, automatic restart after mains connection, undervoltage, and loading of the Lenze setting is inhibited.

#### 4.3.1 "Inhibit at device on" auto-start option

The auto-start option "Inhibit at device on" prevents the change to the "[SwitchedOn](#)" status after mains connection if the controller is already enabled at mains connection.



#### Danger!

If the "Inhibit at device on" auto-start option has been deactivated in [C00142](#), (bit 0 = 0), the motor can directly start to run if the controller is enabled after mains connection!

The following three cases describe the behaviour of the inverter after mains connection depending on whether the controller is enabled and the set auto-start option. Here, it is assumed that after mains connection, no errors and trouble occur in the inverter and the "EnableOperation" control bit in the *wDriveControl* is set to "1".

**Case 1: No controller enable at mains connection**

If the controller is not enabled at mains connection, the inverter remains in the "[SwitchedOn](#)" status. Only with the controller enable, the device changes to the "[OperationEnabled](#)" status, independent of the set auto-start option:

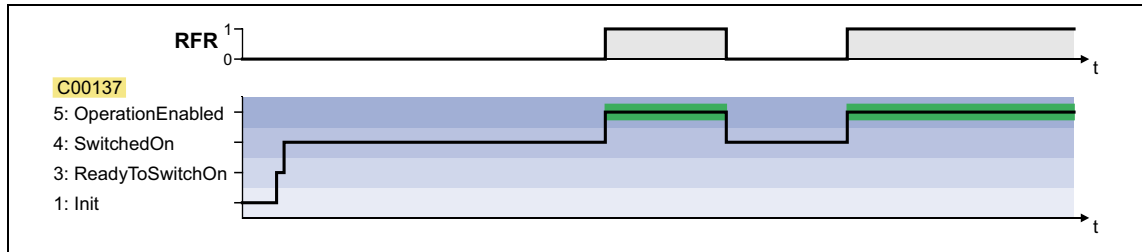
**Case 2: Controller enable at mains connection and "Inhibit at device on" activated**

If the controller is enabled at mains connection and the auto-start option "Inhibit at device on" is activated, the inverter remains in the "[ReadyToSwitchOn](#)" status. For changing to the "[SwitchedOn](#)" status, the controller enable must first be deactivated. Only when the controller is enabled again afterwards, the status changes to "[OperationEnabled](#)":

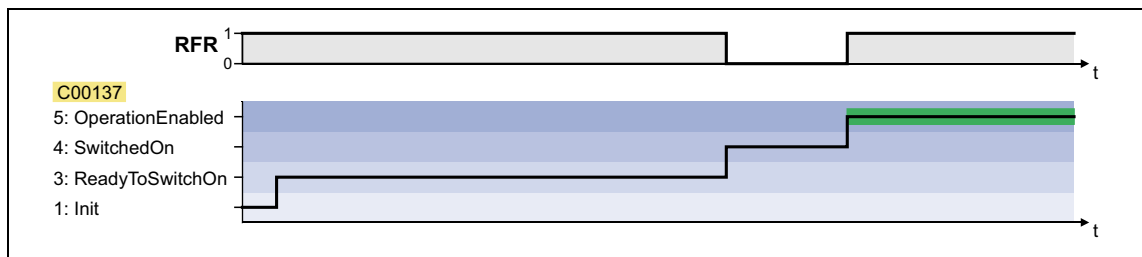
**Case 3: Controller enable at mains connection and "Inhibit at device on" deactivated**

If in [C00142](#) the autostart option "Inhibit at device on" is deactivated (bit 0 = 0), the status first changes from "[ReadyToSwitchOn](#)" to "[SwitchedOn](#)" and then to "[OperationEnabled](#)" after mains connection with an enabled controller:

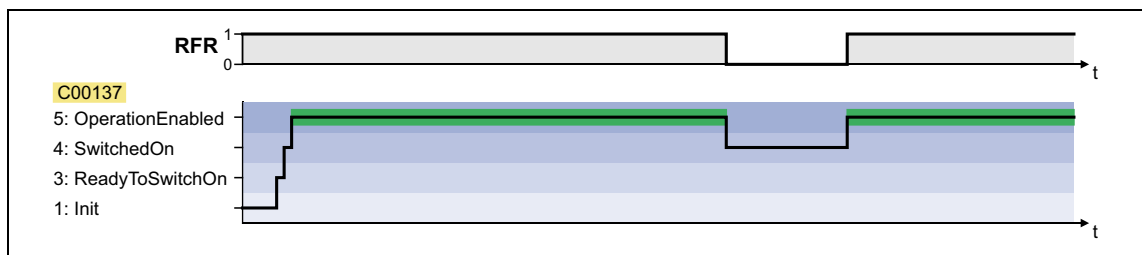

### 4.3.2 Auto-start option "Inhibit at trouble"

The auto-start option "Inhibit at trouble" (Bit 1 = 1) does the following: After the state "[Trouble](#)", it prevents the system switching to the state "[SwitchedOn](#)" if the controller is already enabled after the state "[Trouble](#)".

To be able to switch to the "[SwitchedOn](#)" state, the controller enable must first be deactivated after the "[Trouble](#)" state. Only when the controller is enabled again afterwards does the state change to "[OperationEnabled](#)".

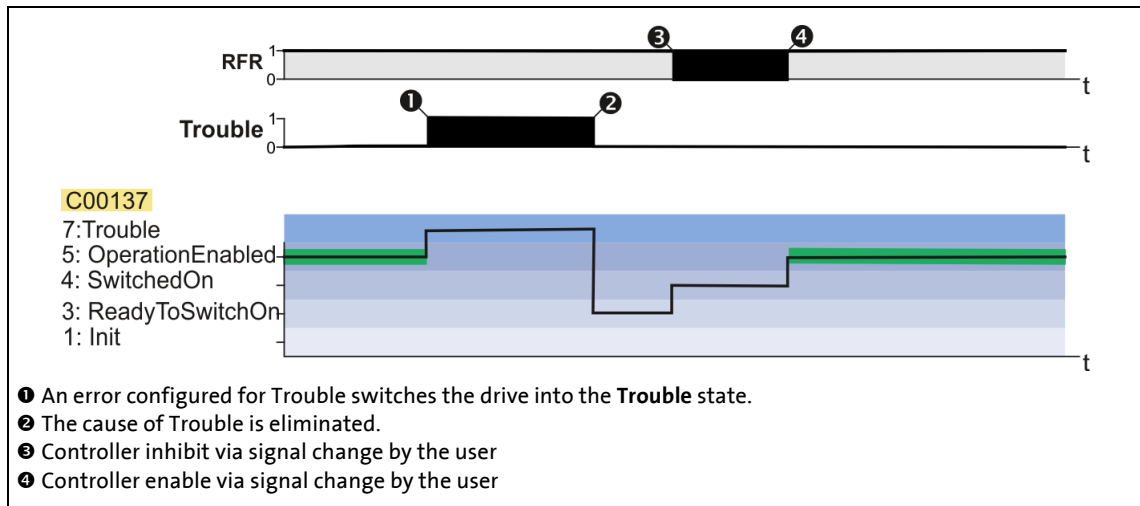

### 4.3.3 Auto-start option "Inhibit at fault"

The auto-start option "Inhibit at fault" (Bit 2 = 1) does the following: After the state "[Fault](#)", it prevents the system switching to the state "[SwitchedOn](#)" if the controller is already enabled after the state "[Fault](#)".

To be able to switch to the "[SwitchedOn](#)" state, the controller enable must first be deactivated after the "[Fault](#)" state. Only when the controller is enabled again afterwards does the state change to "[OperationEnabled](#)".

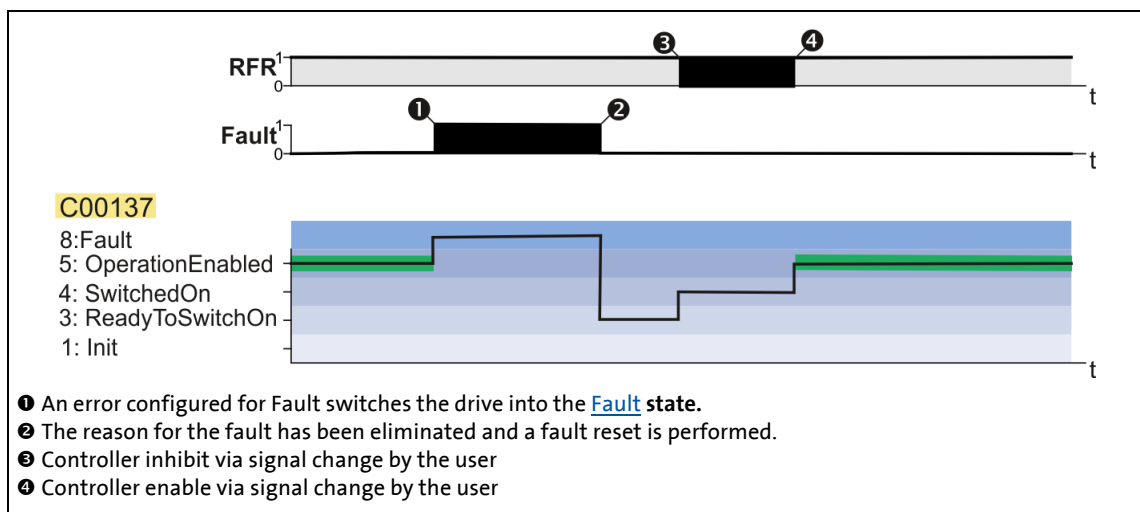

#### 4.3.4 Auto-start option "Inhibit at undervoltage"

The auto-start option "Inhibit at undervoltage" (Bit 3 = 1) prevents the system switching to the state "[SwitchedOn](#)" after an instance of undervoltage if the controller is already enabled after the instance of undervoltage.

To be able to switch to the "[SwitchedOn](#)" state, the controller enable must first be deactivated after the instance of undervoltage. Only when the controller is enabled again afterwards does the state change to "[OperationEnabled](#)"

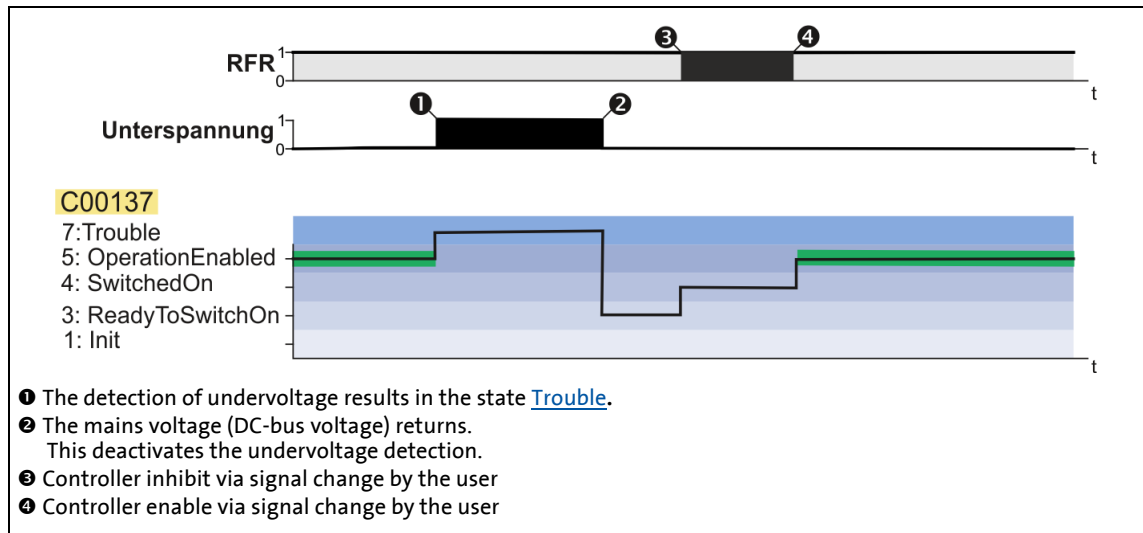

## 4.3.5 Auto-start option "Inhibit at Lenze setting"

This function extension is available from version 06.00.00!

The "Inhibit at Lenze setting" auto-start option configurable via bit 4 of [C00142](#) prevents the change to the "[SwitchedOn](#)" status after the Lenze setting has been loaded and the controller is enabled.

For a change to the "[SwitchedOn](#)" status, the controller enable must first be deactivated after the Lenze setting has been loaded. Only if the controller is enabled again afterwards, the status changes to "[OperationEnabled](#)":

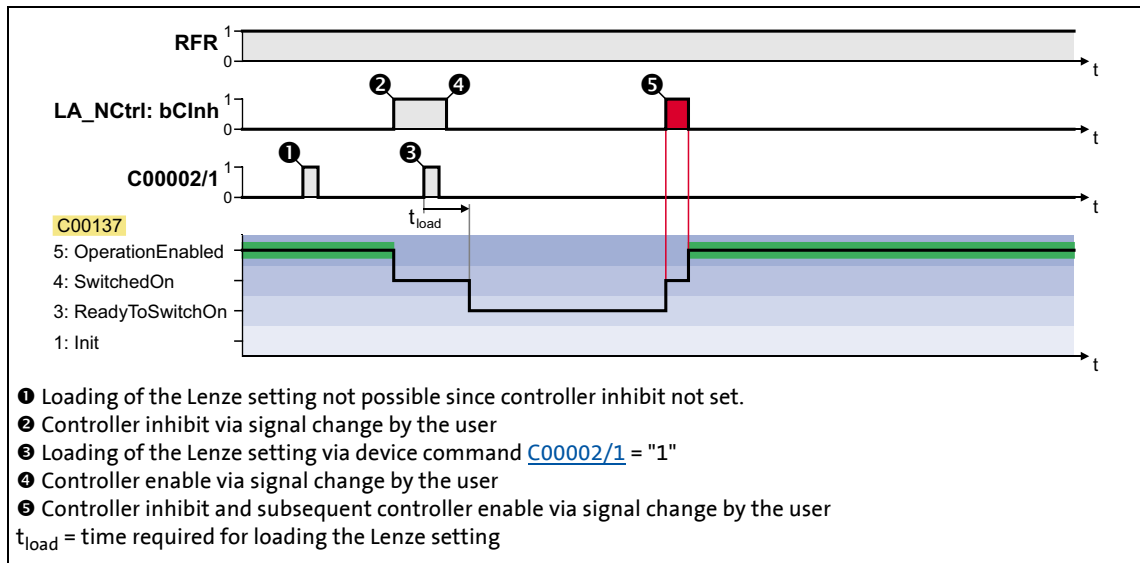

[4-1] Example 1: Behaviour with activated auto-start option "Inhibit at Lenze setting" ([C00142](#): Bit 4 = "1")

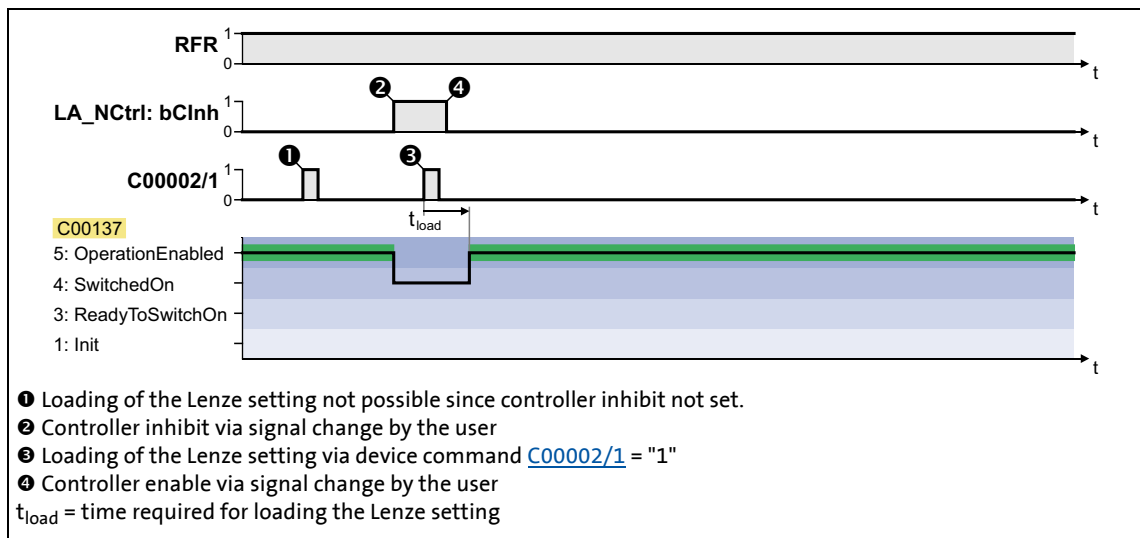

[4-2] Example 2: Behaviour with deactivated auto-start option "Inhibit at Lenze setting" ([C00142](#): Bit 4 = "0")

4.4 Internal interfaces | "LS\_DriveInterface" system block

The LS\_DriveInterface system block displays the device control in the FB Editor.

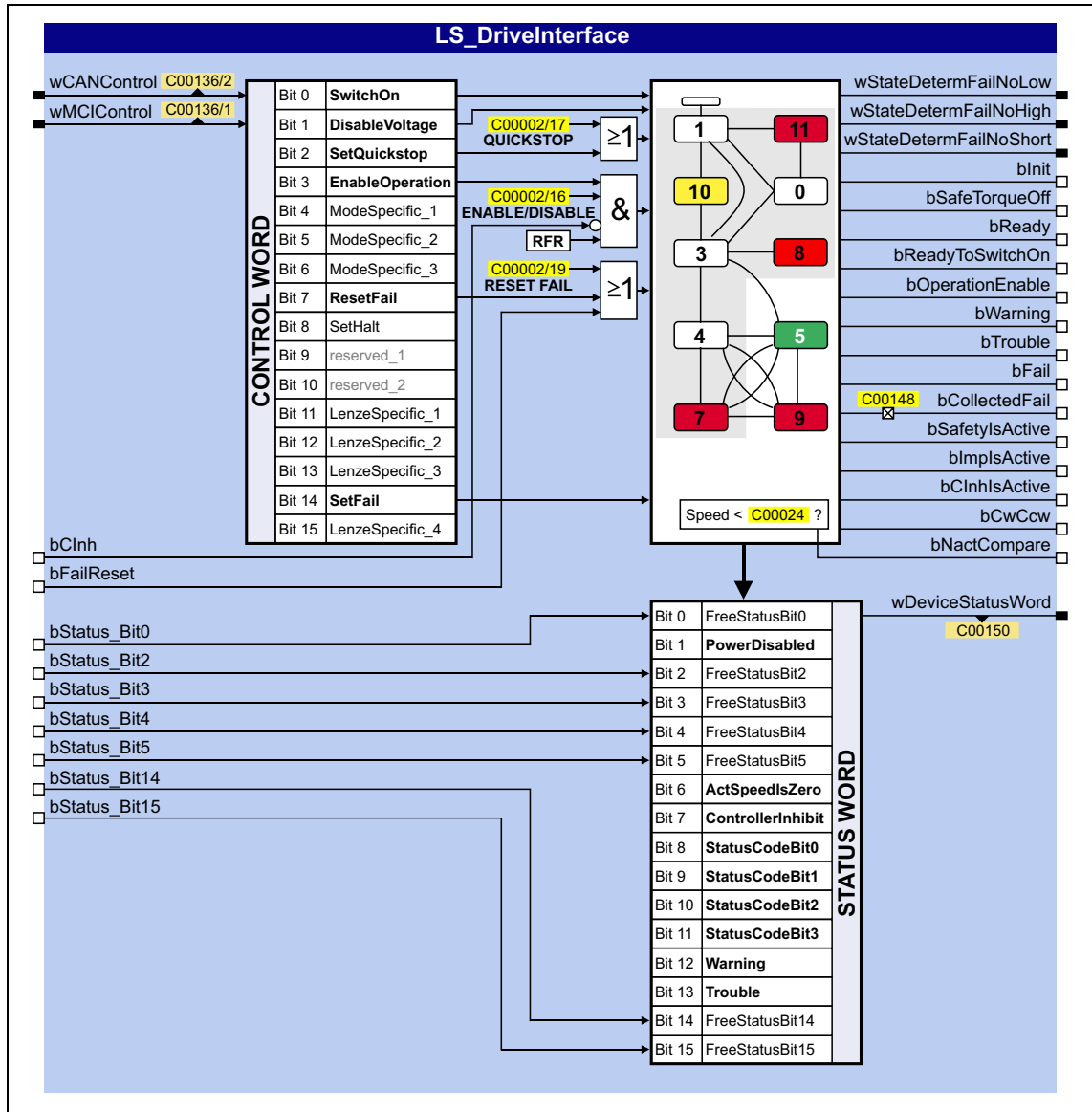



## inputs

Designator DIS code   data type	Information/possible settings
wCANControl <a href="#">C00136/2</a>   WORD	Control word via system bus (CAN) <ul style="list-style-type: none"> <li>The inverter controlled by a master control (e.g. IPC) receives its control word by the CANopen system bus interface. The process data word is provided at this input by the upstream port block <a href="#">LP_CanIn1</a>.</li> <li>For a detailed description of the individual control bits, see chapter "<a href="#">wCANControl/wMCIControl control words</a>". (<a href="#">□ 107</a>)</li> </ul>
wMCIControl <a href="#">C00136/1</a>   WORD	Control word via communication module (e.g. PROFIBUS) <ul style="list-style-type: none"> <li>The inverter controlled by a master control (e.g. IPC) receives its control word by a plugged-in communication module. The process data word is provided at this input by the upstream port block <a href="#">LP_McIn1</a>.</li> <li>For a detailed description of the individual control bits, see chapter "<a href="#">wCANControl/wMCIControl control words</a>". (<a href="#">□ 107</a>)</li> </ul>
bCIInh <a href="#">C00833/36</a>   BOOL	▶ <a href="#">Enable/inhibit inverter</a> ( <a href="#">□ 84</a> )
	FALSE Enable inverter: The inverter switches to the " <a href="#">OperationEnabled</a> " device status if no other source for controller inhibit is active. <ul style="list-style-type: none"> <li><a href="#">C00158</a> provides a bit coded representation of all active sources/triggers of a controller inhibit.</li> </ul>
bFailReset <a href="#">C00833/37</a>   BOOL	TRUE Inhibit inverter (controller inhibit): The inverter switches to the " <a href="#">SwitchedOn</a> " device status.
	▶ <a href="#">Reset error message</a> ( <a href="#">□ 463</a> )
bStatus_Bit0 bStatus_Bit2 bStatus_Bit3 bStatus_Bit4 bStatus_Bit5 bStatus_Bit14 bStatus_Bit15 <a href="#">C00833/38 ... 44</a>   BOOL	FALSE↔TRUE The current error is reset.
	Freely assignable bits in the status word of the inverter <ul style="list-style-type: none"> <li>You can use these bits for returning information to the master control (e.g. IPC).</li> </ul>
bFree_1 bFree_2 bFree_3 bFree_4 <a href="#">C00833/45 ... 48</a>   BOOL	Reserved inputs have no function

## outputs

Designator DIS code   data type	Value/meaning
wDeviceStatusWord <a href="#">C00150</a>   WORD	Status word of the inverter (based on DSP-402) <ul style="list-style-type: none"> <li>The status word contains all information relevant for controlling the inverter.</li> <li>The status word is sent as a process data word to the master control via a port block: <ul style="list-style-type: none"> <li>Port block <a href="#">LP_CanOut1</a> when the CANopen system bus interface is used or</li> <li>Port block <a href="#">LP_MciOut</a> when a plugged-in communication module is used (e.g. PROFIBUS).</li> </ul> </li> <li>For a detailed description of each status bit see chapter "<a href="#">wDeviceStatusWord status word</a>". (□ 109)</li> </ul>
wStateDetermFailNoLow WORD	Display of the status determining error (32-bit error number, Low-Word) <ul style="list-style-type: none"> <li><b>From version 06.00.00 onwards:</b> If the "Use 16BitFailNo." (Bit 15 = "1") option is activated in <a href="#">C00148</a>, the short 16-bit error number (<i>wStateDetermFailNoShort</i>) is provided via this output as well.</li> <li>In this case, the <i>wStateDetermFailNoHigh</i> output is "0".</li> <li>Advantage: The bus transfer of the error numbers is possible via a data word without changing the interconnection of the technology application.</li> </ul>
wStateDetermFailNoHigh WORD	Display of the status determining error (32-bit error number, High-Word)
wStateDetermFailNoShort WORD (from version 06.00.00)	Display of the status determining error (16-bit error number)
bInIt BOOL	TRUE "Init" device state is active
bSafeTorqueOff BOOL	TRUE "SafeTorqueOff" device state is active <ul style="list-style-type: none"> <li><i>bSafeTorqueOff</i> will only be output if the DC bus is loaded.</li> <li>The STO feedback signal is always pending at the X80/GO terminal.</li> </ul>
bReady BOOL	TRUE "SwitchedOn" device state is active
bReadyToSwitchOn BOOL	TRUE "ReadyToSwitchOn" device state is active
bOperationEnable BOOL	TRUE "OperationEnabled" device state is active
bWarning BOOL	TRUE A warning is indicated
bMessage BOOL	TRUE "Trouble" device state is active
bFail BOOL	TRUE "Fault" device state is active
bCollectedFail BOOL (from version 04.00.00)	TRUE Group error: A device status according to the group error configuration in <a href="#">C00148</a> has occurred, the drive is not able to follow the setpoint selection.
bSafetyIsActive BOOL	TRUE In preparation
bImplsActive BOOL	TRUE Pulse inhibit is active
bCInhIsActive BOOL	TRUE Controller inhibit is active
bCwCcw BOOL	FALSE Motor rotates in CW direction
	TRUE Motor rotates in CCW direction
bNactCompare BOOL	TRUE During open-loop operation: Speed setpoint < Comparison value ( <a href="#">C00024</a> ) During closed-loop operation: Actual speed value < Comparison value ( <a href="#">C00024</a> )

### Option "Lock bFail at TroubleQSP"

The [TroubleQSP](#) device status gets active as soon as a monitoring function responds that has been parameterised for the "TroubleQSP" error response. Since the *bFail* status output is not set in this case, it is not recognisable after pulse inhibit due to e.g. automatic brake operation (as well for a higher-level control), why the drive is standing und does not start when the setpoint is selected. Only after an error reset, a setpoint is accepted again.

**From version 11.00.00:** If the "Lock bFail at TroubleQSP" option is activated (bit 14 = "1") in [C00148](#), the *bFail* status output is also set to TRUE if the device status is [TroubleQSP](#).

#### 4.4.1 wCANControl/wMCIControl control words

The inverter is controlled by a master control (e.g. IPC) via the *wCanControl* or *wMCIControl* control word, respectively.

- *wCANControl*: Control word via system bus (CAN)
  - The process data word is provided at the *wCanControl* input via the upstream [LP\\_CanIn1](#) port block.
  - Display parameter: [C00136/2](#)
- *wMCIControl*: Control word via a plugged-in communication module (e.g. PROFIBUS)
  - The process data word is provided at the *wMCIControl* input via the upstream [LP\\_McIn1](#) port block.
  - Display parameter: [C00136/1](#)
- The bit assignment for the *wCanControl*/*wMCIControl* control words can be seen from the table below.

**Note!**

The assignment of bits 11 ... 13 and bit 15 depends on the technology application selected in [C00005!](#)

- See description of the corresponding technology application.

Bit	Name	Function
Bit 0	SwitchOn	1 ≙ Change to the " <a href="#">SwitchedOn</a> " device status <ul style="list-style-type: none"> <li>• <a href="#">From version 05.01.00 onwards, the following applies:</a> This bit must be set in the CAN <b>AND</b> MCI control word in order that the drive changes to the "<a href="#">SwitchedOn</a>" device state after mains connection. In order to reach the "<a href="#">ReadyToSwitchOn</a>" state, it is sufficient to set the bit to 0 in one of the two control words.</li> <li>• <a href="#">Up to and including version 05.00.00 the following applies:</a> This bit must be set in the CAN <b>OR</b> MCI control word in order that the drive changes to the "<a href="#">SwitchedOn</a>" state after mains connection.</li> </ul>
Bit 1	DisableVoltage	1 ≙ Inhibit inverter control (pulse inhibit)
Bit 2	SetQuickStop	Activate quick stop (QSP) ▶ <a href="#">Activate/deactivate quick stop</a> (□ 85)
Bit 3	EnableOperation	1 ≙ Enable inverter (RFR) <ul style="list-style-type: none"> <li>• This bit must be set in CAN <b>AND</b> in the MCI control word, otherwise the controller will be inhibited.</li> </ul>
Bit 4	ModeSpecific_1	Reserved (currently not assigned)
Bit 5	ModeSpecific_2	
Bit 6	ModeSpecific_3	
Bit 7	ResetFault	1 ≙ Reset fault (trip reset) <ul style="list-style-type: none"> <li>• Acknowledge error message (if the error cause has been eliminated).</li> </ul>
Bit 8	SetHalt	1 ≙ Activate stop function <ul style="list-style-type: none"> <li>• Stop drive via stopping ramp (in preparation).</li> </ul>
Bit 9	reserved_1	Reserved (currently not assigned)
Bit 10	reserved_2	
Bit 11	LenzeSpecific_1	Assignment depends on the selected technology application <ul style="list-style-type: none"> <li>• See description of the corresponding technology application.</li> </ul>
Bit 12	LenzeSpecific_2	
Bit 13	LenzeSpecific_3	
Bit 14	SetFail	1 ≙ Set error (trip set)
Bit 15	LenzeSpecific_4	Assignment depends on the selected technology application <ul style="list-style-type: none"> <li>• See description of the corresponding technology application.</li> </ul>

**Tip!**

If a bus control is not wanted (e.g. in case of control via terminals):

Connect both control word inputs with the *wDriveCtrl* output signal of the [LS\\_ParFix](#) system block. This output signal has the fixed value "9", which corresponds to the following assignment:

- Bit 0, SwitchOn = 1
- Bit 3, EnableOperation = 1
- All others: 0

#### 4.4.2 wDeviceStatusWord status word

The *wDeviceStatusWord* status word provided by the control system contains all information relevant for controlling the inverter.

- The status word is sent as a process data word to the master control via a port block:
  - The **LP\_CanOut1** port block if "CAN on board" is used or
  - the **LP\_MciOut1** port block if a plugged-in communication module is used (e.g. PROFIBUS).
- Display parameter: [C00150](#)
- The bit assignment of the *wDeviceStatusWord* status word can be seen from the table below.

Bit	Name	Status
Bit 0	FreeStatusBit0	Free status bit 0
Bit 1	PowerDisabled	1 ≙ Inverter control inhibited (pulse inhibit is active)
Bit 2	FreeStatusBit2	Free status bit 2 (not assigned, freely assignable)
Bit 3	FreeStatusBit3	Free status bit 3 (not assigned, freely assignable)
Bit 4	FreeStatusBit4	Free status bit 4 (not assigned, freely assignable)
Bit 5	FreeStatusBit5	Free status bit 5 (not assigned, freely assignable)
Bit 6	ActSpeedIsZero	During open-loop operation: 1 ≙ Speed setpoint < Comparison value ( <a href="#">C00024</a> ) During closed-loop operation: 1 ≙ Actual speed value < Comparison value ( <a href="#">C00024</a> )
Bit 7	ControllerInhibit	1 ≙ Inverter is inhibited (controller inhibit is active)
Bit 8	StatusCodeBit0	Bit coded display of the active device status ▶ <a href="#">Device state machine and device states</a> (see table <a href="#">[4-1]</a> )
Bit 9	StatusCodeBit1	
Bit 10	StatusCodeBit2	
Bit 11	StatusCodeBit3	
Bit 12	Warning	1 ≙ a warning is indicated
Bit 13	Trouble	1 ≙ Inverter is in the " <a href="#">Trouble</a> " device status • E.g. if an overvoltage has occurred.
Bit 14	FreeStatusBit14	Free status bit 14 (not assigned, freely assignable)
Bit 15	FreeStatusBit15	Free status bit 15 (not assigned, freely assignable)

## 4 Device control (DCTRL)

### 4.5 Energy saving mode

---

#### 4.5 Energy saving mode

This function extension is available from version 17.00.00 onwards!

---

In energy saving mode, the energy demand of the inverter can be adapted to the most diverse environments and applications.

Via [C1704](#), various functions can be utilised in a user-defined fashion, bringing the energy consumption of the inverter down to a minimum value:

- inhibiting the power output stages (controller inhibit)
- entering the energy saving mode using quick stop
- switching off the LEDs
- switching off all outputs

If the use of the energy saving mode is not desired, [C1704](#) provides the possibility of inhibiting this operating status.

The functions for the energy saving mode provide the basis for implementing the **PROFenergy** PROFINET profile.



#### Tip!

Detailed information about the **PROFenergy** PROFINET profile can be obtained from the PROFINET specifications.

**Activating / deactivating the energy saving mode**

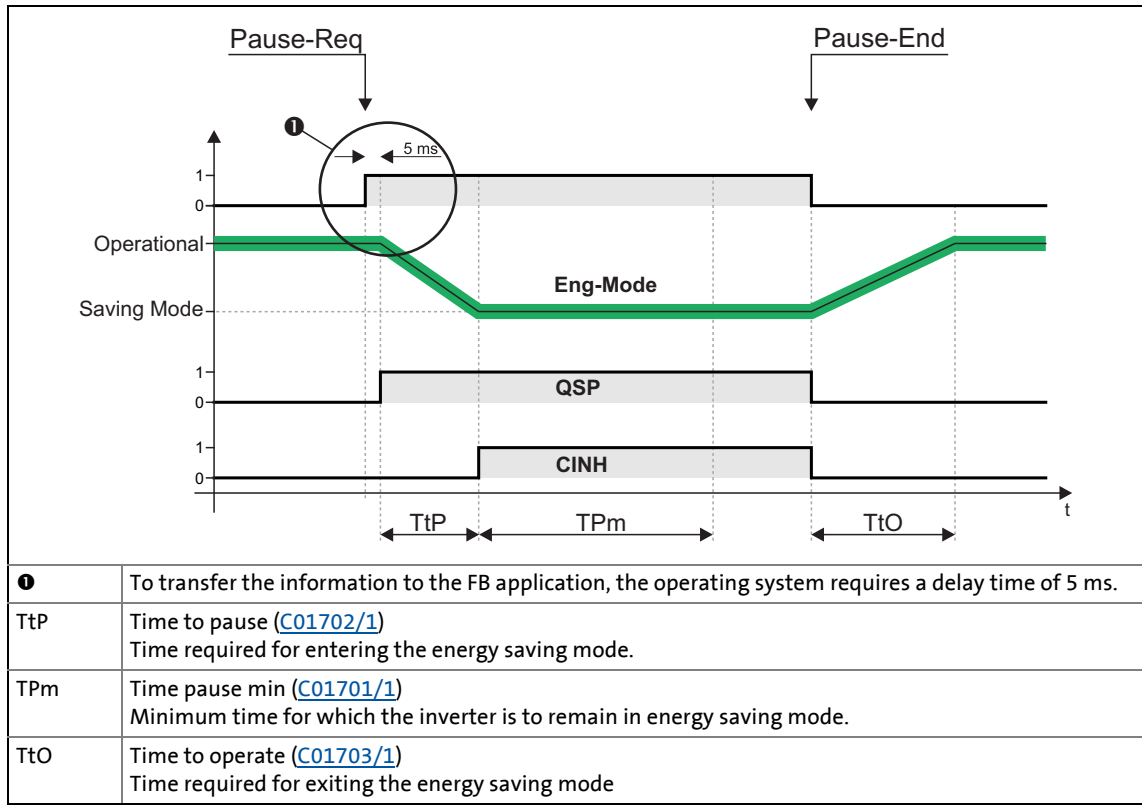

The energy saving mode is activated via the **PROFenergy** PROFINET profile as follows:

1. Via a "Pause-Req" command, entry into the energy saving mode is requested.
  - At the same time, a dead time is transferred with the command.
2. If the sum of the times set in [C1701/1](#), [C1702/1](#), and [C1703/1](#) is smaller than the dead time requested, the inverter starts entering the energy saving mode.
3. Via a "Pause-End" command, this operating status can be exited again.

### 5 Motor control (MCTRL)

This chapter provides information on the parameter setting of the inverter's internal motor control.

#### Topics:

##### Basic settings:

- ▶ [Motor selection/Motor data](#)
- ▶ [Selecting the control mode](#)
- ▶ [Defining current and speed limits](#)

##### Description of the motor control types:

- ▶ [V/f characteristic control \(VFCplus\)](#)
- ▶ [V/f characteristic control - energy-saving \(VFCplusEco\)](#)
- ▶ [V/f control \(VFCplus + encoder\)](#)
- ▶ [Sensorless vector control \(SLVC\)](#)
- ▶ [Sensorless control for synchronous motors \(SLPSM\)](#)

##### Parameterisable additional functions:

- ▶ [Selection of switching frequency](#)
- ▶ [Operation with increased rated power](#)
- ▶ [Flying restart function](#)
- ▶ [DC-injection braking](#)
- ▶ [Slip compensation](#)
- ▶ [Oscillation damping](#)
- ▶ [Phase sequence reversal for correcting misconnected UVW motor phases](#)

##### Further topics:

- ▶ [Encoder/feedback system](#)
- ▶ [Braking operation/brake energy management](#)
- ▶ [Monitoring](#)

##### Internal interfaces (process signals):

- ▶ [Internal interfaces | System block "LS\\_MotorInterface"](#)
- ▶ [Internal status signals | System block "LS\\_DeviceMonitor"](#)



# 5 Motor control (MCTRL)

## 5.1 Motor selection/Motor data

### 5.1 Motor selection/Motor data

The motor data term comprises all parameters that only depend on the motor and that only characterise the electrical behaviour of the machine. The motor data are independent of the application in which the inverter and the motor are used.



Proceed as follows to open the dialog for parameterising the motor data:

1. »Engineer« Go to the *Project* view and select the 8400 StateLine inverter.
2. Select the **Application parameters** tab from the *Workspace*.
3. Go to the *Overview* dialog level and click the following button:

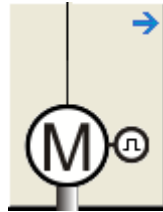

#### Parameterisation dialog in the »Engineer«

- Via the **From Motor Catalogue** button, the motor catalogue can be opened to select another motor. ▶ [Selecting a motor from the motor catalogue in the »Engineer«](#) (117)
- Via the **From inverter...** button, the motor data set in the inverter can be copied to the »Engineer« when an online connection has been established.
- When an online connection has been established to the inverter, the **Identification in progress...** button serves to automatically identify different motor data. ▶ [Automatic motor data identification](#) (119)
- The **Encoder/feedback system...** button serves to get to the settings for the encoder/feedback system, if available. ▶ [Encoder/feedback system](#) (230)

**Stop!**

Motors with electronic nameplates (ETS) must not be operated on 8400 inverters!

**Note!**

Sensorless vector control (SLVC) and sensorless control for synchronous motors (SLPSM) in particular requires the motor data parameters to be set. The motor data comprise the data of the motor nameplate and the data of the motor equivalent circuit.

If the motor has been selected via the motor catalogue of the »Engineer« or the motor data have been adapted offline using the »Engineer«, all motor data must then be copied to the inverter and saved power-failure-proof to the memory module (device command: [C00002/11](#)) when an online connection has been established.

**Note!****Setting a rated motor frequency with a decimal position**

If the motor has a rated motor frequency with a decimal position (e.g. motor nameplate data "23.7 Hz"):

- [Up to and including version 11.xx.xx](#), the following motor nameplate data must be increased by a factor of 10:
  - [C00089](#): Rated motor frequency  
(a value of "23.7 Hz", for instance, must be increased to 237 Hz.)
  - [C00081](#): Rated motor power
  - [C00087](#): Rated motor speed
  - [C00090](#): Rated motor voltage
- [From version 12.00.00](#), the rated motor frequency must be entered without decimal position to clearly identify the right motor type. (a value of "23.7 Hz", for instance, must be set to 23 Hz in [C00089](#))
  - [C01000](#) displays the set motor type (ASM or PSM).
  - [C00969](#) displays the set number of motor pole pairs.
- [From version 14.00.00 onwards](#), the motor type (ASM or PSM) can also be set manually in [C01001/1](#) for a clear identification.

**Note!**

If a rated motor speed is set for an asynchronous motor (ASM) in [C00087](#) which corresponds to a very high slip speed, the number of pole pairs is identified incorrectly. Moreover, a synchronous motor (PSM) is detected instead of an asynchronous motor (ASM) at certain slip speeds. Detailed information and possible remedies can be found here:

- ▶ [Application notes for asynchronous motors with high slip speed](#) (📖 125)

### Motor data

In the parameterisation dialog, the data of the motor nameplate for the selected motor are displayed under "Motor data".

Parameters	Info
<a href="#">C00081</a>	Rated motor power
<a href="#">C00087</a>	Rated motor speed
<a href="#">C00088</a>	Rated motor current
<a href="#">C00089</a>	Rated motor frequency
<a href="#">C00090</a>	Rated motor voltage
<a href="#">C00091</a>	Motor cos $\varphi$

### Actual values

When an online connection to the inverter has been established, the following actual values are displayed in the parameterisation dialog under "Actual values":

Parameters	Info
<a href="#">C00051</a>	Actual speed value
<a href="#">C00052</a>	Motor voltage
<a href="#">C00053</a>	DC-bus voltage
<a href="#">C00054</a>	Motor current
<a href="#">C00066</a>	Thermal motor load (I2xt)
Greyed out = display parameter	

### Adapting motor data manually

If a third party manufacturer's motor is used, the displayed motor data can exactly be adapted to the real motor by clicking the **From project...** button and selecting the "Own motor settings" entry from the **Motor selection** dialog box afterwards. For this purpose, the data of the motor nameplate and the equivalent circuit diagram must be available.



#### Tip!

For a better concentricity factor, we recommend to perform motor parameter identification of the third party manufacturer's motor first. The motor parameters can be manually adapted afterwards.

Improving the concentricity factor includes

- the adjustment of the inverter error characteristic to the drive system and
- the knowledge of the motor cable resistance.

Both factors are determined in the course of motor parameter identification.

▶ [Automatic motor data identification](#) (119)

# 5 Motor control (MCTRL)

## 5.1 Motor selection/Motor data

### Other motor data

Click the **Other motor data...** button and go to the *Other motor data* dialog box including the motor equivalent circuit (in the following for an asynchronous motor):

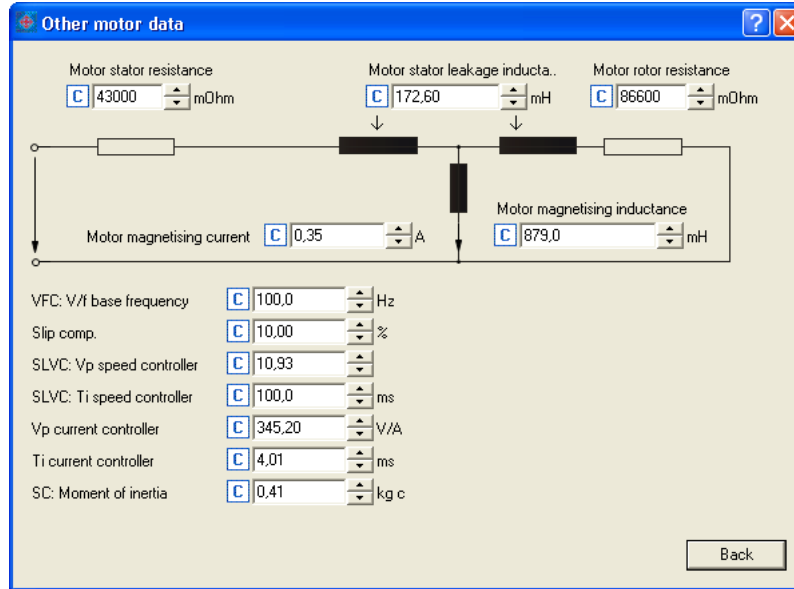

Parameters	Info	ASM	PSM
<a href="#">C00084</a>	Motor stator resistance	●	●
<a href="#">C00085</a>	Motor stator leakage inductance	●	●
<a href="#">C00082</a>	Motor rotor resistance	●	
<a href="#">C00095</a>	Motor magnetising current	●	
<a href="#">C00092</a>	Motor magnetising inductance	●	
<a href="#">C00015</a>	VFC: V/f base frequency	●	●
<a href="#">C00021</a>	Slip compensation	●	
<a href="#">C00070/1</a>	SLVC: Vp speed controller	●	
<a href="#">C00071/1</a>	SLVC: Ti speed controller	●	
<a href="#">C00075</a>	Vp current controller	●	●
<a href="#">C00076</a>	Ti current controller	●	●
<a href="#">C00273</a>	Moment of inertia	●	●
<a href="#">C00016</a>	VFC: Vmin boost	●	●
<a href="#">C00070/3</a>	SLPSM: Vp speed controller	●	●
<a href="#">C00071/4</a>	SLPSM: Ti speed controller	●	●
<a href="#">C00011</a>	Appl.: Reference speed	●	●
<a href="#">C00022</a>	Imax in motor mode	●	●
<a href="#">C00966</a>	VFC: Time const. slip comp.	●	
<a href="#">C00982</a>	VFC-ECO: Voltage reduction ramp	●	
<a href="#">C00073/1</a>	VFC: Vp Imax controller	●	●

- From version 12.00.00 onwards, [C01000](#) displays the set motor type (ASM or PSM).
- Generally, a synchronous motor without speed feedback can also be operated with the [V/f characteristic control \(VFCplus\)](#) control mode. The parameters for this control mode (e.g. V/f base frequency) thus also have an according influence on synchronous motors.

# 5 Motor control (MCTRL)

## 5.1 Motor selection/Motor data

### 5.1.1 Selecting a motor from the motor catalogue in the »Engineer«

If you, when inserting the inverter into the project in the dialog step "Other components", put a checkmark in the control field **Motor**, you can select as a further dialog step the motor for the inverter from the motor catalogue:

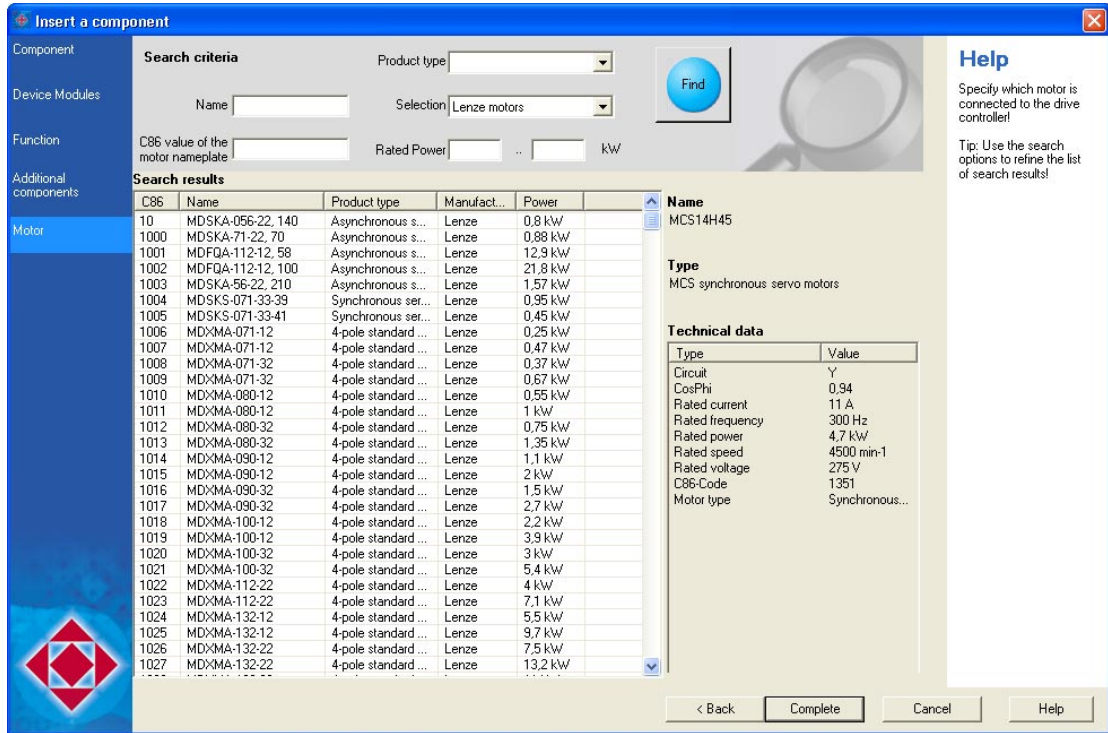

- Alternatively, the motor can be inserted into the project at a later time via the **Insert a component** command.
- Go to the **Application parameters** tab in the *Overview* → *Motor data* dialog level and click the **From motor catalogue...** button to also reach the motor catalogue for the selection of another motor.

### Accepting the default values of the motor

If a motor is selected from the motor catalogue at a later time, the *Use motor's default values* dialog box is displayed afterwards which includes all motor data of the selected motor. Please select here which of the default values are to be copied to the inverter:

Controller: 8400 StateLine C V04.00.00 [8400 StateLine C V04.00.00]  
 Motor: SDSGA047-22, 100 (Y)

Motor parameter

Use selection of motor controller in C0006: No default value available for this motor

Use following values in drive controller:

Code	Subcode	Description	Value	Unit
0015	000	VFC: V/f base frequency	100	Hz
0016	000	VFC: rpm boost	4.93	%
0021	000	Slip comp.	10	%
0073	001	VFC: Vp Imax controller	1.45	
0075	000	Vp current controller	345.2	V/A
0076	000	Ti current controller	4.01	ms
0081	000	Rated motor power	0.08	kW
0082	000	Motor rotor resistance	86600	mOhm
0084	000	Motor stator resistance	43000	mOhm
0085	000	Motor stator leakage inductance	172.6	mH

Path parameters for operation with zero load

Use following values in drive controller:

Code	Subcode	Description	Value	Unit
0022	000	Imax in motor mode	0.95	A
0070	001	SLVC: Vp Drehzahlregler	10.93	
0071	001	SLVC: Ti speed controller	100	ms
0273	000	SC: Moment of inertia	0.41	kg cm <sup>2</sup>

OK

- The listed motor parameters are already optimally preset for the selected Lenze motor. An adaptation is not required.
- The "plant parameter" term comprises all parameters that result from the combination of motor and load. These characterise the transfer behaviour of the entire controlled system.
  - The plant parameters depend on the application in which the inverter and motor are used.
  - When a Lenze motor is selected in the »Engineer«, plant parameters are suggested for this motor for a load-free operation.

 **Tip!**

If a third party manufacturer's motor is used, select a Lenze motor from the motor catalogue first which is similar in terms of current, voltage and speed rating. Adapt the preselected motor data exactly to the real motor afterwards.

# 5 Motor control (MCTRL)

## 5.1 Motor selection/Motor data

### 5.1.2 Automatic motor data identification

The motor parameter identification serves to automatically identify the inverter characteristic, the influences of the motor cable and various motor parameters.



#### Note!

We strongly recommend motor parameter identification before the initial commissioning of the sensorless vector control (SLVC) and the sensorless control for synchronous motors (SLPSM).

#### Automatically identified motor parameters

Parameters	Info	ASM	PSM
<a href="#">C00015</a>	V/f base frequency	●	●
<a href="#">C00016</a>	V <sub>min</sub> boost	●	●
<a href="#">C00021</a>	Slip compensation	●	
<a href="#">C00082</a>	Motor rotor resistance	●	
<a href="#">C00083</a>	Motor rotor time constant	●	
<a href="#">C00084</a>	Motor stator resistance	●	●
<a href="#">C00085</a>	Motor stator leakage inductance	●	●
<a href="#">C00092</a>	Motor magnetising inductance	●	
<a href="#">C00095</a>	Motor magnetising current	●	

#### Automatic calculation of the current controller and field controller parameters

From version 12.00.00 onwards: Following successful motor parameter identification, the current controller and field controller parameters listed in the below table are calculated as well.

- If these parameters are not to be calculated, bit 4 of [C02865/1](#) must be set to "1".

Parameters	Info	ASM	PSM
<a href="#">C00073/1</a>	VFC: Vp I <sub>max</sub> controller	●	●
<a href="#">C00075</a>	Vp current controller	●	●
<a href="#">C00076</a>	Ti current controller	●	●

**OPTIONAL: Automatic calculation of the speed controller parameters**

From version 12.00.00 onwards: Following successful motor parameter identification, the speed controller parameters listed in the below table can also be calculated automatically.

- If these parameters are to be calculated, bit 6 of [C02865/1](#) must be set to "5".

Parameters	Info	ASM	PSM
<a href="#">C00070/1</a>	SLVC: Vp speed controller	●	
<a href="#">C00071/1</a>	SLVC: Ti speed controller	●	
<a href="#">C00070/3</a>	SLPSM: Vp speed controller	●	●
<a href="#">C00071/3</a>	SLPSM: Ti speed controller	●	●

- Care must be taken that the constant mass inertia of the drive (mass inertia of motor, gearbox, shaft and constant load) is entered as exactly as possible in [C00273](#) to calculate the speed controller parameters as dynamically as possible.
  - Mass inertias that are not constant (e.g. changing loads of reels or different loads of hoists) must be entered in [C00919/1](#).
  - If the mass inertia set in [C00273](#) is too low, the speed controller parameters are calculated less dynamically.
  - If the mass inertia set in [C00273](#) is too high, speed controller operation is unstable.
- If the mass inertia in [C00273](#) is set to "0", the setting of bit 5 in [C02865](#) has no effect on the speed controller parameter calculation. In this case, the speed controller parameters will not be calculated automatically after motor parameter identification.

**OPTIONAL: Automatic calculation of other controller parameters**

From version 12.00.00 onwards: Following successful motor parameter identification, the controller parameters listed in the below table can also be calculated automatically.

- If these parameters are to be calculated, bit 6 of [C02865/1](#) must be set to "6".

Parameters	Info	ASM	PSM
<a href="#">C00011</a>	Appl.: Reference speed	●	●
<a href="#">C00022</a>	I <sub>max</sub> in motor mode	●	●
<a href="#">C00497</a>	Nact filter time constant	●	●
<a href="#">C00966</a>	VFC: Time const. slip comp.	●	
<a href="#">C00982</a>	VFC-ECO: Voltage reduction ramp	●	



### Principal sequence of the motor parameter identification

1. The motor stator resistance ([C00084](#)) is measured.
2. The inverter error characteristic is measured.
3. The motor stator leakage inductance ([C00085](#)) is measured.
4. The V/f base frequency ([C00015](#)) is calculated.
5. The slip compensation ([C00021](#)) is calculated.
6. The  $V_{\min}$  boost ([C00016](#)) is detected.
7. Only for asynchronous motors:  
The motor magnetising inductance ([C00092](#)) and the motor rotor resistance ([C00082](#)) are measured.  
The motor magnetising current ([C00095](#)) is measured.

From version 12.00.00:

8. If [C02865/1](#) - bit 4 = "0" (Lenze setting):  
The current controller and field controller parameters are calculated. (See [table](#).)
9. If [C02865/1](#) - bit 5 = "1":  
The speed controller parameters are calculated. (See [table](#).)
10. If [C02865/1](#) - bit 6 = "1":  
Other controller parameters are calculated. (See [table](#).)

### Selection of the identification mode

From version 10.00.00 onwards, two identification modes are available in [C02867/1](#):

- "1: Basic identification" (previous mode)
  - Only for asynchronous motors
  - Duration approx. 30 s
- "2: extended identification"
  - Stands out due to increased accuracy of the determined motor parameters.
  - Also supports synchronous motors and asynchronous motors with a power of more than 11 kW.
  - Duration approx. 80 s



#### Tip!

In the Lenze setting, a setting of "0: automatic" is selected in [C02867/1](#). This setting ensures that the inverter automatically selects the optimum procedure for motor parameter identification.

### Preconditions for executing the motor parameter identification

- The motor parameter identification must be carried out when the motor is cold!
- The load machine may remain connected. Holding brakes, if present, may remain in the braking position.
- In case of a synchronous motor:
  - The shaft must be able to rotate freely (must not be locked).
  - An identification is only possible with the extended motor parameter identification.
- For an asynchronous motor from a power of 11 kW:  
An identification is only possible with the extended motor parameter identification.
- The inverter has to be ready for enable (has to be in the "[SwitchedOn](#)" state).  
Inhibit the inverter if it is enabled, e.g. via the [C00002/16](#) device command or a LOW signal at the X4/RFR terminal.
- The motor has to be at standstill.

### Required parameter settings before the motor parameter identification is executed

- For an extended motor parameter identification, a motor control suitable for the motor has to be set in [C00006](#). When the identification starts, this setting determines whether an asynchronous motor or a synchronous motor has to be identified. ▶ [Selecting the control mode](#) ([□ 126](#))
- The motor parameters listed in the table below are excluded from automatic identification and must therefore be adapted to the used motor before motor parameter identification is carried out (see motor nameplate).

Parameters	Info
<a href="#">C00081</a>	Rated motor power
<a href="#">C00087</a>	Rated motor speed
<a href="#">C00088</a>	Rated motor current (according to the connection method $\lambda/\Delta$ )  <b>Note</b> The amplitude of the rated motor current ( <a href="#">C00088</a> ) is injected to identify the stator resistance. If the rated motor current amounts to less than 60 % of the rated inverter current, at least 60 % of the rated inverter current will be injected to ensure sufficient motor parameter identification accuracy.
<a href="#">C00089</a>	Rated motor frequency (according to the connection method $\lambda/\Delta$ )
<a href="#">C00090</a>	Rated motor voltage (according to the connection method $\lambda/\Delta$ )
<a href="#">C00091</a>	Motor $\cos \varphi$

- If the motor nameplate data are entered in the »Engineer« motor catalogue instead of selecting a motor, it is recommendable to use the extended motor parameter identification ([C02867/1](#) = "2: extended identification").
- Especially for third-party motors, it is also recommendable to carry out the slip calculation with the motor equivalent circuit diagram data ([C02879/1](#)). If the slip calculation is derived from the motor nameplate data, this can negatively affect the stability and accuracy of the drive behaviour because the rated speed specified on the motor nameplate often is rather inaccurate.

- The available motor cable must be specified in terms of length and cross-section:

Parameters	Info
<a href="#">C00915</a>	Motor cable length
<a href="#">C00916</a>	Motor cable cross-section

The motor cable resistance resulting from these settings is displayed in [C00917](#).

- For the measurement of the required variables, the motor is energised via the inverter terminals U, V and W during the motor parameter identification. The corresponding current controller is preset in the Lenze setting so that an optimal controller behaviour is achieved with an asynchronous motor power-adapted to the inverter.

Thanks to optimisation, the current controller can be set via the following parameters:

Parameters	Info	Lenze setting	
		Value	Unit
<a href="#">C00075</a>	Vp current controller	7.00	V/A
<a href="#">C00076</a>	Ti current controller	10.61	ms

- Switching frequency for the motor parameter identification:
  - Up to and including version 13.xx.xx, the motor parameter identification is executed with a switching frequency of 4 kHz.
  - From version 14.00.00, the motor parameter identification can also be executed with a switching frequency of 8 kHz instead of 4 kHz. For this purpose, the option "Motor ident.: Switching frequency 8 kHz" (Bit 4 = "1") has to be set in [C02864/1](#).  
 Example of how to use this option: Between the output of the inverter and the motor, a sinusoidal filter is connected which may only be operated with a minimum switching frequency of 8 kHz. (See also the section "[Preventing a decrease of the switching frequency](#)".) ([□ 213](#))

Generally, a switching frequency of 4 kHz is recommended for the motor parameter identification as it serves to obtain the most accurate results.

### Premature abort of the motor parameter identification



#### Stop!

If motor parameter identification is aborted, unstable drive behaviour may be the result!

The motor parameter identification can be aborted in the following cases:

- If a special motor (e.g. mid-frequency motor) or a servo motor is used.
- If there is a large deviation between inverter and motor power.

In case of a simple motor parameter identification, we recommend the following:

- to reduce the P component Vp of the current controller ([C00075](#)) e.g. by halving.
- to increase the time constant Ti of the current controller ([C00076](#)) e.g. by doubling.

In case of the extended motor parameter identification, the current controller parameters are determined automatically. If the identification is aborted all the same, the current controller parameters set in [C00075](#) and [C00076](#) can be used by parameterising [C02866](#) to "1".

Another cause for the abort of the motor parameter identification could be the implausibility of the entered nameplate data, e.g. the entry P = 0 kW for the motor power.

---

### Execute automatic motor parameter identification



#### Danger!

During motor parameter identification, the motor is energised via the outputs U, V and W of the inverter!

- Observe the corresponding safety instructions!
- With an idling motor, a small angular offset may occur at the motor shaft.
- During the motor parameter identification, rotations occur in case of a synchronous motor.



#### How to carry out automatic motor parameter identification:

1. Activate motor parameter identification via the [C00002/23](#) = "1: On / start" device command.
2. Enable inverter.
  - The inverter changes to the "[Ident](#)" device status.
  - Motor parameter identification starts.
  - The progress of the identification run can be seen in [C00002/23](#).
  - The identification is completed if the "0: Off / ready" message is displayed in [C00002/23](#).
  - After successful identification, it changes back to the "[SwitchedOn](#)" device status.
3. Inhibit inverter again.

### 5.1.3 Application notes for asynchronous motors with high slip speed



#### Note!

If a rated motor speed is set for an asynchronous motor (ASM) in [C00087](#) which corresponds to a very high slip speed, the number of motor pole pairs is identified incorrectly.

Moreover, a synchronous motor is (PSM) is detected instead of an asynchronous motor (ASM). In this case, the "[Id7](#)" error message can occur since motor and motor control type do not match.

Examples, possible impacts and remedies are described in the following sections.

#### Examples:

Number of pole pairs	Mechanical synchronous speed	Rated motor frequency (C00089)	Incorrect number of pole pairs if the rated motor speed (C00087) is lower:
1	3000 rpm	50 Hz	1986 rpm
2	1500 rpm	50 Hz	1195 rpm
3	1000 rpm	50 Hz	854 rpm
4	750 rpm	50 Hz	665 rpm

#### Possible impacts depending on the motor control type:

Motor control type	Possible impacts on the drive
<a href="#">V/f control (VFCplus + encoder)</a>	The motor can accelerate up to maximum speed of the motor.
<a href="#">Sensorless vector control (SLVC)</a>	The output speed is considerably too high.
<a href="#">V/f characteristic control (VFCplus)</a>	Example: $p=2, f_n=50 \text{ Hz}, n_n=1195 \text{ min}^{-1} \rightarrow$ Speed is 50 % too high

#### Remedies:

- For version 12.xx.xx and version 13.xx.xx the following applies:  
Limit the rated motor speed: [C00087](#) = [C00089](#) \* 60 / (number of pole pairs + 0.5)
- From version 14.00.00:  
Set the motor type ("ASM" or "PSM") manually in [C01001/1](#). The rated motor speed does not need to be limited since the number of pole pairs can be detected safely when the motor type has been set manually.

# 5 Motor control (MCTRL)

## 5.2 Selecting the control mode

### 5.2 Selecting the control mode

The 8400 StateLine inverter supports various modes for motor control (open loop or closed loop).

- V/f characteristic control (VFCplus) with linear characteristic for asynchronous motors is preset.
- The control mode can be selected in the »Engineer« on the **Application parameter** tab via the **Motor control (C0006)** list field:

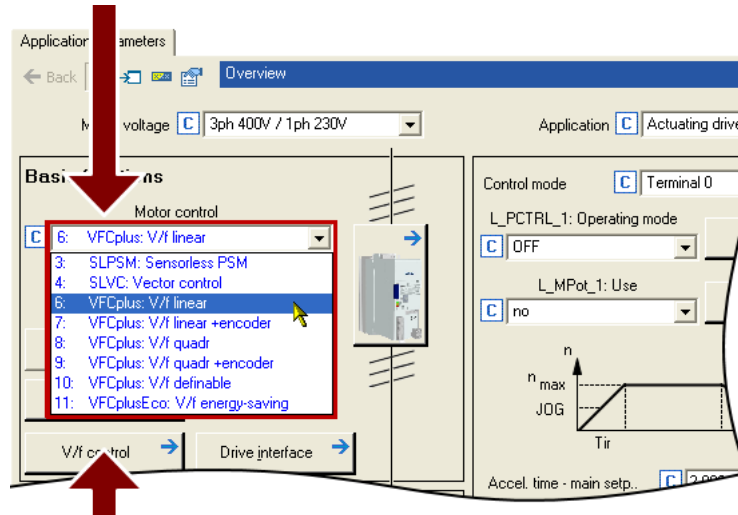

- A click on the **Motor control...** button leads you to the parameterisation dialog of the selected motor control. (The button is labelled according to the selected motor control.)



#### Tip!

In order to make the selection of the motor control easier, we provide a selection help with recommendations and alternatives for standard applications in the subchapter entitled "[Selection help](#)". (130)

The following section briefly describe the control modes. A reference to more details can be found at the end of each section.

**V/f characteristic control (VFCplus)**

The V/f characteristic control (VFCplus) is a motor control mode for standard frequency inverter applications based on a simple and robust control process which is suitable for the operation of asynchronous motors with linear or square-law load torque characteristic (e.g. fans). Furthermore, this motor control mode is also suitable for group drives and special motors. Due to the low parameterisation effort, commissioning of such applications is fast and easy.

The  $V_{\min}$  boost ([C00016](#)) and slip compensation ([C00021](#)) required for optimising the drive behaviour are dimensioned for asynchronous motors with power adaptations to the inverter in the Lenze setting.

▶ [V/f characteristic control \(VFCplus\)](#) (📖 134)

**Energy-saving V/f characteristic control (VFCplusEco)**

From version 10.00.00

In contrast to the V/f characteristic control mode (VFCplus), this motor control mode uses a  $\cos\phi$  control in partial load operational range to automatically reduce the power loss in the asynchronous motor (energy optimisation).

The motor data required for the  $\cos\phi$  control and the  $V_{\min}$  boost ([C00016](#)) and slip compensation ([C00021](#)) required for optimising the drive behaviour are dimensioned for asynchronous motors with power adaptations to the inverter in the Lenze setting.

The required motor data (motor rotor resistance, motor stator resistance, motor stator leakage inductance and mutual motor inductance) only affect the extent of energy optimisation but not the stability.

In case of applications with dynamically very high sudden load variations from the unloaded operation, this motor control mode should not be used since a motor stalling cannot be excluded.

Energy optimisation for dynamic applications is not possible with this motor control mode.

▶ [V/f characteristic control - energy-saving \(VFCplusEco\)](#) (📖 152)

**V/f control (VFCplus + encoder)**

The V/f control can be selected for operating asynchronous motors with speed feedback. With this motor control, a slip regulator can be additionally parameterised which adjusts the actual speed value dynamically to the speed setpoint.

▶ [V/f control \(VFCplus + encoder\)](#) (📖 162)

**Sensorless vector control (SLVC)**

Sensorless (field-oriented) vector control for asynchronous motors is based on a decoupled, separate control for the torque-producing and the field-producing current component. In addition, the actual speed is reconstructed by means of a motor model so that a speed sensor is not required.

In comparison to the V/f characteristic control without feedback, the following can be achieved by means of sensorless vector control SLVC:

- A higher maximum torque throughout the entire speed range
- A higher speed accuracy
- A higher concentricity factor
- A higher level of efficiency
- The implementation of torque-actuated operation with speed limitation
- The limitation of the maximum torque in motor and generator mode for speed-actuated operation

**Tip!**

If a high torque without feedback is to be provided at small speeds, we recommend the "Sensorless vector control" motor control mode.

▶ [Sensorless vector control \(SLVC\)](#) (📖 169)

**Sensorless control for synchronous motors (SLPSM)**

From version 10.00.00

This sensorless control enables an encoderless control of synchronous motors. The process is based on field-oriented control within a higher speed range (e.g. > 10 % of the rated motor speed). The actual speed value and rotor position are reconstructed via a motor model.

Standard applications for this control type are pumps and fans, horizontal materials handling and simple positioning technology.

▶ [Sensorless control for synchronous motors \(SLPSM\)](#) (📖 186)



# 5 Motor control (MCTRL)

## 5.2 Selecting the control mode

### Speed feedback

As shown in the following graphics, the drive systems with feedback have, independently of the motor control, more advantages than systems without feedback.

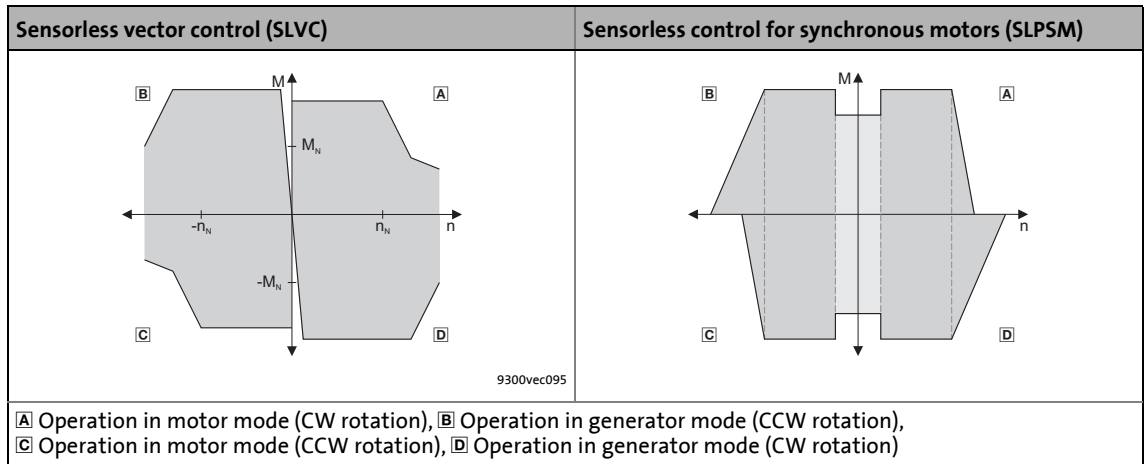
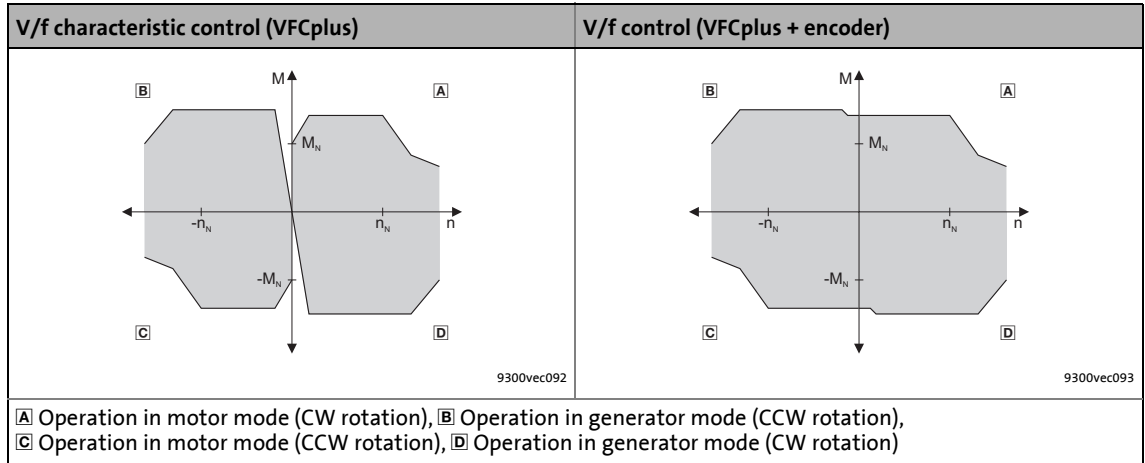

# 5 Motor control (MCTRL)

## 5.2 Selecting the control mode

### 5.2.1 Selection help

To ease the selection of the motor control mode, the two following tables contain recommendations and alternatives to standard applications.

Application	recommended	Alternatively
<b>Single drives</b>		
With constant load	VFCplus: V/f linear	SLVC or SLPSM
With extremely alternating loads	VFCplus: V/f linear	SLVC
With high starting duty	SLVC	VFCplus: V/f linear
Torque limitation	SLVC	SLPSM
With torque limitation (power control)	VFCplus: V/f linear	SLPSM
Three-phase reluctance motor	VFCplus: V/f linear	-
Three-phase sliding rotor motor	VFCplus: V/f linear	-
Three-phase AC motors with permanently assigned frequency/voltage characteristic	VFCplus: V/f linear	-
Pump and fan drives with quadratic load characteristic	VFCplus: U/f square-law From version 10.00.00 onwards: VFCplusEco	SLVC or SLPSM
Simple hoists	VFCplus: V/f linear	-
<b>Group drives (several motors connected to inverter)</b>		
Identical motors and loads	VFCplus: V/f linear	-
Different motors and/or alternating loads	VFCplus: V/f linear	-

[5-1] Standard applications without speed feedback

Application	recommended	Alternatively
<b>Single drives</b>		
With constant load	VFCplus: V/f linear	SLVC
With extremely alternating loads	VFCplus: V/f linear	SLVC
With high starting duty	VFCplus: V/f linear	SLVC
With speed control (speed feedback)	VFCplus: V/f linear	-
With high dynamic performance e.g. for positioning and infeed drives	VFCplus: V/f linear	-
Torque limitation	VFCplus: V/f linear	SLVC
With torque limitation (power control)	-	-
Winder with dancer position control	VFCplus: V/f linear	-
Unwinder with dancer position control	VFCplus: V/f linear	-
Three-phase reluctance motor	-	-
Three-phase sliding rotor motor	-	-
Three-phase AC motors with permanently assigned frequency/voltage characteristic	-	-
Pump and fan drives with quadratic load characteristic	-	-
Simple hoists	VFCplus: V/f linear	-
<b>Group drives (several motors connected to inverter)</b>		
Identical motors and loads	VFCplus	-
Different motors and/or alternating loads	VFCplus	-

[5-2] Standard applications with speed feedback

# 5 Motor control (MCTRL)

## 5.3 Defining current and speed limits

### 5.3 Defining current and speed limits

#### Limitation of the speed setpoint

Parameterising the reference speed in [C00011](#) means that the drive must rotate at the set speed if a speed setpoint of 100% is specified.

All speed setpoint selections are provided in % and always refer to the reference speed set in [C00011](#).



#### Tip!

For reasons of achievable resolution and the accuracy involved, the reference speed should be geared to the speed range required for the respective application.

Lenze recommendation: Reference speed ([C00011](#)) = 1500 ... 3000 rpm

Irrespective of the selected motor control, there are more limitation options:

Parameters	Info	Lenze setting	
		Value	Unit
<a href="#">C00909/1</a>	Max. positive speed	120	%
<a href="#">C00909/2</a>	Max. negative speed	120	%
<a href="#">C00910/1</a>	Max. positive output frequency	1000	Hz
<a href="#">C00910/2</a>	Max. negative output frequency	1000	Hz



#### Note!

In the torque-controlled operation (*bTorquemodeOn* = TRUE), the limitation of the speed setpoint set in [C00909/x](#) has no impact!

For the torque-controlled operation, a permissible speed range can be defined via the speed limitation (inputs *nSpeedHighLimit\_a* and *nSpeedLowLimit\_a* at the SB [LS MotorInterface](#)).

For a correct function of the speed limitation in both direction, the following applies:

The speed limitation operates with a internal hysteresis of 50 min<sup>-1</sup>. The upper or lower speed limit resulting from the settings has to be higher than this hysteresis!

### Current limitation in motor and generator mode

In the various motor control modes, the inverter is provided with functions which determine the dynamic behaviour under load and counteract exceedance of the maximum current in motor or generator mode.

Parameters	Info	Lenze setting	
		Value	Unit
<a href="#">C00022</a>	I <sub>max</sub> in motor mode	47.00	A
<a href="#">C00023</a>	I <sub>max</sub> in generator mode • 100 % ≙ I <sub>max</sub> in motor mode ( <a href="#">C00022</a> )	100	%

The current limits must be selected depending on

- the permissible maximum current of the motor → recommendation:  $I(\text{Mot})_N < 1.5 \dots 2.0$
- the permissible maximum current of the inverter
- the torque in motor/generator mode required for the application



#### Note!

##### Highly dynamic applications

(that have e.g. too short acceleration/deceleration times or excessively changing loads)

The overcurrent disconnection may respond (fault message oC1 or oC11) if the setting of the maximum current in motor mode in [C00022](#) approximately corresponds to the maximum permissible value of the respective inverter.

##### Remedies:

- Increase of the acceleration and deceleration ramp times
- Reduction of the maximum current in motor mode ([C00022](#))
- Reduction of the maximum current in generator mode ([C00023](#))
- Adaptation of the indirect peak current limitation (procedure depends on the selected motor control mode, see below)
- Reduction of the reset time of the current limiting controller ([C00074/1](#))

##### Influencing the torque in motor/generator mode

The torque in motor and generator mode can be limited via the *nTorqueMotLim* and *nTorqueGenLim* process signal inputs.

- If V/f characteristic control (VFCplus) is selected, limitation is indirectly performed via a so-called  $I_{\text{max}}$  controller.
- If sensorless vector control (SLVC) and sensorless control for synchronous motors (SLPSM) is selected, limitation has a direct effect on the torque-producing current component.

If keypad control is selected, the *nTorqueMotLim* and *nTorqueGenLim* process signals can be parameterised via [C00728/1...2](#).

##### From version 18.00.00 onwards

The positive and negative torque can be limited via the two process signal inputs *nTorqueMotLimit\_a* and *nTorqueGenLimit\_a*.

- [C02864](#): Bit 15 = 1: *nTorqueMotLimit\_a* acts as *nTorqueHighLimit\_a* (positive torque limitation) and *nTorqueGenLimit\_a* acts as *nTorqueLowLimit\_a* (negative torque limitation).

**How to adapt the peak current limitation:**

V/f characteristic control (VFCplus):

- Reduce the slip compensation with [C00021](#).

V/f control (VFCplus + encoder):

- Reduce the slip limitation to twice the rated motor slip with [C00971](#).
- Reduce the  $V_{\min}$  boost in [C00016](#).

Sensorless vector control (SLVC):

- Reduce the slip compensation with [C00021](#).
- Reduce the limitation of the torque in motor mode via  $nTorqueMotLimit\_a$  ([C00728/1](#)) and the limitation of the torque in generator mode via  $nTorqueGenLimit\_a$  ([C00728/2](#)).

## 5.4 V/f characteristic control (VFCplus)

In case of the V/f characteristic control (VFCplus), the motor voltage of the inverter is determined by means of a linear or quadratic characteristic depending on the field frequency or motor speed to be generated. The voltage follows a preselected characteristic.



### Stop!

- The V/f characteristic control is only suitable for asynchronous motors.
- The following must be observed when operating drives with quadratic V/f characteristic:
  - Please always check whether the corresponding drive is suitable for operation with a quadratic V/f characteristic!
  - If you pump or fan drive is not suitable for operation with a square-law V/f characteristic, we recommend using the energy-saving V/f characteristic control (VFCplusEco). Alternatively, you can use the V/f characteristic control with linear V/f characteristic or the sensorless vector control (SLVC).
- For adjustment, observe the thermal performance of the connected asynchronous motor at low output frequencies.
  - Usually, standard asynchronous motors with insulation class B can be operated for a short time with their rated current in the frequency range 0 Hz ... 25 Hz.
  - Contact the motor manufacturer to get the exact setting values for the max. permissible motor current of self-ventilated motors in the lower speed range.
  - If you select square-law V/f characteristics, we recommend setting a lower  $V_{\min}$  or using the energy-saving V/f characteristic control (VFCplusEco).
- The nameplate data of the motor (at least rated speed and rated frequency) must be entered if, instead of a standard motor, an asynchronous motor is used with the following values:
  - rated frequency  $\neq$  50 Hz (star) or
  - rated frequency  $\neq$  87 Hz (delta) or
  - number of pole pairs  $\neq$  2



### Note!

When the auto DCB threshold ([C00019](#)) is set  $> 0$  rpm, there is no torque at the motor shaft in the lower speed range!

▶ [Automatic DC-injection braking \(Auto-DCB\)](#) (□ 222)

### 5.4.1 Parameterisation dialog/signal flow



Proceed as follows to open the dialog for parameterising the motor control:

1. »Engineer« Go to the *Project view* and select the 8400 StateLine inverter.
2. Select the **Application parameters** tab from the *Workspace*.
3. Select the motor control from the *Overview* dialog level in the **Motor control** list field:
  - "6: VFCplus: V/f linear" for linear characteristic or
  - "8: VFCplus: V/f quadr" for square-law characteristic

More available V/f characteristic control modes:

- "10: VFCplus: U/f definable" (from version 04.00.00 onwards).  
With this motor control, the V/f characteristic can be freely defined. ▶ [Defining a user-defined V/f characteristic](#) (□ 148)
  - "11: VFCplusEco: V/f energy-saving" (from version 10.00.00 onwards).  
With this motor control, the motor is always operated in an optimal efficiency range via a  $\cos\phi$  control and the resulting voltage reduction (reduced copper losses in the asynchronous motor). ▶ [V/f characteristic control - energy-saving \(VFCplusEco\)](#) (□ 152)
4. Click the **Motor control V/f** button to change to the *Overview* → *Motor control V/f* dialog box.
    - This dialog level only shows a simplified signal flow with the most important parameters.
    - When you click the >>**More details** button in the left-most position, a signal flow with more details/parameters is displayed.

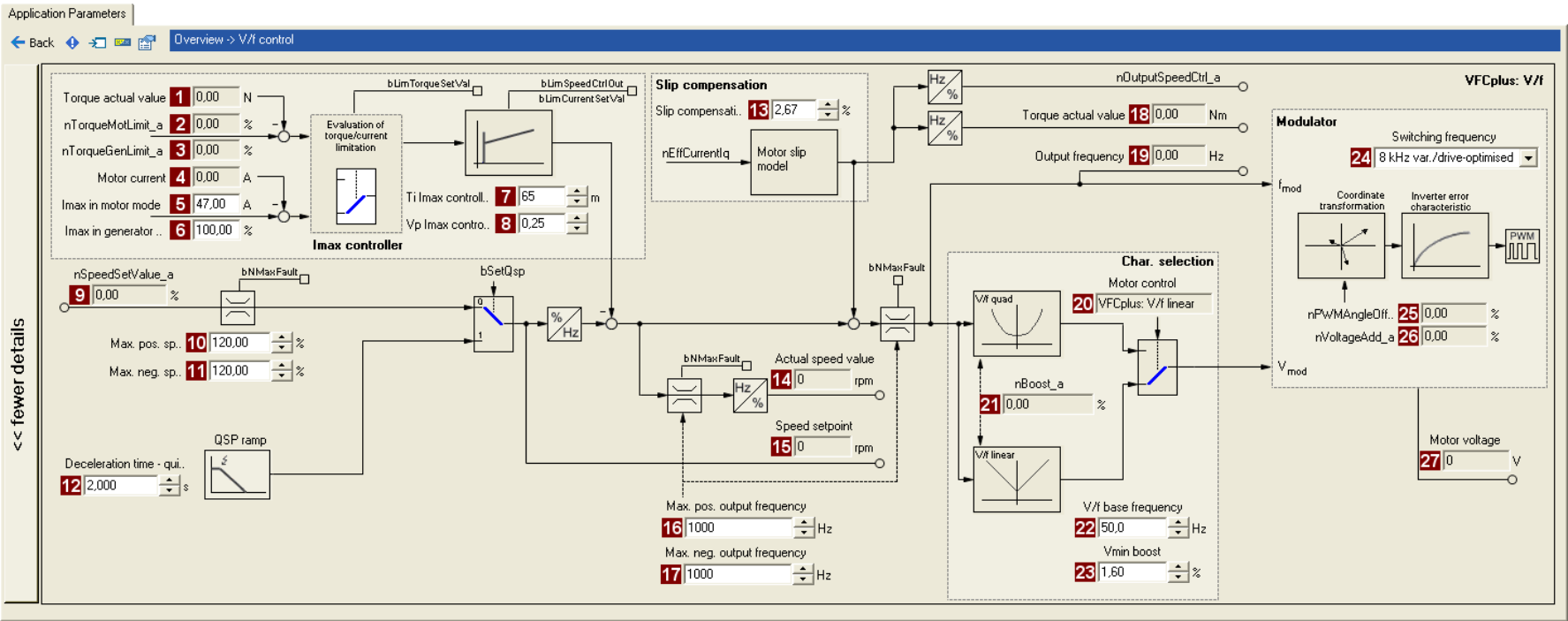

<< fewer details >>

Parameters	Info	Parameters	Info	Parameters	Info
1	<a href="#">C00056/2</a> Actual torque value	13	<a href="#">C00021</a> Slip compensation	18	<a href="#">C00056/2</a> Actual torque value
2	<a href="#">C00830/29</a> Limitation of torque in motor mode	14	<a href="#">C00051</a> Actual speed value	19	<a href="#">C00058</a> Output frequency
3	<a href="#">C00830/28</a> Limitation of torque in generator mode	15	<a href="#">C00050</a> Speed setpoint	20	<a href="#">C00006</a> Motor control
4	<a href="#">C00054</a> Motor current	16	<a href="#">C00910/1</a> Max. pos. output frequency	21	<a href="#">C00830/26</a> MCTRL: nBoost_a
5	<a href="#">C00022</a> I <sub>max</sub> in motor mode	17	<a href="#">C00910/2</a> Max. neg. output frequency	22	<a href="#">C00015</a> V/f base frequency
6	<a href="#">C00023</a> I <sub>max</sub> in generator mode			23	<a href="#">C00016</a> V <sub>min</sub> boost
7	<a href="#">C00074</a> T <sub>i</sub> I <sub>max</sub> controller			24	<a href="#">C00018</a> Switching frequency
8	<a href="#">C00073</a> V <sub>p</sub> I <sub>max</sub> controller			25	<a href="#">C00830/32</a> MCTRL: nPWMAngleOffset_a
9	<a href="#">C00830/22</a> Speed setpoint			26	<a href="#">C00830/31</a> MCTRL: nVoltageAdd_a
10	<a href="#">C00909/1</a> Max. pos. speed			27	<a href="#">C00052</a> Motor voltage
11	<a href="#">C00909/2</a> Max. neg. speed				
12	<a href="#">C00105</a> Decel. time - quick stop				



### 5.4.2 Basic settings

The "Initial commissioning steps" listed in the table below are sufficient for a simple characteristic control.

- Detailed information on the individual steps can be found in the following subchapters.

Initial commissioning steps	
1.	<a href="#">Define V/f characteristic shape.</a> (📖 138)
2.	<a href="#">Defining current limits (I<sub>max</sub> controller).</a> (📖 139)



#### Tip!

Information on the optimisation of the control mode and the adaptation to the real application is provided in chapter "[Optimising the control mode](#)". (📖 140)

Parameterisable additional functions are described correspondingly in the chapter "[Parameterisable additional functions](#)". (📖 212)

### 5.4.2.1 Define V/f characteristic shape

In principle, four different characteristic shapes can be stipulated:

1. **Linear V/f characteristic:**  
For drives for a constant, speed-independent load torque.
2. **Quadratic V/f characteristic:**  
For drives with a load torque curve which is quadratic or in relation to speed. Quadratic V/f characteristics are preferred in the case of centrifugal pumps and fan drives.
3. **User-definable V/f characteristic (from version 04.00.00 onwards):**  
For drives that require adaptation of the magnetising current by means of the output speed. The freely definable V/f characteristic can be used e.g. for operation in conjunction with special machines such as reluctance motors in order to suppress oscillations at the machine or to optimise energy consumption.

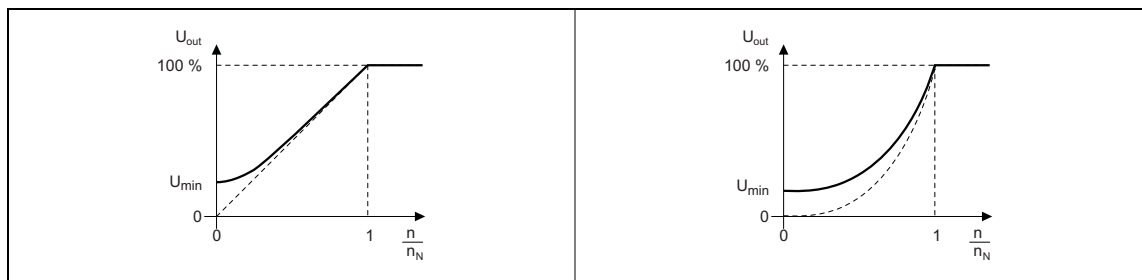

[5-3] Principle of a linear V/f characteristic (on the left) and a quadratic V/f characteristic (on the right)

4. **Linear V/f characteristic with voltage reduction (from version 10.00.00 onwards):**  
For drives which often work in partial load operation, the energy-saving V/f characteristic control (VFCplusEco) offers the opportunity to reduce the voltage at low load in order to save energy. At higher loads, the voltage reduction is cancelled and a linear characteristic is caused.

The V/f characteristic shape is defined by selecting the corresponding motor control mode in [C00006](#):

V/f characteristic shape	Motor control to be selected (C00006)
Linear V/f characteristic	6: VFCplus: V/f linear
Square-law V/f characteristic	8: VFCplus: V/f quadr
User-definable V/f characteristic	10: VFCplus: V/f definable
Linear V/f characteristic with voltage reduction	11: VFCplusEco: V/f energy-saving



#### Tip!

- You can find detailed information on freely definable V/f characteristics in the subchapter entitled "[Defining a user-defined V/f characteristic](#)". (📖 148)
- You can find detailed information on the linear V/f characteristic with voltage reduction in the chapter entitled "[V/f characteristic control - energy-saving \(VFCplusEco\)](#)". (📖 152)

### 5.4.2.2 Defining current limits (I<sub>max</sub> controller)

The V/f characteristic control (VFCplus) and the V/f control (VFCplus + encoder) operating modes are provided with a current limitation control which is decisive for the dynamic behaviour under load and counteracts exceedance of the maximum current in motor or generator mode. This current limitation control is called I<sub>max</sub> control.

- The efficiency (motor current) measured by the I<sub>max</sub> control is compared with the current limit value for motor load set in [C00022](#) and the current limit value for generator load set in [C00023](#).
- If the current limit values are exceeded, the inverter changes its dynamic behaviour.

#### Motor overload during acceleration

The inverter prolongs the acceleration ramp to keep the current on or below the current limit.

#### Generator overload during deceleration

The inverter prolongs the acceleration ramp to keep the current on or below the current limit.

#### Increasing load with constant speed

- If the motor current limit value is reached:
  - The inverter reduces the effective speed setpoint until a stable working point is set or an effective speed setpoint of 0 rpm is reached.
  - If the load is reduced, the inverter increases the effective speed setpoint until the setpoint speed is reached or the load reaches the current limit value again.
- When the generator current limit value is reached:
  - The inverter increases the effective speed setpoint until a stable working point is set or the maximally permissible speed ([C00909](#)) or output frequency is reached ([C000910](#)).
  - If the load is reduced, the inverter reduces the effective speed setpoint until the setpoint speed is reached or the load reaches the current limit value again.
- If a sudden load is built up at the motor shaft (e.g. drive is blocked), the overcurrent disconnection may respond (fault message oC1 or oC11).

### 5.4.3 Optimising the control mode

The V/f characteristic control (VFCplus) is generally ready for operation. It can be adapted subsequently by adapting the characteristic and/or the drive behaviour.



#### Note!

Following successful motor parameter identification, the V/f base frequency ([C00015](#)) and the  $V_{\min}$  boost ([C00016](#)) as well as the slip constant for slip compensation ([C00021](#)) are calculated automatically.

From version 12.00.00:

- Following successful motor parameter identification, the gain of the  $I_{\max}$  controller ([C00073/1](#)) is calculated automatically.
  - If these parameters are not to be calculated, bit 4 of [C02865/1](#) must be set to "1".
- Following successful motor parameter identification, other controller parameters ([C00011](#), [C00022](#), [C00966](#)) can be calculated automatically.
  - If these parameters are to be calculated, bit 6 of [C02865/1](#) must be set to "6".

#### Adapting characteristic

For the linear and quadratic characteristic, it is also possible to match its curve to different load profiles or motors by adapting the V/f base frequency ([C00015](#)) and the  $V_{\min}$  boost ([C00016](#)).

- ▶ [Adapting the V/f base frequency](#) (📖 141)
- ▶ [Adapting the  \$V\_{\min}\$  boost](#) (📖 143)

#### Freely defining the characteristic

From version 04.00.00 onwards, the V/f characteristic can also be defined freely if the linear and square-law characteristic are not suitable.

- ▶ [Defining a user-defined V/f characteristic](#) (📖 148)

#### Adapting drive behaviour

- Limitation of the maximum current by a current limitation controller (e.g. to prevent the motor from stalling or to limit to the maximally permissible motor current). ▶ [Optimising the  \$I\_{\max}\$  controller](#) (📖 144)
- Adaptation of the field frequency by a load-dependent slip compensation (improved speed accuracy for systems without feedback)
- Adaptation of the controller parameters of the slip regulator if V/f control (VFCplus + encoder) is selected. ▶ [Parameterising the slip regulator](#) (📖 166)

# 5 Motor control (MCTRL)

## 5.4 V/f characteristic control (VFCplus)

### 5.4.3.1 Adapting the V/f base frequency

The V/f base frequency ([C00015](#)) determines the slope of the V/f characteristic and has considerable influence on the current, torque, and power performance of the motor.

- The setting in [C00015](#) applies to all permitted mains voltages.
- Mains fluctuations or fluctuations of the DC-bus voltage (operation in generator mode) do not need to be considered when the V/f base frequency is set. They are automatically compensated for by the internal mains voltage compensation of the device.
- Depending on the setting in [C00015](#), it may be required to adapt the reference speed ([C00011](#)) to traverse the entire speed range of the motor.
- The V/f base frequency is automatically calculated from the stored motor nameplate data by the motor parameter identification:

$$C00015 \text{ [Hz]} = \frac{U_{FI} \text{ [V]}}{U_{Ratedmot} \text{ [V]}} \cdot f_{Rated} \text{ [Hz]}$$

$U_{FI}$ : Mains voltage 400 V or 230 V  
 $U_{ratedmot}$ : Rated motor voltage depending on the connection method  
 $f_{rated}$ : Rated motor frequency

[5-4] Calculation of the V/f base frequency

#### Typical values of the V/f base frequency

Inverter with 400-V mains connection			
Motor voltage [V]	Motor frequency [Hz]	Motor connection	V/f base frequency (C00015)
230 / 400	50	Y	50 Hz
220 / 380	50	Y	52.6 Hz
280 / 480	60	Y	50 Hz
400 / 690	50	Δ	50 Hz
400	50		
230 / 400	50	Δ	87 Hz
280 / 480	60		
400	87		
220 / 380	50	Δ	90.9 Hz

Inverter with 230-V mains connection			
Motor voltage [V]	Motor frequency [Hz]	Motor connection	V/f base frequency (C00015)
230	50	Δ	50 Hz
220 / 380	50	Δ	52.3 Hz

**Note!****87-Hz operation**

4-pole asynchronous motors which are designed for a rated frequency of  $f = 50$  Hz in star connection can be operated in delta connection when being constantly excited up to  $f = 87$  Hz.

- Advantages:
  - Higher speed-setting range
  - 73% higher power output in case of standard motors
- Motor current and motor power increase by the factor  $\sqrt{3}$ .
- The field weakening range starts above 87 Hz.
- Generally, this process can also be used with motors which have different numbers of pole pairs. In case of 2-pole asynchronous motors, the mechanical limit speed must be maintained.

### 5.4.3.2 Adapting the V<sub>min</sub> boost

The V<sub>min</sub> boost ([C00016](#)) of the motor voltage serves to select a load independent magnetising current which is required for asynchronous motors. The torque behaviour of the motor can be optimised by adapting the setting in [C00016](#).

The *nBoost\_a* process signal at the SB [LS\\_MotorInterface](#) serves to carry out a V<sub>min</sub> boost as well:

Designator DIS code   data type	Information/possible settings
nBoost_a <a href="#">C00830/26</a>   INT	<p>Process signal for the V<sub>min</sub> boost</p> <ul style="list-style-type: none"> <li>This signal is added to <a href="#">C00016</a> and has thus an increasing or decreasing effect.</li> <li>This signal serves to implement a load-dependent V<sub>min</sub> boost to improve the torque behaviour in different load states, as for instance in case of operation in generator or motor mode.</li> <li>Scaling: 16384 ≙ 100 % rated device voltage V<sub>FU</sub> (400 V or 230 V)</li> </ul>
	<p><b>STOP</b> Stop!</p> <p>Values selected too high may cause the motor to heat up due to the resulting current!</p>



#### Note!

The V<sub>min</sub> boost has an effect on output frequencies below the V/f base frequency ([C00015](#)).

The general linear and quadratic V/f characteristics are shown in the illustrations below. The illustrations show the impacts of the parameters used to adapt the characteristic shape.

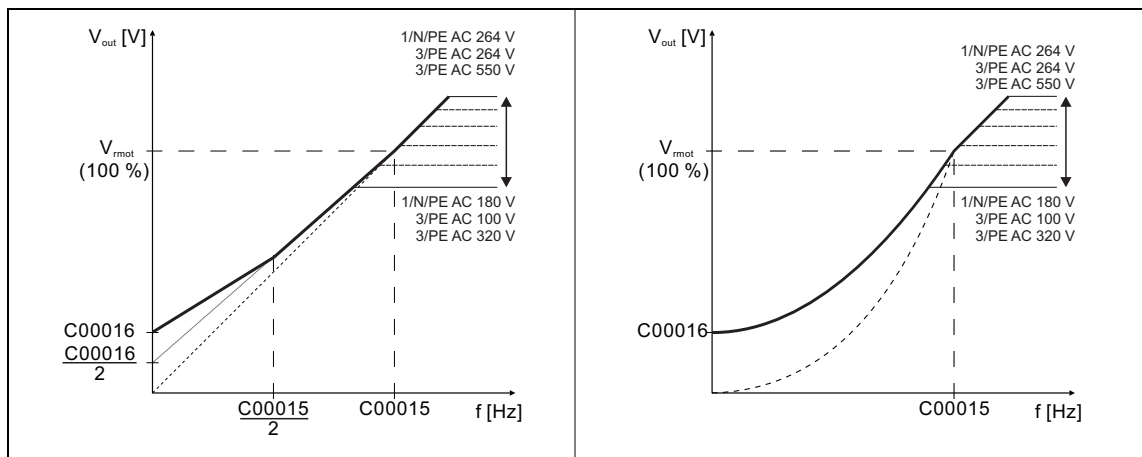

[5-5] Representation of the linear V/f characteristic (on the left) and quadratic V/f characteristic (on the right)



#### How to set the V<sub>min</sub> boost:

- Operate motor in idle state at approx. 6 % of the rated motor speed.
- Increase V<sub>min</sub> boost ([C00016](#)) until the following motor current is reached:

Motor in short-time operation up to 0.5 n<sub>rated</sub>

- for self-ventilated motors: I<sub>motor</sub> ≈ I<sub>rated motor</sub>
- for forced ventilated motors: I<sub>motor</sub> ≈ I<sub>rated motor</sub>

Motor in continuous operation up to  $0.5 n_{\text{rated}}$

- for self-ventilated motors:  $I_{\text{motor}} \approx 0.8 I_{\text{rated motor}}$
- for forced ventilated motors:  $I_{\text{motor}} \approx I_{\text{rated motor}}$



### Note!

$V_{\text{min}}$  boost is automatically calculated by the motor parameter identification using the data specified on the motor nameplate so that a no-load current of approx.  $0.8 I_{\text{rated motor}}$  results at the slip frequency of the machine.

#### V/f control (VFCplus + encoder)

If V/f control (VFCplus + encoder) is selected, we recommend a decidedly lower  $V_{\text{min}}$  boost:

- In this case, select a  $V_{\text{min}}$  boost which ensures that approx. 50 % of the rated motor current flows at slip frequency when the motor is idling.

### 5.4.3.3 Optimising the $I_{\text{max}}$ controller

Using the Lenze setting of the current limitation controller, the drive is stable:

Parameters	Info	Lenze setting	
		Value	Unit
<a href="#">C00073/1</a>	VFC: Vp $I_{\text{max}}$ controller	0.25	
<a href="#">C00074/1</a>	VFC: Ti $I_{\text{max}}$ controller	65	ms

Most applications do not require optimisation.

The setting of the current limitation controller must be adapted if

- power control including great moments of inertia is performed.
  - Recommendation: Increase of the reset time Ti ([C00074/1](#)) of the  $I_{\text{max}}$  controller.
- vibrations occur in the V/f control (VFCplus + encoder) mode during the intervention of the current limitation controller.
  - Recommendation: Increase of the reset time Ti ([C00074/1](#)) of the  $I_{\text{max}}$  controller.
- overcurrent errors (e.g. OC3) occur due to load impulses or too high acceleration ramps.
  - Recommendation: Reduction of the gain Vp ([C00073/1](#)) and reset time Ti ([C00074/1](#)) of the  $I_{\text{max}}$  controller.



#### 5.4.3.4 Optimising the stalling behaviour

Motor stalling due to a torque overload in the field weakening range is prevented in all characteristic-based motor control types (VFCplus) by means of an inverter-internal stalling current monitoring. In the field weakening range, hence at frequencies above the base frequency, it reduces the maximum current to prevent the motor from stalling. The reduction depends on the current field frequency, the base frequency, the DC-bus voltage and the maximum current ([C00022](#)). Generally it applies that a higher field frequency causes a stronger limitation of the maximum current.

The behaviour in the field weakening range can be adapted via the override point of field weakening ([C00080](#)). This parameter serves to shift the frequency-dependent maximum current characteristic:

- [C00080](#) > 0 Hz:
  - The maximum current characteristic is shifted by the entered frequency to higher field frequencies.
  - The maximally permissible current and the maximum torque increase in the field weakening range.
  - The risk of motor stalling increases.
- [C00080](#) < 0 Hz:
  - The maximum current characteristic is shifted by the entered frequency to lower field frequencies.
  - The maximally permissible current and the maximum torque are reduced in the field weakening range.
  - The risk of motor stalling is reduced.



#### Note!

We recommend to keep the Lenze setting (0 Hz).

### 5.4.3.5 Torque limitation

The previous chapter, "[Optimising the I<sub>max</sub> controller](#)", describes how the drive can be protected from overload. During commissioning, these settings are carried out once and remain unchanged afterwards. However, it is often necessary to limit the torque to a lower value for plant or process reasons.

- To avoid overload in the drive train, the torque in motor mode can be limited via the *nTorqueMotLimit\_a* process input signal, and the torque in generator mode can be limited via the *nTorqueGenLimit\_a* process input signal:

Designator <small>DIS code   data type</small>	Information/possible settings
nTorqueMotLimit_a <a href="#">C00830/29</a>   INT	Torque limitation in motor mode <ul style="list-style-type: none"> <li>• Scaling: 16384 ≙ 100 % M<sub>max</sub> (<a href="#">C00057</a>)</li> <li>• Setting range: 0 ... +199.99 %</li> <li>• If keypad control is performed: Parameterisable via <a href="#">C00728/1</a>.</li> </ul> From version 18.00.00 onwards: <a href="#">C02864</a> : Bit 15 = 1: positive torque limitation (nTorqueHighLimit_a)
nTorqueGenLimit_a <a href="#">C00830/28</a>   INT	Torque limitation in generator mode <ul style="list-style-type: none"> <li>• Scaling: 16384 ≙ 100 % M<sub>max</sub> (<a href="#">C00057</a>)</li> <li>• Setting range: -199.99 ... 0 %</li> <li>• If keypad control is performed: Parameterisable via <a href="#">C00728/2</a>.</li> </ul> From version 18.00.00 onwards: <a href="#">C02864</a> : Bit 15 = 1: negative torque limitation (nTorqueLowLimit_a)



#### Note!

- The actual torque ([C00056/2](#)) is directly calculated from the current slip speed of the machine. This requires correct entry of the motor data. (113) ▶ [Motor selection/Motor data](#)
- To avoid instabilities during operation with active slip compensation, the torque limit values are internally processed as absolute values.
- If slip compensation is deactivated ([C00021](#) = 0), indirect torque limitation (differential signal between apparent motor current and *nTorqueMotLimit\_a* or *nTorqueGenLimit\_a*) occurs. Above the no-load current of the motor, the accuracy of the indirect torque limitation is limited.

# 5 Motor control (MCTRL)

## 5.4 V/f characteristic control (VFCplus)

### V/f characteristic control (VFC)

The accuracy of the torque limitation is limited because the actual torque ([C00056/2](#)) is only calculated from the slip speed measured indirectly via the motor current.

### V/f control (VFC + encoder)

The slip speed of the motor is available at the slip controller output. This leads to a high accuracy for the actual torque ([C00056/2](#)) and the torque limitation.

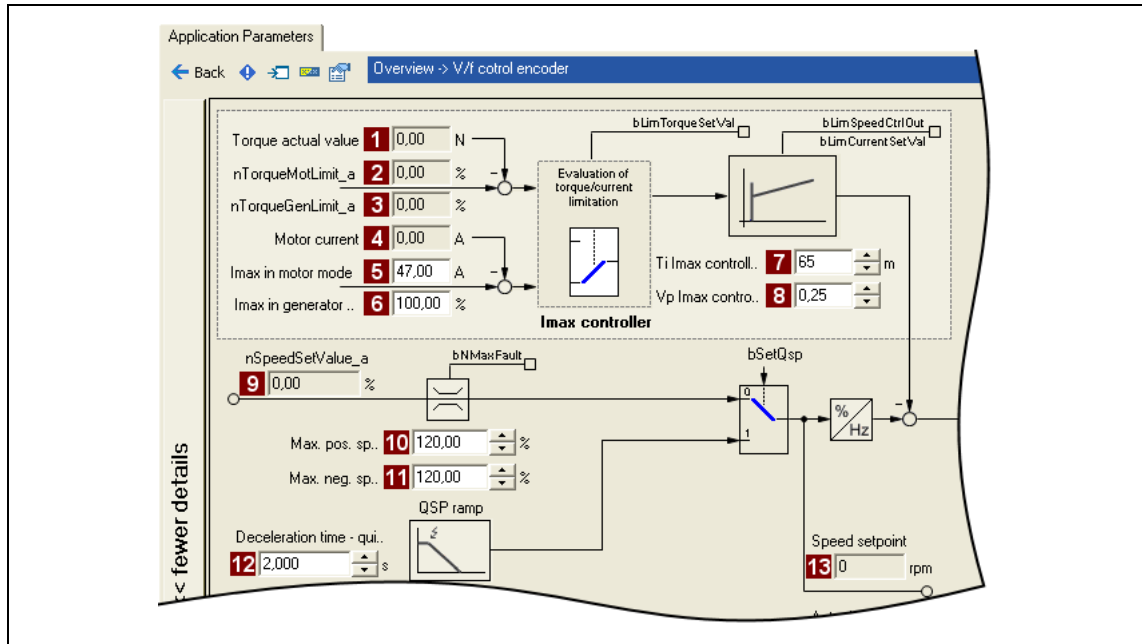

[5-6] Extract from the signal flow of the V/f control (VFC + encoder)

Parameters	Info	Parameters	Info
1	<a href="#">C00056/2</a> Actual torque value	9	<a href="#">C00830/22</a> MCTRL: nSpeedSetValue_a
2	<a href="#">C00830/29</a> Limitation of torque in motor mode	10	<a href="#">C00909/1</a> Max. pos. speed
3	<a href="#">C00830/28</a> Limitation of torque in generator mode	11	<a href="#">C00909/2</a> Max. neg. speed
4	<a href="#">C00054</a> Motor current	12	<a href="#">C00105</a> Decel. time - quick stop
5	<a href="#">C00022</a> Imax in motor mode	13	<a href="#">C00050</a> Speed setpoint
6	<a href="#">C00023</a> Imax in generator mode		
7	<a href="#">C00074</a> Ti Imax controller		
8	<a href="#">C00073</a> Vp Imax controller		

### 5.4.3.6 Defining a user-defined V/f characteristic

This function extension is only available from version 04.00.00!

For individual adaptation of the motor magnetisation to the actual application, the motor control "10: VFCplus: V/f definable" with a freely definable characteristic can be selected in [C00006](#) as an alternative if the linear and quadratic characteristics are not suitable.



#### Note!

The V/f base frequency ([C00015](#)) and the  $V_{\min}$  boost ([C00016](#)) no longer exert an influence if this motor control is chosen.

- The 11 grid points (voltage/frequency values) of the characteristic are selected via the 11 subcodes of [C00967](#) and [C00968](#).
  - It is necessary to set all 11 grid points by means of corresponding subcodes.
  - If fewer grid points (voltage/frequency values) are needed, this can be achieved indirectly by ascribing the same voltage and frequency values to consecutive grid points.  
Example:  $C00967/3 = C00967/4$  and  $C00968/3 = C00968/4$
  - The grid points can be specified in any sequence. Internally, they are automatically ordered from the minimum to the maximum frequency value.
  - Above the maximum and below the minimum frequency, the previous rise is continued until the maximum output voltage.
- In the Lenze setting, the 11 grid points represent a linear characteristic.
  - 3-phase devices: Output voltage 400 V at  $f = 50$  Hz
  - 1-phase devices: Output voltage 230 V at  $f = 50$  Hz

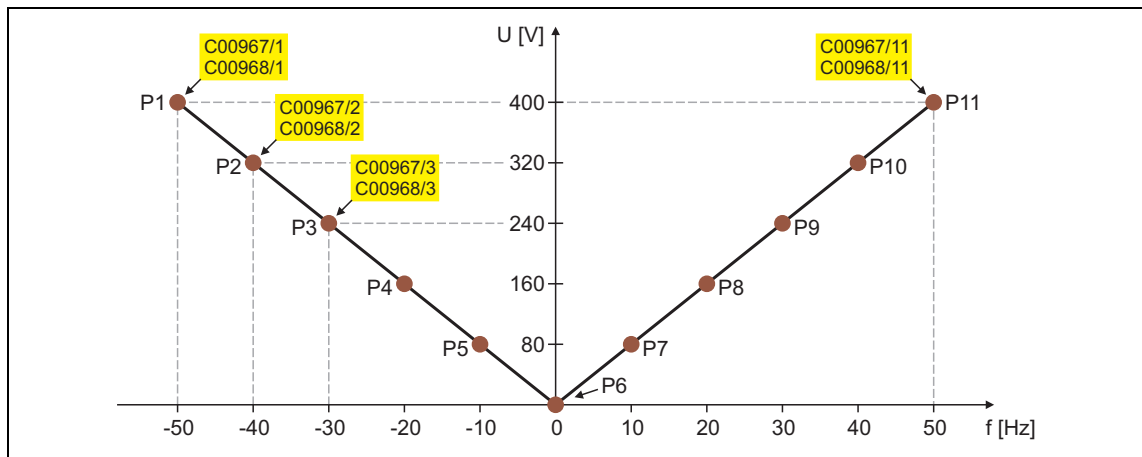

	P1	P2	P3	P4	P5	P6	P7	P8	P9	P10	P11
V	400 V	320 V	240 V	160 V	80 V	0 V	80 V	160 V	240 V	320 V	400 V
f	-50 Hz	-40 Hz	-30 Hz	-20 Hz	-10 Hz	0 Hz	10 Hz	20 Hz	30 Hz	40 Hz	50 Hz

[5-7] Freely definable characteristic (Lenze setting for 3-phase devices)

**Tip!**

Cases of application for this function:

- Operation of reluctance motors or synchronous motors during controlled acceleration (reduction of natural frequencies caused by wrong excitation).
- Adaptation of the voltage requirement for the motor, depending on specific load conditions.



**Proceed as follows to open the dialog for parameterising the motor control:**

1. »Engineer« Go to the *Project view* and select the 8400 StateLine inverter.
2. Select the **Application parameters** tab from the *Workspace*.
3. Select the motor control "10: VFCplus: V/f definable" from the *Overview* dialog box in the **Motor control** list field:
4. Click the **Motor control V/f definable** button to change to the *Overview → Motor control V/f* dialog box.
  - This dialog level only shows a simplified signal flow with the most important parameters.
  - When you click the **>>More details** button in the left-most position, a signal flow with more details/parameters is displayed.

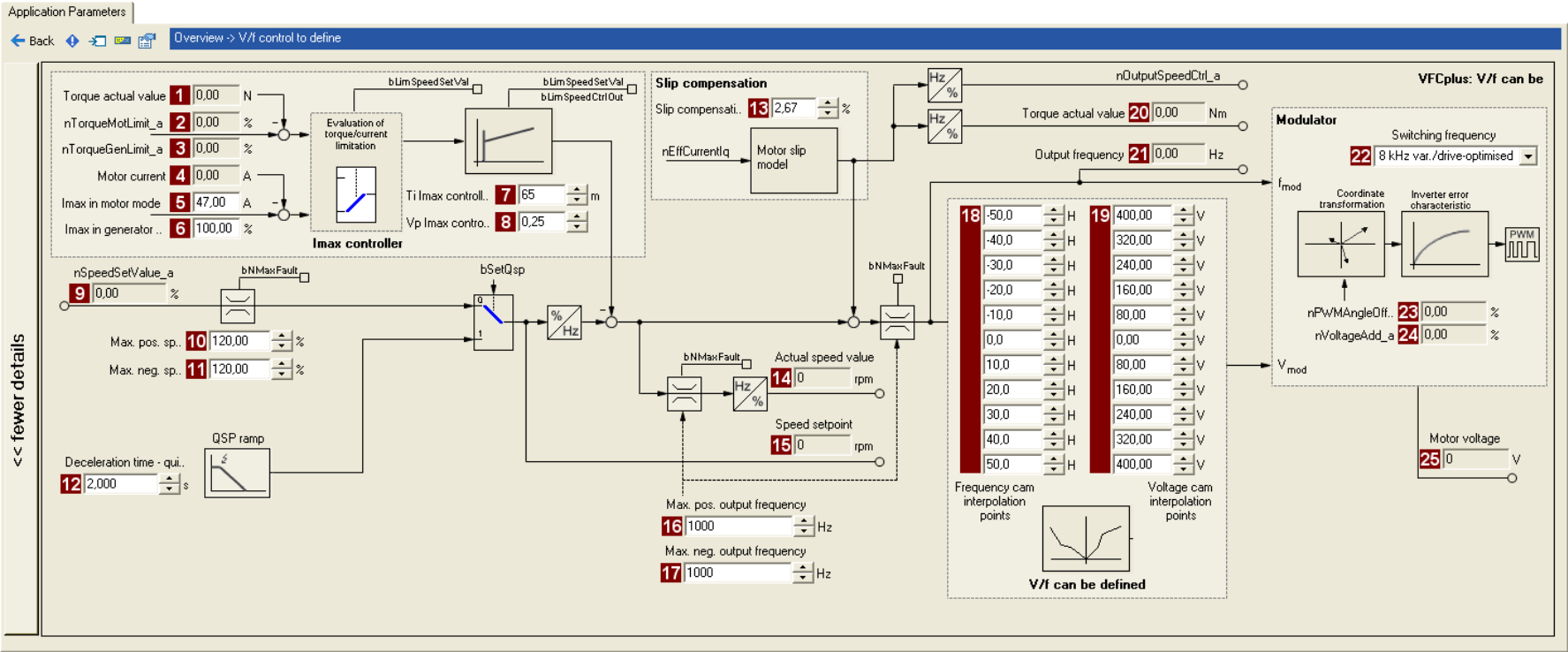

Parameters	Info	Parameters	Info	Parameters	Info
1	<a href="#">C00056/2</a> Actual torque value	13	<a href="#">C00021</a> Slip compensation	18	<a href="#">C00967/x</a> Frequency interpol. points
2	<a href="#">C00830/29</a> Limitation of torque in motor mode	14	<a href="#">C00051</a> Actual speed value	19	<a href="#">C00968/x</a> Voltage interpol. points
3	<a href="#">C00830/28</a> Limitation of torque in generator mode	15	<a href="#">C00050</a> Speed setpoint	20	<a href="#">C00056/2</a> Actual torque value
4	<a href="#">C00054</a> Motor current	16	<a href="#">C00910/1</a> Max. pos. output frequency	21	<a href="#">C00058</a> Output frequency
5	<a href="#">C00022</a> I <sub>max</sub> in motor mode	17	<a href="#">C00910/2</a> Max. neg. output frequency	22	<a href="#">C00018</a> Switching frequency
6	<a href="#">C00023</a> I <sub>max</sub> in generator mode			23	<a href="#">C00830/32</a> MCTRL: nPWMAngleOffset_a
7	<a href="#">C00074</a> T <sub>i</sub> I <sub>max</sub> controller			24	<a href="#">C00830/31</a> MCTRL: nVoltageAdd_a
8	<a href="#">C00073</a> V <sub>p</sub> I <sub>max</sub> controller			25	<a href="#">C00052</a> Motor voltage
9	<a href="#">C00830/22</a> Speed setpoint				
10	<a href="#">C00909/1</a> Max. pos. speed				
11	<a href="#">C00909/2</a> Max. neg. speed				
12	<a href="#">C00105</a> Decel. time - quick stop				

#### 5.4.4 Remedies for undesired drive behaviour

Drive behaviour	Remedy
Inadequate smooth running at low speeds, especially in the case of operation with a long motor cable	▶ <a href="#">Automatic motor data identification</a> (📖 119)
Problems in case of high starting duty (great mass inertia)	▶ <a href="#">Adapting the Vmin boost</a> (📖 143)
Drive does not follow the speed setpoint.	<p>The current controller intervenes in the set field frequency to limit the controller output current to the maximum current (C0022, C0023). Therefore:</p> <ul style="list-style-type: none"> <li>• Prolong acceleration/deceleration times: <ul style="list-style-type: none"> <li><a href="#">C00012</a>: Accel. time - main setpoint</li> <li><a href="#">C00013</a>: Decel. time - main setpoint</li> </ul> </li> <li>• Consider a sufficient magnetising time of the motor. Depending on the motor power, the magnetising time amounts to 0.1 ... 0.2 s.</li> <li>• Increase the maximally permissible current: <ul style="list-style-type: none"> <li><a href="#">C00022</a>: I<sub>max</sub> in motor mode</li> <li><a href="#">C00023</a>: I<sub>max</sub> in generator mode)</li> </ul> </li> </ul>
For operation without speed feedback ( <a href="#">C00006</a> = 6): Insufficient speed constancy at high load (setpoint and motor speed are not proportional anymore)	<ul style="list-style-type: none"> <li>• Increase slip compensation (<a href="#">C00021</a>). Important: Unstable drive due to overcompensation!</li> <li>• With cyclic load impulses (e. g. centrifugal pump), a smooth motor characteristic is achieved by smaller values in <a href="#">C00021</a> (possibly negative values).</li> </ul> <p>Note: The slip compensation is only active for operation without speed feedback.</p>
"Clamp operation active" error message (oC11): Inverter cannot follow dynamic processes, i.e. too short acceleration/deceleration times in terms of load ratios.	<ul style="list-style-type: none"> <li>• Increase the gain of the I<sub>max</sub> controller (<a href="#">C00073/1</a>)</li> <li>• Reduce the reset time of the I<sub>max</sub> controller (<a href="#">C00074/1</a>)</li> <li>• Prolong the acceleration time (<a href="#">C00012</a>)</li> <li>• Prolong the deceleration time (<a href="#">C00013</a>)</li> </ul>
Motor stalling in the field weakening range (adaptation especially required for small machines)	<ul style="list-style-type: none"> <li>• Reduce the override point of field weakening (<a href="#">C00080</a>)</li> <li>• If motor power &lt; inverter power: Set <a href="#">C00022</a> to I<sub>max</sub> = 2 I<sub>rated motor</sub></li> <li>• Reduce dynamic performance of setpoint generation</li> </ul>

## 5.5 V/f characteristic control - energy-saving (VFCplusEco)

This function extension is available from version 10.00.00!

With the energy-saving V/f characteristic control mode (VFCplusEco), the motor voltage of the inverter is detected by means of a linear characteristic depending on the field frequency to be created or the motor speed. Moreover, a  $\cos\phi$  control and the resulting voltage reduction causes the motor to be always operated in the optimum efficiency range (reduction of copper losses in the asynchronous motor).

- Hence, these are the advantages of this motor control mode:
  - Good robustness
  - Easy parameter setting
  - High energy efficiency (lower heating of the motor in partial load operational range)
  - Same speed accuracy and maximum torques as with VFCplus
  - Less noise generation of the motor with active voltage reduction
- Predestinated application areas of this motor control mode are materials handling technology and pump and fan systems.
- This motor control mode serves to improve efficiency of standard asynchronous motors with efficiency class IE1 (standard IEC 60034-30 2008) in the range 0 ...  $M_{\text{efficiency\_max}}$  between 0 ... 20 % ( $\emptyset$  5 ... 10 %).
  - For asynchronous motors with energy efficiency class IE2 the potential for efficiency improvement is reduced to approx. 0 ... 15 %.
  - Description of  $M_{\text{efficiency\_max}}$ : Indicates the torque [%] of  $M_{\text{rated\_motor}}$ , where the motor has the max. efficiency.)
- In case of asynchronous motors with a higher energy efficiency class (IE2 and IE3), the absolute energy saving of the motor control mode is lower due to improved efficiency of the machine. However, energy saving is still achieved in a higher load range.
- $M_{\text{efficiency\_max}}$  is performance-related and listed in the following table for some power values of the energy efficiency class IE1 and IE2:

Performance	$M_{\text{efficiency\_max}}$ (related to $M_{\text{rated\_motor}}$ )	
	IE1	IE2
0.25 kW	75 %	
0.75 kW	65 %	75 %
2.2 kW	55 %	85 %
7.5 kW	30 %	45 %
22 kW	23 %	
45 kW	21 %	





### Stop!

- For adjustment, observe the thermal performance of the connected asynchronous motor at low output frequencies.
  - Usually, standard asynchronous motors with insulation class B can be operated for a short time with their rated current in the frequency range 0 Hz ... 25 Hz.
  - Contact the motor manufacturer to get the exact setting values for the max. permissible motor current of self-ventilated motors in the lower speed range.
- The nameplate data of the motor (at least rated speed and rated frequency) must be entered if, instead of a standard motor, an asynchronous motor is used with the following values:
  - rated frequency  $\neq$  50 Hz (star) or
  - rated frequency  $\neq$  87 Hz (delta) or
  - number of pole pairs  $\neq$  2

#### 5.5.1 Parameterisation dialog/signal flow



Proceed as follows to open the dialog for parameterising the motor control:

1. »Engineer« Go to the *Project view* and select the 8400 StateLine inverter.
2. Select the **Application parameters** tab from the *Workspace*.
3. Select the motor control "11: VFCplusEco: V/f energy-saving" from the *Overview* dialog box in the **Motor control** list field:
4. Click the **Motor control V/f Eco** button to change to the *Overview* → *Motor control V/f* dialog box.
  - This dialog level only shows a simplified signal flow with the most important parameters.
  - When you click the >>**More details** button in the left-most position, a signal flow with more details/parameters is displayed.

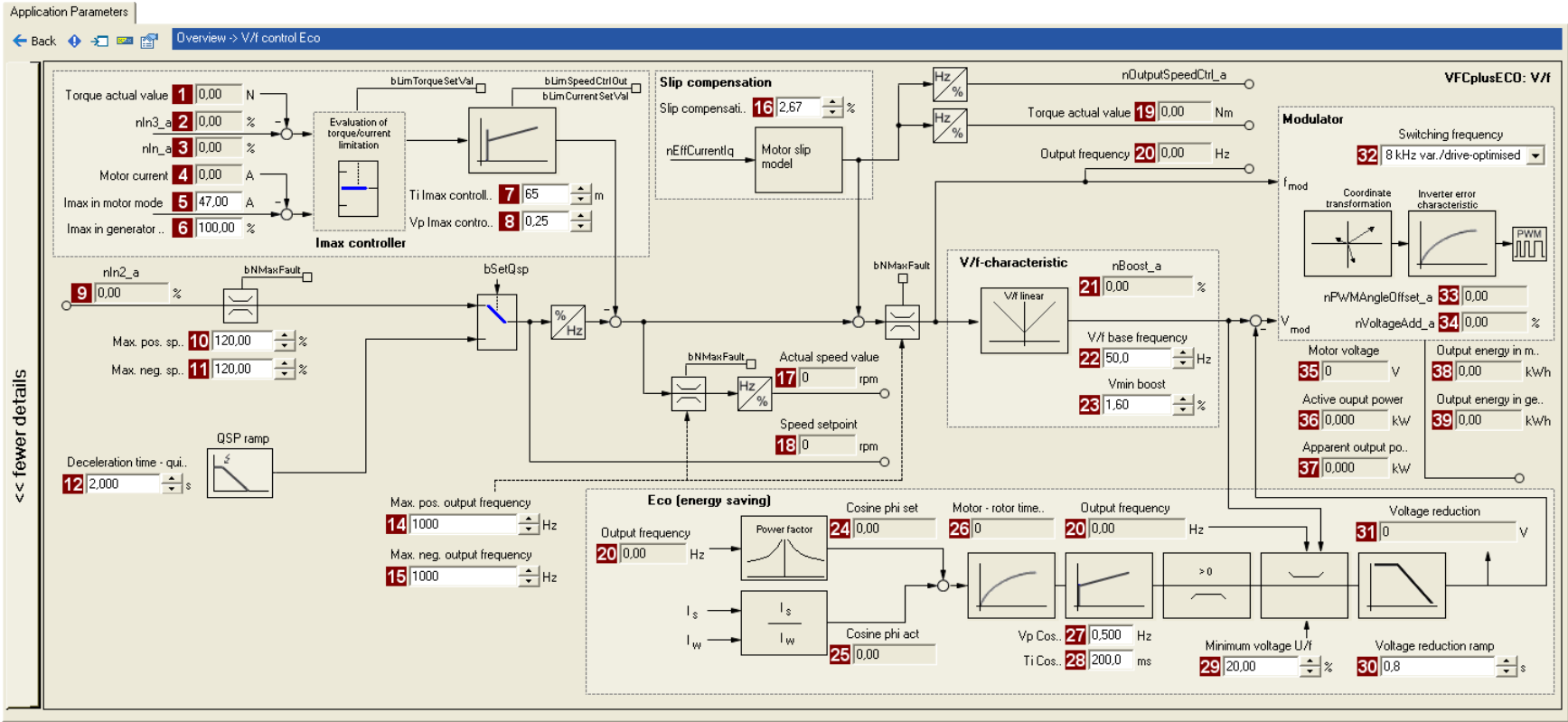

Parameters	Info	Parameters	Info	Parameters	Info
1	<a href="#">C00056/2</a> Actual torque value	14	<a href="#">C00910/1</a> Max. pos. output frequency	27	<a href="#">C00975</a> VFC-ECO: Vp
2	<a href="#">C00830/4</a> Limitation of torque in motor mode	15	<a href="#">C00910/2</a> Max. neg. output frequency	28	<a href="#">C00976</a> VFC-ECO: Ti
3	<a href="#">C00830/5</a> Limitation of torque in generator mode	16	<a href="#">C00021</a> Slip compensation	29	<a href="#">C00977</a> VFC-ECO: Minimum voltage V/f
4	<a href="#">C00054</a> Motor current	17	<a href="#">C00051</a> Actual speed value	30	<a href="#">C00982</a> VFC-ECO: Voltage reduction ramp
5	<a href="#">C00022</a> I <sub>max</sub> in motor mode	18	<a href="#">C00050</a> Speed setpoint	31	<a href="#">C00978</a> VFC-ECO: Voltage reduction
6	<a href="#">C00023</a> I <sub>max</sub> in generator mode	19	<a href="#">C00056/2</a> Actual torque value	32	<a href="#">C00018</a> Switching frequency
7	<a href="#">C00074</a> Ti I <sub>max</sub> controller	20	<a href="#">C00058</a> Output frequency	33	<a href="#">C00830/32</a> MCTRL: nPWMAngleOffset_a
8	<a href="#">C00073</a> Vp I <sub>max</sub> controller	21	<a href="#">C00830/26</a> MCTRL: nBoost_a	34	<a href="#">C00830/31</a> MCTRL: nVoltageAdd_a
9	<a href="#">C00830/3</a> Speed setpoint	22	<a href="#">C00015</a> V/f base frequency	35	<a href="#">C00052</a> Motor voltage
10	<a href="#">C00909/1</a> Max. pos. speed	23	<a href="#">C00016</a> V <sub>min</sub> boost	36	<a href="#">C00980/1</a> Active output power
11	<a href="#">C00909/2</a> Max. neg. speed	24	<a href="#">C00979/2</a> Cosine phi set	37	<a href="#">C00980/2</a> Apparent output power
12	<a href="#">C00105</a> Decel. time - quick stop	25	<a href="#">C00979/1</a> Cosine phi act	38	<a href="#">C00981/1</a> Output energy in motor mode
13	-	26	<a href="#">C00083</a> Motor rotor time constant	39	<a href="#">C00981/2</a> Output energy in generator mode

### 5.5.2 Comparison of VFCplusEco - VFCplus

The following characteristics show the impact of the energy-saving V/f characteristic control (VFCplusEco) compared to the standard V/f characteristic control (VFCplus).

- The characteristics were recorded with a standard asynchronous motor 2.2 kW with energy efficiency class IE1 at speed = 600 rpm.

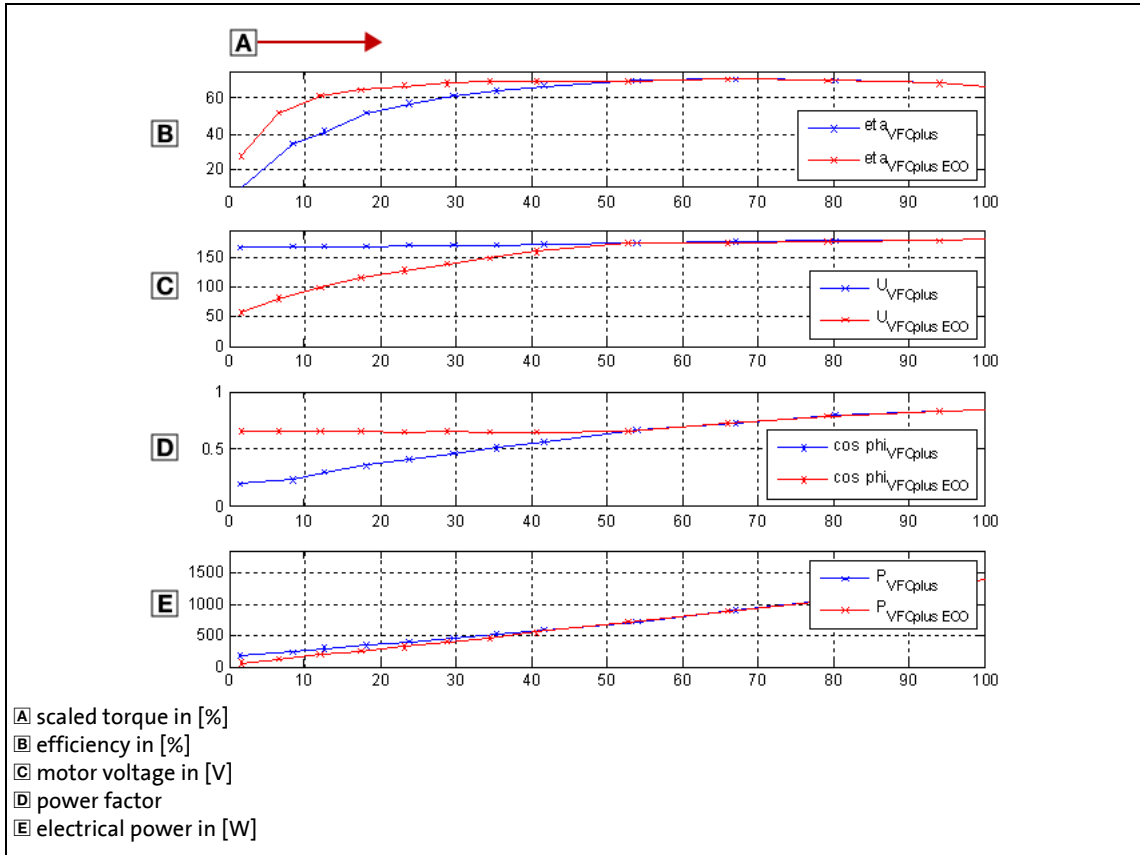

[5-8] Comparison of VFCplusEco - VFCplus

### 5.5.3 Basic settings

The "Initial commissioning steps" listed in the table below are sufficient for the V/f characteristic control - energy-saving (VFCplusECo).

- Detailed information on the individual steps can be found in the following subchapters.

Initial commissioning steps			
1.	Determine the motor control: <a href="#">C00006</a> = "11: VFCplusEco: V/f energy-saving"		
2.	<p>The required motor data are pre-initialised depending on the device and thus, they do not need to be entered directly. In order to achieve a high energy optimisation, these motor data can be entered (see the following section).</p> <p>Set the motor selection/motor data</p> <ul style="list-style-type: none"> <li>• When selecting and parameterising the motor, the motor nameplate data and the equivalent circuit diagram data are relevant. Detailed information can be found in the chapter "<a href="#">Motor selection/Motor data</a>". (☞ 113)</li> </ul> <p>Depending on the motor manufacturer, proceed as follows:</p> <table border="0"> <tr> <td style="vertical-align: top;"> <p><b>Lenze motor:</b> <a href="#">Selecting a motor from the motor catalogue in the »Engineer«</a> - or - 1. Set the motor nameplate data 2. <a href="#">Automatic motor data identification</a></p> </td> <td style="vertical-align: top;"> <p><b>Third party manufacturer's motor:</b> 1. Set the motor nameplate data 2. <a href="#">Automatic motor data identification</a> or set known equivalent circuit diagram manually: <a href="#">C00084</a>: Motor stator resistance <a href="#">C00085</a>: Motor stator leakage inductance <a href="#">C00092</a>: Motor magnetising inductance</p> </td> </tr> </table>	<p><b>Lenze motor:</b> <a href="#">Selecting a motor from the motor catalogue in the »Engineer«</a> - or - 1. Set the motor nameplate data 2. <a href="#">Automatic motor data identification</a></p>	<p><b>Third party manufacturer's motor:</b> 1. Set the motor nameplate data 2. <a href="#">Automatic motor data identification</a> or set known equivalent circuit diagram manually: <a href="#">C00084</a>: Motor stator resistance <a href="#">C00085</a>: Motor stator leakage inductance <a href="#">C00092</a>: Motor magnetising inductance</p>
<p><b>Lenze motor:</b> <a href="#">Selecting a motor from the motor catalogue in the »Engineer«</a> - or - 1. Set the motor nameplate data 2. <a href="#">Automatic motor data identification</a></p>	<p><b>Third party manufacturer's motor:</b> 1. Set the motor nameplate data 2. <a href="#">Automatic motor data identification</a> or set known equivalent circuit diagram manually: <a href="#">C00084</a>: Motor stator resistance <a href="#">C00085</a>: Motor stator leakage inductance <a href="#">C00092</a>: Motor magnetising inductance</p>		
3.	<a href="#">Defining current limits (I<sub>max</sub> controller)</a> . (☞ 139)		



#### Tip!

Information on the optimisation of the control mode and the adaptation to the real application is provided in chapter "[Optimising the control mode](#)". (☞ 157)

Parameterisable additional functions are described correspondingly in the chapter "[Parameterisable additional functions](#)". (☞ 212)

#### 5.5.4 Optimising the control mode

The V/f characteristic control - energy-saving (VFCplus) is generally ready for operation. It can be adapted subsequently by adapting the characteristic and/or the drive behaviour.



#### Note!

Following successful motor parameter identification, the V/f base frequency ([C00015](#)) and the  $V_{\min}$  boost ([C00016](#)) as well as the slip constant for slip compensation ([C00021](#)) are calculated automatically.

From version 12.00.00:

- Following successful motor parameter identification, the gain of the  $I_{\max}$  controller ([C00073/1](#)) is calculated automatically.
  - If these parameters are not to be calculated, bit 4 of [C02865/1](#) must be set to "1".
- Following successful motor parameter identification, other controller parameters ([C00011](#), [C00022](#), [C00966](#), [C00982](#)) can be calculated automatically.
  - If these parameters are to be calculated, bit 6 of [C02865/1](#) must be set to "6".

#### Adapting characteristic

For the linear characteristic as part of the V/f characteristic control - energy-saving (VFCplusEco), it is also possible (like in case of the standard V/f characteristic control) to match its curve to different load profiles or motors by adapting the V/f base frequency ([C00015](#)) and the  $V_{\min}$  boost ([C00016](#)).

- ▶ [Adapting the V/f base frequency](#) (📖 141)
- ▶ [Adapting the  \$V\_{\min}\$  boost](#) (📖 143)

#### Adapting drive behaviour

- Limitation of the maximum current by a current limitation controller (e.g. to prevent the motor from stalling or to limit to the maximally permissible motor current). ▶ [Optimising the  \$I\_{\max}\$  controller](#) (📖 144)
- Adaptation of the field frequency by a load-dependent slip compensation (improved speed accuracy for systems without feedback).
- [Improving the behaviour at high dynamic load changes](#). (📖 158)
- [Adapting the slope limitation for lowering the Eco function](#). (📖 159)
- [Optimising the  \$\cos/\phi\$  controller](#). (📖 159)

#### Torque limitation

Limit the torque to a lower value. ▶ [Torque limitation](#) (📖 146)

### 5.5.4.1 Improving the behaviour at high dynamic load changes

Due to the voltage reduction executed via the  $\cos\phi$  control, the motor may stall in the Lenze setting at high dynamic load torque changes. This is caused by the flux reduction and the connected reduction of the stalling torque of the motor current:

$$M_{\text{Max}(t)} = M_{\text{Stalling}} \cdot \frac{U_{\text{Motor}(t)}^2}{(U_{\text{Motor}(t)} - U_{\text{Reduction}})^2} \quad \text{with } M_{\text{Stalling}} = 1.6 \dots 2.5 \cdot M_{\text{Rated\_motor}}$$

$V_{\text{Motor}}$  = display in [C00052](#)  
 $V_{\text{Reduction}}$  = display in [C00978](#)

It generally applies that when the output voltage is divided in halves, the maximum torque is approx. reduced by the factor 4. A reduction by the factor 5 reduces the torque to approx. 15 ... 50 % of the rated torque.

The minimum voltage and thus the maximum influence access of the Eco function on the output voltage can be defined in [C00977](#). With full influence of the Eco function, the following stalling torque can be ensured depending on the setting in [C00977](#):

Minimum voltage V/f <a href="#">(C00977)</a>	Maximum torque
100 %	160 % ... 250 % $M_{\text{rated}}$
70 %	80 % ... 130 % $M_{\text{rated}}$
50 %	40 % ... 70 % $M_{\text{rated}}$
20 %	15 % ... 50 % $M_{\text{rated}}$

An adaptation of the minimum voltage V/f ([C00977](#)) improves the stability in case of load impulses.

- In the Lenze setting, the minimum voltage V/f is set to 20 % for the highest energy optimisation. This setting serves to respond to load torques if these amount to approx. 25 % of the rated torque or occur with low dynamics.
- An increase of the minimum voltage V/f to 70 % permits to apply a dynamic load impulse from 0 to 100 % rated motor torque without the motor stalling. This reduces the energy optimisation to be achieved by approx. 75 %.
- A further increase of the stability at still higher dynamic load impulses can be achieved by a further increase of the minimum voltage V/f, but means a further loss in energy optimisation.



#### Note!

In case of applications with very high dynamic sudden load variations from the unloaded operation, this motor control mode should not be used or the energy optimisation should be switched off, since a motor stalling cannot be excluded.

- The energy optimisation can be switched off by setting the minimum voltage V/f ([C00977](#)) to 100 %. Then, the behaviour corresponds to the V/f characteristic control (VFCplus) with linear characteristic.
- From version 13.00.00, the energy optimisation can be switched off via the *bVfcEcoDisable* process signal if a dynamic load change is known to take place.

#### 5.5.4.2 Adapting the slope limitation for lowering the Eco function

The ramp set in [C00982](#) for voltage reduction serves as slope limitation in order to prevent that voltage is suddenly applied to the motor when the Eco function is deactivated. Otherwise, the overvoltage limitation (Imax, Clamp) would be activated.

- This ramp is, depending on the device, pre-initialised to approx. the triple rotor time constant. An adaptation of this parameter is not required.

When the Eco function is switched off, a quick reaction (high dynamic performance) is required, but with a low current overshoot and a small torque jump. Thus, the Lenze setting of [C00982](#) is a compromise regarding the switch-off of the Eco function (voltage reduction = 0).

- To increase the dynamics when switching off the Eco function:  
Reduce → setting in [C00982](#).  
(Current compensation actions increase when the Eco function is switched off.)
- In order to reduce current compensation actions when switching off the Eco function:  
Increase → setting in [C00982](#).  
(The dynamics when switching off the eco function is reduced)

#### 5.5.4.3 Optimising the cos/phi controller

With the Lenze setting, the cos $\phi$  controller is set such that usually no adaptation is required for all power ratings and application cases.

Behaviour	Remedy/recommendation
The cos $\phi$ actual value ( <a href="#">C00979/1</a> ) varies greatly.	Reduce gain Vp ( <a href="#">C00975</a> ) and reset time Ti ( <a href="#">C00976</a> ).
The cos $\phi$ actual value ( <a href="#">C00979/1</a> ) is permanently lower than the cos $\phi$ setpoint ( <a href="#">C00979/2</a> ).	Increase gain Vp ( <a href="#">C00975</a> ) and reset time Ti ( <a href="#">C00976</a> ).

## 5.5.5 Remedies for undesired drive behaviour

Drive behaviour	Remedy
Inadequate smooth running at low speeds, especially in the case of operation with a long motor cable	<p>▶ <a href="#">Automatic motor data identification</a> (☞ 119)</p> <p>Reduce the influence of the Eco function by increasing the minimum voltage V/f (<a href="#">C00977</a>) if necessary.</p>
Problems in case of high starting duty (great mass inertia)	<ol style="list-style-type: none"> <li>1. Set motor control VFCplus with linear characteristic (<a href="#">C00006</a> = 6).</li> <li>2. <a href="#">Adapting the Vmin boost.</a> (☞ 143)</li> <li>3. Again set motor control VFCplusEco (<a href="#">C00006</a> = 11).</li> </ol>
Drive does not follow the speed setpoint	<p>The current controller intervenes in the set field frequency to limit the controller output current to the maximum current (<a href="#">C0022</a>, <a href="#">C0023</a>). Therefore:</p> <ul style="list-style-type: none"> <li>• Prolong acceleration/deceleration times: <ul style="list-style-type: none"> <li><a href="#">C00012</a>: Accel. time - main setpoint</li> <li><a href="#">C00013</a>: Decel. time - main setpoint</li> </ul> </li> <li>• Consider a sufficient magnetising time of the motor. Depending on the motor power, the magnetising time amounts to 0.1 ... 0.2 s.</li> <li>• Increase the maximally permissible current: <ul style="list-style-type: none"> <li><a href="#">C00022</a>: I<sub>max</sub> in motor mode</li> <li><a href="#">C00023</a>: I<sub>max</sub> in generator mode</li> </ul> </li> <li>• Make adaptations for the Eco function: <ul style="list-style-type: none"> <li>• <a href="#">Improving the behaviour at high dynamic load changes.</a> (☞ 158)</li> <li>• <a href="#">Adapting the slope limitation for lowering the Eco function.</a> (☞ 159)</li> <li>• <a href="#">Optimising the cos/phi controller.</a> (☞ 159)</li> </ul> </li> </ul>
Insufficient speed constancy at high load (setpoint and motor speed are not proportional anymore)	<ul style="list-style-type: none"> <li>• Increase slip compensation (<a href="#">C00021</a>).</li> </ul> <p>Important: Unstable drive due to overcompensation!</p> <ul style="list-style-type: none"> <li>• With cyclic load impulses (e. g. centrifugal pump), a smooth motor characteristic is achieved by smaller values in <a href="#">C00021</a> (possibly negative values).</li> </ul> <p>Note: The slip compensation is only active for operation without speed feedback.</p>
"Clamp operation active" error message (oC11): Inverter cannot follow dynamic processes, i.e. too short acceleration/deceleration times in terms of load ratios.	<ul style="list-style-type: none"> <li>• Increase the gain of the I<sub>max</sub> controller (<a href="#">C00073</a>)</li> <li>• Reduce the reset time of the I<sub>max</sub> controller (<a href="#">C00074</a>)</li> <li>• Prolong the acceleration time (<a href="#">C00012</a>)</li> <li>• Prolong the deceleration time (<a href="#">C00013</a>)</li> <li>• Make adaptations for the Eco function: <ul style="list-style-type: none"> <li>• <a href="#">Improving the behaviour at high dynamic load changes.</a> (☞ 158)</li> <li>• <a href="#">Adapting the slope limitation for lowering the Eco function.</a> (☞ 159)</li> </ul> </li> </ul>
Motor stalling in the field weakening range (adaptation especially required for small machines)	<ul style="list-style-type: none"> <li>• If motor power &lt; inverter power: <ul style="list-style-type: none"> <li>Set <a href="#">C00022</a> to I<sub>max</sub> = 2 I<sub>rated motor</sub></li> </ul> </li> <li>• Reduce dynamic performance of setpoint generation</li> <li>• Make adaptations for the Eco function: <ul style="list-style-type: none"> <li>• <a href="#">Improving the behaviour at high dynamic load changes.</a> (☞ 158)</li> <li>• <a href="#">Adapting the slope limitation for lowering the Eco function.</a> (☞ 159)</li> </ul> </li> </ul>
Speed variations in no-load operation for speeds > 1/3 rated speed.	<p>Minimise speed oscillations with oscillation damping (<a href="#">C00234</a>).</p>



Drive behaviour	Remedy
Speed variations in no-load operation and with load for speeds > rated speed.	Minimise speed oscillations with increasing the oscillation damping field weakening (C00236). Caution: If C00236 is increased, the maximum output voltage of the device is reduced!
Output voltage is too low. There is a too low maximum torque in the high field weakening range.	Reduction of the oscillation damping field weakening (C00236). Caution: When C00236 = 0, oscillation damping field weakening is inactive. Thus, a maximum output voltage is available but the tendency to speed oscillations in the field weakening range at no-load operation and with load increases.

# 5 Motor control (MCTRL)

## 5.6 V/f control (VFCplus + encoder)

### 5.6 V/f control (VFCplus + encoder)

The V/f characteristic control (VFCplus) described above can be operated with a speed feedback. This has the following advantages:

- Steady-state accuracy of the speed
- Less parameterisation effort compared to the sensorless vector control (SLVC)
- Improved dynamics compared to V/f characteristic control without feedback or to sensorless vector control (SLVC).
- Suitability for group drives



#### Stop!

The V/f control requires a speed feedback!

- The speed sensor used has to be set in [C00495](#). This setting is not made automatically with the selection of the motor from the »Engineer« motor catalogue!
- If no speed sensor is set in [C00495](#) and the controller is enabled, an impermissibly high motor current occurs which may destroy the motor thermally!
- From version 14.00.00, the error response set in [C00571/2](#) (Lenze setting: "Fault") takes place if in case of controller enable it is detected that a motor control type with feedback is set in [C00006](#) but no speed encoder is set in [C00495](#).



#### Stop!

##### V/f emergency operation

From version 15.00.00, it is internally switched to the encoderless V/f characteristic control in case of an encoder open circuit in order to avoid impermissible motor movements.

- In order that this "V/f emergency operation" works properly, the parameters relevant for the V/f characteristic control (base frequency, Vmin boost, slip compensation, etc.) have to be set correctly. As an alternative, a motor parameter identification can be executed as well.
- The change-over to "V/f emergency operation" is reported via bit 4 in [C01000](#) and via the *bWirebreakUfLinearActive* status signal at the SB [LS DeviceMonitor](#).
- The change-over to "V/f emergency operation" can be suppressed by setting bit 8 to "1" in [C02864/1](#).
- When selecting the speed sensor and position encoder for the encoder signal *FreqIn12* or *FreqIn67* ([C00495 = 1 / 2](#) and/or [C00490 = 1 / 2](#))
  - "Latching of open circuit" must be performed: [C02864](#), Bit11 = 1.  
This causes the system to switch to the encoderless V/f characteristic control in case of wire breakage.
  - The output speed will drop briefly and then start up again with an encoderless V/f characteristic control. V/f emergency operation will only be exited after CINH.

**Note!**

- Make sure that, when the motor control with speed feedback is in use, the maximum input frequency of 10 kHz is not exceeded. ▶ [Using DI1 and DI2 as frequency inputs](#) (📖 279)
- As the slip is calculated in the feedback V/f operation and injected through the slip regulator, the slip compensation ([C00021](#)) is deactivated with V/f control.



The descriptions in chapter "[V/f characteristic control \(VFCplus\)](#)" also apply to the V/f control. (📖 134)

Detailed information on the speed feedback can be found in the chapter "[Encoder/feedback system](#)". (📖 230)

**5.6.1 Parameterisation dialog/signal flow**

Proceed as follows to open the dialog for parameterising the motor control:

1. »Engineer« Go to the *Project view* and select the 8400 StateLine inverter.
2. Select the **Application parameters** tab from the *Workspace*.
3. Select the motor control from the *Overview* dialog level in the **Motor control** ([C00006](#)) list field:
  - "7: VFCplus: V/f linear +encoder" for linear characteristic or
  - "9: VFCplus: V/f quadr +encoder" for quadratic characteristic
4. Click the **Motor control V/f encoder** button to change to the *Overview → Motor control V/f* dialog box.
  - This dialog level only shows a simplified signal flow with the most important parameters.
  - When you click the **>>More details** button in the left-most position, a signal flow with more details/parameters is displayed, as shown in the following subchapter.

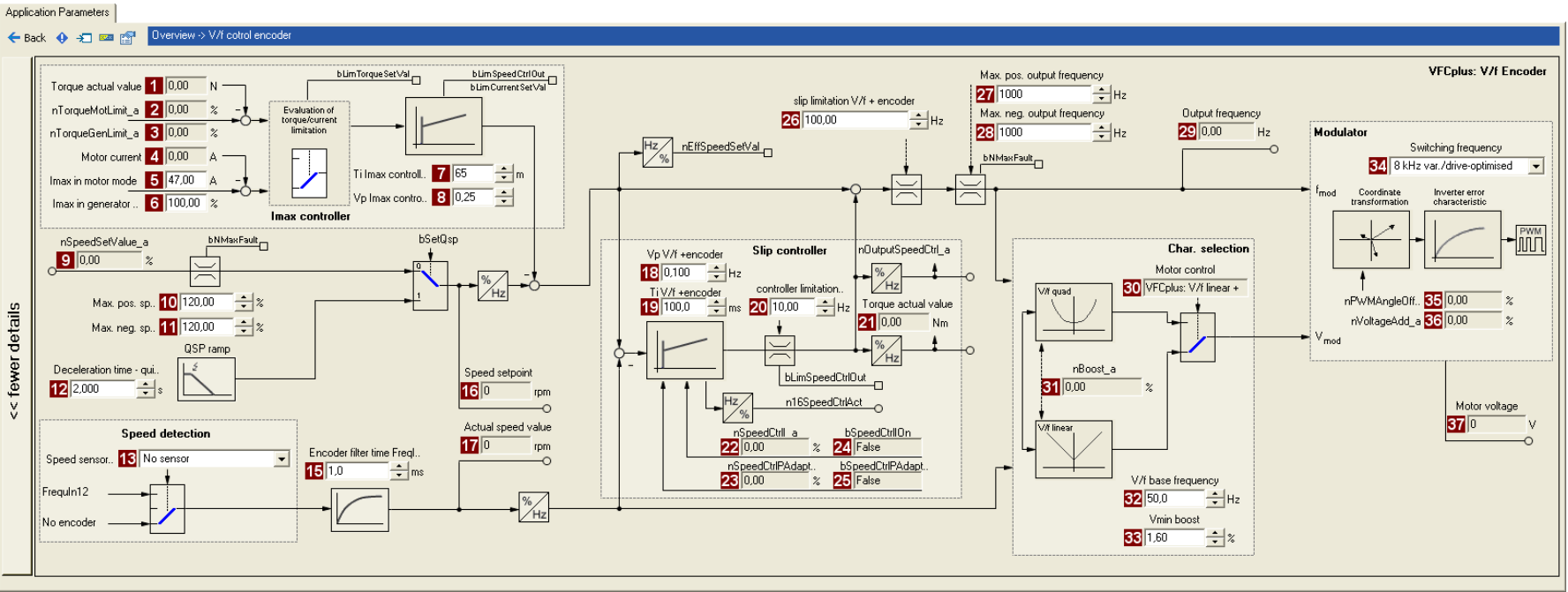

Parameters	Info	Parameters	Info	Parameters	Info
1	<a href="#">C00056/2</a> Actual torque value	16	<a href="#">C00050</a> Speed setpoint	29	<a href="#">C00058</a> Output frequency
2	<a href="#">C00830/29</a> Limitation of torque in motor mode	17	<a href="#">C00051</a> Actual speed value	30	<a href="#">C00006</a> Motor control
3	<a href="#">C00830/28</a> Limitation of torque in generator mode	18	<a href="#">C00972</a> Vp Vf+encoder	31	<a href="#">C00830/26</a> MCTRL: nBoost_a
4	<a href="#">C00054</a> Motor current	19	<a href="#">C00973</a> Ti Vf+encoder	32	<a href="#">C00015</a> V/f base frequency
5	<a href="#">C00022</a> I_max in motor mode	20	<a href="#">C00971/1</a> Controller limitation Vf+encoder	33	<a href="#">C00016</a> Vmin boost
6	<a href="#">C00023</a> I_max in generator mode	21	<a href="#">C00056/2</a> Actual torque value	34	<a href="#">C00018</a> Switching frequency
7	<a href="#">C00074</a> Ti I_max controller	22	<a href="#">C00830/24</a> MCTRL: nSpeedCtrl_a	35	<a href="#">C00830/32</a> MCTRL: nPWMAngleOffset_a
8	<a href="#">C00073</a> Vp I_max controller	23	<a href="#">C00830/25</a> MCTRL: nSpeedCtrlAdapt_a	36	<a href="#">C00830/31</a> MCTRL: nVoltageAdd_a
9	<a href="#">C00830/22</a> Speed setpoint	24	<a href="#">C00833/31</a> MCTRL: bSpeedCtrlOn	37	<a href="#">C00052</a> Motor voltage
10	<a href="#">C00909/1</a> Max. pos. speed	25	<a href="#">C00833/69</a> MCTRL: bSpeedCtrlAdaptOn		
11	<a href="#">C00909/2</a> Max. neg. speed	26	<a href="#">C00971/2</a> Slip limitation Vf+encoder		More relevant parameters for <a href="#">Encoder/feedback system</a> :
12	<a href="#">C00105</a> Decel. time - quick stop	27	<a href="#">C00910/1</a> Max. pos. output frequency		<a href="#">C00115</a> DI1/2 & DI6/7 function
13	<a href="#">C00495</a> Speed sensor selection	28	<a href="#">C00910/2</a> Max. neg. output frequency		<a href="#">C00420</a> Number of encoder increments
14	-				<a href="#">C00425</a> Encoder scanning time
15	<a href="#">C00497/1</a> Encoder filter time FreqIn12				<a href="#">C00496</a> Encoder evaluation method

### 5.6.2 Basic settings

In order to protect the drive system, carry out the commissioning of the V/f control and the slip regulator in several steps.

- Detailed information on the single steps can be found in the following subchapters or in the corresponding subchapters for V/f characteristic control.

Initial commissioning steps	
1	Define the V/f characteristic: <ul style="list-style-type: none"> <li>• <a href="#">C00006</a> = 7: Linear characteristic</li> <li>• <a href="#">C00006</a> = 9: Quadratic characteristic</li> </ul>
2.	<a href="#">Defining current limits (I<sub>max</sub> controller)</a> . (☞ 139)
3.	Parameterise encoder/feedback system. ▶ <a href="#">Encoder/feedback system</a> (☞ 230)
4.	If special motors with a rated frequency other than 50 Hz or with a number of pole pairs ≠ 2 are used, set the motor parameters according to the motor nameplate. ▶ <a href="#">Motor selection/Motor data</a> (☞ 113)
5th	Define speed setpoint (e.g. 20 % of the rated speed) and enable inverter.
6.	Check whether the actual speed value ( <a href="#">C00051</a> ) ≈ speed setpoint ( <a href="#">C00050</a> ) and then inhibit the inverter again. <ul style="list-style-type: none"> <li>• In case of a sign reversal between actual value and setpoint, check the connection of the encoder (e.g. change track A or B of the encoder or invert the actual speed value).</li> <li>• In case the actual value differs considerably from the setpoint (factor 2), set the motor parameters according to motor nameplate. Then repeat step 5.</li> </ul>
6.	To protect the drive, reduce the slip regulator limitation in <a href="#">C00971/1</a> . <ul style="list-style-type: none"> <li>• e.g. reduction to half the slip frequency (≈ 2 Hz)</li> </ul>
8	Define speed setpoint (e.g. 20 % of the rated speed) and enable inverter.
9	In case of a semi-stable operational performance, reduce the reset time ( <a href="#">C00972</a> ) or the proportional gain ( <a href="#">C00973</a> ) of the slip regulator until a stable operation has been achieved. ▶ <a href="#">Parameterising the slip regulator</a> (☞ 166)
10	In a final step, increase the slip regulator limitation again in <a href="#">C00971/1</a> . <ul style="list-style-type: none"> <li>• e.g. increase to twice the slip frequency</li> </ul>



#### Tip!

Information on the further optimisation of the control mode and the adaptation to the real application is provided in the "[Optimising the control mode](#)" chapter for the V/f characteristic control (VFCplus). (☞ 140)

Parameterisable additional functions are described correspondingly in the chapter "[Parameterisable additional functions](#)". (☞ 212)

# 5 Motor control (MCTRL)

## 5.6 V/f control (VFCplus + encoder)

### 5.6.2.1 Parameterising the slip regulator

The slip regulator is designed as a PI controller. In order to improve the response to setpoint changes, the setpoint speed or setpoint frequency is added to the output (correcting variable) of the slip regulator as feedforward control value.

- Unlike traditional speed controllers, the slip regulator only controls the slip.
- In the Lenze setting, the configuration of the slip regulator provides robustness and moderate dynamics.

Parameters	Info	Lenze setting	
		Value	Unit
<a href="#">C00971/1</a>	VFC: Controller limitation V/f +encoder	10.00	Hz
<a href="#">C00971/2</a>	VFC: Slip limitation V/f +encoder	100.00	Hz
<a href="#">C00972</a>	VFC: Vp V/f +encoder	0.100	Hz/Hz
<a href="#">C00973</a>	VFC: Ti V/f +encoder	100.0	ms

#### Slip regulator gain Vp

The setting range of the slip regulator gain Vp ([C00972](#)) which leads to a stable operational performance, mainly depends on the resolution of the speed sensor. There is a direct relationship between encoder resolution and gain:

- The higher the encoder resolution, the higher the gain can be set.

The following table provides maximum and recommended slip regulator gains for encoder with standard encoder increments:

Encoder increment [Increments/revolution]	Slip regulator gain Vp	
	maximum	recommended
8	0.09	0.06
64	0.52	0,31
100	0.79	0.47
120	0.94	0.57
128	1.00	0.60
256	1.29	0.77
386	1.63	0.98
512	1.97	1.18
640	2.31	1.38
768	2.65	1.59
896	2.99	1.79
1014	3.33	2.00
1536	4.69	2.81
2048	6.05	3.63
3072	8.77	5.26
4096	11.49	6.90

[5-1] Slip regulator gain Vp based on the encoder increment



#### How to adapt the slip regulator gain to the operating conditions:

1. Adapt the slip regulator gain ([C00972](#)) to the encoder increment according to table [\[5-1\]](#).
2. Set controller limitation ([C00971/1](#)) to half the slip frequency ( $\approx 2$  Hz).
3. Select speed setpoint (e.g. 20 % of the rated speed).
4. Enable inverter.
5. Increase the slip regulator gain ([C00972](#)) until the drive is semi-stable.
  - This can be recognised by motor noises or "humming" of the motor or by a noise on the actual speed signal.
6. Reduce slip regulator gain ([C00972](#)) until the drive runs stable again (no motor "humming").
7. Reduce slip regulator gain ([C00972](#)) to approx. half the value.
  - With low encoder resolutions, another reduction of the slip regulator gain for low speeds may be necessary (speed setpoint  $\approx 0$ ).
  - We recommend to finally check the behaviour at setpoint speed = 0 and to further reduce the slip regulator gain if irregular running occurs.
8. Increase controller limitation ([C00971/1](#)) again (e.g. to twice the slip frequency).

#### Slip regulator time constant $T_i$



#### How to set the slip regulator time constant:

1. Set controller limitation ([C00971/1](#)) to half the slip frequency ( $\approx 2$  Hz).
2. Select speed setpoint (e.g. 20 % of the rated speed).
3. Enable inverter.
4. Reduce the slip regulator time constant ([C00973](#)) until the drive is semi-stable.
  - This can be recognised by motor noise, "motor vibrations" or resonance on the actual speed value signal.
5. Increase slip regulator time constant ([C00973](#)) until the drive runs stable again (no motor "oscillation").
6. Increase the slip regulator time constant ([C00973](#)) to approx. twice the value.
7. Increase controller limitation ([C00971/1](#)) again (e.g. to twice the slip frequency).

### Controller limitation

Max. intervention of the controller is limited by the controller limitation ([C00971/1](#)).

- The controller can be limited depending on the application.
- We recommend to limit the max. intervention to twice the rated slip of the motor.
- The rated slip is calculated as follows:

$$f_{\text{Slip}_{\text{Rated}}} [\text{Hz}] = f_{\text{Rated}} [\text{Hz}] - \left( \frac{n_{\text{Motor}_{\text{Rated}}} [\text{rpm}]}{60} \cdot p_{\text{Number of pole pairs}} \right)$$

[5-9] Calculation of the rated slip



### Note!

A setting of [C00971/1](#) = 0 Hz deactivates the slip regulator. In this case, the structure of the V/f control corresponds to the structure of a V/f characteristic control without feedback.

### Slip limitation

In addition to limiting the slip regulator, the field frequency to be injected can also be limited by another limiting element, the slip limitation ([C00971/2](#)).

- If the slip is e.g. limited to twice the rated slip of the motor, a stalling of the motor during very dynamic processes can be avoided.
- Motor stalling is caused by:
  - a high overcurrent at very steep speed ramps
  - very fast speed changes due to load, e.g. abrupt stopping of the drive due to an encounter with a stop or a load that is not moving.



### 5.7 Sensorless vector control (SLVC)

Sensorless vector control (SLVC) is based on a better motor current control according to a field-oriented control mode by Lenze.



#### Stop!

- The sensorless vector control (SLVC) is only suitable for asynchronous motors.
- The connected motor may be maximally two power classes lower than the motor assigned to the inverter.
- Operation of the sensorless vector control (SLVC) is only permissible for one single drive!
- Operation of the sensorless vector control (SLVC) is not permissible for hoists!
- The Lenze setting permits the operation of a power-adapted motor. Optimal operation is only possible if either:
  - the motor is selected via the »Engineer« motor catalogue,
  - the motor nameplate data are entered and motor parameter identification is carried out afterwards
  - or -
  - the nameplate data and equivalent circuit data of the motor (motor leakage inductance and mutual motor inductance, slip compensation and motor stator resistance) are entered manually.
- When you enter the motor nameplate data, take into account the phase connection implemented for the motor (star or delta connection). Only enter the data applying to the selected connection type.
  - In this context, also observe the instructions in chapter "[Adapting the V/f base frequency](#)" relating to V/f characteristic control. (📖 141)



#### Note!

Optimal operation of the sensorless vector control (SLVC) can be achieved from a minimum speed of approx. 0.5-fold slip speed. At lower speed values below the 0.5-fold slip speed, the maximum torque is reduced.

The maximum field frequency with this motor control mode is 650 Hz.

In comparison to the V/f characteristic control without feedback, the following can be achieved by means of sensorless vector control SLVC:

- A higher maximum torque throughout the entire speed range
- A higher speed accuracy
- A higher concentricity factor
- A higher level of efficiency
- The implementation of torque-controlled operation with speed limitation
- The limitation of the maximum torque in motor and generator mode for speed-controlled operation

### 5.7.1 Parameterisation dialog/signal flow



Proceed as follows to open the dialog for parameterising the motor control:

1. »Engineer« Go to the *Project view* and select the 8400 StateLine inverter.
2. Select the **Application parameters** tab from the *Workspace*.
3. Select the motor control "4: SLVC: Vector control" from the *Overview* dialog level in the **Motor control** list field ([C00006](#)):
4. Click the **Motor control vector** button to change to the *Overview* → *Motor control vector* dialog box.
  - This dialog level only shows a simplified signal flow with the most important parameters.
  - When you click the >>**More details** button in the left-most position, a signal flow with more details/parameters is displayed, as shown in the following subchapter.

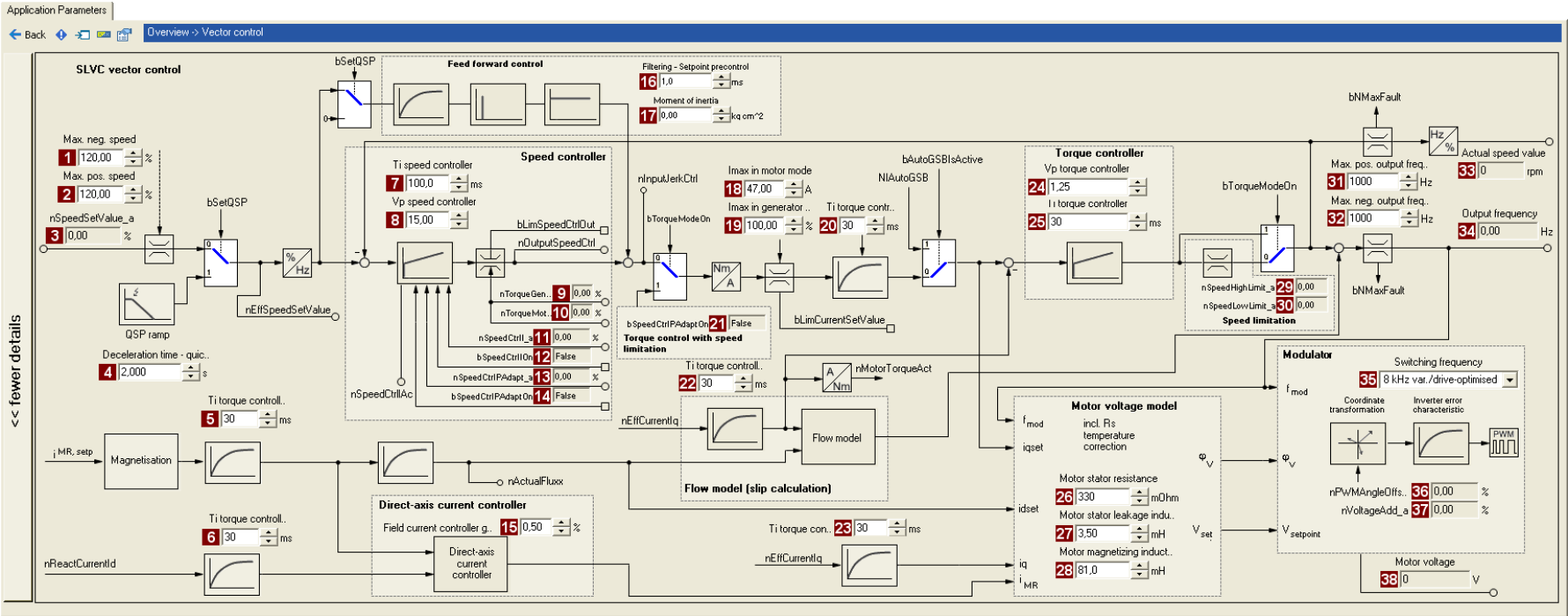

Parameters	Info	Parameters	Info	Parameters	Info
1	<a href="#">C00909/2</a> Max. neg. speed	16	<a href="#">C00275</a> Setpoint feedforward control filtering	24	<a href="#">C00073/2</a> SLVC: Vp torque controller
2	<a href="#">C00909/1</a> Max. pos. speed	17	<a href="#">C00273</a> Moment of inertia	25	<a href="#">C00074/2</a> SLVC: Ti torque controller
3	<a href="#">C00830/22</a> Speed setpoint	18	<a href="#">C00022</a> Imax in motor mode	26	<a href="#">C00084</a> Motor stator resistance
4	<a href="#">C00105</a> Decel. time - quick stop	19	<a href="#">C00023</a> Imax in generator mode	27	<a href="#">C00085</a> Motor stator leakage inductance
5	<a href="#">C00074/2</a> SLVC: Ti torque controller	20	<a href="#">C00074/2</a> SLVC: Ti torque controller	28	<a href="#">C00092</a> Motor magnetising inductance
6	<a href="#">C00074/2</a> SLVC: Ti torque controller	21	<a href="#">C00833/69</a> MCTRL: bSpeedCtrlPAdaptOn	29	<a href="#">C00830/88</a> MCTRL: nSpeedHighLimit_a
7	<a href="#">C00071/1</a> SLVC: Ti speed controller	22	<a href="#">C00074/2</a> SLVC: Ti torque controller	30	<a href="#">C00830/23</a> MCTRL: nSpeedLowLimit_a
8	<a href="#">C00070/1</a> SLVC: Vp speed controller	23	<a href="#">C00074/2</a> SLVC: Ti torque controller	31	<a href="#">C00910/1</a> Max. pos. output frequency
9	<a href="#">C00830/28</a> Limitation of torque in generator mode			32	<a href="#">C00910/2</a> Max. neg. output frequency
10	<a href="#">C00830/29</a> Limitation of torque in motor mode			33	<a href="#">C00051</a> Actual speed value
11	<a href="#">C00830/24</a> MCTRL: nSpeedCtrlI_a			34	<a href="#">C00058</a> Output frequency
12	<a href="#">C00833/31</a> MCTRL: bSpeedCtrlIOn			35	<a href="#">C00018</a> Switching frequency
13	<a href="#">C00830/25</a> MCTRL: nSpeedCtrlPAdapt_a			36	<a href="#">C00830/32</a> MCTRL: nPWMAngleOffset_a
14	<a href="#">C00833/69</a> MCTRL: bSpeedCtrlPAdaptOn			37	<a href="#">C00830/31</a> MCTRL: nVoltageAdd_a
15	<a href="#">C00985</a> SLVC: Gain of field current controller			38	<a href="#">C00052</a> Motor voltage

# 5 Motor control (MCTRL)

## 5.7 Sensorless vector control (SLVC)

### 5.7.2 Types of control

The sensorless vector control can be operated in two different modes:

- [Speed control with torque limitation](#) (*bTorquemodeOn* = FALSE)
- [Torque control with speed limitation](#) (*bTorquemodeOn* = TRUE)

#### 5.7.2.1 Speed control with torque limitation

When *bTorquemodeOn* = FALSE, the drive system is operated with a selected speed setpoint in a speed-controlled manner.



#### Note!

From version 13.00.00, the torque setpoint *nSpeedSetValue\_a* is set to 0 by quick stop (QSP) device-internally and the torque limit values *nTorqueMotLimit\_a* and *nTorqueGenLimit\_a* are set to 100 % to stop the drive quickly and safely anytime. The previous behaviour can be set in [C2865/1](#) via bit 12 and bit 13.

The operational performance can be adapted in the following ways:

- A. Overload limitation in the drive train
- B. Motor current limitation
- C. Slip compensation

#### Overload limitation in the drive train

The torque is limited via the torque setpoint.

- The torque setpoint is identical to the value at the output of the speed controller, *nOutputSpeedCtrl*.
- To avoid overload in the drive train, the torque in motor mode can be limited via the *nTorqueMotLimit\_a* process input signal, and the torque in generator mode can be limited via the *nTorqueGenLimit\_a* process input signal:

Designator <small>DIS code   data type</small>	Information/possible settings
<i>nTorqueMotLimit_a</i> <a href="#">C00830/29</a>   INT	Torque limitation in motor mode <ul style="list-style-type: none"><li>• Scaling: 16384 <math>\equiv</math> 100 % <math>M_{\max}</math> (<a href="#">C00057</a>)</li><li>• Setting range: 0 ... +199.99 %</li><li>• If keypad control is performed: Parameterisable via <a href="#">C00728/1</a>.</li></ul> <p>From version 18.00.00 onwards: <a href="#">C02864</a>: Bit 15 = 1: positive torque limitation (<i>nTorqueHighLimit_a</i>)</p>
<i>nTorqueGenLimit_a</i> <a href="#">C00830/28</a>   INT	Torque limitation in generator mode <ul style="list-style-type: none"><li>• Scaling: 16384 <math>\equiv</math> 100 % <math>M_{\max}</math> (<a href="#">C00057</a>)</li><li>• Setting range: -199.99 ... 0 %</li><li>• If keypad control is performed: Parameterisable via <a href="#">C00728/2</a>.</li></ul> <p>From version 18.00.00 onwards: <a href="#">C02864</a>: Bit 15 = 1: negative torque limitation (<i>nTorqueLowLimit_a</i>)</p>



#### Note!

To avoid instabilities during operation, the torque limit values are internally processed as absolute values.

### Motor current limitation

A cross current setpoint is calculated from the torque setpoint which is limited depending on the magnetising current, the max. current in motor mode ([C00022](#)) and the max. current in generator mode ([C00023](#)). The total current injected into the motor does not exceed the max. currents in motor mode and in generator mode.

### Slip compensation

The slip of the machine is reconstructed using the slip model. An influencing parameter is the slip constant ([C00021](#)). [▶ Slip compensation](#) (📖 225)

## 5.7.2.2 Torque control with speed limitation

When *bTorquemodeOn* = TRUE, a torque-controlled operation is activated. The setpoint torque directly follows the default value *nTorqueSetValue\_a*.

Due to its speed limitation, the torque-controlled drive can only rotate within a speed range whose positive speed is limited by *nSpeedHighLimit\_a* and whose negative speed is limited by *nSpeedLowLimit\_a*.



### Note!

- Absolute speed limitation to speed 0 rpm (*nSpeedLowLimit\_a* or *nSpeedHighLimit\_a* = 0) is only possible [from version 12.00.00](#).
- Quick stop (QSP) is used to switch over to [Speed control with torque limitation](#).
  - [From version 13.00.00](#), the torque setpoint *nSpeedSetValue\_a* is set to 0 by quick stop (QSP) device-internally and the two torque limit values *nTorqueMotLimit\_a* and *nTorqueGenLimit\_a* are set to 100 % to stop the drive quickly and safely anytime. The previous behaviour can be set in [C2865/1](#) via bit 12 and bit 13.

- [From version 13.00.00](#), the *bLimSpeedTorquemodeOn* status signal is used to show that the speed limitation is active.
- The speed is defined by the process.
- The torque setpoint is calculated directly from *nTorqueSetValue\_a*.
  - [From version 12.00.00 onwards](#), the torque limitation is active via *nTorqueMotLimit\_a* and *nTorqueGenLimit\_a* in this control mode, too, for the torque setpoint to be limited. The torque limitation can be deactivated in [C2865/1](#) via bit 0 to obtain the previous function.

# 5 Motor control (MCTRL)

## 5.7 Sensorless vector control (SLVC)

Designator <small>DIS code   data type</small>	Information/possible settings
nTorqueSetValue_a <a href="#">C00830/27</a>   INT	Torque setpoint / additive torque <ul style="list-style-type: none"> <li>• Scaling: 16384 <math>\equiv</math> 100 % <math>M_{\max}</math> (<a href="#">C00057</a>)</li> </ul>
nSpeedHighLimit_a <a href="#">C00830/88</a>   INT	Upper speed limit for the speed limitation <ul style="list-style-type: none"> <li>• During torque-controlled operation only (<i>bTorquemodeOn</i> = TRUE)</li> <li>• Scaling: 16384 <math>\equiv</math> 100 % rated speed (<a href="#">C00011</a>)</li> </ul>
nSpeedLowLimit_a <a href="#">C00830/23</a>   INT	Lower speed limit for speed limitation <ul style="list-style-type: none"> <li>• During torque-controlled operation only (<i>bTorquemodeOn</i> = TRUE)</li> <li>• Scaling: 16384 <math>\equiv</math> 100 % rated speed (<a href="#">C00011</a>)</li> </ul>
nTorqueMotLimit_a <a href="#">C00830/29</a>   INT	Torque limitation in motor mode <ul style="list-style-type: none"> <li>• Scaling: 16384 <math>\equiv</math> 100 % <math>M_{\max}</math> (<a href="#">C00057</a>)</li> <li>• Setting range: 0 ... +199.99 %</li> <li>• If keypad control is performed: Parameterisable via <a href="#">C00728/1</a>.</li> </ul> <p>From version 18.00.00 onwards:  <a href="#">C02864</a>: Bit 15 = 1: positive torque limitation (nTorqueHighLimit_a)</p>
nTorqueGenLimit_a <a href="#">C00830/28</a>   INT	Torque limitation in generator mode <ul style="list-style-type: none"> <li>• Scaling: 16384 <math>\equiv</math> 100 % <math>M_{\max}</math> (<a href="#">C00057</a>)</li> <li>• Setting range: -199.99 ... 0 %</li> <li>• If keypad control is performed: Parameterisable via <a href="#">C00728/2</a>.</li> </ul> <p>From version 18.00.00 onwards:  <a href="#">C02864</a>: Bit 15 = 1: negative torque limitation (nTorqueLowLimit_a)</p>

### 5.7.3 Basic settings

The following "Initial commissioning steps" must be performed to commission the sensorless vector control:

Initial commissioning steps			
1	Determine the motor control: <a href="#">C00006</a> = "4: SLVC: Vector control"		
2	<p>Set the motor selection/motor data</p> <ul style="list-style-type: none"> <li>• When selecting and parameterising the motor, the motor nameplate data and the equivalent circuit diagram data are relevant. Detailed information can be found in the chapter "<a href="#">Motor selection/Motor data</a>". (<a href="#">□ 113</a>)</li> </ul> <p>Depending on the motor manufacturer, proceed as follows:</p> <table border="0" style="width: 100%;"> <tr> <td style="vertical-align: top; width: 50%;"> <p><b>Lenze motor:</b>  <a href="#">Selecting a motor from the motor catalogue in the »Engineer«</a>                      - or -                      1. Set the motor nameplate data                      2. <a href="#">Automatic motor data identification</a></p> </td> <td style="vertical-align: top; width: 50%;"> <p><b>Third party manufacturer's motor:</b>                      1. Set the motor nameplate data                      2. <a href="#">Automatic motor data identification</a> or set known equivalent circuit diagram data manually:  <a href="#">C00082</a>: Motor rotor resistance  <a href="#">C00084</a>: Motor stator resistance  <a href="#">C00085</a>: Motor stator leakage inductance  <a href="#">C00092</a>: Motor magnetising inductance  <a href="#">C00095</a>: Motor magnetising current</p> </td> </tr> </table>	<p><b>Lenze motor:</b>  <a href="#">Selecting a motor from the motor catalogue in the »Engineer«</a>                      - or -                      1. Set the motor nameplate data                      2. <a href="#">Automatic motor data identification</a></p>	<p><b>Third party manufacturer's motor:</b>                      1. Set the motor nameplate data                      2. <a href="#">Automatic motor data identification</a> or set known equivalent circuit diagram data manually:  <a href="#">C00082</a>: Motor rotor resistance  <a href="#">C00084</a>: Motor stator resistance  <a href="#">C00085</a>: Motor stator leakage inductance  <a href="#">C00092</a>: Motor magnetising inductance  <a href="#">C00095</a>: Motor magnetising current</p>
<p><b>Lenze motor:</b>  <a href="#">Selecting a motor from the motor catalogue in the »Engineer«</a>                      - or -                      1. Set the motor nameplate data                      2. <a href="#">Automatic motor data identification</a></p>	<p><b>Third party manufacturer's motor:</b>                      1. Set the motor nameplate data                      2. <a href="#">Automatic motor data identification</a> or set known equivalent circuit diagram data manually:  <a href="#">C00082</a>: Motor rotor resistance  <a href="#">C00084</a>: Motor stator resistance  <a href="#">C00085</a>: Motor stator leakage inductance  <a href="#">C00092</a>: Motor magnetising inductance  <a href="#">C00095</a>: Motor magnetising current</p>		
3	Define the type of control: <i>bTorquemodeOn</i> = FALSE: <a href="#">Speed control with torque limitation</a> <i>bTorquemodeOn</i> = TRUE: <a href="#">Torque control with speed limitation</a>		
4	Set the slip compensation ( <a href="#">C00021</a> ). ▶ <a href="#">Slip compensation</a> ( <a href="#">□ 225</a> )		



#### Tip!

Information on the optimisation of the control mode and the adaptation to the real application is provided in chapter "[Optimising the control mode](#)". ([□ 176](#))

We recommend to use the flying restart function for connecting/synchronising the inverter to an already rotating drive system. ▶ [Flying restart function](#) ([□ 218](#))

# 5 Motor control (MCTRL)

## 5.7 Sensorless vector control (SLVC)

---

Parameterisable additional functions are described correspondingly in the chapter "[Parameterisable additional functions](#)". (📖 212)

### 5.7.4 Optimising the control mode



#### Note!

From version 12.00.00:

- Following successful motor parameter identification, the current controller parameters ([C00075](#), [C00076](#)) are calculated automatically.
  - If these parameters are not to be calculated, bit 4 of [C02865/1](#) must be set to "1".
- Following successful motor parameter identification, the speed controller parameters ([C00070/1](#), [C00071/1](#)) can be calculated automatically.
  - If these parameters are to be calculated, bit 6 of [C02865/1](#) must be set to "5".
- Following successful motor parameter identification, other controller parameters ([C00011](#), [C00022](#)) can be calculated automatically.
  - If these parameters are to be calculated, bit 6 of [C02865/1](#) must be set to "6".

#### 5.7.4.1 Optimising the starting performance after a controller enable

After the inverter has been enabled, the starting action of the motor is delayed due to the magnetisation of the motor. Under consideration of the motor rotor time constant ([C00083](#)), the time delay is calculated as follows:

$$\text{Magnetisation} = 1.5 * \text{motor rotor time constant}$$

If this delay cannot be tolerated for specific applications, the motor must always be operated in an energised condition. For this, select one of the following options:

##### Procedure without setting a controller inhibit

1. Deactivate the auto DCB function with [C00019](#) = 0.
2. Do not activate the controller inhibit. Instead, stop the drive by selecting a setpoint of 0 or by activating the quick stop function.

##### Procedure with setting a controller inhibit due to application requirements

1. Deactivate the auto DCB function with [C00019](#) = 0.
2. Enter a greater value for the motor rotor resistance (max. factor 2!) to reduce the magnetisation time in [C00082](#).



#### Note!

During the starting action, a jerk may occur in the machine due to the temporarily increased motor current!



### 5.7.4.2 Optimise speed controller

The speed controller is designed as a PI controller.

- In the Lenze setting, the configuration of the speed controller provides robustness and moderate dynamics.

Parameters	Info	Lenze setting	
		Value	Unit
<a href="#">C00070/1</a>	SLVC: Vp speed controller	15.00	
<a href="#">C00071/1</a>	SLVC: Ti speed controller	100.0	ms

#### Speed controller gain Vp

The gain Vp ([C00070/1](#)) of the speed controller is defined in a scaled representation which enables a comparable parameterisation almost independent of the power of the motor or inverter. Here, the speed input difference of the controller is scaled to the rated motor speed whereas the output torque refers to the rated motor torque. A gain of 10 means that a speed difference of 1 % is gained through the P component with 10 % torque.

If the rated data of the motor and the mass inertia of the drive system are known, we recommend the following setting:

$$V_p \approx 1.5 \dots 3 \cdot \frac{T_M[s]}{0.01[s]}$$

$$T_M[s] = \frac{2 \cdot \pi \cdot n_N[\text{rpm}]}{M_N[\text{Nm}] \cdot 60} \cdot J_{\text{Drive, total}}[\text{kgm}^2]$$

$$M_N[\text{Nm}] = \frac{P_N[\text{W}] \cdot 60}{2 \cdot \pi \cdot n_N[\text{rpm}]}$$

V<sub>p</sub> = Gain of the speed controller ([C00070/1](#))  
 T<sub>M</sub> = Time constant for the acceleration of the motor  
 M<sub>N</sub> = Rated motor torque  
 n<sub>N</sub> = Rated motor speed  
 J<sub>drive, total</sub> = Total moment of inertia of the drive

[5-10] Recommendation for the setting of the gain of the speed controller



#### Tip!

Values recommended by Lenze for the setting of the (proportional) gain:

- For drive systems without feedback: Vp = 6 ... 25
  - For drive systems with a good disturbance behaviour: Vp > 15
- In this case, we recommend the optimisation of the dynamic performance of the torque controller.

### Speed controller reset time $T_i$

Apart from setting the P component, [C00071/1](#) provides the possibility to take influence on the I component of the PI controller.



#### Tip!

Value range recommended by Lenze for the setting of the reset time:

$T_i = 20 \text{ ms} \dots 150 \text{ ms}$

### 5.7.4.3 Optimising dynamic performance and field weakening behaviour

In the Lenze setting, the torque controller has been preset in such a way that robust and stable operation with a moderate dynamic response is enabled over the entire speed range. Retrospective optimisation of the controller parameters is not necessary.

Parameters	Info	Lenze setting	
		Value	Unit
<a href="#">C00073/2</a>	SLVC: Vp torque controller	1.25	
<a href="#">C00074/2</a>	SLVC: Ti torque controller	30	ms

A greater dynamic performance of the sensorless vector control can be achieved by reducing time constant  $T_i$  of the speed controller ([C00074/2](#)).

A greater dynamic performance of the field weakening function can be achieved by setting a time constant  $\leq 15 \text{ ms}$ . This means for actual speeds above rated speed a better torque-speed-characteristic in the field weakening range:

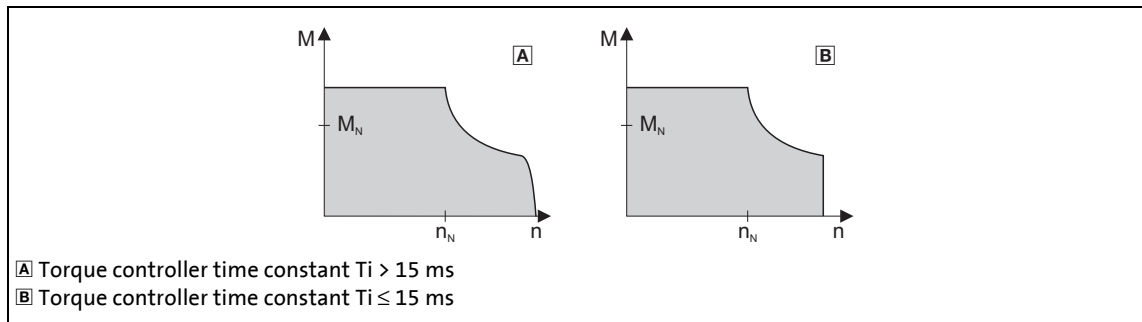

[5-11] Speed / torque characteristic diagram in the field weakening range

- For  $T_i > 15 \text{ ms}$  (see A), the actual speed value slightly drops in the field weakening range if the load torque increases in the motor mode.
- For  $T_i \leq 15 \text{ ms}$  (see B), the speed remains stable in the field weakening range if the torque is within the M/n characteristic field highlighted in grey.



#### Tip!

For applications with high dynamic performance and speed/torque accuracy requirements in the field weakening range, we recommend a time constant  $T_i \leq 15 \text{ ms}$ .

In this case, the maximum torque should be limited via the  $nTorqueMotLimit\_a$  and  $nTorqueGenLimit\_a$  process input signals to  $1.5 \times M_N$  to ensure stable operation in the field weakening range.

#### 5.7.4.4 Optimising the stalling behaviour

Motor stalling due to a torque overload in the field weakening range is prevented in sensorless vector control by means of an inverter-internal stalling current monitoring. In the field weakening range, hence at frequencies above the base frequency, it reduces the maximum current to prevent the motor from stalling. The reduction depends on the current field frequency, the base frequency, the DC-bus voltage and the maximum current ([C00022](#)). Generally it applies that a higher field frequency causes a stronger limitation of the maximum current.

The field weakening behaviour of the sensorless vector control depends on the setting of the reset time  $T_i$  of the torque controller ([C00074/2](#)).

**The following applies to the reset time  $T_i$  ([C00074/2](#)) > 15 ms:**

The behaviour in the field weakening range can be adapted via the override point of field weakening ([C00080](#)). This parameter serves to shift the frequency-dependent maximum current characteristic:

- [C00080](#) > 0 Hz:
  - The maximum current characteristic is shifted by the entered frequency to higher field frequencies.
  - The maximally permissible current and the maximum torque increase in the field weakening range.
  - The risk of motor stalling increases.
- [C00080](#) < 0 Hz:
  - The maximum current characteristic is shifted by the entered frequency to lower field frequencies.
  - The maximally permissible current and the maximum torque are reduced in the field weakening range.
  - The risk of motor stalling is reduced.



#### Note!

We recommend to keep the Lenze setting (0 Hz).

**The following applies to the reset time  $T_i$  ([C00074/2](#)) ≤ 15 ms:**

The reduction of the magnetising current in the field weakening range can be adapted via the override point of field weakening ([C00080](#)):

- [C00080](#) > 0 Hz: The reduction of the magnetising current is shifted to higher field frequencies. Here, there is a risk of the motor being magnetised too much and having too little voltage reserve for the torque-creating current.
- [C00080](#) < 0 Hz: The reduction of the magnetising current is shifted to lower field frequencies.



#### Note!

A function for enabling a stable operation can only be implemented to a limited extent with a reset time  $T_i$  ≤ 15 ms. For applications with speeds above the 2-fold rated speed, we recommend a reset time  $T_i$  ([C00074/2](#)) > 15 ms.

### 5.7.4.5 Optimise response to setpoint changes and determine mass inertia

#### Optimisation at constant mass inertia

Setting the total moment of inertia under [C00273](#) provides the optimum torque feedforward control. Depending on the application, an adjustment of the setting under [C00273](#) may be necessary to optimise the response to position/speed setpoint changes by means of the torque feedforward control.

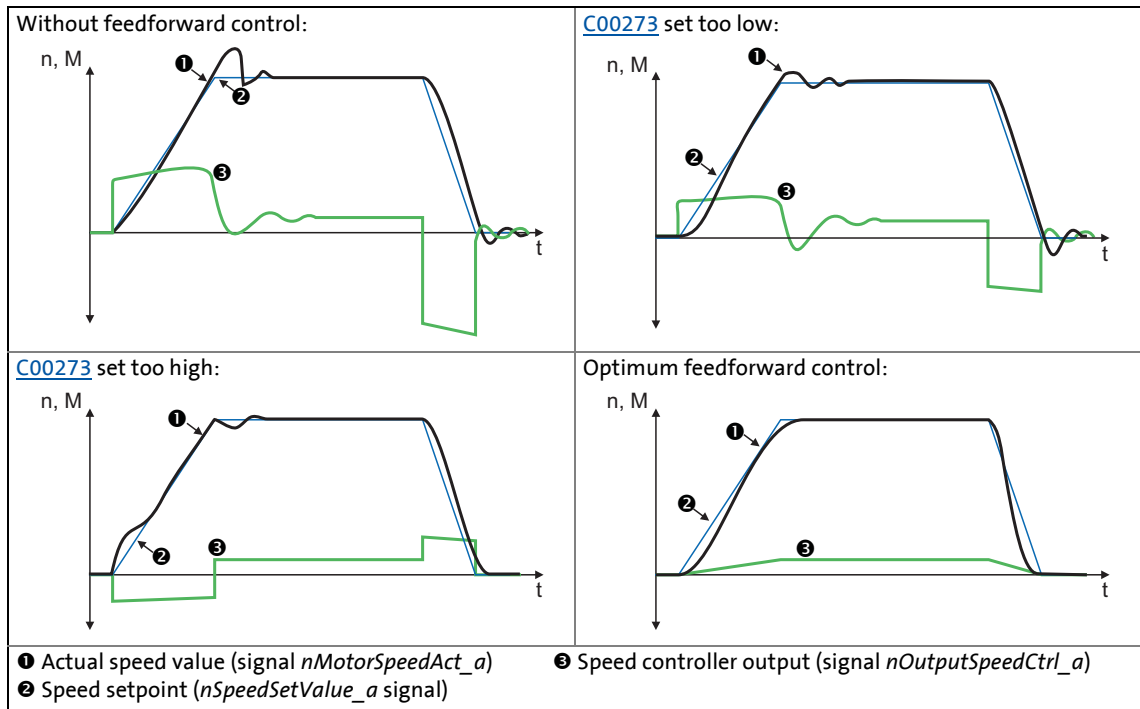

[5-12] Typical signal characteristics for different settings of the load moment of inertia



#### How to optimise the torque feedforward control:

- Run a typical speed profile and record the inputs and outputs of the speed controller with the data logger.
  - Motor control variables to be recorded:
    - nSpeedSetValue\_a* (speed setpoint)
    - nMotorSpeedAct\_a* (actual speed value)
    - nOutputSpeedCtrl\_a* (speed controller output)
- Estimate the moment of inertia and set it in [C00273](#) in relation to the motor end (i.e. with account being taken of the gearbox factors).
- Repeat the data logger recording (see step 1).
 

Now the data logger should show that part of the required torque is generated by the feedforward control and the speed controller output signal (*nOutputSpeedCtrl\_a*) is correspondingly smaller. The resulting following error decreases.
- Change the setting in [C00273](#) and repeat the data logger recording until the intended response to setpoint changes is reached.
  - The optimisation could aim at the speed controller being completely relieved (see signal characteristics in Fig. [5-12]).
- Save the parameter set (device command: [C00002/11](#)).

### Optimisation at variable mass inertia

From version V12.00.00, mass inertia that changes during the process (e.g. a reel) can be taken into account when optimising the response to setpoint changes.

#### How to proceed:

1. In [C00273](#) the known constant total moment of inertia (motor, gearbox, shaft, etc.) must be set or determined according to previous instructions ("[How to optimise ...](#)").
  - The determination requires travelling the typical speed profile without variable mass inertia (e.g. reels).
2. At the [LS\\_MotorInterface](#) SB, the *nInertiaAdapt\_a* process signal must be interconnected in a way which ensures that a value of "100 %" is applied at this input.
3. In [C00919/1](#) set the known maximum value of the variable moment of inertia or determine the value according to previous instructions ("[How to optimise ...](#)").
  - The determination requires travelling the typical speed profile including variable mass inertia (e.g. maximum reels).
4. The *nInertiaAdapt\_a* process signal can be used during the process to dynamically control the percentage of the variable moment of inertia set in [C00919/1](#) which is to be considered for setpoint feedforward control.

#### Example :

- If there is no variable moment of inertia (e.g. no reel), the *nInertiaAdapt\_a* process signal must be set to "0 %".
- If the maximally variable moment of inertia is available (e.g. maximum reels), the *nInertiaAdapt\_a* process signal must be set to "100 %".



#### Tip!

Via the *nTorqueSetValue\_a* process signal at the [LS\\_MotorInterface](#) SB, any differential signal can be defined for torque feedforward control. First the speed controller, then this additive torque is connected which is hence not derived from the differential change in speed setpoint.

### Other functions for differential setpoint feedforward control

From version V12.00.00 onwards, the following additional functions are available for differential setpoint feedforward control (torque feedforward control):

- In [C00653/1](#), the sensitivity of setpoint feedforward control can be adapted.
- In [C00654/1](#), alternatively to the *nSpeedSetValue\_a* process signal, the new *nSpeedSetValueInertia\_a* process signal for the setpoint feedforward control can be selected at the [LS\\_MotorInterface](#) SB. Via the *nSpeedSetValueInertia\_a* process signal, an optional input value (e.g. setpoint of the position or process controller) for the torque feedforward control can be specified.
- For *bTorqueModeOn* = TRUE, the setpoint feedforward control is added to the torque setpoint *nTorqueSetValue\_a*. In this way, feedforward control of torque is also possible for torque-controlled operation (e.g. for winder applications).

From version V18.00.00 onwards, the following additional functions are available for differential setpoint feedforward control (torque feedforward control):

- In [C00654/1](#), an exact torque feedforward control can be set for the *nSpeedSetValue\_a* speed setpoint. In case of a very dynamic application, set [C00654/1](#) = 2.
- From version V15.00.00 onwards, the torque feedforward control behaves differently than in version V14.00.00 or older. In order to achieve the same behaviour as in version V14.00.00 or older, set [C00654/1](#) = 3.



### Stop!

In the Lenze setting of [C00654/1](#), the speed setpoint of the speed controller (*nSpeedSetValue\_a*) is used for the torque feedforward control which is why it is also called "differential setpoint feedforward control". A very sharp change of the speed setpoint at the speed controller thus causes a strong torque impulse at the machine!

#### Causes for a very sharp change of the speed setpoint of the speed controller:

- A control creates the setpoint ramp itself and the speed setpoint is only written every 20 ms to the drive. (In this case, the speed setpoint is changed every 20 ms.)
  - Recommendation: Deactivate the torque feedforward control for the speed setpoint in [C00654/1](#) if the speed setpoint changes very sharply or the mass inertia is unknown (e.g. in case of hoists)!
- The reference speed [C0011](#) is much higher than the rated motor speed set in [C0087](#).
  - Recommendation: Deactivate the torque feedforward control for the speed setpoint in [C00654/1](#) if the reference speed [C0011](#) is 5 times higher than the rated motor speed [C0087](#).

### 5.7.4.6 Slip calculation from motor equivalent circuit diagram data

This function extension is available from version 11.00.00!

In order to achieve a better speed stability and torque accuracy, the slip calculation can be either derived from the motor nameplate data (e.g. rated motor speed) or the motor equivalent circuit diagram data (stator resistance, rotor resistance etc.).

The data to be used for sensorless vector control is selected via bit 0 in [C02879/1](#):

setting		Info
Bit 0	SLVC	In case of sensorless vector control: <ul style="list-style-type: none"><li>• "0" ≙ Slip calculation from motor nameplate data (Lenze setting)</li><li>• "1" ≙ Slip calculation from motor equivalent circuit diagram data</li></ul>
Bit 1 ... 7	Reserved	



#### Note!

In order that the slip can be calculated from the motor equivalent circuit diagram data, the equivalent circuit data (stator resistance, rotor resistance etc.) must be known as exactly as possible.

- Selecting a motor in the »Engineer« motor catalogue loads the exact motor equivalent circuit diagram data.
- When the motor nameplate data is entered manually and the motor equivalent circuit diagram data is then detected via the motor parameter identification, the "extended identification" ([C02867/1](#) = 2) must be used. ▶ [Automatic motor data identification](#) (119)

In the slip calculation from the motor equivalent circuit diagram data, the slip compensation ([C00021](#)) has no influence anymore.

### 5.7.4.7 Optimising field feedforward control and torque feedforward control

At the start of an acceleration process and at the end of a deceleration process, the field current ( $nReaktCurrentId\_a$ ) may oscillate.

- Especially when accelerating via small acceleration ramps, these oscillations become obvious by the speed being unable to follow the setpoint or speed drops during acceleration.
- Oscillating can be reduced by increasing the gain of the field current controller in [C00985](#). A small increase of the cross current controller gain in [C00986](#) can further improve the starting performance for small acceleration ramps.

In the field weakening range, the cross current ( $nEffCurrentIq\_a$ ) may oscillate when an acceleration process starts or a deceleration process ends.

- In case of some motors, this cross current oscillation ( $nEffCurrentIq\_a$ ) can also occur in the motor setting range/field weakening range transitions which may also cause an overcurrent interruption.
- These oscillations can be reduced by again increasing the cross current controller gain slightly in [C00986](#).



#### Note!

The setting of [C00985](#) and [C00986](#) reduces the torque setting range.



# 5 Motor control (MCTRL)

## 5.7 Sensorless vector control (SLVC)

### 5.7.5 Remedies for undesired drive behaviour

Drive behaviour	Remedy
Deviation between no-load current and magnetising current or bad speed or torque accuracy.	<p>Adapt the motor magnetising inductance (<a href="#">C00092</a>) for no-load operation.</p> <ul style="list-style-type: none"> <li>If the no-load current is greater than the magnetising current (<a href="#">C00095</a>) at 0.5-fold rated motor speed, the magnetising inductance must be reduced until the no-load current and the magnetising current have the same values.</li> <li>Otherwise, the magnetising inductance must be increased.</li> </ul> <p>Tendency of the correction of <a href="#">C00092</a>:</p> <p>PN: Rated motor power</p>
Insufficient speed constancy at high load: Setpoint and motor speed are not proportional anymore. <b>Caution:</b> Overcompensation of the settings mentioned under "Remedy" may result in unstable behaviour!	<p>Via the slip compensation (<a href="#">C00021</a>), the speed stability under high loads can be affected:</p> <ul style="list-style-type: none"> <li>If <math>n_{act} &gt; n_{slip}</math>, reduce the value in <a href="#">C00021</a></li> <li>If <math>n_{act} &lt; n_{slip}</math>, increase the value in <a href="#">C00021</a></li> </ul>
Unstable control with higher speeds.	<ul style="list-style-type: none"> <li>Check the setting of the magnetising inductance (<a href="#">C00092</a>) by comparing the current consumption in no-load operation with the rated magnetising current (<a href="#">C00095</a>).</li> <li>Optimise oscillation damping (<a href="#">C00234</a>).</li> </ul>
"Short circuit" (oC1) or "Clamp operation active" (oC11) error messages at short acceleration time ( <a href="#">C00012</a> ) in proportion to the load (inverter cannot follow the dynamic processes).	<ul style="list-style-type: none"> <li>Increase the gain of the torque controller (<a href="#">C00073/2</a>).</li> <li>Reduce the reset time of the torque controller (<a href="#">C00074/2</a>).</li> <li>Increase the acceleration (<a href="#">C00012</a>)/deceleration (<a href="#">C00013</a>) time.</li> </ul>
Mechanical resonance at certain speeds.	The <a href="#">L_NSet_1</a> function block masks out those speed ranges that include resonance.
Speed variations in no-load operation for speeds > 1/3 rated speed.	Minimise speed oscillations with oscillation damping ( <a href="#">C00234</a> ).
Drive runs unstable.	<p>Check set motor data (nameplate data and equivalent circuit diagram data).</p> <p>► <a href="#">Motor selection/Motor data</a> (□ 113)</p>
Setpoint speed and actual speed differ strongly.	
The torque required is not generated at standstill.	<p>Increase motor magnetising current (<a href="#">C00095</a>).</p>
Current overshoots occur when heavy loads are accelerated from standstill (OC1 or OC11 error).	
The machine runs uneven.	

## 5.8

## Sensorless control for synchronous motors (SLPSM)

This function extension is available from version 10.00.00!

The sensorless control for synchronous motors is based on a decoupled and separated control of the torque-creating and field-creating current share of synchronous motors. In contrast to the servo control, the actual speed value and the rotor position are reconstructed via a motor model.



### Stop!

- When the maximum output frequency is limited to  $\pm 599$  Hz, the devices are not subject to the export restrictions of the "EC-Dual-Use Regulation" - EC 428/2009. This applies to the devices supplied from the middle of the year 2015. The maximum possible output frequency is given on the nameplate.
- For certain applications, the devices can be supplied with the previous maximum output frequency of  $\pm 1000$  Hz. If required, get in touch with your Lenze contact person.
- The sensorless control for synchronous motors is only possible up to a maximum output frequency of 650 Hz (from version 14.00.00: 1000 Hz)!
  - Depending on the number of motor pole pairs, the reference speed ([C00011](#)) may only be selected that high that the output frequency displayed in [C00059](#) is less than or equal to 650 Hz (from version 14.00.00: 1000 Hz).
- We recommend to select a power-adapted combination of inverter and motor.
- The Lenze setting permits the operation of a power-adapted motor. Optimal operation is only possible if either:
  - the motor is selected via the »Engineer« motor catalogue,
  - the motor nameplate data are entered and motor parameter identification is carried out afterwards
  - or -
  - the nameplate data and equivalent circuit data of the motor (motor leakage inductance and motor stator resistance) are entered manually.
- When you enter the motor nameplate data, take into account the phase connection implemented for the motor (star or delta connection). Only enter the data applying to the selected connection type.
- In order to protect the motor (e.g. from demagnetisation) we recommend setting the ultimate motor current in [C00939](#). This ensures motor protection even with an unstable operation. ▶ [Maximum current monitoring](#) ([259](#))
- Controller enable is only possible if the motor is at standstill.
  - When the controller is enabled, a jerk may occur due to an angle jump since the rotor displacement angle is not known after controller enable. For some applications, this jerk in the machine is not acceptable.
  - From version 11.00.00, the rotor displacement angle is identified with every controller enable in the Lenze setting, and thus a jerk in the machine after controller enable can be avoided. ▶ [Pole position identification without motion](#) ([207](#))
  - A flying restart circuit for synchronising to rotating motors is in preparation.
- The injection of a constant current may cause an unwanted heating of the motor at controlled operation.
  - We recommend using a temperature feedback via PTC or thermal contact. ▶ [Motor temperature monitoring \(PTC\)](#) ([253](#))



### Note!

Currently, the sensorless control does not contain a flying restart function that enables a synchronisation of the inverter to a rotating machine.

- Thus, we recommend taking measures for preventing overvoltages at operation in generator mode (e.g. brake resistor).
- By any means, the delay time for the "DC-bus overvoltage" error trigger in [C00601/1](#) must be set to 0 s.

The motor model-based speed monitoring requires a rotating machine. Thus, the operational performance of the sensorless control for synchronous motors is divided into two categories:

1. Open-loop controlled operation ( $|n_{\text{setpoint}}| < n_{C00996}$ )
  - In the range of low speeds, the speed of a synchronous motor is not possible. Thus, only an adjustable and constant current is injected that enables an acceleration.
2. Closed-loop controlled operation ( $|n_{\text{setpoint}}| > n_{C00996}$ )
  - In this range, the rotor flux position and the speed are reconstructed via an observer. The control is carried out field-oriented. Only the current is injected that is needed for the required torque.

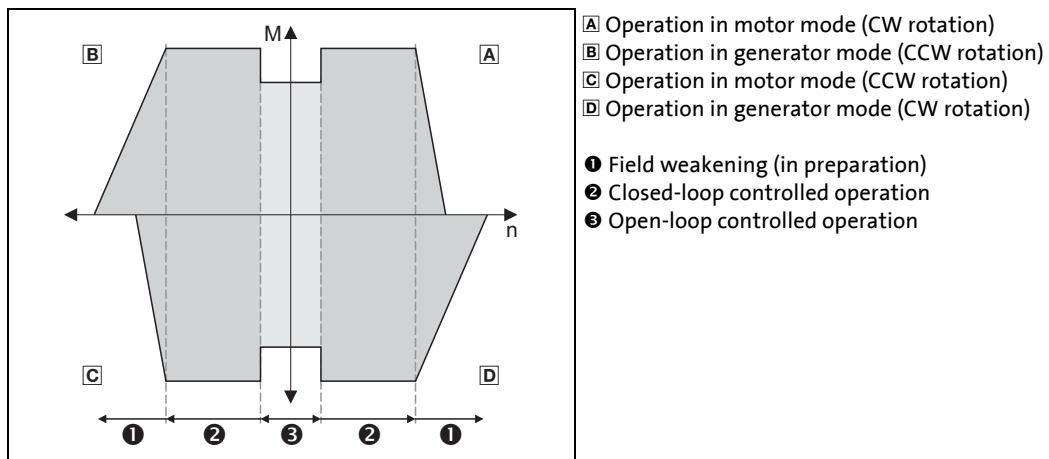

[5-13] Operating ranges of the sensorless control for synchronous motors

The sensorless control for synchronous motors has similar advantages for the closed-loop controlled operating range and the servo control (SC) for synchronous motors. Compared to asynchronous motors, there are the following advantages:

- Higher power density of the motor
- Higher efficiency
- Limitation of the maximum torque in motor mode and generator mode in closed-loop operating range
- Implementation of simple positioning



### Note!

In the open-loop controlled operation for synchronous motors, usually less maximum torque is created than in the closed-loop controlled operation. Thus, the dynamics of this control is limited and a high acceleration of the drive is not possible in this control mode.

From [version V17.00.00](#) onwards, the `bSlpsmSpeedopenLoopControl` process output is available at SB [LS DeviceMonitor](#) (open-loop controlled operation of the SLPM is active). This signal can be connected to the additional ramp `L_Nset.bTixt` to realise an own ramp in the open-loop controlled operation. This serves to set a flat ramp for the open-loop controlled operation and a steep ramp for the closed-loop controlled operation and thus achieve a considerably higher acceleration of the entire drive. Moreover, less vibrations are caused.

### 5.8.1 Parameterisation dialog/signal flow



Proceed as follows to open the dialog for parameterising the motor control:

1. »Engineer« Go to the *Project view* and select the 8400 StateLine inverter.
2. Select the **Application parameters** tab from the *Workspace*.
3. Select the motor control "3: SLPSM: Sensorless PSM" from the *Overview* dialog level in the **Motor control** list field:
4. Click the **Motor control servo SLPSM** button to change to the *Overview* → *Motor control vector* dialog box.
  - This dialog level only shows a simplified signal flow with the most important parameters.
  - When you click the >>**More details** button in the left-most position, a signal flow with more details/parameters is displayed.

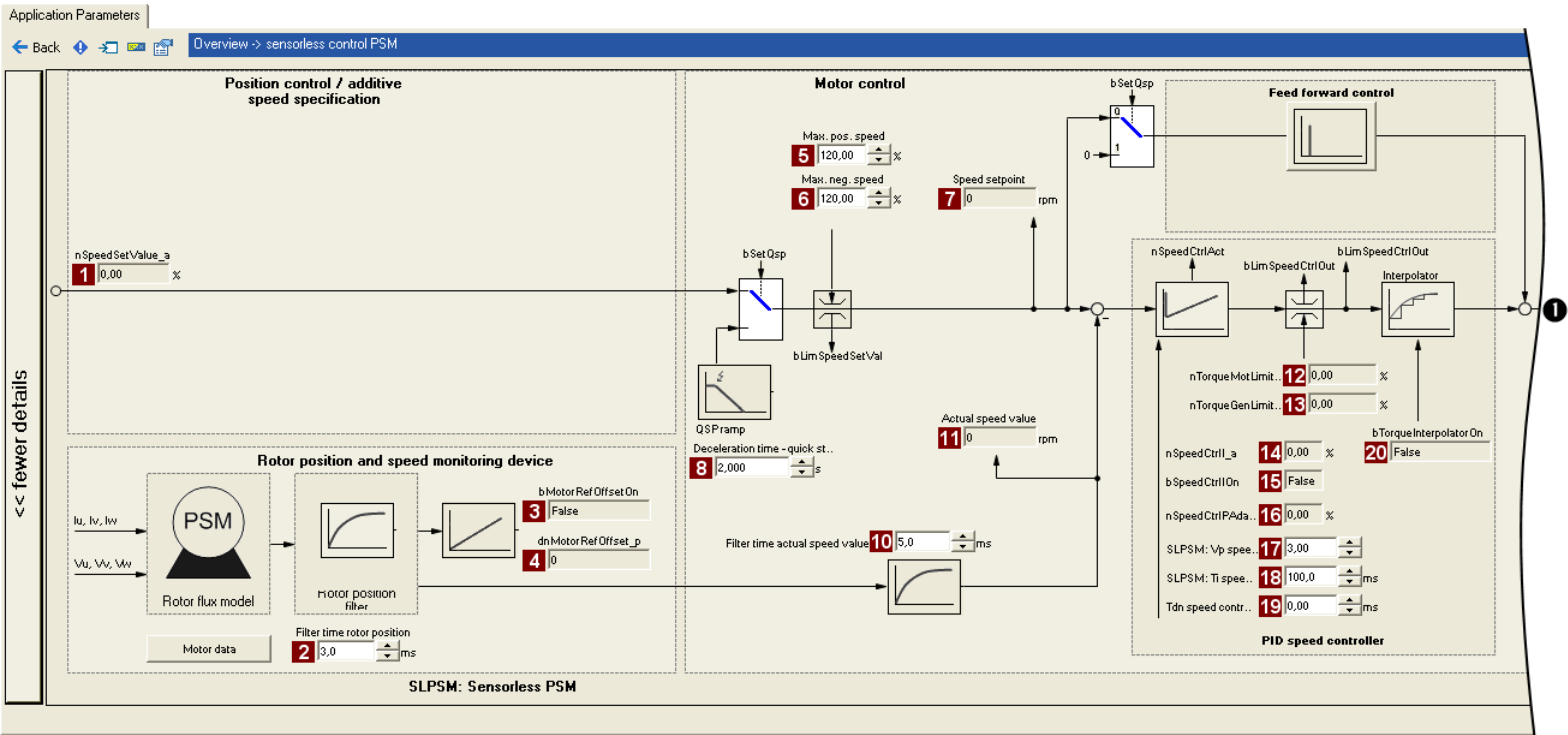

Parameters	Info	Parameters	Info	Parameters	Info
1	<a href="#">C00830/22</a> Speed setpoint	5	<a href="#">C00909/1</a> Max. pos. speed	12	<a href="#">C00830/29</a> Limitation of torque in motor mode
2	<a href="#">C00998/1</a> SLPSM: Filter time rotor position	6	<a href="#">C00909/2</a> Max. neg. speed	13	<a href="#">C00830/28</a> Limitation of torque in generator mode
3	<a href="#">C00833/68</a> MCTRL: bMotorRefOffsetOn	7	<a href="#">C00050</a> Speed setpoint	14	<a href="#">C00830/24</a> MCTRL: nSpeedCtrlI_a
4	<a href="#">C00834/6</a> MCTRL: dnMotorRefOffset_p	8	<a href="#">C00105</a> Decel. time - quick stop	15	<a href="#">C00833/31</a> MCTRL: bSpeedCtrlIOn
		9	-	16	<a href="#">C00830/25</a> MCTRL: nSpeedCtrlPADapt_a
		10	<a href="#">C00998/2</a> SLPSM: Filter time actual speed value	17	<a href="#">C00070/3</a> SLPSM: Vp speed controller
		11	<a href="#">C00051</a> Actual speed value	18	<a href="#">C00071/3</a> SLPSM: Ti speed controller
				19	<a href="#">C00072</a> SC: Tdn speed controller
				20	<a href="#">C00833/29</a> MCTRL: bTorqueInterpolatorOn

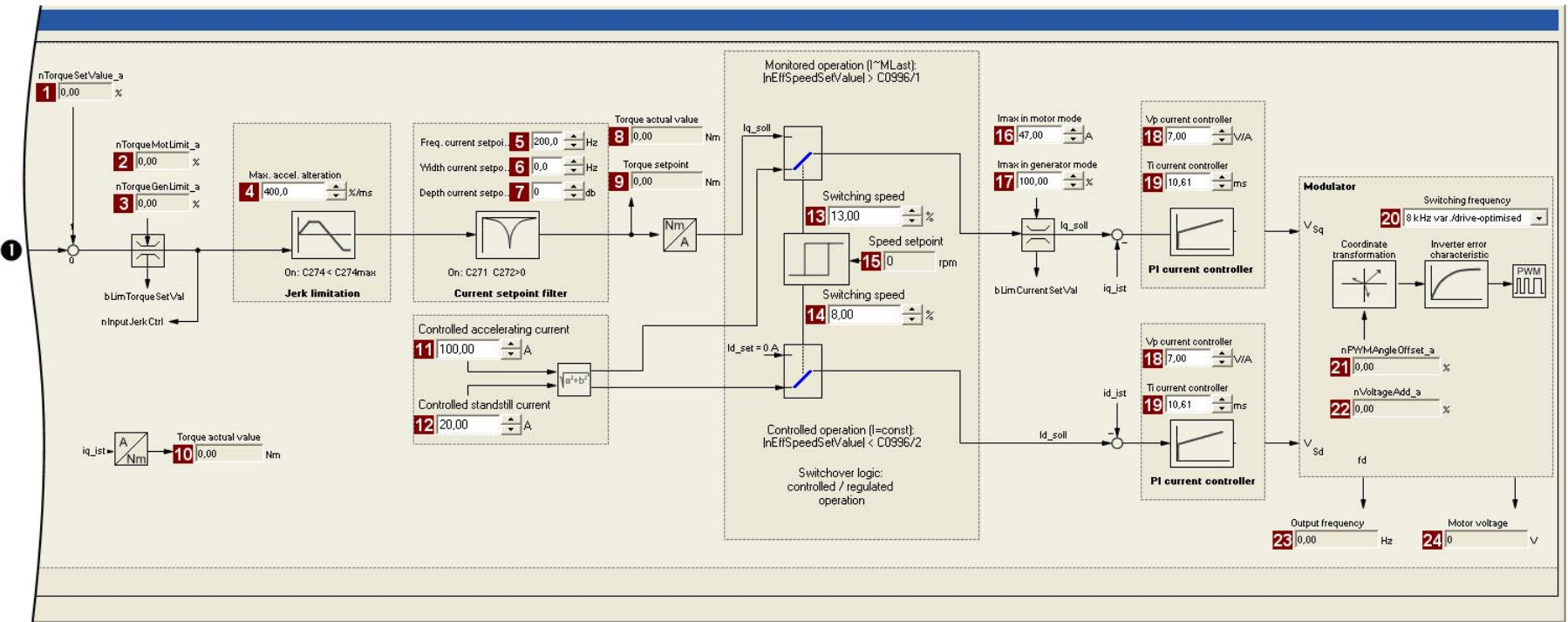

Parameters	Info	Parameters	Info	Parameters	Info
1	<a href="#">C00830/27</a> MCTRL: nTorqueSetValue_a	11	<a href="#">C00995/1</a> SLPSM: Open-loop controlled accelerating current	18	<a href="#">C00075</a> Vp current controller
2	<a href="#">C00830/29</a> Limitation of torque in motor mode	12	<a href="#">C00995/2</a> SLPSM: Open-loop controlled standstill current	19	<a href="#">C00076</a> Ti current controller
3	<a href="#">C00830/28</a> Limitation of torque in generator mode	13	<a href="#">C00996/1</a> SLPSM: Closed-loop controlled switching speed	20	<a href="#">C00018</a> Switching frequency
4	<a href="#">C00274</a> SC: Max. change in acceleration	14	<a href="#">C00996/2</a> SLPSM: Open-loop controlled switching speed	21	<a href="#">C00830/32</a> MCTRL: nPWMAngleOffset_a
5	<a href="#">C00270</a> SC: Freq. current setpoint filter	15	<a href="#">C00050</a> Speed setpoint	22	<a href="#">C00830/31</a> MCTRL: nVoltageAdd_a
6	<a href="#">C00271</a> SC: Current setpoint filter width	16	<a href="#">C00022</a> Imax in motor mode	23	<a href="#">C00058</a> Output frequency
7	<a href="#">C00272</a> SC: Current setpoint filter depth	17	<a href="#">C00023</a> Imax in generator mode	24	<a href="#">C00052</a> Motor voltage
8	<a href="#">C00056/2</a> Actual torque value				
9	<a href="#">C00056/1</a> Torque demand				
10	<a href="#">C00056/2</a> Actual torque value				

### 5.8.2 Types of control

Sensorless control for synchronous motors can only be executed in the "Speed control with torque limitation" (*bTorquemodeOn* = FALSE) mode.

#### Speed control with torque limitation

A speed setpoint is selected and the drive system is operated in a speed-controlled manner. For adapting the operational performance, the overload in the drive train can be limited:

- The torque is limited via the torque setpoint.
- The torque setpoint is identical to the value at the output of the speed controller, *nOutputSpeedCtrl*.
- To avoid overload in the drive train, the torque in motor mode can be limited via the *nTorqueMotLimit\_a* process input signal, and the torque in generator mode can be limited via the *nTorqueGenLimit\_a* process input signal:

Designator <small>DIS code   data type</small>	Information/possible settings
<i>nTorqueMotLimit_a</i> <a href="#">C00830/29</a>   INT	Torque limitation in motor mode <ul style="list-style-type: none"> <li>• Scaling: 16384 <math>\equiv</math> 100 % <math>M_{\max}</math> (<a href="#">C00057</a>)</li> <li>• Setting range: 0 ... +199.99 %</li> <li>• If keypad control is performed: Parameterisable via <a href="#">C00728/1</a>.</li> </ul> From version 18.00.00 onwards: <a href="#">C02864</a> : Bit 15 = 1: positive torque limitation ( <i>nTorqueHighLimit_a</i> )
<i>nTorqueGenLimit_a</i> <a href="#">C00830/28</a>   INT	Torque limitation in generator mode <ul style="list-style-type: none"> <li>• Scaling: 16384 <math>\equiv</math> 100 % <math>M_{\max}</math> (<a href="#">C00057</a>)</li> <li>• Setting range: -199.99 ... 0 %</li> <li>• If keypad control is performed: Parameterisable via <a href="#">C00728/2</a>.</li> </ul> From version 18.00.00 onwards: <a href="#">C02864</a> : Bit 15 = 1: negative torque limitation ( <i>nTorqueLowLimit_a</i> )



#### Stop!

Torque limitation is only active in the closed-loop controlled operation ( $|n_{\text{Setpoint}}| > n_{\text{C00996}}!$ )

- It must be prevented that the actual speed value is braked into the non-observable area due to the torque limitation!



#### Note!

To avoid instabilities during operation, the torque limit values are internally processed as absolute values.

### 5.8.3 Basic settings

The following "Initial commissioning steps" must be performed to commission the sensorless control for synchronous motors:

Initial commissioning steps					
1	Select motor control: <a href="#">C00006</a> = "3: SLPSM: Sensorless PSM"				
2	<p>Set the motor selection/motor data</p> <ul style="list-style-type: none"> <li>When selecting and parameterising the motor, the motor nameplate data and the equivalent circuit diagram data are relevant. Detailed information can be found in the "<a href="#">Motor selection/Motor data</a>" chapter. (<a href="#">113</a>)</li> </ul> <p>Depending on the motor manufacturer, proceed as follows:</p> <table border="1"> <thead> <tr> <th>Lenze motor:</th> <th>Third party manufacturer's motor:</th> </tr> </thead> <tbody> <tr> <td> <p><a href="#">Selecting a motor from the motor catalogue in the »Engineer«</a></p> <p>- or -</p> <ol style="list-style-type: none"> <li>Set the motor nameplate data</li> <li><a href="#">Automatic motor data identification</a></li> </ol> </td> <td> <ol style="list-style-type: none"> <li>Set the motor nameplate data</li> <li><a href="#">Automatic motor data identification</a> or set known equivalent circuit diagram manually: <a href="#">C00084</a>: Motor stator resistance <a href="#">C00085</a>: Motor stator leakage inductance</li> </ol> </td> </tr> </tbody> </table>	Lenze motor:	Third party manufacturer's motor:	<p><a href="#">Selecting a motor from the motor catalogue in the »Engineer«</a></p> <p>- or -</p> <ol style="list-style-type: none"> <li>Set the motor nameplate data</li> <li><a href="#">Automatic motor data identification</a></li> </ol>	<ol style="list-style-type: none"> <li>Set the motor nameplate data</li> <li><a href="#">Automatic motor data identification</a> or set known equivalent circuit diagram manually: <a href="#">C00084</a>: Motor stator resistance <a href="#">C00085</a>: Motor stator leakage inductance</li> </ol>
Lenze motor:	Third party manufacturer's motor:				
<p><a href="#">Selecting a motor from the motor catalogue in the »Engineer«</a></p> <p>- or -</p> <ol style="list-style-type: none"> <li>Set the motor nameplate data</li> <li><a href="#">Automatic motor data identification</a></li> </ol>	<ol style="list-style-type: none"> <li>Set the motor nameplate data</li> <li><a href="#">Automatic motor data identification</a> or set known equivalent circuit diagram manually: <a href="#">C00084</a>: Motor stator resistance <a href="#">C00085</a>: Motor stator leakage inductance</li> </ol>				
3	<p>Set speed switching thresholds between open-loop and closed-loop controlled operation:</p> <ul style="list-style-type: none"> <li>Set transition speed from closed-loop to open-loop operation in <a href="#">C00996/1</a> in [%] with regard to the rated motor speed (<a href="#">C00087</a>).</li> <li>Set transition speed from closed-loop to open-loop operation in <a href="#">C00996/2</a> in [%] with regard to the rated motor speed (<a href="#">C00087</a>).</li> </ul> <p><b>Tip!</b></p> <ul style="list-style-type: none"> <li>With voltage-adjusted motors, a speed switching threshold of 10 % is recommended.</li> <li>As a rule of thumb, the speed switching threshold should be selected as follows:</li> </ul> $C00996/1...2 [\%] = \frac{U_{Rated, motor} [V]}{U_{Rated, FI} [V]} \cdot 10$				
4	<p>Set open-loop accelerating current in <a href="#">C00995/1</a> in [%] with regard to the rated motor current (<a href="#">C00088</a>).</p> <ul style="list-style-type: none"> <li>This value defines the height of the current that is injected during the acceleration process.</li> <li>The accelerating current must be dimensioned so that the required torque in the lower speed range can always be reached (acceleration torque + load torque):</li> </ul> $C00995/1 [\%] = \frac{M_{Meax} [Nm]}{M_{Rated} [Nm]} \cdot I_{Rated, motor} [A] \cdot 1.3$				
5th	<p>Set open-loop steady-state current in <a href="#">C00995/2</a> in [%] with regard to the rated motor current (<a href="#">C00088</a>).</p> <ul style="list-style-type: none"> <li>This value defines the height of the current for processes without acceleration (e.g. standstill or constant setpoint speed).</li> </ul>				
6	<p>For improving the operating characteristics: If required, adapt the filter time for reconstructing the rotor position and the actual speed value through the motor model in <a href="#">C00998/1</a> and <a href="#">C00998/2</a>.</p> <ul style="list-style-type: none"> <li>We recommend using the Lenze setting: Filter time rotor position (<a href="#">C00998/1</a>) = 3 ms Filter time actual speed value (<a href="#">C00998/2</a>) = 5 ms</li> <li>Deviant from this, the following value range can be used: Filter time rotor position (<a href="#">C00998/1</a>) = 2 ... 5 ms Filter time actual speed value (<a href="#">C00998/2</a>) = 3 ... 8 ms</li> </ul>				
6	<p>For protecting the motor from demagnetisation: Set the ultimate current in <a href="#">C00939</a>.</p>				



#### Note!

The Lenze settings of the current controller are predefined for a power-adapted motor. For an optimal drive behaviour of a synchronous motor, we recommend to adapt the controller settings.



**Tip!**

Information on the optimisation of the control mode and the adaptation to the real application is provided in the "[Optimising the control mode](#)" chapter.

Parameterisable additional functions are described correspondingly in the chapter "[Parameterisable additional functions](#)". ([📖 212](#))

### 5.8.3.1 Reduction of speed overshoot

During the transition from the controlled to the speed-monitored range, the I component of the speed controller will be preloaded with the maximum possible torque of the controlled range. The determining variable for this maximum torque is the controlled accelerating current ([C00995/1](#)). The Lenze setting ([C00995/1](#) = 100 %) corresponds to the maximum torque.

In the event that less torque is actually required from the motor, a brief speed overshoot occurs during the transition from the controlled range to the speed-monitored range.

This speed overshoot is strongly noticeable in synchronous machines with very low power (e.g. type **MCS06C41** with  $P_N = 250$  W).

For versions < 21.00.00, the speed overshoot can be reduced by decreasing the controlled accelerating current ([C00995/1](#)). Disadvantage of this measure: the maximum possible motor torque is reduced.

This function expansion is available from version 21.00.00.

---

If necessary, an adjustment for loading the I component of the speed controller during transition from the controlled range to the speed-monitored range can be performed to reduce this speed overshoot. The maximum possible torque is still available in this case because the controlled accelerating current continues to have an effect.

The adjustment can be performed with

[C00936/1](#) = 0 ... 200% (SLPSM: load value of the speed controller)

#### Recommendations

- Synchronous machines with low power  
Setting for the load value of the speed controller for synchronous machines with low power (e.g. type **MCS06C41** with  $P_N = 250$  W):  
[C00936/1](#) = 50%.
- Drives with high starting torque:  
Setting for the load value of the speed controller when a very high starting torque is required from the drive:  
[C00936/1](#) = 101% ... 200%  
The load value of the speed controller is 100%.

#### 5.8.4 Optimising the control mode



#### Note!

From version 12.00.00:

- Following successful motor parameter identification, the current controller parameters ([C00075](#), [C00076](#)) are calculated automatically.
  - If these parameters are not to be calculated, bit 4 of [C02865/1](#) must be set to "1".
- Following successful motor parameter identification, the speed controller parameters ([C00070/3](#), [C00071/3](#)) can be calculated automatically.
  - If these parameters are to be calculated, bit 6 of [C02865/1](#) must be set to "5".
- Following successful motor parameter identification, other controller parameters ([C00011](#), [C00022](#)) can be calculated automatically.
  - If these parameters are to be calculated, bit 6 of [C02865/1](#) must be set to "6".

The measures described in the following subchapters serve to further optimise the control behaviour of the sensorless control for synchronous motors and adjust it to the concrete application.

- [Optimise current controller.](#) (📖 196)
  - The current controller should always be optimised if a motor of a third-party manufacturer with unknown motor data is used!
- [Optimise speed controller.](#) (📖 197)
  - The setting of the speed controller must be adapted depending on the mechanical path.
- [Optimise response to setpoint changes and determine mass inertia.](#) (📖 200)
  - For an optimal reference behaviour, the total moment of inertia can be used to make a feedforward control of the speed setpoint.
- [Current-dependent stator leakage inductance Ppp\(!\).](#) (📖 203)
  - If the motor is operated with very low and very high currents during the process (e.g. in *Pick and place*-applications), the stator leakage inductance and current controller parameters can be tracked by means of an adjustable saturation characteristic.



#### Note!

##### Current setpoint filter (band-stop filter) / jerk limitation

The use of the functions is only recommended in exceptional cases.

- ▶ [Setting the current setpoint filter \(band-stop filter\)](#) (📖 205)
- ▶ [Adapting the max. acceleration change \(jerk limitation\)](#) (📖 206)

## 5.8.4.1 Optimise current controller

**Note!**

An optimisation of the current controller should generally be carried out unless a power-adapted standard motor is used or the motor has been selected from the motor catalogue of the »Engineer«!

An optimisation of the current controller is sensible since the two control parameters gain ([C00075](#)) and reset time ([C00076](#)) depend on the required maximum current and the set switching frequency.

Parameters	Info	Lenze setting	
		Value	Unit
<a href="#">C00075</a>	Vp current controller	7.00	V/A
<a href="#">C00076</a>	Ti current controller	10.61	ms

- Gain and reset time can be calculated as per the following formulae:

$$V_p = \frac{L_{ss}[H]}{T_E[s]}$$

$$T_i = \frac{L_{ss}[H]}{R_s[\Omega]}$$

$V_p$  = Current controller gain ([C00075](#))

$T_i$  = Current controller reset time ([C00076](#))

$L_{ss}$  = Motor stator leakage inductance ([C00085](#))

$R_s$  = Motor stator resistance ([C00084](#))

$T_E$  = Equivalent time constant (= 500  $\mu$ s)

### 5.8.4.2 Optimise speed controller

The speed controller is in the form of a PID controller with an additional differential speed-setpoint gain. For optimum behaviour, the PID speed controller has to be optimised and the overall mass inertia of the drive train has to be determined.

- In the Lenze setting, the configuration of the speed controller provides robustness and moderate dynamics.

Parameters	Info	Lenze setting	
		Value	Unit
<a href="#">C00070/3</a>	SLPSM: Vp speed controller	3.00	
<a href="#">C00071/3</a>	SLPSM: Ti speed controller	100.0	ms
<a href="#">C00072</a>	SC: Tdn speed controller	0.00	ms

#### Speed controller gain Vp

The gain Vp ([C00070/3](#)) of the speed controller is defined in a scaled representation which enables a comparable parameterisation almost independent of the power of the motor or inverter. Here, the speed input difference of the controller is scaled to the rated motor speed whereas the output torque refers to the rated motor torque. A gain of 10 means that a speed difference of 1 % is gained through the P component with 10 % torque.

If the rated data of the motor and the mass inertia of the drive system are known, we recommend the following setting:

$$V_p \approx 0.2 \dots 0.5 \cdot \frac{T_M[s]}{0.01[s]}$$

$$T_M[s] = \frac{2 \cdot \pi \cdot n_N[\text{rpm}]}{M_N[\text{Nm}] \cdot 60} \cdot J_{\text{Drive, total}}[\text{kgm}^2]$$

$$M_N[\text{Nm}] = \frac{P_N[\text{W}] \cdot 60}{2 \cdot \pi \cdot n_N[\text{rpm}]}$$

$V_p$  = Gain of the speed controller ([C00070/3](#))  
 $T_M$  = Time constant for the acceleration of the motor  
 $M_N$  = Rated motor torque  
 $n_N$  = Rated motor speed  
 $J_{\text{drive, total}}$  = Total moment of inertia of the drive

[5-14] Recommendation for the setting of the gain of the speed controller

If the mass inertia of the drive is unknown, the optimisation can be achieved as follows:

1. Specify speed setpoint.
  - A small speed just above the switching threshold is recommended in the closed-loop controlled operation.
2. Increase  $V_p$  ([C00070/3](#)) until the drive starts to oscillate (observe engine noise).
3. Reduce  $V_p$  ([C00070/3](#)) until the drive runs stable again.
4. Reduce  $V_p$  ([C00070/3](#)) to approx. half the value.
5. Afterwards check results of the optimisation in the entire speed range (one-time passing through of the speed range).



**Tip!**

Values recommended by Lenze for the setting of the (proportional) gain:

- For drive systems without feedback:  $V_p = 2 \dots 8$
- For drive systems with a good disturbance behaviour:  $V_p > 6$

#### Speed controller reset time $T_i$

Apart from setting the P component, [C00071/3](#) provides the possibility to take influence on the I component of the PI controller.

If the mass inertia of the drive is unknown, the optimisation can be achieved as follows:

1. Specify speed setpoint.
2. Reduce  $T_i$  ([C00071/3](#)) until the drive starts to oscillate (observe engine noise).
3. Increase  $T_i$  ([C00071/3](#)) until the drive runs stable again.
4. Increase  $T_i$  ([C00071/3](#)) to approx. twice the value.



**Tip!**

Value range recommended by Lenze for the setting of the reset time:

$T_i = 20 \text{ ms} \dots 150 \text{ ms}$

#### Using the ramp response for setting the speed controller

If the mechanical components cannot be operated at the stability limit, the ramp response can also be used for setting the speed controller.



**Stop!**

If the controller parameters are preset unfavourably, the control can tend to heavy overshoots up to instability!

- Following and speed errors can adopt very high values.
- If the mechanics are sensitive, the corresponding monitoring functions are to be activated.



### Note!

For an optimal setting, we recommend to determine the mass inertia (optimal response to setpoint changes) first.

► [Optimise response to setpoint changes and determine mass inertia](#) (200)



### How to optimise the speed controller setting by means of the ramp response:

- Run a typical speed profile and record the ramp response of the speed using the data logger.
  - Motor control variables to be recorded:
    - nSpeedSetValue\_a* (speed setpoint)
    - nMotorSpeedAct\_a* (actual speed value)
- Evaluate the ramp response:

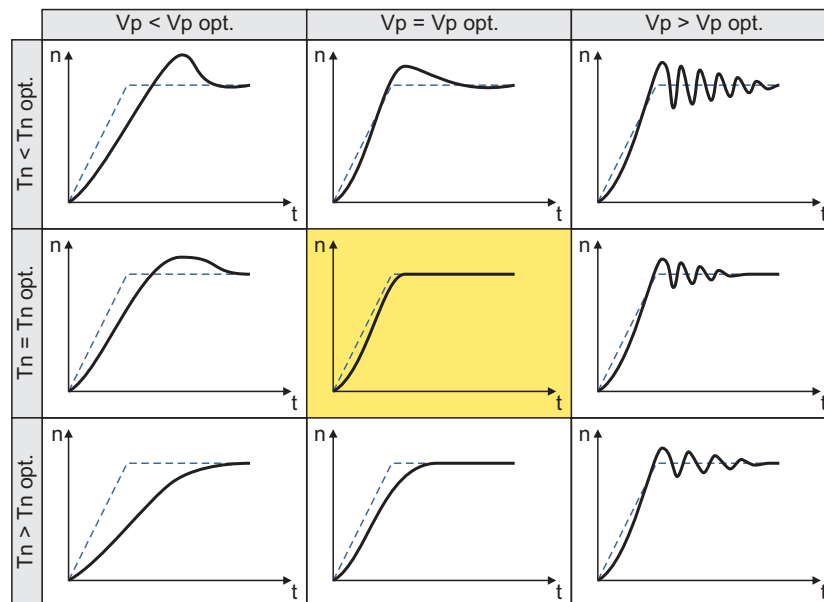

- Solid line = ramp response (actual speed value)
- Dash line = speed setpoint

- Change gain  $V_p$  in [C00070/3](#) and reset time  $T_n$  in [C00071/3](#).
- Repeat steps 1 ... 3 until the optimum ramp response is reached.

### 5.8.4.3 Optimise response to setpoint changes and determine mass inertia

#### Optimisation at constant mass inertia

Setting the total moment of inertia under [C00273](#) provides the optimum torque feedforward control. Depending on the application, an adjustment of the setting under [C00273](#) may be necessary to optimise the response to position/speed setpoint changes by means of the torque feedforward control.

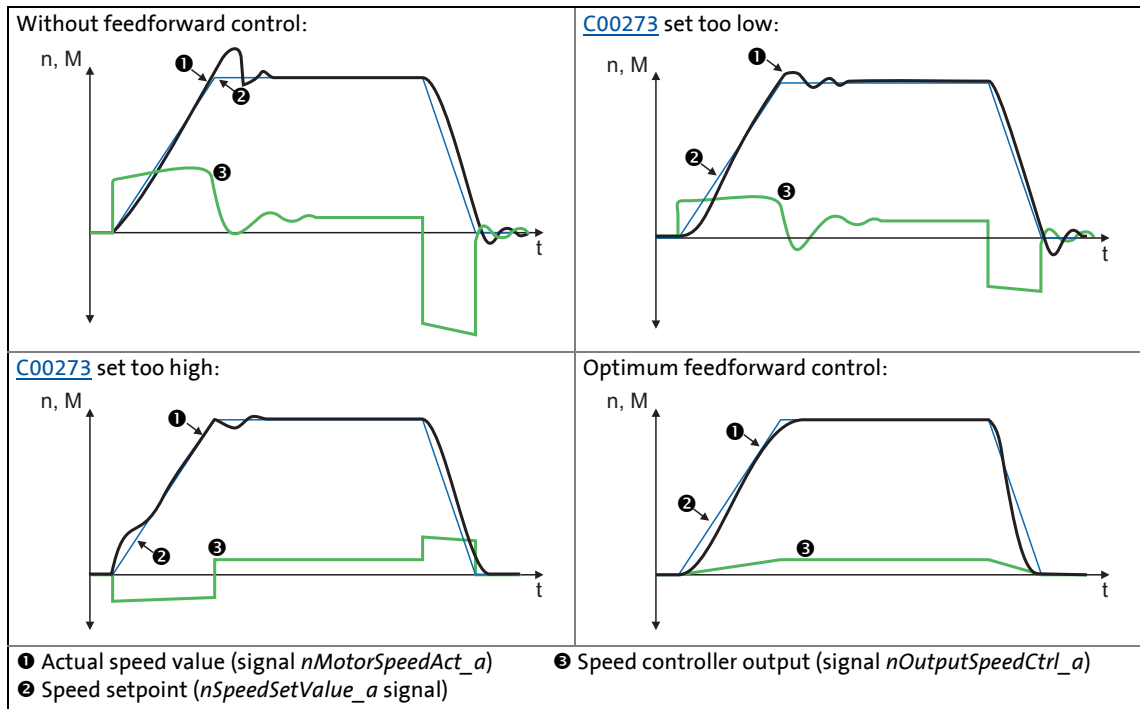

[5-15] Typical signal characteristics for different settings of the load moment of inertia



#### How to optimise the torque feedforward control:

- Run a typical speed profile and record the inputs and outputs of the speed controller with the data logger.
  - Motor control variables to be recorded:
    - nSpeedSetValue\_a* (speed setpoint)
    - nMotorSpeedAct\_a* (actual speed value)
    - nOutputSpeedCtrl\_a* (speed controller output)
- Estimate the moment of inertia and set it in [C00273](#) in relation to the motor end (i.e. with account being taken of the gearbox factors).
- Repeat the data logger recording (see step 1).
 

Now the data logger should show that part of the required torque is generated by the feedforward control and the speed controller output signal (*nOutputSpeedCtrl\_a*) is correspondingly smaller. The resulting following error decreases.
- Change the setting in [C00273](#) and repeat the data logger recording until the intended response to setpoint changes is reached.
  - The optimisation could aim at the speed controller being completely relieved (see signal characteristics in Fig. [5-15]).
- Save the parameter set (device command: [C00002/11](#)).



### Optimisation at variable mass inertia

From version V12.00.00, mass inertia that changes during the process (e.g. a reel) can be taken into account when optimising the response to setpoint changes.

#### How to proceed:

1. In [C00273](#) the known constant total moment of inertia (motor, gearbox, shaft, etc.) must be set or determined according to previous instructions ("[How to optimise ...](#)").
  - The determination requires travelling the typical speed profile without variable mass inertia (e.g. reels).
2. At the [LS\\_MotorInterface](#) SB, the *nInertiaAdapt\_a* process signal must be interconnected in a way which ensures that a value of "100 %" is applied at this input.
3. In [C00919/1](#) set the known maximum value of the variable moment of inertia or determine the value according to previous instructions ("[How to optimise ...](#)").
  - The determination requires travelling the typical speed profile including variable mass inertia (e.g. maximum reels).
4. The *nInertiaAdapt\_a* process signal can be used during the process to dynamically control the percentage of the variable moment of inertia set in [C00919/1](#) which is to be considered for setpoint feedforward control.

#### Example :

- If there is no variable moment of inertia (e.g. no reel), the *nInertiaAdapt\_a* process signal must be set to "0 %".
- If the maximally variable moment of inertia is available (e.g. maximum reels), the *nInertiaAdapt\_a* process signal must be set to "100 %".



#### Tip!

Via the *nTorqueSetValue\_a* process signal at the [LS\\_MotorInterface](#) SB, any differential signal can be defined for torque feedforward control. First the speed controller, then this additive torque is connected which is hence not derived from the differential change in speed setpoint.

### Other functions for differential setpoint feedforward control

From version V12.00.00 onwards, the following additional functions are available for differential setpoint feedforward control (torque feedforward control):

- In [C00653/1](#), the sensitivity of setpoint feedforward control can be adapted.
- In [C00654/1](#), alternatively to the *nSpeedSetValue\_a* process signal, the new *nSpeedSetValueInertia\_a* process signal for the setpoint feedforward control can be selected at the [LS\\_MotorInterface](#) SB. Via the *nSpeedSetValueInertia\_a* process signal, an optional input value (e.g. setpoint of the position or process controller) for the torque feedforward control can be specified.
- For *bTorqueModeOn* = TRUE, the setpoint feedforward control is added to the torque setpoint *nTorqueSetValue\_a*. In this way, feedforward control of torque is also possible for torque-controlled operation (e.g. for winder applications).

From version V18.00.00 onwards, the following additional functions are available for differential setpoint feedforward control (torque feedforward control):

- In [C00654/1](#), an exact torque feedforward control can be set for the *nSpeedSetValue\_a* speed setpoint. In case of a very dynamic application, set [C00654/1](#) = 2.
- From version V15.00.00 onwards, the torque feedforward control behaves differently than in version V14.00.00 or older. In order to achieve the same behaviour as in version V14.00.00 or older, set [C00654/1](#) = 3.



### Stop!

In the Lenze setting of [C00654/1](#), the speed setpoint of the speed controller (*nSpeedSetValue\_a*) is used for the torque feedforward control which is why it is also called "differential setpoint feedforward control". A very sharp change of the speed setpoint at the speed controller thus causes a strong torque impulse at the machine!

#### Causes for a very sharp change of the speed setpoint of the speed controller:

- A control creates the setpoint ramp itself and the speed setpoint is only written every 20 ms to the drive. (In this case, the speed setpoint is changed every 20 ms.)
  - Recommendation: Deactivate the torque feedforward control for the speed setpoint in [C00654/1](#) if the speed setpoint changes very sharply or the mass inertia is unknown (e.g. in case of hoists)!
- The reference speed [C0011](#) is much higher than the rated motor speed set in [C0087](#).
  - Recommendation: Deactivate the torque feedforward control for the speed setpoint in [C00654/1](#) if the reference speed [C0011](#) is 5 times higher than the rated motor speed [C0087](#).

#### 5.8.4.4 Current-dependent stator leakage inductance Ppp(I)

The current controller must be adjusted to the electrical characteristics of the motor stator resistance ([C00084](#)) and stator leakage inductance ([C00085](#)). In case of modern motors, the stator leakage inductance changes with the height of the current so that a new current controller setting is required for each current height.

When the motor is operated with very low and very high currents (e.g. in *Pick and place* applications), it is not always possible to achieve a satisfactory current controller setting for all operating points. For this purpose, the correction of the stator leakage inductance and current controller parameters is now possible via an adjustable saturation characteristic (17 interpolation points).

**Short overview of the relevant parameters:**

Parameters	Info	Lenze setting	
		Value	Unit
<a href="#">C02853/1...17</a>	PSM: Ppp saturation characteristic (17 interpolation points)	100	%
<a href="#">C02855</a>	PSM: I <sub>max</sub> L <sub>ss</sub> saturation characteristic	3000.0	A
<a href="#">C02859</a>	PSM: Activate Ppp saturation char.	0	Off



#### Note!

- The saturation characteristic is not only used for the correction of the current controller but also influences the current controller feedforward control ([C00079/1](#)).
- When a Lenze motor is selected from the »Engineer« motor catalogue, the corresponding saturation characteristic is set in [C02853/1...17](#) and – if required – the correction via this saturation characteristic is switched on in [C02859](#).
- For third-party motors: If the current controller becomes unstable with high currents, contact the motor manufacturer to find out whether the stator leakage inductance changes with the current level. If required, the saturation characteristic of this motor must be set in [C02853/1...17](#) and then activated in [C02859](#).

### Distribution of the grid points

- The saturation characteristic is represented by 17 interpolation points linearly distributed on the X axis ([C02853/1...17](#)).
- Interpolation point 17 represents 100 % of the maximum motor current in the process ([C02855](#)).
- The following diagram shows the saturation characteristic stored in the »Engineer« motor catalogue for the Lenze motor "MCS12H15" as an example:

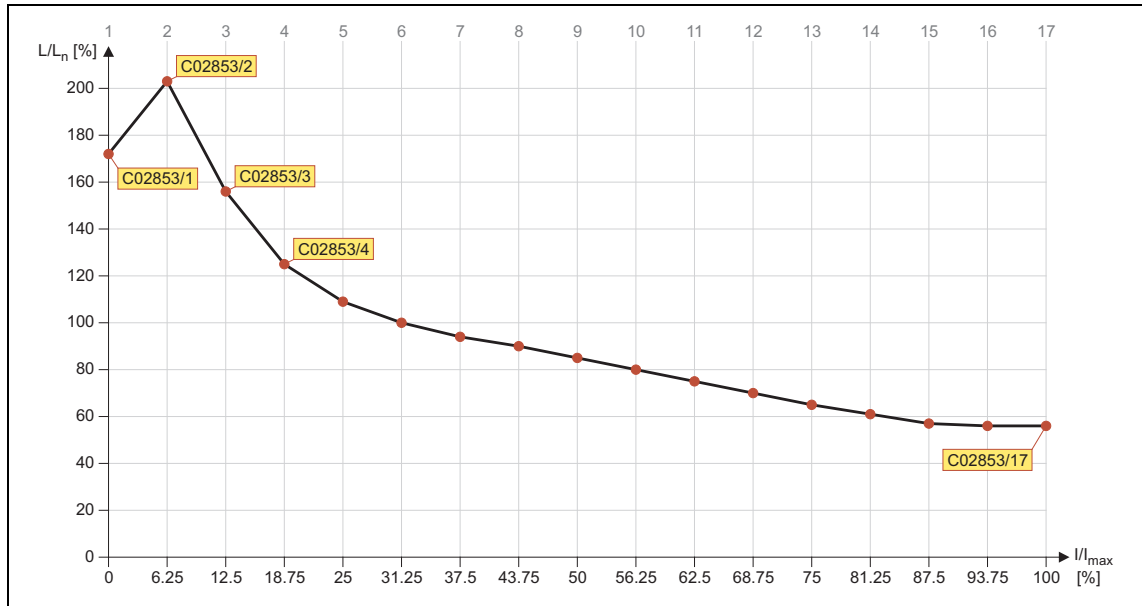

[5-16] Saturation characteristic: Inductance referring to the inductance for rated current

#### 5.8.4.5 Setting the current setpoint filter (band-stop filter)

Due to the high dynamic performance/limit frequency of the closed current control loop, mechanical natural frequencies can be activated which may lead to an unstable speed control loop.

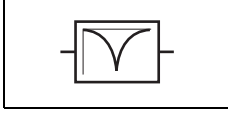

To mask out or at least damp these resonant frequencies, a so-called current setpoint filter is integrated into the speed control loop of the inverter.

Parameters	Info	Lenze setting	
		Value	Unit
<a href="#">C00270</a>	SC: Freq. current setpoint filter	200.0	Hz
<a href="#">C00271</a>	SC: Current setpoint filter width	0.0	Hz
<a href="#">C00272</a>	SC: Current setpoint filter depth	0	dB

- In the default setting of 0 db of the filter depth ([C00272](#)), the current setpoint filter is switched off.

#### Setting of the current setpoint filter

Since the frequency response of the speed controlled system is only rarely known to such an extent that the current setpoint filter can be adjusted to the controlled system in the run-up, the following example describes how to set the current setpoint filter.



#### How to set the current setpoint filter:

1. [Optimise current controller.](#) (📖 196)
2. [Optimise speed controller.](#) (📖 197)
3. Measure the oscillation frequency (observe current or speed).
4. Set the measured oscillation frequency in [C00270](#) as filter frequency.
5. Set "25%" of the filter frequency in [C00271](#) as filter width.
  - Example: Filter frequency = 200 Hz → filter width = 50 Hz.
6. Set "40 dB" in [C00272](#) as filter depth.
  - If the filter depth is set to "0 dB" (default setting), the filter is not active.



#### Note!

Readjust the speed controller after setting the current setpoint filter. ▶ [Optimise speed controller.](#) (📖 197)

#### 5.8.4.6 Adapting the max. acceleration change (jerk limitation)

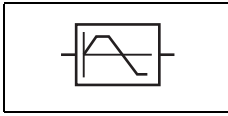

Via the max. acceleration change that can be set in [C00274](#), the change of the setpoint torque can be limited for jerk limitation. Hence, sudden torque step changes can be avoided. The entire speed characteristic is smoothed.

Parameters	Info	Lenze setting	
		Value	Unit
<a href="#">C00274</a>	SC: Max. change in acceleration	400.0	%/ms

In the default setting of 400 %/ms of the max. acceleration change ([C00274](#)), jerk limitation is switched off.

The setting defines the permissible maximum torque change per ms (based on the rated motor torque).



#### Note!

Only activate this jerk limitation for speed-controlled applications!

### 5.8.5 Pole position identification without motion

This function extension is available from version 11.00.00!

From version 11.00.00 onwards, when sensorless control is active for synchronous motors (SLPSM), the rotor displacement angle is identified with every controller enable in the Lenze setting and thus a jerk in the machine after controller enable can be avoided.

The "Pole position identification without motion" is able to identify the electrical rotor displacement angle with an accuracy of up to 10°. The identification takes 1 ... 15 ms depending on the motor. The function is preset in the Lenze setting so that no further settings need to be made in the majority of cases. In order to get the same behaviour as before, the function can be deactivated in [C02874](#).

#### Short overview of the relevant parameters:

Parameters	Info	Lenze setting	
		Value	Unit
<a href="#">C02874</a>	Pole position identification	1: On	
<a href="#">C02872</a>	PLI: adaptation of the PLI time period during operation	0	
<a href="#">C02875</a>	PLI: adaptation of the PLI ID angle during operation	0	°
<a href="#">C02870</a>	PLI: degree of optimisation	-	%
<a href="#">C02871</a>	PLI: duration of the identification process	-	ms
<a href="#">C02873</a>	PLI: rotor displacement angle identified	-	°

Greyed out = display parameter



#### Note!

For synchronous motors with a stator time constant < 1 ms, the pole position identification is not carried out because the resulting test current pulse may exceed the permissible motor current.

- This, however, concerns only few synchronous motors with a very low power (e.g. Lenze motor MDSKS-020-13-300 with a rated power of 40 W).
- A pole position identification that has not been carried out is indicated by [C02870](#) = 0 % and [C02871](#) = 0 ms.

- The stator time constant can be calculated on the basis of the following formula:

$$T_s[\text{ms}] = \frac{L_{ss}[\text{mH}]}{R_s[\Omega]}$$

$T_s$  = stator time constant

$L_{ss}$  = Motor stator leakage inductance ([C00085](#))

$R_s$  = Motor stator resistance ([C00084](#))

### Optimising the pole position identification



#### Stop!

When the setting in [C02872](#) is too high, an impermissible motor current may flow whilst the pole position identification is carried out. In this case, the "Fault" error response is triggered, and the "Id5: pole position identification error" error message is entered into the logbook.

With a setting in [C02872](#) that is **excessively high**:

- The following other current monitoring functions may be activated:
  - OC7: motor overcurrent
  - OC11: clamp operation active
  - OC1: Power section - short circuit
- In [C02870](#), the degree of optimisation "0 %" is shown.
- In [C02871](#), the time period "0 ms" is shown.



#### How to optimise the pole position identification without movement:

1. For the optimisation, execute controller enable at different rotor displacement angle.
2. After every controller enable, check the degree of optimisation shown in [C02870](#).  
The pole position identification is set optimally if a degree of optimisation in the range of 70 ...130 % is displayed in [C02870](#) after every controller enable.
3. If the degree of optimisation is > 130 %:  
reduce the setting in [C02872](#) step by step and execute controller enable at different rotor displacement angles until a degree of optimisation < 130 % is shown.
4. If the degree of optimisation is < 70 %:  
increase the setting in [C02872](#) step by step and execute controller enable at different rotor displacement angles until a degree of optimisation > 70 % is shown.
5. Optionally: via [C02875](#), the electrical rotor displacement angle identified can be increased or reduced. Due to the accuracy of the identification, this can for instance serve to prevent the motor from rotating backwards, if this is required by specific applications.



## 5.8.6 Field weakening for synchronous motors

This function extension is available from version 11.00.00!

**Note!**

In the Lenze setting, the field weakening for synchronous motors is activated in [C00079/4](#).

- If a high energy efficiency is required, keep the field weakening switched off or restrict the field weakening operation via [C00938](#).

**Stop!**

In the field weakening operation, a current is injected into the synchronous motor even in idle state which can rise to maximum current ([C00022](#)).

Ensure that this no-load current does not cause the motor to be heated impermissibly!

- We recommend using a temperature feedback via PTC or thermal contact. ▶ [Motor temperature monitoring \(PTC\)](#) (📖 253)

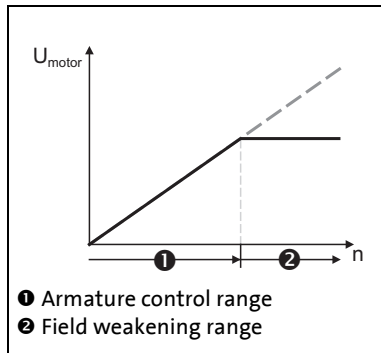

- When field weakening is switched on, the motor magnetising current is increased from 0 A to the maximally effective magnetising current via an internal control loop when the voltage limit is reached.
- As a result, a higher speed can be reached at the same motor voltage or DC-bus voltage.

[5-17] Voltage/speed characteristic with switched-on field weakening

$$n_{\max} = n_{\text{nenn\_mot}} \cdot \frac{800\text{V}}{\sqrt{2} \cdot U_{\text{nenn\_mot}}}$$

[5-18] Calculation of the maximally reachable speed with switched-on field weakening

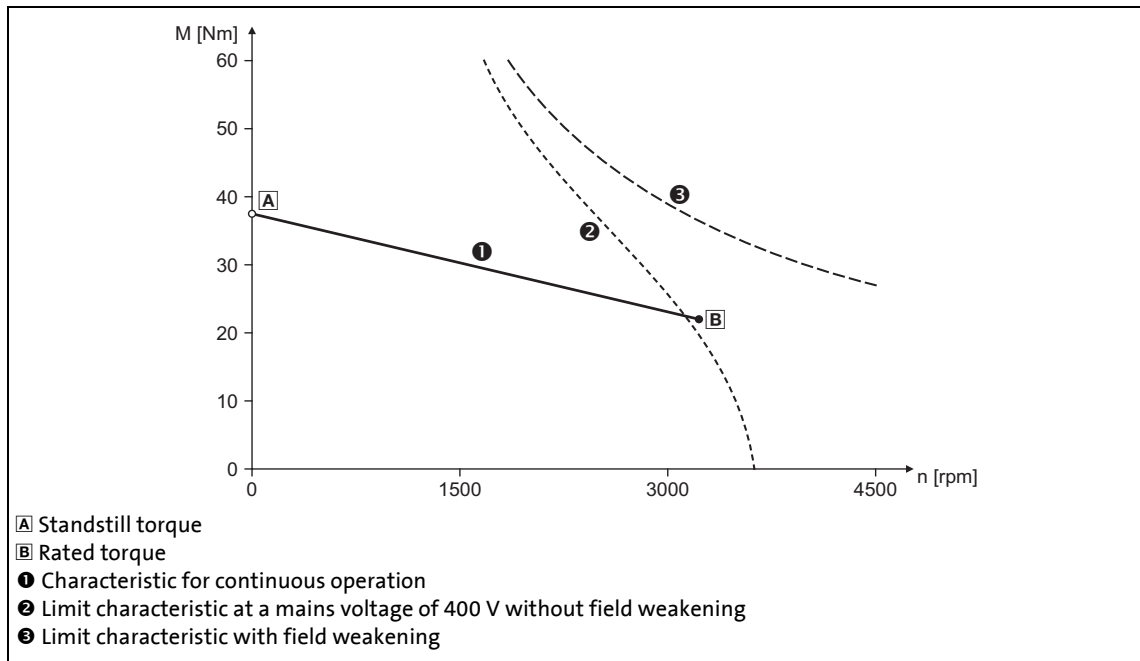

[5-19] Speed/torque characteristics of a synchronous servo motor with field weakening

#### Short overview of the relevant parameters:

Parameters	Info	Lenze setting	
		Value	Unit
<a href="#">C00079/4</a>	Field weakening	1	On
<a href="#">C00938</a>	Limitation of maximally effective field-producing motor current • With regard to rated motor current ( <a href="#">C00088</a> )	30	%
<a href="#">C00937/1</a>	Maximally effective field-producing motor current	-	A

Greyed out = display parameter

- The maximally effective field-producing motor current is calculated based on the motor data set in [C00085](#), [C00089](#) and [C00098](#). Then, the value is internally limited to 98 % of the set maximum current ([C00022](#) or maximally permissible current for the permanent switching frequency set in [C00018](#)).
- [C00938](#) serves to limit the maximally effective field-producing motor current as well.
  - In the Lenze setting, the field weakening for synchronous motors is active ([C00079/4](#)). However, the field-producing motor current is limited via [C00938](#) to 30 % of the rated motor current ([C00088](#)). Hence, the maximum speed is limited during field weakening operation and, at the same time, the temperature rise of the motor during field weakening operation and no-load operation is also limited.
  - If a higher speed for the field weakening operation is required or the current in the field weakening operation is to be limited (e.g. since no motor temperature detection is available and/or heating in the field weakening operation is to be limited), the value must be increased or reduced accordingly in [C00938](#).

- In [C000937/1](#), the actually used maximally effective field-producing motor current is displayed.
  - With switched-on and active field weakening: 0.00 A ... -x.xx A
  - With sensorless control for synchronous motors (SLPSM), the injected current is displayed in open-loop controlled operation: 0.00 A ... +x.xx A
  - If neither field weakening nor open-loop controlled operation are active, "0.00 A" is displayed.



### Note!

#### If a Lenze motor is used:

The inverter is automatically parameterised so that field weakening operates optimally and the maximally permissible speed is monitored.



### Stop!

#### If an OEM motor is used:

If pulse inhibit is set in the inverter, the DC bus is loaded with the voltage that corresponds to the current speed of the machine.

Since with switched-on field weakening higher speeds can be achieved at a correspondingly higher rotor voltage of the motor, the DC bus can be loaded to a voltage higher than the set DC-bus voltage in case of pulse inhibit and a currently high motor speed and even exceed the maximally permissible voltage of 800 V!

For device protection, either use a brake chopper or parameterise the motor speed monitoring via [C00965](#) in such a way that only a maximum speed is possible which would be also reachable without field weakening with a DC-bus voltage of = 800 V.

▶ [Motor speed monitoring](#) (📖 261)

#### Example: Voltage increase in the DC bus when field weakening is switched off

(For instance by an active setting of the controller inhibit or by tripping a fault or error at high motor speed.)

Field weakening	Speed n	Motor voltage peak value
Switched off	4000 rpm	560 V
	5700 rpm	800 V
	6000 rpm	840 V
Switched on	6000 rpm	560 V

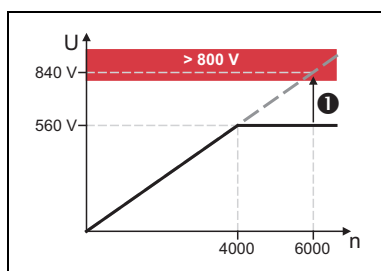

- If pulse inhibit occurs at 6000 rpm and switched-on field weakening, the DC bus is loaded to more than 800 V (❶).
- A speed limitation to 5700 rpm is required since this speed causes a DC-bus voltage of 800 V if field weakening is switched off.

[5-20] Example: Possible DC-bus voltage > 800 V if field weakening gets lost

## 5.9 Parameterisable additional functions

### 5.9.1 Selection of switching frequency

The switching frequency of the inverter that can be selected in [C00018](#) influences the smooth running performance and the noise generation in the connected motor as well as the power losses in the inverter.

The lower the switching frequency the higher the concentricity factor, the smaller the losses, and the higher the noise generation.



#### Stop!

If operated at a switching frequency of 16 kHz, the inverter output current must not exceed the current limit values specified in the technical data! (See "Rated data" section of the hardware manual.)



#### Note!

- Operate mid-frequency motors only at a switching frequency of 8 kHz or 16 kHz (var./drive-opt.).
- If operated at a switching frequency of 16 kHz, the Ixt evaluation ([C00064](#)) is considered including the required derating to 67 % of the rated device current at switching frequencies of 2.4 and 8 kHz.
- Ensure that the value does not fall below the permissible switching frequency,
  - if the motor is not approved for the setting switching frequency
  - or -
  - if a sinusoidal filter has been connected between the output of the inverter and the motor which is not approved for the setting switching frequency. (see section "[Preventing a decrease of the switching frequency](#)")

#### Short overview of the relevant parameters:

Parameters	Info	Lenze setting	
		Value	Unit
<a href="#">C00018</a>	Switching frequency	2: "8 kHz var./drive-opt."	
<a href="#">C00144</a>	Switching frequency reduction (temp.)	1: On	
<a href="#">C00725</a>	Current switching frequency	-	
<a href="#">C00910/1</a>	Max. pos. output frequency	1000	Hz
<a href="#">C00910/2</a>	Max. neg. output frequency	1000	Hz
<a href="#">C02864/1</a>	MCTRL: Special settings 2 Bit 4: Option "Motor ident: Switching frequency 8 kHz" (from version 14.00.00)	0x0000 (Off)	
Greyed out = display parameter			

### Settable switching frequencies

Selection in <a href="#">C00018</a>			
1	4 kHz var./drive-optimised	21	8 kHz var./drive-opt./4 kHz min
2	<b>8 kHz var./drive-optimised</b>	22	16 kHz var./drive-opt./4 kHz min
3	16 kHz var./drive-optimised	23	16 kHz var./drive-opt./8 kHz min
5	2 kHz constant/drive-optimised	31	8 kHz var./min. Pv/4 kHz min
6	4 kHz constant/drive-optimised	32	16 kHz var./min. Pv/4 kHz min
7	8 kHz constant/drive-optimised	33	16 kHz var./min. Pv/8 kHz min
8	16 kHz constant/drive-optimised	Abbreviations used: • "var.": Adaptation of the switching frequency depending on the current • "drive-opt.": drive-optimised modulation ("sine/delta modulation") • "fixed": fixed switching frequencies • "min. Pv": additional reduction of power loss	
11	4 kHz var./min. Pv		
12	8 kHz var./min. Pv		
13	16 kHz var./min. Pv		
15	2 kHz constant/min. Pv		
16	4 kHz constant/min. Pv		
17	8 kHz constant/min. Pv		
18	16 kHz constant/min. Pv		



#### Tip!

The Lenze setting [C00018](#) = "2: 8 kHz var.drive-opt." is the optimal value for standard applications.

### Preventing a decrease of the switching frequency

The value must not fall below the permissible switching frequency if the motor is not approved for the setting switching frequency or if a sinusoidal filter is connected between the output of the inverter and the motor that is not approved for the setting switching frequency.

In order to prevent a decrease of the switching frequency, the following settings have to be made:

1. The temporary switching frequency reduction has to be activated by the setting [C00144](#) = "0: Off".
2. The switching frequency has to be set in [C00018](#) so that the value is not fallen below the permissible switching frequency.
3. If a sinusoidal filter is available, only a drive-optimised switching frequency ("drive-opt.") is permissible.

#### Example :

A sinusoidal filter is connected between the output of the inverter and the motor which only is to be operated with a minimum switching frequency of 8 kHz.

In this case, only the following settings in [C00018](#) are permissible:

Selection in <a href="#">C00018</a>	
7	8 kHz constant/drive-optimised
8	16 kHz constant/drive-optimised
23	16 kHz var./drive-opt./8 kHz min



### Note!

#### Switching frequency for the motor parameter identification

Up to and including version 13.xx.xx, the motor parameter identification is executed with a switching frequency of 4 kHz.

- Thus, a motor parameter identification is not permissible for the previously mentioned example as the sinusoidal filter may only be operated with a minimum switching frequency of 8 kHz!

From version 14.00.00, the motor parameter identification can also be executed with a switching frequency of 8 kHz instead of 4 kHz. For this purpose, the option "Motor ident.: Switching frequency 8 kHz" (Bit 4 = "1") has to be set in [C02864/1](#).

- With this setting, a motor parameter identification would be permissible for the previously mentioned example.

Generally, a switching frequency of 4 kHz is recommended for the motor parameter identification as it serves to obtain the most accurate results.

▶ [Automatic motor data identification](#) (119)

#### Lowering the switching frequency due to high heatsink temperatures

Exceeding the maximally permissible heatsink temperature would lead to an inhibited drive due to the "Overtemperature" error and a torquelessly coasting motor. Therefore, if the Lenze setting is selected, the switching frequency is reduced to the next frequency below when the heatsink temperature has risen to 5 °C below the maximally permissible temperature. After the heatsink has cooled down, the inverter automatically switches to the next frequency above until the set switching frequency is reached.

Switching frequency reduction due to high heatsink temperature can be deactivated via [C00144](#). If the switching frequency reduction is deactivated, the "oH1: Heatsink overtemperature" error message will be issued when the maximally permissible heatsink temperature is reached. An "Error" response is the result and the motor is coasting.

Parameters	Info	Lenze setting
<a href="#">C00144</a>	Switching frequency reduction (temp.)	1: On

#### Lowering of the switching frequency depending on the output current

"Variable" switching frequencies can be selected for the inverter in [C00018](#), where the inverter automatically lowers the switching frequency depending on the inverter output current. The modulation mode will not be changed.



The changeover thresholds are listed in the **8400 hardware manual** in the rated data. The hardware manual has been stored in electronic form on the data carrier supplied with the 8400 inverter.

When a "fixed" switching frequency is selected, no switching frequency changeover takes place. In case of fixed frequencies, the inverter output current is limited to the permissible value of the corresponding switching frequency. In case of larger load impulses, the overcurrent interruption may be activated, to which the inverter responds with "Error".

---

### Limiting the maximum output frequency

The maximum output frequency ([C00910](#)) of the inverter is not limited depending on the switching frequency. Therefore, adapt the maximum output frequency according to our recommendation:

$$\text{Maximum output frequency} \leq \frac{1}{8} \text{ Switching frequency}$$

- At a switching frequency of 4 kHz, for instance, 500 Hz for the maximum output frequency should not be exceeded.

Carry out further measures:

- If required, deactivate the switching frequency changeover by the heatsink temperature via [C00144](#).
- If required, ensure that the changeover threshold of the inverter output current to the next switching frequency below will not be exceeded. If required, select a constant switching frequency in [C00018](#).

### Operation at an ambient temperature of 45°C

The inverter is designed so that operation at an ambient temperature of 45° C without derating is permissible at a switching frequency of 4 kHz.

### 5.9.2 Operation with increased rated power

Under the operating conditions described here and under continuous operation, the inverter can be operated with a higher power motor (increased rated power). The remaining overload capacity of the drive system (for 60 s/3 s) is reduced accordingly to approx. 120 %/160 %.

Typical applications stand out due to low dynamic requirements, e.g. pumps and fans, general horizontal materials handling technology and line drives.



The inverters which can be operated at an increased rated power are listed in the **8400 hardware manual** in the rated data. The hardware manual is stored in electronic form on the data carrier which is supplied with the 8400 inverter.



#### Stop!

Operation at increased rated power is only permitted ...

- with the inverters listed in the **8400 hardware manual** for this type of operation in the stated mains voltage range.
- at switching frequencies of 2 kHz and 4 kHz.
- at a max. ambient temperature of 40 °C.
- with the types of installation stated in the **8400 hardware manual**.
- with the fuses, cable cross-sections, mains chokes, and filters as required in the **8400 hardware manual** for this operation.
- after parameterisation according to the specifications below.

#### Required parameterisation

Operation at increased rated power requires the following settings to be made particularly for the V/f characteristic control (VFCplus), but also for all other types of control:

Parameters	Info	Required setting
<a href="#">C00016</a>	VFC: Vmin boost	adapt to motor (reduce)
<a href="#">C00018</a>	Switching frequency	1: 4 kHz var./drive-opt.
<a href="#">C00021</a>	Slip compensation	adapt to motor
<a href="#">C00120</a>	Setting of motor overload ( $I^2xt$ )	adapt to motor
<a href="#">C00123</a>	Device utilisat. threshold (lxt)	120   %
<a href="#">C00173</a>	Mains voltage	see hardware manual → Rated data



All other types of control require the following settings in addition:

Parameters	Info	Required setting
<a href="#">C00022</a>	I <sub>max</sub> in motor mode	higher than rated motor current (max. 160 % rated motor current)
<a href="#">C00081</a>	Rated motor power	adapt motor data (see motor nameplate), then carry out identification run ▶ <a href="#">Automatic motor data identification</a> (📖 119)
<a href="#">C00087</a>	Rated motor speed	
<a href="#">C00088</a>	Rated motor current	
<a href="#">C00089</a>	Rated motor frequency	
<a href="#">C00090</a>	Rated motor voltage	
<a href="#">C00091</a>	Motor cos φ	

### 5.9.3 Flying restart function

The flying restart circuit for asynchronous motors uses a simple motor model which requires knowledge of the motor stator resistance  $R_S$  and the rated motor current.



#### Note!

- Currently, the flying restart circuit is only available for asynchronous motors. (A flying restart circuit for synchronous motors is in preparation.)
- For a correct functioning of the flying restart circuit, we recommend to perform a parameter identification first. ▶ [Automatic motor data identification](#) (📖 119)
- The flying restart function works safely and reliably for drives with great centrifugal masses.
- Do not use the flying restart function if several motors with different centrifugal masses are connected to an inverter.
- After the controller is enabled, the motor can start for a short time or reverse when machines with low friction and low mass inertia are used.
- The flying restart function serves to identify max. field frequencies up to  $\pm 200$  Hz.
- When power-adapted standard asynchronous motors are used (rated motor power approximately corresponds to the rated inverter power), a motor parameter identification is not required.
- On drive systems with feedback, you do not need to use the flying restart function because the synchronisation to the speed detected by the feedback is always carried out in a jerk-free manner.
- Especially in case of very high power, very high mass inertia and a mains voltage higher than 440 V, an overvoltage in the DC bus may be caused temporarily. Using a brake resistor may avoid this behaviour.
  - From version 15.00.00, frequency can be set as a remedy in [C00989](#) which is added to the found flying restart frequency. Here, the setting in [C00989](#) has to be increased in small steps up to double the slip frequency until the behaviour does not occur anymore.



#### Tip!

In association with the flying restart function, we recommend information provided in this documentation on the following topic:

- ▶ [Automatic DC-injection braking \(Auto-DCB\)](#) (📖 222)

### General information

This function serves to activate a mode which is used to "catch" a coasting motor during operation without speed feedback. This means that the synchronicity between inverter and motor is to be adjusted in such a way that a jerk-free transition to the rotating machines is achieved in the instant of connection.

The inverter determines the synchronicity by identifying the synchronous field frequency.

### Duration

The "catching" process is completed after approx. 0.5 ... 1.5 seconds. The duration is influenced by the starting value. If the field frequency is not known, we recommend a fixed starting value of 10 Hz (or -10 Hz with systems rotating in negative direction).

### Short overview of the relevant parameters:

Parameters	Info	Lenze setting	
		Value	Unit
<a href="#">C00989</a>	Restart on the fly: Flying restart frequency $f_{d\_add}$ (from version 15.00.00)	0.00	Hz
<a href="#">C00990</a>	Flying restart fct.: Activate	Off	
<a href="#">C00991</a>	Flying restart fct.: Process	-n...+n   Start: +10 Hz	
<a href="#">C00992</a>	Flying restart: Start frequency	5	Hz
<a href="#">C00993</a>	Flying restart: Integration time	300	ms
<a href="#">C00994</a>	Flying restart: Current	25.00	%



### How to parameterise the flying restart function:

1. Activate the flying restart circuit by selecting "1: On" in [C00990](#).
  - Every time the controller is enabled, a synchronisation to the rotating or standing drive is carried out.

When the Lenze setting is used, most applications do not require additional inverter settings.

If additional settings are necessary, proceed as follows:

2. Define the process and hence the speed range/rotational frequency range in [C00991](#) which is to be examined by the flying restart circuit:
  - positive speed range ( $n \geq 0$  rpm)
  - negative speed range ( $n \leq 0$  rpm)
  - entire speed range
3. Define the starting frequency.

The starting frequency which defines the starting point of the flying restart function is 10 or -10 Hz for processes 0 ... 3 and has been pre-optimised for standard motors.

If process 4 is selected in [C00991](#), an arbitrary starting frequency can be defined via [C00992](#). This is especially recommended for motors with higher rated frequencies.

- We recommend to define a starting frequency of approximately 20 % of the rated motor frequency to enable a safe and fast connection to standing drive systems.
  - For systems with a known search speed (e.g. torque-controlled drive systems which are to synchronise to a defined speed) the starting value can be adapted to reduce the flying restart time.
4. Set the flying restart current in [C00994](#).

We recommend setting a flying restart current of 10 % ... 25 % of the rated motor current.

- During a flying restart process, a current is injected into the motor to identify the speed.
- Reducing the current causes a reduction of the motor torque during the flying restart process. A short-time starting action or reversing of the motor is prevented with low flying restart currents.
- An increase of the current improves the robustness of the flying restart function.
- At too high mass inertias and high speeds at the same time, the flying restart circuit may cause an overvoltage in the DC bus ("oU") if no brake resistor is connected. In this case, reduce the flying restart current.



### Tip!

#### Use of motors with higher rated frequencies

For trouble-free operation, we recommend to manually enter a starting frequency of 20 % of the rated motor frequency in [C00992](#) as well as to accelerate the flying restart process (see above) and to use a lower flying restart current (10 % of the rated motor current) if motors with higher rated frequencies are used.

#### Optimisation of the flying restart time

From version 05.00.00 onwards, the duration of the flying restart process can be influenced via the setting of the integration time ([C00993](#)). A reduction of the integration time causes the flying restart function to accelerate and thus a reduced flying restart time.

- We recommend not to change the Lenze setting of the integration time.
- When special motor are used (e.g. multi-pole motors or ASM servo motors), a reduced integration time may improve the flying restart behaviour.

#### Optimising the current controller if the behaviour is unstable

During the execution of flying restart function, peak currents/torques are avoided by controlling the current amplitude.

Gain ([C00075](#)) and reset time ([C00076](#)) of the current controller can be adapted to improve the jerk-free/torque-free connection of the inverter to the supply of the rotating motor.

- We recommend not to change the Lenze setting of the current controller.
- If the behaviour of the current controller is unstable, gain and reset time can be calculated as per the following formulae:

$V_p = \frac{L_{ss}[H]}{T_E[s]}$ $T_i = \frac{L_{ss}[H]}{R_s[\Omega]}$	<p><math>V_p</math> = Current controller gain (<a href="#">C00075</a>)  <math>T_i</math> = Current controller reset time (<a href="#">C00076</a>)  <math>L_{ss}</math> = Motor stator leakage inductance (<a href="#">C00085</a>)  <math>R_s</math> = Motor stator resistance (<a href="#">C00084</a>)  <math>T_E</math> = Equivalent time constant (= 500 <math>\mu</math>s)</p>
--	---

[5-21] Formulae for the calculation of the gain and reset time of the current controller

## 5.9.4 DC-injection braking

**Note!**

The DC-injection braking function (manually or automatically) is only possible for the following motor control modes:

- [V/f characteristic control \(VFCplus\)](#) (☰ 134)
- [V/f characteristic control - energy-saving \(VFCplusEco\)](#) (☰ 152)
- [V/f control \(VFCplus + encoder\)](#) (☰ 162)
- [Sensorless vector control \(SLVC\)](#) (☰ 169)

**Danger!**

Holding braking is not possible when this braking mode is used!

For low-wear control of a holding brake, use the basic function "[Holding brake control](#)". (☰ 416)

DC-injection braking allows the drive to be quickly braked to a standstill without the need to use an external brake resistor.

- The braking current is set in [C00036](#).
- The maximum braking torque to be generated by the DC braking current is approx. 20 ... 30 % of the rated motor torque. It is lower than that for braking in generator mode with an external brake resistor.
- The DC-injection braking can be activated manually via a control input of the application or automatically ("Auto-DCB"). The two different modes are described in the following subchapters.

**Tip!**

DC-injection braking has the advantage that it is possible to influence the braking time by changing the motor current or the braking torque..

The automatic DC-injection braking (Auto-DCB) improves the starting performance of the motor in case of V/f operation without speed feedback.

**Short overview of the relevant parameters:**

Parameters	Info	Lenze setting	
		Value	Unit
<a href="#">C00019</a>	Auto-DCB: Threshold • Operating threshold for activating DC-injection braking	3	rpm
<a href="#">C00036</a>	DC braking: Current • Braking current in [%] based on rated device current ( <a href="#">C00098</a> )	50	%
<a href="#">C00106</a>	Auto-DCB: Hold time	0.500	s
<a href="#">C00107</a>	DC braking: Hold time • When "999.000 s" is set, the hold time is infinite.	999.000	s

### 5.9.4.1 Manual DC-injection braking (DCB)

DC-injection braking can be activated manually for the two technology applications "speed actuating drive" and "switch-off positioning" by connecting the *bSetDCBrake* input of the [LA\\_NCtrl](#) or [LA\\_SwitchPos](#) application block to a digital signal source (e.g. via a digital signal source *bCtrl1\_B3* of the [LP\\_CanIn1](#) port block).

- For HIGH-active inputs, DC-injection braking is active as long as the signal is at HIGH level.
- After the hold time ([C00107](#)) has expired, the inverter set the pulse inhibit.

Short overview of the relevant configuration parameters:

Parameters	Info	Lenze setting
<a href="#">C00701/4</a>	<a href="#">LA_NCtrl</a> : <i>bSetDCBrake</i> <ul style="list-style-type: none"> <li>• "Speed actuating drive" application: Selection of the signal source for manually activating DC-injection braking.</li> </ul>	Dependent on the selected control mode
<a href="#">C00761/4</a>	<a href="#">LA_SwitchPos</a> : <i>bSetDCBrake</i> <ul style="list-style-type: none"> <li>• "Switch-off positioning" application: Selection of the signal source for manually activating DC-injection braking.</li> </ul>	Dependent on the selected control mode

### 5.9.4.2 Automatic DC-injection braking (Auto-DCB)

"Automatic DC-injection braking" (referred to in the following as "auto DCB") can be used if there is a requirement that the drive be isolated from the supply at  $n \approx 0$ .



#### Note!

**Deactivate automatic DC-injection braking when a holding brake is used!**

- For this purpose, go to [C00019](#) and set the auto DCB threshold to "0".
- Background: Controller inhibit is already activated by the [Holding brake control](#).  
([416](#))

#### Function

For understanding the auto DCB function, it is necessary to distinguish between three different types of operation:

- The drive has been enabled and, in the course of operation, the speed setpoint falls below the auto DCB threshold.
  - In case of V/f operation without speed feedback, a braking current ([C00036](#)) is injected. After the auto DCB hold time ([C00106](#)) has expired, the motor is deenergised via the auto DCB function, i.e. pulse inhibit is set.
  - In case of V/f operation with speed feedback, the motor is deenergised via the auto DCB function after the auto DCB hold time ([C00106](#)) has expired, i.e. pulse inhibit is set. The braking current which can be parameterised in [C00036](#) does not have any effect during operation with speed feedback.
- When the controller is enabled, the drive is at standstill ( $n = 0$ ).  
If the enabled drive is to start, the speed setpoint passed via the acceleration ramp must exceed the auto DCB threshold ([C00019](#)). Below this threshold, the motor will not be energised.

- C. When the controller is enabled, the motor (still) rotates at a speed which is above the auto DCB threshold. If the speed setpoint reached via the acceleration ramp exceeds the auto DCB threshold ([C00019](#)), the motor will be energised and the following action will take place:
- During V/f operation without speed feedback, the drive is "caught". ▶ [Flying restart function](#) ([□ 218](#))
  - During V/f operation with speed feedback, the drive synchronises to the current actual speed value.

**Tip!**

We recommend to deactivate the auto DCB function during V/f operation with speed feedback via a setting of [C00019](#) = 0.

### Auto DCB function during V/f operation with speed feedback

**Stop!**

If the DC-injection braking operation is too long and the braking current or braking voltage is too high, the connected motor may overheat!

If you want to use the auto DCB function contrary to our recommendation (see above), the auto DCB threshold must not fall below the following values depending on the number of encoder increments:

Number of encoder increments ( <a href="#">C00420</a> )	Auto-DCB threshold ( <a href="#">C00019</a> )
8	16
16	8
32	4
64	2
> 128	No restrictions

### Setting the auto-DCB function

**How to set the automatic DC-injection braking:**

1. Set a hold time in [C00106](#) > 0 s.
  - Automatic DC-injection braking is active for the time set.
  - In case of V/f operation without speed feedback, the braking set in [C00036](#) is injected.
  - After the set hold time has expired, the inverter sets pulse inhibit.
2. Set the operating threshold in [C00019](#).
  - The operating threshold can serve to set a dead band in the setpoint. If DC-injection braking is not to be active then, [C00106](#) must be set to a value of "0".

### Explanation of the automatic DC-injection braking function by means of two examples

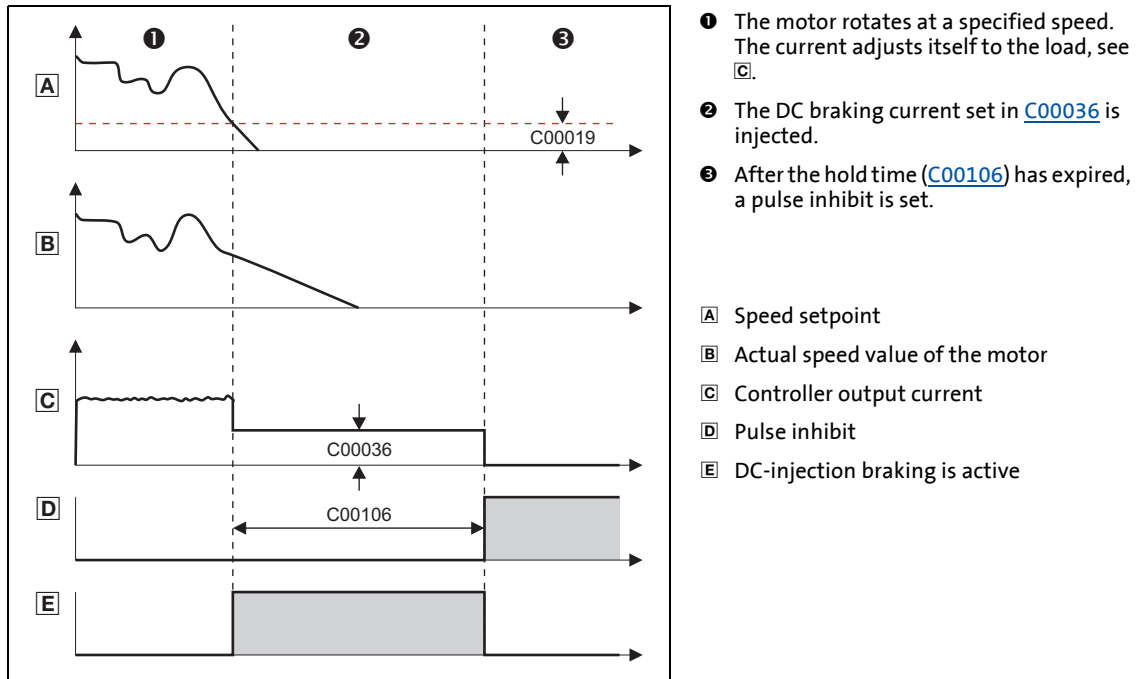

[5-22] Example 1: Auto-GSB signal characteristic during V/f operation without speed feedback

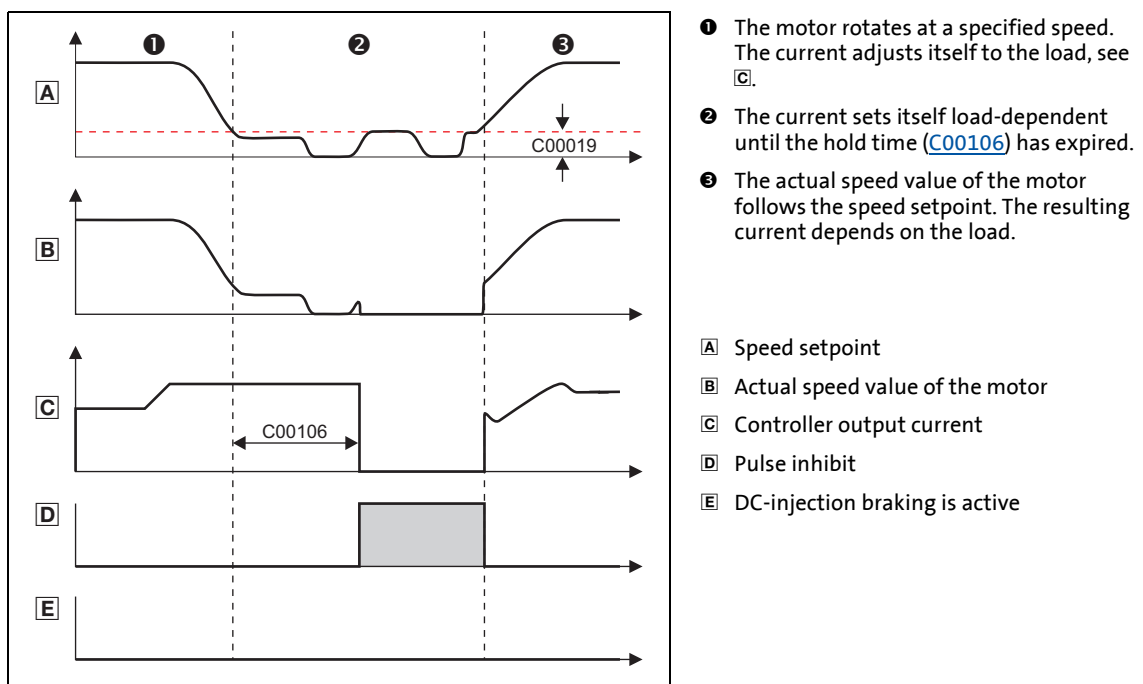

[5-23] Example 2: Auto-GSB signal characteristic during V/f operation with speed feedback



## 5.9.5 Slip compensation

**Note!**

Slip compensation is only active with the following motor control modes:

- [V/f characteristic control \(VFCplus\)](#) (☞ 134)
- [Sensorless vector control \(SLVC\)](#) (☞ 169)

Under load, the speed of an asynchronous motor decreases. This load-dependent speed drop is called slip. The slip can partly be compensated for by the setting in [C00021](#).

Parameters	Info	Lenze setting	
		Value	Unit
<a href="#">C00021</a>	Slip compensation	2.11	%

- The setting of [C00021](#) can be done automatically in the course of motor parameter identification. ▶ [Automatic motor data identification](#) (☞ 119)
- The setting must be made manually if the motor parameter identification cannot be called up.

**How to set the slip compensation manually:**

1. Set rated motor current ([C00088](#)) and rated motor frequency ([C00089](#)).
2. Calculate the slip compensation according to motor nameplate data:

$$s = \frac{n_{rsyn} - n_r}{n_{rsyn}} \cdot 100\%$$

$$n_{rsyn} = \frac{f_r \cdot 60}{p}$$

- $s$  Slip constant ([C00021](#)) [%]
- $n_{rsyn}$  Synchronous motor speed [rpm]
- $n_r$  Rated motor speed according to the motor nameplate [rpm]
- $f_r$  Rated motor frequency according to the motor nameplate [Hz]
- $p$  Number of motor pole pairs (1, 2, 3 ...)

3. Transfer the calculated slip constant  $s$  to [C00021](#).
4. Correct the setting in [C00021](#) while the drive is running until the load-dependent speed drop does not occur anymore between idling and maximum load of the motor in the desired speed range.

**Tip!**

The following guide value applies to a correctly set slip compensation:

- Deviation from the rated motor speed  $\leq 1\%$  for the speed range of 10 % ... 100 % of the rated motor speed and loads  $\leq$  rated motor torque.
- Greater deviations are possible in the field weakening range.
- If [C00021](#) is set too high, the drive may get unstable.
- Negative slip ([C00021](#) < 0) with V/f characteristic control results in "smoother" drive behaviour at heavy load impulses or applications requiring a significant speed drop under load.

### 5.9.6 Oscillation damping

Mechanical oscillations are undesirable effects in every process and they may have an adverse effect on the single system components and/or the production output.

Mechanical oscillations in the form of speed oscillations are suppressed by the oscillation damping function.

Mechanical oscillations may occur:

- In the voltage range (output voltage is lower than max. voltage)
  - Here, the oscillations occur in no-load operation.
  - Here, speeds of 40 ... 80 % of the rated speed are typical.
  - See subchapter "[Oscillation damping voltage range](#)". (☞ 227)
- In the field weakening range (output voltage has reached maximum voltage)
  - Here, the oscillations occur in no-load operation and with load.
  - Here, speeds higher than the rated speed are typical, especially when the output frequency is close to the mains frequency.
  - See subchapter "[Oscillation damping in the field weakening range](#)". (☞ 228)

### 5.9.6.1 Oscillation damping voltage range

The oscillation damping voltage range is successfully used with

- unloaded motors (no-load oscillations)
- motors whose rated power deviates from the rated power of the inverter.
  - e.g. during operation at high switching frequency including the power derating involved.
- operation with higher-pole motors
- operation with special motors
- compensation of resonance in the drive
  - At an output frequency of approx. 20 ... 40 Hz, some asynchronous motors can show resonance which causes current and speed variations and thus destabilise the running operation.

Parameters	Info	Lenze setting	
		Value	Unit
<a href="#">C00234</a>	Impact of oscillation damping	5.00	%
<a href="#">C00235</a>	Oscillation damping filter time	32	ms



#### Note!

Compensate the resonance during operation with feedback (closed loop, feedback of  $n_{act}$ ) via the parameters of the slip regulator.

▶ [Parameterising the slip regulator](#) (166)



**How to eliminate speed oscillations in no-load operation at speeds with 40 ... 80 % of the rated speed:**

1. Approach the area where the speed oscillations occur.
2. Reduce the speed oscillations by changing [C00234](#) step by step (increment 1 %).
  - The filter time oscillation damping ([C00235](#)) should not be changed.
3. These can be indicators for smooth running:
  - Constant motor current characteristic
  - Reduction of the mechanical oscillations in the bearing seat

### 5.9.6.2 Oscillation damping in the field weakening range

When the max. possible output voltage (full modulation) has been reached, a voltage dip in the DC bus causes a voltage fluctuation in the motor. With load and during no-load operation this voltage fluctuation can cause mechanical oscillations.

The "oscillation damping field weakening" adjustable in [C00236](#) serves to limit the maximum output voltage. This can be used to always compensate voltage dips in the DC bus to the output voltage (constant output voltage). This serves to prevent mechanical oscillations due to these voltage dips.

Parameters	Info	Lenze setting	
		Value	Unit
<a href="#">C00236</a>	Oscillation damping field weakening • Setting "0" ≙ 100 % output voltage can be reached	14	

- With the Lenze setting of [C00236](#) the limitation of the output voltage is set so that voltage dips in the DC bus in the output voltage for the single-phase and three-phase devices can largely be compensated so that no speed oscillations may be expected. Thus, an adaptation of [C00236](#) is not required in the majority of cases.
- Maximum output voltage to be reached with Lenze setting of [C00236](#):
  - Single-phase devices: 98.2 %
  - Three-phase devices: 99.7 %



#### Note!

The limitation of the output voltage via [C00236](#) in the extreme field weakening range (high speeds) causes a reduction of the max. possible output torque (stalling torque).

- If the output torque to be reached in the extreme field weakening range is not sufficient (motor is stalling too early), reduce the setting in [C00236](#).



#### How to eliminate speed oscillations in the field weakening range:

1. Approach the area where the speed oscillations occur.
2. Reduce the speed oscillations by changing [C00236](#) step by step (increment 1).
3. These can be indicators for smooth running:
  - Constant motor current characteristic
  - Reduction of the mechanical oscillations in the bearing seat

---

### 5.9.7 Phase sequence reversal for correcting misconnected UVW motor phases

This function extension is only available from version 04.00.00!

---



#### Note!

Up to and including version 11.00.00, this function may only be activated for the following motor control types:

- [V/f characteristic control \(VFCplus\)](#) (☰ 134)
- [V/f characteristic control - energy-saving \(VFCplusEco\)](#) (☰ 152)

For all other motor control types, this function must not be activated because the set control mode would not work in that case!

From version 12.00.00, this function may be activated for all motor control types with the exception of the ones for synchronous motor.

The activation of this function does not affect the control types for synchronous motor since these control types require an in-phase connection of the synchronous motor.

If the motor phases are misconnected at the inverter output (e.g. phase u takes the place of phase v), the motor will rotate in the wrong direction.

To correct such misconnected motor phases, the rotating field of the inverter's output can be reversed by selecting "1: Inverted" in [C00905](#). In this case, a phase will be reversed at the output of the inverter.

This function does not have any effect on setpoints and actual values, i.e. the polarity of the speed setpoint/actual speed value, actual torque, output frequency, and AngleOffset do not change.



#### Tip!

Cases of application for this function:

- Phase sequence reversal in case of misconnected motor phases.
- Setting of the correctly signed direction of rotation for inversely mounted motors.

### 5.10 Encoder/feedback system

For motor control with speed feedback, the feedback signal can be fed to the digital terminals (DI1/DI2) via an HTL encoder.



#### Danger!

- To avoid interference injections when an encoder is used, only use shielded motor and encoder cables.
- If an HTL encoder is used at the digital input terminals:  
Observe the maximum input frequencies of the digital inputs!
  - DI1/DI2: max. 10 kHz
- Generally, we recommend the use of encoder signals with increments  $\geq 4$ 
  - With increments  $< 4$ , the evaluation may cause implausible values or a number range overflow may occur when further processing the value.
  - Increments  $> 2$  are at least required for encoder signals that are exclusively processed in the FB interconnection.



#### Note!

In the Lenze setting (e.g. when the device is delivered), the open-circuit monitoring of the encoder is activated. ▶ [Encoder open-circuit monitoring](#) (📖 262)



Wiring diagram, assignment and electrical data of the digital input terminals can be found in the **hardware manual 8400** in the chapter "technical data". The hardware manual is stored in electronic form on the data carrier supplied with the 8400 inverter.

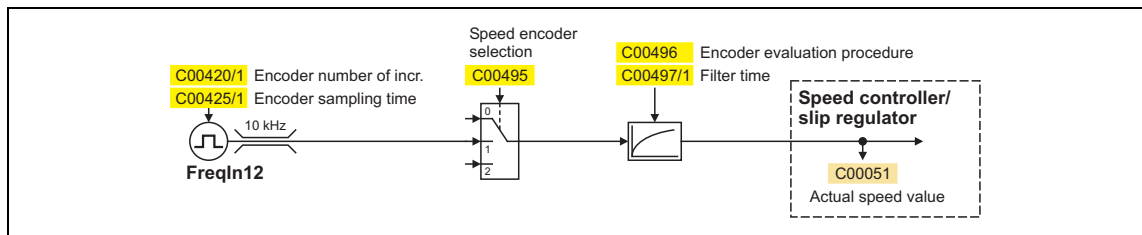

[5-24] Signal flow - encoder interface



### How to get to the parameterisation dialog of the encoder/feedback system:

1. »Engineer« Go to the *Project view* and select the 8400 StateLine inverter.
2. Select the **Application parameters** tab from the *Workspace*.
3. Go to the *Overview* dialog level and click the following button:

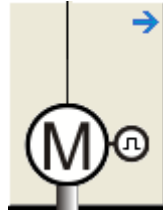

4. Go to the *Overview* → *Motor data* dialog level and click the **Encoder/Feedback system...** button.

### Parameterisation dialog in the »Engineer«

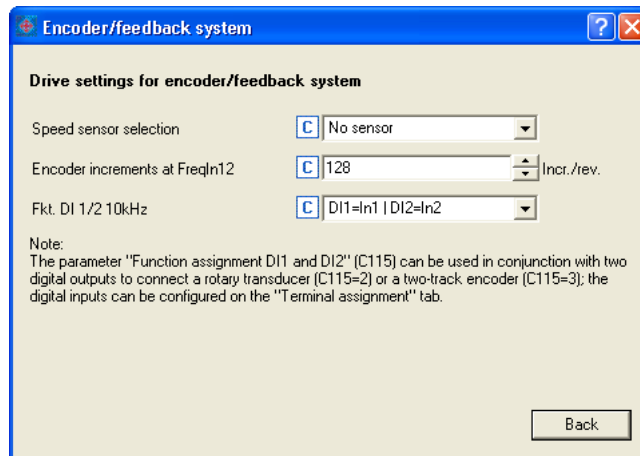

### Short overview of the relevant parameters:

Parameters	Info	Lenze setting	
		Value	Unit
<b>Encoder selection / General settings</b>			
<a href="#">C00495</a>	Speed sensor selection • Source of feedback signal for speed control.	0: No sensor	
<a href="#">C00490</a>	Position encoder selection • From version 12.00.00 • Selection of the speed signal, the <i>dnMotorPosAct_p</i> position signal is derived from.	0: no sensor: nSpeedSetValue_a	
<b>Settings for HTL encoder at DI1/DI2</b>			
<a href="#">C00115/1</a>	Fct. DI 1/2 10kHz • Function of the digital inputs DI1 and DI2	0: DI1=In1   DI2=In2	
<a href="#">C00420/1</a>	FreqIn12: Encoder increment • If the digital inputs DI1 and DI2 are used as encoder inputs.	128	Inc./rev.
<a href="#">C00425/1</a>	FreqIn12: Encoder scanning time • If the digital inputs DI1 and DI2 are used as encoder inputs.	10	ms
Greyed out = display parameter			

# 5 Motor control (MCTRL)

## 5.10 Encoder/feedback system

Parameters	Info	Lenze setting	
		Value	Unit
<a href="#">C00497/1</a>	FreqIn12: Encoder filter time • If the digital inputs DI1 and DI2 are used as encoder inputs.	1.0	ms
<a href="#">C00496</a>	▶ <a href="#">Encoder evaluation method DigIn12</a> (📖 235)	1: Low-resolution encoder (StateLine)	
<a href="#">C00055/1</a>	Actual value - HTL encoder FreqIn12	-	rpm
<b>Monitoring</b>			
<a href="#">C00586</a>	Resp. to encoder open circuit HTL ▶ <a href="#">Encoder open-circuit monitoring</a> (📖 262)	1: Fault	
Greyed out = display parameter			



### General procedure

(if the encoder is connected to the digital inputs DI1 and DI2)

1. Define the function of the digital inputs DI1 and DI2 in [C00115/1](#).
2. Set the encoder increments in [C00420/1](#).
3. Select "1: Encoder signal FreqIn12" in [C00495](#).
4. Adapt the filter time of the speed measurement in [C00497/1](#).

### 5.10.1 Parameterising digital inputs as encoder inputs

Define the function of the digital inputs DI1 and DI2 in [C00115/1](#).

To be able to use the digital inputs as encoder inputs, select 2, 3, or 4 (Lenze recommendation: 2) in [C00115/](#) depending on the input terminals used.

Selection in <a href="#">C00115/1</a>	Function
2: (DI1/DI2)=FreqIn12 (2-track)	DI1 and DI2 = 2-track frequency input • Permits a two-track evaluation of the encoder including correct detection of the direction of rotation.
3: (DI1/DI2=+-)=FreqIn12	DI1 = 1-track frequency input DI2 = specification of direction
4: DI1=CountIn1   DI2=In2	DI1 = counter input DI2 = digital input



### Danger!

For single-track evaluation, make sure that the sign is correctly specified. Otherwise, the motor may overspeed.



### Note!

If the digital inputs are parameterised as encoder inputs, the corresponding output signals (*bIn1/bIn2*) at the [LS\\_DigitalInput](#) system block are automatically set to FALSE.



The wiring diagram and assignment of the input terminals are described in the **8400 hardware manual**. The hardware manual has been stored in electronic form on the data carrier supplied with the 8400 inverter.

### Related topics:

- ▶ [Digital terminals](#) (📖 274)
- ▶ [Using DI1 and DI2 as frequency inputs](#) (📖 279)

### 5.10.2 Generation of the actual speed value

Up to and including version 11.xx.xx the following applies:

- For motor control types without speed feedback ([C00495](#) = "0: No encoder") a speed-proportional unit is taken for calculating the *nMotorSpeedAct\_v* speed signal. This derivation, however, is very imprecise so that in case of applications with synchronous motors without speed feedback it is not possible to calculate the current position from the current *nMotorSpeedAct\_v* speed signal.
- The *dnMotorPosAct\_p* position signal is always derived from the *nSpeedSetValue\_a* speed setpoint. This derivation, however, is very imprecise since in this case, speed limitations (e.g. by overcurrent limitations) are not considered.

From version 12.00.00 the following applies:

- For applications with synchronous motors without speed feedback, an *nMotorSpeedAct\_v* error-free speed signal is available. This is calculated from the electrical output angle considering the number of pole pairs of the *nMotorSpeedAct\_v* speed signal.
- When synchronous or reluctance motors without feedback are used in the motor control types [V/f characteristic control \(VFCplus\)](#) and [Sensorless control for synchronous motors \(SLPSM\)](#), the *nMotorSpeedAct\_v* speed signal can be used to create an error-free position signal via a control if the *nMotorSpeedAct\_v* signal is read out by the control in a 1 ms cycle.
- The speed signal for deriving the *dnMotorPosAct\_p* position signal can now be selected in [C00490](#). In the Lenze setting, the position signal is continued to be derived from the *nSpeedSetValue\_a* speed setpoint. If, however, "10: No encoder: C495 or nMotorSpeedSetAct\_v" is selected, the position signal is either calculated from the set speed feedback (if [C00495](#) > 0) or from the *nMotorSpeedAct\_v* speed signal (if [C00495](#) = 0).
  - For all motor control types without speed feedback, this selection serves to improve the creation of the *dnMotorPosAct\_p* position signal.
  - When synchronous or reluctance motors without feedback are used, the *dnMotorPosAct\_p* position signal can be created correctly.
  - In case of the motor control types with speed feedback, the *dnMotorPosAct\_p* position signal is directly created from the speed feedback signal.

### 5.10.3 HTL encoder at DI1/DI2



#### Note!

At the digital terminals DI1 and DI2, only encoders with HTL level can be used.

In spite of the selected operating mode without encoder feedback, the actual speed value ([C00051](#)) is calculated if an encoder is connected and "1: Encoder signal FrqIn12" is selected in [C00495](#).

#### Encoder evaluation method DigIn12

Depending on the encoder used at the digital terminals DI1 and DI2, the following table specifies which evaluation method should be selected in [C00496](#):

Selection in <a href="#">C00496</a>	Encoder evaluation method
1: Low-resolution encoder (Lenze setting)	High-precision procedure for low-resolution encoders (<=128 increments) <ul style="list-style-type: none"> <li>• Exact method for speed measurement with automatic scanning time setting (0.5 ... 500 ms) for low-resolution encoders in the range of 4 ... 128 increments.</li> <li>• Evaluation with automatic scanning time minimisation for an optimum dynamic performance.</li> <li>• Method is also suited for encoders with poor signal quality, e.g. for encoders with high error rate in scanning ratio and phase offset.</li> <li>• This method requires an equidistant period length per encoder increment.</li> <li>• Wiring according to EMC (e.g. motor and encoder cable shielding) is required!</li> </ul>
3: Edge-counting procedure	Simple edge counting procedure with adjustable scanning time ( <a href="#">C00425</a> ) <ul style="list-style-type: none"> <li>• Speed measurement by means of the edges of tracks A and B measured per scanning interval.</li> <li>• Integrated correction algorithm for EMC interference.</li> <li>• Limited suitability for systems with unshielded encoder and/or motor cable.</li> <li>• Limited suitability for encoders with poor signal quality, i.e. high error rate in scanning ratio and phase offset.</li> </ul>



#### Tip!

We recommend the use of the preset procedure for low-resolution encoders ([C00496](#) = 1). This procedure can also be used for dynamic applications (e.g. V/f + encoder).

### Low speeds (except for edge counting)

For the first method ([C00496](#) = 1), the minimum speed that can be measured depends on the encoder resolution.

The quantisation error

- is independent of the encoder resolution,
- exclusively depends on the encoder quality (encoder errors).
- at least amounts to 0.5 rpm.

Internal arithmetic operations automatically maintain the minimally required value of the scanning time in order to achieve maximum dynamics.

Encoder resolution (Number of increments)	Min. measurable speed in [rpm]
8	16
16	8
32	4
64	2
128	1
256	0.5

### Low speeds with edge counting

The minimum speed that can be measured and the quantisation error of speed measurement in the edge-counting procedure ([C00496](#) = 3) depend on the scanning time that can be set in [C00425/1](#) and the encoder resolution.

Depending on accuracy and the requirements with regard to the dynamic performance, the respective scanning time must be selected and set in [C00425/1](#):

Encoder resolution (Number of increments)	Scanning time [ms]									
	1	2	5	10	20	50	100	200	500	1000
	Min. measurable speed in [rpm]									
8	1875	938	375	188	93.8	37.5	18.8	9.4	3.8	1.9
16	938	469	188	94	46.9	18.8	9.4	4.7	1.9	0.9
32	469	234	94	46.9	23.4	9.4	4.7	2.3	0.9	0.5
64	234	117	46.9	23.4	11.7	4.7	2.3	1.2	0.5	0.2
128	117	58.6	23.4	11.7	5.9	2.3	1.2	0.6	0.2	0.12
256	58.6	29.3	11.7	5.9	2.9	1.2	0.6	0.3	0.12	0.06

---

## 5.11 Braking operation/brake energy management

When braking electrical motors, the kinetic energy of the drive train is fed back regeneratively to the DC bus. This energy results in a boost of the DC-bus voltage.

- Several different strategies can serve to avoid DC-bus overvoltages:
  - Use of a brake resistor
  - Stopping of the ramp function generator if brake chopper threshold exceeded (RFG\_Stop)
  - Use of the "inverter motor brake" function ([from version 04.00.00](#))
  - Combination of the above named options
- In the case of inverters with a 3-phase supply, the following is also possible:
  - Coupling of the inverters in a DC-bus connection
  - Recovery of regenerative energy with a regenerative module



### Stop!

If the connected brake resistor is smaller than required, the brake chopper can be destroyed!

- Appropriate protective measures are described in subchapter "[Avoiding thermal overload of the brake resistor](#)". (📖 245)

If no brake resistor or regenerative module is used, the overvoltage switch-off ("oU") may respond, e.g. in case of short deceleration times during feedback operation. ▶ [Error messages of the operating system](#) (📖 459)

### Using the integrated brake chopper

We recommend to use the brake chopper (brake transistor) which is integrated into the inverter for the braking operation, regardless of the selected motor mode.

- Connect the required brake resistor to the  $R_{B1}$  and  $R_{B2}$  terminals of the inverter.
- In [C00175](#), a ramp function generator stop (FB [L\\_NSet\\_1](#)) can be set for instances when the brake resistor is controlled. This prevents overvoltage deactivation in the case of short deceleration times. ▶ [Selecting the response to an increase of the DC-bus voltage](#) (📖 240)



#### Note!

The brake transistor will be switched off if it remains switched on for a period of 4 seconds.

- If the DC-bus voltage falls under the brake chopper threshold for a short time again, the brake transistor can switch on again for a maximum of 4 seconds, without interruption.
- This protective function is used to prevent the brake chopper from being switched on permanently due to e.g. too high voltages at all times or incorrect interconnection of the *bBrakeChopperOn* signal (from version V12.00.00).
- From version 14.00.00, the limitation of the operating time can be deactivated to max. 4 seconds. For this purpose, set bit 1 to "1" in [C02864/1](#).

The integrated brake chopper is always triggered via the DC-bus voltage with exceedance of the "voltage threshold for braking operation" independent of the device status.

From version 14.00.00, the brake chopper can also be switched off at pulse inhibit or when the "Fault" device status is activated.

- For a switch-off at pulse inhibit, set bit 7 to "1" in [C02865/1](#).
- For a switch-off in the "Fault" device status, set bit 2 to "1" in [C02864/1](#).

### DC-bus system

For a DC-bus connection with other devices, we recommend to connect the regenerative power supply module to terminals +UG and –UG.



#### Note!

DC-bus system without the use of a regenerative module:

- [Up to and including version V11.xx.xx](#), only one internal brake chopper can be used in the DC-bus system to dissipate regenerative energy.
- From version V12.00.00, all internal brake choppers can be used in the DC-bus system to dissipate regenerative energy ("Master-slave operation"). ▶ [Control of multiple internal brake choppers in the DC-bus system](#) (📖 245)



In order to install the regenerative module, follow the notes in the **8400 hardware manual**. The hardware manual has been stored in electronic form on the data carrier supplied with the 8400 inverter.



Proceed as follows to open the dialog for parameterising the brake energy management:

1. »Engineer« Go to the *Project view* and select the 8400 StateLine inverter.
2. Select the **Application parameters** tab from the *Workspace*.
3. Go to the *Overview* dialog level and click the "basic functions" button.
4. Go to the *Overview* → *basic functions* dialog box and click the **Brake energy management** button.

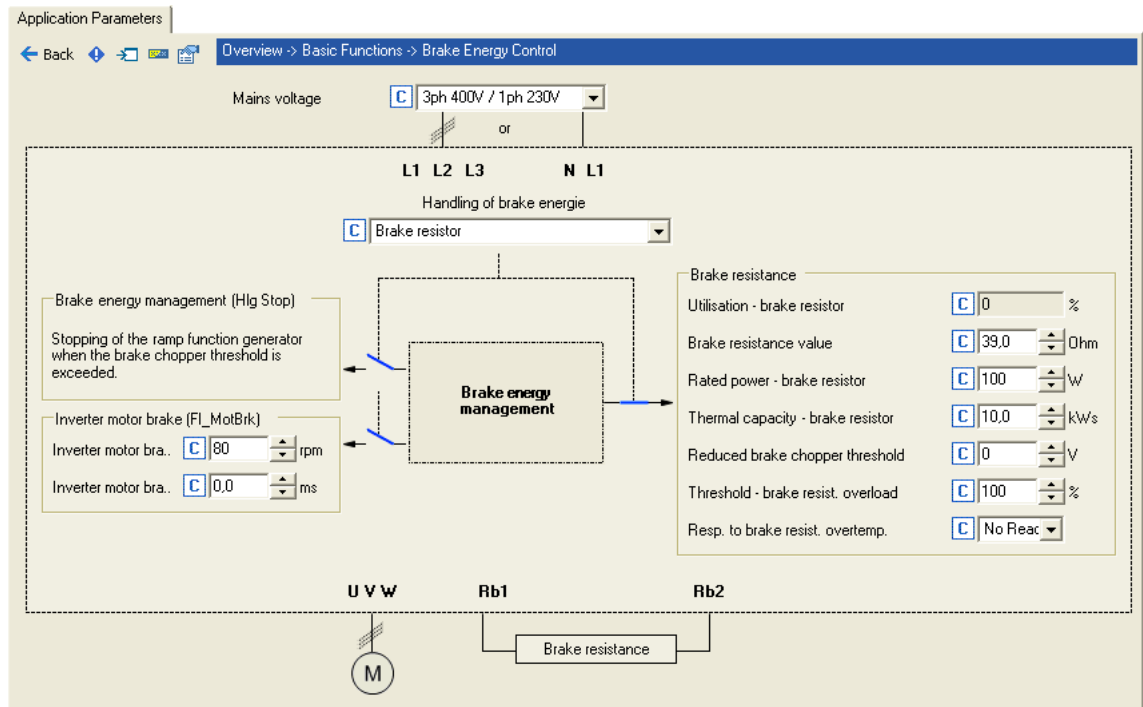

Short overview of the relevant parameters:

Parameters	Info	Lenze setting	
		Value	Unit
<a href="#">C00173</a>	Mains voltage	3ph 400 V / 1ph 230 V	
<a href="#">C00175</a>	Brake energy management	R_Brake (brake resistance)	
<b>Brake resistor</b>			
<a href="#">C00133</a>	Brake resistor utilisation	-	%
<a href="#">C00129</a>	Brake resistance value	39.0	Ohm
<a href="#">C00130</a>	Rated brake resistor power	100	W
<a href="#">C00131</a>	Thermal capacity - brake resistor	10.0	kW/s
<a href="#">C00174</a>	Reduced brake chopper threshold	0	V
<a href="#">C00572</a>	Threshold - brake resist. overload	100	%
<a href="#">C00574</a>	Resp. to brake resist. overtemp.	No response	
<b>Inverter motor brake</b>			
<a href="#">C00987</a>	Inverter motor brake: nAdd	80	rpm
<a href="#">C00988</a>	Inverter motor brake: PT1 filter time	0.0	ms

Greyed out = display parameter

### 5.11.1 Setting the voltage source for braking operation

The voltage threshold for braking operation is set via the mains voltage ([C00173](#)) and the reduced brake chopper threshold ([C00174](#)). When this "brake chopper threshold" is exceeded, the response selected in [C00175](#) takes place in the DC bus. The selected function (e.g. use of a brake resistor) serves to dissipate energy in the DC bus and reduce the DC-bus voltage.

- The "brake chopper threshold" is preset as follows so that it is higher than the specified mains voltage ([C00173](#)):

C00173	Mains voltage		Brake chopper threshold	
	1-phase	3-phase	1-phase	3-phase
0	1ph 230V	3ph 400V	DC380V	DC725V
1	1ph 230V	3ph 440V	DC380V	DC735V
2	1ph 230V	3ph 480V	DC380V	DC775V
3	1ph 230V	3ph 500V	DC380V	DC790V

- This brake chopper threshold can be reduced by 0 ... 150 V by means of [C00174](#).



#### Stop!

The brake chopper threshold resulting from [C00173](#) and [C00174](#) must not fall below the stabilised DC-bus voltage!

#### Example :

- A 400 V device has a maximum mains voltage of 420 V AC.
  - Maximum stationary DC-bus voltage:  $420 \text{ V AC} \cdot 1.414 = 594 \text{ V DC}$
  - [C00173](#) has been set with the selection "0" for 400 V AC mains.
- This means that [C00174](#) can be set to a maximum of 131 V DC (725 V DC - 594 V DC).

### 5.11.2 Selecting the response to an increase of the DC-bus voltage

If the brake chopper threshold resulting from [C00173](#) and [C00174](#) is exceeded in the DC bus, the reaction selected in [C00175](#) takes place (use of the brake resistor and/or stop of the ramp function generator and/or inverter-motor brake).

- Optimum following of the actual speed value until the speed setpoint is reached (e.g. the motor is stopped rapidly) is always achieved with the help of a brake resistor.
- Stopping the ramp function generator enables smoother deceleration with lower torque oscillation..
- The inverter motor brake is available in [C00175](#) from version 04.00.00 onwards. This function enables rapid braking without a brake resistor. Torque oscillations can occur due to the traversing dynamics. ▶ [Inverter motor brake](#) (☞ 242)





## Stop!

- The two braking procedures "Stopping of the ramp function generator" and "Inverter motor brake" can only be used for speed-controlled applications without the influence of a position controller!
- When the "inverter motor brake" function is used, the [Motor overload monitoring \(I2xt\)](#) is not adapted. If it is braked too frequently, there is a risk of the motor being thermally overloaded or the motor overload monitoring does not work properly!
- The "inverter motor brake" function must not be used with vertical conveyors (hoists) or with active loads!

The way in which the different braking procedures work is demonstrated schematically in the following illustration:

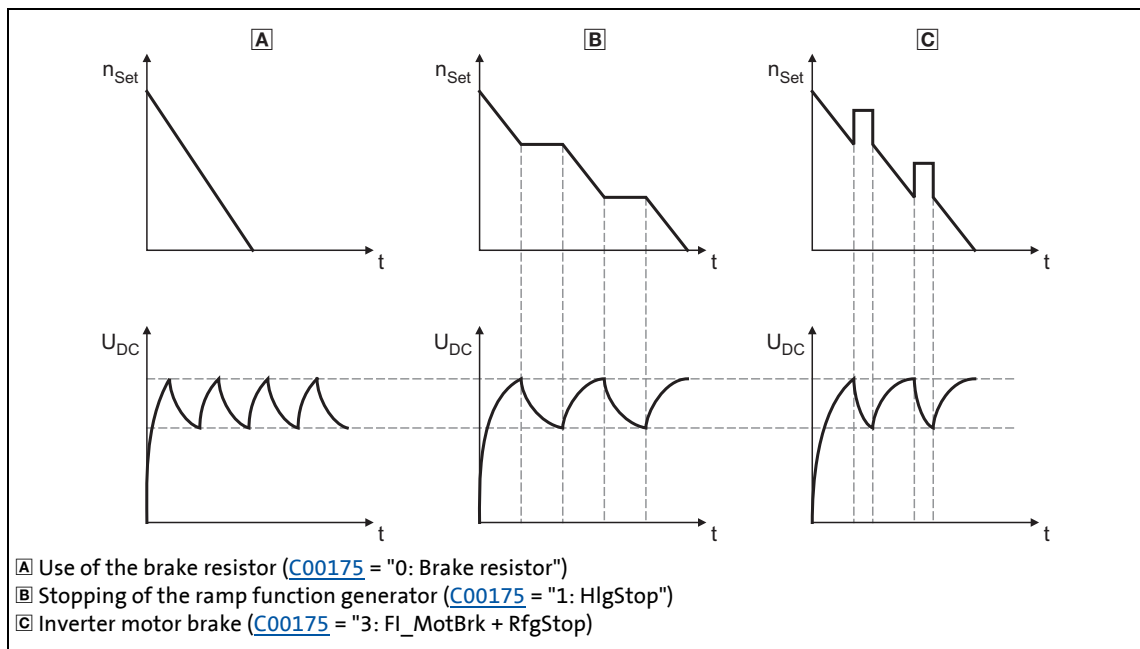

[5-25] Graph of the effective speed setpoint and the DC bus voltage during braking



### Tip!

Independent of the selected motor control, all procedures given in [C00175](#) can be used. The actual speed value always follows the speed setpoint in an optimal way when a brake resistor is used.

If it is possible to dispense with exact adherence to the deceleration ramp in simple applications, selection of a braking method without an external brake resistor enables costs to be reduced due to the avoidance of having to use a brake resistor.

With the "inverter motor brake" function, an effective braking torque of 10 ... 20 % of the rated motor torque can be achieved.

A combination of all three braking procedures is also possible, e.g. for emergency braking if the brake resistor fails

([C00175](#) = "4: Brake resistor + FI\_MotBrk + RfgStop").

### 5.11.2.1 Inverter motor brake

This function extension is only available from version 04.00.00!

With this braking method, which can be selected as an alternative in [C00175](#), the regenerative energy in the motor is converted as a result of dynamic acceleration/deceleration with down-ramping of the ramp function generator..



#### Stop!

- This braking method only works without intervention of a position controller in the case of speed-controlled applications!
- When the "inverter motor brake" function is used, the [Motor overload monitoring \(I2xt\)](#) is not adapted. If it is braked too frequently, there is a risk of the motor being thermally overloaded or the motor overload monitoring does not work properly!
- The "inverter motor brake" function must not be used with vertical conveyors (hoists) or with active loads!



#### Tip!

If no brake resistor is used, the DC injection brake can also be used for a braking process in addition to the "inverter motor brake" and "Stopping of the ramp function generator".

▶ [DC-injection braking](#) (📖 221)

In applications with high mass inertia and long braking times (> 2 s), we recommend the use of the DC injection brake.

- The DC injection brake provides for an oscillation-minimised braking. The braking process generally takes more time than the "inverter motor brake" function with an optimised setting. Moreover, the function is only recommended for braking to a standstill.

In the following cases we recommend the "inverter motor brake" function:

- For all applications that do not require braking to a standstill (e.g. braking to a lower speed setpoint) or the braking process can be interrupted by selecting a new speed setpoint.
- For applications with low mass inertias and a short braking time (< 1 s).
- For all applications where braking should be as quick as possible.

### Operating mode of the inverter motor brake

The ramp function generator is stopped during acceleration. The speed set in [C00987](#) is added to the speed setpoint by means of a hysteresis-type 2-point DC bus voltage controller, whereby the sign of the current actual speed is taken into account. In addition, the ramp function generator is stopped during overvoltage.

If the DC bus voltage falls below a defined DC bus voltage potential of the hysteresis controller, the added speed is subtracted again and the ramp function generator is activated again.

The energy is converted into heat in the motor due to alternating instances of acceleration and deceleration as a result of this switching operation.

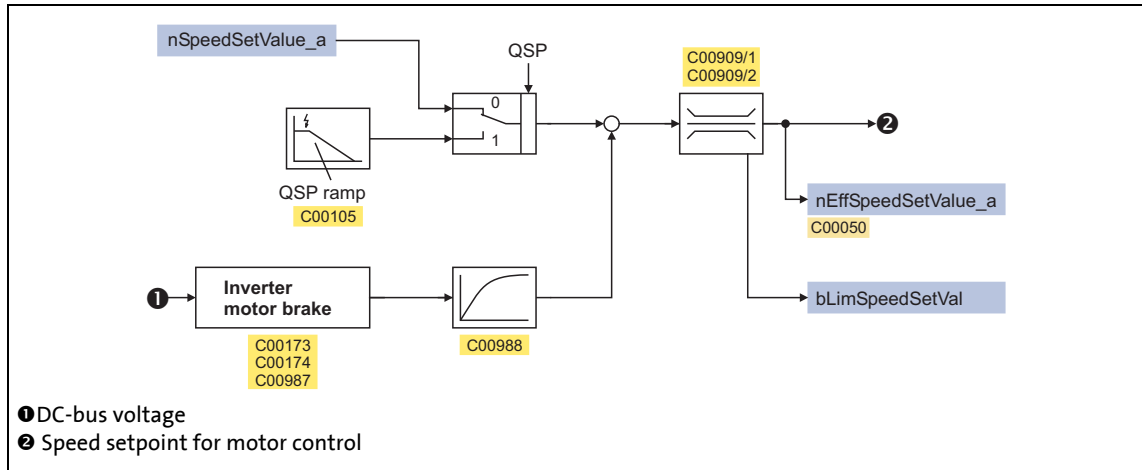

[5-26] Signal flow of the "Inverter motor brake" function

- In case of an asynchronous motor, the additive speed setpoint ([C00987](#)) should be 1 ... 4 times the slip of the machine:

$$C00987 \text{ [rpm]} = 1 \dots 4 \cdot (n_{\text{Sync}} \text{ [rpm]} - n_{\text{Rated}} \text{ [rpm]})$$

$$n_{\text{Sync}} \text{ [rpm]} = \frac{f_{\text{Rated}} \text{ [Hz]} \cdot 60}{p}$$

$p$  = number of pole pairs  
 $n_{\text{Rat}}$  = Rated speed of the motor  
 $f_{\text{Rat}}$  = Rated frequency of the motor  
 $n_{\text{Sync}}$  = Synchronous speed of the motor

[5-27] Formula for calculating the additive speed setpoint for an asynchronous motor

- In case of a synchronous motor, the additive speed setpoint ([C00987](#)) should be 5 ... 20 % of the rated machine speed.

## Short overview of the relevant parameters:

Parameters	Info	Lenze setting	
		Value	Unit
<a href="#">C00173</a>	Mains voltage	3ph 400V / 1ph 230V	
<a href="#">C00174</a>	Reduced brake chopper threshold	0	V
<a href="#">C00175</a>	Resp. to brake resistor control	Brake resistor	
<a href="#">C00987</a>	Inverter motor brake: nAdd • Speed lift which is connected in pulses to the brake ramp when the motor is braked.	80	rpm
<a href="#">C00988</a>	Inverter motor brake: PT1 filter time • PT1 filter time for smoothing the speed lift which is added in pulses.	0.0	ms

**Note!**

When the "inverter motor brake" function is used, torque oscillations occur which may have a negative effect on the service life of the components of the mechanical drive train (e.g. gearbox).

- The extent of the occurring oscillations depends on the drive train (mass inertia, natural frequencies, etc.) and the function setting.
- We recommend optimising the "inverter motor brake" function for an oscillation-free operation as described in the following. Usually, this setting does not cause any torque oscillations which affect the service life of the gearbox.
- The settings of implementing a maximum acceleration ramp are only recommended if the inverter motor brake is used infrequently (e.g. in case of quick stop).

**How to set the "inverter motor brake" function for an oscillation-reduced operation:**

For V/f characteristic open-loop control/closed-loop control (VFCplus):

- Set reduced brake chopper threshold ([C00174](#)) to approx. 70 V.
- Set additive speed ([C00987](#)) to rated slip speed.
- Adapt the deceleration ramp so that the deceleration time is slightly below (10 ... 30 %) the deceleration time that can be realised with the inverter motor brake.

For sensorless vector control (SLVC):

- Set reduced brake chopper threshold ([C00174](#)) to approx. 50 V.
- Set additive speed ([C00987](#)) to 1 ... 2-fold rated slip speed.
- Adapt the deceleration ramp so that the deceleration time is slightly below (10 ... 30 %) the deceleration time that can be realised with the inverter motor brake.

**How to set the "inverter motor brake" function for a maximum acceleration ramp:**

For V/f characteristic open-loop control/closed-loop control (VFCplus):

- Set reduced brake chopper threshold ([C00174](#)) to approx. 70 V.
- Set additive speed ([C00987](#)) to 1,5 ... 2,5-fold rated slip speed.
- Adapt the deceleration ramp so that the deceleration time is slightly below (10 ... 30 %) the deceleration time that can be realised with the inverter motor brake.

---

For sensorless vector control (SLVC):

- Set reduced brake chopper threshold ([C00174](#)) to approx. 70 V.
- Set additive speed ([C00987](#)) to 2 ... 4-fold rated slip speed.
- Adapt the deceleration ramp so that the deceleration time is slightly below (10 ... 30 %) the deceleration time that can be realised with the inverter motor brake.

### 5.11.3 Avoiding thermal overload of the brake resistor

- Parameterisation of an error response in [C00574](#) and evaluation of the parameterised error message within the application or within the machine control system.
  - See chapter entitled "[Brake resistor monitoring \(l2xt\)](#)". ([□ 254](#))
- External interconnection using the thermal contact on the brake resistor (e.g. supply interruption via the mains contactor and activation of the mechanical brakes).

### 5.11.4 Control of multiple internal brake choppers in the DC-bus system

This function extension is available from version 12.00.00!

---

If an additional control signal is used, all internal brake choppers can be used in the DC-bus system to dissipate regenerative energy ("Master-slave operation").



#### Stop!

The integration of external brake choppers (e.g. brake chopper 9352) in the above-described "Master-slave operation" is not permissible since the voltage levels for the input and output of the external brake chopper are not suitable for the brake transistor control or, more precisely, for the output of the state of the brake transistor.

If the internal brake choppers of the DC-bus system are not sufficient, they should be replaced by an external brake chopper. It can be synchronised with other external brake choppers, if need be, so that simultaneous switch-on of all external brake choppers is ensured.



#### Note!

For trouble-free operation, the setting of the mains voltage in [C00173](#) must be identical for all inverters of the DC-bus system since this setting also influences the brake chopper threshold for switching on the brake chopper.

### Functional principle

One of the inverters of the DC-bus system is assigned the role of the "brake chopper master".

- For logical reasons, the "brake chopper master" should be the most powerful inverter.
- The "brake chopper master" controls its internal brake chopper via the DC-bus voltage as before. In addition, the "brake chopper master" transmits the *bBrakeChopperActive* status signal of its internal brake chopper control to the other inverters of the DC-bus system via fieldbus or digital output.

All the other inverters of the DC-bus system are "brake chopper slaves".

- The "brake chopper slaves" have the *bBrakeChopperActive* status signal received from the "brake chopper master" connected to the *bBrakeChopperOn* control input.
- If the internal brake transistor of the "brake chopper master" is switched on, the internal brake transistors of the "brake chopper slaves" are switched on at the same time.

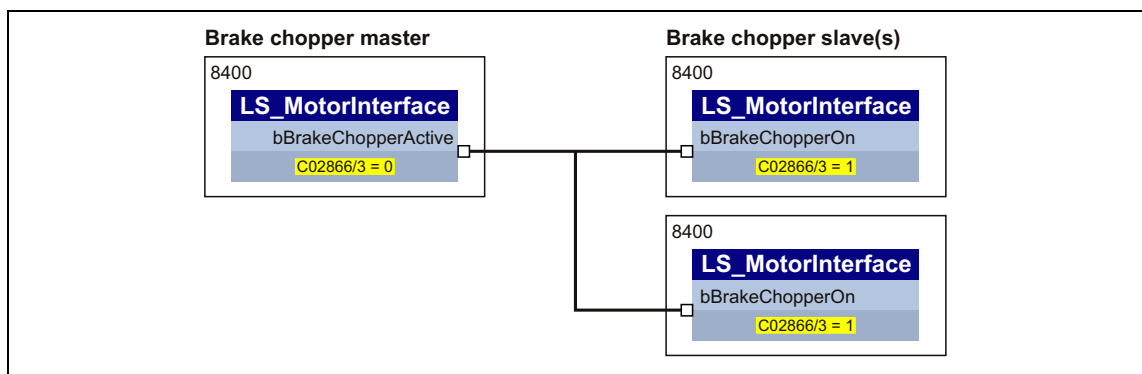

[5-28] Functional principle of the "Brake chopper master-slave operation" (simplified representation)

### Procedure

1. Assign the role of the "brake chopper master" to one of the inverters of the DC-bus system.
2. Adapt the function block interconnection for the "brake chopper master" so that the *bBrakeChopperActive* status signal of the [LS\\_MotorInterface](#) SB is provided to the other inverters for controlling the internal brake chopper.
  - The *bBrakeChopperActive* signal can e.g. be output via port block to the fieldbus or via digital output.
  - A free output of the application block can be used to transfer the signal from application level to I/O level.
3. Configure all the other inverters of the DC-bus system as "brake chopper slaves". Select "1: Yes" in [C2866/3](#) for these inverters.
  - With this setting, the brake chopper is not controlled via the DC-bus voltage anymore. Its control now depends on the *bBrakeChopperOn* control signal.
4. Adapt the function block interconnection for the "brake chopper slaves" so that the *bBrakeChopperActive* signal received from the "brake chopper master" is connected to the *bBrakeChopperOn* input of the [LS\\_MotorInterface](#) SB.
  - Depending on the output at the "brake chopper master", the signal must be read in e.g. via port block or digital input.
  - A free input of the application block can be used to transfer the signal from I/O level to application level.
  - If the digital inputs/outputs are used for transmitting the signal, they must be connected electrically accordingly.

**Note!**

If the brake chopper master-slave operation is activated, plausibility monitoring is carried out in the "brake chopper slaves":

- The brake transistor can only be switched on via the *bBrakeChopperOn* control signal if the DC-bus voltage is greater than the brake chopper threshold minus 40 V<sub>DC</sub>.
- Exception: From a mains voltage of 513 V<sub>AC</sub> (or 725 V<sub>DC</sub>) and a mains voltage of 480 V or 500 V set in [C00173](#), the plausibility monitoring is not effective anymore.

**Fast discharge of the DC bus**

The *bBrakeChopperOn* control input of the "brake chopper master" can be optionally used for a fast discharge of the DC bus after the supply voltage has been switched off. The FB interconnection of the "brake chopper master" has to be adapted so that the *bBrakeChopperOn* control input of the SB [LS\\_MotorInterface](#) is connected to a digital bus or hardware signal (e.g. digital input on HIGH level).

**Note!**

Only the brake transistor of the "brake chopper master" is switched on with this function (max. 4 seconds, without interruption).

A complete discharge of the DC-bus cannot be achieved using this function!

From version 14.00.00, the limitation of the operating time can be deactivated to max. 4 seconds. For this purpose, set bit 1 to "1" in [C02864/1](#).

- We recommend this setting when this function is used in order to achieve a higher discharge of the DC bus - especially in case of high device power.

# 5 Motor control (MCTRL)

## 5.12 Monitoring

### 5.12 Monitoring

Many monitoring functions that are integrated in the inverter can detect errors and thus protect the device/motor from damage or overload.

- Detailed information on the individual monitoring functions can be found in the following subchapters.

Monitoring	Response		Error message (with activated monitoring)
	Lenze setting	Configuration	
<a href="#">Device overload monitoring (Ixt)</a>	Warning	<a href="#">C00604</a>	<a href="#">oC5</a>
<a href="#">Motor overload monitoring (I2xt)</a>	Warning	<a href="#">C00606</a>	<a href="#">oC6</a>
<a href="#">Motor overcurrent monitoring</a>	Fault	-	<a href="#">oC7</a>
<a href="#">Motor temperature monitoring (PTC)</a>	Fault	<a href="#">C00585</a>	<a href="#">oH3</a>
<a href="#">Brake resistor monitoring (I2xt)</a>	No Reaction	<a href="#">C00574</a>	<a href="#">oC12</a>
<a href="#">Motor phase failure monitoring</a>	No Reaction	<a href="#">C00597</a>	<a href="#">LP1</a>
<a href="#">Motor phase error monitoring before operation</a>	No Reaction	<a href="#">C02866/2</a>	
<a href="#">Mains phase failure monitoring</a>	Warning	<a href="#">C00565</a>	<a href="#">Su02</a>
<a href="#">Maximum current monitoring</a>	No Reaction	<a href="#">C00609</a>	<a href="#">oC10</a>
<a href="#">Current monitoring for overload</a>	No Reaction	<a href="#">C00584/1</a>	<a href="#">oC18</a>
<a href="#">Maximum torque monitoring</a>	No Reaction	<a href="#">C00608</a>	<a href="#">oT1</a>
<a href="#">Motor speed monitoring</a>	Fault	-	<a href="#">oS2</a>
<a href="#">Encoder open-circuit monitoring</a>	Fault	<a href="#">C00586</a>	<a href="#">Sd3</a>

#### Parameterisable responses

If a monitoring function trips, the response set via the corresponding parameter is carried out. The following responses can be selected:

- "No response": Response/monitoring is deactivated.
- "Fault": Change of the operating status by a pulse inhibit of the power output stage.
- "Warning": Operating status of the inverter remains unchanged. Only a message is entered into the Logbook of the inverter.

#### Related topics:

- ▶ [Device state machine and device states](#) (📖 88)
- ▶ [Diagnostics & error management](#) (📖 434)
- ▶ [Basics on error handling in the inverter](#) (📖 434)
- ▶ [Error messages of the operating system](#) (📖 459)



### 5.12.1 Device overload monitoring (Ixt)

[C00064/1...3](#) displays the device utilisation (ixt) in [%] in different time intervals:

Parameters	Info
<a href="#">C00064/1</a>	Device utilisation (Ixt) <ul style="list-style-type: none"> <li>• Maximum value of pulse utilisation (<a href="#">C00064/2</a>) and permanent utilisation (<a href="#">C00064/3</a>).</li> </ul>
<a href="#">C00064/2</a>	Device utilisation (Ixt) 15s <ul style="list-style-type: none"> <li>• Pulse utilisation over the last 15 seconds (only for loads &gt;160 %).</li> </ul>
<a href="#">C00064/3</a>	Device utilisation (Ixt) 3 min <ul style="list-style-type: none"> <li>• Permanent utilisation over the last 3 minutes.</li> </ul>
Greyed out = display parameter	

- If the device utilisation reaches the switch-off threshold set in [C00123](#):
  - The error response set in [C00604](#) will be carried out (Lenze setting: "Warning").
  - The "[oC5: Ixt overload](#)" error message will be entered into the Logbook.
  - The *bMctrlIxtOverload* status output of the [LS\\_DeviceMonitor](#) system block will be set to TRUE.
- A setting of [C00604](#) = "0: No Reaction" deactivates the monitoring.

### 5.12.2 Motor overload monitoring (I2xt)

The Inverter Drives 8400 are provided with a simple, sensorless, thermal I<sup>2</sup>xt motor monitoring of self-ventilated standard motors which is based on a mathematical model.

- [C00066](#) displays the calculated motor load in [%].
- If the calculated motor load reaches the motor load setting ([C00120](#)):
  - The error response set in [C00606](#) will be carried out (Lenze setting: "Warning").
  - The "[oC6: I2xt motor overload](#)" error message will be entered into the Logbook.
  - The *bMctrlI2xtOverload* status output of the [LS DeviceMonitor](#) system block will be set to TRUE.
- A setting of [C00606](#) = "0: No Reaction" deactivates the monitoring.



#### Stop!

I<sup>2</sup>xt motor monitoring does not provide full motor protection!

As the motor utilisation calculated in the thermal motor model is lost after mains switching, for instance the following operating states cannot be detected correctly:

- Restarting (after mains switching) of a motor that is already very hot.
- Change of the cooling conditions (e.g. cooling air flow interrupted or too warm).

Full motor protection requires additional measures such as the evaluation of temperature sensors that are located directly in the winding or the use of thermal contacts.

For the installation according to UL or UR, the safety instructions provided in the hardware manual must be observed! Among other things, the activation of the motor overload monitoring (I2xt) is required here.



#### Note!

From version 12.00.00, the thermal motor load displayed in [C00066](#) can be pre-initialised when the device is connected to the mains, optionally using a fixed value or the value used last at the time when the device was switched off. The desired initialisation is selected in [C00122](#). In the Lenze setting of [C00122](#), the behaviour remains unchanged (no initialisation).

### Adjustment of the motor utilisation meter

The motor utilisation meter for indicating the motor load in [C00066](#) begins to count when the apparent motor current ([C00054](#)) is greater than the motor overload setting ([C00120](#)).

The overload threshold ([C00120](#)) is to be set as follows:

$$C00120 = \frac{\text{Rated motor current (C00088)}}{\text{Rated device current (C00098)}} \cdot 100 \%$$

- If you reduce [C00120](#) starting from the calculated value, the motor utilisation meter will already be counted up before the rated overload threshold is reached.
- If you increase [C00120](#) starting from the calculated value, the motor utilisation meter will not be counted up until the rated overload threshold is reached.

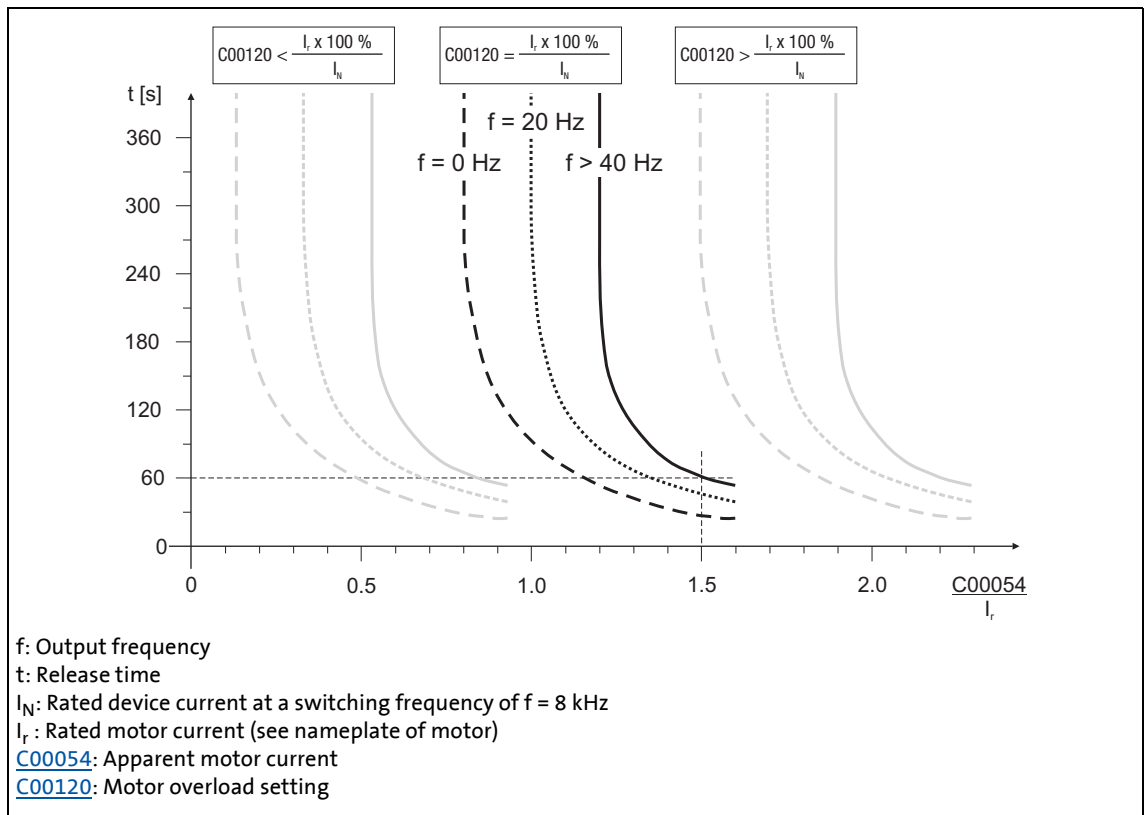

[5-29] Tripping characteristic of the I<sup>2</sup>xt monitoring

Example in Figure [5-29]:

$$C00120 = I_r / I_{rated} \times 100 \%$$

$$C00054 = 150 \% \text{ rated motor current}$$

- After approx. 60 seconds, [C00066](#) has reached the final value (100 %) at output frequencies f > 40 Hz.
- The inverter outputs the "[oC6: I2xt overload motor](#)" error message and triggers the response set in [C00606](#) (default setting: "Warning").



### Tip!

- If forced ventilated motors are used, a premature response of the overload threshold can be avoided by deactivating this function if necessary ([C00606](#) = "0: No Reaction").
- The current limits set in [C00022](#) and [C00023](#) influence the  $I^2 \times t$  calculation only in an indirect way. However, the operation of the motor at maximum possible load can be averted. ▶ [Defining current and speed limits](#) (□ 131)

### 5.12.3 Motor overcurrent monitoring

The ultimate motor current to be parameterised in [C00939](#) is a limit value to protect the motor from destruction, influence of the rated data and demagnetisation.

- This limit value must not be travelled cyclically in the drive process.
- If the instantaneous value of the motor current exceeds the limit value set in [C00939](#), the error response "Fault" occurs to protect the motor and the error message "[oC7: Motor overcurrent](#)" is entered into the logbook.
- The maximum currents to be parameterised in [C00022](#) and [C00023](#) should have a sufficient distance to this limit value.



### Note!

If a Lenze motor is selected from the catalogue whose plant parameters are transferred into the inverter, the setting of the maximum current in [C00022](#) and [C00023](#) will automatically be adapted to the selected motor.

#### Related topics:

- ▶ [Maximum current monitoring](#) (□ 259)

### 5.12.4 Motor temperature monitoring (PTC)

For detecting and monitoring of the motor temperature, a PTC thermistor (DIN 44081/DIN 44082) or a thermal contact (NC contact) can be connected to the terminals X106/T1 and X106/T2.



#### Stop!

- The inverter can only evaluate one PTC thermistor!  
Do not connect several PTC thermistors in series or parallel.
- If several motors are operated on one inverter, use thermal contacts (NC contacts) connected in series.
- To achieve full motor protection, an additional temperature monitoring with separate evaluation must be installed.



#### Note!

- In the Lenze setting ([C00585](#) = "1: Fault"), motor temperature monitoring is activated!
- There is a wire jumper between the terminals X106/T1 and X106/T2 by default.
- Lenze three-phase AC motors are provided with a thermal contact on delivery.

- If  $1.6\text{ k}\Omega < R < 4\text{ k}\Omega$  at the terminals X106/T1 and X106/T2, the monitoring will respond, see functional test below.
- If the monitoring responds:
  - The error response set in [C00585](#) is activated (Lenze setting: "Fault").
  - The "[oH3: Motor temperature \(X106\) triggered](#)" error message is entered into the Logbook.
  - The *bMctrl/MotorPtc* status output of the [LS DeviceMonitor](#) system block is set to TRUE.
- A setting of [C00585](#) = "0: No Reaction" deactivates the monitoring.



#### Tip!

We recommend to always activate the PTC input when using motors which are equipped with PTC thermistors or thermostats. This prevents the motor from being destroyed by overheating.

#### Functional test

Connect a fixed resistor to the PTC input:

- $R > 4\text{ k}\Omega$  : Fault message must be activated.
- $R < 1\text{ k}\Omega$  : Fault message must not be activated.

### 5.12.5 Brake resistor monitoring (I<sup>2</sup>xt)

Due to the converted braking power, the brake resistor is thermally stressed and can even be thermally destroyed by excessive braking power.

The monitoring of the I<sup>2</sup>xt utilisation of the inverter serves to protect the brake resistor. It acts in proportion to the converted braking power.



#### Danger!

In the Lenze setting ([C00574](#) = "0: No Reaction"), the response of the monitoring function does not stop the braking process!

In particular for applications such as hoists or applications with a DC-bus connection, it must be checked if a stopping of the braking process due to a setting of [C00574](#) = "1: Fault" is permissible.



#### Stop!

Implement appropriate protective measures against thermal overload of the brake resistor!

#### Examples:

- Parameterisation of an error response in [C00574](#) and evaluation of the parameterised error message within the application or the machine control system.
  - Interruption of the mains supply by means of the temperature contact at the brake resistor and a simultaneous activation of the mechanical brake.
- 
- If the I<sup>2</sup>xt utilisation reaches the switch-off threshold set in [C00572](#):
    - The error response set in [C00574](#) will take place.
    - The "[oC12: I2xt brake resistor overload](#)" error message is entered into the Logbook.
    - The *bMctrlBrakeChopperFault* status output of the [LS\\_DeviceMonitor](#) system block will be set to TRUE.
  - If the system is dimensioned correctly, the monitoring should not be activated. If individual pieces of rated data of the actually connected brake resistor are not known, they have to be identified.
  - If the DC-bus voltage exceeds the overvoltage threshold due to a braking energy that is too high, the monitoring for overvoltage in the DC bus is activated ("OU: DC-bus overvoltage" error message).
  - Apart from the threshold of the I<sup>2</sup>xt utilisation that can be set in [C00572](#), there is the switching threshold of the brake transistor which results from the mains voltage ([C00173](#)) and the reduced brake chopper threshold ([C00174](#)).

### Temperature model

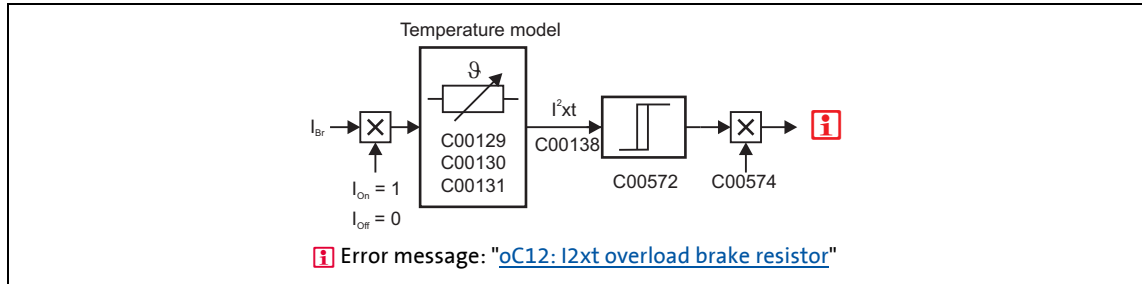

[5-30] Signal flow for monitoring the brake resistor

The monitoring function calculates the braking current  $I_{Br}$  from the current DC-bus voltage  $U_{DC\_act}$  and the brake resistance parameterised in [C00129](#):

$$I_{Br} = \frac{U_{DC\_act}}{C00129}$$



### Note!

The monitoring function can also be triggered due to a value entered in [C00129](#) although a brake resistor is not even connected.

- The calculation considers the thermal utilisation of the brake resistor based on the following parameters:
  - Resistance value ([C00129](#))
  - Continuous power ([C00130](#))
  - Thermal capacity ([C00131](#))
- In the Lenze setting these parameters are preset with the corresponding power-adapted Lenze brake resistor.
- [C00133](#) indicates the calculated utilisation of the brake resistor in [%].
  - A utilisation of 100 % corresponds to the continuous power of the brake resistor depending on the maximally permissible temperature limit.

### Related topics:

▶ [Braking operation/brake energy management](#) (📖 237)

### 5.12.6 Motor phase failure monitoring



#### Note!

In the Lenze setting ([C00597](#) = "0: No Reaction"), the motor phase failure monitoring is not activated!

In the case of a synchronous motor,

- the motor phase failure monitoring is basically deactivated. (Due to the low no-load current, the monitoring would be permanently activated.)
- only the [Motor phase error monitoring before operation](#) is active (for Lenze setting [C2866/2](#) = "1: Yes").

In order to safely detect the failure of a motor phase, a certain motor current must flow for the current sensor system. Thus, the response set in [C00597](#) (Lenze setting: "No Reaction") is caused after a delay time of maximally 2 s after controller enable if a current-carrying motor phase U, V, W fails or if motor connection is missing. If the current threshold value set in [C00599](#) is already exceeded within the delay time, the motor phase failure monitoring starts from this point in time.

The monitoring mode checks the current flow for each motor phase as a function of the commutation angle. Monitoring is activated if a commutation angle of approx. 140° is covered without the current set in [C00599](#) being exceeded. Monitoring is activated at an output frequency of 0 Hz if none of the three motor phases reaches the threshold value set in [C00599](#).

- If the motor phase failure detection is tripped:
  - The response set in [C00597](#) will take place.
  - The error message "[LP1: Motor phase failure](#)" is entered into the logbook.
  - The *bMctrlMotorPhaseFault* status output of the [LS DeviceMonitor](#) system block is set to TRUE.



#### Note!

If an error response of "1: Fault" is set in [C00597](#), the *bMctrlMotorPhaseFault* status output of the [LS DeviceMonitor](#) SB will be set to TRUE for only 1 second in the event of a motor phase failure because it is no longer possible to detect a motor phase fault via the error response with a pulse inhibit. However, the Logbook and [C00561/3...5](#) still display the cause of the motor phase failure.

- The motor phase failure detection is inactive if
  - a controller inhibit is set,
  - connection to a rotating machine is carried out (flying restart circuit or connection to actual speed value),
  - an error is pending due to a DC-bus overvoltage ("[OU](#)"),
  - motor parameter identification is carried out,
  - DC-injection braking is active.



---

### 5.12.7 Motor phase error monitoring before operation

This function extension is available from version 11.00.00!

This extended motor phase failure monitoring can both detect a phase failure on the basis of test signals and check for the existence of the motor.

- The "motor phase error monitoring before operation" is only directly active after controller enable if
  - an error response is set in [C00597](#) **AND**
  - the motor phase error monitoring is switched on ([C2866/2](#) = "1: Yes").
- The following parameters show the cause of the motor phase failure:
  - [C00561/3](#): Motor phase U
  - [C00561/4](#): Motor phase V
  - [C00561/5](#): Motor phase W



#### Note!

The motor phase error monitoring before operation must not be connected to a rotating or coasting machine (high compensation currents and effect of the DC injection braking).

- In case of motor control with feedback, no motor phase error monitoring is executed if the actual speed value is > 10 rpm.
- In case of motor control without feedback, the user must ensure that the motor phase error monitoring will only be executed if the speed is 0.

If the motor is at quick stop and the brake is applied, no motor phase error monitoring is executed when quick stop is deactivated (same with "0" speed and applied brake).

If the rated current of the connected motor is lower than 10 % of the rated device current, the motor phase error monitoring can be activated although no motor phase error has occurred. In this case, the motor phase error monitoring must be switched off before operation ([C2866/2](#) = "0: No").

**Note!****With automatic brake control:**

In case of automatic brake control, the brake will only be released if no motor phase failure exists and the magnetisation of the field-oriented control types is completed.

**With manual brake control:**

In case of manual brake control and forced release of the brake, the brake will be controlled directly as before.

The user himself must ensure that the brake will only be opened if all of the following conditions are met:

- Motor phase failure monitoring ([C00597](#)) and motor phase error monitoring before operation ([C2866/2](#)) are active.
- The inverter is enabled (controller enable).
- The *bMctrlMotorPhaseFault* status output of the SB [LS\\_DeviceMonitor](#) is set to FALSE.
- Bit 10 of the *MCTRL\_Status3* status word must be set to 0 before the brake opening is triggered.
  - When the controller is enabled, this bit is set to 1 and will not be set to 0 again before the "Motor phase error monitoring before operation" is successfully completed.
  - The *MCTRL\_Status3* status word can be integrated in the application via configuration parameters (e.g. [C00620](#)) (*MCTRL\_Status3* = selection 34906 in [Selection list - analog signals](#)).

### 5.12.8 Mains phase failure monitoring



#### Stop!

Under load, the mains input of a three-phase inverter can be destroyed if the device is only supplied by two phases (e.g. if a mains phase fails).

The inverter has a simple mains-phase failure detection function with which a mains phase failure can be detected under load.

- In the case of power-adapted machines, approx. 50 % of the rated motor power must be exceeded so that a main-phase failure can be detected.
- If the mains phase failure monitoring is tripped:
  - The error response set in [C00565](#) will be carried out (Lenze setting: "Warning").
  - The "[Su02: One mains phase is missing](#)" error message will be entered into the logbook.
  - The *bMctrlMainsFault* status output of the [LS\\_DeviceMonitor](#) system block will be set to TRUE.

### 5.12.9 Maximum current monitoring



#### Note!

In the Lenze setting ([C00609](#) = "0: No Reaction"), the maximum current monitoring is not activated!

If a Lenze motor is selected from the catalogue whose plant parameters are transferred into the inverter, the setting of the maximum current in [C00022](#) and [C00023](#) will automatically be adapted to the selected motor.

If the parameterised maximum current is reached, the response set in [C00609](#) is triggered (Lenze setting: "0: No Reaction").

If the activated monitoring is tripped:

- The "[oC10: Maximum current reached](#)" error message is entered in the logbook.

#### Related topics:

- ▶ [Motor overcurrent monitoring](#) (📖 252)

### 5.12.10 Current monitoring for overload

This function extension is available from version 16.00.00!

---

If the apparent motor current exceeds a defined threshold value [C00124/1](#)) for a certain time ([C00563/1](#)) an overload has taken place.

Monitoring responds as follows:

- The *bCurrentMonitoringOverload* signal is set to TRUE  
See [selection list - digital signals](#)
- The response set in [C00584/1](#) is activated (Lenze setting: "No response")
- The **OC18** error message, current monitoring overload, is entered into the logbook.
- The *bCurrentMonitoringOverload* status output of the **LS\_DeviceMonitor** FB is set to TRUE.

If the overload decreases, the apparent motor current has to decrease below the value  $C00124/1 - 0.05 \times I_{rated}$  in order that the *bCurrentMonitoringOverload* signal can accept the FALSE state.

When *bCurrentMonitoringOverload* = FALSE, the delay time in the resolution is set to the value 0 s again.

### 5.12.11 Maximum torque monitoring

This function extension is only available from version 04.00.00!

---



#### Note!

In the Lenze setting ([C00608](#) = "0: No Reaction"), the maximum torque monitoring is not activated!

If the maximum possible torque [C00057](#) is reached at the motor shaft, the response set in [C00608](#) will be carried out (Lenze setting: "0: No Reaction").

If the activated monitoring is tripped:

- The "[oT1: Maximum torque reached](#)" error message is entered into the logbook.
- The *bMctrlTorqueMax* status output of the [LS\\_DeviceMonitor](#) system block will be set to TRUE.

### 5.12.12 Motor speed monitoring

This function extension is available from version 11.00.00!

---

If the drive reaches the maximally permissible motor speed ([C00965](#)):

- The error response "Fault" occurs, i.e. the inverter is inhibited and the motor changes to torque-free operation (coasts down).
- The error message "[oS2: Max. motor speed reached](#)" is entered into the logbook.

### 5.12.13 Encoder open-circuit monitoring



#### Note!

In the Lenze setting ([C00586](#) = "1: Fault"), open-circuit monitoring of the encoder is activated!

#### When does the open-circuit monitoring system respond?

The open-circuit monitoring will trigger if

- an open circuit occurs in the encoder cable.
- an extreme overload (e.g. blocked motor shaft) occurs during the start-up phase of the motor.
- highly dynamic reversion of the motor occurs.

#### Which measured values lead to an actuation of the open-circuit monitoring system?

The following measured values checked for plausibility lead to an actuation of the open-circuit monitoring system:

1. If the total deviation between actual speed and setpoint speed is higher than  $f = 40$  Hz for a time  $> 0.1$  s.
2. If the sign of the injected frequency and the actual speed is not the same, the  $I_{\max}$  controller is active and this status is active for 0.1 s. Usually this is the case when A/B tracks are reversed.

#### Response to open circuit

- If the open-circuit monitoring is tripped:
  - The error response set in [C00586](#) is activated (Lenze setting: "Fault").
  - The "[Sd3: Open circuit - feedback system](#)" is entered into the Logbook.
  - The `bMctrlEncoderComFault` status output of the [LS DeviceMonitor](#) SB is set to TRUE.
- A setting of [C00586](#) = "0: No Reaction" deactivates the monitoring.

#### Related topics:

- ▶ [Encoder/feedback system](#) (📖 230)

### 5.13 Internal interfaces | System block "LS\_MotorInterface"

The **LS\_MotorInterface** system block provides the internal interfaces to the driving machine in the function block editor.

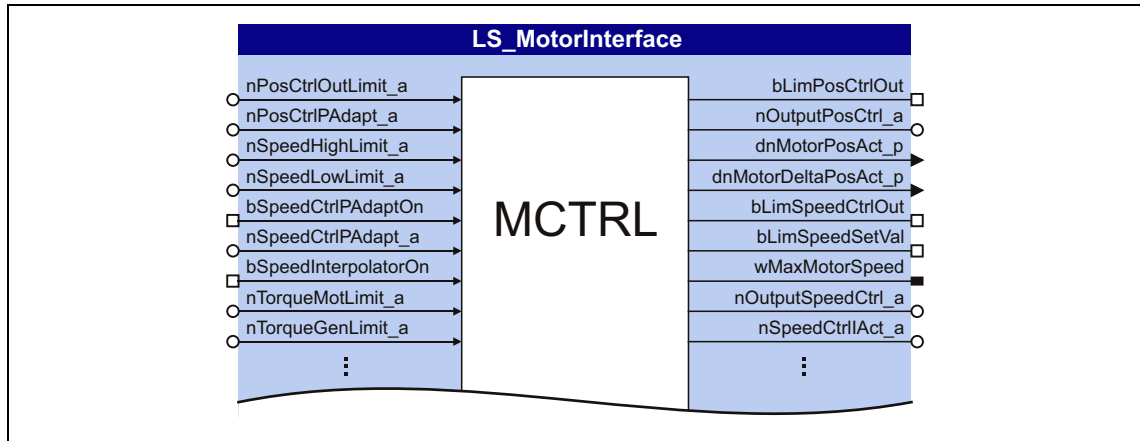

[5-31] LS\_MotorInterface system block (excerpt)

#### inputs

Designator <small>DIS code   data type</small>	Information/possible settings				
<code>nPosCtrlOutLimit_a</code> <a href="#">C00830/21</a>   INT	Limitation of the position controller output <ul style="list-style-type: none"> <li>Scaling: 16384 <math>\equiv</math> 100 % reference speed (<a href="#">C00011</a>)</li> </ul>				
<code>nPosCtrlPAdapt_a</code> <a href="#">C00830/20</a>   INT	Adaptation of the position controller gain <ul style="list-style-type: none"> <li>Scaling: 16384 <math>\equiv</math> 100 % Vp position controller</li> </ul>				
<code>nSpeedHighLimit_a</code> <a href="#">C00830/88</a>   INT	Upper speed limit for the speed limitation <ul style="list-style-type: none"> <li>During torque-controlled operation only (<i>bTorquemodeOn</i> = TRUE)</li> <li>Scaling: 16384 <math>\equiv</math> 100 % reference speed (<a href="#">C00011</a>)</li> </ul> <p><b>Note:</b> For a correct function of the speed limitation in both direction, the following applies: The speed limitation operates with a internal hysteresis of 50 rpm. The upper or lower speed limit resulting from the settings has to be higher than this hysteresis!</p>				
<code>nSpeedLowLimit_a</code> <a href="#">C00830/23</a>   INT	Lower speed limit for speed limitation <ul style="list-style-type: none"> <li>During torque-controlled operation only (<i>bTorquemodeOn</i> = TRUE)</li> <li>Scaling: 16384 <math>\equiv</math> 100 % reference speed (<a href="#">C00011</a>)</li> </ul> <p><b>Note:</b> For a correct function of the speed limitation in both direction, the following applies: The speed limitation operates with a internal hysteresis of 50 rpm. The upper or lower speed limit resulting from the settings has to be higher than this hysteresis!</p>				
<code>bSpeedCtrlPAdaptOn</code> <a href="#">C00833/69</a>   BOOL	Adaptation of the speed controller gain <table border="1" style="width: 100%; border-collapse: collapse;"> <tr> <td style="text-align: center;">FALSE</td> <td>Deactivate adaptive adaptation.</td> </tr> <tr> <td style="text-align: center;">TRUE</td> <td>Activate adaptive adaptation.</td> </tr> </table>	FALSE	Deactivate adaptive adaptation.	TRUE	Activate adaptive adaptation.
FALSE	Deactivate adaptive adaptation.				
TRUE	Activate adaptive adaptation.				
<code>nSpeedCtrlPAdapt_a</code> <a href="#">C00830/25</a>   INT	Adaptation of the speed controller gain <ul style="list-style-type: none"> <li>Scaling: 16384 <math>\equiv</math> 100 % Vp (<a href="#">C00070</a>)</li> </ul>				
<code>bSpeedInterpolatorOn</code> <a href="#">C00833/28</a>   BOOL	Speed setpoint interpolation <table border="1" style="width: 100%; border-collapse: collapse;"> <tr> <td style="text-align: center;">FALSE</td> <td>Deactivate interpolation</td> </tr> <tr> <td style="text-align: center;">TRUE</td> <td>Activate interpolation</td> </tr> </table>	FALSE	Deactivate interpolation	TRUE	Activate interpolation
FALSE	Deactivate interpolation				
TRUE	Activate interpolation				

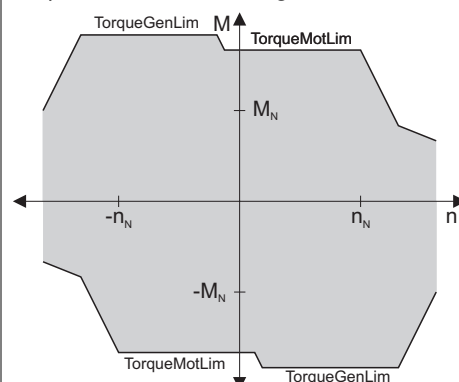
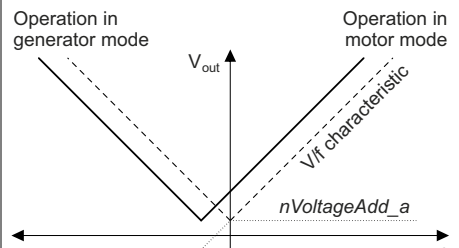
Designator DIS code   data type	Information/possible settings				
nTorqueMotLimit_a <a href="#">C00830/29</a>   INT nTorqueGenLimit_a <a href="#">C00830/28</a>   INT	<p>Torque limitation in motor mode and in generator mode</p> <ul style="list-style-type: none"> <li>The drive cannot output a higher torque in motor/generator mode than set here.</li> <li>The applied values (any polarity) are internally interpreted as absolute values.</li> <li>If V/f characteristic control (VFCplus) is selected, limitation is <u>indirectly</u> performed via a so-called <math>I_{max}</math> controller.</li> <li>If sensorless vector control (SLVC) is selected, the limitation has a <u>direct</u> effect on the torque-producing current component.</li> <li>Scaling: 16384 <math>\equiv</math> 100 % <math>M_{max}</math> (<a href="#">C00057</a>)</li> </ul> <p>From version 18.00.00 onwards:  <a href="#">C02864</a>: Bit 15 = 1: positive torque limitation (nTorqueHighLimit_a) and negative torque limitation (nTorqueLowLimit_a).</p> <p>Torque limits in motor and generator mode:</p> 				
bTorqueInterpolatorOn <a href="#">C00833/29</a>   BOOL	<p>Torque setpoint interpolation</p> <table border="1" data-bbox="638 1097 1037 1176"> <tr> <td>FALSE</td> <td>Deactivate interpolation</td> </tr> <tr> <td>TRUE</td> <td>Activate interpolation</td> </tr> </table>	FALSE	Deactivate interpolation	TRUE	Activate interpolation
FALSE	Deactivate interpolation				
TRUE	Activate interpolation				
nVoltageAdd_a <a href="#">C00830/31</a>   INT	<p>Additive voltage impression</p> <ul style="list-style-type: none"> <li>An additional setpoint for the motor voltage can be specified via this process input.</li> <li>If there are, for instance, different loads at the motor output end, it is possible to apply a voltage boost at the starting time.</li> <li>If the value is negative, the voltage is reduced.</li> <li>Scaling: 16384 <math>\equiv</math> 1000 V</li> </ul> <p>This process signal also serves to implement a load adaptation.                      Example of V/f characteristic control (VFCplus): Adaptation of the voltage characteristic as a function of the load in motor mode/in generator mode in case of CW/CCW rotation</p>  <ul style="list-style-type: none"> <li>CW rotation in motor mode: Increase voltage</li> <li>CCW rotation in generator mode: Reduce voltage</li> </ul> <p><b>STOP Stop!</b>                      Values selected too high may cause the motor to heat up due to the resulting current!</p>				
bAutoBoostOn <a href="#">C00833/32</a>   BOOL (from version 04.00.00)	<p>Reserved</p>				

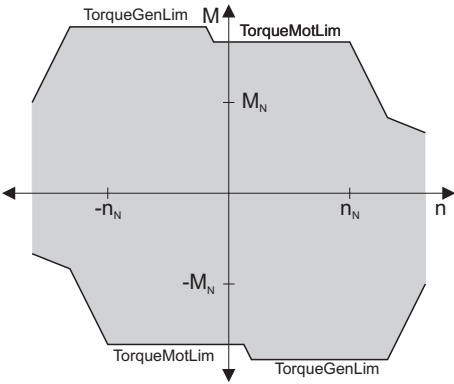
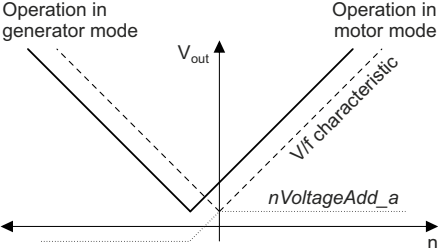

Designator	Information/possible settings				
<p>nTorqueMotLimit_a <a href="#">C00830/29</a>   INT</p> <p>nTorqueGenLimit_a <a href="#">C00830/28</a>   INT</p>	<p>Torque limitation in motor mode and in generator mode</p> <ul style="list-style-type: none"> <li>• The drive cannot output a higher torque in motor/generator mode than set here.</li> <li>• The applied values (any polarity) are internally interpreted as absolute values.</li> <li>• If V/f characteristic control (VFCplus) is selected, limitation is <u>indirectly</u> performed via a so-called <math>I_{max}</math> controller.</li> <li>• If sensorless vector control (SLVC) is selected, the limitation has a <u>direct</u> effect on the torque-producing current component.</li> <li>• Scaling: 16384 <math>\equiv</math> 100 % <math>M_{max}</math> (<a href="#">C00057</a>)</li> </ul> <p>From version 18.00.00 onwards: <a href="#">C02864</a>: Bit 15 = 1: positive torque limitation (nTorqueHighLimit_a) and negative torque limitation (nTorqueLowLimit_a).</p> <p>Torque limits in motor and generator mode:</p> 				
<p>bTorqueInterpolatorOn <a href="#">C00833/29</a>   BOOL</p>	<p>Torque setpoint interpolation</p> <table border="1" style="width: 100%; border-collapse: collapse;"> <tr> <td style="text-align: center;">FALSE</td> <td>Deactivate interpolation</td> </tr> <tr> <td style="text-align: center;">TRUE</td> <td>Activate interpolation</td> </tr> </table>	FALSE	Deactivate interpolation	TRUE	Activate interpolation
FALSE	Deactivate interpolation				
TRUE	Activate interpolation				
<p>nVoltageAdd_a <a href="#">C00830/31</a>   INT</p>	<p>Additive voltage impression</p> <ul style="list-style-type: none"> <li>• An additional setpoint for the motor voltage can be specified via this process input.</li> <li>• If there are, for instance, different loads at the motor output end, it is possible to apply a voltage boost at the starting time.</li> <li>• If the value is negative, the voltage is reduced.</li> <li>• Scaling: 16384 <math>\equiv</math> 1000 V</li> </ul> <p>This process signal also serves to implement a load adaptation. Example of V/f characteristic control (VFCplus): Adaptation of the voltage characteristic as a function of the load in motor mode/in generator mode in case of CW/CCW rotation</p>  <ul style="list-style-type: none"> <li>• CW rotation in motor mode: Increase voltage</li> <li>• CCW rotation in generator mode: Reduce voltage</li> </ul> <p><b>STOP Stop!</b> Values selected too high may cause the motor to heat up due to the resulting current!</p>				
<p>bAutoBoostOn <a href="#">C00833/32</a>   BOOL (from version 04.00.00)</p>	<p>Reserved</p>				

Designator DIS code   data type	Information/possible settings				
nBoost_a <a href="#">C00830/26</a>   INT	<p>Process signal for the <math>V_{\min}</math> boost</p> <ul style="list-style-type: none"> <li>This signal is added to <a href="#">C00016</a> and has thus an increasing or decreasing effect.</li> <li>This signal serves to implement a load-dependent <math>V_{\min}</math> boost to improve the torque behaviour in different load states, as for instance in case of operation in generator or motor mode.</li> <li>Scaling: 16384 <math>\equiv</math> 100 % rated device voltage <math>V_{FU}</math> (400 V or 230 V)</li> </ul> <p>► <a href="#">Adapting the Vmin boost</a> (<a href="#">□ 143</a>)</p>				
	<p> <b>Stop!</b></p> <p>Values selected too high may cause the motor to heat up due to the resulting current!</p>				
bPosCtrlOn	Inputs of 8400 StateLine have no function!				
bDeltaPosOn					
dnDeltaPos_p					
dnPosSetValue_p					
bPosDerivativeOn					
bSetRefValue <a href="#">C00833/68</a>   BOOL (from version 18.00.00)	<p>Trigger signal to set the actual position to the home position when the reference setting is requested or the reference signal is detected during the referencing procedure.</p> <table border="1"> <tr> <td>TRUE</td> <td>Set actual position to home position.</td> </tr> </table>	TRUE	Set actual position to home position.		
TRUE	Set actual position to home position.				
dnPosRefValue_p	Input at 8400 StateLine has no function!				
bQspOn <a href="#">C00833/33</a>   BOOL	<p>Quick stop</p> <table border="1"> <tr> <td>FALSE</td> <td>Deactivate quick stop</td> </tr> <tr> <td>TRUE</td> <td>Activate quick stop</td> </tr> </table>	FALSE	Deactivate quick stop	TRUE	Activate quick stop
FALSE	Deactivate quick stop				
TRUE	Activate quick stop				
nPWMAngleOffset_a <a href="#">C00830/32</a>   INT	<p>Angle step change of output voltage phasor</p> <ul style="list-style-type: none"> <li>Scaling: 65535 <math>\equiv</math> 1 revolution</li> </ul>				
bSpeedCtrlOn <a href="#">C00833/31</a>   BOOL	<p>Directly set the I-component of speed controller</p> <ul style="list-style-type: none"> <li>In order to statically specify a minimum torque, e.g. when a load is being lifted.</li> </ul> <table border="1"> <tr> <td>TRUE</td> <td>Se the I-component of the speed controller to the value <math>nSpeedCtrl\_a</math>.</td> </tr> </table>	TRUE	Se the I-component of the speed controller to the value $nSpeedCtrl\_a$ .		
TRUE	Se the I-component of the speed controller to the value $nSpeedCtrl\_a$ .				
nSpeedCtrlI_a <a href="#">C00830/24</a>   INT	<p>Value of the speed controller integrator</p> <ul style="list-style-type: none"> <li>Scaling depends on the selected motor control: <ul style="list-style-type: none"> <li>V/f control (VFCplus + encoder): 16384 <math>\equiv</math> 100 % reference speed (<a href="#">C00011</a>)</li> <li>Vector control (SLVC): 16384 <math>\equiv</math> 100 % <math>M_{\max}</math> (<a href="#">C00057</a>)</li> </ul> </li> </ul>				
nSpeedSetValue_a <a href="#">C00830/22</a>   INT	<p>Speed setpoint</p> <ul style="list-style-type: none"> <li>Scaling: 16384 <math>\equiv</math> 100 % reference speed (<a href="#">C00011</a>)</li> </ul>				
bTorquemodeOn <a href="#">C00833/30</a>   BOOL	<p>Selection: Speed/Torque control</p> <table border="1"> <tr> <td>FALSE</td> <td>Speed control with torque limitation</td> </tr> <tr> <td>TRUE</td> <td>Torque control with speed limitation</td> </tr> </table>	FALSE	Speed control with torque limitation	TRUE	Torque control with speed limitation
FALSE	Speed control with torque limitation				
TRUE	Torque control with speed limitation				
nTorqueSetValue_a <a href="#">C00830/27</a>   INT	<p>Torque setpoint / additive torque</p> <ul style="list-style-type: none"> <li>Scaling: 16384 <math>\equiv</math> 100 % <math>M_{\max}</math> (<a href="#">C00057</a>)</li> </ul>				
bDcBrakeOn <a href="#">C00833/34</a>   BOOL	<p>Activate DC injection brake</p> <table border="1"> <tr> <td>FALSE</td> <td>Deactivate DC-injection braking</td> </tr> <tr> <td>TRUE</td> <td>Activate DC-injection braking</td> </tr> </table>	FALSE	Deactivate DC-injection braking	TRUE	Activate DC-injection braking
FALSE	Deactivate DC-injection braking				
TRUE	Activate DC-injection braking				
bTorqueLimitAdaptOn <a href="#">C00833/98</a>   BOOL	<p>Adaptation of torque limitation</p> <table border="1"> <tr> <td>TRUE</td> <td>Activate adaptation of torque limitation.</td> </tr> </table>	TRUE	Activate adaptation of torque limitation.		
TRUE	Activate adaptation of torque limitation.				
nTorqueLimitAdapt_a <a href="#">C00830/70</a>   INT	<p>Value for adaptation of torque limitation</p> <ul style="list-style-type: none"> <li>Scaling: 16384 <math>\equiv</math> 100 % <math>nTorqueMotLimit\_a</math> and <math>nTorqueGenLimit\_a</math></li> </ul>				

Designator DIS code   data type	Information/possible settings				
nInertiaAdapt_a <a href="#">C00830/96</a>   INT (from version 12.00.00)	Adaptation of the moment of inertia <ul style="list-style-type: none"> <li>This process signal can be used during the process to dynamically control the percentage of the variable moment of inertia (e.g. a reel) set in <a href="#">C00919/1</a> which is to be considered for setpoint feedforward control.</li> <li>Scaling: 16384 <math>\equiv</math> 100 % moment of inertia - process (<a href="#">C00919/1</a>)</li> </ul>				
bBrakeChopperOn <a href="#">C00833/130</a>   BOOL (from version 12.00.00)	Switch on the internal brake chopper as "brake chopper slave" ( <a href="#">C02866/3</a> = "1: Yes") when the inverter is configured <a href="#">▶ Control of multiple internal brake choppers in the DC-bus system</a> (□ 245) <table border="1"> <tr> <td>TRUE</td> <td>Switch on internal brake chopper.</td> </tr> </table>	TRUE	Switch on internal brake chopper.		
TRUE	Switch on internal brake chopper.				
nSpeedSetValueInertia_a <a href="#">C00830/97</a>   INT (from version 12.00.00)	Input for differential setpoint feedforward control (torque feedforward control) <ul style="list-style-type: none"> <li>If the selection "1: nSpeedSetValueInertia_a" is set in <a href="#">C00654/1</a>, this process signal can be used to preselect any input value (e.g. setpoint of the position or process controller) for torque feedforward control.</li> <li>Scaling: 16384 <math>\equiv</math> 100 % reference speed (<a href="#">C00011</a>)</li> </ul>				
bVfcEcoDisable <a href="#">C00833/131</a>   BOOL (from version 13.00.00)	Deactivate energy optimisation for VFCplusEco <a href="#">▶ Improving the behaviour at high dynamic load changes</a> <table border="1"> <tr> <td>FALSE</td> <td>Activate energy optimisation.</td> </tr> <tr> <td>TRUE</td> <td>Deactivate energy optimisation.</td> </tr> </table>	FALSE	Activate energy optimisation.	TRUE	Deactivate energy optimisation.
FALSE	Activate energy optimisation.				
TRUE	Deactivate energy optimisation.				

## outputs

Designator DIS code   data type	Value/meaning		
bLimPosCtrlOut BOOL	"Position controller output inside the limitation" status signal <table border="1"> <tr> <td>TRUE</td> <td>The position controller output is internally limited</td> </tr> </table>	TRUE	The position controller output is internally limited
TRUE	The position controller output is internally limited		
nOutputPosCtrl_a INT	Position controller output <ul style="list-style-type: none"> <li>Scaling: 16384 <math>\equiv</math> 100 % reference speed (<a href="#">C00011</a>)</li> </ul>		
dnMotorPosAct_p DINT	Current position of the motor shaft in [increments]		
dnMotorDeltaPosAct_p DINT	Current following error in [increments] <ul style="list-style-type: none"> <li>Following error = Difference between set position and actual position</li> </ul>		
bLimSpeedCtrlOut BOOL	"Speed controller or manipulating variable of the slip regulator inside the limitation" status signal <table border="1"> <tr> <td>TRUE</td> <td>The speed controller output is internally limited</td> </tr> </table>	TRUE	The speed controller output is internally limited
TRUE	The speed controller output is internally limited		
bLimSpeedSetVal BOOL	"Reduction or increase of the setpoint speed active" status signal <table border="1"> <tr> <td>TRUE</td> <td>Reduction or increase of the setpoint speed by the <math>I_{max}</math> controller is active</td> </tr> </table>	TRUE	Reduction or increase of the setpoint speed by the $I_{max}$ controller is active
TRUE	Reduction or increase of the setpoint speed by the $I_{max}$ controller is active		
wMaxMotorSpeed <a href="#">C00011</a>   BOOL	Reference speed ( <a href="#">C00011</a> )		
nOutputSpeedCtrl_a INT	Speed controller output <ul style="list-style-type: none"> <li>Scaling: 16384 <math>\equiv</math> 100 % <math>M_{max}</math> (<a href="#">C00057</a>)</li> <li>In case of the "VFC (+encoder)" motor control, this output is the output of the slip regulator. In this case, the scaling depends on the reference frequency (display in <a href="#">C00059</a>): <ul style="list-style-type: none"> <li><a href="#">C00059</a> &lt; 650 Hz: 16384 <math>\equiv</math> 327.68 Hz (24000 <math>\equiv</math> 480.00 Hz)</li> <li><a href="#">C00059</a> &gt; 650 Hz: 16384 <math>\equiv</math> 655.36 Hz (12000 <math>\equiv</math> 480.00 Hz)</li> </ul> </li> </ul>		
nSpeedCtrlIntAct_a INT	Current value of speed controller integrator <ul style="list-style-type: none"> <li>Scaling depends on the selected motor control: <ul style="list-style-type: none"> <li>V/f control (VFCplus + encoder): 16384 <math>\equiv</math> 100 % reference speed (<a href="#">C00011</a>)</li> <li>Vector control (SLVC): 16384 <math>\equiv</math> 100 % <math>M_{max}</math> (<a href="#">C00057</a>)</li> </ul> </li> </ul>		
nEffSpeedSetValue_a INT	Effective speed setpoint <ul style="list-style-type: none"> <li>Scaling: 16384 <math>\equiv</math> 100 % reference speed (<a href="#">C00011</a>)</li> </ul>		

Designator DIS code   data type	Value/meaning
nMotorSpeedAct_a <a href="#">C00051</a>   INT	Actual speed value • Scaling: 16384 ≙ 100 % reference speed ( <a href="#">C00011</a> )
nMotorSpeedAct_v INT	Actual speed value • Scaling: 65535 ≙ 1 revolution
nMotorFreqAct_a <a href="#">C00058</a>   INT	Current field frequency • Scaling depends on the reference frequency (display in <a href="#">C00059</a> ): • <a href="#">C00059</a> < 650 Hz: 16384 ≙ 327.68 Hz (24000 ≙ 480.00 Hz) • <a href="#">C00059</a> > 650 Hz: 16384 ≙ 655.36 Hz (12000 ≙ 480.00 Hz)
bLimTorqueSetVal BOOL	"Setpoint torque inside the limitation" status signal TRUE   The setpoint torque is internally limited
wMaxMotorTorque <a href="#">C00057</a>	Maximum motor torque • Scaling: 100 = 0.01 Nm • From version 06.00.00: $wMaxMotorTorque = 10 * M_{max}$ ( <a href="#">C00057</a> )
nInputTorqueCtrl_a INT	Input value of the torque control (torque setpoint) • Scaling: 16384 ≙ 100 % $M_{max}$ ( <a href="#">C00057</a> )
nMotorTorqueAct_a <a href="#">C00056/2</a>   INT	Actual torque • In the "VFC (+encoder)" motor control mode, this value is determined from the current motor current and only approximately corresponds to the actual torque value.. • Scaling: 16384 ≙ 100 % $M_{max}$ ( <a href="#">C00057</a> )
nInputJerkCtrl_a INT	Input value of the jerk limitation • Scaling: 16384 ≙ 100 % $M_{max}$ ( <a href="#">C00057</a> )
bLimCurrentSetVal BOOL	"Current setpoint inside the limitation" status signal TRUE   The current setpoint is internally limited
nStatorCurrentIS_a INT	Current stator current/effective motor current • Scaling: 16384 ≙ 100 % $I_{max\_mot}$ ( <a href="#">C00022</a> )
nEffCurrentIq_a INT	Current torque-producing cross current • Scaling: 16384 ≙ 100 % $I_{max\_mot}$ ( <a href="#">C00022</a> )
nReaktCurrentId_a INT	Current field-producing direct-axis current • Scaling: 16384 ≙ 100 % $I_{max\_mot}$ ( <a href="#">C00022</a> )
nActualFluxx_a INT	Current magnetising current • Scaling: 16384 ≙ 100 % $I_{max\_mot}$ ( <a href="#">C00022</a> )
nDCVoltage_a INT	Current DC-bus voltage • Scaling: 16384 ≙ 1000 V
nMotorVoltage_a INT	Current motor voltage/inverter output voltage • Scaling: 16384 ≙ 1000 V
bQspActive BOOL	"Quick stop active" status signal TRUE   Quick stop is active
bAutoDCBActive BOOL	"Automatic DC-injection braking active" status signal ▶ <a href="#">DC-injection braking</a> ( <a href="#">□ 221</a> ) TRUE   Automatic DC-injection braking is active
bIdentificationActive BOOL	"Motor parameter identification active" status signal ▶ <a href="#">Automatic motor data identification</a> ( <a href="#">□ 119</a> ) TRUE   Motor parameter identification is active
bFlyingSyncActive BOOL	"Flying restart function active" status signal ▶ <a href="#">Flying restart function</a> ( <a href="#">□ 218</a> ) TRUE   Flying restart function is active

Designator DIS code   data type	Value/meaning
bHlgLoad BOOL	Control signal for an additional loading function of the ramp function generator <ul style="list-style-type: none"> <li>• → <a href="#">L_NSet_1.bExternalCINH</a></li> <li>• To enable the ramp function generator to follow automatically when the controller is inhibited, for jerk-free setpoint connection.</li> </ul>
	TRUE   Set the ramp function generator to a setpoint of <i>nHlgSetValue_a</i>
nHlgSetValue_a INT	Setpoint for an additional loading function of the ramp function generator <ul style="list-style-type: none"> <li>• → <a href="#">L_NSet_1.nClnhVal_a</a></li> <li>• For speed-controlled drive tasks, the current actual speed value (e.g. in case of an active pulse inhibit, flying restart function, controller inhibit) is provided at this output.</li> <li>• Scaling: 16384 ≙ 100 % reference speed (<a href="#">C00011</a>)</li> </ul>
bHlgStop BOOL	Control signal for stopping the ramp function generator ( <a href="#">L_NSet_1</a> )
	TRUE   Stop the ramp function generator
bBrakeChopperActive BOOL (from version 12.00.00 onwards)	Status signal of the internal brake chopper control ▶ <a href="#">Control of multiple internal brake choppers in the DC-bus system</a> (☰ 245)
	TRUE   Internal brake chopper is switched-on.
nVoltageAngleAct_a INT (from version 13.00.00)	Current electrical voltage output angle of the inverter <ul style="list-style-type: none"> <li>• Scaling: 16384 ≙ 360°</li> </ul>
bLimSpeedTorquemodeOn BOOL (from version 13.00.00)	Status signal of torque control with speed limitation
	TRUE   Speed limitation for torque control is active.

## 5.14 Internal status signals | System block "LS\_DeviceMonitor"

The **LS\_DeviceMonitor** system block provides the status signals of the motor control in the function block editor.



### Note!

The **LS\_DeviceMonitor** system block can only be inserted on the application level.

If status signals of the motor control function are to be output via digital outputs or example, you can use the free *bFreeOut1 ... bFreeOut8* outputs of the application block to transfer the desired status signals from the application level to the I/O level. On the I/O level, you can then establish the logical link to the digital output terminals.

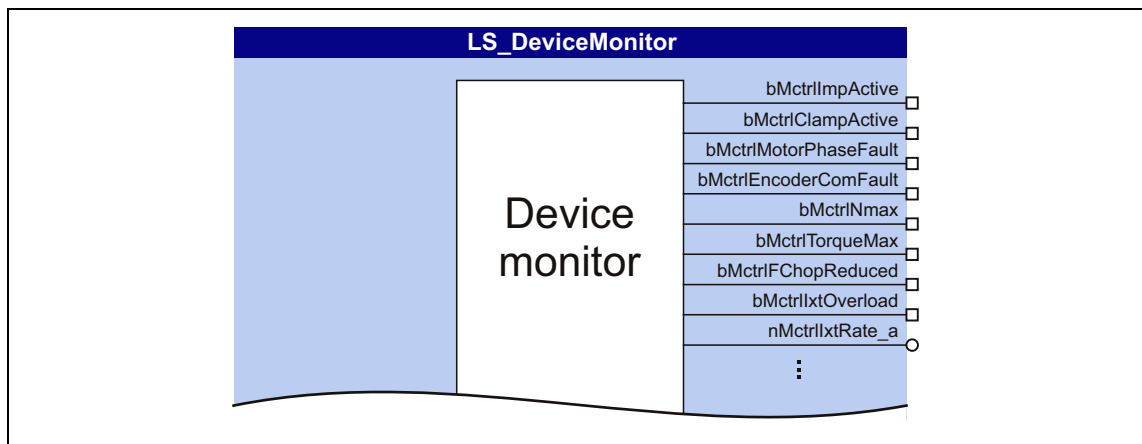

[5-32] LS\_DeviceMonitor system block (excerpt)

### outputs

Designator	Data type	Value/meaning	
bMctrlImpActive	BOOL	TRUE	Pulse inhibit is active
bMctrlClampActive	BOOL	TRUE	Clamp current limitation is active
bMctrlMotorPhaseFault	BOOL	Status of the <a href="#">Motor phase failure monitoring</a> Regardless of the response setting for motor phase failure monitoring ( <a href="#">C00597</a> ), bMctrlMotorPhaseFault is always displayed in the DeviceMonitor	
		TRUE	Motor phase fault has been detected
bMctrlEncoderComFault	BOOL	TRUE	Encoder error has been detected
bMctrlNmax	BOOL	TRUE	Max. speed limitation is active
bMctrlTorqueMax	BOOL	Status of the <a href="#">Maximum torque monitoring</a>	
		TRUE	Max. torque limitation is active
bMctrlFChopReduced	BOOL	TRUE	PWM frequency reduction is active
bMctrlIxtOverload	BOOL	Status of the <a href="#">Device overload monitoring (Ixt)</a>	
		TRUE	Device utilisation (Ixt) $\geq$ device utilisation threshold ( <a href="#">C00123</a> ) • Lenze setting: <a href="#">C00123</a> = 100 %

Designator	Data type	Value/meaning
nMctrlIxtRate_a	INT	Current device utilisation (Ixt) • Scaling: 16384 $\equiv$ 100 %
bMctrlI2xtOverload	BOOL	Status of the <a href="#">Motor overload monitoring (I2xt)</a>
		TRUE Thermal motor overload (I <sup>2</sup> xt) $\geq$ motor overload setting ( <a href="#">C00120</a> ) • Lenze setting: <a href="#">C00120</a> = 100 %.
nMctrlI2xtRate_a	INT	Current thermal motor load (I2xt) • Scaling: 16384 $\equiv$ 100 %
bMctrlMotorPTC	BOOL	Status of the <a href="#">Motor temperature monitoring (PTC)</a>
		TRUE Temperature monitoring: An error has been detected
bMctrlMotorTemp	BOOL	TRUE Thermal motor overload
bMctrlHeatSinkTemp	BOOL	TRUE Thermal inverter overload
		<ul style="list-style-type: none"> <li>The heatsink temperature (display in <a href="#">C00061</a>) has reached the maximally permissible temperature. The "<a href="#">oH1: Overtemperature heatsink</a>" error message is pending and the "Fault" response is activated.</li> <li>Furthermore, this output is set if the heatsink temperature has exceeded the maximally permissible temperature for the switching frequency set. A response with an "<a href="#">oH4: Heatsink temp. &gt; switch-off temp. -5°C</a>" error message can be set in <a href="#">C00582</a>. In the Lenze setting, no response will be effected.</li> </ul>
bMctrlMainsFault	BOOL	Status of the <a href="#">Mains phase failure monitoring</a>
		TRUE Mains phase failure/Mains failure
bMctrlFanFault	BOOL	TRUE Fan monitoring: An error has been detected
bMctrlNmaxForFChop	BOOL	TRUE The maximum field frequency for the respective switching frequency has been exceeded.
bMctrlShortCircuit	BOOL	TRUE Motor short circuit has been detected
bMctrlEarthFault	BOOL	TRUE Earth fault has been detected
bMctrlIUVDetected	BOOL	TRUE An undervoltage has been detected
bMctrlIOVDetected	BOOL	TRUE An overvoltage has been detected
bMctrlBrakeChopperFault	BOOL	Status of the <a href="#">Brake resistor monitoring (I2xt)</a> • This output is set independent of the set error response of the monitoring function.
		TRUE The I <sup>2</sup> xt utilisation has reached the switch-off threshold set in <a href="#">C00572</a> . • Lenze setting: <a href="#">C00572</a> = 100 %.
wUB24V	WORD	Current 24 V supply voltage • Scaling: 1000 $\equiv$ 1.000 V
nMctrlActiveOutputPower_a	INT	Current active output power • Scaling: 16384 $\equiv$ double rated power of the inverter <small>(from version 14.00.00)</small>
nMctrlApparentOutputPower_a	INT	Current apparent output power • Scaling: 16384 $\equiv$ double rated power of the inverter <small>(from version 14.00.00)</small>
nMctrlCosinePhiAct_a	INT	Current cosine phi • Scaling: 16384 $\equiv$ cosine phi of 1.0 <small>(from version 14.00.00)</small>

Designator	Data type	Value/meaning
bWirebreakUfLinearActive <small>(from version 15.00.00)</small>	BOOL	Status "V/f emergency operation due to encoder open circuit active" • The internal change-over to "V/f emergency operation" can be suppressed by setting bit 8 to "1" in <a href="#">C02864/1</a> .
		TRUE   Due to an encoder open circuit, it is internally switched to the encoderless V/f characteristic control in order to avoid impermissible motor movements. This does not influence the setting in <a href="#">C00006</a> .
bSlpsmSpeedopen LoopControl <small>(from version 17.00.00)</small>	BOOL	Implementation of an own flat ramp in the open-loop controlled operation of the SLPSM. Setting a flat ramp in the open-loop controlled operation and a steep ramp in the closed-loop controlled operation serves to achieve a considerably higher acceleration of the entire drive.
		TRUE   Open-loop controlled operation of the SLPSM is active
		FALSE   Open-loop controlled operation of the SLPSM is not active



## 6 I/O terminals

This chapter provides information on the function, possible parameter settings, and technical data of the input/output terminals of the inverter.

In the »Engineer«, the input and output terminals are parameterised on the **Terminal assignment** tab. To do this, go to the **Control terminals** list field and select the terminals that you wish to parameterise:

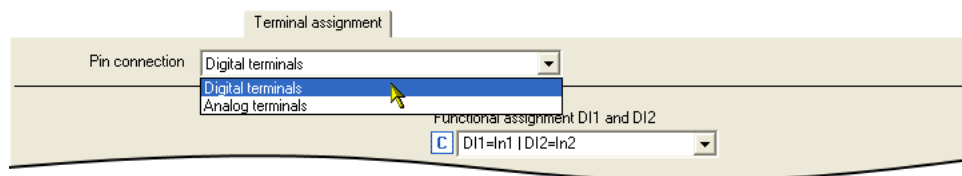

You can find further information in the respective subchapter:

- ▶ [Digital terminals](#) (📖 274)
- ▶ [Analog terminals](#) (📖 293)

**Note!**

The input and output terminals of the inverter have already been functionally assigned in the default setting ("Lenze setting"). The preconfigured assignment depends on the technology application selected in [C00005](#) and the control mode selected in [C00007](#):

- TA "Actuating drive speed": [Terminal assignment of the control modes](#) (📖 322)
- TA "Switch-off positioning": [Terminal assignment of the control modes](#) (📖 382)



Wiring diagram, assignment and electrical data of the input and output terminals can be found in the **hardware manual 8400** in the chapter "technical data". The hardware manual is stored in electronic form on the data carrier supplied with the 8400 inverter.

**Tip!**

How you can alter the preconfigured assignment of the input and output terminals is described in the chapter entitled "[User-defined terminal assignment](#)". (📖 302)

---

## 6.1 Digital terminals

The digital input terminals together with the digital output terminals are located on the X4 plug connector.

### Digital input terminals

The inverter has 4 parameterisable input terminals (DI1 ... DI4) for detecting digital signals. The RFR control input for enabling the inverter is permanently connected to the device control unit.

### Digital output terminals

The inverter has

- a parameterisable output terminal (DO1) for outputting digital signals,
- a relay output (terminal strip X101),



### Note!

Initialisation behaviour:

- After mains switching up to the start of the application, the digital output remains set to FALSE.

Exception handling:

- In case of a critical exception in the application (e.g. reset), the digital output is set to FALSE considering the terminal polarity parameterised in [C00118](#).

Switching cycle diagnostics of the relay:

- A reference for evaluating the wear limit can be obtained via the number of switching cycles of the relay displayed in [C00177/2](#).

Parameterisation dialog in the »Engineer«:

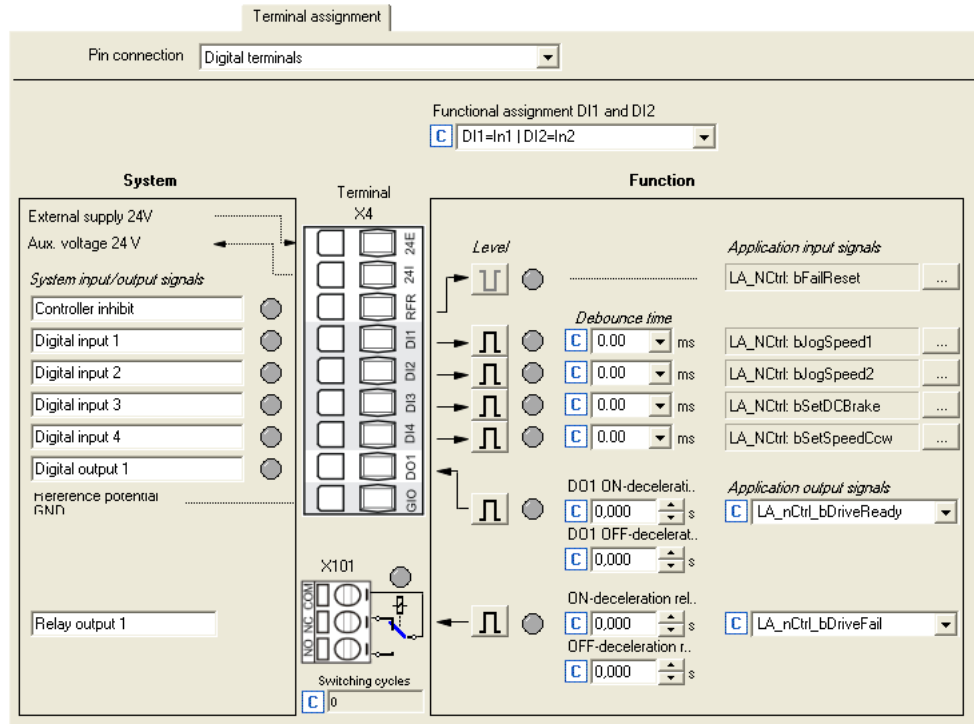

Button	Function
	Indicates the polarity of the input is HIGH active. The polarity can be changed from HIGH active to LOW active by clicking this button.
	Indicates that the polarity of the input is LOW active. The polarity can be changed from LOW active to HIGH active by clicking this button.
	Open the parameterising dialog for assigning application inputs to the digital input. ▶ <a href="#">Changing the terminal assignment with the »Engineer«</a> (306)

## Short overview of the parameters for the digital terminals:

Parameters	Info	Lenze setting	
		Value	Unit
<a href="#">C00115/1</a>	Fct. DI 1/2 10kHz ▶ <a href="#">Change function assignment (📖 277)</a>	0: DI1=In1 / DI2=In2	
<b>Digital inputs DI1 ... DI4</b>			
<a href="#">C00114</a>	DigInX: Inversion	Bit coded	
<a href="#">C02830/1...4</a>	DI1...DI4: Debounce time	1: 0.25	
<a href="#">C00443/1</a>	Dlx: Terminal level	-	
<a href="#">C00443/2</a>	Dlx: Output level	-	
<b>Digital output DO1</b>			
<a href="#">C00118</a>	DigOutX: Inversion	Bit coded	
<a href="#">C00423/3</a>	DO1 ON delay	0.000	s
<a href="#">C00423/4</a>	DO1 OFF delay	0.000	s
<a href="#">C00444/1</a>	DOx: Input level	-	
<a href="#">C00444/2</a>	DOx: Terminal level	-	
<b>Relay output</b>			
<a href="#">C00423/1</a>	Relay ON delay	0.000	s
<a href="#">C00423/2</a>	Relay OFF delay	0.000	s
<b>Digital outputs - terminal configuration</b>			
<a href="#">C00621/1</a>	LS_DigitalOutput:bRelay	1001: LA_nCtrl_bDriveFail	
<a href="#">C00621/2</a>	LS_DigitalOutput:bOut1	1000: LA_nCtrl_bDriveReady	
Greyed out = display parameter			

## Related topics:

- ▶ [Configuring exception handling of the output terminals \(📖 301\)](#)
- ▶ [User-defined terminal assignment \(📖 302\)](#)

### 6.1.1 Change function assignment

The internal processing function of the digital input terminals DI1 and DI2 can be reconfigured in [C00115](#) if necessary. In this way, these input terminals can alternatively be used as frequency or counting inputs in order to implement the following functions:

- Detection of the input frequency
- Detection and processing of two unipolar input frequencies to one bipolar frequency
- Counting of input pulses
- Evaluation of the speed feedback (HTL encoder) for the motor control (speed-controlled operation)

C00115/1: Function assignment DI1 and DI2		Function assignment	
		DI1	DI2
0	DI1=In1 / DI2=In2	Digital input	Digital input
1	DI1=FreqIn12 / DI2=In2	Frequency input	Digital input
2	DI1&DI2=FreqIn (2-track)	Frequency input (2-track)	
3	( DI1/DI2=+- ) = FreqIn12	Frequency input (speed)	Frequency input (direction)
4	DI1=CountIn1 / DI2=In2	Count input	Digital input



#### Note!

- In the Lenze setting of [C00115](#), the digital input terminals DI1 and DI2 have been configured as "normal" digital inputs.
- The digital input terminals DI3 ... DI4 are basically designed as "normal" digital inputs.
- Very high pulse frequencies can be measured at the DI1 and DI2 input terminals if the latter have been configured as frequency or counting inputs in [C00115](#). Scanning is then carried out within less than  $\mu\text{s}$  instead of the otherwise usual scanning rate of 1 kHz (1 ms).

You can find detailed information on the respective function assignment in the following subchapters:

- ▶ [Using DI1 and DI2 as digital inputs](#) (📖 278)
- ▶ [Using DI1 and DI2 as frequency inputs](#) (📖 279)
- ▶ [Using DI1 as counting input](#) (📖 283)

# 6 I/O terminals

## 6.1 Digital terminals

### 6.1.1.1 Using DI1 and DI2 as digital inputs

#### Function assignment 0: DI1=In1 / DI2=In2

With this setting in [C00115](#), the digital input terminals have been configured as "normal" digital inputs.

- For each digital input, the debounce time ([C02830/1...4](#)) and the terminal polarity ([C00114](#)) can be set individually.
- The current terminal level at the input of the internal processing function is shown in [C00443/1](#) in bit-coded form.
- The output level for the application is shown in [C00443/2](#) in bit-coded form.

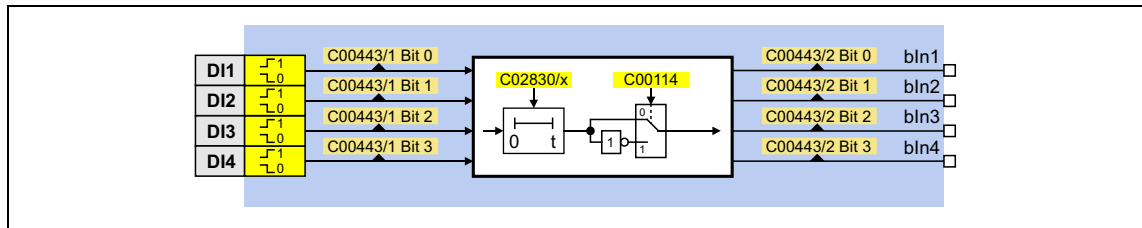

#### Internal interfaces to the application

- Relevant outputs at the [LS\\_DigitalInput](#) system block:

Output	Value/meaning
<small>DIS code   data type</small> bIn1 ... bIn4 <a href="#">C00443/2</a>   BOOL	Digital input DI1 ... DI4

#### Related topics:

- ▶ [Using DI1 and DI2 as frequency inputs](#) (279)
- ▶ [Using DI1 as counting input](#) (283)
- ▶ [Internal interfaces | System block "LS\\_DigitalInput"](#) (286)

### 6.1.1.2 Using DI1 and DI2 as frequency inputs

#### General information on using the input terminals as frequency inputs

The frequency inputs serve to detect HTL encoders with any number of increments and single-track and two-track signals. Single-track signals can be evaluated with or without rotation signal.



#### Note!

- Make sure that, when motor control with speed feedback is in use, the maximum input frequency of the respective input terminal is not exceeded.
  - DI1/DI2:  $f_{\max} = 10 \text{ kHz}$
- If the encoder signal is used as an actual speed value:  
Number of encoder pulses / revolution  $\leq 8192!$

Example of DI1/DI2 (in accordance with the preceding note):

- Encoder increment: 512 pulses / motor revolution
- Reference speed (C00011): 1500 rpm
- Speed setpoint: 100 %

$$\text{Input frequency} = \frac{1500 \text{ rpm}}{60 \text{ s}} \times 512 \text{ pulses} = 12800 \text{ pulses/s} = 12.8 \text{ kHz}$$

- Result: The speed or the number of increments is too high!



#### Tip!

From version 06.00.00 onwards, the [LS\\_DigitalInput](#) system block can also provide the encoder position. Detailed information on this topic is provided in chapter "[Output of the encoder position of the DI1/DI2 frequency input](#)". (📖 288)

**Function assignment 1: DI1=FreqIn / DI2=In**

This setting in [C00115](#) configures the input terminal DI1 as frequency input. The input terminal DI2 remains configured as "normal" digital input..

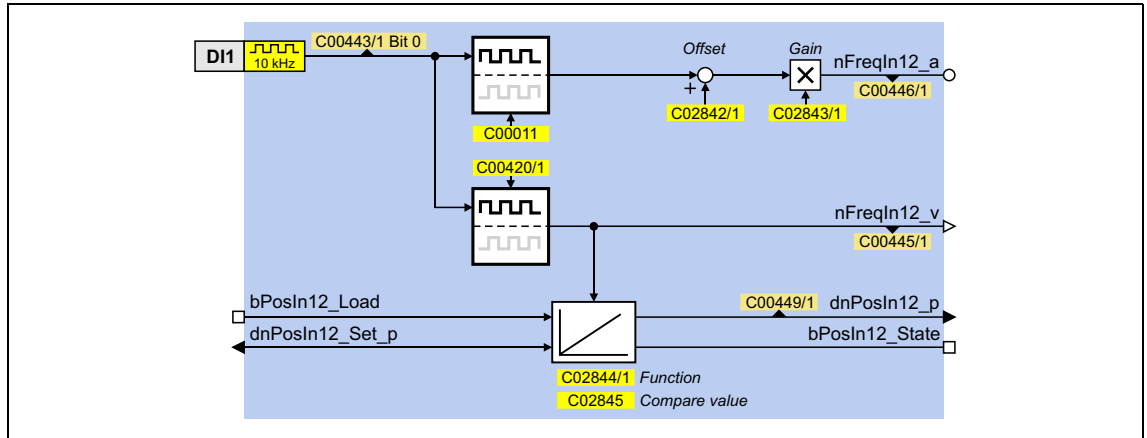

**Function assignment 2: DI1&DI2=FreqIn (2-track)**

This setting in [C00115](#) can be used to connect a two-track encoder to the DI1/DI2 terminals.

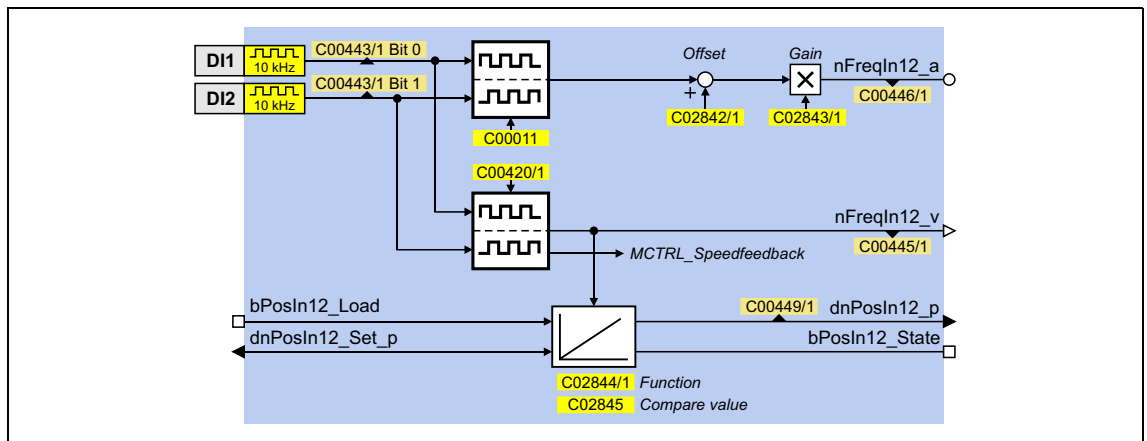



**Function assignment 3: DI1=FreqIn / DI2=direction**

This setting in [C00115](#) can be used to connect a single-track encoder to terminals DI1/DI2. For this purpose, the rotation speed is evaluated via terminal DI1 and the direction of rotation of the encoder (LOW level  $\equiv$  CW direction of rotation) is evaluated via the DI2 terminal.

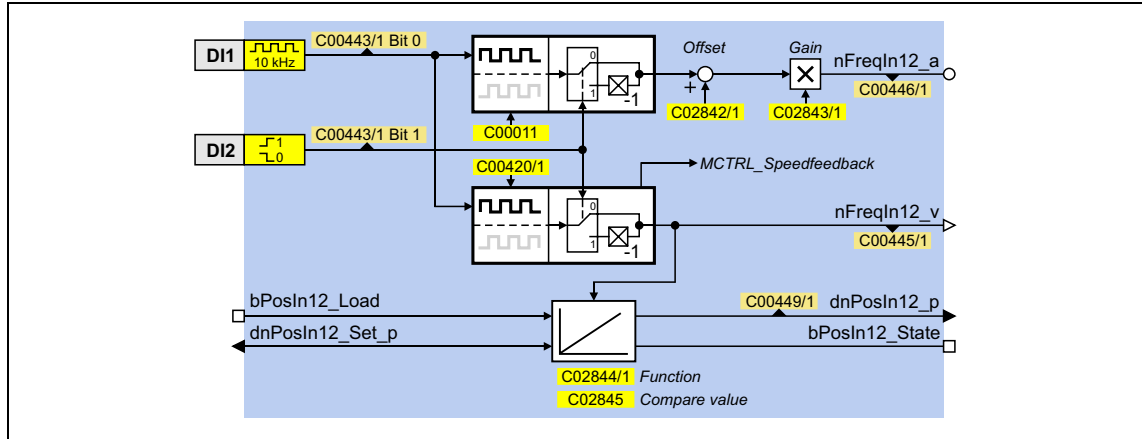

**Short overview of the parameters for the frequency inputs:**

Parameters	Info	Lenze setting	
		Value	Unit
<a href="#">C00011</a>	Appl.: Reference speed	1500	rpm
<b>Frequency input DI1/DI2</b>			
<a href="#">C00115/1</a>	Fct. DI 1/2 10kHz	0: DI1=In1 / DI2=In2	
<a href="#">C00420/1</a>	Encoder increments at FreqIn12	128	Incr./rev.
<a href="#">C02842/1</a>	FreqIn12: Offset	0.00	%
<a href="#">C02843/1</a>	FreqIn12: Gain	100.00	%
<a href="#">C02844/1</a>	PosIn12: Function	Loading with level	
<a href="#">C02845</a>	PosIn12: Comparison value	0	
<a href="#">C00443/1</a>	Dlx: Terminal level	-	
<a href="#">C00445/1</a>	FreqIn12_nOut_v	-	Incr/ms
<a href="#">C00446/1</a>	FreqIn12_nOut_a	-	%
<a href="#">C00449/1</a>	FreqIn12_dnOut_p	-	Incr
Greyed out = display parameter			

### Internal interfaces to the application

- Relevant inputs at the [LS\\_DigitalInput](#) system block:

Input	Data type	Information/possible settings
<b>Frequency input DI1/DI2</b>		
bPosIn12_Load <small>(from version 06.00.00)</small>	BOOL	Load angle integrator with starting value and reset status signal
		TRUE Angle integrator is loaded with the value at <i>dnPosIn12_Set_p</i> and <i>bPosIn12_State</i> is reset to FALSE.
dnPosIn12_Set_p <small>(from version 06.00.00)</small>	DINT	Starting value for angle integrator

- Relevant outputs at the [LS\\_DigitalInput](#) system block:

Output	Data type	Value/meaning
<b>Frequency input DI1/DI2</b>		
nFreqIn12_a <small>C00446/1</small>	INT	Output frequency as scaled analog signal in [%]
nFreqIn12_v <small>C00445/1</small>	INT	Output frequency as speed signal in [inc/ms]

### Related topics:

- ▶ [Output of the encoder position of the DI1/DI2 frequency input](#) (📖 288)
- ▶ [Using DI1 and DI2 as digital inputs](#) (📖 278)
- ▶ [Using DI1 as counting input](#) (📖 283)
- ▶ [Internal interfaces | System block "LS\\_DigitalInput"](#) (📖 286)

### 6.1.1.3 Using DI1 as counting input

#### General information on use as a counting input

The counting input is used for counting fast edges. A 32-bit counter counts from a parameterisable starting value up to a parameterisable comparison value and then outputs a corresponding status signal.

- Possible counting range:  $0 \dots 2^{31} - 1$  (0 ... 2147483647)



#### Note!

- The starting value must have been set so that it is smaller than the comparison value. Otherwise, the counter will be kept at the starting value because the condition "Count value  $\geq$  Comparison value" has been satisfied.
- Note the maximum input frequency of the input terminal:
  - DI1:  $f_{\max} = 10 \text{ kHz}$

#### Function assignment 4: DI1=CountIn / DI2=In

This setting in [C00115](#) configures the input terminal DI1 as counting input. The input terminal DI2 remains configured as "normal" digital input..

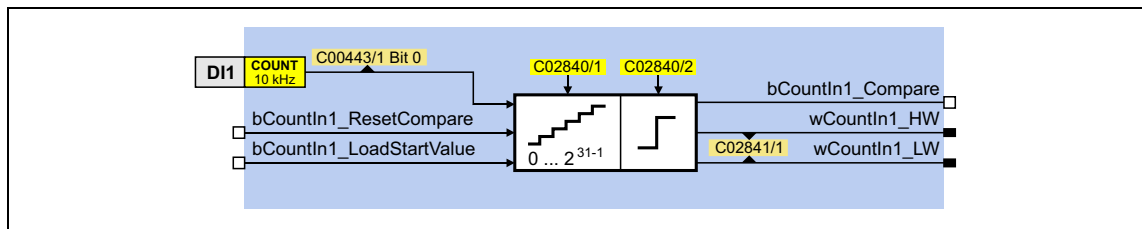

#### Short overview of parameters for the counting inputs:

Parameters	Info	Lenze setting	
		Value	Unit
<b>Counting input DI1</b>			
<a href="#">C00115/1</a>	Fct. DI 1/2 10kHz	0: DI1=In1 / DI2=In2	
<a href="#">C00621/3</a>	LS_DigitalInput: bCountIn1_Reset	0: Not connected	
<a href="#">C00621/4</a>	LS_DigitalInput: bCountIn1_LoadStartValue	0: Not connected	
<a href="#">C02840/1</a>	CountIn1: Starting value	0	incr
<a href="#">C02840/2</a>	CountIn1: Comparison value	65535	incr
<a href="#">C02841/1</a>	CountIn1: Counter content	-	incr
<a href="#">C00443/1</a>	Dix: Terminal level	-	-
Greyed out = display parameter			

### Internal interfaces to the application

- Relevant inputs at the [LS\\_DigitalInput](#) system block:

Designator <small>DIS code   data type</small>	Information/possible settings
<b>Counting input DI1</b>	
bCountIn1_ResetCompare <small>BOOL</small>	Reset status signal "Comparison value reached"
	FALSE↗TRUE   The output <i>bCountIn1_Compare</i> is reset to FALSE.
bCountIn1_LoadStartValue <small>BOOL</small>	Load starting value into counter
	FALSE↗TRUE   The starting value set in <a href="#">C02840/1</a> is accepted as the current count value.

- Relevant outputs at the [LS\\_DigitalInput](#) system block:

Designator <small>DIS code   data type</small>	Value/meaning
<b>Counting input DI1</b>	
bCountIn1_Compare <small>BOOL</small>	Status signal "Comparison value reached"
	FALSE   Current count value < comparison value ( <a href="#">C02840/2</a> )
	TRUE   Current count value ≥ comparison value ( <a href="#">C02840/2</a> )
wCountIn1_HW wCountIn1_LW <small><a href="#">C02841/1</a>   WORD</small>	Current count value <ul style="list-style-type: none"> <li>• Output as High and Low word (without sign)</li> <li>• Possible counting range: 0 ... <math>2^{31} - 1</math></li> </ul>

### Counting behaviour

The following temporal characteristic shows the counting process depending on the signals of the interfaces described before:

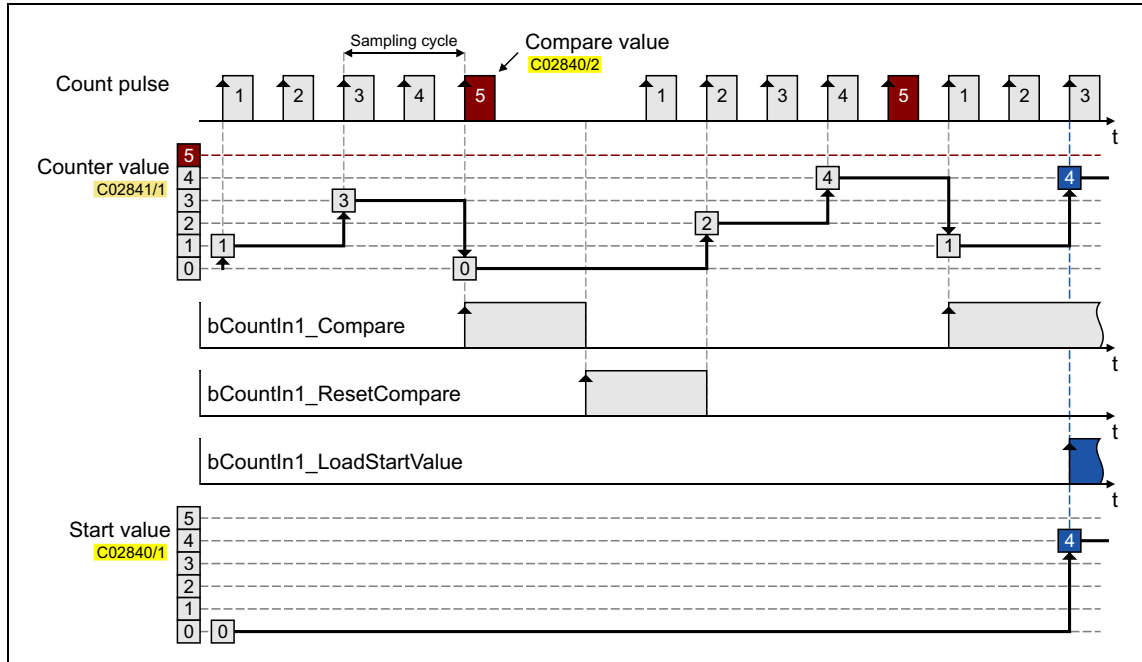

[6-1] Transient characteristic of a quick counter block, sampling cycle = 1 ms

- The counter starts with the parameterised starting value.
- If the comparison value is reached or exceeded:
  - The counter jumps back to its starting value.
  - The *bCount1\_Compare* output is set to TRUE.
- If there is a FALSE/TRUE edge at the *bCountIn1\_ResetCompare* input, the *bCountIn1\_Compare* output can be reset to FALSE.
- If there is a FALSE-TRUE edge at the input *bCountIn1\_LoadStartValue*, the current counter content can be reset to the parameterised starting value.

### Related topics:

- ▶ [Using DI1 and DI2 as digital inputs](#) (📖 278)
- ▶ [Using DI1 and DI2 as frequency inputs](#) (📖 279)
- ▶ [Internal interfaces | System block "LS\\_DigitalInput"](#) (📖 286)

# 6 I/O terminals

## 6.1 Digital terminals

### 6.1.2 Internal interfaces | System block "LS\_DigitalInput"

The system block **LS\_DigitalInput** maps the digital input terminals in the FB editor.

- The internal processing function of the digital DI1/2 input terminals can be reconfigured in [C00115](#) if necessary. These input terminals can then be alternatively used as frequency inputs or counting inputs.
- The DI3 ... DI4 input terminals are basically designed as "normal" digital inputs.

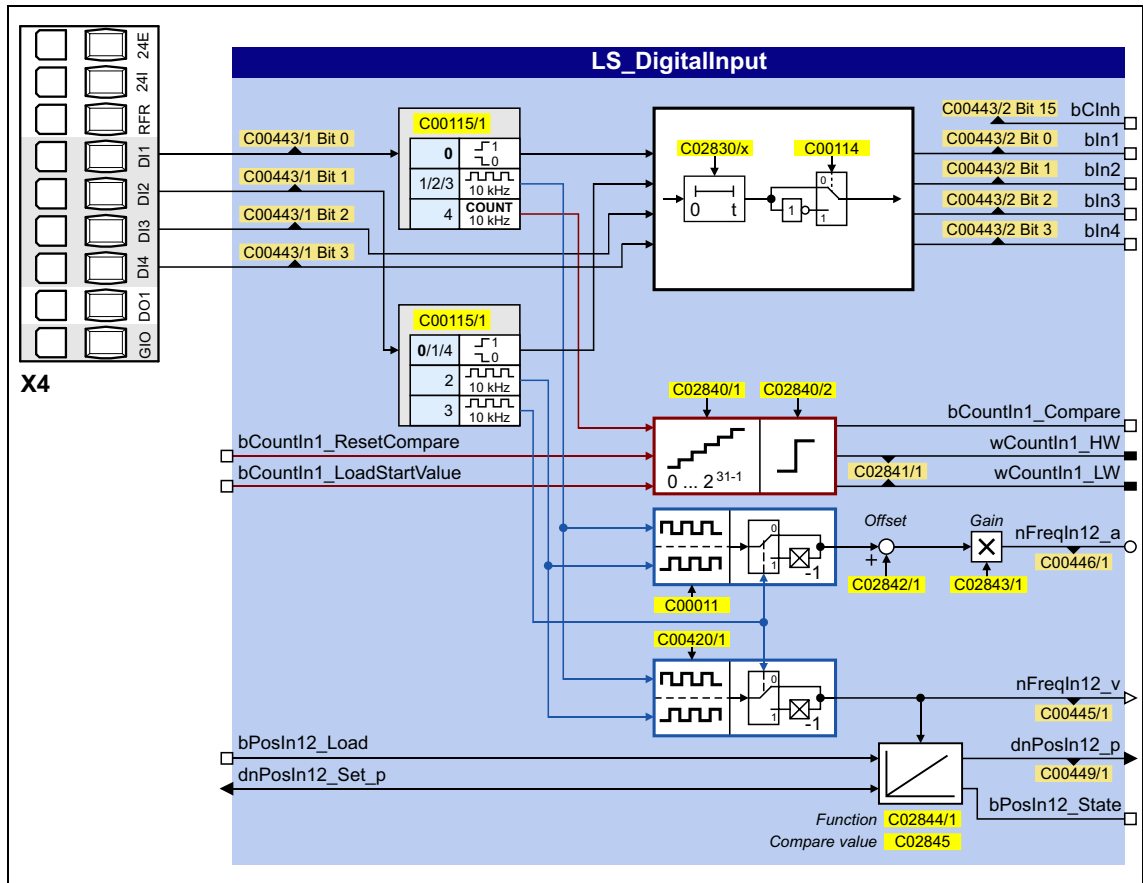

## inputs

Designator <small>DIS code   data type</small>	Information/possible settings
<b>Counting input DI1</b>	▶ <a href="#">Using DI1 as counting input</a>
bCountIn1_ResetCompare <small>BOOL</small>	Reset status signal "Comparison value reached" FALSE↗TRUE   The output <i>bCountIn1_Compare</i> is reset to FALSE.
bCountIn1_LoadStartValue <small>BOOL</small>	Load starting value into counter FALSE↗TRUE   The starting value set in <a href="#">C02840/1</a> is accepted as the current count value.
<b>Frequency input DI1/DI2</b>	▶ <a href="#">Output of the encoder position of the DI1/DI2 frequency input</a>
bPosIn12_Load <small>BOOL</small> <small>(from version 06.00.00)</small>	Load angle integrator with starting value and reset status signal TRUE   Angle integrator is loaded with the value at <i>dnPosIn12_Set_p</i> and <i>bPosIn12_State</i> is reset to FALSE.
dnPosIn12_Set_p <small>DINT</small> <small>(from version 06.00.00)</small>	Starting value for angle integrator

## outputs

Designator <small>DIS code   data type</small>	Value/meaning
bCInh <small>C00443/2   BOOL</small>	RFR digital input (controller enable)
<b>Digital inputs DI1 ... DI4</b>	▶ <a href="#">Using DI1 and DI2 as digital inputs</a>
bln1 ... bln4 <small>C00443/2   BOOL</small>	Digital input DI1 ... DI4
<b>Counting input DI1</b>	▶ <a href="#">Using DI1 as counting input</a>
bCountIn1_Compare <small>BOOL</small>	Status signal "Comparison value reached" FALSE   Current count value < comparison value ( <a href="#">C02840/2</a> ) TRUE   Current count value ≥ comparison value ( <a href="#">C02840/2</a> )
wCountIn1_HW wCountIn1_LW <small>C02841/1   WORD</small>	Current count value • Output as High and Low word (without sign) • Possible counting range: 0 ... 2 <sup>31</sup> - 1
<b>Frequency input DI1/DI2</b>	▶ <a href="#">Using DI1 and DI2 as frequency inputs</a>
nFreqIn12_a <small>C00446/1   INT</small>	Output frequency as scaled analog signal in [%]
nFreqIn12_v <small>C00445/1   INT</small>	Output frequency as speed signal in [inc/ms]
dnPosIn12_p <small>DINT</small> <small>(from version 06.00.00)</small>	Angle output signal • 65536 [incr.] ≙ 1 encoder revolution • Overflow is possible (display via <i>bPosIn12_State</i> )
bPosIn12_State <small>BOOL</small> <small>(from version 06.00.00)</small>	Status signal "Overflow occurred/distance processed" TRUE   Overflow has occurred or distance is processed.

### 6.1.2.1 Output of the encoder position of the DI1/DI2 frequency input

This function extension is available from version 06.00.00!

The [LS DigitalInput](#) system block has been extended by the integrator function for providing the encoder position.

- The integrator can take max.  $\pm 32000$  encoder revolutions.
- The starting position can be loaded via inputs.
- The internal function can be set via parameters.
- In addition to the encoder position, the "Overflow occurred/distance processed" status signal is provided.

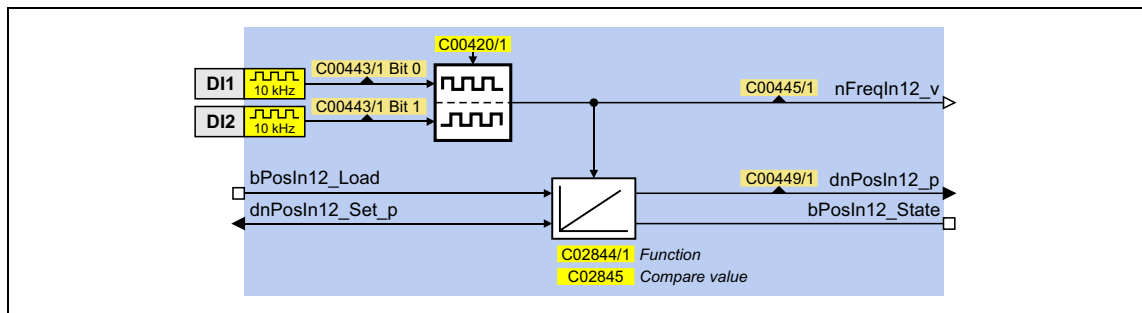

#### inputs

Designator DIS code   data type	Information/possible settings
bPosIn12_Load BOOL	Load angle integrator with starting value and reset status signal TRUE   Angle integrator is loaded with the value at <i>dnPosIn12_Set_p</i> and <i>bPosIn12_State</i> is reset to FALSE.
dnPosIn12_Set_p DINT	Starting value for angle integrator

#### outputs

Designator DIS code   data type	Value/meaning
dnPosIn12_p DINT	Angle output signal • 65536 [incr.] $\equiv$ 1 encoder revolution • Overflow is possible (display via <i>bPosIn12_State</i> )
bPosIn12_State BOOL	Status signal "Overflow occurred/distance processed" • Status signal can be reset via <i>bPosIn12_Load</i> . TRUE   Overflow has occurred or distance is processed.



## Parameters

Parameters	Possible settings	Info	
<a href="#">C02844/1</a>	0 Loading with level	Load integrator with TRUE level at the <i>bPosIn12_Load</i> input (Lenze setting).	
	1 Loading with edge	Load integrator with FALSE/TRUE edge at the <i>bPosIn12_Load</i> input.	
	2 Loading with level + reset	Load integrator when reaching the comparison value or with TRUE level at the <i>bPosIn12_Load</i> input.	
<a href="#">C02845</a>	0	2000000000	Comparison value <ul style="list-style-type: none"> <li>• Is valid for both the positive and the negative value range.</li> <li>• Lenze setting: 0</li> </ul>

## Function at constant input value

Selection: [C02844/1](#) = "0: Loading with level" or "1: Loading with edge"

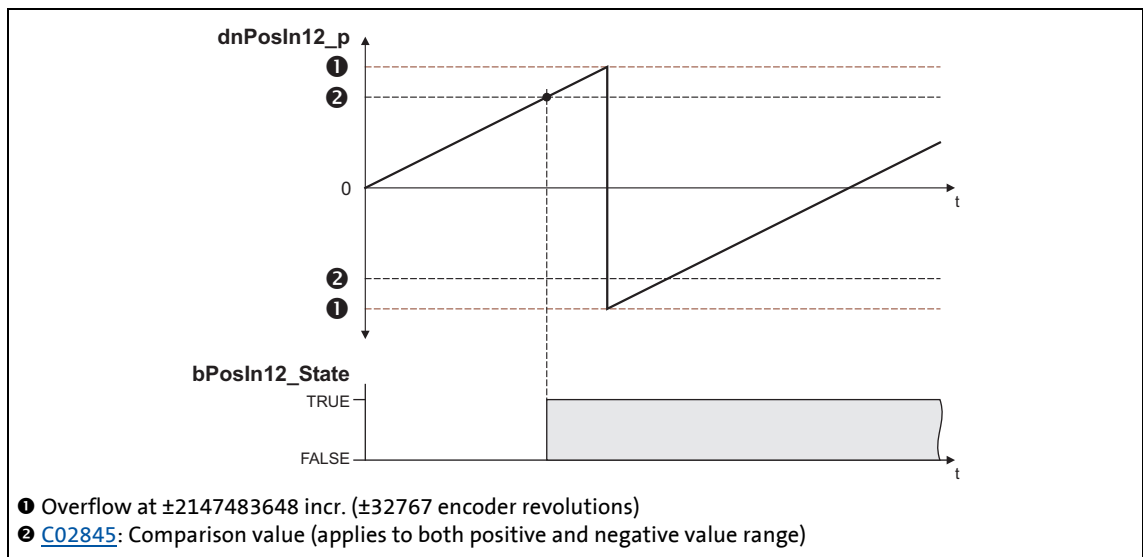

[6-2] Switching performance if the overflow is in the positive direction

- If "0: Loading with level" is selected in [C02844/1](#), the *bPosIn12\_Load* input is status-controlled: In case of a TRUE signal, the integrator is loaded with the value at *dnPosIn12\_Set\_p* and the *bPosIn12\_State* output is set to FALSE.
- If "1: Loading with edge" is selected in [C02844/1](#), the *bPosIn12\_Load* input is edge-controlled: In case of a FALSE/TRUE edge, the integrator is loaded with the value at *dnPosIn12\_Set\_p* and then immediately continues to integrate, the *bPosIn12\_State* output is set to FALSE.
- A positive *nFreqIn12\_v* signal is incremented (the counter content is increased with every cycle).
- A negative *nFreqIn12\_v* signal is decremented (the counter content is reduced with every cycle).

- *dnPosIn12\_p* provides the counter content of the bipolar integrator.
  - If the counter content exceeds a value of +32767 encoder revolutions (corresponds to +2147483647 incr.), an overflow occurs and the counting process continues at a value of -32768 encoder revolutions.
  - If the counter content falls below a value of -32768 encoder revolutions (corresponds to -2147483648 incr.), an overflow occurs and the counting process starts at a value of +32767 encoder revolutions.
- *bPosIn12\_State* is set to TRUE if the comparison value set in [C02845](#) has been reached.

### Function at input value with sign reversal

Selection: [C02844/1](#) = "2: Loading with level + reset"

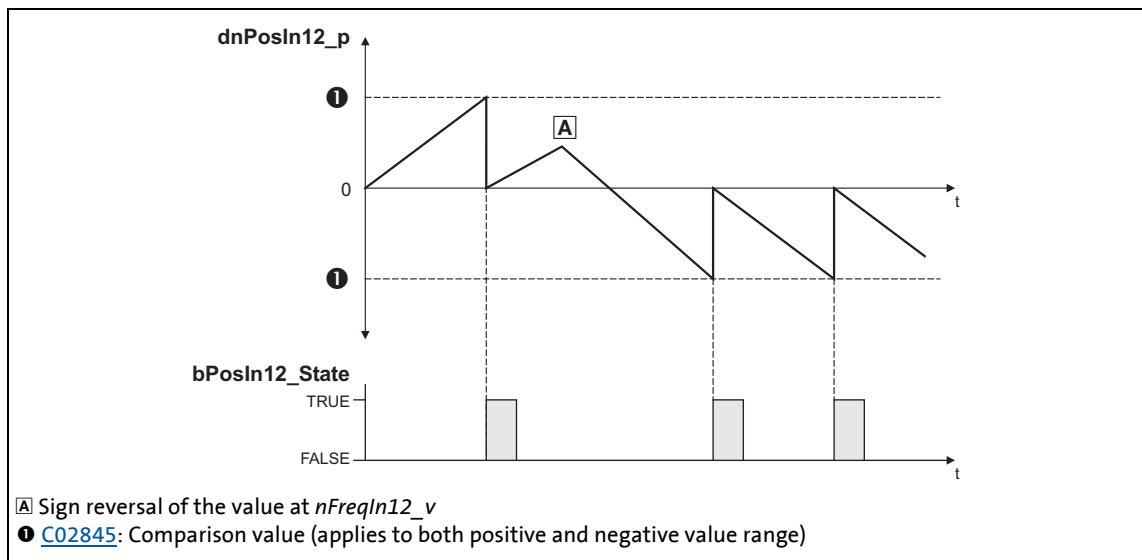

[6-3] Switching performance if the input signal changes signs

- If "2: Loading with level + reset" is selected in [C02844/1](#), the *bPosIn12\_Load* input is status-controlled: In case of a TRUE signal, the integrator is loaded with the value at *dnPosIn12\_Set\_p* and the *bPosIn12\_State* output is set to FALSE.
- A positive *nFreqIn12\_v* signal is incremented (the counter content is increased with every cycle).
- A negative *nFreqIn12\_v* signal is decremented (the counter content is reduced with every cycle).
- *dnPosIn12\_p* provides the counter content of the bipolar integrator.
  - If the positive counter content is higher than the comparison value set in [C02845](#), the comparison value will be subtracted from the counter content, and *bPosIn12\_State* will be set to TRUE for one task cycle.
  - If the negative counter content is lower than the comparison value set in [C02845](#), the comparison value will be added to the counter content, and *bPosIn12\_State* will be set to TRUE for one task cycle.

**Calculation of the output signal**

The output value at  $dnPosIn12\_p$  is calculated as per the formula below:

$$dnPosIn12\_p \text{ [incr.]} = nFreqIn12\_v \text{ [rpm]} \cdot t \text{ [s]} \cdot 65535 \text{ [incr./rev.]}$$

$t$  = integration time

16384  $\approx$  15000 rpm

1  $\approx$  1 incr.

**Example**

You want to determine the counter content of the integrator at a certain speed at the input and a certain integration time  $t$ .

Given values:

- $nFreqIn12\_v = 1000 \text{ rpm} \approx \text{integer value } 1092$
- Integration time  $t = 10 \text{ s}$
- Starting value of the integrator = 0

Solution:

- Conversion of the  $nFreqIn12\_v$  input signal:

$$1000 \text{ rpm} = \frac{1000 \text{ rev.}}{60 \text{ s}}$$

- Calculation of the output value:

$$dnPosIn12\_p = \frac{1000 \text{ rev.}}{60 \text{ s}} \cdot 10 \text{ s} \cdot \frac{65535 \text{ incr.}}{\text{Rev.}} = 10922666 \text{ incr.}$$

# 6 I/O terminals

## 6.1 Digital terminals

### 6.1.3 Internal interfaces | System block "LS\_DigitalOutput"

The LS\_DigitalOutput system block maps the digital output terminals in the FB editor.

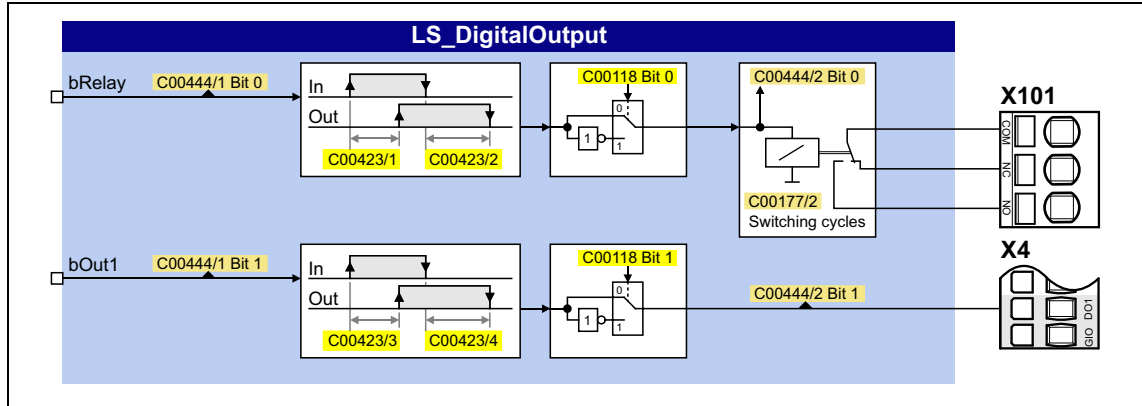

Input	Information/possible settings
bRelay <small>DIS code   data type</small> <a href="#">C00444/1</a>   BOOL	Relay output (potential-free two-way switch)
bOut1 <small>DIS code   data type</small> <a href="#">C00444/1</a>   BOOL	DO1 digital output

# 6 I/O terminals

## 6.2 Analog terminals

### 6.2 Analog terminals

The analog input terminals together with the analog output terminals are located on the X3 plug connector.

#### Analog input terminals

The inverter has two analog input terminals for detecting one current signal and one voltage signal:

- Voltage signal in the  $\pm 10$  V range  
The voltage signal can be e.g. an analog speed setpoint or the signal of an external sensor (temperature, pressure, etc.).
- Current signal in the  $0/+ 4 \dots + 20$  mA range  
For open-circuit monitoring, the current signal can be evaluated with regard to "Life Zero" or "Dead Zero":
  - 0 ... 20 mA, without open-circuit monitoring
  - 4 ... 20 mA, with open-circuit monitoring



#### Note!

To avoid undefined states, free input terminals of the inverter must be assigned as well, e.g. by applying 0 V to the terminal.

#### Analog output terminal

The inverter has an analog output terminal for outputting an analog voltage signal (O1U).



#### Note!

Initialisation behaviour:



- After mains switching up to the start of the application, the analog output remains set to 0 V.

Exception handling:

- In case of a critical exception in the application (e.g. reset), the analog output is set to 0 V.

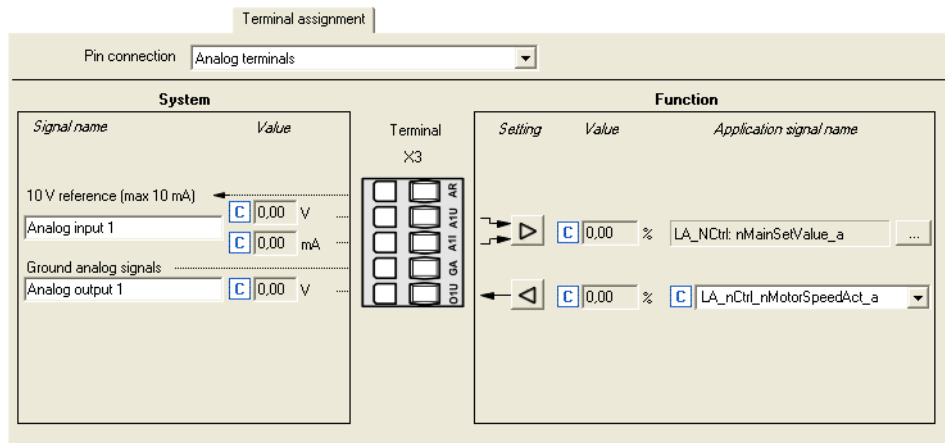
#### Parameterisation dialog in the »Engineer«:



Button	Function
	<a href="#">Parameterising analog input</a> (📖 295)
	<a href="#">Parameterising analog output</a> (📖 299)
	Open the parameterising dialog for assigning application inputs to the analog input. ▶ <a href="#">Changing the terminal assignment with the »Engineer«</a> (📖 306)

#### Short overview of parameters for the analog terminals:

Parameters	Info	Lenze setting	
		Value	Unit
<b>Analog input 1</b>			
<a href="#">C00028/1</a>	AIN1: Input voltage	-	V
<a href="#">C00029/1</a>	AIN1: Input current	-	mA
<a href="#">C00033/1</a>	AIN1: Output value (to application)	-	%
<b>Analog output 1</b>			
<a href="#">C00439/1</a>	O1U: Input value (from application)	-	%
<a href="#">C00436/1</a>	O1U: Voltage	-	V
<b>Analog output 1 - terminal assignment</b>			
<a href="#">C00620/1</a>	LS_AnalogOutput: nOut1_a (V)	1003: LA_nCtrl_nMotorSpeedAct_a	
Greyed out = display parameter			

#### Related topics:

- ▶ [Configuring exception handling of the output terminals](#) (📖 301)
- ▶ [User-defined terminal assignment](#) (📖 302)

# 6 I/O terminals

## 6.2 Analog terminals

### 6.2.1 Parameterising analog input

By clicking on the  button on the **Terminal assignment** tab, you reach the parameterising dialog for the analog input:

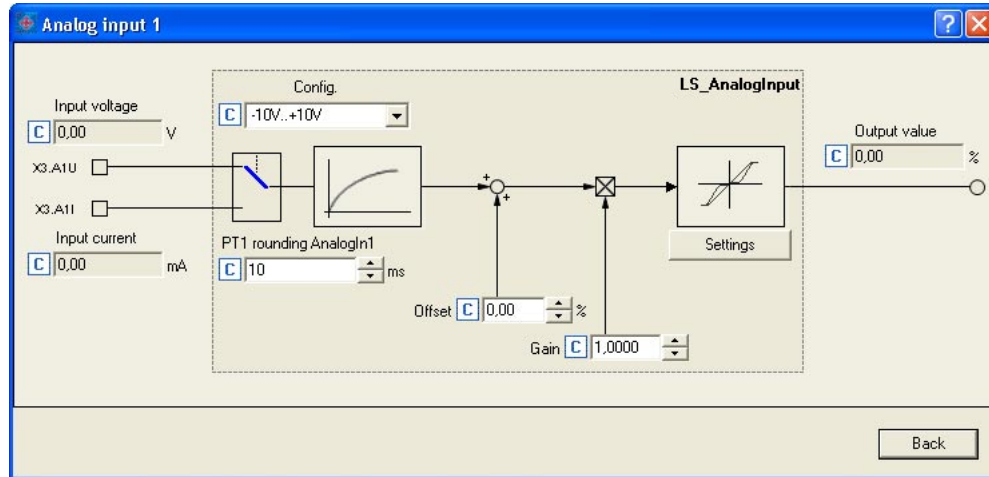

Short overview of the parameters for the analog input:

Parameters	Info	Lenze setting	
		Value	Unit
<b>Analog input 1</b>			
<a href="#">C00034/1</a>	AIN1: Config.	0: -10V..+10V	
<a href="#">C00026/1</a>	AIN1: Offset	0.00	%
<a href="#">C00027/1</a>	AIN1: Gain	1.0000	
<a href="#">C00028/1</a>	AIN1: Input voltage	-	V
<a href="#">C00029/1</a>	AIN1: Input current	-	mA
<a href="#">C00033/1</a>	AIN1: Output value (to application)	-	%
<a href="#">C00440/1</a>	PT1 rounding AnalogIn1	10	ms
<a href="#">C00598/1</a>	Resp. to open circuit AIN1	3: TroubleQuickStop	
Greyed out = display parameter			

---

### Using current input A1I

In the Lenze setting, voltage signals in the range of  $\pm 10$  V are evaluated via the A1U input terminal. If current signals are detected via the A1I input terminal instead, the selection "1: 0...20mA" or "2: 4...20mA" is to be set in [C00034](#).

**Tip!**

By selecting "2: 4...20mA", you can implement a 4 ...20 mA current loop, e.g. for stipulation of the speed setpoint.

### Open-circuit monitoring

In the case of configuration as a 4 ... 20 mA current loop, the fault response set in [C00598](#) takes place in the event of a wire breakage (Lenze setting: "TroubleQuickStop").



### 6.2.1.1 Signal adaptation by means of characteristic

This function extension is only available from version 04.00.00!

According to the illustration below, an individual characteristic can be parameterised for the analog input via the subcodes of [C00010](#) to provide different slopes and a dead band. Here, the input signal corresponds to the X axis and the output signal corresponds to the Y axis:

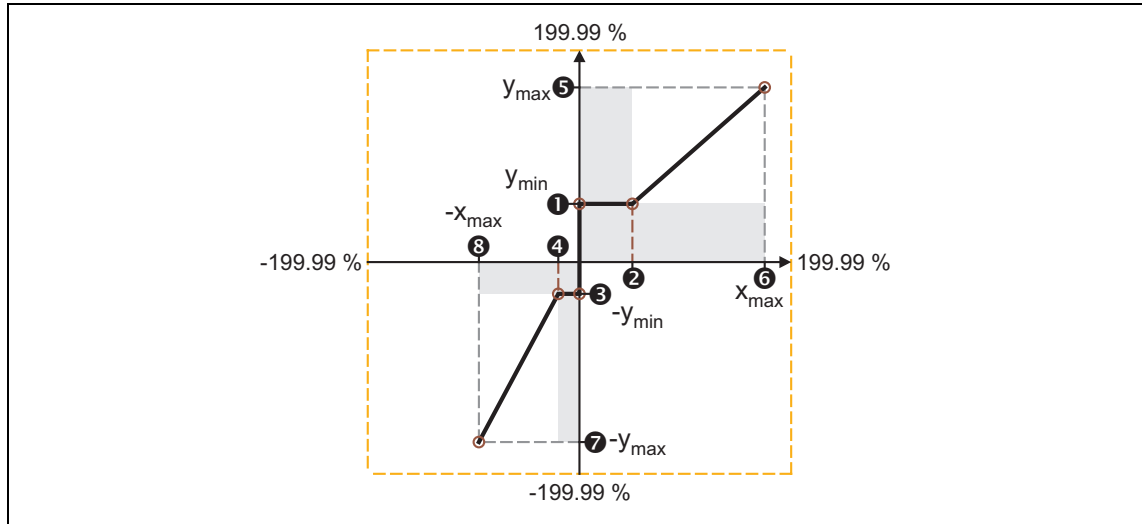

[6-4] Characteristic for analog inputs

Parameters	Info	Lenze setting	
		Value	Unit
<a href="#">C00010/1</a>	① AIN1: (+y0) = min	0.00	%
<a href="#">C00010/2</a>	② AIN1: (+x0) = Dead band	0.00	%
<a href="#">C00010/3</a>	③ AIN1: (-y0) = (-min)	0.00	%
<a href="#">C00010/4</a>	④ AIN1: (-x0) = (-Dead band)	0.00	%
<a href="#">C00010/5</a>	⑤ AIN1: (+ymax)	199.99	%
<a href="#">C00010/6</a>	⑥ AIN1: (+xmax)	199.99	%
<a href="#">C00010/7</a>	⑦ AIN1: (-ymax)	199.99	%
<a href="#">C00010/8</a>	⑧ AIN1: (-xmax)	199.99	%

In the »Engineer«, there is a parameterising dialog for entering the characteristic. This dialog also displays the set characteristic graphically.



Proceed as follows to open the dialog for parameterising the characteristic:

1. Go to the **Terminal assignment** tab and select the "Analog terminals" entry in the **Control connections** list field.
2. Click on the  button for the analog input in order to open the *Analog input* dialog.

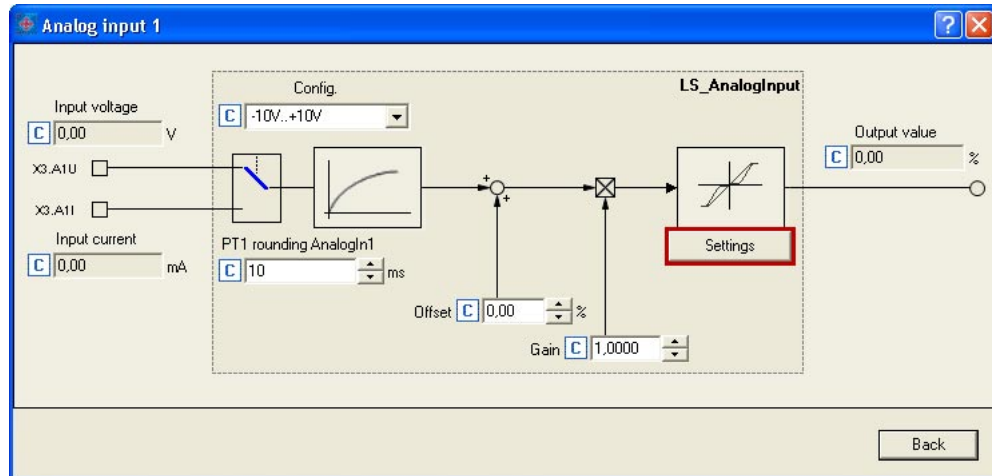

3. Click on the **Settings** button in order to open the *Analog input - Characteristic* dialog box:

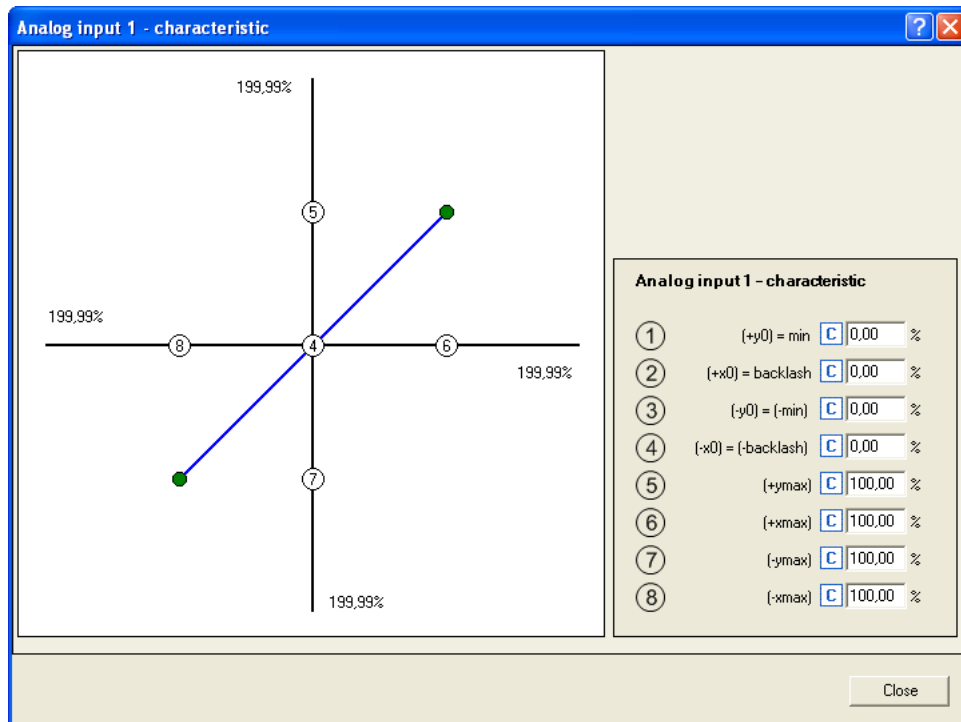

# 6 I/O terminals

## 6.2 Analog terminals

### 6.2.2 Parameterising analog output

By clicking on the  button on the **Terminal assignment** tab, you reach the parameterising dialog for the analog output:

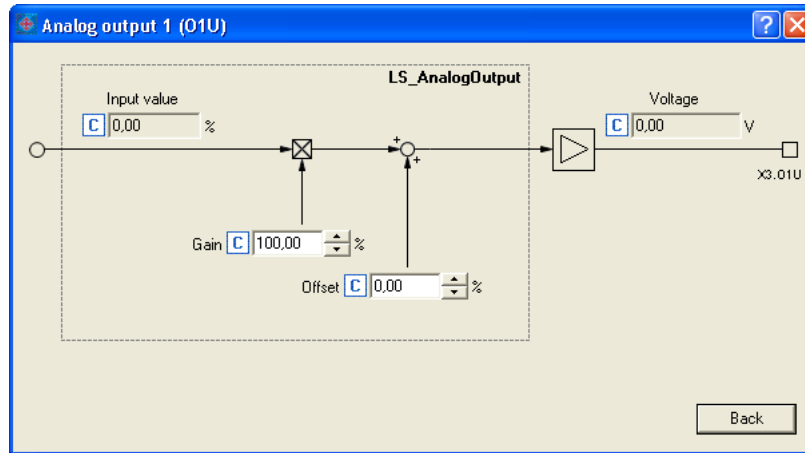

Short overview of parameters for the analog output:

Parameters	Info	Lenze setting	
		Value	Unit
<b>Analog output 1</b>			
<a href="#">C00434/1</a>	O1U: Gain	100.00	%
<a href="#">C00435/1</a>	O1U: Offset	0.00	%
<a href="#">C00439/1</a>	O1U: Input value (from application)	-	%

Greyed out = display parameter

# 6 I/O terminals

## 6.2 Analog terminals

### 6.2.3 Internal interfaces | System block "LS\_AnalogInput"

The LS\_AnalogInput system block maps the analog input in the FB editor.

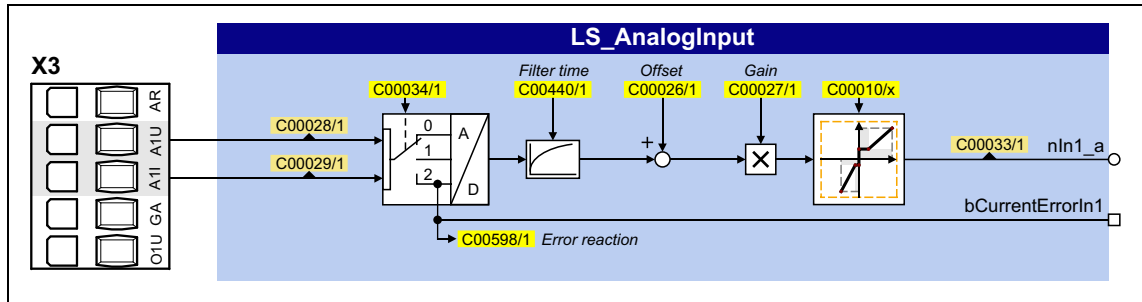

Output	Data type	Value/meaning
nIn1_a	<a href="#">C00033/1</a>   INT	Analog input 1 <ul style="list-style-type: none"> <li>Scaling:                             <ul style="list-style-type: none"> <li><math>\pm 2^{14} \frac{1}{2} \pm 10 \text{ V}</math> for use as voltage input</li> <li><math>\pm 2^{14} \frac{1}{2} \pm 20 \text{ mA}</math> for use as current input</li> </ul> </li> </ul>
bCurrentErrorIn1	BOOL	Status signal "Current input error" <ul style="list-style-type: none"> <li>Only when analog input 1 is used as current input.</li> <li>Application: Cable-breakage monitoring of the 4 ...20 mA circuit.</li> </ul>
		TRUE   $ I_{AIN1}  < 4 \text{ mA}$

### 6.2.4 Internal interfaces | System block "LS\_AnalogOutput"

The LS\_AnalogInput system block maps the analog output in the FB editor.

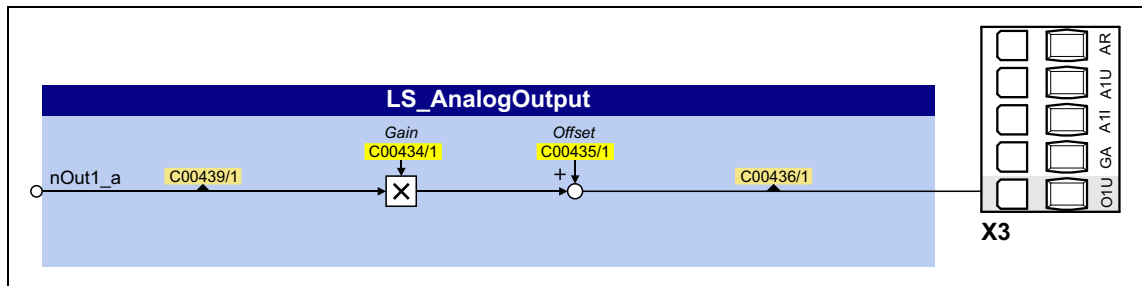

Input	Data type	Information/possible settings
nOut1U_a	INT	Analog output 1 <ul style="list-style-type: none"> <li>Scaling: <math>2^{14} \equiv 16384 \equiv 10 \text{ V}</math></li> </ul>

### 6.3 Configuring exception handling of the output terminals

This function extension is only available from version 04.00.00!

Exception handling for the analog and digital output terminals in the event of an error can be set via decoupling configuration and decoupling values.

- Bit coded selection is carried out in [C00441](#) for the analog output terminal, defining the events that will trigger decoupling.
- Bit coded selection is carried out in [C00447](#) for the digital output terminal, defining the events that will trigger decoupling.

Bit	Event
Bit 0 <input type="checkbox"/>	SafeTorqueOff
Bit 1 <input type="checkbox"/>	ReadyToSwitchOn
Bit 2 <input type="checkbox"/>	SwitchedOn
Bit 3 <input type="checkbox"/>	Reserved
Bit 4 <input type="checkbox"/>	Trouble
Bit 5 <input type="checkbox"/>	Fault
Bit 6 <input type="checkbox"/>	Reserved
Bit 7 <input type="checkbox"/>	Reserved
Bit 8 <input type="checkbox"/>	Reserved
Bit 9 <input type="checkbox"/>	Fail CAN_Management
Bit 10 <input type="checkbox"/>	Reserved
Bit 11 <input type="checkbox"/>	Reserved
Bit 12 <input type="checkbox"/>	Reserved
Bit 13 <input type="checkbox"/>	Reserved
Bit 14 <input type="checkbox"/>	Reserved
Bit 15 <input type="checkbox"/>	Reserved

Finally, the following parameters define the value/status that the output terminals are to have when they are decoupled:

Parameters	Info	Lenze setting	
		Value	Unit
<a href="#">C00442/1</a>	AOut1_U: Decoupling value	0.00	%
<a href="#">C00448</a>	DigOut decoupling value	Bit coded	

#### Related topics:

- ▶ [Configuring exception handling of the CAN PDOs](#) (542)

---

## 6.4 User-defined terminal assignment

In order to individually adapt the preconfigured assignment of the input/output terminals to your application, you can choose one of the following procedures:

- A. In the »Engineer«:
  - Change the terminal assignment on the **Terminal assignment** tab.
  - Change the signal assignment on the **Application Parameters** tab, on the dialog level *Overview* → *Signal flow*.
  - Change the interconnections in the FB editor (on the I/O level).
- B. In the »Engineer« or with the keypad:
  - Change the parameters for signal configuration in the parameters list.



### Note!

If you change the preconfigured assignment of the input/output terminals, the terminal assignment will be a user-defined one. In [C00007](#), control mode "0: Interconnection changed" will be shown.



### Tip!

First of all, select a Lenze configuration useful for the purpose at hand by going to [C00005](#) and selecting a technology application that matches your drive task and then going to [C00007](#) and selecting an appropriate control mode. You will then have an application for which there is a signal flow, logical block links and terminal assignment.

We recommend using the »Engineer« for the implementation of comprehensive user-defined drive solutions.

### 6.4.1 Source-destination principle

The I/O configuration of the input and output signals is carried out according to the source/destination principle:

- A connection always has a direction and therefore always has a source and a target.
- The inputs signals of the technology application are logically linked to the outputs of system blocks which represent the device input terminals.
- The inputs of system blocks that represent the device output terminals are logically linked to output signals of the technology application.

The following graphic illustrates the source/destination principle:

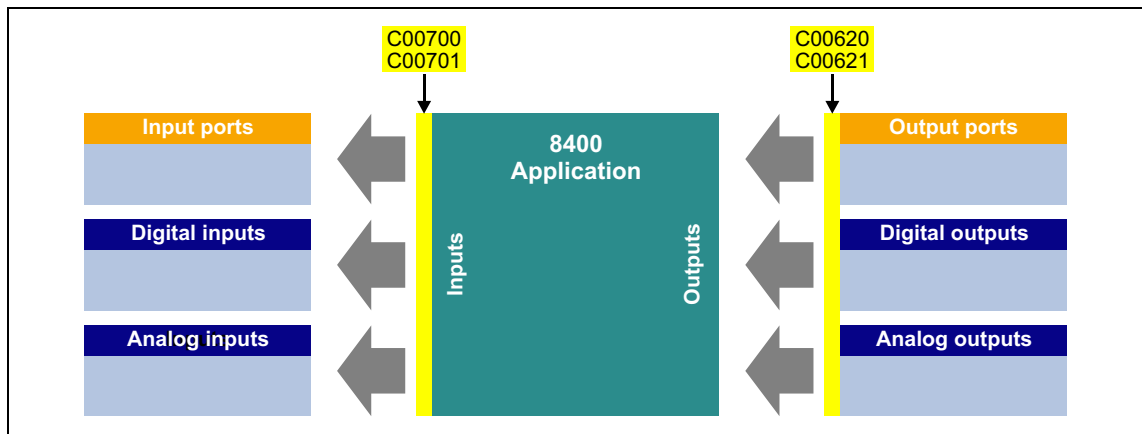

[6-5] Source-destination principle

Note the following:

- An equipment input terminal can be logically linked to several inputs of the application block.
- Every input of the application block can only be logically linked to one input signal.
- An output of the application block can be logically linked to several device output terminals.

### 6.4.2 Changing the terminal assignment with the keypad

You can reconfigure the preconfigured terminal assignment with the keypad (and with the »Engineer«) by means of so-called configuration parameters.

- Each configuration parameter represents a signal input of a system block or application block.
- Each configuration parameter contains a selection list with output signals of the same type of data.
- Logical linking is thus carried out by selecting the output signal for the corresponding signal input.

In the following example, digital output 1 (**LS\_DigitalOutput.bOut1** input) is logically linked to the status signal "Drive ready" (**LA\_nCtrl\_bDriveReady** output signal):

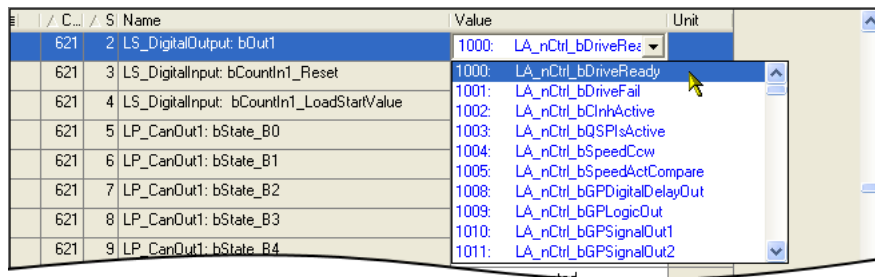

### Configuration parameters for the analog and digital output terminals

The preconfigured assignment of the analog and digital output terminals can be altered by means of the subcodes of [C00620](#) and [C00621](#):

Parameters	Info	Lenze setting	
		Value	Unit
<b>Analog outputs - terminal assignment</b>			
<a href="#">C00620/1</a>	LS_AnalogOutput: nOut1_a	1003: LA_nCtrl_nMotorSpeedAct_a	
<b>Digital outputs - terminal assignment</b>			
<a href="#">C00621/1</a>	LS_DigitalOutput:bRelay	1001: LA_nCtrl_bDriveFail	
<a href="#">C00621/2</a>	LS_DigitalOutput:bOut1	1000: LA_nCtrl_bDriveReady	

Other subcodes (not shown here) allow the configuration of input signals of different system blocks and port blocks.



### Configuration parameters for the inputs of the technology application

The following parameters can be used to change the preconfigured assignment of the application inputs:

Parameters	Info
TA "Actuating drive speed": <a href="#">Configuration parameters (335)</a>	
<a href="#">C00700/1...20</a>	Analog connection list
<a href="#">C00701/1...48</a>	Digital connection list
TA "Switch-off positioning": <a href="#">Configuration parameters (395)</a>	
<a href="#">C00760/1...16</a>	Analog connection list
<a href="#">C00761/1...47</a>	Digital connection list

#### Example

**Task:** Starting from the preset technology application "Actuating drive speed" and the "Terminals 0" control mode, the DI2 digital input is to be used for choosing an alternative acceleration/deceleration time for the main setpoint instead of for choosing the fixed setpoint 2/3. To do this, the DI2 digital input is not to be linked to the *bJogSpeed2* input but to the *bJogRamp1* input of the application module.

#### Procedure:

1. Use the keypad to go to the menu level **Applications → Actuating drive speed (conf.)**. This menu level contains all the configuration parameters of the "Actuating drive speed" technology application". ▶ [Configuration parameters \(335\)](#)
2. Navigate to the configuration parameter LA\_NCtrl: bJogSpeed2 ([C00701/10](#)) which represents the logical signal link of the application input *bJogSpeed2*.
3. Change the setting of [C00701/10](#):  
Change selection "16001: DigIn\_bIn2" in selection "0: Not interconnected".
4. Navigate to the configuration parameter LA\_NCtrl: bJogRamp1 ([C00701/13](#)) which represents the logical signal link of the application input *bJogRamp1*.
5. Change the setting of [C00701/13](#):  
Change selection "0: Not interconnected" in selection "16001: DigIn\_bIn2".



#### Tip!

The example shows that, for each input of the application block, the associated configuration parameter ([C00700/x](#) or [C00701/x](#)) is only allowed to contain one source that you enter.

### 6.4.3 Changing the terminal assignment with the »Engineer«

Whereas the configuration parameters referred to have to be parameterised with the keypad, implementation in the »Engineer« is much easier due to the availability of the corresponding dialogs. The following task illustrates the respective procedure.

**Task:** Starting from the preset technology application "Actuating drive speed" and the "Terminals 0" control mode, the DI2 digital input is to be used for choosing an alternative acceleration/deceleration time for the main setpoint instead of for choosing the fixed setpoint 2/3. To do this, the DI2 digital input is not to be linked to the *bJogSpeed2* input but to the *bJogRamp1* input of the application module.

#### Possibility 1: Change terminal assignment by means of the Terminal Assignment tab

##### Procedure:

1. Go to the **Terminal Assignment** tab and select "Digital terminals" in the **Control connections** list field:

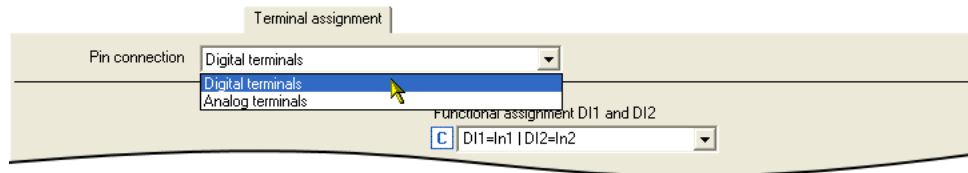

2. Click on the **...** button for the DI2 terminal in order to open the dialog box *Assignment Terminal --> Function block*.
  - In the list field, all block inputs that are currently logically linked to digital input DI2 are marked with a checkmark:

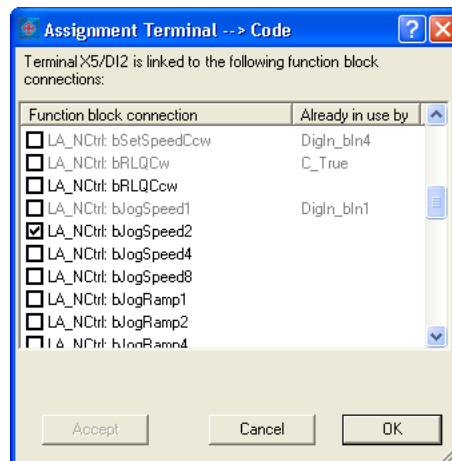

3. Remove checkmark for the connection **LA\_NCtrl: bJogSpeed2** in order to cancel the existing logical link.
4. Set checkmark for connection **LA\_NCtrl: bJogRamp1** in order to logically link this application input to digital input DI2.

### Possibility 2: Change terminal assignment by means of the signal flow shown

#### Procedure:

1. Go to the **Application parameters** tab.
2. Go to the **Application Parameters** tab and click on the **Signal flow** button in order to change to the dialog level *Overview* → *Signal flow*.
3. On the dialog level *Overview* → *Signal flow*, click on the **Digital control signals** button in order to open the *Digital control signals* dialog box:

Section	Signal Name	Radio Button	Dropdown Selection
DCTRL	bClnh	<input type="radio"/>	Not interconnected
	bFailReset	<input type="radio"/>	DigIn_Clnh
MCTRL	bSetQuickstop	<input type="radio"/>	Not interconnected
	bSetDCBrake	<input type="radio"/>	DigIn_bln3
MCK	bMBRKRelease	<input type="radio"/>	Not interconnected
	bMANJogPos	<input type="radio"/>	Not interconnected
	bMANJogNeg	<input type="radio"/>	Not interconnected
Motor potentiometer	bMPOTUp	<input type="radio"/>	Not interconnected
	bMPOTDown	<input type="radio"/>	Not interconnected
	bMPOTInAct	<input type="radio"/>	Not interconnected
	bMPotEnable	<input type="radio"/>	Not interconnected
NSET	bSetSpeedCw	<input type="radio"/>	DigIn_bln4
	bJogSpeed1	<input type="radio"/>	DigIn_bln1
	bJogSpeed2	<input type="radio"/>	DigIn_bln2
	bJogSpeed4	<input type="radio"/>	Not interconnected
	bJogSpeed8	<input type="radio"/>	Not interconnected
	bJogRamp1	<input type="radio"/>	Not interconnected
	bJogRamp2	<input type="radio"/>	Not interconnected
	bJogRamp4	<input type="radio"/>	Not interconnected
PID/PCTRL	bPIDEnableInfluenceRamp	<input type="radio"/>	Not interconnected

Back

4. In the **bJogSpeed2** list field, set the selection "0: Not interconnected".
5. In the **bJogRamp1** list field, set the selection "16001: DigIn\_bln2".
6. Click on the **Back** button in order to close the dialog box again.

**Possibility 3: Change terminal assignment with the FB editor****Procedure:**

1. Go to the **FB Editor** tab.
2. Delete the existing interconnection from **LS\_DigitalInput.bIn2** to **LA\_NCtrl.bJogSpeed2**:

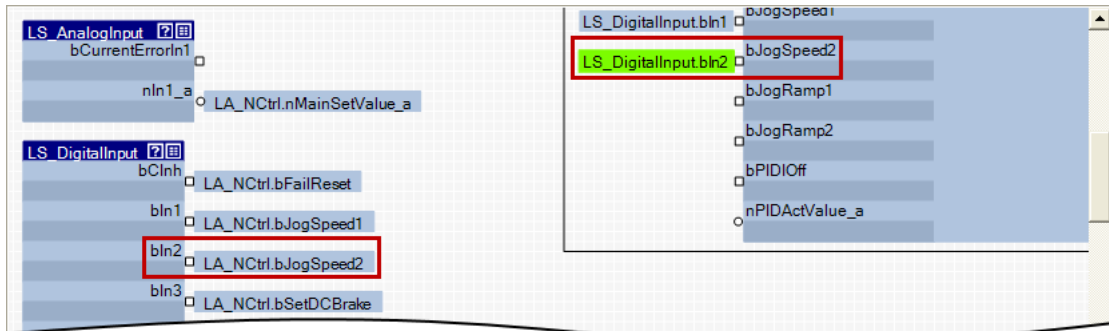

3. Establish a new interconnection from **LS\_DigitalInput.bIn2** to **LA\_NCtrl.bJogRamp1**:

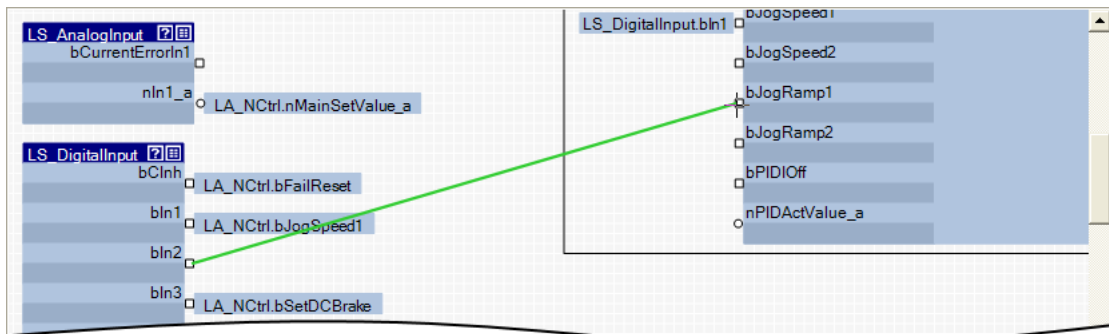
**Tip!**

You can find detailed information on how to use the FB editor of the »Engineer« in the main chapter entitled "[Working with the FB Editor](#)". (📖 882)

## 7 Technology applications

This chapter describes the handling and the functional range of the technology applications available for the 8400 StateLine inverter.



### Technology application "Actuating drive speed"

This technology application preset in [C00005](#) serves to solve speed-controlled drive tasks, e.g. conveyor drives (interconnected), extruders, test benches, vibrators, travelling drives, presses, machine tools, dosing systems.

▶ [TA "Actuating drive speed"](#) (📖 311)



### Technology application "actuating drive speed (AC Drive profile)"

This technology application available [from version 13.00.00](#) provides a speed and torque control by means of "AC Drive Profile". The fieldbuses EtherNet/IP™ and system bus (CANopen) are supported.

▶ [TA "actuating drive speed \(AC Drive Profile\)"](#) (📖 338)



### "Switch-off positioning" technology application

This technology application available [from version 04.00.00](#) is used to solve speed-controlled drive tasks which require a pre-switch off or stopping at certain positions, e.g. roller conveyors and conveying belts. The pre-switch off is implemented by connecting switch-off sensors.

▶ [TA "Switch-off positioning"](#) (📖 371)



### Note!

Please note that the "StateLine", "HighLine" and "TopLine" device types differ with regard to the number, functional range, and flexibility of the technology applications offered.

### Related topics:

- ▶ [Integrated technology applications](#) (📖 26)
- ▶ [Commissioning of the "Actuating drive speed" technology application](#) (📖 55)
- ▶ [Commissioning of the "Switch-off positioning" technology application](#) (📖 63)

# 7 Technology applications

## 7.1 Selection of the technology application and the control mode

### 7.1 Selection of the technology application and the control mode

The technology application to be used is selected in [C00005](#).

- You can select the technology application in the »Engineer« on the **Application parameter** tab via the **Application** list field:

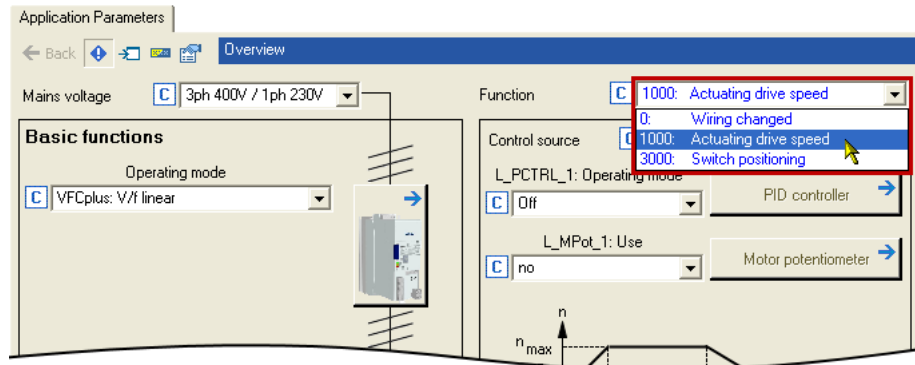

Different control modes can be selected for every application in [C00007](#). By selecting the control mode you set the way by which the technology application should be controlled, e.g. via terminals or via a fieldbus. The interconnection of the input/output terminals and ports shown in the FB editor in the I/O level changes accordingly.

- You can select the control mode in the »Engineer« on the **Application parameter** tab via the **Control mode** list field:

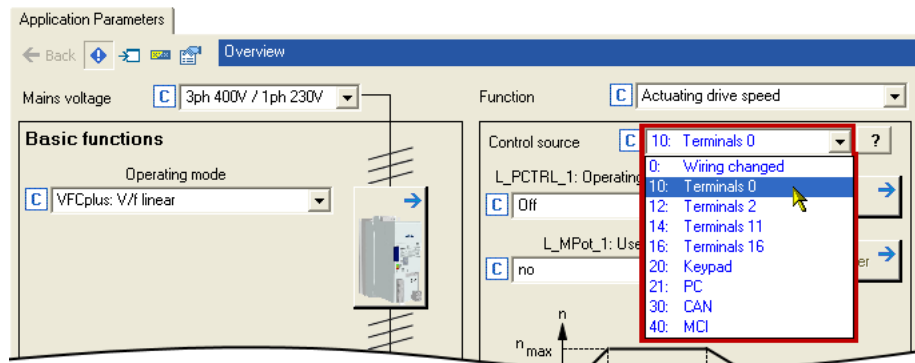

#### Tip!

You can infer the pre-configured assignment of the input/output terminals and ports for each control mode from the description of the corresponding technology application:

TA "Actuating drive speed": [Terminal assignment of the control modes](#) (📖 322)

TA "Switch-off positioning": [Terminal assignment of the control modes](#) (📖 382)

Detailed information on the individual configuration of the input/output terminals can be found in the description of the I/O terminals in the subchapter "[User-defined terminal assignment](#)". (📖 302)

### 7.2 TA "Actuating drive speed"

#### Product features

- Pre-configured control modes for terminals and bus control (with predefined process data connection to the fieldbus)
- Free configuration of input and output signals
- Offset, gain, and negation of main setpoint, additional setpoint, actual process controller value
- Up to 15 fixed setpoints for speed and ramp time
- Adjustable setpoint ramp times
- Freely selectable, variable ramp shape
- Automatic holding brake control
- Quick stop (QSP) with adjustable ramp time
- Motor potentiometer function
- Process controller
- Load monitoring (*in preparation*)
- Integrated, freely available "GeneralPurpose" functions:  
Analog switch, arithmetic, multiplication/division, binary delay element, binary logic, analog comparison, D-flipflop
- Interface to the safety module (optional)
- Integration of encoder feedback

#### Related topics:

- ▶ [Commissioning of the "Actuating drive speed" technology application](#) (📖 55)

7.2.1 Basic signal flow

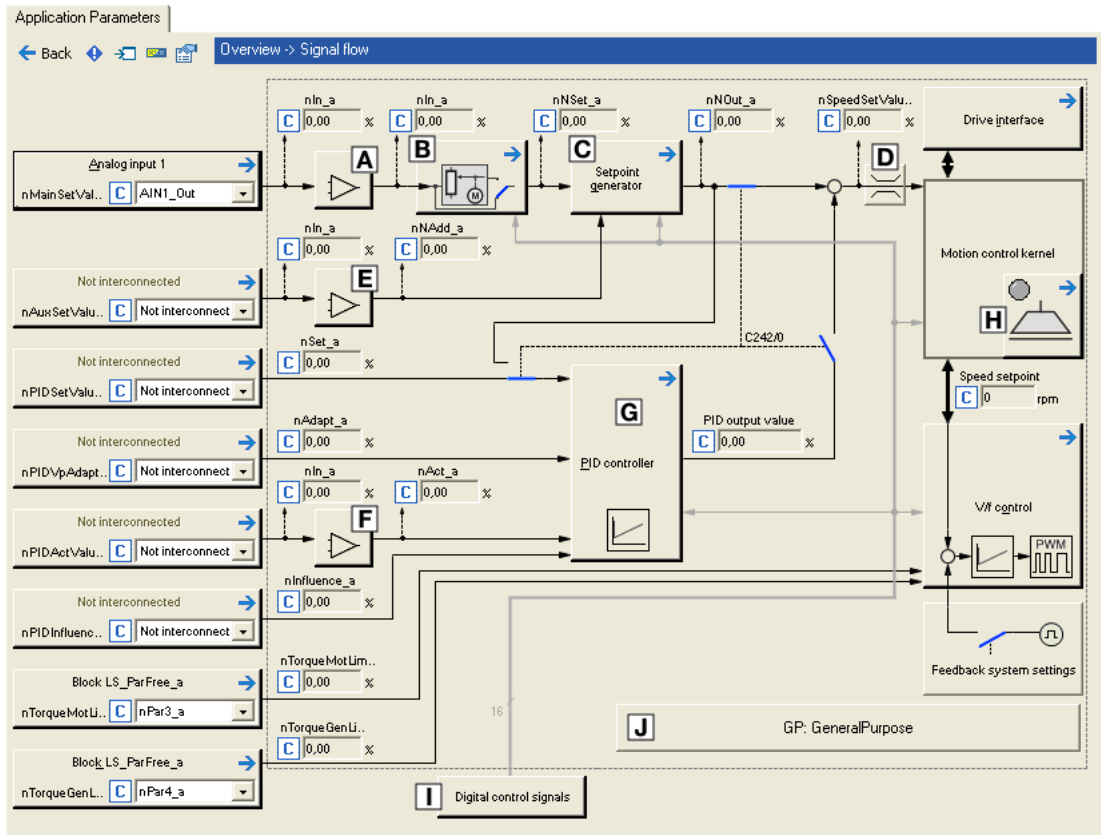

[7-1] Signal flow of the technology application "Actuating drive speed"

- Ⓐ Main speed setpoint offset and gain ([L\\_OffsetGainP\\_1](#))
- Ⓑ Motor potentiometer function ([L\\_MPot\\_1](#))
- Ⓒ Setpoint generator ([L\\_NSet\\_1](#))
- Ⓓ Speed setpoint input limitation
- Ⓔ Additional speed setpoint offset and gain ([L\\_OffsetGainP\\_2](#))
- Ⓕ Actual speed/sensor value offset and gain ([L\\_OffsetGainP\\_3](#))
- Ⓖ Process controller ([L\\_PCTRL\\_1](#))
- Ⓗ [Holding brake control](#)
- Ⓘ Terminal assignment & display of digital control signals
- ⓵ Integrated disposable "[GeneralPurpose](#)" functions: Analog switch, arithmetic, multiplication/division, binary delay element, binary logic, analog comparison, D-flipflop



### Selection of the main speed setpoint

The main speed setpoint is selected in the Lenze setting via the analog input 1.

- Offset and gain of this input signal can be set in [C00696](#) and [C00670](#) for a simple signal adjustment of a setpoint encoder.
- Scaling:  $16384 \equiv 100\%$  reference speed ([C00011](#))
- The main setpoint is transformed to a speed setpoint in the setpoint encoder via a ramp function generator with linear or S-shaped ramps.
- Upstream to the ramp function generator, a blocking speed masking function and a setpoint MinMax limitation are effective.
- For a detailed functional description see the [L\\_NSet](#) FB.

### Motor potentiometer function

Alternatively, the main speed setpoint can be generated via a motor potentiometer function.

- In the Lenze setting, the motor potentiometer function is deactivated.
- Activation is possible via [C00806](#) or via the *bMPotEnable* input.
- The behaviour of the motor potentiometer during switch-on of the drive system can be selected in [C00805](#).
- For a detailed functional description see the [L\\_MPot](#) FB.

### Optional selection of an additional speed setpoint

You can optionally select an additional speed setpoint (e.g. as a correcting signal).

- The additional speed setpoint can be linked arithmetically with the main speed setpoint behind the ramp function generator.
- You must set the setpoint arithmetic to "1: NOut = NSet + NAdd" in [C00190](#) in order to activate the additional speed setpoint.
- Offset and gain of this input signal can be set in [C00697](#) and [C00671](#) for a simple signal adjustment of a setpoint encoder.
- Scaling:  $16384 \equiv 100\%$  reference speed ([C00011](#))
- The acceleration and deceleration time for the additional speed setpoint can be set in [C00220](#) and [C00221](#).
- For a detailed functional description see the [L\\_NSet](#) FB.



#### Tip!

In the case of a grinding machine, the additional speed setpoint can, for instance, be used to control a constant circumferential speed while the grinding disk diameter is reduced.

## 7.2.2 Internal interfaces | application block "LA\_NCtrl"



**Note!**

The connectors greyed out in the following table are hidden in the function block editor in the Lenze setting.

- These connections can be shown via the **Connector visibilities** command in the *Context menu* of the application block.

**inputs**

Designator	Data type	Information/possible settings		
wCANDriveControl	WORD	Control word via system bus (CAN) for device control <ul style="list-style-type: none"> <li>• See the "<a href="#">wCANControl/wMCIControl control words</a>" subchapter of the chapter on device control for a detailed description of the individual control bits.</li> </ul>		
wMCIDriveControl	WORD	Control word via communication module (e.g. PROFIBUS) for device control <ul style="list-style-type: none"> <li>• See the "<a href="#">wCANControl/wMCIControl control words</a>" subchapter of the chapter on device control for a detailed description of the individual control bits.</li> </ul>		
wSMControl	WORD	Interface to the optional safety system. <ul style="list-style-type: none"> <li>• Setting control bit 0 ("SafeStop1") in this control word causes e.g. the automatic deceleration of the drive to standstill within this application (in the <b>Motion Control Kernel</b>).</li> <li>• See the subchapter "<a href="#">Interface to safety system</a>" of the chapter on basic drive functions for a detailed description of the individual control bits.</li> </ul>		
bCInh	BOOL	<a href="#">Enable/inhibit inverter</a>		
		<table border="1"> <tr> <td>FALSE</td> <td>Enable inverter: The inverter switches to the "<a href="#">OperationEnabled</a>" device status if no other source for controller inhibit is active.               <ul style="list-style-type: none"> <li>• <a href="#">C00158</a> provides a bit coded representation of all active sources/triggers of a controller inhibit.</li> </ul> </td> </tr> <tr> <td>TRUE</td> <td>Inhibit inverter (controller inhibit): The inverter switches to the "<a href="#">SwitchedOn</a>" device status.</td> </tr> </table>	FALSE	Enable inverter: The inverter switches to the " <a href="#">OperationEnabled</a> " device status if no other source for controller inhibit is active. <ul style="list-style-type: none"> <li>• <a href="#">C00158</a> provides a bit coded representation of all active sources/triggers of a controller inhibit.</li> </ul>
FALSE	Enable inverter: The inverter switches to the " <a href="#">OperationEnabled</a> " device status if no other source for controller inhibit is active. <ul style="list-style-type: none"> <li>• <a href="#">C00158</a> provides a bit coded representation of all active sources/triggers of a controller inhibit.</li> </ul>			
TRUE	Inhibit inverter (controller inhibit): The inverter switches to the " <a href="#">SwitchedOn</a> " device status.			
bFailReset	BOOL	<a href="#">Reset error message</a> In the Lenze setting this input is connected to the digital input controller enable so that a possibly existing error message is reset together with the controller enable (if the cause for the fault is eliminated).		
		<table border="1"> <tr> <td>TRUE</td> <td>The current fault is reset, if the cause for the fault is eliminated.               <ul style="list-style-type: none"> <li>• If the fault still exists, the error status remains unchanged.</li> </ul> </td> </tr> </table>	TRUE	The current fault is reset, if the cause for the fault is eliminated. <ul style="list-style-type: none"> <li>• If the fault still exists, the error status remains unchanged.</li> </ul>
TRUE	The current fault is reset, if the cause for the fault is eliminated. <ul style="list-style-type: none"> <li>• If the fault still exists, the error status remains unchanged.</li> </ul>			
bSetQuickstop	BOOL	Activate quick stop (QSP) <ul style="list-style-type: none"> <li>• Also see device command "<a href="#">Activate/deactivate quick stop</a>".</li> </ul>		
		<table border="1"> <tr> <td>TRUE</td> <td>Activate quick stop               <ul style="list-style-type: none"> <li>• Motor control is decoupled from the setpoint selection and, within the deceleration time parameterised in <a href="#">C00105</a>, the motor is brought to a standstill (<math>n_{act} = 0</math>).</li> <li>• The motor is kept at a standstill during closed-loop operation.</li> <li>• A pulse inhibit is set if the auto-DCB function has been activated via <a href="#">C00019</a>.</li> </ul> </td> </tr> </table>	TRUE	Activate quick stop <ul style="list-style-type: none"> <li>• Motor control is decoupled from the setpoint selection and, within the deceleration time parameterised in <a href="#">C00105</a>, the motor is brought to a standstill (<math>n_{act} = 0</math>).</li> <li>• The motor is kept at a standstill during closed-loop operation.</li> <li>• A pulse inhibit is set if the auto-DCB function has been activated via <a href="#">C00019</a>.</li> </ul>
		TRUE	Activate quick stop <ul style="list-style-type: none"> <li>• Motor control is decoupled from the setpoint selection and, within the deceleration time parameterised in <a href="#">C00105</a>, the motor is brought to a standstill (<math>n_{act} = 0</math>).</li> <li>• The motor is kept at a standstill during closed-loop operation.</li> <li>• A pulse inhibit is set if the auto-DCB function has been activated via <a href="#">C00019</a>.</li> </ul>	
<table border="1"> <tr> <td>FALSE</td> <td>Deactivate quick stop               <ul style="list-style-type: none"> <li>• The quick stop is deactivated if no other source for the quick stop is active.</li> <li>• <a href="#">C00159</a> displays a bit code of active sources/causes for the quick stop.</li> </ul> </td> </tr> </table>	FALSE	Deactivate quick stop <ul style="list-style-type: none"> <li>• The quick stop is deactivated if no other source for the quick stop is active.</li> <li>• <a href="#">C00159</a> displays a bit code of active sources/causes for the quick stop.</li> </ul>		
FALSE	Deactivate quick stop <ul style="list-style-type: none"> <li>• The quick stop is deactivated if no other source for the quick stop is active.</li> <li>• <a href="#">C00159</a> displays a bit code of active sources/causes for the quick stop.</li> </ul>			

Designator	Data type	Information/possible settings
bSetDCBrake	BOOL	Manual DC-injection braking (DCB) <ul style="list-style-type: none"> <li>Detailed information on DC-injection braking is provided in the motor control chapter, subchapter "<a href="#">DC-injection braking</a>".</li> </ul>
		 <b>Note!</b> Holding braking is not possible when this braking mode is used! Use the basic " <a href="#">Holding brake control</a> " function for controlling the holding brake with a low rate of wear.
		FALSE   Deactivate DC-injection braking.
		TRUE   Activate DC-injection braking, i.e. the drive is brought to a standstill by means of DC-injection braking. <ul style="list-style-type: none"> <li>The braking effect stops when the rotor is at standstill.</li> <li>After the hold time (<a href="#">C00107</a>) has expired, the controller sets the pulse inhibit.</li> </ul>
bRFG_Stop	BOOL	Ramp function generator: Maintain the current value of the main setpoint integrator <ul style="list-style-type: none"> <li>The speed, for instance, of a running ramp process is immediately kept constant when <i>bRFG_Stop</i> is activated. At the same time, the acceleration/deceleration jumps to the value "0".</li> <li>For a detailed functional description see the <a href="#">L_NSet</a> FB.</li> </ul>
		TRUE   The current value of the main setpoint integrator is held.
bRFG_0	BOOL	Ramp function generator: Lead the main setpoint integrator to "0" within the current <i>Ti</i> times <ul style="list-style-type: none"> <li>For a detailed functional description see the <a href="#">L_NSet</a> FB.</li> </ul>
		TRUE   The current value of the main setpoint integrator is led to "0" within the <i>Ti</i> time set.
nVoltageAdd_a	INT	Additive voltage impression <ul style="list-style-type: none"> <li>An additional setpoint for the motor voltage can be specified via this process input.</li> <li>If there are, for instance, different loads at the motor output end, it is possible to apply a voltage boost at the starting time.</li> <li>If the value is negative, the voltage is reduced.</li> <li>Scaling: 16384 <math>\equiv</math> 1000 V</li> </ul>
		 <b>Stop!</b> Values selected too high may cause the motor to heat up due to the resulting current!
nBoost_a	INT	Additional setpoint for the motor voltage at speed = 0 <ul style="list-style-type: none"> <li>The entire voltage-frequency characteristic is provided with an offset.</li> <li>Scaling: 16384 <math>\equiv</math> 1000 V</li> </ul>
		 <b>Stop!</b> Values selected too high may cause the motor to heat up due to the resulting current!
nPWMAngleOffset	INT	Additional offset for the electrical angle of rotation <ul style="list-style-type: none"> <li>If a torque is connected, e.g. dynamic acceleration processes can be generated.</li> <li>Scaling: <math>\pm 32767 \equiv \pm 180^\circ</math> angle of rotation</li> </ul>

Designator	Data type	Information/possible settings				
nTorqueMotLim_a nTorqueGenLim_a	INT	<p>Torque limitation in motor mode and in generator mode</p> <ul style="list-style-type: none"> <li>• These input signals are directly transferred to the motor control to limit the inverter's maximum torque in motor and generator mode.</li> <li>• The drive cannot output a higher torque in motor/generator mode than set here.</li> <li>• The applied values (any polarity) are internally interpreted as absolute values.</li> <li>• If V/f characteristic control (VFCplus) is selected, limitation is <u>indirectly</u> performed via a so-called <math>I_{max}</math> controller.</li> <li>• If sensorless vector control (SLVC) is selected, the limitation has a <u>direct</u> effect on the torque-producing current component.</li> <li>• Scaling: <math>16384 \equiv 100\% M_{max}</math> (<a href="#">C00057</a>)</li> </ul> <p>Torque limits in motor and generator mode:</p>				
bSetSpeedCcw	BOOL	<p>Change of direction of rotation</p> <ul style="list-style-type: none"> <li>• For instance if a motor or gearbox is fixed laterally reversed to a machine part, but the setpoint selection should still be executed for the positive direction of rotation.</li> </ul> <table border="1"> <tr> <td>FALSE</td> <td>Clockwise rotation (Cw)</td> </tr> <tr> <td>TRUE</td> <td>Direction of rotation to the left (Ccw)</td> </tr> </table>	FALSE	Clockwise rotation (Cw)	TRUE	Direction of rotation to the left (Ccw)
FALSE	Clockwise rotation (Cw)					
TRUE	Direction of rotation to the left (Ccw)					
bRLQCw	BOOL	<p>Activate clockwise rotation (fail-safe)</p> <ul style="list-style-type: none"> <li>• For a detailed functional description see the <a href="#">L_RLO</a> FB.</li> </ul> <table border="1"> <tr> <td>FALSE</td> <td>Quick stop</td> </tr> <tr> <td>TRUE</td> <td>CW rotation</td> </tr> </table>	FALSE	Quick stop	TRUE	CW rotation
FALSE	Quick stop					
TRUE	CW rotation					
bRLQCcw	BOOL	<p>Activate counter-clockwise rotation (fail-safe)</p> <ul style="list-style-type: none"> <li>• For a detailed functional description see the <a href="#">L_RLO</a> FB.</li> </ul> <table border="1"> <tr> <td>FALSE</td> <td>Quick stop</td> </tr> <tr> <td>TRUE</td> <td>CCW rotation</td> </tr> </table>	FALSE	Quick stop	TRUE	CCW rotation
FALSE	Quick stop					
TRUE	CCW rotation					
nMainSetValue_a	INT	<p>Main speed setpoint</p> <ul style="list-style-type: none"> <li>• Offset and gain of this input signal can be set in <a href="#">C00696</a> and <a href="#">C00670</a> for a simple signal adjustment of a setpoint encoder.</li> <li>• Scaling: <math>16384 \equiv 100\%</math> reference speed (<a href="#">C00011</a>)</li> <li>• The main setpoint is transformed to a speed setpoint in the setpoint encoder via a ramp function generator with linear or S-shaped ramps.</li> <li>• Upstream to the ramp function generator, a blocking speed masking function and a setpoint MinMax limitation are effective.</li> <li>• For a detailed functional description see the <a href="#">L_NSet</a> FB.</li> </ul>				

Designator	Data type	Information/possible settings
nAuxSetValue_a	INT	<p>Additional speed setpoint</p> <ul style="list-style-type: none"> <li>The additional speed setpoint can be linked arithmetically with the main speed setpoint behind the ramp function generator.</li> <li>You must set the setpoint arithmetic to "1: NOut = NSet + NAdd" in <a href="#">C00190</a> in order to activate the additional speed setpoint.</li> <li>Offset and gain of this input signal can be set in <a href="#">C00697</a> and <a href="#">C00671</a> for a simple signal adjustment of a setpoint encoder.</li> <li>Scaling: 16384 ≙ 100 % reference speed (<a href="#">C00011</a>)</li> <li>The acceleration and deceleration time for the additional speed setpoint can be set in <a href="#">C00220</a> and <a href="#">C00221</a>.</li> <li>For a detailed functional description see the <a href="#">L_NSet</a> FB.</li> </ul>
bJogSpeed1 bJogSpeed2	BOOL	<p>Inputs for overriding fixed setpoints (JOG setpoints) for the main setpoint</p> <ul style="list-style-type: none"> <li>A fixed setpoint for the setpoint generator can be activated instead of the main setpoint via these selection inputs.</li> <li>The four selection inputs are binary coded, therefore 15 fixed setpoints can be selected.</li> <li>In the case of binary coded selection "0" (all inputs = FALSE or not assigned), main setpoint <i>nMainSetValue_a</i> is active.</li> <li>The selection of the fixed setpoints is carried out in <a href="#">C00039/1...15</a> in [%] based on the reference speed (<a href="#">C00011</a>).</li> <li>For a detailed functional description see the <a href="#">L_NSet</a> FB.</li> </ul>
bJogSpeed4 bJogSpeed8	BOOL	
bJogRamp1 bJogRamp2	BOOL	<p>Selection inputs for alternative acceleration/deceleration times for the main setpoint</p> <ul style="list-style-type: none"> <li>The four selection inputs are binary coded, therefore 15 alternative acceleration/deceleration times can be selected.</li> <li>For main setpoint <i>nMainSetValue_a</i>, the set acceleration time (<a href="#">C00012</a>) and deceleration time (<a href="#">C00013</a>) are active in the case of the binary coded selection "0" (all inputs = FALSE or not assigned).</li> <li>Alternative acceleration times are selected in <a href="#">C00101/1...15</a>.</li> <li>The selection of the alternative deceleration times is carried out in <a href="#">C00103/1...15</a>.</li> <li>For a detailed functional description see the <a href="#">L_NSet</a> FB.</li> </ul>
bJogRamp4 bJogRamp8	BOOL	
<p><b>Motor potentiometer</b></p> <p>Alternatively to the input signal <i>nMainSetValue_a</i>, the main setpoint can also be generated by a motor potentiometer function.</p> <ul style="list-style-type: none"> <li>In the Lenze setting, the motor potentiometer function is deactivated.</li> <li>Activation is possible via <a href="#">C00806</a> or via the <i>bMPotEnable</i> input.</li> <li>The behaviour of the motor potentiometer during switch-on of the drive system can be selected in <a href="#">C00805</a>.</li> <li>For a detailed functional description see the <a href="#">L_MPot</a> FB.</li> </ul>		
bMPotEnable	BOOL	Activating the motor potentiometer function
		TRUE The motor potentiometer function is active; the speed setpoint can be changed via the <i>bMPotUp</i> and <i>bMPotDown</i> control inputs.
bMPotUp	BOOL	Increasing the speed setpoint
		TRUE Approach the upper speed limit value set in <a href="#">C00800</a> with the acceleration time set in <a href="#">C00802</a> .
bMPotInAct	BOOL	Activating the inactive function
		TRUE The speed setpoint behaves according to the inactive function set in <a href="#">C00804</a> . • In the Lenze setting, the speed setpoint is maintained.
bMPotDown	BOOL	Decreasing the speed setpoint
		TRUE Approach the lower speed limit value set in <a href="#">C00801</a> with the deceleration time set in <a href="#">C00803</a> .

Designator	Data type	Information/possible settings		
<b>Process controller</b>				
<ul style="list-style-type: none"> <li>In the Lenze setting, the process controller is deactivated.</li> <li>The activation is executed by selecting the operating mode in <a href="#">C00242</a>.</li> <li>For a detailed functional description see FB <a href="#">L_PCTRL</a>.</li> </ul>				
bPIDEnableInfluenceRamp	BOOL	Activate ramp for influencing factor		
		<table border="1"> <tr> <td>FALSE</td> <td>Influencing factor of the PID controller is ramped down to "0".</td> </tr> <tr> <td>TRUE</td> <td>Influencing factor of the PID controller is ramped up to the value <i>nPIDInfluence_a</i>.</td> </tr> </table>	FALSE	Influencing factor of the PID controller is ramped down to "0".
FALSE	Influencing factor of the PID controller is ramped down to "0".			
TRUE	Influencing factor of the PID controller is ramped up to the value <i>nPIDInfluence_a</i> .			
bPIDIOff	BOOL	Switch off the I-component of the process controller		
		<ul style="list-style-type: none"> <li>In conjunction with the operating mode set in <a href="#">C00242</a> (Lenze setting: "Off").</li> </ul> <table border="1"> <tr> <td>TRUE</td> <td>I-component of the process controller is switched off.</td> </tr> </table>	TRUE	I-component of the process controller is switched off.
TRUE	I-component of the process controller is switched off.			
nPIDVpAdapt_a	INT	Adaptation of gain Vp set in <a href="#">C00222</a> in percent <ul style="list-style-type: none"> <li>Scaling: 16384 <math>\equiv</math> 100 %</li> <li>Internal limitation to <math>\pm</math> 199.99 %</li> <li>Changes can be done online.</li> </ul>		
nPIDSetValue_a	INT	Sensor and process setpoint for operating modes 2, 4 and 5 <ul style="list-style-type: none"> <li>Scaling: 16384 <math>\equiv</math> 100 %</li> <li>Internal limitation to <math>\pm</math> 199.99 %</li> </ul>		
nPIDActValue_a	INT	Speed or actual sensor value (actual process value) <ul style="list-style-type: none"> <li>Offset and gain for this input signal can be set in <a href="#">C00698</a> and <a href="#">C00672</a>.</li> <li>Scaling: 16384 <math>\equiv</math> 100 %</li> <li>Internal limitation to <math>\pm</math> 199.99 %</li> </ul>		
nPIDInfluence_a	INT	Limitation of the influencing factor in percent <ul style="list-style-type: none"> <li>The influence factor of the PID controller can be limited to a certain value (-199.99% ... + 199.99%) via <i>nPIDInfluence_a</i>.</li> <li>Scaling: 16384 <math>\equiv</math> 100 %</li> <li>Internal limitation to <math>\pm</math> 199.99 %</li> </ul>		
<b>MCK basic functions</b>				
bMBrakeRelease	BOOL	<a href="#">Holding brake control</a> : Release/apply brake <ul style="list-style-type: none"> <li>In conjunction with the operating mode selected in <a href="#">C02580</a> (Lenze setting: "Brake control off").</li> </ul>		
		FALSE	Apply brake. <ul style="list-style-type: none"> <li>During automatic operation, the internal brake logic controls the brake.</li> </ul>	
		TRUE	Release brake manually (forced release). <ul style="list-style-type: none"> <li><b>Note!</b> The brake can also be released when the controller is inhibited!</li> <li>During automatic operation, the internal brake logic is deactivated and the brake is released (supervisor operation). If a controller inhibit has been set by the brake control, it will be deactivated.</li> <li>In semi-automatic operation, the brake is released including feedforward control.</li> </ul>	

Designator	Data type	Information/possible settings				
<b>GP: GeneralPurpose</b> The following inputs are interconnected with logic/arithmetic functions on application level for free usage. ▶ <a href="#">"GeneralPurpose" functions</a>						
bGPFree1 ... bGPFree2 <small>(from version 11.00.00)</small>	BOOL	Free inputs for digital signals <ul style="list-style-type: none"> <li>Digital signals can be transferred from the I/O level to the application level via these inputs.</li> </ul>				
nGPAnalogSwitchIn1_a nGPAnalogSwitchIn2_a	INT	<a href="#">Analog switch</a> : Input signals <ul style="list-style-type: none"> <li>The input signal selected via the selection input <i>bGPAnalogSwitchSet</i> is output at output <i>nGPAnalogSwitchOut_a</i>.</li> </ul>				
bGPAnalogSwitchSet	BOOL	<a href="#">Analog switch</a> : Selection input <table border="1" style="margin-left: 20px;"> <tr> <td>FALSE</td> <td><i>nGPAnalogSwitchOut_a</i> = <i>nGPAnalogSwitchIn1_a</i></td> </tr> <tr> <td>TRUE</td> <td><i>nGPAnalogSwitchOut_a</i> = <i>nGPAnalogSwitchIn2_a</i></td> </tr> </table>	FALSE	<i>nGPAnalogSwitchOut_a</i> = <i>nGPAnalogSwitchIn1_a</i>	TRUE	<i>nGPAnalogSwitchOut_a</i> = <i>nGPAnalogSwitchIn2_a</i>
FALSE	<i>nGPAnalogSwitchOut_a</i> = <i>nGPAnalogSwitchIn1_a</i>					
TRUE	<i>nGPAnalogSwitchOut_a</i> = <i>nGPAnalogSwitchIn2_a</i>					
nGPArithmetikIn1_a nGPArithmetikIn2_a	INT	<a href="#">Arithmetic</a> : Input signals <ul style="list-style-type: none"> <li>The arithmetic function is selected in <a href="#">C00338</a>.</li> <li>The result is output at output <i>nGPArithmetikOut_a</i>.</li> </ul>				
nGPMulDivIn_a	INT	<a href="#">Multiplication/Division</a> : Input signal <ul style="list-style-type: none"> <li>The factor for the multiplication can be set in <a href="#">C00699/1</a> (numerator) and <a href="#">C00699/2</a> (denominator).</li> <li>The result is output at output <i>nGPMulDivOut_a</i>.</li> </ul>				
bGPDigitalDelayIn	BOOL	<a href="#">Binary delay element</a> : Input signal <ul style="list-style-type: none"> <li>The on-delay can be set in <a href="#">C00720/1</a>.</li> <li>The off-delay can be set in <a href="#">C00720/2</a>.</li> <li>The time-delayed input signal is output at output <i>bGPDigitalDelayOut</i>.</li> </ul>				
bGPLogicIn1 bGPLogicIn2 bGPLogicIn3	BOOL	<a href="#">Binary logic</a> : Input signals <ul style="list-style-type: none"> <li>The logic operation is selected in <a href="#">C00820</a>.</li> <li>The result is output at output <i>bGPLogicOut</i>.</li> </ul>				
nGPCompareIn1_a nGPCompareIn2_a	INT	<a href="#">Analog comparison</a> : Input signals <ul style="list-style-type: none"> <li>The comparison operation is selected in <a href="#">C00680</a>.</li> <li>Hysteresis and window size can be set in <a href="#">C00680</a> and <a href="#">C00682</a>.</li> <li>If the comparison statement is true, the output <i>bGPCompareOut</i> will be set to TRUE.</li> </ul>				
bGPDFlipFlop_InD bGPDFlipFlop_InClk bGPDFlipFlop_InClr	BOOL	<a href="#">D-FlipFlop</a> : Input signals <ul style="list-style-type: none"> <li>Data, clock and reset input</li> </ul>				
<b>Free inputs</b> The following inputs can freely be interconnected on the application level. The signals can be transferred from the I/O level to the application level via these inputs.						
bFreeIn1 ... bFreeIn8	BOOL	Free inputs for digital signals				
wFreeIn1 ... wFreeIn4	WORD	Free inputs for 16-bit signals				

### outputs

Designator	Data type	Value/meaning	
wDriveControlStatus	WORD	Status word of the inverter <ul style="list-style-type: none"> <li>The status word contains information on the currents status of the inverter.</li> <li>See the "<a href="#">wDeviceStatusWord status word</a>" subchapter of the chapter on device control for a detailed description of the bit assignment.</li> </ul>	
wStateDetermFailNoLow	WORD	Display of the status determining error (LOW word)	
wStateDetermFailNoHigh	WORD	Display of the status determining error (HIGH word)	
bDriveFail	BOOL	TRUE	Inverter in error status. <ul style="list-style-type: none"> <li>"<a href="#">Fault</a>" device status is active.</li> </ul>
bDriveReady	BOOL	TRUE	Inverter is ready for operation <ul style="list-style-type: none"> <li>"<a href="#">SwitchedOn</a>" device status is active.</li> <li>The drive is in this device status if the DC bus voltage is applied and the inverter is still inhibited by the user (controller inhibit).</li> </ul>
bCInhActive	BOOL	TRUE	Controller inhibit is active.
bQSPisActive	BOOL	TRUE	Quick stop is active.
bSpeedCcw	BOOL	Current direction of rotation	
		FALSE	Clockwise rotation (Cw)
		TRUE	Direction of rotation to the left (Ccw)
bSpeedActCompare	BOOL	Result of the speed comparison (detection of speed=0)	
		TRUE	During open-loop operation: Speed setpoint < Comparison value ( <a href="#">C00024</a> )
			During closed-loop operation: Actual speed value < Comparison value ( <a href="#">C00024</a> )
bOverLoadActive	BOOL	In preparation (output is not interconnected on the application level)	
bUnderLoadActive	BOOL	In preparation (output is not interconnected on the application level)	
blmaxActive	BOOL	"Current setpoint inside the limitation" status signal	
		TRUE	The current setpoint is internally limited (the inverter operates at the maximum current limit).
bSpeedSetReached	BOOL	Status signal "setpoint = 0"	
		TRUE	Speed setpoint from the ramp function generator = 0
bSpeedActEqSet	BOOL	TRUE	Actual speed value = speed setpoint
nMotorCurrent_a	INT	Current stator current/effective motor current <ul style="list-style-type: none"> <li>Scaling: <math>16384 \equiv 100\% I_{\max\_mot}</math> (<a href="#">C00022</a>)</li> </ul>	
nMotorSpeedSet_a	INT	Speed setpoint <ul style="list-style-type: none"> <li>Scaling: <math>16384 \equiv 100\%</math> reference speed (<a href="#">C00011</a>)</li> </ul>	
nMotorSpeedAct_a	INT	Actual speed value <ul style="list-style-type: none"> <li>Scaling: <math>16384 \equiv 100\%</math> reference speed (<a href="#">C00011</a>)</li> </ul>	
nMotorTorqueAct_a	INT	Actual torque <ul style="list-style-type: none"> <li>In the "VFC (+encoder)" operating mode of the motor control, this value is determined from the current motor current and corresponds to the actual torque only by approximation.</li> <li>Scaling: <math>16384 \equiv 100\% M_{\max}</math> (<a href="#">C00057</a>)</li> </ul>	



Designator	Data type	Value/meaning
nDCVoltage_a	INT	Current DC-bus voltage • Scaling: 16384 $\equiv$ 1000 V
nMotorVoltage_a	INT	Current motor voltage/inverter output voltage • Scaling: 16384 $\equiv$ 1000 V
<b>MCK basic functions</b>		
bMBrakeReleaseOut	BOOL	<a href="#">Holding brake control</a> : Trigger signal for the holding brake control switching element via a digital output • Use bit 0 in <a href="#">C02582</a> to activate inverted switching element triggering.
		FALSE   Apply brake.
		TRUE   Release brake.
bMBrakeReleased	BOOL	<a href="#">Holding brake control</a> : "Brake released" considering the brake release time • When the holding brake is triggered to close, <i>bMBrakeReleased</i> is immediately set to FALSE even if the brake closing time has not yet elapsed!
		TRUE   Brake released (after the brake release time has expired).
<b>GP: GeneralPurpose</b> The following outputs are interconnected with logic/arithmetic functions on application level for free usage. ▶ " <a href="#">GeneralPurpose</a> " functions		
nGPAnalogSwitchInOut_a	INT	<a href="#">Analog switch</a> : Output signal
nGPArithmeticOut_a	INT	<a href="#">Arithmetic</a> : Output signal
nGPMulDivOut_a	INT	<a href="#">Multiplication/Division</a> : Output signal
bGPDigitalDelayOut	BOOL	<a href="#">Binary delay element</a> : Output signal
bGPLogicOut	BOOL	<a href="#">Binary logic</a> : Output signal
bGPCompareOut	BOOL	<a href="#">Analog comparison</a> : Output signal
bGPSignalOut1 ... bGPSignalOut4	BOOL	<a href="#">Binary signal monitor</a> : Output signals • The signal sources to be output are selected in <a href="#">C00411/1...4</a> . • A bit coded inversion of the output signals can be parameterised in <a href="#">C00412</a> .
nGPSignalOut1_a ... nGPSignalOut4_a	BOOL	<a href="#">Analog signal monitor</a> : Output signals • The signal sources to be output are selected in <a href="#">C00410/1...4</a> . • Gain and offset for each output signal can be parameterised in <a href="#">C00413/1...8</a> .
bGPDFlipFlop_Out	BOOL	<a href="#">D-FlipFlop</a> : Output signal
bGPDFlipFlop_NegOut	BOOL	<a href="#">D-FlipFlop</a> : Negated output signal
<b>Free outputs</b> The following outputs can freely be interconnected on the application level. The signals from the application level can be transferred to the I/O level via these outputs.		
bFreeOut1 ... bFreeOut8	BOOL	Free outputs for digital signals
wFreeOut1 ... wFreeOut4	WORD	Free outputs for 16-bit signals

### 7.2.3 Terminal assignment of the control modes

The following comparison provides information about which inputs/outputs of the application block **LA\_NCtrl** are interconnected to the digital and analog input/output terminals of the inverter in the different control modes.

		Control mode (C00007)							
		10: <a href="#">Terminals 0</a>	12: <a href="#">Terminals 2</a>	14: <a href="#">Terminals 11</a>	16: <a href="#">Terminal 16</a>	20: <a href="#">Keypad</a>	21: <a href="#">PC</a>	30: <a href="#">CAN</a>	40: <a href="#">MCI</a>
<b>Digital input terminals</b>									
X4/RFR	Controller enable / Reset of error message bFailReset								
X4/DI1	Fixed setpoint 1/3 bJogSpeed1		Change of direction of rotation bSetSpeedCcw		Fixed setpoint 1/3 bJogSpeed1		-	-	Quick stop bSetQuickstop
X4/DI2	Fixed setpoint 2/3 bJogSpeed2		Activate manual DC-injection braking (DCB) bSetDCBrake		Fixed setpoint 2/3 bJogSpeed2		-	-	-
X4/DI3	Activate manual DC-injection braking (DCB) bSetDCBrake	Quick stop bSetQuickstop		Motor potentiometer: Increase speed bMPotUp		CW rotation quick stop bRLQCw		-	-
X4/DI4	Change of direction of rotation bSetSpeedCcw		Motor potentiometer: Decrease speed bMPotDown		CCW rotation quick stop bRLQCcw		-	-	-
<b>Analog input terminals</b>									
X3/A1U, A1I	Main speed setpoint nMainSetValue_a 10 V ≙ 100 % reference speed ( <a href="#">C00011</a> )				-		-	Additional speed setpoint nAuxSetValue_a 10 V ≙ 100 % reference speed ( <a href="#">C00011</a> )	
<b>Digital output terminals</b>									
X4/DO1	Status "Drive is ready" bDriveReady								
X101/COM, NO	Status "Error is pending" bDriveFail								
<b>Analog output terminal</b>									
X3/O1U	Actual speed value nMotorSpeedAct_a 10 V ≙ 100 % reference speed ( <a href="#">C00011</a> )								

### 7.2.3.1 Terminals 0

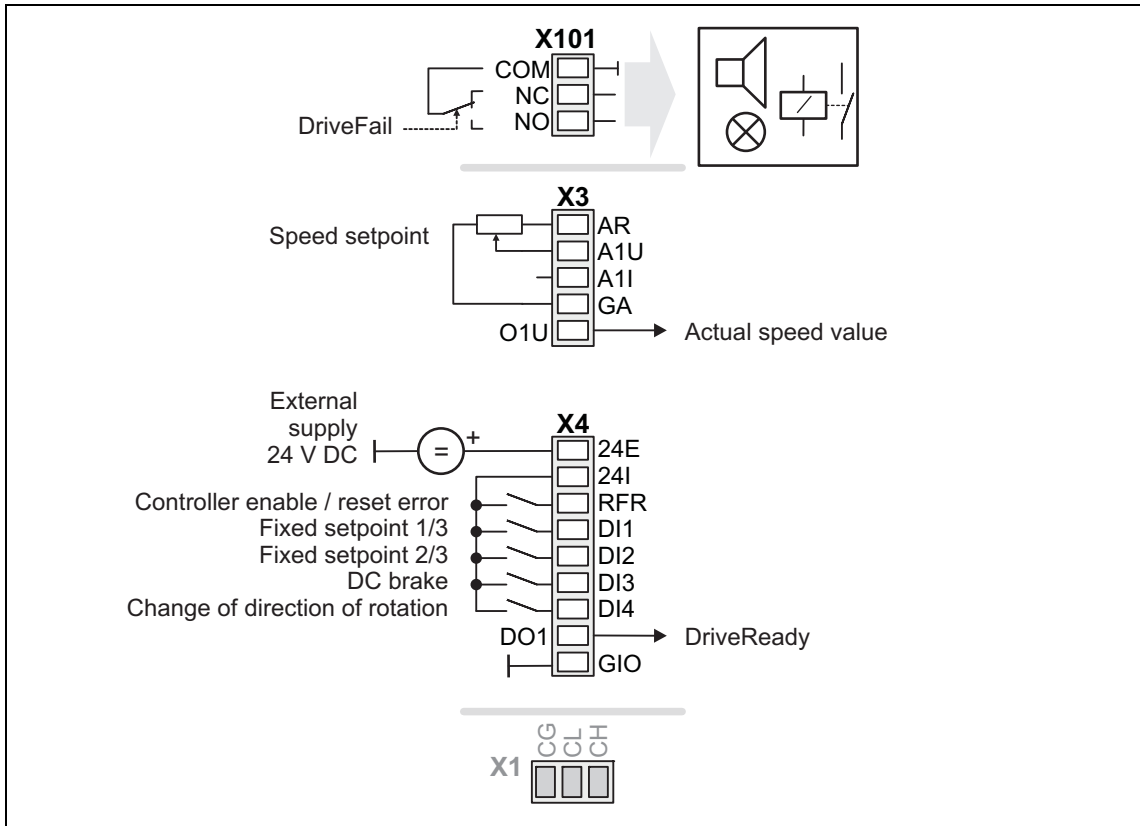

Connection	Assignment	Connection	Assignment
X101/NC-NO	LA_NCtrl.bDriveFail		
X4/RFR	LA_NCtrl.bFailReset	X3/A1U	LA_NCtrl.nMainSetValue_a *
X4/DI1	LA_NCtrl.bJogSpeed1	X3/A1I	-
X4/DI2	LA_NCtrl.bJogSpeed2	X3/O1U	LA_NCtrl.nMotorSpeedAct_a *
X4/DI3	LA_NCtrl.bSetDCBrake		* 10 V ≙ 100 % reference speed (C00011)
X4/DI4	LA_NCtrl.bSetSpeedCcw	X4/DO1	LA_NCtrl.bDriveReady

7.2.3.2 Terminals 2

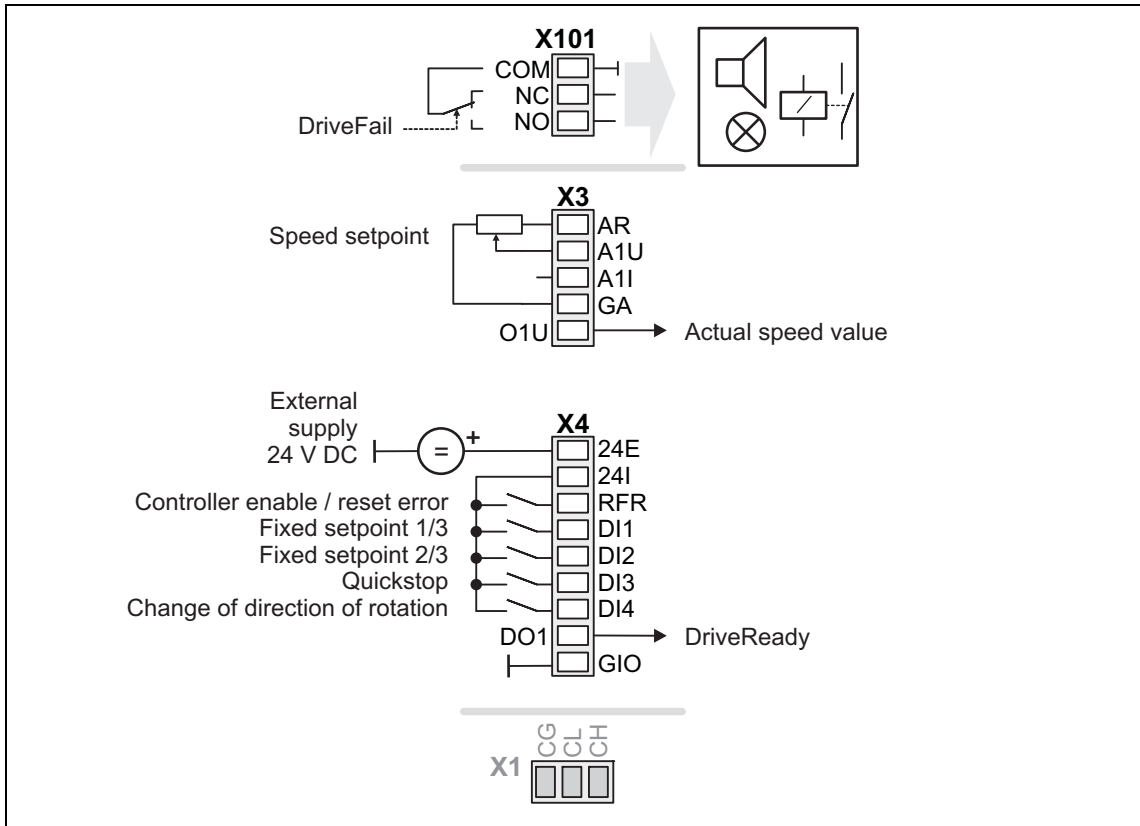

Connection	Assignment	Connection	Assignment
X101/NC-NO	LA_NCtrl.bDriveFail		
X4/RFR	LA_NCtrl.bFailReset	X3/A1U	LA_NCtrl.nMainSetValue_a *
X4/DI1	LA_NCtrl.bJogSpeed1	X3/A1I	-
X4/DI2	LA_NCtrl.bJogSpeed2	X3/O1U	LA_NCtrl.nMotorSpeedAct_a *
X4/DI3	LA_NCtrl.bSetQuickstop		* 10 V ≙ 100 % reference speed (C00011)
X4/DI4	LA_NCtrl.bSetSpeedCcw	X4/DO1	LA_NCtrl.bDriveReady

7.2.3.3 Terminals 11

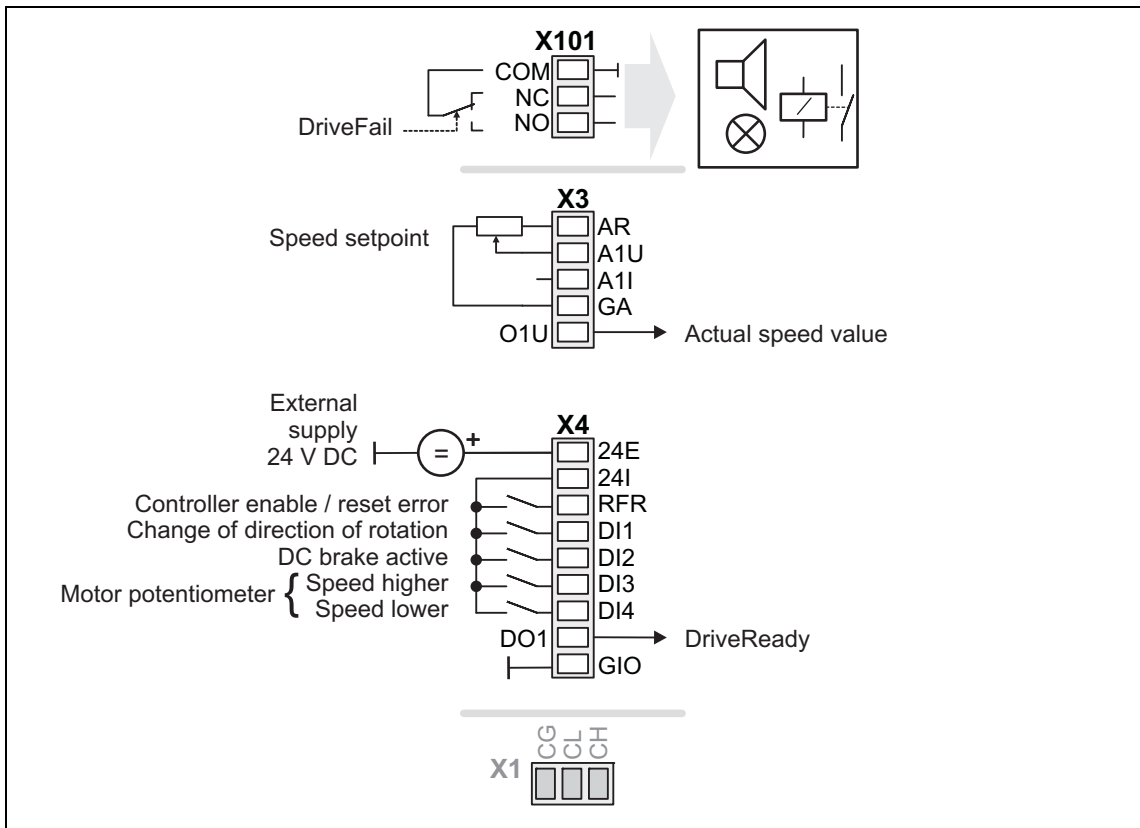

Connection	Assignment	Connection	Assignment
X101/NC-NO	LA_NCtrl.bDriveFail		
X4/RFR	LA_NCtrl.bFailReset	X3/A1U	LA_NCtrl.nMainSetValue_a *
X4/DI1	LA_NCtrl.bSetSpeedCcw	X3/A1I	-
X4/DI2	LA_NCtrl.bSetDCBrake	X3/O1U	LA_NCtrl.nMotorSpeedAct_a *
X4/DI3	LA_NCtrl.bMPotUp		* 10 V ≙ 100 % reference speed (C00011)
X4/DI4	LA_NCtrl.bMPotDown	X4/DO1	LA_NCtrl.bDriveReady

7.2.3.4 Terminal 16

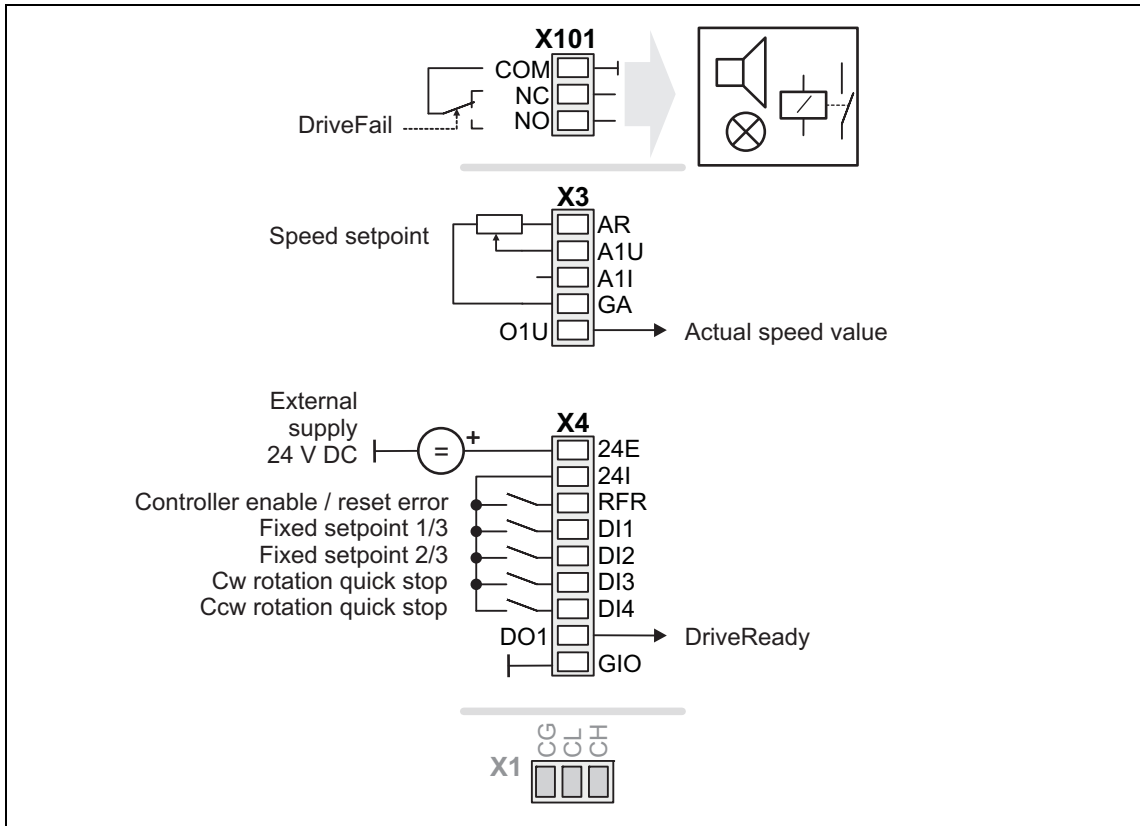

Connection	Assignment	Connection	Assignment
X101/NC-NO	LA_NCtrl.bDriveFail		
X4/RFR	LA_NCtrl.bFailReset	X3/A1U	LA_NCtrl.nMainSetValue_a *
X4/DI1	LA_NCtrl.bJogSpeed1	X3/A1I	-
X4/DI2	LA_NCtrl.bJogSpeed2	X3/O1U	LA_NCtrl.nMotorSpeedAct_a *
X4/DI3	LA_NCtrl.bRLQCw		* 10 V ≙ 100 % reference speed (C00011)
X4/DI4	LA_NCtrl.bRLQCcw	X4/DO1	LA_NCtrl.bDriveReady

7.2.3.5 Keypad

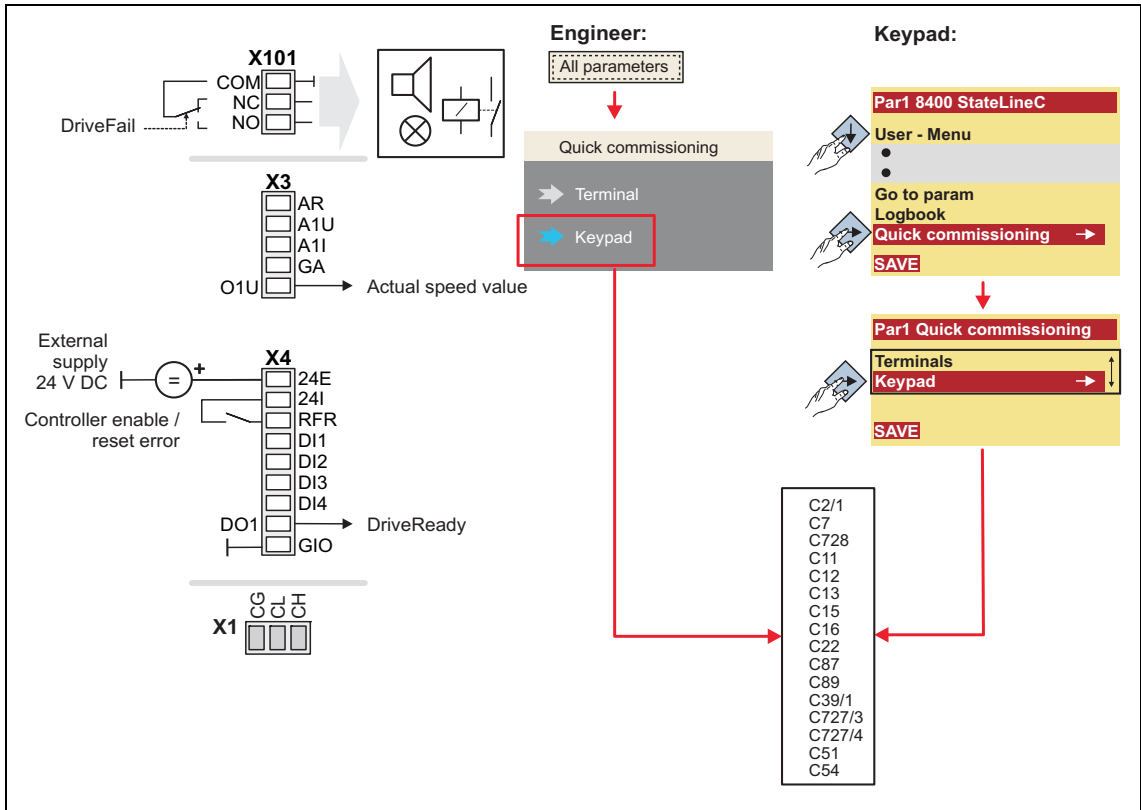

Connection	Assignment	Connection	Assignment
X101/NC-NO	LA_NCtrl.bDriveFail		
X4/RFR	LA_NCtrl.bFailReset	X3/A1U	-
X4/DI1	-	X3/A1I	-
X4/DI2	-	X3/O1U	LA_NCtrl.nMotorSpeedAct_a *
X4/DI3	-		* 10 V ≙ 100 % reference speed (C00011)
X4/DI4	-	X4/DO1	LA_NCtrl.bDriveReady

# 7 Technology applications

## 7.2 TA "Actuating drive speed"

### 7.2.3.6 PC

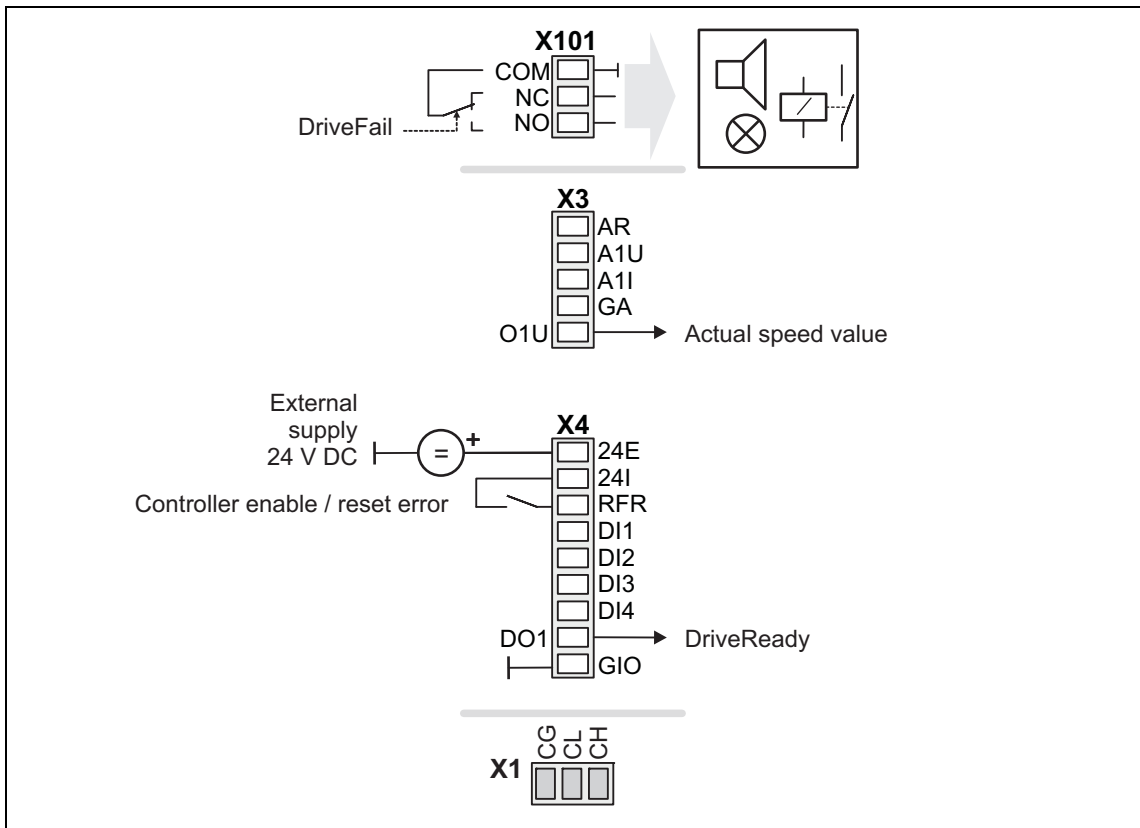

Connection	Assignment	Connection	Assignment
X101/NC-NO	LA_NCtrl.bDriveFail		
X4/RFR	LA_NCtrl.bFailReset	X3/A1U	-
X4/DI1	-	X3/A1I	-
X4/DI2	-	X3/O1U	LA_NCtrl.nMotorSpeedAct_a *
X4/DI3	-		* 10 V ≙ 100 % reference speed (C00011)
X4/DI4	-	X4/DO1	LA_NCtrl.bDriveReady



### 7.2.3.7 CAN

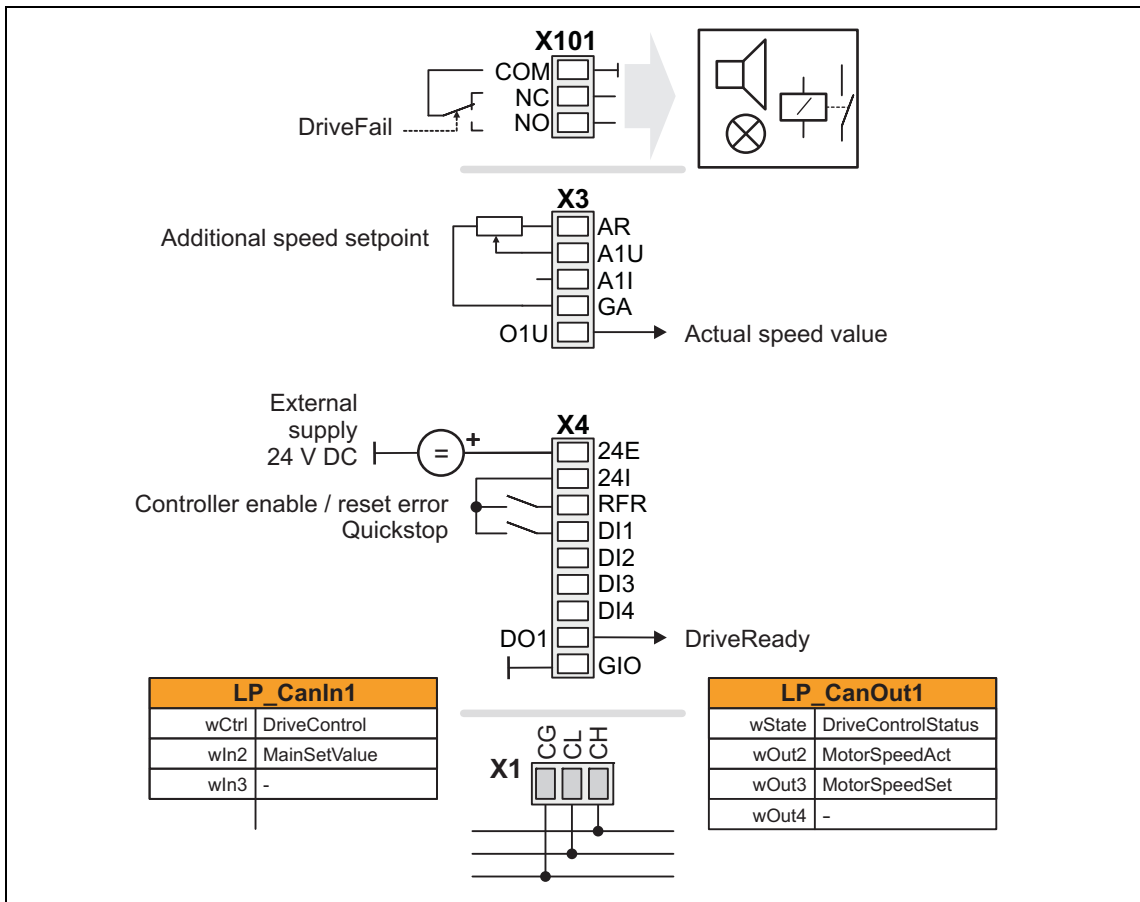

Connection	Assignment	Connection	Assignment
X101/NC-NO	LA_NCtrl.bDriveFail		
X4/RFR	LA_NCtrl.bFailReset	X3/A1U	LA_NCtrl.nAuxSetValue_a *
X4/DI1	LA_NCtrl.bSetQuickStop	X3/A1I	-
X4/DI2	-	X3/O1U	LA_NCtrl.nMotorSpeedAct_a *
X4/DI3	-		* 10 V ≙ 100 % reference speed (C00011)
X4/DI4	-	X4/DO1	LA_NCtrl.bDriveReady

▶ [Process data assignment for fieldbus communication \(□ 331\)](#)



### Note!

- You must set the setpoint arithmetic in [C00190](#) to "1: NOut = NSet + NAdd" so that the additional speed setpoint selected via the analog input A1U has an additive effect.
- The "manual jog" function via digital terminals is being prepared!

### 7.2.3.8 MCI

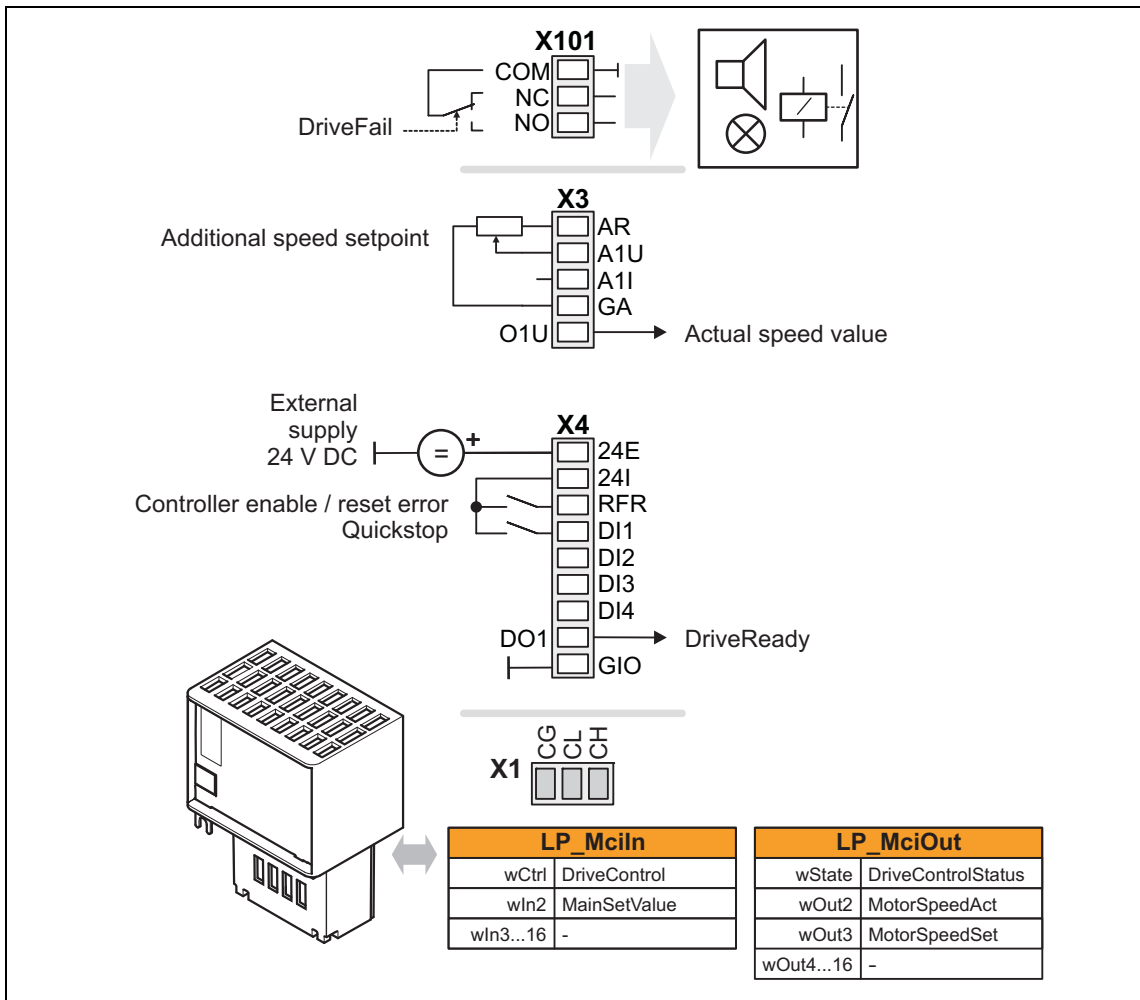

Connection	Assignment	Connection	Assignment
X101/NC-NO	LA_NCtrl.bDriveFail		
X4/RFR	LA_NCtrl.bFailReset	X3/A1U	LA_NCtrl.nAuxSetValue_a *
X4/DI1	LA_NCtrl.bSetQuickStop	X3/A1I	-
X4/DI2	-	X3/O1U	LA_NCtrl.nMotorSpeedAct_a *
X4/DI3	-	* 10 V ≙ 100 % reference speed (C00011)	
X4/DI4	-	X4/DO1	LA_NCtrl.bDriveReady

▶ [Process data assignment for fieldbus communication \(331\)](#)



### Note!

- You must set the setpoint arithmetic in [C00190](#) to "1: NOut = NSet + NAdd" so that the additional speed setpoint selected via the analog input A1U has an additive effect.
- The "manual jog" function via digital terminals is being prepared!

### 7.2.4 Process data assignment for fieldbus communication

The fieldbus communication is connected (preconfigured) to the previously selected technology application by selecting the corresponding control mode in [C00007](#):

- "30: [CAN](#)" for the connection to the system bus (CAN)
- "40: [MCI](#)" for the connection to a plugged-on communication module (e.g. PROFIBUS)

The assignment of the process data words depends only on the application, not on the bus system used:

Input words	Name	Assignment
Word 1	DriveControl	Control word <ul style="list-style-type: none"> <li>• For bit assignment see the table below.</li> </ul>
Word 2	MainSetValue	Speed setpoint <ul style="list-style-type: none"> <li>• Scaling: 16384 <math>\equiv</math> 100 % reference speed (<a href="#">C00011</a>)</li> </ul>
Word 3	-	Not preconfigured
Word 4	-	Not preconfigured
Words 5 ... 16	-	Not preconfigured <ul style="list-style-type: none"> <li>• Only available in control mode "40: MCI".</li> </ul>

Control word	Name	Function
Bit 0	SwitchOn	1 $\equiv$ Change to the " <a href="#">SwitchedOn</a> " device status <ul style="list-style-type: none"> <li>• This bit must be set in the CAN/MCI control word to ensure that the device changes to the "<a href="#">SwitchedOn</a>" device status after mains connection without the need for a master control specifying this bit via fieldbus.</li> <li>• If control via a bus system is not wanted (e.g. in the case of control via terminals), the <i>wDriveCtrl</i> output signal of the <a href="#">LS_ParFix</a> system block can be connected to the control word inputs.</li> </ul>
Bit 1	DisableVoltage	1 $\equiv$ Inhibit inverter control (pulse inhibit)
Bit 2	SetQuickStop	1 $\equiv$ Activate quick stop (QSP). <a href="#">▶ Activate/deactivate quick stop (□ 85)</a>
Bit 3	EnableOperation	1 $\equiv$ Enable inverter (RFR) <ul style="list-style-type: none"> <li>• If control via terminals is performed, this bit must be set both in the CAN control word and in the MCI control word. Otherwise, the controller is inhibited.</li> </ul> <a href="#">▶ Enable/inhibit inverter (□ 84)</a>
Bit 4	ModeSpecific_1	Reserved (currently not assigned)
Bit 5	ModeSpecific_2	
Bit 6	ModeSpecific_3	
Bit 7	ResetFault	1 $\equiv$ Reset fault (trip reset) <ul style="list-style-type: none"> <li>• Acknowledge error message (if the error cause has been eliminated).</li> </ul> <a href="#">▶ Reset error (□ 86)</a>
Bit 8	SetHalt	1 $\equiv$ Activate stop function <ul style="list-style-type: none"> <li>• Stop drive via stopping ramp (in preparation).</li> </ul>
Bit 9	reserved_1	Reserved (currently not assigned)
Bit 10	reserved_2	
Bit 11	SetDCBrake	1 $\equiv$ Activate DC-injection braking <a href="#">▶ Manual DC-injection braking (DCB) (□ 222)</a>
Bit 12	JogSpeed1	Activation of fixed speed 1 ... 3
Bit 13	JogSpeed2	

Control word	Name	Function
Bit 14	SetFail	1 ≙ Set error (trip set)
Bit 15	SetSpeedCcw	0 ≙ Direction of rotation to the right (Cw) 1 ≙ Direction of rotation to the left (Ccw)

Output words	Name	Assignment
Word 1	DriveControlStatus	Status word • For bit assignment see the table below.
Word 2	MotorSpeedAct	Actual speed value • Scaling: 16384 ≙ 100 % reference speed ( <a href="#">C00011</a> )
Word 3	MotorSpeedSet	Resulting overall setpoint • Scaling: 16384 ≙ 100 % reference speed ( <a href="#">C00011</a> )
Word 4	-	Not preconfigured
Words 5 ... 16	-	Not preconfigured • Only available in control mode "40: MCI".

Status word	Name	Status
Bit 0	FreeStatusBit0	Free status bit 0 (not assigned, freely assignable)
Bit 1	PowerDisabled	1 ≙ Inverter control inhibited (pulse inhibit is active)
Bit 2	FreeStatusBit2	Free status bit 2 (not assigned, freely assignable)
Bit 3	FreeStatusBit3	Free status bit 3 (not assigned, freely assignable)
Bit 4	FreeStatusBit4	Free status bit 4 (not assigned, freely assignable)
Bit 5	FreeStatusBit5	Free status bit 5 (not assigned, freely assignable)
Bit 6	ActSpeedIsZero	During open-loop operation: 1 ≙ Speed setpoint < Comparison value ( <a href="#">C00024</a> ) During closed-loop operation: 1 ≙ Actual speed value < Comparison value ( <a href="#">C00024</a> )
Bit 7	ControllerInhibit	1 ≙ Inverter is inhibited (controller inhibit is active)
Bit 8	StatusCodeBit0	Bit coded display of the active device status ▶ <a href="#">Device state machine and device states</a> (see table <a href="#">[4-1]</a> )
Bit 9	StatusCodeBit1	
Bit 10	StatusCodeBit2	
Bit 11	StatusCodeBit3	
Bit 12	Warning	1 ≙ a warning is indicated
Bit 13	Trouble	1 ≙ Inverter is in the " <a href="#">Trouble</a> " device status • E.g. if an overvoltage has occurred.
Bit 14	FreeStatusBit14	Free status bit 14 (not assigned, freely assignable)
Bit 15	FreeStatusBit15	Free status bit 15 (not assigned, freely assignable)

## 7.2.5 Setting parameters (short overview)

Parameters	Info	Lenze setting	
		Value	Unit
<a href="#">C00012</a>	Accel. time - main setpoint	2.000	s
<a href="#">C00013</a>	Decel. time - main setpoint	2.000	s
<a href="#">C00019</a>	Auto-DCB: Threshold	3	rpm
<a href="#">C00024</a>	LS_DriveInterface: bNActCompare	0.00	%
<a href="#">C00036</a>	DCB braking: Current	50.00	%
<a href="#">C00039/1</a>	Preset setpoint 1	40.00	%
<a href="#">C00039/2</a>	Preset setpoint 2	60.00	%
<a href="#">C00039/3</a>	Preset setpoint 3	80.00	%
<a href="#">C00039/4...15</a>	Fixed setpoint 4 ... 15	0.00	%
<a href="#">C00101/1...15</a>	Add. accel. time 1 ... 15	0.000	s
<a href="#">C00103/1...15</a>	Add. decel. time 1 ... 15	0.000	s
<a href="#">C00105</a>	Decel. time - quick stop	2.000	s
<a href="#">C00106</a>	Auto-DCB: Hold time	0.500	s
<a href="#">C00107</a>	DCB braking: Hold time	999.000	s
<a href="#">C00134</a>	L_NSet_1: Ramp smoothing	0: Off	
<a href="#">C00182</a>	L_NSet_1: S-ramp time PT1	20.00	s
<a href="#">C00190</a>	L_NSet_1: Setpoint arithmetic	0: Out = Set	
<a href="#">C00220</a>	L_NSet_1: Acceleration time - add. setpoint	0.000	s
<a href="#">C00221</a>	L_NSet_1: Deceleration time - add. setpoint	0.000	s
<a href="#">C00222</a>	L_PCTRL_1: Vp	1.0	
<a href="#">C00223</a>	L_PCTRL_1: Tn	400	ms
<a href="#">C00224</a>	L_PCTRL_1: Kd	0.0	
<a href="#">C00225</a>	L_PCTRL_1: MaxLimit	199.99	%
<a href="#">C00226</a>	L_PCTRL_1: MinLimit	-199.99	%
<a href="#">C00227</a>	L_PCTRL_1: Acceleration time	0.010	s
<a href="#">C00228</a>	L_PCTRL_1: Deceleration time	0.010	s
<a href="#">C00233</a>	L_PCTRL_1: Root function	0: Off	
<a href="#">C00241</a>	L_NSet_1: Hyst. NSet reached	0.50	%
<a href="#">C00242</a>	Operating mode of process controller	0: Off	
<a href="#">C00243</a>	L_PCTRL_1: Accel. time influence	5.000	s
<a href="#">C00244</a>	L_PCTRL_1: Deceleration time influence	5.000	s
<a href="#">C00632/1</a>	L_NSet_1: Blocking speed 1 max	0.00	%
<a href="#">C00632/2</a>	L_NSet_1: Blocking speed 2 max	0.00	%
<a href="#">C00632/3</a>	L_NSet_1: Blocking speed 3 max	0.00	%
<a href="#">C00633/1</a>	L_NSet_1: Blocking speed 1 min	0.00	%
<a href="#">C00633/2</a>	L_NSet_1: Blocking speed 2 min	0.00	%
<a href="#">C00633/3</a>	L_NSet_1: Blocking speed 3 min	0.00	%
<a href="#">C00635</a>	L_NSet_1: nMaxLimit	199.99	%
<a href="#">C00636</a>	L_NSet_1: nMinLimit	-199.99	%
<a href="#">C00670</a>	L_OffsetGainP_1: Gain	1.0000	
<a href="#">C00671</a>	L_OffsetGainP_2: Gain	1.0000	
<a href="#">C00672</a>	L_OffsetGainP_3: Gain	1.0000	

Parameters	Info	Lenze setting	
		Value	Unit
<a href="#">C00696</a>	L_OffsetGainP_1: Offset	0.00	%
<a href="#">C00697</a>	L_OffsetGainP_2: Offset	0.00	%
<a href="#">C00698</a>	L_OffsetGainP_3: Offset	0.00	%
<a href="#">C00800</a>	L_MPot_1: Upper limit	100.00	%
<a href="#">C00801</a>	L_MPot_1: Lower limit	-100.00	%
<a href="#">C00802</a>	L_MPot_1: Acceleration time	10.0	s
<a href="#">C00803</a>	L_MPot_1: Deceleration time	10.0	s
<a href="#">C00804</a>	L_MPot_1: Inactive fct.	0: Retain value	
<a href="#">C00805</a>	L_MPot_1: Init fct.	0: Load last value	
<a href="#">C00806</a>	Use of motor potentiometer	0: No	

**Related topics:**

▶ ["GeneralPurpose" functions](#) (📖 398)

7.2.6 Configuration parameters

If required, the subcodes of [C00700](#) and [C00701](#) serve to change the pre-configured assignment of the application inputs:

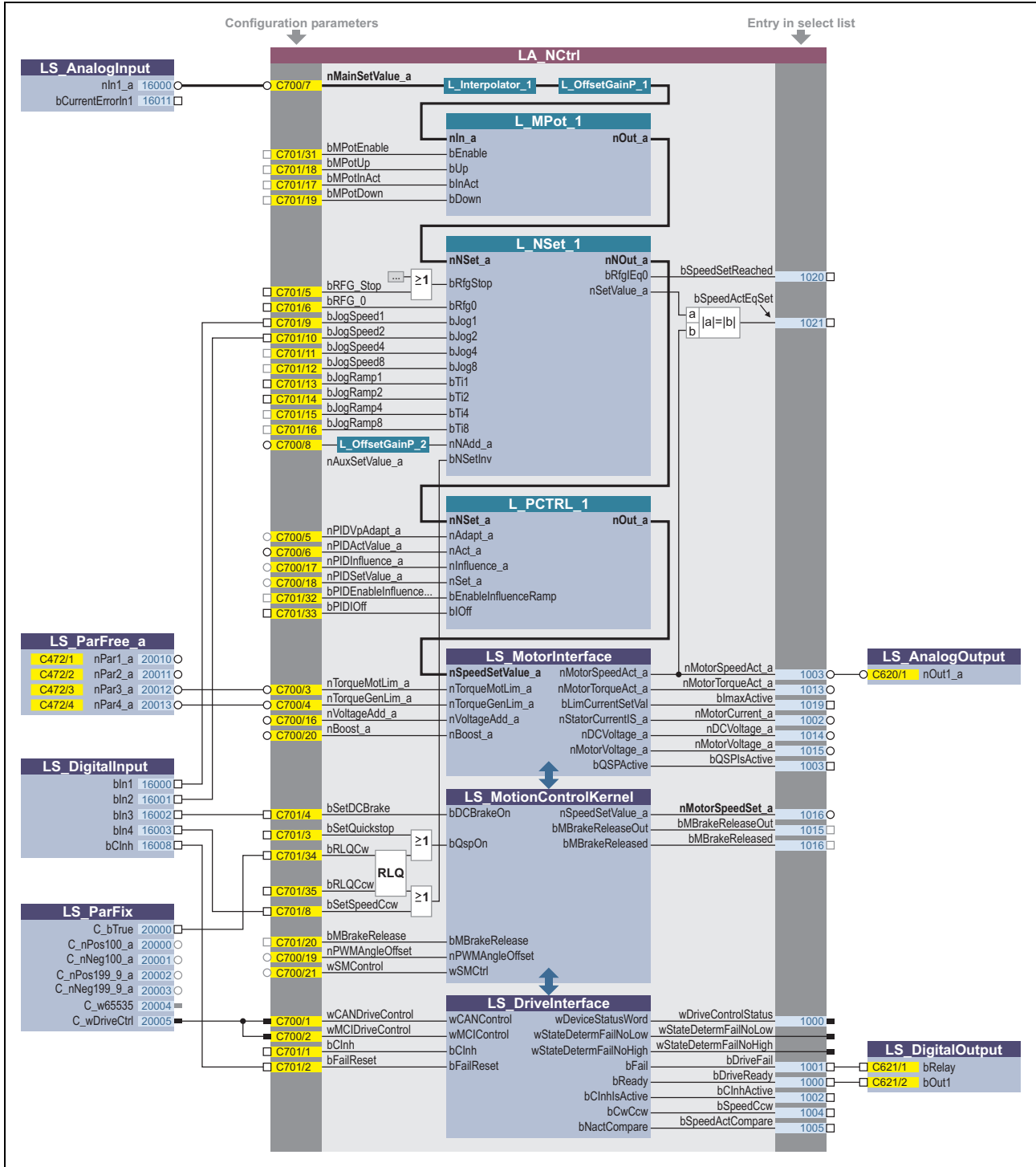

[7-2] Pre-assignment of the "Actuating drive speed" application in the "Terminals 0" control mode

Configuration parameters for "GeneralPurpose" functions

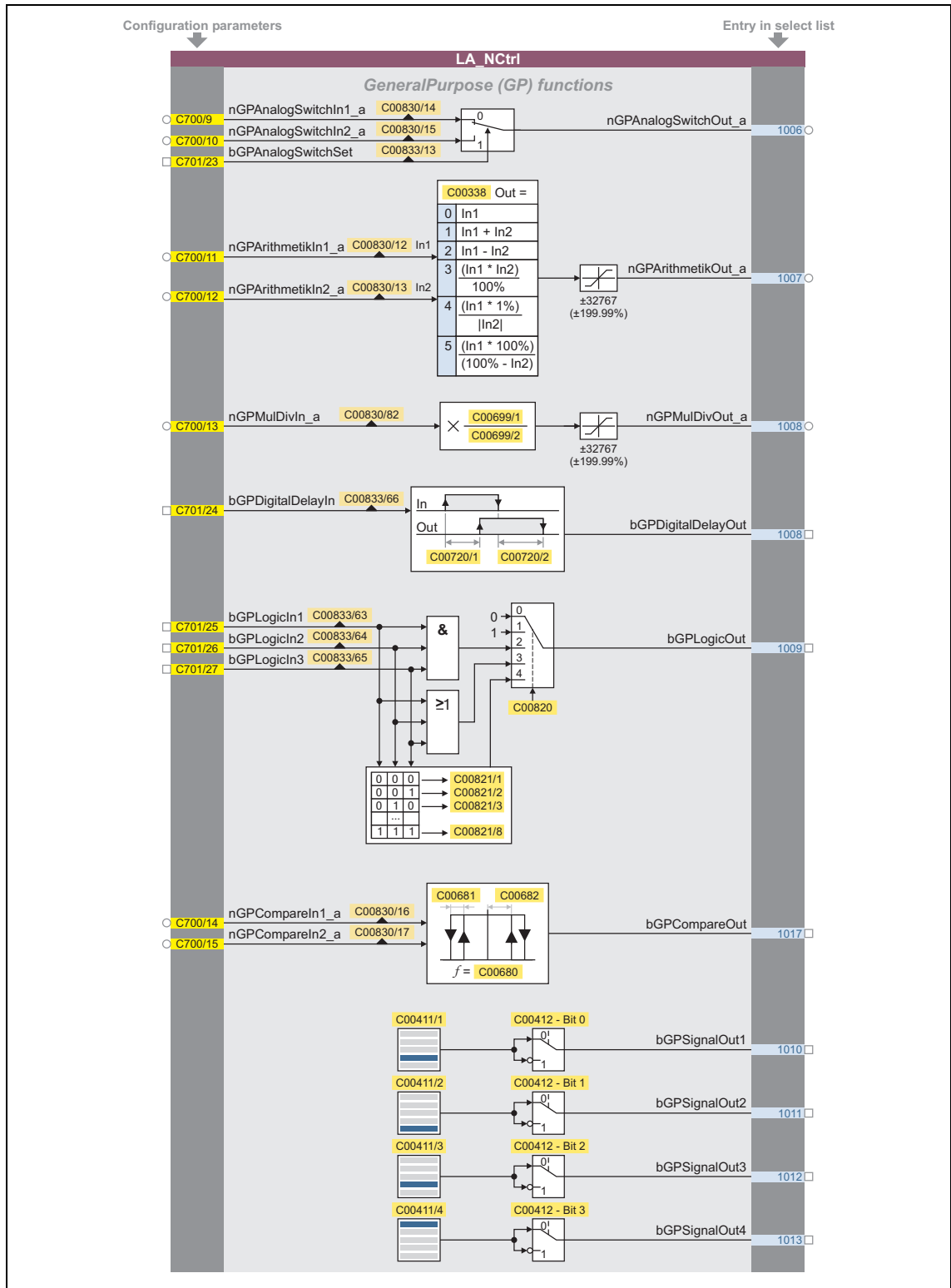

[7-3] "GeneralPurpose" functions



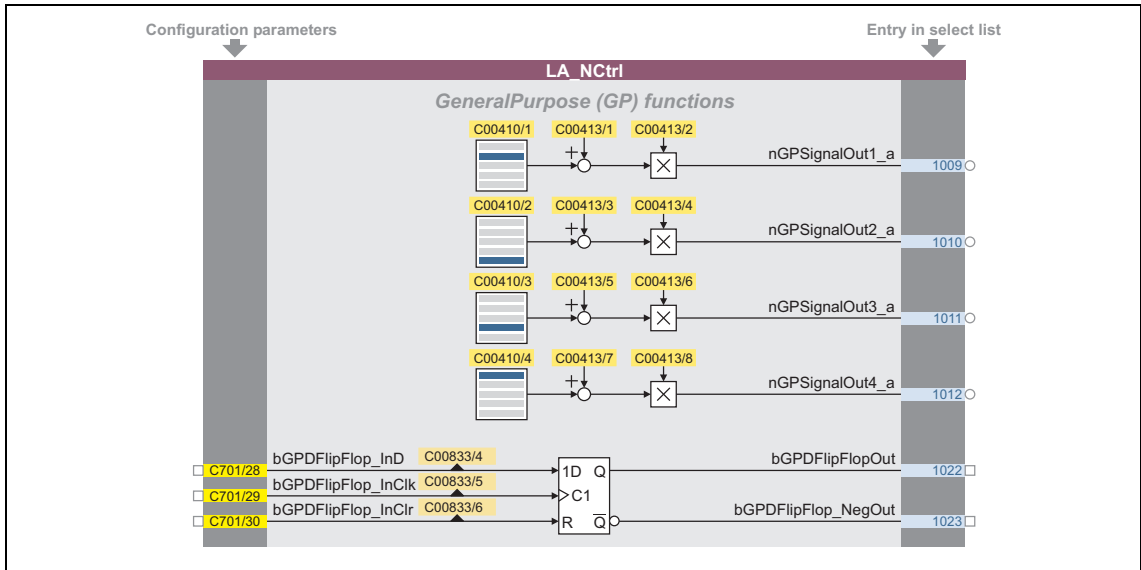

[7-4] "GeneralPurpose" functions (continuation)

**Free inputs and outputs**

These inputs can be freely interconnected in the application level. They can be used to transfer signals from the I/O level to the application level and vice versa.

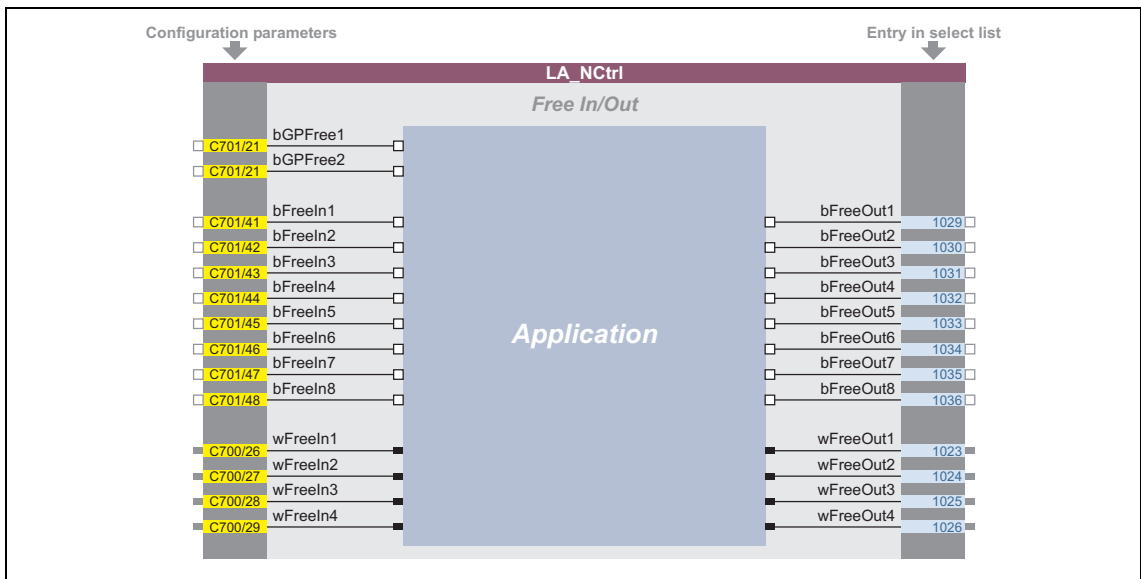

[7-5] Free inputs/outputs

**Related topics:**

- ▶ [User-defined terminal assignment](#) (📖 302)
- ▶ ["GeneralPurpose" functions](#) (📖 398)

### 7.3 TA "actuating drive speed (AC Drive Profile)"

This technology application is available from version 13.00.00!

The EtherNet/IP™ communication module supports the "AC Drive Profile".

When the inverter is provided with an EtherNet/IP™ communication module and the control is to be carried out by means of "AC Drive Profile" via EtherNet/IP™, make the following settings:

1. Set the application "1100: Actuating drive speed (AC Drive Profile)" in [C00005](#).
2. Set the "40: MCI" control mode in [C00007](#).
  - The process data word received by the master control is then interpreted by the application as "AC Drive Profile" control word.
  - When the control is carried out via the system bus (CANopen), set the "30: CAN" control mode instead in [C00007](#).

#### Product features

- Pre-configured control modes for terminals and bus control (with predefined process data connection to the fieldbus)
- Free configuration of input and output signals
- adjustable offset, gain and negation of the speed setpoint
- Up to 15 fixed setpoints for speed and ramp time
- Adjustable setpoint ramp times
- Freely selectable, variable ramp shape
- Automatic holding brake control
- Quick stop (QSP) with adjustable ramp time
- Motor potentiometer function (optional)
- Process controller (optional)
- Integrated, freely available "GeneralPurpose" functions:  
Analog switch, arithmetic, multiplication/division, binary delay element, binary logic, analog comparison, D-flipflop
- Interface to the safety module (optional)
- Integration of encoder feedback



#### Note!

In contrast to the "actuating drive speed" standard application, this application makes use of the *nAuxSetValue\_a* input to determine a local speed setpoint (when NetRef=0). For this reason, the *nNAdd\_a* input at the [L\\_NSet\\_1](#) setpoint generator for determining an additional speed setpoint is not connected in the Lenze setting.

### 7.3.1 I/O assemblies

For the data exchange, the technology application supports the assembly output object instance 23 (0x17) and assembly input object instance 73 (0x49) defined by the ODVA (Open DeviceNet Vendor Association).

Instance 23 (0x17): Extended Speed and Torque Control Output								
Bytes	Bit 7	Bit 6	Bit 5	Bit 4	Bit 3	Bit 2	Bit 1	Bit 0
0		Net Ref	NetCtrl			Fault Reset	Run Rev	Run Fwd
1								
2	Speed Reference (Low Byte)							
3	Speed Reference (High Byte)							
4	Torque Reference (Low Byte)							
5	Torque Reference (High Byte)							

Instance 73 (0x49): Extended Speed and Torque Control Input								
Bytes	Bit 7	Bit 6	Bit 5	Bit 4	Bit 3	Bit 2	Bit 1	Bit 0
0	At Reference	RefFrom Net	CtrlFrom Net	Ready	Running2 (Rev)	Running1 (Fwd)	Warning	Faulted
1	Drive State							
2	Speed Actual (Low Byte)							
3	Speed Actual (High Byte)							
4	Torque Actual (Low Byte)							
5	Torque Actual (High Byte)							



Detailed information on the data transfer and "AC Drive Profile" can be found in the E84AYCEO communication manual (EtherNet/IP™).



#### Tip!

Detailed information on EtherNet/IP™ can be found at the web page of the ODVA (Open DeviceNet Vendor Association) user organisation:

<http://www.odva.org>

#### Related topics:

- ▶ [Process data assignment for fieldbus communication](#)
- ▶ [Run/Stop event](#)
- ▶ [Scaling of speed and torque values](#)

## 7.3.2 Basic signal flow

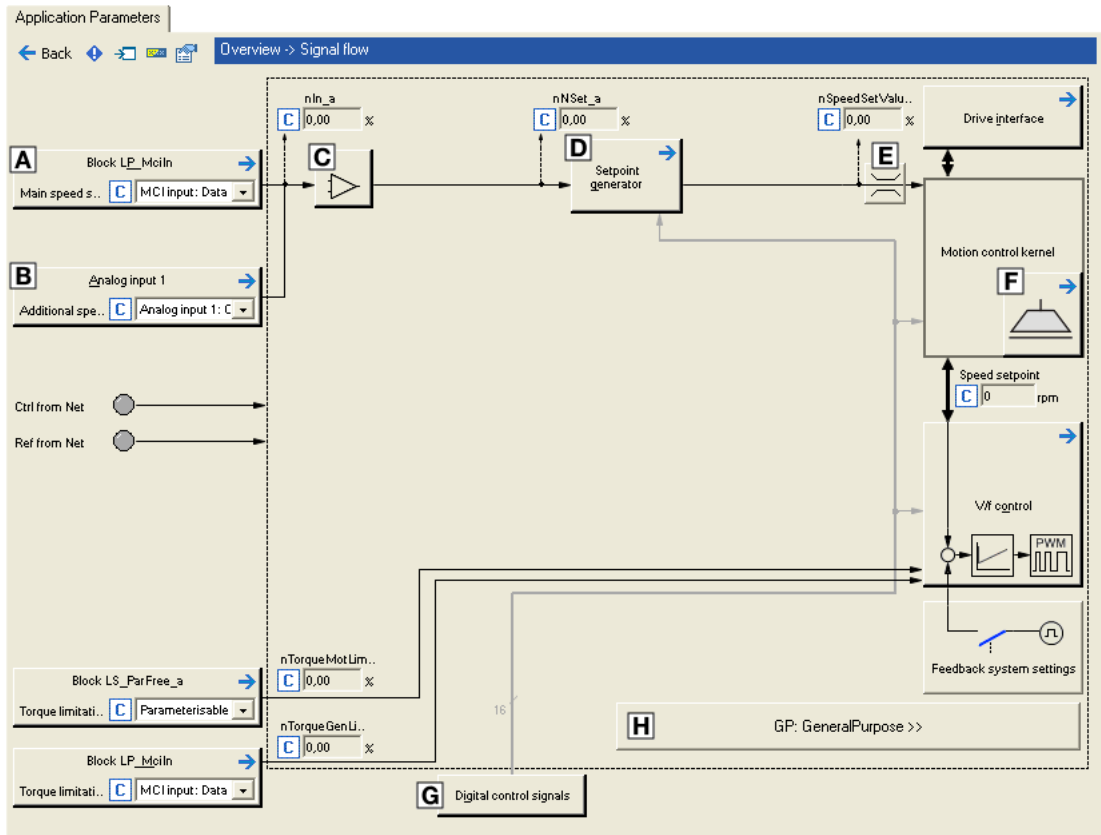



[7-6] Signal flow of the "actuating drive speed (AC Drive Profile)" technology application

- A Configuration of the signal source for setpoint selection via fieldbus (NetRef=1)
- B Configuration of the signal source for local setpoint selection (NetRef=0)
- C Offset and gain for speed setpoint ([L\\_OffsetGainP\\_1](#))
- D Setpoint generator ([L\\_NSet\\_1](#))
- E Speed setpoint input limitation
- F [Holding brake control](#)
- G Terminal assignment & display of digital control signals
- H Integrated disposable "[GeneralPurpose](#)" functions: Analog switch, arithmetic, multiplication/division, binary delay element, binary logic, analog comparison, D-flipflop

### Definition of the speed setpoint

The speed setpoint is usually defined as process data via the fieldbus. If set accordingly, the speed setpoint can also be determined locally (e.g. via the analog input 1). Depending on the selection, either only the *nMainSetValue\_a* application input or only the application input *nAuxSetValue\_a* is effective. The following table shows the relationships:

Fieldbus used	Control mode (C00007)	Speed reference	AC Drive Profile control word (wMCIDriveControl)	effective input (at LA_NCtrl)
	40: MCI	via fieldbus (data word 2)	Bit 6 ("NetRef") = 1	<i>nMainSetValue_a</i>
		local*	Bit 6 ("NetRef") = 0	<i>nAuxSetValue_a</i>
	30: CAN	via fieldbus (data word 2)	Bit 6 ("NetRef") = 1	<i>nMainSetValue_a</i>
		local*	Bit 6 ("NetRef") = 0	<i>nAuxSetValue_a</i>
-	10: Terminals 0 12: Terminals 2 14: Terminals 11 16: Terminals 16	local*	9 ≡ 0x0009 • Bit 0, SwitchOn = TRUE • Bit 3, EnableOperation = TRUE • All others: FALSE	<i>nAuxSetValue_a</i>
	20: Keypad	<a href="#">C00728/3</a>		
	21: PC	<a href="#">C00472/1</a>		

\* The local setpoint is selected in the Lenze setting via the analog input 1

### Scaling of the speed setpoint

If the setpoint is determined via fieldbus (NetRef=1), the setpoint applied to the *nMainSetValue\_a* application input is evaluated with the speed scaling set in [C01353/1](#) (AC Drive Attribute 22). ▶ [Scaling of speed and torque values](#).

If the setpoint is determined locally (e.g. via the analog input 1), the setpoint applied to the *nAuxSetValue\_a* application input is scaled as follows:

$$16384 \equiv 100 \% \text{ reference speed (C00011).}$$

### Offset & gain

Offset and gain of the speed signal can be set in [C00696](#) and [C00670](#) for a simple signal adjustment of a setpoint encoder.

### Ramp function generator

The setpoint is transformed to a speed setpoint in the setpoint encoder via a ramp function generator with linear or S-shaped ramps.

- Upstream to the ramp function generator, a blocking speed masking function and a setpoint MinMax limitation are effective.
- For a detailed functional description see the [L\\_NSet](#) FB.

### Selection of the direction of rotation

- In case of control via fieldbus via bit 0 "Run Forward" and bit 1 "Run Backward" of the AC Drive Profile control word.
- In case of local control via the *bSetSpeedCcw* application input or by selecting negative fixed setpoints.



### Selection of the torque setpoint in torque mode

In torque mode", the *nTorqueGenLim\_a* application input has the function of the torque setpoint selection.

The torque setpoint is usually defined as process data via the fieldbus. If set accordingly, the torque setpoint can also be determined locally (e.g. via the analog input 1).

For the local selection of the torque setpoint, the same application input (*nAuxSetValue\_a*) is used as for the local selection of the speed setpoint. In "torque mode" however, the *nAuxSetValue\_a* input is internally connected to the *nTorqueGenLim\_a* input. In this case, the speed setpoint is internally permanently set to "100 %".

The relationships are shown in the following table:

Fieldbus used	Control mode (C00007)	Torque reference	AC Drive Profile control word (wMCIDriveControl)	effective input (at LA_NCtrl)
	40: MCI	via fieldbus (data word 3)	Bit 6 ("NetRef") = 1	<i>nTorqueGenLim_a</i>
		local*	Bit 6 ("NetRef") = 0	<i>nAuxSetValue_a</i>
	30: CAN	via fieldbus (data word 3)	Bit 6 ("NetRef") = 1	<i>nTorqueGenLim_a</i>
		local*	Bit 6 ("NetRef") = 0	<i>nAuxSetValue_a</i>
-	10: Terminals 0 12: Terminals 2 14: Terminals 11 16: Terminals 16	local*	9 ≡ 0x0009 • Bit 0, SwitchOn = TRUE • Bit 3, EnableOperation = TRUE • All others: FALSE	<i>nAuxSetValue_a</i>
	20: Keypad	<a href="#">C00728/3</a>		
	21: PC	<a href="#">C00472/1</a>		

\* The local setpoint is selected in the Lenze setting via the analog input 1

## 7.3.3 Internal interfaces | application block "LA\_NCtrl"



**Note!**

The connectors greyed out in the following table are hidden in the function block editor in the Lenze setting.

- These connections can be shown via the **Connector visibilities** command in the *Context menu* of the application block.

**inputs**

Designator	Data type	Information/possible settings		
wCANDriveControl	WORD	Input for CAN control word <ul style="list-style-type: none"> <li>• Is not used in this configuration and is thus set to the permanent value "9" in the Lenze setting (SwitchOn = TRUE and EnableOperation = TRUE).</li> <li>• For the evaluation of the AC Drive Profile control word received via fieldbus, the <i>wMCIDriveControl</i> input is used in the control modes 30: CAN" and "40: MCI".</li> </ul>		
wMCIDriveControl	WORD	Input for the AC Drive Profile control word received via fieldbus <ul style="list-style-type: none"> <li>• The AC Drive Profile control word operates the inverter in compliance with the assembly output object instances 20 ... 23. For this purpose, the control bits are evaluated and lead to a corresponding modification of the control signals <i>bFailReset</i>, <i>bRFG_0</i> and <i>bSetSpeedCw</i> which results in the AC Drive-specific behaviour.</li> <li>• See the "<a href="#">Process data assignment for fieldbus communication</a>" subchapter for a detailed description of the individual control bits.</li> <li>• Display parameter: <a href="#">C01351/1</a></li> </ul>		
wSMControl	WORD	Interface to the optional safety system. <ul style="list-style-type: none"> <li>• Setting control bit 0 ("SafeStop1") in this control word causes e.g. the automatic deceleration of the drive to standstill within this application (in the <b>Motion Control Kernel</b>).</li> <li>• See the subchapter "<a href="#">Interface to safety system</a>" of the chapter on basic drive functions for a detailed description of the individual control bits.</li> </ul>		
bCInh	BOOL	<a href="#">Enable/inhibit inverter</a>		
		<table border="1"> <tr> <td>FALSE</td> <td>Enable inverter: The inverter switches to the "<a href="#">OperationEnabled</a>" device status if no other source for controller inhibit is active.               <ul style="list-style-type: none"> <li>• <a href="#">C00158</a> provides a bit coded representation of all active sources/triggers of a controller inhibit.</li> </ul> </td> </tr> <tr> <td>TRUE</td> <td>Inhibit inverter (controller inhibit): The inverter switches to the "<a href="#">SwitchedOn</a>" device status.</td> </tr> </table>	FALSE	Enable inverter: The inverter switches to the " <a href="#">OperationEnabled</a> " device status if no other source for controller inhibit is active. <ul style="list-style-type: none"> <li>• <a href="#">C00158</a> provides a bit coded representation of all active sources/triggers of a controller inhibit.</li> </ul>
FALSE	Enable inverter: The inverter switches to the " <a href="#">OperationEnabled</a> " device status if no other source for controller inhibit is active. <ul style="list-style-type: none"> <li>• <a href="#">C00158</a> provides a bit coded representation of all active sources/triggers of a controller inhibit.</li> </ul>			
TRUE	Inhibit inverter (controller inhibit): The inverter switches to the " <a href="#">SwitchedOn</a> " device status.			
bFailReset	BOOL	<a href="#">Reset error message</a> <ul style="list-style-type: none"> <li>• In the Lenze setting this input is connected to the digital input controller enable so that a possibly existing error message is reset together with the controller enable (if the cause for the fault is eliminated).</li> <li>• <b>In case of control via fieldbus (NetCtrl=1):</b> This input is OR'd with bit 2 ("fault reset") of the AC Drive Profile control word.</li> </ul>		
		<table border="1"> <tr> <td>TRUE</td> <td>The current fault is reset, if the cause for the fault is eliminated.               <ul style="list-style-type: none"> <li>• If the fault still exists, the error status remains unchanged.</li> </ul> </td> </tr> </table>	TRUE	The current fault is reset, if the cause for the fault is eliminated. <ul style="list-style-type: none"> <li>• If the fault still exists, the error status remains unchanged.</li> </ul>
TRUE	The current fault is reset, if the cause for the fault is eliminated. <ul style="list-style-type: none"> <li>• If the fault still exists, the error status remains unchanged.</li> </ul>			

Designator	Data type	Information/possible settings	
bSetQuickstop	BOOL	Activate quick stop (QSP) <ul style="list-style-type: none"> <li>• Also see device command "<a href="#">Activate/deactivate quick stop</a>".</li> </ul>	
		TRUE	Activate quick stop <ul style="list-style-type: none"> <li>• Motor control is decoupled from the setpoint selection and, within the deceleration time parameterised in <a href="#">C00105</a>, the motor is brought to a standstill (<math>n_{act} = 0</math>).</li> <li>• The motor is kept at a standstill during closed-loop operation.</li> <li>• A pulse inhibit is set if the auto-DCB function has been activated via <a href="#">C00019</a>.</li> </ul>
		FALSE	Deactivate quick stop <ul style="list-style-type: none"> <li>• The quick stop is deactivated if no other source for the quick stop is active.</li> <li>• <a href="#">C00159</a> displays a bit code of active sources/causes for the quick stop.</li> </ul>
bSetDCBrake	BOOL	Manual DC-injection braking (DCB) <ul style="list-style-type: none"> <li>• Detailed information on DC-injection braking is provided in the motor control chapter, subchapter "<a href="#">DC-injection braking</a>".</li> </ul>	
		 <b>Note!</b> Holding braking is not possible when this braking mode is used! Use the basic " <a href="#">Holding brake control</a> " function for controlling the holding brake with a low rate of wear.	
		FALSE	Deactivate DC-injection braking.
		TRUE	Activate DC-injection braking, i.e. the drive is brought to a standstill by means of DC-injection braking. <ul style="list-style-type: none"> <li>• The braking effect stops when the rotor is at standstill.</li> <li>• After the hold time (<a href="#">C00107</a>) has expired, the controller sets the pulse inhibit.</li> </ul>
bRFG_Stop	BOOL	Ramp function generator: Maintain the current value of the main setpoint integrator <ul style="list-style-type: none"> <li>• The speed, for instance, of a running ramp process is immediately kept constant when <i>bRFG_Stop</i> is activated. At the same time, the acceleration/deceleration jumps to the value "0".</li> <li>• For a detailed functional description see the <a href="#">L_NSet</a> FB.</li> </ul>	
		TRUE	The current value of the main setpoint integrator is held.
bRFG_0	BOOL	Ramp function generator: Lead the main setpoint integrator to "0" within the current $T_i$ times <ul style="list-style-type: none"> <li>• <b>In case of control via fieldbus (NetCtrl=1):</b> If a stop is triggered via bit 0 ("Run Forward") and bit 1 ("Run Backward") of the AC Drive Profile control word, this signal is internally set to TRUE and thus the drive is braked to standstill.</li> <li>• For a detailed functional description see the <a href="#">L_NSet</a> FB.</li> </ul>	
		TRUE	The current value of the main setpoint integrator is led to "0" within the $T_i$ time set.
nVoltageAdd_a	INT	Additive voltage impression <ul style="list-style-type: none"> <li>• An additional setpoint for the motor voltage can be specified via this process input.</li> <li>• If there are, for instance, different loads at the motor output end, it is possible to apply a voltage boost at the starting time.</li> <li>• If the value is negative, the voltage is reduced.</li> <li>• Scaling: <math>16384 \equiv 1000 \text{ V}</math></li> </ul>	
		 <b>Stop!</b> Values selected too high may cause the motor to heat up due to the resulting current!	

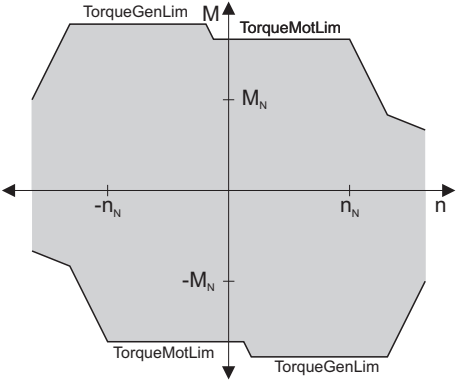

Designator	Data type	Information/possible settings				
nBoost_a	INT	<p>Additional setpoint for the motor voltage at speed = 0</p> <ul style="list-style-type: none"> <li>The entire voltage-frequency characteristic is provided with an offset.</li> <li>Scaling: 16384 <math>\equiv</math> 1000 V</li> </ul> <p><b>STOP Stop!</b></p> <p>Values selected too high may cause the motor to heat up due to the resulting current!</p>				
nPWMAngleOffset	INT	<p>Additional offset for the electrical angle of rotation</p> <ul style="list-style-type: none"> <li>If a torque is connected, e.g. dynamic acceleration processes can be generated.</li> <li>Scaling: <math>\pm 32767 \equiv \pm 180^\circ</math> angle of rotation</li> </ul>				
nTorqueMotLim_a nTorqueGenLim_a	INT	<p>Torque limitation in motor mode and in generator mode (speed mode) or torque setpoint selection (torque mode)</p> <p><b>When "speed mode" is set, the following applies:</b></p> <ul style="list-style-type: none"> <li>The torque limitation in motor mode and generator mode are determined via <i>nTorqueMotLim_a</i>.</li> <li>The <i>nTorqueGenLim_a</i> input is not effective.</li> </ul> <p><b>When "torque mode" is set, the following applies:</b></p> <ul style="list-style-type: none"> <li>The torque setpoint is determined via <i>nTorqueGenLim_a</i>.</li> <li>The <i>nTorqueMotLim_a</i> input is not effective.</li> </ul> <p>More notes for both inputs:</p> <ul style="list-style-type: none"> <li>These input signals are directly transferred to the motor control to limit the inverter's maximum torque in motor and generator mode.</li> <li>The drive cannot output a higher torque in motor/generator mode than set here.</li> <li>The applied values (any polarity) are internally interpreted as absolute values.</li> <li>If V/f characteristic control (VFCplus) is selected, limitation is <u>indirectly</u> performed via a so-called <math>I_{\max}</math> controller.</li> <li>If sensorless vector control (SLVC) or servo control (SC) is selected, limitation has a <u>direct</u> effect on the torque-producing current component.</li> <li>Scaling: 16384 <math>\equiv</math> 100 % <math>M_{\max}</math> (<a href="#">C00057</a>)</li> </ul> <p>Torque limits in motor and generator mode:</p> 				
bSetSpeedCcw	BOOL	<p>Change of direction of rotation</p> <ul style="list-style-type: none"> <li>For instance if a motor or gearbox is fixed laterally reversed to a machine part, but the setpoint selection should still be executed for the positive direction of rotation.</li> <li><b>Input only effective in case of local control (NetCtrl=0)</b></li> </ul> <table border="1"> <tr> <td>FALSE</td> <td>Clockwise rotation (Cw)</td> </tr> <tr> <td>TRUE</td> <td>Direction of rotation to the left (Ccw)</td> </tr> </table>	FALSE	Clockwise rotation (Cw)	TRUE	Direction of rotation to the left (Ccw)
FALSE	Clockwise rotation (Cw)					
TRUE	Direction of rotation to the left (Ccw)					
bRLQCw	BOOL	<p>Activate clockwise rotation (fail-safe)</p> <ul style="list-style-type: none"> <li>For a detailed functional description see the <a href="#">L_RLO</a> FB.</li> </ul> <table border="1"> <tr> <td>FALSE</td> <td>Quick stop</td> </tr> <tr> <td>TRUE</td> <td>CW rotation</td> </tr> </table>	FALSE	Quick stop	TRUE	CW rotation
FALSE	Quick stop					
TRUE	CW rotation					

Designator	Data type	Information/possible settings				
bRLQCcw	BOOL	<p>Activate counter-clockwise rotation (fail-safe)</p> <ul style="list-style-type: none"> <li>• <b>Input only effective in case of local control (NetCtrl=0)</b></li> <li>• For a detailed functional description see the <a href="#">L_RLO</a> FB.</li> </ul> <table border="1"> <tr> <td>FALSE</td> <td>Quick stop</td> </tr> <tr> <td>TRUE</td> <td>CCW rotation</td> </tr> </table>	FALSE	Quick stop	TRUE	CCW rotation
FALSE	Quick stop					
TRUE	CCW rotation					
nMainSetValue_a	INT	<p>Speed setpoint via fieldbus in [rpm]</p> <ul style="list-style-type: none"> <li>• <b>Input only effective in case of setpoint selection via fieldbus (NetRef=1)</b></li> <li>• This input is evaluated with the speed scaling set in <a href="#">C01353/1</a> (AC Drive Attribute 22). ▶ <a href="#">Scaling of speed and torque values</a></li> <li>• An absolute value is created internally (the sign has no meaning).</li> <li>• Offset and gain of this input signal can be set in <a href="#">C00696</a> and <a href="#">C00670</a> for a simple signal adjustment of a setpoint encoder.</li> <li>• The setpoint is transformed to a speed setpoint in the setpoint encoder via a ramp function generator with linear or S-shaped ramps.</li> <li>• Upstream to the ramp function generator, a blocking speed masking function and a setpoint MinMax limitation are effective.</li> <li>• For a detailed functional description see the <a href="#">L_NSet</a> FB.</li> </ul>				
nAuxSetValue_a	INT	<p>Local speed setpoint (speed mode) or torque setpoint (torque mode)</p> <ul style="list-style-type: none"> <li>• <b>Input only effective in case of local setpoint selection (NetRef=0)</b></li> </ul> <p><b>When "speed mode" is set, the following applies:</b></p> <ul style="list-style-type: none"> <li>• The input value is interpreted as speed setpoint.</li> <li>• Scaling: 16384 ≙ 100 % reference speed (<a href="#">C00011</a>)</li> <li>• Offset and gain of this input signal can be set in <a href="#">C00696</a> and <a href="#">C00670</a> for a simple signal adjustment of a setpoint encoder.</li> <li>• The setpoint is transformed to a speed setpoint in the setpoint encoder via a ramp function generator with linear or S-shaped ramps.</li> <li>• Upstream to the ramp function generator, a blocking speed masking function and a setpoint MinMax limitation are effective.</li> <li>• For a detailed functional description see the <a href="#">L_NSet</a> FB.</li> </ul> <p><b>When "torque mode" is set, the following applies:</b></p> <ul style="list-style-type: none"> <li>• The input value is interpreted as torque setpoint. (Input <i>nAuxSetValue_a</i> is internally connected to input <i>nTorqueGenLim_a</i>).</li> <li>• Scaling: 16384 ≙ 100 % <math>M_{max}</math> (<a href="#">C00057</a>)</li> <li>• The speed setpoint is internally permanently set to "100 %".</li> </ul>				
bJogSpeed1 bJogSpeed2	BOOL	<p>Selection inputs for override fixed setpoints (JOG setpoints)</p> <ul style="list-style-type: none"> <li>• <b>Inputs only effective in case of local setpoint selection (NetRef=0)</b></li> <li>• These selection inputs can be used to activate a fixed setpoint for the setpoint generator instead of the setpoint applied to the <i>nAuxSetValue_a</i> input.</li> <li>• The four selection inputs are binary coded, therefore 15 fixed setpoints can be selected.</li> <li>• In case of binary coded selection "0" (all inputs = FALSE or not assigned), the main setpoint applied to the <i>nAuxSetValue_a</i> input is active.</li> <li>• The selection of the fixed setpoints is carried out in <a href="#">C00039/1...15</a> in [%] based on the reference speed (<a href="#">C00011</a>).</li> <li>• For a detailed functional description see the <a href="#">L_NSet</a> FB.</li> </ul>				
bJogSpeed4 bJogSpeed8	BOOL					
bJogRamp1 bJogRamp2	BOOL	<p>Selection inputs for alternative acceleration/deceleration times</p> <ul style="list-style-type: none"> <li>• The four selection inputs are binary coded, therefore 15 alternative acceleration/deceleration times can be selected.</li> <li>• In case of binary selection "0" (all inputs = FALSE or not assigned), the acceleration time (<a href="#">C00012</a>) and deceleration time (<a href="#">C00013</a>) set for the main setpoint are active.</li> <li>• Alternative acceleration times are selected in <a href="#">C00101/1...15</a>.</li> <li>• The selection of the alternative deceleration times is carried out in <a href="#">C00103/1...15</a>.</li> <li>• For a detailed functional description see the <a href="#">L_NSet</a> FB.</li> </ul>				
bJogRamp4 bJogRamp8	BOOL					

Designator	Data type	Information/possible settings
<b>Motor potentiometer</b>		
<p>Alternatively to the input signal <i>nMainSetValue_a</i> (or <i>nAuxSetValue_a</i> in case of local setpoint selection), the speed setpoint can also be generated via a motor potentiometer function.</p> <ul style="list-style-type: none"> <li>In the Lenze setting, the motor potentiometer function is deactivated.</li> <li>Activation is possible via <a href="#">C00806</a> or via the <i>bMPotEnable</i> input.</li> <li>The behaviour of the motor potentiometer during switch-on of the drive system can be selected in <a href="#">C00805</a>.</li> <li>For a detailed functional description see the <a href="#">L_MPot</a> FB.</li> </ul>		
bMPotEnable	BOOL	Activating the motor potentiometer function <ul style="list-style-type: none"> <li>This input and <a href="#">C00806</a> are OR'd.</li> </ul>
		TRUE The motor potentiometer function is active; the speed setpoint can be changed via the <i>bMPotUp</i> and <i>bMPotDown</i> control inputs.
bMPotUp	BOOL	Increasing the speed setpoint
		TRUE Approach the upper speed limit value set in <a href="#">C00800</a> with the acceleration time set in <a href="#">C00802</a> .
bMPotInAct	BOOL	Activating the inactive function
		TRUE The speed setpoint behaves according to the inactive function set in <a href="#">C00804</a> . <ul style="list-style-type: none"> <li>In the Lenze setting, the speed setpoint is maintained.</li> </ul>
bMPotDown	BOOL	Decreasing the speed setpoint
		TRUE Approach the lower speed limit value set in <a href="#">C00801</a> with the deceleration time set in <a href="#">C00803</a> .
<b>Process controller</b>		
<ul style="list-style-type: none"> <li>In the Lenze setting, the process controller is deactivated.</li> <li>The activation is executed by selecting the operating mode in <a href="#">C00242</a>.</li> <li>For a detailed functional description see FB <a href="#">L_PCTRL</a>.</li> </ul>		
bPIDEnableInfluenceRamp	BOOL	Activate ramp for influencing factor
		FALSE Influencing factor of the PID controller is ramped down to "0".
		TRUE Influencing factor of the PID controller is ramped up to the value <i>nPIDInfluence_a</i> .
bPIDIOff	BOOL	Switch off the I-component of the process controller <ul style="list-style-type: none"> <li>In conjunction with the operating mode set in <a href="#">C00242</a> (Lenze setting: "Off").</li> </ul>
		TRUE I-component of the process controller is switched off.
nPIDVpAdapt_a	INT	Adaptation of gain Vp set in <a href="#">C00222</a> in percent <ul style="list-style-type: none"> <li>Scaling: 16384 <math>\equiv</math> 100 %</li> <li>Internal limitation to <math>\pm</math> 199.99 %</li> <li>Changes can be done online.</li> </ul>
nPIDSetValue_a	INT	Sensor and process setpoint for operating modes 2, 4 and 5 <ul style="list-style-type: none"> <li>Scaling: 16384 <math>\equiv</math> 100 %</li> <li>Internal limitation to <math>\pm</math> 199.99 %</li> </ul>
nPIDActValue_a	INT	Speed or actual sensor value (actual process value) <ul style="list-style-type: none"> <li>Offset and gain for this input signal can be set in <a href="#">C00698</a> and <a href="#">C00672</a>.</li> <li>Scaling: 16384 <math>\equiv</math> 100 %</li> <li>Internal limitation to <math>\pm</math> 199.99 %</li> </ul>
nPIDInfluence_a	INT	Limitation of the influencing factor in percent <ul style="list-style-type: none"> <li>The influence factor of the PID controller can be limited to a certain value (-199.99% ... + 199.99%) via <i>nPIDInfluence_a</i>.</li> <li>Scaling: 16384 <math>\equiv</math> 100 %</li> <li>Internal limitation to <math>\pm</math> 199.99 %</li> </ul>

Designator	Data type	Information/possible settings	
<b>MCK basic functions</b>			
bMBrakeRelease	BOOL	<b> Holding brake control:</b> Release/apply brake <ul style="list-style-type: none"> <li>In conjunction with the operating mode selected in <a href="#">C02580</a> (Lenze setting: "Brake control off").</li> </ul>	
		FALSE	Apply brake. <ul style="list-style-type: none"> <li>During automatic operation, the internal brake logic controls the brake.</li> </ul>
		TRUE	Release brake manually (forced release). <ul style="list-style-type: none"> <li><b>Note!</b> The brake can also be released when the controller is inhibited!</li> <li>During automatic operation, the internal brake logic is deactivated and the brake is released (supervisor operation). If a controller inhibit has been set by the brake control, it will be deactivated.</li> <li>In semi-automatic operation, the brake is released including feedforward control.</li> </ul>
<b>GP: GeneralPurpose</b>			
The following inputs are interconnected with logic/arithmetic functions on application level for free usage. ▶ <a href="#">"GeneralPurpose" functions</a>			
bGPFree1 ... bGPFree2	BOOL	Free inputs for digital signals <ul style="list-style-type: none"> <li>Digital signals can be transferred from the I/O level to the application level via these inputs.</li> </ul>	
nGPAAnalogSwitchIn1_a nGPAAnalogSwitchIn2_a	INT	<b>Analog switch:</b> Input signals <ul style="list-style-type: none"> <li>The input signal selected via the selection input <i>bGPAAnalogSwitchSet</i> is output at output <i>nGPAAnalogSwitchOut_a</i>.</li> </ul>	
bGPAAnalogSwitchSet	BOOL	<b>Analog switch:</b> Selection input	
		FALSE	<i>nGPAAnalogSwitchOut_a</i> = <i>nGPAAnalogSwitchIn1_a</i>
		TRUE	<i>nGPAAnalogSwitchOut_a</i> = <i>nGPAAnalogSwitchIn2_a</i>
nGPArithmetikIn1_a nGPArithmetikIn2_a	INT	<b>Arithmetic:</b> Input signals <ul style="list-style-type: none"> <li>The arithmetic function is selected in <a href="#">C00338</a>.</li> <li>The result is output at output <i>nGPArithmetikOut_a</i>.</li> </ul>	
nGPMulDivIn_a	INT	<b>Multiplication/Division:</b> Input signal <ul style="list-style-type: none"> <li>The factor for the multiplication can be set in <a href="#">C00699/1</a> (numerator) and <a href="#">C00699/2</a> (denominator).</li> <li>The result is output at output <i>nGPMulDivOut_a</i>.</li> </ul>	
bGPDigitalDelayIn	BOOL	<b>Binary delay element:</b> Input signal <ul style="list-style-type: none"> <li>The on-delay can be set in <a href="#">C00720/1</a>.</li> <li>The off-delay can be set in <a href="#">C00720/2</a>.</li> <li>The time-delayed input signal is output at output <i>bGPDigitalDelayOut</i>.</li> </ul>	
bGPLogicIn1 bGPLogicIn2 bGPLogicIn3	BOOL	<b>Binary logic:</b> Input signals <ul style="list-style-type: none"> <li>The logic operation is selected in <a href="#">C00820</a>.</li> <li>The result is output at output <i>bGPLogicOut</i>.</li> </ul>	
nGPCompareIn1_a nGPCompareIn2_a	INT	<b>Analog comparison:</b> Input signals <ul style="list-style-type: none"> <li>The comparison operation is selected in <a href="#">C00680</a>.</li> <li>Hysteresis and window size can be set in <a href="#">C00680</a> and <a href="#">C00682</a>.</li> <li>If the comparison statement is true, the output <i>bGPCompareOut</i> will be set to TRUE.</li> </ul>	
bGPDFlipFlop_InD bGPDFlipFlop_InClk bGPDFlipFlop_InClr	BOOL	<b>D-FlipFlop:</b> Input signals <ul style="list-style-type: none"> <li>Data, clock and reset input</li> </ul>	

Designator Data type	Information/possible settings
<b>Free inputs</b> The following inputs can freely be interconnected on the application level. The signals can be transferred from the I/O level to the application level via these inputs.	
bFreeIn1 ... bFreeIn8 BOOL	Free inputs for digital signals
wFreeIn1 ... wFreeIn4 WORD	Free inputs for 16-bit signals

### outputs

Designator Data type	Value/meaning
wDriveControlStatus WORD	AC Drive Profile status word <ul style="list-style-type: none"> <li>The status word contains information on the currents status of the inverter.</li> <li>For a detailed description of the individual status bits, see subchapter entitled "<a href="#">Process data assignment for fieldbus communication</a>."</li> <li>Display parameter: <a href="#">C01352/1</a></li> </ul>
wStateDetermFailNoLow WORD	Display of the status determining error (LOW word)
wStateDetermFailNoHigh WORD	Display of the status determining error (HIGH word)
bDriveFail BOOL	TRUE Inverter in error status. <ul style="list-style-type: none"> <li>"<a href="#">Fault</a>" device status is active.</li> </ul>
bDriveReady BOOL	TRUE Inverter is ready for operation <ul style="list-style-type: none"> <li>"<a href="#">SwitchedOn</a>" device status is active.</li> <li>The drive is in this device status if the DC bus voltage is applied and the inverter is still inhibited by the user (controller inhibit).</li> </ul>
bCInhActive BOOL	TRUE Controller inhibit is active.
bQSPisActive BOOL	TRUE Quick stop is active.
bSpeedCcw BOOL	Current direction of rotation <ul style="list-style-type: none"> <li>FALSE Clockwise rotation (Cw)</li> <li>TRUE Direction of rotation to the left (Ccw)</li> </ul>
bSpeedActCompare BOOL	Result of the speed comparison (detection of speed=0) <ul style="list-style-type: none"> <li>TRUE During open-loop operation: Speed setpoint &lt; Comparison value (<a href="#">C00024</a>)</li> <li>During closed-loop operation: Actual speed value &lt; Comparison value (<a href="#">C00024</a>)</li> </ul>
bOverLoadActive BOOL	In preparation (output is not interconnected on the application level)
bUnderLoadActive BOOL	In preparation (output is not interconnected on the application level)
bI <sub>max</sub> Active BOOL	"Current setpoint inside the limitation" status signal <ul style="list-style-type: none"> <li>TRUE The current setpoint is internally limited (the inverter operates at the maximum current limit).</li> </ul>
bSpeedSetReached BOOL	Status signal "setpoint = 0" <ul style="list-style-type: none"> <li>TRUE Speed setpoint from the ramp function generator = 0</li> </ul>
bSpeedActEqSet BOOL	TRUE Actual speed value = speed setpoint
nMotorCurrent_a INT	Current stator current/effective motor current <ul style="list-style-type: none"> <li>Scaling: 16384 ≙ 100 % I<sub>max_mot</sub> (<a href="#">C00022</a>)</li> </ul>

Designator	Data type	Value/meaning
nMotorSpeedSet_a	INT	Speed setpoint <ul style="list-style-type: none"> <li>• Scaling: 16384 <math>\equiv</math> 100 % reference speed (<a href="#">C00011</a>)</li> </ul>
nMotorSpeedAct_a	INT	Actual speed value <ul style="list-style-type: none"> <li>• Scaling: 16384 <math>\equiv</math> 100 % reference speed (<a href="#">C00011</a>)</li> <li>• The absolute value is output (the sign has no meaning).</li> </ul>
nMotorTorqueAct_a	INT	Actual torque <ul style="list-style-type: none"> <li>• In the "VFC (+encoder)" operating mode of the motor control, this value is determined from the current motor current and corresponds to the actual torque only by approximation.</li> <li>• Scaling: 16384 <math>\equiv</math> 100 % <math>M_{\max}</math> (<a href="#">C00057</a>)</li> <li>• The absolute value is output (the sign has no meaning).</li> </ul>
nDCVoltage_a	INT	Current DC-bus voltage <ul style="list-style-type: none"> <li>• Scaling: 16384 <math>\equiv</math> 1000 V</li> </ul>
nMotorVoltage_a	INT	Current motor voltage/inverter output voltage <ul style="list-style-type: none"> <li>• Scaling: 16384 <math>\equiv</math> 1000 V</li> </ul>
<b>MCK basic functions</b>		
bMBrakeReleaseOut	BOOL	<a href="#">Holding brake control</a> : Trigger signal for the holding brake control switching element via a digital output <ul style="list-style-type: none"> <li>• Use bit 0 in <a href="#">C02582</a> to activate inverted switching element triggering.</li> </ul>
		FALSE   Apply brake.
		TRUE   Release brake.
bMBrakeReleased	BOOL	<a href="#">Holding brake control</a> : "Brake released" considering the brake release time <ul style="list-style-type: none"> <li>• When the holding brake is triggered to close, <i>bMBrakeReleased</i> is immediately set to FALSE even if the brake closing time has not yet elapsed!</li> </ul>
		TRUE   Brake released (after the brake release time has expired).
<b>GP: GeneralPurpose</b>		
The following outputs are interconnected with logic/arithmetic functions on application level for free usage. ▶ <a href="#">"GeneralPurpose" functions</a>		
nGPAAnalogSwitchInOut_a	INT	<a href="#">Analog switch</a> : Output signal
nGPArithmeticOut_a	INT	<a href="#">Arithmetic</a> : Output signal
nGPMulDivOut_a	INT	<a href="#">Multiplication/Division</a> : Output signal
bGPDigitalDelayOut	BOOL	<a href="#">Binary delay element</a> : Output signal
bGPLogicOut	BOOL	<a href="#">Binary logic</a> : Output signal
bGPCompareOut	BOOL	<a href="#">Analog comparison</a> : Output signal
bGPSignalOut1 ... bGPSignalOut4	BOOL	<a href="#">Binary signal monitor</a> : Output signals <ul style="list-style-type: none"> <li>• The signal sources to be output are selected in <a href="#">C00411/1...4</a>.</li> <li>• A bit coded inversion of the output signals can be parameterised in <a href="#">C00412</a>.</li> </ul>
nGPSignalOut1_a ... nGPSignalOut4_a	BOOL	<a href="#">Analog signal monitor</a> : Output signals <ul style="list-style-type: none"> <li>• The signal sources to be output are selected in <a href="#">C00410/1...4</a>.</li> <li>• Gain and offset for each output signal can be parameterised in <a href="#">C00413/1...8</a>.</li> </ul>
bGPDFlipFlop_Out	BOOL	<a href="#">D-FlipFlop</a> : Output signal
bGPDFlipFlop_NegOut	BOOL	<a href="#">D-FlipFlop</a> : Negated output signal

---

Designator	Data type	Value/meaning
<b>Free outputs</b>		
The following outputs can freely be interconnected on the application level. The signals from the application level can be transferred to the I/O level via these outputs.		
bFreeOut1 ... bFreeOut8	BOOL	Free outputs for digital signals
wFreeOut1 ... wFreeOut4	WORD	Free outputs for 16-bit signals

### 7.3.4 Terminal assignment of the control modes

The following comparison provides information about which inputs/outputs of the application block **LA\_NCtrl** are interconnected to the digital and analog input/output terminals of the inverter in the different control modes.

		Control mode (C00007)							
		10: <a href="#">Terminals 0</a>	12: <a href="#">Terminals 2</a>	14: <a href="#">Terminals 11</a>	16: <a href="#">Terminal 16</a>	20: <a href="#">Keypad</a>	21: <a href="#">PC</a>	30: <a href="#">CAN</a>	40: <a href="#">MCI</a>
<b>Digital input terminals</b>									
X4/RFR	Controller enable / Reset of error message bFailReset								
X4/DI1	Fixed setpoint 1/3 bJogSpeed1		Change of direction of rotation bSetSpeedCcw		Fixed setpoint 1/3 bJogSpeed1	-	-	Only if NetCtrl=0: fixed setpoint 1/3 bJogSpeed1	
X4/DI2	Fixed setpoint 2/3 bJogSpeed2		Activate manual DC-injection braking (DCB) bSetDCBrake		Fixed setpoint 2/3 bJogSpeed2	-	-	Only if NetCtrl=0: fixed setpoint 2/3 bJogSpeed2	
X4/DI3	Activate manual DC-injection braking (DCB) bSetDCBrake	Quick stop bSetQuickstop	Motor potentiometer: Increase speed bMPotUp		CW rotation quick stop bRLQCw	-	-	Only if NetCtrl=0: Activate manual DC-injection braking (DCB) bSetDCBrake	
X4/DI4	Change of direction of rotation bSetSpeedCcw		Motor potentiometer: Decrease speed bMPotDown		CCW rotation quick stop bRLQCcw	-	-	Only if NetCtrl=0: change of direction of rotation bSetSpeedCcw	
<b>Analog input terminals</b>									
X3/A1U, A1I	Local setpoint nAuxSetValue_a Speed mode: 10 V ≙ 100 % reference speed (C00011) Torque mode: 10 V ≙ 100 % M <sub>max</sub> (C00057); speed setpoint = 100 % (fixed)					-	-	Only if NetRef=0: Local setpoint nAuxSetValue_a Speed mode: 10 V ≙ 100 % reference speed (C00011) Torque mode: 10 V ≙ 100 % M <sub>max</sub> (C00057)	
<b>Digital output terminals</b>									
X4/DO1	Status "Drive is ready" bDriveReady								
X101/COM, NO	Status "Error is pending" bDriveFail								
<b>Analog output terminal</b>									
X3/O1U	Actual speed value nMotorSpeedAct_a 10 V ≙ 100 % reference speed (C00011)								



7.3.4.1 Terminals 0

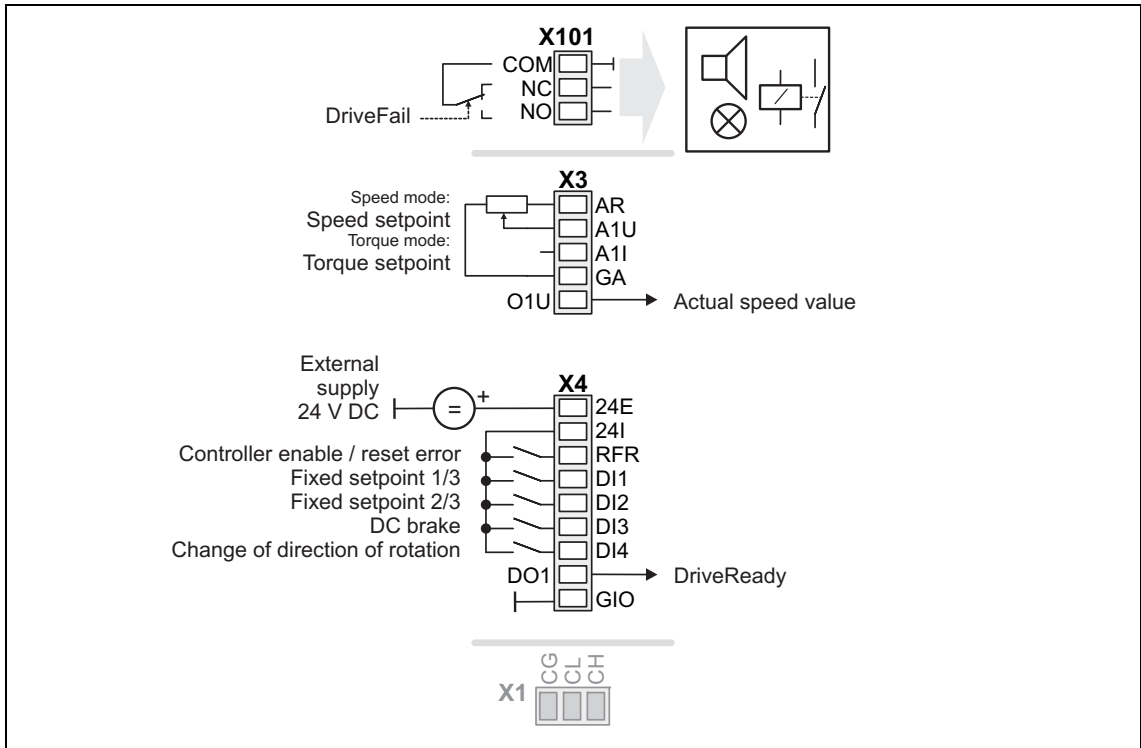

Connection	Assignment	Connection	Assignment
X101/NC-NO	LA_NCtrl.bDriveFail		
X4/RFR	LA_NCtrl.bFailReset	X3/A1U	LA_NCtrl.nAuxSetValue_a *
X4/DI1	LA_NCtrl.bJogSpeed1	X3/A1I	-
X4/DI2	LA_NCtrl.bJogSpeed2	X3/O1U	LA_NCtrl.nMotorSpeedAct_a *
X4/DI3	LA_NCtrl.bSetDCBrake		* 10 V ≙ 100 % reference speed (C00011)
X4/DI4	LA_NCtrl.bSetSpeedCcw	X4/DO1	LA_NCtrl.bDriveReady

7.3.4.2 Terminals 2

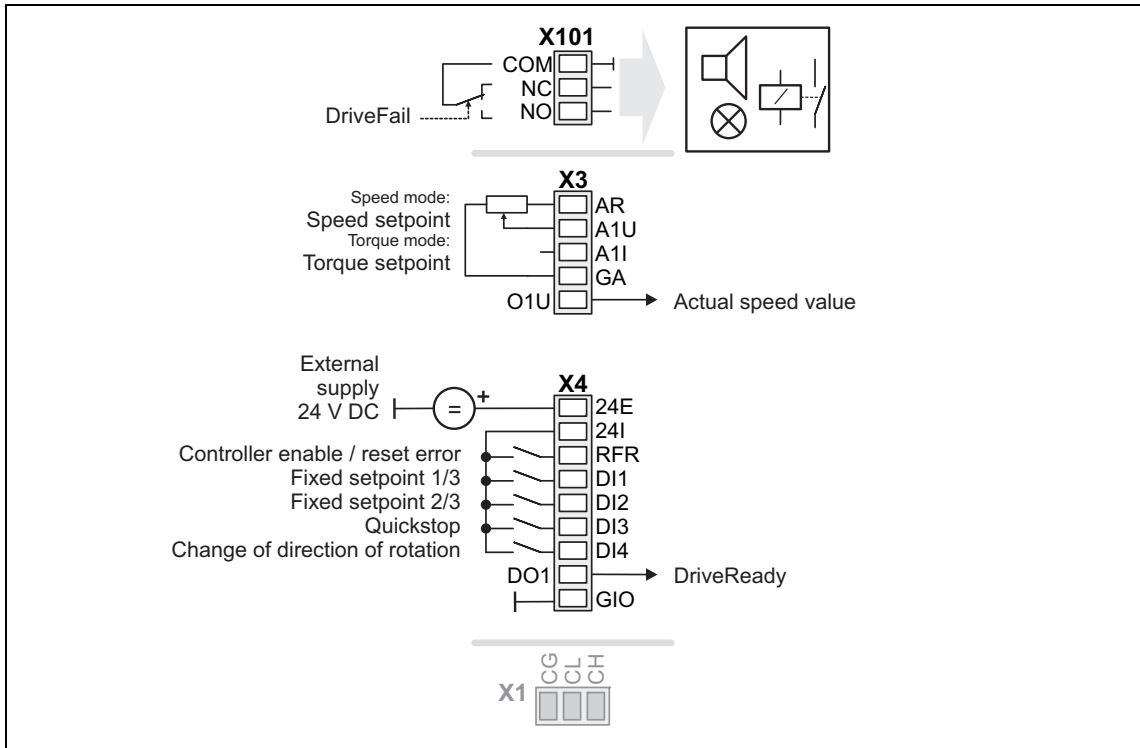

Connection	Assignment	Connection	Assignment
X101/NC-NO	LA_NCtrl.bDriveFail		
X4/RFR	LA_NCtrl.bFailReset	X3/A1U	LA_NCtrl.nAuxSetValue_a *
X4/DI1	LA_NCtrl.bJogSpeed1	X3/A1I	-
X4/DI2	LA_NCtrl.bJogSpeed2	X3/O1U	LA_NCtrl.nMotorSpeedAct_a *
X4/DI3	LA_NCtrl.bSetQuickstop		* 10 V ≙ 100 % reference speed (C00011)
X4/DI4	LA_NCtrl.bSetSpeedCcw	X4/DO1	LA_NCtrl.bDriveReady

7.3.4.3 Terminals 11

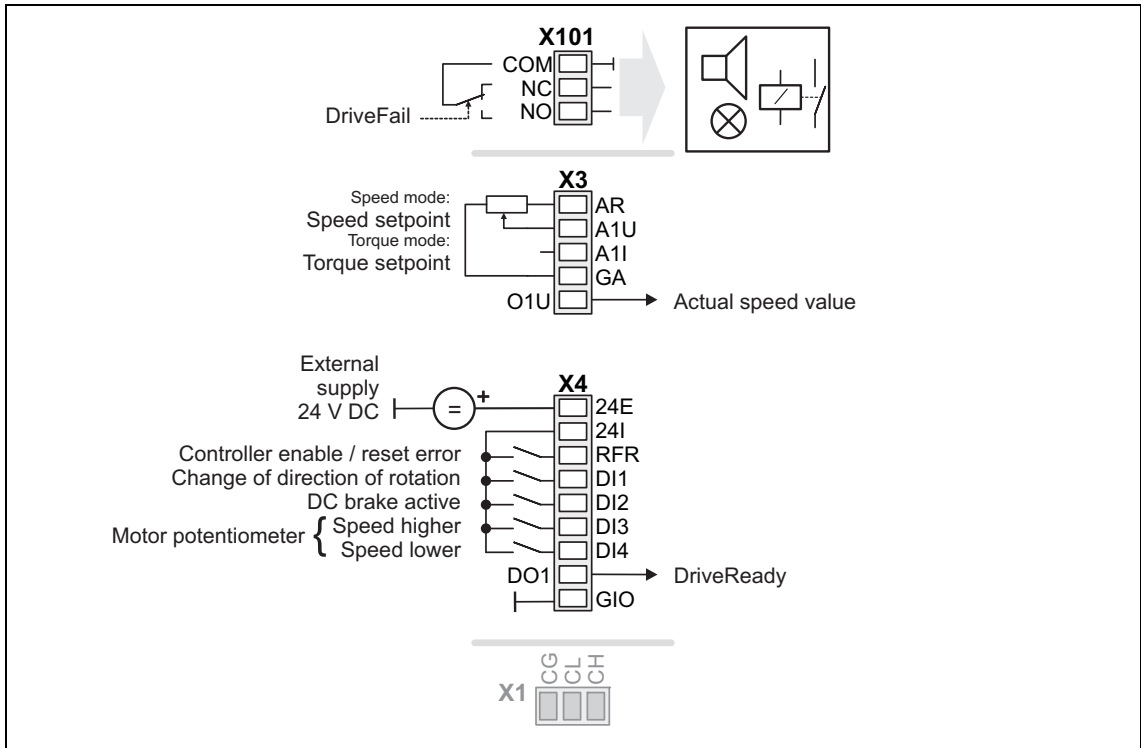

Connection	Assignment	Connection	Assignment
X101/NC-NO	LA_NCtrl.bDriveFail		
X4/RFR	LA_NCtrl.bFailReset	X3/A1U	LA_NCtrl.nAuxSetValue_a *
X4/DI1	LA_NCtrl.bSetSpeedCcw	X3/A1I	-
X4/DI2	LA_NCtrl.bSetDCBrake	X3/O1U	LA_NCtrl.nMotorSpeedAct_a *
X4/DI3	LA_NCtrl.bMPotUp		* 10 V ≙ 100 % reference speed (C00011)
X4/DI4	LA_NCtrl.bMPotDown	X4/DO1	LA_NCtrl.bDriveReady

7.3.4.4 Terminal 16

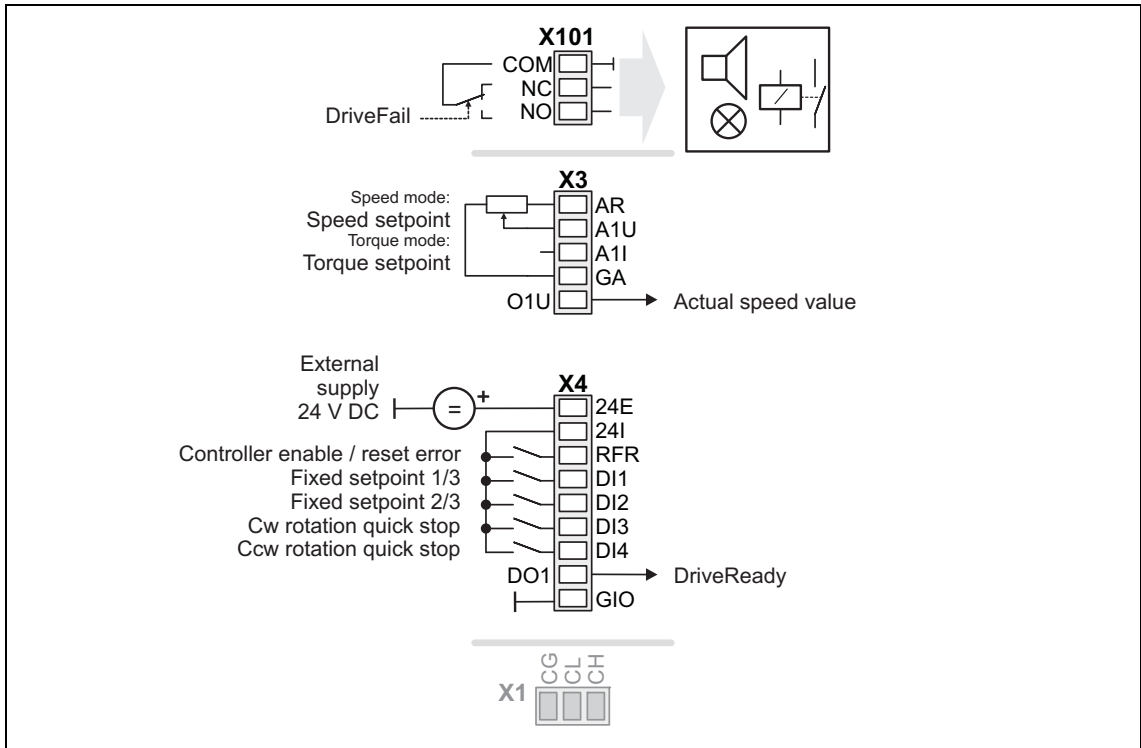

Connection	Assignment	Connection	Assignment
X101/NC-NO	LA_NCtrl.bDriveFail		
X4/RFR	LA_NCtrl.bFailReset	X3/A1U	LA_NCtrl.nAuxSetValue_a *
X4/DI1	LA_NCtrl.bJogSpeed1	X3/A1I	-
X4/DI2	LA_NCtrl.bJogSpeed2	X3/O1U	LA_NCtrl.nMotorSpeedAct_a *
X4/DI3	LA_NCtrl.bRLQCw		* 10 V ≙ 100 % reference speed (C00011)
X4/DI4	LA_NCtrl.bRLQCcw	X4/DO1	LA_NCtrl.bDriveReady

7.3.4.5 Keypad

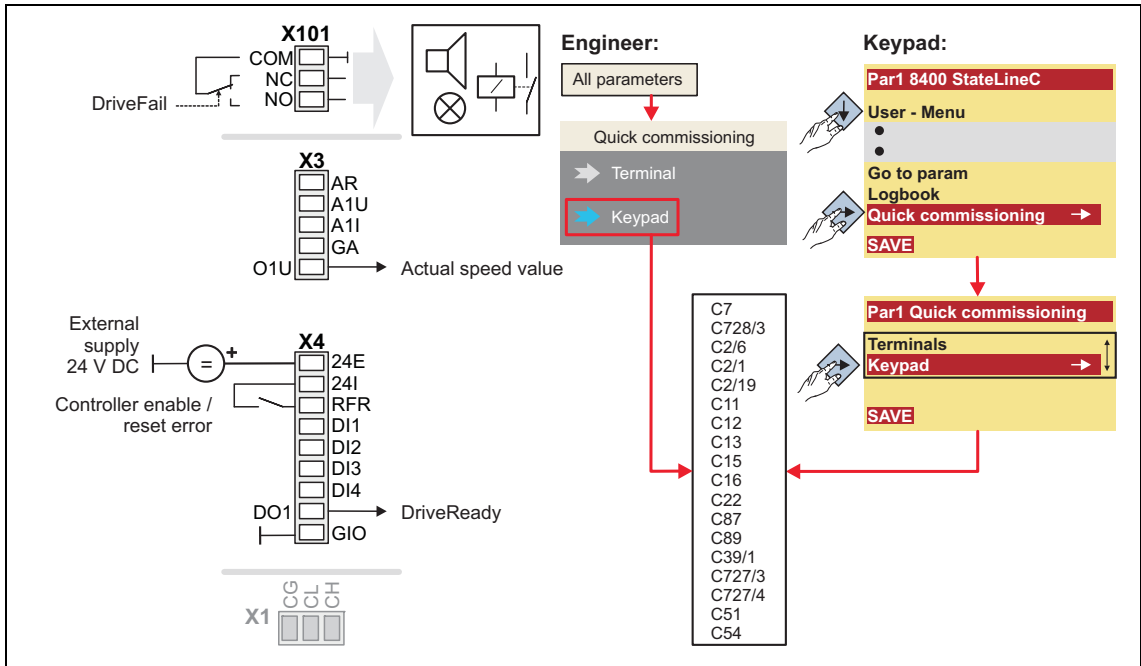

Connection	Assignment	Connection	Assignment
X101/NC-NO	LA_NCtrl.bDriveFail		
X4/RFR	LA_NCtrl.bFailReset	X3/A1U	-
X4/DI1	-	X3/A1I	-
X4/DI2	-	X3/O1U	LA_NCtrl.nMotorSpeedAct_a *
X4/DI3	-		* 10 V ≙ 100 % reference speed (C00011)
X4/DI4	-	X4/DO1	LA_NCtrl.bDriveReady

7.3.4.6 PC

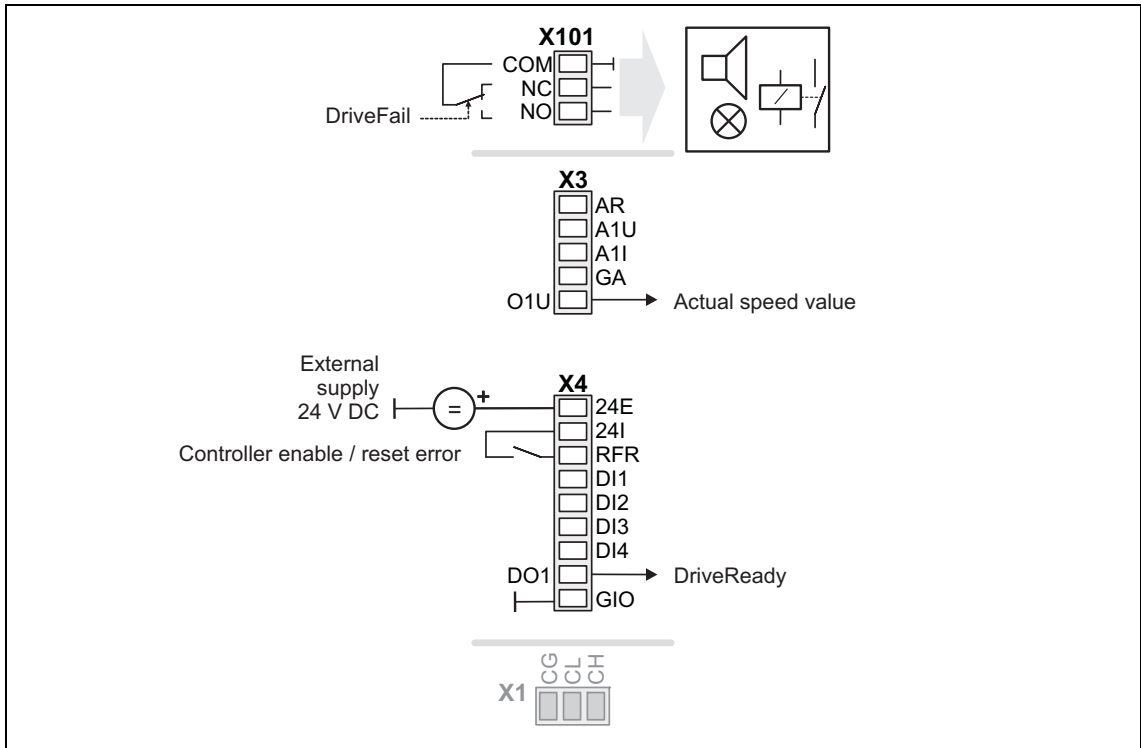

Connection	Assignment	Connection	Assignment
X101/NC-NO	LA_NCtrl.bDriveFail		
X4/RFR	LA_NCtrl.bFailReset	X3/A1U	-
X4/DI1	-	X3/A1I	-
X4/DI2	-	X3/O1U	LA_NCtrl.nMotorSpeedAct_a *
X4/DI3	-		* 10 V ≙ 100 % reference speed (C00011)
X4/DI4	-	X4/DO1	LA_NCtrl.bDriveReady

7.3.4.7 CAN

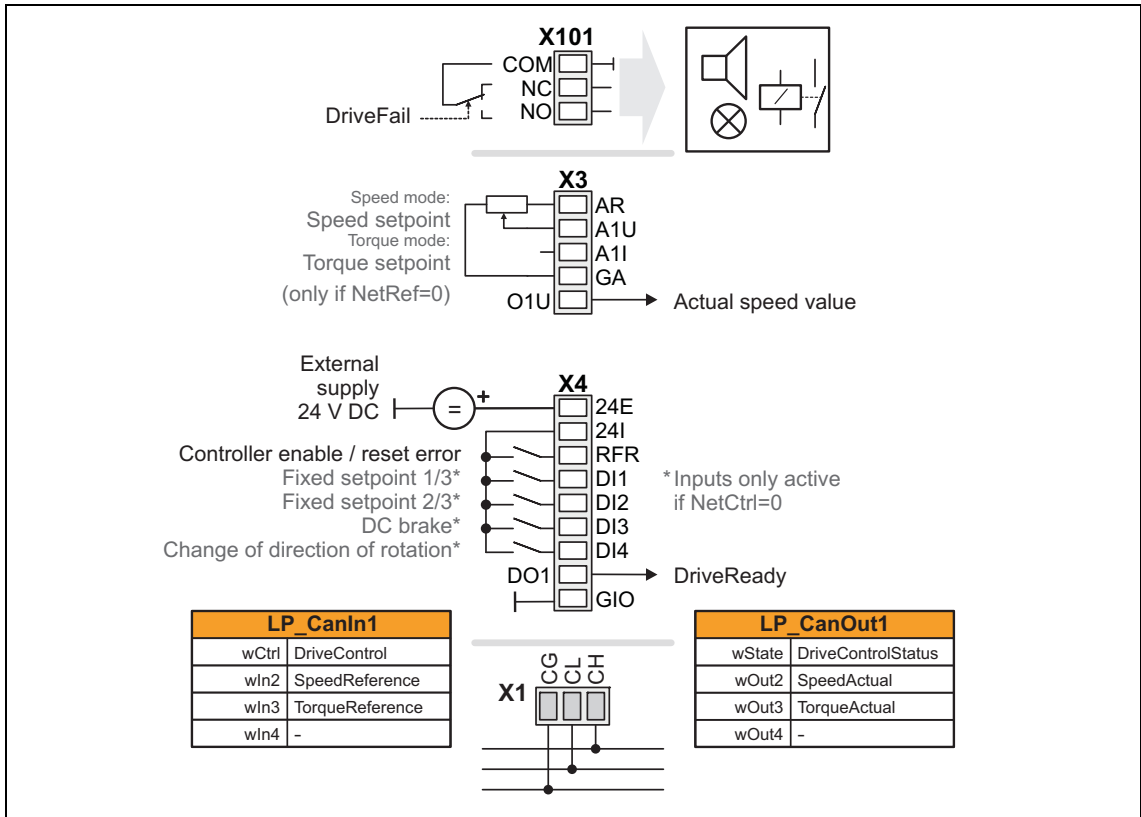

Connection	Assignment	Connection	Assignment
X101/NC-NO	LA_NCtrl.bDriveFail		
X4/RFR	LA_NCtrl.bFailReset	X3/A1U	LA_NCtrl.nAuxSetValue_a *
X4/DI1	LA_NCtrl.bJogSpeed1	X3/A1I	-
X4/DI2	LA_NCtrl.bJogSpeed2	X3/O1U	LA_NCtrl.nMotorSpeedAct_a *
X4/DI3	LA_NCtrl.bSetDCBrake		* 10 V ≙ 100 % reference speed (C00011)
X4/DI4	LA_NCtrl.bSetSpeedCcw	X4/DO1	LA_NCtrl.bDriveReady

▶ [Process data assignment for fieldbus communication \(331\)](#)

7.3.4.8 MCI

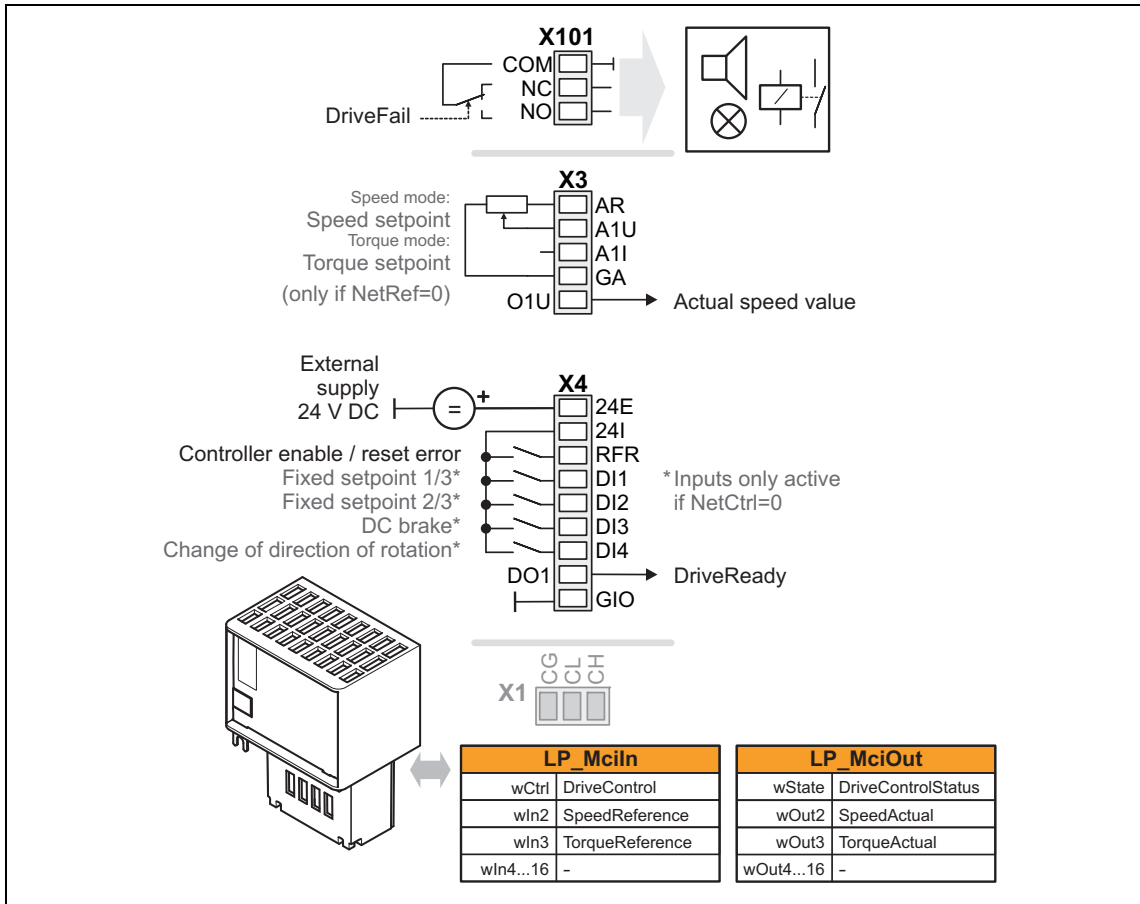

Connection	Assignment	Connection	Assignment
X101/NC-NO	LA_NCtrl.bDriveFail		
X4/RFR	LA_NCtrl.bFailReset	X3/A1U	LA_NCtrl.nAuxSetValue_a *
X4/DI1	LA_NCtrl.bJogSpeed1	X3/A1I	-
X4/DI2	LA_NCtrl.bJogSpeed2	X3/O1U	LA_NCtrl.nMotorSpeedAct_a *
X4/DI3	LA_NCtrl.bSetDCBrake		* 10 V ≙ 100 % reference speed (C00011)
X4/DI4	LA_NCtrl.bSetSpeedCcw	X4/DO1	LA_NCtrl.bDriveReady

▶ [Process data assignment for fieldbus communication \(361\)](#)



### 7.3.5 Process data assignment for fieldbus communication

The fieldbus communication is connected (preconfigured) to the previously selected technology application by selecting the corresponding control mode in [C00007](#):

- "30: [CAN](#)" for the connection to the system bus (CAN)
- "40: [MCI](#)" for the connection to a plugged-in communication module (e.g. EtherNet/IP™)

The assignment of the process data words depends only on the application, not on the bus system used:

Input words	Name	Assignment
Word 1	DriveControl	Control word <ul style="list-style-type: none"> <li>• For bit assignment see the table below.</li> <li>• Display parameter: <a href="#">C01351/1</a></li> </ul>
Word 2	SpeedReference	Speed setpoint in [rpm] <ul style="list-style-type: none"> <li>▶ <a href="#">Scaling of speed and torque values</a></li> </ul>
Word 3	TorqueReference	Torque setpoint in [Nm] <ul style="list-style-type: none"> <li>▶ <a href="#">Scaling of speed and torque values</a></li> </ul>
Word 4	-	Not preconfigured
Words 5 ... 16	-	Not preconfigured <ul style="list-style-type: none"> <li>• Only available in control mode "40: MCI".</li> </ul>

Control word	Name	Function
Bit 0	Run Forward	Relationships between Run1 and Run2 and trigger events can be found in the chapter " <a href="#">Run/Stop event</a> ".
Bit 1	Run Backward	
Bit 2	Fault Reset	071 ≙ Reset error 0 ≙ No response
Bit 3	Reserved	-
Bit 4	Reserved	-
Bit 5	NetCtrl	Run/Stop control: 0 ≙ via local setting in the device or terminal 1 ≙ via fieldbus (e.g. by the scanner)
Bit 6	NetRef	Reference speed/reference torque: 0 ≙ via local setting in the device or terminal 1 ≙ via fieldbus (e.g. by the scanner)
Bit 7 ... 15	Reserved	-

Output words	Name	Assignment
Word 1	DriveControlStatus	Status word <ul style="list-style-type: none"> <li>• For bit assignment see the table below.</li> <li>• Display parameter: <a href="#">C01352/1</a></li> </ul>
Word 2	SpeedActual	Actual speed value in [rpm] <ul style="list-style-type: none"> <li>▶ <a href="#">Scaling of speed and torque values</a></li> </ul>
Word 3	TorqueActual	Actual torque in [Nm] <ul style="list-style-type: none"> <li>▶ <a href="#">Scaling of speed and torque values</a></li> </ul>
Word 4	-	Not preconfigured
Words 5 ... 16	-	Not preconfigured <ul style="list-style-type: none"> <li>• Only available in control mode "40: MCI".</li> </ul>

Status word	Name	Status
Bit 0	Faulted	0 ≡ No errors 1 ≡ Errors have occurred
Bit 1	Warning	0 ≡ No warnings 1 ≡ Warnings have occurred
Bit 2	Running1 (Fwd)	Relationships between Run1 and Run2 and trigger events can be found in the chapter " <a href="#">Run/Stop event</a> ".
Bit 3	Running2 (Rev)	
Bit 4	Ready	0 ≡ Different status than in case of "1" 1 ≡ Ready or Enabled or Stopping
Bit 5	Ctrl from Net	Run/Stop control: 0 ≡ via local setting in the device or terminal 1 ≡ via fieldbus (e.g. by the scanner)
Bit 6	Ref from Net	Reference speed/reference torque: 0 ≡ via local setting in the device or terminal 1 ≡ via fieldbus (e.g. by the scanner)
Bit 7	At Reference	1 ≡ The drive currently runs with reference speed (speed mode) or reference torque (Torque mode)
Bit 8	Drive State	The "Drive State" is coded as follows: 0: Manufacturer-specific (not used with 8400) 1: Start-up (drive initialisation) 2: Not_Ready (mains voltage switched off) 3: Ready (mains voltage switched-on) 4: Enabled (drive has received "Run" command) 5: Stopping (drive has received "Stop" command and is stopped) 6: Fault_Stop (drive is stopped due to an error) 7: Faulted (errors have occurred)
Bit 9	Drive State	
Bit 10	Drive State	
Bit 11	Drive State	
Bit 12	Drive State	
Bit 13	Drive State	
Bit 14	Drive State	
Bit 15	Drive State	

### 7.3.5.1 Run/Stop event

Relationships between Run1 and Run2:

	Starter					Drive
	Contactur	Starter	Reverser	Speed	Soft start	
Run1	Close	Run	RunFwd	RunLow	RunRamp1	RunFwd
Run2	No Action	No Action	RunRev	RunHigh	RunRamp2	RunRev

Run1 and Run2 trigger:

Run1	Run2	Trigger event	Run type
0	0	Stop,	No Action
0 → 1	0	Run	Run1
0	0 → 1	Run	Run2
0 → 1	0 → 1	No Action	No Action
1	1	No Action	No Action
1 → 0	1	Run	Run2
1	1 → 0	Run	Run1

### 7.3.5.2 Scaling of speed and torque values

#### Scaling of the speed values

The speed setpoint is defined by the bus in [rpm]. The conversion then takes place in the inverter as all speed-related signals are processed to a reference variable in percent. An adjustable scaling factor serves to make an additional scaling.

Equation for scaling the speed setpoint		
$\text{Speed setpoint}_{\text{Application}} = \text{Speed setpoint}_{\text{Bus}} [\text{rpm}] \cdot \frac{16384}{\text{Reference speed} [\text{rpm}]} \cdot \frac{1}{2^{\text{Scaling factor}}}$		
Parameters	Name	Description
<a href="#">C00011</a>	Appl.: Reference speed	Reference variable for speed-related signals
<a href="#">C01353/1</a>	ACDrive: Speed scaling	In the Lenze setting "0", no scaling takes place ( $2^0 = 1$ )

For the output of the actual speed value to the bus, the following conversion is made:

Equation for scaling the actual speed value		
$\text{Actual speed value}_{\text{Bus}} [\text{rpm}] = \text{Actual speed value}_{\text{Application}} \cdot \frac{\text{Reference speed} [\text{rpm}]}{16384} \cdot 2^{\text{Scaling factor}}$		
Parameters	Name	Description
<a href="#">C00011</a>	Appl.: Reference speed	Reference variable for speed-related signals
<a href="#">C01353/1</a>	ACDrive: Speed scaling	In the Lenze setting "0", no scaling takes place ( $2^0 = 1$ )

#### Scaling of the torque values

The torque setpoint is defined by the bus in [Nm]. The conversion then takes place in the inverter as all torque-related signals are processed to a reference variable in percent. An adjustable scaling factor serves to make an additional scaling.

Equation for scaling the torque setpoint		
$\text{Torque setpoint}_{\text{Application}} = \text{Torque setpoint}_{\text{Bus}} [\text{Nm}] \cdot \frac{16384 \cdot 100}{\text{Maximum torque} [0.01 \text{ Nm}]} \cdot \frac{1}{2^{\text{Scaling factor}}}$		
Parameters	Name	Description
<a href="#">C00057</a>	Maximum torque	Reference variable for torque-related signals
<a href="#">C01353/2</a>	ACDrive: Torque scaling	In the Lenze setting "0", no scaling takes place ( $2^0 = 1$ )

For the output of the actual torque value to the bus, the following conversion is made:

Equation for scaling the actual torque		
$\text{Actual torque}_{\text{Bus}} [\text{Nm}] = \text{Actual torque}_{\text{Application}} \cdot \frac{\text{Maximum torque} [0.01 \text{ Nm}]}{16384 \cdot 100} \cdot 2^{\text{Scaling factor}}$		
Parameters	Name	Description
<a href="#">C00057</a>	Maximum torque	Reference variable for torque-related signals
<a href="#">C01353/2</a>	ACDrive: Torque scaling	In the Lenze setting "0", no scaling takes place ( $2^0 = 1$ )

### 7.3.6 AC Drive Profile diagnostic parameters

In the **All parameters** tab, the parameters for diagnostic purposes listed in the following table are displayed in the **AC Drive Profile** category.



#### Note!

These parameter are set by the EtherNet/IP™ communication module and should not be written by the user.

Parameters	Info	Lenze setting
<a href="#">C01350/1</a>	ACDrive: DriveMode	1: Speed mode
<a href="#">C01351/1</a>	ACDrive: Control word	-
<a href="#">C01352/1</a>	ACDrive: Status word	-
<a href="#">C01353/1</a>	ACDrive: Speed scaling	0
<a href="#">C01353/2</a>	ACDrive: Torque scaling	0
Greyed out = display parameter		

### 7.3.7 Setting parameters (short overview)

Parameters	Info	Lenze setting	
		Value	Unit
<a href="#">C00012</a>	Accel. time - main setpoint	2.000	s
<a href="#">C00013</a>	Decel. time - main setpoint	2.000	s
<a href="#">C00019</a>	Auto-DCB: Threshold	3	rpm
<a href="#">C00024</a>	LS_DriveInterface: bNActCompare	0.00	%
<a href="#">C00036</a>	DCB braking: Current	50.00	%
<a href="#">C00039/1</a>	Preset setpoint 1	40.00	%
<a href="#">C00039/2</a>	Preset setpoint 2	60.00	%
<a href="#">C00039/3</a>	Preset setpoint 3	80.00	%
<a href="#">C00039/4...15</a>	Fixed setpoint 4 ... 15	0.00	%
<a href="#">C00101/1...15</a>	Add. accel. time 1 ... 15	0.000	s
<a href="#">C00103/1...15</a>	Add. decel. time 1 ... 15	0.000	s
<a href="#">C00105</a>	Decel. time - quick stop	2.000	s
<a href="#">C00106</a>	Auto-DCB: Hold time	0.500	s
<a href="#">C00107</a>	DCB braking: Hold time	999.000	s
<a href="#">C00134</a>	L_NSet_1: Ramp smoothing	0: Off	
<a href="#">C00182</a>	L_NSet_1: S-ramp time PT1	20.00	s
<a href="#">C00190</a>	L_NSet_1: Setpoint arithmetic	0: Out = Set	
<a href="#">C00220</a>	L_NSet_1: Acceleration time - add. setpoint	0.000	s
<a href="#">C00221</a>	L_NSet_1: Deceleration time - add. setpoint	0.000	s
<a href="#">C00222</a>	L_PCTRL_1: Vp	1.0	
<a href="#">C00223</a>	L_PCTRL_1: Tn	400	ms
<a href="#">C00224</a>	L_PCTRL_1: Kd	0.0	

Parameters	Info	Lenze setting	
		Value	Unit
<a href="#">C00225</a>	L_PCTRL_1: MaxLimit	199.99	%
<a href="#">C00226</a>	L_PCTRL_1: MinLimit	-199.99	%
<a href="#">C00227</a>	L_PCTRL_1: Acceleration time	0.010	s
<a href="#">C00228</a>	L_PCTRL_1: Deceleration time	0.010	s
<a href="#">C00233</a>	L_PCTRL_1: Root function	0: Off	
<a href="#">C00241</a>	L_NSet_1: Hyst. NSet reached	0.50	%
<a href="#">C00242</a>	Operating mode of process controller	0: Off	
<a href="#">C00243</a>	L_PCTRL_1: Accel. time influence	5.000	s
<a href="#">C00244</a>	L_PCTRL_1: Deceleration time influence	5.000	s
<a href="#">C00632/1</a>	L_NSet_1: Blocking speed 1 max	0.00	%
<a href="#">C00632/2</a>	L_NSet_1: Blocking speed 2 max	0.00	%
<a href="#">C00632/3</a>	L_NSet_1: Blocking speed 3 max	0.00	%
<a href="#">C00633/1</a>	L_NSet_1: Blocking speed 1 min	0.00	%
<a href="#">C00633/2</a>	L_NSet_1: Blocking speed 2 min	0.00	%
<a href="#">C00633/3</a>	L_NSet_1: Blocking speed 3 min	0.00	%
<a href="#">C00635</a>	L_NSet_1: nMaxLimit	199.99	%
<a href="#">C00636</a>	L_NSet_1: nMinLimit	-199.99	%
<a href="#">C00670</a>	L_OffsetGainP_1: Gain	1.0000	
<a href="#">C00671</a>	L_OffsetGainP_2: Gain	1.0000	
<a href="#">C00672</a>	L_OffsetGainP_3: Gain	1.0000	
<a href="#">C00696</a>	L_OffsetGainP_1: Offset	0.00	%
<a href="#">C00697</a>	L_OffsetGainP_2: Offset	0.00	%
<a href="#">C00698</a>	L_OffsetGainP_3: Offset	0.00	%
<a href="#">C00800</a>	L_MPot_1: Upper limit	100.00	%
<a href="#">C00801</a>	L_MPot_1: Lower limit	-100.00	%
<a href="#">C00802</a>	L_MPot_1: Acceleration time	10.0	s
<a href="#">C00803</a>	L_MPot_1: Deceleration time	10.0	s
<a href="#">C00804</a>	L_MPot_1: Inactive fct.	0: Retain value	
<a href="#">C00805</a>	L_MPot_1: Init fct.	0: Load last value	
<a href="#">C00806</a>	Use of motor potentiometer	0: No	

**Related topics:**

▶ ["GeneralPurpose" functions \(398\)](#)

7.3.8 Configuration parameters

If required, the subcodes of [C00700](#) and [C00701](#) serve to change the pre-configured assignment of the application inputs:

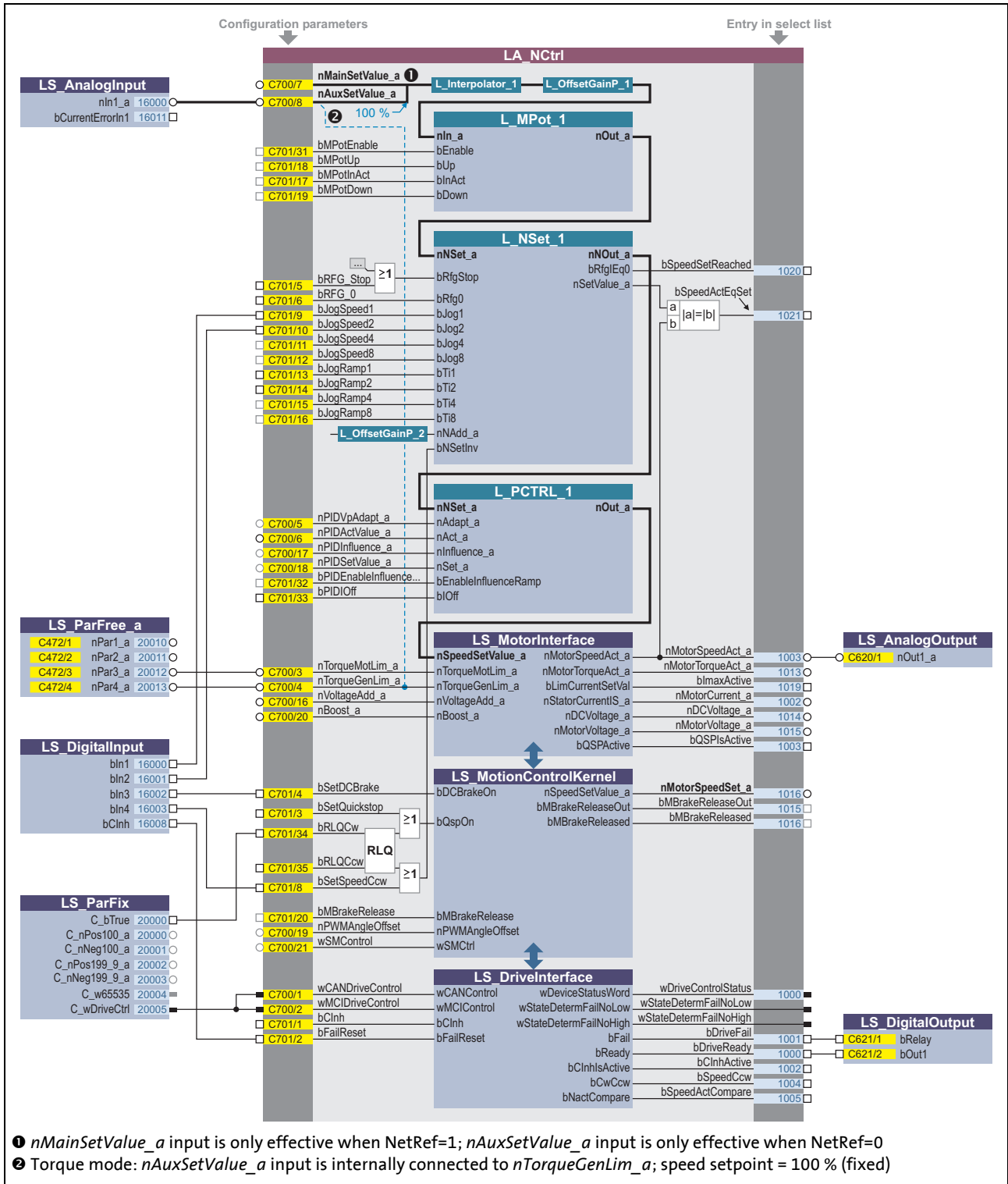

[7-7] Pre-assignment of the "Actuating drive speed" (AC Drive Profile) application in the "Terminals 0" control mode

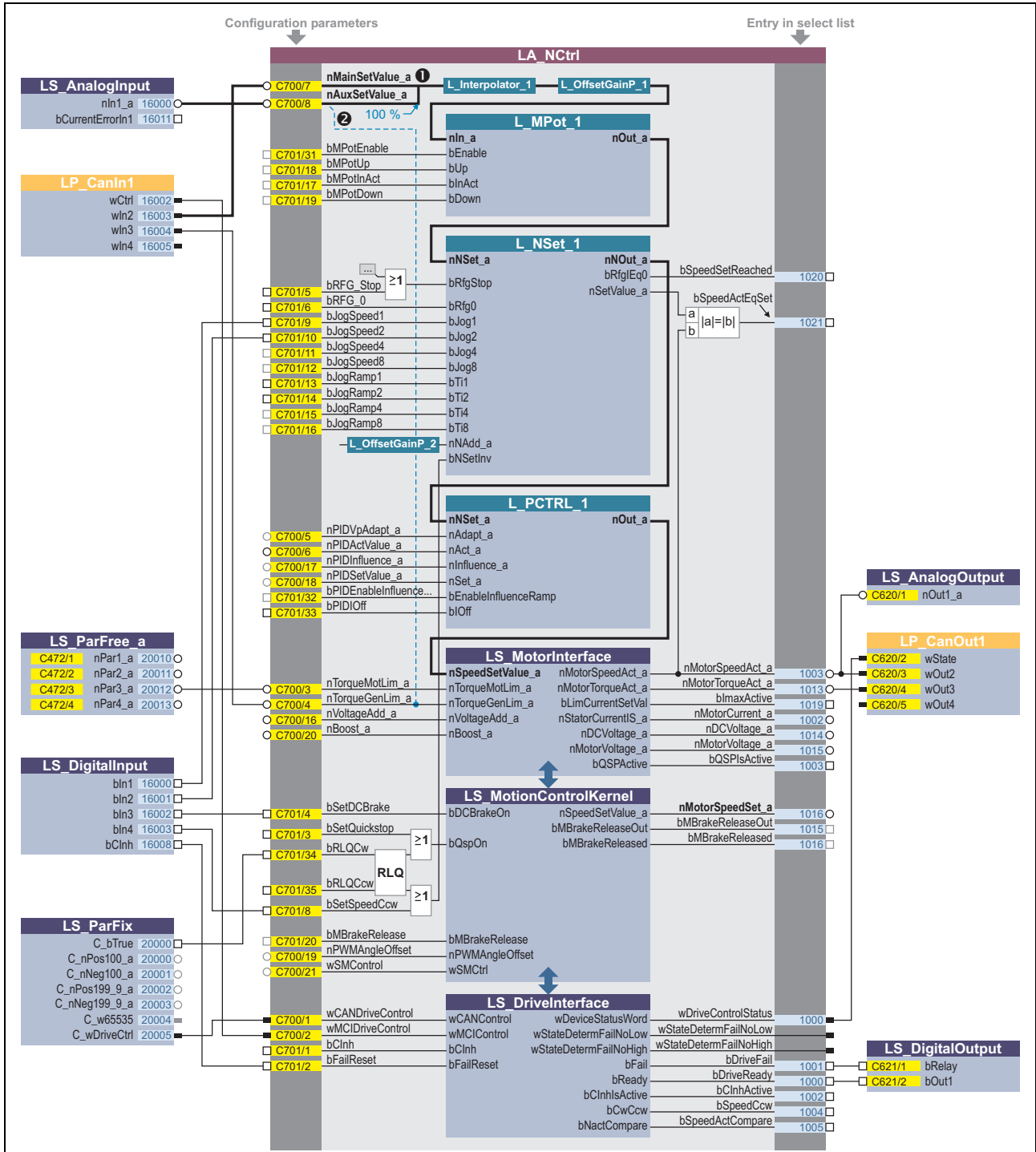

- ❶ nMainSetValue\_a input is only effective when NetRef=1; nAuxSetValue\_a input is only effective when NetRef=0
- ❷ Torque mode: nAuxSetValue\_a input is internally connected to nTorqueGenLim\_a; speed setpoint = 100 % (fixed)

[7-8] Pre-assignment of the "Actuating drive speed" (AC Drive Profile) application in the "CAN" control mode

# 7 Technology applications

## 7.3 TA "actuating drive speed (AC Drive Profile)"

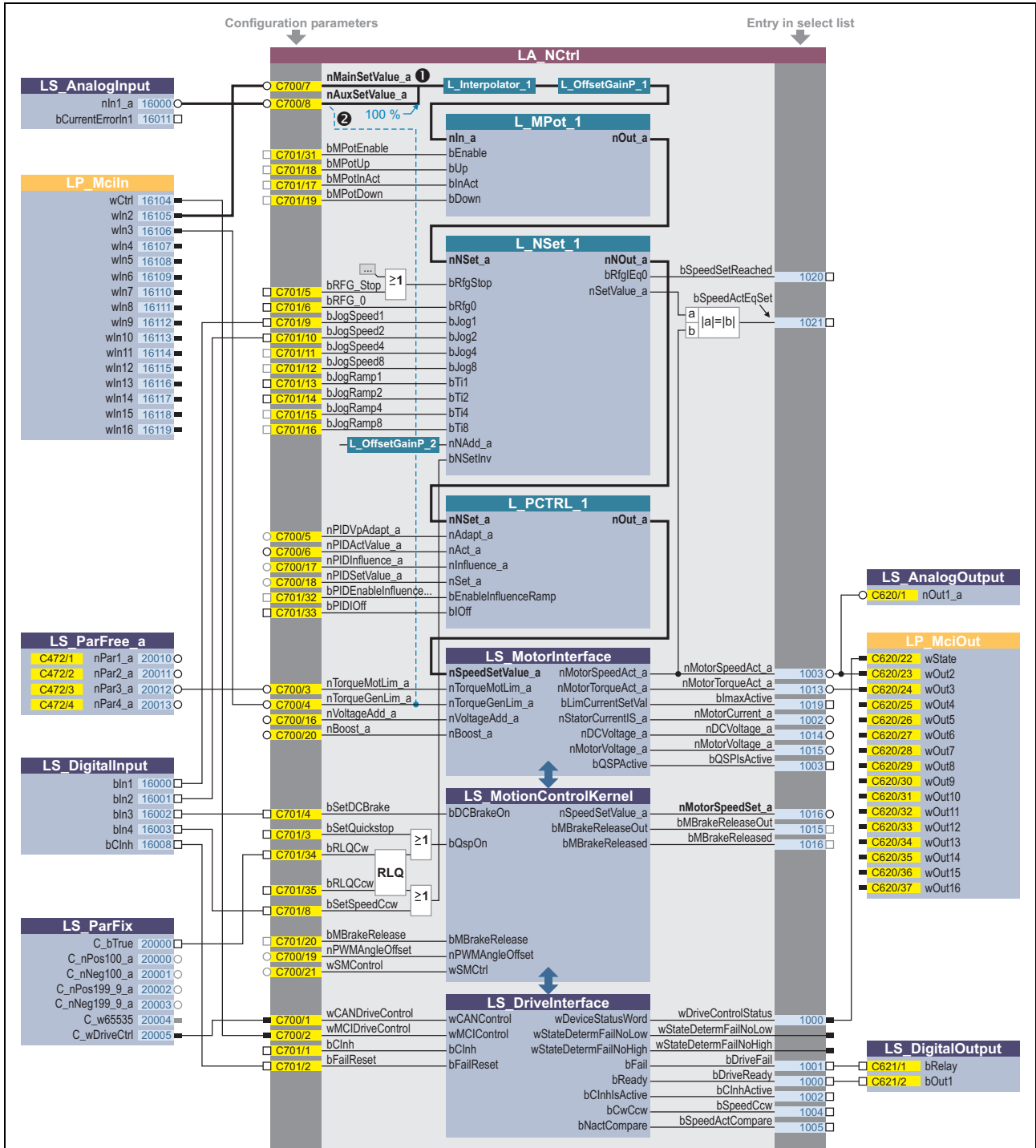

- ① *nMainSetValue\_a* input is only effective when NetRef=1; *nAuxSetValue\_a* input is only effective when NetRef=0
- ② Torque mode: *nAuxSetValue\_a* input is internally connected to *nTorqueGenLim\_a*; speed setpoint = 100% (fixed)

[7-9] Pre-assignment of the "Actuating drive speed" (AC Drive Profile) application in the "MCI" control mode



Configuration parameters for "GeneralPurpose" functions

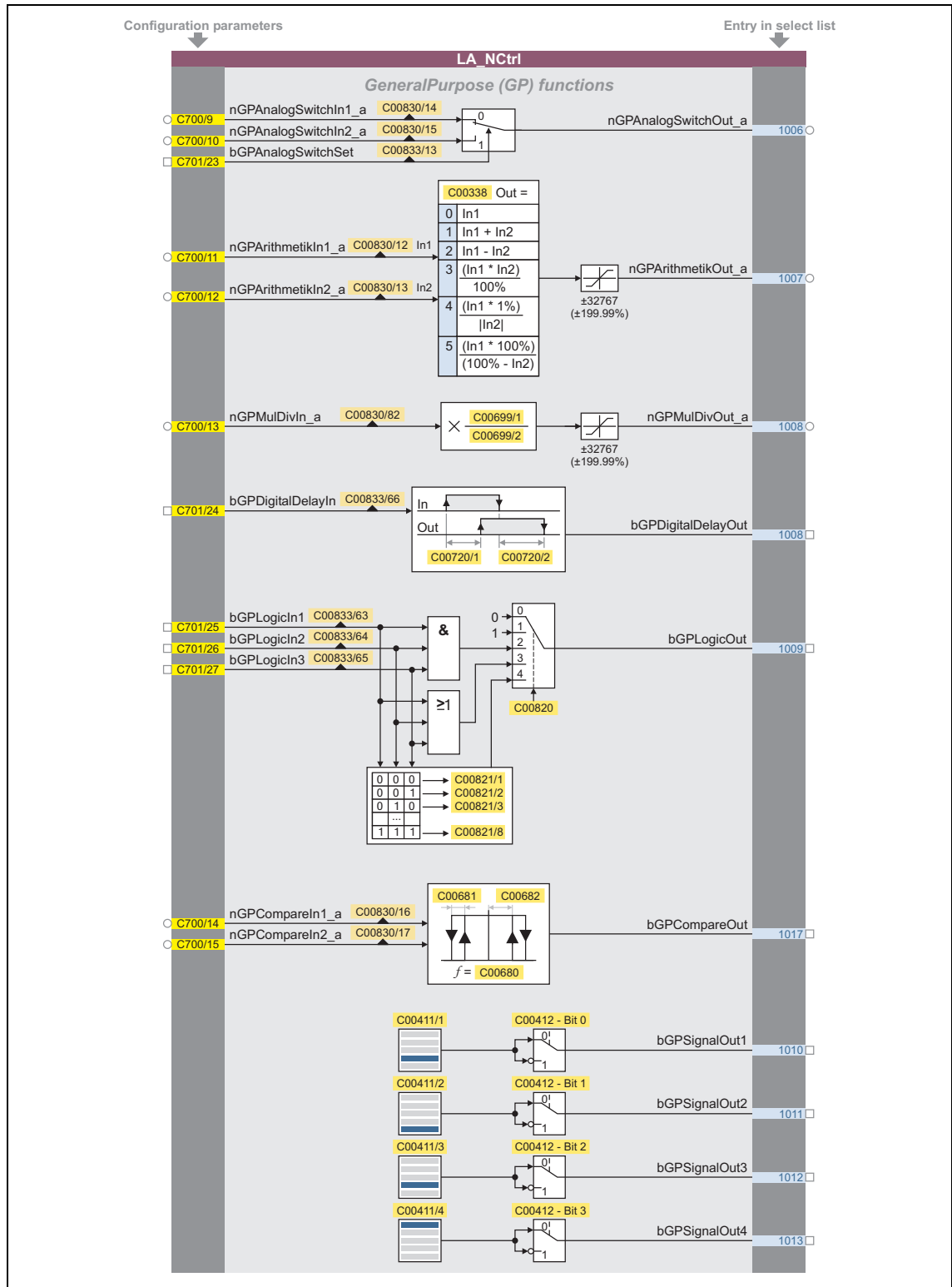

[7-10] "GeneralPurpose" functions

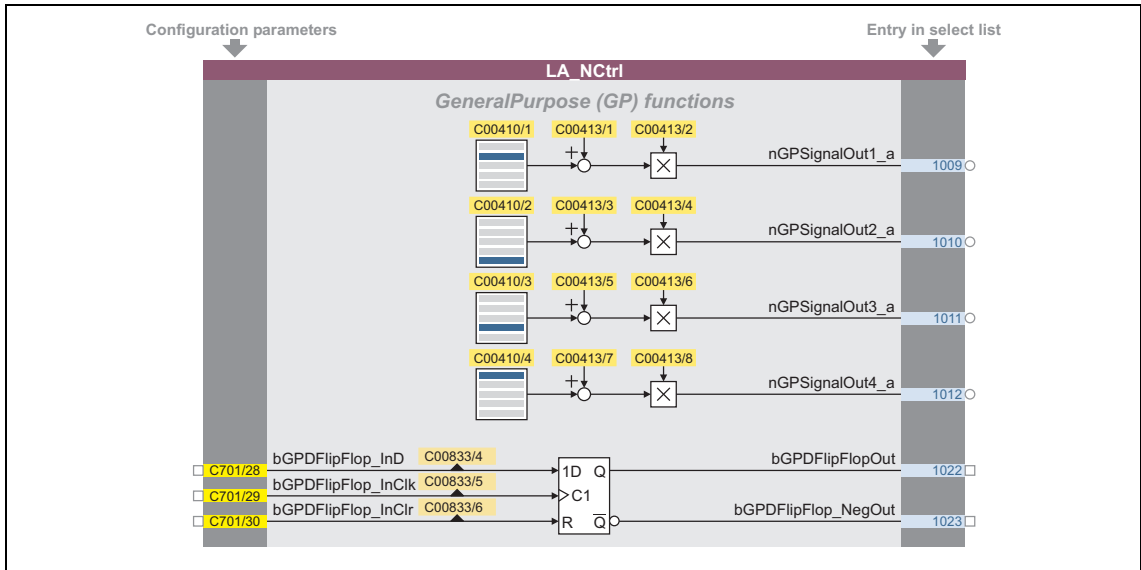

[7-11] "GeneralPurpose" functions (continuation)

**Free inputs and outputs**

These inputs can be freely interconnected in the application level. They can be used to transfer signals from the I/O level to the application level and vice versa.

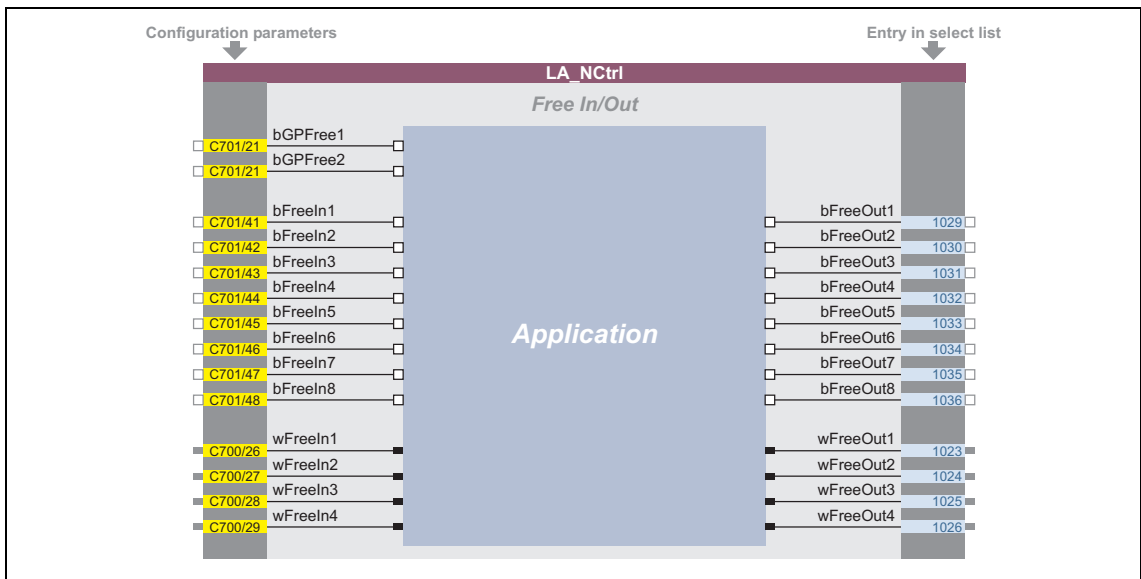

[7-12] Free inputs/outputs

**Related topics:**

- ▶ [User-defined terminal assignment](#) (📖 302)
- ▶ ["GeneralPurpose" functions](#) (📖 398)

## 7.4 TA "Switch-off positioning"

This technology application is only available from version 04.00.00!

The basic principle of this technology application is to travel to a switch-off sensor (e.g. a limit switch) in a speed-controlled manner and to stop as close as possible at this position. Unlike other positioning controls, the switch-off positioning neither has a position feedback nor calculates the path in advance. Thus, the accuracy that can be achieved depends on various factors such as the speed at which the switch-off sensor is advanced.

In addition, a pre-switch off can be implemented which requires a sufficient number of unassigned digital inputs on the inverter which can be used to connect other sensors for the additional stop positions. These sensors effect a reduction in speed before the last switch-off sensor is reached.

### Product features

- Pre-configured control modes for terminals and bus control (with predefined process data connection to the fieldbus)
- Free configuration of input and output signals
- Offset, gain, and negation of main setpoint & additional setpoint
- Up to 15 fixed setpoints for speed and ramp time
- Adjustable setpoint ramp times
- Freely selectable, variable ramp shape
- Automatic holding brake control
- Quick stop (QSP) with adjustable ramp time
- Integrated, freely available "GeneralPurpose" functions:  
Analog switch, arithmetic, multiplication/division, binary delay element, binary logic, analog comparison, D-flipflop
- Interface to the safety module (optional)
- Integration of encoder feedback
- Switch-off sensor management for the implementation of a pre-switch off

### Decision criteria

Criteria	Switch-off positioning with constant load	Switch-off positioning with variable load
<b>Operating mode</b>	V/f characteristic without speed sensor. Alternatively for large breakaway torques: Use of a sensorless vector control (only applicable for horizontal movements).	
<b>Limit switch evaluation</b>	One limit switch is required per direction of movement. When the limit switch is reached, the drive is brought to a standstill led by the deceleration ramp or the QSP ramp.	One limit switch and an initiator are required for fast/slow changeover per direction of movement. When the initiator has been reached, the speed of the drive is reduced to a creeping speed (fixed setpoint 2) in a controlled way. When the limit switch is reached, the drive is brought to a standstill led by the deceleration ramp or the QSP ramp.

Criteria	Switch-off positioning with constant load	Switch-off positioning with variable load
<b>Positioning accuracy at the motor shaft</b> The positioning accuracy of the load depends, among other things, on the clearance and friction of the selected mechanics and has to be determined individually.	The ideal case is 5-10° at the motor shaft. Consider the influence of the motor temperature. In the case of a constant load, you can assume a good repeat accuracy during positioning. In the case of variable loads, you must take significant deviations into account.	5-10° at the motor shaft. As the positioning is executed in a creeping speed, a good repeat accuracy is reached even for variable loads.
<b>Speed setting range</b>	1 : 50, based on 50Hz and $M_n$	1 : 50, based on 50Hz and $M_n$
<b>Typical applications</b>	Switch-off positioning with constant load, e.g. travelling drive, roll-up door.	Switch-off positioning with variable load, e.g. travelling drive, conveying belt, hoists approaching a stop position.

### System limits and exclusion criteria

They result from the non-compliance with the decision criteria.

- Compared to systems with speed feedback, the positioning and repeat accuracy is reduced.
- Due to the mechanical hardware limit switches, this concept is only applicable for systems with only a few fixed positions. Changing the target position during the operation or the teaching is not possible.
- If necessary, additional functions like manual jog or homing must be realised externally, e.g. via a control.
- As the 8400 Stateline inverter does not meet safety-related functions except STO (Safe Torque Off), you must observe that all safety-related aspects are realised by the plant instructor.
- Especially in the case of an outdoor use or in wet areas, you must consider the corresponding discharge currents when operated with a fault current circuit breaker.
- A table positioning or sequential positioning control is required for highly dynamic applications and jerk-free traversing profiles which is available with the "HighLine" device version.

### Related topics:

- ▶ [Commissioning of the "Switch-off positioning" technology application](#) (□ 63)

7.4.1 Basic signal flow

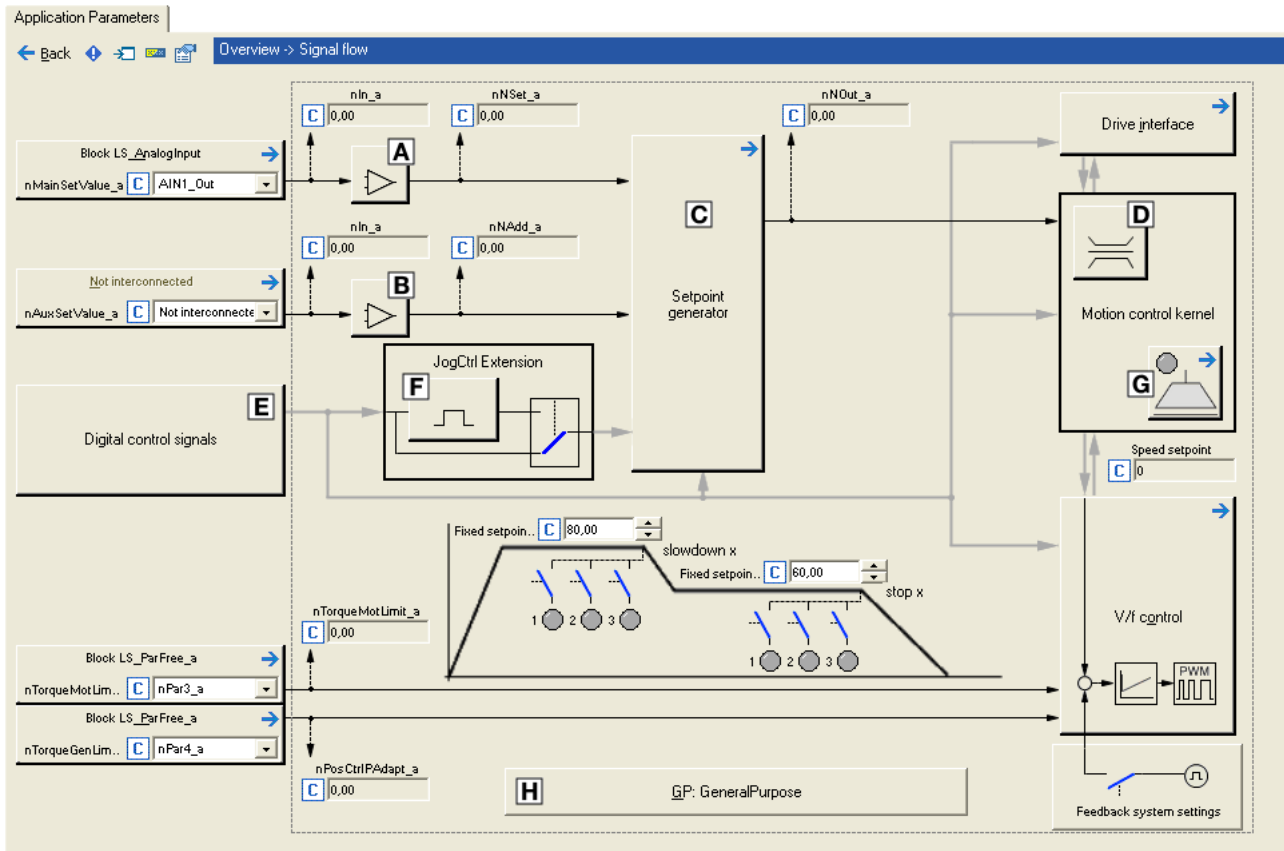

[7-13] Signal flow of the switch-off positioning

- Ⓐ Main speed setpoint offset and gain ([L\\_OffsetGainP\\_1](#))
- Ⓑ Additional speed setpoint offset and gain ([L\\_OffsetGainP\\_2](#))
- Ⓒ Setpoint generator ([L\\_NSet\\_1](#))
- Ⓓ Speed setpoint input limitation
- Ⓔ Terminal assignment & display of digital control signals
- Ⓕ Selection of edge/level for tripping the ramp down and stop functions ([L\\_JogCtrlExtension\\_1](#))
- Ⓖ [Holding brake control](#)
- Ⓗ Integrated disposable "[GeneralPurpose](#)" functions: Analog switch, arithmetic, multiplication/division, binary delay element, binary logic, analog comparison, D-flipflop

## 7.4.2 Internal interfaces | application block "LA\_SwitchPos"



**Note!**

The connectors greyed out in the following table are hidden in the function block editor in the Lenze setting.

- These connections can be shown via the **Connector visibilities** command in the *Context menu* of the application block.

**inputs**

Designator	Data type	Information/possible settings		
wCANDriveControl	WORD	Control word via system bus (CAN) for device control <ul style="list-style-type: none"> <li>• See the "<a href="#">wCANControl/wMCIControl control words</a>" subchapter of the chapter on device control for a detailed description of the individual control bits.</li> </ul>		
wMCIDriveControl	WORD	Control word via communication module (e.g. PROFIBUS) for device control <ul style="list-style-type: none"> <li>• See the "<a href="#">wCANControl/wMCIControl control words</a>" subchapter of the chapter on device control for a detailed description of the individual control bits.</li> </ul>		
wSMControl	WORD	Interface to the optional safety system. <ul style="list-style-type: none"> <li>• Setting control bit 0 ("SafeStop1") in this control word causes e.g. the automatic deceleration of the drive to standstill within this application (in the <b>Motion Control Kernel</b>).</li> <li>• See the subchapter "<a href="#">Interface to safety system</a>" of the chapter on basic drive functions for a detailed description of the individual control bits.</li> </ul>		
bCInh	BOOL	<a href="#">Enable/inhibit inverter</a>		
		<table border="1"> <tr> <td>FALSE</td> <td>Enable inverter: The inverter switches to the "<a href="#">OperationEnabled</a>" device status if no other source for controller inhibit is active.               <ul style="list-style-type: none"> <li>• <a href="#">C00158</a> provides a bit coded representation of all active sources/triggers of a controller inhibit.</li> </ul> </td> </tr> <tr> <td>TRUE</td> <td>Inhibit inverter (controller inhibit): The inverter switches to the "<a href="#">SwitchedOn</a>" device status.</td> </tr> </table>	FALSE	Enable inverter: The inverter switches to the " <a href="#">OperationEnabled</a> " device status if no other source for controller inhibit is active. <ul style="list-style-type: none"> <li>• <a href="#">C00158</a> provides a bit coded representation of all active sources/triggers of a controller inhibit.</li> </ul>
FALSE	Enable inverter: The inverter switches to the " <a href="#">OperationEnabled</a> " device status if no other source for controller inhibit is active. <ul style="list-style-type: none"> <li>• <a href="#">C00158</a> provides a bit coded representation of all active sources/triggers of a controller inhibit.</li> </ul>			
TRUE	Inhibit inverter (controller inhibit): The inverter switches to the " <a href="#">SwitchedOn</a> " device status.			
bFailReset	BOOL	<a href="#">Reset error message</a> In the Lenze setting this input is connected to the digital input controller enable so that a possibly existing error message is reset together with the controller enable (if the cause for the fault is eliminated).		
		<table border="1"> <tr> <td>TRUE</td> <td>The current fault is reset, if the cause for the fault is eliminated.               <ul style="list-style-type: none"> <li>• If the fault still exists, the error status remains unchanged.</li> </ul> </td> </tr> </table>	TRUE	The current fault is reset, if the cause for the fault is eliminated. <ul style="list-style-type: none"> <li>• If the fault still exists, the error status remains unchanged.</li> </ul>
TRUE	The current fault is reset, if the cause for the fault is eliminated. <ul style="list-style-type: none"> <li>• If the fault still exists, the error status remains unchanged.</li> </ul>			
bSetQuickstop	BOOL	Activate quick stop (QSP) <ul style="list-style-type: none"> <li>• Also see device command "<a href="#">Activate/deactivate quick stop</a>".</li> </ul>		
		<table border="1"> <tr> <td>TRUE</td> <td>Activate quick stop               <ul style="list-style-type: none"> <li>• Motor control is decoupled from the setpoint selection and, within the deceleration time parameterised in <a href="#">C00105</a>, the motor is brought to a standstill (<math>n_{act} = 0</math>).</li> <li>• The motor is kept at a standstill during closed-loop operation.</li> <li>• A pulse inhibit is set if the auto-DCB function has been activated via <a href="#">C00019</a>.</li> </ul> </td> </tr> </table>	TRUE	Activate quick stop <ul style="list-style-type: none"> <li>• Motor control is decoupled from the setpoint selection and, within the deceleration time parameterised in <a href="#">C00105</a>, the motor is brought to a standstill (<math>n_{act} = 0</math>).</li> <li>• The motor is kept at a standstill during closed-loop operation.</li> <li>• A pulse inhibit is set if the auto-DCB function has been activated via <a href="#">C00019</a>.</li> </ul>
		TRUE	Activate quick stop <ul style="list-style-type: none"> <li>• Motor control is decoupled from the setpoint selection and, within the deceleration time parameterised in <a href="#">C00105</a>, the motor is brought to a standstill (<math>n_{act} = 0</math>).</li> <li>• The motor is kept at a standstill during closed-loop operation.</li> <li>• A pulse inhibit is set if the auto-DCB function has been activated via <a href="#">C00019</a>.</li> </ul>	
<table border="1"> <tr> <td>FALSE</td> <td>Deactivate quick stop               <ul style="list-style-type: none"> <li>• The quick stop is deactivated if no other source for the quick stop is active.</li> <li>• <a href="#">C00159</a> displays a bit code of active sources/causes for the quick stop.</li> </ul> </td> </tr> </table>	FALSE	Deactivate quick stop <ul style="list-style-type: none"> <li>• The quick stop is deactivated if no other source for the quick stop is active.</li> <li>• <a href="#">C00159</a> displays a bit code of active sources/causes for the quick stop.</li> </ul>		
FALSE	Deactivate quick stop <ul style="list-style-type: none"> <li>• The quick stop is deactivated if no other source for the quick stop is active.</li> <li>• <a href="#">C00159</a> displays a bit code of active sources/causes for the quick stop.</li> </ul>			

Designator	Data type	Information/possible settings
bSetDCBrake	BOOL	Manual DC-injection braking (DCB) <ul style="list-style-type: none"> <li>Detailed information on DC-injection braking is provided in the motor control chapter, subchapter "<a href="#">DC-injection braking</a>".</li> </ul>
		 <b>Note!</b> Holding braking is not possible when this braking mode is used! Use the basic " <a href="#">Holding brake control</a> " function for controlling the holding brake with a low rate of wear.
		FALSE   Deactivate DC-injection braking.
		TRUE   Activate DC-injection braking, i.e. the drive is brought to a standstill by means of DC-injection braking. <ul style="list-style-type: none"> <li>The braking effect stops when the rotor is at standstill.</li> <li>After the hold time (<a href="#">C00107</a>) has expired, the controller sets the pulse inhibit.</li> </ul>
bRFG_Stop	BOOL	Ramp function generator: Maintain the current value of the main setpoint integrator <ul style="list-style-type: none"> <li>The speed, for instance, of a running ramp process is immediately kept constant when <i>bRFG_Stop</i> is activated. At the same time, the acceleration/deceleration jumps to the value "0".</li> <li>For a detailed functional description see the <a href="#">L_NSet</a> FB.</li> </ul>
		TRUE   The current value of the main setpoint integrator is held.
nVoltageAdd_a	INT	Additive voltage impression <ul style="list-style-type: none"> <li>An additional setpoint for the motor voltage can be specified via this process input.</li> <li>If there are, for instance, different loads at the motor output end, it is possible to apply a voltage boost at the starting time.</li> <li>If the value is negative, the voltage is reduced.</li> <li>Scaling: 16384 <math>\equiv</math> 1000 V</li> </ul>
		 <b>Stop!</b> Values selected too high may cause the motor to heat up due to the resulting current!
nBoost_a	INT	Additional setpoint for the motor voltage at speed = 0 <ul style="list-style-type: none"> <li>The entire voltage-frequency characteristic is provided with an offset.</li> <li>Scaling: 16384 <math>\equiv</math> 1000 V</li> </ul>
		 <b>Stop!</b> Values selected too high may cause the motor to heat up due to the resulting current!
nPWMAngleOffset	INT	Additional offset for the electrical angle of rotation <ul style="list-style-type: none"> <li>If a torque is connected, e.g. dynamic acceleration processes can be generated.</li> <li>Scaling: <math>\pm 32767 \equiv \pm 180^\circ</math> angle of rotation</li> </ul>

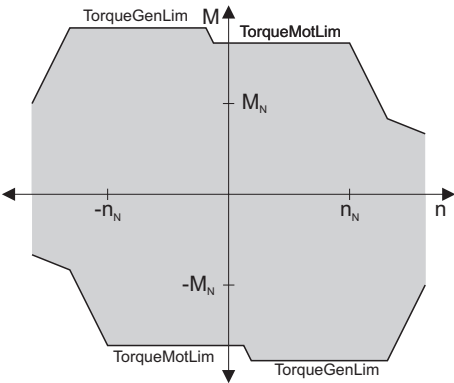
Designator	Data type	Information/possible settings				
nTorqueMotLim_a nTorqueGenLim_a	INT	<p>Torque limitation in motor mode and in generator mode</p> <ul style="list-style-type: none"> <li>• These input signals are directly transferred to the motor control to limit the inverter's maximum torque in motor and generator mode.</li> <li>• The drive cannot output a higher torque in motor/generator mode than set here.</li> <li>• The applied values (any polarity) are internally interpreted as absolute values.</li> <li>• If V/f characteristic control (VFCplus) is selected, limitation is <u>indirectly</u> performed via a so-called <math>I_{max}</math> controller.</li> <li>• If sensorless vector control (SLVC) is selected, the limitation has a <u>direct</u> effect on the torque-producing current component.</li> <li>• Scaling: <math>16384 \equiv 100\% M_{max}</math> (C00057)</li> </ul> <p>Torque limits in motor and generator mode:</p> 				
bSetSpeedCcw	BOOL	<p>Change of direction of rotation</p> <ul style="list-style-type: none"> <li>• For instance if a motor or gearbox is fixed laterally reversed to a machine part, but the setpoint selection should still be executed for the positive direction of rotation.</li> </ul> <table border="1"> <tr> <td>FALSE</td> <td>Clockwise rotation (Cw)</td> </tr> <tr> <td>TRUE</td> <td>Direction of rotation to the left (Ccw)</td> </tr> </table>	FALSE	Clockwise rotation (Cw)	TRUE	Direction of rotation to the left (Ccw)
FALSE	Clockwise rotation (Cw)					
TRUE	Direction of rotation to the left (Ccw)					
bRLQCw	BOOL	<p>Activate clockwise rotation (fail-safe)</p> <ul style="list-style-type: none"> <li>• For a detailed functional description see the <a href="#">L_RLO</a> FB.</li> </ul> <table border="1"> <tr> <td>FALSE</td> <td>Quick stop</td> </tr> <tr> <td>TRUE</td> <td>CW rotation</td> </tr> </table>	FALSE	Quick stop	TRUE	CW rotation
FALSE	Quick stop					
TRUE	CW rotation					
bRLQCcw	BOOL	<p>Activate counter-clockwise rotation (fail-safe)</p> <ul style="list-style-type: none"> <li>• For a detailed functional description see the <a href="#">L_RLO</a> FB.</li> </ul> <table border="1"> <tr> <td>FALSE</td> <td>Quick stop</td> </tr> <tr> <td>TRUE</td> <td>CCW rotation</td> </tr> </table>	FALSE	Quick stop	TRUE	CCW rotation
FALSE	Quick stop					
TRUE	CCW rotation					
nMainSetValue_a	INT	<p>Main speed setpoint</p> <ul style="list-style-type: none"> <li>• Offset and gain of this input signal can be set in <a href="#">C00696</a> and <a href="#">C00670</a> for a simple signal adjustment of a setpoint encoder.</li> <li>• Scaling: <math>16384 \equiv 100\%</math> reference speed (C00011)</li> <li>• The main setpoint is transformed to a speed setpoint in the setpoint encoder via a ramp function generator with linear or S-shaped ramps.</li> <li>• Upstream to the ramp function generator, a blocking speed masking function and a setpoint MinMax limitation are effective.</li> <li>• For a detailed functional description see the <a href="#">L_NSet</a> FB.</li> </ul>				
nAuxSetValue_a	INT	<p>Additional speed setpoint</p> <ul style="list-style-type: none"> <li>• Offset and gain of this input signal can be set in <a href="#">C00697</a> and <a href="#">C00671</a> for a simple signal adjustment of a setpoint encoder.</li> <li>• Scaling: <math>16384 \equiv 100\%</math> reference speed (C00011)</li> <li>• The additional speed setpoint can be linked arithmetically with the main speed setpoint behind the ramp function generator.</li> <li>• The additional speed setpoint can be shown via ramp times of a second ramp function generator.</li> <li>• For a detailed functional description see the <a href="#">L_NSet</a> FB.</li> </ul>				



Designator	Data type	Information/possible settings	
<b>Switch-off positioning</b>			
bJogCtrlInputSel1 bJogCtrlInputSel2	BOOL	Selection inputs for a binary coded selection of the switch-off position 1 ... 3 <ul style="list-style-type: none"> <li>Activation of the signal pairs <i>bJogCtrlSlowDown1/bJogCtrlStop1</i>, <i>bJogCtrlSlowDown2/bJogCtrlStop2</i> or <i>bJogCtrlSlowDown3/bJogCtrlStop3</i> according to the <a href="#">Truth table for activating the pre-switch off</a>.</li> </ul>	
bJogCtrlRfgrIn	BOOL	Ramping down of the setpoint generator in the downstream <a href="#">L_NSet</a> FB according to the <a href="#">Truth table for activating the pre-switch off</a>	
bJogCtrlJog1 bJogCtrlJog2	BOOL	Inputs for overriding fixed setpoints (JOG setpoints) for the main setpoint <ul style="list-style-type: none"> <li>If the pre-switch off is inactive (<i>bJogCtrlInputSel1</i> and <i>bJogCtrlInputSel2</i> are both set to FALSE), the two control signals are passed through 1:1 to the downstream FB <a href="#">L_NSet</a>.</li> <li>To achieve the desired behaviour (starting at high speed, pre-switch off at low speed), both inputs must be set to TRUE.</li> <li>Fixed setpoint 2 must be less than fixed setpoint 3! Otherwise, the drive will start at a low speed and accelerate after the pre-switch off.</li> <li>If in addition to the inputs <i>bJogCtrlJog1</i> and <i>bJogCtrlJog2</i> the selection inputs <i>bJogSpeed4</i> and <i>bJogSpeed8</i> are assigned, different fixed setpoints can result from this and the drive may travel with different speeds than selected via <i>bJogCtrlJog1</i> and <i>bJogCtrlJog2</i>.</li> </ul>	
bJogCtrlSlowDown1 bJogCtrlSlowDown2 bJogCtrlSlowDown3	BOOL	Activation of fixed setpoint 2 in the downstream <a href="#">L_NSet</a> FB <ul style="list-style-type: none"> <li>These inputs only have a function if they have been previously activated via <i>bJogCtrlInputSel1</i> and <i>bJogCtrlInputSel2</i> (see <a href="#">Truth table for activating the pre-switch off</a>).</li> </ul>	
bJogCtrlStop1 bJogCtrlStop2 bJogCtrlStop3	BOOL	Ramping down of the ramp function generator in the downstream <a href="#">L_NSet</a> FB <ul style="list-style-type: none"> <li>These inputs only have a function if they have been previously activated via <i>bJogCtrlInputSel1</i> and <i>bJogCtrlInputSel2</i> (see <a href="#">Truth table for activating the pre-switch off</a>).</li> </ul>	
bJogSpeed4 bJogSpeed8	BOOL	Inputs for overriding fixed setpoints (JOG setpoints) for the main setpoint <ul style="list-style-type: none"> <li>A fixed setpoint for the setpoint generator can be activated instead of the main setpoint via these selection inputs.</li> <li>The selection inputs are binary coded.</li> <li>For a detailed functional description see the <a href="#">L_NSet</a> FB.</li> </ul>	
bJogRamp1 ... bJogRamp8	BOOL	Selection inputs for alternative acceleration/deceleration times for the main setpoint <ul style="list-style-type: none"> <li>The four selection inputs are binary coded, therefore 15 alternative acceleration/deceleration times can be selected.</li> <li>For main setpoint <i>nMainSetValue_a</i>, the set acceleration time (<a href="#">C00012</a>) and deceleration time (<a href="#">C00013</a>) are active in the case of the binary coded selection "0" (all inputs = FALSE or not assigned).</li> <li>Alternative acceleration times are selected in <a href="#">C00101/1...15</a>.</li> <li>The selection of the alternative deceleration times is carried out in <a href="#">C00103/1...15</a>.</li> <li>For a detailed functional description see the <a href="#">L_NSet</a> FB.</li> </ul>	
<b>MCK basic functions</b>			
bMBrakeRelease	BOOL	<a href="#">Holding brake control</a> : Release/apply brake <ul style="list-style-type: none"> <li>In conjunction with the operating mode selected in <a href="#">C02580</a> (Lenze setting: "Brake control off").</li> </ul>	
		FALSE	Apply brake. <ul style="list-style-type: none"> <li>During automatic operation, the internal brake logic controls the brake.</li> </ul>
		TRUE	Release brake manually (forced release). <ul style="list-style-type: none"> <li><b>Note!</b> The brake can also be released when the controller is inhibited!</li> <li>During automatic operation, the internal brake logic is deactivated and the brake is released (supervisor operation). If a controller inhibit has been set by the brake control, it will be deactivated.</li> <li>In semi-automatic operation, the brake is released including feedforward control.</li> </ul>

Designator Data type	Information/possible settings				
<b>GP: GeneralPurpose</b> The following inputs are interconnected with logic/arithmetic functions on application level for free usage. ▶ <a href="#">"GeneralPurpose" functions</a>					
nGPAAnalogSwitchIn1_a nGPAAnalogSwitchIn2_a INT	<a href="#">Analog switch</a> : Input signals <ul style="list-style-type: none"> <li>The input signal selected via the selection input <i>bGPAAnalogSwitchSet</i> is output at output <i>nGPAAnalogSwitchOut_a</i>.</li> </ul>				
bGPAAnalogSwitchSet BOOL	<a href="#">Analog switch</a> : Selection input <table border="1"> <tr> <td>FALSE</td> <td><i>nGPAAnalogSwitchOut_a</i> = <i>nGPAAnalogSwitchIn1_a</i></td> </tr> <tr> <td>TRUE</td> <td><i>nGPAAnalogSwitchOut_a</i> = <i>nGPAAnalogSwitchIn2_a</i></td> </tr> </table>	FALSE	<i>nGPAAnalogSwitchOut_a</i> = <i>nGPAAnalogSwitchIn1_a</i>	TRUE	<i>nGPAAnalogSwitchOut_a</i> = <i>nGPAAnalogSwitchIn2_a</i>
FALSE	<i>nGPAAnalogSwitchOut_a</i> = <i>nGPAAnalogSwitchIn1_a</i>				
TRUE	<i>nGPAAnalogSwitchOut_a</i> = <i>nGPAAnalogSwitchIn2_a</i>				
nGPArithmetikIn1_a nGPArithmetikIn2_a INT	<a href="#">Arithmetic</a> : Input signals <ul style="list-style-type: none"> <li>The arithmetic function is selected in <a href="#">C00338</a>.</li> <li>The result is output at output <i>nGPArithmetikOut_a</i>.</li> </ul>				
nGPMulDivIn_a INT	<a href="#">Multiplication/Division</a> : Input signal <ul style="list-style-type: none"> <li>The factor for the multiplication can be set in <a href="#">C00699/1</a> (numerator) and <a href="#">C00699/2</a> (denominator).</li> <li>The result is output at output <i>nGPMulDivOut_a</i>.</li> </ul>				
bGPDigitalDelayIn BOOL	<a href="#">Binary delay element</a> : Input signal <ul style="list-style-type: none"> <li>The on-delay can be set in <a href="#">C00720/1</a>.</li> <li>The off-delay can be set in <a href="#">C00720/2</a>.</li> <li>The time-delayed input signal is output at output <i>bGPDigitalDelayOut</i>.</li> </ul>				
bGPLogicIn1 bGPLogicIn2 bGPLogicIn3 BOOL	<a href="#">Binary logic</a> : Input signals <ul style="list-style-type: none"> <li>The logic operation is selected in <a href="#">C00820</a>.</li> <li>The result is output at output <i>bGPLogicOut</i>.</li> </ul>				
nGPCompareIn1_a nGPCompareIn2_a INT	<a href="#">Analog comparison</a> : Input signals <ul style="list-style-type: none"> <li>The comparison operation is selected in <a href="#">C00680</a>.</li> <li>Hysteresis and window size can be set in <a href="#">C00680</a> and <a href="#">C00682</a>.</li> <li>If the comparison statement is true, the output <i>bGPCompareOut</i> will be set to TRUE.</li> </ul>				
bGPDFlipFlop_InD bGPDFlipFlop_InClk bGPDFlipFlop_InClr BOOL	<a href="#">D-FlipFlop</a> : Input signals <ul style="list-style-type: none"> <li>Data, clock and reset input</li> </ul>				
<b>Free inputs</b> The following inputs can freely be interconnected on the application level. The signals can be transferred from the I/O level to the application level via these inputs.					
bFreeIn1 ... bFreeIn8 BOOL	Free inputs for digital signals				
wFreeIn1 ... wFreeIn4 WORD	Free inputs for 16-bit signals				
dnFreeIn1_p ... dnFreeIn2_p DINT	Free inputs for 32-bit signals				

## outputs

Designator Data type	Value/meaning
wDriveControlStatus WORD	Status word of the inverter <ul style="list-style-type: none"> <li>The status word contains information on the current status of the inverter.</li> <li>See the "<a href="#">wDeviceStatusWord status word</a>" subchapter of the chapter on device control for a detailed description of the bit assignment.</li> </ul>
wStateDetermFailNoLow WORD	Display of the status determining error (LOW word)
wStateDetermFailNoHigh WORD	Display of the status determining error (HIGH word)

Designator	Data type	Value/meaning	
bDriveFail	BOOL	TRUE	Inverter in error status. • " <a href="#">Fault</a> " device status is active.
bWarningActive	BOOL	TRUE	A monitoring in the inverter, for which the error response "Warning" or "Warning locked" has been parameterised, responded.
bSafeTorqueOff	BOOL	TRUE	Safe torque off. • " <a href="#">SafeTorqueOff</a> " device status is active.
bDriveReady	BOOL	TRUE	Inverter is ready for operation. • " <a href="#">SwitchedOn</a> " device status is active. • The drive is in this device status if the DC bus voltage is applied and the inverter is still inhibited by the user (controller inhibit).
bCInhActive	BOOL	TRUE	Controller inhibit is active.
bImpIsActive	BOOL	TRUE	Pulse inhibit is active.
bQSPLsActive	BOOL	TRUE	Quick stop is active.
bSpeedCcw	BOOL	Current direction of rotation	
		FALSE	Clockwise rotation (Cw)
		TRUE	Direction of rotation to the left (Ccw)
bSpeedActCompare	BOOL	Result of the speed comparison (detection of speed=0)	
		TRUE	During open-loop operation: Speed setpoint < Comparison value ( <a href="#">C00024</a> )
			During closed-loop operation: Actual speed value < Comparison value ( <a href="#">C00024</a> )
blmaxActive	BOOL	"Current setpoint inside the limitation" status signal	
		TRUE	The current setpoint is internally limited (the inverter operates at the maximum current limit).
bSpeedSetReached	BOOL	Status signal "setpoint = 0"	
		TRUE	Speed setpoint from the ramp function generator = 0
bSpeedActEqSet	BOOL	TRUE	Actual speed value = speed setpoint
nMotorCurrent_a	INT	Current stator current/effective motor current • Scaling: 16384 $\equiv$ 100 % $I_{\max\_mot}$ ( <a href="#">C00022</a> )	
nMotorSpeedSet_a	INT	Speed setpoint • Scaling: 16384 $\equiv$ 100 % reference speed ( <a href="#">C00011</a> )	
nMotorSpeedAct_a	INT	Actual speed value • Scaling: 16384 $\equiv$ 100 % reference speed ( <a href="#">C00011</a> )	
nMotorTorqueAct_a	INT	Actual torque • In the "VFC (+encoder)" operating mode of the motor control, this value is determined from the current motor current and corresponds to the actual torque only by approximation. • Scaling: 16384 $\equiv$ 100 % $M_{\max}$ ( <a href="#">C00057</a> )	
nDCVoltage_a	INT	Current DC-bus voltage • Scaling: 16384 $\equiv$ 1000 V	
nMotorVoltage_a	INT	Current motor voltage/inverter output voltage • Scaling: 16384 $\equiv$ 1000 V	

Designator	Data type	Value/meaning	
<b>MCK basic functions</b>			
bMBrakeReleaseOut	BOOL	<a href="#">Holding brake control</a> : Trigger signal for the holding brake control switching element via a digital output <ul style="list-style-type: none"> <li>Use bit 0 in <a href="#">C02582</a> to activate inverted switching element triggering.</li> </ul>	
		FALSE	Apply brake.
		TRUE	Release brake.
bMBrakeReleased	BOOL	<a href="#">Holding brake control</a> : "Brake released" considering the brake release time <ul style="list-style-type: none"> <li>When the holding brake is triggered to close, <i>bMBrakeReleased</i> is immediately set to FALSE even if the brake closing time has not yet elapsed!</li> </ul>	
		TRUE	Brake released (after the brake release time has expired).
<b>GP: GeneralPurpose</b> The following outputs are interconnected with logic/arithmetic functions on application level for free usage. ▶ <a href="#">"GeneralPurpose" functions</a>			
nGPAAnalogSwitchInOut_a	INT	<a href="#">Analog switch</a> : Output signal	
nGPArithmetikOut_a	INT	<a href="#">Arithmetic</a> : Output signal	
nGPMulDivOut_a	INT	<a href="#">Multiplication/Division</a> : Output signal	
bGPDigitalDelayOut	BOOL	<a href="#">Binary delay element</a> : Output signal	
bGPLogicOut	BOOL	<a href="#">Binary logic</a> : Output signal	
bGPCompareOut	BOOL	<a href="#">Analog comparison</a> : Output signal	
bGPSignalOut1 ... bGPSignalOut4	BOOL	<a href="#">Binary signal monitor</a> : Output signals <ul style="list-style-type: none"> <li>The signal sources to be output are selected in <a href="#">C00411/1...4</a>.</li> <li>A bit coded inversion of the output signals can be parameterised in <a href="#">C00412</a>.</li> </ul>	
nGPSignalOut1_a ... nGPSignalOut4_a	BOOL	<a href="#">Analog signal monitor</a> : Output signals <ul style="list-style-type: none"> <li>The signal sources to be output are selected in <a href="#">C00410/1...4</a>.</li> <li>Gain and offset for each output signal can be parameterised in <a href="#">C00413/1...8</a>.</li> </ul>	
bGPDFlipFlop_Out	BOOL	<a href="#">D-FlipFlop</a> : Output signal	
bGPDFlipFlop_NegOut	BOOL	<a href="#">D-FlipFlop</a> : Negated output signal	
<b>Free outputs</b> The following outputs can freely be interconnected on the application level. The signals from the application level can be transferred to the I/O level via these outputs.			
bFreeOut1 ... bFreeOut8	BOOL	Free outputs for digital signals	
wFreeOut1 ... wFreeOut4	WORD	Free outputs for 16-bit signals	
dnFreeOut1_p dnFreeOut2_p	WORD	Free outputs for 32-bit signals	

### 7.4.2.1 Truth table for activating the pre-switch off

Input		Function	Response in the setpoint generator (FB L_NSet)
bJogCtrl InputSel1	bJogCtrl InputSel2		
FALSE	FALSE	Pre-switch off inactive	No response <ul style="list-style-type: none"> <li>The input signal <i>bJogCtrlRfgIn</i> is output directly at output <i>bRfgOut</i>.</li> <li>The input signals <i>bJogCtrlJog1</i> and <i>bJogCtrlJog2</i> are passed through 1:1 to the downstream FB <a href="#">L_NSet</a> for the selection of fixed setpoints.</li> </ul>
TRUE	FALSE	The <i>bJogCtrlSlowDown1</i> and <i>bJogCtrlStop1</i> inputs are evaluated.	<b>Pre-switch off can be activated</b> <ul style="list-style-type: none"> <li>If the slowdown function is activated via the selected <i>bJogCtrlSlowDown</i> input, fixed setpoint 2 is activated in the setpoint generator.</li> <li>If the stop function is activated via the selected <i>bJogCtrlStop</i> input, the setpoint generator is deactivated.</li> </ul>
FALSE	TRUE	The <i>bJogCtrlSlowDown2</i> and <i>bJogCtrlStop2</i> inputs are evaluated.	
TRUE	TRUE	The inputs <i>bJogCtrlSlowDown3</i> and <i>bJogCtrlStop3</i> are evaluated.	

[7-1] Truth table for activating the pre-switch off

### 7.4.3 Terminal assignment of the control modes

The following comparison provides information about which inputs/outputs of the application block **LA\_SwitchPos** are interconnected to the digital and analog input/output terminals of the inverter in the different control modes.

		Control mode (C00007)							
		10: <a href="#">Terminals 0</a>	12: <a href="#">Terminals 2</a>	14: <a href="#">Terminals 11</a>	16: <a href="#">Terminal 16</a>	20: <a href="#">Keypad</a>	21: <a href="#">PC</a>	30: <a href="#">CAN</a>	40: <a href="#">MCI</a>
<b>Digital input terminals</b>									
X4/RFR	Controller enable	Controller enable / Reset of error message bFailReset							
X4/DI1	Fixed setpoint 1/3 bJogCtrlJog1	Stop function 1 bJogCtrlStop1			Fixed setpoint 1/3 bJogCtrlJog1	-	-	Stop function 1 bJogCtrlStop1	
X4/DI2	Fixed setpoint 2/3 bJogCtrlJog2	Stop function 2 bJogCtrlStop2	Selection: Pre-switch off 1 bJogCtrlSlowDown 1		Fixed setpoint 2/3 bJogCtrlJog2	-	-	Selection: Pre-switch off 1 bJogCtrlSlowDown 1	
X4/DI3	Reset error message bFailReset	CW rotation quick stop bRLQCw Selection: Switch-off position 1 bJogCtrlInputSel1			CW rotation quick stop bRLQCw	-	-	Stop function 2 bJogCtrlStop2	
X4/DI4	Change of direction of rotation bSetSpeedCcw	CCW rotation quick stop bRLQCcw Selection: Switch-off position 2 bJogCtrlInputSel2			CCW rotation quick stop bRLQCcw	-	-	Selection: Pre-switch off 2 bJogCtrlSlowDown 2	
<b>Analog input terminals</b>									
X3/A1U, A1I	Main speed setpoint nMainSetValue_a 10 V ≙ 100 % reference speed (C00011)					-	-	Additional speed setpoint nAuxSetValue_a 10 V ≙ 100 % reference speed (C00011)	
<b>Digital output terminals</b>									
X4/DO1	-	-	-	-	-	-	-	-	-
X101/COM, NO	-	-	-	-	-	-	-	-	-
<b>Analog output terminal</b>									
X3/O1U	-	-	-	-	-	-	-	-	-

7.4.3.1 Terminals 0

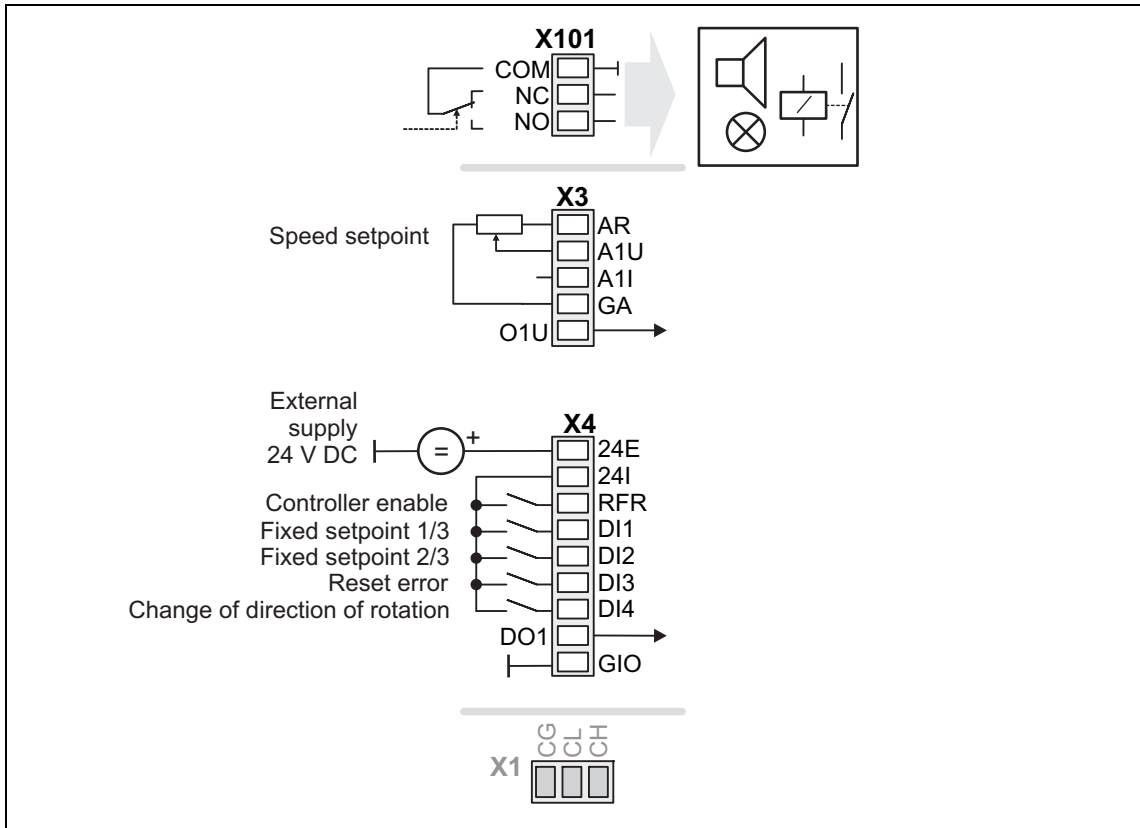

Connection	Assignment	Connection	Assignment
X101/NC-NO	LA_SwitchPos.bDriveFail		
X4/RFR	-	X3/A1U	LA_SwitchPos.nMainSetValue_a *
X4/DI1	LA_SwitchPos.bJogCtrlJog1	X3/A1I	-
X4/DI2	LA_SwitchPos.bJogCtrlJog2	X3/O1U	-
X4/DI3	LA_SwitchPos.bFailReset		* 10 V ≙ 100 % reference speed (C00011)
X4/DI4	LA_SwitchPos.bSetSpeedCcw	X4/DO1	LA_SwitchPos.bDriveReady

7.4.3.2 Terminals 2

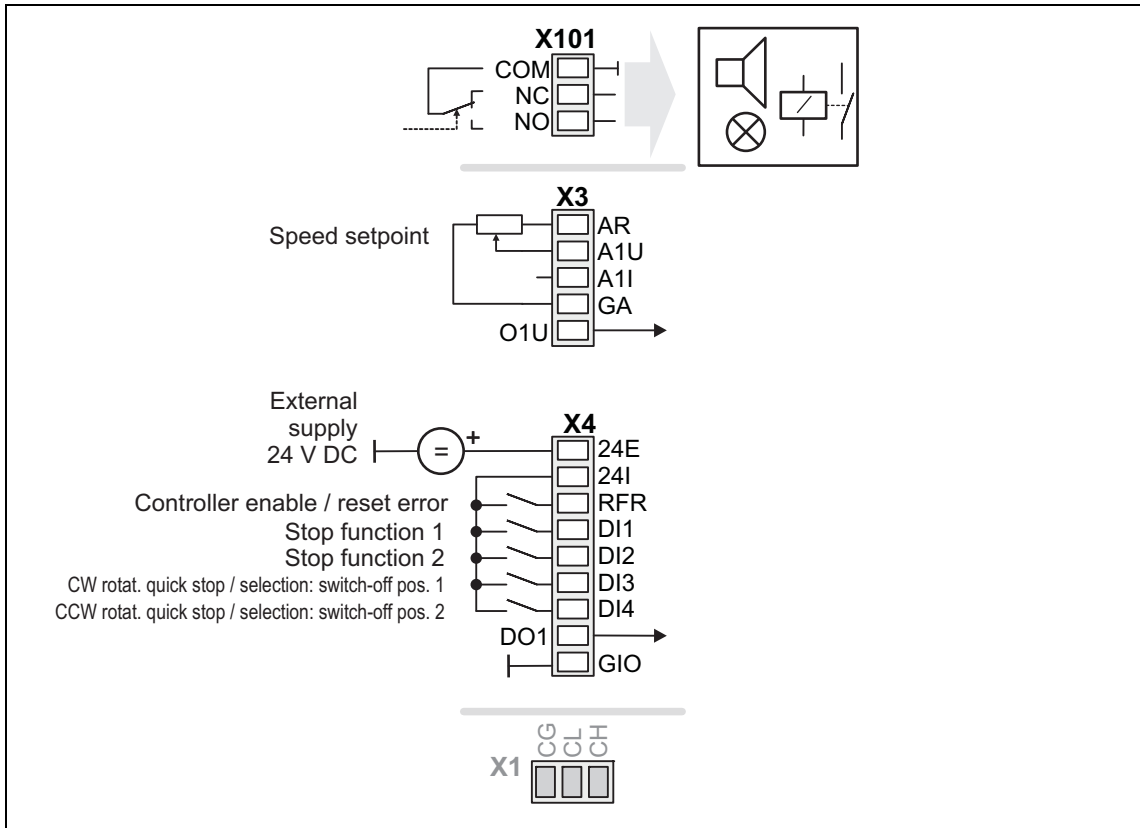

Connection	Assignment	Connection	Assignment
X101/NC-NO	LA_SwitchPos.bDriveFail		
X4/RFR	LA_SwitchPos: bFailReset	X3/A1U	LA_SwitchPos.nMainSetValue_a *
X4/DI1	LA_SwitchPos: bJogCtrlStop1	X3/A1I	-
X4/DI2	LA_SwitchPos: bJogCtrlStop2	X3/O1U	-
X4/DI3	LA_SwitchPos: bRLQCw LA_SwitchPos: bJogCtrlInputSel1		* 10 V ≙ 100 % reference speed (C00011)
X4/DI4	LA_SwitchPos: bRLQCcw LA_SwitchPos: bJogCtrlInputSel2	X4/DO1	LA_SwitchPos.bDriveReady



7.4.3.3 Terminals 11

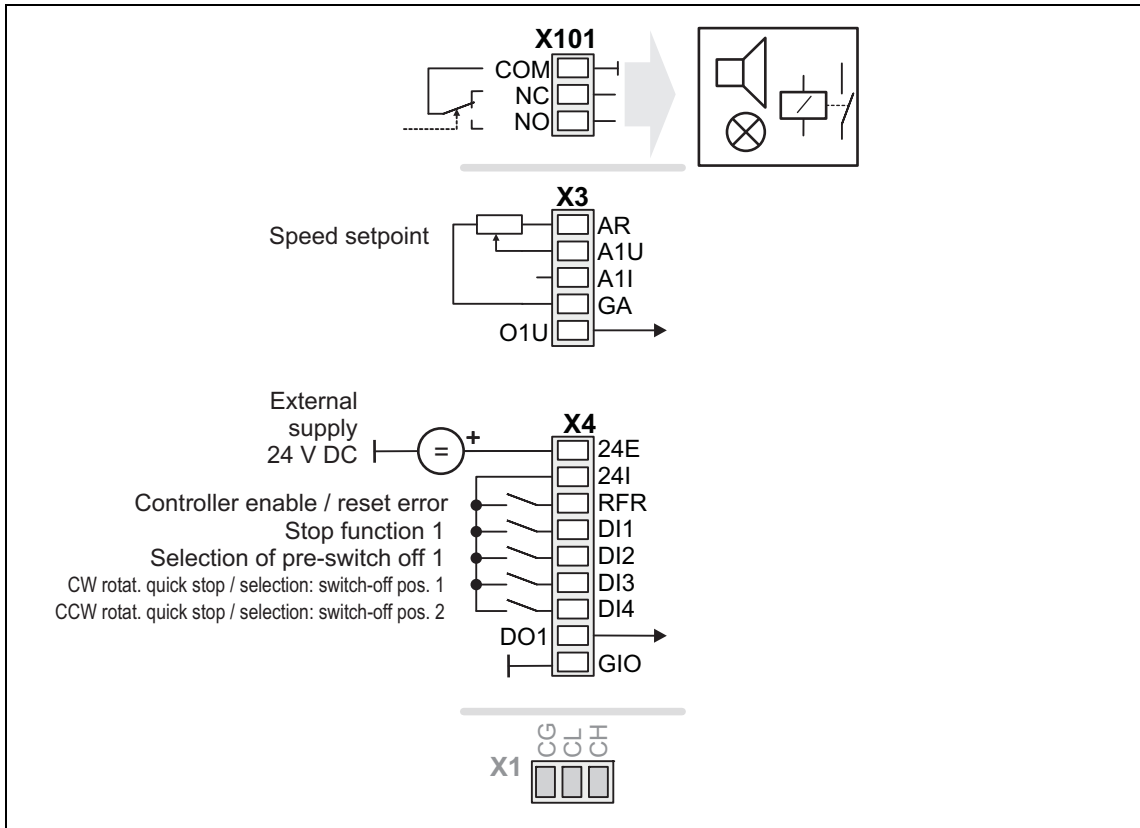

Connection	Assignment	Connection	Assignment
X101/NC-NO	LA_SwitchPos.bDriveFail		
X4/RFR	LA_SwitchPos: bFailReset	X3/A1U	LA_SwitchPos.nMainSetValue_a *
X4/DI1	LA_SwitchPos: bJogCtrlStop1	X3/A1I	-
X4/DI2	LA_SwitchPos: bJogCtrlSlowDown1	X3/O1U	-
X4/DI3	LA_SwitchPos: bRLQCw LA_SwitchPos: bJogCtrlInputSel1		* 10 V ≙ 100 % reference speed (C00011)
X4/DI4	LA_SwitchPos: bRLQCcw LA_SwitchPos: bJogCtrlInputSel2	X4/DO1	LA_SwitchPos.bDriveReady

7.4.3.4 Terminal 16

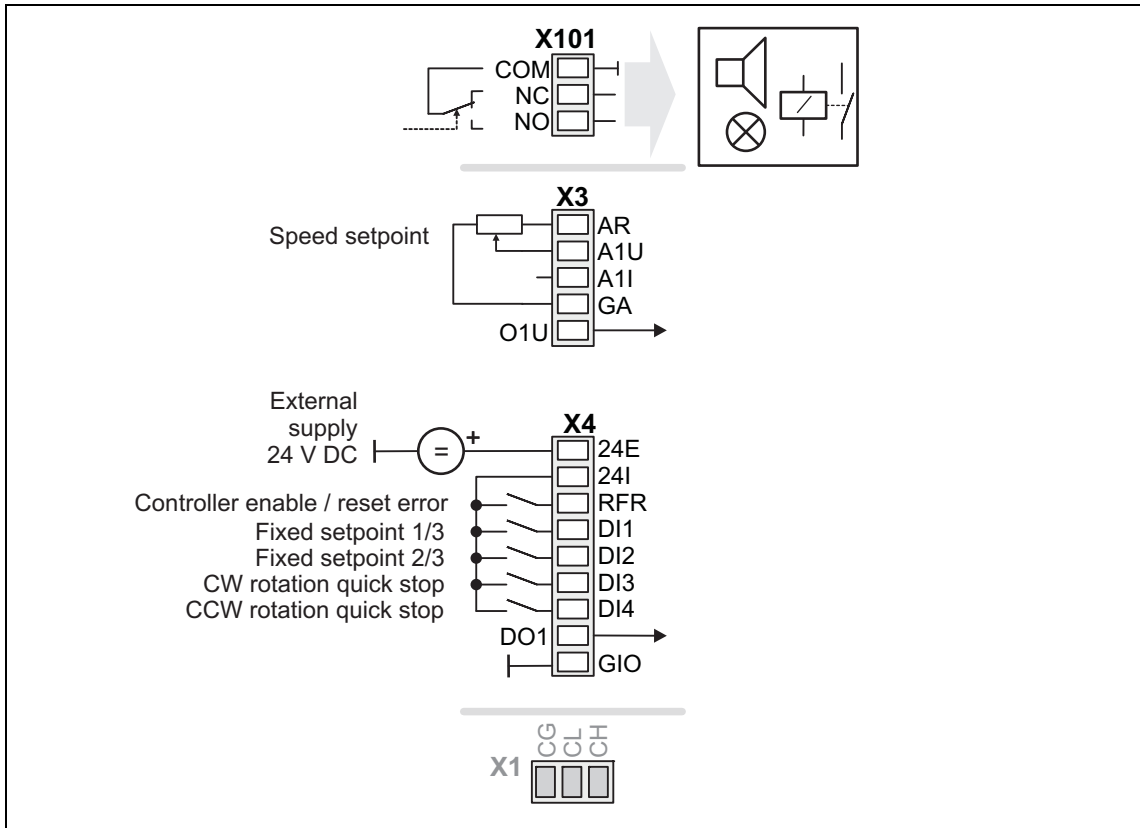

Connection	Assignment	Connection	Assignment
X101/NC-NO	LA_SwitchPos.bDriveFail		
X4/RFR	LA_SwitchPos: bFailReset	X3/A1U	LA_SwitchPos.nMainSetValue_a *
X4/DI1	LA_SwitchPos: bJogCtrlJog1	X3/A1I	-
X4/DI2	LA_SwitchPos: bJogCtrlJog2	X3/O1U	-
X4/DI3	LA_SwitchPos: bRLQCw		* 10 V ≙ 100 % reference speed (C00011)
X4/DI4	LA_SwitchPos: bRLQCcw	X4/DO1	LA_SwitchPos.bDriveReady

7.4.3.5 Keypad

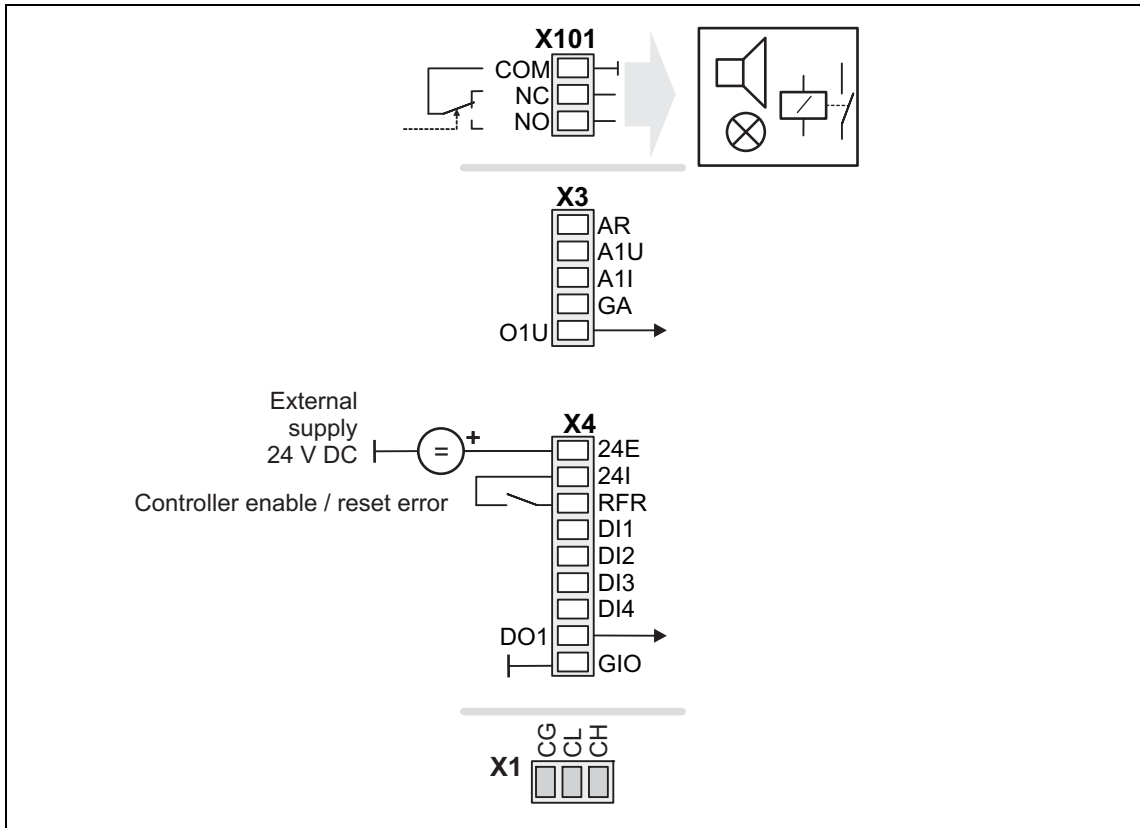

Connection	Assignment	Connection	Assignment
X101/NC-NO	LA_SwitchPos.bDriveFail		
X4/RFR	LA_SwitchPos.bFailReset	X3/A1U	-
X4/DI1	-	X3/A1I	-
X4/DI2	-	X3/O1U	-
X4/DI3	-		
X4/DI4	-	X4/DO1	LA_SwitchPos.bDriveReady

7.4.3.6 PC

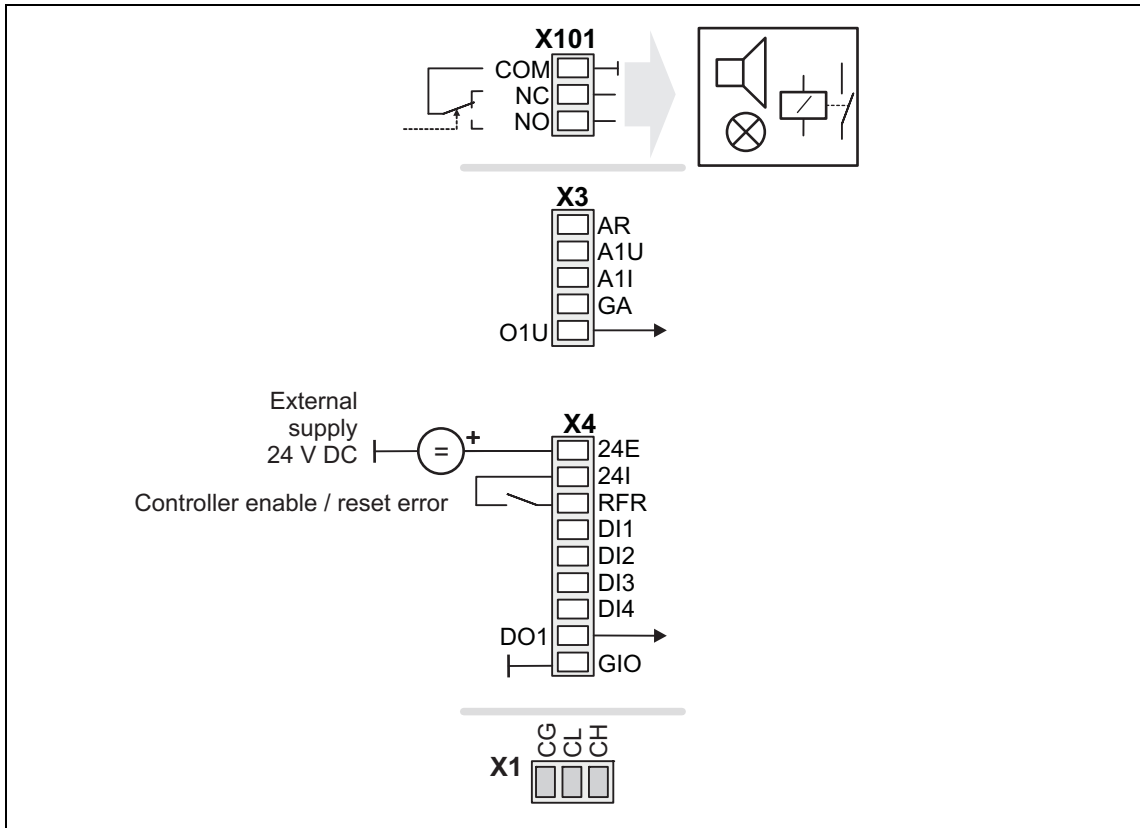

Connection	Assignment	Connection	Assignment
X101/NC-NO	LA_SwitchPos.bDriveFail		
X4/RFR	LA_SwitchPos.bFailReset	X3/A1U	-
X4/DI1	-	X3/A1I	-
X4/DI2	-	X3/O1U	-
X4/DI3	-		
X4/DI4	-	X4/DO1	LA_SwitchPos.bDriveReady

7.4.3.7 CAN

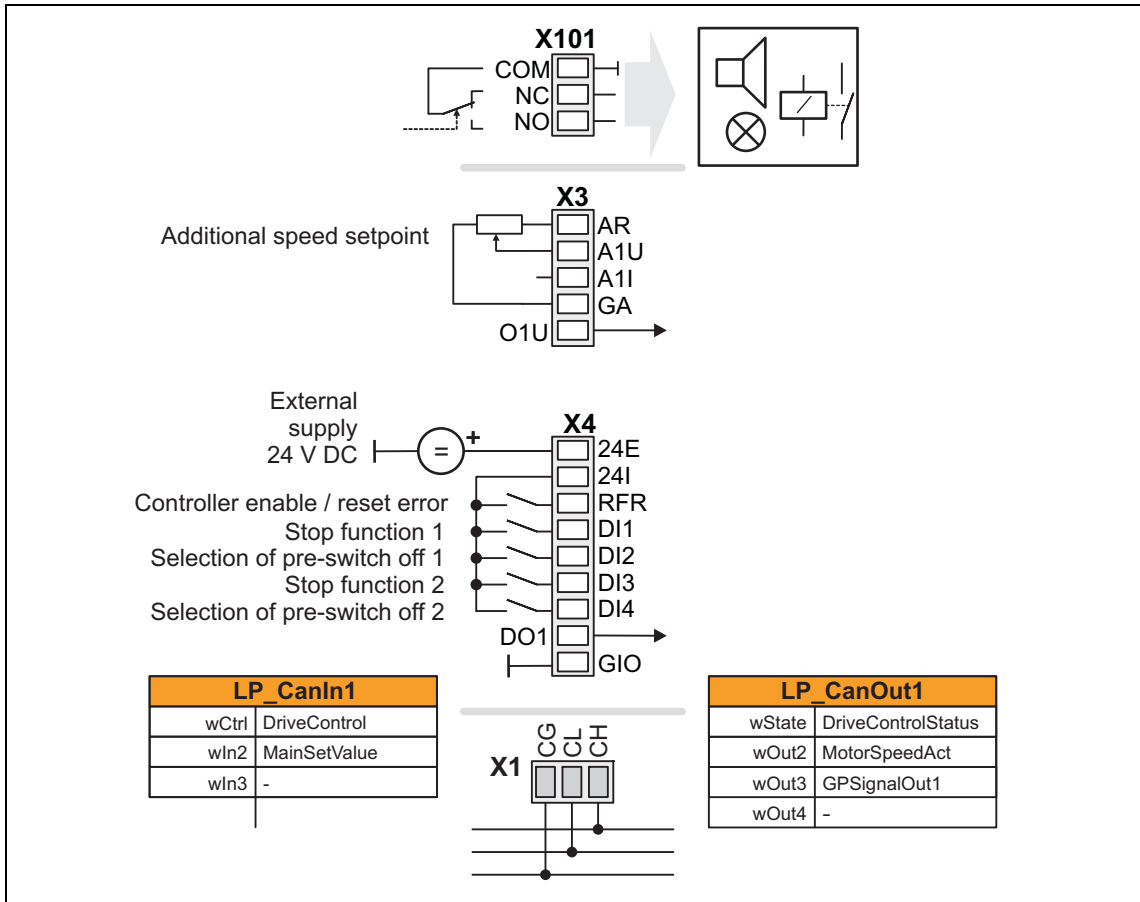

Connection	Assignment	Connection	Assignment
X101/NC-NO	LA_SwitchPos.bDriveFail		
X4/RFR	LA_SwitchPos: bFailReset	X3/A1U	LA_SwitchPos.nAuxSetValue_a *
X4/DI1	LA_SwitchPos: bJogCtrlStop1	X3/A1I	-
X4/DI2	LA_SwitchPos: bJogCtrlSlowDown1	X3/O1U	-
X4/DI3	LA_SwitchPos: bJogCtrlStop2		* 10 V ≙ 100 % reference speed (C00011)
X4/DI4	LA_SwitchPos: bJogCtrlSlowDown2	X4/DO1	LA_SwitchPos.bDriveReady

▶ [Process data assignment for fieldbus communication \(391\)](#)



**Note!**

You must set the setpoint arithmetic in [C00190](#) to "1: NOut = NSet + NAdd" so that the additional speed setpoint selected via the analog input A1U has an additive effect.

7.4.3.8 MCI

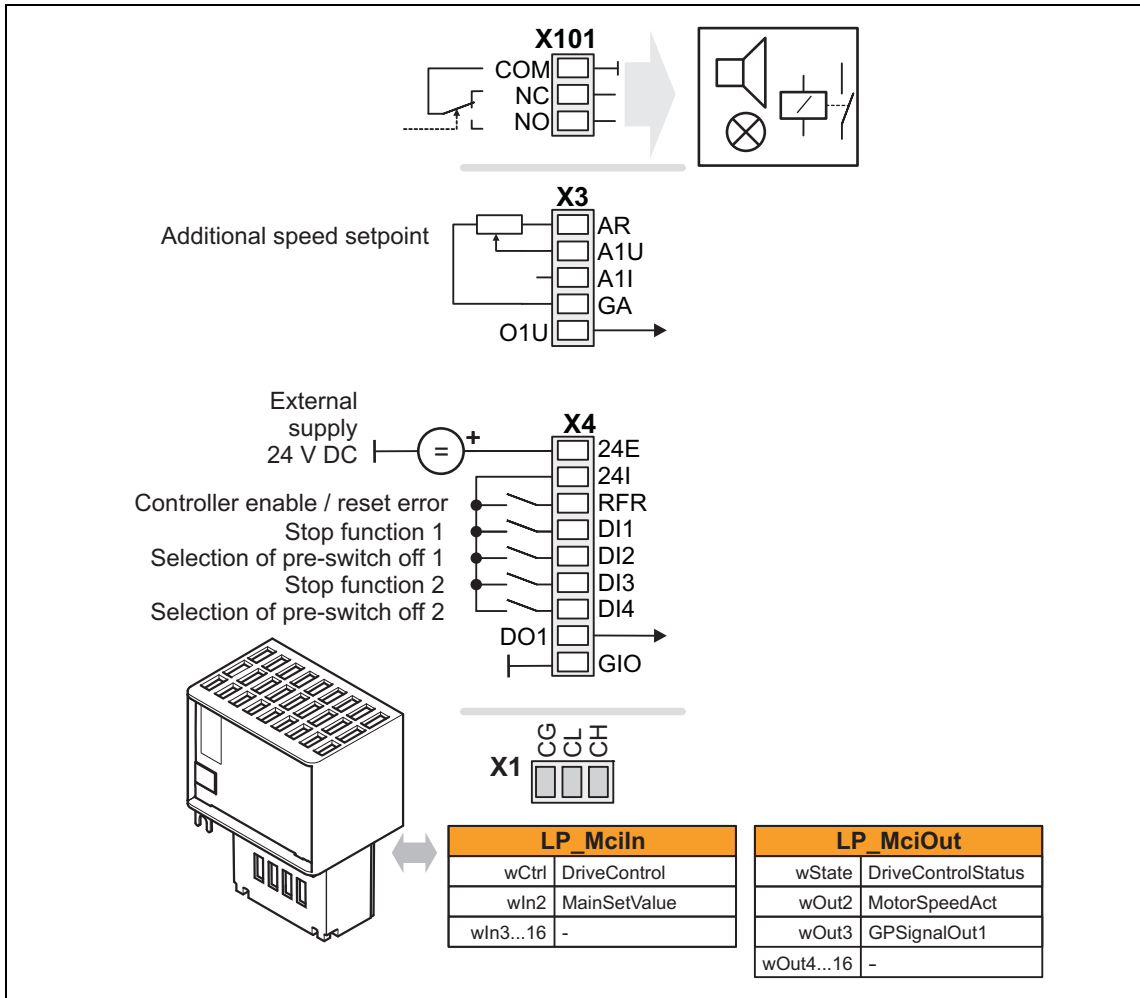

Connection	Assignment	Connection	Assignment
X101/NC-NO	LA_SwitchPos.bDriveFail		
X4/RFR	LA_SwitchPos: bFailReset	X3/A1U	LA_SwitchPos.nAuxSetValue_a *
X4/DI1	LA_SwitchPos: bJogCtrlStop1	X3/A1I	-
X4/DI2	LA_SwitchPos: bJogCtrlSlowDown1	X3/O1U	-
X4/DI3	LA_SwitchPos: bJogCtrlStop2		* 10 V ≙ 100 % reference speed (C00011)
X4/DI4	LA_SwitchPos: bJogCtrlSlowDown2	X4/DO1	LA_SwitchPos.bDriveReady

▶ [Process data assignment for fieldbus communication \(391\)](#)



**Note!**

You must set the setpoint arithmetic in [C00190](#) to "1: NOut = NSet + NAdd" so that the additional speed setpoint selected via the analog input A1U has an additive effect.

#### 7.4.4 Process data assignment for fieldbus communication

The fieldbus communication is connected (preconfigured) to the previously selected technology application by selecting the corresponding control mode in [C00007](#):

- "30: [CAN](#)" for the connection to the system bus (CAN)
- "40: [MCI](#)" for the connection to a plugged-on communication module (e.g. PROFIBUS)

The assignment of the process data words depends only on the application, not on the bus system used:

Input words	Name	Assignment
Word 1	DriveControl	Control word • For bit assignment see the table below.
Word 2	MainSetValue	Speed setpoint • Scaling: 16384 $\equiv$ 100 % reference speed ( <a href="#">C00011</a> )
Word 3	-	Not preconfigured
Word 4	-	Not preconfigured
Words 5 ... 16	-	Not preconfigured • Only available in control mode "40: MCI".

Control word	Name	Function
Bit 0	SwitchOn	1 $\equiv$ Change to the " <a href="#">SwitchedOn</a> " device status • This bit must be set in the CAN/MCI control word to ensure that the device changes to the " <a href="#">SwitchedOn</a> " device status after mains connection without the need for a master control specifying this bit via fieldbus. • If control via a bus system is not wanted (e.g. in the case of control via terminals), the <i>wDriveCtrl</i> output signal of the <a href="#">LS_ParFix</a> system block can be connected to the control word inputs.
Bit 1	DisableVoltage	1 $\equiv$ Inhibit inverter control (pulse inhibit)
Bit 2	SetQuickStop	1 $\equiv$ Activate quick stop (QSP). ▶ <a href="#">Activate/deactivate quick stop</a> (☞ 85)
Bit 3	EnableOperation	1 $\equiv$ Enable inverter (RFR) • If control via terminals is performed, this bit must be set both in the CAN control word and in the MCI control word. Otherwise, the controller is inhibited. ▶ <a href="#">Enable/inhibit inverter</a> (☞ 84)
Bit 4	ModeSpecific_1	Reserved (currently not assigned)
Bit 5	JogCtrlInputSel1	Binary coded selection of the switch-off position 1 ... 3 • Activation of the signal pairs <i>bJogCtrlSlowDown1/bJogCtrlStop1</i> , <i>bJogCtrlSlowDown2/bJogCtrlStop2</i> or <i>bJogCtrlSlowDown3/bJogCtrlStop3</i> according to the <a href="#">Truth table for activating the pre-switch off</a> .
Bit 6	JogCtrlInputSel2	
Bit 7	ResetFault	1 $\equiv$ Reset fault (trip reset) • Acknowledge error message (if the error cause has been eliminated). ▶ <a href="#">Reset error</a> (☞ 86)
Bit 8	bJogCtrlRfglN	Ramping down of the setpoint generator in the downstream <a href="#">L_NSet</a> FB according to the <a href="#">Truth table for activating the pre-switch off</a>
Bit 9	reserved_1	Reserved (currently not assigned)
Bit 10	reserved_2	

Control word	Name	Function
Bit 11	MBrkRelease	<a href="#">Holding brake control</a> : 0 ≡ Apply brake 1 ≡ Release brake • In conjunction with the operating mode selected in <a href="#">C02580</a> (Lenze setting: "Brake control off").
Bit 12	JogCtrlJog1	Binary coded selection of the fixed setpoints (JOG setpoints)
Bit 13	JogCtrlJog2	
Bit 14	SetFail	1 ≡ Set error (trip set)
Bit 15	SetSpeedCcw	0 ≡ Direction of rotation to the right (Cw) 1 ≡ Direction of rotation to the left (Ccw)

Output words	Name	Assignment
Word 1	DriveControlStatus	Status word • For bit assignment see the table below.
Word 2	MotorSpeedAct	Actual speed value • Scaling: 16384 ≡ 100 % reference speed ( <a href="#">C00011</a> )
Word 3	GPSignalOut1	Analog signal monitor: Output signal 1 • The selection of the signal source to output is executed in <a href="#">C00410/1</a> . • Gain and offset for the output signal can be parameterised in <a href="#">C00413/1</a> and <a href="#">C00413/2</a> . • For a detailed functional description see the <a href="#">L_SignalMonitor_a</a> FB.
Word 4	-	Not preconfigured
Words 5 ... 16	-	Not preconfigured • Only available in control mode "40: MCI".

Status word	Name	Status
Bit 0	DriveFail	1 ≡ Inverter in the error status • " <a href="#">Fault</a> " device status is active.
Bit 1	PowerDisabled	1 ≡ Inverter control inhibited (pulse inhibit is active)
Bit 2	DriveReady	1 ≡ Inverter is ready for operation • " <a href="#">SwitchedOn</a> " device status is active. • The drive is in this device status if the DC bus voltage is applied and the inverter is still inhibited by the user (controller inhibit).
Bit 3	SpeedCcw	0 ≡ Direction of rotation to the right (Cw) 1 ≡ Direction of rotation to the left (Ccw)
Bit 4	QSPIsActive	1 ≡ Quick stop is active
Bit 5	BrakeReleased	1 ≡ Brake released (after the brake opening time has elapsed)
Bit 6	ActSpeedIsZero	During open-loop operation: 1 ≡ Speed setpoint < Comparison value ( <a href="#">C00024</a> )
		During closed-loop operation: 1 ≡ Actual speed value < Comparison value ( <a href="#">C00024</a> )
Bit 7	ControllerInhibit	1 ≡ Inverter is inhibited (controller inhibit is active)
Bit 8	StatusCodeBit0	Bit coded display of the active device status ▶ <a href="#">Device state machine and device states</a> (see table <a href="#">[4-1]</a> )
Bit 9	StatusCodeBit1	
Bit 10	StatusCodeBit2	
Bit 11	StatusCodeBit3	
Bit 12	Warning	



Status word	Name	Status
Bit 13	Trouble	1 ≙ Inverter is in the "Trouble" device status • E.g. if an overvoltage has occurred.
Bit 14	JogCtrlInputSel1	Binary coded selection of the switch-off position 1 ... 3 • Bit 5 and bit 6 of the control word.
Bit 15	JogCtrlInputSel2	

### 7.4.5 Setting parameters (short overview)

Parameters	Info	Lenze setting	
		Value	Unit
<a href="#">C00011</a>	Appl.: Reference speed	1500	rpm
<a href="#">C00012</a>	Accel. time - main setpoint	2.000	s
<a href="#">C00013</a>	Decel. time - main setpoint	2.000	s
<a href="#">C00105</a>	Decel. time - quick stop	2.000	s
<a href="#">C00039/1</a>	Preset setpoint 1	40.00	%
<a href="#">C00039/2</a>	Preset setpoint 2	60.00	%
<a href="#">C00039/3</a>	Preset setpoint 3	80.00	%
<a href="#">C00039/4...15</a>	Fixed setpoint 4 ... 15	0.00	%
<a href="#">C00101/1...15</a>	Add. accel. time 1 ... 15	0.000	s
<a href="#">C00103/1...15</a>	Add. decel. time 1 ... 15	0.000	s
<a href="#">C00105</a>	Decel. time - quick stop	2.000	s
<a href="#">C00106</a>	Auto-DCB: Hold time	0.500	s
<a href="#">C00107</a>	DCB braking: Hold time	999.000	s
<a href="#">C00134</a>	L_NSet_1: Ramp smoothing	0: Off	
<a href="#">C00182</a>	L_NSet_1: S-ramp time PT1	20.00	s
<a href="#">C00190</a>	L_NSet_1: Setpoint arithmetic	0: Out = Set	
<a href="#">C00220</a>	L_NSet_1: Acceleration time - add. setpoint	0.000	s
<a href="#">C00221</a>	L_NSet_1: Deceleration time - add. setpoint	0.000	s
<a href="#">C00241</a>	L_NSet_1: Hyst. NSet reached	0.50	%
<a href="#">C00488/1</a>	InputSens.SlowDown1	0: Level	
<a href="#">C00488/2</a>	InputSens.Stop1	0: Level	
<a href="#">C00488/3</a>	InputSens.SlowDown2	0: Level	
<a href="#">C00488/4</a>	InputSens.Stop2	0: Level	
<a href="#">C00488/5</a>	InputSens.SlowDown3	0: Level	
<a href="#">C00488/6</a>	InputSens.Stop3	0: Level	
<a href="#">C00632/1</a>	L_NSet_1: Blocking speed 1 max	0.00	%
<a href="#">C00632/2</a>	L_NSet_1: Blocking speed 2 max	0.00	%
<a href="#">C00632/3</a>	L_NSet_1: Blocking speed 3 max	0.00	%
<a href="#">C00633/1</a>	L_NSet_1: Blocking speed 1 min	0.00	%
<a href="#">C00633/2</a>	L_NSet_1: Blocking speed 2 min	0.00	%
<a href="#">C00633/3</a>	L_NSet_1: Blocking speed 3 min	0.00	%
<a href="#">C00635</a>	L_NSet_1: nMaxLimit	199.99	%
<a href="#">C00636</a>	L_NSet_1: nMinLimit	-199.99	%
<a href="#">C00670</a>	L_OffsetGainP_1: Gain	1.0000	

Parameters	Info	Lenze setting	
		Value	Unit
<a href="#">C00671</a>	L_OffsetGainP_2: Gain	1.0000	
<a href="#">C00672</a>	L_OffsetGainP_3: Gain	1.0000	
<a href="#">C00696</a>	L_OffsetGainP_1: Offset	0.00	%
<a href="#">C00697</a>	L_OffsetGainP_2: Offset	0.00	%
<a href="#">C00698</a>	L_OffsetGainP_3: Offset	0.00	%
<a href="#">C00800</a>	L_MPot_1: Upper limit	100.00	%
<a href="#">C00801</a>	L_MPot_1: Lower limit	-100.00	%
<a href="#">C00802</a>	L_MPot_1: Acceleration time	10.0	s
<a href="#">C00803</a>	L_MPot_1: Deceleration time	10.0	s
<a href="#">C00804</a>	L_MPot_1: Inactive fct.	0: Retain value	
<a href="#">C00805</a>	L_MPot_1: Init fct.	0: Load last value	
<a href="#">C00806</a>	Use of motor potentiometer	0: No	
<a href="#">C02610/2</a>	MCK: Ramp time synchr. setpoint	2.000	s
<a href="#">C02611/1</a>	MCK: Pos. max. speed	199.99	%
<a href="#">C02611/2</a>	MCK: Pos. min. speed	0.00	%
<a href="#">C02611/3</a>	MCK: Neg. min. speed	0.00	%
<a href="#">C02611/4</a>	MCK: Neg. max. speed	199.99	%

**Related topics:**

- ▶ ["GeneralPurpose" functions \(📖 398\)](#)

7.4.6 Configuration parameters

If required, the subcodes of [C00760](#) and [C00761](#) serve to change the pre-configured assignment of the application inputs:

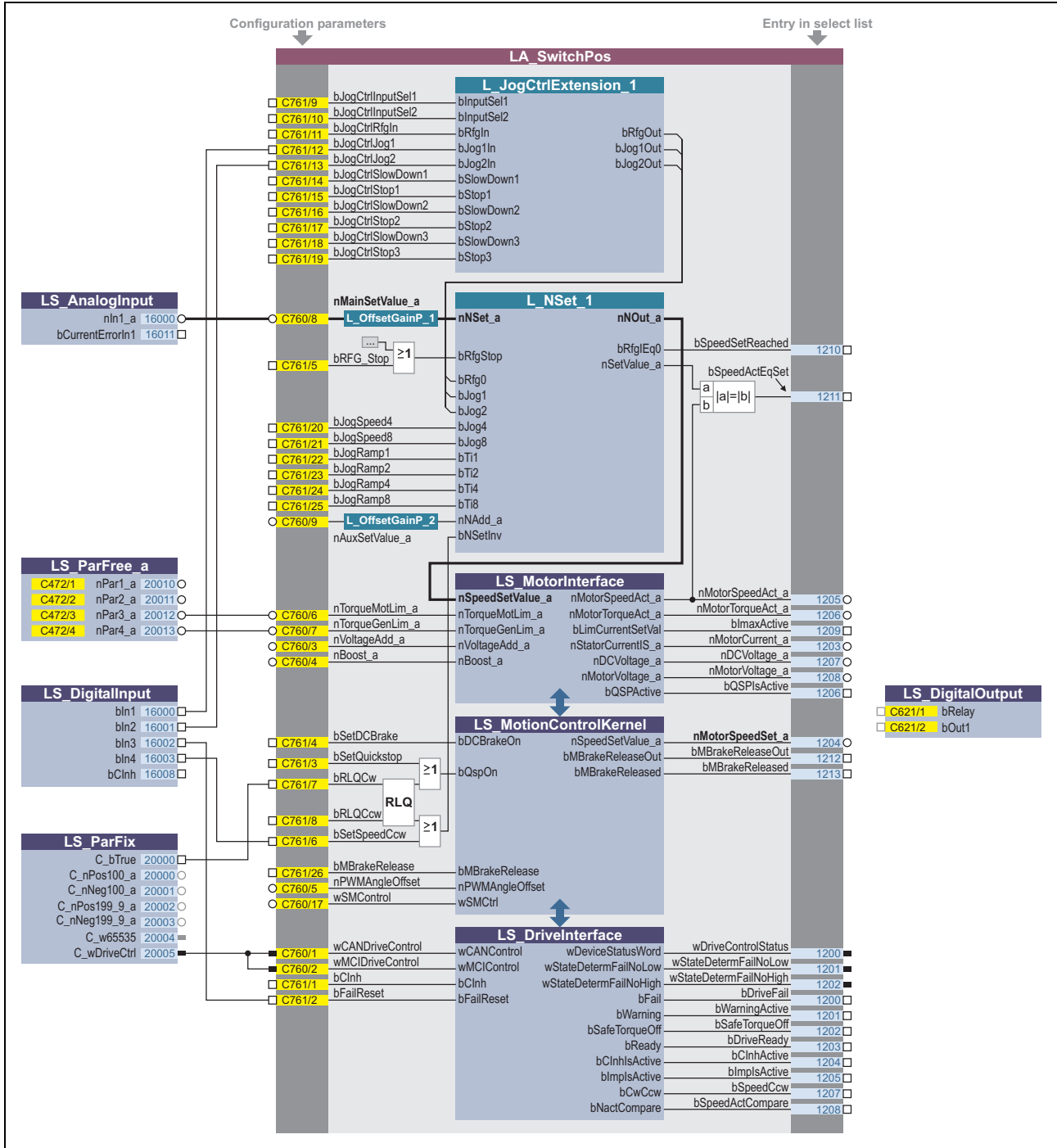

[7-14] Pre-assignment of the "Switch-off positioning" application in the "Terminals 0" control mode

Configuration parameters for "GeneralPurpose" functions

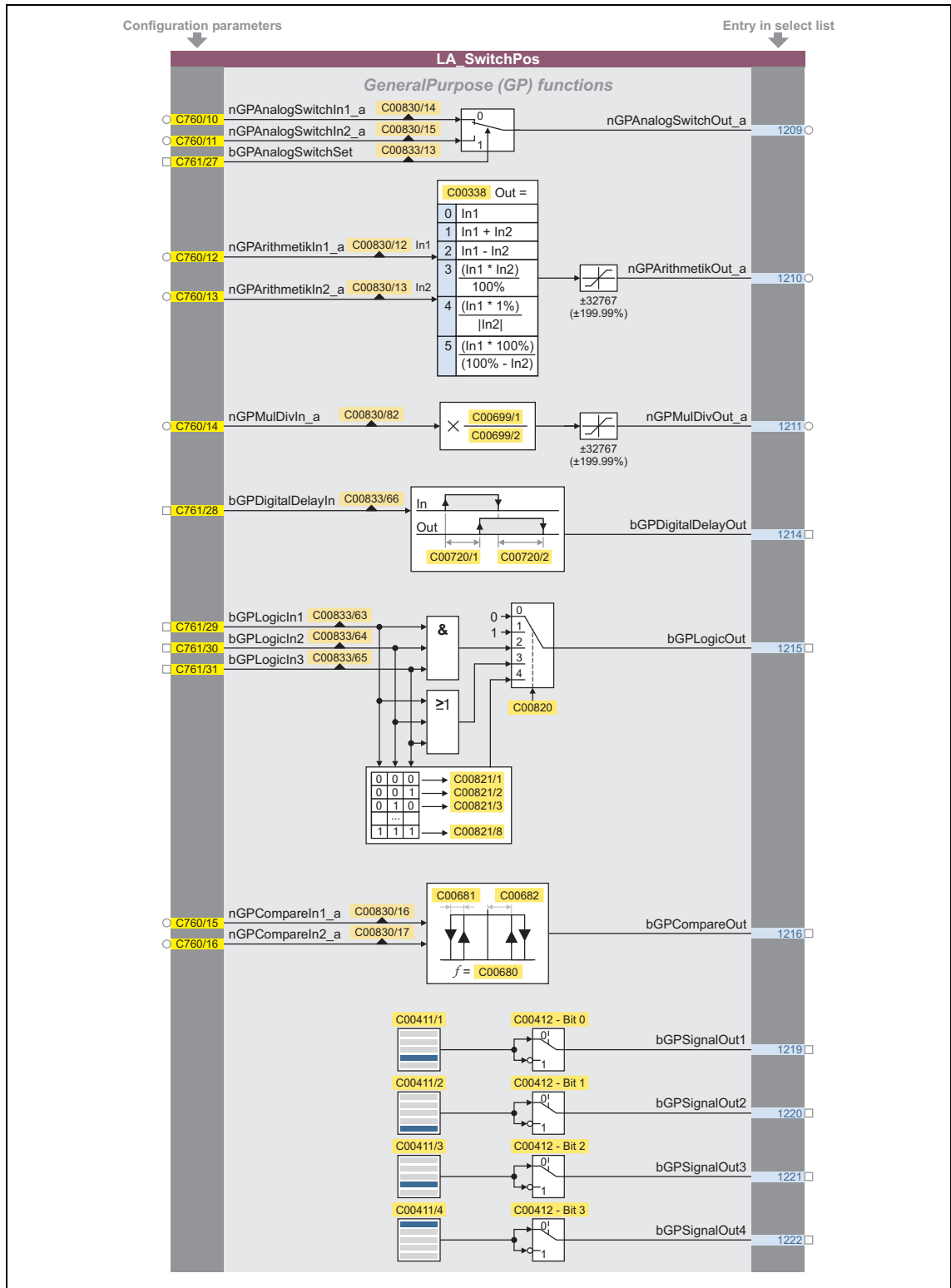

[7-15] "GeneralPurpose" functions

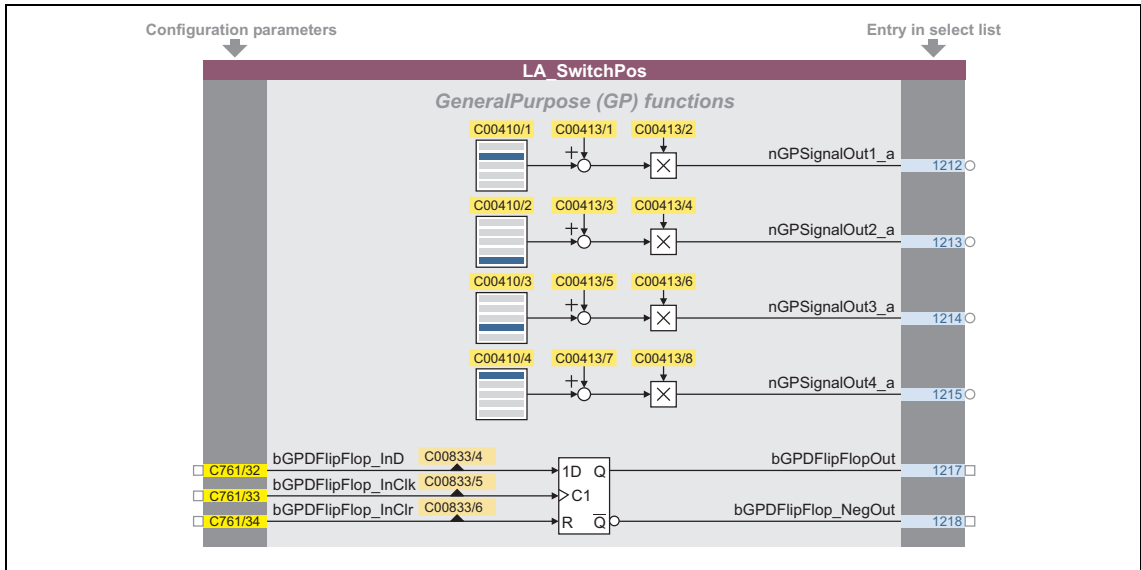

[7-16] "GeneralPurpose" functions (continuation)

**Free inputs and outputs**

These inputs can be freely interconnected in the application level. They can be used to transfer signals from the I/O level to the application level and vice versa.

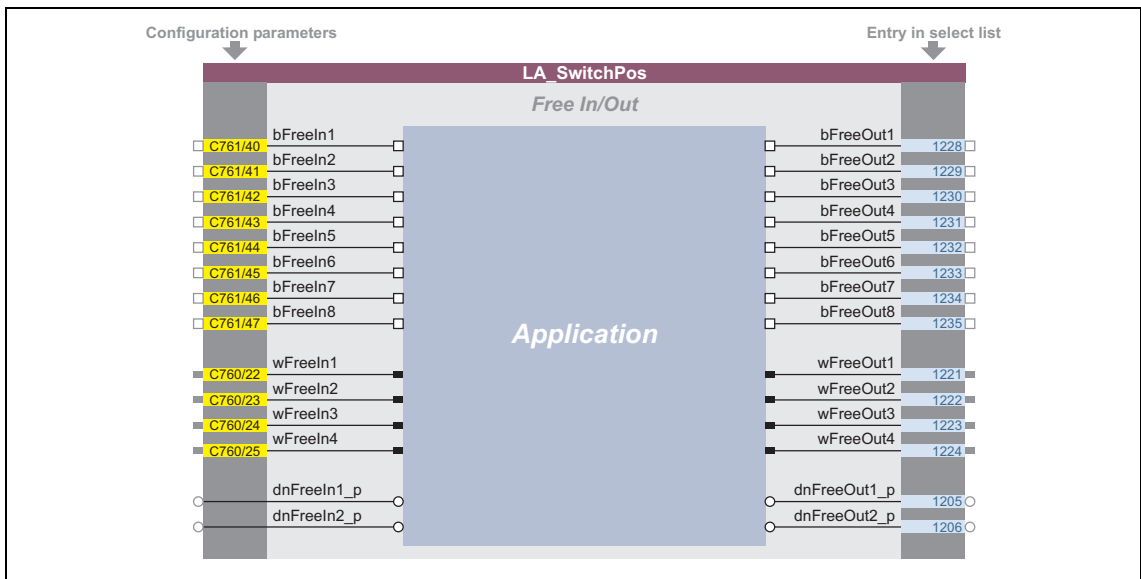

[7-17] Free inputs/outputs

**Related topics:**

- ▶ [User-defined terminal assignment](#) (📖 302)
- ▶ ["GeneralPurpose" functions](#) (📖 398)

### 7.5 "GeneralPurpose" functions

Each technology application provides different free logic and arithmetic functions, so-called "GeneralPurpose" functions.

For the interconnection of these functions, the application block features inputs and outputs on the I/O level, which are linked to the logic/arithmetic function.



#### Note!

In the Lenze setting, the connectors for the "GeneralPurpose" functions are hidden in the function block editor.

- These connections can be shown via the **Connector visibilities** command in the *Context menu* of the application block.



#### Tip!

The inputs of the "GeneralPurpose" functions can also be linked to other output signals via the configuration parameters of the technology application.

On the other hand, the outputs of the "GeneralPurpose" functions can be selected in the configuration parameters of other inputs.

#### Related topics:

- ▶ [User-defined terminal assignment](#) (📖 302)
- ▶ [TA "Actuating drive speed": Configuration parameters](#) (📖 335)
- ▶ [TA "Switch-off positioning": Configuration parameters](#) (📖 395)

### 7.5.1 Analog switch

This function switches between two analog input signals. The switch-over is controlled by a boolean input signal.

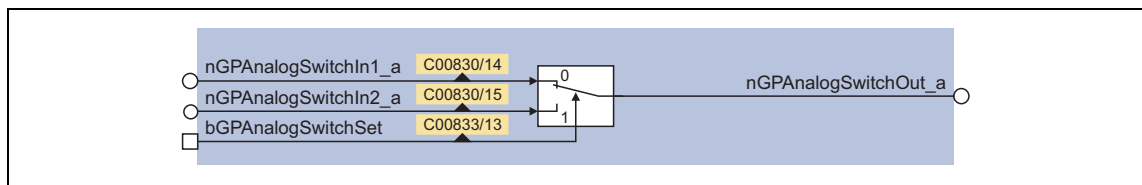

[7-18] GeneralPurpose function "Analog switch"

- For a detailed functional description see FB [L\\_AnalogSwitch](#).

### 7.5.2 Arithmetic

This function links two analog signals arithmetically. The arithmetic function can be parameterised.

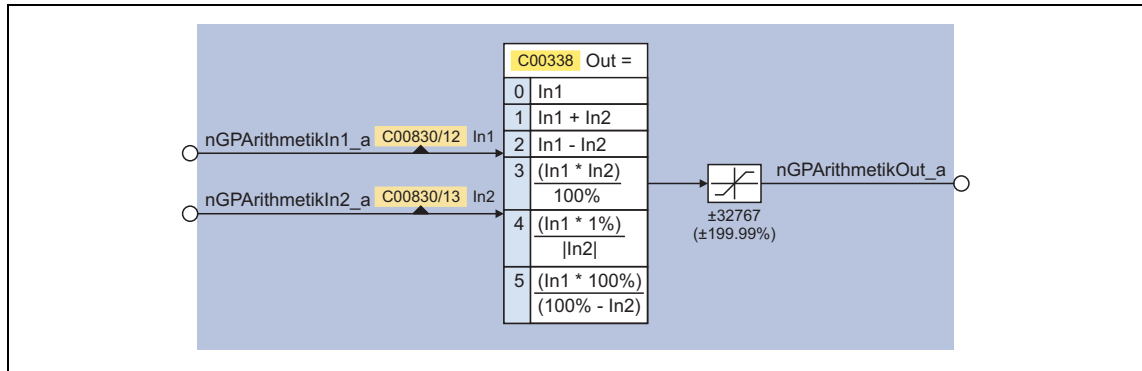

[7-19] GeneralPurpose function "Arithmetic"

Parameters	Info	Lenze setting	
		Value	Unit
<a href="#">C00338</a>	L_Arithmetik_1: Function	0: nOut_a = nIn1_a	

- For a detailed functional description see the [L\\_Arithmetik](#) FB.

### 7.5.3 Multiplication/Division

This function multiplies an analog input signal with a parameterisable factor. The factor must be selected in the form of a quotient (numerator and denominator).

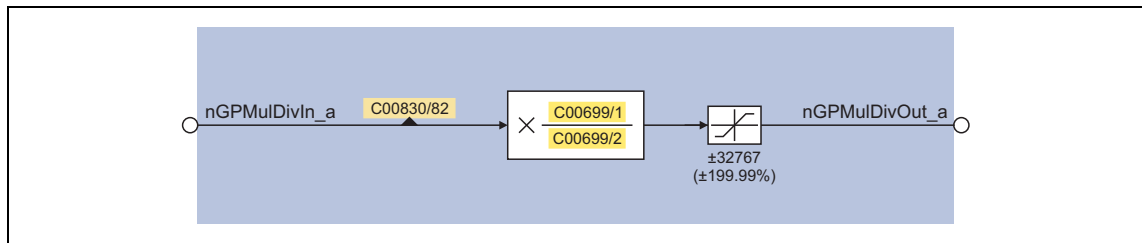

[7-20] GeneralPurpose function "Multiplication/division"

Parameters	Info	Lenze setting	
		Value	Unit
<a href="#">C00699/1</a>	L_MulDiv_1: Numerator	0	
<a href="#">C00699/2</a>	L_MulDiv_1: Denominator	10000	

- For a detailed functional description see FB [L\\_MulDiv](#).

### 7.5.4 Binary delay element

This function timely delays binary signals. On-delay and off-delay can be parameterised separately.

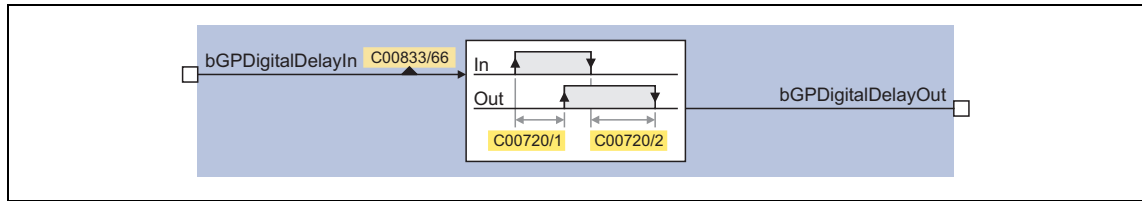

[7-21] GeneralPurpose function "Binary delay element"

Parameters	Info	Lenze setting	
		Value	Unit
<a href="#">C00720/1</a>	L_DigitalDelay_1: On delay	0.000	s
<a href="#">C00720/2</a>	L_DigitalDelay_1: Off delay	0.000	s

- For a detailed functional description see FB [L\\_DigitalDelay](#).

### 7.5.5 Binary logic

This function provides a binary output signal which is formed by a logic operation of the input signals. Alternatively, you can also select a fixed binary value which is independent of the input signals.

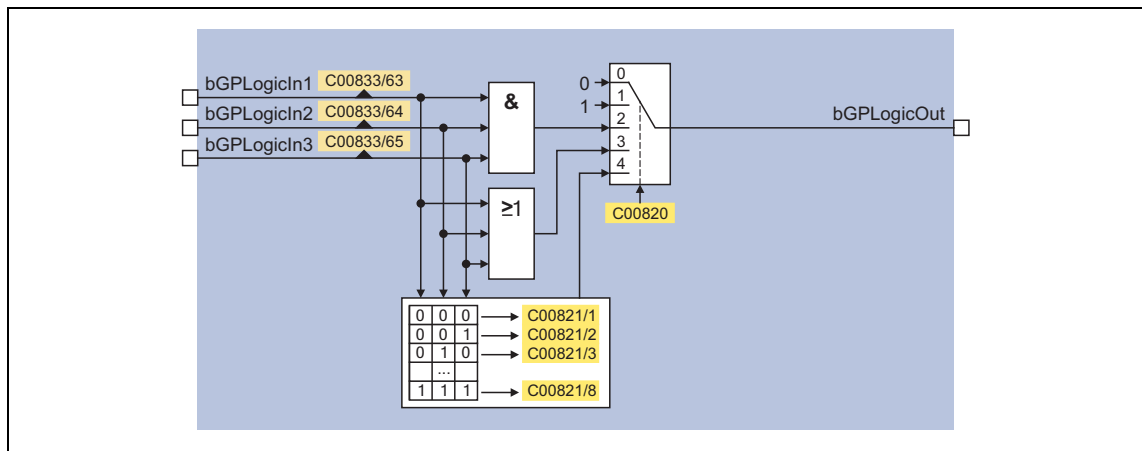

[7-22] GeneralPurpose function "Binary logic"

Parameters	Info	Lenze setting	
		Value	Unit
<a href="#">C00820</a>	L_DigitalLogic_1: Function	0: bOut = 0	
<a href="#">C00821/1</a>	bIn1=0/bIn2=0/bIn3=0	0: FALSE	
<a href="#">C00821/...</a>	...	...	
<a href="#">C00821/8</a>	bIn1=1/bIn2=1/bIn3=1	0: FALSE	

- For a detailed functional description see FB [L\\_DigitalLogic](#).



### 7.5.6 Analog comparison

This function compares two analog signals and can be used e.g. to realise a trigger. The comparison operation, hysteresis and window size can be parameterised.

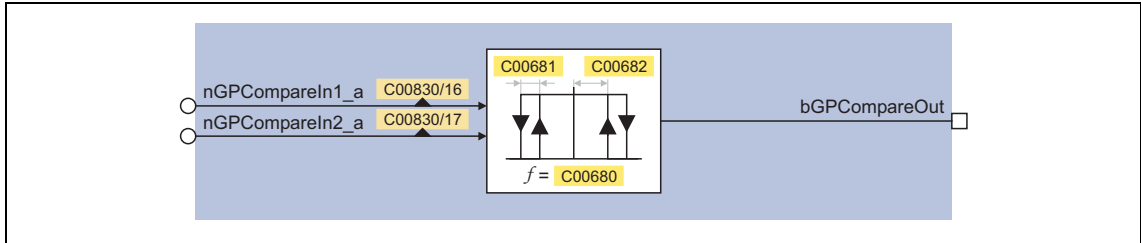

[7-23] GeneralPurpose function "Analog comparison"

Parameters	Info	Lenze setting	
		Value	Unit
<a href="#">C00680</a>	L_Compare_1: Fct.	6:  In1  <  In2	
<a href="#">C00681</a>	L_Compare_1: Hysteresis	0.50	%
<a href="#">C00682</a>	L_Compare_1: Window	2.00	%

- For a detailed functional description see FB [L\\_Compare](#).

### 7.5.7 Binary signal monitor

This function serves to output four binary signals selected from a list of all binary output signals available in the inverter. You can set an inversion of the output signals.

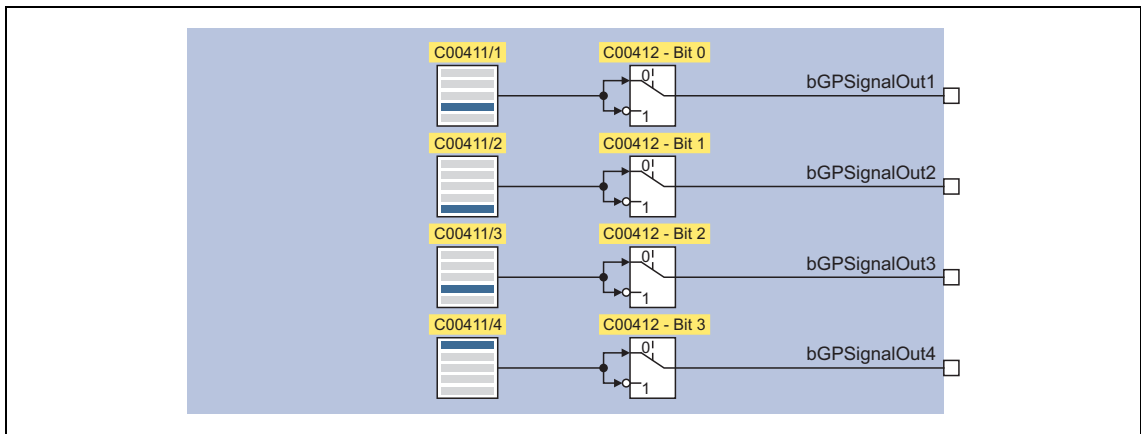

[7-24] GeneralPurpose function "Binary signal monitor"

Parameters	Info	Lenze setting	
		Value	Unit
<a href="#">C00411/1...4</a>	L_SignalMonitor_b: Signal 1 ... 4	0: Not connected	
<a href="#">C00412</a>	L_SignalMonitor_b: Inversion	Bit coded	

- For a detailed functional description see FB [L\\_SignalMonitor\\_b](#).

### 7.5.8 Analog signal monitor

This function serves to output four analog signals selected from a list of all analog output signals available in the inverter. Offset and gain of the source signals can be adjusted.

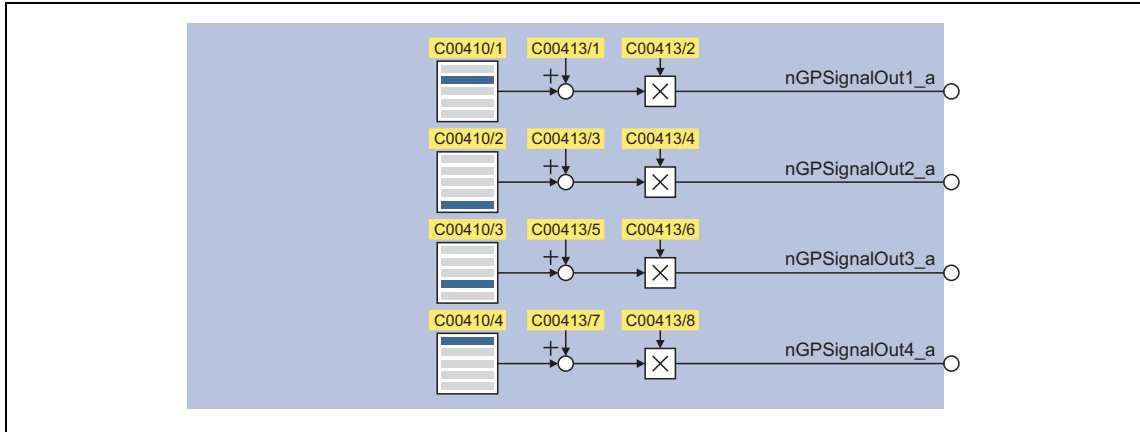

[7-25] GeneralPurpose function "Analog signal monitor"

Parameters	Info	Lenze setting	
		Value	Unit
<a href="#">C00410/1...4</a>	L_SignalMonitor_a: Signal 1 ... 4	0: Not connected	
<a href="#">C00413/1</a>	L_SignalMonitor_a: Signal 1 offset	0.00	%
<a href="#">C00413/2</a>	L_SignalMonitor_a: Signal 1 gain	100.00	%
<a href="#">C00413/3</a>	L_SignalMonitor_a: Signal 2 offset	0.00	%
<a href="#">C00413/4</a>	L_SignalMonitor_a: Signal 2 gain	100.00	%
<a href="#">C00413/5</a>	L_SignalMonitor_a: Signal 3 offset	0.00	%
<a href="#">C00413/6</a>	L_SignalMonitor_a: Signal 3 gain	100.00	%
<a href="#">C00413/7</a>	L_SignalMonitor_a: Signal 4 offset	0.00	%
<a href="#">C00413/8</a>	L_SignalMonitor_a: Signal 4 gain	100.00	%

- For a detailed functional description see the [L\\_SignalMonitor\\_a](#) FB.

### 7.5.9 D-FlipFlop

This function saves the logic status of the data input (1D) in case of an active clock edge at the clock input (C1) and puts out its value in sequence at the output Q. If there is no active clock edge, the input value is not accepted.

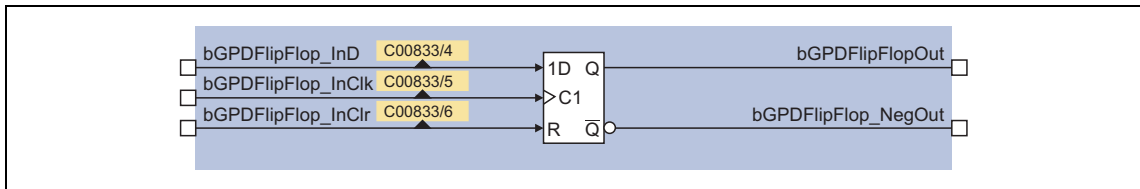

[7-26] GeneralPurpose function "D-FlipFlop" (clock-edge controlled)

- For a detailed functional description see FB [L\\_DFliPflOp](#).

### 8 Basic drive functions (MCK)

In this chapter, the standard and basic drive functions integrated in the **Motion Control Kernel (MCK)** of the 8400 StateLine are described to which the active technology application can gain access via defined internal interfaces. As a result, the time-consuming creation of individual FB interconnections is avoided and the amount of work and complexity involved in the implementation of standard functions is minimised.

In the **Motion Control Kernel**, for example, an automatic holding brake control function is integrated which controls the holding brake in relation to the speed setpoint and various other internal control signals. Due to integrated automatic brake operation, the user is relieved of the task of managing these control signals.

# 8 Basic drive functions (MCK)

## 8.1 Basic signal flow

### 8.1 Basic signal flow

The **Motion Control Kernel** is connected between setpoint generator (e.g. ramp generator, PID process controller, etc.) and the motor control function in the case of the available technology applications. For problem-free interaction of the **Motion Control Kernel** and motor control function, the two associated system blocks [LS\\_MotionControlKernel](#) and [LS\\_MotorInterface](#) have interfaces with corresponding inputs/outputs. These are visible in the FB Editor for monitoring purposes and must be connected to each other:

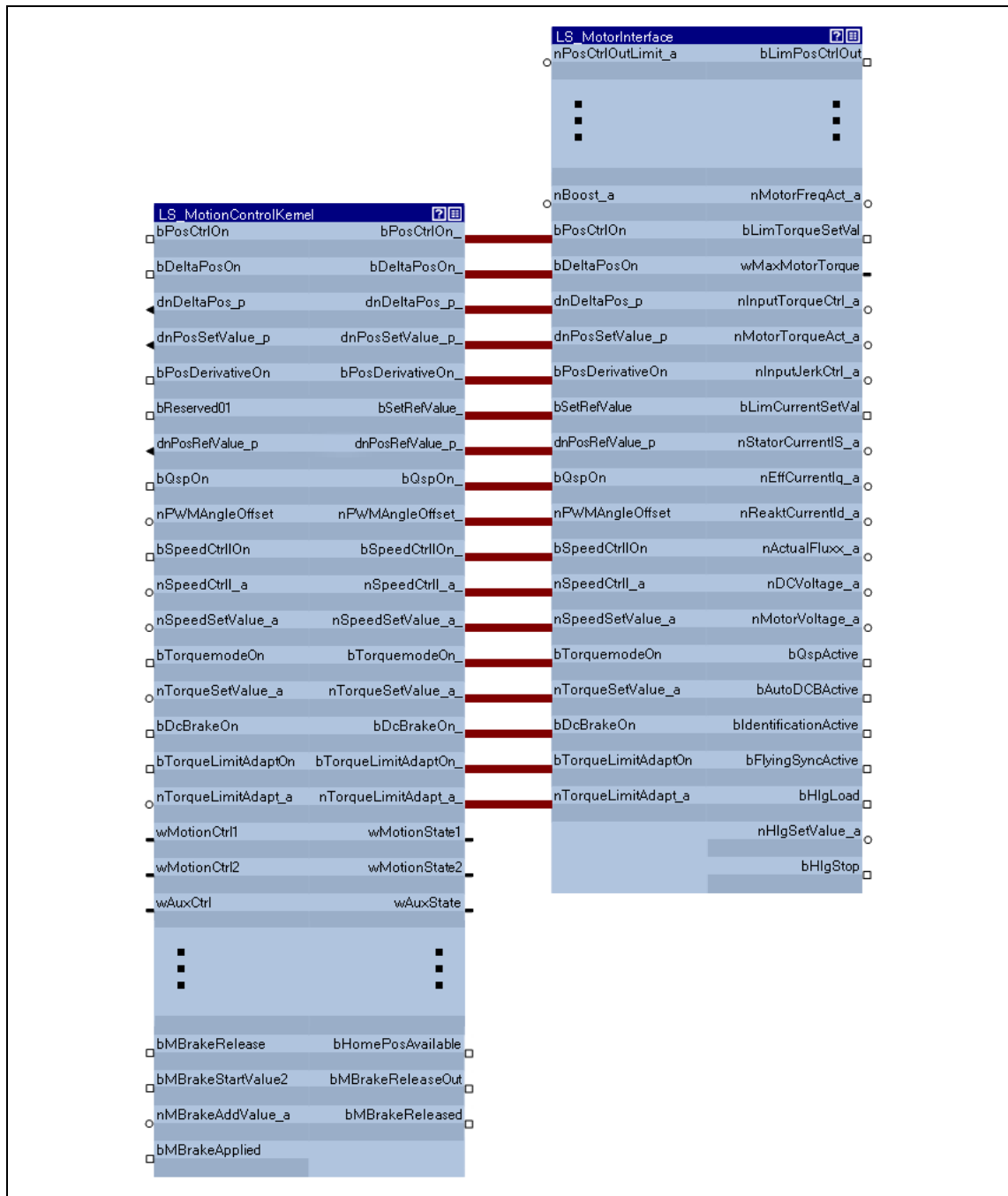

[8-1] Interconnection of Motion Control Kernel and motor control function

In the interconnection previously shown, the **Motion Control Kernel** monitors every interface. Some of the signals such as a quick stop request or a DC-injection braking request are directly passed through to the motor control. However, other signals are passed through or modified depending on the operating mode (e.g. synchronising a setpoint selection via ramp function).

## 8.2 Internal interfaces | System block "LS\_MotionControlKernel"

In the Function Block editor, the system block **LS\_MotionControlKernel** provides the interfaces to the **Motion Control Kernel**.

### inputs

Designator Data type	Information/possible settings
<b>Control and setpoint signals for motor control</b> The purpose of the following inputs is to transfer control signals and setpoints to the internal motor control function ( <a href="#">LS_MotorInterface</a> ).	
bPosCtrlOn	Inputs of 8400 StateLine have no function!
bDeltaPosOn	
dnDeltaPos_p	
dnPosSetValue_p	
bPosDerivativeOn	
bReserved01	
dnPosRefValue_p	
bQspOn BOOL	Trigger quick stop (QSP) via the MCK <ul style="list-style-type: none"> <li>Also see device command "<a href="#">Activate/deactivate quick stop</a>".</li> </ul>
	TRUE Activate quick stop <ul style="list-style-type: none"> <li>Motor control is decoupled from the setpoint selection and, within the deceleration time parameterised in <a href="#">C00105</a>, the motor is brought to a standstill (<math>n_{act} = 0</math>).</li> <li>A pulse inhibit is set if the auto-DCB function has been activated via <a href="#">C00019</a>.</li> <li>The motor is kept at a standstill during closed-loop operation (function in preparation).</li> </ul>
	FALSE Deactivate quick stop <ul style="list-style-type: none"> <li>The quick stop is deactivated if no other source for the quick stop is active.</li> <li><a href="#">C00159</a> displays a bit code of active sources/causes for the quick stop.</li> </ul>
nPWMAngleOffset INT	Angular offset input <ul style="list-style-type: none"> <li>Scaling: 16384 <math>\equiv</math> 100 %</li> <li>Setting range: 0 ... 199.99 %</li> </ul>
bSpeedCtrlOn BOOL	Directly set the I-component of speed controller <ul style="list-style-type: none"> <li>In order to statically specify a minimum torque, e.g. when a load is being lifted.</li> </ul>
	TRUE Set the I-component of the speed controller to the value $nSpeedCtrlI_a$ .
nSpeedCtrlI_a INT	I-component of the speed controller <ul style="list-style-type: none"> <li>Value is adopted in the case of a FALSE-TRUE edge at the input <math>bSpeedCtrlOn</math>.</li> </ul>
nSpeedSetValue_a INT	Rotation speed/velocity setpoint
bTorquemodeOn BOOL	TRUE Switch on torque-controlled operation
nTorqueSetValue_a INT	Torque setpoint

Designator	Data type	Information/possible settings				
bDcBrakeOn	BOOL	<p>Manual DC-injection braking (DCB)</p> <ul style="list-style-type: none"> <li>For this function, the <i>bDcBrakeOn_</i> output signal must be connected to the <i>bDcBrakeOn</i> input of the same name of the <a href="#">LS MotorInterface</a> system block.</li> <li>Detailed information on DC-injection braking is provided in the motor control chapter, subchapter "<a href="#">DC-injection braking</a>".</li> </ul> <p> <b>Note!</b></p> <p>Holding braking is not possible when this braking mode is used! Use the basic "<a href="#">Holding brake control</a>" function for controlling the holding brake with a low rate of wear.</p> <table border="1"> <tr> <td>FALSE</td> <td>Deactivate DC-injection braking.</td> </tr> <tr> <td>TRUE</td> <td>Activate DC-injection braking, i.e. the drive is brought to a standstill by means of DC-injection braking. <ul style="list-style-type: none"> <li>The braking effect stops when the rotor is at standstill.</li> <li>After the hold time (<a href="#">C00107</a>) has expired, the controller sets the pulse inhibit.</li> </ul> </td> </tr> </table>	FALSE	Deactivate DC-injection braking.	TRUE	Activate DC-injection braking, i.e. the drive is brought to a standstill by means of DC-injection braking. <ul style="list-style-type: none"> <li>The braking effect stops when the rotor is at standstill.</li> <li>After the hold time (<a href="#">C00107</a>) has expired, the controller sets the pulse inhibit.</li> </ul>
FALSE	Deactivate DC-injection braking.					
TRUE	Activate DC-injection braking, i.e. the drive is brought to a standstill by means of DC-injection braking. <ul style="list-style-type: none"> <li>The braking effect stops when the rotor is at standstill.</li> <li>After the hold time (<a href="#">C00107</a>) has expired, the controller sets the pulse inhibit.</li> </ul>					
bTorqueLimitAdaptOn		Inputs of 8400 StateLine have no function!				
nTorqueLimitAdapt_a						
<b>Control words</b>						
MCK: wMotionCtrl1 wMotionCtrl2		Inputs of 8400 StateLine have no function!				
wAuxCtrl						
wSMCtrl	WORD	<p>Interface to the optional safety system.</p> <ul style="list-style-type: none"> <li>Setting control bit 0 ("SafeStop1") in this control word causes e.g. the automatic deceleration of the drive to standstill within this application (in the <b>Motion Control Kernel</b>).</li> <li>See the "<a href="#">Interface to safety system</a>" subchapter for a detailed description of the individual control bits.</li> </ul>				
<b>Control and setpoint signals for Motion Control Kernel function</b>						
dnProfilePosition_p		Inputs of 8400 StateLine have no function!				
nSpeedAddValue_v						
nSpeedOverride_a						
nAccOverride_a						
nSRampOverride_a						
bLimitSwitchPos						
bLimitSwitchNeg						
bHomingMark						
bMBrakeRelease	BOOL	<p><a href="#">Holding brake control:</a> Releasing/applying the brake in connection with the selected operating mode</p> <table border="1"> <tr> <td>FALSE</td> <td>Apply brake. <ul style="list-style-type: none"> <li>During automatic operation, the internal brake logic controls the brake.</li> </ul> </td> </tr> <tr> <td>TRUE</td> <td>Release brake manually (forced release). <ul style="list-style-type: none"> <li><b>Note!</b> The brake can also be released when the controller is inhibited!</li> <li>During automatic operation, the internal brake logic is deactivated and the brake is released (supervisor operation). If a controller inhibit has been set by the brake control, it will be deactivated.</li> <li>In semi-automatic operation, the brake is released including feedforward control.</li> </ul> </td> </tr> </table>	FALSE	Apply brake. <ul style="list-style-type: none"> <li>During automatic operation, the internal brake logic controls the brake.</li> </ul>	TRUE	Release brake manually (forced release). <ul style="list-style-type: none"> <li><b>Note!</b> The brake can also be released when the controller is inhibited!</li> <li>During automatic operation, the internal brake logic is deactivated and the brake is released (supervisor operation). If a controller inhibit has been set by the brake control, it will be deactivated.</li> <li>In semi-automatic operation, the brake is released including feedforward control.</li> </ul>
FALSE	Apply brake. <ul style="list-style-type: none"> <li>During automatic operation, the internal brake logic controls the brake.</li> </ul>					
TRUE	Release brake manually (forced release). <ul style="list-style-type: none"> <li><b>Note!</b> The brake can also be released when the controller is inhibited!</li> <li>During automatic operation, the internal brake logic is deactivated and the brake is released (supervisor operation). If a controller inhibit has been set by the brake control, it will be deactivated.</li> <li>In semi-automatic operation, the brake is released including feedforward control.</li> </ul>					

Designator	Data type	Information/possible settings				
bMBrakeStartValue2 <small>(from version 11.00.00)</small>	BOOL	<p><b>Holding brake control:</b> Selection of the torque feedforward control value ▶ <a href="#">Feedforward control of the motor before release</a></p> <table border="1"> <tr> <td>FALSE</td> <td>Starting value 1 is active (see the following figure).</td> </tr> <tr> <td>TRUE</td> <td>Starting value 2 is active (see the following figure).</td> </tr> </table> <p>Creation of the feedforward control value for the release process of the brake:  <b>A</b> Signal path for motor control <u>with</u> feedback  <b>B</b> Signal path for motor control <u>without</u> feedback  <b>C</b> Feedforward control value</p> <p> <b>1</b> <a href="#">C02581/1</a>: Switching threshold  <b>2</b> <a href="#">C02581/2</a>: Hysteresis for release  <b>3</b> <a href="#">C02581/3</a>: Hysteresis for application  <b>4</b> <a href="#">C02581/4</a>: Starting value 1 for manual feedforward control  <b>5</b> <a href="#">C02581/5</a>: Starting value 2 for manual feedforward control  <b>6</b> <a href="#">C02582/Bit 4</a>: Selection of the feedforward control value (automatic/manual selection)                 </p>	FALSE	Starting value 1 is active (see the following figure).	TRUE	Starting value 2 is active (see the following figure).
FALSE	Starting value 1 is active (see the following figure).					
TRUE	Starting value 2 is active (see the following figure).					
nMBrakeAddValue_a <small>(from version 11.00.00)</small>	INT	<p><b>Holding brake control:</b> Additive feedforward control value (speed or torque) in [%] for torque feedforward control when the respective control mode is started</p> <ul style="list-style-type: none"> <li>For speed control: 100 % ≙ reference speed (<a href="#">C00011</a>)</li> <li>For torque control: 100 % ≙ maximum torque (<a href="#">C00057</a>)</li> </ul> <p>▶ <a href="#">Feedforward control of the motor before release</a></p>				
bMBrakeApplied <small>(from version 11.00.00)</small>	BOOL	<p><b>Holding brake control:</b> Input for status detection via switching contacts at the brake</p> <ul style="list-style-type: none"> <li>Only effective if bit 5 in <a href="#">C02582</a> is set to "1".</li> </ul> <table border="1"> <tr> <td>FALSE</td> <td>Brake is released.</td> </tr> <tr> <td>TRUE</td> <td>Brake is applied.</td> </tr> </table>	FALSE	Brake is released.	TRUE	Brake is applied.
FALSE	Brake is released.					
TRUE	Brake is applied.					

### outputs

Designator	Data type	Value/meaning	
<b>Control and setpoint signals for motor control</b>			
The following outputs are used to transfer control signals and setpoints to the internal motor control function ( <a href="#">LS_MotorInterface</a> ).			
bPosCtrlOn_		Outputs of 8400 StateLine have no function!	
bDeltaPosOn_			
dnDeltaPos_p_			
dnPosSetValue_p_			
bPosDerivativeOn_			
bSetRefValue_	BOOL	TRUE	Set actual position to home position. • Trigger signal when reference setting is requested or the reference signal is detected during the referencing procedure.
(from version 18.00.00)			
dnPosRefValue_p_		Output of 8400 Stateline have no function!	
bQspOn_	BOOL	TRUE	Activate quick stop
nPWMAngleOffset_a_	INT	Angular offset input	
bSpeedCtrlOn_	BOOL	TRUE	Set I-component of speed controller.
nSpeedCtrlI_a_	INT	I-component of the speed controller	
nSpeedSetValue_a_	INT	Main setpoint of speed	
bTorqueModeOn_	BOOL	TRUE	Switch on torque-guided operation.
nTorqueSetValue_a_	INT	Torque setpoint	
bDcBrakeOn_	BOOL	TRUE	Activate DC-injection braking.
bTorqueLimitAdaptOn_		Outputs of 8400 StateLine have no function!	
nTorqueLimitAdapt_a_			
<b>Status words</b>			
wMotionState1		MCK status word 1 & 2 • For a detailed description of the individual status bits, see subchapter entitled " <a href="#">MCK status word</a> ."	
wMotionState2	WORD		
wAuxState		Output of 8400 Stateline have no function!	
<b>Status signal and actual-value signals from Motion Control Kernel functions</b>			
nSpeedSet_v		Outputs of 8400 StateLine have no function!	
dnPosTarget_p			
dnPosSet_p			
dnPosSetRelative_p			
wActProfileNo			
wFollowProfileNo			
bBusy			
bDone			
bHomingDone			
bHomePosAvailable			



Designator	Data type	Value/meaning	
bMBrakeReleaseOut	BOOL	Trigger signal for switching element holding brake control via a digital output <ul style="list-style-type: none"> <li>• Use bit 0 in <a href="#">C02582</a> to activate inverted switching element triggering.</li> </ul> ▶ <a href="#">Holding brake control</a>	
		FALSE	Apply brake.
		TRUE	Release brake.
bMBrakeReleased	BOOL	"Brake released" status signal considering the brake release time <ul style="list-style-type: none"> <li>• When the holding brake is triggered to close, <i>bMBrakeReleased</i> is immediately set to FALSE even if the brake closing time has not yet elapsed!</li> </ul> ▶ <a href="#">Holding brake control</a>	
		TRUE	Brake released (after the brake release time has expired).

### 8.2.1 MCK status word

#### MCK status word 1 (wMotionState1)

Bit	Designation	Description	Bit 3	Bit 2	Bit 1	Bit 0
0	ActOpModeBit00	<b>Active operating mode</b> <a href="#">Speed follower</a> <a href="#">Safe stop 1 (SS1)</a> StandBy (internal operating mode in the event of quick stop, pulse inhibit, and DC-injection braking)				
...	...		0	0	0	0
3	ActOpModeBit03		0	1	0	0
			1	1	1	1
4	Busy	For 8400 StateLine no function (always "0")!				
5	Done					
6	AcceleratingActive					
7	ConstSpeedDuty					
8	DeceleratingActive					
9	S_ShapingActive					
10	Pos. HW-Limit Detected					
11	Neg. HW-Limit Detected					
12	HomPosDone					
13	HomPosAvailable					
14	Reserved	-				
15	Reserved	-				



#### Note!

The internal "StandBy" operating mode is assumed if pulse inhibit, quick stop and/or DC-injection braking are activated.

- In this operating mode, no setpoint generation takes place through the **Motion Control Kernel**.
- If the holding brake control sets a controller inhibit when the holding brake is closed, the internal "StandBy" operating mode is not assumed.

#### MCK status word 2 (wMotionState2)

Bit	Designation	Description
16	DwellTime	For 8400 StateLine no function (always "0")!
17	InTarget	
18	PosDone	
19	Reserved	
20	ActPosMode_Bit00	
...	...	
23	ActPosMode_Bit03	
24	ActProfileNo_Bit00	
...	...	
31	ActProfileNo_Bit07	

## 8.2.2 MCK state machine

Prio	Condition	
1	15 Setpoint generation through <a href="#">Motor control (MCTRL)</a> : • DCB = DC-injection braking • QSP = quick stop • CINH = controller inhibit	
2	4 "Safe stop 1" (SS1) requested ▶ <a href="#">Interface to safety system</a>	
3	0 <a href="#">Speed follower</a> requested	

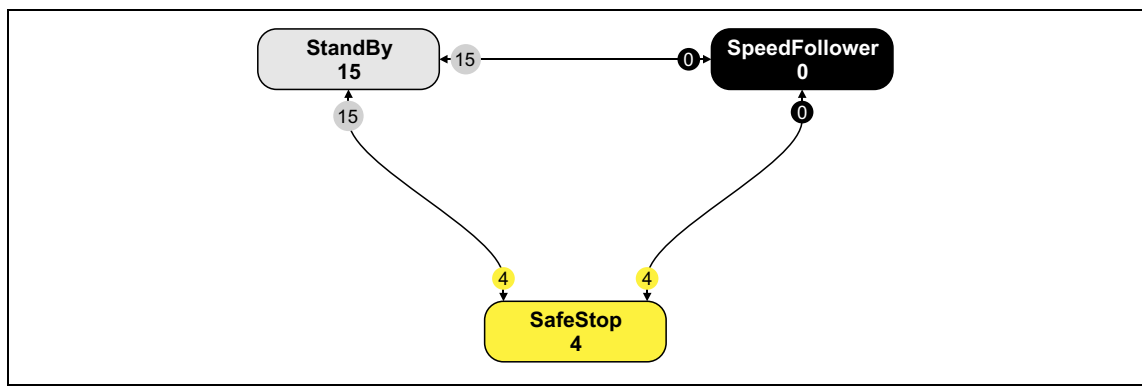

[8-2] MCK state machine

## 8.2.2.1 "StandBy" operating mode

The internal "StandBy" operating mode is implicitly assumed if controller inhibit, pulse inhibit, quick stop and/or DC-injection braking are activated. Thus, there is no setpoint generation by the **Motion Control Kernel** in the "StandBy" operating mode.

- If the holding brake control sets a controller inhibit when the holding brake is closed, the internal "StandBy" operating mode is not assumed.
- The "StandBy" operating mode cannot be activated via the MCK control word.
- When the "StandBy" operating mode is active, bits 0 ... 3 are set in the MCK status word.

**Speed acceptance when the "StandBy" operating mode is quit**

If the operating mode is changed from "StandBy" to "SpeedFollower", not only controller inhibit, pulse inhibit, quick stop and/or DC-injection braking are cancelled but also the current speed is transferred to the speed setpoint if [Flying restart function](#) is activated.

From version V12.00.00 onwards, a sensitive threshold can be set in [C2611/5](#). If the absolute value of the current speed is below the sensitivity threshold, the value "0" is transferred to the speed setpoint instead of the current speed.

In the Lenze setting "0.5 %", the sensitivity threshold corresponds to approx. 7.5 rpm at a reference speed of 1500 rpm set in [C00011](#).

### 8.2.2.2 Status bit "bReadyToOperate"

This function extension is available from version 16.00.00!

The **LS\_MotionControlKernel** with status bit 19 in the status word 2 (wMotionState2) provides the signalling for the readiness to process the setpoint signals or setpoint commands. The state of bit *bReadyToOperate* provides TRUE if, for instance, a defined speed setpoint or a command (e.g. "manual jog positive") can be directly processed by the **LS\_MotionControlKernel**.

The status of this bit depends on three factors:

- Operating mode of the MotionControlKernel
  - *bReadyToOperate* = FALSE if operating mode **Standby** or **Stop**
- Synchronisation status
  - *bReadyToOperate* = FALSE if **LS\_MotionControlKernel** executes a synchronisation process in the operating modes **Speed follower** or **Position follower**.

The figure shows the logical relationship:

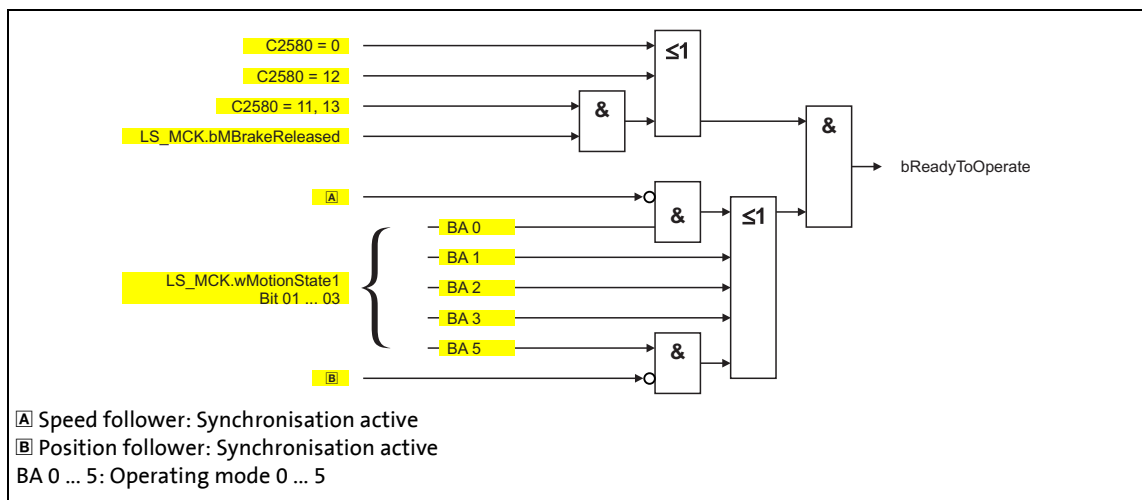

[8-3] Creation of the status bit *bReadyToOperate*

### 8.2.3 Interface to safety system

For operation with optional safety system, the [LS\\_MotionControlKernel](#) system block has the *wSMCtrl* input. This interface is used to transfer a control word by means of which the **Motion Control Kernel** can be supplied with information on requested or active safety functions. The **Motion Control Kernel** then initiates the necessary motion sequence (e.g. braking).

At the moment, only bit 0 in the *wSMCtrl* control word has a function. Additional functions are in preparation:

Bit	Designation	Description
0	SafeStop1	"1" ≙ Request for "Safe Stop 1" (SS1).
1	Reserved	In preparation - Still without function!
...		
15		

#### Behaviour in case of request for "Safe Stop 1" (SS1)

The drive is brought to a standstill with the stopping ramp set in [C02610/3](#).

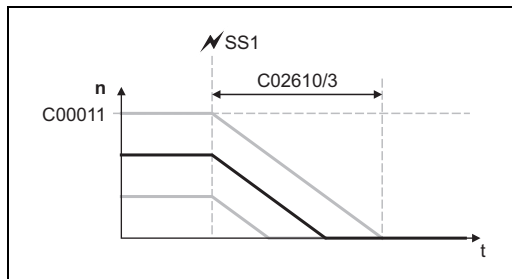

- The time set in [C02610/3](#) refers to the down-ramping of the reference speed set in [C00011](#).
- If the current speed is lower, the time to standstill is accordingly lower as well.

[8-4] Ramping down to standstill

If the request is reset during the down-ramping process (bit 0 = "1↘0"), the behaviour depends on the active operating mode:

- In the "[Speed follower](#)" operating mode, direct synchronisation with the target speed takes place with the ramp time set in [C02610/2](#).

# 8 Basic drive functions (MCK)

## 8.3 Speed follower

### 8.3 Speed follower

The 8400 StateLine inverter only supports the "speed follower" operating mode where the drive follows a speed setpoint.

#### 8.3.1 Parameter setting

Short overview of parameters for the "speed follower" operating mode:

Parameters	Info	Lenze setting	
		Value	Unit
<a href="#">C02610/2</a>	MCK: Ramp time synchr. setpoint	2.000	s
<a href="#">C02611/1</a>	MCK: Pos. max. speed	199.99	%
<a href="#">C02611/2</a>	MCK: Pos. min. speed	0.00	%
<a href="#">C02611/3</a>	MCK: Neg. min. speed	0.00	%
<a href="#">C02611/4</a>	MCK: Neg. max. speed	199.99	%

In the »Engineer«, you can set the initial limit by means of the dialog box *Min/Max speed*.

- Open the *Min/max speed* dialog box by opening the **Application Parameters** tab and clicking on the following button on the dialog level *Overview* → *Signal flow*:



### 8.3.2 Setpoint selection

The speed setpoint is selected via the *nSpeedSetValue\_a* process input and additively via the *nSpeedAddValue\_v* process input.

- Usually, the ramp generator [L\\_NSet](#) and, optionally, the process controller [L\\_PCTRL](#) are upstream of the *nSpeedSetValue\_a* process input.
- The speed setpoint is limited internally to the speed limits set in [C02611/1...4](#).

#### Speed setpoint generation

When the speed limit values are set, the **Motion Control Kernel** influences the setpoint generation with a synchronisation mode. The synchronisation mode serves to travel the synchronisation range dynamically with the synchronisation ramp set in [C02610/2](#):

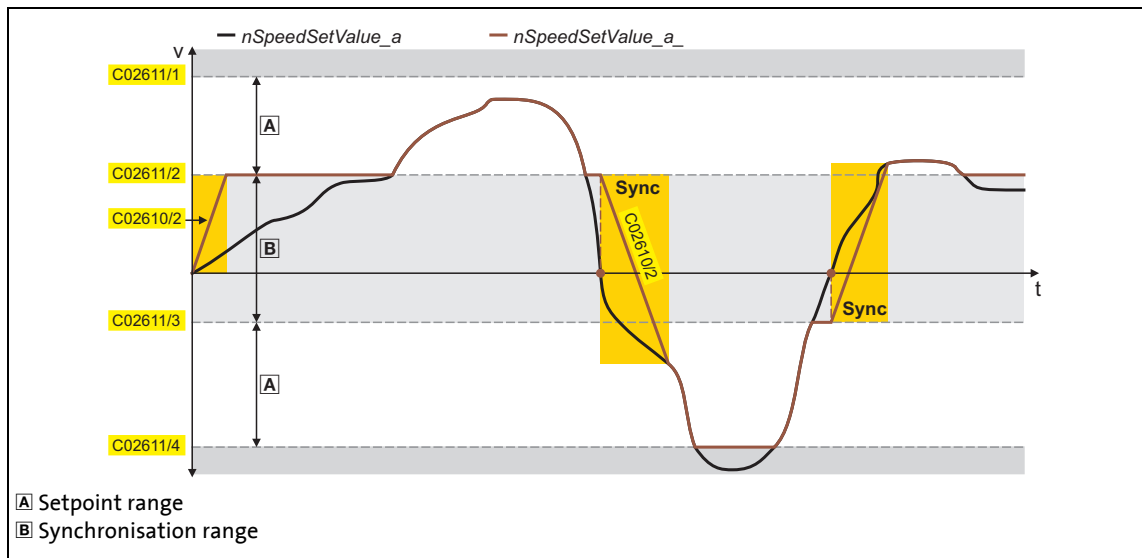

[8-5] Example: Speed setpoint generation in the "Speed follower" operating mode (with *nSpeedAddValue\_v* = 0)

### 8.4 Holding brake control

This basic function is used for low-wear control of a holding brake.



#### Danger!

Please note that the holding brake is an important element of the safety concept of the machine as a whole.

Thus, proceed very carefully when commissioning this system part!



#### Stop!

Holding brakes on Lenze motors are not intended for braking during operation. The increased wear caused by braking during operation can destroy the motor holding brake!



#### Note!

- **Deactivate automatic DC-injection braking when a holding brake is used!**
  - For this purpose, go to [C00019](#) and set the [Auto DCB](#) threshold to "0".
  - Background: Controller inhibit is already activated by the holding brake control.
- If an electrically holding (self-releasing) brake is to be controlled instead of an electrically released (self-holding) brake, the trigger signal must be inverted!
  - ▶ [Functional settings](#) (□ 422)
- Detailed information on mounting and electrical installation of the motor holding brake can be found in the documentation on the motor holding brake.

#### Intended use

Motor holding brakes are used to lock axes if the controller is inhibited or in case of "mains off" system status. This is not only important for vertical axes but also for e.g. horizontal axes which may cause various problems if the motion is not controlled.

Examples:

- Loss of the reference information after mains OFF and further spinning of the drive.
- Collision with other moving machine parts.



### 8.4.1 Internal interfaces

In the function block editor, the [LS MotionControlKernel](#) system block provides the following internal interfaces for the basic function "holding brake control":

#### inputs

Designator	Data type	Information/possible settings				
bMBrakeRelease	BOOL	Releasing/applying the brake in connection with the selected operating mode <table border="1" style="width: 100%; border-collapse: collapse;"> <tr> <td style="width: 10%; text-align: center;">FALSE</td> <td>Apply brake.                             <ul style="list-style-type: none"> <li>During automatic operation, the internal brake logic controls the brake.</li> </ul> </td> </tr> <tr> <td style="text-align: center;">TRUE</td> <td>Release brake manually (forced release).                             <ul style="list-style-type: none"> <li><b>Note!</b> The brake can also be released when the controller is inhibited!</li> <li>During automatic operation, the internal brake logic is deactivated and the brake is released (supervisor operation). If a controller inhibit has been set by the brake control, it will be deactivated.</li> <li>In semi-automatic operation, the brake is released including feedforward control.</li> </ul> </td> </tr> </table>	FALSE	Apply brake. <ul style="list-style-type: none"> <li>During automatic operation, the internal brake logic controls the brake.</li> </ul>	TRUE	Release brake manually (forced release). <ul style="list-style-type: none"> <li><b>Note!</b> The brake can also be released when the controller is inhibited!</li> <li>During automatic operation, the internal brake logic is deactivated and the brake is released (supervisor operation). If a controller inhibit has been set by the brake control, it will be deactivated.</li> <li>In semi-automatic operation, the brake is released including feedforward control.</li> </ul>
FALSE	Apply brake. <ul style="list-style-type: none"> <li>During automatic operation, the internal brake logic controls the brake.</li> </ul>					
TRUE	Release brake manually (forced release). <ul style="list-style-type: none"> <li><b>Note!</b> The brake can also be released when the controller is inhibited!</li> <li>During automatic operation, the internal brake logic is deactivated and the brake is released (supervisor operation). If a controller inhibit has been set by the brake control, it will be deactivated.</li> <li>In semi-automatic operation, the brake is released including feedforward control.</li> </ul>					
bMBrakeStartValue2 <small>(from version 11.00.00)</small>	BOOL	Selection of the torque feedforward control value <a href="#">▶ Feedforward control of the motor before release</a> <table border="1" style="width: 100%; border-collapse: collapse;"> <tr> <td style="width: 10%; text-align: center;">FALSE</td> <td>Starting value 1 is active (see the following figure).</td> </tr> <tr> <td style="text-align: center;">TRUE</td> <td>Starting value 2 is active (see the following figure).</td> </tr> </table> <p>Creation of the feedforward control value for the release process of the brake:</p> <p> <span style="border: 1px solid black; padding: 2px;">A</span> Signal path for motor control <u>with</u> feedback  <span style="border: 1px solid black; padding: 2px;">B</span> Signal path for motor control <u>without</u> feedback  <span style="border: 1px solid black; padding: 2px;">C</span> Feedforward control value                     </p> <p> <span style="border: 1px solid black; padding: 2px;">1</span> <a href="#">C02581/1</a>: Switching threshold  <span style="border: 1px solid black; padding: 2px;">2</span> <a href="#">C02581/2</a>: Hysteresis for release  <span style="border: 1px solid black; padding: 2px;">3</span> <a href="#">C02581/3</a>: Hysteresis for application  <span style="border: 1px solid black; padding: 2px;">4</span> <a href="#">C02581/4</a>: Starting value 1 for manual feedforward control  <span style="border: 1px solid black; padding: 2px;">5</span> <a href="#">C02581/5</a>: Starting value 2 for manual feedforward control  <span style="border: 1px solid black; padding: 2px;">6</span> <a href="#">C02582/Bit 4</a>: Selection of the feedforward control value (automatic/manual selection)                     </p>	FALSE	Starting value 1 is active (see the following figure).	TRUE	Starting value 2 is active (see the following figure).
FALSE	Starting value 1 is active (see the following figure).					
TRUE	Starting value 2 is active (see the following figure).					
nMBrakeAddValue_a <small>(from version 11.00.00)</small>	INT	Additive feedforward control value (speed or torque) in [%] for torque feedforward control when the respective control mode is started <ul style="list-style-type: none"> <li>For speed control: 100 % ≙ reference speed (<a href="#">C00011</a>)</li> <li>For torque control: 100 % ≙ maximum torque (<a href="#">C00057</a>)</li> </ul> <a href="#">▶ Feedforward control of the motor before release</a>				

Designator	Data type	Information/possible settings
bMBrakeApplied <small>(from version 11.00.00)</small>	BOOL	Input for status detection via switching contacts at the brake • Only effective if bit 5 in <a href="#">C02582</a> is set to "1".
		FALSE   Brake is released.
		TRUE   Brake is applied.

### outputs

Designator	Data type	Value/meaning
bMBrakeReleaseOut	BOOL	Trigger signal for switching element holding brake control via a digital output • Use bit 0 under <a href="#">C02582</a> to activate inverted switching element triggering. ▶ <a href="#">Functional settings</a>
		FALSE   Apply brake.
		TRUE   Release brake.
bMBrakeReleased	BOOL	"Brake released" status signal considering the brake release time • When the holding brake is triggered to close, <i>bMBrakeReleased</i> is immediately set to FALSE even if the brake closing time has not yet elapsed!
		TRUE   Brake released (after the brake release time has expired).



### Stop!

The digital outputs are not suitable for the "direct" control of a holding brake!

- Connect the digital output connected to the trigger signal *bMBrakeReleaseOut* with a relay or power contactor which switches the brake supply.
- When a power contactor is used, the response and release time of the earth contact is added to the response and release time of the brake. Both times must also be considered for parameterising the closing and opening time of the holding brake

### 8.4.2 Parameter setting



#### Danger!

A faultless brake control function requires a correct setting of the different deceleration times in the following parameters!

A wrong setting of the delay times can cause a faulty control of the brake!



#### How to go to the parameterisation dialog of the holding brake control:

1. »Engineer« Go to the *Project view* and select the 8400 StateLine inverter.
2. Select the **Application parameters** tab from the *Workspace*.
3. Go to the *Overview* dialog level and click the "**Basic functions**" button.
4. Go to the *Overview* → *Basic functions* dialog box and click the **Holding brake control** button.

#### Short overview of parameters for holding brake control:

Parameters	Info	Lenze setting	
		Value	Unit
<a href="#">C02580</a>	Holding brake: Operating mode	0: Brake control off	
<a href="#">C02581/1</a>	Holding brake: Switching threshold	5.00	%
<a href="#">C02581/2</a>	Holding brake: Hyst. release	1.00	%
<a href="#">C02581/3</a>	Holding brake: Hyst. close	1.00	%
<a href="#">C02581/4</a>	Holding brake: FF control starting value 1	0	%
<a href="#">C02581/5</a>	Holding brake: FF control starting value 2	0	%
<a href="#">C02582</a>	Holding brake: Setting	0	

Greyed out = display parameter

# 8 Basic drive functions (MCK)

## 8.4 Holding brake control

Parameters	Info	Lenze setting	
		Value	Unit
<a href="#">C02589/1</a>	Holding brake: Closing time	100	ms
<a href="#">C02589/2</a>	Holding brake: Release time	100	ms
<a href="#">C02589/3</a>	Holding brake: Waiting time status	100	ms
<a href="#">C02589/4</a>	Holding brake: Ramp FF control	0	ms
<a href="#">C02593/1</a>	Holding brake: Actual value monitoring	0.000	ms
<a href="#">C02593/2</a>	Holding brake: Application delay	0.000	ms
<a href="#">C02610/1</a>	MCK: Holding brake ramp time synchr.	2.000	s
<a href="#">C02607</a>	Holding brake: Status	-	
<a href="#">C00830/68</a>	MCK: nMBrakeAddValue_a	-	%
<a href="#">C00833/80</a>	MCK: bMBrakeRelease	-	
<a href="#">C00833/81</a>	MCK: bMBrakeStartValue2	-	
<a href="#">C00833/82</a>	MCK: bMBrakeApplied	-	
Greyed out = display parameter			

### 8.4.2.1 Operating mode

For different applications and tasks, different operating modes are available in [C02580](#). The selected operating mode determines whether the holding brake control is used and how the holding brake will be switched.

#### Mode 0: Brake control off

In this mode, brake control is switched off (not active).

- The *bMBrakeReleaseOut* trigger signal for the holding brake control switching element is set to FALSE.
- The *bMBrakeReleased* status signal is set to FALSE.



#### Note!

In the Lenze setting, the mode 0 is preset to get into a safe state after the mains is switched on.

#### Mode 11: Manual control

In this mode, brake release and brake application can be directly controlled via the *bMBrakeRelease* input without special logic or automatic.

- Setting pulse inhibit or controller inhibit has no influence on the *bMBrakeReleaseOut* trigger signal for the holding brake control switching element.
- After the brake has been activated and the brake application time has expired, the controller is inhibited automatically by the basic "Holding brake control" function.



#### Tip!

You can use mode 11 to easily check if the brake switches correctly.

**Mode 12: Automatic control**

In this mode, the brake is controlled automatically.

**Danger!**

In this mode, the input *bMBrakeRelease* should be permanently set to FALSE unless manual release (supervisor operation) is required.

If the *bMBrakeRelease* input is set to TRUE, the brake is released immediately, even if the controller is inhibited!

- If the requested speed setpoint reaches a parameterisable upper speed threshold that allows traversing of the drive, the brake will be released and operation enabled.
- On the other hand, if speed setpoint and actual speed fall below a parameterisable lower speed threshold, the brake will be applied under consideration of different time parameters.
- The brake will also be activated automatically if quick stop is activated in the drive, e.g. by a device command or as response to an error, and in the event of controller inhibit or pulse inhibit.
- After automatic brake activation and expiration of the brake application time, the controller is inhibited automatically by the basic "Holding brake control" function.

**Tip!**

The 2/12 mode is the usual mode to control the brake.

**Mode 13: Semi-automatic control**

From version 11.00.00

In this mode, brake release and brake application can be directly controlled via the *bMBrakeRelease* input without special logic or automatic.

In contrast to the manual operation (mode 11)

- the feedforward control is active in this mode, preventing a sagging e.g. in case of a hoist.
- the brake in this mode also closes when the controller is inhibited in order to prevent the axis in a hoist from falling.

**Related topics:**

▶ [TroubleQSP](#) (📖 96)

▶ [Behaviour in case of pulse inhibit](#) (📖 431)

### 8.4.2.2 Functional settings

The following bit coded functional settings for the holding brake control can be made in [C02582](#):

Bit	Option	Info
Bit 0	bMBrakeReleaseOut invert.	Activation of inverted control <ul style="list-style-type: none"> <li>"1" ≡ Inverted logic of the trigger signal for the holding brake control switching element</li> </ul>
Bit 1	Horizontal brake protection	Brake response in case of pulse inhibit <ul style="list-style-type: none"> <li>"1" ≡ In the case of a pulse inhibit, the actual speed value is monitored which must reach the "Close" threshold value to cause the holding brake to be applied.</li> </ul> <b>Note:</b> <ul style="list-style-type: none"> <li>This function is only active if bit 3 (horizontal/winding technology) is set as well. The function is used in order that, when the controller is inhibited, the holding brake of a drive with horizontal traverse path does not wear out during rotation.</li> <li>With vertical motion (bit 3 = 0), this function is not active. Especially with hoists and activated pulse inhibit of the inverter, an immediate application of the brake is essential for safety-related reasons!</li> </ul>
Bit 2	with hoist inv. feedfwd. control	Direction of feedforward control with vertical/hoist technology: <ul style="list-style-type: none"> <li>"0" ≡ Positive direction</li> <li>"1" ≡ Negative direction</li> </ul> <b>Note:</b> Reversal (Ccw) is then considered.
Bit 3	Horizontal application	Direction of movement of the axis <ul style="list-style-type: none"> <li>"0" ≡ The axis performs vertical movements. Gravitational acceleration causes movements.</li> <li>"1" ≡ The direction of the axis is horizontal or rotary. The gravitational acceleration does not cause any movement.</li> </ul> If <a href="#">C002868/1</a> : Bit 7 is set to 1, the holding brake is released without injecting a feedforward control torque or frequency.
Bit 4	Feedforward control C2581 (from version 11.00.00)	Selection of the feedforward control value <ul style="list-style-type: none"> <li>"0" ≡ Automatic selection. <ul style="list-style-type: none"> <li>The torque saved at the last stop is used.</li> </ul> </li> <li>"1" ≡ Manual selection. <ul style="list-style-type: none"> <li>bMBrakeStartValue2 = FALSE: The feedforward control value 1 set in <a href="#">C02581/4</a> is used.</li> <li>bMBrakeStartValue2 = TRUE: The feedforward control value set in <a href="#">C02581/5</a> is used.</li> </ul> </li> </ul>
Bit 5	Feedback monitoring (from version 11.00.00)	Activation of status monitoring <ul style="list-style-type: none"> <li>"1" ≡ The bMBrakeApplied input for status detection of the brake (via a switching contact at the brake) is monitored after the waiting time set in <a href="#">C02589/3</a> has expired.</li> </ul>
Bit 6	Sync ramp L_NSet_1 (from version 11.00.00)	Selection of the ramp time for the synchronisation process to setpoint speed after the brake opening time has elapsed <b>Revised behaviour from version 11.00.00:</b> <ul style="list-style-type: none"> <li>"1" ≡ The ramp time of the effective acceleration of the ramp function generator (<a href="#">L_NSet_1</a>) is used (Lenze setting).</li> <li>"0" ≡ As before, the ramp time set in <a href="#">C02610/1</a> is used.</li> </ul> <b>Note:</b> The changeover can be dynamically both via the ramp parameter and via bit 6.
Bit 7	Reserved	

## 8 Basic drive functions (MCK)

### 8.4 Holding brake control

---

#### Related topics:

- ▶ [Behaviour in case of pulse inhibit](#) (📖 431)
- ▶ [Feedforward control of the motor before release](#) (📖 432)

#### 8.4.2.3 Switching thresholds



#### Stop!

Do not set the lower speed threshold for closing the brake too high to prevent excessive wear of the brake!



#### Note!

When comparing speeds, only the absolute value of the motor speed and not the direction of rotation is considered.

#### Upper speed threshold for brake release:

Switching threshold ([C02581/1](#)) + hysteresis for release ([C02581/2](#))

#### Lower speed threshold for brake application:

Switching threshold ([C02581/1](#)) - hysteresis for application ([C02581/3](#))



#### Tip!

The lower speed threshold for brake application should be set to approximately 5 ... 20 % of the maximum speed to minimise the wear of the brake and provide for an optimum brake reaction by a low grinding of the brake.

#### Related topics:

- ▶ [Process when brake is released](#) (📖 428)
- ▶ [Process when brake is closed](#) (📖 429)

### 8.4.2.4 Application and release time



#### Danger!

A wrong setting of the application and release time can cause a faulty control of the brake!

- If the application time is set too low, the controller is inhibited and the drive becomes torqueless before the brake is applied completely.

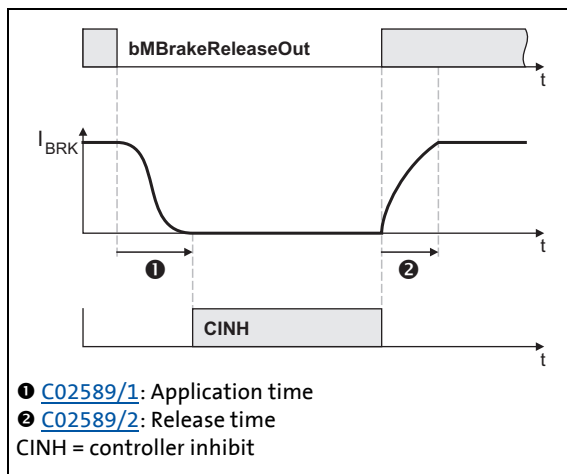

- Every mechanical holding brake comes with a construction-conditioned application and release time which must be considered by the holding brake control and is set in [C02589](#).
- The application and release time of the Lenze holding brake is indicated in the supplied operating instructions in the "Technical data" chapter.
- If the application and release times are too long, this is uncritical in respect of safety but leads to unnecessarily long delays during cyclical braking processes.

[8-6] Definition of the application and release time with the example of the PM brake



#### Tip!

The application and release times do not only vary between the brake types but also depend on the basic conditions in the plant:

- Parameters of the hardware (cable length, temperature, level of supply voltage etc.)
- Contact elements used (brake module or contactor at the digital output)
- Type of overvoltage limitation/suppressor circuit

For optimisation purposes, detect in individual cases the response times by measurement.



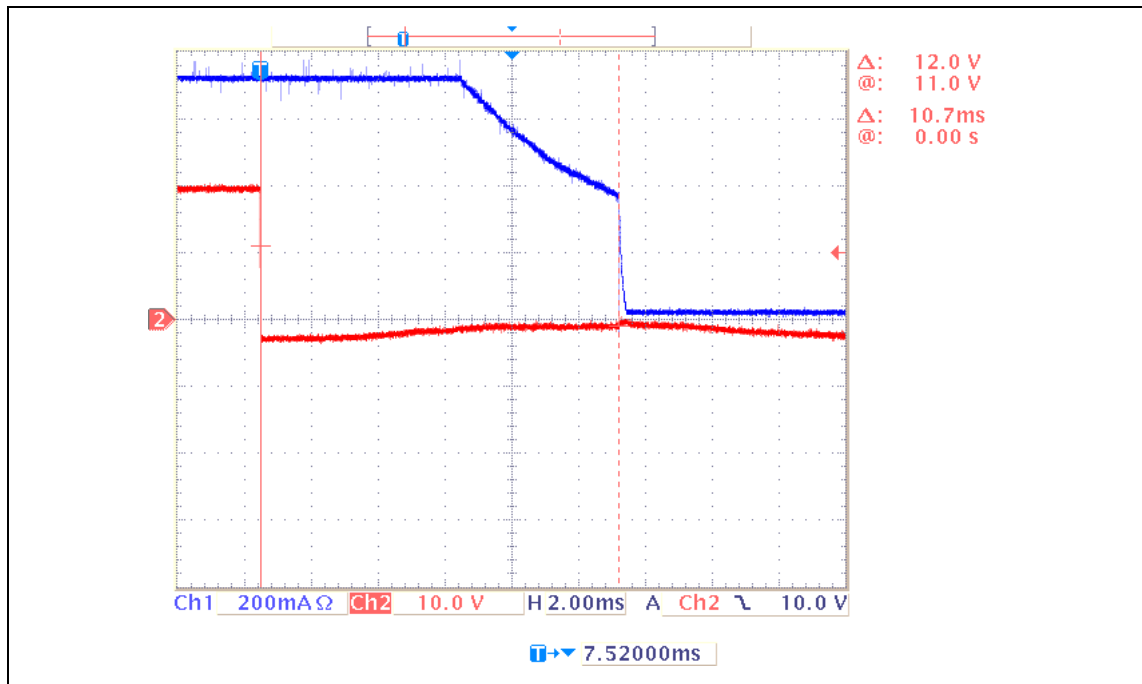

[8-7] Oscillogram 1: Current characteristic for the application of a mechanical holding brake (application time: 10.7 ms)

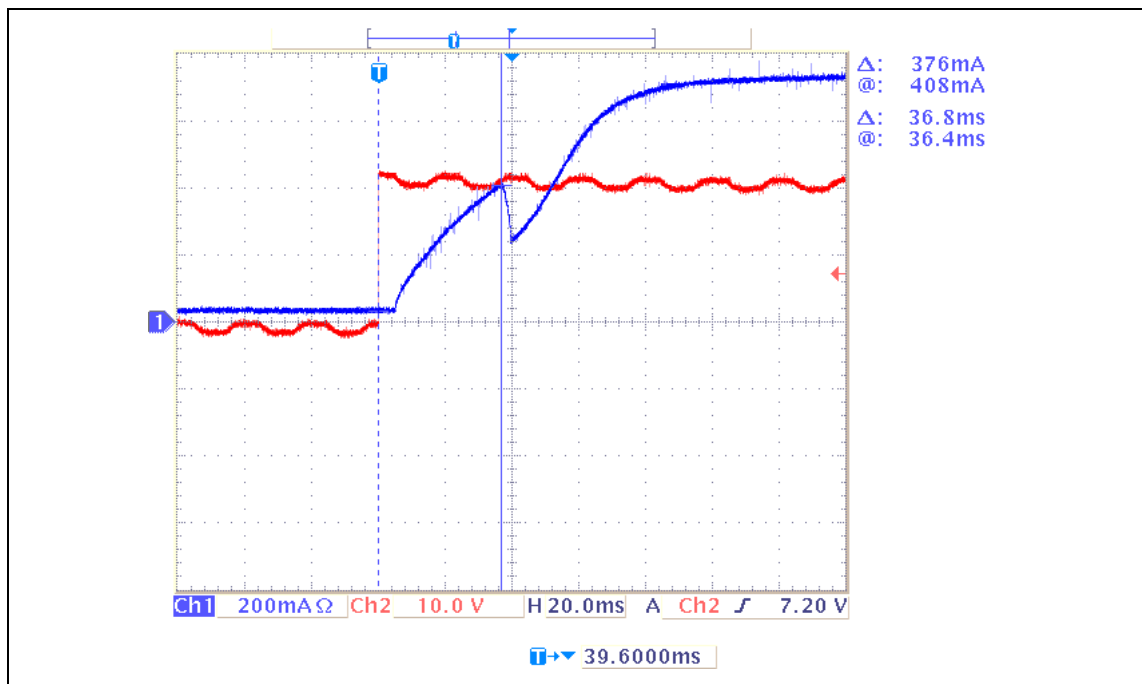

[8-8] Oscillogram 2: Current characteristic for the release of a mechanical holding brake (release time: 36.8 ms)

#### Related topics:

- ▶ [Process when brake is released](#) (□ 428)
- ▶ [Process when brake is closed](#) (□ 429)

### 8.4.2.5 Ramp time for approaching the setpoint speed

For the "[Speed follower](#)" operating mode, a ramp time can be set in [C02610/1](#) if the setpoint is already out of reach while the holding brake is initiating the feedforward control process.

#### Example :

A setpoint of 90 % is selected via the ramp function generator while the brake is applied (controller is inhibited).

1. At the set ramp (in most cases [C00012](#)), the ramp function generator ramps up to 90 %.
2. The brake identifies the setpoint selection of 5 % (release switching threshold). The feedforward control of the brake provides 3 % of the setpoint and will not report the release of the brake after approx. 1 s has expired.

**Conclusion:** 90 % of the selected setpoint is already ramped up while the brake is only providing 3 % of the setpoint via the feedforward control.

Since at this point a step change from 3 % to 90 % may cause mechanical jerks, the setpoint is ramped up from 3 % to 90 %, using the ramp time set in [C02610/1](#) (Lenze setting: 2 s).

Our example is based on the V/f characteristic control mode (VFCplus). However, ramping up to a setpoint that is out of reach is carried out for all motor control modes because there is always a mechanical/electric delay when controlling a holding brake.

This delay is due to:

- Motor magnetisation (in the case of servo control only)
- Mechanical delay of all switching elements connected upstream to the holding brake
- Mechanical delay of the holding brake itself
- Generation of the holding torque by the motor

#### Related topics:

- ▶ [Process when brake is released](#) (📖 428)

### 8.4.2.6 Motor magnetising time (only with asynchronous motor)

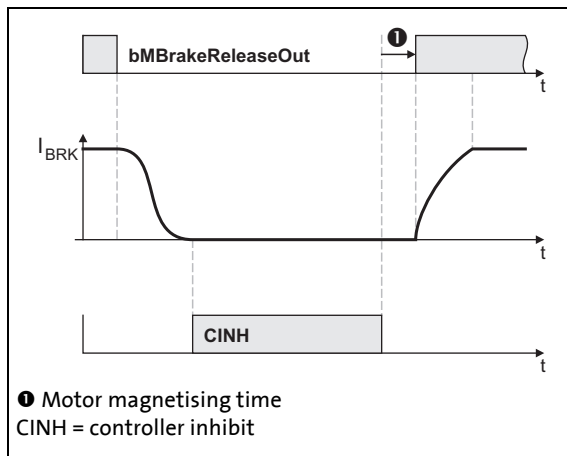

- When an asynchronous motor is used, first the magnetic field required for the holding torque is created (which is already available when a synchronous motor is used) after the controller inhibit is deactivated.
- The motor is internally magnetised through internal feedforward control of the lower speed threshold. The release time set in [C02589/2](#) is considered here.

[8-9] Considering the motor magnetising time taking the PM brake as an example

#### Related topics:

▶ [Process when brake is released](#) (📖 428)

### 8.4.2.7 Actual value monitoring

If an actual value monitoring time  $> 0$  s is selected in [C02593/1](#), the actual speed time monitoring is active.

- The monitoring time starts when the speed setpoint has reached the lower switching threshold and the actual speed is still above this threshold. (see illustration [\[8-12\]](#) in chapter "[Process when brake is closed](#)".)
- If the actual speed is still above the threshold when the monitoring time has expired, the brake will be automatically applied in the automatic brake control mode (mode 12).



#### Note!

In the Lenze setting, the actual speed time monitoring is deactivated ([C02593/1](#) = "0 s"), i.e. the brake will only be applied when the actual speed has reached the lower switching threshold.

### 8.4.3 Process when brake is released

1. The controller inhibit is deactivated.
2. The magnetic field required for the holding torque is created in the motor (is already available when a synchronous machine is used).
3. The *bMBrakeReleaseOut* trigger signal for holding brake switching element is set to TRUE for releasing the brake.
4. After the brake opening time has elapsed:
  - The *bMBrakeReleased* status signal ("brake released") is set to TRUE.
  - In the "[Speed follower](#)" operating mode, the drive synchronises to the already accelerated speed setpoint.
5. After the waiting time set in [C02589/3](#) has additionally expired, the status monitoring starts again (if activated via bit 5 in [C02582](#)).

#### Time diagram

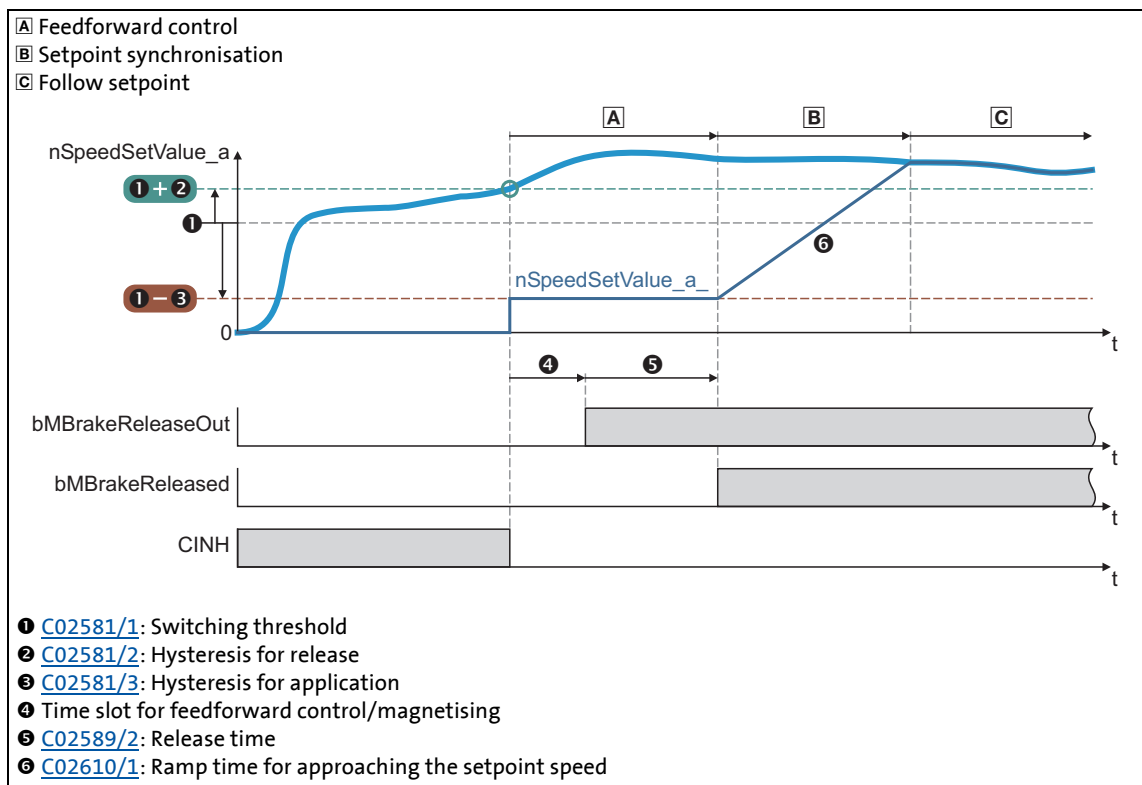

[8-10] Release holding brake in automatic mode via speed threshold

#### Related topics:

- ▶ [Feedforward control of the motor before release](#) (📖 432)

### 8.4.4 Process when brake is closed

1. The motor is decelerated when the setpoint is reduced by the user (e.g. turn down the potentiometer, setpoint selection via CAN).
  - The motor can also be decelerated by the "Quick stop" function or by "DC-injection braking", either directly requested by the user or as response to an error.
2. If the speed setpoint and the actual speed have fallen below the lower speed threshold or only the speed setpoint has fallen below the lower speed threshold and the actual value monitoring time has expired:
  - The *bMBrakeReleaseOut* trigger signal for the holding brake switching element is set to FALSE for closing the brake.
  - The *bMBrakeReleased* status signal is reset to FALSE.
  - The brake application time starts to expire.
3. After the brake application time has expired, the controller is inhibited.
4. After the waiting time set in [C02589/3](#) has additionally expired, the status monitoring starts again (if activated via bit 5 in [C02582](#)).
5. In order to prevent the drive from further rotating/accelerating in the event of an error of the feedback contact, controller inhibit is cancelled again and the drive is held at standstill in a speed-controlled manner.

#### Time diagrams

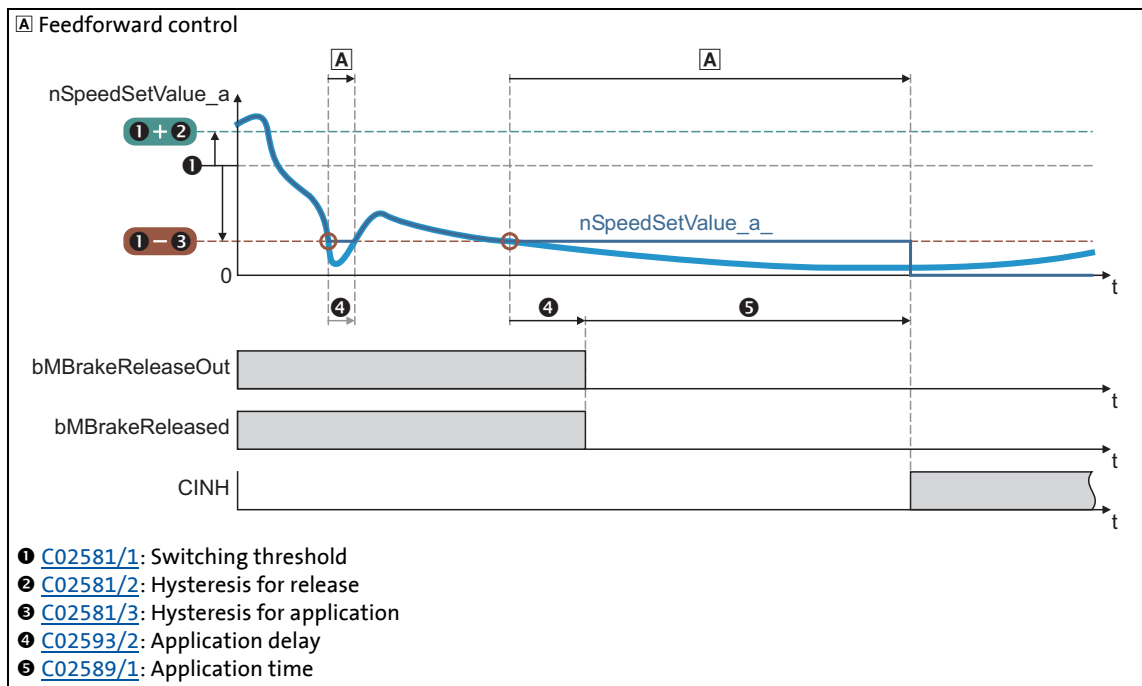

[8-11] Close holding brake in automatic mode via speed threshold (actual value = setpoint)

# 8 Basic drive functions (MCK)

## 8.4 Holding brake control

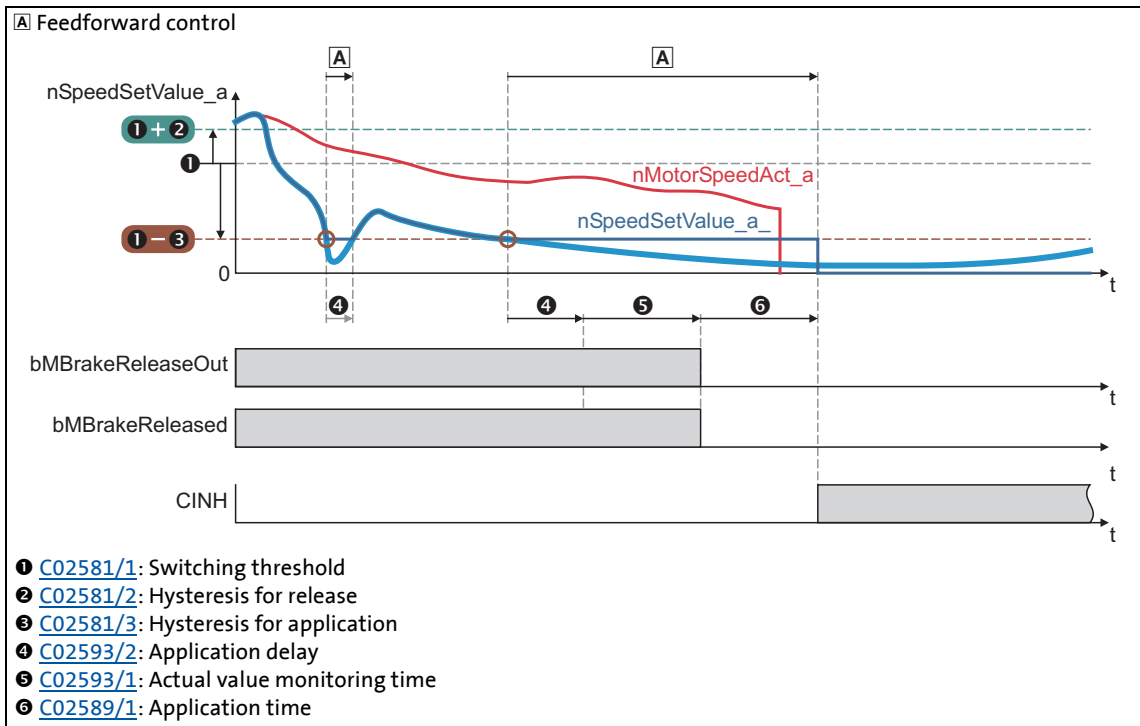

[8-12] Close holding brake in automatic mode with actual value monitoring time ([C02593/1](#) > 0 s)

### 8.4.5 Behaviour in case of pulse inhibit

Setting the pulse inhibit causes a load-controlled coasting of the motor until the pulse is enabled again. In the enabled inverter, the pulse can be inhibited e.g. due to a DC overvoltage, DC undervoltage or the "Safe torque off" request.

The brake response to pulse inhibit can be parameterised under [C02582](#).



#### Stop!

For parameterising the response to pulse inhibit in [C02582](#), the energy conditions of the machine should be evaluated first.

The energy stored in the machine can be considerably higher than the permissible switching energy and thus lead to the destruction of the brake if applied directly!

#### Activate brake immediately when pulse is inhibited

If bit 1 is set to "0" in [C02582](#) (Lenze setting), the brake will be immediately applied when the pulse is inhibited to avoid damage to the mechanical components.

Especially in the case of hoist drives, immediate engagement of the brake is absolutely necessary for safety reasons if the pulse inhibit function of the inverter has been activated!



#### Danger!

This behaviour is valid in (semi) automatic operation when the *bMBrakeRelease* input is set to FALSE.

When the *bMBrakeRelease* input is set to TRUE (supervisor operation) in automatic mode, the brake is not applied at pulse inhibit!

#### Only activate brake below threshold for brake activation

If bit 1 and bit 3 are set to "1" in [C02582](#), the brake remains released until the lower speed threshold is reached to avoid an excessive wear of the brake.

- The braking action only takes places due to the friction in the load mechanics.
- The brake will not be applied until the motor speed has reached the threshold for brake activation. Hence, the function depends on the signal of the speed encoder.

During uncritical operation (horizontal loading condition), delayed brake application may be required to protect the brake in case of high centrifugal masses.

In case of vertical motion (bit 3 = 0), this function is not active due to safety-related reasons.

#### Related topics:

- ▶ [Functional settings](#) (📖 422)
- ▶ [Switching thresholds](#) (📖 423)

### 8.4.6 Feedforward control of the motor before release

The motor is precontrolled by selecting the lower speed threshold for applying the brake. When the upper speed threshold for brake release is reached, the motor is precontrolled for 200 ms with the lower threshold value before the brake switches to the release mode.

Here, the direction of the feedforward control depends on two conditions:

1. On the settings selected under [C02582](#):
  - Bit 2 = feedforward control inverted
  - Bit 3 = direction of the axis
2. On the sign of the setpoint.

**Truth table for the direction of the feedforward control**

Setpoint	Direction	Feedforward control	Scheme	Direction	
				Feedforward control value	Start value
$n \geq 0$	vertical/hoist ( <a href="#">C02582</a> : Bit 3 = 0)	Not inverted ( <a href="#">C02582</a> : Bit 2 = 0)		+	+
		inverted ( <a href="#">C02582</a> : Bit 2 = 1)		-	+
$n < 0$		Not inverted ( <a href="#">C02582</a> : Bit 2 = 0)		+	-
		inverted ( <a href="#">C02582</a> : Bit 2 = 1)		-	-
$n \geq 0$	horizontal/winding drive ( <a href="#">C02582</a> : Bit 3 = 1)	Inversion via bit 2 with horizontal direction not effective		+	+
$n < 0$				-	-
$n \geq 0$	horizontal/winding drive ( <a href="#">C02582</a> : Bit 3 = 1)	Release holding brake without injecting feedforward control torque or frequency <a href="#">C002868/1</a> : Bit 7 = 1		0	+
$n < 0$				0	-



#### Note!

The effective direction of the torque when the drive is stopped also determines the direction of the feedforward control value. In case of emergency stop scenarios or mechanical blocking torques can be stored when the drive is stopped that act against the desired feedforward control direction. If such scenarios are not excluded in applications, you should not use the automatic storage of the holding torque.

- Alternatively use the manual selection ([C02582](#): bit 4 = 1).



### Selection of the feedforward control value

From version 11.00.00 onwards, the feedforward control value can be selected via bit 4 in [C02582](#):

- Bit 4 = 0: Automatic selection
  - The torque saved at the last stop is used.
- Bit 4 = 1: Manual selection
  - *bMBrakeStartValue2* = FALSE: The feedforward control value 1 set in [C02581/4](#) is used.
  - *bMBrakeStartValue2* = TRUE: The feedforward control value set in [C02581/5](#) is used.

### Related topics:

- ▶ [Functional settings](#) (📖 422)
- ▶ [Switching thresholds](#) (📖 423)

## 9 Diagnostics & error management

This chapter provides information on error handling, drive diagnostics, and fault analysis.

### 9.1 Basics on error handling in the inverter

Many of the functions integrated in the inverter can

- detect errors and thus protect the device from damage or overload, e.g. short-circuit detection, Ixt overload detection, overtemperature detection, etc.
- detect an operating error by the user, e.g. a missing memory module, a required or missing communication module, etc.
- output a warning signal if desired, e.g. if the speed is too high or too low, etc.

Depending on the importance, the error detection in the device responds very fast (e.g. short-circuit detection < 1 ms) or in a slower cycle (e.g. temperature monitoring approx. 100 ms).

All functions provided with an error detection (e.g. the motor control) supply information to a so-called error handler. The error handler is processed every 1 ms and evaluates all information.

In this evaluation, the so-called status determining error (display in [C00168](#)) and the current error (display in [C00170](#)) are generated, and the inverter is caused to take the respective error status (e.g. TroubleQSP).

These two types of error information serve to diagnose errors systematically and contain the following information:

1. The error type (e.g. "Warning")
2. The error subject area (e.g. "CAN generally integrated")
3. The error ID within the error subject area

Together all types of information form the real error number which is unique in the whole device system. ▶ [Structure of the 32-bit error number \(bit coding\)](#) (📖 459)





In addition to the control of the device status by the error handler, a logbook function records the errors and their histories. ▶ [Logbook](#) (📖 443)



#### Tip!

For many device errors, the error type and hence the response of the inverter to the error can be parameterised. ▶ [Setting the error response](#) (📖 453)

### 9.2 LED status displays

	CAN-RUN
	CAN-ERR
	DRV-RDY
	DRV-ERR





Information on some of the operating states can be quickly obtained via the LED display on the front of the inverter.

Labelling	Colour	Description	
CAN-RUN	green	CAN bus ok	▶ <a href="#">LED status displays for the system bus (📖 514)</a>
CAN-ERR	red	CAN bus error	
DRV-RDY	green	Standard device ready for operation	▶ <a href="#">LED status displays of the device status (📖 436)</a>
DRV-ERR	red	Warning/trouble/fault	

#### Related topics:













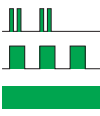

- ▶ [Device control \(DCTRL\) \(📖 76\)](#)
- ▶ [Device state machine and device states \(📖 88\)](#)
- ▶ [System bus "CAN on board" \(📖 508\)](#)

### 9.2.1 LED status displays of the device status

	CAN-RUN
	CAN-ERR
	DRV-RDY
	DRV-ERR

The control of the two LEDs "DRV-RDY" and "DRV-ERR" on the front of the inverter depends on the device status.

The meaning can be seen from the table below.

DRV-RDY	DRV-ERR	Description	Device status (Display in <a href="#">C00137</a> )
OFF	OFF	OFF or initialisation active	<a href="#">Init</a>
	OFF	Safe torque off is active	<a href="#">SafeTorqueOff</a>
	OFF	Device is ready to start	<a href="#">ReadyToSwitchOn</a>
	OFF	Device is switched on	<a href="#">SwitchedOn</a>
	OFF	Motor data identification/operation	<a href="#">OperationEnabled</a>
		The inverter is ready to switch on, switched on or the operation is enabled and a warning is indicated.	
		Fault active, quick stop	<a href="#">TroubleQSP</a>
OFF		Trouble active	<a href="#">Trouble</a>
OFF		Error active	<a href="#">Fault</a>
<b>Legend</b>			
Meaning of the symbols used to describe the LED states:			
	LED is flashing once approx. every 3 seconds ( <i>slow flash</i> )		
	LED is flashing once approx. every 1.25 seconds ( <i>flash</i> )		
	LED is flashing twice approx. every 1.25 seconds ( <i>double flash</i> )		
	LED is blinking every second		
	LED is permanently on		

#### Related topics:

- ▶ [Device state machine and device states](#) (88)

### 9.3 Drive diagnostics with the »Engineer«

When an online connection to the inverter has been established, the connected inverter can be diagnosed and relevant actual inverter states can be displayed in a clearly arranged visualisation using the »Engineer«.

#### Example: Representation of the diagnostic information in the »Engineer« V2.19

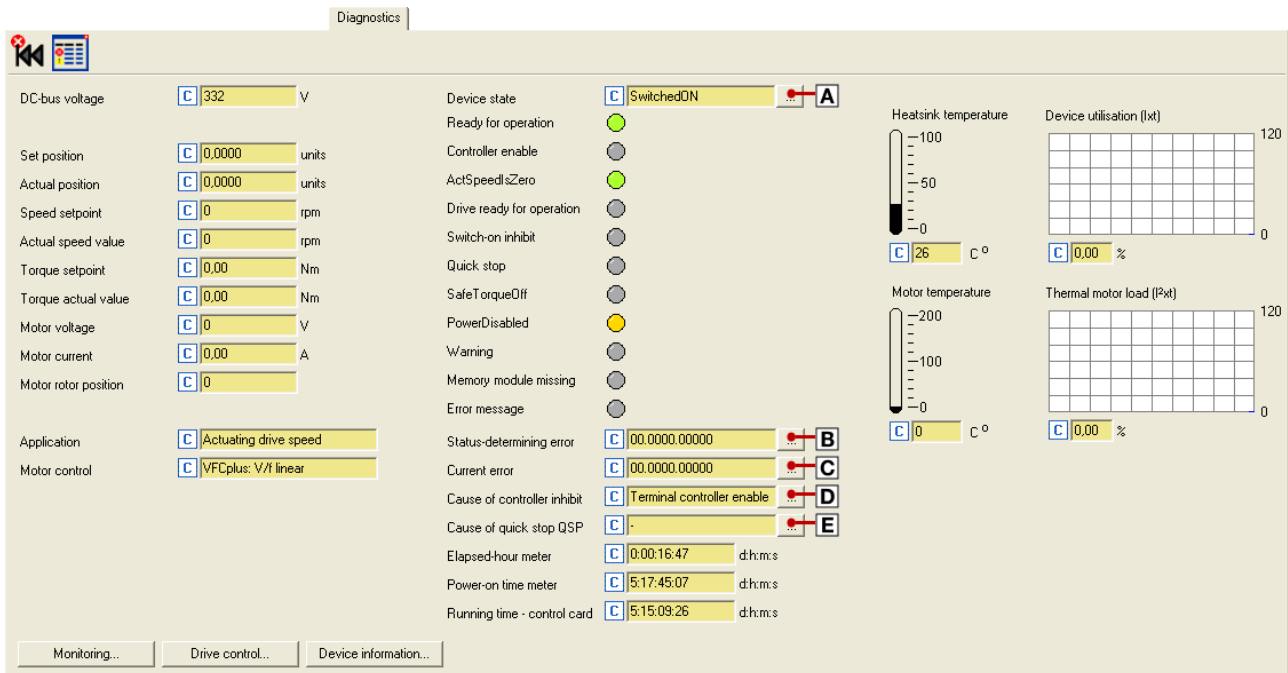

Button	Function
	Acknowledge error message (if the error cause has been eliminated).
	Display the <a href="#">Logbook</a> of the inverter. ( <a href="#">443</a> )
	<b>A</b> Display the internal state machine including the current device status.
	<b>B</b> Display details of the status determining error.
	<b>C</b> Display details of the current error.
	<b>D</b> Display all active sources of a controller inhibit.
	<b>E</b> Display all active sources of a quick stop.
<b>Monitoring...</b>	Configure the <a href="#">Monitoring</a> . ( <a href="#">451</a> )
<b>Drive control...</b>	Display the bit assignment of the following control-related words: <ul style="list-style-type: none"> <li>• MCI control word (<a href="#">C00136/1</a>)</li> <li>• CAN control word (<a href="#">C00136/2</a>)</li> <li>• Cause of controller inhibit (<a href="#">C00158</a>)</li> <li>• Cause of quick stop (<a href="#">C00159</a>)</li> <li>• Status word (<a href="#">C00150</a>)</li> <li>• Status word 2 (<a href="#">C00155</a>)</li> </ul>
<b>Device information...</b>	Display identification data, e.g. firmware information or serial number of individual inverter components.

**How to diagnose a drive with the »Engineer«:**

1. Go to the *Project view* and select the 8400 Stateline inverter.
2. Click the  icon or select the **Online→Go online** command to build up an online connection with the inverter.
3. Select the **Diagnostics** tab.
  - With an online connection, the **Diagnostics** tab displays current status information about the inverter.

**Tip!**

The online connection to the inverter can be established via the following device interfaces:

- CAN interface X1  
Diagnostics via the [System bus "CAN on board"](#) (📖 508)
- X6 diagnostic interface  
We recommend this diagnostic connection when the X1 CAN interface is used for process communication.

### 9.3.1 Display details of the error

If you go to the **Diagnostics** tab and click the  button for the status determining or current error, the *Error details* dialog box displays further information on the error:

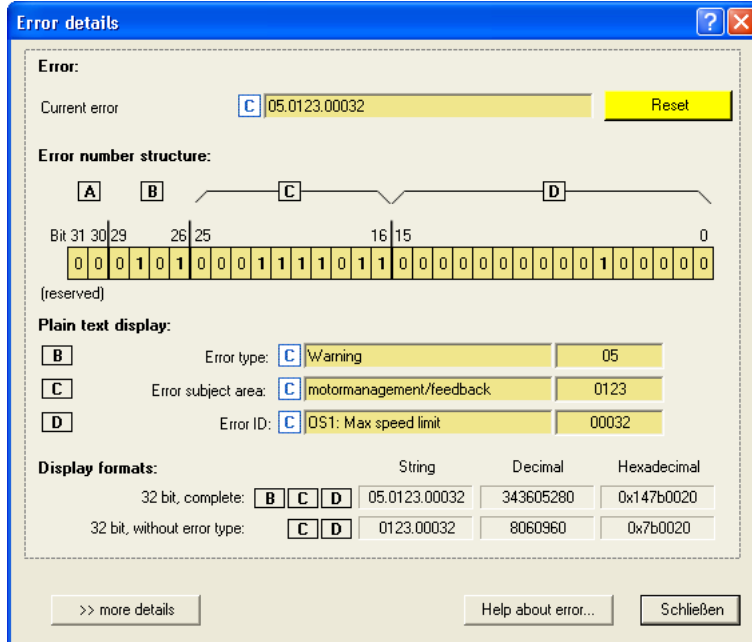

- Click the **Help about error...** button to open the online help with information on the error cause and possible remedies.

From version 06.00.00 / »Engineer V2.13« onwards:

- The **>> more details** button serves to provide more information about the structure of the 16-bit error number:

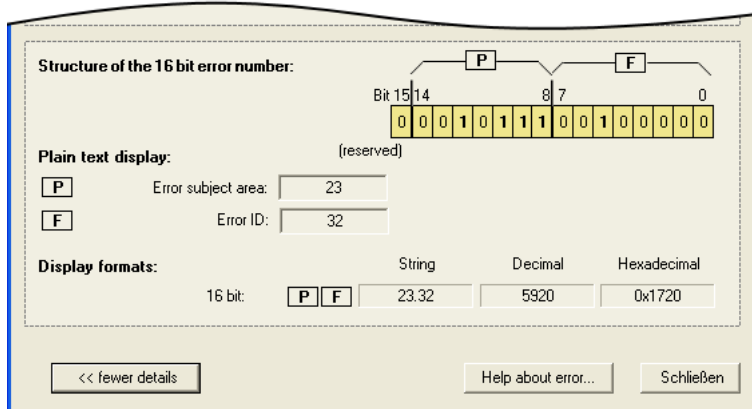

#### Related topics:

- ▶ [Structure of the 32-bit error number \(bit coding\)](#) (□ 459)
- ▶ [Structure of the 16 bit error number \(bit coding\)](#) (□ 462)

### 9.4 Drive diagnostics via keypad/bus system

#### Keypad display of the inverter status

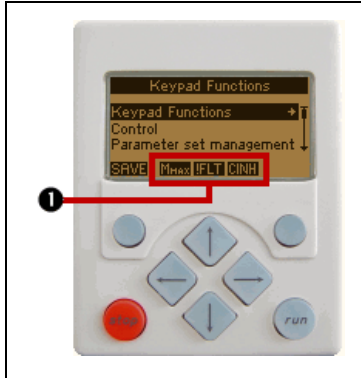

- If the keypad on the front of the inverter is connected to the diagnostic interface X6, the status of the inverter is shown via different icons on the LCD display in the area ❶.

Symbol	Meaning	Notes
<b>RDY</b>	Inverter is switched on.	▶ <a href="#">SwitchedOn</a> (📖 94)
<b>RUN</b>	Inverter is enabled.	
<b>STP</b>	Application in the inverter is stopped.	
<b>QSP</b>	Quick stop active	
<b>CINH</b>	Inverter is inhibited.	The power outputs are inhibited.
<b>OFF</b>	Inverter is ready to start.	▶ <a href="#">ReadyToSwitchOn</a> (📖 93)
<b>Mmax</b>	Speed controller 1 at the limit.	The drive is torque-controlled.
<b>Imax</b>	Set current limit has been exceeded in motor or generator mode.	
<b>IMP</b>	Pulse inhibit active	The power outputs are inhibited.
<b>IFLT</b>	Fault	▶ <a href="#">Fault</a> (📖 98)
<b>ITRB</b>	Trouble	▶ <a href="#">Trouble</a> (📖 97)
<b>!Tosp</b>	TroubleQSP	▶ <a href="#">TroubleQSP</a> (📖 96)
<b>WRN</b>	Warning is active	



### Display parameters

The parameters listed in the following tables serve to query current states and actual values of the inverter for diagnostic purposes, e.g. by using the keypad, a bus system or the »Engineer« (with an online connection to the inverter).

- These parameters are listed in the »Engineer« parameter list and the keypad in the **Diagnostics** category.
- A detailed description of these parameters can be found in the chapter "[Parameter reference](#)" ([□ 611](#)).

Parameters	Display
<a href="#">C00051</a>	MCTRL: Actual speed value
<a href="#">C00052</a>	Motor voltage
<a href="#">C00053</a>	DC-bus voltage
<a href="#">C00054</a>	Motor current
<a href="#">C00056/1</a>	Torque demand
<a href="#">C00056/2</a>	Actual torque value
<a href="#">C00058</a>	Output frequency
<a href="#">C00061</a>	Heatsink temperature
<a href="#">C00064/1</a>	Device utilisation (lxt)
<a href="#">C00064/2</a>	Device utilisation (lxt) 15s
<a href="#">C00064/3</a>	Device utilisation (lxt) 3 min
<a href="#">C00133</a>	Brake resistor utilisation
<a href="#">C00136/1</a>	MCI control word
<a href="#">C00136/2</a>	CAN control word
<a href="#">C00137</a>	Device status
<a href="#">C00138/1</a>	SYS control signals
<a href="#">C00138/2</a>	MCK control signals
<a href="#">C00138/3</a>	FWM control signals
<a href="#">C00150</a>	Status word
<a href="#">C00158</a>	Cause of controller inhibit
<a href="#">C00159</a>	Cause of quick stop QSP
<a href="#">C00165/1</a>	Status determining error (displayed as a numeric text)
<a href="#">C00165/2</a>	Current error (displayed as a numeric text)
<a href="#">C00168</a>	Status determining error (display of 32-bit number)
<a href="#">C00170</a>	Current error
<a href="#">C00166/1</a>	Error type, status determining
<a href="#">C00166/2</a>	Error subject area, status determining
<a href="#">C00166/3</a>	Error ID, status determining
<a href="#">C00166/4</a>	Error type, current
<a href="#">C00166/5</a>	Error subject area, current
<a href="#">C00166/6</a>	Error ID, current
<a href="#">C00177/1</a>	Switching cycles mains switching
<a href="#">C00177/2</a>	Switching cycles output relay
<a href="#">C00177/3</a>	Stress counter - short circuit
<a href="#">C00177/4</a>	Stress counter - earth fault
<a href="#">C00177/5</a>	Stress meter clamp

Parameters	Display
<a href="#">C00177/6</a>	STO counter after power-on
<a href="#">C00177/7</a>	DigIn CINH counter after power-on
<a href="#">C00177/8</a>	IMP counter after power-on
<a href="#">C00178</a>	Time the inverter was enabled (elapsed-hour meter)
<a href="#">C00179</a>	Power-up time (power-on time meter)
<a href="#">C00180/1</a>	Runtime - control card
<a href="#">C00180/2</a>	Running time - heatsink fan
<a href="#">C00180/3</a>	Running time - internal fan

### Identification data

The parameters listed in the following table belong to the **Identification** category of the »Engineer« parameter list and the keypad and serve to display the identification data of the inverter:

Parameters	Display
<a href="#">C00099</a>	Firmware version (as a string)
<a href="#">C00199/1</a>	Device name ▶ <a href="#">Automatic acceptance of the device name in the »Engineer«</a>
<a href="#">C00200</a>	Firmware product type
<a href="#">C00201/1...6</a>	Firmware of the control card and the power section
<a href="#">C00203/1...9</a>	Product type code of the individual device components
<a href="#">C00204/1...9</a>	Serial numbers of the individual device components

### 9.5 Logbook

The integrated logbook function of the inverter chronologically logs important events within the system and plays an important role for troubleshooting and inverter diagnostics.

#### Events that can be logged

The following events can be logged in the logbook:

- [Error messages of the operating system](#) (📖 459)
- Error messages generated by the application (via [LS\\_SetError](#))
- Loading/saving of parameter sets, loading of the Lenze setting (*in preparation*)
- Transmitting the firmware to the inverter (*in preparation*)
- Switching on/off of the inverter

#### Information saved

For each event, the following information is saved in the logbook:

- Type of response to the event (e.g. fault, warning or information)
- Subject area that activated the event (e.g. CAN or USER).
- Event
- Value of power-on time meter
- Selected process values (analog % signals, binary signals)

#### Memory depth

Maximum number of logbook entries:

- 8400 StateLine: 15 logbook entries
- 8400 HighLine/TopLine: 50 logbook entries

#### 9.5.1 Functional description

The structure of the logbook corresponds to a ring buffer:

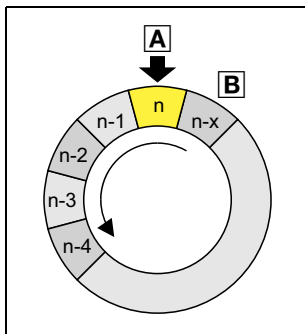

- As long as free logbook memory is available, the entry is placed in the next free position within the memory (A).
- If all memory units are assigned, the oldest entry (B) is deleted for a new entry.
- The newest entries will always remain available.



#### Note!

In the event of a supply voltage failure, the logbook is saved and reloaded automatically when the inverter is switched on. This ensures that the error history of the device does not get lost. For this reason it is very important to act with caution when deleting the logbook entries.

### 9.5.2 Filtering logbook entries

The logbook adds new entries to the ring buffer after they have been passed through a parameterisable filter. This filter helps you to exclude certain events from being entered into the logbook which would trigger a certain error response (fault, trouble, warning, information, etc.).

[C00169](#) (bit 1 ... bit 6) includes a bit coded specification of the events which are to be entered into the logbook. In the Lenze setting, all events are entered into the logbook.



#### Note!

Events with the "No response" setting are not entered into the logbook.

#### Counter for multiple entries

In order to prevent the ring buffer from overflowing with identical errors with frequent occurrence e.g. during commissioning, identical errors will not lead to new line entries in the configuration of the logbook in the Lenze setting. Instead, one counter will be counted up for this error.

- The time of the error is always the time of its first occurrence. Hence, a new logbook line will only be generated if a new error occurs.
- The error counter can be deactivated by resetting bit 9 in [C00169](#).

In [C00169](#), bit 9 and bit 10 determine the logbook update in case of similar errors.

Meaning of bit 9 / bit 10:

- Bit 9: Error counter
- Bit 10: Update of the logbook line

In the Lenze setting ([C00169](#) = 0x067E), bits 9 and 10 are active.

The following cases can be distinguished depending of the activation of bit 9 and bit 10:

1. Bit 9 inactive, bit 10 active/inactive
  - Every time an error occurs, a new line is created in the logbook.
  - The setting of bit 10 has no effect!
2. Bit 9 active, bit 10 inactive
  - Only one line is created for the first occurrence of the error. If the error occurs again, only the error counter in the line is increased.
3. Bit 9 active / bit 10 active (Lenze setting)
  - The time of the last occurrence of similar errors is logged.
  - The time stamp and the optional measured values are updated in the error line of the logbook.
  - When the count value = 255 is reached and an error occurs again, a new line is created.

### 9.5.3 Automatic recording of device-internal signals at the time the error occurs

For purposes of error analysis, two optional device-internal digital signals and an analog signal (16 bit) can be recorded at the time the error occurs.

- The digital signals to be recorded are selected in [C00163/1](#) and [C00163/2](#).
  - Scaling of the value recorded: 0 ≡ FALSE; 1 ≡ TRUE

- The analog signal to be recorded is selected in [C00164/1](#).
  - Scaling of the value recorded:  $16384 \equiv 100\%$

### 9.5.4 Reading out logbook entries

With an online connection, the existing logbook entries can easily be displayed in the »Engineer«. Alternatively, the logbook entries can also be read out via the corresponding parameters (e.g. using the keypad).



#### Note!

Reading out the logbook entries is only permissible by one engineering tool at a time!

- If the logbook entries are tried to be read out via two engineering tools at the same time, missing lines or a permanent refresh may be caused.
- The parameter interface for reading out the logbook by an external control/visualisation, is available as well. ▶ [Reading out the logbook from an external control/visualisation](#) (📖 449)



#### How to display logbook entries in the »Engineer«:

1. Go to the *Project view* and select the 8400 Stateline inverter.
2. Click the icon or select the **Online→Go online** command to build up an online connection with the inverter.
3. Select the **Diagnostics** tab from the *Workspace*.
4. Click **Logbook**.

#### Example: Representation of the logbook in the »Engineer« V2.13

Cons...	Acti...	Num...	Type	Subject matter	Error text	Time stamp	Error number	Anal...	Digit...	Digit...
1	X	1	Warning	User error 1	1	00194.39.25	05.0980.00001	-	-	-
2		2	Trouble	Motor management/enc...	LU: DC bus undervoltage	00194.29.47	02.0123.00015	-	-	-

Filter criteria: Type:  All,  Pulse inhibit error,  Trouble,  Quick stop error,  Stopped warning,  Warning,  Information,  Unknown. Active: All, Subject matter: All. Delete Filter button.

Buttons: Export..., Im Projekt ablegen, Delete, Configure..., >> more details..., Help, Reset error, Close.

Status: 2 entries read, cyclic update of logbook in progress... Power-on meter | 00196.09.06

Button	Function
Delete Filter	Reset set filter criteria to display all available logbook entries.
Export...	Export the entries available in the logbook into a *.log file. ▶ <a href="#">Exporting logbook entries to a file</a> (□ 447)
Storing in the project	File the current logbook in the Engineer project to be able to access it offline, too. ▶ <a href="#">Storing the logbook in the project</a> (□ 448)
Delete	Delete all entries available in the logbook.
Configuration of...	Open parameterisation dialog for configuring the logbook.
>> more details	Show more details: <ul style="list-style-type: none"> <li>• Analog value 1, digital values 1 &amp; 2</li> <li>• More output types of the error numbers (32-bit, internal 32-bit and internal 16-bit).</li> <li>• Instead of the &gt;&gt; <b>more details</b> button, the &lt;&lt; <b>less details</b> is now displayed via which the details can be hidden again.</li> </ul>
Help	Open online help for the logbook.
Error reset	Acknowledge existing error message if the error cause has been eliminated and thus the error is not pending anymore. <ul style="list-style-type: none"> <li>• After the reset (acknowledgement) of the current error, further errors may be pending which must also be reset.</li> </ul>
Close	Close the <i>Logbook</i> dialog box again.

### 9.5.5 Exporting logbook entries to a file



#### How to export the logbook entries to a file:

1. Click **Export...** in the *Logbook* dialog box.
  - The *Export logbook* dialog box is displayed.
2. Specify the folder, file name, and file type for the file.
3. Click the **Save** button to export the logbook entries into the given file.
  - Hidden logbook entries are not exported, i.e. the filter criteria specified are accounted for during the export.
  - The logbook entries are written to the file in the form of a semicolon separated list.

### Structure of the semicolon separated list

The list includes the following information:

- |                   |                              |
|-------------------|------------------------------|
| 1. Cons. no.      | 9. Error number              |
| 2. Active         | 10. Source - analog value 1  |
| 3. Counter        | 11. Analog value 1           |
| 4. Type           | 12. Source - digital value 1 |
| 5. Subject matter | 13. Digital value 1          |
| 6. Error text     | 14. Source - digital value 2 |
| 7. Time stamp     | 15. Digital value 2          |
| 8. Relative time  |                              |

### 9.5.6 Storing the logbook in the project

If you want to display the currently available logbook entries at a later date in offline mode, i.e. without a connection to the inverter, you can store the current logbook in the project.



#### How to store the logbook in the project:

Go to the *Logbook* dialog box and click the **File in project** button.

- The logbook with all the entries uploaded up to now is stored in the Engineer project independent of the set filter criteria.
- A logbook of the same device already stored before will be overwritten without querying the user.
- The filter settings are not stored in the project.
- When a logbook is filed in the project, the logbook can also be opened in offline mode via the **Logbook** button on the **Diagnostics** tab.



#### Note!

Storing the logbook changes the project.

- When the project is closed, you are asked to save the changed project.
- Only if the changed project is saved, the new logbook entries stored in the project remain stored.



### 9.5.7 Reading out the logbook from an external control/visualisation

This function extension is available from version 12.00.00!

The parameters described in the following provide a second interface via which an external control or visualisation can exclusively access the logbook and read out logbook contents. Logbook contents can even be read out via this additional interface if the logbook is read out by the »Engineer« or »EASY Starter« at the same time.

#### Structure of the interface

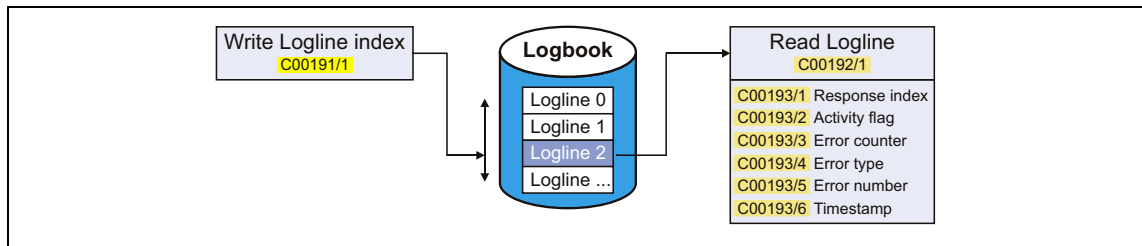

- The line index of the logbook entry to be read out has to be set in [C00191/1](#).
- Then the logbook entry addressed is stored as "OCTET STRING" in [C00192/1](#).
  - Via this display parameter, the logbook entry can be read out by the control.
  - The "OCTET STRING" has a length of 8 double words of 4 successive bytes (= 32 bytes), starting with byte 0 in each case:

OCTET STRING	Byte 0	Byte 1	Byte 2	Byte 3
DWORD 0	Reserved	Reserved	Response index	Reserved
DWORD 1	Error activity flag	Error counter	Reserved	Reserved
DWORD 2	32-bit error number  A Reserved    B Error type    C Error subject area    D Error ID			
DWORD 3	Time in [s] during which the power was switched on (power-on time meter).			
DWORD 4	Reserved	Reserved	Reserved	Reserved
DWORD 5	Source - analog value 1	Reserved	Analog value 1 (scaling: 16384 ≙ 100 %)	
DWORD 6	Source - digital value 1	Reserved	Digital value 1	Reserved
DWORD 7	Source - digital value 2	Reserved	Digital value 2	Reserved

- Additionally, a read access to different individual elements of the logbook entry addressed can be executed via the subcodes of [C00193](#). These parameters have a uniform data format (32 bits) and represent the most important part of the logbook data:

Parameters	Display
<a href="#">C00193/1</a>	Response index, reference to the index requested ( <a href="#">C00191/1</a> )
<a href="#">C00193/2</a>	Error activity flag (0 = error not active; 1 = error active)
<a href="#">C00193/3</a>	Error counter (0 ... 255) <ul style="list-style-type: none"> <li>• This information depends on the logbook configuration. In the Lenze setting the logbook configured so that identical errors do not produce a new line entry, but a counter is incremented for this error.</li> </ul>
<a href="#">C00193/4</a>	Error type (bits 26 ... 29 of the <a href="#">32-bit error number</a> )
<a href="#">C00193/5</a>	Error subject area + error ID (bits 0 ... 25 of the <a href="#">32-bit error number</a> )
<a href="#">C00193/6</a>	Time in [s] during which the power was switched on (power-on time meter).



### Note!

- In the case of a simultaneous read access to the logbook entry ([C00192/1](#)) and its individual elements ([C00193/x](#)), the line index in [C00191/1](#) must only be reset by the control after the read process is fully completed. Otherwise the data read are inconsistent.
- Depending on the device version, the maximum number of logbook entries can vary:
  - 8400 StateLine: 15 logbook entries
  - 8400 HighLine/TopLine: 50 logbook entries

### Basic workflow

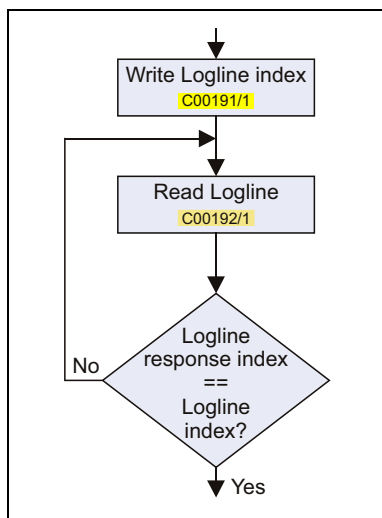

- The logbook can be read out by an external control or visualisation via the procedure shown on the left.
- The "Response index" query ensures that the logbook entry read really corresponds to the logbook entry requested.





### Related topics:

- ▶ [Structure of the 32-bit error number \(bit coding\)](#)

### 9.6 Monitoring

The inverter is provided with various monitoring functions which protect the drive against impermissible operating conditions.

- If a monitoring function responds,
  - an entry will be made into the [Logbook](#) of the inverter,
  - the response (TroubleQSP, Warning, Fault, etc.) set for this monitoring function will be triggered,
  - the status of the internal device control changes according to the selected response, controller inhibit is set, and the "DRV- ERR" LED on the front of the inverter goes on:

Response	Entry in the logbook	Display in <a href="#">C00168</a>	Pulse inhibit	Disable drive function	Acknowledgement required	LED "DRV-ERR"
None						OFF
Fault	<input checked="" type="checkbox"/>	<input checked="" type="checkbox"/>	<input checked="" type="checkbox"/>	<input checked="" type="checkbox"/>	<input checked="" type="checkbox"/>	
Trouble	<input checked="" type="checkbox"/>	<input checked="" type="checkbox"/>	<input checked="" type="checkbox"/>	<input checked="" type="checkbox"/>		
TroubleQSP	<input checked="" type="checkbox"/>	<input checked="" type="checkbox"/>			<input checked="" type="checkbox"/>	
WarningLocked	<input checked="" type="checkbox"/>	<input checked="" type="checkbox"/>			<input checked="" type="checkbox"/>	
Warning	<input checked="" type="checkbox"/>	<input checked="" type="checkbox"/>				
Information	<input checked="" type="checkbox"/>	<input checked="" type="checkbox"/>				OFF

#### Related topics:

- ▶ [LED status displays of the device status](#) (📖 436)
- ▶ [Device state machine and device states](#) (📖 88)
- ▶ [Device overload monitoring \(lxt\)](#) (📖 249)
- ▶ [Motor overload monitoring \(I2xt\)](#) (📖 250)
- ▶ [Motor temperature monitoring \(PTC\)](#) (📖 253)
- ▶ [Brake resistor monitoring \(I2xt\)](#) (📖 254)
- ▶ [Motor phase failure monitoring](#) (📖 256)
- ▶ [Mains phase failure monitoring](#) (📖 259)
- ▶ [Maximum current monitoring](#) (📖 259)
- ▶ [Maximum torque monitoring](#) (📖 261)
- ▶ [Encoder open-circuit monitoring](#) (📖 262)

### 9.6.1 Monitoring configuration



**How to configure the monitoring functions using the »Engineer«:**

1. Go to the *Project view* and select the 8400 Stateline inverter.
2. Select the **Diagnostics** tab from the *Workspace*.
3. Click the **Monitoring...** button.
  - The *8400 monitoring configuration* dialog box is displayed via which the desired settings can be made:

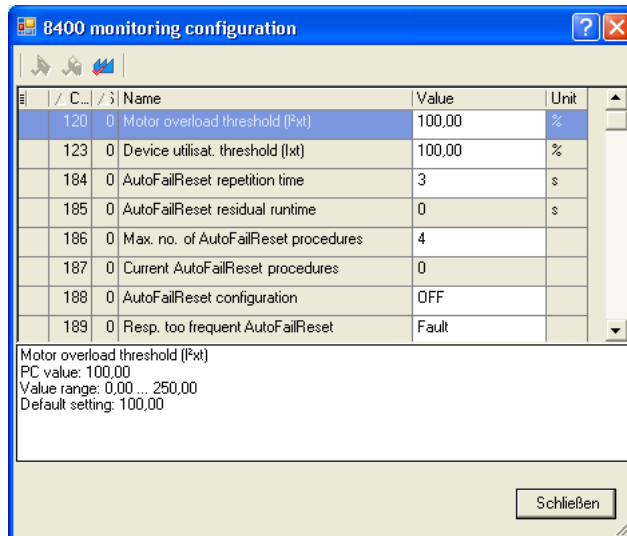

#### Related topics:

- ▶ [Setting the error response](#) (453)

### 9.6.2 Setting the error response

When a monitoring function responds, the response set for this monitoring function (TroubleQSP, Warning, Fault, etc.) will be triggered.

- For many monitoring functions the response can be individually parameterised via parameters.

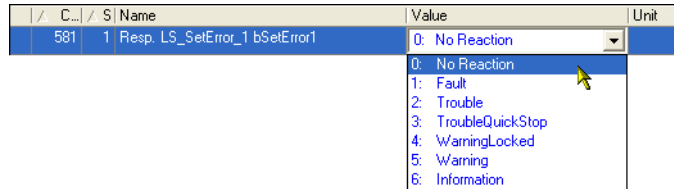

**Tip!**

The table in the chapter "[Short overview \(A-Z\)](#)" contains the error messages for which the response can be set. (465)

### Warning thresholds

Some of the monitoring functions are activated if a defined warning threshold (e.g. temperature) has been exceeded.

- The corresponding preset threshold values can be changed via the following parameters:

Parameters	Info
<a href="#">C00120</a>	Setting of motor overload (I <sup>2</sup> xt)
<a href="#">C00123</a>	Device utilisat. threshold (Ixt)
<a href="#">C00572</a>	Brake resistor overload threshold
<a href="#">C00599</a>	Motor phase failure threshold

### 9.6.3 AutoFailReset function

The AutoFailReset function serves to automatically reset the latching "Fault" and "TroubleQSP" errors as well as the latching "WarningLocked" warning.

The "latching" term means that the effect on the inverter remains active even after the error cause has been removed.

To reset latching errors and warnings, the following options are available:

- Manual reset
  - with device command [C00002/19](#) (activated by Low-High edge)
  - by a Low-High edge at the *bResetFail* input of the [LS DriveInterface](#) (the "FailReset" control bit in the control word must be parameterised with a value of "1").
- Automatic reset
  - using the AutoFailReset function.

#### Overview of the relevant parameters

Parameters	Info
<a href="#">C00184</a>	Repetition time of the error reset processes
<a href="#">C00185</a>	Time left until the next error reset process
<a href="#">C00186</a>	Max. number of permissible <u>unsuccessful</u> error reset processes <ul style="list-style-type: none"> <li>• When the number set is reached, the response parameterised in <a href="#">C00189</a> is executed.</li> </ul>
<a href="#">C00187</a>	Current number of <u>unsuccessful</u> error reset processes carried out
<a href="#">C00188</a>	Configuration of the AutoFailReset function <ul style="list-style-type: none"> <li>• 0: Off</li> <li>• 1: Fault + TroubleQSP</li> <li>• 2: WarningLocked</li> <li>• 3: All locking</li> </ul>
<a href="#">C00189</a>	Response after max. number of <u>unsuccessful</u> error reset processes has been reached
Greyed out = display parameter	

## 9.7 Maloperation of the drive

Maloperation	Cause	Remedy
Motor does not rotate	DC-bus voltage is too low <ul style="list-style-type: none"> <li>Red LED is blinking every 1 s</li> <li>Display in the keypad: <i>LU</i></li> </ul>	Check mains voltage
	Inverter is inhibited <ul style="list-style-type: none"> <li>Green LED is blinking</li> <li>Display in the keypad: <b>CINH</b></li> </ul>	Deactivate controller inhibit <ul style="list-style-type: none"> <li>Note: Controller inhibit can be set via several sources !</li> <li><a href="#">C00158</a> displays all active sources for controller inhibit.</li> </ul>
	Automatic start is inhibited (Bit 0 in <a href="#">C00142</a> = 1)	LOW/HIGH edge at RFR If required, correct starting condition with <a href="#">C00142</a>
	DC-injection braking (DCB) is active	Deactivate DC injection brake
	Mechanical motor brake is not released	Release mechanical motor brake manually or electrically
	Quick stop (QSP) is active <ul style="list-style-type: none"> <li>Display in the keypad: <b>IMP</b></li> </ul>	Deactivate quick stop <ul style="list-style-type: none"> <li>Note: Quick stop can be set via several sources!</li> <li><a href="#">C00159</a> displays all active sources for quick stop.</li> </ul>
	Setpoint = 0	Select setpoint
	JOG frequency = 0 at activated JOG setpoint	Set JOG setpoint in <a href="#">C00039/1...15</a>
	Trouble active	Clear fault
	With <a href="#">C00006</a> = 4, "SLVC: Vector control" has been set, but no motor parameter identification has been carried out.	Execute automatic motor parameter identification with the <a href="#">C00002/23</a> device command
Assignment of several mutually exclusive functions with a signal source in <a href="#">C00701</a>	Correct configuration in <a href="#">C00701</a>	
Motor rotates irregularly	Motor cable is defective	Check motor cable
	Maximum motor current in motor or generator mode is set too low	Adjust settings to the application: <a href="#">C00022</a> : I <sub>max</sub> in motor mode <a href="#">C00023</a> : I <sub>max</sub> in generator mode
	Motor is underexcited or overexcited	Check parameterisation: <a href="#">C00006</a> : Motor control <a href="#">C00015</a> : VFC: V/f base frequency <a href="#">C00016</a> : VFC: V <sub>min</sub> boost
	Rated motor data (stator resistance, speed, current, frequency, voltage) and cos φ and/or magnetising inductance is not adapted to the motor data	Execute automatic motor parameter identification with the <a href="#">C00002/23</a> device command - or - Adjust motor parameters manually: <a href="#">C00084</a> : Motor stator resistance <a href="#">C00087</a> : Rated motor speed <a href="#">C00088</a> : Rated motor current <a href="#">C00089</a> : Rated motor frequency <a href="#">C00090</a> : Rated motor voltage <a href="#">C00091</a> : Motor cosine phi <a href="#">C00092</a> : Motor magnetising inductance
	Motor windings are wired incorrectly	Reverse from star connection to delta connection

Maloperation	Cause	Remedy
Motor rotates regardless of setpoint "0"	The setpoint is selected via the analog input (blank where necessary). The analog input has a tolerance of $\pm 1\%$ and is designed as bipolar input unlike in the case of the 8200 vector. For this reason, no dead band has been set in the Lenze setting. When a setpoint of 0.3% has been selected, e.g. a speed of 4.5 rpm (with reference speed = 1500 rpm) is the result. As the auto-DCB threshold in <a href="#">C00019</a> is set to 3 rpm, the speed oscillates between 0 and 4 rpm.	Set dead band for the analog input in <a href="#">C00010/2</a> and <a href="#">C00010/4</a> (see chapter "Signal adaptation by means of characteristic") - or - Increase auto-DCB threshold in <a href="#">C00019</a>
Motor consumes too much current	$V_{\min}$ boost has been selected too high	Correct setting with <a href="#">C00016</a>
	V/f base frequency has been selected too low	Correct setting with <a href="#">C00015</a>
	Rated motor data (stator resistance, speed, current, frequency, voltage) and $\cos \varphi$ and/or magnetising inductance is not adapted to the motor data	Execute automatic motor parameter identification with the <a href="#">C00002/23</a> device command - or - Adjust motor parameters manually: <a href="#">C00084</a> : Motor stator resistance <a href="#">C00087</a> : Rated motor speed <a href="#">C00088</a> : Rated motor current <a href="#">C00089</a> : Rated motor frequency <a href="#">C00090</a> : Rated motor voltage <a href="#">C00091</a> : Motor cosine phi <a href="#">C00092</a> : Motor magnetising inductance
Motor parameter identification is aborted with error LP1	Motor is too small compared to the rated device power ( $>1 : 3$ )	Use device with lower rated power
	DC injection brake (DCB) is active via terminal	Deactivate DC injection brake
Drive behaviour with vector control is not satisfactory	different	Optimise or manually adapt vector control
		Execute automatic motor parameter identification with the <a href="#">C00002/23</a> device command
Torque dip in field weakening range or motor stalling when being operated in the field weakening range	Motor is overloaded	Check motor load
	Motor windings are wired incorrectly	Reverse from star connection to delta connection
	V/f reference point is set too high	Correct setting with <a href="#">C00015</a>
	Override point of field weakening is set too low	Correct setting with <a href="#">C00080</a>



Maloperation	Cause	Remedy
An asynchronous motor with feedback rotates without control and with too low speed	<p>Motor phases have been interchanged</p> <ul style="list-style-type: none"> <li>• Thus the rotating field of the motor is not identical anymore with the rotating field of the feedback system.</li> <li>• Therefore, the drive shows the following behaviour if V/f characteristic control (<a href="#">C00006</a> = 7) is performed: <ul style="list-style-type: none"> <li>• The motor rotates faster than the speed setpoint by the value set in <a href="#">C00074</a>.</li> <li>• After the controller has been enabled, the inverter will not stop if the speed setpoint = 0 or a quick stop (QSP) occurs.</li> <li>• Among other things, the final motor current depends on the value set for the <math>V_{\min}</math> boost and may rise up to <math>I_{\max}</math> which can trigger the "oC5: Ixt overload" fault message.</li> </ul> </li> </ul>	<p>Check the phase position of the motor cable</p> <p>If possible: Actuate the motor with deactivated feedback (<a href="#">C00006</a> = 6) and check direction of rotation of the motor</p>
Motor phase (LP1) monitoring does not respond if the motor phases are interrupted	Monitoring is not active ( <a href="#">C00597</a> = 0)	Activate monitoring ( <a href="#">C00597</a> = 1)

### 9.8 Operation without mains supply



#### Note!

Observe the following restrictions for operation without mains supply:

##### Safety state

Inverters of the 8400 series can be optionally equipped with the integrated "Safe torque off (STO)" safety system.

- **Up to and including version 13.xx.xx, the following applies:**  
If merely the external 24-V supply of the inverter is switched on, the "Safe torque off" status in [C00137](#) (bit 10) will not be updated.
- **From version 14.00.00 the following applies:**  
If merely the external 24-V supply of the inverter is switched on, the "Safe torque off" status in [C00137](#) (bit 10) will be updated.

##### Fan monitoring functions

The fan monitoring functions are only active if the mains supply is switched on.

The following display parameters have a value of "0" if the mains supply is switched off and the external 24 V supply of the inverter is switched on:

Parameters	Info
<a href="#">C00050</a>	MCTRL: Speed setpoint
<a href="#">C00051</a>	MCTRL: Actual speed value
<a href="#">C00052</a>	Motor voltage
<a href="#">C00053</a>	DC-bus voltage
<a href="#">C00054</a>	Motor current
<a href="#">C00058</a>	Output frequency
<a href="#">C00061</a>	Heatsink temperature
<a href="#">C00064/1...3</a>	Device utilisation (Ixt)
<a href="#">C00066</a>	Thermal motor load (I <sup>2</sup> xt)
<a href="#">C00177</a>	Switching cycles
<a href="#">C00725</a>	Current switching frequency

### 9.9 Error messages of the operating system

This chapter describes all error messages of the inverter operating system and possible causes & remedies.



**Tip!**

Each error message is also saved to the logbook in chronological order. ▶ [Logbook](#) (☰ 443)

#### 9.9.1 Structure of the 32-bit error number (bit coding)

If an error occurs in the inverter, the internal fault memory saves a 32-bit value which contains the following information:

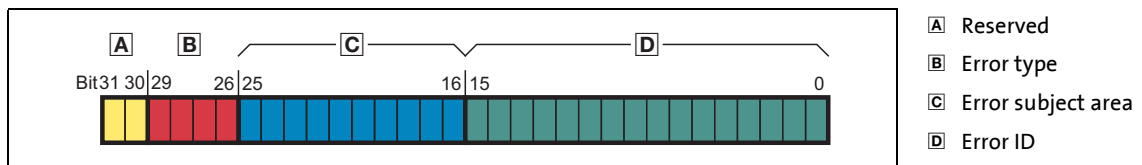

[9-1] Structure of the error number

- Display parameter: [C00168](#)
  - From version 13.00.00: [C00162/1](#) additionally displays the 32-bit error number without error type, i.e. this error number only contains the error subject area and the error ID (bit 0 ... bit 25).
- The [LS DriveInterface](#) system block shows the 32-bit error number at the outputs *wStateDetermFailNoLow* (Low Word) and *wStateDetermFailNoHigh* (High Word).
  - From version 06.00.00 onwards: If the "Use 16BitFailNo." (Bit 15 = "1") option is activated in [C00148](#), the short 16-bit error number is provided by the SB [LS DriveInterface](#) at the *wStateDetermFailNoLow* output and the value "0" is provided at the *wStateDetermFailNoHigh* output (see the following chapter).
- For the sake of legibility, the error number in the logbook and in [C00165](#) is displayed with the following syntax:  
**[Error type].[Error subject area no.].[Error ID]**

### Error type



The error type gives information about the behaviour/response of the inverter to the error. The error type for some device errors can also be parameterised.

Bit 29	Bit 28	Bit 27	Bit 26	Meaning
0	0	0	0	0: No Response
0	0	0	1	1: Fault
0	0	1	0	2: Trouble
0	0	1	1	3: TroubleQSP
0	1	0	0	4: WarningLocked
0	1	0	1	5: Warning
0	1	1	0	6: Information

### Error subject area

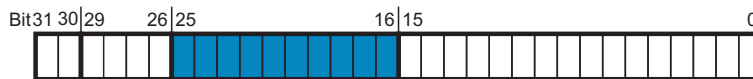

The error subject area indicates the internal "function unit" of the inverter in which the error has occurred:

Error subject area		Assigned errors	Remedy possible by user?
No.	Name		
111	Supply voltage	Errors that occur in connection with the supply voltage of the device.	Yes
119	Temperature	Errors that occur for temperature reasons.	Yes
123	Motor management / encoder	Errors that occur within the motor control or encoder evaluation.	Yes
125	Analog I/O integrated	Errors that occur in connection with the analog inputs and outputs.	Yes
127	Extension module slot 1	Errors that are reported by the extension module, and communication errors to the plugged-in extension module.	Yes if it is a fieldbus error.
131	CAN integrated (general)	Errors related to general CAN functions.	Yes
135	CAN process data object (PDO)	Errors that are explicitly only related to the CAN-PDO (process data objects).	Yes
140	Device configuration	Errors that occur due to incompatibilities of the plugged-in individual components (fieldbus module, safety module, et al.).	Yes if the error relates to a module plugged-in by the user.
144	Parameter set	Errors that occur in connection with the parameter set or the parameter set memory (memory module).	Yes if the error relates to a missing or incompatible memory module.
145	Device firmware (internal error)	Internal error of the device firmware.	No
184	MotionControlKernel	Errors that occur within the MotionControl basic functions (e.g. profile generation, brake control, positioning).	Yes
400	Defective device hardware	Errors that occur due to defective device hardware.	No
444	Fieldbus	Errors that occur in connection with fieldbus communication.	Yes
980 ... 983	User error 1 ... User error 4	Errors generated by the user (by the application) via the <a href="#">LS_SetError_1</a> system block.	Yes

### Error ID



16-bit value (0 ... 65535) for error identification within the error subject area.

**Example for bit coding of the error number**

[C00168](#) displays the internal error number "142278671".

- This decimal value corresponds to the following bit sequence:

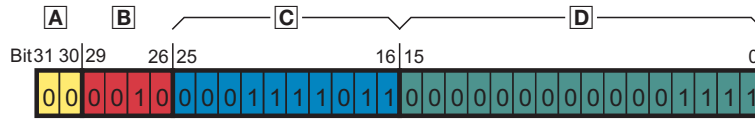

Assignment	Information	Meaning in the example
<span style="background-color: yellow; border: 1px solid black; padding: 2px;">00</span>	Reserved	-
<span style="background-color: red; border: 1px solid black; padding: 2px;">0010</span>	Error type	2: Trouble
<span style="background-color: blue; border: 1px solid black; padding: 2px;">0001111011</span>	Error subject area	123: Motor management / encoder
<span style="background-color: teal; border: 1px solid black; padding: 2px;">00000000001111</span>	Error ID	15: " <a href="#">LU: DC bus undervoltage</a> "

- Thus, error number "142278671" means:  
 A DC bus undervoltage has been detected in the "Motor management / encoder" subject area.  
 The error response is a "Fault".

### 9.9.2 Structure of the 16 bit error number (bit coding)

This function extension is available from version 06.00.00!

In addition to the 32-bit error number, a 16-bit error number is generated if an error occurs. It consists of the following information:

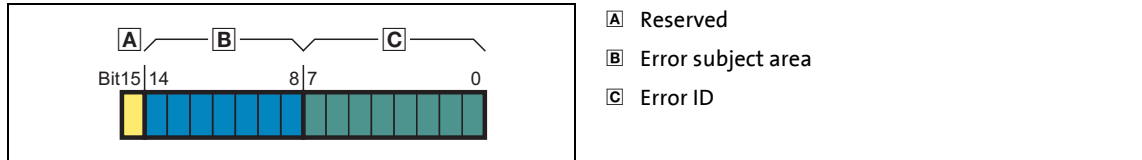

[9-2] Structure of the error number

- Display parameter: [C00160](#)
- The [LS\\_DriveInterface](#) system block shows the 16-bit error number at the output *wStateDetermFailNoShort*.
- If the "Use 16BitFailNo." option is activated in [C00148](#) (bit 15 = "1"), the [LS\\_DriveInterface](#) system block also shows the short 16-bit error number at the output *wStateDetermFailNoLow* (Low Word of the 32-bit error number).
  - The output *wStateDetermFailNoHigh* (High Word of the 32-bit error number) in this case is "0".
  - Advantage: The bus transfer of the error numbers is possible via a data word without changing the interconnection of the technology application.
- For the sake of legibility, the 16-bit error number in the logbook is displayed with the following syntax::  
**[Error subject area no.].[Error ID]**

#### Error subject area

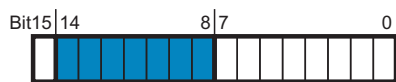

The error subject area indicates the internal "function unit" of the inverter in which the error has occurred.



#### Note!

Due to the smaller value range (0 ...127), the number assignment to the error subject area differs from the 32-bit error number.

Error subject area		Assigned errors	Remedy possible by user?
No.	Name		
11	Supply voltage	Errors that occur in connection with the supply voltage of the device.	Yes
19	Temperature	Errors that occur for temperature reasons.	Yes
23	Motor management / encoder	Errors that occur within the motor control or encoder evaluation.	Yes
25	Analog I/O integrated	Errors that occur in connection with the analog inputs and outputs.	Yes
26	Defective device hardware	Errors that occur due to defective device hardware.	No
27	Extension module slot 1	Errors that are reported by the extension module, and communication errors to the plugged-in extension module.	Yes if it is a fieldbus error.
31	CAN integrated (general)	Errors related to general CAN functions.	Yes

Error subject area		Assigned errors	Remedy possible by user?
No.	Name		
35	CAN process data object (PDO)	Errors that are explicitly only related to the CAN-PDO (process data objects).	Yes
40	Device configuration	Errors that occur due to incompatibilities of the plugged-in individual components (fieldbus module, safety module, et al.).	Yes if the error relates to a module plugged-in by the user.
44	Parameter set	Errors that occur in connection with the parameter set or the parameter set memory (memory module).	Yes if the error relates to a missing or incompatible memory module.
45	Device firmware (internal error)	Internal error of the device firmware.	No
54	Fieldbus	Errors that occur in connection with fieldbus communication.	Yes
84	MotionControlKernel	Errors that occur within the MotionControl basic functions (e.g. profile generation, brake control, positioning).	Yes
100 ... 103	User error 1 ... User error 4	Errors generated by the user (by the application) via the <a href="#">LS_SetError_1</a> system block.	Yes

### Error ID

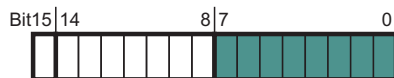

8-bit value (0 ... 255) for error identification within the error subject area.



#### Tip!

All possible 16-bit error numbers are listed in the table entitled "[Short overview \(A-Z\)](#)" in the second column. ([465](#))

### 9.9.3

#### Reset error message

An error message with the response "Fault", "Trouble", "TroubleQSP" or "Warning locked" must be explicitly reset (acknowledged) after the cause of the error has been eliminated.



To reset (acknowledge) a pending error message, execute device command [C00002/19](#) = "1".



#### Tip!

When an online connection to the inverter has been established, use the **Diagnostics** tab of »Engineer« and click **Reset error** to reset a pending error message.

### 9.9.4 Export error texts

All error texts of the inverter can be exported into a text file (\*.txt) for further processing.

- The error text is preceded with the corresponding 32-bit error number (no error type) and the 16-bit error number, both as decimal number.
- If there is no corresponding 16-bit error number for a 32-bit error number, the field remains empty.

#### Example

Output of the German and English error texts:

32-BitError	16-BitError	DE-de	EN-en
0	0	No error	No error
111	11	Versorgungsspannung	Supply voltage
119 / 19			
12323		Motor management / encoder	
125	25	E/A integriert	I/O integrated
...			
26214416	6672	dH10: Lüfterausfall	dH10: Fan failure
26214505	6761	dH69: Abgleichdatenfehler	dH69: Adjustment fault



#### How to export the error texts into a text file:

1. Go to the *Project view* in the *Context menu* of the 8400 StateLine inverter and execute the **Export error texts...** command.
2. Define the following options in the *Export error texts* dialog box:
  - Output file and memory location
  - Languages to be exported (German/English/French)
  - Device/module to be exported
  - Separator (tabulator or semicolon)
  - Font (UTF8, standard font or ASCII)
3. Click **OK** to start the export.
  - After the export, a message appears indicating whether the export was successful.



#### Tip!

From version 13.00.00, the 32-bit number of the state-determining error is displayed in [C00162/1](#) without error type.

If, for instance, the error texts are stored in a master control or on an operator panel, the error text to be displayed can be detected by reading the [C00162/1](#) code.



### 9.9.5 Short overview (A-Z)

The table below contains all error messages of the inverter operating system in alphabetical order.



#### Note!

For the sake of legibility, the [Logbook](#) and [C00165](#) display the error number with the following syntax:

**[Error type].[Error subject area no.].[Error ID]**

In this documentation, "xx", a wildcard, stands for the error type since it is configurable for many error messages.



#### Tip!

If you click the cross-reference in the first column, "Error number", you will reach the detailed description of the respective error message in the following chapter "[Cause & possible remedies](#)". (📖 468)

Error number	C00162/1		Error message	Response (Lenze setting)	Adjustable in	CAN emergency error code	
	32 bits	16 bits <sub>hex</sub>					16 bits <sub>dec</sub>
<a href="#">▶ xx.0125.00001</a>	0x1901	6401	8192001	An01: AIN1_1 < 4 mA	TroubleQuickStop	<a href="#">C00598/1</a>	0xF000
<a href="#">▶ xx.0131.00006</a>	0x1f06	7942	8585222	CA06: CAN CRC error	No Reaction	<a href="#">C00592/1</a>	0x8000
<a href="#">▶ xx.0131.00007</a>	0x1f07	7943	8585223	CA07: CAN Bus Warn	No Reaction	<a href="#">C00592/3</a>	0x8000
<a href="#">▶ xx.0131.00008</a>	0x1f08	7944	8585224	CA08: CAN Bus Stopped	No Reaction	<a href="#">C00592/4</a>	0x8000
<a href="#">▶ xx.0131.00011</a>	0x1f0b	7947	8585227	CA0b: CAN HeartBeatEvent	No Reaction	<a href="#">C00592/5</a>	0x8130
<a href="#">▶ xx.0131.00015</a>	0x1f0f	7951	8585231	CA0F: CAN control word	Fault	<a href="#">C00594/1</a>	0xF000
<a href="#">▶ xx.0127.00002</a>	0x1b02	6914	8323074	CE04: MCI communication error	No Reaction	<a href="#">C01501/1</a>	0x7000
<a href="#">▶ xx.0127.00015</a>	0x1b0f	6927	8323087	CE0F: MCI control word	Fault	<a href="#">C00594/2</a>	0xF000
<a href="#">▶ xx.0135.00001</a>	0x2301	8961	8847361	CE1: CAN RPDO1	No Reaction	<a href="#">C00593/1</a>	0x8100
<a href="#">▶ xx.0135.00002</a>	0x2302	8962	8847362	CE2: CAN RPDO2	No Reaction	<a href="#">C00593/2</a>	0x8100
<a href="#">▶ xx.0135.00003</a>	0x2303	8963	8847363	CE3: CAN RPDO3	No Reaction	<a href="#">C00593/3</a>	0x8100
<a href="#">▶ xx.0131.00000</a>	0x1f00	7936	8585216	CE4: CAN Bus Off	No Reaction	<a href="#">C00592/2</a>	0x8000
<a href="#">▶ xx.0135.00004</a>	0x2304	8964	8847364	CE5: CAN RPDO4	No Reaction	<a href="#">C00593/4</a>	0x8100
<a href="#">▶ xx.0140.00013</a>	0x280d	10253	9175053	CI01: Module missing/incompatible	No Reaction	<a href="#">C01501/2</a>	0x7000
<a href="#">▶ xx.0184.00005</a>	0x5405	21509	12058629	Ck15: Error message sig. brake	TroubleQuickStop	-	0x8600
<a href="#">▶ xx.0184.00064</a>	0x5440	21568	12058688	Ck16: Time overrun manual operation	Fault	-	
<a href="#">▶ xx.0145.00001</a>	0x2d01	11521	9502721	dF01: FW updated	No Reaction	-	
<a href="#">▶ xx.0145.00035</a>	0x2d23	11555	9502755	dF10: AutoTrip reset	Fault	<a href="#">C00189</a>	0xF000
<a href="#">▶ xx.0145.00014</a>	0x2d0e	11534	9502734	dF14: SW-HW invalid	Fault	-	
<a href="#">▶ xx.0145.00024</a>	0x2d18	11544	9502744	dF18: BU RCOM error	Fault	-	0x6100
<a href="#">▶ xx.0145.00033</a>	0x2d21	11553	9502753	dF21: BU watchdog	Fault	-	0x6100
<a href="#">▶ xx.0145.00034</a>	0x2d22	11554	9502754	dF22: CU Watchdog	Fault	-	0x6100
<a href="#">▶ xx.0145.00025</a>	0x2d19	11545	9502745	dF25: CU RCOM error	Fault	-	0x6100
<a href="#">▶ xx.0145.00026</a>	0x2d1a	11546	9502746	dF26: Appl. watchdog	No Reaction	<a href="#">C00580/1</a>	0x6200
<a href="#">▶ xx.0145.00050</a>	0x2d32	11570	9502770	dF50: Retain error	Fault	-	0x6100
<a href="#">▶ xx.0145.00051</a>	0x2d33	11571	9502771	dF51: CuCcr error	Fault	-	0x6100
<a href="#">▶ xx.0145.00052</a>	0x2d34	11572	9502772	dF52: BuCcr error	Fault	-	0x6100
<a href="#">▶ xx.0400.00009</a>	0x1a09	6665	26214409	dH09: EEPROM power unit	Fault	-	0x5500
<a href="#">▶ xx.0400.00016</a>	0x1a10	6672	26214416	dH10: Fan failure	Warning	<a href="#">C00566</a>	0x5000
<a href="#">▶ xx.0400.00104</a>	0x1a68	6760	26214504	dH68: Adjustment data error CU	Fault	-	0x5500
<a href="#">▶ xx.0400.00105</a>	0x1a69	6761	26214505	dH69: Adjustment data error BU	Fault	-	0x5500

# 9 Diagnostics & error management

## 9.9 Error messages of the operating system

Error number	C00162/1		Error message	Response (Lenze setting)	Adjustable in	CAN emergency error code	
	32 bits	16 bits <sub>hex</sub>					16 bits <sub>dec</sub>
▶ <a href="#">xx.0400.00106</a>	0x1a6a	6762	26214506	dH70: ControlUnit is unequal to BaseUnit	Fault	-	0x5500
▶ <a href="#">xx.0123.00094</a>	0x175e	5982	8061022	FC01: Switching frequency reduction	No Reaction	<a href="#">C00590</a>	0x2000
▶ <a href="#">xx.0123.00095</a>	0x175f	5983	8061023	FC02: Maximum speed for Fchop	No Reaction	<a href="#">C00588</a>	0xF000
▶ <a href="#">xx.0123.00099</a>	0x1763	5987	8061027	FC03: Limitation field controller	No Reaction	<a href="#">C00570/4</a>	0xF000
▶ <a href="#">xx.0123.00057</a>	0x1739	5945	8060985	ld1: Motor data identification error	Fault	-	0xF000
▶ <a href="#">xx.0123.00058</a>	0x173a	5946	8060986	ld3: CINH identification	WarningLocked	-	0xF000
▶ <a href="#">xx.0123.00059</a>	0x173b	5947	8060987	ld4: Resistance identification error	Warning	-	0xF000
▶ <a href="#">xx.0123.00074</a>	0x174a	5962	8061002	ld5: Pole position identification error	Fault	<a href="#">C00643/1</a>	
▶ <a href="#">xx.0123.00060</a>	0x173c	5948	8060988	ld7: Motor control does not match motor data		<a href="#">C00571/1</a>	0xF000
▶ <a href="#">xx.0123.00061</a>	0x173d	5949	8060989	ld8: Speed sensor has not been set	Fault	<a href="#">C00571/2</a>	0x7120
▶ <a href="#">xx.0123.00145</a>	0x1791	6033	8061073	LP1: Motor phase failure	No Reaction	<a href="#">C00597</a>	0x3000
▶ <a href="#">xx.0123.00015</a>	0x170f	5903	8060943	LU: DC bus undervoltage	Trouble	<a href="#">C00600/1</a>	0x3100
▶ <a href="#">xx.0123.00016</a>	0x1710	5904	8060944	oC1: Power section - short circuit	Fault	-	0x2000
▶ <a href="#">xx.0123.00030</a>	0x171e	5918	8060958	oC10: Maximum current reached	No Reaction	<a href="#">C00609</a>	0x2000
▶ <a href="#">xx.0123.00071</a>	0x1747	5959	8060999	oC11: Clamp operation active	Fault	-	0xF000
▶ <a href="#">xx.0123.00065</a>	0x1741	5953	8060993	oC12: I2xt brake resistor overload	No Reaction	<a href="#">C00574</a>	0xF000
▶ <a href="#">xx.0123.00090</a>	0x175a	5978	8061018	oC13: Maximum current for Fch exceeded	Fault	-	0xF000
▶ <a href="#">xx.0123.00096</a>	0x1760	5984	8061024	oC14: Direct-axis current controller limitation	No Reaction	<a href="#">C00570/1</a>	0xF000
▶ <a href="#">xx.0123.00097</a>	0x1761	5985	8061025	oC15: Cross current controller limitation	No Reaction	<a href="#">C00570/2</a>	0xF000
▶ <a href="#">xx.0123.00098</a>	0x1762	5986	8061026	oC16: Torque controller limitation	No Reaction	<a href="#">C00570/3</a>	0xF000
▶ <a href="#">xx.0123.00031</a>	0x171f	5919	8060959	oC17: Clamp sets pulse inhibit	No Reaction	<a href="#">C00569/1</a>	0xF000
▶ <a href="#">xx.0123.00034</a>	0x1722	5922	8060962	oC18: Current monitoring overload	No Reaction	<a href="#">C00584/1</a>	0x2000
▶ <a href="#">xx.0123.00066</a>	0x1742	5954	8060994	oC19: short circuit of brake resistor	Fault	-	
▶ <a href="#">xx.0123.00017</a>	0x1711	5905	8060945	oC2: Power section - earth fault	Fault	-	0x2000
▶ <a href="#">xx.0119.00050</a>	0x1332	4914	7798834	oC5: Ixt overload	Warning	<a href="#">C00604</a>	0x2000
▶ <a href="#">xx.0123.00105</a>	0x1769	5993	8061033	oC6: I2xt motor overload	Warning	<a href="#">C00606</a>	0x2000
▶ <a href="#">xx.0123.00007</a>	0x1707	5895	8060935	oC7: Motor overcurrent	Fault	-	0x2000
▶ <a href="#">xx.0119.00001</a>	0x1301	4865	7798785	oH1: Heatsink overtemperature	Fault	-	0x4000
▶ <a href="#">xx.0119.00015</a>	0x130f	4879	7798799	oH3: Motor temperature (X106) triggered	Fault	<a href="#">C00585</a>	0x4000
▶ <a href="#">xx.0119.00000</a>	0x1300	4864	7798784	oH4: Heatsink temp. > shutdown temp. -5°C	No Reaction	<a href="#">C00582</a>	0x4000
▶ <a href="#">xx.0123.00032</a>	0x1720	5920	8060960	oS1: Maximum speed limit reached	No Reaction	<a href="#">C00579</a>	0x8400
▶ <a href="#">xx.0123.00033</a>	0x1721	5921	8060961	oS2: Max. motor speed	Fault	-	0x8400
▶ <a href="#">xx.0123.00001</a>	0x1701	5889	8060929	ot1: Max. torque reached	No Reaction	<a href="#">C00608</a>	0x8300
▶ <a href="#">xx.0123.00093</a>	0x175d	5981	8061021	ot2: Speed controller output limited	No Reaction	<a href="#">C00567</a>	0xF000
▶ <a href="#">xx.0123.00014</a>	0x170e	5902	8060942	OU: DC bus overvoltage	Trouble	-	0x3100
▶ <a href="#">xx.0144.00001</a>	0x2c01	11265	9437185	PS01: No memory module	Warning	-	0x6300
▶ <a href="#">xx.0144.00002</a>	0x2c02	11266	9437186	PS02: Par. set invalid	Fault	-	0x6300
▶ <a href="#">xx.0144.00003</a>	0x2c03	11267	9437187	PS03: Par. set device invalid	Fault	-	0x6300
▶ <a href="#">xx.0144.00004</a>	0x2c04	11268	9437188	PS04: Invalid MCI par. set	Fault	-	0x6300
▶ <a href="#">xx.0144.00007</a>	0x2c07	11271	9437191	PS07: Par. mem. module invalid	Fault	-	0x6300
▶ <a href="#">xx.0144.00008</a>	0x2c08	11272	9437192	PS08: Par. device invalid	Fault	-	0x6300
▶ <a href="#">xx.0144.00009</a>	0x2c09	11273	9437193	PS09: Par. format invalid	Fault	-	0x6300
▶ <a href="#">xx.0144.00010</a>	0x2c0a	11274	9437194	PS10: Memory module link invalid	Fault	-	
▶ <a href="#">xx.0144.00011</a>	0x2c0b	11275	9437195	PS11: Lenze setting loaded	No Reaction	-	
▶ <a href="#">xx.0144.00012</a>	0x2c0c	11276	9437196	PS12: Parameter sets loaded	No Reaction	-	
▶ <a href="#">xx.0144.00013</a>	0x2c0e	11277	9437197	PS13: Parameter sets saved	No Reaction	-	
▶ <a href="#">xx.0123.00205</a>	0x17cd	6093	8061133	Sd3: Open circuit HTL 2-fold or 4-fold	Fault	<a href="#">C00586</a>	0x7300
▶ <a href="#">xx.0123.00200</a>	0x17c8	6088	8061128	Sd10: Speed limit for feedback system 12	Fault	<a href="#">C00607</a>	0x7300
▶ <a href="#">xx.0123.00210</a>	0x17d2	6098	8061138	Sd18: V/f emergency operation	Information	-	
▶ <a href="#">xx.0111.00002</a>	0x0b02	2818	7274498	Su02: One mains phase is missing	Warning	<a href="#">C00565</a>	0x3000
▶ <a href="#">xx.0111.00003</a>	0x0b03	2819	7274499	Su03: Too frequent mains switching	Fault	-	0x3000

# 9 Diagnostics & error management

## 9.9 Error messages of the operating system

Error number		16 bits <sub>hex</sub>	16 bits <sub>dec</sub>	C00162/1	Error message	Response (Lenze setting)	Adjustable in	CAN emergency error code
32 bits								
▶ <a href="#">xx.0111.00004</a>	0x0b04	2820	7274500	Su04: CU insufficiently supplied	Warning	-	0x3000	
▶ <a href="#">xx.0111.00006</a>	0x0b06	2822	7274502	Su06: Power input overload	Fault	-	0x3000	
▶ <a href="#">xx.0111.00007</a>	0x0b07	2823	7274503	Su07: 24V supply off	No Reaction	-	-	
Freely configurable user error messages (see <a href="#">LS_SetError_1</a> )								
▶ <a href="#">xx.0980.00001</a>	25600 <sub>dec</sub> + <a href="#">C161/1</a> *			User error 1	No Reaction	<a href="#">C00581/1</a>	0x6200	
▶ <a href="#">xx.0981.00002</a>	25856 <sub>dec</sub> + <a href="#">C161/2</a> *			User error 2	No Reaction	<a href="#">C00581/2</a>	0x6200	
▶ <a href="#">xx.0982.00003</a>	26112 <sub>dec</sub> + <a href="#">C161/3</a> *			User error 3	No Reaction	<a href="#">C00581/3</a>	0x6200	
▶ <a href="#">xx.0983.00004</a>	26368 <sub>dec</sub> + <a href="#">C161/4</a> *			User error 4	No Reaction	<a href="#">C00581/4</a>	0x6200	
* Only the lower 8 bits of the adjustable error ID ( <a href="#">C161/x</a> ) can be used.								

### 9.9.6 Cause & possible remedies

This chapter contains all error messages of the inverter operating system in numerical order of the error numbers. The list provides detailed information on the response to the error message as well as information on the cause & possible remedies.



#### Note!

For the sake of legibility, the [Logbook](#) and [C00165](#) display the error number with the following syntax:

**[Error type].[Error subject area no.].[Error ID]**

In this documentation, "xx", a wildcard, stands for the error type since it is configurable for many error messages.



#### Tip!

A list of all error messages of the inverter operating system in alphabetical order can be found in the previous chapter "[Short overview \(A-Z\)](#)" ([□ 465](#)).

#### Su02: One mains phase is missing [xx.0111.00002]

<b>Response</b> (Lenze setting printed in bold)	<b>Setting:</b> <a href="#">C00565</a> ( <input checked="" type="checkbox"/> Adjustable response)
<input checked="" type="checkbox"/> 0: No Reaction <input checked="" type="checkbox"/> 1: Fault <input type="checkbox"/> 2: Trouble <input type="checkbox"/> 3: TroubleQuickStop <input type="checkbox"/> 4: WarningLocked <input checked="" type="checkbox"/> 5: Warning <input type="checkbox"/> 6: Information	
<b>Cause</b>	<b>Remedy</b>
A mains phase of a three-phase supply has failed.	Check mains connection (terminal X100).

#### Su03: Too frequent mains switching [xx.0111.00003]

<b>Response</b> (Lenze setting printed in bold)	<b>Setting:</b> <a href="#">C00565</a> ( <input checked="" type="checkbox"/> Adjustable response)
<input type="checkbox"/> 0: No Reaction <input checked="" type="checkbox"/> 1: Fault <input type="checkbox"/> 2: Trouble <input type="checkbox"/> 3: TroubleQuickStop <input type="checkbox"/> 4: WarningLocked <input type="checkbox"/> 5: Warning <input type="checkbox"/> 6: Information	
<b>Cause</b>	<b>Remedy</b>
<p>Too frequent mains switching of the power section.</p> <ul style="list-style-type: none"> <li>The device recognises if the power section is switched on and off too frequently.</li> <li>To protect internal charging connections from destruction, the device reports this error and prevents the controller inhibit. All other functions are active.</li> </ul> <p>Use of a power supply module in the DC-bus connection, the DC terminals of which are connected downstream to the charging connection for the voltage DC bus (e.g. 9400 from 45 kW).</p>	<p>The error must be acknowledged by mains switching. The charging circuit can only cool down when the mains is switched off.</p> <ul style="list-style-type: none"> <li>After switching the mains 3 times in one minute, there must be a switching pause of 9 minutes.</li> <li>Cyclic mains switching every 3 minutes is permissible.</li> </ul> <p><b>From version 12.00.00 onwards</b>, this power supply module can be used in the DC-bus connection by enabling it via <a href="#">C02865</a> (bit 8).</p> <p><b>Note:</b> For further configuration of devices in the DC-bus connection with 8400, the DC terminals of which are connected downstream to the charging connection for the voltage DC bus (e.g. 9400 from 45 kW with 8400) contact Lenze.</p>

# 9 Diagnostics & error management

## 9.9 Error messages of the operating system

### Su04: CU insufficiently supplied [xx.0111.00004]

<b>Response</b> (Lenze setting printed in bold)	
<input type="checkbox"/> 0: No Reaction <input type="checkbox"/> 1: Fault <input type="checkbox"/> 2: Trouble <input type="checkbox"/> 3: TroubleQuickStop <input type="checkbox"/> 4: WarningLocked <input checked="" type="checkbox"/> 5: Warning <input type="checkbox"/> 6: Information	
<b>Cause</b>	<b>Remedy</b>
After switching on the device, the 24V supply voltage for the control electronics is too low (100 ms after switch-on U is < 19V). <ul style="list-style-type: none"> <li>The current supply voltage is displayed in <a href="#">C00065</a>.</li> </ul>	With internal supply voltage via the power electronics, the inverter must be replaced. With external supply voltage, check the correct connection and/or the stability of the supply voltage.

### Su06: Mains input overload [xx.0111.00006]

<b>Response</b> (Lenze setting printed in bold)	
<input type="checkbox"/> 0: No Reaction <input checked="" type="checkbox"/> 1: Fault <input type="checkbox"/> 2: Trouble <input type="checkbox"/> 3: TroubleQuickStop <input type="checkbox"/> 4: WarningLocked <input type="checkbox"/> 5: Warning <input type="checkbox"/> 6: Information	
<b>Cause</b>	<b>Remedy</b>
In order to protect the device from overload, the following device outputs have a hardware detection in the mains input: 7.5 kW, 11 kW, 15 kW, 30 kW, 37 kW, 45 kW. In case of the error message "Su06", this hardware detection has responded.	<ul style="list-style-type: none"> <li>Check whether all mains phases are connected (a 2-phase supply may be existent).</li> <li>Provide for sufficient cooling of the device.</li> </ul>

### Su07: 24V supply off [xx.0111.00007]

<b>Response</b> (Lenze setting printed in bold)	
<input type="checkbox"/> 0: No Reaction <input type="checkbox"/> 1: Fault <input type="checkbox"/> 2: Trouble <input type="checkbox"/> 3: TroubleQuickStop <input type="checkbox"/> 4: WarningLocked <input type="checkbox"/> 5: Warning <input type="checkbox"/> 6: Information	
<b>Cause</b>	<b>Remedy</b>

### oH4: Heatsink temp. > shutdown temp. -5°C [xx.0119.00000]

<b>Response</b> (Lenze setting printed in bold)	<b>Setting:</b> <a href="#">C00582</a> ( <input checked="" type="checkbox"/> Adjustable response )
<input checked="" type="checkbox"/> 0: No Reaction <input checked="" type="checkbox"/> 1: Fault <input type="checkbox"/> 2: Trouble <input type="checkbox"/> 3: TroubleQuickStop <input type="checkbox"/> 4: WarningLocked <input checked="" type="checkbox"/> 5: Warning <input type="checkbox"/> 6: Information	
<b>Cause</b>	<b>Remedy</b>
The heatsink temperature now only differs by 5 °C from the shutdown temperature of the motor.	Prevent further heating, i.e. reduce motor load or set controller inhibit so that the heatsink can cool down again.

### oH1: Heatsink overtemperature [xx.0119.00001]

<b>Response</b> (Lenze setting printed in bold)	
<input type="checkbox"/> 0: No Reaction <input checked="" type="checkbox"/> 1: Fault <input type="checkbox"/> 2: Trouble <input type="checkbox"/> 3: TroubleQuickStop <input type="checkbox"/> 4: WarningLocked <input type="checkbox"/> 5: Warning <input type="checkbox"/> 6: Information	
<b>Cause</b>	<b>Remedy</b>
The heatsink temperature is higher than the fixed limit temperature (90 °C). Maybe the ambient temperature of the controller is too high or the fan or its ventilation slots are dirty.	<ul style="list-style-type: none"> <li>Check control cabinet temperature.</li> <li>Clean filter.</li> <li>Clean inverter.</li> <li>If required, clean or replace the fan.</li> <li>Provide for sufficient cooling of the device.</li> </ul>

# 9 Diagnostics & error management

## 9.9 Error messages of the operating system

### oH3: Motor temperature (X106) triggered [xx.0119.00015]

<b>Response</b> (Lenze setting printed in bold)		<b>Setting:</b> <a href="#">C00585</a> (☑ Adjustable response)
☑ 0: No Reaction ☑ <b>1: Fault</b> ☐ 2: Trouble ☐ 3: TroubleQuickStop ☐ 4: WarningLocked ☑ 5: Warning ☐ 6: Information		
<b>Cause</b>	<b>Remedy</b>	
<p>The motor temperature monitoring function at the plug connector X106, terminal T1 /T2, has tripped.</p> <p>Possible causes:</p> <ul style="list-style-type: none"> <li>• The motor is overheated so that the thermal contact integrated into the motor has been switched.</li> <li>• An open circuit or a loose contact at the connections mentioned above has occurred.</li> </ul>	<ul style="list-style-type: none"> <li>• Check motor temperature monitoring.</li> <li>• Provide for sufficient cooling of the motor.</li> <li>• Check terminals for open circuit or loose contact.</li> </ul>	

### oC5: Ixt overload [xx.0119.00050]

<b>Response</b> (Lenze setting printed in bold)		<b>Setting:</b> <a href="#">C00604</a> (☑ Adjustable response)
☑ 0: No Reaction ☑ <b>1: Fault</b> ☐ 2: Trouble ☐ 3: TroubleQuickStop ☐ 4: WarningLocked ☑ <b>5: Warning</b> ☐ 6: Information		
<b>Cause</b>	<b>Remedy</b>	
<p>The Ixt overload check has tripped.</p> <ul style="list-style-type: none"> <li>• Operating threshold = 100 % Ixt (adjustable in <a href="#">C00123</a>)</li> </ul> <p>Possible causes:</p> <ul style="list-style-type: none"> <li>• Wrong dimensioning of the device with regard to its motor load.</li> <li>• Load cycles are not complied with.</li> </ul>	<ul style="list-style-type: none"> <li>• Check and, if required, correct dimensioning of the device and the motor load with regard to technical data.</li> <li>• Reduce motor load cycles (observe load cycles according to documentation).</li> </ul>	

### ot1: Maximum torque reached [xx.0123.00001]

<b>Response</b> (Lenze setting printed in bold)		<b>Setting:</b> <a href="#">C00608</a> (☑ Adjustable response)
☑ <b>0: No Reaction</b> ☑ <b>1: Fault</b> ☐ 2: Trouble ☐ 3: TroubleQuickStop ☐ 4: WarningLocked ☑ 5: Warning ☐ 6: Information		
<b>Cause</b>	<b>Remedy</b>	
<p>The device indicates that the maximally possible torque at the motor shaft has been reached.</p> <ul style="list-style-type: none"> <li>• <a href="#">C00057</a> displays the current torque.</li> </ul>	Reduce motor load.	

### oC7: Motor overcurrent [xx.0123.00007]

<b>Response</b> (Lenze setting printed in bold)		
☐ 0: No Reaction ☑ <b>1: Fault</b> ☐ 2: Trouble ☐ 3: TroubleQuickStop ☐ 4: WarningLocked ☐ 5: Warning ☐ 6: Information		
<b>Cause</b>	<b>Remedy</b>	
<p>The maximum current monitoring function has been triggered.</p> <ul style="list-style-type: none"> <li>• The instantaneous value of the motor current has exceeded the limit value set in <a href="#">C00939</a>.</li> </ul>	Check and, if required, correct dimensioning of the load with regard to the installed device power.	

# 9 Diagnostics & error management

## 9.9 Error messages of the operating system

### oU: DC bus overvoltage [xx.0123.00014]

Response (Lenze setting printed in bold)	
<input type="checkbox"/> 0: No Reaction <input checked="" type="checkbox"/> 1: Fault <input checked="" type="checkbox"/> 2: <b>Trouble</b> <input type="checkbox"/> 3: TroubleQuickStop <input type="checkbox"/> 4: WarningLocked <input type="checkbox"/> 5: Warning <input type="checkbox"/> 6: Information	
Cause	Remedy
<p>The device has detected an overvoltage in the DC bus. To protect the device hardware, the inverter control is switched off.</p> <ul style="list-style-type: none"> <li>Depending on the configuration of the auto-start lock function, set <a href="#">C00142</a> so that, when this error is tripped, the inverter only restarts after the controller inhibit has been switched.</li> <li>If this error message remains active longer than the time set in <a href="#">C00601</a>, a "Fault" is tripped. Otherwise, the deactivation of the error message causes the inverter control to be enabled again             <ul style="list-style-type: none"> <li>In case of the control types VFCplus and SLVC, the motor voltage is approached to the voltage setpoint alongside a ramp.</li> <li>From version 15.00.00, this voltage ramp can be set in <a href="#">C00983/2</a>. If the described remedies are not possible or do not have any effect, it may be required to increase this voltage ramp as otherwise an overcurrent interruption may be caused. This only happens in case of high motor power and mass inertia so that the Lenze setting of 1 s should be sufficient in the majority of cases.</li> </ul> </li> </ul>	<ul style="list-style-type: none"> <li>Reduce regenerative load.</li> <li>Use brake resistor.</li> <li>Use a regenerative power supply unit.</li> <li>Establish a DC-bus connection.</li> <li>Select a braking method in <a href="#">C00175</a> which stops the ramp function generator when reaching the brake chopper threshold ("HlgStop").</li> </ul>

### LU: DC bus undervoltage [xx.0123.00015]

Response (Lenze setting printed in bold)	
<input type="checkbox"/> 0: No Reaction <input checked="" type="checkbox"/> 1: Fault <input checked="" type="checkbox"/> 2: <b>Trouble</b> <input type="checkbox"/> 3: TroubleQuickStop <input type="checkbox"/> 4: WarningLocked <input type="checkbox"/> 5: Warning <input type="checkbox"/> 6: Information	
Setting: <a href="#">C00600/1</a> ( <input checked="" type="checkbox"/> Adjustable response )	
Cause	Remedy
<p>The device has detected a DC bus undervoltage. The inverter control is switched off because the drive properties of the motor control cannot be provided anymore due to the DC bus undervoltage.</p> <ul style="list-style-type: none"> <li>Depending on the configuration of the auto-start lock function, set <a href="#">C00142</a> so that, when this error is tripped, the inverter only restarts after the controller inhibit has been switched.</li> </ul>	<ul style="list-style-type: none"> <li>Switch on mains supply or ensure sufficient supply via DC bus.</li> <li>Adjust setting in <a href="#">C00142</a> if required.</li> </ul>

### oC1: Power section - short circuit [xx.0123.00016]

Response (Lenze setting printed in bold)	
<input type="checkbox"/> 0: No Reaction <input checked="" type="checkbox"/> 1: <b>Fault</b> <input type="checkbox"/> 2: Trouble <input type="checkbox"/> 3: TroubleQuickStop <input type="checkbox"/> 4: WarningLocked <input type="checkbox"/> 5: Warning <input type="checkbox"/> 6: Information	
Cause	Remedy
<p>The device has recognised a short circuit of the motor phases. To protect the device electronics, the inverter control is switched off.</p> <ul style="list-style-type: none"> <li>Mostly, incorrectly executed motor connections are the cause.</li> <li>If the device is inappropriately dimensioned with regard to the motor load and the current limitation in the controller (I<sub>max</sub> controller) is set incorrectly, this error message may also occur.</li> </ul> <p>► <a href="#">Motor control: Defining current limits</a></p>	<ul style="list-style-type: none"> <li>Check motor connections and the corresponding plug connector on the device.</li> <li>Only use permissible combinations of device power and motor power.</li> <li>Do not set the dynamics of the current limitation controller too high.</li> </ul>

# 9 Diagnostics & error management

## 9.9 Error messages of the operating system

### oC2: Power section - earth fault [xx.0123.00017]

Response (Lenze setting printed in bold)	
<input type="checkbox"/> 0: No Reaction <input checked="" type="checkbox"/> 1: <b>Fault</b> <input type="checkbox"/> 2: Trouble <input type="checkbox"/> 3: TroubleQuickStop <input type="checkbox"/> 4: WarningLocked <input type="checkbox"/> 5: Warning <input type="checkbox"/> 6: Information	
Cause	Remedy
<p>The device has recognised an earth fault at one of the motor phases. To protect the device electronics, the inverter control is switched off.</p> <ul style="list-style-type: none"> <li>• Mostly, incorrectly executed motor connections are the cause.</li> <li>• If motor filter, motor cable length, and cable type (shielding capacity) are dimensioned incorrectly, this error message may occur due to leakage currents to PE.</li> <li>• If motor filters with additional terminals for +UG and –UG and devices greater or equal 3 kW are used, the earth fault detection may be triggered due to leakage currents to +UG and –UG.</li> <li>• A cause can also be the use of shielded motor cables longer than 50 m.</li> </ul>	<ul style="list-style-type: none"> <li>• Check motor connections and the corresponding plug connector on the device.</li> <li>• Use motor filters, cable lengths, and cable types recommended by Lenze.</li> <li>• If motor filters with additional terminals for +UG and –UG and devices greater or equal 3 kW are used:             <ul style="list-style-type: none"> <li>• <b>up to version V05.00.00:</b> Set resp. to earth fault (<a href="#">C00602</a>) to "0: No Reaction".</li> <li>• <b>From version V05.01.00 onwards:</b> Deactivate earth-fault detection during operation by setting the filter time (<a href="#">C01770</a>) to 250 ms.</li> </ul> </li> <li>• If motor cables longer than 50 m are used:             <ul style="list-style-type: none"> <li>• <b>From version V05.01.00 onwards:</b> Increase filter time for earth-fault detection during operation (<a href="#">C01770</a>).</li> </ul> </li> </ul>

### oC10: Maximum current reached [xx.0123.00030]

Response (Lenze setting printed in bold)	
Setting: <a href="#">C00609</a> ( <input checked="" type="checkbox"/> Adjustable response ) <input checked="" type="checkbox"/> 0: <b>No Reaction</b> <input checked="" type="checkbox"/> 1: <b>Fault</b> <input type="checkbox"/> 2: Trouble <input type="checkbox"/> 3: TroubleQuickStop <input type="checkbox"/> 4: WarningLocked <input checked="" type="checkbox"/> 5: <b>Warning</b> <input type="checkbox"/> 6: Information	
Cause	Remedy
<p>The device displays that the maximum current has been reached.</p>	<ul style="list-style-type: none"> <li>• Check and, if required, correct dimensioning of the load with regard to the installed device power.</li> <li>• Check the maximum current settings in <a href="#">C00022</a> (Imax in motor mode) and <a href="#">C00023</a> (Imax in generator mode).</li> </ul>

### oC17: Clamp sets pulse inhibit [xx.0123.00031]

Response (Lenze setting printed in bold)	
Setting: <a href="#">C00569/1</a> ( <input checked="" type="checkbox"/> Adjustable response ) <input checked="" type="checkbox"/> 0: <b>No Reaction</b> <input checked="" type="checkbox"/> 1: <b>Fault</b> <input type="checkbox"/> 2: Trouble <input type="checkbox"/> 3: TroubleQuickStop <input type="checkbox"/> 4: WarningLocked <input checked="" type="checkbox"/> 5: <b>Warning</b> <input type="checkbox"/> 6: Information	
Cause	Remedy
<p>Due to a short overcurrent, the inverter was switched off for a short time (clamp disconnection).</p>	<ul style="list-style-type: none"> <li>• Check and, if required, correct dimensioning of the load with regard to the installed device power.</li> <li>• Reduce the dynamics of the setpoint change or speed control.</li> </ul>

### oS1: Maximum speed limit reached [xx.0123.00032]

Response (Lenze setting printed in bold)	
Setting: <a href="#">C00579</a> ( <input checked="" type="checkbox"/> Adjustable response ) <input checked="" type="checkbox"/> 0: <b>No Reaction</b> <input checked="" type="checkbox"/> 1: <b>Fault</b> <input type="checkbox"/> 2: Trouble <input type="checkbox"/> 3: TroubleQuickStop <input type="checkbox"/> 4: WarningLocked <input checked="" type="checkbox"/> 5: <b>Warning</b> <input type="checkbox"/> 6: Information	
Cause	Remedy
<p>The device has recognised that the maximum speed has been reached.</p>	<ul style="list-style-type: none"> <li>• Limit setpoint selection to maximum values.</li> <li>• Adjust set speed limitation (<a href="#">C00909</a>) and frequency limitation (<a href="#">C00910</a>).</li> </ul>



# 9 Diagnostics & error management

## 9.9 Error messages of the operating system

### oS2: Max. motor speed [xx.0123.00033]

Response (Lenze setting printed in bold)	
<input type="checkbox"/> 0: No Reaction <input checked="" type="checkbox"/> <b>1: Fault</b> <input type="checkbox"/> 2: Trouble <input type="checkbox"/> 3: TroubleQuickStop <input type="checkbox"/> 4: WarningLocked <input type="checkbox"/> 5: Warning <input type="checkbox"/> 6: Information	
Cause	Remedy
The device has recognised that the maximally permissible motor speed has been reached.	<ul style="list-style-type: none"> <li>Limit setpoint selection to the maximally permissible motor speed.</li> <li>If required, adapt set maximum motor speed (<a href="#">C00965</a>).</li> </ul>

### oC18: Current monitoring overload [xx.0123.00034]

Response (Lenze setting printed in bold)		Setting: <a href="#">C00584/1</a> <input checked="" type="checkbox"/> Adjustable response)
<input checked="" type="checkbox"/> <b>0: No Reaction</b> <input checked="" type="checkbox"/> <b>1: Fault</b> <input type="checkbox"/> 2: Trouble <input checked="" type="checkbox"/> <b>3: TroubleQuickStop</b> <input checked="" type="checkbox"/> <b>4: WarningLocked</b> <input checked="" type="checkbox"/> <b>5: Warning</b> <input checked="" type="checkbox"/> <b>6: Information</b>		
Cause	Remedy	
The current monitoring overload has tripped because the apparent motor current has exceeded the switch-off threshold set in <a href="#">C00124/1</a> for the delay time set in <a href="#">C00563/1</a> C00563/1.	<ul style="list-style-type: none"> <li>Reduce overload.</li> <li>Increase switch-off threshold (<a href="#">C00124/1</a>).</li> </ul>	

### Id1: Motor data identification error [xx.0123.00057]

Response (Lenze setting printed in bold)	
<input type="checkbox"/> 0: No Reaction <input checked="" type="checkbox"/> <b>1: Fault</b> <input type="checkbox"/> 2: Trouble <input type="checkbox"/> 3: TroubleQuickStop <input type="checkbox"/> 4: WarningLocked <input type="checkbox"/> 5: Warning <input type="checkbox"/> 6: Information	
Cause	Remedy
During the identification of motor parameters, an error has occurred. Possible causes: <ul style="list-style-type: none"> <li>Interrupted motor cable.</li> <li>Switched-off power section during the identification.</li> <li>Implausible start parameter settings.</li> </ul>	<ul style="list-style-type: none"> <li>Check the motor connections and the corresponding plug connector on the device and, if necessary, the motor terminal box.</li> <li>Correct start parameters for the motor parameter identification (motor nameplate data).</li> <li>Stable power supply of the device.</li> </ul>

### Id3: CINH identification [xx.0123.00058]

Response (Lenze setting printed in bold)	
<input type="checkbox"/> 0: No Reaction <input type="checkbox"/> 1: Fault <input type="checkbox"/> 2: Trouble <input type="checkbox"/> 3: TroubleQuickStop <input checked="" type="checkbox"/> <b>4: WarningLocked</b> <input type="checkbox"/> 5: Warning <input type="checkbox"/> 6: Information	
Cause	Remedy
The device has detected controller inhibit during the motor data identification. <ul style="list-style-type: none"> <li>This cancels the identification process. The Lenze setting of the motor data is used.</li> </ul>	<ul style="list-style-type: none"> <li>Do not set controller inhibit during the motor data identification.</li> <li>Do not execute any device function which may activate controller inhibit.</li> </ul>

### Id4: Resistor identification error [xx.0123.00059]

Response (Lenze setting printed in bold)	
<input type="checkbox"/> 0: No Reaction <input type="checkbox"/> 1: Fault <input type="checkbox"/> 2: Trouble <input type="checkbox"/> 3: TroubleQuickStop <input type="checkbox"/> 4: WarningLocked <input checked="" type="checkbox"/> <b>5: Warning</b> <input type="checkbox"/> 6: Information	
Cause	Remedy
The device has recognised that an error has occurred in the calculation of the motor cable resistance. <ul style="list-style-type: none"> <li>The parameters for cable cross-section and cable length are implausible.</li> </ul>	Enter sensible values for cable cross-section and motor cable length.

# 9 Diagnostics & error management

## 9.9 Error messages of the operating system

### Id7: Motor control does not match motor data [xx.0123.00060]

<b>Response</b> (Lenze setting printed in bold)		<b>Setting:</b> <a href="#">C00571/1</a> ( <input checked="" type="checkbox"/> Adjustable response)
<input checked="" type="checkbox"/> 0: No Reaction <input checked="" type="checkbox"/> 1: <b>Fault</b> <input checked="" type="checkbox"/> 2: Trouble <input checked="" type="checkbox"/> 3: TroubleQuickStop <input checked="" type="checkbox"/> 4: WarningLocked <input checked="" type="checkbox"/> 5: Warning <input checked="" type="checkbox"/> 6: <b>Information</b>		
<b>Cause</b>	<b>Remedy</b>	
At controller enable, the device has detected that the motor control type set in <a href="#">C00006</a> cannot control the motor type set. <ul style="list-style-type: none"> <li>• Example: Motor nameplate data for an asynchronous motor have been entered; however, a motor control type for a synchronous motor is set in <a href="#">C00006</a>.</li> </ul> <b>Note:</b> Since the "VFCplus" control types are able to control every motor to a certain extent, this error message will never occur here.	Enter correct motor nameplate data and set a matching motor control type in <a href="#">C00006</a> : <ul style="list-style-type: none"> <li>• Motor nameplate data asynchronous motor → motor control type must be ASM, SLVC or VFCplus servo control.</li> <li>• Motor nameplate data synchronous motor → motor control type must be PSM, SLPSM or VFCplus servo control.</li> </ul>	

### Id8: Speed encoder has not been set [xx.0123.00061]

<b>Response</b> (Lenze setting printed in bold)		<b>Setting:</b> <a href="#">C00571/2</a> ( <input checked="" type="checkbox"/> Adjustable response)
<input checked="" type="checkbox"/> 0: No Reaction <input checked="" type="checkbox"/> 1: <b>Fault</b> <input checked="" type="checkbox"/> 2: Trouble <input checked="" type="checkbox"/> 3: TroubleQuickStop <input checked="" type="checkbox"/> 4: WarningLocked <input checked="" type="checkbox"/> 5: Warning <input checked="" type="checkbox"/> 6: Information		
<b>Cause</b>	<b>Remedy</b>	
When being In controller enable status, the device has detected that a motor control type with feedback has been set in <a href="#">C00006</a> , but no speed sensor has been set in <a href="#">C00495</a> .	Set the speed sensor in <a href="#">C00495</a> . <b>Note:</b> The error can only be reset if the settings in <a href="#">C00006</a> and <a href="#">C00495</a> match.	

### oC12: I2xt overload - brake resistor [xx.0123.00065]

<b>Response</b> (Lenze setting printed in bold)		<b>Setting:</b> <a href="#">C00574/1</a> ( <input checked="" type="checkbox"/> Adjustable response)
<input checked="" type="checkbox"/> 0: No Reaction <input type="checkbox"/> 1: <b>Fault</b> <input type="checkbox"/> 2: Trouble <input type="checkbox"/> 3: TroubleQuickStop <input type="checkbox"/> 4: WarningLocked <input type="checkbox"/> 5: Warning <input type="checkbox"/> 6: Information		
<b>Cause</b>	<b>Remedy</b>	
Too frequent and too long braking processes.	Check drive dimensioning.	

### oC19: Brake resistor - short circuit [xx.0123.00066]

<b>Response</b> (Lenze setting printed in bold)		
<input type="checkbox"/> 0: No Reaction <input checked="" type="checkbox"/> 1: <b>Fault</b> <input type="checkbox"/> 2: Trouble <input type="checkbox"/> 3: TroubleQuickStop <input type="checkbox"/> 4: WarningLocked <input type="checkbox"/> 5: Warning <input type="checkbox"/> 6: Information		
<b>Cause</b>	<b>Remedy</b>	
<ul style="list-style-type: none"> <li>• Short circuit at the terminals of the brake resistor.</li> <li>• Low-resistance brake resistor.</li> </ul>	<ul style="list-style-type: none"> <li>• Check terminals of the brake resistor.</li> <li>• Check brake resistor.</li> </ul>	

### oC11: Clamp operation active [xx.0123.00071]

<b>Response</b> (Lenze setting printed in bold)		
<input type="checkbox"/> 0: No Reaction <input checked="" type="checkbox"/> 1: <b>Fault</b> <input type="checkbox"/> 2: Trouble <input type="checkbox"/> 3: TroubleQuickStop <input type="checkbox"/> 4: WarningLocked <input type="checkbox"/> 5: Warning <input type="checkbox"/> 6: Information		
<b>Cause</b>	<b>Remedy</b>	
The device indicates that the "CLAMP" overcurrent limitation has been activated. <ul style="list-style-type: none"> <li>• A permanent clamp operation causes an overload disconnection.</li> </ul>	Reduce setpoint generation dynamics or motor load.	

**Id5: Pole position identification error [xx.0123.00074]**

<b>Response</b> (Lenze setting printed in bold)	<b>Setting:</b> <a href="#">C00643/1</a> ( <input checked="" type="checkbox"/> Adjustable response)
<input checked="" type="checkbox"/> 0: No Reaction <input checked="" type="checkbox"/> 1: <b>Fault</b> <input type="checkbox"/> 2: Trouble <input checked="" type="checkbox"/> 3: TroubleQuickStop <input checked="" type="checkbox"/> 4: WarningLocked <input checked="" type="checkbox"/> 5: Warning <input checked="" type="checkbox"/> 6: Information	
<b>Cause</b>	<b>Remedy</b>
Pole position identification has not been completed successfully.	Check parameter setting of the pole position identification.

**oC13: Maximum current for Fch exceeded [xx.0123.00090]**

<b>Response</b> (Lenze setting printed in bold)	
<input type="checkbox"/> 0: No Reaction <input checked="" type="checkbox"/> 1: <b>Fault</b> <input type="checkbox"/> 2: Trouble <input type="checkbox"/> 3: TroubleQuickStop <input type="checkbox"/> 4: WarningLocked <input type="checkbox"/> 5: Warning <input type="checkbox"/> 6: Information	
<b>Cause</b>	<b>Remedy</b>
The device has detected a motor current which exceeds the maximum current limit at permanent switching frequency of the inverter. <ul style="list-style-type: none"> <li>If a permanent switching frequency inverter is set, a certain limit arises for the maximum current, depending on the setting. If this current limit is exceeded due to a load impulse or overload, an error message is displayed.</li> </ul>	<ul style="list-style-type: none"> <li>Observe the maximum current setting depending on the set switching frequency of the inverter.</li> <li>Reduce the required load or setting of the dynamic switching frequency if necessary.</li> </ul>

**ot2: Speed controller output limited [xx.0123.00093]**

<b>Response</b> (Lenze setting printed in bold)	<b>Setting:</b> <a href="#">C00567</a> ( <input checked="" type="checkbox"/> Adjustable response)
<input checked="" type="checkbox"/> 0: <b>No Reaction</b> <input checked="" type="checkbox"/> 1: Fault <input type="checkbox"/> 2: Trouble <input type="checkbox"/> 3: TroubleQuickStop <input type="checkbox"/> 4: WarningLocked <input checked="" type="checkbox"/> 5: Warning <input type="checkbox"/> 6: Information	
<b>Cause</b>	<b>Remedy</b>
The output of the speed controller has reached the internal limit value. In this status, the speed controller is not able anymore to correct the system deviation. <ul style="list-style-type: none"> <li>Only during "Closed loop" operation or with vector control (SLVC).</li> </ul>	<ul style="list-style-type: none"> <li>Observe load requirements.</li> <li>Correct dimensioning or reduce setpoint generation dynamics if necessary.</li> </ul> <p>▶ <a href="#">Motor control</a></p>

**FC01: Switching frequency reduction [xx.0123.00094]**

<b>Response</b> (Lenze setting printed in bold)	<b>Setting:</b> <a href="#">C00590</a> ( <input checked="" type="checkbox"/> Adjustable response)
<input checked="" type="checkbox"/> 0: <b>No Reaction</b> <input checked="" type="checkbox"/> 1: Fault <input type="checkbox"/> 2: Trouble <input type="checkbox"/> 3: TroubleQuickStop <input type="checkbox"/> 4: WarningLocked <input checked="" type="checkbox"/> 5: Warning <input type="checkbox"/> 6: Information	
<b>Cause</b>	<b>Remedy</b>
Load-dependent switching frequency reduction	<ul style="list-style-type: none"> <li>Observe load requirements.</li> <li>Correct dimensioning or reduce setpoint generation dynamics if necessary.</li> </ul> <p>▶ <a href="#">Motor control</a></p>

**FC02: Maximum speed for Fchop [xx.0123.00095]**

<b>Response</b> (Lenze setting printed in bold)	<b>Setting:</b> <a href="#">C00588</a> ( <input checked="" type="checkbox"/> Adjustable response)
<input checked="" type="checkbox"/> 0: <b>No Reaction</b> <input checked="" type="checkbox"/> 1: Fault <input type="checkbox"/> 2: Trouble <input type="checkbox"/> 3: TroubleQuickStop <input type="checkbox"/> 4: WarningLocked <input checked="" type="checkbox"/> 5: Warning <input type="checkbox"/> 6: Information	
<b>Cause</b>	<b>Remedy</b>
Maximum speed for chopper frequency has been reached. <ul style="list-style-type: none"> <li>The maximum speed has been exceeded depending on the switching frequency.</li> </ul>	Select the correct maximum speed as a function of the switching frequency. <p>▶ <a href="#">Motor control: Determine speed limits</a></p>

# 9 Diagnostics & error management

## 9.9 Error messages of the operating system

### oC14: Direct-axis current controller limitation [xx.0123.00096]

<b>Response</b> (Lenze setting printed in bold)		<b>Setting:</b> <a href="#">C00570/1</a> (☑ Adjustable response)
☑ 0: No Reaction    ☑ 1: Fault    ☐ 2: Trouble    ☐ 3: TroubleQuickStop    ☐ 4: WarningLocked    ☑ 5: Warning    ☐ 6: Information		
<b>Cause</b>	<b>Remedy</b>	
Direct-axis current controller limitation is active.	<ul style="list-style-type: none"> <li>• Observe load requirements.</li> <li>• Correct dimensioning or reduce setpoint generation dynamics if necessary.</li> </ul> <p>▶ <a href="#">Motor control</a></p>	

### oC15: Cross current controller limitation [xx.0123.00097]

<b>Response</b> (Lenze setting printed in bold)		<b>Setting:</b> <a href="#">C00570/2</a> (☑ Adjustable response)
☑ 0: No Reaction    ☑ 1: Fault    ☐ 2: Trouble    ☐ 3: TroubleQuickStop    ☐ 4: WarningLocked    ☑ 5: Warning    ☐ 6: Information		
<b>Cause</b>	<b>Remedy</b>	
Cross current controller limitation is active.	<ul style="list-style-type: none"> <li>• Observe load requirements.</li> <li>• Correct dimensioning or reduce setpoint generation dynamics if necessary.</li> <li>• Check parameter setting of the current controller with regard to the motor controllers (e.g. reduce Vp).</li> </ul> <p>▶ <a href="#">Motor control</a></p>	

### oC16: Torque controller limitation [xx.0123.00098]

<b>Response</b> (Lenze setting printed in bold)		<b>Setting:</b> <a href="#">C00570/3</a> (☑ Adjustable response)
☑ 0: No Reaction    ☑ 1: Fault    ☐ 2: Trouble    ☐ 3: TroubleQuickStop    ☐ 4: WarningLocked    ☑ 5: Warning    ☐ 6: Information		
<b>Cause</b>	<b>Remedy</b>	
Actuator limitation according to speed controller.	<ul style="list-style-type: none"> <li>• Observe load requirements.</li> <li>• Correct dimensioning or reduce setpoint generation dynamics if necessary.</li> </ul> <p>▶ <a href="#">Motor control</a></p>	

### FC03: Field controller limitation [xx.0123.00099]

<b>Response</b> (Lenze setting printed in bold)		<b>Setting:</b> <a href="#">C00570/4</a> (☑ Adjustable response)
☑ 0: No Reaction    ☑ 1: Fault    ☐ 2: Trouble    ☐ 3: TroubleQuickStop    ☐ 4: WarningLocked    ☑ 5: Warning    ☐ 6: Information		
<b>Cause</b>	<b>Remedy</b>	
The output of the field controller has reached its maximum limit value. The drive is at the torque limit in the field weakening range.	<ul style="list-style-type: none"> <li>• Observe load requirements.</li> <li>• Correct dimensioning or reduce setpoint from the field weakening range if necessary.</li> </ul> <p>▶ <a href="#">Motor control</a></p>	

### oC6: I2xt overload - motor [xx.0123.00105]

<b>Response</b> (Lenze setting printed in bold)		<b>Setting:</b> <a href="#">C00606</a> (☑ Adjustable response)
☑ 0: No Reaction    ☑ 1: Fault    ☐ 2: Trouble    ☐ 3: TroubleQuickStop    ☐ 4: WarningLocked    ☑ 5: Warning    ☐ 6: Information		
<b>Cause</b>	<b>Remedy</b>	
Thermal overload of the motor.	<p>Only self-ventilated motors can be monitored using the I2xt function.</p> <ul style="list-style-type: none"> <li>• Check whether is it a self-ventilated motor. If not, set <a href="#">C00606</a> to "0: No Reaction".</li> <li>• Observe load requirements.</li> <li>• Correct dimensioning if necessary.</li> <li>• For VFCplus control type: Check Vmin boost (<a href="#">C00016</a>).</li> </ul> <p>▶ <a href="#">Set Vmin boost</a></p>	

# 9 Diagnostics & error management

## 9.9 Error messages of the operating system

### LP1: Motor phase failure [xx.0123.00145]

<b>Response</b> (Lenze setting printed in bold)	<b>Setting:</b> <a href="#">C00597</a> (☑ Adjustable response)
☑ 0: No Reaction ☑ 1: <b>Fault</b> ☐ 2: Trouble ☐ 3: TroubleQuickStop ☐ 4: WarningLocked ☑ 5: Warning ☐ 6: Information	
<b>Cause</b>	<b>Remedy</b>
Motor phase failure - power section <ul style="list-style-type: none"> <li>This error message is displayed if a motor phase carries less current of one half-wave than set in <a href="#">C00599</a>.</li> </ul>	<ul style="list-style-type: none"> <li>Check the motor connections and the corresponding plug connector on the device and, if necessary, the motor terminal box.</li> <li>Check the trigger threshold (<a href="#">C00599</a>).</li> </ul>

### Sd10: Speed limit - feedback system 12 [xx.0123.00200]

<b>Response</b> (Lenze setting printed in bold)	<b>Setting:</b> <a href="#">C00607</a> (☑ Adjustable response)
☑ 0: No Reaction ☑ 1: <b>Fault</b> ☐ 2: Trouble ☐ 3: TroubleQuickStop ☐ 4: WarningLocked ☑ 5: Warning ☐ 6: Information	
<b>Cause</b>	<b>Remedy</b>
Maximally permissible speed of the feedback system connected to DI1/DI2 reached.	Reduce speed of the rotation shaft/feedback system. $n_{\text{encoder}} \leq (f_{\text{max}} \times 60) / \text{encoder increments}$ (for $f_{\text{max}} = 10 \text{ kHz}$ )

### Sd3: Open circuit HTL 2-fold or 4-fold [xx.0123.00205]

<b>Response</b> (Lenze setting printed in bold)	<b>Setting:</b> <a href="#">C00586</a> (☑ Adjustable response)
☑ 0: No Reaction ☑ 1: <b>Fault</b> ☐ 2: Trouble ☐ 3: TroubleQuickStop ☐ 4: WarningLocked ☑ 5: Warning ☐ 6: Information	
<b>Cause</b>	<b>Remedy</b>
<ul style="list-style-type: none"> <li>HTL encoder cable interrupted.</li> <li>HTL encoder is defective.</li> </ul> Note: May also be caused by a very dynamic acceleration or starting up against a blocked motor shaft (e.g. with a closed holding brake).	<ul style="list-style-type: none"> <li>Check HTL encoder cable.</li> <li>Check HTL encoder.</li> <li>Check related terminals.</li> <li>Switch off monitoring (<a href="#">C00586</a> = "0: No reaction") when the HTL encoder is not used.</li> </ul>

### Sd18: V/f emergency operation [xx.0123.00210]

<b>Response</b> (Lenze setting printed in bold)	
☐ 0: No Reaction ☐ 1: Fault ☐ 2: Trouble ☐ 3: TroubleQuickStop ☐ 4: WarningLocked ☐ 5: Warning ☑ 6: Information	
<b>Cause</b>	<b>Remedy</b>
Error in encoder system	Check all available encoder error messages. Perform the troubleshooting measures for these error messages as described in this manual.

### An01: AIN1\_I < 4 mA [xx.0125.00001]

<b>Response</b> (Lenze setting printed in bold)	<b>Setting:</b> <a href="#">C00598/1</a> (☑ Adjustable response)
☑ 0: No Reaction ☑ 1: <b>Fault</b> ☑ 2: <b>Trouble</b> ☑ 3: <b>TroubleQuickStop</b> ☐ 4: WarningLocked ☑ 5: Warning ☐ 6: Information	
<b>Cause</b>	<b>Remedy</b>
Open-circuit monitoring for analog input 1 has tripped. <ul style="list-style-type: none"> <li>Only if the analog input has been configured as a current loop of 4 ... 20 mA (<a href="#">C00034/1</a> = 2).</li> </ul>	<ul style="list-style-type: none"> <li>Check wiring of the analog X3/A11 input terminal for open circuit.</li> <li>Check minimum current values of the signal sources.</li> </ul>

# 9 Diagnostics & error management

## 9.9 Error messages of the operating system

### CE04: MCI communication error [xx.0127.00002]

<b>Response</b> (Lenze setting printed in bold)		<b>Setting:</b> <a href="#">C01501/1</a> (☑ Adjustable response)
☑ 0: No Reaction ☑ 1: Fault ☑ 2: Trouble ☑ 3: TroubleQuickStop ☑ 4: WarningLocked ☑ 5: Warning ☑ 6: Information		
Cause	Remedy	
Communication error with extension module in slot 1.	<ul style="list-style-type: none"> <li>• Check setting of sync window (<a href="#">C01123</a>) if sync signal source (<a href="#">C01120</a>) is set to "4: MCI".</li> <li>• Eliminate EMC interference.</li> <li>• Switch off inverter, correctly plug in the module, switch on the inverter again.</li> <li>• Switch mains or restart inverter.</li> <li>• Replace module/inverter.</li> <li>• Please contact Lenze if the problem occurs again.</li> </ul>	

### CE0F: MCI control word [xx.0127.00015]

<b>Response</b> (Lenze setting printed in bold)		<b>Setting:</b> <a href="#">C00594/2</a> (☑ Adjustable response)
☑ 0: No Reaction ☑ 1: Fault ☑ 2: Trouble ☑ 3: TroubleQuickStop ☐ 4: WarningLocked ☑ 5: Warning ☐ 6: Information		
Cause	Remedy	
Bit 14 ("SetFail") of the wMciCtrl control word of the <a href="#">LS_DriveInterface</a> system block has been set.	Trace back signal source on the bus (e.g. PROFIBUS) that sets bit 14 ("SetFail").	

### CE4: CAN bus off [xx.0131.00000]

<b>Response</b> (Lenze setting printed in bold)		<b>Setting:</b> <a href="#">C00592/2</a> (☑ Adjustable response)
☑ 0: No Reaction ☑ 1: Fault ☑ 2: Trouble ☑ 3: TroubleQuickStop ☑ 4: WarningLocked ☑ 5: Warning ☑ 6: Information		
Cause	Remedy	
<b>CAN on board:</b> "Bus off" status <ul style="list-style-type: none"> <li>• Received too many faulty telegrams.</li> <li>• Damaged cable (e.g. loose contact).</li> <li>• Two nodes with the same ID.</li> </ul>	<ul style="list-style-type: none"> <li>• Check wiring and bus terminating resistor.</li> <li>• Set identical baud rate for each bus node.</li> <li>• Assign different IDs to nodes.</li> <li>• Eliminate electrical interference (e.g. EMC).</li> </ul>	

### CA06: CAN CRC error [xx.0131.00006]

<b>Response</b> (Lenze setting printed in bold)		<b>Setting:</b> <a href="#">C00592/1</a> (☑ Adjustable response)
☑ 0: No Reaction ☑ 1: Fault ☑ 2: Trouble ☑ 3: TroubleQuickStop ☑ 4: WarningLocked ☑ 5: Warning ☑ 6: Information		
Cause	Remedy	
<b>CAN on board:</b> A faulty CAN telegram has been detected.	<ul style="list-style-type: none"> <li>• Check wiring and bus terminating resistor.</li> <li>• Eliminate electrical interference (e.g. EMC).</li> </ul>	

### CA07: CAN bus warning [xx.0131.00007]

<b>Response</b> (Lenze setting printed in bold)		<b>Setting:</b> <a href="#">C00592/3</a> (☑ Adjustable response)
☑ 0: No Reaction ☑ 1: Fault ☑ 2: Trouble ☑ 3: TroubleQuickStop ☑ 4: WarningLocked ☑ 5: Warning ☑ 6: Information		
Cause	Remedy	
<b>CAN on board:</b> Incorrect transmission or reception of more than 96 CAN telegrams. <ul style="list-style-type: none"> <li>• The current number of incorrectly transmitted CAN telegrams is displayed in <a href="#">C00372/1</a>.</li> <li>• The current number of incorrectly received CAN telegrams is displayed in <a href="#">C00372/2</a>.</li> <li>• The current CAN error status is displayed in <a href="#">C00345</a>.</li> </ul>	<ul style="list-style-type: none"> <li>• Check wiring and bus terminating resistor.</li> <li>• Set identical baud rate for each bus node.</li> <li>• Assign different IDs to nodes.</li> <li>• Eliminate electrical interference (e.g. EMC).</li> </ul>	

# 9 Diagnostics & error management

## 9.9 Error messages of the operating system

### CA08: CAN bus stopped [xx.0131.00008]

<b>Response</b> (Lenze setting printed in bold)	<b>Setting:</b> <a href="#">C00592/4</a> (☑ Adjustable response)
☑ 0: No Reaction ☑ 1: Fault ☑ 2: Trouble ☑ 3: TroubleQuickStop ☑ 4: WarningLocked ☑ 5: Warning ☑ 6: Information	
<b>Cause</b>	<b>Remedy</b>
<a href="#">CAN on board</a> : The device has received the "Stop Remote Node" NMT telegram.	Check CAN master (NMT master).

### CA0b: CAN HeartBeatEvent [xx.0131.00011]

<b>Response</b> (Lenze setting printed in bold)	<b>Setting:</b> <a href="#">C00592/5</a> (☑ Adjustable response)
☑ 0: No Reaction ☑ 1: Fault ☑ 2: Trouble ☑ 3: TroubleQuickStop ☑ 4: WarningLocked ☑ 5: Warning ☑ 6: Information	
<b>Cause</b>	<b>Remedy</b>
<a href="#">CAN on board</a> : Cyclic node monitoring <ul style="list-style-type: none"> <li>• Being a Heartbeat consumer, the device has not received a Heartbeat telegram from Heartbeat producer 1 ... 7 within the defined time.</li> <li>• The current states of the Heartbeat producers are displayed in <a href="#">C00347/1...7</a>.</li> </ul>	<ul style="list-style-type: none"> <li>• Reactivate Heartbeat producers by mains switching, restarting the inverter, or a CAN Reset Node.</li> <li>• Reparameterise CAN Heartbeat producer time or switch off consumer monitoring and reset error status if latched.</li> </ul> ▶ <a href="#">Heartbeat protocol</a>

### CA0F: CAN control word [xx.0131.00015]

<b>Response</b> (Lenze setting printed in bold)	<b>Setting:</b> <a href="#">C00594/1</a> (☑ Adjustable response)
☑ 0: No Reaction ☑ 1: Fault ☑ 2: Trouble ☑ 3: TroubleQuickStop ☐ 4: WarningLocked ☑ 5: Warning ☐ 6: Information	
<b>Cause</b>	<b>Remedy</b>
Bit 14 ("SetFail") in the wCANControl control word of the <a href="#">LS DriveInterface</a> system block has been set.	Trace back signal source on the CAN bus that sets bit 14 ("SetFail").

### CE1: CAN RPDO1 [xx.0135.00001]

<b>Response</b> (Lenze setting printed in bold)	<b>Setting:</b> <a href="#">C00593/1</a> (☑ Adjustable response)
☑ 0: No Reaction ☑ 1: Fault ☑ 2: Trouble ☑ 3: TroubleQuickStop ☑ 4: WarningLocked ☑ 5: Warning ☑ 6: Information	
<b>Cause</b>	<b>Remedy</b>
<a href="#">CAN on board</a> : Time monitoring for RPDO1 has been triggered. <ul style="list-style-type: none"> <li>• RPDO1 has not been received within the monitoring time set in <a href="#">C00357/1</a> or was faulty.</li> </ul>	<ul style="list-style-type: none"> <li>• Set correct telegram length for CAN master (transmitter).</li> <li>• Eliminate electrical interference (e.g. EMC).</li> <li>• Adjust monitoring time <a href="#">C00357/1</a> or switch off time monitoring.</li> </ul>

### CE2: CAN RPDO2 [xx.0135.00002]

<b>Response</b> (Lenze setting printed in bold)	<b>Setting:</b> <a href="#">C00593/2</a> (☑ Adjustable response)
☑ 0: No Reaction ☑ 1: Fault ☑ 2: Trouble ☑ 3: TroubleQuickStop ☑ 4: WarningLocked ☑ 5: Warning ☑ 6: Information	
<b>Cause</b>	<b>Remedy</b>
<a href="#">CAN on board</a> : Time monitoring for RPDO2 has been triggered. <ul style="list-style-type: none"> <li>• RPDO2 has not been received within the monitoring time set in <a href="#">C00357/2</a> or was faulty.</li> </ul>	<ul style="list-style-type: none"> <li>• Set correct telegram length for CAN master (transmitter).</li> <li>• Eliminate electrical interference (e.g. EMC).</li> <li>• Adjust monitoring time <a href="#">C00357/2</a> or switch off time monitoring.</li> </ul>

# 9 Diagnostics & error management

## 9.9 Error messages of the operating system

### CE3: CAN RPDO3 [xx.0135.00003]

<b>Response</b> (Lenze setting printed in bold)		<b>Setting:</b> <a href="#">C00593/3</a> (☑ Adjustable response)
☑ 0: No Reaction ☑ 1: Fault ☑ 2: Trouble ☑ 3: TroubleQuickStop ☑ 4: WarningLocked ☑ 5: Warning ☑ 6: Information		
<b>Cause</b>	<b>Remedy</b>	
<a href="#">CAN on board</a> : Time monitoring for RPDO3 has been triggered. <ul style="list-style-type: none"><li>RPDO3 has not been received within the monitoring time set in <a href="#">C00357/3</a> or was faulty.</li></ul>	<ul style="list-style-type: none"><li>Set correct telegram length for CAN master (transmitter).</li><li>Eliminate electrical interference (e.g. EMC).</li><li>Adjust monitoring time <a href="#">C00357/3</a> or switch off time monitoring.</li></ul>	

### CE5: CAN RPDO4 [xx.0135.00004]

<b>Response</b> (Lenze setting printed in bold)		<b>Setting:</b> <a href="#">C00593/4</a> (☑ Adjustable response)
☑ 0: No Reaction ☑ 1: Fault ☑ 2: Trouble ☑ 3: TroubleQuickStop ☑ 4: WarningLocked ☑ 5: Warning ☑ 6: Information		
<b>Cause</b>	<b>Remedy</b>	
<a href="#">CAN on board</a> : Time monitoring for RPDO4 has been triggered. <ul style="list-style-type: none"><li>RPDO4 has not been received within the monitoring time set in <a href="#">C00357/4</a> or was faulty.</li></ul>	<ul style="list-style-type: none"><li>Set correct telegram length for CAN master (transmitter).</li><li>Eliminate electrical interference (e.g. EMC).</li><li>Adjust monitoring time <a href="#">C00357/4</a> or switch off time monitoring.</li></ul>	

### CI01: Module missing/incompatible [xx.0140.00013]

<b>Response</b> (Lenze setting printed in bold)		<b>Setting:</b> <a href="#">C01501/2</a> (☑ Adjustable response)
☑ 0: No Reaction ☑ 1: Fault ☑ 2: Trouble ☑ 3: TroubleQuickStop ☑ 4: WarningLocked ☑ 5: Warning ☑ 6: Information		
<b>Cause</b>	<b>Remedy</b>	
The optional communication module has been removed or there is a connection problem or incompatibility with the standard device.	<ul style="list-style-type: none"><li>Check connection between the communication module and standard device.</li><li>Check if the module is plugged in correctly.</li><li>In case of an incompatibility, either the module or the software of the standard device is out of date. In this case, please contact Lenze.</li></ul>	

### PS01: No memory module [xx.0144.00001]

<b>Response</b> (Lenze setting printed in bold)		
☐ 0: No Reaction ☐ 1: Fault ☐ 2: Trouble ☐ 3: TroubleQuickStop ☐ 4: WarningLocked ☑ 5: Warning ☐ 6: Information		
<b>Cause</b>	<b>Remedy</b>	
Memory module is either not available or not snapped into place correctly.	<ul style="list-style-type: none"><li>If a memory module has been provided: Plug the memory module into the slot of the standard device intended for this purpose.</li><li>If a memory module has been provided: Check if the memory module has been plugged-in correctly.</li></ul>	



## PS02: Par. set invalid [xx.0144.00002]

Response (Lenze setting printed in bold)	
<input type="checkbox"/> 0: No Reaction <input checked="" type="checkbox"/> 1: <b>Fault</b> <input type="checkbox"/> 2: Trouble <input type="checkbox"/> 3: TroubleQuickStop <input type="checkbox"/> 4: WarningLocked <input type="checkbox"/> 5: Warning <input type="checkbox"/> 6: Information	
Cause	Remedy
<p>The parameter set stored in the memory module is invalid. The reason for this can be as follows:</p> <ul style="list-style-type: none"> <li>• Incomplete storage of the parameter set due to voltage failure.</li> <li>• The plugged-in module stems from a device with new firmware (compare <a href="#">C00099</a>) or from a different device type (e.g. 8400 BaseLine).</li> </ul>	<p>The error can only be removed by loading the Lenze setting with the <a href="#">C00002/1</a> = "1: On / start" device command.</p> <ul style="list-style-type: none"> <li>• In order to prevent the error, do not switch off the voltage during the saving process.</li> <li>• If the parameter set is to be transferred from one device with a higher version to a device with a lower version, use the "copy parameter set" function of the keypad. Make sure that you do not use functions that are not available in the older device.</li> </ul>

## PS03: Par. set device invalid [xx.0144.00003]

Response (Lenze setting printed in bold)	
<input type="checkbox"/> 0: No Reaction <input checked="" type="checkbox"/> 1: <b>Fault</b> <input type="checkbox"/> 2: Trouble <input type="checkbox"/> 3: TroubleQuickStop <input type="checkbox"/> 4: WarningLocked <input type="checkbox"/> 5: Warning <input type="checkbox"/> 6: Information	
Cause	Remedy
<p>The parameter set saved to the memory module is incompatible to the standard device.</p> <ul style="list-style-type: none"> <li>• An incompatibility of the parameter set is caused e.g. when the memory module of an 8400 HighLine is plugged into an 8400 StateLine or the parameter set in the memory module has a higher version than expected by the standard device.</li> </ul> <p>If the parameter set stored in the memory module is compatible with the standard device but has a different (lower) version, this message is only output as "Information". The message can be eliminated by saving the parameter set again.</p> <p><b>Note:</b> If you save the parameter set to a higher device version, you can no longer load this parameter set to a lower device version.</p> <p>▶ <a href="#">Replacement of the inverter</a></p>	<p>When the memory modules are replaced, observe the compatibility:</p> <ul style="list-style-type: none"> <li>• OK: StateLine V2.0 to StateLine V3.0</li> <li>• OK: StateLine V2.0 to HighLine V2.0</li> <li>• Not OK: HighLine Vx.x to StateLine Vx.x</li> <li>• Not OK: StateLine V3.0 to StateLine &lt; V3.0</li> </ul>

## PS04: Par. set Mci invalid [xx.0144.00004]

Response (Lenze setting printed in bold)	
<input type="checkbox"/> 0: No Reaction <input checked="" type="checkbox"/> 1: <b>Fault</b> <input type="checkbox"/> 2: Trouble <input type="checkbox"/> 3: TroubleQuickStop <input type="checkbox"/> 4: WarningLocked <input type="checkbox"/> 5: Warning <input type="checkbox"/> 6: Information	
Cause	Remedy
<p>The parameter set saved to the communication module is incompatible to the standard device.</p> <ul style="list-style-type: none"> <li>• An incompatibility of the parameter set is caused e.g. when the MCI module parameters in the memory module do not match the plugged communication module.</li> </ul>	<p>When the memory modules are replaced, observe the compatibility:</p> <ul style="list-style-type: none"> <li>• Not OK: Profibus V1.0 to EtherCAT V1.0</li> </ul>

**PS07: Par. memory module invalid [xx.0144.00007]**

<b>Response</b> (Lenze setting printed in bold)	
<input type="checkbox"/> 0: No Reaction <input checked="" type="checkbox"/> 1: <b>Fault</b> <input type="checkbox"/> 2: Trouble <input type="checkbox"/> 3: TroubleQuickStop <input type="checkbox"/> 4: WarningLocked <input type="checkbox"/> 5: Warning <input type="checkbox"/> 6: Information	
<b>Cause</b>	<b>Remedy</b>
The parameter set saved to the memory module is invalid. <ul style="list-style-type: none"> <li>• The error occurs while loading the parameter set.</li> <li>• The memory module plugged in the device lacks a code or a code is incorrect.</li> </ul>	Please contact Lenze.

**PS08: Par. device invalid [xx.0144.00008]**

<b>Response</b> (Lenze setting printed in bold)	
<input type="checkbox"/> 0: No Reaction <input checked="" type="checkbox"/> 1: <b>Fault</b> <input type="checkbox"/> 2: Trouble <input type="checkbox"/> 3: TroubleQuickStop <input type="checkbox"/> 4: WarningLocked <input type="checkbox"/> 5: Warning <input type="checkbox"/> 6: Information	
<b>Cause</b>	<b>Remedy</b>
The parameter set in the device is invalid. <ul style="list-style-type: none"> <li>• The error occurs while loading the parameter set.</li> <li>• One code in the device is incorrect.</li> </ul>	Please contact Lenze.

**PS09: Par. format invalid [xx.0144.00009]**

<b>Response</b> (Lenze setting printed in bold)	
<input type="checkbox"/> 0: No Reaction <input checked="" type="checkbox"/> 1: <b>Fault</b> <input type="checkbox"/> 2: Trouble <input type="checkbox"/> 3: TroubleQuickStop <input type="checkbox"/> 4: WarningLocked <input type="checkbox"/> 5: Warning <input type="checkbox"/> 6: Information	
<b>Cause</b>	<b>Remedy</b>
The code format is invalid. <ul style="list-style-type: none"> <li>• The error occurs while loading the parameter set.</li> </ul>	Please contact Lenze.

**PS10: Memory module binding invalid [xx.0144.00010]**

<b>Response</b> (Lenze setting printed in bold)	
<input type="checkbox"/> 0: No Reaction <input checked="" type="checkbox"/> 1: <b>Fault</b> <input type="checkbox"/> 2: Trouble <input type="checkbox"/> 3: TroubleQuickStop <input type="checkbox"/> 4: WarningLocked <input type="checkbox"/> 5: Warning <input type="checkbox"/> 6: Information	
<b>Cause</b>	<b>Remedy</b>
Device personalisation is active: The binding ID of the memory module does not comply with the binding ID of the inverter.	<ul style="list-style-type: none"> <li>• Use memory module/inverter with matching binding IDs.</li> <li>• Contact machine manufacturer.</li> </ul> <p><b>Note:</b> It is not possible for Lenze to modify a replacement device via special accesses in such a way that it cooperates with a personalised memory module.</p>

**PS11: Lenze setting loaded [xx.0144.00011]**

<b>Response</b> (Lenze setting printed in bold)	
<input type="checkbox"/> 0: No Reaction <input type="checkbox"/> 1: Fault <input type="checkbox"/> 2: Trouble <input type="checkbox"/> 3: TroubleQuickStop <input type="checkbox"/> 4: WarningLocked <input type="checkbox"/> 5: Warning <input type="checkbox"/> 6: Information	
<b>Cause</b>	<b>Remedy</b>

**PS12: Parameter sets loaded [xx.0144.00012]**

<b>Response</b> (Lenze setting printed in bold)	
<input type="checkbox"/> 0: No Reaction <input type="checkbox"/> 1: Fault <input type="checkbox"/> 2: Trouble <input type="checkbox"/> 3: TroubleQuickStop <input type="checkbox"/> 4: WarningLocked <input type="checkbox"/> 5: Warning <input type="checkbox"/> 6: Information	
<b>Cause</b>	<b>Remedy</b>

**PS13: Parameter sets saved [xx.0144.00013]**

<b>Response</b> (Lenze setting printed in bold)	
<input type="checkbox"/> 0: No Reaction <input type="checkbox"/> 1: Fault <input type="checkbox"/> 2: Trouble <input type="checkbox"/> 3: TroubleQuickStop <input type="checkbox"/> 4: WarningLocked <input type="checkbox"/> 5: Warning <input type="checkbox"/> 6: Information	
<b>Cause</b>	<b>Remedy</b>

**dF01: FW updated [xx.0145.00001]**

<b>Response</b> (Lenze setting printed in bold)	
<input type="checkbox"/> 0: No Reaction <input type="checkbox"/> 1: Fault <input type="checkbox"/> 2: Trouble <input type="checkbox"/> 3: TroubleQuickStop <input type="checkbox"/> 4: WarningLocked <input type="checkbox"/> 5: Warning <input type="checkbox"/> 6: Information	
<b>Cause</b>	<b>Remedy</b>

**dF14: SW-HW invalid [xx.0145.00014]**

<b>Response</b> (Lenze setting printed in bold)	
<input type="checkbox"/> 0: No Reaction <input checked="" type="checkbox"/> 1: Fault <input type="checkbox"/> 2: Trouble <input type="checkbox"/> 3: TroubleQuickStop <input type="checkbox"/> 4: WarningLocked <input type="checkbox"/> 5: Warning <input type="checkbox"/> 6: Information	
<b>Cause</b>	<b>Remedy</b>
Device error	Please contact Lenze.

**dF18: BU RCOM error [xx.0145.00024]**

<b>Response</b> (Lenze setting printed in bold)	
<input type="checkbox"/> 0: No Reaction <input checked="" type="checkbox"/> 1: Fault <input type="checkbox"/> 2: Trouble <input type="checkbox"/> 3: TroubleQuickStop <input type="checkbox"/> 4: WarningLocked <input type="checkbox"/> 5: Warning <input type="checkbox"/> 6: Information	
<b>Cause</b>	<b>Remedy</b>
Device error	Please contact Lenze.

**dF25: CU RCOM error [xx.0145.00025]**

<b>Response</b> (Lenze setting printed in bold)	
<input type="checkbox"/> 0: No Reaction <input checked="" type="checkbox"/> 1: Fault <input type="checkbox"/> 2: Trouble <input type="checkbox"/> 3: TroubleQuickStop <input type="checkbox"/> 4: WarningLocked <input type="checkbox"/> 5: Warning <input type="checkbox"/> 6: Information	
<b>Cause</b>	<b>Remedy</b>
Device error	Please contact Lenze.

**dF26: Appl. watchdog [xx.0145.00026]**

<b>Response</b> (Lenze setting printed in bold)		<b>Setting:</b> <a href="#">C00580/1</a> ( <input checked="" type="checkbox"/> Adjustable response)
<input checked="" type="checkbox"/> 0: No Reaction <input checked="" type="checkbox"/> 1: Fault <input type="checkbox"/> 2: Trouble <input type="checkbox"/> 3: TroubleQuickStop <input type="checkbox"/> 4: WarningLocked <input checked="" type="checkbox"/> 5: Warning <input type="checkbox"/> 6: Information		
<b>Cause</b>	<b>Remedy</b>	
Time-out of the application. The required computing time of the application exceeds the available computing time.	Reduction of the function block interconnection or the complexity of the application.	

## dF21: BU watchdog [xx.0145.00033]

<b>Response</b> (Lenze setting printed in bold)	
<input type="checkbox"/> 0: No Reaction <input checked="" type="checkbox"/> <b>1: Fault</b> <input type="checkbox"/> 2: Trouble <input type="checkbox"/> 3: TroubleQuickStop <input type="checkbox"/> 4: WarningLocked <input type="checkbox"/> 5: Warning <input type="checkbox"/> 6: Information	
<b>Cause</b>	<b>Remedy</b>
Device error	Please contact Lenze.

## dF22: CU watchdog [xx.0145.00034]

<b>Response</b> (Lenze setting printed in bold)	
<input type="checkbox"/> 0: No Reaction <input checked="" type="checkbox"/> <b>1: Fault</b> <input type="checkbox"/> 2: Trouble <input type="checkbox"/> 3: TroubleQuickStop <input type="checkbox"/> 4: WarningLocked <input type="checkbox"/> 5: Warning <input type="checkbox"/> 6: Information	
<b>Cause</b>	<b>Remedy</b>
Device error	Please contact Lenze.

## dF10: AutoTrip reset [xx.0145.00035]

<b>Response</b> (Lenze setting printed in bold)	<b>Setting:</b> <a href="#">C00189</a> ( <input checked="" type="checkbox"/> Adjustable response)
<input checked="" type="checkbox"/> 0: No Reaction <input checked="" type="checkbox"/> <b>1: Fault</b> <input checked="" type="checkbox"/> 2: Trouble <input checked="" type="checkbox"/> 3: TroubleQuickStop <input checked="" type="checkbox"/> 4: WarningLocked <input checked="" type="checkbox"/> 5: Warning <input checked="" type="checkbox"/> 6: Information	
<b>Cause</b>	<b>Remedy</b>
Too frequent auto-trip reset.	<ul style="list-style-type: none"> <li>• Check the error cause that activates the auto-trip reset.</li> <li>• Eliminate error cause and reset (acknowledge) error manually afterwards.</li> </ul>

## dF50: Retain error [xx.0145.00050]

<b>Response</b> (Lenze setting printed in bold)	
<input type="checkbox"/> 0: No Reaction <input checked="" type="checkbox"/> <b>1: Fault</b> <input type="checkbox"/> 2: Trouble <input type="checkbox"/> 3: TroubleQuickStop <input type="checkbox"/> 4: WarningLocked <input type="checkbox"/> 5: Warning <input type="checkbox"/> 6: Information	
<b>Cause</b>	<b>Remedy</b>
An error has occurred when accessing retain data. <ul style="list-style-type: none"> <li>• Either caused by an internal hardware error or by lack of mains switching after a firmware download.</li> </ul>	Mains switching <ul style="list-style-type: none"> <li>• Please contact Lenze if the problem occurs again.</li> </ul>

## dF51: CuCcr error [xx.0145.00051]

<b>Response</b> (Lenze setting printed in bold)	
<input type="checkbox"/> 0: No Reaction <input checked="" type="checkbox"/> <b>1: Fault</b> <input type="checkbox"/> 2: Trouble <input type="checkbox"/> 3: TroubleQuickStop <input type="checkbox"/> 4: WarningLocked <input type="checkbox"/> 5: Warning <input type="checkbox"/> 6: Information	
<b>Cause</b>	<b>Remedy</b>
Device error	Mains switching <ul style="list-style-type: none"> <li>• Please contact Lenze if the problem occurs again.</li> </ul>

## dF52: BuCcr error [xx.0145.00052]

<b>Response</b> (Lenze setting printed in bold)	
<input type="checkbox"/> 0: No Reaction <input checked="" type="checkbox"/> <b>1: Fault</b> <input type="checkbox"/> 2: Trouble <input type="checkbox"/> 3: TroubleQuickStop <input type="checkbox"/> 4: WarningLocked <input type="checkbox"/> 5: Warning <input type="checkbox"/> 6: Information	
<b>Cause</b>	<b>Remedy</b>
Device error	Mains switching <ul style="list-style-type: none"> <li>• Please contact Lenze if the problem occurs again.</li> </ul>

**Ck15: Error status sign. brake [xx.0184.00005]**

<b>Response</b> (Lenze setting printed in bold)	
<input type="checkbox"/> 0: No Reaction <input type="checkbox"/> 1: Fault <input type="checkbox"/> 2: Trouble <input checked="" type="checkbox"/> 3: <b>TroubleQuickStop</b> <input type="checkbox"/> 4: WarningLocked <input type="checkbox"/> 5: Warning <input type="checkbox"/> 6: Information	
<b>Cause</b>	<b>Remedy</b>
MCK: The status monitoring of the holding brake control has tripped.	<ul style="list-style-type: none"> <li>• Check configuration of the <i>bMBrakeApplied</i> input for status detection of the brake (via a switching contact at the brake).</li> <li>• Check wiring/function of the switching contact.</li> <li>• Adapt waiting time (<a href="#">C02589/3</a>).</li> <li>• Deactivate status monitoring (via bit 5 in <a href="#">C02582</a>).</li> </ul>

**Ck16: Time overflow manual operation [xx.0184.00064]**

<b>Response</b> (Lenze setting printed in bold)	
<input type="checkbox"/> 0: No Reaction <input checked="" type="checkbox"/> 1: <b>Fault</b> <input type="checkbox"/> 2: Trouble <input type="checkbox"/> 3: TroubleQuickStop <input type="checkbox"/> 4: WarningLocked <input type="checkbox"/> 5: Warning <input type="checkbox"/> 6: Information	
<b>Cause</b>	<b>Remedy</b>
PC manual control: The connection monitoring has tripped. <ul style="list-style-type: none"> <li>• The online connection between the PC and the inverter has been interrupted for a longer period of time than the timeout set in <a href="#">C00464/1</a>.</li> </ul>	<ul style="list-style-type: none"> <li>• Check communication link between PC and inverter.</li> <li>• Check voltage supply/function of the inverter.</li> <li>• Adjust the timeout (<a href="#">C00464/1</a>).</li> </ul>

**dH09: EEPROM power section [xx.0400.00009]**

<b>Response</b> (Lenze setting printed in bold)	
<input type="checkbox"/> 0: No Reaction <input checked="" type="checkbox"/> 1: <b>Fault</b> <input type="checkbox"/> 2: Trouble <input type="checkbox"/> 3: TroubleQuickStop <input type="checkbox"/> 4: WarningLocked <input type="checkbox"/> 5: Warning <input type="checkbox"/> 6: Information	
<b>Cause</b>	<b>Remedy</b>
Device error	Please contact Lenze.

**dH10: Fan failure [xx.0400.00016]**

<b>Response</b> (Lenze setting printed in bold)	<b>Setting:</b> <a href="#">C00566</a> ( <input checked="" type="checkbox"/> Adjustable response)
<input checked="" type="checkbox"/> 0: No Reaction <input checked="" type="checkbox"/> 1: <b>Fault</b> <input type="checkbox"/> 2: Trouble <input type="checkbox"/> 3: TroubleQuickStop <input type="checkbox"/> 4: WarningLocked <input checked="" type="checkbox"/> 5: <b>Warning</b> <input type="checkbox"/> 6: Information	
<b>Cause</b>	<b>Remedy</b>
The device fan has failed. Possible causes: <ul style="list-style-type: none"> <li>• The short-circuit check of the fan connection has tripped.</li> <li>• The speed monitoring of the fan has tripped.</li> </ul>	<ul style="list-style-type: none"> <li>• Check the fan for short-circuit.</li> <li>• Clean the fan.</li> </ul>

**dH68: Adjustment data error CU [xx.0400.00104]**

<b>Response</b> (Lenze setting printed in bold)	
<input type="checkbox"/> 0: No Reaction <input checked="" type="checkbox"/> 1: <b>Fault</b> <input type="checkbox"/> 2: Trouble <input type="checkbox"/> 3: TroubleQuickStop <input type="checkbox"/> 4: WarningLocked <input type="checkbox"/> 5: Warning <input type="checkbox"/> 6: Information	
<b>Cause</b>	<b>Remedy</b>
Device error	Please contact Lenze.

# 9 Diagnostics & error management

## 9.9 Error messages of the operating system

### dH69: Adjustment data error BU [xx.0400.00105]

Response (Lenze setting printed in bold)	
<input type="checkbox"/> 0: No Reaction <input checked="" type="checkbox"/> 1: <b>Fault</b> <input type="checkbox"/> 2: Trouble <input type="checkbox"/> 3: TroubleQuickStop <input type="checkbox"/> 4: WarningLocked <input type="checkbox"/> 5: Warning <input type="checkbox"/> 6: Information	
Cause	Remedy
Device error	Please contact Lenze.

### dH70: ControlUnit is unequal to BaseUnit [xx.0400.00106]

Response (Lenze setting printed in bold)	
<input type="checkbox"/> 0: No Reaction <input checked="" type="checkbox"/> 1: <b>Fault</b> <input type="checkbox"/> 2: Trouble <input type="checkbox"/> 3: TroubleQuickStop <input type="checkbox"/> 4: WarningLocked <input type="checkbox"/> 5: Warning <input type="checkbox"/> 6: Information	
Cause	Remedy
Device error	Please contact Lenze.

### User error 1 [xx.0980.00000 ... xx.0980.65535]

Response (Lenze setting printed in bold)	Setting: <a href="#">C00581/1</a> ( <input checked="" type="checkbox"/> Adjustable response)
<input checked="" type="checkbox"/> 0: <b>No Reaction</b> <input checked="" type="checkbox"/> 1: <b>Fault</b> <input checked="" type="checkbox"/> 2: <b>Trouble</b> <input checked="" type="checkbox"/> 3: <b>TroubleQuickStop</b> <input checked="" type="checkbox"/> 4: <b>WarningLocked</b> <input checked="" type="checkbox"/> 5: <b>Warning</b> <input checked="" type="checkbox"/> 6: <b>Information</b>	
Cause	Remedy
User error 1 has been tripped via the <i>bSetError1</i> input of the <a href="#">LS_SetError_1</a> system block.	User-defined.

### User error 2 [xx.0981.00000 ... xx.0981.65535]

Response (Lenze setting printed in bold)	Setting: <a href="#">C00581/2</a> ( <input checked="" type="checkbox"/> Adjustable response)
<input checked="" type="checkbox"/> 0: <b>No Reaction</b> <input checked="" type="checkbox"/> 1: <b>Fault</b> <input checked="" type="checkbox"/> 2: <b>Trouble</b> <input checked="" type="checkbox"/> 3: <b>TroubleQuickStop</b> <input checked="" type="checkbox"/> 4: <b>WarningLocked</b> <input checked="" type="checkbox"/> 5: <b>Warning</b> <input checked="" type="checkbox"/> 6: <b>Information</b>	
Cause	Remedy
User error 2 has been tripped via the <i>bSetError2</i> input of the <a href="#">LS_SetError_1</a> system block.	User-defined.

### User error 3 [xx.0982.00000 ... xx.0982.65535]

Response (Lenze setting printed in bold)	Setting: <a href="#">C00581/3</a> ( <input checked="" type="checkbox"/> Adjustable response)
<input checked="" type="checkbox"/> 0: <b>No Reaction</b> <input checked="" type="checkbox"/> 1: <b>Fault</b> <input checked="" type="checkbox"/> 2: <b>Trouble</b> <input checked="" type="checkbox"/> 3: <b>TroubleQuickStop</b> <input checked="" type="checkbox"/> 4: <b>WarningLocked</b> <input checked="" type="checkbox"/> 5: <b>Warning</b> <input checked="" type="checkbox"/> 6: <b>Information</b>	
Cause	Remedy
User error 3 has been tripped via the <i>bSetError3</i> input of the <a href="#">LS_SetError_1</a> system block.	User-defined.

### User error 4 [xx.0983.00000 ... xx.0983.65535]

Response (Lenze setting printed in bold)	Setting: <a href="#">C00581/4</a> ( <input checked="" type="checkbox"/> Adjustable response)
<input checked="" type="checkbox"/> 0: <b>No Reaction</b> <input checked="" type="checkbox"/> 1: <b>Fault</b> <input checked="" type="checkbox"/> 2: <b>Trouble</b> <input checked="" type="checkbox"/> 3: <b>TroubleQuickStop</b> <input checked="" type="checkbox"/> 4: <b>WarningLocked</b> <input checked="" type="checkbox"/> 5: <b>Warning</b> <input checked="" type="checkbox"/> 6: <b>Information</b>	
Cause	Remedy
User error 4 has been tripped via the <i>bSetError4</i> input of the <a href="#">LS_SetError_1</a> system block.	User-defined.

### 9.10 "LS\_SetError\_1" system block

This system block is used to implement error handling within the application.

- The application can trip up to four different user error messages with parameterisable error IDs and error responses via the four boolean inputs.
- If several inputs are set to TRUE at the same time, the input with the lowest number will trip the error message.

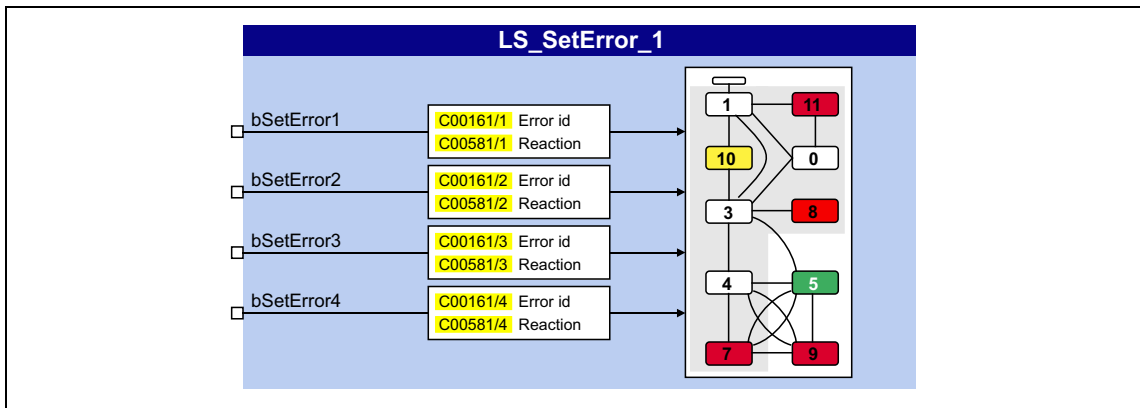

#### inputs

Designator	Data type	Information/possible settings
bSetError1	BOOL	Input for tripping " <a href="#">User error 1</a> " <ul style="list-style-type: none"> <li>• Error subject number: 980</li> <li>• Error number: <math>(C00581/1 \times 0x0400000) + (980 \times 0x10000) + (C00161/1)</math></li> </ul>
bSetError2	BOOL	Input for tripping " <a href="#">User error 2</a> " <ul style="list-style-type: none"> <li>• Error subject number: 981</li> <li>• Error number: <math>(C00581/2 \times 0x0400000) + (981 \times 0x10000) + (C00161/2)</math></li> </ul>
bSetError3	BOOL	Input for tripping " <a href="#">User error 3</a> " <ul style="list-style-type: none"> <li>• Error subject number: 982</li> <li>• Error number: <math>(C00581/3 \times 0x0400000) + (982 \times 0x10000) + (C00161/3)</math></li> </ul>
bSetError4	BOOL	Input for tripping " <a href="#">User error 4</a> " <ul style="list-style-type: none"> <li>• Error subject number: 983</li> <li>• Error number: <math>(C00581/4 \times 0x0400000) + (983 \times 0x10000) + (C00161/4)</math></li> </ul>

#### Parameters

Parameters	Possible settings	Info														
<a href="#">C00161/1...4</a>	0 ... 65535	Error ID for user errors 1 ... 4														
<a href="#">C00581/1...4</a>	<table border="1"> <tr><td>0</td><td>No Reaction</td></tr> <tr><td>1</td><td>Fault</td></tr> <tr><td>2</td><td>Trouble</td></tr> <tr><td>3</td><td>TroubleQuickStop</td></tr> <tr><td>4</td><td>WarningLocked</td></tr> <tr><td>5</td><td>Warning</td></tr> <tr><td>6</td><td>Information</td></tr> </table>	0	No Reaction	1	Fault	2	Trouble	3	TroubleQuickStop	4	WarningLocked	5	Warning	6	Information	Response to user errors 1 ... 4
0	No Reaction															
1	Fault															
2	Trouble															
3	TroubleQuickStop															
4	WarningLocked															
5	Warning															
6	Information															

## 10 Oscilloscope function

[This function extension is available from version 12.00.00!](#)

---

The oscilloscope function integrated in the 8400 StateLine can be used as support for commissioning, maintenance, and troubleshooting. It is operated via a user interface in the engineering tool.

### Typical applications

- Graphic display of measured variable (e.g. speed setpoint, actual speed value and torque)
- Detection of process values without additional measuring instruments (e.g. oscilloscope, voltmeter and ammeter)
- Convenient documentation for fine tuning of control circuits or parameter changes of the inverter

### Special features

- Recording and saving of measured values in the 8400 StateLine
- Simultaneous measuring on four independent channels
- Measuring fast and slow signals by means of adjustable sample rate
- Triggering on a channel, an application variable or system event
- Detecting measured values before and after the trigger event
- Transferring measured values to the Engineering PC for the purpose of graphic display and evaluation in the engineering tool
- The measured values represented in the form of interpolated curves can be optionally shown and hidden, represented in any colour or overlaid with the signal characteristics of other variables recorded.
- Cursor and zoom function for the measurement analysis
- Saving & loading oscilloscope configurations on the Engineering PC
- Export of measured values via the clipboard for further processing
- Linking channel values with arithmetic operations (addition, subtraction and multiplication)
- Simple signal analysis by frequency transformation of time signals with FFT ("Fast Fourier Transformation").



### Functional description

When an online connection to the 8400 StateLine has been established, use the oscilloscope user interface of the engineering tool to set the trigger condition and the sample rate and select the signal sources to be recorded. Here, "signal sources" are the internal output signals of the function, system, application and port blocks.

The changed configuration is only then taken over by the device when pressing the "start" button in the toolbar.

The values are validated after each input acknowledgement by the "Return" key. If the check shows invalid settings, the oscilloscope triggers an error.

With an online connection, the measured 8400 StateLine values are transferred to the engineering tool and graphically represented on the oscilloscope user interface as soon as the measurement has been completed.

## 10.1

### Technical data

Oscilloscope function of 8400 StateLine	
Number of channels	1 ... 4
Depth of the measured value memory	Max. 4096 measured values, depending on the number of channels and the size of the signal sources to be recorded
Data width of a channel	Max. 32 bits, corresponding to the data type of the signal sources to be recorded
Sample rate	1 ms or a multiple thereof
Time base	5, 10, 20, 50, 100, 200, 500 ms or 1 s
Trigger level	Corresponding to the value range of the signal sources to be triggered
Trigger selection	The trigger is activated if the trigger value set for the respective channel is fallen short of or exceeded. The trigger value "must actually pass" the threshold.
Trigger delay	- 200 % ... + 200 %
Trigger source	Channel 1 ... 4

---

## 10.2 Operation

This chapter describes step-by-step how to record the signal characteristics of 8400 StateLine signal sources and represent, analyse, document and process them in the oscilloscope.



### Note!

Recording can only be started when an online connection has been established to the 8400 StateLine.

### 10.2.1 User interface

The oscilloscope user interface is available in the following Lenze engineering tools:

<input checked="" type="checkbox"/> »Engineer« from version 2.16	<input type="checkbox"/> »PLC Designer«	<input checked="" type="checkbox"/> »EASY Starter« from version 1.9
--	---	---



#### How to go to the oscilloscope user interface:





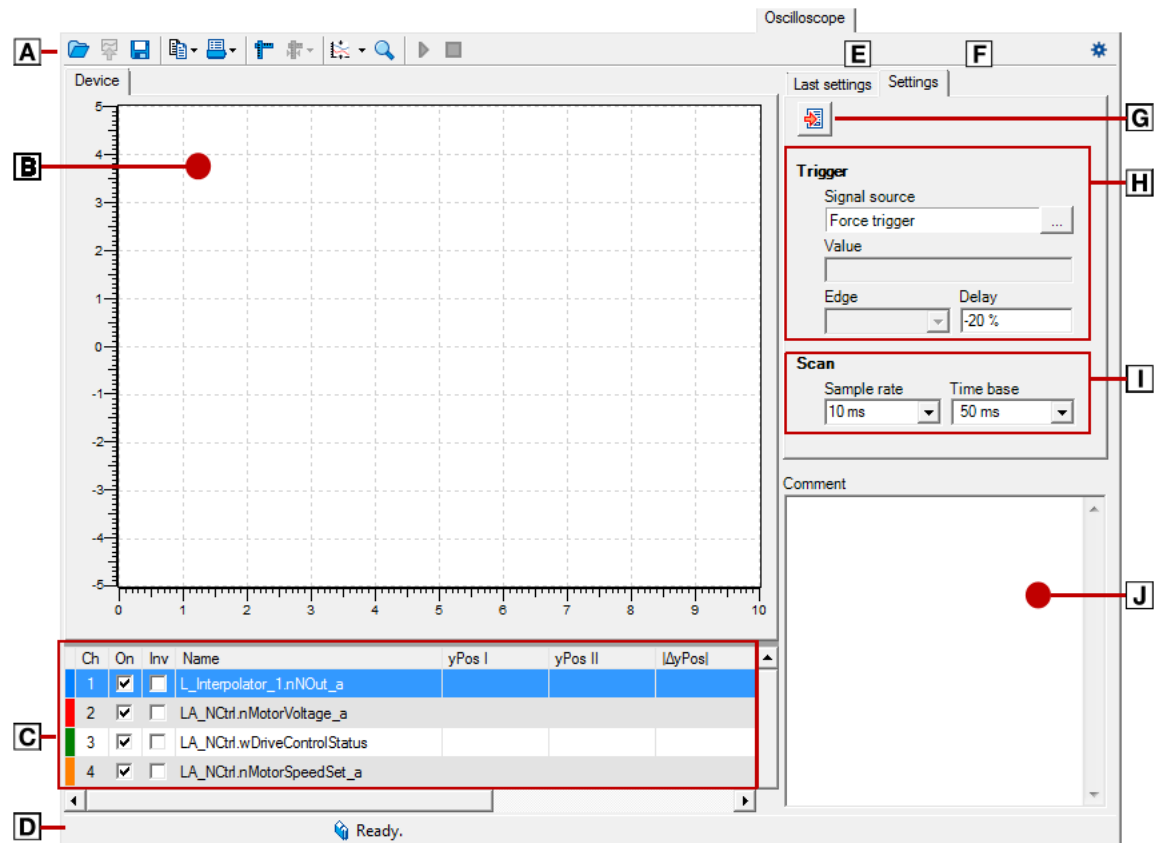





1. Go to the *Project view* and select the servo inverter.
2. Select the **Oscilloscope** tab from the *Workspace*.

The oscilloscope user interface contains the following control and function elements:



- A** [Oscilloscope toolbar](#)
- B** [Oscillogram selection](#)
- C** Channel list
  - ▶ [Selecting the signal sources to be recorded](#)
- D** Status bar
- E** [Last settings](#)
- F** Settings
- G** Import settings from a loaded oscillogram
- H** [Trigger settings](#)
- I** Input fields for [sampling rate and time base](#)
- J** Input field for [comments](#)

## Oscilloscope toolbar

Symbol	Function
	<a href="#">Loading the oscillogram file</a> (📖 505)
	Upload recorded oscillogram from device <ul style="list-style-type: none"> <li>• Transfer values from the measured value memory of the 8400 Stateline to the Engineering PC.</li> <li>• Only possible when an online connection has been established to the 8400 Stateline.</li> </ul>
	<a href="#">Saving the oscillogram in a file</a> (📖 504)
	Copy to clipboard: Copy as text   Copy as picture   Copy as table <ul style="list-style-type: none"> <li>• For documentation purposes, it is possible to copy the measured value of an oscilloscope as a table or, alternatively, the oscilloscope user interface as a picture, to the clipboard for use in other programs.</li> </ul>
	Printer settings   Print view   Print
	Show cursor
	Automatically scale vertically <ul style="list-style-type: none"> <li>• Set all Y positions to zero</li> </ul>
	Activate zoom function <ul style="list-style-type: none"> <li>▶ <a href="#">Adjusting the representation</a> (📖 497)</li> </ul>
	Start recording <ul style="list-style-type: none"> <li>• The settings are transferred to the device and the recording is started.</li> </ul>
	Stop recording
	Oscilloscope settings <ul style="list-style-type: none"> <li>• <a href="#">Cyclic recording of oscillograms</a></li> <li>• Always load oscillograms after recording is completed without a query</li> </ul>

### 10.2.2 Selecting the signal sources to be recorded

The oscilloscope supports up to four channels. Thus, the **channel list** can record maximally four signal sources.

The **channel list** serves to configure the signal sources to be recorded. Four signal sources have already been selected in the default setting:

Ch	On	Inv	Name	yPos I	yPos II	ΔyPos	Unit	AS	1/Div	Offset	Position
1	<input checked="" type="checkbox"/>	<input type="checkbox"/>	L_Interpolator_1.nNOUt_a				%	<input checked="" type="checkbox"/>	50	0	2.63870
2	<input checked="" type="checkbox"/>	<input type="checkbox"/>	LA_NCtrl.nMotorVoltage_a				V	<input type="checkbox"/>	100	0	1.5650
3	<input checked="" type="checkbox"/>	<input type="checkbox"/>	LA_NCtrl.wDriveControlStatus					<input checked="" type="checkbox"/>	2 k	0	0.680
4	<input checked="" type="checkbox"/>	<input type="checkbox"/>	LA_NCtrl.nMotorSpeedSet_a				rpm	<input type="checkbox"/>	2 k	0	-0.35675...

Name	Meaning
-	Curve colour for representation in the oscillogram • A double-click on the colour area of the channel serves to set a user-defined colour.
Ch	Channel number
On	Can visible / invisible
Inv	Inversion yes / no
Name	Name of the signal source
yPos I	y position of cursor I
yPos II	y position of cursor II
ΔyPos	Difference of the y positions of both cursors • Difference =  yPos I - yPos II
Unit	Unit of the signal source
AS	Select/deselect channel for automatic scaling
1/Div	Vertical scaling factor
Offset	Offset value • The offset value is subtracted from the recorded raw value before scaling is executed. This serves, for instance, to make very slight value fluctuations visible within one constantly very high recording value (e.g. harmonics with low amplitude).
Position	Position value • The position value determines the vertical position of the zero point of the y axis of a curve with regard to the vertical curve scale (- 5 ... + 5).

**How to select a signal source for recording:**

1. Double-click a non-assigned line in the **channel list** to open the *Select signal source* dialog box.
  - Double-clicking an already pre-assigned selection enables you to assign it with another signal source.
2. Select a new variable in the *Select signal source* dialog box.
3. Click the **OK** button.
  - The dialog box is closed and the selection is accepted.

**How to delete a selection:**

1. Go to the **channel list** and click the signal source to be removed.
2. Right-click the *context menu* to open it.
3. Select the **Delete signal source** command in the *context menu*.

You can add so many signal sources for recording until all four channels are assigned.

### 10.2.3 Selecting the recording time/sample rate

**How to define the sampling rate and time base for recording:**

1. Select the desired time base from the **time base** list field.
  - The current time base setting multiplied by ten results in the recording time.
  - Since the measured value memory of the 8400 StateLine has a limited capacity, usually a compromise is made between sample rate and recording time.
2. Enter the desired sampling rate in [ms] in the **sampling rate** input field.

### 10.2.4 Defining the trigger condition

The trigger condition serves to define the starting time of recording in the 8400 StateLine. The oscilloscope provides various trigger conditions by means of which recording of the measured values can be controlled.



If the **Last settings** tab is in the foreground, click the **Settings** tab to show the input fields for configuring the trigger condition. The **Settings** tab contains the button  which serves to import settings from a loaded oscillogram.

setting	Function
<b>Signal source</b>	Selection of the trigger source
Variable	Selection of an application variable as signal source
Channel	The oscilloscope triggers on a channel configured in the <b>channel list</b> .

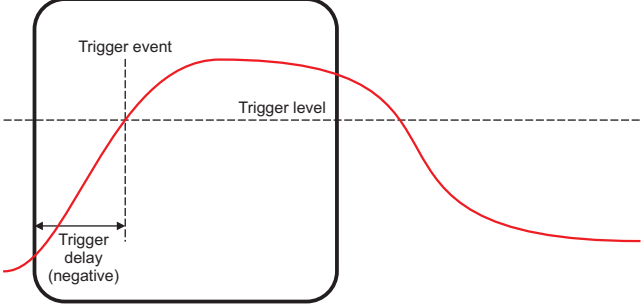
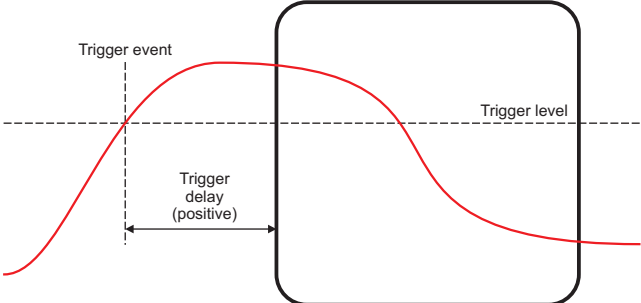
setting	Function
System event	The following system events serve as trigger source: <ul style="list-style-type: none"> <li>• Fault,</li> <li>• Warning</li> <li>• Error</li> </ul>
Direct trigger	No trigger condition, recording takes place immediately after clicking the symbol  in the <i>oscilloscope toolbar</i> .
Value	Value from which on triggering is activated.
Deceleration	Delay between recording and trigger event. Unit: [%]
Trigger delay	Select a negative delay time to detect signals <b>prior to</b> the trigger event. <div style="text-align: center;">  </div> <ul style="list-style-type: none"> <li>• In the oscillogram, the trigger time is marked by a dashed line.</li> <li>• When triggering on occurrence of an event, it is thus possible to detect the values that have caused the event.</li> </ul> <p>Select a positive delay time to detect signals occurring a certain time <b>after</b> the trigger event.</p> <div style="text-align: center;">  </div>
Edge	Three trigger types are available:
Positive edge	First, the selected trigger value must be fallen below and then exceeded in order that the trigger is activated.
Negative edge	First, the selected trigger value must be exceeded and then fallen below in order that the trigger is activated.
Change	For triggering on a Boolean signal source: <ul style="list-style-type: none"> <li>• Trigger activation requires a state change.</li> </ul> For triggering on a different signal source: <ul style="list-style-type: none"> <li>• The current value must be different than the last value in order that the trigger is activated.</li> </ul>



### 10.2.5 Starting recording



#### Note!

Recording can only be started when an online connection has been established to the 8400 StateLine.



Go to the *oscilloscope toolbar* and click the  button to activate recording. Recording starts as a function of the settings for triggering the signal source.

To obtain a maximum sample rate when recording the signal source values, the data are first stored in the measured value memory of the 8400 StateLine and then transferred to the Engineering PC. The current recording status is displayed in the status bar.

### 10.2.6 Cyclic recording



#### How to record oscillogram cyclically:

1. Click the  symbol in the *oscilloscope toolbar* to open the **Oscilloscope settings** dialog box.
2. In order that the recording process is restarted automatically after the upload of an oscillogram, set the checkmark accordingly.
  - Cyclic recording is only possible for time base values  $\geq 500$  ms.

For monitoring certain situations, this serves, for instance, to obtain the increased view of the interesting part of a characteristic even after the cyclic update, as originally zoomed.







### 10.2.7 Adjusting the representation

After the variable values have been recorded and the oscillogram has been transferred to the PC, it is visualised. If required, the representation can now be adjusted by using the zoom or the automatic scaling function.

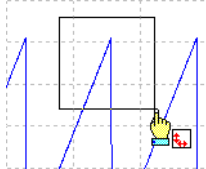
#### Zoom function



Go to the *oscilloscope toolbar* and click the  icon to activate the zoom function.



Zoom function	Procedure	
Zoom selection		<p>Hold down the left mouse button and draw the oscillogram section to be zoomed:</p>  <ul style="list-style-type: none"> <li>• While being drawn, the selection is shown with a frame.</li> <li>• When the left mouse button is released, the selection is zoomed in the oscillogram.</li> </ul>
Horizontal stretching		Hold down the left mouse button and move the mouse pointer on the horizontal scale to the left to stretch the shown selection from the right edge.
		Hold down the right mouse button and move the mouse pointer on the horizontal scale to the right to stretch the shown selection from the left edge.
	Moving the mouse pointer in opposite direction continuously reduces the stretching.	
Vertical stretching		Hold down the left mouse button and move the mouse pointer on the vertical scale to the bottom to stretch the shown selection from the top.
		Hold down the right mouse button and move the mouse pointer on the vertical scale to the top to stretch the shown selection from the bottom.
	Moving the mouse pointer in opposite direction continuously reduces the stretching.	
Return to original representation		Click the right mouse button in the oscillogram to return step by step to the original representation.

### Automatic scaling function

Use the automatic scaling function to automatically scale and reposition the representation of selectable signal characteristics in the oscillogram and reset the offset to "0".



#### How to carry out automatic scaling:

1. Activate the automatic scaling for each channel in the **channel list** by a checkmark in the "AS" column.
2. Go to the *oscilloscope toolbar* and click the  icon to activate the automatic scaling function for the activated channels.
3. Click the **OK** button.
  - The dialog box is closed and the selected channels/signal sources are scaled automatically.
4. Go to the *oscilloscope toolbar* and click the arrow next to the  symbol to set all the displayed curves to the Y position "0". This way, the curves are displayed "above one another".



### How to carry out the scaling manually for each channel:

- Go to the **channel list** and click the entry to be changed in the "unit" column (double-clicking an empty line has no effect.)
  - The dialog for entering the scaling opens which permits the entry of the lower and upper limit and the entry of the unit as shown in the example:

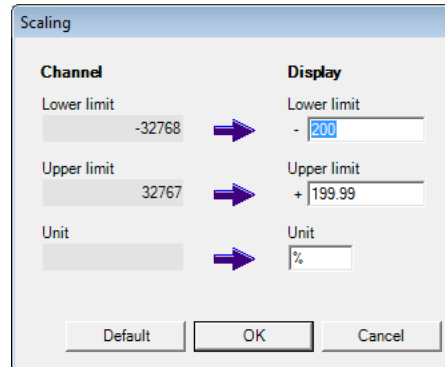



- Enter the lower limit, the upper limit and the unit.
  - On the right, you can enter any scaling values as upper and lower limits.
  - On the left side of the dialog, the limits of the data type of the recorded value are displayed.
- Click the **OK** button.
  - The dialog box is closed.

### 10.2.8 Cursor function: Reading individual measured values

In addition to the zoom and scaling function, the oscilloscope offers a "cursor function" that can be used to display individual measured values of a selectable channel or the difference between two measured values.



#### How to use the cursor function:

- Go to the *oscilloscope toolbar* and click the  icon to activate the cursor function.
  - Another button  is displayed which enables a centering of two vertical measuring lines that are independent of each other and can be moved.
  - The status bar displays the position of both measuring lines and the difference between them.
- Select the channel for which individual measured values are to be indicated from the **Channel list** field.

- 
3. Hold down the left mouse button and drag the red vertical measuring line to the desired position.
    - The active measuring line is represented by a continuous line, the inactive measuring line is represented by a dashed line.
    - If you click the inactive measuring line, it automatically becomes active.
    - The value measured at the position of the active measuring line is indicated in the value group box.
    - The difference between the values measured at the two measuring lines is indicated in the Differential value group field.
    - Comparing peak values: Several values displayed in the oscillogram can be compared by means of a horizontal measuring line. This measuring line is automatically generated based on the current cursor position and thus cannot be moved separately.

---

### 10.2.9 Automatic recording directly after mains connection

This function expansion is available from version 21.00.00.

---

#### Prerequisite

- The oscilloscope is configured using the Lenze Engineering Tool (e.g. EASY Starter).
- The user must configure the individual channels and the trigger conditions.

[Topic-IDs]



#### How to start the recording immediately after connection to the mains:

1. Set [C00759/0](#) = 1
  - The oscilloscope is automatically prepared after connection to the mains. Recording is triggered once the selected trigger condition is reached.
2. The device command [C00002/10](#) = 1 is used to save the configuration in the memory module with mains failure protection.

Now the internal oscilloscope is sufficiently prepared and the mains supply can be switched off.

The next time the device is connected to the mains, the oscilloscope integrated in the device will start automatically and begins measurement upon detecting the trigger event.

The recorded oscillogram is loaded from the device and displayed on the **Oscilloscope** tab.

### 10.2.10 Last settings

All information included in the **Last settings** tab refer to the oscillogram loaded into the device:

Last settings

Uploaded from device  
-

**Trigger**

Signal source  
-

Value  
-

Edge      Delay  
-      -

**Scan**

Sample rate      Time base  
-      -

The contents cannot be changed.

### 10.3 Managing oscillograms

If several oscillograms are loaded in the oscilloscope at the same time, the oscillogram to be displayed is selected via the corresponding tab below the toolbar. In general, the following oscillograms are to be distinguished:

#### Device oscillogram

The device oscillogram is the only oscillogram which can be used to establish a connection to the target system to carry out an oscilloscope measurement.

#### MERGE oscillogram

If two or more oscillograms are loaded in the oscilloscope, a "MERGE" tab is available.

- In the merge tab, several characteristics from the currently loaded data records can be overlaid, e.g. to compare signal characteristics from different recordings. ▶ [Overlay function](#) (📖 506)

#### Loaded oscillogram

An oscillogram loaded from a file.

#### 10.3.1 Commenting the oscillogram

The **Comment** text field serves to enter a comment on the selected oscillogram.

- If you execute the  [Saving the oscillogram in a file](#) command, the comment is saved together with the oscillogram in the file.

### 10.3.2 Saving the oscillogram in a file

After the signal sources to be recorded have been selected and the required settings have been entered, you can save the configuration and recording, if already executed, for future use in the project or export them to a file.



#### Note!

The reuse of a saved configuration is only reasonable for devices of the same type, as otherwise due to a scaling of the oscilloscope channels that is not adapted, incorrect values are displayed!



#### How to save an oscillogram in the project:

1. Click the  icon in the *oscilloscope toolbar*.
  - The *Open oscillogram file* dialog box appears.
2. Specify a file name in the **File name** input field.
3. Click the **Filing in the project** button.
  - The dialog box is closed and the current oscillogram is filed in the project.



#### Note!

The oscillogram is only saved if the entire project is saved!



#### How to save an oscillogram as external file:

1. Click the  icon in the *oscilloscope toolbar*.
  - The *Open oscillogram file* dialog box appears.
2. Press the **Save as external file ...** button.
  - A new window opens in which the directory and the file name for the oscillogram to be saved have to be specified.
3. Click the **Save** button.
  - The dialog box is closed and the current oscillogram is saved.



### 10.3.3 Loading the oscillogram file

Configurations/oscillograms already saved can be reloaded into the oscilloscope any time, e.g. for the overlay function.



#### Note!

The reuse of a saved configuration is only possible for devices of the same type, as otherwise due to a scaling of the oscilloscope channels that is not adapted, incorrect values are displayed!



#### How to load an oscillogram file from the project:

1. Click the  icon in the *oscilloscope toolbar*.
  - The *Load oscillogram file* dialog box appears.
2. Select the file to be loaded from the upper list field.
3. Click the **OK** button.
  - The dialog box is closed and the oscillogram file is accepted.



#### How to load an oscillogram file from an external file:

1. Click the  icon in the *oscilloscope toolbar*.
  - The *Load oscillogram file* dialog box appears.
2. Press the **Load from external file...** button.
  - A new window opens in which the directory and the file name for the oscillogram file to be loaded have to be selected.
3. Click **Open**.
  - The dialog box is closed and the oscillogram file is loaded.
  - The oscillogram is displayed on an additionally appearing tab.
  - If the configuration to be loaded contains signal sources that are no longer available in the device, these variables are automatically removed from the configuration.

---

#### 10.3.4 Overlay function

The overlay function serves to lay several characteristics from the currently loaded oscillogram files on top of each other, e.g. to compare signal characteristics from different recordings.

- If two or more oscillograms are loaded in the oscilloscope, e.g. the device oscillogram and an oscillogram previously saved in the project, a "MERGE" tab is available.
- If the MERGE tab is selected, the desired characteristics to be overload or compared can be selected from the loaded files in the **channel list**.
- If a device oscillogram is used in the merge tab, an update is carried out in the MERGE oscillogram in case of a renewed recording.
- Removing signal sources from the device oscillogram causes the characteristics in the MERGE oscillogram to be deleted.

---

### 10.3.5 Deleting an oscillogram file saved in the project



How to delete an oscillogram file saved in the project:

1. Click the  icon in the *oscilloscope toolbar*.
  - The *Load oscillogram file* dialog box appears.

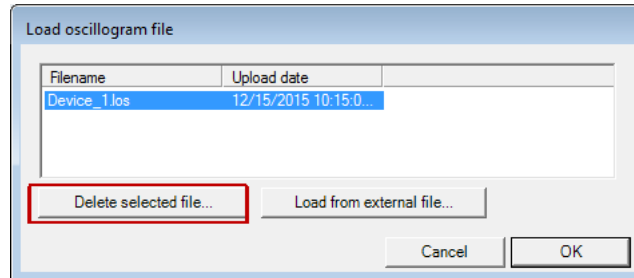

2. Select one or several oscillogram files from the upper list field.
3. Press the **Delete selected file...** button.
  - The selected file(s) is/are deleted and the dialog box is closed.

## 11 System bus "CAN on board"

---

### 11 System bus "CAN on board"

The inverter has an integrated CANopen interface ("CAN on board") which is used to exchange i.a. process data and parameter values between the nodes. Furthermore, other modules can be connected via this interface such as decentralised terminals, operator and input devices (HMIs), as well as external controls and host systems.

The interface transfers CAN objects following the CANopen communication profile (CiA DS301, version 4.02) developed by the umbrella organisation of CiA (CAN in Automation) in conformity with the CAL (CAN Application Layer).



#### Tip!

- In the »Engineer« parameter list, category **CAN**, you can find the parameters relevant for the CANopen interface classified in different subcategories.
- Information on CAN communication modules and CANopen interfaces of other Lenze devices is provided in the "CAN" communication manual in the Lenze library.

## 11.1 General information

For many years, the system bus (CAN) based on the CANopen communication profile has been integrated in Lenze inverters. Due to the lower number of data objects available, the functionality and compatibility of the previous system bus are lower as compared to CANopen. For parameter setting, two parameter data channels are always available to the user while CANopen provides only one active parameter channel.

The system bus (CANopen) of the Inverter Drives 8400 is a further development of the system bus (CAN) including the following properties:

- Full compatibility with CANopen DS301 V4.02.
- Support of the "Heartbeat" NMT slave function (DS301 V4.02)
- 1 or 2 parameterisable parameter data channels for transmitting SDOs (*Service Data Objects*)
- Up to four parameterisable process data channels (dependent on the device version) for transmitting PDOs (*Process Data Objects*)
  - All process data channels are functionally equivalent
  - Monitoring of the receive PDOs for data reception
- Adjustable error response to ...
  - physical CAN errors (frame, bit, ACK error)
  - bus-stop, bus working
  - absent PDOs
- Telegram counters for SDOs and PDOs
- Bus status diagnostics
- Boot-up telegram generation
- Emergency telegram generation
- Reset node telegram generation (for master configuration)
- Sync telegram generation and response to sync telegrams:
  - Data transmission/reception
  - Device-internal time base synchronisation
- Abort codes
- All CAN on board functions can be parameterised via codes
- Object directory (all mandatory functions, optional functions, indexes)

### 11.1.1 General data and application conditions

Range	Values
Communication profile	CANopen, DS301 V4.02
Communication medium	DIN ISO 11898
Network topology	Line terminated at both ends
Node addresses that can be set (max. number of nodes)	Depending on the number of SDO channels set in <a href="#">C00366</a> : <ul style="list-style-type: none"> <li>• 1 SDO: Node address 1 ... 127 (max. 127 nodes)</li> <li>• 2 SDO: Node address 1 ... 63 (max. 63 nodes)</li> <li>• adjustable via DIP switches or via code <a href="#">C00350</a>.</li> </ul>
Adjustable baud rates	20, 50, 125, 250, 500, 1000 kbps <ul style="list-style-type: none"> <li>• adjustable via DIP switches or via code <a href="#">C00351</a>.</li> <li>• 1000 kbps are supported <a href="#">from version 11.00.00</a>.</li> </ul>

Range	Values
Process data	For "BaseLine C" version: <ul style="list-style-type: none"> <li>• Max. 2 transmit PDOs (TPDOs) with 1 ... 8 bytes (adjustable)</li> <li>• Max. 2 receive PDOs (RPDOs) with 1 ... 8 bytes (adjustable)</li> </ul>
	For "StateLine C" version: <ul style="list-style-type: none"> <li>• Max. 4 transmit PDOs (TPDOs) with 1 ... 8 bytes (adjustable)</li> <li>• Max. 4 receive PDOs (RPDOs) with 1 ... 8 bytes (adjustable)</li> </ul> (Process data channel 4 is available <a href="#">from version 15.00.00!</a> )
Parameter data	Max. 2 server SDO channels with 1 ... 8 bytes <ul style="list-style-type: none"> <li>• Because of the 2 server SDO channels, the address range from 1 ... 63 is available</li> </ul>
Transfer mode for TPDOs	<ul style="list-style-type: none"> <li>• in case of data change (including adjustable blocking time)</li> <li>• Time-controlled, 1 to x ms</li> <li>• After the reception of 1 to 240 sync telegrams</li> </ul>

### 11.1.2 Supported protocols

Reports	
Standard PDO protocols	PDO write PDO read
SDO protocols	SDO download SDO download initiate SDO download segment
	SDO upload SDO upload initiate SDO upload segment
	SDO abort transfer
	SDO block download SDO block download initiate SDO block download end
	SDO block upload SDO block upload initiate SDO block upload end
NMT protocols	Start remote node (master and slave)
	Stop remote node (slave)
	Enter pre-operational (slave)
	Reset node (slave and local device)
	Reset communication protocol (slave)
Monitoring protocols	Heartbeat (heartbeat producer and heartbeat consumer) <ul style="list-style-type: none"> <li>• Up to 7 Heartbeat Producers can be monitored.</li> </ul>
	Emergency telegram (to master)
More protocols	Transmitting and receiving a sync telegram <ul style="list-style-type: none"> <li>• Synchronisation of the internal time base to the reception of the CAN sync telegram is possible. ▶ <a href="#">Synchronisation of the internal time base</a></li> </ul>

### 11.1.3 Communication time

The communication time is the time between the start of a request and the arrival of the corresponding response.

**Tip!**

The communication times in the CAN network depend on:

- the processing time in the device
- the telegram runtime (baud rate/telegram length)
- the bus load (especially if the bus is charged with PDOs and SDOs at a low baud rate)

#### Processing time in the 8400 inverter

There are no interdependencies between parameter data and process data.

- Parameter data: approx. 5 ms (typical value)
  - For parameters concerning the motor control (e.g. C00011), the processing time may be longer (up to 30 ms).
- Process data: 1 ms

# 11 System bus "CAN on board"

## 11.2 Possible settings via DIP switch

### 11.2 Possible settings via DIP switch

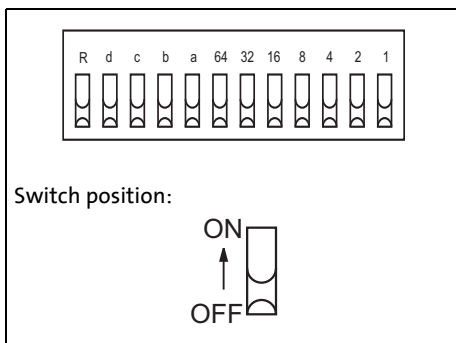

[11-1] DIP switch

The following can be set via the front panel DIP switches:

- Bus terminating resistor  
Switch: "R"
- Baud rate  
Switch: "a" ... "d"
- Node address  
Switch: "1" ... "64"

Lenze setting: All DIP switches are in the "OFF" position



#### Note!

- The DIP switch settings are accepted if a node address is unequal zero when the device or the 24-V supply is switched on by the DIP address.
- If all DIP switches are OFF when the device or the 24 V supply is switched on, the setting of the baud rate and node address are read out of the parameter set/parameter.



#### Tip!

The current DIP switch settings are displayed in code [C00349](#).

Bit 15 indicates that the setting of the DIP switches has been accepted when the device or the 24V supply has been switched on.

#### 11.2.1 Activating the bus terminating resistor

The system bus must be terminated between CAN low and CAN high at the first and last physical node each by a resistor (120 Ω). The 8400 inverter is provided with an integrated bus terminating resistor, which can be activated via the unlabelled DIP switch.

DIP switch position ("R"):

- OFF = bus terminating resistor is inactive
- ON = bus terminating resistor is active



# 11 System bus "CAN on board"

## 11.2 Possible settings via DIP switch

### 11.2.2 Setting the baud rate

The baud rate can be set via code [C00351](#) or with the DIP switches a to d.



#### Note!

- All DIP switches (a ... d, 1 ... 64) = OFF (Lenze setting):
  - At switching on, the settings under code [C00350](#) (node address) and [C00351](#) (baud rate) will become active.
- Preset baud rate: 500 kbps

DIP switch position				Baud rate
d	c	b	a	
OFF	<b>ON</b>	OFF	<b>ON</b>	20 kbps
OFF	OFF	<b>ON</b>	<b>ON</b>	50 kbps
OFF	OFF	<b>ON</b>	OFF	125 kbps
OFF	OFF	OFF	<b>ON</b>	250 kbps
OFF	OFF	OFF	OFF	<b>500 kbps</b>
OFF	<b>ON</b>	OFF	OFF	1000 kbps*

\* From version 11.00.00

### 11.2.3 Setting the node address

The node address can be set via code [C00350](#) or with the DIP switches 1 to 64.

- The labelling on the housing corresponds to the values of the individual DIP switches for determining the node address.
- The valid address range depends on the number of SDO channels set in [C00366](#):
  - 1 SDO (Lenze setting): 1 ... 127
  - 2 SDO: 1 ... 63



#### Note!





- The addresses of the nodes must differ from each other.
- All DIP switches (a ... d, 1 ... 64) = OFF (Lenze setting):
  - At switching on, the settings under code [C00350](#) (node address) and [C00351](#) (baud rate) will become active.

**Example: Setting of the node address 23**

DIP switch	64	32	16	8	4	2	1
Switch position	OFF	OFF	ON	OFF	ON	ON	ON
Value	0	0	16	0	4	2	1
Node address	= Sum of the values = 16 + 4 + 2 + 1 = 23						

**11.3**

**LED status displays for the system bus**

	CAN-RUN
	CAN-ERR
	DRV-RDY
	DRV-ERR

Information about the status of the system bus can be obtained quickly via LED displays "CAN-RUN" and "CAN-ERR" on the front of the inverter.

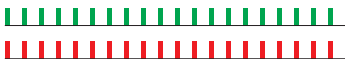

The meaning can be seen from the tables below.

**Inverter is not (yet) active on the system bus**



LED display	Meaning
 (CAN-ERR is permanently lit)	Inverter is not active on the system bus / Bus Off
 (CAN-RUN and CAN-ERR flicker)	Automatic detection of baud rate is active

**Inverter is active on the system bus**

- LED "CAN-RUN" signals the CANopen state:

LED display	CANopen state
 (CAN-RUN is blinking every 0.2 seconds)	Pre-Operational
 (CAN-RUN is permanently lit)	Operational
 (CAN-RUN is blinking every second)	Stopped

- LED "CAN-ERR" signals a CANopen error:

LED display	CANopen error
 (CAN-ERR is blinking once, then off for 1 second)	Warning Limit reached
 (CAN-ERR is blinking twice, then off for 1 second)	Node Guard Event
 (CAN-ERR is blinking three times, then off for 1 second)	Sync Message Error (only possible in the "Operational" state)

## 11.4 Going online via the system bus

The integrated system bus interface (CAN on board, X1 terminal) can also be used for the communication between the »Engineer« and the inverter, alternatively to the USB diagnostic adapter.

- Lenze offers the following communication accessories for connection to the PC:

Communication accessories	PC interface
<b>PC system bus adapter 2173</b> incl. connection cable and voltage supply adapter <ul style="list-style-type: none"> <li>• for DIN keyboard connection (EMF2173IB)</li> <li>• for PS/2 keyboard connection (EMF2173IBV002)</li> <li>• for PS/2 keyboard connection with electrical isolation (EMF2173IBV003)</li> </ul>	Parallel interface (LPT port)
<b>PC system bus adapter 2177</b> incl. connection cable (EMF2177IB)	USB (Universal Serial Bus)



### Note!

- For detailed information about the PC system bus adapter, please see the "CAN Communication Manual".
- Please observe the documentation for the PC system bus adapter!
- In the »Engineer«, go to the *Device assignment offline devices* dialog box and select the "System bus CAN" entry from the **Bus connection** list field to establish an online connection.

## 11.5 Reinitialising the CANopen interface

The [C00002/26](#) = "1: On / start" device command reinitialises the CANopen interface of the inverter ("Reset node"), which is required after e.g. changing the data transfer rate, the node address or the identifiers, respectively.

# 11 System bus "CAN on board"

## 11.6 Structure of the CAN data telegram

### 11.6 Structure of the CAN data telegram

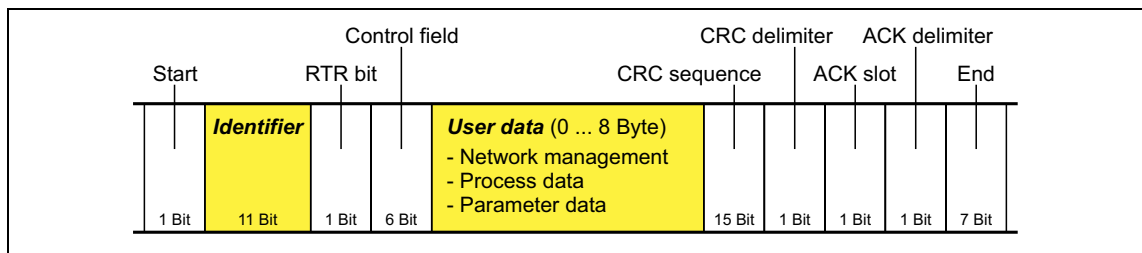

[11-2] Basic structure of the CAN telegram

The following subchapters provide a detailed description of the identifier and the user data. The other signals refer to the transfer characteristics of the CAN telegram whose description is not included in the scope of this documentation.



#### Tip!

Please visit the homepage of the CAN user organisation CiA (CAN in automation) for further information:

<http://www.can-cia.org>

#### 11.6.1 Identifier

The principle of the CAN communication is based on a message-oriented data exchange between a transmitter and many receivers. All nodes can transmit and receive quasi-simultaneously.

The identifier, also called COB-ID (abbr. for communication object identifier), is used to control which node is to receive a transmitted message. In addition to the addressing, the identifier contains information on the priority of the message and the type of user data.

The identifier consists of a basic identifier and the node address of the node to be addressed:

**Identifier (COB-ID) = basic identifier + node address (node ID)**

Exception: The identifier for process data/heartbeat/emergency objects as well as network management and sync telegrams is freely assigned by the user (either manually or automatically by the network configurator), or is permanently assigned.

### Node address (node ID)

Every node of the system bus network must be assigned to a node address (also called node ID) within the valid address range (1 ... 127) for unambiguous identification.

- Assigning a node address more than once within a network is impermissible.
- The own node address can be configured via the DIP switches or via code [C00350](#). ▶ [Setting the node address](#) (☞ 513)

### Identifier assignment

The system bus is message-oriented instead of node-oriented. Every message has an unambiguous identification, the identifier. For CANopen, node-oriented transfer is achieved by the fact that every message has only one transmitter.

- The basic identifiers for network management (NMT) and the basic SDO channel (SDO1) are defined in the CANopen protocol and cannot be changed.
- The basic identifiers of the PDOs are preset in the Lenze setting according to the "Predefined Connection Set" of DS301 V4.02.

Communication object		Basis identifier (CANBaseID)		Direction
Network management (NMT)		0	0x0000	
Sync <sup>1)</sup>		128	0x0080	
Emergency <sup>1)</sup>		128	0x0080	Device → system bus
PDO1 (Process data channel 1)	TPDO1	384	0x0180	Device → system bus
	RPDO1	512	0x0200	System bus → device
PDO2 (Process data channel 2)	TPDO2	640	0x280	Device → system bus
	RPDO2	768	0x300	System bus → device
PDO3 (Process data channel 3)	TPDO3	896	0x380	Device → system bus
	RPDO3	1024	0x400	System bus → device
PDO4 <sup>2)</sup> (Process data channel 4)	TPDO4	1152	0x480	Device → system bus
	RPDO4	1280	0x500	System bus → device
SDO1 (Parameter data channel 1)	TSDO1	1408	0x0580	Device → system bus
	RSDO1	1536	0x0600	System bus → device
SDO2 (Parameter data channel 2)	TSDO2	1472	0x05C0	Device → system bus
	RSDO2	1600	0x0640	System bus → device
Heartbeat		1792	0x0700	Device → system bus
Boot-up		1792	0x0700	Device → system bus

<sup>1)</sup> If you set the sync identifiers manually, observe the use of the emergency telegram, since it has the same COB-ID.  
<sup>2)</sup> From version 15.00.00



#### Tip!

If required, the identifiers of the PDOs and the identifiers for the sync telegram can be changed via parameters/indices.

▶ [Identifiers of the process data objects](#) (☞ 537)

▶ [Synchronisation of PDOs via sync telegram](#) (☞ 541)

The active identifiers of the PDOs are displayed in [C00355/x](#).

### 11.6.2 User data

All nodes communicate by exchanging data telegrams via the system bus. The user data area of the CAN telegram either contains network management data or parameter data or process data:

#### Network management data

(NMT data)

- Control information on start, stop, reset, etc. of communication to specific nodes or to all nodes of the CAN network.

#### Process data

(PDOs – process data objects)

- Process data are transferred via the process data channel.
- Process data can be used to control the inverter.
- Process data are not saved in the inverter.
- Process data are transmitted between host system and nodes to ensure continuous exchange of current input and output data.
- Process data usually are unscaled/scalable raw data.
- Process data are, for instance, setpoints and actual values.
- The exact meaning of the PDO file contents is determined via the function block editor (FB Editor) in the I/O level or via the PDO mapping.

#### Parameter data

(SDOs – service data objects)

- Parameter data are the CANopen indexes or, in case of Lenze devices, the codes.
- Parameters are set, for instance, when the system is initially adjusted during commissioning or when the material of the production machine is changed.
- Parameter data are transmitted as SDOs via the parameter data channel. They are acknowledged by the receiver, i.e. the transmitter gets a feedback about the transmission being successful or not.
- The parameter data channel enables access to all Lenze codes and CANopen indexes.
- Parameter changes are automatically saved to the inverter until mains switching.
- In general, the parameter transfer is not time-critical.
- Parameter data are, for instance, operating parameters, diagnostic information and motor data as well as control information on the interconnection of function blocks in the I/O level of the FB Editor.

## 11.7 Communication phases/network management

Regarding communication via the system bus, the inverter distinguishes between the following statuses:

State	Explanation
"Initialisation" (Initialisation)	After switch-on, an initialisation run is carried out. <ul style="list-style-type: none"> <li>• During this phase, the inverter is not involved in the data exchange via the bus.</li> <li>• The standard values are re-written to all CAN-relevant parameters.</li> <li>• After initialisation is completed, the inverter is automatically set to the "Pre-Operational" status.</li> </ul>
"Pre-Operational" (before being ready for operation)	Parameter data can be received, process data are ignored.
"Operational" (ready for operation)	Parameter data and process data can be received!
"Stopped" (stopped)	Only network management telegrams can be received.

Communication object	Initialisation	Pre-Operational	Operational	Stopped
PDO			●	
SDO		●	●	
Sync		●	●	
Emergency		●	●	
Boot-up	●			
Network management (NMT)		●	●	●



### Tip!



Part of the initialisation or the entire initialisation can be carried out anew in every status by transferring the corresponding network management telegrams.

The current CAN status is displayed in [C00359](#) for diagnostic purposes.

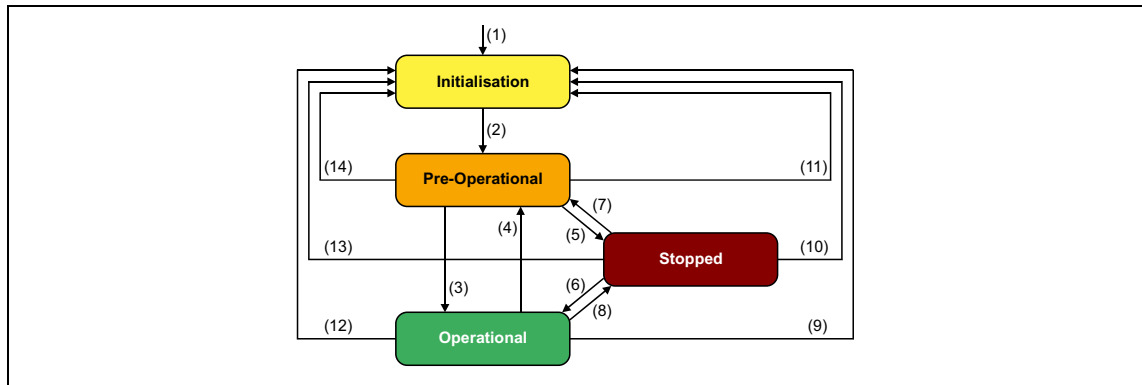
11.7.1 Status transitions



[11-3] NMT status transitions in the CAN network

Transition	NMT command	Status after change	Effects on process/parameter data after status change
(1)	-	Initialisation	Initialisation starts automatically when the mains is switched on. <ul style="list-style-type: none"> <li>• During initialisation, the inverter is not involved in the data exchange.</li> <li>• After the initialisation is completed, the node sends a boot-up message with an individual identifier and automatically changes to the "pre-operational" status.</li> </ul>
(2)	-	Pre-Operational	In this phase, the master determines the way in which the node(s) takes/take part in communication.
	From here, the master changes the statuses for the entire network. <ul style="list-style-type: none"> <li>• A target address included in the NMT command defines the receiver(s).</li> <li>• If the 8400 inverter is configured as CAN master, the status is automatically changed to "Operational" after a waiting time has expired (<a href="#">C00356/1</a>), and the 0x0100 ("Start remote node") NMT command is transmitted to all nodes.</li> <li>• Data can only be exchanged via process data objects if the status is "Operational"!</li> </ul>		
(3), (6)	0x01 xx Start remote node	Operational	Network management/sync/emergency telegrams as well as process data (PDO) and parameter data (SDO) are active. Optional: When the status is changed, event and time-controlled process data (PDOs) are transmitted once.
(4), (7)	0x80 xx Enter Pre-Operational	Pre-Operational	Network management/sync/emergency telegrams and parameter data (SDO) are active.
(5), (8)	0x02 xx Stop remote node	Stopped	Only network management telegrams can be received.
(9), (10), (11)	0x81 xx Reset node	Initialisation	All CAN-relevant parameters (CiA DS 301) are initialised with the saved values.
(12), (13), (14)	0x82 xx Reset communication		All CAN-relevant parameters (CiA DS 301) are initialised with the saved values.
	Meaning of the node address in the NMT command: <ul style="list-style-type: none"> <li>• xx = 0x00: If this assignment is selected, the telegram addresses all nodes (broadcast telegram). The status of all nodes can be changed at the same time.</li> <li>• xx = Node ID: If a node address is specified, only the status of the node with the corresponding address changes.</li> </ul>		



### 11.7.2 Network management telegram (NMT)

The telegram for the network management contains identifier "0" and the command included in the user data which consists of the command byte and the node address:

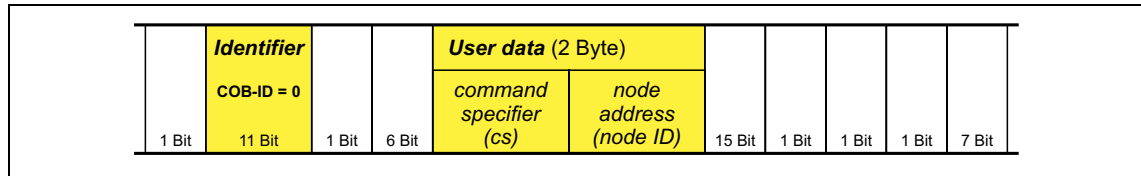

[11-4] Network management telegram for changing over the communication phases

Command specifier (cs)		NMT command
dec	hex	
1	0x01	Start remote node
2	0x02	Stop remote node
128	0x80	Enter Pre-Operational
129	0x81	Reset node
130	0x82	Reset communication

The communication phases are changed over by a node, the CAN master, for the entire network. The CAN master can also be a inverter. ▶ [Parameterising the inverter as CAN master \(522\)](#)

Meaning of the node address in the user data:

- node ID = "0": The telegram addresses all nodes (broadcast telegram). The status of all nodes can be changed at the same time.
- node ID = "1" ... "127": If a node address is specified, only the status of the node with the corresponding address changes.

#### Example:

Data can only be exchanged via process data objects if the status is "Operational". If the CAN master is supposed to switch all nodes connected to the bus from the "Pre-Operational" communication status to the "Operational" communication status, the identifier and user data in the transmission telegram must be set as follows:

- Identifier: 0x00 (network management)
- User data: 0x0100 ("Start remote node" NMT command to all nodes)

### 11.7.3 Parameterising the inverter as CAN master

If the initialisation of the system bus and the associated status change from "Pre-Operational" to "Operational" is not effected by a superimposed host system, the inverter can instead be defined to be a "quasi" master to execute this task.

The inverter is configured as CAN master in [C00352](#).

- Being the CAN master, the inverter sets all nodes connected to the bus (broadcast telegram) to the "Operational" communication status with the "Start remote node" NMT telegram. Only in this communication status, data can be exchanged via process data objects.
- A delay time can be set in [C00356/1](#) which must expire after mains switching before the inverter transmits the "Start remote node" NMT telegram.

Parameters	Info	Lenze setting	
		Value	Unit
<a href="#">C00352</a>	CAN slave/master	slave	
<a href="#">C00356/1</a>	CAN delay boot-up - Operational	3000	ms



#### Note!

The changes of the master/slave operation in [C00352](#) will not be activated until

- another mains switching of the inverter

or

- the "Reset node" or "Reset communication" NMT telegram has been transmitted to the inverter.

The "CAN reset node" device command ([C00002/26](#)) is provided as an alternative to the "Reset node" NMT telegram for the reinitialisation of the CAN-specific device parameters.



#### Tip!

Master functionality is only required during the initialisation phase of the drive system.

### 11.8 Process data transfer

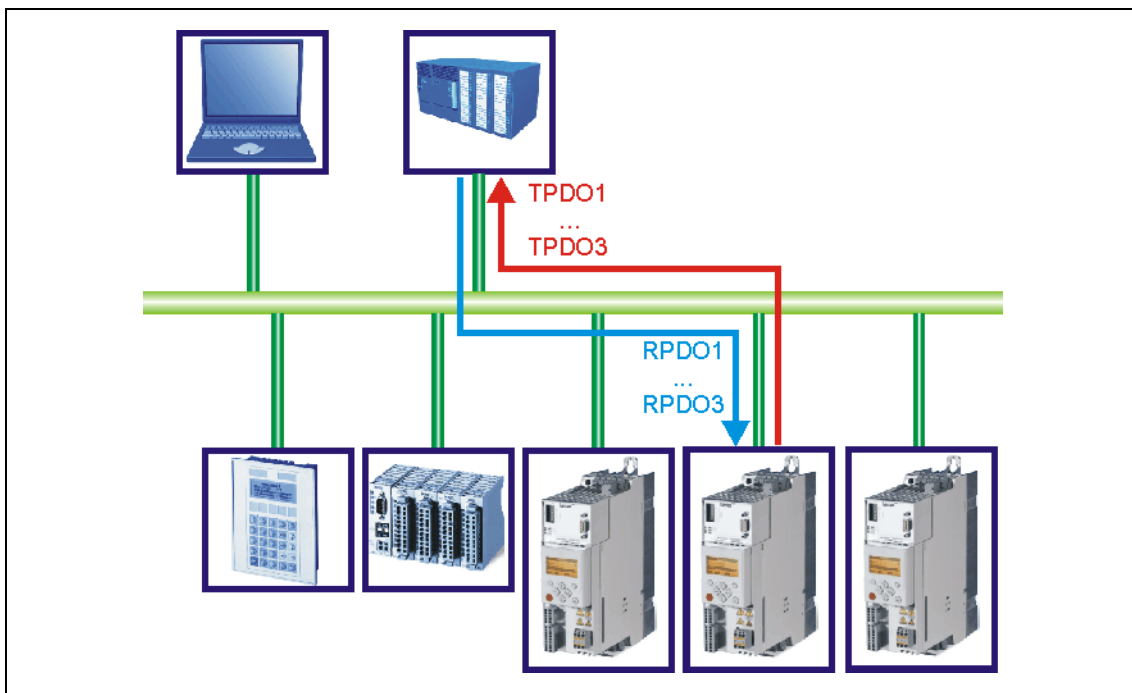

[11-5] PDO data transfer from / to the higher-level host system

For transmitting process data, up to four separated process data channels (PDO1 ... PDO4) are available depending on the device version and software version.

#### Definitions

- Process data telegrams between the host system and the devices are distinguished in terms of direction as follows:
  - Process data telegrams to the device (RPDO)
  - Process data telegrams from the device (TPDO)
- The CANopen process data objects are designated as seen from the node's view:
  - Receive PDOs (RPDOx): Process data object received by a node
  - Transmit PDOs (TPDOx): Process data object sent by a node



#### Note!

Data can only be exchanged via process data objects if the status is "Operational"!

▶ [Communication phases/network management](#) (📖 519)

### 11.8.1 Available process data objects

The number of available process data objects for inverters of the 8400 series depends on the device version:

Process data object	Version	
	BaseLine C	StateLine C HighLine C TopLine C
<a href="#">RPDO1   Port block "LP_CanIn1"</a>	●	●
<a href="#">RPDO2   "LP_CanIn2" port block</a>	●	●
<a href="#">RPDO3   "LP_CanIn3" port block</a>		●
<a href="#">RPDO4   "LP_CanIn4" port block</a>		● (from version 15.00.00)
<a href="#">TPDO1   "LP_CanOut1" port block</a>	●	●
<a href="#">TPDO2   "LP_CanOut2" port block</a>	●	●
<a href="#">TPDO3   "LP_CanOut3" port block</a>		●
<a href="#">TPDO4   "LP_CanOut4" port block</a>		● (from version 15.00.00)

#### Receive PDOs (RPDOs)

The process data objects transmitted from the system bus to the drive are processed via the [LP\\_CanIn1](#) ... [LP\\_CanIn4](#) port blocks.

- Every port block provides 4 words (2 bytes/word). The data of every first word are provided in a bit decoded manner (bit 0 ... 15).
- The first word of the [LP\\_CanIn1](#) port block is defined as control word *wCtrl*. The *wCtrl* control word does not have a permanent connection to the device control and can be used as required. The predefined assignment of the *wCtrl* control word in the [C00007](#) = "30: CAN" control mode depends on the technology application selected in [C00005](#):
  - **TA "Actuating drive speed":**  
[Process data assignment for fieldbus communication](#) (☞ 331)
  - **TA "Abschaltpositionierung":**  
[Process data assignment for fieldbus communication](#) (☞ 391)

#### Transmit PDOs (TPDOs)

The process data transmitted from the drive to the system bus are processed via the [LP\\_CanOut1](#) ... [LP\\_CanOut4](#) port blocks.

- Every port block receives 4 words (2 bytes/word). The data of every first word are transmitted bit by bit (bit 0 ... 15).
- The first word of the [LP\\_CanOut1](#) port block is defined as the *wState* status word. The *wState* status word does not have a permanent connection to the device control and can be used as required.
  - For a predefined assignment, see the [wDeviceStatusWord status word](#) of the drive interface.

11.8.1.1 RPDO1 | Port block "LP\_CanIn1"

The LP\_CanIn1 port block maps process data object RPDO1 in the FB Editor.

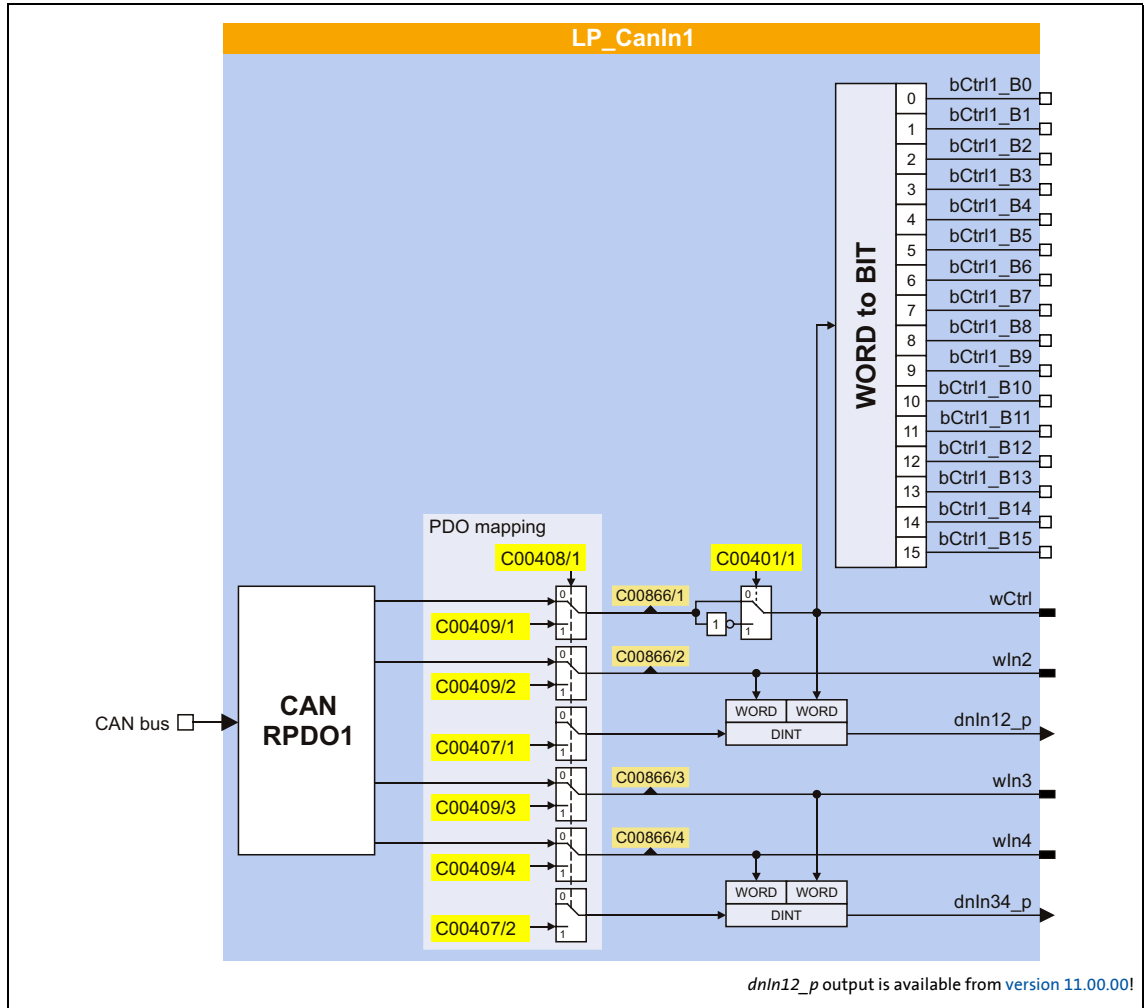

Short overview of the parameters for LP\_CanIn1:

Parameters	Info	Lenze setting
<a href="#">C00401/1</a>	LP_CanIn1: Inversion bCtrl1_B0..15	0x0000
<a href="#">C00866/1</a>	LP_CanIn1: wCtrl	-
<a href="#">C00866/2</a>	LP_CanIn1: wIn2	-
<a href="#">C00866/3</a>	LP_CanIn1: wIn3	-
<a href="#">C00866/4</a>	LP_CanIn1: wIn4	-
<b>PDO mapping</b>		
<a href="#">C00408/1</a>	LP_CanIn1: Mapping selection	CanIn
<a href="#">C00409/1</a>	LP_CanIn1: wCtrl MapVal	0
<a href="#">C00409/2</a>	LP_CanIn1: wIn2 MapVal	0
<a href="#">C00409/3</a>	LP_CanIn1: wIn3 MapVal	0
<a href="#">C00409/4</a>	LP_CanIn1: wIn4 MapVal	0
Greyed out = display parameter		

---

Parameters	Info	Lenze setting
<a href="#">C00407/1</a>	LP_CanIn1: dwIn12 MapVal • From version 12.00.00 • The mapping for the double word is ORed with the mapping setting in <a href="#">C00409/1</a> and <a href="#">C00409/2</a> .	0
<a href="#">C00407/2</a>	LP_CanIn1: dwIn34 MapVal • From version 12.00.00 • The mapping for the double word is ORed with the mapping setting in <a href="#">C00409/3</a> and <a href="#">C00409/4</a> .	0

Greyed out = display parameter

### 11.8.1.2 RPDO2 | "LP\_CanIn2" port block

The LP\_CanIn2 port block maps process data object RPDO2 in the FB Editor.

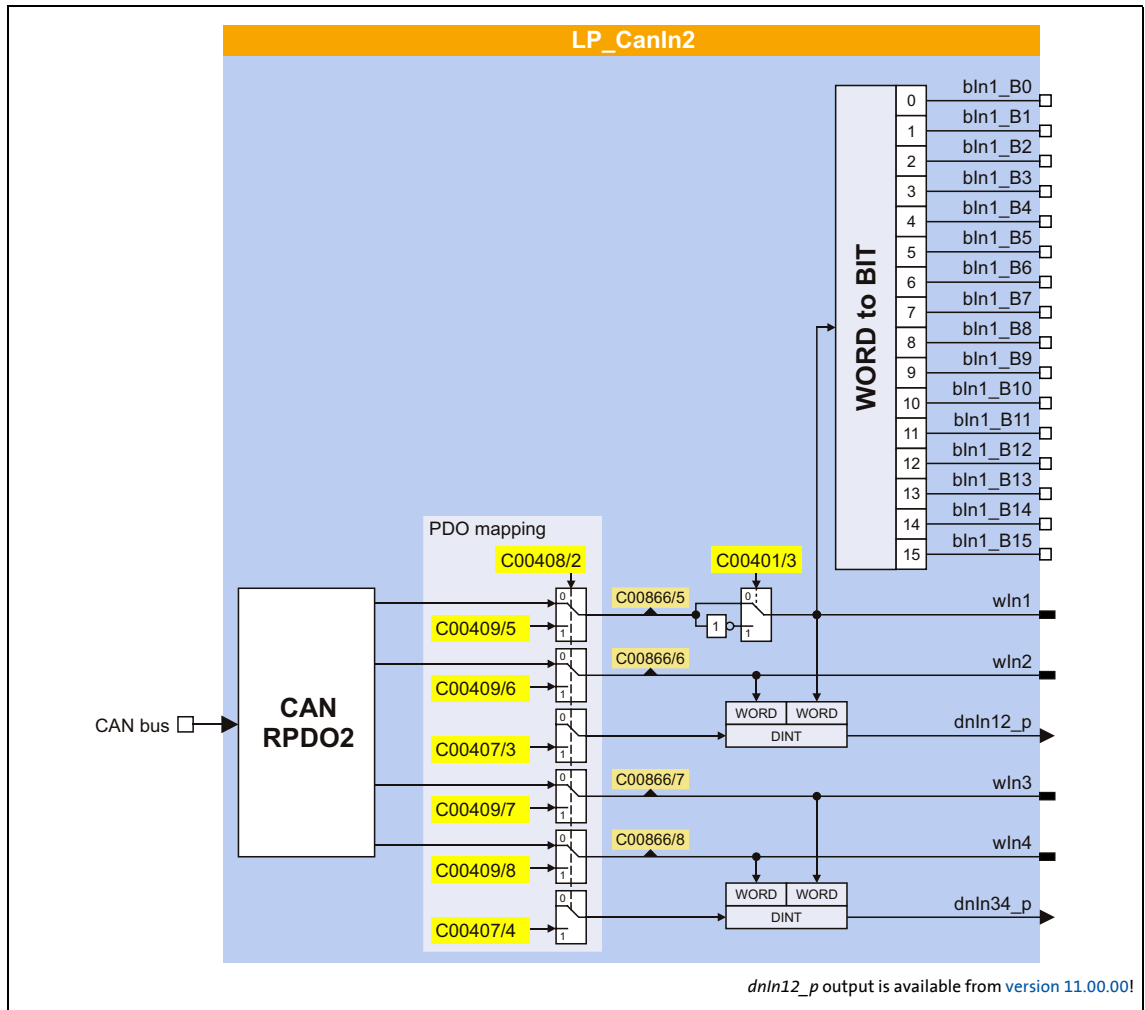

Short overview of the parameters for LP\_CanIn2:

Parameters	Info	Lenze setting
<a href="#">C00401/3</a>	LP_CanIn2: Inversion bln1_B0..15	0x0000
<a href="#">C00866/5</a>	LP_CanIn2: wln1	-
<a href="#">C00866/6</a>	LP_CanIn2: wln2	-
<a href="#">C00866/7</a>	LP_CanIn2: wln3	-
<a href="#">C00866/8</a>	LP_CanIn2: wln4	-
<b>PDO mapping</b>		
<a href="#">C00408/2</a>	LP_CanIn2: Mapping selection	CanIn
<a href="#">C00409/5</a>	LP_CanIn2: wln1 MapVal	0
<a href="#">C00409/6</a>	LP_CanIn2: wln2 MapVal	0
<a href="#">C00409/7</a>	LP_CanIn2: wln3 MapVal	0
<a href="#">C00409/8</a>	LP_CanIn2: wln4 MapVal	0
Greyed out = display parameter		

---

Parameters	Info	Lenze setting
<a href="#">C00407/3</a>	LP_CanIn2: dwIn12 MapVal • From version 12.00.00 • The mapping for the double word is ORed with the mapping setting in <a href="#">C00409/5</a> and <a href="#">C00409/6</a> .	0
<a href="#">C00407/4</a>	LP_CanIn2: dwIn34 MapVal • From version 12.00.00 • The mapping for the double word is ORed with the mapping setting in <a href="#">C00409/7</a> and <a href="#">C00409/8</a> .	0
Greyed out = display parameter		



### 11.8.1.3 RPDO3 | "LP\_CanIn3" port block

The LP\_CanIn3 port block maps process data object RPDO3 in the FB Editor.

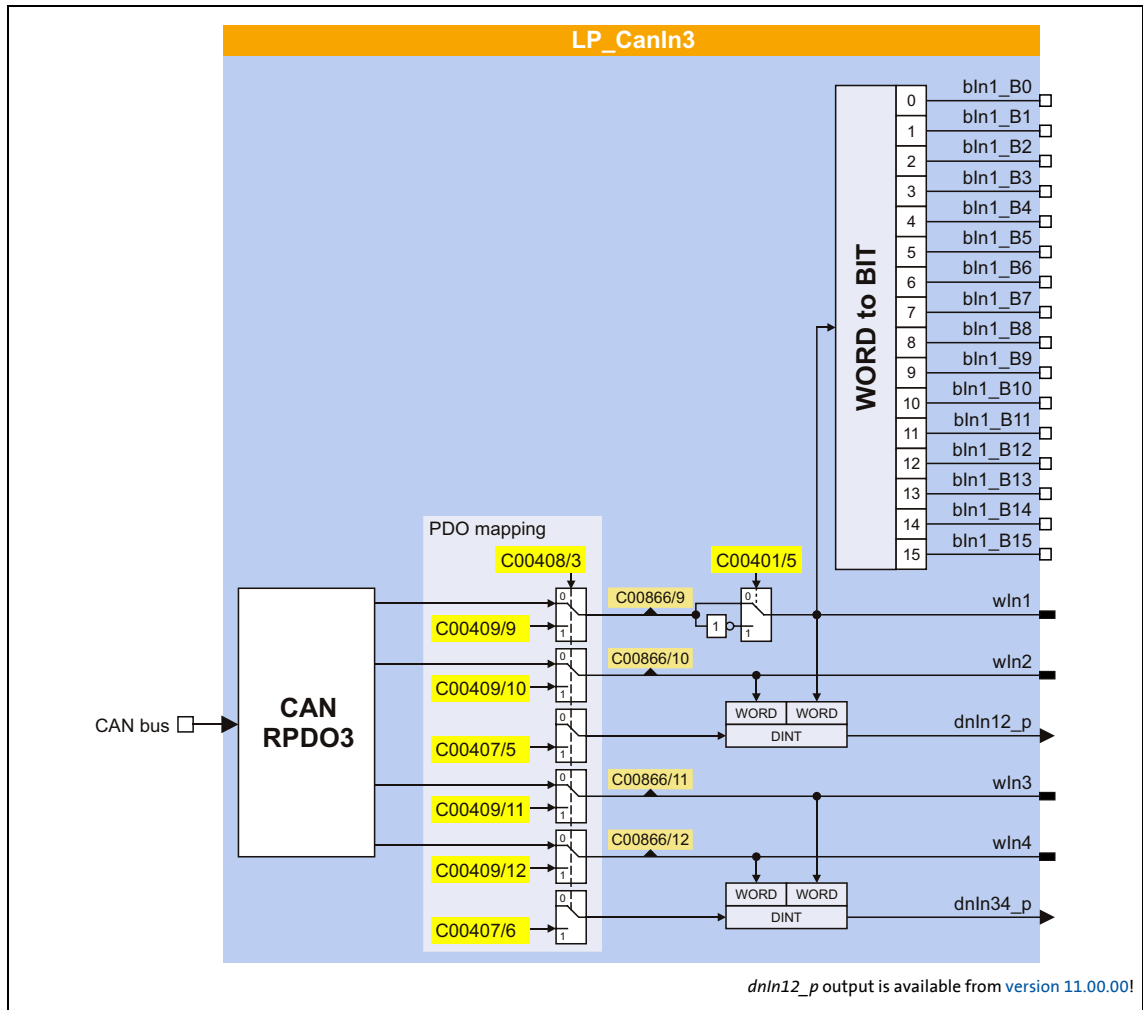

#### Short overview of the parameters for LP\_CanIn3:

Parameters	Info	Lenze setting
<a href="#">C00401/5</a>	LP_CanIn3: Inversion bln1_B0..15	0x0000
<a href="#">C00866/9</a>	LP_CanIn3: wln1	-
<a href="#">C00866/10</a>	LP_CanIn3: wln2	-
<a href="#">C00866/11</a>	LP_CanIn3: wln3	-
<a href="#">C00866/12</a>	LP_CanIn3: wln4	-
<b>PDO mapping</b>		
<a href="#">C00408/3</a>	LP_CanIn3: Mapping selection	CanIn
<a href="#">C00409/9</a>	LP_CanIn3: wln1 MapVal	0
<a href="#">C00409/10</a>	LP_CanIn3: wln2 MapVal	0
<a href="#">C00409/11</a>	LP_CanIn3: wln3 MapVal	0
<a href="#">C00409/12</a>	LP_CanIn3: wln4 MapVal	0
Greyed out = display parameter		

---

Parameters	Info	Lenze setting
<a href="#">C00407/5</a>	LP_CanIn3: dwIn12 MapVal • From version 12.00.00 • The mapping for the double word is ORed with the mapping setting in <a href="#">C00409/9</a> and <a href="#">C00409/10</a> .	0
<a href="#">C00407/6</a>	LP_CanIn3: dwIn34 MapVal • From version 12.00.00 • The mapping for the double word is ORed with the mapping setting in <a href="#">C00409/11</a> and <a href="#">C00409/12</a> .	0

Greyed out = display parameter

# 11 System bus "CAN on board"

## 11.8 Process data transfer

### 11.8.1.4 RPDO4 | "LP\_CanIn4" port block

This function extension is available from version 15.00.00!

The LP\_CanIn4 port block maps process data object RPDO4 in the FB Editor.

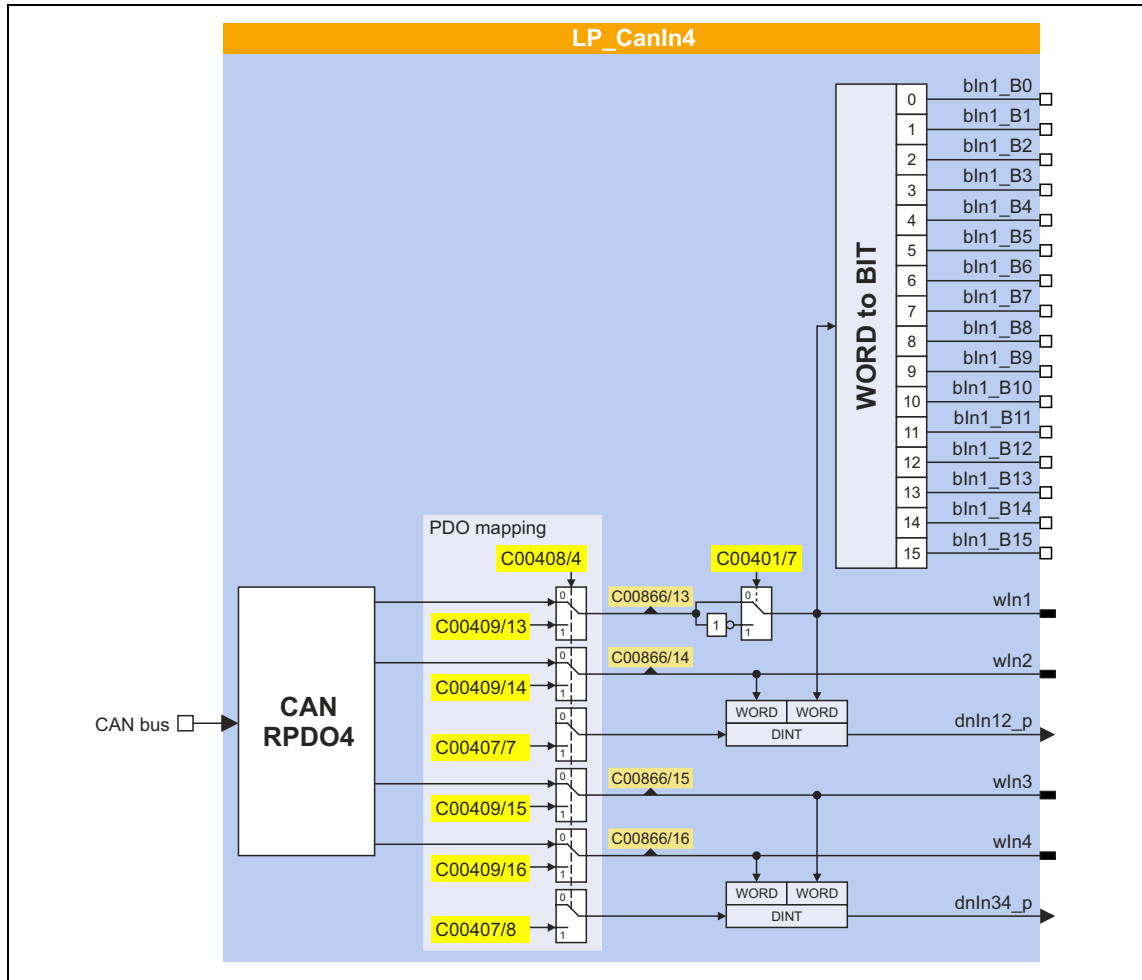

#### Short overview of the parameters for LP\_CanIn4:

Parameters	Info	Lenze setting
<a href="#">C00401/7</a>	LP_CanIn4: Inversion bIn1_B0..15	0x0000
<a href="#">C00866/13</a>	LP_CanIn4: wln1	-
<a href="#">C00866/14</a>	LP_CanIn4: wln2	-
<a href="#">C00866/15</a>	LP_CanIn4: wln3	-
<a href="#">C00866/16</a>	LP_CanIn4: wln4	-
<b>PDO mapping</b>		
<a href="#">C00408/4</a>	LP_CanIn4: Mapping Selection	CanIn
<a href="#">C00409/13</a>	LP_CanIn4: wln1 MapVal	0
<a href="#">C00409/14</a>	LP_CanIn4: wln2 MapVal	0
<a href="#">C00409/15</a>	LP_CanIn4: wln3 MapVal	0
<a href="#">C00409/16</a>	LP_CanIn4: wln4 MapVal	0

Greyed out = display parameter

Parameters	Info	Lenze setting
<a href="#">C00407/7</a>	LP_CanIn4: dwIn12 MapVal <ul style="list-style-type: none"> <li>The mapping for the double word is ORed with the mapping setting in <a href="#">C00409/13</a> and <a href="#">C00409/14</a>.</li> </ul>	0
<a href="#">C00407/8</a>	LP_CanIn4: dwIn34 MapVal <ul style="list-style-type: none"> <li>The mapping for the double word is ORed with the mapping setting in <a href="#">C00409/15</a> and <a href="#">C00409/16</a>.</li> </ul>	0
Greyed out = display parameter		

### 11.8.1.5 TPDO1 | "LP\_CanOut1" port block

The LP\_CanOut1 port block maps process data object TPDO1 in the FB Editor.

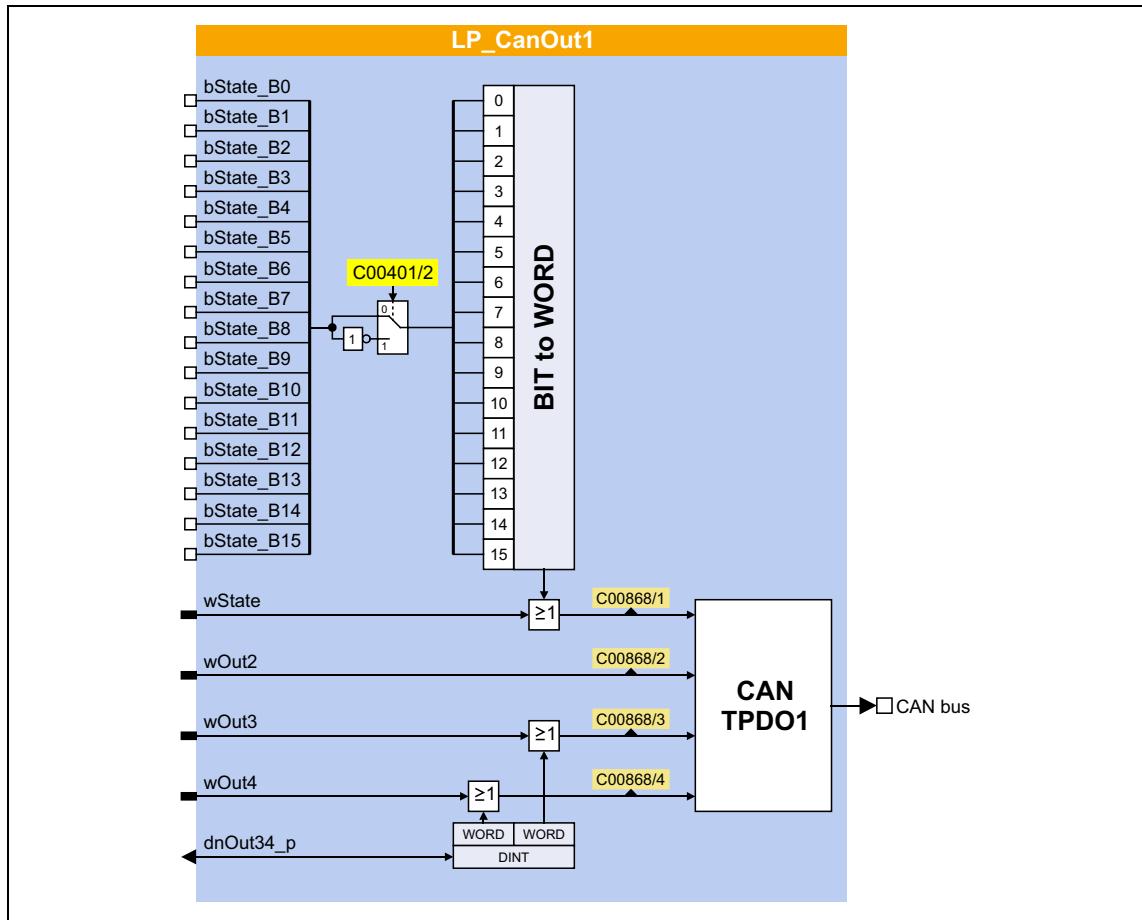

#### Short overview of the parameters for LP\_CanOut1:

Parameters	Info	Lenze setting
<a href="#">C00401/2</a>	LP_CanOut1: Inversion bState_B0..15	0x0000
<a href="#">C00868/1</a>	LP_CanOut1:wState	-
<a href="#">C00868/2</a>	LP_CanOut1:wOut2	-
<a href="#">C00868/3</a>	LP_CanOut1:wOut3	-
<a href="#">C00868/4</a>	LP_CanOut1: wOut4	-

Greyed out = display parameter

# 11 System bus "CAN on board"

## 11.8 Process data transfer

### 11.8.1.6 TPDO2 | "LP\_CanOut2" port block

The LP\_CanOut2 port block maps process data object TPDO2 in the FB Editor.

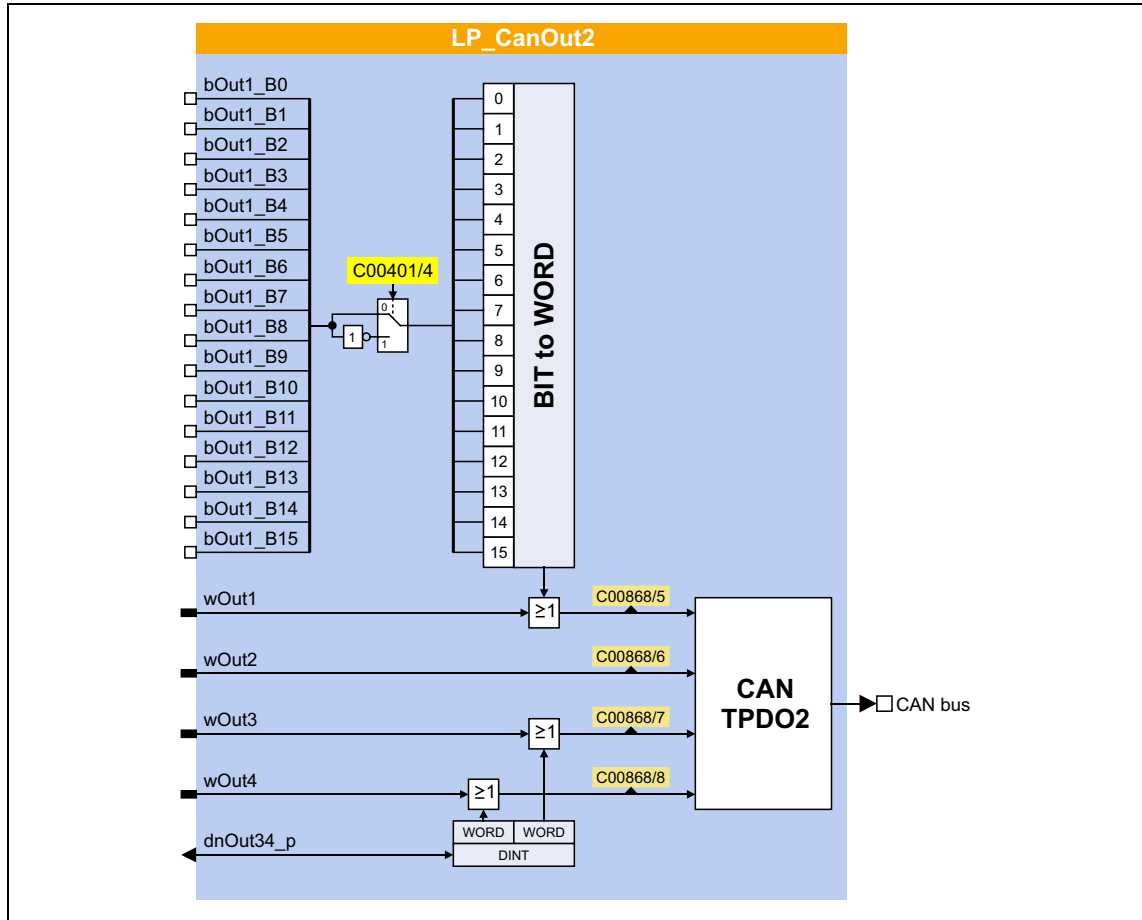

#### Short overview of the parameters for LP\_CanOut2:

Parameters	Info	Lenze setting
<a href="#">C00401/4</a>	LP_CanOut2: Inversion bOut1_B0..15	0x0000
<a href="#">C00868/5</a>	LP_CanOut2: wOut1	-
<a href="#">C00868/6</a>	LP_CanOut2: wOut2	-
<a href="#">C00868/7</a>	LP_CanOut2: wOut3	-
<a href="#">C00868/8</a>	LP_CanOut2: wOut4	-

Greyed out = display parameter

# 11 System bus "CAN on board"

## 11.8 Process data transfer

### 11.8.1.7 TPDO3 | "LP\_CanOut3" port block

The LP\_CanOut3 port block maps process data object TPDO3 in the FB Editor.

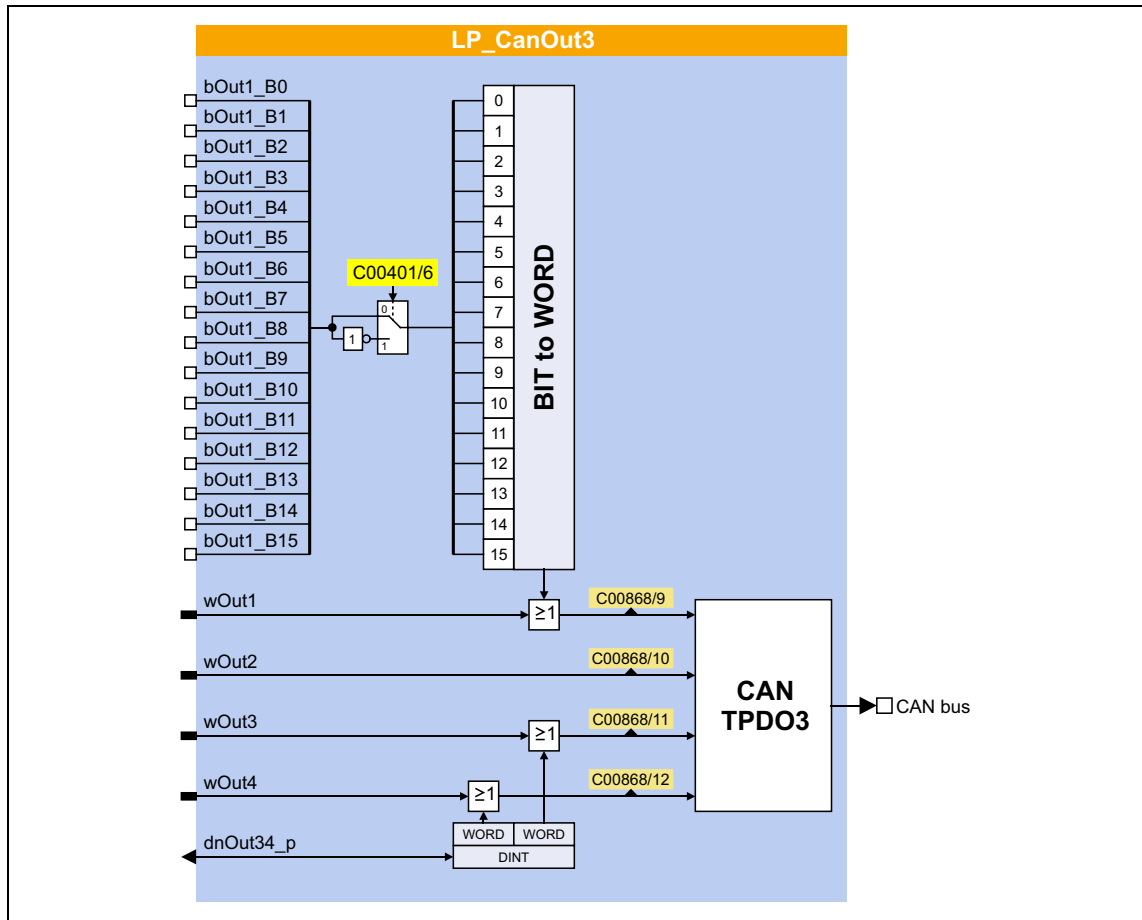

#### Short overview of the parameters for LP\_CanOut3:

Parameters	Info	Lenze setting
<a href="#">C00401/6</a>	LP_CanOut3: Inversion bOut1_B0..15	0x0000
<a href="#">C00868/9</a>	LP_CanOut3: wOut1	-
<a href="#">C00868/10</a>	LP_CanOut3: wOut2	-
<a href="#">C00868/11</a>	LP_CanOut3: wOut3	-
<a href="#">C00868/12</a>	LP_CanOut3: wOut4	-

Greyed out = display parameter

# 11 System bus "CAN on board"

## 11.8 Process data transfer

### 11.8.1.8 TPDO4 | "LP\_CanOut4" port block

This function extension is available from version 15.00.00!

The LP\_CanOut4 port block maps process data object TPDO4 in the FB Editor.

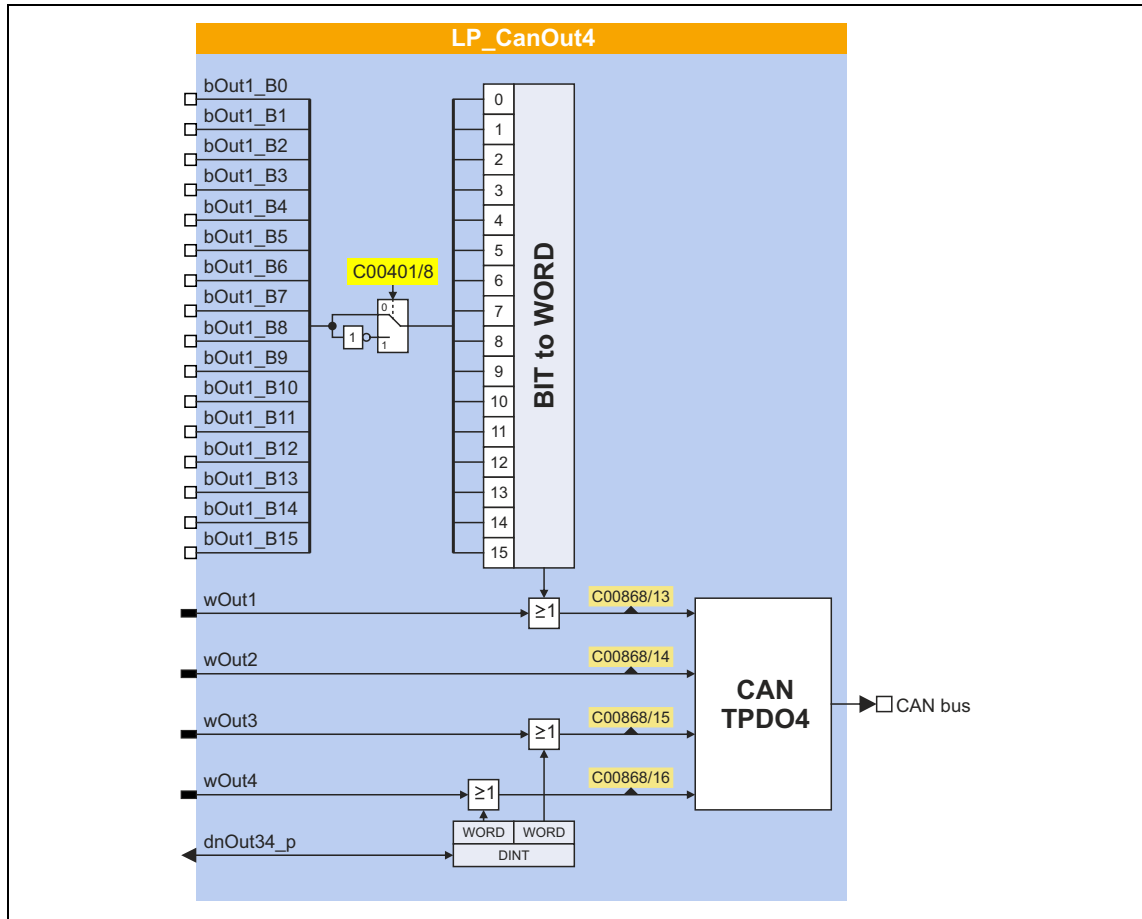

Short overview of the parameters for LP\_CanOut4:

Parameters	Info	Lenze setting
<a href="#">C00401/8</a>	LP_CanOut4: Inversion bOut1_B0..15	0x0000
<a href="#">C00868/13</a>	LP_CanOut4: wOut1	-
<a href="#">C00868/14</a>	LP_CanOut4: wOut2	-
<a href="#">C00868/15</a>	LP_CanOut4: wOut3	-
<a href="#">C00868/16</a>	LP_CanOut4: wOut4	-

Greyed out = display parameter



### 11.8.2 Identifiers of the process data objects

For the process data objects PDO1 ... PDO4, three identifier assignment procedures are available in [C00353/1...4](#):

- Identifier (COB-ID) = node address (C00350) + CANBaseID (Lenze setting)
- Identifier (COB-ID) = node address (C00350) + LenzeBaseID
- Identifier (COB-ID) = C0354/x

#### Lenze setting: Basic identifiers according to the "Predefined Connection Set" of DS301 V4.02

In the Lenze setting, the identifiers for the process data objects PDO1 ... PDO4 consist of the node address set in [C00350](#) and a basic identifier (CANBaseID) which corresponds to the "Predefined Connection Set" of DS301 V4.02:

Object			Basis identifier (CANBaseID)	
PDO1	TPDO1	COB-ID = node address ( <a href="#">C00350</a> ) +	384	0x180
	RPDO1		512	0x200
PDO2	TPDO2		640	0x280
	RPDO2		768	0x300
PDO3	TPDO3		896	0x380
	RPDO3		1024	0x400
PDO4	TPDO4		1152	0x480
	RPDO4		1280	0x500



#### Tip!

The active identifiers (COB-ID) are displayed in [C00355/x](#).

#### OPTIONAL: Use the basic identifier according to Lenze definition (LenzeBaseID)

If the basic identifiers shall be used instead according to the Lenze definition, go to [C00353/x](#) and select "0: COBID = C0350 + LenzeBaseID" for the corresponding PDO.

The basic Lenze identifiers which differ from the "Predefined Connection Set" are highlighted in colour in the following table:

Object			Basic identifier (LenzeBaseID)	
PDO1	TPDO1	COB-ID = node address ( <a href="#">C00350</a> ) +	384	0x180
	RPDO1		512	0x200
PDO2	TPDO2		641	0x281
	RPDO2		640	0x280
PDO3	TPDO3		769	0x301
	RPDO3		768	0x300
PDO4	TPDO4		897	0x381
	RPDO4		896	0x380

**OPTIONAL: Set identifier individually**

When "2: COBID = C0354/x" in [C00353/x](#), the identifiers for the PDOs can be individually set via the Lenze codes and CANopen indexes listed in the table below. That way, identifiers independent of the node address can be set for specific PDOs.

- If identifiers are assigned individually, all PDOs must have basic identifier values in the range of 385 ... 1407.

Object			Lenze code	CANopen index	Default setting
PDO1	TPDO1	COB-ID =	<a href="#">C00354/1</a>	<a href="#">I-1400/1</a>	0x201
	RPDO1		<a href="#">C00354/2</a>	<a href="#">I-1800/1</a>	0x181
PDO2	TPDO2		<a href="#">C00354/3</a>	<a href="#">I-1401/1</a>	0x301
	RPDO2		<a href="#">C00354/4</a>	<a href="#">I-1801/1</a>	0x281
PDO3	TPDO3		<a href="#">C00354/5</a>	<a href="#">I-1402/1</a>	0x401
	RPDO3		<a href="#">C00354/6</a>	<a href="#">I-1802/1</a>	0x381
PDO4	TPDO4		<a href="#">C00354/7</a>	<a href="#">I-1403/1</a>	0x501
	RPDO4		<a href="#">C00354/8</a>	<a href="#">I-1803/1</a>	0x481

**Note!**

After a node address change ([C00350](#)) and a CAN reset node afterwards, the subcodes of [C00354](#) automatically resume the values which result from the respective basic identifier and the set node address.

### 11.8.3 Transmission type

Process data objects can be transmitted in an event-controlled or time-controlled manner. The below table shows that it is possible to combine the different methods by means of logic operations (AND, OR):

- Event-controlled  
The PDO is sent when a special device-internal event has occurred, e.g. when the data contents of the TPDO have changed or when a transmission cycle time has elapsed
- Synchronous transmission  
A TPDO (or RPDO) is transmitted (or received) after the device has received a sync telegram (COB-ID 0x80).
- Cyclic transmission  
The cyclic transmission of PDOs takes place when the transmission cycle time has elapsed.
- Polled via RTR  
A TPDO is transmitted when another device requests it by means of a data request telegram (RTR remote transmit request). For this purpose, the data requester (e.g. the master) sends the data request telegram with the COB-ID of the TPDO requested to be sent. The receiver recognises the RTR and transmits the corresponding PDO.

Transmission type	PDO transmission			Logic combination of different transmission types
	cyclic	synchronous	event-controlled	
0		●	●	AND
1 ... 240		●		-
254, 255	●		●	OR

Transmission type	Description
0	Synchronous and acyclic: The PDO is transmitted on an event-controlled basis with every sync (e.g. when a bit change occurs in the PDO).
1 ... 240	Synchronous and cyclic (sync-controlled with response): <ul style="list-style-type: none"> <li>• Selection n = 1: The PDO is transmitted with <u>every</u> sync.</li> <li>• Selection 1 &lt; n ≤ 240: The PDO is transmitted with <u>every n-th</u> sync.</li> </ul> From version 16.00.00 onwards, the transmit PDOs are also sent when the sync telegram is generated. Precondition: the sync Tx identifier and sync Rx identifier have the same value.
241 ... 251	Reserved
252	Synchronous - RTR only
253	Asynchronous - RTR only
254, 255	Asynchronous - manufacturer-specific / device profile-specific: If this value is entered, the PDO transmission is event-controlled <u>or</u> cyclic. (Note: The values "254" and "255" have the same meaning). For a cyclic transmission, a cycle time must be entered for the respective PDO. In this case, cyclic transmission takes place in addition to event-controlled transmission.

The communication parameters such as the transmission mode and cycle time can be set freely for every PDO and independently of the settings of other PDOs:

Parameters	Info	Lenze setting	
		Value	Unit
<b>CAN1_OUT</b>			
<a href="#">C00322/1</a>	Transmission mode	254	
<a href="#">C00324/2</a>	Blocking time	0	ms
<a href="#">C00356/5</a>	Cycle time	0	ms
<a href="#">C00358/1</a>	Data length	8	Byte
<b>CAN2_OUT</b>			
<a href="#">C00322/2</a>	Transmission mode	254	
<a href="#">C00324/3</a>	Blocking time	0	ms
<a href="#">C00356/2</a>	Cycle time	0	ms
<a href="#">C00358/2</a>	Data length	8	Byte
<b>CAN3_OUT</b>			
<a href="#">C00322/3</a>	Transmission mode	254	
<a href="#">C00324/4</a>	Blocking time	0	ms
<a href="#">C00356/3</a>	Cycle time	0	ms
<a href="#">C00358/3</a>	Data length	8	Byte
<b>CAN4_OUT (from version 15.00.00)</b>			
<a href="#">C00322/4</a>	Transmission mode	254	
<a href="#">C00324/5</a>	Blocking time	0	ms
<a href="#">C00356/6</a>	Cycle time	0	ms
<a href="#">C00358/4</a>	Data length	8	Byte
<b>CAN1_IN ... CAN4_IN</b>			
<a href="#">C00323/1...4</a>	Transmission mode CAN1_IN ... CAN4_IN • In the case of the RPDO serves as monitoring setting in the case of sync-controlled PDOs.	254	

### Blocking time

In [C00324/x](#) a "blocking time" can be set which defines the shortest transmission cycle with the transmission type "asynchronous - manufacturer-specific/device profile-specific".

Example: Cycle time = 500 ms, blocking time = 100 ms, sporadic data change:

- With a sporadic data change < 500 ms, quickest transmission takes place every 100 ms due to the set blocking time (event-controlled transmission). The transmission cycle timer is reset to 0 if the transmission has been activated in an event-controlled way.
- In the case of a sporadic data change > 500 ms, due to the cycle time set, transmission takes place every 500 ms (cyclic transmission).



### Tip!

The communication parameters can also be set via the following CANopen objects:

- [I-1400](#) ... [I-1403](#): Communication parameters for RPDO1 ... RPDO4
- [I-1800](#) ... [I-1803](#): Communication parameters for TPDO1 ... TPDO4

### 11.8.4 Synchronisation of PDOs via sync telegram

During cyclic transmission, one or more PDOs are transmitted/received in fixed time intervals. An additional specific telegram, the so-called sync telegram, is used for synchronising cyclic process data.

- The sync telegram is the trigger point for the transmission of process data from the slaves to the master and for the acceptance of process data from the master in the slaves.
- For sync-controlled process data processing, the sync telegram must be generated accordingly.
- The response to a sync telegram is determined by the transmission type selected.
  - ▶ [Transmission type](#) (📖 539)

#### Basic workflow

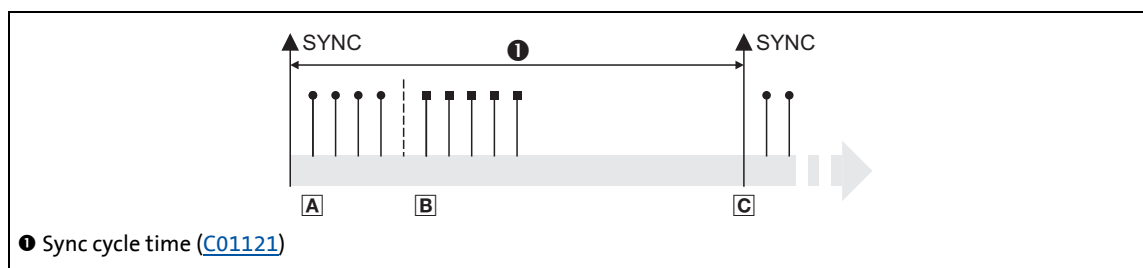

[11-6] Sync telegram

- After the sync telegram has been received, the slaves transmit the synchronous process data to the master (TPDOs). The master reads them as process input data.
- When the transmission process is completed, the slaves receive (RPDOs) the process output data (of the master).
  - All other telegrams (e.g. parameters or event-controlled process data) are accepted acyclically by the slaves after the transmission is completed.
  - Illustration [\[11-6\]](#) does not include acyclic data. However, they need to be considered when dimensioning the cycle time.
- The data are accepted in the slave with the next sync telegram if the Rx mode is set to 1 ... 240. If the Rx mode is 254 or 255, the data are accepted in the next device cycle, irrespective of the sync telegram.

#### Short overview: Parameters for the synchronisation via sync telegram

Parameters	Info	Lenze setting		Assignment	
		Value	Unit	Sync master	Sync slave
<a href="#">C00367</a>	CAN SYNC Rx identifier	0x0080			●
<a href="#">C00368</a>	CAN SYNC Tx identifier	0x0080		●	
<a href="#">C00369</a>	CAN sync transmission cycle time	0	ms	●	

#### Related topics:

- ▶ [Synchronisation of the internal time base](#) (📖 595)

### 11.8.5 Monitoring of the RPDOs for data reception

For RPDO1 ... RPDO4 each, a monitoring time can be parameterised within which the RPDO must arrive. If the RPDO is not received within the monitoring time or not with the configured sync, the response parameterised for each RPDO takes place.

#### Short overview: Parameters for RPDO monitoring

Parameters	Info	Lenze setting	
		Value	Unit
<a href="#">C00357/1...4</a>	CAN1...4_IN monitoring time	3000	ms
<a href="#">C00593/1...4</a>	Resp. to CAN1...4_IN monitoring	No response	

### 11.8.6 Configuring exception handling of the CAN PDOs

[This function extension is only available from version 04.00.00!](#)

Exception handling for the CAN PDOs in the event of an error can be set via decoupling configuration and decoupling values.

- Bit coded selection is carried out in [C00342/1](#) for the process data words read by the bus, defining the events that will trigger decoupling.
- Bit coded selection is carried out in [C00342/2](#) for the process data words output by the application, defining the events that will trigger decoupling.

Bit	Event
Bit 0 <input type="checkbox"/>	BusOff_MsgErr
Bit 1 <input type="checkbox"/>	Warning
Bit 2 <input type="checkbox"/>	NodeStopped
Bit 3 <input type="checkbox"/>	HeartBeatEvent
Bit 4 <input type="checkbox"/>	CAN1_In_Überw.
Bit 5 <input type="checkbox"/>	CAN2_In_Überw.
Bit 6 <input type="checkbox"/>	CAN3_In_Überw.
Bit 7 <input type="checkbox"/>	CAN4_In_Überw.
Bit 8 <input type="checkbox"/>	Reserved
Bit 9 <input type="checkbox"/>	Reserved
Bit 10 <input type="checkbox"/>	Reserved
Bit 11 <input type="checkbox"/>	Reserved
Bit 12 <input type="checkbox"/>	Reserved
Bit 13 <input type="checkbox"/>	Reserved
Bit 14 <input type="checkbox"/>	Trouble
Bit 15 <input type="checkbox"/>	Fault

Finally, the following parameters define the value that the process data words are to have when they are decoupled:

Parameters	Info	Lenze setting	
		Value	Unit
<a href="#">C00343/1</a>	LP_CanIn1:wCtrl DiscVal	0	
<a href="#">C00343/2...4</a>	LP_CanIn1:wIn2...wIn4 DiscVal	0	
<a href="#">C00343/5...8</a>	LP_CanIn2:wIn1...wIn4 DiscVal	0	
<a href="#">C00343/9...12</a>	LP_CanIn3:wIn1...wIn4 DiscVal	0	
<a href="#">C00343/13...16</a>	LP_CanIn4:wIn1...wIn4 DiscVal	0	
<a href="#">C00344/1</a>	LP_CanOut1:wState DiscVal	0	
<a href="#">C00344/2...4</a>	LP_CanOut1:wOut2...wOut4 DiscVal	0	
<a href="#">C00344/5...8</a>	LP_CanOut2:wOut1...wOut4 DiscVal	0	
<a href="#">C00344/9...12</a>	LP_CanOut3:wOut1...wOut4 DiscVal	0	
<a href="#">C00344/13...16</a>	LP_CanOut4:wOut1...wOut4 DiscVal	0	

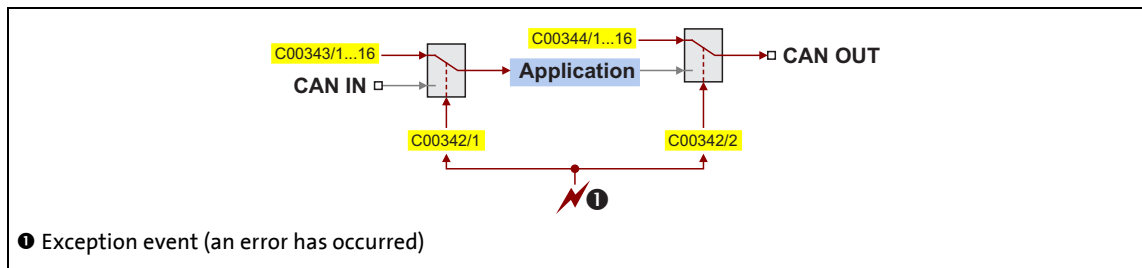

[11-7] General signal flow in the event of a configured exception

**Related topics:**

- ▶ [Configuring exception handling of the output terminals \(301\)](#)

### 11.9 Parameter data transfer

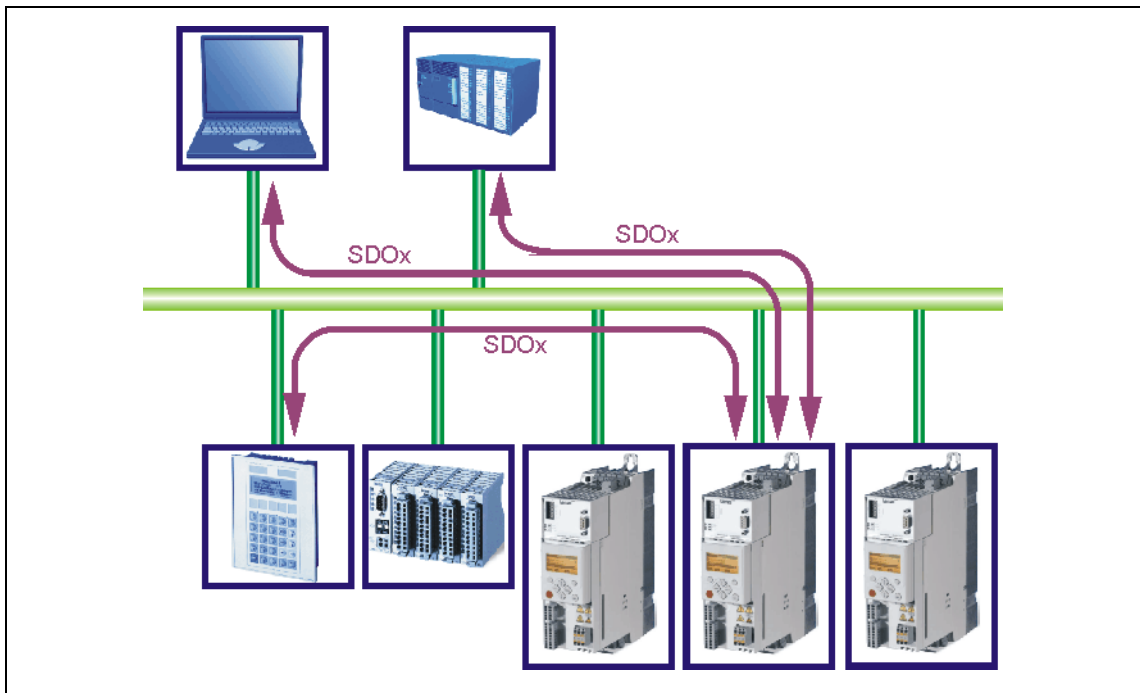

[11-8] Parameter data transfer via the available parameter data channels

Parameters are values stored in codes on Lenze controllers.

Two parameter data channels are available for parameter setting, enabling the simultaneous connection of different devices for configuration purposes.

Parameter data are transmitted via the system bus as SDOs (*Service Data Objects*) and acknowledged by the receiver. The SDO enables read and write access to all device parameters and to the CANopen object directory integrated in the device. Indices (e.g. 0x1000) ensure access to device parameters and functions included in the object directory. To transfer SDOs, the information contained in the user data must comply with the CAN SDO protocol.



#### Note!

Up to and including version 05.00.00, the parameter channels 1 and 2 are activated in the Lenze setting.

From version 05.01.00 onwards, only the parameter data channel 1 is activated in the Lenze setting according to CANopen.

- In order to activate both parameter data channels according to the previous behaviour, set "2 SDO Lenze" in [C00366](#).



### 11.9.1 Identifiers of the parameter data objects

In the Lenze setting, the basic identifiers of the SDOs are preset according to the "Predefined Connection Set".

The identifiers of the parameter data objects SDO1 and SDO2 result from the basic identifier and the node address set under code [C00350](#):

**Identifier = basic identifier + node address**

Object		Direction		Lenze-Base-ID		CANopen-Base-ID	
		from device	to device	dec	hex	dec	hex
SDO1 (Parameter data channel 1)	TSDO1	●		1408	580	1408	580
	RSDO1		●	1536	600	1536	600
SDO2 (Parameter data channel 2)	TSDO2	●		1472	5C0	1472	5C0
	RSDO2		●	1600	640	1600	640
Heartbeat		●		1792	700	1792	700
Boot-up		●		1792	700	1792	700

### 11.9.2 User data

Structure of the user data of the parameter data telegram

1st byte	2nd byte	3rd byte	4. byte	5th byte	6. byte	7th byte	8th byte
Command	Index		Subindex	Data 1	Data 2	Data 3	Data 4
	LOW byte	HIGH byte		LOW word		HIGH word	
				LOW byte	HIGH byte	LOW byte	HIGH byte



#### Note!

For the user data, the Motorola format is used.

► [Parameter data telegram examples](#) (📖 551)

The following subchapters provide detailed information on user data.

### 11.9.2.1 Command

1st byte	2nd byte	3rd byte	4. byte	5th byte	6. byte	7th byte	8th byte
<b>Command</b>	<b>Index</b>		<b>Subindex</b>	<b>Data 1</b>	<b>Data 2</b>	<b>Data 3</b>	<b>Data 4</b>
	LOW byte	HIGH byte		LOW word		HIGH word	
				LOW byte	HIGH byte	LOW byte	HIGH byte

The following commands can be transmitted or received for writing and reading the parameters:

Command	1st byte		Data length	Info
	hex	dec		
Write request	0x23	35	4 bytes	Writing of a parameter to the inverter.
	0x2B	43	2 bytes	
	0x2F	47	1 byte	
	0x21	33	Block	
Write response	0x60	96	4 bytes	Inverter acknowledges a write request.
Read request	0x40	64	4 bytes	Reading of a parameter from the inverter.
Read response	0x43	67	4 bytes	Inverter's response to a read request with the current parameter value.
	0x4B	75	2 bytes	
	0x4F	79	1 byte	
	0x41	65	Block	
Error response	0x80	128	4 bytes	Response from the inverter when the read/write request could not be executed correctly. ▶ <a href="#">Error messages</a> (549)

More precisely, the command byte comprises the following information:

Command	1st byte							
	Command specifier (cs)			Toggle (t)	Length*		e	s
	Bit 7	Bit 6	Bit 5	Bit 4	Bit 3	Bit 2	Bit 1	Bit 0
Write request	0	0	1	0	0/1	0/1	1	1
Write response	0	1	1	0	0	0	0	0
Read request	0	1	0	0	0	0	0	0
Read response	0	1	0	0	0/1	0/1	1	1
Error response	1	0	0	0	0	0	0	0

\*Bit coding of the length: 00 = 4 bytes, 01 = 3 bytes, 10 = 2 bytes, 11 = 1 byte  
e: expedited (shortened block service)  
s: segmented (normal block service)



#### Tip!

More commands are defined in CANopen specification DS301, V4.02 (e.g. segmented transfer).

### 11.9.2.2 Addressing by means of index and subindex

1st byte	2nd byte	3rd byte	4. byte	5th byte	6. byte	7th byte	8th byte
Command	Index		Subindex	Data 1	Data 2	Data 3	Data 4
	LOW byte	HIGH byte		LOW word		HIGH word	
				LOW byte	HIGH byte	LOW byte	HIGH byte

A parameter (a Lenze code) is addressed as per the following formula:  
**Index = 24575 - (Lenze code number)**

#### Example

The [C00011](#) parameter (motor reference speed) is to be addressed.

Calculation:

- Index:
  - Decimal:  $24575 - 11 = 24564$
  - Hexadecimal:  $0x5FFF - 0xB = 0x5FF4$
- Subindex: 0x00 (subindex 0 since the parameter does not have any subcodes)

Entries:

1st byte	2nd byte	3rd byte	4. byte	5th byte	6. byte	7th byte	8th byte
Command	Index		Subindex	Data 1	Data 2	Data 3	Data 4
	0xF4	0x5F	0x00				

## 11.9.2.3 Data 1 ... Data 4

1st byte	2nd byte	3rd byte	4. byte	5th byte	6. byte	7th byte	8th byte
Command	Index		Subindex	Data 1	Data 2	Data 3	Data 4
	LOW byte	HIGH byte		LOW word		HIGH word	
				LOW byte	HIGH byte	LOW byte	HIGH byte

Maximally 4 bytes are available for parameter value entries. Depending on the data format, they are assigned as follows:

5th byte	6. byte	7th byte	8th byte
Parameter value (1 byte)	0x00	0x00	0x00
Parameter value (2 bytes)		0x00	0x00
LOW byte	HIGH byte		
Parameter value (4 bytes)			
LOW word		HIGH word	
LOW byte	HIGH byte	LOW byte	HIGH byte

**Note!**

The "Factor" column of the [Table of attributes](#) contains a so-called scaling factor for all Lenze parameters. The scaling factor is relevant to the transfer of parameter values which have one or more decimal positions in the parameter list.

If the scaling factor is > 1, the value must be multiplied by the indicated scaling factor prior to transmission to be able to transfer the value as an integer. At the SDO client end, the integer must be divided by the scaling factor to obtain the original value including decimal positions again.

**Example**

A value of "123.45" is to be transmitted for a code, unit: "%" (e.g. C00039/1: "Fixed setpoint-JOG1"). In inverters of the 8400 series, parameters with the "%" unit have two decimal positions and hence a scaling factor of "100".

Calculation:

- Value to be transmitted = scaling factor x value
- Data (1...4) = 100 x 123.45 = 12345 (0x00 00 30 39)

Entries:

1st byte	2nd byte	3rd byte	4. byte	5th byte	6. byte	7th byte	8th byte
Command	Index		Subindex	Data 1	Data 2	Data 3	Data 4
				0x39	0x30	0x00	0x00

#### 11.9.2.4 Error messages

1st byte	2nd byte	3rd byte	4. byte	5th byte	6. byte	7th byte	8th byte
<b>Command</b>	<b>Index</b>		<b>Subindex</b>	<b>Error code</b>			
0x80 (128)	LOW byte	HIGH byte		LOW word		HIGH word	
				LOW byte	HIGH byte	LOW byte	HIGH byte

In the event of an error, the addressed node generates a telegram with the "Error response" (0x80) command.

- The telegram includes the index and subindex of the code where the error occurred.
- The error code is entered in bytes 5 ... 8.
  - The error codes are standardised according to DS301, V4.02.
  - The representation of the error codes is provided in reverse read direction (see example below).

#### Example

Representation of error code "0x06 04 00 41" in bytes 5 ... 8:

1st byte	2nd byte	3rd byte	4. byte	5th byte	6. byte	7th byte	8th byte
<b>Command</b>	<b>Index</b>		<b>Subindex</b>	<b>Error code</b>			
				0x41	0x00	0x04	0x06

### Meaning of the error codes

The error codes are standardised acc. to DS301, V4.02.

Error code	Explanation
0x0503 0000	Toggle bit not changed
0x0504 0000	SDO protocol expired
0x0504 0001	Invalid or unknown client/server command specifier
0x0504 0002	Invalid block size (only block mode)
0x0504 0003	Invalid sequence number (only block mode)
0x0504 0004	CRC error (only block mode)
0x0504 0005	Not sufficient memory
0x0601 0000	Object access not supported
0x0601 0001	Attempt to read a write-only object
0x0601 0002	Attempt to write to a read-only object
0x0602 0000	Object not listed in object directory
0x0604 0041	Object not mapped to PDO
0x0604 0042	Number and length of objects to be transferred longer than PDO length.
0x0604 0043	General parameter incompatibility
0x0604 0047	General internal device incompatibility
0x0606 0000	Access denied because of hardware error
0x0607 0010	Unsuitable data type, unsuitable service parameter length
0x0607 0012	Unsuitable data type, service parameter length exceeded
0x0607 0013	Unsuitable data type, service parameter length not long enough
0x0609 0011	Subindex does not exist
0x0609 0030	Parameter value range exceeded
0x0609 0031	Parameter values too high
0x0609 0032	Parameter values too low
0x0609 0036	Maximum value falls below minimum value
0x0800 0000	General error
0x0800 0020	Data cannot be transferred/saved for application.
0x0800 0021	Data cannot be transferred/saved for application due to local control.
0x0800 0022	Data cannot be transferred/saved for application due to current device status.
0x0800 0023	Dynamic generation of object directory failed or no object directory available (e.g. object directory generated from file, generation not possible because of a file error).

### 11.9.3 Parameter data telegram examples

#### 11.9.3.1 Read parameters

**Task:** The heatsink temperature of 43 °C (code [C00061](#), data format INTEGER16, scaling factor 1) of the inverter with node address "5" is to be read.

#### Telegram to drive

Identifier	User data							
	1st byte	2nd byte	3rd byte	4. byte	5th byte	6. byte	7th byte	8th byte
	Command	Index		Subindex	Data 1	Data 2	Data 3	Data 4
0x0605	0x40	0xC2	0x5F	0x00	0x00	0x00	0x00	0x00

Explanations on the telegram to the drive	
Identifier	= 1536 + node address = 1536 + 5 = 1541 = 0x0605 (1536 = SDO1 basic identifier to the inverter)
Command	= 0x40 = "Read request" (read request of a parameter from the inverter)
Index	= 24575 - code number = 24575 - 61 = 24514 = 0x5FC2
Subindex	= 0 (code <a href="#">C00061</a> does not have any subcodes)

#### Response telegram from drive (if data have been correctly transmitted)

Identifier	User data							
	1st byte	2nd byte	3rd byte	4. byte	5th byte	6. byte	7th byte	8th byte
	Command	Index		Subindex	Data 1	Data 2	-	-
0x0585	0x4B	0xC2	0x5F	0x00	0x2B	0x00	-	-

Explanations on the telegram from the drive	
Identifier	= 1408 + node address = 1408 + 5 = 1413 = 0x0585 (1408 = SDO1 basic identifier from the inverter)
Command	= 0x4B = "Read Response" (response to the read request with current value)
Index	as in telegram to the drive
Subindex	
Data 1 ... 2	= 0x002B = 43 [°C]

### 11.9.3.2 Write parameters

**Task:** The rated current of the connected motor is to be entered with  $I_N = 10.20$  A (code [C00088](#)) into the inverter with node address "2".

Data 1 ... 4	Calculation
Value for motor current, (data type U16; display factor 1/100)	$10.20 \times 100 = 1020$ (0x03 FC)

#### Telegram to drive

Identifier	User data							
	1st byte	2nd byte	3rd byte	4. byte	5th byte	6. byte	7th byte	8th byte
	Command	Index		Subindex	Data 1	Data 2	Data 3	Data 4
0x0602	0x23	0xA7	0x5F	0x00	0xFC	0x03	0x00	0x00

Explanations on the telegram to the drive	
Identifier	= $1536 + \text{node address} = 1536 + 2 = 1538 = 0x0602$ (1536 = SDO1 basic identifier to the inverter)
Command	= 0x23 = "Write request" (write request of a parameter to the inverter)
Index	= $24575 - \text{code number} = 24575 - 88 = 24487 = 0x5FA7$
Subindex	= 0 (code <a href="#">C00088</a> does not have any subcodes)
Data 1 ... 4	= $10.20 \times 100 = 1020 = 0x000003FC$ (motor current value; data type U32; display factor 1/100)

#### Response telegram from drive (if data have been correctly transmitted)

Identifier	User data							
	1st byte	2nd byte	3rd byte	4. byte	5th byte	6. byte	7th byte	8th byte
	Command	Index		Subindex	Data 1	Data 2	Data 3	Data 4
0x0582	0x60	0xA7	0x5F	0x00	0x00	0x00	0x00	0x00

Explanations on the telegram from the drive	
Identifier	= $1408 + \text{node address} = 1408 + 2 = 1410 = 0x0582$ (1408 = SDO1 basic identifier from the inverter)
Command	= 0x60 = "Write response" (Acknowledgement of the write access from the inverter)
Index	as in telegram to the drive
Subindex	



### 11.9.3.3 Read block parameters

**Task:** The firmware version (code [C00099](#)) is to be read from the parameter set of the inverter with node address "12". The firmware version has a length of 11 ASCII characters which are transmitted as a block parameter. Depending on the block, the data width from the 2nd to 8th byte is assigned within the user data.

#### Telegram 1 to the drive: Read request

Identifier	User data							
	1st byte	2nd byte	3rd byte	4. byte	5th byte	6. byte	7th byte	8th byte
	Command	Index		Subindex	Data 1	Data 2	Data 3	Data 4
0x060C	0x40	0x9C	0x5F	0x00	0x00	0x00	0x00	0x00

Explanations on the telegram to the drive	
Identifier	= 1536 + node address = 1536 + 12 = 1548 = 0x060C (1536 = SDO1 basic identifier to the inverter)
Command	= 0x40 = "Read request" (read request of a parameter from the inverter)
Index	= 24575 - code number = 24575 - 99 = 24476 = 0x5F9C
Subindex	= 0 (code <a href="#">C00099</a> does not have any subcodes)

#### Response telegram 1 from the drive: Indication of the block length (11 characters)

Identifier	User data							
	1st byte	2nd byte	3rd byte	4. byte	5th byte	6. byte	7th byte	8th byte
	Command	Index		Subindex	Data 1	Data 2	Data 3	Data 4
0x058C	0x41	0x9C	0x5F	0x00	0x0B	0x00	0x00	0x00

Explanations on the telegram from the drive	
Identifier	= 1408 + node address = 1408 + 12 = 1420 = 0x058C (1408 = SDO1 basic identifier from the inverter)
Command	= 0x41 = "Read response" (response is block telegram)
Index	as in telegram to the drive
Subindex	
Data 1 ... 4	= 0x0000000B = data length of 11 characters in the ASCII format

### Telegram 2 to the drive: Request of the 1st data block

Identifier	User data							
	1st byte	2nd byte	3rd byte	4. byte	5th byte	6. byte	7th byte	8th byte
	Command	Data 1	Data 2	Data 3	Data 4	Data 5	Data 6	Data 7
0x060C	0x60	0x00	0x00	0x00	0x00	0x00	0x00	0x00

Explanations on the telegram to the drive	
Command	= 0x60 = "Read segment request" (request: read data block) <ul style="list-style-type: none"> <li>• Bit 4 = 0 (toggle bit)</li> </ul>
	<b>Influence of the toggle bit on the request command</b> The single blocks are toggled one after another, i.e. first the request is made with the "0x60" command (= 0b0110*0000), then with the "0x70" command (= 0b0111*0000), and then again with the "0x60" command, etc. * Toggle bit

### Response telegram 2 from the drive: Transmission of the 1st data block

Identifier	User data							
	1st byte	2nd byte	3rd byte	4. byte	5th byte	6. byte	7th byte	8th byte
	Command	Data 1	Data 2	Data 3	Data 4	Data 5	Data 6	Data 7
0x058C	0x00	0x30	0x31	0x2E	0x30	0x30	0x2E	0x30
		0 <sub>asc</sub>	1 <sub>asc</sub>	·asc	0 <sub>asc</sub>	0 <sub>asc</sub>	·asc	0 <sub>asc</sub>

Explanations on the telegram to the drive	
Command	= 0x00 = 0b00000000 <ul style="list-style-type: none"> <li>• Bit 4 = 0 (toggle bit)</li> </ul>
	<b>Influence of the toggle bit on the transmission command</b> <ul style="list-style-type: none"> <li>• The 1st response of the inverter in the command byte is "0b0000*0000" if bytes 2 ... 8 are completely filled with data and other telegrams are following.</li> <li>• The 2nd response of the inverter in the command byte is "0b00011*0000" if bytes 2 ... 8 are completely filled with data and other telegrams are following.</li> </ul> * Toggle bit
Data 1 ... 7	= "01.00.0" (ASCII representation)

**Telegram 3 to the drive: Request of the 2nd data block**

Identifier	User data							
	1st byte	2nd byte	3rd byte	4. byte	5th byte	6. byte	7th byte	8th byte
	Command	Data 1	Data 2	Data 3	Data 4	Data 5	Data 6	Data 7
0x060C	0x70	0x00	0x00	0x00	0x00	0x00	0x00	0x00

Explanations on telegram 3 to the drive	
Command	= 0x70 = "Read segment request" (request: read data block) • Bit 4 = 1 (toggle bit)

**Response telegram 3 from the drive: Transmission of the 2nd data block including end identifier**

Identifier	User data							
	1st byte	2nd byte	3rd byte	4. byte	5th byte	6. byte	7th byte	8th byte
	Command	Data 1	Data 2	Data 3	Data 4	Data 5	Data 6	Data 7
0x058C	0x17	0x30	0x2E	0x30	0x30	0x00	0x00	0x00
		0 <sub>asc</sub>	·asc	0 <sub>asc</sub>	0 <sub>asc</sub>	-	-	-

Explanations on telegram 3 from the drive	
Command	= 0x17 = 0b00010111: • Bit 0 = 1 (end of transmission) • Bit 1 ... bit 3 = 0b011 (3 bytes do not contain any data) • Bit 4 = 1 (toggle bit)
	<b>Influence of the final bit and the residual data length on the transmission command</b> • The end of transmission is signalled via the set final bit 0. • Bits 1 ... 3 reveal the number of bytes that do not contain any data anymore. * Toggle bit
Data 1 ... 7	= "0.00" (ASCII representation) The result of the data block transmission is: "01.00.00.00"

# 11 System bus "CAN on board"

## 11.10 Monitoring

### 11.10 Monitoring

#### 11.10.1 Integrated error detection

If a node detects an error, it rejects the CAN telegram bits received so far and transmits an error flag. The error flag consists of 6 consecutive bits with the same logic value.

The following errors are detected:

Error	Description
<b>Bit error</b>	The sending node follows the transmission on the bus and interrupts the transmission if it receives a different logic value than the value transmitted. With the next bit, the sending node starts the transmission of an error flag. In the arbitration phase, the transmitter only detects a bit error if a dominantly sent bit is received as recessive bit. In the ACK slot as well, the dominant overwriting of a recessive bit is not indicated as a bit error.
<b>Stuff-bit error</b>	If more than 5 consecutive bits have the same logic value before the ACK delimiter in the telegram, the previously transmitted telegram will be rejected and an error flag will be sent with the next bit.
<b>CRC error</b>	If the received CRC checksum does not correspond to the checksum calculated in the bus controller, the bus controller will send an error flag after the ACK delimiter and the previously transmitted telegram will be annulled.
<b>Acknowledgement error</b>	If the sent ACK slot recessively sent by the transmitting node is not dominantly overwritten by a receiver, the transmitting node will cancel the transmission. The transmitting node will annul the transmitted telegram and will send an error flags with the next bit.
<b>Format error</b>	If a dominant bit is detected in the CRC delimiter, in the ACK delimiter or in the first 6 bits of the EOF field, the received telegram will be rejected and an error flag will be sent with the next bit.



#### Tip!

The errors mentioned before indicate that a physical error has occurred in the bus system.

Possible causes are:

- Several nodes with identical node address
- Wrong baud rate of one or several nodes
- Too high cable length
- Too many or no terminating resistors
- Too high bus load/too many data telegrams  
(e.g. since a node permanently transmits event-controlled due to data changes of an analog signal/actual value.)
- EMC interferences on the system bus  
(e.g. since the CAN bus cable next to the motor cable is unshielded.)

[C00364](#) displays whether such an error is active.

### 11.10.2 Heartbeat protocol

The heartbeat protocol can be used for node monitoring purposes within a CAN network.

#### Basic workflow

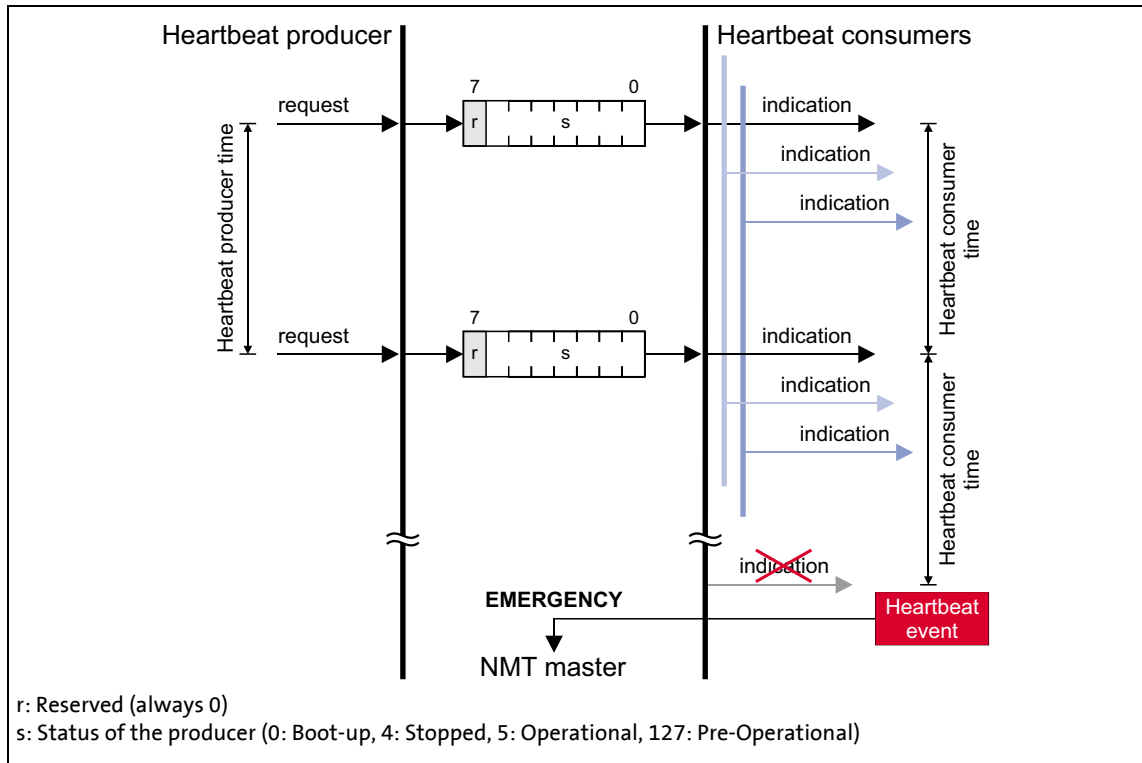

[11-9] Heartbeat protocol

1. A heartbeat producer cyclically transmits a so-called heartbeat telegram to one or more consumers.
2. The consumer(s) monitor the heartbeat telegram for arrival on a regular basis.

#### 11.10.2.1 Telegram structure

- The heartbeat telegram of the producer has the following identifier:  
Identifier (COB-ID) = 1792 + producer's node address
- The user data (1 byte) contain the status (s) of the producer:

Heartbeat producer status		Data							
Communication status	Decimal value (s)	(r)	Producer status (s)						
		Bit 7	Bit 6	Bit 5	Bit 4	Bit 3	Bit 2	Bit 1	Bit 0
Boot-up	0	0	0	0	0	0	0	0	0
Stopped	4	0	0	0	0	0	1	0	0
Operational	5	0	0	0	0	0	1	0	1
Pre-Operational	127	0	1	1	1	1	1	1	1

### 11.10.2.2 Parameter setting

Short overview of the parameters for the "Heartbeat" monitoring function:

Parameters	Info	Lenze setting		Assignment	
		Value	Unit	Consumer	Producer
<a href="#">C00347/1...n</a>	CAN status of the heartbeat producer 1 ... n	-		●	
<a href="#">C00381</a>	Heartbeat producer time	0	ms		●
<a href="#">C00385/1...n</a>	CAN node address of the heartbeat producer 1 ... n	0		●	
<a href="#">C00386/1...n</a>	Heartbeat consumer time for the heartbeat producer 1 ... n	0	ms	●	
<a href="#">C00592/5</a>	Resp. to heartbeat event	No response		●	
Greyed out = display parameter					

#### Heartbeat producer time

Time interval for the transmission of the heartbeat telegram to the consumer(s).

- Parameterisable in [C00381](#) or via object [I-1017](#). The parameterised time is rounded down to an integer multiple of 5 ms.
- The heartbeat telegram is sent automatically as soon as a time > 0 ms is set.

#### Heartbeat consumer time

Monitoring time for the nodes (producers) to be monitored.

- Parameterisable in [C00386/1...n](#) or via object [I-1016](#).
- The parameterised time is rounded down to an integer multiple of 5 ms and must have a greater value than the heartbeat producer time of the node to be monitored.
- The maximum number of the nodes to be monitored depends on the device version:
  - "Baseline C": 1 Heartbeat Producer can be monitored.
  - "StateLine C": Up to 7 Heartbeat Producers can be monitored.
  - "HighLine C": Up to 15 Heartbeat Producers can be monitored.
  - "TopLine C": Up to 15 Heartbeat Producers can be monitored.
- The node address(es) of the nodes to be monitored is/are set in [C00385/1...n](#) or via object [I-1016](#), too.

#### Heartbeat event

The "Heartbeat event" is activated in the consumer if it does not receive any heartbeat telegram from the producer within the heartbeat consumer time:

- The consumer changes from the "Operational" communication status to the "Pre-Operational" communication status.
- The NMT master receives an emergency telegram containing emergency error code 0x8130.
- The response parameterised in [C00592/5](#) is activated (Lenze setting: "No response").

**Note!**

The heartbeat monitoring will not start until the first heartbeat telegram of a monitored producer has been received successfully and the "Pre-Operational" NMT status has been assumed.

The boot-up telegram counts as the first heartbeat telegram.

**11.10.2.3 Commissioning example****Task**

An 8400 inverter (node 2) which is configured as heartbeat consumer is to monitor another 8400 inverter (heartbeat producer, node 1).

- The heartbeat producer is to transmit a heartbeat telegram to the heartbeat consumer every 10 ms.
- The heartbeat consumer monitors the heartbeat telegram for arrival. A response is to be activated in the event of an error.

**Parameterising the heartbeat producer (node 1)**

1. Set the heartbeat producer time ([C00381](#)) to 10 ms.

**Parameterising the heartbeat consumer (node 2)**

1. Set the CAN node address of the producer in [C00385/1](#).
2. Set the heartbeat consumer time in [C00386/1](#).
  - Note: The heartbeat consumer time must be greater than the heartbeat producer time of the node to be monitored set in [C00381](#).
3. Set the desired response in [C00592/5](#) which is to be activated should a heartbeat event in the consumer occur.

**Tip!**

[C00347/1...n](#) displays the heartbeat status of the monitored nodes.

**Heartbeat telegram**

- The heartbeat telegram of the producer has the following identifier:  
Identifier (COB-ID) = 1792 + producer's node address = 1792 + 1 = 1793 = 0x701

### 11.10.3 Emergency telegram

If the error status changes because an internal device error occurs or has been eliminated, the NMT master receives an emergency telegram once with the following structure:

1st byte	2nd byte	3rd byte	4. byte	5th byte	6. byte	7th byte	8th byte
Emergency error codes		Error register	Manufacturer-specific error message				
LOW byte	HIGH byte	<a href="#">I-1001</a>	0x00 (Reserved)	LOW word		HIGH word	
See table below				LOW byte	HIGH byte	LOW byte	HIGH byte
			<ul style="list-style-type: none"> <li>For emergency error code 0xF000: Lenze error number (value displayed in <a href="#">C00168</a>)</li> <li>All other emergency error codes have a value of "0" here.</li> </ul>				

Emergency error codes	Error register	Cause
0x0000	0xXX	One of several errors eliminated
	0x00	One error has been eliminated (error-free status afterwards)
0x3100	0x01	Supply voltage of standard device faulty or failed
0x8100	0x11	Communication error (warning)
0x8130	0x11	Life guarding error or heartbeat error
0x8150	0x11	Collision of identifiers (COB-IDs): An identifier parameterised for reception is also used for transmission.
0x8210	0x11	PDO length shorter than expected
0x8220	0x11	PDO length greater than expected
0x8700	0x11	Monitoring of the sync telegram
0xF000	0x01	Generic error <ul style="list-style-type: none"> <li>An error with a "Fault", "Trouble", "TroubleQSP", "Warning" error response occurred in the standard device.</li> <li>Error message is the Lenze error number (<a href="#">C00168</a>).</li> </ul>

The [Short overview \(A-Z\)](#) of error messages of the operating system includes a list of more emergency error codes. (465)

#### Example

1st byte	2nd byte	3rd byte	4. byte	5th byte	6. byte	7th byte	8th byte
Emergency error codes		Error register	Manufacturer-specific error message				
0x00	0xF0	0x01	0x00 (Reserved)	Lenze error number			
Generic error				<a href="#">Error messages of the operating system</a> Corresponding error-free message: Value "0x00000000"			



#### Tip!

A detailed description can be found in CAN specification DS301, V4.02.



## 11.11 CANopen objects implemented

Lenze devices can be parameterised with both Lenze codes and manufacturer-independent "CANopen objects". Fully CANopen-compliant communication can only be achieved by exclusively using CANopen objects for the parameterisation. The CANopen objects described in this chapter are defined in the DS301 V4.02 CAN specification.

Many CANopen objects can be mapped on Lenze codes. In the following table, the corresponding Lenze codes are listed in the column "Relationship to Lenze codes".



### Note!

Some of the terms used here derive from the CANopen protocol.

### Overview of CANopen indices and their relationship to Lenze codes

CANopen object			Relationship to Lenze code
Index	Subindex	Name	
<a href="#">I-1000</a>	0	Device type	-
<a href="#">I-1001</a>	0	Error register	-
<a href="#">I-1003</a>	Predefined error field		
	0	Number of errors	-
	1 ... 10	Standard error field	-
<a href="#">I-1005</a>	0	COB-ID SYNC message	<a href="#">C00367</a> <a href="#">C00368</a>
<a href="#">I-1006</a>	0	Communication cycle period	<a href="#">C00369</a>
<a href="#">I-1014</a>	0	COB-ID EMCY	-
<a href="#">I-1016</a>	Consumer heartbeat time		
	0	Highest subindex supported	-
	1 ... n	Consumer heartbeat time • "BaseLine C" version: n = 1 • "StateLine C" version: n = 7 • "HighLine C" version: n = 15 • "TopLine C" version: n = 15	<a href="#">C00385/1...n</a> <a href="#">C00386/1...n</a>
<a href="#">I-1017</a>	0	Producer heartbeat time	<a href="#">C00381</a>
<a href="#">I-1018</a>	Identity object		
	0	Highest subindex supported	-
	1	Vendor ID	-
	2	Product code	-
	3	Revision number	-
	4	Serial number	-
<a href="#">I-1200</a>	SDO1 server parameter		
	0	Highest subindex supported	-
	1	COB-ID client → server (rx)	-
	2	COB-ID server → client (tx)	-
<a href="#">I-1201</a>	SDO2 server parameter		
	0	Highest subindex supported	-
	1	COB-ID client → server (rx)	-
	2	COB-ID server → client (tx)	-

CANopen object			Relationship to Lenze code
Index	Subindex	Name	
<a href="#">I-1400</a>	RPDO1 communication parameter		
	0	Highest subindex supported	-
	1	COB-ID used by RPDO	<a href="#">C00355/1</a>
	2	Transmission type	<a href="#">C00323/1</a>
<a href="#">I-1401</a>	RPDO2 communication parameter		
	0	Highest subindex supported	-
	1	COB-ID used by RPDO	<a href="#">C00355/3</a>
	2	Transmission type	<a href="#">C00323/2</a>
<a href="#">I-1402</a>	RPDO3 communication parameter		
	0	Highest subindex supported	-
	1	COB-ID used by RPDO	<a href="#">C00355/5</a>
	2	Transmission type	<a href="#">C00323/3</a>
<a href="#">I-1403</a>	RPDO4 communication parameter (from version 15.00.00)		
	0	Highest subindex supported	-
	1	COB-ID used by RPDO	<a href="#">C00355/7</a>
	2	Transmission type	<a href="#">C00323/4</a>
<a href="#">I-1600</a>	RPDO1 mapping parameter		
	0	Number of mapped application objects in PDO	-
	1 ... 4	Application object 1 ... 4	<a href="#">C00409/1...4</a> <a href="#">C00866/1...4</a>
<a href="#">I-1601</a>	RPDO2 mapping parameter		
	0	Number of mapped application objects in PDO	-
	1 ... 4	Application object 1 ... 4	<a href="#">C00409/5...8</a> <a href="#">C00866/5...8</a>
<a href="#">I-1602</a>	RPDO3 mapping parameter		
	0	Number of mapped application objects in PDO	-
	1 ... 4	Application object 1 ... 4	<a href="#">C00409/9...12</a> <a href="#">C00866/9...12</a>
<a href="#">I-1603</a>	RPDO4 mapping parameter (from version 15.00.00)		
	0	Number of mapped application objects in PDO	-
	1 ... 4	Application object 1 ... 4	<a href="#">C00409/13...16</a> <a href="#">C00866/13...16</a>
<a href="#">I-1800</a>	TPDO1 communication parameter		
	0	Highest subindex supported	-
	1	COB-ID used by TPDO	<a href="#">C00355/2</a>
	2	Transmission type	<a href="#">C00322/1</a>
	3	Inhibit time	<a href="#">C00324/2</a>
	5	Event timer	<a href="#">C00356/5</a> <a href="#">C00369</a>

CANopen object			Relationship to Lenze code
Index	Subindex	Name	
<a href="#">I-1801</a>	TPDO2 communication parameter		
	0	Highest subindex supported	-
	1	COB-ID used by TPDO	<a href="#">C00355/4</a>
	2	Transmission type	<a href="#">C00322/2</a>
	3	Inhibit time	<a href="#">C00324/3</a>
	5	Event timer	<a href="#">C00356/2</a> <a href="#">C00369</a>
<a href="#">I-1802</a>	TPDO3 communication parameter		
	0	Highest subindex supported	-
	1	COB-ID used by TPDO	<a href="#">C00355/6</a>
	2	Transmission type	<a href="#">C00322/3</a>
	3	Inhibit time	<a href="#">C00324/4</a>
	5	Event timer	<a href="#">C00356/3</a> <a href="#">C00369</a>
<a href="#">I-1803</a>	TPDO4 communication parameter (from version 15.00.00)		
	0	Highest subindex supported	-
	1	COB-ID used by TPDO	<a href="#">C00355/8</a>
	2	Transmission type	<a href="#">C00322/4</a>
	3	Inhibit time	<a href="#">C00324/5</a>
	5	Event timer	<a href="#">C00356/4</a> <a href="#">C00369</a>
<a href="#">I-1A00</a>	TPDO1 mapping parameter		
	0	Number of mapped application objects in PDO	-
	1 ... 4	Application object 1 ... 4	<a href="#">C00868/1...4</a>
<a href="#">I-1A01</a>	TPDO2 mapping parameter		
	0	Number of mapped application objects in PDO	-
	1 ... 4	Application object 1 ... 4	<a href="#">C00868/5...8</a>
<a href="#">I-1A02</a>	TPDO3 mapping parameter		
	0	Number of mapped application objects in PDO	-
	1 ... 4	Application object 1 ... 4	<a href="#">C00868/9...12</a>
<a href="#">I-1A03</a>	TPDO4 mapping parameter (from version 15.00.00)		
	0	Number of mapped application objects in PDO	-
	1 ... 4	Application object 1 ... 4	<a href="#">C00868/13...16</a>

## I-1000

Index <b>I-1000</b>	Name: <b>Device type</b>				
Subindex	Default setting	Display range (min. value   unit   max. value)		Access	Data type
0: Device type	0	0		4294967295	ro U32

The CANopen index I-1000 specifies the profile for this device. Furthermore, additional information defined in the device profile itself can be stored here.

8th byte	7th byte	6. byte	5th byte
Data 4	Data 3	Data 2	Data 1
HIGH word		LOW word	
HIGH byte	LOW byte	HIGH byte	LOW byte
Additional information		ECAT: Device Profile Number	

[11-1] Data frame assignment

In case of 8400 series inverters, the four bytes contain the following values:

- 5th and 6th byte: The data content is 0x0000, i.e. no profile definition.
- 7th byte: The data content specifies the device type: Here the value is 0x00 for inverters.
- 8th byte: The data content is 0x00.

The data content for the 8400 inverter thus is: 00 00 00 00

## I-1001

Index: <b>I-1001</b>	Name: <b>Error register</b>				
Subindex	Default setting	Display range (min. value   unit   max. value)		Access	Data type
0: Error register	-	0		255	ro U8

Error register

The error status in the data byte (U8) is bit coded. The following error states are coded in the data byte (U8):

Bit 7	Bit 6	Bit 5	Bit 4	Bit 3	Bit 2	Bit 1	Bit 0	Error state
0	0	0	0	0	0	0	0	No error
0	0	0	0	0	0	0	1	Device error message
0	0	0	1	0	0	0	1	Communication error

## I-1003

Index: <b>I-1003</b>		Name: <b>Predefined error field</b>			
Subindex	Default setting	Setting range (min. value   unit   max. value)		Access	Data type
0: Number of errors	0	0		255	rw U8
1 ... 10: Standard error field	-	0		4294967295	ro U32

## Error history

This object indicates that an error has occurred in the module and in the standard device.

Subindex	Meaning
0	Number of saved error messages
1 ... 10	Display of the error list The error messages (U32) consist of a 16-bit error code and a manufacturer-specific information field comprising 16 bits.

**Note!**

The values in the "standard error field" under subindex 1 ... 10 will be deleted if the subindex "number of recorded errors" is overwritten with the value "0".

Emergency error codes	Cause	Entry in the error register ( <a href="#">I-1001</a> )
0x0000	One of several errors eliminated	0xXX
	Elimination of one single error (afterwards no more errors)	0x00
0x1000	Standard device is in error status (error response "fault", "message", "warning", "error", "quick stop by trouble")	0x01
0x3100	Supply voltage of standard device faulty or failed	0x01
0x8100	Communication error (warning)	0x11
0x8130	Life guard error or heartbeat error	0x11
0x8150	Collision of COB-IDs: An ID parameterised for reception is also used for transmission.	0x11
0x8210	PDO length shorter than expected	0x11
0x8220	PDO length greater than expected	0x11
0x8700	Monitoring of the sync telegram	0x11

## I-1005

Index: <b>I-1005</b>	Name: <b>COB-ID SYNC message</b>				
Subindex	Default setting	Setting range (min. value   unit   max. value)		Access	Data type
0: COB-ID SYNC message	0x0000 0080 or 0x8000 0080	0		4294967295	rw U32

This object can be used to activate the generation of sync telegrams and to write the identifier value.

- This object relates to codes [C00367](#) and [C00368](#).

### Creating sync telegrams

To create sync telegrams, bit 30 (see below) must be set to "1". The interval of the sync telegrams can be set with the object [I-1006](#).

### Writing identifiers

To receive PDOs, the value 0x80 must be entered in the 11-bit identifier in the Lenze setting (and according to CANopen specification) . This means that all modules are by default set to the same sync telegram.

- If sync telegrams are only to be received by certain communication modules, their identifiers can be entered with values up to and including 0x07FF.
- The identifier can only be changed if the communication module does not send any sync telegrams (bit 30 = "0").
- How to change the identifier:
  - Deactivate identifier (set bit 30 to "0").
  - Change identifier.
  - Activate identifier (set bit 30 to "1").

8th byte		7th byte		6. byte		5th byte	
Data 4		Data 3		Data 2		Data 1	
Bit 31	Bit 30	Bit 29 ... bit 11				Bit 10 ... bit 0	
<b>x</b>	<b>0/1</b>	<b>Extended identifier*</b>				<b>11-bit identifier</b>	
* The extended identifier is not supported. Bit 11 ... bit 29 must be set to "0".							

[11-2] Data frame assignment

## I-1006

Index: <b>I-1006</b>	Name: <b>Communication cycle period</b>					
Subindex	Default setting	Setting range (min. value   unit   max. value)			Access	Data type
0: Communication cycle period	0 µs	0	µs	65535000	rw	U32

Setting the sync telegram cycle time.

- The cycle time can be selected as "1000" or as an integer multiple of it.
- If "0 µs" is set (Lenze setting), no sync telegrams are created.
- This object relates to code [C00369](#).

## I-1014

Index: <b>I-1014</b>	Name: <b>COB-ID EMCY</b>					
Subindex	Default setting	Setting range (min. value   unit   max. value)			Access	Data type
0: COB-ID EMCY	0x80 + node ID	0		4294967295	rw	U32

When communication errors occur and are acknowledged or when internal errors occur in the communication module or inverter (e.g. "fault"), the system bus sends an error message. The telegram is sent once for every error. This function can be activated or deactivated with bit 31.

8th byte		7th byte		6. byte		5th byte	
Data 4		Data 3		Data 2		Data 1	
Bit 31	Bit 30	Bit 29 ... bit 11				Bit 10 ... bit 0	
0/1	0	Extended identifier*				11-bit identifier	
* The extended identifier is not supported. Bit 11 ... bit 29 must be set to "0".							

[11-3] Data frame assignment

Bit	setting	
Bit 31	0	Emergency object is valid.
	1	Emergency object is invalid.

**Note!**

The identifier can only be changed in the "emergency object invalid" status (bit 31 = 1).

## I-1016

Index: I-1016	Name: Consumer heartbeat time					
Subindex	Default setting	Setting range (min. value   unit   max. value)			Access	Data type
0: Highest subindex supported	BaseLine C: 1 StateLine C: 7 HighLine C: 15 TopLine C: 15	- (read access only)			ro	U16
1 ... n: Consumer heartbeat time	0	0		65535	rw	U16

Monitoring time for the nodes to be monitored via heartbeat. ▶ [Heartbeat protocol](#) (☞ 557)

- The parameterised time is rounded down to an integer multiple of 5 ms and must have a greater value than the heartbeat producer time of the node to be monitored.

Subindex	Meaning	Lenze code
0	Number of nodes to be monitored	
1 ... n	Node ID and heartbeat time of the node to be monitored	Node ID: <a href="#">C00385/x</a> Heartbeat time: <a href="#">C00386/x</a>

8th byte	7th byte	6. byte	5th byte
Data 4	Data 3	Data 2	Data 1
Bit 31 ... bit 24	Bit 23 ... Bit 16	Bit 15 ... Bit 0	
0 (Reserved)	Node ID	Heartbeat time in [ms]	

[11-4] Data frame assignment



## I-1017

Index: I-1017	Name: Producer heartbeat time					
Subindex	Default setting	Setting range (min. value   unit   max. value)			Access	Data type
0: Producer heartbeat time	0	0	ms	65535	rw	U16

Time interval for sending the heartbeat telegram to the consumer(s). ▶ [Heartbeat protocol](#) (📖 557)

- The parameterised time is rounded down to an integer multiple of 5 ms.
- The heartbeat telegram is automatically sent as soon as a time > 0 ms is entered. In this case, the "node guarding" monitoring function is deactivated.
- This object relates to code [C00381](#).

## I-1018

Index: I-1018	Name: Identity object					
Subindex	Default setting	Display range (min. value   unit   max. value)			Access	Data type
0: Highest subindex supported	see below	0		4294967295	ro	U32
1: Vendor ID						
2: Product code						
3: Revision number						
4: Serial number						

Subindex	Meaning
1	Manufacturer's identification number <ul style="list-style-type: none"> <li>• The identification number allocated to Lenze by the organisation "CAN in Automation e. V." is "0x0000003B".</li> </ul>
2	Product code
	84001 8400 BaseLine C
	84002 8400 StateLine C
	84003 8400 HighLine C
	84004 8400 TopLine C
3	Main and subversion of firmware
4	Serial number

## I-1200

Index: <b>I-1200</b>	Name: <b>SDO1 server parameter</b>					
Subindex	Default setting	Display range (min. value   unit   max. value)			Access	Data type
0: Highest subindex supported	2	2		2	ro	U8
1: COB-ID client -> server (rx)	node ID + 0x600	0		4294967295	ro	U32
2: COB-ID server -> client (tx)	node ID + 0x580	0		4294967295	ro	U32

Identifiers for SDO server channel 1 (basic SDO channel).

- According to DS301 V4.02, the basic SDO channel can neither be changed nor deactivated.

Subindex	Meaning
1	Specification of receive identifier <ul style="list-style-type: none"> <li>• For SDO server channel 1: node address (C00350) + 0x600</li> </ul>
2	Specification of send identifier <ul style="list-style-type: none"> <li>• For SDO server channel 1: node address (C00350) + 0x580</li> </ul>

8th byte		7th byte		6. byte		5th byte	
Data 4		Data 3		Data 2		Data 1	
Bit 31	Bit 30	Bit 29 ... bit 11				Bit 10 ... bit 0	
<b>0</b>	<b>0</b>	<b>Extended identifier*</b>				<b>11-bit identifier</b>	

\* The extended identifier is not supported. Bit 11 ... bit 29 must be set to "0".

[11-5] Data frame assignment

## I-1201

Index: <b>I-1201</b>	Name: <b>SDO2 server parameter</b>					
Subindex	Default setting	Setting range (min. value   unit   max. value)		Access	Data type	
0: Highest subindex supported	3	- (read access only)		ro	U8	
1: COB-ID client -> server (rx)	0x80000000	0		4294967295	rw	U32
2: COB-ID server -> client (tx)	0x80000000	0		4294967295	rw	U32

Identifiers for SDO server channel 2.

- The SDO server parameter is only valid, if bit 31 is set to "0" for both transmission directions (subindex 1 and 2).
- In the Lenze setting, the SDO server channels 2 are deactivated (bit 31 = "1").
- The identifier can only be changed if the SDO is invalid (bit 31 = "1").

Subindex	Meaning
1	Specification of receive identifier
2	Specification of send identifier

8th byte		7th byte		6. byte		5th byte	
Data 4		Data 3		Data 2		Data 1	
Bit 31	Bit 30	Bit 29 ... bit 11				Bit 10 ... bit 0	
<b>0/1</b>	<b>0</b>	<b>Extended identifier*</b>				<b>11-bit identifier</b>	
* The extended identifier is not supported. Bit 11 ... bit 29 must be set to "0".							

[11-6] Data frame assignment

Bit	setting	
Bit 31	0	SDO is valid.
	1	SDO is invalid.

How to change the identifier:

1. Deactivate identifier (set bit 31 to "1").
2. Change identifier.
3. Activate identifier (set bit 31 to "0").

**Example**

Parameter data channel 2 of the inverter with node address 4 shall be activated.

- For this purpose, bit 31 in the subindexes 1 and 2 of the [I-1201](#) object must be set to the value "0" (≡ "SDO valid").
- The master must send the two "write request" commands to the nodes via the basic SDO channel.

**Identifier calculation**

- Identifier (COB-ID) = basic identifier + node address (node ID)
- Basic identifier SDO2 from master to drive: 1600 (0x640)  
→ Identifier = 0x640 + 0x4 = 0x644
- Basic identifier SDO2 from drive to master: 1472 (0x5C0)  
→ Identifier = 0x5C0 + 0x4 = 0x5C4

**Resulting data (data 1 ... data 4)**

8th byte		7th byte		6. byte		5th byte	
Data 4		Data 3		Data 2		Data 1	
Bit 31	Bit 30	Bit 29 ... bit 11				Bit 10 ... bit 0	
0	0	Extended identifier = 0				11-bit identifier = 0x644	
0x00		0x00		0x06		0x44	

[11-7] Data telegram assignment for subindex 1

8th byte		7th byte		6. byte		5th byte	
Data 4		Data 3		Data 2		Data 1	
Bit 31	Bit 30	Bit 29 ... bit 11				Bit 10 ... bit 0	
0	0	Extended identifier = 0				11-bit identifier = 0x5C4	
0x00		0x00		0x05		0xC4	

[11-8] Data telegram assignment for subindex 2

**User data assignment**

1st byte	2nd byte	3rd byte	4. byte	5th byte	6. byte	7th byte	8th byte
Command	Index		Subindex	Data 1	Data 2	Data 3	Data 4
0x23	0x01	0x12	0x01	0x44	0x06	0x00	0x00

[11-9] User data assignment for writing to subindex 1

1st byte	2nd byte	3rd byte	4. byte	5th byte	6. byte	7th byte	8th byte
Command	Index		Subindex	Data 1	Data 2	Data 3	Data 4
0x23	0x01	0x12	0x02	0xC4	0x05	0x00	0x00

[11-10] User data assignment for writing to subindex 2

## I-1400

Index: <b>I-1400</b>	Name: <b>RPDO1 communication parameter</b>				
Subindex	Default setting	Setting range (min. value   unit   max. value)		Access	Data type
0: Highest subindex supported	5	- (read access only)		ro	U8
1: COB-ID used by RPDO	0x200 + node ID	0	4294967295	rw	U32
2: Transmission type	254	0	255	rw	U8
3: Inhibit time	-	- (not used for RPDOs)		rw	U16
4: Compatibility entry	-	- (reserved, read or write access leads to error message 0x06090011)		rw	U8
5: Event timer	-	- (not used for RPDOs)		rw	U16

Communication parameter for receiving process data via RPDO1

Subindex	Meaning	Code
0	"5" is permanently set. • Max. 5 subindices are supported.	-
1	RPDO1 identifier • According to the "Predefined Connection Set", the basic setting is: Identifier = 0x200 + node ID	<a href="#">C00354/1</a>
2	RPDO Transmission type according to DS301 V4.02 ▶ <a href="#">Transmission type</a> (📄 539)	<a href="#">C00323/1</a>

8th byte		7th byte		6. byte		5th byte	
Data 4		Data 3		Data 2		Data 1	
Bit 31	Bit 30	Bit 29 ... bit 11				Bit 10 ... bit 0	
0/1	0/1	Extended identifier*				11-bit identifier	

\* The extended identifier is not supported. Bit 11 ... bit 29 must be set to "0".

[11-11] Data frame assignment

How to change the identifier:

1. Deactivate identifier (set bit 31 to "1").
2. Change identifier.
3. Activate identifier (set bit 31 to "0").

Description of subindex 1

Bit no.	Value	Explanation
0 ... 10	0/1	11-bit identifier
(11 ... 28)*	0	*) The extended identifier (29 bits) is not supported. Any of these bits must be "0".
29*	0	
30	0	RTR to this PDO possible (cannot be set)
	1	RTR to this PDO not possible (Lenze)
31	0	PDO active
	1	PDO not active

[11-12] I-1400 ... I-1402, subindex 1

## Description of subindex 2

	PDO transmission		Transmission type	Explanation
	cyclic	synchronous		
X	X		n = 1 ... 240	When a value n is entered, this PDO will be accepted with every nth SYNC.
		X	n = 254	PDO will be accepted immediately.

[11-13] I-1400 ... I-1402, subindex 2

## I-1401

Index: I-1401	Name: RPDO2 communication parameter				
Subindex	Default setting	Setting range (min. value   unit   max. value)		Access	Data type
0: Highest subindex supported	5	- (read access only)		ro	U8
1: COB-ID used by RPDO	0x300 + node ID	0	4294967295	rw	U32
2: Transmission type	254	0	255	rw	U8
3: Inhibit time	-	- (not used for RPDOs)		rw	U16
4: Compatibility entry	-	- (reserved, read or write access leads to error message 0x06090011)		rw	U8
5: Event timer	-	- (not used for RPDOs)		rw	U16

## Communication parameter for receiving process data via RPDO2

Subindex	Meaning	Code
0	"5" is permanently set. • Max. 5 subindices are supported.	-
1	RPDO2 identifier • According to the "Predefined Connection Set", the basic setting is: Identifier = 0x300 + node ID	<a href="#">C00354/3</a>
2	RPDO Transmission type according to DS301 V4.02 ▶ <a href="#">Transmission type</a> (□ 539)	<a href="#">C00323/2</a>

- For data telegram assignment and description of subindices 1 and 2, see object [I-1400](#).

## How to change the identifier:

1. Deactivate identifier (set bit 31 to "1").
2. Change identifier.
3. Activate identifier (set bit 31 to "0").

## I-1402

Index: <b>I-1402</b>	Name: <b>RPDO3 communication parameter</b>					
Subindex	Default setting	Setting range (min. value   unit   max. value)			Access	Data type
0: Highest subindex supported	5	- (read access only)			ro	U8
1: COB-ID used by RPDO	0x400 + node ID	0		4294967295	rw	U32
2: Transmission type	254	0		255	rw	U8
3: Inhibit time	-	- (not used for RPDOs)			rw	U16
4: Compatibility entry	-	- (reserved, read or write access leads to error message 0x06090011)			rw	U8
5: Event timer	-	- (not used for RPDOs)			rw	U16

Communication parameter for receiving process data via RPDO3

Subindex	Meaning	Code
0	"5" is permanently set. • Max. 5 subindices are supported.	-
1	RPDO3 identifier • According to the "Predefined Connection Set", the basic setting is: Identifier = 0x400 + node ID	<a href="#">C00354/5</a>
2	RPDO transmission type according to DS301 V4.02 ▶ <a href="#">Transmission type</a> (☞ 539)	<a href="#">C00323/3</a>

- For data telegram assignment and description of subindices 1 and 2, see object [I-1400](#).

How to change the identifier:

1. Deactivate identifier (set bit 31 to "1").
2. Change identifier.
3. Activate identifier (set bit 31 to "0").

## I-1403

From version 15.00.00

Index: <b>I-1403</b>	Name: <b>RPDO4 communication parameter</b>				
Subindex	Default setting	Setting range (min. value   unit   max. value)		Access	Data type
0: Highest subindex supported	5	- (read access only)		ro	U8
1: COB-ID used by RPDO	0x500 + node ID	0		4294967295	rw U32
2: Transmission type	254	0		255	rw U8
3: Inhibit time	-	- (not used for RPDOs)		rw	U16
4: Compatibility entry	-	- (reserved, read or write access leads to error message 0x06090011)		rw	U8
5: Event timer	-	- (not used for RPDOs)		rw	U16

Communication parameter for receiving process data via RPDO4

Subindex	Meaning	Code
0	"5" is permanently set. • Max. 5 subindices are supported.	-
1	Identifier RPDO4 • According to the "Predefined Connection Set", the basic setting is: Identifier = 0x500 + node ID	<a href="#">C00354/7</a>
2	RPDO transmission type according to DS301 V4.02 ▶ <a href="#">Transmission type</a> (□ 539)	<a href="#">C00323/4</a>

- For data telegram assignment and description of subindices 1 and 2, see object [I-1400](#).

How to change the identifier:

1. Deactivate identifier (set bit 31 to "1").
2. Change identifier.
3. Activate identifier (set bit 31 to "0").



## I-1600

Index: <b>I-1600</b>	Name: <b>RPDO1 mapping parameter</b>					
Subindex	Default setting	Setting range (min. value   unit   max. value)			Access	Data type
0: Number of mapped application objects in PDO	0	0		8	rw	U8
1 ... 4: Application object 1 ... 4	0	0		4294967295	rw	U32

The object I-1600 serves to receive parameter data as RPDO1.

- This object relates to codes [C00409/1...4](#) and [C00866/1...4](#).
- **From version 12.00.00 onwards:** For 32-bit values, this object relates to codes [C00407/1...2](#).

Subindex	Meaning
0	Number of mapped objects
1 ... 4	Mapping entries 1 ... 4 for RPDO1 <ul style="list-style-type: none"> <li>• The 4th mapping entry is used for the statistic mapping. For this, there is no value available.</li> </ul>

8th byte	7th byte	6. byte	5th byte
Data 4	Data 3	Data 2	Data 1
Bit 31 ... bit 16		Bit 15 ... bit 8	Bit 7 ... bit 0
Index		Subindex	Length

[11-14] Data frame assignment

IEC 61131 process data words are mapped. Only whole bytes can be mapped (1-byte/mapping entry).

#### Related topics:

- ▶ [RPDO1 | Port block "LP\\_CanIn1"](#) (📖 525)

## I-1601

Index: I-1601	Name: RPDO2 mapping parameter					
Subindex	Default setting	Setting range (min. value   unit   max. value)			Access	Data type
0: Number of mapped application objects in PDO	0	0			8 rw	U8
1 ... 4: Application object 1 ... 4	0	0		4294967295	rw	U32

The object I-1601 serves to receive parameter data as RPDO2.

- This object relates to codes [C00409/5...8](#) and [C00866/5...8](#).
- **From version 12.00.00 onwards:** For 32-bit values, this object relates to codes [C00407/3...4](#).

Subindex	Meaning
0	Number of mapped objects
1 ... 4	Mapping entries 1 ... 4 for RPDO2 <ul style="list-style-type: none"> <li>• The 4th mapping entry is used for the statistic mapping. For this, there is no value available.</li> </ul>

- For assignment of the data telegram see object [I-1600](#).

## Related topics:

- ▶ [RPDO2 | "LP\\_CanIn2" port block](#) (📖 527)

## I-1602

Index: I-1602	Name: RPDO3 mapping parameter					
Subindex	Default setting	Setting range (min. value   unit   max. value)			Access	Data type
0: Number of mapped application objects in PDO	0	0			8 rw	U8
1 ... 4: Application object 1 ... 4	0	0		4294967295	rw	U32

The object I-1602 serves to receive parameter data as RPDO3.

- This object relates to codes [C00409/9...12](#) and [C00866/9...12](#).
- **From version 12.00.00 onwards:** For 32-bit values, this object relates to codes [C00407/5...6](#).

Subindex	Meaning
0	Number of mapped objects
1 ... 4	Mapping entries 1 ... 4 for RPDO3 <ul style="list-style-type: none"> <li>• The 4th mapping entry is used for the statistic mapping. For this, there is no value available.</li> </ul>

- For assignment of the data telegram see object [I-1600](#).

## Related topics:

- ▶ [RPDO3 | "LP\\_CanIn3" port block](#) (📖 529)

## I-1603

From version 15.00.00

Index: <b>I-1603</b>	Name: <b>RPDO4 mapping parameter</b>					
Subindex	Default setting	Setting range (min. value   unit   max. value)			Access	Data type
0: Number of mapped application objects in PDO	0	0		8	rw	U8
1 ... 4: Application object 1 ... 4	0	0		4294967295	rw	U32

The object I-1603 serves to receive parameter data as RPDO4.

- This object relates to codes [C00409/13...16](#) and [C00866/13...16](#).
- For 32-bit values, this object relates to the codes [C00407/7...8](#).

Subindex	Meaning
0	Number of mapped objects
1 ... 4	Mapping entries 1 ... 4 for RPDO4 <ul style="list-style-type: none"> <li>• The 4th mapping entry is used for the statistic mapping. For this, there is no value available.</li> </ul>

- For assignment of the data telegram see object [I-1600](#).

**Related topics:**

- ▶ [RPDO4 | "LP\\_CanIn4" port block](#) (📖 531)

## I-1800

Index: <b>I-1800</b>		Name: <b>TPDO1 communication parameter</b>				
Subindex	Default setting	Setting range (min. value   unit   max. value)			Access	Data type
0: Highest subindex supported	5	- (read access only)			ro	U8
1: COB-ID used by TPDO	0x180 + node ID	0		4294967295	rw	U32
2: Transmission type	254	0		255	rw	U8
3: Inhibit time	0 ms	0	0.1 ms	65535	rw	U16
4: Reserved	-	- (reserved, read or write access leads to error message 0x06090011)			rw	U8
5: Event timer	0 ms	0	ms	65535	rw	U16

Communication parameter for sending process data via TPDO1

Subindex	Meaning	Code
0	"5" is permanently set. • Max. 5 subindices are supported.	-
1	TPDO1 identifier • According to the "Predefined Connection Set", the basic setting is: Identifier = 0x180 + node ID	<a href="#">C00354/2</a>
2	TPDO transmission type according to DS301 V4.02 ▶ <a href="#">Transmission type</a> (☐ 539)	<a href="#">C00322/1</a>
3	Minimum time between sending two identical TPDOs (see DS301 V4.02).	<a href="#">C00324/2</a>
5	Cycle time for PDO transmission with transmission type "254".	<a href="#">C00356/5</a> <a href="#">C00369</a>

8th byte		7th byte		6. byte		5th byte	
Data 4		Data 3		Data 2		Data 1	
Bit 31	Bit 30	Bit 29 ... bit 11				Bit 10 ... bit 0	
<b>0/1</b>	<b>0/1</b>	<b>Extended identifier*</b>				<b>11-bit identifier</b>	

\* The extended identifier is not supported. Bit 11 ... bit 29 must be set to "0".

[11-15] Data frame assignment

Bit	setting	
Bit 30	0	RTR to this PDO possible (Lenze).
	1	RTR to this PDO not possible (not adjustable)
Bit 31	0	PDO active
	1	PDO inactive

How to change the identifier:

1. Deactivate identifier (set bit 31 to "1").
2. Change identifier.
3. Activate identifier (set bit 31 to "0").

**Subindex 2 - transmission type**

PDO transmission			Transmission type	Explanation
cyclic	synchronous	event-controlled		
●	●		n = 1 ... 240	When a value n is entered, this PDO will be accepted with every nth SYNC.
	●		n = 252	On sync, the PDO is filled with new data, but only sent on RTR.
		●	n = 254, 255	Event-controlled or cyclic

**Subindex 3 - inhibit time****Note!**

The delay time can only be changed when the PDO is not active (see subindex 1, bit 31 = 1).

The entered value multiplied by 0.1 gives the delay time in [ms]. Only integers will be considered, i.e. fractional numbers will be **rounded down** to integers.

Example:

- Entered value: 26
- Calculated time =  $26 \times 0.1$  [ms] = 2.6 [ms] → delay time = 2 [ms]

**Subindex 5 - event timer**

For cyclic operation (transmission type 254), the cycle time for sending the process data object on the system bus can be set under subindex 5:

The entered value corresponds to the time in [ms].

## I-1801

Index: I-1801	Name: TPDO2 communication parameter					
Subindex	Default setting	Setting range (min. value   unit   max. value)			Access	Data type
0: Highest subindex supported	5	- (read access only)			ro	U8
1: COB-ID used by TPDO	0x280 + node ID	0		4294967295	rw	U32
2: Transmission type	254	0		255	rw	U8
3: Inhibit time	0 ms	0	0.1 ms	65535	rw	U16
4: Reserved	-	- (reserved, read or write access leads to error message 0x06090011)			rw	U8
5: Event timer	0 ms	0	ms	65535	rw	U16

Communication parameter for sending process data via TPDO2

Subindex	Meaning	Code
0	"5" is permanently set. • Max. 5 subindices are supported.	-
1	TPDO2 identifier • According to the "Predefined Connection Set", the basic setting is: Identifier = 0x280 + node ID	<a href="#">C00354/4</a>
2	TPDO transmission type according to DS301 V4.02 ▶ <a href="#">Transmission type</a> (539)	<a href="#">C00322/2</a>
3	Minimum time between sending two identical TPDOs (see DS301 V4.02).	<a href="#">C00324/3</a>
5	Cycle time for PDO transmission with transmission type "254".	<a href="#">C00356/2</a> <a href="#">C00369</a>

- For data telegram assignment and description of subindices, see object [I-1800](#).

How to change the identifier:

1. Deactivate identifier (set bit 31 to "1").
2. Change identifier.
3. Activate identifier (set bit 31 to "0").

## I-1802

Index: I-1802	Name: TPDO3 communication parameter					
Subindex	Default setting	Setting range (min. value   unit   max. value)			Access	Data type
0: Highest subindex supported	5	- (read access only)			ro	U8
1: COB-ID used by TPDO	0x380 + node ID	0		4294967295	rw	U32
2: Transmission type	254	0		255	rw	U8
3: Inhibit time	0 ms	0	0.1 ms	65535	rw	U16
4: Reserved	-	- (reserved, read or write access leads to error message 0x06090011)			rw	U8
5: Event timer	0 ms	0	ms	65535	rw	U16

Communication parameter for sending process data via TPDO3

Subindex	Meaning	Code
0	"5" is permanently set. • Max. 5 subindices are supported.	-
1	TPDO3 identifier • According to the "Predefined Connection Set", the basic setting is: Identifier = 0x380 + node ID	<a href="#">C00354/6</a>
2	TPDO transmission type according to DS301 V4.02 ▶ <a href="#">Transmission type</a> (☞ 539)	<a href="#">C00322/3</a>
3	Minimum time between sending two identical TPDOs (see DS301 V4.02).	<a href="#">C00324/4</a>
5	Cycle time for PDO transmission with transmission type "254".	<a href="#">C00356/3</a> <a href="#">C00369</a>

- For data telegram assignment and description of subindices, see object [I-1800](#).

How to change the identifier:

1. Deactivate identifier (set bit 31 to "1").
2. Change identifier.
3. Activate identifier (set bit 31 to "0").

## I-1803

From version 15.00.00

Index: I-1803	Name: TPDO4 communication parameter				
Subindex	Default setting	Setting range (min. value   unit   max. value)		Access	Data type
0: Highest subindex supported	5	- (read access only)		ro	U8
1: COB-ID used by TPDO	0x480 + node ID	0		4294967295	rw U32
2: Transmission type	254	0		255	rw U8
3: Inhibit time	0 ms	0	0.1 ms	65535	rw U16
4: Reserved	-	- (reserved, read or write access leads to error message 0x06090011)		rw	U8
5: Event timer	0 ms	0	ms	65535	rw U16

Communication parameter for sending process data via TPDO4

Subindex	Meaning	Code
0	"5" is permanently set. • Max. 5 subindices are supported.	-
1	Identifier TPDO4 • According to the "Predefined Connection Set", the basic setting is: Identifier = 0x480 + node ID	<a href="#">C00354/8</a>
2	TPDO transmission type according to DS301 V4.02 ▶ <a href="#">Transmission type</a> (□ 539)	<a href="#">C00322/4</a>
3	Minimum time between sending two identical TPDOs (see DS301 V4.02).	<a href="#">C00324/5</a>
5	Cycle time for PDO transmission with transmission type "254".	<a href="#">C00356/4</a> <a href="#">C00369</a>

- For data telegram assignment and description of subindices, see object [I-1800](#).

How to change the identifier:

1. Deactivate identifier (set bit 31 to "1").
2. Change identifier.
3. Activate identifier (set bit 31 to "0").



## I-1A00

Index: I-1A00	Name: TPDO1 mapping parameter					
Subindex	Default setting	Setting range (min. value   unit   max. value)			Access	Data type
0: Number of mapped application objects in PDO	0	0		8	rw	U8
1 ... 4: Application object 1 ... 4	0	0		4294967295	rw	U32

The object I-1A00 serves to send parameter data as TPDO1.

- This object relates to code [C00868/1...4](#).

Subindex	Meaning
0	Number of mapped objects
1 ... 4	Mapping entries 1 ... 4 for TPDO1 <ul style="list-style-type: none"> <li>• The 4th mapping entry is used for the statistic mapping. For this, there is no value available.</li> </ul>

8th byte	7th byte	6. byte	5th byte
Data 4	Data 3	Data 2	Data 1
Bit 31 ... bit 16		Bit 15 ... bit 8	
Index		Subindex	
		Length	

[11-16] Data frame assignment

IEC 61131 process data words are mapped. Only whole bytes can be mapped (1-byte/mapping entry).

#### Related topics:

- ▶ [TPDO1 | "LP\\_CanOut1" port block](#) (📖 533)

## I-1A01

Index: I-1A01	Name: TPDO2 mapping parameter					
Subindex	Default setting	Setting range (min. value   unit   max. value)			Access	Data type
0: Number of mapped application objects in PDO	0	0		8	rw	U8
1 ... 4: Application object 1 ... 4	0	0		4294967295	rw	U32

The object I-1A01 serves to send parameter data as TPDO2.

- This object relates to code [C00868/5...8](#).

Subindex	Meaning
0	Number of mapped objects
1 ... 4	Mapping entries 1 ... 4 for TPDO2 <ul style="list-style-type: none"> <li>• The 4th mapping entry is used for the statistic mapping. For this, there is no value available.</li> </ul>

- For assignment of the data telegram see object [I-1A00](#).

#### Related topics:

- ▶ [TPDO2 | "LP\\_CanOut2" port block](#) (📖 534)

## I-1A02

Index: I-1A02	Name: TPDO3 mapping parameter					
Subindex	Default setting	Setting range (min. value   unit   max. value)			Access	Data type
0: Number of mapped application objects in PDO	0	0		8	rw	U8
1 ... 4: Application object 1 ... 4	0	0		4294967295	rw	U32

The object I-1A02 serves to send parameter data as TPDO3.

- This object relates to code [C00868/9...12](#).

Subindex	Meaning
0	Number of mapped objects
1 ... 4	Mapping entries 1 ... 4 for TPDO3 <ul style="list-style-type: none"> <li>• The 4th mapping entry is used for the statistic mapping. For this, there is no value available.</li> </ul>

- For assignment of the data telegram see object [I-1A00](#).

## Related topics:

- ▶ [TPDO3 | "LP\\_CanOut3" port block](#) (📖 535)

## I-1A03

Index: I-1A03	Name: TPDO4 mapping parameter					
Subindex	Default setting	Setting range (min. value   unit   max. value)			Access	Data type
0: Number of mapped application objects in PDO	0	0		8	rw	U8
1 ... 4: Application object 1 ... 4	0	0		4294967295	rw	U32

The object I-1A03 serves to send parameter data as TPDO4.

- This object relates to code [C00868/13...16](#).

Subindex	Meaning
0	Number of mapped objects
1 ... 4	Mapping entries 1 ... 4 for TPDO4 <ul style="list-style-type: none"> <li>• The 4th mapping entry is used for the statistic mapping. For this, there is no value available.</li> </ul>

- For assignment of the data telegram see object [I-1A00](#).

## Related topics:

- ▶ [TPDO4 | "LP\\_CanOut4" port block](#) (📖 536)

11.12 Internal interfaces | System block "LS\_CANManagement"

This function extension is only available from version 04.00.00!

The **LS\_CANManagement** system block serves to control internal functions of the CAN driver (reset node and re-initialisation) and to display the "Operational" status as well as the node address (analogous to the 9300 ServoPLC and ECS devices).

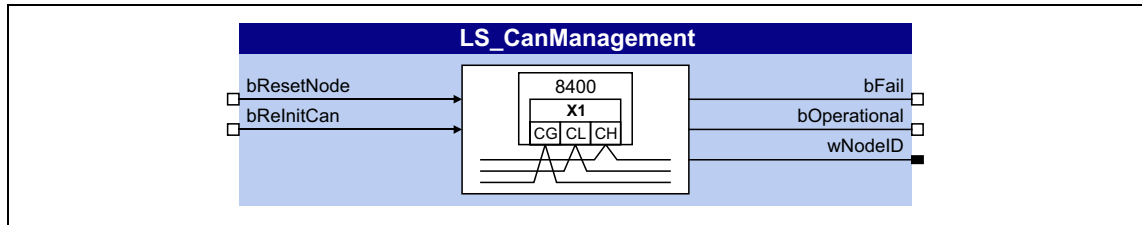

inputs

Designator	Data type	Information/possible settings
bResetNode	BOOL	Reset node
		TRUE Carry out reset node • If the inverter is configured as CAN master in <a href="#">C00352</a> , the NMT command "Start Remote Node" is sent to all nodes at the bus (broadcast telegram). ▶ <a href="#">Network management telegram (NMT)</a>
bReInitCAN	BOOL	Reinitialisation
		TRUE Reinitialise "CAN on board" interface.

outputs

Designator	Data type	Value/meaning
bFail	BOOL	Error
		TRUE An event according to the error configuration in <a href="#">C00341</a> has occurred
bOperational	BOOL	"Operational" status signal
		TRUE The system bus is in the "Operational" status
wNodeID	WORD	Output of the node address



**Note!**

If a "Bus off" error is detected, the "CAN on board" interface will automatically be reinitialised after 1 second.







Hence, 1 second after the "Bus off" has occurred, the inverter will automatically be active again on the system bus ("Auto bus off recovery").

## 12 Fieldbus interface (MCI)

The Inverter Drives 8400 can accommodate plug-in communication modules and can therefore take part in the data transfer of an existing fieldbus system.

When using a communication module, the major advantage for the user is the possibility of parameterising, controlling, and diagnosing the drive system via the available fieldbus.

The following fieldbuses are supported by the 8400 StateLine:

Fieldbus	Communication module (type designation)
	<a href="#">System bus "CAN on board"</a> (permanently integrated in the standard device)
	EtherCAT® (E84AYCET)
	Ethernet POWERLINK (E84AYCEC)
	EtherNet/IP™ (E84AYCEO)
	INTERBUS (E84AYCIB)
	PROFIBUS® (E84AYCPM)
	PROFINET® (E84AYCER)



Detailed information is provided in the communication manual (KHB) for the respective fieldbus and in the »Engineer« online help.

### 12.1 Process data transfer

The process data serve to control the inverter. Thus the transfer of the process data is time-critical.

- The process cycle is 1 ms, irrespective of the respectively plugged-in bus system and the type of inverter.
- The process data transfer between the host system and the inverters is cyclical.
  - This concerns the continuous exchange of current input and output data.
  - In the case of the 8400 inverter, 16 words per direction are exchanged.
- The master computer can directly access the process data.  
Access to the process data takes place via the port blocks **LP\_MciIn** and **LP\_MciOut** (see FB interconnection of the »Engineer«).  
These port blocks are also called process data channels.
- The process data are not saved in the inverter.

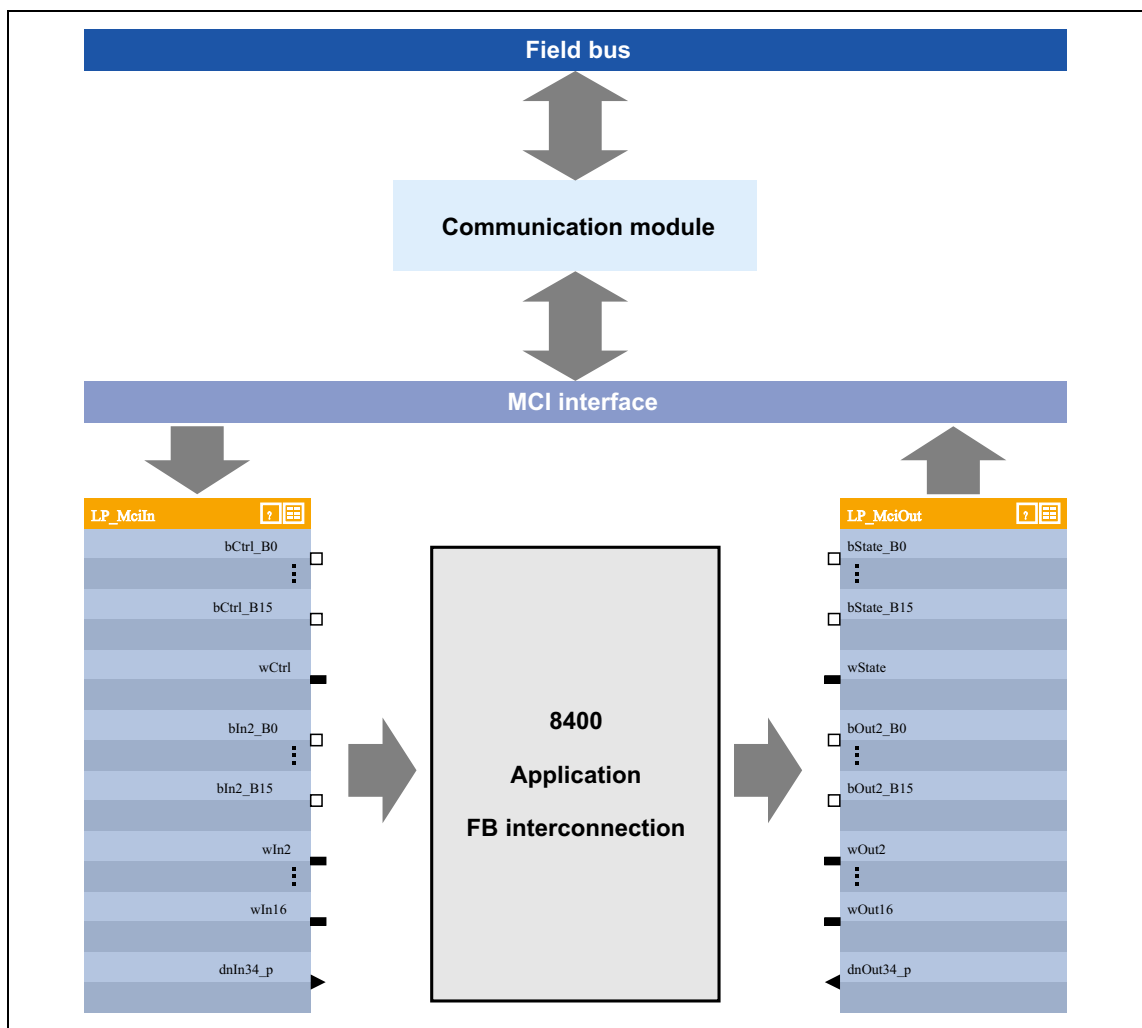

[12-1] External and internal data transfer between bus system, inverter and function block interconnection

---

### Voltage supply

Depending on the complexity and functional range of the fieldbus, the communication modules are supplied by the standard device or an external 24 V supply at the module.

The external 24 V voltage supply of the communication module is required if the supply of the standard device fails but the communication via the bus is to continue.

### Parameter setting of the communication modules

All codes which must be parameterised for establishing the fieldbus communication are saved in the memory module of the inverter.

The archived data can be addressed by all bus systems supported by the inverter.

### Hotplug

The communication module (MCI module) can be plugged in/out while the inverter is switched on. When the module is plugged in, it is automatically detected and checked for plausibility regarding the function and version.

### Fieldbus-specific device profiles and PDO mapping

When specific bus systems are used, the inverter is to behave according to a defined, manufacturer-spanning standard. The following definitions have been made for this:

- Definitions of the device state machine (e.g. DSP402, DriveCOM, ProfiDrive etc.)
- Definition of the bit assignment of control and status words
- Definition of signal scaling (on a limited scale)
- Definition of parameter scaling (on a limited scale)
- Definition of the process data mapping

These device profiles are not mapped in the communication module since some definitions have a strong effect on the device-internal behaviour and the device profiles are not uniform regarding this matter.

- The task of the communication modules is
  - to address parameters (SDOs),
  - to transfer PDOs and
  - the signal mapping of the PDOs.
- The process data objects (e.g. the meaning of the control word bits or the speed setpoint stipulated) are interpreted in the inverter.

---

## 12.2 Control mode "MCI"

"40: MCI" can be selected as a control mode in [C00007](#) in order to quickly and easily set-up inverter control by means of MCI-PDOs via the fieldbus interface.

Given that the technology applications are fundamentally different and have different requirements regarding the signals sent to them, predefined assignment of the MCI-PDOs depends on the technology application selected in [C00005](#):

- **TA "Actuating drive speed":**  
[Process data assignment for fieldbus communication](#) (📖 331)
- **TA "Abschaltpositionierung":**  
[Process data assignment for fieldbus communication](#) (📖 391)

**Tip!**

The predefined assignment of the MCI-PDOs can be parameterised by means of PDO mapping and can be freely configured on the I/O level in the function block editor (FB editor).

12.2.1 Port block "LP\_MciIn"

The LP\_MciIn port block maps the received MCI-PDOs in the FB Editor.

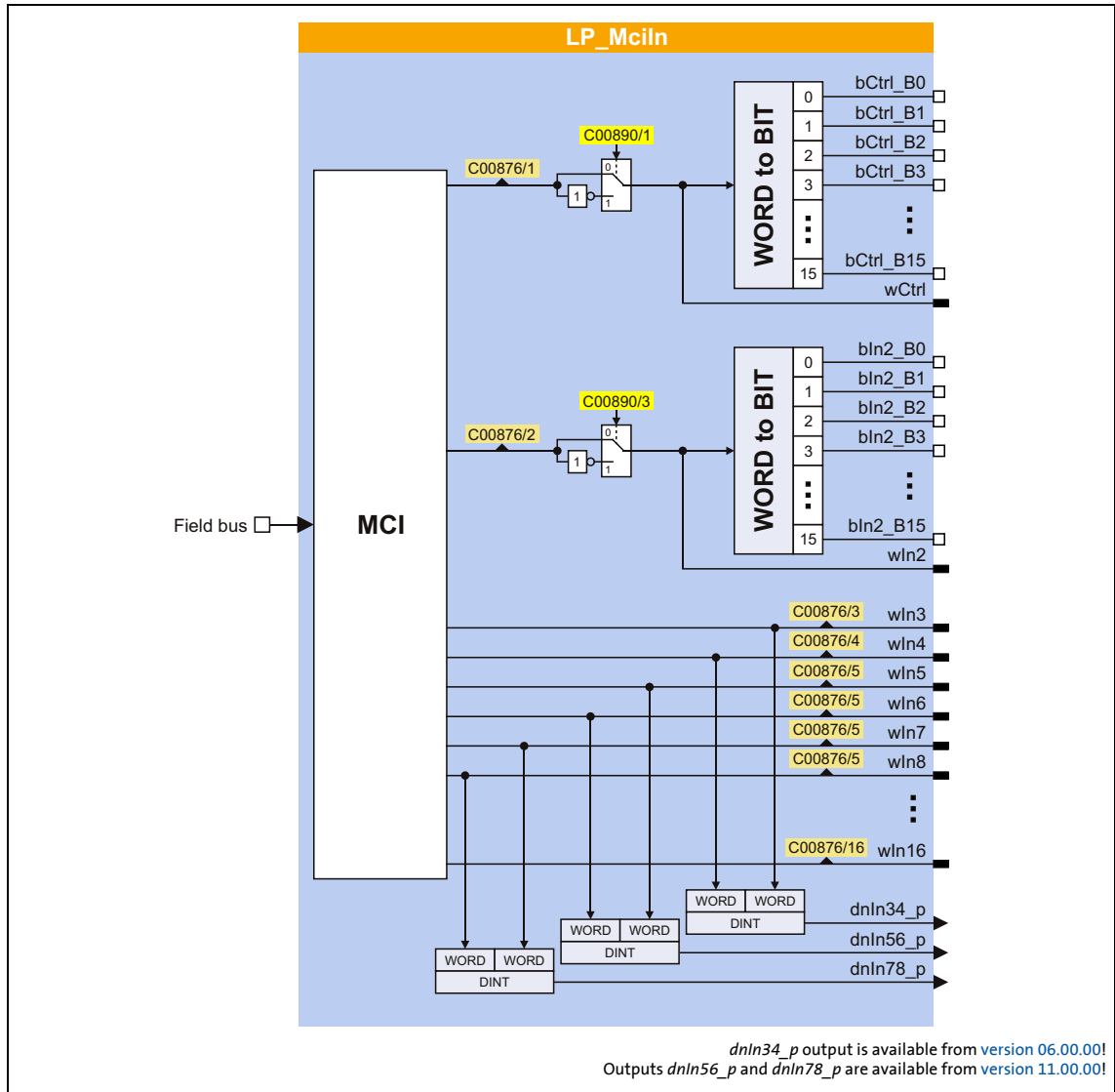

Short overview of the parameters for LP\_MciIn:

Parameters	Info	Lenze setting
<a href="#">C00876/1</a>	LP_MciIn:wCtrl	-
<a href="#">C00876/2...16</a>	LP_MciIn: wIn2 ... wIn16	-
<a href="#">C00890/1</a>	LP_MciIn: Inversion bCtrl_B0..15	0x0000
<a href="#">C00890/3</a>	LP_MciIn: Inversion bIn2_B0..15	0x0000

Greyed out = display parameter



# 12 Fieldbus interface (MCI)

## 12.2 Control mode "MCI"

### 12.2.2 Port block "LP\_MciOut"

The LP\_MciOut port block maps the MCI-PDOs to be transmitted in the FB Editor.

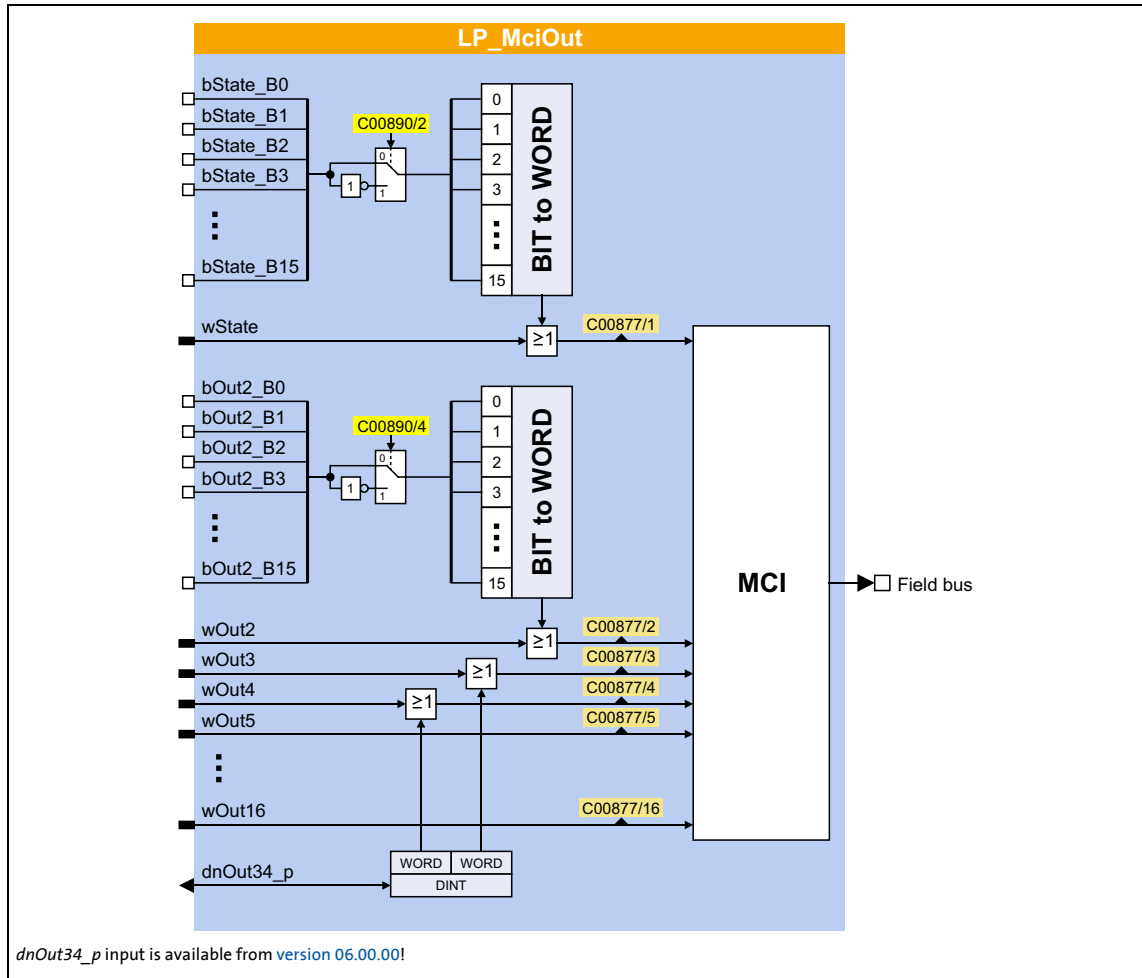

#### Short overview of the parameters for LP\_MciOut:

Parameters	Info	Lenze setting
<a href="#">C00877/1</a>	LP_MciOut:wState	-
<a href="#">C00877/2...16</a>	LP_MciOut: wOut2 ... wOut16	-
<a href="#">C00890/2</a>	LP_MciOut: Inversion bState_B0..15	0x0000
<a href="#">C00890/4</a>	LP_MciOut: Inversion bOut2_B0..15	0x0000

Greyed out = display parameter

### 12.3 CAN gateway

This function extension is available from version 12.00.00!

The CAN gateway functionality forwards the read/write requests of the attached communication module to a connected *remote* device via the "CAN on board" system bus. It also receives the responses via this way.

- From the point of view of the attached communication module, the read/write requests are identical to accesses to its own standard device.
- Block services (reading/writing parameters of the "String" data type) can also be executed via the CAN gateway.

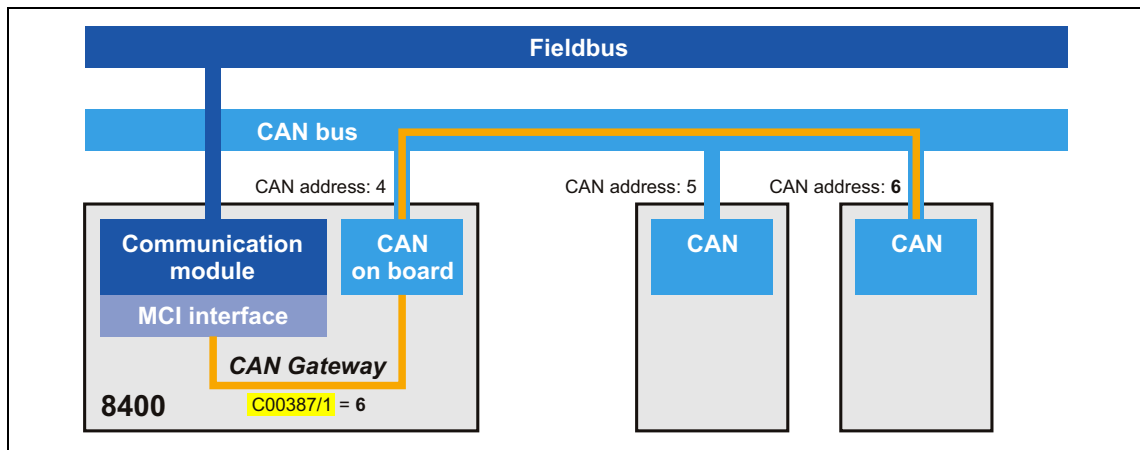

[12-2] Functional principle of "CAN gateway"

#### Activating the CAN gateway

To activate the CAN gateway, the CAN address (1 ... 127) of the connected *remote* device must be set in [C00387/1](#).

- In the Lenze setting [C00387/1](#) = "0", the function is switched off.
- If the CAN gateway is activated, the own inverter is the client and the *remote* device is the server.
- If the own CAN address is set, the read/write requests are forwarded to the own inverter.
- The parameters of the communication module (C13000 ... C13999) are always processed in the own inverter.
- The parameters [C00387/1](#) (CAN gateway address) and [C00350](#) (CAN node address) are not transferred to the *remote* device.

## 13 Synchronisation of the internal time base

In a drive system, synchronising the internal time bases of all inverters involved makes sense because cyclic process data should be processed synchronously in all drives.

- One of the following signal sources can be used for automatic synchronisation of the internal time base of the inverter:
  - CAN bus ("CAN on board") → [sync telegram](#)
  - MCI → sync signal of a plugged-in communication module (EtherCAT, PROFINET or Powerlink)

### Short overview of the parameters for the synchronisation of the internal time base:

Parameters	Info	Lenze setting	
		Value	Unit
<a href="#">C00370/1</a>	CAN Sync instant of transmission	-	µs
<a href="#">C00370/2</a>	Sync instant of reception	-	µs
<a href="#">C01120</a>	Sync signal source	Off	
<a href="#">C01121</a>	Sync cycle time setpoint	1000	µs
<a href="#">C01122</a>	Sync phase position	0	µs
<a href="#">C01123</a>	Sync window	100	µs
<a href="#">C01124</a>	Sync correction width	300	ns

Greyed out = display parameter

### Sync signal source

The synchronisation signal source can be selected in [C01120](#). As a general rule, only one source can be used to synchronise the internal time base.

### Sync cycle time setpoint

Time with which the internal phase-locking loop (PLL) expects the synchronisation signals. The time must be set in [C01121](#) in accordance with the cycle of the synchronisation source selected in [C01120](#).



### Note!

- Only integer multiples of 1000 µs can be set in [C01121](#).
- Intelligent communication modules usually define the cycle time setpoint derived from the bus cycle. In this case, a manual change is not possible.

### Example:

For the CAN bus, 2 ms has been selected as interval between two synchronisation signals. If the CAN bus is to be used as synchronisation source, a cycle time setpoint of 2000 µs must be selected in [C01121](#).

### Sync window

In [C01123](#), a time slot can be defined around the expected synchronisation time. The time slot defines the range in which the synchronisation signal is expected.

If "4:MCI" is selected in [C01120](#), the time slot must be set to 100 µs.

**Sync phase position**

The phase position determines the zero-time of the internal system cycle with regard to the synchronisation signal (bus cycle). Since PDO processing is an inherent part of the system part of the application, the instant of acceptance of the PDOs is postponed as well by a changed phase position.

- If "0" is set, the internal system cycle starts at the same time as the synchronisation signal.
- If a value > 0 is set, the internal system cycle starts by the set time earlier (the phase position has a negative effect) than the synchronisation signal.
- Intelligent communication modules define the optimal time with activated synchronisation by themselves. In this case, a manual change is not possible.
- For determining [C01122](#), the point in time where all bus nodes have valid PDOs is decisive.

Example: If the phase position is set to 550 µs, the system part of the application starts 550 µs before the arrival of the synchronisation signal.

**Sync correction width**

If the cycle times of the synchronisation signal and the phase-locking loop (PLL) are different, the setting in [C01124](#) defines the correction increments for the phase-locking loop.

- The recommended reset time for the CAN bus as synchronisation source in case of occurring deviations is 300 ns (Lenze setting).
- If synchronisation is not reached, select a higher correction width.
- The optimum setting depends on quartz precision and must be determined empirically if required.

**13.1 Internal interfaces | System block "LS\_SyncManagement"**

This function extension is available from version 11.00.00!

The SB **LS\_SyncManagement** provides status information for synchronising the internal time base:

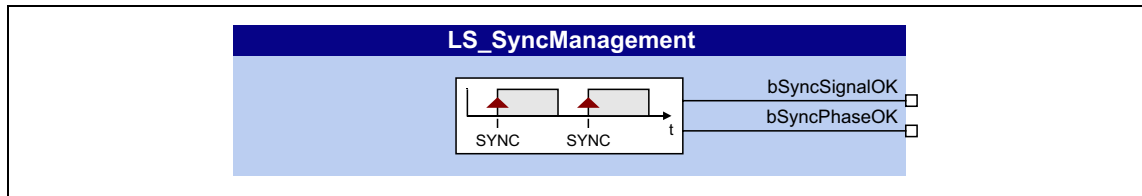

**outputs**

Designator	Data type	Value/meaning
bSyncSignalOK	BOOL	TRUE Sync signal OK
bSyncPhaseOK	BOOL	TRUE Sync phase position OK

## 14 Parameter change-over

This function extension is only available from version 04.00.00!

For up to 32 freely selectable parameters, this basic function provides a change-over between four sets with different parameter values.

The parameter list is created in the same way as the user menu is composed, namely by means of parameterisation. In the »Engineer«, a user-friendly parameterisation dialog with import and export functions is available for this purpose.

### Motor data changeover

From version 12.00.00, an optional changeover between four parameter sets with different motor and control settings is supported in addition.

The optional motor data changeover is provided for applications/machines which have multiple axes controlled successively but which do not require the simultaneous operation of multiple motors. In this case, the very same inverter can control the motors successively. Advantages of this solution: Fewer components ( inverters) and hence less energy consumption.

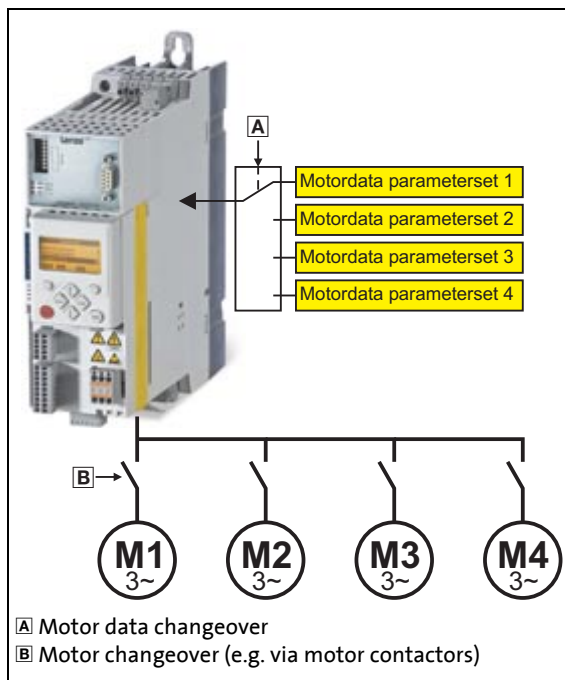

### Principle:

- The motor which is being controlled at the moment is connected to the inverter via motor contactors. (The contactor system can e.g. be controlled via the digital outputs of the inverter.)
- At the same time, the motor data changeover serves to activate the motor and control settings suitable for the motor in the inverter.

### Note:

The motor data changeover is carried out within 2 ms and hence within the opening and closing times of most motor contactors.

[14-1] Principle of the selective control of multiple motors using one inverter

### 14.1 Configuring parameter change-over via the »Engineer« parameterisation dialog



Proceed as follows to open the dialog for parameterising the parameter change-over:

1. »Engineer« Go to the *Project* view and select the 8400 StateLine inverter.
2. Select the **Application parameters** tab from the *Workspace*.
3. Go to the *Overview* dialog level and click the "Basic functions" button.
4. Go to the *Overview* → *Basic functions* dialog box and click the **Parameter change-over** button.

The screenshot shows the 'Application Parameters' dialog box with the 'Overview -> Basic Functions -> WriteParamList' view selected. The dialog is divided into several sections:

- Writing to parameter list:** Three dropdown menus for 'Activate', 'Select value set - 1', and 'Select value set - 2', all currently set to 'Not connected'.
- Execute Mode:** A dropdown menu set to '0: By Execute'.
- Definable parameter list:** A dropdown menu set to 'ON'.
- Motor data parameter list:** A dropdown menu set to 'OFF'.
- Error status:** A dropdown menu set to '0'.
- Error line:** A dropdown menu set to '0'.
- Selected value:** A text input field.
- Copy values:** A button.
- Table:** A table with columns: Line, Code, Name, Unit, Active value, Value 1, Value 2, Value 3, Value 4. The table is currently empty.
- Buttons:** 'Configure...', 'Import...', and 'Export...' buttons at the bottom.



#### Note!

The "parameter change-over" basic function is always processed, even if the corresponding [LS\\_WriteParamList](#) system block has been removed from the interconnection by the function block editor.

If you do not require this basic function anymore, delete the composed parameter list in order that no unwanted parameter write operations take place.

### 14.1.1 Configuring the parameter list(s)

#### Configuring the definable parameter list

In the Lenze setting, the definable parameter list does not yet contain any parameters.



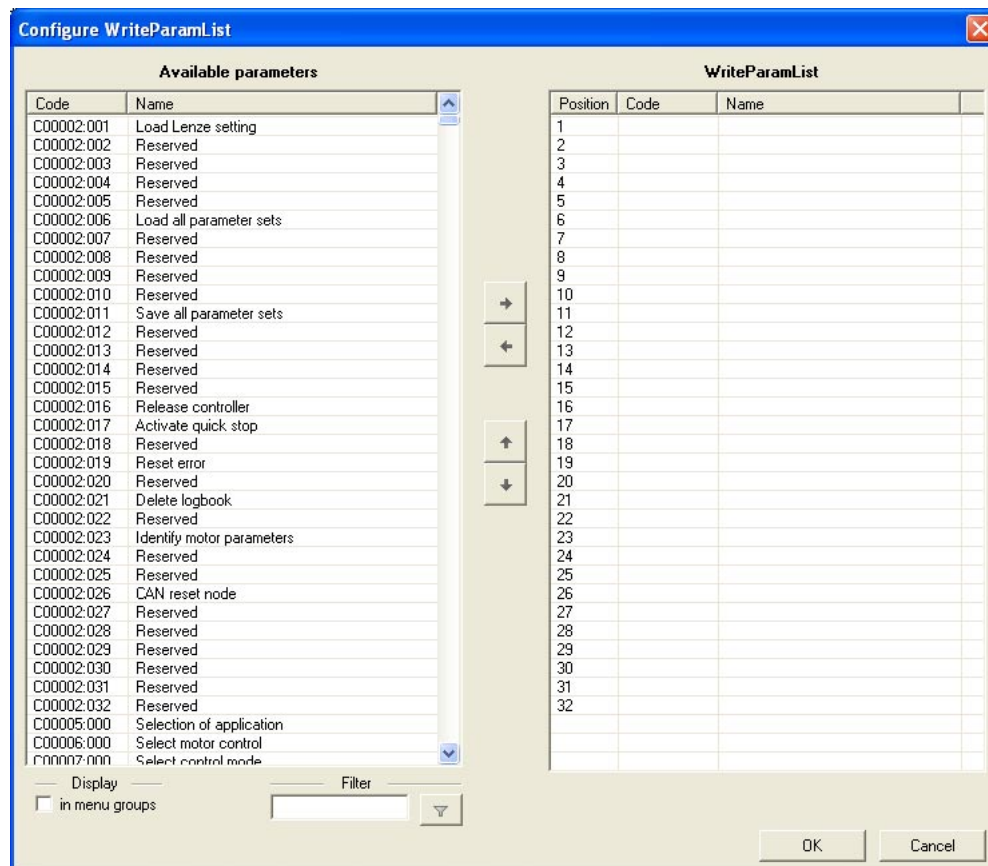

#### How to configure the definable parameter list:

1. Click the **Adapt...** button.
  - The dialog box entitled *Configure WriteParamList* is shown:



- On the left-hand side, all the parameters of the inverter with write and read access are shown in the list entitled **Available parameters**.
  - If the option **In menu groups** is activated, all parameters are shown assigned to their functions.
  - By clicking on the  button in the **Filter** area, you can shorten the list of available parameters. If, for example, you enter the text "ain1" and then click on the button, only those parameters whose designation contains this text are shown for selection.
2. Highlight the parameter/parameters in the **Available parameters** list that is/are to be added to the *WriteParamList*.
    - For a multi-selection you can, just like in the general Windows function, use the **<Ctrl>** and **<Shift>** key.

3. Click on the  button in order to add the highlighted parameters to the *WriteParamList* on the right-hand side.
  - With the  and  buttons, you can alter the sequence of parameters in the *WriteParamList*.

To remove parameters from the *WriteParamList*, proceed as follows:

  - Highlight the parameter/parameters in the **WriteParamList** that is/are to be removed from the *WriteParamList*.
  - Click on the  button to remove the highlighted parameters from the *WriteParamList*.
4. Click the **OK** button to accept the configuration and close the dialog box.
  - You can call the configuration dialog again at any time in order to change or expand the *WriteParamList* retrospectively.

### Changing the values of the definable parameter list

After the compilation of the definable parameter list, the values in the columns **1st value ... 4th value** first correspond to the Lenze setting of the respective parameter.

- Just click one of the input fields in these columns to change the displayed value.
- If you place the cursor in an input field, the permitted value range for the corresponding parameter is shown under the table.

### Changing the values of the motor data parameter list

Click the **Motor data parameter list** register to put it in the foreground:

Definable parameter list		Motor data parameter list				Copy values			
Line	Code	Name	Unit	Active value	Value 1	Value 2	Value 3	Value 4	
01	C0006:000	Motor control		6	6	6	6	6	
02	C0015:000	VFC: V/f base frequency	Hz	50	50	50	50	50	
03	C0016:000	VFC: Vmin boost	%	1,6	1,6	1,6	1,6	1,6	
04	C0018:000	Switching frequency		2	2	2	2	2	
05	C0019:000	Auto-DCB: Threshold	rpm	3	3	3	3	3	
06	C0021:000	Slip compensation	%	2,67	2,67	2,67	2,67	2,67	
07	C0022:000	I <sub>max</sub> in motor mode	A	47	47	47	47	47	
08	C0023:000	I <sub>max</sub> in generator mode	%	100	100	100	100	100	

- Unlike the "definable" parameter list, the motor data parameter list has a fixed assignment to the motor and control parameters.
  - A list of the switchable motor and control parameters is provided in chapter "[Configuring the motor data parameter list by means of parameterisation](#)". (605)
- The preset values are changed in the same way as the definable parameter list.



### Copying values

All the settings of a value set can be copied to another value set.



To copy values, proceed as follows:

1. Click on the **Copy values** button.
  - The *Copy values* dialog box is displayed:

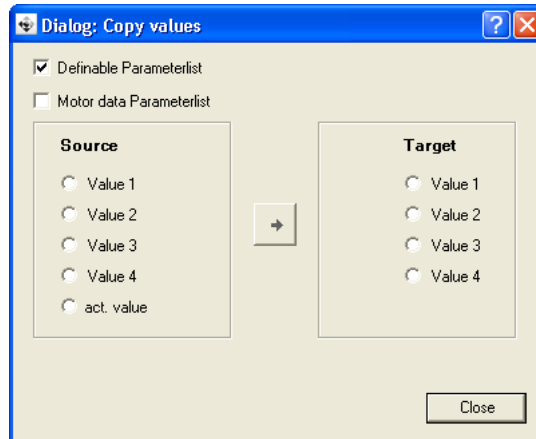

2. Define the parameter list to be copied via the two upper checkboxes.
3. Select **Source** and **Target**.
4. Click on  button in order to copy the values from **Source** to **target**.

### Importing/exporting the list

For cross-device reuse of the configured *WriteParamList*, you can click on the **Export** and **Import** buttons to save the parameter selection as an \*.epc file and then to re-import the saved \*.epc file into another 8400 inverter.

14.1.2 Configuring control inputs

The three control inputs for parameter change-over can be configured via the following parameters:

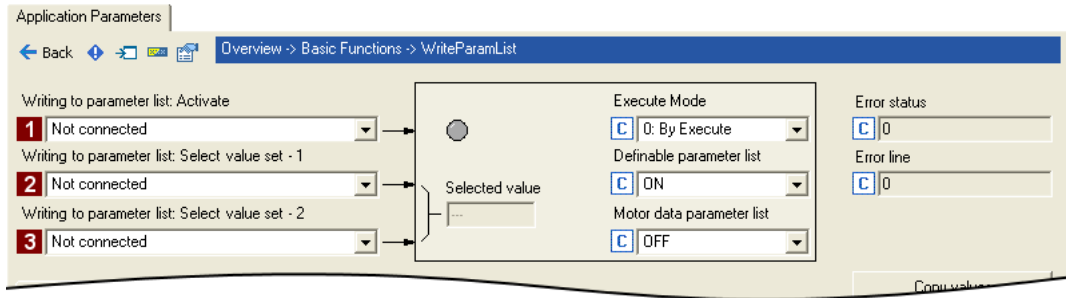

Parameters	Lenze setting	Info
<b>1</b> <b>Activate writing</b> (C00621/123)	0: Not connected	Selection of the signal source that activates writing to the parameter list (for <b>Execute Mode</b> = "0: by Execute").
<b>2</b> <b>Selection value set - 1</b> (C00621/124)	0: Not connected	Selection of the two signal sources for the binary-coded selection of the value set 1 ... 4 to be used (see following truth table).
<b>3</b> <b>Selection value set - 2</b> (C00621/125)	0: Not connected	

Truth table for the selection of the value set to be used:

Selection value set - 1	Selection value set - 2	Value set used
FALSE	FALSE	Value set 1
TRUE	FALSE	Value set 2
FALSE	TRUE	Value set 3
TRUE	TRUE	Value set 4

### 14.1.3 Functional settings

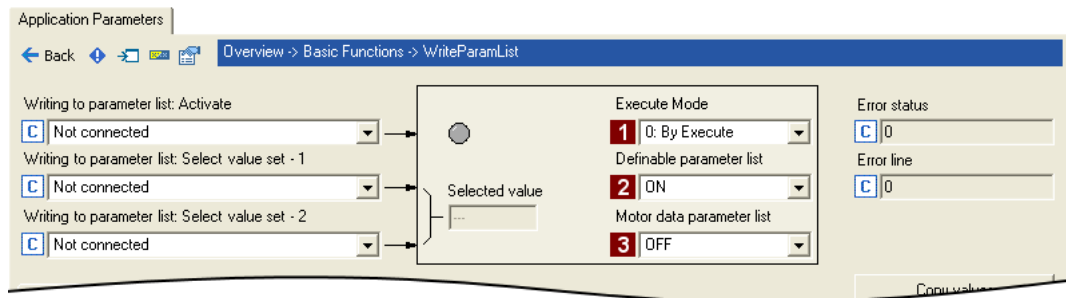

Parameters	Lenze setting	Info
<b>1</b> <b>Execute Mode</b> (C01082)	0: by Execute	For writing the parameter list, two modes are available: <ul style="list-style-type: none"> <li>• 0: by Execute (Lenze setting) The writing of the parameter list is activated by a FALSE/TRUE edge at the <i>bExecute</i> control input.</li> <li>• 1: by Input Select The parameter list is written when the selection inputs <i>bSelectWriteValue_1</i> and <i>bSelectWriteValue_2</i> are changed and once during the initialisation of the inverter.</li> </ul> <b>Note:</b> If the execute mode changes from "0: by Execute" to "1: by Input Select", the parameter list selected by the selection inputs is written once. In the execute mode "1: by Input Select", the parameter list then is only written again when a change occurs on the selection inputs .
<b>2</b> <b>Definable parameter list</b> (C02200/1)	1: On	Switch on/off parameter changeover for the definable parameter list.
<b>3</b> <b>Motor data parameter list</b> (C02200/2)	0: Off	Switch on/off parameter changeover for the motor data parameter list.

### 14.1.4 Error message

With every run through the main program, one parameter of the definable parameter list is written until the parameter list has been executed completely. If an error occurs, [C01083](#) displays an error status and [C01084](#) displays the number of the list entry causing the error (in connection with the selected value set).

Please observe the note regarding the processing time of the main program in section

▶ [LS\\_ParReadWrite\\_1-3](#) (1030)

- If several errors occur at the same time, only the first incorrect list entry will be displayed. Hence, after elimination of the displayed error and another activation, more errors may be displayed.
- The parameter list will always be processed from beginning to end, even if errors occur in the meantime.

## 14.2 Configuring the definable parameter list by means of parameterisation

The following application example shows the necessary procedure for configuring the list without using the »Engineer« parameterisation dialog.

### Task:

The LS\_WriteParamList SB is to be used to write to parameters [C00012](#), [C00026/1](#) and [C00027/1](#).

### Compiling the parameter list

In [C01085/1 ... n](#), specify the above-named parameters in the <Code>,<Subcode> format:

- [C01085/1](#) = 12.000
- [C01085/2](#) = 26.001
- [C01085/3](#) = 27.001
- [C01085/4 ... n](#) = 0.000 (no parameter)



### Note!

Gaps in the parameter list (setting = 0.000) are permissible and are skipped in the process.

Invalid parameter entries are not accepted when being entered.

### Entering values for the parameters (value set 1)

In [C01086/1 ... n](#), specify the values to be used to describe the selected parameters. The values are entered according to the scaling format/scaling factor of the respective parameter.

- [C01086/1](#) = <value> for list entry 1 (in our example: for parameter [C00012](#))
- [C01086/2](#) = <value> for list entry 2 (in our example: for parameter [C00026/1](#))
- [C01086/3](#) = <value> for list entry 3 (in our example: for parameter [C00027/1](#))

These values are used in the writing process if the two *bSelectWriteValue\_1* and *bSelectWriteValue\_2* inputs are not assigned or both set to FALSE.

### Entering other values for the parameters (value sets 2 ... 4)

If required, up to three other sets can be set in the same way in [C01087/1 ... n](#) to [C01089/1 ... n](#) which can optionally be written to the parameters. The decision as to which value set is finally used is dependent upon the assignment of the two *bSelectWriteValue\_1* and *bSelectWriteValue\_2* inputs:

### 14.3 Configuring the motor data parameter list by means of parameterisation

The setting of the values for value sets 1 ... 4 of the motor data parameter list can also be carried out directly via the codes from code [C02210](#) (see following table; columns 1st value ... 4th value).

- Unlike the "definable" parameter list, the motor data parameter list has a fixed assignment to the motor and control parameters.
- The preset values for value sets 1 ... 4 correspond to the Lenze setting of the respective motor or control parameter.
- The values are entered according to the scaling format / scaling factor of the respective motor or control parameter.

Code	Name	Lenze setting	1st value	2nd value	3rd value	4th value
<a href="#">C00006</a>	Motor control	6	<a href="#">C02210/1</a>	<a href="#">C02210/2</a>	<a href="#">C02210/3</a>	<a href="#">C02210/4</a>
<a href="#">C00015</a>	VFC: V/f base frequency	50.0 Hz	<a href="#">C02212/1</a>	<a href="#">C02212/2</a>	<a href="#">C02212/3</a>	<a href="#">C02212/4</a>
<a href="#">C00016</a>	VFC: Vmin boost	1.60 %	<a href="#">C02213/1</a>	<a href="#">C02213/2</a>	<a href="#">C02213/3</a>	<a href="#">C02213/4</a>
<a href="#">C00018</a>	Switching frequency	2	<a href="#">C02214/1</a>	<a href="#">C02214/2</a>	<a href="#">C02214/3</a>	<a href="#">C02214/4</a>
<a href="#">C00019</a>	Auto-DCB: Threshold	3 rpm	<a href="#">C02215/1</a>	<a href="#">C02215/2</a>	<a href="#">C02215/3</a>	<a href="#">C02215/4</a>
<a href="#">C00021</a>	Slip comp.	2.67 %	<a href="#">C02216/1</a>	<a href="#">C02216/2</a>	<a href="#">C02216/3</a>	<a href="#">C02216/4</a>
<a href="#">C00022</a>	Imax in motor mode	47.00 A	<a href="#">C02217/1</a>	<a href="#">C02217/2</a>	<a href="#">C02217/3</a>	<a href="#">C02217/4</a>
<a href="#">C00023</a>	Imax in generator mode	100.00 %	<a href="#">C02218/1</a>	<a href="#">C02218/2</a>	<a href="#">C02218/3</a>	<a href="#">C02218/4</a>
<a href="#">C00036</a>	DC braking: Current	50.00 %	<a href="#">C02219/1</a>	<a href="#">C02219/2</a>	<a href="#">C02219/3</a>	<a href="#">C02219/4</a>
<a href="#">C00070/1</a>	SLVC: Vp speed controller	15.00	<a href="#">C02220/1</a>	<a href="#">C02220/2</a>	<a href="#">C02220/3</a>	<a href="#">C02220/4</a>
<a href="#">C00070/2</a>	Reserved	6.00	<a href="#">C02220/5</a>	<a href="#">C02220/6</a>	<a href="#">C02220/7</a>	<a href="#">C02220/8</a>
<a href="#">C00070/3</a>	SLPSM: Vp speed controller	3.00	<a href="#">C02220/9</a>	<a href="#">C02220/10</a>	<a href="#">C02220/11</a>	<a href="#">C02220/12</a>
<a href="#">C00071/1</a>	SLVC: Ti speed controller	100.0 ms	<a href="#">C02221/1</a>	<a href="#">C02221/2</a>	<a href="#">C02221/3</a>	<a href="#">C02221/4</a>
<a href="#">C00071/2</a>	Reserved	50.0 ms	<a href="#">C02221/5</a>	<a href="#">C02221/6</a>	<a href="#">C02221/7</a>	<a href="#">C02221/8</a>
<a href="#">C00071/3</a>	SLPSM: Ti speed controller	100.0 ms	<a href="#">C02221/9</a>	<a href="#">C02221/10</a>	<a href="#">C02221/11</a>	<a href="#">C02221/12</a>
<a href="#">C00072</a>	SC: Tdn speed controller	0.00 ms	<a href="#">C02222/1</a>	<a href="#">C02222/2</a>	<a href="#">C02222/3</a>	<a href="#">C02222/4</a>
<a href="#">C00073/1</a>	VFC: Vp Imax controller	0.25	<a href="#">C02223/1</a>	<a href="#">C02223/2</a>	<a href="#">C02223/3</a>	<a href="#">C02223/4</a>
<a href="#">C00073/2</a>	SLVC: Vp torque controller	1.25	<a href="#">C02223/5</a>	<a href="#">C02223/6</a>	<a href="#">C02223/7</a>	<a href="#">C02223/8</a>
<a href="#">C00074/1</a>	VFC: Ti Imax controller	65 ms	<a href="#">C02224/1</a>	<a href="#">C02224/2</a>	<a href="#">C02224/3</a>	<a href="#">C02224/4</a>
<a href="#">C00074/2</a>	SLVC: Ti torque controller	30 ms	<a href="#">C02224/5</a>	<a href="#">C02224/6</a>	<a href="#">C02224/7</a>	<a href="#">C02224/8</a>
<a href="#">C00075</a>	Vp current controller	7.00 V/A	<a href="#">C02225/1</a>	<a href="#">C02225/2</a>	<a href="#">C02225/3</a>	<a href="#">C02225/4</a>
<a href="#">C00076</a>	Ti current controller	10.61 ms	<a href="#">C02226/1</a>	<a href="#">C02226/2</a>	<a href="#">C02226/3</a>	<a href="#">C02226/4</a>
<a href="#">C00079/1</a>	SC: Current controller - feedforward control	0	<a href="#">C02229/1</a>	<a href="#">C02229/2</a>	<a href="#">C02229/3</a>	<a href="#">C02229/4</a>
<a href="#">C00079/2</a>	SC: adapt. field weak. controller	1	<a href="#">C02229/5</a>	<a href="#">C02229/6</a>	<a href="#">C02229/7</a>	<a href="#">C02229/8</a>
<a href="#">C00079/3</a>	SC: n-Ctrl Anti-Wind-Up	0	<a href="#">C02229/9</a>	<a href="#">C02229/10</a>	<a href="#">C02229/11</a>	<a href="#">C02229/12</a>
<a href="#">C00080</a>	Override point of field weakening	0 Hz	<a href="#">C02230/1</a>	<a href="#">C02230/2</a>	<a href="#">C02230/3</a>	<a href="#">C02230/4</a>
<a href="#">C00081</a>	Rated motor power	11.00 kW	<a href="#">C02231/1</a>	<a href="#">C02231/2</a>	<a href="#">C02231/3</a>	<a href="#">C02231/4</a>
<a href="#">C00082</a>	Motor rotor resistance	276 mohm	<a href="#">C02232/1</a>	<a href="#">C02232/2</a>	<a href="#">C02232/3</a>	<a href="#">C02232/4</a>
<a href="#">C00084</a>	Motor stator resistance	330 mohm	<a href="#">C02233/1</a>	<a href="#">C02233/2</a>	<a href="#">C02233/3</a>	<a href="#">C02233/4</a>
<a href="#">C00085</a>	Motor stator leakage inductance	3.50 mH	<a href="#">C02234/1</a>	<a href="#">C02234/2</a>	<a href="#">C02234/3</a>	<a href="#">C02234/4</a>
<a href="#">C00087</a>	Rated motor speed	1460 rpm	<a href="#">C02236/1</a>	<a href="#">C02236/2</a>	<a href="#">C02236/3</a>	<a href="#">C02236/4</a>
<a href="#">C00088</a>	Rated motor current	21.00 A	<a href="#">C02237/1</a>	<a href="#">C02237/2</a>	<a href="#">C02237/3</a>	<a href="#">C02237/4</a>
<a href="#">C00089</a>	Rated motor frequency	50 Hz	<a href="#">C02238/1</a>	<a href="#">C02238/2</a>	<a href="#">C02238/3</a>	<a href="#">C02238/4</a>
<a href="#">C00090</a>	Rated motor voltage	400 V	<a href="#">C02239/1</a>	<a href="#">C02239/2</a>	<a href="#">C02239/3</a>	<a href="#">C02239/4</a>
<a href="#">C00091</a>	Motor cosine phi	0.85	<a href="#">C02240/1</a>	<a href="#">C02240/2</a>	<a href="#">C02240/3</a>	<a href="#">C02240/4</a>
<a href="#">C00092</a>	Motor magnetising inductance	81.0 mH	<a href="#">C02241/1</a>	<a href="#">C02241/2</a>	<a href="#">C02241/3</a>	<a href="#">C02241/4</a>
<a href="#">C00095</a>	Motor magnetising current	8.50 A	<a href="#">C02242/1</a>	<a href="#">C02242/2</a>	<a href="#">C02242/3</a>	<a href="#">C02242/4</a>
<a href="#">C00106</a>	Auto-DCB: Hold time	0.500 s	<a href="#">C02244/1</a>	<a href="#">C02244/2</a>	<a href="#">C02244/3</a>	<a href="#">C02244/4</a>
<a href="#">C00107</a>	DC braking: Hold time	999.000 s	<a href="#">C02245/1</a>	<a href="#">C02245/2</a>	<a href="#">C02245/3</a>	<a href="#">C02245/4</a>
<a href="#">C00120</a>	Setting of motor overload (I <sup>2</sup> xt)	100.00 %	<a href="#">C02246/1</a>	<a href="#">C02246/2</a>	<a href="#">C02246/3</a>	<a href="#">C02246/4</a>
<a href="#">C00234</a>	Oscillation damping influence	5.00 %	<a href="#">C02249/1</a>	<a href="#">C02249/2</a>	<a href="#">C02249/3</a>	<a href="#">C02249/4</a>

Code	Name	Lenze setting	1st value	2nd value	3rd value	4th value
<a href="#">C00235</a>	Oscillation damping filter time	32 ms	<a href="#">C02250/1</a>	<a href="#">C02250/2</a>	<a href="#">C02250/3</a>	<a href="#">C02250/4</a>
<a href="#">C00236</a>	Oscillation damping field weakening	14	<a href="#">C02251/1</a>	<a href="#">C02251/2</a>	<a href="#">C02251/3</a>	<a href="#">C02251/4</a>
<a href="#">C00273</a>	Motor moment of inertia	0.00 kg cm <sup>2</sup>	<a href="#">C02256/1</a>	<a href="#">C02256/2</a>	<a href="#">C02256/3</a>	<a href="#">C02256/4</a>
<a href="#">C00653/1</a>	Sensibility - Setpoint feedforward control	0	<a href="#">C02264/1</a>	<a href="#">C02264/2</a>	<a href="#">C02264/3</a>	<a href="#">C02264/4</a>
<a href="#">C00905</a>	Motor phase direction of rotation	0	<a href="#">C02272/1</a>	<a href="#">C02272/2</a>	<a href="#">C02272/3</a>	<a href="#">C02272/4</a>
<a href="#">C00909/1</a>	Max. pos. speed	120.00 %	<a href="#">C02273/1</a>	<a href="#">C02273/2</a>	<a href="#">C02273/3</a>	<a href="#">C02273/4</a>
<a href="#">C00909/2</a>	Max. neg. speed	120.00 %	<a href="#">C02273/5</a>	<a href="#">C02273/6</a>	<a href="#">C02273/7</a>	<a href="#">C02273/8</a>
<a href="#">C00910/1</a>	Max. pos. output frequency	1000 Hz	<a href="#">C02274/1</a>	<a href="#">C02274/2</a>	<a href="#">C02274/3</a>	<a href="#">C02274/4</a>
<a href="#">C00910/2</a>	Max. neg. output frequency	1000 Hz	<a href="#">C02274/5</a>	<a href="#">C02274/6</a>	<a href="#">C02274/7</a>	<a href="#">C02274/8</a>
<a href="#">C00915</a>	Motor cable length	5.0 m	<a href="#">C02275/1</a>	<a href="#">C02275/2</a>	<a href="#">C02275/3</a>	<a href="#">C02275/4</a>
<a href="#">C00916</a>	Motor cable cross-section	6.00 mm <sup>2</sup>	<a href="#">C02276/1</a>	<a href="#">C02276/2</a>	<a href="#">C02276/3</a>	<a href="#">C02276/4</a>
<a href="#">C00938</a>	PSM: Maximum motor current field weakening	30.00 %	<a href="#">C02278/1</a>	<a href="#">C02278/2</a>	<a href="#">C02278/3</a>	<a href="#">C02278/4</a>
<a href="#">C00939</a>	Ultimate motor current	3000.0 A	<a href="#">C02279/1</a>	<a href="#">C02279/2</a>	<a href="#">C02279/3</a>	<a href="#">C02279/4</a>
<a href="#">C00965</a>	Max. motor speed	60000 rpm	<a href="#">C02280/1</a>	<a href="#">C02280/2</a>	<a href="#">C02280/3</a>	<a href="#">C02280/4</a>
<a href="#">C00966</a>	VFC: Time const. slip comp.	100 ms	<a href="#">C02281/1</a>	<a href="#">C02281/2</a>	<a href="#">C02281/3</a>	<a href="#">C02281/4</a>
<a href="#">C00971/1</a>	VFC: Controller limitation V/f +encoder	10.00 Hz	<a href="#">C02284/1</a>	<a href="#">C02284/2</a>	<a href="#">C02284/3</a>	<a href="#">C02284/4</a>
<a href="#">C00971/2</a>	VFC: Slip limitation V/f +encoder	100.00 Hz	<a href="#">C02284/5</a>	<a href="#">C02284/6</a>	<a href="#">C02284/7</a>	<a href="#">C02284/8</a>
<a href="#">C00972</a>	VFC: Vp V/f +encoder	0.100 Hz/Hz	<a href="#">C02285/1</a>	<a href="#">C02285/2</a>	<a href="#">C02285/3</a>	<a href="#">C02285/4</a>
<a href="#">C00973</a>	VFC: Ti V/f +encoder	100.0 ms	<a href="#">C02286/1</a>	<a href="#">C02286/2</a>	<a href="#">C02286/3</a>	<a href="#">C02286/4</a>
<a href="#">C00975</a>	VFC-ECO: Vp CosPhi controller	0.500 Hz/Hz	<a href="#">C02287/1</a>	<a href="#">C02287/2</a>	<a href="#">C02287/3</a>	<a href="#">C02287/4</a>
<a href="#">C00976</a>	VFC-ECO: Ti CosPhi controller	200.0 ms	<a href="#">C02288/1</a>	<a href="#">C02288/2</a>	<a href="#">C02288/3</a>	<a href="#">C02288/4</a>
<a href="#">C00977</a>	VFC-ECO: Minimum voltage V/f	20.00 %	<a href="#">C02289/1</a>	<a href="#">C02289/2</a>	<a href="#">C02289/3</a>	<a href="#">C02289/4</a>
<a href="#">C00982</a>	VFC-ECO: Voltage reduction ramp	0.8 s	<a href="#">C02290/1</a>	<a href="#">C02290/2</a>	<a href="#">C02290/3</a>	<a href="#">C02290/4</a>
<a href="#">C00985</a>	SLVC: Gain of field current controller	0.50 %	<a href="#">C02291/1</a>	<a href="#">C02291/2</a>	<a href="#">C02291/3</a>	<a href="#">C02291/4</a>
<a href="#">C00986</a>	SLVC: Gain of cross current controller	0.00 %	<a href="#">C02292/1</a>	<a href="#">C02292/2</a>	<a href="#">C02292/3</a>	<a href="#">C02292/4</a>
<a href="#">C00987</a>	Inverter motor brake: nAdd	80 rpm	<a href="#">C02293/1</a>	<a href="#">C02293/2</a>	<a href="#">C02293/3</a>	<a href="#">C02293/4</a>
<a href="#">C00988</a>	Inverter motor brake: PT1 filter time	0.0 ms	<a href="#">C02294/1</a>	<a href="#">C02294/2</a>	<a href="#">C02294/3</a>	<a href="#">C02294/4</a>
<a href="#">C00990</a>	Flying restart fct.: Activate	0	<a href="#">C02295/1</a>	<a href="#">C02295/2</a>	<a href="#">C02295/3</a>	<a href="#">C02295/4</a>
<a href="#">C00991</a>	Flying restart fct.: Process	2	<a href="#">C02296/1</a>	<a href="#">C02296/2</a>	<a href="#">C02296/3</a>	<a href="#">C02296/4</a>
<a href="#">C00992</a>	Flying restart: Start frequency	10 Hz	<a href="#">C02297/1</a>	<a href="#">C02297/2</a>	<a href="#">C02297/3</a>	<a href="#">C02297/4</a>
<a href="#">C00993</a>	Flying restart: Integration time	300.0 ms	<a href="#">C02298/1</a>	<a href="#">C02298/2</a>	<a href="#">C02298/3</a>	<a href="#">C02298/4</a>
<a href="#">C00994</a>	Flying restart: Current	25.00 %	<a href="#">C02299/1</a>	<a href="#">C02299/2</a>	<a href="#">C02299/3</a>	<a href="#">C02299/4</a>
<a href="#">C00995/1</a>	SLPSM: Controlled accelerating current	100.00 %	<a href="#">C02300/1</a>	<a href="#">C02300/2</a>	<a href="#">C02300/3</a>	<a href="#">C02300/4</a>
<a href="#">C00995/2</a>	SLPSM: Controlled standstill current	20.00 %	<a href="#">C02300/5</a>	<a href="#">C02300/6</a>	<a href="#">C02300/7</a>	<a href="#">C02300/8</a>
<a href="#">C00996/1</a>	SLPSM: Switching speed, closed-loop control	13.00 %	<a href="#">C02301/1</a>	<a href="#">C02301/2</a>	<a href="#">C02301/3</a>	<a href="#">C02301/4</a>
<a href="#">C00996/2</a>	SLPSM: Switching speed, open-loop control	8.00 %	<a href="#">C02301/5</a>	<a href="#">C02301/6</a>	<a href="#">C02301/7</a>	<a href="#">C02301/8</a>
<a href="#">C00997</a>	SLPSM: Filter cutoff frequency	5.00 %	<a href="#">C02302/1</a>	<a href="#">C02302/2</a>	<a href="#">C02302/3</a>	<a href="#">C02302/4</a>
<a href="#">C00998/1</a>	SLPSM: Filter time rotor position	3.0 ms	<a href="#">C02303/1</a>	<a href="#">C02303/2</a>	<a href="#">C02303/3</a>	<a href="#">C02303/4</a>
<a href="#">C00998/2</a>	SLPSM: Filter time actual speed value	5.0 ms	<a href="#">C02303/5</a>	<a href="#">C02303/6</a>	<a href="#">C02303/7</a>	<a href="#">C02303/8</a>
<a href="#">C00999</a>	SLPSM: PLL gain	400 %	<a href="#">C02304/1</a>	<a href="#">C02304/2</a>	<a href="#">C02304/3</a>	<a href="#">C02304/4</a>
<a href="#">C01001/1</a>	Manual entry of motor type	0	<a href="#">C02315/1</a>	<a href="#">C02315/2</a>	<a href="#">C02315/3</a>	<a href="#">C02315/4</a>
<a href="#">C02853/1</a>	PSM: Lss saturation characteristic	100 %	<a href="#">C02305/1</a>	<a href="#">C02305/2</a>	<a href="#">C02305/3</a>	<a href="#">C02305/4</a>
<a href="#">C02853/2</a>	PSM: Lss saturation characteristic	100 %	<a href="#">C02305/5</a>	<a href="#">C02305/6</a>	<a href="#">C02305/7</a>	<a href="#">C02305/8</a>
<a href="#">C02853/3</a>	PSM: Lss saturation characteristic	100 %	<a href="#">C02305/9</a>	<a href="#">C02305/10</a>	<a href="#">C02305/11</a>	<a href="#">C02305/12</a>
<a href="#">C02853/4</a>	PSM: Lss saturation characteristic	100 %	<a href="#">C02305/13</a>	<a href="#">C02305/14</a>	<a href="#">C02305/15</a>	<a href="#">C02305/16</a>
<a href="#">C02853/5</a>	PSM: Lss saturation characteristic	100 %	<a href="#">C02305/17</a>	<a href="#">C02305/18</a>	<a href="#">C02305/19</a>	<a href="#">C02305/20</a>
<a href="#">C02853/6</a>	PSM: Lss saturation characteristic	100 %	<a href="#">C02305/21</a>	<a href="#">C02305/22</a>	<a href="#">C02305/23</a>	<a href="#">C02305/24</a>
<a href="#">C02853/7</a>	PSM: Lss saturation characteristic	100 %	<a href="#">C02305/25</a>	<a href="#">C02305/26</a>	<a href="#">C02305/27</a>	<a href="#">C02305/28</a>
<a href="#">C02853/8</a>	PSM: Lss saturation characteristic	100 %	<a href="#">C02305/29</a>	<a href="#">C02305/30</a>	<a href="#">C02305/31</a>	<a href="#">C02305/32</a>
<a href="#">C02853/9</a>	PSM: Lss saturation characteristic	100 %	<a href="#">C02305/33</a>	<a href="#">C02305/34</a>	<a href="#">C02305/35</a>	<a href="#">C02305/36</a>
<a href="#">C02853/10</a>	PSM: Lss saturation characteristic	100 %	<a href="#">C02305/37</a>	<a href="#">C02305/38</a>	<a href="#">C02305/39</a>	<a href="#">C02305/40</a>
<a href="#">C02853/11</a>	PSM: Lss saturation characteristic	100 %	<a href="#">C02305/41</a>	<a href="#">C02305/42</a>	<a href="#">C02305/43</a>	<a href="#">C02305/44</a>

Code	Name	Lenze setting	1st value	2nd value	3rd value	4th value
<a href="#">C02853/12</a>	PSM: Lss saturation characteristic	100 %	<a href="#">C02305/45</a>	<a href="#">C02305/46</a>	<a href="#">C02305/47</a>	<a href="#">C02305/48</a>
<a href="#">C02853/13</a>	PSM: Lss saturation characteristic	100 %	<a href="#">C02305/49</a>	<a href="#">C02305/50</a>	<a href="#">C02305/51</a>	<a href="#">C02305/52</a>
<a href="#">C02853/14</a>	PSM: Lss saturation characteristic	100 %	<a href="#">C02305/53</a>	<a href="#">C02305/54</a>	<a href="#">C02305/55</a>	<a href="#">C02305/56</a>
<a href="#">C02853/15</a>	PSM: Lss saturation characteristic	100 %	<a href="#">C02305/57</a>	<a href="#">C02305/58</a>	<a href="#">C02305/59</a>	<a href="#">C02305/60</a>
<a href="#">C02853/16</a>	PSM: Lss saturation characteristic	100 %	<a href="#">C02305/61</a>	<a href="#">C02305/62</a>	<a href="#">C02305/63</a>	<a href="#">C02305/64</a>
<a href="#">C02853/17</a>	PSM: Lss saturation characteristic	100 %	<a href="#">C02305/65</a>	<a href="#">C02305/66</a>	<a href="#">C02305/67</a>	<a href="#">C02305/68</a>
<a href="#">C02855</a>	PSM: I <sub>max</sub> Lss saturation characteristic	3000.0 A	<a href="#">C02306/1</a>	<a href="#">C02306/2</a>	<a href="#">C02306/3</a>	<a href="#">C02306/4</a>
<a href="#">C02859</a>	PSM: Activate Ppp saturation char.	0	<a href="#">C02307/1</a>	<a href="#">C02307/2</a>	<a href="#">C02307/3</a>	<a href="#">C02307/4</a>
<a href="#">C02872/1</a>	PLI without movement: adaptation of time duration	0	<a href="#">C02311/1</a>	<a href="#">C02311/2</a>	<a href="#">C02311/3</a>	<a href="#">C02311/4</a>
<a href="#">C02874/1</a>	PLI without movement	0x0001	<a href="#">C02312/1</a>	<a href="#">C02312/2</a>	<a href="#">C02312/3</a>	<a href="#">C02312/4</a>
<a href="#">C02875/1</a>	PLI without movement: adaptation of ident angle	0 °	<a href="#">C02313/1</a>	<a href="#">C02313/2</a>	<a href="#">C02313/3</a>	<a href="#">C02313/4</a>

14.4 Internal interfaces | System block "LS\_WriteParamList"

The LS\_WriteParamList system block provides the internal interfaces for the basic "Parameter change-over" function.



**Note!**

The "parameter change-over" basic function is always processed, even if the LS\_WriteParamList system block has been removed from the interconnection by the FB Editor.

If you do not require this basic function anymore, delete the composed parameter list in order that no unwanted parameter write operations take place.

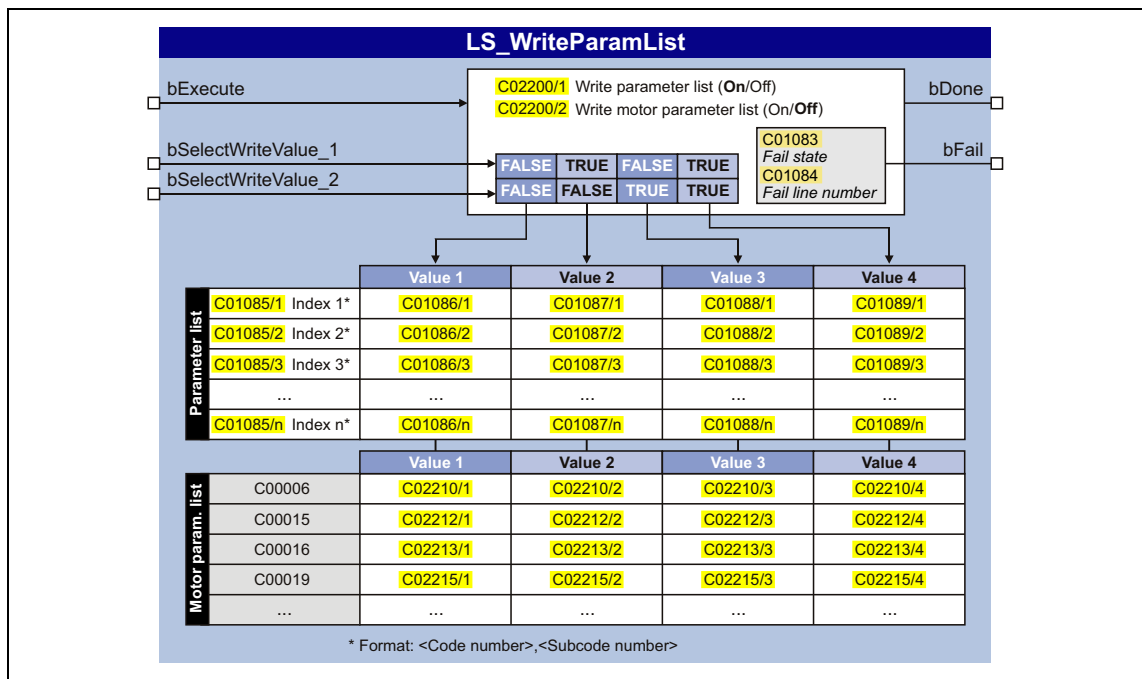

**inputs**

Designator	Data type	Information/possible settings															
bExecute	BOOL	FALSE → TRUE For Execute Mode (C01082) = "0: by Execute": Activate writing of the parameter list															
bSelectWriteValue_1 bSelectWriteValue_2	BOOL	Binary coded selection of the value set 1 ... 4 to be used.															
		<table border="1"> <thead> <tr> <th>bSelectWrite Value_1</th> <th>bSelectWrite Value_2</th> <th></th> </tr> </thead> <tbody> <tr> <td>FALSE</td> <td>FALSE</td> <td>Value set 1</td> </tr> <tr> <td>TRUE</td> <td>FALSE</td> <td>Value set 2</td> </tr> <tr> <td>FALSE</td> <td>TRUE</td> <td>Value set 3</td> </tr> <tr> <td>TRUE</td> <td>TRUE</td> <td>Value set 4</td> </tr> </tbody> </table>	bSelectWrite Value_1	bSelectWrite Value_2		FALSE	FALSE	Value set 1	TRUE	FALSE	Value set 2	FALSE	TRUE	Value set 3	TRUE	TRUE	Value set 4
bSelectWrite Value_1	bSelectWrite Value_2																
FALSE	FALSE	Value set 1															
TRUE	FALSE	Value set 2															
FALSE	TRUE	Value set 3															
TRUE	TRUE	Value set 4															



**outputs**

Designator	Data type	Value/meaning	
bDone	BOOL	"Writing of the parameter list completed" status signal <ul style="list-style-type: none"> <li>The output is automatically reset to FALSE if writing via <i>bExecute</i> is activated again.</li> </ul>	
		TRUE	Writing of the parameter list successfully completed.
		FALSE	The FALSE status can have the following meanings: <ol style="list-style-type: none"> <li>There is no active writing of the parameter list.</li> <li>Writing of the parameter list has not been completed yet.</li> <li>An error has occurred (if <i>bFail</i> = TRUE).</li> </ol>
bFail	BOOL	"Error" status	
		TRUE	An error has occurred (group signal). <ul style="list-style-type: none"> <li>See display parameter <a href="#">(C01083)</a> for details.</li> </ul>



### 15 Parameter reference

This chapter describes all parameters which can be used for parameterising and monitoring the inverter.

---

Parameters which are only available in the inverter from a certain software version onwards are marked with a corresponding note in the parameter description ("from version xx.xx.xx").

The parameter descriptions are based on software version V21.00.00

---



#### Tip!

For quick reference of a parameter with a certain name simply use the **index** of the online documentation. The index always contains the corresponding code in parentheses behind the name.

General information on parameter setting can be found in the chapter "[Introduction: Parameterising the inverter](#)". (📖 24)

For general information on how to read and change parameters, please see the online documentation for the »Engineer«.

## 15.1 Structure of the parameter descriptions

Each parameter is described in the [Parameter list](#) in the form of a table which consists of the following three areas:

### Table header

The table header contains the following general information:

- Parameter number (Cxxxxx)
- Parameter name (display text in the »Engineer« and keypad)
- [Data type](#)
- Parameter index in decimal and hexadecimal notation for access via a fieldbus (e.g. CAN system bus).



### Tip!

The parameter index is calculated as follows:

- Index [dec] = 24575 - code
- Index [hex] = 0x5FFF - code

Example for code C00005:

- Index [dec] = 24575 - 5 = 24570
- Index [hex] = 0x5FFF - 0x{5} = 0x5FFA

### Table contents

The table contains further general explanations & notes on the parameter and the possible settings, which are represented in different ways depending on the parameter type:

- [Parameters with read-only access](#)
- [Parameters with write access](#)

### Table footer

The table footer contains the [Parameter attributes](#).

### 15.1.1 Data type

The following data types are available for parameters:

Data type	Meaning
INTEGER_16	16-bit value with sign
INTEGER_32	32-bit value with sign
UNSIGNED_8	8-bit value without sign
UNSIGNED_16	16-bit value without sign
UNSIGNED_32	32-bit value without sign
VISIBLE_STRING	String of characters of printable characters

### 15.1.2 Parameters with read-only access

Parameters for which the "write access" attribute has not been set can only be read and not be changed by the user.

#### Description structure

Parameter Name: Cxxxxx   _____	Data type: _____ Index: _____
Description	
Display range (min. value   unit   max. value)	
<input checked="" type="checkbox"/> Read access <input type="checkbox"/> Write access <input type="checkbox"/> CINH <input type="checkbox"/> PLC STOP <input type="checkbox"/> No transfer <input type="checkbox"/> COM <input type="checkbox"/> MOT           Scaling factor: 1	

#### Representation in the »Engineer«

The »Engineer« displays these parameters with a grey background or, with an online connection, with a pale-yellow background:

Icon	C...	S	Name	Value	Unit
	3	0	Status of last device command	Successful	

# 15 Parameter reference

## 15.1 Structure of the parameter descriptions

### 15.1.3 Parameters with write access

Only parameters with a check mark (☑) in front of the "write access" attribute can be changed by the user. The Lenze setting for these parameters is **printed in bold**.

- The settings can either be selected from a selection list or the values can be entered directly.
- Values outside the valid setting range are represented in red in the »Engineer«.

#### 15.1.3.1 Parameters with setting range

##### Description structure

Parameter   Name: Cxxxxx   _____	Data type: _____ Index: _____
Description	
<b>Setting range (min. value   unit   max. value)</b>	<b>Lenze setting</b>
<input checked="" type="checkbox"/> Read access <input checked="" type="checkbox"/> Write access <input type="checkbox"/> CINH <input type="checkbox"/> PLC STOP <input type="checkbox"/> No transfer <input type="checkbox"/> COM <input type="checkbox"/> MOT    Scaling factor: 1	

##### Parameter setting in the »Engineer«

In the »Engineer«, parameters are set by entering the desired value into the input field:

C... / S	Name	Value	Unit
11 0	Appl.: Reference speed	1500	rpm

#### 15.1.3.2 Parameters with selection list

##### Description structure

Parameter   Name: Cxxxxx   _____	Data type: _____ Index: _____
Description	
<b>Selection list(Lenze setting printed in bold)</b>	
<b>1</b>	
2	
3	
<input checked="" type="checkbox"/> Read access <input checked="" type="checkbox"/> Write access <input type="checkbox"/> CINH <input type="checkbox"/> PLC STOP <input type="checkbox"/> No transfer <input type="checkbox"/> COM <input type="checkbox"/> MOT    Scaling factor: 1	

**Parameter setting in the »Engineer«**

In the »Engineer«, a list field is used for parameter setting:

	C...	S	Name	Value	Unit
	173	0	Mains voltage	0: 3ph 400V / 1ph 230V	

0: 3ph 400V / 1ph 230V

1: 3ph 440V / 1ph 230V

2: 3ph 480V / 1ph 230V

3: 3ph 500V / 1ph 230V

4: 3ph 400V / 1ph 115V

**15.1.3.3 Parameters with bit-coded setting**

**Description structure**

Parameter Name: Cxxxxx   _____	Data type: _____ Index: _____
Description	
<b>Value is bit-coded:</b>	
Bit 0	
...	
Bit 31	
<input checked="" type="checkbox"/> Read access <input checked="" type="checkbox"/> Write access <input type="checkbox"/> CINH <input type="checkbox"/> PLC STOP <input type="checkbox"/> No transfer <input type="checkbox"/> COM <input type="checkbox"/> MOT                   Scaling factor: 1	

**Parameter setting in the »Engineer«**

The »Engineer« uses a dialog box for parameter setting in which the individual bits can be set or reset. Alternatively, the value can be entered as a decimal or hexadecimal value:

**L\_SignalMonitor\_b: Inversion**

Value

Decimal: 0      Hexadecimal: 0x0

Bit	Comment
<input type="checkbox"/> 0	bOut1 inverted
<input type="checkbox"/> 1	bOut2 inverted
<input type="checkbox"/> 2	bOut3 inverted
<input type="checkbox"/> 3	bOut4 inverted
<input type="checkbox"/> 4	Reserved
<input type="checkbox"/> 5	Reserved
<input type="checkbox"/> 6	Reserved
<input type="checkbox"/> 7	Reserved

OK      Cancel

### 15.1.3.4 Parameters with subcodes

#### Description structure

Parameter   Name: Cxxxxx   _____		Data type: _____ Index: _____
Description		
Setting range (min. value   unit   max. value)		
<b>Subcodes</b>	<b>Lenze setting</b>	
Cxxxxx/1		
Cxxxxx/2		
Cxxxxx/3		
Cxxxxx/4		
<input checked="" type="checkbox"/> Read access <input checked="" type="checkbox"/> Write access <input type="checkbox"/> CINH <input type="checkbox"/> PLC STOP <input type="checkbox"/> No transfer <input type="checkbox"/> COM <input type="checkbox"/> MOT           Scaling factor: 1		

#### Parameter setting in the »Engineer«

The »Engineer« parameter list displays each subcode individually. The parameters are set as described in the previous chapters.

	C...	S	Name	Value	Unit
	39	1	Fixed setpoint 1	40.00	%
	39	2	Fixed setpoint 2	60.00	%
	39	3	Fixed setpoint 3	80.00	%
	39	4	Fixed setpoint 4	0.00	%

### 15.1.4 Parameter attributes

The table footers contain the parameter attributes:

<input checked="" type="checkbox"/> Read access <input checked="" type="checkbox"/> Write access <input type="checkbox"/> CINH <input type="checkbox"/> PLC STOP <input type="checkbox"/> No transfer <input type="checkbox"/> COM <input type="checkbox"/> MOT           Scaling factor: 1
---

Attribute	Meaning
<input checked="" type="checkbox"/> Read access	Read access to parameter possible.
<input checked="" type="checkbox"/> Write access	Write access to parameter possible. • Please also observe the following attributes:
	<input checked="" type="checkbox"/> CINH      Parameter value can only be changed when the controller is inhibited.
	<input checked="" type="checkbox"/> PLC STOP      Parameter value can only be changed when the application is stopped.
<input checked="" type="checkbox"/> No transfer	Parameter is <b>not</b> transferred to inverter when the command <u>Download parameter set</u> is executed.
<input checked="" type="checkbox"/> COM	Communication-relevant parameter • This parameter is relevant for parameter data transfer via the (CAN) system bus.
<input checked="" type="checkbox"/> MOT	Motor control parameters



### Scaling factor

The "scaling factor" is important for parameter access via a bus system.

Signal type	Scaling factor	Resolution	Value range
Analog (scaled)	100	16 bits signed	± 199.99 %
Angular velocity	1	16 bits signed	± 32767 incr./ms
Position in [units]	10000	32 bits signed	± 214748.3647 [units]
Digital (BOOL)	1	8 bits unsigned	0 ≡ FALSE; 1 ≡ TRUE
Time	1000	16 bits unsigned	0 ... 999.000 s
Selection value	1	16 bits unsigned	0 ... 65535

**Example 1:** The value "654" of the parameter [C00028/1](#) (AIN1: input voltage) read via a bus system must be divided by the corresponding scaling factor "100" to obtain the actual display value "6.54 V".

$$\frac{\text{Read value (via bus system)}}{\text{Scaling factor}} = \text{Indicated value (Engineer)}$$

[15-1] Conversion formula for read access via bus system

**Example 2:** In order to set the parameter [C00012](#) (acceleration time main setpoint) to the value "123.45 %" via a bus system, the integer value "12345" must be transferred, i.e. the value to be set must be multiplied by the corresponding scaling factor "100".

$$\text{Value to be written (via bus system)} = \text{Value to be set} \cdot \text{Scaling factor}$$

[15-2] Conversion formula for write access via bus system

### Character length

In case of parameters of "VISIBLE\_STRING" data type, the character length is given in addition. This is also important for the parameter access via a bus system.

## 15.2 Parameter list

This chapter lists all parameters of the operating system in numerically ascending order.



### Note!

The parameter descriptions are based on software version V21.00.00.

### C00001

Parameter   Name: <b>C00001   Keypad Userlevel</b>		Data type: UNSIGNED_8 Index: 24574 <sub>d</sub> = 5FFE <sub>h</sub>
<p>From version 12.00.00 onwards, the extent of menus, submenus and codes shown in the keypad can be adapted by selecting the "userlevel".</p> <ul style="list-style-type: none"> <li>When the userlevel has been changed, the menus of the keypad will be reconfigured according to the selected user level.</li> <li>Independently of the set userlevel, the parameters of the attached communication module will always be displayed completely.</li> </ul>		
Selection list		Info
10	Standard	Only the most important menus and codes are displayed on the keypad.
20	Expert	All menus and codes are displayed on the keypad.
30	Service	Only for servicing purposes (Lenze service).
Subcodes	Lenze setting	Info
C00001/1	10: Standard	Keypad UserLevel
<input checked="" type="checkbox"/> Read access <input checked="" type="checkbox"/> Write access <input type="checkbox"/> CINH <input type="checkbox"/> PLC STOP <input type="checkbox"/> No transfer <input type="checkbox"/> COM <input type="checkbox"/> MOT           Scaling factor: 1		

### C00002

Parameter   Name: <b>C00002   Device command</b>		Data type: UNSIGNED_8 Index: 24573 <sub>d</sub> = 5FFD <sub>h</sub>
<p><b>Note:</b></p> <ul style="list-style-type: none"> <li>Before switching off the supply voltage after a device command has been executed, check the successful execution of the device command via the status display in <a href="#">C00003</a>!</li> <li>Before activating device commands by a master control, wait for the "Ready" signal of the inverter.</li> <li>The device will reject a write process to C00002/x if the value is &gt;1 and issue an error message.</li> </ul> <p style="text-align: right;">▶ <a href="#">Drive control (DCTRL): Device commands</a></p>		
Selection list		Info
0	Off / ready	
1	On / start	
4	Action cancelled	
5	No access	
6	No access controller inhibit	
20	20% working	
40	40% working	
60	60% working	
80	80% working	
Subcodes	Lenze setting	Info

Parameter   Name: <b>C00002   Device command</b>		Data type: UNSIGNED 8 Index: 24573 <sub>d</sub> = 5FFD <sub>h</sub>
C00002/1	0: Off / ready	Load Lenze setting <ul style="list-style-type: none"> <li>• All parameters are reset to the Lenze setting.</li> <li>• Only possible when the controller is inhibited.</li> </ul> ▶ <a href="#">Load Lenze setting</a>
C00002/2	0: Off / ready	Reserved
C00002/3	0: Off / ready	Reserved
C00002/4	0: Off / ready	Reserved
C00002/5	0: Off / ready	Reserved
C00002/6	0: Off / ready	Load all parameter sets <ul style="list-style-type: none"> <li>• All parameter sets are loaded by the memory module.</li> <li>• Only possible when the controller is inhibited.</li> </ul> ▶ <a href="#">Load all parameter sets</a>
C00002/7	0: Off / ready	Reserved
C00002/8	0: Off / ready	Reserved
C00002/9	0: Off / ready	Reserved
C00002/10	0: Off / ready	Save oscilloscope configuration
C00002/11	0: Off / ready	Save all parameter sets <ul style="list-style-type: none"> <li>• All parameter sets are saved to the memory module safe against mains failure.</li> </ul> ▶ <a href="#">Save all parameter sets</a>
C00002/12	0: Off / ready	Reserved
C00002/13	0: Off / ready	Reserved
C00002/14	0: Off / ready	Reserved
C00002/15	0: Off / ready	Reserved
C00002/16	1: On / start	Enable inverter <ul style="list-style-type: none"> <li>1 ≡ Enable inverter</li> <li>0 ≡ Inhibit inverter</li> </ul> ▶ <a href="#">Enable/inhibit inverter</a>
C00002/17	0: Off / ready	Activate quick stop <ul style="list-style-type: none"> <li>1 ≡ Activate quick stop</li> <li>0 ≡ Deactivate quick stop</li> </ul> ▶ <a href="#">Activate/deactivate quick stop</a>
C00002/18	0: Off / ready	Reserved
C00002/19	0: Off / ready	Reset error <ul style="list-style-type: none"> <li>• After the reset (acknowledgement) of the current error, further errors may be pending which must also be reset.</li> <li>• The status determining error is displayed in <a href="#">C00168</a>.</li> <li>• The current error is displayed in <a href="#">C00170</a>.</li> </ul> ▶ <a href="#">Error messages of the operating system</a>
C00002/20	0: Off / ready	Reserved
C00002/21	0: Off / ready	Delete logbook <ul style="list-style-type: none"> <li>• All entries in the logbook of the inverter are deleted.</li> <li>• In the logbook, information on the error history is saved.</li> </ul> ▶ <a href="#">Logbook</a>
C00002/22	0: Off / ready	Reserved

Parameter   Name: <b>C00002   Device command</b>		Data type: UNSIGNED 8 Index: 24573 <sub>d</sub> = 5FFD <sub>h</sub>
C00002/23	0: Off / ready	Identify motor parameters <ul style="list-style-type: none"> <li>• This device command serves to carry out automatic motor parameter identification.</li> <li>• The device command is only executed when the inverter is in the "SwitchedOn" status.</li> <li>• In order to identify the motor parameters, the inverter must be enabled after this device command.</li> <li>• From version 10.00.00 onwards, the identification mode can be selected in <a href="#">C02867</a>.</li> </ul> ▶ <a href="#">Automatic motor parameter identification</a>
C00002/24	0: Off / ready	Reserved
C00002/25	0: Off / ready	Reserved
C00002/26	0: Off / ready	CAN reset node <ul style="list-style-type: none"> <li>• Reinitialise "CAN on board" interface.</li> <li>• Required when changing the baud rate, node address, or identifiers.</li> </ul> ▶ <a href="#">"CAN on board" system bus</a>
C00002/27	0: Off / ready	Device search function <ul style="list-style-type: none"> <li>• From version 06.00.00</li> <li>• This device command serves to optically locate an inverter connected online (e.g. for maintenance work).</li> </ul> ▶ <a href="#">Device search function</a>
C00002/28	0: Off / ready	Check MasterPin <ul style="list-style-type: none"> <li>• From version 06.00.00</li> </ul> ▶ <a href="#">Unlocking the inverter with a MasterPin</a>
C00002/29	0: Off / ready	Set binding ID <ul style="list-style-type: none"> <li>• From version 06.00.00</li> </ul> ▶ <a href="#">Device personalisation</a>
C00002/30	0: Off / ready	Delete binding ID <ul style="list-style-type: none"> <li>• From version 06.00.00</li> </ul> ▶ <a href="#">Device personalisation</a>
C00002/31	0: Off / ready	Set password <ul style="list-style-type: none"> <li>• From version 06.00.00</li> </ul> ▶ <a href="#">Password protection</a>
C00002/32	0: Off / ready	Check password <ul style="list-style-type: none"> <li>• From version 06.00.00</li> </ul> ▶ <a href="#">Password protection</a>
C00002/33	0: Off / ready	Delete password <ul style="list-style-type: none"> <li>• From version 06.00.00</li> </ul> ▶ <a href="#">Password protection</a>
<input checked="" type="checkbox"/> Read access <input checked="" type="checkbox"/> Write access <input type="checkbox"/> CINH <input type="checkbox"/> PLC STOP <input checked="" type="checkbox"/> No transfer <input type="checkbox"/> COM <input type="checkbox"/> MOT   Scaling factor: 1		

## C00003

Parameter   Name: <b>C00003   Status of last device command</b>		Data type: UNSIGNED_8 Index: 24572 <sub>d</sub> = 5FFC <sub>h</sub>
Status of the device command executed last ( <a href="#">C00002</a> ).		
<b>Note:</b> Before switching off the supply voltage after carrying out a device command, check whether the device command has been carried out successfully via the status display! <a href="#">▶ Drive control (DCTRL): Device commands</a>		
Selection list (read only)	Info	
0	Successful	Device command has been executed successfully.
1	Command unknown	Device command implausible or unknown to the system.
2	Password protection	Unauthorised access for requested device command. <a href="#">▶ Password protection</a>
3	Time-out	Device command could not be processed in the defined time (timeout).
4	System fault	
5	Command server assigned	
6	Controller inhibit required	
7	unexpected controller inhibit	
10	Memory module binding error	<a href="#">▶ Device personalisation</a>
11	Password too short	<a href="#">▶ Password protection</a>
12	Wrong password	
13	Password already set	
14	Password not assigned	
15	Incorrect checksum	
30	Incorrect pole position identification	
31	Pole position identification started without encoder	
<input checked="" type="checkbox"/> Read access <input type="checkbox"/> Write access <input type="checkbox"/> CINH <input type="checkbox"/> PLC STOP <input checked="" type="checkbox"/> No transfer <input type="checkbox"/> COM <input type="checkbox"/> MOT Scaling factor: 1		

## C00005

Parameter   Name: <b>C00005   Application</b>		Data type: UNSIGNED_16 Index: 24570 <sub>d</sub> = 5FFA <sub>h</sub>
Selection of the technology application		
Selection list (Lenze setting printed in bold)	Info	

Parameter   Name: <b>C00005   Application</b>		Data type: UNSIGNED_16 Index: 24570 <sub>d</sub> = 5FFA <sub>h</sub>
0	Wiring has changed	This display appears if the FB interconnection has been changed in the application level using the FB Editor.
1000	<b>Actuating drive speed</b>	This technology application is used to solve speed-controlled drive tasks, e.g. conveying belts. ▶ <a href="#">TA "Speed actuating drive"</a>
1100	Actuating drive speed (AC Drive Profile)	<b>From version 13.00.00</b> This technology application is used to solve speed-controlled drive tasks, e.g. conveying belts. The process data word received by the master control is interpreted as "AC Drive Profile" control word. ▶ <a href="#">TA "Actuating drive speed (AC Drive Profile)"</a>
3000	Switch-off positioning	<b>From version 04.00.00</b> This technology application is used to solve speed-controlled drive tasks which require a pre-switch off or stopping at certain positions, e.g. roller conveyors and conveying belts. This is implemented by connecting switch-off sensors. ▶ <a href="#">TA "Switch-off positioning"</a>
<input checked="" type="checkbox"/> Read access <input checked="" type="checkbox"/> Write access <input type="checkbox"/> CINH <input type="checkbox"/> PLC STOP <input type="checkbox"/> No transfer <input type="checkbox"/> COM <input type="checkbox"/> MOT             Scaling factor: 1		

**C00006**

Parameter   Name: <b>C00006   Motor control</b>		Data type: UNSIGNED_8 Index: 24569 <sub>d</sub> = 5FF9 <sub>h</sub>
Selection of the motor control mode		▶ <a href="#">Motor control (MCTRL): Select control mode</a>
Selection list (Lenze setting printed in bold)	Info	
3	<b>SLPSM: Sensorless PSM</b>	<b>From version 10.00.00</b> This control type is used for the sensorless control of a synchronous motor. ▶ <a href="#">Sensorless control for synchronous motors</a>
4	<b>SLVC: Vector control</b>	This control type is used for sensorless vector control of an asynchronous motor. • The control type requires motor parameters to be set as exactly as possible! ▶ <a href="#">Sensorless vector control</a>
6	<b>VFCplus: V/f linear</b>	This control type is used for the speed control of an asynchronous motor via a linear V/f characteristic and is the simplest control type. • For setting the V/f characteristic, only the rated frequency ( <a href="#">C00089</a> ) and the rated voltage ( <a href="#">C00090</a> ) of the motor have to be entered. ▶ <a href="#">V/f characteristic control</a>
7	<b>VFCplus: V/f linear + encoder</b>	This control type is used for speed control of an asynchronous motor via a linear V/f characteristic. • The control type requires a speed feedback via an encoder mounted to the motor! • For setting the V/f characteristic, only the rated frequency ( <a href="#">C00089</a> ) and the rated voltage ( <a href="#">C00090</a> ) of the motor have to be entered. ▶ <a href="#">V/f control</a>
8	<b>VFCplus: V/f quadr</b>	This control type is used for speed control of an asynchronous motor via a square-law V/f characteristic. • For setting the V/f characteristic, only the rated frequency ( <a href="#">C00089</a> ) and the rated voltage ( <a href="#">C00090</a> ) of the motor have to be entered. ▶ <a href="#">V/f characteristic control</a>

Parameter   Name: <b>C00006   Motor control</b>		Data type: UNSIGNED_8 Index: 24569 <sub>d</sub> = 5FF9 <sub>h</sub>
9	VFCplus: V/f quadr + encoder	This control type is used for speed control of an asynchronous motor via a square-law V/f characteristic. <ul style="list-style-type: none"> <li>The control type requires a speed feedback via an encoder mounted to the motor!</li> <li>For setting the V/f characteristic, only the rated frequency (<a href="#">C00089</a>) and the rated voltage (<a href="#">C00090</a>) of the motor have to be entered.</li> </ul> <p>► <a href="#">V/f control</a></p>
10	VFCplus: V/f definable	<b>From version 04.00.00</b> This type of control is used for the speed control of an asynchronous motor via a user-definable characteristic with several interpolation points. <ul style="list-style-type: none"> <li>For setting the V/f characteristic, only the rated frequency (<a href="#">C00089</a>) and the rated voltage (<a href="#">C00090</a>) of the motor have to be entered.</li> </ul> <p>► <a href="#">V/f characteristic control</a></p>
11	VFCplusEco: V/f energy-saving	<b>From version 10.00.00</b> This control type is used for energy-saving speed control of an asynchronous motor via a linear V/f characteristic. <ul style="list-style-type: none"> <li>For setting the V/f characteristic, only the rated frequency (<a href="#">C00089</a>) and the rated voltage (<a href="#">C00090</a>) of the motor have to be entered.</li> <li>Predestinated application areas of this control type are materials handling technology and pump and fan systems.</li> </ul> <p>► <a href="#">V/f characteristic control, energy-saving</a></p>
<input checked="" type="checkbox"/> Read access <input checked="" type="checkbox"/> Write access <input type="checkbox"/> CINH <input type="checkbox"/> PLC STOP <input type="checkbox"/> No transfer <input type="checkbox"/> COM <input checked="" type="checkbox"/> MOT   Scaling factor: 1		

**C00007**

Parameter   Name: <b>C00007   Control mode</b>		Data type: UNSIGNED_16 Index: 24568 <sub>d</sub> = 5FF8 <sub>h</sub>
<p>With this parameter the control mode for the technology application selected under <a href="#">C00005</a> is defined, i.e. how the inputs and outputs of the technology application are connected to the I/Os of the inverter.</p> <ul style="list-style-type: none"> <li>How the inputs and outputs are connected in the individual control modes is described in the corresponding technology application: <ul style="list-style-type: none"> <li><a href="#">"Actuating drive speed" TA</a></li> <li><a href="#">"TA "actuating drive speed (AC Drive Profile)"</a></li> <li><a href="#">"Switch-off positioning" TA</a></li> </ul> </li> </ul>		
Selection list(Lenze setting printed in bold)		Info
0	Wiring has changed	This is displayed when the FB interconnection has been changed in the I/O level via the FB Editor.
<b>10</b>	<b>Terminals 0</b>	The technology application is controlled via the digital and analog input terminals of the inverter. <ul style="list-style-type: none"> <li>A short overview of the preconfigured terminal assignment is included in the description of the respective technology application in the "Terminal assignment of the control modes".</li> </ul>
12	Terminals 2	
14	Terminals 11	
16	Terminal 16	
20	Keypad	The technology application is controlled via the keypad.
21	PC	The technology application is controlled via the "Free parameters" of the inverter (PC control).
30	CAN	The technology application is controlled by means of CAN-PDOs via the system bus "CAN on board". <p>► <a href="#">"CAN on board" system bus</a></p>
40	MCI	The technology application is controlled by means of MCI-PDOs via the MCI-interface of an attached communication module (e.g. PROFIBUS).
<input checked="" type="checkbox"/> Read access <input checked="" type="checkbox"/> Write access <input type="checkbox"/> CINH <input type="checkbox"/> PLC STOP <input type="checkbox"/> No transfer <input type="checkbox"/> COM <input type="checkbox"/> MOT   Scaling factor: 1		

## C00008

Parameter   Name: C00008   Original application control source		Data type: UNSIGNED_16 Index: 24567 <sub>d</sub> = 5FF7 <sub>h</sub>
Display of the originally selected technology application and the originally selected control mode. <ul style="list-style-type: none"> <li>• This parameter shows the selection that was set with <a href="#">C00005</a> and <a href="#">C00007</a> before a change in the I/O level or the application level was carried out.</li> <li>• For diagnostic purposes, this display serves to determine whether there is a standard interconnection in the inverter or a change carried out by the user.</li> </ul>		
Selection list (read only)		Info
0	Free Free	Application: Interconnection has been changed. I/O level: Interconnection has been changed.
10	Free Terminal0	Application: Interconnection has been changed. I/O level: "Terminals 0" control mode
12	Free Terminal2	Application: Interconnection has been changed. I/O level: "Terminal 2" control mode
14	Free Terminal11	Application: Interconnection has been changed. I/O level: "Terminal 11" control mode
16	Free Terminal 16	Application: Interconnection has been changed. I/O level: "Terminal 16" control mode
20	Free Keypad	Application: Interconnection has been changed. I/O level: "Keypad" control mode
21	Free PC	Application: Interconnection has been changed. I/O level: "PC" control mode
30	Free CAN	Application: Interconnection has been changed. I/O level: "CAN" control mode
40	Free MCI	Application: Interconnection has been changed. I/O level: "MCI" control mode
1000	Speed Free	Application: Actuating drive speed I/O level: Interconnection has been changed.
1010	Speed Terminal0	Application: Actuating drive speed I/O level: "Terminals 0" control mode
1012	Speed Terminal2	Application: Actuating drive speed I/O level: "Terminal 2" control mode
1014	Speed Terminal11	Application: Actuating drive speed I/O level: "Terminal 11" control mode
1016	Speed Terminal16	Application: Actuating drive speed I/O level: "Terminal 16" control mode
1020	Speed Keypad	Application: Actuating drive speed I/O level: "Keypad" control mode
1021	Speed PC	Application: Actuating drive speed I/O level: "PC" control mode
1030	Speed CAN	Application: Actuating drive speed I/O level: "CAN" control mode
1040	Speed MCI	Application: Actuating drive speed I/O level: "MCI" control mode
1100	SpeedACdrive Free	Application: Actuating drive speed (AC Drive Profile) I/O level: Interconnection has been changed.
1110	SpeedACdrive Terminal0	Application: Actuating drive speed (AC Drive Profile) I/O level: "Terminals 0" control mode
1112	SpeedACdrive Klemme2	Application: Actuating drive speed (AC Drive Profile) I/O level: "Terminal 2" control mode
1114	SpeedACdrive Klemme11	Application: Actuating drive speed (AC Drive Profile) I/O level: "Terminal 11" control mode



Parameter   Name: <b>C00008   Original application control source</b>		Data type: UNSIGNED_16 Index: 24567 <sub>d</sub> = 5FF7 <sub>h</sub>
1116	SpeedACdrive Klemme16	Application: Actuating drive speed (AC Drive Profile) I/O level: "Terminal 16" control mode
1120	SpeedACdrive Keypad	Application: Actuating drive speed (AC Drive Profile) I/O level: "Keypad" control mode
1121	SpeedACdrive PC	Application: Actuating drive speed (AC Drive Profile) I/O level: "PC" control mode
1130	SpeedACdrive CAN	Application: Actuating drive speed (AC Drive Profile) I/O level: "CAN" control mode
1140	SpeedACdrive MCI	Application: Actuating drive speed (AC Drive Profile) I/O level: "MCI" control mode
3000	SwitchPos Free	Application: Switch-off positioning I/O level: Interconnection has been changed.
3010	SwitchPos Terminal0	Application: Switch-off positioning I/O level: "Terminals 0" control mode
3012	SwitchPos Terminal 2	Application: Switch-off positioning I/O level: "Terminal 2" control mode
3014	SwitchPos Terminal 11	Application: Switch-off positioning I/O level: "Terminal 11" control mode
3016	SwitchPos Terminal 16	Application: Switch-off positioning I/O level: "Terminal 16" control mode
3020	SwitchPos Keypad	Application: Switch-off positioning I/O level: "Keypad" control mode
3021	SwitchPos PC	Application: Switch-off positioning I/O level: "PC" control mode
3030	SwitchPos CAN	Application: Switch-off positioning I/O level: "CAN" control mode
3040	SwitchPos MCI	Application: Switch-off positioning I/O level: "MCI" control mode
<input checked="" type="checkbox"/> Read access <input type="checkbox"/> Write access <input type="checkbox"/> CINH <input type="checkbox"/> PLC STOP <input type="checkbox"/> No transfer <input type="checkbox"/> COM <input type="checkbox"/> MOT   Scaling factor: 1		

**C00010**

Parameter   Name: <b>C00010   AIN1: Characteristic</b>		Data type: INTEGER_16 Index: 24565 <sub>d</sub> = 5FF5 <sub>h</sub>
From version 04.00.00		► <a href="#">Analog terminals: Signal adaptation via characteristic</a>
Setting range (min. value   unit   max. value)		
0.00	%	199.99
Subcodes	Lenze setting	Info
C00010/1	0.00 %	AIN1: (+y0) = min
C00010/2	0.00 %	AIN1: (+x0) = Dead band
C00010/3	0.00 %	AIN1: (-y0) = (-min)
C00010/4	0.00 %	AIN1: (-x0) = (-Dead band)
C00010/5	100.00 %	AIN1: (+ymax)
C00010/6	100.00 %	AIN1: (+xmax)
C00010/7	100.00 %	AIN1: (-ymax)
C00010/8	100.00 %	AIN1: (-xmax)
<input checked="" type="checkbox"/> Read access <input checked="" type="checkbox"/> Write access <input type="checkbox"/> CINH <input type="checkbox"/> PLC STOP <input type="checkbox"/> No transfer <input type="checkbox"/> COM <input type="checkbox"/> MOT   Scaling factor: 100		

## C00011

Parameter   Name: <b>C00011   Appl.: Reference speed</b>		Data type: UNSIGNED_16 Index: 24564 <sub>d</sub> = 5FF4 <sub>h</sub>	
Setting the reference speed <ul style="list-style-type: none"> <li>In the inverter, all speed-related signals are processed to one reference variable in percent.</li> <li>Set a reference speed here that corresponds to 100 %.</li> <li>The frequency that corresponds to the set reference speed is displayed in <a href="#">C00059</a>.</li> </ul>			
<b>Note:</b> This is not a maximum limitation! All values in percent in the inverter may be in a range of 0 ... 199.99 %.			
<b>Recommendation:</b> Deactivate the torque feedforward control for the speed setpoint in <a href="#">C00654/1</a> if the reference speed <a href="#">C00011</a> is 5 times higher than the rated motor speed <a href="#">C00087</a> .			
<b>Setting range</b> (min. value   unit   max. value)		<b>Lenze setting</b>	
50	rpm	60000	<b>1500 rpm</b>
<input checked="" type="checkbox"/> Read access <input checked="" type="checkbox"/> Write access <input type="checkbox"/> CINH <input type="checkbox"/> PLC STOP <input type="checkbox"/> No transfer <input type="checkbox"/> COM <input checked="" type="checkbox"/> MOT Scaling factor: 1			

## C00012

Parameter   Name: <b>C00012   Accel. time - main setpoint</b>		Data type: UNSIGNED_32 Index: 24563 <sub>d</sub> = 5FF3 <sub>h</sub>	
The <a href="#">L_NSet_1</a> FB: Acceleration time of the ramp generator for the main speed setpoint <ul style="list-style-type: none"> <li>Generally, this ramp generator is used for all speed-controlled technology applications.</li> </ul>			
<b>Setting range</b> (min. value   unit   max. value)		<b>Lenze setting</b>	
0.000	s	999.999	<b>2.000 s</b>
<input checked="" type="checkbox"/> Read access <input checked="" type="checkbox"/> Write access <input type="checkbox"/> CINH <input type="checkbox"/> PLC STOP <input type="checkbox"/> No transfer <input type="checkbox"/> COM <input type="checkbox"/> MOT Scaling factor: 1000			

## C00013

Parameter   Name: <b>C00013   Decel. time - main setpoint</b>		Data type: UNSIGNED_32 Index: 24562 <sub>d</sub> = 5FF2 <sub>h</sub>	
The <a href="#">L_NSet_1</a> FB: Deceleration time of the ramp generator for the main speed setpoint <ul style="list-style-type: none"> <li>Generally, this ramp generator is used for all speed-controlled technology applications.</li> </ul>			
<b>Setting range</b> (min. value   unit   max. value)		<b>Lenze setting</b>	
0.000	s	999.999	<b>2.000 s</b>
<input checked="" type="checkbox"/> Read access <input checked="" type="checkbox"/> Write access <input type="checkbox"/> CINH <input type="checkbox"/> PLC STOP <input type="checkbox"/> No transfer <input type="checkbox"/> COM <input type="checkbox"/> MOT Scaling factor: 1000			

## C00015

Parameter   Name: <b>C00015   VFC: V/f base frequency</b>		Data type: UNSIGNED_16 Index: 24560 <sub>d</sub> = 5FF0 <sub>h</sub>	
V/f base frequency for V/f characteristic control ( <a href="#">VFCplus</a> ) and V/f control ( <a href="#">VFCplus+encoder</a> ) <ul style="list-style-type: none"> <li>The motor voltage increases linearly with the frequency until the base frequency is reached. From this value on, the motor voltage remains constant, the speed increases and the maximum torque decreases.</li> <li>After the motor to be used has been selected from the motor catalogue, the suitable value can be entered automatically. An automatic detection via the motor parameter identification is possible as well.</li> </ul>			
<b>Setting range</b> (min. value   unit   max. value)		<b>Lenze setting</b>	
7.5	Hz	2600.0	<b>50.0 Hz</b>
<input checked="" type="checkbox"/> Read access <input checked="" type="checkbox"/> Write access <input type="checkbox"/> CINH <input type="checkbox"/> PLC STOP <input type="checkbox"/> No transfer <input type="checkbox"/> COM <input checked="" type="checkbox"/> MOT Scaling factor: 10			

## C00016

Parameter   Name: <b>C00016   VFC: Vmin boost</b>		Data type: UNSIGNED_16 Index: 24559 <sub>d</sub> = 5FEF <sub>h</sub>
Boost of the V/f voltage characteristic in the range of small speeds or frequencies with V/f characteristic control ( <a href="#">VFCplus</a> ) and V/f control ( <a href="#">VFCplus+encoder</a> ) <ul style="list-style-type: none"> <li>• This may increase the starting torque.</li> <li>• After the motor to be used has been selected from the motor catalogue, the suitable value can be entered automatically. An automatic detection via the motor parameter identification is possible as well.             <ul style="list-style-type: none"> <li>▶ <a href="#">Motor control (MCTRL): Setting the Vmin boost</a></li> </ul> </li> </ul>		
<b>Setting range (min. value   unit   max. value)</b>		<b>Lenze setting</b>
0.00	%	100.00
		power-related (see <a href="#">table</a> )
<input checked="" type="checkbox"/> Read access <input checked="" type="checkbox"/> Write access <input type="checkbox"/> CINH <input type="checkbox"/> PLC STOP <input type="checkbox"/> No transfer <input type="checkbox"/> COM <input checked="" type="checkbox"/> MOT             Scaling factor: 100		

## C00018

Parameter   Name: <b>C00018   Switching frequency</b>		Data type: UNSIGNED_8 Index: 24557 <sub>d</sub> = 5FED <sub>h</sub>
Selection of the pulse width modulated switching frequency transferred from the inverter to the motor <ul style="list-style-type: none"> <li>• Select between an ideal setting for the drive which provides smooth running, and an optimal setting with regard to the inverter which keeps its losses to a minimum (min. Pv).</li> <li>• Both possibilities offer fixed and variable switching frequencies.</li> <li>• When a variable switching frequency is selected, the switching frequency may change as a function of the load and rotational frequency.</li> </ul> <p style="text-align: right;">▶ <a href="#">Selection of switching frequency</a></p>		
<b>Selection list(Lenze setting printed in bold)</b>		
1	4 kHz var./drive-optimised	
2	<b>8 kHz var./drive-optimised</b>	
3	16 kHz var./drive-optimised	
5	2 kHz constant/drive-optimised	
6	4 kHz constant/drive-optimised	
7	8 kHz constant/drive-optimised	
8	16 kHz constant/drive-optimised	
11	4 kHz var./min. Pv	
12	8 kHz var./min. Pv	
13	16 kHz var./min. Pv	
15	2 kHz constant/min. Pv	
16	4 kHz constant/min. Pv	
17	8 kHz constant/min. Pv	
18	16 kHz constant/min. Pv	
21	8 kHz var./drive-opt./4 kHz min	
22	16 kHz var./drive-opt./4 kHz min	
23	16 kHz var./drive-opt./8 kHz min	
31	8 kHz var./min. Pv/4 kHz min	
32	16 kHz var./min. Pv/4 kHz min	
33	16 kHz var./min. Pv/8 kHz min	
<input checked="" type="checkbox"/> Read access <input checked="" type="checkbox"/> Write access <input type="checkbox"/> CINH <input type="checkbox"/> PLC STOP <input type="checkbox"/> No transfer <input type="checkbox"/> COM <input checked="" type="checkbox"/> MOT             Scaling factor: 1		

## C00019

Parameter   Name: <b>C00019   Auto DCB: Threshold</b>		Data type: UNSIGNED_16 Index: 24556 <sub>d</sub> = 5FECh	
Setpoint speed threshold for automatic DC injection braking <ul style="list-style-type: none"> <li>For speed setpoints with values below the thresholds a DC current is injected or the motor is not supplied with current, depending on the setting.</li> </ul> <p style="text-align: right;"><a href="#">▶ DC-injection braking</a></p>			
<b>Setting range</b> (min. value   unit   max. value)		<b>Lenze setting</b>	
0	rpm	60000	<b>3 rpm</b>
<input checked="" type="checkbox"/> Read access <input checked="" type="checkbox"/> Write access <input type="checkbox"/> CINH <input type="checkbox"/> PLC STOP <input type="checkbox"/> No transfer <input type="checkbox"/> COM <input type="checkbox"/> MOT   Scaling factor: 1			

## C00021

Parameter   Name: <b>C00021   Slip comp.</b>		Data type: INTEGER_16 Index: 24554 <sub>d</sub> = 5FEAh	
Slip compensation for V/f characteristic control ( <a href="#">VFCplus</a> ) and sensorless vector control ( <a href="#">SLVC</a> ) <ul style="list-style-type: none"> <li>A higher slip compensation results in a higher increase in frequency and voltage when the machine is under load.</li> <li>After the motor to be used has been selected from the motor catalogue, the suitable value can be entered automatically. An automatic detection via the motor parameter identification is possible as well.</li> </ul> <p style="text-align: right;"><a href="#">▶ Motor control (MCTRL): Optimising the operational performance by slip compensation</a></p>			
<b>Setting range</b> (min. value   unit   max. value)		<b>Lenze setting</b>	
-100.00	%	100.00	power-related (see <a href="#">table</a> )
<input checked="" type="checkbox"/> Read access <input checked="" type="checkbox"/> Write access <input type="checkbox"/> CINH <input type="checkbox"/> PLC STOP <input type="checkbox"/> No transfer <input type="checkbox"/> COM <input checked="" type="checkbox"/> MOT   Scaling factor: 100			

## C00022

Parameter   Name: <b>C00022   I<sub>max</sub> in motor mode</b>		Data type: UNSIGNED_16 Index: 24553 <sub>d</sub> = 5FE9h	
Maximum current in motor mode for all motor control modes <p><b>Note:</b> The parameter has a value range depending on the device power. The device automatically limits the entered value to the corresponding value range.</p>			
<b>Setting range</b> (min. value   unit   max. value)		<b>Lenze setting</b>	
0.00	A	655.35	power-related (see <a href="#">table</a> )
<input checked="" type="checkbox"/> Read access <input checked="" type="checkbox"/> Write access <input type="checkbox"/> CINH <input type="checkbox"/> PLC STOP <input type="checkbox"/> No transfer <input type="checkbox"/> COM <input checked="" type="checkbox"/> MOT   Scaling factor: 100			

## C00023

Parameter   Name: <b>C00023   I<sub>max</sub> in generator mode</b>		Data type: INTEGER_16 Index: 24552 <sub>d</sub> = 5FE8h	
Maximum current in generator mode for all motor control modes <ul style="list-style-type: none"> <li>100 % ≙ I<sub>max</sub> in motor mode (<a href="#">C00022</a>)</li> </ul>			
<b>Setting range</b> (min. value   unit   max. value)		<b>Lenze setting</b>	
0.00	%	100.00	<b>100.00 %</b>
<input checked="" type="checkbox"/> Read access <input checked="" type="checkbox"/> Write access <input type="checkbox"/> CINH <input type="checkbox"/> PLC STOP <input type="checkbox"/> No transfer <input type="checkbox"/> COM <input checked="" type="checkbox"/> MOT   Scaling factor: 100			

## C00024

Parameter   Name: <b>C00024   LS_DriveInterface: bNActCompare</b>			Data type: INTEGER_16 Index: 24551 <sub>d</sub> = 5FE7 <sub>h</sub>
Threshold for the actual speed comparison			
<ul style="list-style-type: none"> <li>This parameter serves to set a threshold that is compared with the actual speed value.</li> <li>If the value falls below this threshold, the <i>bNActCompare</i> output sets the <a href="#">LS_DriveInterface</a> system block to TRUE.</li> <li>Switching hysteresis = +1 %</li> </ul>			
CAUTION: There are errors in the evaluation if the sum of 199.98 % is exceeded in case of the set value combinations.			
<b>Setting range (min. value   unit   max. value)</b>			<b>Lenze setting</b>
0.00	%	199.99	<b>0.00 %</b>
<input checked="" type="checkbox"/> Read access <input checked="" type="checkbox"/> Write access <input type="checkbox"/> CINH <input type="checkbox"/> PLC STOP <input type="checkbox"/> No transfer <input type="checkbox"/> COM <input type="checkbox"/> MOT   Scaling factor: 100			

## C00025

Parameter   Name: <b>C00025   LS_DriveInterface: bNActHysteres</b>			Data type: INTEGER_16 Index: 24550 <sub>d</sub> = 5FE6 <sub>h</sub>
From version 16.00.00			
Selection of the switching hysteresis for the actual speed value comparison in <a href="#">C00024</a> .			
CAUTION: There are errors in the evaluation if the sum of 199.98 % is exceeded in case of the set value combinations.			
<b>Setting range (min. value   unit   max. value)</b>			
0.00	%	199.99	
<b>Subcodes</b>	<b>Lenze setting</b>	<b>Info</b>	
C00025/1	1.00 %	<a href="#">LS_DriveInterface: bNActHysteres</a>	
<input checked="" type="checkbox"/> Read access <input checked="" type="checkbox"/> Write access <input type="checkbox"/> CINH <input type="checkbox"/> PLC STOP <input type="checkbox"/> No transfer <input type="checkbox"/> COM <input type="checkbox"/> MOT   Scaling factor: 100			

## C00026

Parameter   Name: <b>C00026   AINx: Offset</b>			Data type: INTEGER_16 Index: 24549 <sub>d</sub> = 5FE5 <sub>h</sub>
Offset for analog input			
<a href="#">▶ Analog terminals</a>			
<b>Setting range (min. value   unit   max. value)</b>			
-199.99	%	199.99	
<b>Subcodes</b>	<b>Lenze setting</b>	<b>Info</b>	
C00026/1	0.00 %	AIN1: Offset	
<input checked="" type="checkbox"/> Read access <input checked="" type="checkbox"/> Write access <input type="checkbox"/> CINH <input type="checkbox"/> PLC STOP <input type="checkbox"/> No transfer <input type="checkbox"/> COM <input type="checkbox"/> MOT   Scaling factor: 100			

## C00027

Parameter   Name: <b>C00027   AINx: Gain</b>			Data type: INTEGER_32 Index: 24548 <sub>d</sub> = 5FE4 <sub>h</sub>
Gain for analog input			
<a href="#">▶ Analog terminals</a>			
<b>Setting range (min. value   unit   max. value)</b>			
-100.0000		100.0000	
<b>Subcodes</b>	<b>Lenze setting</b>	<b>Info</b>	
C00027/1	1.0000	AIN1: Gain	
<input checked="" type="checkbox"/> Read access <input checked="" type="checkbox"/> Write access <input type="checkbox"/> CINH <input type="checkbox"/> PLC STOP <input type="checkbox"/> No transfer <input type="checkbox"/> COM <input type="checkbox"/> MOT   Scaling factor: 10000			

## C00028

Parameter   Name: <b>C00028   AINx: Input voltage</b>		Data type: INTEGER_16 Index: 24547 <sub>d</sub> = 5FE3 <sub>h</sub>
Display of the input voltage at the analog input		<a href="#">▶ Analog terminals</a>
<b>Display range (min. value   unit   max. value)</b>		
-10.00	V	10.00
<b>Subcodes</b>		<b>Info</b>
C00028/1		AIN1: Input voltage
<input checked="" type="checkbox"/> Read access <input type="checkbox"/> Write access <input type="checkbox"/> CINH <input type="checkbox"/> PLC STOP <input checked="" type="checkbox"/> No transfer <input type="checkbox"/> COM <input type="checkbox"/> MOT           Scaling factor: 100		

## C00029

Parameter   Name: <b>C00029   AINx: Input current</b>		Data type: INTEGER_16 Index: 24546 <sub>d</sub> = 5FE2 <sub>h</sub>
Display of the Input current at the analog input		<a href="#">▶ Analog terminals</a>
<ul style="list-style-type: none"> <li>• When the analog input is configured for current measurement (<a href="#">C00034/1</a> = 1 or 2).</li> <li>• When <a href="#">C00034/1</a> is set = 2 (4 ... 20 mA), 0 ... 16 mA is displayed.</li> </ul>		
<b>Display range (min. value   unit   max. value)</b>		
0.00	mA	20.00
<b>Subcodes</b>		<b>Info</b>
C00029/1		AIN1: Input current
<input checked="" type="checkbox"/> Read access <input type="checkbox"/> Write access <input type="checkbox"/> CINH <input type="checkbox"/> PLC STOP <input checked="" type="checkbox"/> No transfer <input type="checkbox"/> COM <input type="checkbox"/> MOT           Scaling factor: 100		

## C00033

Parameter   Name: <b>C00033   AINx: Output value</b>		Data type: INTEGER_16 Index: 24542 <sub>d</sub> = 5FDE <sub>h</sub>
Display of the output value in percent of the analog input amplifier		<a href="#">▶ Analog terminals</a>
<ul style="list-style-type: none"> <li>• 100 % ≙ 16384 ≙ +10 V / +20 mA</li> </ul>		
<b>Display range (min. value   unit   max. value)</b>		
-199.99	%	199.99
<b>Subcodes</b>		<b>Info</b>
C00033/1		AIN1: Output value
<input checked="" type="checkbox"/> Read access <input type="checkbox"/> Write access <input type="checkbox"/> CINH <input type="checkbox"/> PLC STOP <input checked="" type="checkbox"/> No transfer <input type="checkbox"/> COM <input type="checkbox"/> MOT           Scaling factor: 100		

## C00034

Parameter   Name:		Data type: UNSIGNED_8 Index: 24541 <sub>d</sub> = 5FDD <sub>h</sub>
<b>C00034   AINx: Configuration</b>		
Configuration of the analog input for current or voltage measurement		
<a href="#">▶ Analog terminals</a>		
Selection list		Info
0	-10...+10 V	Input signal is the voltage signal -10 V ... +10 V • -10 V ... +10 V ≡ -100 % ... +100 %
1	0...20 mA	Input signal is the current signal 0 mA ... 20 mA • 0 mA ... 20 mA ≡ 0 % ... +100 %
2	4...20 mA	Input signal is the current signal 4 mA ... 20 mA • 4 mA ... 20 mA ≡ 0 % ... +100 % • The current loop is monitored for open circuit (I < 4 mA) by the device.
Subcodes	Lenze setting	Info
C00034/1	0: -10...+10 V	AIN1: Config.
<input checked="" type="checkbox"/> Read access <input checked="" type="checkbox"/> Write access <input type="checkbox"/> CINH <input type="checkbox"/> PLC STOP <input type="checkbox"/> No transfer <input type="checkbox"/> COM <input type="checkbox"/> MOT             Scaling factor: 1		

## C00036

Parameter   Name:		Data type: INTEGER_16 Index: 24539 <sub>d</sub> = 5FDB <sub>h</sub>
<b>C00036   DC braking: Current</b>		
Braking current in [%] based on rated device current ( <a href="#">C00098</a> )		
• 100% ≡ <a href="#">C00098</a>		
<a href="#">▶ DC-injection braking</a>		
Setting range (min. value   unit   max. value)		Lenze setting
0.00	%	200.00
		<b>50.00 %</b>
<input checked="" type="checkbox"/> Read access <input checked="" type="checkbox"/> Write access <input type="checkbox"/> CINH <input type="checkbox"/> PLC STOP <input type="checkbox"/> No transfer <input type="checkbox"/> COM <input checked="" type="checkbox"/> MOT             Scaling factor: 100		

## C00039

Parameter   Name:		Data type: INTEGER_16 Index: 24536 <sub>d</sub> = 5FD8 <sub>h</sub>
<b>C00039   Fixed setpoint x (L_NSet_1 n-Fix)</b>		
The <a href="#">L_NSet_1</a> FB: Fixed speed setpoints (JOG values) for the setpoint generator		
• 100% ≡ <a href="#">C00011</a>		
Setting range (min. value   unit   max. value)		
-199.99	%	199.99
Subcodes	Lenze setting	Info
C00039/1	40.00 %	Preset setpoint 1
C00039/2	60.00 %	Preset setpoint 2
C00039/3	80.00 %	Preset setpoint 3
C00039/4	0.00 %	Fixed setpoint 4
C00039/5	0.00 %	Fixed setpoint 5
C00039/6	0.00 %	Fixed setpoint 6
C00039/7	0.00 %	Fixed setpoint 7
C00039/8	0.00 %	Fixed setpoint 8
C00039/9	0.00 %	Fixed setpoint 9
C00039/10	0.00 %	Fixed setpoint 10
C00039/11	0.00 %	Fixed setpoint 11

Parameter   Name: <b>C00039   Fixed setpoint x (L_NSet_1 n-Fix)</b>		Data type: INTEGER_16 Index: 24536 <sub>d</sub> = 5FD8 <sub>h</sub>
C00039/12	0.00 %	Fixed setpoint 12
C00039/13	0.00 %	Fixed setpoint 13
C00039/14	0.00 %	Fixed setpoint 14
C00039/15	0.00 %	Fixed setpoint 15
<input checked="" type="checkbox"/> Read access <input checked="" type="checkbox"/> Write access <input type="checkbox"/> CINH <input type="checkbox"/> PLC STOP <input type="checkbox"/> No transfer <input type="checkbox"/> COM <input type="checkbox"/> MOT   Scaling factor: 100		

**C00050**

Parameter   Name: <b>C00050   MCTRL: Speed setpoint</b>		Data type: INTEGER_32 Index: 24525 <sub>d</sub> = 5FCD <sub>h</sub>
Display of the speed setpoint at the speed setpoint input of the motor control		
<b>Display range (min. value   unit   max. value)</b>		
-120000	rpm	120000
<input checked="" type="checkbox"/> Read access <input type="checkbox"/> Write access <input type="checkbox"/> CINH <input type="checkbox"/> PLC STOP <input checked="" type="checkbox"/> No transfer <input type="checkbox"/> COM <input type="checkbox"/> MOT   Scaling factor: 1		

**C00051**

Parameter   Name: <b>C00051   MCTRL: Actual speed value</b>		Data type: INTEGER_32 Index: 24524 <sub>d</sub> = 5FCC <sub>h</sub>
Display of the actual speed value of the motor shaft		
<b>Note:</b> The displayed value only corresponds to the real actual speed value of the motor shaft if an encoder is connected to the motor and the evaluation of the feedback signal has been set correctly ("Closed loop" operation). In case of operation without speed feedback, the signal is calculated from the motor control and thus may not correspond to the real actual speed.		
<b>Display range (min. value   unit   max. value)</b>		
-120000	rpm	120000
<input checked="" type="checkbox"/> Read access <input type="checkbox"/> Write access <input type="checkbox"/> CINH <input type="checkbox"/> PLC STOP <input checked="" type="checkbox"/> No transfer <input type="checkbox"/> COM <input type="checkbox"/> MOT   Scaling factor: 1		

**C00052**

Parameter   Name: <b>C00052   Motor voltage</b>		Data type: UNSIGNED_16 Index: 24523 <sub>d</sub> = 5FCB <sub>h</sub>
Display of the current motor voltage/output voltage of the inverter		
<b>Display range (min. value   unit   max. value)</b>		
0	V	1000
<input checked="" type="checkbox"/> Read access <input type="checkbox"/> Write access <input type="checkbox"/> CINH <input type="checkbox"/> PLC STOP <input checked="" type="checkbox"/> No transfer <input type="checkbox"/> COM <input type="checkbox"/> MOT   Scaling factor: 1		

**C00053**

Parameter   Name: <b>C00053   DC-bus voltage</b>		Data type: UNSIGNED_16 Index: 24522 <sub>d</sub> = 5FCA <sub>h</sub>
Display of the current DC-bus voltage		
<b>Display range (min. value   unit   max. value)</b>		
0	V	1000
<input checked="" type="checkbox"/> Read access <input type="checkbox"/> Write access <input type="checkbox"/> CINH <input type="checkbox"/> PLC STOP <input checked="" type="checkbox"/> No transfer <input type="checkbox"/> COM <input type="checkbox"/> MOT   Scaling factor: 1		



## C00054

Parameter   Name: <b>C00054   Motor current</b>		Data type: UNSIGNED_16 Index: 24521 <sub>d</sub> = 5FC9 <sub>h</sub>
Display of the current motor current/output current of the inverter		
<b>Display range (min. value   unit   max. value)</b>		
0.00	A	300.00
<input checked="" type="checkbox"/> Read access <input type="checkbox"/> Write access <input type="checkbox"/> CINH <input type="checkbox"/> PLC STOP <input checked="" type="checkbox"/> No transfer <input type="checkbox"/> COM <input type="checkbox"/> MOT Scaling factor: 100		

## C00055

Parameter   Name: <b>C00055   Actual values</b>		Data type: INTEGER_16 Index: 24520 <sub>d</sub> = 5FC8 <sub>h</sub>
<b>Note:</b> When a single-track feedback has been selected for the HTL encoder ( <a href="#">C00115</a> = 1 or 3), the sign of the actual speed value is created from the sign of the speed setpoint. In C00055/1, a positive speed is always displayed.		
<b>Display range (min. value   unit   max. value)</b>		
-32767	rpm	32767
<b>Subcodes</b>		<b>Info</b>
C00055/1		Actual value - HTL encoder FreqIn12
<input checked="" type="checkbox"/> Read access <input type="checkbox"/> Write access <input type="checkbox"/> CINH <input type="checkbox"/> PLC STOP <input checked="" type="checkbox"/> No transfer <input type="checkbox"/> COM <input type="checkbox"/> MOT Scaling factor: 1		

## C00056

Parameter   Name: <b>C00056   Torque</b>		Data type: INTEGER_32 Index: 24519 <sub>d</sub> = 5FC7 <sub>h</sub>
Display of the current torque		
<b>Display range (min. value   unit   max. value)</b>		
-65000.00	Nm	65000.00
<b>Subcodes</b>		<b>Info</b>
C00056/1		Torque demand • Only in case of sensorless vector control ( <a href="#">SLVC</a> ).
C00056/2		Actual torque value • Estimated actual torque for all motor control modes.
<input checked="" type="checkbox"/> Read access <input type="checkbox"/> Write access <input type="checkbox"/> CINH <input type="checkbox"/> PLC STOP <input checked="" type="checkbox"/> No transfer <input type="checkbox"/> COM <input type="checkbox"/> MOT Scaling factor: 100		

## C00057

Parameter   Name: <b>C00057   Maximum torque</b>		Data type: UNSIGNED_32 Index: 24518 <sub>d</sub> = 5FC6 <sub>h</sub>
Display of the maximum torque to be generated by the motor • The maximum torque to be generated by the motor depends on various factors, e.g. on I <sub>max</sub> in motor mode ( <a href="#">C00022</a> ) and the motor type used.		
<b>Display range (min. value   unit   max. value)</b>		
0.00	Nm	65000.00
<input checked="" type="checkbox"/> Read access <input type="checkbox"/> Write access <input type="checkbox"/> CINH <input type="checkbox"/> PLC STOP <input checked="" type="checkbox"/> No transfer <input type="checkbox"/> COM <input type="checkbox"/> MOT Scaling factor: 100		

## C00058

Parameter   Name: <b>C00058   Output frequency</b>		Data type: INTEGER_32 Index: 24517 <sub>d</sub> = 5FC5 <sub>h</sub>
Display of the current output frequency		
<b>Display range (min. value   unit   max. value)</b>		
-1300.00	Hz	1300.00
<input checked="" type="checkbox"/> Read access <input type="checkbox"/> Write access <input type="checkbox"/> CINH <input type="checkbox"/> PLC STOP <input checked="" type="checkbox"/> No transfer <input type="checkbox"/> COM <input type="checkbox"/> MOT Scaling factor: 100		

## C00059

Parameter   Name: <b>C00059   Appl.: Reference frequency C11</b>		Data type: UNSIGNED_32 Index: 24516 <sub>d</sub> = 5FC4 <sub>h</sub>
Display of the field frequency which corresponds to the reference speed set in <a href="#">C00011</a> .		
<b>Display range (min. value   unit   max. value)</b>		
0.00	Hz	1300.00
<input checked="" type="checkbox"/> Read access <input type="checkbox"/> Write access <input type="checkbox"/> CINH <input type="checkbox"/> PLC STOP <input checked="" type="checkbox"/> No transfer <input type="checkbox"/> COM <input type="checkbox"/> MOT Scaling factor: 100		

## C00061

Parameter   Name: <b>C00061   Heatsink temperature</b>		Data type: INTEGER_16 Index: 24514 <sub>d</sub> = 5FC2 <sub>h</sub>
Display of the current heatsink temperature		
<b>Display range (min. value   unit   max. value)</b>		
-50	°C	150
<input checked="" type="checkbox"/> Read access <input type="checkbox"/> Write access <input type="checkbox"/> CINH <input type="checkbox"/> PLC STOP <input checked="" type="checkbox"/> No transfer <input type="checkbox"/> COM <input type="checkbox"/> MOT Scaling factor: 1		

## C00062

Parameter   Name: <b>C00062   Temperature inside the controller</b>		Data type: INTEGER_16 Index: 24513 <sub>d</sub> = 5FC1 <sub>h</sub>
From version 11.00.00		
Display of the current temperature inside the controller		
<b>Display range (min. value   unit   max. value)</b>		
-200	°C	200
<b>Subcodes</b>		<b>Info</b>
C00062/1		Interior temperature of CU
<input checked="" type="checkbox"/> Read access <input type="checkbox"/> Write access <input type="checkbox"/> CINH <input type="checkbox"/> PLC STOP <input checked="" type="checkbox"/> No transfer <input type="checkbox"/> COM <input type="checkbox"/> MOT Scaling factor: 1		

## C00064

Parameter   Name: <b>C00064   Device utilisation (lxt)</b>		Data type: INTEGER_16 Index: 24511 <sub>d</sub> = 5FBF <sub>h</sub>
Display of the device utilisation lxt in different time resolutions		
<ul style="list-style-type: none"> <li>If the value displayed here exceeds the threshold set in <a href="#">C00123</a>, the fault message "OC5: Device overload (lxt)" is output and the fault response set in <a href="#">C00604</a> is executed (default setting: "Warning").</li> </ul>		
<b>Display range (min. value   unit   max. value)</b>		
0.00	%	250.00

Parameter   Name: <b>C00064   Device utilisation (lxt)</b>		Data type: INTEGER_16 Index: 24511 <sub>d</sub> = 5FBF <sub>h</sub>
Subcodes	Info	
C00064/1	Device utilisation (lxt) • Maximum value of the pulse utilisation (C00064/2) and permanent utilisation (C00064/3).	
C00064/2	Device utilisation (lxt) 15s • Pulse utilisation over the last 15 seconds (only for loads >160 %).	
C00064/3	Device utilisation (lxt) 3 min • Permanent utilisation over the last 3 minutes.	
<input checked="" type="checkbox"/> Read access <input type="checkbox"/> Write access <input type="checkbox"/> CINH <input type="checkbox"/> PLC STOP <input checked="" type="checkbox"/> No transfer <input type="checkbox"/> COM <input type="checkbox"/> MOT                   Scaling factor: 100		

**C00065**

Parameter   Name: <b>C00065   Supply voltage 24V</b>		Data type: INTEGER_16 Index: 24510 <sub>d</sub> = 5FBE <sub>h</sub>
Display of the 24V supply voltage for the supply of the control electronics		
<b>Note:</b> The 24 V supply for the control electronics is either provided by an external supply or by the invter itself if it is connected to the mains voltage.		
Display range (min. value   unit   max. value)		
0.0	V	3276.7
<input checked="" type="checkbox"/> Read access <input type="checkbox"/> Write access <input type="checkbox"/> CINH <input type="checkbox"/> PLC STOP <input checked="" type="checkbox"/> No transfer <input type="checkbox"/> COM <input type="checkbox"/> MOT                   Scaling factor: 10		

**C00066**

Parameter   Name: <b>C00066   Thermal motor load (I²xt)</b>		Data type: INTEGER_16 Index: 24509 <sub>d</sub> = 5FBD <sub>h</sub>
Display of the thermal motor load, sensorlessly determined using a motor model		
• If the value displayed here exceeds "100.00 %", the error message "OC6: Thermal motor overload (I2xt)" is output and the fault response set in <a href="#">C00606</a> is executed (default setting: "Warning"). ▶ <a href="#">Motor overload monitoring (I2xt)</a>		
Display range (min. value   unit   max. value)		
0.00	%	199.99
<input checked="" type="checkbox"/> Read access <input type="checkbox"/> Write access <input type="checkbox"/> CINH <input type="checkbox"/> PLC STOP <input checked="" type="checkbox"/> No transfer <input type="checkbox"/> COM <input type="checkbox"/> MOT                   Scaling factor: 100		

**C00070**

Parameter   Name: <b>C00070   Vp speed controller</b>		Data type: UNSIGNED_16 Index: 24505 <sub>d</sub> = 5FB9 <sub>h</sub>
Gain factor Vp of the speed controller for different motor control types		
Setting range (min. value   unit   max. value)		
0.00		600.00
Subcodes	Lenze setting	Info
C00070/1	power-related (see <a href="#">table</a> )	<a href="#">SLVC</a> : Vp speed controller
C00070/2	power-related (see <a href="#">table</a> )	Reserved • 0: The reset time is inactive.
C00070/3	power-related (see <a href="#">table</a> )	<a href="#">SLPSM</a> : Vp speed controller • 0: The reset time is inactive.
<input checked="" type="checkbox"/> Read access <input checked="" type="checkbox"/> Write access <input type="checkbox"/> CINH <input type="checkbox"/> PLC STOP <input type="checkbox"/> No transfer <input type="checkbox"/> COM <input checked="" type="checkbox"/> MOT                   Scaling factor: 100		

## C00071

Parameter   Name: <b>C00071   Ti speed controller</b>		Data type: UNSIGNED_16 Index: 24504 <sub>d</sub> = 5FB8 <sub>h</sub>	
Reset time Ti of the speed controller for different motor control types			
<b>Setting range</b> (min. value   unit   max. value)			
0.0	ms	6000.0	
<b>Subcodes</b>	<b>Lenze setting</b>	<b>Info</b>	
C00071/1	100.0 ms	<a href="#">SLVC</a> : Ti speed controller	
C00071/2	50.0 ms	Reserved	
C00071/3	50.0 ms	<a href="#">SLPSM</a> : Ti speed controller	
<input checked="" type="checkbox"/> Read access <input checked="" type="checkbox"/> Write access <input type="checkbox"/> CINH <input type="checkbox"/> PLC STOP <input type="checkbox"/> No transfer <input type="checkbox"/> COM <input checked="" type="checkbox"/> MOT Scaling factor: 10			

## C00072

Parameter   Name: <b>C00072   SC: Tdn speed controller</b>		Data type: UNSIGNED_16 Index: 24503 <sub>d</sub> = 5FB7 <sub>h</sub>	
Differential time constant Tdn of the speed controller for sensorless control for synchronous motors ( <a href="#">SLPSM</a> )			
<b>Setting range</b> (min. value   unit   max. value)		<b>Lenze setting</b>	
0.00	ms	3.00	<b>0.00 ms</b>
<input checked="" type="checkbox"/> Read access <input checked="" type="checkbox"/> Write access <input type="checkbox"/> CINH <input type="checkbox"/> PLC STOP <input type="checkbox"/> No transfer <input type="checkbox"/> COM <input checked="" type="checkbox"/> MOT Scaling factor: 100			

## C00073

Parameter   Name: <b>C00073   Imax/M controller gain</b>		Data type: UNSIGNED_16 Index: 24502 <sub>d</sub> = 5FB6 <sub>h</sub>	
Amplification factor Vp of certain controllers for different motor control modes			
<b>Setting range</b> (min. value   unit   max. value)			
0.00		100.00	
<b>Subcodes</b>	<b>Lenze setting</b>	<b>Info</b>	
C00073/1	power-related (see <a href="#">table</a> )	<a href="#">VFC</a> : Vp Imax controller • After the motor to be used has been selected from the motor catalogue, the suitable value can be entered automatically.	
C00073/2	power-related (see <a href="#">table</a> )	<a href="#">SLVC</a> : Vp torque controller	
<input checked="" type="checkbox"/> Read access <input checked="" type="checkbox"/> Write access <input type="checkbox"/> CINH <input type="checkbox"/> PLC STOP <input type="checkbox"/> No transfer <input type="checkbox"/> COM <input checked="" type="checkbox"/> MOT Scaling factor: 100			

## C00074

Parameter   Name: <b>C00074   Reset time Imax/M controller</b>		Data type: UNSIGNED_16 Index: 24501 <sub>d</sub> = 5FB5 <sub>h</sub>	
Reset time Ti of certain controllers for different motor control modes			
<b>Setting range</b> (min. value   unit   max. value)			
0	ms	9990	
<b>Subcodes</b>	<b>Lenze setting</b>	<b>Info</b>	
C00074/1	power-related (see <a href="#">table</a> ) ms	<a href="#">VFC</a> : Ti Imax controller	
C00074/2	power-related (see <a href="#">table</a> ) ms	<a href="#">SLVC</a> : Ti torque controller	
<input checked="" type="checkbox"/> Read access <input checked="" type="checkbox"/> Write access <input type="checkbox"/> CINH <input type="checkbox"/> PLC STOP <input type="checkbox"/> No transfer <input type="checkbox"/> COM <input checked="" type="checkbox"/> MOT Scaling factor: 1			

## C00075

Parameter   Name: <b>C00075   Vp current controller</b>		Data type: UNSIGNED_16 Index: 24500 <sub>d</sub> = 5FB4 <sub>h</sub>	
Gain factor Vp of the current controller for certain inverter functions (parameter identification, flying restart circuit) • After the motor to be used has been selected from the motor catalogue, the suitable value can be entered automatically.			
<b>Setting range (min. value   unit   max. value)</b>		<b>Lenze setting</b>	
0.00	V/A	500.00	power-related (see <a href="#">table</a> )
<input checked="" type="checkbox"/> Read access <input checked="" type="checkbox"/> Write access <input type="checkbox"/> CINH <input type="checkbox"/> PLC STOP <input type="checkbox"/> No transfer <input type="checkbox"/> COM <input checked="" type="checkbox"/> MOT Scaling factor: 100			

## C00076

Parameter   Name: <b>C00076   Ti current controller</b>		Data type: UNSIGNED_16 Index: 24499 <sub>d</sub> = 5FB3 <sub>h</sub>	
Reset time Ti of the current controller for certain inverter functions (parameter identification, flying restart circuit) • After the motor to be used has been selected from the motor catalogue, the suitable value can be entered automatically.			
<b>Setting range (min. value   unit   max. value)</b>		<b>Lenze setting</b>	
0.00	ms	500.00	power-related (see <a href="#">table</a> )
<input checked="" type="checkbox"/> Read access <input checked="" type="checkbox"/> Write access <input type="checkbox"/> CINH <input type="checkbox"/> PLC STOP <input type="checkbox"/> No transfer <input type="checkbox"/> COM <input checked="" type="checkbox"/> MOT Scaling factor: 100			

## C00079

Parameter   Name: <b>C00079   SC: Settings</b>		Data type: UNSIGNED_8 Index: 24496 <sub>d</sub> = 5FB0 <sub>h</sub>	
Configuration of different options for sensorless control for synchronous motors ( <a href="#">SLPSM</a> )			
<b>Selection list</b>			
0	Off		
1	On		
<b>Subcodes</b>	<b>Lenze setting</b>	<b>Info</b>	
C00079/1	0: Off	SC: Current controller - feedforward control	
C00079/2	1: On	SC: Adapt. VP in the field weakening range	
C00079/3	0: Off	SC: n-Ctrl Anti-Wind-Up	
C00079/4	1: On	<a href="#">Field weakening for synchronous motors</a> • From version 11.00.00	
<input checked="" type="checkbox"/> Read access <input checked="" type="checkbox"/> Write access <input type="checkbox"/> CINH <input type="checkbox"/> PLC STOP <input type="checkbox"/> No transfer <input type="checkbox"/> COM <input checked="" type="checkbox"/> MOT Scaling factor: 1			

## C00080

Parameter   Name: <b>C00080   Override point of field weakening</b>		Data type: INTEGER_16 Index: 24495 <sub>d</sub> = 5FAF <sub>h</sub>	
Offset of the override point for field weakening • In the V/f characteristic control mode ( <a href="#">VFCplus</a> ), the stall protection function or the max. permissible current in the field weakening range can be adapted.			
<b>Setting range (min. value   unit   max. value)</b>		<b>Lenze setting</b>	
-500	Hz	500	0 Hz
<input checked="" type="checkbox"/> Read access <input checked="" type="checkbox"/> Write access <input type="checkbox"/> CINH <input type="checkbox"/> PLC STOP <input type="checkbox"/> No transfer <input type="checkbox"/> COM <input checked="" type="checkbox"/> MOT Scaling factor: 1			

## C00081

Parameter   Name: <b>C00081   Rated motor power</b>		Data type: UNSIGNED_16 Index: 24494 <sub>d</sub> = 5FAE <sub>h</sub>	
This value can be obtained from the motor nameplate. After the motor to be used has been selected from the motor catalogue, the suitable value can be entered automatically.			
<b>Note:</b> It is mandatory to give the rated motor power for the sensorless vector control ( <a href="#">SLVC</a> ).			
<b>Setting range (min. value   unit   max. value)</b>		<b>Lenze setting</b>	
0.00	kW	500.00	power-related (see <a href="#">table</a> )
<input checked="" type="checkbox"/> Read access <input checked="" type="checkbox"/> Write access <input type="checkbox"/> CINH <input type="checkbox"/> PLC STOP <input type="checkbox"/> No transfer <input type="checkbox"/> COM <input checked="" type="checkbox"/> MOT Scaling factor: 100			

## C00082

Parameter   Name: <b>C00082   Motor rotor resistance</b>		Data type: UNSIGNED_32 Index: 24493 <sub>d</sub> = 5FAD <sub>h</sub>	
After the motor to be used has been selected from the motor catalogue, the suitable value can be entered automatically. An automatic detection via the motor parameter identification is possible as well.			
<b>Setting range (min. value   unit   max. value)</b>		<b>Lenze setting</b>	
0	mohm	200000	power-related (see <a href="#">table</a> )
<input checked="" type="checkbox"/> Read access <input checked="" type="checkbox"/> Write access <input type="checkbox"/> CINH <input type="checkbox"/> PLC STOP <input type="checkbox"/> No transfer <input type="checkbox"/> COM <input checked="" type="checkbox"/> MOT Scaling factor: 1			

## C00083

Parameter   Name: <b>C00083   Motor rotor time constant</b>		Data type: UNSIGNED_16 Index: 24492 <sub>d</sub> = 5FAC <sub>h</sub>	
From version 02.00.00 Display of the rotor time constant of the motor <ul style="list-style-type: none"> <li>This value is calculated from the rotor resistance and the rotor inductance (leakage and magnetising inductance).</li> </ul>			
<b>Display range (min. value   unit   max. value)</b>		<b>Lenze setting</b>	
0	ms	32767	
<input checked="" type="checkbox"/> Read access <input type="checkbox"/> Write access <input type="checkbox"/> CINH <input type="checkbox"/> PLC STOP <input checked="" type="checkbox"/> No transfer <input type="checkbox"/> COM <input type="checkbox"/> MOT Scaling factor: 1			

## C00084

Parameter   Name: <b>C00084   Motor stator resistance</b>		Data type: UNSIGNED_32 Index: 24491 <sub>d</sub> = 5FAB <sub>h</sub>	
After the motor to be used has been selected from the motor catalogue, the suitable value can be entered automatically. An automatic detection via the motor parameter identification is possible as well.			
<b>Setting range (min. value   unit   max. value)</b>		<b>Lenze setting</b>	
0	mohm	200000	power-related (see <a href="#">table</a> )
<input checked="" type="checkbox"/> Read access <input checked="" type="checkbox"/> Write access <input type="checkbox"/> CINH <input type="checkbox"/> PLC STOP <input type="checkbox"/> No transfer <input type="checkbox"/> COM <input checked="" type="checkbox"/> MOT Scaling factor: 1			

## C00085

Parameter   Name: <b>C00085   Motor stator leakage inductance</b>		Data type: UNSIGNED_16 Index: 24490 <sub>d</sub> = 5FAA <sub>h</sub>	
After the motor to be used has been selected from the motor catalogue, the suitable value can be entered automatically. An automatic detection via the motor parameter identification is possible as well.			
<b>Setting range (min. value   unit   max. value)</b>		<b>Lenze setting</b>	
0.00	mH	650.00	power-related (see <a href="#">table</a> )
<input checked="" type="checkbox"/> Read access <input checked="" type="checkbox"/> Write access <input type="checkbox"/> CINH <input type="checkbox"/> PLC STOP <input type="checkbox"/> No transfer <input type="checkbox"/> COM <input checked="" type="checkbox"/> MOT Scaling factor: 100			

## C00087

Parameter   Name: <b>C00087   Rated motor speed</b>			Data type: UNSIGNED_16 Index: 24488 <sub>d</sub> = 5FA8 <sub>h</sub>
This value can be obtained from the motor nameplate. After the motor to be used has been selected from the motor catalogue, the suitable value can be entered automatically.			
<b>Note:</b> It is mandatory to give the rated motor speed for the sensorless vector control ( <a href="#">SLVC</a> ).			
Setting range (min. value   unit   max. value)			Lenze setting
50	rpm	60000	power-related (see <a href="#">table</a> )
<input checked="" type="checkbox"/> Read access <input checked="" type="checkbox"/> Write access <input type="checkbox"/> CINH <input type="checkbox"/> PLC STOP <input type="checkbox"/> No transfer <input type="checkbox"/> COM <input checked="" type="checkbox"/> MOT Scaling factor: 1			

## C00088

Parameter   Name: <b>C00088   Rated motor current</b>			Data type: UNSIGNED_16 Index: 24487 <sub>d</sub> = 5FA7 <sub>h</sub>
This value can be obtained from the motor nameplate. After the motor to be used has been selected from the motor catalogue, the suitable value can be entered automatically.			
<b>Note:</b> It is mandatory to give the rated motor current for the sensorless vector control ( <a href="#">SLVC</a> ).			
Setting range (min. value   unit   max. value)			Lenze setting
0.20	A	320.00	power-related (see <a href="#">table</a> )
<input checked="" type="checkbox"/> Read access <input checked="" type="checkbox"/> Write access <input type="checkbox"/> CINH <input type="checkbox"/> PLC STOP <input type="checkbox"/> No transfer <input type="checkbox"/> COM <input checked="" type="checkbox"/> MOT Scaling factor: 100			

## C00089

Parameter   Name: <b>C00089   Rated motor frequency</b>			Data type: UNSIGNED_16 Index: 24486 <sub>d</sub> = 5FA6 <sub>h</sub>
This value can be obtained from the motor nameplate. After the motor to be used has been selected from the motor catalogue, the suitable value can be entered automatically.			
<b>Note:</b> It is mandatory to give the rated motor frequency for the sensorless vector control ( <a href="#">SLVC</a> ).			
Setting range (min. value   unit   max. value)			Lenze setting
1	Hz	1000	50 Hz
<input checked="" type="checkbox"/> Read access <input checked="" type="checkbox"/> Write access <input type="checkbox"/> CINH <input type="checkbox"/> PLC STOP <input type="checkbox"/> No transfer <input type="checkbox"/> COM <input checked="" type="checkbox"/> MOT Scaling factor: 1			

## C00090

Parameter   Name: <b>C00090   Rated motor voltage</b>			Data type: UNSIGNED_16 Index: 24485 <sub>d</sub> = 5FA5 <sub>h</sub>
This value can be obtained from the motor nameplate. After the motor to be used has been selected from the motor catalogue, the suitable value can be entered automatically.			
Setting range (min. value   unit   max. value)			Lenze setting
0	V	5000	power-related (see <a href="#">table</a> )
<input checked="" type="checkbox"/> Read access <input checked="" type="checkbox"/> Write access <input type="checkbox"/> CINH <input type="checkbox"/> PLC STOP <input type="checkbox"/> No transfer <input type="checkbox"/> COM <input checked="" type="checkbox"/> MOT Scaling factor: 1			

## C00091

Parameter   Name: <b>C00091   Motor cosine phi</b>		Data type: UNSIGNED_8 Index: 24484 <sub>d</sub> = 5FA4 <sub>h</sub>
This value can be obtained from the motor nameplate. After the motor to be used has been selected from the motor catalogue, the suitable value can be entered automatically.		
<b>Setting range (min. value   unit   max. value)</b>		<b>Lenze setting</b>
0.20		1.00 power-related (see <a href="#">table</a> )
<input checked="" type="checkbox"/> Read access <input checked="" type="checkbox"/> Write access <input type="checkbox"/> CINH <input type="checkbox"/> PLC STOP <input type="checkbox"/> No transfer <input type="checkbox"/> COM <input checked="" type="checkbox"/> MOT Scaling factor: 100		

## C00092

Parameter   Name: <b>C00092   Motor magnetising inductance</b>		Data type: UNSIGNED_16 Index: 24483 <sub>d</sub> = 5FA3 <sub>h</sub>
After the motor to be used has been selected from the motor catalogue, the suitable value can be entered automatically. An automatic detection via the motor parameter identification is possible as well.		
<b>Setting range (min. value   unit   max. value)</b>		<b>Lenze setting</b>
0.0	mH	6500.0 power-related (see <a href="#">table</a> )
<input checked="" type="checkbox"/> Read access <input checked="" type="checkbox"/> Write access <input type="checkbox"/> CINH <input type="checkbox"/> PLC STOP <input type="checkbox"/> No transfer <input type="checkbox"/> COM <input checked="" type="checkbox"/> MOT Scaling factor: 10		

## C00093

Parameter   Name: <b>C00093   Power section identification</b>		Data type: UNSIGNED_16 Index: 24482 <sub>d</sub> = 5FA2 <sub>h</sub>
Display of the identification of the detected power section of the inverter		
<b>Display range (min. value   unit   max. value)</b>		
0		65535
<input checked="" type="checkbox"/> Read access <input type="checkbox"/> Write access <input type="checkbox"/> CINH <input type="checkbox"/> PLC STOP <input checked="" type="checkbox"/> No transfer <input type="checkbox"/> COM <input type="checkbox"/> MOT Scaling factor: 1		

## C00095

Parameter   Name: <b>C00095   Motor magnetising current</b>		Data type: UNSIGNED_16 Index: 24480 <sub>d</sub> = 5FA0 <sub>h</sub>
After the motor to be used has been selected from the motor catalogue, the suitable value can be entered automatically. An automatic detection via the motor parameter identification is possible as well.		
<b>Setting range (min. value   unit   max. value)</b>		<b>Lenze setting</b>
0.00	A	320.00 power-related (see <a href="#">table</a> )
<input checked="" type="checkbox"/> Read access <input checked="" type="checkbox"/> Write access <input type="checkbox"/> CINH <input type="checkbox"/> PLC STOP <input type="checkbox"/> No transfer <input type="checkbox"/> COM <input checked="" type="checkbox"/> MOT Scaling factor: 100		

## C00097

Parameter   Name: <b>C00097   Rated motor torque</b>		Data type: UNSIGNED_32 Index: 24478 <sub>d</sub> = 5F9E <sub>h</sub>
Display of the rated motor torque • The value displayed here is calculated from different parameters, e.g. the maximum current set in <a href="#">C00022</a> .		
<b>Display range (min. value   unit   max. value)</b>		
0.00	Nm	100000.00
<input checked="" type="checkbox"/> Read access <input type="checkbox"/> Write access <input type="checkbox"/> CINH <input type="checkbox"/> PLC STOP <input checked="" type="checkbox"/> No transfer <input type="checkbox"/> COM <input type="checkbox"/> MOT Scaling factor: 100		



## C00098

Parameter   Name: <b>C00098   Device rated current</b>		Data type: UNSIGNED_16 Index: 24477 <sub>d</sub> = 5F9D <sub>h</sub>
Display of the rated inverter current which is defined by the integrated power section.		
<b>Display range (min. value   unit   max. value)</b>		
0.0	A	6000.0
<input checked="" type="checkbox"/> Read access <input type="checkbox"/> Write access <input type="checkbox"/> CINH <input type="checkbox"/> PLC STOP <input checked="" type="checkbox"/> No transfer <input type="checkbox"/> COM <input checked="" type="checkbox"/> MOT           Scaling factor: 10		

## C00099

Parameter   Name: <b>C00099   Firmware version</b>		Data type: VISIBLE_STRING Index: 24476 <sub>d</sub> = 5F9C <sub>h</sub>
Display of the firmware version of the device as string		
<input checked="" type="checkbox"/> Read access <input type="checkbox"/> Write access <input type="checkbox"/> CINH <input type="checkbox"/> PLC-STOP <input checked="" type="checkbox"/> No transfer <input type="checkbox"/> COM <input type="checkbox"/> MOT           Character length: 12		

## C00100

Parameter   Name: <b>C00100   Firmware version</b>		Data type: UNSIGNED_8 Index: 24475 <sub>d</sub> = 5F9B <sub>h</sub>
Display of the firmware version of the device, divided into subsections.		
<b>Display range (min. value   unit   max. value)</b>		
0		99
<b>Subcodes</b>	<b>Info</b>	
C00100/1	Firmware version - main version	
C00100/2	Firmware version - subversion	
C00100/3	Firmware version - release	
C00100/4	Firmware version - build	
<input checked="" type="checkbox"/> Read access <input type="checkbox"/> Write access <input type="checkbox"/> CINH <input type="checkbox"/> PLC STOP <input checked="" type="checkbox"/> No transfer <input type="checkbox"/> COM <input type="checkbox"/> MOT           Scaling factor: 1		

## C00101

Parameter   Name: <b>C00101   Add. acceleration time x</b>		Data type: UNSIGNED_32 Index: 24474 <sub>d</sub> = 5F9A <sub>h</sub>
The <a href="#">L_NSet_1</a> : FB: Additional acceleration times for the main setpoint		
<ul style="list-style-type: none"> <li>The additional acceleration times set here can be selected via the binary inputs <i>bT11</i> ... <i>bT18</i> of the <a href="#">L_NSet_1</a> FB.</li> </ul>		
<b>Setting range (min. value   unit   max. value)</b>		
0.000	s	999.999
<b>Subcodes</b>	<b>Lenze setting</b>	<b>Info</b>
C00101/1	0.000 s	Add. accel. time 1 ... 15
C00101/...		
C00101/15		
<input checked="" type="checkbox"/> Read access <input checked="" type="checkbox"/> Write access <input type="checkbox"/> CINH <input type="checkbox"/> PLC STOP <input type="checkbox"/> No transfer <input type="checkbox"/> COM <input type="checkbox"/> MOT           Scaling factor: 1000		

## C00103

Parameter   Name: <b>C00103   Add. decel. time x</b>		Data type: UNSIGNED_32 Index: 24472 <sub>d</sub> = 5F98 <sub>h</sub>	
The <a href="#">L_NSet 1</a> FB: Additional deceleration times for the main setpoint <ul style="list-style-type: none"> <li>The additional deceleration times set here can be selected via the binary inputs <i>bT11</i> ... <i>bT18</i> of the <a href="#">L_NSet 1</a> FB.</li> </ul>			
<b>Setting range (min. value   unit   max. value)</b>			
0.000	s	999.999	
<b>Subcodes</b>	<b>Lenze setting</b>	<b>Info</b>	
C00103/1	0.000 s	Add. decel. time 1 ... 15	
C00103/...			
C00103/15			
<input checked="" type="checkbox"/> Read access <input checked="" type="checkbox"/> Write access <input type="checkbox"/> CINH <input type="checkbox"/> PLC STOP <input type="checkbox"/> No transfer <input type="checkbox"/> COM <input type="checkbox"/> MOT   Scaling factor: 1000			

## C00105

Parameter   Name: <b>C00105   Decel. time - quick stop</b>		Data type: UNSIGNED_32 Index: 24470 <sub>d</sub> = 5F96 <sub>h</sub>	
The set deceleration time determines the ramp slope at quick stop <p style="text-align: right;"><a href="#">▶ Activate/deactivate quick stop</a></p>			
<b>Setting range (min. value   unit   max. value)</b>		<b>Lenze setting</b>	
0.000	s	999.900	<b>2.000 s</b>
<input checked="" type="checkbox"/> Read access <input checked="" type="checkbox"/> Write access <input type="checkbox"/> CINH <input type="checkbox"/> PLC STOP <input type="checkbox"/> No transfer <input type="checkbox"/> COM <input type="checkbox"/> MOT   Scaling factor: 1000			

## C00106

Parameter   Name: <b>C00106   Auto DCB: Hold time</b>		Data type: UNSIGNED_32 Index: 24469 <sub>d</sub> = 5F95 <sub>h</sub>	
Hold time of the automatic DC injection brake <ul style="list-style-type: none"> <li>The DC injection brake is applied for the time set here if the value falls below the speed setpoint set in <a href="#">C00019</a>.</li> </ul> <p style="text-align: right;"><a href="#">▶ DC-injection braking</a></p>			
<b>Setting range (min. value   unit   max. value)</b>		<b>Lenze setting</b>	
0.000	s	999.000	<b>0.500 s</b>
<input checked="" type="checkbox"/> Read access <input checked="" type="checkbox"/> Write access <input type="checkbox"/> CINH <input type="checkbox"/> PLC STOP <input type="checkbox"/> No transfer <input type="checkbox"/> COM <input type="checkbox"/> MOT   Scaling factor: 1000			

## C00107

Parameter   Name: <b>C00107   DC braking: Hold time</b>		Data type: UNSIGNED_32 Index: 24468 <sub>d</sub> = 5F94 <sub>h</sub>	
Maximum hold time of the manual DC injection brake <ul style="list-style-type: none"> <li>A time can be set here after which the DC injection brake is switched off automatically to prevent the motor from thermal overload.</li> <li>When "999.000 s" is set, the hold time is infinite.</li> </ul> <p style="text-align: right;"><a href="#">▶ DC-injection braking</a></p>			
<b>Setting range (min. value   unit   max. value)</b>		<b>Lenze setting</b>	
0.000	s	999.000	<b>999.000 s</b>
<input checked="" type="checkbox"/> Read access <input checked="" type="checkbox"/> Write access <input type="checkbox"/> CINH <input type="checkbox"/> PLC STOP <input type="checkbox"/> No transfer <input type="checkbox"/> COM <input type="checkbox"/> MOT   Scaling factor: 1000			

## C00114

Parameter   Name: C00114   DigInX: Inversion		Data type: UNSIGNED_16 Index: 24461 <sub>d</sub> = 5F8D <sub>h</sub>
The polarity of each digital input of the device can be inverted via this bit field. <a href="#">▶ Digital terminals</a>		
Setting range (min. hex value   max. hex value)		Lenze setting
0x0000	0xFFFF	0x0000 (decimal: 0)
Value is bit-coded: ( <input checked="" type="checkbox"/> = bit set)		Info
Bit 0 <input type="checkbox"/>	DI1 inverted	Inversion of digital input 1
Bit 1 <input type="checkbox"/>	DI2 inverted	Inversion of digital input 2
Bit 2 <input type="checkbox"/>	DI3 inverted	Inversion of digital input 3
Bit 3 <input type="checkbox"/>	DI4 inverted	Inversion of digital input 4
Bit 4 <input type="checkbox"/>	Reserved	
Bit 5 <input type="checkbox"/>	Reserved	
Bit 6 <input type="checkbox"/>	Reserved	
Bit 7 <input type="checkbox"/>	Reserved	
Bit 8 <input type="checkbox"/>	Reserved	
Bit 9 <input type="checkbox"/>	Reserved	
Bit 10 <input type="checkbox"/>	Reserved	
Bit 11 <input type="checkbox"/>	Reserved	
Bit 12 <input type="checkbox"/>	Reserved	
Bit 13 <input type="checkbox"/>	Reserved	
Bit 14 <input type="checkbox"/>	Reserved	
Bit 15 <input type="checkbox"/>	Clnh inverted	Inversion of digital input RFR (controller enable)
<input checked="" type="checkbox"/> Read access <input checked="" type="checkbox"/> Write access <input type="checkbox"/> CINH <input type="checkbox"/> PLC STOP <input type="checkbox"/> No transfer <input type="checkbox"/> COM <input type="checkbox"/> MOT		

## C00115

Parameter   Name: C00115   DI1  DI2: Function		Data type: UNSIGNED_8 Index: 24460 <sub>d</sub> = 5F8C <sub>h</sub>
Function assignment of the digital terminals DI1 and DI2 <a href="#">▶ Digital terminals: Function assignment</a>		
Selection list		Info
0	DI1=In1   DI2=In2	DI1 = digital input DI2 = digital input
1	DI1=FreqIn12   DI2=In2	DI1 = 1-track frequency input DI2 = digital input
2	(DI1/DI2)=FreqIn12 (2-track)	DI1 and DI2 = 2-track frequency input
3	(DI1/DI2=+-)=FreqIn12	DI1 = 1-track frequency input DI2 = specification of direction
4	DI1=CountIn1   DI2=In2	DI1 = counter input DI2 = digital input
Subcodes	Lenze setting	Info
C00115/1	0: DI1=In1   DI2=In2	Function assignment of DI1 and DI2
<input checked="" type="checkbox"/> Read access <input checked="" type="checkbox"/> Write access <input type="checkbox"/> CINH <input type="checkbox"/> PLC STOP <input type="checkbox"/> No transfer <input type="checkbox"/> COM <input checked="" type="checkbox"/> MOT             Scaling factor: 1		

## C00118

Parameter   Name:		Data type: UNSIGNED_8 Index: 24457 <sub>d</sub> = 5F89 <sub>h</sub>	
<b>C00118   DigOutX: Inversion</b>			
The polarity of each digital output of the device can be inverted via this bit field.			
<a href="#">▶ Digital terminals</a>			
Setting range (min. hex value   max. hex value)		Lenze setting	
0x00		0xFF	0x00 (decimal: 0)
Value is bit-coded: ( <input checked="" type="checkbox"/> = bit set)		Info	
Bit 0 <input type="checkbox"/>	Relay inverted	Relay inversion	
Bit 1 <input type="checkbox"/>	DO1 inverted	Inversion of digital output 1	
Bit 2 <input type="checkbox"/>	Reserved		
Bit 3 <input type="checkbox"/>	Reserved		
Bit 4 <input type="checkbox"/>	Reserved		
Bit 5 <input type="checkbox"/>	Reserved		
Bit 6 <input type="checkbox"/>	Reserved		
Bit 7 <input type="checkbox"/>	Reserved		
<input checked="" type="checkbox"/> Read access <input checked="" type="checkbox"/> Write access <input type="checkbox"/> CINH <input type="checkbox"/> PLC STOP <input type="checkbox"/> No transfer <input type="checkbox"/> COM <input type="checkbox"/> MOT			

## C00120

Parameter   Name:		Data type: INTEGER_16 Index: 24455 <sub>d</sub> = 5F87 <sub>h</sub>	
<b>C00120   Setting of motor overload (I<sup>2</sup>t)</b>			
Operating threshold for the "OC6: Motor overload (I <sup>2</sup> t)" error message			
<ul style="list-style-type: none"> <li>• The response for reaching the threshold can be selected in <a href="#">C00606</a>.</li> <li>• The current thermal motor load is displayed in <a href="#">C00066</a>.</li> </ul>			
<a href="#">▶ Motor overload monitoring (I2xt)</a>			
Setting range (min. value   unit   max. value)		Lenze setting	
0.00	%	250.00	100.00 %
<input checked="" type="checkbox"/> Read access <input checked="" type="checkbox"/> Write access <input type="checkbox"/> CINH <input type="checkbox"/> PLC STOP <input type="checkbox"/> No transfer <input type="checkbox"/> COM <input checked="" type="checkbox"/> MOT Scaling factor: 100			

## C00122

Parameter   Name:		Data type: UNSIGNED_16 Index: 24453 <sub>d</sub> = 5F85 <sub>h</sub>	
<b>C00122   Starting value — Overload</b>			
<a href="#">From version 12.00.00</a>			
The thermal motor load displayed in <a href="#">C00066</a> is pre-initialised with the value set here when the device is connected to the mains.			
<ul style="list-style-type: none"> <li>• If "100.00 %" is set, the last value at switching off the device is used for the initialisation.</li> <li>• Recommended setting for operation according to UL: 30.00 %</li> </ul>			
<a href="#">▶ Motor overload monitoring (I2xt)</a>			
Setting range (min. value   unit   max. value)			
0.00	%	100.00	
Subcodes	Lenze setting	Info	
C00122/1	0.00 %	Initial value motor overload (I <sup>2</sup> t)	
C00122/2	0.00 %	Starting value — Brake resistance overload	
<input checked="" type="checkbox"/> Read access <input checked="" type="checkbox"/> Write access <input type="checkbox"/> CINH <input type="checkbox"/> PLC STOP <input type="checkbox"/> No transfer <input type="checkbox"/> COM <input checked="" type="checkbox"/> MOT Scaling factor: 100			

## C00123

Parameter   Name: <b>C00123   Device utilisation threshold (Ixt)</b>		Data type: INTEGER_16 Index: 24452 <sub>d</sub> = 5F84 <sub>h</sub>	
Operating threshold for the "OC5: Device overload (Ixt)" error message <ul style="list-style-type: none"> <li>• The response for reaching the threshold can be selected in <a href="#">C00604</a>.</li> <li>• The current device utilisation is displayed in <a href="#">C00064</a>.</li> </ul>			
<b>Setting range (min. value   unit   max. value)</b>		<b>Lenze setting</b>	
0.00	%	200.00	<b>100.00 %</b>
<input checked="" type="checkbox"/> Read access <input checked="" type="checkbox"/> Write access <input type="checkbox"/> CINH <input type="checkbox"/> PLC STOP <input type="checkbox"/> No transfer <input type="checkbox"/> COM <input checked="" type="checkbox"/> MOT   Scaling factor: 100			

## C00124

Parameter   Name: <b>C00124   Current monitoring: Breaking current</b>		Data type: UNSIGNED_16 Index: 24451 <sub>d</sub> = 5F83 <sub>h</sub>	
From version 16.00.00			
▶ <a href="#">Current monitoring overload</a>			
<b>Setting range (min. value   unit   max. value)</b>			
0.00	%	200.00	
<b>Subcodes</b>	<b>Lenze setting</b>	<b>Info</b>	
C00124/1	200.00 %	Current monitoring: Breaking current overload	
<input checked="" type="checkbox"/> Read access <input checked="" type="checkbox"/> Write access <input type="checkbox"/> CINH <input type="checkbox"/> PLC STOP <input type="checkbox"/> No transfer <input type="checkbox"/> COM <input checked="" type="checkbox"/> MOT   Scaling factor: 100			

## C00129

Parameter   Name: <b>C00129   Brake resistance value</b>		Data type: UNSIGNED_16 Index: 24446 <sub>d</sub> = 5F7E <sub>h</sub>	
From version 03.00.00			
Resistance value of the connected brake resistor <ul style="list-style-type: none"> <li>• The value to be entered can be obtained from the nameplate of the brake resistor.</li> <li>• For every device type, the value is preset to the minimum adapted Lenze brake resistor.</li> </ul>			
<b>Setting range (min. value   unit   max. value)</b>		<b>Lenze setting</b>	
0.0	Ohm	500.0	power-related (see <a href="#">table</a> )
<input checked="" type="checkbox"/> Read access <input checked="" type="checkbox"/> Write access <input type="checkbox"/> CINH <input type="checkbox"/> PLC STOP <input type="checkbox"/> No transfer <input type="checkbox"/> COM <input checked="" type="checkbox"/> MOT   Scaling factor: 100			

## C00130

Parameter   Name: <b>C00130   Rated power - brake resistor</b>		Data type: UNSIGNED_16 Index: 24445 <sub>d</sub> = 5F7D <sub>h</sub>	
From version 03.00.00			
Rated power of the connected brake resistor <ul style="list-style-type: none"> <li>• The value to be entered can be obtained from the nameplate of the brake resistor.</li> </ul>			
<b>Setting range (min. value   unit   max. value)</b>		<b>Lenze setting</b>	
0	W	65535	power-related (see <a href="#">table</a> )
<input checked="" type="checkbox"/> Read access <input checked="" type="checkbox"/> Write access <input type="checkbox"/> CINH <input type="checkbox"/> PLC STOP <input type="checkbox"/> No transfer <input type="checkbox"/> COM <input checked="" type="checkbox"/> MOT   Scaling factor: 1			

## C00131

Parameter   Name: <b>C00131   Rated heat amount of brake resist.</b>		Data type: UNSIGNED_16 Index: 24444 <sub>d</sub> = 5F7C <sub>h</sub>
From version 03.00.00 Heat quantity of the brake resistor connected		
<ul style="list-style-type: none"> <li>• Lenze brake resistor: The value is preset to the adapted minimum Lenze brake resistance.</li> <li>• Brake resistor from a third party manufacturer: The value to be entered can be obtained from the nameplate of the brake resistor.</li> </ul>		
<b>Setting range</b> (min. value   unit   max. value)		<b>Lenze setting</b>
0.0	kWs	6553.5 power-related (see <a href="#">table</a> )
<input checked="" type="checkbox"/> Read access <input checked="" type="checkbox"/> Write access <input type="checkbox"/> CINH <input type="checkbox"/> PLC STOP <input type="checkbox"/> No transfer <input type="checkbox"/> COM <input checked="" type="checkbox"/> MOT   Scaling factor: 10		

## C00133

Parameter   Name: <b>C00133   Brake resistor utilisation</b>		Data type: UNSIGNED_16 Index: 24442 <sub>d</sub> = 5F7A <sub>h</sub>
From version 03.00.00 Display of the utilisation of the connected brake resistor		
<b>Display range</b> (min. value   unit   max. value)		
0	%	65535
<input checked="" type="checkbox"/> Read access <input type="checkbox"/> Write access <input type="checkbox"/> CINH <input type="checkbox"/> PLC STOP <input type="checkbox"/> No transfer <input type="checkbox"/> COM <input checked="" type="checkbox"/> MOT   Scaling factor: 1		

## C00134

Parameter   Name: <b>C00134   L_NSet_1: Ramp smoothing</b>		Data type: UNSIGNED_8 Index: 24441 <sub>d</sub> = 5F79 <sub>h</sub>
The <a href="#">L_NSet_1</a> FB: Configuration of the ramp rounding for the main setpoint		
<b>Selection list</b> (Lenze setting printed in bold)		<b>Info</b>
<b>0</b>	<b>Off</b>	Ramp rounding deactivated
1	PT1 behaviour	Ramp rounding with PT1 behaviour <ul style="list-style-type: none"> <li>• The corresponding S-ramp time must be set in <a href="#">C00182</a>.</li> </ul>
<input checked="" type="checkbox"/> Read access <input checked="" type="checkbox"/> Write access <input type="checkbox"/> CINH <input type="checkbox"/> PLC STOP <input type="checkbox"/> No transfer <input type="checkbox"/> COM <input type="checkbox"/> MOT   Scaling factor: 1		

## C00136

Parameter   Name: <b>C00136   Communication control words</b>		Data type: UNSIGNED_16 Index: 24439 <sub>d</sub> = 5F77 <sub>h</sub>
Control words of the communication interfaces		
<b>Display area</b> (min. hex value   max. hex value)		
0x0000		0xFFFF

Parameter   Name: <b>C00136   Communication control words</b>		Data type: UNSIGNED_16 Index: 24439 <sub>d</sub> = 5F77 <sub>h</sub>
<b>Value is bit-coded:</b>		
Bit 0	SwitchOn	
Bit 1	DisableVoltage	
Bit 2	SetQuickStop	
Bit 3	EnableOperation	
Bit 4	ModeSpecific_1	
Bit 5	ModeSpecific_2	
Bit 6	ModeSpecific_3	
Bit 7	ResetFault	
Bit 8	SetHalt	
Bit 9	Reserved_1	
Bit 10	Reserved_2	
Bit 11	LenzeSpecific_1	
Bit 12	LenzeSpecific_2	
Bit 13	LenzeSpecific_3	
Bit 14	SetFail	
Bit 15	LenzeSpecific_4	
Subcodes		Info
C00136/1		MCI control word • Control word of the MCI communication interface (communication module)
C00136/2		CAN control word • Control word of the CAN communication interface (CAN on board)
<input checked="" type="checkbox"/> Read access <input type="checkbox"/> Write access <input type="checkbox"/> CINH <input type="checkbox"/> PLC STOP <input checked="" type="checkbox"/> No transfer <input type="checkbox"/> COM <input type="checkbox"/> MOT		

**C00137**

Parameter   Name: <b>C00137   Device status</b>		Data type: UNSIGNED_16 Index: 24438 <sub>d</sub> = 5F76 <sub>h</sub>
Display of the current device status		

Parameter   Name: <b>C00137   Device status</b>		Data type: UNSIGNED_16 Index: 24438 <sub>d</sub> = 5F76 <sub>h</sub>
<b>Selection list (read only)</b>		
0	FirmwareUpdate	
1	Init	
2	Ident	
3	ReadyToSwitchON	
4	SwitchedON	
5	OperationEnable	
6	Warning	
7	Trouble	
8	Fault	
9	TroubleQSP	
10	SafeTorqueOff	
11	SystemFail	
12	Reserved_1	
13	Reserved_2	
14	Reserved_3	
15	Reserved_4	
<input checked="" type="checkbox"/> Read access <input type="checkbox"/> Write access <input type="checkbox"/> CINH <input type="checkbox"/> PLC STOP <input checked="" type="checkbox"/> No transfer <input type="checkbox"/> COM <input type="checkbox"/> MOT                   Scaling factor: 1		

**C00138**

Parameter   Name: <b>C00138   Internal control signals</b>		Data type: UNSIGNED_16 Index: 24437 <sub>d</sub> = 5F75 <sub>h</sub>
Bit coded display of internal control signals of different sources		
<b>Display area (min. hex value   max. hex value)</b>		
0x0000		0xFFFF
<b>Value is bit-coded:</b>		
Bit 0	Reserved	
Bit 1	DisableVoltage	
Bit 2	SetQuickStop	
Bit 3	EnableOperation	
Bit 4	InitFinishedOK	
Bit 5	ModeSpecific_2	
Bit 6	ModeSpecific_3	
Bit 7	ResetFault	
Bit 8	SetHalt	
Bit 9	FirmwareUpdate	
Bit 10	MotorIdent	
Bit 11	SetMessage	
Bit 12	SetIMP	
Bit 13	SetSystemFail	
Bit 14	SetFail	
Bit 15	SetFailQSP	



Parameter   Name: <b>C00138   Internal control signals</b>		Data type: UNSIGNED_16 Index: 24437 <sub>d</sub> = 5F75 <sub>h</sub>
Subcodes	Info	
C00138/1	SYS control signals	
C00138/2	MCK control signals	
C00138/3	FWM control signals	
<input checked="" type="checkbox"/> Read access <input type="checkbox"/> Write access <input type="checkbox"/> CINH <input type="checkbox"/> PLC STOP <input checked="" type="checkbox"/> No transfer <input type="checkbox"/> COM <input type="checkbox"/> MOT		

**C00142**

Parameter   Name: <b>C00142   Auto-start option</b>		Data type: UNSIGNED_8 Index: 24433 <sub>d</sub> = 5F71 <sub>h</sub>
The <b>Auto-start option</b> function describes the starting performance of the inverter after <ul style="list-style-type: none"> <li>• connection to the mains and/or switching on the external 24-V supply (Bit 0)</li> <li>• Deactivation of "Trouble" or "Fault" (Bit 1 / 2)</li> <li>• Undervoltage (Bit 3)</li> <li>• Loading the Lenze setting (Bit 4)</li> </ul> <p style="text-align: right;"><a href="#">▶ Auto-start option "inhibit at device on"</a></p>		
Setting range (min. hex value   max. hex value)	Lenze setting	
0x00	0xFF	<b>0x19</b> (decimal: 25)
Value is bit-coded: ( <input checked="" type="checkbox"/> = bit set)	Info	
Bit 0 <input checked="" type="checkbox"/>	Inhibit at device on	
Bit 1 <input type="checkbox"/>	Inhibit at trouble	
Bit 2 <input type="checkbox"/>	Inhibit at fault	
Bit 3 <input checked="" type="checkbox"/>	Inhibit at undervoltage	
Bit 4 <input checked="" type="checkbox"/>	Inhibit at Lenze setting	From version 06.00.00
Bit 5 <input type="checkbox"/>	Reserved	
Bit 6 <input type="checkbox"/>	Reserved	
Bit 7 <input type="checkbox"/>	Reserved	
<input checked="" type="checkbox"/> Read access <input checked="" type="checkbox"/> Write access <input type="checkbox"/> CINH <input type="checkbox"/> PLC STOP <input type="checkbox"/> No transfer <input type="checkbox"/> COM <input type="checkbox"/> MOT		

**C00144**

Parameter   Name: <b>C00144   Switching freq. reduct. (Temp.)</b>		Data type: UNSIGNED_8 Index: 24431 <sub>d</sub> = 5F6F <sub>h</sub>
Activation of the automatic switching frequency reduction if the temperature is too high		
Selection list(Lenze setting printed in bold)	Info	
0 Off	Automatic switching frequency reduction deactivated	
<b>1 On</b>	Automatic switching frequency reduction activated	
<input checked="" type="checkbox"/> Read access <input checked="" type="checkbox"/> Write access <input type="checkbox"/> CINH <input type="checkbox"/> PLC STOP <input type="checkbox"/> No transfer <input type="checkbox"/> COM <input type="checkbox"/> MOT   Scaling factor: 1		

## C00148

Parameter   Name: C00148   LS_DriveInterface: Error message config.		Data type: UNSIGNED_16 Index: 24427 <sub>d</sub> = 5F6B <sub>h</sub>
From version 04.00.00 Selection of the device statuses for which the <i>bCollectedFail</i> group error output of SB <a href="#">LS_DriveInterface</a> is to be set to TRUE.		
Setting range (min. hex value   max. hex value)		Lenze setting
0x0000		0xFFFF 0x0030 (decimal: 48)
Value is bit-coded: ( <input checked="" type="checkbox"/> = bit set)		Info
Bit 0 <input type="checkbox"/>	SafeTorqueOff	
Bit 1 <input type="checkbox"/>	ReadyToSwitchOn	
Bit 2 <input type="checkbox"/>	SwitchedOn	
Bit 3 <input type="checkbox"/>	TroubleQSP	From version 06.00.00
Bit 4 <input checked="" type="checkbox"/>	Trouble	
Bit 5 <input checked="" type="checkbox"/>	Fault	
Bit 6 <input type="checkbox"/>	Warning	
Bit 7 <input type="checkbox"/>	ImplsActive	
Bit 8 <input type="checkbox"/>	ClnhlsActive	
Bit 9 <input type="checkbox"/>	Fail CAN_Management	
Bit 10 <input type="checkbox"/>	Reserved	
Bit 11 <input type="checkbox"/>	Reserved	
Bit 12 <input type="checkbox"/>	Reserved	
Bit 13 <input type="checkbox"/>	Lock bCollectedFail at TroubleQSP	From version 18.00.00 onwards
Bit 14 <input type="checkbox"/>	Lock bFail at TroubleQSP	From version 11.00.00 1 ≙ The <i>bFail</i> output of the SB <a href="#">LS_DriveInterface</a> is also set in the "TroubleQSP" status. • Advantage: Even in the "TroubleQSP" status, an error occurred before can still be recognised.
Bit 15 <input type="checkbox"/>	Use 16BitFailNo.	From version 06.00.00 1 ≙ The short 16-bit error number <i>wStateDetermFailNoShort</i> is provided at the <i>wStateDetermFailNoLow</i> output of the SB <a href="#">LS_DriveInterface</a> . • In this case, the <i>wStateDetermFailNoHigh</i> output is "0". • Advantage: The bus transfer of the error numbers is possible via a data word without changing the interconnection of the technology application.
<input checked="" type="checkbox"/> Read access <input checked="" type="checkbox"/> Write access <input type="checkbox"/> CINH <input type="checkbox"/> PLC STOP <input type="checkbox"/> No transfer <input type="checkbox"/> COM <input type="checkbox"/> MOT		

## C00150

Parameter   Name: C00150   Status word		Data type: UNSIGNED_16 Index: 24425 <sub>d</sub> = 5F69 <sub>h</sub>
Bit coded device status word		
Display area (min. hex value   max. hex value)		
0x0000		0xFFFF
Value is bit-coded:		Info
Bit 0	FreeStatus	Free status bit 0
Bit 1	PowerDisabled	Power switched off
Bit 2	FreeStatus	Free status bit 2

Parameter   Name: <b>C00150   Status word</b>		Data type: UNSIGNED_16 Index: 24425 <sub>d</sub> = 5F69 <sub>h</sub>
Bit 3	FreeStatus	Free status bit 3
Bit 4	FreeStatus	Free status bit 4
Bit 5	FreeStatus	Free status bit 5
Bit 6	ActSpeedIsZero	Current speed is 0
Bit 7	ControllerInhibit	Controller is inhibited
Bit 8	StatusCodeBit0	Status code bit 0
Bit 9	StatusCodeBit1	Status code bit 1
Bit 10	StatusCodeBit2	Status code bit 2
Bit 11	StatusCodeBit3	Status code bit 3
Bit 12	Warning	Warning
Bit 13	Trouble	Interference
Bit 14	FreeStatus	Free status bit 14
Bit 15	FreeStatus	Free status bit 15
<input checked="" type="checkbox"/> Read access <input type="checkbox"/> Write access <input type="checkbox"/> CINH <input type="checkbox"/> PLC STOP <input checked="" type="checkbox"/> No transfer <input type="checkbox"/> COM <input type="checkbox"/> MOT		

**C00155**

Parameter   Name: <b>C00155   Extended status word</b>		Data type: UNSIGNED_16 Index: 24420 <sub>d</sub> = 5F64 <sub>h</sub>
Bit coded device status word 2		
<b>Display area</b> (min. hex value   max. hex value)		
0x0000		0xFFFF
<b>Value is bit-coded:</b>		<b>Info</b>
Bit 0	Fail	Error
Bit 1	M_max	Maximum torque
Bit 2	I_max	Maximum current
Bit 3	PowerDisabled	Power switched off
Bit 4	Ready	Controller is ready for operation
Bit 5	ControllerInhibit	Controller is inhibited
Bit 6	Trouble	Interference
Bit 7	InitState	Initialisation
Bit 8	CwCcw	CW/CCW rotation
Bit 9	TroubleQSP	Quick stop due to fault is active
Bit 10	SafeTorqueOff	Safe torque off
Bit 11	ApplicationRunning	Application is running
Bit 12	AplParSetBit0	Application parameter set - bit 0
Bit 13	AplParSetBit1	Application parameter set - bit 1
Bit 14	quick stop	Quick stop active
Bit 15	Motor parameter identification	Motor parameter identification is active
<input checked="" type="checkbox"/> Read access <input type="checkbox"/> Write access <input type="checkbox"/> CINH <input type="checkbox"/> PLC STOP <input checked="" type="checkbox"/> No transfer <input type="checkbox"/> COM <input type="checkbox"/> MOT		

**C00158**

Parameter   Name: <b>C00158   Cause of controller inhibit</b>		Data type: UNSIGNED_16 Index: 24417 <sub>d</sub> = 5F61 <sub>h</sub>
Bit coded display of the cause/source of the controller inhibit		
<b>Display area (min. hex value   max. hex value)</b>		
0x0000		0xFFFF
<b>Value is bit-coded:</b>		
Bit 0	Terminal controller enable	
Bit 1	CAN control word	
Bit 2	MCI control word	
Bit 3	SwitchOn	
Bit 4	Application	
Bit 5	Device command	
Bit 6	Error response	
Bit 7	Internal signal	
Bit 8	Reserved	
Bit 9	Energy saving mode	
Bit 10	AutoStartLock	
Bit 11	Motor parameter identification	
Bit 12	Automatic brake operation	
Bit 13	DCB-IMP	
Bit 14	Reserved	
Bit 15	Reserved	
<input checked="" type="checkbox"/> Read access <input type="checkbox"/> Write access <input type="checkbox"/> CINH <input type="checkbox"/> PLC STOP <input checked="" type="checkbox"/> No transfer <input type="checkbox"/> COM <input type="checkbox"/> MOT		

**C00159**

Parameter   Name: <b>C00159   Cause of quick stop QSP</b>		Data type: UNSIGNED_16 Index: 24416 <sub>d</sub> = 5F60 <sub>h</sub>
Bit coded display of the cause/source of the quick stop		
<b>Display area (min. hex value   max. hex value)</b>		
0x0000		0xFFFF

Parameter   Name: <b>C00159   Cause of quick stop QSP</b>		Data type: UNSIGNED_16 Index: 24416 <sub>d</sub> = 5F60 <sub>h</sub>
<b>Value is bit-coded:</b>		
Bit 0	Reserved	
Bit 1	CAN control word	
Bit 2	MCI control word	
Bit 3	Reserved	
Bit 4	Application	
Bit 5	Device command	
Bit 6	Error response	
Bit 7	Internal signal	
Bit 8	Reserved	
Bit 9	Energy saving mode	
Bit 10	Operating system	
Bit 11	Reserved	
Bit 12	MCK	
Bit 13	Reserved	
Bit 14	Reserved	
Bit 15	Reserved	
<input checked="" type="checkbox"/> Read access <input type="checkbox"/> Write access <input type="checkbox"/> CINH <input type="checkbox"/> PLC STOP <input checked="" type="checkbox"/> No transfer <input type="checkbox"/> COM <input type="checkbox"/> MOT		

**C00160**

Parameter   Name: <b>C00160   Status determining error (16bit)</b>		Data type: UNSIGNED_16 Index: 24415 <sub>d</sub> = 5F5F <sub>h</sub>
<b>From version 06.00.00</b> Display of the short 16-bit error number of the status determining error ▶ <a href="#">Structure of the 16-bit error number (bit coding)</a>		
<b>Display range (min. value   unit   max. value)</b>		
0		65535
<b>Subcodes</b>		<b>Info</b>
C00160/1		Status determining error (16-bit)
<input checked="" type="checkbox"/> Read access <input type="checkbox"/> Write access <input type="checkbox"/> CINH <input type="checkbox"/> PLC STOP <input checked="" type="checkbox"/> No transfer <input type="checkbox"/> COM <input type="checkbox"/> MOT           Scaling factor: 1		

**C00161**

Parameter   Name: <b>C00161   LS_SetError_x: Error number</b>		Data type: UNSIGNED_16 Index: 24414 <sub>d</sub> = 5F5E <sub>h</sub>
Setting of the error number for user error messages		
<b>Setting range (min. value   unit   max. value)</b>		
0		65535
<b>Subcodes</b>	<b>Lenze setting</b>	<b>Info</b>
C00161/1	1	<a href="#">LS_SetError_1</a> : Error no.1
C00161/2	2	<a href="#">LS_SetError_1</a> : Error no.2
C00161/3	3	<a href="#">LS_SetError_1</a> : Error no.3
C00161/4	4	<a href="#">LS_SetError_1</a> : Error no.4
<input checked="" type="checkbox"/> Read access <input checked="" type="checkbox"/> Write access <input type="checkbox"/> CINH <input type="checkbox"/> PLC STOP <input type="checkbox"/> No transfer <input type="checkbox"/> COM <input type="checkbox"/> MOT           Scaling factor: 1		

## C00162

Parameter   Name: <b>C00162   Error number masked</b>		Data type: UNSIGNED_32 Index: 24413 <sub>d</sub> = 5F5D <sub>h</sub>
From version 13.00.00 Display of the 32-bit error number of the status determining error without error type <ul style="list-style-type: none"> <li>The error number displayed here only contains the error subject area and error ID (lower 26 bits of the 32-bit error number)</li> </ul> <p style="text-align: right;">▶ <a href="#">Structure of the 32-bit error number (bit coding)</a></p>		
<b>Display range</b> (min. value   unit   max. value)		
0		4294967295
<b>Subcodes</b>		<b>Info</b>
C00162/1		Subject area + Id statuserror
<input checked="" type="checkbox"/> Read access <input type="checkbox"/> Write access <input type="checkbox"/> CINH <input type="checkbox"/> PLC STOP <input checked="" type="checkbox"/> No transfer <input type="checkbox"/> COM <input type="checkbox"/> MOT   Scaling factor: 1		

## C00163

Parameter   Name: <b>C00163   Logbook - binary elements</b>		Data type: UNSIGNED_16 Index: 24412 <sub>d</sub> = 5F5C <sub>h</sub>
Selection of two binary signals to be logged in the logbook		
<b>Selection list</b>		<b>Info</b>
0	No signal	
1	DI1: Input signal	
2	DI2: Input signal	
3	DI3: Input signal	
4	DI4: Input signal	
5	Controller inhibit signal	
6	Digital counter: Comparison bit	
7	CAN1 input bit 0	
8	CAN1 input bit 1	
9	CAN1 input bit 2	
10	CAN1 input bit 3	
11	CAN1 input bit 4	
12	CAN1 input bit 5	
13	CAN1 input bit 6	
14	CAN1 input bit 7	
15	CAN1 input bit 8	
16	CAN1 input bit 9	
17	CAN1 input bit 10	
18	CAN1 input bit 11	
19	CAN1 input bit 12	
20	CAN1 input bit 13	
21	CAN1 input bit 14	
22	CAN1 input bit 15	
23	CAN2 input bit 0	
24	CAN2 input bit 1	
25	CAN2 input bit 2	
26	CAN2 input bit 3	
27	CAN2 input bit 4	

Parameter   Name: <b>C00163   Logbook - binary elements</b>		Data type: UNSIGNED_16 Index: 24412 <sub>d</sub> = 5F5C <sub>h</sub>
28	CAN2 input bit 5	
29	CAN2 input bit 6	
30	CAN2 input bit 7	
31	CAN2 input bit 8	
32	CAN2 input bit 9	
33	CAN2 input bit 10	
34	CAN2 input bit 11	
35	CAN2 input bit 12	
36	CAN2 input bit 13	
37	CAN2 input bit 14	
38	CAN2 input bit 15	
39	CAN3 input bit 0	
40	CAN3 input bit 1	
41	CAN3 input bit 2	
42	CAN3 input bit 3	
43	CAN3 input bit 4	
44	CAN3 input bit 5	
45	CAN3 input bit 6	
46	CAN3 input bit 7	
47	CAN3 input bit 8	
48	CAN3 input bit 9	
49	CAN3 input bit 10	
50	CAN3 input bit 11	
51	CAN3 input bit 12	
52	CAN3 input bit 13	
53	CAN3 input bit 14	
54	CAN3 input bit 15	
55	MCI word1 input bit0	
56	MCI word1 input bit1	
57	MCI word1 input bit2	
58	MCI word1 input bit3	
59	MCI Word 1 Input bit 4	
60	MCI word1 input bit5	
61	MCI word1 input bit6	
62	MCI word1 input bit7	
63	MCI word1 input bit8	
64	MCI word1 input bit9	
65	MCI word1 input bit10	
66	MCI word1 input bit11	
67	MCI word1 input bit12	
68	MCI word1 input bit13	
69	MCI word1 input bit14	
70	MCI word1 input bit15	
71	MCI word2 input bit0	

Parameter   Name: <b>C00163   Logbook - binary elements</b>		Data type: UNSIGNED_16 Index: 24412 <sub>d</sub> = 5F5C <sub>h</sub>
72	MCI word2 input bit1	
73	MCI Word 2 Input bit 2	
74	MCI word2 input bit3	
75	MCI word2 input bit4	
76	MCI word2 input bit5	
77	MCI word2 input bit6	
78	MCI word 2 input bit 7	
79	MCI word2 input bit8	
80	MCI word2 input bit9	
81	MCI word2 input bit10	
82	MCI word2 input bit11	
83	MCI Word 2 Input bit 12	
84	MCI word2 input bit13	
85	MCI word2 input bit14	
86	MCI word2 input bit15	
87	Position controller: Limit	
88	Speed controller: Limit	
89	Speed setpoint: Limit	
90	Torque setpoint: Limit	
91	Current setpoint: Limit	
92	DC injection brake active	
93	Quick stop active	
94	Pulse inhibit active	
95	Controller inhibit active	
96	Safe status active	
97	Direction of rotation ccw	
98	Actual speed = 0	
99	L_Or_1: Out	
100	L_DFlipFlop_1: Out	
101	L_DigitalDelay_1: Out	
102	L_Compare_1: Out	
103	L_Compare_2: Out	
104	L_NSet_1: Setpoint reached	
105	L_DigitalLogic_1: Out	
106	L_SignalMonitor_b: Out1	
107	L_SignalMonitor_b: Out2	
108	L_SignalMonitor_b: Out3	
109	L_SignalMonitor_b: Out4	
110	L_PCTRL_1: act=set	
Subcodes	Lenze setting	Info
C00163/1	0: No signal	Logbook - binary element 1
C00163/2	0: No signal	Logbook - binary element 2
<input checked="" type="checkbox"/> Read access <input checked="" type="checkbox"/> Write access <input type="checkbox"/> CINH <input type="checkbox"/> PLC STOP <input type="checkbox"/> No transfer <input type="checkbox"/> COM <input type="checkbox"/> MOT   Scaling factor: 1		



## C00164

Parameter   Name: C00164   Logbook - analog elements		Data type: UNSIGNED_16 Index: 24411 <sub>d</sub> = 5F5B <sub>h</sub>
Selection of an analog signal to be logged in the logbook		
Selection list		Info
0	No signal	
1	AIN1	
2	CAN1 control word	
3	CAN1 input word 2	
4	CAN1 input word 3	
5	CAN1 input word 4	
6	CAN2 input word 1	
7	CAN2 input word 2	
8	CAN2 input word 3	
9	CAN2 input word 4	
10	CAN3 input word 1	
11	CAN3 input word 2	
12	CAN3 input word 3	
13	CAN3 input word 4	
14	Digital counter LowWord	
15	Digital counter HighWord	
16	MCI word 1	
17	MCI word 2	
18	MCI word 3	
19	MCI word 4	
20	MCI word 5	
21	MCI word 6	
22	MCI word 7	
23	MCI word 8	
24	MCI word 9	
25	MCI word 10	
26	MCI word 11	
27	MCI word 12	
28	MCI word 13	
29	MCI word 14	
30	MCI word 15	
31	MCI word 16	
32	Current motor speed	
33	Current motor torque	
34	DC-bus voltage	
35	Current motor current	
36	Current motor voltage	
37	Current motor frequency	
38	Effective speed setpoint	
39	Device utilisation	

Parameter   Name: <b>C00164   Logbook - analog elements</b>		Data type: UNSIGNED_16 Index: 24411 <sub>d</sub> = 5F5B <sub>h</sub>
40	Motor utilisation	
41	L_OffsetGainPar_1: Out	
42	L_OffsetGainPar_2: Out	
43	L_OffsetGainPar_3: Out	
44	L_Arithmetik_1: Out	
45	L_AnalogSwitch_1: Out	
46	L_NSet_1: Out	
47	L_MotorPoti_1: Out	
48	L_PCTRL_1: Out	
49	L_SignalMonitor_a: Out1	
50	L_SignalMonitor_a: Out2	
51	L_SignalMonitor_a: Out3	
52	L_SignalMonitor_a: Out4	
53	L_MulDiv_1: Out	
54	L_NSet_1: Target setpoint	
Subcodes	Lenze setting	Info
C00164/1	0: No signal	Logbook - analog element 1
<input checked="" type="checkbox"/> Read access <input checked="" type="checkbox"/> Write access <input type="checkbox"/> CINH <input type="checkbox"/> PLC STOP <input type="checkbox"/> No transfer <input type="checkbox"/> COM <input type="checkbox"/> MOT             Scaling factor: 1		

**C00165**

Parameter   Name: <b>C00165   Error information</b>		Data type: VISIBLE_STRING Index: 24410 <sub>d</sub> = 5F5A <sub>h</sub>
Display of the error number divided into sectors in the event of an error		
Subcodes	Info	
C00165/1	Status determining error	
C00165/2	Current error	
<input checked="" type="checkbox"/> Read access <input type="checkbox"/> Write access <input type="checkbox"/> CINH <input type="checkbox"/> PLC-STOP <input checked="" type="checkbox"/> No transfer <input type="checkbox"/> COM <input type="checkbox"/> MOT             Character length: 14		

**C00166**

Parameter   Name: <b>C00166   Error information text</b>		Data type: VISIBLE_STRING Index: 24409 <sub>d</sub> = 5F59 <sub>h</sub>
Display of details on the status determining error and on the currently pending error		
Subcodes	Info	
C00166/1	Resp. to status det. error • Response to the status determining error	
C00166/2	Subj. - status det. error • Subject area of the status determining error	
C00166/3	Mess. - status det. error • Textual message of the status determining error	
C00166/4	Resp. to curr. error • Response of the currently pending error	
C00166/5	Subj. - curr. error • Subject area of the currently pending error	
C00166/6	Mess. - curr. error • Textual message of the currently pending error	
<input checked="" type="checkbox"/> Read access <input type="checkbox"/> Write access <input type="checkbox"/> CINH <input type="checkbox"/> PLC-STOP <input checked="" type="checkbox"/> No transfer <input type="checkbox"/> COM <input type="checkbox"/> MOT             Character length: 31		

C00167

Parameter   Name: <b>C00167   Logbook data</b>	Data type: OCTET_STRING Index: 24408 <sub>d</sub> = 5F58 <sub>h</sub>
<b>This code is used device-internally and must not be written by the user side!</b>	

C00168

Parameter   Name: <b>C00168   Status determining error</b>	Data type: UNSIGNED_32 Index: 24407 <sub>d</sub> = 5F57 <sub>h</sub>
Display of the 32-bit error number of the status determining error <span style="float: right;">▶ <a href="#">Structure of the 32-bit error number (bit coding)</a></span>	
<b>Display range (min. value   unit   max. value)</b>	
0	4294967295
<input checked="" type="checkbox"/> Read access <input type="checkbox"/> Write access <input type="checkbox"/> CINH <input type="checkbox"/> PLC STOP <input checked="" type="checkbox"/> No transfer <input type="checkbox"/> COM <input type="checkbox"/> MOT                   Scaling factor: 1	

C00169

Parameter   Name: <b>C00169   Logbook setting</b>	Data type: UNSIGNED_16 Index: 24406 <sub>d</sub> = 5F56 <sub>h</sub>
Configuration which message types are to be logged in the logbook.	
<b>Setting range (min. hex value   max. hex value)</b>	<b>Lenze setting</b>
0x0000	0xFFFF <b>0x067E (decimal: 1662)</b>
<b>Value is bit-coded: (<input checked="" type="checkbox"/> = bit set)</b>	
Bit 0 <input type="checkbox"/>	Reserved
Bit 1 <input checked="" type="checkbox"/>	Log entry: Fault
Bit 2 <input checked="" type="checkbox"/>	Log entry: Trouble
Bit 3 <input checked="" type="checkbox"/>	Log entry: TroubleQuickstop
Bit 4 <input checked="" type="checkbox"/>	Log entry: WarningLocked
Bit 5 <input checked="" type="checkbox"/>	Log entry: Warning
Bit 6 <input checked="" type="checkbox"/>	Log entry: Information
Bit 7 <input type="checkbox"/>	Reserved
Bit 8 <input type="checkbox"/>	Reserved
Bit 9 <input checked="" type="checkbox"/>	Activation: Error counter
Bit 10 <input checked="" type="checkbox"/>	Activation: Log line refresh
Bit 11 <input type="checkbox"/>	Reserved
Bit 12 <input type="checkbox"/>	Reserved
Bit 13 <input type="checkbox"/>	Reserved
Bit 14 <input type="checkbox"/>	Reserved
Bit 15 <input type="checkbox"/>	Reserved
<input checked="" type="checkbox"/> Read access <input checked="" type="checkbox"/> Write access <input type="checkbox"/> CINH <input type="checkbox"/> PLC STOP <input type="checkbox"/> No transfer <input type="checkbox"/> COM <input type="checkbox"/> MOT	

C00170

Parameter   Name: <b>C00170   Current error</b>	Data type: UNSIGNED_32 Index: 24405 <sub>d</sub> = 5F55 <sub>h</sub>
Display of the internal error number of the currently pending error	
<b>Display range (min. value   unit   max. value)</b>	
0	4294967295
<input checked="" type="checkbox"/> Read access <input type="checkbox"/> Write access <input type="checkbox"/> CINH <input type="checkbox"/> PLC STOP <input checked="" type="checkbox"/> No transfer <input type="checkbox"/> COM <input type="checkbox"/> MOT                   Scaling factor: 1	

C00171

Parameter   Name: <b>C00171   Logbook access index</b>	Data type: UNSIGNED_8 Index: 2440 <sub>d</sub> = 5F54 <sub>h</sub>
<b>This code is used device-internally and must not be written by the user side!</b>	

C00173

Parameter   Name: <b>C00173   Mains voltage</b>	Data type: UNSIGNED_8 Index: 2440 <sub>d</sub> = 5F52 <sub>h</sub>
<p>If the rated mains voltage differs from 230 V or 400 V, set the mains voltage the drive is operated with. The set mains voltage influences the brake chopper threshold, the monitoring of the device utilisation (Ixt) and the switch-off threshold in case of undervoltage in the DC bus.</p> <ul style="list-style-type: none"> <li>The brake chopper threshold must not be smaller than the stabilised DC-bus voltage</li> </ul>	
Selection list(Lenze setting printed in bold)	Info
0 <b>3ph 400V / 1ph 230V</b>	3-phase 400 V or 1-phase 230 V
1 3ph 440V / 1ph 230V	3-phase 440 V or 1-phase 230 V
2 3ph 480V / 1ph 230V	3-phase 480 V or 1-phase 230 V
3 3ph 500V / 1ph 230V	3-phase 500 V or 1-phase 230 V
4 Reserved / reserved	
<input checked="" type="checkbox"/> Read access <input checked="" type="checkbox"/> Write access <input checked="" type="checkbox"/> CINH <input type="checkbox"/> PLC STOP <input type="checkbox"/> No transfer <input type="checkbox"/> COM <input type="checkbox"/> MOT                   Scaling factor: 1	

C00174

Parameter   Name: <b>C00174   Reduc. brake chopper threshold</b>	Data type: UNSIGNED_8 Index: 2440 <sub>d</sub> = 5F51 <sub>h</sub>
<p>The threshold from which the brake chopper is controlled is reduced by the voltage value set here.</p> <ul style="list-style-type: none"> <li>The brake chopper threshold must not be smaller than the stabilised DC-bus voltage</li> </ul>	
Setting range (min. value   unit   max. value)	Lenze setting
0                                  V                                  150	<b>0 V</b>
<input checked="" type="checkbox"/> Read access <input checked="" type="checkbox"/> Write access <input type="checkbox"/> CINH <input type="checkbox"/> PLC STOP <input type="checkbox"/> No transfer <input type="checkbox"/> COM <input type="checkbox"/> MOT                   Scaling factor: 1	

C00175

Parameter   Name: <b>C00175   Brake energy management</b>	Data type: UNSIGNED_8 Index: 2440 <sub>d</sub> = 5F50 <sub>h</sub>
<p>From version 03.00.00 Selection of the braking procedure</p> <p style="text-align: right;">▶ <a href="#">Select response if the brake resistor is controlled</a></p>	
Selection list(Lenze setting printed in bold)	Info
0 <b>R_Brems</b>	The brake resistor is used. When the threshold voltage ( <a href="#">C00174</a> ) is exceeded, the brake resistor is energised.

Parameter   Name: <b>C00175   Brake energy management</b>		Data type: UNSIGNED_8 Index: 24400 <sub>d</sub> = 5F50 <sub>h</sub>
1	RfgStop	The "Ramp function generator stop" signal ( <i>MCTRL_bRfgStop</i> ) is used. When the threshold voltage is exceeded ( <a href="#">C00174</a> ), the ramp function generator is stopped.
2	R_Brems + HlgStop	The brake resistor and the "Ramp function generator stop" signal are used. When the threshold voltage is exceeded ( <a href="#">C00174</a> ), the brake resistor is energised and the ramp function generator is stopped.
3	FI_MotBrk + RfgStop	<a href="#">From version 04.00.00</a> Braking is performed by a superimposed speed setpoint vibration in conjunction with "Ramp function generator stop".
4	R_Brems + FU_MotBrk + HlgStop	<a href="#">From version 04.00.00</a> Braking is performed by combining all three braking procedures.
<input checked="" type="checkbox"/> Read access <input checked="" type="checkbox"/> Write access <input checked="" type="checkbox"/> CINH <input type="checkbox"/> PLC STOP <input type="checkbox"/> No transfer <input type="checkbox"/> COM <input type="checkbox"/> MOT             Scaling factor: 1		

**C00176**

Parameter   Name: <b>C00176   Undervoltage threshold for mains OFF</b>	Data type: UNSIGNED_16 Index: 24399 <sub>d</sub> = 5F4F <sub>h</sub>
<b>This code is used device-internally and must not be written by the user side!</b>	

**C00177**

Parameter   Name: <b>C00177   Switching cycles</b>		Data type: UNSIGNED_32 Index: 24398 <sub>d</sub> = 5F4E <sub>h</sub>
Counter of different switching cycles and stressful situations		
<b>Display range</b> (min. value   unit   max. value)		
0		2147483647
<b>Subcodes</b>		<b>Info</b>
C00177/1		Number of mains switching cycles
C00177/2		Number of switching cycles of the output relay
C00177/3		Short circuit counter
C00177/4		Earth fault counter
C00177/5		"Clamp" counter
C00177/6		Counter for "safe torque off" (STO) after power-on • <a href="#">From version 12.00.00</a>
C00177/7		Counter for controller inhibit via terminal after power-on • <a href="#">From version 12.00.00</a>
C00177/8		Counter for pulse inhibit (IMP) after power-on • <a href="#">From version 12.00.00</a>
C00177/9		Service code
<input checked="" type="checkbox"/> Read access <input type="checkbox"/> Write access <input type="checkbox"/> CINH <input type="checkbox"/> PLC STOP <input checked="" type="checkbox"/> No transfer <input type="checkbox"/> COM <input type="checkbox"/> MOT             Scaling factor: 1		

## C00178

Parameter   Name: <b>C00178   Elapsed-hour meter</b>		Data type: UNSIGNED_32 Index: 24397 <sub>d</sub> = 5F4D <sub>h</sub>
Display of operating hours in seconds		
<b>Display range (min. value   unit   max. value)</b>		
0	s	2147483647
<input checked="" type="checkbox"/> Read access <input type="checkbox"/> Write access <input type="checkbox"/> CINH <input type="checkbox"/> PLC STOP <input checked="" type="checkbox"/> No transfer <input type="checkbox"/> COM <input type="checkbox"/> MOT           Scaling factor: 1		

## C00179

Parameter   Name: <b>C00179   Power-on time meter</b>		Data type: UNSIGNED_32 Index: 24396 <sub>d</sub> = 5F4C <sub>h</sub>
Display of the power-on time in seconds		
<b>Display range (min. value   unit   max. value)</b>		
0	s	2147483647
<input checked="" type="checkbox"/> Read access <input type="checkbox"/> Write access <input type="checkbox"/> CINH <input type="checkbox"/> PLC STOP <input checked="" type="checkbox"/> No transfer <input type="checkbox"/> COM <input type="checkbox"/> MOT           Scaling factor: 1		

## C00180

Parameter   Name: <b>C00180   Running time</b>		Data type: UNSIGNED_32 Index: 24395 <sub>d</sub> = 5F4B <sub>h</sub>
Display of various running times in seconds		
<b>Display range (min. value   unit   max. value)</b>		
0	s	2147483647
<b>Subcodes</b>		<b>Info</b>
C00180/1		Runtime - control card
C00180/2		Running time - heatsink fan
C00180/3		Running time - internal fan
<input checked="" type="checkbox"/> Read access <input type="checkbox"/> Write access <input type="checkbox"/> CINH <input type="checkbox"/> PLC STOP <input checked="" type="checkbox"/> No transfer <input type="checkbox"/> COM <input type="checkbox"/> MOT           Scaling factor: 1		

## C00181

Parameter   Name: <b>C00181   Time settings</b>		Data type: UNSIGNED_16 Index: 24394 <sub>d</sub> = 5F4A <sub>h</sub>
From version 06.00.00 Time for device search function (optical location)		
<a href="#">▶ Device search function</a>		
<b>Setting range (min. value   unit   max. value)</b>		
0	s	6000
<b>Subcodes</b>		<b>Info</b>
C00181/1		Time - device search function
<input checked="" type="checkbox"/> Read access <input checked="" type="checkbox"/> Write access <input type="checkbox"/> CINH <input type="checkbox"/> PLC STOP <input type="checkbox"/> No transfer <input type="checkbox"/> COM <input type="checkbox"/> MOT           Scaling factor: 1		

## C00182

Parameter   Name: <b>C00182   L_NSet_1: S-ramp time PT1</b>		Data type: INTEGER_16 Index: 24393 <sub>d</sub> = 5F49 <sub>h</sub>	
FB <a href="#">L_NSet_1</a> : PT1 S-ramp time for the main setpoint ramp function generator • Only effective with activated ramp rounding ( <a href="#">C00134</a> = "1").			
<b>Setting range</b> (min. value   unit   max. value)		<b>Lenze setting</b>	
0.01	s	50.00	<b>20.00 s</b>
<input checked="" type="checkbox"/> Read access <input checked="" type="checkbox"/> Write access <input type="checkbox"/> CINH <input type="checkbox"/> PLC STOP <input type="checkbox"/> No transfer <input type="checkbox"/> COM <input type="checkbox"/> MOT Scaling factor: 100			

## C00184

Parameter   Name: <b>C00184   AutoFailReset repetition time</b>		Data type: UNSIGNED_16 Index: 24391 <sub>d</sub> = 5F47 <sub>h</sub>	
After the time set here has expired, an error message of an error that has occurred will be reset automatically if "AutoFailReset" had been configured correspondingly in <a href="#">C00188</a> . <a href="#">▶ AutoFailReset function</a>			
<b>Setting range</b> (min. value   unit   max. value)		<b>Lenze setting</b>	
1	s	600	<b>3 s</b>
<input checked="" type="checkbox"/> Read access <input checked="" type="checkbox"/> Write access <input type="checkbox"/> CINH <input type="checkbox"/> PLC STOP <input type="checkbox"/> No transfer <input type="checkbox"/> COM <input type="checkbox"/> MOT Scaling factor: 1			

## C00185

Parameter   Name: <b>C00185   AutoFailReset remaining time</b>		Data type: UNSIGNED_16 Index: 24390 <sub>d</sub> = 5F46 <sub>h</sub>	
Display of the residual runtime of the "AutoFailReset" function <a href="#">▶ AutoFailReset function</a>			
<b>Display range</b> (min. value   unit   max. value)			
0	s	600	
<input checked="" type="checkbox"/> Read access <input type="checkbox"/> Write access <input type="checkbox"/> CINH <input type="checkbox"/> PLC STOP <input type="checkbox"/> No transfer <input type="checkbox"/> COM <input type="checkbox"/> MOT Scaling factor: 1			

## C00186

Parameter   Name: <b>C00186   Max. number of AutoFailReset processes</b>		Data type: UNSIGNED_8 Index: 24389 <sub>d</sub> = 5F45 <sub>h</sub>	
Maximum number of "AutoFailReset" procedures <a href="#">▶ AutoFailReset function</a>			
<b>Setting range</b> (min. value   unit   max. value)		<b>Lenze setting</b>	
1		16	<b>4</b>
<input checked="" type="checkbox"/> Read access <input checked="" type="checkbox"/> Write access <input type="checkbox"/> CINH <input type="checkbox"/> PLC STOP <input type="checkbox"/> No transfer <input type="checkbox"/> COM <input type="checkbox"/> MOT Scaling factor: 1			

## C00187

Parameter   Name: <b>C00187   Current AutoFailReset processes</b>		Data type: UNSIGNED_8 Index: 24388 <sub>d</sub> = 5F44 <sub>h</sub>	
Data of the current number of "AutoFailReset" procedures <a href="#">▶ AutoFailReset function</a>			
<b>Display range</b> (min. value   unit   max. value)			
0		16	
<input checked="" type="checkbox"/> Read access <input type="checkbox"/> Write access <input type="checkbox"/> CINH <input type="checkbox"/> PLC STOP <input type="checkbox"/> No transfer <input type="checkbox"/> COM <input type="checkbox"/> MOT Scaling factor: 1			

## C00188

Parameter   Name: <b>C00188   AutoFailReset configuration</b>		Data type: UNSIGNED_8 Index: 24387 <sub>d</sub> = 5F43 <sub>h</sub>
Setting which error messages are to be reset automatically. <a href="#">▶ AutoFailReset function</a>		
Selection list(Lenze setting printed in bold)		Info
0	<b>Off</b>	No automatic error message reset
1	Fault + TroubleQSP	Error messages with the response "Fault" and "TroubleQSP" are reset automatically
2	WarningLocked	Error messages with the response "WarningLocked" are reset automatically
3	All locking	All "locking" error messages are reset automatically
<input checked="" type="checkbox"/> Read access <input checked="" type="checkbox"/> Write access <input type="checkbox"/> CINH <input type="checkbox"/> PLC STOP <input type="checkbox"/> No transfer <input type="checkbox"/> COM <input type="checkbox"/> MOT             Scaling factor: 1		

## C00189

Parameter   Name: <b>C00189   Resp. to too frequent AutoFailReset</b>		Data type: UNSIGNED_8 Index: 24386 <sub>d</sub> = 5F42 <sub>h</sub>
Response to exceeding the maximum number of "AutoFailReset" processes set in <a href="#">C00186</a> . <a href="#">▶ AutoFailReset function</a>		
Selection list(Lenze setting printed in bold)		
0	No Reaction	
1	<b>Fault</b>	
2	Trouble	
3	TroubleQuickStop	
4	WarningLocked	
5	Warning	
6	Information	
<input checked="" type="checkbox"/> Read access <input checked="" type="checkbox"/> Write access <input type="checkbox"/> CINH <input type="checkbox"/> PLC STOP <input type="checkbox"/> No transfer <input type="checkbox"/> COM <input type="checkbox"/> MOT             Scaling factor: 1		

## C00190

Parameter   Name: <b>C00190   L_NSet_1: Setpoint arithmetic</b>		Data type: UNSIGNED_8 Index: 24385 <sub>d</sub> = 5F41 <sub>h</sub>
The <a href="#">L_NSet_1</a> FB: Selection of arithmetics • To be able to influence the main setpoint (NSet) by an additional setpoint (NAdd).		
Selection list(Lenze setting printed in bold)		
0	<b>Out = Set</b>	
1	Out = Set + Add	
2	NOut = NSet - NAdd	
3	NOut = (NSet * NAdd) / 100%	
4	NOut = (NSet * 1%) /  NAdd	
5	Out = (Set*100%)/(100%-Add)	
<input checked="" type="checkbox"/> Read access <input checked="" type="checkbox"/> Write access <input type="checkbox"/> CINH <input type="checkbox"/> PLC STOP <input type="checkbox"/> No transfer <input type="checkbox"/> COM <input type="checkbox"/> MOT             Scaling factor: 1		



## C00191

Parameter   Name: <b>C00191   Logbook access index User</b>		Data type: UNSIGNED_8 Index: 24384 <sub>d</sub> = 5F40 <sub>h</sub>
From version 12.00.00		<a href="#">▶ Logbook read interface</a>
<b>Setting range (min. value   unit   max. value)</b>		
0		255
<b>Subcodes</b>	<b>Lenze setting</b>	<b>Info</b>
C00191/1	255	Logbook access index User
<input checked="" type="checkbox"/> Read access <input checked="" type="checkbox"/> Write access <input type="checkbox"/> CINH <input type="checkbox"/> PLC STOP <input checked="" type="checkbox"/> No transfer <input type="checkbox"/> COM <input type="checkbox"/> MOT   Scaling factor: 1		

## C00192

Parameter   Name: <b>C00192   Logbook data User</b>		Data type: OCTET_STRING Index: 24383 <sub>d</sub> = 5F3F <sub>h</sub>
From version 12.00.00		<a href="#">▶ Logbook read interface</a>
<b>Display range (min. value   unit   max. value)</b>		
<b>Subcodes</b>	<b>Info</b>	
C00192/1	Logbook data User	
<input checked="" type="checkbox"/> Read access <input type="checkbox"/> Write access <input type="checkbox"/> CINH <input type="checkbox"/> PLC STOP <input checked="" type="checkbox"/> No transfer <input type="checkbox"/> COM <input type="checkbox"/> MOT		

## C00193

Parameter   Name: <b>C00193   Logbook element User</b>		Data type: UNSIGNED_32 Index: 24382 <sub>d</sub> = 5F3E <sub>h</sub>
From version 12.00.00		<a href="#">▶ Logbook read interface</a>
<b>Display range (min. value   unit   max. value)</b>		
0		2147483647
<b>Subcodes</b>	<b>Info</b>	
C00193/1	Response index	
C00193/2	Activity	
C00193/3	Meters	
C00193/4	Error type	
C00193/5	Error number	
C00193/6	Time stamp	
<input checked="" type="checkbox"/> Read access <input type="checkbox"/> Write access <input type="checkbox"/> CINH <input type="checkbox"/> PLC STOP <input checked="" type="checkbox"/> No transfer <input type="checkbox"/> COM <input type="checkbox"/> MOT   Scaling factor: 1		

## C00199

Parameter   Name: <b>C00199   Description data</b>		Data type: VISIBLE_STRING Index: 24376 <sub>d</sub> = 5F38 <sub>h</sub>
From version 06.00.00 Parameters for storing decription data for the inverter <span style="float: right;"><a href="#">▶ Device identification</a></span>		
Subcodes	Lenze setting	Info
C00199/1		Device name
C00199/2		User text • From version 12.00.00
C00199/3		User text • From version 12.00.00
C00199/4		User text • From version 12.00.00
C00199/5		User text • From version 12.00.00
<input checked="" type="checkbox"/> Read access <input checked="" type="checkbox"/> Write access <input type="checkbox"/> CINH <input type="checkbox"/> PLC-STOP <input type="checkbox"/> No transfer <input type="checkbox"/> COM <input type="checkbox"/> MOT             Character length: 32		

## C00200

Parameter   Name: <b>C00200   Firmware product type</b>		Data type: VISIBLE_STRING Index: 24375 <sub>d</sub> = 5F37 <sub>h</sub>
Display of the firmware product type		
<input checked="" type="checkbox"/> Read access <input type="checkbox"/> Write access <input type="checkbox"/> CINH <input type="checkbox"/> PLC-STOP <input checked="" type="checkbox"/> No transfer <input type="checkbox"/> COM <input type="checkbox"/> MOT             Character length: 19		

## C00201

Parameter   Name: <b>C00201   Firmware</b>		Data type: VISIBLE_STRING Index: 24374 <sub>d</sub> = 5F36 <sub>h</sub>
Display of the firmware data of the control card and the power section		
Subcodes	Info	
C00201/1	Firmware type - ctrl card	
C00201/2	Firmware version - ctrl card	
C00201/3	Firmware comp. file - ctrl card	
C00201/4	Firmware type - power section	
C00201/5	Firmware version - power sect.	
C00201/6	Firmw. comp. file - power sect.	
<input checked="" type="checkbox"/> Read access <input type="checkbox"/> Write access <input type="checkbox"/> CINH <input type="checkbox"/> PLC-STOP <input checked="" type="checkbox"/> No transfer <input type="checkbox"/> COM <input type="checkbox"/> MOT             Character length: 22		

## C00203

Parameter   Name: <b>C00203   Product type code</b>		Data type: VISIBLE_STRING Index: 24372 <sub>d</sub> = 5F34 <sub>h</sub>
Display of the types of the individual device components		
Subcodes	Info	
C00203/1	Type: Control card	
C00203/2	Type: Power section	
C00203/3	Type: MCI module	
C00203/4	Reserved	
C00203/5	Type: Memory module	

Parameter   Name: <b>C00203   Product type code</b>		Data type: VISIBLE_STRING Index: 24372 <sub>d</sub> = 5F34 <sub>h</sub>
C00203/6	Type: Safety card	
C00203/7	Type: Standard device	
C00203/8	Type: Complete device	
C00203/9	Reserved	
<input checked="" type="checkbox"/> Read access <input type="checkbox"/> Write access <input type="checkbox"/> CINH <input type="checkbox"/> PLC-STOP <input checked="" type="checkbox"/> No transfer <input type="checkbox"/> COM <input type="checkbox"/> MOT                   Character length: 24		

**C00204**

Parameter   Name: <b>C00204   Serial number</b>		Data type: VISIBLE_STRING Index: 24371 <sub>d</sub> = 5F33 <sub>h</sub>
Display of the serial numbers of the individual device components		
<b>Subcodes</b>	<b>Info</b>	
C00204/1	Serial no.: Control card	
C00204/2	Serial no.: Power section	
C00204/3	Serial no.: MCI module	
C00204/4	Reserved	
C00204/5	Serial no.: Memory module	
C00204/6	Serial no.: Safety card	
C00204/7	Serial no.: Standard device	
C00204/8	Serial no.: Complete device	
C00204/9	Reserved	
<input checked="" type="checkbox"/> Read access <input type="checkbox"/> Write access <input type="checkbox"/> CINH <input type="checkbox"/> PLC-STOP <input checked="" type="checkbox"/> No transfer <input type="checkbox"/> COM <input type="checkbox"/> MOT                   Character length: 24		

**C00205**

Parameter   Name: <b>C00205   Info</b>		Data type: VISIBLE_STRING Index: 24370 <sub>d</sub> = 5F32 <sub>h</sub>
<b>This code is used device-internally and must not be written by the user side!</b>		

**C00206**

Parameter   Name: <b>C00206   Production date</b>		Data type: VISIBLE_STRING Index: 24369 <sub>d</sub> = 5F31 <sub>h</sub>
<b>This code is used device-internally and must not be written by the user side!</b>		

**C00210**

Parameter   Name: <b>C00210   HW version</b>		Data type: VISIBLE_STRING Index: 24365 <sub>d</sub> = 5F2D <sub>h</sub>
<b>This code is used device-internally and must not be written by the user side!</b>		

## C00219

Parameter   Name: <b>C00219   Identity</b>		Data type: UNSIGNED_32 Index: 24356 <sub>d</sub> = 5F24 <sub>h</sub>	
From version 12.00.00			
<b>Display range</b> (min. value   unit   max. value)			
0		4294967295	
<b>Subcodes</b>		<b>Info</b>	
C00219/1		CAN manufacturer no.	
C00219/2		CAN device type	
C00219/3		CAN version	
C00219/4		CAN count no.	
<input checked="" type="checkbox"/> Read access <input type="checkbox"/> Write access <input type="checkbox"/> CINH <input type="checkbox"/> PLC STOP <input checked="" type="checkbox"/> No transfer <input type="checkbox"/> COM <input type="checkbox"/> MOT   Scaling factor: 1			

## C00220

Parameter   Name: <b>C00220   L_NSet_1: Acceleration time - add. setpoint</b>		Data type: UNSIGNED_32 Index: 24355 <sub>d</sub> = 5F23 <sub>h</sub>	
The <a href="#">L_NSet_1</a> FB: Acceleration time for the additional setpoint <i>nNAdd_a</i>			
<b>Setting range</b> (min. value   unit   max. value)		<b>Lenze setting</b>	
0.000	s	999.999	<b>0.000 s</b>
<input checked="" type="checkbox"/> Read access <input checked="" type="checkbox"/> Write access <input type="checkbox"/> CINH <input type="checkbox"/> PLC STOP <input type="checkbox"/> No transfer <input type="checkbox"/> COM <input type="checkbox"/> MOT   Scaling factor: 1000			

## C00221

Parameter   Name: <b>C00221   L_NSet_1: Deceleration time - add. setpoint</b>		Data type: UNSIGNED_32 Index: 24354 <sub>d</sub> = 5F22 <sub>h</sub>	
The <a href="#">L_NSet_1</a> FB: Deceleration time for the additional setpoint <i>nNAdd_a</i>			
<b>Setting range</b> (min. value   unit   max. value)		<b>Lenze setting</b>	
0.000	s	999.999	<b>0.000 s</b>
<input checked="" type="checkbox"/> Read access <input checked="" type="checkbox"/> Write access <input type="checkbox"/> CINH <input type="checkbox"/> PLC STOP <input type="checkbox"/> No transfer <input type="checkbox"/> COM <input type="checkbox"/> MOT   Scaling factor: 1000			

## C00222

Parameter   Name: <b>C00222   L_PCTRL_1: Vp</b>		Data type: INTEGER_16 Index: 24353 <sub>d</sub> = 5F21 <sub>h</sub>	
The <a href="#">L_PCTRL_1</a> FB: Gain factor Vp for the PID process controller			
<b>Setting range</b> (min. value   unit   max. value)		<b>Lenze setting</b>	
0.1		500.0	<b>1.0</b>
<input checked="" type="checkbox"/> Read access <input checked="" type="checkbox"/> Write access <input type="checkbox"/> CINH <input type="checkbox"/> PLC STOP <input type="checkbox"/> No transfer <input type="checkbox"/> COM <input type="checkbox"/> MOT   Scaling factor: 10			

## C00223

Parameter   Name: <b>C00223   L_PCTRL_1: Tn</b>		Data type: UNSIGNED_16 Index: 24352 <sub>d</sub> = 5F20 <sub>h</sub>	
The <a href="#">L_PCTRL_1</a> FB: Reset time Tn for the PID process controller			
<b>Setting range</b> (min. value   unit   max. value)		<b>Lenze setting</b>	
20	ms	6000	<b>400 ms</b>
<input checked="" type="checkbox"/> Read access <input checked="" type="checkbox"/> Write access <input type="checkbox"/> CINH <input type="checkbox"/> PLC STOP <input type="checkbox"/> No transfer <input type="checkbox"/> COM <input type="checkbox"/> MOT   Scaling factor: 1			

## C00224

Parameter   Name: <b>C00224   L_PCTRL_1: Kd</b>		Data type: UNSIGNED_16 Index: 24351 <sub>d</sub> = 5F1F <sub>h</sub>	
The <a href="#">L_PCTRL_1</a> FB: Derivative-action coefficient Kd for the PID process controller			
<b>Setting range</b> (min. value   unit   max. value)		<b>Lenze setting</b>	
0.0		5.0	<b>0.0</b>
<input checked="" type="checkbox"/> Read access <input checked="" type="checkbox"/> Write access <input type="checkbox"/> CINH <input type="checkbox"/> PLC STOP <input type="checkbox"/> No transfer <input type="checkbox"/> COM <input type="checkbox"/> MOT Scaling factor: 10			

## C00225

Parameter   Name: <b>C00225   L_PCTRL_1: MaxLimit</b>		Data type: INTEGER_16 Index: 24350 <sub>d</sub> = 5F1E <sub>h</sub>	
The <a href="#">L_PCTRL_1</a> FB: Maximum output value of the PID process controller			
<b>Setting range</b> (min. value   unit   max. value)		<b>Lenze setting</b>	
-199.99	%	199.99	<b>199.99 %</b>
<input checked="" type="checkbox"/> Read access <input checked="" type="checkbox"/> Write access <input type="checkbox"/> CINH <input type="checkbox"/> PLC STOP <input type="checkbox"/> No transfer <input type="checkbox"/> COM <input type="checkbox"/> MOT Scaling factor: 100			

## C00226

Parameter   Name: <b>C00226   L_PCTRL_1: MinLimit</b>		Data type: INTEGER_16 Index: 24349 <sub>d</sub> = 5F1D <sub>h</sub>	
The <a href="#">L_PCTRL_1</a> FB: Minimum output value of the PID process controller			
<b>Setting range</b> (min. value   unit   max. value)		<b>Lenze setting</b>	
-199.99	%	199.99	<b>-199.99 %</b>
<input checked="" type="checkbox"/> Read access <input checked="" type="checkbox"/> Write access <input type="checkbox"/> CINH <input type="checkbox"/> PLC STOP <input type="checkbox"/> No transfer <input type="checkbox"/> COM <input type="checkbox"/> MOT Scaling factor: 100			

## C00227

Parameter   Name: <b>C00227   L_PCTRL_1: Acceleration time</b>		Data type: UNSIGNED_32 Index: 24348 <sub>d</sub> = 5F1C <sub>h</sub>	
The <a href="#">L_PCTRL_1</a> FB: Acceleration time for the output value of the PID process controller			
<b>Setting range</b> (min. value   unit   max. value)		<b>Lenze setting</b>	
0.000	s	999.999	<b>0.010 s</b>
<input checked="" type="checkbox"/> Read access <input checked="" type="checkbox"/> Write access <input type="checkbox"/> CINH <input type="checkbox"/> PLC STOP <input type="checkbox"/> No transfer <input type="checkbox"/> COM <input type="checkbox"/> MOT Scaling factor: 1000			

## C00228

Parameter   Name: <b>C00228   L_PCTRL_1: Deceleration time</b>		Data type: UNSIGNED_32 Index: 24347 <sub>d</sub> = 5F1B <sub>h</sub>	
The <a href="#">L_PCTRL_1</a> FB: Deceleration time for the output value of the PID process controller			
<b>Setting range</b> (min. value   unit   max. value)		<b>Lenze setting</b>	
0.000	s	999.999	<b>0.010 s</b>
<input checked="" type="checkbox"/> Read access <input checked="" type="checkbox"/> Write access <input type="checkbox"/> CINH <input type="checkbox"/> PLC STOP <input type="checkbox"/> No transfer <input type="checkbox"/> COM <input type="checkbox"/> MOT Scaling factor: 1000			

## C00231

Parameter   Name: <b>C00231   L_PCTRL_1: Operating range</b>		Data type: INTEGER_16 Index: 24344 <sub>d</sub> = 5F18 <sub>h</sub>
From version 02.00.00 The <a href="#">L_PCTRL_1</a> FB: Operating range for the PID process controller		
<b>Setting range (min. value   unit   max. value)</b>		
0.00	%	199.99
<b>Subcodes</b>	<b>Lenze setting</b>	<b>Info</b>
C00231/1	199.99 %	<a href="#">L_PCTRL_1</a> : Pos. maximum
C00231/2	0.00 %	<a href="#">L_PCTRL_1</a> : Pos. minimum
C00231/3	0.00 %	<a href="#">L_PCTRL_1</a> : Neg. minimum
C00231/4	199.99 %	<a href="#">L_PCTRL_1</a> : Neg. maximum
<input checked="" type="checkbox"/> Read access <input checked="" type="checkbox"/> Write access <input type="checkbox"/> CINH <input type="checkbox"/> PLC STOP <input type="checkbox"/> No transfer <input type="checkbox"/> COM <input type="checkbox"/> MOT   Scaling factor: 100		

## C00233

Parameter   Name: <b>C00233   L_PCTRL_1: Root function</b>		Data type: UNSIGNED_8 Index: 24342 <sub>d</sub> = 5F16 <sub>h</sub>
The <a href="#">L_PCTRL_1</a> FB: Use of the root function at the actual value input		
<b>Selection list(Lenze setting printed in bold)</b>		<b>Info</b>
<b>0</b>	<b>Off</b>	Root function inactive • The actual value <i>nAct_a</i> remains unchanged for further processing
<b>1</b>	<b>On</b>	Root function active • The root is extracted of the actual value <i>nAct_a</i> for further processing
<input checked="" type="checkbox"/> Read access <input checked="" type="checkbox"/> Write access <input type="checkbox"/> CINH <input type="checkbox"/> PLC STOP <input type="checkbox"/> No transfer <input type="checkbox"/> COM <input type="checkbox"/> MOT   Scaling factor: 1		

## C00234

Parameter   Name: <b>C00234   Oscillation damping influence</b>		Data type: UNSIGNED_16 Index: 24341 <sub>d</sub> = 5F15 <sub>h</sub>
From a device power of 2.2 kW: 50 %		<a href="#">Oscillation damping</a>
<b>Setting range (min. value   unit   max. value)</b>		<b>Lenze setting</b>
0.00	%	250.00 <b>5.00 %</b>
<input checked="" type="checkbox"/> Read access <input checked="" type="checkbox"/> Write access <input type="checkbox"/> CINH <input type="checkbox"/> PLC STOP <input type="checkbox"/> No transfer <input type="checkbox"/> COM <input checked="" type="checkbox"/> MOT   Scaling factor: 100		

## C00235

Parameter   Name: <b>C00235   Oscillation damping filter time</b>		Data type: UNSIGNED_8 Index: 24340 <sub>d</sub> = 5F14 <sub>h</sub>
		<a href="#">Oscillation damping</a>
<b>Setting range (min. value   unit   max. value)</b>		<b>Lenze setting</b>
2	ms	250 <b>32 ms</b>
<input checked="" type="checkbox"/> Read access <input checked="" type="checkbox"/> Write access <input type="checkbox"/> CINH <input type="checkbox"/> PLC STOP <input type="checkbox"/> No transfer <input type="checkbox"/> COM <input checked="" type="checkbox"/> MOT   Scaling factor: 1		

## C00236

Parameter   Name: <b>C00236   Field weakening oscillation damping</b>		Data type: UNSIGNED_8 Index: 24339 <sub>d</sub> = 5F13 <sub>h</sub>	
Oscillation damping for idling machines			
<a href="#">Oscillation damping</a>			
<b>Setting range</b> (min. value   unit   max. value)		<b>Lenze setting</b>	
0		40	<b>14</b>
<input checked="" type="checkbox"/> Read access <input checked="" type="checkbox"/> Write access <input type="checkbox"/> CINH <input type="checkbox"/> PLC STOP <input type="checkbox"/> No transfer <input type="checkbox"/> COM <input checked="" type="checkbox"/> MOT   Scaling factor: 1			

## C00241

Parameter   Name: <b>C00241   L_NSet_1: Hyst. NSet reached</b>		Data type: INTEGER_16 Index: 24334 <sub>d</sub> = 5F0E <sub>h</sub>	
The <a href="#">L_NSet_1</a> FB: Hysteresis window for the zero detection of the speed output setpoint			
<ul style="list-style-type: none"> <li>The speed threshold for the zero detection is 1 %</li> </ul>			
<b>Setting range</b> (min. value   unit   max. value)		<b>Lenze setting</b>	
0.00	%	100.00	<b>0.50 %</b>
<input checked="" type="checkbox"/> Read access <input checked="" type="checkbox"/> Write access <input type="checkbox"/> CINH <input type="checkbox"/> PLC STOP <input type="checkbox"/> No transfer <input type="checkbox"/> COM <input type="checkbox"/> MOT   Scaling factor: 100			

## C00242

Parameter   Name: <b>C00242   L_PCTRL_1: Operating mode</b>		Data type: UNSIGNED_8 Index: 24333 <sub>d</sub> = 5F0D <sub>h</sub>	
The <a href="#">L_PCTRL_1</a> FB: Selection of the operating mode			
<ul style="list-style-type: none"> <li>Depending on the selection, the blue switches in the displayed signal flow are set accordingly in the Engineer on the <b>Application parameters</b> tab for the <a href="#">L_PCTRL_1</a> FB.</li> </ul>			
<b>Selection list</b> (Lenze setting printed in bold)		<b>Info</b>	
0	<b>Off</b>	The input setpoint $nNSet_a$ is output without any changes at the output $nOut_a$ .	
1	nNSet + nNSet_PID	$nNSet_a$ and $nAct_a$ are used as PID input values. The arriving $nNSet_a$ is additively linked to the value output by the PID element.	
2	nSet_PID	$nSet_a$ and $nAct_a$ are used as PID input values. The input $nNSet_a$ is not considered.	
3	nNSet_PID	$nNSet_a$ and $nAct_a$ are used as PID input values. The input $nSet_a$ is not considered.	
4	nNSet + nSet_PID	$nSet_a$ and $nAct_a$ are used as PID input values. The arriving $nNSet_a$ setpoint is additively linked to the value output by the PID element.	
5	nNSet    nSet_PID	$nSet_a$ and $nAct_a$ are used as PID input values. The setpoint $nNSet_a$ is output at the output $nOut_a$ . The PID output value is output at the output $nPIDOut_a$ .	
<input checked="" type="checkbox"/> Read access <input checked="" type="checkbox"/> Write access <input type="checkbox"/> CINH <input type="checkbox"/> PLC STOP <input type="checkbox"/> No transfer <input type="checkbox"/> COM <input type="checkbox"/> MOT   Scaling factor: 1			

## C00243

Parameter   Name: <b>C00243   L_PCTRL_1: Acceleration time influence</b>		Data type: UNSIGNED_32 Index: 24332 <sub>d</sub> = 5F0C <sub>h</sub>	
The <a href="#">L_PCTRL_1</a> FB: Acceleration time for showing the PID output value			
<b>Setting range</b> (min. value   unit   max. value)		<b>Lenze setting</b>	
0.000	s	999.999	<b>5.000 s</b>
<input checked="" type="checkbox"/> Read access <input checked="" type="checkbox"/> Write access <input type="checkbox"/> CINH <input type="checkbox"/> PLC STOP <input type="checkbox"/> No transfer <input type="checkbox"/> COM <input type="checkbox"/> MOT   Scaling factor: 1000			

## C00244

Parameter   Name: <b>C00244   L_PCTRL_1: Deceleration time influence</b>		Data type: UNSIGNED_32 Index: 24331 <sub>d</sub> = 5F0B <sub>h</sub>	
The <a href="#">L_PCTRL_1</a> FB: Deceleration time for masking out the PID output value			
<b>Setting range</b> (min. value   unit   max. value)		<b>Lenze setting</b>	
0.000	s	999.999	<b>5.000 s</b>
<input checked="" type="checkbox"/> Read access <input checked="" type="checkbox"/> Write access <input type="checkbox"/> CINH <input type="checkbox"/> PLC STOP <input type="checkbox"/> No transfer <input type="checkbox"/> COM <input type="checkbox"/> MOT Scaling factor: 1000			

## C00245

Parameter   Name: <b>C00245   L_PCTRL_1: PID output value</b>		Data type: INTEGER_16 Index: 24330 <sub>d</sub> = 5F0A <sub>h</sub>	
The <a href="#">L_PCTRL_1</a> FB: Display of the output value of the PID process controller			
<b>Display range</b> (min. value   unit   max. value)			
-199.99	%	199.99	
<input checked="" type="checkbox"/> Read access <input type="checkbox"/> Write access <input type="checkbox"/> CINH <input type="checkbox"/> PLC STOP <input type="checkbox"/> No transfer <input type="checkbox"/> COM <input type="checkbox"/> MOT Scaling factor: 100			

## C00246

Parameter   Name: <b>C00246   L_PCTRL_1: nAct_a internal</b>		Data type: INTEGER_16 Index: 24329 <sub>d</sub> = 5F09 <sub>h</sub>	
From version 04.00.00 FB <a href="#">L_PCTRL_1</a> : Display of the internal actual value			
<b>Display range</b> (min. value   unit   max. value)			
-199.99	%	199.99	
<input checked="" type="checkbox"/> Read access <input type="checkbox"/> Write access <input type="checkbox"/> CINH <input type="checkbox"/> PLC STOP <input type="checkbox"/> No transfer <input type="checkbox"/> COM <input type="checkbox"/> MOT Scaling factor: 100			

## C00247

Parameter   Name: <b>C00247   L_PCTRL_1: Window setpoint reached</b>		Data type: INTEGER_16 Index: 24328 <sub>d</sub> = 5F08 <sub>h</sub>	
From version 06.00.00 FB <a href="#">L_PCTRL_1</a> : Window for comparison operation "actual value = setpoint"			
<b>Setting range</b> (min. value   unit   max. value)		<b>Lenze setting</b>	
0.00	%	100.00	<b>2.00 %</b>
<input checked="" type="checkbox"/> Read access <input checked="" type="checkbox"/> Write access <input type="checkbox"/> CINH <input type="checkbox"/> PLC STOP <input type="checkbox"/> No transfer <input type="checkbox"/> COM <input type="checkbox"/> MOT Scaling factor: 100			

## C00249

Parameter   Name: <b>C00249   L_PT1_1: Time constant</b>		Data type: UNSIGNED_16 Index: 24326 <sub>d</sub> = 5F06 <sub>h</sub>	
FB <a href="#">L_PT1_1</a> : Time constant Tn			
<b>Setting range</b> (min. value   unit   max. value)		<b>Lenze setting</b>	
0	ms	5000	<b>2000 ms</b>
<input checked="" type="checkbox"/> Read access <input checked="" type="checkbox"/> Write access <input type="checkbox"/> CINH <input type="checkbox"/> PLC STOP <input type="checkbox"/> No transfer <input type="checkbox"/> COM <input type="checkbox"/> MOT Scaling factor: 1			

## C00254

Parameter   Name: <b>C00254   Service parameter</b>		Data type: UNSIGNED_16 Index: 24321 <sub>d</sub> = 5F01 <sub>h</sub>	
<b>This code is used device-internally and must not be written by the user side!</b>			



## C00265

Parameter   Name: <b>C00265   SLVC: Filtering of setpoint and actual currents</b>	Data type: UNSIGNED_8 Index: 24310 <sub>d</sub> = 5EF6 <sub>h</sub>
<b>This code is used device-internally and must not be written by the user side!</b>	

## C00270

Parameter   Name: <b>C00270   SC: Freq. current setpoint filter</b>	Data type: UNSIGNED_16 Index: 24305 <sub>d</sub> = 5EF1 <sub>h</sub>
Frequency to be inhibited by the current setpoint filter at sensorless control for synchronous motors ( <a href="#">SLPSM</a> ).	
<b>Setting range (min. value   unit   max. value)</b>	<b>Lenze setting</b>
40.0                      Hz                      1000.0	<b>200.0 Hz</b>
<input checked="" type="checkbox"/> Read access <input checked="" type="checkbox"/> Write access <input type="checkbox"/> CINH <input type="checkbox"/> PLC STOP <input type="checkbox"/> No transfer <input type="checkbox"/> COM <input checked="" type="checkbox"/> MOT   Scaling factor: 10	

## C00271

Parameter   Name: <b>C00271   SC: Width of current setpoint filter</b>	Data type: UNSIGNED_16 Index: 24304 <sub>d</sub> = 5EF0 <sub>h</sub>
Frequency width of the current setpoint filter with sensorless control for synchronous motors ( <a href="#">SLPSM</a> ) • Width around the frequency to be inhibited ( <a href="#">C00270</a> ).	
<b>Setting range (min. value   unit   max. value)</b>	<b>Lenze setting</b>
0.0                      Hz                      500.0	<b>0.0 Hz</b>
<input checked="" type="checkbox"/> Read access <input checked="" type="checkbox"/> Write access <input type="checkbox"/> CINH <input type="checkbox"/> PLC STOP <input type="checkbox"/> No transfer <input type="checkbox"/> COM <input checked="" type="checkbox"/> MOT   Scaling factor: 10	

## C00272

Parameter   Name: <b>C00272   SC: Depth of current setpoint filter</b>	Data type: UNSIGNED_16 Index: 24303 <sub>d</sub> = 5EEF <sub>h</sub>
Damping of the current setpoint filter with sensorless control for synchronous motors ( <a href="#">SLPSM</a> )	
<b>Setting range (min. value   unit   max. value)</b>	<b>Lenze setting</b>
0                      dB                      100	<b>0 db</b>
<input checked="" type="checkbox"/> Read access <input checked="" type="checkbox"/> Write access <input type="checkbox"/> CINH <input type="checkbox"/> PLC STOP <input type="checkbox"/> No transfer <input type="checkbox"/> COM <input checked="" type="checkbox"/> MOT   Scaling factor: 1	

## C00273

Parameter   Name: <b>C00273   Moment of inertia motor</b>	Data type: UNSIGNED_32 Index: 24302 <sub>d</sub> = 5EEE <sub>h</sub>
<b>From version 03.00.00</b>	
Moment of inertia for setpoint feedforward control with sensorless vector control ( <a href="#">SLVC</a> )	
<b>Setting range (min. value   unit   max. value)</b>	<b>Lenze setting</b>
0.00                      kg cm <sup>2</sup> 6000000.00	<b>0.00 kg cm<sup>2</sup></b>
<input checked="" type="checkbox"/> Read access <input checked="" type="checkbox"/> Write access <input type="checkbox"/> CINH <input type="checkbox"/> PLC STOP <input type="checkbox"/> No transfer <input type="checkbox"/> COM <input checked="" type="checkbox"/> MOT   Scaling factor: 100	

## C00274

Parameter   Name: <b>C00274   SC: Max. change in acceleration</b>		Data type: UNSIGNED_16 Index: 24301 <sub>d</sub> = 5EED <sub>h</sub>	
Limitation of the acceleration change with sensorless control for synchronous motors ( <a href="#">SLPSM</a> )			
• Setting in % of M_Nenn per ms.			
<b>Setting range (min. value   unit   max. value)</b>		<b>Lenze setting</b>	
0.0	%/ms	400.0	<b>400.0 %/ms</b>
<input checked="" type="checkbox"/> Read access <input checked="" type="checkbox"/> Write access <input type="checkbox"/> CINH <input type="checkbox"/> PLC STOP <input type="checkbox"/> No transfer <input type="checkbox"/> COM <input checked="" type="checkbox"/> MOT Scaling factor: 10			

## C00275

Parameter   Name: <b>C00275   Filter setpoint feedforward control</b>		Data type: UNSIGNED_16 Index: 24300 <sub>d</sub> = 5EEC <sub>h</sub>	
From version 03.00.00			
Filter time of the setpoint feedforward control with sensorless vector control ( <a href="#">SLVC</a> )			
• The setpoint feedforward control requires the entry of the moment of inertia in <a href="#">C00273</a> .			
<b>Setting range (min. value   unit   max. value)</b>		<b>Lenze setting</b>	
0.0	ms	1000.0	<b>1.0 ms</b>
<input checked="" type="checkbox"/> Read access <input checked="" type="checkbox"/> Write access <input type="checkbox"/> CINH <input type="checkbox"/> PLC STOP <input type="checkbox"/> No transfer <input type="checkbox"/> COM <input checked="" type="checkbox"/> MOT Scaling factor: 10			

## C00276

Parameter   Name: <b>C00276   SC: Max. output voltage</b>		Data type: UNSIGNED_8 Index: 24299 <sub>d</sub> = 5EEB <sub>h</sub>	
From version 11.00.00			
<b>Setting range (min. value   unit   max. value)</b>		<b>Lenze setting</b>	
80	%	99	<b>95 %</b>
<input checked="" type="checkbox"/> Read access <input checked="" type="checkbox"/> Write access <input type="checkbox"/> CINH <input type="checkbox"/> PLC STOP <input type="checkbox"/> No transfer <input type="checkbox"/> COM <input checked="" type="checkbox"/> MOT Scaling factor: 1			

## C00280

Parameter   Name: <b>C00280   SC: Filter time const. DC detection</b>		Data type: UNSIGNED_16 Index: 24295 <sub>d</sub> = 5EE7 <sub>h</sub>	
From version 11.00.00			
<b>Setting range (min. value   unit   max. value)</b>		<b>Lenze setting</b>	
1	ms	1000	<b>25 ms</b>
<input checked="" type="checkbox"/> Read access <input checked="" type="checkbox"/> Write access <input type="checkbox"/> CINH <input type="checkbox"/> PLC STOP <input type="checkbox"/> No transfer <input type="checkbox"/> COM <input checked="" type="checkbox"/> MOT Scaling factor: 1			

## C00290

Parameter   Name: <b>C00290   RCOM error counter</b>		Data type: UNSIGNED_16 Index: 24285 <sub>d</sub> = 5EDD <sub>h</sub>	
<b>This code is used device-internally and must not be written by the user side!</b>			

## C00291

Parameter   Name: <b>C00291   Error type RCOM</b>		Data type: UNSIGNED_8 Index: 24284 <sub>d</sub> = 5EDC <sub>h</sub>	
<b>This code is used device-internally and must not be written by the user side!</b>			

## C00295

Parameter   Name:	Data type: INTEGER_32
<b>C00295   savecycle memory modul</b>	Index: 24280 <sub>d</sub> = 5ED8 <sub>h</sub>
<b>This code is used device-internally and must not be written by the user side!</b>	

## C00296

Parameter   Name:	Data type: UNSIGNED_16
<b>C00296   ICOM error number</b>	Index: 24279 <sub>d</sub> = 5ED7 <sub>h</sub>
<b>This code is used device-internally and must not be written by the user side!</b>	

## C00297

Parameter   Name:	Data type: UNSIGNED_8
<b>C00297   Counter Receive Error Isr</b>	Index: 24278 <sub>d</sub> = 5ED6 <sub>h</sub>
<b>This code is used device-internally and must not be written by the user side!</b>	

## C00301

Parameter   Name:	Data type: UNSIGNED_16
<b>C00301   DebugAccess</b>	Index: 24274 <sub>d</sub> = 5ED2 <sub>h</sub>
<b>This code is used device-internally and must not be written by the user side!</b>	

## C00302

Parameter   Name:	Data type: UNSIGNED_8
<b>C00302   Internal Commands</b>	Index: 24273 <sub>d</sub> = 5ED1 <sub>h</sub>
<b>This code is used device-internally and must not be written by the user side!</b>	

## C00304

Parameter   Name:	Data type: UNSIGNED_32
<b>C00304   Password1</b>	Index: 24271 <sub>d</sub> = 5ECF <sub>h</sub>
<b>This code is used device-internally and must not be written by the user side!</b>	

## C00305

Parameter   Name:	Data type: UNSIGNED_32
<b>C00305   Password2</b>	Index: 24270 <sub>d</sub> = 5ECF <sub>h</sub>
<b>This code is used device-internally and must not be written by the user side!</b>	

## C00306

Parameter   Name:	Data type: UNSIGNED_32
<b>C00306   Debug address</b>	Index: 24269 <sub>d</sub> = 5ECD <sub>h</sub>
<b>This code is used device-internally and must not be written by the user side!</b>	

## C00307

Parameter   Name:	Data type: UNSIGNED_16
<b>C00307   Debug value</b>	Index: 24268 <sub>d</sub> = 5ECC <sub>h</sub>
<b>This code is used device-internally and must not be written by the user side!</b>	

## C00308

Parameter   Name: <b>C00308   PartitionOffset</b>	Data type: UNSIGNED_16 Index: 24267 <sub>d</sub> = 5ECB <sub>h</sub>
<b>This code is used device-internally and must not be written by the user side!</b>	

## C00309

Parameter   Name: <b>C00309   PartitionSel</b>	Data type: UNSIGNED_8 Index: 24266 <sub>d</sub> = 5ECA <sub>h</sub>
<b>This code is used device-internally and must not be written by the user side!</b>	

## C00310

Parameter   Name: <b>C00310   PartitionValue</b>	Data type: UNSIGNED_16 Index: 24265 <sub>d</sub> = 5EC9 <sub>h</sub>
<b>This code is used device-internally and must not be written by the user side!</b>	

## C00311

Parameter   Name: <b>C00311   Runtime measurement</b>	Data type: UNSIGNED_32 Index: 24264 <sub>d</sub> = 5EC8 <sub>h</sub>
<b>This code is used device-internally and must not be written by the user side!</b>	

## C00312

Parameter   Name: <b>C00312   System runtimes</b>	Data type: UNSIGNED_32 Index: 24263 <sub>d</sub> = 5EC7 <sub>h</sub>	
From version 11.00.00		
<b>Setting range</b> (min. value   unit   max. value)		
0.000	μs	1638.375
<b>Subcodes</b>	<b>Lenze setting</b>	<b>Info</b>
C00312/1	0.000 μs	System runtime reserve
<input checked="" type="checkbox"/> Read access <input checked="" type="checkbox"/> Write access <input type="checkbox"/> CINH <input type="checkbox"/> PLC STOP <input checked="" type="checkbox"/> No transfer <input type="checkbox"/> COM <input type="checkbox"/> MOT   Scaling factor: 1000		

## C00313

Parameter   Name: <b>C00313   LS_DataAccess: Activation</b>	Data type: UNSIGNED_8 Index: 24262 <sub>d</sub> = 5EC6 <sub>h</sub>
<b>This code is used device-internally and must not be written by the user side!</b>	

## C00314

Parameter   Name: <b>C00314   LS_DataAccess: Address access</b>	Data type: UNSIGNED_32 Index: 24261 <sub>d</sub> = 5EC5 <sub>h</sub>
<b>This code is used device-internally and must not be written by the user side!</b>	

## C00315

Parameter   Name: <b>C00315   SystemFail-Adr</b>	Data type: UNSIGNED_32 Index: 24260 <sub>d</sub> = 5EC4 <sub>h</sub>
<b>This code is used device-internally and must not be written by the user side!</b>	

## C00316

Parameter   Name: <b>C00316   SystemFail-Info</b>	Data type: UNSIGNED_16 Index: 24259 <sub>d</sub> = 5EC3 <sub>h</sub>
<b>This code is used device-internally and must not be written by the user side!</b>	

## C00317

Parameter   Name: <b>C00317   WatchdogTimeMax</b>	Data type: UNSIGNED_16 Index: 24258 <sub>d</sub> = 5EC2 <sub>h</sub>
<b>This code is used device-internally and must not be written by the user side!</b>	

## C00320

Parameter   Name: <b>C00320   Debug information</b>	Data type: UNSIGNED_32 Index: 24254 <sub>d</sub> = 5EBF <sub>h</sub>
<b>This code is used device-internally and must not be written by the user side!</b>	

## C00321

Parameter   Name: <b>C00321   Main program runtime</b>	Data type: UNSIGNED_16 Index: 24254 <sub>d</sub> = 5EBF <sub>h</sub>
Display of the current and the maximum runtime of the main program in the inverter	
<b>Setting range (min. value   unit   max. value)</b>	
0	ms 65535
<b>Subcodes</b>	<b>Lenze setting</b> <b>Info</b>
C00321/1	0 ms Curr. runtime of main program
C00321/2	0 ms Max. runtime of main program
<input checked="" type="checkbox"/> Read access <input checked="" type="checkbox"/> Write access <input type="checkbox"/> CINH <input type="checkbox"/> PLC STOP <input checked="" type="checkbox"/> No transfer <input type="checkbox"/> COM <input type="checkbox"/> MOT   Scaling factor: 1	

## C00322

Parameter   Name: <b>C00322   Transmission mode CAN TxPDOs</b>	Data type: UNSIGNED_8 Index: 24253 <sub>d</sub> = 5EBD <sub>h</sub>
TPDO transmission type according to DS301 V4.02 <ul style="list-style-type: none"> <li>The following transmission modes are supported: <ul style="list-style-type: none"> <li>0: Synchronous and acyclic</li> <li>1 ... 240: Synchronous and cyclic</li> <li>252: Synchronous - RTR only</li> <li>253: Asynchronous - RTR only</li> <li>254: Asynchronous - manufacturer-specific</li> <li>255: Asynchronous - device-profile specific</li> </ul> </li> <li>The basic setting for all PDOs is "Asynchronous - manufacturer-specific" (254).</li> <li>Illustration of the CANopen objects <a href="#">I-1800/2</a> ... <a href="#">I-1803/2</a> (see DS301 V4.02).</li> </ul>	
<b>Setting range (min. value   unit   max. value)</b>	
0	255
<b>Subcodes</b>	<b>Lenze setting</b> <b>Info</b>
	▶ <a href="#">"CAN on board" system bus</a>

Parameter   Name:		Data type: UNSIGNED_8 Index: 24253 <sub>d</sub> = 5EBD <sub>h</sub>
<b>C00322   Transmission mode CAN TxPDOs</b>		
C00322/1	254	Transmission mode CAN1 OUT
C00322/2	254	Transmission mode CAN2 OUT
C00322/3	254	Transmission mode CAN3 OUT
C00322/4	254	Transmission mode CAN4 OUT • <a href="#">From version 15.00.00</a>
<input checked="" type="checkbox"/> Read access <input checked="" type="checkbox"/> Write access <input type="checkbox"/> CINH <input type="checkbox"/> PLC STOP <input type="checkbox"/> No transfer <input checked="" type="checkbox"/> COM <input type="checkbox"/> MOT             Scaling factor: 1		

**C00323**

Parameter   Name:		Data type: UNSIGNED_8 Index: 24252 <sub>d</sub> = 5EBC <sub>h</sub>
<b>C00323   Transmission mode CAN Rx PDOs</b>		
RPDO transmission type according to DS301 V4.02 <ul style="list-style-type: none"> <li>• In the case of the RPDO serves as monitoring setting in the case of sync-controlled PDOs.</li> <li>• The following transmission modes are supported:               <ul style="list-style-type: none"> <li>• 0: Synchronous and acyclic</li> <li>• 1 ... 240: Synchronous and cyclic</li> <li>• 252: Synchronous - RTR only</li> <li>• 253: Asynchronous - RTR only</li> <li>• 254: Asynchronous - manufacturer-specific</li> <li>• 255: Asynchronous - device-profile specific</li> </ul> </li> <li>• The basic setting for all PDOs is "Asynchronous - manufacturer-specific" (254).</li> <li>• Illustration of the CANopen objects <a href="#">I-1400/2</a> ... <a href="#">I-1403/2</a> (see DS301 V4.02).</li> </ul> <p style="text-align: right;">▶ <a href="#">"CAN on board" system bus</a></p>		
<b>Setting range (min. value   unit   max. value)</b>		
0		255
<b>Subcodes</b>	<b>Lenze setting</b>	<b>Info</b>
C00323/1	254	Transmission mode CAN1 IN
C00323/2	254	Transmission mode CAN2 IN
C00323/3	254	Transmission mode CAN3 IN
C00323/4	254	Transmission mode CAN4 IN • <a href="#">From version 15.00.00</a>
<input checked="" type="checkbox"/> Read access <input checked="" type="checkbox"/> Write access <input type="checkbox"/> CINH <input type="checkbox"/> PLC STOP <input type="checkbox"/> No transfer <input checked="" type="checkbox"/> COM <input type="checkbox"/> MOT             Scaling factor: 1		

**C00324**

Parameter   Name:		Data type: UNSIGNED_16 Index: 24251 <sub>d</sub> = 5EBB <sub>h</sub>
<b>C00324   CAN transmission blocking time</b>		
<a href="#">From version 06.00.00</a> Blocking time for the transmission of the emergency telegram and the process data		
<b>Note:</b> If the "Asynchronous - manufacturer-specific/device profile-specific" transmission type is set, the transmission cycle timer is reset to 0 if event-controlled transmission has been triggered. Example: Cycle time ( <a href="#">C00356/x</a> ) = 500 ms, blocking time = 100 ms, data change sporadically: <ul style="list-style-type: none"> <li>• In the case of a sporadic data change &lt; 500 ms, due to the blocking time set, transmission takes place every 100 ms (event-controlled transmission) as quickly as possible.</li> <li>• In the case of a sporadic data change &gt; 500 ms, due to the cycle time set, transmission takes place every 500 ms (cyclic transmission).</li> </ul> <p style="text-align: right;">▶ <a href="#">"CAN on board" system bus</a></p>		
<b>Setting range (min. value   unit   max. value)</b>		
0	ms	6500
<b>Subcodes</b>	<b>Lenze setting</b>	<b>Info</b>
C00324/1	0 ms	CAN emergency blocking time

Parameter   Name:		Data type: UNSIGNED_16 Index: 24251 <sub>d</sub> = 5EBB <sub>h</sub>
<b>C00324   CAN transmission blocking time</b>		
C00324/2	0 ms	CAN1_OUT blocking time
C00324/3	0 ms	CAN2_OUT blocking time
C00324/4	0 ms	CAN3_OUT blocking time
C00324/5	0 ms	CAN4_OUT blocking time • From version 15.00.00
<input checked="" type="checkbox"/> Read access <input checked="" type="checkbox"/> Write access <input type="checkbox"/> CINH <input type="checkbox"/> PLC STOP <input type="checkbox"/> No transfer <input checked="" type="checkbox"/> COM <input type="checkbox"/> MOT   Scaling factor: 1		

**C00338**

Parameter   Name:		Data type: UNSIGNED_8 Index: 24237 <sub>d</sub> = 5EAD <sub>h</sub>
<b>C00338   L_Arithmetik_1: Function</b>		
The <a href="#">L_Arithmetik_1</a> FB: Selection of internal arithmetics		
<b>Selection list</b> (Lenze setting printed in bold)		
<b>0</b>	<b>Out = In1</b>	
1	Out = In1 + In2	
2	nOut_a = nIn1_a - nIn2_a	
3	Out = (In1 * In2) / 100%	
4	nOut_a = (nIn1_a * 1%) /  nIn2_a	
5	nOut_a = (nIn1_a * 100%) / (100% - nIn2_a)	
<input checked="" type="checkbox"/> Read access <input checked="" type="checkbox"/> Write access <input type="checkbox"/> CINH <input type="checkbox"/> PLC STOP <input type="checkbox"/> No transfer <input type="checkbox"/> COM <input type="checkbox"/> MOT   Scaling factor: 1		

**C00339**

Parameter   Name:		Data type: UNSIGNED_8 Index: 24236 <sub>d</sub> = 5EAC <sub>h</sub>
<b>C00339   L_Arithmetik_2: Function</b>		
From version 11.00.00		
The <a href="#">L_Arithmetik_2</a> FB: Selection of internal arithmetics		
<b>Selection list</b> (Lenze setting printed in bold)		
<b>0</b>	<b>nOut_a = nIn1_a</b>	
1	nOut_a = nIn1_a + nIn2_a	
2	nOut_a = nIn1_a - nIn2_a	
3	nOut_a = (nIn1_a * nIn2_a) / 100%	
4	nOut_a = (nIn1_a * 1%) /  nIn2_a	
5	nOut_a = (nIn1_a * 100%) / (100% - nIn2_a)	
<input checked="" type="checkbox"/> Read access <input checked="" type="checkbox"/> Write access <input type="checkbox"/> CINH <input type="checkbox"/> PLC STOP <input type="checkbox"/> No transfer <input type="checkbox"/> COM <input type="checkbox"/> MOT   Scaling factor: 1		

**C00341**

Parameter   Name:		Data type: UNSIGNED_16 Index: 24234 <sub>d</sub> = 5EAA <sub>h</sub>
<b>C00341   CAN management - error configuration</b>		
From version 04.00.00		
Selection of the events for which the <i>bFail</i> error output of the <a href="#">LS_CANManagement</a> SB must be set to TRUE.		
Setting range (min. hex value   max. hex value)		Lenze setting
0x0000	0xFFFF	<b>0x0000</b> (decimal: 0)
Value is bit-coded: ( <input checked="" type="checkbox"/> = bit set)		Info
Bit 0 <input type="checkbox"/>	BusOff_MsgErr	
Bit 1 <input type="checkbox"/>	Warning	

Parameter   Name: <b>C00341   CAN management - error configuration</b>		Data type: UNSIGNED_16 Index: 24234 <sub>d</sub> = 5EA9 <sub>h</sub>
Bit 2	<input type="checkbox"/> NodeStopped	
Bit 3	<input type="checkbox"/> HeartBeatEvent	
Bit 4	<input type="checkbox"/> CAN1_In_Überw.	
Bit 5	<input type="checkbox"/> CAN2_In_Überw.	
Bit 6	<input type="checkbox"/> CAN3_In_Überw.	
Bit 7	<input type="checkbox"/> CAN4_In_Überw.	From version 15.00.00
Bit 8	<input type="checkbox"/> Reserved	
Bit 9	<input type="checkbox"/> Reserved	
Bit 10	<input type="checkbox"/> Reserved	
Bit 11	<input type="checkbox"/> Reserved	
Bit 12	<input type="checkbox"/> Reserved	
Bit 13	<input type="checkbox"/> Reserved	
Bit 14	<input type="checkbox"/> Reserved	
Bit 15	<input type="checkbox"/> Reserved	
<input checked="" type="checkbox"/> Read access <input checked="" type="checkbox"/> Write access <input type="checkbox"/> CINH <input type="checkbox"/> PLC STOP <input type="checkbox"/> No transfer <input type="checkbox"/> COM <input type="checkbox"/> MOT		

**C00342**

Parameter   Name: <b>C00342   CAN decoupling PDOInOut</b>		Data type: UNSIGNED_16 Index: 24233 <sub>d</sub> = 5EA9 <sub>h</sub>
From version 04.00.00 Configuration defining the events that lead to a decoupling of the process data words. ▶ <a href="#">Configuring exception handling of the CAN PDOs</a>		
<b>Setting range (min. hex value   max. hex value)</b>		
0x0000		0xFFFF
<b>Value is bit-coded:</b>		<b>Info</b>
Bit 0	BusOff_MsgErr	
Bit 1	Warning	
Bit 2	NodeStopped	
Bit 3	HeartBeatEvent	
Bit 4	CAN1_In_Überw.	
Bit 5	CAN2_In_Überw.	
Bit 6	CAN3_In_Überw.	
Bit 7	CAN4_In_Überw.	From version 15.00.00
Bit 8	Reserved	
Bit 9	Reserved	
Bit 10	Reserved	
Bit 11	Reserved	
Bit 12	Reserved	
Bit 13	Reserved	
Bit 14	Trouble	
Bit 15	Fault	
<b>Subcodes</b>	<b>Lenze setting</b>	<b>Info</b>
C00342/1	0x0000	CAN decoupling PDO_In from the bus
C00342/2	0x0000	CAN decoupling PDO_Out from the appl.
<input checked="" type="checkbox"/> Read access <input checked="" type="checkbox"/> Write access <input type="checkbox"/> CINH <input type="checkbox"/> PLC STOP <input type="checkbox"/> No transfer <input type="checkbox"/> COM <input type="checkbox"/> MOT		



## C00343

Parameter   Name: C00343   LP_CanIn decoupling value		Data type: UNSIGNED_16 Index: 24232 <sub>d</sub> = 5EA8 <sub>h</sub>
From version 04.00.00 Definition of the value the process data words are to have in the decoupled state. ▶ <a href="#">Configuring exception handling of the CAN PDOs</a>		
Setting range (min. value   unit   max. value)		
0		65535
Subcodes	Lenze setting	Info
C00343/1	0	<a href="#">LP_CanIn1:wCtrl</a> DiscVal
C00343/2	0	<a href="#">LP_CanIn1:wIn2</a> DiscVal
C00343/3	0	<a href="#">LP_CanIn1:wIn3</a> DiscVal
C00343/4	0	<a href="#">LP_CanIn1:wIn4</a> DiscVal
C00343/5	0	<a href="#">LP_CanIn2:wIn1</a> DiscVal
C00343/6	0	<a href="#">LP_CanIn2:wIn2</a> DiscVal
C00343/7	0	<a href="#">LP_CanIn2:wIn3</a> DiscVal
C00343/8	0	<a href="#">LP_CanIn2:wIn4</a> DiscVal
C00343/9	0	<a href="#">LP_CanIn3:wIn1</a> DiscVal
C00343/10	0	<a href="#">LP_CanIn3:wIn2</a> DiscVal
C00343/11	0	<a href="#">LP_CanIn3:wIn3</a> DiscVal
C00343/12	0	<a href="#">LP_CanIn3:wIn4</a> DiscVal
C00343/13	0	<a href="#">LP_CanIn4:wIn1</a> DiscVal • From version 15.00.00
C00343/14	0	<a href="#">LP_CanIn4:wIn2</a> DiscVal • From version 15.00.00
C00343/15	0	<a href="#">LP_CanIn4:wIn3</a> DiscVal • From version 15.00.00
C00343/16	0	<a href="#">LP_CanIn4:wIn4</a> DiscVal • From version 15.00.00
<input checked="" type="checkbox"/> Read access <input checked="" type="checkbox"/> Write access <input type="checkbox"/> CINH <input type="checkbox"/> PLC STOP <input type="checkbox"/> No transfer <input type="checkbox"/> COM <input type="checkbox"/> MOT   Scaling factor: 1		

## C00344

Parameter   Name: C00344   LP_CanOut decoupling value		Data type: UNSIGNED_16 Index: 24231 <sub>d</sub> = 5EA7 <sub>h</sub>
From version 04.00.00 Definition of the value the process data words are to have in the decoupled state. ▶ <a href="#">Configuring exception handling of the CAN PDOs</a>		
Setting range (min. value   unit   max. value)		
0		65535
Subcodes	Lenze setting	Info
C00344/1	0	<a href="#">LP_CanOut1:wState</a> DiscVal
C00344/2	0	<a href="#">LP_CanOut1:wOut2</a> DiscVal
C00344/3	0	<a href="#">LP_CanOut1:wOut3</a> DiscVal
C00344/4	0	<a href="#">LP_CanOut1:wOut4</a> DiscVal
C00344/5	0	<a href="#">LP_CanOut2:wOut1</a> DiscVal
C00344/6	0	<a href="#">LP_CanOut2:wOut2</a> DiscVal
C00344/7	0	<a href="#">LP_CanOut2:wOut3</a> DiscVal
C00344/8	0	<a href="#">LP_CanOut2:wOut4</a> DiscVal

Parameter   Name: <b>C00344   LP_CanOut decoupling value</b>		Data type: UNSIGNED_16 Index: 24231 <sub>d</sub> = 5EA7 <sub>h</sub>
C00344/9	0	<a href="#">LP_CanOut3:wOut1 DiscVal</a>
C00344/10	0	<a href="#">LP_CanOut3:wOut2 DiscVal</a>
C00344/11	0	<a href="#">LP_CanOut3:wOut3 DiscVal</a>
C00344/12	0	<a href="#">LP_CanOut3:wOut4 DiscVal</a>
C00344/13	0	<a href="#">LP_CanOut4:wOut1 DiscVal</a> • From version 15.00.00
C00344/14	0	<a href="#">LP_CanOut4:wOut2 DiscVal</a> • From version 15.00.00
C00344/15	0	<a href="#">LP_CanOut4:wOut3 DiscVal</a> • From version 15.00.00
C00344/16	0	<a href="#">LP_CanOut4:wOut4 DiscVal</a> • From version 15.00.00
<input checked="" type="checkbox"/> Read access <input checked="" type="checkbox"/> Write access <input type="checkbox"/> CINH <input type="checkbox"/> PLC STOP <input type="checkbox"/> No transfer <input type="checkbox"/> COM <input type="checkbox"/> MOT                   Scaling factor: 1		

**C00345**

Parameter   Name: <b>C00345   CAN error status</b>		Data type: UNSIGNED_8 Index: 24230 <sub>d</sub> = 5EA6 <sub>h</sub>
<a href="#">From version 02.00.00</a>		<a href="#">▶ "CAN on board" system bus</a>
Selection list (read only)		
0	No Error	
1	Warning ErrActive	
2	Warning ErrPassive	
3	Bus off	
4	Reserved	
5	Reserved	
<input checked="" type="checkbox"/> Read access <input type="checkbox"/> Write access <input type="checkbox"/> CINH <input type="checkbox"/> PLC STOP <input checked="" type="checkbox"/> No transfer <input type="checkbox"/> COM <input type="checkbox"/> MOT                   Scaling factor: 1		

**C00347**

Parameter   Name: <b>C00347   CAN status HeartBeat producer</b>		Data type: UNSIGNED_8 Index: 24228 <sub>d</sub> = 5EA4 <sub>h</sub>
<a href="#">From version 03.00.00</a>		<a href="#">▶ Heartbeat protocol</a>
Selection list		
0	Boot-up	
4	Stopped	
5	Operational	
127	Pre-Operat.	
250	Failed	
255	NoResponse	
Subcodes	Info	
C00347/1	Status node 1 ... 7	
C00347/...		
C00347/7		
<input checked="" type="checkbox"/> Read access <input type="checkbox"/> Write access <input type="checkbox"/> CINH <input type="checkbox"/> PLC STOP <input checked="" type="checkbox"/> No transfer <input type="checkbox"/> COM <input type="checkbox"/> MOT                   Scaling factor: 1		

**C00349**

Parameter   Name: <b>C00349   CAN setting - DIP switch</b>		Data type: UNSIGNED_16 Index: 24226 <sub>d</sub> = 5EA2 <sub>h</sub>
DIP switch setting during last mains power-on		
<a href="#">▶ "CAN on board" system bus</a>		
<b>Display area</b> (min. hex value   max. hex value)		
0x0000		0xFFFF
<b>Value is bit-coded:</b>		
Bit 0	Node address 1	
Bit 1	Node address 2	
Bit 2	Node address 4	
Bit 3	Node address 8	
Bit 4	Node address 16	
Bit 5	Node address 32	
Bit 6	Node address 64	
Bit 7	Baud rate 1	
Bit 8	Baud rate 2	
Bit 9	Baud rate 4	
Bit 10	Reserved	
Bit 11	Reserved	
Bit 12	Reserved	
Bit 13	Reserved	
Bit 14	Reserved	
Bit 15	DIP switch at 24V-ON accepted	
<input checked="" type="checkbox"/> Read access <input type="checkbox"/> Write access <input type="checkbox"/> CINH <input type="checkbox"/> PLC STOP <input checked="" type="checkbox"/> No transfer <input type="checkbox"/> COM <input type="checkbox"/> MOT		

**C00350**

Parameter   Name: <b>C00350   CAN node address</b>		Data type: UNSIGNED_8 Index: 24225 <sub>d</sub> = 5EA1 <sub>h</sub>
Setting of the node address via parameters		
<ul style="list-style-type: none"> <li>• The node address can only be parameterised if the node address "0" is set via the DIP switches.</li> <li>• A change in the node address will not be effective until a CAN Reset Node is performed.</li> </ul>		
<a href="#">▶ "CAN on board" system bus</a>		
<b>Setting range</b> (min. value   unit   max. value)		<b>Lenze setting</b>
1		127 <b>1</b>
<input checked="" type="checkbox"/> Read access <input checked="" type="checkbox"/> Write access <input type="checkbox"/> CINH <input type="checkbox"/> PLC STOP <input type="checkbox"/> No transfer <input checked="" type="checkbox"/> COM <input type="checkbox"/> MOT                   Scaling factor: 1		

## C00351

Parameter   Name: <b>C00351   CAN baud rate</b>		Data type: UNSIGNED_8 Index: 24224 <sub>d</sub> = 5EA0 <sub>h</sub>
Setting of the baud rate via parameters		
<ul style="list-style-type: none"> <li>The baud rate can only be parameterised if the baud rate "0" is set via the DIP switches.</li> <li>A change in the baud rate will not be effective until a CAN Reset Node is performed.</li> </ul>		
<a href="#">▶ "CAN on board" system bus</a>		
Selection list(Lenze setting printed in bold)		
0	<b>500 kbps</b>	
1	250 kbps	
2	125 kbps	
3	50 kbps	
4	1000 kbps	
5	20 kbps	
<input checked="" type="checkbox"/> Read access <input checked="" type="checkbox"/> Write access <input type="checkbox"/> CINH <input type="checkbox"/> PLC STOP <input type="checkbox"/> No transfer <input checked="" type="checkbox"/> COM <input type="checkbox"/> MOT   Scaling factor: 1		

## C00352

Parameter   Name: <b>C00352   CAN slave/master</b>		Data type: UNSIGNED_8 Index: 24223 <sub>d</sub> = 5E9F <sub>h</sub>
The drive starts as CAN master after mains switching if a value of "1" has been entered and saved here.		
<a href="#">▶ "CAN on board" system bus</a>		
Selection list(Lenze setting printed in bold)		
0	<b>slave</b>	
1	master	
<input checked="" type="checkbox"/> Read access <input checked="" type="checkbox"/> Write access <input type="checkbox"/> CINH <input type="checkbox"/> PLC STOP <input type="checkbox"/> No transfer <input checked="" type="checkbox"/> COM <input type="checkbox"/> MOT   Scaling factor: 1		

## C00353

Parameter   Name: <b>C00353   CAN IN/OUT COBID source</b>		Data type: UNSIGNED_8 Index: 24222 <sub>d</sub> = 5E9E <sub>h</sub>
Identifier assignment procedure for the CANx In/Out process data		
<a href="#">▶ System bus "CAN on board": Identifier of the process data objects</a>		
Selection list		Info
0	COBID = C0350 + LenzeBaseID	COBID = node address + LenzeBaseID
1	COBID = C0350 + CANBaseID	COBID = node address + CANBaseID ( <a href="#">C00354/x</a> )
2	COBID = C0354/x	COBID = direct setting from <a href="#">C00354/x</a>
Subcodes	Lenze setting	Info
C00353/1	1: COBID = C0350 + CANBaseID	COBID source CAN1_IN/OUT
C00353/2	1: COBID = C0350 + CANBaseID	COBID source CAN2_IN/OUT
C00353/3	1: COBID = C0350 + CANBaseID	COBID source CAN3_IN/OUT
C00353/4	1: COBID = C0350 + CANBaseID	COBID source CAN4_IN/OUT • From version 15.00.00
<input checked="" type="checkbox"/> Read access <input checked="" type="checkbox"/> Write access <input type="checkbox"/> CINH <input type="checkbox"/> PLC STOP <input type="checkbox"/> No transfer <input checked="" type="checkbox"/> COM <input type="checkbox"/> MOT   Scaling factor: 1		

## C00354

Parameter   Name: C00354   COBID		Data type: UNSIGNED_32 Index: 24221 <sub>d</sub> = 5E9D <sub>h</sub>
Setting of the default COBID according to CANopen <ul style="list-style-type: none"> <li>A change in the COBID will not be effective until a CAN reset node is performed.</li> </ul> <p style="text-align: right;">▶ <a href="#">System bus "CAN on board": Identifier of the process data objects</a></p>		
Setting range (min. hex value   max. hex value)		
0x00000000		0xFFFFFFFF
Value is bit-coded:		Info
Bit 0	COBID Bit0	<ul style="list-style-type: none"> <li>Bit 0 ... 10: COB-ID</li> <li>Bit 11 ... 30: Reserved</li> <li>Bit 31: PDO invalid (is not transmitted)</li> </ul>
...	...	
Bit 31	PDO invalid	
Subcodes	Lenze setting	Info
C00354/1	0x00000201	COBID CAN1_IN
C00354/2	0x00000181	COBID CAN1_OUT
C00354/3	0x00000301	COBID CAN2_IN
C00354/4	0x00000281	COBID CAN2_OUT
C00354/5	0x00000401	COBID CAN3_IN
C00354/6	0x00000381	COBID CAN3_OUT
C00354/7	0x00000501	COBID CAN4_IN <ul style="list-style-type: none"> <li>From version 15.00.00</li> </ul>
C00354/8	0x00000481	COBID CAN4_OUT <ul style="list-style-type: none"> <li>From version 15.00.00</li> </ul>
<input checked="" type="checkbox"/> Read access <input checked="" type="checkbox"/> Write access <input type="checkbox"/> CINH <input type="checkbox"/> PLC STOP <input type="checkbox"/> No transfer <input checked="" type="checkbox"/> COM <input type="checkbox"/> MOT		

## C00355

Parameter   Name: C00355   Active COBID		Data type: UNSIGNED_16 Index: 24220 <sub>d</sub> = 5E9C <sub>h</sub>
Display of the COBID of the PDOs that is active in the CAN stack <p style="text-align: right;">▶ <a href="#">System bus "CAN on board": Identifier of the process data objects</a></p>		
Display range (min. value   unit   max. value)		
0		2047
Subcodes	Info	
C00355/1	Active COBID CAN1_IN	
C00355/2	Active COBID CAN1_OUT	
C00355/3	Active COBID CAN2_IN	
C00355/4	Active COBID CAN2_OUT	
C00355/5	Active COBID CAN3_IN	
C00355/6	Active COBID CAN3_OUT	
C00355/7	Active COBID CAN4_IN <ul style="list-style-type: none"> <li>From version 15.00.00</li> </ul>	
C00355/8	Active COBID CAN4_OUT <ul style="list-style-type: none"> <li>From version 15.00.00</li> </ul>	
<input checked="" type="checkbox"/> Read access <input type="checkbox"/> Write access <input type="checkbox"/> CINH <input type="checkbox"/> PLC STOP <input checked="" type="checkbox"/> No transfer <input checked="" type="checkbox"/> COM <input type="checkbox"/> MOT   Scaling factor: 1		

## C00356

Parameter   Name:		Data type: UNSIGNED_16 Index: 24219 <sub>d</sub> = 5E9B <sub>h</sub>	
<b>C00356   CAN time settings</b>			
Different time settings for the CAN interface			
<a href="#">▶ "CAN on board" system bus</a>			
Setting range (min. value   unit   max. value)			
0	ms	65000	
Subcodes	Lenze setting	Info	
C00356/1	3000 ms	CAN delay boot-up - operat. • Delay time for NMT state change from "Boot-up" to "Operational".	
C00356/2	0 ms	CAN2_OUT cycle time	
C00356/3	0 ms	CAN3_OUT cycle time	
C00356/4	0 ms	CANx_OUT operat. - 1.transmit • When the "Operational" NMT status is reached, the delay time set here is started. After the delay time has been elapsed, the PDOs CAN2_OUT and CAN3_OUT are sent for the first time.	
C00356/5	0 ms	CAN1_OUT cycle time	
C00356/6	0 ms	CAN4_OUT cycle time • From version 15.00.00	
<input checked="" type="checkbox"/> Read access <input checked="" type="checkbox"/> Write access <input type="checkbox"/> CINH <input type="checkbox"/> PLC STOP <input type="checkbox"/> No transfer <input checked="" type="checkbox"/> COM <input type="checkbox"/> MOT             Scaling factor: 1			

## C00357

Parameter   Name:		Data type: UNSIGNED_16 Index: 24218 <sub>d</sub> = 5E9A <sub>h</sub>	
<b>C00357   CAN monitoring times</b>			
Mapping of the RPDO event time (see DS301 V4.02)			
<ul style="list-style-type: none"> <li>• If a value unequal to "0" is entered, the RPDO is not expected before the set time has expired.</li> <li>• If the RPDO is not received within the expected time, the response set in <a href="#">C00593/1...4</a> will be triggered.</li> </ul>			
<a href="#">▶ "CAN on board" system bus</a>			
Setting range (min. value   unit   max. value)			
0	ms	65000	
Subcodes	Lenze setting	Info	
C00357/1	3000 ms	CAN1_IN monitoring time	
C00357/2	3000 ms	CAN2_IN monitoring time	
C00357/3	3000 ms	CAN3_IN monitoring time	
C00357/4	3000 ms	CAN4_IN monitoring time • From version 15.00.00	
<input checked="" type="checkbox"/> Read access <input checked="" type="checkbox"/> Write access <input type="checkbox"/> CINH <input type="checkbox"/> PLC STOP <input type="checkbox"/> No transfer <input checked="" type="checkbox"/> COM <input type="checkbox"/> MOT             Scaling factor: 1			

## C00358

Parameter   Name:		Data type: UNSIGNED_8 Index: 24217 <sub>d</sub> = 5E99 <sub>h</sub>	
<b>C00358   CANx_OUT data length</b>			
From version 03.00.00			
Setting of the data length for TX PDOs			
<a href="#">▶ "CAN on board" system bus</a>			
Setting range (min. value   unit   max. value)			
1		8	
Subcodes	Lenze setting	Info	

Parameter   Name: <b>C00358   CANx_OUT data length</b>		Data type: UNSIGNED_8 Index: 24217 <sub>d</sub> = 5E99 <sub>h</sub>
C00358/1	8	CAN1_OUT data length
C00358/2	8	CAN2_OUT data length
C00358/3	8	CAN3_OUT data length
C00358/4	8	CAN4_OUT data length • From version 15.00.00
<input checked="" type="checkbox"/> Read access <input checked="" type="checkbox"/> Write access <input type="checkbox"/> CINH <input type="checkbox"/> PLC STOP <input type="checkbox"/> No transfer <input checked="" type="checkbox"/> COM <input type="checkbox"/> MOT                   Scaling factor: 1		

**C00359**

Parameter   Name: <b>C00359   CAN status</b>		Data type: UNSIGNED_8 Index: 24216 <sub>d</sub> = 5E98 <sub>h</sub>
<a href="#">▶ "CAN on board" system bus</a>		
<b>Selection list (read only)</b>		
0	Operational	
1	Pre-Operat.	
2	Reserved	
3	Reserved	
4	BootUp	
5	Stopped	
6	Reserved	
7	Reset	
<input checked="" type="checkbox"/> Read access <input type="checkbox"/> Write access <input type="checkbox"/> CINH <input type="checkbox"/> PLC STOP <input checked="" type="checkbox"/> No transfer <input checked="" type="checkbox"/> COM <input type="checkbox"/> MOT                   Scaling factor: 1		

**C00360**

Parameter   Name: <b>C00360   CAN telegram counter</b>		Data type: UNSIGNED_16 Index: 24215 <sub>d</sub> = 5E97 <sub>h</sub>
<a href="#">▶ "CAN on board" system bus</a>		
<b>Display range (min. value   unit   max. value)</b>		
0		65535
<b>Subcodes</b>		<b>Info</b>
C00360/1		All PDO/SDO sent
C00360/2		All PDO/SDO received
C00360/3		Telegram counter CAN1_OUT
C00360/4		Telegram counter CAN2_OUT
C00360/5		Telegram counter CAN3_OUT
C00360/6		Telegram counter SDO1 OUT
C00360/7		Telegram counter SDO2 OUT
C00360/8		Telegram counter CAN1_IN
C00360/9		Telegram counter CAN2_IN
C00360/10		Telegram counter CAN3_IN

Parameter   Name: <b>C00360   CAN telegram counter</b>		Data type: UNSIGNED_16 Index: 24215 <sub>d</sub> = 5E97 <sub>h</sub>
C00360/11	Telegram counter SDO1 IN	
C00360/12	Telegram counter SDO2 IN	
C00360/13	Telegram counter CAN4_OUT • From version 15.00.00	
C00360/14	Telegram counter CAN4_IN • From version 15.00.00	
<input checked="" type="checkbox"/> Read access <input type="checkbox"/> Write access <input type="checkbox"/> CINH <input type="checkbox"/> PLC STOP <input checked="" type="checkbox"/> No transfer <input checked="" type="checkbox"/> COM <input type="checkbox"/> MOT             Scaling factor: 1		

**C00364**

Parameter   Name: <b>C00364   CAN MessageError</b>		Data type: UNSIGNED_8 Index: 24211 <sub>d</sub> = 5E93 <sub>h</sub>
<a href="#">▶ "CAN on board" system bus</a>		
<b>Selection list (read only)</b>		
0	No Error	
1	StuffError	
2	FormError	
3	AckError	
4	Bit1Error	
5	Bit0Error	
6	CRCErrror	
7	Reserved	
<input checked="" type="checkbox"/> Read access <input type="checkbox"/> Write access <input type="checkbox"/> CINH <input type="checkbox"/> PLC STOP <input checked="" type="checkbox"/> No transfer <input checked="" type="checkbox"/> COM <input type="checkbox"/> MOT             Scaling factor: 1		

**C00366**

Parameter   Name: <b>C00366   Number of CAN SDO channels</b>		Data type: UNSIGNED_8 Index: 24209 <sub>d</sub> = 5E91 <sub>h</sub>
<b>Functional change from version 05.01.00 onwards</b> Selection of the number of active parameter data channels <ul style="list-style-type: none"> <li>• Up to and including version 05.00.00, the parameter channels 1 and 2 are activated in the Lenze setting.</li> <li>• From version 05.01.00 onwards, only the parameter data channel 1 is activated in the Lenze setting according to CANopen. In order to activate both parameter data channels according to the previous behaviour, set "2 SDO Lenze".</li> </ul>		
<a href="#">▶ "CAN on board" system bus</a>		
<b>Selection list(Lenze setting printed in bold)</b>		
0	<b>1 SDO CANOpen</b>	
1	2 SDO Lenze	
<input checked="" type="checkbox"/> Read access <input checked="" type="checkbox"/> Write access <input type="checkbox"/> CINH <input type="checkbox"/> PLC STOP <input type="checkbox"/> No transfer <input checked="" type="checkbox"/> COM <input type="checkbox"/> MOT             Scaling factor: 1		



## C00367

Parameter   Name:		Data type: UNSIGNED_16 Index: 24208 <sub>d</sub> = 5E90 <sub>h</sub>	
<b>C00367   CAN SYNC Rx identifier</b>			
Identifier by means of which the sync slave is to receive sync telegrams. <ul style="list-style-type: none"> <li>• Mapping of the CANopen object <a href="#">I-1005</a> (see DS301 V4.02).</li> </ul> <p style="text-align: right;">▶ <a href="#">"CAN on board" system bus</a></p>			
Setting range (min. hex value   max. hex value)		Lenze setting	
0x0000		0xFFFF	<b>0x0080</b> (decimal: 128)
Value is bit-coded: ( <input checked="" type="checkbox"/> = bit set)			
Bit 0	<input type="checkbox"/> COBID Bit0		
Bit 1	<input type="checkbox"/> COBID Bit1		
Bit 2	<input type="checkbox"/> COBID Bit2		
Bit 3	<input type="checkbox"/> COBID Bit3		
Bit 4	<input type="checkbox"/> COBID Bit4		
Bit 5	<input type="checkbox"/> COBID Bit5		
Bit 6	<input type="checkbox"/> COBID Bit6		
Bit 7	<input checked="" type="checkbox"/> COBID Bit7		
Bit 8	<input type="checkbox"/> COBID Bit8		
Bit 9	<input type="checkbox"/> COBID Bit9		
Bit 10	<input type="checkbox"/> COBID Bit10		
Bit 11	<input type="checkbox"/> Reserved		
Bit 12	<input type="checkbox"/> Reserved		
Bit 13	<input type="checkbox"/> Reserved		
Bit 14	<input type="checkbox"/> Reserved		
Bit 15	<input type="checkbox"/> Reserved		
<input checked="" type="checkbox"/> Read access <input checked="" type="checkbox"/> Write access <input type="checkbox"/> CINH <input type="checkbox"/> PLC STOP <input type="checkbox"/> No transfer <input checked="" type="checkbox"/> COM <input type="checkbox"/> MOT			

## C00368

Parameter   Name:		Data type: UNSIGNED_16 Index: 24207 <sub>d</sub> = 5E8F <sub>h</sub>	
<b>C00368   CAN SYNC Tx identifier</b>			
Identifier by means of which the sync master is to transmit sync telegrams. <ul style="list-style-type: none"> <li>• Mapping of the CANopen object <a href="#">I-1005</a> (see DS301 V4.02).</li> </ul> <p style="text-align: right;">▶ <a href="#">"CAN on board" system bus</a></p>			
Setting range (min. hex value   max. hex value)		Lenze setting	
0x0000		0xFFFF	<b>0x0080</b> (decimal: 128)

Parameter   Name: <b>C00368   CAN SYNC Tx identifier</b>		Data type: UNSIGNED_16 Index: 24207 <sub>d</sub> = 5E8F <sub>h</sub>
<b>Value is bit-coded: (<input checked="" type="checkbox"/> = bit set)</b>		
Bit 0 <input type="checkbox"/>	COBID Bit0	
Bit 1 <input type="checkbox"/>	COBID Bit1	
Bit 2 <input type="checkbox"/>	COBID Bit2	
Bit 3 <input type="checkbox"/>	COBID Bit3	
Bit 4 <input type="checkbox"/>	COBID Bit4	
Bit 5 <input type="checkbox"/>	COBID Bit5	
Bit 6 <input type="checkbox"/>	COBID Bit6	
Bit 7 <input checked="" type="checkbox"/>	COBID Bit7	
Bit 8 <input type="checkbox"/>	COBID Bit8	
Bit 9 <input type="checkbox"/>	COBID Bit9	
Bit 10 <input type="checkbox"/>	COBID Bit10	
Bit 11 <input type="checkbox"/>	Reserved	
Bit 12 <input type="checkbox"/>	Reserved	
Bit 13 <input type="checkbox"/>	Reserved	
Bit 14 <input type="checkbox"/>	Reserved	
Bit 15 <input type="checkbox"/>	Sync-transmit off	
<input checked="" type="checkbox"/> Read access <input checked="" type="checkbox"/> Write access <input type="checkbox"/> CINH <input type="checkbox"/> PLC STOP <input type="checkbox"/> No transfer <input checked="" type="checkbox"/> COM <input type="checkbox"/> MOT		

**C00369**

Parameter   Name: <b>C00369   CAN sync transmission cycle time</b>		Data type: UNSIGNED_16 Index: 24206 <sub>d</sub> = 5E8E <sub>h</sub>
Cycle during which the sync master is to transmit sync telegrams. <ul style="list-style-type: none"> <li>• If "0 ms" is set (Lenze setting), no sync telegrams are generated.</li> <li>• Mapping of the CANopen object <a href="#">I-1006</a> (see DS301 V4.02).</li> </ul>		
<a href="#">▶ "CAN on board" system bus</a>		
<b>Setting range (min. value   unit   max. value)</b>		<b>Lenze setting</b>
0	ms	65000 <b>0 ms</b>
<input checked="" type="checkbox"/> Read access <input checked="" type="checkbox"/> Write access <input type="checkbox"/> CINH <input type="checkbox"/> PLC STOP <input type="checkbox"/> No transfer <input checked="" type="checkbox"/> COM <input type="checkbox"/> MOT                   Scaling factor: 1		

**C00370**

Parameter   Name: <b>C00370   SyncTxRxTimes</b>		Data type: INTEGER_16 Index: 24205 <sub>d</sub> = 5E8D <sub>h</sub>
From version 04.00.00		
<a href="#">▶ "CAN on board" system bus</a>		
<b>Display range (min. value   unit   max. value)</b>		
-1638	µs	1638
<b>Subcodes</b>		<b>Info</b>
C00370/1		CAN Sync instant of transmission
C00370/2		Sync instant of reception
<input checked="" type="checkbox"/> Read access <input type="checkbox"/> Write access <input type="checkbox"/> CINH <input type="checkbox"/> PLC STOP <input checked="" type="checkbox"/> No transfer <input type="checkbox"/> COM <input type="checkbox"/> MOT                   Scaling factor: 1		

## C00371

Parameter   Name: <b>C00371   CAN ErrorCode</b>		Data type: UNSIGNED_16 Index: 24204 <sub>d</sub> = 5E8C <sub>h</sub>
From version 13.00.00		<a href="#">▶ "CAN on board" system bus</a>
<b>Display range (min. value   unit   max. value)</b>		
0		65535
<b>Subcodes</b>		<b>Info</b>
C00371/1		CAN ErrorCode
<input checked="" type="checkbox"/> Read access <input type="checkbox"/> Write access <input type="checkbox"/> CINH <input type="checkbox"/> PLC STOP <input checked="" type="checkbox"/> No transfer <input checked="" type="checkbox"/> COM <input type="checkbox"/> MOT           Scaling factor: 1		

## C00372

Parameter   Name: <b>C00372   CAN_Tx_Rx_Error</b>		Data type: UNSIGNED_8 Index: 24203 <sub>d</sub> = 5E8B <sub>h</sub>
		<a href="#">▶ "CAN on board" system bus</a>
<b>Display range (min. value   unit   max. value)</b>		
0		255
<b>Subcodes</b>		<b>Info</b>
C00372/1		CAN Tx_Error
C00372/2		CAN Rx_Error
C00372/3		CAN Tx_Overflow
C00372/4		CAN Rx_Overflow
<input checked="" type="checkbox"/> Read access <input type="checkbox"/> Write access <input type="checkbox"/> CINH <input type="checkbox"/> PLC STOP <input checked="" type="checkbox"/> No transfer <input checked="" type="checkbox"/> COM <input type="checkbox"/> MOT           Scaling factor: 1		

## C00381

Parameter   Name: <b>C00381   CAN Heartbeat producer time</b>		Data type: UNSIGNED_16 Index: 24194 <sub>d</sub> = 5E82 <sub>h</sub>
Time interval for the transmission of the heartbeat telegram to the consumer(s). <ul style="list-style-type: none"> <li>• The heartbeat telegram is sent automatically as soon as a time &gt; 0 ms is set.</li> <li>• Mapping of the CANopen object <a href="#">I-1017</a> (see DS301 V4.02).</li> </ul>		<a href="#">▶ Heartbeat protocol</a>
<b>Setting range (min. value   unit   max. value)</b>		<b>Lenze setting</b>
0	ms	65535 <b>0 ms</b>
<input checked="" type="checkbox"/> Read access <input checked="" type="checkbox"/> Write access <input type="checkbox"/> CINH <input type="checkbox"/> PLC STOP <input type="checkbox"/> No transfer <input checked="" type="checkbox"/> COM <input type="checkbox"/> MOT           Scaling factor: 1		

## C00385

Parameter   Name: <b>C00385   CAN node addr. HeartBeat producer</b>		Data type: UNSIGNED_8 Index: 24190 <sub>d</sub> = 5E7E <sub>h</sub>
From version 03.00.00		<a href="#">▶ Heartbeat protocol</a>
The subcodes represent the nodes to be monitored by heartbeat.		
<b>Setting range (min. value   unit   max. value)</b>		
0		127

Parameter   Name: <b>C00385   CAN node addr. HeartBeat producer</b>		Data type: UNSIGNED_8 Index: 24190 <sub>d</sub> = 5E7E <sub>h</sub>
Subcodes	Lenze setting	Info
C00385/1	0	CAN node address HeartBeat Producer 1 ... 7
C00385/...		
C00385/7		
<input checked="" type="checkbox"/> Read access <input checked="" type="checkbox"/> Write access <input type="checkbox"/> CINH <input type="checkbox"/> PLC STOP <input type="checkbox"/> No transfer <input type="checkbox"/> COM <input type="checkbox"/> MOT   Scaling factor: 1		

**C00386**

Parameter   Name: <b>C00386   ConsumerTime HeartBeat Producer</b>		Data type: UNSIGNED_16 Index: 24189 <sub>d</sub> = 5E7D <sub>h</sub>
From version 03.00.00 The subcodes represent the nodes to be monitored by heartbeat.		
▶ <a href="#">Heartbeat protocol</a>		
Setting range (min. value   unit   max. value)		
0	ms	60000
Subcodes	Lenze setting	Info
C00386/1	0 ms	ConsumerTime HeartBeat Producer 1 ... 7
C00386/...		
C00386/7		
<input checked="" type="checkbox"/> Read access <input checked="" type="checkbox"/> Write access <input type="checkbox"/> CINH <input type="checkbox"/> PLC STOP <input type="checkbox"/> No transfer <input type="checkbox"/> COM <input type="checkbox"/> MOT   Scaling factor: 1		

**C00387**

Parameter   Name: <b>C00387   CAN-GatewayAddr</b>		Data type: UNSIGNED_8 Index: 24188 <sub>d</sub> = 5E7C <sub>h</sub>
From version 12.00.00		
▶ <a href="#">CAN gateway</a>		
Setting range (min. value   unit   max. value)		
0		127
Subcodes	Lenze setting	Info
C00387/1	0	CAN_Gateway: Addr.
<input checked="" type="checkbox"/> Read access <input checked="" type="checkbox"/> Write access <input type="checkbox"/> CINH <input type="checkbox"/> PLC STOP <input type="checkbox"/> No transfer <input type="checkbox"/> COM <input type="checkbox"/> MOT   Scaling factor: 1		

**C00400**

Parameter   Name: <b>C00400   LS_PulseGenerator</b>		Data type: UNSIGNED_16 Index: 24175 <sub>d</sub> = 5E6F <sub>h</sub>
Time setting of the pulse to be output by the SB <a href="#">LS_PulseGenerator</a>		
<b>Note:</b> The real length of the low or high level at the <i>bSquareWave</i> output is always 1 ms higher than set here in subcode 1 or 2. If "0 ms" is set, a level with a length of 1 ms is created length, for instance, and if "1000 ms" is set, a level with a length of 1001 ms is created.		
Setting range (min. value   unit   max. value)		
0	ms	60000

Parameter   Name: <b>C00400   LS_PulseGenerator</b>		Data type: UNSIGNED_16 Index: 24175 <sub>d</sub> = 5E6F <sub>h</sub>
Subcodes	Lenze setting	Info
C00400/1	1000 ms	Length of the low level (break) + 1 ms
C00400/2	1000 ms	Length of the high level + 1 ms
C00400/3	100 ms	<b>From version 06.00.00</b> Delay time for status signal <i>bFirstCycleDone</i> <ul style="list-style-type: none"> <li>The <i>bFirstCycleDone</i> status signal is set to TRUE when the first task cycle is complete and the time set here has expired.</li> </ul>
<input checked="" type="checkbox"/> Read access <input checked="" type="checkbox"/> Write access <input type="checkbox"/> CINH <input type="checkbox"/> PLC STOP <input type="checkbox"/> No transfer <input type="checkbox"/> COM <input type="checkbox"/> MOT             Scaling factor: 1		

**C00401**

Parameter   Name: <b>C00401   CANxInOut: Inversion</b>		Data type: UNSIGNED_16 Index: 24174 <sub>d</sub> = 5E6E <sub>h</sub>
<b>From version 03.00.00</b> This parameter serves to invert the control/status bits of the CAN port blocks. <p style="text-align: right;"><a href="#">▶ CAN port block</a></p>		
Setting range (min. hex value   max. hex value)		
0x0000		0xFFFF
Value is bit-coded:		Info
Bit 0	Active	Bit set = bit is inverted
...	...	
Bit 15	Active	
Subcodes	Lenze setting	Info
C00401/1	0x0000	Inversion of LP_CanIn1.bCtrl1_B0...15
C00401/2	0x0000	Inversion of LP_CanOut1.bState1_B0...15
C00401/3	0x0000	Inversion of LP_CanIn2.bIn1_B0...15
C00401/4	0x0000	Inversion of LP_CanOut2.bOut1_B0...15
C00401/5	0x0000	Inversion of LP_CanIn3.bIn1_B0...15
C00401/6	0x0000	Inversion of LP_CanOut3.bOut1_B0...15
C00401/7	0x0000	Inversion of LP_CanIn4.bIn1_B0...15 <ul style="list-style-type: none"> <li>• <b>From version 15.00.00</b></li> </ul>
C00401/8	0x0000	Inversion of LP_CanOut4.bOut1_B0...15 <ul style="list-style-type: none"> <li>• <b>From version 15.00.00</b></li> </ul>
<input checked="" type="checkbox"/> Read access <input checked="" type="checkbox"/> Write access <input type="checkbox"/> CINH <input type="checkbox"/> PLC STOP <input type="checkbox"/> No transfer <input type="checkbox"/> COM <input type="checkbox"/> MOT		

**C00407**

Parameter   Name: <b>C00407   LP_CanIn Mapping</b>		Data type: UNSIGNED_32 Index: 24168 <sub>d</sub> = 5E68 <sub>h</sub>
<b>From version 12.00.00</b> Mapping for port blocks LP_CanIn1...4 <ul style="list-style-type: none"> <li>These settings are ORed with the mapping settings for the single words in <a href="#">C00409/x</a>.</li> </ul> <p style="text-align: right;"><a href="#">▶ CAN port block</a></p>		
Setting range (min. value   unit   max. value)		
0		4294967295
Subcodes	Lenze setting	Info
C00407/1	0	<a href="#">LP_CanIn1</a> :dwIn12 MapVal
C00407/2	0	<a href="#">LP_CanIn1</a> :dwIn34 MapVal

Parameter   Name: <b>C00407   LP_CanIn Mapping</b>		Data type: UNSIGNED_32 Index: 24168 <sub>d</sub> = 5E68 <sub>h</sub>
C00407/3	0	<a href="#">LP_CanIn2:dwIn12</a> MapVal
C00407/4	0	<a href="#">LP_CanIn2:dwIn34</a> MapVal
C00407/5	0	<a href="#">LP_CanIn3:dwIn12</a> MapVal
C00407/6	0	<a href="#">LP_CanIn3:dwIn34</a> MapVal
C00407/7	0	<a href="#">LP_CanIn4:dwIn12</a> MapVal • From version 15.00.00
C00407/8	0	<a href="#">LP_CanIn4:dwIn34</a> MapVal • From version 15.00.00
<input checked="" type="checkbox"/> Read access <input checked="" type="checkbox"/> Write access <input type="checkbox"/> CINH <input type="checkbox"/> PLC STOP <input type="checkbox"/> No transfer <input type="checkbox"/> COM <input type="checkbox"/> MOT             Scaling factor: 1		

**C00408**

Parameter   Name: <b>C00408   LP_CanIn mapping selection</b>		Data type: UNSIGNED_8 Index: 24167 <sub>d</sub> = 5E67 <sub>h</sub>
From version 03.00.00 Selection of the mapping source for port blocks LP_CanIn1...4 <div style="text-align: right;"><a href="#">▶ CAN port block</a></div>		
Selection list		Info
0	CanIn	CanIn
1	Par.C409 C407	Mapping configured in <a href="#">C00409</a>
Subcodes	Lenze setting	Info
C00408/1	0: CanIn	Mapping selection LP_CanIn1
C00408/2	0: CanIn	Mapping selection LP_CanIn2
C00408/3	0: CanIn	Mapping selection LP_CanIn3
C00408/4	0: CanIn	Mapping selection LP_CanIn4 • From version 15.00.00
<input checked="" type="checkbox"/> Read access <input checked="" type="checkbox"/> Write access <input type="checkbox"/> CINH <input type="checkbox"/> PLC STOP <input type="checkbox"/> No transfer <input type="checkbox"/> COM <input type="checkbox"/> MOT             Scaling factor: 1		

**C00409**

Parameter   Name: <b>C00409   LP_CanIn Mapping</b>		Data type: UNSIGNED_16 Index: 24166 <sub>d</sub> = 5E66 <sub>h</sub>
From version 03.00.00 Mapping for port blocks LP_CanIn1...4 • These settings are ORed with the mapping settings for the double words in <a href="#">C00407/x</a> . <div style="text-align: right;"><a href="#">▶ CAN port block</a></div>		
Setting range (min. value   unit   max. value)		
0		65535
Subcodes	Lenze setting	Info
C00409/1	0	<a href="#">LP_CanIn1:wCtrl</a> MapVal
C00409/2	0	<a href="#">LP_CanIn1:wIn2</a> MapVal
C00409/3	0	<a href="#">LP_CanIn1:wIn3</a> MapVal
C00409/4	0	<a href="#">LP_CanIn1:wIn4</a> MapVal
C00409/5	0	<a href="#">LP_CanIn2:wIn1</a> MapVal
C00409/6	0	<a href="#">LP_CanIn2:wIn2</a> MapVal
C00409/7	0	<a href="#">LP_CanIn2:wIn3</a> MapVal
C00409/8	0	<a href="#">LP_CanIn2:wIn4</a> MapVal
C00409/9	0	<a href="#">LP_CanIn3:wIn1</a> MapVal

Parameter   Name: <b>C00409   LP_CanIn Mapping</b>		Data type: UNSIGNED_16 Index: 24166 <sub>d</sub> = 5E66 <sub>h</sub>
C00409/10	0	<a href="#">LP_CanIn3:wIn2</a> MapVal
C00409/11	0	<a href="#">LP_CanIn3:wIn3</a> MapVal
C00409/12	0	<a href="#">LP_CanIn3:wIn4</a> MapVal
C00409/13	0	<a href="#">LP_CanIn4:wIn1</a> MapVal • From version 15.00.00
C00409/14	0	<a href="#">LP_CanIn4:wIn2</a> MapVal • From version 15.00.00
C00409/15	0	<a href="#">LP_CanIn4:wIn3</a> MapVal • From version 15.00.00
C00409/16	0	<a href="#">LP_CanIn4:wIn4</a> MapVal • From version 15.00.00
<input checked="" type="checkbox"/> Read access <input checked="" type="checkbox"/> Write access <input type="checkbox"/> CINH <input type="checkbox"/> PLC STOP <input type="checkbox"/> No transfer <input type="checkbox"/> COM <input type="checkbox"/> MOT             Scaling factor: 1		

**C00410**

Parameter   Name: <b>C00410   L_SignalMonitor_a: Signal sources</b>		Data type: UNSIGNED_16 Index: 24165 <sub>d</sub> = 5E65 <sub>h</sub>
The <a href="#">L_SignalMonitor_a</a> FB: Selection of the signal sources		
<b>Selection list</b>		
See <a href="#">selection list - analog signals</a>		
Subcodes	Lenze setting	Info
C00410/1	0: Not connected	Signal source for output <i>nOut1_a</i>
C00410/2	0: Not connected	Signal source for output <i>nOut2_a</i>
C00410/3	0: Not connected	Signal source for output <i>nOut3_a</i>
C00410/4	0: Not connected	Signal source for output <i>nOut4_a</i>
<input checked="" type="checkbox"/> Read access <input checked="" type="checkbox"/> Write access <input type="checkbox"/> CINH <input type="checkbox"/> PLC STOP <input type="checkbox"/> No transfer <input type="checkbox"/> COM <input type="checkbox"/> MOT             Scaling factor: 1		

**C00411**

Parameter   Name: <b>C00411   L_SignalMonitor_b: Signal sources</b>		Data type: UNSIGNED_16 Index: 24164 <sub>d</sub> = 5E64 <sub>h</sub>
The <a href="#">L_SignalMonitor_b</a> FB: Selection of the signal sources		
<b>Selection list</b>		
See <a href="#">selection list - digital signals</a>		
Subcodes	Lenze setting	Info
C00411/1	0: Not connected	Signal source for output <i>bOut1</i>
C00411/2	0: Not connected	Signal source for output <i>bOut2</i>
C00411/3	0: Not connected	Signal source for output <i>bOut3</i>
C00411/4	0: Not connected	Signal source for output <i>bOut4</i>
<input checked="" type="checkbox"/> Read access <input checked="" type="checkbox"/> Write access <input type="checkbox"/> CINH <input type="checkbox"/> PLC STOP <input type="checkbox"/> No transfer <input type="checkbox"/> COM <input type="checkbox"/> MOT             Scaling factor: 1		

## C00412

Parameter   Name: C00412   L_SignalMonitor_b: Inversion		Data type: UNSIGNED_8 Index: 24163 <sub>d</sub> = 5E63 <sub>h</sub>
The <a href="#">L_SignalMonitor_b</a> FB: Inversion of the binary outputs		
Setting range (min. hex value   max. hex value)		Lenze setting
0x00		0xFF 0x00 (decimal: 0)
Value is bit-coded: ( <input checked="" type="checkbox"/> = bit set)		Info
Bit 0 <input type="checkbox"/>	bOut1 inverted	Bit set = inversion active
Bit 1 <input type="checkbox"/>	bOut2 inverted	
Bit 2 <input type="checkbox"/>	bOut3 inverted	
Bit 3 <input type="checkbox"/>	bOut4 inverted	
Bit 4 <input type="checkbox"/>	Reserved	
Bit 5 <input type="checkbox"/>	Reserved	
Bit 6 <input type="checkbox"/>	Reserved	
Bit 7 <input type="checkbox"/>	Reserved	
<input checked="" type="checkbox"/> Read access <input checked="" type="checkbox"/> Write access <input type="checkbox"/> CINH <input type="checkbox"/> PLC STOP <input type="checkbox"/> No transfer <input type="checkbox"/> COM <input type="checkbox"/> MOT		

## C00413

Parameter   Name: C00413   L_SignalMonitor_a: Offs./gain		Data type: INTEGER_16 Index: 24162 <sub>d</sub> = 5E62 <sub>h</sub>
The <a href="#">L_SignalMonitor_a</a> FB: Gain and offset of the analog signals		
Setting range (min. value   unit   max. value)		
-199.99	%	199.99
Subcodes	Lenze setting	Info
C00413/1	0.00 %	Offset for output <i>nOut1_a</i>
C00413/2	100.00 %	Gain for output <i>nOut1_a</i>
C00413/3	0.00 %	Offset for output <i>nOut2_a</i>
C00413/4	100.00 %	Gain for output <i>nOut2_a</i>
C00413/5	0.00 %	Offset for output <i>nOut3_a</i>
C00413/6	100.00 %	Gain for output <i>nOut3_a</i>
C00413/7	0.00 %	Offset for output <i>nOut4_a</i>
C00413/8	100.00 %	Gain for output <i>nOut4_a</i>
<input checked="" type="checkbox"/> Read access <input checked="" type="checkbox"/> Write access <input type="checkbox"/> CINH <input type="checkbox"/> PLC STOP <input type="checkbox"/> No transfer <input type="checkbox"/> COM <input type="checkbox"/> MOT             Scaling factor: 100		

## C00420

Parameter   Name: C00420   Number of encoder increments		Data type: UNSIGNED_16 Index: 24155 <sub>d</sub> = 5E5B <sub>h</sub>
Indication of the encoder constant		
<a href="#">Encoder/feedback system</a>		
Setting range (min. value   unit   max. value)		
1	Incr./rev.	32767
Subcodes	Lenze setting	Info
C00420/1	128 incr./rev.	FreqIn12: Encoder increment
<input checked="" type="checkbox"/> Read access <input checked="" type="checkbox"/> Write access <input type="checkbox"/> CINH <input type="checkbox"/> PLC STOP <input type="checkbox"/> No transfer <input type="checkbox"/> COM <input checked="" type="checkbox"/> MOT             Scaling factor: 1		



## C00423

Parameter   Name:		Data type: UNSIGNED_16 Index: 24152 <sub>d</sub> = 5E58 <sub>h</sub>	
<b>C00423   DOx: Delay times</b>			
Delay times for the digital output terminals			
<a href="#">▶ Digital terminals</a>			
Setting range (min. value   unit   max. value)			
0.000	s	65.000	
Subcodes	Lenze setting	Info	
C00423/1	0.000 s	Relay ON delay	
C00423/2	0.000 s	Relay OFF delay	
C00423/3	0.000 s	DO1 ON delay	
C00423/4	0.000 s	DO1 OFF delay	
<input checked="" type="checkbox"/> Read access <input checked="" type="checkbox"/> Write access <input type="checkbox"/> CINH <input type="checkbox"/> PLC STOP <input type="checkbox"/> No transfer <input type="checkbox"/> COM <input type="checkbox"/> MOT             Scaling factor: 1000			

## C00425

Parameter   Name:		Data type: UNSIGNED_8 Index: 24150 <sub>d</sub> = 5E56 <sub>h</sub>	
<b>C00425   Encoder scanning time</b>			
From version 03.00.00			
Encoder sample time for the digital input terminals when configured as frequency inputs			
<a href="#">▶ Using DI1 and DI2 as frequency inputs</a>			
Selection list			
0	1 ms		
1	2 ms		
2	5 ms		
3	10 ms		
4	20 ms		
5	50 ms		
6	100 ms		
7	200 ms		
8	500 ms		
9	1000 ms		
Subcodes	Lenze setting	Info	
C00425/1	3: 10 ms	FreqIn12: Encoder scanning time	
<input checked="" type="checkbox"/> Read access <input checked="" type="checkbox"/> Write access <input checked="" type="checkbox"/> CINH <input type="checkbox"/> PLC STOP <input type="checkbox"/> No transfer <input type="checkbox"/> COM <input checked="" type="checkbox"/> MOT             Scaling factor: 1			

## C00434

Parameter   Name:		Data type: INTEGER_16 Index: 24141 <sub>d</sub> = 5E4D <sub>h</sub>	
<b>C00434   O1U: Gain</b>			
Gain of the analog output			
<a href="#">▶ Analog terminals</a>			
Setting range (min. value   unit   max. value)			
-199.99	%	199.99	
Subcodes	Lenze setting	Info	
C00434/1	100.00 %	O1U: Gain	
<input checked="" type="checkbox"/> Read access <input checked="" type="checkbox"/> Write access <input type="checkbox"/> CINH <input type="checkbox"/> PLC STOP <input type="checkbox"/> No transfer <input type="checkbox"/> COM <input type="checkbox"/> MOT             Scaling factor: 100			

## C00435

Parameter   Name: <b>C00435   O1U: Offset</b>		Data type: INTEGER_16 Index: 24140 <sub>d</sub> = 5E4C <sub>h</sub>
Offset of the analog output		<a href="#">▶ Analog terminals</a>
<b>Setting range (min. value   unit   max. value)</b>		
-199.99	%	199.99
<b>Subcodes</b>	<b>Lenze setting</b>	<b>Info</b>
C00435/1	0.00 %	O1U: Offset
<input checked="" type="checkbox"/> Read access <input checked="" type="checkbox"/> Write access <input type="checkbox"/> CINH <input type="checkbox"/> PLC STOP <input type="checkbox"/> No transfer <input type="checkbox"/> COM <input type="checkbox"/> MOT   Scaling factor: 100		

## C00436

Parameter   Name: <b>C00436   O1U: Voltage</b>		Data type: INTEGER_16 Index: 24139 <sub>d</sub> = 5E4B <sub>h</sub>
Display of the analog output voltage		<a href="#">▶ Analog terminals</a>
<b>Display range (min. value   unit   max. value)</b>		
0.00	V	10.00
<b>Subcodes</b>	<b>Info</b>	
C00436/1	O1U: Output voltage	
<input checked="" type="checkbox"/> Read access <input type="checkbox"/> Write access <input type="checkbox"/> CINH <input type="checkbox"/> PLC STOP <input checked="" type="checkbox"/> No transfer <input type="checkbox"/> COM <input type="checkbox"/> MOT   Scaling factor: 100		

## C00439

Parameter   Name: <b>C00439   O1U: Input value</b>		Data type: INTEGER_16 Index: 24136 <sub>d</sub> = 5E48 <sub>h</sub>
Display of the input values for the analog outputs		<a href="#">▶ Analog terminals</a>
Display of the input value for the analog output		<a href="#">▶ Analog terminals</a>
<b>Display range (min. value   unit   max. value)</b>		
-199.99	%	199.99
<b>Subcodes</b>	<b>Info</b>	
C00439/1	O1U: Input value • 100 % ≙ 10 V	
<input checked="" type="checkbox"/> Read access <input type="checkbox"/> Write access <input type="checkbox"/> CINH <input type="checkbox"/> PLC STOP <input checked="" type="checkbox"/> No transfer <input type="checkbox"/> COM <input type="checkbox"/> MOT   Scaling factor: 100		

## C00440

Parameter   Name: <b>C00440   LS_AnalogIn1: PT1 time constant</b>		Data type: UNSIGNED_16 Index: 24135 <sub>d</sub> = 5E47 <sub>h</sub>
PT1 time constant (S-ramp time) for the analog input		<a href="#">▶ Analog terminals</a>
<b>Setting range (min. value   unit   max. value)</b>		
0	ms	1000
<b>Subcodes</b>	<b>Lenze setting</b>	<b>Info</b>
C00440/1	10 ms	PT1 rounding AnalogIn1
<input checked="" type="checkbox"/> Read access <input checked="" type="checkbox"/> Write access <input type="checkbox"/> CINH <input type="checkbox"/> PLC STOP <input type="checkbox"/> No transfer <input type="checkbox"/> COM <input type="checkbox"/> MOT   Scaling factor: 1		

**C00441**

Parameter   Name: <b>C00441   Decoupling AnalogOut</b>		Data type: UNSIGNED_16 Index: 24134 <sub>d</sub> = 5E46 <sub>h</sub>
From version 04.00.00 Configuration defining the events that lead to a decoupling of the analog output terminals. ▶ <a href="#">Configuring exception handling of the output terminals</a>		
<b>Setting range (min. hex value   max. hex value)</b>		<b>Lenze setting</b>
0x0000		0xFFFF <b>0x0000</b> (decimal: 0)
<b>Value is bit-coded: (<input checked="" type="checkbox"/> = bit set)</b>		
Bit 0 <input type="checkbox"/>	SafeTorqueOff	
Bit 1 <input type="checkbox"/>	ReadyToSwitchOn	
Bit 2 <input type="checkbox"/>	SwitchedOn	
Bit 3 <input type="checkbox"/>	Reserved	
Bit 4 <input type="checkbox"/>	Trouble	
Bit 5 <input type="checkbox"/>	Fault	
Bit 6 <input type="checkbox"/>	Reserved	
Bit 7 <input type="checkbox"/>	Reserved	
Bit 8 <input type="checkbox"/>	Reserved	
Bit 9 <input type="checkbox"/>	Fail CAN_Management	
Bit 10 <input type="checkbox"/>	Reserved	
Bit 11 <input type="checkbox"/>	Energy saving mode	
Bit 12 <input type="checkbox"/>	Reserved	
Bit 13 <input type="checkbox"/>	Reserved	
Bit 14 <input type="checkbox"/>	Reserved	
Bit 15 <input type="checkbox"/>	Reserved	
<input checked="" type="checkbox"/> Read access <input checked="" type="checkbox"/> Write access <input type="checkbox"/> CINH <input type="checkbox"/> PLC STOP <input type="checkbox"/> No transfer <input type="checkbox"/> COM <input type="checkbox"/> MOT		

**C00442**

Parameter   Name: <b>C00442   AOut1: Decoupling value</b>		Data type: INTEGER_16 Index: 24133 <sub>d</sub> = 5E45 <sub>h</sub>
From version 04.00.00 Definition of the value the analog output terminals are to have in the decoupled state. ▶ <a href="#">Configuring exception handling of the output terminals</a>		
<b>Setting range (min. value   unit   max. value)</b>		
0.00	%	100.00
<b>Subcodes</b>	<b>Lenze setting</b>	<b>Info</b>
C00442/1	0.00 %	AOut1_U: Decoupling value
<input checked="" type="checkbox"/> Read access <input checked="" type="checkbox"/> Write access <input type="checkbox"/> CINH <input type="checkbox"/> PLC STOP <input type="checkbox"/> No transfer <input type="checkbox"/> COM <input type="checkbox"/> MOT                   Scaling factor: 100		

**C00443**

Parameter   Name: <b>C00443   DIx: Level</b>		Data type: UNSIGNED_16 Index: 24132 <sub>d</sub> = 5E44 <sub>h</sub>
Bit coded display of the level of the digital inputs		<a href="#">▶ Digital terminals</a>
<b>Display area (min. hex value   max. hex value)</b>		
0x0000		0xFFFF
<b>Value is bit-coded:</b>		<b>Info</b>
Bit 0	DI1	Bit set = HIGH level
Bit 1	DI2	
Bit 2	DI3	
Bit 3	DI4	
Bit 4	Reserved	
Bit 5	Reserved	
Bit 6	Reserved	
Bit 7	Reserved	
Bit 8	Reserved	
Bit 9	Reserved	
Bit 10	Reserved	
Bit 11	Reserved	
Bit 12	Reserved	
Bit 13	Reserved	
Bit 14	Reserved	
Bit 15	CINH	
<b>Subcodes</b>		<b>Info</b>
C00443/1		DIx: Terminal level
C00443/2		DIx: Output level
<input checked="" type="checkbox"/> Read access <input type="checkbox"/> Write access <input type="checkbox"/> CINH <input type="checkbox"/> PLC STOP <input checked="" type="checkbox"/> No transfer <input type="checkbox"/> COM <input type="checkbox"/> MOT		

**C00444**

Parameter   Name: <b>C00444   DOx: Level</b>		Data type: UNSIGNED_16 Index: 24131 <sub>d</sub> = 5E43 <sub>h</sub>
Bit coded display of the level of the digital outputs		<a href="#">▶ Digital terminals</a>
<b>Display area (min. hex value   max. hex value)</b>		
0x0000		0xFFFF
<b>Value is bit-coded:</b>		<b>Info</b>

Parameter   Name: <b>C00444   DOx: Level</b>		Data type: UNSIGNED_16 Index: 24131 <sub>d</sub> = 5E43 <sub>h</sub>
Bit 0	Relay	Bit set = HIGH level
Bit 1	DO1	
Bit 2	Reserved	
Bit 3	Reserved	
Bit 4	Reserved	
Bit 5	Reserved	
Bit 6	Reserved	
Bit 7	Reserved	
Bit 8	Reserved	
Bit 9	Reserved	
Bit 10	Reserved	
Bit 11	Reserved	
Bit 12	Reserved	
Bit 13	Reserved	
Bit 14	Reserved	
Bit 15	Reserved	
Subcodes		Info
C00444/1		DOx: Input level
C00444/2		DOx: Terminal level
<input checked="" type="checkbox"/> Read access <input type="checkbox"/> Write access <input type="checkbox"/> CINH <input type="checkbox"/> PLC STOP <input checked="" type="checkbox"/> No transfer <input type="checkbox"/> COM <input type="checkbox"/> MOT		

**C00445**

Parameter   Name: <b>C00445   FreqInxx_nOut_v</b>		Data type: INTEGER_16 Index: 24130 <sub>d</sub> = 5E42 <sub>h</sub>
From version 03.00.00 Display of the frequency input signals which are fed into the application.  <div style="text-align: right;"><a href="#">▶ Using DI1 and DI2 as frequency inputs</a></div>		
Display range (min. value   unit   max. value)		
-32767	Incr/ms	32767
Subcodes		Info
C00445/1		FreqIn12_nOut_v
<input checked="" type="checkbox"/> Read access <input type="checkbox"/> Write access <input type="checkbox"/> CINH <input type="checkbox"/> PLC STOP <input checked="" type="checkbox"/> No transfer <input type="checkbox"/> COM <input type="checkbox"/> MOT             Scaling factor: 1		

**C00446**

Parameter   Name: <b>C00446   FreqInxx_nOut_a</b>		Data type: INTEGER_16 Index: 24129 <sub>d</sub> = 5E41 <sub>h</sub>
From version 03.00.00 Display of the frequency input signals which are fed into the application.  <div style="text-align: right;"><a href="#">▶ Using DI1 and DI2 as frequency inputs</a></div>		
Display range (min. value   unit   max. value)		
-199.99	%	199.99
Subcodes		Info
C00446/1		FreqIn12_nOut_a
<input checked="" type="checkbox"/> Read access <input type="checkbox"/> Write access <input type="checkbox"/> CINH <input type="checkbox"/> PLC STOP <input checked="" type="checkbox"/> No transfer <input type="checkbox"/> COM <input type="checkbox"/> MOT             Scaling factor: 100		

**C00447**

Parameter   Name: <b>C00447   DigOut decoupling</b>		Data type: UNSIGNED_16 Index: 24128 <sub>d</sub> = 5E40 <sub>h</sub>
<p>From version 04.00.00</p> <p>Configuration defining the events that lead to a decoupling of the digital output terminals.</p> <p style="text-align: right;">▶ <a href="#">Configuring exception handling of the output terminals</a></p>		
<b>Setting range</b> (min. hex value   max. hex value)		<b>Lenze setting</b>
0x0000		0xFFFF <b>0x0000</b> (decimal: 0)
<b>Value is bit-coded:</b> ( <input checked="" type="checkbox"/> = bit set)		
Bit 0 <input type="checkbox"/>	SafeTorqueOff	
Bit 1 <input type="checkbox"/>	ReadyToSwitchOn	
Bit 2 <input type="checkbox"/>	SwitchedOn	
Bit 3 <input type="checkbox"/>	Reserved	
Bit 4 <input type="checkbox"/>	Trouble	
Bit 5 <input type="checkbox"/>	Fault	
Bit 6 <input type="checkbox"/>	Reserved	
Bit 7 <input type="checkbox"/>	Reserved	
Bit 8 <input type="checkbox"/>	Reserved	
Bit 9 <input type="checkbox"/>	Fail CAN_Management	
Bit 10 <input type="checkbox"/>	Reserved	
Bit 11 <input type="checkbox"/>	Energy saving mode	
Bit 12 <input type="checkbox"/>	Reserved	
Bit 13 <input type="checkbox"/>	Reserved	
Bit 14 <input type="checkbox"/>	Reserved	
Bit 15 <input type="checkbox"/>	Reserved	
<input checked="" type="checkbox"/> Read access <input checked="" type="checkbox"/> Write access <input type="checkbox"/> CINH <input type="checkbox"/> PLC STOP <input type="checkbox"/> No transfer <input type="checkbox"/> COM <input type="checkbox"/> MOT		

**C00448**

Parameter   Name: <b>C00448   DigOut decoupling value</b>		Data type: UNSIGNED_16 Index: 24127 <sub>d</sub> = 5E3F <sub>h</sub>
<p>From version 04.00.00</p> <p>Definition of the value the digital output terminals are to have in the decoupled state.</p> <ul style="list-style-type: none"> <li>• Bit set = HIGH level</li> </ul> <p style="text-align: right;">▶ <a href="#">Configuring exception handling of the output terminals</a></p>		
<b>Setting range</b> (min. hex value   max. hex value)		<b>Lenze setting</b>
0x0000		0xFFFF <b>0x0000</b> (decimal: 0)

Parameter   Name: <b>C00448   DigOut decoupling value</b>		Data type: UNSIGNED_16 Index: 24127 <sub>d</sub> = 5E3F <sub>h</sub>
<b>Value is bit-coded: (<input checked="" type="checkbox"/> = bit set)</b>		
Bit 0 <input type="checkbox"/>	Relay_ON	
Bit 1 <input type="checkbox"/>	DigOut1_ON	
Bit 2 <input type="checkbox"/>	Reserved	
Bit 3 <input type="checkbox"/>	Reserved	
Bit 4 <input type="checkbox"/>	Reserved	
Bit 5 <input type="checkbox"/>	Reserved	
Bit 6 <input type="checkbox"/>	Reserved	
Bit 7 <input type="checkbox"/>	Reserved	
Bit 8 <input type="checkbox"/>	Reserved	
Bit 9 <input type="checkbox"/>	Reserved	
Bit 10 <input type="checkbox"/>	Reserved	
Bit 11 <input type="checkbox"/>	Reserved	
Bit 12 <input type="checkbox"/>	Reserved	
Bit 13 <input type="checkbox"/>	Reserved	
Bit 14 <input type="checkbox"/>	Reserved	
Bit 15 <input type="checkbox"/>	Reserved	
<input checked="" type="checkbox"/> Read access <input checked="" type="checkbox"/> Write access <input type="checkbox"/> CINH <input type="checkbox"/> PLC STOP <input type="checkbox"/> No transfer <input type="checkbox"/> COM <input type="checkbox"/> MOT		

**C00449**

Parameter   Name: <b>C00449   FreqInxx_dnOut_p</b>		Data type: INTEGER_32 Index: 24126 <sub>d</sub> = 5E3E <sub>h</sub>
From version 06.00.00		
▶ <a href="#">Output of the encoder position of the DI1/DI2 frequency input</a>		
<b>Display range (min. value   unit   max. value)</b>		
-2147483647	Incr.	2147483647
<b>Subcodes</b>		<b>Info</b>
C00449/1		FreqIn12_dnOut_p
<input checked="" type="checkbox"/> Read access <input type="checkbox"/> Write access <input type="checkbox"/> CINH <input type="checkbox"/> PLC STOP <input checked="" type="checkbox"/> No transfer <input type="checkbox"/> COM <input type="checkbox"/> MOT             Scaling factor: 1		

**C00450**

Parameter   Name: <b>C00450   HTL encoder input frequency</b>		Data type: UNSIGNED_32 Index: 24125 <sub>d</sub> = 5E3D <sub>h</sub>
<b>Display range (min. value   unit   max. value)</b>		
0.000	kHz	2147483.647
<b>Subcodes</b>		<b>Info</b>
C00450/1		FreqIn12: input frequency
<input checked="" type="checkbox"/> Read access <input type="checkbox"/> Write access <input type="checkbox"/> CINH <input type="checkbox"/> PLC STOP <input checked="" type="checkbox"/> No transfer <input type="checkbox"/> COM <input type="checkbox"/> MOT             Scaling factor: 1000		

## C00453

Parameter   Name: <b>C00453   Keypad: Default manual jog</b>		Data type: UNSIGNED_32 Index: 24122 <sub>d</sub> = 5E3A <sub>h</sub>
From version 14.00.00		
<b>Setting range</b> (min. value   unit   max. value)		
0.000		16000.000
<b>Subcodes</b>	<b>Lenze setting</b>	<b>Info</b>
C00453/1	729.001	Keypad: Speed setpoint
C00453/2	56.002	Keypad: Display bar
C00453/3	51.000	Keypad: Def. parameter
<input checked="" type="checkbox"/> Read access <input checked="" type="checkbox"/> Write access <input type="checkbox"/> CINH <input type="checkbox"/> PLC STOP <input type="checkbox"/> No transfer <input type="checkbox"/> COM <input type="checkbox"/> MOT   Scaling factor: 1000		

## C00455

Parameter   Name: <b>C00455   FB_call table</b>	Data type: UNSIGNED_16 Index: 24120 <sub>d</sub> = 5E38 <sub>h</sub>
<b>This code is used device-internally and must not be written by the user side!</b>	

## C00456

Parameter   Name: <b>C00456   Editor level</b>	Data type: UNSIGNED_8 Index: 24119 <sub>d</sub> = 5E37 <sub>h</sub>
<b>This code is used device-internally and must not be written by the user side!</b>	

## C00458

Parameter   Name: <b>C00458   SYS_call table</b>	Data type: UNSIGNED_16 Index: 24117 <sub>d</sub> = 5E35 <sub>h</sub>
<b>This code is used device-internally and must not be written by the user side!</b>	

## C00459

Parameter   Name: <b>C00459   SYS_Output table</b>	Data type: UNSIGNED_16 Index: 24116 <sub>d</sub> = 5E34 <sub>h</sub>
<b>This code is used device-internally and must not be written by the user side!</b>	

## C00460

Parameter   Name: <b>C00460   Reserved</b>	Data type: UNSIGNED_8 Index: 24115 <sub>d</sub> = 5E33 <sub>h</sub>
<b>This code is used device-internally and must not be written by the user side!</b>	



## C00461

Parameter   Name: <b>C00461   Remote: Acceleration/deceleration time</b>		Data type: UNSIGNED_32 Index: 24114 <sub>d</sub> = 5E32 <sub>h</sub>
From version 06.00.00		
<a href="#">▶ PC manual control</a>		
<b>Setting range (min. value   unit   max. value)</b>		
0.000	s	999.999
<b>Subcodes</b>	<b>Lenze setting</b>	<b>Info</b>
C00461/1	2.000 s	Remote: Acceleration/deceleration time
<input checked="" type="checkbox"/> Read access <input checked="" type="checkbox"/> Write access <input type="checkbox"/> CINH <input type="checkbox"/> PLC STOP <input type="checkbox"/> No transfer <input type="checkbox"/> COM <input type="checkbox"/> MOT   Scaling factor: 1000		

## C00462

Parameter   Name: <b>C00462   Remote: Control</b>		Data type: UNSIGNED_16 Index: 24113 <sub>d</sub> = 5E31 <sub>h</sub>
From version 06.00.00		
<a href="#">▶ PC manual control</a>		
<b>Setting range (min. value   unit   max. value)</b>		
0		65535
<b>Subcodes</b>	<b>Lenze setting</b>	<b>Info</b>
C00462/1	0	Remote: Control mode
C00462/2	0	Remote: Monitoring counter
<input checked="" type="checkbox"/> Read access <input checked="" type="checkbox"/> Write access <input type="checkbox"/> CINH <input type="checkbox"/> PLC STOP <input checked="" type="checkbox"/> No transfer <input type="checkbox"/> COM <input type="checkbox"/> MOT   Scaling factor: 1		

## C00463

Parameter   Name: <b>C00463   Remote: MCK control</b>		Data type: UNSIGNED_32 Index: 24112 <sub>d</sub> = 5E30 <sub>h</sub>
From version 06.00.00		
This parameter serves to control the functions of the Motion Control Kernel for <a href="#">PC manual control</a> .		
<b>Setting range (min. hex value   max. hex value)</b>		
0x00000000		0xFFFFFFFF

Parameter   Name: <b>C00463   Remote: MCK control</b>		Data type: UNSIGNED_32 Index: 24112 <sub>d</sub> = 5E30 <sub>h</sub>
<b>Value is bit-coded:</b>		
Bit 0	OpMode_Bit0	
Bit 1	OpMode_Bit1	
Bit 2	OpMode_Bit2	
Bit 3	OpMode_Bit3	
Bit 4	ManJogPos	
Bit 5	ManJogNeg	
Bit 6	ManExecute2ndSpeed	
Bit 7	ReleaseLimitSwitch	
Bit 8	HomStartStop	
Bit 9	HomSetPos	
Bit 10	HomResetPos	
Bit 11	EnableSpeedOverride	
Bit 12	EnableAccOverride	
Bit 13	EnableSRampOverride	
Bit 14	PosTeachSetPos	
Bit 15	PosTeachActPos	
Bit 16	PosExecute	
Bit 17	PosFinishTarget	
Bit 18	PosDisableFollowProfile	
Bit 19	PosStop	
Bit 20	PosModeBit0	
Bit 21	PosModeBit1	
Bit 22	PosModeBit2	
Bit 23	PosModeBit3	
Bit 24	ProfileNo_Bit0	
Bit 25	ProfileNo_Bit1	
Bit 26	ProfileNo_Bit2	
Bit 27	ProfileNo_Bit3	
Bit 28	ProfileNo_Bit4	
Bit 29	ProfileNo_Bit5	
Bit 30	ProfileNo_Bit6	
Bit 31	ProfileNo_Bit7	
<b>Subcodes</b>	<b>Lenze setting</b>	<b>Info</b>
C00463/1	0x00000000	Remote: MCK control
<input checked="" type="checkbox"/> Read access <input checked="" type="checkbox"/> Write access <input type="checkbox"/> CINH <input type="checkbox"/> PLC STOP <input checked="" type="checkbox"/> No transfer <input type="checkbox"/> COM <input type="checkbox"/> MOT		

## C00464

Parameter   Name: <b>C00464   Remote: Monitoring timeout</b>		Data type: UNSIGNED_16 Index: 24111 <sub>d</sub> = 5E2F <sub>h</sub>
From version 06.00.00		<a href="#">▶ PC manual control</a>
<b>Setting range (min. value   unit   max. value)</b>		
200	ms	5000
<b>Subcodes</b>	<b>Lenze setting</b>	<b>Info</b>
C00464/1	2000 ms	Remote: Monitoring timeout
<input checked="" type="checkbox"/> Read access <input checked="" type="checkbox"/> Write access <input type="checkbox"/> CINH <input type="checkbox"/> PLC STOP <input type="checkbox"/> No transfer <input type="checkbox"/> COM <input type="checkbox"/> MOT           Scaling factor: 1		

## C00465

Parameter   Name: <b>C00465   Keypad: Timeout welcome screen</b>		Data type: INTEGER_32 Index: 24110 <sub>d</sub> = 5E2E <sub>h</sub>
Time setting for the automatic change of the keypad display to the welcome screen		
<b>Selection list(Lenze setting printed in bold)</b>		
<b>0</b>	<b>Never show welcome screen</b>	
5	5 min	
15	15 min	
30	30 min	
60	60 min	
<input checked="" type="checkbox"/> Read access <input checked="" type="checkbox"/> Write access <input type="checkbox"/> CINH <input type="checkbox"/> PLC STOP <input type="checkbox"/> No transfer <input type="checkbox"/> COM <input type="checkbox"/> MOT           Scaling factor: 1		

## C00466

Parameter   Name: <b>C00466   Keypad: Default parameter</b>		Data type: INTEGER_32 Index: 24109 <sub>d</sub> = 5E2D <sub>h</sub>
Setting of the default parameter for the keypad		
<b>Setting range (min. value   unit   max. value)</b>		<b>Lenze setting</b>
0		65535 <b>51</b>
<input checked="" type="checkbox"/> Read access <input checked="" type="checkbox"/> Write access <input type="checkbox"/> CINH <input type="checkbox"/> PLC STOP <input type="checkbox"/> No transfer <input type="checkbox"/> COM <input type="checkbox"/> MOT           Scaling factor: 1		

## C00467

Parameter   Name: <b>C00467   Keypad: Default welcome screen</b>		Data type: INTEGER_32 Index: 24108 <sub>d</sub> = 5E2C <sub>h</sub>
Selection of the welcome screen for the keypad		
<b>Selection list(Lenze setting printed in bold)</b>		
0	Main menu	
<b>1</b>	<b>Parameter list</b>	
<input checked="" type="checkbox"/> Read access <input checked="" type="checkbox"/> Write access <input type="checkbox"/> CINH <input type="checkbox"/> PLC STOP <input type="checkbox"/> No transfer <input type="checkbox"/> COM <input type="checkbox"/> MOT           Scaling factor: 1		

## C00468

Parameter   Name: <b>C00468   Service code</b>		Data type: INTEGER_32 Index: 24107 <sub>d</sub> = 5E2B <sub>h</sub>
<b>This code is used device-internally and must not be written by the user side!</b>		

## C00469

Parameter   Name: C00469   Keypad: Fct. STOP key		Data type: INTEGER_32 Index: 24106 <sub>d</sub> = 5E2A <sub>h</sub>
Selection of the function for the STOP key on the keypad		
Selection list(Lenze setting printed in bold)		Info
0	No function	STOP key does not have any function
<b>1</b>	<b>Inhibit inverter</b>	STOP key sets controller inhibit in the drive
2	Activate quick stop	STOP key sets quick stop in the drive
4	Inhibit inverter and reset error	<b>From version 14.00.00</b> STOP key sets controller inhibit in the drive. An error reset is carried out at the same time.
5	Activate quick stop and reset error	<b>From version 14.00.00</b> STOP key sets quick stop in the drive. An error reset is carried out at the same time.
<input checked="" type="checkbox"/> Read access <input checked="" type="checkbox"/> Write access <input checked="" type="checkbox"/> CINH <input type="checkbox"/> PLC STOP <input type="checkbox"/> No transfer <input type="checkbox"/> COM <input type="checkbox"/> MOT             Scaling factor: 1		

## C00470

Parameter   Name: C00470   LS_ParFree_b		Data type: UNSIGNED_8 Index: 24105 <sub>d</sub> = 5E29 <sub>h</sub>
The <a href="#">LS_ParFree_b</a> SB: Setting of the signal level to be output		
Selection list		
0	False	
1	True	
Subcodes	Lenze setting	Info
C00470/1	0: FALSE	Signal level for output <i>bPar1 ... bPar16</i>
C00470/...		
C00470/16		
<input checked="" type="checkbox"/> Read access <input checked="" type="checkbox"/> Write access <input type="checkbox"/> CINH <input type="checkbox"/> PLC STOP <input type="checkbox"/> No transfer <input type="checkbox"/> COM <input type="checkbox"/> MOT             Scaling factor: 1		

## C00471

Parameter   Name: C00471   LS_ParFree		Data type: UNSIGNED_16 Index: 24104 <sub>d</sub> = 5E28 <sub>h</sub>
The <a href="#">LS_ParFree</a> SB: Setting of the words to be output		
Setting range (min. hex value   max. hex value)		
0x0000		0xFFFF
Value is bit-coded:		
Bit 0	Bit0	
...	...	
Bit 15	Bit15	
Subcodes	Lenze setting	Info
C00471/1	0x0000	Values for output <i>wPar1 ... wPar4</i>
C00471/...		
C00471/4		
<input checked="" type="checkbox"/> Read access <input checked="" type="checkbox"/> Write access <input type="checkbox"/> CINH <input type="checkbox"/> PLC STOP <input type="checkbox"/> No transfer <input type="checkbox"/> COM <input type="checkbox"/> MOT		

## C00472

Parameter   Name: <b>C00472   LS_ParFree_a</b>		Data type: INTEGER_16 Index: 24103 <sub>d</sub> = 5E27 <sub>h</sub>
The <a href="#">LS_ParFree_a</a> SB: Setting of the analog signals to be output		
<b>Setting range</b> (min. value   unit   max. value)		
-199.99	%	199.99
<b>Subcodes</b>	<b>Lenze setting</b>	<b>Info</b>
C00472/1	0.00 %	Value for output <i>nPar1_a</i>
C00472/2	0.00 %	Value for output <i>nPar2_a</i>
C00472/3	100.00 %	Value for output <i>nPar3_a</i>
C00472/4	100.00 %	Value for output <i>nPar4_a</i>
<input checked="" type="checkbox"/> Read access <input checked="" type="checkbox"/> Write access <input type="checkbox"/> CINH <input type="checkbox"/> PLC STOP <input type="checkbox"/> No transfer <input type="checkbox"/> COM <input type="checkbox"/> MOT   Scaling factor: 100		

## C00473

Parameter   Name: <b>C00473   LS_ParFree_v</b>		Data type: INTEGER_16 Index: 24102 <sub>d</sub> = 5E26 <sub>h</sub>
The <a href="#">LS_ParFree_v</a> SB: Setting of the speed signals to be output		
<b>Setting range</b> (min. value   unit   max. value)		
-32767	Incr./ms	32767
<b>Subcodes</b>	<b>Lenze setting</b>	<b>Info</b>
C00473/1	0 incr./ms	Values for output <i>nPar1_v</i> ... <i>nPar4_v</i>
C00473/...		
C00473/4		
<input checked="" type="checkbox"/> Read access <input checked="" type="checkbox"/> Write access <input type="checkbox"/> CINH <input type="checkbox"/> PLC STOP <input type="checkbox"/> No transfer <input type="checkbox"/> COM <input type="checkbox"/> MOT   Scaling factor: 1		

## C00474

Parameter   Name: <b>C00474   LS_ParFree_p</b>		Data type: INTEGER_32 Index: 24101 <sub>d</sub> = 5E25 <sub>h</sub>
<b>Setting range</b> (min. value   unit   max. value)		
-2147483647	Incr.	2147483647
<b>Subcodes</b>	<b>Lenze setting</b>	<b>Info</b>
C00474/1	0 incr.	<a href="#">LS_ParFree</a> : dnPar1_p
C00474/2	0 incr.	<a href="#">LS_ParFree</a> : dnPar2_p
C00474/3	0 incr.	<a href="#">LS_ParFree</a> : dnPar3_p
C00474/4	0 incr.	<a href="#">LS_ParFree</a> : dnPar4_p
<input checked="" type="checkbox"/> Read access <input checked="" type="checkbox"/> Write access <input type="checkbox"/> CINH <input type="checkbox"/> PLC STOP <input type="checkbox"/> No transfer <input type="checkbox"/> COM <input type="checkbox"/> MOT   Scaling factor: 1		

## C00480

Parameter   Name: <b>C00480   LS_DisFree_b</b>		Data type: UNSIGNED_8 Index: 24095 <sub>d</sub> = 5E1F <sub>h</sub>
The <a href="#">LS_DisFree_b</a> SB: Display of the input values		
<b>Display area</b> (min. hex value   max. hex value)		
0x00		0xFF

Parameter   Name: <b>C00480   LS_DisFree_b</b>		Data type: UNSIGNED_8 Index: 24095 <sub>d</sub> = 5E1F <sub>h</sub>
<b>Value is bit-coded:</b>		<b>Info</b>
Bit 0	bDis1	Signal level input <i>bDis1</i> ... <i>bDis8</i>
...	...	
Bit 7	bDis8	
<input checked="" type="checkbox"/> Read access <input type="checkbox"/> Write access <input type="checkbox"/> CINH <input type="checkbox"/> PLC STOP <input checked="" type="checkbox"/> No transfer <input type="checkbox"/> COM <input type="checkbox"/> MOT		

**C00481**

Parameter   Name: <b>C00481   LS_DisFree</b>		Data type: UNSIGNED_16 Index: 24094 <sub>d</sub> = 5E1E <sub>h</sub>
The <a href="#">LS_DisFree</a> SB: Display of the input values		
<b>Display area</b> (min. hex value   max. hex value)		
0x0000		0xFFFF
<b>Value is bit-coded:</b>		
Bit 0	Active	
...	...	
Bit 15	Active	
<b>Subcodes</b>		<b>Info</b>
C00481/1		Input values <i>wDis1</i> ... <i>wDis4</i>
C00481/...		
C00481/4		
<input checked="" type="checkbox"/> Read access <input type="checkbox"/> Write access <input type="checkbox"/> CINH <input type="checkbox"/> PLC STOP <input checked="" type="checkbox"/> No transfer <input type="checkbox"/> COM <input type="checkbox"/> MOT		

**C00482**

Parameter   Name: <b>C00482   LS_DisFree_a</b>		Data type: INTEGER_16 Index: 24093 <sub>d</sub> = 5E1D <sub>h</sub>
The <a href="#">LS_DisFree_a</a> SB: Display of the input values		
<b>Display range</b> (min. value   unit   max. value)		
-199.99	%	199.99
<b>Subcodes</b>		<b>Info</b>
C00482/1		Input values <i>nDis1_a</i> ... <i>nDis4_a</i>
C00482/...		
C00482/4		
<input checked="" type="checkbox"/> Read access <input type="checkbox"/> Write access <input type="checkbox"/> CINH <input type="checkbox"/> PLC STOP <input checked="" type="checkbox"/> No transfer <input type="checkbox"/> COM <input type="checkbox"/> MOT                   Scaling factor: 100		

**C00484**

Parameter   Name: <b>C00484   Application units: Offset</b>		Data type: INTEGER_16 Index: 24091 <sub>d</sub> = 5E1B <sub>h</sub>
From version 06.00.00 The <a href="#">LS_DisFree_a</a> SB: Offset for display of the input variables in application unit ▶ <a href="#">Display of internal process factors in application units</a>		
<b>Setting range</b> (min. value   unit   max. value)		
-199.99	%	199.99
<b>Subcodes</b>	<b>Lenze setting</b>	<b>Info</b>

Parameter   Name: <b>C00484   Application units: Offset</b>		Data type: INTEGER_16 Index: 24091 <sub>d</sub> = 5E1B <sub>h</sub>
C00484/1	0.00 %	Application unit 1: Offset
C00484/2	0.00 %	Application unit 2: Offset
C00484/3	0.00 %	Application unit 3: Offset
C00484/4	0.00 %	Application unit 4: Offset
<input checked="" type="checkbox"/> Read access <input checked="" type="checkbox"/> Write access <input type="checkbox"/> CINH <input type="checkbox"/> PLC STOP <input type="checkbox"/> No transfer <input type="checkbox"/> COM <input type="checkbox"/> MOT   Scaling factor: 100		

**C00485**

Parameter   Name: <b>C00485   Application units: Display factor</b>		Data type: INTEGER_32 Index: 24090 <sub>d</sub> = 5E1A <sub>h</sub>
From version 06.00.00 The <a href="#">LS_DisFree_a</a> SB: Display factor for display of the input variables in application unit ▶ <a href="#">Display of internal process factors in application units</a>		
<b>Setting range (min. value   unit   max. value)</b>		
-65536.0000		65536.0000
<b>Subcodes</b>	<b>Lenze setting</b>	<b>Info</b>
C00485/1	1.0000	Application unit 1: Display factor
C00485/2	1.0000	Application unit 2: Display factor
C00485/3	1.0000	Application unit 3: Display factor
C00485/4	1.0000	Application unit 4: Display factor
<input checked="" type="checkbox"/> Read access <input checked="" type="checkbox"/> Write access <input type="checkbox"/> CINH <input type="checkbox"/> PLC STOP <input type="checkbox"/> No transfer <input type="checkbox"/> COM <input type="checkbox"/> MOT   Scaling factor: 10000		

**C00486**

Parameter   Name: <b>C00486   Application units: Text</b>		Data type: VISIBLE_STRING Index: 24089 <sub>d</sub> = 5E19 <sub>h</sub>
From version 06.00.00 The <a href="#">LS_DisFree_a</a> SB: Text for the display of the input variables in application unit ▶ <a href="#">Display of internal process factors in application units</a>		
<b>Subcodes</b>	<b>Lenze setting</b>	<b>Info</b>
C00486/1		Application unit 1: Text
C00486/2		Application unit 2: Text
C00486/3		Application unit 3: Text
C00486/4		Application unit 4: Text
<input checked="" type="checkbox"/> Read access <input checked="" type="checkbox"/> Write access <input type="checkbox"/> CINH <input type="checkbox"/> PLC-STOP <input type="checkbox"/> No transfer <input type="checkbox"/> COM <input type="checkbox"/> MOT   Character length: 7		

**C00487**

Parameter   Name: <b>C00487 - Application units</b>		Data type: INTEGER_32 Index: 24088 <sub>d</sub> = 5E18 <sub>h</sub>
From version 06.00.00 SB <a href="#">LS_DisFree_a</a> : Display of the input values in a configurable application unit ▶ <a href="#">Display of internal process factors in application units</a>		
<b>Display range (min. value   unit   max. value)</b>		
-21474836.47	units	21474836.47
<b>Subcodes</b>	<b>Info</b>	

Parameter   Name: <b>C00487 - Application units</b>		Data type: INTEGER_32 Index: 24088 <sub>d</sub> = 5E18 <sub>h</sub>
C00487/1	Application units 1	
C00487/2	Application units 2	
C00487/3	Application units 3	
C00487/4	Application units 4	
<input checked="" type="checkbox"/> Read access <input type="checkbox"/> Write access <input type="checkbox"/> CINH <input type="checkbox"/> PLC STOP <input checked="" type="checkbox"/> No transfer <input type="checkbox"/> COM <input type="checkbox"/> MOT   Scaling factor: 100		

**C00488**

Parameter   Name: <b>C00488   L_JogCtrlEdgeDetect</b>		Data type: UNSIGNED_8 Index: 24087 <sub>d</sub> = 5E17 <sub>h</sub>
From version 03.00.00 The <a href="#">L_JogCtrlExtension_1</a> FB: Signal methodology <ul style="list-style-type: none"> <li>• Selection whether the corresponding function is to be activated by edge or level.</li> </ul>		
<b>Selection list</b>		
0	Level	
1	Edge	
<b>Subcodes</b>	<b>Lenze setting</b>	<b>Info</b>
C00488/1	0: Level	InputSens.SlowDown1 • Selection of edge or level for starting slow-down function 1
C00488/2	0: Level	InputSens.Stop1 • Selection of edge or level for stop function 1
C00488/3	0: Level	InputSens.SlowDown2 • Selection of edge or level for starting slow-down function 2
C00488/4	0: Level	InputSens.Stop2 • Selection of edge or level for stop function 2
C00488/5	0: Level	InputSens.SlowDown3 • Selection of edge or level for starting slow-down function 3
C00488/6	0: Level	InputSens.Stop3 • Selection of edge or level for stop function 3
<input checked="" type="checkbox"/> Read access <input checked="" type="checkbox"/> Write access <input type="checkbox"/> CINH <input type="checkbox"/> PLC STOP <input type="checkbox"/> No transfer <input type="checkbox"/> COM <input type="checkbox"/> MOT   Scaling factor: 1		

**C00490**

Parameter   Name: <b>C00490   Position encoder selection</b>		Data type: UNSIGNED_8 Index: 24085 <sub>d</sub> = 5E15 <sub>h</sub>
From version 12.00.00 Selection of the procedure of generating the actual position <p style="text-align: right;"><a href="#">► Encoder/feedback system</a></p>		
<b>Selection list</b> (Lenze setting printed in bold)		<b>Info</b>
<b>0</b>	<b>No sensor: nSpeedSetValue_a</b>	The position signal <i>dnMotorPosAct_p</i> is derived from the speed setpoint <i>nSpeedSetValue_a</i> .
10	Encoder selection C495 or nVoltageAngleAct_a	The position signal <i>dnMotorPosAct_p</i> is either calculated from the set speed feedback (for <a href="#">C00495</a> > 0) or from the speed signal <i>nMotorSpeedAct_v</i> (for <a href="#">C00495</a> = 0).
<input checked="" type="checkbox"/> Read access <input checked="" type="checkbox"/> Write access <input type="checkbox"/> CINH <input type="checkbox"/> PLC STOP <input type="checkbox"/> No transfer <input type="checkbox"/> COM <input checked="" type="checkbox"/> MOT   Scaling factor: 1		



## C00495

Parameter   Name: <b>C00495   Speed sensor selection</b>		Data type: UNSIGNED_8 Index: 24080 <sub>d</sub> = 5E10 <sub>h</sub>
Selection of the feedback system for the actual speed for motor control and display <a href="#">▶ Encoder/feedback system</a>		
Selection list(Lenze setting printed in bold)		Info
<b>0</b>	<b>No sensor</b>	No sensor available for the actual speed detection
1	Sensor signal FreqIn12	Speed sensor signal is fed via the digital DI1 and DI2 inputs
<input checked="" type="checkbox"/> Read access <input checked="" type="checkbox"/> Write access <input type="checkbox"/> CINH <input type="checkbox"/> PLC STOP <input type="checkbox"/> No transfer <input type="checkbox"/> COM <input checked="" type="checkbox"/> MOT   Scaling factor: 1		

## C00496

Parameter   Name: <b>C00496   Encoder evaluation method Dign12</b>		Data type: UNSIGNED_8 Index: 24079 <sub>d</sub> = 5E0F <sub>h</sub>
From version 03.00.00 <a href="#">▶ Encoder/feedback system</a>		
Selection list(Lenze setting printed in bold)		Info
<b>1</b>	<b>Low-resolution encoder (StateLine)</b>	High-precision procedure for low-resolution encoders (<=128 increments)
3	Edge-counting procedure	Simple edge counting procedure with adjustable scanning time ( <a href="#">C00425</a> )
<input checked="" type="checkbox"/> Read access <input checked="" type="checkbox"/> Write access <input checked="" type="checkbox"/> CINH <input type="checkbox"/> PLC STOP <input type="checkbox"/> No transfer <input type="checkbox"/> COM <input checked="" type="checkbox"/> MOT   Scaling factor: 1		

## C00497

Parameter   Name: <b>C00497   Filter time constant</b>		Data type: UNSIGNED_16 Index: 24078 <sub>d</sub> = 5E0E <sub>h</sub>
From version 03.00.00 <a href="#">▶ Encoder/feedback system</a>		
Setting range (min. value   unit   max. value)		
0.0	ms	500.0
Subcodes	Lenze setting	Info
C00497/1	1.0 ms	FreqIn12: Encoder filter time
<input checked="" type="checkbox"/> Read access <input checked="" type="checkbox"/> Write access <input type="checkbox"/> CINH <input type="checkbox"/> PLC STOP <input type="checkbox"/> No transfer <input type="checkbox"/> COM <input checked="" type="checkbox"/> MOT   Scaling factor: 10		

## C00505

Parameter   Name: <b>C00505   Password data</b>		Data type: VISIBLE_STRING Index: 24070 <sub>d</sub> = 5E06 <sub>h</sub>
From version 06.00.00 <a href="#">▶ Device access protection</a>		
Subcodes	Lenze setting	Info
C00505/1		MasterPin
C00505/2		Binding ID
C00505/3		Password
<input checked="" type="checkbox"/> Read access <input checked="" type="checkbox"/> Write access <input type="checkbox"/> CINH <input type="checkbox"/> PLC-STOP <input checked="" type="checkbox"/> No transfer <input type="checkbox"/> COM <input type="checkbox"/> MOT   Character length: 16		

## C00506

Parameter   Name:		Data type: UNSIGNED_16 Index: 24069 <sub>d</sub> = 5E05 <sub>h</sub>
<b>C00506   PW protection internal config</b>		
From version 15.00.00 Configuration of the password protection for device-internal parameter access ▶ <a href="#">Individual password protection for single communication channels</a>		
Setting range (min. hex value   max. hex value)		
0x0000		0xFFFF
Value is bit-coded:		Info
Bit 0	Only access to user menu	The menus in the keypad are reduced. Only the user menu can be used to change parameters.
Bit 1	Parameter write protection	Via system blocks ( <a href="#">LS_ParReadWrite1-6</a> and <a href="#">LS_WriteParamList</a> ), write/read parameters cannot be written.
Bit 2	Parameter read protection	Via system blocks ( <a href="#">LS_ParReadWrite1-6</a> and <a href="#">LS_WriteParamList</a> ), write/read parameters cannot be read.
Bit 3	Reserved	
Bit 4	Reserved	
Bit 5	Reserved	
Bit 6	Reserved	
Bit 7	Reserved	
Bit 8	Reserved	
Bit 9	Reserved	
Bit 10	Reserved	
Bit 11	Reserved	
Bit 12	Reserved	
Bit 13	Reserved	
Bit 14	Reserved	
Bit 15	Reserved	
Subcodes		Info
C00506/1	Lenze setting 0x0007	PW protection internal config
<input checked="" type="checkbox"/> Read access <input checked="" type="checkbox"/> Write access <input type="checkbox"/> CINH <input type="checkbox"/> PLC STOP <input type="checkbox"/> No transfer <input type="checkbox"/> COM <input type="checkbox"/> MOT		

## C00507

Parameter   Name:		Data type: UNSIGNED_16 Index: 24068 <sub>d</sub> = 5E04 <sub>h</sub>
<b>C00507   Current password protection</b>		
From version 06.00.00 Display of the currently active device access protection (password protection and device personalisation) <b>Note:</b> As the password protection can be configured individually for each single communication channel <a href="#">from version 15.00.00</a> bit 1 and bit 2 indicate the active protection always with regard to the communication channel used. ▶ <a href="#">Device access protection</a>		
Display area (min. hex value   max. hex value)		
0x0000		0xFFFF
Value is bit-coded:		Info
Bit 0	Only access to user menu	1 ≙ The menus in the keypad are reduced. Only the user menu can be used to change parameters. ▶ <a href="#">Password protection</a>

Parameter   Name: <b>C00507   Current password protection</b>		Data type: UNSIGNED_16 Index: 24068 <sub>d</sub> = 5E04 <sub>h</sub>
Bit 1	Parameter write protection	1 ≙ The currently used communication channel cannot be used to write into write/read parameters. ▶ <a href="#">Password protection</a>
Bit 2	Parameter read protection	1 ≙ The currently used communication channel cannot be used to read write/read parameters. ▶ <a href="#">Password protection</a>
Bit 3	Reserved	
Bit 4	Reserved	
Bit 5	Reserved	
Bit 6	Reserved	
Bit 7	Reserved	
Bit 8	Reserved	
Bit 9	Reserved	
Bit 10	Reserved	
Bit 11	Reserved	
Bit 12	Reserved	
Bit 13	Reserved	
Bit 14	Reserved	
Bit 15	Memory module binding on	1 ≙ Device personalisation is active. All write/read actions between inverter and memory module are only executed if both components have the same binding ID. ▶ <a href="#">Device personalisation</a>
<b>Subcodes</b>		<b>Info</b>
C00507/1		Password protection - all communication channels
<input checked="" type="checkbox"/> Read access <input type="checkbox"/> Write access <input type="checkbox"/> CINH <input type="checkbox"/> PLC STOP <input checked="" type="checkbox"/> No transfer <input type="checkbox"/> COM <input type="checkbox"/> MOT		

**C00508**

Parameter   Name: <b>C00508   PW protection config X6(DIAG)</b>		Data type: UNSIGNED_16 Index: 24067 <sub>d</sub> = 5E03 <sub>h</sub>
<b>From version 15.00.00</b> Configuration of the password protection for parameter access via diagnostic interface X6 ("DIAG") ▶ <a href="#">Individual password protection for single communication channels</a>		
<b>Setting range (min. hex value   max. hex value)</b>		
0x0000		0xFFFF
<b>Value is bit-coded:</b>		<b>Info</b>
Bit 0	Reserved	
Bit 1	Parameter write protection	The diagnostics interface X6 cannot be used to write into write/read parameters.
Bit 2	Parameter read protection	The diagnostics interface X6 cannot be used to read write/read parameters.
Bit 3	Reserved	
Bit 4	Reserved	
Bit 5	Reserved	
Bit 6	Reserved	
Bit 7	Reserved	
Bit 8	Reserved	
Bit 9	Reserved	

Parameter   Name: <b>C00508   PW protection config X6(DIAG)</b>		Data type: UNSIGNED_16 Index: 24067 <sub>d</sub> = 5E03 <sub>h</sub>
Bit 10	Reserved	
Bit 11	Reserved	
Bit 12	Reserved	
Bit 13	Reserved	
Bit 14	Reserved	
Bit 15	Reserved	
Subcodes	Lenze setting	Info
C00508/1	0x0006	PW protection config X6(DIAG)
<input checked="" type="checkbox"/> Read access <input checked="" type="checkbox"/> Write access <input type="checkbox"/> CINH <input type="checkbox"/> PLC STOP <input type="checkbox"/> No transfer <input type="checkbox"/> COM <input type="checkbox"/> MOT		

**C00509**

Parameter   Name: <b>C00509   PW protection config X1(CAN)</b>		Data type: UNSIGNED_16 Index: 24066 <sub>d</sub> = 5E02 <sub>h</sub>
From version 15.00.00 Configuration of the password protection for parameter access via CANopen interface X1 ("CAN on board") ▶ <a href="#">Individual password protection for single communication channels</a>		
Setting range (min. hex value   max. hex value)		
0x0000		0xFFFF
Value is bit-coded:	Info	
Bit 0	Reserved	
Bit 1	Parameter write protection	The CANopen interface X1 cannot be used to write into write/read parameters.
Bit 2	Parameter read protection	The CANopen interface X1 cannot be used to read write/read parameters.
Bit 3	Reserved	
Bit 4	Reserved	
Bit 5	Reserved	
Bit 6	Reserved	
Bit 7	Reserved	
Bit 8	Reserved	
Bit 9	Reserved	
Bit 10	Reserved	
Bit 11	Reserved	
Bit 12	Reserved	
Bit 13	Reserved	
Bit 14	Reserved	
Bit 15	Reserved	
Subcodes	Lenze setting	Info
C00509/1	0x0006	PW protection config X1 (CAN)
<input checked="" type="checkbox"/> Read access <input checked="" type="checkbox"/> Write access <input type="checkbox"/> CINH <input type="checkbox"/> PLC STOP <input type="checkbox"/> No transfer <input type="checkbox"/> COM <input type="checkbox"/> MOT		

## C00510

Parameter   Name:		Data type: UNSIGNED_16 Index: 24065 <sub>d</sub> = 5E01 <sub>h</sub>
<b>C00510   PW protection config MCI</b>		
From version 15.00.00 Configuration of the password protection for parameter access via fieldbus interface ("MCI") ▶ <a href="#">Individual password protection for single communication channels</a>		
Setting range (min. hex value   max. hex value)		
0x0000		0xFFFF
Value is bit-coded:		Info
Bit 0	Reserved	
Bit 1	Parameter write protection	The fieldbus interface (MCI) cannot be used to write into write/read parameters.
Bit 2	Parameter read protection	The fieldbus interface (MCI) cannot be used to read write/read parameters.
Bit 3	Reserved	
Bit 4	Reserved	
Bit 5	Reserved	
Bit 6	Reserved	
Bit 7	Reserved	
Bit 8	Reserved	
Bit 9	Reserved	
Bit 10	Reserved	
Bit 11	Reserved	
Bit 12	Reserved	
Bit 13	Reserved	
Bit 14	Reserved	
Bit 15	Reserved	
Subcodes	Lenze setting	Info
C00510/1	0x0006	PW protection config. MCI
<input checked="" type="checkbox"/> Read access <input checked="" type="checkbox"/> Write access <input type="checkbox"/> CINH <input type="checkbox"/> PLC STOP <input type="checkbox"/> No transfer <input type="checkbox"/> COM <input type="checkbox"/> MOT		

## C00516

Parameter   Name:		Data type: UNSIGNED_32 Index: 24059 <sub>d</sub> = 5DFB <sub>h</sub>
<b>C00516   Checksums</b>		
<b>This code is used device-internally and must not be written by the user side!</b>		

## C00517

Parameter   Name:		Data type: INTEGER_32 Index: 24058 <sub>d</sub> = 5DFA <sub>h</sub>
<b>C00517   User menu</b>		
When a system is installed, parameters must be changed time and again until the system runs satisfactorily. The user menu of a device serves to create a selection of frequently used parameters to be able to access and change these parameters quickly. <ul style="list-style-type: none"> <li>• Format: &lt;code number&gt;,&lt;subcode number&gt;</li> <li>• If "0.000" is set, no entry will be displayed in the user menu.</li> </ul>		
Setting range (min. value   unit   max. value)		
0.000		16000.000
Subcodes	Lenze setting	Info
C00517/1	51.000	<a href="#">C00051</a> : Display of actual speed value

Parameter   Name: <b>C00517   User menu</b>		Data type: INTEGER_32 Index: 24058 <sub>d</sub> = 5DFA <sub>h</sub>
C00517/2	53.000	<a href="#">C00053</a> : Display of DC-bus voltage
C00517/3	54.000	<a href="#">C00054</a> : Display of motor current
C00517/4	61.000	<a href="#">C00061</a> : Display of heatsink temperature
C00517/5	137.000	<a href="#">C00137</a> : Display of device status
C00517/6	166.003	<a href="#">C00166/3</a> : Display of current error message
C00517/7	0.000	User menu: Entry 7
C00517/8	11.000	<a href="#">C00011</a> : Reference speed
C00517/9	39.001	<a href="#">C00039/1</a> : Fixed setpoint 1
C00517/10	39.002	<a href="#">C00039/2</a> : Fixed setpoint 2
C00517/11	12.000	<a href="#">C00012</a> : Accel. time - main setpoint
C00517/12	13.000	<a href="#">C00013</a> : Decel. time - main setpoint
C00517/13	15.000	<a href="#">C00015</a> : V/f base frequency
C00517/14	16.000	<a href="#">C00016</a> : Vmin boost
C00517/15	22.000	<a href="#">C00022</a> : I <sub>max</sub> in motor mode
C00517/16	120.000	<a href="#">C00120</a> : Setting of motor overload (I <sup>2</sup> xt)
C00517/17	87.000	<a href="#">C00087</a> : Rated motor speed
C00517/18	99.000	<a href="#">C00099</a> : Display of firmware version
C00517/19	200.000	<a href="#">C00200</a> : Display of firmware product type
C00517/20	0.000	User menu: Entry 20
C00517/21	0.000	User menu: Entry 21
C00517/22	0.000	User menu: Entry 22
C00517/23	0.000	User menu: Entry 23
C00517/24	105.000	<a href="#">C00105</a> : Decel. time - quick stop
C00517/25	173.000	<a href="#">C00173</a> : Mains voltage
C00517/26	0.000	User menu: Entry 26
C00517/27	0.000	User menu: Entry 27
C00517/28	0.000	User menu: Entry 28
C00517/29	0.000	User menu: Entry 29
C00517/30	0.000	User menu: Entry 30
C00517/31	0.000	User menu: Entry 31
C00517/32	0.000	User menu: Entry 32
<input checked="" type="checkbox"/> Read access <input checked="" type="checkbox"/> Write access <input type="checkbox"/> CINH <input type="checkbox"/> PLC STOP <input type="checkbox"/> No transfer <input type="checkbox"/> COM <input type="checkbox"/> MOT             Scaling factor: 1000		

**C00560**

Parameter   Name: <b>C00560   Fan switching status</b>		Data type: UNSIGNED_8 Index: 24015 <sub>d</sub> = 5DCF <sub>h</sub>
<b>From version 02.00.00</b>		
Display of the function status of the device fans		

Parameter   Name: <b>C00560   Fan switching status</b>		Data type: UNSIGNED_8 Index: 24015 <sub>d</sub> = 5DC <sub>Fh</sub>
<b>Selection list</b>		
0	Off	
1	On	
2	No fan	
<b>Subcodes</b>		<b>Info</b>
C00560/1		Switching status - internal fan
C00560/2		Switching status - heatsink fan
<input checked="" type="checkbox"/> Read access <input type="checkbox"/> Write access <input type="checkbox"/> CINH <input type="checkbox"/> PLC STOP <input checked="" type="checkbox"/> No transfer <input type="checkbox"/> COM <input type="checkbox"/> MOT           Scaling factor: 1		

**C00561**

Parameter   Name: <b>C00561   Failure indication</b>		Data type: UNSIGNED_8 Index: 24014 <sub>d</sub> = 5DC <sub>Eh</sub>
<a href="#">From version 02.00.00</a> Failure display of device fans and motor phases		
<b>Selection list</b>		
0	No error	
1	Error	
<b>Subcodes</b>		<b>Info</b>
C00561/1		Internal fan
C00561/2		Heatsink fan
C00561/3		Motor phase U • <a href="#">From version 11.00.00</a>
C00561/4		Motor phase V • <a href="#">From version 11.00.00</a>
C00561/5		Motor phase W • <a href="#">From version 11.00.00</a>
<input checked="" type="checkbox"/> Read access <input type="checkbox"/> Write access <input type="checkbox"/> CINH <input type="checkbox"/> PLC STOP <input checked="" type="checkbox"/> No transfer <input type="checkbox"/> COM <input type="checkbox"/> MOT           Scaling factor: 1		

**C00563**

Parameter   Name: <b>C00563   Current monitoring: Delay time</b>		Data type: UNSIGNED_32 Index: 24012 <sub>d</sub> = 5DC <sub>Ch</sub>
<a href="#">From version 16.00.00</a> <div style="text-align: right;"><a href="#">▶ Current monitoring overload</a></div>		
<b>Setting range (min. value   unit   max. value)</b>		
0.000	s	999.900
<b>Subcodes</b>		<b>Info</b>
C00563/1	Lenze setting 3.000 s	Current monitoring: Delay time overload
<input checked="" type="checkbox"/> Read access <input checked="" type="checkbox"/> Write access <input type="checkbox"/> CINH <input type="checkbox"/> PLC STOP <input type="checkbox"/> No transfer <input type="checkbox"/> COM <input type="checkbox"/> MOT           Scaling factor: 1000		

## C00565

Parameter   Name: <b>C00565   Resp. to mains phase failure</b>		Data type: UNSIGNED_8 Index: 24010 <sub>d</sub> = 5DCA <sub>h</sub>
Response to the failure of mains phases		
<b>Selection list</b> (Lenze setting printed in bold)		
0	No Reaction	
1	Fault	
5	<b>Warning</b>	
<input checked="" type="checkbox"/> Read access <input checked="" type="checkbox"/> Write access <input type="checkbox"/> CINH <input type="checkbox"/> PLC STOP <input type="checkbox"/> No transfer <input type="checkbox"/> COM <input checked="" type="checkbox"/> MOT   Scaling factor: 1		

## C00566

Parameter   Name: <b>C00566   Resp. to fan failure</b>		Data type: UNSIGNED_8 Index: 24009 <sub>d</sub> = 5DC9 <sub>h</sub>
Response to the detection of a fan failure		
<b>Selection list</b> (Lenze setting printed in bold)		
0	No Reaction	
1	Fault	
5	<b>Warning</b>	
<input checked="" type="checkbox"/> Read access <input checked="" type="checkbox"/> Write access <input type="checkbox"/> CINH <input type="checkbox"/> PLC STOP <input type="checkbox"/> No transfer <input type="checkbox"/> COM <input checked="" type="checkbox"/> MOT   Scaling factor: 1		

## C00567

Parameter   Name: <b>C00567   Resp. to speed controller limited</b>		Data type: UNSIGNED_8 Index: 24008 <sub>d</sub> = 5DC8 <sub>h</sub>
Response if speed controller output is limited ( <i>bLimSpeedCtrlOut</i> = TRUE)		
<b>Selection list</b> (Lenze setting printed in bold)		
0	<b>No Reaction</b>	
1	Fault	
5	Warning	
<input checked="" type="checkbox"/> Read access <input checked="" type="checkbox"/> Write access <input type="checkbox"/> CINH <input type="checkbox"/> PLC STOP <input type="checkbox"/> No transfer <input type="checkbox"/> COM <input checked="" type="checkbox"/> MOT   Scaling factor: 1		

## C00569

Parameter   Name: <b>C00569   Resp. to peak current</b>		Data type: UNSIGNED_8 Index: 24006 <sub>d</sub> = 5DC6 <sub>h</sub>
Configuration of monitoring of the motor control (group 1)		
<b>Selection list</b>		
0	No Reaction	
1	Fault	
5	Warning	
<b>Subcodes</b>	<b>Lenze setting</b>	<b>Info</b>
C00569/1	0: No Reaction	Response for overcurrent detection and clamp operation
<input checked="" type="checkbox"/> Read access <input checked="" type="checkbox"/> Write access <input type="checkbox"/> CINH <input type="checkbox"/> PLC STOP <input type="checkbox"/> No transfer <input type="checkbox"/> COM <input checked="" type="checkbox"/> MOT   Scaling factor: 1		



## C00570

Parameter   Name:		Data type: UNSIGNED_8 Index: 24005 <sub>d</sub> = 5DC5 <sub>h</sub>
<b>C00570   Resp. to controller limitations</b>		
Configuration of monitoring of the motor control (group 2)		
Selection list		
0	No Reaction	
1	Fault	
5	Warning	
Subcodes	Lenze setting	Info
C00570/1	0: No Reaction	Response if direct-axis current controller is limited
C00570/2	0: No Reaction	Response if cross current controller is limited
C00570/3	0: No Reaction	Response if torque setpoint is limited • Limitation of the speed controller output, the differential setpoint control and the additive torque with sensorless vector control ( <a href="#">SLVC</a> ).
C00570/4	0: No Reaction	Response if field controller is limited
<input checked="" type="checkbox"/> Read access <input checked="" type="checkbox"/> Write access <input type="checkbox"/> CINH <input type="checkbox"/> PLC STOP <input type="checkbox"/> No transfer <input type="checkbox"/> COM <input checked="" type="checkbox"/> MOT   Scaling factor: 1		

## C00571

Parameter   Name:		Data type: UNSIGNED_8 Index: 24004 <sub>d</sub> = 5DC4 <sub>h</sub>
<b>C00571   Resp. to wrong controller setting</b>		
<a href="#">From version 14.00.00</a>		
Selection list		
0	No Reaction	
1	Fault	
2	Trouble	
3	TroubleQuickStop	
4	WarningLocked	
5	Warning	
6	Information	
Subcodes	Lenze setting	Info
C00571/1	6: Information	Resp. to: Motor control does not match motor data
C00571/2	1: Fault	Resp. to a non-set speed controller
<input checked="" type="checkbox"/> Read access <input checked="" type="checkbox"/> Write access <input type="checkbox"/> CINH <input type="checkbox"/> PLC STOP <input type="checkbox"/> No transfer <input checked="" type="checkbox"/> COM <input type="checkbox"/> MOT   Scaling factor: 1		

## C00572

Parameter   Name:		Data type: UNSIGNED_8 Index: 24003 <sub>d</sub> = 5DC3 <sub>h</sub>
<b>C00572   Brake resistor overload threshold</b>		
<a href="#">From version 03.00.00</a>		
Adjustable threshold for monitoring the brake resistor utilisation • The response for reaching the threshold can be selected in <a href="#">C00574</a> .		
Setting range (min. value   unit   max. value)	Lenze setting	
0   %   100	100 %	
<input checked="" type="checkbox"/> Read access <input checked="" type="checkbox"/> Write access <input type="checkbox"/> CINH <input type="checkbox"/> PLC STOP <input type="checkbox"/> No transfer <input type="checkbox"/> COM <input checked="" type="checkbox"/> MOT   Scaling factor: 1		

## C00574

Parameter   Name: <b>C00574   Resp. to brake resist. overtemp.</b>		Data type: UNSIGNED_8 Index: 24001 <sub>d</sub> = 5DC1 <sub>h</sub>
Response which is triggered if the threshold set in <a href="#">C00572</a> for monitoring brake resistor utilisation is reached.		
<b>Selection list</b> (Lenze setting printed in bold)		
0	<b>No Reaction</b>	
1	Fault	
5	Warning	
<input checked="" type="checkbox"/> Read access <input checked="" type="checkbox"/> Write access <input type="checkbox"/> CINH <input type="checkbox"/> PLC STOP <input type="checkbox"/> No transfer <input type="checkbox"/> COM <input checked="" type="checkbox"/> MOT           Scaling factor: 1		

## C00575

Parameter   Name: <b>C00575   Resp. to logbook information</b>		Data type: UNSIGNED_8 Index: 24000 <sub>d</sub> = 5DC0 <sub>h</sub>
<b>This code is used device-internally and must not be written by the user side!</b>		

## C00579

Parameter   Name: <b>C00579   Resp. to max. speed/output freq. reached</b>		Data type: UNSIGNED_8 Index: 23996 <sub>d</sub> = 5DBC <sub>h</sub>
Response when the max. speed limit ( <a href="#">C00909</a> ) or output frequency limit ( <a href="#">C00910</a> ) has been reached.		
<b>Selection list</b> (Lenze setting printed in bold)		
0	<b>No Reaction</b>	
1	Fault	
5	Warning	
<input checked="" type="checkbox"/> Read access <input checked="" type="checkbox"/> Write access <input type="checkbox"/> CINH <input type="checkbox"/> PLC STOP <input type="checkbox"/> No transfer <input type="checkbox"/> COM <input checked="" type="checkbox"/> MOT           Scaling factor: 1		

## C00580

Parameter   Name: <b>C00580   Resp. to operating system error</b>		Data type: UNSIGNED_8 Index: 23995 <sub>d</sub> = 5DBB <sub>h</sub>
<i>From version 11.00.00</i>		
Response if the required computing time of the application exceeds the available computing time.		
<b>Selection list</b>		
0	No Reaction	
1	Fault	
5	Warning	
<b>Subcodes</b>	<b>Lenze setting</b>	<b>Info</b>
C00580/1	0: No Reaction	Resp. to runtime exceedance
<input checked="" type="checkbox"/> Read access <input checked="" type="checkbox"/> Write access <input type="checkbox"/> CINH <input type="checkbox"/> PLC STOP <input type="checkbox"/> No transfer <input type="checkbox"/> COM <input type="checkbox"/> MOT           Scaling factor: 1		

## C00581

Parameter   Name:		Data type: UNSIGNED_8 Index: 23994 <sub>d</sub> = 5DBA <sub>h</sub>
<b>C00581   Resp. to LS_SetError_x</b>		
Selection of the error responses for application error messages • An application error message is tripped by a FALSE/TRUE edge at the binary inputs <i>bSetError1...4</i> .		
Selection list		
0	No Reaction	
1	Fault	
2	Trouble	
3	TroubleQuickStop	
4	WarningLocked	
5	Warning	
6	Information	
Subcodes	Lenze setting	Info
C00581/1	0: No Reaction	<a href="#">LS_SetError_1</a> : Resp. to bSetError1
C00581/2	0: No Reaction	<a href="#">LS_SetError_1</a> : Resp. to bSetError2
C00581/3	0: No Reaction	<a href="#">LS_SetError_1</a> : Resp. to bSetError3
C00581/4	0: No Reaction	<a href="#">LS_SetError_1</a> : Resp. to bSetError4
<input checked="" type="checkbox"/> Read access <input checked="" type="checkbox"/> Write access <input type="checkbox"/> CINH <input type="checkbox"/> PLC STOP <input type="checkbox"/> No transfer <input type="checkbox"/> COM <input type="checkbox"/> MOT Scaling factor: 1		

## C00582

Parameter   Name:		Data type: UNSIGNED_8 Index: 23993 <sub>d</sub> = 5DB9 <sub>h</sub>
<b>C00582   Resp. to heatsink temp. &gt; shutdown temp. -5°C</b>		
Response if the heatsink temperature has reached the switch-off temperature threshold.		
Selection list(Lenze setting printed in bold)		
<b>0</b>	<b>No Reaction</b>	
1	Fault	
5	Warning	
<input checked="" type="checkbox"/> Read access <input checked="" type="checkbox"/> Write access <input type="checkbox"/> CINH <input type="checkbox"/> PLC STOP <input type="checkbox"/> No transfer <input type="checkbox"/> COM <input checked="" type="checkbox"/> MOT Scaling factor: 1		

## C00584

Parameter   Name:		Data type: UNSIGNED_8 Index: 23991 <sub>d</sub> = 5DB7 <sub>h</sub>
<b>C00584   Resp. to current monitoring</b>		
From version 16.00.00 Response in the event of current overload <a href="#">▶ Current monitoring overload</a>		
Selection list		Info
0	No Reaction	
1	Fault	
3	TroubleQuickStop	
4	WarningLocked	
5	Warning	
6	Information	
Subcodes	Lenze setting	Info
C00584/1	0: No Reaction	Resp. to current monitoring overload
<input checked="" type="checkbox"/> Read access <input checked="" type="checkbox"/> Write access <input type="checkbox"/> CINH <input type="checkbox"/> PLC STOP <input type="checkbox"/> No transfer <input type="checkbox"/> COM <input checked="" type="checkbox"/> MOT Scaling factor: 1		

## C00585

Parameter   Name: <b>C00585   Resp. to motor overtemp. PTC</b>		Data type: UNSIGNED_8 Index: 23990 <sub>d</sub> = 5DB6 <sub>h</sub>
Response to motor overtemperature • The motor temperature is measured by means of a PTC thermistor at terminal X106.		
<b>Selection list</b> (Lenze setting printed in bold)		
0	No Reaction	
<b>1</b>	<b>Fault</b>	
5	Warning	
<input checked="" type="checkbox"/> Read access <input checked="" type="checkbox"/> Write access <input type="checkbox"/> CINH <input type="checkbox"/> PLC STOP <input type="checkbox"/> No transfer <input type="checkbox"/> COM <input checked="" type="checkbox"/> MOT   Scaling factor: 1		

## C00586

Parameter   Name: <b>C00586   Resp. to open circuit HTL encoder</b>		Data type: UNSIGNED_8 Index: 23989 <sub>d</sub> = 5DB5 <sub>h</sub>
Response to encoder feedback system failure or encoder feedback system track failure due to open circuit		
<b>Selection list</b> (Lenze setting printed in bold)		
0	No Reaction	
<b>1</b>	<b>Fault</b>	
2	Trouble	
3	TroubleQuickStop	
4	WarningLocked	
5	Warning	
6	Information	
<input checked="" type="checkbox"/> Read access <input checked="" type="checkbox"/> Write access <input type="checkbox"/> CINH <input type="checkbox"/> PLC STOP <input type="checkbox"/> No transfer <input type="checkbox"/> COM <input checked="" type="checkbox"/> MOT   Scaling factor: 1		

## C00588

Parameter   Name: <b>C00588   Resp. to max. speed at switching freq.</b>		Data type: UNSIGNED_8 Index: 23987 <sub>d</sub> = 5DB3 <sub>h</sub>
Response if the maximum speed for the set inverter switching frequency is reached ( <a href="#">C00018</a> )		
<b>Selection list</b> (Lenze setting printed in bold)		
<b>0</b>	<b>No Reaction</b>	
1	Fault	
5	Warning	
<input checked="" type="checkbox"/> Read access <input checked="" type="checkbox"/> Write access <input type="checkbox"/> CINH <input type="checkbox"/> PLC STOP <input type="checkbox"/> No transfer <input type="checkbox"/> COM <input checked="" type="checkbox"/> MOT   Scaling factor: 1		

## C00590

Parameter   Name: <b>C00590   Resp. to switching frequency red.</b>		Data type: UNSIGNED_8 Index: 23985 <sub>d</sub> = 5DB1 <sub>h</sub>
Response to reduction of the inverter switching frequency ( <a href="#">C00018</a> )		
<b>Selection list</b> (Lenze setting printed in bold)		
<b>0</b>	<b>No Reaction</b>	
1	Fault	
5	Warning	
<input checked="" type="checkbox"/> Read access <input checked="" type="checkbox"/> Write access <input type="checkbox"/> CINH <input type="checkbox"/> PLC STOP <input type="checkbox"/> No transfer <input type="checkbox"/> COM <input checked="" type="checkbox"/> MOT   Scaling factor: 1		

## C00592

Parameter   Name:		Data type: UNSIGNED_8 Index: 23983 <sub>d</sub> = 5DAF <sub>h</sub>
<b>C00592   Resp. to CAN bus connection</b>		
Configuration of monitoring of the CAN interface (group 1)		<a href="#">▶ "CAN on board" system bus</a>
Selection list		
0	No Reaction	
1	Fault	
2	Trouble	
3	TroubleQuickStop	
4	WarningLocked	
5	Warning	
6	Information	
Subcodes	Lenze setting	Info
C00592/1	0: No Reaction	Response to incorrect telegram for CAN communication
C00592/2	0: No Reaction	Response to "BusOff" (bus system switched off)
C00592/3	0: No Reaction	Response to warnings of the CAN controller
C00592/4	0: No Reaction	Response to communication stop of a CAN bus node
C00592/5	0: No Reaction	Response to an event in the case of monitoring via <a href="#">heartbeat protocol</a>
<input checked="" type="checkbox"/> Read access <input checked="" type="checkbox"/> Write access <input type="checkbox"/> CINH <input type="checkbox"/> PLC STOP <input type="checkbox"/> No transfer <input checked="" type="checkbox"/> COM <input type="checkbox"/> MOT             Scaling factor: 1		

## C00593

Parameter   Name:		Data type: UNSIGNED_8 Index: 23982 <sub>d</sub> = 5DAE <sub>h</sub>
<b>C00593   Resp. to CANx_IN monitoring</b>		
Configuration of monitoring of the CAN interface (group 2)		<a href="#">▶ "CAN on board" system bus</a>
Selection list		
0	No Reaction	
1	Fault	
2	Trouble	
3	TroubleQuickStop	
4	WarningLocked	
5	Warning	
6	Information	
Subcodes	Lenze setting	Info
C00593/1	0: No Reaction	Response if the monitoring time set in <a href="#">C00357/1</a> for the reception of the PDO CAN1_IN is exceeded.
C00593/2	0: No Reaction	Response if the monitoring time set in <a href="#">C00357/2</a> for the reception of the PDO CAN2_IN is exceeded.
C00593/3	0: No Reaction	Response if the monitoring time set in <a href="#">C00357/3</a> for the reception of the PDO CAN3_IN is exceeded.
C00593/4	0: No Reaction	Response if the monitoring time set in <a href="#">C00357/4</a> for the reception of the PDO CAN4_IN is exceeded. • <a href="#">From version 15.00.00</a>
<input checked="" type="checkbox"/> Read access <input checked="" type="checkbox"/> Write access <input type="checkbox"/> CINH <input type="checkbox"/> PLC STOP <input type="checkbox"/> No transfer <input checked="" type="checkbox"/> COM <input type="checkbox"/> MOT             Scaling factor: 1		

## C00594

Parameter   Name: C00594   Resp. to control word error		Data type: UNSIGNED_8 Index: 23981 <sub>d</sub> = 5DAD <sub>h</sub>
Configuration of device control monitoring		
Selection list		
0	No Reaction	
1	Fault	
2	Trouble	
3	TroubleQuickStop	
5	Warning	
Subcodes	Lenze setting	Info
C00594/1	1: Fault	Response if error bit 14 in the CAN control word is set.
C00594/2	1: Fault	Response if error bit 14 in the MCI control word is set.
<input checked="" type="checkbox"/> Read access <input checked="" type="checkbox"/> Write access <input type="checkbox"/> CINH <input type="checkbox"/> PLC STOP <input type="checkbox"/> No transfer <input type="checkbox"/> COM <input type="checkbox"/> MOT             Scaling factor: 1		

## C00595

Parameter   Name: C00595   MCK: Resp. to MCK error		Data type: UNSIGNED_8 Index: 23980 <sub>d</sub> = 5DAC <sub>h</sub>
Configuration of monitoring of the Motion Control Kernel		<a href="#">Basic drive functions</a>
Selection list		
0	No Reaction	
1	Fault	
3	TroubleQuickStop	
4	WarningLocked	
5	Warning	
6	Information	
Subcodes	Lenze setting	Info
C00595/1	0: No Reaction	Reserved
C00595/2	0: No Reaction	Reserved
C00595/3	0: No Reaction	Reserved
C00595/4	0: No Reaction	Reserved
C00595/5	0: No Reaction	Reserved
C00595/6	0: No Reaction	Reserved
C00595/7	0: No Reaction	Reserved
C00595/8	0: No Reaction	Reserved
C00595/9	0: No Reaction	Reserved
C00595/10	0: No Reaction	Reserved
C00595/11	0: No Reaction	Reserved
C00595/12	0: No Reaction	Reserved
C00595/13	0: No Reaction	Reserved

Parameter   Name: <b>C00595   MCK: Resp. to MCK error</b>		Data type: UNSIGNED_8 Index: 23980 <sub>d</sub> = 5DAC <sub>h</sub>
C00595/14	0: No Reaction	Reserved
C00595/15	1: Fault	Response to activated connection monitoring in case of PC manual control • From version 11.00.00
C00595/16	0: No Reaction	Reserved
C00595/17	0: No Reaction	Reserved
<input checked="" type="checkbox"/> Read access <input checked="" type="checkbox"/> Write access <input type="checkbox"/> CINH <input type="checkbox"/> PLC STOP <input type="checkbox"/> No transfer <input type="checkbox"/> COM <input type="checkbox"/> MOT   Scaling factor: 1		

**C00597**

Parameter   Name: <b>C00597   Resp. to motor phase failure</b>		Data type: UNSIGNED_8 Index: 23978 <sub>d</sub> = 5DAA <sub>h</sub>
Response to motor phase failure • If a phase current does not exceed the threshold set in <a href="#">C00599</a> for more than one period, the response set here will be triggered.		
<b>Selection list</b> (Lenze setting printed in bold)		
	<b>0</b> No Reaction	
	1 Fault	
	5 Warning	
<input checked="" type="checkbox"/> Read access <input checked="" type="checkbox"/> Write access <input type="checkbox"/> CINH <input type="checkbox"/> PLC STOP <input type="checkbox"/> No transfer <input type="checkbox"/> COM <input checked="" type="checkbox"/> MOT   Scaling factor: 1		

**C00598**

Parameter   Name: <b>C00598   Resp. to open circuit AINx</b>		Data type: UNSIGNED_8 Index: 23977 <sub>d</sub> = 5DA9 <sub>h</sub>
Configuration of monitoring the analog input		<a href="#">▶ Analog terminals</a>
<b>Selection list</b>		
	0 No Reaction	
	1 Fault	
	2 Trouble	
	3 TroubleQuickStop	
	5 Warning	
<b>Subcodes</b>	<b>Lenze setting</b>	<b>Info</b>
C00598/1	3: TroubleQuickStop	Response to open circuit at AIN1 if configured as 4 ... 20 mA current loop
<input checked="" type="checkbox"/> Read access <input checked="" type="checkbox"/> Write access <input type="checkbox"/> CINH <input type="checkbox"/> PLC STOP <input type="checkbox"/> No transfer <input type="checkbox"/> COM <input type="checkbox"/> MOT   Scaling factor: 1		

**C00599**

Parameter   Name: <b>C00599   Motor phase failure threshold</b>		Data type: INTEGER_16 Index: 23976 <sub>d</sub> = 5DA8 <sub>h</sub>
Threshold for motor phase failure monitoring • 100 % ≙ rated inverter current ( <a href="#">C00098</a> ) • If a phase current does not exceed the threshold set here for more than one period, the response to motor phase failure set in <a href="#">C00597</a> will be triggered.		
<b>Setting range</b> (min. value   unit   max. value)		<b>Lenze setting</b>
0.00	%	100.00 <b>5.00 %</b>
<input checked="" type="checkbox"/> Read access <input checked="" type="checkbox"/> Write access <input type="checkbox"/> CINH <input type="checkbox"/> PLC STOP <input type="checkbox"/> No transfer <input type="checkbox"/> COM <input checked="" type="checkbox"/> MOT   Scaling factor: 100		

## C00600

Parameter   Name: <b>C00600   Resp. to DC bus voltage</b>		Data type: UNSIGNED_8 Index: 23975 <sub>d</sub> = 5DA7 <sub>h</sub>
Configuration of monitoring of the motor control (group 3)		
<b>Selection list</b>		
1	Fault	
2	Trouble	
<b>Subcodes</b>	<b>Lenze setting</b>	<b>Info</b>
C00600/1	2: Trouble	Response to DC bus undervoltage
<input checked="" type="checkbox"/> Read access <input checked="" type="checkbox"/> Write access <input type="checkbox"/> CINH <input type="checkbox"/> PLC STOP <input type="checkbox"/> No transfer <input type="checkbox"/> COM <input checked="" type="checkbox"/> MOT   Scaling factor: 1		

## C00601

Parameter   Name: <b>C00601   Del. resp. to fault: DC bus overvoltage</b>		Data type: UNSIGNED_16 Index: 23974 <sub>d</sub> = 5DA6 <sub>h</sub>
Error response delay times		
<b>Setting range (min. value   unit   max. value)</b>		
0.000	s	65.000
<b>Subcodes</b>	<b>Lenze setting</b>	<b>Info</b>
C00601/1	2.000 s	Delay time for triggering the "DC-bus overvoltage" error • If a DC-bus overvoltage occurs, an error will not be triggered until the set delay time has elapsed.
<input checked="" type="checkbox"/> Read access <input checked="" type="checkbox"/> Write access <input type="checkbox"/> CINH <input type="checkbox"/> PLC STOP <input type="checkbox"/> No transfer <input type="checkbox"/> COM <input checked="" type="checkbox"/> MOT   Scaling factor: 1000		

## C00602

Parameter   Name: <b>C00602   Resp. to earth fault</b>		Data type: UNSIGNED_8 Index: 23973 <sub>d</sub> = 5DA5 <sub>h</sub>
Response to earth fault in the motor phase(s)		
<b>Selection list(Lenze setting printed in bold)</b>		
0	No Reaction	
<b>1</b>	<b>Fault</b>	
<input checked="" type="checkbox"/> Read access <input checked="" type="checkbox"/> Write access <input type="checkbox"/> CINH <input type="checkbox"/> PLC STOP <input type="checkbox"/> No transfer <input type="checkbox"/> COM <input checked="" type="checkbox"/> MOT   Scaling factor: 1		

## C00604

Parameter   Name: <b>C00604   Resp. to device overload (lxt)</b>		Data type: UNSIGNED_8 Index: 23971 <sub>d</sub> = 5DA3 <sub>h</sub>
Response if the adjustable device utilisation threshold ( <a href="#">C00123</a> ) is reached. • The current device utilisation is displayed in <a href="#">C00064</a> .		
<b>Selection list(Lenze setting printed in bold)</b>		
0	No Reaction	
1	Fault	
<b>5</b>	<b>Warning</b>	
<input checked="" type="checkbox"/> Read access <input checked="" type="checkbox"/> Write access <input type="checkbox"/> CINH <input type="checkbox"/> PLC STOP <input type="checkbox"/> No transfer <input type="checkbox"/> COM <input type="checkbox"/> MOT   Scaling factor: 1		



## C00606

Parameter   Name: <b>C00606   Resp. to motor overload (I<sup>2</sup>t)</b>		Data type: UNSIGNED_8 Index: 23969 <sub>d</sub> = 5DA1 <sub>h</sub>
Response when the motor load displayed in <a href="#">C00066</a> reaches the value "100.00 %". <a href="#">▶ Motor overload monitoring (I2xt)</a>		
<b>Selection list</b> (Lenze setting printed in bold)		
0	No Reaction	
1	Fault	
5	<b>Warning</b>	
<input checked="" type="checkbox"/> Read access <input checked="" type="checkbox"/> Write access <input type="checkbox"/> CINH <input type="checkbox"/> PLC STOP <input type="checkbox"/> No transfer <input type="checkbox"/> COM <input checked="" type="checkbox"/> MOT   Scaling factor: 1		

## C00607

Parameter   Name: <b>C00607   Resp. to max freq. feedb. DIG12/67</b>		Data type: UNSIGNED_8 Index: 23968 <sub>d</sub> = 5DA0 <sub>h</sub>
Response when the maximum input frequency has been reached via the digital inputs.		
<b>Selection list</b> (Lenze setting printed in bold)		
0	No Reaction	
1	<b>Fault</b>	
2	Trouble	
3	TroubleQuickStop	
4	WarningLocked	
5	Warning	
6	Information	
<input checked="" type="checkbox"/> Read access <input checked="" type="checkbox"/> Write access <input type="checkbox"/> CINH <input type="checkbox"/> PLC STOP <input type="checkbox"/> No transfer <input type="checkbox"/> COM <input checked="" type="checkbox"/> MOT   Scaling factor: 1		

## C00608

Parameter   Name: <b>C00608   Resp. to maximum torque</b>		Data type: UNSIGNED_8 Index: 23967 <sub>d</sub> = 5D9F <sub>h</sub>
Response if the maximum torque ( <a href="#">C00057</a> ) is reached.		
<b>Selection list</b> (Lenze setting printed in bold)		
0	<b>No Reaction</b>	
1	Fault	
5	Warning	
<input checked="" type="checkbox"/> Read access <input checked="" type="checkbox"/> Write access <input type="checkbox"/> CINH <input type="checkbox"/> PLC STOP <input type="checkbox"/> No transfer <input type="checkbox"/> COM <input checked="" type="checkbox"/> MOT   Scaling factor: 1		

## C00609

Parameter   Name: <b>C00609   Resp. to maximum current</b>		Data type: UNSIGNED_8 Index: 23966 <sub>d</sub> = 5D9E <sub>h</sub>
Response if the maximum current ( <a href="#">C00022</a> , <a href="#">C00023</a> ) is reached.		
<b>Selection list</b> (Lenze setting printed in bold)		
0	<b>No Reaction</b>	
1	Fault	
5	Warning	
<input checked="" type="checkbox"/> Read access <input checked="" type="checkbox"/> Write access <input type="checkbox"/> CINH <input type="checkbox"/> PLC STOP <input type="checkbox"/> No transfer <input type="checkbox"/> COM <input checked="" type="checkbox"/> MOT   Scaling factor: 1		

## C00610

Parameter   Name: <b>C00610   16-bit connection table</b>	Data type: UNSIGNED_16 Index: 23965 <sub>d</sub> = 5D9D <sub>h</sub>
<b>This code is used device-internally and must not be written by the user side!</b>	

## C00611

Parameter   Name: <b>C00611   Bool connection table</b>	Data type: UNSIGNED_16 Index: 23964 <sub>d</sub> = 5D9C <sub>h</sub>
<b>This code is used device-internally and must not be written by the user side!</b>	

## C00612

Parameter   Name: <b>C00612   32-bit connection table</b>	Data type: UNSIGNED_16 Index: 23963 <sub>d</sub> = 5D9B <sub>h</sub>
<b>This code is used device-internally and must not be written by the user side!</b>	

## C00620

Parameter   Name: <b>C00620   System connection list: 16-bit</b>	Data type: UNSIGNED_16 Index: 23953 <sub>d</sub> = 5D93 <sub>h</sub>	
<p>Connection parameters: 16-bit inputs</p> <ul style="list-style-type: none"> <li>• Selection of the 16 bit output signals to be connected to the 16 bit input signals</li> <li>• The selection list contains all 16 bit output signals which can be assigned to the 16 bit inputs displayed by the subcodes.</li> <li>• Non-listed subcodes are "reserved".</li> </ul>		
<b>Selection list</b>		
See <a href="#">selection list - analog signals</a>		
<b>Subcodes</b>	<b>Lenze setting</b>	<b>Info</b>
C00620/1	1003: LA_NCtrl: nMotorSpeedAct_a	<a href="#">LS AnalogOutput</a> : nOut1_a Analog output 1: Voltage
C00620/2	0: Not connected	<a href="#">LP_CanOut1</a> : wState CAN1 output: Status word
C00620/3	0: Not connected	<a href="#">LP_CanOut1</a> : wOut2 CAN1 output: Data word 2
C00620/4	0: Not connected	<a href="#">LP_CanOut1</a> : wOut3 CAN1 output: Data word 3
C00620/5	0: Not connected	<a href="#">LP_CanOut1</a> : wOut4 CAN1 output: Data word 4
C00620/6	0: Not connected	<a href="#">LP_CanOut2</a> : wOut1 CAN2 output: Data word 1
C00620/7	0: Not connected	<a href="#">LP_CanOut2</a> : wOut2 CAN2 output: Data word 2
C00620/8	0: Not connected	<a href="#">LP_CanOut2</a> : wOut3 CAN2 output: Data word 3
C00620/9	0: Not connected	<a href="#">LP_CanOut2</a> : wOut4 CAN2 output: Data word 4
C00620/10	0: Not connected	<a href="#">LP_CanOut3</a> : wOut1 CAN3 output: Data word 1
C00620/11	0: Not connected	<a href="#">LP_CanOut3</a> : wOut2 CAN3 output: Data word 2
C00620/12	0: Not connected	<a href="#">LP_CanOut3</a> : wOut3 CAN3 output: Data word 3

Parameter   Name: <b>C00620   System connection list: 16-bit</b>		Data type: UNSIGNED_16 Index: 23955 <sub>d</sub> = 5D93 <sub>h</sub>
C00620/13	0: Not connected	<a href="#">LP_CanOut3</a> : wOut4 CAN3 output: Data word 4
C00620/14	0: Not connected	<a href="#">LS_DisFree_a</a> : nDis1_a Display of analog signal 1
C00620/15	0: Not connected	<a href="#">LS_DisFree_a</a> : nDis2_a Display of analog signal 2
C00620/16	0: Not connected	<a href="#">LS_DisFree_a</a> : nDis3_a Display of analog signal 3
C00620/17	0: Not connected	<a href="#">LS_DisFree_a</a> : nDis4_a Display of analog signal 4
C00620/18	0: Not connected	<a href="#">LS_DisFree</a> : wDis1 Display of 16-bit signal 1
C00620/19	0: Not connected	<a href="#">LS_DisFree</a> : wDis2 Display of 16-bit signal 2
C00620/20	0: Not connected	<a href="#">LS_DisFree</a> : wDis3 Display of 16-bit signal 3
C00620/21	0: Not connected	<a href="#">LS_DisFree</a> : wDis4 Display of 16-bit signal 4
C00620/22	0: Not connected	<a href="#">LP_MciOut</a> : wState MCI output: Status word
C00620/23	0: Not connected	<a href="#">LP_MciOut</a> : wOut2 MCI output: Data word 2
C00620/24	0: Not connected	<a href="#">LP_MciOut</a> : wOut3 MCI output: Data word 3
C00620/25	0: Not connected	<a href="#">LP_MciOut</a> : wOut4 MCI output: Data word 4
C00620/26	0: Not connected	<a href="#">LP_MciOut</a> : wOut5 MCI output: Data word 5
C00620/27	0: Not connected	<a href="#">LP_MciOut</a> : wOut6 MCI output: Data word 6
C00620/28	0: Not connected	<a href="#">LP_MciOut</a> : wOut7 MCI output: Data word 7
C00620/29	0: Not connected	<a href="#">LP_MciOut</a> : wOut8 MCI output: Data word 8
C00620/30	0: Not connected	<a href="#">LP_MciOut</a> : wOut9 MCI output: Data word 9
C00620/31	0: Not connected	<a href="#">LP_MciOut</a> : wOut10 MCI output: Data word 10
C00620/32	0: Not connected	<a href="#">LP_MciOut</a> : wOut11 MCI output: Data word 11
C00620/33	0: Not connected	<a href="#">LP_MciOut</a> : wOut12 MCI output: Data word 12
C00620/34	0: Not connected	<a href="#">LP_MciOut</a> : wOut13 MCI output: Data word 13
C00620/35	0: Not connected	<a href="#">LP_MciOut</a> : wOut14 MCI output: Data word 14
C00620/36	0: Not connected	<a href="#">LP_MciOut</a> : wOut15 MCI output: Data word 15
C00620/37	0: Not connected	<a href="#">LP_MciOut</a> : wOut16 MCI output: Data word 16

Parameter   Name: <b>C00620   System connection list: 16-bit</b>		Data type: UNSIGNED_16 Index: 23955 <sub>d</sub> = 5D93 <sub>h</sub>
C00620/49	0: Not connected	<a href="#">LS ParReadWrite 1</a> : wParIndex Read/write request 1: Code
C00620/50	0: Not connected	<a href="#">LS ParReadWrite 1</a> : wParSubindex Read/write request 1: Subcode
C00620/51	0: Not connected	<a href="#">LS ParReadWrite 1</a> : wInHWord Read/write request 1: Value (high word)
C00620/52	0: Not connected	<a href="#">LS ParReadWrite 1</a> : wInLWord Read/write request 1: Value (low word)
C00620/53	0: Not connected	<a href="#">LS ParReadWrite 2</a> : wParIndex Read/write request 2: Code
C00620/54	0: Not connected	<a href="#">LS ParReadWrite 2</a> : wParSubindex Read/write request 2: Subcode
C00620/55	0: Not connected	<a href="#">LS ParReadWrite 2</a> : wInHWord Read/write request 2: Value (high word)
C00620/56	0: Not connected	<a href="#">LS ParReadWrite 2</a> : wInLWord Read/write request 2: Value (low word)
C00620/57	0: Not connected	<a href="#">LS ParReadWrite 3</a> : wParIndex Read/write request 3: Code
C00620/58	0: Not connected	<a href="#">LS ParReadWrite 3</a> : wParSubindex Read/write request 3: Subcode
C00620/59	0: Not connected	<a href="#">LS ParReadWrite 3</a> : wInHWord Read/write request 3: Value (high word)
C00620/60	0: Not connected	<a href="#">LS ParReadWrite 3</a> : wInLWord Read/write request 3: Value (low word)
C00620/108	0: Not connected	<a href="#">LP CanOut4</a> : wOut1
C00620/109	0: Not connected	<a href="#">LP CanOut4</a> : wOut2
C00620/110	0: Not connected	<a href="#">LP CanOut4</a> : wOut3
C00620/111	0: Not connected	<a href="#">LP CanOut4</a> : wOut4
<input checked="" type="checkbox"/> Read access <input checked="" type="checkbox"/> Write access <input type="checkbox"/> CINH <input type="checkbox"/> PLC STOP <input type="checkbox"/> No transfer <input type="checkbox"/> COM <input type="checkbox"/> MOT             Scaling factor: 1		

**C00621**

Parameter   Name: <b>C00621   System connection list: Bool</b>		Data type: UNSIGNED_16 Index: 23954 <sub>d</sub> = 5D92 <sub>h</sub>
Connection parameters: Binary inputs <ul style="list-style-type: none"> <li>• Selection of the binary output signals to be connected to the binary input signals</li> <li>• The selection list contains all binary output signals which can be assigned to the binary inputs mapped by the subcodes.</li> <li>• Non-listed subcodes are "reserved".</li> </ul>		
<b>Selection list</b>		
See <a href="#">selection list - digital signals</a>		
Subcodes	Lenze setting	Info
C00621/1	1001: LA_NCtrl: bDriveFail	<a href="#">LS DigitalOutput</a> : bRelay Digital relay output: Input signal
C00621/2	1000: LA_NCtrl: bDriveReady	<a href="#">LS DigitalOutput</a> : bOut1 Digital output 1: Input signal
C00621/3	0: Not connected	<a href="#">LS DigitalInput</a> : bCountIn1_Reset Digital input 1: Reset counter
C00621/4	0: Not connected	<a href="#">LS DigitalInput</a> : bCountIn1_LoadStartValue Digital input 1: Load counter starting value

Parameter   Name: <b>C00621   System connection list: Bool</b>		Data type: UNSIGNED_16 Index: 23954 <sub>d</sub> = 5D92 <sub>h</sub>
C00621/5	0: Not connected	<a href="#">LP_CanOut1</a> : bState_B0 CAN1 output: Status word bit 0
C00621/6	0: Not connected	<a href="#">LP_CanOut1</a> : bState_B1 CAN1 output: Status word bit 1
C00621/7	0: Not connected	<a href="#">LP_CanOut1</a> : bState_B2 CAN1 output: Status word bit 2
C00621/8	0: Not connected	<a href="#">LP_CanOut1</a> : bState_B3 CAN1 output: Status word bit 3
C00621/9	0: Not connected	<a href="#">LP_CanOut1</a> : bState_B4 CAN1 output: Status word bit 4
C00621/10	0: Not connected	<a href="#">LP_CanOut1</a> : bState_B5 CAN1 output: Status word bit 5
C00621/11	0: Not connected	<a href="#">LP_CanOut1</a> : bState_B6 CAN1 output: Status word bit 6
C00621/12	0: Not connected	<a href="#">LP_CanOut1</a> : bState_B7 CAN1 output: Status word bit 7
C00621/13	0: Not connected	<a href="#">LP_CanOut1</a> : bState_B8 CAN1 output: Status word bit 8
C00621/14	0: Not connected	<a href="#">LP_CanOut1</a> : bState_B9 CAN1 output: Status word bit 9
C00621/15	0: Not connected	<a href="#">LP_CanOut1</a> : bState_B10 CAN1 output: Status word bit 10
C00621/16	0: Not connected	<a href="#">LP_CanOut1</a> : bState_B11 CAN1 output: Status word bit 11
C00621/17	0: Not connected	<a href="#">LP_CanOut1</a> : bState_B12 CAN1 output: Status word bit 12
C00621/18	0: Not connected	<a href="#">LP_CanOut1</a> : bState_B13 CAN1 output: Status word bit 13
C00621/19	0: Not connected	<a href="#">LP_CanOut1</a> : bState_B14 CAN1 output: Status word bit 14
C00621/20	0: Not connected	<a href="#">LP_CanOut1</a> : bState_B15 CAN1 output: Status word bit 15
C00621/21	0: Not connected	<a href="#">LS_DisFree_b</a> : bDis1 Display of digital signal 1
C00621/22	0: Not connected	<a href="#">LS_DisFree_b</a> : bDis2 Display of digital signal 2
C00621/23	0: Not connected	<a href="#">LS_DisFree_b</a> : bDis3 Display of digital signal 3
C00621/24	0: Not connected	<a href="#">LS_DisFree_b</a> : bDis4 Display of digital signal 4
C00621/25	0: Not connected	<a href="#">LS_DisFree_b</a> : bDis5 Display of digital signal 5
C00621/26	0: Not connected	<a href="#">LS_DisFree_b</a> : bDis6 Display of digital signal 6
C00621/27	0: Not connected	<a href="#">LS_DisFree_b</a> : bDis7 Display of digital signal 7
C00621/28	0: Not connected	<a href="#">LS_DisFree_b</a> : bDis8 Display of digital signal 8
C00621/29	0: Not connected	<a href="#">LP_CanOut2</a> : bOut1_B0 CAN2 output: Data word 1- bit 0

Parameter   Name: <b>C00621   System connection list: Bool</b>		Data type: UNSIGNED_16 Index: 23954 <sub>d</sub> = 5D92 <sub>h</sub>
C00621/30	0: Not connected	<a href="#">LP_CanOut2</a> : bOut1_B1 CAN2 output: Data word 1- bit 1
C00621/31	0: Not connected	<a href="#">LP_CanOut2</a> : bOut1_B2 CAN2 output: Data word 1- bit 2
C00621/32	0: Not connected	<a href="#">LP_CanOut2</a> : bOut1_B3 CAN2 output: Data word 1- bit 3
C00621/33	0: Not connected	<a href="#">LP_CanOut2</a> : bOut1_B4 CAN2 output: Data word 1- bit 4
C00621/34	0: Not connected	<a href="#">LP_CanOut2</a> : bOut1_B5 CAN2 output: Data word 1- bit 5
C00621/35	0: Not connected	<a href="#">LP_CanOut2</a> : bOut1_B6 CAN2 output: Data word 1- bit 6
C00621/36	0: Not connected	<a href="#">LP_CanOut2</a> : bOut1_B7 CAN2 output: Data word 1- bit 7
C00621/37	0: Not connected	<a href="#">LP_CanOut2</a> : bOut1_B8 CAN2 output: Data word 1- bit 8
C00621/38	0: Not connected	<a href="#">LP_CanOut2</a> : bOut1_B9 CAN2 output: Data word 1- bit 9
C00621/39	0: Not connected	<a href="#">LP_CanOut2</a> : bOut1_B10 CAN2 output: Data word 1- bit 10
C00621/40	0: Not connected	<a href="#">LP_CanOut2</a> : bOut1_B11 CAN2 output: Data word 1- bit 11
C00621/41	0: Not connected	<a href="#">LP_CanOut2</a> : bOut1_B12 CAN2 output: Data word 1- bit 12
C00621/42	0: Not connected	<a href="#">LP_CanOut2</a> : bOut1_B13 CAN2 output: Data word 1- bit 13
C00621/43	0: Not connected	<a href="#">LP_CanOut2</a> : bOut1_B14 CAN2 output: Data word 1- bit 14
C00621/44	0: Not connected	<a href="#">LP_CanOut2</a> : bOut1_B15 CAN2 output: Data word 1- bit 15
C00621/45	0: Not connected	<a href="#">LP_CanOut3</a> : bOut1_B0 CAN3 output: Data word 1- bit 0
C00621/46	0: Not connected	<a href="#">LP_CanOut3</a> : bOut1_B1 CAN3 output: Data word 1- bit 1
C00621/47	0: Not connected	<a href="#">LP_CanOut3</a> : bOut1_B2 CAN3 output: Data word 1- bit 2
C00621/48	0: Not connected	<a href="#">LP_CanOut3</a> : bOut1_B3 CAN3 output: Data word 1- bit 3
C00621/49	0: Not connected	<a href="#">LP_CanOut3</a> : bOut1_B4 CAN3 output: Data word 1- bit 4
C00621/50	0: Not connected	<a href="#">LP_CanOut3</a> : bOut1_B5 CAN3 output: Data word 1- bit 5
C00621/51	0: Not connected	<a href="#">LP_CanOut3</a> : bOut1_B6 CAN3 output: Data word 1- bit 6
C00621/52	0: Not connected	<a href="#">LP_CanOut3</a> : bOut1_B7 CAN3 output: Data word 1- bit 7
C00621/53	0: Not connected	<a href="#">LP_CanOut3</a> : bOut1_B8 CAN3 output: Data word 1- bit 8
C00621/54	0: Not connected	<a href="#">LP_CanOut3</a> : bOut1_B9 CAN3 output: Data word 1- bit 9

Parameter   Name: <b>C00621   System connection list: Bool</b>		Data type: UNSIGNED_16 Index: 23954 <sub>d</sub> = 5D92 <sub>h</sub>
C00621/55	0: Not connected	<a href="#">LP_CanOut3</a> : bOut1_B10 CAN3 output: Data word 1- bit 10
C00621/56	0: Not connected	<a href="#">LP_CanOut3</a> : bOut1_B11 CAN3 output: Data word 1- bit 11
C00621/57	0: Not connected	<a href="#">LP_CanOut3</a> : bOut1_B12 CAN3 output: Data word 1- bit 12
C00621/58	0: Not connected	<a href="#">LP_CanOut3</a> : bOut1_B13 CAN3 output: Data word 1- bit 13
C00621/59	0: Not connected	<a href="#">LP_CanOut3</a> : bOut1_B14 CAN3 output: Data word 1- bit 14
C00621/60	0: Not connected	<a href="#">LP_CanOut3</a> : bOut1_B15 CAN3 output: Data word 1- bit 15
C00621/61	0: Not connected	<a href="#">LP_MciOut</a> : bState_B0 MCI output: Status word - bit 0
C00621/62	0: Not connected	<a href="#">LP_MciOut</a> : bState_B1 MCI output: Status word - bit 1
C00621/63	0: Not connected	<a href="#">LP_MciOut</a> : bState_B2 MCI output: Status word - bit 2
C00621/64	0: Not connected	<a href="#">LP_MciOut</a> : bState_B3 MCI output: Status word - bit 3
C00621/65	0: Not connected	<a href="#">LP_MciOut</a> : bState_B4 MCI output: Status word - bit 4
C00621/66	0: Not connected	<a href="#">LP_MciOut</a> : bState_B5 MCI output: Status word - bit 5
C00621/67	0: Not connected	<a href="#">LP_MciOut</a> : bState_B6 MCI output: Status word - bit 6
C00621/68	0: Not connected	<a href="#">LP_MciOut</a> : bState_B7 MCI output: Status word - bit 7
C00621/69	0: Not connected	<a href="#">LP_MciOut</a> : bState_B8 MCI output: Status word - bit 8
C00621/70	0: Not connected	<a href="#">LP_MciOut</a> : bState_B9 MCI output: Status word - bit 9
C00621/71	0: Not connected	<a href="#">LP_MciOut</a> : bState_B10 MCI output: Status word - bit 10
C00621/72	0: Not connected	<a href="#">LP_MciOut</a> : bState_B11 MCI output: Status word - bit 11
C00621/73	0: Not connected	<a href="#">LP_MciOut</a> : bState_B12 MCI output: Status word - bit 12
C00621/74	0: Not connected	<a href="#">LP_MciOut</a> : bState_B13 MCI output: Status word - bit 13
C00621/75	0: Not connected	<a href="#">LP_MciOut</a> : bState_B14 MCI output: Status word - bit 14
C00621/76	0: Not connected	<a href="#">LP_MciOut</a> : bState_B15 MCI output: Status word - bit 15
C00621/77	0: Not connected	<a href="#">LP_MciOut</a> : bOut2_B0 MCI output: Data word 2 - bit 0
C00621/78	0: Not connected	<a href="#">LP_MciOut</a> : bOut2_B1 MCI output: Data word 2 - bit 1
C00621/79	0: Not connected	<a href="#">LP_MciOut</a> : bOut2_B2 MCI output: Data word 2 - bit 2

Parameter   Name: <b>C00621   System connection list: Bool</b>		Data type: UNSIGNED_16 Index: 23954 <sub>d</sub> = 5D92 <sub>h</sub>
C00621/80	0: Not connected	<a href="#">LP_MciOut</a> : bOut2_B3 MCI output: Data word 2 - bit 3
C00621/81	0: Not connected	<a href="#">LP_MciOut</a> : bOut2_B4 MCI output: Data word 2 - bit 4
C00621/82	0: Not connected	<a href="#">LP_MciOut</a> : bOut2_B5 MCI output: Data word 2 - bit 5
C00621/83	0: Not connected	<a href="#">LP_MciOut</a> : bOut2_B6 MCI output: Data word 2 - bit 6
C00621/84	0: Not connected	<a href="#">LP_MciOut</a> : bOut2_B7 MCI output: Data word 2 - bit 7
C00621/85	0: Not connected	<a href="#">LP_MciOut</a> : bOut2_B8 MCI output: Data word 2 - bit 8
C00621/86	0: Not connected	<a href="#">LP_MciOut</a> : bOut2_B9 MCI output: Data word 2 - bit 9
C00621/87	0: Not connected	<a href="#">LP_MciOut</a> : bOut2_B10 MCI output: Data word 2 - bit 10
C00621/88	0: Not connected	<a href="#">LP_MciOut</a> : bOut2_B11 MCI output: Data word 2 - bit 11
C00621/89	0: Not connected	<a href="#">LP_MciOut</a> : bOut2_B12 MCI output: Data word 2 - bit 12
C00621/90	0: Not connected	<a href="#">LP_MciOut</a> : bOut2_B13 MCI output: Data word 2 - bit 13
C00621/91	0: Not connected	<a href="#">LP_MciOut</a> : bOut2_B14 MCI output: Data word 2 - bit 14
C00621/92	0: Not connected	<a href="#">LP_MciOut</a> : bOut2_B15 MCI output: Data word 2 - bit 15
C00621/93	0: Not connected	<a href="#">LS_SetError_1</a> : bSetError1 Input for tripping "US01: User error 1"
C00621/94	0: Not connected	<a href="#">LS_SetError_1</a> : bSetError2 Input for tripping "US02: User error 2"
C00621/95	0: Not connected	<a href="#">LS_SetError_1</a> : bSetError3 Input for tripping "US03: User error 3"
C00621/96	0: Not connected	<a href="#">LS_SetError_1</a> : bSetError4 Input for tripping "US04: User error 4"
C00621/111	0: Not connected	<a href="#">LS_ParReadWrite_1</a> : bExecute Read/write request 1: Trigger
C00621/112	0: Not connected	<a href="#">LS_ParReadWrite_1</a> : bReadWrite Read/write request 1: Selection of reading/writing
C00621/113	0: Not connected	<a href="#">LS_ParReadWrite_2</a> : bExecute Read/write request 2: Trigger
C00621/114	0: Not connected	<a href="#">LS_ParReadWrite_2</a> : bReadWrite Read/write request 2: Selection of reading/writing
C00621/115	0: Not connected	<a href="#">LS_ParReadWrite_3</a> : bExecute Read/write request 3: Trigger
C00621/116	0: Not connected	<a href="#">LS_ParReadWrite_3</a> : bReadWrite Read/write request 3: Selection of reading/writing
C00621/123	0: Not connected	<a href="#">LS_WriteParamList</a> : bExecute Writing the parameter list: Activate
C00621/124	0: Not connected	<a href="#">LS_WriteParamList</a> : bSelectWriteValue_1 Writing to parameter list: Selection of value set - 1



Parameter   Name: <b>C00621   System connection list: Bool</b>		Data type: UNSIGNED_16 Index: 23954 <sub>d</sub> = 5D92 <sub>h</sub>
C00621/125	0: Not connected	<a href="#">LS_WriteParamList</a> : bSelectWriteValue_2 Writing to parameter list: Selection of value set - 2
C00621/126	0: Not connected	<a href="#">LS_CANManagement</a> : bResetNode Reset CAN node
C00621/127	0: Not connected	<a href="#">LS_CANManagement</a> : bReInitCAN Reinitialise CAN interface
C00621/128	0: Not connected	<a href="#">LS_DigitalInput</a> : bPosIn12_Load Frequency input DI1/DI2: Load angle integrator with starting value and reset status signal
C00621/184	0: Not connected	<a href="#">LP_CanOut4</a> : bOut1_B0
C00621/185	0: Not connected	<a href="#">LP_CanOut4</a> : bOut1_B1
C00621/186	0: Not connected	<a href="#">LP_CanOut4</a> : bOut1_B2
C00621/187	0: Not connected	<a href="#">LP_CanOut4</a> : bOut1_B3
C00621/188	0: Not connected	<a href="#">LP_CanOut4</a> : bOut1_B4
C00621/189	0: Not connected	<a href="#">LP_CanOut4</a> : bOut1_B5
C00621/190	0: Not connected	<a href="#">LP_CanOut4</a> : bOut1_B6
C00621/191	0: Not connected	<a href="#">LP_CanOut4</a> : bOut1_B7
C00621/192	0: Not connected	<a href="#">LP_CanOut4</a> : bOut1_B8
C00621/193	0: Not connected	<a href="#">LP_CanOut4</a> : bOut1_B9
C00621/194	0: Not connected	<a href="#">LP_CanOut4</a> : bOut1_B10
C00621/195	0: Not connected	<a href="#">LP_CanOut4</a> : bOut1_B11
C00621/196	0: Not connected	<a href="#">LP_CanOut4</a> : bOut1_B12
C00621/197	0: Not connected	<a href="#">LP_CanOut4</a> : bOut1_B13
C00621/198	0: Not connected	<a href="#">LP_CanOut4</a> : bOut1_B14
C00621/199	0: Not connected	<a href="#">LP_CanOut4</a> : bOut1_B15
<input checked="" type="checkbox"/> Read access <input checked="" type="checkbox"/> Write access <input type="checkbox"/> CINH <input type="checkbox"/> PLC STOP <input type="checkbox"/> No transfer <input type="checkbox"/> COM <input type="checkbox"/> MOT             Scaling factor: 1		

**C00622**

Parameter   Name: <b>C00622   System connection list: Angle</b>		Data type: UNSIGNED_16 Index: 23953 <sub>d</sub> = 5D91 <sub>h</sub>
Connection parameters: 32-bit inputs <ul style="list-style-type: none"> <li>• Selection of the 32-bit output signals for connection with the 32-bit input signals.</li> <li>• The selection list contains all 32-bit output signals which can be assigned to the 32-bit inputs mapped by the subcodes.</li> <li>• Non-listed subcodes are "reserved".</li> </ul>		
<b>Selection list</b>		
See <a href="#">selection list - angle signals</a>		
Subcodes	Lenze setting	Info
C00622/9	0: Not connected	<a href="#">LP_CanOut1</a> : dnOut34_p CAN1 output: Data words 3 + 4
C00622/10	0: Not connected	<a href="#">LP_CanOut2</a> : dnOut34_p CAN2 output: Data words 3 + 4

Parameter   Name: <b>C00622   System connection list: Angle</b>		Data type: UNSIGNED_16 Index: 23953 <sub>d</sub> = 5D91 <sub>h</sub>
C00622/11	0: Not connected	<a href="#">LP_CanOut3</a> : dnOut34_p CAN3 output: Data words 3 + 4
C00622/12	0: Not connected	<a href="#">LP_MciOut</a> : dnOut34_p MCI output: Data words 3 + 4
C00622/13	0: Not connected	<a href="#">LS_DigitalInput</a> : dnPosIn12_Set_p Frequency input DI1/DI2: Starting value for angle integrator
C00622/25	0: Not connected	<a href="#">LP_CanOut4</a> : dnOut34_p CAN4 output: Data words 3 + 4
<input checked="" type="checkbox"/> Read access <input checked="" type="checkbox"/> Write access <input type="checkbox"/> CINH <input type="checkbox"/> PLC STOP <input type="checkbox"/> No transfer <input type="checkbox"/> COM <input type="checkbox"/> MOT   Scaling factor: 1		

**C00632**

Parameter   Name: <b>C00632   L_NSet_1: Max.SkipFrq.</b>		Data type: INTEGER_16 Index: 23943 <sub>d</sub> = 5D87 <sub>h</sub>
Maximum limit values for the speed blocking zones • Selection of the maximum limit values for the blocking zones in which the speed must not be constant.		
<b>Setting range (min. value   unit   max. value)</b>		
0.00	%	199.99
<b>Subcodes</b>	<b>Lenze setting</b>	<b>Info</b>
C00632/1	0.00 %	<a href="#">L_NSet_1</a> : Blocking speed1 max
C00632/2	0.00 %	<a href="#">L_NSet_1</a> : Blocking speed2 max
C00632/3	0.00 %	<a href="#">L_NSet_1</a> : Blocking speed3 max
<input checked="" type="checkbox"/> Read access <input checked="" type="checkbox"/> Write access <input type="checkbox"/> CINH <input type="checkbox"/> PLC STOP <input type="checkbox"/> No transfer <input type="checkbox"/> COM <input type="checkbox"/> MOT   Scaling factor: 100		

**C00633**

Parameter   Name: <b>C00633   L_NSet_1: Min.SkipFrq.</b>		Data type: INTEGER_16 Index: 23942 <sub>d</sub> = 5D86 <sub>h</sub>
Minimum limit values for the speed blocking zones • Selection of the minimum limit values for the blocking zones in which the speed must not be constant.		
<b>Setting range (min. value   unit   max. value)</b>		
0.00	%	199.99
<b>Subcodes</b>	<b>Lenze setting</b>	<b>Info</b>
C00633/1	0.00 %	<a href="#">L_NSet_1</a> : Blocking speed1 min
C00633/2	0.00 %	<a href="#">L_NSet_1</a> : Blocking speed2 min
C00633/3	0.00 %	<a href="#">L_NSet_1</a> : Blocking speed3 min
<input checked="" type="checkbox"/> Read access <input checked="" type="checkbox"/> Write access <input type="checkbox"/> CINH <input type="checkbox"/> PLC STOP <input type="checkbox"/> No transfer <input type="checkbox"/> COM <input type="checkbox"/> MOT   Scaling factor: 100		

**C00634**

Parameter   Name: <b>C00634   L_NSet_1: wState</b>		Data type: UNSIGNED_16 Index: 23941 <sub>d</sub> = 5D85 <sub>h</sub>
The <a href="#">L_NSet_1</a> FB: Bit coded status display		
<b>Display area (min. hex value   max. hex value)</b>		
0x0000		0xFFFF
<b>Value is bit-coded:</b>		<b>Info</b>
Bit 0	No blocking zone active	1 ≙ No blocking zone set for constant speeds

Parameter   Name: <b>C00634   L_NSet_1: wState</b>		Data type: UNSIGNED_16 Index: 23941 <sub>d</sub> = 5D85 <sub>h</sub>
Bit 1	Blocking zone 1 active	1 ≙ Suppression of constant speed characteristics within the limits of blocking zone 1
Bit 2	Blocking zone 2 active	1 ≙ Suppression of constant speed characteristics within the limits of blocking zone 2
Bit 3	Blocking zone 3 active	1 ≙ Suppression of constant speed characteristics within the limits of blocking zone 3
Bit 4	Jog in blocking zone	1 ≙ A ramp is used to keep the speed setpoint within a speed blocking zone
Bit 5	MaxLimit active	1 ≙ Speed setpoint is at the maximum speed limit
Bit 6	MinLimit active	1 ≙ Speed setpoint is at the minimum speed limit
Bit 7	Reserved	
Bit 8	Reserved	
Bit 9	Reserved	
Bit 10	Reserved	
Bit 11	Reserved	
Bit 12	Reserved	
Bit 13	Reserved	
Bit 14	Reserved	
Bit 15	Reserved	
<input checked="" type="checkbox"/> Read access <input type="checkbox"/> Write access <input type="checkbox"/> CINH <input type="checkbox"/> PLC STOP <input checked="" type="checkbox"/> No transfer <input type="checkbox"/> COM <input type="checkbox"/> MOT		

**C00635**

Parameter   Name: <b>C00635   L_NSet_1: nMaxLimit</b>		Data type: INTEGER_16 Index: 23940 <sub>d</sub> = 5D84 <sub>h</sub>
The <a href="#">L_NSet_1</a> FB: Maximum speed setpoint for speed setpoint limitation		
Setting range (min. value   unit   max. value)		Lenze setting
-199.99	%	199.99 <b>199.99 %</b>
<input checked="" type="checkbox"/> Read access <input checked="" type="checkbox"/> Write access <input type="checkbox"/> CINH <input type="checkbox"/> PLC STOP <input type="checkbox"/> No transfer <input type="checkbox"/> COM <input type="checkbox"/> MOT             Scaling factor: 100		

**C00636**

Parameter   Name: <b>C00636   L_NSet_1: nMinLimit</b>		Data type: INTEGER_16 Index: 23939 <sub>d</sub> = 5D83 <sub>h</sub>
The <a href="#">L_NSet_1</a> FB: Minimum speed setpoint for speed setpoint limitation		
Setting range (min. value   unit   max. value)		Lenze setting
-199.99	%	199.99 <b>-199.99 %</b>
<input checked="" type="checkbox"/> Read access <input checked="" type="checkbox"/> Write access <input type="checkbox"/> CINH <input type="checkbox"/> PLC STOP <input type="checkbox"/> No transfer <input type="checkbox"/> COM <input type="checkbox"/> MOT             Scaling factor: 100		

**C00637**

Parameter   Name: <b>C00637   L_NSet_1: Output blocking zones</b>		Data type: INTEGER_16 Index: 23938 <sub>d</sub> = 5D82 <sub>h</sub>
The <a href="#">L_NSet_1</a> FB: Speed setpoint is displayed after being processed by blocking zone function		
Display range (min. value   unit   max. value)		
-199.99	%	199.99
<input checked="" type="checkbox"/> Read access <input type="checkbox"/> Write access <input type="checkbox"/> CINH <input type="checkbox"/> PLC STOP <input checked="" type="checkbox"/> No transfer <input type="checkbox"/> COM <input type="checkbox"/> MOT             Scaling factor: 100		

C00638

Parameter   Name: <b>C00638   L_NSet_1: Output ramp rounding</b>		Data type: INTEGER_16 Index: 23937 <sub>d</sub> = 5D81 <sub>h</sub>
The <a href="#">L_NSet_1</a> FB: Speed setpoint is displayed after being processed by PT1 filter function		
<b>Display range (min. value   unit   max. value)</b>		
-199.99	%	199.99
<input checked="" type="checkbox"/> Read access <input type="checkbox"/> Write access <input type="checkbox"/> CINH <input type="checkbox"/> PLC STOP <input checked="" type="checkbox"/> No transfer <input type="checkbox"/> COM <input type="checkbox"/> MOT                   Scaling factor: 100		

C00639

Parameter   Name: <b>C00639   L_NSet_1: Output additional value</b>		Data type: INTEGER_16 Index: 23936 <sub>d</sub> = 5D80 <sub>h</sub>
The <a href="#">L_NSet_1</a> FB: Additional speed setpoint is displayed after being processed by the ramp generator		
<b>Display range (min. value   unit   max. value)</b>		
-199.99	%	199.99
<input checked="" type="checkbox"/> Read access <input type="checkbox"/> Write access <input type="checkbox"/> CINH <input type="checkbox"/> PLC STOP <input type="checkbox"/> No transfer <input type="checkbox"/> COM <input type="checkbox"/> MOT                   Scaling factor: 100		

C00640

Parameter   Name: <b>C00640   L_NSet_1: nNOut_a</b>		Data type: INTEGER_16 Index: 23935 <sub>d</sub> = 5D7F <sub>h</sub>
The <a href="#">L_NSet_1</a> FB: Display of the generated main speed setpoint at the output <i>nNOut_a</i>		
<b>Display range (min. value   unit   max. value)</b>		
-199.99	%	199.99
<input checked="" type="checkbox"/> Read access <input type="checkbox"/> Write access <input type="checkbox"/> CINH <input type="checkbox"/> PLC STOP <input checked="" type="checkbox"/> No transfer <input type="checkbox"/> COM <input type="checkbox"/> MOT                   Scaling factor: 100		

C00643

Parameter   Name: <b>C00643   Resp. to PLI monitoring</b>		Data type: UNSIGNED_8 Index: 23932 <sub>d</sub> = 5D7C <sub>h</sub>
From version 11.00.00		<a href="#">► Pole position identification without movement</a>
<b>Selection list</b>		
0	No Reaction	
1	Fault	
3	TroubleQuickStop	
4	WarningLocked	
5	Warning	
6	Information	
<b>Subcodes</b>	<b>Lenze setting</b>	<b>Info</b>
C00643/1	1: Fault	Response to PLI monitoring
<input checked="" type="checkbox"/> Read access <input checked="" type="checkbox"/> Write access <input type="checkbox"/> CINH <input type="checkbox"/> PLC STOP <input type="checkbox"/> No transfer <input type="checkbox"/> COM <input checked="" type="checkbox"/> MOT                   Scaling factor: 1		

## C00653

Parameter   Name: <b>C00653   Sensibility - Setpoint feedforward control</b>		Data type: UNSIGNED_8 Index: 23922 <sub>d</sub> = 5D72 <sub>h</sub>
From version 12.00.00		
Selection of the sensitivity of the differential setpoint feedforward control		
<ul style="list-style-type: none"> <li>Depending on the selection, the number of indicated higher-order bits is evaluated.</li> </ul>		
<b>Note:</b>		
The most significant bit determines the sign of the value, the remaining bits determine the numerical value.		
Selection list		Info
0	Inactive	
1	15 bits	Bit 0 ... bit 14 are evaluated
2	14 Bit	Bit 0 ... bit 13 are evaluated
3	13 bits	Bit 0 ... bit 12 are evaluated
4	12 bits	Bit 0 ... bit 11 are evaluated
5	11 Bit	Bit 0 ... bit 10 are evaluated
6	10 Bit	Bit 0 ... bit 9 are evaluated
7	9 Bit	Bit 0 ... bit 8 are evaluated
Subcodes	Lenze setting	Info
C00653/1	0: Inactive	Sensibility - Setpoint feedforward control
<input checked="" type="checkbox"/> Read access <input checked="" type="checkbox"/> Write access <input type="checkbox"/> CINH <input type="checkbox"/> PLC STOP <input type="checkbox"/> No transfer <input type="checkbox"/> COM <input checked="" type="checkbox"/> MOT   Scaling factor: 1		

## C00654

Parameter   Name: <b>C00654   Source of diff. setpoint feedforward control</b>		Data type: UNSIGNED_8 Index: 23921 <sub>d</sub> = 5D71 <sub>h</sub>
Selection list		Info
0	nSpeedSetValue_a	
1	nSpeedSetValueInertia_a	
2	nSpeedSetValue_a exact	
3	nSpeedSetValue_a V14.0	
Subcodes	Lenze setting	Info
C00654/1	0: nSpeedSetValue_a	Source of diff. setpoint feedforward control
<input checked="" type="checkbox"/> Read access <input checked="" type="checkbox"/> Write access <input type="checkbox"/> CINH <input type="checkbox"/> PLC STOP <input type="checkbox"/> No transfer <input type="checkbox"/> COM <input checked="" type="checkbox"/> MOT   Scaling factor: 1		

## C00670

Parameter   Name: <b>C00670   L_OffsetGainP_1: Gain</b>		Data type: INTEGER_32 Index: 23905 <sub>d</sub> = 5D61 <sub>h</sub>
The <u>L_OffsetGainP_1</u> FB: Gain as multiplier of the input signal + offset		
Setting range (min. value   unit   max. value)		Lenze setting
-100.0000		100.0000 <b>1.0000</b>
<input checked="" type="checkbox"/> Read access <input checked="" type="checkbox"/> Write access <input type="checkbox"/> CINH <input type="checkbox"/> PLC STOP <input type="checkbox"/> No transfer <input type="checkbox"/> COM <input type="checkbox"/> MOT   Scaling factor: 10000		

## C00671

Parameter   Name: <b>C00671   L_OffsetGainP_2: Gain</b>		Data type: INTEGER_32 Index: 23904 <sub>d</sub> = 5D60 <sub>h</sub>	
The <a href="#">L_OffsetGainP_2</a> FB: Gain as multiplier of the input signal + offset			
Setting range (min. value   unit   max. value)		Lenze setting	
-100.0000		100.0000	<b>1.0000</b>
<input checked="" type="checkbox"/> Read access <input checked="" type="checkbox"/> Write access <input type="checkbox"/> CINH <input type="checkbox"/> PLC STOP <input type="checkbox"/> No transfer <input type="checkbox"/> COM <input type="checkbox"/> MOT Scaling factor: 10000			

## C00672

Parameter   Name: <b>C00672   L_OffsetGainP_3: Gain</b>		Data type: INTEGER_32 Index: 23903 <sub>d</sub> = 5D5F <sub>h</sub>	
The <a href="#">L_OffsetGainP_3</a> FB: Gain as multiplier of the input signal + offset			
Setting range (min. value   unit   max. value)		Lenze setting	
-100.0000		100.0000	<b>1.0000</b>
<input checked="" type="checkbox"/> Read access <input checked="" type="checkbox"/> Write access <input type="checkbox"/> CINH <input type="checkbox"/> PLC STOP <input type="checkbox"/> No transfer <input type="checkbox"/> COM <input type="checkbox"/> MOT Scaling factor: 10000			

## C00680

Parameter   Name: <b>C00680   L_Compare_1: Fct.</b>		Data type: UNSIGNED_8 Index: 23895 <sub>d</sub> = 5D57 <sub>h</sub>	
The <a href="#">L_Compare_1</a> FB: Comparison operation			
• If the statement of the selected comparison operation is true, the binary <i>bOut</i> output will be set to TRUE.			
Selection list(Lenze setting printed in bold)			
1	In1 = In2		
2	In1 > In2		
3	In1 < In2		
4	In1  =  In2		
5	In1  >  In2		
6	In1  <  In2		
<input checked="" type="checkbox"/> Read access <input checked="" type="checkbox"/> Write access <input type="checkbox"/> CINH <input type="checkbox"/> PLC STOP <input type="checkbox"/> No transfer <input type="checkbox"/> COM <input type="checkbox"/> MOT Scaling factor: 1			

## C00681

Parameter   Name: <b>C00681   L_Compare_1: Hysteresis</b>		Data type: INTEGER_16 Index: 23894 <sub>d</sub> = 5D56 <sub>h</sub>	
The <a href="#">L_Compare_1</a> FB: Hysteresis for the comparison function selected in <a href="#">C00680</a>			
Setting range (min. value   unit   max. value)		Lenze setting	
0.00	%	100.00	<b>0.50 %</b>
<input checked="" type="checkbox"/> Read access <input checked="" type="checkbox"/> Write access <input type="checkbox"/> CINH <input type="checkbox"/> PLC STOP <input type="checkbox"/> No transfer <input type="checkbox"/> COM <input type="checkbox"/> MOT Scaling factor: 100			

## C00682

Parameter   Name: <b>C00682   L_Compare_1: Window</b>		Data type: INTEGER_16 Index: 23893 <sub>d</sub> = 5D55 <sub>h</sub>	
The <a href="#">L_Compare_1</a> FB: Window for the comparison function selected in <a href="#">C00680</a>			
Setting range (min. value   unit   max. value)		Lenze setting	
0.00	%	100.00	<b>2.00 %</b>
<input checked="" type="checkbox"/> Read access <input checked="" type="checkbox"/> Write access <input type="checkbox"/> CINH <input type="checkbox"/> PLC STOP <input type="checkbox"/> No transfer <input type="checkbox"/> COM <input type="checkbox"/> MOT Scaling factor: 100			

## C00685

Parameter   Name: <b>C00685   L_Compare_2: Fct.</b>		Data type: UNSIGNED_8 Index: 23890 <sub>d</sub> = 5D52 <sub>h</sub>
The <a href="#">L_Compare_2</a> FB: Comparison operation		
• If the statement of the selected comparison operation is true, the binary <i>bOut</i> output will be set to TRUE.		
Selection list(Lenze setting printed in bold)		
1	In1 = In2	
2	In1 > In2	
3	In1 < In2	
4	<b> In1  =  In2 </b>	
5	In1  >  In2	
6	In1  <  In2	
<input checked="" type="checkbox"/> Read access <input checked="" type="checkbox"/> Write access <input type="checkbox"/> CINH <input type="checkbox"/> PLC STOP <input type="checkbox"/> No transfer <input type="checkbox"/> COM <input type="checkbox"/> MOT		Scaling factor: 1

## C00686

Parameter   Name: <b>C00686   L_Compare_2: Hysteresis</b>		Data type: INTEGER_16 Index: 23889 <sub>d</sub> = 5D51 <sub>h</sub>
The <a href="#">L_Compare_2</a> FB: Hysteresis for the comparison function selected in <a href="#">C00685</a>		
Setting range (min. value   unit   max. value)		Lenze setting
0.00	%	100.00 <b>0.50 %</b>
<input checked="" type="checkbox"/> Read access <input checked="" type="checkbox"/> Write access <input type="checkbox"/> CINH <input type="checkbox"/> PLC STOP <input type="checkbox"/> No transfer <input type="checkbox"/> COM <input type="checkbox"/> MOT		Scaling factor: 100

## C00687

Parameter   Name: <b>C00687   L_Compare_2: Window</b>		Data type: INTEGER_16 Index: 23888 <sub>d</sub> = 5D50 <sub>h</sub>
The <a href="#">L_Compare_2</a> FB: Window for the comparison function selected in <a href="#">C00685</a>		
Setting range (min. value   unit   max. value)		Lenze setting
0.00	%	100.00 <b>2.00 %</b>
<input checked="" type="checkbox"/> Read access <input checked="" type="checkbox"/> Write access <input type="checkbox"/> CINH <input type="checkbox"/> PLC STOP <input type="checkbox"/> No transfer <input type="checkbox"/> COM <input type="checkbox"/> MOT		Scaling factor: 100

## C00690

Parameter   Name: <b>C00690   L_Compare_3: Function</b>		Data type: UNSIGNED_8 Index: 23885 <sub>d</sub> = 5D4D <sub>h</sub>
From version 11.00.00		
The <a href="#">L_Compare_3</a> FB: Comparison operation		
• If the statement of the selected comparison operation is true, the binary <i>bOut</i> output will be set to TRUE.		
Selection list(Lenze setting printed in bold)		
1	<b>In1 = In2</b>	
2	In1 > In2	
3	In1 < In2	
4	In1  =  In2	
5	In1  >  In2	
6	In1  <  In2	
<input checked="" type="checkbox"/> Read access <input checked="" type="checkbox"/> Write access <input type="checkbox"/> CINH <input type="checkbox"/> PLC STOP <input type="checkbox"/> No transfer <input type="checkbox"/> COM <input type="checkbox"/> MOT		Scaling factor: 1

## C00691

Parameter   Name: <b>C00691   L_Compare_3: Hysteresis</b>			Data type: INTEGER_16 Index: 23884 <sub>d</sub> = 5D4C <sub>h</sub>
From version 11.00.00 FB <a href="#">L_Compare_3</a> : Hysteresis for the comparison operation selected in <a href="#">C00690</a>			
<b>Setting range (min. value   unit   max. value)</b>			<b>Lenze setting</b>
0.00	%	100.00	<b>0.00 %</b>
<input checked="" type="checkbox"/> Read access <input checked="" type="checkbox"/> Write access <input type="checkbox"/> CINH <input type="checkbox"/> PLC STOP <input type="checkbox"/> No transfer <input type="checkbox"/> COM <input type="checkbox"/> MOT Scaling factor: 100			

## C00692

Parameter   Name: <b>C00692   L_Compare_3: Window</b>			Data type: INTEGER_16 Index: 23883 <sub>d</sub> = 5D4B <sub>h</sub>
From version 11.00.00 FB <a href="#">L_Compare_3</a> : window for the comparison operation selected in <a href="#">C00690</a>			
<b>Setting range (min. value   unit   max. value)</b>			<b>Lenze setting</b>
0.00	%	100.00	<b>0.00 %</b>
<input checked="" type="checkbox"/> Read access <input checked="" type="checkbox"/> Write access <input type="checkbox"/> CINH <input type="checkbox"/> PLC STOP <input type="checkbox"/> No transfer <input type="checkbox"/> COM <input type="checkbox"/> MOT Scaling factor: 100			

## C00696

Parameter   Name: <b>C00696   L_OffsetGainP_1: Offset</b>			Data type: INTEGER_16 Index: 23879 <sub>d</sub> = 5D47 <sub>h</sub>
The <a href="#">L_OffsetGainP_1</a> FB: Offset (additive to the input signal)			
<b>Setting range (min. value   unit   max. value)</b>			<b>Lenze setting</b>
-199.99	%	199.99	<b>0.00 %</b>
<input checked="" type="checkbox"/> Read access <input checked="" type="checkbox"/> Write access <input type="checkbox"/> CINH <input type="checkbox"/> PLC STOP <input type="checkbox"/> No transfer <input type="checkbox"/> COM <input type="checkbox"/> MOT Scaling factor: 100			

## C00697

Parameter   Name: <b>C00697   L_OffsetGainP_2: Offset</b>			Data type: INTEGER_16 Index: 23878 <sub>d</sub> = 5D46 <sub>h</sub>
The <a href="#">L_OffsetGainP_2</a> FB: Offset (additive to the input signal)			
<b>Setting range (min. value   unit   max. value)</b>			<b>Lenze setting</b>
-199.99	%	199.99	<b>0.00 %</b>
<input checked="" type="checkbox"/> Read access <input checked="" type="checkbox"/> Write access <input type="checkbox"/> CINH <input type="checkbox"/> PLC STOP <input type="checkbox"/> No transfer <input type="checkbox"/> COM <input type="checkbox"/> MOT Scaling factor: 100			

## C00698

Parameter   Name: <b>C00698   L_OffsetGainP_3: Offset</b>			Data type: INTEGER_16 Index: 23877 <sub>d</sub> = 5D45 <sub>h</sub>
The <a href="#">L_OffsetGainP_3</a> FB: Offset (additive to the input signal)			
<b>Setting range (min. value   unit   max. value)</b>			<b>Lenze setting</b>
-199.99	%	199.99	<b>0.00 %</b>
<input checked="" type="checkbox"/> Read access <input checked="" type="checkbox"/> Write access <input type="checkbox"/> CINH <input type="checkbox"/> PLC STOP <input type="checkbox"/> No transfer <input type="checkbox"/> COM <input type="checkbox"/> MOT Scaling factor: 100			



## C00699

Parameter   Name: <b>C00699   L_MulDiv_1: Parameter</b>		Data type: INTEGER_16 Index: 23876 <sub>d</sub> = 5D44 <sub>h</sub>
The <a href="#">L_MulDiv_1</a> FB: Numerator and denominator		
<b>Setting range</b> (min. value   unit   max. value)		
-32767		32767
<b>Subcodes</b>	<b>Lenze setting</b>	<b>Info</b>
C00699/1	0	<a href="#">L_MulDiv_1</a> : Numerator
C00699/2	10000	<a href="#">L_MulDiv_1</a> : Denominator
<input checked="" type="checkbox"/> Read access <input checked="" type="checkbox"/> Write access <input type="checkbox"/> CINH <input type="checkbox"/> PLC STOP <input type="checkbox"/> No transfer <input type="checkbox"/> COM <input type="checkbox"/> MOT   Scaling factor: 1		

## C00700

Parameter   Name: <b>C00700   LA_NCtrl: Analog connection list</b>		Data type: UNSIGNED_16 Index: 23876 <sub>d</sub> = 5D43 <sub>h</sub>
Connection parameters for "Actuating drive speed" application: 16-bit inputs <ul style="list-style-type: none"> <li>• Selection of the 16 bit output signals to be connected to the 16 bit input signals</li> <li>• The selection list contains all 16 bit output signals which can be assigned to the 16 bit inputs displayed by the subcodes.</li> </ul>		
<b>Selection list</b>		
See <a href="#">selection list - analog signals</a>		
<b>Subcodes</b>	<b>Lenze setting</b>	<b>Info</b>
C00700/1	20005: LS_ParFix: wDriveCtrl	<a href="#">LA_NCtrl</a> : wCANDriveControl Input for control word from CAN to device control
C00700/2	20005: LS_ParFix: wDriveCtrl	<a href="#">LA_NCtrl</a> : wMCIDriveControl Input for control word from communication interface to device control
C00700/3	20012: LS_ParFree_a: nC472_3_a	<a href="#">LA_NCtrl</a> : nTorqueMotLim_a Input for maximum torque in motor mode
C00700/4	20013: LS_ParFree_a: nC472_4_a	<a href="#">LA_NCtrl</a> : nTorqueGenLim_a Input for maximum torque in generator mode
C00700/5	0: Not connected	<a href="#">LA_NCtrl</a> : nPIDVpAdapt_a Input for adapting the PID controller gain
C00700/6	0: Not connected	<a href="#">LA_NCtrl</a> : nPIDActValue_a Input for actual PID controller value
C00700/7	16000: LS_AnalogInput: nIn1_a	<a href="#">LA_NCtrl</a> : nMainSetValue_a Input for main speed setpoint
C00700/8	0: Not connected	<a href="#">LA_NCtrl</a> : nAuxSetValue_a Input for additional speed setpoint
C00700/9	0: Not connected	<a href="#">LA_NCtrl</a> : nGPAnalogSwitchIn1_a Input for analog switch - analog signal 1
C00700/10	0: Not connected	<a href="#">LA_NCtrl</a> : nGPAnalogSwitchIn2_a Input for analog switch - analog signal 2
C00700/11	0: Not connected	<a href="#">LA_NCtrl</a> : nGPArithmetikIn1_a Input for arithmetic function - analog signal 1
C00700/12	0: Not connected	<a href="#">LA_NCtrl</a> : nGPArithmetikIn2_a Input for arithmetic function - analog signal 2
C00700/13	0: Not connected	<a href="#">LA_NCtrl</a> : nGPMulDivIn_a Input for analog signal for multiplication/division
C00700/14	0: Not connected	<a href="#">LA_NCtrl</a> : nGPCompareIn1_a Input for comparison operation - analog signal 1

Parameter   Name: C00700   LA_NCtrl: Analog connection list		Data type: UNSIGNED_16 Index: 23875 <sub>d</sub> = 5D43 <sub>h</sub>
C00700/15	0: Not connected	<a href="#">LA_NCtrl: nGPCompareIn2_a</a> Input for comparison operation - analog signal 2
C00700/16	0: Not connected	<a href="#">LA_NCtrl: nVoltageAdd_a</a> Input for additive voltage boost
C00700/17	0: Not connected	<a href="#">LA_NCtrl: nPIDInfluence_a</a> Input for influence signal of PID controller correcting variable
C00700/18	0: Not connected	<a href="#">LA_NCtrl: nPIDSetValue_a</a> Input for PID controller setpoint
C00700/19	0: Not connected	<a href="#">LA_NCtrl: nPWMAngleOffset</a> Input for pulse width modulation phase offset
C00700/20	0: Not connected	<a href="#">LA_NCtrl: nBoost_a</a> Input for additional setpoint for motor voltage at speed = 0
C00700/21	0: Not connected	<a href="#">LA_NCtrl: wSMCtrl</a> Interface to the optional safety system
C00700/22	0: Not connected	Reserved
C00700/23	0: Not connected	Reserved
C00700/24	0: Not connected	Reserved
C00700/25	0: Not connected	Reserved
C00700/26	0: Not connected	<a href="#">LA_NCtrl: wFreeIn1</a> Input for user signal 1
C00700/27	0: Not connected	<a href="#">LA_NCtrl: wFreeIn2</a> Input for user signal 2
C00700/28	0: Not connected	<a href="#">LA_NCtrl: wFreeIn3</a> Input for user signal 3
C00700/29	0: Not connected	<a href="#">LA_NCtrl: wFreeIn4</a> Input for user signal 4
<input checked="" type="checkbox"/> Read access <input checked="" type="checkbox"/> Write access <input type="checkbox"/> CINH <input type="checkbox"/> PLC STOP <input type="checkbox"/> No transfer <input type="checkbox"/> COM <input type="checkbox"/> MOT   Scaling factor: 1		

## C00701

Parameter   Name: C00701   LA_NCtrl: Digital connection list		Data type: UNSIGNED_16 Index: 23874 <sub>d</sub> = 5D42 <sub>h</sub>
Connection parameters for "Actuating drive speed" application: Binary inputs <ul style="list-style-type: none"> <li>• Selection of the binary output signals to be connected to the binary input signals</li> <li>• The selection list contains all binary output signals which can be assigned to the binary inputs mapped by the subcodes.</li> </ul>		
<b>Selection list</b>		
See <a href="#">selection list - digital signals</a>		
Subcodes	Lenze setting	Info
C00701/1	0: Not connected	<a href="#">LA_NCtrl: bCInh</a> Control input for setting controller inhibit
C00701/2	16008: LS_DigitalInput: bCInh	<a href="#">LA_NCtrl: bFailReset</a> Control input for error acknowledgement
C00701/3	0: Not connected	<a href="#">LA_NCtrl: bSetQuickstop</a> Control input for quick stop request
C00701/4	16002: LS_DigitalInput: bIn3	<a href="#">LA_NCtrl: bSetDCBrake</a> Control input for DC-injection braking request

Parameter   Name: C00701   LA_NCtrl: Digital connection list		Data type: UNSIGNED_16 Index: 23874 <sub>d</sub> = 5D42 <sub>h</sub>
C00701/5	0: Not connected	<a href="#">LA_NCtrl: bRFG_Stop</a> Control input for stopping the speed ramp function generator
C00701/6	0: Not connected	<a href="#">LA_NCtrl: bRFG_0</a> Control input for setting the speed ramp function generator to 0
C00701/7	0: Not connected	Reserved
C00701/8	16003: LS_DigitalInput: bIn4	<a href="#">LA_NCtrl: bSetSpeedCcw</a> Control input for change of direction of rotation
C00701/9	16000: LS_DigitalInput: bIn1	<a href="#">LA_NCtrl: bJogSpeed1</a> Selection input for fixed setpoints
C00701/10	16001: LS_DigitalInput: bIn2	<a href="#">LA_NCtrl: bJogSpeed2</a> Selection input for fixed setpoints
C00701/11	0: Not connected	<a href="#">LA_NCtrl: bJogSpeed4</a> Selection input for fixed setpoints
C00701/12	0: Not connected	<a href="#">LA_NCtrl: bJogSpeed8</a> Selection input for fixed setpoints
C00701/13	0: Not connected	<a href="#">LA_NCtrl: bJogRamp1</a> Selection input for additional acceleration/deceleration times
C00701/14	0: Not connected	<a href="#">LA_NCtrl: bJogRamp2</a> Selection input for additional acceleration/deceleration times
C00701/15	0: Not connected	<a href="#">LA_NCtrl: bJogRamp4</a> Selection input for additional acceleration/deceleration times
C00701/16	0: Not connected	<a href="#">LA_NCtrl: bJogRamp8</a> Selection input for additional acceleration/deceleration times
C00701/17	0: Not connected	<a href="#">LA_NCtrl: bMPOTInAct</a> Control input for deactivation of motor potentiometer
C00701/18	0: Not connected	<a href="#">LA_NCtrl: bMPOTUp</a> Control input for motor potentiometer ramp-up
C00701/19	0: Not connected	<a href="#">LA_NCtrl: bMPOTDown</a> Control input for motor potentiometer ramp-down
C00701/20	0: Not connected	<a href="#">LA_NCtrl: bMBRKRelease</a> Control input for manual holding brake release request
C00701/21	0: Not connected	<a href="#">LA_NCtrl: bGPFree1</a> Input for binary user signal
C00701/22	0: Not connected	<a href="#">LA_NCtrl: bGPFree2</a> Input for binary user signal
C00701/23	0: Not connected	<a href="#">LA_NCtrl: bGPAnalogSwitchSet</a> Control input for analog-value selector change-over
C00701/24	0: Not connected	<a href="#">LA_NCtrl: bGPDigitalDelayIn</a> Input for digital signal with time delay
C00701/25	0: Not connected	<a href="#">LA_NCtrl: bGPLogicIn1</a> Input signal 1 for digital logic
C00701/26	0: Not connected	<a href="#">LA_NCtrl: bGPLogicIn2</a> Input signal 2 for digital logic
C00701/27	0: Not connected	<a href="#">LA_NCtrl: bGPLogicIn3</a> Input signal 3 for digital logic

Parameter   Name: <b>C00701   LA_NCtrl: Digital connection list</b>		Data type: UNSIGNED_16 Index: 23874 <sub>d</sub> = 5D42 <sub>h</sub>
C00701/28	0: Not connected	<a href="#">LA_NCtrl: bGPDFlipFlopInD</a> Control input for DFlipFlop setting signal
C00701/29	0: Not connected	<a href="#">LA_NCtrl: bGPDFlipFlopInClk</a> Control input for DFlipFlop clock signal
C00701/30	0: Not connected	<a href="#">LA_NCtrl: bGPDFlipFlopInClr</a> Control input for DFlipFlop reset signal
C00701/31	0: Not connected	<a href="#">LA_NCtrl: bMPotEnable</a> Control input for activation of motor potentiometer
C00701/32	0: Not connected	<a href="#">LA_NCtrl: bPIDEnableInfluenceRamp</a> Control input for activation of influence of output correcting variable of PID controller
C00701/33	0: Not connected	<a href="#">LA_NCtrl: bPIDIOff</a> Control input for deactivation of PID controller I component
C00701/34	20000: LS_ParFix: bTrue	<a href="#">LA_NCtrl: bRLQCw</a> Control input for activation of CW direction of rotation of speed setpoint
C00701/35	0: Not connected	<a href="#">LA_NCtrl: bRLQCcw</a> Control input for activation of CCW direction of rotation of speed setpoint
C00701/36	0: Not connected	Reserved
C00701/37	0: Not connected	Reserved
C00701/38	0: Not connected	Reserved
C00701/39	0: Not connected	Reserved
C00701/40	0: Not connected	Reserved
C00701/41	0: Not connected	<a href="#">LA_NCtrl: bFreeIn1</a> Input for binary user signal 1
C00701/42	0: Not connected	<a href="#">LA_NCtrl: bFreeIn2</a> Input for binary user signal 2
C00701/43	0: Not connected	<a href="#">LA_NCtrl: bFreeIn3</a> Input for binary user signal 3
C00701/44	0: Not connected	<a href="#">LA_NCtrl: bFreeIn4</a> Input for binary user signal 4
C00701/45	0: Not connected	<a href="#">LA_NCtrl: bFreeIn5</a> Input for binary user signal 5
C00701/46	0: Not connected	<a href="#">LA_NCtrl: bFreeIn6</a> Input for binary user signal 6
C00701/47	0: Not connected	<a href="#">LA_NCtrl: bFreeIn7</a> Input for binary user signal 7
C00701/48	0: Not connected	<a href="#">LA_NCtrl: bFreeIn8</a> Input for binary user signal 8
<input checked="" type="checkbox"/> Read access <input checked="" type="checkbox"/> Write access <input type="checkbox"/> CINH <input type="checkbox"/> PLC STOP <input type="checkbox"/> No transfer <input type="checkbox"/> COM <input type="checkbox"/> MOT   Scaling factor: 1		

**C00705**

Parameter   Name: <b>C00705   LA_NCtrl_Out: Analog signal list</b>		Data type: UNSIGNED_16 Index: 23870 <sub>d</sub> = 5D3E <sub>h</sub>
<b>This code is used device-internally and must not be written by the user side!</b>		

## C00706

Parameter   Name: <b>C00706   LA_NCtrl_Out digital signal list</b>	Data type: UNSIGNED_16 Index: 23869 <sub>d</sub> = 5D3D <sub>h</sub>
<b>This code is used device-internally and must not be written by the user side!</b>	

## C00720

Parameter   Name: <b>C00720   L_DigitalDelay_1: Delay</b>	Data type: UNSIGNED_32 Index: 23855 <sub>d</sub> = 5D2F <sub>h</sub>
Switch-on/off delay time	
<b>Setting range (min. value   unit   max. value)</b>	
0.000	s      3600.000
<b>Subcodes</b>	<b>Lenze setting</b> <b>Info</b>
C00720/1	0.000 s <a href="#">L_DigitalDelay_1</a> : ON delay
C00720/2	0.000 s <a href="#">L_DigitalDelay_1</a> : OFF delay
<input checked="" type="checkbox"/> Read access <input checked="" type="checkbox"/> Write access <input type="checkbox"/> CINH <input type="checkbox"/> PLC STOP <input type="checkbox"/> No transfer <input type="checkbox"/> COM <input type="checkbox"/> MOT   Scaling factor: 1000	

## C00725

Parameter   Name: <b>C00725   Current switching frequency</b>	Data type: UNSIGNED_8 Index: 23850 <sub>d</sub> = 5D2A <sub>h</sub>
Display of the current switching frequency <ul style="list-style-type: none"> <li>• In <a href="#">C00018</a> you can choose between a drive-optimised setting for good smooth-running characteristics and an inverter loss-optimised setting (min. Pv).</li> <li>• Both possibilities offer fixed and variable switching frequencies.</li> <li>• When a variable switching frequency is selected in <a href="#">C00018</a>, the switching frequency may change as a function of the load and rotational frequency.</li> </ul>	

Parameter   Name: <b>C00725   Current switching frequency</b>		Data type: UNSIGNED_8 Index: 23850 <sub>d</sub> = 5D2A <sub>h</sub>
<b>Selection list (read only)</b>		
1	4 kHz var./drive-optimised	
2	8 kHz var./drive-optimised	
3	16 kHz var./drive-optimised	
5	2 kHz constant/drive-optimised	
6	4 kHz constant/drive-optimised	
7	8 kHz constant/drive-optimised	
8	16 kHz constant/drive-optimised	
11	4 kHz var./min. Pv	
12	8 kHz var./min. Pv	
13	16 kHz var./min. Pv	
14	Reserved	
15	2 kHz constant/min. Pv	
16	4 kHz constant/min. Pv	
17	8 kHz constant/min. Pv	
18	16 kHz constant/min. Pv	
21	8 kHz var./drive-opt./4 kHz min	
22	16 kHz var./drive-opt./4 kHz min	
23	16 kHz var./drive-opt./8 kHz min	
31	8 kHz var./min. Pv/4 kHz min	
32	16 kHz var./min. Pv/4 kHz min	
33	16 kHz var./min. Pv/8 kHz min	
<input checked="" type="checkbox"/> Read access <input type="checkbox"/> Write access <input type="checkbox"/> CINH <input type="checkbox"/> PLC STOP <input checked="" type="checkbox"/> No transfer <input type="checkbox"/> COM <input type="checkbox"/> MOT                   Scaling factor: 1		

**C00726**

Parameter   Name: <b>C00726   Current limit values</b>		Data type: UNSIGNED_8 Index: 23849 <sub>d</sub> = 5D29 <sub>h</sub>
<b>This code is used device-internally and must not be written by the user side!</b>		

**C00727**

Parameter   Name: <b>C00727   LS_Keypad digital values</b>		Data type: UNSIGNED_8 Index: 23848 <sub>d</sub> = 5D28 <sub>h</sub>
Execution of control commands for keypad operation		
<b>Setting range (min. value   unit   max. value)</b>		
0		1
<b>Subcodes</b>	<b>Lenze setting</b>	<b>Info</b>
C00727/1	0	1 ≙ request quick stop
C00727/2	0	1 ≙ request DC-injection braking
C00727/3	0	1 ≙ request change of direction of rotation
C00727/4	0	1 ≙ request fixed speed setpoint 1

Parameter   Name:		Data type: UNSIGNED_8 Index: 23848 <sub>d</sub> = 5D28 <sub>h</sub>
<b>C00727   LS_Keypad digital values</b>		
C00727/5	0	1 ≙ request fixed speed setpoint 2
C00727/6	0	1 ≙ motor potentiometer: request activation
C00727/7	0	1 ≙ motor potentiometer: request pos. acceleration
C00727/8	0	1 ≙ motor potentiometer: request neg. acceleration
<input checked="" type="checkbox"/> Read access <input checked="" type="checkbox"/> Write access <input type="checkbox"/> CINH <input type="checkbox"/> PLC STOP <input type="checkbox"/> No transfer <input type="checkbox"/> COM <input type="checkbox"/> MOT             Scaling factor: 1		

**C00728**

Parameter   Name:		Data type: INTEGER_16 Index: 23847 <sub>d</sub> = 5D27 <sub>h</sub>
<b>C00728   Keypad analog values</b>		
Selection of different setpoints when operating via keypad		
Setting range (min. value   unit   max. value)		
-199.99	%	199.99
Subcodes	Lenze setting	Info
C00728/1	100.00 %	Torque limit in motor mode
C00728/2	100.00 %	Torque limit in generator mode
C00728/3	0.00 %	Setpoint speed • 100% ≙ <a href="#">C00011</a>
<input checked="" type="checkbox"/> Read access <input checked="" type="checkbox"/> Write access <input type="checkbox"/> CINH <input type="checkbox"/> PLC STOP <input type="checkbox"/> No transfer <input type="checkbox"/> COM <input type="checkbox"/> MOT             Scaling factor: 100		

**C00729**

Parameter   Name:		Data type: INTEGER_16 Index: 23846 <sub>d</sub> = 5D26 <sub>h</sub>
<b>C00729   Remote: Setpoint selection</b>		
Setting range (min. value   unit   max. value)		
-199.99		199.99
Subcodes	Lenze setting	Info
C00729/1	0.00	Remote: Setpoint keypad
C00729/2	0.00	Remote: Setpoint PC
<input checked="" type="checkbox"/> Read access <input checked="" type="checkbox"/> Write access <input type="checkbox"/> CINH <input type="checkbox"/> PLC STOP <input checked="" type="checkbox"/> No transfer <input type="checkbox"/> COM <input type="checkbox"/> MOT             Scaling factor: 100		

**C00730**

Parameter   Name:		Data type: UNSIGNED_32 Index: 23845 <sub>d</sub> = 5D25 <sub>h</sub>
<b>C00730   Oscilloscope scanning interval</b>		
<b>This code is used device-internally and must not be written by the user side!</b>		

**C00731**

Parameter   Name:		Data type: UNSIGNED_32 Index: 23844 <sub>d</sub> = 5D24 <sub>h</sub>
<b>C00731   Oscilloscope recording length</b>		
<b>This code is used device-internally and must not be written by the user side!</b>		

**C00732**

Parameter   Name:		Data type: UNSIGNED_8 Index: 23843 <sub>d</sub> = 5D23 <sub>h</sub>
<b>C00732   Oscilloscope command</b>		
<b>This code is used device-internally and must not be written by the user side!</b>		

## C00734

Parameter   Name:	Data type: UNSIGNED_16 Index: 23841 <sub>d</sub> = 5D21 <sub>h</sub>
<b>C00734   Oscilloscope trigger channel selection</b>	
<b>This code is used device-internally and must not be written by the user side!</b>	

## C00735

Parameter   Name:	Data type: UNSIGNED_8 Index: 23840 <sub>d</sub> = 5D20 <sub>h</sub>
<b>C00735   Oscilloscope channel source type</b>	
<b>This code is used device-internally and must not be written by the user side!</b>	

## C00736

Parameter   Name:	Data type: UNSIGNED_16 Index: 23839 <sub>d</sub> = 5D1F <sub>h</sub>
<b>C00736   Oscilloscope data type/data width</b>	
<b>This code is used device-internally and must not be written by the user side!</b>	

## C00740

Parameter   Name:	Data type: UNSIGNED_32 Index: 23835 <sub>d</sub> = 5D1B <sub>h</sub>
<b>C00740   Oscilloscope offset variables</b>	
<b>This code is used device-internally and must not be written by the user side!</b>	

## C00741

Parameter   Name:	Data type: UNSIGNED_8 Index: 23834 <sub>d</sub> = 5D1A <sub>h</sub>
<b>C00741   Oscilloscope trigger mode</b>	
<b>This code is used device-internally and must not be written by the user side!</b>	

## C00742

Parameter   Name:	Data type: INTEGER_16 Index: 23833 <sub>d</sub> = 5D19 <sub>h</sub>
<b>C00742   Oscilloscope trigger delay</b>	
<b>This code is used device-internally and must not be written by the user side!</b>	

## C00743

Parameter   Name:	Data type: UNSIGNED_32 Index: 23832 <sub>d</sub> = 5D18 <sub>h</sub>
<b>C00743   Oscilloscope trigger level</b>	
<b>This code is used device-internally and must not be written by the user side!</b>	

## C00744

Parameter   Name:	Data type: UNSIGNED_32 Index: 23831 <sub>d</sub> = 5D17 <sub>h</sub>
<b>C00744   Oscilloscope trigger mask</b>	
<b>This code is used device-internally and must not be written by the user side!</b>	

## C00746

Parameter   Name:	Data type: UNSIGNED_32 Index: 23829 <sub>d</sub> = 5D15 <sub>h</sub>
<b>C00746   Oscilloscope trigger counter</b>	
<b>This code is used device-internally and must not be written by the user side!</b>	



## C00747

Parameter   Name:	Data type: UNSIGNED_16 Index: 23828 <sub>d</sub> = 5D14 <sub>h</sub>
<b>C00747   Oscilloscope status word</b>	
<b>This code is used device-internally and must not be written by the user side!</b>	

## C00748

Parameter   Name:	Data type: UNSIGNED_32 Index: 23827 <sub>d</sub> = 5D13 <sub>h</sub>
<b>C00748   Oscilloscope no. of measured values</b>	
<b>This code is used device-internally and must not be written by the user side!</b>	

## C00749

Parameter   Name:	Data type: UNSIGNED_32 Index: 23826 <sub>d</sub> = 5D12 <sub>h</sub>
<b>C00749   Oscilloscope recording</b>	
<b>This code is used device-internally and must not be written by the user side!</b>	

## C00750

Parameter   Name:	Data type: UNSIGNED_8 Index: 23825 <sub>d</sub> = 5D11 <sub>h</sub>
<b>C00750   Select. of MCTRL oscillos. channels</b>	
<b>This code is used device-internally and must not be written by the user side!</b>	

## C00751

Parameter   Name:	Data type: UNSIGNED_32 Index: 23824 <sub>d</sub> = 5D10 <sub>h</sub>
<b>C00751   Oscilloscope data memory</b>	
<b>This code is used device-internally and must not be written by the user side!</b>	

## C00753

Parameter   Name:	Data type: OCTET_STRING Index: 23822 <sub>d</sub> = 5D0E <sub>h</sub>
<b>C00753   Oscilloscope data memory octet string</b>	
<b>This code is used device-internally and must not be written by the user side!</b>	

## C00759

Parameter   Name:	Data type: UNSIGNED_8 Index: 23816 <sub>d</sub> = 5D08 <sub>h</sub>
<b>C00759   Oscilloscope: start after mains power ON</b>	
<b>Selection list</b>	<b>Info</b>
0   No	Oscilloscope does not start automatically after switching on the device.
1   Yes	Oscilloscope starts automatically after switching on the device.

## C00760

Parameter   Name: C00760   LA_SwitchPos: Analog connection list		Data type: UNSIGNED_16 Index: 23815 <sub>d</sub> = 5D07 <sub>h</sub>
Connection parameters for "Switch-off positioning" application: 16-bit inputs <ul style="list-style-type: none"> <li>• Selection of the 16 bit output signals to be connected to the 16 bit input signals</li> <li>• The selection list contains all 16 bit output signals which can be assigned to the 16 bit inputs displayed by the subcodes.</li> </ul>		
<b>Selection list</b>		
See <a href="#">selection list - analog signals</a>		
Subcodes	Lenze setting	Info
C00760/1	0: Not connected	<a href="#">LA_SwitchPos</a> : wCANDriveControl Input for control word from CAN to device control
C00760/2	0: Not connected	<a href="#">LA_SwitchPos</a> : wMCIDriveControl Input for control word from communication interface to device control
C00760/3	0: Not connected	<a href="#">LA_SwitchPos</a> : nVoltageAdd_a Input for additive voltage impression
C00760/4	0: Not connected	<a href="#">LA_SwitchPos</a> : nBoost_a Input for additional setpoint for motor voltage at speed = 0
C00760/5	0: Not connected	<a href="#">LA_SwitchPos</a> : nPWMAngleOffset Input for additional offset for the electrical angle of rotation
C00760/6	0: Not connected	<a href="#">LA_SwitchPos</a> : nTorqueMotLim_a Input for maximum torque in motor mode
C00760/7	0: Not connected	<a href="#">LA_SwitchPos</a> : nTorqueGenLim_a Input for maximum torque in generator mode
C00760/8	0: Not connected	<a href="#">LA_SwitchPos</a> : nMainSetValue_a Input for main speed setpoint
C00760/9	0: Not connected	<a href="#">LA_SwitchPos</a> : nAuxSetValue_a Input for additional speed setpoint
C00760/10	0: Not connected	<a href="#">LA_SwitchPos</a> : nGPAnalogSwitchIn1_a Input for analog switch - analog signal 1
C00760/11	0: Not connected	<a href="#">LA_SwitchPos</a> : nGPAnalogSwitchIn2_a Input for analog switch - analog signal 2
C00760/12	0: Not connected	<a href="#">LA_SwitchPos</a> : nGPArithmetikIn1_a Input for arithmetic function - analog signal 1
C00760/13	0: Not connected	<a href="#">LA_SwitchPos</a> : nGPArithmetikIn2_a Input for arithmetic function - analog signal 2
C00760/14	0: Not connected	<a href="#">LA_SwitchPos</a> : nGPMulDivIn_a Input for analog signal for multiplication/division
C00760/15	0: Not connected	<a href="#">LA_SwitchPos</a> : nGPCompareIn1_a Input for comparison operation - analog signal 1
C00760/16	0: Not connected	<a href="#">LA_SwitchPos</a> : nGPCompareIn2_a Input for comparison operation - analog signal 2
C00760/17	0: Not connected	<a href="#">LA_SwitchPos</a> : wSMCtrl Interface to the optional safety system
C00760/18	0: Not connected	Reserved
C00760/19	0: Not connected	Reserved
C00760/20	0: Not connected	Reserved
C00760/21	0: Not connected	Reserved

Parameter   Name: <b>C00760   LA_SwitchPos: Analog connection list</b>		Data type: UNSIGNED_16 Index: 23815 <sub>d</sub> = 5D07 <sub>h</sub>
C00760/22	0: Not connected	<a href="#">LA_SwitchPos</a> : wFreeIn1 Input for user signal 1
C00760/23	0: Not connected	<a href="#">LA_SwitchPos</a> : wFreeIn2 Input for user signal 2
C00760/24	0: Not connected	<a href="#">LA_SwitchPos</a> : wFreeIn3 Input for user signal 3
C00760/25	0: Not connected	<a href="#">LA_SwitchPos</a> : wFreeIn4 Input for user signal 4
<input checked="" type="checkbox"/> Read access <input checked="" type="checkbox"/> Write access <input type="checkbox"/> CINH <input type="checkbox"/> PLC STOP <input type="checkbox"/> No transfer <input type="checkbox"/> COM <input type="checkbox"/> MOT             Scaling factor: 1		

**C00761**

Parameter   Name: <b>C00761   LA_SwitchPos: Digital connection list</b>		Data type: UNSIGNED_16 Index: 23814 <sub>d</sub> = 5D06 <sub>h</sub>
Connection parameters for "Switch-off positioning" application: Binary inputs <ul style="list-style-type: none"> <li>• Selection of the binary output signals to be connected to the binary input signals</li> <li>• The selection list contains all binary output signals which can be assigned to the binary inputs mapped by the subcodes.</li> </ul>		
<b>Selection list</b>		
See <a href="#">selection list - digital signals</a>		
Subcodes	Lenze setting	Info
C00761/1	0: Not connected	<a href="#">LA_SwitchPos</a> : bCInh Control input for setting controller inhibit
C00761/2	0: Not connected	<a href="#">LA_SwitchPos</a> : bFailReset Control input for error acknowledgement
C00761/3	0: Not connected	<a href="#">LA_SwitchPos</a> : bSetQuickstop Control input for quick stop request
C00761/4	0: Not connected	<a href="#">LA_SwitchPos</a> : bSetDCBrake Control input for DC-injection braking request
C00761/5	0: Not connected	<a href="#">LA_SwitchPos</a> : bRFG_Stop Control input for stopping the speed ramp function generator
C00761/6	0: Not connected	<a href="#">LA_SwitchPos</a> : bSetSpeedCcw Control input for change of direction of rotation
C00761/7	0: Not connected	<a href="#">LA_SwitchPos</a> : bRLQCw Control input for activation of CW rotation (fail-safe)
C00761/8	0: Not connected	<a href="#">LA_SwitchPos</a> : bRLQCcw Control input for activation of CCW rotation (fail-safe)
C00761/9	0: Not connected	<a href="#">LA_SwitchPos</a> : bJogCtrlInputSel1 Selection input 1 for binary coded selection of the switch-off position 1 ... 3
C00761/10	0: Not connected	<a href="#">LA_SwitchPos</a> : bJogCtrlInputSel2 Selection input 2 for binary coded selection of the switch-off position 1 ... 3
C00761/11	0: Not connected	<a href="#">LA_SwitchPos</a> : bJogCtrlRfgIn Control input for setpoint generator ramp-down
C00761/12	0: Not connected	<a href="#">LA_SwitchPos</a> : bJogCtrlJog1 Selection input 1 for overriding fixed setpoints (JOG setpoints) for the main setpoint
C00761/13	0: Not connected	<a href="#">LA_SwitchPos</a> : bJogCtrlJog2 Selection input 2 for overriding fixed setpoints (JOG setpoints) for the main setpoint

Parameter   Name: C00761   LA_SwitchPos: Digital connection list		Data type: UNSIGNED_16 Index: 23814 <sub>d</sub> = 5D06 <sub>h</sub>
C00761/14	0: Not connected	<a href="#">LA_SwitchPos</a> : bJogCtrlSlowDown1 Control input for selection of pre-switch off 1
C00761/15	0: Not connected	<a href="#">LA_SwitchPos</a> : bJogCtrlStop1 Control input for stop function 1
C00761/16	0: Not connected	<a href="#">LA_SwitchPos</a> : bJogCtrlSlowDown2 Control input for selection of pre-switch off 2
C00761/17	0: Not connected	<a href="#">LA_SwitchPos</a> : bJogCtrlStop2 Control input for stop function 2
C00761/18	0: Not connected	<a href="#">LA_SwitchPos</a> : bJogCtrlSlowDown3 Control input for selection of pre-switch off 3
C00761/19	0: Not connected	<a href="#">LA_SwitchPos</a> : bJogCtrlStop3 Control input for stop function 3
C00761/20	0: Not connected	<a href="#">LA_SwitchPos</a> : bJogSpeed4 Selection input for fixed setpoints
C00761/21	0: Not connected	<a href="#">LA_SwitchPos</a> : bJogSpeed8 Selection input for fixed setpoints
C00761/22	0: Not connected	<a href="#">LA_SwitchPos</a> : bJogRamp1 Selection input for additional acceleration/deceleration times
C00761/23	0: Not connected	<a href="#">LA_SwitchPos</a> : bJogRamp2 Selection input for additional acceleration/deceleration times
C00761/24	0: Not connected	<a href="#">LA_SwitchPos</a> : bJogRamp4 Selection input for additional acceleration/deceleration times
C00761/25	0: Not connected	<a href="#">LA_SwitchPos</a> : bJogRamp8 Selection input for additional acceleration/deceleration times
C00761/26	0: Not connected	<a href="#">LA_SwitchPos</a> : bMBrkRelease Control input for manual holding brake release request
C00761/27	0: Not connected	<a href="#">LA_SwitchPos</a> : bGPAnalogSwitchSet Control input for analog-value selector change-over
C00761/28	0: Not connected	<a href="#">LA_SwitchPos</a> : bGPDigitalDelayIn Input for digital signal with time delay
C00761/29	0: Not connected	<a href="#">LA_SwitchPos</a> : bGPLogicIn1 Input signal 1 for digital logic
C00761/30	0: Not connected	<a href="#">LA_SwitchPos</a> : bGPLogicIn2 Input signal 2 for digital logic
C00761/31	0: Not connected	<a href="#">LA_SwitchPos</a> : bGPLogicIn3 Input signal 3 for digital logic
C00761/32	0: Not connected	<a href="#">LA_SwitchPos</a> : bGPDFlipFlop_InD Control input for DFlipFlop setting signal
C00761/33	0: Not connected	<a href="#">LA_SwitchPos</a> : bGPDFlipFlop_InClk Control input for DFlipFlop clock signal
C00761/34	0: Not connected	<a href="#">LA_SwitchPos</a> : bGPDFlipFlop_InClr Control input for DFlipFlop reset signal
C00761/35	0: Not connected	Reserved
C00761/36	0: Not connected	Reserved
C00761/37	0: Not connected	Reserved
C00761/38	0: Not connected	Reserved
C00761/39	0: Not connected	Reserved

Parameter   Name:		Data type: UNSIGNED_16 Index: 23814 <sub>d</sub> = 5D06 <sub>h</sub>
<b>C00761   LA_SwitchPos: Digital connection list</b>		
C00761/40	0: Not connected	<a href="#">LA_SwitchPos</a> : bFreeIn1 Input for binary user signal 1
C00761/41	0: Not connected	<a href="#">LA_SwitchPos</a> : bFreeIn2 Input for binary user signal 2
C00761/42	0: Not connected	<a href="#">LA_SwitchPos</a> : bFreeIn3 Input for binary user signal 3
C00761/43	0: Not connected	<a href="#">LA_SwitchPos</a> : bFreeIn4 Input for binary user signal 4
C00761/44	0: Not connected	<a href="#">LA_SwitchPos</a> : bFreeIn5 Input for binary user signal 5
C00761/45	0: Not connected	<a href="#">LA_SwitchPos</a> : bFreeIn6 Input for binary user signal 6
C00761/46	0: Not connected	<a href="#">LA_SwitchPos</a> : bFreeIn7 Input for binary user signal 7
C00761/47	0: Not connected	<a href="#">LA_SwitchPos</a> : bFreeIn8 Input for binary user signal 8
<input checked="" type="checkbox"/> Read access <input checked="" type="checkbox"/> Write access <input type="checkbox"/> CINH <input type="checkbox"/> PLC STOP <input type="checkbox"/> No transfer <input type="checkbox"/> COM <input type="checkbox"/> MOT             Scaling factor: 1		

**C00762**

Parameter   Name:		Data type: UNSIGNED_16 Index: 23813 <sub>d</sub> = 5D05 <sub>h</sub>
<b>C00762   LA_SwitchPos: phi connection list</b>		
<b>This code is used device-internally and must not be written by the user side!</b>		

**C00765**

Parameter   Name:		Data type: UNSIGNED_16 Index: 23810 <sub>d</sub> = 5D02 <sub>h</sub>
<b>C00765   LA_SwitchPos_Out: Analog signal list</b>		
<b>This code is used device-internally and must not be written by the user side!</b>		

**C00766**

Parameter   Name:		Data type: UNSIGNED_16 Index: 23809 <sub>d</sub> = 5D01 <sub>h</sub>
<b>C00766   LA_SwitchPos_Out: Digital signal list</b>		
<b>This code is used device-internally and must not be written by the user side!</b>		

**C00767**

Parameter   Name:		Data type: UNSIGNED_16 Index: 23808 <sub>d</sub> = 5D00 <sub>h</sub>
<b>C00767   LA_SwitchPos_Out: phi signal list</b>		
<b>This code is used device-internally and must not be written by the user side!</b>		

**C00800**

Parameter   Name:		Data type: INTEGER_16 Index: 23775 <sub>d</sub> = 5CDF <sub>h</sub>
<b>C00800   L_MPot_1: Upper limit</b>		
The <a href="#">L_MPot_1</a> FB: Upper limit of the motor potentiometer function		
Setting range (min. value   unit   max. value)		Lenze setting
-199.99	%	199.99
		<b>100.00 %</b>
<input checked="" type="checkbox"/> Read access <input checked="" type="checkbox"/> Write access <input type="checkbox"/> CINH <input type="checkbox"/> PLC STOP <input type="checkbox"/> No transfer <input type="checkbox"/> COM <input type="checkbox"/> MOT             Scaling factor: 100		

## C00801

Parameter   Name: <b>C00801   L_MPot_1: Lower limit</b>			Data type: INTEGER_16 Index: 23774 <sub>d</sub> = 5CDE <sub>h</sub>
The <a href="#">L_MPot_1</a> FB: Lower limit of the motor potentiometer function			
<b>Setting range</b> (min. value   unit   max. value)		<b>Lenze setting</b>	
-199.99	%	199.99	<b>-100.00 %</b>
<input checked="" type="checkbox"/> Read access <input checked="" type="checkbox"/> Write access <input type="checkbox"/> CINH <input type="checkbox"/> PLC STOP <input type="checkbox"/> No transfer <input type="checkbox"/> COM <input type="checkbox"/> MOT   Scaling factor: 100			

## C00802

Parameter   Name: <b>C00802   L_MPot_1: Acceleration time</b>			Data type: UNSIGNED_16 Index: 23773 <sub>d</sub> = 5CDD <sub>h</sub>
The <a href="#">L_MPot_1</a> FB: Acceleration time of the motor potentiometer function			
<b>Setting range</b> (min. value   unit   max. value)		<b>Lenze setting</b>	
0.1	s	6000.0	<b>10.0 s</b>
<input checked="" type="checkbox"/> Read access <input checked="" type="checkbox"/> Write access <input type="checkbox"/> CINH <input type="checkbox"/> PLC STOP <input type="checkbox"/> No transfer <input type="checkbox"/> COM <input type="checkbox"/> MOT   Scaling factor: 10			

## C00803

Parameter   Name: <b>C00803   L_MPot_1: Deceleration time</b>			Data type: UNSIGNED_16 Index: 23772 <sub>d</sub> = 5CDC <sub>h</sub>
The <a href="#">L_MPot_1</a> FB: Deceleration time of the motor potentiometer function			
<b>Setting range</b> (min. value   unit   max. value)		<b>Lenze setting</b>	
0.1	s	6000.0	<b>10.0 s</b>
<input checked="" type="checkbox"/> Read access <input checked="" type="checkbox"/> Write access <input type="checkbox"/> CINH <input type="checkbox"/> PLC STOP <input type="checkbox"/> No transfer <input type="checkbox"/> COM <input type="checkbox"/> MOT   Scaling factor: 10			

## C00804

Parameter   Name: <b>C00804   L_MPot_1: Inactive fct.</b>			Data type: UNSIGNED_8 Index: 23771 <sub>d</sub> = 5CDB <sub>h</sub>
The <a href="#">L_MPot_1</a> FB: Selection of the response if the motor potentiometer is deactivated via input <i>blnAct</i>			
<b>Selection list</b> (Lenze setting printed in bold)		<b>Info</b>	
<b>0</b>	<b>Retain value</b>	Keep output value	
1	Deceleration to 0	Deceleration via ramp to 0	
2	Deceleration to lower limit	Deceleration via ramp to the lower limit ( <a href="#">C00801</a> )	
3	Without ramp to 0	Step change to 0	
4	Without ramp to lower limit	Jump to lower limit ( <a href="#">C00800</a> )	
5	Acceleration to upper limit	Acceleration via ramp to upper limit ( <a href="#">C00800</a> )	
<input checked="" type="checkbox"/> Read access <input checked="" type="checkbox"/> Write access <input type="checkbox"/> CINH <input type="checkbox"/> PLC STOP <input type="checkbox"/> No transfer <input type="checkbox"/> COM <input type="checkbox"/> MOT   Scaling factor: 1			

## C00805

Parameter   Name: <b>C00805   L_MPot_1: Init fct.</b>			Data type: UNSIGNED_8 Index: 23770 <sub>d</sub> = 5CDA <sub>h</sub>
The <a href="#">L_MPot_1</a> FB: Selection of the response at device switch-on			
<b>Selection list</b> (Lenze setting printed in bold)			
<b>0</b>	<b>Load last value</b>		
1	Load lower limit		
2	Load 0		
<input checked="" type="checkbox"/> Read access <input checked="" type="checkbox"/> Write access <input type="checkbox"/> CINH <input type="checkbox"/> PLC STOP <input type="checkbox"/> No transfer <input type="checkbox"/> COM <input type="checkbox"/> MOT   Scaling factor: 1			

## C00806

Parameter   Name: <b>C00806   L_MPot_1: Use</b>		Data type: UNSIGNED_8 Index: 23769 <sub>d</sub> = 5CD9 <sub>h</sub>
The <a href="#">L_MPot_1</a> FB: Use of the motor potentiometer		
Selection list (Lenze setting printed in bold)		Info
0	<b>No</b>	The motor potentiometer is not used. • The analog value applied to the <i>nIn_a</i> input is looped through without any changes to the <i>nOut_a</i> output.
1	Yes	The motor potentiometer is used. • The analog value applied at the <i>nIn_a</i> input is led via the motor potentiometer and provided at the <i>nOut_a</i> output.
<input checked="" type="checkbox"/> Read access <input checked="" type="checkbox"/> Write access <input type="checkbox"/> CINH <input type="checkbox"/> PLC STOP <input type="checkbox"/> No transfer <input type="checkbox"/> COM <input type="checkbox"/> MOT   Scaling factor: 1		

## C00820

Parameter   Name: <b>C00820   L_DigitalLogic_1: Function</b>		Data type: UNSIGNED_8 Index: 23755 <sub>d</sub> = 5CCB <sub>h</sub>
The <a href="#">L_DigitalLogic_1</a> FB: Selection of the internal logic function		
Selection list (Lenze setting printed in bold)		Info
0	<b>bOut = 0</b>	Constant value "FALSE"
1	<b>bOut = 1</b>	Constant value "TRUE"
2	<b>bOut = bIn1 AND bIn2 AND bIn3</b>	AND operation
3	<b>bOut = bIn1 OR bIn2 OR bIn3</b>	OR operation
4	<b>bOut = f (truth table)</b>	The truth table parameterised in <a href="#">C00821</a> is used.
<input checked="" type="checkbox"/> Read access <input checked="" type="checkbox"/> Write access <input type="checkbox"/> CINH <input type="checkbox"/> PLC STOP <input type="checkbox"/> No transfer <input type="checkbox"/> COM <input type="checkbox"/> MOT   Scaling factor: 1		

## C00821

Parameter   Name: <b>C00821   L_DigitalLogic_1: Truth table</b>		Data type: UNSIGNED_8 Index: 23754 <sub>d</sub> = 5CCA <sub>h</sub>
The <a href="#">L_DigitalLogic_1</a> FB: Parameterisation of the truth table		
Selection list		
0	False	
1	True	
Subcodes	Lenze setting	Info
C00821/1	0: FALSE	<a href="#">L_DigitalLogic_1</a> : bOut: bIn3...bIn1=0 0 0
C00821/2	0: FALSE	<a href="#">L_DigitalLogic_1</a> : bOut: bIn3...bIn1=0 0 1
C00821/3	0: FALSE	<a href="#">L_DigitalLogic_1</a> : bOut: bIn3...bIn1=0 1 0
C00821/4	0: FALSE	<a href="#">L_DigitalLogic_1</a> : bOut: bIn3...bIn1=0 1 1
C00821/5	0: FALSE	<a href="#">L_DigitalLogic_1</a> : bOut: bIn3...bIn1=1 0 0
C00821/6	0: FALSE	<a href="#">L_DigitalLogic_1</a> : bOut: bIn3...bIn1=1 0 1
C00821/7	0: FALSE	<a href="#">L_DigitalLogic_1</a> : bOut: bIn3...bIn1=1 1 0
C00821/8	0: FALSE	<a href="#">L_DigitalLogic_1</a> : bOut: bIn3...bIn1=1 1 1
C00821/9	0: FALSE	<a href="#">L_DigitalLogic_1</a> : bOut2: bIn3...bIn1=0 0 0
C00821/10	0: FALSE	<a href="#">L_DigitalLogic_1</a> : bOut2: bIn3...bIn1=0 0 1
C00821/11	0: FALSE	<a href="#">L_DigitalLogic_1</a> : bOut2: bIn3...bIn1=0 1 0
C00821/12	0: FALSE	<a href="#">L_DigitalLogic_1</a> : bOut2: bIn3...bIn1=0 1 1
C00821/13	0: FALSE	<a href="#">L_DigitalLogic_1</a> : bOut2: bIn3...bIn1=1 0 0

Parameter   Name: <b>C00821   L_DigitalLogic_1: Truth table</b>		Data type: UNSIGNED_8 Index: 23754 <sub>d</sub> = 5CCA <sub>h</sub>
C00821/14	0: FALSE	<a href="#">L_DigitalLogic_1</a> : bOut2: bIn3...bIn1=1 0 1
C00821/15	0: FALSE	<a href="#">L_DigitalLogic_1</a> : bOut2: bIn3...bIn1=1 1 0
C00821/16	0: FALSE	<a href="#">L_DigitalLogic_1</a> : bOut2: bIn3...bIn1=1 1 1
C00821/17	0: FALSE	<a href="#">L_DigitalLogic_1</a> : bOut3: bIn3...bIn1=0 0 0
C00821/18	0: FALSE	<a href="#">L_DigitalLogic_1</a> : bOut3: bIn3...bIn1=0 0 1
C00821/19	0: FALSE	<a href="#">L_DigitalLogic_1</a> : bOut3: bIn3...bIn1=0 1 0
C00821/20	0: FALSE	<a href="#">L_DigitalLogic_1</a> : bOut3: bIn3...bIn1=0 1 1
C00821/21	0: FALSE	<a href="#">L_DigitalLogic_1</a> : bOut3: bIn3...bIn1=1 0 0
C00821/22	0: FALSE	<a href="#">L_DigitalLogic_1</a> : bOut3: bIn3...bIn1=1 0 1
C00821/23	0: FALSE	<a href="#">L_DigitalLogic_1</a> : bOut3: bIn3...bIn1=1 1 0
C00821/24	0: FALSE	<a href="#">L_DigitalLogic_1</a> : bOut3: bIn3...bIn1=1 1 1
<input checked="" type="checkbox"/> Read access <input checked="" type="checkbox"/> Write access <input type="checkbox"/> CINH <input type="checkbox"/> PLC STOP <input type="checkbox"/> No transfer <input type="checkbox"/> COM <input type="checkbox"/> MOT             Scaling factor: 1		

**C00828**

Parameter   Name: <b>C00828   L_DigitalLogic_3: Function</b>		Data type: UNSIGNED_8 Index: 23747 <sub>d</sub> = 5CC3 <sub>h</sub>
From version 11.00.00 The <a href="#">L_DigitalLogic_3</a> FB: Selection of the internal logic function		
Selection list(Lenze setting printed in bold)		Info
0	<b>bOut = 0</b>	Constant value "FALSE"
1	<b>bOut = 1</b>	Constant value "TRUE"
2	<b>bOut = bIn1 AND bIn2 AND bIn3</b>	AND operation
3	<b>bOut = bIn1 OR bIn2 OR bIn3</b>	OR operation
4	<b>bOut = f (truth table)</b>	The truth table parameterised in <a href="#">C00829</a> is used.
<input checked="" type="checkbox"/> Read access <input checked="" type="checkbox"/> Write access <input type="checkbox"/> CINH <input type="checkbox"/> PLC STOP <input type="checkbox"/> No transfer <input type="checkbox"/> COM <input type="checkbox"/> MOT             Scaling factor: 1		

**C00829**

Parameter   Name: <b>C00829   L_DigitalLogic_3: Truth table</b>		Data type: UNSIGNED_8 Index: 23746 <sub>d</sub> = 5CC2 <sub>h</sub>
From version 11.00.00 The <a href="#">L_DigitalLogic_3</a> FB: Parameterisation of the truth table		
Selection list		
0	False	
1	True	
Subcodes	Lenze setting	Info
C00829/1	0: FALSE	<a href="#">L_DigitalLogic_3</a> : bOut: bIn3...bIn1=0 0 0
C00829/2	0: FALSE	<a href="#">L_DigitalLogic_3</a> : bOut: bIn3...bIn1=0 0 1
C00829/3	0: FALSE	<a href="#">L_DigitalLogic_3</a> : bOut: bIn3...bIn1=0 1 0
C00829/4	0: FALSE	<a href="#">L_DigitalLogic_3</a> : bOut: bIn3...bIn1=0 1 1
C00829/5	0: FALSE	<a href="#">L_DigitalLogic_3</a> : bOut: bIn3...bIn1=1 0 0
C00829/6	0: FALSE	<a href="#">L_DigitalLogic_3</a> : bOut: bIn3...bIn1=1 0 1
C00829/7	0: FALSE	<a href="#">L_DigitalLogic_3</a> : bOut: bIn3...bIn1=1 1 0
C00829/8	0: FALSE	<a href="#">L_DigitalLogic_3</a> : bOut: bIn3...bIn1=1 1 1
C00829/9	0: FALSE	<a href="#">L_DigitalLogic_3</a> : bOut2: bIn3...bIn1=0 0 0
C00829/10	0: FALSE	<a href="#">L_DigitalLogic_3</a> : bOut2: bIn3...bIn1=0 0 1



Parameter   Name: <b>C00829   L_DigitalLogic_3: Truth table</b>		Data type: UNSIGNED_8 Index: 23746 <sub>d</sub> = 5CC2 <sub>h</sub>
C00829/11	0: FALSE	<a href="#">L_DigitalLogic_3</a> : bOut2: bIn3...bIn1=0 1 0
C00829/12	0: FALSE	<a href="#">L_DigitalLogic_3</a> : bOut2: bIn3...bIn1=0 1 1
C00829/13	0: FALSE	<a href="#">L_DigitalLogic_3</a> : bOut2: bIn3...bIn1=1 0 0
C00829/14	0: FALSE	<a href="#">L_DigitalLogic_3</a> : bOut2: bIn3...bIn1=1 0 1
C00829/15	0: FALSE	<a href="#">L_DigitalLogic_3</a> : bOut2: bIn3...bIn1=1 1 0
C00829/16	0: FALSE	<a href="#">L_DigitalLogic_3</a> : bOut2: bIn3...bIn1=1 1 1
C00829/17	0: FALSE	<a href="#">L_DigitalLogic_3</a> : bOut3: bIn3...bIn1=0 0 0
C00829/18	0: FALSE	<a href="#">L_DigitalLogic_3</a> : bOut3: bIn3...bIn1=0 0 1
C00829/19	0: FALSE	<a href="#">L_DigitalLogic_3</a> : bOut3: bIn3...bIn1=0 1 0
C00829/20	0: FALSE	<a href="#">L_DigitalLogic_3</a> : bOut3: bIn3...bIn1=0 1 1
C00829/21	0: FALSE	<a href="#">L_DigitalLogic_3</a> : bOut3: bIn3...bIn1=1 0 0
C00829/22	0: FALSE	<a href="#">L_DigitalLogic_3</a> : bOut3: bIn3...bIn1=1 0 1
C00829/23	0: FALSE	<a href="#">L_DigitalLogic_3</a> : bOut3: bIn3...bIn1=1 1 0
C00829/24	0: FALSE	<a href="#">L_DigitalLogic_3</a> : bOut3: bIn3...bIn1=1 1 1
<input checked="" type="checkbox"/> Read access <input checked="" type="checkbox"/> Write access <input type="checkbox"/> CINH <input type="checkbox"/> PLC STOP <input type="checkbox"/> No transfer <input type="checkbox"/> COM <input type="checkbox"/> MOT             Scaling factor: 1		

**C00830**

Parameter   Name: <b>C00830   16-bit inputs [%]</b>		Data type: INTEGER_16 Index: 23745 <sub>d</sub> = 5CC1 <sub>h</sub>
Display in percent of 16-bit input values of different blocks • Non-listed subcodes are "reserved".		
<b>Display range</b> (min. value   unit   max. value)		
-199.99	%	199.99
<b>Subcodes</b>	<b>Info</b>	
C00830/1	<a href="#">L_Absolut_1</a> : nIn_a	
C00830/2	<a href="#">L_AddSub_1</a> : nIn1_a	
C00830/3	<a href="#">L_AddSub_1</a> : nIn2_a	
C00830/4	<a href="#">L_AddSub_1</a> : nIn3_a	
C00830/5	<a href="#">L_OffsetGain_1</a> : nIn_a	
C00830/6	<a href="#">L_OffsetGain_1</a> : nOffset_a	
C00830/7	<a href="#">L_OffsetGain_1</a> : nGain_a	
C00830/8	<a href="#">L_Negation_1</a> : nIn_a	
C00830/9	<a href="#">L_GainOffset_1</a> : nIn_a	
C00830/10	<a href="#">L_GainOffset_1</a> : nGain_a	
C00830/11	<a href="#">L_GainOffset_1</a> : nOffset_a	
C00830/12	<a href="#">L_Arithmetik_1</a> : nIn1_a	
C00830/13	<a href="#">L_Arithmetik_1</a> : nIn2_a	
C00830/14	<a href="#">L_AnalogSwitch_1</a> : nIn1_a	
C00830/15	<a href="#">L_AnalogSwitch_1</a> : nIn2_a	
C00830/16	<a href="#">L_Compare_1</a> : nIn1_a	
C00830/17	<a href="#">L_Compare_1</a> : nIn2_a	
C00830/18	<a href="#">MCTRL</a> : nTorqueLimitAdapt_a	
C00830/20	<a href="#">MCTRL</a> : nPosCtrlPAdapt_a	
C00830/21	<a href="#">MCTRL</a> : nPosCtrlOutLimit_a	

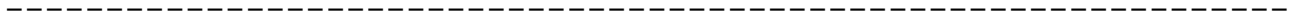

C00830/21	<a href="#">MCTRL: nPosCtrlOutLimit_a</a>

Parameter   Name: <b>C00830   16-bit inputs [%]</b>		Data type: INTEGER_16 Index: 23745 <sub>d</sub> = 5CC1 <sub>h</sub>
C00830/75	MCK: nSpeedOverride_a	
C00830/76	MCK: nAccOverride_a	
C00830/77	MCK: nSpeedAdd_v	
C00830/78	MCK: wAuxCtrl	
C00830/79	MCK: wSMCtrl	
C00830/80	<a href="#">L_OffsetGainP_3</a> : nIn_a	
C00830/81	<a href="#">L_MPot_1</a> : nIn_a	
C00830/82	<a href="#">L_MulDiv_1</a> : nIn_a	
C00830/83	LS_DataAccess: wIn1 (Lenze-internal)	
C00830/84	LS_DataAccess: wIn2 (Lenze-internal)	
C00830/85	LS_DataAccess: wIn3 (Lenze-internal)	
C00830/86	LS_DataAccess: wIn4 (Lenze-internal)	
C00830/87	<a href="#">L_PT1_1</a> : nIn_a	
C00830/88	<a href="#">MCTRL</a> : nSpeedHighLimit_a	
C00830/89	<a href="#">L_PCTRL_1</a> : nNSet_a	
C00830/90	<a href="#">L_PCTRL_1</a> : nISet_a	
C00830/91	<a href="#">L_Interpolator_1</a> : nPhdIn_v	
C00830/92	<a href="#">L_Interpolator_1</a> : nNIn_a	
C00830/96	<a href="#">MCTRL</a> : nInertiaAdapt_a	
C00830/97	<a href="#">MCTRL</a> : nSpeedSetValueInertiaAdapt_a	
<input checked="" type="checkbox"/> Read access <input type="checkbox"/> Write access <input type="checkbox"/> CINH <input type="checkbox"/> PLC STOP <input checked="" type="checkbox"/> No transfer <input type="checkbox"/> COM <input type="checkbox"/> MOT             Scaling factor: 100		

**C00831**

Parameter   Name: <b>C00831   16-bit inputs</b>		Data type: UNSIGNED_16 Index: 23744 <sub>d</sub> = 5CC0 <sub>h</sub>
Decimal/hexadecimal/bit coded display of 16 bit input values of various blocks • Non-listed subcodes are "reserved".		
<b>Display area (min. hex value   max. hex value)</b>		
0x0000		0xFFFF
<b>Value is bit-coded:</b>		
Bit 0	Active	
...	...	
Bit 15	Active	
<b>Subcodes</b>	<b>Info</b>	
C00831/1	<a href="#">L_Absolut_1</a> : nIn_a	
C00831/2	<a href="#">L_AddSub_1</a> : nIn1_a	
C00831/3	<a href="#">L_AddSub_1</a> : nIn2_a	
C00831/4	<a href="#">L_AddSub_1</a> : nIn3_a	
C00831/5	<a href="#">L_OffsetGain_1</a> : nIn_a	
C00831/6	<a href="#">L_OffsetGain_1</a> : nOffset_a	
C00831/7	<a href="#">L_OffsetGain_1</a> : nGain_a	

Parameter   Name: <b>C00831   16-bit inputs</b>		Data type: UNSIGNED_16 Index: 23744 <sub>d</sub> = 5C0 <sub>h</sub>
C00831/8	<a href="#">L Negation 1</a> : nIn_a	
C00831/9	<a href="#">L GainOffset 1</a> : nIn_a	
C00831/10	<a href="#">L GainOffset 1</a> : nGain_a	
C00831/11	<a href="#">L GainOffset 1</a> : nOffset_a	
C00831/12	<a href="#">L Arithmetik 1</a> : nIn1_a	
C00831/13	<a href="#">L Arithmetik 1</a> : nIn2_a	
C00831/14	<a href="#">L AnalogSwitch 1</a> : nIn1_a	
C00831/15	<a href="#">L AnalogSwitch 1</a> : nIn2_a	
C00831/16	<a href="#">L Compare 1</a> : nIn1_a	
C00831/17	<a href="#">L Compare 1</a> : nIn2_a	
C00831/18	<a href="#">MCTRL</a> : nTorqueLimitAdapt_a	
C00831/20	<a href="#">MCTRL</a> : nPosCtrlPADapt_a	
C00831/21	<a href="#">MCTRL</a> : nPosCtrlOutLimit_a	
C00831/22	<a href="#">MCTRL</a> : nSpeedSetValue_a	
C00831/23	<a href="#">MCTRL</a> : nSpeedLowLimit_a	
C00831/24	<a href="#">MCTRL</a> : nSpeedCtrlI_a	
C00831/25	<a href="#">MCTRL</a> : nSpeedCtrlPADapt_a	
C00831/26	<a href="#">MCTRL</a> : nBoost_a	
C00831/27	<a href="#">MCTRL</a> : nTorqueSetValue_a	
C00831/28	<a href="#">MCTRL</a> : nTorqueGenLimit_a	
C00831/29	<a href="#">MCTRL</a> : nTorqueMotLimit_a	
C00831/31	<a href="#">MCTRL</a> : nVoltageAdd_a	
C00831/32	<a href="#">MCTRL</a> : nPWMAngleOffset_a	
C00831/33	<a href="#">L NSet 1</a> : nCInhVal_a	
C00831/34	<a href="#">L NSet 1</a> : nNSet_a	
C00831/35	<a href="#">L NSet 1</a> : nSet_a	
C00831/36	<a href="#">L NSet 1</a> : nAdd_a	
C00831/37	<a href="#">DCTRL</a> : wCANControl	
C00831/38	<a href="#">DCTRL</a> : wMCIControl	
C00831/41	<a href="#">L Compare 2</a> : nIn1_a	
C00831/42	<a href="#">L Compare 2</a> : nIn2_a	
C00831/45	<a href="#">L AnalogSwitch 2</a> : nIn1_a	
C00831/46	<a href="#">L AnalogSwitch 2</a> : nIn2_a	
C00831/47	<a href="#">L AnalogSwitch 3</a> : nIn1_a	
C00831/48	<a href="#">L AnalogSwitch 3</a> : nIn2_a	
C00831/53	<a href="#">L GainOffset 2</a> : nIn_a	
C00831/54	<a href="#">L GainOffset 2</a> : nGain_a	
C00831/55	<a href="#">L GainOffset 2</a> : nOffset_a	
C00831/56	<a href="#">L OffsetGainP 1</a> : nIn_a	
C00831/57	<a href="#">L OffsetGainP 2</a> : nIn_a	
C00831/58	<a href="#">L OffsetGain 2</a> : nIn_a	
C00831/59	<a href="#">L OffsetGain 2</a> : nOffset_a	
C00831/60	<a href="#">L OffsetGain 2</a> : nGain_a	
C00831/61	<a href="#">L PCTRL 1</a> : nAct_a	

Parameter   Name: <b>C00831   16-bit inputs</b>		Data type: UNSIGNED_16 Index: 23744 <sub>d</sub> = 5C0 <sub>h</sub>
C00831/62	<a href="#">L_PCTRL_1</a> : nAdapt_a	
C00831/63	<a href="#">L_PCTRL_1</a> : nSet_a	
C00831/64	<a href="#">L_PCTRL_1</a> : nInfluence_a	
C00831/65	MCK: nSpeedCtrlI_a	
C00831/66	MCK: nPWMAngleOffset_a	
C00831/68	MCK: nMBrakeAddValue_a	
C00831/69	MCK: nTorqueSetValue_a	
C00831/70	MCK: nTorqueLimitAdapt_a	
C00831/71	MCK: nSRampOverride_a	
C00831/72	MCK: nSpeedSetValue_a	
C00831/73	MCK: wMotionCtrl2	
C00831/74	MCK: wMotionCtrl1	
C00831/75	MCK: nSpeedOverride_a	
C00831/76	MCK: nAccOverride_a	
C00831/77	MCK: nSpeedAdd_v	
C00831/78	MCK: wAuxCtrl	
C00831/79	MCK: wSMCtrl	
C00831/80	<a href="#">L_OffsetGainP_3</a> : nIn_a	
C00831/81	<a href="#">L_MPot_1</a> : nIn_a	
C00831/82	<a href="#">L_MulDiv_1</a> : nIn_a	
C00831/83	LS_DataAccess: wIn1 (Lenze-internal)	
C00831/84	LS_DataAccess: wIn2 (Lenze-internal)	
C00831/85	LS_DataAccess: wIn3 (Lenze-internal)	
C00831/86	LS_DataAccess: wIn4 (Lenze-internal)	
C00831/87	<a href="#">L_PT1_1</a> : nIn_a	
C00831/88	<a href="#">MCTRL</a> : nSpeedHighLimit_a	
C00831/89	<a href="#">L_PCTRL_1</a> : nNSet_a	
C00831/90	<a href="#">L_PCTRL_1</a> : nISet_a	
C00831/91	<a href="#">L_Interpolator_1</a> : nPhdIn_v	
C00831/92	<a href="#">L_Interpolator_1</a> : nNIn_a	
C00831/96	<a href="#">MCTRL</a> : nInertiaAdapt_a	
C00831/97	<a href="#">MCTRL</a> : nSpeedSetValueInertia_a	
<input checked="" type="checkbox"/> Read access <input type="checkbox"/> Write access <input type="checkbox"/> CINH <input type="checkbox"/> PLC STOP <input checked="" type="checkbox"/> No transfer <input type="checkbox"/> COM <input type="checkbox"/> MOT		

**C00833**

Parameter   Name: <b>C00833   Binary inputs</b>		Data type: UNSIGNED_8 Index: 23742 <sub>d</sub> = 5CB <sub>h</sub>
Display of the signal status of the binary inputs of different blocks <ul style="list-style-type: none"> <li>• Non-listed subcodes are "reserved".</li> </ul>		

Parameter   Name: <b>C00833   Binary inputs</b>		Data type: UNSIGNED_8 Index: 23742 <sub>d</sub> = 5CBE <sub>h</sub>
<b>Selection list</b>		
0	False	
1	True	
<b>Subcodes</b>		<b>Info</b>
C00833/1		<a href="#">L_And 1</a> : bIn1
C00833/2		<a href="#">L_And 1</a> : bIn2
C00833/3		<a href="#">L_And 1</a> : bIn3
C00833/4		<a href="#">L_DFlipFlop 1</a> : bD
C00833/5		<a href="#">L_DFlipFlop 1</a> : bClk
C00833/6		<a href="#">L_DFlipFlop 1</a> : bClr
C00833/7		<a href="#">L_Not 1</a> : bIn
C00833/8		<a href="#">L_Or 1</a> : bIn1
C00833/9		<a href="#">L_Or 1</a> : bIn2
C00833/10		<a href="#">L_Or 1</a> : bIn3
C00833/11		<a href="#">L_RLO 1</a> : bCw
C00833/12		<a href="#">L_RLO 1</a> : bCcw
C00833/13		<a href="#">L_AnalogSwitch 1</a> : bSet
C00833/14		<a href="#">L_NSet 1</a> : bRfgStop
C00833/15		<a href="#">L_NSet 1</a> : bRfg0
C00833/16		<a href="#">L_NSet 1</a> : bNSetInv
C00833/17		<a href="#">L_NSet 1</a> : bJog1
C00833/18		<a href="#">L_NSet 1</a> : bJog2
C00833/19		<a href="#">L_NSet 1</a> : bJog4
C00833/20		<a href="#">L_NSet 1</a> : bJog8
C00833/21		<a href="#">L_NSet 1</a> : bTi1
C00833/22		<a href="#">L_NSet 1</a> : bTi2
C00833/23		<a href="#">L_NSet 1</a> : bTi4
C00833/24		<a href="#">L_NSet 1</a> : bTi8
C00833/25		<a href="#">L_NSet 1</a> : bLoad
C00833/26		<a href="#">L_NSet 1</a> : bExternalCINH
C00833/27		<a href="#">MCTRL</a> : bPosCtrlOn
C00833/28		<a href="#">MCTRL</a> : bSpeedInterpolatorOn
C00833/29		<a href="#">MCTRL</a> : bTorqueInterpolatorOn
C00833/30		<a href="#">MCTRL</a> : bTorquemodeOn
C00833/31		<a href="#">MCTRL</a> : bSpeedCtrlOn
C00833/32		<a href="#">MCTRL</a> : bAutoBoostOn
C00833/33		<a href="#">MCTRL</a> : bQSPOn
C00833/34		<a href="#">MCTRL</a> : bDcBrakeOn
C00833/35		<a href="#">MCTRL</a> : bDeltaPosOn
C00833/36		<a href="#">DCTRL</a> : bCINH
C00833/37		<a href="#">DCTRL</a> : bFailReset
C00833/38		<a href="#">DCTRL</a> : bStatus_B0
C00833/39		<a href="#">DCTRL</a> : bStatus_B2
C00833/40		<a href="#">DCTRL</a> : bStatus_B3

Parameter   Name: <b>C00833   Binary inputs</b>		Data type: UNSIGNED_8 Index: 23742 <sub>d</sub> = 5CBE <sub>h</sub>
C00833/41	<a href="#">DCTRL: bStatus_B4</a>	
C00833/42	<a href="#">DCTRL: bStatus_B5</a>	
C00833/43	<a href="#">DCTRL: bStatus_B14</a>	
C00833/44	<a href="#">DCTRL: bStatus_B15</a>	
C00833/45	<a href="#">DCTRL: bFree_1</a>	
C00833/46	<a href="#">DCTRL: bFree_2</a>	
C00833/47	<a href="#">DCTRL: bFree_3</a>	
C00833/48	<a href="#">DCTRL: bFree_4</a>	
C00833/49	<a href="#">L_And_2: bIn1</a>	
C00833/50	<a href="#">L_And_2: bIn2</a>	
C00833/51	<a href="#">L_And_2: bIn3</a>	
C00833/52	<a href="#">L_And_3: bIn1</a>	
C00833/53	<a href="#">L_And_3: bIn2</a>	
C00833/54	<a href="#">L_And_3: bIn3</a>	
C00833/55	<a href="#">L_Or_2: bIn1</a>	
C00833/56	<a href="#">L_Or_2: bIn2</a>	
C00833/57	<a href="#">L_Or_2: bIn3</a>	
C00833/58	<a href="#">L_Or_3: bIn1</a>	
C00833/59	<a href="#">L_Or_3: bIn2</a>	
C00833/60	<a href="#">L_Or_3: bIn3</a>	
C00833/61	<a href="#">L_Not_2: bIn</a>	
C00833/62	<a href="#">L_Not_3: bIn</a>	
C00833/63	<a href="#">L_DigitalLogic_1: bIn1</a>	
C00833/64	<a href="#">L_DigitalLogic_1: bIn2</a>	
C00833/65	<a href="#">L_DigitalLogic_1: bIn3</a>	
C00833/66	<a href="#">L_DigitalDelay_1: bIn</a>	
C00833/67	<a href="#">MCTRL: bPosDerivativeOn</a>	
C00833/68	<a href="#">MCTRL: bSetRefValue</a>	
C00833/69	<a href="#">MCTRL: bSpeedCtrlPAdaptOn</a>	
C00833/70	<a href="#">L_AnalogSwitch_2: bSet</a>	
C00833/71	<a href="#">L_AnalogSwitch_3: bSet</a>	
C00833/72	<a href="#">L_MPot_1: bUp</a>	
C00833/73	<a href="#">L_MPot_1: bInAct</a>	
C00833/74	<a href="#">L_MPot_1: bDown</a>	
C00833/75	<a href="#">L_PCTRL_1: bPIDOff</a>	
C00833/76	<a href="#">L_PCTRL_1: bInAct</a>	
C00833/77	<a href="#">L_PCTRL_1: bOff</a>	
C00833/78	MCK: bSpeedCtrlOn	
C00833/79	MCK: bDcBrakeOn	
C00833/80	MCK: bMBrakeRelease	
C00833/81	MCK: bMBrakeStartValue2	
C00833/82	MCK: bMBrakeApplied	
C00833/83	MCK: bLimitSwitchPos	
C00833/84	MCK: bLimitSwitchNeg	

Parameter   Name: <b>C00833   Binary inputs</b>		Data type: UNSIGNED 8 Index: 23742 <sub>d</sub> = 5CBE <sub>h</sub>
C00833/85	MCK: bPosCtrlOn	
C00833/86	MCK: bDeltaPosOn	
C00833/87	MCK: bPosDerivativeOn	
C00833/88	MCK: bReserved01	
C00833/89	MCK: bQspOn	
C00833/90	MCK: bTorquemodeOn	
C00833/91	MCK: bTorqueLimitAdaptOn	
C00833/92	MCK: bHomMark	
C00833/93	<a href="#">L_Transient_1</a> : bln	
C00833/94	<a href="#">L_Transient_2</a> : bln	
C00833/95	<a href="#">L_Transient_3</a> : bln	
C00833/96	<a href="#">L_Transient_4</a> : bln	
C00833/98	<a href="#">MCTRL</a> : bTorqueLimitAdaptOn	
C00833/99	<a href="#">L_NSet_1</a> : bNAddInv	
C00833/100	<a href="#">L_MPot_1</a> : bEnable	
C00833/102	LS_DataAccess: bEnableIn1 (Lenze-internal)	
C00833/103	LS_DataAccess: bEnableIn2 (Lenze-internal)	
C00833/104	LS_DataAccess: bEnableIn3 (Lenze-internal)	
C00833/105	LS_DataAccess: bEnableIn4 (Lenze-internal)	
C00833/106	<a href="#">L_PCTRL_1</a> : bEnableInfluenceRamp	
C00833/111	<a href="#">L_JogCtrlExtension</a> : bInputSel1	
C00833/112	<a href="#">L_JogCtrlExtension</a> : bInputSel2	
C00833/113	<a href="#">L_JogCtrlExtension</a> : bRfgIn	
C00833/114	<a href="#">L_JogCtrlExtension</a> : bJog1In	
C00833/115	<a href="#">L_JogCtrlExtension</a> : bJog2In	
C00833/116	<a href="#">L_JogCtrlExtension</a> : bSlowDown1	
C00833/117	<a href="#">L_JogCtrlExtension</a> : bStop1	
C00833/118	<a href="#">L_JogCtrlExtension</a> : bbSlowDown2	
C00833/119	<a href="#">L_JogCtrlExtension</a> : bStop2	
C00833/120	<a href="#">L_JogCtrlExtension</a> : bSlowDown3	
C00833/121	<a href="#">L_JogCtrlExtension</a> : bStop3	
C00833/122	<a href="#">L_PCTRL_1</a> : bISet	
C00833/123	<a href="#">L_Interpolator_1</a> : bSpeedAct0	
C00833/124	<a href="#">L_Or_4</a> : bln1	
C00833/125	<a href="#">L_Or_4</a> : bln2	
C00833/126	<a href="#">L_Or_4</a> : bln3	
C00833/127	<a href="#">L_DigitalLogic_3</a> : bln1	
C00833/128	<a href="#">L_DigitalLogic_3</a> : bln2	
C00833/129	<a href="#">L_DigitalLogic_3</a> : bln3	
C00833/130	<a href="#">MCTRL</a> : bBrakeChopperOn	



Parameter   Name: <b>C00833   Binary inputs</b>		Data type: UNSIGNED_8 Index: 23742 <sub>d</sub> = 5CB <sub>Eh</sub>
C00833/131	<a href="#">MCTRL</a> : bVfcEcoDisable	
<input checked="" type="checkbox"/> Read access <input type="checkbox"/> Write access <input type="checkbox"/> CINH <input type="checkbox"/> PLC STOP <input checked="" type="checkbox"/> No transfer <input type="checkbox"/> COM <input type="checkbox"/> MOT           Scaling factor: 1		

**C00834**

Parameter   Name: <b>C00834   32-bit inputs [incr]</b>		Data type: INTEGER_32 Index: 23741 <sub>d</sub> = 5CB <sub>Dh</sub>
<a href="#">From version 03.00.00</a> Display in [increments] of 32 bit input values of various blocks • Non-listed subcodes are "reserved".		
<b>Display range (min. value   unit   max. value)</b>		
-2147483647	Incr.	2147483647
<b>Subcodes</b>		<b>Info</b>
C00834/1	MCK: dnPosSetValue_p	
C00834/2	MCK: dnPosRefValue_p	
C00834/3	MCK: dnDeltaPos_p	
C00834/4	<a href="#">MCTRL</a> : dnDeltaPos_p	
C00834/5	<a href="#">MCTRL</a> : dnPosSetValue_p	
C00834/6	<a href="#">MCTRL</a> : dnPosRefValue_p	
C00834/7	MCK: dnProfilePosition_p	
C00834/8	<a href="#">L Interpolator 1</a> : dnPhiIn_p	
<input checked="" type="checkbox"/> Read access <input type="checkbox"/> Write access <input type="checkbox"/> CINH <input type="checkbox"/> PLC STOP <input checked="" type="checkbox"/> No transfer <input type="checkbox"/> COM <input type="checkbox"/> MOT           Scaling factor: 1		

**C00840**

Parameter   Name: <b>C00840   16-bit inputs I/O level [%]</b>		Data type: INTEGER_16 Index: 23735 <sub>d</sub> = 5CB7 <sub>h</sub>
Display in percent of 16 bit input values of various blocks of the I/O level • Non-listed subcodes are "reserved".		
<b>Display range (min. value   unit   max. value)</b>		
-199.99	%	199.99
<b>Subcodes</b>		<b>Info</b>
C00840/1	<a href="#">LS AnalogOutput</a> : nOut1_a	
C00840/2	<a href="#">LP CanOut1</a> : wState	
C00840/3	<a href="#">LP CanOut1</a> : wOut2	
C00840/4	<a href="#">LP CanOut1</a> : wOut3	
C00840/5	<a href="#">LP CanOut1</a> : wOut4	
C00840/6	<a href="#">LP CanOut2</a> : wOut1	
C00840/7	<a href="#">LP CanOut2</a> : wOut2	
C00840/8	<a href="#">LP CanOut2</a> : wOut3	
C00840/9	<a href="#">LP CanOut2</a> : wOut4	
C00840/10	<a href="#">LP CanOut3</a> : wOut1	
C00840/11	<a href="#">LP CanOut3</a> : wOut2	
C00840/12	<a href="#">LP CanOut3</a> : wOut3	
C00840/13	<a href="#">LP CanOut3</a> : wOut4	
C00840/14	<a href="#">LS DisFree a</a> : nDis1_a	
C00840/15	<a href="#">LS DisFree a</a> : nDis2_a	

Parameter   Name: <b>C00840   16-bit inputs I/O level [%]</b>		Data type: INTEGER_16 Index: 23735 <sub>d</sub> = 5CB7 <sub>h</sub>
C00840/16	<a href="#">LS_DisFree_a</a> : nDis3_a	
C00840/17	<a href="#">LS_DisFree_a</a> : nDis4_a	
C00840/18	<a href="#">LS_DisFree</a> : wDis1	
C00840/19	<a href="#">LS_DisFree</a> : wDis2	
C00840/20	<a href="#">LS_DisFree</a> : wDis3	
C00840/21	<a href="#">LS_DisFree</a> : wDis4	
C00840/22	<a href="#">LP_MciOut</a> : wState	
C00840/23	<a href="#">LP_MciOut</a> : wOut2	
C00840/24	<a href="#">LP_MciOut</a> : wOut3	
C00840/25	<a href="#">LP_MciOut</a> : wOut4	
C00840/26	<a href="#">LP_MciOut</a> : wOut5	
C00840/27	<a href="#">LP_MciOut</a> : wOut6	
C00840/28	<a href="#">LP_MciOut</a> : wOut7	
C00840/29	<a href="#">LP_MciOut</a> : wOut8	
C00840/30	<a href="#">LP_MciOut</a> : wOut9	
C00840/31	<a href="#">LP_MciOut</a> : wOut10	
C00840/32	<a href="#">LP_MciOut</a> : wOut11	
C00840/33	<a href="#">LP_MciOut</a> : wOut12	
C00840/34	<a href="#">LP_MciOut</a> : wOut13	
C00840/35	<a href="#">LP_MciOut</a> : wOut14	
C00840/36	<a href="#">LP_MciOut</a> : wOut15	
C00840/37	<a href="#">LP_MciOut</a> : wOut16	
C00840/49	<a href="#">LS_ParReadWrite_1</a> : wParIndex	
C00840/50	<a href="#">LS_ParReadWrite_1</a> : wParSubindex	
C00840/51	<a href="#">LS_ParReadWrite_1</a> : wInHWord	
C00840/52	<a href="#">LS_ParReadWrite_1</a> : wInLWord	
C00840/53	<a href="#">LS_ParReadWrite_2</a> : wParIndex	
C00840/54	<a href="#">LS_ParReadWrite_2</a> : wParSubindex	
C00840/55	<a href="#">LS_ParReadWrite_2</a> : wInHWord	
C00840/56	<a href="#">LS_ParReadWrite_2</a> : wInLWord	
C00840/57	<a href="#">LS_ParReadWrite_3</a> : wParIndex	
C00840/58	<a href="#">LS_ParReadWrite_3</a> : wParSubindex	
C00840/59	<a href="#">LS_ParReadWrite_3</a> : wInHWord	
C00840/60	<a href="#">LS_ParReadWrite_3</a> : wInLWord	
C00840/108	<a href="#">LP_CanOut4</a> : wOut1	
C00840/109	<a href="#">LP_CanOut4</a> : wOut2	
C00840/110	<a href="#">LP_CanOut4</a> : wOut3	
C00840/111	<a href="#">LP_CanOut4</a> : wOut4	
<input checked="" type="checkbox"/> Read access <input type="checkbox"/> Write access <input type="checkbox"/> CINH <input type="checkbox"/> PLC STOP <input checked="" type="checkbox"/> No transfer <input type="checkbox"/> COM <input type="checkbox"/> MOT             Scaling factor: 100		

## C00841

Parameter   Name: C00841   16-bit inputs I/O level		Data type: UNSIGNED_16 Index: 23734 <sub>d</sub> = 5CB6 <sub>h</sub>
Decimal/hexadecimal/bit coded display of 16 bit input values of various blocks of the I/O level • Non-listed subcodes are "reserved".		
<b>Display area</b> (min. hex value   max. hex value)		
0x0000		0xFFFF
<b>Value is bit-coded:</b>		
Bit 0	Active	
...	...	
Bit 15	Active	
<b>Subcodes</b>	<b>Info</b>	
C00841/1	<a href="#">LS_AnalogOutput</a> : nOut1_a	
C00841/2	<a href="#">LP_CanOut1</a> : wState	
C00841/3	<a href="#">LP_CanOut1</a> : wOut2	
C00841/4	<a href="#">LP_CanOut1</a> : wOut3	
C00841/5	<a href="#">LP_CanOut1</a> : wOut4	
C00841/6	<a href="#">LP_CanOut2</a> : wOut1	
C00841/7	<a href="#">LP_CanOut2</a> : wOut2	
C00841/8	<a href="#">LP_CanOut2</a> : wOut3	
C00841/9	<a href="#">LP_CanOut2</a> : wOut4	
C00841/10	<a href="#">LP_CanOut3</a> : wOut1	
C00841/11	<a href="#">LP_CanOut3</a> : wOut2	
C00841/12	<a href="#">LP_CanOut3</a> : wOut3	
C00841/13	<a href="#">LP_CanOut3</a> : wOut4	
C00841/14	<a href="#">LS_DisFree_a</a> : nDis1_a	
C00841/15	<a href="#">LS_DisFree_a</a> : nDis2_a	
C00841/16	<a href="#">LS_DisFree_a</a> : nDis3_a	
C00841/17	<a href="#">LS_DisFree_a</a> : nDis4_a	
C00841/18	<a href="#">LS_DisFree</a> : wDis1	
C00841/19	<a href="#">LS_DisFree</a> : wDis2	
C00841/20	<a href="#">LS_DisFree</a> : wDis3	
C00841/21	<a href="#">LS_DisFree</a> : wDis4	
C00841/22	<a href="#">LP_MciOut</a> : wState	
C00841/23	<a href="#">LP_MciOut</a> : wOut2	
C00841/24	<a href="#">LP_MciOut</a> : wOut3	
C00841/25	<a href="#">LP_MciOut</a> : wOut4	
C00841/26	<a href="#">LP_MciOut</a> : wOut5	
C00841/27	<a href="#">LP_MciOut</a> : wOut6	
C00841/28	<a href="#">LP_MciOut</a> : wOut7	
C00841/29	<a href="#">LP_MciOut</a> : wOut8	
C00841/30	<a href="#">LP_MciOut</a> : wOut9	
C00841/31	<a href="#">LP_MciOut</a> : wOut10	
C00841/32	<a href="#">LP_MciOut</a> : wOut11	
C00841/33	<a href="#">LP_MciOut</a> : wOut12	
C00841/34	<a href="#">LP_MciOut</a> : wOut13	

Parameter   Name: <b>C00841   16-bit inputs I/O level</b>		Data type: UNSIGNED_16 Index: 23734 <sub>d</sub> = 5CB6 <sub>h</sub>
C00841/35	<a href="#">LP_MciOut</a> : wOut14	
C00841/36	<a href="#">LP_MciOut</a> : wOut15	
C00841/37	<a href="#">LP_MciOut</a> : wOut16	
C00841/49	<a href="#">LS_ParReadWrite_1</a> : wParIndex	
C00841/50	<a href="#">LS_ParReadWrite_1</a> : wParSubindex	
C00841/51	<a href="#">LS_ParReadWrite_1</a> : wInHWord	
C00841/52	<a href="#">LS_ParReadWrite_1</a> : wInLWord	
C00841/53	<a href="#">LS_ParReadWrite_2</a> : wParIndex	
C00841/54	<a href="#">LS_ParReadWrite_2</a> : wParSubindex	
C00841/55	<a href="#">LS_ParReadWrite_2</a> : wInHWord	
C00841/56	<a href="#">LS_ParReadWrite_2</a> : wInLWord	
C00841/57	<a href="#">LS_ParReadWrite_3</a> : wParIndex	
C00841/58	<a href="#">LS_ParReadWrite_3</a> : wParSubindex	
C00841/59	<a href="#">LS_ParReadWrite_3</a> : wInHWord	
C00841/60	<a href="#">LS_ParReadWrite_3</a> : wInLWord	
C00841/108	<a href="#">LP_CanOut4</a> : wOut1	
C00841/109	<a href="#">LP_CanOut4</a> : wOut2	
C00841/110	<a href="#">LP_CanOut4</a> : wOut3	
C00841/111	<a href="#">LP_CanOut4</a> : wOut4	
<input checked="" type="checkbox"/> Read access <input type="checkbox"/> Write access <input type="checkbox"/> CINH <input type="checkbox"/> PLC STOP <input checked="" type="checkbox"/> No transfer <input type="checkbox"/> COM <input type="checkbox"/> MOT		

**C00843**

Parameter   Name: <b>C00843   Binary inputs I/O level</b>		Data type: UNSIGNED_8 Index: 23732 <sub>d</sub> = 5CB4 <sub>h</sub>
Display of the signal status of the binary inputs of different I/O level blocks		
• Non-listed subcodes are "reserved".		
<b>Selection list</b>		
0	False	
1	True	
<b>Subcodes</b>	<b>Info</b>	
C00843/1	<a href="#">LS_DigitalOutput</a> : bRelay	
C00843/2	<a href="#">LS_DigitalOutput</a> : bOut1	
C00843/3	<a href="#">LS_DigitalInput</a> : bCountIn1_Reset	
C00843/4	<a href="#">LS_DigitalInput</a> : bCountIn1_LoadStartValue	
C00843/5	<a href="#">LP_CanOut1</a> : bState_B0	
C00843/6	<a href="#">LP_CanOut1</a> : bState_B1	
C00843/7	<a href="#">LP_CanOut1</a> : bState_B2	
C00843/8	<a href="#">LP_CanOut1</a> : bState_B3	
C00843/9	<a href="#">LP_CanOut1</a> : bState_B4	
C00843/10	<a href="#">LP_CanOut1</a> : bState_B5	
C00843/11	<a href="#">LP_CanOut1</a> : bState_B6	
C00843/12	<a href="#">LP_CanOut1</a> : bState_B7	
C00843/13	<a href="#">LP_CanOut1</a> : bState_B8	
C00843/14	<a href="#">LP_CanOut1</a> : bState_B9	

Parameter   Name: <b>C00843   Binary inputs I/O level</b>		Data type: UNSIGNED 8 Index: 23732 <sub>d</sub> = 5CB4 <sub>h</sub>
C00843/15	<a href="#">LP_CanOut1</a> : bState_B10	
C00843/16	<a href="#">LP_CanOut1</a> : bState_B11	
C00843/17	<a href="#">LP_CanOut1</a> : bState_B12	
C00843/18	<a href="#">LP_CanOut1</a> : bState_B13	
C00843/19	<a href="#">LP_CanOut1</a> : bState_B14	
C00843/20	<a href="#">LP_CanOut1</a> : bState_B15	
C00843/21	<a href="#">LS_DisFree_b</a> : bDis1	
C00843/22	<a href="#">LS_DisFree_b</a> : bDis2	
C00843/23	<a href="#">LS_DisFree_b</a> : bDis3	
C00843/24	<a href="#">LS_DisFree_b</a> : bDis4	
C00843/25	<a href="#">LS_DisFree_b</a> : bDis5	
C00843/26	<a href="#">LS_DisFree_b</a> : bDis6	
C00843/27	<a href="#">LS_DisFree_b</a> : bDis7	
C00843/28	<a href="#">LS_DisFree_b</a> : bDis8	
C00843/29	<a href="#">LP_CanOut2</a> : bOut1_B0	
C00843/30	<a href="#">LP_CanOut2</a> : bOut1_B1	
C00843/31	<a href="#">LP_CanOut2</a> : bOut1_B2	
C00843/32	<a href="#">LP_CanOut2</a> : bOut1_B3	
C00843/33	<a href="#">LP_CanOut2</a> : bOut1_B4	
C00843/34	<a href="#">LP_CanOut2</a> : bOut1_B5	
C00843/35	<a href="#">LP_CanOut2</a> : bOut1_B6	
C00843/36	<a href="#">LP_CanOut2</a> : bOut1_B7	
C00843/37	<a href="#">LP_CanOut2</a> : bOut1_B8	
C00843/38	<a href="#">LP_CanOut2</a> : bOut1_B9	
C00843/39	<a href="#">LP_CanOut2</a> : bOut1_B10	
C00843/40	<a href="#">LP_CanOut2</a> : bOut1_B11	
C00843/41	<a href="#">LP_CanOut2</a> : bOut1_B12	
C00843/42	<a href="#">LP_CanOut2</a> : bOut1_B13	
C00843/43	<a href="#">LP_CanOut2</a> : bOut1_B14	
C00843/44	<a href="#">LP_CanOut2</a> : bOut1_B15	
C00843/45	<a href="#">LP_CanOut3</a> : bOut1_B0	
C00843/46	<a href="#">LP_CanOut3</a> : bOut1_B1	
C00843/47	<a href="#">LP_CanOut3</a> : bOut1_B2	
C00843/48	<a href="#">LP_CanOut3</a> : bOut1_B3	
C00843/49	<a href="#">LP_CanOut3</a> : bOut1_B4	
C00843/50	<a href="#">LP_CanOut3</a> : bOut1_B5	
C00843/51	<a href="#">LP_CanOut3</a> : bOut1_B6	
C00843/52	<a href="#">LP_CanOut3</a> : bOut1_B7	
C00843/53	<a href="#">LP_CanOut3</a> : bOut1_B8	
C00843/54	<a href="#">LP_CanOut3</a> : bOut1_B9	
C00843/55	<a href="#">LP_CanOut3</a> : bOut1_B10	
C00843/56	<a href="#">LP_CanOut3</a> : bOut1_B11	
C00843/57	<a href="#">LP_CanOut3</a> : bOut1_B12	
C00843/58	<a href="#">LP_CanOut3</a> : bOut1_B13	

Parameter   Name: <b>C00843   Binary inputs I/O level</b>		Data type: UNSIGNED_8 Index: 23732 <sub>d</sub> = 5CB4 <sub>h</sub>
C00843/59	<a href="#">LP_CanOut3</a> : bOut1_B14	
C00843/60	<a href="#">LP_CanOut3</a> : bOut1_B15	
C00843/61	<a href="#">LP_MciOut</a> : bState_B0	
C00843/62	<a href="#">LP_MciOut</a> : bState_B1	
C00843/63	<a href="#">LP_MciOut</a> : bState_B2	
C00843/64	<a href="#">LP_MciOut</a> : bState_B3	
C00843/65	<a href="#">LP_MciOut</a> : bState_B4	
C00843/66	<a href="#">LP_MciOut</a> : bState_B5	
C00843/67	<a href="#">LP_MciOut</a> : bState_B6	
C00843/68	<a href="#">LP_MciOut</a> : bState_B7	
C00843/69	<a href="#">LP_MciOut</a> : bState_B8	
C00843/70	<a href="#">LP_MciOut</a> : bState_B9	
C00843/71	<a href="#">LP_MciOut</a> : bState_B10	
C00843/72	<a href="#">LP_MciOut</a> : bState_B11	
C00843/73	<a href="#">LP_MciOut</a> : bState_B12	
C00843/74	<a href="#">LP_MciOut</a> : bState_B13	
C00843/75	<a href="#">LP_MciOut</a> : bState_B14	
C00843/76	<a href="#">LP_MciOut</a> : bState_B15	
C00843/77	<a href="#">LP_MciOut</a> : bOut2_B0	
C00843/78	<a href="#">LP_MciOut</a> : bOut2_B1	
C00843/79	<a href="#">LP_MciOut</a> : bOut2_B2	
C00843/80	<a href="#">LP_MciOut</a> : bOut2_B3	
C00843/81	<a href="#">LP_MciOut</a> : bOut2_B4	
C00843/82	<a href="#">LP_MciOut</a> : bOut2_B5	
C00843/83	<a href="#">LP_MciOut</a> : bOut2_B6	
C00843/84	<a href="#">LP_MciOut</a> : bOut2_B7	
C00843/85	<a href="#">LP_MciOut</a> : bOut2_B8	
C00843/86	<a href="#">LP_MciOut</a> : bOut2_B9	
C00843/87	<a href="#">LP_MciOut</a> : bOut2_B10	
C00843/88	<a href="#">LP_MciOut</a> : bOut2_B11	
C00843/89	<a href="#">LP_MciOut</a> : bOut2_B12	
C00843/90	<a href="#">LP_MciOut</a> : bOut2_B13	
C00843/91	<a href="#">LP_MciOut</a> : bOut2_B14	
C00843/92	<a href="#">LP_MciOut</a> : bOut2_B15	
C00843/93	<a href="#">LS_SetError_1</a> : bSetError1	
C00843/94	<a href="#">LS_SetError_1</a> : bSetError2	
C00843/95	<a href="#">LS_SetError_1</a> : bSetError3	
C00843/96	<a href="#">LS_SetError_1</a> : bSetError4	
C00843/111	<a href="#">LS_ParReadWrite_1</a> : bExecute	
C00843/112	<a href="#">LS_ParReadWrite_1</a> : bReadWrite	
C00843/113	<a href="#">LS_ParReadWrite_2</a> : bExecute	
C00843/114	<a href="#">LS_ParReadWrite_2</a> : bReadWrite	
C00843/115	<a href="#">LS_ParReadWrite_3</a> : bExecute	
C00843/116	<a href="#">LS_ParReadWrite_3</a> : bReadWrite	

Parameter   Name: <b>C00843   Binary inputs I/O level</b>		Data type: UNSIGNED_8 Index: 23732 <sub>d</sub> = 5CB4 <sub>h</sub>
C00843/123	<a href="#">LS_WriteParamList</a> : bExecute	
C00843/124	<a href="#">LS_WriteParamList</a> : bSelectWriteValue_1	
C00843/125	<a href="#">LS_WriteParamList</a> : bSelectWriteValue_2	
C00843/126	<a href="#">LS_CANManagement</a> : bResetNode	
C00843/127	<a href="#">LS_CANManagement</a> : bReInitCAN	
C00843/128	<a href="#">LS_DigitalInput</a> : bPosIn12_Load	
C00843/184	<a href="#">LP_CanOut4</a> : bOut1_B0	
C00843/185	<a href="#">LP_CanOut4</a> : bOut1_B1	
C00843/186	<a href="#">LP_CanOut4</a> : bOut1_B2	
C00843/187	<a href="#">LP_CanOut4</a> : bOut1_B3	
C00843/188	<a href="#">LP_CanOut4</a> : bOut1_B4	
C00843/189	<a href="#">LP_CanOut4</a> : bOut1_B5	
C00843/190	<a href="#">LP_CanOut4</a> : bOut1_B6	
C00843/191	<a href="#">LP_CanOut4</a> : bOut1_B7	
C00843/192	<a href="#">LP_CanOut4</a> : bOut1_B8	
C00843/193	<a href="#">LP_CanOut4</a> : bOut1_B9	
C00843/194	<a href="#">LP_CanOut4</a> : bOut1_B10	
C00843/195	<a href="#">LP_CanOut4</a> : bOut1_B11	
C00843/196	<a href="#">LP_CanOut4</a> : bOut1_B12	
C00843/197	<a href="#">LP_CanOut4</a> : bOut1_B13	
C00843/198	<a href="#">LP_CanOut4</a> : bOut1_B14	
C00843/199	<a href="#">LP_CanOut4</a> : bOut1_B15	
<input checked="" type="checkbox"/> Read access <input type="checkbox"/> Write access <input type="checkbox"/> CINH <input type="checkbox"/> PLC STOP <input checked="" type="checkbox"/> No transfer <input type="checkbox"/> COM <input type="checkbox"/> MOT             Scaling factor: 1		

**C00844**

Parameter   Name: <b>C00844   32-bit inputs I/O level [incr]</b>		Data type: INTEGER_32 Index: 23731 <sub>d</sub> = 5CB3 <sub>h</sub>
Display of 32-bit input values of different I/O level blocks in [increments] • Non-listed subcodes are "reserved".		
<b>Display range (min. value   unit   max. value)</b>		
-2147483647	Incr.	2147483647
<b>Subcodes</b>		<b>Info</b>
C00844/9		<a href="#">LP_CanOut1</a> : dnOut34_p
C00844/10		<a href="#">LP_CanOut2</a> : dnOut34_p
C00844/11		<a href="#">LP_CanOut3</a> : dnOut34_p
C00844/12		<a href="#">LP_MciOut</a> : dnOut34_p
C00844/13		<a href="#">LS_DigitalInput</a> : dnPosIn12_Set_p
C00844/25		<a href="#">LP_CanOut4</a> : dnOut34_p
<input checked="" type="checkbox"/> Read access <input type="checkbox"/> Write access <input type="checkbox"/> CINH <input type="checkbox"/> PLC STOP <input checked="" type="checkbox"/> No transfer <input type="checkbox"/> COM <input type="checkbox"/> MOT             Scaling factor: 1		

C00866

Parameter   Name: <b>C00866   CAN input words</b>		Data type: UNSIGNED_16 Index: 23709 <sub>d</sub> = 5C9D <sub>h</sub>
Display of the 16 bit input values of the CAN interface		
▶ <a href="#">"CAN on board" system bus</a>		
<b>Display area (min. hex value   max. hex value)</b>		
0x0000		0xFFFF
<b>Value is bit-coded:</b>		
Bit 0	Active	
...	...	
Bit 15	Active	
<b>Subcodes</b>		<b>Info</b>
C00866/1	<a href="#">LP_CanIn1</a> : wCtrl	
C00866/2	<a href="#">LP_CanIn1</a> : wIn2	
C00866/3	<a href="#">LP_CanIn1</a> : wIn3	
C00866/4	<a href="#">LP_CanIn1</a> : wIn4	
C00866/5	<a href="#">LP_CanIn2</a> : wIn1	
C00866/6	<a href="#">LP_CanIn2</a> : wIn2	
C00866/7	<a href="#">LP_CanIn2</a> : wIn3	
C00866/8	<a href="#">LP_CanIn2</a> : wIn4	
C00866/9	<a href="#">LP_CanIn3</a> : wIn1	
C00866/10	<a href="#">LP_CanIn3</a> : wIn2	
C00866/11	<a href="#">LP_CanIn3</a> : wIn3	
C00866/12	<a href="#">LP_CanIn3</a> : wIn4	
C00866/13	<a href="#">LP_CanIn4</a> : wIn1 • From version 15.00.00	
C00866/14	<a href="#">LP_CanIn4</a> : wIn2 • From version 15.00.00	
C00866/15	<a href="#">LP_CanIn4</a> : wIn3 • From version 15.00.00	
C00866/16	<a href="#">LP_CanIn4</a> : wIn4 • From version 15.00.00	
<input checked="" type="checkbox"/> Read access <input type="checkbox"/> Write access <input type="checkbox"/> CINH <input type="checkbox"/> PLC STOP <input checked="" type="checkbox"/> No transfer <input type="checkbox"/> COM <input type="checkbox"/> MOT		

C00868

Parameter   Name: <b>C00868   CAN output words</b>		Data type: UNSIGNED_16 Index: 23707 <sub>d</sub> = 5C9B <sub>h</sub>
Display of the 16 bit output values of the CAN interface		
▶ <a href="#">"CAN on board" system bus</a>		
<b>Display area (min. hex value   max. hex value)</b>		
0x0000		0xFFFF



Parameter   Name: <b>C00868   CAN output words</b>		Data type: UNSIGNED_16 Index: 23707 <sub>d</sub> = 5C9B <sub>h</sub>
<b>Value is bit-coded:</b>		
Bit 0	Active	
Bit 1	Active	
Bit 2	Active	
Bit 3	Active	
Bit 4	Active	
Bit 5	Active	
Bit 6	Active	
Bit 7	Active	
Bit 8	Active	
Bit 9	Active	
Bit 10	Active	
Bit 11	Active	
Bit 12	Active	
Bit 13	Active	
Bit 14	Active	
Bit 15	Active	
Subcodes	Info	
C00868/1	<a href="#">LP_CanOut1</a> : wState	
C00868/2	<a href="#">LP_CanOut1</a> : wOut2	
C00868/3	<a href="#">LP_CanOut1</a> : wOut3	
C00868/4	<a href="#">LP_CanOut1</a> : wOut4	
C00868/5	<a href="#">LP_CanOut2</a> : wOut1	
C00868/6	<a href="#">LP_CanOut2</a> : wOut2	
C00868/7	<a href="#">LP_CanOut2</a> : wOut3	
C00868/8	<a href="#">LP_CanOut2</a> : wOut4	
C00868/9	<a href="#">LP_CanOut3</a> : wOut1	
C00868/10	<a href="#">LP_CanOut3</a> : wOut2	
C00868/11	<a href="#">LP_CanOut3</a> : wOut3	
C00868/12	<a href="#">LP_CanOut3</a> : wOut4	
C00868/13	<a href="#">LP_CanOut4</a> : wOut1 • From version 15.00.00	
C00868/14	<a href="#">LP_CanOut4</a> : wOut2 • From version 15.00.00	
C00868/15	<a href="#">LP_CanOut4</a> : wOut3 • From version 15.00.00	
C00868/16	<a href="#">LP_CanOut4</a> : wOut4 • From version 15.00.00	
<input checked="" type="checkbox"/> Read access <input type="checkbox"/> Write access <input type="checkbox"/> CINH <input type="checkbox"/> PLC STOP <input checked="" type="checkbox"/> No transfer <input type="checkbox"/> COM <input type="checkbox"/> MOT		

## C00876

Parameter   Name: C00876   MCI input words		Data type: UNSIGNED_16 Index: 23699 <sub>d</sub> = 5C93 <sub>h</sub>
Display of the 16 bit input values of the communication module		
<b>Display area (min. hex value   max. hex value)</b>		
0x0000		0xFFFF
<b>Value is bit-coded:</b>		
Bit 0	Active	
...	...	
Bit 15	Active	
<b>Subcodes</b>		<b>Info</b>
C00876/1		<a href="#">LP_MciIn</a> : wCtrl
C00876/2		<a href="#">LP_MciIn</a> : wIn2
C00876/3		<a href="#">LP_MciIn</a> : wIn3
C00876/4		<a href="#">LP_MciIn</a> : wIn4
C00876/5		<a href="#">LP_MciIn</a> : wIn5
C00876/6		<a href="#">LP_MciIn</a> : wIn6
C00876/7		<a href="#">LP_MciIn</a> : wIn7
C00876/8		<a href="#">LP_MciIn</a> : wIn8
C00876/9		<a href="#">LP_MciIn</a> : wIn9
C00876/10		<a href="#">LP_MciIn</a> : wIn10
C00876/11		<a href="#">LP_MciIn</a> : wIn11
C00876/12		<a href="#">LP_MciIn</a> : wIn12
C00876/13		<a href="#">LP_MciIn</a> : wIn13
C00876/14		<a href="#">LP_MciIn</a> : wIn14
C00876/15		<a href="#">LP_MciIn</a> : wIn15
C00876/16		<a href="#">LP_MciIn</a> : wIn16
<input checked="" type="checkbox"/> Read access <input type="checkbox"/> Write access <input type="checkbox"/> CINH <input type="checkbox"/> PLC STOP <input checked="" type="checkbox"/> No transfer <input type="checkbox"/> COM <input type="checkbox"/> MOT		

## C00877

Parameter   Name: C00877   MCI output words		Data type: UNSIGNED_16 Index: 23698 <sub>d</sub> = 5C92 <sub>h</sub>
Display of the 16 bit output values of the communication module		
<b>Display area (min. hex value   max. hex value)</b>		
0x0000		0xFFFF
<b>Value is bit-coded:</b>		
Bit 0	Active	
...	...	
Bit 15	Active	
<b>Subcodes</b>		<b>Info</b>
C00877/1		<a href="#">LP_MciOut</a> : wState
C00877/2		<a href="#">LP_MciOut</a> : wOut2
C00877/3		<a href="#">LP_MciOut</a> : wOut3
C00877/4		<a href="#">LP_MciOut</a> : wOut4
C00877/5		<a href="#">LP_MciOut</a> : wOut5
C00877/6		<a href="#">LP_MciOut</a> : wOut6

Parameter   Name: <b>C00877   MCI output words</b>		Data type: UNSIGNED_16 Index: 23698 <sub>d</sub> = 5C92 <sub>h</sub>
C00877/7	<a href="#">LP_MciOut</a> : wOut7	
C00877/8	<a href="#">LP_MciOut</a> : wOut8	
C00877/9	<a href="#">LP_MciOut</a> : wOut9	
C00877/10	<a href="#">LP_MciOut</a> : wOut10	
C00877/11	<a href="#">LP_MciOut</a> : wOut11	
C00877/12	<a href="#">LP_MciOut</a> : wOut12	
C00877/13	<a href="#">LP_MciOut</a> : wOut13	
C00877/14	<a href="#">LP_MciOut</a> : wOut14	
C00877/15	<a href="#">LP_MciOut</a> : wOut15	
C00877/16	<a href="#">LP_MciOut</a> : wOut16	
<input checked="" type="checkbox"/> Read access <input type="checkbox"/> Write access <input type="checkbox"/> CINH <input type="checkbox"/> PLC STOP <input checked="" type="checkbox"/> No transfer <input type="checkbox"/> COM <input type="checkbox"/> MOT		

**C00890**

Parameter   Name: <b>C00890   MCI_InOut: Inversion</b>		Data type: UNSIGNED_16 Index: 23685 <sub>d</sub> = 5C85 <sub>h</sub>
From version 03.00.00 This parameter serves to invert the control/status bits of the MCI port blocks.		
<b>Setting range (min. hex value   max. hex value)</b>		
0x0000		0xFFFF
<b>Value is bit-coded:</b>		<b>Info</b>
Bit 0	Active	Bit set = inversion active
...	...	
Bit 15	Active	
<b>Subcodes</b>	<b>Lenze setting</b>	<b>Info</b>
C00890/1	0x0000	<a href="#">LP_MciIn</a> : Invert.Ctrl_B0..15
C00890/2	0x0000	<a href="#">LP_MciOut</a> : Invert.State_B0..15
C00890/3	0x0000	<a href="#">LP_MciIn</a> : Invert.In2_B0..15
C00890/4	0x0000	<a href="#">LP_MciOut</a> : Invert.Out2_B0..15
<input checked="" type="checkbox"/> Read access <input checked="" type="checkbox"/> Write access <input type="checkbox"/> CINH <input type="checkbox"/> PLC STOP <input type="checkbox"/> No transfer <input type="checkbox"/> COM <input type="checkbox"/> MOT		

## C00905

Parameter   Name: <b>C00905   Motor phase direction of rotation</b>		Data type: UNSIGNED_8 Index: 23670 <sub>d</sub> = 5C76 <sub>h</sub>
From version 04.00.00		
To correct such misconnected motor phases, the rotating field of the inverter's output can be reversed by selecting "1: Inverted". In this case, a phase will be reversed at the output of the inverter.		
<b>Note:</b>		
Up to and including version 07.00.00, this function may only be activated for the following motor control types:		
<ul style="list-style-type: none"> <li>• V/f characteristic control (VFCplus)</li> <li>• Energy-saving V/f characteristic control (VFCplusEco)</li> </ul>		
For all other motor control types, this function must not be activated because the set control mode would not work in that case!		
From version 12.00.00, this function may be activated for all motor control types with the exception of the ones for synchronous motor.		
The activation of this function does not affect the control types for synchronous motor since these control types require an in-phase connection of the synchronous motor.		
<b>Selection list</b> (Lenze setting printed in bold)		
0	Not inverted	
1	inverted	
<input checked="" type="checkbox"/> Read access <input checked="" type="checkbox"/> Write access <input checked="" type="checkbox"/> CINH <input type="checkbox"/> PLC STOP <input type="checkbox"/> No transfer <input type="checkbox"/> COM <input type="checkbox"/> MOT           Scaling factor: 1		

## C00909

Parameter   Name: <b>C00909   Speed limitation</b>		Data type: INTEGER_16 Index: 23666 <sub>d</sub> = 5C72 <sub>h</sub>
Max. positive/negative speed for all motor control modes		
<b>Setting range</b> (min. value   unit   max. value)		
0.00	%	175.00
<b>Subcodes</b>	<b>Lenze setting</b>	<b>Info</b>
C00909/1	120.00 %	Max. pos. speed
C00909/2	120.00 %	Max. neg. speed
<input checked="" type="checkbox"/> Read access <input checked="" type="checkbox"/> Write access <input type="checkbox"/> CINH <input type="checkbox"/> PLC STOP <input type="checkbox"/> No transfer <input type="checkbox"/> COM <input checked="" type="checkbox"/> MOT           Scaling factor: 100		

## C00910

Parameter   Name: <b>C00910   Frequency limitation</b>		Data type: UNSIGNED_16 Index: 23665 <sub>d</sub> = 5C71 <sub>h</sub>
Max. positive/negative output frequency for all motor control modes		
<b>Setting range</b> (min. value   unit   max. value)		
0	Hz	1300
<b>Subcodes</b>	<b>Lenze setting</b>	<b>Info</b>
C00910/1	1000 Hz	Max. pos. output frequency
C00910/2	1000 Hz	Max. neg. output frequency
<input checked="" type="checkbox"/> Read access <input checked="" type="checkbox"/> Write access <input type="checkbox"/> CINH <input type="checkbox"/> PLC STOP <input type="checkbox"/> No transfer <input type="checkbox"/> COM <input checked="" type="checkbox"/> MOT           Scaling factor: 1		

## C00915

Parameter   Name: <b>C00915   Motor cable length</b>		Data type: UNSIGNED_16 Index: 23660 <sub>d</sub> = 5C6C <sub>h</sub>	
From version 02.00.00			
Single motor cable length for calculating the motor cable resistance			
<ul style="list-style-type: none"> <li>The calculated motor cable resistance is displayed in <a href="#">C00917</a>.</li> </ul>			
<b>Setting range</b> (min. value   unit   max. value)		<b>Lenze setting</b>	
0.0	m	1000.0	5.0 m
<input checked="" type="checkbox"/> Read access <input checked="" type="checkbox"/> Write access <input type="checkbox"/> CINH <input type="checkbox"/> PLC STOP <input type="checkbox"/> No transfer <input type="checkbox"/> COM <input checked="" type="checkbox"/> MOT   Scaling factor: 10			

## C00916

Parameter   Name: <b>C00916   Motor cable cross-section</b>		Data type: UNSIGNED_16 Index: 23659 <sub>d</sub> = 5C6B <sub>h</sub>	
From version 02.00.00			
Motor cable cross-section of a phase/cable for calculating the motor cable resistance			
<ul style="list-style-type: none"> <li>The calculated motor cable resistance is displayed in <a href="#">C00917</a>.</li> </ul>			
<b>Setting range</b> (min. value   unit   max. value)		<b>Lenze setting</b>	
0.50	mm <sup>2</sup>	100.00	power-related (see <a href="#">table</a> )
<input checked="" type="checkbox"/> Read access <input checked="" type="checkbox"/> Write access <input type="checkbox"/> CINH <input type="checkbox"/> PLC STOP <input type="checkbox"/> No transfer <input type="checkbox"/> COM <input checked="" type="checkbox"/> MOT   Scaling factor: 100			

## C00917

Parameter   Name: <b>C00917   Motor cable resistance</b>		Data type: UNSIGNED_16 Index: 23658 <sub>d</sub> = 5C6A <sub>h</sub>	
From version 02.00.00			
Display of the motor cable resistance of a motor cable phase			
<ul style="list-style-type: none"> <li>The motor cable resistance is calculated from the motor cable length set in <a href="#">C00915</a> and the motor cable cross-section set in <a href="#">C00916</a>.</li> </ul>			
<b>Display range</b> (min. value   unit   max. value)			
0	mohm	64000	
<input checked="" type="checkbox"/> Read access <input type="checkbox"/> Write access <input type="checkbox"/> CINH <input type="checkbox"/> PLC STOP <input checked="" type="checkbox"/> No transfer <input type="checkbox"/> COM <input type="checkbox"/> MOT   Scaling factor: 1			

## C00919

Parameter   Name: <b>C00919   Moment of inertia from load</b>		Data type: UNSIGNED_32 Index: 23656 <sub>d</sub> = 5C68 <sub>h</sub>	
From version 12.00.00			
In order to take account of mass inertias changing during the process (e.g. reels) when optimising the response to setpoint changes, the maximum value of the changing moment of inertia must be set here. The process signal <i>nInertiaAdapt_a</i> of the <a href="#">LS_MotorInterface</a> SB can then be used in the process to dynamically control what percentage of it is to be taken into account for the setpoint feedforward control.			
<b>Setting range</b> (min. value   unit   max. value)			
0.00	kg cm <sup>2</sup>	6000000.00	
<b>Subcodes</b>	<b>Lenze setting</b>	<b>Info</b>	
C00919/1	0.00 kg cm <sup>2</sup>	Load moment of inertia	
<input checked="" type="checkbox"/> Read access <input checked="" type="checkbox"/> Write access <input type="checkbox"/> CINH <input type="checkbox"/> PLC STOP <input type="checkbox"/> No transfer <input type="checkbox"/> COM <input checked="" type="checkbox"/> MOT   Scaling factor: 100			

## C00920

Parameter   Name: <b>C00920   Rated device currents</b>		Data type: UNSIGNED_16 Index: 23655 <sub>d</sub> = 5C67 <sub>h</sub>
<b>Display range (min. value   unit   max. value)</b>		
0.0	A	6000.0
<b>Subcodes</b>		<b>Info</b>
C00920/1	Rated current 3ph 400V/1ph 230V	
C00920/2	Rated current 3ph 440V	
C00920/3	Rated current 3ph 480V	
C00920/4	Rated current 3ph 500V	
C00920/5	Increased rated current 3ph 400V/1ph 230V	
C00920/6	Increased rated current 3ph 440V	
C00920/7	Increased rated current 3ph 480V	
C00920/8	Increased rated current 3ph 500V	
<input checked="" type="checkbox"/> Read access <input type="checkbox"/> Write access <input checked="" type="checkbox"/> CINH <input checked="" type="checkbox"/> PLC STOP <input checked="" type="checkbox"/> No transfer <input checked="" type="checkbox"/> COM <input checked="" type="checkbox"/> MOT           Scaling factor: 10		

## C00922

Parameter   Name: <b>C00922   ICM_DiagnosticCounter</b>		Data type: UNSIGNED_16 Index: 23655 <sub>d</sub> = 5C65 <sub>h</sub>
<b>This code is used device-internally and must not be written by the user side!</b>		

## C00936

Parameter   Name: <b>C00936   SLPSM: Load value — speed controller</b>		Data type: UNSIGNED_16 Index: 23639 <sub>d</sub> = 5C57 <sub>h</sub>
<b>Setting range (min. value   unit   max. value)</b>		
0.00	%	200.00
<b>Subcodes</b>		<b>Info</b>
C00936/1	Lenze setting 0.00 %	<a href="#">SLPSM: Load value — speed controller</a>
<input checked="" type="checkbox"/> Read access <input checked="" type="checkbox"/> Write access <input type="checkbox"/> CINH <input type="checkbox"/> PLC STOP <input type="checkbox"/> No transfer <input type="checkbox"/> COM <input checked="" type="checkbox"/> MOT           Scaling factor: 100		

## C00937

Parameter   Name: <b>C00937   Field-oriented motor currents</b>		Data type: INTEGER_16 Index: 23638 <sub>d</sub> = 5C56 <sub>h</sub>
From version 11.00.00		
▶ <a href="#">Field weakening for synchronous motors</a>		
<b>Display range (min. value   unit   max. value)</b>		
-320.00	A	320.00
<b>Subcodes</b>		<b>Info</b>
C00937/1	Field-producing current	
C00937/2	Torque-producing current	
<input checked="" type="checkbox"/> Read access <input type="checkbox"/> Write access <input checked="" type="checkbox"/> CINH <input checked="" type="checkbox"/> PLC STOP <input checked="" type="checkbox"/> No transfer <input checked="" type="checkbox"/> COM <input checked="" type="checkbox"/> MOT           Scaling factor: 100		

## C00938

Parameter   Name: <b>C00938   PSM: Maximum motor current field weakening</b>		Data type: UNSIGNED_16 Index: 23637 <sub>d</sub> = 5C55 <sub>h</sub>	
From version 11.00.00			
<a href="#">▶ Field weakening for synchronous motors</a>			
Setting range (min. value   unit   max. value)			Lenze setting
0.00	%	500.00	<b>30.00 %</b>
<input checked="" type="checkbox"/> Read access <input checked="" type="checkbox"/> Write access <input type="checkbox"/> CINH <input type="checkbox"/> PLC STOP <input type="checkbox"/> No transfer <input type="checkbox"/> COM <input checked="" type="checkbox"/> MOT Scaling factor: 100			

## C00939

Parameter   Name: <b>C00939   Ultimate motor current</b>		Data type: UNSIGNED_16 Index: 23636 <sub>d</sub> = 5C54 <sub>h</sub>	
From version 10.00.00			
Setting range (min. value   unit   max. value)			Lenze setting
0.0	A	3000.0	<b>3000.0 A</b>
<input checked="" type="checkbox"/> Read access <input checked="" type="checkbox"/> Write access <input type="checkbox"/> CINH <input type="checkbox"/> PLC STOP <input type="checkbox"/> No transfer <input type="checkbox"/> COM <input checked="" type="checkbox"/> MOT Scaling factor: 10			

## C00950

Parameter   Name: <b>C00950   L_Interpolator_1: Activation FB functions</b>		Data type: UNSIGNED_8 Index: 23624 <sub>d</sub> = 5C49 <sub>h</sub>	
From version 04.00.00			
The <a href="#">L_Interpolator_1</a> FB: Activation of signal interpolation and signal monitoring			
Selection list			
0	Off		
1	On		
Subcodes	Lenze setting	Info	
C00950/1	0: Off	<a href="#">L_Interpolator_1</a> : Signal interpolation	
C00950/2	0: Off	<a href="#">L_Interpolator_1</a> : Signal monitoring	
C00950/3	0: Off	<a href="#">L_Interpolator_1</a> : Master value monitoring	
<input checked="" type="checkbox"/> Read access <input checked="" type="checkbox"/> Write access <input type="checkbox"/> CINH <input type="checkbox"/> PLC STOP <input type="checkbox"/> No transfer <input type="checkbox"/> COM <input type="checkbox"/> MOT Scaling factor: 1			

## C00951

Parameter   Name: <b>C00951   L_Interpolator_1: No. of interpolation steps</b>		Data type: UNSIGNED_16 Index: 23624 <sub>d</sub> = 5C48 <sub>h</sub>	
From version 04.00.00			
The <a href="#">L_Interpolator_1</a> FB: No. of interpolation steps			
Setting range (min. value   unit   max. value)			Lenze setting
0		65535	<b>1</b>
<input checked="" type="checkbox"/> Read access <input checked="" type="checkbox"/> Write access <input type="checkbox"/> CINH <input type="checkbox"/> PLC STOP <input type="checkbox"/> No transfer <input type="checkbox"/> COM <input type="checkbox"/> MOT Scaling factor: 1			

## C00952

Parameter   Name: <b>C00952   L_Interpolator_1: Limit value - error cycles</b>		Data type: UNSIGNED_16 Index: 23623 <sub>d</sub> = 5C47 <sub>h</sub>	
From version 04.00.00 The <a href="#">L_Interpolator_1</a> FB: Limit value for missing data telegrams			
<b>Setting range</b> (min. value   unit   max. value)		<b>Lenze setting</b>	
0		65535	<b>5</b>
<input checked="" type="checkbox"/> Read access <input checked="" type="checkbox"/> Write access <input type="checkbox"/> CINH <input type="checkbox"/> PLC STOP <input type="checkbox"/> No transfer <input type="checkbox"/> COM <input type="checkbox"/> MOT   Scaling factor: 1			

## C00953

Parameter   Name: <b>C00953   L_Interpolator_1: Speed-up</b>		Data type: UNSIGNED_8 Index: 23622 <sub>d</sub> = 5C46 <sub>h</sub>	
From version 04.00.00 FB <a href="#">L_Interpolator_1</a> : Limitation of the number of correction increments per cycle (speed-up)			
<b>Setting range</b> (min. value   unit   max. value)		<b>Lenze setting</b>	
0		100	<b>0</b>
<input checked="" type="checkbox"/> Read access <input checked="" type="checkbox"/> Write access <input type="checkbox"/> CINH <input type="checkbox"/> PLC STOP <input type="checkbox"/> No transfer <input type="checkbox"/> COM <input type="checkbox"/> MOT   Scaling factor: 1			

## C00954

Parameter   Name: <b>C00954   L_Interpolator_1: Synchronisation mode</b>		Data type: UNSIGNED_8 Index: 23621 <sub>d</sub> = 5C45 <sub>h</sub>	
<b>Selection list</b> (Lenze setting printed in bold)		<b>Info</b>	
<b>0</b>	<b>No synchronisation</b>		
1	CAN PDO 1		
2	CAN PDO 2		
3	CAN PDO 3		
4	CAN PDO 4		
5	CAN Sync		
10	MCI Sync		
20	Input bStart		
<input checked="" type="checkbox"/> Read access <input checked="" type="checkbox"/> Write access <input type="checkbox"/> CINH <input type="checkbox"/> PLC STOP <input type="checkbox"/> No transfer <input type="checkbox"/> COM <input type="checkbox"/> MOT   Scaling factor: 1			

## C00965

Parameter   Name: <b>C00965   Max. motor speed</b>		Data type: UNSIGNED_16 Index: 23610 <sub>d</sub> = 5C3A <sub>h</sub>	
From version 10.00.00 When the drive reaches the motor speed set here: <ul style="list-style-type: none"> <li>• The "Fault" error response takes place, i.e. the motor is shut down immediately.</li> <li>• The error message "<a href="#">oS2: Max. motor speed reached</a>" is entered into the logbook.</li> </ul>			
<b>Setting range</b> (min. value   unit   max. value)		<b>Lenze setting</b>	
50	rpm	65000	<b>60000 rpm</b>
<input checked="" type="checkbox"/> Read access <input checked="" type="checkbox"/> Write access <input type="checkbox"/> CINH <input type="checkbox"/> PLC STOP <input type="checkbox"/> No transfer <input type="checkbox"/> COM <input checked="" type="checkbox"/> MOT   Scaling factor: 1			



## C00966

Parameter   Name: <b>C00966   VFC: Time const. slip comp.</b>		Data type: UNSIGNED_16 Index: 23609 <sub>d</sub> = 5C39 <sub>h</sub>
From version 02.00.00		
Filter time constant of the slip compensation for V/f characteristic control ( <a href="#">VFCplus</a> )		
<ul style="list-style-type: none"> <li>The time constant of slip compensation serves to specify the dynamics of slip compensation for V/f characteristic control without feedback.</li> <li>The lower the selected time constant, the higher the dynamic performance of the slip compensation.</li> </ul>		
Setting range (min. value   unit   max. value)		Lenze setting
1	ms	6000
		power-related (see <a href="#">table</a> )
<input checked="" type="checkbox"/> Read access <input checked="" type="checkbox"/> Write access <input type="checkbox"/> CINH <input type="checkbox"/> PLC STOP <input type="checkbox"/> No transfer <input type="checkbox"/> COM <input checked="" type="checkbox"/> MOT   Scaling factor: 1		

## C00967

Parameter   Name: <b>C00967   VFC: Frequency interpol. point n</b>		Data type: INTEGER_16 Index: 23608 <sub>d</sub> = 5C38 <sub>h</sub>
From version 04.00.00		
Selection of the interpolation points (frequency values) for the V/f characteristic control ( <a href="#">VFCplus</a> ) with user-definable V/f characteristic ( <a href="#">C00006</a> = "10")		
Setting range (min. value   unit   max. value)		
-2600.0	Hz	2600.0
Subcodes	Lenze setting	Info
C00967/1	-50.0 Hz	<a href="#">VFC</a> : Frequency interpol. point 1
C00967/2	-40.0 Hz	<a href="#">VFC</a> : Frequency interpol. point 2
C00967/3	-30.0 Hz	<a href="#">VFC</a> : Frequency interpol. point 3
C00967/4	-20.0 Hz	<a href="#">VFC</a> : Frequency interpol. point 4
C00967/5	-10.0 Hz	<a href="#">VFC</a> : Frequency interpol. point 5
C00967/6	0.0 Hz	<a href="#">VFC</a> : Frequency interpol. point 6
C00967/7	10.0 Hz	<a href="#">VFC</a> : Frequency interpol. point 7
C00967/8	20.0 Hz	<a href="#">VFC</a> : Frequency interpol. point 8
C00967/9	30.0 Hz	<a href="#">VFC</a> : Frequency interpol. point 9
C00967/10	40.0 Hz	<a href="#">VFC</a> : Frequency interpol. point 10
C00967/11	50.0 Hz	<a href="#">VFC</a> : Frequency interpol. point 11
<input checked="" type="checkbox"/> Read access <input checked="" type="checkbox"/> Write access <input type="checkbox"/> CINH <input type="checkbox"/> PLC STOP <input type="checkbox"/> No transfer <input type="checkbox"/> COM <input checked="" type="checkbox"/> MOT   Scaling factor: 10		

## C00968

Parameter   Name: <b>C00968   VFC: Voltage interpol. point n</b>		Data type: UNSIGNED_16 Index: 23607 <sub>d</sub> = 5C37 <sub>h</sub>
From version 04.00.00		
Selection of the interpolation points (voltage values) for the V/f characteristic control ( <a href="#">VFCplus</a> ) with user-definable V/f characteristic ( <a href="#">C00006</a> = "10")		
Setting range (min. value   unit   max. value)		
0.00	V	600.00
Subcodes	Lenze setting	Info
C00968/1	400.00 V	<a href="#">VFC</a> : Voltage interpol. point 1
C00968/2	320.00 V	<a href="#">VFC</a> : Voltage interpol. point 2
C00968/3	240.00 V	<a href="#">VFC</a> : Voltage interpol. point 3
C00968/4	160.00 V	<a href="#">VFC</a> : Voltage interpol. point 4
C00968/5	80.00 V	<a href="#">VFC</a> : Voltage interpol. point 5

Parameter   Name: <b>C00968   VFC: Voltage interpol. point n</b>		Data type: UNSIGNED_16 Index: 23607 <sub>d</sub> = 5C37 <sub>h</sub>
C00968/6	0.00 V	<a href="#">VFC</a> : Voltage interpol. point 6
C00968/7	80.00 V	<a href="#">VFC</a> : Voltage interpol. point 7
C00968/8	160.00 V	<a href="#">VFC</a> : Voltage interpol. point 8
C00968/9	240.00 V	<a href="#">VFC</a> : Voltage interpol. point 9
C00968/10	320.00 V	<a href="#">VFC</a> : Voltage interpol. point 10
C00968/11	400.00 V	<a href="#">VFC</a> : Voltage interpol. point 11
<input checked="" type="checkbox"/> Read access <input checked="" type="checkbox"/> Write access <input type="checkbox"/> CINH <input type="checkbox"/> PLC STOP <input type="checkbox"/> No transfer <input type="checkbox"/> COM <input checked="" type="checkbox"/> MOT   Scaling factor: 100		

**C00969**

Parameter   Name: <b>C00969   Motorparameter</b>		Data type: UNSIGNED_8 Index: 23606 <sub>d</sub> = 5C36 <sub>h</sub>
<a href="#">From version 12.00.00</a>		
Display range (min. value   unit   max. value)		
1		255
Subcodes		Info
C00969/1		Motor - number of pole pairs
<input checked="" type="checkbox"/> Read access <input type="checkbox"/> Write access <input type="checkbox"/> CINH <input type="checkbox"/> PLC STOP <input checked="" type="checkbox"/> No transfer <input type="checkbox"/> COM <input type="checkbox"/> MOT   Scaling factor: 1		

**C00970**

Parameter   Name: <b>C00970   Rated device voltage</b>		Data type: UNSIGNED_16 Index: 23605 <sub>d</sub> = 5C35 <sub>h</sub>
Display range (min. value   unit   max. value)		
0	V	1000
Subcodes		Info
C00970/1		Rated device voltage
<input checked="" type="checkbox"/> Read access <input type="checkbox"/> Write access <input type="checkbox"/> CINH <input type="checkbox"/> PLC STOP <input checked="" type="checkbox"/> No transfer <input type="checkbox"/> COM <input type="checkbox"/> MOT   Scaling factor: 1		

**C00971**

Parameter   Name: <b>C00971   VFC: Limitation V/f +encoder</b>		Data type: UNSIGNED_16 Index: 23604 <sub>d</sub> = 5C34 <sub>h</sub>
Limitation of the output frequency of the slip regulator and limitation of the injected stator frequency for the V/f control ( <a href="#">VFCplus+encoder</a> )		
Setting range (min. value   unit   max. value)		
0.00	Hz	100.00
Subcodes		Info
C00971/1	10.00 Hz	Maximum output / correcting variable of the slip regulator <ul style="list-style-type: none"> <li>• The slip regulator output is limited to the value set here in motor/generator mode.</li> <li>• We recommend defining a limit value of one or two times the motor slip frequency.</li> </ul>
C00971/2	100.00 Hz	Maximum frequency deviation between the rotational frequency (speed) measured mechanically by the encoder and the injected stator frequency. <ul style="list-style-type: none"> <li>• A limitation may e.g. avoid overcurrent interruption when traversing to a fixed limit stop.</li> </ul>
<input checked="" type="checkbox"/> Read access <input checked="" type="checkbox"/> Write access <input type="checkbox"/> CINH <input type="checkbox"/> PLC STOP <input type="checkbox"/> No transfer <input type="checkbox"/> COM <input checked="" type="checkbox"/> MOT   Scaling factor: 100		

## C00972

Parameter   Name: <b>C00972   VFC: Vp V/f +encoder</b>		Data type: UNSIGNED_16 Index: 23603 <sub>d</sub> = 5C33 <sub>h</sub>	
Proportional gain of the slip regulator for V/f control ( <a href="#">VFCplus+encoder</a> )			
<ul style="list-style-type: none"> <li>The gain must be selected depending on the drive system and the sensor resolution (range: 0.005 ... 5).</li> <li>A high gain requires a high number of increments.</li> </ul>			
<b>Setting range (min. value   unit   max. value)</b>		<b>Lenze setting</b>	
0.000	Hz/Hz	64.000	<b>0.100 Hz/Hz</b>
<input checked="" type="checkbox"/> Read access <input checked="" type="checkbox"/> Write access <input type="checkbox"/> CINH <input type="checkbox"/> PLC STOP <input type="checkbox"/> No transfer <input type="checkbox"/> COM <input checked="" type="checkbox"/> MOT   Scaling factor: 1000			

## C00973

Parameter   Name: <b>C00973   VFC: Ti V/f +encoder</b>		Data type: UNSIGNED_16 Index: 23602 <sub>d</sub> = 5C32 <sub>h</sub>	
Integral time constant of the slip regulator for V/f control ( <a href="#">VFCplus+encoder</a> )			
<ul style="list-style-type: none"> <li>In general, the time constant should be selected in a range of 20 ms (high dynamics) to 200 (low dynamics).</li> </ul>			
<b>Setting range (min. value   unit   max. value)</b>		<b>Lenze setting</b>	
0.0	ms	6000.0	<b>100.0 ms</b>
<input checked="" type="checkbox"/> Read access <input checked="" type="checkbox"/> Write access <input type="checkbox"/> CINH <input type="checkbox"/> PLC STOP <input type="checkbox"/> No transfer <input type="checkbox"/> COM <input checked="" type="checkbox"/> MOT   Scaling factor: 10			

## C00975

Parameter   Name: <b>C00975   VFC-ECO: Vp CosPhi controller</b>		Data type: UNSIGNED_16 Index: 23600 <sub>d</sub> = 5C30 <sub>h</sub>	
<a href="#">From version 10.00.00</a>			
Proportional gain of the Cos-Phi controller for energy-saving V/f characteristic control ( <a href="#">VFCplusEco</a> )			
<b>Setting range (min. value   unit   max. value)</b>		<b>Lenze setting</b>	
0.000	Hz/Hz	64.000	<b>0.500 Hz/Hz</b>
<input checked="" type="checkbox"/> Read access <input checked="" type="checkbox"/> Write access <input type="checkbox"/> CINH <input type="checkbox"/> PLC STOP <input type="checkbox"/> No transfer <input type="checkbox"/> COM <input checked="" type="checkbox"/> MOT   Scaling factor: 1000			

## C00976

Parameter   Name: <b>C00976   VFC-ECO: Ti CosPhi controller</b>		Data type: UNSIGNED_16 Index: 23599 <sub>d</sub> = 5C2F <sub>h</sub>	
<a href="#">From version 10.00.00</a>			
Reset time of the Cos-Phi controller for energy-saving V/f characteristic control ( <a href="#">VFCplusEco</a> )			
<b>Setting range (min. value   unit   max. value)</b>		<b>Lenze setting</b>	
0.0	ms	6000.0	<b>200.0 ms</b>
<input checked="" type="checkbox"/> Read access <input checked="" type="checkbox"/> Write access <input type="checkbox"/> CINH <input type="checkbox"/> PLC STOP <input type="checkbox"/> No transfer <input type="checkbox"/> COM <input checked="" type="checkbox"/> MOT   Scaling factor: 10			

## C00977

Parameter   Name: <b>C00977   VFC-ECO: Minimum voltage V/f</b>		Data type: INTEGER_16 Index: 23598 <sub>d</sub> = 5C2E <sub>h</sub>	
<a href="#">From version 10.00.00</a>			
Minimum voltage V/f of the Cos-Phi controller for energy-saving V/f characteristic control ( <a href="#">VFCplusEco</a> )			
<b>Setting range (min. value   unit   max. value)</b>		<b>Lenze setting</b>	
20.00	%	100.00	<b>20.00 %</b>
<input checked="" type="checkbox"/> Read access <input checked="" type="checkbox"/> Write access <input type="checkbox"/> CINH <input type="checkbox"/> PLC STOP <input type="checkbox"/> No transfer <input type="checkbox"/> COM <input checked="" type="checkbox"/> MOT   Scaling factor: 100			

## C00978

Parameter   Name: <b>C00978   VFC-ECO: Voltage reduction</b>		Data type: INTEGER_16 Index: 23597 <sub>d</sub> = 5C2D <sub>h</sub>
From version 10.00.00 Display of the voltage reduction with energy-saving V/f characteristic control ( <a href="#">VFCplusEco</a> )		
<b>Display range (min. value   unit   max. value)</b>		
-1000	V	1000
<input checked="" type="checkbox"/> Read access <input type="checkbox"/> Write access <input type="checkbox"/> CINH <input type="checkbox"/> PLC STOP <input type="checkbox"/> No transfer <input type="checkbox"/> COM <input type="checkbox"/> MOT           Scaling factor: 1		

## C00979

Parameter   Name: <b>C00979   Cosine phi</b>		Data type: INTEGER_16 Index: 23596 <sub>d</sub> = 5C2C <sub>h</sub>
From version 10.00.00 Display of the $\cos\phi$ setpoint and actual value with energy-saving V/f characteristic control ( <a href="#">VFCplusEco</a> )		
<b>Display range (min. value   unit   max. value)</b>		
-1.00		1.00
<b>Subcodes</b>		<b>Info</b>
C00979/1		Cosine phi act
C00979/2		Cosine phi set
<input checked="" type="checkbox"/> Read access <input type="checkbox"/> Write access <input type="checkbox"/> CINH <input type="checkbox"/> PLC STOP <input type="checkbox"/> No transfer <input type="checkbox"/> COM <input type="checkbox"/> MOT           Scaling factor: 100		

## C00980

Parameter   Name: <b>C00980   Performance indication</b>		Data type: INTEGER_32 Index: 23595 <sub>d</sub> = 5C2B <sub>h</sub>
From version 10.00.00 Display parameter for an energy analysis in the prevailing application. From this, decisions can be deduced whether a measure for energy optimisation is economic.		
<b>Display range (min. value   unit   max. value)</b>		
-180.000	kW	180.000
<b>Subcodes</b>		<b>Info</b>
C00980/1		Active output power
C00980/2		Apparent output power
C00980/3		Rated device power • From version 17.00.00 onwards
C00980/4		Input power • From version 17.00.00 onwards
<input checked="" type="checkbox"/> Read access <input type="checkbox"/> Write access <input type="checkbox"/> CINH <input type="checkbox"/> PLC STOP <input type="checkbox"/> No transfer <input type="checkbox"/> COM <input type="checkbox"/> MOT           Scaling factor: 1000		

## C00981

Parameter   Name: <b>C00981   Energy display</b>		Data type: INTEGER_32 Index: 23594 <sub>d</sub> = 5C2A <sub>h</sub>
From version 10.00.00		
Display parameter for an energy analysis in the prevailing application. From this, decisions can be deduced whether a measure for energy optimisation is economic.		
<ul style="list-style-type: none"> <li>The values are saved to the device by switching off the mains and cannot be reset.</li> </ul>		
<b>Display range (min. value   unit   max. value)</b>		
0.00	kWh	21474836.47
<b>Subcodes</b>		<b>Info</b>
C00981/1		Output energy in motor mode
C00981/2		Output energy in generator mode
<input checked="" type="checkbox"/> Read access <input type="checkbox"/> Write access <input checked="" type="checkbox"/> CINH <input checked="" type="checkbox"/> PLC STOP <input checked="" type="checkbox"/> No transfer <input checked="" type="checkbox"/> COM <input checked="" type="checkbox"/> MOT   Scaling factor: 100		

## C00982

Parameter   Name: <b>C00982   VFC-ECO: Voltage reduction ramp</b>		Data type: UNSIGNED_8 Index: 23593 <sub>d</sub> = 5C29 <sub>h</sub>
From version 10.00.00		
Voltage ramp for cancelling V-Sub with energy-saving V/f characteristic control ( <a href="#">VFCplusEco</a> )		
<b>Setting range (min. value   unit   max. value)</b>		<b>Lenze setting</b>
0.0	s	5.0 power-related (see <a href="#">table</a> )
<input checked="" type="checkbox"/> Read access <input checked="" type="checkbox"/> Write access <input type="checkbox"/> CINH <input type="checkbox"/> PLC STOP <input type="checkbox"/> No transfer <input type="checkbox"/> COM <input checked="" type="checkbox"/> MOT   Scaling factor: 10		

## C00983

Parameter   Name: <b>C00983   Delay</b>		Data type: UNSIGNED_16 Index: 23592 <sub>d</sub> = 5C28 <sub>h</sub>
<b>Setting range (min. value   unit   max. value)</b>		
0	ms	4000
<b>Subcodes</b>		<b>Lenze setting</b>
C00983/1		50 ms
C00983/2		1000 ms
		<b>Info</b>
		Delay I <sub>max</sub>
		<a href="#">VFC</a> : Voltage ramp after overvoltage oU
		• From version 15.00.00
<input checked="" type="checkbox"/> Read access <input checked="" type="checkbox"/> Write access <input checked="" type="checkbox"/> CINH <input checked="" type="checkbox"/> PLC STOP <input checked="" type="checkbox"/> No transfer <input checked="" type="checkbox"/> COM <input checked="" type="checkbox"/> MOT   Scaling factor: 1		

## C00985

Parameter   Name: <b>C00985   SLVC: Gain of field current controller</b>		Data type: INTEGER_16 Index: 23590 <sub>d</sub> = 5C26 <sub>h</sub>
Gain of the direct-axis current difference (I <sub>d</sub> ) between setpoint and actual current for the voltage model of the sensorless vector control ( <a href="#">SLVC</a> )		
<ul style="list-style-type: none"> <li>The gain should be selected within the range 0 ...1 %.</li> </ul>		
<b>Setting range (min. value   unit   max. value)</b>		<b>Lenze setting</b>
0.00	%	20.00 <b>0.50 %</b>
<input checked="" type="checkbox"/> Read access <input checked="" type="checkbox"/> Write access <input checked="" type="checkbox"/> CINH <input checked="" type="checkbox"/> PLC STOP <input checked="" type="checkbox"/> No transfer <input checked="" type="checkbox"/> COM <input checked="" type="checkbox"/> MOT   Scaling factor: 100		

## C00986

Parameter   Name: <b>C00986   SLVC: Gain of cross current controller</b>		Data type: INTEGER_16 Index: 23589 <sub>d</sub> = 5C25 <sub>h</sub>
Gain of the IQ difference for the voltage model of the sensorless vector control ( <a href="#">SLVC</a> )		
<b>Setting range (min. value   unit   max. value)</b>		<b>Lenze setting</b>
0.00	%	20.00 <b>0.00 %</b>
<input checked="" type="checkbox"/> Read access <input checked="" type="checkbox"/> Write access <input type="checkbox"/> CINH <input type="checkbox"/> PLC STOP <input type="checkbox"/> No transfer <input type="checkbox"/> COM <input checked="" type="checkbox"/> MOT Scaling factor: 100		

## C00987

Parameter   Name: <b>C00987   Inverter motor brake: nAdd</b>		Data type: INTEGER_16 Index: 23588 <sub>d</sub> = 5C24 <sub>h</sub>
From version 04.00.00 Speed lift which is connected in pulses to the brake ramp when the motor is braked. <a href="#">▶ Inverter motor brake</a>		
<b>Setting range (min. value   unit   max. value)</b>		<b>Lenze setting</b>
0	rpm	1000 power-related (see <a href="#">table</a> )
<input checked="" type="checkbox"/> Read access <input checked="" type="checkbox"/> Write access <input type="checkbox"/> CINH <input type="checkbox"/> PLC STOP <input type="checkbox"/> No transfer <input type="checkbox"/> COM <input checked="" type="checkbox"/> MOT Scaling factor: 1		

## C00988

Parameter   Name: <b>C00988   Inverter motor brake: PT1 filter time</b>		Data type: INTEGER_16 Index: 23587 <sub>d</sub> = 5C23 <sub>h</sub>
From version 04.00.00 PT1 filter time for smoothing the speed lift which is added in pulses ( <a href="#">C00987</a> ) <a href="#">▶ Inverter motor brake</a>		
<b>Setting range (min. value   unit   max. value)</b>		<b>Lenze setting</b>
0.0	ms	100.0 <b>0.0 ms</b>
<input checked="" type="checkbox"/> Read access <input checked="" type="checkbox"/> Write access <input type="checkbox"/> CINH <input type="checkbox"/> PLC STOP <input type="checkbox"/> No transfer <input type="checkbox"/> COM <input type="checkbox"/> MOT Scaling factor: 10		

## C00989

Parameter   Name: <b>C00989   Restart on the fly: Flying restart frequency fd_add</b>		Data type: INTEGER_16 Index: 23586 <sub>d</sub> = 5C22 <sub>h</sub>
From version 15.00.00 <a href="#">▶ Flying restart fct.</a>		
<b>Setting range (min. value   unit   max. value)</b>		
0.00	Hz	5.00
<b>Subcodes</b>	<b>Lenze setting</b>	<b>Info</b>
C00989/1	0.00 Hz	Restart on the fly: Flying restart frequency fd_add
<input checked="" type="checkbox"/> Read access <input checked="" type="checkbox"/> Write access <input type="checkbox"/> CINH <input type="checkbox"/> PLC STOP <input type="checkbox"/> No transfer <input type="checkbox"/> COM <input checked="" type="checkbox"/> MOT Scaling factor: 100		

## C00990

Parameter   Name: <b>C00990   Flying restart fct.: Activation</b>		Data type: UNSIGNED_8 Index: 23585 <sub>d</sub> = 5C21 <sub>h</sub>
Switch on/activate flying restart circuit for non-feedback drive systems		
<a href="#">▶ Flying restart fct.</a>		
<b>Selection list</b> (Lenze setting printed in bold)		
<b>0</b>	<b>Off</b>	
1	On	
<input checked="" type="checkbox"/> Read access <input checked="" type="checkbox"/> Write access <input checked="" type="checkbox"/> CINH <input type="checkbox"/> PLC STOP <input type="checkbox"/> No transfer <input type="checkbox"/> COM <input checked="" type="checkbox"/> MOT           Scaling factor: 1		

## C00991

Parameter   Name: <b>C00991   Flying restart fct.: Process</b>		Data type: UNSIGNED_16 Index: 23584 <sub>d</sub> = 5C20 <sub>h</sub>
Selection of the starting value and the speed search range for the flying restart function		
<a href="#">▶ Flying restart fct.</a>		
<b>Selection list</b> (Lenze setting printed in bold)		<b>Info</b>
0	0...+n   Start: +10 Hz	Search positive speed range (0 ... +n) with a start frequency of +10 Hz
1	-n...0   Start: -10 Hz	Search negative speed range (-n ... 0) with a start frequency of -10 Hz
<b>2</b>	<b>-n...+n   Start: +10 Hz</b>	Search negative and positive speed range (-n ... n) with a start frequency of +10 Hz
3	-n...+n   Start: -10 Hz	Search negative and positive speed range (-n ... n) with a start frequency of -10 Hz
4	-n...+n   Start: Cx992	Search the negative and positive speed range (-n ... n) with the start frequency set in <a href="#">C00992</a>
<input checked="" type="checkbox"/> Read access <input checked="" type="checkbox"/> Write access <input type="checkbox"/> CINH <input type="checkbox"/> PLC STOP <input type="checkbox"/> No transfer <input type="checkbox"/> COM <input checked="" type="checkbox"/> MOT           Scaling factor: 1		

## C00992

Parameter   Name: <b>C00992   Flying restart fct.: Start frequency</b>		Data type: INTEGER_16 Index: 23583 <sub>d</sub> = 5C1F <sub>h</sub>
Manual selection of the starting value for the flying restart function		
<ul style="list-style-type: none"> <li>• Only active if <a href="#">C00991</a> = 4</li> </ul>		
<a href="#">▶ Flying restart fct.</a>		
<b>Setting range</b> (min. value   unit   max. value)		<b>Lenze setting</b>
-200	Hz	200
		<b>10 Hz</b>
<input checked="" type="checkbox"/> Read access <input checked="" type="checkbox"/> Write access <input type="checkbox"/> CINH <input type="checkbox"/> PLC STOP <input type="checkbox"/> No transfer <input type="checkbox"/> COM <input checked="" type="checkbox"/> MOT           Scaling factor: 1		

## C00993

Parameter   Name: <b>C00993   Flying restart fct: Int. time</b>		Data type: UNSIGNED_16 Index: 23582 <sub>d</sub> = 5C1E <sub>h</sub>
Time constant of the angular difference controller of the flying restart function		
<ul style="list-style-type: none"> <li>• The time constant is to amount between 60 ... 300 ms.</li> </ul>		
<a href="#">▶ Flying restart fct.</a>		
<b>Setting range</b> (min. value   unit   max. value)		<b>Lenze setting</b>
0.0	ms	6000.0
		power-related (see <a href="#">table</a> )
<input checked="" type="checkbox"/> Read access <input checked="" type="checkbox"/> Write access <input type="checkbox"/> CINH <input type="checkbox"/> PLC STOP <input type="checkbox"/> No transfer <input type="checkbox"/> COM <input checked="" type="checkbox"/> MOT           Scaling factor: 10		

## C00994

Parameter   Name: <b>C00994   Flying restart fct.: Current</b>		Data type: INTEGER_16 Index: 23581 <sub>d</sub> = 5C1D <sub>h</sub>
Current to be injected during the flying restart process <ul style="list-style-type: none"> <li>• 100 % ≡ rated motor current (<a href="#">C00088</a>).</li> <li>• The flying restart current should amount to 10 ... 25 % of the rated motor current.</li> </ul> <p style="text-align: right;"><a href="#">▶ Flying restart fct.</a></p>		
<b>Setting range (min. value   unit   max. value)</b>		<b>Lenze setting</b>
0.00	%	100.00 <b>25.00 %</b>
<input checked="" type="checkbox"/> Read access <input checked="" type="checkbox"/> Write access <input type="checkbox"/> CINH <input type="checkbox"/> PLC STOP <input type="checkbox"/> No transfer <input type="checkbox"/> COM <input checked="" type="checkbox"/> MOT   Scaling factor: 100		

## C00995

Parameter   Name: <b>C00995   SLPSM: Controlled current setpoint</b>		Data type: UNSIGNED_16 Index: 23580 <sub>d</sub> = 5C1C <sub>h</sub>
From version 10.00.00 <a href="#">▶ Sensorless control for synchronous motors (SLPSM)</a>		
<b>Setting range (min. value   unit   max. value)</b>		
5.00	%	400.00
<b>Subcodes</b>	<b>Lenze setting</b>	<b>Info</b>
C00995/1	100.00 %	<a href="#">SLPSM</a> : Controlled accelerating current
C00995/2	20.00 %	<a href="#">SLPSM</a> : Controlled standstill current
<input checked="" type="checkbox"/> Read access <input checked="" type="checkbox"/> Write access <input type="checkbox"/> CINH <input type="checkbox"/> PLC STOP <input type="checkbox"/> No transfer <input type="checkbox"/> COM <input checked="" type="checkbox"/> MOT   Scaling factor: 100		

## C00996

Parameter   Name: <b>C00996   SLPSM: Switching speed</b>		Data type: INTEGER_16 Index: 23579 <sub>d</sub> = 5C1B <sub>h</sub>
From version 10.00.00 <a href="#">▶ Sensorless control for synchronous motors (SLPSM)</a>		
<b>Setting range (min. value   unit   max. value)</b>		
0.00	%	100.00
<b>Subcodes</b>	<b>Lenze setting</b>	<b>Info</b>
C00996/1	13.00 %	<a href="#">SLPSM</a> : Switching speed, closed-loop control
C00996/2	8.00 %	<a href="#">SLPSM</a> : Switching speed, open-loop control
<input checked="" type="checkbox"/> Read access <input checked="" type="checkbox"/> Write access <input type="checkbox"/> CINH <input type="checkbox"/> PLC STOP <input type="checkbox"/> No transfer <input type="checkbox"/> COM <input type="checkbox"/> MOT   Scaling factor: 100		

## C00997

Parameter   Name: <b>C00997   SLPSM: Filter cutoff frequency</b>		Data type: INTEGER_16 Index: 23578 <sub>d</sub> = 5C1A <sub>h</sub>
From version 10.00.00 <a href="#">▶ Sensorless control for synchronous motors (SLPSM)</a>		
<b>Setting range (min. value   unit   max. value)</b>		<b>Lenze setting</b>
0.00	%	100.00 <b>5.00 %</b>
<input checked="" type="checkbox"/> Read access <input checked="" type="checkbox"/> Write access <input type="checkbox"/> CINH <input type="checkbox"/> PLC STOP <input type="checkbox"/> No transfer <input type="checkbox"/> COM <input type="checkbox"/> MOT   Scaling factor: 100		



## C00998

Parameter   Name: <b>C00998   SLPSM: Filter time rotor position</b>		Data type: INTEGER_16 Index: 23577 <sub>d</sub> = 5C19 <sub>h</sub>
From version 10.00.00		
▶ <a href="#">Sensorless control for synchronous motors (SLPSM)</a>		
<b>Setting range (min. value   unit   max. value)</b>		
0.5	ms	20.0
<b>Subcodes</b>	<b>Lenze setting</b>	<b>Info</b>
C00998/1	3.0 ms	<a href="#">SLPSM</a> : Filter time rotor position
C00998/2	5.0 ms	<a href="#">SLPSM</a> : Filter time actual speed value
<input checked="" type="checkbox"/> Read access <input checked="" type="checkbox"/> Write access <input type="checkbox"/> CINH <input type="checkbox"/> PLC STOP <input type="checkbox"/> No transfer <input type="checkbox"/> COM <input checked="" type="checkbox"/> MOT   Scaling factor: 10		

## C00999

Parameter   Name: <b>C00999   SLPSM: PLL gain</b>		Data type: INTEGER_16 Index: 23576 <sub>d</sub> = 5C18 <sub>h</sub>
From version 10.00.00		
▶ <a href="#">Sensorless control for synchronous motors (SLPSM)</a>		
<b>Setting range (min. value   unit   max. value)</b>		<b>Lenze setting</b>
0	%	1000 <b>400 %</b>
<input checked="" type="checkbox"/> Read access <input checked="" type="checkbox"/> Write access <input type="checkbox"/> CINH <input type="checkbox"/> PLC STOP <input type="checkbox"/> No transfer <input type="checkbox"/> COM <input checked="" type="checkbox"/> MOT   Scaling factor: 1		

## C01000

Parameter   Name: <b>C01000   MCTRL: Status</b>		Data type: UNSIGNED_16 Index: 23575 <sub>d</sub> = 5C17 <sub>h</sub>
From version 10.00.00		
<b>Display area (min. hex value   max. hex value)</b>		
0x0000		0xFFFF
<b>Value is bit-coded:</b>		<b>Info</b>
Bit 0	SLPSM: Speed closed-loop control	1 ≙ The sensorless control for synchronous motors is in the closed-loop controlled operation ( $ n_{\text{Setpoint}}  > n_{\text{C00996}}$ ). ▶ <a href="#">Sensorless control for synchronous motors (SLPSM)</a>
Bit 1	SLPSM: Speed open-loop control	From version 12.00.00 1 ≙ The sensorless control for synchronous motors is in the open-loop controlled operation ( $ n_{\text{Setpoint}}  > n_{\text{C00996}}$ ). ▶ <a href="#">Sensorless control for synchronous motors (SLPSM)</a>
Bit 2	Motor ASM	From version 12.00.00 1 ≙ Set motor type is "Asynchronous motor"
Bit 3	Motor PSM	From version 12.00.00 1 ≙ Set motor type is "Synchronous motor"
Bit 4	Encoder open circuit: V/f linear active	From version 15.00.00 1 ≙ Due to an encoder open circuit, it has been internally switched to the encoderless V/f characteristic control to avoid impermissible motor movements.
Bit 5	Speed limit. C909/C910/fdmax	
Bit 6	Reserved	
Bit 7	Reserved	
Bit 8	Reserved	
Bit 9	Reserved	

Parameter   Name: <b>C01000   MCTRL: Status</b>		Data type: UNSIGNED_16 Index: 23575 <sub>d</sub> = 5C17 <sub>h</sub>
Bit 10	Reserved	
Bit 11	Reserved	
Bit 12	Reserved	
Bit 13	Reserved	
Bit 14	Reserved	
Bit 15	Reserved	
<input checked="" type="checkbox"/> Read access <input type="checkbox"/> Write access <input type="checkbox"/> CINH <input type="checkbox"/> PLC STOP <input type="checkbox"/> No transfer <input type="checkbox"/> COM <input checked="" type="checkbox"/> MOT		

**C01001**

Parameter   Name: <b>C01001   Manual entry of motor type</b>		Data type: UNSIGNED_8 Index: 23574 <sub>d</sub> = 5C16 <sub>h</sub>
From version 14.00.00		
<b>Selection list</b>		
0	Automatic	
1	ASM	
2	PSM	
<b>Subcodes</b>	<b>Lenze setting</b>	<b>Info</b>
C01001/1	0: Automatic	Manual entry of motor type
<input checked="" type="checkbox"/> Read access <input checked="" type="checkbox"/> Write access <input type="checkbox"/> CINH <input type="checkbox"/> PLC STOP <input type="checkbox"/> No transfer <input type="checkbox"/> COM <input checked="" type="checkbox"/> MOT                   Scaling factor: 1		

**C01004**

Parameter   Name: <b>C01004   Device command: Configuration</b>		Data type: UNSIGNED_16 Index: 23571 <sub>d</sub> = 5C13 <sub>h</sub>
<b>Setting range (min. hex value   max. hex value)</b>		
0x0000		0xFFFF
<b>Value is bit-coded:</b>		<b>Info</b>
Bit 0	Communication module	
Bit 1	CAN OnBoard	
Bit 2	Reserved	
Bit 3	Reserved	
Bit 4	Reserved	
Bit 5	Reserved	
Bit 6	Reserved	
Bit 7	Reserved	
Bit 8	Reserved	
Bit 9	Reserved	
Bit 10	Reserved	
Bit 11	Reserved	
Bit 12	Reserved	
Bit 13	Reserved	

Parameter   Name: <b>C01004   Device command: Configuration</b>		Data type: UNSIGNED_16 Index: 23571 <sub>d</sub> = 5C13 <sub>h</sub>
Bit 14	Reserved	
Bit 15	Reserved	
<b>Subcodes</b>	<b>Lenze setting</b>	<b>Info</b>
C01004/1	0x0000	Load Lenze setting without:
<input checked="" type="checkbox"/> Read access <input checked="" type="checkbox"/> Write access <input type="checkbox"/> CINH <input type="checkbox"/> PLC STOP <input checked="" type="checkbox"/> No transfer <input type="checkbox"/> COM <input type="checkbox"/> MOT		

**C01082**

Parameter   Name: <b>C01082   LS_WriteParamList: Execute Mode</b>		Data type: UNSIGNED_8 Index: 23493 <sub>d</sub> = 5BC5 <sub>h</sub>
From version 04.00.00 <a href="#">Parameter change-over</a> : Selection of the activation method		
<b>Selection list</b> (Lenze setting printed in bold)		<b>Info</b>
<b>0</b>	<b>by Execute</b>	The writing of the parameter list is activated by a FALSE/TRUE edge at the <i>bExecute</i> input.
1	by Input Select	The writing of the parameter list is carried out if a change is made at the select inputs and if the inverter is initialised.
<input checked="" type="checkbox"/> Read access <input checked="" type="checkbox"/> Write access <input type="checkbox"/> CINH <input type="checkbox"/> PLC STOP <input type="checkbox"/> No transfer <input type="checkbox"/> COM <input type="checkbox"/> MOT   Scaling factor: 1		

**C01083**

Parameter   Name: <b>C01083   LS_WriteParamList: Error status</b>		Data type: UNSIGNED_16 Index: 23492 <sub>d</sub> = 5BC4 <sub>h</sub>
From version 04.00.00 <a href="#">Parameter change-over</a> : Error status:		
<ul style="list-style-type: none"> <li>• 0 = no error</li> <li>• 33803   0x840B = invalid data type (e.g. STRING)</li> <li>• 33804   0x840C = limit violation</li> <li>• 33806   0x840E = invalid code</li> <li>• 33813   0x8415 = no element of the selection list</li> <li>• 33815   0x8417 = writing of the parameter not permitted</li> <li>• 33816   0x8418 = writing of the parameter only permitted if controller is inhibited</li> <li>• 33829   0x8425 = invalid subcode</li> <li>• 33865   0x8449 = no parameter with subcodes</li> </ul>		
<b>Display range</b> (min. value   unit   max. value)		
0		34000
<input checked="" type="checkbox"/> Read access <input type="checkbox"/> Write access <input type="checkbox"/> CINH <input type="checkbox"/> PLC STOP <input checked="" type="checkbox"/> No transfer <input type="checkbox"/> COM <input type="checkbox"/> MOT   Scaling factor: 1		

**C01084**

Parameter   Name: <b>C01084   LS_WriteParamList: Error line</b>		Data type: UNSIGNED_8 Index: 23491 <sub>d</sub> = 5BC3 <sub>h</sub>
From version 04.00.00 <a href="#">Parameter change-over</a> : Display of the number of list entry where the error occurred (in connection with the value set selected via <i>bSelectWriteValue_1</i> and <i>bSelectWriteValue_2</i> ).		
<b>Display range</b> (min. value   unit   max. value)		
0		32
<input checked="" type="checkbox"/> Read access <input type="checkbox"/> Write access <input type="checkbox"/> CINH <input type="checkbox"/> PLC STOP <input checked="" type="checkbox"/> No transfer <input type="checkbox"/> COM <input type="checkbox"/> MOT   Scaling factor: 1		

## C01085

Parameter   Name: <b>C01085   LS_WriteParamList: Index</b>		Data type: INTEGER_32 Index: 23490 <sub>d</sub> = 5BC2 <sub>h</sub>
From version 04.00.00 <a href="#">Parameter change-over</a> : Parameter for entry 1 ... 32		
<b>Setting range (min. value   unit   max. value)</b>		
0.000		16000.000
<b>Subcodes</b>	<b>Lenze setting</b>	<b>Info</b>
C01085/1	0.000	Parameter for entries 1 ... 32 • Format: <code number>.<subcode number> • Examples: "12.000" = C00012; "26.001" = C00026/1
C01085/...		
C01085/32		
<input checked="" type="checkbox"/> Read access <input checked="" type="checkbox"/> Write access <input type="checkbox"/> CINH <input type="checkbox"/> PLC STOP <input type="checkbox"/> No transfer <input type="checkbox"/> COM <input type="checkbox"/> MOT   Scaling factor: 1000		

## C01086

Parameter   Name: <b>C01086   LS_WriteParamList: WriteValue_1</b>		Data type: INTEGER_32 Index: 23489 <sub>d</sub> = 5BC1 <sub>h</sub>
From version 04.00.00 <a href="#">Parameter change-over</a> : Parameter values - value set 1		
<b>Setting range (min. value   unit   max. value)</b>		
-2147483647		2147483647
<b>Subcodes</b>	<b>Lenze setting</b>	<b>Info</b>
C01086/1	0	Parameter values - value set 1 • Parameter values for the parameters defined in <a href="#">C01085/1 ... 32</a> .
C01086/...		
C01086/32		
<input checked="" type="checkbox"/> Read access <input checked="" type="checkbox"/> Write access <input type="checkbox"/> CINH <input type="checkbox"/> PLC STOP <input type="checkbox"/> No transfer <input type="checkbox"/> COM <input type="checkbox"/> MOT   Scaling factor: 1		

## C01087

Parameter   Name: <b>C01087   LS_WriteParamList: WriteValue_2</b>		Data type: INTEGER_32 Index: 23488 <sub>d</sub> = 5BC0 <sub>h</sub>
From version 04.00.00 <a href="#">Parameter change-over</a> : Parameter values - value set 2		
<b>Setting range (min. value   unit   max. value)</b>		
-2147483647		2147483647
<b>Subcodes</b>	<b>Lenze setting</b>	<b>Info</b>
C01087/1	0	Parameter values - value set 2 • Parameter values for the parameters defined in <a href="#">C01085/1 ... 32</a> .
C01087/...		
C01087/32		
<input checked="" type="checkbox"/> Read access <input checked="" type="checkbox"/> Write access <input type="checkbox"/> CINH <input type="checkbox"/> PLC STOP <input type="checkbox"/> No transfer <input type="checkbox"/> COM <input type="checkbox"/> MOT   Scaling factor: 1		

## C01088

Parameter   Name: <b>C01088   LS_WriteParamList: WriteValue_3</b>		Data type: INTEGER_32 Index: 23487 <sub>d</sub> = 5BBF <sub>h</sub>
From version 04.00.00 <a href="#">Parameter change-over</a> : Parameter values - value set 3		
<b>Setting range (min. value   unit   max. value)</b>		
-2147483647		2147483647
<b>Subcodes</b>	<b>Lenze setting</b>	<b>Info</b>
C01088/1	0	Parameter values - value set 3 • Parameter values for the parameters defined in <a href="#">C01085/1 ... 32</a> .
C01088/...		
C01088/32		
<input checked="" type="checkbox"/> Read access <input checked="" type="checkbox"/> Write access <input type="checkbox"/> CINH <input type="checkbox"/> PLC STOP <input type="checkbox"/> No transfer <input type="checkbox"/> COM <input type="checkbox"/> MOT           Scaling factor: 1		

## C01089

Parameter   Name: <b>C01089   LS_WriteParamList: WriteValue_4</b>		Data type: INTEGER_32 Index: 23486 <sub>d</sub> = 5BBE <sub>h</sub>
From version 04.00.00 <a href="#">Parameter change-over</a> : Parameter values - value set 4		
<b>Setting range (min. value   unit   max. value)</b>		
-2147483647		2147483647
<b>Subcodes</b>	<b>Lenze setting</b>	<b>Info</b>
C01089/1	0	Parameter values - value set 4 • Parameter values for the parameters defined in <a href="#">C01085/1 ... 32</a> .
C01089/...		
C01089/32		
<input checked="" type="checkbox"/> Read access <input checked="" type="checkbox"/> Write access <input type="checkbox"/> CINH <input type="checkbox"/> PLC STOP <input type="checkbox"/> No transfer <input type="checkbox"/> COM <input type="checkbox"/> MOT           Scaling factor: 1		

## C01090

Parameter   Name: <b>C01090   LS_ParReadWrite 1-3: Index</b>		Data type: INTEGER_32 Index: 23485 <sub>d</sub> = 5BBD <sub>h</sub>
From version 06.00.00 Parameter to be read or written. • Format: <code number>, <subcode number> • For a setting of "0,000", inputs <i>wParIndex</i> and <i>wParSubindex</i> are effective for addressing purposes instead.		
<b>Setting range (min. value   unit   max. value)</b>		
0.000		16000.000
<b>Subcodes</b>	<b>Lenze setting</b>	<b>Info</b>
C01090/1	0.000	<a href="#">LS_ParReadWrite_1</a> : Index
C01090/2	0.000	<a href="#">LS_ParReadWrite_2</a> : Index
C01090/3	0.000	<a href="#">LS_ParReadWrite_3</a> : Index
<input checked="" type="checkbox"/> Read access <input checked="" type="checkbox"/> Write access <input type="checkbox"/> CINH <input type="checkbox"/> PLC STOP <input type="checkbox"/> No transfer <input type="checkbox"/> COM <input type="checkbox"/> MOT           Scaling factor: 1000		

## C01091

Parameter   Name: <b>C01091   LS_ParReadWrite 1-3: Cycle time</b>		Data type: UNSIGNED_16 Index: 23484 <sub>d</sub> = 5BBCh
From version 04.00.00 Time interval for cyclic reading/writing		
Selection list		
0	0 (by Execute)	
20	20 ms	
50	50 ms	
100	100 ms	
200	200 ms	
500	500 ms	
1000	1000 ms	
2000	2000 ms	
5000	5000 ms	
10000	10000 ms	
Subcodes	Lenze setting	Info
C01091/1	0: 0 (by Execute)	<a href="#">LS_ParReadWrite 1</a> : Cycle time
C01091/2	0: 0 (by Execute)	<a href="#">LS_ParReadWrite 2</a> : Cycle time
C01091/3	0: 0 (by Execute)	<a href="#">LS_ParReadWrite 3</a> : Cycle time
<input checked="" type="checkbox"/> Read access <input checked="" type="checkbox"/> Write access <input type="checkbox"/> CINH <input type="checkbox"/> PLC STOP <input type="checkbox"/> No transfer <input type="checkbox"/> COM <input type="checkbox"/> MOT   Scaling factor: 1		

## C01092

Parameter   Name: <b>C01092   LS_ParReadWrite 1-3: FailState</b>		Data type: UNSIGNED_16 Index: 23483 <sub>d</sub> = 5BBBh
From version 04.00.00 Error status:		
<ul style="list-style-type: none"> <li>• 0 = no error</li> <li>• 33803   0x840B = invalid data type (e.g. STRING)</li> <li>• 33804   0x840C = limit violation</li> <li>• 33806   0x840E = invalid code</li> <li>• 33813   0x8415 = no element of the selection list</li> <li>• 33815   0x8417 = writing of the parameter not permitted</li> <li>• 33816   0x8418 = writing of the parameter only permitted if controller is inhibited</li> <li>• 33829   0x8425 = invalid subcode</li> <li>• 33865   0x8449 = no parameter with subcodes</li> </ul>		
Display range (min. value   unit   max. value)		
0		34000
Subcodes	Info	
C01092/1	<a href="#">LS_ParReadWrite 1</a> : Error status	
C01092/2	<a href="#">LS_ParReadWrite 2</a> : Error status	
C01092/3	<a href="#">LS_ParReadWrite 3</a> : Error status	
<input checked="" type="checkbox"/> Read access <input type="checkbox"/> Write access <input type="checkbox"/> CINH <input type="checkbox"/> PLC STOP <input checked="" type="checkbox"/> No transfer <input type="checkbox"/> COM <input type="checkbox"/> MOT   Scaling factor: 1		

## C01093

Parameter   Name: <b>C01093   LS_ParReadWrite 1-3: Arithmetic mode</b>		Data type: UNSIGNED_8 Index: 23482 <sub>d</sub> = 5BB <sub>Ah</sub>
From version 06.00.00 The integrated <a href="#">arithmetic function</a> allows for easy arithmetic conversion of the process value to be written or which was read into the format of the target parameter via parameterisable factors and without the need for an additional arithmetic FB.		
<b>Selection list</b>		
0	No arithmetic	
1	In16Bit: LW=+/-32767	
2	In16Bit: HW=+/-; LW=0..65535	
3	In32Bit: HW_LW=+/-2147483647	
<b>Subcodes</b>	<b>Lenze setting</b>	<b>Info</b>
C01093/1	0: no arithmetic	<a href="#">LS_ParReadWrite 1</a> : Arithmetic mode
C01093/2	0: no arithmetic	<a href="#">LS_ParReadWrite 2</a> : Arithmetic mode
C01093/3	0: no arithmetic	<a href="#">LS_ParReadWrite 3</a> : Arithmetic mode
<input checked="" type="checkbox"/> Read access <input checked="" type="checkbox"/> Write access <input type="checkbox"/> CINH <input type="checkbox"/> PLC STOP <input type="checkbox"/> No transfer <input type="checkbox"/> COM <input type="checkbox"/> MOT Scaling factor: 1		

## C01094

Parameter   Name: <b>C01094   LS_ParReadWrite 1-3: Numerator</b>		Data type: INTEGER_16 Index: 23481 <sub>d</sub> = 5BB9 <sub>h</sub>
From version 06.00.00 <a href="#">Arithmetic function</a> : Factor (numerator) for internal conversion in arithmetic modes 1 ... 3.		
<b>Setting range (min. value   unit   max. value)</b>		
-32767		32767
<b>Subcodes</b>	<b>Lenze setting</b>	<b>Info</b>
C01094/1	1	<a href="#">LS_ParReadWrite 1</a> : Numerator
C01094/2	1	<a href="#">LS_ParReadWrite 2</a> : Numerator
C01094/3	1	<a href="#">LS_ParReadWrite 3</a> : Numerator
<input checked="" type="checkbox"/> Read access <input checked="" type="checkbox"/> Write access <input type="checkbox"/> CINH <input type="checkbox"/> PLC STOP <input type="checkbox"/> No transfer <input type="checkbox"/> COM <input type="checkbox"/> MOT Scaling factor: 1		

## C01095

Parameter   Name: <b>C01095   LS_ParReadWrite 1-3: Denominator</b>		Data type: INTEGER_16 Index: 23480 <sub>d</sub> = 5BB8 <sub>h</sub>
From version 06.00.00 <a href="#">Arithmetic function</a> : Factor (denominator) for internal conversion in arithmetic modes 1 ... 3.		
<b>Setting range (min. value   unit   max. value)</b>		
1		32767
<b>Subcodes</b>	<b>Lenze setting</b>	<b>Info</b>
C01095/1	1	<a href="#">LS_ParReadWrite 1</a> : Denominator
C01095/2	1	<a href="#">LS_ParReadWrite 2</a> : Denominator
C01095/3	1	<a href="#">LS_ParReadWrite 3</a> : Denominator
<input checked="" type="checkbox"/> Read access <input checked="" type="checkbox"/> Write access <input type="checkbox"/> CINH <input type="checkbox"/> PLC STOP <input type="checkbox"/> No transfer <input type="checkbox"/> COM <input type="checkbox"/> MOT Scaling factor: 1		

## C01098

Parameter   Name: <b>C01098   LS_ParReadWrite 1-3: Configuration</b>		Data type: UNSIGNED_16 Index: 23477 <sub>d</sub> = 5BB5 <sub>h</sub>
<b>Setting range (min. hex value   max. hex value)</b>		
0x0000		0xFFFF
<b>Value is bit-coded:</b>		<b>Info</b>
Bit 0	Keeping the value	
Bit 1	Keeping the value in the event of an error	
Bit 2	Reserved	
Bit 3	Reserved	
Bit 4	Reserved	
Bit 5	Reserved	
Bit 6	Reserved	
Bit 7	Reserved	
Bit 8	Reserved	
Bit 9	Reserved	
Bit 10	Reserved	
Bit 11	Reserved	
Bit 12	Reserved	
Bit 13	Reserved	
Bit 14	Reserved	
Bit 15	Reserved	
<b>Subcodes</b>	<b>Lenze setting</b>	<b>Info</b>
C01098/1	0x0000	<a href="#">LS_ParReadWrite 1</a> : Configuration
C01098/2	0x0000	<a href="#">LS_ParReadWrite 2</a> : Configuration
C01098/3	0x0000	<a href="#">LS_ParReadWrite 3</a> : Configuration
<input checked="" type="checkbox"/> Read access <input checked="" type="checkbox"/> Write access <input type="checkbox"/> CINH <input type="checkbox"/> PLC STOP <input type="checkbox"/> No transfer <input type="checkbox"/> COM <input type="checkbox"/> MOT		

## C01120

Parameter   Name: <b>C01120   Sync signal source</b>		Data type: UNSIGNED_8 Index: 23455 <sub>d</sub> = 5B9F <sub>h</sub>
<b>From version 03.00.00</b> Selection of the signal source for device synchronisation <ul style="list-style-type: none"> <li>The drive can only be synchronised by one source.</li> </ul> <p style="text-align: right;">▶ <a href="#">Synchronisation of the internal time base</a></p>		
<b>Selection list</b> (Lenze setting printed in bold)		<b>Info</b>
<b>0</b>	<b>Off</b>	Synchronisation off
1	CAN on board	Synchronisation via CAN bus ▶ <a href="#">Sync telegram</a>
4	MCI	Synchronisation via MCI (communication module)
<input checked="" type="checkbox"/> Read access <input checked="" type="checkbox"/> Write access <input checked="" type="checkbox"/> CINH <input checked="" type="checkbox"/> PLC STOP <input checked="" type="checkbox"/> No transfer <input checked="" type="checkbox"/> COM <input checked="" type="checkbox"/> MOT   Scaling factor: 1		



## C01121

Parameter   Name: <b>C01121   Sync cycle time setpoint</b>		Data type: UNSIGNED_16 Index: 23454 <sub>d</sub> = 5B9E <sub>h</sub>
From version 03.00.00		
Cycle time setpoint for device synchronisation		
<ul style="list-style-type: none"> <li>• Time interval at which the phase control loop (PLL) in the inverter expects the synchronisation signals.</li> <li>• The cycle time setpoint must be set according to the cycle of the respective synchronisation source.</li> </ul>		
<b>Note:</b>		
<ul style="list-style-type: none"> <li>• Only integer multiples of 1000 µs can be set.</li> <li>• Intelligent communication modules usually define the cycle time setpoint derived from the bus cycle. In this case, a manual change is not possible.</li> </ul>		
Example: For the CAN bus, a distance of 2 ms has been set between two synchronisation signals. If the CAN bus is to be used as synchronisation source, a synchronisation cycle of 2000 µs must be set in C01121.		
<a href="#">Synchronisation of the internal time base</a>		
<b>Setting range</b> (min. value   unit   max. value)		<b>Lenze setting</b>
1000	µs	20000
		<b>1000 µs</b>
<input checked="" type="checkbox"/> Read access <input checked="" type="checkbox"/> Write access <input type="checkbox"/> CINH <input type="checkbox"/> PLC STOP <input type="checkbox"/> No transfer <input type="checkbox"/> COM <input type="checkbox"/> MOT   Scaling factor: 1		

## C01122

Parameter   Name: <b>C01122   Sync phase position</b>		Data type: UNSIGNED_16 Index: 23453 <sub>d</sub> = 5B9D <sub>h</sub>
From version 03.00.00		
Phase position for device synchronisation		
<ul style="list-style-type: none"> <li>• The phase position determines the zero-time of the internal system cycle with regard to the synchronisation signal (bus cycle). Since PDO processing is an inherent part of the system part of the application, the instant of acceptance of the PDOs is postponed as well by a changed phase position.</li> <li>• With a setting = 0, the system cycle starts simultaneously with the synchronisation signal.</li> <li>• With a setting &gt; 0, the internal system cycle starts earlier by the set time with regard to the synchronisation signal (the phase position acts negatively).</li> <li>• Intelligent communication modules define the optimal time with activated synchronisation by themselves. In this case, a manual change is not possible.</li> <li>• The decisive factor for defining C01122 is the time where all nodes are provided with valid PDOs.</li> </ul>		
Example: If the phase position is set to 550 µs, the system part of the application starts 550 µs before the arrival of the synchronisation signal.		
<a href="#">Synchronisation of the internal time base</a>		
<b>Setting range</b> (min. value   unit   max. value)		<b>Lenze setting</b>
0	µs	1000
		<b>0 µs</b>
<input checked="" type="checkbox"/> Read access <input checked="" type="checkbox"/> Write access <input type="checkbox"/> CINH <input type="checkbox"/> PLC STOP <input type="checkbox"/> No transfer <input type="checkbox"/> COM <input type="checkbox"/> MOT   Scaling factor: 1		

## C01123

Parameter   Name: <b>C01123   Sync window</b>		Data type: UNSIGNED_16 Index: 23452 <sub>d</sub> = 5B9C <sub>h</sub>
From version 03.00.00		
Time slot for monitoring the synchronisation signal or the phase position		
<ul style="list-style-type: none"> <li>• The synchronisation signal or the current phase position must be within this time slot around the corresponding expected value (<a href="#">C01122</a>).</li> <li>• With the setting "1000 µs" there will be no monitoring.</li> </ul>		
<a href="#">Synchronisation of the internal time base</a>		
<b>Setting range</b> (min. value   unit   max. value)		<b>Lenze setting</b>
0	µs	10000
		<b>100 µs</b>
<input checked="" type="checkbox"/> Read access <input checked="" type="checkbox"/> Write access <input type="checkbox"/> CINH <input type="checkbox"/> PLC STOP <input type="checkbox"/> No transfer <input type="checkbox"/> COM <input type="checkbox"/> MOT   Scaling factor: 1		

## C01124

Parameter   Name: <b>C01124   Sync correction width</b>		Data type: UNSIGNED_8 Index: 23451 <sub>d</sub> = 5B9B <sub>h</sub>
From version 03.00.00		
Correction increment for device synchronisation		
<ul style="list-style-type: none"> <li>• If the cycle times of the synchronisation signal differs and phase-locked loop (PLL) differ from each other, this setting defines the measure the phase-locking loop is reset with.</li> <li>• If synchronisation is not reached, select a higher correction constant.</li> <li>• The optimum setting depends on quartz precision and must be determined empirically if required.</li> </ul>		
▶ <a href="#">Synchronisation of the internal time base</a>		
Selection list(Lenze setting printed in bold)		
1	100ns	
2	200ns	
3	<b>300ns</b>	
4	400ns	
<input checked="" type="checkbox"/> Read access <input checked="" type="checkbox"/> Write access <input type="checkbox"/> CINH <input type="checkbox"/> PLC STOP <input type="checkbox"/> No transfer <input type="checkbox"/> COM <input type="checkbox"/> MOT             Scaling factor: 1		

## C01138

Parameter   Name: <b>C01138   L_Transient 1-4: Function</b>		Data type: UNSIGNED_8 Index: 23437 <sub>d</sub> = 5B8D <sub>h</sub>
From version 04.00.00		
Selection of edge evaluation		
Selection list		
0	High edge	
1	Low edge	
2	High and low edge	
Subcodes	Lenze setting	Info
C01138/1	0: High edge	<a href="#">L_Transient 1</a> : Function
C01138/2	0: High edge	<a href="#">L_Transient 2</a> : Function
C01138/3	0: High edge	<a href="#">L_Transient 3</a> : Function
C01138/4	0: High edge	<a href="#">L_Transient 4</a> : Function
<input checked="" type="checkbox"/> Read access <input checked="" type="checkbox"/> Write access <input type="checkbox"/> CINH <input type="checkbox"/> PLC STOP <input type="checkbox"/> No transfer <input type="checkbox"/> COM <input type="checkbox"/> MOT             Scaling factor: 1		

## C01139

Parameter   Name: <b>C01139   L_Transient 1-4: Pulse duration</b>		Data type: UNSIGNED_16 Index: 23436 <sub>d</sub> = 5B8C <sub>h</sub>
From version 04.00.00		
Setting range (min. value   unit   max. value)		
0.000	s	60.000
Subcodes	Lenze setting	Info
C01139/1	0.000 s	<a href="#">L_Transient 1</a> : Pulse duration
C01139/2	0.000 s	<a href="#">L_Transient 2</a> : Pulse duration
C01139/3	0.000 s	<a href="#">L_Transient 3</a> : Pulse duration
C01139/4	0.000 s	<a href="#">L_Transient 4</a> : Pulse duration
<input checked="" type="checkbox"/> Read access <input checked="" type="checkbox"/> Write access <input type="checkbox"/> CINH <input type="checkbox"/> PLC STOP <input type="checkbox"/> No transfer <input type="checkbox"/> COM <input type="checkbox"/> MOT             Scaling factor: 1000		

## C01350

Parameter   Name: C01350   ACDrive: Drive mode		Data type: UNSIGNED_8 Index: 23225 <sub>d</sub> = 5AB9 <sub>h</sub>
<b>Selection list</b>		
1	Speed mode	
3	Torque mode	
Subcodes	Lenze setting	Info
C01350/1	1: Speed mode	ACDrive: Drive mode
<input checked="" type="checkbox"/> Read access <input checked="" type="checkbox"/> Write access <input type="checkbox"/> CINH <input type="checkbox"/> PLC STOP <input type="checkbox"/> No transfer <input type="checkbox"/> COM <input type="checkbox"/> MOT             Scaling factor: 1		

## C01351

Parameter   Name: C01351   ACDrive: Control word		Data type: UNSIGNED_16 Index: 23224 <sub>d</sub> = 5AB8 <sub>h</sub>
From version 13.00.00 Display of the "AC Drive Profile" control word for the inverter <ul style="list-style-type: none"> <li>Detailed information on the "AC Drive Profile" can be found in the EtherNet/IP™ communication manual.               <ul style="list-style-type: none"> <li>▶ <a href="#">Actuating drive speed (AC Drive Profile)</a></li> </ul> </li> </ul>		
<b>Display area</b> (min. hex value   max. hex value)		
0x0000		0xFFFF
<b>Value is bit-coded:</b>		<b>Info</b>
Bit 0	Run Forward	Relationships between Run1 and Run2 and trigger events can be found in the chapter " <a href="#">Run/Stop Event</a> ".
Bit 1	Run Backward	
Bit 2	Fault Reset	0->1 ≡ Reset error 0 ≡ No response
Bit 3	Reserved	
Bit 4	Reserved	
Bit 5	NetCtrl	Run/Stop control: 0 ≡ via local setting in the device or terminal 1 ≡ via fieldbus (e.g. by the scanner)
Bit 6	NetRef	Reference speed/reference torque: 0 ≡ via local setting in the device or terminal 1 ≡ via fieldbus (e.g. by the scanner)
Bit 7	Reserved	
Bit 8	Reserved	
Bit 9	Reserved	
Bit 10	Reserved	
Bit 11	Reserved	
Bit 12	Reserved	
Bit 13	Reserved	
Bit 14	Reserved	
Bit 15	Reserved	
Subcodes	Info	
C01351/1	ACDrive: Control word	
<input checked="" type="checkbox"/> Read access <input type="checkbox"/> Write access <input type="checkbox"/> CINH <input type="checkbox"/> PLC STOP <input checked="" type="checkbox"/> No transfer <input type="checkbox"/> COM <input type="checkbox"/> MOT		

## C01352

Parameter   Name: <b>C01352   ACDrive: Status word</b>		Data type: UNSIGNED_16 Index: 23223 <sub>d</sub> = 5AB7 <sub>h</sub>
From version 13.00.00 Display of the "AC Drive Profile" status word of the inverter <ul style="list-style-type: none"> <li>Detailed information on the "AC Drive Profile" can be found in the EtherNet/IP™ communication manual.               <ul style="list-style-type: none"> <li>▶ <a href="#">Actuating drive speed (AC Drive Profile)</a></li> </ul> </li> </ul>		
<b>Display area</b> (min. hex value   max. hex value)		
0x0000		0xFFFF
<b>Value is bit-coded:</b>		<b>Info</b>
Bit 0	Faulted	0 ≡ No errors 1 ≡ Errors have occurred
Bit 1	Warning	0 ≡ No warnings 1 ≡ Warnings have occurred
Bit 2	Running1 (Fwd)	Relationships between Run1 and Run2 and trigger events can be found in the chapter " <a href="#">Run/Stop Event</a> ".
Bit 3	Running2 (Rev)	
Bit 4	Ready	0 ≡ Different status than in case of "1" 1 ≡ Ready or Enabled or Stopping
Bit 5	Ctrl from Net	Run/Stop control: 0 ≡ via local setting in the device or terminal 1 ≡ via fieldbus (e.g. by the scanner)
Bit 6	Ref from Net	Reference speed/reference torque: 0 ≡ via local setting in the device or terminal 1 ≡ via fieldbus (e.g. by the scanner)
Bit 7	At Reference	1 ≡ Currently, the inverter runs with the reference speed or reference torque (depending on the "drive mode" set in <a href="#">C01350/1</a> ).
Bit 8	DriveState_0	The "Drive State" is coded as follows: 0: Manufacturer-specific (not used with 8400) 1: Start-up (drive initialisation) 2: Not_Ready (mains voltage switched off) 3: Ready (mains voltage switched-on) 4: Enabled (drive has received "Run" command) 5: Stopping (drive has received "Stop" command and is stopped) 6: Fault_Stop (drive is stopped due to an error) 7: Faulted (errors have occurred)
Bit 9	DriveState_1	
Bit 10	DriveState_2	
Bit 11	DriveState_3	
Bit 12	DriveState_4	
Bit 13	DriveState_5	
Bit 14	DriveState_6	
Bit 15	DriveState_7	
<b>Subcodes</b>		<b>Info</b>
C01352/1		ACDrive: Status word
<input checked="" type="checkbox"/> Read access <input type="checkbox"/> Write access <input type="checkbox"/> CINH <input type="checkbox"/> PLC STOP <input checked="" type="checkbox"/> No transfer <input type="checkbox"/> COM <input type="checkbox"/> MOT		

## C01353

Parameter   Name: <b>C01353   ACDrive: Setpoint scaling</b>		Data type: INTEGER_8 Index: 23222 <sub>d</sub> = 5AB6 <sub>h</sub>
From version 13.00.00 ▶ <a href="#">Actuating drive speed (AC Drive Profil): Scaling of the speed and torque values</a>		

Parameter   Name: <b>C01353   ACDrive: Setpoint scaling</b>		Data type: INTEGER 8 Index: 23222 <sub>d</sub> = 5AB6 <sub>h</sub>
<b>Setting range</b> (min. value   unit   max. value)		
-128		127
<b>Subcodes</b>	<b>Lenze setting</b>	<b>Info</b>
C01353/1	0	ACDrive: Speed scaling
C01353/2	0	ACDrive: Torque scaling
<input checked="" type="checkbox"/> Read access <input checked="" type="checkbox"/> Write access <input type="checkbox"/> CINH <input type="checkbox"/> PLC STOP <input type="checkbox"/> No transfer <input type="checkbox"/> COM <input type="checkbox"/> MOT   Scaling factor: 1		

**C01501**

Parameter   Name: <b>C01501   Resp. to communication error with MCI</b>		Data type: UNSIGNED 8 Index: 23074 <sub>d</sub> = 5A22 <sub>h</sub>
Configuration of monitoring functions for the communication module		
<b>Selection list</b>		
0	No Reaction	
1	Fault	
2	Trouble	
3	TroubleQuickStop	
4	WarningLocked	
5	Warning	
6	Information	
<b>Subcodes</b>	<b>Lenze setting</b>	<b>Info</b>
C01501/1	0: No Reaction	Resp. to MCI connection error • Response to a communication error of the attached communication module.
C01501/2	0: No Reaction	Resp. to MCI invalid module • Response to an unplugged or incompatible communication module
<input checked="" type="checkbox"/> Read access <input checked="" type="checkbox"/> Write access <input type="checkbox"/> CINH <input type="checkbox"/> PLC STOP <input type="checkbox"/> No transfer <input type="checkbox"/> COM <input type="checkbox"/> MOT   Scaling factor: 1		

**C01700**

Parameter   Name: <b>C01700   Energy saving mode: Mode</b>		Data type: UNSIGNED 8 Index: 22875 <sub>d</sub> = 595B <sub>h</sub>
From version 17.00.00 onwards		
Display of the energy saving modes maximally provided		
<b>Display range</b> (min. value   unit   max. value)		
0		1
<b>Subcodes</b>		<b>Info</b>
C01700/1		Number of energy saving modes maximally provided = 1
C01700/2		Current mode • 1 ≙ Energy saving mode is active • 0 ≙ Energy saving mode is not active
<input checked="" type="checkbox"/> Read access <input type="checkbox"/> Write access <input type="checkbox"/> CINH <input type="checkbox"/> PLC STOP <input checked="" type="checkbox"/> No transfer <input type="checkbox"/> COM <input type="checkbox"/> MOT   Scaling factor: 1		

## C01701

Parameter   Name: <b>C01701   Energy saving mode: toff min</b>		Data type: UNSIGNED_16 Index: 22874 <sub>d</sub> = 595A <sub>h</sub>
From version 17.00.00 onwards Minimum time for which the inverter is to remain in the energy saving mode (TPm: Time Pause min).		
<b>Setting range (min. value   unit   max. value)</b>		
0	s	65535
<b>Subcodes</b>	<b>Lenze setting</b>	<b>Info</b>
C01701/1	0 s	Energy saving mode 1: toff min
Ž Read access    Ž Write access    ① CINH    ① PLC STOP    ① No transfer    ① COM    ① MOT    Scaling factor: 1		

## C01702

Parameter   Name: <b>C01702   Energy saving mode: toff</b>		Data type: UNSIGNED_16 Index: 22873 <sub>d</sub> = 5959 <sub>h</sub>
From version 17.00.00 onwards Time until the energy saving mode is entered (TtP: Time to Pause) If the quick stop energy saving function is to be used, this time always has to be set to a greater value than the maximum time required for braking via the quickstop function.		
<b>Setting range (min. value   unit   max. value)</b>		
0	s	65535
<b>Subcodes</b>	<b>Lenze setting</b>	<b>Info</b>
C01702/1	0 s	Energy saving mode 1: toff
Ž Read access    Ž Write access    ① CINH    ① PLC STOP    ① No transfer    ① COM    ① MOT    Scaling factor: 1		

## C01703

Parameter   Name: <b>C01703   Energy saving mode: ton</b>		Data type: UNSIGNED_16 Index: 22872 <sub>d</sub> = 5958 <sub>h</sub>
From version 17.00.00 onwards Time for exiting the energy saving mode (TtO: Time to Operate).		
<b>Setting range (min. value   unit   max. value)</b>		
0	s	65535
<b>Subcodes</b>	<b>Lenze setting</b>	<b>Info</b>
C01703/1	0 s	Energy saving mode 1: ton
Ž Read access    Ž Write access    ① CINH    ① PLC STOP    ① No transfer    ① COM    ① MOT    Scaling factor: 1		

## C01704

Parameter   Name: <b>C01704   Energy saving mode: Function</b>		Data type: UNSIGNED_16 Index: 22871 <sub>d</sub> = 5957 <sub>h</sub>
From version 17.00.00 onwards		
Response of the device in energy saving mode		
Setting range (min. hex value   max. hex value)		
0x0000		0xFFFF
Value is bit-coded:		Info
Bit 0	CINH	With entering the energy saving mode, controller inhibit is set. Controller inhibit is reset when the "Pause-End" command is received. <ul style="list-style-type: none"> <li>• Diagnostics of active controller inhibit with <a href="#">C00158/0, bit 9</a></li> <li>• Display: "Energy saving mode"</li> </ul>
Bit 1	QSP	When the "Pause-Req" command is received, the inverter executes a quick stop. <ul style="list-style-type: none"> <li>• Quick stop is cancelled when the "Pause-End" command has been accepted.</li> <li>• Quick stop diagnostics with <a href="#">C00159/0, bit 9</a></li> <li>• Display: "Energy saving mode"</li> </ul>
Bit 2	Dimming the LEDs	Most of the LEDs of the inverter are switched off or their lighting intensity is reduced. <ul style="list-style-type: none"> <li>• Only a few LEDs remain active in order to check the vitality of the inverter, e.g. the "DRV-RDY" LED.</li> </ul>
Bit 3	Reserved	
Bit 4	Decoupling the IOs	The digital output terminals are decoupled from the application (FB Editor). The output levels for these outputs can be defined via the decoupling values. In order to render the decoupling values effective, decoupling must be activated via the following parameters: <ul style="list-style-type: none"> <li>• Digital outputs: <a href="#">C00447/0</a> and <a href="#">C00448/0</a></li> </ul>
Bit 5	Reserved	
Bit 6	Reserved	
Bit 7	Reserved	
Bit 8	Reserved	
Bit 9	Reserved	
Bit 10	Reserved	
Bit 11	Reserved	
Bit 12	Reserved	
Bit 13	Reserved	
Bit 14	Reserved	
Bit 15	Off	Deactivate energy saving mode.
Subcodes	Lenze setting	Info
C01704/1	0x0000	Energy saving mode: components to be switched off.
<input checked="" type="checkbox"/> Read access <input checked="" type="checkbox"/> Write access <input type="checkbox"/> CINH <input type="checkbox"/> PLC STOP <input type="checkbox"/> No transfer <input type="checkbox"/> COM <input type="checkbox"/> MOT		

## C01709

Parameter   Name: <b>C01709   Energy saving mode: Status</b>		Data type: UNSIGNED_8 Index: 22866 <sub>d</sub> = 5952 <sub>h</sub>
From version 17.00.00 onwards		
Display range (min. value   unit   max. value)		
0		255
Subcodes		Info
C01709/1		Energy saving mode: Status
Ž Read access   ® Write access   ® CINH   ® PLC STOP   Ž No transfer   ® COM   ® MOT   Scaling factor: 1		

## C01751

Parameter   Name: <b>C01751   Service code inverter characteristic</b>		Data type: UNSIGNED_8 Index: 22824 <sub>d</sub> = 5928 <sub>h</sub>
This code is used device-internally and must not be written by the user side!		

## C01752

Parameter   Name: <b>C01752   Service par. inverter charact. function</b>		Data type: UNSIGNED_8 Index: 22823 <sub>d</sub> = 5927 <sub>h</sub>
This code is used device-internally and must not be written by the user side!		

## C01755

Parameter   Name: <b>C01755   Service par. inverter charact. factor</b>		Data type: INTEGER_16 Index: 22820 <sub>d</sub> = 5924 <sub>h</sub>
This code is used device-internally and must not be written by the user side!		

## C01763

Parameter   Name: <b>C01763   Service code -clamp threshold</b>		Data type: INTEGER_16 Index: 22812 <sub>d</sub> = 591C <sub>h</sub>
This code is used device-internally and must not be written by the user side!		

## C01764

Parameter   Name: <b>C01764   Service par. clamp time</b>		Data type: UNSIGNED_8 Index: 22811 <sub>d</sub> = 591B <sub>h</sub>
This code is used device-internally and must not be written by the user side!		

## C01765

Parameter   Name: <b>C01765   Service code - difference threshold UG</b>		Data type: UNSIGNED_16 Index: 22810 <sub>d</sub> = 591A <sub>h</sub>
This code is used device-internally and must not be written by the user side!		



## C01770

Parameter   Name: <b>C01770   Filter time - earth-fault detect. is running</b>		Data type: UNSIGNED_8 Index: 22805 <sub>d</sub> = 5915 <sub>h</sub>
From version 05.00.00		
Setting range (min. value   unit   max. value)		Lenze setting
0	ms	250 <b>2 ms</b>
<input type="checkbox"/> Read access <input checked="" type="checkbox"/> Write access <input type="checkbox"/> CINH <input type="checkbox"/> PLC STOP <input type="checkbox"/> No transfer <input type="checkbox"/> COM <input checked="" type="checkbox"/> MOT   Scaling factor: 1		

## C01771

Parameter   Name: <b>C01771   BU-Osc: Cycle time selection</b>		Data type: UNSIGNED_8 Index: 22804 <sub>d</sub> = 5914 <sub>h</sub>
This code is used device-internally and must not be written by the user side!		

## C01772

Parameter   Name: <b>C01772   BU-Osc: Trigger channel selection</b>		Data type: UNSIGNED_8 Index: 22803 <sub>d</sub> = 5913 <sub>h</sub>
This code is used device-internally and must not be written by the user side!		

## C01773

Parameter   Name: <b>C01773   BU-Osc: Trigger command</b>		Data type: UNSIGNED_8 Index: 22802 <sub>d</sub> = 5912 <sub>h</sub>
This code is used device-internally and must not be written by the user side!		

## C01774

Parameter   Name: <b>C01774   BU-Osc: Trigger mode</b>		Data type: UNSIGNED_8 Index: 22801 <sub>d</sub> = 5911 <sub>h</sub>
This code is used device-internally and must not be written by the user side!		

## C01775

Parameter   Name: <b>C01775   BU-Osc: Trigger</b>		Data type: INTEGER_16 Index: 22800 <sub>d</sub> = 5910 <sub>h</sub>
This code is used device-internally and must not be written by the user side!		

## C01902

Parameter   Name: <b>C01902   Diagnostics X6: Max. baud rate</b>		Data type: UNSIGNED_16 Index: 22673 <sub>d</sub> = 5891 <sub>h</sub>
Maximally permissible baud rate in the standard device after determination of the baud rate at the diagnostic interface X6		

Parameter   Name: <b>C01902   Diagnostics X6: Max. baud rate</b>		Data type: UNSIGNED_16 Index: 22673 <sub>d</sub> = 5891 <sub>h</sub>
<b>Selection list</b> (Lenze setting printed in bold)		
192	19.200 Bd	
384	38.400 Bd	
576	57.600 Bd	
750	75.000 Bd	
751	75.000 Bd ext.	
1152	115.200 Bd	
1500	150.000 Bd	
2500	250.000 Bd	
3750	375.000 Bd	
<b>7500</b>	<b>750.000 Bd</b>	
7501	750.000 Bd ext.	
<input checked="" type="checkbox"/> Read access <input checked="" type="checkbox"/> Write access <input type="checkbox"/> CINH <input type="checkbox"/> PLC STOP <input type="checkbox"/> No transfer <input checked="" type="checkbox"/> COM <input type="checkbox"/> MOT             Scaling factor: 1		

**C01903**

Parameter   Name: <b>C01903   Diagnostics X6: Change baud rate</b>		Data type: UNSIGNED_8 Index: 22672 <sub>d</sub> = 5890 <sub>h</sub>
New baud rate determination at the diagnostic interface X6		
<b>Selection list</b> (Lenze setting printed in bold)		
<b>0</b>	<b>Ignore changes</b>	
1	Negotiate baud rate	
<input checked="" type="checkbox"/> Read access <input checked="" type="checkbox"/> Write access <input type="checkbox"/> CINH <input type="checkbox"/> PLC STOP <input checked="" type="checkbox"/> No transfer <input checked="" type="checkbox"/> COM <input type="checkbox"/> MOT             Scaling factor: 1		

**C01905**

Parameter   Name: <b>C01905   Diagnostics X6: Current baud rate</b>		Data type: UNSIGNED_32 Index: 22670 <sub>d</sub> = 588E <sub>h</sub>
Current baud rate at the diagnostic interface X6		
<b>Display range</b> (min. value   unit   max. value)		
0	Bd	3000000
<input checked="" type="checkbox"/> Read access <input type="checkbox"/> Write access <input type="checkbox"/> CINH <input type="checkbox"/> PLC STOP <input checked="" type="checkbox"/> No transfer <input checked="" type="checkbox"/> COM <input type="checkbox"/> MOT             Scaling factor: 1		

**C02200**

Parameter   Name: <b>C02200   LS_WriteParamList: Function</b>		Data type: UNSIGNED_8 Index: 22375 <sub>d</sub> = 5767 <sub>h</sub>
From version 12.00.00		
Configuration of which parameter lists are to be subject to the " <a href="#">Parameter change-over</a> " function.		
<b>Selection list</b>		
0	Off	
1	On	
<b>Subcodes</b>	<b>Lenze setting</b>	<b>Info</b>
C02200/1	1: On	Definable parameter list
C02200/2	0: Off	Motor data parameter list
<input checked="" type="checkbox"/> Read access <input checked="" type="checkbox"/> Write access <input type="checkbox"/> CINH <input type="checkbox"/> PLC STOP <input type="checkbox"/> No transfer <input type="checkbox"/> COM <input type="checkbox"/> MOT             Scaling factor: 1		

## C02210

Parameter   Name:		Data type: UNSIGNED_8 Index: 22365 <sub>d</sub> = 575D <sub>h</sub>
<b>C02210   LS_WriteParamList: Motor control</b>		
From version 12.00.00 onwards: Parameter values (1st value ... 4th value) for optional <a href="#">motor data change-over</a>		
Selection list		
3	SLPSM: Sensorless PSM	
4	SLVC: Vector control	
6	VFCplus: V/f linear	
7	VFCplus: V/f linear + encoder	
8	VFCplus: V/f quadr	
9	VFCplus: V/f quadr + encoder	
10	VFCplus: V/f definable	
11	VFCplusEco: V/f energy-saving	
Subcodes	Lenze setting	Info
C02210/1	6: VFCplus: V/f linear	<a href="#">LS_WriteParamList: c6_val1</a>
C02210/2	6: VFCplus: V/f linear	<a href="#">LS_WriteParamList: c6_val2</a>
C02210/3	6: VFCplus: V/f linear	<a href="#">LS_WriteParamList: c6_val3</a>
C02210/4	6: VFCplus: V/f linear	<a href="#">LS_WriteParamList: c6_val3</a>
<input checked="" type="checkbox"/> Read access <input checked="" type="checkbox"/> Write access <input type="checkbox"/> CINH <input type="checkbox"/> PLC STOP <input type="checkbox"/> No transfer <input type="checkbox"/> COM <input checked="" type="checkbox"/> MOT Scaling factor: 1		

## C02212

Parameter   Name:		Data type: UNSIGNED_16 Index: 22363 <sub>d</sub> = 575B <sub>h</sub>
<b>C02212   LS_WriteParamList: VFC: V/f base frequency</b>		
From version 12.00.00 onwards: Parameter values (1st value ... 4th value) for optional <a href="#">motor data change-over</a>		
Setting range (min. value   unit   max. value)		
7.5	Hz	2600.0
Subcodes	Lenze setting	Info
C02212/1	50.0 Hz	<a href="#">LS_WriteParamList: c15_val1</a>
C02212/2	50.0 Hz	<a href="#">LS_WriteParamList: c15_val2</a>
C02212/3	50.0 Hz	<a href="#">LS_WriteParamList: c15_val3</a>
C02212/4	50.0 Hz	<a href="#">LS_WriteParamList: c15_val4</a>
<input checked="" type="checkbox"/> Read access <input checked="" type="checkbox"/> Write access <input type="checkbox"/> CINH <input type="checkbox"/> PLC STOP <input type="checkbox"/> No transfer <input type="checkbox"/> COM <input checked="" type="checkbox"/> MOT Scaling factor: 10		

## C02213

Parameter   Name:		Data type: UNSIGNED_16 Index: 22362 <sub>d</sub> = 575A <sub>h</sub>
<b>C02213   LS_WriteParamList: VFC: Vmin boost</b>		
From version 12.00.00 onwards: Parameter values (1st value ... 4th value) for optional <a href="#">motor data change-over</a>		
Setting range (min. value   unit   max. value)		
0.00	%	100.00
Subcodes	Lenze setting	Info
C02213/1	1.60 %	<a href="#">LS_WriteParamList: c16_val1</a>
C02213/2	1.60 %	<a href="#">LS_WriteParamList: c16_val2</a>
C02213/3	1.60 %	<a href="#">LS_WriteParamList: c16_val3</a>
C02213/4	1.60 %	<a href="#">LS_WriteParamList: c16_val4</a>
<input checked="" type="checkbox"/> Read access <input checked="" type="checkbox"/> Write access <input type="checkbox"/> CINH <input type="checkbox"/> PLC STOP <input type="checkbox"/> No transfer <input type="checkbox"/> COM <input checked="" type="checkbox"/> MOT Scaling factor: 100		

## C02214

Parameter   Name:		Data type: UNSIGNED_8 Index: 22361 <sub>d</sub> = 5759 <sub>h</sub>
<b>C02214   LS_WriteParamList: Switching frequency</b>		
From version 12.00.00 onwards: Parameter values (1st value ... 4th value) for optional <a href="#">motor data change-over</a>		
Selection list		
1	4 kHz var./drive-optimised	
2	8 kHz var./drive-optimised	
3	16 kHz var./drive-optimised	
5	2 kHz constant/drive-optimised	
6	4 kHz constant/drive-optimised	
7	8 kHz constant/drive-optimised	
8	16 kHz constant/drive-optimised	
11	4 kHz var./min. Pv	
12	8 kHz var./min. Pv	
13	16 kHz var./min. Pv	
15	2 kHz constant/min. Pv	
16	4 kHz constant/min. Pv	
17	8 kHz constant/min. Pv	
18	16 kHz constant/min. Pv	
21	8 kHz var./drive-opt./4 kHz min	
22	16 kHz var./drive-opt./4 kHz min	
23	16 kHz var./drive-opt./8 kHz min	
31	8 kHz var./min. Pv/4 kHz min	
32	16 kHz var./min. Pv/4 kHz min	
33	16 kHz var./min. Pv/8 kHz min	
Subcodes	Lenze setting	Info
C02214/1	2: 8 kHz var./drive-opt.	<a href="#">LS_WriteParamList: c18_val1</a>
C02214/2	2: 8 kHz var./drive-opt.	<a href="#">LS_WriteParamList: c18_val2</a>
C02214/3	2: 8 kHz var./drive-opt.	<a href="#">LS_WriteParamList: c18_val3</a>
C02214/4	2: 8 kHz var./drive-opt.	<a href="#">LS_WriteParamList: c18_val4</a>
<input checked="" type="checkbox"/> Read access <input checked="" type="checkbox"/> Write access <input type="checkbox"/> CINH <input type="checkbox"/> PLC STOP <input type="checkbox"/> No transfer <input type="checkbox"/> COM <input checked="" type="checkbox"/> MOT             Scaling factor: 1		

## C02215

Parameter   Name:		Data type: UNSIGNED_16 Index: 22360 <sub>d</sub> = 5758 <sub>h</sub>
<b>C02215   LS_WriteParamList: Auto-DCB: Threshold</b>		
From version 12.00.00 onwards: Parameter values (1st value ... 4th value) for optional <a href="#">motor data change-over</a>		
Setting range (min. value   unit   max. value)		
0	rpm	60000
Subcodes	Lenze setting	Info
C02215/1	3 rpm	<a href="#">LS_WriteParamList: c19_val1</a>
C02215/2	3 rpm	<a href="#">LS_WriteParamList: c19_val2</a>
C02215/3	3 rpm	<a href="#">LS_WriteParamList: c19_val3</a>
C02215/4	3 rpm	<a href="#">LS_WriteParamList: c19_val4</a>
<input checked="" type="checkbox"/> Read access <input checked="" type="checkbox"/> Write access <input type="checkbox"/> CINH <input type="checkbox"/> PLC STOP <input type="checkbox"/> No transfer <input type="checkbox"/> COM <input type="checkbox"/> MOT             Scaling factor: 1		

## C02216

Parameter   Name: <b>C02216   LS_WriteParamList: Slip compensation</b>		Data type: INTEGER_16 Index: 22359 <sub>d</sub> = 5757 <sub>h</sub>
From version 12.00.00 onwards: Parameter values (1st value ... 4th value) for optional <a href="#">motor data change-over</a>		
<b>Setting range (min. value   unit   max. value)</b>		
-100.00	%	100.00
<b>Subcodes</b>	<b>Lenze setting</b>	<b>Info</b>
C02216/1	2.67 %	<a href="#">LS_WriteParamList: c21_val1</a>
C02216/2	2.67 %	<a href="#">LS_WriteParamList: c21_val2</a>
C02216/3	2.67 %	<a href="#">LS_WriteParamList: c21_val3</a>
C02216/4	2.67 %	<a href="#">LS_WriteParamList: c21_val4</a>
<input checked="" type="checkbox"/> Read access <input checked="" type="checkbox"/> Write access <input type="checkbox"/> CINH <input type="checkbox"/> PLC STOP <input type="checkbox"/> No transfer <input type="checkbox"/> COM <input checked="" type="checkbox"/> MOT   Scaling factor: 100		

## C02217

Parameter   Name: <b>C02217   LS_WriteParamList: I<sub>max</sub> in motor mode</b>		Data type: UNSIGNED_16 Index: 22359 <sub>d</sub> = 5756 <sub>h</sub>
From version 12.00.00 onwards: Parameter values (1st value ... 4th value) for optional <a href="#">motor data change-over</a>		
<b>Setting range (min. value   unit   max. value)</b>		
0.00	A	655.35
<b>Subcodes</b>	<b>Lenze setting</b>	<b>Info</b>
C02217/1	47.00 A	<a href="#">LS_WriteParamList: c22_val1</a>
C02217/2	47.00 A	<a href="#">LS_WriteParamList: c22_val2</a>
C02217/3	47.00 A	<a href="#">LS_WriteParamList: c22_val3</a>
C02217/4	47.00 A	<a href="#">LS_WriteParamList: c22_val4</a>
<input checked="" type="checkbox"/> Read access <input checked="" type="checkbox"/> Write access <input type="checkbox"/> CINH <input type="checkbox"/> PLC STOP <input type="checkbox"/> No transfer <input type="checkbox"/> COM <input checked="" type="checkbox"/> MOT   Scaling factor: 100		

## C02218

Parameter   Name: <b>C02218   LS_WriteParamList: I<sub>max</sub> in generator mode</b>		Data type: INTEGER_16 Index: 22357 <sub>d</sub> = 5755 <sub>h</sub>
From version 12.00.00 onwards: Parameter values (1st value ... 4th value) for optional <a href="#">motor data change-over</a>		
<b>Setting range (min. value   unit   max. value)</b>		
0.00	%	100.00
<b>Subcodes</b>	<b>Lenze setting</b>	<b>Info</b>
C02218/1	100.00 %	<a href="#">LS_WriteParamList: c23_val1</a>
C02218/2	100.00 %	<a href="#">LS_WriteParamList: c23_val2</a>
C02218/3	100.00 %	<a href="#">LS_WriteParamList: c23_val3</a>
C02218/4	100.00 %	<a href="#">LS_WriteParamList: c23_val4</a>
<input checked="" type="checkbox"/> Read access <input checked="" type="checkbox"/> Write access <input type="checkbox"/> CINH <input type="checkbox"/> PLC STOP <input type="checkbox"/> No transfer <input type="checkbox"/> COM <input checked="" type="checkbox"/> MOT   Scaling factor: 100		

## C02219

Parameter   Name: <b>C02219   LS_WriteParamList: DC braking: Current</b>		Data type: INTEGER_16 Index: 22356 <sub>d</sub> = 5754 <sub>h</sub>
From version 12.00.00 onwards: Parameter values (1st value ... 4th value) for optional <a href="#">motor data change-over</a>		
<b>Setting range (min. value   unit   max. value)</b>		
0.00	%	200.00
<b>Subcodes</b>	<b>Lenze setting</b>	<b>Info</b>
C02219/1	50.00 %	<a href="#">LS_WriteParamList: c36_val1</a>
C02219/2	50.00 %	<a href="#">LS_WriteParamList: c36_val2</a>
C02219/3	50.00 %	<a href="#">LS_WriteParamList: c36_val3</a>
C02219/4	50.00 %	<a href="#">LS_WriteParamList: c36_val4</a>
<input checked="" type="checkbox"/> Read access <input checked="" type="checkbox"/> Write access <input type="checkbox"/> CINH <input type="checkbox"/> PLC STOP <input type="checkbox"/> No transfer <input type="checkbox"/> COM <input checked="" type="checkbox"/> MOT   Scaling factor: 100		

## C02220

Parameter   Name: <b>C02220   LS_WriteParamList: Vp speed controller</b>		Data type: UNSIGNED_16 Index: 22355 <sub>d</sub> = 5753 <sub>h</sub>
From version 12.00.00 onwards: Parameter values (1st value ... 4th value) for optional <a href="#">motor data change-over</a>		
<b>Setting range (min. value   unit   max. value)</b>		
0.00		600.00
<b>Subcodes</b>	<b>Lenze setting</b>	<b>Info</b>
C02220/1	15.00	<a href="#">LS_WriteParamList: c70_s1_val1</a>
C02220/2	15.00	<a href="#">LS_WriteParamList: c70_s1_val2</a>
C02220/3	15.00	<a href="#">LS_WriteParamList: c70_s1_val3</a>
C02220/4	15.00	<a href="#">LS_WriteParamList: c70_s1_val4</a>
C02220/5	6.00	Reserved
C02220/6	6.00	Reserved
C02220/7	6.00	Reserved
C02220/8	6.00	Reserved
C02220/9	3.00	<a href="#">LS_WriteParamList: c70_s3_val1</a>
C02220/10	3.00	<a href="#">LS_WriteParamList: c70_s3_val2</a>
C02220/11	3.00	<a href="#">LS_WriteParamList: c70_s3_val3</a>
C02220/12	3.00	<a href="#">LS_WriteParamList: c70_s3_val4</a>
<input checked="" type="checkbox"/> Read access <input checked="" type="checkbox"/> Write access <input type="checkbox"/> CINH <input type="checkbox"/> PLC STOP <input type="checkbox"/> No transfer <input type="checkbox"/> COM <input checked="" type="checkbox"/> MOT   Scaling factor: 100		

## C02221

Parameter   Name: <b>C02221   LS_WriteParamList: Ti speed controller</b>		Data type: UNSIGNED_16 Index: 22354 <sub>d</sub> = 5752 <sub>h</sub>
From version 12.00.00 onwards: Parameter values (1st value ... 4th value) for optional <a href="#">motor data change-over</a>		
<b>Setting range (min. value   unit   max. value)</b>		
0.0	ms	6000.0
<b>Subcodes</b>	<b>Lenze setting</b>	<b>Info</b>
C02221/1	100.0 ms	<a href="#">LS_WriteParamList: c71_s1_val1</a>
C02221/2	100.0 ms	<a href="#">LS_WriteParamList: c71_s1_val2</a>
C02221/3	100.0 ms	<a href="#">LS_WriteParamList: c71_s1_val3</a>
C02221/4	100.0 ms	<a href="#">LS_WriteParamList: c71_s1_val4</a>
C02221/5	50.0 ms	Reserved

Parameter   Name: C02221   LS_WriteParamList: Ti speed controller		Data type: UNSIGNED_16 Index: 22354 <sub>d</sub> = 5752 <sub>h</sub>
C02221/6	50.0 ms	Reserved
C02221/7	50.0 ms	Reserved
C02221/8	50.0 ms	Reserved
C02221/9	50.0 ms	<a href="#">LS_WriteParamList: c71_s3_val1</a>
C02221/10	50.0 ms	<a href="#">LS_WriteParamList: c71_s3_val2</a>
C02221/11	50.0 ms	<a href="#">LS_WriteParamList: c71_s3_val3</a>
C02221/12	50.0 ms	<a href="#">LS_WriteParamList: c71_s3_val4</a>
<input checked="" type="checkbox"/> Read access <input checked="" type="checkbox"/> Write access <input type="checkbox"/> CINH <input type="checkbox"/> PLC STOP <input type="checkbox"/> No transfer <input type="checkbox"/> COM <input checked="" type="checkbox"/> MOT             Scaling factor: 10		

## C02222

Parameter   Name: C02222   LS_WriteParamList: SC: Tdn speed controller		Data type: UNSIGNED_16 Index: 22353 <sub>d</sub> = 5751 <sub>h</sub>
From version 12.00.00 onwards: Parameter values (1st value ... 4th value) for optional <a href="#">motor data change-over</a>		
Setting range (min. value   unit   max. value)		
0.00	ms	3.00
Subcodes	Lenze setting	Info
C02222/1	0.00 ms	<a href="#">LS_WriteParamList: c72_val1</a>
C02222/2	0.00 ms	<a href="#">LS_WriteParamList: c72_val2</a>
C02222/3	0.00 ms	<a href="#">LS_WriteParamList: c72_val3</a>
C02222/4	0.00 ms	<a href="#">LS_WriteParamList: c72_val4</a>
<input checked="" type="checkbox"/> Read access <input checked="" type="checkbox"/> Write access <input type="checkbox"/> CINH <input type="checkbox"/> PLC STOP <input type="checkbox"/> No transfer <input type="checkbox"/> COM <input checked="" type="checkbox"/> MOT             Scaling factor: 100		

## C02223

Parameter   Name: C02223   LS_WriteParamList: Imax/M controller gain		Data type: UNSIGNED_16 Index: 22352 <sub>d</sub> = 5750 <sub>h</sub>
From version 12.00.00 onwards: Parameter values (1st value ... 4th value) for optional <a href="#">motor data change-over</a>		
Setting range (min. value   unit   max. value)		
0.00		100.00
Subcodes	Lenze setting	Info
C02223/1	0.25	<a href="#">LS_WriteParamList: c73_s1_val1</a>
C02223/2	0.25	<a href="#">LS_WriteParamList: c73_s1_val2</a>
C02223/3	0.25	<a href="#">LS_WriteParamList: c73_s1_val3</a>
C02223/4	0.25	<a href="#">LS_WriteParamList: c73_s1_val4</a>
C02223/5	1.25	<a href="#">LS_WriteParamList: c73_s2_val1</a>
C02223/6	1.25	<a href="#">LS_WriteParamList: c73_s2_val2</a>
C02223/7	1.25	<a href="#">LS_WriteParamList: c73_s2_val3</a>
C02223/8	1.25	<a href="#">LS_WriteParamList: c73_s2_val4</a>
<input checked="" type="checkbox"/> Read access <input checked="" type="checkbox"/> Write access <input type="checkbox"/> CINH <input type="checkbox"/> PLC STOP <input type="checkbox"/> No transfer <input type="checkbox"/> COM <input checked="" type="checkbox"/> MOT             Scaling factor: 100		

## C02224

Parameter   Name: <b>C02224   LS_WriteParamList: Imax/M controller reset time</b>		Data type: UNSIGNED_16 Index: 22351 <sub>d</sub> = 574F <sub>h</sub>
From version 12.00.00 onwards: Parameter values (1st value ... 4th value) for optional <a href="#">motor data change-over</a>		
<b>Setting range (min. value   unit   max. value)</b>		
0	ms	9990
<b>Subcodes</b>	<b>Lenze setting</b>	<b>Info</b>
C02224/1	65 ms	<a href="#">LS_WriteParamList: c74_s1_val1</a>
C02224/2	65 ms	<a href="#">LS_WriteParamList: c74_s1_val2</a>
C02224/3	65 ms	<a href="#">LS_WriteParamList: c74_s1_val3</a>
C02224/4	65 ms	<a href="#">LS_WriteParamList: c74_s1_val4</a>
C02224/5	30 ms	<a href="#">LS_WriteParamList: c74_s2_val1</a>
C02224/6	30 ms	<a href="#">LS_WriteParamList: c74_s2_val2</a>
C02224/7	30 ms	<a href="#">LS_WriteParamList: c74_s2_val3</a>
C02224/8	30 ms	<a href="#">LS_WriteParamList: c74_s2_val4</a>
<input checked="" type="checkbox"/> Read access <input checked="" type="checkbox"/> Write access <input type="checkbox"/> CINH <input type="checkbox"/> PLC STOP <input type="checkbox"/> No transfer <input type="checkbox"/> COM <input checked="" type="checkbox"/> MOT   Scaling factor: 1		

## C02225

Parameter   Name: <b>C02225   LS_WriteParamList: Vp current controller</b>		Data type: UNSIGNED_16 Index: 22350 <sub>d</sub> = 574E <sub>h</sub>
From version 12.00.00 onwards: Parameter values (1st value ... 4th value) for optional <a href="#">motor data change-over</a>		
<b>Setting range (min. value   unit   max. value)</b>		
0.00	V/A	500.00
<b>Subcodes</b>	<b>Lenze setting</b>	<b>Info</b>
C02225/1	7.00 V/A	<a href="#">LS_WriteParamList: c75_val1</a>
C02225/2	7.00 V/A	<a href="#">LS_WriteParamList: c75_val2</a>
C02225/3	7.00 V/A	<a href="#">LS_WriteParamList: c75_val3</a>
C02225/4	7.00 V/A	<a href="#">LS_WriteParamList: c75_val4</a>
<input checked="" type="checkbox"/> Read access <input checked="" type="checkbox"/> Write access <input type="checkbox"/> CINH <input type="checkbox"/> PLC STOP <input type="checkbox"/> No transfer <input type="checkbox"/> COM <input checked="" type="checkbox"/> MOT   Scaling factor: 100		

## C02226

Parameter   Name: <b>C02226   LS_WriteParamList: Ti current controller</b>		Data type: UNSIGNED_16 Index: 22349 <sub>d</sub> = 574D <sub>h</sub>
From version 12.00.00 onwards: Parameter values (1st value ... 4th value) for optional <a href="#">motor data change-over</a>		
<b>Setting range (min. value   unit   max. value)</b>		
0.00	ms	500.00
<b>Subcodes</b>	<b>Lenze setting</b>	<b>Info</b>
C02226/1	10.61 ms	<a href="#">LS_WriteParamList: c76_val1</a>
C02226/2	10.61 ms	<a href="#">LS_WriteParamList: c76_val2</a>
C02226/3	10.61 ms	<a href="#">LS_WriteParamList: c76_val3</a>
C02226/4	10.61 ms	<a href="#">LS_WriteParamList: c76_val4</a>
<input checked="" type="checkbox"/> Read access <input checked="" type="checkbox"/> Write access <input type="checkbox"/> CINH <input type="checkbox"/> PLC STOP <input type="checkbox"/> No transfer <input type="checkbox"/> COM <input checked="" type="checkbox"/> MOT   Scaling factor: 100		



## C02229

Parameter   Name: C02229   LS_WriteParamList: SC: Settings		Data type: UNSIGNED_8 Index: 22346 <sub>d</sub> = 574A <sub>h</sub>
From version 12.00.00 onwards: Parameter values (1st value ... 4th value) for optional <a href="#">motor data change-over</a>		
Selection list		
0	Off	
1	On	
Subcodes	Lenze setting	Info
C02229/1	0: Off	<a href="#">LS_WriteParamList: c79_s1_val1</a>
C02229/2	0: Off	<a href="#">LS_WriteParamList: c79_s1_val2</a>
C02229/3	0: Off	<a href="#">LS_WriteParamList: c79_s1_val3</a>
C02229/4	0: Off	<a href="#">LS_WriteParamList: c79_s1_val4</a>
C02229/5	1: On	<a href="#">LS_WriteParamList: c79_s2_val1</a>
C02229/6	1: On	<a href="#">LS_WriteParamList: c79_s2_val2</a>
C02229/7	1: On	<a href="#">LS_WriteParamList: c79_s2_val3</a>
C02229/8	1: On	<a href="#">LS_WriteParamList: c79_s2_val4</a>
C02229/9	0: Off	<a href="#">LS_WriteParamList: c79_s3_val1</a>
C02229/10	0: Off	<a href="#">LS_WriteParamList: c79_s3_val2</a>
C02229/11	0: Off	<a href="#">LS_WriteParamList: c79_s3_val3</a>
C02229/12	0: Off	<a href="#">LS_WriteParamList: c79_s3_val4</a>
C02229/13	1: On	<a href="#">LS_WriteParamList: c79_s4_val1</a>
C02229/14	1: On	<a href="#">LS_WriteParamList: c79_s4_val2</a>
C02229/15	1: On	<a href="#">LS_WriteParamList: c79_s4_val3</a>
C02229/16	1: On	<a href="#">LS_WriteParamList: c79_s4_val4</a>
<input checked="" type="checkbox"/> Read access <input checked="" type="checkbox"/> Write access <input type="checkbox"/> CINH <input type="checkbox"/> PLC STOP <input type="checkbox"/> No transfer <input type="checkbox"/> COM <input checked="" type="checkbox"/> MOT             Scaling factor: 1		

## C02230

Parameter   Name: C02230   LS_WriteParamList: Override point of field weakening		Data type: INTEGER_16 Index: 22345 <sub>d</sub> = 5749 <sub>h</sub>
From version 12.00.00 onwards: Parameter values (1st value ... 4th value) for optional <a href="#">motor data change-over</a>		
Setting range (min. value   unit   max. value)		
-500	Hz	500
Subcodes	Lenze setting	Info
C02230/1	0 Hz	<a href="#">LS_WriteParamList: c80_val1</a>
C02230/2	0 Hz	<a href="#">LS_WriteParamList: c80_val2</a>
C02230/3	0 Hz	<a href="#">LS_WriteParamList: c80_val3</a>
C02230/4	0 Hz	<a href="#">LS_WriteParamList: c80_val4</a>
<input checked="" type="checkbox"/> Read access <input checked="" type="checkbox"/> Write access <input type="checkbox"/> CINH <input type="checkbox"/> PLC STOP <input type="checkbox"/> No transfer <input type="checkbox"/> COM <input checked="" type="checkbox"/> MOT             Scaling factor: 1		

## C02231

Parameter   Name: <b>C02231   LS_WriteParamList: Rated motor power</b>		Data type: UNSIGNED_16 Index: 22344 <sub>d</sub> = 5748 <sub>h</sub>
From version 12.00.00 onwards: Parameter values (1st value ... 4th value) for optional <a href="#">motor data change-over</a>		
<b>Setting range (min. value   unit   max. value)</b>		
0.00	kW	500.00
<b>Subcodes</b>	<b>Lenze setting</b>	<b>Info</b>
C02231/1	11.00 kW	<a href="#">LS_WriteParamList: c81_val1</a>
C02231/2	11.00 kW	<a href="#">LS_WriteParamList: c81_val2</a>
C02231/3	11.00 kW	<a href="#">LS_WriteParamList: c81_val3</a>
C02231/4	11.00 kW	<a href="#">LS_WriteParamList: c81_val4</a>
<input checked="" type="checkbox"/> Read access <input checked="" type="checkbox"/> Write access <input type="checkbox"/> CINH <input type="checkbox"/> PLC STOP <input type="checkbox"/> No transfer <input type="checkbox"/> COM <input checked="" type="checkbox"/> MOT   Scaling factor: 100		

## C02232

Parameter   Name: <b>C02232   LS_WriteParamList: Motor rotor resistance</b>		Data type: UNSIGNED_32 Index: 22343 <sub>d</sub> = 5747 <sub>h</sub>
From version 12.00.00 onwards: Parameter values (1st value ... 4th value) for optional <a href="#">motor data change-over</a>		
<b>Setting range (min. value   unit   max. value)</b>		
0	mohm	200000
<b>Subcodes</b>	<b>Lenze setting</b>	<b>Info</b>
C02232/1	276 mohms	<a href="#">LS_WriteParamList: c82_val1</a>
C02232/2	276 mohms	<a href="#">LS_WriteParamList: c82_val2</a>
C02232/3	276 mohms	<a href="#">LS_WriteParamList: c82_val3</a>
C02232/4	276 mohms	<a href="#">LS_WriteParamList: c82_val4</a>
<input checked="" type="checkbox"/> Read access <input checked="" type="checkbox"/> Write access <input type="checkbox"/> CINH <input type="checkbox"/> PLC STOP <input type="checkbox"/> No transfer <input type="checkbox"/> COM <input checked="" type="checkbox"/> MOT   Scaling factor: 1		

## C02233

Parameter   Name: <b>C02233   LS_WriteParamList: Motor stator resistance</b>		Data type: UNSIGNED_32 Index: 22342 <sub>d</sub> = 5746 <sub>h</sub>
From version 12.00.00 onwards: Parameter values (1st value ... 4th value) for optional <a href="#">motor data change-over</a>		
<b>Setting range (min. value   unit   max. value)</b>		
0	mohm	200000
<b>Subcodes</b>	<b>Lenze setting</b>	<b>Info</b>
C02233/1	330 mohms	<a href="#">LS_WriteParamList: c84_val1</a>
C02233/2	330 mohms	<a href="#">LS_WriteParamList: c84_val2</a>
C02233/3	330 mohms	<a href="#">LS_WriteParamList: c84_val3</a>
C02233/4	330 mohms	<a href="#">LS_WriteParamList: c84_val4</a>
<input checked="" type="checkbox"/> Read access <input checked="" type="checkbox"/> Write access <input type="checkbox"/> CINH <input type="checkbox"/> PLC STOP <input type="checkbox"/> No transfer <input type="checkbox"/> COM <input checked="" type="checkbox"/> MOT   Scaling factor: 1		

## C02234

Parameter   Name: <b>C02234   LS_WriteParamList: Motor stator leakage inductance</b>		Data type: UNSIGNED_16 Index: 22341 <sub>d</sub> = 5745 <sub>h</sub>
From version 12.00.00 onwards: Parameter values (1st value ... 4th value) for optional <a href="#">motor data change-over</a>		
<b>Setting range (min. value   unit   max. value)</b>		
0.00	mH	650.00
<b>Subcodes</b>	<b>Lenze setting</b>	<b>Info</b>
C02234/1	3.50 mH	<a href="#">LS_WriteParamList: c85_val1</a>
C02234/2	3.50 mH	<a href="#">LS_WriteParamList: c85_val2</a>
C02234/3	3.50 mH	<a href="#">LS_WriteParamList: c85_val3</a>
C02234/4	3.50 mH	<a href="#">LS_WriteParamList: c85_val4</a>
<input checked="" type="checkbox"/> Read access <input checked="" type="checkbox"/> Write access <input type="checkbox"/> CINH <input type="checkbox"/> PLC STOP <input type="checkbox"/> No transfer <input type="checkbox"/> COM <input checked="" type="checkbox"/> MOT   Scaling factor: 100		

## C02236

Parameter   Name: <b>C02236   LS_WriteParamList: Rated motor speed</b>		Data type: UNSIGNED_16 Index: 22339 <sub>d</sub> = 5743 <sub>h</sub>
From version 12.00.00 onwards: Parameter values (1st value ... 4th value) for optional <a href="#">motor data change-over</a>		
<b>Setting range (min. value   unit   max. value)</b>		
50	rpm	60000
<b>Subcodes</b>	<b>Lenze setting</b>	<b>Info</b>
C02236/1	1460 rpm	<a href="#">LS_WriteParamList: c87_val1</a>
C02236/2	1460 rpm	<a href="#">LS_WriteParamList: c87_val2</a>
C02236/3	1460 rpm	<a href="#">LS_WriteParamList: c87_val3</a>
C02236/4	1460 rpm	<a href="#">LS_WriteParamList: c87_val4</a>
<input checked="" type="checkbox"/> Read access <input checked="" type="checkbox"/> Write access <input type="checkbox"/> CINH <input type="checkbox"/> PLC STOP <input type="checkbox"/> No transfer <input type="checkbox"/> COM <input checked="" type="checkbox"/> MOT   Scaling factor: 1		

## C02237

Parameter   Name: <b>C02237   LS_WriteParamList: Rated motor current</b>		Data type: UNSIGNED_16 Index: 22338 <sub>d</sub> = 5742 <sub>h</sub>
From version 12.00.00 onwards: Parameter values (1st value ... 4th value) for optional <a href="#">motor data change-over</a>		
<b>Setting range (min. value   unit   max. value)</b>		
0.20	A	320.00
<b>Subcodes</b>	<b>Lenze setting</b>	<b>Info</b>
C02237/1	21.00 A	<a href="#">LS_WriteParamList: c88_val1</a>
C02237/2	21.00 A	<a href="#">LS_WriteParamList: c88_val2</a>
C02237/3	21.00 A	<a href="#">LS_WriteParamList: c88_val3</a>
C02237/4	21.00 A	<a href="#">LS_WriteParamList: c88_val4</a>
<input checked="" type="checkbox"/> Read access <input checked="" type="checkbox"/> Write access <input type="checkbox"/> CINH <input type="checkbox"/> PLC STOP <input type="checkbox"/> No transfer <input type="checkbox"/> COM <input checked="" type="checkbox"/> MOT   Scaling factor: 100		

## C02238

Parameter   Name: <b>C02238   LS_WriteParamList: Rated motor frequency</b>		Data type: UNSIGNED_16 Index: 22337 <sub>d</sub> = 5741 <sub>h</sub>
From version 12.00.00 onwards: Parameter values (1st value ... 4th value) for optional <a href="#">motor data change-over</a>		
<b>Setting range (min. value   unit   max. value)</b>		
1	Hz	1000
<b>Subcodes</b>	<b>Lenze setting</b>	<b>Info</b>
C02238/1	50 Hz	<a href="#">LS_WriteParamList: c89_val1</a>
C02238/2	50 Hz	<a href="#">LS_WriteParamList: c89_val2</a>
C02238/3	50 Hz	<a href="#">LS_WriteParamList: c89_val3</a>
C02238/4	50 Hz	<a href="#">LS_WriteParamList: c89_val4</a>
<input checked="" type="checkbox"/> Read access <input checked="" type="checkbox"/> Write access <input type="checkbox"/> CINH <input type="checkbox"/> PLC STOP <input type="checkbox"/> No transfer <input type="checkbox"/> COM <input checked="" type="checkbox"/> MOT   Scaling factor: 1		

## C02239

Parameter   Name: <b>C02239   LS_WriteParamList: Rated motor voltage</b>		Data type: UNSIGNED_16 Index: 22336 <sub>d</sub> = 5740 <sub>h</sub>
From version 12.00.00 onwards: Parameter values (1st value ... 4th value) for optional <a href="#">motor data change-over</a>		
<b>Setting range (min. value   unit   max. value)</b>		
0	V	5000
<b>Subcodes</b>	<b>Lenze setting</b>	<b>Info</b>
C02239/1	400 V	<a href="#">LS_WriteParamList: c90_val1</a>
C02239/2	400 V	<a href="#">LS_WriteParamList: c90_val2</a>
C02239/3	400 V	<a href="#">LS_WriteParamList: c90_val3</a>
C02239/4	400 V	<a href="#">LS_WriteParamList: c90_val4</a>
<input checked="" type="checkbox"/> Read access <input checked="" type="checkbox"/> Write access <input type="checkbox"/> CINH <input type="checkbox"/> PLC STOP <input type="checkbox"/> No transfer <input type="checkbox"/> COM <input checked="" type="checkbox"/> MOT   Scaling factor: 1		

## C02240

Parameter   Name: <b>C02240   LS_WriteParamList: Motor cosine phi</b>		Data type: UNSIGNED_8 Index: 22335 <sub>d</sub> = 573F <sub>h</sub>
From version 12.00.00 onwards: Parameter values (1st value ... 4th value) for optional <a href="#">motor data change-over</a>		
<b>Setting range (min. value   unit   max. value)</b>		
0.20		1.00
<b>Subcodes</b>	<b>Lenze setting</b>	<b>Info</b>
C02240/1	0.85	<a href="#">LS_WriteParamList: c91_val1</a>
C02240/2	0.85	<a href="#">LS_WriteParamList: c91_val2</a>
C02240/3	0.85	<a href="#">LS_WriteParamList: c91_val3</a>
C02240/4	0.85	<a href="#">LS_WriteParamList: c91_val4</a>
<input checked="" type="checkbox"/> Read access <input checked="" type="checkbox"/> Write access <input type="checkbox"/> CINH <input type="checkbox"/> PLC STOP <input type="checkbox"/> No transfer <input type="checkbox"/> COM <input checked="" type="checkbox"/> MOT   Scaling factor: 100		

## C02241

Parameter   Name: <b>C02241   LS_WriteParamList: Motor magnetizing inductance</b>		Data type: UNSIGNED_16 Index: 22334 <sub>d</sub> = 573E <sub>h</sub>
From version 12.00.00 onwards: Parameter values (1st value ... 4th value) for optional <a href="#">motor data change-over</a>		
<b>Setting range (min. value   unit   max. value)</b>		
0.0	mH	6500.0
<b>Subcodes</b>	<b>Lenze setting</b>	<b>Info</b>
C02241/1	81.0 mH	<a href="#">LS_WriteParamList: c92_val1</a>
C02241/2	81.0 mH	<a href="#">LS_WriteParamList: c92_val2</a>
C02241/3	81.0 mH	<a href="#">LS_WriteParamList: c92_val3</a>
C02241/4	81.0 mH	<a href="#">LS_WriteParamList: c92_val4</a>
<input checked="" type="checkbox"/> Read access <input checked="" type="checkbox"/> Write access <input type="checkbox"/> CINH <input type="checkbox"/> PLC STOP <input type="checkbox"/> No transfer <input type="checkbox"/> COM <input checked="" type="checkbox"/> MOT   Scaling factor: 10		

## C02242

Parameter   Name: <b>C02242   LS_WriteParamList: Motor magnetising current</b>		Data type: UNSIGNED_16 Index: 22334 <sub>d</sub> = 573E <sub>h</sub>
From version 12.00.00 onwards: Parameter values (1st value ... 4th value) for optional <a href="#">motor data change-over</a>		
<b>Setting range (min. value   unit   max. value)</b>		
0.00	A	320.00
<b>Subcodes</b>	<b>Lenze setting</b>	<b>Info</b>
C02242/1	8.50 A	<a href="#">LS_WriteParamList: c95_val1</a>
C02242/2	8.50 A	<a href="#">LS_WriteParamList: c95_val2</a>
C02242/3	8.50 A	<a href="#">LS_WriteParamList: c95_val3</a>
C02242/4	8.50 A	<a href="#">LS_WriteParamList: c95_val4</a>
<input checked="" type="checkbox"/> Read access <input checked="" type="checkbox"/> Write access <input type="checkbox"/> CINH <input type="checkbox"/> PLC STOP <input type="checkbox"/> No transfer <input type="checkbox"/> COM <input checked="" type="checkbox"/> MOT   Scaling factor: 100		

## C02244

Parameter   Name: <b>C02244   LS_WriteParamList: Auto-DCB: Hold time</b>		Data type: UNSIGNED_32 Index: 22331 <sub>d</sub> = 573B <sub>h</sub>
From version 12.00.00 onwards: Parameter values (1st value ... 4th value) for optional <a href="#">motor data change-over</a>		
<b>Setting range (min. value   unit   max. value)</b>		
0.000	s	999.000
<b>Subcodes</b>	<b>Lenze setting</b>	<b>Info</b>
C02244/1	0.500 s	<a href="#">LS_WriteParamList: c106_val1</a>
C02244/2	0.500 s	<a href="#">LS_WriteParamList: c106_val2</a>
C02244/3	0.500 s	<a href="#">LS_WriteParamList: c106_val3</a>
C02244/4	0.500 s	<a href="#">LS_WriteParamList: c106_val4</a>
<input checked="" type="checkbox"/> Read access <input checked="" type="checkbox"/> Write access <input type="checkbox"/> CINH <input type="checkbox"/> PLC STOP <input type="checkbox"/> No transfer <input type="checkbox"/> COM <input type="checkbox"/> MOT   Scaling factor: 1000		

## C02245

Parameter   Name: <b>C02245   LS_WriteParamList: DC braking: Hold time</b>		Data type: UNSIGNED_32 Index: 22330 <sub>d</sub> = 573A <sub>h</sub>
From version 12.00.00 onwards: Parameter values (1st value ... 4th value) for optional <a href="#">motor data change-over</a>		
<b>Setting range (min. value   unit   max. value)</b>		
0.000	s	999.000
<b>Subcodes</b>	<b>Lenze setting</b>	<b>Info</b>
C02245/1	998.999 s	<a href="#">LS_WriteParamList: c107_val1</a>
C02245/2	998.999 s	<a href="#">LS_WriteParamList: c107_val2</a>
C02245/3	998.999 s	<a href="#">LS_WriteParamList: c107_val3</a>
C02245/4	998.999 s	<a href="#">LS_WriteParamList: c107_val4</a>
<input checked="" type="checkbox"/> Read access <input checked="" type="checkbox"/> Write access <input type="checkbox"/> CINH <input type="checkbox"/> PLC STOP <input type="checkbox"/> No transfer <input type="checkbox"/> COM <input type="checkbox"/> MOT   Scaling factor: 1000		

## C02246

Parameter   Name: <b>C02246   LS_WriteParamList: Setting of motor overload (I<sup>xt</sup>)</b>		Data type: INTEGER_16 Index: 22320 <sub>d</sub> = 5739 <sub>h</sub>
From version 12.00.00 onwards: Parameter values (1st value ... 4th value) for optional <a href="#">motor data change-over</a>		
<b>Setting range (min. value   unit   max. value)</b>		
0.00	%	250.00
<b>Subcodes</b>	<b>Lenze setting</b>	<b>Info</b>
C02246/1	100.00 %	<a href="#">LS_WriteParamList: c120_val1</a>
C02246/2	100.00 %	<a href="#">LS_WriteParamList: c120_val2</a>
C02246/3	100.00 %	<a href="#">LS_WriteParamList: c120_val3</a>
C02246/4	100.00 %	<a href="#">LS_WriteParamList: c120_val4</a>
<input checked="" type="checkbox"/> Read access <input checked="" type="checkbox"/> Write access <input type="checkbox"/> CINH <input type="checkbox"/> PLC STOP <input type="checkbox"/> No transfer <input type="checkbox"/> COM <input checked="" type="checkbox"/> MOT   Scaling factor: 100		

## C02249

Parameter   Name: <b>C02249   LS_WriteParamList: Oscillation damping influence</b>		Data type: UNSIGNED_16 Index: 22326 <sub>d</sub> = 5736 <sub>h</sub>
From version 12.00.00 onwards: Parameter values (1st value ... 4th value) for optional <a href="#">motor data change-over</a>		
<b>Setting range (min. value   unit   max. value)</b>		
0.00	%	250.00
<b>Subcodes</b>	<b>Lenze setting</b>	<b>Info</b>
C02249/1	5.00 %	<a href="#">LS_WriteParamList: c234_val1</a>
C02249/2	5.00 %	<a href="#">LS_WriteParamList: c234_val2</a>
C02249/3	5.00 %	<a href="#">LS_WriteParamList: c234_val3</a>
C02249/4	5.00 %	<a href="#">LS_WriteParamList: c234_val4</a>
<input checked="" type="checkbox"/> Read access <input checked="" type="checkbox"/> Write access <input type="checkbox"/> CINH <input type="checkbox"/> PLC STOP <input type="checkbox"/> No transfer <input type="checkbox"/> COM <input checked="" type="checkbox"/> MOT   Scaling factor: 100		

## C02250

Parameter   Name: <b>C02250   LS_WriteParamList: Filter time - oscill. damping</b>		Data type: UNSIGNED_8 Index: 22325 <sub>d</sub> = 5735 <sub>h</sub>
From version 12.00.00 onwards: Parameter values (1st value ... 4th value) for optional <a href="#">motor data change-over</a>		
<b>Setting range (min. value   unit   max. value)</b>		
2	ms	250
<b>Subcodes</b>	<b>Lenze setting</b>	<b>Info</b>
C02250/1	32 ms	<a href="#">LS_WriteParamList: c235_val1</a>
C02250/2	32 ms	<a href="#">LS_WriteParamList: c235_val2</a>
C02250/3	32 ms	<a href="#">LS_WriteParamList: c235_val3</a>
C02250/4	32 ms	<a href="#">LS_WriteParamList: c235_val4</a>
<input checked="" type="checkbox"/> Read access <input checked="" type="checkbox"/> Write access <input type="checkbox"/> CINH <input type="checkbox"/> PLC STOP <input type="checkbox"/> No transfer <input type="checkbox"/> COM <input checked="" type="checkbox"/> MOT   Scaling factor: 1		

## C02251

Parameter   Name: <b>C02251   LS_WriteParamList: Oscillation damping field weakening</b>		Data type: UNSIGNED_8 Index: 22324 <sub>d</sub> = 5734 <sub>h</sub>
From version 12.00.00 onwards: Parameter values (1st value ... 4th value) for optional <a href="#">motor data change-over</a>		
<b>Setting range (min. value   unit   max. value)</b>		
0		40
<b>Subcodes</b>	<b>Lenze setting</b>	<b>Info</b>
C02251/1	14	<a href="#">LS_WriteParamList: c236_val1</a>
C02251/2	14	<a href="#">LS_WriteParamList: c236_val2</a>
C02251/3	14	<a href="#">LS_WriteParamList: c236_val3</a>
C02251/4	14	<a href="#">LS_WriteParamList: c236_val4</a>
<input checked="" type="checkbox"/> Read access <input checked="" type="checkbox"/> Write access <input type="checkbox"/> CINH <input type="checkbox"/> PLC STOP <input type="checkbox"/> No transfer <input type="checkbox"/> COM <input checked="" type="checkbox"/> MOT   Scaling factor: 1		

## C02256

Parameter   Name: <b>C02256   LS_WriteParamList: Moment of inertia</b>		Data type: UNSIGNED_32 Index: 22319 <sub>d</sub> = 572F <sub>h</sub>
From version 12.00.00 onwards: Parameter values (1st value ... 4th value) for optional <a href="#">motor data change-over</a>		
<b>Setting range (min. value   unit   max. value)</b>		
0.00	kg cm <sup>2</sup>	6000000.00
<b>Subcodes</b>	<b>Lenze setting</b>	<b>Info</b>
C02256/1	0.00 kg cm <sup>2</sup>	<a href="#">LS_WriteParamList: c273_val1</a>
C02256/2	0.00 kg cm <sup>2</sup>	<a href="#">LS_WriteParamList: c273_val2</a>
C02256/3	0.00 kg cm <sup>2</sup>	<a href="#">LS_WriteParamList: c273_val3</a>
C02256/4	0.00 kg cm <sup>2</sup>	<a href="#">LS_WriteParamList: c273_val4</a>
<input checked="" type="checkbox"/> Read access <input checked="" type="checkbox"/> Write access <input type="checkbox"/> CINH <input type="checkbox"/> PLC STOP <input type="checkbox"/> No transfer <input type="checkbox"/> COM <input checked="" type="checkbox"/> MOT   Scaling factor: 100		

## C02260

Parameter   Name:		Data type: UNSIGNED_8 Index: 22315 <sub>d</sub> = 572B <sub>h</sub>
<b>C02260   LS_WriteParamList: Speed sensor selection</b>		
From version 12.00.00 onwards: Parameter values (1st value ... 4th value) for optional <a href="#">motor data change-over</a>		
Selection list		
0	No sensor	
1	Sensor signal FreqIn12	
Subcodes	Lenze setting	Info
C02260/1	0: No sensor	<a href="#">LS_WriteParamList: c495_val1</a>
C02260/2	0: No sensor	<a href="#">LS_WriteParamList: c495_val2</a>
C02260/3	0: No sensor	<a href="#">LS_WriteParamList: c495_val3</a>
C02260/4	0: No sensor	<a href="#">LS_WriteParamList: c495_val4</a>
<input checked="" type="checkbox"/> Read access <input checked="" type="checkbox"/> Write access <input type="checkbox"/> CINH <input type="checkbox"/> PLC STOP <input type="checkbox"/> No transfer <input type="checkbox"/> COM <input checked="" type="checkbox"/> MOT             Scaling factor: 1		

## C02264

Parameter   Name:		Data type: UNSIGNED_8 Index: 22311 <sub>d</sub> = 5727 <sub>h</sub>
<b>C02264   LS_WriteParamList: Empfindlichkeit Sollwertvorsteuerung</b>		
From version 12.00.00 onwards: Parameter values (1st value ... 4th value) for optional <a href="#">motor data change-over</a>		
Selection list		
0	Inactive	
1	15 bits	
2	14 Bit	
3	13 bits	
4	12 bits	
5	11 Bit	
6	10 Bit	
7	9 Bit	
Subcodes	Lenze setting	Info
C02264/1	0: Inactive	<a href="#">LS_WriteParamList: C653_s1_val1</a>
C02264/2	0: Inactive	<a href="#">LS_WriteParamList: C653_s1_val2</a>
C02264/3	0: Inactive	<a href="#">LS_WriteParamList: C653_s1_val3</a>
C02264/4	0: Inactive	<a href="#">LS_WriteParamList: C653_s1_val4</a>
<input checked="" type="checkbox"/> Read access <input checked="" type="checkbox"/> Write access <input type="checkbox"/> CINH <input type="checkbox"/> PLC STOP <input type="checkbox"/> No transfer <input type="checkbox"/> COM <input checked="" type="checkbox"/> MOT             Scaling factor: 1		

## C02272

Parameter   Name:		Data type: UNSIGNED_8 Index: 22303 <sub>d</sub> = 571F <sub>h</sub>
<b>C02272   LS_WriteParamList: Motor phase direction of rotation</b>		
From version 12.00.00 onwards: Parameter values (1st value ... 4th value) for optional <a href="#">motor data change-over</a>		
Selection list		
0	Not inverted	
1	Inverted	
Subcodes	Lenze setting	Info



Parameter   Name:		Data type: UNSIGNED_8 Index: 22303 <sub>d</sub> = 571F <sub>h</sub>
<b>C02272   LS_WriteParamList: Motor phase direction of rotation</b>		
C02272/1	0: Not inverted	<a href="#">LS_WriteParamList: c905_val1</a>
C02272/2	0: Not inverted	<a href="#">LS_WriteParamList: c905_val2</a>
C02272/3	0: Not inverted	<a href="#">LS_WriteParamList: c905_val3</a>
C02272/4	0: Not inverted	<a href="#">LS_WriteParamList: c905_val4</a>
<input checked="" type="checkbox"/> Read access <input checked="" type="checkbox"/> Write access <input checked="" type="checkbox"/> CINH <input type="checkbox"/> PLC STOP <input type="checkbox"/> No transfer <input type="checkbox"/> COM <input type="checkbox"/> MOT             Scaling factor: 1		

**C02273**

Parameter   Name:		Data type: INTEGER_16 Index: 22302 <sub>d</sub> = 571E <sub>h</sub>
<b>C02273   LS_WriteParamList: Speed limitation</b>		
From version 12.00.00 onwards: Parameter values (1st value ... 4th value) for optional <a href="#">motor data change-over</a>		
Setting range (min. value   unit   max. value)		
0.00	%	175.00
Subcodes	Lenze setting	Info
C02273/1	120.00 %	<a href="#">LS_WriteParamList: c909_s1_val1</a>
C02273/2	120.00 %	<a href="#">LS_WriteParamList: c909_s1_val2</a>
C02273/3	120.00 %	<a href="#">LS_WriteParamList: c909_s1_val3</a>
C02273/4	120.00 %	<a href="#">LS_WriteParamList: c909_s1_val4</a>
C02273/5	120.00 %	<a href="#">LS_WriteParamList: c909_s2_val1</a>
C02273/6	120.00 %	<a href="#">LS_WriteParamList: c909_s2_val2</a>
C02273/7	120.00 %	<a href="#">LS_WriteParamList: c909_s2_val3</a>
C02273/8	120.00 %	<a href="#">LS_WriteParamList: c909_s2_val4</a>
<input checked="" type="checkbox"/> Read access <input checked="" type="checkbox"/> Write access <input type="checkbox"/> CINH <input type="checkbox"/> PLC STOP <input type="checkbox"/> No transfer <input type="checkbox"/> COM <input checked="" type="checkbox"/> MOT             Scaling factor: 100		

**C02274**

Parameter   Name:		Data type: UNSIGNED_16 Index: 22301 <sub>d</sub> = 571D <sub>h</sub>
<b>C02274   LS_WriteParamList: Frequency limitation</b>		
From version 12.00.00 onwards: Parameter values (1st value ... 4th value) for optional <a href="#">motor data change-over</a>		
Setting range (min. value   unit   max. value)		
0	Hz	1300
Subcodes	Lenze setting	Info
C02274/1	1000 Hz	<a href="#">LS_WriteParamList: c910_s1_val1</a>
C02274/2	1000 Hz	<a href="#">LS_WriteParamList: c910_s1_val2</a>
C02274/3	1000 Hz	<a href="#">LS_WriteParamList: c910_s1_val3</a>
C02274/4	1000 Hz	<a href="#">LS_WriteParamList: c910_s1_val4</a>
C02274/5	1000 Hz	<a href="#">LS_WriteParamList: c910_s2_val1</a>
C02274/6	1000 Hz	<a href="#">LS_WriteParamList: c910_s2_val2</a>
C02274/7	1000 Hz	<a href="#">LS_WriteParamList: c910_s2_val3</a>
C02274/8	1000 Hz	<a href="#">LS_WriteParamList: c910_s2_val4</a>
<input checked="" type="checkbox"/> Read access <input checked="" type="checkbox"/> Write access <input type="checkbox"/> CINH <input type="checkbox"/> PLC STOP <input type="checkbox"/> No transfer <input type="checkbox"/> COM <input checked="" type="checkbox"/> MOT             Scaling factor: 1		

## C02275

Parameter   Name: <b>C02275   LS_WriteParamList: Motor cable length</b>		Data type: UNSIGNED_16 Index: 22300 <sub>d</sub> = 571C <sub>h</sub>
From version 12.00.00 onwards: Parameter values (1st value ... 4th value) for optional <a href="#">motor data change-over</a>		
<b>Setting range (min. value   unit   max. value)</b>		
0.0	m	1000.0
<b>Subcodes</b>	<b>Lenze setting</b>	<b>Info</b>
C02275/1	5.0 m	<a href="#">LS_WriteParamList: c915_val1</a>
C02275/2	5.0 m	<a href="#">LS_WriteParamList: c915_val2</a>
C02275/3	5.0 m	<a href="#">LS_WriteParamList: c915_val3</a>
C02275/4	5.0 m	<a href="#">LS_WriteParamList: c915_val4</a>
<input checked="" type="checkbox"/> Read access <input checked="" type="checkbox"/> Write access <input type="checkbox"/> CINH <input type="checkbox"/> PLC STOP <input type="checkbox"/> No transfer <input type="checkbox"/> COM <input checked="" type="checkbox"/> MOT   Scaling factor: 10		

## C02276

Parameter   Name: <b>C02276   LS_WriteParamList: Motor cable cross-section</b>		Data type: UNSIGNED_16 Index: 22299 <sub>d</sub> = 571B <sub>h</sub>
From version 12.00.00 onwards: Parameter values (1st value ... 4th value) for optional <a href="#">motor data change-over</a>		
<b>Setting range (min. value   unit   max. value)</b>		
0.50	mm <sup>2</sup>	100.00
<b>Subcodes</b>	<b>Lenze setting</b>	<b>Info</b>
C02276/1	6.00 mm <sup>2</sup>	<a href="#">LS_WriteParamList: c916_val1</a>
C02276/2	6.00 mm <sup>2</sup>	<a href="#">LS_WriteParamList: c916_val2</a>
C02276/3	6.00 mm <sup>2</sup>	<a href="#">LS_WriteParamList: c916_val3</a>
C02276/4	6.00 mm <sup>2</sup>	<a href="#">LS_WriteParamList: c916_val4</a>
<input checked="" type="checkbox"/> Read access <input checked="" type="checkbox"/> Write access <input type="checkbox"/> CINH <input type="checkbox"/> PLC STOP <input type="checkbox"/> No transfer <input type="checkbox"/> COM <input checked="" type="checkbox"/> MOT   Scaling factor: 100		

## C02278

Parameter   Name: <b>C02278   LS_WriteParamList: PSM: Maximum motor current field weakening</b>		Data type: UNSIGNED_16 Index: 22297 <sub>d</sub> = 5719 <sub>h</sub>
From version 12.00.00 onwards: Parameter values (1st value ... 4th value) for optional <a href="#">motor data change-over</a>		
<b>Setting range (min. value   unit   max. value)</b>		
0.00	%	500.00
<b>Subcodes</b>	<b>Lenze setting</b>	<b>Info</b>
C02278/1	30.00 %	<a href="#">LS_WriteParamList: c938_val1</a>
C02278/2	30.00 %	<a href="#">LS_WriteParamList: c938_val2</a>
C02278/3	30.00 %	<a href="#">LS_WriteParamList: c938_val3</a>
C02278/4	30.00 %	<a href="#">LS_WriteParamList: c938_val4</a>
<input checked="" type="checkbox"/> Read access <input checked="" type="checkbox"/> Write access <input type="checkbox"/> CINH <input type="checkbox"/> PLC STOP <input type="checkbox"/> No transfer <input type="checkbox"/> COM <input checked="" type="checkbox"/> MOT   Scaling factor: 100		

## C02279

Parameter   Name: <b>C02279   LS_WriteParamList: Ultimate motor current</b>		Data type: UNSIGNED_16 Index: 22296 <sub>d</sub> = 5718 <sub>h</sub>
From version 12.00.00 onwards: Parameter values (1st value ... 4th value) for optional <a href="#">motor data change-over</a>		
<b>Setting range (min. value   unit   max. value)</b>		
0.0	A	3000.0
<b>Subcodes</b>	<b>Lenze setting</b>	<b>Info</b>
C02279/1	3000.0 A	<a href="#">LS_WriteParamList: c939_val1</a>
C02279/2	3000.0 A	<a href="#">LS_WriteParamList: c939_val2</a>
C02279/3	3000.0 A	<a href="#">LS_WriteParamList: c939_val3</a>
C02279/4	3000.0 A	<a href="#">LS_WriteParamList: c939_val4</a>
<input checked="" type="checkbox"/> Read access <input checked="" type="checkbox"/> Write access <input type="checkbox"/> CINH <input type="checkbox"/> PLC STOP <input type="checkbox"/> No transfer <input type="checkbox"/> COM <input checked="" type="checkbox"/> MOT Scaling factor: 10		

## C02280

Parameter   Name: <b>C02280   LS_WriteParamList: Max. motor speed</b>		Data type: UNSIGNED_16 Index: 22295 <sub>d</sub> = 5717 <sub>h</sub>
From version 12.00.00 onwards: Parameter values (1st value ... 4th value) for optional <a href="#">motor data change-over</a>		
<b>Setting range (min. value   unit   max. value)</b>		
50	rpm	65000
<b>Subcodes</b>	<b>Lenze setting</b>	<b>Info</b>
C02280/1	60000 rpm	<a href="#">LS_WriteParamList: c965_val1</a>
C02280/2	60000 rpm	<a href="#">LS_WriteParamList: c965_val2</a>
C02280/3	60000 rpm	<a href="#">LS_WriteParamList: c965_val3</a>
C02280/4	60000 rpm	<a href="#">LS_WriteParamList: c965_val4</a>
<input checked="" type="checkbox"/> Read access <input checked="" type="checkbox"/> Write access <input type="checkbox"/> CINH <input type="checkbox"/> PLC STOP <input type="checkbox"/> No transfer <input type="checkbox"/> COM <input checked="" type="checkbox"/> MOT Scaling factor: 1		

## C02281

Parameter   Name: <b>C02281   LS_WriteParamList: VFC: Time const. slip comp.</b>		Data type: UNSIGNED_16 Index: 22294 <sub>d</sub> = 5716 <sub>h</sub>
From version 12.00.00 onwards: Parameter values (1st value ... 4th value) for optional <a href="#">motor data change-over</a>		
<b>Setting range (min. value   unit   max. value)</b>		
1	ms	6000
<b>Subcodes</b>	<b>Lenze setting</b>	<b>Info</b>
C02281/1	100 ms	<a href="#">LS_WriteParamList: c966_val1</a>
C02281/2	100 ms	<a href="#">LS_WriteParamList: c966_val2</a>
C02281/3	100 ms	<a href="#">LS_WriteParamList: c966_val3</a>
C02281/4	100 ms	<a href="#">LS_WriteParamList: c966_val4</a>
<input checked="" type="checkbox"/> Read access <input checked="" type="checkbox"/> Write access <input type="checkbox"/> CINH <input type="checkbox"/> PLC STOP <input type="checkbox"/> No transfer <input type="checkbox"/> COM <input checked="" type="checkbox"/> MOT Scaling factor: 1		

## C02284

Parameter   Name: <b>C02284   LS_WriteParamList: VFC: limitation V/f +encoder</b>		Data type: UNSIGNED_16 Index: 22291 <sub>d</sub> = 5713 <sub>h</sub>
From version 12.00.00 onwards: Parameter values (1st value ... 4th value) for optional <a href="#">motor data change-over</a>		
<b>Setting range (min. value   unit   max. value)</b>		
0.00	Hz	100.00
<b>Subcodes</b>	<b>Lenze setting</b>	<b>Info</b>
C02284/1	10.00 Hz	<a href="#">LS_WriteParamList: c971_s1_val1</a>
C02284/2	10.00 Hz	<a href="#">LS_WriteParamList: c971_s1_val2</a>
C02284/3	10.00 Hz	<a href="#">LS_WriteParamList: c971_s1_val3</a>
C02284/4	10.00 Hz	<a href="#">LS_WriteParamList: c971_s1_val4</a>
C02284/5	100.00 Hz	<a href="#">LS_WriteParamList: c971_s2_val1</a>
C02284/6	100.00 Hz	<a href="#">LS_WriteParamList: c971_s2_val2</a>
C02284/7	100.00 Hz	<a href="#">LS_WriteParamList: c971_s2_val3</a>
C02284/8	100.00 Hz	<a href="#">LS_WriteParamList: c971_s2_val4</a>
<input checked="" type="checkbox"/> Read access <input checked="" type="checkbox"/> Write access <input type="checkbox"/> CINH <input type="checkbox"/> PLC STOP <input type="checkbox"/> No transfer <input type="checkbox"/> COM <input checked="" type="checkbox"/> MOT Scaling factor: 100		

## C02285

Parameter   Name: <b>C02285   LS_WriteParamList: VFC: Vp V/f +encoder</b>		Data type: UNSIGNED_16 Index: 22290 <sub>d</sub> = 5712 <sub>h</sub>
From version 12.00.00 onwards: Parameter values (1st value ... 4th value) for optional <a href="#">motor data change-over</a>		
<b>Setting range (min. value   unit   max. value)</b>		
0.000	Hz/Hz	64.000
<b>Subcodes</b>	<b>Lenze setting</b>	<b>Info</b>
C02285/1	0.100 Hz/Hz	<a href="#">LS_WriteParamList: c972_val1</a>
C02285/2	0.100 Hz/Hz	<a href="#">LS_WriteParamList: c972_val2</a>
C02285/3	0.100 Hz/Hz	<a href="#">LS_WriteParamList: c972_val3</a>
C02285/4	0.100 Hz/Hz	<a href="#">LS_WriteParamList: c972_val4</a>
<input checked="" type="checkbox"/> Read access <input checked="" type="checkbox"/> Write access <input type="checkbox"/> CINH <input type="checkbox"/> PLC STOP <input type="checkbox"/> No transfer <input type="checkbox"/> COM <input checked="" type="checkbox"/> MOT Scaling factor: 1000		

## C02286

Parameter   Name: <b>C02286   LS_WriteParamList: VFC: Ti V/f +encoder</b>		Data type: UNSIGNED_16 Index: 22289 <sub>d</sub> = 5711 <sub>h</sub>
From version 12.00.00 onwards: Parameter values (1st value ... 4th value) for optional <a href="#">motor data change-over</a>		
<b>Setting range (min. value   unit   max. value)</b>		
0.0	ms	6000.0
<b>Subcodes</b>	<b>Lenze setting</b>	<b>Info</b>
C02286/1	100.0 ms	<a href="#">LS_WriteParamList: c973_val1</a>
C02286/2	100.0 ms	<a href="#">LS_WriteParamList: c973_val2</a>
C02286/3	100.0 ms	<a href="#">LS_WriteParamList: c973_val3</a>
C02286/4	100.0 ms	<a href="#">LS_WriteParamList: c973_val4</a>
<input checked="" type="checkbox"/> Read access <input checked="" type="checkbox"/> Write access <input type="checkbox"/> CINH <input type="checkbox"/> PLC STOP <input type="checkbox"/> No transfer <input type="checkbox"/> COM <input checked="" type="checkbox"/> MOT Scaling factor: 10		

## C02287

Parameter   Name: <b>C02287   LS_WriteParamList: VFC-ECO: Vp CosPhi controller</b>		Data type: UNSIGNED_16 Index: 22288 <sub>d</sub> = 5710 <sub>h</sub>
From version 12.00.00 onwards: Parameter values (1st value ... 4th value) for optional <a href="#">motor data change-over</a>		
<b>Setting range (min. value   unit   max. value)</b>		
0.000	Hz/Hz	64.000
<b>Subcodes</b>	<b>Lenze setting</b>	<b>Info</b>
C02287/1	0.500 Hz/Hz	<a href="#">LS_WriteParamList: c975_val1</a>
C02287/2	0.500 Hz/Hz	<a href="#">LS_WriteParamList: c975_val2</a>
C02287/3	0.500 Hz/Hz	<a href="#">LS_WriteParamList: c975_val3</a>
C02287/4	0.500 Hz/Hz	<a href="#">LS_WriteParamList: c975_val4</a>
<input checked="" type="checkbox"/> Read access <input checked="" type="checkbox"/> Write access <input type="checkbox"/> CINH <input type="checkbox"/> PLC STOP <input type="checkbox"/> No transfer <input type="checkbox"/> COM <input checked="" type="checkbox"/> MOT   Scaling factor: 1000		

## C02288

Parameter   Name: <b>C02288   LS_WriteParamList: VFC-ECO: Ti CosPhi controller</b>		Data type: UNSIGNED_16 Index: 22288 <sub>d</sub> = 5710 <sub>h</sub>
From version 12.00.00 onwards: Parameter values (1st value ... 4th value) for optional <a href="#">motor data change-over</a>		
<b>Setting range (min. value   unit   max. value)</b>		
0.0	ms	6000.0
<b>Subcodes</b>	<b>Lenze setting</b>	<b>Info</b>
C02288/1	200.0 ms	<a href="#">LS_WriteParamList: c976_val1</a>
C02288/2	200.0 ms	<a href="#">LS_WriteParamList: c976_val2</a>
C02288/3	200.0 ms	<a href="#">LS_WriteParamList: c976_val3</a>
C02288/4	200.0 ms	<a href="#">LS_WriteParamList: c976_val4</a>
<input checked="" type="checkbox"/> Read access <input checked="" type="checkbox"/> Write access <input type="checkbox"/> CINH <input type="checkbox"/> PLC STOP <input type="checkbox"/> No transfer <input type="checkbox"/> COM <input checked="" type="checkbox"/> MOT   Scaling factor: 10		

## C02289

Parameter   Name: <b>C02289   LS_WriteParamList: VFC-ECO: Minimum voltage U/f</b>		Data type: INTEGER_16 Index: 22289 <sub>d</sub> = 5711 <sub>h</sub>
From version 12.00.00 onwards: Parameter values (1st value ... 4th value) for optional <a href="#">motor data change-over</a>		
<b>Setting range (min. value   unit   max. value)</b>		
20.00	%	100.00
<b>Subcodes</b>	<b>Lenze setting</b>	<b>Info</b>
C02289/1	20.00 %	<a href="#">LS_WriteParamList: c977_val1</a>
C02289/2	20.00 %	<a href="#">LS_WriteParamList: c977_val2</a>
C02289/3	20.00 %	<a href="#">LS_WriteParamList: c977_val3</a>
C02289/4	20.00 %	<a href="#">LS_WriteParamList: c977_val4</a>
<input checked="" type="checkbox"/> Read access <input checked="" type="checkbox"/> Write access <input type="checkbox"/> CINH <input type="checkbox"/> PLC STOP <input type="checkbox"/> No transfer <input type="checkbox"/> COM <input checked="" type="checkbox"/> MOT   Scaling factor: 100		

## C02290

Parameter   Name: <b>C02290   LS_WriteParamList: VFC-ECO: Voltage reduction ramp</b>		Data type: UNSIGNED_8 Index: 22285 <sub>d</sub> = 570D <sub>h</sub>
From version 12.00.00 onwards: Parameter values (1st value ... 4th value) for optional <a href="#">motor data change-over</a>		
<b>Setting range (min. value   unit   max. value)</b>		
0.0	s	5.0
<b>Subcodes</b>	<b>Lenze setting</b>	<b>Info</b>
C02290/1	0.8 s	<a href="#">LS_WriteParamList: c982_val1</a>
C02290/2	0.8 s	<a href="#">LS_WriteParamList: c982_val2</a>
C02290/3	0.8 s	<a href="#">LS_WriteParamList: c982_val3</a>
C02290/4	0.8 s	<a href="#">LS_WriteParamList: c982_val4</a>
<input checked="" type="checkbox"/> Read access <input checked="" type="checkbox"/> Write access <input type="checkbox"/> CINH <input type="checkbox"/> PLC STOP <input type="checkbox"/> No transfer <input type="checkbox"/> COM <input checked="" type="checkbox"/> MOT Scaling factor: 10		

## C02291

Parameter   Name: <b>C02291   LS_WriteParamList: SLVC: Field current controller gain</b>		Data type: INTEGER_16 Index: 22284 <sub>d</sub> = 570C <sub>h</sub>
From version 12.00.00 onwards: Parameter values (1st value ... 4th value) for optional <a href="#">motor data change-over</a>		
<b>Setting range (min. value   unit   max. value)</b>		
0.00	%	20.00
<b>Subcodes</b>	<b>Lenze setting</b>	<b>Info</b>
C02291/1	0.50 %	<a href="#">LS_WriteParamList: c985_val1</a>
C02291/2	0.50 %	<a href="#">LS_WriteParamList: c985_val2</a>
C02291/3	0.50 %	<a href="#">LS_WriteParamList: c985_val3</a>
C02291/4	0.50 %	<a href="#">LS_WriteParamList: c985_val4</a>
<input checked="" type="checkbox"/> Read access <input checked="" type="checkbox"/> Write access <input type="checkbox"/> CINH <input type="checkbox"/> PLC STOP <input type="checkbox"/> No transfer <input type="checkbox"/> COM <input checked="" type="checkbox"/> MOT Scaling factor: 100		

## C02292

Parameter   Name: <b>C02292   LS_WriteParamList: SLVC: Cross current controller gain</b>		Data type: INTEGER_16 Index: 22283 <sub>d</sub> = 570B <sub>h</sub>
From version 12.00.00 onwards: Parameter values (1st value ... 4th value) for optional <a href="#">motor data change-over</a>		
<b>Setting range (min. value   unit   max. value)</b>		
0.00	%	20.00
<b>Subcodes</b>	<b>Lenze setting</b>	<b>Info</b>
C02292/1	0.00 %	<a href="#">LS_WriteParamList: c986_val1</a>
C02292/2	0.00 %	<a href="#">LS_WriteParamList: c986_val2</a>
C02292/3	0.00 %	<a href="#">LS_WriteParamList: c986_val3</a>
C02292/4	0.00 %	<a href="#">LS_WriteParamList: c986_val4</a>
<input checked="" type="checkbox"/> Read access <input checked="" type="checkbox"/> Write access <input type="checkbox"/> CINH <input type="checkbox"/> PLC STOP <input type="checkbox"/> No transfer <input type="checkbox"/> COM <input checked="" type="checkbox"/> MOT Scaling factor: 100		

## C02293

Parameter   Name: <b>C02293   LS_WriteParamList: Inverter motor brake: nAdd</b>		Data type: INTEGER_16 Index: 22282 <sub>d</sub> = 570A <sub>h</sub>
From version 12.00.00 onwards: Parameter values (1st value ... 4th value) for optional <a href="#">motor data change-over</a>		
<b>Setting range (min. value   unit   max. value)</b>		
0	rpm	1000
<b>Subcodes</b>	<b>Lenze setting</b>	<b>Info</b>
C02293/1	80 rpm	<a href="#">LS_WriteParamList: c987_val1</a>
C02293/2	80 rpm	<a href="#">LS_WriteParamList: c987_val2</a>
C02293/3	80 rpm	<a href="#">LS_WriteParamList: c987_val3</a>
C02293/4	80 rpm	<a href="#">LS_WriteParamList: c987_val4</a>
<input checked="" type="checkbox"/> Read access <input checked="" type="checkbox"/> Write access <input type="checkbox"/> CINH <input type="checkbox"/> PLC STOP <input type="checkbox"/> No transfer <input type="checkbox"/> COM <input checked="" type="checkbox"/> MOT   Scaling factor: 1		

## C02294

Parameter   Name: <b>C02294   LS_WriteParamList: Inverter motor brake: PT1 filter time</b>		Data type: INTEGER_16 Index: 22281 <sub>d</sub> = 5709 <sub>h</sub>
From version 12.00.00 onwards: Parameter values (1st value ... 4th value) for optional <a href="#">motor data change-over</a>		
<b>Setting range (min. value   unit   max. value)</b>		
0.0	ms	100.0
<b>Subcodes</b>	<b>Lenze setting</b>	<b>Info</b>
C02294/1	0.0 ms	<a href="#">LS_WriteParamList: c988_val1</a>
C02294/2	0.0 ms	<a href="#">LS_WriteParamList: c988_val2</a>
C02294/3	0.0 ms	<a href="#">LS_WriteParamList: c988_val3</a>
C02294/4	0.0 ms	<a href="#">LS_WriteParamList: c988_val4</a>
<input checked="" type="checkbox"/> Read access <input checked="" type="checkbox"/> Write access <input type="checkbox"/> CINH <input type="checkbox"/> PLC STOP <input type="checkbox"/> No transfer <input type="checkbox"/> COM <input type="checkbox"/> MOT   Scaling factor: 10		

## C02295

Parameter   Name: <b>C02295   LS_WriteParamList: Flying restart fct.: Activation</b>		Data type: UNSIGNED_8 Index: 22280 <sub>d</sub> = 5708 <sub>h</sub>
From version 12.00.00 onwards: Parameter values (1st value ... 4th value) for optional <a href="#">motor data change-over</a>		
<b>Selection list</b>		
0	Off	
1	On	
<b>Subcodes</b>	<b>Lenze setting</b>	<b>Info</b>
C02295/1	0: Off	<a href="#">LS_WriteParamList: c990_val1</a>
C02295/2	0: Off	<a href="#">LS_WriteParamList: c990_val2</a>
C02295/3	0: Off	<a href="#">LS_WriteParamList: c990_val3</a>
C02295/4	0: Off	<a href="#">LS_WriteParamList: c990_val4</a>
<input checked="" type="checkbox"/> Read access <input checked="" type="checkbox"/> Write access <input checked="" type="checkbox"/> CINH <input type="checkbox"/> PLC STOP <input type="checkbox"/> No transfer <input type="checkbox"/> COM <input checked="" type="checkbox"/> MOT   Scaling factor: 1		

## C02296

Parameter   Name: <b>C02296   LS_WriteParamList: Flying restart fct.: process</b>		Data type: UNSIGNED_16 Index: 22279 <sub>d</sub> = 5707 <sub>h</sub>
From version 12.00.00 onwards: Parameter values (1st value ... 4th value) for optional <a href="#">motor data change-over</a>		
Selection list		
0	0...+n   Start: +10 Hz	
1	-n...0   Start: -10 Hz	
2	-n...+n   Start: +10 Hz	
3	-n...+n   Start: -10 Hz	
4	-n...+n   Start: Cx992	
Subcodes	Lenze setting	Info
C02296/1	2: -n...+n   Start: +10 Hz	<a href="#">LS_WriteParamList: c991_val1</a>
C02296/2	2: -n...+n   Start: +10 Hz	<a href="#">LS_WriteParamList: c991_val2</a>
C02296/3	2: -n...+n   Start: +10 Hz	<a href="#">LS_WriteParamList: c991_val3</a>
C02296/4	2: -n...+n   Start: +10 Hz	<a href="#">LS_WriteParamList: c991_val4</a>
<input checked="" type="checkbox"/> Read access <input checked="" type="checkbox"/> Write access <input type="checkbox"/> CINH <input type="checkbox"/> PLC STOP <input type="checkbox"/> No transfer <input type="checkbox"/> COM <input checked="" type="checkbox"/> MOT   Scaling factor: 1		

## C02297

Parameter   Name: <b>C02297   LS_WriteParamList: Flying restart: Start frequency</b>		Data type: INTEGER_16 Index: 22278 <sub>d</sub> = 5706 <sub>h</sub>
From version 12.00.00 onwards: Parameter values (1st value ... 4th value) for optional <a href="#">motor data change-over</a>		
Setting range (min. value   unit   max. value)		
-200	Hz	200
Subcodes	Lenze setting	Info
C02297/1	10 Hz	<a href="#">LS_WriteParamList: c992_val1</a>
C02297/2	10 Hz	<a href="#">LS_WriteParamList: c992_val2</a>
C02297/3	10 Hz	<a href="#">LS_WriteParamList: c992_val3</a>
C02297/4	10 Hz	<a href="#">LS_WriteParamList: c992_val4</a>
<input checked="" type="checkbox"/> Read access <input checked="" type="checkbox"/> Write access <input type="checkbox"/> CINH <input type="checkbox"/> PLC STOP <input type="checkbox"/> No transfer <input type="checkbox"/> COM <input checked="" type="checkbox"/> MOT   Scaling factor: 1		

## C02298

Parameter   Name: <b>C02298   LS_WriteParamList: Flying restart fct: Int. time</b>		Data type: UNSIGNED_16 Index: 22277 <sub>d</sub> = 5705 <sub>h</sub>
From version 12.00.00 onwards: Parameter values (1st value ... 4th value) for optional <a href="#">motor data change-over</a>		
Setting range (min. value   unit   max. value)		
0.0	ms	6000.0
Subcodes	Lenze setting	Info
C02298/1	300.0 ms	<a href="#">LS_WriteParamList: c993_val1</a>
C02298/2	300.0 ms	<a href="#">LS_WriteParamList: c993_val2</a>
C02298/3	300.0 ms	<a href="#">LS_WriteParamList: c993_val3</a>
C02298/4	300.0 ms	<a href="#">LS_WriteParamList: c993_val4</a>
<input checked="" type="checkbox"/> Read access <input checked="" type="checkbox"/> Write access <input type="checkbox"/> CINH <input type="checkbox"/> PLC STOP <input type="checkbox"/> No transfer <input type="checkbox"/> COM <input checked="" type="checkbox"/> MOT   Scaling factor: 10		



## C02299

Parameter   Name: <b>C02299   LS_WriteParamList: Flying restart fct.: Current</b>		Data type: INTEGER_16 Index: 22276 <sub>d</sub> = 5704 <sub>h</sub>
From version 12.00.00 onwards: Parameter values (1st value ... 4th value) for optional <a href="#">motor data change-over</a>		
<b>Setting range (min. value   unit   max. value)</b>		
0.00	%	100.00
<b>Subcodes</b>	<b>Lenze setting</b>	<b>Info</b>
C02299/1	25.00 %	<a href="#">LS_WriteParamList: c994_val1</a>
C02299/2	25.00 %	<a href="#">LS_WriteParamList: c994_val2</a>
C02299/3	25.00 %	<a href="#">LS_WriteParamList: c994_val3</a>
C02299/4	25.00 %	<a href="#">LS_WriteParamList: c994_val4</a>
<input checked="" type="checkbox"/> Read access <input checked="" type="checkbox"/> Write access <input type="checkbox"/> CINH <input type="checkbox"/> PLC STOP <input type="checkbox"/> No transfer <input type="checkbox"/> COM <input checked="" type="checkbox"/> MOT   Scaling factor: 100		

## C02300

Parameter   Name: <b>C02300   LS_WriteParamList: SLPSM: Controlled current setpoint</b>		Data type: UNSIGNED_16 Index: 22275 <sub>d</sub> = 5703 <sub>h</sub>
From version 12.00.00 onwards: Parameter values (1st value ... 4th value) for optional <a href="#">motor data change-over</a>		
<b>Setting range (min. value   unit   max. value)</b>		
5.00	%	400.00
<b>Subcodes</b>	<b>Lenze setting</b>	<b>Info</b>
C02300/1	100.00 %	<a href="#">LS_WriteParamList: c995_s1_val1</a>
C02300/2	100.00 %	<a href="#">LS_WriteParamList: c995_s1_val2</a>
C02300/3	100.00 %	<a href="#">LS_WriteParamList: c995_s1_val3</a>
C02300/4	100.00 %	<a href="#">LS_WriteParamList: c995_s1_val4</a>
C02300/5	20.00 %	<a href="#">LS_WriteParamList: c995_s2_val1</a>
C02300/6	20.00 %	<a href="#">LS_WriteParamList: c995_s2_val2</a>
C02300/7	20.00 %	<a href="#">LS_WriteParamList: c995_s2_val3</a>
C02300/8	20.00 %	<a href="#">LS_WriteParamList: c995_s2_val4</a>
<input checked="" type="checkbox"/> Read access <input checked="" type="checkbox"/> Write access <input type="checkbox"/> CINH <input type="checkbox"/> PLC STOP <input type="checkbox"/> No transfer <input type="checkbox"/> COM <input checked="" type="checkbox"/> MOT   Scaling factor: 100		

## C02301

Parameter   Name: <b>C02301   LS_WriteParamList: SLPSM: Switching speed</b>		Data type: INTEGER_16 Index: 22274 <sub>d</sub> = 5702 <sub>h</sub>
From version 12.00.00 onwards: Parameter values (1st value ... 4th value) for optional <a href="#">motor data change-over</a>		
<b>Setting range (min. value   unit   max. value)</b>		
0.00	%	100.00
<b>Subcodes</b>	<b>Lenze setting</b>	<b>Info</b>
C02301/1	13.00 %	<a href="#">LS_WriteParamList: c996_s1_val1</a>
C02301/2	13.00 %	<a href="#">LS_WriteParamList: c996_s1_val2</a>
C02301/3	13.00 %	<a href="#">LS_WriteParamList: c996_s1_val3</a>
C02301/4	13.00 %	<a href="#">LS_WriteParamList: c996_s1_val4</a>
C02301/5	8.00 %	<a href="#">LS_WriteParamList: c996_s2_val1</a>
C02301/6	8.00 %	<a href="#">LS_WriteParamList: c996_s2_val2</a>
C02301/7	8.00 %	<a href="#">LS_WriteParamList: c996_s2_val3</a>
C02301/8	8.00 %	<a href="#">LS_WriteParamList: c996_s2_val4</a>
<input checked="" type="checkbox"/> Read access <input checked="" type="checkbox"/> Write access <input type="checkbox"/> CINH <input type="checkbox"/> PLC STOP <input type="checkbox"/> No transfer <input type="checkbox"/> COM <input type="checkbox"/> MOT   Scaling factor: 100		

## C02302

Parameter   Name: <b>C02302   LS_WriteParamList: SLPSM: Filter time - rotor position</b>		Data type: INTEGER_16 Index: 22273 <sub>d</sub> = 5701 <sub>h</sub>
From version 12.00.00 onwards: Parameter values (1st value ... 4th value) for optional <a href="#">motor data change-over</a>		
<b>Setting range (min. value   unit   max. value)</b>		
0.00	%	100.00
<b>Subcodes</b>	<b>Lenze setting</b>	<b>Info</b>
C02302/1	5.00 %	<a href="#">LS_WriteParamList: c997_val1</a>
C02302/2	5.00 %	<a href="#">LS_WriteParamList: c997_val2</a>
C02302/3	5.00 %	<a href="#">LS_WriteParamList: c997_val3</a>
C02302/4	5.00 %	<a href="#">LS_WriteParamList: c997_val4</a>
<input checked="" type="checkbox"/> Read access <input checked="" type="checkbox"/> Write access <input type="checkbox"/> CINH <input type="checkbox"/> PLC STOP <input type="checkbox"/> No transfer <input type="checkbox"/> COM <input type="checkbox"/> MOT   Scaling factor: 100		

## C02303

Parameter   Name: <b>C02303   LS_WriteParamList: SLPSM: Filter time rotor position</b>		Data type: INTEGER_16 Index: 22273 <sub>d</sub> = 5701 <sub>h</sub>
From version 12.00.00 onwards: Parameter values (1st value ... 4th value) for optional <a href="#">motor data change-over</a>		
<b>Setting range (min. value   unit   max. value)</b>		
0.5	ms	20.0
<b>Subcodes</b>	<b>Lenze setting</b>	<b>Info</b>
C02303/1	3.0 ms	<a href="#">LS_WriteParamList: c998_s1_val1</a>
C02303/2	3.0 ms	<a href="#">LS_WriteParamList: c998_s1_val2</a>
C02303/3	3.0 ms	<a href="#">LS_WriteParamList: c998_s1_val3</a>
C02303/4	3.0 ms	<a href="#">LS_WriteParamList: c998_s1_val4</a>
C02303/5	5.0 ms	<a href="#">LS_WriteParamList: c998_s2_val1</a>
C02303/6	5.0 ms	<a href="#">LS_WriteParamList: c998_s2_val2</a>
C02303/7	5.0 ms	<a href="#">LS_WriteParamList: c998_s2_val3</a>
C02303/8	5.0 ms	<a href="#">LS_WriteParamList: c998_s2_val4</a>
<input checked="" type="checkbox"/> Read access <input checked="" type="checkbox"/> Write access <input type="checkbox"/> CINH <input type="checkbox"/> PLC STOP <input type="checkbox"/> No transfer <input type="checkbox"/> COM <input checked="" type="checkbox"/> MOT   Scaling factor: 10		

## C02304

Parameter   Name: <b>C02304   LS_WriteParamList: SLPSM: PLL gain</b>		Data type: INTEGER_16 Index: 22271 <sub>d</sub> = 56FF <sub>h</sub>
From version 12.00.00 onwards: Parameter values (1st value ... 4th value) for optional <a href="#">motor data change-over</a>		
<b>Setting range (min. value   unit   max. value)</b>		
0	%	1000
<b>Subcodes</b>	<b>Lenze setting</b>	<b>Info</b>
C02304/1	400 %	<a href="#">LS_WriteParamList: c999_val1</a>
C02304/2	400 %	<a href="#">LS_WriteParamList: c999_val2</a>
C02304/3	400 %	<a href="#">LS_WriteParamList: c999_val3</a>
C02304/4	400 %	<a href="#">LS_WriteParamList: c999_val4</a>
<input checked="" type="checkbox"/> Read access <input checked="" type="checkbox"/> Write access <input type="checkbox"/> CINH <input type="checkbox"/> PLC STOP <input type="checkbox"/> No transfer <input type="checkbox"/> COM <input checked="" type="checkbox"/> MOT   Scaling factor: 1		

## C02305

Parameter   Name:		Data type: UNSIGNED_8
C02305   LS_WriteParamList: PSM: Ppp saturation characteristic		Index: 22270 <sub>d</sub> = 56FE <sub>h</sub>
From version 12.00.00 onwards: Parameter values (1st value ... 4th value) for optional <a href="#">motor data change-over</a>		
Setting range (min. value   unit   max. value)		
0	%	255
Subcodes	Lenze setting	Info
C02305/1	100 %	<a href="#">LS_WriteParamList: c2853_s1_val1</a>
C02305/2	100 %	<a href="#">LS_WriteParamList: c2853_s1_val2</a>
C02305/3	100 %	<a href="#">LS_WriteParamList: c2853_s1_val3</a>
C02305/4	100 %	<a href="#">LS_WriteParamList: c2853_s1_val4</a>
C02305/5	100 %	<a href="#">LS_WriteParamList: c2853_s2_val1</a>
C02305/6	100 %	<a href="#">LS_WriteParamList: c2853_s2_val2</a>
C02305/7	100 %	<a href="#">LS_WriteParamList: c2853_s2_val3</a>
C02305/8	100 %	<a href="#">LS_WriteParamList: c2853_s2_val4</a>
C02305/9	100 %	<a href="#">LS_WriteParamList: c2853_s3_val1</a>
C02305/10	100 %	<a href="#">LS_WriteParamList: c2853_s3_val2</a>
C02305/11	100 %	<a href="#">LS_WriteParamList: c2853_s3_val3</a>
C02305/12	100 %	<a href="#">LS_WriteParamList: c2853_s3_val4</a>
C02305/13	100 %	<a href="#">LS_WriteParamList: c2853_s4_val1</a>
C02305/14	100 %	<a href="#">LS_WriteParamList: c2853_s4_val2</a>
C02305/15	100 %	<a href="#">LS_WriteParamList: c2853_s4_val3</a>
C02305/16	100 %	<a href="#">LS_WriteParamList: c2853_s4_val4</a>
C02305/17	100 %	<a href="#">LS_WriteParamList: c2853_s5_val1</a>
C02305/18	100 %	<a href="#">LS_WriteParamList: c2853_s5_val2</a>
C02305/19	100 %	<a href="#">LS_WriteParamList: c2853_s5_val3</a>
C02305/20	100 %	<a href="#">LS_WriteParamList: c2853_s5_val4</a>
C02305/21	100 %	<a href="#">LS_WriteParamList: c2853_s6_val1</a>
C02305/22	100 %	<a href="#">LS_WriteParamList: c2853_s6_val2</a>
C02305/23	100 %	<a href="#">LS_WriteParamList: c2853_s6_val3</a>
C02305/24	100 %	<a href="#">LS_WriteParamList: c2853_s6_val4</a>
C02305/25	100 %	<a href="#">LS_WriteParamList: c2853_s7_val1</a>
C02305/26	100 %	<a href="#">LS_WriteParamList: c2853_s7_val2</a>
C02305/27	100 %	<a href="#">LS_WriteParamList: c2853_s7_val3</a>
C02305/28	100 %	<a href="#">LS_WriteParamList: c2853_s7_val4</a>
C02305/29	100 %	<a href="#">LS_WriteParamList: c2853_s8_val1</a>
C02305/30	100 %	<a href="#">LS_WriteParamList: c2853_s8_val2</a>
C02305/31	100 %	<a href="#">LS_WriteParamList: c2853_s8_val3</a>
C02305/32	100 %	<a href="#">LS_WriteParamList: c2853_s8_val4</a>
C02305/33	100 %	<a href="#">LS_WriteParamList: c2853_s9_val1</a>
C02305/34	100 %	<a href="#">LS_WriteParamList: c2853_s9_val2</a>
C02305/35	100 %	<a href="#">LS_WriteParamList: c2853_s9_val3</a>
C02305/36	100 %	<a href="#">LS_WriteParamList: c2853_s9_val4</a>
C02305/37	100 %	<a href="#">LS_WriteParamList: c2853_s10_val1</a>
C02305/38	100 %	<a href="#">LS_WriteParamList: c2853_s10_val2</a>

Parameter   Name:		Data type: UNSIGNED_8 Index: 22270 <sub>d</sub> = 56FE <sub>h</sub>
<b>C02305   LS_WriteParamList: PSM: Ppp saturation characteristic</b>		
C02305/39	100 %	<a href="#">LS_WriteParamList: c2853_s10_val3</a>
C02305/40	100 %	<a href="#">LS_WriteParamList: c2853_s10_val4</a>
C02305/41	100 %	<a href="#">LS_WriteParamList: c2853_s11_val1</a>
C02305/42	100 %	<a href="#">LS_WriteParamList: c2853_s11_val2</a>
C02305/43	100 %	<a href="#">LS_WriteParamList: c2853_s11_val3</a>
C02305/44	100 %	<a href="#">LS_WriteParamList: c2853_s11_val4</a>
C02305/45	100 %	<a href="#">LS_WriteParamList: c2853_s12_val1</a>
C02305/46	100 %	<a href="#">LS_WriteParamList: c2853_s12_val2</a>
C02305/47	100 %	<a href="#">LS_WriteParamList: c2853_s12_val3</a>
C02305/48	100 %	<a href="#">LS_WriteParamList: c2853_s12_val4</a>
C02305/49	100 %	<a href="#">LS_WriteParamList: c2853_s13_val1</a>
C02305/50	100 %	<a href="#">LS_WriteParamList: c2853_s13_val2</a>
C02305/51	100 %	<a href="#">LS_WriteParamList: c2853_s13_val3</a>
C02305/52	100 %	<a href="#">LS_WriteParamList: c2853_s13_val4</a>
C02305/53	100 %	<a href="#">LS_WriteParamList: c2853_s14_val1</a>
C02305/54	100 %	<a href="#">LS_WriteParamList: c2853_s14_val2</a>
C02305/55	100 %	<a href="#">LS_WriteParamList: c2853_s14_val3</a>
C02305/56	100 %	<a href="#">LS_WriteParamList: c2853_s14_val4</a>
C02305/57	100 %	<a href="#">LS_WriteParamList: c2853_s15_val1</a>
C02305/58	100 %	<a href="#">LS_WriteParamList: c2853_s15_val2</a>
C02305/59	100 %	<a href="#">LS_WriteParamList: c2853_s15_val3</a>
C02305/60	100 %	<a href="#">LS_WriteParamList: c2853_s15_val4</a>
C02305/61	100 %	<a href="#">LS_WriteParamList: c2853_s16_val1</a>
C02305/62	100 %	<a href="#">LS_WriteParamList: c2853_s16_val2</a>
C02305/63	100 %	<a href="#">LS_WriteParamList: c2853_s16_val3</a>
C02305/64	100 %	<a href="#">LS_WriteParamList: c2853_s16_val4</a>
C02305/65	100 %	<a href="#">LS_WriteParamList: c2853_s17_val1</a>
C02305/66	100 %	<a href="#">LS_WriteParamList: c2853_s17_val2</a>
C02305/67	100 %	<a href="#">LS_WriteParamList: c2853_s17_val3</a>
C02305/68	100 %	<a href="#">LS_WriteParamList: c2853_s17_val4</a>
<input checked="" type="checkbox"/> Read access <input checked="" type="checkbox"/> Write access <input type="checkbox"/> CINH <input type="checkbox"/> PLC STOP <input type="checkbox"/> No transfer <input type="checkbox"/> COM <input checked="" type="checkbox"/> MOT             Scaling factor: 1		

## C02306

Parameter   Name:		Data type: UNSIGNED_16 Index: 22269 <sub>d</sub> = 56FD <sub>h</sub>
<b>C02306   LS_WriteParamList: PSM: Imax Ppp saturation characteristic</b>		
From version 12.00.00 onwards: Parameter values (1st value ... 4th value) for optional <a href="#">motor data change-over</a>		
Setting range (min. value   unit   max. value)		
0.0	A	3000.0
Subcodes	Lenze setting	Info
C02306/1	3000.0 A	<a href="#">LS_WriteParamList: c2855_val1</a>
C02306/2	3000.0 A	<a href="#">LS_WriteParamList: c2855_val2</a>
C02306/3	3000.0 A	<a href="#">LS_WriteParamList: c2855_val3</a>
C02306/4	3000.0 A	<a href="#">LS_WriteParamList: c2855_val4</a>
<input checked="" type="checkbox"/> Read access <input checked="" type="checkbox"/> Write access <input type="checkbox"/> CINH <input type="checkbox"/> PLC STOP <input type="checkbox"/> No transfer <input type="checkbox"/> COM <input checked="" type="checkbox"/> MOT             Scaling factor: 10		

## C02307

Parameter   Name: <b>C02307   LS_WriteParamList: PSM: Activate Ppp saturation char.</b>		Data type: UNSIGNED_8 Index: 22268 <sub>d</sub> = 56FC <sub>h</sub>
From version 12.00.00 onwards: Parameter values (1st value ... 4th value) for optional <a href="#">motor data change-over</a>		
<b>Selection list</b>		
0	Off	
1	On	
<b>Subcodes</b>	<b>Lenze setting</b>	<b>Info</b>
C02307/1	0: Off	<a href="#">LS_WriteParamList</a> : c2859_val1
C02307/2	0: Off	<a href="#">LS_WriteParamList</a> : c2859_val
C02307/3	0: Off	<a href="#">LS_WriteParamList</a> : c2859_val
C02307/4	0: Off	<a href="#">LS_WriteParamList</a> : c2859_val
<input checked="" type="checkbox"/> Read access <input checked="" type="checkbox"/> Write access <input type="checkbox"/> CINH <input type="checkbox"/> PLC STOP <input type="checkbox"/> No transfer <input type="checkbox"/> COM <input checked="" type="checkbox"/> MOT   Scaling factor: 1		

## C02311

Parameter   Name: <b>C02311   LS_WriteParamList: PLI without motion: Adaptation of time duration</b>		Data type: INTEGER_8 Index: 22264 <sub>d</sub> = 56F8 <sub>h</sub>
From version 12.00.00 onwards: Parameter values (1st value ... 4th value) for optional <a href="#">motor data change-over</a>		
<b>Setting range (min. value   unit   max. value)</b>		
-10		10
<b>Subcodes</b>	<b>Lenze setting</b>	<b>Info</b>
C02311/1	0	<a href="#">LS_WriteParamList</a> : c2872_s1_val1
C02311/2	0	<a href="#">LS_WriteParamList</a> : c2872_s1_val2
C02311/3	0	<a href="#">LS_WriteParamList</a> : c2872_s1_val3
C02311/4	0	<a href="#">LS_WriteParamList</a> : c2872_s1_val4
<input checked="" type="checkbox"/> Read access <input checked="" type="checkbox"/> Write access <input type="checkbox"/> CINH <input type="checkbox"/> PLC STOP <input type="checkbox"/> No transfer <input type="checkbox"/> COM <input checked="" type="checkbox"/> MOT   Scaling factor: 1		

## C02312

Parameter   Name: <b>C02312   LS_WriteParamList: PLI without motion</b>		Data type: UNSIGNED_16 Index: 22263 <sub>d</sub> = 56F7 <sub>h</sub>
From version 12.00.00 onwards: Parameter values (1st value ... 4th value) for optional <a href="#">motor data change-over</a>		
<b>Setting range (min. hex value   max. hex value)</b>		
0x0000		0xFFFF

Parameter   Name:		Data type: UNSIGNED_16 Index: 22263 <sub>d</sub> = 56F7 <sub>h</sub>
<b>C02312   LS_WriteParamList: PLI without motion</b>		
<b>Value is bit-coded:</b>		
Bit 0	for SLPSM with controller enable	
Bit 1	for SC PSM with mains on	
Bit 2	for SC PSM with controller enable	
Bit 3	for SC PSM once after fault reset	
Bit 4	Reserved	
Bit 5	Reserved	
Bit 6	Reserved	
Bit 7	Reserved	
Bit 8	Reserved	
Bit 9	Reserved	
Bit 10	Reserved	
Bit 11	Reserved	
Bit 12	Reserved	
Bit 13	Reserved	
Bit 14	Reserved	
Bit 15	Reserved	
Subcodes	Lenze setting	Info
C02312/1	0x0001	<a href="#">LS_WriteParamList: c2874_s1_val1</a>
C02312/2	0x0001	<a href="#">LS_WriteParamList: c2874_s1_val2</a>
C02312/3	0x0001	<a href="#">LS_WriteParamList: c2874_s1_val3</a>
C02312/4	0x0001	<a href="#">LS_WriteParamList: c2874_s1_val4</a>
<input checked="" type="checkbox"/> Read access <input checked="" type="checkbox"/> Write access <input type="checkbox"/> CINH <input type="checkbox"/> PLC STOP <input type="checkbox"/> No transfer <input type="checkbox"/> COM <input checked="" type="checkbox"/> MOT		

**C02313**

Parameter   Name:		Data type: INTEGER_8 Index: 22262 <sub>d</sub> = 56F6 <sub>h</sub>
<b>C02313   LS_WriteParamList: PLI without motion: Adaptation of ident angle</b>		
From version 12.00.00 onwards: Parameter values (1st value ... 4th value) for optional <a href="#">motor data change-over</a>		
<b>Setting range (min. value   unit   max. value)</b>		
-100	°	100
Subcodes	Lenze setting	Info
C02313/1	0 °	<a href="#">LS_WriteParamList: c2875_s1_val1</a>
C02313/2	0 °	<a href="#">LS_WriteParamList: c2875_s1_val2</a>
C02313/3	0 °	<a href="#">LS_WriteParamList: c2875_s1_val3</a>
C02313/4	0 °	<a href="#">LS_WriteParamList: c2875_s1_val4</a>
<input checked="" type="checkbox"/> Read access <input checked="" type="checkbox"/> Write access <input type="checkbox"/> CINH <input type="checkbox"/> PLC STOP <input type="checkbox"/> No transfer <input type="checkbox"/> COM <input checked="" type="checkbox"/> MOT             Scaling factor: 1		

**C02314**

Parameter   Name:		Data type: UNSIGNED_8 Index: 22261 <sub>d</sub> = 56F5 <sub>h</sub>
<b>C02314   Reserved</b>		
<b>This code is used device-internally and must not be written by the user side!</b>		

## C02315

Parameter   Name: <b>C02315   LS_WriteParamList: Manual entry of motor type</b>		Data type: UNSIGNED_8 Index: 22260 <sub>d</sub> = 56F4 <sub>h</sub>
From version 14.00.00 onwards: Parameter values (1st value ... 4th value) for optional <a href="#">motor data change-over</a>		
Selection list		
0	Automatic	
1	ASM	
2	PSM	
Subcodes	Lenze setting	Info
C02315/1	0: Automatic	<a href="#">LS_WriteParamList: c1001_s1_val1</a>
C02315/2	0: Automatic	<a href="#">LS_WriteParamList: c1001_s1_val2</a>
C02315/3	0: Automatic	<a href="#">LS_WriteParamList: c1001_s1_val3</a>
C02315/4	0: Automatic	<a href="#">LS_WriteParamList: c1001_s1_val4</a>
<input checked="" type="checkbox"/> Read access <input checked="" type="checkbox"/> Write access <input type="checkbox"/> CINH <input type="checkbox"/> PLC STOP <input type="checkbox"/> No transfer <input type="checkbox"/> COM <input checked="" type="checkbox"/> MOT   Scaling factor: 1		

## C02556

Parameter   Name: <b>C02556   Service parameter</b>		Data type: INTEGER_32 Index: 22019 <sub>d</sub> = 5603 <sub>h</sub>
<b>This code is used device-internally and must not be written by the user side!</b>		

## C02580

Parameter   Name: <b>C02580   Holding brake: Operating mode</b>		Data type: UNSIGNED_8 Index: 21995 <sub>d</sub> = 55EB <sub>h</sub>
Selection of the operating mode for holding brake control		▶ <a href="#">Holding brake control</a>
Selection list (Lenze setting printed in bold)		Info
<b>0</b>	<b>Brake control off</b>	No holding brake is used. Internal control is switched off.
11	Manually controlled	The holding brake is released and closed via a control bit in the MCK control word.
12	Autom. controlled	The holding brake is automatically released and closed via speed setpoint comparisons.
13	Semi-automat. controlled	<p>From version 11.00.00</p> <p>The holding brake is released and closed via a control bit in the MCK control word.</p> <ul style="list-style-type: none"> <li>• In contrast to the manual operation (mode 11) <ul style="list-style-type: none"> <li>• the feedforward control is active in this mode, preventing a sagging e.g. in case of a hoist.</li> <li>• the brake in this mode also closes when the controller is inhibited in order to prevent the axis in a hoist from falling.</li> </ul> </li> </ul>
<input checked="" type="checkbox"/> Read access <input checked="" type="checkbox"/> Write access <input type="checkbox"/> CINH <input type="checkbox"/> PLC STOP <input type="checkbox"/> No transfer <input type="checkbox"/> COM <input type="checkbox"/> MOT   Scaling factor: 1		

## C02581

Parameter   Name: C02581   Holding brake: Speed thresholds		Data type: INTEGER_16 Index: 21994 <sub>d</sub> = 55EA <sub>h</sub>
Speed setpoint threshold and hysteresis for automatic holding brake control <a href="#">▶ Holding brake control</a>		
Setting range (min. value   unit   max. value)		
-199.99	%	199.99
Subcodes	Lenze setting	Info
C02581/1	5.00 %	Holding brake: Switching threshold • Switching threshold of the speed setpoint from which on the holding brake is released/applied automatically.
C02581/2	1.00 %	Holding brake: Hyst.release • Hysteresis for holding brake release. • Release threshold = switching threshold + release hysteresis
C02581/3	1.00 %	Holding brake: Hyst. close • Hysteresis for holding brake application. • Application threshold = switching threshold - application hysteresis
C02581/4	0.00 %	Holding brake: FF control starting value 1 • From version 11.00.00
C02581/5	0.00 %	Holding brake: FF control starting value 2 • From version 11.00.00
<input checked="" type="checkbox"/> Read access <input checked="" type="checkbox"/> Write access <input type="checkbox"/> CINH <input type="checkbox"/> PLC STOP <input type="checkbox"/> No transfer <input type="checkbox"/> COM <input type="checkbox"/> MOT   Scaling factor: 100		

## C02582

Parameter   Name: C02582   Holding brake: Setting		Data type: UNSIGNED_8 Index: 21993 <sub>d</sub> = 55E9 <sub>h</sub>
Activation of functional holding brake control options <a href="#">▶ Holding brake control</a>		
Setting range (min. hex value   max. hex value)		Lenze setting
0x00	0xFF	0x40 (decimal: 64)
Value is bit-coded: ( <input checked="" type="checkbox"/> = bit set)		Info
Bit 0 <input type="checkbox"/>	bMBrakeReleaseOut invert.	Activation of inverted control • 1 ≙ Inverted logic of the control signal for the holding brake control switching element.
Bit 1 <input type="checkbox"/>	Horizontal brake protection	Brake response in case of pulse inhibit • 1 ≙ In the case of a pulse inhibit, the actual speed value is monitored which must reach the "Close" threshold value to cause the holding brake to be applied. <b>Note:</b> • This function is only active if bit 3 (horizontal/winding technology) is set as well. The function is used in order that, when the controller is inhibited, the holding brake of a drive with horizontal traverse path does not wear out during rotation. • With vertical motion (bit 3 = 0), this function is not active. Especially with hoists and activated pulse inhibit of the inverter, an immediate application of the brake is essential for safety-related reasons!



Parameter   Name: <b>C02582   Holding brake: Setting</b>		Data type: UNSIGNED_8 Index: 21993 <sub>d</sub> = 55E9 <sub>h</sub>
Bit 2 <input type="checkbox"/>	with hoist inv. feedfwd. control	Direction of feedforward control with vertical/hoist technology: <ul style="list-style-type: none"> <li>• 0 ≡ Positive direction</li> <li>• 1 ≡ Negative direction</li> </ul> <b>Note:</b> Reversal (Ccw) is then considered.
Bit 3 <input type="checkbox"/>	Horizontal application	Direction of movement of the axis <ul style="list-style-type: none"> <li>• 0 ≡ The axis performs vertical movements. Gravitational acceleration causes movements.</li> <li>• 1 ≡ The direction of the axis is horizontal or rotary. The gravitational acceleration does not cause any movement.</li> </ul>
Bit 4 <input type="checkbox"/>	Feedforward control C2581	<b>From version 11.00.00</b> Selection of the feedforward control value <ul style="list-style-type: none"> <li>• 0 ≡ Automatic selection. <ul style="list-style-type: none"> <li>• The torque saved at the last stop is used.</li> </ul> </li> <li>• 1 ≡ Manual selection. <ul style="list-style-type: none"> <li>• <i>bMBrakeStartValue2</i> = FALSE: The feedforward control value 1 set in <a href="#">C02581/4</a> is used.</li> <li>• <i>bMBrakeStartValue2</i> = TRUE: The feedforward control value set in <a href="#">C02581/5</a> is used.</li> </ul> </li> </ul>
Bit 5 <input type="checkbox"/>	Feedback monitoring	<b>From version 11.00.00</b> Activation of status monitoring <ul style="list-style-type: none"> <li>• 1 ≡ The <i>bMBrakeApplied</i> input for status detection of the brake (via a switching contact at the brake) is monitored after the waiting time set in <a href="#">C02589/3</a> has expired.</li> </ul>
Bit 6 <input checked="" type="checkbox"/>	SyncRampe L_NSet_1	<b>From version 11.00.00</b> Selection of the ramp time for the synchronisation process to setpoint speed after the brake opening time has elapsed <b>Revised behaviour from version 11.00.00:</b> <ul style="list-style-type: none"> <li>• 1 ≡ The ramp time of the effective acceleration of the ramp function generator (<a href="#">L_NSet_1</a>) is used (Lenze setting).</li> <li>• 0 ≡ As before, the ramp time set in <a href="#">C02610/1</a> is used.</li> </ul> <b>Note:</b> The changeover can be dynamically both via the ramp parameter and via bit 6.
Bit 7 <input type="checkbox"/>	Reserved	
<input checked="" type="checkbox"/> Read access <input checked="" type="checkbox"/> Write access <input type="checkbox"/> CINH <input type="checkbox"/> PLC STOP <input type="checkbox"/> No transfer <input type="checkbox"/> COM <input type="checkbox"/> MOT		

## C02589

Parameter   Name: <b>C02589   Holding brake: Time system</b>		Data type: UNSIGNED_16 Index: 21986 <sub>d</sub> = 55E2 <sub>h</sub>
Operating times of the holding brake <ul style="list-style-type: none"> <li>• The electromechanical delay times of the holding brake are specified in the data sheets or on the holding brake nameplate.</li> </ul> <p style="text-align: right;"><a href="#">▶ Holding brake control</a></p>		
<b>Setting range</b> (min. value   unit   max. value)		
0	ms	60000
<b>Subcodes</b>	<b>Lenze setting</b>	<b>Info</b>

Parameter   Name: <b>C02589   Holding brake: Time system</b>		Data type: UNSIGNED_16 Index: 21986 <sub>d</sub> = 55E2 <sub>h</sub>
C02589/1	100 ms	Holding brake: Application time • Time in which the holding brake is completely applied from the beginning of control and in which the controller is inhibited.
C02589/2	100 ms	Holding brake: Release time • Time in which the holding brake is completely released from the beginning of control.
C02589/3	100 ms	Holding brake: Waiting time status • Time after which all transient reactions are completed and the switching status of the holding brake is stable. Beginning of monitoring the feedback signal for the switching status of the holding brake.
C02589/4	0 ms	Holding brake: Ramp time FF ctrl • From version 11.00.00
<input checked="" type="checkbox"/> Read access <input checked="" type="checkbox"/> Write access <input type="checkbox"/> CINH <input type="checkbox"/> PLC STOP <input type="checkbox"/> No transfer <input type="checkbox"/> COM <input type="checkbox"/> MOT   Scaling factor: 1		

**C02593**

Parameter   Name: <b>C02593   Holding brake: Activation time</b>		Data type: UNSIGNED_32 Index: 21982 <sub>d</sub> = 55DE <sub>h</sub>
Time parameter for the delay of trigger signals of the holding brake control <a href="#">▶ Holding brake control</a>		
Setting range (min. value   unit   max. value)		
0.000	s	3600.000
Subcodes	Lenze setting	Info
C02593/1	0.000 s	Holding brake: Actual value monitoring • Time in which the actual value is supposed to reach the threshold for closing the brake if the setpoint has already reached the threshold. • Time > 0 s: If the actual speed value has not reached the threshold within the time for brake application, the holding brake is applied by control. • Time = 0 s: The brake is only applied by control when the actual speed has reached the application threshold.
C02593/2	0.000 s	Holding brake: Application delay
C02593/3	0.000 s	Holding brake: Reserved
C02593/4	0.000 s	Holding brake: Reserved
<input checked="" type="checkbox"/> Read access <input checked="" type="checkbox"/> Write access <input checked="" type="checkbox"/> CINH <input checked="" type="checkbox"/> PLC STOP <input checked="" type="checkbox"/> No transfer <input checked="" type="checkbox"/> COM <input checked="" type="checkbox"/> MOT   Scaling factor: 1000		

**C02607**

Parameter   Name: <b>C02607   Holding brake: Status</b>		Data type: UNSIGNED_16 Index: 21968 <sub>d</sub> = 55D0 <sub>h</sub>
Switching status of the holding brake control <a href="#">▶ Holding brake control</a>		
Display area (min. hex value   max. hex value)		
0x0000		0xFFFF
Value is bit-coded:		Info
Bit 0	Brake applied	1 ≙ Holding brake is completely applied
Bit 1	Brake released	1 ≙ Holding brake is completely released
Bit 2	Feedforward control active	1 ≙ Feedforward control for holding of the load via the motor is active before the holding brake releases.

Parameter   Name: <b>C02607   Holding brake: Status</b>		Data type: UNSIGNED_16 Index: 21968 <sub>d</sub> = 55D0 <sub>h</sub>
Bit 3	Closing active	1 ≙ The brake closing time ( <a href="#">C02589/1</a> ) expires
Bit 4	Forced release active	1 ≙ In case of automatic operation of the holding brake control, the brake is directly released via the MCK input <i>bMBrakeRelease</i> = TRUE
Bit 5	Release active	1 ≙ The brake release time ( <a href="#">C02589/2</a> ) expires
Bit 6	Setpoint synchronisation active	1 ≙ A speed setpoint at the MCK is approached along a defined ramp after brake release
Bit 7	Signalling contact error	
Bit 8	Reserved	
Bit 9	Reserved	
Bit 10	Reserved	
Bit 11	Reserved	
Bit 12	Reserved	
Bit 13	Reserved	
Bit 14	Reserved	
Bit 15	Reserved	
<input checked="" type="checkbox"/> Read access <input type="checkbox"/> Write access <input type="checkbox"/> CINH <input type="checkbox"/> PLC STOP <input checked="" type="checkbox"/> No transfer <input type="checkbox"/> COM <input type="checkbox"/> MOT		

**C02610**

Parameter   Name: <b>C02610   MCK: Accel./decel. times</b>		Data type: UNSIGNED_32 Index: 21965 <sub>d</sub> = 55CD <sub>h</sub>
Ramp times for speed setpoint synchronisation		
<b>Setting range (min. value   unit   max. value)</b>		
0.000	s	999.999
<b>Subcodes</b>	<b>Lenze setting</b>	<b>Info</b>
C02610/1	2.000 s	Holding brake: ramp time synchr. • Ramp time for the synchronisation process to setpoint speed after the brake opening time has elapsed <b>Revised behaviour from version 11.00.00:</b> • The setting made here is only effective if bit 6 "SyncRampe L_NSet_1" in <a href="#">C02582</a> is set to "0". • In the Lenze setting of <a href="#">C02582</a> (Bit 6 = "1"), the ramp time of the effective acceleration of the ramp function generator ( <a href="#">L_NSet_1</a> ) is used. ▶ <a href="#">Holding brake control</a>
C02610/2	2.000 s	MCK: Ramp time synchr. setpoint • Time for synchronisation ramps between setpoint jumps occurring through the exceedance of minimum and maximum speed setpoint limit ranges.
C02610/3	2.000 s	MCK: SM stopping ramp
<input checked="" type="checkbox"/> Read access <input checked="" type="checkbox"/> Write access <input type="checkbox"/> CINH <input type="checkbox"/> PLC STOP <input type="checkbox"/> No transfer <input type="checkbox"/> COM <input type="checkbox"/> MOT             Scaling factor: 1000		

## C02611

Parameter   Name: <b>C02611   MCK: Limitations</b>		Data type: INTEGER_16 Index: 21964 <sub>d</sub> = 55CC <sub>h</sub>
<p>From version 02.00.00</p> <p>Speed setpoint limits for the determination of limited validity ranges</p> <p><b>Note:</b> Traversing with setpoints through resulting blocking zones is executed with the ramp set in <a href="#">C02610/2</a>. ▶ <a href="#">Speed Min/Max</a></p>		
Setting range (min. value   unit   max. value)		
0.00	%	199.99
Subcodes	Lenze setting	Info
C02611/1	199.99 %	MCK: Pos. max. speed • Upper limit of the speed setpoint limitation in positive direction of rotation.
C02611/2	0.00 %	MCK: Pos. min. speed • Lower limit of the speed setpoint limitation in positive direction of rotation.
C02611/3	0.00 %	MCK: Neg. min. speed • Lower limit of the speed setpoint limitation in negative direction of rotation.
C02611/4	199.99 %	MCK: Neg. max. speed • Upper limit of the speed setpoint limitation in negative direction of rotation.
C02611/5	0.50 %	MCK: Max. speed • From version 12.00.00 • Maximum value for transferring the current speed to the speed setpoint when the internal operating mode " <a href="#">StandBy</a> " is exited.
<input checked="" type="checkbox"/> Read access <input checked="" type="checkbox"/> Write access <input type="checkbox"/> CINH <input type="checkbox"/> PLC STOP <input type="checkbox"/> No transfer <input type="checkbox"/> COM <input type="checkbox"/> MOT   Scaling factor: 100		

## C02830

Parameter   Name: <b>C02830   DigInX: Debounce time</b>		Data type: UNSIGNED_8 Index: 21745 <sub>d</sub> = 54F1 <sub>h</sub>
Debounce times for the digital inputs		▶ <a href="#">Digital terminals</a>

Parameter   Name: <b>C02830   DigInX: Debounce time</b>		Data type: UNSIGNED_8 Index: 21745 <sub>d</sub> = 54F1 <sub>h</sub>
<b>Selection list</b>		
0	0.00 ms	
4	1.00 ms	
8	2.00 ms	
12	3.00 ms	
16	4.00 ms	
20	5.00 ms	
24	6.00 ms	
28	7.00 ms	
32	8.00 ms	
36	9.00 ms	
40	10.0 ms	
44	11.0 ms	
48	12.0 ms	
52	13.0 ms	
56	14.0 ms	
64	16.0 ms	
72	18.0 ms	
80	20.0 ms	
88	22.0 ms	
96	24.0 ms	
104	26.0 ms	
112	28.0 ms	
120	30.0 ms	
128	32.0 ms	
<b>Subcodes</b>	<b>Lenze setting</b>	<b>Info</b>
C02830/1	0: 0.00 ms	DigIn1: Debounce time
C02830/2	0: 0.00 ms	DigIn2: Debounce time
C02830/3	0: 0.00 ms	DigIn3: Debounce time
C02830/4	0: 0.00 ms	DigIn4: Debounce time
<input checked="" type="checkbox"/> Read access <input checked="" type="checkbox"/> Write access <input type="checkbox"/> CINH <input type="checkbox"/> PLC STOP <input type="checkbox"/> No transfer <input type="checkbox"/> COM <input type="checkbox"/> MOT   Scaling factor: 1		

**C02840**

Parameter   Name: <b>C02840   CountIn1: Parameter</b>		Data type: UNSIGNED_32 Index: 21735 <sub>d</sub> = 54E7 <sub>h</sub>
<b>From version 03.00.00</b> Starting and comparison value for digital counting input <p style="text-align: right;"><a href="#">▶ Using DI1 as counting input</a></p>		
<b>Setting range (min. value   unit   max. value)</b>		
0	Incr.	2147483647
<b>Subcodes</b>	<b>Lenze setting</b>	<b>Info</b>
C02840/1	0 incr.	CountIn1: Starting value
C02840/2	65535 incr.	CountIn1: Comparison value
<input checked="" type="checkbox"/> Read access <input checked="" type="checkbox"/> Write access <input type="checkbox"/> CINH <input type="checkbox"/> PLC STOP <input type="checkbox"/> No transfer <input type="checkbox"/> COM <input type="checkbox"/> MOT   Scaling factor: 1		

## C02841

Parameter   Name: <b>C02841   CountIn1: Counter content</b>		Data type: UNSIGNED_32 Index: 21734 <sub>d</sub> = 54E6 <sub>h</sub>
From version 03.00.00 Display of the current counter content of the digital counting input <a href="#">▶ Using DI1 as counting input</a>		
<b>Display range (min. value   unit   max. value)</b>		
0	Incr.	2147483647
<b>Subcodes</b>		<b>Info</b>
C02841/1		CountIn1: Counter content
<input checked="" type="checkbox"/> Read access <input type="checkbox"/> Write access <input type="checkbox"/> CINH <input type="checkbox"/> PLC STOP <input checked="" type="checkbox"/> No transfer <input type="checkbox"/> COM <input type="checkbox"/> MOT           Scaling factor: 1		

## C02842

Parameter   Name: <b>C02842   FreqInxx: Offset</b>		Data type: INTEGER_16 Index: 21733 <sub>d</sub> = 54E5 <sub>h</sub>
From version 03.00.00 Offset for digital frequency input <a href="#">▶ Using DI1 and DI2 as frequency inputs</a>		
<b>Setting range (min. value   unit   max. value)</b>		
-199.99	%	199.99
<b>Subcodes</b>		<b>Info</b>
C02842/1		FreqIn12: Offset
<input checked="" type="checkbox"/> Read access <input checked="" type="checkbox"/> Write access <input type="checkbox"/> CINH <input type="checkbox"/> PLC STOP <input type="checkbox"/> No transfer <input type="checkbox"/> COM <input type="checkbox"/> MOT           Scaling factor: 100		

## C02843

Parameter   Name: <b>C02843   FreqInxx: Gain</b>		Data type: INTEGER_16 Index: 21732 <sub>d</sub> = 54E4 <sub>h</sub>
From version 03.00.00 Gain for digital frequency input <a href="#">▶ Using DI1 and DI2 as frequency inputs</a>		
<b>Setting range (min. value   unit   max. value)</b>		
-199.99	%	199.99
<b>Subcodes</b>		<b>Info</b>
C02843/1		FreqIn12: Gain
<input checked="" type="checkbox"/> Read access <input checked="" type="checkbox"/> Write access <input type="checkbox"/> CINH <input type="checkbox"/> PLC STOP <input type="checkbox"/> No transfer <input type="checkbox"/> COM <input type="checkbox"/> MOT           Scaling factor: 100		

## C02844

Parameter   Name: <b>C02844   FreqIn12: Function</b>		Data type: UNSIGNED_8 Index: 21731 <sub>d</sub> = 54E3 <sub>h</sub>
From version 06.00.00 <a href="#">▶ Output of the encoder position of the DI1/DI2 frequency input</a>		
<b>Selection list</b>		
0	Loading with level	
1	Loading with edge	
2	Loading with level + reset	
<b>Subcodes</b>		<b>Info</b>
C02844/1		FreqIn12: PosIn function
<input checked="" type="checkbox"/> Read access <input checked="" type="checkbox"/> Write access <input type="checkbox"/> CINH <input type="checkbox"/> PLC STOP <input type="checkbox"/> No transfer <input type="checkbox"/> COM <input type="checkbox"/> MOT           Scaling factor: 1		

## C02845

Parameter   Name: <b>C02845   FreqIn12: PosIn comparison value</b>		Data type: INTEGER_32 Index: 21730 <sub>d</sub> = 54E2 <sub>h</sub>
From version 06.00.00		
▶ <a href="#">Output of the encoder position of the DI1/DI2 frequency input</a>		
Setting range (min. value   unit   max. value)		Lenze setting
0	Incr.	2147418112
0 incr.		
<input type="checkbox"/> Read access <input type="checkbox"/> Write access <input type="checkbox"/> CINH <input type="checkbox"/> PLC STOP <input type="checkbox"/> No transfer <input type="checkbox"/> COM <input type="checkbox"/> MOT   Scaling factor: 1		

## C02853

Parameter   Name: <b>C02853   PSM: Lss saturation characteristic</b>		Data type: UNSIGNED_8 Index: 21722 <sub>d</sub> = 54DA <sub>h</sub>
From version 10.00.00		
▶ <a href="#">Current-dependent stator leakage inductance Lss(l)</a>		
Setting range (min. value   unit   max. value)		Lenze setting
0	%	255
Subcodes	Lenze setting	Info
C02853/1	100 %	PSM: Lss saturation characteristic
C02853/2	100 %	PSM: Lss saturation characteristic
C02853/3	100 %	PSM: Lss saturation characteristic
C02853/4	100 %	PSM: Lss saturation characteristic
C02853/5	100 %	PSM: Lss saturation characteristic
C02853/6	100 %	PSM: Lss saturation characteristic
C02853/7	100 %	PSM: Lss saturation characteristic
C02853/8	100 %	PSM: Lss saturation characteristic
C02853/9	100 %	PSM: Lss saturation characteristic
C02853/10	100 %	PSM: Lss saturation characteristic
C02853/11	100 %	PSM: Lss saturation characteristic
C02853/12	100 %	PSM: Lss saturation characteristic
C02853/13	100 %	PSM: Lss saturation characteristic
C02853/14	100 %	PSM: Lss saturation characteristic
C02853/15	100 %	PSM: Lss saturation characteristic
C02853/16	100 %	PSM: Lss saturation characteristic
C02853/17	100 %	PSM: Lss saturation characteristic
<input type="checkbox"/> Read access <input type="checkbox"/> Write access <input type="checkbox"/> CINH <input type="checkbox"/> PLC STOP <input type="checkbox"/> No transfer <input type="checkbox"/> COM <input type="checkbox"/> MOT   Scaling factor: 1		

## C02855

Parameter   Name: <b>C02855   PSM: I<sub>max</sub> Lss saturation characteristic</b>		Data type: UNSIGNED_16 Index: 21720 <sub>d</sub> = 54D8 <sub>h</sub>
From version 10.00.00		
▶ <a href="#">Current-dependent stator leakage inductance Lss(l)</a>		
Setting range (min. value   unit   max. value)		Lenze setting
0.0	A	3000.0
3000.0 A		
<input checked="" type="checkbox"/> Read access <input checked="" type="checkbox"/> Write access <input type="checkbox"/> CINH <input type="checkbox"/> PLC STOP <input type="checkbox"/> No transfer <input type="checkbox"/> COM <input type="checkbox"/> MOT   Scaling factor: 10		

## C02859

Parameter   Name: <b>C02859   PSM: Activate Lss saturation char.</b>		Data type: UNSIGNED_8 Index: 21716 <sub>d</sub> = 54D4 <sub>h</sub>
From version 10.00.00		▶ <a href="#">Current-dependent stator leakage inductance Lss(l)</a>
<b>Selection list</b> (Lenze setting printed in bold)		
0	<b>Off</b>	
1	On	
̈ Read access ̈ Write access ̈ CINH ̈ PLC STOP ̈ No transfer ̈ COM ̈ MOT Scaling factor: 1		

## C02864

Parameter   Name: <b>C02864   MCTRL: Optimisations</b>		Data type: UNSIGNED_16 Index: 21711 <sub>d</sub> = 54CF <sub>h</sub>
From version 14.00.00		
Activation of special functions of the internal motor control		
<b>Setting range</b> (min. hex value   max. hex value)		
0x0000		0xFFFF
<b>Value is bit-coded:</b>		<b>Info</b>
Bit 0	Motor temp. 90° for operation without KTY	1 ≡ Warm machine. In case the temperature tracking is not active, a motor temperature of 90 °C is assumed.
Bit 1	No switch-off of the brake chopper after 4s	1 ≡ Limitation of the operating time of the brake chopper (brake transistor) is deactivated. ▶ <a href="#">Braking operation/brake energy management</a>
Bit 2	Brake chopper off in case of trip	0 ≡ No response of the brake chopper in the "Fault" device status. 1 ≡ In the "Fault" device status, the brake chopper is permanently switched off without any delay. ▶ <a href="#">Braking operation/brake energy management</a>
Bit 3	Reserved (do not change!)	
Bit 4	Motor ident: Switching frequency 8kHz	Switching frequency for motor parameter identification: 0 ≡ 4 kHz 1 ≡ 8 kHz ▶ <a href="#">Preventing a decrease of the switching frequency</a>
Bit 5	Reserved	
Bit 6	For C173=3: OUon=810V OUoff=800V	
Bit 7	Reserved	



Parameter   Name: <b>C02864   MCTRL: Optimisations</b>		Data type: UNSIGNED_16 Index: 21711 <sub>d</sub> = 54CF <sub>h</sub>
Bit 8	Suppress V/f emergency operation	<p>From version 15.00.00, it is internally switched to the encoderless V/f characteristic control in case of a motor control type with feedback and an encoder open circuit in order to avoid impermissible motor movements.</p> <ul style="list-style-type: none"> <li>In order that this "V/f emergency operation" works properly, the parameters relevant for the V/f characteristic control (base frequency, Vmin boost, slip compensation, etc.) have to be set correctly. As an alternative, a motor parameter identification can be executed as well.</li> <li>The change-over to "V/f emergency operation" is reported via bit 4 in <a href="#">C01000</a> and via the <i>bWirebreakUfLinearActive</i> status signal at the <a href="#">SB LS_DeviceMonitor</a>.</li> <li>The setting in <a href="#">C00006</a> is not affected by the change-over.</li> </ul> <p>The "V/f emergency operation" can be suppressed by setting bit 8 to "1".            0 ≡ V/f emergency operation in case of encoder open circuit            1 ≡ No V/f emergency operation in case of encoder open circuit</p>
Bit 9	Reserved	
Bit 10	V/f+encoder without adaptation of voltage	
Bit 11	Latching of open circuit FreqIn12	
Bit 12	SLVC: No smoothing of nMotorTorqueAct_a	
Bit 13	SLVC: Setpoint feedforward control is active	
Bit 14	Wenn C173=3: OUon 810V OUoff=800V	
Bit 15	Activate nTorqueHigh and nTorqueLowLimit_a	
Subcodes	Lenze setting	Info
C02864/1	0x0000	<a href="#">MCTRL: Optimisations</a>
<input checked="" type="checkbox"/> Read access <input checked="" type="checkbox"/> Write access <input type="checkbox"/> CINH <input type="checkbox"/> PLC STOP <input type="checkbox"/> No transfer <input type="checkbox"/> COM <input checked="" type="checkbox"/> MOT		

## C02865

Parameter   Name: <b>C02865   MCTRL: Special settings</b>		Data type: UNSIGNED_16 Index: 21710 <sub>d</sub> = 54CE <sub>h</sub>
<p>From version 12.00.00            Activation of special functions of the internal motor control</p>		
Setting range (min. hex value   max. hex value)		
0x0000		0xFFFF
Value is bit-coded:		Info
Bit 0	No TorqueLimit if TorquemodeOn	<p>From version 12.00.00 onwards: If sensorless vector control (<a href="#">SLVC</a>) is used, in the "torque control with speed limitation", mode the torque limitation via <i>nTorqueMotLimit_a</i> and <i>nTorqueGenLimit_a</i> is also active to limit the torque setpoint.            If you want to deactivate the torque limitation to retain the former function, set bit 0 to "1".            0 ≡ Torque limitation is active            1 ≡ Torque limitation is not active</p>

Parameter   Name: <b>C02865   MCTRL: Special settings</b>		Data type: UNSIGNED_16 Index: 21710 <sub>d</sub> = 54CE <sub>h</sub>
Bit 1	250ms IMP before DCB	
Bit 2	1000ms IMP before DCB	
Bit 3	DCB: Current controller and C036 app. to C088	
Bit 4	Motorident.: No calculation C73 C75 C76 C77 C78	<p><b>From version 12.00.00 onwards:</b> Following successful motor parameter identification, the current controller and field controller parameters are calculated as well. If these parameters are not to be calculated, bit 4 must be set to "1".</p> <p>0 ≡ Calculate parameter 1 ≡ Do not calculate parameter</p> <p>▶ <a href="#">Automatic motor data identification</a></p>
Bit 5	Motorident.: Calculation C70 C71 C72	<p><b>From version 12.00.00 onwards:</b> Following successful motor parameter identification, the speed controller parameters can automatically be calculated as well. If these parameters are to be calculated, bit 5 must be set to "1".</p> <p>0 ≡ Do not calculate parameter 1 ≡ Calculate parameter</p> <p>▶ <a href="#">Automatic motor data identification</a></p>
Bit 6	Motorident.: Calculation C11 C22 C497 C966 C982	<p><b>From version 12.00.00 onwards:</b> Following successful motor parameter identification, further controller parameters can be calculated automatically. If these parameters are to be calculated, bit 6 must be set to "1".</p> <p>0 ≡ Do not calculate parameter 1 ≡ Calculate parameter</p> <p>▶ <a href="#">Automatic motor data identification</a></p>
Bit 7	Brake chopper off in case of pulse inhibit	<p><b>From version 14.00.00</b></p> <p>0 ≡ No response of the brake chopper in case of pulse inhibit. 1 ≡ In case of pulse inhibit, the brake chopper is permanently switched off without any delay.</p> <p>▶ <a href="#">Braking operation/brake energy management</a></p>
Bit 8	DC-bus supply with DC charging connection	
Bit 9	Inverter characteristics inactive	<p><b>From version 12.00.00</b></p> <p>In case of very low-inductance motors (e.g. synchronous motor with a rated frequency of 1000 Hz) the inverter error characteristic needs to be switched off as otherwise the current of the device might be switched off.</p> <p>0 ≡ Inverter error characteristic is active 1 ≡ Inverter error characteristic is not active</p>
Bit 10	SCPSM: Extrapolation - actual speed value inactive	
Bit 11	TopLine: Speed encoder signal cycle 500us	
Bit 12	In case of QSP - nTorqueSetValue_a active	<b>From version 13.00.00</b>
Bit 13	In case of QSP - nTorquexxxLimit_a active	<b>From version 13.00.00</b>
Bit 14	Sensitivity of setpoint feedf. ctrl. 16 bits	<b>From version 14.00.00</b>
Bit 15	SC: Dead time of speed setpoint 500us	<b>From version 14.00.00</b>
<b>Subcodes</b>	<b>Lenze setting</b>	<b>Info</b>

Parameter   Name: <b>C02865   MCTRL: Special settings</b>		Data type: UNSIGNED_16 Index: 21710 <sub>d</sub> = 54CE <sub>h</sub>
C02865/1	0x0000	<a href="#">MCTRL: Special settings</a>
<input checked="" type="checkbox"/> Read access <input checked="" type="checkbox"/> Write access <input type="checkbox"/> CINH <input type="checkbox"/> PLC STOP <input type="checkbox"/> No transfer <input type="checkbox"/> COM <input checked="" type="checkbox"/> MOT		

**C02866**

Parameter   Name: <b>C02866   MCTRL: Special settings</b>		Data type: UNSIGNED_8 Index: 21709 <sub>d</sub> = 54CD <sub>h</sub>
Activation of special functions of the internal motor control		
<b>Selection list</b>		
0	No	
1	Yes	
<b>Subcodes</b>	<b>Lenze setting</b>	<b>Info</b>
C02866/1	1: Yes	Motor ident.: Current controller par. from C075 C076 <ul style="list-style-type: none"> <li>• From version 06.00.00</li> </ul> ▶ <a href="#">Automatic motor data identification</a>
C02866/2	0: No	Motor phase error monitoring before operation <ul style="list-style-type: none"> <li>• From version 11.00.00</li> </ul> ▶ <a href="#">Motor phase error monitoring before operation</a>
C02866/3	0: No	Brake chopper DC-bus slave <ul style="list-style-type: none"> <li>• From version 12.00.00</li> </ul> ▶ <a href="#">Control of multiple internal brake choppers in the DC-bus system</a>
<input checked="" type="checkbox"/> Read access <input checked="" type="checkbox"/> Write access <input checked="" type="checkbox"/> CINH <input type="checkbox"/> PLC STOP <input type="checkbox"/> No transfer <input type="checkbox"/> COM <input checked="" type="checkbox"/> MOT   Scaling factor: 1		

**C02867**

Parameter   Name: <b>C02867 - Identification procedure</b>		Data type: UNSIGNED_8 Index: 21708 <sub>d</sub> = 54CC <sub>h</sub>
From version 10.00.00		
Selection of the identification procedure for motor parameter identification ▶ <a href="#">Automatic motor parameter identification</a>		
<b>Selection list</b>		<b>Info</b>
0	automatic	Automatic selection of the optimum identification procedure: <ul style="list-style-type: none"> <li>• For synchronous motors, the extended identification procedure is always used.</li> <li>• For asynchronous motors with a rated motor power of up to 11 kW, the basic identification procedure is used.</li> <li>• For asynchronous motors with a rated motor power of more than 11 kW, the extended identification procedure is used.</li> </ul>
1	standard identification	<ul style="list-style-type: none"> <li>• Only for asynchronous motors.</li> <li>• Duration approx. 30 s</li> </ul>
2	extended identification	<ul style="list-style-type: none"> <li>• Stands out due to increased accuracy of the determined motor parameters.</li> <li>• Also supports synchronous motors and asynchronous motors with a power of more than 11 kW.</li> <li>• Duration approx. 80 s</li> </ul>
<b>Subcodes</b>	<b>Lenze setting</b>	<b>Info</b>
C02867/1	0: automatic	Motor parameter identification: Process
<input checked="" type="checkbox"/> Read access <input checked="" type="checkbox"/> Write access <input checked="" type="checkbox"/> CINH <input type="checkbox"/> PLC STOP <input type="checkbox"/> No transfer <input type="checkbox"/> COM <input checked="" type="checkbox"/> MOT   Scaling factor: 1		

## C02868

Parameter   Name: <b>C02868   Setting of compatibility</b>		Data type: UNSIGNED_32 Index: 21707 <sub>d</sub> = 54CB <sub>h</sub>
<p><b>From version 16.00.00</b></p> <p>This parameter serves to activate corrections and optimisations in various functions of the inverter. The activation causes a deviation of the respective functionality from the previous firmware versions! In each case, the changed functionality has to be checked after the activation took place. For a detailed explanation, the version information in the AKB has to be used.</p>		
Setting range (min. hex value   max. hex value)		
0x00000000		0xFFFFFFFF
Value is bit-coded:		Info
Bit 0	xx.01: MCK stop ramp opt.	<p>0 ≡ (Maloperation): Profile stop activation with corresponding machine and profile data causes a rotation in the opposite direction and setpoint oscillations around zero speed.</p> <p>1 ≡ (Correction): Corrected traversing of stop ramp may reduce the stopping times.</p>
Bit 1	xx.02: MCK deceleration ramp opt.	<p>0 ≡ (Maloperation): When corresponding profile parameters are entered, an impermissible jerk is caused during the braking phase when entering into the target position within a traversing profile.</p> <p>1 ≡ (Correction): Depending on the profile data constellation, corrected traversing extends the respective traversing process towards the target position.</p>
Bit 2	xx.03: MCK Overchange opt.	<p>0 ≡ (error CK10 occurs):</p> <ul style="list-style-type: none"> <li>Traversing profile with final speed ≠ 0 needs a reversing process after reaching the target position.</li> <li>Parameterised final speed in profile parameters cannot be reached at the target approach (final speed too high).</li> <li>Position target cannot be approached if <ul style="list-style-type: none"> <li>the initial speed of the traversing profile ± final speed</li> </ul> </li> </ul> <p>1 ≡ (Correction): Ck10 does not occur anymore in this setting.</p> <ul style="list-style-type: none"> <li>Travelling profiles with final speed is always executed in such a way that the target position will be reached if the parameterised final speed is neglected.</li> <li>Expected Ck10 errors do not occur anymore, traversing blocks are executed.</li> </ul>
Bit 3	xx.04: MCK PosFollower TargetPos	<p>0 ≡ (Previous procedure):</p> <ul style="list-style-type: none"> <li>No information on target position <i>LS_MotionControlKernel.dnPosTarget_p</i> when a synchronisation process is started in the position follower mode. Previous display of the target position remains unchanged.</li> </ul> <p>1 ≡ Display of the target position and thus the rejection of the previously saved values in <i>LS_MotionControlKernel.dnPosTarget_p</i>.</p>
Bit 4	xx.05: MCK speed, change in op. mode, opt.	<p><b>From version 17.00.00 onwards</b></p> <p>0 ≡ (Previous procedure):</p> <ul style="list-style-type: none"> <li>The change from "StandBy" mode to a different operating mode (except for "SpeedFollower") causes the speed to jump to 0 if <a href="#">C02611/51</a> <i>LS_MotorInterface.nHlgSetValue_a</i> is set.</li> </ul> <p>1 ≡ Instead of a speed jump, the "Stop" ramp is used to decelerate the motor to standstill. This applies to the state transition from "StandBy" to "Homing", "ManualJog" or "Stop" if no further actions take place in the new operating mode.</p>

Parameter   Name: <b>C02868   Setting of compatibility</b>		Data type: UNSIGNED_32 Index: 21707 <sub>d</sub> = 54CB <sub>h</sub>
Bit 5	xx.06: MCK modulo multi, opt.	
Bit 6	xx.07: MCK suppression Ck10	<p><b>From version 21.00.00</b></p> <p>0 ≡ (Previous procedure): Feedforward control is always provided for the holding brake, even if the configuration option "horizontal motion control" is activated.</p> <ul style="list-style-type: none"> <li>• Tripping of a Ck10 error (distance calculation error).</li> </ul> <p>1 ≡ Feedforward control for holding brake operation and the option "horizontal motion control" are deactivated.</p>
Bit 7	xx.08: MCK h brake feedf. ctrl off	<p><b>From version 21.00.00</b></p> <p>0 ≡ (Previous procedure): Feedforward control is always provided for the holding brake, even if the configuration option "horizontal motion control" is activated.</p> <p>1 ≡ Feedforward control for holding brake operation and the option "horizontal motion control" are deactivated.</p>
Bit 8	xx.09: Deactivate acceleration dynamics	<p><b>From version 21.00.00</b></p> <p>0 ≡ (Previous procedure): Adjusting/increasing the acceleration reduces reversal procedures for restarts during ongoing positioning procedures.</p> <p>1 ≡ Reversal procedures are no longer reduced as the max. acceleration is not subject to any increase.</p>
Bit 9	xx.10: Reserved	
Bit 10	xx.11: Reserved	
Bit 11	xx.12: Reserved	
Bit 12	xx.13: Reserved	
Bit 13	xx.14: Reserved	
Bit 14	xx.15: Reserved	
Bit 15	xx.16: Reserved	
Bit 16	xx.17: Reserved	
Bit 17	xx.18: Reserved	
Bit 18	xx.19: Reserved	
Bit 19	xx.20: Reserved	
Bit 20	xx.21: Reserved	
Bit 21	xx.22: Reserved	
Bit 22	xx.23: Reserved	
Bit 23	xx.24: Reserved	
Bit 24	xx.25: Reserved	
Bit 25	xx.26: Reserved	
Bit 26	xx.27: Reserved	
Bit 27	xx.28: Reserved	
Bit 28	xx.29: Reserved	
Bit 29	xx.30: Reserved	
Bit 30	xx.31: Reserved	
Bit 31	xx.32: Reserved	
<b>Subcodes</b>	<b>Lenze setting</b>	<b>Info</b>
C02868/1	0x00000000	List of modifications 01
<input checked="" type="checkbox"/> Read access <input checked="" type="checkbox"/> Write access <input type="checkbox"/> CINH <input type="checkbox"/> PLC STOP <input type="checkbox"/> No transfer <input type="checkbox"/> COM <input type="checkbox"/> MOT		

C02869

Parameter   Name: <b>C02869   MCTRL: Special settings 2</b>		Data type: UNSIGNED_16 Index: 21706 <sub>d</sub> = 54CA <sub>h</sub>
<b>Setting range (min. hex value   max. hex value)</b>		
0x0000		0xFFFF
<b>Value is bit-coded:</b>		<b>Info</b>
Bit 0	Reserved	
Bit 1	Reserved	
Bit 2	Reserved	
Bit 3	Reserved	
Bit 4	Reserved	
Bit 5	Reserved	
Bit 6	Reserved	
Bit 7	Reserved	
Bit 8	Reserved	
Bit 9	Reserved	
Bit 10	Reserved	
Bit 11	Reserved	
Bit 12	Reserved	
Bit 13	Reserved	
Bit 14	Reserved	
Bit 15	Reserved	
<b>Subcodes</b>	<b>Lenze setting</b>	<b>Info</b>
C02869/1	0x0000	<a href="#">MCTRL: Special settings 2</a>
<input checked="" type="checkbox"/> Read access <input checked="" type="checkbox"/> Write access <input type="checkbox"/> CINH <input type="checkbox"/> PLC STOP <input type="checkbox"/> No transfer <input type="checkbox"/> COM <input checked="" type="checkbox"/> MOT		

C02870

Parameter   Name: <b>C02870   PLI without motion: Optimisation factor</b>		Data type: INTEGER_16 Index: 21705 <sub>d</sub> = 54C9 <sub>h</sub>
From version 11.00.00		
▶ <a href="#">Pole position identification without movement</a>		
<b>Display range (min. value   unit   max. value)</b>		
0.00	%	300.00
<b>Subcodes</b>		<b>Info</b>
C02870/1		PLI without movement: degree of optimisation
<input checked="" type="checkbox"/> Read access <input type="checkbox"/> Write access <input checked="" type="checkbox"/> CINH <input checked="" type="checkbox"/> PLC STOP <input checked="" type="checkbox"/> No transfer <input checked="" type="checkbox"/> COM <input checked="" type="checkbox"/> MOT                 Scaling factor: 100		

C02871

Parameter   Name: <b>C02871   PLI without motion: Running time</b>		Data type: INTEGER_16 Index: 21704 <sub>d</sub> = 54C8 <sub>h</sub>
From version 11.00.00		
▶ <a href="#">Pole position identification without movement</a>		

Parameter   Name: <b>C02871   PLI without motion: Running time</b>		Data type: INTEGER_16 Index: 21704 <sub>d</sub> = 54C8 <sub>h</sub>
<b>Display range</b> (min. value   unit   max. value)		
0.00	ms	300.00
<b>Subcodes</b>		<b>Info</b>
C02871/1		PLI without movement: runtime
<input checked="" type="checkbox"/> Read access <input type="checkbox"/> Write access <input type="checkbox"/> CINH <input type="checkbox"/> PLC STOP <input type="checkbox"/> No transfer <input type="checkbox"/> COM <input type="checkbox"/> MOT           Scaling factor: 100		

**C02872**

Parameter   Name: <b>C02872   PLI without motion: Adaptation of time duration</b>		Data type: INTEGER_8 Index: 21703 <sub>d</sub> = 54C7 <sub>h</sub>
From version 11.00.00		
▶ <a href="#">Pole position identification without movement</a>		
<b>Setting range</b> (min. value   unit   max. value)		
-10		10
<b>Subcodes</b>	<b>Lenze setting</b>	<b>Info</b>
C02872/1	0	PLI without movement: adaptation of time duration
<input checked="" type="checkbox"/> Read access <input checked="" type="checkbox"/> Write access <input type="checkbox"/> CINH <input type="checkbox"/> PLC STOP <input type="checkbox"/> No transfer <input type="checkbox"/> COM <input checked="" type="checkbox"/> MOT           Scaling factor: 1		

**C02873**

Parameter   Name: <b>C02873   PLI without motion: Ident. el. rotor displ. angle</b>		Data type: INTEGER_16 Index: 21702 <sub>d</sub> = 54C6 <sub>h</sub>
From version 11.00.00		
▶ <a href="#">Pole position identification without movement</a>		
<b>Display range</b> (min. value   unit   max. value)		
0	°	360
<b>Subcodes</b>		<b>Info</b>
C02873/1		PLI without movement: Ident. el. rotor displ. angle
<input checked="" type="checkbox"/> Read access <input type="checkbox"/> Write access <input type="checkbox"/> CINH <input type="checkbox"/> PLC STOP <input type="checkbox"/> No transfer <input type="checkbox"/> COM <input type="checkbox"/> MOT           Scaling factor: 1		

**C02874**

Parameter   Name: <b>C02874   PLI without motion</b>		Data type: UNSIGNED_16 Index: 21701 <sub>d</sub> = 54C5 <sub>h</sub>
From version 11.00.00		
▶ <a href="#">Pole position identification without movement</a>		
<b>Setting range</b> (min. hex value   max. hex value)		
0x0000		0xFFFF

Parameter   Name: <b>C02874   PLI without motion</b>		Data type: UNSIGNED_16 Index: 21701 <sub>d</sub> = 54C5 <sub>h</sub>
<b>Value is bit-coded:</b>		
Bit 0	for SLPSM with controller enable	
Bit 1	Reserved	
Bit 2	Reserved	
Bit 3	Reserved	
Bit 4	Reserved	
Bit 5	Reserved	
Bit 6	Reserved	
Bit 7	Reserved	
Bit 8	Reserved	
Bit 9	Reserved	
Bit 10	Reserved	
Bit 11	Reserved	
Bit 12	Reserved	
Bit 13	Reserved	
Bit 14	Reserved	
Bit 15	Reserved	
Subcodes	Lenze setting	Info
C02874/1	0x0001	PLI without movement
<input checked="" type="checkbox"/> Read access <input checked="" type="checkbox"/> Write access <input type="checkbox"/> CINH <input type="checkbox"/> PLC STOP <input type="checkbox"/> No transfer <input type="checkbox"/> COM <input checked="" type="checkbox"/> MOT		

**C02875**

Parameter   Name: <b>C02875   PLI without motion: Adaptation of ident angle</b>		Data type: INTEGER_8 Index: 21700 <sub>d</sub> = 54C4 <sub>h</sub>
From version 11.00.00		
		<a href="#">▶ Pole position identification without movement</a>
Setting range (min. value   unit   max. value)		
-100	°	100
Subcodes	Lenze setting	Info
C02875/1	0°	PLI without movement: adaptation of ident angle
<input checked="" type="checkbox"/> Read access <input checked="" type="checkbox"/> Write access <input type="checkbox"/> CINH <input type="checkbox"/> PLC STOP <input type="checkbox"/> No transfer <input type="checkbox"/> COM <input checked="" type="checkbox"/> MOT             Scaling factor: 1		

**C02879**

Parameter   Name: <b>C02879   Slip calculation from equivalent circuit diagram</b>		Data type: UNSIGNED_16 Index: 21696 <sub>d</sub> = 54C0 <sub>h</sub>
From version 11.00.00		
In order to achieve a better speed stability and torque accuracy, the slip calculation can be either derived from the motor nameplate data (e.g. rated motor speed) or the motor equivalent circuit diagram data (stator resistance, rotor resistance etc.).		
		<a href="#">▶ Slip calculation</a>
Setting range (min. hex value   max. hex value)		
0x0000		0xFFFF



Parameter   Name: <b>C02879   Slip calculation from equivalent circuit diagram</b>		Data type: UNSIGNED_16 Index: 21696 <sub>d</sub> = 54C0 <sub>h</sub>
<b>Value is bit-coded:</b>		
Bit 0	SLVC	
Bit 1	Reserved	
Bit 2	Reserved	
Bit 3	Reserved	
Bit 4	Reserved	
Bit 5	Reserved	
Bit 6	Reserved	
Bit 7	Reserved	
Bit 8	Reserved	
Bit 9	Reserved	
Bit 10	Reserved	
Bit 11	Reserved	
Bit 12	Reserved	
Bit 13	Reserved	
Bit 14	Reserved	
Bit 15	Reserved	
<b>Subcodes</b>	<b>Lenze setting</b>	<b>Info</b>
C02879/1	0x0000	Slip calculation from equivalent circuit diagram
<input checked="" type="checkbox"/> Read access <input checked="" type="checkbox"/> Write access <input checked="" type="checkbox"/> CINH <input checked="" type="checkbox"/> PLC STOP <input type="checkbox"/> No transfer <input checked="" type="checkbox"/> COM <input checked="" type="checkbox"/> MOT		

**C02993**

Parameter   Name: <b>C02993   FB xy position</b>		Data type: UNSIGNED_32 Index: 21582 <sub>d</sub> = 544E <sub>h</sub>
<b>This code is used device-internally and must not be written by the user side!</b>		

**C02994**

Parameter   Name: <b>C02994   FB xy position</b>		Data type: UNSIGNED_32 Index: 21581 <sub>d</sub> = 544D <sub>h</sub>
<b>This code is used device-internally and must not be written by the user side!</b>		

**C02995**

Parameter   Name: <b>C02995   FB display InputOutput</b>		Data type: UNSIGNED_32 Index: 21580 <sub>d</sub> = 544C <sub>h</sub>
<b>This code is used device-internally and must not be written by the user side!</b>		

**C02998**

Parameter   Name: <b>C02998   FB displayinputoutput3</b>		Data type: UNSIGNED_32 Index: 21577 <sub>d</sub> = 5449 <sub>h</sub>
<b>This code is used device-internally and must not be written by the user side!</b>		

## Overview of all parameters with power-related Lenze setting

Parameters	Name	Unit	Mains voltage / device power											
			1 * 230 V						3 * 400 V					
			0.25 kW	0.37 kW	0.55 kW	0.75 kW	1.1 kW	1.5 kW	2.2 kW	0.37 kW	0.55 kW	0.75 kW	1.1 kW	1.5 kW
<a href="#">C00016</a>	VFC: Vmin boost	%	5.51	4.32	4.02	3.79	4.32	2.93	2.25	4.32	4.02	3.79	4.32	2.93
<a href="#">C00021</a>	Slip comp.	%	8.67	6	6.33	6	7.33	7	4	6	6.33	6	7.33	7
<a href="#">C00022</a>	Imax in motor mode	A	2.97	4.2	5.25	7	9.62	12.25	16.62	2.27	3.15	4.2	5.6	6.82
<a href="#">C00070/1</a>	SLVC: Vp speed controller		7.62	15.76	12.59	18.9	12.52	12.45	15.76	15.76	12.59	18.9	12.52	12.45
<a href="#">C00070/3</a>	SLPSM: Vp speed controller		1.09	2.25	1.79	2.7	1.79	1.78	2.25	2.25	1.8	2.7	1.79	1.78
<a href="#">C00073/1</a>	VFC: Vp Imax controller		0.46	0.32	0.33	0.27	0.33	0.32	0.2	0.28	0.3	0.27	0.33	0.32
<a href="#">C00074/1</a>	VFC: Ti Imax controller	ms	65	65	65	65	65	65	65	65	65	65	65	65
<a href="#">C00075</a>	Vp current controller	V/A	41.88	34.59	23.43	14.97	9.53	7.23	4.73	103.76	70.29	44.9	28.54	21.7
<a href="#">C00076</a>	Ti current controller	ms	1.99	2.42	2.6	2.39	1.97	2.83	3.55	2.42	2.6	2.39	1.97	2.83
<a href="#">C00081</a>	Rated motor power	kW	0.25	0.37	0.55	0.75	1.1	1.5	2.2	0.37	0.55	0.75	1.1	1.5
<a href="#">C00082</a>	Motor rotor resistance	mohm	11460	5480	3860	2820	2060	1438	740	16442	11580	8454	6150	4320
<a href="#">C00084</a>	Motor stator resistance	mohm	10533	7133	4500	3127	2420	1277	667	21400	13500	9380	7260	3830
<a href="#">C00085</a>	Motor stator leakage inductance	mH	20.94	17.29	11.72	7.48	4.77	3.62	2.37	51.88	35.15	22.45	14.27	10.85
<a href="#">C00087</a>	Rated motor speed	rpm	1370	1410	1405	1410	1390	1395	1440	1410	1405	1410	1390	1395
<a href="#">C00088</a>	Rated motor current	A	1.4	1.6	2.4	3.3	4.8	6.3	9.2	0.95	1.4	1.9	2.8	3.6
<a href="#">C00090</a>	Rated motor voltage	V	230	230	230	230	230	230	230	400	400	400	400	400
<a href="#">C00091</a>	Motor cosine phi		0.63	0.72	0.72	0.8	0.8	0.79	0.71	0.77	0.77	0.8	0.8	0.79
<a href="#">C00092</a>	Motor magnetising inductance	mH	333.3	386.7	286.7	300	186.7	116.7	70	1160	860	900	560	350
<a href="#">C00093</a>	Power section ID		2512	3712	5512	7512	1122	1522	2222	3714	5514	7514	1124	1524
<a href="#">C00095</a>	Motor magnetising current	A	0.94	0.88	1.35	1.28	2.25	3.46	5.54	0.51	0.78	0.74	1.3	2
<a href="#">C00098</a>	Rated device current	A	1.7	2.4	3	4	5.5	7	9.5	1.3	1.8	2.4	3.2	3.9
<a href="#">C00129</a>	Brake resistance value	Ohm	180	180	100	100	33	33	33	390	390	390	180	180
<a href="#">C00130</a>	Rated brake resistor power	W	50	50	100	100	200	200	300	100	100	100	200	200
<a href="#">C00131</a>	Rated heat amount of brake resist.	kWs	7.5	7.5	15	15	30	30	45	15	15	15	30	30
<a href="#">C00497</a>	Filter time constant	ms	1	1	1	1	1	1	1	1	1	1	1	1
<a href="#">C00916</a>	Motor cable cross-section	mm <sup>2</sup>	1	1	1	1	1.5	1.5	1.5	1	1	1	1.5	1.5
<a href="#">C00966</a>	VFC: Time const. slip comp.	ms	100	100	100	100	100	100	100	100	100	109	100	100
<a href="#">C00982</a>	VFC-ECO: Voltage reduction ramp	s	0.1	0.2	0.2	0.3	0.3	0.3	0.3	0.2	0.2	0.3	0.3	0.3
<a href="#">C00987</a>	Inverter motor brake: nAdd	rpm	260	180	190	180	220	210	120	180	190	180	220	210
<a href="#">C00993</a>	Flying restart: Integration time	ms	300	300	300	300	300	300	300	300	300	300	300	300

Parameters	Name	Unit	Mains voltage / device power											
			3 * 400 V											
			2.2 kW	3.0 kW	4.0 kW	5.5 kW	7.5 kW	11 kW	15 kW	18 kW	22 kW	30 kW	37 kW	45 kW
C00016	VFC: Vmin boost	%	2.25	2.48	2.06	1.94	1.7	1.47	1.36	1.32	1.24	0.97	0.7	0.59
<a href="#">C00021</a>	Slip comp.	%	4	4.67	3.33	3.67	3	2.67	2.67	2	2.93	2.33	1.13	1.33
<a href="#">C00022</a>	Imax in motor mode	A	9.8	12.77	16.62	22.75	28.87	41.12	56	68.25	82.25	103.25	126	155.75
<a href="#">C00070/1</a>	SLVC: Vp speed controller		15.76	11.4	15.42	14.05	26	32.41	29.22	43.23	40.95	36.28	75.12	72.06
<a href="#">C00070/3</a>	SLPSM: Vp speed controller		2.25	1.63	2.2	2.01	3.72	4.63	4.18	6.18	5.85	5.18	10.73	10.3
<a href="#">C00073/1</a>	VFC: Vp lmax controller		0.2	0.23	0.17	0.17	0.14	0.11	0.11	0.08	0.12	0.1	0.09	0.09
<a href="#">C00074/1</a>	VFC: Ti lmax controller	ms	65	65	65	65	65	750	750	750	750	750	750	750
<a href="#">C00075</a>	Vp current controller	V/A	17	14.2	11.1	6.97	8.1	7	5.5	4	3.8	1.8	1.49	1.06
<a href="#">C00076</a>	Ti current controller	ms	4.25	4.38	5.34	4.77	8.62	10.61	11.96	10.53	12.67	10.59	14.57	15.17
<a href="#">C00081</a>	Rated motor power	kW	2.2	3	4	5.5	7.5	11	15	18.5	22	30	37	45
<a href="#">C00082</a>	Motor rotor resistance	mohm	2220	1938	1262	842	642	276	186	168	130	111	36	29
<a href="#">C00084</a>	Motor stator resistance	mohm	2000	1620	1040	730	470	330	230	190	150	85	51	35
<a href="#">C00085</a>	Motor stator leakage inductance	mH	8.5	7.1	5.55	3.49	4.05	3.5	2.75	2	1.9	0.9	0.74	0.53
<a href="#">C00087</a>	Rated motor speed	rpm	1440	1430	1450	1445	1455	1460	1460	1470	1456	1465	1483	1480
<a href="#">C00088</a>	Rated motor current	A	5.3	7.2	9.3	12.5	17	21	27.8	32.8	38.8	53.9	65	79
<a href="#">C00090</a>	Rated motor voltage	V	400	400	400	400	400	400	400	400	400	400	400	400
<a href="#">C00091</a>	Motor cosine phi		0.73	0.75	0.73	0.77	0.76	0.85	0.87	0.9	0.9	0.87	0.87	0.88
<a href="#">C00092</a>	Motor magnetising inductance	mH	210	168	170	103	68	81	65.5	73	62.5	52.6	35.1	24.4
<a href="#">C00093</a>	Power section ID		2224	3024	4024	5524	7524	1134	1534	1834	2234	3034	3734	4534
<a href="#">C00095</a>	Motor magnetising current	A	3.2	4	4.1	6.7	10.2	8.5	10.5	9.5	11.1	13.2	20.5	29.5
<a href="#">C00098</a>	Rated device current	A	5.6	7.3	9.5	13	16.5	23.5	32	39	47	59	72	89
<a href="#">C00129</a>	Brake resistance value	Ohm	180	82	47	47	27	27	18	15	15	7.5	7.5	7.5
<a href="#">C00130</a>	Rated brake resistor power	W	300	200	400	800	600	1200	1400	1200	1200	1900	1900	1900
<a href="#">C00131</a>	Rated heat amount of brake resist.	kWs	45	30	60	120	120	90	210	180	180	285	285	285
<a href="#">C00497</a>	Filter time constant	ms	1	1	1	1	2	2	2	2	2	2	2	2
<a href="#">C00916</a>	Motor cable cross-section	mm^2	1.5	2.5	2.5	2.5	4	6	6	6	6	10	10	10
<a href="#">C00966</a>	VFC: Time const. slip comp.	ms	100	100	139	126	112	306	367	446	495	489	1016	877
<a href="#">C00982</a>	VFC-ECO: Voltage reduction ramp	s	0.3	0.3	0.4	0.8	0.8	0.8	1.1	1.3	1.5	1.5	1.5	1.5
<a href="#">C00987</a>	Inverter motor brake: nAdd	rpm	120	140	100	110	90	80	80	60	88	70	60	60
<a href="#">C00993</a>	Flying restart: Integration time	ms	300	300	417.3	379.4	336.7	1159.4	1237.3	1387.3	1265.1	1445	2989.5	2577.3

## 15.4 Selection list - analog signals

This selection list is relevant for the following configuration parameters:

Parameters	
<a href="#">C00410</a>	L_SignalMonitor_a: Signal sources
<a href="#">C00620</a>	System connection list: 16-bit
<a href="#">C00700</a>	LA_NCtrl: Analog connection list
<a href="#">C00760</a>	LA_SwitchPos: Analog connection list

Selection list - analog signals	
0	Not connected
1000	LA_NCtrl: wDriveControlStatus
1001	LA_NCtrl: wStateDetermFailNoLow
1002	LA_NCtrl: nMotorCurrent_a
1003	LA_NCtrl: nMotorSpeedAct_a
1006	LA_NCtrl: nGPAnalogSwitchOut_a
1007	LA_NCtrl: nGPArithmetikOut_a
1008	LA_NCtrl: nGPMulDivOut_a
1009	LA_NCtrl: nGPSignalOut1_a
1010	LA_NCtrl: nGPSignalOut2_a
1011	LA_NCtrl: nGPSignalOut3_a
1012	LA_NCtrl: nGPSignalOut4_a
1013	LA_NCtrl: nMotorTorqueAct_a
1014	LA_NCtrl: nDCVoltage_a
1015	LA_NCtrl: nMotorVoltage_a
1016	LA_NCtrl: nMotorSpeedSet_a
1017	LA_NCtrl: wStateDetermFailNoHigh
1023	LA_NCtrl: wFreeOut1
1024	LA_NCtrl: wFreeOut2
1025	LA_NCtrl: wFreeOut3
1026	LA_NCtrl: wFreeOut4
1200	LA_SwitchPos: wDriveControlStatus
1201	LA_SwitchPos: wStateDetermFailNoLow
1202	LA_SwitchPos: wStateDetermFailNoHigh
1203	LA_SwitchPos: nMotorCurrent_a
1204	LA_SwitchPos: nMotorSpeedSet_a
1205	LA_SwitchPos: nMotorSpeedAct_a
1206	LA_SwitchPos: nMotorTorqueAct_a
1207	LA_SwitchPos: nDCVoltage_a
1208	LA_SwitchPos: nMotorVoltage_a
1209	LA_SwitchPos: nGPAnalogSwitchOut_a
1210	LA_SwitchPos: nGPArithmetikOut_a
1211	LA_SwitchPos: nGPMulDivOut_a
1212	LA_SwitchPos: nGPSignalOut1_a
1213	LA_SwitchPos: nGPSignalOut2_a
1214	LA_SwitchPos: nGPSignalOut3_a
1215	LA_SwitchPos: nGPSignalOut4_a
1221	LA_SwitchPos: wFreeOut1
1222	LA_SwitchPos: wFreeOut2
1223	LA_SwitchPos: wFreeOut3
1224	LA_SwitchPos: wFreeOut4

Selection list - analog signals	
16000	LS_AnalogInput: nIn1_a
16002	LP_CanIn1: wCtrl
16003	LP_CanIn1: wIn2
16004	LP_CanIn1: wIn3
16005	LP_CanIn1: wIn4
16006	LP_CanIn2: wIn1
16007	LP_CanIn2: wIn2
16008	LP_CanIn2: wIn3
16009	LP_CanIn2: wIn4
16010	LP_CanIn3: wIn1
16011	LP_CanIn3: wIn2
16012	LP_CanIn3: wIn3
16013	LP_CanIn3: wIn4
16014	LS_DigitalInput: wCountIn1_LW
16015	LS_DigitalInput: wCountIn1_HW
16016	LS_DigitalInput: nFreqIn12_a
16017	LS_DigitalInput: nFreqIn12_v
16100	LS_DataAccess: wOut1
16101	LS_DataAccess: wOut2
16102	LS_DataAccess: wOut3
16103	LS_DataAccess: wOut4
16104	LP_McIn: wCtrl
16105	LP_McIn: wIn2
16106	LP_McIn: wIn3
16107	LP_McIn: wIn4
16108	LP_McIn: wIn5
16109	LP_McIn: wIn6
16110	LP_McIn: wIn7
16111	LP_McIn: wIn8
16112	LP_McIn: wIn9
16113	LP_McIn: wIn10
16114	LP_McIn: wIn11
16115	LP_McIn: wIn12
16116	LP_McIn: wIn13
16117	LP_McIn: wIn14
16118	LP_McIn: wIn15
16119	LP_McIn: wIn16
16120	LS_Keypad: nTorqueMotLim_a
16121	LS_Keypad: nTorqueGenLim_a
16122	LS_Keypad: nMainSetValue_a
16123	LS_CANManagement: wNodeID
16130	LS_ParReadWrite_1: wOutHWord
16131	LS_ParReadWrite_1: wOutLWord
16132	LS_ParReadWrite_2: wOutHWord
16133	LS_ParReadWrite_2: wOutLWord
16134	LS_ParReadWrite_3: wOutHWord
16135	LS_ParReadWrite_3: wOutLWord
16360	LP_CanIn4: wIn1
16361	LP_CanIn4: wIn2
16362	LP_CanIn4: wIn3

Selection list - analog signals	
16363	LP_CanIn4: wIn4
20000	LS_ParFix: nPos100_a
20001	LS_ParFix: nNeg100_a
20002	LS_ParFix: nPos199_99_a
20003	LS_ParFix: nNeg199_99_a
20004	LS_ParFix: w65535
20005	LS_ParFix: wDriveCtrl
20010	LS_ParFree_a: nC472_1_a
20011	LS_ParFree_a: nC472_2_a
20012	LS_ParFree_a: nC472_3_a
20013	LS_ParFree_a: nC472_4_a
20018	LS_ParFree_v: nC473_1_v
20019	LS_ParFree_v: nC473_2_v
20020	LS_ParFree_v: nC473_3_v
20021	LS_ParFree_v: nC473_4_v
20026	LS_ParFree: wC471_1
20027	LS_ParFree: wC471_2
20028	LS_ParFree: wC471_3
20029	LS_ParFree: wC471_4
32000	LS_MotorInterface: nMotorSpeedAct_a
32001	LS_MotorInterface: nOutputSpeedCtrl_a
32002	LS_MotorInterface: nInputJerkCtrl_a
32003	LS_MotorInterface: nInputTorqueCtrl_a
32004	LS_MotorInterface: nMotorTorqueAct_a
32005	LS_MotorInterface: nActualFlux_a
32006	LS_MotorInterface: nDCVoltage_a
32007	LS_MotorInterface: nStatorCurrentIS_a
32008	LS_MotorInterface: nEffCurrentIq_a
32009	LS_MotorInterface: nReaktCurrentId_a
32010	LS_MotorInterface: wMaxMotorSpeed
32011	LS_MotorInterface: wMaxMotorTorque
32012	LS_MotorInterface: nMotorVoltage_a
32013	LS_MotorInterface: nMotorFreqAct_a
32014	LS_MotorInterface: nEffSpeedSetValue_a
32015	LS_DeviceMonitor: nMctrlIxtRate_a
32016	LS_DeviceMonitor: nMctrlI2xtRate_a
32017	LS_MotorInterface: nOutputPosCtrl_a
32018	LS_MotorInterface: nHlgSetValue_a
32019	LS_MotorInterface: nMotorSpeedAct_v
32020	LS_MotorInterface: nSpeedCtrlAct_a
32021	LS_MotorInterface: nVoltageAngleAct_a
32022	LS_DeviceMonitor: nMctrlActiveOuputPower_a
32023	LS_DeviceMonitor: nMctrlApparentOuputPower_a
32024	LS_DeviceMonitor: nMctrlCosinePhiAct_a
32100	LS_DriveInterface: wDeviceStatusWord
32101	LS_DriveInterface: wDeviceAuxStateWord
32102	LS_DriveInterface: wStateDetermFailNoLow
32103	LS_DriveInterface: wStateDetermFailNoHigh
32104	LS_DriveInterface: wStateDetermFailNoShort
32200	LS_MotionControlKernel: nSpeedSet_v
32201	LS_MotionControlKernel: nSpeedCtrl_a
32202	LS_MotionControlKernel: nSpeedSetValue_a

Selection list - analog signals	
32203	LS_MotionControlKernel: nTorqueSetValue_a
32204	LS_MotionControlKernel: wActProfileNo
32205	LS_MotionControlKernel: wFollowProfileNo
32206	LS_MotionControlKernel: wMotionState1
32207	LS_MotionControlKernel: wMotionState2
32208	LS_MotionControlKernel: wAuxState
32209	LS_MotionControlKernel: nPWMAngleOffset
32210	LS_MotionControlKernel: nTorqueLimitAdapt_a
32211	Reserved: a32211
34900	MCTRL: OszCh1
34901	MCTRL: OszCh2
34902	MCTRL: OszCh3
34903	MCTRL: OszCh4
34904	MCTRL: Status1
34905	MCTRL: Status2
34906	MCTRL: Status3
34907	LS_DeviceMonitor: wUB24V
36000	L_Absolut_1: nOut_a
36001	L_AddSub_1: nOut_a
36002	L_OffsetGain_1: nOut_a
36003	L_OffsetGain_2: nOut_a
36004	L_OffsetGainP_1: nOut_a
36005	L_OffsetGainP_2: nOut_a
36006	L_GainOffset_1: nOut_a
36007	L_GainOffset_2: nOut_a
36010	L_Negation_1: nOut_a
36011	L_Arithmetik_1: nOut_a
36012	L_Arithmetik_2: nOut_a
36013	L_AnalogSwitch_1: nOut_a
36014	L_AnalogSwitch_2: nOut_a
36015	L_AnalogSwitch_3: nOut_a
36018	L_NSet_1: nOut_a
36019	L_MPot_1: nOut_a
36020	L_PCTRL_1: nOut_a
36021	L_SignalMonitor_a: nOut1_a
36022	L_SignalMonitor_a: nOut2_a
36025	L_OffsetGainP_3: nOut_a
36027	L_SignalMonitor_a: nOut3_a
36028	L_SignalMonitor_a: nOut4_a
36029	L_MulDiv_1: nOut_a
36031	L_NSet_1: wState
36032	L_NSet_1: nSetValue_a
36033	L_PT1_1: nOut_a
36091	L_PCTRL_1: nPIDOut1_a
36092	L_PCTRL_1: nPIDOut2_a
36093	L_PCTRL_1: nInfluenceOut_a
36095	L_Interpolator_1: nPhdOut_v
36096	L_Interpolator_1: nNOut_a
42000	LA_NCtrl_In: wCANDriveControl
42001	LA_NCtrl_In: wMCIDriveControl
42002	LA_NCtrl_In: nTorqueMotLim_a
42003	LA_NCtrl_In: nTorqueGenLim_a

Selection list - analog signals	
42004	LA_NCtrl_In: nPIDVpAdapt_a
42005	LA_NCtrl_In: nPIDActValue_a
42006	LA_NCtrl_In: nMainSetValue_a
42007	LA_NCtrl_In: nAuxSetValue_a
42008	LA_NCtrl_In: nGPAnalogSwitchIn1_a
42009	LA_NCtrl_In: nGPAnalogSwitchIn2_a
42010	LA_NCtrl_In: nGPArithmetikIn1_a
42011	LA_NCtrl_In: nGPArithmetikIn2_a
42012	LA_NCtrl_In: nGPMulDivIn_a
42013	LA_NCtrl_In: nGPCompareIn1_a
42014	LA_NCtrl_In: nGPCompareIn2_a
42015	LA_NCtrl_In: nVoltageAdd_a
42016	LA_NCtrl_In: nPIDInfluence_a
42017	LA_NCtrl_In: nPIDSetValue_a
42018	LA_NCtrl_In: nPWMAngleOffset
42019	LA_NCtrl_In: nBoost_a
42020	LA_NCtrl_In: wSMControl
42025	LA_NCtrl_In: wFreeln1
42026	LA_NCtrl_In: wFreeln2
42027	LA_NCtrl_In: wFreeln3
42028	LA_NCtrl_In: wFreeln4
42200	LA_SwitchPos_In: wCANDriveControl
42201	LA_SwitchPos_In: wMCIDriveControl
42202	LA_SwitchPos_In: nVoltageAdd_a
42203	LA_SwitchPos_In: nBoost_a
42204	LA_SwitchPos_In: nPWMAngleOffset
42205	LA_SwitchPos_In: nTorqueMotLim_a
42206	LA_SwitchPos_In: nTorqueGenLim_a
42207	LA_SwitchPos_In: nMainSetValue_a
42208	LA_SwitchPos_In: nAuxSetValue_a
42209	LA_SwitchPos_In: nGPAnalogSwitchIn1_a
42210	LA_SwitchPos_In: nGPAnalogSwitchIn2_a
42211	LA_SwitchPos_In: nGPArithmetikIn1_a
42212	LA_SwitchPos_In: nGPArithmetikIn2_a
42213	LA_SwitchPos_In: nGPMulDivIn_a
42214	LA_SwitchPos_In: nGPCompareIn1_a
42215	LA_SwitchPos_In: nGPCompareIn2_a
42216	LA_SwitchPos_In: wSMControl
42221	LA_SwitchPos_In: wFreeln1
42222	LA_SwitchPos_In: wFreeln2
42223	LA_SwitchPos_In: wFreeln3
42224	LA_SwitchPos_In: wFreeln4

## 15.5 Selection list - digital signals

This selection list is relevant for the following configuration parameters:

Parameters	
<a href="#">C00411</a>	L_SignalMonitor_b: Signal sources
<a href="#">C00621</a>	System connection list: Bool
<a href="#">C00701</a>	LA_NCtrl: Digital connection list
<a href="#">C00761</a>	LA_SwitchPos: Digital connection list

Selection list - digital signals	
0	Not connected
1000	LA_NCtrl: bDriveReady
1001	LA_NCtrl: bDriveFail
1002	LA_NCtrl: bClnhActive
1003	LA_NCtrl: bQSPisActive
1004	LA_NCtrl: bSpeedCcw
1005	LA_NCtrl: bSpeedActCompare
1008	LA_NCtrl: bGPDigitalDelayOut
1009	LA_NCtrl: bGLogicOut
1010	LA_NCtrl: bGPSignalOut1
1011	LA_NCtrl: bGPSignalOut2
1012	LA_NCtrl: bGPSignalOut3
1013	LA_NCtrl: bGPSignalOut4
1014	LA_NCtrl: bOverLoadActive
1015	LA_NCtrl: bMBrakeReleaseOut
1016	LA_NCtrl: bMBrakeReleased
1017	LA_NCtrl: bGPCCompareOut
1018	LA_NCtrl: bUnderLoadActive
1019	LA_NCtrl: blmaxActive
1020	LA_NCtrl: bSpeedSetReached
1021	LA_NCtrl: bSpeedActEqSet
1022	LA_NCtrl: bGPDFlipFlop_Out
1023	LA_NCtrl: bGPDFlipFlop_NegOut
1029	LA_NCtrl: bFreeOut1
1030	LA_NCtrl: bFreeOut2
1031	LA_NCtrl: bFreeOut3
1032	LA_NCtrl: bFreeOut4
1033	LA_NCtrl: bFreeOut5
1034	LA_NCtrl: bFreeOut6
1035	LA_NCtrl: bFreeOut7
1036	LA_NCtrl: bFreeOut8
1200	LA_SwitchPos: bDriveFail
1201	LA_SwitchPos: bWarningActive
1202	LA_SwitchPos: bSafeTorqueOff
1203	LA_SwitchPos: bDriveReady
1204	LA_SwitchPos: bClnhActive
1205	LA_SwitchPos: blmplsActive
1206	LA_SwitchPos: bQSPisActive
1207	LA_SwitchPos: bSpeedCcw
1208	LA_SwitchPos: bSpeedActCompare
1209	LA_SwitchPos: blmaxActive

Selection list - digital signals	
1210	LA_SwitchPos: bSpeedSetReached
1211	LA_SwitchPos: bSpeedActEqSet
1212	LA_SwitchPos: bMBrakeReleaseOut
1213	LA_SwitchPos: bMBrakeReleased
1214	LA_SwitchPos: bGPDigitalDelayOut
1215	LA_SwitchPos: bGLogicOut
1216	LA_SwitchPos: bGPCCompareOut
1217	LA_SwitchPos: bGPDFlipFlop_Out
1218	LA_SwitchPos: bGPDFlipFlop_NegOut
1219	LA_SwitchPos: bGPSignalOut1
1220	LA_SwitchPos: bGPSignalOut2
1221	LA_SwitchPos: bGPSignalOut3
1222	LA_SwitchPos: bGPSignalOut4
1228	LA_SwitchPos: bFreeOut1
1229	LA_SwitchPos: bFreeOut2
1230	LA_SwitchPos: bFreeOut3
1231	LA_SwitchPos: bFreeOut4
1232	LA_SwitchPos: bFreeOut5
1233	LA_SwitchPos: bFreeOut6
1234	LA_SwitchPos: bFreeOut7
1235	LA_SwitchPos: bFreeOut8
16000	LS_DigitalInput: bln1
16001	LS_DigitalInput: bln2
16002	LS_DigitalInput: bln3
16003	LS_DigitalInput: bln4
16008	LS_DigitalInput: bClnh
16009	LS_DigitalInput: bCountIn1_Compare
16011	LS_AnalogInput: bCurrentErrorIn1
16013	LP_CanIn1: bCtrl1_B0
16014	LP_CanIn1: bCtrl1_B1
16015	LP_CanIn1: bCtrl1_B2
16016	LP_CanIn1: bCtrl1_B3
16017	LP_CanIn1: bCtrl1_B4
16018	LP_CanIn1: bCtrl1_B5
16019	LP_CanIn1: bCtrl1_B6
16020	LP_CanIn1: bCtrl1_B7
16021	LP_CanIn1: bCtrl1_B8
16022	LP_CanIn1: bCtrl1_B9
16023	LP_CanIn1: bCtrl1_B10
16024	LP_CanIn1: bCtrl1_B11
16025	LP_CanIn1: bCtrl1_B12
16026	LP_CanIn1: bCtrl1_B13
16027	LP_CanIn1: bCtrl1_B14
16028	LP_CanIn1: bCtrl1_B15
16029	LP_CanIn2: bln1_B0
16030	LP_CanIn2: bln1_B1
16031	LP_CanIn2: bln1_B2
16032	LP_CanIn2: bln1_B3
16033	LP_CanIn2: bln1_B4
16034	LP_CanIn2: bln1_B5

Selection list - digital signals	
16035	LP_CanIn2: bln1_B6
16036	LP_CanIn2: bln1_B7
16037	LP_CanIn2: bln1_B8
16038	LP_CanIn2: bln1_B9
16039	LP_CanIn2: bln1_B10
16040	LP_CanIn2: bln1_B11
16041	LP_CanIn2: bln1_B12
16042	LP_CanIn2: bln1_B13
16043	LP_CanIn2: bln1_B14
16044	LP_CanIn2: bln1_B15
16045	LP_CanIn3: bln1_B0
16046	LP_CanIn3: bln1_B1
16047	LP_CanIn3: bln1_B2
16048	LP_CanIn3: bln1_B3
16049	LP_CanIn3: bln1_B4
16050	LP_CanIn3: bln1_B5
16051	LP_CanIn3: bln1_B6
16052	LP_CanIn3: bln1_B7
16053	LP_CanIn3: bln1_B8
16054	LP_CanIn3: bln1_B9
16055	LP_CanIn3: bln1_B10
16056	LP_CanIn3: bln1_B11
16057	LP_CanIn3: bln1_B12
16058	LP_CanIn3: bln1_B13
16059	LP_CanIn3: bln1_B14
16060	LP_CanIn3: bln1_B15
16061	LP_Mciln: bCtrl_B0
16062	LP_Mciln: bCtrl_B1
16063	LP_Mciln: bCtrl_B2
16064	LP_Mciln: bCtrl_B3
16065	LP_Mciln: bCtrl_B4
16066	LP_Mciln: bCtrl_B5
16067	LP_Mciln: bCtrl_B6
16068	LP_Mciln: bCtrl_B7
16069	LP_Mciln: bCtrl_B8
16070	LP_Mciln: bCtrl_B9
16071	LP_Mciln: bCtrl_B10
16072	LP_Mciln: bCtrl_B11
16073	LP_Mciln: bCtrl_B12
16074	LP_Mciln: bCtrl_B13
16075	LP_Mciln: bCtrl_B14
16076	LP_Mciln: bCtrl_B15
16077	LP_Mciln: bln2_B0
16078	LP_Mciln: bln2_B1
16079	LP_Mciln: bln2_B2
16080	LP_Mciln: bln2_B3
16081	LP_Mciln: bln2_B4
16082	LP_Mciln: bln2_B5
16083	LP_Mciln: bln2_B6
16084	LP_Mciln: bln2_B7
16085	LP_Mciln: bln2_B8
16086	LP_Mciln: bln2_B9

Selection list - digital signals	
16087	LP_Mciln: bln2_B10
16088	LP_Mciln: bln2_B11
16089	LP_Mciln: bln2_B12
16090	LP_Mciln: bln2_B13
16091	LP_Mciln: bln2_B14
16092	LP_Mciln: bln2_B15
16093	LS_Keypad: bSetQuickstop
16094	LS_Keypad: bSetDCBrake
16095	LS_Keypad: bSetSpeedCcw
16096	LS_Keypad: bJogSpeed1
16097	LS_Keypad: bJogSpeed2
16098	LS_Keypad: bMPotEnable
16099	LS_Keypad: bMPotUp
16100	LS_Keypad: bMPotDown
16101	LS_DigitalInput: bPosIn12_State
16110	LS_ParReadWrite_1: bDone
16111	LS_ParReadWrite_1: bFail
16112	LS_ParReadWrite_2: bDone
16113	LS_ParReadWrite_2: bFail
16114	LS_ParReadWrite_3: bDone
16115	LS_ParReadWrite_3: bFail
16122	LS_WriteParamList: bDone
16123	LS_WriteParamList: bFail
16161	LS_CANManagement: bFail
16162	LS_CANManagement: bOperational
16200	LS_SyncManagement: bSyncSignalOK
16201	LS_SyncManagement: bSyncPhaseOK
16400	LP_CanIn4: bln1_B0
16401	LP_CanIn4: bln1_B1
16402	LP_CanIn4: bln1_B2
16403	LP_CanIn4: bln1_B3
16404	LP_CanIn4: bln1_B4
16405	LP_CanIn4: bln1_B5
16406	LP_CanIn4: bln1_B6
16407	LP_CanIn4: bln1_B7
16408	LP_CanIn4: bln1_B8
16409	LP_CanIn4: bln1_B9
16410	LP_CanIn4: bln1_B10
16411	LP_CanIn4: bln1_B11
16412	LP_CanIn4: bln1_B12
16413	LP_CanIn4: bln1_B13
16414	LP_CanIn4: bln1_B14
16415	LP_CanIn4: bln1_B15
20000	LS_ParFix: bTrue
20001	LS_ParFree_b: bC470_1
20002	LS_ParFree_b: bC470_2
20003	LS_ParFree_b: bC470_3
20004	LS_ParFree_b: bC470_4
20005	LS_ParFree_b: bC470_5
20006	LS_ParFree_b: bC470_6
20007	LS_ParFree_b: bC470_7
20008	LS_ParFree_b: bC470_8



Selection list - digital signals	
20009	LS_ParFree_b: bC470_9
20010	LS_ParFree_b: bC470_10
20011	LS_ParFree_b: bC470_11
20012	LS_ParFree_b: bC470_12
20013	LS_ParFree_b: bC470_13
20014	LS_ParFree_b: bC470_14
20015	LS_ParFree_b: bC470_15
20016	LS_ParFree_b: bC470_16
20033	LS_PulseGenerator: b100Hz
20034	LS_PulseGenerator: b10Hz
20035	LS_PulseGenerator: b2Hz
20036	LS_PulseGenerator: b1Hz
20037	LS_PulseGenerator: b1HzFlash
20038	LS_PulseGenerator: b2HzFlash
20039	LS_PulseGenerator: bSingleFlash1
20040	LS_PulseGenerator: bSingleFlash2
20041	LS_PulseGenerator: bDoubleFlash
20042	LS_PulseGenerator: bSquareWave
20043	LS_PulseGenerator: bFirstCycleDone
32000	LS_DeviceMonitor: bMctrlFanFault
32001	LS_DeviceMonitor: bMctrlHeatSinkTemp
32002	LS_MotorInterface: bLimPosCtrlOut
32003	LS_MotorInterface: bLimSpeedCtrlOut
32004	LS_MotorInterface: bLimSpeedSetVal
32005	LS_MotorInterface: bLimTorqueSetVal
32006	LS_MotorInterface: bLimCurrentSetVal
32007	LS_DeviceMonitor: bMctrlUVDetected
32008	LS_DeviceMonitor: bMctrlOVDetected
32009	LS_DeviceMonitor: bMctrlMotorPhaseFault
32010	LS_DeviceMonitor: bMctrlEncoderComFault
32011	LS_DeviceMonitor: bMctrlIxtOverload
32012	LS_DeviceMonitor: bMctrlI2xtOverload
32013	LS_MotorInterface: bIdentificationActive
32014	LS_MotorInterface: bFlyingSyncActive
32015	LS_DeviceMonitor: bMctrlTorqueMax
32016	LS_DeviceMonitor: bMctrlNMax
32017	LS_DeviceMonitor: bMctrlFChopReduced
32018	LS_DeviceMonitor: bMctrlMotorPtc
32019	LS_DeviceMonitor: bMctrlMotorTemp
32020	LS_MotorInterface: bDcbActive
32021	LS_DeviceMonitor: bMctrlBrakeChopperFault
32022	LS_MotorInterface: bQsplsActive
32023	LS_MotorInterface: bHlgLoad
32024	LS_MotorInterface: bHlgStop
32025	LS_DeviceMonitor: bMctrlImpActive
32026	LS_DeviceMonitor: bMctrlClampActive
32027	LS_DeviceMonitor: bMctrlMainsFault
32028	LS_DeviceMonitor: bMctrlNmaxForFChop
32029	LS_DeviceMonitor: bMctrlShortCircuit
32030	LS_DeviceMonitor: bMctrlEarthFault
32031	LS_DeviceMonitor: bWirebreakUfLinearActive
32032	LS_DeviceMonitor: bCurrentMonitoringOverload

Selection list - digital signals	
32033	LS_DeviceMonitor: bSlpsmSpeedOpenLoopControl
32100	LS_DriveInterface: bInit
32101	LS_DriveInterface: bReady
32102	LS_DriveInterface: bReadyToSwitchOn
32103	LS_DriveInterface: bOperationEnable
32104	LS_DriveInterface: bWarning
32105	LS_DriveInterface: bTrouble
32106	LS_DriveInterface: bFail
32107	LS_DriveInterface: bCollectedFail
32108	LS_DriveInterface: bSafeTorqueOff
32109	LS_DriveInterface: bImplsActive
32110	LS_DriveInterface: bCInhIsActive
32111	LS_DriveInterface: bSafetyIsActive
32112	LS_DriveInterface: bCwCcw
32113	LS_DriveInterface: bNActCompare
32200	LS_MotionControlKernel: bPosCtrlOn_
32201	LS_MotionControlKernel: bSpeedCtrlOn_
32202	LS_MotionControlKernel: bTorquemodeOn_
32203	LS_MotionControlKernel: bDcBrakeOn_
32204	LS_MotionControlKernel: bMBrakeReleaseOut
32205	LS_MotionControlKernel: bMBrakeReleased
32206	LS_MotionControlKernel: bDeltaPosOn_
32207	LS_MotionControlKernel: bPosDerivativeOn_
32208	LS_MotionControlKernel: bMotorRefOffsetOn_
32209	LS_MotionControlKernel: bQspOn_
32210	LS_MotionControlKernel: bPosBusy
32211	LS_MotionControlKernel: bPosDone
32212	LS_MotionControlKernel: bHomDone
32213	LS_MotionControlKernel: bHomAvailable
32214	LS_MotionControlKernel: bTorqueLimitAdaptOn_
32215	Reserved: b32215
32216	Reserved: b32216
32217	Reserved: b32217
32218	Reserved: b32218
32219	LS_MotionControlKernel: bFollowErrLim1
32220	LS_MotionControlKernel: bFollowErrLim2
32221	LS_MotionControlKernel: bReadyToOperate
36000	L_And_1: bOut
36001	L_And_2: bOut
36002	L_And_3: bOut
36003	L_Or_1: bOut
36004	L_Or_2: bOut
36005	L_Or_3: bOut
36006	L_Not_1: bOut
36007	L_Not_2: bOut
36008	L_Not_3: bOut
36009	L_DFlipFlop_1: bOut
36010	L_RLQ_1: bQsp
36011	L_RLQ_1: bCwCcw
36012	L_DigitalDelay_1: bOut
36013	L_Compare_1: bOut
36014	L_Compare_2: bOut

Selection list - digital signals	
36015	L_Compare_3: bOut
36016	L_NSet_1: bRfgEqO
36017	L_DigitalLogic_1: bOut
36019	L_SignalMonitor_b: bOut1
36020	L_SignalMonitor_b: bOut2
36021	L_SignalMonitor_b: bOut3
36022	L_SignalMonitor_b: bOut4
36023	L_PCTRL_1: bActEqSet
36025	L_DFlipFlop_1: bNegOut
36039	L_Or_4: bOut
36040	L_DigitalLogic_3: bOut
36131	L_JogCtrlExtension_1: bRfgOut
36132	L_JogCtrlExtension_1: bJog1Out
36133	L_JogCtrlExtension_1: bJog2Out
36135	L_Interpolator_1: bIPulse
36136	L_Interpolator_1: bSignalError
36138	L_Transient_1: bOut
36139	L_Transient_2: bOut
36140	L_Transient_3: bOut
36141	L_Transient_4: bOut
36293	L_DigitalLogic_1: bOut2
36294	L_DigitalLogic_1: bOut3
36297	L_DigitalLogic_3: bOut2
36298	L_DigitalLogic_3: bOut3
42000	LA_NCtrl_In: bClnh
42001	LA_NCtrl_In: bFailReset
42002	LA_NCtrl_In: bSetQuickstop
42003	LA_NCtrl_In: bSetDCBrake
42004	LA_NCtrl_In: bRFG_Stop
42005	LA_NCtrl_In: bRFG_0
42007	LA_NCtrl_In: bSetSpeedCcw
42008	LA_NCtrl_In: bJogSpeed1
42009	LA_NCtrl_In: bJogSpeed2
42010	LA_NCtrl_In: bJogSpeed4
42011	LA_NCtrl_In: bJogSpeed8
42012	LA_NCtrl_In: bJogRamp1
42013	LA_NCtrl_In: bJogRamp2
42014	LA_NCtrl_In: bJogRamp4
42015	LA_NCtrl_In: bJogRamp8
42017	LA_NCtrl_In: bMPotInAct
42018	LA_NCtrl_In: bMPotUp
42019	LA_NCtrl_In: bMPotDown
42020	LA_NCtrl_In: bMBrakeRelease
42021	LA_NCtrl_In: bGPFree1
42022	LA_NCtrl_In: bGPFree2
42023	LA_NCtrl_In: bGPAnalogSwitchSet
42024	LA_NCtrl_In: bGPDigitalDelayIn
42025	LA_NCtrl_In: bGPLogicIn1
42026	LA_NCtrl_In: bGPLogicIn2
42027	LA_NCtrl_In: bGPLogicIn3
42028	LA_NCtrl_In: bGPDFlipFlop_InD
42029	LA_NCtrl_In: bGPDFlipFlop_InClk

Selection list - digital signals	
42030	LA_NCtrl_In: bGPDFlipFlop_InClr
42031	LA_NCtrl_In: bMPotEnable
42032	LA_NCtrl_In: bPIDEnableInfluenceRamp
42033	LA_NCtrl_In: bPIDIOff
42034	LA_NCtrl_In: bRLQCw
42035	LA_NCtrl_In: bRLQCcw
42041	LA_NCtrl_In: bFreeln1
42042	LA_NCtrl_In: bFreeln2
42043	LA_NCtrl_In: bFreeln3
42044	LA_NCtrl_In: bFreeln4
42045	LA_NCtrl_In: bFreeln5
42046	LA_NCtrl_In: bFreeln6
42047	LA_NCtrl_In: bFreeln7
42048	LA_NCtrl_In: bFreeln8
42200	LA_SwitchPos_In: bClnh
42201	LA_SwitchPos_In: bFailReset
42202	LA_SwitchPos_In: bSetQuickstop
42203	LA_SwitchPos_In: bSetDCBrake
42204	LA_SwitchPos_In: bRFG_Stop
42205	LA_SwitchPos_In: bSetSpeedCcw
42206	LA_SwitchPos_In: bRLQCw
42207	LA_SwitchPos_In: bRLQCcw
42208	LA_SwitchPos_In: bJogCtrlInputSel1

Selection list - digital signals	
42209	LA_SwitchPos_In: bJogCtrlInputSel2
42210	LA_SwitchPos_In: bJogCtrlRfgIn
42211	LA_SwitchPos_In: bJogCtrlJog1
42212	LA_SwitchPos_In: bJogCtrlJog2
42213	LA_SwitchPos_In: bJogCtrlSlowDown1
42214	LA_SwitchPos_In: bJogCtrlStop1
42215	LA_SwitchPos_In: bJogCtrlSlowDown2
42216	LA_SwitchPos_In: bJogCtrlStop2
42217	LA_SwitchPos_In: bJogCtrlSlowDown3
42218	LA_SwitchPos_In: bJogCtrlStop3
42219	LA_SwitchPos_In: bJogSpeed4
42220	LA_SwitchPos_In: bJogSpeed8
42221	LA_SwitchPos_In: bJogRamp1
42222	LA_SwitchPos_In: bJogRamp2
42223	LA_SwitchPos_In: bJogRamp4
42224	LA_SwitchPos_In: bJogRamp8
42225	LA_SwitchPos_In: bMBrakeRelease
42226	LA_SwitchPos_In: bGPAnalogSwitchSet
42227	LA_SwitchPos_In: bGPDigitalDelayIn
42228	LA_SwitchPos_In: bGPLogicIn1
42229	LA_SwitchPos_In: bGPLogicIn2
42230	LA_SwitchPos_In: bGPLogicIn3
42231	LA_SwitchPos_In: bGPDFlipFlop_InD
42232	LA_SwitchPos_In: bGPDFlipFlop_InClk
42233	LA_SwitchPos_In: bGPDFlipFlop_InClr
42239	LA_SwitchPos_In: bFreelIn1
42240	LA_SwitchPos_In: bFreelIn2
42241	LA_SwitchPos_In: bFreelIn3
42242	LA_SwitchPos_In: bFreelIn4
42243	LA_SwitchPos_In: bFreelIn5
42244	LA_SwitchPos_In: bFreelIn6
42245	LA_SwitchPos_In: bFreelIn7
42246	LA_SwitchPos_In: bFreelIn8
42247	LS_MotorInterface: bBrakeChopperActive
42248	LS_MotorInterface: bLimSpeedTorquemodeOn

## 15.6 Selection list - angle signals

This selection list is relevant for the following configuration parameters:

Parameters	
<a href="#">C00622</a>	System connection list: Angle

Selection list - angle signals	
0	Not connected
1005	LA_NCtrl: dnFreeOut1_p
1006	LA_NCtrl: dnFreeOut2_p
1205	LA_SwitchPos: dnFreeOut1_p
1206	LA_SwitchPos: dnFreeOut2_p
16000	LP_CanIn1: dnIn34_p
16001	LP_CanIn2: dnIn34_p
16002	LP_CanIn3: dnIn34_p
16003	LP_McIn: dnIn34_p
16006	LP_CanIn1: dnIn12_p
16007	LP_CanIn2: dnIn12_p
16008	LP_CanIn3: dnIn12_p
16009	LP_McIn: dnIn56_p
16010	LP_McIn: dnIn78_p
16011	LP_CanIn4: dnIn12_p
16012	LP_CanIn4: dnIn34_p
17020	LS_DigitalInput: dnPosIn12_p
20000	LS_ParFree_p: dnC474_1_p
20001	LS_ParFree_p: dnC474_2_p
20002	LS_ParFree_p: dnC474_3_p
20003	LS_ParFree_p: dnC474_4_p
32000	LS_MotorInterface: dnMotorPosAct_p
32001	LS_MotorInterface: dnMotorDeltaPosAct_p
32200	LS_MotionControlKernel: dnPosTarget_p
32201	LS_MotionControlKernel: dnPosSetValue_p_
32202	LS_MotionControlKernel: dnDeltaPos_p_
32203	LS_MotionControlKernel: dnMotorRefOffset_p_
32204	LS_MotionControlKernel: dnPosSet_p
32205	LS_MotionControlKernel: dnPosSetRelative_p
32206	LS_MotionControlKernel: dnPosCycle_p
36080	L_Interpolator_1: dnPhiOut_p
42005	LA_NCtrl_In: dnFreeIn1_p
42006	LA_NCtrl_In: dnFreeIn2_p
42205	LA_SwitchPos_In: dnFreeIn1_p
42206	LA_SwitchPos_In: dnFreeIn2_p

## 15.7 Table of attributes

The table of attributes contains information that is required for communication with the inverter via parameters.

### How to read the table of attributes:

Column	Meaning		Entry	
Code	Parameter name		Cxxxxx	
Name	Parameter short text (display text)		Text	
Type	Parameter type		Selection list	Value from selection list
			Bit coded	Bit coded value
			Linear value	Value with setting range
			String	String
Index	dec	Index under which the parameter is addressed. The subindex for array variables corresponds to the Lenze subcode number.	24575 - Lenze code number	Is only required for access via a bus system.
	hex		5FFF <sub>n</sub> - Lenze code number	
Data	DS	Data structure	E	Single variable (only one parameter element)
			A	Array variable (several parameter elements)
	DA	Number of array elements (subcodes)	Number	
	DT	Data type	INTEGER_16	2 bytes with sign
			INTEGER_32	4 bytes with sign
			UNSIGNED_8	1 byte without sign
			UNSIGNED_16	2 bytes without sign
			UNSIGNED_32	4 bytes without sign
	VISIBLE_STRING [xx]	ASCII string (with character length xx)		
Factor	Factor for data transmission via a bus system, depending on the number of decimal positions	Factor	1 ≙ No decimal positions 10 ≙ 1 decimal position 100 ≙ 2 decimal positions 1000 ≙ 3 decimal positions 10000 ≙ 4 decimal positions	
CINH	Writing is only possible if the controller is inhibited	CINH		

Code	Name	Parameter type	Index		DS	DA	Data		
			dec	hex			Data type	Factor	CINH
<a href="#">C00001</a>	Keypad UserLevel	Selection list	24574	5FFE	A	1	UNSIGNED_8	1	
<a href="#">C00002</a>	Device commands	Selection list	24573	5FFD	A	33	UNSIGNED_8	1	
<a href="#">C00003</a>	Status of the last device command	Selection list	24572	5FFC	E	1	UNSIGNED_8	1	
<a href="#">C00005</a>	Application	Selection list	24570	5FFA	E	1	UNSIGNED_16	1	
<a href="#">C00006</a>	Motor control	Selection list	24569	5FF9	E	1	UNSIGNED_8	1	
<a href="#">C00007</a>	Control mode	Selection list	24568	5FF8	E	1	UNSIGNED_16	1	
<a href="#">C00008</a>	Original application control source	Selection list	24567	5FF7	E	1	UNSIGNED_16	1	
<a href="#">C00010</a>	AIN1: Characteristic	Linear value	24565	5FF5	A	8	INTEGER_16	100	
<a href="#">C00011</a>	Appl.: Reference speed	Linear value	24564	5FF4	E	1	UNSIGNED_16	1	
<a href="#">C00012</a>	Accel. time - main setpoint	Linear value	24563	5FF3	E	1	UNSIGNED_32	1000	
<a href="#">C00013</a>	Decel. time - main setpoint	Linear value	24562	5FF2	E	1	UNSIGNED_32	1000	
<a href="#">C00015</a>	VFC: V/f base frequency	Linear value	24560	5FF0	E	1	UNSIGNED_16	10	
<a href="#">C00016</a>	VFC: Vmin boost	Linear value	24559	5FEF	E	1	UNSIGNED_16	100	
<a href="#">C00018</a>	Switching frequency	Selection list	24557	5FED	E	1	UNSIGNED_8	1	
<a href="#">C00019</a>	Auto-DCB: Threshold	Linear value	24556	5FEC	E	1	UNSIGNED_16	1	
<a href="#">C00021</a>	Slip comp.	Linear value	24554	5FEA	E	1	INTEGER_16	100	
<a href="#">C00022</a>	Imax in motor mode	Linear value	24553	5FE9	E	1	UNSIGNED_16	100	
<a href="#">C00023</a>	Imax in generator mode	Linear value	24552	5FE8	E	1	INTEGER_16	100	
Greyed out = display parameter (read access only)									

Code	Name	Parameter type	Index		DS	DA	Data		
			dec	hex			Data type	Factor	CINH
<a href="#">C00024</a>	LS_DriveInterface: bNActCompare	Linear value	24551	5FE7	E	1	INTEGER_16	100	
<a href="#">C00025</a>	LS_DriveInterface: bNActHysteresis	Linear value	24550	5FE6	A	1	INTEGER_16	100	
<a href="#">C00026</a>	AINx: Offset	Linear value	24549	5FE5	A	1	INTEGER_16	100	
<a href="#">C00027</a>	AINx: Gain	Linear value	24548	5FE4	A	1	INTEGER_32	10000	
<a href="#">C00028</a>	AINx: Input voltage	Linear value	24547	5FE3	A	1	INTEGER_16	100	
<a href="#">C00029</a>	AINx: Input current	Linear value	24546	5FE2	A	1	INTEGER_16	100	
<a href="#">C00033</a>	AINx: Output value	Linear value	24542	5FDE	A	1	INTEGER_16	100	
<a href="#">C00034</a>	AINx: Configuration	Selection list	24541	5FDD	A	1	UNSIGNED_8	1	
<a href="#">C00036</a>	DC braking: Current	Linear value	24539	5FDB	E	1	INTEGER_16	100	
<a href="#">C00039</a>	Fixed setpoint x (L_NSet_1 n-Fix)	Linear value	24536	5FD8	A	15	INTEGER_16	100	
<a href="#">C00050</a>	MCTRL: Speed setpoint	Linear value	24525	5FCD	E	1	INTEGER_32	1	
<a href="#">C00051</a>	MCTRL: Actual speed value	Linear value	24524	5FCC	E	1	INTEGER_32	1	
<a href="#">C00052</a>	Motor voltage	Linear value	24523	5FCB	E	1	UNSIGNED_16	1	
<a href="#">C00053</a>	DC-bus voltage	Linear value	24522	5FCA	E	1	UNSIGNED_16	1	
<a href="#">C00054</a>	Motor current	Linear value	24521	5FC9	E	1	UNSIGNED_16	100	
<a href="#">C00055</a>	Actual values	Linear value	24520	5FC8	A	1	INTEGER_16	1	
<a href="#">C00056</a>	Torque	Linear value	24519	5FC7	A	2	INTEGER_32	100	
<a href="#">C00057</a>	Maximum torque	Linear value	24518	5FC6	E	1	UNSIGNED_32	100	
<a href="#">C00058</a>	Output frequency	Linear value	24517	5FC5	E	1	INTEGER_32	100	
<a href="#">C00059</a>	Appl.: Reference frequency C11	Linear value	24516	5FC4	E	1	UNSIGNED_32	100	
<a href="#">C00061</a>	Heatsink temperature	Linear value	24514	5FC2	E	1	INTEGER_16	1	
<a href="#">C00062</a>	Interior temperature	Linear value	24513	5FC1	A	1	INTEGER_16	1	
<a href="#">C00064</a>	Device utilisation (Ixt)	Linear value	24511	5FBF	A	3	INTEGER_16	100	
<a href="#">C00065</a>	Supply voltage 24V	Linear value	24510	5FBE	E	1	INTEGER_16	10	
<a href="#">C00066</a>	Thermal motor load (I*xt)	Linear value	24509	5FBD	E	1	INTEGER_16	100	
<a href="#">C00070</a>	Vp speed controller	Linear value	24505	5FB9	A	3	UNSIGNED_16	100	
<a href="#">C00071</a>	Ti speed controller	Linear value	24504	5FB8	A	3	UNSIGNED_16	10	
<a href="#">C00072</a>	SC: Tdn speed controller	Linear value	24503	5FB7	E	1	UNSIGNED_16	100	
<a href="#">C00073</a>	I <sub>max</sub> /M controller gain	Linear value	24502	5FB6	A	2	UNSIGNED_16	100	
<a href="#">C00074</a>	Reset time I <sub>max</sub> /M controller	Linear value	24501	5FB5	A	2	UNSIGNED_16	1	
<a href="#">C00075</a>	Vp current controller	Linear value	24500	5FB4	E	1	UNSIGNED_16	100	
<a href="#">C00076</a>	Ti current controller	Linear value	24499	5FB3	E	1	UNSIGNED_16	100	
<a href="#">C00079</a>	SC: Settings	Selection list	24496	5FB0	A	4	UNSIGNED_8	1	
<a href="#">C00080</a>	Override point of field weakening	Linear value	24495	5FAF	E	1	INTEGER_16	1	
<a href="#">C00081</a>	Rated motor power	Linear value	24494	5FAE	E	1	UNSIGNED_16	100	
<a href="#">C00082</a>	Motor rotor resistance	Linear value	24493	5FAD	E	1	UNSIGNED_32	1	
<a href="#">C00083</a>	Motor rotor time constant	Linear value	24492	5FAC	E	1	UNSIGNED_16	1	
<a href="#">C00084</a>	Motor stator resistance	Linear value	24491	5FAB	E	1	UNSIGNED_32	1	
<a href="#">C00085</a>	Motor stator leakage inductance	Linear value	24490	5FAA	E	1	UNSIGNED_16	100	
<a href="#">C00087</a>	Rated motor speed	Linear value	24488	5FA8	E	1	UNSIGNED_16	1	
<a href="#">C00088</a>	Rated motor current	Linear value	24487	5FA7	E	1	UNSIGNED_16	100	
<a href="#">C00089</a>	Rated motor frequency	Linear value	24486	5FA6	E	1	UNSIGNED_16	1	
<a href="#">C00090</a>	Rated motor voltage	Linear value	24485	5FA5	E	1	UNSIGNED_16	1	
<a href="#">C00091</a>	Motor cosine phi	Linear value	24484	5FA4	E	1	UNSIGNED_8	100	
<a href="#">C00092</a>	Motor magnetising inductance	Linear value	24483	5FA3	E	1	UNSIGNED_16	10	
<a href="#">C00093</a>	Power section ID	Linear value	24482	5FA2	E	1	UNSIGNED_16	1	
<a href="#">C00095</a>	Motor magnetising current	Linear value	24480	5FA0	E	1	UNSIGNED_16	100	
<a href="#">C00097</a>	Rated motor torque	Linear value	24478	5F9E	E	1	UNSIGNED_32	100	
<a href="#">C00098</a>	Rated device current	Linear value	24477	5F9D	E	1	UNSIGNED_16	10	
<a href="#">C00099</a>	Firmware version	String	24476	5F9C	E	1	VISIBLE_STRING [12]		

Greyed out = display parameter (read access only)

Code	Name	Parameter type	Index		DS	DA	Data		
			dec	hex			Data type	Factor	CINH
<a href="#">C00100</a>	Firmware version	Linear value	24475	5F9B	A	4	UNSIGNED_8	1	
<a href="#">C00101</a>	Add. acceleration time x	Linear value	24474	5F9A	A	15	UNSIGNED_32	1000	
<a href="#">C00103</a>	Add. acceleration time x	Linear value	24472	5F98	A	15	UNSIGNED_32	1000	
<a href="#">C00105</a>	Decel. time - quick stop	Linear value	24470	5F96	E	1	UNSIGNED_32	1000	
<a href="#">C00106</a>	Auto-DCB: Hold time	Linear value	24469	5F95	E	1	UNSIGNED_32	1000	
<a href="#">C00107</a>	DC braking: Hold time	Linear value	24468	5F94	E	1	UNSIGNED_32	1000	
<a href="#">C00114</a>	DigInX: Inversion	Bit coded	24461	5F8D	E	1	UNSIGNED_16	1	
<a href="#">C00115</a>	DI1  DI2: Function	Selection list	24460	5F8C	A	1	UNSIGNED_8	1	
<a href="#">C00118</a>	DigOutX: Inversion	Bit coded	24457	5F89	E	1	UNSIGNED_8	1	
<a href="#">C00120</a>	Setting of motor overload (I*xt)	Linear value	24455	5F87	E	1	INTEGER_16	100	
<a href="#">C00122</a>	Initial value motor overload (I*xt)	Linear value	24453	5F85	A	1	UNSIGNED_16	100	
<a href="#">C00123</a>	Device utilisat. threshold (Ixt)	Linear value	24452	5F84	E	1	INTEGER_16	100	
<a href="#">C00124</a>	Current monitoring: Breaking current	Linear value	24451	5F83	A	1	UNSIGNED_16	100	
<a href="#">C00129</a>	Brake resistance value	Linear value	24446	5F7E	E	1	UNSIGNED_16	10	
<a href="#">C00130</a>	Rated brake resistor power	Linear value	24445	5F7D	E	1	UNSIGNED_16	1	
<a href="#">C00131</a>	Rated heat amount of brake resist.	Linear value	24444	5F7C	E	1	UNSIGNED_16	10	
<a href="#">C00133</a>	Brake resistor utilisation	Linear value	24442	5F7A	E	1	UNSIGNED_16	1	
<a href="#">C00134</a>	L_NSet_1: Ramp smoothing	Selection list	24441	5F79	E	1	UNSIGNED_8	1	
<a href="#">C00136</a>	Communication control words	Bit coded	24439	5F77	A	2	UNSIGNED_16	1	
<a href="#">C00137</a>	Device status	Selection list	24438	5F76	E	1	UNSIGNED_16	1	
<a href="#">C00138</a>	Internal control signals	Bit coded	24437	5F75	A	3	UNSIGNED_16	1	
<a href="#">C00142</a>	Auto-start option	Bit coded	24433	5F71	E	1	UNSIGNED_8	1	
<a href="#">C00144</a>	Thermal switching frequency reduction	Selection list	24431	5F6F	E	1	UNSIGNED_8	1	
<a href="#">C00148</a>	LS_DriveInterface: Error message config.	Bit coded	24427	5F6B	E	1	UNSIGNED_16	1	
<a href="#">C00150</a>	Status word	Bit coded	24425	5F69	E	1	UNSIGNED_16	1	
<a href="#">C00155</a>	Extended status word	Bit coded	24420	5F64	E	1	UNSIGNED_16	1	
<a href="#">C00158</a>	Cause of controller inhibit	Bit coded	24417	5F61	E	1	UNSIGNED_16	1	
<a href="#">C00159</a>	Cause of quick stop QSP	Bit coded	24416	5F60	E	1	UNSIGNED_16	1	
<a href="#">C00160</a>	Status determining error (16-bit)	Linear value	24415	5F5F	A	1	UNSIGNED_16	1	
<a href="#">C00161</a>	LS_SetError_x: Error number	Linear value	24414	5F5E	A	4	UNSIGNED_16	1	
<a href="#">C00162</a>	Error number masked	Linear value	24413	5F5D	A	1	UNSIGNED_32	1	
<a href="#">C00163</a>	Logbook - binary elements	Selection list	24412	5F5C	A	2	UNSIGNED_16	1	
<a href="#">C00164</a>	Logbook - analog elements	Selection list	24411	5F5B	A	1	UNSIGNED_16	1	
<a href="#">C00165</a>	Error information	String	24410	5F5A	A	2	VISIBLE_STRING [14]		
<a href="#">C00166</a>	Error information text	String	24409	5F59	A	6	VISIBLE_STRING [31]		
<a href="#">C00168</a>	Status determining error	Linear value	24407	5F57	E	1	UNSIGNED_32	1	
<a href="#">C00169</a>	Logbook setting	Bit coded	24406	5F56	E	1	UNSIGNED_16	1	
<a href="#">C00170</a>	Current error	Linear value	24405	5F55	E	1	UNSIGNED_32	1	
<a href="#">C00173</a>	Mains voltage	Selection list	24402	5F52	E	1	UNSIGNED_8	1	CINH
<a href="#">C00174</a>	Reduced brake chopper threshold	Linear value	24401	5F51	E	1	UNSIGNED_8	1	
<a href="#">C00175</a>	Brake energy management	Selection list	24400	5F50	E	1	UNSIGNED_8	1	CINH
<a href="#">C00177</a>	Switching cycles	Linear value	24398	5F4E	A	9	UNSIGNED_32	1	
<a href="#">C00178</a>	Elapsed-hour meter	Linear value	24397	5F4D	E	1	UNSIGNED_32	1	
<a href="#">C00179</a>	Power-on time meter	Linear value	24396	5F4C	E	1	UNSIGNED_32	1	
<a href="#">C00180</a>	Running time	Linear value	24395	5F4B	A	3	UNSIGNED_32	1	
<a href="#">C00181</a>	Time settings	Linear value	24394	5F4A	A	1	UNSIGNED_16	1	
<a href="#">C00182</a>	L_NSet_1: S-ramp time PT1	Linear value	24393	5F49	E	1	INTEGER_16	100	
<a href="#">C00184</a>	AutoFailReset repetition time	Linear value	24391	5F47	E	1	UNSIGNED_16	1	
<a href="#">C00185</a>	AutoFailReset residual runtime	Linear value	24390	5F46	E	1	UNSIGNED_16	1	

Greyed out = display parameter (read access only)

Code	Name	Parameter type	Index		DS	DA	Data		
			dec	hex			Data type	Factor	CINH
<a href="#">C00186</a>	Max. number of AutoFailReset processes	Linear value	24389	5F45	E	1	UNSIGNED_8	1	
<a href="#">C00187</a>	Current AutoFailReset processes	Linear value	24388	5F44	E	1	UNSIGNED_8	1	
<a href="#">C00188</a>	AutoFailReset configuration	Selection list	24387	5F43	E	1	UNSIGNED_8	1	
<a href="#">C00189</a>	Resp. to too frequent AutoFailReset	Selection list	24386	5F42	E	1	UNSIGNED_8	1	
<a href="#">C00190</a>	L_NSet_1: Setpoint arithmetic	Selection list	24385	5F41	E	1	UNSIGNED_8	1	
<a href="#">C00191</a>	Logbook access index User	Linear value	24384	5F40	A	1	UNSIGNED_8	1	
<a href="#">C00192</a>	Logbook data User	String	24383	5F3F	A	1	OCTET_STRING [32]		
<a href="#">C00193</a>	Logbook element User	Linear value	24382	5F3E	A	6	UNSIGNED_32	1	
<a href="#">C00199</a>	Description data	String	24376	5F38	A	5	VISIBLE_STRING [32]		
<a href="#">C00200</a>	Firmware product type	String	24375	5F37	E	1	VISIBLE_STRING [19]		
<a href="#">C00201</a>	Firmware	String	24374	5F36	A	6	VISIBLE_STRING [22]		
<a href="#">C00203</a>	Product type code	String	24372	5F34	A	9	VISIBLE_STRING [24]		
<a href="#">C00204</a>	Serial number	String	24371	5F33	A	9	VISIBLE_STRING [24]		
<a href="#">C00219</a>	Identification	Linear value	24356	5F24	A	4	UNSIGNED_32	1	
<a href="#">C00220</a>	L_NSet_1: Acceleration time - add. setpoint	Linear value	24355	5F23	E	1	UNSIGNED_32	1000	
<a href="#">C00221</a>	L_NSet_1: Deceleration time - add. setpoint	Linear value	24354	5F22	E	1	UNSIGNED_32	1000	
<a href="#">C00222</a>	L_PCTRL_1: Vp	Linear value	24353	5F21	E	1	INTEGER_16	10	
<a href="#">C00223</a>	L_PCTRL_1: Tn	Linear value	24352	5F20	E	1	UNSIGNED_16	1	
<a href="#">C00224</a>	L_PCTRL_1: Kd	Linear value	24351	5F1F	E	1	UNSIGNED_16	10	
<a href="#">C00225</a>	L_PCTRL_1: MaxLimit	Linear value	24350	5F1E	E	1	INTEGER_16	100	
<a href="#">C00226</a>	L_PCTRL_1: MinLimit	Linear value	24349	5F1D	E	1	INTEGER_16	100	
<a href="#">C00227</a>	L_PCTRL_1: Acceleration time	Linear value	24348	5F1C	E	1	UNSIGNED_32	1000	
<a href="#">C00228</a>	L_PCTRL_1: Deceleration time	Linear value	24347	5F1B	E	1	UNSIGNED_32	1000	
<a href="#">C00231</a>	L_PCTRL_1: Operating range	Linear value	24344	5F18	A	4	INTEGER_16	100	
<a href="#">C00233</a>	L_PCTRL_1: Root function	Selection list	24342	5F16	E	1	UNSIGNED_8	1	
<a href="#">C00234</a>	Oscillation damping influence	Linear value	24341	5F15	E	1	UNSIGNED_16	100	
<a href="#">C00235</a>	Oscillation damping filter time	Linear value	24340	5F14	E	1	UNSIGNED_8	1	
<a href="#">C00236</a>	Oscillation damping field weakening	Linear value	24339	5F13	E	1	UNSIGNED_8	1	
<a href="#">C00241</a>	L_NSet_1: Hyst. NSet reached	Linear value	24334	5F0E	E	1	INTEGER_16	100	
<a href="#">C00242</a>	L_PCTRL_1: Operating mode	Selection list	24333	5F0D	E	1	UNSIGNED_8	1	
<a href="#">C00243</a>	L_PCTRL_1: Accel. time influence	Linear value	24332	5F0C	E	1	UNSIGNED_32	1000	
<a href="#">C00244</a>	L_PCTRL_1: Deceleration time influence	Linear value	24331	5F0B	E	1	UNSIGNED_32	1000	
<a href="#">C00245</a>	L_PCTRL_1: PID output value	Linear value	24330	5F0A	E	1	INTEGER_16	100	
<a href="#">C00246</a>	L_PCTRL_1: nAct_a internal	Linear value	24329	5F09	E	1	INTEGER_16	100	
<a href="#">C00247</a>	L_PCTRL_1: Window setpoint reached	Linear value	24328	5F08	E	1	INTEGER_16	100	
<a href="#">C00249</a>	L_PT1_1: Time constant	Linear value	24326	5F06	E	1	UNSIGNED_16	1	
<a href="#">C00270</a>	SC: Freq. current setpoint filter	Linear value	24305	5EF1	E	1	UNSIGNED_16	10	
<a href="#">C00271</a>	SC: Current setpoint filter width	Linear value	24304	5EF0	E	1	UNSIGNED_16	10	
<a href="#">C00272</a>	SC: Current setpoint filter depth	Linear value	24303	5EEF	E	1	UNSIGNED_16	1	
<a href="#">C00273</a>	Motor moment of inertia	Linear value	24302	5EEE	E	1	UNSIGNED_32	100	
<a href="#">C00274</a>	SC: Max. change in acceleration	Linear value	24301	5EED	E	1	UNSIGNED_16	10	
<a href="#">C00275</a>	Setpoint feedforward control filtering	Linear value	24300	5EEC	E	1	UNSIGNED_16	10	
<a href="#">C00276</a>	SC: max. output voltage	Linear value	24299	5EEB	E	1	UNSIGNED_8	1	
<a href="#">C00280</a>	SC: Filter time const. DC detection	Linear value	24295	5EE7	E	1	UNSIGNED_16	1	
<a href="#">C00312</a>	System runtimes	Linear value	24263	5EC7	A	1	UNSIGNED_32	1000	
<a href="#">C00321</a>	Main program runtime	Linear value	24254	5EBE	A	2	UNSIGNED_16	1	
<a href="#">C00322</a>	Transmission mode CAN TxPDOs	Linear value	24253	5EBD	A	4	UNSIGNED_8	1	

Greyed out = display parameter (read access only)



Code	Name	Parameter type	Index		DS	DA	Data		
			dec	hex			Data type	Factor	CINH
<a href="#">C00323</a>	Transmission mode CAN Rx PDOs	Linear value	24252	5EBC	A	4	UNSIGNED_8	1	
<a href="#">C00324</a>	CAN transmit blocking time	Linear value	24251	5EBB	A	5	UNSIGNED_16	1	
<a href="#">C00338</a>	L_Arithmetik_1: Function	Selection list	24237	5EAD	E	1	UNSIGNED_8	1	
<a href="#">C00339</a>	L_Arithmetik_2: Function	Selection list	24236	5EAC	E	1	UNSIGNED_8	1	
<a href="#">C00341</a>	CAN management - error configuration	Bit coded	24234	5EAA	E	1	UNSIGNED_16	1	
<a href="#">C00342</a>	CAN decoupling PDOInOut	Bit coded	24233	5EA9	A	2	UNSIGNED_16	1	
<a href="#">C00343</a>	LP_CanIn decoupling value	Linear value	24232	5EA8	A	16	UNSIGNED_16	1	
<a href="#">C00344</a>	LP_CanOut decoupling value	Linear value	24231	5EA7	A	16	UNSIGNED_16	1	
<a href="#">C00345</a>	CAN error status	Selection list	24230	5EA6	E	1	UNSIGNED_8	1	
<a href="#">C00347</a>	CAN status HeartBeat producer	Selection list	24228	5EA4	A	7	UNSIGNED_8	1	
<a href="#">C00349</a>	CAN setting - DIP switch	Bit coded	24226	5EA2	E	1	UNSIGNED_16	1	
<a href="#">C00350</a>	CAN node address	Linear value	24225	5EA1	E	1	UNSIGNED_8	1	
<a href="#">C00351</a>	CAN baud rate	Selection list	24224	5EA0	E	1	UNSIGNED_8	1	
<a href="#">C00352</a>	CAN slave/master	Selection list	24223	5E9F	E	1	UNSIGNED_8	1	
<a href="#">C00353</a>	CAN IN/OUT COBID source	Selection list	24222	5E9E	A	4	UNSIGNED_8	1	
<a href="#">C00354</a>	COBID	Bit coded	24221	5E9D	A	8	UNSIGNED_32	1	
<a href="#">C00355</a>	Active COBID	Linear value	24220	5E9C	A	8	UNSIGNED_16	1	
<a href="#">C00356</a>	CAN time settings	Linear value	24219	5E9B	A	6	UNSIGNED_16	1	
<a href="#">C00357</a>	CAN monitoring times	Linear value	24218	5E9A	A	4	UNSIGNED_16	1	
<a href="#">C00358</a>	CANx_OUT data length	Linear value	24217	5E99	A	4	UNSIGNED_8	1	
<a href="#">C00359</a>	CAN status	Selection list	24216	5E98	E	1	UNSIGNED_8	1	
<a href="#">C00360</a>	CAN telegram counter	Linear value	24215	5E97	A	14	UNSIGNED_16	1	
<a href="#">C00364</a>	CAN MessageError	Selection list	24211	5E93	E	1	UNSIGNED_8	1	
<a href="#">C00366</a>	Number of CAN SDO channels	Selection list	24209	5E91	E	1	UNSIGNED_8	1	
<a href="#">C00367</a>	CAN SYNC Rx identifier	Bit coded	24208	5E90	E	1	UNSIGNED_16	1	
<a href="#">C00368</a>	CAN SYNC Tx identifier	Bit coded	24207	5E8F	E	1	UNSIGNED_16	1	
<a href="#">C00369</a>	CAN sync transmission cycle time	Linear value	24206	5E8E	E	1	UNSIGNED_16	1	
<a href="#">C00370</a>	SyncTxRxTimes	Linear value	24205	5E8D	A	2	INTEGER_16	1	
<a href="#">C00371</a>	CAN ErrorCode	Linear value	24204	5E8C	A	1	UNSIGNED_16	1	
<a href="#">C00372</a>	CAN_Tx_Rx_Error	Linear value	24203	5E8B	A	4	UNSIGNED_8	1	
<a href="#">C00381</a>	CAN Heartbeat producer time	Linear value	24194	5E82	E	1	UNSIGNED_16	1	
<a href="#">C00385</a>	CAN node addr. HeartBeat producer	Linear value	24190	5E7E	A	7	UNSIGNED_8	1	
<a href="#">C00386</a>	ConsumerTime HeartBeat Producer	Linear value	24189	5E7D	A	7	UNSIGNED_16	1	
<a href="#">C00387</a>	CAN-GatewayAddr	Linear value	24188	5E7C	A	1	UNSIGNED_8	1	
<a href="#">C00400</a>	LS_PulseGenerator	Linear value	24175	5E6F	A	3	UNSIGNED_16	1	
<a href="#">C00401</a>	CANxInOut: Inversion	Bit coded	24174	5E6E	A	8	UNSIGNED_16	1	
<a href="#">C00407</a>	LP_CanIn mapping	Linear value	24168	5E68	A	8	UNSIGNED_32	1	
<a href="#">C00408</a>	LP_CanIn mapping selection	Selection list	24167	5E67	A	4	UNSIGNED_8	1	
<a href="#">C00409</a>	LP_CanIn mapping	Linear value	24166	5E66	A	16	UNSIGNED_16	1	
<a href="#">C00410</a>	L_SignalMonitor_a: Signal sources	Selection list	24165	5E65	A	4	UNSIGNED_16	1	
<a href="#">C00411</a>	L_SignalMonitor_b: Signal sources	Selection list	24164	5E64	A	4	UNSIGNED_16	1	
<a href="#">C00412</a>	L_SignalMonitor_b: Inversion	Bit coded	24163	5E63	E	1	UNSIGNED_8	1	
<a href="#">C00413</a>	L_SignalMonitor_a: Offs./gain	Linear value	24162	5E62	A	8	INTEGER_16	100	
<a href="#">C00420</a>	Number of encoder increments	Linear value	24155	5E5B	A	1	UNSIGNED_16	1	
<a href="#">C00423</a>	DOx: Delay times	Linear value	24152	5E58	A	4	UNSIGNED_16	1000	
<a href="#">C00425</a>	Encoder scanning time	Selection list	24150	5E56	A	1	UNSIGNED_8	1	CINH
<a href="#">C00434</a>	O1U: Gain	Linear value	24141	5E4D	A	1	INTEGER_16	100	
<a href="#">C00435</a>	O1U: Offset	Linear value	24140	5E4C	A	1	INTEGER_16	100	
<a href="#">C00436</a>	O1U: Voltage	Linear value	24139	5E4B	A	1	INTEGER_16	100	

Greyed out = display parameter (read access only)

Code	Name	Parameter type	Index		DS	DA	Data		
			dec	hex			Data type	Factor	CINH
<a href="#">C00439</a>	O1U: Input value	Linear value	24136	5E48	A	1	INTEGER_16	100	
<a href="#">C00440</a>	LS_AnalogIn1: PT1 time constant	Linear value	24135	5E47	A	1	UNSIGNED_16	1	
<a href="#">C00441</a>	Decoupling AnalogOut	Bit coded	24134	5E46	E	1	UNSIGNED_16	1	
<a href="#">C00442</a>	AOut1: Decoupling value	Linear value	24133	5E45	A	1	INTEGER_16	100	
<a href="#">C00443</a>	Dlx: Level	Bit coded	24132	5E44	A	2	UNSIGNED_16	1	
<a href="#">C00444</a>	DOx: Level	Bit coded	24131	5E43	A	2	UNSIGNED_16	1	
<a href="#">C00445</a>	FreqInxx_nOut_v	Linear value	24130	5E42	A	1	INTEGER_16	1	
<a href="#">C00446</a>	FreqInxx_nOut_a	Linear value	24129	5E41	A	1	INTEGER_16	100	
<a href="#">C00447</a>	DigOut decoupling	Bit coded	24128	5E40	E	1	UNSIGNED_16	1	
<a href="#">C00448</a>	DigOut decoupling value	Bit coded	24127	5E3F	E	1	UNSIGNED_16	1	
<a href="#">C00449</a>	FreqInxx_dnOut_p	Linear value	24126	5E3E	A	1	INTEGER_32	1	
<a href="#">C00453</a>	Keypad: Default manual jog	Linear value	24122	5E3A	A	2	UNSIGNED_32	1000	
<a href="#">C00461</a>	Remote: Acceleration/deceleration time	Linear value	24114	5E32	A	1	UNSIGNED_32	1000	
<a href="#">C00462</a>	Remote: Control	Linear value	24113	5E31	A	2	UNSIGNED_16	1	
<a href="#">C00463</a>	Remote: MCK control	Bit coded	24112	5E30	A	1	UNSIGNED_32	1	
<a href="#">C00464</a>	Remote: Monitoring timeout	Linear value	24111	5E2F	A	1	UNSIGNED_16	1	
<a href="#">C00465</a>	Keypad: Time-out welcome screen	Selection list	24110	5E2E	E	1	INTEGER_32	1	
<a href="#">C00466</a>	Keypad: Default parameter	Linear value	24109	5E2D	E	1	INTEGER_32	1	
<a href="#">C00467</a>	Keypad: Default welcome screen	Selection list	24108	5E2C	E	1	INTEGER_32	1	
<a href="#">C00469</a>	Keypad: Fct. STOP key	Selection list	24106	5E2A	E	1	INTEGER_32	1	CINH
<a href="#">C00470</a>	LS_ParFree_b	Selection list	24105	5E29	A	16	UNSIGNED_8	1	
<a href="#">C00471</a>	LS_ParFree	Bit coded	24104	5E28	A	4	UNSIGNED_16	1	
<a href="#">C00472</a>	LS_ParFree_a	Linear value	24103	5E27	A	4	INTEGER_16	100	
<a href="#">C00473</a>	LS_ParFree_v	Linear value	24102	5E26	A	4	INTEGER_16	1	
<a href="#">C00474</a>	LS_ParFree_p	Linear value	24101	5E25	A	4	INTEGER_32	1	
<a href="#">C00480</a>	LS_DisFree_b	Bit coded	24095	5E1F	E	1	UNSIGNED_8	1	
<a href="#">C00481</a>	LS_DisFree	Bit coded	24094	5E1E	A	4	UNSIGNED_16	1	
<a href="#">C00482</a>	LS_DisFree_a	Linear value	24093	5E1D	A	4	INTEGER_16	100	
<a href="#">C00484</a>	Application units: Offset	Linear value	24091	5E1B	A	4	INTEGER_16	100	
<a href="#">C00485</a>	Application units: Display factor	Linear value	24090	5E1A	A	4	INTEGER_32	10000	
<a href="#">C00486</a>	Application units: Text	String	24089	5E19	A	4	VISIBLE_STRING [7]		
<a href="#">C00487</a>	Application units	Linear value	24088	5E18	A	4	INTEGER_32	100	
<a href="#">C00488</a>	L_JogCtrlEdgeDetect_1	Selection list	24087	5E17	A	6	UNSIGNED_8	1	
<a href="#">C00490</a>	Position encoder selection	Selection list	24085	5E15	E	1	UNSIGNED_8	1	
<a href="#">C00495</a>	Speed sensor selection	Selection list	24080	5E10	E	1	UNSIGNED_8	1	
<a href="#">C00496</a>	Encoder evaluation method DigIn12	Selection list	24079	5E0F	E	1	UNSIGNED_8	1	CINH
<a href="#">C00497</a>	Filter time constant	Linear value	24078	5E0E	A	1	UNSIGNED_16	10	
<a href="#">C00505</a>	Password data	String	24070	5E06	A	3	VISIBLE_STRING [16]		
<a href="#">C00506</a>	PW protection internal config	Bit coded	24069	5E05	A	1	UNSIGNED_16	1	
<a href="#">C00507</a>	Current password protection	Bit coded	24068	5E04	A	1	UNSIGNED_16	1	
<a href="#">C00508</a>	PW protection config X6(DIAG)	Bit coded	24067	5E03	A	1	UNSIGNED_16	1	
<a href="#">C00509</a>	PW protection config X1 (CAN)	Bit coded	24066	5E02	A	1	UNSIGNED_16	1	
<a href="#">C00510</a>	PW protection config. MCI	Bit coded	24065	5E01	A	1	UNSIGNED_16	1	
<a href="#">C00517</a>	User menu	Linear value	24058	5DFA	A	32	INTEGER_32	1000	
<a href="#">C00560</a>	Fan switching status	Selection list	24015	5DCF	A	2	UNSIGNED_8	1	
<a href="#">C00561</a>	Failure indication	Selection list	24014	5DCE	A	5	UNSIGNED_8	1	
<a href="#">C00563</a>	Current monitoring: Delay time	Linear value	24012	5DCC	A	1	UNSIGNED_32	1000	
<a href="#">C00565</a>	Resp. to mains phase failure	Selection list	24010	5DCA	E	1	UNSIGNED_8	1	
<a href="#">C00566</a>	Resp. to fan failure	Selection list	24009	5DC9	E	1	UNSIGNED_8	1	
Greyed out = display parameter (read access only)									

Code	Name	Parameter type	Index		DS	DA	Data		
			dec	hex			Data type	Factor	CINH
<a href="#">C00567</a>	Resp. to speed controller limited	Selection list	24008	5DC8	E	1	UNSIGNED_8	1	
<a href="#">C00569</a>	Resp. to peak current	Selection list	24006	5DC6	A	1	UNSIGNED_8	1	
<a href="#">C00570</a>	Resp. to controller limitations	Selection list	24005	5DC5	A	4	UNSIGNED_8	1	
<a href="#">C00571</a>	Resp. to wrong controller setting	Selection list	24004	5DC4	A	2	UNSIGNED_8	1	
<a href="#">C00572</a>	Brake resistor overload threshold	Linear value	24003	5DC3	E	1	UNSIGNED_8	1	
<a href="#">C00574</a>	Resp. to brake resist. overtemp.	Selection list	24001	5DC1	E	1	UNSIGNED_8	1	
<a href="#">C00579</a>	Resp. to max. speed/output freq. reached	Selection list	23996	5DBC	E	1	UNSIGNED_8	1	
<a href="#">C00580</a>	Resp. to operating system error	Selection list	23995	5DBB	A	1	UNSIGNED_8	1	
<a href="#">C00581</a>	Resp. to LS_SetError_x	Selection list	23994	5DBA	A	4	UNSIGNED_8	1	
<a href="#">C00582</a>	Resp. to heatsink temp.> shutdown temp. -5°C	Selection list	23993	5DB9	E	1	UNSIGNED_8	1	
<a href="#">C00584</a>	Resp. to current monitoring	Selection list	23991	5DB7	A	1	UNSIGNED_8	1	
<a href="#">C00585</a>	Resp. to motor overtemp. PTC	Selection list	23990	5DB6	E	1	UNSIGNED_8	1	
<a href="#">C00586</a>	Resp. open circuit HTL encoder	Selection list	23989	5DB5	E	1	UNSIGNED_8	1	
<a href="#">C00588</a>	Resp. to max. speed at switching freq.	Selection list	23987	5DB3	E	1	UNSIGNED_8	1	
<a href="#">C00590</a>	Resp. to switch. frequency red.	Selection list	23985	5DB1	E	1	UNSIGNED_8	1	
<a href="#">C00592</a>	Resp. to CAN bus connection	Selection list	23983	5DAF	A	5	UNSIGNED_8	1	
<a href="#">C00593</a>	Resp. to CANx_IN monitoring	Selection list	23982	5DAE	A	4	UNSIGNED_8	1	
<a href="#">C00594</a>	Resp. to control word error	Selection list	23981	5DAD	A	2	UNSIGNED_8	1	
<a href="#">C00595</a>	MCK: Resp. to MCK error	Selection list	23980	5DAC	A	17	UNSIGNED_8	1	
<a href="#">C00597</a>	Resp. to motor phase failure	Selection list	23978	5DAA	E	1	UNSIGNED_8	1	
<a href="#">C00598</a>	Resp. to open circuit AINx	Selection list	23977	5DA9	A	1	UNSIGNED_8	1	
<a href="#">C00599</a>	Motor phase failure threshold	Linear value	23976	5DA8	E	1	INTEGER_16	100	
<a href="#">C00600</a>	Resp. to DC bus voltage	Selection list	23975	5DA7	A	1	UNSIGNED_8	1	
<a href="#">C00601</a>	Delayed resp. to fault: DC bus overvoltage	Linear value	23974	5DA6	A	1	UNSIGNED_16	1000	
<a href="#">C00602</a>	Resp. to earth fault	Selection list	23973	5DA5	E	1	UNSIGNED_8	1	
<a href="#">C00604</a>	Resp. to device overload (Ixt)	Selection list	23971	5DA3	E	1	UNSIGNED_8	1	
<a href="#">C00606</a>	Resp. to motor overload (I*xt)	Selection list	23969	5DA1	E	1	UNSIGNED_8	1	
<a href="#">C00607</a>	Resp. to max. freq. feedb. DIG12/67	Selection list	23968	5DA0	E	1	UNSIGNED_8	1	
<a href="#">C00608</a>	Resp. to maximum torque	Selection list	23967	5D9F	E	1	UNSIGNED_8	1	
<a href="#">C00609</a>	Resp. to maximum current	Selection list	23966	5D9E	E	1	UNSIGNED_8	1	
<a href="#">C00620</a>	System connection list: 16-bit	Selection list	23955	5D93	A	111	UNSIGNED_16	1	
<a href="#">C00621</a>	System connection list: Bool	Selection list	23954	5D92	A	199	UNSIGNED_16	1	
<a href="#">C00622</a>	System connection list: Angle	Selection list	23953	5D91	A	25	UNSIGNED_16	1	
<a href="#">C00632</a>	L_NSet_1: Max. skip freq.	Linear value	23943	5D87	A	3	INTEGER_16	100	
<a href="#">C00633</a>	L_NSet_1: Min. skip freq.	Linear value	23942	5D86	A	3	INTEGER_16	100	
<a href="#">C00634</a>	L_NSet_1: wState	Bit coded	23941	5D85	E	1	UNSIGNED_16	1	
<a href="#">C00635</a>	L_NSet_1: nMaxLimit	Linear value	23940	5D84	E	1	INTEGER_16	100	
<a href="#">C00636</a>	L_NSet_1: nMinLimit	Linear value	23939	5D83	E	1	INTEGER_16	100	
<a href="#">C00637</a>	L_NSet_1: Output blocking zones	Linear value	23938	5D82	E	1	INTEGER_16	100	
<a href="#">C00638</a>	L_NSet_1: Output ramp rounding	Linear value	23937	5D81	E	1	INTEGER_16	100	
<a href="#">C00639</a>	L_NSet_1: Output add.value	Linear value	23936	5D80	E	1	INTEGER_16	100	
<a href="#">C00640</a>	L_NSet_1: nNOut_a	Linear value	23935	5D7F	E	1	INTEGER_16	100	
<a href="#">C00643</a>	Resp. to PLI monitoring	Selection list	23932	5D7C	A	1	UNSIGNED_8	1	
<a href="#">C00653</a>	Sensibility - Setpoint feedforward control	Selection list	23922	5D72	A	1	UNSIGNED_8	1	
<a href="#">C00654</a>	Source of diff. setpoint feedforward control	Selection list	23921	5D71	A	1	UNSIGNED_8	1	
<a href="#">C00670</a>	L_OffsetGainP_1: Gain	Linear value	23905	5D61	E	1	INTEGER_32	10000	
<a href="#">C00671</a>	L_OffsetGainP_2: Gain	Linear value	23904	5D60	E	1	INTEGER_32	10000	

Greyed out = display parameter (read access only)

Code	Name	Parameter type	Index		DS	DA	Data		
			dec	hex			Data type	Factor	CINH
<a href="#">C00672</a>	L_OffsetGainP_3: Gain	Linear value	23903	5D5F	E	1	INTEGER_32	10000	
<a href="#">C00680</a>	L_Compare_1: Fct.	Selection list	23895	5D57	E	1	UNSIGNED_8	1	
<a href="#">C00681</a>	L_Compare_1: Hysteresis	Linear value	23894	5D56	E	1	INTEGER_16	100	
<a href="#">C00682</a>	L_Compare_1: Window	Linear value	23893	5D55	E	1	INTEGER_16	100	
<a href="#">C00685</a>	L_Compare_2: Fct.	Selection list	23890	5D52	E	1	UNSIGNED_8	1	
<a href="#">C00686</a>	L_Compare_2: Hysteresis	Linear value	23889	5D51	E	1	INTEGER_16	100	
<a href="#">C00687</a>	L_Compare_2: Window	Linear value	23888	5D50	E	1	INTEGER_16	100	
<a href="#">C00690</a>	L_Compare_3: Fct.	Selection list	23885	5D4D	E	1	UNSIGNED_8	1	
<a href="#">C00691</a>	L_Compare_3: Hysteresis	Linear value	23884	5D4C	E	1	INTEGER_16	100	
<a href="#">C00692</a>	L_Compare_3: Window	Linear value	23883	5D4B	E	1	INTEGER_16	100	
<a href="#">C00696</a>	L_OffsetGainP_1: Offset	Linear value	23879	5D47	E	1	INTEGER_16	100	
<a href="#">C00697</a>	L_OffsetGainP_2: Offset	Linear value	23878	5D46	E	1	INTEGER_16	100	
<a href="#">C00698</a>	L_OffsetGainP_3: Offset	Linear value	23877	5D45	E	1	INTEGER_16	100	
<a href="#">C00699</a>	L_MulDiv_1: Parameter	Linear value	23876	5D44	A	2	INTEGER_16	1	
<a href="#">C00700</a>	LA_NCtrl: Analog connection list	Selection list	23875	5D43	A	29	UNSIGNED_16	1	
<a href="#">C00701</a>	LA_NCtrl: Digital connection list	Selection list	23874	5D42	A	48	UNSIGNED_16	1	
<a href="#">C00720</a>	L_DigitalDelay_1: Delay	Linear value	23855	5D2F	A	2	UNSIGNED_32	1000	
<a href="#">C00725</a>	Current switching frequency	Selection list	23850	5D2A	E	1	UNSIGNED_8	1	
<a href="#">C00727</a>	LS_Keypad digital values	Linear value	23848	5D28	A	8	UNSIGNED_8	1	
<a href="#">C00728</a>	Analog values - keypad	Linear value	23847	5D27	A	3	INTEGER_16	100	
<a href="#">C00729</a>	Remote: Setpoint selection	Linear value	23846	5D26	A	2	INTEGER_16	100	
<a href="#">C00760</a>	LA_SwitchPos: Analog connection list	Selection list	23815	5D07	A	25	UNSIGNED_16	1	
<a href="#">C00761</a>	LA_SwitchPos: Digital connection list	Selection list	23814	5D06	A	47	UNSIGNED_16	1	
<a href="#">C00800</a>	L_MPot_1: Upper limit	Linear value	23775	5CDF	E	1	INTEGER_16	100	
<a href="#">C00801</a>	L_MPot_1: Lower limit	Linear value	23774	5CDE	E	1	INTEGER_16	100	
<a href="#">C00802</a>	L_MPot_1: Acceleration time	Linear value	23773	5CDD	E	1	UNSIGNED_16	10	
<a href="#">C00803</a>	L_MPot_1: Deceleration time	Linear value	23772	5CDC	E	1	UNSIGNED_16	10	
<a href="#">C00804</a>	L_MPot_1: Inactive fct.	Selection list	23771	5CDB	E	1	UNSIGNED_8	1	
<a href="#">C00805</a>	L_MPot_1: Init fct.	Selection list	23770	5CDA	E	1	UNSIGNED_8	1	
<a href="#">C00806</a>	L_MPot_1: Use	Selection list	23769	5CD9	E	1	UNSIGNED_8	1	
<a href="#">C00820</a>	L_DigitalLogic_1: Function	Selection list	23755	5CCB	E	1	UNSIGNED_8	1	
<a href="#">C00821</a>	L_DigitalLogic_1: Truth table	Selection list	23754	5CCA	A	24	UNSIGNED_8	1	
<a href="#">C00828</a>	L_DigitalLogic_3: Function	Selection list	23747	5CC3	E	1	UNSIGNED_8	1	
<a href="#">C00829</a>	L_DigitalLogic_3: truth table	Selection list	23746	5CC2	A	24	UNSIGNED_8	1	
<a href="#">C00830</a>	16-bit inputs [%]	Linear value	23745	5CC1	A	105	INTEGER_16	100	
<a href="#">C00831</a>	16-bit inputs	Bit coded	23744	5CC0	A	105	UNSIGNED_16	1	
<a href="#">C00833</a>	Binary inputs	Selection list	23742	5CBE	A	131	UNSIGNED_8	1	
<a href="#">C00834</a>	32-bit inputs [incr]	Linear value	23741	5CBD	A	12	INTEGER_32	1	
<a href="#">C00840</a>	16-bit inputs I/O level [%]	Linear value	23735	5CB7	A	111	INTEGER_16	100	
<a href="#">C00841</a>	16-bit inputs I/O level	Bit coded	23734	5CB6	A	111	UNSIGNED_16	1	
<a href="#">C00843</a>	Binary inputs I/O level	Selection list	23732	5CB4	A	199	UNSIGNED_8	1	
<a href="#">C00844</a>	32-bit inputs I/O level [incr]	Linear value	23731	5CB3	A	25	INTEGER_32	1	
<a href="#">C00866</a>	CAN input words	Bit coded	23709	5C9D	A	16	UNSIGNED_16	1	
<a href="#">C00868</a>	CAN output words	Bit coded	23707	5C9B	A	16	UNSIGNED_16	1	
<a href="#">C00876</a>	MCI input words	Bit coded	23699	5C93	A	16	UNSIGNED_16	1	
<a href="#">C00877</a>	MCI output words	Bit coded	23698	5C92	A	16	UNSIGNED_16	1	
<a href="#">C00890</a>	MCI_InOut: Inversion	Bit coded	23685	5C85	A	4	UNSIGNED_16	1	
<a href="#">C00905</a>	Motor phase direction of rotation	Selection list	23670	5C76	E	1	UNSIGNED_8	1	CINH
<a href="#">C00909</a>	Speed limitation	Linear value	23666	5C72	A	2	INTEGER_16	100	
<a href="#">C00910</a>	Frequency limitation	Linear value	23665	5C71	A	2	UNSIGNED_16	1	

Greyed out = display parameter (read access only)

Code	Name	Parameter type	Index		DS	DA	Data		
			dec	hex			Data type	Factor	CINH
<a href="#">C00915</a>	Motor cable length	Linear value	23660	5C6C	E	1	UNSIGNED_16	10	
<a href="#">C00916</a>	Motor cable cross-section	Linear value	23659	5C6B	E	1	UNSIGNED_16	100	
<a href="#">C00917</a>	Motor cable resistance	Linear value	23658	5C6A	E	1	UNSIGNED_16	1	
<a href="#">C00919</a>	Load moment of inertia	Linear value	23656	5C68	A	1	UNSIGNED_32	100	
<a href="#">C00920</a>	Rated device currents	Linear value	23655	5C67	A	8	UNSIGNED_16	10	
<a href="#">C00937</a>	Field-oriented motor currents	Linear value	23638	5C56	A	2	INTEGER_16	100	
<a href="#">C00938</a>	PSM: Maximum motor current field weakening	Linear value	23637	5C55	E	1	UNSIGNED_16	100	
<a href="#">C00939</a>	Ultimate motor current	Linear value	23636	5C54	E	1	UNSIGNED_16	10	
<a href="#">C00950</a>	L_Interpolator_1: Activation FB functions	Selection list	23625	5C49	A	3	UNSIGNED_8	1	
<a href="#">C00951</a>	L_Interpolator_1: No. of interpolation steps	Linear value	23624	5C48	E	1	UNSIGNED_16	1	
<a href="#">C00952</a>	L_Interpolator_1: Limit value - error cycles	Linear value	23623	5C47	E	1	UNSIGNED_16	1	
<a href="#">C00953</a>	L_Interpolator_1: Speed-up	Linear value	23622	5C46	E	1	UNSIGNED_8	1	
<a href="#">C00965</a>	Max. motor speed	Linear value	23610	5C3A	E	1	UNSIGNED_16	1	
<a href="#">C00966</a>	VFC: Time const. slip comp.	Linear value	23609	5C39	E	1	UNSIGNED_16	1	
<a href="#">C00967</a>	VFC: Frequency interpol. point n	Linear value	23608	5C38	A	11	INTEGER_16	10	
<a href="#">C00968</a>	VFC: Voltage interpol. point n	Linear value	23607	5C37	A	11	UNSIGNED_16	100	
<a href="#">C00969</a>	Motor parameters	Linear value	23606	5C36	A	1	UNSIGNED_8	1	
<a href="#">C00970</a>	Rated device voltage	Linear value	23605	5C35	A	1	UNSIGNED_16	1	
<a href="#">C00971</a>	VFC: V/f +encoder limitation	Linear value	23604	5C34	A	2	UNSIGNED_16	100	
<a href="#">C00972</a>	VFC: Vp V/f +encoder	Linear value	23603	5C33	E	1	UNSIGNED_16	1000	
<a href="#">C00973</a>	VFC: Ti V/f +encoder	Linear value	23602	5C32	E	1	UNSIGNED_16	10	
<a href="#">C00975</a>	VFC-ECO: Vp CosPhi controller	Linear value	23600	5C30	E	1	UNSIGNED_16	1000	
<a href="#">C00976</a>	VFC-ECO: Ti CosPhi controller	Linear value	23599	5C2F	E	1	UNSIGNED_16	10	
<a href="#">C00977</a>	VFC-ECO: Minimum voltage V/f	Linear value	23598	5C2E	E	1	INTEGER_16	100	
<a href="#">C00978</a>	VFC-ECO: Voltage reduction	Linear value	23597	5C2D	E	1	INTEGER_16	1	
<a href="#">C00979</a>	Cosine phi	Linear value	23596	5C2C	A	2	INTEGER_16	100	
<a href="#">C00980</a>	Performance indication	Linear value	23595	5C2B	A	4	INTEGER_32	1000	
<a href="#">C00981</a>	Energy display	Linear value	23594	5C2A	A	2	INTEGER_32	100	
<a href="#">C00982</a>	VFC-ECO: Voltage reduction ramp	Linear value	23593	5C29	E	1	UNSIGNED_8	10	
<a href="#">C00983</a>	Delay	Linear value	23592	5C28	A	2	UNSIGNED_16	1	
<a href="#">C00985</a>	SLVC: Gain of field current controller	Linear value	23590	5C26	E	1	INTEGER_16	100	
<a href="#">C00986</a>	SLVC: Gain of cross current controller	Linear value	23589	5C25	E	1	INTEGER_16	100	
<a href="#">C00987</a>	Inverter motor brake: nAdd	Linear value	23588	5C24	E	1	INTEGER_16	1	
<a href="#">C00988</a>	Inverter motor brake: PT1 filter time	Linear value	23587	5C23	E	1	INTEGER_16	10	
<a href="#">C00989</a>	Restart on the fly: Flying restart frequency fd_add	Linear value	23586	5C22	A	1	INTEGER_16	100	
<a href="#">C00990</a>	Flying restart fct.: Activate	Selection list	23585	5C21	E	1	UNSIGNED_8	1	CINH
<a href="#">C00991</a>	Flying restart fct.: Process	Selection list	23584	5C20	E	1	UNSIGNED_16	1	
<a href="#">C00992</a>	Flying restart: Start frequency	Linear value	23583	5C1F	E	1	INTEGER_16	1	
<a href="#">C00993</a>	Flying restart: Integration time	Linear value	23582	5C1E	E	1	UNSIGNED_16	10	
<a href="#">C00994</a>	Flying restart: Current	Linear value	23581	5C1D	E	1	INTEGER_16	100	
<a href="#">C00995</a>	SLPSM: Controlled current setpoint	Linear value	23580	5C1C	A	2	UNSIGNED_16	100	
<a href="#">C00996</a>	SLPSM: Switching speed	Linear value	23579	5C1B	A	2	INTEGER_16	100	
<a href="#">C00997</a>	SLPSM: Filter cutoff frequency	Linear value	23578	5C1A	E	1	INTEGER_16	100	
<a href="#">C00998</a>	SLPSM: Filter time rotor position	Linear value	23577	5C19	A	2	INTEGER_16	10	
<a href="#">C00999</a>	SLPSM: PLL gain	Linear value	23576	5C18	E	1	INTEGER_16	1	
<a href="#">C01000</a>	MCTRL: Status	Bit coded	23575	5C17	E	1	UNSIGNED_16	1	
<a href="#">C01001</a>	Manual entry of motor type	Selection list	23574	5C16	A	1	UNSIGNED_8	1	

Greyed out = display parameter (read access only)

Code	Name	Parameter type	Index		DS	DA	Data		
			dec	hex			Data type	Factor	CINH
<a href="#">C01082</a>	LS_WriteParamList: Execute Mode	Selection list	23493	5BC5	E	1	UNSIGNED_8	1	
<a href="#">C01083</a>	LS_WriteParamList: Error status	Linear value	23492	5BC4	E	1	UNSIGNED_16	1	
<a href="#">C01084</a>	LS_WriteParamList: Error line	Linear value	23491	5BC3	E	1	UNSIGNED_8	1	
<a href="#">C01085</a>	LS_WriteParamList: Index	Linear value	23490	5BC2	A	32	INTEGER_32	1000	
<a href="#">C01086</a>	LS_WriteParamList: WriteValue_1	Linear value	23489	5BC1	A	32	INTEGER_32	1	
<a href="#">C01087</a>	LS_WriteParamList: WriteValue_2	Linear value	23488	5BC0	A	32	INTEGER_32	1	
<a href="#">C01088</a>	LS_WriteParamList: WriteValue_3	Linear value	23487	5BBF	A	32	INTEGER_32	1	
<a href="#">C01089</a>	LS_WriteParamList: WriteValue_4	Linear value	23486	5BBE	A	32	INTEGER_32	1	
<a href="#">C01090</a>	LS_ParReadWrite 1-3: Index	Linear value	23485	5BBD	A	3	INTEGER_32	1000	
<a href="#">C01091</a>	LS_ParReadWrite 1-3: Cycle time	Selection list	23484	5BBC	A	3	UNSIGNED_16	1	
<a href="#">C01092</a>	LS_ParReadWrite 1-3: FailState	Linear value	23483	5BBB	A	3	UNSIGNED_16	1	
<a href="#">C01093</a>	LS_ParReadWrite 1-3: Arithmetic mode	Selection list	23482	5BBA	A	3	UNSIGNED_8	1	
<a href="#">C01094</a>	LS_ParReadWrite 1-3: Numerator	Linear value	23481	5BB9	A	3	INTEGER_16	1	
<a href="#">C01095</a>	LS_ParReadWrite 1-3: Denominator	Linear value	23480	5BB8	A	3	INTEGER_16	1	
<a href="#">C01098</a>	LS_ParReadWrite 1-3: Configuration	Bit coded	23477	5BB5	A	3	UNSIGNED_16	1	
<a href="#">C01120</a>	Sync signal source	Selection list	23455	5B9F	E	1	UNSIGNED_8	1	
<a href="#">C01121</a>	Sync cycle time setpoint	Linear value	23454	5B9E	E	1	UNSIGNED_16	1	
<a href="#">C01122</a>	Sync phase position	Linear value	23453	5B9D	E	1	UNSIGNED_16	1	
<a href="#">C01123</a>	Sync window	Linear value	23452	5B9C	E	1	UNSIGNED_16	1	
<a href="#">C01124</a>	Sync correction width	Selection list	23451	5B9B	E	1	UNSIGNED_8	1	
<a href="#">C01138</a>	L_Transient 1-4: Function	Selection list	23437	5B8D	A	4	UNSIGNED_8	1	
<a href="#">C01139</a>	L_Transient 1-4: Pulse duration	Linear value	23436	5B8C	A	4	UNSIGNED_16	1000	
<a href="#">C01350</a>	ACDrive: Drive mode	Selection list	23225	5AB9	A	1	UNSIGNED_8	1	
<a href="#">C01351</a>	ACDrive: Control word	Bit coded	23224	5AB8	A	1	UNSIGNED_16	1	
<a href="#">C01352</a>	ACDrive: Status word	Bit coded	23223	5AB7	A	1	UNSIGNED_16	1	
<a href="#">C01353</a>	ACDrive: Setpoint scaling	Linear value	23222	5AB6	A	2	INTEGER_8	1	
<a href="#">C01501</a>	Resp. to communication error with MCI	Selection list	23074	5A22	A	2	UNSIGNED_8	1	
<a href="#">C01700</a>	Energy saving mode: Mode	Linear value	22875	595B	A	2	UNSIGNED_8	1	
<a href="#">C01701</a>	Energy saving mode: toff min	Linear value	22874	595A	A	1	UNSIGNED_16	1	
<a href="#">C01702</a>	Energy saving mode: toff	Linear value	22873	5959	A	1	UNSIGNED_16	1	
<a href="#">C01703</a>	Energy saving mode: ton	Linear value	22872	5958	A	1	UNSIGNED_16	1	
<a href="#">C01704</a>	Energy saving mode: Function	Bit coded	22871	5957	A	1	UNSIGNED_16	1	
<a href="#">C01709</a>	Energy saving mode: Status	Linear value	22866	5952	A	1	UNSIGNED_8	1	
<a href="#">C01770</a>	Filter time - earth-fault detect. is running	Linear value	22805	5915	E	1	UNSIGNED_8	1	
<a href="#">C01902</a>	Diagnostics X6: Max. baud rate	Selection list	22673	5891	E	1	UNSIGNED_16	1	
<a href="#">C01903</a>	Diagnostics X6: Change baud rate	Selection list	22672	5890	E	1	UNSIGNED_8	1	
<a href="#">C01905</a>	Diagnostics X6: Current baud rate	Linear value	22670	588E	E	1	UNSIGNED_32	1	
<a href="#">C02200</a>	LS_WriteParamList: Function	Selection list	22375	5767	A	2	UNSIGNED_8	1	
<a href="#">C02210</a>	LS_WriteParamList: Motor control	Selection list	22365	575D	A	4	UNSIGNED_8	1	
<a href="#">C02212</a>	LS_WriteParamList: VFC: V/f base frequency	Linear value	22363	575B	A	4	UNSIGNED_16	10	
<a href="#">C02213</a>	LS_WriteParamList: VFC: Vmin boost	Linear value	22362	575A	A	4	UNSIGNED_16	100	
<a href="#">C02214</a>	LS_WriteParamList: Switching frequency	Selection list	22361	5759	A	4	UNSIGNED_8	1	
<a href="#">C02215</a>	LS_WriteParamList: Auto-DCB: Threshold	Linear value	22360	5758	A	4	UNSIGNED_16	1	
<a href="#">C02216</a>	LS_WriteParamList: Slip compensation	Linear value	22359	5757	A	4	INTEGER_16	100	
<a href="#">C02217</a>	LS_WriteParamList: Imax in motor mode	Linear value	22358	5756	A	4	UNSIGNED_16	100	
Greyed out = display parameter (read access only)									

Code	Name	Parameter type	Index		DS	DA	Data		
			dec	hex			Data type	Factor	CINH
<a href="#">C02218</a>	LS_WriteParamList: I <sub>max</sub> in generator mode	Linear value	22357	5755	A	4	INTEGER_16	100	
<a href="#">C02219</a>	LS_WriteParamList: DC braking: Current	Linear value	22356	5754	A	4	INTEGER_16	100	
<a href="#">C02220</a>	LS_WriteParamList: V <sub>p</sub> speed controller	Linear value	22355	5753	A	12	UNSIGNED_16	100	
<a href="#">C02221</a>	LS_WriteParamList: T <sub>i</sub> speed controller	Linear value	22354	5752	A	12	UNSIGNED_16	10	
<a href="#">C02222</a>	LS_WriteParamList: S <sub>C</sub> : T <sub>dn</sub> speed controller	Linear value	22353	5751	A	4	UNSIGNED_16	100	
<a href="#">C02223</a>	LS_WriteParamList: I <sub>max</sub> /M controller gain	Linear value	22352	5750	A	8	UNSIGNED_16	100	
<a href="#">C02224</a>	LS_WriteParamList: I <sub>max</sub> /M controller reset time	Linear value	22351	574F	A	8	UNSIGNED_16	1	
<a href="#">C02225</a>	LS_WriteParamList: V <sub>p</sub> current controller	Linear value	22350	574E	A	4	UNSIGNED_16	100	
<a href="#">C02226</a>	LS_WriteParamList: T <sub>i</sub> current controller	Linear value	22349	574D	A	4	UNSIGNED_16	100	
<a href="#">C02229</a>	LS_WriteParamList: S <sub>C</sub> : settings	Selection list	22346	574A	A	16	UNSIGNED_8	1	
<a href="#">C02230</a>	LS_WriteParamList: Override point of field weakening	Linear value	22345	5749	A	4	INTEGER_16	1	
<a href="#">C02231</a>	LS_WriteParamList: Rated motor power	Linear value	22344	5748	A	4	UNSIGNED_16	100	
<a href="#">C02232</a>	LS_WriteParamList: Motor rotor resistance	Linear value	22343	5747	A	4	UNSIGNED_32	1	
<a href="#">C02233</a>	LS_WriteParamList: Motor stator resistance	Linear value	22342	5746	A	4	UNSIGNED_32	1	
<a href="#">C02234</a>	LS_WriteParamList: Motor stator leakage inductance	Linear value	22341	5745	A	4	UNSIGNED_16	100	
<a href="#">C02236</a>	LS_WriteParamList: Rated motor speed	Linear value	22339	5743	A	4	UNSIGNED_16	1	
<a href="#">C02237</a>	LS_WriteParamList: Rated motor current	Linear value	22338	5742	A	4	UNSIGNED_16	100	
<a href="#">C02238</a>	LS_WriteParamList: Rated motor frequency	Linear value	22337	5741	A	4	UNSIGNED_16	1	
<a href="#">C02239</a>	LS_WriteParamList: Rated motor voltage	Linear value	22336	5740	A	4	UNSIGNED_16	1	
<a href="#">C02240</a>	LS_WriteParamList: Motor cosine phi	Linear value	22335	573F	A	4	UNSIGNED_8	100	
<a href="#">C02241</a>	LS_WriteParamList: Motor magnetizing inductance	Linear value	22334	573E	A	4	UNSIGNED_16	10	
<a href="#">C02242</a>	LS_WriteParamList: Motor magnetising current	Linear value	22333	573D	A	4	UNSIGNED_16	100	
<a href="#">C02244</a>	LS_WriteParamList: Auto-DCB: hold time	Linear value	22331	573B	A	4	UNSIGNED_32	1000	
<a href="#">C02245</a>	LS_WriteParamList: DC braking: Hold time	Linear value	22330	573A	A	4	UNSIGNED_32	1000	
<a href="#">C02246</a>	LS_WriteParamList: Setting of motor overload (I <sup>x</sup> t)	Linear value	22329	5739	A	4	INTEGER_16	100	
<a href="#">C02249</a>	LS_WriteParamList: Oscillation damping influence	Linear value	22326	5736	A	4	UNSIGNED_16	100	
<a href="#">C02250</a>	LS_WriteParamList: Filter time - oscill. damping	Linear value	22325	5735	A	4	UNSIGNED_8	1	
<a href="#">C02251</a>	LS_WriteParamList: Oscillation damping field weakening	Linear value	22324	5734	A	4	UNSIGNED_8	1	
<a href="#">C02256</a>	LS_WriteParamList: Moment of inertia	Linear value	22319	572F	A	4	UNSIGNED_32	100	
<a href="#">C02260</a>	LS_WriteParamList: Speed sensor selection	Selection list	22315	572B	A	4	UNSIGNED_8	1	
<a href="#">C02264</a>	LS_WriteParamList: Sensibility - Setpoint feedforward control	Selection list	22311	5727	A	4	UNSIGNED_8	1	
<a href="#">C02272</a>	LS_WriteParamList: Motor phase direction of rotation	Selection list	22303	571F	A	4	UNSIGNED_8	1	CINH
<a href="#">C02273</a>	LS_WriteParamList: Speed limitation	Linear value	22302	571E	A	8	INTEGER_16	100	

Greyed out = display parameter (read access only)

Code	Name	Parameter type	Index		DS	DA	Data		
			dec	hex			Data type	Factor	CINH
<a href="#">C02274</a>	LS_WriteParamList: Frequency limitation	Linear value	22301	571D	A	8	UNSIGNED_16	1	
<a href="#">C02275</a>	LS_WriteParamList: Motor cable length	Linear value	22300	571C	A	4	UNSIGNED_16	10	
<a href="#">C02276</a>	LS_WriteParamList: Motor cable cross-section	Linear value	22299	571B	A	4	UNSIGNED_16	100	
<a href="#">C02278</a>	LS_WriteParamList: PSM: Maximum motor current field weakening	Linear value	22297	5719	A	4	UNSIGNED_16	100	
<a href="#">C02279</a>	LS_WriteParamList: Ultimate motor current	Linear value	22296	5718	A	4	UNSIGNED_16	10	
<a href="#">C02280</a>	LS_WriteParamList: Max. motor speed	Linear value	22295	5717	A	4	UNSIGNED_16	1	
<a href="#">C02281</a>	LS_WriteParamList: VFC: Time const. slip comp.	Linear value	22294	5716	A	4	UNSIGNED_16	1	
<a href="#">C02284</a>	LS_WriteParamList: VFC: limitation V/f +encoder	Linear value	22291	5713	A	8	UNSIGNED_16	100	
<a href="#">C02285</a>	LS_WriteParamList: VFC: Vp V/f +encoder	Linear value	22290	5712	A	4	UNSIGNED_16	1000	
<a href="#">C02286</a>	LS_WriteParamList: VFC: Ti V/f +encoder	Linear value	22289	5711	A	4	UNSIGNED_16	10	
<a href="#">C02287</a>	LS_WriteParamList: VFC-ECO: Vp CosPhi controller	Linear value	22288	5710	A	4	UNSIGNED_16	1000	
<a href="#">C02288</a>	LS_WriteParamList: VFC-ECO: Ti CosPhi controller	Linear value	22287	570F	A	4	UNSIGNED_16	10	
<a href="#">C02289</a>	LS_WriteParamList: VFC-ECO: Minimum voltage U/f	Linear value	22286	570E	A	4	INTEGER_16	100	
<a href="#">C02290</a>	LS_WriteParamList: VFC-ECO: Voltage reduction ramp	Linear value	22285	570D	A	4	UNSIGNED_8	10	
<a href="#">C02291</a>	LS_WriteParamList: SLVC: Field current controller gain	Linear value	22284	570C	A	4	INTEGER_16	100	
<a href="#">C02292</a>	LS_WriteParamList: SLVC: Cross current controller gain	Linear value	22283	570B	A	4	INTEGER_16	100	
<a href="#">C02293</a>	LS_WriteParamList: Inverter motor brake: nAdd	Linear value	22282	570A	A	4	INTEGER_16	1	
<a href="#">C02294</a>	LS_WriteParamList: Inverter motor brake: PT1 filter time	Linear value	22281	5709	A	4	INTEGER_16	10	
<a href="#">C02295</a>	LS_WriteParamList: Flying restart fct.: activation	Selection list	22280	5708	A	4	UNSIGNED_8	1	CINH
<a href="#">C02296</a>	LS_WriteParamList: Flying restart fct.: process	Selection list	22279	5707	A	4	UNSIGNED_16	1	
<a href="#">C02297</a>	LS_WriteParamList: Flying restart: start frequency	Linear value	22278	5706	A	4	INTEGER_16	1	
<a href="#">C02298</a>	LS_WriteParamList: Flying restart fct: int. time	Linear value	22277	5705	A	4	UNSIGNED_16	10	
<a href="#">C02299</a>	LS_WriteParamList: Flying restart fct.: current	Linear value	22276	5704	A	4	INTEGER_16	100	
<a href="#">C02300</a>	LS_WriteParamList: SLPSM: Controlled current setpoint	Linear value	22275	5703	A	8	UNSIGNED_16	100	
<a href="#">C02301</a>	LS_WriteParamList: SLPSM: Switching speed	Linear value	22274	5702	A	8	INTEGER_16	100	
<a href="#">C02302</a>	LS_WriteParamList: SLPSM: Filter time - rotor position	Linear value	22273	5701	A	4	INTEGER_16	100	
<a href="#">C02303</a>	LS_WriteParamList: SLPSM: Filter time rotor position	Linear value	22272	5700	A	8	INTEGER_16	10	
<a href="#">C02304</a>	LS_WriteParamList: SLPSM: PLL gain	Linear value	22271	56FF	A	4	INTEGER_16	1	
<a href="#">C02305</a>	LS_WriteParamList: PSM: Ppp saturation characteristic	Linear value	22270	56FE	A	68	UNSIGNED_8	1	
<a href="#">C02306</a>	LS_WriteParamList: PSM: Imax Ppp saturation characteristic	Linear value	22269	56FD	A	4	UNSIGNED_16	10	
<a href="#">C02307</a>	LS_WriteParamList: PSM: Activate Ppp saturation char.	Selection list	22268	56FC	A	4	UNSIGNED_8	1	
<a href="#">C02311</a>	LS_WriteParamList: PLI without motion: Adaptation of time duration	Linear value	22264	56F8	A	4	INTEGER_8	1	

Greyed out = display parameter (read access only)



Code	Name	Parameter type	Index		DS	DA	Data		
			dec	hex			Data type	Factor	CINH
<a href="#">C02312</a>	LS_WriteParamList: PLI without motion	Bit coded	22263	56F7	A	4	UNSIGNED_16	1	
<a href="#">C02313</a>	LS_WriteParamList: PLI without motion: Adaptation of ident angle	Linear value	22262	56F6	A	4	INTEGER_8	1	
<a href="#">C02315</a>	LS_WriteParamList: Manual entry of motor type	Selection list	22260	56F4	A	4	UNSIGNED_8	1	
<a href="#">C02580</a>	Holding brake: Operating mode	Selection list	21995	55EB	E	1	UNSIGNED_8	1	
<a href="#">C02581</a>	Holding brake: Speed thresholds	Linear value	21994	55EA	A	5	INTEGER_16	100	
<a href="#">C02582</a>	Holding brake: Setting	Bit coded	21993	55E9	E	1	UNSIGNED_8	1	
<a href="#">C02589</a>	Holding brake: Time system	Linear value	21986	55E2	A	4	UNSIGNED_16	1	
<a href="#">C02593</a>	Holding brake: Activation time	Linear value	21982	55DE	A	4	UNSIGNED_32	1000	
<a href="#">C02607</a>	Holding brake: Status	Bit coded	21968	55D0	E	1	UNSIGNED_16	1	
<a href="#">C02610</a>	MCK: Accel./decel. times	Linear value	21965	55CD	A	3	UNSIGNED_32	1000	
<a href="#">C02611</a>	MCK: Limitations	Linear value	21964	55CC	A	5	INTEGER_16	100	
<a href="#">C02830</a>	DigInX: Debounce time	Selection list	21745	54F1	A	4	UNSIGNED_8	1	
<a href="#">C02840</a>	CountIn1: Parameter	Linear value	21735	54E7	A	2	UNSIGNED_32	1	
<a href="#">C02841</a>	CountIn1: Counter content	Linear value	21734	54E6	A	1	UNSIGNED_32	1	
<a href="#">C02842</a>	FreqInxx: Offset	Linear value	21733	54E5	A	1	INTEGER_16	100	
<a href="#">C02843</a>	FreqInxx: Gain	Linear value	21732	54E4	A	1	INTEGER_16	100	
<a href="#">C02844</a>	FreqIn12: Function	Selection list	21731	54E3	A	1	UNSIGNED_8	1	
<a href="#">C02845</a>	FreqIn12: PosIn comparison value	Linear value	21730	54E2	E	1	INTEGER_32	1	
<a href="#">C02853</a>	PSM: Lss saturation characteristic	Linear value	21722	54DA	A	17	UNSIGNED_8	1	
<a href="#">C02855</a>	PSM: I <sub>max</sub> Lss saturation characteristic	Linear value	21720	54D8	E	1	UNSIGNED_16	10	
<a href="#">C02859</a>	PSM: Activate Ppp saturation char.	Selection list	21716	54D4	E	1	UNSIGNED_8	1	
<a href="#">C02864</a>	MCTRL: Optimisations	Bit coded	21711	54CF	A	1	UNSIGNED_16	1	
<a href="#">C02865</a>	MCTRL: Special settings	Bit coded	21710	54CE	A	1	UNSIGNED_16	1	
<a href="#">C02866</a>	MCTRL: Special settings	Selection list	21709	54CD	A	3	UNSIGNED_8	1	CINH
<a href="#">C02867</a>	Identification process	Selection list	21708	54CC	A	1	UNSIGNED_8	1	CINH
<a href="#">C02868</a>	Setting of compatibility	Bit coded	21707	54CB	A	1	UNSIGNED_32	1	
<a href="#">C02870</a>	PLI without movement: degree of optimisation	Linear value	21705	54C9	A	1	INTEGER_16	100	
<a href="#">C02871</a>	PLI without movement: runtime	Linear value	21704	54C8	A	1	INTEGER_16	100	
<a href="#">C02872</a>	PLI without movement: adaptation of time duration	Linear value	21703	54C7	A	1	INTEGER_8	1	
<a href="#">C02873</a>	PLI without movement: Ident. el. rotor displ. angle	Linear value	21702	54C6	A	1	INTEGER_16	1	
<a href="#">C02874</a>	PLI without movement	Bit coded	21701	54C5	A	1	UNSIGNED_16	1	
<a href="#">C02875</a>	PLI without movement: adaptation of ident angle	Linear value	21700	54C4	A	1	INTEGER_8	1	
<a href="#">C02879</a>	Slip calculation from equivalent circuit diagram	Bit coded	21696	54C0	A	1	UNSIGNED_16	1	

Greyed out = display parameter (read access only)

## 16 Working with the FB Editor

The function block editor (in the following called "FB Editor") is available in the »Engineer« from the "StateLine" device version.

The FB Editor can be used to carry out an online monitoring of the technology application running in the device (e.g. for diagnostic purposes) and reconfigure the I/O interconnection of the technology application.

### Functional range

The options for processing function block interconnections depend on the device version:

Function	Inverter Drives 8400		
	StateLine C	HighLine C	TopLine C
I/O interconnection can be reconfigured	●	●	●
Application interconnection can be reconfigured	●	●	●
Free interconnection	(●)	●	●
(●) Free interconnection for "StateLine C" is only available from version 12.00.00 and »Engineer« V2.17.			



### Note!

The illustrations of the FB Editor user interface and the dialog boxes in this documentation are based on the »Engineer« V2.10.

### 16.1 Basics

Using the function block interconnection, any signal interconnection can be implemented. Various FBs are available for digital signal processing, signal conversion and logic modules.

For special tasks it has proved of value to use the integrated technology applications as a basis for modifications or extensions of the available FB interconnections. Depending on the device version (see [Functional range](#)), the experienced user has the opportunity to implement own drive solutions independent of the predefined technology applications by using the "free interconnection".

For this purpose, the FB Editor provides the following functions:

- Copying & pasting of interconnection elements (also device-independent)
- Export & import of the interconnection
- Comparison of two interconnections (also online <-> offline comparison)
- Overview window and zoom functions
- Comments on the signal flow
- Online monitoring

The option to mask out non-used inputs and outputs of modules is also sensible to minimise the complexity of the FB interconnection and to adapt the clarity of the interconnection to the customers need.

All graphical information of the FB interconnection view (positions of the FBs, line or flag presentation of the connection, visibility of the inputs/outputs) are saved with the parameter set in the memory module of the inverter and can be uploaded any time into the FB Editor of the »Engineer« even if the Engineer project is not available.

**16.1.1 Basic components of a drive solution**

A drive solution consists of the following basic components:

- Signal inputs (for control and setpoint signals)
- Signal flow of the technology application
- Signal outputs (for status and actual value signals)

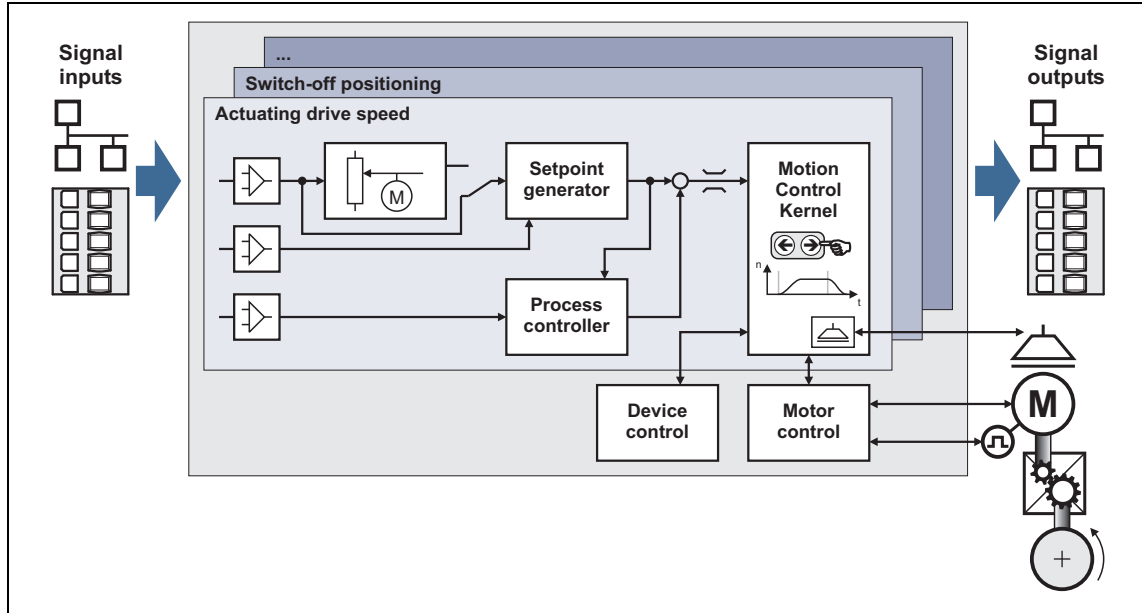

[16-1] Basic components of a drive solution

Regarding the 8400 device series, these three components are available for the FB interconnection and classified as follows:

Module type	Name	Task	Example
Function block	L_name	General function block for free interconnection (only HighLine)	<a href="#">L_Compare_1</a> <a href="#">L_PCTRL_1</a>
System block	LS_name	Signal interface to inverter-internal functions	<a href="#">LS_DigitalInput</a> <a href="#">LS_DriveInterface</a>
Port block	LP_name	<ul style="list-style-type: none"> <li>• Process data communication via a fieldbus using a communication module</li> <li>• Process data communication via CAN on board</li> </ul>	<a href="#">LP_CanIn1</a> <a href="#">LP_CanOut1</a> <a href="#">LP_MciIn</a> <a href="#">LP_MciOut</a>
Application block	LA_name	Block for a technology application	<a href="#">LA_NCtrl</a> <a href="#">LA_SwitchPos</a>

Further information on the individual modules can be obtained from the following subchapters!

### 16.1.1.1 What is a function block?

A function block (FB) can be compared with an integrated circuit that contains a certain control logic and provides one or several values when being executed.

- The function blocks are classified alphabetically in a "function library".
- Each function block has a unique identifier and a processing number which defines the position at which the function block is calculated during runtime.

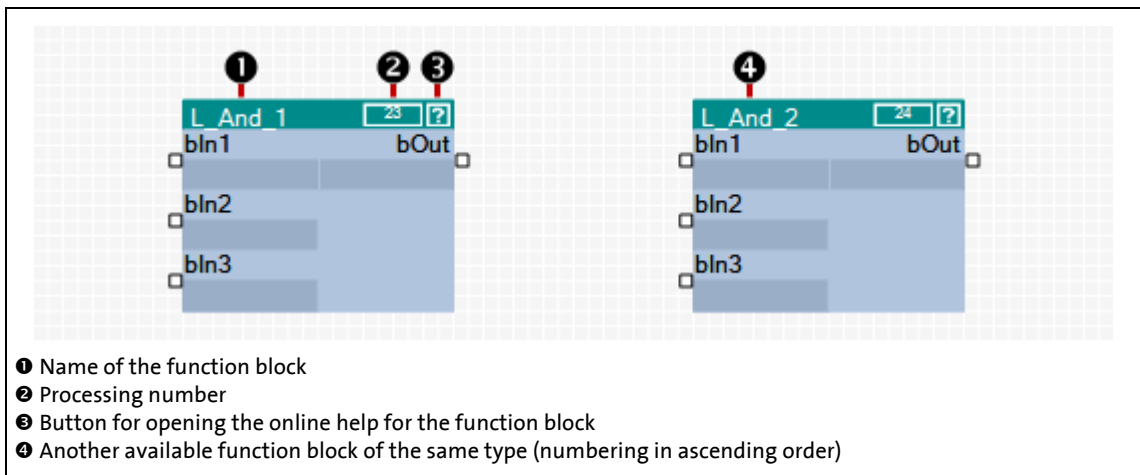

[16-2] Information on a function block in the FB Editor



#### Tip!

A detailed description of all available function blocks can be found in the main chapter "[Function library](#)". (📖 934)

**16.1.1.2 Parameterisable function blocks**

Some function blocks have parameters which serve to change particular settings during operation, if required, or which display actual values & status information.

- The  icon in the head of the module, a double-click on the module, or the **Parameter...** command in the *Context menu* of the module serve to open the parameterisation dialog or the parameter list for the module.

**Example**

Parameterisation dialog for the FB **L\_DigitalDelay\_2**:

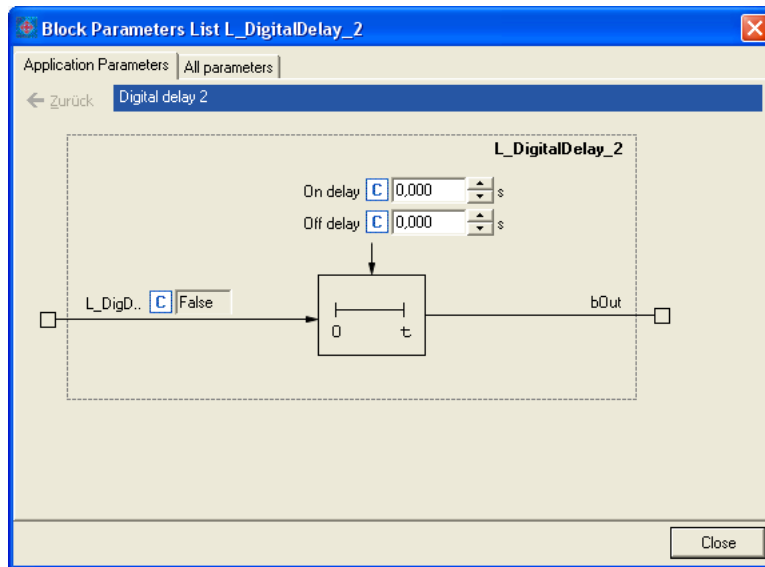

**16.1.1.3 What is a system block?**

System blocks are a special variant of a function block. They partly activate real hardware, e. g. the digital and analog inputs/outputs and the motor control.

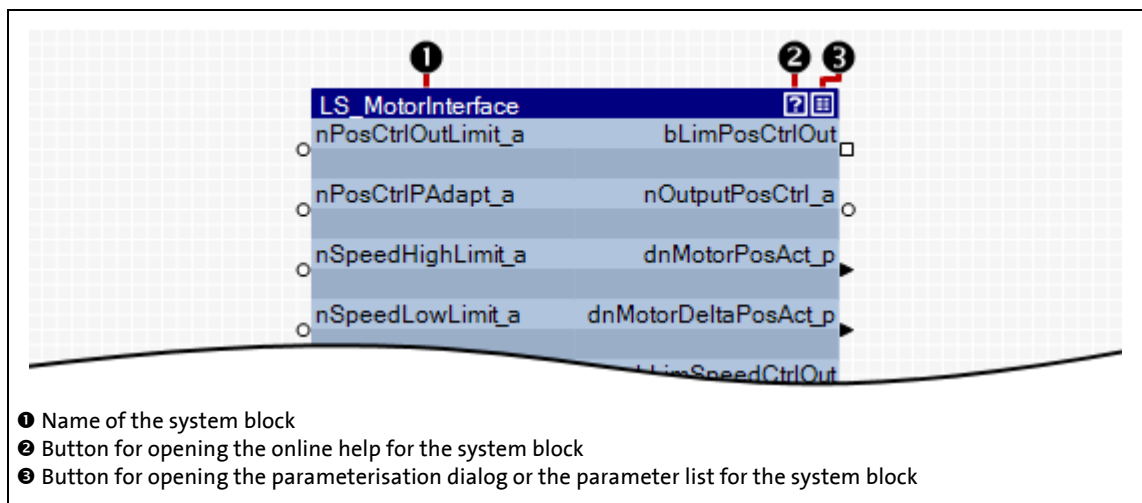

[16-3] Example: System block "LS\_MotorInterface" for mapping the motor control

#### 16.1.1.4 What is a port block?

A port block is a signal interface to a fieldbus. Input/output ports represent the input and output process data of the fieldbus.

- Port blocks LP\_CanIn/LP\_CanOut: Signal interface to the CAN bus
- Port blocks LP\_MciIn/LP\_MciOut: Signal interface to a plugged fieldbus module

If, for instance, the inverter is to be controlled via CAN bus or a fieldbus module, the input/output ports are connected to the application block (device-internal signal processing) in the I/O level of the FB Editor.

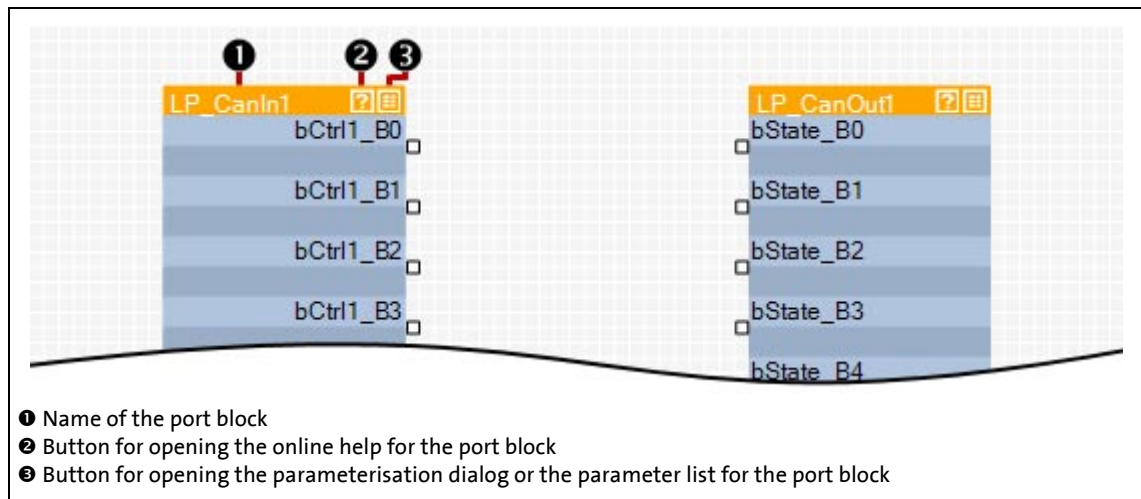

[16-4] Example: Input port "LP\_CanIn1" and output port "LP\_CanOut1"

#### 16.1.1.5 What is an application block?

The application/technology function set in [C00005](#) is shown as application block in the I/O level of the FB Editor.

The application block comprises the signal flow processing generated via function block interconnection for the selected application in each case (e.g. "actuating drive speed" or "switch-off positioning"). The function block interconnection is shown in detail on the application level.



Every application block features so-called "free inputs and outputs" which you can use to transfer signals from the I/O level to the application level and vice versa.

- In the Lenze setting, these connectors are hidden in the function block editor.
- These connections can be shown via the **Connector visibilities** command in the *Context menu* of the application block.

### 16.1.2 Conventions used for input/output identifiers

This chapter describes the conventions used for the identifiers of the inputs/outputs of the blocks. The conventions ensure a uniform and consistent terminology and make reading and comprehending the interconnection and application easier.



#### Tip!

The conventions used by Lenze are based on the "Hungarian Notation". This ensures that the most significant characteristics of the corresponding input/output (e.g. the data type) can be instantly recognised from its identifier.

An identifier consists of

- a data type entry
- an identifier (the "proper" name of the input/output)
- an (optional) signal type specification

#### Data type entry

The data type entry provides information about the data type of the corresponding input/output:

Data type entry	Meaning	Resolution	Value range
b	BOOL	1 bit	0 ≡ FALSE / 1 ≡ TRUE
dn	DINT	32 bits	-2147483647 ... 2147483647
n	INT	16 bits	-32767 ... 32767
w	WORD	16 bits	0 ... 65535

#### Identifier

The identifier is the proper name of the input/output and should indicate the application or function.

- Identifiers always start with a capital letter.
- If an identifier consists of several "words", then each "word" must start with a capital letter.
- All other letters are written in lower case.

### Signal type entry

In general, it is possible to assign a certain signal type to the inputs and outputs of the Lenze function blocks. There are e.g. digital, scaled, position, acceleration and speed signals.

- A corresponding ending (preceded by an underscore) is added to the identifier of the corresponding input/output to indicate the signal type.

Signal type entry & port symbol in the FB Editor	Meaning	Resolution	Value range
_a	○	16 bits	± 199.99 %
_v	◀/▶	16 bits	± 30000.0 rpm
_p	◀/▶	32 bits	$-2^{31} \dots 2^{31}-1$ increments
	□	8 bits	0 ≡ FALSE; 1 ≡ TRUE
	■	16 bits	0 ... 65535
	■	32 bits	-2147483647 ... 2147483647

### 16.1.3 Scaling of physical units

With regard to the parameter setting & configuration of the inverter it is very helpful to know the signal types and their scaling listed in the following table, which are used to process physical values (e.g. an angular velocity or position) in the function block interconnection.

Signal type entry & port symbol in the FB Editor	Meaning	Scaling	
		External value	≡ internal value
_a	○	100 %	≡ $2^{14} \equiv 16384$
_v	◀/▶	15000 rpm	≡ $2^{14} \equiv 16384$
_p	◀/▶	1 encoder revolution	≡ $2^{16}$ increments



## 16.2 User interface

**How to access the FB Editor:**

1. Go to the *Project view* and select the 8400 inverter.
2. Go to *Workspace* and select the **FB Editor** tab.

The FB Editor displays the wiring of the technology function selected in [C00005](#). The interconnection of the I/Os of the inverter depends on the control mode selected in [C00007](#).

The user interface of the FB Editor includes the following control and function elements:

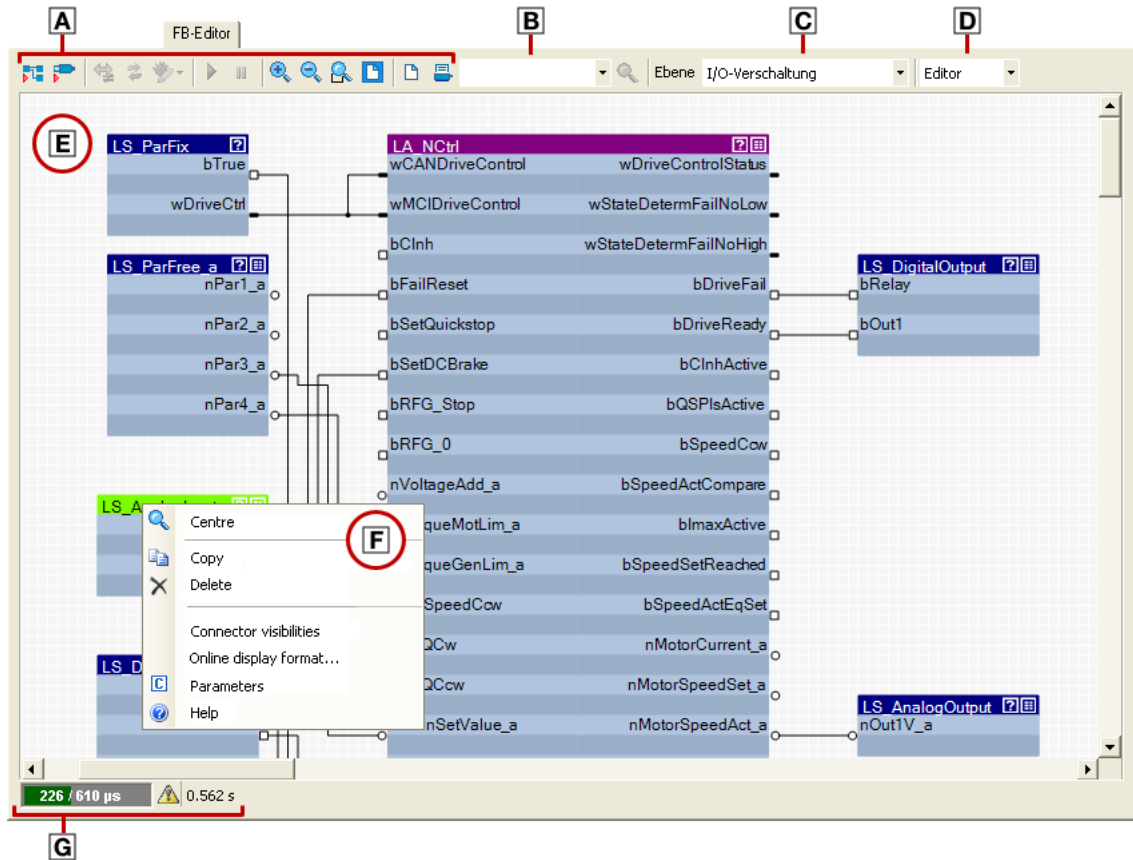

A [Toolbar](#)

B [Search function](#)

C [Plane selection](#)

D [Editor view/overview](#)

E [Drawing area](#)

F [Context menu](#)

G [Status bar](#)

Not shown:  
[Overview](#)















**Tip!**

Go to the »*Engineer*« toolbar and click the  icon to hide the *Project View* and the *Message Window*. This increases the *Workspace* available for the FB Editor. A renewed click on the symbol shows the *Project View* and the *Message Window* again.

### 16.2.1 Toolbar

The FB Editor is provided with an individual toolbar in the upper position which in the following text is called *FB Editor toolbar*.

- Click on an icon to execute the corresponding function.

Symbol	Function
	Insert function block or system block <ul style="list-style-type: none"> <li>▶ <a href="#">Inserting a function block</a> (📖 904)</li> <li>▶ <a href="#">Inserting a system block</a> (📖 906)</li> </ul>
	<a href="#">Insert port block</a> (📖 908)
	<a href="#">Adjusting online and offline interconnection</a> (📖 927)
	Acknowledge error in the interconnection / reload interconnection
	Correct interconnection
	Start online monitoring
	Interrupt online monitoring
	Close online monitoring
	Enlarge view of interconnection
	Reduce view of interconnection
	Enlarge cutout of interconnection
	Show entire interconnection in the drawing area
	Show print view
	<a href="#">Printing the interconnection</a> (📖 928)
	<a href="#">Search function</a> (📖 891)

16.2.2 Search function

Use the search function to get quickly to a certain module of the interconnection.

- The list field of the search function contains all function blocks, system blocks, and port blocks of the interconnection:

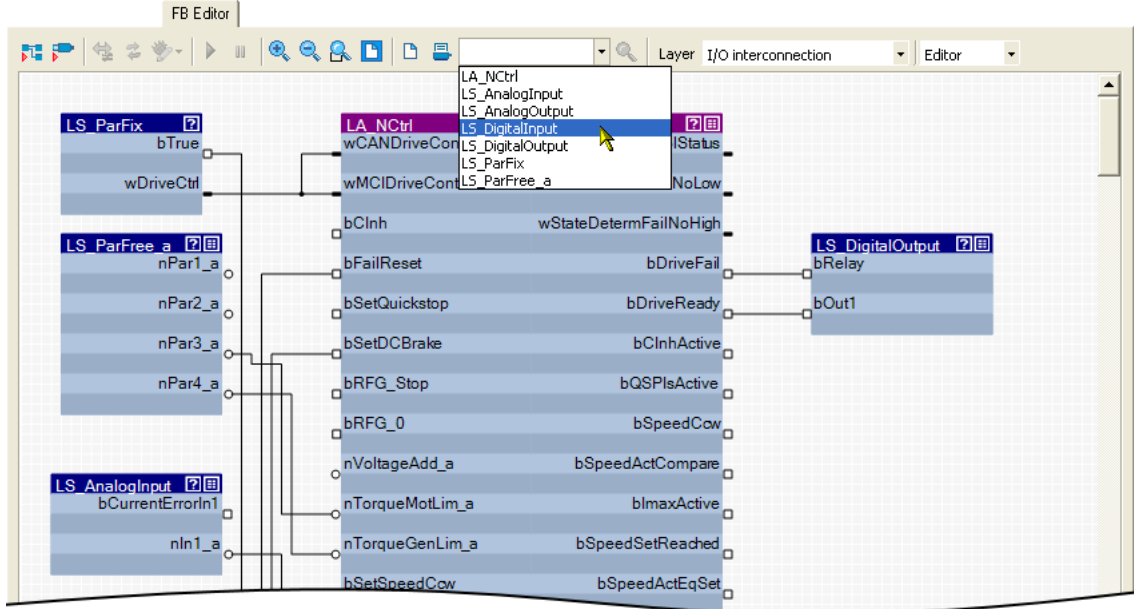

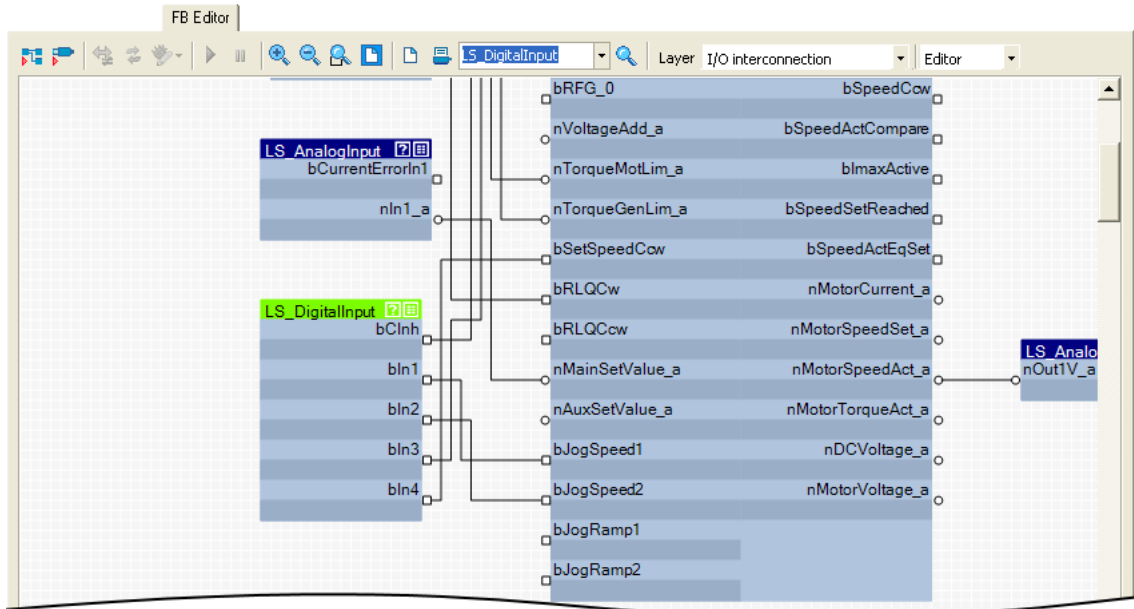

- When you select a module in the list field, this module is zoomed in and selected at the same time (the following example shows the LS\_DigitalInput system block):



**Tip!**

You can also enter any search text in the input field.

- If you click the  icon, the cutout is moved to the object which contains this search text.
- Another click on the  icon leads to a new search. Thus, you can navigate successively to all objects which contain the entered search text.
- The search text does not consider case sensitivity.

### 16.2.3 Plane selection

Go to the **Level selection** list field and select the interconnection level to be displayed.

#### "I/O interconnection" level

This level displays only the I/O interconnection of the currently selected technology application for a better overview.

- Details of the application are masked out in this level.
- The interconnection of the I/Os of the inverter with the inputs and outputs of the application in detail depends on the control mode selected in [C00007](#).
- The parameterisation dialogs on the **Application parameter** tab correspond to the application block displayed in this level.

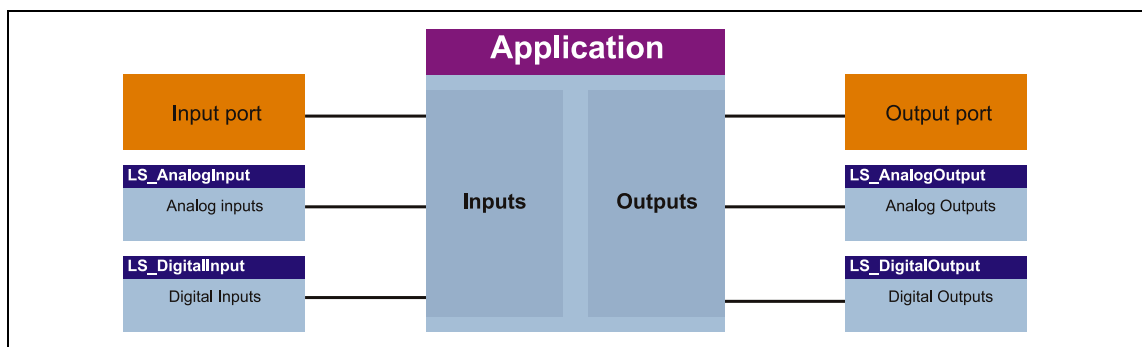

[16-5] Schematic diagram of "I/O interconnection"

### "Application interconnection" level

This level displays the interconnection of the application selected in [C00005](#) in detail. All function blocks used in the application and the system blocks which provide the interfaces to the drive and motor interface and to the MotionControlKernel (MCK) are displayed with their connections.

- The interconnection of the I/Os of the inverter with the inputs and outputs of the application is masked out in this level.

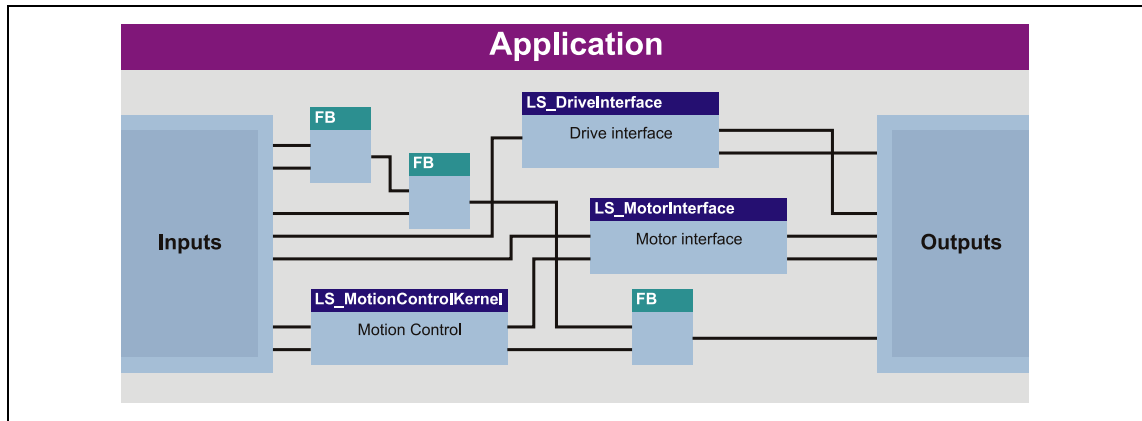

[16-6] Schematic diagram of "Application interconnection"



#### Tip!

Every application block features so-called "free inputs and outputs" which you can use to transfer signals from the I/O level to the application level and vice versa.

- In the Lenze setting, these connectors are hidden in the function block editor.
- These connections can be shown via the **Connector visibilities** command in the *Context menu* of the application block.

### "Free interconnection" level

This level serves to implement an individual drive solution for the device versions "StateLine C" (from version 12.00.00 and »Engineer« V2.17), "HighLine C" and "TopLine C".



#### Note!

When you select the "Free interconnection" level for the first time, you are prompted to confirm whether the interconnection from the I/O level and the application level are to be combined and copied into this level.

When you confirm this confirmation prompt with **Yes**, the I/O level and the application level are not available anymore. This action can only be undone by resetting the application to a predefined Lenze application! ▶ [Resetting changed interconnection](#) (926)

### 16.2.4 Editor view/overview

Use the list field at the top right to change from the Editor to the overview and vice versa.

The overview shows all function blocks used of the interconnection in the upper list field in the order of their processing. The lower list field shows all used system blocks.

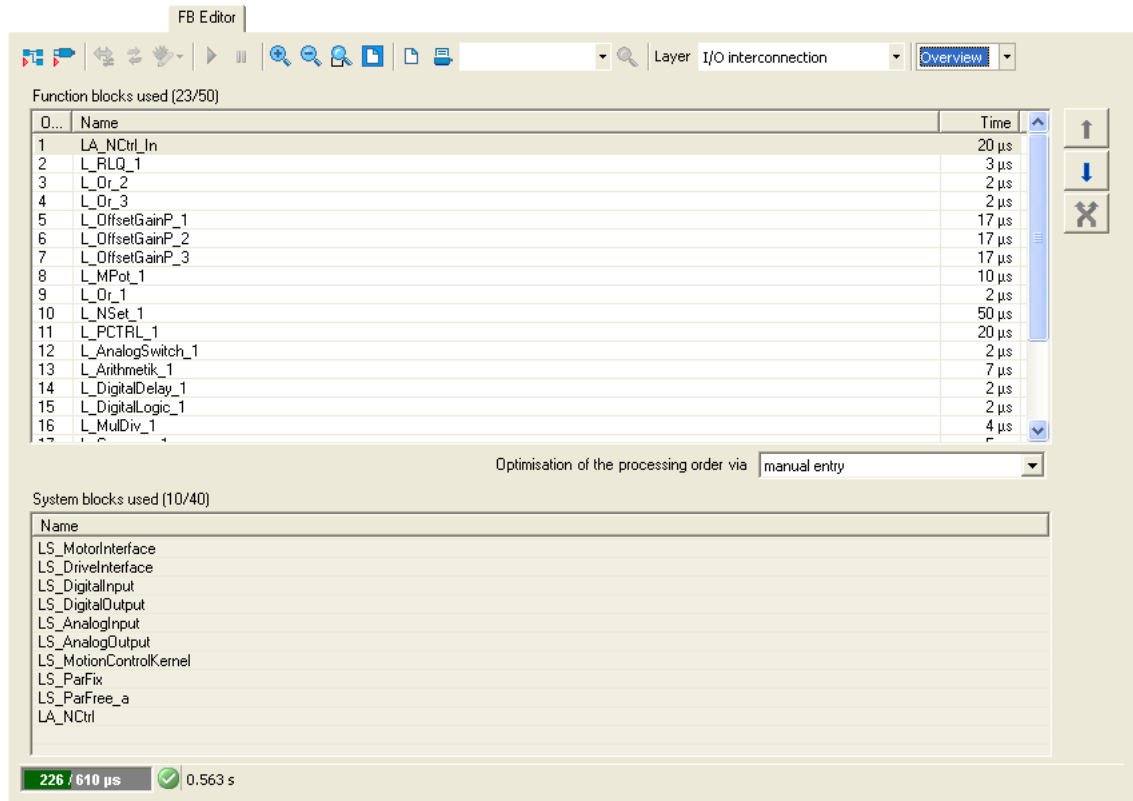

- The processing order of the function blocks can be optimised manually or according to an automatically generated selection. ▶ [Changing the processing order](#) (921)

### 16.2.5 Context menu

You can open a *context menu* via the right mouse button for each object (function block, system block, line, comment, etc.) and for the drawing area:

- The contents of the *context menu* depend on the type of object you click on.
- Example: *Context menu* for a function block:

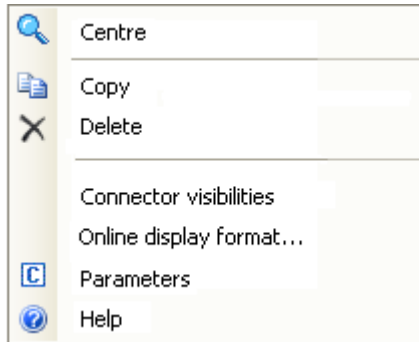

### 16.2.6 Status bar

The status bar of the FB Editor shows, among other things, information about the system load and the error status of the interconnection:



Symbol	Meaning
<b>A System load</b>	
	Here: out of the available computing time of 610 µs, 226 µs are required by the application.
<b>B Error status of the interconnection</b>	
	The interconnection has no errors and no warnings
	The interconnection has errors and/or warnings
<b>C Communication status</b>	
	Offline
	Online
	Communication error
<b>D Adjustment status</b>	
	Offline and online interconnection match
	Offline and online interconnection are different
<b>E Update rate for monitoring values</b>	

### 16.2.7 Overview

The overview window shows the drawing area in a reduced view. The overview window serves to e.g. move quickly through a more complex interconnection.



#### How to show the monitor window:

Go to the *Context Menu* of the drawing area and select the **Overview Window**.

- If you execute this command again, the overview window is hidden again.

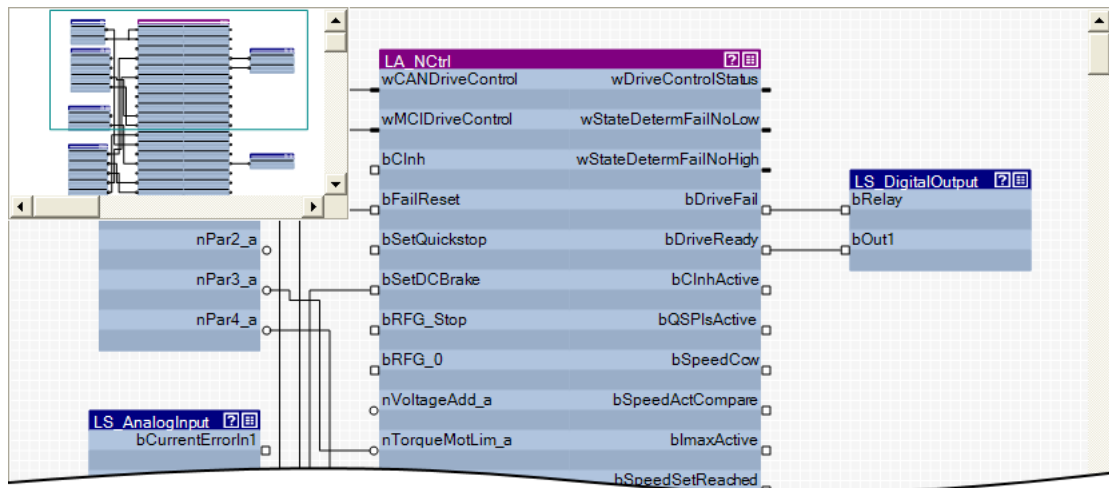

- The green frame in the overview window indicates the interconnection cutout that is currently displayed in the drawing area.
- Use the mouse pointer to shift and resize the cutout to be displayed.



#### How to shift the cutout presented in the drawing area:

1. Position the mouse pointer to the green frame in the overview window.
  - The mouse pointer symbol becomes a positioning cross.
2. Click left mouse button and shift the green frame to its new position by keeping the mouse button pressed, so that the desired cutout of the interconnection is displayed in the drawing area.





### How to redefine the cutout to be presented:

In the overview window draw a frame around the area of the interconnection which is to be presented in the drawing window by keeping the left mouse button pressed:



- The aspect ratio of the frame is automatically adapted to the aspect ratio of the drawing area.
- According to the size of the frame that is drawn, also the presentation size of the objects in the drawing area changes.



### Tip!

Go to the *FB Editor toolbar* and click the  icon to adapt the view size so that all objects included in the interconnection are visible in the drawing area.

### Automatic scroll ("AutoScroll function")

If you reach a window limitation in the drawing area when shifting an object or in the overview window when shifting the green frame, and if you then shortly hold the mouse pointer in this position, an automatic scrolling into the corresponding direction is carried out:

### 16.3 Using the FB Editor as "Viewer"

The main purpose of the FB Editor is the individual configuration of the selected technology application. However, you can also use the FB Editor to

- make a diagnosis of the application (when an online connection has been established),
- get a better understanding for the operating mode of the application,
- use the interconnection as an alternative parameterisation access.

#### Diagnostics of the application

When an online connection to the inverter has been established, the current values are displayed at the inputs and outputs of the objects:

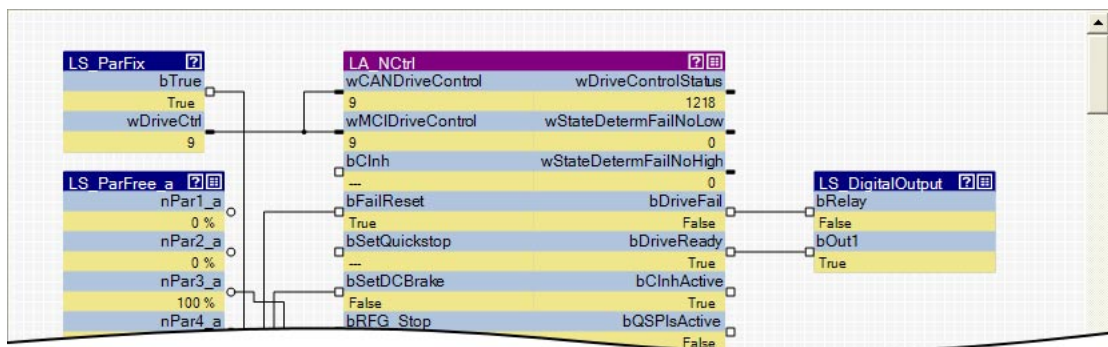

- Process-scaled signals can be scaled in a "user-defined" way for easy diagnostics in the FB Editor.
  - ▶ [Change online display format](#) (📖 901)

#### Getting a better understanding for the operating mode of the application

Make yourself familiar with the signal flow of the interconnection to get a better understanding of the operating mode of the application or individual functional areas.

- The  symbol in the head of the block or the **Help** command in the *context menu* for the block serve to open the online help for the block.

#### Using the interconnection as an alternative parameterisation access

- The  icon in the head of the module, a double-click on the module, or the **Parameter...** command in the *Context menu* of the module serve to open the parameterisation dialog or the parameter list for the module.

### 16.3.1 Following connections of inputs and outputs

In addition to the [Search function](#) you can use the *context menu* of inputs and outputs to follow connections and quickly reach certain signals.



#### How to navigate from one output to another connected input:

1. Open the *context menu* (right mouse button) of the port symbol at the output.
  - The *context menu* for the port symbol contains all inputs which are connected to the output:

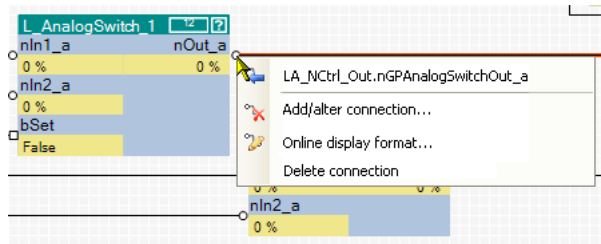

2.  Select input in the *context menu* to which you want to navigate.
  - As a result, the selected input is displayed in the centre of the drawing area (in this example: nGPAnalogSwitchOut\_a):

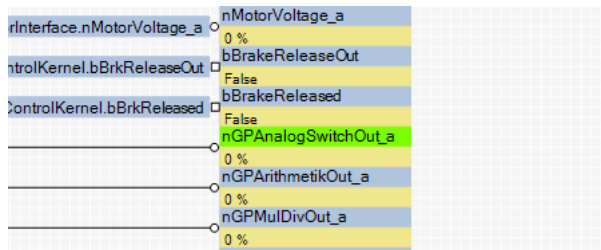



### How to navigate from one input to another connected output:

If the input is connected to a flag:

- Double-click the flag:

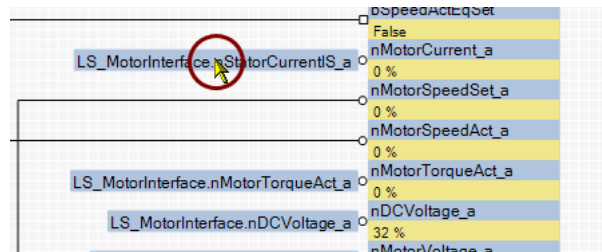

If the input is connected to a line:

1. Open the *context menu* (right mouse button) of the port symbol at the output:

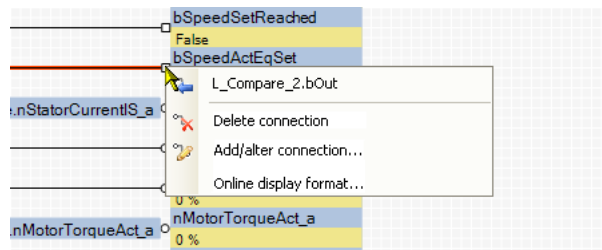

2.  Select output in the *context menu*.
  - Since an output can only be connected to an input, the *context menu* contains only an output.

The output is displayed in the centre of the drawing area.

### 16.3.2 Keyboard commands for navigation

Keyboard command	Function
<Picture ▲ >	Scroll up
<Picture ▼ >	Scroll down
<Shift> + <picture ▲ >	Scroll to the left
<Shift> + <picture ▼ >	Scroll to the right
<POS1>	Scroll to the left edge of the interconnection
<END>	Scroll to the right edge of the interconnection
<Ctrl> + <Pos1>	Scroll to the left upper corner of the interconnection
<Ctrl> + <End>	Scroll to the right lower corner of the interconnection

### 16.3.3 Change online display format

For online monitoring in the FB Editor the display format of the input and output data of a block can be adapted individually. Process-scaled signals can be scaled in a "user-defined" way for easy diagnostics in the FB Editor. Thus, the display of these signals gets a process reference.



#### How to change the data display format of block inputs/outputs:

- Go to the *context menu* of the block and select the **Online display format** command.
  - Tip:** You can call the *context menu* of a block by clicking with the right mouse button on the header of the block.
  - The *Display format* dialog box is displayed:

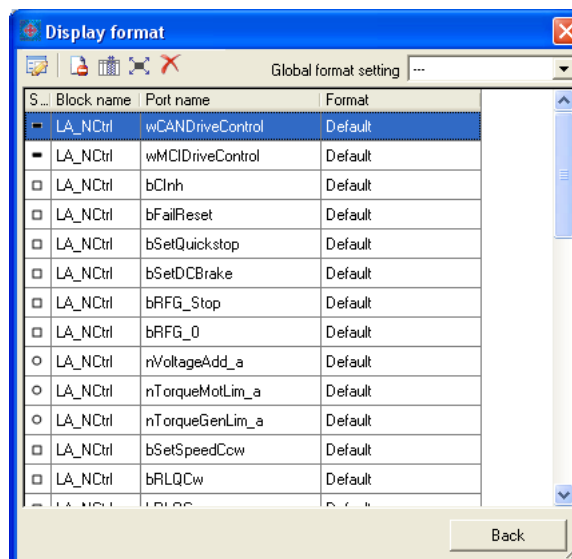

- Select the inputs/outputs from the list the display format of which is to be changed.
  - Note:** In the **Global format setting** list field the "---" entry must be selected so that the display format can be changed.
  - If you click further inputs/outputs while pressing **<Ctrl>** they are added to an already existing selection (multi-selection).
  - The **<Shift>** key serves to select a related area of inputs/outputs.
  - More functions:
    - Display masked out connections
    - Display additional information
    - Select all inputs/outputs
    - Reset all format information

3. Click the  symbol to edit the display format of the selected inputs/outputs.
  - The *Edit display format* dialog box is displayed:

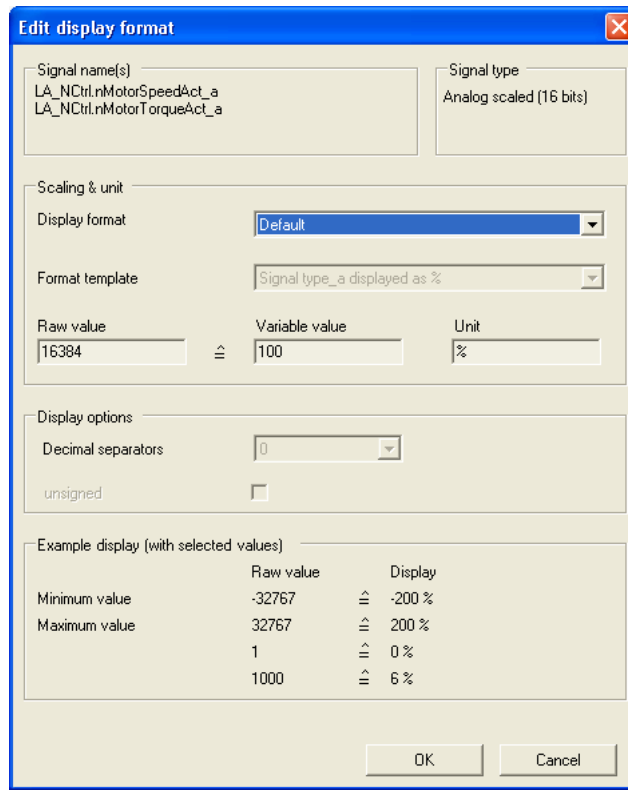

Raw value	Variable value	Unit
16384	100	%

Example display (with selected values)	Raw value	Display
Minimum value	-32767	-200 %
Maximum value	32767	200 %
	1	0 %
	1000	6 %

4. Go to the **Display format** list field and select the "User-defined" entry.
5. Go to the **Format template** list field and select "No template".
6. Select the required scaling, unit, number of decimal positions, and sign handling.
7. Click **OK** to accept the settings and close the *Edit display format* dialog box.
  - The *Display format* dialog box now displays the text "User-defined" for the changed inputs/outputs in the **Format** column.

After all required formats have been changed:

8. Click **Back** to close the *Display format* dialog box.
  - For online monitoring, the changed format is used.

## 16.4 Reconfiguring the predefined interconnection

How to proceed:

1. Insert additionally required objects into the interconnection.
2. Hide unneeded inputs/outputs of function blocks and system blocks to obtain a clearly arranged interconnection.
3. Arrange the objects in the drawing area in a reasonable manner.
4. Establish the connections required for the desired function.
5. If required, change (optimise) the processing order of the function blocks.



### Tip!

Detailed information on the individual steps can be obtained from the following subchapters!





### Note!

With the "StateLine" version, the interconnection shown in the application level cannot be edited.

### 16.4.1 Inserting/Deleting objects

Objects can be inserted in the interconnection via the *FB Editor toolbar* and the *context menu* of the drawing area. The following subchapters provide detailed information on how to insert/delete the different objects.

Symbol	Function
	<a href="#">Inserting a function block</a> (📖 904)
	<a href="#">Inserting a system block</a> (📖 906)
	<a href="#">Insert port block</a> (📖 908)
	<a href="#">Inserting a comment</a> (📖 910)



### Tip!

Use the *context menu* of the drawing area to insert a function block, system block, port block or comment directly to the current position of the mouse pointer in the drawing area.

If you insert an object via the corresponding icon in the *FB Editor toolbar*, the object is always placed at the top left corner in the drawing area.

Interconnection elements cannot only be copied within the same interconnection but also across all devices within the same project, as long as the devices stem from the same product family. ▶ [Copying interconnection elements \(across all devices\)](#) (📖 923)

### 16.4.1.1 Inserting a function block



#### Note!

In the FB Editor, function blocks are only available in the "Application interconnection" level!



#### How to insert a function block into the interconnection:

1. In the *FB Editor toolbar*, click the icon.
  - The *Insert Function Block* dialog box appears:
2. Unless it is already displayed, select the **Function Blocks** tab.
  - All function blocks available are displayed in the **Search results** list field.

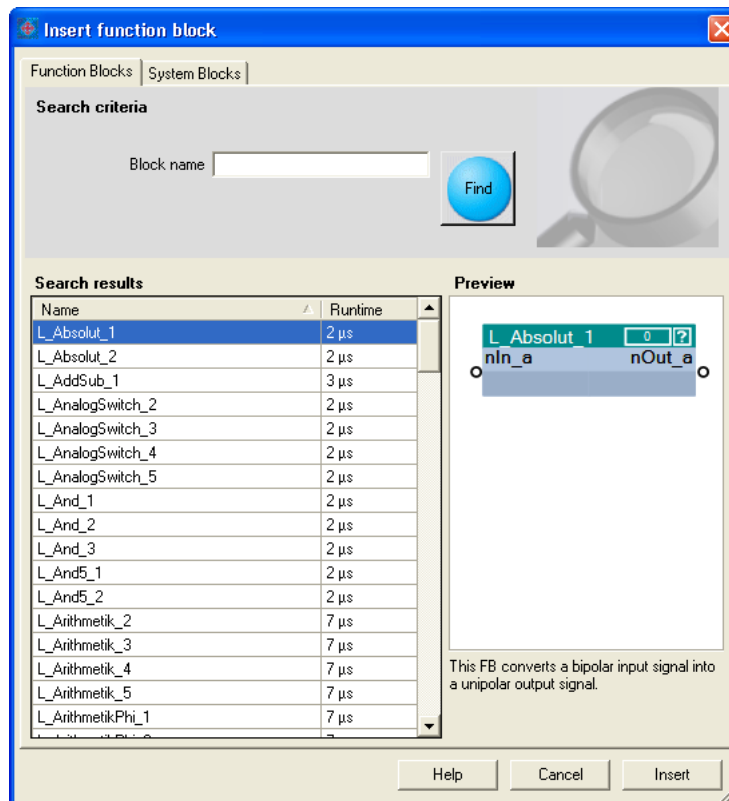



- A preview of the selected function block is displayed.
  - A detailed description of all available function blocks can be found in the main chapter "[Function library](#)". ([934](#))
3. If required, define **Search criteria** to narrow down the available function blocks:
    - **Block name:**  
String which must be contained in the name of the function block.
  4. After changing the search criteria, press the **Find** button to update the selection.
    - Then, only the function blocks complying with the features set in the search criteria are shown in the **Search Results** list field.
    - If no search criteria are set, all function blocks available are shown.
  5. Select the function block to be inserted in the **Search results** list field.



6. Press **Insert** button.
  - The dialog box is closed and the selected function block is inserted into the interconnection.

### Context menu for the function block

If you right-click on the header of a function block, a *context menu* opens via which you can execute the following functions in addition to the general processing functions (Copy, Insert, Delete):

Command	Function
 Centre	Move the visible cutout of the drawing area so that the block is centred.
Connector visibilities...	Define visible inputs and outputs of the block. ▶ <a href="#">Changing connector visibilities</a> (📖 913)
Online display format...	Adapt the display format of the input and output data of the block individually for online monitoring. ▶ <a href="#">Change online display format</a> (📖 901)
 Parameters...	Open the parameter list/parameterisation dialog for the block. <ul style="list-style-type: none"> <li>• Only if function block is parameterisable.</li> </ul>
 Help	Show online help for the block.

### Related topics

- ▶ [Deleting objects that are no longer required](#) (📖 912)
- ▶ [Changing connector visibilities](#) (📖 913)
- ▶ [Arranging objects in the drawing area](#) (📖 914)
- ▶ [Creating/deleting connections](#) (📖 915)
- ▶ [Changing the processing order](#) (📖 921)

### 16.4.1.2 Inserting a system block

A system block is inserted similarly to the way a function block is inserted.



**How to insert a system block into the interconnection:**

1. In the *FB Editor toolbar*, click the  icon.
  - The *Insert Function Block* dialog box appears:
2. Unless it is already displayed, select the **System Blocks** tab.
  - All system blocks available are displayed in the **Search results** list field.

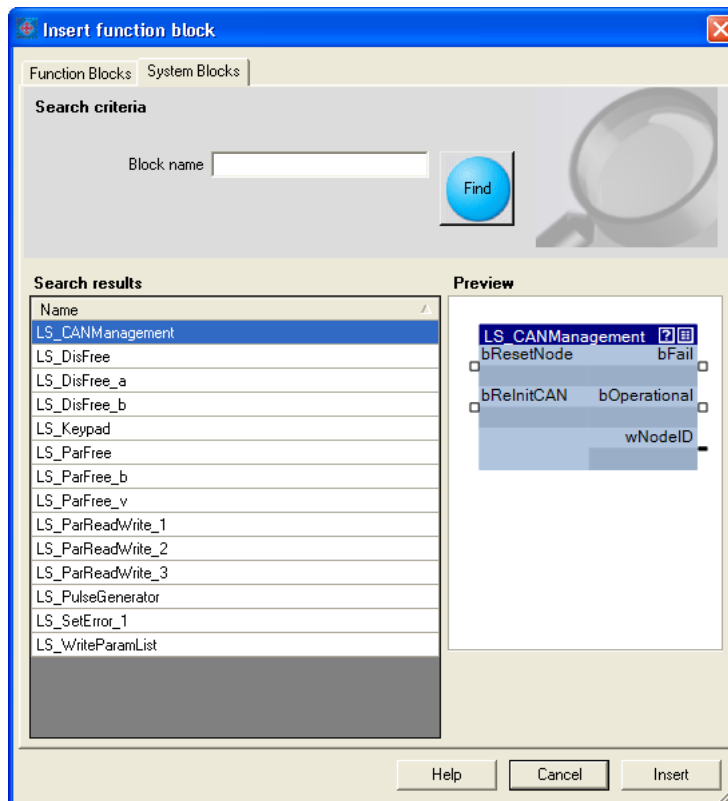



- A preview of the selected function block is displayed.
3. If required, define **Search criteria** to accordingly narrow down the system blocks available:
    - **Block name:**  
String which must be contained in the name of the system block.
  4. After changing the search criteria, press the **Find** button to update the selection.
    - Then, only the system blocks complying with the features set in the search criteria are shown in the **Search Results** list field.
    - If no search criteria are set, all system blocks available are shown.

5. Select the system block to be inserted in the **Search results** list field.
6. Press **Insert** button.
  - The dialog box is closed and the selected system block is inserted into the interconnection.

### Context menu for the system block

If you right-click on the header of a system block, a *context menu* opens via which you can execute the following functions in addition to the general processing functions (Copy, Insert, Delete):

Command		Function
	Centre	Move the visible cutout of the drawing area so that the block is centred.
	Connector visibilities...	Define visible inputs and outputs of the block. ▶ <a href="#">Changing connector visibilities</a> (📖 913)
	Online display format...	Adapt the display format of the input and output data of the block individually for online monitoring. ▶ <a href="#">Change online display format</a> (📖 901)
	Parameters...	Open the parameter list/parameterisation dialog for the block.
	Help	Show online help for the block.

### Related topics

- ▶ [Deleting objects that are no longer required](#) (📖 912)
- ▶ [Changing connector visibilities](#) (📖 913)
- ▶ [Arranging objects in the drawing area](#) (📖 914)
- ▶ [Creating/deleting connections](#) (📖 915)

### 16.4.1.3 Insert port block

All input/output ports defined for the application on the **Ports** tab can be inserted into the interconnection in the form of port blocks in order to get access to the associated element variables.



#### Tip!

You can change between the **Ports** and **FB Editor** tabs at any time to define new ports and afterwards insert them into the interconnection.



#### How to insert a port block into the interconnection:

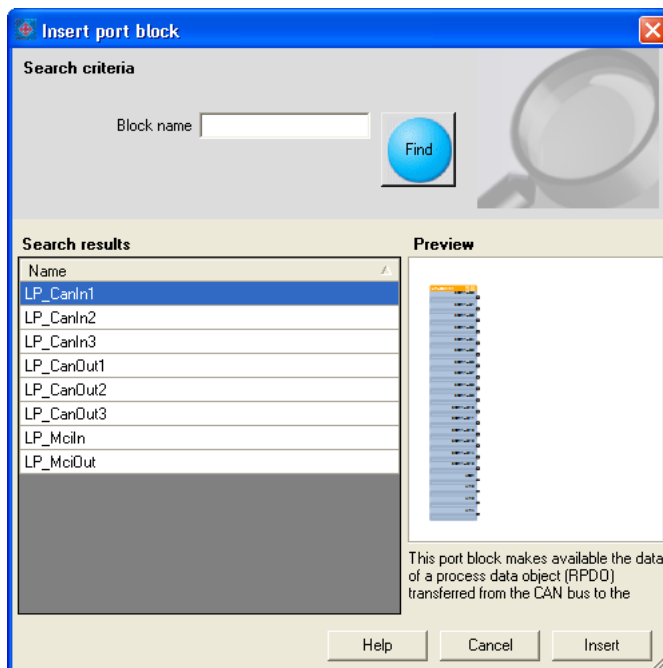

- In the *FB Editor toolbar*, click the  icon.
  - The *Insert port block* dialog box appears.
  - All port blocks available are displayed in the **Search results** list field.



- A preview of the selected port block is displayed.
- If required, define **search criteria** to accordingly narrow down the port blocks available:
    - Block name:**  
String which must be contained in the name of the port block.
  - After changing the search criteria, press the **Find** button to update the selection.
    - Then, only the port blocks complying with the features set in the search criteria are shown in the **Search Results** list field.
    - If no search criteria are set, all port blocks available are shown.
  - Select the port block to be inserted in the **Search results** list field.
  - Press **Insert** button.
    - The dialog box is closed and the selected port block is inserted into the interconnection.

### Context menu for the port block

If you right-click on the header of a port block, a *context menu* opens via which you can execute the following functions in addition to the general processing functions (Copy, Insert, Delete):

Command	Function
 Centre	Move the visible cutout of the drawing area so that the block is centred.
Connector visibilities...	Define visible inputs and outputs of the block. ▶ <a href="#">Changing connector visibilities</a> (📖 913)
Online display format...	Adapt the display format of the input and output data of the block individually for online monitoring. ▶ <a href="#">Change online display format</a> (📖 901)
 Parameters...	Open the parameter list/parameterisation dialog for the block.
 Help	Show online help for the block.

### Related topics

- ▶ [Deleting objects that are no longer required](#) (📖 912)
- ▶ [Changing connector visibilities](#) (📖 913)
- ▶ [Arranging objects in the drawing area](#) (📖 914)
- ▶ [Creating/deleting connections](#) (📖 915)

#### 16.4.1.4 Inserting a comment

Comments can be inserted at any position in the drawing area.

As of the »Engineer« V2.10, the interior colour and text alignment of a comment can be changed via a properties dialog. Now the sizes of comments can also be changed using the mouse pointer. When using different interior colours you can use comments to graphically arrange areas that belong together in terms of function or separate them from other areas:

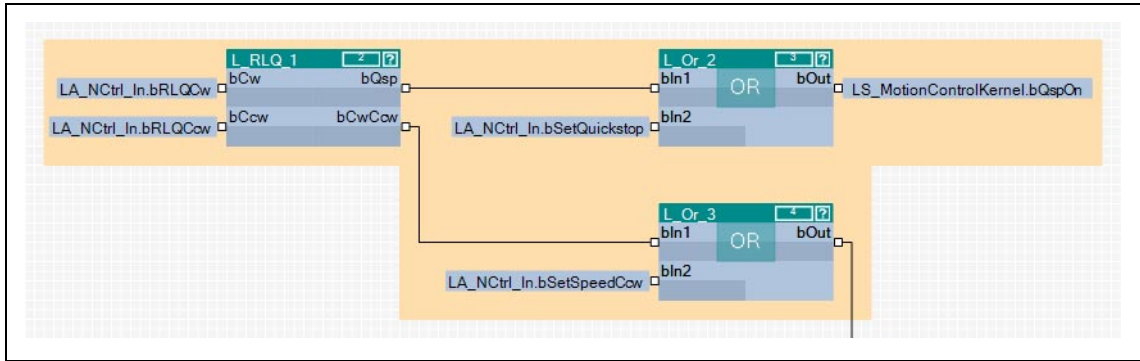

[16-7] Example: Graphical arrangement of FBs by means of two comments that overlap.



#### Note!

The term "Arrangement" does not mean a logical arrangement of the function blocks. The comments are only graphical presentation elements of the FB Editor.



#### How to insert a new comment into the interconnection:

1. Move the mouse pointer to the (free) position in the drawing area where the comment is to be inserted.
2. Go to the *Context menu* (right mouse key) and select the **New comment** command.
  - The *Properties* dialog box is displayed:

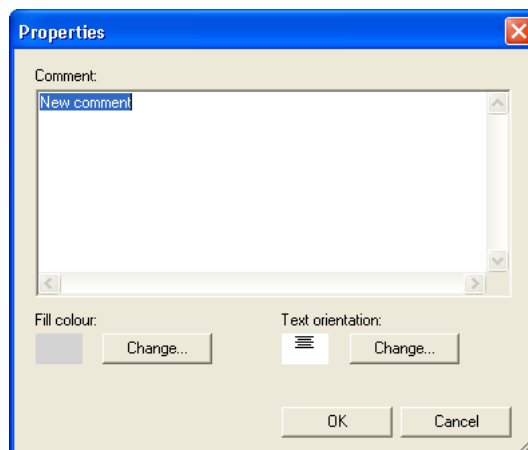

3. Enter the required comment into the text field.
4. Optional: Change preset interior colour.
  - For this purpose, click the left **Change...** button to open the *Colour* dialog box to select another interior colour.

5. Optional: Change preset text alignment.
  - For this purpose, click the right **Change...** button to open the *Text alignment* dialog box to select another text alignment.
6. Press **OK** to close the *Properties* dialog box and insert the comment.
  - After being inserted, the corner points of the comment are shown:



7. Optional: Change size of the comment.
  - For this purpose click one of the corner points with the left mouse button and enlarge the comment to the required size with the mouse button pressed.



8. Optional: Drag comment.
  - For this purpose click the comment with the left mouse button and move the comment to the required position with the mouse button pressed.

**Tip!**

The *Properties* dialog box for a comment already available can be opened by double-clicking the comment.

**Related topics**

- ▶ [Deleting objects that are no longer required](#) (📖 912)
- ▶ [Arranging objects in the drawing area](#) (📖 914)
- ▶ [Creating/deleting connections](#) (📖 915)

---

### 16.4.1.5 Deleting objects that are no longer required

Objects that are no longer required can be easily deleted again. "Delete" only means that the object is removed from the drawing area. If you have deleted an object from the drawing area, you can reinsert it any time into the interconnection.



#### Note!

Deleting an object cannot be undone.

Together with the object, all available connections to this object are deleted.



#### How to delete objects that are no longer required:

1. Select objects to be deleted.
  - You can select a single object by clicking the header of the object.
  - You can select objects that are placed together by drawing a frame around these objects while keeping the mouse button pressed.
  - If you click the header of further objects while pressing **<Ctrl>**, these will be added to an already existing selection (multi-selection).
  - All selected objects are highlighted by a light green header.
2. Press **<Del>**.

#### Related topics

- ▶ [Deleting connections that are no longer required \(p. 920\)](#)



### 16.4.2 Changing connector visibilities

Inputs and outputs that are not connected can be hidden for each block. This serves to reduce the dimension of the block. The interconnection becomes clearer.



**How to define the visible inputs and outputs:**

1. Go to the context menu of the block and select the **Connector visibilities** command.
  - The *Define Visible Inputs and Outputs for Function Blocks* is displayed:

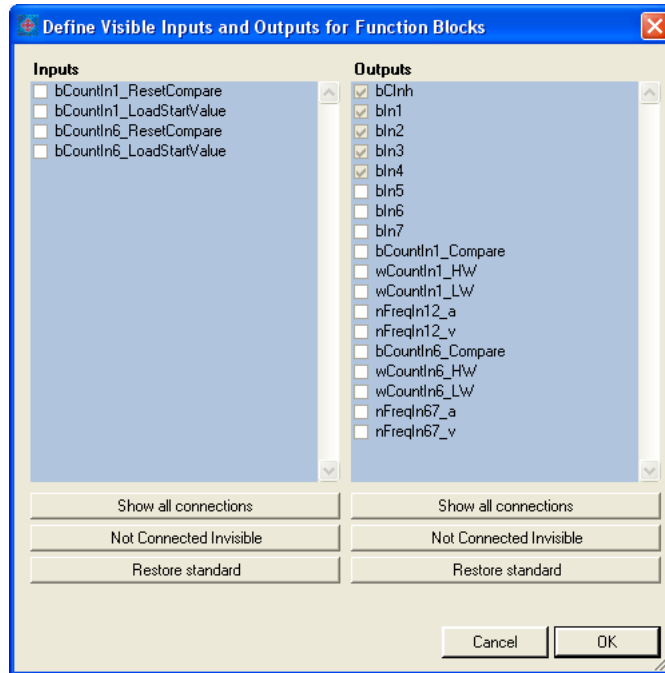

- All visible connections have a checkmark.
  - In case of a block that is inserted anew, all inputs and outputs are visible at first.
  - Inputs and outputs with a light grey checkbox are already connected and thus cannot be hidden.
2. By setting/removing the checkmarks or via the buttons you can define the visible inputs and outputs.
  3. Press **OK** to accept the selected definition and close the dialog box.

### 16.4.3 Arranging objects in the drawing area

All objects can be freely arranged in the drawing area by dragging with the mouse.

We recommend to make an arrangement in which the required connections between the inputs and outputs can be created easily. A division into functional areas may also be sensible to get a better understanding of the application.

Objects which are already connected, can also be dragged to another (free) position in the drawing area. The available connections will be automatically re-routed after dragging.



#### How to drag an object:

1. Click the header of the object (and keep the button pressed).
2. Keep the button pressed and drag the object to the required position in the drawing area.
  - Via **<Esc>** you can cancel this action.



#### How to drag several objects at the same time:

1. Select the objects to be dragged.
  - You can select a single object by clicking the header of the object.
  - If you click the header of further objects while pressing **<Ctrl>**, these will be added to an already existing selection (multi-selection).
  - You can easily select objects that are placed together by drawing a frame around these objects while keeping the mouse button pressed.
  - All selected objects are highlighted by a light green header.
2. Keep the mouse button pressed on the header of one of the selected objects and drag it to the required position in the drawing area.
  - Via **<Esc>** you can cancel this action.



#### Note!

A red header indicates that the object overlaps with other objects in the drawing area!  
Arrange the objects so that no overlap occurs.

**16.4.4 Creating/deleting connections**

After adding objects and arranging them in a reasonable manner within the drawing area, you can create the connections between the available objects which are required for the desired function.

A connection always has a direction and therefore always has a source and a target.

- An output represents a possible source in the interconnection.
- An input represents a possible target in the interconnection.

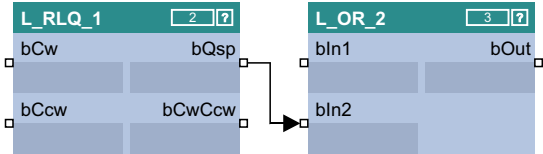

**Permissible/impermissible connections**

Several connections can lead from one output.

- Therefore it is always possible to start a new connection from an output.

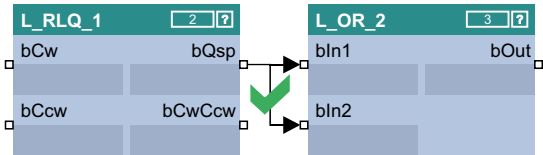

However, maximally one connection may end in an input.

- Therefore it is only possible to start a new connection from an input if there is no connection already ending in this input.

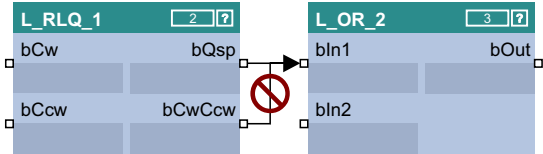

Only inputs/outputs of the same signal type can be connected.

- Thus, a connection between different port symbol cannot be established.

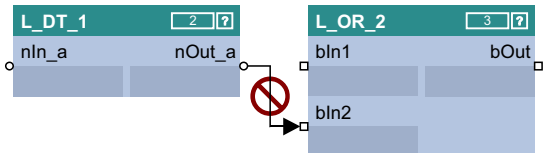

From the »Engineer« V2.12 "Analog/scaled" (\_a) and "Miscellaneous (WORD)" signal types can also be interconnected.

- The implicit type conversion is indicated by a vertical black bar at the port symbol.

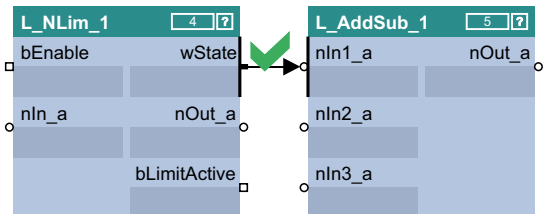

From the »Engineer« V2.13 "Analog/scaled" (\_a) and "Angular velocity" (\_v) signal types can also be interconnected.

### Connection types

Connections can either be created by means of connection lines or port identifiers ("flags")

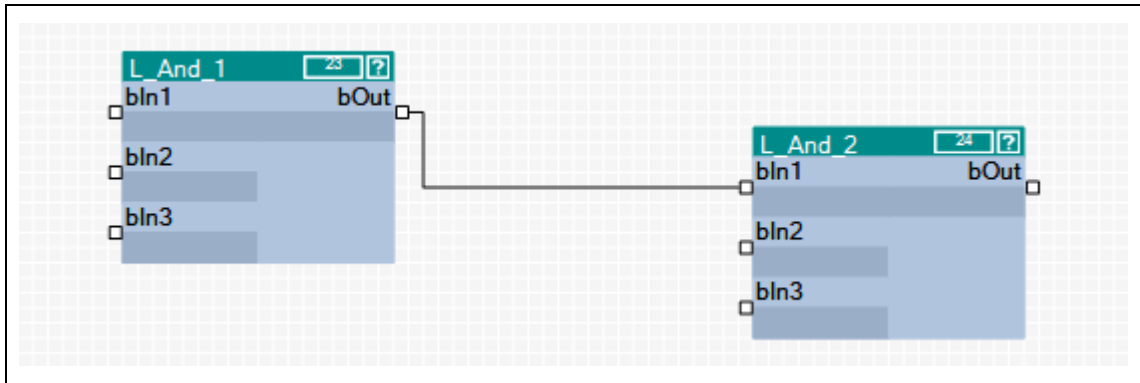

[16-8] Example 1: Connection via connection line

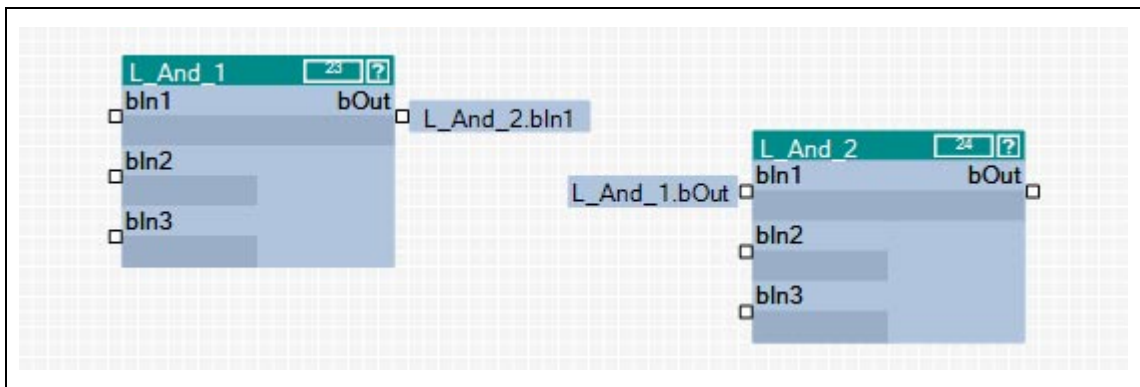

[16-9] Example 2: Connection via flags



#### Tip!

The commands **Show as flag** or **Show as line** in the *context menu* of a connection serve to change the representation of the connection at any time.

When an output is connected to several inputs via flags, three points are displayed ("...") at the output instead of the concrete input identifier. The *context menu* of the port symbol shows all inputs which are connected to the output.

### 16.4.4.1 Creating a connection using the connection line



**How to create a connection using the connection line:**

1. Click the port symbol from which the new connection is to be started.
  - It is only possible to start a new connection from an input if there is no connection already ending in this input.
  - If you then move the mouse pointer away from the port symbol, a new connection is "drawn" from this port symbol.
  - Via <Esc> you can cancel this action.
2. Click the port symbol where the connection is to end.
  - Thereupon the corresponding connection is routed automatically if the connection is permissible.



**Tip!**

If you move the mouse pointer across the port symbol while drawing a new connection, you can see whether the connection is permissible or not from the colour of the drawn line and from the mouse pointer symbol.

- Permissible connection:



- Impermissible connection (different port symbol):

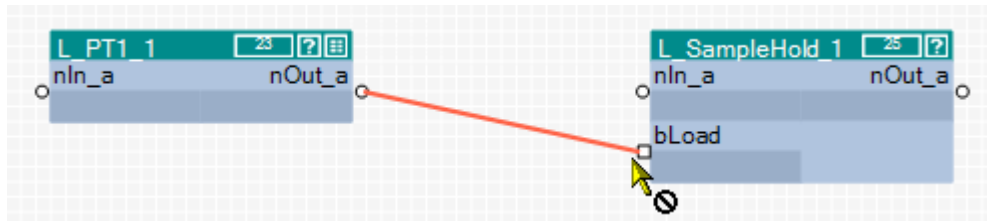

The command **Show as flag** in the *context menu* of a line serves to change the representation of the connection at any time.

### 16.4.4.2 Creating a connection using port identifiers



How to create a connection with port identifiers:

- Click the port identifier.
  - The selected port is highlighted in light green:

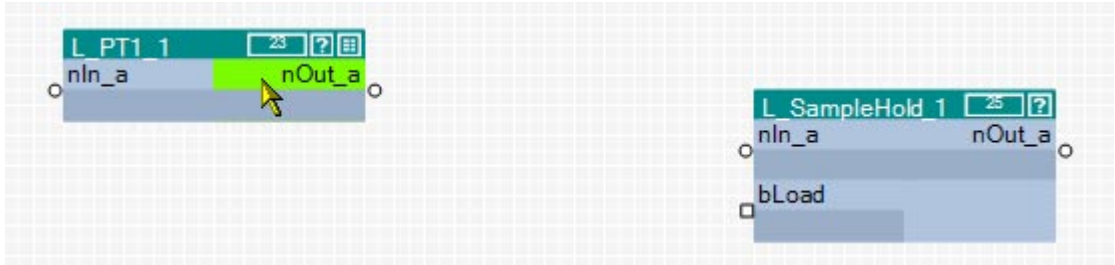

- Drag the port segment to the required port while keeping the left mouse button pressed:

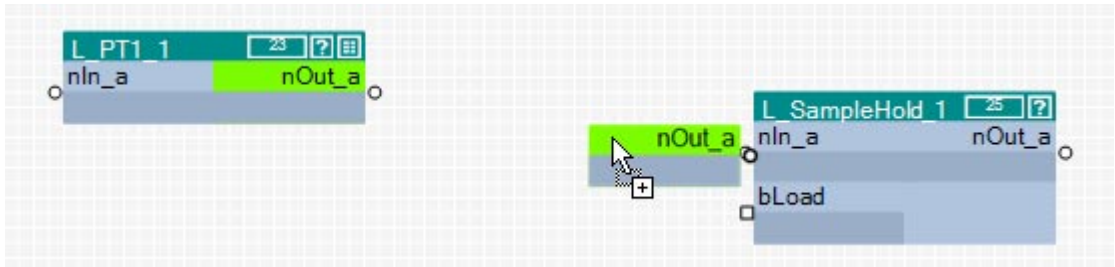

After releasing the mouse button, the connection via port identifiers (flags) is created. The corresponding port identifier consists of the block name and the name of the input/output:

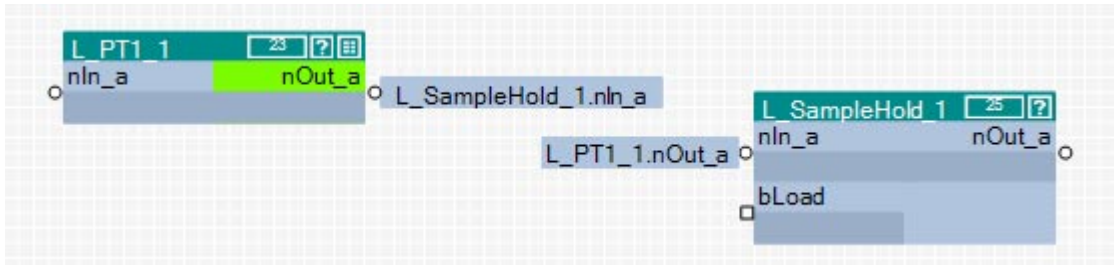

**Tip!**

The command **Show as line** in the *context menu* of a flag serves to change the representation of the connection at any time.

### 16.4.4.3 Creating a connection via connection dialog

You can also create connections by means of a selection dialog instead of dragging by mouse. This especially makes sense if there is a great distance between the ports to be connected in the drawing area.



#### How to create a connection using the selection dialog:

1. Right-click the port identifier or click the port symbol from which the connection is to start.
  - The *context menu* for the port is displayed.
2. Go to the *context menu* for the port and select the **Add/change connection...** command.
  - The *Add/change connection* dialog box is displayed:

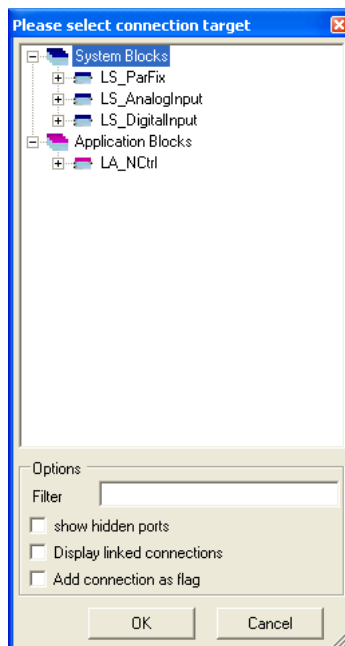

- In a tree structure all inputs and outputs of the application are shown to which a connection is permissible.
  - You can enter an optional text into the **Filter** input field to reduce the selection to the blocks or ports which contain the entered text.
  - If you activate the **Show hidden ports** control field, the hidden ports for system and function blocks are shown as well.
3. Select the port where the connection is to end from the tree structure.
  4. Activate the **Add connection as flag** control field if a port identifier (flag) is to be inserted instead of a connection line.
  5. Press **OK** to create the connection to the selected port and close the dialog box.

---

#### 16.4.4.4 Deleting connections that are no longer required

**How to delete connection lines:**

1. Select connection lines to be deleted.
  - Select a single connection line by directly clicking on the connection line with the right mouse button.
  - If you click further connection lines while pressing **<Ctrl>** they are added to an already existing selection (multi-selection).
  - All connection lines are highlighted in red.
2. Press **<Del>**.

**How to delete port identifiers/flags:**

1. Select the port identifiers to be deleted.
  - Select a single port identifier by directly clicking on the port identifier with the left mouse button.
  - If you click further port identifiers while pressing **<Ctrl>** they are added to an already existing selection (multi-selection).
  - All selected port identifiers are highlighted by a light green header.
2. Press **<Del>**.

**Related topics**

- ▶ [Deleting objects that are no longer required](#) (📄 912)



### 16.4.5 Changing the processing order

If you insert a function block into the interconnection, an order index is automatically assigned to this function block. By means of this order index it is defined in which order the individual function blocks are calculated at runtime.

- The first function block inserted contains the order index "1", the next function block inserted contains the order index "2", etc.
- The respective order index is displayed in the header of the function block in the rectangle after the block name.

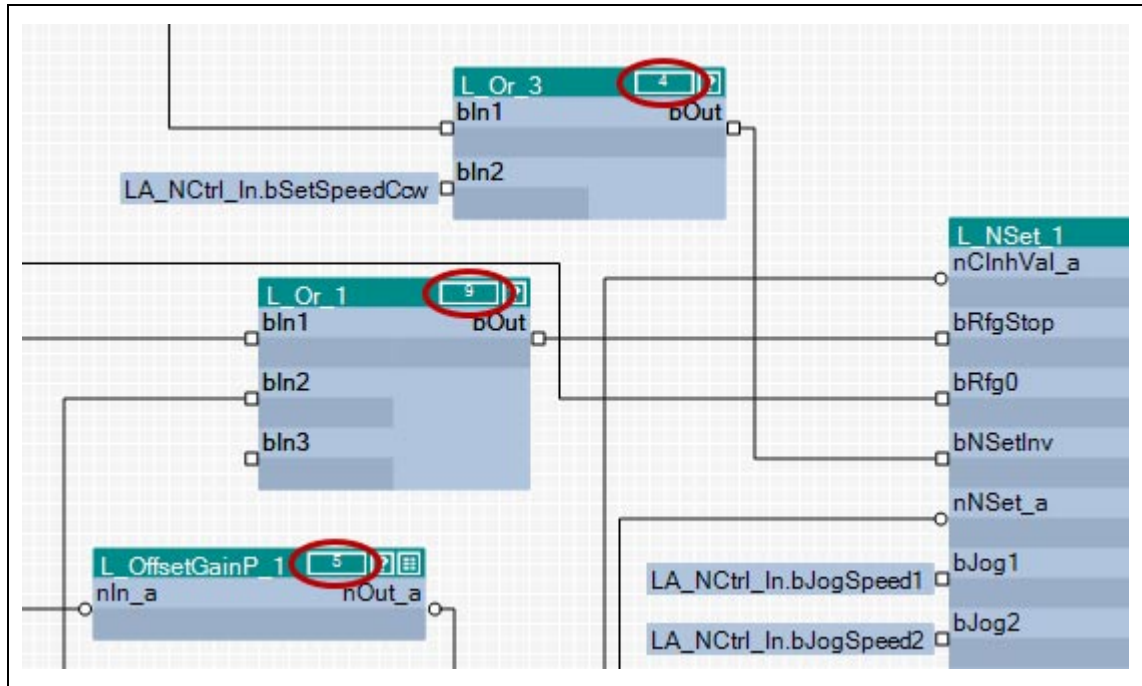

[16-10] Example: Function blocks with order index



#### Note!

When a function block is shifted, its order index is maintained.

The processing order influences the result!

- In certain cases it may be sensible to change the processing order, but if you select an unfavourable processing order, errors may arise!



### How to change the processing order manually:

- Use the list field at the top right to change from the Editor to the overview.
  - The overview displays all function blocks of the interconnection in the order of their processing
  - In the first "Order" column the order index of each function block is listed.
- Unless already selected, select the entry "Manual selection" in the **Optimisation...** list field.

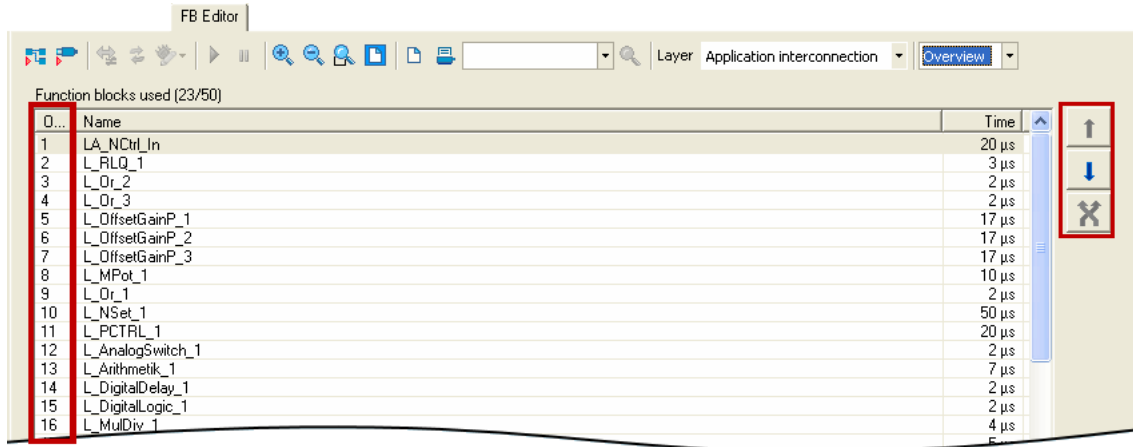

- Select the function block which is to receive a different position within the processing order.
  - If you click further function blocks while pressing **<Ctrl>** they are added to an already existing selection (multi-selection).
  - The **<Shift>** key serves to select a related area of function blocks.
- Move the function block(s) to the desired position using the and buttons.
  - The button serves to exchange two selected function blocks with regard to their order.
- Repeat steps 3 and 4 until the required processing order has been established.

### Changing the processing order according to an automatically generated selection

In addition to the manual selection, the **Optimisation...** list field also offers two options for an automatic adaptation of the processing order:

- **Signal flow:** The processing order is optimised according to the signal flow.
- **Topology:** The processing order is optimised according to the x/y arrangement of the function blocks in the FB Editor.

As long as an automatic adaptation has been selected, a manual change of the processing order is not possible.

### 16.4.6 Copying interconnection elements (across all devices)

Interconnection elements can be copied across the devices within the project if the devices belong to the same product family (e.g. Inverter Drives 8400).

All types of blocks and comments can be copied to the clipboard via the **Copy** command or the **<Ctrl>+<c>** shortcut and then be inserted into the FB interconnection of the same or another project device of the same product family using the **Paste** command or the **<Ctrl>+<v>** shortcut.

- During the copy process into the clipboard, existing connections between copied blocks are copied as well, and the layout is kept too. Moreover, the separate technical objects (e.g port definition) are copied. Selected connections cannot be copied on their own.
- The **Paste** command is available if the clipboard is not empty and if it was copied from a device of the same product family. Within this product family, all device types (e.g. 8400 xxxxLine Vxx.xx) are permitted.
- After the **Paste** command has been selected, a dialog box is displayed which serves to select which elements are to be inserted from the clipboard and how to solve name conflicts, if any.
- After inserting the elements, they are marked in the target interconnection in order to be repositioned or deleted again to undo the insertion.
- Inserting from the clipboard can be repeated. The originally copied contents of the clipboard remains unchanged when it is inserted.



#### How to copy one or several interconnection elements:

1. Select the objects to be copied.
  - You can select a single object by clicking the header of the object.
  - If you click the header of further objects while pressing **<Ctrl>**, these will be added to an already existing selection (multi-selection).
  - You can easily select elements that are placed together by drawing a frame around these elements while keeping the mouse button pressed.
  - All selected objects are highlighted by a light green header.
2. Go to the *context menu* and select the **Copy** command (or **<Ctrl>+<c>**).
  - The selected elements are copied into the clipboard of the FB Editor.
3. If the elements are to be copied into a function block interconnection of another project device, change to the corresponding interconnection via the *project view*.
4. Go to the *context menu* and select the **Paste** command (or **<Ctrl>+<v>**).
5. Go to the *Insert FB interconnection* dialog box and select the elements to be inserted from the clipboard.
  - Detailed information on this dialog box can be obtained from the following subchapter "[Insert options for copied elements](#)". (📖 925)

- 
6. Click **Insert** to insert the selected elements into the target interconnection as defined.
    - Only possible if at least one element in the list has been selected for insertion.
    - Insertion is also possible via the **<Enter>** button if at least one element is selected from the list for insertion.
    - The original layout and the relative position of the inserted blocks to each other are maintained.
    - When copying across the devices, you also insert the corresponding separate technical objects (e.g. port definition).
    - The inserted elements are deleted from the list. If the list is empty, the dialog box is closed and the connections are inserted depending on the selected option.
  7. If there are still elements to be entered in the list, repeat steps 5 and 6 until all elements are inserted as intended.
  8. Press **Close** to stop the insertion and close the dialog box.
    - You can also use **<Esc>** or **<Enter>** to close the dialog box if "Insert" is not active.
    - The elements inserted into the target interconnection so far are maintained.
    - The connections for the blocks inserted so far are inserted depending on the selected option.

### 16.4.6.1 Insert options for copied elements

If interconnection elements have been copied to the clipboard, the »Engineer« will display a list of all elements contained in the clipboard when selecting the command **Insert** in the *Insert FB interconnection* dialog box:

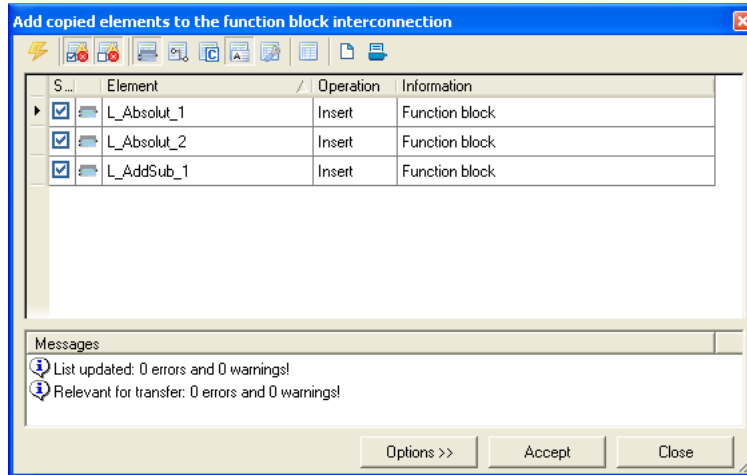

The list shows the elements which can be added to the target interconnection, and the elements which cannot be added.

- In the "Selection" column, you can check/uncheck the elements to be added.
- Connections are only inserted when the dialog box is closed, which applies to all modules inserted so far. They are displayed as lines or flags, like in the original, but re-routed.
- The symbols in the *Toolbar* serve to execute the following functions:

Symbol	Function
	Add the selected elements to the interconnection
	Show the elements to be added but are marked with an error or warning.
	Show the elements not to be added and marked with an error or warning.
	Show blocks
	Show connections
	Show parameters
	Show comments
	Show system elements
	Show all
	Print Preview
	Print list

- The buttons serve to execute the following functions:

Button	Function
Paste	Add elements selected in the list to the target interconnection <ul style="list-style-type: none"> <li>• Only possible if at least one element in the list has been selected for insertion.</li> <li>• Insertion is also possible via the &lt;Enter&gt; button if at least one element is selected from the list for insertion.</li> <li>• The original layout and the relative position of the inserted blocks to each other are maintained.</li> <li>• When copying across the devices, you also insert the corresponding separate technical objects (e.g. port definition).</li> <li>• The added elements are simultaneously deleted from the list. The connections are added depending on the selected option.</li> </ul>
Close	Close dialog box. <ul style="list-style-type: none"> <li>• You can also use &lt;Esc&gt; or &lt;Enter&gt; to close the dialog box if "Insert" is not active.</li> <li>• The elements inserted into the target interconnection so far are maintained.</li> <li>• The connections for the blocks inserted so far are inserted depending on the selected option.</li> </ul>

### 16.4.7 Resetting changed interconnection

If you only made changes on the I/O level, you can reset them by selecting a predefined control scheme in [C00007](#). If you have also made changes on the application level, you must first reset the changed application to a predefined application in [C00005](#).



**How to reset the application interconnection to a predefined application:**

1. Go to the **Application parameters** tab.
2. Select the required application in the **Application** list field.



**How to reset the I/O interconnection to a predefined control scheme:**

1. Go to the **Application parameters** tab.
2. Select the required control scheme in the **Control source** list field.

## 16.5 Adjusting online and offline interconnection

If the »Engineer« detects that online and offline interconnection differ from each other, the *Compare interconnection* dialog box is displayed with various options for the adjustment:

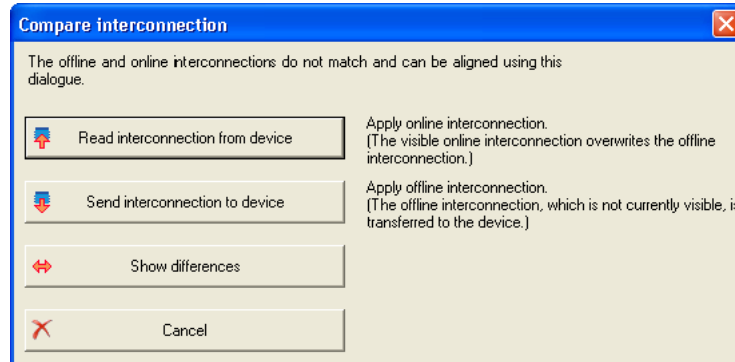

**Tip!**

The dialog box can also be opened via the  symbol in the *FB Editor toolbar*.

Button	Function
<b>Read interconnection from device</b>	Add the interconnection in the device to the FB Editor. The interconnection existing in the FB Editor will be overwritten by this action.
<b>Send interconnection to device</b>	Transfer the offline interconnection which is currently not visible in the FB Editor to the device. The interconnection existing in the device will be overwritten by this action.
<b>Show differences</b>	Showing differences between online and offline interconnection.
<b>Cancel</b>	Close the <i>Adjust interconnection</i> dialog box without making an adjustment.

---

## 16.6 Printing the interconnection

The interconnection can be printed for documentation purposes, optionally on one page, on four pages, or not scaled.

**Tip!**

By clicking the  icon in the *FB Editor toolbar*, you can get a print view before printing.

**How to print the interconnection:**

1. In the *FB Editor toolbar*, click the  icon.
  - The *Circuit print size* dialog box is displayed.
2. Select the desired size and press **OK**.
  - The standard dialog box *Print* appears.
3. Press **OK** to start the printing process.



## 16.7 Comparing interconnections

The comparison operation serves to compare FB interconnections of 8400 devices within the project. An offline<>online comparison and the comparison of two online devices are possible.



### Note!

Only applications can be compared which have been enabled in the FB Editor!  
Block positions, line representations, and connector visibilities are not compared.



### How to compare two FB interconnections:

1. Select the command **Application data**→**Compare FB interconnections...**
  - The *Compare FB interconnections* dialog box is displayed:

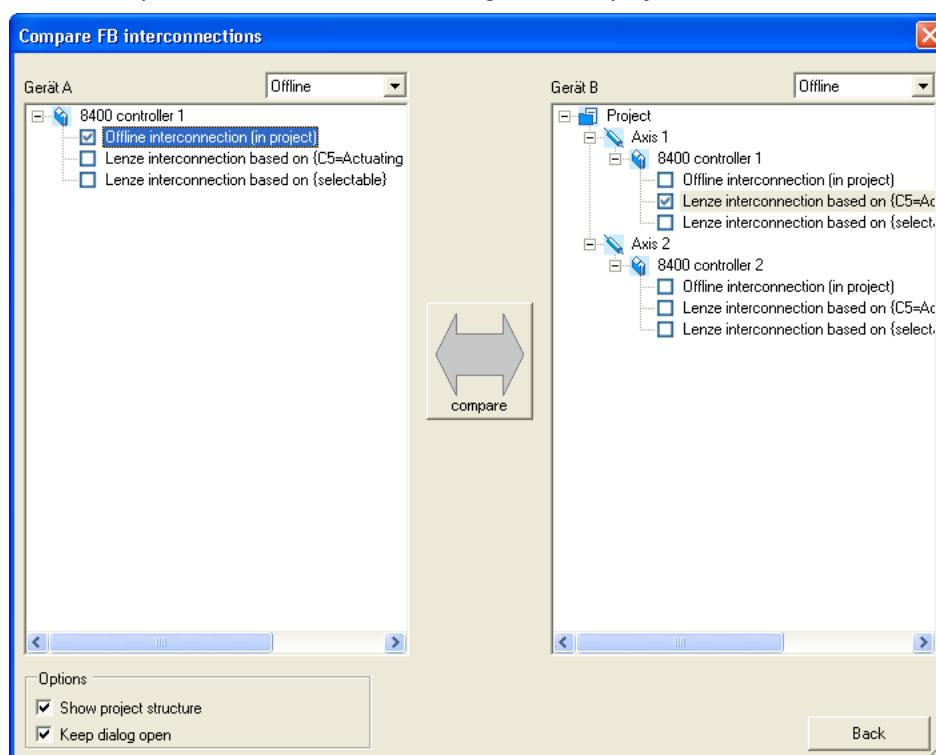

2. Select the interconnections to be compared in the project view represented on the left and right.
  - In order to execute a comparison with an online device, select "Online" in one of the two upper list fields. Then all available online devices are displayed for selection.
  - If you select "Online" in one of the two upper list fields, you can also compare the interconnections of two available online devices.
3. Click **Compare**.
  - If the comparison was executed successfully, the comparison result is displayed as a list (see the following section).
  - If a comparison of the selected interconnections is not possible, a corresponding message is displayed.
4. In order to stop the comparison operation and close the dialog box: Press **Back**.

### Representation of the comparison result



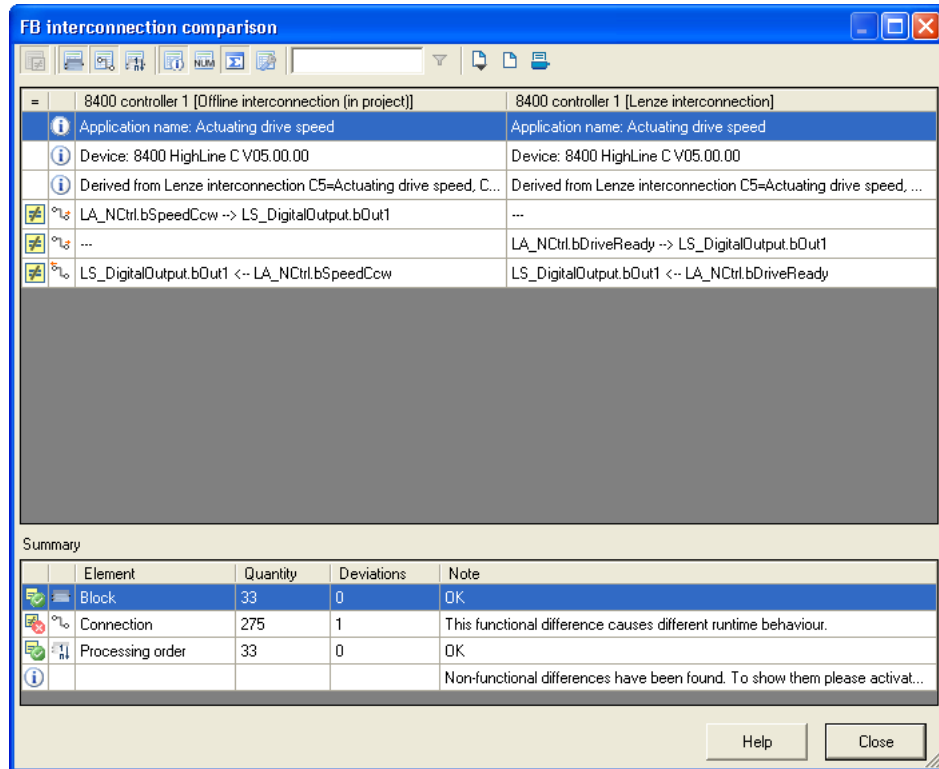

The comparison result is displayed in the form of a list in the *FB interconnection comparison* dialog box:



- The symbols in the *Toolbar* serve to show or hide different details and export and print the shown list.

Symbol	Function
	Only show differences • Button can only be activated in expert mode.
	Show blocks
	Show connections
	Show processing sequence
	Show properties for blocks and connections • Function is only available in expert mode.
	Show comments • Function is only available in expert mode.
	Show block parameters • Function is only available in expert mode.
	Show application parameters • Function is only available in expert mode.
	Show all • Function is only available in expert mode.
	Show general information
	Show summary

---

Symbol	Function
	Activate expert mode • In the expert mode, also non-functional differences are shown.
	Use filter • Only show list entries which contain the text entered in the input field. • Function is only available in expert mode.
	Export shown list as comma-separated list (*.csv)
	Print Preview
	Print list

---

## 16.8 Copying an interconnection

In contrast to copying/inserting selected interconnection elements via the clipboard, the function described in this chapter serves to replace the current FB interconnection of a device completely by the FB interconnection of another project device.



### Note!

The complete FB interconnection can only be copied between devices of the same device type and version (e.g. 8400 HighLine C V1.0).

A complete interconnection comprises:

- Function blocks (use and parameter values)
- System blocks (application and parameter values)
- Port blocks (use and parameter values)
- Connections
- Comments
- Interconnection layout (arrangement of the modules)
- Port definition of the ports used in the FB interconnection



### How to copy the complete interconnection into another project device:

1. Select the application with the FB interconnection to be copied in the *project view*.
2. Select the command **Application data→Copy FB interconnections....**
3. Go to *project view* and select the application which is to be inserted into the copied FB interconnection.
4. Select the command **Application data→Add FB interconnection....**
  - The command can only be activated if an FB interconnection has been copied from a device of the same device type and version.
  - After the command has been executed, the module assembly is compared. If there are relevant deviations, the insertion is refused and a corresponding message is displayed.
  - If an insertion is possible, you are asked if the FB interconnection is to be inserted.
5. Confirm the question if the copied FB interconnection is to be inserted with **Yes**.
  - After the insertion, an update of the project is required.

---

## 16.9 Exporting/Importing an interconnection

The interconnection existing in the project can be exported to a file for reuse/transfer to other devices.



### Note!

The file can only be imported to devices of the same device type and version (e.g. 8400 HighLine C V1.0).



#### How to export the interconnection from the project to a file:

1. Go to the *Project view* in the *context menu* of the inverter and select the **Export FB interconnection...** command.
2. Enter the memory location and the file name for the interconnection to be exported in the *Export FB interconnection* dialog box.
3. Click **Save** to export the interconnection and close the dialog box.



#### How to import the interconnection from a file to the project:

1. Go to the *Project view* in the *context menu* of the inverter and select the **Import FB interconnection...** command.
2. Select the file with the interconnection to be imported in the *Import FB interconnection* dialog box.
3. Click **Open** to import the interconnection and close the dialog box.

# 17 Function library

## 17.1 Function blocks

# 17 Function library

## 17.1 Function blocks

This chapter describes the function blocks which are available for the inverter in the FB Editor.



The system blocks are described in the following chapter "[System blocks](#)". (📖 1015)

### Overview of function blocks available

Function block	Runtime	Function
<a href="#">L Absolute_1</a>	2 µs	... converts a bipolar input signal into a unipolar output signal.
<a href="#">L AddSub_1</a>	3 µs	... adds / subtracts analog input signals.
<a href="#">L AnalogSwitch_1</a> <a href="#">L AnalogSwitch_2</a> <a href="#">L AnalogSwitch_3</a>	2 µs	... switches between two analog input signals.
<a href="#">L And_1</a> <a href="#">L And_2</a> <a href="#">L And_3</a>	2 µs	... ANDs three binary signals.
<a href="#">L Arithmetik_1</a> <a href="#">L Arithmetik_2</a>	7 µs	... combines two analog signals arithmetically. • <a href="#">L_Arithmetik_2</a> is available from version 11.00.00 onwards.
<a href="#">L Compare_1</a> <a href="#">L Compare_2</a> <a href="#">L Compare_3</a>	5 µs	... compares two analog signals and can be used e.g. to implement a trigger. • <a href="#">L_Compare_3</a> is available from version 11.00.00 onwards.
<a href="#">L DFlipFlop_1</a>	1 µs	... provides two stable states depending on the input signals.
<a href="#">L DigitalDelay_1</a>	2 µs	... delays binary signals.
<a href="#">L DigitalLogic_1</a> <a href="#">L DigitalLogic_3</a>	2 µs	... provides a binary output signal which is generated by the logic combination of three input signals. • <a href="#">L_DigitalLogic_3</a> is available from version 11.00.00.
<a href="#">L GainOffset_1</a> <a href="#">L GainOffset_2</a> <a href="#">L GainOffset_3</a>	3 µs	... can amplify an analog input signal and then add an offset to it. • Gain and offset can be set via FB inputs.
<a href="#">L Interpolator_1</a>	5 µs	... can interpolate a position setpoint and/or an analog value e.g. to compensate for larger bus transmission cycles or to continue signal characteristics if data telegrams are missing.
<a href="#">L JogCtrlExtension_1</a>	5 µs	... can be connected upstream to the <a href="#">L_NSet</a> ramp generator to implement a switch-off positioning at limit switch.
<a href="#">L MPot_1</a>	10 µs	... replaces a hardware motor potentiometer as setpoint source.
<a href="#">L MulDiv_1</a>	4 µs	... multiplies the analog input signal with a factor.
<a href="#">L Negation_1</a>	2 µs	... negates an analog input signal.
<a href="#">L Not_1</a> <a href="#">L Not_2</a> <a href="#">L Not_3</a>	2 µs	... inverts a digital input signal.
<a href="#">L NSet_1</a>	50 µs	... contains a ramp generator with comprehensive parameterisation and control options to condition a setpoint signal.
<a href="#">L OffsetGain_1</a> <a href="#">L OffsetGain_2</a>	4 µs	... can add an offset to an analog input signal and amplify it afterwards. • Offset and gain can be set via FB inputs.
<a href="#">L OffsetGainP_1</a> <a href="#">L OffsetGainP_2</a> <a href="#">L OffsetGainP_3</a>	17 µs	... can add an offset to an analog input signal and amplify it afterwards. • Offset and gain can be set via parameters.

Function block	Runtime	Function
<a href="#">L_Or_1</a> <a href="#">L_Or_2</a> <a href="#">L_Or_3</a> <a href="#">L_Or_4</a>	2 $\mu$ s	... ORs three binary signals. • <a href="#">L_Or_4</a> is available from version 11.00.00.
<a href="#">L_PCTRL_1</a>	20 $\mu$ s	... is a PID inverter and can be used for various control tasks.
<a href="#">L_PT1_1</a>	1 $\mu$ s	... filters and delays analog signals.
<a href="#">L_RLO_1</a>	3 $\mu$ s	... links a selected direction of rotation to the QSP function with wire-break protection.
<a href="#">L_SignalMonitor_a</a>	15 $\mu$ s	... serves to output analog output signals of other FBs, SBs or LAs.
<a href="#">L_SignalMonitor_b</a>	3 $\mu$ s	... serves to output binary output signals of other FBs, SBs or LAs.
<a href="#">L_Transient_1</a> <a href="#">L_Transient_2</a> <a href="#">L_Transient_3</a> <a href="#">L_Transient_4</a>	3 $\mu$ s	... evaluates digital signal edges and converts them into timed pulses.

**Related topics:**

- ▶ [Overview of system blocks available](#) (📖 1015)
- ▶ [Working with the FB Editor](#) (📖 882)

### 17.1.1 L\_Absolut\_1

This FB converts a bipolar input signal into a unipolar output signal.

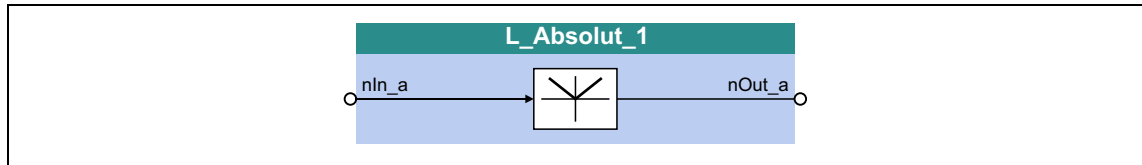

#### inputs

Designator	Data type	Information/possible settings
nIn_a	INT	Input signal

#### outputs

Designator	Data type	Value/meaning
nOut_a	INT	Output signal



17.1.2 L\_AddSub\_1

This FB has two adding inputs and one subtracting input.

- The value provided at the *nOut\_a* output is internally limited to  $\pm 32767$ .

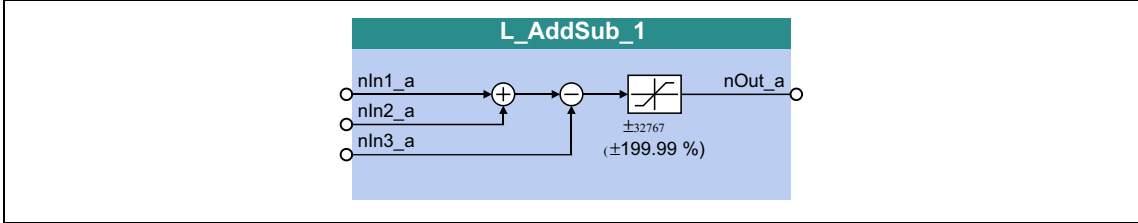

inputs

Designator	Data type	Information/possible settings
nln1_a	INT	Input signal 1 • This input is added
nln2_a	INT	Input signal 2 • This input is added
nln3_a	INT	Input signal 3 • This input is subtracted

outputs

Designator	Data type	Value/meaning
nOut_a	INT	Output signal • $nOut_a = nln1_a + nln2_a - nln3_a$ • Internal limitation to $\pm 32767$ ( $\pm 199.99\%$ )

**17.1.3 L\_AnalogSwitch\_1**

This FB changes over between two analog input signals. The change-over is controlled via a boolean input signal.

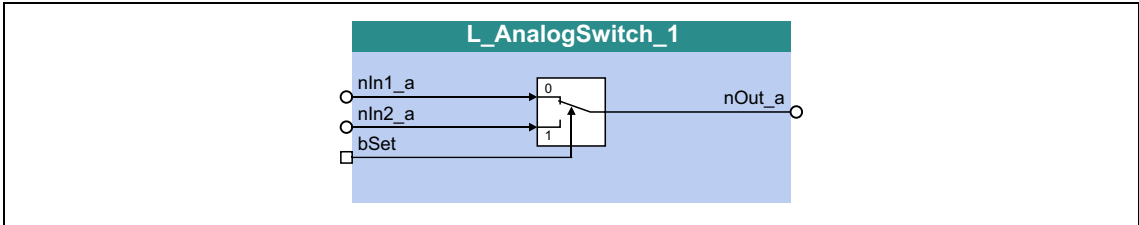

**inputs**

Designator	Data type	Information/possible settings
nln1_a	INT	Input signal 1
nln2_a	INT	Input signal 2
bSet	BOOL	Selection of the input signal for the output to <i>nOut_a</i>
		FALSE   <i>nln1_a</i>
		TRUE   <i>nln2_a</i>

**outputs**

Designator	Data type	Value/meaning
nOut_a	INT	Output signal

17.1.4 L\_AnalogSwitch\_2

This FB changes over between two analog input signals. The change-over is controlled via a boolean input signal.

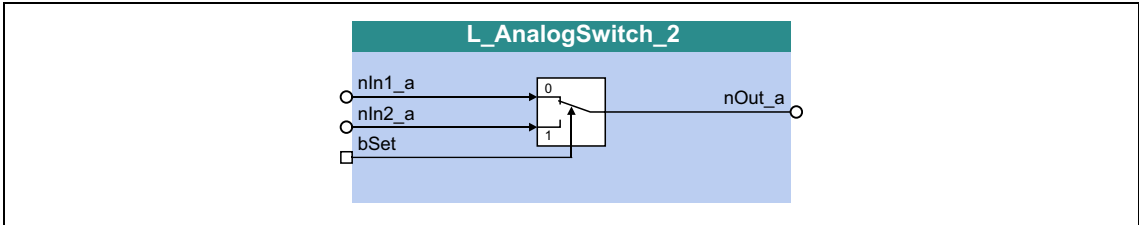

inputs

Designator	Data type	Information/possible settings	
nln1_a	INT	Input signal 1	
nln2_a	INT	Input signal 2	
bSet	BOOL	Selection of the input signal for the output to <i>nOut_a</i>	
		FALSE	<i>nln1_a</i>
		TRUE	<i>nln2_a</i>

outputs

Designator	Data type	Value/meaning
nOut_a	INT	Output signal

17.1.5 L\_AnalogSwitch\_3

This FB changes over between two analog input signals. The change-over is controlled via a boolean input signal.

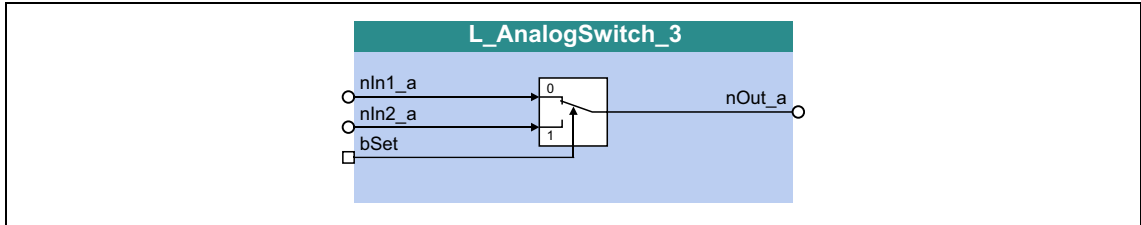

inputs

Designator	Data type	Information/possible settings	
nln1_a	INT	Input signal 1	
nln2_a	INT	Input signal 2	
bSet	BOOL	Selection of the input signal for the output to <i>nOut_a</i>	
		FALSE	<i>nln1_a</i>
		TRUE	<i>nln2_a</i>

outputs

Designator	Data type	Value/meaning
nOut_a	INT	Output signal

**17.1.6 L\_And\_1**

This FB implements AND operations for input signals.

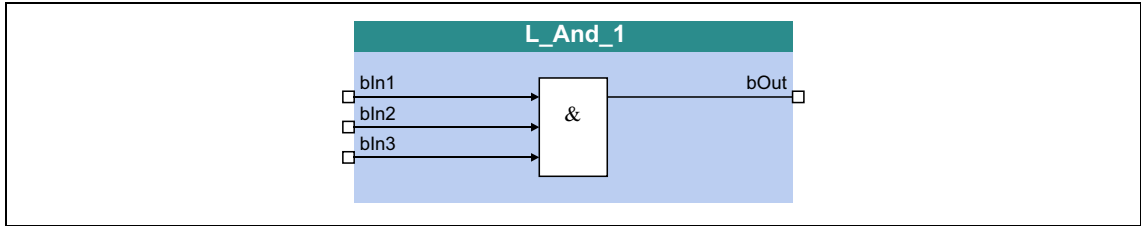

**inputs**

Designator	Data type	Information/possible settings
bIn1 bIn2 bIn3	BOOL	Input signal

**outputs**

Designator	Data type	Value/meaning
bOut	BOOL	Output signal

**Function**

inputs			Output
bIn3	bIn2	bIn1	bOut
FALSE	FALSE	FALSE	FALSE
FALSE	FALSE	TRUE	
FALSE	TRUE	FALSE	
FALSE	TRUE	TRUE	
TRUE	FALSE	FALSE	
TRUE	FALSE	TRUE	
TRUE	TRUE	FALSE	
TRUE	TRUE	TRUE	TRUE

[17-1] Truth table of the FB L\_And\_1

**17.1.7 L\_And\_2**

This FB implements AND operations for input signals.

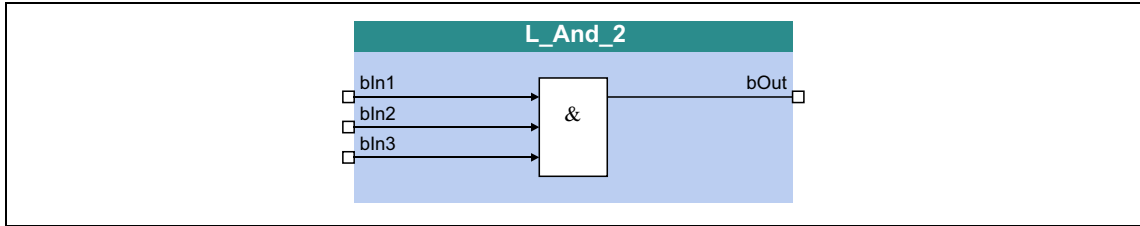

**inputs**

Designator	Data type	Information/possible settings
bIn1 bIn2 bIn3	BOOL	Input signal

**outputs**

Designator	Data type	Value/meaning
bOut	BOOL	Output signal

**Function**

inputs			Output
bIn3	bIn2	bIn1	bOut
FALSE	FALSE	FALSE	FALSE
FALSE	FALSE	TRUE	
FALSE	TRUE	FALSE	
FALSE	TRUE	TRUE	
TRUE	FALSE	FALSE	
TRUE	FALSE	TRUE	
TRUE	TRUE	FALSE	
TRUE	TRUE	TRUE	TRUE

[17-2] Truth table of the FB L\_And\_2

**17.1.8 L\_And\_3**

This FB implements AND operations for input signals.

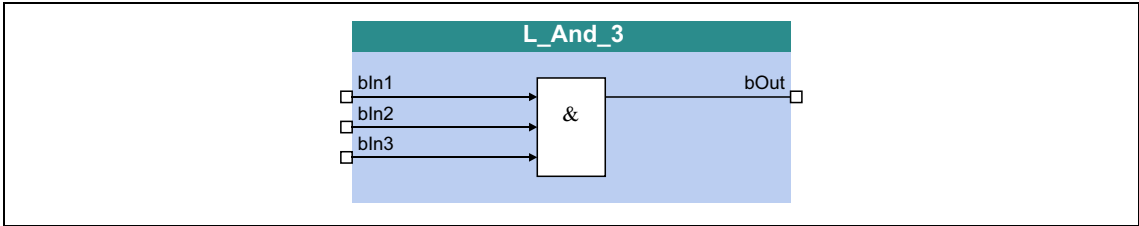

**inputs**

Designator	Data type	Information/possible settings
bIn1 bIn2 bIn3	BOOL	Input signal

**outputs**

Designator	Data type	Value/meaning
bOut	BOOL	Output signal

**Function**

inputs			Output
bIn3	bIn2	bIn1	bOut
FALSE	FALSE	FALSE	FALSE
FALSE	FALSE	TRUE	
FALSE	TRUE	FALSE	
FALSE	TRUE	TRUE	
TRUE	FALSE	FALSE	
TRUE	FALSE	TRUE	
TRUE	TRUE	FALSE	
TRUE	TRUE	TRUE	TRUE

[17-3] Truth table of the FB L\_And\_3

## 17.1.9 L\_Arithmetik\_1

This FB can implement an arithmetic link between two analog signals.

- The arithmetic function is selected in [C00338](#).
- All internal intermediate results and the value output at the *nOut\_a* output are internally limited to  $\pm 32767$ .
- Division is not remainder considered.

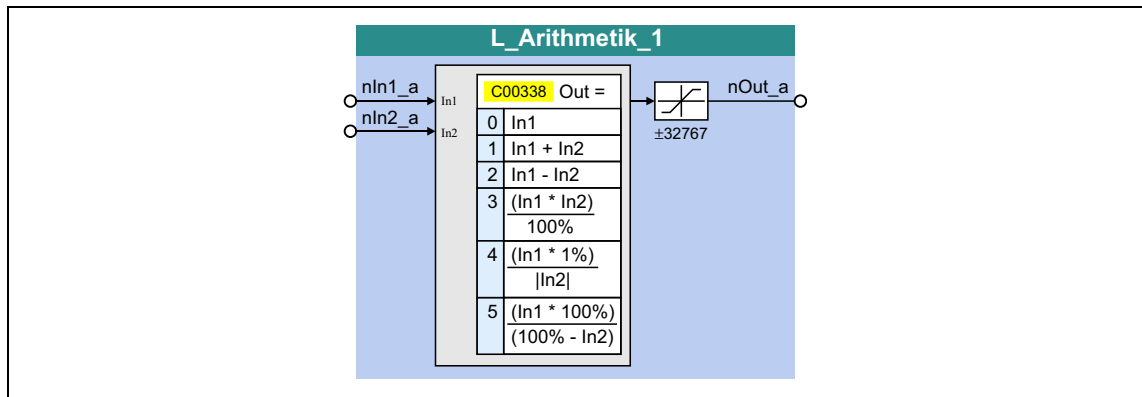

## inputs

Designator	Data type	Information/possible settings
nln1_a	INT	Input signal 1
nln2_a	INT	Input signal 2

## outputs

Designator	Data type	Value/meaning
nOut_a	INT	Output signal • Internal limitation to $\pm 32767$ ( $\pm 199.99\%$ )

## Parameters

Parameters	Possible settings	Info
<a href="#">C00338</a>		Function selection
	0 $nOut\_a = nln1\_a$	
	1 $nOut\_a = nln1\_a + nln2\_a$	
	2 $nOut\_a = nln1\_a - nln2\_a$	
	3 $nOut\_a = \frac{nln1\_a \cdot nln2\_a}{16384}$	
	4 $nOut\_a = \frac{nln1\_a}{ nln2\_a } \cdot 164$	When the denominator has the value "0", it will be set to "1".
	5 $nOut\_a = \frac{nln1\_a}{16384 - nln2\_a} \cdot 16384$	



### 17.1.10 L\_Arithmetik\_2

This FB can implement an arithmetic link between two analog signals.

- The arithmetic function is selected in [C00339](#).
- All internal intermediate results and the value output at the *nOut\_a* output are internally limited to  $\pm 32767$ .
- Division is not remainder considered.

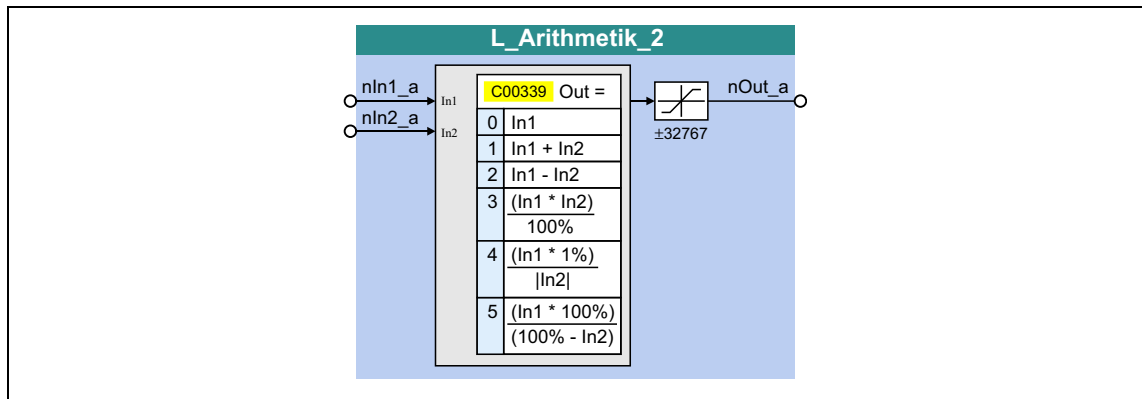

#### inputs

Designator	Data type	Information/possible settings
nln1_a	INT	Input signal 1
nln2_a	INT	Input signal 2

#### outputs

Designator	Data type	Value/meaning
nOut_a	INT	Output signal • Internal limitation to $\pm 32767$ ( $\pm 199.99\%$ )

#### Parameters

Parameters	Possible settings	Info
<a href="#">C00339</a>		Function selection
	0 $nOut\_a = nln1\_a$	
	1 $nOut\_a = nln1\_a + nln2\_a$	
	2 $nOut\_a = nln1\_a - nln2\_a$	
	3 $nOut\_a = \frac{nln1\_a \cdot nln2\_a}{16384}$	
	4 $nOut\_a = \frac{nln1\_a}{ nln2\_a } \cdot 164$	When the denominator has the value "0", it will be set to "1".
	5 $nOut\_a = \frac{nln1\_a}{16384 - nln2\_a} \cdot 16384$	

### 17.1.11 L\_Compare\_1

This FB compares two analog signals and can be used e.g. to implement a trigger.

- Comparison operation, hysteresis and window size can be parameterised.

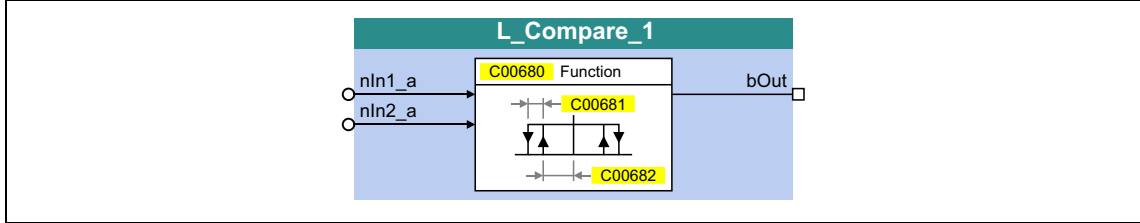

#### inputs

Designator	Data type	Information/possible settings
nln1_a	INT	Input signal 1
nln2_a	INT	Input signal 2

#### outputs

Designator	Data type	Value/meaning
bOut	BOOL	Status signal "Comparison statement is true"
		TRUE   The statement of the selected comparison mode is true.

#### Parameters

Parameters	Possible settings			Info												
<a href="#">C00680</a>	<table border="1"> <tr><td>1</td><td>nln1 = nln2</td></tr> <tr><td>2</td><td>nln1 &gt; nln2</td></tr> <tr><td>3</td><td>nln1 &lt; nln2</td></tr> <tr><td>4</td><td> nln1  =  nln2 </td></tr> <tr><td>5</td><td> nln1  &gt;  nln2 </td></tr> <tr><td>6</td><td> nln1  &lt;  nln2 </td></tr> </table>			1	nln1 = nln2	2	nln1 > nln2	3	nln1 < nln2	4	nln1  =  nln2	5	nln1  >  nln2	6	nln1  <  nln2	Function selection
1	nln1 = nln2															
2	nln1 > nln2															
3	nln1 < nln2															
4	nln1  =  nln2															
5	nln1  >  nln2															
6	nln1  <  nln2															
<a href="#">C00681</a>	0.00	%	100.00	Hysteresis • Lenze setting: 0.50 %												
<a href="#">C00682</a>	0.00	%	100.00	Window • Lenze setting: 2.00 %												

### 17.1.11.1 Function 1: nln1 = nln2

This function compares two signals with regard to equality. It can, for instance, provide the comparison "actual speed equals setpoint speed" ( $n_{act} = n_{set}$ ).

- Use [C00682](#) to set the window within which the equality is to apply.
- Use [C00681](#) to set a hysteresis if the input signals are not stable and the output oscillates.

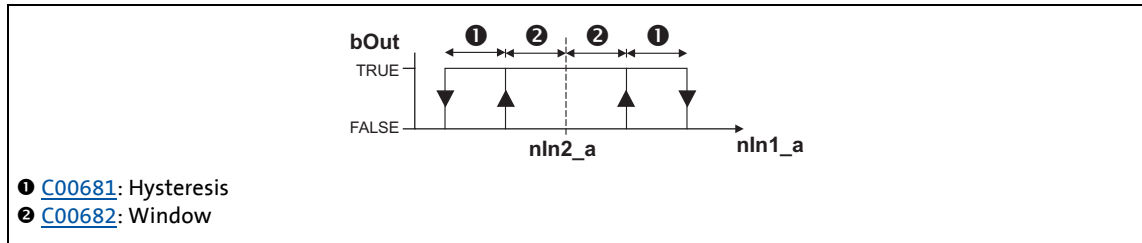

[17-4] Function 1: Switching performance

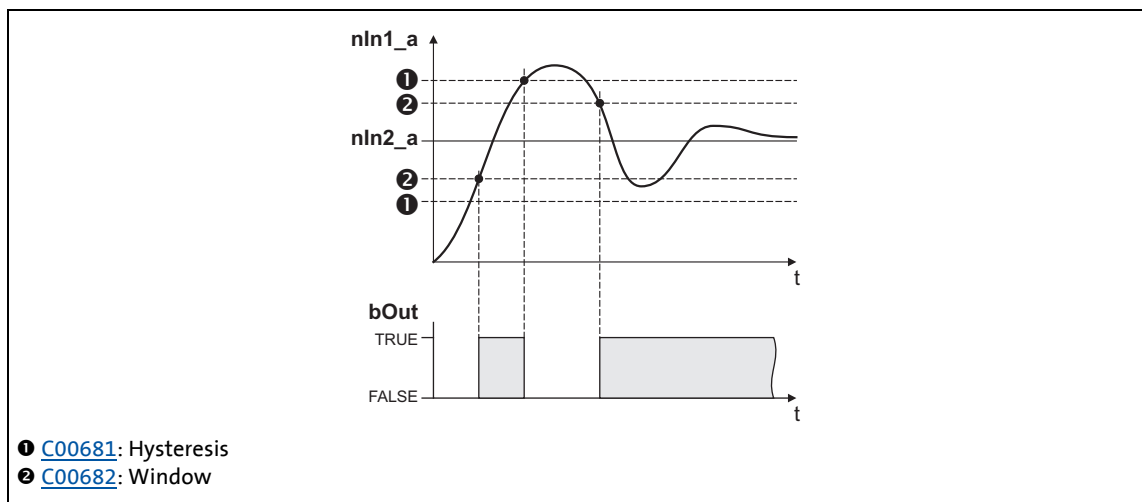

[17-5] Function 1: Example

### 17.1.11.2 Function 2: $nIn1 > nIn2$

This function serves, for instance, to implement the comparison "actual speed is higher than a limit value" ( $n_{act} > n_x$ ) for one direction of rotation.

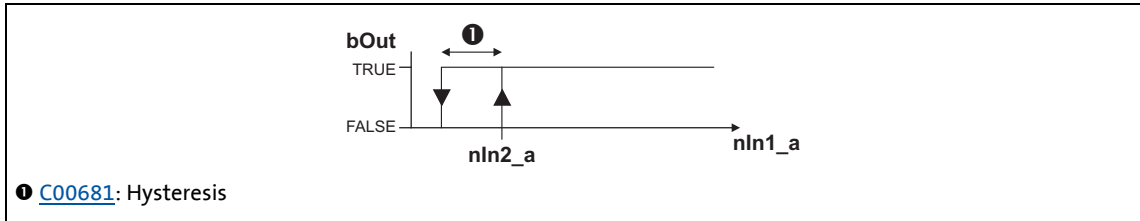

[17-6] Function 2: Switching performance

#### Functional sequence

1. If the value at  $nIn1\_a$  exceeds the value  $nIn2\_a$ ,  $bOut$  changes from FALSE to TRUE.
2. Only if the signal at  $nIn1\_a$  falls below the value of  $nIn2\_a$  - *hysteresis* again,  $bOut$  changes back from TRUE to FALSE.

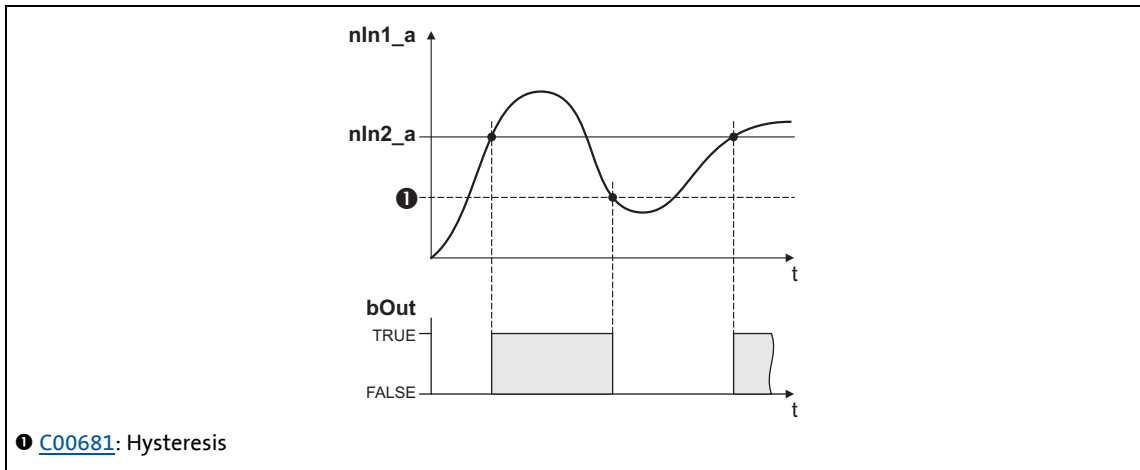

[17-7] Function 2: Example

### 17.1.11.3 Function 3: $nIn1 < nIn2$

This function serves, for instance, to implement the comparison "actual speed is lower than a limit value" ( $n_{act} < n_x$ ) for one direction of rotation.

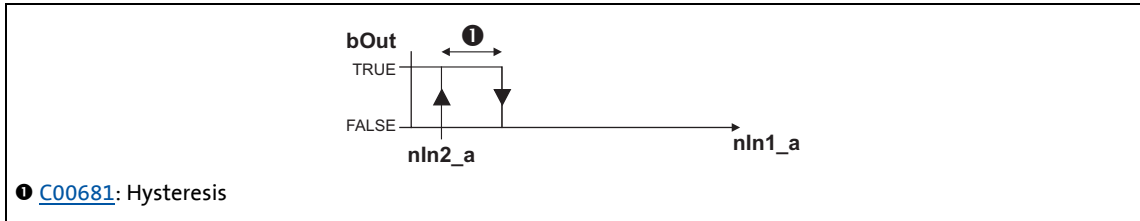

[17-8] Function 3: Switching performance

#### Functional sequence

1. If the value at  $nIn1\_a$  falls below the value at  $nIn2\_a$ ,  $bOut$  changes from FALSE to TRUE.
2. Only if the signal at  $nIn1\_a$  exceeds the value of  $nIn2\_a - \text{hysteresis}$  again,  $bOut$  changes back from TRUE to FALSE.

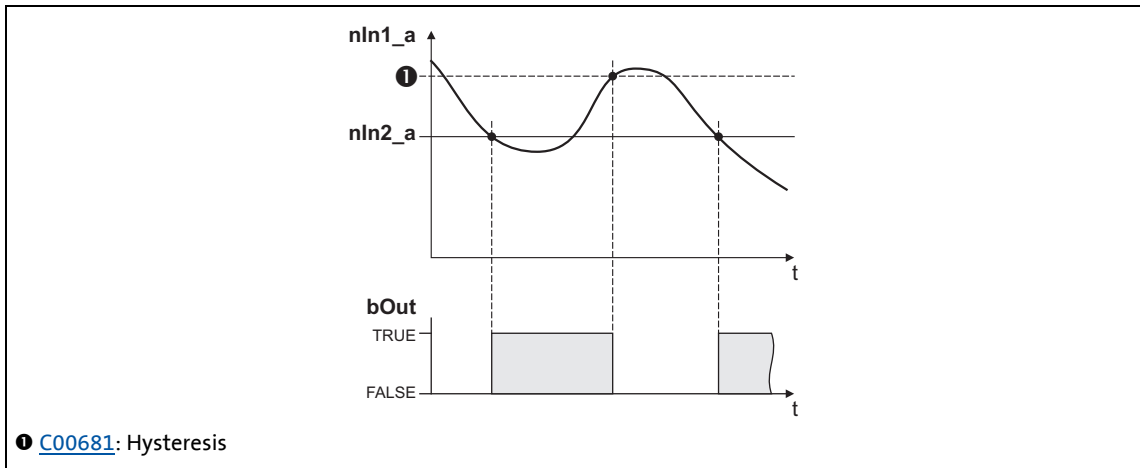

[17-9] Function 3: Example

# 17 Function library

## 17.1 Function blocks

---

### 17.1.11.4 Function 4: $|n_{ln1}| = |n_{ln2}|$

This function serves to implement e.g. the comparison " $n_{act} = 0$ ". This function is similar to function 1. However, the amount is generated by the input signals before signal processing (without sign).

▶ [Function 1:  \$n\_{ln1} = n\_{ln2}\$](#)

### 17.1.11.5 Function 5: $|n_{ln1}| > |n_{ln2}|$

This function serves to implement e.g. the comparison " $|n_{act}| > |n_x|$ " irrespective of the direction of rotation. This function is similar to function 2. However, the amount is generated by the input signals before signal processing (without sign).

▶ [Function 2:  \$n\_{ln1} > n\_{ln2}\$](#)

### 17.1.11.6 Function 6: $|n_{ln1}| < |n_{ln2}|$

This function serves to implement the comparison " $|n_{act}| < |n_x|$ " independent of the direction of rotation. This function is similar to function 3. However, the amount is generated by the input signals before signal processing (without sign).

▶ [Function 3:  \$n\_{ln1} < n\_{ln2}\$](#)

17.1.12 L\_Compare\_2

This FB compares two analog signals and can be used e.g. to implement a trigger.

- Comparison operation, hysteresis and window size can be parameterised.

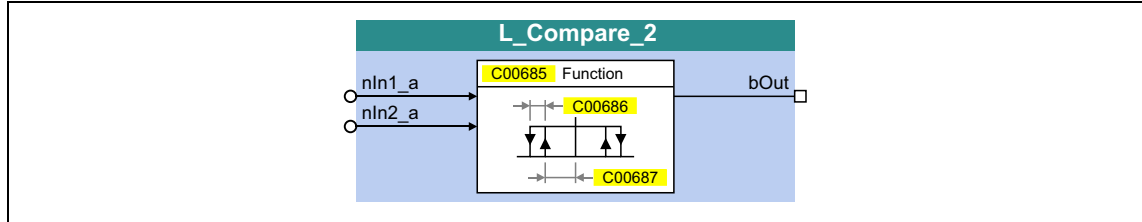

inputs

Designator	Data type	Information/possible settings
nln1_a	INT	Input signal 1
nln2_a	INT	Input signal 2

outputs

Designator	Data type	Value/meaning
bOut	BOOL	Status signal "Comparison statement is true"
		TRUE   The statement of the selected comparison mode is true.

Parameters

Parameters	Possible settings			Info
<a href="#">C00685</a>	1	nln1 = nln2		Function selection
	2	nln1 > nln2		
	3	nln1 < nln2		
	4	nln1  =  nln2		
	5	nln1  >  nln2		
	6	nln1  <  nln2		
<a href="#">C00686</a>	0.00	%	100.00	Hysteresis • Lenze setting: 0.50 %
<a href="#">C00687</a>	0.00	%	100.00	Window • Lenze setting: 2.00 %



For a detailed functional description see [L\\_Compare\\_1](#).

17.1.13 L\_Compare\_3

This FB compares two analog signals and can be used e.g. to implement a trigger.

- Comparison operation, hysteresis and window size can be parameterised.

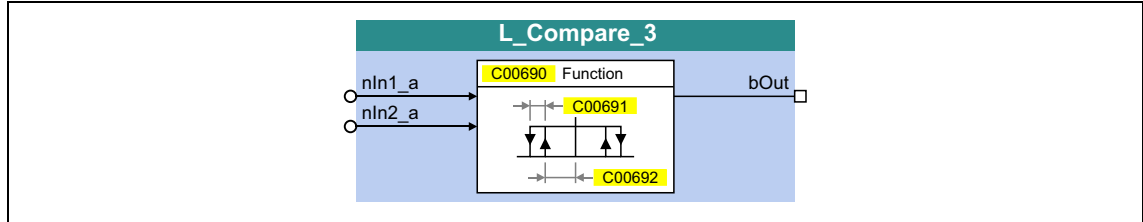

inputs

Designator	Data type	Information/possible settings
nln1_a	INT	Input signal 1
nln2_a	INT	Input signal 2

outputs

Designator	Data type	Value/meaning
bOut	BOOL	Status signal "Comparison statement is true"
		TRUE   The statement of the selected comparison mode is true.

Parameters

Parameters	Possible settings			Info												
<a href="#">C00690</a>	<table border="1"> <tr><td>1</td><td>nln1 = nln2</td></tr> <tr><td>2</td><td>nln1 &gt; nln2</td></tr> <tr><td>3</td><td>nln1 &lt; nln2</td></tr> <tr><td>4</td><td> nln1  =  nln2 </td></tr> <tr><td>5</td><td> nln1  &gt;  nln2 </td></tr> <tr><td>6</td><td> nln1  &lt;  nln2 </td></tr> </table>			1	nln1 = nln2	2	nln1 > nln2	3	nln1 < nln2	4	nln1  =  nln2	5	nln1  >  nln2	6	nln1  <  nln2	Function selection
1	nln1 = nln2															
2	nln1 > nln2															
3	nln1 < nln2															
4	nln1  =  nln2															
5	nln1  >  nln2															
6	nln1  <  nln2															
<a href="#">C00691</a>	0.00	%	100.00	Hysteresis • Lenze setting: 0.50 %												
<a href="#">C00692</a>	0.00	%	100.00	Window • Lenze setting: 2.00 %												

 For a detailed functional description see [L\\_Compare\\_1](#).



### 17.1.14 L\_DFliPfloP\_1

The FB saves binary signals (DFliPfloP) in a clock-controlled way.

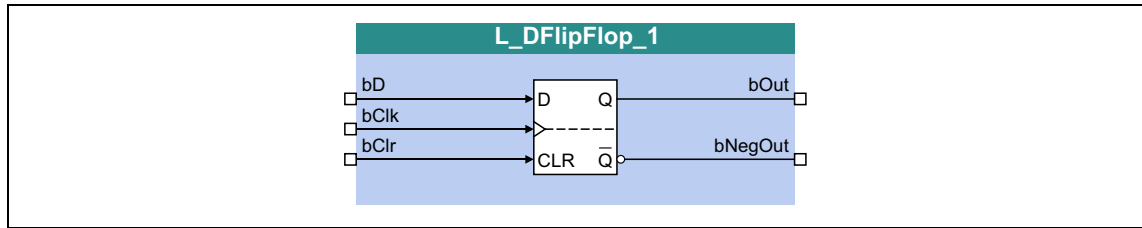

#### inputs

Designator	Data type	Information/possible settings		
bD	BOOL	Data input		
bClk	BOOL	Clock input • Only FALSE/TRUE edges are evaluated		
bClr	BOOL	Reset input		
		<table border="1"> <tr> <td>TRUE</td> <td> <ul style="list-style-type: none"> <li>The <i>bOut</i> output is set to FALSE.</li> <li>The <i>bNegOut</i> output is set to TRUE.</li> </ul> </td> </tr> </table>	TRUE	<ul style="list-style-type: none"> <li>The <i>bOut</i> output is set to FALSE.</li> <li>The <i>bNegOut</i> output is set to TRUE.</li> </ul>
TRUE	<ul style="list-style-type: none"> <li>The <i>bOut</i> output is set to FALSE.</li> <li>The <i>bNegOut</i> output is set to TRUE.</li> </ul>			

#### outputs

Designator	Data type	Value/meaning
bOut	BOOL	Output signal
bNegOut	BOOL	Output signal, inverted

#### Function

If the *bClr* input = FALSE, a signal edge at the *bClk* input switches the static input signal *bD* to the *bOut* output, where it is retained:

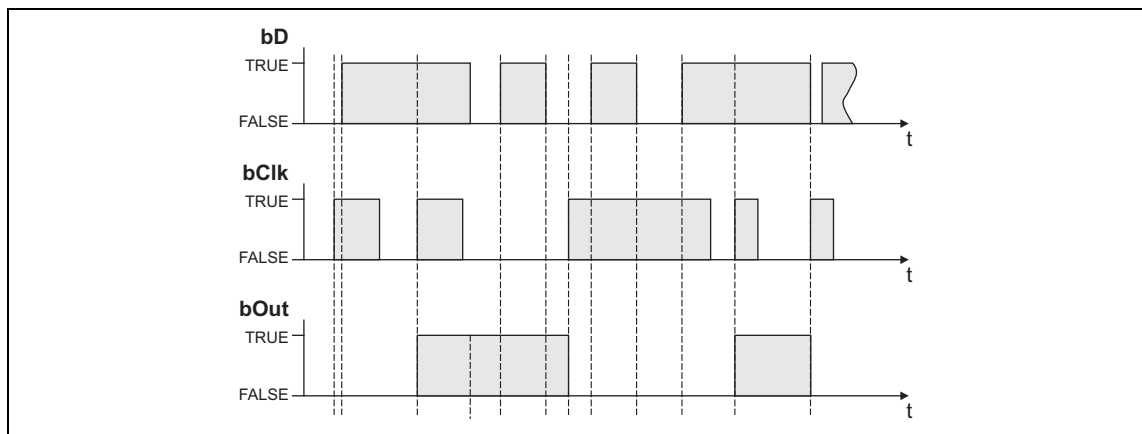

If the *bClr* input = TRUE:

- Due to the priority *bClr* > *bClk*, *bD* the *bOut* output signal can be set any time to the *FALSE* status by the *bClr* input signal = TRUE.
- The output signal is kept in this status independent of the other input signals.

17.1.15 L\_DigitalDelay\_1

This FB applies a time delay to binary signals.

- ON and OFF-deceleration can be parameterised separately.

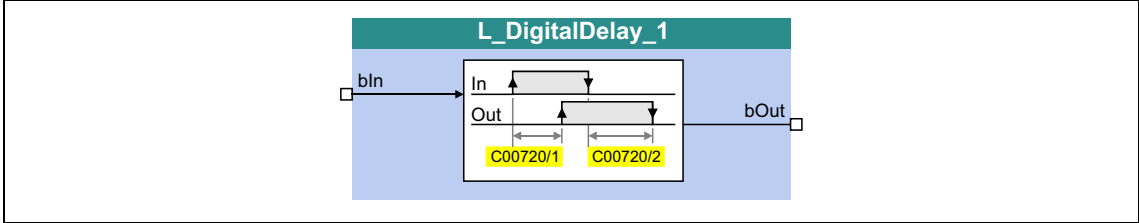

inputs

Designator	Data type	Information/possible settings
bIn	BOOL	Input signal

outputs

Designator	Data type	Value/meaning
bOut	BOOL	Output signal (time-delayed input signal)

Parameters

Parameters	Possible settings			Info
<a href="#">C00720/1</a>	0.000	s	3600.000	ON-deceleration • Lenze setting: 0.000 s
<a href="#">C00720/2</a>	0.000	s	3600.000	OFF-deceleration • Lenze setting: 0.000 s

**Function**

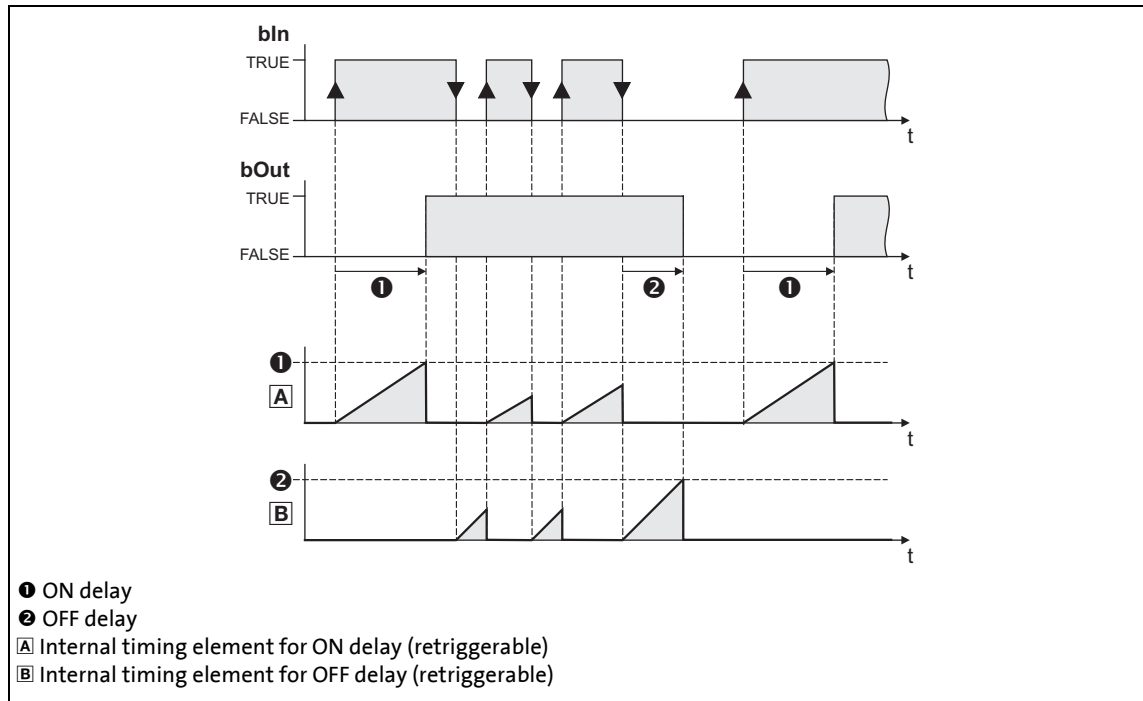

1. A FALSE-TRUE edge at *bIn* starts the internal timing element for the ON delay.
2. After the defined ON delay, the input signal *bIn* is output at *bOut*.
3. A TRUE-FALSE edge at *bIn* starts the internal timing element for the OFF delay.
4. After the defined OFF delay, the input signal *bIn* is output at *bOut*.

### 17.1.16 L\_DigitalLogic\_1

This FB provides a binary output signal created by a logic operation of the input signals. Optionally, one of the constant binary values independent from the input signals can be output.

- Output of a constant binary value
- AND operation of the inputs
- OR operation of the inputs
- Output depending on the combination of the input signals

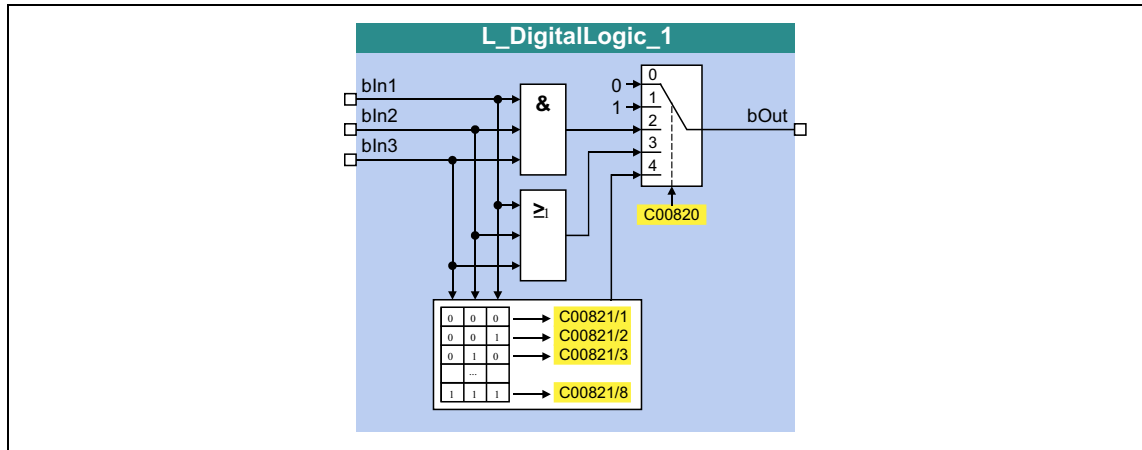

#### inputs

Designator	Data type	Information/possible settings
bIn1	BOOL	Input signal 1
bIn2	BOOL	Input signal 2
bIn3	BOOL	Input signal 3

#### outputs

Designator	Data type	Value/meaning
bOut	BOOL	Output signal

#### Parameters

Parameters	Possible settings	Info
<a href="#">C00820</a>	0 "0"	Function selection Constant value "FALSE"
	1 "1"	Constant value "TRUE"
	2 $bOut = bIn1 \wedge bIn2 \wedge bIn3$	AND operation
	3 $bOut = bIn1 \vee bIn2 \vee bIn3$	OR operation
	4 $bOut = f(\text{truth table})$	The output value depends on the truth table parameterised in <a href="#">C00821/1...8</a>

Parameters	Possible settings	Info
<a href="#">C00821/1...8</a>		Truth table for function "4: bOut = f (truth table)" <ul style="list-style-type: none"> <li>• Each of the eight possible input combinations can be assigned to the output value FALSE or TRUE.</li> <li>• For an application example see the following section.</li> </ul>
	0 FALSE	
	1 TRUE	

#### Function "4: bOut = f (Truth table)"

When the function "4: bOut = f (truth table)" is selected in [C00820](#), the output value *bOut* depends on the truth table parameterised in [C00821/1...8](#).

The following table shows which setting may be required in [C00821/1...8](#) to realise the logic operations NAND, NOR, XOR and XNOR:

Input signals			Output <i>bOut</i>	Parameter setting for logic operation:			
<i>bIn3</i>	<i>bIn2</i>	<i>bIn1</i>		NAND	NOR	XOR	XNOR
0	0	0	<a href="#">C00821/1</a> =	1	1	0	1
0	0	1	<a href="#">C00821/2</a> =	1	0	1	0
0	1	0	<a href="#">C00821/3</a> =	1	0	1	0
0	1	1	<a href="#">C00821/4</a> =	1	0	0	1
1	0	0	<a href="#">C00821/5</a> =	1	0	1	0
1	0	1	<a href="#">C00821/6</a> =	1	0	0	1
1	1	0	<a href="#">C00821/7</a> =	1	0	0	1
1	1	1	<a href="#">C00821/8</a> =	0	0	0	1

### 17.1.17 L\_DigitalLogic\_3

This FB provides a binary output signal created by a logic operation of the input signals. Optionally, one of the constant binary values independent from the input signals can be output.

- Output of a constant binary value
- AND operation of the inputs
- OR operation of the inputs
- Output depending on the combination of the input signals

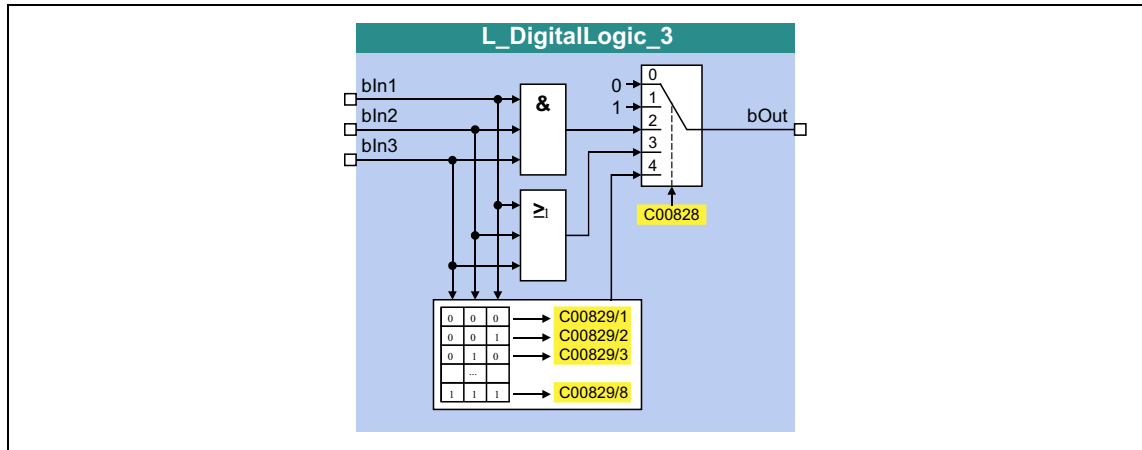

#### inputs

Designator	Data type	Information/possible settings
bIn1	BOOL	Input signal 1
bIn2	BOOL	Input signal 2
bIn3	BOOL	Input signal 3

#### outputs

Designator	Data type	Value/meaning
bOut	BOOL	Output signal

#### Parameters

Parameters	Possible settings	Info
<a href="#">C00828</a>	0 "0"	Function selection
	1 "1"	Constant value "FALSE"
	2 $bOut = bIn1 \wedge bIn2 \wedge bIn3$	Constant value "TRUE"
	3 $bOut = bIn1 \vee bIn2 \vee bIn3$	AND operation
	4 $bOut = f(\text{truth table})$	OR operation
		The output value depends on the truth table parameterised in <a href="#">C00829/1...8</a>

Parameters	Possible settings	Info				
<a href="#">C00829/1...8</a>	<table border="1"> <tr> <td>0</td> <td>FALSE</td> </tr> <tr> <td>1</td> <td>TRUE</td> </tr> </table>	0	FALSE	1	TRUE	Truth table for function "4: bOut = f (truth table)" <ul style="list-style-type: none"> <li>• Each of the eight possible input combinations can be assigned to the output value FALSE or TRUE.</li> <li>• For an application example see the following section.</li> </ul>
0	FALSE					
1	TRUE					

#### Function "4: bOut = f (Truth table)"

When the function "4: bOut = f (truth table)" is selected in [C00828](#), the output value *bOut* depends on the truth table parameterised in [C00829/1...8](#).

The following table shows which setting may be required in [C00829/1...8](#) to realise the logic operations NAND, NOR, XOR and XNOR:

Input signals			Output <i>bOut</i>	Parameter setting for logic operation:			
<i>bIn3</i>	<i>bIn2</i>	<i>bIn1</i>		NAND	NOR	XOR	XNOR
0	0	0	<a href="#">C00829/1</a> =	1	1	0	1
0	0	1	<a href="#">C00829/2</a> =	1	0	1	0
0	1	0	<a href="#">C00829/3</a> =	1	0	1	0
0	1	1	<a href="#">C00829/4</a> =	1	0	0	1
1	0	0	<a href="#">C00829/5</a> =	1	0	1	0
1	0	1	<a href="#">C00829/6</a> =	1	0	0	1
1	1	0	<a href="#">C00829/7</a> =	1	0	0	1
1	1	1	<a href="#">C00829/8</a> =	0	0	0	1



**17.1.18 L\_GainOffset\_1**

This FB can amplify an analog input signal and add an offset to it afterwards. Preferably to be interconnected directly after the analog input terminals.

- The internal calculations (addition and subtraction) are carried out with 32 bits without overflow/underflow. Division is not remainder considered.
- Gain and offset are selected via FB inputs.
- The value provided at the *nOut\_a* output is internally limited to  $\pm 199.99\%$ .

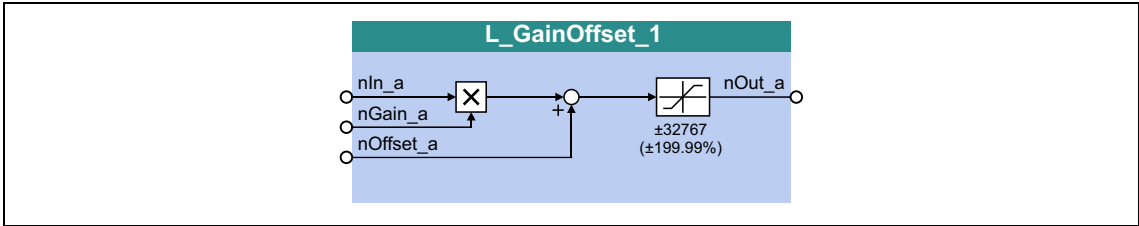

**inputs**

Designator	Data type	Information/possible settings
nIn_a	INT	Input signal • Scaling: 16384 $\equiv$ 100 %
nGain_a	INT	Gain factor • Scaling: 16384 $\equiv$ 100 % • 199.99 % $\approx$ 2
nOffset_a	INT	Offset • Scaling: 16384 $\equiv$ 100 %

**outputs**

Designator	Data type	Value/meaning
nOut_a	INT	Output signal • Internal limitation to $\pm 199.99\%$

**Function**

$$nOut\_a = (nIn\_a \cdot \text{Gain factor}) + \text{Offset}$$

### 17.1.19 L\_GainOffset\_2

This FB can amplify an analog input signal and add an offset to it afterwards. Preferably to be interconnected directly after the analog input terminals.

- The internal calculations (addition and subtraction) are carried out with 32 bits without overflow/underflow. Division is not remainder considered.
- Gain and offset are selected via FB inputs.
- The value provided at the *nOut\_a* output is internally limited to  $\pm 199.99\%$ .

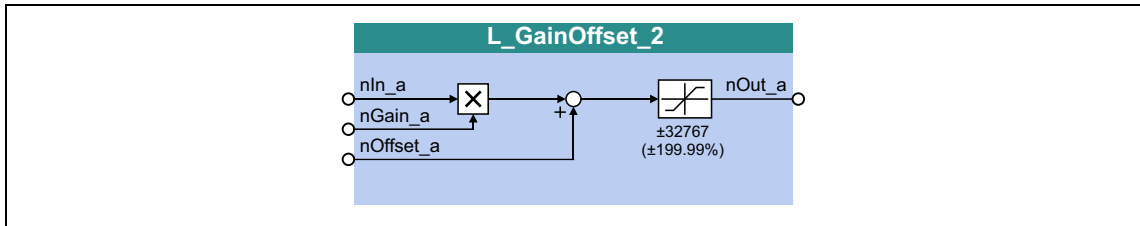

#### inputs

Designator	Data type	Information/possible settings
nIn_a	INT	Input signal • Scaling: 16384 $\equiv$ 100 %
nGain_a	INT	Gain factor • Scaling: 16384 $\equiv$ 100 % • 199.99 % $\approx$ 2
nOffset_a	INT	Offset • Scaling: 16384 $\equiv$ 100 %

#### outputs

Designator	Data type	Value/meaning
nOut_a	INT	Output signal • Internal limitation to $\pm 199.99\%$

#### Function

$$nOut\_a = (nIn\_a \cdot \text{Gain factor}) + \text{Offset}$$

### 17.1.20 L\_GainOffset\_3

This FB can amplify an analog input signal and add an offset to it afterwards. Preferably to be interconnected directly after the analog input terminals.

- The internal calculations (addition and subtraction) are carried out with 32 bits without overflow/underflow. Division is not remainder considered.
- Gain and offset are selected via FB inputs.
- The value provided at the *nOut\_a* output is internally limited to  $\pm 199.99\%$ .

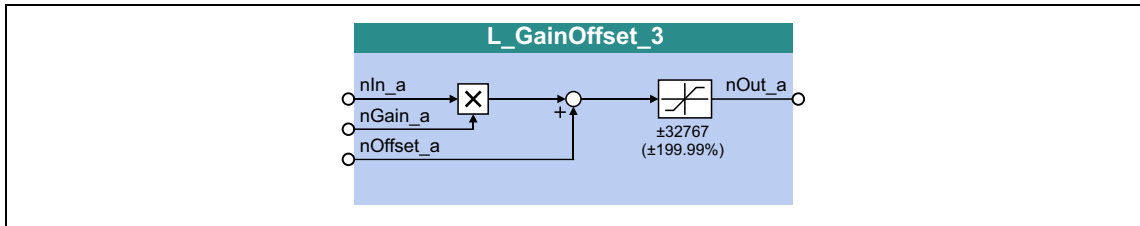

#### inputs

Designator	Data type	Information/possible settings
nIn_a	INT	Input signal • Scaling: 16384 $\equiv$ 100 %
nGain_a	INT	Gain factor • Scaling: 16384 $\equiv$ 100 % • 199.99 % $\approx$ 2
nOffset_a	INT	Offset • Scaling: 16384 $\equiv$ 100 %

#### outputs

Designator	Data type	Value/meaning
nOut_a	INT	Output signal • Internal limitation to $\pm 199.99\%$

#### Function

$$nOut\_a = (nIn\_a \cdot \text{Gain factor}) + \text{Offset}$$

### 17.1.21 L\_Interpolator\_1

This FB interpolates a position setpoint and/or an analog value e.g. to compensate for larger bus transmission cycles or to continue signal characteristics if data telegrams are missing.

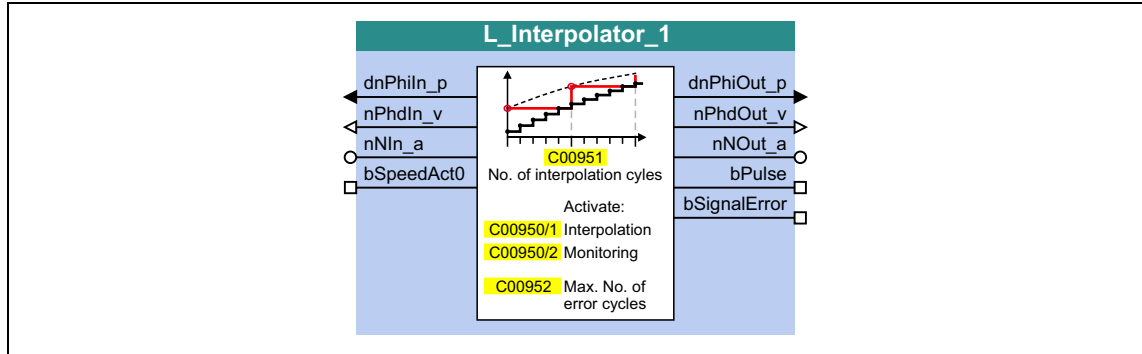

#### inputs

Designator	Data type	Information/possible settings
dnPhIn_p	DINT	Position setpoint <ul style="list-style-type: none"> <li>Is interpolated and completed when signal interpolation is activated.</li> </ul>
nPhdIn_v	INT	Angular velocity <ul style="list-style-type: none"> <li>Is only passed through to the <i>nPhdOut_v</i> output.</li> </ul>
nNIn_a	INT	Analog value <ul style="list-style-type: none"> <li>Is interpolated when signal interpolation is activated.</li> </ul>
bSpeedAct0	BOOL	Input for detecting the "Current speed is zero" status <ul style="list-style-type: none"> <li>This status signal needs to be transmitted by the setpoint source to ensure trouble-free operation.</li> </ul>
		TRUE   Current speed is zero.

#### outputs

Designator	Data type	Value/meaning
dnPhiOut_p	DINT	Output of the <i>dnPhIn_p</i> position setpoint which, if applicable, has been interpolated and completed
nPhdOut_v	INT	Output of the <i>nPhdIn_v</i> angular velocity
nNOut_a	INT	Output of the <i>nNIn_a</i> analog value which, if applicable, has been interpolated
bPulse	BOOL	"Input values have been accepted" status signal
		TRUE   The input values have been accepted during this cycle.
bSignalError	BOOL	"Signal error" status signal <ul style="list-style-type: none"> <li>Only if signal monitoring is active (<a href="#">C00950/2</a> = "1: On").</li> </ul>
		TRUE   The number of missing data telegrams has exceeded the limit value parameterised in <a href="#">C00952</a> .

### Parameters

Parameters	Possible settings	Info				
<a href="#">C00950/1</a>	<table border="1"> <tr> <td>0</td> <td>Off</td> </tr> <tr> <td>1</td> <td>On</td> </tr> </table>	0	Off	1	On	Signal interpolation of the <i>dnPhIn_p</i> and <i>nNIn_a</i> input signals • Lenze setting: Off ▶ <a href="#">Signal interpolation (📖 965)</a>
0	Off					
1	On					
<a href="#">C00950/2</a>	<table border="1"> <tr> <td>0</td> <td>Off</td> </tr> <tr> <td>1</td> <td>On</td> </tr> </table>	0	Off	1	On	Signal monitoring of the <i>dnPhIn_p</i> input signal • Lenze setting: Off ▶ <a href="#">Signal monitoring (📖 966)</a>
0	Off					
1	On					
<a href="#">C00951</a>	1	65535 Number of interpolation steps • Corresponds to the receive cycle of the data telegrams in [ms]. • Lenze setting: 1				
<a href="#">C00952</a>	0	65535 Limit value for missing data telegrams • Lenze setting: 5 ▶ <a href="#">Signal monitoring (📖 966)</a>				
<a href="#">C00953</a>	0	100 Speed-up • Limitation of the amount of correction increments per cycle • Scaling: 1 increment/ms $\equiv$ 0.9155 rpm				

#### 17.1.21.1 Signal interpolation

If signal interpolation is active ([C00950/1](#) = 1), the output signal will not reach the level of the corresponding input signal until all interpolation steps parameterised in [C00951](#) have been performed:

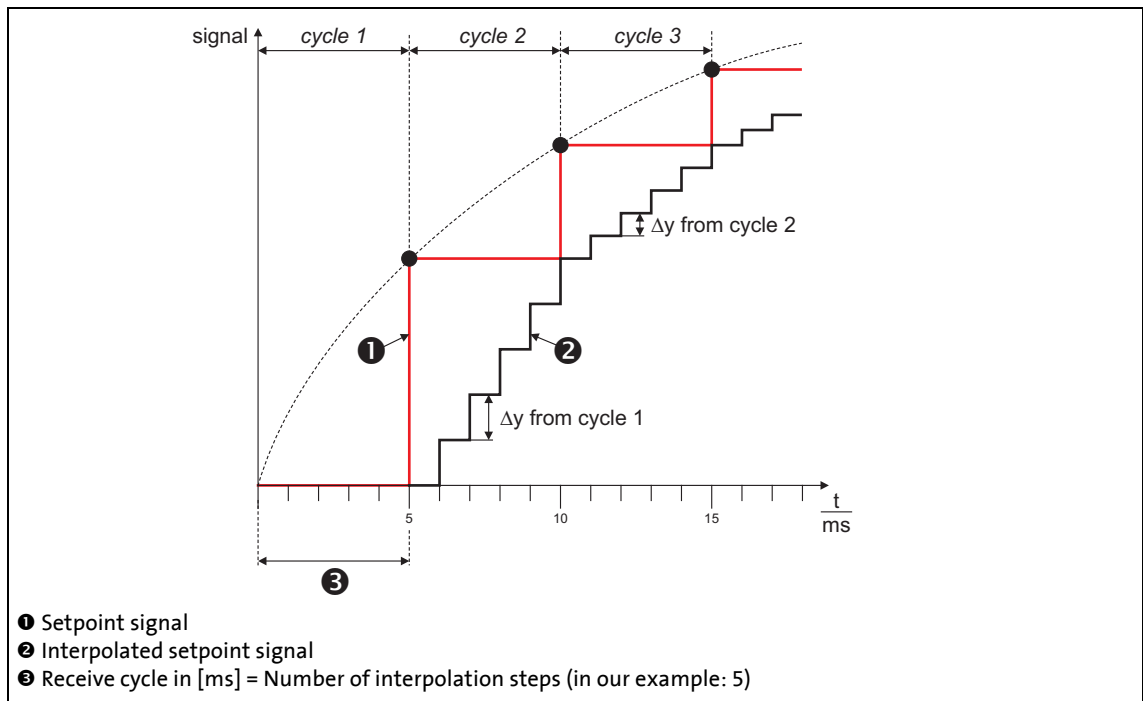

[17-10] Signal characteristic

**Note!**

Do not change the number of interpolation steps during operation. Otherwise the interpolation becomes inaccurate.

**17.1.21.2 Signal monitoring**

If signal monitoring is active ([C00950/2](#) = 1), the signal characteristic of the *dnPhIn\_p* input signal is continued even if the data telegram is missing (setpoint selection via CAN).

Monitoring is performed on the basis of the *dnPhIn\_p* position setpoint and the *bSpeedAct0* status signal:

- If the *dnPhIn\_p* position setpoint remains the same in the next device cycle, it is either because the speed is zero or because no data telegram has been received.
- The evaluation of the *bSpeedAct0* status signal gives information about which reason applies. This status signal needs to be transmitted by the setpoint source to ensure trouble-free operation:
  - *bSpeedAct0* = FALSE means that the speed is not zero, so an error is assumed: The signal characteristic of the *dnPhIn\_p* input signal is completed (the current slope is retained).
  - *bSpeedAct0* = TRUE means that the speed is zero, so the unchanged position setpoint is not treated as an error.
- If the number of missing data telegrams exceeds the limit value parameterised in [C00952](#), the *bSignalError* output is set to TRUE.
  - The *bSignalError* output is automatically reset to FALSE if correct signals are detected at *dnPhIn\_p* and *bSpeedAct0* again.

**Note!**

The *nNIn\_a* analog value is not monitored!

### 17.1.22 L\_JogCtrlExtension\_1

This FB can be connected upstream to the [L\\_NSet](#) ramp function generator/setpoint generator to implement a switch-off positioning at limit switch.

- Detailed information on this operating mode can be found in the description
  - ▶ [TA "Switch-off positioning"](#) (📖 371).

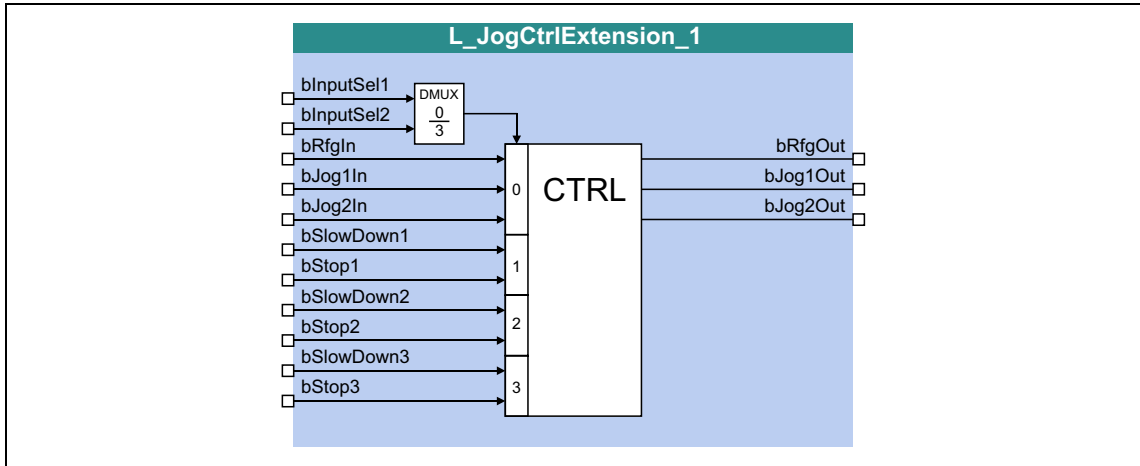

#### inputs

Designator	Data type	Information/possible settings
bInputSel1 bInputSel2	BOOL	Activation of the <i>bSlowDown1/bStop1</i> , <i>bSlowDown2/bStop2</i> and <i>bSlowDown3/bStop3</i> signal pairs according to the <a href="#">Truth table</a>
bRfgIn	BOOL	Ramping down of the setpoint generator in the downstream <a href="#">L_NSet</a> FB according to the <a href="#">Truth table</a>
bJog1In bJog2In	BOOL	Selection inputs for setting fixed speeds in the setpoint generator <ul style="list-style-type: none"> <li>If the pre-switch off is inactive (<i>bInputSel1</i> and <i>bInputSel2</i> are both set to FALSE), the two control signals are output one-to-one at the <i>bJog1Out</i> and <i>bJog2Out</i> outputs.</li> <li>To achieve the desired behaviour (starting at high speed, pre-switch off at low speed), both inputs must be set to TRUE.</li> <li>Fixed setpoint 2 must be less than fixed setpoint 3! Otherwise, the drive will start at a low speed and accelerate after the pre-switch off.</li> <li>If, in addition to the <i>bJog1In</i> and <i>bJog2In</i> inputs, other jog signals are set at the <a href="#">L_NSet</a> FB, new fixed setpoints are reached, and the drive traverses at speeds that differ from the selection via <i>bJog1In</i> and <i>bJog2In</i>.</li> </ul>
bSlowDown1 bSlowDown2 bSlowDown3	BOOL	Activation of fixed setpoint 2 in the downstream <a href="#">L_NSet</a> FB <ul style="list-style-type: none"> <li>These inputs only fulfil a function if they have been activated via <i>bInputSel1</i> and <i>bInputSel2</i> previously (see <a href="#">Truth table</a>).</li> </ul>
bStop1 bStop2 bStop3	BOOL	Ramping down of the ramp function generator in the downstream <a href="#">L_NSet</a> FB <ul style="list-style-type: none"> <li>These inputs only fulfil a function if they have been activated via <i>bInputSel1</i> and <i>bInputSel2</i> previously (see <a href="#">Truth table</a>).</li> </ul>

### outputs

Designator	Data type	Value/meaning
bRfgOut	BOOL	Control signal for ramping down the setpoint generator <ul style="list-style-type: none"> <li>Connect this output to the <i>bRfg0</i> input of the <a href="#">L_NSet</a> FB.</li> </ul>
bJog1Out	BOOL	Control signal for setting fixed speeds in the setpoint generator <ul style="list-style-type: none"> <li>Connect this output to the <i>bJog1</i> input of the <a href="#">L_NSet</a> FB.</li> </ul>
bJog2Out	BOOL	Control signal for setting fixed speeds in the setpoint generator <ul style="list-style-type: none"> <li>Connect this output to the <i>bJog2</i> input of the <a href="#">L_NSet</a> FB.</li> </ul>

### Truth table

Input		Function	Response in the L_NSet FB
bInputSel1	bInputSel2		
FALSE	FALSE	Pre-switch off inactive	No response <ul style="list-style-type: none"> <li>The <i>bRfgIn</i> input signal is directly provided at the <i>bRfgOut</i> output.</li> <li>The <i>bJogIn1</i> and <i>bJogIn2</i> input signals are directly output at the <i>bJog1Out</i> and <i>bJog2Out</i> outputs.</li> </ul>
TRUE	FALSE	The <i>bSlowDown1</i> and <i>bStop1</i> inputs are evaluated.	<b>Pre-switch off can be activated</b> <ul style="list-style-type: none"> <li>If the SlowDown function is activated via the selected <i>bSlowDown</i> input, fixed setpoint 2 in the setpoint generator is activated via the <i>bJog1Out</i> and <i>bJog2Out</i> outputs.</li> <li>If the Stop function is activated via the selected <i>bStop</i> input, the <i>bRfgOut</i> output is set to TRUE and hence the setpoint generator is deactivated.</li> </ul>
FALSE	TRUE	The <i>bSlowDown2</i> and <i>bStop2</i> inputs are evaluated.	
TRUE	TRUE	The <i>bSlowDown3</i> and <i>bStop3</i> inputs are evaluated.	

[17-1] Truth table for activating the pre-switch off



### 17.1.23 L\_MPot\_1

This FB replaces a hardware motor potentiometer and can be used as an alternative setpoint source controlled via two inputs.

- The signal is output via a ramp function generator with linear ramps.
- The acceleration and deceleration times are set via parameters.
- Constant ramping even with speed limit values changed online.
- The motor potentiometer function can be switched on/off online.

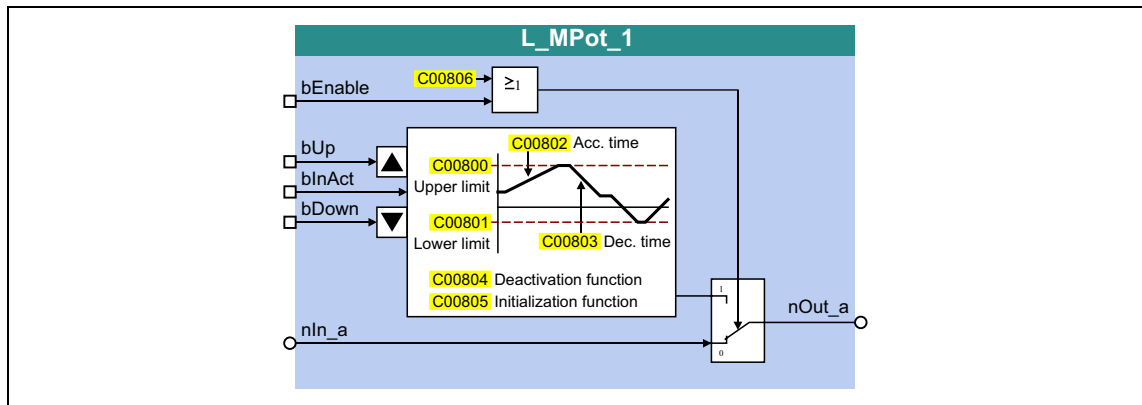

#### inputs

Designator	Data type	Information/possible settings
bEnable	BOOL	Switch over motor potentiometer function <i>bEnable</i> input and <a href="#">C00806</a> code are ORed.
		TRUE Motor potentiometer function is active, setpoint can be changed via <i>bUp</i> and <i>bDown</i> . • With switching to TRUE, the value applied to <i>nIn_a</i> is automatically transferred to the motor potentiometer.
		FALSE The value applied to <i>nIn_a</i> is output at <i>nOut_a</i> .
nIn_a	INT	When bEnable = FALSE, the analog nIn_ is input signal switched to the nOut_a output.
bUp	BOOL	Approaching of the upper speed limit value set in <a href="#">C00800</a> .
		TRUE The <i>nOut_a</i> output signal runs to its upper limit value ( <i>nHighLimit</i> ). • If the <i>bDown</i> input is simultaneously set to TRUE, the <i>nOut_a</i> output signal is not changed.
bDown	BOOL	Approaching of the lower speed limit value set in <a href="#">C00801</a> .
		TRUE The <i>nOut_a</i> output signal runs to its lower limit value ( <i>nLowLimit</i> ). • If the <i>bUp</i> input is simultaneously set to TRUE, the <i>nOut_a</i> output signal is not changed.
bInAct	BOOL	Deactivate motor potentiometer function • This input has the highest priority. • When the motor potentiometer is deactivated, the <i>nOut_a</i> output signal follows the function set with code <a href="#">C00804</a> .
		TRUE Motor potentiometer function is deactivated.

### outputs

Designator	Data type	Value/meaning
nOut_a	INT	Output signal

### Parameters

Parameters	Possible settings			Info
<a href="#">C00800</a>	-199.99	%	199.99	Upper limit • Lenze setting: 100.00 %
<a href="#">C00801</a>	-199.99	%	199.99	Lower limit • Lenze setting: -100.00 %
<a href="#">C00802</a>	0.1	s	6000.0	Acceleration time • Lenze setting: 10.0 s
<a href="#">C00803</a>	0.1	s	6000.0	Deceleration time • Lenze setting: 10.0 s
<a href="#">C00804</a>				Inactive function • Selection of response when deactivating the motor potentiometer via the input <i>blnAct</i> . • Lenze setting: 0
	0	No further action; <i>nOut_a</i> retains its value.		
	1	The motor potentiometer returns to 0 % within the deceleration time $T_{if}$		
	2	The motor potentiometer runs to the lower limit value ( <a href="#">C00801</a> ) within the deceleration time $T_{if}$		
	3	The motor potentiometer output immediately changes to 0 %		<b>Important for the emergency stop function</b>
	4	The motor potentiometer output immediately changes to the lower limit value ( <a href="#">C00801</a> )		
	5	The motor potentiometer runs to the upper limit value ( <a href="#">C00800</a> ) within the acceleration time $T_{ir}$		
<a href="#">C00805</a>				Init function • Selection of response when switching on the device. • Lenze setting: 0
	0	The output value being output during mains power-off is saved non-volatily in the internal memory of the inverter. It will be reloaded during mains power-on.		
	1	The lower limit value ( <a href="#">C00801</a> ) is loaded during mains power-on.		
	2	An output value = 0 % is loaded during mains power-on.		
<a href="#">C00806</a>				Use of the motor potentiometer • When switching to 1: YES, the value applied to <i>nIn_a</i> is automatically transferred to the motor potentiometer. • Lenze setting: 0
	0	No		
	1	Yes		

**17.1.23.1 Activate & control motor potentiometer**

When *blnAct* is set to FALSE, the motor potentiometer is activated.

- The currently active function depends on the current output signal *nOut\_a*, the limit values set and the control signals at *bUp* and *bDown*.
- When the *nOut\_a* output signal is outside the limits set, the output signal runs to the next limit with the *Ti* times set. This process is independent of the control signals at *bUp* and *bDown*.
- When the *nOut\_a* output signal is inside the limits set, the output signal changes according to the control signals at *bUp* and *bDown*.

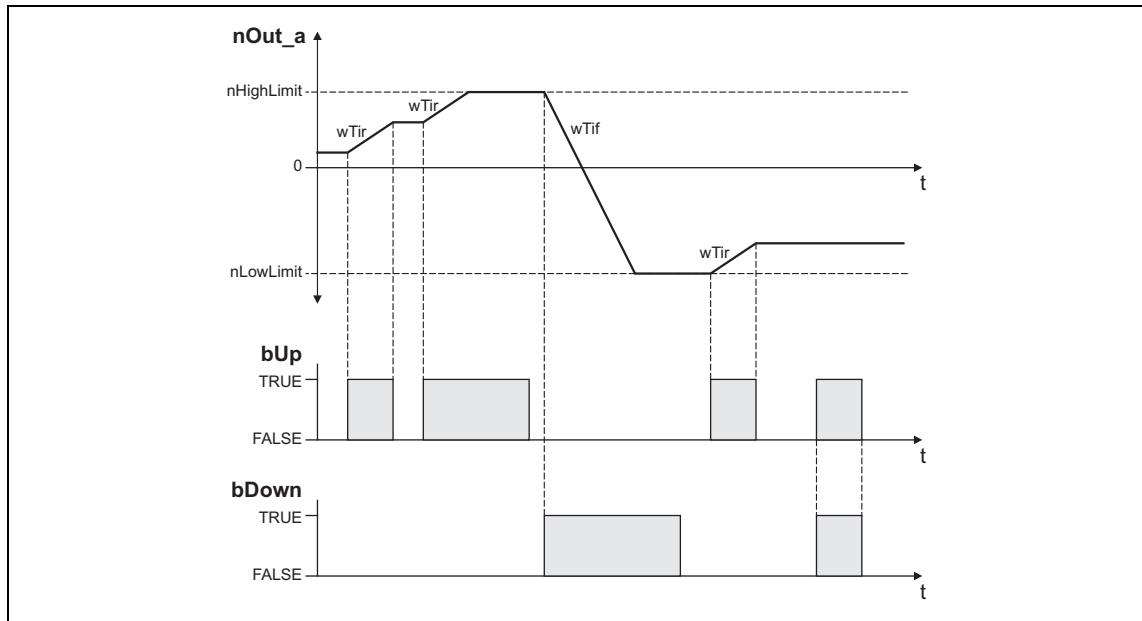

[17-11] Example: Control of the motor potentiometer

bUp	bDown	blnact	Function
FALSE	FALSE	FALSE	The <i>nOut_a</i> output signal remains unchanged.
TRUE	FALSE		The <i>nOut_a</i> output signal runs to its upper limit value ( <i>nHighLimit</i> ).
FALSE	TRUE		The <i>nOut_a</i> output signal runs to its lower limit value ( <i>nLowLimit</i> ).
TRUE	TRUE		The <i>nOut_a</i> output signal remains unchanged.
-	-	TRUE	The motor potentiometer function is deactivated. The <i>nOut_a</i> output signal responds according to the function selected via <i>Function</i> .

### 17.1.23.2 Deactivate motor potentiometer

When the motor potentiometer is deactivated by setting *blnAct* to TRUE, the *nOut\_a* output signal responds according to the function selected via *Function*.

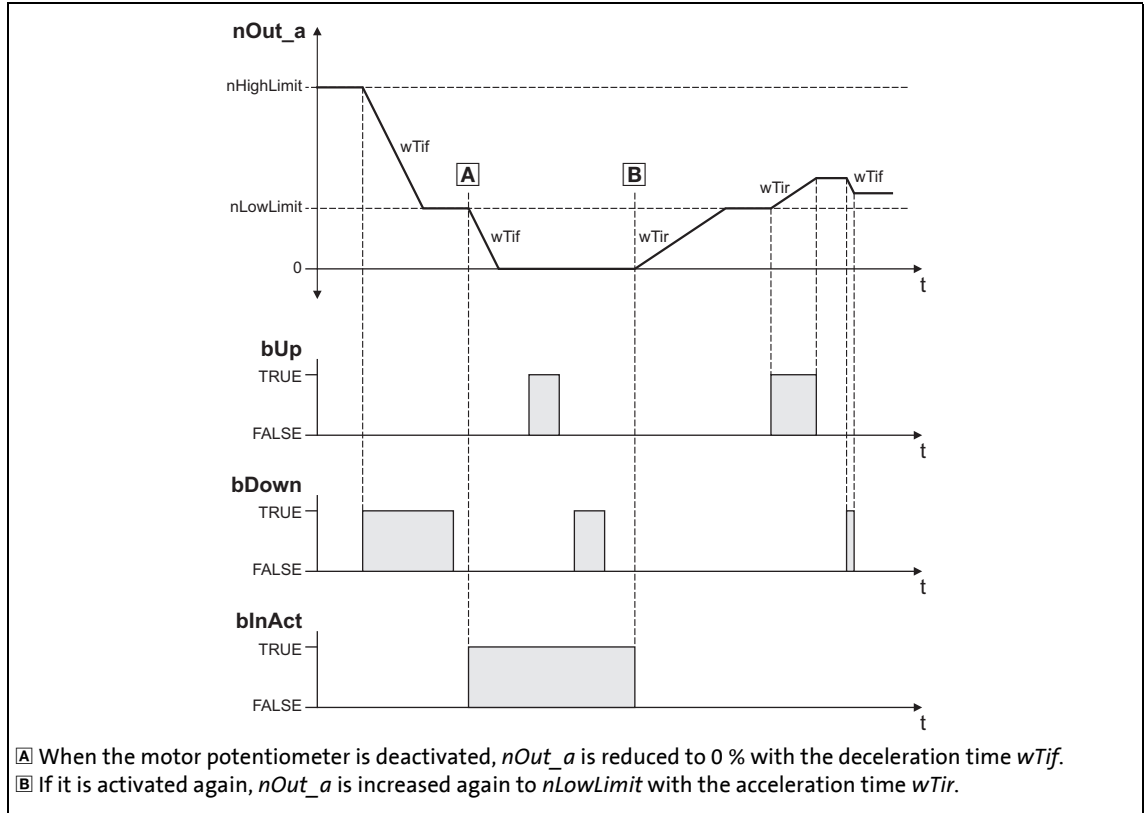

[17-12] Example: Deactivation of the motor potentiometer when the *Function* = 1 has been selected

17.1.24 L\_MulDiv\_1

This FB multiplies the analog input signal with a parameterisable factor.

- The value of the factor is determined by a quotient consisting of numerator and denominator .
- The value output at *nOut\_a* is limited to ±199.99 %.
- Division is not remainder considered.

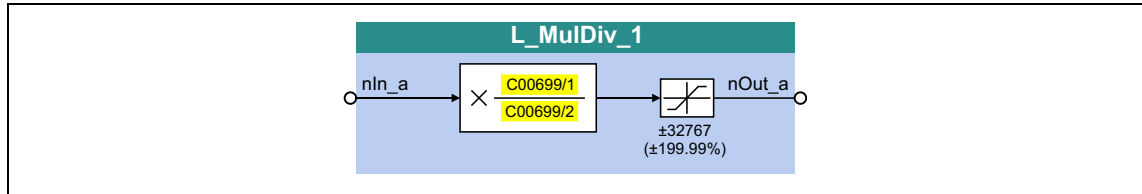

inputs

Designator	Data type	Information/possible settings
nIn1	INT	Input signal

outputs

Designator	Data type	Value/meaning
nOut_a	INT	Product value (result of the multiplication) • Internal limitation to ± 32767

Parameters

Parameters	Possible settings	Info
<a href="#">C00699/1</a>	-32767	32767 Counter
<a href="#">C00699/2</a>	-32767	32767 Denominator

Function

$$nOut\_a = nIn\_a \times \frac{C00699/1}{C00699/2}$$

**17.1.25 L\_Negation\_1**

This FB converts the sign of the input signal, i.e. the input signal is multiplied by the value -1 and is then output.

- With the value - 32768 at the *nIn\_a* input, the value + 32767 is provided at the *nOut\_a* output.

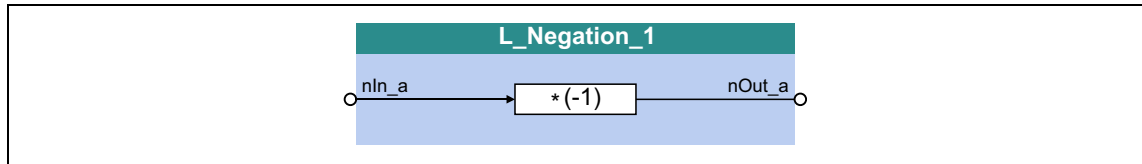
**inputs**

Designator	Data type	Value/meaning
nIn_a	INT	Input signal

**outputs**

Designator	Data type	Value/meaning
nOut_a	INT	Output signal

**17.1.26 L\_Not\_1**

This FB negates a BOOL data type signal.

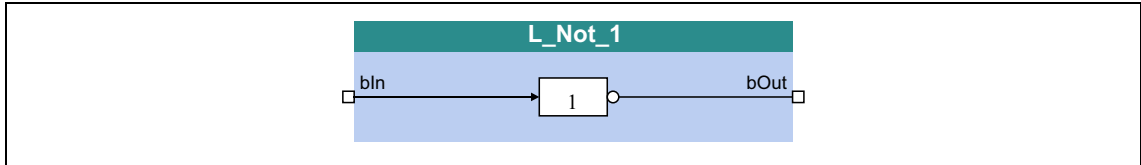

**inputs**

Designator	Data type	Value/meaning
bIn	BOOL	Input signal

**outputs**

Designator	Data type	Value/meaning
bOut	BOOL	Result of the NOT operation (negated input signal)

**17.1.27 L\_Not\_2**

This FB negates a BOOL data type signal.

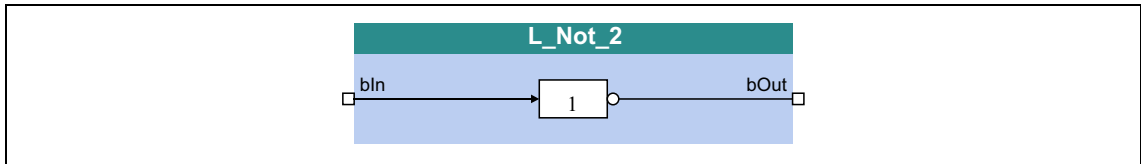

**inputs**

Designator	Data type	Value/meaning
bIn	BOOL	Input signal

**outputs**

Designator	Data type	Value/meaning
bOut	BOOL	Result of the NOT operation (negated input signal)

**17.1.28 L\_Not\_3**

This FB negates a BOOL data type signal.

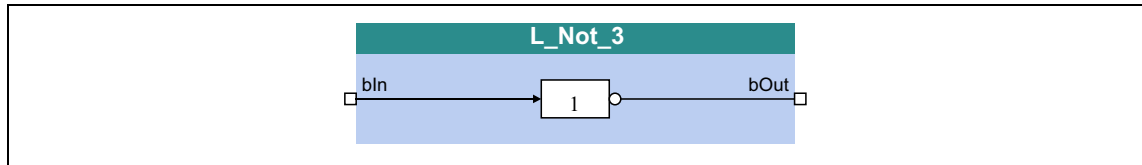
**inputs**

Designator	Data type	Value/meaning
bIn	BOOL	Input signal

**outputs**

Designator	Data type	Value/meaning
bOut	BOOL	Result of the NOT operation (negated input signal)



# 17 Function library

## 17.1 Function blocks

### 17.1.29 L\_NSet\_1

This FB is used for general signal processing of process values and is provided with the following functions:

- Ramp function generator
  - With linear ramps for main and additional setpoint path
  - With S-shaped ramp (PT1 rounding)
  - Setting and holding
- Internal limitation of the input signal
- 3 adjustable blocking zones
- Arithmetic function
- 15 fixed setpoints (JOG setpoints)
- 15 acceleration and deceleration times

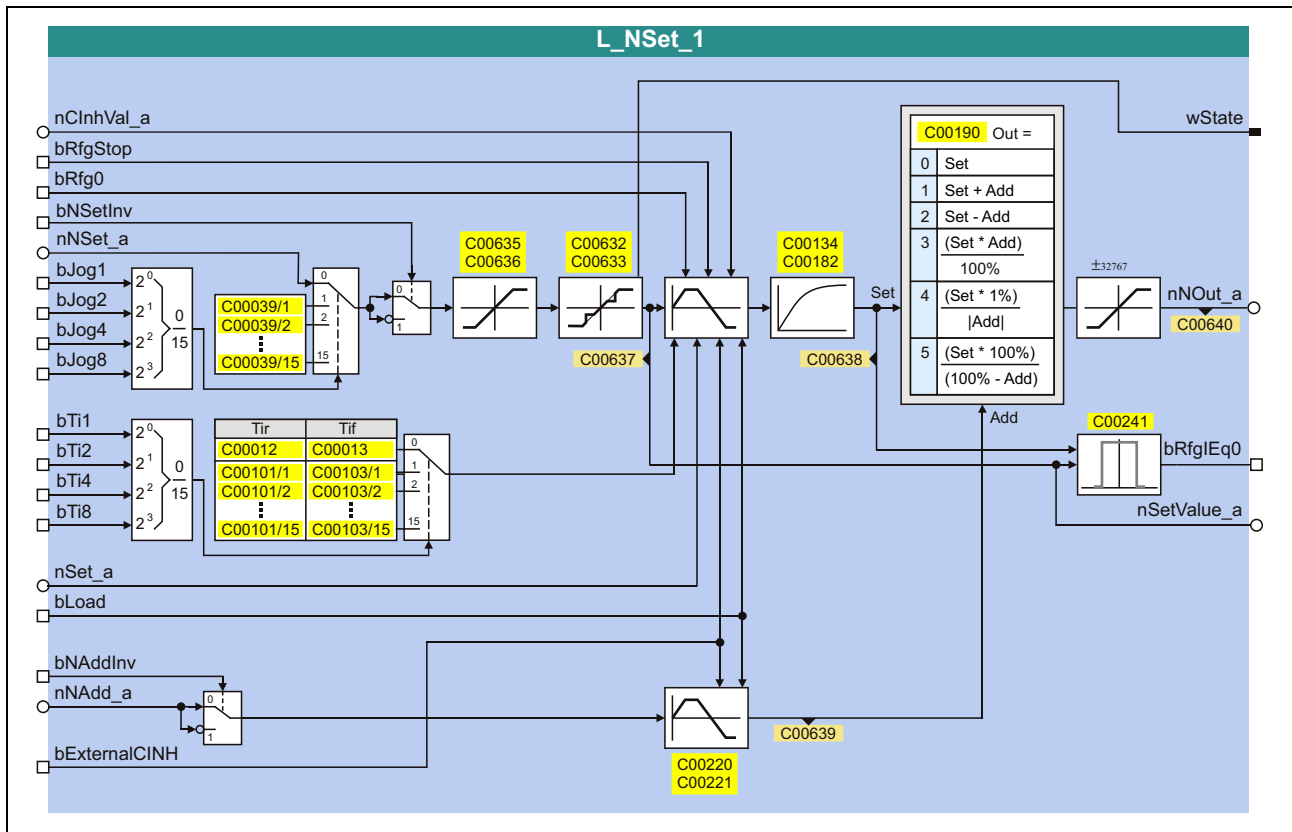

## inputs

Designator	Data type	Information/possible settings
nClnhVal_a	INT	Main setpoint signal which is to be accepted by the main setpoint integrator when the controller is inhibited.
bRfgStop	BOOL	Holding (freezing) of the current value of the main setpoint integrator TRUE   The current value of the main setpoint integrator is held.
bRfg0	BOOL	Leading the main setpoint integrator to 0 within the current Ti times TRUE   The current value of the main setpoint integrator is led to "0" within the Ti time set.
bNsetInv	BOOL	Signal inversion for the main setpoint TRUE   Main setpoint signal is inverted.
nNset_a	INT	Main setpoint signal • Other signals are also permitted
bJog1 ... bJog8	BOOL	Inputs for overriding fixed setpoints (JOG setpoints) for the main setpoint • Selection inputs are binary coded.
bTI1 ... bTI8	BOOL	Selection inputs for alternative acceleration/deceleration times for the main setpoint • Selection inputs are binary coded.
nSet_a	INT	Starting value which is loaded into the main setpoint integrator by setting <i>bLoad</i> to TRUE.
bLoad	BOOL	Control of both ramp function generators in special situations, e.g. QSP TRUE   The <i>nSet_a</i> input signal is loaded into the main setpoint integrator and the additional setpoint integrator is set to "0".
bAddInv	BOOL	Signal inversion for the additional setpoint TRUE   Additional setpoint signal is inverted.
nNAdd_a	INT	Additional setpoint signal • Other signals are also permitted
bExternalCINH	BOOL	Additional load input for the main setpoint integrator and the additional setpoint integrator TRUE   The main setpoint integrator is set to the value applied at <i>nClnhVal_a</i> . The additional setpoint integrator is set to "0". ▶ <a href="#">Application example for the additional load function</a> (987)

## outputs

Designator	Data type	Value/meaning
nNOut_a	INT	Speed setpoint output signal • Scaling: 16384 ≙ 100 %
bRfgIEqO	BOOL	Status signal "setpoint = 0"

Designator	Data type	Value/meaning
wState	WORD	Bit-coded status word • Bits that are not listed are reserved for future extensions.
		Bit 0 No blocking zone active
		Bit 1 Blocking zone 1 active
		Bit 2 Blocking zone 2 active
		Bit 3 Blocking zone 3 active
		Bit 4 Jog in blocking zone
		Bit 5 MaxLimit active
		Bit 6 MinLimit active
nSetValue_a	INT	Speed-setpoint input signal of the ramp function generator • Scaling: 16384 $\equiv$ 100 %

### Parameters

Parameters	Possible settings			Info												
<a href="#">C00012</a>	0.000	s	999.900	Acceleration time $T_{ir}$ for the main setpoint • Lenze setting: 0.000 s												
<a href="#">C00013</a>	0.000	s	999.900	Deceleration time $T_{if}$ for the main setpoint • Lenze setting: 0.000 s												
<a href="#">C00039/1..15</a>	-199.99	%	199.99	Fixed setpoints (JOG setpoints) • Lenze setting: 0.00 %												
<a href="#">C00101/1..15</a>	0.000	s	999.900	Alternative acceleration times ( $T_{ir}$ ) for the main setpoint • Lenze setting: 0.000 s												
<a href="#">C00103/1..15</a>	0.000	s	999.900	Alternative deceleration times ( $T_{if}$ ) for the main setpoint • Lenze setting: 0.000 s												
<a href="#">C00134</a>	<table border="1"> <tr> <td>0</td> <td>Off</td> </tr> <tr> <td>1</td> <td>PT1 behaviour</td> </tr> </table>			0	Off	1	PT1 behaviour	Activates ramp rounding with PT1 behaviour for the main setpoint • The corresponding S-ramp time must be set in <a href="#">C00182</a> . • Lenze setting: 0 (deactivated)								
0	Off															
1	PT1 behaviour															
<a href="#">C00182</a>	0.01	s	50.00	S-ramp time PT1 • Lenze setting: 20.00 s												
<a href="#">C00190</a>	<table border="1"> <tr> <td>0</td> <td><math>N_{Out} = N_{Set}</math></td> </tr> <tr> <td>1</td> <td><math>N_{Out} = N_{Set} + N_{Add}</math></td> </tr> <tr> <td>2</td> <td><math>N_{Out} = N_{Set} - N_{Add}</math></td> </tr> <tr> <td>3</td> <td><math>N_{Out} = (N_{Set} * N_{Add}) / 100\%</math></td> </tr> <tr> <td>4</td> <td><math>N_{Out} = (N_{Set} * 1\%) /  N_{Add} </math></td> </tr> <tr> <td>5</td> <td><math>N_{Out} = (N_{Set} * 100\%) / (100\% - N_{Add})</math></td> </tr> </table>			0	$N_{Out} = N_{Set}$	1	$N_{Out} = N_{Set} + N_{Add}$	2	$N_{Out} = N_{Set} - N_{Add}$	3	$N_{Out} = (N_{Set} * N_{Add}) / 100\%$	4	$N_{Out} = (N_{Set} * 1\%) /  N_{Add} $	5	$N_{Out} = (N_{Set} * 100\%) / (100\% - N_{Add})$	Selection of the arithmetic function for combining main and additional setpoint  Lenze setting • The additional setpoint is not processed.
0	$N_{Out} = N_{Set}$															
1	$N_{Out} = N_{Set} + N_{Add}$															
2	$N_{Out} = N_{Set} - N_{Add}$															
3	$N_{Out} = (N_{Set} * N_{Add}) / 100\%$															
4	$N_{Out} = (N_{Set} * 1\%) /  N_{Add} $															
5	$N_{Out} = (N_{Set} * 100\%) / (100\% - N_{Add})$															
<a href="#">C00220</a>	0.000	s	999.900	Acceleration time $T_{ir}$ for the additional setpoint • Lenze setting: 0.000 s												

Parameters	Possible settings			Info
<a href="#">C00221</a>	0.000	s	999.900	Deceleration time $T_{if}$ for the additional setpoint <ul style="list-style-type: none"> <li>Lenze setting: 0.000 s</li> </ul>
<a href="#">C00241</a>	0.00	%	100.00	Hysteresis window for zero detection of speed output setpoint (output <i>bRfgIEqO</i> ) <ul style="list-style-type: none"> <li>Lenze setting: 0.50 %</li> </ul>
<a href="#">C00632/1...3</a>	0.00	%	199.99	Maximum limit values for the speed blocking zones <ul style="list-style-type: none"> <li>Selection of the maximum limit values for the blocking zones in which the speed must not be constant.</li> <li>Lenze setting: 0.00 %</li> </ul>
<a href="#">C00633/1...3</a>	0.00	%	199.99	Minimum limit values for the speed blocking zones <ul style="list-style-type: none"> <li>Selection of the minimum limit values for the blocking zones in which the speed must not be constant.</li> <li>Lenze setting: 0.00 %</li> </ul>
<a href="#">C00634</a>				Status (bit-coded) <ul style="list-style-type: none"> <li>Bits that are not listed are reserved for future extensions.</li> </ul>
	Bit 0	No blocking zone active		
	Bit 1	Blocking zone 1 active		
	Bit 2	Blocking zone 2 active		
	Bit 3	Blocking zone 3 active		
	Bit 4	Jog in blocking zone		
	Bit 5	MaxLimit active		
	Bit 6	MinLimit active		
<a href="#">C00635</a>	-199.99	%	199.99	nMaxLimit <ul style="list-style-type: none"> <li>Maximum speed setpoint for speed setpoint limitation</li> <li>Lenze setting: 199.99 %</li> </ul>
<a href="#">C00636</a>	-199.99	%	199.99	nMinLimit <ul style="list-style-type: none"> <li>Minimum speed setpoint for speed setpoint limitation</li> <li>Lenze setting: -199.99 %</li> </ul>
<a href="#">C00637</a>	-199.99	%	199.99	Blocking zone output <ul style="list-style-type: none"> <li>Display of the speed setpoint after being processed by blocking zone function.</li> </ul>
<a href="#">C00638</a>	-199.99	%	199.99	Ramp smoothing output <ul style="list-style-type: none"> <li>Display of the speed setpoint after being processed by PT1 filter function.</li> </ul>
<a href="#">C00639</a>	-199.99	%	199.99	Additional value output <ul style="list-style-type: none"> <li>Display of the additional speed setpoint after being processed by ramp generator.</li> </ul>
<a href="#">C00640</a>	-199.99	%	199.99	Output nNOut_a <ul style="list-style-type: none"> <li>Display of the generated main speed setpoint at the <i>nNOut_a</i> output.</li> </ul>

### 17.1.29.1 Main setpoint path

- The signals in the main setpoint path are limited to a value range of  $\pm 32767$ .
- The signal at *nNSet\_a* is first led via the JOG selection function.
- A selected JOG value switches the *nNSet\_a* input inactive. Then, the subsequent signal conditioning operates with the JOG value.

### 17.1.29.2 JOG setpoints

In addition to the direct main setpoint selection via the *nNSet\_a* input, so-called JOG setpoints can be preset in [C00039/1...15](#).

- The JOG setpoints are binary-coded and can be called using the *bJog1 ... bJog8* selection inputs so that 15 options are available:

Selection inputs				Main setpoint Main setpoint
<i>bJog8</i>	<i>bJog4</i>	<i>bJog2</i>	<i>bJog1</i>	
FALSE	FALSE	FALSE	FALSE	<i>nNset_a</i>
FALSE	FALSE	FALSE	TRUE	<a href="#">C00039/1</a>
FALSE	FALSE	TRUE	FALSE	<a href="#">C00039/2</a>
FALSE	FALSE	TRUE	TRUE	<a href="#">C00039/3</a>
FALSE	TRUE	FALSE	FALSE	<a href="#">C00039/4</a>
FALSE	TRUE	FALSE	TRUE	<a href="#">C00039/5</a>
FALSE	TRUE	TRUE	FALSE	<a href="#">C00039/6</a>
FALSE	TRUE	TRUE	TRUE	<a href="#">C00039/7</a>
TRUE	FALSE	FALSE	FALSE	<a href="#">C00039/8</a>
TRUE	FALSE	FALSE	TRUE	<a href="#">C00039/9</a>
TRUE	FALSE	TRUE	FALSE	<a href="#">C00039/10</a>
TRUE	FALSE	TRUE	TRUE	<a href="#">C00039/11</a>
TRUE	TRUE	FALSE	FALSE	<a href="#">C00039/12</a>
TRUE	TRUE	FALSE	TRUE	<a href="#">C00039/13</a>
TRUE	TRUE	TRUE	FALSE	<a href="#">C00039/14</a>
TRUE	TRUE	TRUE	TRUE	<a href="#">C00039/15</a>

- The number of selection inputs to be assigned depends on the number of JOG setpoints required:

Number of JOG setpoints required	Number of selection inputs to be assigned ( <i>bJog1 ... bJog8</i> )
1	At least 1
2 ... 3	at least 2
4 ... 7	at least 3
8 ... 15	4

### 17.1.29.3 Setpoint inversion

The output signal of the JOG function is led via an inverter.

The sign of the setpoint changes if *bNSetInv* is set to TRUE.

### 17.1.29.4 Value range of the input signal

The value range of the input signal can be limited by using the following parameters:

- [C00635](#): MaxLimit (default setting: +199.99 %)
- [C00636](#): MinLimit (default setting: -199.99 %)

### 17.1.29.5 Skip frequency function

If the speed setpoints in speed-variable drives are linearly increasing, for instance, the frequency/speed range is divided into a number of equal time segments. Therefore, there may be speeds during acceleration time which must be bridged very fast (e.g. natural resonant frequencies).

The skip frequency function offers the opportunity to select a range in which the initial speed is maintained. If the speed setpoint leaves that range, the drive will be accelerated to reach the desired speed.



#### Note!

- Blocking frequencies act on the main setpoint only.
- It is not possible to exclude "0" speed if there is a sign reversal of the speed setpoint.

**Definition of the blocking zones**

The subcodes of codes [C00632](#) and [C00633](#) can be used to define three zones which are to be skipped by the output setpoint and which are to be passed as fast as possible by the ramp function generator.

The example below shows the parameter setting of two blocking zones:

Parameters	Blocking zone 1	Blocking zone 2	Blocking zone 3
Minimum limit value	C00633/1: 48 %	C00633/2: 138 %	C00633/3: 0 %
Maximum limit value	C00632/1: 104 %	C00632/2: 178 %	C00632/3: 0 %

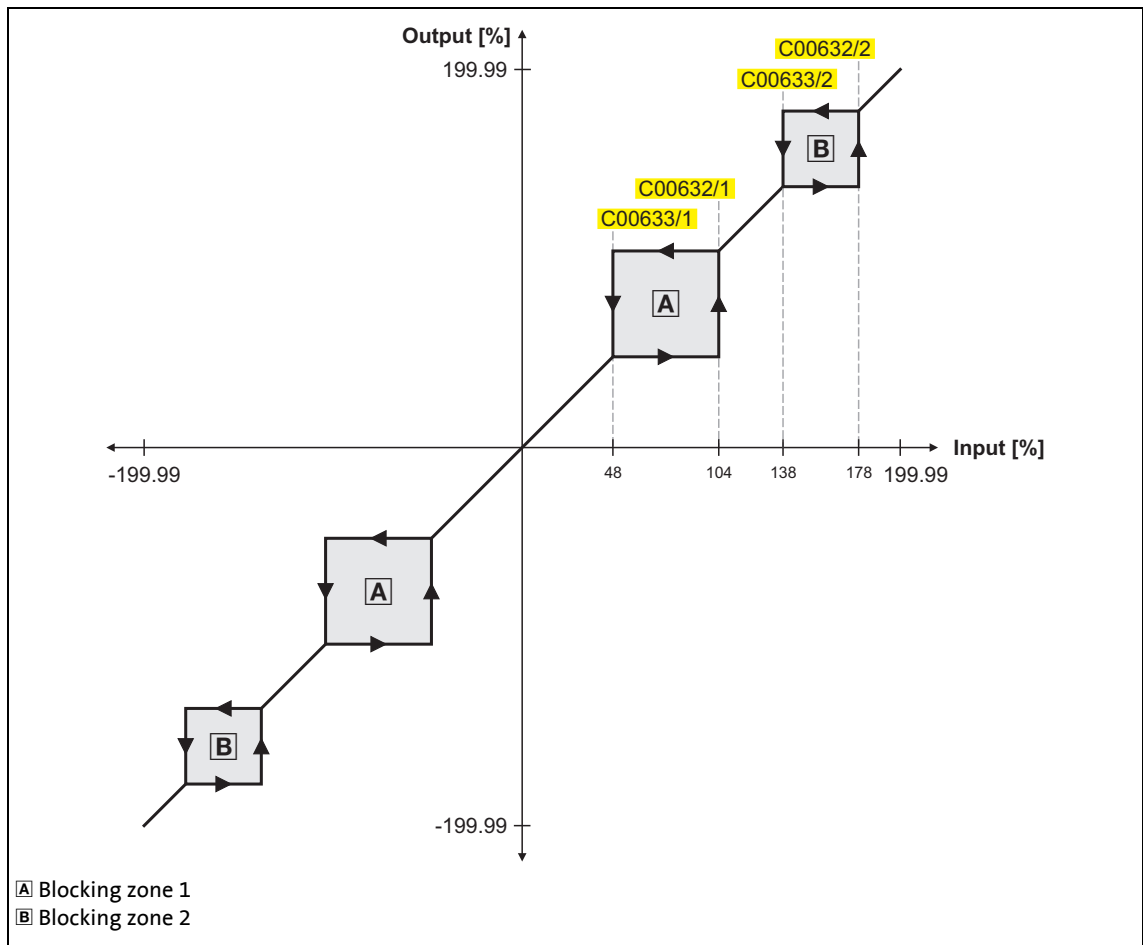

[17-13] Zone masking by means of parameterisable blocking zones

- The parameterised blocking zones have the same effect on negative input signals.
- A blocking zone is deactivated by entering identical limit values (in our example: blocking zone 3).

**Overlapping of blocking zones**

If blocking zones overlap, the lowest and highest value of the overlapping zones form a new zone. In this case, the status display (output *wState* or display parameter [C00634](#)) only indicates one zone (the lower of the two original zones).

**Abutting blocking zones**

If two blocking zones abut (e.g. 20 ... 30 % and 30 ... 40 %), the limit value between the two zones (in this example 30 %) is also passed through.

The same applies to a limit range of 0 ... xx %. During zero crossing of the speed setpoint, "0" speed is output as setpoint. It is possible to exclude "0" speed. However, in this case, the output speed will remain on the upper limit value when the input setpoint becomes "0".



**Tip!**

As described above, the acceleration phase starts after the blocking zones have been passed through. The ramp function generator integrated in the **L\_Nset** function block limits the progression of the speed. For this reason, the time values set for the integrated ramp function generator should be as low as possible whereas the setpoint for the **L\_Nset** function block should be generated by a ramp function generator with higher time values (e.g. [L\\_MPot](#) function block).

**17.1.29.6 Ramp function generator for the main setpoint**

The setpoint is now led via a ramp function generator with linear characteristic. The ramp function generator converts setpoint step-changes at the input into a ramp.

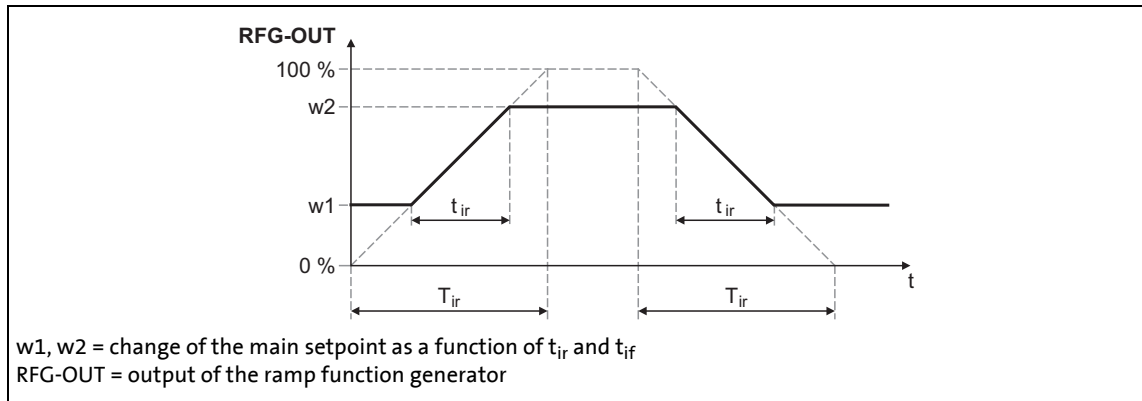

[17-14] Acceleration and deceleration times

- $t_{ir}$  and  $t_{if}$  are the desired times for changing between  $w1$  and  $w2$ .
- S-ramps are possible by selecting S-ramp times.
- The  $t_{ir}/t_{if}$  values are converted into the required  $T_i$  times according to the following formula:

$T_{ir} = t_{ir} \cdot \frac{100\%}{w2 - w1}$	$T_{if} = t_{if} \cdot \frac{100\%}{w2 - w1}$
---	---



### Setting and selection of Ti times

Via parameters, you can select 16 different  $T_{ir}$  and  $T_{if}$  times each for the ramp function generator.

- The selection is made via the binary coded selection inputs  $bT_{I1}$  ...  $bT_{I8}$ :

bTI8	Selection inputs			Used Acceleration time	Used Deceleration time
	bTI4	bTI2	bTI1		
FALSE	FALSE	FALSE	FALSE	<a href="#">C00012</a>	<a href="#">C00013</a>
FALSE	FALSE	FALSE	TRUE	<a href="#">C00101/1</a>	<a href="#">C00103/1</a>
FALSE	FALSE	TRUE	FALSE	<a href="#">C00101/2</a>	<a href="#">C00103/2</a>
FALSE	FALSE	TRUE	TRUE	<a href="#">C00101/3</a>	<a href="#">C00103/3</a>
FALSE	TRUE	FALSE	FALSE	<a href="#">C00101/4</a>	<a href="#">C00103/4</a>
FALSE	TRUE	FALSE	TRUE	<a href="#">C00101/5</a>	<a href="#">C00103/5</a>
FALSE	TRUE	TRUE	FALSE	<a href="#">C00101/6</a>	<a href="#">C00103/6</a>
FALSE	TRUE	TRUE	TRUE	<a href="#">C00101/7</a>	<a href="#">C00103/7</a>
TRUE	FALSE	FALSE	FALSE	<a href="#">C00101/8</a>	<a href="#">C00103/8</a>
TRUE	FALSE	FALSE	TRUE	<a href="#">C00101/9</a>	<a href="#">C00103/9</a>
TRUE	FALSE	TRUE	FALSE	<a href="#">C00101/10</a>	<a href="#">C00103/10</a>
TRUE	FALSE	TRUE	TRUE	<a href="#">C00101/11</a>	<a href="#">C00103/11</a>
TRUE	TRUE	FALSE	FALSE	<a href="#">C00101/12</a>	<a href="#">C00103/12</a>
TRUE	TRUE	FALSE	TRUE	<a href="#">C00101/13</a>	<a href="#">C00103/13</a>
TRUE	TRUE	TRUE	FALSE	<a href="#">C00101/14</a>	<a href="#">C00103/14</a>
TRUE	TRUE	TRUE	TRUE	<a href="#">C00101/15</a>	<a href="#">C00103/15</a>

### Function

- When the controller is inhibited (CINH), the ramp function generator accepts the value applied at  $nClnhVal\_a$  and transfers it to the downstream function. This function has priority over all other functions.
- $bRfgStop = TRUE$ 
  - The ramp function generator is stopped. Changes at the input of the ramp function generator have no effect on the output signal.
- $bRfg0 = TRUE$ 
  - The ramp function generator runs to 0 along its deceleration ramp.
- Furthermore it is possible to load the ramp function generator online with a defined value. For this purpose,  $bLoad$  must be set to TRUE. As long as this input is set, the value at  $nSet\_a$  is transferred to the ramp function generator and provided at the output.

**Priorities:**

CINH	bLoad	bRfg0	bRfgStop	Function
FALSE	FALSE	FALSE	FALSE	The ramp function generator follows the input value via the set ramps.
FALSE	FALSE	FALSE	<b>TRUE</b>	<b>Stop the ramp function generator:</b> The value at the output of the ramp function generator is held.
FALSE	FALSE	<b>TRUE</b>	FALSE	<b>Ramp down the ramp function generator:</b> The ramp function generator runs to 0 within the set deceleration time.
FALSE	FALSE	<b>TRUE</b>	TRUE	
FALSE	<b>TRUE</b>	FALSE	FALSE	<b>Load ramp function generator online:</b> The ramp function generator accepts the value at <i>nSet_a</i> and provides it at its output.
FALSE	<b>TRUE</b>	FALSE	TRUE	
FALSE	<b>TRUE</b>	TRUE	FALSE	
FALSE	<b>TRUE</b>	TRUE	TRUE	
<b>TRUE</b>	FALSE	FALSE	FALSE	<b>Controller inhibit:</b> The ramp function generator accepts the value at <i>nClnhVal_a</i> and provides it at its output.
<b>TRUE</b>	FALSE	FALSE	TRUE	
<b>TRUE</b>	FALSE	TRUE	FALSE	
<b>TRUE</b>	FALSE	TRUE	TRUE	
<b>TRUE</b>	TRUE	FALSE	FALSE	
<b>TRUE</b>	TRUE	FALSE	TRUE	
<b>TRUE</b>	TRUE	TRUE	FALSE	
<b>TRUE</b>	TRUE	TRUE	TRUE	

**17.1.29.7 S-ramp**

A PT1 element is connected downstream of the linear ramp function generator. This arrangement implements an S-shaped ramp for a nearly jerk-free acceleration and deceleration.

- The PT1 element can be switched on/off via the *bSShapeActive* input.
- The corresponding S-ramp time can be set under [C00182](#).

### 17.1.29.8 Additional setpoint

Use the *nNAdd\_a* input to define an additional value (e.g. a correcting signal) and combine it arithmetically with the main setpoint *nNSet\_a*.

- First, the additional setpoint is led via a ramp function generator with linear characteristic. Its Ti times can be set in [C00220](#) (acceleration time) and [C00221](#) (deceleration time).
- When the input *bNAddInv* is set to TRUE, the additional setpoint can be inverted before having an effect on the ramp function generator.
- When the input *bLoad* is set to TRUE, the ramp function generator is set to zero for the additional setpoint and held there without considering the Ti times. The same applies when the controller is inhibited.
- The following arithmetic combination of main setpoint and additional setpoint can be selected in [C00190](#):

Value in C00190	Function	Info
0	$nNOut\_a = nNSet\_a$	The additional setpoint <i>nNAdd_a</i> is not processed.
1	$nNOut\_a = nNSet\_a + nNAdd\_a$	
2	$nNOut\_a = nNSet\_a - nNAdd\_a$	
3	$nNOut\_a = (nNSet\_a * nNAdd\_a) / 100 \%$	Internal scaling: • 100 % ≙ 16384 • 1 % ≙ 164
4	$nNOut\_a = (nNSet\_a * 1 \%) /  nNAdd\_a $	
5	$nNOut\_a = (nNSet\_a * 100 \%) / (100 \% - nNAdd\_a)$	

### 17.1.29.9 Application example for the additional load function

The motor control of the drive is provided with a function for automatically carrying along ramp function generators for "jerk-free" setpoint connection. For speed-controlled drive tasks, the [LS\\_MotorInterface](#) SB outputs the current actual speed value via the *nHlgSetValue\_a* output (e.g. in case of a pulse inhibit, flying restart, controller inhibit).

- In case of a pulse inhibit, the main setpoint generator must be carried along with the current actual speed value to ensure jerk-free setpoint transfer.
- The actual speed value is carried along automatically if the following wiring is provided:
  - [LS\\_MotorInterface.nHlgSetValue\\_a](#) → [L\\_NSet\\_1.nClnhValue\\_a](#)
  - [LS\\_MotorInterface.bHlgLoad](#) → [L\\_NSet\\_1.bExternalCINH](#)

### 17.1.30 L\_OffsetGain\_1

This FB can add an offset to an analog input signal and amplify it afterwards. Preferably to be interconnected directly after the analog input terminals.

- The internal calculations (addition and subtraction) are carried out with 32 bits without overflow/underflow. Division is not remainder considered.
- Offset and gain are selected via FB inputs.
- The value provided at the *nOut\_a* output is internally limited to  $\pm 199.99\%$ .

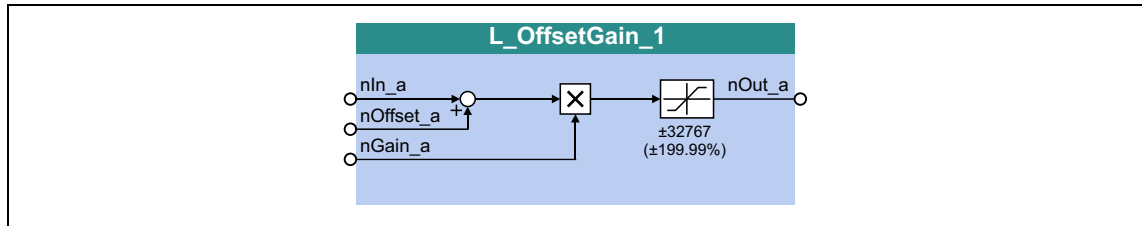

#### inputs

Designator	Data type	Information/possible settings
nIn_a	INT	Input signal • Scaling: 16384 $\equiv$ 100 %
nOffset_a	INT	Offset • Scaling: 16384 $\equiv$ 100 %
nGain_a	INT	Gain factor • Scaling: 16384 $\equiv$ 100 % • 199.99 % $\approx$ 2

#### outputs

Designator	Data type	Value/meaning
nOut_a	INT	Output signal • Internal limitation to $\pm 199.99\%$

#### Function

$$nOut\_a = (nIn\_a + Offset) \cdot Gain\ factor$$

### 17.1.31 L\_OffsetGain\_2

This FB can add an offset to an analog input signal and amplify it afterwards. Preferably to be interconnected directly after the analog input terminals.

- The internal calculations (addition and subtraction) are carried out with 32 bits without overflow/underflow. Division is not remainder considered.
- Offset and gain are selected via FB inputs.
- The value provided at the *nOut\_a* output is internally limited to  $\pm 199.99\%$ .

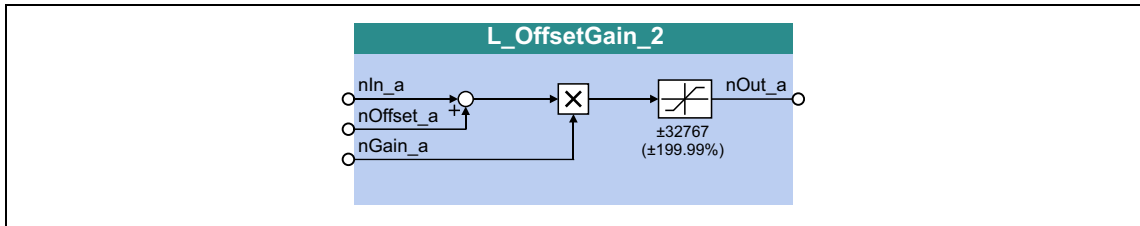

#### inputs

Designator	Data type	Information/possible settings
nIn_a	INT	Input signal • Scaling: 16384 $\equiv$ 100 %
nOffset_a	INT	Offset • Scaling: 16384 $\equiv$ 100 %
nGain_a	INT	Gain factor • Scaling: 16384 $\equiv$ 100 % • 199.99 % $\approx$ 2

#### outputs

Designator	Data type	Value/meaning
nOut_a	INT	Output signal • Internal limitation to $\pm 199.99\%$

#### Function

$$nOut\_a = (nIn\_a + Offset) \cdot Gain\ factor$$

### 17.1.32 L\_OffsetGainP\_1

This FB can add an offset to an analog input signal and amplify it afterwards. Preferably to be interconnected directly after the analog input terminals.

- The internal calculations (addition and subtraction) are carried out with 32 bits without overflow/underflow. Division is not remainder considered.
- Offset and gain are selected via parameters.
- The value provided at the *nOut\_a* output is internally limited to  $\pm 199.99\%$ .

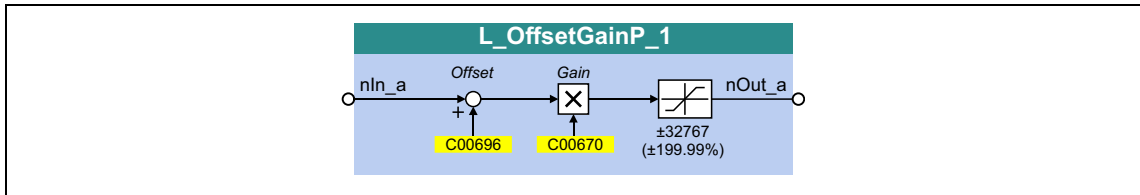

#### inputs

Designator	Data type	Information/possible settings
nIn_a	INT	Input signal

#### outputs

Designator	Data type	Value/meaning
nOut_a	INT	Output signal • Internal limitation to $\pm 199.99\%$

#### Parameters

Parameters	Possible settings			Info
<a href="#">C00670</a>	-100.0000		100.0000	Gain factor • High gain factor for further processing of smallest input signals. • Please observe the difference with regard to the gain factors of other blocks in percent ( $\pm 199.99\% \approx 2$ ). • Lenze setting: 1.0000
<a href="#">C00696</a>	-199.99	%	199.99	Offset • Lenze setting: 0.00 %

#### Function

$$nOut\_a = (nIn\_a + Offset) \cdot Gain\ factor$$

### 17.1.33 L\_OffsetGainP\_2

This FB can add an offset to an analog input signal and amplify it afterwards. Preferably to be interconnected directly after the analog input terminals.

- The internal calculations (addition and subtraction) are carried out with 32 bits without overflow/underflow. Division is not remainder considered.
- Offset and gain are selected via parameters.
- The value provided at the *nOut\_a* output is internally limited to  $\pm 199.99\%$ .

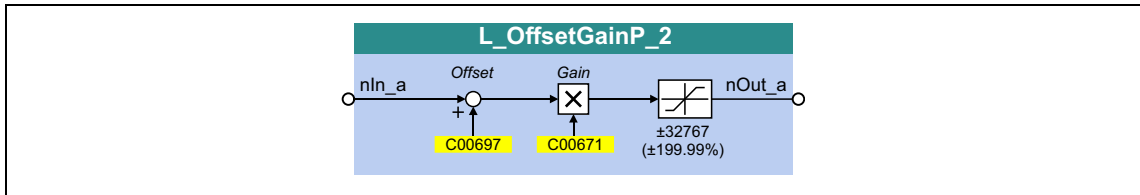

#### inputs

Designator	Data type	Information/possible settings
nIn_a	INT	Input signal

#### outputs

Designator	Data type	Value/meaning
nOut_a	INT	Output signal • Internal limitation to $\pm 199.99\%$

#### Parameters

Parameters	Possible settings			Info
<a href="#">C00671</a>	-100.0000		100.0000	Gain factor • High gain factor for further processing of smallest input signals. • Please observe the difference with regard to the gain factors of other blocks in percent ( $\pm 199.99\% \approx 2$ ). • Lenze setting: 1.0000
<a href="#">C00697</a>	-199.99	%	199.99	Offset • Lenze setting: 0.00 %

#### Function

$$nOut\_a = (nIn\_a + Offset) \cdot Gain\ factor$$

### 17.1.34 L\_OffsetGainP\_3

This FB can add an offset to an analog input signal and amplify it afterwards. Preferably to be interconnected directly after the analog input terminals.

- The internal calculations (addition and subtraction) are carried out with 32 bits without overflow/underflow. Division is not remainder considered.
- Offset and gain are selected via parameters.
- The value provided at the *nOut\_a* output is internally limited to  $\pm 199.99\%$ .

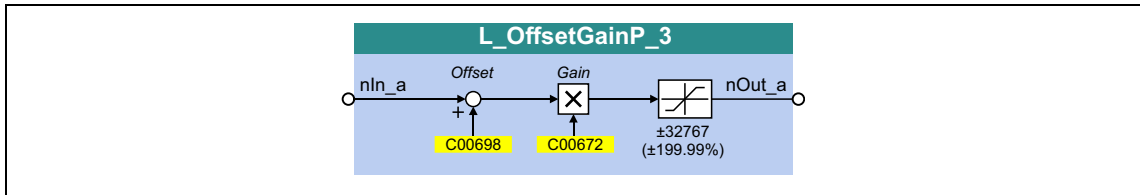

#### inputs

Designator	Data type	Information/possible settings
nIn_a	INT	Input signal

#### outputs

Designator	Data type	Value/meaning
nOut_a	INT	Output signal • Internal limitation to $\pm 199.99\%$

#### Parameters

Parameters	Possible settings			Info
<a href="#">C00672</a>	-100.0000		100.0000	Gain factor • High gain factor for further processing of smallest input signals. • Please observe the difference with regard to the gain factors of other blocks in percent ( $\pm 199.99\% \approx 2$ ). • Lenze setting: 1.0000
<a href="#">C00698</a>	-199.99	%	199.99	Offset • Lenze setting: 0.00 %

#### Function

$$nOut\_a = (nIn\_a + Offset) \cdot Gain\ factor$$



**17.1.35 L\_Or\_1**

This FB implements the OR operation of input signals.

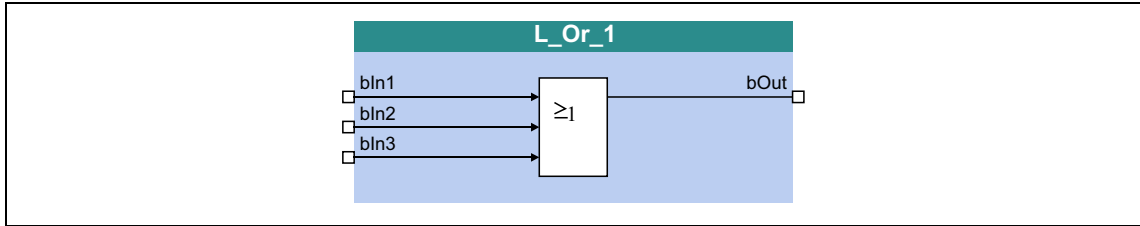

**inputs**

Designator	Data type	Information/possible settings
bIn1 bIn2 bIn3	BOOL	Input signal

**outputs**

Designator	Data type	Value/meaning
bOut	BOOL	Output signal

**Function**

inputs			Output
bIn3	bIn2	bIn1	bOut
FALSE	FALSE	FALSE	FALSE
FALSE	FALSE	TRUE	TRUE
FALSE	TRUE	FALSE	
FALSE	TRUE	TRUE	
TRUE	FALSE	FALSE	
TRUE	FALSE	TRUE	
TRUE	TRUE	FALSE	
TRUE	TRUE	TRUE	

[17-15] Truth table of the FB L\_Or\_1

**17.1.36 L\_Or\_2**

This FB implements the OR operation of input signals.

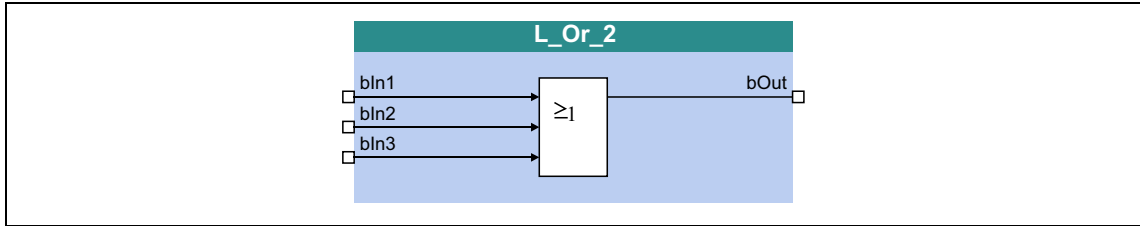

**inputs**

Designator	Data type	Information/possible settings
bIn1 bIn2 bIn3	BOOL	Input signal

**outputs**

Designator	Data type	Value/meaning
bOut	BOOL	Output signal

**Function**

inputs			Output
bIn3	bIn2	bIn1	bOut
FALSE	FALSE	FALSE	FALSE
FALSE	FALSE	TRUE	TRUE
FALSE	TRUE	FALSE	TRUE
FALSE	TRUE	TRUE	TRUE
TRUE	FALSE	FALSE	TRUE
TRUE	FALSE	TRUE	TRUE
TRUE	TRUE	FALSE	TRUE
TRUE	TRUE	TRUE	TRUE

[17-16] Truth table of the FB L\_Or\_2

# 17 Function library

## 17.1 Function blocks

### 17.1.37 L\_Or\_3

This FB implements the OR operation of input signals.

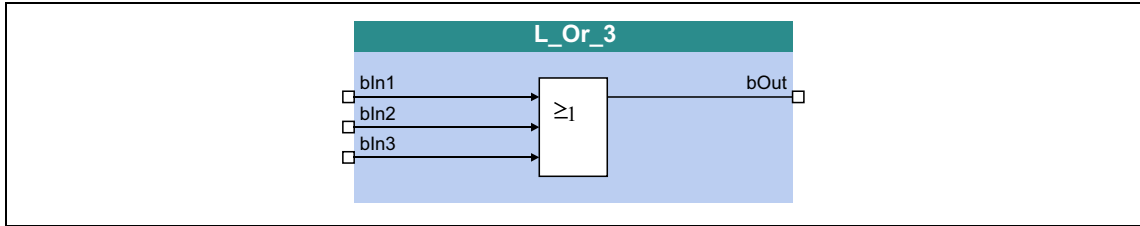

#### inputs

Designator	Data type	Information/possible settings
bIn1 bIn2 bIn3	BOOL	Input signal

#### outputs

Designator	Data type	Value/meaning
bOut	BOOL	Output signal

#### Function

inputs			Output
bIn3	bIn2	bIn1	bOut
FALSE	FALSE	FALSE	FALSE
FALSE	FALSE	TRUE	TRUE
FALSE	TRUE	FALSE	TRUE
FALSE	TRUE	TRUE	TRUE
TRUE	FALSE	FALSE	TRUE
TRUE	FALSE	TRUE	TRUE
TRUE	TRUE	FALSE	TRUE
TRUE	TRUE	TRUE	TRUE

[17-17] Truth table of the L\_Or\_3 FB

**17.1.38 L\_Or\_4**

This FB implements the OR operation of input signals.

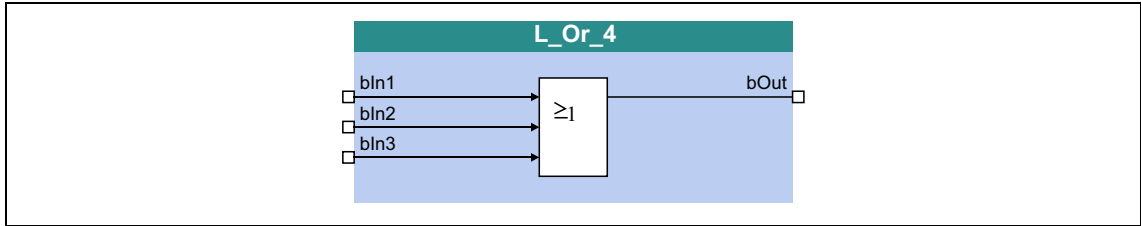

**inputs**

Designator	Data type	Information/possible settings
bIn1 bIn2 bIn3	BOOL	Input signal

**outputs**

Designator	Data type	Value/meaning
bOut	BOOL	Output signal

**Function**

inputs			Output
bIn3	bIn2	bIn1	bOut
FALSE	FALSE	FALSE	FALSE
FALSE	FALSE	TRUE	TRUE
FALSE	TRUE	FALSE	TRUE
FALSE	TRUE	TRUE	TRUE
TRUE	FALSE	FALSE	TRUE
TRUE	FALSE	TRUE	TRUE
TRUE	TRUE	FALSE	TRUE
TRUE	TRUE	TRUE	TRUE

[17-18] Truth table of the L\_Or\_4 FB

### 17.1.39 L\_PCTRL\_1

This FB is a PID controller and can be used for various control tasks (e.g. as dancer position controller, tension controller, or pressure controller).

The FB is provided with the following functions:

- Adjustable control algorithm (P, PI, PID)
- Ramp function generator for preventing setpoint step-changes at the input
- Limitation of the controller output
- Factorisation of the output signal
- Vp adaptation
- Integral action component can be switched off
- Comparison function "Actual value = setpoint"

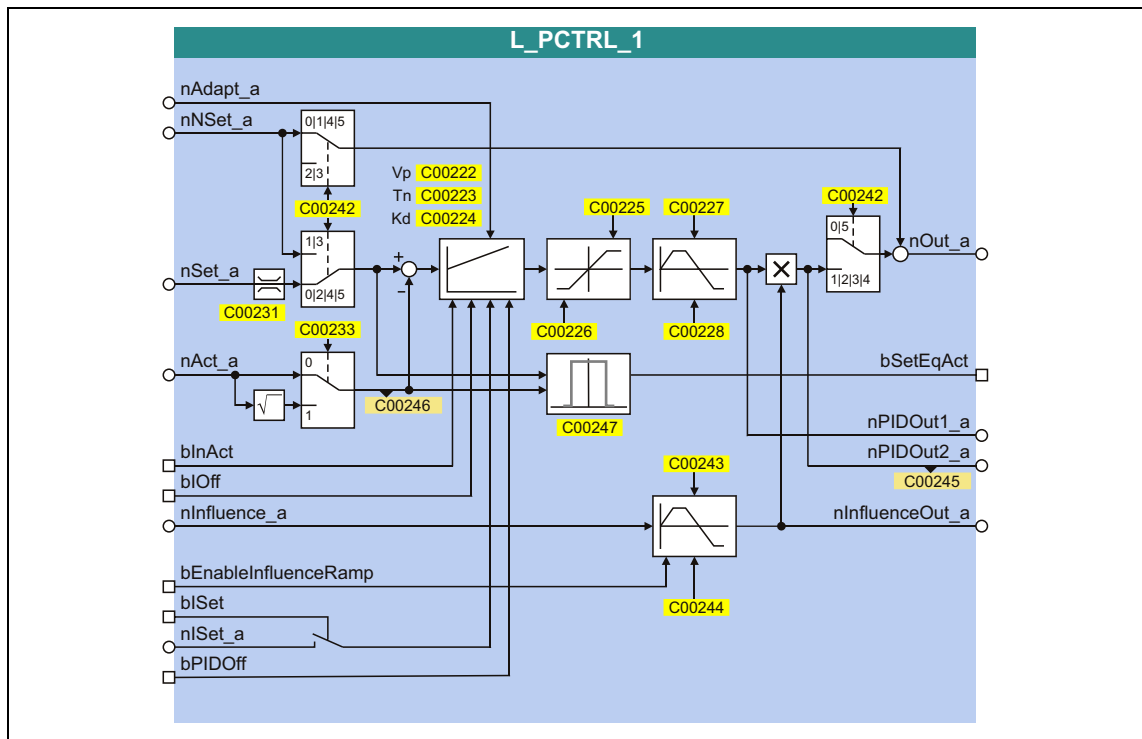

#### inputs

Designator	Data type	Information/possible settings
nAdapt_a	INT	<p>Percentage adaptation of the gain Vp set in <a href="#">C00222</a> and the reset time Tn set in <a href="#">C00223</a>.</p> <p>Then, the adapted reset time is as follows:</p> $T_n = \frac{V_{pC222} \cdot nAdapt\_a [\%] \cdot T_{nC223} [ms]}{100 [\%]}$ <ul style="list-style-type: none"> <li>• Internal limitation to ± 199.99 %</li> <li>• Changes can be done online.</li> <li>• Display parameter: <a href="#">C00830/62</a></li> </ul>
nNset_a	INT	<p>Speed setpoint</p> <ul style="list-style-type: none"> <li>• Scaling: 16384 ≙ 100 %</li> <li>• Internal limitation to ± 199.99 %</li> <li>• Display parameter: <a href="#">C00830/89</a></li> </ul>

Designator	Data type	Information/possible settings
nSet_a	INT	Sensor and process setpoint for operating modes 2, 4 and 5 <ul style="list-style-type: none"> <li>• Scaling: 16384 <math>\equiv</math> 100 %</li> <li>• Internal limitation to <math>\pm</math> 199.99 %</li> <li>• Display parameter: <a href="#">C00830/63</a></li> </ul>
nAct_a	INT	Speed or actual sensor value (actual process value) <ul style="list-style-type: none"> <li>• Scaling: 16384 <math>\equiv</math> 100 %</li> <li>• Internal limitation to <math>\pm</math> 199.99 %</li> <li>• Display parameter: <a href="#">C00830/61</a></li> </ul>
bInAct	BOOL	Deactivate process controller temporarily (stop) <ul style="list-style-type: none"> <li>• Changes can be done online.</li> <li>• Display parameter: <a href="#">C00833/76</a></li> </ul> Note: This input is not interconnected in the LA_NCtrl application block.
		TRUE <ul style="list-style-type: none"> <li>• The current output value is frozen.</li> <li>• The internal control algorithm is stopped.</li> <li>• However, a setpoint selected via input <i>nNSet_a</i> is still provided in operating modes 0/1/4/5.</li> </ul>
bIOff	BOOL	Switch off the I-component of the process controller <ul style="list-style-type: none"> <li>• Changes can be done online.</li> <li>• Display parameter: <a href="#">C00833/77</a></li> </ul>
		TRUE The I component of the process controller is set to zero.
nInfluence_a	INT	Limitation of the influencing factor in percent <ul style="list-style-type: none"> <li>• <i>nInfluence_a</i> serves to limit the influencing factor of the PID controller contained in the FB to a required value (- 199.99 % ... + 199.99 %).</li> <li>• Scaling: 16384 <math>\equiv</math> 100 %</li> <li>• Internal limitation to <math>\pm</math> 199.99 %</li> <li>• Display parameter: <a href="#">C00830/64</a></li> </ul>
bEnableInfluenceRamp	BOOL	Activate ramp for influencing factor <ul style="list-style-type: none"> <li>• Display parameter: <a href="#">C00833/106</a></li> </ul>
		TRUE Influencing factor of the PID controller is ramped up to the <i>nInfluence_a</i> value.
		FALSE Influencing factor of the PID controller is ramped down to "0".
bISet	BOOL	Accept I component <i>nISet_a</i> in PID controller
		TRUE The value at the input <i>nISet_a</i> is accepted in the PID controller.
nISet_a	INT	Selection of I component of PID controller <ul style="list-style-type: none"> <li>• With a TRUE signal at <i>bISet</i>, the assigned value is accepted in the PID controller.</li> <li>• Scaling: 16384 <math>\equiv</math> 100 %</li> <li>• Internal limitation to <math>\pm</math> 199.99 %</li> </ul>
bPIDOff	BOOL	Reset the entire PID controller
		TRUE <ul style="list-style-type: none"> <li>• The I component of the controller is set to zero.</li> <li>• The controller output is set to zero.</li> <li>• The internal control algorithm is stopped.</li> </ul>
		(from version 06.00.00)

### outputs

Designator	Data type	Value/meaning		
nOut_a	INT	Output signal <ul style="list-style-type: none"> <li>• Internal limitation to <math>\pm 32767</math> (<math>\pm 199.99</math> %)</li> <li>• Scaling: <math>16384 \equiv 100</math> %</li> </ul>		
bSetEqAct	INT	Status output "Setpoint and actual value are identical" <table border="1" data-bbox="758 521 1396 584"> <tr> <td>TRUE</td> <td>Setpoint and actual value are identical, i.e. no system deviation available.</td> </tr> </table>	TRUE	Setpoint and actual value are identical, i.e. no system deviation available.
TRUE	Setpoint and actual value are identical, i.e. no system deviation available.			
nPIDOut1_a	INT	PID controller output <u>without</u> influencing factor <i>nInfluence_a</i> <ul style="list-style-type: none"> <li>• Inputs <i>bEnableInfluenceRamp</i> and <i>nInfluence_a</i> do not have any effect here, the limited PID output value influenced by the internal ramp times is output.</li> <li>• There is no connection with the additive input <i>nNSet_a</i>.</li> <li>• Scaling: <math>16384 \equiv 100</math> %</li> </ul>		
nPIDOut2_a	INT	PID controller output <u>with</u> influencing factor <i>nInfluence_a</i> . <ul style="list-style-type: none"> <li>• There is no connection with the additive input <i>nNSet_a</i>.</li> <li>• Scaling: <math>16384 \equiv 100</math> %</li> <li>• Display parameter: <a href="#">C00245</a></li> </ul>		
nInfluenceOut_a	INT	Current influencing factor ("ramp status") on the PID output value <ul style="list-style-type: none"> <li>• Scaling: <math>16384 \equiv 100</math> %</li> </ul>		

### Parameters

Parameters	Possible settings			Info
<a href="#">C00222</a>	0.1	0.1	500.0	Gain Vp <ul style="list-style-type: none"> <li>• Lenze setting: 1.0</li> </ul>
<a href="#">C00223</a>	20	ms	6000	Reset time Tn <ul style="list-style-type: none"> <li>• Lenze setting: 400 ms</li> </ul>
<a href="#">C00224</a>	0.0	0.1	5.0	Differential component Kd <ul style="list-style-type: none"> <li>• Lenze setting: 0.0</li> </ul>
<a href="#">C00225</a>	-199.99	%	+199.99	MaxLimit <ul style="list-style-type: none"> <li>• Maximum value of the PID operating range</li> <li>• Lenze setting: 199.99 %</li> </ul>
<a href="#">C00226</a>	-199.99	%	+199.99	MinLimit <ul style="list-style-type: none"> <li>• Minimum value of the PID operating range</li> <li>• Lenze setting: -199.99 %</li> </ul>
<a href="#">C00227</a>	0.000	s	999.999	Acceleration time for the ramp at the PID output (should be set as steep as possible) <ul style="list-style-type: none"> <li>• Lenze setting: 0.010 s</li> </ul>
<a href="#">C00228</a>	0.000	s	999.999	Deceleration time for the ramp at the PID output <ul style="list-style-type: none"> <li>• Lenze setting: 0.010 s</li> </ul>
<a href="#">C00231/1</a> (Pos. Maximum) <a href="#">C00231/2</a> (Pos. Minimum) <a href="#">C00231/3</a> (Neg. Minimum) <a href="#">C00231/4</a> (Neg. Maximum)	0.00	%	199.99	Operating range <ul style="list-style-type: none"> <li>• Determination of the operating range for the PID process controller by limiting the input signal <i>nSet_a</i>.</li> <li>• Lenze setting: No limitation (-199.99 % ... +199.99 %)</li> </ul>

Parameters	Possible settings			Info
<a href="#">C00233</a>				Root function • Lenze setting: "0: Off"
	0	Off		The actual value at $nAct\_a$ is not changed for further processing.
	1	On		The square root of the actual value at $nAct\_a$ is taken for further processing.
<a href="#">C00242</a>				Operating mode • Lenze setting: "0: Off"
	0	Off		The input setpoint $nNSet\_a$ is output without any changes at the output $nOut\_a$ .
	1	$nNSet + nNSet\_PID$		$nNSet\_a$ and $nAct\_a$ are used as PID input values. The arriving $nNSet\_a$ is additively linked to the value output by the PID element.
	2	$nSet\_PID$		$nSet\_a$ and $nAct\_a$ are used as PID input values. The input $nNSet\_a$ is not considered.
	3	$nNSet\_PID$		$nNSet\_a$ and $nAct\_a$ are used as PID input values. The input $nSet\_a$ is not considered.
	4	$nNSet + nSet\_PID$		$nSet\_a$ and $nAct\_a$ are used as PID input values. The arriving $nNSet\_a$ setpoint is additively linked to the value output by the PID element.
	5	$nNSet    nSet\_PID$		$nSet\_a$ and $nAct\_a$ are used as PID input values. The setpoint $nNSet\_a$ is output at the output $nOut\_a$ . The PID output value is output at the output $nPIDOut\_a$ .
<a href="#">C00243</a>	0.000	s	999.999	Influence acceleration time • Acceleration time $T_{ir}$ for the influencing factor. • Lenze setting: 5.000 s
<a href="#">C00244</a>	0.000	s	999.999	Influence deceleration time • Deceleration time $T_{if}$ for the influencing factor. • Lenze setting: 5.000 s
<a href="#">C00245</a>	-199.99	%	+199.99	Display of PID output value $nPIDOut\_a$
<a href="#">C00246</a> (from version 04.00.00)	-199.99	%	+199.99	Display of the internal PID input value $nAct\_a$
<a href="#">C00247</a> (from version 06.00.00)	0	%	100	Window for comparison function "Actual value = setpoint" • Lenze setting: 2 % • Hysteresis: 1 % (fixed)



**17.1.39.1 Control characteristic**

The PI algorithm is active in the Lenze setting.

**Gain (P component)**

The input value is controlled by a linear characteristic. The slope of the characteristic is determined by the controller gain  $V_p$ .

The controller gain  $V_p$  is set under [C00222](#).

- The controller gain can be adapted via the input  $nAdapt\_a$  (also possible in online mode).
- The input value  $nAdapt\_a$  has a direct effect on the controller gain:

$$P = nAdapt\_a \cdot C00222$$

Example: With the parameterised controller gain  $V_p = 2.0$  and  $nAdapt\_a = 75\%$ , the resulting gain factor is as follows:

$$P = \frac{75 [\%]}{100 [\%]} \cdot 2.0 = 1.5$$

**Integral action component (I component)**

The I component can be selected via the input  $nISet\_a$ . With a TRUE signal at  $bISet$ , the assigned value is accepted in the PID controller.

- Setting the adjustment time  $T_n$  to the maximum value of "6000 ms" deactivates the I component.
- The I component of the controller can also be deactivated by setting the input  $bIOff$  to TRUE.
- The I component can be switched on and off online.

**Reset time**

The adjustment time  $T_n$  is set under [C00223](#).

**Differential component  $K_d$  (D component)**

The differential component  $K_d$  is set under [C00224](#).

- The setting "0.0 s" deactivates the D component (Lenze setting). In this way, the PID controller becomes a PI controller or P controller, if the I component has been deactivated as well.

### 17.1.39.2 Ramp function generator

The PID output is led via a ramp function generator with linear characteristic. This serves to transfer setpoint step-changes at the PID output into a ramp which should be as steep as possible.

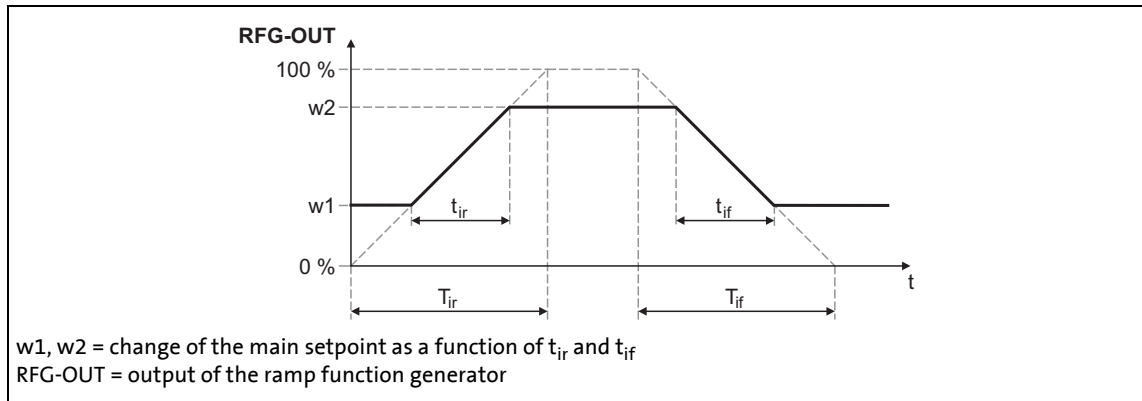

[17-19] Acceleration and deceleration times

- $t_{ir}$  and  $t_{if}$  are the desired times for changing between  $w1$  and  $w2$ .
- The ramps for acceleration and deceleration can be set individually.
  - [C00227](#): Acceleration time  $t_{ir}$
  - [C00228](#): Deceleration time  $t_{if}$
- The  $t_{ir}/t_{if}$  values are converted into the required  $T_i$  times according to the following formula:

$T_{ir} = t_{ir} \cdot \frac{100\%}{w2 - w1}$	$T_{if} = t_{if} \cdot \frac{100\%}{w2 - w1}$
---	---

- The ramp function generator is immediately set to "0" by setting *blnAct* to TRUE.

### 17.1.39.3 Operating range of the PID process controller

The value range of the input signal *nSet\_a* and thus the operating range of the PID process controller can be limited with the following parameters:

- [C00231/1](#): Pos. maximum (default setting: 199.99 %)
- [C00231/2](#): Pos. minimum (default setting: 0.00 %)
- [C00231/3](#): Neg. minimum (default setting: 0.00 %)
- [C00231/4](#): Neg. maximum (default setting: 199.99 %)

### 17.1.39.4 Evaluation of the output signal

After the limitation, the output signal is evaluated with the influencing factor  $nInfluence_a$ . The evaluation is activated/suppressed along a ramp when the  $bEnableInfluenceRamp$  input is set to TRUE. The ramp times are set with the parameters "Influence acceleration time" ([C00243](#)) and "Influence deceleration time" ([C00244](#)).

### 17.1.39.5 Comparison function "Actual value = setpoint"

If setpoint and actual value are identical and there is no system deviation, the  $bSetEqAct$  status output is set to TRUE.

- The hysteresis of the comparison function has a fixed value of 1 %.
- From version 06.00.00 onwards, the symmetrical window around the setpoint for the comparison function can be set in [C00247](#) (Lenze setting: 2 %).

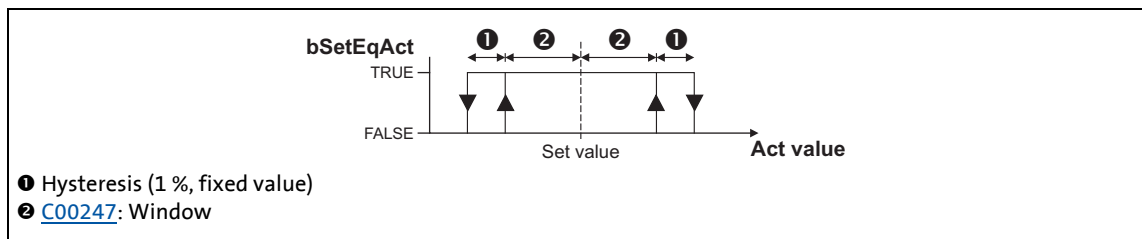

[17-20] Comparison function: Switching performance

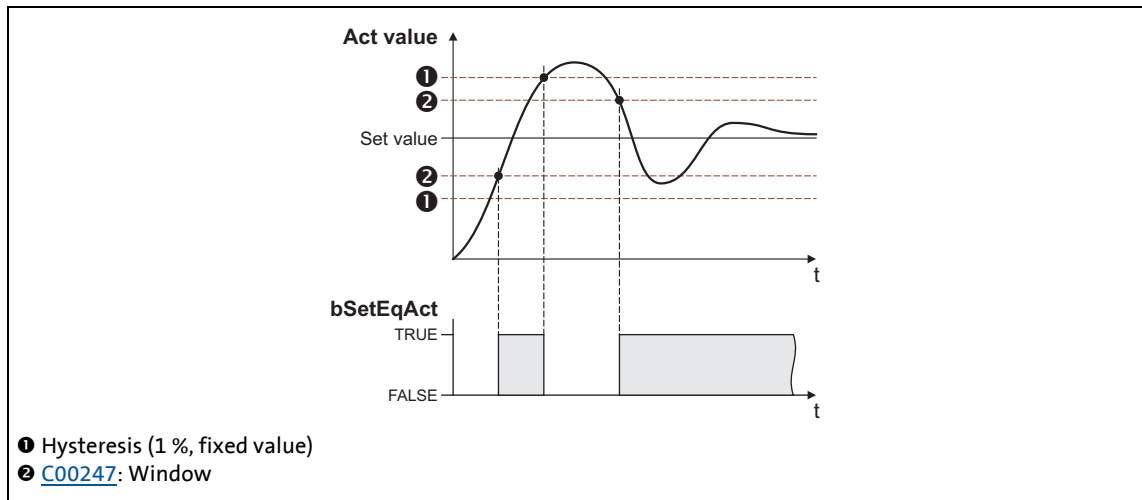

[17-21] Comparison function: Example

### 17.1.39.6 Control functions

The process controller has various digital inputs for controlling the FB:

Designator	Data type	Information/possible settings
bInAct	BOOL	Deactivate process controller temporarily (stop) <ul style="list-style-type: none"> <li>Changes can be done online.</li> <li>Display parameter: <a href="#">C00833/76</a></li> </ul> Note: This input is not interconnected in the LA_NCtrl application block.
		TRUE <ul style="list-style-type: none"> <li>The current output value is frozen.</li> <li>The internal control algorithm is stopped.</li> <li>However, a setpoint selected via input <i>nNSet_a</i> is still provided in operating modes 0/1/4/5.</li> </ul>
bIOff	BOOL	Switch off the I-component of the process controller <ul style="list-style-type: none"> <li>Changes can be done online.</li> <li>Display parameter: <a href="#">C00833/77</a></li> </ul>
		TRUE The I component of the process controller is set to zero.
bPIDOff <small>(from version 06.00.00)</small>	BOOL	Reset the entire PID controller
		TRUE <ul style="list-style-type: none"> <li>The I component of the controller is set to zero.</li> <li>The controller output is set to zero.</li> <li>The internal control algorithm is stopped.</li> </ul>

17.1.40 L\_PT1\_1

This FB filters and delays analog signals.

- The filter time constant T can be set under [C00249](#).
- The gain is defined with  $V_p = 1$ .

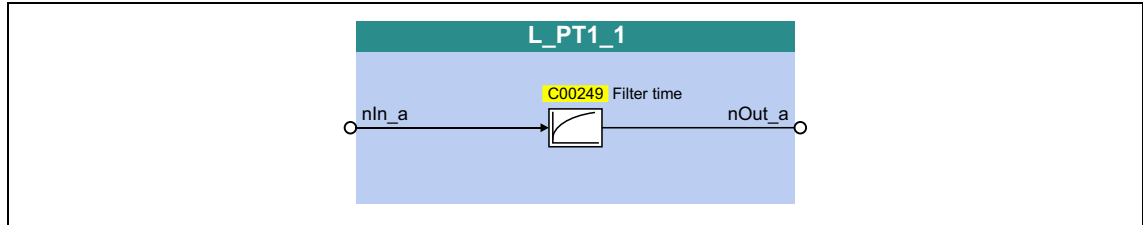

inputs

Designator	Data type	Information/possible settings
nIn_a	INT	Input signal

outputs

Designator	Data type	Value/meaning
nOut	INT	Output signal

Parameters

Parameters	Possible settings			Info
<a href="#">C00249</a>	0	ms	5000	Filter time constant • The filter is not active with a setting of "0 ms". The input signal is passed through one-to-one to the output. • Lenze setting: 2000 ms

Function

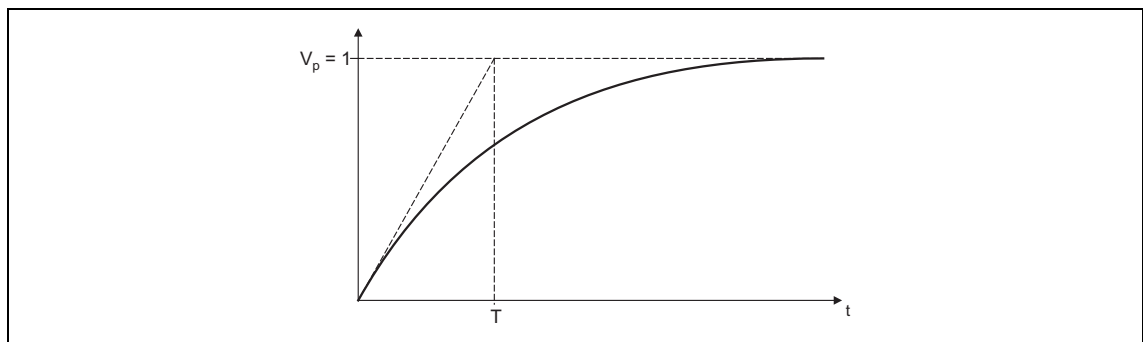

[17-22] Filter time constant T of the first-order delay element

### 17.1.41 L\_RLQ\_1

This FB links a selected direction of rotation to the quick stop function with wire-break protection.

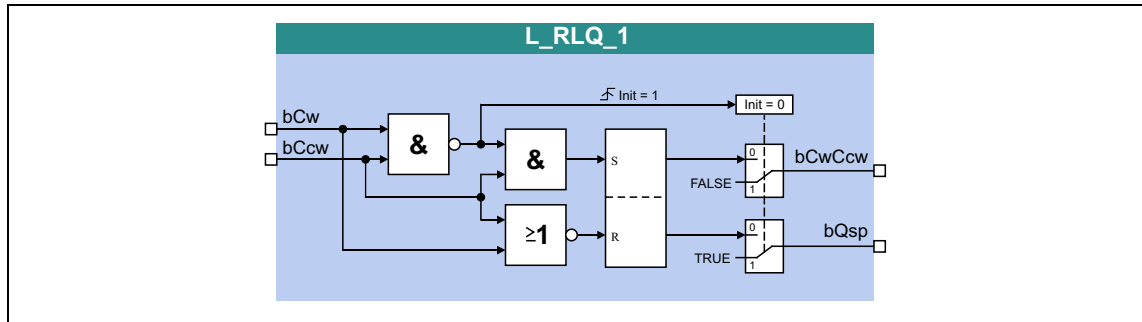

#### inputs

Designator	Data type	Information/possible settings
bCw	BOOL	Input • TRUE = CW rotation
bCCw	BOOL	Input • TRUE = CCW rotation

#### outputs

Designator	Data type	Value/meaning
bQSP	BOOL	Output signal for quick stop (QSP)
bCwCcw	BOOL	Output signal for CW/CCW rotation • TRUE = CCW rotation

#### Function

inputs		outputs		Notes
bCw	bCCw	bCwCcw	bQSP	
TRUE	TRUE	FALSE	TRUE	The inputs have this status only if a TRUE signal is being applied to <u>both</u> inputs at the moment of switch-on! See also FB illustration above, "Init" = 1.
If <i>one</i> of the inputs has the TRUE status, the following truth table applies:				
FALSE	FALSE	FALSE	TRUE	See also FB illustration above, "Init" = 0.
TRUE	FALSE	FALSE	FALSE	
FALSE	TRUE	TRUE	FALSE	
TRUE	TRUE	X (save)		

[17-23] Truth table of the FB L\_RLQ, 0 = FALSE, 1 = TRUE

### 17.1.42 L\_SignalMonitor\_a

This FB outputs four analog signals which can be selected from a list of analog output signals of all function blocks provided in the device.

- Offset and gain of the source signals are adjustable.

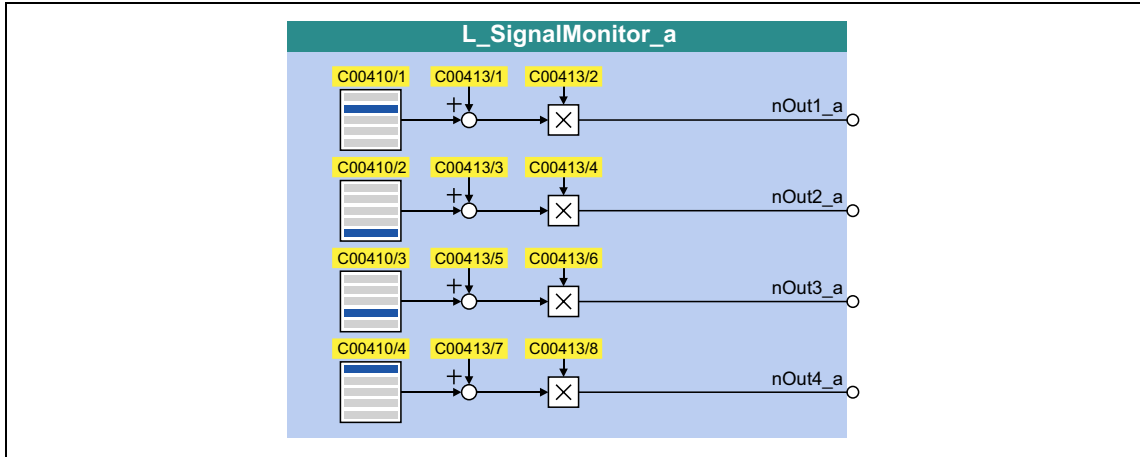

#### outputs

Designator	Data type	Value/meaning
nOut1_a	INT	Output signal • Internal limitation to $\pm 32767$
nOut2_a	INT	Output signal • Internal limitation to $\pm 32767$
nOut3_a	INT	Output signal • Internal limitation to $\pm 32767$
nOut4_a	INT	Output signal • Internal limitation to $\pm 32767$

#### Parameters

Parameters	Possible settings	Info
<a href="#">C00410/1</a> ... <a href="#">C00410/4</a>	See <a href="#">selection list - analog signals</a>	Selection of the signal sources for <i>nOut1_a</i> ... <i>nOut4_a</i>
<a href="#">C00413/1</a> <a href="#">C00413/3</a> <a href="#">C00413/5</a> <a href="#">C00413/7</a>	-199.99      %      +199.99	Offset
<a href="#">C00413/2</a> <a href="#">C00413/4</a> <a href="#">C00413/6</a> <a href="#">C00413/8</a>	-199.99      %      +199.99	Gain

### 17.1.43 L\_SignalMonitor\_b

This FB outputs four binary signals which can be selected from a list of binary output signals of all function blocks provided in the device.

- Inversion of the output signals can be set.

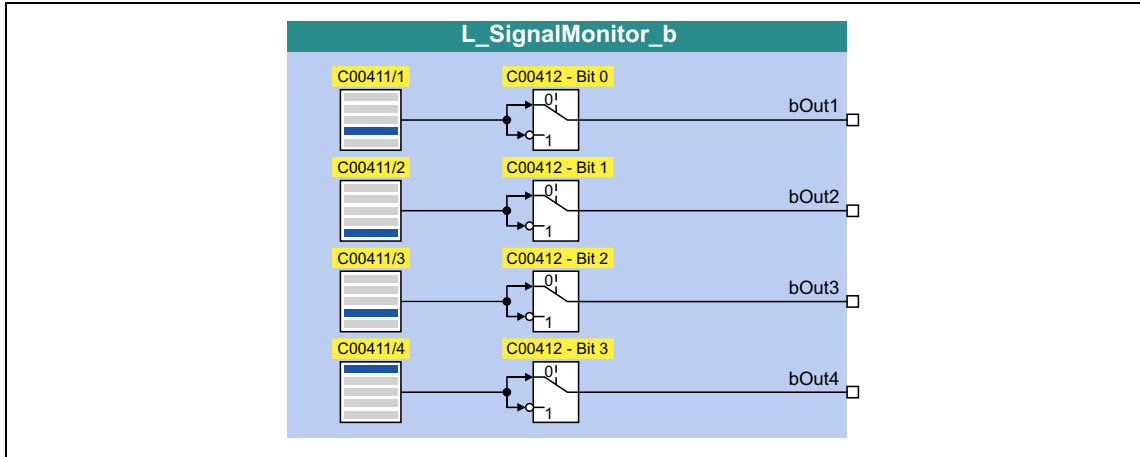

#### outputs

Designator	Data type	Value/meaning
bOut1 ... bOut4	BOOL	Output signal FALSE / TRUE

#### Parameters

Parameters	Possible settings	Info																
<a href="#">C00411/1</a> ... <a href="#">C00411/4</a>	See <a href="#">selection list - digital signals</a>	Selection of the signal sources for <i>bOut1 ... bOut4</i>																
<a href="#">C00412</a>	Value is bit-coded: <table border="1"> <tr><td>Bit 0</td><td>bOut1 inverted</td></tr> <tr><td>Bit 1</td><td>bOut2 inverted</td></tr> <tr><td>Bit 2</td><td>bOut3 inverted</td></tr> <tr><td>Bit 3</td><td>bOut4 inverted</td></tr> <tr><td>Bit 4</td><td>Reserved</td></tr> <tr><td>Bit 5</td><td>Reserved</td></tr> <tr><td>Bit 6</td><td>Reserved</td></tr> <tr><td>Bit 7</td><td>Reserved</td></tr> </table>	Bit 0	bOut1 inverted	Bit 1	bOut2 inverted	Bit 2	bOut3 inverted	Bit 3	bOut4 inverted	Bit 4	Reserved	Bit 5	Reserved	Bit 6	Reserved	Bit 7	Reserved	Inversion • Bit set = inversion active
Bit 0	bOut1 inverted																	
Bit 1	bOut2 inverted																	
Bit 2	bOut3 inverted																	
Bit 3	bOut4 inverted																	
Bit 4	Reserved																	
Bit 5	Reserved																	
Bit 6	Reserved																	
Bit 7	Reserved																	



## 17.1.44 L\_Transient\_1

This FB serves to evaluate digital signal edges and convert them into timed, retriggerable pulses. Rising signal edges, falling signal edges or both signal edges can be evaluated.

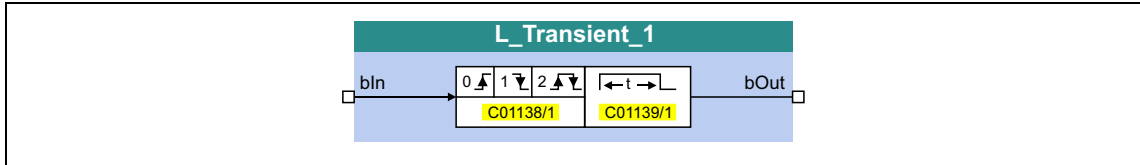

## inputs

Designator	Data type	Information/possible settings
bIn	BOOL	Input for edge evaluation • The function depends on the selection of edge evaluation in <a href="#">C01138/1</a> .

## outputs

Designator	Data type	Value/meaning
bOut	BOOL	Output (retriggerable)

## Parameters

Parameters	Possible settings	Info		
<a href="#">C01138/1</a>	0	High edge	Function • Selection of edge evaluation	
	1	Low edge	Lenze setting	
	2	High and low edge		
<a href="#">C01139/1</a>	0.001	s	60.000	Pulse duration • Lenze setting: 0.001 s

### 17.1.44.1 Function 0: Evaluate rising signal edges

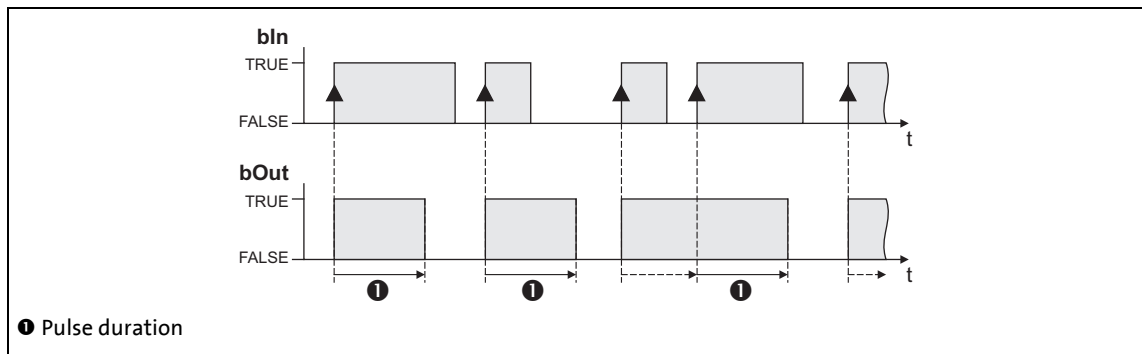

[17-24] Switching performance for function selection "0: High edge"

#### Functional sequence

1. A FALSE-TRUE edge at the *bIn* input sets the *bOut* output to TRUE.
2. After the parameterised pulse duration has elapsed, the *bOut* output is reset to FALSE unless another FALSE/TRUE edge has been set at the *bIn* input.
  - If an additional FALSE-TRUE edge occurs at the *bIn* input, the pulse duration starts again from the beginning, i.e. the *bOut* output can be retriggered.

### 17.1.44.2 Function 1: Evaluate falling signal edges

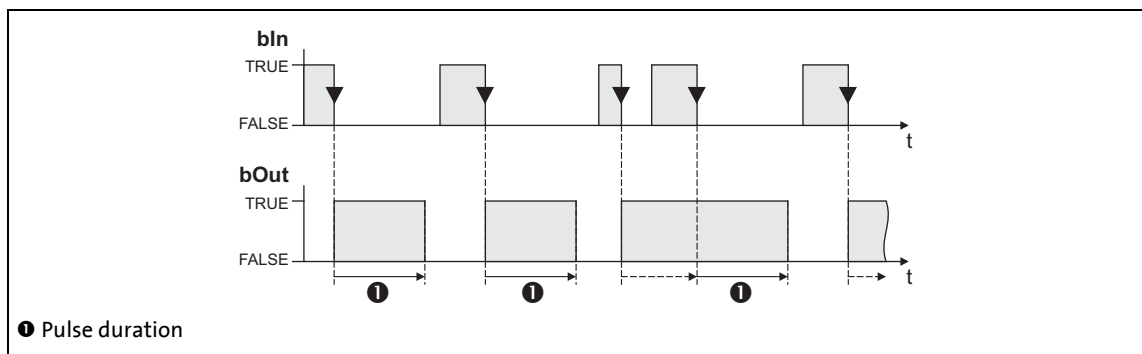

[17-25] Switching performance for function selection "1: Low edge"

#### Functional sequence

1. A TRUE-FALSE edge at the *bIn* inputs sets the *bOut* output to TRUE.
2. After the parameterised pulse duration has elapsed, the *bOut* output is reset to FALSE unless another TRUE/FALSE edge has been set at the *bIn* input.
  - If an additional TRUE-FALSE edge occurs at the *bIn* input, the pulse duration starts again from the beginning, i.e. the *bOut* output can be retriggered.

### 17.1.44.3 Function 2: Evaluate rising and falling signal edges

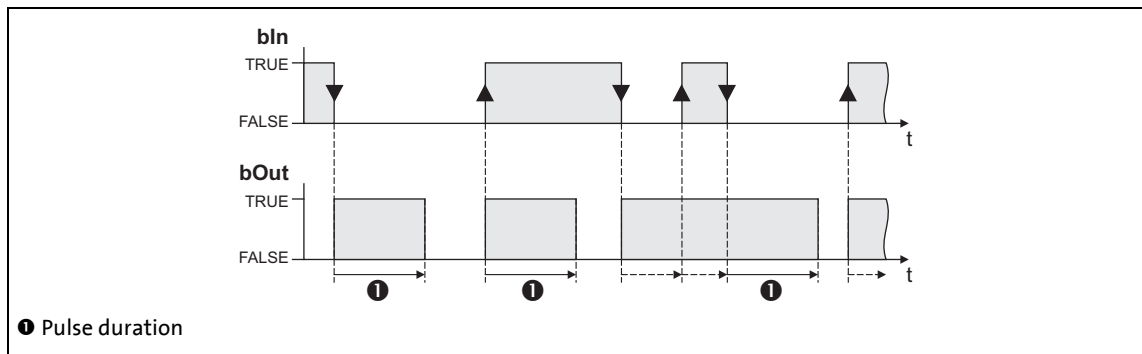

[17-26] Switching performance for function selection "2: High and low edge"

#### Functional sequence

1. A signal change (FALSE/TRUE edge or TRUE/FALSE edge) at the *bIn* input sets the *bOut* output to TRUE.
2. After the parameterised pulse duration has elapsed, the *bOut* output is reset to FALSE unless another signal change has taken place at the *bIn* input.
  - In case of another signal change at the input *bIn*, the pulse time restarts to elapse, i.e. the output *bOut* can be retriggered.

### 17.1.45 L\_Transient\_2

This FB serves to evaluate digital signal edges and convert them into timed, retriggerable pulses. Rising signal edges, falling signal edges or both signal edges can be evaluated.

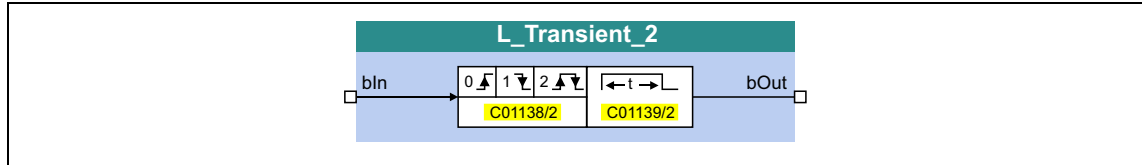

#### inputs

Designator	Data type	Information/possible settings
bIn	BOOL	Input for edge evaluation <ul style="list-style-type: none"> <li>The function depends on the selection of edge evaluation in <a href="#">C01138/2</a>.</li> </ul>

#### outputs

Designator	Data type	Value/meaning
bOut	BOOL	Output (retriggerable)

#### Parameters

Parameters	Possible settings	Info		
<a href="#">C01138/2</a>	0	High edge		
	1	Low edge		
	2	High and low edge		
<a href="#">C01139/2</a>	0.001	s	60.000	Pulse duration <ul style="list-style-type: none"> <li>Lenze setting: 0.001 s</li> </ul>



For a detailed functional description see [L\\_Transient\\_1](#).

## 17.1.46 L\_Transient\_3

This FB serves to evaluate digital signal edges and convert them into timed, retriggerable pulses. Rising signal edges, falling signal edges or both signal edges can be evaluated.

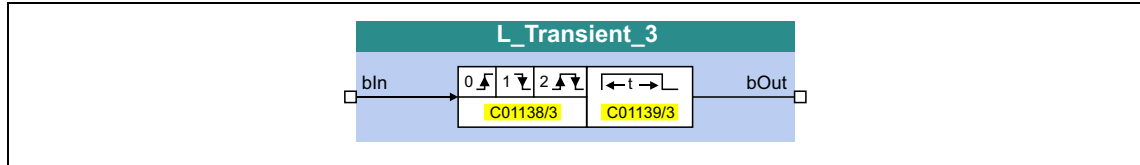

## inputs

Designator	Data type	Information/possible settings
bIn	BOOL	Input for edge evaluation • The function depends on the selection of edge evaluation in <a href="#">C01138/3</a> .

## outputs

Designator	Data type	Value/meaning
bOut	BOOL	Output (retriggerable)

## Parameters

Parameters	Possible settings	Info		
<a href="#">C01138/3</a>	0	High edge	Function • Selection of edge evaluation	
	1	Low edge	Lenze setting	
	2	High and low edge		
<a href="#">C01139/3</a>	0.001	s	60.000	Pulse duration • Lenze setting: 0.001 s



For a detailed functional description see [L\\_Transient\\_1](#).

### 17.1.47 L\_Transient\_4

This FB serves to evaluate digital signal edges and convert them into timed, retriggerable pulses. Rising signal edges, falling signal edges or both signal edges can be evaluated.

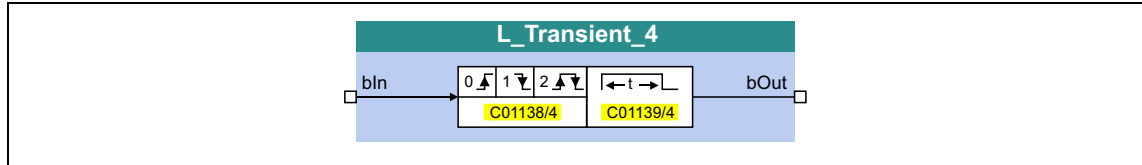

#### inputs

Designator	Data type	Information/possible settings
bIn	BOOL	Input for edge evaluation <ul style="list-style-type: none"> <li>The function depends on the selection of edge evaluation in <a href="#">C01138/4</a>.</li> </ul>

#### outputs

Designator	Data type	Value/meaning
bOut	BOOL	Output (retriggerable)

#### Parameters

Parameters	Possible settings			Info
<a href="#">C01138/4</a>	0	High edge		Function <ul style="list-style-type: none"> <li>Selection of edge evaluation</li> </ul>
	1	Low edge		Lenze setting
	2	High and low edge		
<a href="#">C01139/4</a>	0.001	s	60.000	Pulse duration <ul style="list-style-type: none"> <li>Lenze setting: 0.001 s</li> </ul>



For a detailed functional description see [L\\_Transient\\_1](#).

## 17.2 System blocks

This chapter describes the system blocks which are available for the inverter in the FB Editor.



The function blocks are described in the previous chapter "[Function blocks](#)". (☞ 934)

## Overview of system blocks available

System block	Function	can be inserted into level:	
		I/O	Appl.
<a href="#">LS_AnalogInput</a>	Interface to the analog input terminals ▶ <a href="#">Analog terminals</a> (☞ 293)	●	
<a href="#">LS_CANManagement</a>	Control of internal functions of the CAN driver and display of the "Operational" status as well as the node address ▶ <a href="#">System bus "CAN on board"</a> (☞ 508)	●	●
LS_DataAccess	<i>Lenze internal only</i>		●
<a href="#">LS_DeviceMonitor</a>	Motor control status signals ▶ <a href="#">Motor control (MCTRL)</a> (☞ 112)		●
<a href="#">LS_DigitalInput</a>	Interface to the digital input terminals ▶ <a href="#">Digital terminals</a> (☞ 274)	●	
<a href="#">LS_DigitalOutput</a>	Interface to the digital output terminals ▶ <a href="#">Digital terminals</a> (☞ 274)	●	
<a href="#">LS_DisFree</a>	Display of 4 arbitrary 16-bit signals of the application on display codes	●	●
<a href="#">LS_DisFree_a</a>	Display of 4 arbitrary analog signals of the application on display codes	●	●
<a href="#">LS_DisFree_b</a>	Display of 8 arbitrary digital signals of the application on a bit coded display code	●	●
<a href="#">LS_DriveInterface</a>	Interface to drive control (DCTRL) ▶ <a href="#">Device control (DCTRL)</a> (☞ 76)		●
<a href="#">LS_Keypad</a>	Control via keypad	●	
<a href="#">LS_MotionControlKernel</a>	Interface to the basic drive function implemented in the Motion Control Kernel (MCK) ▶ <a href="#">Basic drive functions (MCK)</a> (☞ 403)		●
<a href="#">LS_MotorInterface</a>	Interface to motor control (MCTRL) ▶ <a href="#">Motor control (MCTRL)</a> (☞ 112)		●
<a href="#">LS_ParFix</a>	Output of frequently used constants (TRUE, FALSE, 100 %, etc.) to be used in the interconnection	●	●
<a href="#">LS_ParFree</a>	Output of 4 parameterisable 16-bit signals	●	●
<a href="#">LS_ParFree_a</a>	Output of 4 parameterisable analog signals	●	●
<a href="#">LS_ParFree_b</a>	Output of 16 parameterisable digital signals	●	●
<a href="#">LS_ParFree_p</a>	Output of 4 parameterisable position signals • This SB is available from version 11.00.00.	●	●
<a href="#">LS_ParFree_v</a>	Output of 4 parameterisable speed signals	●	●
<a href="#">LS_ParReadWrite_1</a> ... <a href="#">LS_ParReadWrite_3</a>	Reading/Writing of local parameters	●	●
<a href="#">LS_PulseGenerator</a>	Output of 9 fixed frequencies and 1 parameterisable frequency	●	●
<a href="#">LS_SetError_1</a>	Parameterisable responses to user-defined events are tripped ▶ <a href="#">Diagnostics &amp; error management</a> (☞ 434)	●	●

System block	Function	can be inserted into level:	
		I/O	Appl.
<a href="#">LS_SyncManagement</a>	Output of status information for synchronising the internal time base ▶ <a href="#">Synchronisation of the internal time base</a> (📖 595)	●	●
<a href="#">LS_WriteParamList</a>	Interface to the basic "Parameter change-over" function ▶ <a href="#">Parameter change-over</a> (📖 597) • This SB is available from version 04.00.00.	●	

**Related topics:**

- ▶ [Overview of function blocks available](#) (📖 934)
- ▶ [Working with the FB Editor](#) (📖 882)



# 17 Function library

## 17.2 System blocks

---

### 17.2.1 LS\_AnalogInput

Interface to the analog input terminals.



For a detailed description see the main chapter "I/O terminals":

▶ [Internal interfaces | System block "LS\\_AnalogInput"](#) (📖 300)

### 17.2.2 LS\_CANManagement

Control of internal functions of the CAN driver and display of the "Operational" status as well as the node address.



For a detailed description see the main chapter "System bus CAN on board":

▶ [Internal interfaces | System block "LS\\_CANManagement"](#) (📖 587)

### 17.2.3 LS\_DataAccess

Only for Lenze-internal use.

### 17.2.4 LS\_DeviceMonitor

Motor control status signals.



For a detailed description see the main chapter "Motor control (MCTRL)":

▶ [Internal status signals | System block "LS\\_DeviceMonitor"](#) (📖 270)

### 17.2.5 LS\_DigitalInput

Interface to the digital input terminals.



For a detailed description see the main chapter "I/O terminals":

▶ [Internal interfaces | System block "LS\\_DigitalInput"](#) (📖 286)

### 17.2.6 LS\_DigitalOutput

Interface to the digital output terminals.



For a detailed description see the main chapter "I/O terminals":

▶ [Internal interfaces | System block "LS\\_DigitalOutput"](#) (📖 292)

## 17.2.7 LS\_DisFree

This system block displays 4 arbitrary 16-bit signals of the application on display codes.

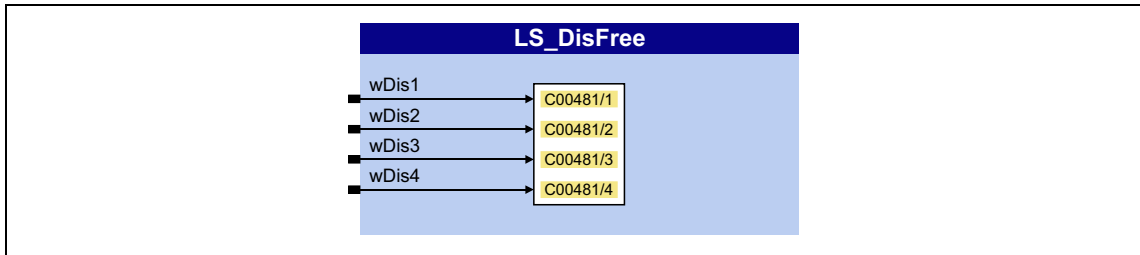

## inputs

Designator	Data type	Information/possible settings
wDis1 ... wDis4	WORD	Inputs for any 16-bit signals of the application
From version 11.00.00 onwards: wC481_1 ... wC481_4_a		<b>Note:</b> From version 11.00.00 the inputs are named according to the display parameter for an easier allocation.

## Parameters

Parameters	Possible settings	Info
<a href="#">C00481/1...4</a>	0x0000	0xFFFF
		Display of the 16-bit signals which are applied at the <i>wDis1</i> ... <i>wDis4</i> inputs

17.2.8 LS\_DisFree\_a

This system block displays 4 arbitrary analog signals of the application on display codes.

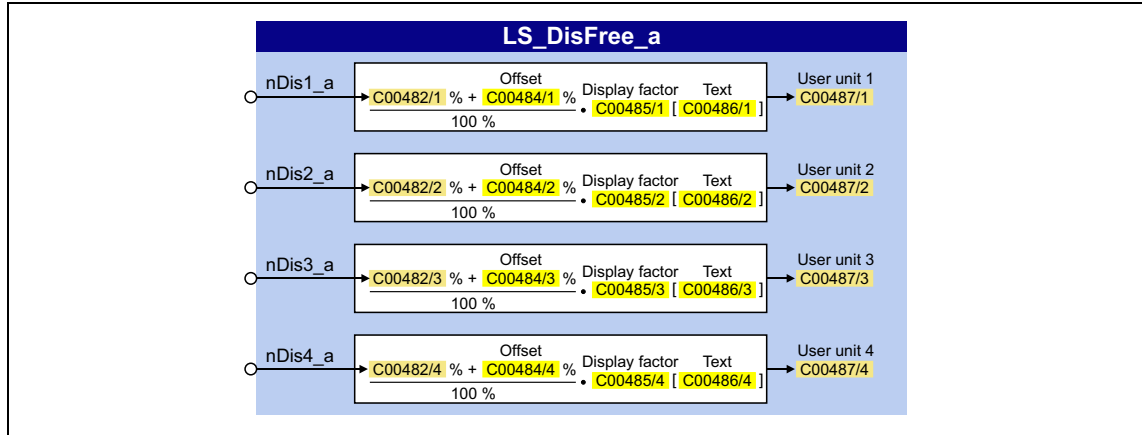

inputs

Designator	Data type	Information/possible settings
nDis1_a ... nDis4_a	INT	Inputs for arbitrary analog signals of the application
nC482_1_a ... nC482_4_a		<b>Note:</b> From version 11.00.00 the inputs are named according to the display parameter for an easier allocation.

Parameters

Parameters	Possible settings	Info
C00482/1...4	-199.99 %	199.99 %
C00484/1...4 ... C00487/1...4	From version 06.00.00 onwards: ▶ <a href="#">Display of internal process factors in application units</a>	

### 17.2.8.1 Display of internal process factors in application units

This function extension is available from version 06.00.00!

In addition to the display in percent in [C00482/1...8](#), for the first four analog signals  $nDis1_a$  ...  $nDis4_a$  the configurable display parameters [C00487/1...4](#) are provided. Via these display parameters, internal process variables can be displayed, e.g. on the keypad, with an individual scaling and an individual unit (from keypad version 02.01).

**Configuration of the display parameters ([C00487/1...4](#)):**

Parameters	Possible settings			Info
<a href="#">C00484/1...4</a>	-199.99	%	199.99	Offset 1 ... 4 • See formula <a href="#">[17-27]</a> . • Lenze setting: 0.00 %
<a href="#">C00485/1...4</a>	-65536.0000		65536.0000	Display factor 1 ... 4 • Scaling of the input variable for the display. • See formula <a href="#">[17-27]</a> . • Lenze setting: 1.0000
<a href="#">C00486/1...4</a>	String (max. 7 digits)			Text 1 ... 4 • For each display value, an individual unit (e.g. "parts") can be set.

$$\text{User unit 1} = \frac{nDis1_a [\%] + \text{Offset 1} [\%]}{100 [\%]} \cdot \text{Display factor 1} [\text{text 1}]$$

[17-27] Formula for scaling the display

#### Example 1:

- Input variable  $nDis1_a = 100 \%$
- Offset 1 ([C00484/1](#)) = 0 %
- Display factor 1 ([C00485/1](#)) = 123.45
- Text 1 ([C00486/1](#)) = "parts"

$$\text{User unit 1} = \frac{100 [\%] + 0 [\%]}{100 [\%]} \cdot 123.45 [\text{parts}] = 123.45 \text{ parts}$$

#### Example 2:

- Input variable  $nDis2_a = 40 \%$
- Offset 2 ([C00484/2](#)) = 35 %
- Display factor 2 ([C00485/2](#)) = 20
- Text 2 ([C00486/2](#)) = "kg"

$$\text{User unit 2} = \frac{40 [\%] + 35 [\%]}{100 [\%]} \cdot 20 [\text{kg}] = 15.00 \text{ kg}$$

### 17.2.9 LS\_DisFree\_b

This system block displays 8 arbitrary digital signals of the application on a bit coded display code.

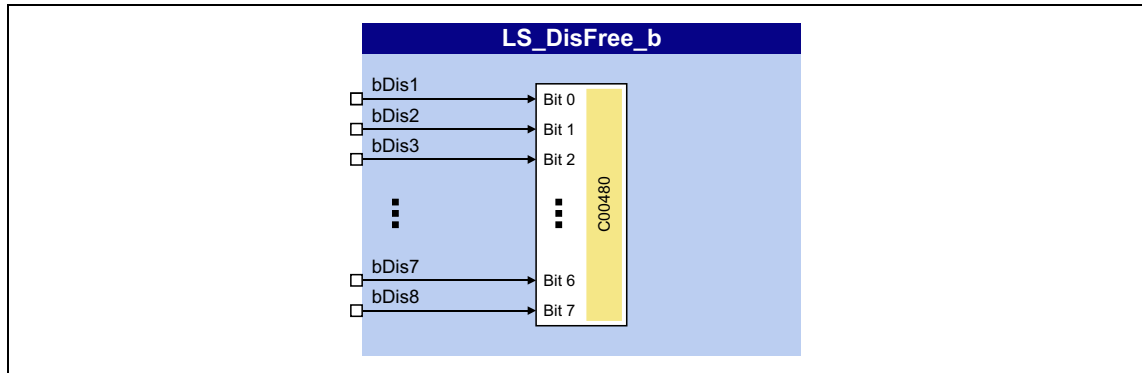

#### inputs

Designator	Data type	Information/possible settings
bDis1 ... bDis8	BOOL	Inputs for arbitrary digital signals of the application
From version 11.00.00 onwards: bC480_B0 ... bC480_B7		<b>Note:</b> From version 11.00.00 the inputs are named according to the display parameter for an easier allocation.

#### Parameters

Parameters	Possible settings	Info	
<a href="#">C00480</a>	0x0000	Display of the digital signals as hexadecimal values applied at the <i>bDis1</i> ... <i>bDis8</i> inputs	
	Bit 0		Signal level at the <i>bDis1</i> input
	Bit 1		Signal level at the <i>bDis2</i> input
	Bit 2		Signal level at the <i>bDis3</i> input
	...		...
	Bit 7		Signal level at the <i>bDis8</i> input

### 17.2.10 LS\_DriveInterface

Interface to internal device control.



For a detailed description see main chapter "Device control (DCTRL)":

▶ [Internal interfaces | "LS\\_DriveInterface" system block](#) (104)

### 17.2.11 LS\_Keypad

This system block is used on I/O interconnection level if the "Keypad" control mode has been selected in [C00007](#).

In the "Keypad" control mode, the **LS\_Keypad** system block passes on various setpoints and control commands to the technology application which can be selected/activated via codes using the keypad.

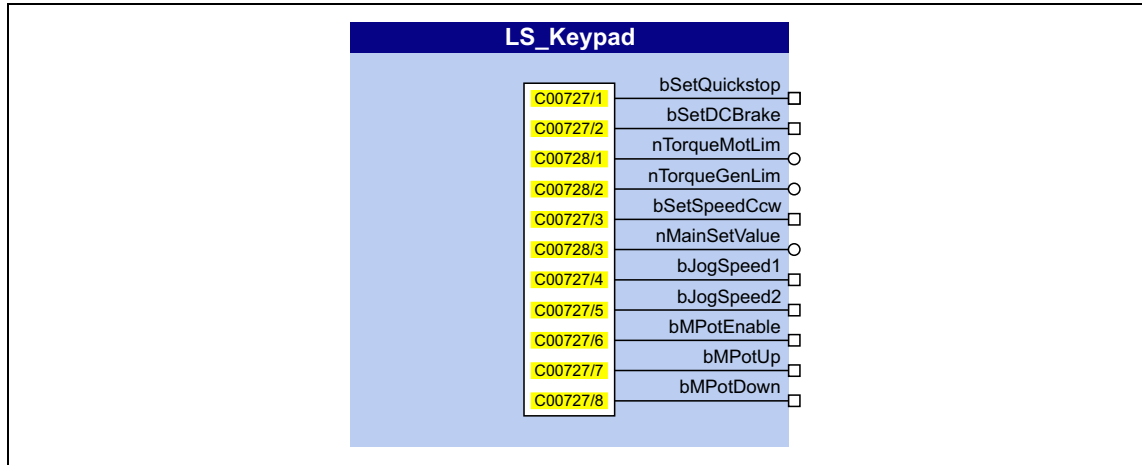

#### outputs

Designator	Data type	Value/meaning
bSetQuickstop	BOOL	<a href="#">C00727/1</a> = "1" ≡ Request quick stop
bSetDCBrake	BOOL	<a href="#">C00727/2</a> = "1" ≡ Request DC-injection braking
nTorqueMotLim	INT	Torque limit in motor mode set in <a href="#">C00728/1</a> • Lenze setting: 100.00 %
nTorqueGenLim	INT	Torque limit in generator mode set in <a href="#">C00728/2</a> • Lenze setting: 100.00 %
bSetSpeedCcw	BOOL	<a href="#">C00727/3</a> = "1" ≡ Request reversal
nMainSetValue	INT	Setpoint speed set in <a href="#">C00728/3</a> • Lenze setting: 0.00 %
bJogSpeed1	BOOL	<a href="#">C00727/4</a> = "1" ≡ Request fixed speed setpoint 1
bJogSpeed2	BOOL	<a href="#">C00727/5</a> = "1" ≡ Request fixed speed setpoint 2
bMPotEnable	BOOL	<a href="#">C00727/6</a> = "1" ≡ Motor potentiometer: Request activation
bMPotUp	BOOL	<a href="#">C00727/7</a> = "1" ≡ Motor potentiometer: Request positive acceleration
bMPotDown	BOOL	<a href="#">C00727/8</a> = "1" ≡ Motor potentiometer: Request negative acceleration

## Parameters

Parameters	Possible settings			Info
<a href="#">C00727/1...8</a>	0		1	Keypad digital values <ul style="list-style-type: none"> <li>• Execution of control commands for keypad operation</li> <li>• See the "Outputs" table for the meaning of the individual subcodes</li> </ul>
<a href="#">C00728/1...3</a>	-199.99	%	199.99	Analog values - keypad <ul style="list-style-type: none"> <li>• Selection of various setpoints for operation via keypad</li> <li>• See the "Outputs" table for the meaning of the individual subcodes</li> </ul>

## 17.2.12 LS\_MotionControlKernel

Interface to the basic drive functions implemented in **Motion Control Kernel (MCK)**.



For a detailed description see the main chapter "Basic drive functions":

▶ [Internal interfaces | System block "LS\\_MotionControlKernel"](#) (📖 405)

## 17.2.13 LS\_MotorInterface

Interface to internal motor control.



For a detailed description see the main chapter "Motor control (MCTRL)":

▶ [Internal interfaces | System block "LS\\_MotorInterface"](#) (📖 263)

## 17.2.14 LS\_ParFix

This system block outputs various fixed values (constants) to be used in the interconnection.

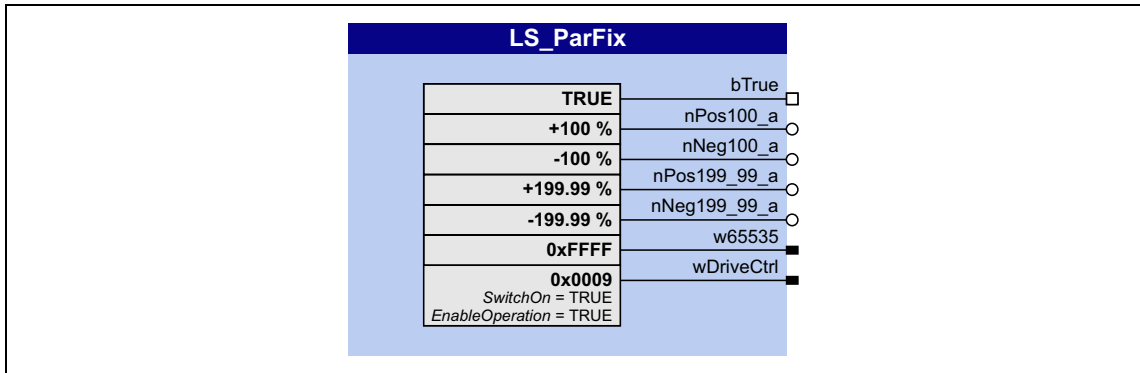

## outputs

Designator	Data type	Value/meaning
bTrue	BOOL	1 ≡ TRUE
nPos100_a	INT	16384 ≡ + 100 %
nNeg100_a	INT	-16384 ≡ - 100 %
nPos199_99_a	INT	32767 ≡ + 199.99 %
nNeg199_99_a	INT	-32767 ≡ - 199.99 %
w65535	WORD	65535 ≡ 0xFFFF
wDriveCtrl	WORD	9 ≡ 0x0009 <ul style="list-style-type: none"> <li>• Bit 0, SwitchOn = TRUE</li> <li>• Bit 3, EnableOperation = TRUE</li> <li>• All others: FALSE</li> </ul> See also: <a href="#">▶ wCANControl/wMCIControl control words (□ 107)</a>



## 17.2.15 LS\_ParFree

This system block outputs 4 parameterisable 16-bit signals.

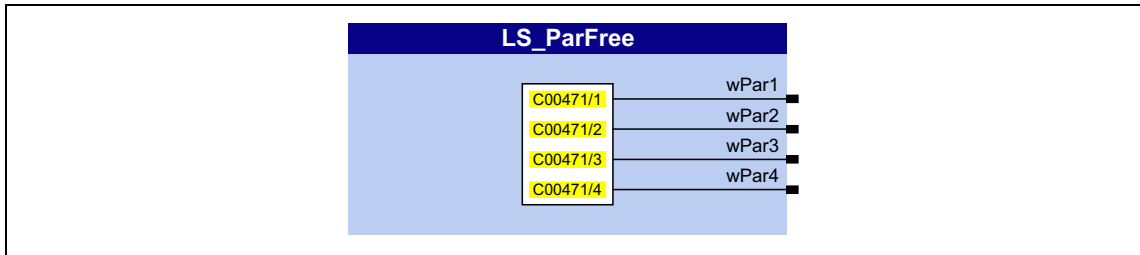

## outputs

Designator	Data type	Value/meaning
wPar1 ... wPar4	WORD	Output of the 16-bit signals parameterised in <a href="#">C00471/1...4</a>
From version 11.00.00 onwards: wC471_1 ... wC471_4		<b>Note:</b> From version 11.00.00 the outputs are named according to the respective setting parameter for an easier allocation.

## Parameters

Parameters	Possible settings			Info
<a href="#">C00471/1...4</a>	0x0000		0xFFFF	Setting of the 16-bit signals to be output

## 17.2.16 LS\_ParFree\_a

This system block outputs 4 parameterisable analog signals.

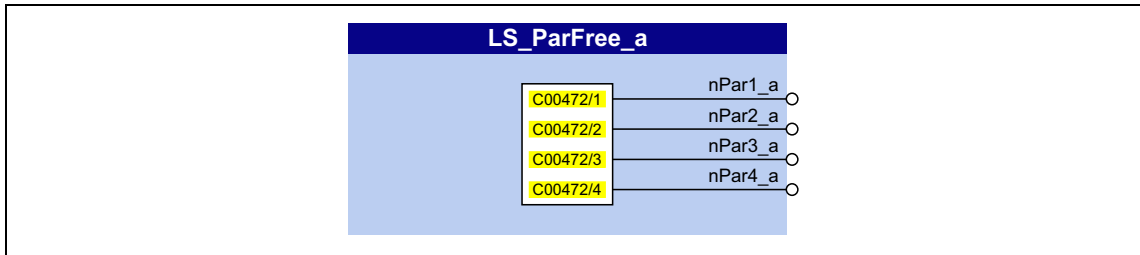

## outputs

Designator	Data type	Value/meaning
nPar1_a ... nPar4_a	INT	Output of the analog signals parameterised in <a href="#">C00472/1...4</a>
From version 11.00.00 onwards: nC472_1_a ... nC472_4_a		<b>Note:</b> From version 11.00.00 the outputs are named according to the respective setting parameter for an easier allocation.

## Parameters

Parameters	Possible settings			Info
<a href="#">C00472/1...4</a>	-199.99	%	+199.99	Selection of analog signals to be output

17.2.17 LS\_ParFree\_b

This system block outputs 16 parameterisable digital signals.

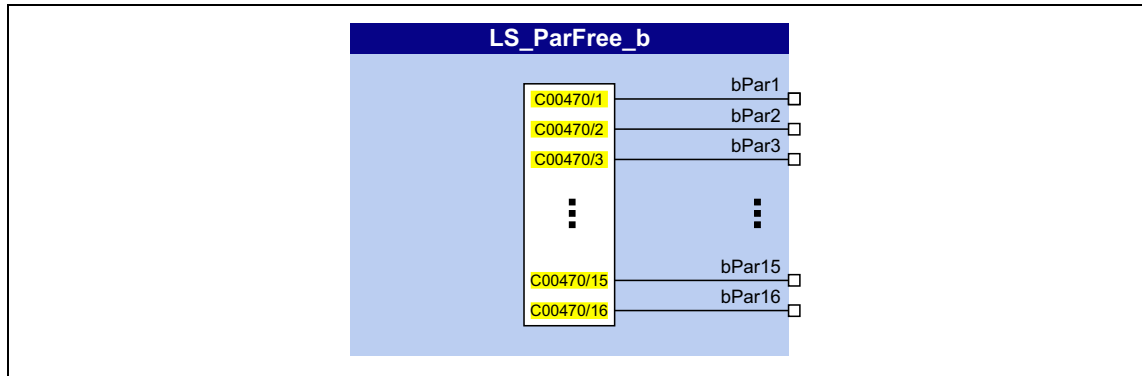

outputs

Designator	Data type	Value/meaning
bPar1 ... bPar16	BOOL	Output of the signal levels (FALSE/TRUE) parameterised in <a href="#">C00470/1...16</a>
From version 11.00.00 onwards: bC470_1 ... bC470_16		<b>Note:</b> From version 11.00.00 the outputs are named according to the respective setting parameter for an easier allocation.

Parameters

Parameters	Possible settings	Info
<a href="#">C00470/1...16</a>		Selection of signal levels to be output • Bit 0 ... 15 = <i>bPar1</i> ... <i>bPar16</i>
	0 "FALSE" signal is output	
	1 "TRUE" signal is output	

**17.2.18 LS\_ParFree\_p**

This system block outputs 4 parameterisable position signals.

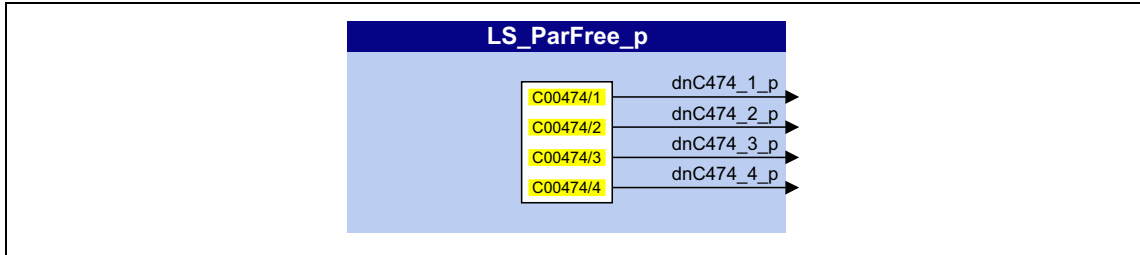

**outputs**

Designator	Value/meaning
Data type	
dnC474_1_p ... dnC474_4_p DINT	Output of the position signals parameterised in <a href="#">C00474/1...4</a>

**Parameters**

Parameters	Possible settings			Info
<a href="#">C00474/1...4</a>	-2147483647	Incr.	2147483647	Setting of the position signals to be output

## 17.2.19 LS\_ParFree\_v

This system block outputs 4 parameterisable speed signals.

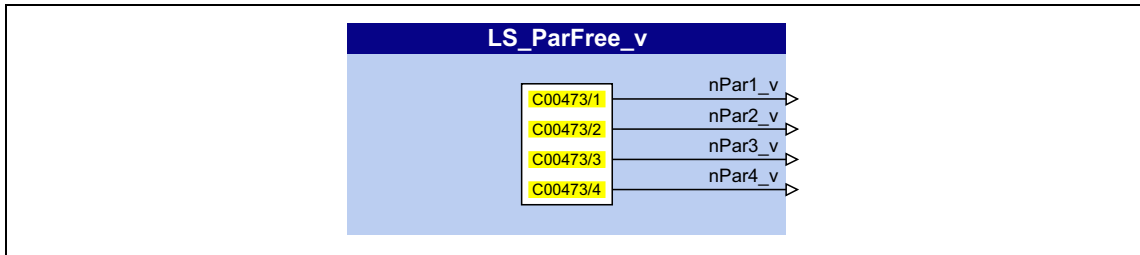

## outputs

Designator	Information/possible settings
nPar1_v ... nPar4_v Data type INT	Output of the speed signals parameterised in <a href="#">C00473/1...4</a>
From version 11.00.00 onwards: nC473_1_v ... nC473_4_v	<b>Note:</b> From version 11.00.00 the outputs are named according to the respective setting parameter for an easier allocation.

## Parameters

Parameters	Possible settings			Info
<a href="#">C00473/1...4</a>	-32767	Incr/ms	+32767	Selection of speed signals to be output

### 17.2.20 LS\_ParReadWrite\_1-3

The **LS\_ParReadWrite\_1 ... LS\_ParReadWrite\_3** system blocks are used for reading and writing local parameters.

The system blocks support one-time and cyclic reading/writing in an adjustable time interval.



#### Note!

The main program, which also contains the parameter communication, runs as a background process with a processing time that can last from several milliseconds to several 100 milliseconds. The outputs *bDone* and *bFail* of the program organisation unit **LS\_ParReadWrite** can be used to receive the exact status of the parameter communication.

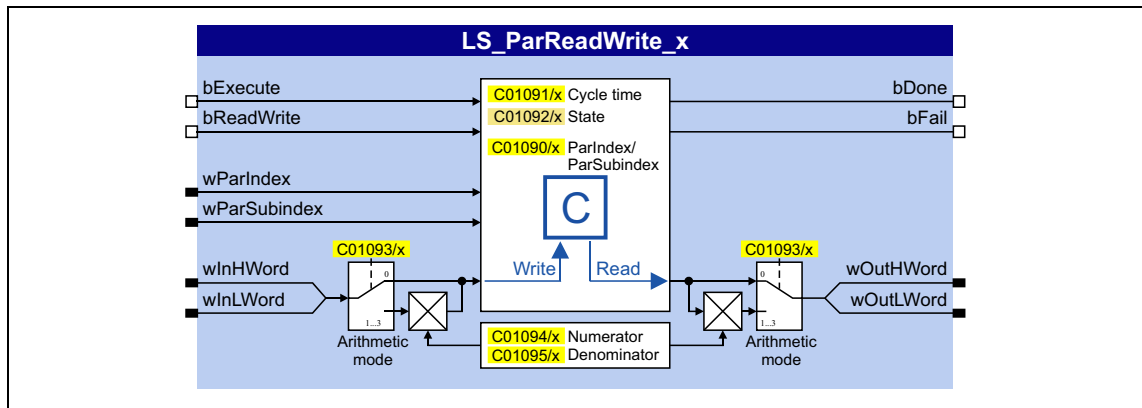

#### inputs

Designator	Data type	Information/possible settings		
bExecute	BOOL	Trip read/write request		
		<table border="0"> <tr> <td>FALSE → TRUE</td> <td>If cycle time (C01091) = "0 ms": One-time reading/writing of the parameter value which has been addressed via the <i>wParIndex</i> and <i>wParSubindex</i> inputs.</td> </tr> <tr> <td>TRUE → FALSE</td> <td>If cycle time (C01091) &gt; "0 ms": Cyclic reading/writing of the parameter value which has been addressed via the <i>wParIndex</i> and <i>wParSubindex</i> inputs.</td> </tr> </table>	FALSE → TRUE	If cycle time (C01091) = "0 ms": One-time reading/writing of the parameter value which has been addressed via the <i>wParIndex</i> and <i>wParSubindex</i> inputs.
FALSE → TRUE	If cycle time (C01091) = "0 ms": One-time reading/writing of the parameter value which has been addressed via the <i>wParIndex</i> and <i>wParSubindex</i> inputs.			
TRUE → FALSE	If cycle time (C01091) > "0 ms": Cyclic reading/writing of the parameter value which has been addressed via the <i>wParIndex</i> and <i>wParSubindex</i> inputs.			
bReadWrite	BOOL	TRUE → FALSE: Deactivate cyclic reading/writing again.		
		Selection: Read or write request		
wParIndex	WORD	FALSE: Read request		
		TRUE: Write request		
wParSubindex	WORD	Code to be read or written. • From version 06.00.00 onwards, this selection can be optionally carried out via C01090.		
wInHWord wInLWord	WORD	Subcode to be read or written. • From version 06.00.00 onwards, this selection can be optionally carried out via C01090.		
wInHWord wInLWord	WORD	Value to be written (DataHigh/DataLow portion)		

### outputs

Designator	Data type	Value/meaning	
bDone	BOOL	"Read/Write request successfully completed" status signal <ul style="list-style-type: none"> <li>The output is automatically reset to FALSE if a new request is activated via <i>bExecute</i> or the cycle time (C01091) expires.</li> </ul>	
		TRUE	Read/Write request successfully completed.
		FALSE	The FALSE status can have the following meanings: <ol style="list-style-type: none"> <li>There is no active read/write request.</li> <li>The read/write request has not been completed yet.</li> <li>An error has occurred (if <i>bFail</i> = TRUE).</li> </ol>
bFail	BOOL	"Error" status	
		TRUE	An error has occurred (group signal). <ul style="list-style-type: none"> <li>See display parameter (C01092) for details.</li> </ul>
wOutHWord wOutLWord	WORD	Value which was read (DataHigh/DataLow portion) after read request	

### Parameters

Parameters	Possible settings	Info
<a href="#">C01090/1...3</a> (from version 06.00.00)	0,000      16000,000 Format: <Code number>,<subcode number>	Parameter to be read or written. <ul style="list-style-type: none"> <li>For a setting of "0,000", inputs <i>wParIndex</i> and <i>wParSubindex</i> are effective for addressing purposes instead.</li> <li>Lenze setting: 0.000</li> </ul>
<a href="#">C01091/1...3</a>	0      One-time reading/writing at <i>bExecute</i> in case of a FALSE/TRUE edge Cyclic reading/writing: 20      20 ms 50      50 ms 100      100 ms 200      200 ms 500      500 ms 1000      1 s 2000      2 s 5000      5 s 10000      10 s	Cycle time <ul style="list-style-type: none"> <li>Subcode 1 = <b>LS_ParReadWrite_1</b></li> <li>Subcode 2 = <b>LS_ParReadWrite_2</b></li> <li>Subcode 3 = <b>LS_ParReadWrite_3</b></li> <li>Lenze setting: 0</li> </ul>

Parameters	Possible settings	Info																		
<a href="#">C01092/1...3</a>	<table border="1"> <tr> <td>0</td> <td>No error</td> </tr> <tr> <td>33803</td> <td>Invalid data type (e.g. STRING)</td> </tr> <tr> <td>33804</td> <td>Limit violation</td> </tr> <tr> <td>33806</td> <td>Invalid code</td> </tr> <tr> <td>33813</td> <td>No element of the selection list</td> </tr> <tr> <td>33815</td> <td>Writing of the parameter not permitted</td> </tr> <tr> <td>33816</td> <td>Writing of the parameter only permitted if controller is inhibited</td> </tr> <tr> <td>33829</td> <td>Invalid subcode</td> </tr> <tr> <td>33865</td> <td>No parameter with subcodes</td> </tr> </table>	0	No error	33803	Invalid data type (e.g. STRING)	33804	Limit violation	33806	Invalid code	33813	No element of the selection list	33815	Writing of the parameter not permitted	33816	Writing of the parameter only permitted if controller is inhibited	33829	Invalid subcode	33865	No parameter with subcodes	Error status <ul style="list-style-type: none"> <li>• If <i>bFail</i> = TRUE: Error status is displayed.</li> <li>• Subcode 1 = <b>LS_ParReadWrite_1</b></li> <li>• Subcode 2 = <b>LS_ParReadWrite_2</b></li> <li>• Subcode 3 = <b>LS_ParReadWrite_3</b></li> </ul>
0	No error																			
33803	Invalid data type (e.g. STRING)																			
33804	Limit violation																			
33806	Invalid code																			
33813	No element of the selection list																			
33815	Writing of the parameter not permitted																			
33816	Writing of the parameter only permitted if controller is inhibited																			
33829	Invalid subcode																			
33865	No parameter with subcodes																			
<a href="#">C01093/1...3</a> (from version 06.00.00)	<table border="1"> <tr> <td>0</td> <td>No arithmetic</td> </tr> <tr> <td>1</td> <td>In16Bit: LW=+/-32767</td> </tr> <tr> <td>2</td> <td>In16Bit: HW=+/-; LW=0..65535</td> </tr> <tr> <td>3</td> <td>In32Bit: HW_LW=+/-2147483647</td> </tr> </table>	0	No arithmetic	1	In16Bit: LW=+/-32767	2	In16Bit: HW=+/-; LW=0..65535	3	In32Bit: HW_LW=+/-2147483647	Arithmetic mode <ul style="list-style-type: none"> <li>• Lenze setting: "0: No arithmetic"</li> <li>▶ <a href="#">Arithmetic function</a></li> </ul>										
0	No arithmetic																			
1	In16Bit: LW=+/-32767																			
2	In16Bit: HW=+/-; LW=0..65535																			
3	In32Bit: HW_LW=+/-2147483647																			
<a href="#">C01094/1...3</a> (from version 06.00.00)	-32767	32767	Meters <ul style="list-style-type: none"> <li>• For internal conversion in arithmetic modes 1 ... 3.</li> <li>• Lenze setting: 1</li> </ul>																	
<a href="#">C01095/1...3</a> (from version 06.00.00)	1	32767	Denominator <ul style="list-style-type: none"> <li>• For internal conversion in arithmetic modes 1 ... 3.</li> <li>• Lenze setting: 1</li> </ul>																	



### 17.2.20.1 Arithmetic function

This function extension is available from version 06.00.00!

The implemented arithmetic function enables easy arithmetic conversion of the process values to be written or read via parameterisable factors into the format of the target parameter without the need of an additional arithmetic function block.

- In [C01093](#), the interpretation of the *wInHWord* and *wInLWord* inputs can be set to be able to write to parameters:

Arithmetic mode		wInHWord	wInLWord	Internal conversion
0	No arithmetic (Lenze setting)	<b>INTEGER_32</b> (4 bytes with sign)		No (same behaviour as before)
		DataHigh portion	DataLow portion	
1	In16Bit: LW=+/-32767	-	<b>INTEGER_16</b> (2 bytes with sign)	Yes (see the following section)
2	In16Bit: HW=+/-; LW=0..65535	<b>Sign</b> (0 ≡ positive value)	<b>UNSIGNED_16</b> (2 bytes without sign)	
3	In32Bit: HW_LW= +/-2147483647	<b>INTEGER_32</b> (4 bytes with sign)		
		DataHigh portion	DataLow portion	

#### Internal conversion

If arithmetic modes 1...3 are selected in [C01093](#), the input value / read parameter value is internally converted via parameterisable factors.

- Division is not remainder considered.

$$\text{parameter value to be written} = \text{Input value}_{[32]} \cdot \frac{\text{Meters}_{[16]}}{\text{Denominator}_{[16]}}$$

[C01094](#): Numerator  
[C01095](#): Denominator

[17-28] Internal conversion with write access

$$\text{Output value}_{[32]} = \text{Read parameter value} \cdot \frac{\text{Meters}_{[16]}}{\text{Denominator}_{[16]}}$$

[C01094](#): Numerator  
[C01095](#): Denominator

[17-29] Internal conversion with read access

### 17.2.21 LS\_PulseGenerator

This system block outputs 9 different fixed frequencies and 1 frequency with parameterisable pulse/dead time.

From version 06.00.00 onwards, the SB provides a TRUE signal at the *bFirstCycleDone* output when the first 1-ms processing cycle is completed and the time set in [C00400/3](#) has expired. This status signal can e.g. be used for the delayed enable of peripheral devices or motor control setpoints so that all required initial values are calculated first after the inverter switch-on.

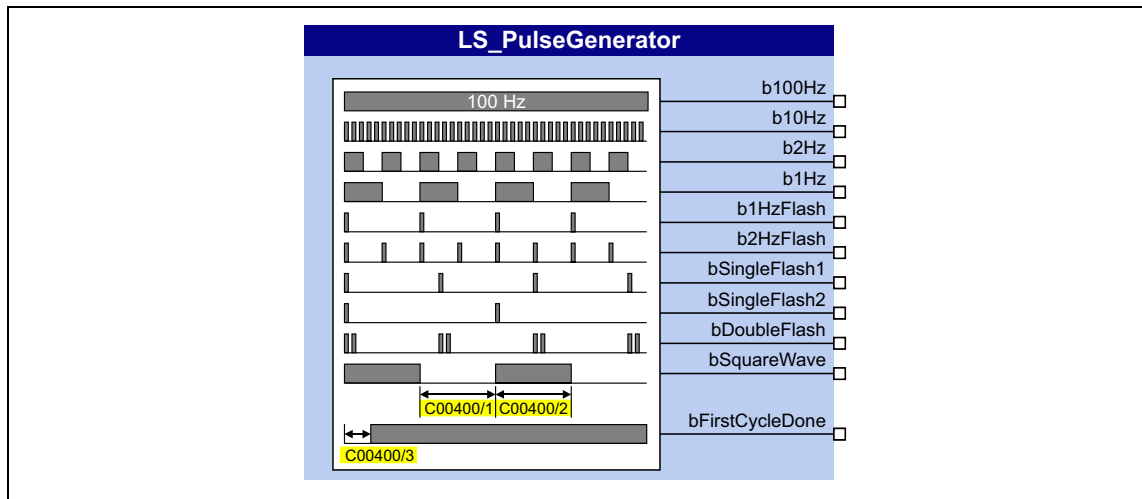

#### outputs

Designator	Data type	Value/meaning		
b100Hz	BOOL	Rectangular signal 100 Hz		
b10Hz	BOOL	Rectangular signal 10 Hz		
b2Hz	BOOL	Rectangular signal 2 Hz		
b1Hz	BOOL	Rectangular signal 1 Hz		
b1HzFlash	BOOL	80 ms-pulse, repetition rate every second		
b2HzFlash	BOOL	80 ms-pulse, repetition rate every 0.5 seconds		
bSingleFlash1	BOOL	80 ms pulse, repetition rate every 1.25 seconds		
bSingleFlash2	BOOL	80 ms pulse, repetition rate every 3 seconds		
bDoubleFlash	BOOL	80 ms-double pulse, repetition rate every 1.25 seconds		
bSquareWave	BOOL	Output frequency with pulse/dead time set in <a href="#">C00400/1...2</a>		
bFirstCycleDone	BOOL	Status signal "First processing cycle completed"		
(from version 06.00.00)		<table border="1"> <tr> <td>TRUE</td> <td>The first 1-ms processing cycle has been completed and the time set in <a href="#">C00400/3</a> has expired (i.e. all FBs have been called at least once).</td> </tr> </table>	TRUE	The first 1-ms processing cycle has been completed and the time set in <a href="#">C00400/3</a> has expired (i.e. all FBs have been called at least once).
TRUE	The first 1-ms processing cycle has been completed and the time set in <a href="#">C00400/3</a> has expired (i.e. all FBs have been called at least once).			

## Parameters

**Note!**

The real length of the low or high level at the *bSquareWave* output is always 1 ms higher than set in [C00400/1](#) or [C00400/2](#). If "0 ms" is set, a level with a length of 1 ms is created length, for instance, and if "1000 ms" is set, a level with a length of 1001 ms is created.

Parameters	Possible settings			Info
<a href="#">C00400/1</a>	0	ms	60000	Length of the low level (break) + 1 ms • For output <i>bSquareWave</i> • Lenze setting: 1000 ms
<a href="#">C00400/2</a>	0	ms	60000	Length of the high level + 1 ms • For output <i>bSquareWave</i> • Lenze setting: 1000 ms
<a href="#">C00400/3</a> (from version 06.00.00)	0	ms	60000	Delay of the status <i>bFirstCycleDone</i> • Lenze setting: 100 ms

**17.2.22 LS\_SetError\_1**

Parameterisable responses to user-defined events are tripped.



For a detailed description see the main chapter "Diagnostics & error management":

▶ ["LS\\_SetError\\_1" system block](#) (📖 487)

**17.2.23 LS\_SyncManagement**

Output of status information for synchronising the internal time base.



For a detailed description see main chapter "Synchronisation of the internal time base of the inverter":

▶ [Internal interfaces | System block "LS\\_SyncManagement"](#) (📖 596)

**17.2.24 LS\_WriteParamList**

Writing to a configurable list which contains up to 32 local parameters.



For a detailed description see the main chapterl "[Parameter change-over](#)". (📖 597)

# 17 Function library

## 17.3 Application blocks

---

### 17.3 Application blocks

#### 17.3.1 Technology application "Actuating drive speed"

This technology application serves to solve speed-controlled drive tasks, e.g. conveyor drives (interconnected), extruders, test benches, vibrators, travelling drives, presses, machining systems, metering units.



For a detailed description see [TA "Actuating drive speed"](#). (📖 311)

#### 17.3.2 Technology application "actuating drive speed (AC Drive profile)"

This technology application available from version 13.00.00 provides a speed and torque control by means of "AC Drive Profile". The fieldbuses EtherNet/IP™ and system bus (CANopen) are supported.



For a detailed description see [TA "actuating drive speed \(AC Drive Profile\)"](#). (📖 338)

#### 17.3.3 "Switch-off positioning" technology application

This technology application is used to solve speed-controlled drive tasks which require a pre-switch off or stopping at certain positions, e.g. roller conveyors and conveying belts. The pre-switch off is implemented by connecting switch-off sensors.



For a detailed description see [TA "Switch-off positioning"](#). (📖 371)

# 17 Function library

## 17.4 Port blocks

---

### 17.4 Port blocks

#### 17.4.1 Port block "LP\_CanIn1"

The LP\_CanIn1 port block maps process data object RPDO1 in the FB Editor.



For a detailed description see [RPDO1 | Port block "LP\\_CanIn1"](#). (525)

#### 17.4.2 Port block "LP\_CanIn2"

The LP\_CanIn2 port block maps process data object RPDO2 in the FB Editor.



For a detailed description see [RPDO2 | "LP\\_CanIn2" port block](#). (527)

#### 17.4.3 Port block "LP\_CanIn3"

The LP\_CanIn3 port block maps process data object RPDO3 in the FB Editor.



For a detailed description see [RPDO3 | "LP\\_CanIn3" port block](#). (529)

#### 17.4.4 Port block "LP\_CanIn4"

The LP\_CanIn4 port block maps process data object RPDO4 in the FB Editor.



For a detailed description see [RPDO4 | "LP\\_CanIn4" port block](#). (531)

#### 17.4.5 Port block "LP\_CanOut1"

The LP\_CanOut1 port block maps process data object TPDO1 in the FB Editor.



For a detailed description see [TPDO1 | "LP\\_CanOut1" port block](#). (533)

# 17 Function library

## 17.4 Port blocks

---

### 17.4.6 Port block "LP\_CanOut2"

The LP\_CanOut2 port block maps process data object TPDO2 in the FB Editor.



For a detailed description see [TPDO2 | "LP\\_CanOut2" port block](#). (📖 534)

### 17.4.7 Port block "LP\_CanOut3"

The LP\_CanOut3 port block maps process data object TPDO3 in the FB Editor.



For a detailed description see [TPDO3 | "LP\\_CanOut3" port block](#). (📖 535)

### 17.4.8 Port block "LP\_CanOut4"

The LP\_CanOut4 port block maps process data object TPDO4 in the FB Editor.



For a detailed description see [TPDO4 | "LP\\_CanOut4" port block](#). (📖 536)

## Symbols

"DRV-RDY" LED [436](#)

»Engineer« motor catalogue [117](#)

## Figures

120 % operation [216](#)

16-bit inputs (C00831) [763](#)

16-bit inputs [%] (C00830) [761](#)

16-bit inputs I/O level (C00841) [771](#)

16-bit inputs I/O level [%] (C00840) [769](#)

24 V supply voltage (C00065) [635](#)

32-bit inputs [incr] (C00834) [769](#)

32-bit inputs I/O level [incr] (C00844) [775](#)

87-Hz operation [142](#)

## A

Accel. time - main setpoint (C00012) [626](#)

Access protection [39](#)

Accessories for commissioning [30](#)

ACDrive

Control word (C01351) [803](#)

Drive mode (C01350) [803](#)

Setpoint scaling (C01353) [804](#)

Status word (C01352) [804](#)

Acknowledgement error [556](#)

Activating the bus terminating resistor [512](#)

Active COBID (C00355) [685](#)

Actual values (C00055) [633](#)

Adapt keypad menus [33](#)

Add. accel. time x (C00101) [641](#)

Add. decel. time x (C00103) [642](#)

AIN1

Characteristic (C00010) [625](#)

AINx

Configuration (C00034) [631](#)

Gain (C00027) [629](#)

Input current (C00029) [630](#)

Input voltage (C00028) [630](#)

Offset (C00026) [629](#)

Output value (C00033) [630](#)

An01: AIN1\_I < 4 mA (error message) [477](#)

Analog terminals [293](#)

For electrical data see the hardware manual

User-defined terminal assignment [302](#)

AOut1

Decoupling value (C00442) [699](#)

Appl.

Reference frequency C11 (C00059) [634](#)

Reference speed (C00011) [626](#)

Application (C00005) [621](#)

Application block "LA\_NCtrl" [314](#), [343](#)

Application block "LA\_SwitchPos" [374](#)

Application notes [23](#)

Application units

Configuration of the display parameters [1020](#)

Display factor (C00485) [711](#)

Offset (C00484) [710](#)

Text (C00486) [711](#)

Application units (C00487) [711](#)

Assignment of the process data objects [524](#)

Auto-DCB [222](#)

Hold time (C00106) [642](#)

Threshold (C00019) [628](#)

AutoFailReset configuration (C00188) [664](#)

AutoFailReset repetition time (C00184) [663](#)

AutoFailReset residual runtime (C00185) [663](#)

Automatic DC-injection braking (auto DCB) [222](#)

Automatic motor data identification [119](#)

Auto-start option [99](#), [101](#), [102](#)

Auto-start option (C00142) [649](#)

## B

Basic drive functions [403](#)

Basic functions [403](#)

Behaviour after mains connection [99](#), [101](#), [102](#)

Binary inputs (C00833) [765](#)

Binary inputs I/O level (C00843) [772](#)

Binding ID [44](#)

Bit error [556](#)

Blocks [934](#)

Brake chopper [237](#)

Master-slave operation [245](#)

Brake control [416](#)

Brake energy management (C00175) [660](#)

Brake resistance value (C00129) [645](#)

Brake resistor [237](#)

Brake resistor monitoring (I2xt) [254](#)

Brake resistor overload threshold (C00572) [721](#)

Brake resistor utilisation (C00133) [646](#)

Braking operation [237](#)

Braking procedures [240](#)

## C

C1 [618](#)

C10 [625](#)

C100 [641](#)

C1000 [793](#)

C1001 [794](#)

C1004 [794](#)

C101 [641](#), [979](#)

C103 [642](#), [979](#)

C105 [642](#)

C106 [642](#)

C107 [642](#)

C1082 [608](#), [795](#)

C1083 [795](#)

C1084 [795](#)

C1085 [796](#)

C1086 [796](#)

# Index

---

C1087 [796](#)  
C1088 [797](#)  
C1089 [797](#)  
C1090 [797](#), [1031](#)  
C1091 [798](#), [1031](#)  
C1092 [798](#), [1032](#)  
C1093 [799](#), [1032](#)  
C1094 [799](#), [1032](#)  
C1095 [799](#), [1032](#)  
C1098 [800](#)  
C11 [626](#)  
C1120 [800](#)  
C1121 [801](#)  
C1122 [801](#)  
C1123 [801](#)  
C1124 [802](#)  
C1138 [802](#), [1009](#), [1012](#), [1013](#), [1014](#)  
C1139 [802](#), [1009](#), [1012](#), [1013](#), [1014](#)  
C114 [643](#)  
C115 [643](#)  
C118 [644](#)  
C12 [626](#), [979](#)  
C120 [644](#)  
C122 [644](#)  
C123 [645](#)  
C124 [645](#)  
C129 [645](#)  
C13 [626](#), [979](#)  
C130 [645](#)  
C131 [646](#)  
C133 [646](#)  
C134 [646](#), [979](#)  
C1350 [803](#)  
C1351 [803](#)  
C1352 [804](#)  
C1353 [804](#)  
C136 [646](#)  
C137 [647](#)  
C138 [648](#)  
C142 [649](#)  
C144 [649](#)  
C148 [650](#)  
C15 [626](#)  
C150 [650](#)  
C1501 [805](#)  
C155 [651](#)  
C158 [652](#)  
C159 [652](#)  
C16 [627](#)  
C160 [653](#)  
C161 [653](#)  
C162 [654](#)  
C163 [654](#)  
C164 [657](#)  
C165 [658](#)  
C166 [658](#)  
C167 [659](#)  
C168 [659](#)  
C169 [659](#)  
C170 [659](#)  
C1700 [805](#)  
C1701 [806](#)  
C1702 [806](#)  
C1703 [806](#)  
C1704 [807](#)  
C1709 [808](#)  
C171 [660](#)  
C173 [660](#)  
C174 [660](#)  
C175 [660](#)  
C1751 [808](#)  
C1752 [808](#)  
C1755 [808](#)  
C176 [661](#)  
C1763 [808](#)  
C1764 [808](#)  
C1765 [808](#)  
C177 [661](#)  
C1770 [809](#)  
C1771 [809](#)  
C1772 [809](#)  
C1773 [809](#)  
C1774 [809](#)  
C1775 [809](#)  
C178 [662](#)  
C179 [662](#)  
C18 [627](#)  
C180 [662](#)  
C181 [662](#)  
C182 [663](#), [979](#)  
C184 [663](#)  
C185 [663](#)  
C186 [663](#)  
C187 [663](#)  
C188 [664](#)  
C189 [664](#)  
C19 [628](#)  
C190 [664](#), [979](#)  
C1902 [809](#)  
C1903 [810](#)  
C1905 [810](#)  
C191 [665](#)  
C192 [665](#)  
C193 [665](#)  
C199 [666](#)  
C2 [618](#)



# Index

---

C200	<a href="#">666</a>	C226	<a href="#">669</a> , <a href="#">999</a>
C201	<a href="#">666</a>	C2260	<a href="#">824</a>
C203	<a href="#">666</a>	C2264	<a href="#">824</a>
C204	<a href="#">667</a>	C227	<a href="#">669</a> , <a href="#">999</a>
C205	<a href="#">667</a>	C2272	<a href="#">824</a>
C206	<a href="#">667</a>	C2273	<a href="#">825</a>
C21	<a href="#">628</a>	C2274	<a href="#">825</a>
C210	<a href="#">667</a>	C2275	<a href="#">826</a>
C219	<a href="#">668</a>	C2276	<a href="#">826</a>
C22	<a href="#">628</a>	C2278	<a href="#">826</a>
C220	<a href="#">668</a> , <a href="#">979</a>	C2279	<a href="#">827</a>
C2200	<a href="#">810</a>	C228	<a href="#">669</a> , <a href="#">999</a>
C221	<a href="#">668</a> , <a href="#">980</a>	C2280	<a href="#">827</a>
C2210	<a href="#">811</a>	C2281	<a href="#">827</a>
C2212	<a href="#">811</a>	C2284	<a href="#">828</a>
C2213	<a href="#">811</a>	C2285	<a href="#">828</a>
C2214	<a href="#">812</a>	C2286	<a href="#">828</a>
C2215	<a href="#">812</a>	C2287	<a href="#">829</a>
C2216	<a href="#">813</a>	C2288	<a href="#">829</a>
C2217	<a href="#">813</a>	C2289	<a href="#">829</a>
C2218	<a href="#">813</a>	C2290	<a href="#">830</a>
C2219	<a href="#">814</a>	C2291	<a href="#">830</a>
C222	<a href="#">668</a> , <a href="#">999</a>	C2292	<a href="#">830</a>
C2220	<a href="#">814</a>	C2293	<a href="#">831</a>
C2221	<a href="#">814</a>	C2294	<a href="#">831</a>
C2222	<a href="#">815</a>	C2295	<a href="#">831</a>
C2223	<a href="#">815</a>	C2296	<a href="#">832</a>
C2224	<a href="#">816</a>	C2297	<a href="#">832</a>
C2225	<a href="#">816</a>	C2298	<a href="#">832</a>
C2226	<a href="#">816</a>	C2299	<a href="#">833</a>
C2229	<a href="#">817</a>	C23	<a href="#">628</a>
C223	<a href="#">668</a> , <a href="#">999</a>	C2300	<a href="#">833</a>
C2230	<a href="#">817</a>	C2301	<a href="#">833</a>
C2231	<a href="#">818</a>	C2302	<a href="#">834</a>
C2232	<a href="#">818</a>	C2303	<a href="#">834</a>
C2233	<a href="#">818</a>	C2304	<a href="#">834</a>
C2234	<a href="#">819</a>	C2305	<a href="#">835</a>
C2236	<a href="#">819</a>	C2306	<a href="#">836</a>
C2237	<a href="#">819</a>	C2307	<a href="#">837</a>
C2238	<a href="#">820</a>	C231	<a href="#">670</a> , <a href="#">999</a>
C2239	<a href="#">820</a>	C2311	<a href="#">837</a>
C224	<a href="#">669</a> , <a href="#">999</a>	C2312	<a href="#">837</a>
C2240	<a href="#">820</a>	C2313	<a href="#">838</a>
C2241	<a href="#">821</a>	C2314	<a href="#">838</a>
C2242	<a href="#">821</a>	C2315	<a href="#">839</a>
C2244	<a href="#">821</a>	C233	<a href="#">670</a> , <a href="#">1000</a>
C2245	<a href="#">822</a>	C234	<a href="#">670</a>
C2246	<a href="#">822</a>	C235	<a href="#">670</a>
C2249	<a href="#">822</a>	C236	<a href="#">671</a>
C225	<a href="#">669</a> , <a href="#">999</a>	C24	<a href="#">629</a>
C2250	<a href="#">823</a>	C241	<a href="#">671</a> , <a href="#">980</a>
C2251	<a href="#">823</a>	C242	<a href="#">671</a> , <a href="#">1000</a>
C2256	<a href="#">823</a>	C243	<a href="#">671</a> , <a href="#">1000</a>

# Index

---

C244	<a href="#">672</a> , <a href="#">1000</a>	C291	<a href="#">674</a>
C245	<a href="#">672</a> , <a href="#">1000</a>	C295	<a href="#">675</a>
C246	<a href="#">672</a> , <a href="#">1000</a>	C296	<a href="#">675</a>
C247	<a href="#">672</a> , <a href="#">1000</a>	C297	<a href="#">675</a>
C249	<a href="#">672</a> , <a href="#">1005</a>	C2993	<a href="#">857</a>
C25	<a href="#">629</a>	C2994	<a href="#">857</a>
C254	<a href="#">672</a>	C2995	<a href="#">857</a>
C2556	<a href="#">839</a>	C2998	<a href="#">857</a>
C2580	<a href="#">839</a>	C3	<a href="#">621</a>
C2581	<a href="#">840</a>	C301	<a href="#">675</a>
C2582	<a href="#">840</a>	C302	<a href="#">675</a>
C2589	<a href="#">841</a>	C304	<a href="#">675</a>
C2593	<a href="#">842</a>	C305	<a href="#">675</a>
C26	<a href="#">629</a>	C306	<a href="#">675</a>
C2607	<a href="#">842</a>	C307	<a href="#">675</a>
C2610	<a href="#">843</a>	C308	<a href="#">676</a>
C2611	<a href="#">844</a>	C309	<a href="#">676</a>
C265	<a href="#">673</a>	C310	<a href="#">676</a>
C27	<a href="#">629</a>	C311	<a href="#">676</a>
C270	<a href="#">673</a>	C312	<a href="#">676</a>
C271	<a href="#">673</a>	C313	<a href="#">676</a>
C272	<a href="#">673</a>	C314	<a href="#">676</a>
C273	<a href="#">673</a>	C315	<a href="#">676</a>
C274	<a href="#">674</a>	C316	<a href="#">677</a>
C275	<a href="#">674</a>	C317	<a href="#">677</a>
C276	<a href="#">674</a>	C320	<a href="#">677</a>
C28	<a href="#">630</a>	C321	<a href="#">677</a>
C280	<a href="#">674</a>	C322	<a href="#">677</a>
C2830	<a href="#">844</a>	C323	<a href="#">678</a>
C2840	<a href="#">845</a>	C324	<a href="#">678</a>
C2841	<a href="#">846</a>	C33	<a href="#">630</a>
C2842	<a href="#">846</a>	C338	<a href="#">679</a> , <a href="#">944</a>
C2843	<a href="#">846</a>	C339	<a href="#">679</a> , <a href="#">945</a>
C2844	<a href="#">289</a> , <a href="#">846</a>	C34	<a href="#">631</a>
C2845	<a href="#">289</a> , <a href="#">847</a>	C341	<a href="#">679</a>
C2853	<a href="#">847</a>	C342	<a href="#">680</a>
C2855	<a href="#">847</a>	C343	<a href="#">681</a>
C2859	<a href="#">848</a>	C344	<a href="#">681</a>
C2864	<a href="#">848</a>	C345	<a href="#">682</a>
C2865	<a href="#">849</a>	C347	<a href="#">682</a>
C2866	<a href="#">851</a>	C349	<a href="#">683</a>
C2867	<a href="#">851</a>	C350	<a href="#">683</a>
C2868	<a href="#">852</a>	C351	<a href="#">684</a>
C2869	<a href="#">854</a>	C352	<a href="#">684</a>
C2870	<a href="#">854</a>	C353	<a href="#">684</a>
C2871	<a href="#">854</a>	C354	<a href="#">685</a>
C2872	<a href="#">855</a>	C355	<a href="#">685</a>
C2873	<a href="#">855</a>	C356	<a href="#">686</a>
C2874	<a href="#">855</a>	C357	<a href="#">686</a>
C2875	<a href="#">856</a>	C358	<a href="#">686</a>
C2879	<a href="#">856</a>	C359	<a href="#">687</a>
C29	<a href="#">630</a>	C36	<a href="#">631</a>
C290	<a href="#">674</a>	C360	<a href="#">687</a>

# Index

---

C364	<a href="#">688</a>	C468	<a href="#">707</a>
C366	<a href="#">688</a>	C469	<a href="#">708</a>
C367	<a href="#">689</a>	C470	<a href="#">708</a> , <a href="#">1027</a>
C368	<a href="#">689</a>	C471	<a href="#">708</a> , <a href="#">1025</a>
C369	<a href="#">690</a>	C472	<a href="#">709</a> , <a href="#">1026</a>
C370	<a href="#">690</a>	C473	<a href="#">709</a> , <a href="#">1029</a>
C371	<a href="#">691</a>	C474	<a href="#">709</a> , <a href="#">1028</a>
C372	<a href="#">691</a>	C480	<a href="#">709</a> , <a href="#">1021</a>
C381	<a href="#">691</a>	C481	<a href="#">710</a> , <a href="#">1018</a>
C385	<a href="#">691</a>	C482	<a href="#">710</a> , <a href="#">1019</a>
C386	<a href="#">692</a>	C484	<a href="#">710</a> , <a href="#">1020</a>
C387	<a href="#">692</a>	C485	<a href="#">711</a> , <a href="#">1020</a>
C39	<a href="#">631</a> , <a href="#">979</a>	C486	<a href="#">711</a> , <a href="#">1020</a>
C400	<a href="#">692</a> , <a href="#">1035</a>	C487	<a href="#">711</a> , <a href="#">1020</a>
C401	<a href="#">693</a>	C488	<a href="#">712</a>
C407	<a href="#">693</a>	C490	<a href="#">712</a>
C408	<a href="#">694</a>	C495	<a href="#">713</a>
C409	<a href="#">694</a>	C496	<a href="#">713</a>
C410	<a href="#">695</a> , <a href="#">1007</a>	C497	<a href="#">713</a>
C411	<a href="#">695</a> , <a href="#">1008</a>	C5	<a href="#">621</a>
C412	<a href="#">696</a> , <a href="#">1008</a>	C50	<a href="#">632</a>
C413	<a href="#">696</a> , <a href="#">1007</a>	C505	<a href="#">713</a>
C420	<a href="#">696</a>	C506	<a href="#">714</a>
C423	<a href="#">697</a>	C507	<a href="#">714</a>
C425	<a href="#">697</a>	C508	<a href="#">715</a>
C434	<a href="#">697</a>	C509	<a href="#">716</a>
C435	<a href="#">698</a>	C51	<a href="#">632</a>
C436	<a href="#">698</a>	C510	<a href="#">717</a>
C439	<a href="#">698</a>	C516	<a href="#">717</a>
C440	<a href="#">698</a>	C517	<a href="#">717</a>
C441	<a href="#">699</a>	C52	<a href="#">632</a>
C442	<a href="#">699</a>	C53	<a href="#">632</a>
C443	<a href="#">700</a>	C54	<a href="#">633</a>
C444	<a href="#">700</a>	C55	<a href="#">633</a>
C445	<a href="#">701</a>	C56	<a href="#">633</a>
C446	<a href="#">701</a>	C560	<a href="#">718</a>
C447	<a href="#">702</a>	C561	<a href="#">719</a>
C448	<a href="#">702</a>	C563	<a href="#">719</a>
C449	<a href="#">703</a>	C565	<a href="#">720</a>
C450	<a href="#">703</a>	C566	<a href="#">720</a>
C453	<a href="#">704</a>	C567	<a href="#">720</a>
C455	<a href="#">704</a>	C569	<a href="#">720</a>
C456	<a href="#">704</a>	C57	<a href="#">633</a>
C458	<a href="#">704</a>	C570	<a href="#">721</a>
C459	<a href="#">704</a>	C571	<a href="#">721</a>
C460	<a href="#">704</a>	C572	<a href="#">721</a>
C461	<a href="#">705</a>	C574	<a href="#">722</a>
C462	<a href="#">705</a>	C575	<a href="#">722</a>
C463	<a href="#">705</a>	C579	<a href="#">722</a>
C464	<a href="#">707</a>	C58	<a href="#">634</a>
C465	<a href="#">707</a>	C580	<a href="#">722</a>
C466	<a href="#">707</a>	C581	<a href="#">723</a>
C467	<a href="#">707</a>	C582	<a href="#">723</a>

# Index

---

C584	<a href="#">723</a>	C687	<a href="#">743</a> , <a href="#">951</a>
C585	<a href="#">724</a>	C690	<a href="#">743</a> , <a href="#">952</a>
C586	<a href="#">724</a>	C691	<a href="#">744</a> , <a href="#">952</a>
C588	<a href="#">724</a>	C692	<a href="#">744</a> , <a href="#">952</a>
C59	<a href="#">634</a>	C696	<a href="#">744</a> , <a href="#">990</a>
C590	<a href="#">724</a>	C697	<a href="#">744</a> , <a href="#">991</a>
C592	<a href="#">725</a>	C698	<a href="#">744</a> , <a href="#">992</a>
C593	<a href="#">725</a>	C699	<a href="#">745</a> , <a href="#">973</a>
C594	<a href="#">726</a>	C7	<a href="#">623</a>
C595	<a href="#">726</a>	C70	<a href="#">635</a>
C597	<a href="#">727</a>	C700	<a href="#">745</a>
C598	<a href="#">727</a>	C701	<a href="#">746</a>
C599	<a href="#">727</a>	C705	<a href="#">748</a>
C6	<a href="#">622</a>	C706	<a href="#">749</a>
C600	<a href="#">728</a>	C71	<a href="#">636</a>
C601	<a href="#">728</a>	C72	<a href="#">636</a>
C602	<a href="#">728</a>	C720	<a href="#">749</a> , <a href="#">955</a>
C604	<a href="#">728</a>	C725	<a href="#">749</a>
C606	<a href="#">729</a>	C726	<a href="#">750</a>
C607	<a href="#">729</a>	C727	<a href="#">750</a> , <a href="#">1023</a>
C608	<a href="#">729</a>	C728	<a href="#">751</a> , <a href="#">1023</a>
C609	<a href="#">729</a>	C729	<a href="#">751</a>
C61	<a href="#">634</a>	C73	<a href="#">636</a>
C610	<a href="#">730</a>	C730	<a href="#">751</a>
C611	<a href="#">730</a>	C731	<a href="#">751</a>
C612	<a href="#">730</a>	C732	<a href="#">751</a>
C62	<a href="#">634</a>	C734	<a href="#">752</a>
C620	<a href="#">730</a>	C735	<a href="#">752</a>
C621	<a href="#">732</a>	C736	<a href="#">752</a>
C622	<a href="#">737</a>	C74	<a href="#">636</a>
C632	<a href="#">738</a> , <a href="#">980</a>	C740	<a href="#">752</a>
C633	<a href="#">738</a> , <a href="#">980</a>	C741	<a href="#">752</a>
C634	<a href="#">738</a> , <a href="#">980</a>	C742	<a href="#">752</a>
C635	<a href="#">739</a> , <a href="#">980</a>	C743	<a href="#">752</a>
C636	<a href="#">739</a> , <a href="#">980</a>	C744	<a href="#">752</a>
C637	<a href="#">739</a> , <a href="#">980</a>	C746	<a href="#">752</a>
C638	<a href="#">740</a> , <a href="#">980</a>	C747	<a href="#">753</a>
C639	<a href="#">740</a> , <a href="#">980</a>	C748	<a href="#">753</a>
C64	<a href="#">634</a>	C749	<a href="#">753</a>
C640	<a href="#">740</a> , <a href="#">980</a>	C75	<a href="#">637</a>
C643	<a href="#">740</a>	C750	<a href="#">753</a>
C65	<a href="#">635</a>	C751	<a href="#">753</a>
C653	<a href="#">741</a>	C753	<a href="#">753</a>
C654	<a href="#">741</a>	C759	<a href="#">753</a>
C66	<a href="#">635</a>	C76	<a href="#">637</a>
C670	<a href="#">741</a> , <a href="#">990</a>	C760	<a href="#">754</a>
C671	<a href="#">742</a> , <a href="#">991</a>	C761	<a href="#">755</a>
C672	<a href="#">742</a> , <a href="#">992</a>	C762	<a href="#">757</a>
C680	<a href="#">742</a> , <a href="#">946</a>	C765	<a href="#">757</a>
C681	<a href="#">742</a> , <a href="#">946</a>	C766	<a href="#">757</a>
C682	<a href="#">742</a> , <a href="#">946</a>	C767	<a href="#">757</a>
C685	<a href="#">743</a> , <a href="#">951</a>	C79	<a href="#">637</a>
C686	<a href="#">743</a> , <a href="#">951</a>	C8	<a href="#">624</a>

# Index

---

- C80 [637](#)
- C800 [757](#), [970](#)
- C801 [758](#), [970](#)
- C802 [758](#), [970](#)
- C803 [758](#), [970](#)
- C804 [758](#), [970](#)
- C805 [758](#)
- C806 [759](#), [970](#)
- C81 [638](#)
- C82 [638](#)
- C820 [759](#), [957](#)
- C821 [759](#), [958](#)
- C828 [760](#), [959](#)
- C829 [760](#), [960](#)
- C83 [638](#)
- C830 [761](#)
- C831 [763](#)
- C833 [765](#)
- C834 [769](#)
- C84 [638](#)
- C840 [769](#)
- C841 [771](#)
- C843 [772](#)
- C844 [775](#)
- C85 [638](#)
- C866 [776](#)
- C868 [776](#)
- C87 [639](#)
- C876 [778](#)
- C877 [778](#)
- C88 [639](#)
- C89 [639](#)
- C890 [779](#)
- C90 [639](#)
- C905 [780](#)
- C909 [780](#)
- C91 [640](#)
- C910 [780](#)
- C915 [781](#)
- C916 [781](#)
- C917 [781](#)
- C919 [781](#)
- C92 [640](#)
- C920 [782](#)
- C922 [782](#)
- C93 [640](#)
- C936 [782](#)
- C937 [782](#)
- C938 [783](#)
- C939 [783](#)
- C95 [640](#)
- C950 [783](#), [965](#)
- C951 [783](#), [965](#)
- C952 [784](#), [965](#)
- C953 [784](#), [965](#)
- C954 [784](#)
- C965 [784](#)
- C966 [785](#)
- C967 [785](#)
- C968 [785](#)
- C969 [786](#)
- C97 [640](#)
- C970 [786](#)
- C971 [786](#)
- C972 [787](#)
- C973 [787](#)
- C975 [787](#)
- C976 [787](#)
- C977 [787](#)
- C978 [788](#)
- C979 [788](#)
- C98 [641](#)
- C980 [788](#)
- C981 [789](#)
- C982 [789](#)
- C983 [789](#)
- C985 [789](#)
- C986 [790](#)
- C987 [790](#)
- C988 [790](#)
- C989 [790](#)
- C99 [641](#)
- C990 [791](#)
- C991 [791](#)
- C992 [791](#)
- C993 [791](#)
- C994 [792](#)
- C995 [792](#)
- C996 [792](#)
- C997 [792](#)
- C998 [793](#)
- C999 [793](#)
- CA06: CAN CRC error (error message) [478](#)
- CA07: CAN bus warning (error message) [478](#)
- CA08: CAN bus stopped (error message) [479](#)
- CA0b: CAN HeartBeatEvent (error message) [479](#)
- CA0F: CAN control word (error message) [479](#)
- Calculating mass inertia (SLVC) [180](#)
- CAN baud rate (C00351) [684](#)
- CAN data telegram [516](#)
- CAN decoupling PDOInOut (C00342) [680](#)
- CAN error status (C00345) [682](#)
- CAN ErrorCode (C00371) [691](#)
- CAN Heartbeat producer time (C00381) [691](#)
- CAN IN/OUT COBID source (C00353) [684](#)
- CAN input words (C00866) [776](#)

- CAN management - error configuration (C00341) [679](#)
  - CAN MessageError (C00364) [688](#)
  - CAN monitoring times (C00357) [686](#)
  - CAN node addr. HeartBeat producer (C00385) [691](#)
  - CAN node address (C00350) [683](#)
  - CAN on board [508](#)
  - CAN output words (C00868) [776](#)
  - CAN reset node [515](#)
  - CAN setting - DIP switch (C00349) [683](#)
  - CAN slave/master (C00352) [684](#)
  - CAN start remote node [522](#)
  - CAN status (C00359) [687](#)
  - CAN status HeartBeat producer (C00347) [682](#)
  - CAN SYNC Rx identifier (C00367) [689](#)
  - CAN sync transmission cycle time (C00369) [690](#)
  - CAN SYNC Tx identifier (C00368) [689](#)
  - CAN telegram counter (C00360) [687](#)
  - CAN time settings (C00356) [686](#)
  - CAN transmission blocking time (C00324) [678](#)
  - CAN\_Tx\_Rx\_Error (C00372) [691](#)
  - CAN-ERR (LED) [514](#)
  - CAN-GatewayAddr (C00387) [692](#)
  - CAN-RUN (LED) [514](#)
  - CANx\_OUT data length (C00358) [686](#)
  - CANxInOut
    - Inversion (C00401) [693](#)
  - Cause of controller inhibit (C00158) [652](#)
  - Cause of quick stop QSP (C00159) [652](#)
  - CE04: MCI communication error (error message) [478](#)
  - CE0F: MCI control word (error message) [478](#)
  - CE1: CAN RPDO1 (error message) [479](#)
  - CE2: CAN RPDO2 (error message) [479](#)
  - CE3: CAN RPDO3 (error message) [480](#)
  - CE4: CAN bus off (error message) [478](#)
  - CE5: CAN RPDO4 (error message) [480](#)
  - Change of the operating mode [411](#)
  - CI01: Module missing/incompatible (error message) [480](#)
  - Ck15: Error status sign. brake (error message) [485](#)
  - Ck16: Time overflow - manual operation (error message) [485](#)
  - COB-ID [516](#)
  - COBID (C00354) [685](#)
  - COB-ID EMCY (I-1014) [567](#)
  - COB-ID SYNC message (I-1005) [566](#)
  - Commissioning wizard 8400 [52](#)
  - Communication control words (C00136) [646](#)
  - Communication cycle period (I-1006) [567](#)
  - Communication time [511](#)
  - Compare FB interconnections [929](#)
  - Comparing applications [929](#)
  - Comparing interconnections [929](#)
  - Configuring exception handling of the CAN PDOs [542](#)
  - Configuring exception handling of the output terminals [301](#)
  - Consumer heartbeat time (I-1016) [568](#)
  - ConsumerTime HeartBeat Producer (C00386) [692](#)
  - Control mode (C00007) [623](#)
  - Control system [126](#)
  - Conventions used [20](#)
  - Conventions used for variable identifiers [887](#)
  - Copy function block interconnection [932](#)
  - Copying a complete interconnection [932](#)
  - Copying an interconnection [932](#)
  - Copying elements [923](#)
  - Copying interconnection elements [923](#)
  - Copying objects [923](#)
  - Correction of the leakage inductance [203](#)
  - Cosine phi (C00979) [788](#)
  - CountIn1
    - Counter content (C02841) [846](#)
    - Parameter (C02840) [845](#)
  - CRC error [556](#)
  - Current AutoFailReset processes (C00187) [663](#)
  - Current error (C00170) [659](#)
  - Current monitoring
    - Breaking current (C00124) [645](#)
    - Delay time (C00563) [719](#)
  - Current monitoring overload [260](#)
  - Current password protection (C00507) [714](#)
  - Current setpoint filter (band-stop filter) [205](#)
  - Current switching frequency (C00725) [749](#)
- ## D
- Data type [613](#)
  - Data type entry [887](#)
  - DC braking
    - Current (C00036) [631](#)
    - Hold time (C00107) [642](#)
  - DCB (DC-injection braking) [222](#)
  - DC-bus system
    - Control of multiple brake choppers [245](#)
  - DC-bus voltage (C00053) [632](#)
  - DC-injection braking [221](#)
  - Decel. time - main setpoint (C00013) [626](#)
  - Decel. time - quick stop (C00105) [642](#)
  - Decoupling AnalogOut (C00441) [699](#)
  - Defining a user-defined V/f characteristic [148](#)
  - Defining the current limits [131](#)
  - Defining the speed limits [131](#)
  - Del.resp. to fault
    - DC-bus overvoltage (C00601) [728](#)
  - Delay (C00983) [789](#)
  - Description data (C00199) [666](#)
  - Device access protection [39](#)
  - Device command
    - Configuration (C01004) [794](#)
  - Device commands (C00002) [618](#)
  - Device overload monitoring (ixt) [249](#)
  - Device personalisation [44](#)

Device search function [87](#)  
Device status (C00137) [647](#)  
Device statuses (LED status display) [436](#)  
Device type (I-1000) [564](#)  
Device utilisat. threshold (lxt) (C00123) [645](#)  
Device utilisation (lxt) (C00064) [634](#)  
dF01: FW updated (error message) [483](#)  
dF10: AutoTrip reset (error message) [484](#)  
dF14: SW-HW invalid (error message) [483](#)  
dF18: BU RCOM error (error message) [483](#)  
dF21: BU watchdog (error message) [484](#)  
dF22: CU watchdog (error message) [484](#)  
dF25: CU RCOM error (error message) [483](#)  
dF26: Appl. watchdog (error message) [483](#)  
dF50: Retain error (error message) [484](#)  
dF51: CuCcr error (error message) [484](#)  
dF52: BuCcr error (error message) [484](#)  
dH09: EEPROM power section (error message) [485](#)  
dH10: Fan failure (error message) [485](#)  
dH68: Adjustment data error CU (error message) [485](#)  
dH69: Adjustment data error BU (error message) [486](#)  
dH70: ControlUnit is unequal to BaseUnit (error message) [486](#)  
DI1| DI2  
    Function (C00115) [643](#)  
Diagnosis terminal X400 [30](#)  
Diagnostic interface (DIAG) [32](#)  
Diagnostics X6  
    Change baud rate (C01903) [810](#)  
    current baud rate (C01905) [810](#)  
    Max. baud rate (C01902) [809](#)  
DigInX  
    Debounce time (C02830) [844](#)  
    Inversion (C00114) [643](#)  
Digital terminals [274](#)  
    For electrical data see the hardware manual  
    User-defined terminal assignment [302](#)  
DigOut decoupling (C00447) [702](#)  
DigOut decoupling value (C00448) [702](#)  
DigOutX  
    Inversion (C00118) [644](#)  
DIP switch settings [512](#)  
Direction of rotation check (manual control) [54](#)  
Display details of the current error [439](#)  
Display error details [439](#)  
Display of internal process factors in application units [1020](#)  
Display process factors on the keypad [1020](#)  
Dlx  
    Level (C00443) [700](#)  
DOx  
    Delay times (C00423) [697](#)  
    Level (C00444) [700](#)  
Drive interface [76](#)  
DRV-ERR (LED) [436](#)  
DRV-RDY (LED) [436](#)

## E

EASY Starter [29](#)  
Elapsed-hour meter (C00178) [662](#)  
Electrical data  
    see hardware manual  
E-mail to Lenze [1058](#)  
Emergency [560](#)  
Emergency operation in case of encoder open circuit [162](#), [272](#)  
Encoder [235](#)  
Encoder evaluation method [235](#)  
Encoder evaluation method DigIn12 (C00496) [713](#)  
Encoder open-circuit monitoring [262](#)  
Encoder scanning time (C00425) [697](#)  
Encoder/feedback system [230](#)  
Energy display (C00981) [789](#)  
Energy saving mode [110](#)  
    Function (C01704) [807](#)  
    Mode (C01700) [805](#)  
    Status (C01709) [808](#)  
    toff (C01702) [806](#)  
    toff min (C01701) [806](#)  
    ton (C01703) [806](#)  
Energy-saving V/f characteristic control (VFCplusEco) [152](#)  
Engineer [29](#)  
Error detection [556](#)  
Error ID [460](#), [463](#)  
Error information (C00165) [658](#)  
Error information text (C00166) [658](#)  
Error messages [459](#)  
Error messages (short overview) [465](#)  
Error messages (system bus) [549](#)  
Error number [459](#), [462](#)  
    xx.0111.00002 [468](#)  
    xx.0111.00003 [468](#)  
    xx.0111.00004 [469](#)  
    xx.0111.00006 [469](#)  
    xx.0111.00007 [469](#)  
    xx.0119.00000 [469](#)  
    xx.0119.00001 [469](#)  
    xx.0119.00015 [470](#)  
    xx.0119.00050 [470](#)  
    xx.0123.00001 [470](#)  
    xx.0123.00007 [470](#)  
    xx.0123.00014 [471](#)  
    xx.0123.00015 [471](#)  
    xx.0123.00016 [471](#)  
    xx.0123.00017 [472](#)  
    xx.0123.00030 [472](#)  
    xx.0123.00031 [472](#)  
    xx.0123.00032 [472](#)  
    xx.0123.00033 [473](#)  
    xx.0123.00034 [473](#)  
    xx.0123.00057 [473](#)  
    xx.0123.00058 [473](#)  
    xx.0123.00059 [473](#)  
    xx.0123.00060 [474](#)

xx.0123.00061 [474](#)  
xx.0123.00065 [474](#)  
xx.0123.00066 [474](#)  
xx.0123.00071 [474](#)  
xx.0123.00074 [475](#)  
xx.0123.00090 [475](#)  
xx.0123.00093 [475](#)  
xx.0123.00094 [475](#)  
xx.0123.00095 [475](#)  
xx.0123.00096 [476](#)  
xx.0123.00097 [476](#)  
xx.0123.00098 [476](#)  
xx.0123.00099 [476](#)  
xx.0123.00105 [476](#)  
xx.0123.00145 [477](#)  
xx.0123.00200 [477](#)  
xx.0123.00205 [477](#)  
xx.0123.00209 [477](#)  
xx.0125.00001 [477](#)  
xx.0127.00002 [478](#)  
xx.0127.00015 [478](#)  
xx.0131.00000 [478](#)  
xx.0131.00006 [478](#)  
xx.0131.00007 [478](#)  
xx.0131.00008 [479](#)  
xx.0131.00011 [479](#)  
xx.0131.00015 [479](#)  
xx.0135.00001 [479](#)  
xx.0135.00002 [479](#)  
xx.0135.00003 [480](#)  
xx.0135.00004 [480](#)  
xx.0140.00013 [480](#)  
xx.0144.00001 [480](#)  
xx.0144.00002 [481](#)  
xx.0144.00003 [481](#)  
xx.0144.00004 [481](#)  
xx.0144.00007 [482](#)  
xx.0144.00008 [482](#)  
xx.0144.00009 [482](#)  
xx.0144.00010 [482](#)  
xx.0144.00011 [482](#)  
xx.0144.00012 [483](#)  
xx.0144.00013 [483](#)  
xx.0145.00001 [483](#)  
xx.0145.00014 [483](#)  
xx.0145.00024 [483](#)  
xx.0145.00025 [483](#)  
xx.0145.00026 [483](#)  
xx.0145.00033 [484](#)  
xx.0145.00034 [484](#)  
xx.0145.00035 [484](#)  
xx.0145.00050 [484](#)  
xx.0145.00051 [484](#)  
xx.0145.00052 [484](#)  
xx.0184.00005 [485](#)  
xx.0184.00064 [485](#)  
xx.0400.00009 [485](#)  
xx.0400.00016 [485](#)

xx.0400.00104 [485](#)  
xx.0400.00105 [486](#)  
xx.0400.00106 [486](#)  
xx.0980.00000 ... xx.0980.65535 [486](#)  
xx.0981.00000 ... xx.0981.65535 [486](#)  
xx.0982.00000 ... xx.0982.65535 [486](#)  
xx.0983.00000 ... xx.0983.65535 [486](#)  
Error number masked (C00162) [654](#)  
Error register (I-1001) [564](#)  
Error subject area [460](#), [462](#)  
Error type [460](#)  
Export error texts [464](#)  
Exporting logbook entries [447](#)  
Extended status word (C00155) [651](#)

## F

Failure indication (C00561) [719](#)  
FB Editor [882](#)  
    Functional range [882](#)  
FC01: Switching frequency reduction (error message) [475](#)  
FC02: Maximum speed for Fchop (error message) [475](#)  
FC03: Field controller limitation (error message) [476](#)  
Feedback to Lenze [1058](#)  
FI brake [240](#)  
Field weakening for synchronous motors [209](#)  
Field weakening oscillation damping (C00236) [671](#)  
Fieldbus interface [588](#)  
Field-oriented motor currents (C00937) [782](#)  
Filter setpoint feedforward control (C00275) [674](#)  
Filter time - earth-fault detect. is running (C01770) [809](#)  
Filter time constant (C00497) [713](#)  
Firmware (C00201) [666](#)  
Firmware product type (C00200) [666](#)  
Firmware update [89](#)  
Firmware version (C00099) [641](#)  
Firmware version (C00100) [641](#)  
Fixed setpoint x (L\_NSet\_1 n-Fix) (C00039) [631](#)  
Flying restart function [218](#)  
    Activation (C00990) [791](#)  
    Current (C00994) [792](#)  
    Integration time (C00993) [791](#)  
    Process (C00991) [791](#)  
    Restart on the fly fd\_add (C00989) [790](#)  
    Start frequency (C00992) [791](#)  
Format error [556](#)  
FreqIn12  
    Function (C02844) [846](#)  
    PosIn comparison value (C02845) [847](#)  
FreqInxx  
    Gain (C02843) [846](#)  
    Offset (C02842) [846](#)  
FreqInxx\_dnOut\_p (C00449) [703](#)  
FreqInxx\_nOut\_a (C00446) [701](#)  
FreqInxx\_nOut\_v (C00445) [701](#)  
Frequency limitation (C00910) [780](#)



Function block editor [882](#)  
Function block interconnection [28](#)  
Function blocks [934](#)  
Function library [934](#)

## G

General data (CAN on board) [509](#)  
General purpose functions [398](#)  
gotolink parameter.fm  
  c1701 [111](#)  
GP functions (GeneralPurpose) [398](#)

## H

Heartbeat protocol [557](#)  
Heatsink temperature (C00061) [634](#)  
Holding brake  
  Activation time (C02593) [842](#)  
  Operating mode (C02580) [839](#)  
  Setting (C02582) [840](#)  
  Speed thresholds (C02581) [840](#)  
  Status (C02607) [842](#)  
  Time system (C02589) [841](#)  
Holding brake control [416](#)  
HTL encoder input frequency (C00450) [703](#)

## I

I-1000 [564](#)  
I-1001 [564](#)  
I-1003 [565](#)  
I-1005 [566](#)  
I-1006 [567](#)  
I-1014 [567](#)  
I-1016 [568](#)  
I-1017 [569](#)  
I-1018 [569](#)  
I-1200 [570](#)  
I-1201 [571](#)  
I-1400 [573](#)  
I-1401 [574](#)  
I-1402 [575](#)  
I-1403 [576](#)  
I-1600 [577](#)  
I-1601 [578](#)  
I-1602 [578](#)  
I-1603 [579](#)  
I-1800 [580](#)  
I-1801 [582](#)  
I-1802 [583](#)  
I-1803 [584](#)  
I-1A00 [585](#)  
I-1A01 [585](#)  
I-1A02 [586](#)  
I-1A03 [586](#)  
Id1: Motor data identification error (error message) [473](#)

Id3: CINH identification (error message) [473](#)  
Id4: Resistance identification error (error message) [473](#)  
Id5: Pole position identification error (error message) [475](#)  
Id7: Motor control does not match motor data (error message) [474](#)  
Id8: Speed sensor has not been set (error message) [474](#)  
Identification procedure (C02867) [851](#)  
Identifier (CAN) [516](#)  
Identifiers of the parameter data objects [545](#)  
Identifiers of the process data objects [537](#)  
Identity (C00219) [668](#)  
Identity object (I-1018) [569](#)  
Imax controller [139](#)  
Imax in generator mode (C00023) [628](#)  
Imax in motor mode (C00022) [628](#)  
Imax/M controller gain (C00073) [636](#)  
Information regarding the validity [18](#)  
Inhibit at fault [101](#)  
Inhibit at trouble [101](#)  
Inhibit at undervoltage [102](#)  
Insert options for copied elements [925](#)  
Inserting complete interconnection from reference project [933](#)  
Inserting copied elements [925](#)  
Inserting FB interconnection from reference project [933](#)  
Integrated error detection [556](#)  
Internal control signals (C00138) [648](#)  
Inverter motor brake [240](#)  
  nAdd (C00987) [790](#)  
  PT1 filter time (C00988) [790](#)

## K

Keypad [30](#), [32](#)  
  Default manual jog (C00453) [704](#)  
  Default parameter (C00466) [707](#)  
  Default welcome screen (C00467) [707](#)  
  Display of internal process factors [1020](#)  
  Fct. STOP key (C00469) [708](#)  
  LCD display [440](#)  
  Set language [34](#)  
  Timeout welcome screen (C00465) [707](#)  
  User level [33](#)  
Keypad analog values (C00728) [751](#)  
Keypad language [34](#)  
Keypad Userlevel (C00001) [618](#)

## L

L\_Absolut [936](#)  
L\_Absolute\_1 [936](#)  
L\_AddSub [937](#)  
L\_AddSub\_1 [937](#)  
L\_AnalogSwitch [938](#)  
L\_AnalogSwitch\_1 [938](#)  
L\_AnalogSwitch\_2 [939](#)  
L\_AnalogSwitch\_3 [940](#)  
L\_And [941](#)

- [L\\_And\\_1](#) [941](#)
- [L\\_And\\_2](#) [942](#)
- [L\\_And\\_3](#) [943](#)
- [L\\_Arithmetik](#) [944](#)
- [L\\_Arithmetik\\_1](#) [944](#)
  - [Function \(C00338\)](#) [679](#)
- [L\\_Arithmetik\\_2](#) [945](#)
  - [Function \(C00339\)](#) [679](#)
- [L\\_Compare](#) [946](#)
- [L\\_Compare\\_1](#) [946](#)
  - [Fct. \(C00680\)](#) [742](#)
  - [Hysteresis \(C00681\)](#) [742](#)
  - [Window \(C00682\)](#) [742](#)
- [L\\_Compare\\_2](#) [951](#)
  - [Fct. \(C00685\)](#) [743](#)
  - [Hysteresis \(C00686\)](#) [743](#)
  - [Window \(C00687\)](#) [743](#)
- [L\\_Compare\\_3](#) [952](#)
  - [Fct. \(C00690\)](#) [743](#)
  - [Hysteresis \(C00691\)](#) [744](#)
  - [Window \(C00692\)](#) [744](#)
- [L\\_DFliPlop](#) [953](#)
- [L\\_DFliPlop\\_1](#) [953](#)
- [L\\_DigitalDelay](#) [955](#)
- [L\\_DigitalDelay\\_1](#) [955](#)
  - [Delay \(C00720\)](#) [749](#)
- [L\\_DigitalLogic](#) [957](#)
- [L\\_DigitalLogic\\_1](#) [957](#)
  - [Function \(C00820\)](#) [759](#)
  - [Truth table \(C00821\)](#) [759](#)
- [L\\_DigitalLogic\\_3](#) [959](#)
  - [Function \(C00828\)](#) [760](#)
  - [Truth table \(C00829\)](#) [760](#)
- [L\\_GainOffset](#) [961](#)
- [L\\_GainOffset\\_1](#) [961](#)
- [L\\_GainOffset\\_2](#) [962](#)
- [L\\_GainOffset\\_3](#) [963](#)
- [L\\_Interpolator](#) [964](#)
- [L\\_Interpolator\\_1](#) [964](#)
  - [Activation FB functions \(C00950\)](#) [783](#)
  - [Limit value - error cycles \(C00952\)](#) [784](#)
  - [No. of interpolation steps \(C00951\)](#) [783](#)
  - [Speed-up \(C00953\)](#) [784](#)
  - [Synchronisation mode \(C00954\)](#) [784](#)
- [L\\_JogCtrlEdgeDetect\\_1 \(C00488\)](#) [712](#)
- [L\\_JogCtrlExtension](#) [967](#)
- [L\\_JogCtrlExtension\\_1](#) [967](#)
- [L\\_MPot](#) [969](#)
- [L\\_MPot\\_1](#) [969](#)
  - [Acceleration time \(C00802\)](#) [758](#)
  - [Deceleration time \(C00803\)](#) [758](#)
  - [Inactive fct. \(C00804\)](#) [758](#)
  - [Init fct. \(C00805\)](#) [758](#)
  - [Lower limit \(C00801\)](#) [758](#)
  - [Upper limit \(C00800\)](#) [757](#)
  - [Use \(C00806\)](#) [759](#)
- [L\\_MulDiv](#) [973](#)
- [L\\_MulDiv\\_1](#) [973](#)
  - [Parameter \(C00699\)](#) [745](#)
- [L\\_Negation](#) [974](#)
- [L\\_Negation\\_1](#) [974](#)
- [L\\_Not](#) [975](#)
- [L\\_Not\\_1](#) [975](#)
- [L\\_Not\\_2](#) [975](#)
- [L\\_Not\\_3](#) [976](#)
- [L\\_NSet](#) [977](#)
- [L\\_NSet\\_1](#) [977](#)
  - [Accel. time - add. setpoint \(C00220\)](#) [668](#)
  - [Additional value output \(C00639\)](#) [740](#)
  - [Decel. time - add. setpoint \(C00221\)](#) [668](#)
  - [Hyst. NSet reached \(C00241\)](#) [671](#)
  - [Max.SkipFrq. \(C00632\)](#) [738](#)
  - [Min.SkipFrq. \(C00633\)](#) [738](#)
  - [nMaxLimit \(C00635\)](#) [739](#)
  - [nMinLimit \(C00636\)](#) [739](#)
  - [nNOut\\_a \(C00640\)](#) [740](#)
  - [Output blocking zones \(C00637\)](#) [739](#)
  - [Output ramp rounding \(C00638\)](#) [740](#)
  - [Ramp smoothing \(C00134\)](#) [646](#)
  - [Setpoint arithmetic \(C00190\)](#) [664](#)
  - [S-ramp time PT1 \(C00182\)](#) [663](#)
  - [wState \(C00634\)](#) [738](#)
- [L\\_OffsetGain](#) [988](#)
- [L\\_OffsetGain\\_1](#) [988](#)
- [L\\_OffsetGain\\_2](#) [989](#)
- [L\\_OffsetGainP](#) [990](#)
- [L\\_OffsetGainP\\_1](#) [990](#)
  - [Gain \(C00670\)](#) [741](#)
  - [Offset \(C00696\)](#) [744](#)
- [L\\_OffsetGainP\\_2](#) [991](#)
  - [Gain \(C00671\)](#) [742](#)
  - [Offset \(C00697\)](#) [744](#)
- [L\\_OffsetGainP\\_3](#) [992](#)
  - [Gain \(C00672\)](#) [742](#)
  - [Offset \(C00698\)](#) [744](#)
- [L\\_Or](#) [993](#)
- [L\\_Or\\_1](#) [993](#)
- [L\\_Or\\_2](#) [994](#)
- [L\\_Or\\_3](#) [995](#)
- [L\\_Or\\_4](#) [996](#)
- [L\\_PCTRL](#) [997](#)
- [L\\_PCTRL\\_1](#) [997](#)
  - [Acceleration time \(C00227\)](#) [669](#)
  - [Acceleration time influence \(C00243\)](#) [671](#)
  - [Deceleration time \(C00228\)](#) [669](#)
  - [Deceleration time influence \(C00244\)](#) [672](#)
  - [Internal actual value nAct\\_a \(C00246\)](#) [672](#)
  - [Kd \(C00224\)](#) [669](#)
  - [MaxLimit \(C00225\)](#) [669](#)
  - [MinLimit \(C00226\)](#) [669](#)
  - [Operating mode \(C00242\)](#) [671](#)
  - [Operating range \(C00231\)](#) [670](#)

- PID output value (C00245) [672](#)
- Root function (C00233) [670](#)
- Tn (C00223) [668](#)
- Vp (C00222) [668](#)
- Window setpoint reached (C00247) [672](#)
- L\_PT1 [1005](#)
- L\_PT1\_1 [1005](#)
  - Time constant (C00249) [672](#)
- L\_RLQ [1006](#)
- L\_RLQ\_1 [1006](#)
- L\_SignalMonitor\_a [1007](#)
  - Offs./gain (C00413) [696](#)
  - Signal sources (C00410) [695](#)
- L\_SignalMonitor\_b [1008](#)
  - Inversion (C00412) [696](#)
  - Signal sources (C00411) [695](#)
- L\_Transient [1009](#)
- L\_Transient 1-4
  - Function (C01138) [802](#)
  - Pulse duration (C01139) [802](#)
- L\_Transient\_1 [1009](#)
- L\_Transient\_2 [1012](#)
- L\_Transient\_3 [1013](#)
- L\_Transient\_4 [1014](#)
- LA\_NCtrl [314](#), [343](#)
  - Analog connection list (C00700) [745](#)
  - Application block [314](#), [343](#)
  - Digital connection list (C00701) [746](#)
- LA\_NCtrl\_In [314](#), [343](#)
- LA\_NCtrl\_Out [314](#), [343](#)
- LA\_SwitchPos [374](#)
  - Analog connection list (C00760) [754](#)
  - Application block [374](#)
  - Digital connection list (C00761) [755](#)
- LA\_SwitchPos\_In [374](#)
- LA\_SwitchPos\_Out [374](#)
- Layout of the safety instructions [23](#)
- LCD display (keypad) [440](#)
- LED "CAN-ERR" [514](#)
- LED "CAN-RUN" [514](#)
- LED "DRV-ERR" [436](#)
- LED status displays [435](#)
- L-force »EASY Starter« [29](#)
- L-force »Engineer« [29](#)
- Library [934](#)
- Lock bFail at TroubleQSP [107](#)
- Logbook - analog elements (C00164) [657](#)
- Logbook - binary elements (C00163) [654](#)
- Logbook access index User (C00191) [665](#)
- Logbook data User (C00192) [665](#)
- Logbook element User (C00193) [665](#)
- Logbook setting (C00169) [659](#)
- LP\_CanIn decoupling value (C00343) [681](#)
- LP\_CanIn mapping (C00407) [693](#)
- LP\_CanIn mapping (C00409) [694](#)
- LP\_CanIn mapping selection (C00408) [694](#)
- LP\_CanIn1 [525](#)
- LP\_CanIn2 [527](#)
- LP\_CanIn3 [529](#)
- LP\_CanIn4 [531](#)
- LP\_CanOut decoupling value (C00344) [681](#)
- LP\_CanOut1 [533](#)
- LP\_CanOut2 [534](#)
- LP\_CanOut3 [535](#)
- LP\_CanOut4 [536](#)
- LP\_MciIn [592](#)
- LP\_MciOut [593](#)
- LP1: Motor phase failure (error message) [477](#)
- LS\_AnalogIn1
  - PT1 time constant (C00440) [698](#)
- LS\_AnalogInput [300](#)
- LS\_AnalogOutput [300](#)
- LS\_Brake [417](#)
- LS\_CANManagement [587](#)
- LS\_DeviceMonitor [270](#)
- LS\_DigitalInput [286](#)
- LS\_DigitalOutput [292](#)
- LS\_DisFree [1018](#)
- LS\_DisFree (C00481) [710](#)
- LS\_DisFree\_a [1019](#)
- LS\_DisFree\_a (C00482) [710](#)
- LS\_DisFree\_b [1021](#)
- LS\_DisFree\_b (C00480) [709](#)
- LS\_DriveInterface [104](#)
  - bNActCompare (C00024) [629](#)
  - bNActHysteresis (C00025) [629](#)
  - Error message config. (C00148) [650](#)
- LS\_Keypad [1022](#)
- LS\_Keypad digital values(C00727) [750](#)
- LS\_MotionControlKernel [405](#)
- LS\_MotorInterface [263](#)
- LS\_ParFix [1024](#)
- LS\_ParFree [1025](#)
- LS\_ParFree (C00471) [708](#)
- LS\_ParFree\_a [1026](#)
- LS\_ParFree\_a (C00472) [709](#)
- LS\_ParFree\_b [1027](#)
- LS\_ParFree\_b (C00470) [708](#)
- LS\_ParFree\_p [1028](#)
- LS\_ParFree\_p (C00474) [709](#)
- LS\_ParFree\_v [1029](#)
- LS\_ParFree\_v (C00473) [709](#)
- LS\_ParReadWrite [1030](#)
- LS\_ParReadWrite 1-3
  - Arithmetic mode (C01093) [799](#)
  - Configuration (C01098) [800](#)
  - Cycle time (C01091) [798](#)
  - Denominator (C01095) [799](#)
  - FailState (C01092) [798](#)

- Index (C01090) [797](#)
  - Numerator (C01094) [799](#)
  - LS\_ParReadWrite\_1 [1030](#)
  - LS\_ParReadWrite\_2 [1030](#)
  - LS\_ParReadWrite\_3 [1030](#)
  - LS\_PulseGenerator [1034](#)
  - LS\_PulseGenerator (C00400) [692](#)
  - LS\_SetError\_1 [487](#)
  - LS\_SetError\_x
    - Error number (C00161) [653](#)
  - LS\_SyncManagement [596](#)
  - LS\_WriteParamList [608](#)
  - Auto-DCB
    - Hold time (C02244) [821](#)
    - Threshold (C02215) [812](#)
  - DC braking
    - Current (C02219) [814](#)
    - Hold time (C02245) [822](#)
  - Empfindlichkeit Sollwertvorsteuerung (C02264) [824](#)
  - Error line (C01084) [795](#)
  - Error status (C01083) [795](#)
  - Execute Mode (C01082) [795](#)
  - Field weakening oscillation damping (C02251) [823](#)
  - Flying restart function
    - Activation (C02295) [831](#)
    - Current (C02299) [833](#)
    - Integration time (C02298) [832](#)
    - Process (C02296) [832](#)
    - Start frequency (C02297) [832](#)
  - Frequency limitation (C02274) [825](#)
  - Function (C02200) [810](#)
  - I<sub>max</sub> in generator mode (C02218) [813](#)
  - I<sub>max</sub> in motor mode (C02217) [813](#)
  - I<sub>max</sub>/M controller gain (C02223) [815](#)
  - Index (C01085) [796](#)
  - Inverter motor brake
    - nAdd (C02293) [831](#)
    - PT1 filter time (C02294) [831](#)
  - Manual entry of motor type (C02315) [839](#)
  - Max. motor speed (C02280) [827](#)
  - Moment of inertia (C02256) [823](#)
  - Motor cable cross-section (C02276) [826](#)
  - Motor cable length (C02275) [826](#)
  - Motor control (C02210) [811](#)
  - Motor cosine phi (C02240) [820](#)
  - Motor magnetising current (C02242) [821](#)
  - Motor magnetising inductance (C02241) [821](#)
  - Motor phase direction of rotation (C02272) [824](#)
  - Motor rotor resistance (C02232) [818](#)
  - Motor stator leakage inductance (C02234) [819](#)
  - Motor stator resistance (C02233) [818](#)
  - Oscillation damping filter time (C02250) [823](#)
  - Oscillation damping influence (C02249) [822](#)
  - Override point of field weakening (C02230) [817](#)
  - PLI without motion (C02312) [837](#)
  - PLI without movement
    - Adaptation of ident angle (C02313) [838](#)
    - Adaptation of time duration (C02311) [837](#)
  - PSM
    - Activate Lss sat. char. (C02307) [837](#)
    - I<sub>max</sub> Lss saturation characteristic (C02306) [836](#)
    - Lss saturation characteristic (C02305) [835](#)
    - Maximum motor current field weakening (C02278) [826](#)
  - Rated motor current (C02237) [819](#)
  - Rated motor frequency (C02238) [820](#)
  - Rated motor power (C02231) [818](#)
  - Rated motor speed (C02236) [819](#)
  - Rated motor voltage (C02239) [820](#)
  - Reset time I<sub>max</sub>/M controller (C02224) [816](#)
  - SC
    - Settings (C02229) [817](#)
    - T<sub>dn</sub> speed controller (C02222) [815](#)
  - Setting of motor overload (I<sup>2</sup>t) (C02246) [822](#)
  - Slip comp. (C02216) [813](#)
  - SLPSM
    - Controlled current setpoint (C02300) [833](#)
    - Filter cutoff frequency (C02302) [834](#)
    - Filter time rotor position (C02303) [834](#)
    - PLL gain (C02304) [834](#)
    - Switching speed (C02301) [833](#)
  - SLVC
    - Cross current controller gain (C02292) [830](#)
    - Field current controller gain (C02291) [830](#)
  - Speed limitation (C02273) [825](#)
  - Speed sensor selection (C02260) [824](#)
  - Switching frequency (C02214) [812](#)
  - Ti current controller (C02226) [816](#)
  - Ti speed controller (C02221) [814](#)
  - Ultimate motor current (C02279) [827](#)
  - VFC
    - Limitation V/f + sensor (C02284) [828](#)
    - Ti V/f +sensor (C02286) [828](#)
    - Time const. slip comp. (C02281) [827](#)
    - V/f base frequency (C02212) [811](#)
    - V<sub>min</sub> boost (C02213) [811](#)
    - Vp V/f +sensor (C02285) [828](#)
  - VFC-ECO
    - Minimum voltage V/f (C02289) [829](#)
    - Ti CosPhi controller (C02288) [829](#)
    - Voltage reduction ramp (C02290) [830](#)
    - Vp CosPhi controller (C02287) [829](#)
  - Vp current controller (C02225) [816](#)
  - Vp speed controller (C02220) [814](#)
  - WriteValue\_1 (C01086) [796](#)
  - WriteValue\_2 (C01087) [796](#)
  - WriteValue\_3 (C01088) [797](#)
  - WriteValue\_4 (C01089) [797](#)
  - LU: DC bus undervoltage (error message) [471](#)
- ## M
- Main program runtime (C00321) [677](#)
  - Mains connection (behaviour) [99](#), [101](#), [102](#)
  - Mains phase failure monitoring [259](#)
  - Mains voltage (C00173) [660](#)

Manual control [54](#)  
Manual DC-injection braking (DCB) [222](#)  
Manual entry of motor type (C01001) [794](#)  
Manual motor direction of rotation check [54](#)  
Master functionality (CAN) [522](#)  
MasterPin [46](#)  
Max. motor speed (C00965) [784](#)  
Max. number of AutoFailReset processes (C00186) [663](#)  
Maximum current monitoring [259](#)  
Maximum torque (C00057) [633](#)  
Maximum torque monitoring [261](#)  
MCI input words (C00876) [778](#)  
MCI output words (C00877) [778](#)  
MCI\_InOut  
  Inversion (C00890) [779](#)  
MCK [403](#)  
  Accel./decel. times (C02610) [843](#)  
  Limitations (C02611) [844](#)  
  Resp. to MCK error (C00595) [726](#)  
MCK state machine [411](#)  
MCK status bit "bReadyToOperate" [412](#)  
MCK status word [410](#)  
MCTRL  
  Actual speed value (C00051) [632](#)  
  Optimisations (C02864) [848](#)  
  Special settings (C02865) [849](#)  
  Special settings (C02866) [851](#)  
  Special settings 2 (C02869) [854](#)  
  Speed setpoint (C00050) [632](#)  
  Status (C01000) [793](#)  
Memory module [36](#)  
  Binding ID [44](#)  
Moment of inertia from load (C00919) [781](#)  
Moment of inertia motor (C00273) [673](#)  
Monitoring [248](#), [451](#)  
Motion Control Kernel (MCK) [403](#)  
Motor cable cross-section (C00916) [781](#)  
Motor cable length (C00915) [781](#)  
Motor cable resistance (C00917) [781](#)  
Motor catalogue [117](#)  
Motor control [112](#)  
  87-Hz operation [142](#)  
  DC-injection braking [221](#)  
  Energy-saving V/f characteristic control (VFCplusEco) [152](#)  
  Flying restart function [218](#)  
  Oscillation damping [226](#)  
  Selection help [130](#)  
  Selection of switching frequency [212](#)  
  Selection of the control type [126](#)  
  Sensorless vector control (SLVC) [169](#)  
  Slip compensation [225](#)  
  V/f characteristic control (VFCplus) [134](#)  
  V/f control (VFCplus + encoder) [162](#)  
Motor control (C00006) [622](#)  
Motor cosine phi (C00091) [640](#)

Motor current (C00054) [633](#)  
Motor data [113](#)  
Motor data changeover [597](#)  
Motor data parameter list [597](#)  
Motor holding brake [416](#)  
Motor load monitoring (I2xt) [250](#)  
Motor magnetising current (C00095) [640](#)  
Motor magnetising inductance (C00092) [640](#)  
Motor overcurrent monitoring [252](#)  
Motor parameter identification [119](#)  
Motor parameter identification is active [91](#)  
Motor phase direction of rotation (C00905) [780](#)  
Motor phase error monitoring before operation [257](#)  
Motor phase failure monitoring [256](#)  
Motor phase failure threshold (C00599) [727](#)  
Motor rotor resistance (C00082) [638](#)  
Motor rotor time constant (C00083) [638](#)  
Motor selection [113](#)  
Motor speed monitoring [261](#)  
Motor stator leakage inductance (C00085) [638](#)  
Motor stator resistance (C00084) [638](#)  
Motor temperature monitoring (PTC) [253](#)  
Motor voltage (C00052) [632](#)  
Motorparameter (C00969) [786](#)  
Multilingualism [34](#)

## N

Network management telegram (NMT) [521](#)  
NMT (network management) [521](#)  
Node address [517](#)  
Node ID [517](#)  
Number of CAN SDO channels (C00366) [688](#)  
Number of encoder increments (C00420) [696](#)

## O

O1U  
  Gain (C00434) [697](#)  
  Input value (C00439) [698](#)  
  Offset (C00435) [698](#)  
  Voltage (C00436) [698](#)  
oC1: Power section - short circuit (error message) [471](#)  
oC10: Maximum current reached (error message) [472](#)  
oC11: Clamp operation active (error message) [474](#)  
oC12: I2xt overload - brake resistor (error message) [474](#)  
oC13: Maximum current for Fch exceeded (error message) [475](#)  
oC14: Direct-axis current controller limitation (error message) [476](#)  
oC15: Cross current controller limitation (error message) [476](#)  
oC16: Torque controller limitation (error message) [476](#)  
oC17: Clamp sets pulse inhibit (error message) [472](#)  
oC18: Current monitoring overload (error message) [473](#)  
oC19: Brake resistor - short circuit (error message) [474](#)  
oC2: Power section - earth fault (error message) [472](#)  
oC5: Ixt overload (error message) [470](#)

oC6: I2xt overload - motor (error message) [476](#)  
oC7 [252](#)  
oC7: Motor overcurrent (error message) [470](#)  
oH1: Heatsink overtemperature (error message) [469](#)  
oH3: Motor temperature (X106) triggered (error message) [470](#)  
oH4: Heatsink temp. > shutdown temp. -5°C (error message) [469](#)  
Open-circuit monitoring - encoder [262](#)  
Operating conditions (CAN on board) [509](#)  
Operating mode  
  Speed follower [414](#)  
  StandBy [411](#)  
Operation with increased rated power [216](#)  
Operation with safety module [413](#)  
Optical tracking [87](#)  
Optimising the response to setpoint changes (SLVC) [180](#)  
Option "Lock bFail at TroubleQSP" [107](#)  
Original application|control source (C00008) [624](#)  
oS1: Maximum speed limit reached (error message) [472](#)  
oS2: Max. motor speed (error message) [473](#)  
Oscillation damping [226](#)  
Oscillation damping filter time (C00235) [670](#)  
Oscillation damping influence (C00234) [670](#)  
Oscilloscope function [488](#)  
ot1: Maximum torque reached (error message) [470](#)  
ot2: Speed controller output limited (error message) [475](#)  
oU: DC bus overvoltage (error message) [471](#)  
Output frequency (C00058) [634](#)  
Override point of field weakening (C00080) [637](#)

## P

Parameter change-over [597](#)  
Parameterisable function blocks [885](#)  
Password data (C00505) [713](#)  
Password protection [40](#)  
PC manual control [71](#)  
PDO mapping [525](#), [527](#), [529](#), [531](#)  
PDO synchronisation [541](#)  
Peak current limitation [131](#)  
Performance indication (C00980) [788](#)  
Phase sequence reversal [229](#)  
Plant parameters [118](#)  
PLI without movement  
  Adaptation of ident angle (C02875) [856](#)  
  Adaptation of time period (C02872) [855](#)  
  Degree of optimisation (C02870) [854](#)  
  Ident. el. rotor displ. angle (C02873) [855](#)  
  Runtime (C02871) [854](#)  
PLI without movement (C02874) [855](#)  
Pole position identification [207](#)  
Port block "LP\_CanIn1" [525](#)  
Port block "LP\_CanIn2" [527](#)  
Port block "LP\_CanIn3" [529](#)  
Port block "LP\_CanIn4" [531](#)

Port block "LP\_CanOut1" [533](#)  
Port block "LP\_CanOut2" [534](#)  
Port block "LP\_CanOut3" [535](#)  
Port block "LP\_CanOut4" [536](#)  
Position encoder selection (C00490) [712](#)  
Power section ID (C00093) [640](#)  
Power-on time meter (C00179) [662](#)  
Pre-defined error field (I-1003) [565](#)  
Printing the interconnection [928](#)  
Process data objects, identifiers [537](#)  
Processing time [511](#)  
Producer heartbeat time (I-1017) [569](#)  
Product type code (C00203) [666](#)  
PS01: No memory module (error message) [480](#)  
PS02: Par. set invalid (error message) [481](#)  
PS03: Par. set device invalid (error message) [481](#)  
PS04: Par. set Mci invalid (error message) [481](#)  
PS07: Par. memory module invalid (error message) [482](#)  
PS08: Par. device invalid (error message) [482](#)  
PS09: Par. format invalid (error message) [482](#)  
PS10: Memory module binding invalid (error message) [482](#)  
PS11: Error  
  Lenze Setting Loaded (error message) [482](#)  
PS12: Parameter sets loaded (error message) [483](#)  
PS13: Parameter sets saved (error message) [483](#)  
PSM  
  Activate Lss sat. char. (C02859) [848](#)  
  Imax Lss saturation characteristic (C02855) [847](#)  
  Lss saturation characteristic (C02853) [847](#)  
  Maximum motor current field weakening (C00938) [783](#)  
PTC [253](#)  
PW protection config MCI (C00510) [717](#)  
PW protection config X1(CAN) (C00509) [716](#)  
PW protection config X6(DIAG) (C00508) [715](#)  
PW protection internal config (C00506) [714](#)

## R

Rated device current (C00098) [641](#)  
Rated device currents (C00920) [782](#)  
Rated device voltage (C00970) [786](#)  
Rated heat amount of brake resist. (C00131) [646](#)  
Rated motor current (C00088) [639](#)  
Rated motor frequency (C00089) [639](#)  
Rated motor power (C00081) [638](#)  
Rated motor speed (C00087) [639](#)  
Rated motor torque (C00097) [640](#)  
Rated motor voltage (C00090) [639](#)  
Rated power - brake resistor (C00130) [645](#)  
Reduc. brake chopper threshold (C00174) [660](#)  
Referential project [933](#)  
Remote  
  Acceleration/deceleration time (C00461) [705](#)  
  Control (C00462) [705](#)  
  MCK control (C00463) [705](#)

Monitoring timeout (C00464) [707](#)  
Setpoint selection (C00729) [751](#)  
Reset error message [463](#)  
Reset node (CAN) [515](#)  
Reset time I<sub>max</sub>/M controller (C00074) [636](#)  
Resp. to brake resist. overtemp. (C00574) [722](#)  
Resp. to CAN bus connection (C00592) [725](#)  
Resp. to CANx\_IN monitoring (C00593) [725](#)  
Resp. to communication error with MCI (C01501) [805](#)  
Resp. to control word error (C00594) [726](#)  
Resp. to controller limitations (C00570) [721](#)  
Resp. to current monitoring (C00584) [723](#)  
Resp. to DC-bus voltage (C00600) [728](#)  
Resp. to device overload (I<sub>xt</sub>) (C00604) [728](#)  
Resp. to earth fault (C00602) [728](#)  
Resp. to fan failure (C00566) [720](#)  
Resp. to heatsink temp. > shutdown temp. -5°C (C00582) [723](#)  
Resp. to LS\_SetError\_x (C00581) [723](#)  
Resp. to mains phase failure (C00565) [720](#)  
Resp. to max. freq. feedb. DIG12/67 (C00607) [729](#)  
Resp. to max. speed at switching freq. (C00588) [724](#)  
Resp. to max. speed/output freq. reached (C00579) [722](#)  
Resp. to maximum current (C00609) [729](#)  
Resp. to maximum torque (C00608) [729](#)  
Resp. to motor overload (I<sup>2</sup>xt) (C00606) [729](#)  
Resp. to motor overtemp. PTC (C00585) [724](#)  
Resp. to motor phase failure (C00597) [727](#)  
Resp. to open circuit AINx (C00598) [727](#)  
Resp. to open circuit HTL encoder (C00586) [724](#)  
Resp. to operating system error (C00580) [722](#)  
Resp. to peak current (C00569) [720](#)  
Resp. to PLI monitoring (C00643) [740](#)  
Resp. to speed controller limited (C00567) [720](#)  
Resp. to switching frequency reduction (C00590) [724](#)  
Resp. to too frequent AutoFailReset (C00189) [664](#)  
Resp. to wrong controller setting (C00571) [721](#)  
Reversing the phase sequence [229](#)  
Rotor position angle detection after controller enable [207](#)  
RPDO1 communication parameter (I-1400) [573](#)  
RPDO1 mapping parameter (I-1600) [577](#)  
RPDO2 communication parameter (I-1401) [574](#)  
RPDO2 mapping parameter (I-1601) [578](#)  
RPDO3 communication parameter (I-1402) [575](#)  
RPDO3 mapping parameter (I-1602) [578](#)  
RPDO4 communication parameter (I-1403) [576](#)  
RPDO4 mapping parameter (I-1603) [579](#)  
Running time (C00180) [662](#)

## S

Safety functions [413](#)  
Safety instructions [23](#)  
Safety module [413](#)  
Saturation characteristic [203](#)

## SC

Depth of current setpoint filter (C00272) [673](#)  
Filter time const. DC detection (C00280) [674](#)  
Freq. current setpoint filter (C00270) [673](#)  
Max. acceleration change (C00274) [674](#)  
max. output voltage (C00276) [674](#)  
Settings (C00079) [637](#)  
Tdn speed controller (C00072) [636](#)  
Width of current setpoint filter (C00271) [673](#)  
Scaling of physical units [888](#)  
Sd10: Speed limit for feedback system 12 (error message) [477](#)  
Sd18: V/f emergency operation (error message) [477](#)  
Sd3: Open circuit HTL 2-fold or 4-fold (error message) [477](#)  
SDO1 server parameter (I-1200) [570](#)  
SDO2 server parameter (I-1201) [571](#)  
Selection help for motor control [130](#)  
Selection of switching frequency [212](#)  
Selection of the control type [126](#)  
Sensibility - Setpoint feedforward control (C00653) [741](#)  
Sensorless control for synchronous machines (SLPSM) [128](#)  
Sensorless vector control (SLVC) [128](#), [169](#)  
Serial number (C00204) [667](#)  
Setpoint synchronisation ramp [415](#)  
Setting of compatibility (C02868) [852](#)  
Setting of motor overload (I<sup>2</sup>xt) (C00120) [644](#)  
Setting the baud rate [513](#)  
Setting the error response [453](#)  
Setting the node address [513](#)  
Short overview of error messages [465](#)  
Signal flow  
    Energy-saving V/f characteristic control (VFCplusEco) [153](#), [188](#)  
    Sensorless vector control (SLVC) [171](#)  
    V/f characteristic control (VFCplus) [135](#), [136](#)  
    V/f control (VFCplus + encoder) [163](#), [164](#), [170](#)  
Signal type entry [888](#)  
Slip calculation from equivalent circuit diagram (C02879) [856](#)  
Slip comp. (C00021) [628](#)  
Slip compensation [225](#)  
Slip regulator [166](#)  
SLPSM  
    Controlled current setpoint (C00995) [792](#)  
    Filter cutoff frequency (C00997) [792](#)  
    Filter time rotor position (C00998) [793](#)  
    Load value — speed controller (C00936) [782](#)  
    PLL gain (C00999) [793](#)  
    Switching speed (C00996) [792](#)  
SLVC  
    Gain of cross current controller (C00986) [790](#)  
    Gain of field current controller (C00985) [789](#)  
Source of diff. setpoint feedforward control (C00654) [741](#)  
Speed control with torque limitation (SLVC) [172](#)  
Speed feedback [129](#)  
Speed follower [414](#)  
Speed limitation (C00909) [780](#)

Speed sensor selection (C00495) [713](#)  
Speed setpoint generation [415](#)  
StandBy (MCK operating mode) [411](#)  
Starting value — Overload (C00122) [644](#)  
State machine (MCK) [411](#)  
Status determining error (16-bit) (C00160) [653](#)  
Status determining error (C00168) [659](#)  
Status displays [435](#)  
Status of last device command (C00003) [621](#)  
Status word (C00150) [650](#)  
Status word (MCK) [410](#)  
Stop of the ramp function generator [240](#)  
Stop the ramp function generator [240](#)  
Stuff-bit error [556](#)  
Su02: One mains phase is missing (error message) [468](#)  
Su03: Too frequent mains switching (error message) [468](#)  
Su04: CU insufficiently supplied (error message) [469](#)  
Su06: Mains input overload (error message) [469](#)  
Su07: 24V supply off (error message) [469](#)  
Switching cycles (C00177) [661](#)  
Switching freq. reduct. (Temp.) (C00144) [649](#)  
Switching frequency [212](#)  
Switching frequency (C00018) [627](#)  
Switching status of the fans (C00560) [718](#)  
Switch-on inhibit [99](#)  
Sync correction width (C01124) [802](#)  
Sync cycle time setpoint (C01121) [801](#)  
Sync phase position (C01122) [801](#)  
Sync signal source (C01120) [800](#)  
Sync telegram [541](#)  
Sync window (C01123) [801](#)  
Synchronous motor  
  Field weakening [209](#)  
SyncTxRxTimes (C00370) [690](#)  
System blocks [1015](#)  
System bus [508](#)  
System connection list  
  16-bit (C00620) [730](#)  
  Angle (C00622) [737](#)  
  Bool (C00621) [732](#)  
System error messages [459](#)  
System runtimes (C00312) [676](#)

**T**

Target group [18](#)  
Task selection [892](#)  
Technology applications [26](#)  
Temperature inside the controller (C00062) [634](#)  
Terminals [273](#)  
  Analog terminals [293](#)  
  Digital terminals [274](#)  
  For electrical data see the hardware manual  
  User-defined terminal assignment [302](#)  
Thermal motor load (I\*xt) (C00066) [635](#)

Ti current controller (C00076) [637](#)  
Ti speed controller (C00071) [636](#)  
Time settings (C00181) [662](#)  
Torque (C00056) [633](#)  
Torque control with speed limitation (SLVC) [173](#)  
Torque feedforward control (SLVC) [180](#)  
Torque limitation [146](#)  
TPDO1 communication parameter (I-1800) [580](#)  
TPDO1 mapping parameter (I-1A00) [585](#)  
TPDO2 communication parameter (I-1801) [582](#)  
TPDO2 mapping parameter (I-1A01) [585](#)  
TPDO3 communication parameter (I-1802) [583](#)  
TPDO3 mapping parameter (I-1A02) [586](#)  
TPDO4 communication parameter (I-1803) [584](#)  
Transmission mode CAN Rx PDOs (C00323) [678](#)  
Transmission mode CAN TxPDOs (C00322) [677](#)  
Transmission type [539](#)

## U

Ultimate motor current [252](#)  
Ultimate motor current (C00939) [783](#)  
USB diagnostic adapter [30](#)  
User data [545](#)  
User error 1 (error message) [486](#)  
User error 2 (error message) [486](#)  
User error 3 (error message) [486](#)  
User error 4 (error message) [486](#)  
User level [33](#)  
User menu [38](#)  
User menu (C00517) [717](#)  
User-definable V/f characteristic [148](#)

## V

V/f base frequency [141](#)  
V/f characteristic control (VFCplus) [127](#), [134](#)  
V/f control (VFCplus + encoder) [162](#)  
V/f emergency operation in case of encoder open circuit [162](#),  
[272](#)  
VFC  
  Frequency interpol. point n (C00967) [785](#)  
  Limitation V/f + sensor (C00971) [786](#)  
  Ti V/f +sensor (C00973) [787](#)  
  Time const. slip comp. (C00966) [785](#)  
  V/f base frequency (C00015) [626](#)  
  Vmin boost (C00016) [627](#)  
  Voltage interpol. point n (C00968) [785](#)  
  Vp V/f +sensor (C00972) [787](#)  
VFC-ECO  
  Minimum voltage V/f (C00977) [787](#)  
  Ti CosPhi controller (C00976) [787](#)  
  Voltage reduction (C00978) [788](#)  
  Voltage reduction ramp (C00982) [789](#)  
  Vp CosPhi controller (C00975) [787](#)  
Vmin boost [143](#)  
Vp current controller (C00075) [637](#)



# Index

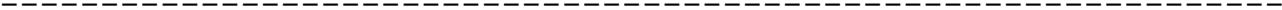

Vp speed controller (C00070) [635](#)



## **Your opinion is important to us**

These instructions were created to the best of our knowledge and belief to give you the best possible support for handling our product.

If you have suggestions for improvement, please e-mail us to:

[feedback-docu@Lenze.de](mailto:feedback-docu@Lenze.de)

Thank you for your support.

*Your Lenze documentation team*

**Lenze Drives GmbH**

Postfach 10 13 52, D-31763 Hameln  
Breslauer Straße 3, D-32699 Extertal  
Germany

HR Lemgo B 6478

☎ +49 5154 82-0

📠 +49 5154 82-2800

@ [sales.de@lenze.com](mailto:sales.de@lenze.com)

🌐 [www.lenze.com](http://www.lenze.com)

**Service**

Lenze Service GmbH

Breslauer Straße 3, D-32699 Extertal  
Germany

☎ 00800 24 46877 (24 h helpline)

📠 +49 5154 82-1112

@ [service.de@lenze.com](mailto:service.de@lenze.com)



# POWERLINK

E84AYCEC

Inverter Drives 8400 -----

Communication manual EN



13564917

# Contents

---

## Contents

<b>1</b>	<b>About this documentation</b> .....	<b>4</b>
1.1	Document history .....	6
1.2	Conventions used .....	7
1.3	Terminology used .....	8
1.4	Notes used .....	9
<b>2</b>	<b>Safety instructions</b> .....	<b>10</b>
2.1	General safety and application notes .....	10
2.2	Device and application-specific safety instructions .....	11
2.3	Residual hazards .....	11
<b>3</b>	<b>Product description</b> .....	<b>12</b>
3.1	Application as directed .....	12
3.2	Identification .....	12
3.3	Product features .....	13
3.4	Connections and interfaces .....	14
<b>4</b>	<b>Technical data</b> .....	<b>15</b>
4.1	General data and operating conditions .....	15
4.2	Protective insulation .....	16
4.3	POWERLINK communication data .....	19
4.4	Dimensions .....	20
<b>5</b>	<b>Installation</b> .....	<b>21</b>
5.1	Mechanical installation .....	22
5.1.1	Mounting for standard devices of 0.25 kW and 0.37 kW .....	22
5.1.2	Mounting for standard devices of 0.55 kW or more .....	23
5.1.3	Exchanging the communication module .....	24
5.2	Electrical installation .....	25
5.2.1	Wiring according to EMC guidelines .....	25
5.2.2	Network topology .....	26
5.2.3	Ethernet POWERLINK .....	28
5.2.4	Basic Ethernet Mode .....	29
5.2.5	POWERLINK connection .....	30
5.2.6	Ethernet cable specification .....	32
5.2.7	External voltage supply .....	34

# Contents

---

<b>6</b>	<b>Commissioning</b> .....	<b>36</b>
6.1	Before initial switch-on .....	36
6.2	Node address setting .....	37
6.3	Setting and displays in the »Engineer« .....	39
6.4	Initial switch-on .....	40
6.5	Drive synchronisation .....	42
6.6	Optimisation of networks .....	43
<b>7</b>	<b>Process data transfer</b> .....	<b>44</b>
7.1	Access to process data / PDO mapping .....	45
7.2	Preconfigured port interconnection of the process data objects (PDO) .....	46
7.3	Freely configuring the port interconnection of the process data objects (PDO) .....	47
<b>8</b>	<b>Monitoring</b> .....	<b>51</b>
<b>9</b>	<b>Diagnostics</b> .....	<b>52</b>
9.1	LED status displays .....	52
9.1.1	Module status displays .....	53
9.1.2	Fieldbus status displays .....	54
9.1.3	Status displays at the RJ45 sockets (X251, X252) .....	55
9.2	Troubleshooting with module signalling .....	56
9.3	Diagnostic data .....	59
<b>10</b>	<b>Error messages</b> .....	<b>61</b>
10.1	Short overview of the POWERLINK error messages .....	61
10.2	Possible causes and remedies .....	62
<b>11</b>	<b>Parameter reference</b> .....	<b>65</b>
11.1	Parameters of the communication module .....	65
11.2	Table of attributes .....	80
<b>12</b>	<b>Index table</b> .....	<b>82</b>
<b>13</b>	<b>Index</b> .....	<b>85</b>

## 1 About this documentation

### Contents

This documentation exclusively describes the E84AYCEC communication module (POWERLINK).



### Note!

This documentation supplements the **mounting instructions** supplied with the communication module and the **hardware manual for the Inverter Drives 8400**.

The features and functions of the communication module POWERLINK are described in detail. Examples illustrate typical applications.

This documentation also contains the following:

- Safety instructions that must be observed
- The basic technical data of the communication module
- Information about the versions of the Lenze standard devices to be used
- Notes on troubleshooting and fault elimination

The theoretical context is only explained as far as it is required for understanding the function of the communication module.

This documentation does not describe any software provided by other manufacturers. No liability can be accepted for corresponding data provided in this documentation. For information on how to use the software, please refer to the host (PLC, *Managing Node* documents).

All brand names mentioned in this documentation are trademarks of their corresponding owners.



### Tip!

Detailed information about POWERLINK can be found on the website of the "Ethernet POWERLINK Standardization Group":

[www.ethernet-powerlink.org](http://www.ethernet-powerlink.org)

### Screenshots/application examples

All screenshots in this documentation are application examples. Depending on the firmware version of the field devices and the software version of the installed engineering tools (»Engineer«), the screenshots in this documentation may differ from the screen representation.

# About this documentation

---

## Target group

This documentation addresses to persons who configure, install, commission, and maintain the networking and remote maintenance of a machine.



### Tip!

Current documentation and software updates with regard to Lenze products can be found in the download area at:

[www.Lenze.com](http://www.Lenze.com)

## Information regarding the validity

The information given in this documentation is valid for the following devices:

Extension module	Type designation	From hardware version	From software version
Communication module POWERLINK	E84AYCEC	VA	01.00



# About this documentation

## Document history

---

### 1.1 Document history

Version			Description
4.0	02/2019	TD23	General updates
3.0	09/2012	TD17	General updates Description of code <a href="#">C13060</a> (0x1006 cycle time) corrected.
2.0	02/2011	TD17	General revision
1.0	11/2010	TD17	First edition



# About this documentation

## Conventions used

---

### 1.2 Conventions used

This documentation uses the following conventions to distinguish between different types of information:

Type of information	Highlighting	Examples/notes
Spelling of numbers		
Decimal	Normal spelling	Example: 1234
Hexadecimal	0x[0 ... 9, A ... F]	Example: 0x60F4
Binary • Nibble	In inverted commas Point	Example: '100' Example: '0110.0100'
Decimal separator	Point	The decimal point is always used. For example: 1234.56
Text		
Program name	» «	PC software Example: Lenze »Engineer«
Window	<i>italics</i>	The <i>message window</i> ... / The <i>Options</i> dialog box...
Control element	<b>Bold</b>	The <b>OK</b> button... / The <b>Copy</b> command... / The <b>Properties</b> tab... / The <b>Name</b> input field...
Hyperlink	<u>Underlined</u>	Optically highlighted reference to another topic. Can be activated with a mouse-click in this documentation.
Icons		
Page reference	 7	Optically highlighted reference to another page. Can be activated with a mouse-click in this documentation.
Step-by-step instructions		Step-by-step instructions are indicated by a pictograph.

# About this documentation

## Terminology used

---

### 1.3 Terminology used

Term	Meaning
Inverter	Lenze inverter of the "Inverter Drives 8400" product series
Standard device	
»Engineer«	Lenze PC software which supports you during the "Engineering" process (parameterisation, diagnostics, and configuration) throughout the whole life cycle, i. e. from planning to maintenance of the machine commissioned.
Code	Parameter which serves to parameterise and monitor the inverter. In normal usage, the term is usually referred to as "Index".
Subcode	If a code contains several parameters, they are stored in "subcodes". This manual uses a slash "/" as a separator between code and subcode (e.g. "C00118/3"). This term is also referred to as "subindex" in common parlance.
Lenze setting	Default settings of the device, preconfigured ex works.
Basic setting	
HW	Hardware
SW	Software
EPL	Abbreviation for "POWERLINK"
(EPL) nodes	POWERLINK nodes ( <i>Managing Node, Controlled Nodes</i> )
CN	Controlled node (EPL slave)
MN	Managing node (EPL master) The <i>Managing Node</i> accepts the control function for the data communication of the decentralised field devices. Typically, the <i>Managing Node</i> is the communication interface of a PLC.
Node ID	EPL node address

# About this documentation

## Notes used

---

### 1.4 Notes used

The following signal words and symbols are used in this documentation to indicate dangers and important information:

#### Safety instructions

Layout of the safety instructions:



#### Pictograph and signal word!

(characterise the type and severity of danger)

#### Note

(describes the danger and gives information about how to prevent dangerous situations)

Pictograph	Signal word	Meaning
	Danger!	<b>Danger of personal injury through dangerous electrical voltage</b> Reference to an imminent danger that may result in death or serious personal injury if the corresponding measures are not taken.
	Danger!	<b>Danger of personal injury through a general source of danger</b> Reference to an imminent danger that may result in death or serious personal injury if the corresponding measures are not taken.
	Stop!	<b>Danger of property damage</b> Reference to a possible danger that may result in property damage if the corresponding measures are not taken.

#### Application notes

Pictograph	Signal word	Meaning
	Note!	Important note to ensure trouble-free operation
	Tip!	Useful tip for easy handling
		Reference to another document

# Safety instructions

General safety and application notes

---

## 2 Safety instructions



### Note!

It is absolutely vital that the stated safety measures are implemented in order to prevent serious injury to persons and damage to material assets.

Always keep this documentation to hand in the vicinity of the product during operation.

### 2.1 General safety and application notes



### Danger!

If the following basic safety measures are disregarded, severe injuries to persons and damage to material assets may result.

- Lenze drive and automation components ...
  - must only be used as directed.
    - ▶ [Application as directed](#) (□ 12)
  - must never be commissioned if they display signs of damage.
  - must never be technically modified.
  - must never be commissioned if they are not fully mounted.
  - must never be operated without required covers.
  - during and after operation can have live, moving and rotating parts, depending on their degree of protection. Surfaces can be hot.
- The following applies to Lenze drive components ...
  - only use the accessories approved.
  - Only use original manufacturer spare parts.
- Observe all specifications contained in the enclosed documentation and related documentation.
  - This is the precondition for safe and trouble-free operation and for obtaining the product features specified.
    - ▶ [Product features](#) (□ 13)
  - The specifications, processes, and circuitry described in this document are for guidance only and must be adapted to your own specific application. Lenze does not take responsibility for the suitability of the process and circuit proposals.
- All works on and with Lenze drive and automation components must only be carried out by qualified personnel. According to IEC 60364 or CENELEC HD 384 these are persons who ...
  - are familiar with installing, mounting, commissioning, and operating the product.
  - who have the corresponding qualifications for their work.
  - who know and can apply all regulations for the prevention of accidents, directives, and laws applicable at the place of use.

# Safety instructions

Device and application-specific safety instructions

---

## 2.2 Device and application-specific safety instructions

- During operation, the communication module must be securely connected to the standard device.
- With external voltage supply, always use a separate power supply unit, safely separated to EN 61800-5-1 in every control cabinet (SELV/PELV).
- Only use cables corresponding to the given specifications.
  - ▶ [Ethernet cable specification](#) (☞ 32)



### Documentation for the standard device, control system, system/machine

All the other measures prescribed in this documentation must also be implemented. Observe the safety instructions and application notes contained in this manual.

## 2.3 Residual hazards

### Protection of persons

- If the Inverter Drives 8400 are operated on a phase-earthed mains with a rated mains voltage of  $\geq 400$  V, external measures need to be implemented in order to ensure protection against accidental contact.
  - ▶ [Protective insulation](#) (☞ 16)

### Device protection

- The communication module contains electronic components which may be damaged or destroyed by electrostatic discharge.
  - ▶ [Installation](#) (☞ 21)

# Product description

Application as directed

## 3 Product description

### 3.1 Application as directed

The communication module ...

- is an accessory module that can be used in conjunction with the following standard devices:

Product series	Type designation	From software version
Inverter Drives 8400 StateLine	E84AxSCxxxx	5.00
Inverter Drives 8400 HighLine	E84AxHCxxxx	5.00
Inverter Drives 8400 TopLine	E84AxTCxxxx	1.00

- is a device intended for use in industrial power systems.
- should only be used under the operating conditions prescribed in this documentation.
- can only be used in POWERLINK networks.

**Any other use shall be deemed inappropriate!**

### 3.2 Identification

Type designation and hardware and software version of the communication module are indicated on the nameplate:

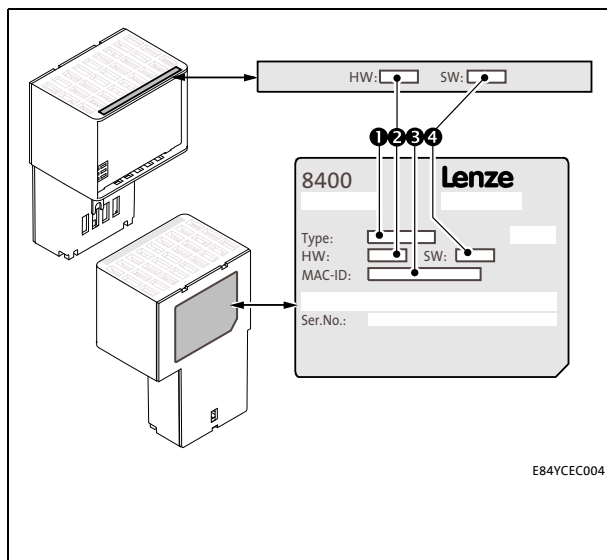

**1 Type designation (type)**  
E84 Product series  
A Version  
Y Module identification: Extension module  
C Module type: Communication module  
EC POWERLINK CN  
V/S V: Coated version  
S: Standard version

**2 Hardware version (HW)**

**3 MAC address (MAC-ID)**  
00-0A-86-xx-yy-zz:  
Hardware address of the communication module for unique identification in the network

**4 Software version (SW)**

E84YCEC004

[3-1] Identification data

# Product description

## Product features

---

### 3.3 Product features

- Interface module for the POWERLINK communication system, for attachment to the expansion slots of Inverter Drives 8400
- The communication module can either be supplied internally by the standard device or externally by a separate voltage source.
- Real-time Ethernet with the Ethernet POWERLINK V2 communication profile for motion and general applications
- A line topology can be implemented by means of the integrated 2-port hub.
- Supported functions:
  - POWERLINK CN
- Use of max. 6 PDO crosslinks for the managing node or the controlled node to create systems with "distributed intelligence"
- Very short CN response times for optimal network performance
- Parallel Ethernet communication between the Lenze »Engineer« and the Inverter Drive 8400 if an EPL router is used.
- Access to all Lenze parameters



# Product description

## Connections and interfaces

### 3.4 Connections and interfaces

- 2 RJ45 sockets for the POWERLINK connection
- 2-pole plug connector for the external voltage supply of the communication module.
- 2 rotary coding switches for setting the node address (node ID)
- Front LEDs for diagnosing the ...
  - voltage supply of the communication module;
  - connection to the standard device;
  - POWERLINK connection;
  - POWERLINK activity.

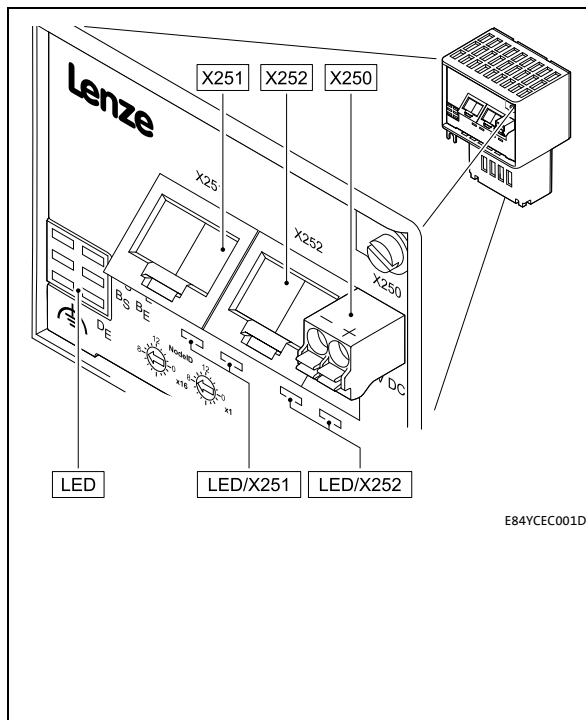

**X250** External voltage supply of the communication module

- 2-pin plug connector with spring connection

▶ [External voltage supply](#) (📖 34)

**X251** POWERLINK port 1

**X252** POWERLINK port 2

- RJ45 sockets according to IEC/EN 60603-7
- each with 2 LED status displays for diagnostics

▶ [POWERLINK connection](#) (📖 30)

▶ [Status displays at the RJ45 sockets \(X251, X252\)](#) (📖 55)

**x1** Rotary coding switch for setting the node

**x16** address (node ID)

▶ [Node address setting](#) (📖 37)

**MS** 5 LED status displays for diagnostics

**ME** ▶ [Module status displays](#) (📖 53)

**BS** ▶ [Fieldbus status displays](#) (📖 54)

**BE**

**EN**

[3-2] E84AYCEC communication module (POWERLINK)

# Technical data

## General data and operating conditions

---

### 4 Technical data

#### 4.1 General data and operating conditions

Range	Values	
Order designation	E84AYCEC	
Communication profile	POWERLINK	
Communication medium	S/FTP (Screened Foiled Twisted Pair, ISO/IEC 11801 or EN 50173), CAT 5e	
Interface	RJ45: Standard Ethernet (in accordance with IEEE 802.3), 100Base-TX (Fast Ethernet)	
Network topology	Tree, star, and line	
Type of node	Controlled node	
Node addresses (node IDs)	1 ... 239	
Transmission mode	Half duplex	
Baud rate	100 Mbps	
Voltage supply	External supply via separate power supply unit • +: U = 24 V DC (20.4 V - 0 % ... 28.8 V + 0 %), I = 140 mA • -: reference potential for external voltage supply	
Conformities, approvals	CE	2004/108/EC, EMC Directive 2006/95/EC, Low-Voltage Directive
	EAC	Eurasian conformity TR CU: Technical Regulations of Customs Union
		TP TC 004/2011 (TR CU 004/2011) About the safety of low voltage equipment
		TP TC 020/2011 (TR CU 020/2011) Electromagnetic compatibility of technical means
UL	UL 508C / C22.2 No. 14, Power Conversion Equipment (File-No. E132659)	



#### Hardware manual for Inverter Drives 8400

Here you can find the **ambient conditions** and data on the **electromagnetic compatibility (EMC)**, which also apply to the communication module.

### 4.2 Protective insulation



#### **Danger!**

##### **Dangerous voltage**

If the Inverter Drives 8400 are operated on a phase-earthed mains with a rated mains voltage of  $\geq 400$  V, external measures need to be implemented in order to ensure protection against accidental contact.

##### **Possible consequences:**

- Death or severe injuries

##### **Protective measures:**

- If protection against accidental contact is required for the control terminals of the inverter and the connections of the device modules plugged, ...
  - a double isolating distance must exist.
  - the components to be connected must be provided with the second isolating distance.



#### **Note!**

The existing protective insulation in the Inverter Drives 8400 is implemented according to EN 61800-5-1.

# Technical data

## Protective insulation

The following illustration ...

- shows the arrangement of the terminal strips and the separate potential areas of the Inverter Drive 8400.
- serves to determine the decisive protective insulation between two terminals located in differently insulated separate potential areas.

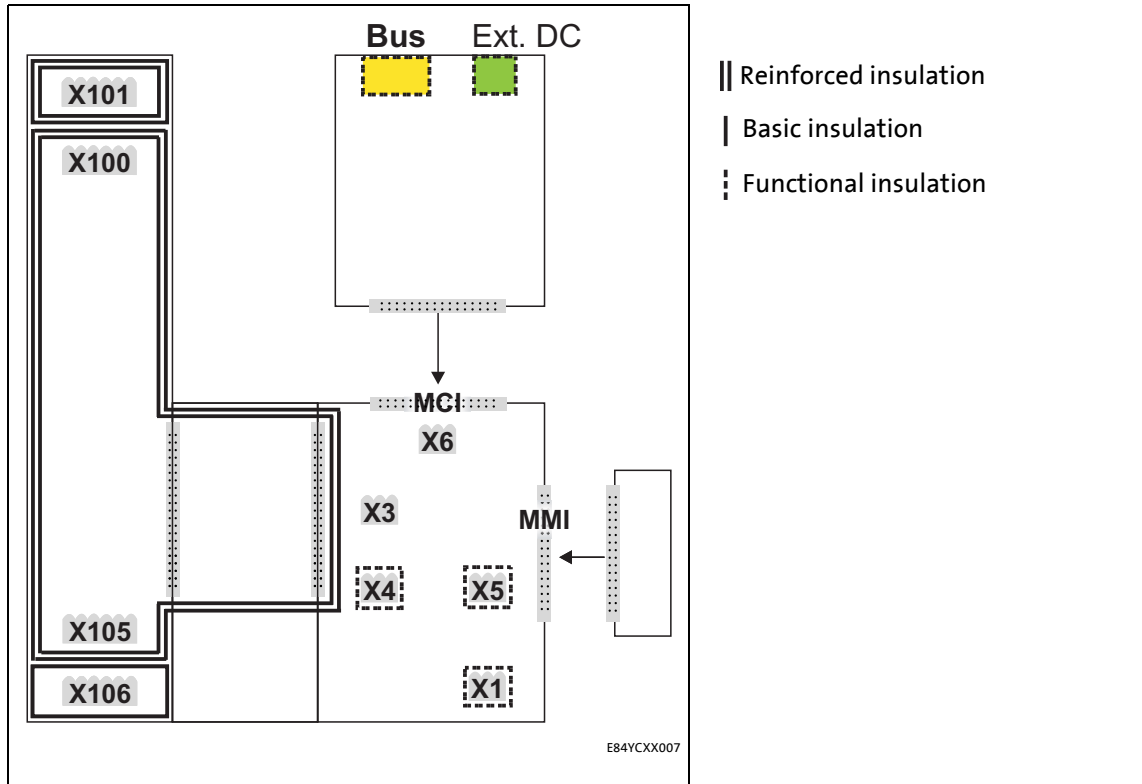

[4-1] Protective insulation in accordance with EN61800-5-1

Terminal strip	Connection
X100	Mains/DC-bus connection
X101	Relay contact
X105	Motor/brake resistor
X106	Motor PTC
X1	System bus (CANopen)
X3	Analog inputs/outputs
X4	Digital outputs
X5	Digital inputs
X6	Diagnostics
MCI	Slot for the communication module
MMI	Slot for the memory module

### Example

Which type of protective insulation is used between the bus terminal of the device module in slot MCI and the X100 mains terminal?

- The separate potential area with the better protective insulation is decisive.
  - The separate potential area of the bus terminal of the device module has a "functional insulation".
  - The separate potential area of the mains terminal has a "reinforced insulation".
- Result: The insulation between the X100 mains terminal and the bus terminal is a "reinforced insulation".

# Technical data

## POWERLINK communication data

### 4.3 POWERLINK communication data

Range	Values
Min. cycle time	400 $\mu$ s
Total cycle times	0.4 / 0.5 / 1.0 / 2.0 / 3.0 ... 20.0 ms
Buffer size	<ul style="list-style-type: none"><li>• Tx-iso: max. 1490 bytes</li><li>• Rx-iso: max. 1490 bytes</li></ul> (max. 32 bytes of PDO user data)
Delay time	<ul style="list-style-type: none"><li>• Controlled node (<math>T_{Preq} - T_{Res}</math>): approx. 2.6 <math>\mu</math>s</li><li>• Controlled node (<math>T_{SoA} - T_{ASnd}</math>): approx. 2.6 <math>\mu</math>s</li></ul>
Frame size	Max. asynchronous telegram size (MTU): 1490 bytes
SDO communication method	UDP/IP or ASND
Number of RPDOs	Max. 6 channels
RPDO user data per application (all RPDOs)	Max. 16 objects (max. 32 bytes)
Number of TPDOs	1 channel (data access of all nodes by broadcasting)
TPDO user data per application	Max. 16 objects (32 bytes)
CN operating modes	Support of ... <ul style="list-style-type: none"><li>• Multiplex CNs</li><li>• Optional CNs</li></ul>

#### Communication time

The communication time is the time between the start of a request and the arrival of the corresponding response.

The communication times in an POWERLINK network depend on the ...

- processing time in the inverter;
- frame runtime (baud rate / frame length);
- the nesting depth of the network.

#### Processing time inside the inverter

Data	Processing time
Process data	Approx. 2 ms + 0 ... 1 ms + 1 ... x ms Update cycle Processing time in the module Runtime of the application task of the technology application used (tolerance)
Parameter data	Approx. 30 ms + a tolerance of 20 ms (typically) <ul style="list-style-type: none"><li>• For some codes, the processing time may be longer (see software manual/»Engineer« online help for the Inverter Drive 8400).</li></ul>

There are no interdependencies between parameter data and process data.

# Technical data

## Dimensions

### 4.4 Dimensions

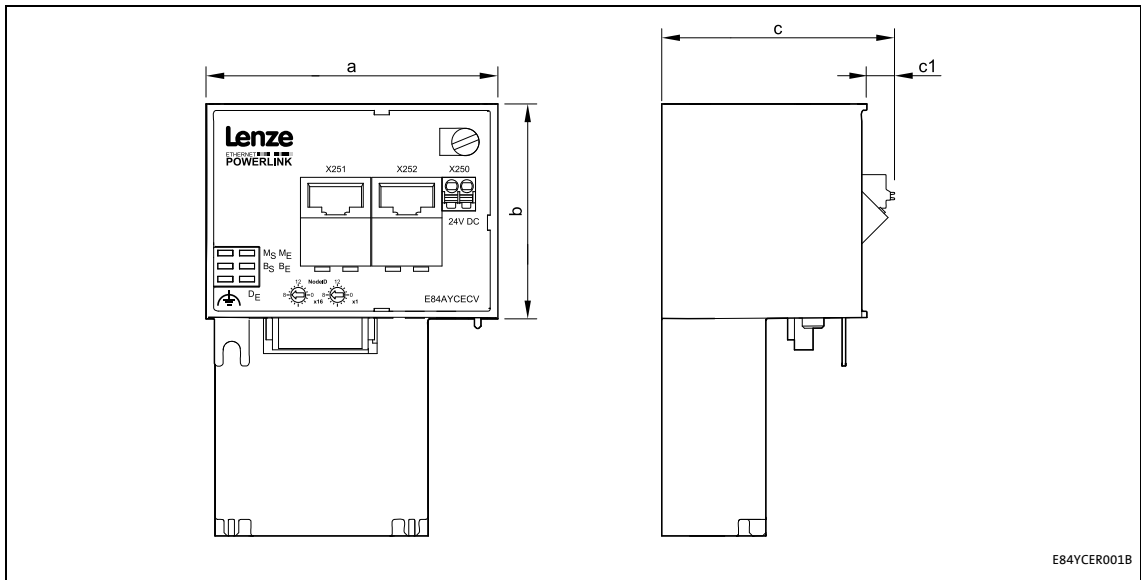

[4-2] Dimensions

Type	Dimensions [mm]			
	a	b	c	c1
E84AYCEC	67	50	57	8

## 5 Installation



### **Stop!**

#### **Electrostatic discharge**

Electronic components within the communication module can be damaged or destroyed by electrostatic discharge.

#### **Possible consequences:**

- The communication module is defective.
- Fieldbus communication is not possible or faulty.

#### **Protective measures**

- Before touching the module, be sure that you are free of electrostatic charge.



# Installation

## Mechanical installation

---

### 5.1 Mechanical installation

The communication module can be plugged in or unplugged from the MCI slot when the inverter is switched on. When the module is plugged in, it is detected automatically, and a function and version plausibility check is executed.

#### 5.1.1 Mounting for standard devices of 0.25 kW and 0.37 kW

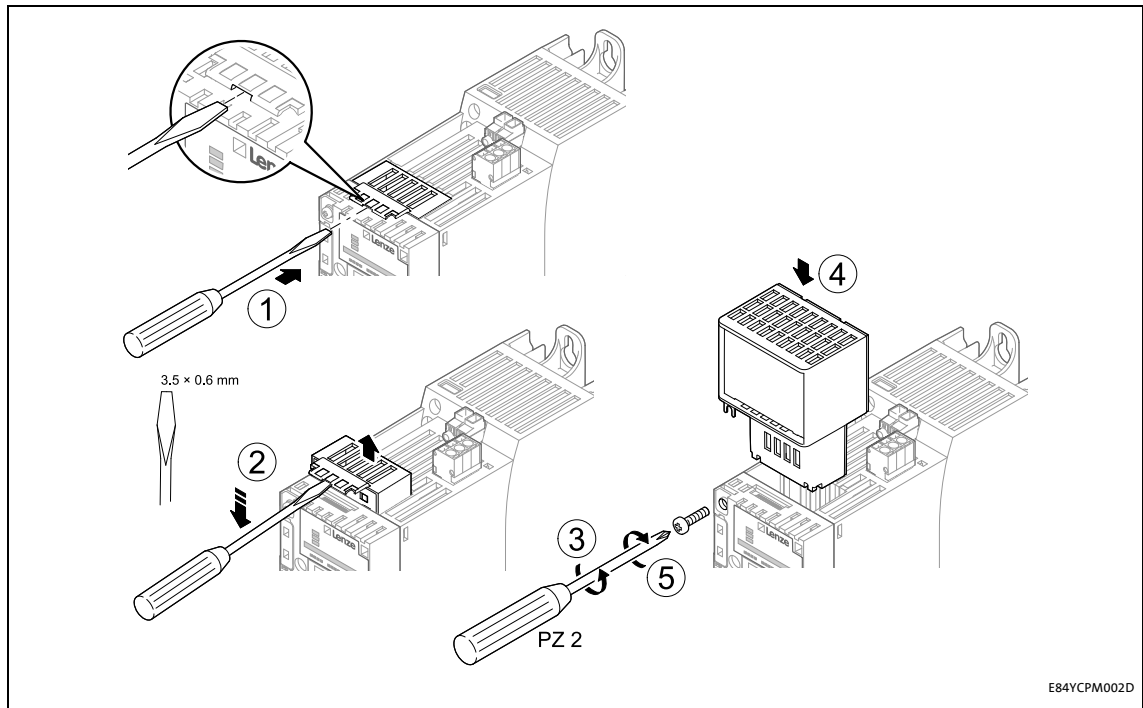

[5-1] Mounting for standard devices of 0.25 kW and 0.37 kW

#### Mounting steps

1. Use a screwdriver to lever out the cover of the MCI slot of the standard device and remove it (1, 2).
2. Loosen the securing screw for the communication module at the standard device (3).
3. Insert the communication module into the MCI slot of the standard device (4).
4. Tighten the securing screw again (5).

# Installation

## Mechanical installation

### 5.1.2 Mounting for standard devices of 0.55 kW or more

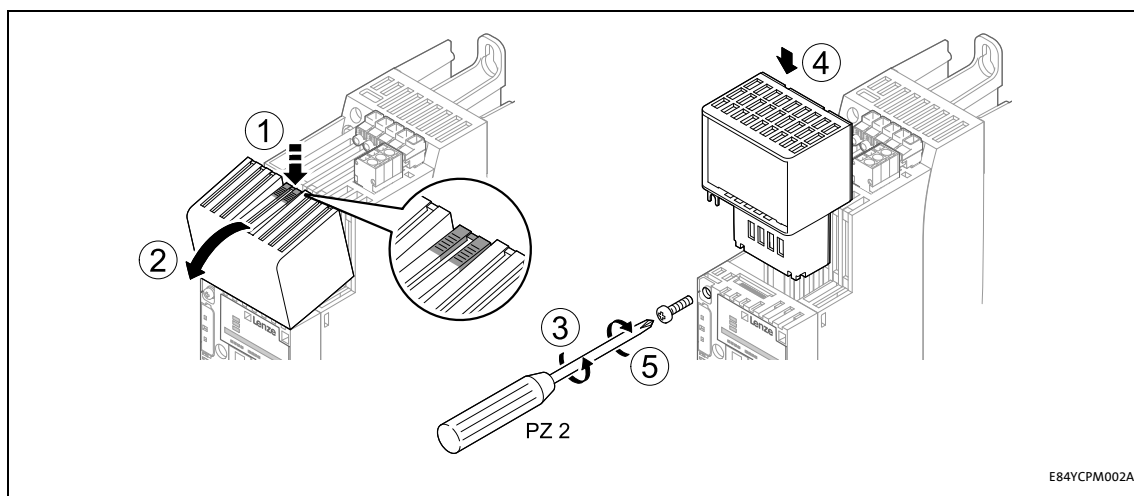

[5-2] Mounting for standard devices of 0.55 kW or more

#### Mounting steps

1. Slightly press on the marked spot on the top of the MCI slot cover of the standard device (1).
2. Tilt the cover forward and remove it from the standard device (2).
3. Loosen the securing screw for the communication module at the standard device (3).
4. Insert the communication module into the MCI slot of the standard device (4).
5. Tighten the securing screw again (5).

# Installation

## Mechanical installation

### 5.1.3 Exchanging the communication module

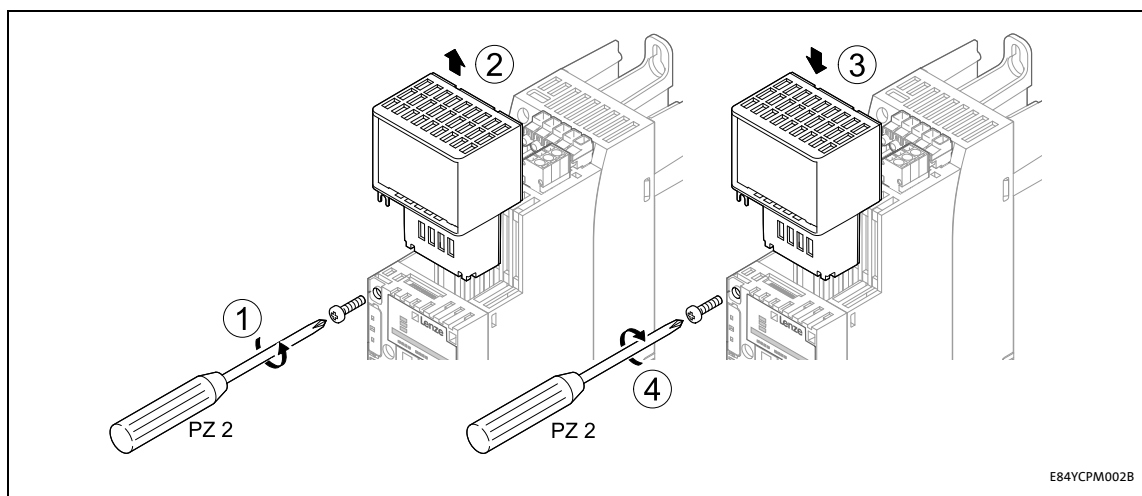

[5-3] Exchanging the communication module

#### Mounting steps

1. Loosen the securing screw for the communication module at the standard device (1).
2. Pull the communication module out of the MCI slot of the standard device (2).
3. Insert the new communication module into the MCI slot of the standard device (3).
4. Tighten the securing screw again (4).

# Installation

## Electrical installation

---

### 5.2 Electrical installation



#### **Documentation for the standard device, control system, system/machine**

Observe the notes and wiring instructions contained in this documentation.

#### 5.2.1 Wiring according to EMC guidelines

In typical systems, standard shielding is sufficient for Ethernet cables.

However, in environments with a very high level of interference, EMC resistance can be improved by additionally earthing the cable shield on both sides.

For this observe the following notes:

1. Remove the plastic sheath of the cable at a length of 2 cm.
2. Fasten the cable shield to the shield support of the standard device.

# Installation

Electrical installation

## 5.2.2 Network topology

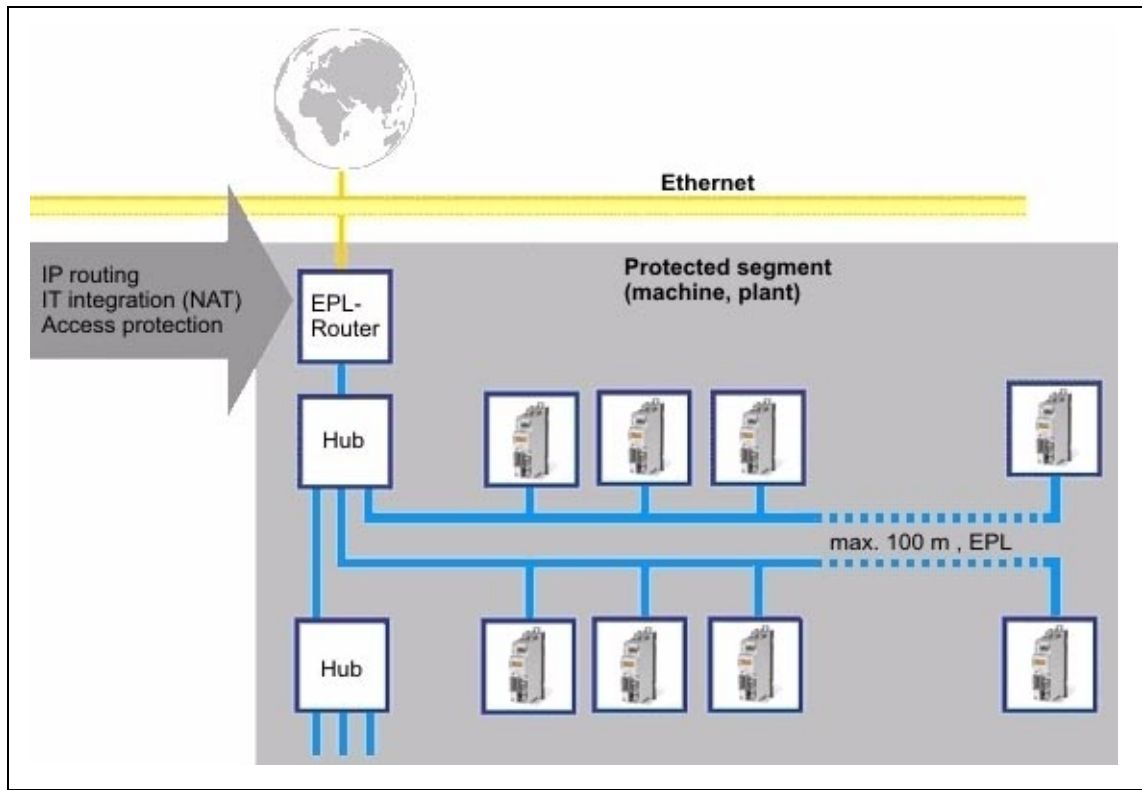

[5-4] Network topology for POWERLINK



### Note!

The use of class I hubs and switches inside the EPL network segment is not permitted.

Inside the segment only Ethernet hubs may be used as infrastructure elements. The hubs must meet the requirements on class II repeaters acc. to IEEE 802.3u.

For this purpose Lenze offers the dual hub integrated into the communication module and the separate eight-fold hub, type E94AZCEH.

Class I hubs and switches are not permissible since they have considerably longer delay times for the frame forwarding and a bigger jitter. Both sizes reduce the real-time capability and dynamics.

The cable length between both nodes is limited to 100 m.

The topology rules (IEEE 802.3u) required for controlling the collisions may be violated in the EPL network segment since according to the EPL access order frame collisions are prevented. This enables a structure of lines and any hybrid forms between star and line topology.

### Recommended topology

For an easy configuration and due to many possible topology variants we recommend to create networks according to the following rules:

1. Create CN groups with up to 10 nodes.
2. Connect CN groups in star shape to the managing node.

# Installation

## Electrical installation

---

3. Connect CN groups to the managing node via one external hub each.
  - For more than 2 CN groups, use an external 8-port hub (e.g. Lenze hub E94AZCEH).
  - For max. 7 CN groups one hub is sufficient.
  - For more than 7 CN groups, use further hubs.
  - The groups can be distributed on the hubs just as you like.
  - Observe the restrictions of the used managing node.



### Note!

#### E94AYCEP communication module als Managing Node

With maximally 2 CN groups and the use of an E94AYCEP communication module as *Managing Node*, connect the CN group(s) directly to the POWERLINK terminals X211 and X212 of the E94AYCEP communication module.

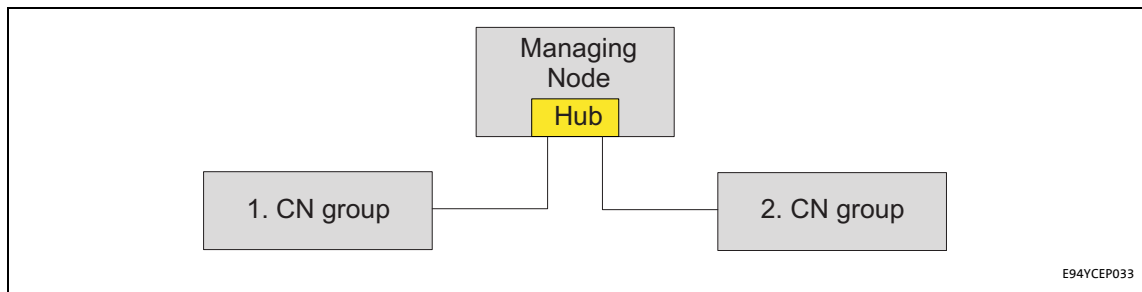

[5-5] Star topology for 1 to 2 CN groups

### 5.2.3 Ethernet POWERLINK



#### Note!

Standard Ethernet nodes are not permitted in the POWERLINK network segment.

In order to use the real-time capability of the POWERLINK technology, POWERLINK nodes must be interconnected in a separate network segment.

In accordance with the EPL rules, only the managing node controls the network access of EPL nodes. The managing node is the only node that transmits autonomously. The slave nodes (i.e. all controlled nodes) only transmit when they are entitled to transmit by the managing node.

Non-EPL nodes (e.g. PCs) typically violate these rules by sending frames independently of the managing node. These frames interfere with the cyclic frame exchange of the EPL nodes and impede the real-time capability of POWERLINK.

#### Connection to the standard Ethernet network

The connection to an external standard Ethernet network is carried out via an POWERLINK router or an POWERLINK gateway.

These infrastructure components separate the network traffic in the POWERLINK network segment from the one in the standard Ethernet. The handling of the frames depend on their direction:

- Standard Ethernet ---> EPL network segment:  
Only frames that are addressed to nodes in the EPL network segment are forwarded. The forwarding takes place in the asynchronous area of the EPL cycle.
- EPL network segment ---> standard Ethernet:  
Only asynchronous frames that are not addressed to nodes in the EPL network segment are forwarded.



#### Tip!

Detailed information on the function and setting of the router or gateway can be found in the documentation of the component manufacturer.

### 5.2.4 Basic Ethernet Mode



#### Note!

Operation in the "Basic Ethernet Mode" does not permit any real-time communication.

The communication module can be operated in the "Basic Ethernet Mode" for a basic parameter setting provided that the following applies:

1. Operation of the module with network address  $\leq 239$ .
  - IP address: 192.168.100.[EPL address]
  - see [Node address setting](#) (37)
2. No operation with real-time EPL must be carried out.
3. No integration of a managing node (EPL address = 240) into the standard Ethernet network.



# Installation

## Electrical installation

### 5.2.5 POWERLINK connection

POWERLINK is connected via the RJ45 sockets **X251 (P1)** and **X252 (P2)**.

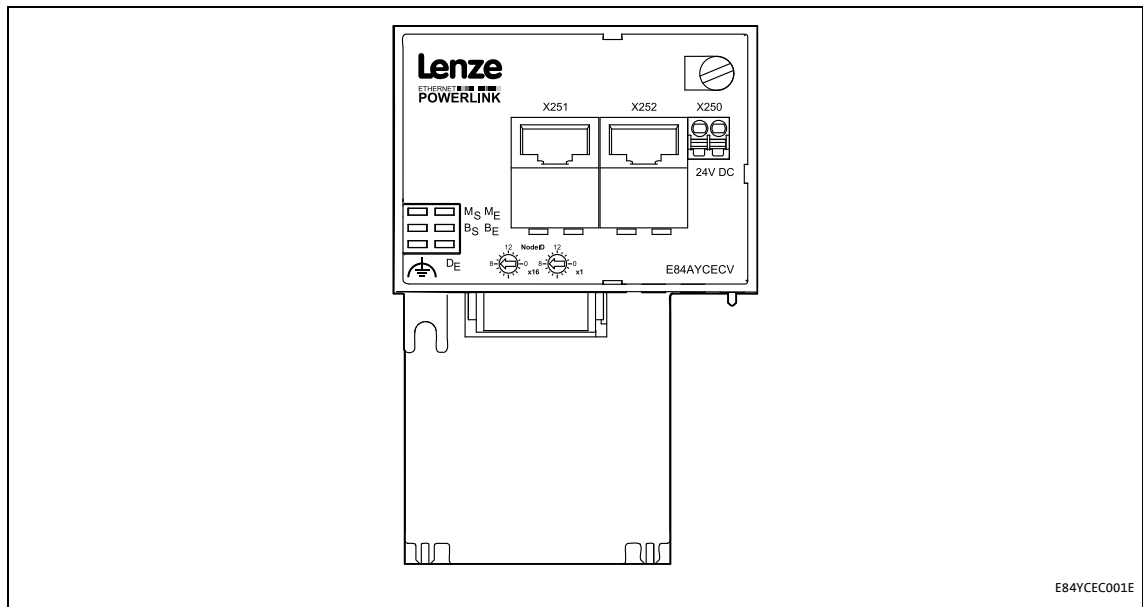

[5-6] POWERLINK connections X251 (P1) and X252 (P2)

- If possible, do not wire more than 10 nodes in a row in a network line.
- In case of more than 10 nodes you should deactivate the automatic calculation of the hub level in the »Engineer« and enter it manually to increase the performance.
- With a cycle time of 1 ms, 25 nodes can be operated.
  - The number of nodes can be increased if the EPL cycle time is increased as well.
- You can use a standard Ethernet patch cable to connect the communication module to the POWERLINK fieldbus (see [Ethernet cable specification](#) (□ 32)).
- The installation and removal of the Ethernet cables is optimised for the use of connectors in accordance with the "Automation Initiative of German Domestic Automobile Manufacturers" (AIDA).



#### Note!

To prevent the RJ45 socket from being damaged, insert or remove the Ethernet cable connector straight (at a right angle) into or from the socket.

# Installation

## Electrical installation

---

### Pin assignment of the RJ45 sockets

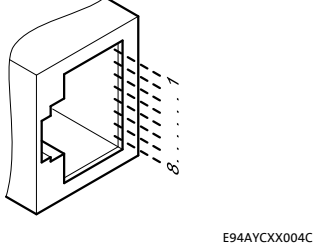
RJ45 socket	Pin	Signal
 E94AYCXX004C	1	Tx +
	2	Tx -
	3	Rx +
	4	-
	5	-
	6	Rx -
	7	-
	8	-



#### Tip!

The POWERLINK interfaces feature an auto-MDIX function. This function adjusts the polarity of the RJ45 interfaces so that a connection can be established irrespective of the polarity of the opposite POWERLINK interface and irrespective of the type of cable used (standard patch cable or crossover cable).

# Installation

## Electrical installation

### 5.2.6 Ethernet cable specification



#### Note!

Only use cables that meet the listed specifications.

Ethernet cable specification	
Ethernet standard	Standard Ethernet (in accordance with IEEE 802.3), 100Base-TX (Fast Ethernet)
Cable type	S/FTP (Screened Foiled Twisted Pair, ISO/IEC 11801 or EN 50173), CAT 5e
Damping	23.2 dB (for 100 MHz and 100 m each)
Crosstalk damping	24 dB (at 100 MHz and per 100 m)
Return loss	10 dB (per 100 m)
Surge impedance	100 $\Omega$

#### Structure of the Ethernet cable

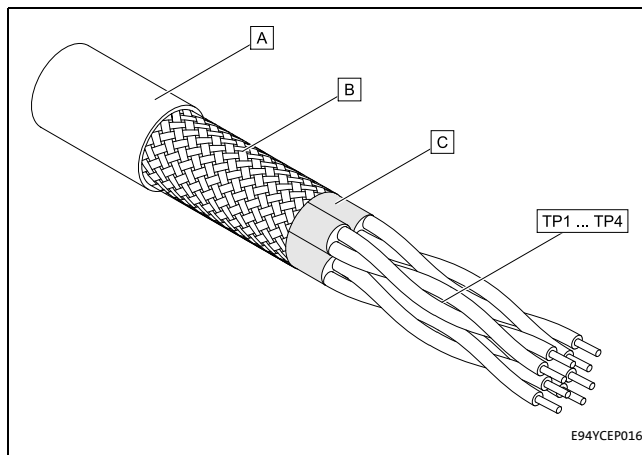

**A** Cable insulation

**B** Braid

**C** Foil shielding

**TP1** Twisted core pairs 1 ... 4

... [▶ Colour code of the Ethernet cable](#)

**TP4** [\(33\)](#)

[5-7] Structure of the Ethernet cable (S/FTP, CAT 5e)

# Installation

## Electrical installation

### Colour code of the Ethernet cable



#### Note!

Wiring and colour code are standardised in EIA/TIA 568A/568B.

In accordance with the industrial standard, the use of 4-pin Ethernet cables is permissible. The cable type only connects the assigned pins 1, 2, 3 and 6 to one another.

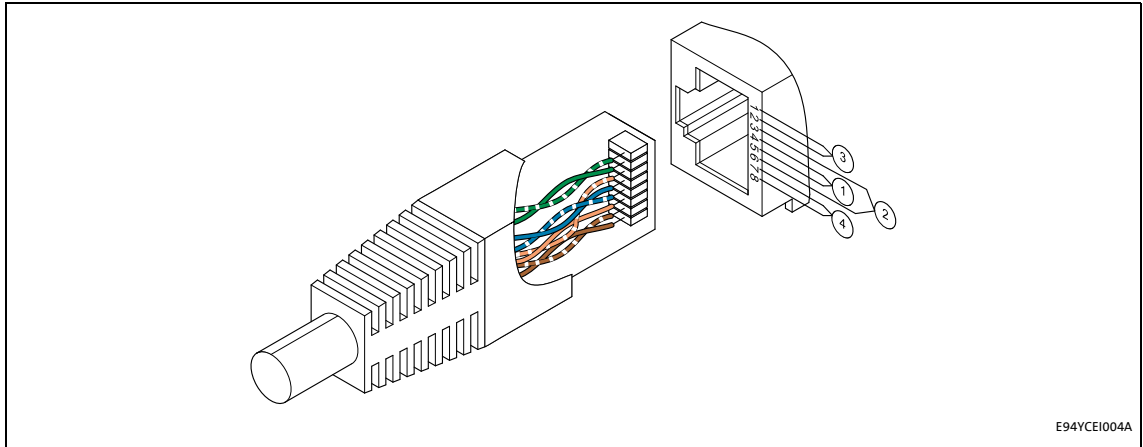

E94YCEI004A

[5-8] Ethernet plug in accordance with EIA/TIA 568A/568B

Pair	Pin	Signal	EIA/TIA 568A	EIA/TIA 568B
3	1	Tx +	White / Green	White / Orange
	2	Tx -	green	orange
2	3	Rx +	White / Orange	White / Green
1	4		blue	blue
	5		White / Blue	Blue / White
2	6	Rx -	orange	green
4	7		White / Brown	White / Brown
	8		brown	brown

# Installation

## Electrical installation

### 5.2.7 External voltage supply

The communication module can be externally supplied with voltage via separate supply cables at the 2-pin plug connector X250.



#### Note!

Always use a separate power supply unit safely separated according to EN 61800-5-1 ("SELV/PELV") in every control cabinet for external voltage supply.

- External voltage supply of the communication module is required if the communication via the bus should be maintained when the supply of the standard device fails.
- Access to parameters of a standard device disconnected from the mains is not possible.

#### Wiring of the X250 plug connector



#### Stop!

Only wire the plug connector if the standard device is disconnected from the mains.

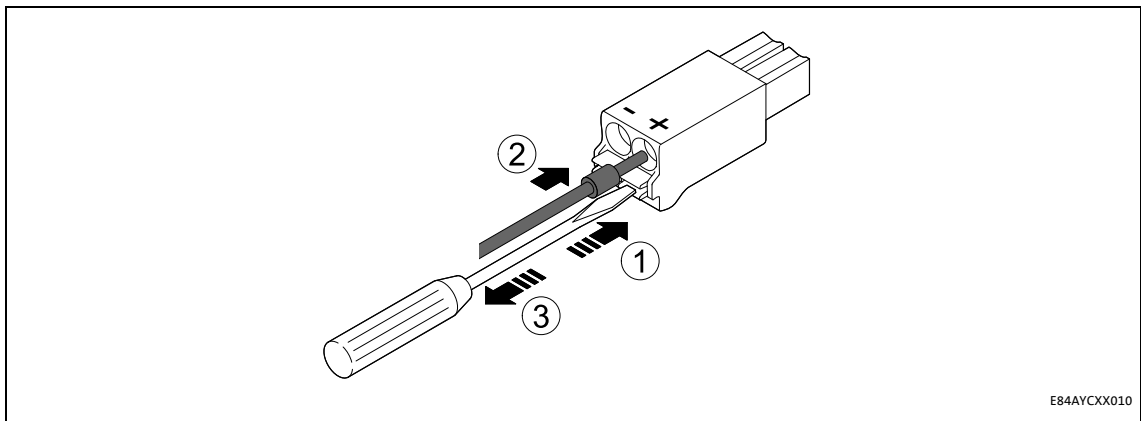

[5-9] Wiring of the 2-pin plug connector with spring connection

How to wire the plug connector with spring connection:

1. Press a screwdriver into the notch below the terminal and keep it pressed.
2. Place the supply cable in the terminal.
3. Remove the screwdriver from the notch.

#### Assignment of the X250 plug connector

Name	Description
+	U = 24 V DC (20.4 V - 0 % ... 28.8 V + 0 %) I = 140 mA
-	Reference potential for the external voltage supply

# Installation

## Electrical installation

### Terminal data

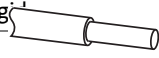
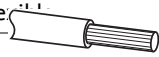
Range	Values
Electrical connection	2-pin plug connector with spring connection
Possible connections	Right 
	0.2 ... 1.5 mm <sup>2</sup> (AWG 24 ... 16)
	Flexible 
	Without wire end ferrule 0.2 ... 1.5 mm <sup>2</sup> (AWG 24 ... 16)
	With wire end ferrule, without plastic sleeve 0.2 ... 1.5 mm <sup>2</sup> (AWG 24 ... 16)
With wire end ferrule, with plastic sleeve 0.2 ... 1.5 mm <sup>2</sup> (AWG 24 ... 16)	
Stripping length	10 mm

# Commissioning

Before initial switch-on

---

## 6 Commissioning

During commissioning, system-related data such as motor parameters, operating parameters, responses, and parameters for fieldbus communication are defined for the inverter. For Lenze devices, this is done via the codes.

The codes of the inverter and communication are saved non-volatilely as a data set in the memory module.

In addition, there are codes for diagnosing and monitoring the stations.

▶ [Parameter reference](#) (□ 65)

### 6.1 Before initial switch-on



#### Stop!

Before switching on the Inverter Drive 8400 and the communication module for the first time, check the entire wiring for completeness, short circuit and earth fault.

### 6.2 Node address setting



#### Note!

- Each network node address must only be used once.
- The node address setting in the configuration software (e.g. »Engineer«) and the rotary encoder switches must be identical for each node.
- Adjustable address range: 1 ... 239
- Switch the voltage supply of the communication module off and on again to activate changed settings.

The node address is set via the two front panel rotary coding switches "Node ID".

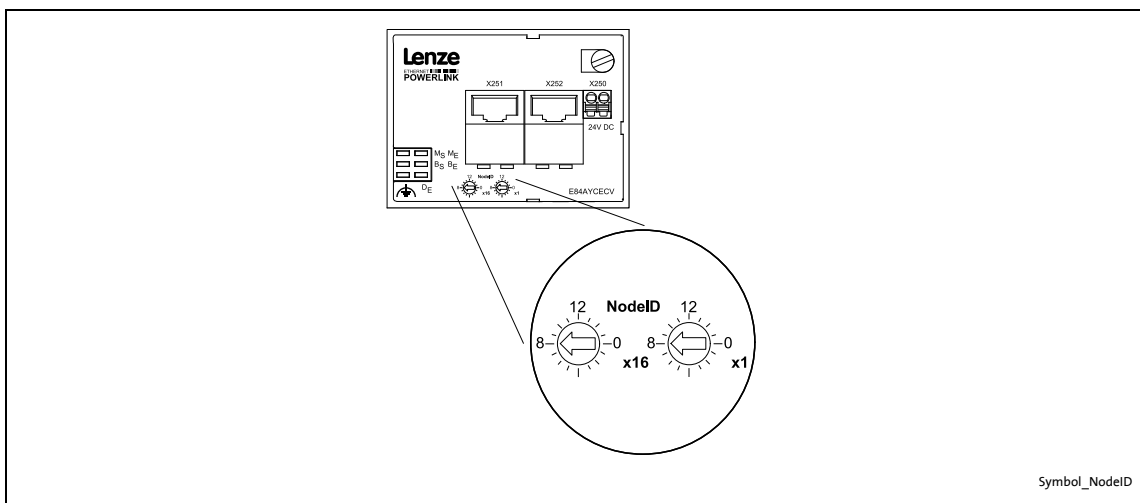

[6-1] Rotary coding switches "Node ID"

- The labelling of the rotary coding switches corresponds to the values for determining the node address.
- Valid addresses for the communication module in the EPL network:
  - 1 ... 100: Controlled node with Lenze module E94AYCEP as managing node
  - 1 ... 239: Controlled node with managing node of another manufacturer
- The corresponding Ethernet IP address of the communication module results from the address setting of the rotary coding switches:
  - IP address: 192.168.100.[EPL address]



# Commissioning

## Node address setting

### Possible settings of the rotary coding switches

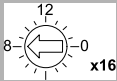
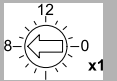
Position of the rotary coding switches				Resulting node address
				
0	× 16	0	× 1	Value from code <a href="#">C13899</a>
0 ... 14		1 ... 15		1 ... 239
15		0 ... 15		239

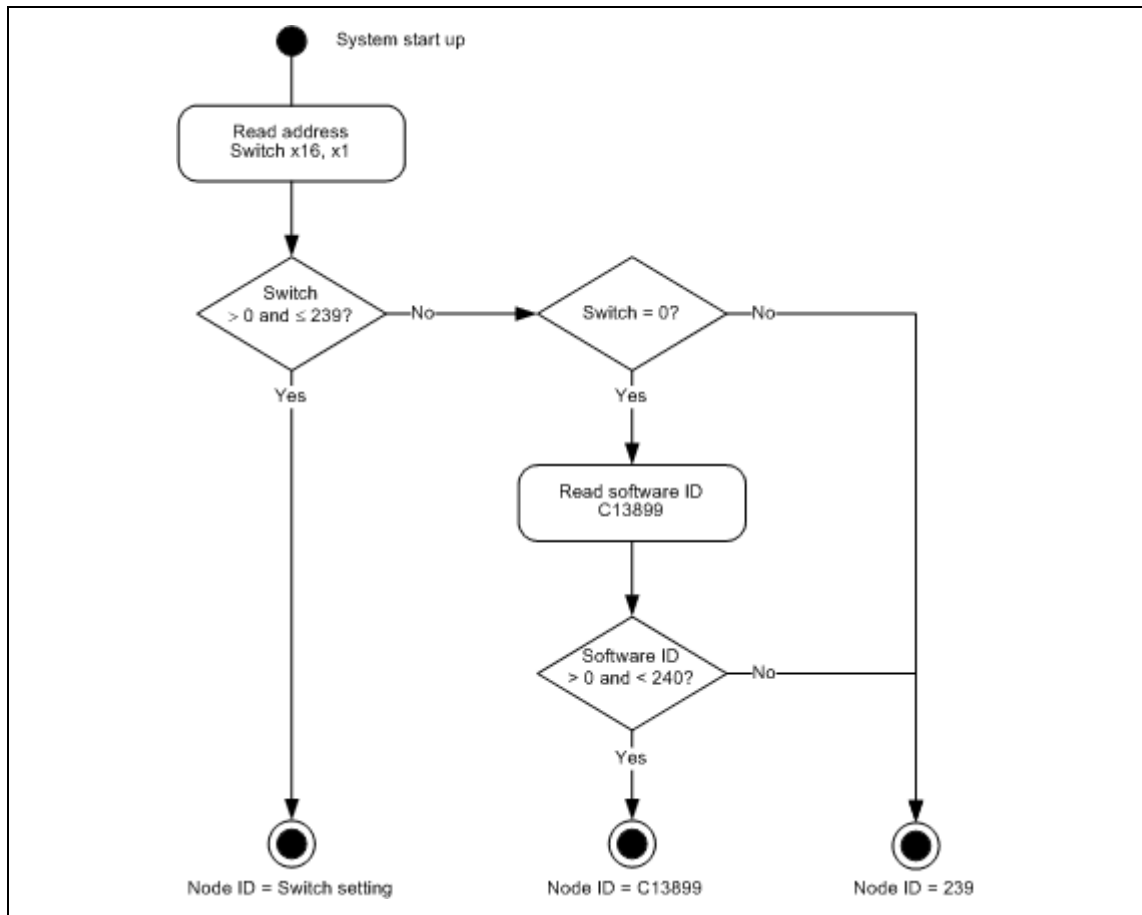

[6-2] Internal check of the rotary coding switch setting after the system start

### Example: Setting of the node address "52"

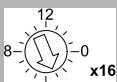
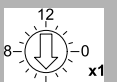
Position of the rotary coding switches				Resulting node address
				
3	× 16	4	× 1	$(3 \times 16) + (4 \times 1) = 52$

# Commissioning

Setting and displays in the »Engineer«

---

## 6.3 Setting and displays in the »Engineer«

The **1** IP address ([C13000](#)) and the **2** MAC address ([C13004](#)) are displayed on the **Settings** tab.

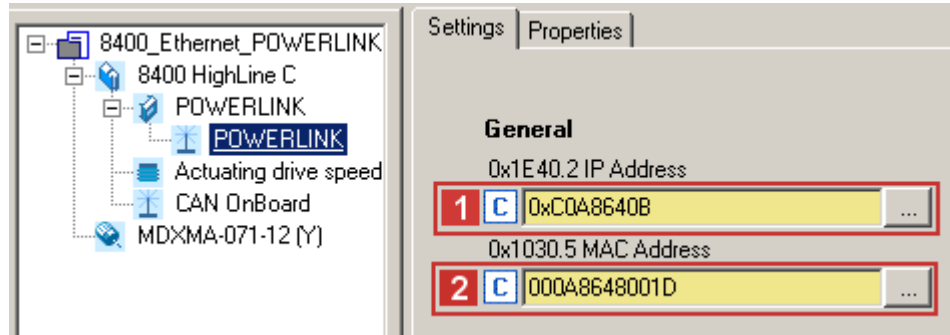

### 6.4 Initial switch-on



#### Documentation for the standard device

Observe the safety instructions and information on residual hazards.



#### Note!

##### Establishing communication

In order to establish communication via an externally supplied communication module, the standard device must be switched on as well.

For further communication of the externally supplied module it is not relevant whether the standard device is switched on or not.

##### Activating changed setting

Sequence for activating changed settings:

- Execute device command "11: Save all parameter sets" via standard device code **C00002**.
- Switch the voltage supply of the communication module off and on again.

##### Protection against uncontrolled restart

After a fault (e.g. short-term mains failure), it is sometimes undesirable or even impermissible for the drive to restart.

The restart protection is activated in the Lenze setting of the Inverter Drives 8400.

The restart behaviour of the inverter can be set via **C00142** ("auto-start option"):

- **C00142 = 9** (Lenze setting)
  - The inverter remains inhibited (even if the fault is no longer active).
  - Bit 0 (inhibit at power-on) and bit 3 (inhibit in the case of undervoltage) are set.
  - The drive restarts in a controlled mode through explicit controller enable: LOW-HIGH edge at digital input X4/RFR.
- **C00142 = 8** (Enabled)
  - In order to enable the device directly when switching it on, set bit 0 to zero (FALSE).
  - An uncontrolled restart of the drive is possible.

# Commissioning

## Initial switch-on



### Initial switch-on and diagnosing

1. Switch on the controller and check whether it is ready for operation using the diagnostic LEDs of the communication module.
  - Red diagnostic LEDs must not be on.
  - The following signalling should be visible:

LED	Colour	Status	Meaning
MS	green	On	Module Status
EN	-	Off	Device Error
X251	green	On	LED is lit if a connection to the node has been established.
X252	green	On	LED is lit if a connection to the node has been established.

2. If not already done, load the EPL configuration into the inverter.
3. Repeat steps 1 and 2 for all EPL nodes.
4. Start network.

The network starts automatically if you set the managing node **last**.

Otherwise there are two options:

- Switch off the network nodes and switch them on together or
  - execute a fault reset on the managing node (EPL address 240).
5. Check the EPL network again using the diagnostic LEDs of the communication module.

The following signalling should be visible:

LED	Colour	Status	Meaning
MS	green	On	Module Status
ME	-	Off	Module Error
BE	-	Off	Bus Error
EN	-	Off	Device Error
BS	green	On	Bus Status
X251	green	On	LED is lit if a connection to the node has been established.
X252	green	On	LED is lit if a connection to the node has been established.

### 6.5 Drive synchronisation

Examples of the use of drive synchronisation via POWERLINK:

- Implementation of the "electrical shaft"
- Specification of cyclic position information
- Exactly simultaneous data processing of several drives
- Optimisation of the processing times of cyclic process data (PDO).

#### Settings in the »Engineer«

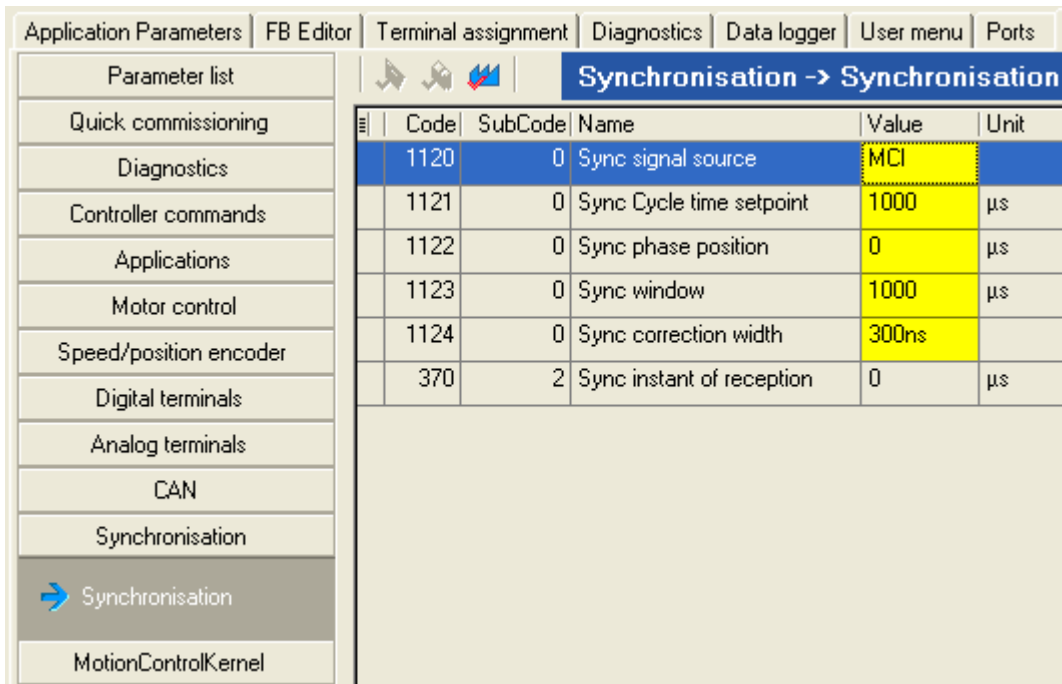

The screenshot shows the »Engineer« software interface with the Synchronisation settings. The left sidebar contains a tree view with the following items: Parameter list, Quick commissioning, Diagnostics, Controller commands, Applications, Motor control, Speed/position encoder, Digital terminals, Analog terminals, CAN, Synchronisation, Synchronisation (highlighted with a blue arrow), and MotionControlKernel. The main window displays a table titled "Synchronisation -> Synchronisation" with the following data:

Code	SubCode	Name	Value	Unit
1120	0	Sync signal source	MCI	
1121	0	Sync Cycle time setpoint	1000	µs
1122	0	Sync phase position	0	µs
1123	0	Sync window	1000	µs
1124	0	Sync correction width	300ns	
370	2	Sync instant of reception	0	µs

- Set "MCI" as synchronisation source in code **C01120** of the inverter.
- The cycle time setpoint **C01121** and the phase position **C01122** are automatically calculated from the communication module. Default settings of these parameters are ignored.
- It is not necessary to adjust the sync window **C01123** and the sync correction width **C01124**.



#### Software manual/»Engineer« online help for the Inverter Drive 8400

Here you can find detailed information on drive synchronisation and the corresponding parameters.

## 6.6 Optimisation of networks

### SDO bandwidth



#### Note!

The channel bandwidth should only be increased if the network is below capacity limit.

The SDO channel width ([C13075](#)) is the size of the asynchronous channel used for parameter setting and diagnostics. A higher value improves the transmission of large amounts of data (e.g. parameter downloads) and at the same time reduces the number of possible nodes.

#### Maximum time for device search

During the device search, the managing node has to wait until all controlled nodes have been found.

- Unless all controlled nodes are available in the defined EPL cycle time, the "EPL\_BOOTUP\_1" error message is generated. The managing node remains in this status.
- If the managing node has found all controlled nodes, it starts the network.

Due to machine or system-specific switch-on sequences, it may be required to adapt the following EPL objects:

- CN object **0x1F99**: NMT\_CNBasicEthernetTimeout\_U32 ([C13078](#))
- MN object **0x1F89**: NMT\_BootTime\_REC



#### Note!

In order to avoid a too quick change to the "[Basic Ethernet Mode](#)" ([82](#)), the value of the **0x1F99** object (NMT\_CNBasicEthernetTimeout\_U32) must be higher than the value of the **0x1F89** object (NMT\_BootTime\_REC) which is the case by default.

▶ [Index table](#) ([82](#))

## 7 Process data transfer

POWERLINK transmits process data, parameter data, configuration data and diagnostic data between the managing node and the controlled nodes. Depending on their time-critical behaviour, the data are transmitted via different communication channels.

- Process data are transmitted via the process data channel.
- Process data serve to control the Inverter Drive 8400.
- The transmission of process data is time-critical.
- Process data are cyclically transferred between the managing node and the controlled nodes (permanent exchange of current input and output data).
- The managing node can directly access the process data. In the PLC, for instance, the data are directly assigned to the I/O area.
- Up to 16 process data words (16 bit/word) can be exchanged per direction.
- Process data are not saved in the inverter.
- Process data are e.g. setpoints, actual values, control words, and status words.

# Process data transfer

Access to process data / PDO mapping

## 7.1 Access to process data / PDO mapping

Process data (MCI-PDOs) are transferred via the MCI interface.

- A maximum of 16 words are exchanged per direction.
- The process data are accessed via the port blocks **LP\_MciIn** and **LP\_MciOut**. These port blocks are also referred to as process data channels.
- The port block **LP\_MciIn** maps the received MCI-PDOs.
- The port block **LP\_MciOut** maps the MCI-PDOs to be sent.
- The port/function block interconnection for the process data objects (PDO) is carried out with the Lenze »Engineer«.

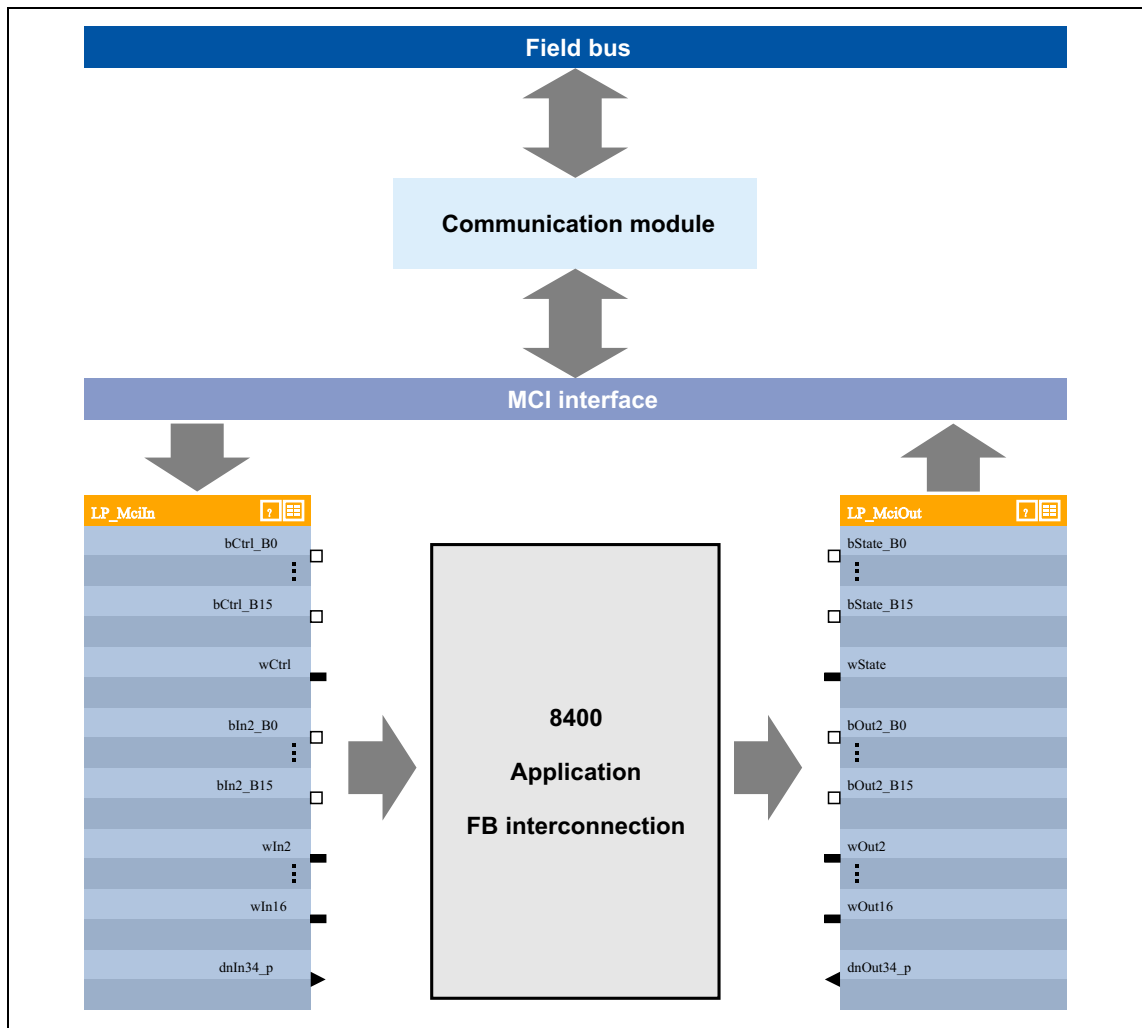

[7-1] External and internal data transfer between the bus system, inverter, and application



### Software manual / »Engineer« online help for the Inverter Drive 8400

Here you can find detailed information on the port/function block interconnection in the »Engineer« and on the port blocks.



# Process data transfer

Preconfigured port interconnection of the process data objects (PDO)



## Note!

The »Engineer« screenshots shown on the following pages are only examples of the setting sequence and the resulting displays.

The data in the display fields may differ from the ones of your project.

## 7.2 Preconfigured port interconnection of the process data objects (PDO)

The preconfigured port interconnection of the process data objects can be activated by setting standard device code **C00007 = "40: MCI"**.

The function block editor (FB Editor) serves to display the **LP\_MciIn** and **LP\_MciOut** port blocks with the preconfigured interconnections:

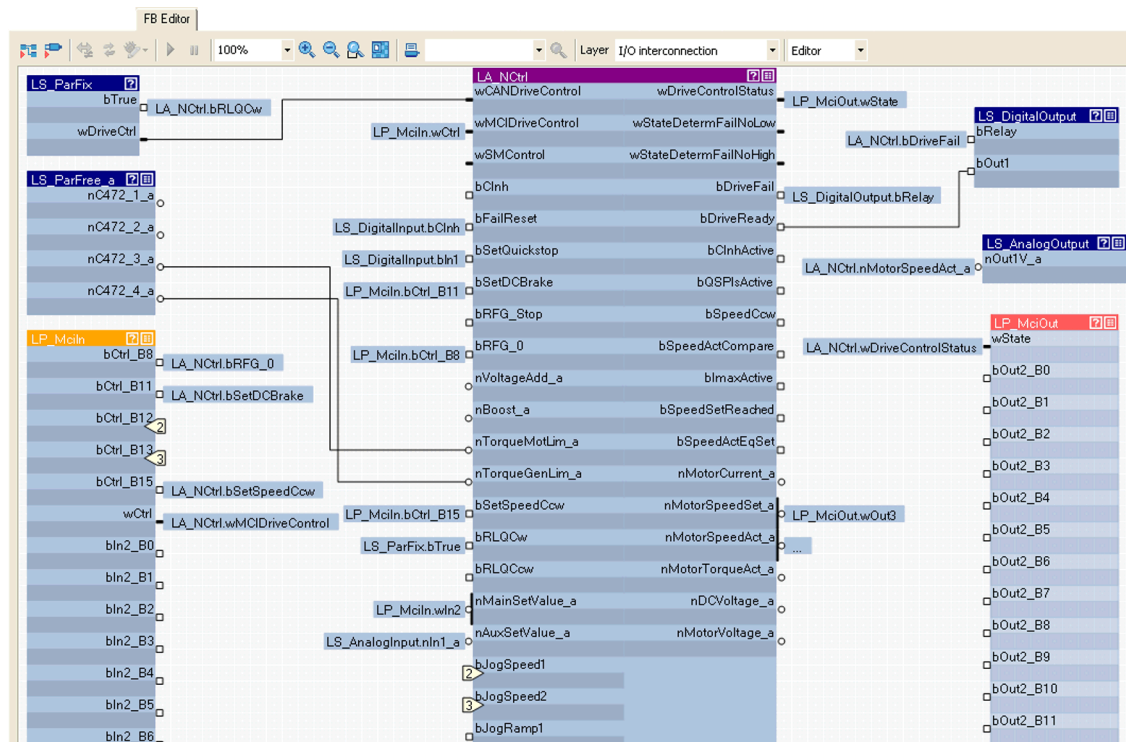

# Process data transfer

Freely configuring the port interconnection of the process data objects (PDO)

## 7.3 Freely configuring the port interconnection of the process data objects (PDO)



How to configure the port interconnection freely in the »Engineer«:

1. Go to the project view of the »Engineer« and select the application (A).
2. Select the port blocks **MCI\_IN** or **MCI\_OUT** on the **Ports** tab with a mouse-click and activate them with the **Activate** button (B).

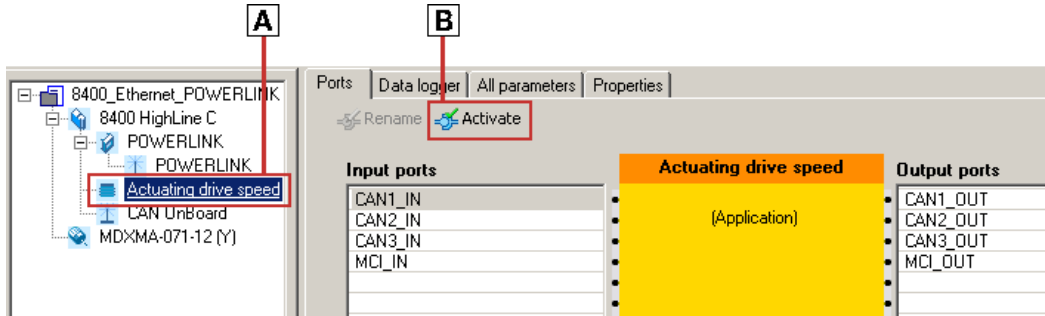

3. Click the **Change Variable ...** button.

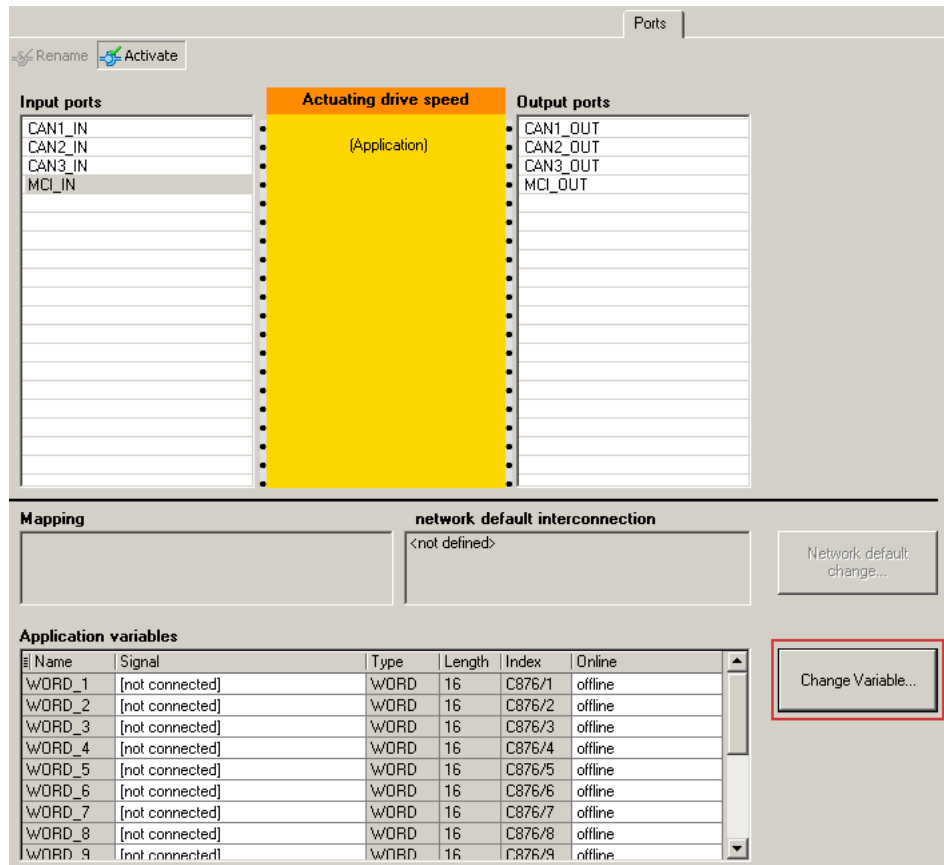

# Process data transfer

Freely configuring the port interconnection of the process data objects (PDO)

4. Via the  button, you can assign signals to the process data words in the *Assignment Signal --> Function Block* dialog window.  
→ Select the signals and then confirm the selection with **OK**.

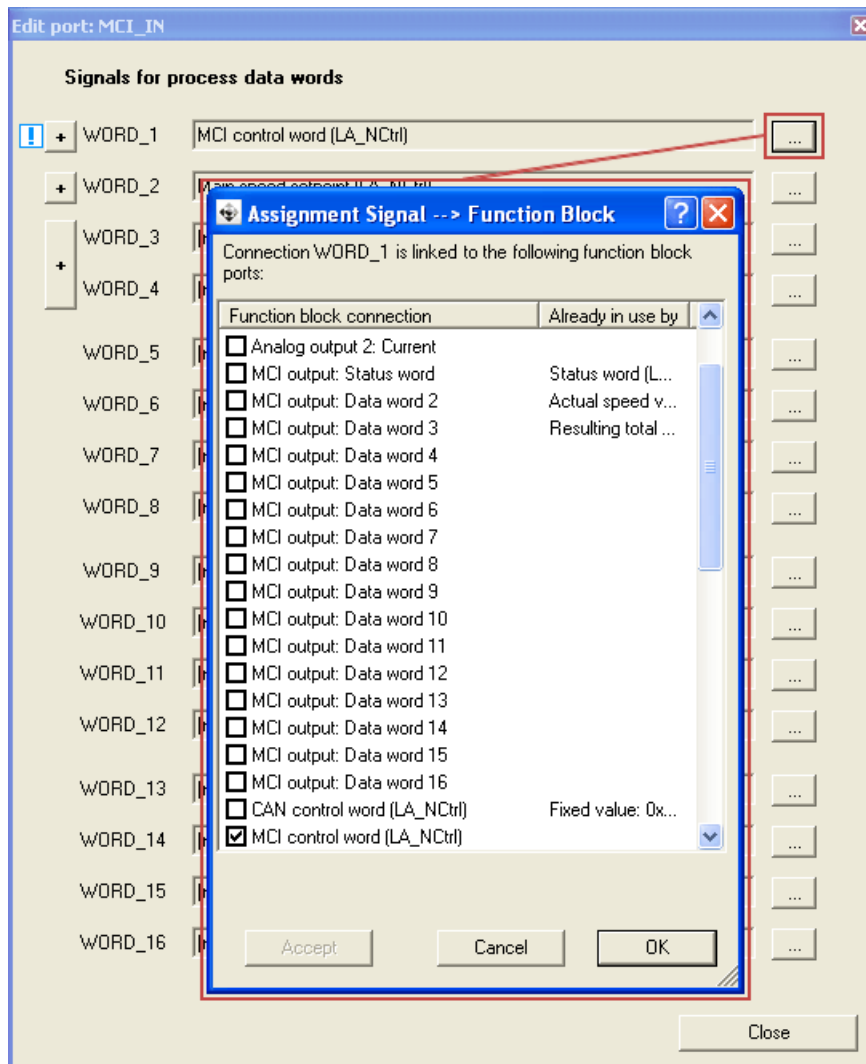

# Process data transfer

Freely configuring the port interconnection of the process data objects (PDO)

Furthermore you can assign signals to the individual control and status bits of the WORD\_1 ... WORD\_4 process data words via the **+** and **...** buttons.  
→ Select signals and confirm the selection by clicking the **OK** button.

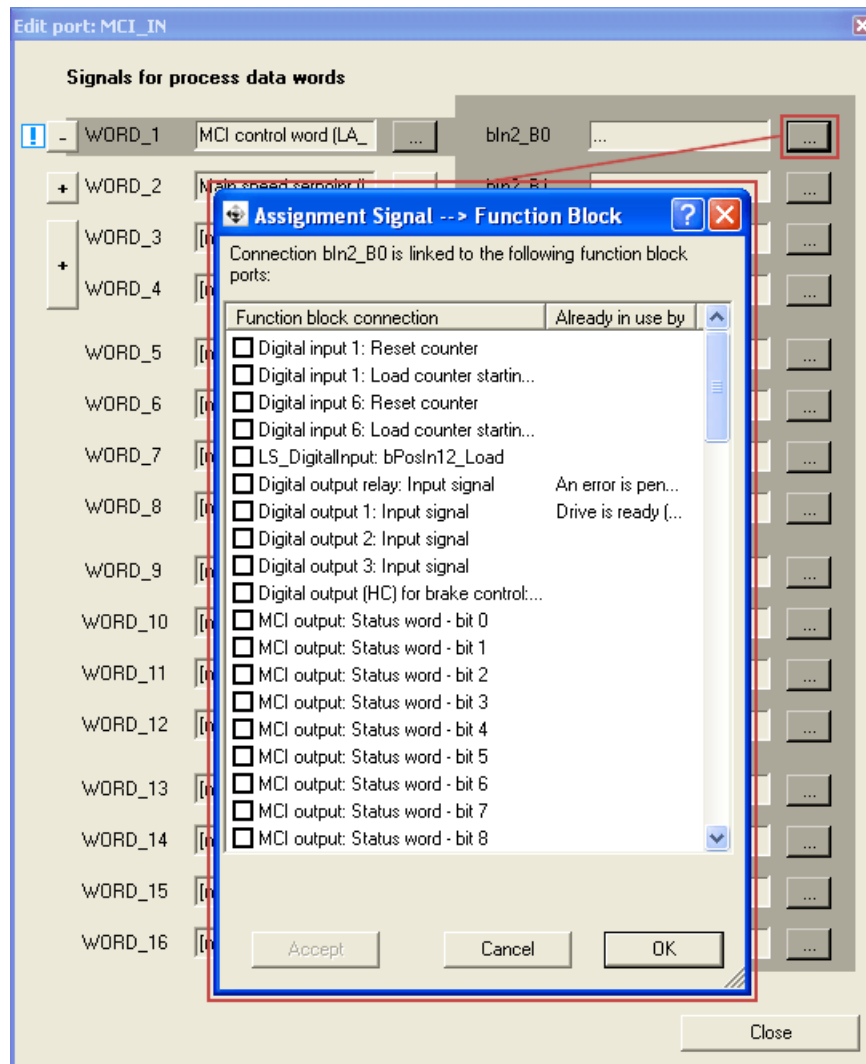

# Process data transfer

Freely configuring the port interconnection of the process data objects (PDO)



Tip!

When the **LP\_MciIn** and **LP\_MciOut** port blocks are activated (see 1.), they will be visible in the FB Editor. Here you can also assign signals to the process data words.

In order to improve the clarity, unassigned signals can be hidden for each block.

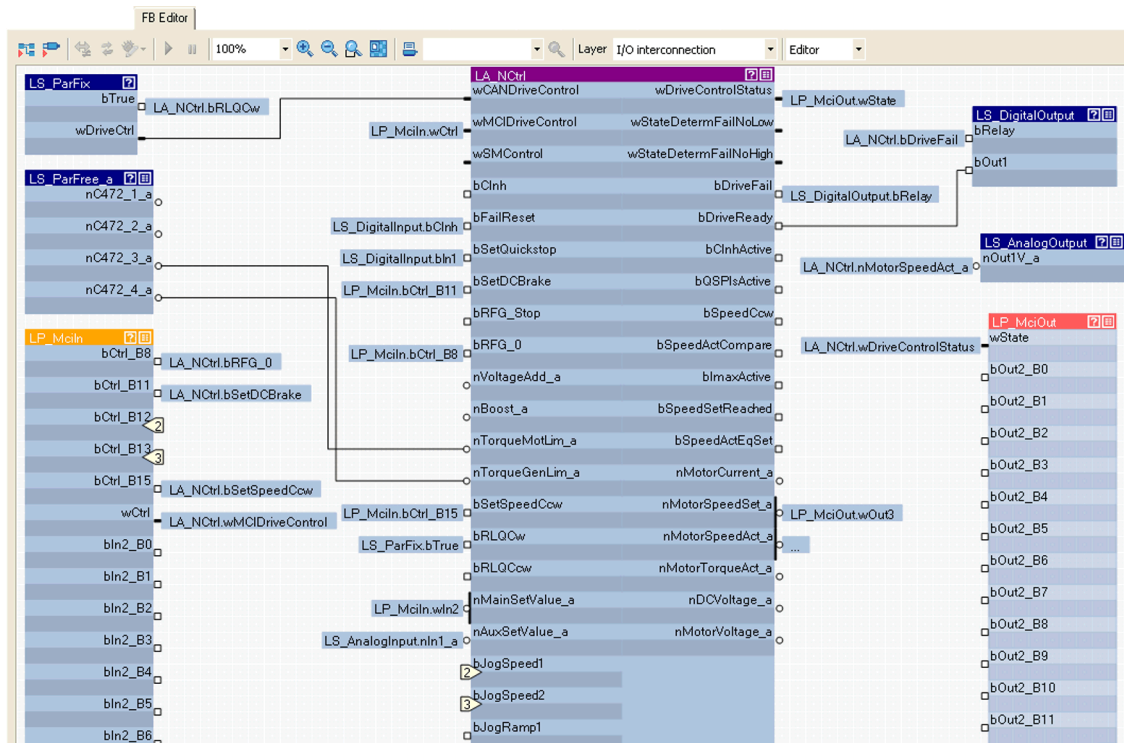

## 8 Monitoring

### Interruption of POWERLINK communication

An interruption of POWERLINK communication in the OPERATIONAL state, e.g. by cable break or failure of the managing node, is detected by the controlled node. The response to this interruption of communication depends on the following settings:

1. The watchdog monitoring time defined in the managing node is transferred to the controlled node when the POWERLINK communication is initialised.  
If the controlled node being in the OPERATIONAL state does not receive valid process data, the process data are handled according to the setting in [C13885](#). (The last data sent by the managing node can either be used or set to zero.)  
If communication fails, the controlled node state changes to PRE-OPERATIONAL (see [C13861](#)) and the red LED "BE" is activated (see [Fieldbus status displays \(□ 54\)](#)).  
By default, there is no response in the controlled node.
2. To cause a response by the controlled node, you additionally have to ...
  - set a response of the controlled node ([C13880/1](#)).

## 9 Diagnostics

The LEDs on the front panel of the communication module serve to diagnose faults.

### 9.1 LED status displays



#### Note!

LED status displays for trouble-free operation:

- The LEDs **MS** (📖 53) and **BS** (📖 54) are permanently lit.
- The green LED at the RJ45 sockets X251 and X252 is permanently lit or blinking (📖 55).

The following status displays are distinguished:

- [Module status displays](#) (📖 53)
- [Fieldbus status displays](#) (📖 54)
- [Status displays at the RJ45 sockets \(X251, X252\)](#) (📖 55)



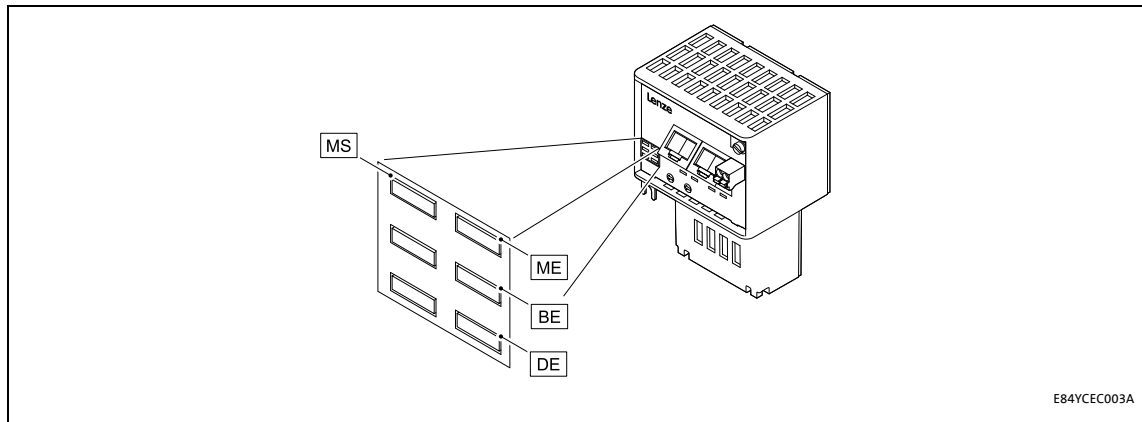

### 9.1.1 Module status displays

The LEDs **MS**, **ME**, **BE** and **DE** indicate the module status.



E84YCEC003A

MS	Module Status
ME	Module Error
BE	Bus Error
EN	Device Error

LED	Colour	Status	Description
MS	green	On	 The communication module is supplied with voltage and is connected to the standard device.
		blinking	 The communication module is supplied with voltage, but has no connection to the standard device. (The standard device is either switched off, in the initialisation phase, or not available).
ME	red	On	 An error has occurred in the communication module.
BE	red	On	 A fieldbus error has occurred.
EN	red	On	 The communication module is not accepted by the standard device. See notes given in the documentation for the standard device.







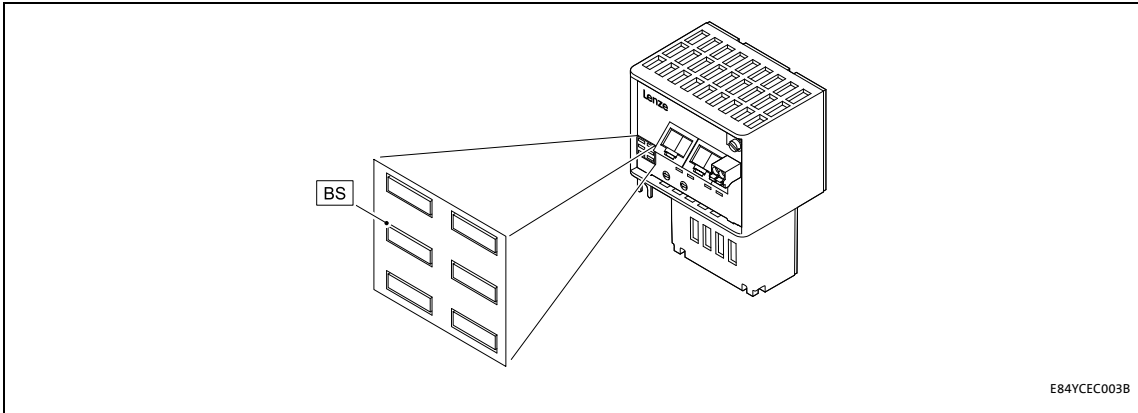

### 9.1.2 Fieldbus status displays

The **BS** LED indicates the fieldbus status.



E84YCEC003B



BS	Bus Status
----	------------

LED	Colour	Status	Description
BS	green	Off	The communication module is not active on the fieldbus or is in the INIT state.
		blinking	 <p>EPL network is in the initialisation phase. EPL status: NMT_CS_PREOPERATIONAL_1</p>
		blinking	 <p>EPL network is in the initialisation phase with cyclic traffic. EPL status: NMT_CS_PREOPERATIONAL_2</p>
		blinking	 <p>EPL node is waiting for the start signal. EPL status: NMT_CS_READY_TO_OPERATE</p>
		blinking	 <p>The EPL node has not found a managing node and is in <a href="#">Basic Ethernet Mode</a> (29). EPL status: NMT_CS_BASIC_ETHERNET</p>
		blinking	 <p>EPL node is in the "Stopped" status (waiting for disconnection). EPL status: NMT_CS_STOPPED</p>
		On	 <p>EPL node is in the operating phase. EPL status: NMT_CS_OPERATIONAL</p>

### 9.1.3 Status displays at the RJ45 sockets (X251, X252)

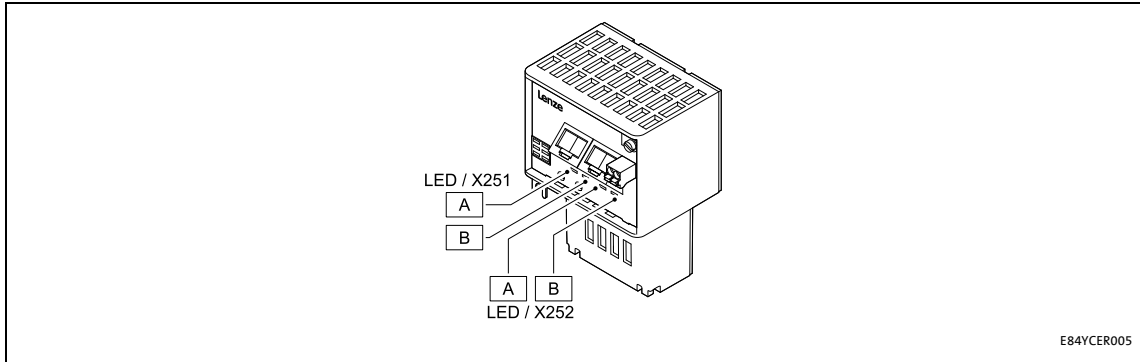
The LEDs at the RJ45 sockets **X251** and **X252** indicate the POWERLINK connection status.



LED	Colour	Status	Description
A	green	Off	No POWERLINK connection
		On	 POWERLINK connection has been established.
		Flickers	 Data communication of POWERLINK connection is active.
B	red	On	 POWERLINK collision has occurred.

### 9.2 Troubleshooting with module signalling

In the following, troubleshooting via the module signals will be described.

Please particularly observe ...

- the basic readiness for operation between the standard device and the communication module;
- the network wiring.

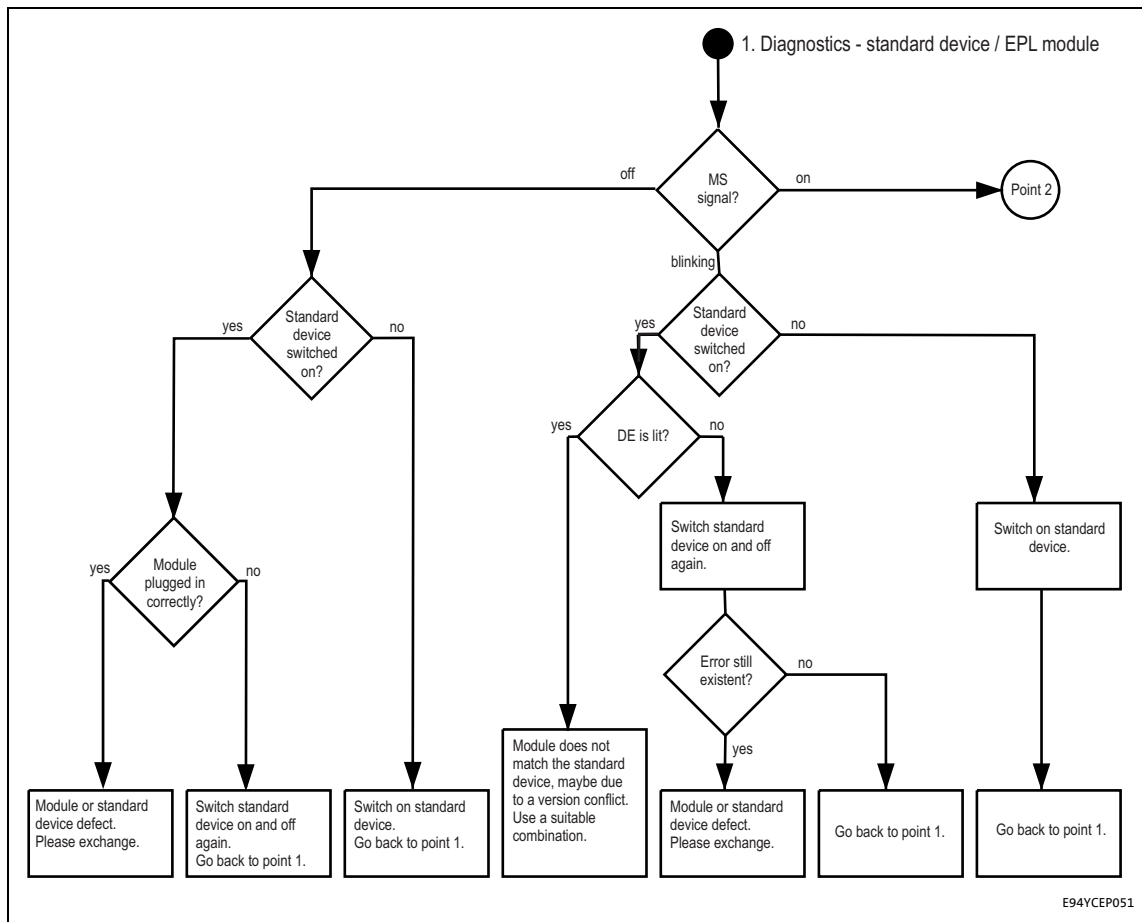

[9-1] Diagnostics - standard device / POWERLINK module

# Diagnostics

## Troubleshooting with module signalling

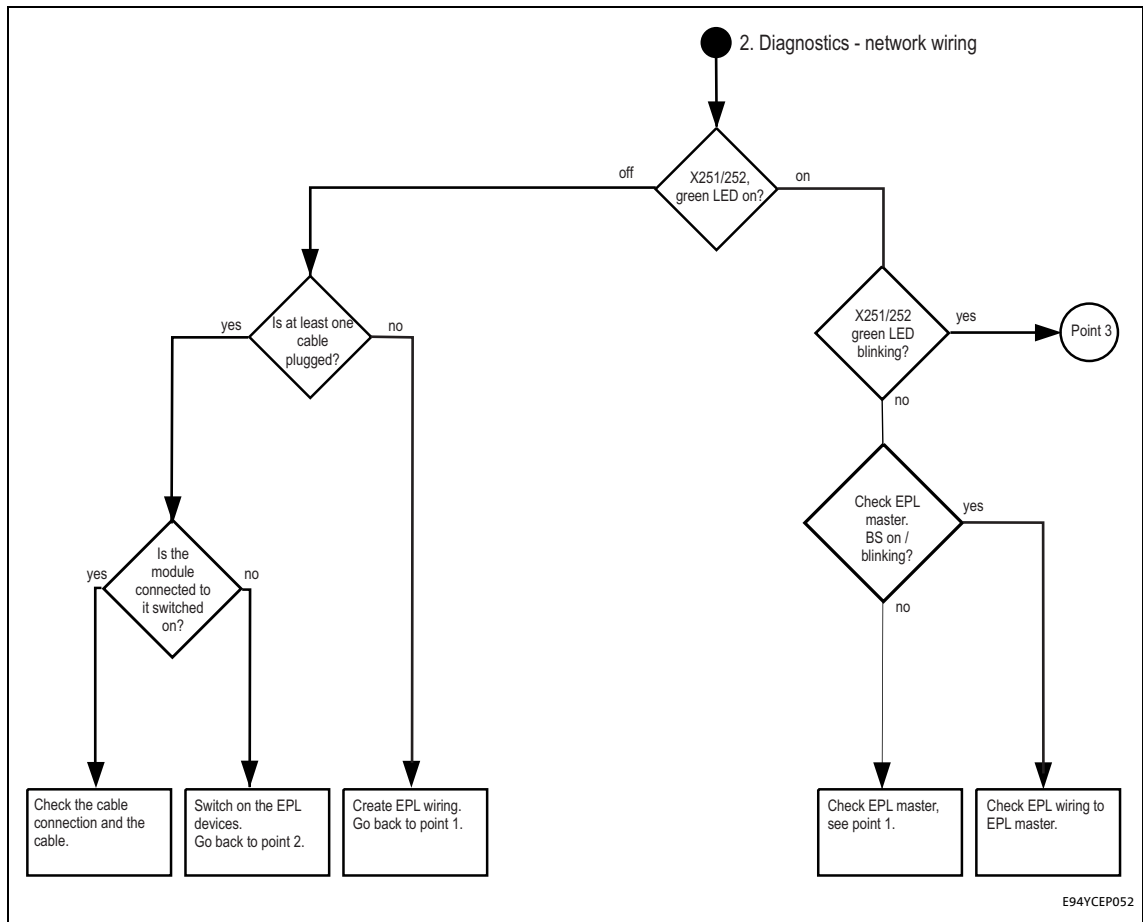

[9-2] Diagnostics - network wiring



### Note!

The **BS** (*Bus State*) LED refers to the Lenze communication module E94AYCEP as managing node.

This status display applies analogously to the managing nodes of other manufacturers.

# Diagnostics

## Troubleshooting with module signalling

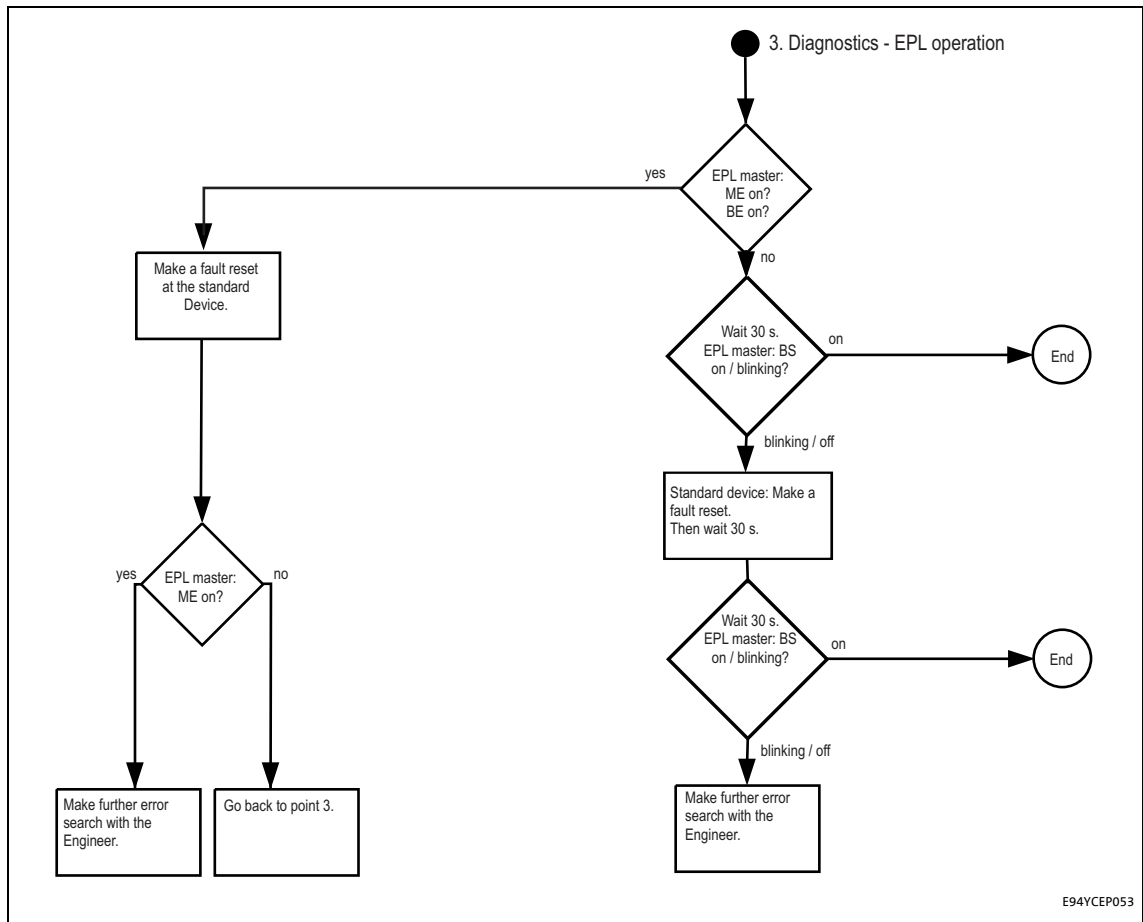

[9-3] Diagnostics - POWERLINK operation



### Note!

The LEDs **ME** (*Module Error*), **BE** (*Bus Error*) and **BS** (*Bus State*) refer to the Lenze communication module E94AYCEP as managing node.

These status displays apply analogously to the managing nodes of other manufacturers.

# Diagnostics

## Diagnostic data

---

### 9.3 Diagnostic data

- Pending diagnostic data are signalled from the controlled node to the managing node by means of an emergency message.
- Code [C13887](#) serves to suppress sending emergency messages to the managing node. You can select which type of error is to be suppressed.
- Errors and warnings in the Inverter Drive 8400 and the plugged communication module are sent to the managing node as extended diagnostic messages.
- The diagnostic data are visible via the PLC Engineering software.

Bytes	Meaning	Value [hex]
1 ... 6	Diagnostic block header	0x0010 001C 0100
7 ... 8	Alarm type	0x0001 (diagnosis)
9 ... 12	API (Application Programming Interface)	0x0000 0000
13, 14	Slot number	0x0001 / 0x0002
15, 16	Subslot number	0x0001
17 ... 20	Module ID	ID according to module
21 ... 24	Submodule number	ID according to module
25, 26	Alarm specification	0xB000
27, 28	User structure ID	0x0001
29 ... 32	Error code	

# Diagnostics

## Diagnostic data

### Error code of Inverter Drive 8400

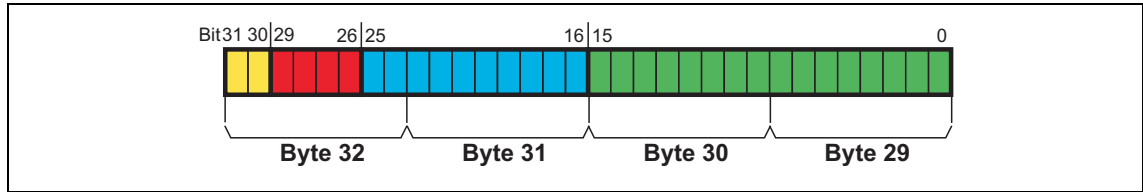

[9-4] Error code of Inverter Drive 8400

- The error code of the Inverter Drive 8400 can be found in bytes 29 ... 32 of the diagnostic message.
- In the logbook and in code **C00165** of the standard device, the error number is shown in the following syntax in order to facilitate the readability:  
**[error type].[error subject area no.].[error ID]**

### Example

Diagnostic message of the error "[EPL: State OPERATIONAL lost \[0x01bc8131\]](#)":

Bit assignment (Bytes 29 ... 32)	Information	Values from the example
Bit31 30  	Reserved	0
Bit29 26 	Error type / error response	Setting via <a href="#">C13880/1</a> : <ul style="list-style-type: none"> <li>• 0: No error response</li> <li>• 1: No Response</li> <li>• 3: Quick stop</li> <li>• 4: Warning locked</li> <li>• 6: Information</li> </ul>
Bit25 16 	Error subject area	<b>0x01bc</b> (444 <sub>dec</sub> )
Bit 15 0 	Error ID	<b>0x8131</b> (33073 <sub>dec</sub> )



Software manual/»Engineer« online help for Inverter Drive 8400

Detailed information on the error codes is provided here.

# Error messages

Short overview of the POWERLINK error messages

## 10 Error messages

[ALinkKeywords]  
Error messages

This chapter supplements the error list in the software manual and the »Engineer« online help for the Inverter Drive 8400 by the error messages of the communication module.



### Software manual/»Engineer« online help for the Inverter Drive 8400

Here you will find general information on diagnostics & fault analysis and on error messages.

[Search-Keywords]  
Error messages

### 10.1 Short overview of the POWERLINK error messages

The following table contains all error messages of the communication module in numerical order of the error numbers. Moreover the preset error response and - if applicable - the parameters for setting the error response are specified.



#### Tip!

If you click on the cross-reference in the first column, you will get a detailed description (causes and remedies) of the corresponding error message.

Error no. [hex]	Subject area no. [dec]	Error no. [dec]	Error text	Error type (Error response)	Adjustable in
<a href="#">0x01bc3100</a>	444	12544	EPL: Lost connection to 8400 target	1: No Response	-
<a href="#">0x01bc5531</a>	444	21809	EPL: NV memory: No access	1: No Response	-
<a href="#">0x01bc5532</a>	444	21810	EPL: NV memory: Read error	1: No Response	-
<a href="#">0x01bc5533</a>	444	21811	EPL: NV memory: Write error	1: No Response	-
<a href="#">0x01bc6010</a>	444	24592	EPL: Restart after watchdog reset	1: No Response	-
<a href="#">0x01bc6011</a>	444	24593	EPL: Watchdog reset	1: No Response	-
<a href="#">0x01bc6100</a>	444	24832	EPL: Software error	1: No Response	-
<a href="#">0x01bc6101</a>	444	24833	EPL: Fatal software error	1: No Response	-
<a href="#">0x01bc6110</a>	444	24848	EPL: Invalid PDO mapping	1: No Response	-
<a href="#">0x01bc641f</a>	444	25631	EPL: Invalid parameter set	1: No Response	-
<a href="#">0x01bc6420</a>	444	25632	EPL: Default setting loaded	1: No Response	-
<a href="#">0x01bc6430</a>	444	25648	EPL: Invalid module configuration	1: No Response	-
<a href="#">0x01bc8131</a>	444	33073	EPL: OPERATIONAL status left	1: No Response	<a href="#">C13880/1</a>
<a href="#">0x01bc8261</a>	444	33377	EPL: Invalid address selected	1: No Response	-
<a href="#">0x01bc8265</a>	444	33381	EPL: Synchronisation of MN lost	0: None	<a href="#">C13880/2</a>
<a href="#">0x01bc8266</a>	444	33382	EPL: Frame error (CRC)	0: None	<a href="#">C13880/3</a>



# Error messages

## Possible causes and remedies

### 10.2 Possible causes and remedies

In this chapter, all error messages of the communication module are listed in numerical order of the error numbers. Possible causes and remedies and responses to the error messages are described in detail.

▶ [Short overview of the POWERLINK error messages](#) (61)

#### EPL: Lost connection to 8400 target [0x01bc3100]

<b>Response</b> (Lenze setting printed in bold)	<b>Setting:</b> not possible
<input type="checkbox"/> No reaction <input type="checkbox"/> System fault <input checked="" type="checkbox"/> <b>Fault</b> <input type="checkbox"/> Trouble <input type="checkbox"/> Quick stop by trouble <input type="checkbox"/> WarningLocked <input type="checkbox"/> Warning <input type="checkbox"/> Information	
<b>Cause</b>	<b>Remedy</b>
MCI communication to Inverter Drive 8400 is interrupted. <ul style="list-style-type: none"><li>• Inverter Drive 8400 is switched off.</li><li>• The communication module is not connected correctly at the MCI slot of the Inverter Drive 8400.</li></ul>	<ul style="list-style-type: none"><li>• Switch on Inverter Drive 8400.</li><li>• Check screwed connection of the communication module at the MCI slot of the Inverter Drive 8400.</li><li>• Send the communication module and Inverter Drive 8400 together with a description of the fault to Lenze.</li></ul>

#### EPL: NV Memory: No access [0x01bc5531]

<b>Response</b> (Lenze setting printed in bold)	<b>Setting:</b> not possible
<input type="checkbox"/> No reaction <input type="checkbox"/> System fault <input checked="" type="checkbox"/> <b>Fault</b> <input type="checkbox"/> Trouble <input type="checkbox"/> Quick stop by trouble <input type="checkbox"/> WarningLocked <input type="checkbox"/> Warning <input type="checkbox"/> Information	
<b>Cause</b>	<b>Remedy</b>
Access to parameter set in memory module via standard device was not successful.	Download application again (including module).

#### EPL: NV Memory: Read error [0x01bc5532]

<b>Response</b> (Lenze setting printed in bold)	<b>Setting:</b> not possible
<input type="checkbox"/> No reaction <input type="checkbox"/> System fault <input checked="" type="checkbox"/> <b>Fault</b> <input type="checkbox"/> Trouble <input type="checkbox"/> Quick stop by trouble <input type="checkbox"/> WarningLocked <input type="checkbox"/> Warning <input type="checkbox"/> Information	
<b>Cause</b>	<b>Remedy</b>
Parameter in the memory module could not be read.	Download application again (including module).

#### EPL: NV Memory: Write error [0x01bc5533]

<b>Response</b> (Lenze setting printed in bold)	<b>Setting:</b> not possible
<input type="checkbox"/> No reaction <input type="checkbox"/> System fault <input checked="" type="checkbox"/> <b>Fault</b> <input type="checkbox"/> Trouble <input type="checkbox"/> Quick stop by trouble <input type="checkbox"/> WarningLocked <input type="checkbox"/> Warning <input type="checkbox"/> Information	
<b>Cause</b>	<b>Remedy</b>
Parameter in the memory module could not be written.	Download application again (including module).

#### EPL: Restart after watchdog reset [0x01bc6010]

<b>Response</b> (Lenze setting printed in bold)	<b>Setting:</b> not possible
<input type="checkbox"/> No reaction <input type="checkbox"/> System fault <input checked="" type="checkbox"/> <b>Fault</b> <input type="checkbox"/> Trouble <input type="checkbox"/> Quick stop by trouble <input type="checkbox"/> WarningLocked <input type="checkbox"/> Warning <input type="checkbox"/> Information	
<b>Cause</b>	<b>Remedy</b>
Communication module is defective.	Send the communication module and a description of the fault to Lenze.

# Error messages

## Possible causes and remedies

### EPL: Watchdog reset [0x01bc6011]

<b>Response</b> (Lenze setting printed in bold)	<b>Setting:</b> not possible
<input type="checkbox"/> No reaction <input type="checkbox"/> System fault <input checked="" type="checkbox"/> <b>Fault</b> <input type="checkbox"/> Trouble <input type="checkbox"/> Quick stop by trouble <input type="checkbox"/> WarningLocked <input type="checkbox"/> Warning <input type="checkbox"/> Information	
<b>Cause</b>	<b>Remedy</b>
Communication module is defective.	Send the communication module and a description of the fault to Lenze.

### EPL: Software error [0x01bc6100]

<b>Response</b> (Lenze setting printed in bold)	<b>Setting:</b> not possible
<input type="checkbox"/> No reaction <input type="checkbox"/> System fault <input checked="" type="checkbox"/> <b>Fault</b> <input type="checkbox"/> Trouble <input type="checkbox"/> Quick stop by trouble <input type="checkbox"/> WarningLocked <input type="checkbox"/> Warning <input type="checkbox"/> Information	
<b>Cause</b>	<b>Remedy</b>
Communication module is defective.	Send the communication module and a description of the fault to Lenze.

### EPL: Fatal software error [0x01bc6101]

<b>Response</b> (Lenze setting printed in bold)	<b>Setting:</b> not possible
<input type="checkbox"/> No reaction <input type="checkbox"/> System fault <input checked="" type="checkbox"/> <b>Fault</b> <input type="checkbox"/> Trouble <input type="checkbox"/> Quick stop by trouble <input type="checkbox"/> WarningLocked <input type="checkbox"/> Warning <input type="checkbox"/> Information	
<b>Cause</b>	<b>Remedy</b>
Communication module is defective.	Send the communication module and a description of the fault to Lenze.

### EPL: PDO Mapping invalid [0x01bc6110]

<b>Response</b> (Lenze setting printed in bold)	<b>Setting:</b> not possible
<input type="checkbox"/> No reaction <input type="checkbox"/> System fault <input checked="" type="checkbox"/> <b>Fault</b> <input type="checkbox"/> Trouble <input type="checkbox"/> Quick stop by trouble <input type="checkbox"/> WarningLocked <input type="checkbox"/> Warning <input type="checkbox"/> Information	
<b>Cause</b>	<b>Remedy</b>
Invalid mapping configuration.	Correct the mapping configuration.

### EPL: Invalid parameter set [0x01bc641f]

<b>Response</b> (Lenze setting printed in bold)	<b>Setting:</b> not possible
<input type="checkbox"/> No reaction <input type="checkbox"/> System fault <input checked="" type="checkbox"/> <b>Fault</b> <input type="checkbox"/> Trouble <input type="checkbox"/> Quick stop by trouble <input type="checkbox"/> WarningLocked <input type="checkbox"/> Warning <input type="checkbox"/> Information	
<b>Cause</b>	<b>Remedy</b>
No active parameter set could be loaded.	Download application again (including module).

### EPL: Factory settings loaded [0x01bc6420]

<b>Response</b> (Lenze setting printed in bold)	<b>Setting:</b> not possible
<input type="checkbox"/> No reaction <input type="checkbox"/> System fault <input checked="" type="checkbox"/> <b>Fault</b> <input type="checkbox"/> Trouble <input type="checkbox"/> Quick stop by trouble <input type="checkbox"/> WarningLocked <input type="checkbox"/> Warning <input type="checkbox"/> Information	
<b>Cause</b>	<b>Remedy</b>
Access to parameter set in memory module via standard device was not successful.	Download application again (including module).

# Error messages

## Possible causes and remedies

### EPL: Invalid module configuration [0x01bc6430]

<b>Response</b> (Lenze setting printed in bold)	<b>Setting:</b> not possible
<input type="checkbox"/> No reaction <input type="checkbox"/> System fault <input checked="" type="checkbox"/> <b>Fault</b> <input type="checkbox"/> Trouble <input type="checkbox"/> Quick stop by trouble <input type="checkbox"/> WarningLocked <input type="checkbox"/> Warning <input type="checkbox"/> Information	
<b>Cause</b>	<b>Remedy</b>
Module configuration is faulty.	Check and correct module configuration.

### EPL: State OPERATIONAL lost [0x01bc8131]

<b>Response</b> (Lenze setting printed in bold)	<b>Setting:</b> <a href="#">C13880/1</a>
<input checked="" type="checkbox"/> No reaction <input type="checkbox"/> System fault <input checked="" type="checkbox"/> <b>Fault</b> <input checked="" type="checkbox"/> Trouble <input checked="" type="checkbox"/> Quick stop by trouble <input checked="" type="checkbox"/> WarningLocked <input type="checkbox"/> Warning <input checked="" type="checkbox"/> Information	
<b>Cause</b>	<b>Remedy</b>
Data exchange via POWERLINK has been terminated. • Also see the chapter " <a href="#">Interruption of POWERLINK communication</a> " ( <a href="#">□ 51</a> ).	<ul style="list-style-type: none"> <li>• Check the network cable (plug) and replace it if necessary.</li> <li>• Connect the network cable to the Ethernet POWERLINK terminals X251 or X252 and continue to check the status of the managing node.</li> </ul>

### EPL: Invalid address selected [0x01bc8261]

<b>Response</b> (Lenze setting printed in bold)	<b>Setting:</b> not possible
<input type="checkbox"/> No reaction <input type="checkbox"/> System fault <input checked="" type="checkbox"/> <b>Fault</b> <input type="checkbox"/> Trouble <input type="checkbox"/> Quick stop by trouble <input type="checkbox"/> WarningLocked <input type="checkbox"/> Warning <input type="checkbox"/> Information	
<b>Cause</b>	<b>Remedy</b>
An invalid IP address has been assigned by the managing node via POWERLINK or set as node ID.	<ul style="list-style-type: none"> <li>• Ensure that a valid IP address is assigned by the managing node via POWERLINK.</li> <li>• Set valid node ID.</li> </ul> <a href="#">▶ Node address setting</a> ( <a href="#">□ 37</a> )

### EPL: Synchronisation lost from MN [0x01bc8265]

<b>Response</b> (Lenze setting printed in bold)	<b>Setting:</b> <a href="#">C13880/2</a>
<input checked="" type="checkbox"/> No reaction <input type="checkbox"/> System fault <input type="checkbox"/> Fault <input checked="" type="checkbox"/> <b>Trouble</b> <input checked="" type="checkbox"/> Quick stop by trouble <input checked="" type="checkbox"/> Warning locked <input type="checkbox"/> Warning <input checked="" type="checkbox"/> Information	
<b>Cause</b>	<b>Remedy</b>
In the controlled node, the synchronisation cycle of the managing node has failed. The controlled node changes automatically to the NMT_CS_PREOPERATIONAL_1 state and waits for a new run-up by the managing node.	<ul style="list-style-type: none"> <li>• Check network cable and components (failure of managing node, router).</li> <li>• Restart managing node if required.</li> </ul>

### EPL: Telegram error detected (CRC) [0x01bc8266]

<b>Response</b> (Lenze setting printed in bold)	<b>Setting:</b> <a href="#">C13880/3</a>
<input checked="" type="checkbox"/> No reaction <input type="checkbox"/> System fault <input type="checkbox"/> Fault <input checked="" type="checkbox"/> <b>Trouble</b> <input checked="" type="checkbox"/> Quick stop by trouble <input checked="" type="checkbox"/> Warning locked <input type="checkbox"/> Warning <input checked="" type="checkbox"/> Information	
<b>Cause</b>	<b>Remedy</b>
Faulty Ethernet frames (CRC error) have been detected. Possible causes: <ul style="list-style-type: none"> <li>• A device in the network is not EPL-compliant.</li> <li>• EMC interference is too strong.</li> </ul>	<ul style="list-style-type: none"> <li>• Check if a non-EPL-compliant device is in the network (e.g. diagnostics PC).</li> <li>• Reduce EMC interference on the network or use an additional shield connection.</li> </ul>

# Parameter reference

Parameters of the communication module

## 11 Parameter reference

[ALinkKeywords]  
Parameters

This chapter supplements the parameter list and the table of attributes for the Inverter Drive 8400 contained in the software manual and in the »Engineer« online help by the parameters of the communication module E84AYCEC (POWERLINK).



**Software manual/»Engineer« online help for Inverter Drive 8400**

Here you will find general information on parameters.

[Search-Keywords]  
Hlp\_Para

### 11.1 Parameters of the communication module

This chapter lists the parameters of the E84AYCEC communication module (POWERLINK) in numerically ascending order.

#### C13000

Parameter   Name: <b>C13000   0x1E40.2 IP Address</b>		Data type: UNSIGNED_32 Index: 11575 <sub>d</sub> = 2D37 <sub>h</sub>
<p>The code displays the IP address of the communication module.</p> <ul style="list-style-type: none"> <li>The IP address is derived from the EPL node address (Node ID): <b>192.168.100.[Node ID]</b></li> <li>The node ID is derived from the coding switch position or from <a href="#">C13899</a>.</li> </ul> <p>▶ <a href="#">Node address setting</a> (□ 37)</p>		
<b>Display range (min. value   unit   max. value)</b>		
0.0.0.0 (0x00000000)		255.255.255.255 (0xFFFFFFFF)
<b>Subcodes</b>		<b>Info</b>
C13000/1		IP address • Lenze setting: 0xC0A86401 = 192.168.100.1
<input checked="" type="checkbox"/> Read access <input type="checkbox"/> Write access <input type="checkbox"/> CINH <input type="checkbox"/> PLC-STOP <input checked="" type="checkbox"/> No transfer <input type="checkbox"/> PDO_MAP_RX <input type="checkbox"/> PDO_MAP_TX <input type="checkbox"/> COM <input type="checkbox"/> MOT		

#### C13001

Parameter   Name: <b>C13001   0x1E40.3 Subnet Mask</b>		Data type: UNSIGNED_32 Index: 11574 <sub>d</sub> = 2D36 <sub>h</sub>
<p>The code declares the IP subnet mask which restricts the directly addressable IP address range (i.e. without a gateway in the EPL segment of the routers). The value 255.255.255.0 (0xFFFFFFFF0) is always assigned to the subnet mask in one segment.</p>		
<b>Display range (min. value   unit   max. value)</b>		
255.0.0.0 (0xFF000000)		255.255.255.0 (0xFFFFFFFF0)
<b>Subcodes</b>		<b>Info</b>
C13001/1		EPL IP Subnet Mask • Lenze setting: 0xFFFFFFFF0 = 255.255.255.0
<input checked="" type="checkbox"/> Read access <input type="checkbox"/> Write access <input type="checkbox"/> CINH <input type="checkbox"/> PLC-STOP <input checked="" type="checkbox"/> No transfer <input type="checkbox"/> PDO_MAP_RX <input type="checkbox"/> PDO_MAP_TX <input type="checkbox"/> COM <input type="checkbox"/> MOT		

# Parameter reference

## Parameters of the communication module

### C13003

Parameter   Name: <b>C13003   0x1E40.5 IP Address Router</b>		Data type: UNSIGNED_32 Index: 11572 <sub>d</sub> = 2D34 <sub>h</sub>
<p>The code declares the IP address of the router which connects the EPL segment to the higher-level network. The standard entry corresponds to the standard router address of the EPL specification:  <b>→ 192.168.100.254</b></p> <p>Permissible entries replace the lowest-order byte of the standard entry with the EPL address of the node which has the function of a router.</p>		
<b>Setting range (min. value   unit   max. value)</b>		
0.0.0.0 (0x00000000)		255.255.255.255 (0xFFFFFFFF)
<b>Subcodes</b>	<b>Lenze setting</b>	<b>Info</b>
C13003/1	3232261374	IP address router • Lenze setting: 0xC0A864FE = 192.168.100.254
<input checked="" type="checkbox"/> Read access <input checked="" type="checkbox"/> Write access <input type="checkbox"/> CINH <input type="checkbox"/> PLC-STOP <input type="checkbox"/> No transfer <input type="checkbox"/> PDO_MAP_RX <input type="checkbox"/> PDO_MAP_TX <input type="checkbox"/> COM <input type="checkbox"/> MOT		

### C13004

Parameter   Name: <b>C13004   0x1030.5 MAC Address</b>		Data type: OCTET_STRING Index: 11571 <sub>d</sub> = 2D33 <sub>h</sub>
<p>The code indicates the physical address (MAC address) of the Ethernet interface of the communication module. When the communication module is produced, the MAC address is assigned unequivocally worldwide and provides addressing on the lowest level.</p>		
<b>Subcodes</b>	<b>Info</b>	
C13004/1	MAC Address (octet string[6]) 00-0A-86-xx-yy-zz • 00-0A-86 = Lenze • xx-yy-zz = consecutive number	
<input checked="" type="checkbox"/> Read access <input type="checkbox"/> Write access <input type="checkbox"/> CINH <input type="checkbox"/> PLC-STOP <input checked="" type="checkbox"/> No transfer <input type="checkbox"/> PDO_MAP_RX <input type="checkbox"/> PDO_MAP_TX <input type="checkbox"/> COM <input type="checkbox"/> MOT		

# Parameter reference

## Parameters of the communication module

C13028

Parameter   Name: <b>C13028   0x1F81 Node Assignment CN</b>		Data type: UNSIGNED_32 Index: 11547 <sub>d</sub> = 2D1B <sub>h</sub>
The code declares the controlled nodes 1 ... 100 and their properties.		
<b>Value is bit-coded:</b>		
Bit 0 ... 31	see below	
<b>Subcodes</b>	<b>Lenze setting</b>	<b>Info</b>
C13028/1	0	
...	..	
C13028/100	0	
<input checked="" type="checkbox"/> Read access <input checked="" type="checkbox"/> Write access <input type="checkbox"/> CINH <input type="checkbox"/> PLC-STOP <input type="checkbox"/> No transfer <input type="checkbox"/> PDO_MAP_RX <input type="checkbox"/> PDO_MAP_TX <input type="checkbox"/> COM <input type="checkbox"/> MOT		

The describing bit field has the following structure:

Bit	Value	Description
0 (LSB)	0	EPL node with this ID does not exist.
	1	EPL node with this ID exists.
1	0	EPL node with this ID is not a controlled node.
	1	EPL node with this ID is a controlled node.
2	0	On detection of a booting controlled node, the application will not be informed.
	1	On detection of a booting controlled node, the application will be informed and the controlled node will be started.
3	0	Optional controlled node
	1	Obligatory controlled node
4	0	The managing node is allowed to send reset commands.
	1	The managing node must not send any reset command.
5	0	Software version verification of the controlled node is not required.
	1	Software version verification of the controlled node is required.
6	0	Automatic application software update is not allowed.
	1	Automatic application software update is allowed.
7	-	Reserved / No function
8	0	Isochronously accessed controlled node
	1	Asynchronously accessed controlled node (bit 9 is irrelevant)
9	0	Continuously accessed controlled node
	1	Multiplex EPL nodes are supported.
10	0	No "POWERLINK to standard Ethernet" router function.
	1	The device can be used as an "POWERLINK to standard Ethernet" router (router type 1).
11	0	No "POWERLINK to fieldbus" router function.
	1	The device can be used as an "POWERLINK to fieldbus" router (router type 1).
12	0	The managing node does not send any PRes frames
	1	The managing node sends PRes frames
13 ... 30	-	Reserved / No function
31 (MSB)	0	Bits 0 ... 30 inhibited
	1	Bits 0 ... 30 enabled

# Parameter reference

## Parameters of the communication module

C13029

Parameter   Name: <b>C13029   0x1F81 Node Assignment</b>		Data type: UNSIGNED_32 Index: 11546 <sub>d</sub> = 2D1A <sub>h</sub>
The code declares managing node, diagnostic device, and router, and describes their properties.		
<b>Value is bit-coded:</b>		
Bit 0 ... 31	see below	
<b>Subcodes</b>	<b>Lenze setting</b>	<b>Info</b>
C13029/1	2147483661	EPL node assignment managing node Lenze setting (hex): 0x8000000D
C13029/2	0	EPL node assignment diagnostic device Lenze setting (hex): 0x00000000
C13029/3	2147483655	EPL node assignment router Lenze setting (hex): 0x80000007
<input checked="" type="checkbox"/> Read access <input checked="" type="checkbox"/> Write access <input type="checkbox"/> CINH <input type="checkbox"/> PLC-STOP <input type="checkbox"/> No transfer <input type="checkbox"/> PDO_MAP_RX <input type="checkbox"/> PDO_MAP_TX <input type="checkbox"/> COM <input type="checkbox"/> MOT		

The describing bit field has the following structure:

Bit	Value	Description
0 (LSB)	0	EPL node with this ID does not exist.
	1	EPL node with this ID exists.
1	0	EPL node with this ID is not a controlled node.
	1	EPL node with this ID is a controlled node.
2	0	On detection of a booting controlled node, the application will not be informed.
	1	On detection of a booting controlled node, the application will be informed and the controlled node will be started.
3	0	Optional controlled node
	1	Obligatory controlled node
4	0	The managing node is allowed to send reset commands.
	1	The managing node must not send any reset command.
5	0	Software version verification of the controlled node is not required.
	1	Software version verification of the controlled node is required.
6	0	Automatic application software update is not allowed.
	1	Automatic application software update is allowed.
7	-	Reserved / No function
8	0	Isochronously accessed controlled node
	1	Asynchronously accessed controlled node (bit 9 is irrelevant)
9	0	Continuously accessed controlled node
	1	Multiplex EPL nodes are supported.
10	0	No "POWERLINK to standard Ethernet" router function.
	1	The device can be used as an "POWERLINK to standard Ethernet" router (router type 1).
11	0	No "POWERLINK to fieldbus" router function.
	1	The device can be used as an "POWERLINK to fieldbus" router (router type 1).
12	0	The managing node does not send any PRes frames
	1	The managing node sends PRes frames
13 ... 30	-	Reserved / No function
31 (MSB)	0	Bits 0 ... 30 inhibited
	1	Bits 0 ... 30 enabled

# Parameter reference

## Parameters of the communication module

C13040

Parameter   Name: <b>C13040   0x1F82 Feature Flags</b>		Data type: UNSIGNED_32 Index: 11535 <sub>d</sub> = 2D0F <sub>h</sub>
The code displays the Ethernet POWERLINK features implemented by the EPL node. Lenze standard value: 0x00000207		
<b>Value is bit-coded:</b>		
Bit 0 ... 31	see below	
<input checked="" type="checkbox"/> Read access <input type="checkbox"/> Write access <input type="checkbox"/> CINH <input type="checkbox"/> PLC-STOP <input checked="" type="checkbox"/> No transfer <input type="checkbox"/> PDO_MAP_RX <input type="checkbox"/> PDO_MAP_TX <input type="checkbox"/> COM <input type="checkbox"/> MOT		

The describing bit field has the following structure:

Bit	Value	Description
0 (LSB)	0	Asynchronous access
	1	Isochronous access
1	0	No SDO by UDP/IP
	1	SDO by UDP/IP
2	0	No SDO by EPL "ASnd"
	1	SDO by EPL "ASnd"
3	0	No SDO integrated in PDO
	1	SDO integrated in PDO
4	0	No "NMT Info Services"
	1	"NMT Info Services" supported
5	0	No extended "NMT State Commands"
	1	Extended "NMT State Commands" supported
6	0	No dynamic PDO mapping
	1	Dynamic PDO mapping supported
7	-	Reserved / No function
8	0	No configuration manager function
	1	Configuration manager function
9	0	Only isochronous cyclic access permitted.
	1	Isochronous multiplexed access possible.
10	0	No address assignment via software
	1	Address assignment via software
11	-	Reserved / No function
12	0	No "POWERLINK to standard Ethernet" router function.
	1	The device can be used as an "POWERLINK to standard Ethernet" router (router type 1).
13	0	No "POWERLINK to fieldbus" router function.
	1	The device can be used as an "POWERLINK to fieldbus" router (router type 1).
14 ... 31 (MSB)	-	Reserved / No function



# Parameter reference

## Parameters of the communication module

### C13060

Parameter   Name: <b>C13060   0x1006 Cycle Time</b>		Data type: UNSIGNED_32 Index: 11515 <sub>d</sub> = 2CFB <sub>h</sub>
<p>The code defines the length of the EPL cycle in <math>\mu\text{s}</math>.</p> <ul style="list-style-type: none"> <li>• In the configured state, this code must have an identical value in all EPL nodes.</li> <li>• The selected value must correspond to the actual bus cycle time so that the internal monitoring functions work correctly.</li> </ul>		
<b>Selection list (Lenze setting printed in bold)</b>		
400	400	
500	500	
600	600	
800	800	
<b>1000</b>	<b>1000</b>	
2000	2000	
3000	3000	
4000	4000	
5000	5000	
6000	6000	
7000	7000	
8000	8000	
9000	9000	
10000	10000	
11000	11000	
12000	12000	
13000	13000	
14000	14000	
15000	15000	
16000	16000	
17000	17000	
18000	18000	
19000	19000	
20000	20000	
<input checked="" type="checkbox"/> Read access <input checked="" type="checkbox"/> Write access <input type="checkbox"/> CINH <input type="checkbox"/> PLC-STOP <input type="checkbox"/> No transfer <input type="checkbox"/> PDO_MAP_RX <input type="checkbox"/> PDO_MAP_TX <input type="checkbox"/> COM <input type="checkbox"/> MOT		

# Parameter reference

## Parameters of the communication module

### C13066

Parameter   Name: <b>C13066   0x1F8D PResPayloadLimit RPDO CN</b>		Data type: UNSIGNED_16 Index: 11509 <sub>d</sub> = 2CF5 <sub>h</sub>
<p>The code defines the reserved user data length of the PRes telegrams for controlled nodes 1 ... 100. Each subcode number corresponds to one EPL node with the same node ID. The EPL node must be enabled via code <a href="#">C13028</a>. The subcodes describe the PRes telegrams received. The value must be within the range of 36 ... 1490 bytes. The values are upper limit values for the entire size of the PDO mappings for received PRes telegrams. <b>In the configured state, the values stored for the EPL nodes must be identical to the corresponding <a href="#">C13072</a> entries. C13066 must have an identical value in all EPL nodes of the network.</b></p>		
<b>Setting range (min. value   unit   max. value)</b>		
0	Byte	1490
<b>Subcodes</b>	<b>Lenze setting</b>	<b>Info</b>
C13066/1	0 byte	
...	...	
C13066/100	0 byte	
<input checked="" type="checkbox"/> Read access <input checked="" type="checkbox"/> Write access <input type="checkbox"/> CINH <input type="checkbox"/> PLC-STOP <input type="checkbox"/> No transfer <input type="checkbox"/> PDO_MAP_RX <input type="checkbox"/> PDO_MAP_TX <input type="checkbox"/> COM <input type="checkbox"/> MOT		

### C13067

Parameter   Name: <b>C13067   0x1F8D PResPayloadLimit RPDO</b>		Data type: UNSIGNED_16 Index: 11508 <sub>d</sub> = 2CF4 <sub>h</sub>
<p>The code defines the reserved user data length of the PRes frames for managing node, diagnostic device or router. Each subcode number corresponds to one EPL node with the same node ID. The EPL node must be enabled via code <a href="#">C13028</a>. The subcode describes the PRes telegrams received. The value must be within the limits of 36 ... 1490 bytes. The values are upper limit values for the entire size of the PDO mappings for received PRes telegrams. <b>In the configured state, the values stored for the nodes must be identical to the corresponding <a href="#">C13072</a> entries. C13067 must have an identical value in all EPL nodes of the network.</b></p>		
<b>Setting range (min. value   unit   max. value)</b>		
0	Byte	1490
<b>Subcodes</b>	<b>Lenze setting</b>	<b>Info</b>
C13067/1	0 byte	Managing node
C13067/2	0 byte	Diagnostics device
C13067/3	0 byte	router
<input checked="" type="checkbox"/> Read access <input checked="" type="checkbox"/> Write access <input type="checkbox"/> CINH <input type="checkbox"/> PLC-STOP <input type="checkbox"/> No transfer <input type="checkbox"/> PDO_MAP_RX <input type="checkbox"/> PDO_MAP_TX <input type="checkbox"/> COM <input type="checkbox"/> MOT		

### C13071

Parameter   Name: <b>C13071   0x1F98.4 PReqPayloadLimit RPDO</b>		Data type: UNSIGNED_16 Index: 11504 <sub>d</sub> = 2CF0 <sub>h</sub>
<p>The code defines the maximum data size to be received by the controlled node via PReq for the current network configuration. C13071 is an upper limit value for the entire size of the PDO mapping for the PReq telegram. <b>In the configured state, the value must be identical to the entry for a response valid for the EPL node.</b></p>		
<b>Setting range (min. value   unit   max. value)</b>		<b>Lenze setting</b>
36	Byte	1490 <b>36 bytes</b>
<input checked="" type="checkbox"/> Read access <input checked="" type="checkbox"/> Write access <input type="checkbox"/> CINH <input type="checkbox"/> PLC-STOP <input type="checkbox"/> No transfer <input type="checkbox"/> PDO_MAP_RX <input type="checkbox"/> PDO_MAP_TX <input type="checkbox"/> COM <input type="checkbox"/> MOT		

# Parameter reference

## Parameters of the communication module

### C13072

Parameter   Name: <b>C13072   0x1F98.5 PResPayloadLimit TPDO</b>		Data type: UNSIGNED_16 Index: 11503 <sub>d</sub> = 2CEF <sub>h</sub>	
The code defines the maximum data size to be sent by the EPL node for the current network configuration. The PDO mapping is allowed to assign data with a total size greater than or equal to C13072. <b>In the configured state, C13072 must be identical to the entry in <a href="#">C13066</a> valid for the EPL node.</b>			
<b>Setting range (min. value   unit   max. value)</b>		<b>Lenze setting</b>	
36	Byte	1490	<b>36 bytes</b>
<input checked="" type="checkbox"/> Read access <input checked="" type="checkbox"/> Write access <input type="checkbox"/> CINH <input type="checkbox"/> PLC-STOP <input type="checkbox"/> No transfer <input type="checkbox"/> PDO_MAP_RX <input type="checkbox"/> PDO_MAP_TX <input type="checkbox"/> COM <input type="checkbox"/> MOT			

### C13074

Parameter   Name: <b>C13074   0x1F98.7 Multiplex Cycle Counter</b>		Data type: UNSIGNED_8 Index: 11501 <sub>d</sub> = 2CED <sub>h</sub>	
This code serves to define the maximum number of the multiplexed cycles. If, for instance, the value "3" is entered, the multiplexed cycle is repeated every three cycles. Within one multiplexed cycle, the nodes are queried according to the value in code <a href="#">C13079</a> . If, for instance, the value "2" is entered for a node in <a href="#">C13079/x</a> , it is always queried only in the second cycle of the three multiplexed cycles.			
<b>Setting range (min. value   unit   max. value)</b>		<b>Lenze setting</b>	
0	Cycles	255	<b>0 cycles</b>
<input checked="" type="checkbox"/> Read access <input checked="" type="checkbox"/> Write access <input type="checkbox"/> CINH <input type="checkbox"/> PLC-STOP <input type="checkbox"/> No transfer <input type="checkbox"/> PDO_MAP_RX <input type="checkbox"/> PDO_MAP_TX <input type="checkbox"/> COM <input type="checkbox"/> MOT			

### C13075

Parameter   Name: <b>C13075   0x1F98.8 SDO Channel Width (AsyncMTU)</b>		Data type: UNSIGNED_16 Index: 11500 <sub>d</sub> = 2CEC <sub>h</sub>	
The code defines the maximum user data size of asynchronous frames. Protocol-specific headers for EPL, UDP/IP and others as well as service-specific headers are to be interpreted as part of the user data. <b>In the configured state, the C13075 values of all EPL nodes must be identical.</b>			
<b>Setting range (min. value   unit   max. value)</b>		<b>Lenze setting</b>	
300	Byte	1500	<b>300 bytes</b>
<input checked="" type="checkbox"/> Read access <input checked="" type="checkbox"/> Write access <input type="checkbox"/> CINH <input type="checkbox"/> PLC-STOP <input type="checkbox"/> No transfer <input type="checkbox"/> PDO_MAP_RX <input type="checkbox"/> PDO_MAP_TX <input type="checkbox"/> COM <input type="checkbox"/> MOT			

### C13076

Parameter   Name: <b>C13076   0x1F98.9 Prescaler_U16</b>		Data type: UNSIGNED_16 Index: 11499 <sub>d</sub> = 2CEB <sub>h</sub>	
This code configures the change rate of the SoC PS flag.			
<b>Setting range (min. value   unit   max. value)</b>		<b>Lenze setting</b>	
0	Cycles	1000	<b>2 Cycles</b>
<input checked="" type="checkbox"/> Read access <input checked="" type="checkbox"/> Write access <input type="checkbox"/> CINH <input type="checkbox"/> PLC-STOP <input type="checkbox"/> No transfer <input type="checkbox"/> PDO_MAP_RX <input type="checkbox"/> PDO_MAP_TX <input type="checkbox"/> COM <input type="checkbox"/> MOT			

### C13078

Parameter   Name: <b>C13078   0x1F99 BasicEthTimeout</b>		Data type: UNSIGNED_32 Index: 11497 <sub>d</sub> = 2CE9 <sub>h</sub>	
The code defines the time interval needed for the booting controlled node to wait for the managing node. If the controlled node detects a managing node within the interval, the controlled node changes to NMT_CS_PREOPERATIONAL_1, if not it changes to "Basic Ethernet Mode".			
<b>Setting range (min. value   unit   max. value)</b>		<b>Lenze setting</b>	
0	µs	4294967295	<b>5000000 µs</b>
<input checked="" type="checkbox"/> Read access <input checked="" type="checkbox"/> Write access <input type="checkbox"/> CINH <input type="checkbox"/> PLC-STOP <input type="checkbox"/> No transfer <input type="checkbox"/> PDO_MAP_RX <input type="checkbox"/> PDO_MAP_TX <input type="checkbox"/> COM <input type="checkbox"/> MOT			

# Parameter reference

## Parameters of the communication module

### C13079

Parameter   Name: <b>C13079   0x1F9B Multiplex Cycle CN</b>		Data type: UNSIGNED_8 Index: 11496 <sub>d</sub> = 2CE8 <sub>h</sub>
<p>This code indicates in which multiplexed cycle the node is queried. The value entered must not exceed the value in code <a href="#">C13074</a>.</p> <p>If, for instance, the value "3" is entered in code <a href="#">C13074</a>, the multiplexed cycle is repeated every three cycles. If now the value "3" is entered for one node in C13079/x, it is always queried only in the second cycle of the three multiplexed cycles.</p>		
<b>Setting range (min. value   unit   max. value)</b>		
0	Cycles	255
<b>Subcodes</b>	<b>Lenze setting</b>	<b>Info</b>
C13079/1	0 cycles	
...	...	
C13079/100	0 cycles	
<input checked="" type="checkbox"/> Read access <input checked="" type="checkbox"/> Write access <input type="checkbox"/> CINH <input type="checkbox"/> PLC-STOP <input type="checkbox"/> No transfer <input type="checkbox"/> PDO_MAP_RX <input type="checkbox"/> PDO_MAP_TX <input type="checkbox"/> COM <input type="checkbox"/> MOT		

# Parameter reference

## Parameters of the communication module

### C13102

Parameter   Name: <b>C13102   0x1F9E NMT Reset Command</b>		Data type: UNSIGNED_8 Index: 11473 <sub>d</sub> = 2CD1 <sub>h</sub>
<p><b>A reset command to a single EPL node in the network can result in cycle and monitoring errors.</b>                  The code initiates a reset of the EPL node.                  When the reset has been executed, the code is automatically set to "NoCommand / NMTInvalidService".</p>		
<b>Selection list</b> (Lenze setting printed in bold)		
40	ResetNode	
41	ResetCommunication	
42	ResetConfiguration	
<b>255</b>	<b>NoCommand</b>	
<input checked="" type="checkbox"/> Read access <input checked="" type="checkbox"/> Write access <input type="checkbox"/> CINH <input type="checkbox"/> PLC-STOP <input checked="" type="checkbox"/> No transfer <input type="checkbox"/> PDO_MAP_RX <input type="checkbox"/> PDO_MAP_TX <input type="checkbox"/> COM <input type="checkbox"/> MOT		

### C13136

Parameter   Name: <b>C13136   SoC Cycle Counter</b>		Data type: UNSIGNED_32 Index: 11439 <sub>d</sub> = 2CAF <sub>h</sub>
<p>The subcodes of the code display a counter for EPL cycles.</p> <ul style="list-style-type: none"> <li>The SoC cycle counter can be used for activity monitoring.</li> <li>The counter is started at "0" each time the EPL node is switched on. The overflow is at "4294967295".</li> </ul>		
<b>Display range</b> (min. value   unit   max. value)		
0		4294967295
<input checked="" type="checkbox"/> Read access <input type="checkbox"/> Write access <input type="checkbox"/> CINH <input type="checkbox"/> PLC-STOP <input checked="" type="checkbox"/> No transfer <input type="checkbox"/> PDO_MAP_RX <input type="checkbox"/> PDO_MAP_TX <input type="checkbox"/> COM <input type="checkbox"/> MOT		

### C13852

Parameter   Name: <b>C13852   PDO words from MN</b>		Data type: UNSIGNED_16 Index: 10723 <sub>d</sub> = 29E3 <sub>h</sub>
The code indicates the PDO words received (from the managing node).		
<b>Subcodes</b>	<b>Info</b>	
C13852/1	wCtrl	
C13852/2	wIn2	
...	...	
C13852/16	wIn16	
<input checked="" type="checkbox"/> Read access <input type="checkbox"/> Write access <input type="checkbox"/> CINH <input type="checkbox"/> PLC-STOP <input checked="" type="checkbox"/> No transfer <input type="checkbox"/> PDO_MAP_RX <input type="checkbox"/> PDO_MAP_TX <input type="checkbox"/> COM <input type="checkbox"/> MOT		

### C13853

Parameter   Name: <b>C13853   PDO words to MN</b>		Data type: UNSIGNED_16 Index: 10722 <sub>d</sub> = 29E2 <sub>h</sub>
The code indicates the PDO words sent (to the managing node).		
<b>Subcodes</b>	<b>Info</b>	
C13853/1	wState	
C13853/2	wOut2	
...	...	
C13853/16	wOut16	
<input checked="" type="checkbox"/> Read access <input type="checkbox"/> Write access <input type="checkbox"/> CINH <input type="checkbox"/> PLC-STOP <input checked="" type="checkbox"/> No transfer <input type="checkbox"/> PDO_MAP_RX <input type="checkbox"/> PDO_MAP_TX <input type="checkbox"/> COM <input type="checkbox"/> MOT		

# Parameter reference

## Parameters of the communication module

### C13859

Parameter   Name: <b>C13859   0x1A00.0 Number of mapped Tx PDO-1</b>		Data type: UNSIGNED_8 Index: 10716 <sub>d</sub> = 29DC <sub>h</sub>
Number of sent PDOs via the PDO channel 1 (Tx)		
<b>Display range (min. value   unit   max. value)</b>		
0		16
<b>Subcodes</b>		<b>Info</b>
C13859/1		0x1A00.0 Number of mapped Tx PDO-1
<input checked="" type="checkbox"/> Read access <input type="checkbox"/> Write access <input type="checkbox"/> CINH <input type="checkbox"/> PLC-STOP <input type="checkbox"/> No transfer <input type="checkbox"/> PDO_MAP_RX <input type="checkbox"/> PDO_MAP_TX <input type="checkbox"/> COM <input type="checkbox"/> MOT		

### C13860

Parameter   Name: <b>C13860   0x160x.0 Number of mapped Rx PDO</b>		Data type: UNSIGNED_8 Index: 10715 <sub>d</sub> = 29DB <sub>h</sub>
Number of received PDOs via PDO channels 1 ... 6 (Rx)		
<b>Display range (min. value   unit   max. value)</b>		
0		16
<b>Subcodes</b>		<b>Info</b>
C13860/1		0x1600.0 Number of mapped Rx PDO-1
...		...
C13860/6		0x1605.0 Number of mapped Rx PDO-6
<input checked="" type="checkbox"/> Read access <input type="checkbox"/> Write access <input type="checkbox"/> CINH <input type="checkbox"/> PLC-STOP <input type="checkbox"/> No transfer <input type="checkbox"/> PDO_MAP_RX <input type="checkbox"/> PDO_MAP_TX <input type="checkbox"/> COM <input type="checkbox"/> MOT		

### C13861

Parameter   Name: <b>C13861   0x1F8C NMT Communication Status</b>		Data type: UNSIGNED_8 Index: 10714 <sub>d</sub> = 29DA <sub>h</sub>
The code displays the current NMT state (according to the Ethernet POWERLINK specification) of the EPL node.		
<b>Selection list (read only)</b>		<b>Info</b>
0	Off	NMT_GS_OFF
25	Initialising	NMT_GS_INITIALISING
41	ResetAppl	NMT_GS_RESET_APPLICATION
57	ResetComm	NMT_GS_RESET_CONFIGURATION
121	ResetConfig	NMT_GS_RESET_CONFIGURATION
28	NotActive	NMT_CS_NOT_ACTIVE
29	PreOp1	NMT_CS_PRE_OPERATIONAL_2
93	PreOp2	NMT_CS_PRE_OPERATIONAL_2
109	ReadyToOp	NMT_CS_READY_TO_OPERATE
253	Operational	NMT_CS_OPERATIONAL
77	Stopped	NMT_CS_STOPPED
30	BasicEthernet	NMT_CS_BASIC_ETHERNET
<input checked="" type="checkbox"/> Read access <input type="checkbox"/> Write access <input type="checkbox"/> CINH <input type="checkbox"/> PLC-STOP <input checked="" type="checkbox"/> No transfer <input type="checkbox"/> PDO_MAP_RX <input type="checkbox"/> PDO_MAP_TX <input type="checkbox"/> COM <input type="checkbox"/> MOT		

# Parameter reference

## Parameters of the communication module

### C13864

Parameter   Name: <b>C13864   0x1F93.1 Node ID</b>		Data type: UNSIGNED_8 Index: 10711 <sub>d</sub> = 29D7 <sub>h</sub>
The code displays the currently valid EPL node address (Node ID). <ul style="list-style-type: none"> <li>• The node ID must be unequivocal in the EPL network segment.</li> <li>• See also <a href="#">C13899</a>.</li> </ul>		
<b>Display range (min. value   unit   max. value)</b>		
1		239
<input checked="" type="checkbox"/> Read access <input type="checkbox"/> Write access <input type="checkbox"/> CINH <input type="checkbox"/> PLC-STOP <input checked="" type="checkbox"/> No transfer <input type="checkbox"/> PDO_MAP_RX <input type="checkbox"/> PDO_MAP_TX <input type="checkbox"/> COM <input type="checkbox"/> MOT		

### C13865

Parameter   Name: <b>C13865   0x1F93.2 Node ID by HW</b>		Data type: UNSIGNED_8 Index: 10710 <sub>d</sub> = 29D6 <sub>h</sub>
The code indicates whether the EPL node address (node ID) has been set via rotary encoder switches at the communication module or via the software. <ul style="list-style-type: none"> <li>• 0 (FALSE): Node ID has been set via software (<a href="#">C13899</a>).</li> <li>• 1 (TRUE): node ID has been set via rotary encoder switches at the communication module.</li> </ul> <a href="#">▶ Node address setting (37)</a>		
<b>Display range (min. value   unit   max. value)</b>		
0		1
<input checked="" type="checkbox"/> Read access <input type="checkbox"/> Write access <input type="checkbox"/> CINH <input type="checkbox"/> PLC-STOP <input checked="" type="checkbox"/> No transfer <input type="checkbox"/> PDO_MAP_RX <input type="checkbox"/> PDO_MAP_TX <input type="checkbox"/> COM <input type="checkbox"/> MOT		

### C13879

Parameter   Name: <b>C13879   Bus error</b>		Data type: UNSIGNED_32 Index: 10696 <sub>d</sub> = 29C8 <sub>h</sub>
The code displays the bus error state which is signalled by the LED "BE" (Bus Error). <ul style="list-style-type: none"> <li>• Bit 0 = 0 (0x00000000) no bus error</li> <li>• Bit 0 = 1 (0x00000001) bus error active</li> </ul>		
<b>Value is bit-coded:</b>		
Bit 0	Bus Error if TRUE	
<input checked="" type="checkbox"/> Read access <input type="checkbox"/> Write access <input type="checkbox"/> CINH <input type="checkbox"/> PLC-STOP <input checked="" type="checkbox"/> No transfer <input type="checkbox"/> PDO_MAP_RX <input type="checkbox"/> PDO_MAP_TX <input type="checkbox"/> COM <input type="checkbox"/> MOT		

### C13880

Parameter   Name: <b>C13880   error response</b>		Data type: UNSIGNED_8 Index: 10695 <sub>d</sub> = 29C7 <sub>h</sub>
The subcodes determine the reaction when the OPERATIONAL state is left, when SoC is lost and when a CRC error occurs.		
<b>Selection list</b>		
0	No response	
1	Error	
3	Quick stop by trouble	
4	Warning Locked	
6	Information	
<b>Subcodes</b>	<b>Lenze setting</b>	<b>Info</b>
C13880/1	0: No Response	Error reaction at OPERATIONAL loss
C13880/2	0: No Response	Error reaction at SoC loss
C13880/3	0: No Response	Error reaction at CRC error
<input checked="" type="checkbox"/> Read access <input checked="" type="checkbox"/> Write access <input type="checkbox"/> CINH <input type="checkbox"/> PLC-STOP <input type="checkbox"/> No transfer <input type="checkbox"/> PDO_MAP_RX <input type="checkbox"/> PDO_MAP_TX <input type="checkbox"/> COM <input type="checkbox"/> MOT		

# Parameter reference

## Parameters of the communication module

### C13884

Parameter   Name: <b>C13884   CU synchronisation active</b>		Data type: BITFIELD_8 Index: 10691 <sub>d</sub> = 29C3 <sub>h</sub>
The code displays if the EPL node is synchronised. <ul style="list-style-type: none"> <li>• Bit 0 = 0 (0x00000000) The EPL node is not synchronised.</li> <li>• Bit 0 = 1 (0x00000001) The EPL node is synchronised.</li> </ul>		
<b>Value is bit-coded:</b>		
Bit 0	CU Synchronisation is locked if TRUE	
<input checked="" type="checkbox"/> Read access <input type="checkbox"/> Write access <input type="checkbox"/> CINH <input type="checkbox"/> PLC-STOP <input type="checkbox"/> No transfer <input type="checkbox"/> PDO_MAP_RX <input type="checkbox"/> PDO_MAP_TX <input type="checkbox"/> COM <input type="checkbox"/> MOT		

### C13885

Parameter   Name: <b>C13885   Response to RPDO monitoring</b>		Data type: UNSIGNED_8 Index: 10690 <sub>d</sub> = 29C2 <sub>h</sub>
The code controls the error response to failing PDO communication with a node. The failure is detected because expected PDO data are missing.		
<b>Selection list (Lenze setting printed in bold)</b>		
0	Maintain PDO	
1	<b>Delete PDO</b>	
<input checked="" type="checkbox"/> Read access <input checked="" type="checkbox"/> Write access <input type="checkbox"/> CINH <input type="checkbox"/> PLC-STOP <input type="checkbox"/> No transfer <input type="checkbox"/> PDO_MAP_RX <input type="checkbox"/> PDO_MAP_TX <input type="checkbox"/> COM <input type="checkbox"/> MOT		

### C13887

Parameter   Name: <b>C13887   Suppress emergency message upon</b>		Data type: BITFIELD_8 Index: 10688 <sub>d</sub> = 29C0 <sub>h</sub>
This code serves to suppress sending alarm messages to the managing node. You can explicitly suppress a certain type of error. Furthermore, all errors are entered into the logbook. <ul style="list-style-type: none"> <li>• A change can only be effective immediately if no error number with the error type selected here is active in <b>C00165</b>.</li> </ul>		
<b>Value is bit-coded:</b>		
Bit 0	Error	
Bit 1	Fault	
Bit 2	Quick stop by trouble	
Bit 3	Warning Locked	
Bit 4	Warning	
Bit 5	Information	
Bit 6	Reserved	
Bit 7	Reserved	
<input checked="" type="checkbox"/> Read access <input checked="" type="checkbox"/> Write access <input type="checkbox"/> CINH <input type="checkbox"/> PLC-STOP <input type="checkbox"/> No transfer <input type="checkbox"/> PDO_MAP_RX <input type="checkbox"/> PDO_MAP_TX <input type="checkbox"/> COM <input type="checkbox"/> MOT		



# Parameter reference

## Parameters of the communication module

### C13898

Parameter   Name: <b>C13898   0x1F9A Host Name</b>	Data type: VISIBLE_STRING Index: 10677 <sub>d</sub> = 29B5 <sub>h</sub>
<p>The code defines a DNS-compatible device name. The length is limited to 20 characters. <b>The device name must be non-ambiguous within the network domain.</b></p> <p>Naming convention: The device name ...</p> <ul style="list-style-type: none"> <li>• starts with a letter;</li> <li>• ends with a letter or a digit.</li> </ul> <p>The device name consists of ...</p> <ul style="list-style-type: none"> <li>• letters (A ... Z, a ... z);</li> <li>• digits (0 ... 9);</li> <li>• hyphen (-).</li> </ul>	
<input checked="" type="checkbox"/> Read access <input checked="" type="checkbox"/> Write access <input type="checkbox"/> CINH <input type="checkbox"/> PLC-STOP <input type="checkbox"/> No transfer <input type="checkbox"/> PDO_MAP_RX <input type="checkbox"/> PDO_MAP_TX <input type="checkbox"/> COM <input type="checkbox"/> MOT	

### C13899

Parameter   Name: <b>C13899   Node ID SW</b>	Data type: UNSIGNED_8 Index: 10676 <sub>d</sub> = 29B4 <sub>h</sub>
<p>This code serves to set the node ID by means of the software. The value "0" is not a valid node ID. It serves to activate the setting via the rotary coding switches.  <a href="#">▶ Node address setting (37)</a></p>	
<b>Setting range (min. value   unit   max. value)</b>	<b>Lenze setting</b>
0	239 0
<input checked="" type="checkbox"/> Read access <input checked="" type="checkbox"/> Write access <input type="checkbox"/> CINH <input type="checkbox"/> PLC-STOP <input type="checkbox"/> No transfer <input type="checkbox"/> PDO_MAP_RX <input type="checkbox"/> PDO_MAP_TX <input type="checkbox"/> COM <input type="checkbox"/> MOT	

### C13900

Parameter   Name: <b>C13900   Firmware Type</b>	Data type: VISIBLE_STRING Index: 10675 <sub>d</sub> = 29B3 <sub>h</sub>
<p>Display of the Lenze firmware type of the communication module (product designation).</p>	
<input checked="" type="checkbox"/> Read access <input type="checkbox"/> Write access <input type="checkbox"/> CINH <input type="checkbox"/> PLC-STOP <input type="checkbox"/> No transfer <input type="checkbox"/> PDO_MAP_RX <input type="checkbox"/> PDO_MAP_TX <input type="checkbox"/> COM <input type="checkbox"/> MOT	

### C13901

Parameter   Name: <b>C13901   Firmware Date</b>	Data type: VISIBLE_STRING Index: 10674 <sub>d</sub> = 29B2 <sub>h</sub>
<p>Display of the creation date of the communication module firmware</p>	
<input checked="" type="checkbox"/> Read access <input type="checkbox"/> Write access <input type="checkbox"/> CINH <input type="checkbox"/> PLC-STOP <input type="checkbox"/> No transfer <input type="checkbox"/> PDO_MAP_RX <input type="checkbox"/> PDO_MAP_TX <input type="checkbox"/> COM <input type="checkbox"/> MOT	

### C13902

Parameter   Name: <b>C13902   Firmware Version</b>	Data type: VISIBLE_STRING Index: 10673 <sub>d</sub> = 29B1 <sub>h</sub>
<p>Display of the version number of the communication module firmware</p>	
<input checked="" type="checkbox"/> Read access <input type="checkbox"/> Write access <input type="checkbox"/> CINH <input type="checkbox"/> PLC-STOP <input type="checkbox"/> No transfer <input type="checkbox"/> PDO_MAP_RX <input type="checkbox"/> PDO_MAP_TX <input type="checkbox"/> COM <input type="checkbox"/> MOT	

# Parameter reference

## Parameters of the communication module

### C13910

Parameter   Name: <b>C13910   Last Module Error</b>		Data type: UNSIGNED_32 Index: 10665 <sub>d</sub> = 29A9 <sub>h</sub>
Display of the error code of the error last occurred in the communication module		
<b>Selection list</b> (Lenze setting printed in bold)		
<b>0</b>	<b>No error</b>	
297566817	Warning locked INVALID_ADDR	
29122816	Software error	
96239921	Fault OPER_LOST	
230457649	Quick stop OPER_LOST	
297566513	Warning locked OPER_LOST	
431784241	Information OPER_LOST	
96240229	Fault CN_SoC_LOSS	
230457957	Quick stop CN_SoC_LOSS	
297566821	Warning locked CN_SoC_LOSS	
431784549	Information CN_SoC_LOSS	
96240230	Fault COM_CRC	
230457958	Quick stop COM_CRC	
297566822	Warning locked COM_CRC	
431784550	Information COM_CRC	
<input checked="" type="checkbox"/> Read access <input checked="" type="checkbox"/> Write access <input type="checkbox"/> CINH <input type="checkbox"/> PLC-STOP <input checked="" type="checkbox"/> No transfer <input type="checkbox"/> PDO_MAP_RX <input type="checkbox"/> PDO_MAP_TX <input type="checkbox"/> COM <input type="checkbox"/> MOT		

### C13915

Parameter   Name: <b>C13915   CustomerObject[16]</b>		Data type: OCTET_STRING Index: 10660 <sub>d</sub> = 29A4 <sub>h</sub>
The code contains an octet string[16] for customised use.		
Subcodes	Lenze setting	Info
C13915/1	00000000000000000000000000000000 000	
<input checked="" type="checkbox"/> Read access <input checked="" type="checkbox"/> Write access <input type="checkbox"/> CINH <input type="checkbox"/> PLC-STOP <input type="checkbox"/> No transfer <input type="checkbox"/> PDO_MAP_RX <input type="checkbox"/> PDO_MAP_TX <input type="checkbox"/> COM <input type="checkbox"/> MOT		

### C13920

Parameter   Name: <b>C13920   Current address switch</b>		Data type: UNSIGNED_8 Index: 10655 <sub>d</sub> = 299F <sub>h</sub>
The code indicates the current switch position for the communication module (node ID). Not all switch positions are useful. The values for node IDs assigned by means of switches usually are between 1 and 239. <a href="#">▶ Node address setting (37)</a>		
Display range (min. value   unit   max. value)		
0		255
<input checked="" type="checkbox"/> Read access <input type="checkbox"/> Write access <input type="checkbox"/> CINH <input type="checkbox"/> PLC-STOP <input checked="" type="checkbox"/> No transfer <input type="checkbox"/> PDO_MAP_RX <input type="checkbox"/> PDO_MAP_TX <input type="checkbox"/> COM <input type="checkbox"/> MOT		

# Parameter reference

## Table of attributes

### 11.2 Table of attributes

The table of attributes contains information required for communicating with the Inverter Drive 8400 via parameters.

#### How to read the table of attributes:

Column		Meaning	Entry		
Code		Parameter name	Cxxxxx		
Name		Parameter short text (display text)	Text		
Index	dec	Index under which the parameter is addressed. The subindex for array variables corresponds to the Lenze subcode number.	24575 - Lenze code number	Is only required for access via a bus system.	
	hex		5FFF <sub>h</sub> - Lenze code number		
Data	DS	Data structure	E	Single variable (only one parameter element)	
			A	Array variable (several parameter elements)	
	DA	Number of array elements (subcodes)	Number		
	DT	Data type	BITFIELD_8	1 byte, bit-coded	
			BITFIELD_16	2 bytes, bit-coded	
			BITFIELD_32	4 bytes, bit-coded	
			INTEGER_8	1 byte, with sign	
			INTEGER_16	2 bytes with sign	
			INTEGER_32	4 bytes, with sign	
			UNSIGNED_8	1 byte without sign	
			UNSIGNED_16	2 bytes without sign	
			UNSIGNED_32	4 bytes, without sign	
	Factor	Factor for data transmission via a bus system, depending on the number of decimal positions	VISIBLE_STRING	ASCII string	
OCTET_STRING					
Access	R	Read access	<input checked="" type="checkbox"/> Reading permitted		
	W	Write access	<input checked="" type="checkbox"/> Writing permitted		
	CINH	Controller inhibit (CINH) required	<input checked="" type="checkbox"/> Writing is only possible when the controller is inhibited (CINH)		

# Parameter reference

## Table of attributes

Table of attributes

Code	Name	Lenze index		Data				Access		
		dec	hex	DS	DA	DT	Factor	R	W	CINH
<a href="#">C13000</a>	0x1E40.2 IP Address	11575	2D37	A	1	UNSIGNED_32		<input checked="" type="checkbox"/>		
<a href="#">C13001</a>	0x1E40.3 Subnet Mask	11574	2D36	A	1	UNSIGNED_32		<input checked="" type="checkbox"/>		
<a href="#">C13003</a>	0x1E40.5 IP Address Router	11572	2D34	A	1	UNSIGNED_32		<input checked="" type="checkbox"/>	<input checked="" type="checkbox"/>	
<a href="#">C13004</a>	0x1030.5 MAC Address	11571	2D33	A	1	OCTET_STRING		<input checked="" type="checkbox"/>		
<a href="#">C13028</a>	0x1F81 Node Assignment CN	11547	2D1B	A	100	UNSIGNED_32		<input checked="" type="checkbox"/>	<input checked="" type="checkbox"/>	
<a href="#">C13029</a>	0x1F81 Node Assignment	11546	2D1A	A	3	UNSIGNED_32		<input checked="" type="checkbox"/>	<input checked="" type="checkbox"/>	
<a href="#">C13040</a>	0x1F82 Feature Flags	11535	2D0F	E	1	UNSIGNED_32		<input checked="" type="checkbox"/>		
<a href="#">C13060</a>	0x1006 Cycle Time	11515	2CFB	E	1	UNSIGNED_32	1	<input checked="" type="checkbox"/>	<input checked="" type="checkbox"/>	
<a href="#">C13066</a>	0x1F8D PResPayloadLimit RPDO CN	11509	2CF5	A	100	UNSIGNED_16	1	<input checked="" type="checkbox"/>	<input checked="" type="checkbox"/>	
<a href="#">C13067</a>	0x1F8D PResPayloadLimit RPDO	11508	2CF4	A	3	UNSIGNED_16	1	<input checked="" type="checkbox"/>	<input checked="" type="checkbox"/>	
<a href="#">C13071</a>	0x1F98.4 PReqPayloadLimit RPDO	11504	2CF0	E	1	UNSIGNED_16	1	<input checked="" type="checkbox"/>	<input checked="" type="checkbox"/>	
<a href="#">C13072</a>	0x1F98.5 PResPayloadLimit TPDO	11503	2CEF	E	1	UNSIGNED_16	1	<input checked="" type="checkbox"/>	<input checked="" type="checkbox"/>	
<a href="#">C13074</a>	0x1F98.7 Multiplex Cycle Counter	11501	2CED	E	1	UNSIGNED_8	1	<input checked="" type="checkbox"/>	<input checked="" type="checkbox"/>	
<a href="#">C13075</a>	0x1F98.8 SDO Channel Width (Asyn- cMTU)	11500	2CEC	E	1	UNSIGNED_16	1	<input checked="" type="checkbox"/>	<input checked="" type="checkbox"/>	
<a href="#">C13076</a>	0x1F98.9 Prescaler_U16	11499	2CEB	E	1	UNSIGNED_16	1	<input checked="" type="checkbox"/>	<input checked="" type="checkbox"/>	
<a href="#">C13078</a>	0x1F99 BasicEthTimeout	11497	2CE9	E	1	UNSIGNED_32	1	<input checked="" type="checkbox"/>	<input checked="" type="checkbox"/>	
<a href="#">C13079</a>	0x1F9B Multiplex Cycle CN	11496	2CE8	A	100	UNSIGNED_8	1	<input checked="" type="checkbox"/>	<input checked="" type="checkbox"/>	
<a href="#">C13102</a>	0x1F9E NMT Reset Command	11473	2CD1	E	1	UNSIGNED_8	1	<input checked="" type="checkbox"/>	<input checked="" type="checkbox"/>	
<a href="#">C13136</a>	SoC Cycle Counter	11439	2CAF	E	1	UNSIGNED_32	1	<input checked="" type="checkbox"/>		
<a href="#">C13852</a>	PDO word from MN	10723	29E3	A	16	UNSIGNED_16		<input checked="" type="checkbox"/>		
<a href="#">C13853</a>	PDO words to MN	10722	29E2	A	16	UNSIGNED_16		<input checked="" type="checkbox"/>		
<a href="#">C13859</a>	0x1A00.0 Number of mapped Tx PDO- 1	10716	29DC	A	1	UNSIGNED_8	1	<input checked="" type="checkbox"/>		
<a href="#">C13860</a>	0x160x.0 Number of mapped Rx PDO	10715	29DB	A	6	UNSIGNED_8	1	<input checked="" type="checkbox"/>		
<a href="#">C13861</a>	0x1F8C NMT Communication Status	10714	29DA	E	1	UNSIGNED_8	1	<input checked="" type="checkbox"/>		
<a href="#">C13864</a>	0x1F93.1 Node ID	10711	29D7	E	1	UNSIGNED_8	1	<input checked="" type="checkbox"/>		
<a href="#">C13865</a>	0x1F93.2 Node ID by HW	10710	29D6	E	1	UNSIGNED_8	1	<input checked="" type="checkbox"/>		
<a href="#">C13879</a>	Bus error	10696	29C8	E	1	UNSIGNED_32		<input checked="" type="checkbox"/>		
<a href="#">C13880</a>	Error response	10695	29C7	A	3	UNSIGNED_8	1	<input checked="" type="checkbox"/>	<input checked="" type="checkbox"/>	
<a href="#">C13884</a>	CU synchronisation active	10691	29C3	E	1	BITFIELD_8		<input checked="" type="checkbox"/>		
<a href="#">C13885</a>	Error reaction on RPDO check	10690	29C2	E	1	UNSIGNED_8	1	<input checked="" type="checkbox"/>	<input checked="" type="checkbox"/>	
<a href="#">C13887</a>	Suppress emergency message upon	10688	29C0	E	1	BITFIELD_8		<input checked="" type="checkbox"/>	<input checked="" type="checkbox"/>	
<a href="#">C13898</a>	0x1F9A Host Name	10677	29B5	E	1	VISIBLE_STRING		<input checked="" type="checkbox"/>	<input checked="" type="checkbox"/>	
<a href="#">C13899</a>	Node ID SW	10676	29B4	E	1	UNSIGNED_8	1	<input checked="" type="checkbox"/>	<input checked="" type="checkbox"/>	
<a href="#">C13900</a>	Firmware Type	10675	29B3	E	1	VISIBLE_STRING		<input checked="" type="checkbox"/>		
<a href="#">C13901</a>	Firmware Date	10674	29B2	E	1	VISIBLE_STRING		<input checked="" type="checkbox"/>		
<a href="#">C13902</a>	Firmware version	10673	29B1	E	1	VISIBLE_STRING		<input checked="" type="checkbox"/>		
<a href="#">C13910</a>	Last Module Error	10665	29A9	E	1	UNSIGNED_32	1	<input checked="" type="checkbox"/>	<input checked="" type="checkbox"/>	
<a href="#">C13915</a>	CustomerObject[16]	10660	29A4	A	1	OCTET_STRING		<input checked="" type="checkbox"/>	<input checked="" type="checkbox"/>	
<a href="#">C13920</a>	Current address switch	10655	299F	E	1	UNSIGNED_8	1	<input checked="" type="checkbox"/>		

## 12 Index table

The following objects specified by the POWERLINK communication profile (DS 301) are supported:

EPL index	Index name	Subindex name	Type	Attr.	Reference / description	Value
0x1000	NMT_DeviceType_U32	-	U32	R	-	0
0x1001	ERR_ErrorRegister_U8	-	I8	R	-	
0x1003.0	ERR_History_ADOM	NumberOfEntries	U8	RW	-	
0x1003.1 ...254	ERR_History_ADOM	ErrorEntry_DOM	DOMAIN	R	-	
0x1006	NMT_CycleLen_U32	-	U32	RW	<a href="#">C13060</a>	2000
0x1008	NMT_ManufactDevName_VS	-	VS5	R	-	Lenze
0x1009	NMT_ManufactHwVers_VS	-	VS2	R	Hardware version, variable	
0x100A	NMT_ManufactSwVers_VS	-	VS6	R	Software version, variable	
0x1016.0	NMT_ConsumerHeartbeatTime_AU32	NumberOfEntries	U8	RW	-	0 ... 4
0x1016.1 ...4	NMT_ConsumerHeartbeatTime_AU32	HeartbeatDescription	U32	RW	Value in [ms]	
0x1018.0	NMT_IdentityObject_REC	NumberOfEntries	U8	R	-	1
0x1018.1	NMT_IdentityObject_REC	VendorId_U32	U32	R	-	59
0x1030.0	NMT_InterfaceGroup_0h_REC	NumberOfEntries	U8	R	-	9
0x1030.1	NMT_InterfaceGroup_0h_REC	InterfaceIndex_U16	U16	R	Interface no. of the Ethernet interface	1
0x1030.2	NMT_InterfaceGroup_0h_REC	InterfaceDescription_VSTR	VS3	R	Description of the Ethernet interface	EPL
0x1030.3	NMT_InterfaceGroup_0h_REC	InterfaceType_U8	U8	R	Interface type	6
0x1030.4	NMT_InterfaceGroup_0h_REC	InterfaceMtu_U32	U32	R	Maximum frame size [byte]	1490
0x1030.5	NMT_InterfaceGroup_0h_REC	InterfacePhysAddress_OSTR	OS6	R	<a href="#">C13004/1</a>	
0x1030.6	NMT_InterfaceGroup_0h_REC	InterfaceName_VSTR	VS16	RW	Symbolic name of the Ethernet interface	ETH0
0x1030.7	NMT_InterfaceGroup_0h_REC	InterfaceOperState_U8	U8	R	Operation status of the Ethernet interface	0: down
0x1030.8	NMT_InterfaceGroup_0h_REC	InterfaceAdminState_U8	U8	RW	Administration status of the Ethernet interface	1: up
0x1030.9	NMT_InterfaceGroup_0h_REC	Valid_BOOL	BOOL	RW	Release of the interface description	1: TRUE
0x1300	SDO_SequLayerTimeout_U32	-	U32	RW	Value in [ms]	15000
0x1301	SDO_CmdLayerTimeout_U32	-	U32	RW	Value in [ms]	30000
0x1400.0	PDO_RxCommParam_00h_REC	NumberOfEntries	U8	R	-	2
0x1400.1	PDO_RxCommParam_00h_REC	NodeId_U8	U8	RW	-	
0x1400.2	PDO_RxCommParam_00h_REC	MappingVersion_U8	U8	R	Version of PDO mapping	0
0x1401.0	PDO_RxCommParam_01h_REC	NumberOfEntries	U8	R	-	2
0x1401.1	PDO_RxCommParam_01h_REC	NodeId_U8	U8	RW	-	
0x1401.2	PDO_RxCommParam_01h_REC	MappingVersion_U8	U8	R	Version of PDO mapping	0
0x1402.0	PDO_RxCommParam_02h_REC	NumberOfEntries	U8	R	-	2
0x1402.1	PDO_RxCommParam_02h_REC	NodeId_U8	U8	RW	-	
0x1402.2	PDO_RxCommParam_02h_REC	MappingVersion_U8	U8	R	Version of PDO mapping	0
0x1403.0	PDO_RxCommParam_03h_REC	NumberOfEntries	U8	R	-	2
0x1403.1	PDO_RxCommParam_03h_REC	NodeId_U8	U8	RW	-	
0x1403.2	PDO_RxCommParam_03h_REC	MappingVersion_U8	U8	R	Version of PDO mapping	0
0x1404.0	PDO_RxCommParam_04h_REC	NumberOfEntries	U8	R	-	2
0x1404.1	PDO_RxCommParam_04h_REC	NodeId_U8	U8	RW	-	
0x1404.2	PDO_RxCommParam_04h_REC	MappingVersion_U8	U8	R	Version of PDO mapping	0
0x1405.0	PDO_RxCommParam_05h_REC	NumberOfEntries	U8	R	-	2
0x1405.1	PDO_RxCommParam_05h_REC	NodeId_U8	U8	RW	-	
0x1405.2	PDO_RxCommParam_05h_REC	MappingVersion_U8	U8	R	Version of PDO mapping	0

# Index table

EPL index	Index name	Subindex name	Type	Attr.	Reference / description	Value
0x1600.0	PDO_RxMappParam_00h_REC	NumberOfEntries	U8	RW	<a href="#">C13860/1</a>	
0x1600.1 ...16	PDO_RxMappParam_00h_REC	ObjectMapping_U64	U64	RW	-	
0x1601.0	PDO_RxMappParam_01h_REC	NumberOfEntries	U8	RW	<a href="#">C13860/2</a>	
0x1601.1 ...16	PDO_RxMappParam_01h_REC	ObjectMapping_U64	U64	RW	-	
0x1602.0	PDO_RxMappParam_02h_REC	NumberOfEntries	U8	RW	<a href="#">C13860/3</a>	
0x1602.1 ...16	PDO_RxMappParam_02h_REC	ObjectMapping_U64	U64	RW	-	
0x1603.0	PDO_RxMappParam_03h_REC	NumberOfEntries	U8	RW	<a href="#">C13860/4</a>	
0x1603.1 ...16	PDO_RxMappParam_03h_REC	ObjectMapping_U64	U64	RW	-	
0x1604.0	PDO_RxMappParam_04h_REC	NumberOfEntries	U8	RW	<a href="#">C13860/5</a>	
0x1604.1 ...16	PDO_RxMappParam_04h_REC	ObjectMapping_U64	U64	RW	-	
0x1605.0	PDO_RxMappParam_05h_REC	NumberOfEntries	U8	RW	<a href="#">C13860/6</a>	
0x1605.1 ...16	PDO_RxMappParam_05h_REC	ObjectMapping_U64	U64	RW	-	
0x1800.0	PDO_TxCommParam_00h_REC	NumberOfEntries	U8	R	-	2
0x1800.1	PDO_TxCommParam_00h_REC	NodeID_U8	U8	R	Node ID of the receiver	0 (pseudo node ID for PRes-Tx)
0x1800.2	PDO_TxCommParam_00h_REC	MappingVersion_U8	U8	R	Version of PDO mapping	0
0x1A00.0	PDO_TxMappParam_00h_REC	NumberOfEntries	U8	RW	<a href="#">C13859/1</a>	
0x1A00.1 ...16	PDO_TxMappParam_00h_REC	ObjectMapping_U64	U64	RW	-	
0x1C0A.0	DLL_CNCollision_REC	NumberOfEntries	U8	R	-	1
0x1C0A.1	DLL_CNCollision_REC	CumulativeCnt_U32	U32	R	-	
0x1C0B.0	DLL_CNLossSoC_REC	NumberOfEntries	U8	R	-	3
0x1C0B.1	DLL_CNLossSoC_REC	CumulativeCnt_U32	U32	R	-	
0x1C0B.2	DLL_CNLossSoC_REC	ThresholdCnt_U32	U32	R	-	
0x1C0B.3	DLL_CNLossSoC_REC	Threshold_U32	U32	RW	-	
0x1C0F.0	DLL_CNCRCErrror_REC	NumberOfEntries	U8	R	-	1
0x1C0F.1	DLL_CNCRCErrror_REC	CumulativeCnt_U32	U32	R	-	
0x1C0F.2	DLL_CNCRCErrror_REC	ThresholdCnt_U32	U32	R	-	
0x1C0F.3	DLL_CNCRCErrror_REC	Threshold_U32	U32	RW	-	
0x1C10	DLL_CNLossOfLinkCum_U32	-	U32	R	-	0
0x1E40.0	NWL_IpAddrTable_0h_REC	NumberOfEntries	U8	R	-	5
0x1E40.1	NWL_IpAddrTable_0h_REC	IIndex_U16	U16	R	-	0
0x1E40.2	NWL_IpAddrTable_0h_REC	Addr_IPAD	U32	R	<a href="#">C13000/1</a>	
0x1E40.3	NWL_IpAddrTable_0h_REC	NetMask_IPAD	U32	R	<a href="#">C13001/1</a>	
0x1E40.4	NWL_IpAddrTable_0h_REC	ReasmMaxSize_U16	U16	R	Maximum frame size which can be reconstructed from frames arriving in fragments [byte].	1490
0x1E40.5	NWL_IpAddrTable_0h_REC	DefaultGateway_IPAD	U32	RW	<a href="#">C13003/1</a>	
0x1E4A.0	NWL_IpGroup_REC	NumberOfEntries	U8	R	-	3
0x1E4A.1	NWL_IpGroup_REC	Forwarding_BOOL	BOOL	R	Release for IP router function	0: FALSE
0x1E4A.2	NWL_IpGroup_REC	DefaultTTL_U16	U16	RW	TimeToLive value for transmitted IP frames Limits the range with regard to router stations passed.	64
0x1E4A.3	NWL_IpGroup_REC	ForwardingDatagrams_U32	U32	R	Counter for routed frames	-
0x1F81.0	NMT_NodeAssignment_AU32	NumberOfEntries	U8	R	-	254
0x1F81.1 ...100	NMT_NodeAssignment_AU32	NodeAssignment	U32	RW	<a href="#">C13028/1...100</a>	
0x1F81.240	NMT_NodeAssignment_AU32	NodeAssignment	U32	RW	<a href="#">C13029/1</a>	
0x1F81.253	NMT_NodeAssignment_AU32	NodeAssignment	U32	RW	<a href="#">C13029/2</a>	

# Index table

EPL index	Index name	Subindex name	Type	Attr.	Reference / description	Value
0x1F81.254	NMT_NodeAssignment_AU32	NodeAssignment	U32	RW	<a href="#">C13029/3</a>	
0x1F82	NMT_FeatureFlags_U32	-	U32	R	<a href="#">C13040</a>	0x20
0x1F83	NMT_EPLVers_U8	-	U8	R	EPL version	
0x1F8C	NMT_CurrState_U8	-	U8	R	<a href="#">C13861</a>	
0x1F8D.0	NMT_MNPResPayloadList_AU32	NumberOfEntries	U8	R	-	254
0x1F8D.1...100	NMT_MNPResPayloadList_AU32	PResPayload	U16	RW	<a href="#">C13066/1...100</a>	
0x1F8D.240	NMT_MNPResPayloadList_AU32	PResPayload	U16	RW	<a href="#">C13067/1</a>	
0x1F8D.253	NMT_MNPResPayloadList_AU32	PResPayload	U16	RW	<a href="#">C13067/2</a>	
0x1F8D.254	NMT_MNPResPayloadList_AU32	PResPayload	U16	RW	<a href="#">C13067/3</a>	
0x1F93.1	NMT_EPLNodeID_REC	NodeID_U8	U8	R	<a href="#">C13864</a>	
0x1F93.2	NMT_EPLNodeID_REC	NodeIDByHW_BOOL	BOOL	R	-	
0x1F98.0	NMT_CycleTiming_REC	NumberOfEntries	U8	R	-	9
0x1F98.1	NMT_CycleTiming_REC	IsochrTxMaxPayload_U16	U16	R	Size of the isochronous transmit memory	1490
0x1F98.2	NMT_CycleTiming_REC	IsochrRxMaxPayload_U16	U16	R	Size of the isochronous receive memory	1490
0x1F98.3	NMT_CycleTiming_REC	PResMaxLatency_U32	U32	R	Isochronous response delay [ns]	2000
0x1F98.4	NMT_CycleTiming_REC	PReqActPayload_U16	U16	RW	<a href="#">C13071</a>	
0x1F98.5	NMT_CycleTiming_REC	PResActPayload_U16	U16	RW	<a href="#">C13072</a>	
0x1F98.6	NMT_CycleTiming_REC	ASndMaxLatency_U32	U32	R	Asynchronous response delay [ns]	80000
0x1F98.7	NMT_CycleTiming_REC	MultipleCycleCnt_U8	U8	RW	<a href="#">C13074</a>	0
0x1F98.8	NMT_CycleTiming_REC	AsyncMTUSize_U16	U16	RW	<a href="#">C13075</a>	
0x1F98.9	NMT_CycleTiming_REC	Prescaler_U16	U16	RW	<a href="#">C13076</a>	
0x1F99	NMT_CNBasicEthernetTimeout_U32	-	U32	RW	<a href="#">C13078</a>	
0x1F9A	NMT_HostName_VSTR	-	VS32	RW	<a href="#">C13898</a>	
0x1F9B.1...100	NMT_MultiplCycleAssign_AU8	CycleNo	U8	RW	<a href="#">C13079</a>	0 ... value of 0x1F98.7
0x1F9E	NMT_ResetCmd_U8	-	U8	W	<a href="#">C13102</a>	

## 13 Index

### 0-9

0x1006 Cycle Time (C13060) [70](#)  
 0x1030.5 MAC Address (C13004) [66](#)  
 0x160x.0 Number of mapped Rx PDO (C13860) [75](#)  
 0x1A00.0 Number of mapped Tx PDO-1 (C13859) [75](#)  
 0x1E40.2 IP Address (C13000) [65](#)  
 0x1E40.3 Subnet Mask (C13001) [65](#)  
 0x1E40.5 IP Address Router (C13003) [66](#)  
 0x1F81 node assignment (C13029) [68](#)  
 0x1F81 Node Assignment CN (C13028) [67](#)  
 0x1F82 Feature Flags (C13040) [69](#)  
 0x1F8C NMT Communication Status (C13861) [75](#)  
 0x1F8D PResPayloadLimit RPDO (C13067) [71](#)  
 0x1F8D PResPayloadLimit RPDO CN (C13066) [71](#)  
 0x1F93.1 Node ID (C13864) [76](#)  
 0x1F93.2 Node ID by HW (C13865) [76](#)  
 0x1F98.4 PReqPayloadLimit RPDO (C13071) [71](#)  
 0x1F98.5 PResPayloadLimit TPDO (C13072) [72](#)  
 0x1F98.7 Multiplex Cycle Counter (C13074) [72](#)  
 0x1F98.8 SDO Channel Width (AsyncMTU) (C13075) [72](#)  
 0x1F98.9 Prescaler\_U16 (C13076) [72](#)  
 0x1F99 BasicEthTimeout (C13078) [72](#)  
 0x1F9A Host Name (C13898) [78](#)  
 0x1F9B Multiplex Cycle CN (C13079) [73](#)  
 0x1F9E NMT Reset Command (C13102) [74](#)

### A

Accessing process data [45](#)  
 Activating changed setting [40](#)  
 Application as directed [12](#)  
 Application notes (representation) [9](#)  
 Approvals [15](#)

### B

Basic Ethernet Mode [29](#)  
 Baud rate [15](#)  
 Before initial switch-on [36](#)  
 Buffer size [19](#)  
 Bus Error (C13879) [76](#)

### C

C13000 | 0x1E40.2 IP Address [65](#)  
 C13001 | 0x1E40.3 Subnet Mask [65](#)  
 C13003 | 0x1E40.5 IP Address Router [66](#)  
 C13004 | 0x1030.5 MAC Address [66](#)  
 C13028 | 0x1F81 Node Assignment CN [67](#)  
 C13029 | 0x1F81 Node Assignment [68](#)  
 C13040 | 0x1F82 Feature Flags [69](#)  
 C13060 | 0x1006 Cycle Time [70](#)  
 C13066 | 0x1F8D PResPayloadLimit RPDO CN [71](#)

C13067 | 0x1F8D PResPayloadLimit RPDO [71](#)  
 C13071 | 0x1F98.4 PReqPayloadLimit RPDO [71](#)  
 C13072 | 0x1F98.5 PResPayloadLimit TPDO [72](#)  
 C13074 | 0x1F98.7 Multiplex Cycle Counter [72](#)  
 C13075 | 0x1F98.8 SDO Channel Width (AsyncMTU) [72](#)  
 C13076 | 0x1F98.9 Prescaler\_U16 [72](#)  
 C13078 | 0x1F99 BasicEthTimeout [72](#)  
 C13079 | 0x1F9B Multiplex Cycle CN [73](#)  
 C13102 | 0x1F9E NMT Reset Command [74](#)  
 C13136 | SoC Cycle Counter [74](#)  
 C13852 | PDO words from MN [74](#)  
 C13853 | PDO words to MN [74](#)  
 C13859 | 0x1A00.0 Number of mapped Tx PDO-1 [75](#)  
 C13860 | 0x160x.0 Number of mapped Rx PDO [75](#)  
 C13861 | 0x1F8C NMT Communication Status [75](#)  
 C13864 | 0x1F93.1 Node ID [76](#)  
 C13865 | 0x1F93.2 Node ID by HW [76](#)  
 C13879 | Bus error [76](#)  
 C13880 | Error response [76](#)  
 C13884 | CU Synchronisation Active [77](#)  
 C13885 | Response to RPDO check [77](#)  
 C13887 | Suppress emergency message upon [77](#)  
 C13898 | 0x1F9A Host Name [78](#)  
 C13899 | Node ID SW [78](#)  
 C13900 | Firmware Type [78](#)  
 C13901 | Firmware Date [78](#)  
 C13902 | Firmware Version [78](#)  
 C13910 | Last Module Error [79](#)  
 C13915 | CustomerObject [79](#)  
 C13920 | Current address switch [79](#)  
 Carry out the port interconnection in the »Engineer« [47](#)  
 CN operating modes [19](#)  
 Codes [65](#)  
 Colour code of the Ethernet cable [33](#)  
 Commissioning [36](#)  
 Communication data [19](#)  
 Communication medium [15](#)  
 Communication profile [15](#)  
 Communication time [19](#)  
 Conformities [15](#)  
 Connection to the standard Ethernet network [28](#)  
 Connections [14](#)  
 Conventions [7](#)  
 Conventions used [7](#)  
 CU Synchronisation Active (C13884) [77](#)  
 Current address switch (C13920) [79](#)  
 CustomerObject (C13915) [79](#)  
 Cycle time [19](#)



## D

- Delay time [19](#)
- Device and application-specific safety instructions [11](#)
- Device protection [11](#)
- Diagnostic data [59](#)
- Diagnostic messages [59](#)
- Diagnostics [52](#)
- Dimensions [20](#)
- Document history [6](#)
- Drive synchronisation [42](#)

## E

- Electrical installation [25](#)
- E-mail to Lenze [91](#)
- Emergency messages [59](#)

## EPL

- Exist. conn. to 8400 lost (error message) [62](#)
- Factory settings loaded (error message) [63](#)
- Fatal software error (error message) [63](#)
- Invalid address selected (error message) [64](#)
- Invalid module configuration (error message) [64](#)
- Invalid Parameter Set (error message) [63](#)
- NV memory
  - No access (error message) [62](#)
  - Read error (error message) [62](#)
  - Write error (error message) [62](#)
- PDO Mapping invalid (error message) [63](#)
- Restart after watchdog reset (error message) [62](#)
- Software error (error message) [63](#)
- State OPERATIONAL lost (error message) [64](#)
- Synchronisation lost from MN (error message) [64](#)
- Telegram error detected (CRC) (error message) [64](#)
- Watchdog reset (error message) [63](#)

Error code of Inverter Drive 8400 [60](#)

Error messages [61](#)

Causes and remedies [62](#)

Error messages (short overview) [61](#)

Error number

- 0x01bc3100 [62](#)
- 0x01bc5531 [62](#)
- 0x01bc5532 [62](#)
- 0x01bc5533 [62](#)
- 0x01bc6010 [62](#)
- 0x01bc6011 [63](#)
- 0x01bc6100 [63](#)
- 0x01bc6101 [63](#)
- 0x01bc6110 [63](#)
- 0x01bc641f [63](#)
- 0x01bc6420 [63](#)
- 0x01bc6430 [64](#)
- 0x01bc8131 [64](#)
- 0x01bc8261 [64](#)
- 0x01bc8265 [64](#)
- 0x01bc8266 [64](#)

Error reaction on RPDO check (C13885) [77](#)

Error response (C13880) [76](#)

Establishing communication [40](#)

Ethernet cable [32](#)

Ethernet cable specification [32](#)

Ethernet cable, colour code [33](#)

Ethernet cable, structure [32](#)

Ethernet POWERLINK [28](#)

Ethernet POWERLINK error messages

Causes and remedies [62](#)

Ethernet POWERLINK error messages (short overview) [61](#)

Exchanging the communication module [24](#)

External voltage supply [34](#)

## F

Feedback to Lenze [91](#)

Fieldbus status displays [54](#)

Firmware Date (C13901) [78](#)

Firmware Type (C13900) [78](#)

Firmware Version (C13902) [78](#)

Frame size [19](#)

Freely configuring the port interconnection of the process data objects (PDO) [47](#)

## G

General data [15](#)

General safety and application notes [10](#)

## I

Identification [12](#)

Initial switch-on [40](#)

Initial switch-on and diagnosing [41](#)

Installation [21](#)

Interface [15](#)

Interfaces [14](#)

Interruption of PROFINET communication [51](#)

## L

Last Module Error (C13910) [79](#)

LED status displays [52](#)

## M

Maximum time for device search [43](#)

Mechanical installation [22](#)

Module status displays [53](#)

Monitoring [51](#)

Mounting for standard devices of 0.25 kW and 0.37 kW [22](#)

Mounting for standard devices of 0.55 kW or more [23](#)

## N

Nameplate [12](#)

Network topology [15](#), [26](#)

Node address setting [37](#)

Node addresses (node IDs) [15](#)

Node ID [15](#)  
Node ID setting [37](#)  
Node ID SW (C13899) [78](#)  
Notes used [9](#)  
Number of RPDOs [19](#)  
Number of TPDOs [19](#)

## O

Operating conditions [15](#)  
Operating modes (CN) [19](#)  
Optimisation of networks [43](#)

## P

Parameter reference [65](#)  
Parameters of the communication module [65](#)  
PDO mapping [45](#)  
PDO words from MN (C13852) [74](#)  
PDO words to MN (C13853) [74](#)  
Pin assignment of the RJ45 sockets [31](#)  
Preconfigured port interconnection of the process data objects (PDO) [46](#)  
Process data [44](#)  
Process data transfer [44](#)  
Processing time [19](#)  
Product description [12](#)  
Product features [13](#)  
PROFINET connection [30](#)  
Protection against uncontrolled restart [40](#)  
Protection of persons [11](#)  
Protective insulation [16](#)

## R

Residual hazards [11](#)  
Rotary coding switches [37](#)  
RPDO user data per application (all RPDOs) [19](#)

## S

Safety instructions [10](#)  
Safety instructions (representation) [9](#)  
Screenshots [4](#)  
SDO bandwidth [43](#)  
SDO communication method [19](#)  
Setting and displays in the »Engineer« [39](#)  
SoC Cycle Counter (C13136) [74](#)  
Status displays (LEDs) [52](#)  
Status displays at the RJ45 sockets (X251, X252) [55](#)  
Structure of the Ethernet cable [32](#)  
Suppress emergency message upon (C13887) [77](#)  
Synchronisation [42](#)  
System error messages [61](#)

## T

Table of attributes [80](#)  
Target group [5](#)

Technical data [15](#)  
Terminals [35](#)  
Terminology used [8](#)  
Terms [8](#)  
Total cycle times [19](#)  
TPDO user data per application [19](#)  
Transmission mode [15](#)  
Type of node [15](#)

## U

Using the communication module [12](#)

## V

Validity of the documentation [5](#)  
Voltage supply [15](#), [34](#)

## W

Wiring according to EMC guidelines [25](#)

# Index

---

# FEEDBACK



## Your opinion is important to us

These instructions were created to the best of our knowledge and belief to give you the best possible support for handling our product.

Perhaps we have not succeeded in achieving this objective in every respect. If you have suggestions for improvement, please e-mail us to:

[feedback-docu@lenze.com](mailto:feedback-docu@lenze.com)

Thank you very much for your support.

*Your Lenze documentation team*

Lenze Drives GmbH

Postfach 10 13 52, D-31763 Hameln

Breslauer Straße 3, D-32699 Extertal

Germany

HR Lemgo B 6478

☎ +49 5154 82-0

📠 +49 5154 82-2800

@ [sales.de@lenze.com](mailto:sales.de@lenze.com)

🌐 [www.lenze.com](http://www.lenze.com)

Lenze Service GmbH

Breslauer Straße 3, D-32699 Extertal

Germany

☎ 008000 24 46877 (24 h helpline)

📠 +49 5154 82-1112

@ [service.de@lenze.com](mailto:service.de@lenze.com)



E84AYCEO

# EtherNet/IP™

Inverter Drives 8400

Communication Manual

EN



13443009

# Contents

---

<b>1</b>	<b>About this documentation</b>	<b>5</b>
1.1	Document history	7
1.2	Conventions used	8
1.3	Terminology used	9
1.4	Definition of the notes used	10
<b>2</b>	<b>Safety instructions</b>	<b>11</b>
2.1	General safety and application notes	11
2.2	Device and application-specific safety instructions	12
2.3	Residual hazards	12
<b>3</b>	<b>Product description</b>	<b>13</b>
3.1	Application as directed	13
3.2	Identification	13
3.3	Product features	14
3.4	Connections and interfaces	15
<b>4</b>	<b>Technical data</b>	<b>16</b>
4.1	General data and operating conditions of the EtherNet/IP	16
4.2	Protective insulation	17
4.3	Protocol data	20
4.4	Communication time	20
4.5	Internal switch latency	21
4.6	Dimensions	22
<b>5</b>	<b>Installation</b>	<b>23</b>
5.1	Mechanical installation	24
5.1.1	Mounting for standard devices of 0.25 kW and 0.37 kW	24
5.1.2	Mounting for standard devices of 0.55 kW or more	25
5.1.3	Replacing the communication module	26
5.2	Electrical installation	27
5.2.1	Wiring according to EMC guidelines	27
5.2.2	Network topology	27
5.2.3	EtherNet/IP connection	29
5.2.4	Ethernet cable specification	31
5.2.5	External voltage supply	33
<b>6</b>	<b>Commissioning</b>	<b>35</b>
6.1	Before initial switch-on	35
6.2	Configuring the host system (scanner)	36
6.2.1	EDS files	37
6.2.2	Example: IP configuration of the Allen-Bradley 1769-L32E CompactLogix controller	38
6.3	Setting node addresses by means of rotary coding switches	40
6.4	Setting the IP configuration of the Inverter Drive 8400	42
6.4.1	Setting via the EtherNet/IP configurator of the »Engineer«	43
6.4.2	Setting via codes in the »Engineer«	45
6.4.3	Setting via a BOOTP/DHCP server	47
6.4.4	Setting via the TCP/IP Interface Object (0xF5)	47
6.4.5	Setting the multicast configuration	48
6.5	Establishing an online connection via EtherNet/IP with the Lenze »Engineer«	49
6.6	Initial switch-on	51

# Contents

---

<b>7</b>	<b>Data transfer</b>	<b>52</b>
7.1	Communication channels	53
7.2	Telegram types	54
7.3	EtherNet/IP state diagram	55
<b>8</b>	<b>I/O data transfer (implicit messages)</b>	<b>56</b>
8.1	I/O data mapping	57
8.2	Technology applications (TA) / drive profiles	58
8.2.1	Lenze technology applications / user-definable parameter sets	58
8.2.2	"AC Drive Profile" application	59
8.3	I/O assemblies	60
8.4	I/O configuration in the »Engineer«	62
8.4.1	Lenze technology application / configuring user-definable parameter sets	62
8.4.2	Configuring "AC Drive Profile" application	67
8.5	I/O configuration with »RSLogix 5000« version 19 or lower	68
8.6	I/O configuration with »RSLogix 5000« version 20 or higher	73
8.7	Saving the I/O configuration in »RSLogix 5000«	83
<b>9</b>	<b>Parameter data transfer (explicit messages)</b>	<b>84</b>
9.1	Write parameters	85
9.2	Read parameters	86
<b>10</b>	<b>Monitoring</b>	<b>88</b>
<b>11</b>	<b>Diagnostics</b>	<b>89</b>
11.1	LED status displays	89
11.1.1	Module status displays	90
11.1.2	CIP™ status displays	91
11.1.3	Status indicators at the RJ45 sockets (X259, X260)	94
11.2	Diagnostics with the »Engineer«	95
<b>12</b>	<b>Error messages</b>	<b>96</b>
12.1	Short overview of the EtherNet/IP error messages	96
12.2	Possible causes and remedies	97
12.3	CIP™ error messages	101
12.4	Mapping of Lenze device errors to DRIVECOM errors	102
<b>13</b>	<b>Parameter reference</b>	<b>106</b>
13.1	Parameters of the communication module	106
13.2	Table of attributes	122



# Contents

---

<b>14</b>	<b>Implemented CIP™ objects</b>	124
14.1	General CIP objects	126
14.1.1	Identity Object (1 / 0x01)	126
14.1.2	Message Router Object (2 / 0x02)	128
14.1.3	Assembly Object (4 / 0x04)	129
14.1.4	Connection Manager Object (6 / 0x06)	135
14.2	EtherNet/IP objects	137
14.2.1	Device Level Ring (DLR) Object (71 / 0x47)	137
14.2.2	Quality of Service (QoS) Object (72 / 0x48)	139
14.2.3	TCP/IP Interface Object (245 / 0xF5)	141
14.2.4	Ethernet Link Object (246 / 0xF6)	145
14.3	"AC Drive Profile" objects	148
14.3.1	Motor Data Object (40 / 0x28)	149
14.3.2	Control Supervisor Object (41 / 0x29)	150
14.3.3	AC Drive Object (42 / 0x2A)	152
14.3.4	Write "DriveMode" attribute	154
14.4	Lenze objects	155
14.4.1	Lenze Class (101 / 0x65)	155
14.4.2	Lenze Class (103 / 0x67)	157
14.4.3	Lenze Class (104 / 0x68)	158
14.4.4	Lenze Class (110 / 0x6E)	159
	<b>Index</b>	160
	Your opinion is important to us	164

# 1 About this documentation

---

## 1 About this documentation

### Contents

This documentation only contains descriptions of the E84AYCEO (EtherNet/IP™) communication module.



### Note!

This documentation supplements the **mounting instructions** supplied with the communication module and the **hardware manual "Inverter Drives 8400"**.

**The hardware manual contains safety instructions that must be observed!**

The features and functions of the communication module are described in detail.

Examples illustrate typical applications.

The theoretical context is only explained as far as it is required for understanding the function of the communication module.

This documentation does not describe the software of another manufacturer. No guarantee can be given for corresponding information in this documentation. Information on the use of the software can be found in the documents for the host (PLC, scanner).

All brand names mentioned in this documentation are trademarks of their corresponding owners.



### Tip!

Detailed information on EtherNet/IP can be found on the website of the user organisation ODVA (Open DeviceNet Vendor Association):

[www.odva.org](http://www.odva.org)

# 1 About this documentation

---

## Target group

This documentation is intended for all persons who plan, install, commission and maintain the networking and remote servicing of a machine.



### Tip!

Current documentation and software updates with regard to Lenze products can be found in the download area at:

[www.Lenze.com](http://www.Lenze.com)

## Information regarding the validity

The information given in this documentation is valid for the following devices:

Extension module	Type designation	From hardware version	From software version
Communication module EtherNet/IP	E84AYCEO	VA	01.01

From software version 01.02, the "AC Drive Profile" of the Inverter Drives 8400 is supported from version V13.00.

## Screenshots/application examples

All screenshots in this documentation are application examples. Depending on the firmware version of the communication module and software version of the installed engineering tools («Engineer», «RSLogix 5000»), the screenshots in this documentation may differ from the screen representation.

# 1 About this documentation

## 1.1 Document history

---

### 1.1 Document history



Version			Description
1.0	08/2012	TD17	First edition
2.0	12/2012	TD17	<ul style="list-style-type: none"><li>• Revision for software version 01.02</li><li>• New layout</li></ul>
3.0	10/2013	TD17	Revised chapters: <ul style="list-style-type: none"><li>▶ <a href="#">I/O data transfer (implicit messages)</a> (📖 56)</li><li>▶ <a href="#">Parameter data transfer (explicit messages)</a> (📖 84)</li><li>▶ <a href="#">Implemented CIP™ objects</a> (📖 124)</li></ul>

# 1 About this documentation

## 1.2 Conventions used

### 1.2 Conventions used

This documentation uses the following conventions to distinguish between different types of information:

Type of information	Writing	Examples/notes
Spelling of numbers		
Decimal separator	Point	The decimal point is always used. For example: 1234.56
Hexadecimal	0x[0 ... 9, A ... F]	Example: 0x60F4
Binary • Nibble	In inverted commas Point	Example: '100' Example: '0110.0100'
Text		
Version information	Blue text colour	All information that applies to from a certain software version of the drive onwards are marked accordingly in this documentation. Example: <a href="#">This function extension is available from software version V3.0 onwards!</a>
Program name	» «	The Lenze PC software »Engineer«...
Window	<i>italics</i>	The <i>Message window...</i> / The dialog box <i>Options...</i>
Variable names		By setting <i>bEnable</i> to TRUE...
Control element	<b>bold</b>	The <b>OK</b> button... / the <b>Copy</b> command... / the <b>Characteristics</b> tab... / the <b>Name</b> input field...
Sequence of menu commands		If several commands are required to execute one function, the single commands are separated by an arrow: Select the <b>File → Open</b> command to...
Hyperlink	<u>underlined</u>	Optically highlighted reference to another topic. It is activated with a mouse-click in this online documentation.
Icons		
Page reference	 9	Optically highlighted reference to another page. In this online documentation activated via mouse-click.
Step-by-step instructions		Step-by-step instructions are indicated by a pictograph.

# 1 About this documentation

## 1.3 Terminology used

### 1.3 Terminology used

Term	Meaning
ACD	Address Conflict Detection
Adapter	EtherNet/IP slave
Inverter / Drive	Lenze inverters of the "Inverter Drives 8400" series
Standard device	
ARP	Address Resolution Protocol
Use BOOTP	Bootstrap Protocol
Code	Parameter which serves to parameterise and monitor the drive. In normal usage, the term is usually referred to as "Index".
Subcode	If a code contains several parameters, they are stored in "subcodes". In the documentation, the slash "/" is used as a separator between the code and the subcode (e.g. "C00118/3"). In everyday language, the term is also referred to as "subindex".
»Engineer«	Software from Lenze which supports you throughout the whole machine life cycle - from planning to maintenance.
	EtherNet/IP™ (EtherNet Industrial Protocol) is a fieldbus system based on Ethernet which uses the Common Industrial Protocol™ (CIP™) for data exchange. EtherNet/IP™ and Common Industrial Protocol™ (CIP™) are trademarks and patented technologies, licensed by the user organisation ODVA (Open DeviceNet Vendor Association), USA.
Use DHCP	Dynamic Host Configuration Protocol
DSCP	Differentiated Services Codepoints
EDS	Electronic Data Sheet
Explicit messages	Explicit Messages are used to transfer parameter data.
HW	Hardware
IGMP	Internet Group Management Protocol
Implicit messages	Implicit Messages are used to transfer I/O data.
"Class 1" connection	I/O connection
"Class 3" connection	Explicit connection
Level 2	EtherNet/IP performance level 2: I/O Message Server including Explicit Message Server
Lenze setting	Default settings of the device, preconfigured ex works.
Basic setting	
PLC	Programmable Logic Controller
QoS	Quality of Service
RPI	Requested Package Interval: Interval requested between 2 telegrams for cyclic data transmission
»RSLogix 5000«	Programming and development software from Rockwell for hosts (scanners) in EtherNet/IP networks (e.g. Allen-Bradley Logix controllers).
Scanner	EtherNet/IP master or client
Host	
SW	Software
TTL	Time To Live: Validity time of data packets in the EtherNet/IP network
UCMM	Unconnected Message Manager

# 1 About this documentation

## 1.4 Definition of the notes used

### 1.4 Definition of the notes used

The following signal words and symbols are used in this documentation to indicate dangers and important information:

#### Safety instructions

Layout of the safety instructions:



#### **Danger!**

(characterises the type and severity of danger)

#### **Note**

(describes the danger and gives information about how to prevent dangerous situations)

Pictograph	Signal word	Meaning
	<b>Danger!</b>	<b>Danger of personal injury through dangerous electrical voltage</b> Reference to an imminent danger that may result in death or serious personal injury if the corresponding measures are not taken.
	<b>Danger!</b>	<b>Danger of personal injury through a general source of danger</b> Reference to an imminent danger that may result in death or serious personal injury if the corresponding measures are not taken.
	<b>Stop!</b>	<b>Danger of property damage</b> Reference to a possible danger that may result in property damage if the corresponding measures are not taken.

#### Application notes

Pictograph	Signal word	Meaning
	<b>Note!</b>	Important note to ensure trouble-free operation
	<b>Tip!</b>	Useful tip for easy handling
		Reference to another document

## 2 Safety instructions



### Note!

It is absolutely vital that the stated safety measures are implemented in order to prevent serious injury to persons and damage to material assets.

Always keep this documentation to hand in the vicinity of the product during operation.

### 2.1 General safety and application notes



### Danger!

If the following basic safety measures are disregarded, severe injuries to persons and damage to material assets may result.

Lenze drive and automation components ...

- must only be used as directed.
- must never be commissioned if they display signs of damage.
- must never be technically modified.
- must never be commissioned if they are not fully mounted.
- must never be operated without required covers.
- during and after operation can have live, moving and rotating parts, depending on their degree of protection. Surfaces can be hot.

The following applies to Lenze drive components ...

- only use the accessories approved.
- Only use original manufacturer spare parts.

Observe all specifications contained in the enclosed documentation and related documentation.

- This is the precondition for safe and trouble-free operation and for obtaining the product features specified.
  - ▶ [Product features](#) (14)
- The specifications, processes, and circuitry described in this document are for guidance only and must be adapted to your own specific application. Lenze does not take responsibility for the suitability of the process and circuit proposals.

All works on and with Lenze drive and automation components must only be carried out by qualified personnel. According to IEC 60364 or CENELEC HD 384 these are persons who ...

- are familiar with installing, mounting, commissioning, and operating the product.
- who have the corresponding qualifications for their work.
- who know and can apply all regulations for the prevention of accidents, directives, and laws applicable at the place of use.



## 2 Safety instructions

### 2.2 Device and application-specific safety instructions

---

#### 2.2 Device and application-specific safety instructions

- During operation, the communication module must be securely connected to the standard device.
- With external voltage supply, always use a separate power supply unit, safely separated to EN 61800-5-1 in every control cabinet (SELV/PELV).
- Only use cables corresponding to the given specifications.
  - ▶ [Ethernet cable specification](#) (📖 31)



#### **Documentation for the standard device, host, system/machine**

All the other measures prescribed in this documentation must also be implemented. Observe the safety instructions and application notes contained in this manual.

#### 2.3 Residual hazards

##### **Protection of persons**

If the Inverter Drives 8400 are used on a phase earthed mains with a rated mains voltage  $\geq 400$  V, protection against accidental contact is not ensured without implementing external measures.

- ▶ [Protective insulation](#) (📖 17)

##### **Device protection**

The communication module contains electronic components which may be damaged or destroyed by electrostatic discharge.

- ▶ [Installation](#) (📖 23)

# 3 Product description

## 3.1 Application as directed

# 3 Product description

## 3.1 Application as directed

The communication module ...

- is an accessory module that can be used in conjunction with the following standard devices:

Product series	Type designation	From software version
Inverter Drives 8400 StateLine	E84AVSCxxxxx	11.00
Inverter Drives 8400 HighLine	E84AVHCxxxxx	11.00
Inverter Drives 8400 TopLine	E84AVTCxxxxx	02.00

- is a device intended for use in industrial power systems.
- should only be used under the operating conditions prescribed in this documentation.
- can only be used in EtherNet/IP networks.

**Any other use shall be deemed inappropriate!**

## 3.2 Identification

The type designation as well as the hardware and software version of the communication module are indicated on the nameplate:

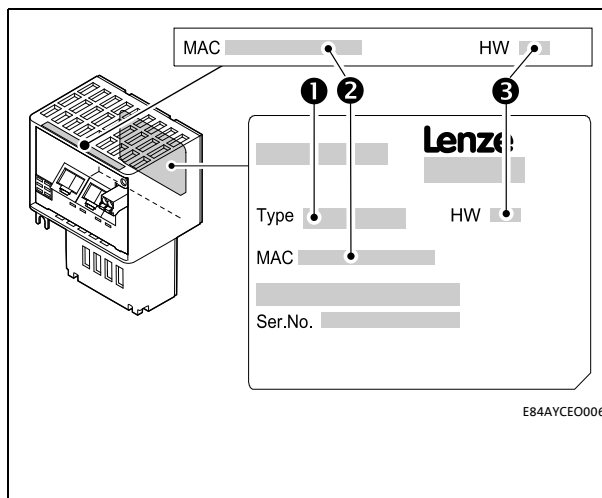

### 1 Type designation (type)

E84 Product series

A Version

Y Module identification: Extension module

C Module type: Communication module

EO EtherNet/IP

V/S V: Coated version

S: Standard version

### 2 MAC address (MAC)

00-0A-86-xx-yy-zz:

Hardware address of the communication module for unique identification in the network

### 3 Hardware version (HW)

[3-1] Identification data

---

**3.3****Product features**

- Interface module for the EtherNet/IP communication system, for attachment to the expansion slots of Inverter Drives 8400
- The communication module can either be supplied internally by the standard device or externally by a separate voltage source.
- The Inverter Drive 8400 is always an adapter device:  
EtherNet/IP adapter with "Level 2" functionality
- 2-port interface with integrated switch functionality
- Access to all Lenze parameters (configurable via TCP/IP using the Lenze »Engineer«)
- Up to 3 TCP/IP socket connections for communication with the Lenze »Engineer«
- Support of "IP Config Pending" (activation of changed IP configuration by "power off/on" or "type 0 reset")
- Support of the redundancy protocol DLR (Device Level Ring) as "beacon-based ring node"
- Up to 16 I/O data words (32 bytes) are possible.
- Further CIP features:
  - Max. 8 CIP connections
  - 1 "exclusive owner" connection
  - I/O connection type: cyclic
  - Minimum I/O cycle time: 4 ms
  - Support of multicast messages, UCMM, ACD, BOOTP/DHCP, VLAN tagging/DSCP

# 3 Product description

## 3.4 Connections and interfaces

### 3.4 Connections and interfaces

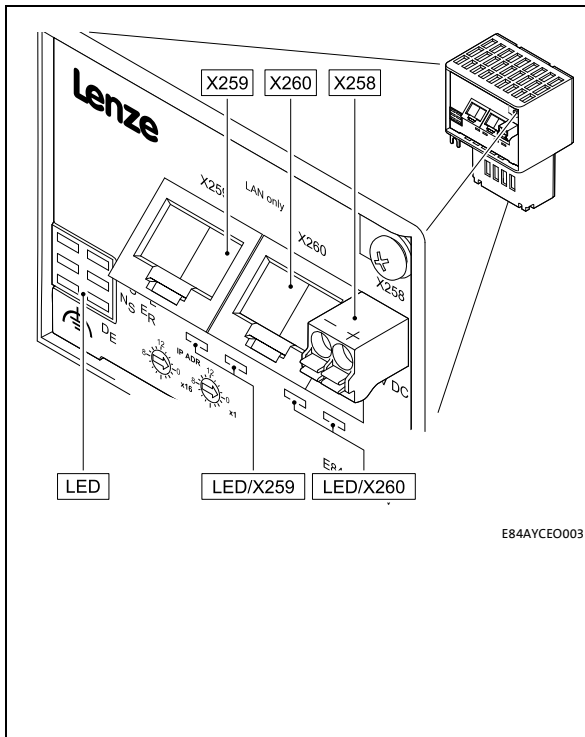

[3-2] E84AYCEO communication module (EtherNet/IP)

**X258** External voltage supply of the communication module

- 2-pin plug connector with spring connection
- ▶ [External voltage supply](#) (📖 33)

**X259** EtherNet/IP terminals

**X260** RJ45-sockets

- each with 2 LED status displays for diagnostics

▶ [Network topology](#) (📖 27)

▶ [EtherNet/IP connection](#) (📖 29)

▶ [Status indicators at the RJ45 sockets \(X259, X260\)](#) (📖 94)

**x1** Rotary coding switches for node address

**x16** setting (IP ADR)

▶ [Setting node addresses by means of rotary coding switches](#) (📖 40)

**MS** 5 LED status displays for diagnostics

**ST** ▶ [Module status displays](#) (📖 90)

**NS** ▶ [CIP™ status displays](#) (📖 91)

**ER**

**DE**

## 4 Technical data

### 4.1 General data and operating conditions of the EtherNet/IP

---

## 4 Technical data

### 4.1 General data and operating conditions of the EtherNet/IP

Range	Values
Order designation	E84AYCEO
Communication profile	EtherNet/IP
Communication medium	S/FTP (Screened Foiled Twisted Pair), ISO/IEC 11801 or EN 50173, CAT 5e
Interface for communication	RJ45 Standard Ethernet (according to IEEE 802.3), 100Base-TX (Fast Ethernet)
Network topology	Tree, star, and line
Type of node	Adapter (slave)
Number of nodes	Max. 254 in the subnetwork
Max. cable length	100 m
Vendor ID	587 (0x24B), Lenze ('Lenze AC Tech' in older Rockwell data)
Device type	2 (0x02), AC Drive
Product code	8400 (0x20D0)
Baud rate	<ul style="list-style-type: none"><li>• 10 Mbps</li><li>• 100 Mbps</li></ul>
Transmission mode	Half duplex / full duplex
Switching method	Store-and-forward / cut-through
Switch latency	Approx. 125 µs at max. telegram length
Voltage supply	External supply via separate power supply unit <ul style="list-style-type: none"><li>• + : U = 24 V DC (20.4 ... 28.8 V), I<sub>max</sub> = 140 mA</li><li>• - : Reference potential for external voltage supply</li></ul>
Conformities , approvals	<ul style="list-style-type: none"><li>• CE</li><li>• UL</li></ul> (see also hardware manual)



#### Hardware manual for Inverter Drives 8400

Here you can find the **ambient conditions** and data on the **electromagnetic compatibility (EMC)**, which also apply to the communication module.

### 4.2 Protective insulation



#### **Danger!**

##### **Dangerous voltage**

If the Inverter Drives 8400 are operated on a phase-earthed mains with a rated mains voltage of  $\geq 400$  V, external measures need to be implemented in order to ensure protection against accidental contact.

##### **Possible consequences:**

Death or severe injuries

##### **Protective measures:**

If protection against accidental contact is required for the control terminals of the inverter and the connections of the plugged device modules, ...

- a double isolating distance must exist.
- the components to be connected must be provided with the second isolating distance.



#### **Note!**

The existing protective insulation in the Inverter Drives 8400 is implemented according to EN 61800-5-1.

# 4 Technical data

## 4.2 Protective insulation

The following illustration ...

- shows the arrangement of the terminal strips and the separate potential areas of the Inverter Drive 8400.
- serves to determine the decisive protective insulation between two terminals located in differently insulated separate potential areas.

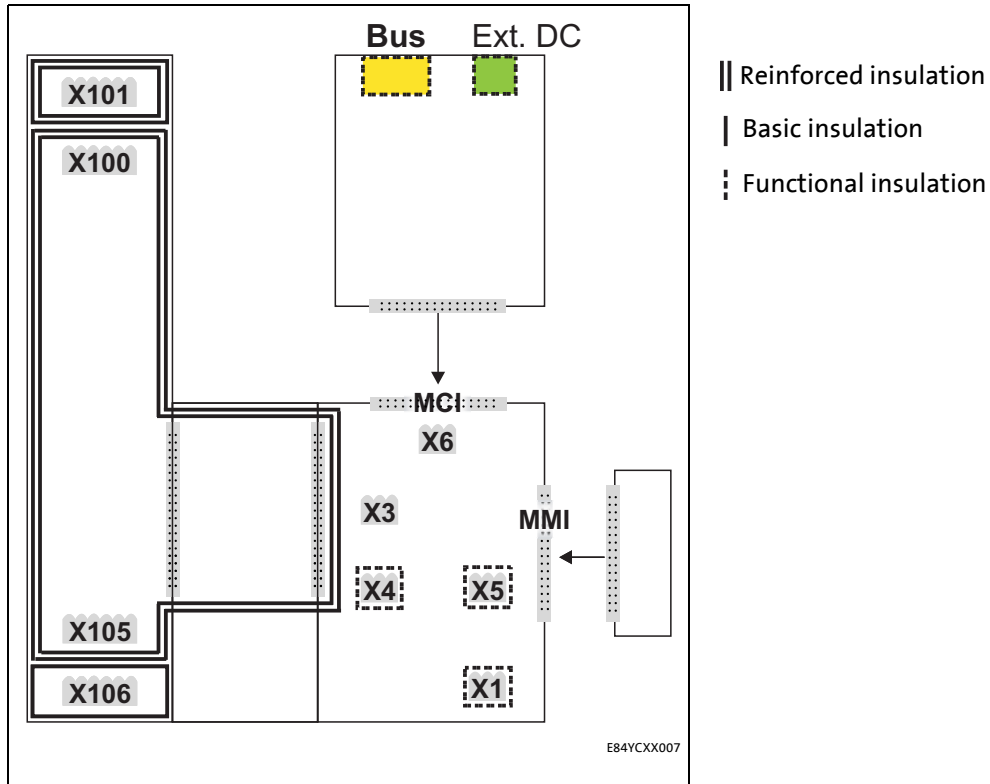

[4-1] Protective insulation in accordance with EN61800-5-1

Terminal strip	Connection
X100	Mains / DC bus connection
X101	Relay contact
X105	Motor/brake resistor
X106	Motor PTC
X1	System bus (CANopen)
X3	Analog inputs/outputs
X4	Digital outputs
X5	Digital inputs
X6	Diagnostics
MCI	Slot for communication module
MMI	Slot for the memory module

**Example**

Which type of protective insulation is used between the bus terminal of the device module in slot MCI and the X100 mains terminal?

The separate potential area with the better protective insulation is decisive.

- The separate potential area of the bus terminal of the device module has a "functional insulation".
- The separate potential area of the mains terminal has a "reinforced insulation".

Result: The insulation between mains terminal X100 and the bus terminal is of the "reinforced insulation" type.



# 4 Technical data

## 4.3 Protocol data

### 4.3 Protocol data

Range	Values
I/O data words	1 ... 16 words (max. 32 bytes, 16 bits/word)
Supported CIP services	<ul style="list-style-type: none"><li>• Get_Attributes_All</li><li>• Get_Attribute_Single</li><li>• Set_Attribute_Single</li><li>• Reset (types '0' and '1' only)</li><li>• Forward_Open</li><li>• Forward_Close</li><li>• Get_Member</li></ul>

### 4.4 Communication time

The communication time is the time between the start of a request and the arrival of the corresponding response.

The communication times in an EtherNet/IP network depend on the ...

- processing time in the inverter;
- telegram runtime (baud rate / telegram length);
- nesting depth of the network.

#### processing time within the inverter

Data	Processing time						
Process data (I/O data)	<table><tr><td>10 ms</td><td>Lenze standard update cycle (can be changed in the Rockwell engineering tool)</td></tr><tr><td>+ 0 ... 1 ms</td><td>Processing time in the module</td></tr><tr><td>+ 1 ... x ms</td><td>Runtime of the application task of the technology application used (tolerance)</td></tr></table>	10 ms	Lenze standard update cycle (can be changed in the Rockwell engineering tool)	+ 0 ... 1 ms	Processing time in the module	+ 1 ... x ms	Runtime of the application task of the technology application used (tolerance)
10 ms	Lenze standard update cycle (can be changed in the Rockwell engineering tool)						
+ 0 ... 1 ms	Processing time in the module						
+ 1 ... x ms	Runtime of the application task of the technology application used (tolerance)						
Parameter data	Approx. 30 ms + a tolerance of 20 ms (typically) For some codes, the processing time may be longer (see software manual/ »Engineer« online help for Inverter Drives 8400).						

There are no interdependencies between parameter data and I/O data.

## 4 Technical data

### 4.5 Internal switch latency

---

#### 4.5 Internal switch latency

The integrated 2-port switch causes runtime delays. For "store-and-forward" and 100 Mbps, these runtime delays can be calculated as follows.

Runtime delay for an output data packet of the scanners incl. 32-bit "run/idle header" with 16-bit sequence counter:

$$\text{Runtime delay} = ((66 \text{ permanent bytes} + \text{I/O data in bytes}) \times 8 \times 10 \text{ nsec}) + 4 \mu\text{sec}$$

Runtime delay for an output data packet of an adapter without 32-bit "run/idle header":

$$\text{Runtime delay} = ((62 \text{ permanent bytes} + \text{I/O data in bytes}) \times 8 \times 10 \text{ nsec}) + 4 \mu\text{sec}$$

#### Example

Delay of an output data packet of the scanners with 8 output data words (16 bytes):

- $((66 \text{ permanent bytes} + 16 \text{ bytes}) \times 8 \times 10 \text{ nsec}) + 4 \mu\text{sec}$
- $(82 \text{ bytes} \times 8 \times 10 \text{ nsec}) + 4 \mu\text{sec}$
- $6.56 \mu\text{sec} + 4 \mu\text{sec} = \mathbf{10.56 \mu\text{sec}}$



#### Note!

The use of external switches can also lead to runtime delays. Depending on the system constellation, it may be useful to create a star topology or a line/mix topology.

▶ [Network topology](#) (📖 27)

# 4 Technical data

## 4.6 Dimensions

### 4.6 Dimensions

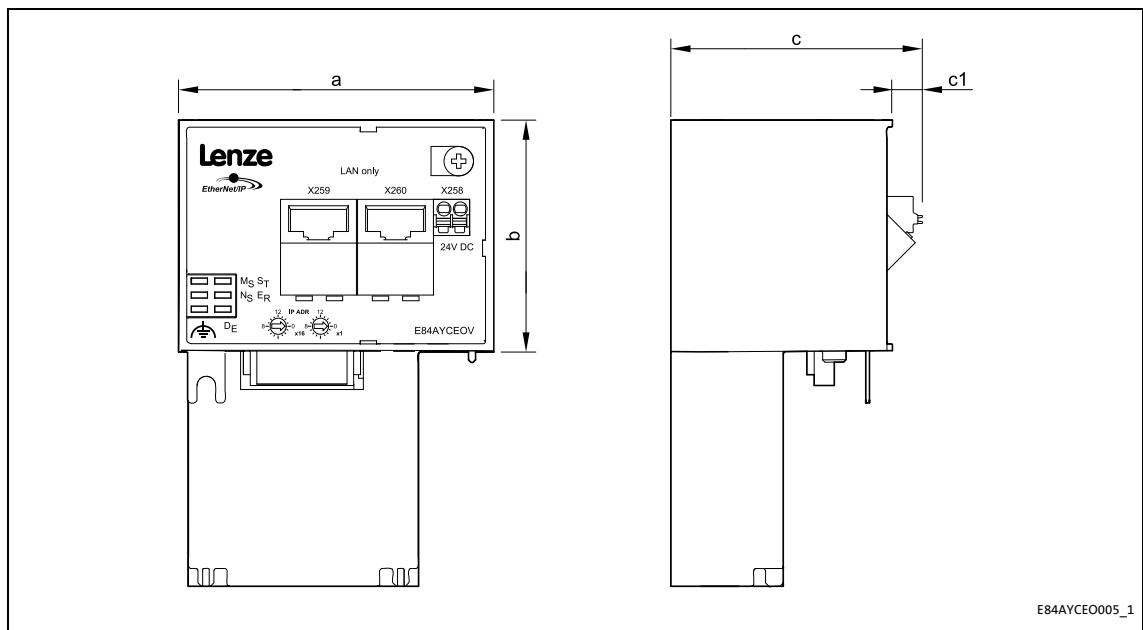

[4-2] Dimensions

Type	Dimensions [mm]			
	a	b	c	c1
E84AYCEO	67	50	57	8

### 5 Installation



#### **Stop!**

##### **Electrostatic discharge**

Electronic components within the communication module can be damaged or destroyed by electrostatic discharge.

##### **Possible consequences:**

- The communication module is defective.
- Fieldbus communication is not possible or faulty.

##### **Protective measures**

Before touching the module, be sure that you are free of electrostatic charge.

# 5 Installation

## 5.1 Mechanical installation

### 5.1 Mechanical installation

The communication module can be plugged in or unplugged from the MCI slot when the drive is switched on. When the module is plugged in, it is detected automatically, and a function and version plausibility check is executed.

#### 5.1.1 Mounting for standard devices of 0.25 kW and 0.37 kW

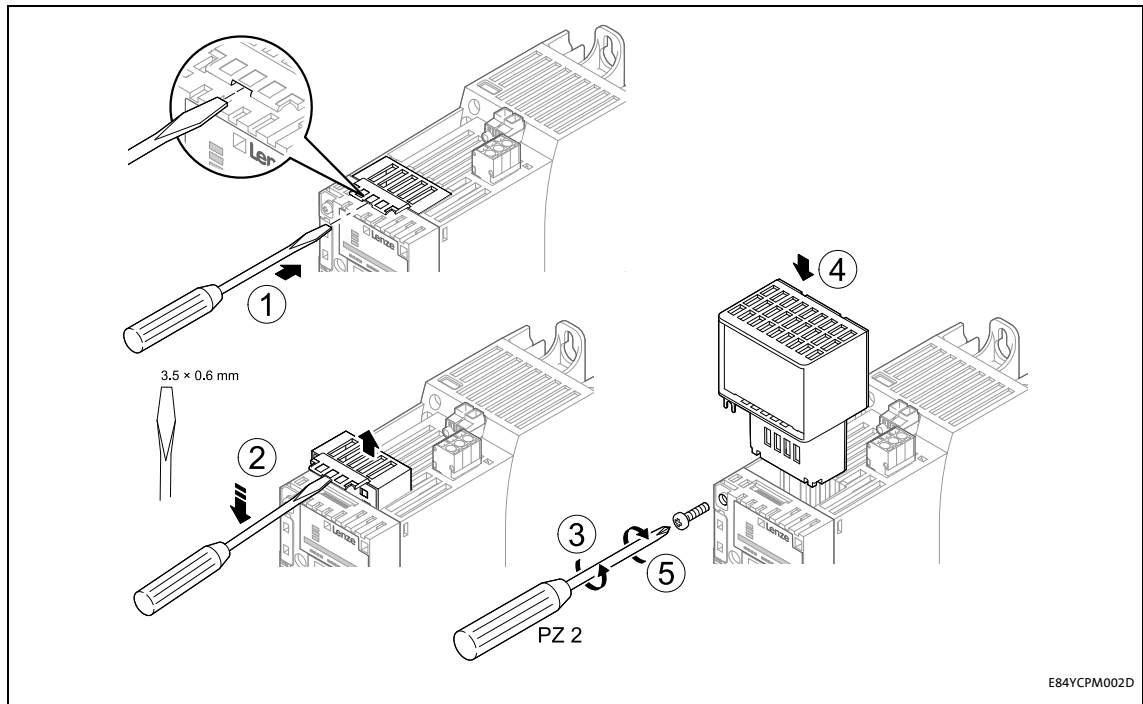

[5-1] Mounting for standard devices of 0.25 kW and 0.37 kW

#### Mounting steps

1. Use a screwdriver to lever out the cover of the MCI slot of the standard device and remove it (1, 2).
2. Loosen the securing screw for the communication module at the standard device (3).
3. Insert the communication module into the MCI slot of the standard device (4).
4. Tighten the securing screw again (5).

### 5.1.2 Mounting for standard devices of 0.55 kW or more

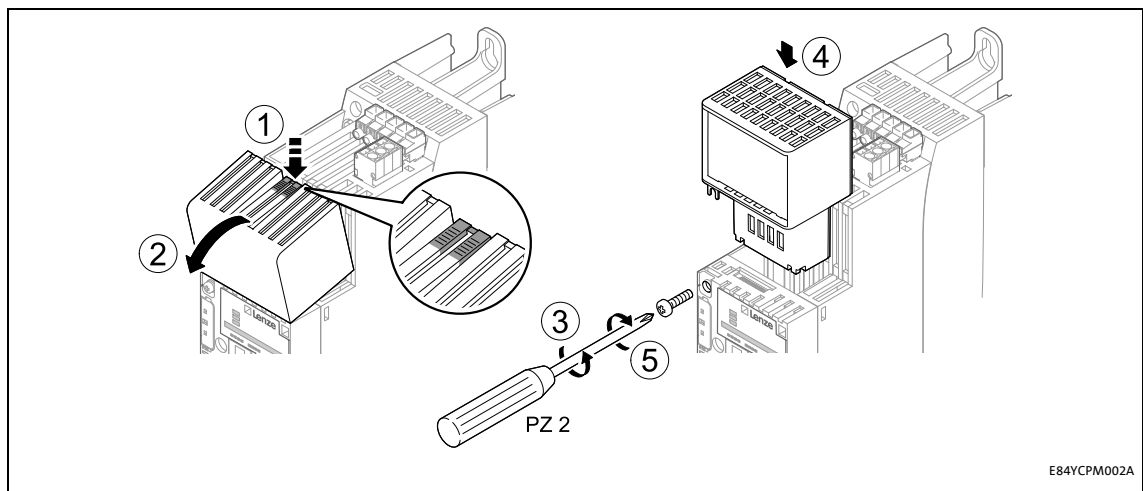

[5-2] Mounting for standard devices of 0.55 kW or more

#### Mounting steps

1. Slightly impress the pressure surface of the top side of the MCI slot cover of the standard device (1).
2. Tilt the cover forward and remove it from the standard device (2).
3. Loosen the securing screw for the communication module at the standard device (3).
4. Insert the communication module into the MCI slot of the standard device (4).
5. Tighten the securing screw again (5).

### 5.1.3 Replacing the communication module

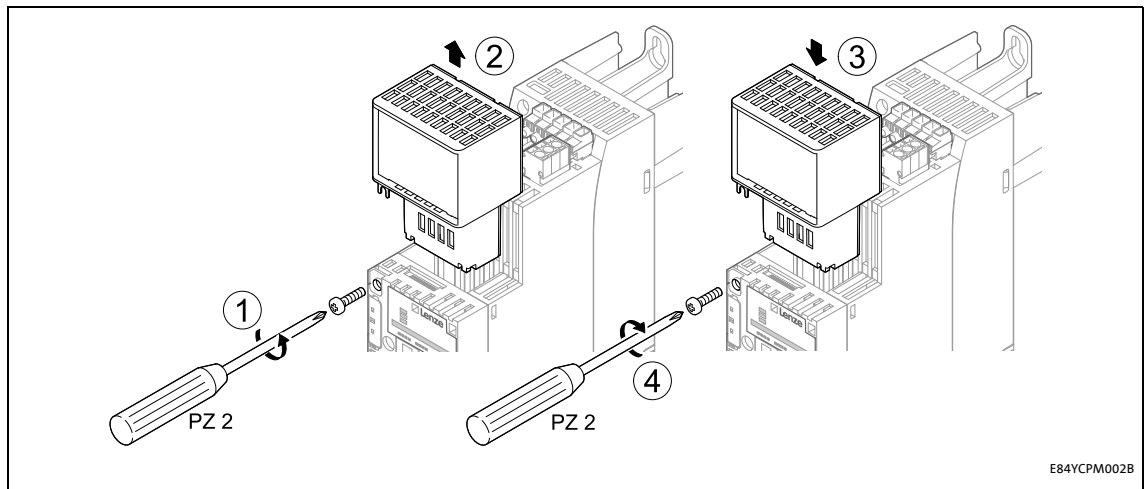

[5-3] Replacing the communication module

#### Mounting steps

1. Loosen the securing screw for the communication module at the standard device (1).
2. Pull the communication module out of the MCI slot of the standard device (2).
3. Insert the new communication module into the MCI slot of the standard device (3).
4. Tighten the securing screw again (4).

## 5.2

## Electrical installation

**Documentation for the standard device, host, system/machine**

Observe the notes and wiring instructions contained in this documentation.

## 5.2.1

**Wiring according to EMC guidelines**

In typical systems, standard shielding is sufficient for Ethernet cables.

However, in environments with a very high level of interference, EMC resistance can be improved by additionally earthing the cable shield on both sides.

For this observe the following notes:

1. Remove the plastic sheath of the cable at a length of 2 cm.
2. Fasten the cable shield to the shield support of the standard device.

## 5.2.2

**Network topology**

It is typical of EtherNet/IP to have a rather free topology the limiting factor of which is large message latencies due to e.g. switches connected in series.

► [Internal switch latency](#) (21)

The combination of a line and a stub is useful for system wiring.

EtherNet/IP supports the following topologies:

- Line

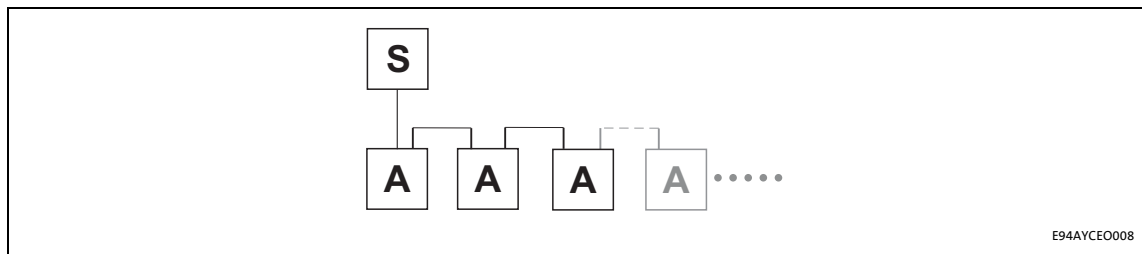

[5-4] Line topology (S = scanner, A = adapter)

- Switch / star

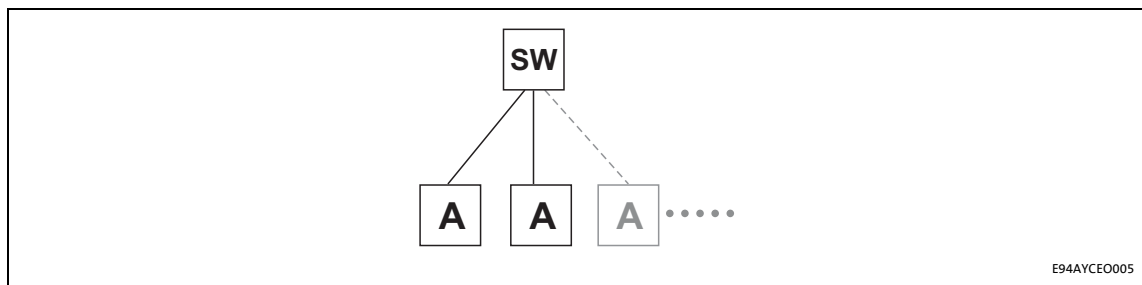

[5-5] Switch / star topology (SW = switch, A = adapter)



- Tree via switches

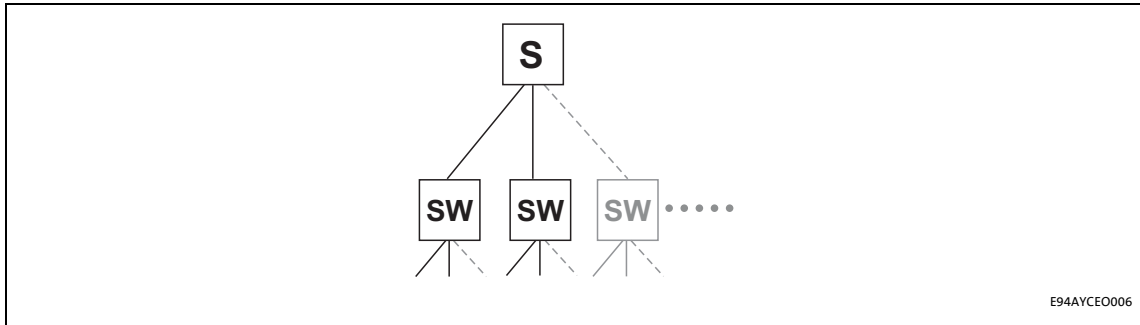

[5-6] Tree topology (S = scanner, SW = switch)

- Switch / switch

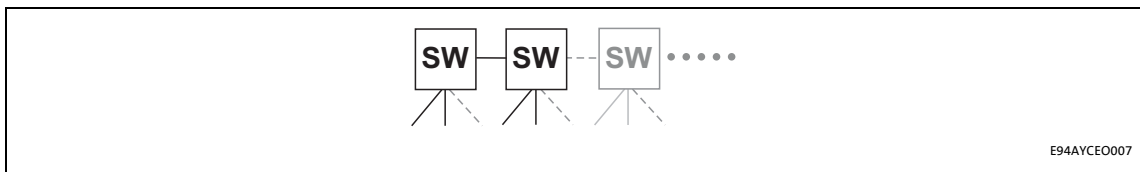

[5-7] Switch / switch topology (SW = switch)

### 5.2.3 EtherNet/IP connection

A connection to the EtherNet/IP network is established via RJ45 sockets **X259** and **X260**.

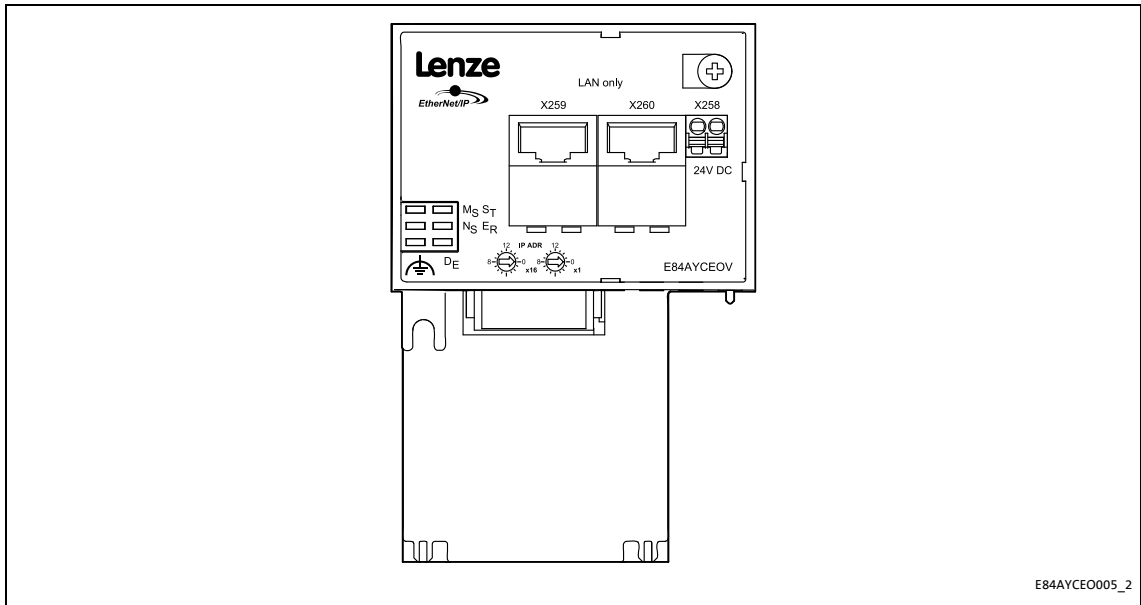

[5-8] EtherNet/IP terminals X259 and X260

For connection of the communication module to the EtherNet/IP fieldbus, a standard Ethernet patch cable is suitable.

► [Ethernet cable specification](#) (31)

The installation and removal of the Ethernet cables is optimised for the use of connectors in accordance with the "Automation Initiative of German Domestic Automobile Manufacturers" (AIDA).



#### Note!

To prevent the RJ45 socket from being damaged, insert or remove the Ethernet cable connector straight (at a right angle) into or from the socket.

### Pin assignment of the RJ45 sockets

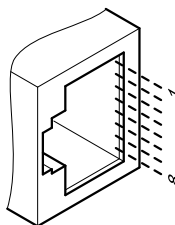
RJ45 socket	Pin	Signal
 <p>E94AYCXX004C</p>	1	Tx +
	2	Tx -
	3	Rx +
	4	-
	5	-
	6	Rx -
	7	-
	8	-



#### Note!

Dependent on the configuration of the Ethernet port of the device to be connected, we recommend the use of a cross-over cable.



#### Tip!

The EtherNet/IP interfaces feature an auto-MDIX function. This function adjusts the polarity of the RJ45 interfaces so that a connection can be established irrespective of the polarity of the opposite EtherNet/IP interface and irrespective of the type of cable used (standard patch cable or crossover cable).

## 5.2.4 Ethernet cable specification

**Note!**

Only use cables that meet the listed specifications.

Ethernet cable specification	
Ethernet standard	Standard Ethernet (in accordance with IEEE 802.3), 100Base-TX (Fast Ethernet)
Cable type	S/FTP (Screened Foiled Twisted Pair), ISO/IEC 11801 or EN 50173, CAT 5e
Damping	23.2 dB (for 100 MHz and 100 m each)
Crosstalk damping	24 dB (at 100 MHz and per 100 m)
Return loss	10 dB (per 100 m)
Surge impedance	100 $\Omega$

## Structure of the Ethernet cable

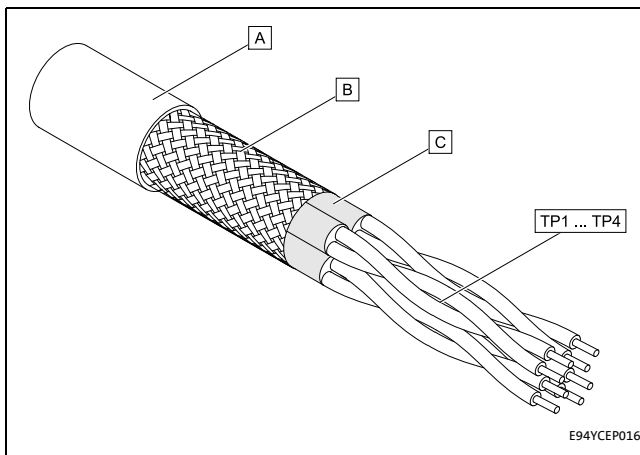

**A** Cable insulation

**B** Braid

**C** Foil shielding

**TP1** Twisted core pairs 1 ... 4

... [▶ Colour code of the Ethernet cable](#)

**TP4** [\(32\)](#)

[5-9] Structure of the Ethernet cable (S/FTP, CAT 5e)

### Colour code of the Ethernet cable



#### Note!

Wiring and colour code are standardised in EIA/TIA 568A/568B.

In accordance with the industrial standard, the use of 4-pin Ethernet cables is permissible. The cable type only connects the assigned pins 1, 2, 3 and 6 to one another.

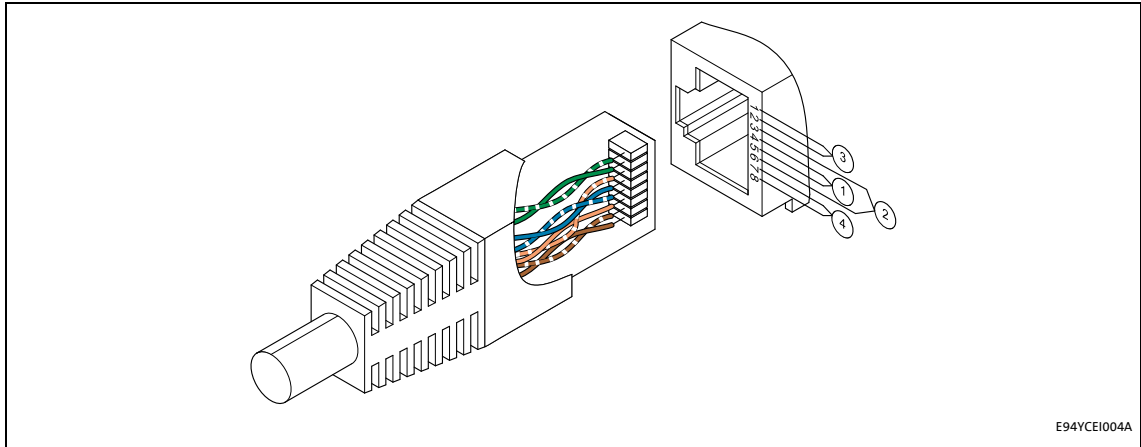

[5-10] Ethernet plug in accordance with EIA/TIA 568A/568B

Pair	Pin	Signal	EIA/TIA 568A	EIA/TIA 568B
3	1	Tx +	white / green	white / orange
	2	Tx -	green	orange
2	3	Rx +	white / orange	white / green
1	4		blue	blue
	5		white / blue	blue / white
2	6	Rx -	orange	green
4	7		white / brown	white / brown
	8		brown	brown

### 5.2.5 External voltage supply

The communication module can be externally supplied with voltage via separate supply cables at the 2-pin plug connector X258.



#### Note!

With external voltage supply, always use a separate power supply unit, safely separated to EN 61800-5-1 in every control cabinet (SELV/PELV).

The external voltage supply of the communication module is necessary if the power supply for the basic device fails but communication via the fieldbus is to be maintained.

The parameters of a standard device separated from the mains cannot be accessed.

#### Wiring of the X258 plug connector



#### Stop!

Only wire the plug connector if the standard device is disconnected from the mains.

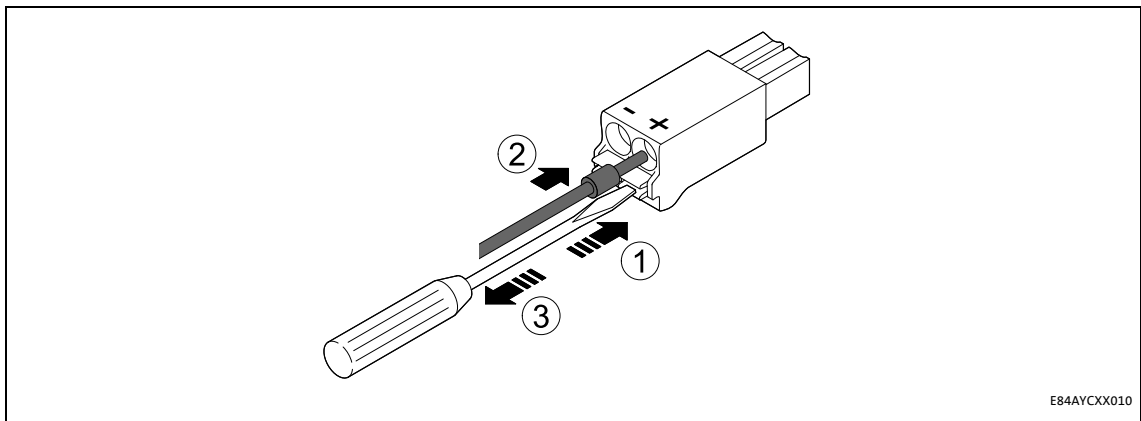

[5-11] Wiring of the 2-pin plug connector with spring connection

How to wire the plug connector with spring connection:

1. Press a screwdriver into the notch below the terminal and keep it pressed.
2. Place the supply cable in the terminal.
3. Remove the screwdriver from the notch.

#### Assignment of the X258 plug connector

Name	Description
+	U = 24 V DC (20.4 V - 0 % ... 28.8 V + 0 %) I = 140 mA
-	Reference potential for the external voltage supply

## Terminal data

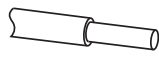
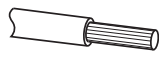
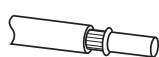
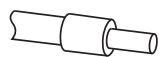
Range	Values	
Electrical connection	2-pin plug connector with spring connection	
Possible connections	Rigid:	
		0.2 ... 1.5 mm <sup>2</sup> (AWG 24 ... 16)
	Flexible:	
		Without wire end ferrule 0.2 ... 1.5 mm <sup>2</sup> (AWG 24 ... 16)
		With wire end ferrule, without plastic sleeve 0.2 ... 1.5 mm <sup>2</sup> (AWG 24 ... 16)
	With wire end ferrule, with plastic sleeve 0.2 ... 1.5 mm <sup>2</sup> (AWG 24 ... 16)	
Stripping length	10 mm	

# 6 Commissioning

## 6.1 Before initial switch-on

---

# 6 Commissioning

During commissioning, plant-specific data such as motor parameters, operating parameters, responses, and parameters for fieldbus communication are defined for the inverter. Lenze devices use codes for this purpose.

The codes of the inverter and for communication are saved to the memory module in a non-volatile data set.

In addition, there are codes for diagnosing and monitoring the stations.

▶ [Parameter reference](#) (□ 106)

## 6.1 Before initial switch-on



### Stop!

Before you switch on the Inverter Drive 8400 with the communication module for the first time, check all the wiring for completeness, short-circuits and earth faults.



## 6.2 Configuring the host system (scanner)

To be able to communicate with the communication module, the host (scanner) must be configured first.

The configuration of EtherNet/IP networks always requires an EtherNet/IP configuration software (e.g. »RSLogix 5000« from Rockwell) for the host system (scanner).

The configuration software is necessary for the programming of controller programs, EtherNet/IP configuration, real-time execution and diagnostics.

The basic parameters of the communication module are stored in the internal configuration memory and can be used for node detection by the scanner.

For node detection (fieldbus scan), the corresponding device descriptions of the Lenze device family are used.



### Tip!

Here you will find information on configuring with the »RSLogix 5000« programming software from Rockwell:

- ▶ [I/O configuration with »RSLogix 5000« version 19 or lower](#) (📖 68)
- ▶ [I/O configuration with »RSLogix 5000« version 20 or higher](#) (📖 73)

### 6.2.1 EDS files

Depending on the EtherNet/IP scanner configuration software, the EDS files (Electronic Data Sheet) may be used for the configuration of the network profile, the communication with the participating devices and the automatic generation of tags. For this purpose, the EDS files have to be imported into the controller project of the EtherNet/IP configuration software.

The EDS file required for the configuration can be found in the download area at:

[www.Lenze.com](http://www.Lenze.com)



#### Tip!

From version 20 onwards, Rockwell's »RSLogix 5000« programming software features an "EDS Hardware Installation Tool" that can be used to ...

- install/import EDS files;
- create EDS files;
- carry out EDS uploads;
- delete EDS files from your controller project.

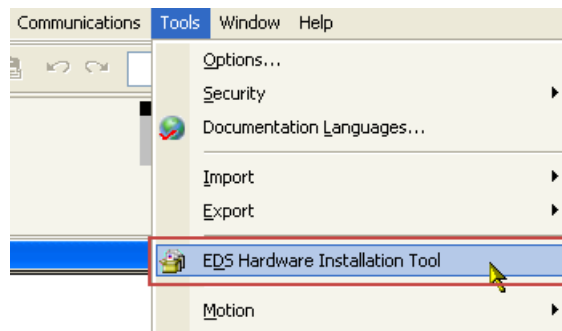

In »RSLogix 5000«, the dialog for the "EDS Hardware Installation Tool" is self-explanatory and not described further in this documentation.

### 6.2.2 Example: IP configuration of the Allen-Bradley 1769-L32E CompactLogix controller

In this example, the Allen-Bradley CompactLogix control unit 1769-L32E with integrated EtherNet/IP interface is used for communication with the Inverter Drives 8400.

The »RSLogix 5000« programming software from Rockwell is used for the configuration.

To establish communication via an EtherNet/IP network, add the controller and its scanner to the I/O configuration.



#### How to set the IP configuration of the 1769-L32E CompactLogix controller using the »RSLogix 5000« programming software:

1. Click on the **I/O Configuration** folder in the configuration tree.
2. Right click on "1769-L32E Ethernet Port LocalENB" and select "Properties" from the context menu.

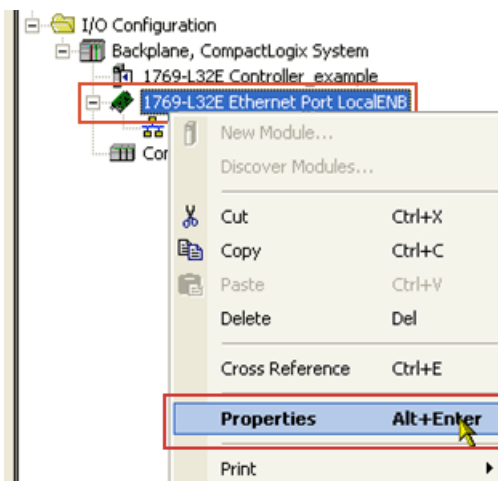

3. Go to the **General** tab of the "Module Properties: ..." dialog window and enter the IP address of the scanner.

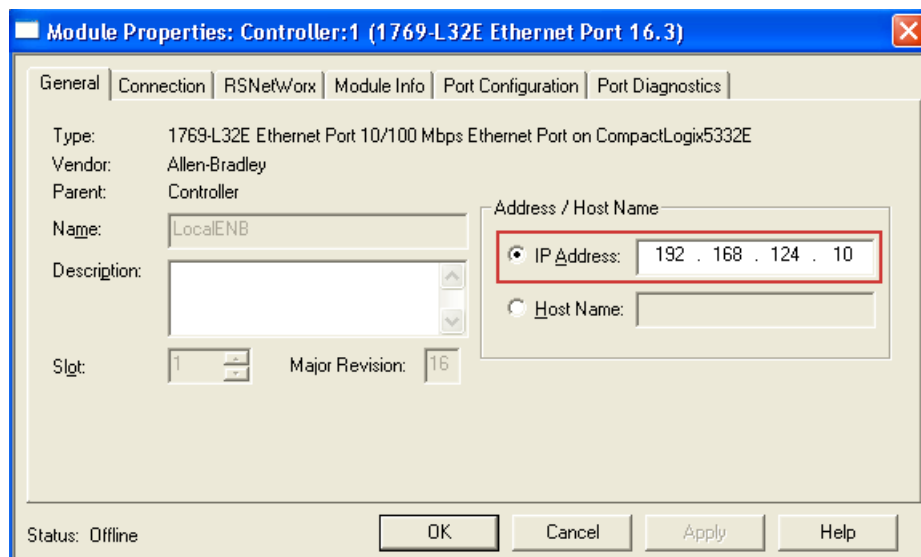

4. Then click **OK**.

5. Go to the **Port Configuration** tab and enter the IP configuration, BOOTP setting, Ethernet baud rate and duplex mode.

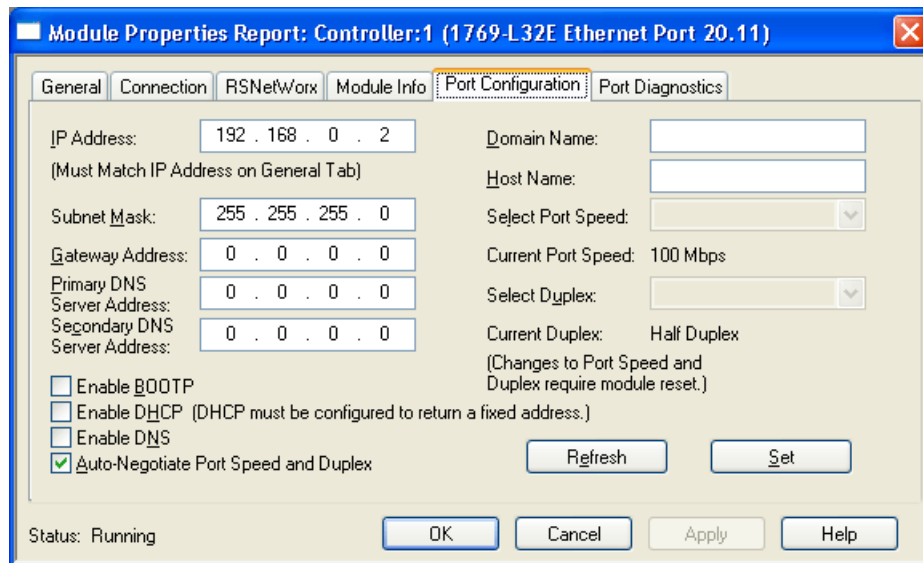

6. Then click **OK**.
  - Now, the scanner is configured for the EtherNet/IP network.
  - Here you will find information on project planning with the »RSLogix 5000« programming software from Rockwell:
    - ▶ [I/O configuration with »RSLogix 5000« version 19 or lower](#) (📖 68)
    - ▶ [I/O configuration with »RSLogix 5000« version 20 or higher](#) (📖 73)

## 6.3

## Setting node addresses by means of rotary coding switches

**Note!**

- Each network node address must only be used once.
- Adjustable address range: 1 ... 254

You can set the node address (IP address) by means of the two "IP ADR" rotary coding switches located on the front.

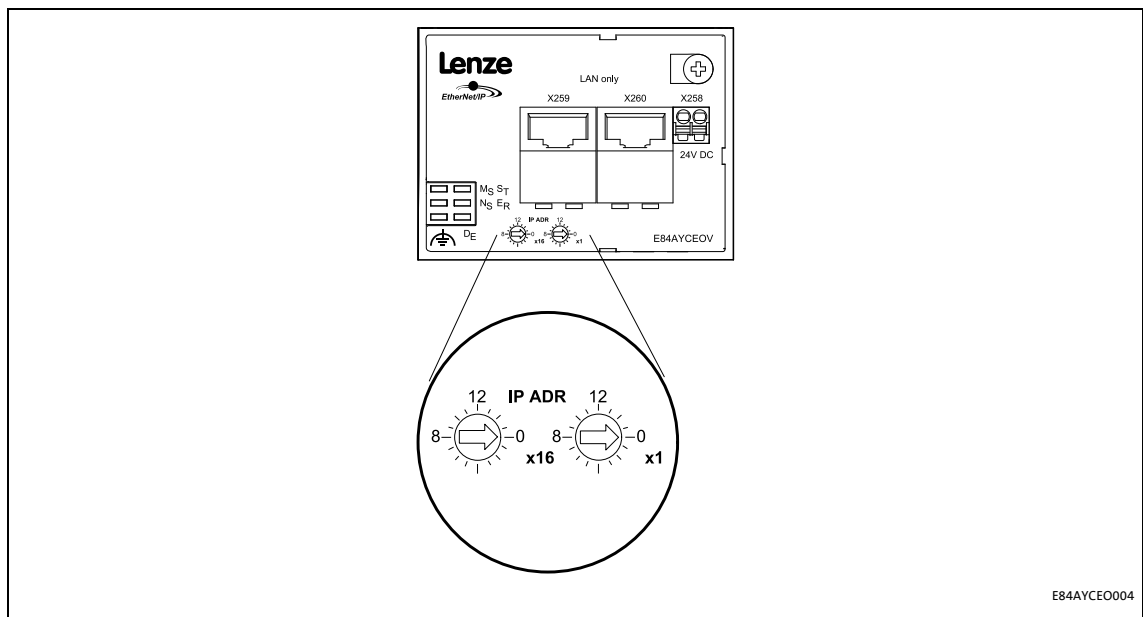

[6-1] "IP ADR" rotary encoding switches

The inscription on the rotary coding switches corresponds to the valencies for determination of the IP address.

The associated IP address of the communication module is the result of address setting by means of the rotary encoder switches, e.g. IP address 192.168.100.[IP ADR]

In the default state, the rotary coding switches have been set to "0".

The rotary coding switch is re-evaluated when the following events occur:

- Type 0 reset service to the [Identity Object \(1 / 0x01\)](#) (C 126);
- Type 1 reset service to the [Identity Object \(1 / 0x01\)](#) (C 126);
- Switch the voltage supply for the communication module off and then on again.

The current value of the rotary coding switch is indicated in code [C13920](#).

## Possible settings of the rotary coding switches

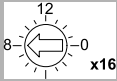
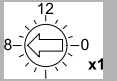
Position of the rotary coding switches				Description
				
0	× 16	0	× 1	Default status: <ul style="list-style-type: none"> <li>Value from code <a href="#">C13005</a> (IP configuration reference, 1: BOOTP)</li> <li>The setting can also be made by means of write-access to attribute 3 (Configuration Control) of instance 1 of the <a href="#">TCP/IP Interface Object (245 / 0xF5)</a> (<a href="#">☰ 141</a>).</li> </ul>
0 ... 15		1 ... 14		IP address 1 ... 254 <ul style="list-style-type: none"> <li>The static address stored in subcode <a href="#">C13000/1...3</a> is used.</li> <li>The subcode <a href="#">C13000/4</a> is replaced with the value of the rotary coding switch.</li> </ul>
15		15		This setting resets the codes for IP configuration: <ul style="list-style-type: none"> <li><a href="#">C13000</a> (IP address)</li> <li><a href="#">C13001</a> (subnet mask)</li> <li><a href="#">C13002</a> (gateway address)</li> <li><a href="#">C13005</a> (IP configuration reference)</li> <li><a href="#">C13006</a> (Multicast IP start address)</li> <li><a href="#">C13017</a> (Ethernet setting: Autonegotiation)</li> <li><a href="#">C13018</a> (Multicast setting: Default algorithm)</li> <li><a href="#">C13021</a> (Quality of Service (VLAN tagging): deactivated)</li> <li><a href="#">C13846</a> (Address conflict detection (ACD): activated)</li> </ul>

## Example: Setting of the node address '52'

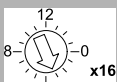
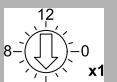
Position of the rotary coding switches				Resulting node address
				
3	× 16	4	× 1	$(3 \times 16) + (4 \times 1) = 52$

## 6.4 Setting the IP configuration of the Inverter Drive 8400

IP configuration is necessary in order to assign an address to the Inverter Drive 8400 so that communication between the PC/»Engineer« or the scanner and the drive is possible via EtherNet/IP. For this purpose, an IP address, subnet mask and gateway address have to be assigned. You can assign these IP parameters for the Inverter Drive 8400 in the following ways:

- [Setting via the EtherNet/IP configurator of the »Engineer«](#) (📖 43)
- [Setting via codes in the »Engineer«](#) (📖 45)
- [Setting via a BOOTP/DHCP server](#) (📖 47)
- [Setting via the TCP/IP Interface Object \(0xF5\)](#) (📖 47)



### Note!

- The assignment of invalid combinations of IP address, subnet mask, and gateway address can have the consequence that no connection to the EtherNet/IP network can be established.
- Codes [C13010](#) (IP address), [C13011](#) (subnet mask), [C13012](#) (gateway address), and [C13016](#) (multicast IP address) show the IP parameters currently used.
- In the case of impermissible settings, the error message [EtherNet/IP: Invalid IP parameters \[0x01bc6533\]](#) (📖 99) is output.

### 6.4.1 Setting via the EtherNet/IP configurator of the »Engineer«



#### Note!

- Changes in the IP parameters will become effective immediately.
- An already existing IP connection to the Inverter Drive 8400 is interrupted.



#### How to set the IP parameters via the EtherNet/IP configurator:

1. Execute the menu command **Online → PROFINET /EtherNet/IP configurator addresses ....**

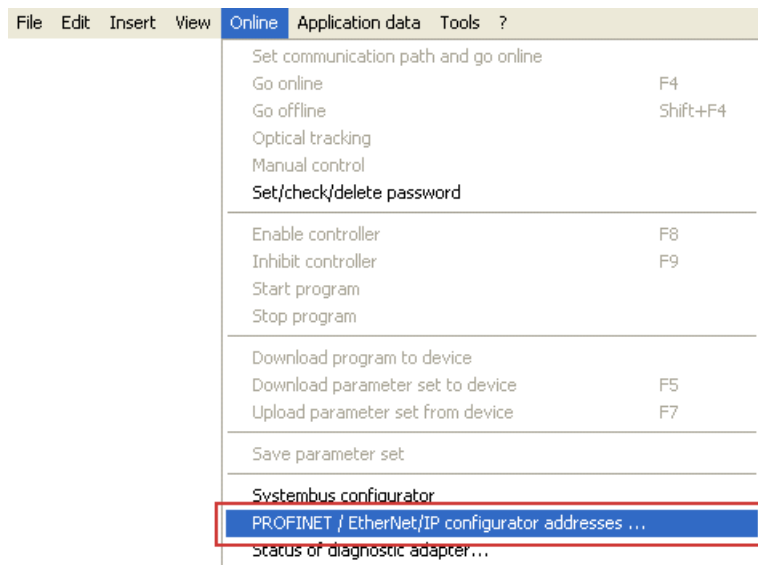

The "Assign IP addresses" dialog window is opened and all Lenze EtherNet/IP nodes connected are listed.

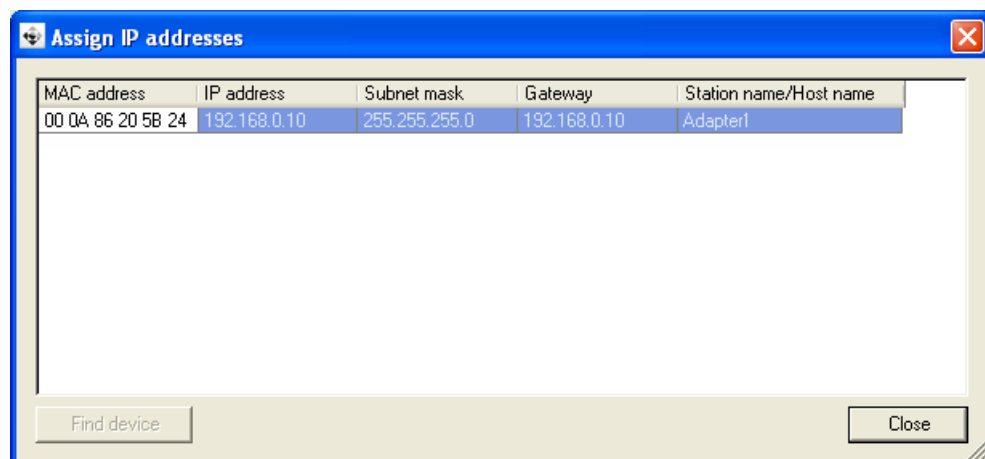



2. A double-click on a EtherNet/IP node opens the "Configure nodes" dialog window. Here you can set the IP parameters.

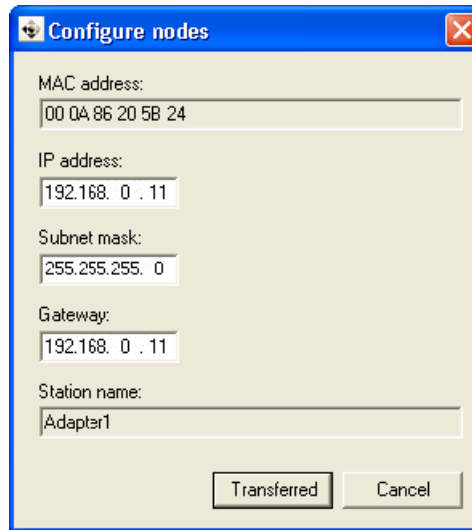

3. Click on **Transferred**.
  - The IP configuration is transferred to the corresponding EtherNet/IP node.
  - The communication module carries out a stack reset.
  - The IP parameters are written to codes [C13000](#) (IP address), [C13001](#) (subnet mask), and [C13002](#) (gateway address).
  - Code [C13005](#) (IP configuration reference) is set to '0: Saved address' to ensure that the transferred address can be used.



**Tip!**

Check whether the configuration has been transferred successfully.

For this purpose, open the "Assign IP addresses" dialog window (see step 1) and click the **Find device** button.

### 6.4.2 Setting via codes in the »Engineer«

You can also set the IP parameters manually in the »Engineer« under the **Settings** tab. The values will be transferred to the corresponding codes.

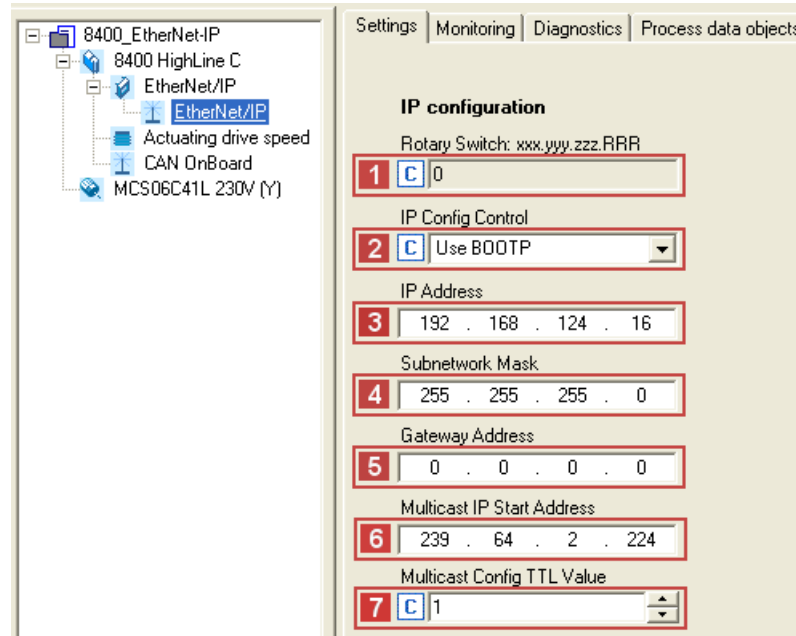

Settings / Display	Description
<b>1</b> Rotary coding switch	Display of the value set by means of the rotary coding switches ( <a href="#">C13920</a> ). ▶ <a href="#">Setting node addresses by means of rotary coding switches</a> (□ 40)
<b>2</b> IP Config Control	Selection ( <a href="#">C13005</a> ) of how the IP configuration is to be made: <ul style="list-style-type: none"> <li>• 0: The IP configuration currently stored in the communication module is used.</li> <li>• 1: The IP configuration is assigned by a BOOTP server using the BOOTP.</li> <li>• 2: The IP configuration is assigned by a DHCP server using the DHCP.</li> </ul>
<b>3</b> IP Address	Setting of the IP address ( <a href="#">C13000</a> )
<b>4</b> Subnet mask	Setting of the subnet mask ( <a href="#">C13001</a> )
<b>5</b> Gateway Address	Setting of the gateway address ( <a href="#">C13002</a> )
<b>6</b> Multicast IP Start Address	Setting of the Multicast IP start address ( <a href="#">C13006</a> ) ▶ <a href="#">Setting the multicast configuration</a> (□ 48)
<b>7</b> Multicast Config TTL Value	Setting of the multicast TTL value ( <a href="#">C13019</a> )



#### How to activate changed settings in the »Engineer«:

1. Execute device command **C00002 = "11: Save all parameter sets"**.  
The current IP configuration is stored in the memory module of the drive.
2. Carry out a "Type 0 reset" for the [Identity Object \(1 / 0x01\)](#) (□ 126) of the node, or switch the voltage supply of the communication module off and on again.

**IP address**

The IP address is set/changed in [C13000](#).

The IP address currently used is displayed in [C13010/1...4](#).

Example: Display of the IP address 192.168.124.16				
Code	<a href="#">C13010/1</a>	<a href="#">C13010/2</a>	<a href="#">C13010/3</a>	<a href="#">C13010/4</a>
Value	192	168	124	16

**Subnet mask**

The subnet mask indicates which part of the IP address is evaluated as net ID or host ID.

Valid subnet masks are defined in accordance with RFC 1878

The subnet mask is set/changed in [C13001](#).

The subnet mask currently used is displayed in [C13011/1...4](#).

Example: Display of the subnet mask 255.255.255.0				
Code	<a href="#">C13011/1</a>	<a href="#">C13011/2</a>	<a href="#">C13011/3</a>	<a href="#">C13011/4</a>
Value	255	255	255	0

**Gateway address**

The gateway address is valid if the network address of the IP address and the gateway address are identical.

If the gateway address and the IP address are identical or if the address is '0.0.0.0', gateway functionality is not used.

The gateway address is set/changed in [C13002](#).

The gateway address currently used is displayed in [C13012/1...4](#).

Example: Display of the gateway address 192.168.124.16				
Code	<a href="#">C13012/1</a>	<a href="#">C13012/2</a>	<a href="#">C13012/3</a>	<a href="#">C13012/4</a>
Value	192	168	124	16

### 6.4.3 Setting via a BOOTP/DHCP server

DHCP is the acronym for "Dynamic Host Configuration Protocol". This protocol is defined in RFC 2131 and is a compatible advancement of the "Bootstrap Protocol" (BOOTP) according to RFC 951.

Both protocols enable network nodes to query information about the network configuration (e.g. the IP address) from a server via a TCP/IP network. The BOOTP/DHCP server assigns the IP address to the client dynamically from a defined address range. This means that the client receives an unambiguous IP address.

Code [C13005](#) is used to select how the IP configuration is to be made:

- Value '0': The IP configuration currently saved in the communication module is used.
- Value '1': BOOTP is used. (Lenze standard setting)
- Value '2': DHCP is used.

The setting can also be selected by write access to attribute 3 (configuration control) of instance 1 of the [TCP/IP Interface Object \(245 / 0xF5\)](#) ([□ 141](#)).

### 6.4.4 Setting via the TCP/IP Interface Object (0xF5)

With a scanner, the IP configuration can be set via attribute 5 (interface configuration) of instance 1 of the [TCP/IP Interface Object \(245 / 0xF5\)](#) ([□ 141](#)).

After the IP configuration, carry out a node reset ("power off/on" or "Type 0 reset" for the [Identity Object \(1 / 0x01\)](#) ([□ 126](#))).

In the »Engineer«, codes [C13010](#) (IP address), [C13011](#) (subnet mask), [C13012](#) (gateway address), and [C13016](#) (multicast IP address) show the IP parameters currently used.

### 6.4.5 Setting the multicast configuration

Several scanners ("Listen only" or "Input only" connections) can access multicast telegrams which are sent by drives. Settings for multicast configuration have to be carried out as well in the EtherNet/IP configuration software (z. B. »RSLogix 5000« from Rockwell).

By default, the communication module automatically generates the Multicast IP start address for I/O data transfer. The standard TTL value for Multicast transfer is '1'; the Multicast I/O data packages are therefore distributed solely via the local network.



#### Note!

You can also explicitly set the multicast IP start address and the multicast TTL value. We recommend, however, not to change the default settings in order to ensure a secure multicast transmission.

The following multicast codes are configurable:

Code	Description
<a href="#">C13018</a>	Selection for multicast IP addressing via instance attribute 9 (Mcast Config) in the <a href="#">TCP/IP Interface Object (245 / 0xF5)</a> ( <a href="#">📖 141</a> ) <ul style="list-style-type: none"> <li>• Value '0': The default algorithm is used.</li> <li>• Value '1': The address from code <a href="#">C13006</a> is used as multicast IP start address.</li> </ul>
<a href="#">C13019</a>	Setting of the multicast TTL value for the validity time of data packets in the EtherNet/IP network (Instance attribute 8 (TTL Value) in the <a href="#">TCP/IP Interface Object (245 / 0xF5)</a> ( <a href="#">📖 141</a> ))
<a href="#">C13020</a>	Used to set how many multicast IP addresses will be assigned. (Instance attribute 9 (Num Mcast) in the <a href="#">TCP/IP Interface Object (245 / 0xF5)</a> ( <a href="#">📖 141</a> ))

#### Multicast IP Start Address

Multicast IP start addresses serve to send a message to the members of a certain group (i.e. possibly to several nodes).

The multicast IP start address is set/changed in [C13006](#).

The currently used multicast IP address of the drive is displayed in [C13016/1...4](#).

Example: Display of the multicast IP address 239.64.2.224				
Code	<a href="#">C13016/1</a>	<a href="#">C13016/2</a>	<a href="#">C13016/3</a>	<a href="#">C13016/4</a>
Value	239	64	2	224

**Note!**

- In order to ensure perfect operation of cyclic EtherNet/IP communication, online access with the »Engineer« should be executed via an IEEE 802.1Q-capable switch.
- The IEEE 802.1Q-capable switch integrated in the communication module can manage cyclical EtherNet/IP-communication primarily for normal TCP/IP communication. In the case of EtherNet/IP, this is done by means of the VLAN identification in the Ethernet frame (can be set in [C13021](#)).
- If the redundancy protocol DLR (Device Level Ring) is used, the switch also must be DLR-compliant.

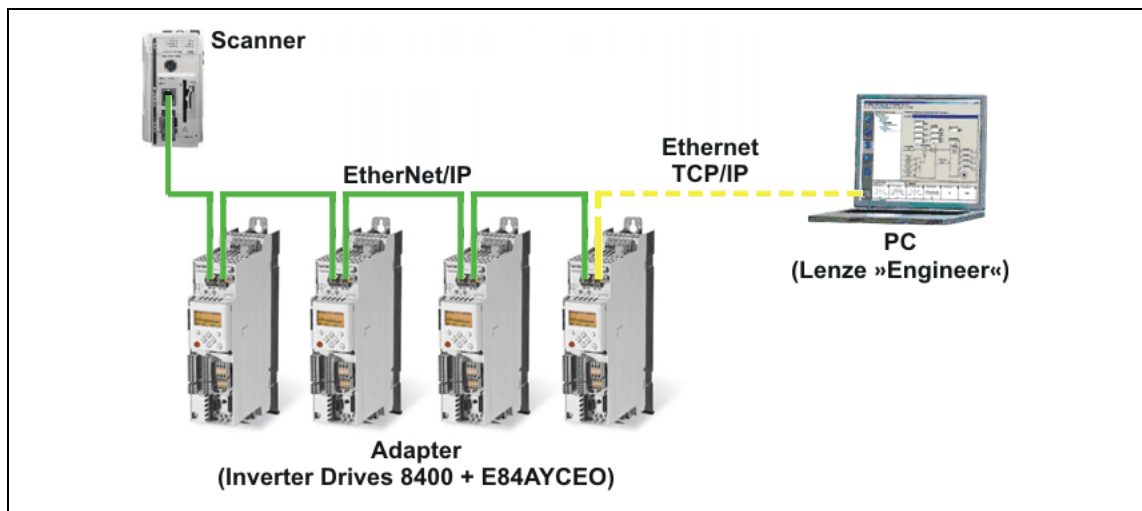

[6-2] Example set-up with an Allen Bradley CompactLogix Controller 1769-L32E (scanner)

For an online connection between the »Engineer« and the drive, the drive must have an IP address (see [Setting the IP configuration of the Inverter Drive 8400](#) (42)).

In the »Engineer«, you can use the **Online → Set communication path and go online** menu command to select the EtherNet/IP communication path. The previously configured EtherNet/IP nodes are shown in the "Communication path" dialog window:

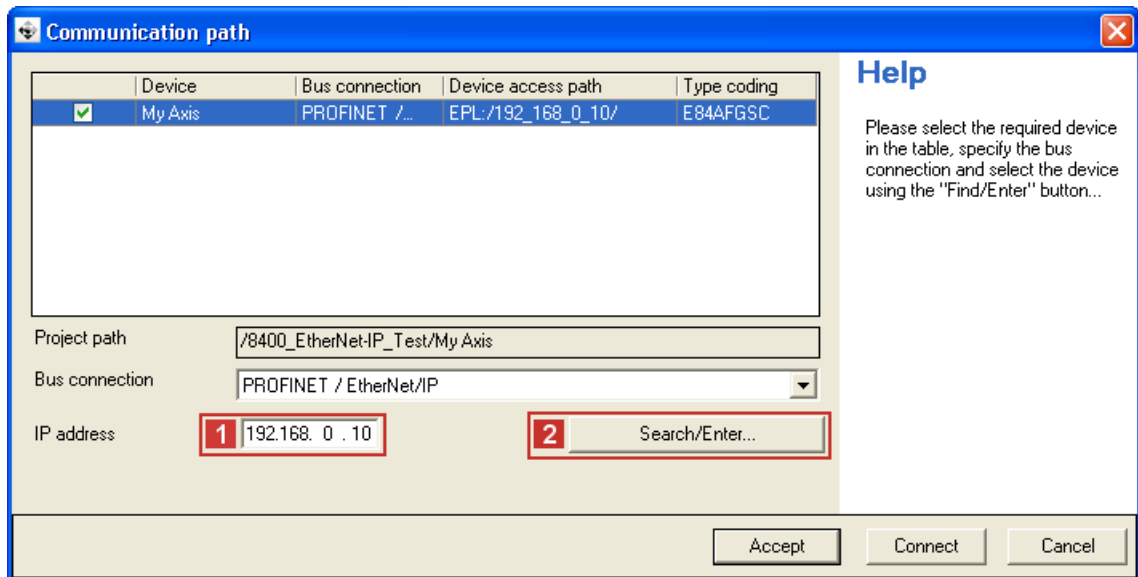

If the device access path is not configured correctly, the **1 IP address** of the drive selected in the display field can be entered manually here.

Via the **2 Search/Enter** button, you can establish a connection to devices which have not appeared in the display field. Corresponding settings for this can be made in the "Enter IP Address" dialog window that will appear:

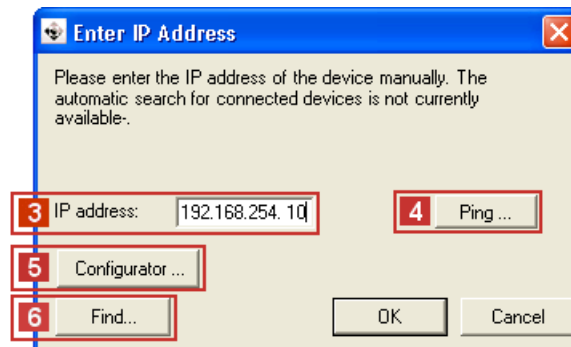

Here you can enter an **3 IP address** manually or execute the following actions using the buttons:

- Execute the console command **4 Ping**.
- Assign the IP address via the **5 Configurator**.
  - ▶ [Setting via the EtherNet/IP configurator of the »Engineer«](#) (43)
- Select the device access path to the desired drive by clicking **6 Find**.

After having established the online connection, you can continue work with the »Engineer« as usual.

## 6.6

## Initial switch-on

**Documentation for the Inverter Drive 8400**

Observe the safety instructions and information on residual hazards.

**Note!****Establishing communication**

In order to establish communication via an externally supplied communication module, the standard device must be switched on as well.

For further communication of the externally supplied module it is not relevant whether the standard device is switched on or not.

**Activating changed setting**

In order to activate any changed settings, ...

- execute the device command "11: Save all parameter sets" via the standard device code **C00002** and ...
- Carry out a "Type 0 reset" for the [Identity Object \(1 / 0x01\)](#) (126) of the node, or switch the voltage supply of the communication module off and on again.

**Protection against uncontrolled restart**

After a fault (e.g. short-term mains failure), it is sometimes undesirable or even impermissible for the drive to restart.

The restart protection is activated in the Lenze setting of the Inverter Drives 8400.

You can set the restart behaviour of the drive via **C00142** ("Autostart Option"):

**C00142 = 9** (Lenze setting)

- The inverter remains inhibited (even if the fault is no longer active).
- Bit 0 (inhibit at "power-on") and bit 3 (inhibit in the case of undervoltage) are set.
- An explicit inverter enable causes the drive to start up in a controlled manner: LOW-HIGH edge at digital input X4/RFR.

**C00142 = 8** (enabled)

- In order to directly enable the device at switch-on, bit 0 must be set to zero (FALSE).
- An uncontrolled restart of the drive is possible.



### 7 Data transfer

EtherNet/IP uses CIP™ (Common Industrial Protocol) for the data exchange between devices via an Ethernet network – just like the closely related bus systems DeviceNet and ControlNet.

Lenze implements the CIP following the ODVA standard (Open DeviceNet Vendor Association, [www.odva.org](http://www.odva.org)) and supports the two main types of EtherNet/IP communication:

- Explicit messaging (for parameter data)
- Implicit messaging (for I/O data)

### 7.1 Communication channels



#### Note!

The terms "input" and "output" refer to the point of view of the scanner:

- Input data is produced by the adapter and consumed by the scanner.
- Output data is produced by the scanner and consumed by the adapter.

EtherNet/IP transmits parameter data and I/O data between the host system (scanner) and the drives (adapters) connected to the fieldbus. The data are transmitted via corresponding communication channels depending on their time-critical behaviour.

The I/O data channel transmits I/O data by means of "implicit messages".

- The inverter is controlled by means of the I/O data.
- The transmission of I/O data is time-critical.
- I/O data are transmitted cyclically between the host system (scanner) and the drives (adapters) (permanent exchange of current input and output data).
- The host system (scanner) has direct access to the I/O data (the data are, for example, stored directly in the I/O area).
- In the case of Inverter Drives 8400, a maximum of 16 data words (max. 32 bytes) can be exchanged per direction.
- I/O data are not stored in the inverter.
- I/O data are e.g. setpoints, actual values, control and status words

The parameter data channel transmits parameter data by means of "explicit messages".

- The transmission of parameter data is usually not time-critical.
- Examples of parameter data are operating parameters, motor data, and diagnostic information.
- The parameter data channel provides access to all Lenze codes.
- Parameter changes must be saved by means of code **C00002** of the Inverter Drive 8400.

# 7 Data transfer

## 7.2 Telegram types

---

### 7.2 Telegram types

The "implicit message" and "explicit message" telegram types are transmitted between the host system (scanner) and the drive (adapter).

#### **Implicit messages (I/O data transfer)**

"Implicit messages" are transmitted or received according to the producer/consumer principle. There is one transmitter and no receiver or an optional number of receivers.

The "cyclic I/O data" transmission mode is supported. The scanner and the adapter use "cyclic I/O data" to generate their data independently of each other, which are then transmitted depending on a timer. The user must set the value of the timer in the scanner.

#### **Explicit messages (parameter data transfer)**

"Explicit messages" serve to configure and parameterise the individual EtherNet/IP nodes.

Two nodes have a client/server relationship:

The client transmits a job (request). The server receives this job and tries to accomplish it. The server then transmits the requested data (positive response) or an error message (negative response).

## 7.3 EtherNet/IP state diagram

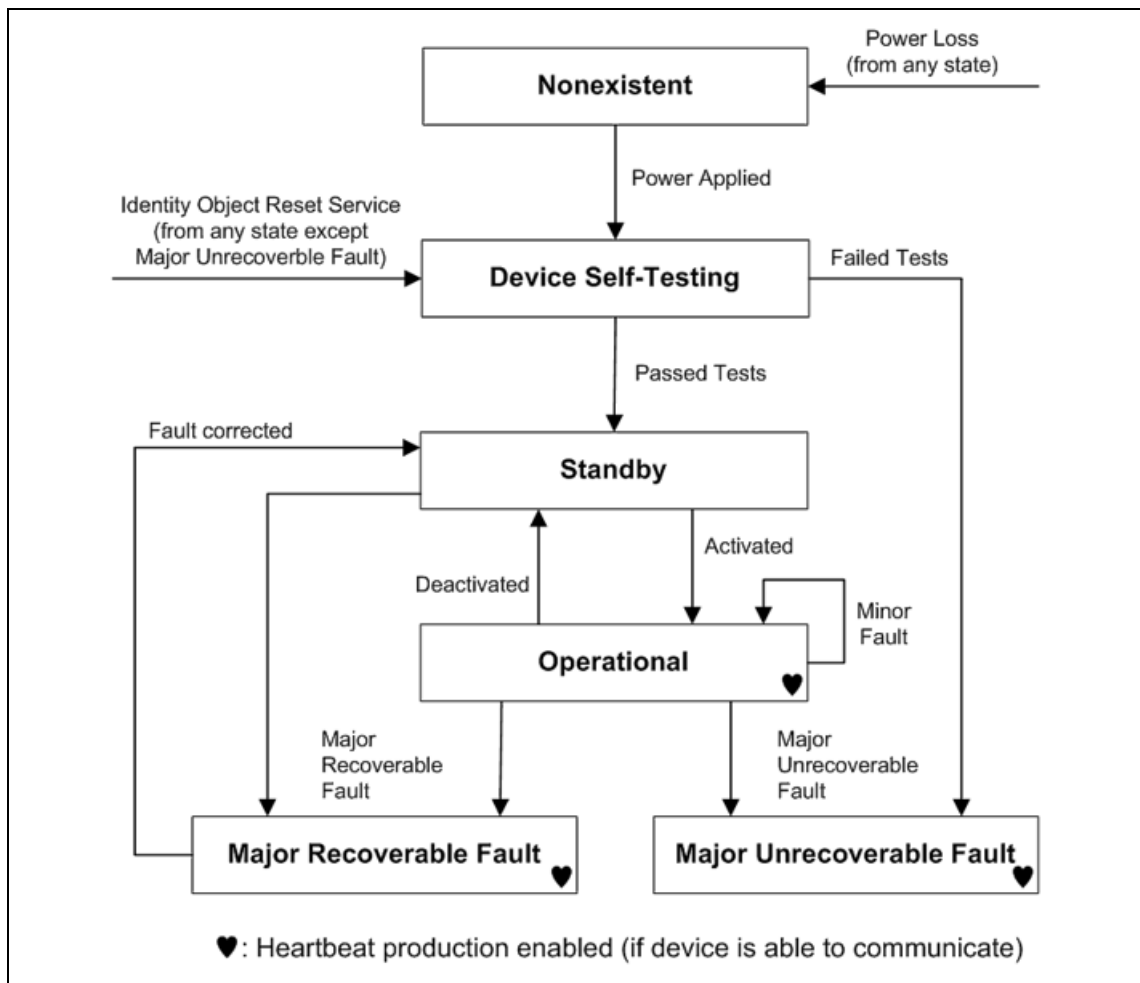

[7-1] EtherNet/IP state diagram

The current EtherNet/IP device state is ...

- output via code [C13861](#);
- output in the [Identity Object \(1 / 0x01\)](#) ([126](#)) via instance attributes 5 and 8;
- indicated via the **MS** LED (see [LED status displays](#) ([89](#))).

## 8 I/O data transfer (implicit messages)

---

### 8 I/O data transfer (implicit messages)

To exchange I/O data (implicit messages) between the host system (scanner) and the drive (adapter), you have to ...

- Assign the I/O data to the internal ports (MCI) in the drive (adapter):
  - ▶ [I/O data mapping](#) (📖 57)
  - ▶ [I/O configuration in the »Engineer«](#) (📖 62)
- Configure the I/O data transfer in the host (scanner):
  - ▶ [I/O configuration with »RSLogix 5000« version 19 or lower](#) (📖 68)
  - ▶ [I/O configuration with »RSLogix 5000« version 20 or higher](#) (📖 73)

# 8 I/O data transfer (implicit messages)

## 8.1 I/O data mapping

### 8.1 I/O data mapping

I/O data transfer takes place via the MCI interface.

- Access to the I/O data takes place via port blocks **LP\_MciIn** and **LP\_MciOut**.
- The **LP\_MciIn** port block maps the received data objects.
- The **LP\_MciOut** port block maps the data objects to be sent.
- Up to 16 data words (32 bytes) per direction can be exchanged.
- The ports/function blocks of the I/O data objects are interconnected with the Lenze »Engineer«.

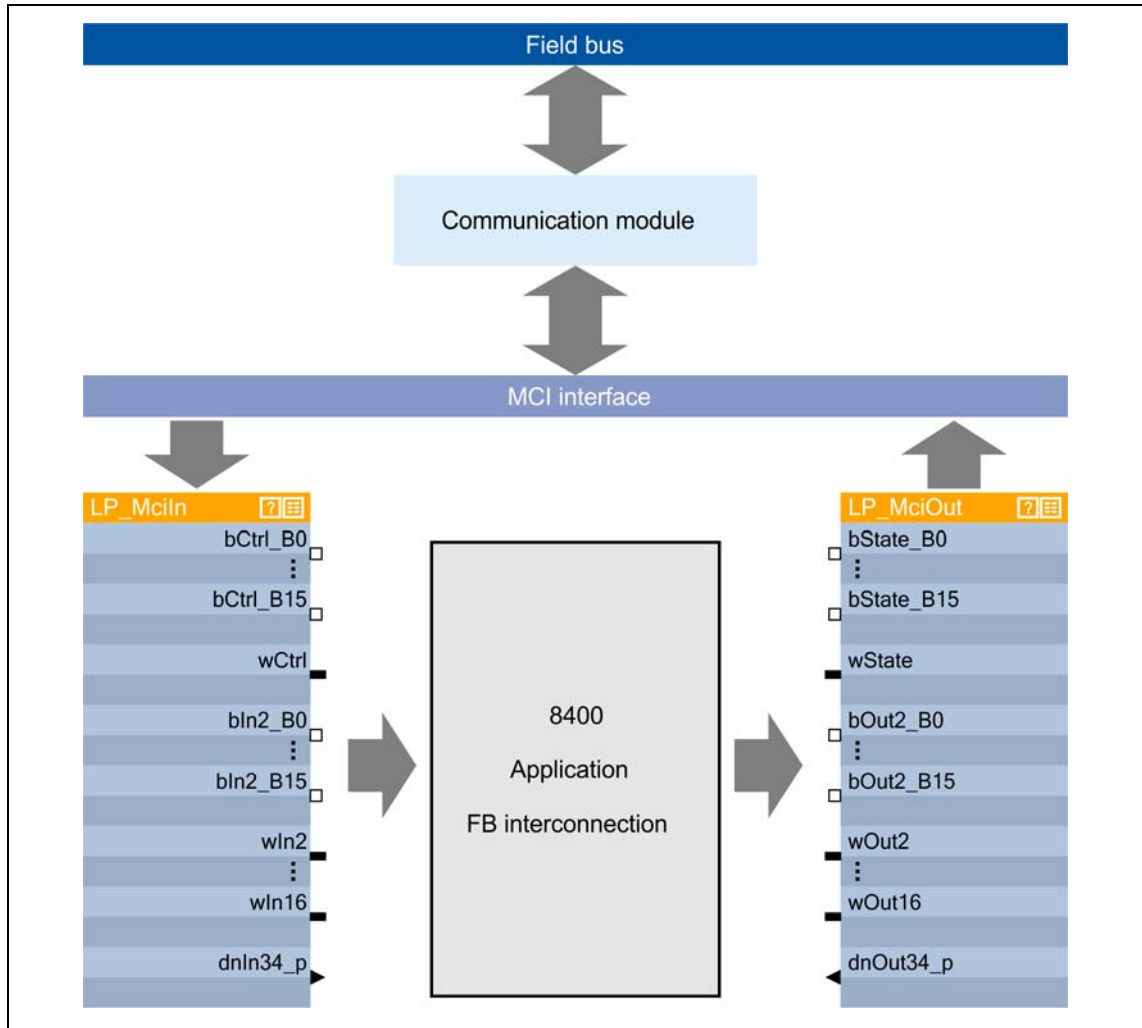

[8-1] Outer and inner data transfer between bus system, inverter, and application



#### Software manual / online help for the Inverter Drive 8400

Here you will find detailed information on the port/function block interconnection in the »Engineer« and on the port blocks.

### 8.2 Technology applications (TA) / drive profiles

The Inverter Drives 8400 is provided with various drive profiles. They define a standardised/individual control and status word assignment and the standardisation of setpoints and actual value scalings.

The following drive profiles are supported by the Inverter Drives 8400:

- Lenze technology applications / user-definable parameter sets
- "AC Drive Profile" application

#### 8.2.1 Lenze technology applications / user-definable parameter sets

The technology applications integrated in the drive provide the main signal flow for realising a general or specific drive solution.

For using the Lenze technology application selection in the »Engineer« via standard device code **C00005**, the following assembly object instances have to be used in the host (scanner):

Instance ID		Assembly object instance
[dec]	[hex]	
110	0x6E	Custom Output (from the adapter to the scanner)
111	0x6F	Custom Input (from the adapter to the scanner)

See also [Assembly Object \(4 / 0x04\)](#) (📖 129).

The custom assemblies also allow for a user-definable parameter setting, depending on the application. 16 data words can be freely assigned with variables of the MCI port blocks in the »Engineer«.

The user-definable parameter setting can be used in addition to the previously set technology application.

▶ [Lenze technology application / configuring user-definable parameter sets](#) (📖 62)



#### Tip!

Here you will find information on configuring with the »RSLogix 5000« programming software from Rockwell:

- ▶ [I/O configuration with »RSLogix 5000« version 19 or lower](#) (📖 68)
- ▶ [I/O configuration with »RSLogix 5000« version 20 or higher](#) (📖 73)

### 8.2.2 "AC Drive Profile" application

From inverter drive version V13.00 and communication module version V01.02, the EtherNet/IP-specific "AC Drive Profile" is supported.

The standard device code **C00005** = "**1100: AC Drive Profile**" serves to select the "AC Drive Profile" application.

The "AC Drive Profile" contains ...

- the data basis for motor parameters,
- management functions of the motor control devices,
- Device-specific functions of the drive, e.g. speed ramps, torque control etc.

For using the "AC Drive Profile", the following assembly object instances in the host (scanner) have to be used:

Instance ID		Assembly object instance	
[dec]	[hex]		
20	0x14	Basic Speed Control Output	Outputs: From the scanner to the adapter
21	0x15	Extended Speed Control Output	
22	0x16	Speed and Torque Control Output	
23	0x17	Extended Speed and Torque Control Output	
70	0x46	Basic Speed Control Input	Inputs: From the adapter to the scanner
71	0x47	Extended Speed Control Input	
72	0x48	Speed and Torque Control Input	
73	0x49	Extended Speed and Torque Control Input	

See also:

- [Assembly Object \(4 / 0x04\)](#) (📖 129)
- ["AC Drive Profile" objects](#) (📖 148)



#### Tip!

Here you will find information on configuring with the »RSLogix 5000« programming software from Rockwell:

- ▶ [I/O configuration with »RSLogix 5000« version 19 or lower](#) (📖 68)
- ▶ [I/O configuration with »RSLogix 5000« version 20 or higher](#) (📖 73)



## 8.3

## I/O assemblies

**Note!**

The terms "input" and "output" refer to the point of view of the scanner:

- Assembly input objects (input) are sent from the adapter to the scanner.
- Assembly output objects (output) are sent from the scanner to the adapter.

The length of the I/O data must correspond with the respective resulting length of the mapped ports ([I/O data mapping](#) (p. 57)).

The communication module supports the [Assembly Object \(4 / 0x04\)](#) (p. 129) and the ["AC Drive Profile" objects](#) (p. 148).

For data exchange, the communication module supports the following assembly object instances:

Application	Instance ID		Assembly object instance
	[dec]	[hex]	
Lenze technology applications / user-definable parameter sets	110	0x6E	Custom Output
	111	0x6F	Custom Input
"AC Drive Profile" application	20	0x14	Basic Speed Control Output
	21	0x15	Extended Speed Control Output
	22	0x16	Speed and Torque Control Output
	23	0x17	Extended Speed and Torque Control Output
	70	0x46	Basic Speed Control Input
	71	0x47	Extended Speed Control Input
	72	0x48	Speed and Torque Control Input
	73	0x49	Extended Speed and Torque Control Input

Assembly output objects (outputs) are usually used for controlling the enable/disable state of the drive and for supplying the speed or torque references.

Assembly input objects (inputs) are usually used to monitor the drive status and the runtime values such as actual speed, current, actual position and position error.

Depending on the data length defined by the scanner, the memory map of the I/O data can have different sizes.

**Assembly output objects (scanner → Adapter)**

Assembly output objects are assumed to have a 4-byte header (32-bit "run/idle header"). When mapping the assemblies, this header will automatically be added to the data stream by most Allen-Bradley PLC/SLC equipment.

If your PLC does not support this header (like the Rockwell PLCs do), add a preceding 32-bit header to the output image.

You can then define the **bit 0** of this header in the process image of your PLC:

- 0: Idle mode
- 1: Run mode

For the operation with Rockwell PLCs, adaptations are not required.

**Assembly input objects (adapter → scanner)**

The assembly input objects are mapped in the adapter memory starting with byte 0.

The input objects are transmitted in a "modeless" manner, i.e. a 4-byte header (32-bit "Run/Idle header") is not included in the transfer.

So the start address in the assembly memory map is the actual start of the first assembly data element.

Please observe the actual assembly lengths when mapping the input objects to the controller memory.

The contents of the input data depends on the I/O data arrangement in the drive ([I/O data mapping](#) (57)).

# 8 I/O data transfer (implicit messages)

## 8.4 I/O configuration in the »Engineer«

### 8.4 I/O configuration in the »Engineer«

#### 8.4.1 Lenze technology application / configuring user-definable parameter sets



**How to configure the Lenze technology applications / user-definable parameter sets in the »Engineer«:**

1. Select the application (C00005 = 1000) in the **Application parameters** tab.

In the example, the "speed actuating drive" application is configured.

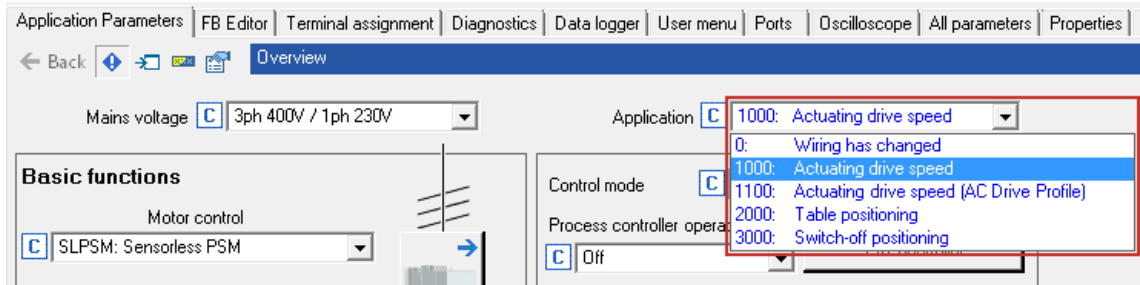

2. Make the default setting of the I/O configuration.

Select "**MCI**" control mode (C00007 = 40).

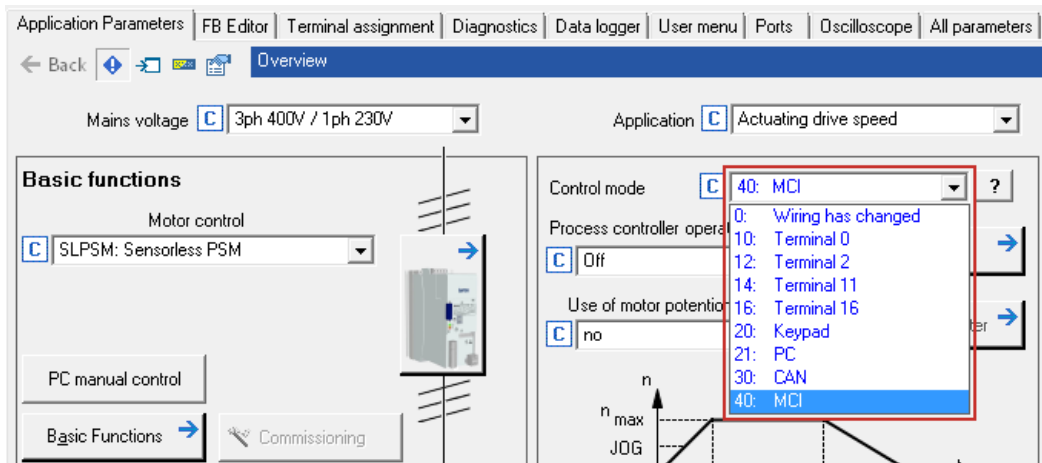

3. On the **Ports** tab, the port blocks **1** **MCI\_IN** and **MCI\_OUT** for the I/O data objects are shown.

The screenshot shows the 'Ports' configuration window. The 'Input ports' column contains CAN1\_IN, CAN2\_IN, CAN3\_IN, and MCI\_IN (highlighted with a red box and labeled '1'). The 'Actuating drive speed' column contains '(Application)'. The 'Output ports' column contains CAN1\_OUT, CAN2\_OUT, CAN3\_OUT, and MCI\_OUT. Below the ports, the 'Mapping' section shows 'EtherNet/IP/MCI\_IN\_ETHERNETIP : 0'. The 'Network default interconnection' section shows '<not defined>'. At the bottom, the 'Application variables' table is shown with the following data:

Name	Signal	Type	Length	Index	Online
WORD_1	MCI control word (LA_NCtrl)	WORD	16	C876/1	offline
WORD_2	Main speed setpoint (LA_NCtrl)	WORD	16	C876/2	offline
WORD_3	[not connected]	WORD	16	C876/3	offline
WORD_4	[not connected]	WORD	16	C876/4	offline
WORD_5	[not connected]	WORD	16	C876/5	offline
WORD_6	[not connected]	WORD	16	C876/6	offline
WORD_7	[not connected]	WORD	16	C876/7	offline
WORD_8	[not connected]	WORD	16	C876/8	offline
WORD_9	[not connected]	WORD	16	C876/9	offline

A red box labeled '3' highlights the 'Change Variable...' button next to the table.

- By clicking the required port, the preconfigured signal combination can be obtained from the **2** **application variables**.
- If you want to complement or change the signal combination, click the **3** **Change Variable ...** button.

4. In the "Edit port" dialog window, you can assign signals to the I/O data words via the  button.  
→ Select the signals and confirm the selection with **OK**.

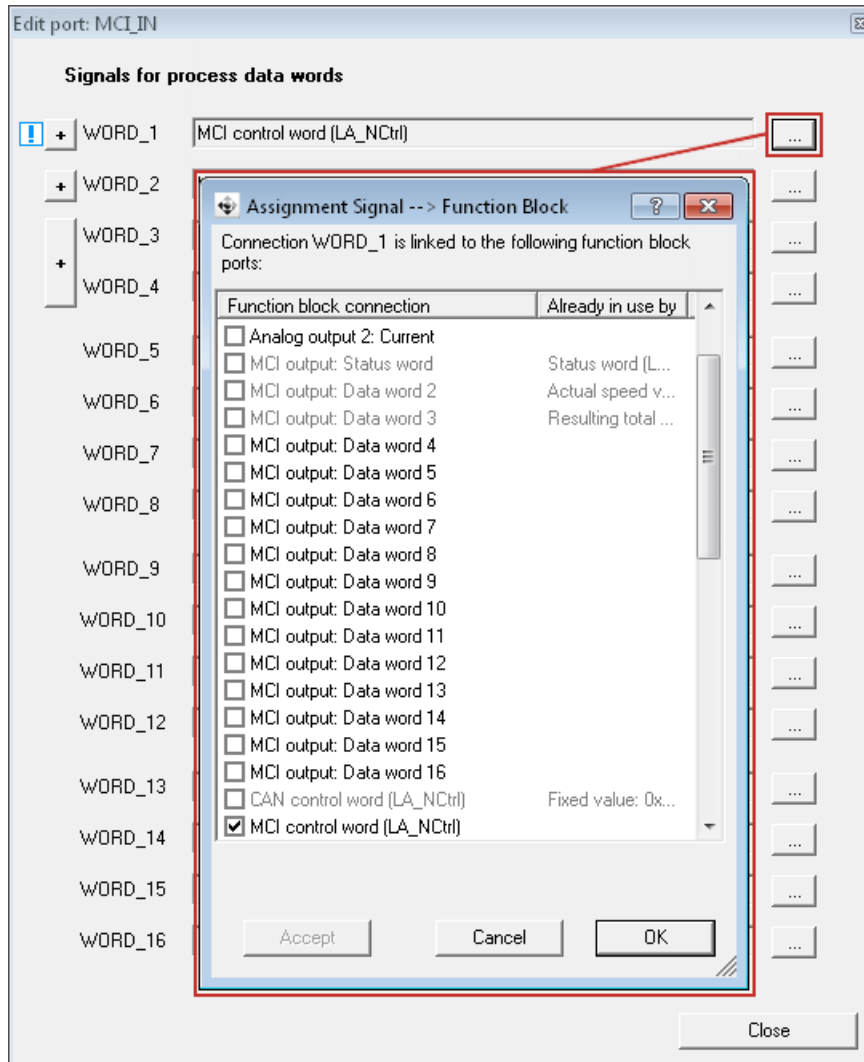

For some data words, you can also assign signals to the individual bits via the **+** and **...** buttons.

→ Select the signals and then confirm the selection with **OK**.

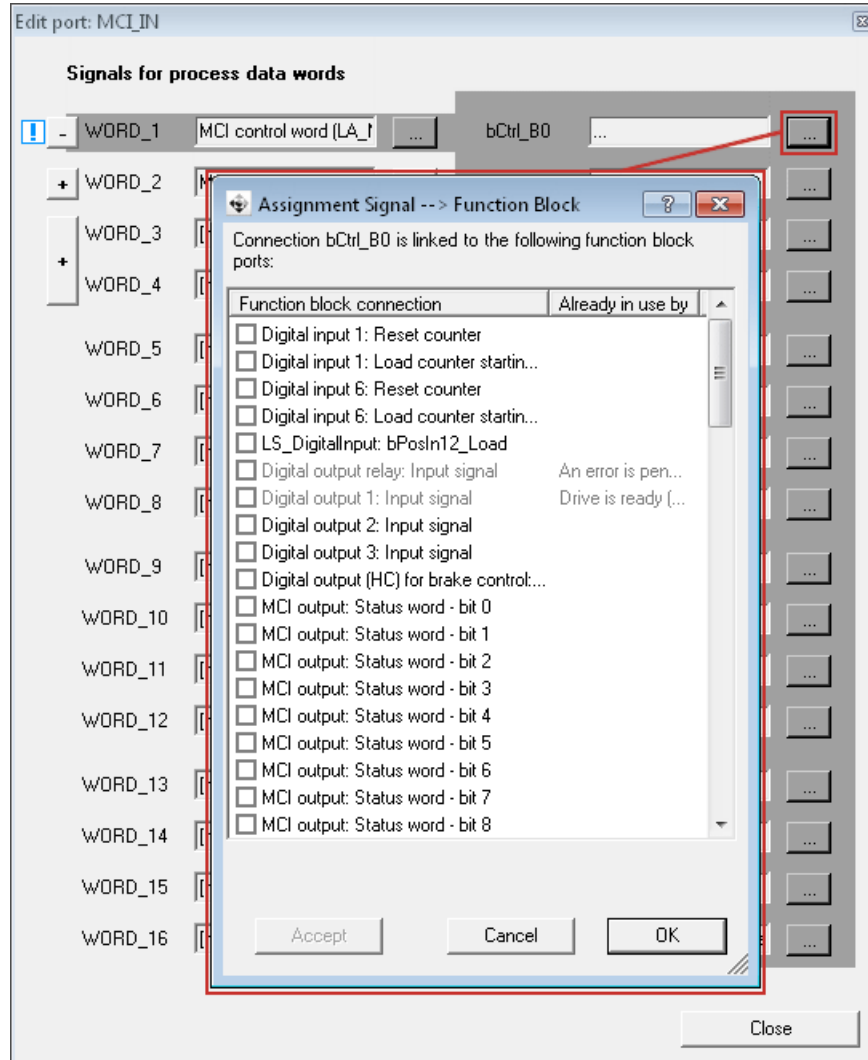

5. Use the standard device code **C00002** to execute the command **"11: Save all parameter sets"**.

The changed settings are activated and saved with mains failure protection.

### Preconfigured signal combination in the "FB Editor"

By setting the standard device code **C00007 = "40: MCI"**, the preconfigured signal combination is activated.

The function block editor (FB Editor) is used to display the port blocks **LP\_MciIn** and **LP\_MciOut** with the preconfigured signal combinations.

Here, you can also complement or change the signal combination.

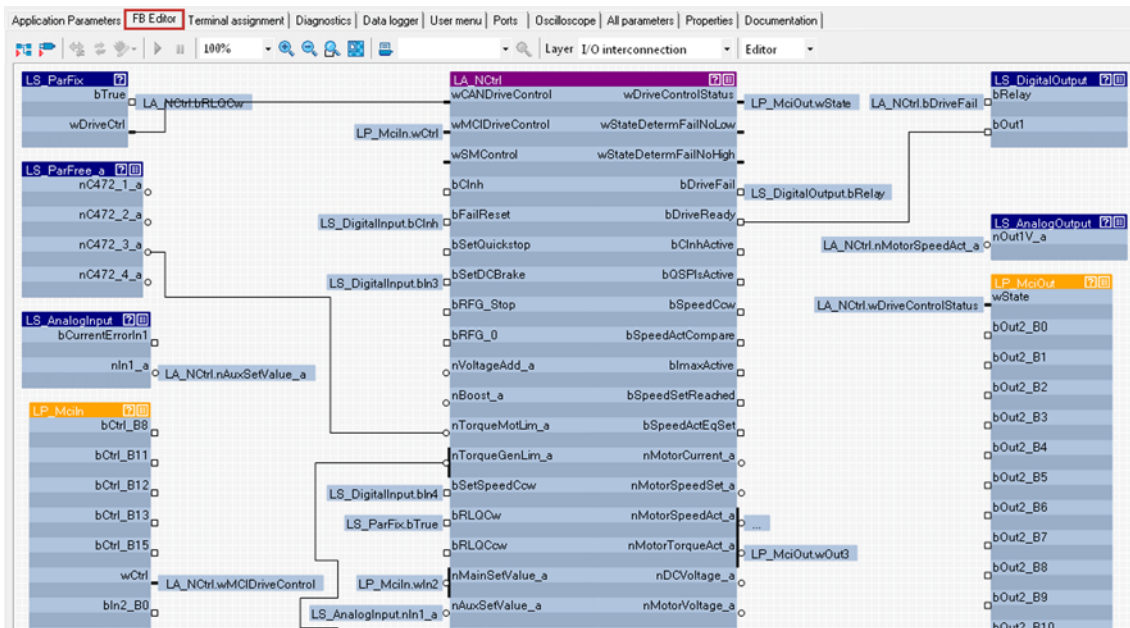

#### Software manual / online help for the Inverter Drive 8400

Here you will find detailed information on the port/function block interconnection in the »Engineer« and on the port blocks.

### 8.4.2 Configuring "AC Drive Profile" application



**How to configure the "AC Drive Profile" application in the »Engineer«:**

1. Select the "AC Drive Profile" application (C00005 = 1100) in the **Application parameters** tab.

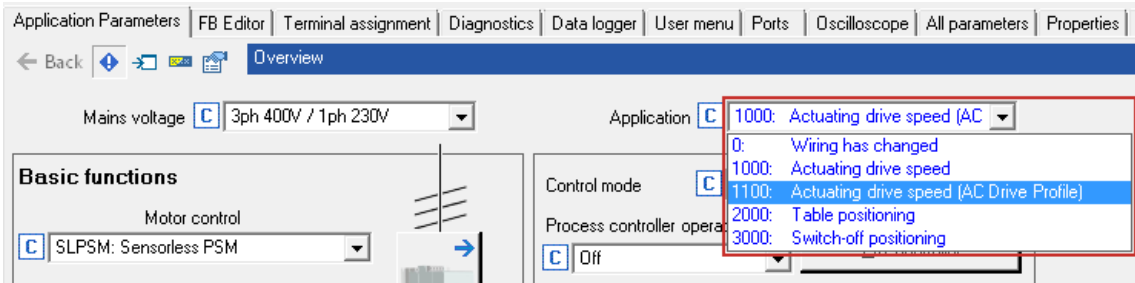

2. Make the default setting of the I/O configuration.

Select "MCI" control mode (C00007 = 40).

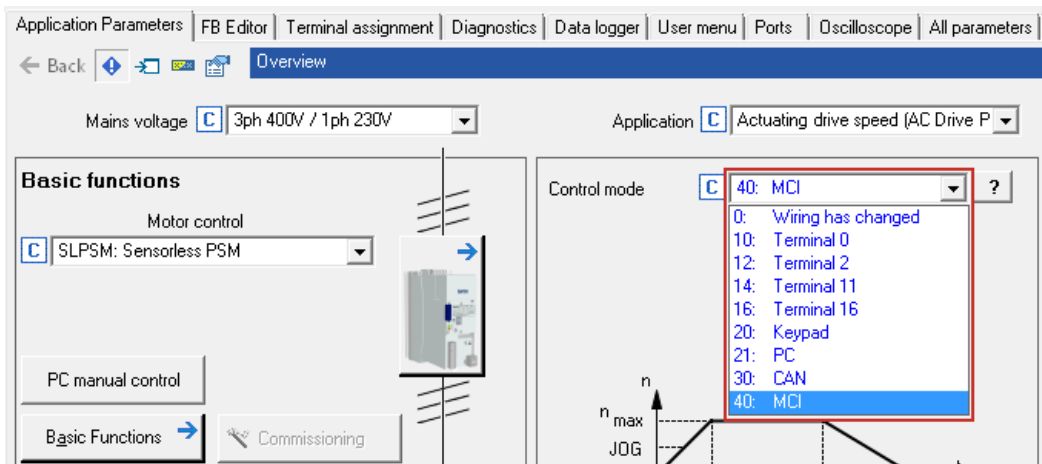



# 8 I/O data transfer (implicit messages)

8.5 I/O configuration with »RSLogix 5000« version 19 or lower

## 8.5 I/O configuration with »RSLogix 5000« version 19 or lower

The following example describes the I/O configuration of the Allen-Bradley 1769-L32E CompactLogix controller using the Rockwell »RSLogix 5000« programming software up to version 19.

Up to and including software version 19, the I/O configuration is carried out without EDS files.



**How to carry out the I/O configuration, taking the CompactLogix controller 1769-L32E with »RSLogix 5000« as an example:**

1. Click the **I/O Configuration** folder in the configuration tree.

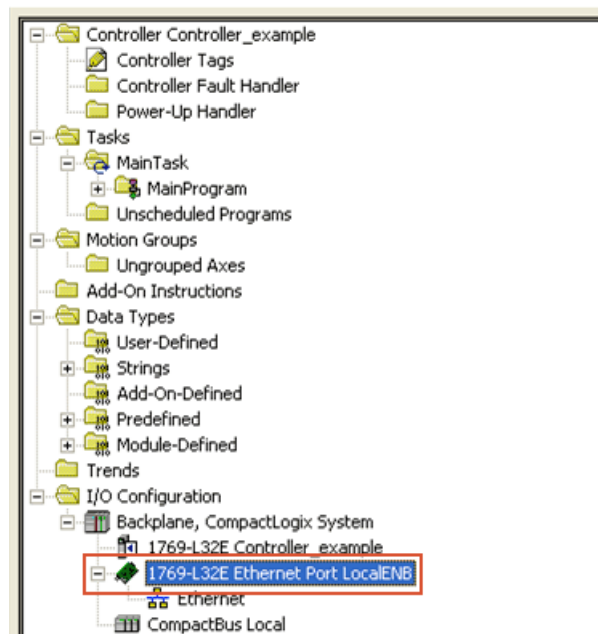

For the 1769-L32E CompactLogix controller, the I/O configuration already includes a local Ethernet port.

If a SoftLogic or ControlLogix controller is used, an Ethernet port scanner needs to be added to the configuration.

2. Right click on "Ethernet" and execute the "New Module ..." command from the context menu.

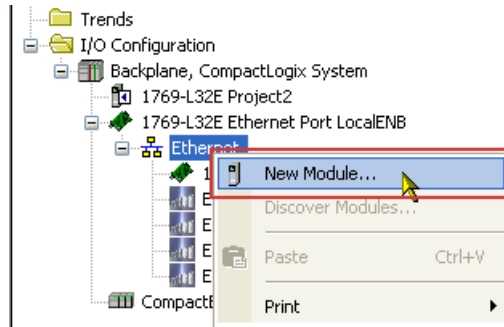

3. Open "Communications" and select "ETHERNET-MODULE | Generic Ethernet Module".

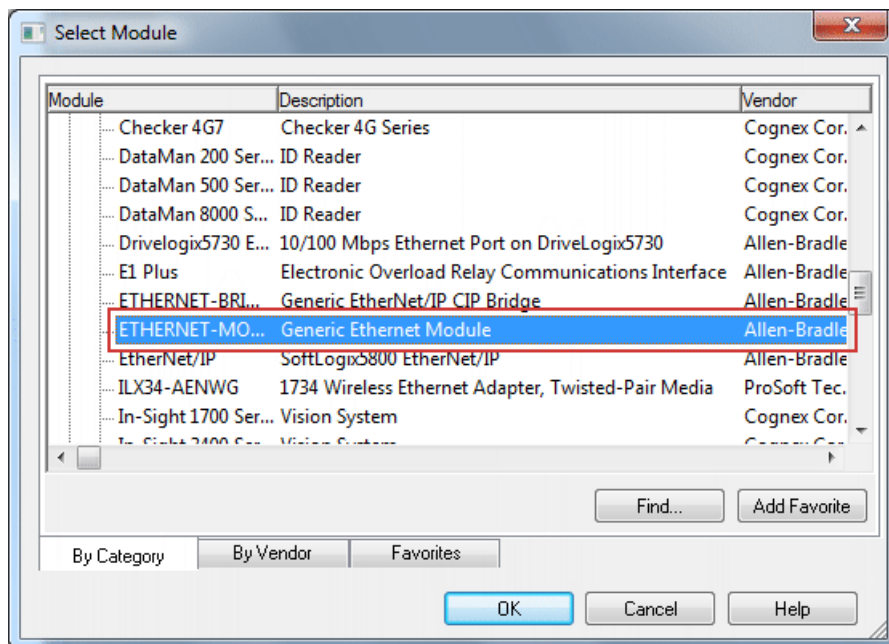

4. Confirm the selection with OK.

5. Go to the "New Module" dialog window and define the properties of the newly added device .

The terms "input" and "output" refer to the point of view of the scanner:

- Assembly input objects (input) are sent from the adapter to the scanner.
- Assembly output objects (output) are sent from the scanner to the adapter.

#### Settings for Lenze technology applications or user-definable parameter sets:

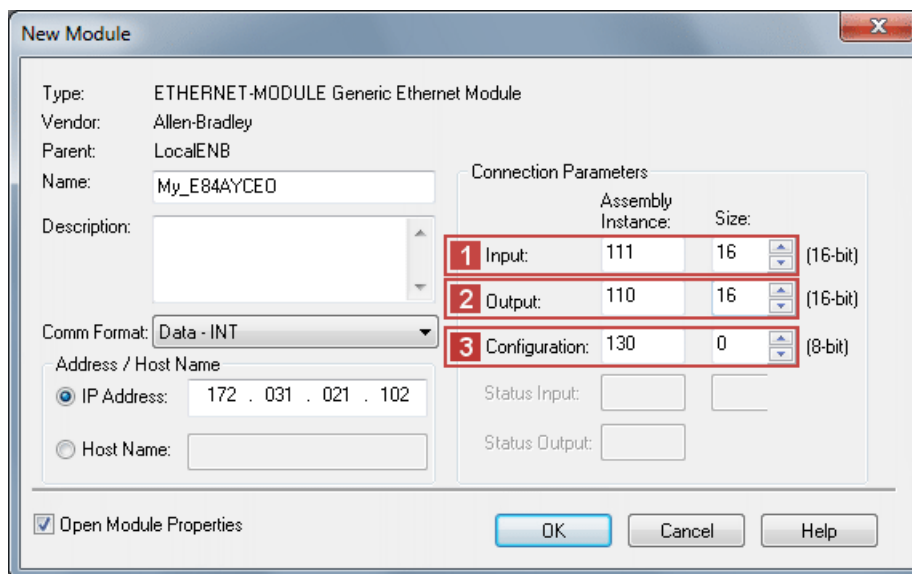

If you use a Lenze technology application or an individual parameter set in the drive, you can exchange up to 16 user-definable words (INT) via the ports MCI\_IN and MCI\_OUT using the assembly object instances **1** "Input = 111" and **2** "Output = 110".

Go to **3** "Configuration" and enter the **Assembly instance "130"** and the **Size "0"**.

**Settings for an "AC Drive Profile" application:**

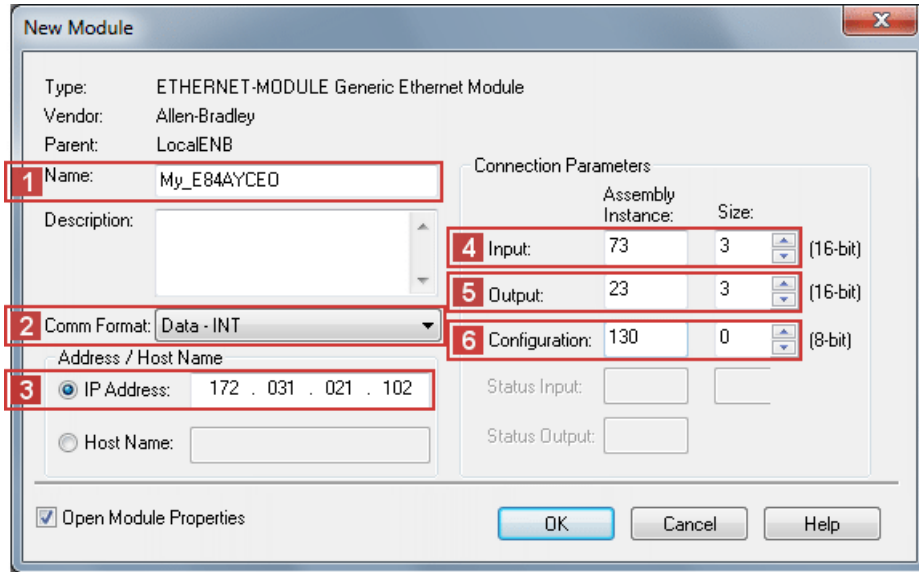

The assembly object instances **4** "Input = 73" and **5** "Output = 23" shown here exemplify the use of the AC Drive Profile "Extended Speed and Torque".

Settings	Description
<b>1</b> Name	Device name or type of the drive, usually with reference to the process (in the example "My_E84AYCEO")
<b>2</b> Comm Format	Data format for the assembly object instances ("connection parameters" area)
<b>3</b> IP Address	IP address of the drive <ul style="list-style-type: none"> <li>The IP address must be in the same subnetwork like the controller. (Depending on the subnet mask; in general, the first 3 octets of the IP address must be identical.)</li> <li>DNS is not supported; the host name merely describes the device.</li> </ul>
<b>4</b> Input	Assembly object instance for input objects <ul style="list-style-type: none"> <li>Max. 16 input data words (32 bytes, 16 bits/word)</li> <li>The number of input data must correspond to the length of the mapped ports in the transmit PDO (PDO_TX0), otherwise the adapter will reject the connection with the error message "Invalid Target to Originator Size" (0x0128).</li> </ul> <a href="#">I/O data mapping</a> (57)
<b>5</b> Output	Assembly object instance for output objects <ul style="list-style-type: none"> <li>Max. 16 output data words (32 bytes, 16 bits/word)</li> <li>The number of output data must correspond to the length of the mapped ports in the receive PDO (PDO_RX0), otherwise the adapter will reject the connection with the error message "Invalid Originator to Target Size" (0x0127).</li> </ul> <a href="#">I/O data mapping</a> (57)
<b>6</b> Configuration	Select the <b>Assembly instance "130"</b> and the <b>Size "0"</b> for the configuration. These values are required!

6. Complete the settings with **OK**.

7. Under **I/O Configuration** in the configuration tree, right click "1769-L32E Ethernet Port LocalENB" and select "Properties".
8. Go to the **Connection** tab and set further properties.

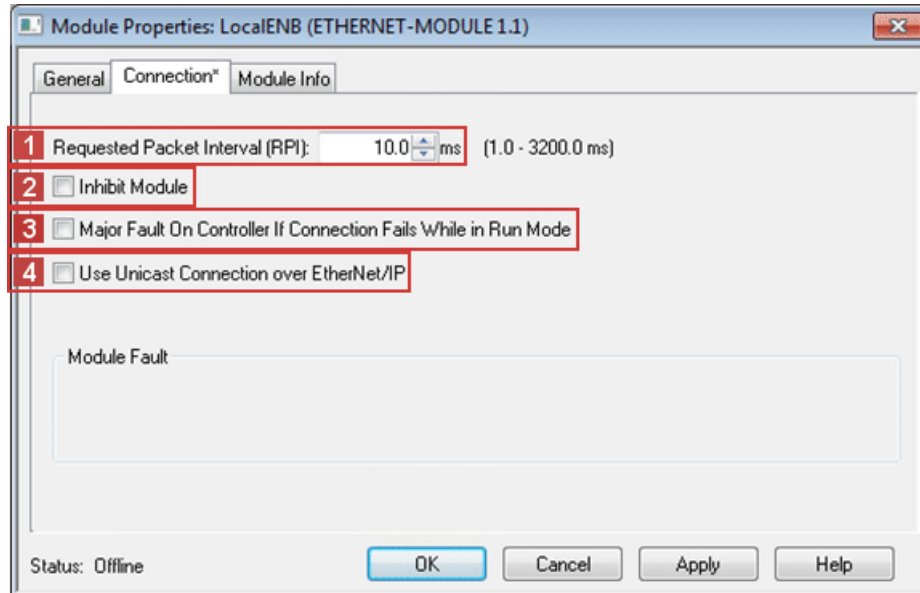

#### Required setting

Setting	Description
1 Requested Packet Interval (RPI)	Set RPI $\geq$ 4.0 ms. (Standard setting: 10 ms) The RPI [ms] specifies the intervals for the I/O data exchange between the drive (adapter) and the controller (scanner).

#### Optional settings

Settings	Description
2 Inhibit module	This option serves to interrupt or inhibit the communication to the adapter.
3 Major Fault On Controller If Connection Fails While In Run Mode	This option serves to put the controller into the error status if the EtherNet/IP connection to the drive fails while the controller is running.
4 Use Unicast Connection over EtherNet/IP	<p><b>Option deactivated (standard setting):</b></p> <ul style="list-style-type: none"> <li>• The input data is sent from the adapter to the scanner by means of <b>multicast telegrams</b>.</li> <li>• Other scanners can access this data in addition to the currently configured scanner ("Listen only" or "Input only" connections).</li> </ul> <p><b>Option activated:</b> The input data is sent from the adapter to the scanner by means of <b>unicast telegrams</b>.</p>

9. Complete the settings with **OK**.
  - The I/O configuration is now complete.
  - The corresponding tags will then be created in the "Controller Tags" of the controller project.
10. The last step is [Saving the I/O configuration in »RSLogix 5000«](#) (□ 83).

# 8 I/O data transfer (implicit messages)

8.6 I/O configuration with »RSLogix 5000« version 20 or higher

## 8.6 I/O configuration with »RSLogix 5000« version 20 or higher

The following example describes the I/O configuration of the Allen-Bradley 1769-L32E CompactLogix controller using the Rockwell »RSLogix 5000« programming software from version 20.

From software version 20 onwards, [EDS files](#) (📄 37) are used for the I/O configuration.



**How to carry out the I/O configuration, taking the CompactLogix controller 1769-L32E with »RSLogix 5000« as an example:**

1. Use the "EDS Hardware Installation Tool" item to import the [EDS files](#) (📄 37) of the EtherNet/IP nodes.

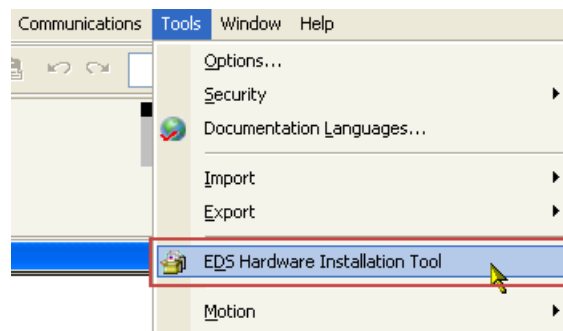

In »RSLogix 5000«, the dialog for the "EDS Hardware Installation Tool" is self-explanatory and not described further in this documentation.

2. Click the **I/O Configuration** folder in the configuration tree.

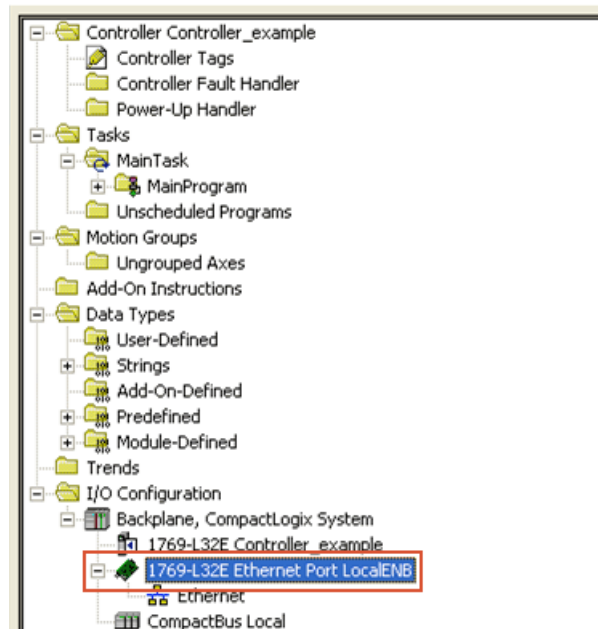

For the 1769-L32E CompactLogix controller, the I/O configuration already includes a local Ethernet port.

If a SoftLogic or ControlLogix controller is used, an Ethernet port scanner needs to be added to the configuration.

- Right click on "Ethernet" and execute the "**New Module ...**" command from the context menu.

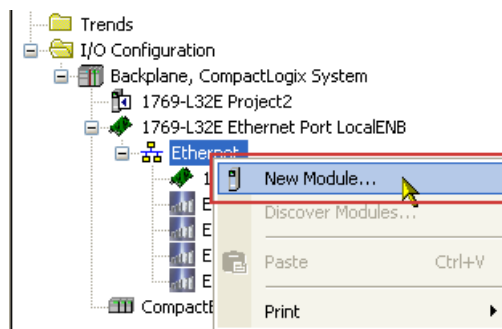

- Go to the "Select Module Type" dialog box and select "E84AYCEO" on the **Catalog** tab.

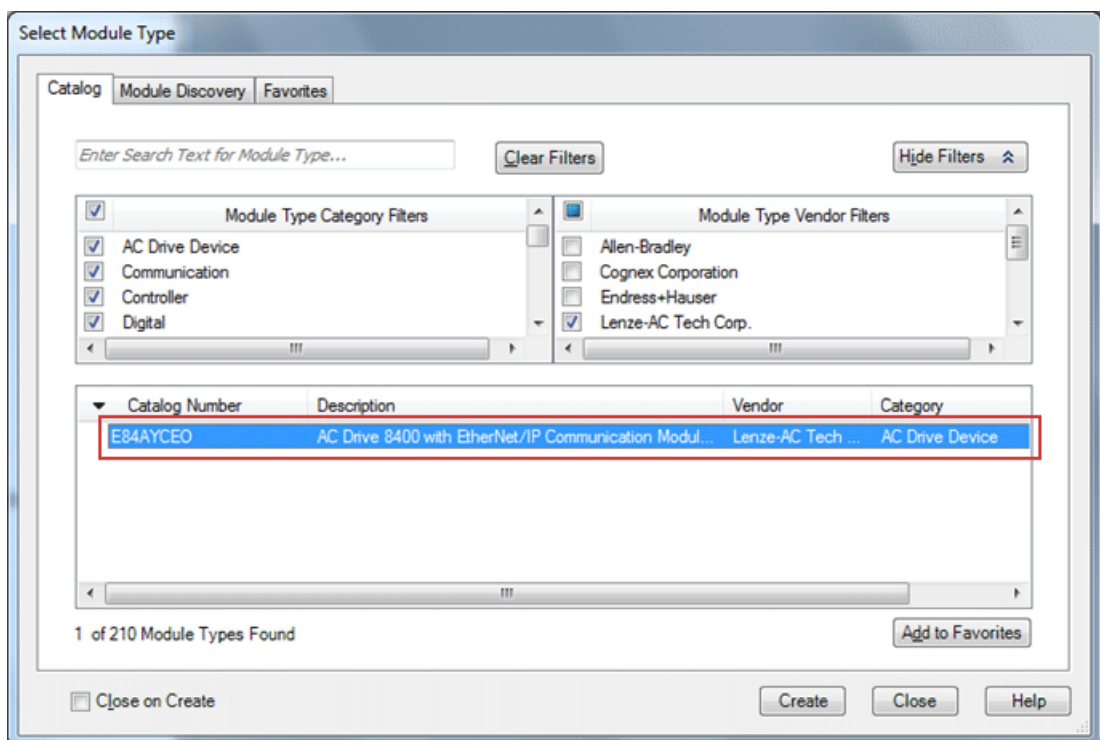

- Confirm the selection with **Create**.

6. In the "New Module" dialog window, select the **General** tab and allocate a **1** name and an unique **2** IP address.

Example settings:

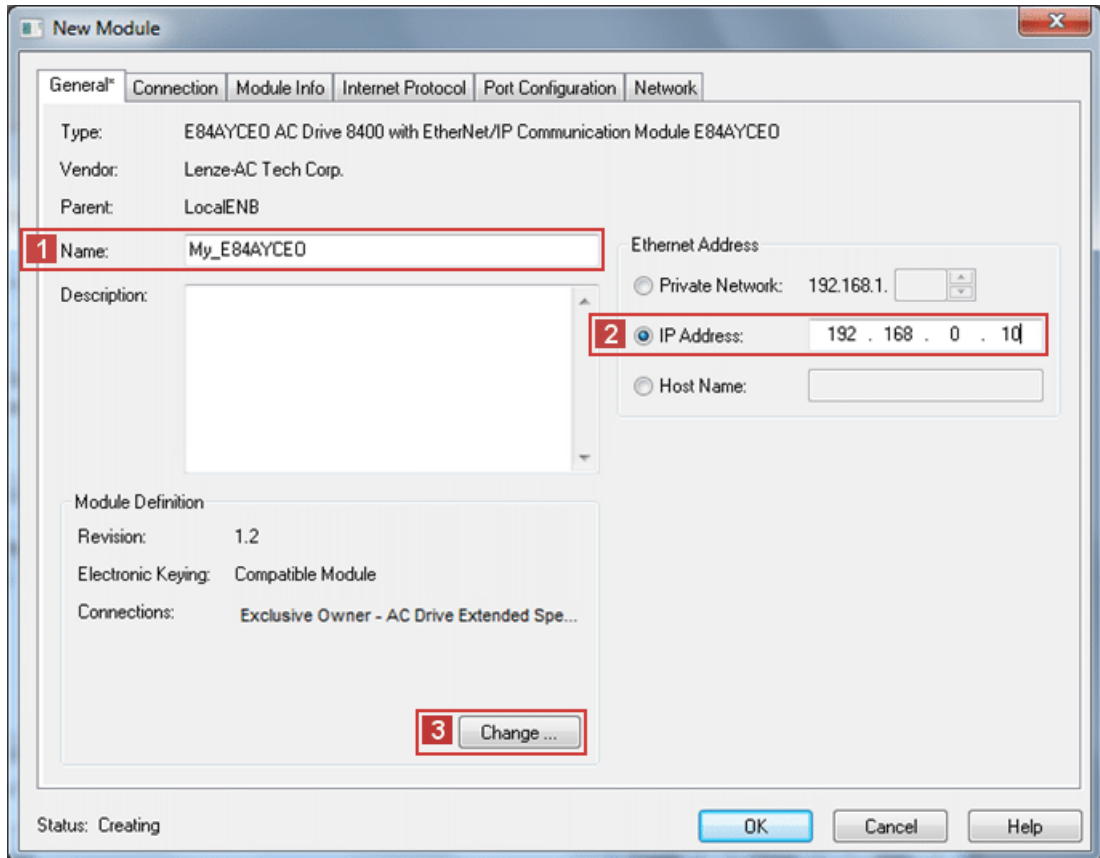

DNS is not supported; the host name merely describes the device.

7. Click the **3** **Change ...** button.



8. Go to the "Module Definition" dialog window and make the connection settings.

The terms "input" and "output" refer to the point of view of the scanner:

- Assembly input objects (input) are sent from the adapter to the scanner.
- Assembly output objects (output) are sent from the scanner to the adapter.

#### Settings for Lenze technology applications or user-definable parameter sets:

- **1** Select "Exclusive Owner - Custom" connection.

If you use the Lenze technology applications or user-definable parameter sets in the drive, the "Exclusive Owner - Custom" assembly object instance always has to be selected.

- **2** Set Data type = INT.

The INT data type is exchanged via the ports MCI\_IN and MCI\_OUT of the Inverter Drives 8400. In case of the SINT data type, an additional PLC logic is required for conversion.

- **3** Set Tag Suffix = 1.

A tag suffix formulates a module-describing tag name.

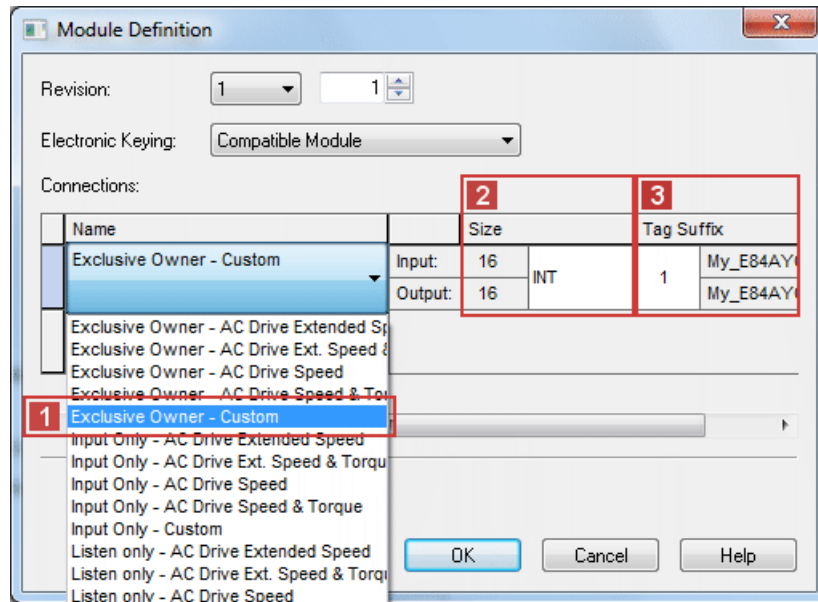

### Settings for an "AC Drive Profile" application:

- **1** Select "AC Drive" connection.  
In the example, the AC Drive Profile "Exclusive Owner - AC Drive Ext. Speed & Torque" is used.
- **2** Set **Data type = INT**.  
The INT data type is exchanged via the ports MCI\_IN and MCI\_OUT of the Inverter Drives 8400. In case of the SINT data type, an additional PLC logic is required for conversion.
- **3** Set **Tag Suffix = 1**.  
A tag suffix formulates a module-describing tag name.

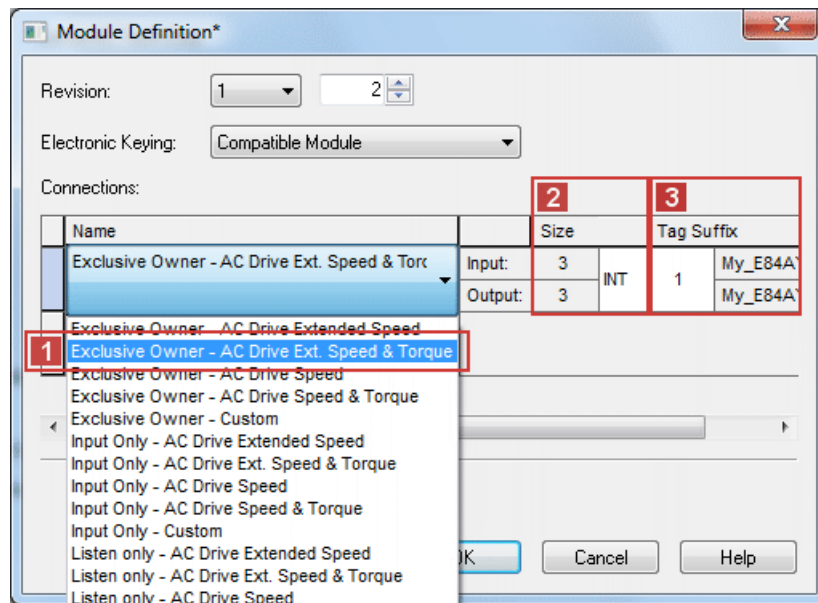

9. Complete the settings with **OK**.

10. Open the "New Module" dialog window, select the **Connection** tab and set further properties.

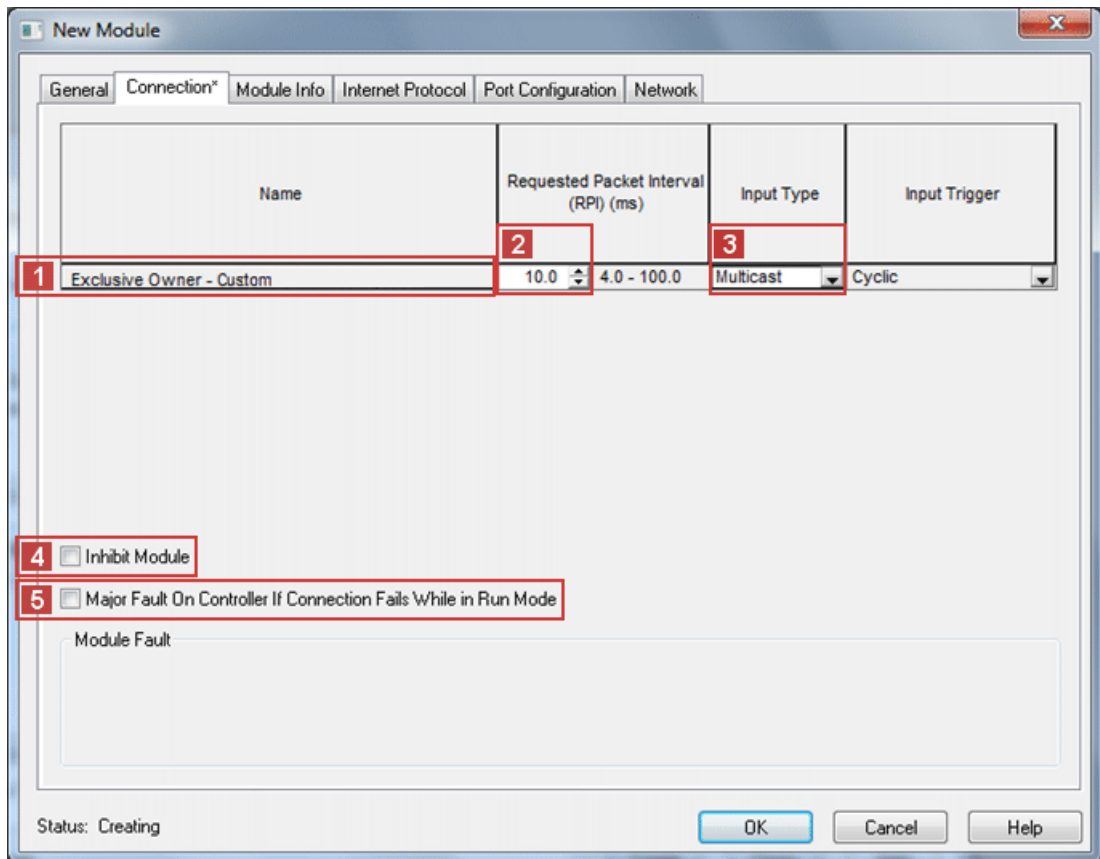

- 1** "Name" displays the name of the connection set under 8..

The example shows an "Exclusive Owner - Custom" connection. According to this, the name of an "AC Drive Profile" connection may be displayed here too.

#### Required settings

Settings	Description
<b>2</b> Requested Packet Interval (RPI)	Set RPI $\geq$ 4.0 ms. (Standard: 10 ms) The RPI [ms] specifies the intervals for the I/O data exchange between the drive (adapter) and the controller (scanner).
<b>3</b> Input type	Select the "Multicast" input type. <ul style="list-style-type: none"> <li>The input data is sent from the adapter to the scanner by means of multicast telegrams.</li> <li>Other scanners can access this data in addition to the currently configured scanner ("Listen only" or "Input only" connections).</li> </ul>

#### Optional settings

Settings	Description
<b>4</b> Inhibit module	This option serves to interrupt or inhibit the communication to the adapter.
<b>5</b> Major Fault On Controller If Connection Fails While In Run Mode	This option serves to put the controller into the error status if the EtherNet/IP connection to the drive fails while the controller is running.

11. Complete the settings with OK.

- The drive is inserted in the configuration tree under the **2** "I/O Configuration".
- The corresponding tags are created in the **1** "Controller Tags".
- The example **3** shows the ...  
input assembly tags as "MY\_EIP8400\_FROM\_EDS:I1";  
output assembly tags as "MY\_EIP8400\_FROM\_EDS:O1";

Name	Value	Force Mask	Style	Data Type
+ Drive_Mode_Select	0		Decimal	DINT
+ MY_EIP8400_FROM_EDS:I1	{...}	{...}		_024B:E84AYCE...
+ MY_EIP8400_FROM_EDS:O1	{...}	{...}		_024B:E84AYCE...
+ Read_INT	0		Decimal	DINT
Read_Target	0.0		Float	REAL
+ SET_Attribute_1	{...}	{...}		MESSAGE
+ TEST2	0		Decimal	INT
Trigger1	0		Decimal	BOOL

If you click the "+" in front of the assembly tag name, all data contained in the assembly tags are shown below it. You can create "alias tags" to reference to single bits of the assembly tag.

12. Create an "alias tag".

**Example with the assembly object instance 23 (0x17):**

For a forward motion of a conveyor, bit '0' (Run Fwd) is to be referenced by byte '0'.

Instance	Byte	Bit 7	Bit 6	Bit 5	Bit 4	Bit 3	Bit 2	Bit 1	Bit 0	
23 (0x17)	0		Net Ref	NetCtrl			Fault Reset	Run Rev	Run Fwd	
	1									
	2	Speed Reference (Low Byte)								
	3	Speed Reference (High Byte)								
	4	Torque Reference (Low Byte)								
	5	Torque Reference (High Byte)								



### Note!

- **NetCtrl (Bit 5)** and **NetRef (Bit 6)** have to be set in order that the drive can receive start/stop commands and speed/torque command via the network.
- In order to be able to use the torque control of the **assembly object distance 23 (0x17)**, the "DriveMode" attribute has to be written by means of explicit message transmission.

▶ [Write "DriveMode" attribute](#) (□ 154)

Right-click an assembly tag and select the command "New Tag..." in the context menu.

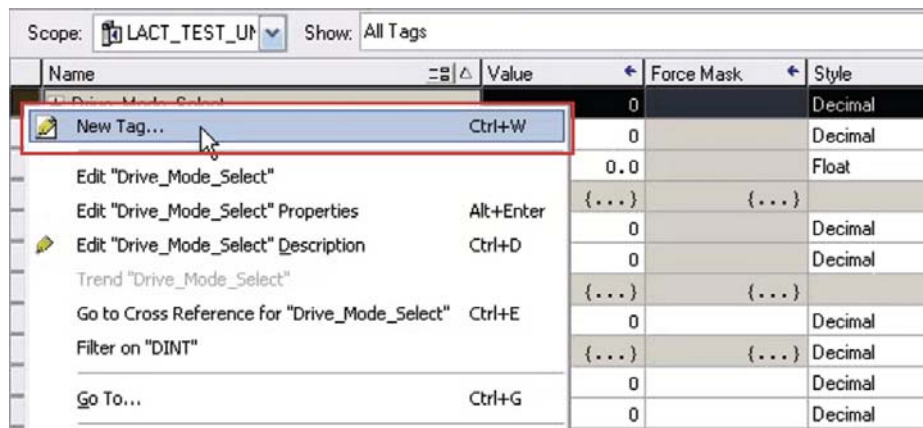

13. Go to the "New Tag" dialog window and ...

- assign a **1** Name for the tag (in the example: "Conveyor\_1\_RUN\_FWD");
- **2** set Type = "Alias";
- select the **3** Alias address which is to be referenced for the alias tag.  
(in the example: "MY\_EIP8400\_FROM\_EDS:01.Data(0).0" (bit '0' of byte '0')

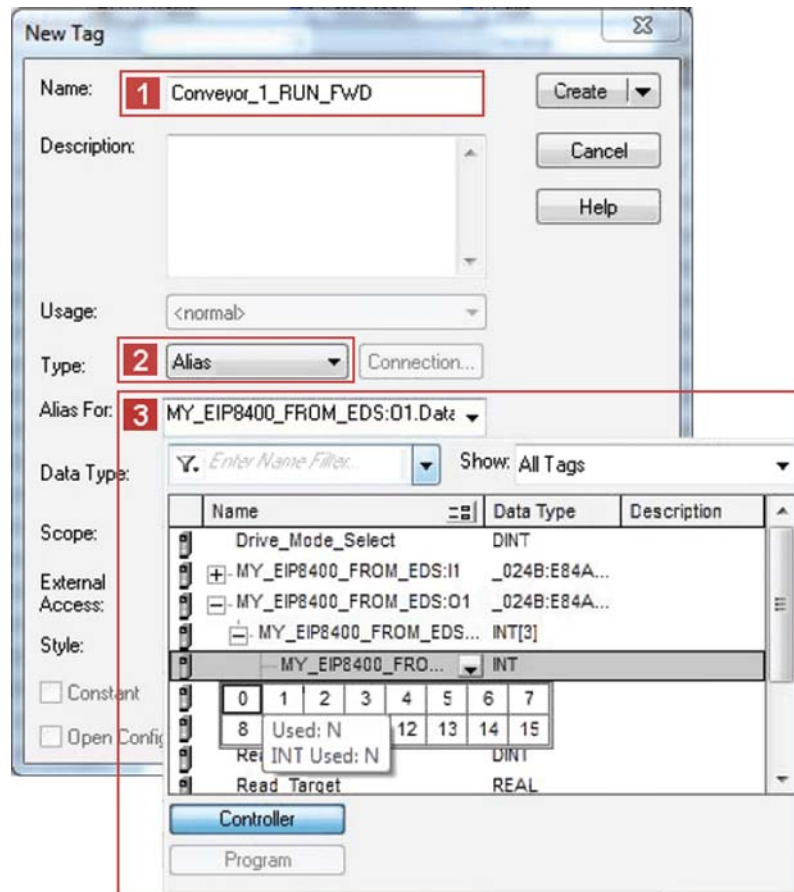

14. Confirm the settings with the **Create** button.

The screenshot shows the 'New Tag' dialog box with the following settings:

- Name: Conveyor\_1\_RUN\_FWD
- Description: (empty)
- Usage: <normal>
- Type: Alias
- Alias For: IP8400\_FROM\_EDS:01.Data[0].0
- Data Type: BOOL
- Scope: LACT\_TEST\_UNIT
- External Access: (empty)
- Style: Decimal
- Constant:
- Open Configuration:

The alias tag "Conveyor\_1\_RUN\_FWD" is created below the "Controller Tags":

Name	Value	Force Mask	Style	Data Type
...	...	...	...	...
[−] MY_EIP8400_FROM_EDS:O1	{..}	{..}		_024B:E84AYCE...
[+] MY_EIP8400_FROM_EDS:O1.Data[1]	0		Decimal	SINT
[+] MY_EIP8400_FROM_EDS:O1.Data[2]	0		Decimal	SINT
[+] MY_EIP8400_FROM_EDS:O1.Data[3]	0		Decimal	SINT
[+] MY_EIP8400_FROM_EDS:O1.Data[4]	0		Decimal	SINT
[+] MY_EIP8400_FROM_EDS:O1.Data[5]	0		Decimal	SINT
<b>Conveyor_1_RUN_FWD</b>	<b>0</b>		<b>Decimal</b>	<b>BOOL</b>

15. The last step is [Saving the I/O configuration in »RSLogix 5000«](#) (□ 83).

### 8.7 Saving the I/O configuration in »RSLogix 5000«

After adding the scanner and the adapter to the I/O configuration, the configuration must be downloaded to the controller. The configuration file should also be saved on your computer.



#### How to save the I/O configuration:

1. Select the menu command **Communications → Download**.
  - The "Download" dialog box will open.
  - If a message box reports that »RSLogix 5000« is unable to go online, select the menu command **Communications → Communications Who Active** and try to find your controller in the "Who Active" dialog box. If the controller is not shown there, the EtherNet/IP driver needs to be added to »RSLinx« or configured in »RSLinx«. For more information, please refer to the »RSLinx« online help.
2. Click the **Download** button.
  - The I/O configuration is downloaded to the controller.
  - When the download has been successfully completed, »RSLogix 5000« changes to online mode and the I/O OK box in the upper left of the screen is green.
3. Select the menu command **File → Save**.
  - If this is the first time the I/O configuration is saved, the "Save As" dialog box will open.
  - Select a folder and enter a file name to save the configuration to a file on your computer.
  - Finally, click the **Save** button.



### 9 Parameter data transfer (explicit messages)

An "explicit message" is a logical instruction in the PLC program used for messaging. It can be used to read or write to either a parameter setting or the data of an assembly object.

For all Allen-Bradley devices of the CompactLogix, ControlLogix and SoftLogix series, the MSG instruction provides the application possibilities described in this chapter. For other PLC types, please consult the programming documentation for the corresponding PLC.



#### Note!

When you use several MSG BLOCKs per adapter, you can work resource-friendly by sequential triggering and hold available enough communication reserves in the EtherNet/IP module for further possible clients.



#### Application note

An example of parameter data transfer (read/write parameters) in a "AC Drive Profile" application can be found in the download area (Application Knowledge Base) at [www.Lenze.com](http://www.Lenze.com).

# 9 Parameter data transfer (explicit messages)

## 9.1 Write parameters

### 9.1 Write parameters

In order to write data into code **C00011** (reference speed) of the Inverter Drive 8400 by means of explicit message transfer, for example, the following settings are necessary:

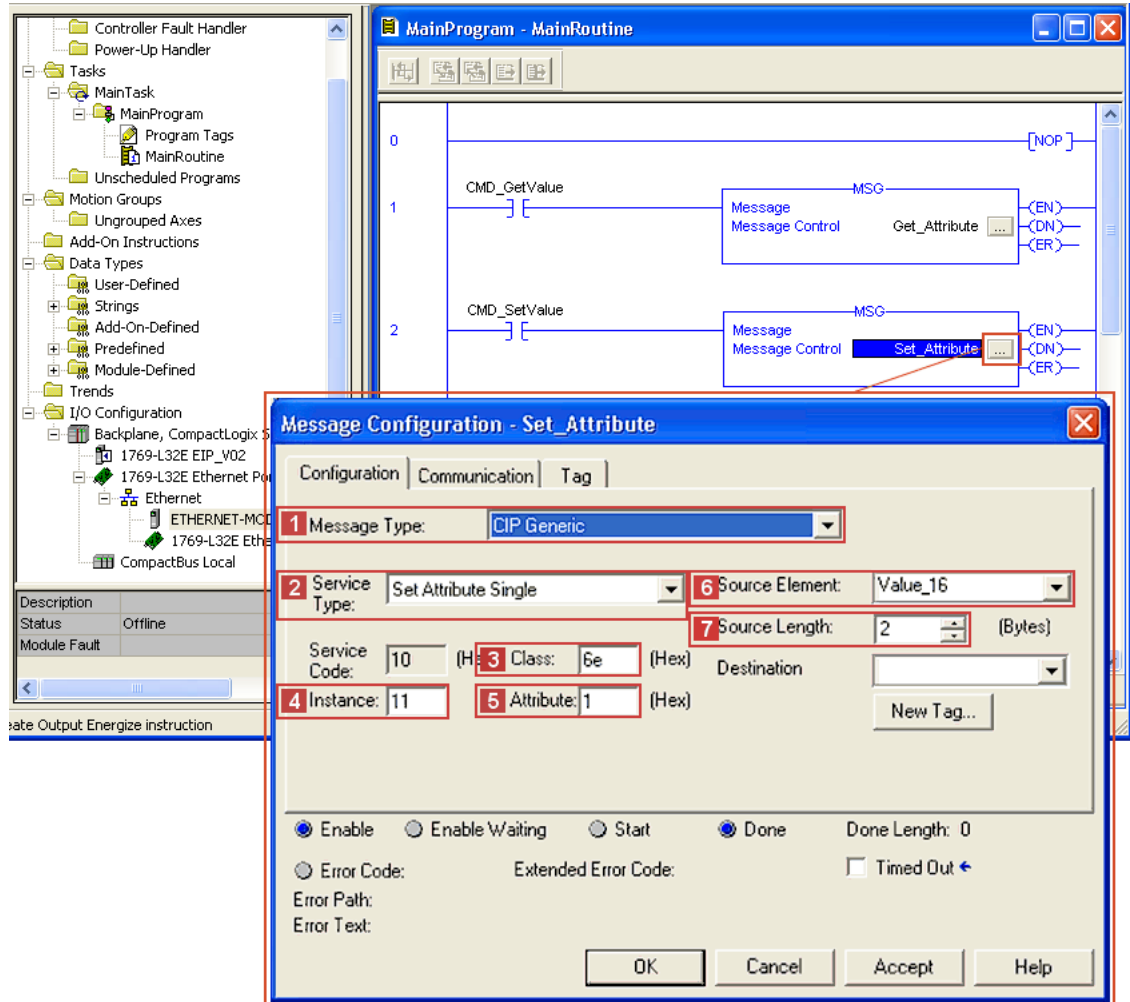

Settings	Value / description
<b>1</b> Message Type	"CIP Generic"
<b>2</b> Service Type	"Set Attribute Single" (service code "0x10")
<b>3</b> Class	"6E" (access to Lenze code)
<b>4</b> Instance	"11" = Lenze code C00011 of Inverter Drive 8400
<b>5</b> Attribute	"1" = Subcode of the Lenze code <ul style="list-style-type: none"> <li>• If the corresponding Lenze code does not have a subcode, the value '1' must be entered here.</li> <li>• A display code cannot be configured by the "SET" service.</li> </ul>
<b>6</b> Source Element	Variable in the PLC program used as data source for writing.
<b>7</b> Source Length	The source length has to be set to the length (data type) of the current parameter (see parameter reference in the software manual/online help of the inverter). For writing to code C00011, set the source length to "2 bytes".

# 9 Parameter data transfer (explicit messages)

## 9.2 Read parameters

### 9.2 Read parameters

In order to read out Lenze code **C00011** (reference speed) of the Inverter Drive 8400 by means of explicit message transfer, for example, the following settings are necessary:

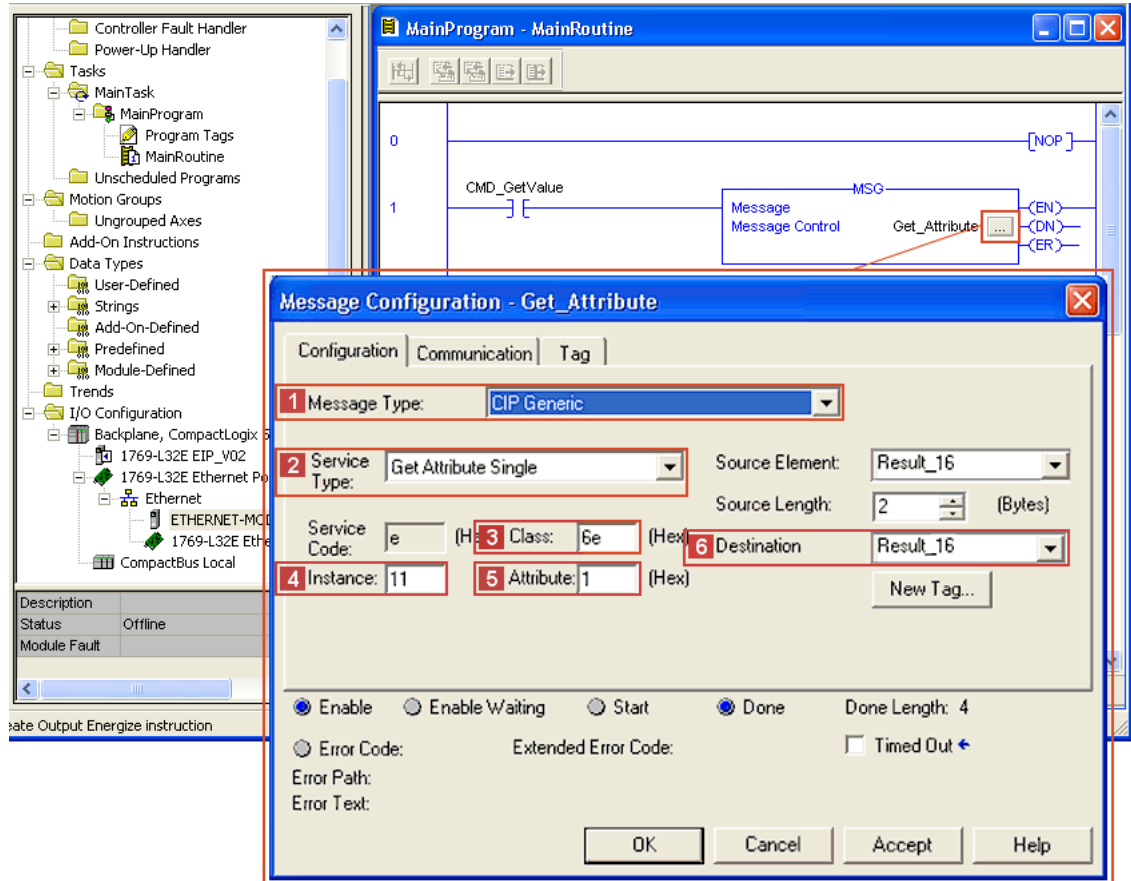

Settings	Value / description
1 Message Type	"CIP Generic"
2 Service Type	"Get Attribute Single" (service code "0x0E")
3 Class	"6E" (access to to Lenze code)
4 Instance	"11" = Lenze code C00011 of Inverter Drive 8400
5 Attribute	"1" = Subcode of the Lenze code If the corresponding Lenze code does not have a subcode, the value '1' must be entered here.
6 Destination	Variable in the PLC program the drive data will be copied to. When reading code C00011, make sure that the tag used as destination is a single word in UINT16 format.

# 9 Parameter data transfer (explicit messages)

## 9.2 Read parameters

For every "explicit message", the path for sending the message via the Ethernet port of the PLC to the IP address of the drive needs to be set under the **Communication** tab. This path depends on the PLC used.

If you need assistance with the setting of this path, please consult the PLC manufacturer.

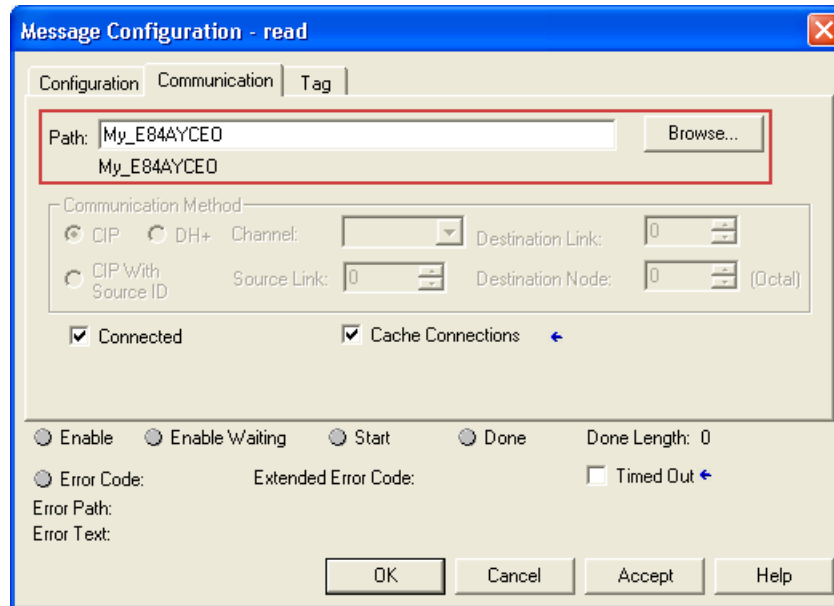

## 10 Monitoring

### Fault with regard to EtherNet/IP communication

You can set the reactions of the Inverter Drive 8400 to a fault in EtherNet/IP communication in »Engineer« by opening the **Monitoring** tab and making the appropriate settings.

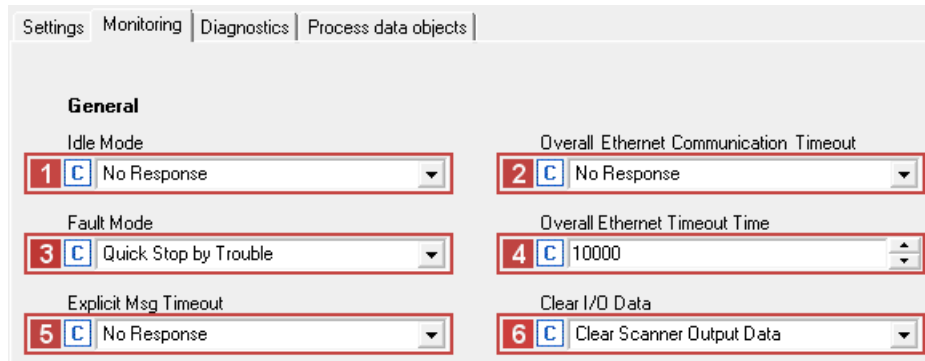

Settings	Description
<b>1</b> Idle Mode	The 32-bit real time header sent by the scanner is evaluated. Run/Idle Flag (Bit 0) = TRUE: <ul style="list-style-type: none"> <li>The scanner indicates the validity of the I/O data.</li> </ul> Run/Idle Flag (Bit 0) = FALSE: <ul style="list-style-type: none"> <li>The I/O data are invalid and the response parameterised here (<a href="#">C13880/1</a>) is executed on the drive.</li> <li>The I/O data are processed as set in <b>6</b> (<a href="#">C13885</a>).</li> </ul>
<b>2</b> Overall Ethernet Communication Timeout	If there is no reception of explicit or implicit messages after expiry of the time set in <b>4</b> ( <a href="#">C13881</a> ) or if access via »Engineer« no longer takes place after this time, the reaction parameterised here takes place in the drive ( <a href="#">C13880/4</a> ). Access to the web server is not monitored.
<b>3</b> Fault Mode	The adapter (communication module) monitors the I/O connection to the scanner. If no "implicit message" has been received within the timeout time for implicit messages parameterised by the scanner, the response parameterised here ( <a href="#">C13880/2</a> ) is executed on the drive.
<b>4</b> Overall Ethernet Timeout Time	Here, the overall message timeout time ( <a href="#">C13881</a> ) is set. If no message has been received within this time, the response parameterised in <b>2</b> ( <a href="#">C13880/4</a> ) is executed. The following messages are monitored: <ul style="list-style-type: none"> <li>Implicit messages</li> <li>Explicit messages</li> <li>»Engineer« access via EtherNet/IP</li> </ul>
<b>5</b> Explicit Msg Timeout	If no "explicit message" has been received within the timeout time for explicit messages parameterised by the scanner, the response parameterised here ( <a href="#">C13880/3</a> ) is executed on the drive.
<b>6</b> Clear I/O Data	( <a href="#">C13885</a> ), serves to set the I/O data to be processed by the adapter to maintain internal communication if ... <ul style="list-style-type: none"> <li>the CIP network status (<a href="#">C13862</a>) of the controlling I/O connection is not "Connected" or</li> <li>an idle event has occurred.</li> </ul>

# 11 Diagnostics

## 11.1 LED status displays

---

# 11 Diagnostics

The LEDs on the front of the communication module serve to diagnose faults. Moreover, the »Engineer« serves to show diagnostic information.

## 11.1 LED status displays



### Note!

LED status displays for trouble-free operation:

- The LEDs **MS** (📖 90) and **NS** (📖 91) light up permanently.
- On the RJ45 sockets **X259** and **X260**, the green LEDs are lit and the yellow LEDs are blinking or jittering (📖 94).

The following status displays are distinguished:



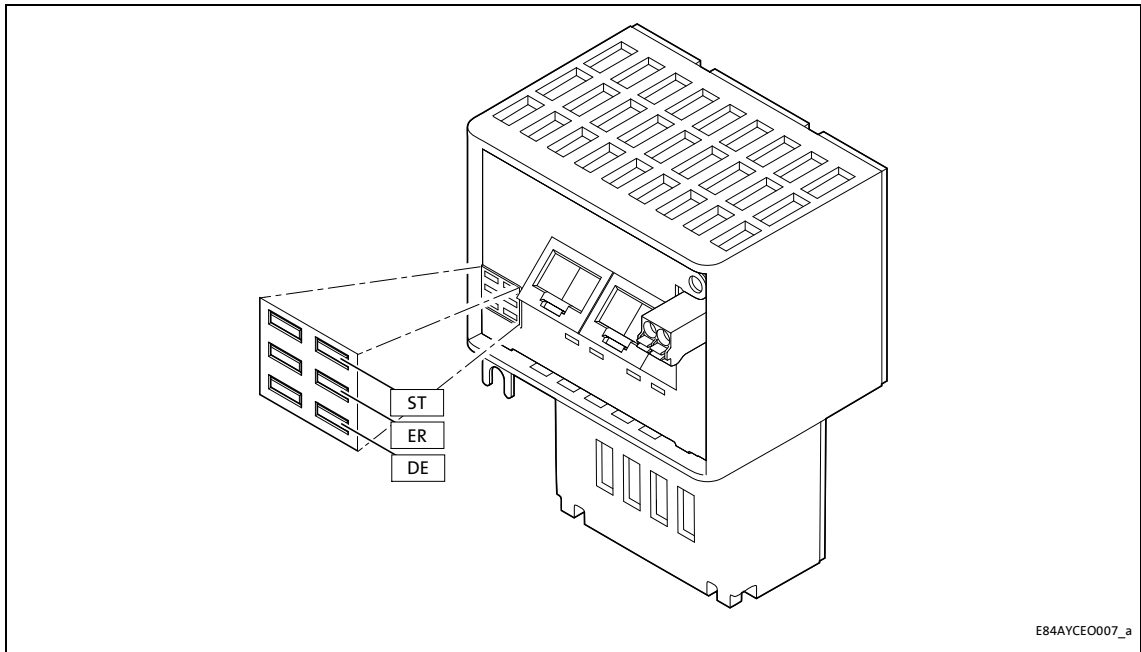

- [Module status displays](#) (📖 90)
- [CIP™ status displays](#) (📖 91)
- [Status indicators at the RJ45 sockets \(X259, X260\)](#) (📖 94)

#### 11.1.1 Module status displays

Module states are indicated by the **ST**, **ER** and **DE** LEDs.



[11-1] LEDs ST, ER, DE

LED	Colour	Status	Description
ST	Green	On	 <p>The communication module is supplied with voltage and is connected to the standard device.</p>
		Blinking	 <p>The communication module is supplied with voltage, but is not connected to the standard device. (Standard device is switched off, in the initialisation phase, or not available.)</p>
ER	Red	On	 <p>An error has occurred in the communication module.</p>
DE	Red	On	 <p>The communication module is not accepted by the basic device or the basic device is not active (see notes in the documentation relating to the basic device.)</p>

---



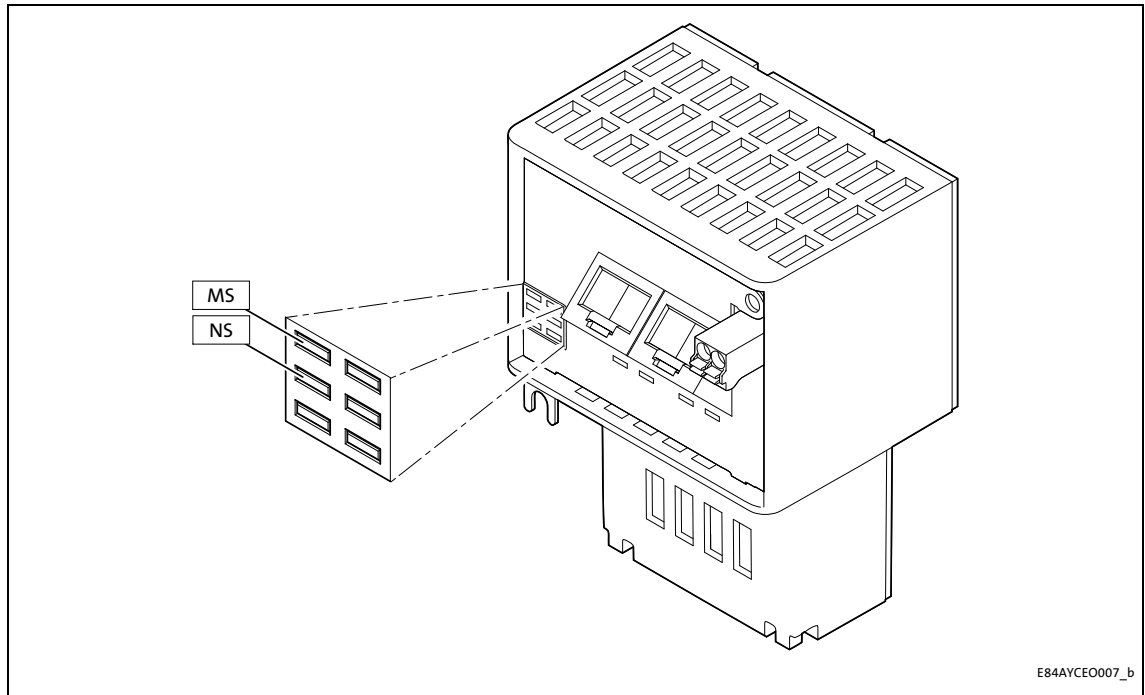

### 11.1.2 CIP™ status displays





CIP statuses are indicated by the **MS** and **NS** LEDs.



[11-2] LEDs MS, NS



LED	Colour / status		Description
MS	Green	Red	
	Off	Off	CIP module status: "Nonexistent" The communication module is not being supplied with voltage.
	Off	On	 CIP module status: "Major Unrecoverable Fault" The communication module has a fault that cannot be rectified. The status is set if the pending status determining device error shows the "System fault" response.
	Off	Blinking	 CIP module status: "Major Recoverable Fault" The communication module has a fault that can be rectified. The status is set if the pending status determining device error shows the "Fault", "Trouble", "Quick stop by trouble", "Warning locked", or "Warning" response.
	On	Off	 CIP module status: "Operational" The communication module is working perfectly.
	Blinking	Off	 CIP module status: "Standby" The communication module has not been completely configured or the configuration is defective.
	Blinking	Blinking	 CIP module status: "Device Self Testing" The communication module is currently undergoing a self-test.



LED	Colour / status		Description
NS	Green	Red	
	Off	Off	CIP network status: "No IP Address" The communication module is not being supplied with voltage or has not been given an IP address.
	Off	On	 CIP network status: "Duplicate IP" The communication module is unable to gain access to the fieldbus (IP address conflict).
	Off	Blinking	 CIP network status: "Connection Timeout" A time-out is executed.
	On	Off	 CIP network status: "Connected" The communication module is working perfectly and has established a connection to the scanner.
	Blinking	Off	 CIP network status: "No Connections" The communication module ... • is working correctly; • has been assigned an IP address; • has not been integrated into the network by the scanner yet.
	Blinking	Blinking	 CIP network status: "Self-Test" The communication module is currently undergoing a self-test.

**11.1.3 Status indicators at the RJ45 sockets (X259, X260)**

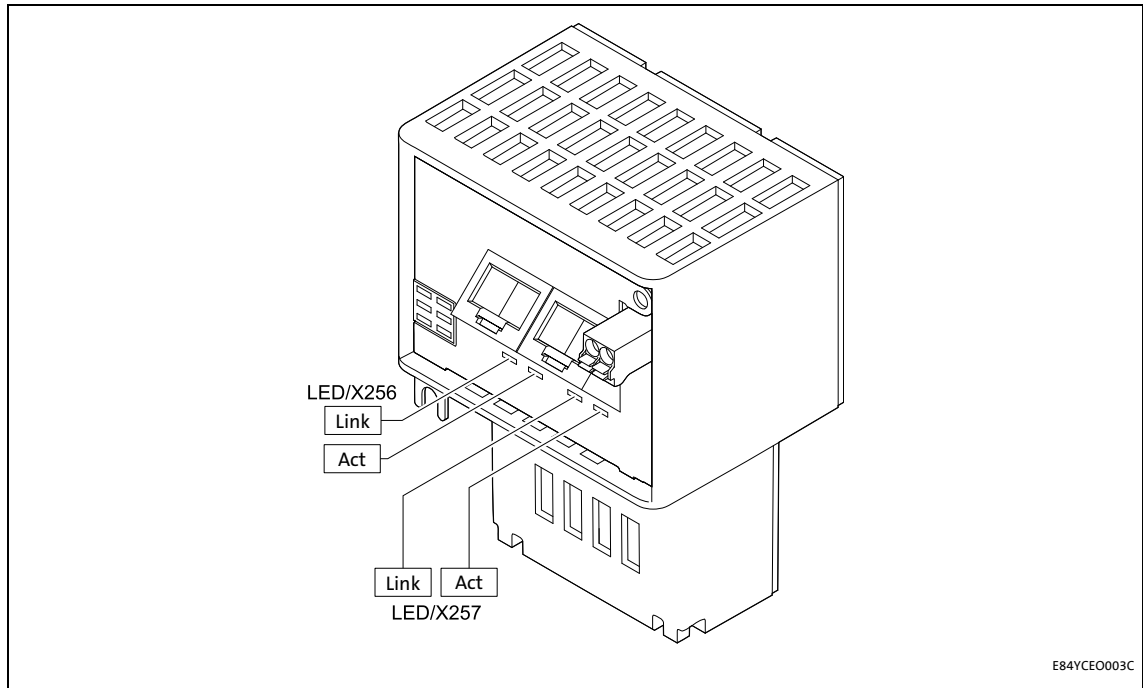
The LEDs at RJ45 sockets **X259** and **X260** indicate the status of the Ethernet connection.



[11-3] LEDs Link , Act

LED	Colour	Status	Description
Link	Green	Off	No Ethernet connection
		On	 There is a physical Ethernet connection.
Act	Yellow	Off	No Ethernet data transfer
		On or flickers	 Data are being exchanged via Ethernet.

## 11.2 Diagnostics with the »Engineer«

In the »Engineer«, the **Diagnostics** tab displays various pieces of EtherNet/IP diagnostic information.

The screenshot shows the Diagnostics tab with the following fields and values:

Address	Status	Ethernet port status
MAC ID: 1 C 00	CIP Module Status: 7 C Nonexistent	Ethernet Port X259 Link State: 9 C No Connection
Active IP Address: 2 0 . 0 . 0 . 0	CIP Network Status: 8 C No IP Address	Ethernet Port X260 Link State: 10 C No Connection
Active Subnetwork Mask: 3 0 . 0 . 0 . 0		
Active Gateway Address: 4 0 . 0 . 0 . 0		
Active Multicast IP Start Address: 5 0 . 0 . 0 . 0		
6 Process data...		

Display	Code
1 MAC-ID	<a href="#">C13003</a>
2 Active IP Address	<a href="#">C13010</a>
3 Active Subnetwork Mask	<a href="#">C13011</a>
4 Active Gateway Address	<a href="#">C13012</a>
5 Active multicast IP address	<a href="#">C13016</a>
6 Process data	<a href="#">C13850</a> , <a href="#">C13851</a> , <a href="#">C13852</a> , <a href="#">C13853</a>
7 CIP Module Status	<a href="#">C13861</a>
8 CIP Network Status	<a href="#">C13862</a>
9 Ethernet Port X259 connection status	<a href="#">C13863/1</a>
10 Ethernet Port X260 connection status	<a href="#">C13863/2</a>

# 12

## Error messages

### 12.1

#### Short overview of the EtherNet/IP error messages

## 12

### Error messages

This chapter supplements the error list in the software manual and in the »Engineer« online help system for the Inverter Drive 8400 by adding the EtherNet/IP error messages to the list.

### 12.1

#### Short overview of the EtherNet/IP error messages



#### Software manual/»Engineer« online help for Inverter Drives 8400

Here you will find general information on diagnostics & fault analysis and on error messages.

The following table lists all EtherNet/IP error messages in the numerical order of the error numbers. Furthermore, the preset error response and - if available - the parameter for setting the error response are specified.



#### Tip!

If you click on the cross-reference in the first column, you will get a detailed description (causes and remedies) of the corresponding error message.

Error no. [hex]	Subject area no. [dec]	Error no. [dec]	Error text	Error type (Error response)	Adjustable in
<a href="#">0x01bc3100</a>	444	12544	EtherNet/IP: Exist. connect. to 8400 lost	0: No Response	-
<a href="#">0x01bc5531</a>	444	21809	EtherNet/IP: Memory: No Access	1: No Response	-
<a href="#">0x01bc5532</a>	444	21810	EtherNet/IP: Memory: Read Error	1: No Response	-
<a href="#">0x01bc5533</a>	444	21811	EtherNet/IP: Memory: Write Error	1: No Response	-
<a href="#">0x01bc6010</a>	444	24592	EtherNet/IP: Restart by Watchdogreset	1: No Response	-
<a href="#">0x01bc6011</a>	444	24593	EtherNet/IP: Internal Error	1: No Response	-
<a href="#">0x01bc6100</a>	444	24832	EtherNet/IP: Internal Error	1: No Response	-
<a href="#">0x01bc6101</a>	444	24833	EtherNet/IP: Internal Error	1: No Response	-
<a href="#">0x01bc641f</a>	444	25631	EtherNet/IP: Invalid Parameter Set	1: No Response	-
<a href="#">0x01bc6420</a>	444	25632	EtherNet/IP: Error: Lenze Setting Loaded	1: No Response	-
<a href="#">0x01bc6430</a>	444	25648	EtherNet/IP: Invalid Configuration	1: No Response	-
<a href="#">0x01bc6533</a>	444	25907	EtherNet/IP: Invalid IP Parameter	1: No Response	-
<a href="#">0x01bc8111</a>	444	33041	EtherNet/IP: Fault Mode	1: No Response	<a href="#">C13880/2</a>
<a href="#">0x01bc8112</a>	444	33042	EtherNet/IP: Explicit Message Timeout	0: No Response	<a href="#">C13880/3</a>
<a href="#">0x01bc8114</a>	444	33044	EtherNet/IP: Overall Ethernet Timeout	0: No Response	<a href="#">C13880/4</a>
<a href="#">0x01bc8121</a>	444	33057	EtherNet/IP: Ethernet cable pulled out	1: No Response	-
<a href="#">0x01bc8132</a>	444	33074	EtherNet/IP: Idle Mode	0: No Response	<a href="#">C13880/1</a>
<a href="#">0x01bc8273</a>	444	33395	EtherNet/IP: Duplicate IP Address	1: No Response	-

## 12.2 Possible causes and remedies

In this chapter, all EtherNet/IP error messages are listed in the numerical order of the error numbers. Possible causes and remedies as well as responses to the error messages are described in detail.

### EtherNet/IP: Exist. connect. to 8400 lost [0x01bc3100]

<b>Response</b> (Lenze setting printed in bold)		<b>Setting:</b> not possible
<input checked="" type="checkbox"/> None <input type="checkbox"/> System fault <input type="checkbox"/> Fault <input type="checkbox"/> Trouble <input type="checkbox"/> Quick stop by trouble <input type="checkbox"/> Warning locked <input type="checkbox"/> Warning <input type="checkbox"/> Information		
<b>Cause</b>		<b>Remedy</b>
<ul style="list-style-type: none"> <li>The communication module is being supplied with external voltage but the Inverter Drive 8400 is not being supplied with voltage.</li> <li>The communication module has not been correctly connected to the Inverter Drive 8400.</li> </ul>		<ul style="list-style-type: none"> <li>Supply the Inverter Drive 8400 with voltage.</li> <li>Securely connect the communication module to the Inverter Drive 8400.</li> </ul>

### EtherNet/IP: Memory: No Access [0x01bc5531]

<b>Response</b> (Lenze setting printed in bold)		<b>Setting:</b> not possible
<input type="checkbox"/> None <input type="checkbox"/> System fault <input checked="" type="checkbox"/> Fault <input type="checkbox"/> Trouble <input type="checkbox"/> Quick stop by trouble <input type="checkbox"/> Warning locked <input type="checkbox"/> Warning <input type="checkbox"/> Information		
<b>Cause</b>		<b>Remedy</b>
Access to memory was not possible.		Send communication module together with a description of the fault to Lenze.

### EtherNet/IP: Memory: Read Error [0x01bc5532]

<b>Response</b> (Lenze setting printed in bold)		<b>Setting:</b> not possible
<input type="checkbox"/> None <input type="checkbox"/> System fault <input checked="" type="checkbox"/> Fault <input type="checkbox"/> Trouble <input type="checkbox"/> Quick stop by trouble <input type="checkbox"/> Warning locked <input type="checkbox"/> Warning <input type="checkbox"/> Information		
<b>Cause</b>		<b>Remedy</b>
Parameter could not be read.		<ul style="list-style-type: none"> <li>Download application again (including module).</li> <li>Send communication module together with a description of the fault to Lenze.</li> </ul>

### EtherNet/IP: Memory: Write Error [0x01bc5533]

<b>Response</b> (Lenze setting printed in bold)		<b>Setting:</b> not possible
<input type="checkbox"/> None <input type="checkbox"/> System fault <input checked="" type="checkbox"/> Fault <input type="checkbox"/> Trouble <input type="checkbox"/> Quick stop by trouble <input type="checkbox"/> Warning locked <input type="checkbox"/> Warning <input type="checkbox"/> Information		
<b>Cause</b>		<b>Remedy</b>
Parameter could not be written.		<ul style="list-style-type: none"> <li>Download application again (including module).</li> <li>Send communication module together with a description of the fault to Lenze.</li> </ul>

### EtherNet/IP: Restart by Watchdogreset [0x01bc6010]

<b>Response</b> (Lenze setting printed in bold)		<b>Setting:</b> not possible
<input type="checkbox"/> None <input type="checkbox"/> System fault <input checked="" type="checkbox"/> Fault <input type="checkbox"/> Trouble <input type="checkbox"/> Quick stop by trouble <input type="checkbox"/> Warning locked <input type="checkbox"/> Warning <input type="checkbox"/> Information		
<b>Cause</b>		<b>Remedy</b>
Communication module is defective.		Send communication module with error description to Lenze.

**EtherNet/IP: Internal Error [0x01bc6011]**

<b>Response</b> (Lenze setting printed in bold)	<b>Setting:</b> not possible
<input type="checkbox"/> None <input type="checkbox"/> System fault <input checked="" type="checkbox"/> <b>Fault</b> <input type="checkbox"/> Trouble <input type="checkbox"/> Quick stop by trouble <input type="checkbox"/> Warning locked <input type="checkbox"/> Warning <input type="checkbox"/> Information	
<b>Cause</b>	<b>Remedy</b>
Communication module is defective.	Send communication module with error description to Lenze.

**EtherNet/IP: Internal Error [0x01bc6100]**

<b>Response</b> (Lenze setting printed in bold)	<b>Setting:</b> not possible
<input type="checkbox"/> None <input type="checkbox"/> System fault <input checked="" type="checkbox"/> <b>Fault</b> <input type="checkbox"/> Trouble <input type="checkbox"/> Quick stop by trouble <input type="checkbox"/> Warning locked <input type="checkbox"/> Warning <input type="checkbox"/> Information	
<b>Cause</b>	<b>Remedy</b>
Communication module is defective.	Send communication module with error description to Lenze.

**EtherNet/IP: Internal Error [0x01bc6101]**

<b>Response</b> (Lenze setting printed in bold)	<b>Setting:</b> not possible
<input type="checkbox"/> None <input type="checkbox"/> System fault <input checked="" type="checkbox"/> <b>Fault</b> <input type="checkbox"/> Trouble <input type="checkbox"/> Quick stop by trouble <input type="checkbox"/> Warning locked <input type="checkbox"/> Warning <input type="checkbox"/> Information	
<b>Cause</b>	<b>Remedy</b>
Communication module is defective.	Send communication module with error description to Lenze.

**EtherNet/IP: Invalid Parameter Set [0x01bc641f]**

<b>Response</b> (Lenze setting printed in bold)	<b>Setting:</b> not possible
<input type="checkbox"/> None <input type="checkbox"/> System fault <input checked="" type="checkbox"/> <b>Fault</b> <input type="checkbox"/> Trouble <input type="checkbox"/> Quick stop by trouble <input type="checkbox"/> Warning locked <input type="checkbox"/> Warning <input type="checkbox"/> Information	
<b>Cause</b>	<b>Remedy</b>
No active parameter set could be loaded.	<ul style="list-style-type: none"> <li>• Download application again (including module).</li> <li>• Send communication module together with a description of the fault to Lenze.</li> </ul>

**EtherNet/IP: Error: Lenze Setting Loaded [0x01bc6420]**

<b>Response</b> (Lenze setting printed in bold)	<b>Setting:</b> not possible
<input type="checkbox"/> None <input type="checkbox"/> System fault <input checked="" type="checkbox"/> <b>Fault</b> <input type="checkbox"/> Trouble <input type="checkbox"/> Quick stop by trouble <input type="checkbox"/> Warning locked <input type="checkbox"/> Warning <input type="checkbox"/> Information	
<b>Cause</b>	<b>Remedy</b>
Access to parameter set was not possible.	<ul style="list-style-type: none"> <li>• Download application again (including module).</li> <li>• Send communication module together with a description of the fault to Lenze.</li> </ul>

**EtherNet/IP: Invalid Configuration [0x01bc6430]**

<b>Response</b> (Lenze setting printed in bold)	<b>Setting:</b> not possible
<input type="checkbox"/> None <input type="checkbox"/> System fault <input checked="" type="checkbox"/> <b>Fault</b> <input type="checkbox"/> Trouble <input type="checkbox"/> Quick stop by trouble <input type="checkbox"/> Warning locked <input type="checkbox"/> Warning <input type="checkbox"/> Information	
<b>Cause</b>	<b>Remedy</b>
Module configuration is faulty.	Check and correct module configuration.

**EtherNet/IP: Invalid IP parameters [0x01bc6533]**

<b>Response</b> (Lenze setting printed in bold)	<b>Setting:</b> not possible
<input type="checkbox"/> None <input type="checkbox"/> System fault <input checked="" type="checkbox"/> <b>Fault</b> <input type="checkbox"/> Trouble <input type="checkbox"/> Quick stop by trouble <input type="checkbox"/> Warning locked <input type="checkbox"/> Warning <input type="checkbox"/> Information	
<b>Cause</b>	<b>Remedy</b>
One or more IP parameters are faulty.	Check and correct IP configuration. <a href="#">▶ Setting the IP configuration of the Inverter Drive 8400 (□ 42)</a>

**EtherNet/IP: Fault Mode [0x01bc8111]**

<b>Response</b> (Lenze setting printed in bold)	<b>Setting:</b> <a href="#">C13880/2</a>
<input checked="" type="checkbox"/> None <input type="checkbox"/> System fault <input checked="" type="checkbox"/> <b>Fault</b> <input type="checkbox"/> Trouble <input type="checkbox"/> Quick stop by trouble <input type="checkbox"/> Warning locked <input type="checkbox"/> Warning <input type="checkbox"/> Information	
<b>Cause</b>	<b>Remedy</b>
<ul style="list-style-type: none"> <li>• Connection to scanner has been interrupted.</li> <li>• Controlling I/O connection failed by timeout.</li> <li>• Within the timeout time for implicit messages parameterised by the scanner, no "implicit messages" have been received.</li> </ul>	<ul style="list-style-type: none"> <li>• Check cables and terminals.</li> <li>• Plug in the network cable into the Ethernet port.</li> <li>• Check Requested Package Interval (RPI) of I/O connection.</li> <li>• Increase timeout time for implicit messages.</li> </ul>

**EtherNet/IP: Explicit Message Timeout [0x01bc8112]**

<b>Response</b> (Lenze setting printed in bold)	<b>Setting:</b> <a href="#">C13880/3</a>
<input checked="" type="checkbox"/> None <input type="checkbox"/> System fault <input checked="" type="checkbox"/> <b>Fault</b> <input type="checkbox"/> Trouble <input type="checkbox"/> Quick stop by trouble <input type="checkbox"/> Warning locked <input type="checkbox"/> Warning <input type="checkbox"/> Information	
<b>Cause</b>	<b>Remedy</b>
<ul style="list-style-type: none"> <li>• Connection to scanner has been interrupted.</li> <li>• Failure of an explicit connection</li> <li>• Within the timeout time for explicit messages parameterised by the scanner, no "explicit messages" have been received.</li> </ul>	<ul style="list-style-type: none"> <li>• Check cables and terminals.</li> <li>• Plug in the network cable into the Ethernet port.</li> <li>• Check Requested Package Interval (RPI) of the explicit connection.</li> <li>• Increase timeout time for explicit messages.</li> </ul>

**EtherNet/IP: Overall Ethernet Timeout [0x01bc8114]**

<b>Response</b> (Lenze setting printed in bold)	<b>Setting:</b> <a href="#">C13880/4</a>
<input checked="" type="checkbox"/> None <input type="checkbox"/> System fault <input checked="" type="checkbox"/> <b>Fault</b> <input type="checkbox"/> Trouble <input type="checkbox"/> Quick stop by trouble <input type="checkbox"/> Warning locked <input type="checkbox"/> Warning <input type="checkbox"/> Information	
<b>Cause</b>	<b>Remedy</b>
<ul style="list-style-type: none"> <li>• Failure of »Engineer« communication via Ethernet</li> <li>• When the time set in <a href="#">C13881</a> has expired, there is no access via the »Engineer«.</li> </ul>	<ul style="list-style-type: none"> <li>• Check cables and terminals.</li> <li>• Plug in the network cable into the Ethernet port.</li> <li>• Increase the overall Ethernet timeout time in <a href="#">C13881</a>.</li> </ul> <a href="#">▶ Fault with regard to EtherNet/IP communication (□ 88)</a>

**EtherNet/IP: Ethernet cable pulled out [0x01bc8121]**

<b>Response</b> (Lenze setting printed in bold)	<b>Setting:</b> not possible
<input type="checkbox"/> None <input type="checkbox"/> system fault <input checked="" type="checkbox"/> <b>Fault</b> <input type="checkbox"/> Trouble <input type="checkbox"/> Quick stop by trouble <input type="checkbox"/> Warning locked <input type="checkbox"/> Warning <input type="checkbox"/> Information	
<b>Cause</b>	<b>Remedy</b>
<ul style="list-style-type: none"> <li>• Network cable has been detached from the Ethernet terminal.</li> <li>• Network cable (plug) is defective.</li> </ul>	<ul style="list-style-type: none"> <li>• Plug the network cable into the Ethernet terminal.</li> <li>• Check the network cable (plug) and replace it if necessary.</li> </ul>



**EtherNet/IP: Idle Mode [0x01bc8132]**

<b>Response</b> (Lenze setting printed in bold)	<b>Setting:</b> <a href="#">C13880/1</a>
<input checked="" type="checkbox"/> None <input type="checkbox"/> system fault <input checked="" type="checkbox"/> <b>Fault</b> <input type="checkbox"/> Trouble <input type="checkbox"/> Quick stop by trouble <input type="checkbox"/> Warning locked <input type="checkbox"/> Warning <input type="checkbox"/> Information	
<b>Cause</b>	<b>Remedy</b>
<ul style="list-style-type: none"> <li>• Scanner has received an idle event.</li> <li>• The scanner is in the "PROG" mode.</li> <li>• In the "Scanner Command Register", the run/idle flag (bit 0) is 0.</li> </ul>	Set the scanner to the run mode. Run/idle flag (bit 0) = 1

**EtherNet/IP: Duplicate IP Address [0x01bc8273]**

<b>Response</b> (Lenze setting printed in bold)	<b>Setting:</b> not possible
<input type="checkbox"/> None <input type="checkbox"/> system fault <input checked="" type="checkbox"/> <b>Fault</b> <input type="checkbox"/> Trouble <input type="checkbox"/> Quick stop by trouble <input type="checkbox"/> Warning locked <input type="checkbox"/> Warning <input type="checkbox"/> Information	
<b>Cause</b>	<b>Remedy</b>
An IP address has been allocated twice within the network. The addresses of the network nodes must differ from each other.	Correct the IP address ( <a href="#">C13000</a> ). ▶ <a href="#">Setting the IP configuration of the Inverter Drive 8400 (42)</a>

### 12.3 CIP™ error messages

Error code [hex]	Error designation	Description
0x000	SUCCESS	No error
0x001	...	<a href="#">Instance error messages (□ 136) des Connection Manager Object (6 / 0x06) (□ 135)</a>
0x002	RESOURCE_UNAVAILABLE	Resource required to perform the service not available.
0x003	INVALID_PARAM_VALUE	Invalid parameter value
0x008	SERVICE_NOT_SUPP	Service is not supported.
0x009	INVALID_ATTRIB_VALUE	Invalid attribute.
0x00B	ALREADY_IN_STATE	The object is already in the required state.
0x00C	OBJ_STATE_CONFLICT	The object cannot perform the service.
0x00E	ATTR_NOT_SETTABLE	The attribute is write-protected.
0x00F	PRIVILEGE_VIOLATION	Access denied.
0x010	DEVICE_STATE_CONFLICT	The current state of the device prohibits performing the requested service.
0x011	REPLY_DATA_TOO_LARGE	The response data are longer than the response buffer
0x013	NOT_ENOUGH_DATA	The data length is too short.
0x014	ATTRIBUTE_NOT_SUPP	The attribute is not supported.
0x015	TOO_MUCH_DATA	The data length is too long.
0x016	OBJECT_DOES_NOT_EXIST	The object is not supported by the adapter.
0x017	FRAGMENTATION	The fragmentation for the requested service is currently not activated.
0x020	INVALID_PARAMETER	Invalid parameter

## 12.4 Mapping of Lenze device errors to DRIVECOM errors

Via the instance attribute "FaultCode" of the [Control Supervisor Object \(41 / 0x29\)](#) (□ 150) Lenze device errors are output with the DRIVECOM error numbers.

From inverter drive version V13.00 and communication module version V01.02 onwards, "CAN Emergency Error Codes" are output as DRIVECOM error numbers!

The following tables show the assignment of the Lenze device errors and "CAN Emergency Error Codes" to the DRIVECOM errors.



### Software manual/»Engineer« online help for Inverter Drive 8400

Here you will find detailed information about the Lenze error messages listed in the following table.

Lenze error		CAN	DRIVECOM error	
Error number [32 bits]	Error message	Emergency Error Code	Error number [hex]	Error message
xx.0111.00002	Su02: One mains phase is missing	0x3000	0x3000	Voltage
xx.0111.00003	Su03: Too frequent mains switching	0x3000	0x3000	Voltage
xx.0111.00004	Su04: CU insufficiently supplied	0x3000	0x3000	Voltage
xx.0111.00006	Su06: Power input overload	0x3000	0x3000	Voltage
xx.0119.00000	OH4: Heat sink temp. > Switch-off temp. -5°C	0x4000	0x4000	Temperature
xx.0119.00001	OH1: Heatsink overtemperature	0x4000	0x4000	Temperature
xx.0119.00002	OH7: Motor temperature resolver > C121	0x4000	0x4000	Temperature
xx.0119.00003	OH9: Motor overtemperature resolver	0x4000	0x4000	Temperature
xx.0119.00012	Sd6: Error temperature sensor resolver	0x7300	0x7300	Sensor
xx.0119.00015	OH3: Motor temperature (X106) triggered	0x4000	0x4000	Temperature
xx.0119.00020	OH6: Motor temperature MultiEncoder > C121	0x4000	0x4000	Temperature
xx.0119.00021	OH12: Motor overtemperature MultiEncoder	0x4000	0x4000	Temperature
xx.0119.00022	Sd12: Error temperature sensor MultiEncoder	0x7300	0x7300	Sensor
xx.0119.00050	OC5: Ixt overload	0x2000	0x2000	Current
xx.0123.00001	OT1: Maximal torque reached	0x8300	0x8302	Torque limiting
xx.0123.00007	OC7: Motor overcurrent	0x2000	0x2000	Current
xx.0123.00014	OU: DC bus overvoltage	0x3100	0x3110	Mains overvoltage
xx.0123.00015	LU: DC bus undervoltage	0x3100	0x3120	Mains undervoltage
xx.0123.00016	OC1: Power section - short circuit	0x2000	0x2130	Short Circuit
xx.0123.00017	OC2: Power section - earth fault	0x2000	0x2120	Short to Earth
xx.0123.00024	Sd2: Wire breakage resolver	0x7300	0x7303	Resolver 1 defective
xx.0123.00026	Sd7: Error encoder communication	0x7300	0x7305	Incremental encoder 1 defective
xx.0123.00027	Sd4: Wire breakage MultiEncoder	0x7300	0x7300	Sensor
xx.0123.00030	OC10: Maximum current reached	0x2000	0x2000	Current
xx.0123.00031	OC17: Clamp sets pulse inhibit	0xF000	0xF000	Additional functions
xx.0123.00032	OS1: Maximum speed limit reached	0x8400	0x8402	Velocity Limiting
xx.0123.00033	OS2: Max. motor speed	0x8400	0x8400	Speed Controller
xx.0123.00056	ID2: Motor data identification error	0xF000	0xF000	Additional functions
xx.0123.00057	ID1: Motor data identification error	0xF000	0xF000	Additional functions
xx.0123.00058	ID3: CINH motor data identification	0xF000	0xF000	Additional functions
xx.0123.00059	ID4: Error resistor identification	0xF000	0xF000	Additional functions
xx.0123.00060	ID7: Motor control does not match motor data	0xF000	0xF000	Additional functions
xx.0123.00062	Sd8: Encoder angular drift monitoring	0x7300	0x7300	Sensor
xx.0123.00065	OC12: I2xt overload - brake resistor	0xF000	0x7110	Brake Chopper

Lenze error		CAN	DRIVECOM error	
Error number [32 bits]	Error message	Emergency Error Code	Error number [hex]	Error message
xx.0123.00071	OC11: Current clamp for too long (>1 sec)	0xF000	0xF000	Additional functions
xx.0123.00074	ID5: Error pole position identification	0xF000	0xF000	Additional functions
xx.0123.00075	ID6: Error resolver ident.	0xF000	0xF000	Additional functions
xx.0123.00090	OC13: Maximum current for Fch exceeded	0x2000	0x2000	Current
xx.0123.00093	OT2: Speed controller output is limited	0xF000	0x7310	Speed
xx.0123.00094	FC01: Switching frequency reduction	0x2000	0xF000	Additional functions
xx.0123.00095	FC02: Maximum speed for Fchop	0xF000	0xF000	Additional functions
xx.0123.00096	OC14: Limitation direct-axis current controller	0xF000	0xF000	Additional functions
xx.0123.00097	OC15: Limitation cross current controller	0xF000	0xF000	Additional functions
xx.0123.00098	OC16: Limitation torque controller	0xF000	0xF000	Additional functions
xx.0123.00099	FC03: Limitation field controller	0xF000	0xF000	Additional functions
xx.0123.00105	OC6: l2xt overload - motor	0x2000	0x7120	Motor
xx.0123.00145	LP1: Motor phase failure	0x3000	0x3130	Phase Failure
xx.0123.00200	SD10: Speed limit - feedback system 12	0x7300	0x7300	Sensor
xx.0123.00201	SD11: Speed limit - feedback system 67	0x7300	0x7300	Sensor
xx.0123.00205	SD3: Open circuit - feedback system	0x7300	0x7301	Tacho defective
xx.0125.00001	An01: AIN1_I < 4 mA	0xF000	0xF000	Additional functions
xx.0125.00002	An02: AIN2_I < 4 mA	0xF000	0xF000	Additional functions
xx.0126.00001	Ab01: Axis bus timeout	0x8000	0x8000	Monitoring
xx.0126.00002	Ab02: Axis bus IO error	0x8100	0x8100	Communication
xx.0127.00002	CE04: MCI communication error	0x7000	0x7500	Communication
xx.0127.00015	CE0F: MCI control word	0xF000	0xF000	Additional functions
xx.0131.00000	CE4: CAN Bus Off	0x8000	0x8000	Monitoring
xx.0131.00006	CA06: CAN CRC error	0x8000	0x8000	Monitoring
xx.0131.00007	CA07: CAN Bus Warn	0x8000	0x8000	Monitoring
xx.0131.00008	CA08: CAN Bus Stopped	0x8000	0x8000	Monitoring
xx.0131.00011	CA0b: CAN HeartBeatEvent	0x8130	0x8000	Monitoring
xx.0131.00015	CA0F: CAN control word	0xF000	0x8000	Monitoring
xx.0135.00001	CE1: CAN RPDO1	0x8100	0x8100	Communication
xx.0135.00002	CE2: CAN RPDO2	0x8100	0x8100	Communication
xx.0135.00003	CE3: CAN RPDO3	0x8100	0x8100	Communication
xx.0135.00004	CP04: CAN RPDO4	0x8100	0x8100	Communication
xx.0140.00013	CI01: Module missing/incompatible	0x7000	0x7000	Additional Modules
xx.0144.00001	PS01: No memory module	0x6300	0x6300	Date Set
xx.0144.00002	PS02: Par. set invalid	0x6300	0x6300	Date Set
xx.0144.00003	PS03: Par. set device invalid	0x6300	0x6300	Date Set
xx.0144.00004	PS04: Par. set device incompatible	0x6300	0x6300	Date Set
xx.0144.00007	PS07: Par. mem. module invalid	0x6300	0x6300	Date Set
xx.0144.00008	PS08: Par. device invalid	0x6300	0x6300	Date Set
xx.0144.00009	PS09: Par. format invalid	0x6300	0x6300	Date Set
xx.0144.00010	PS10: Memory module link invalid	0x5000	0x5000	Device Hardware
xx.0144.00031	PS31: Ident. error	0x6300	0x6300	Date Set
xx.0145.00014	dF14: SW-HW invalid	0x5530	0x6000	Device software
xx.0145.00015	dF15: DCCOM CU2 error	0x6100	0x6100	Internal software
xx.0145.00024	dF18: BU RCOM error	0x6100	0x6100	Internal software
xx.0145.00025	dF25: CU RCOM error	0x6100	0x6100	Internal software
xx.0145.00026	dF26: Appl. watchdog	0x6200	0x6010	Software reset (watchdog)
xx.0145.00033	dF21: BU watchdog	0x6100	0x6010	Software reset (watchdog)
xx.0145.00034	dF22: CU Watchdog	0x6100	0x6010	Software reset (watchdog)
xx.0145.00035	dF10: AutoTrip reset	0xF000	0xF000	Additional functions

Lenze error		CAN	DRIVECOM error	
Error number [32 bits]	Error message	Emergency Error Code	Error number [hex]	Error message
xx.0145.00050	dF50: Retain error	0x6100	0x6100	Internal software
xx.0145.00051	dF51: CuCcr error	0x6100	0x6100	Internal software
xx.0145.00052	dF52: BuCcr error	0x6100	0x6100	Internal software
xx.0184.00001	Ck01: Pos. HW limit switch	0x8600	0x8600	Positioning controller
xx.0184.00002	Ck02: Neg. HW limit switch	0x8600	0x8600	Positioning controller
xx.0184.00005	Ck15: Error message sig. brake	0x8600	0x8600	Positioning controller
xx.0184.00007	Ck03: Pos. SW limit position	0x8600	0x8600	Positioning controller
xx.0184.00008	Ck04: Neg. SW limit position	0x8600	0x8600	Positioning controller
xx.0184.00015	Ck14: Target position outside SW limit position	0x8600	0x8600	Positioning controller
xx.0184.00064	Ck16: Time overrun manual operation	0x8600	0x8600	Positioning controller
xx.0184.00153	Ck05: Error following error 1	0x8611	0x8611	Following error
xx.0184.00154	Ck06: Error following error 2	0x8611	0x8611	Following error
xx.0184.00155	Ck07: Traversing range limit exceeded	0x8612	0x8612	Reference limit
xx.0184.00156	Ck08: Reference position unknown	0x8612	0x8612	Reference limit
xx.0184.08005	Ck09: Positioning mode invalid	0x8600	0x8600	Positioning controller
xx.0184.08007	Ck10: Profile data implausible	0x8600	0x8600	Positioning controller
xx.0184.08009	Ck11: Operating mode invalid	0x8600	0x8600	Positioning controller
xx.0184.08014	Ck12: Profile number invalid	0x8600	0x8600	Positioning controller
xx.0184.08015	Ck13: Error FB MCKCtrlInterface	0x8600	0x8600	Positioning controller
xx.0400.00009	dH09: EEPROM power unit	0x5530	0x7600	Data memory
xx.0400.00016	dH10: Fan failure	0x5000	0x5000	Device Hardware
xx.0400.00104	dH68: Adjustment data error CU	0x5530	0x6000	Device software
xx.0400.00105	dH69: Adjustment data error BU	0x5530	0x6000	Device software
xx.0980.00001	User error 1	0x6200	0x6200	User software
xx.0981.00002	User error 2	0x6200	0x6200	User software
xx.0982.00003	User error 3	0x6200	0x6200	User software
xx.0983.00004	User error 4	0x6200	0x6200	User software
xx.0984.00001	User error 5	0x6200	0x6200	User software
xx.0985.00002	User error 6	0x6200	0x6200	User software
xx.0986.00003	User error 7	0x6200	0x6200	User software
xx.0987.00004	User error 8	0x6200	0x6200	User software

**EtherNet/IP error messages**

Lenze error		DRIVECOM error	
Error number [32 bits]	Error message	Error number [hex]	Error message
<a href="#">xx.0444.12544</a>	EtherNet/IP: Exist. connect. to 8400 lost	0x7510	Serial Interface No 1
<a href="#">xx.0444.21809</a>	EtherNet/IP: Memory: No Access	0x7600	Data memory
<a href="#">xx.0444.21810</a>	EtherNet/IP: Memory: Read Error	0x7600	Data memory
<a href="#">xx.0444.21811</a>	EtherNet/IP: Memory: Write Error	0x7600	Data memory
<a href="#">xx.0444.24592</a>	EtherNet/IP: Restart by Watchdogreset	0x6010	Software reset (watchdog)
<a href="#">xx.0444.24593</a>	EtherNet/IP: Internal Error	0x6100	Internal software
<a href="#">xx.0444.24832</a>	EtherNet/IP: Internal Error	0x6100	Internal software
<a href="#">xx.0444.24833</a>	EtherNet/IP: Internal Error	0x6100	Internal software
<a href="#">xx.0444.25631</a>	EtherNet/IP: Invalid Parameter Set	0x7421	Invalid Parameters
<a href="#">xx.0444.25632</a>	EtherNet/IP: Error: Lenze Setting Loaded	0x7421	Invalid Parameters
<a href="#">xx.0444.25648</a>	EtherNet/IP: Invalid Configuration	0x7421	Invalid Parameters
<a href="#">xx.0444.25907</a>	EtherNet/IP: Invalid IP Parameter	0x7421	Invalid Parameters
<a href="#">xx.0444.33041</a>	EtherNet/IP: Fault Mode	0x7000	Additional Modules
<a href="#">xx.0444.33042</a>	EtherNet/IP: Explicit Message Timeout	0x7500	Communication
<a href="#">xx.0444.33044</a>	EtherNet/IP: Overall Ethernet Timeout	0x7500	Communication
<a href="#">xx.0444.33057</a>	EtherNet/IP: Ethernet cable pulled out	0x9000	External malfunction
<a href="#">xx.0444.33074</a>	EtherNet/IP: Idle Mode	0x7000	Additional Modules
<a href="#">xx.0444.33395</a>	EtherNet/IP: Duplicate IP Address	0x7421	Invalid Parameters

# 13 Parameter reference

## 13.1 Parameters of the communication module

# 13 Parameter reference

This chapter supplements the parameter list and the table of attributes for the Inverter Drive 8400 contained in the software manual and in the »Engineer« online help by the parameters of the communication module E84AYCEO (EtherNet/IP).

## 13.1 Parameters of the communication module



### Software manual/»Engineer« online help for Inverter Drives 8400

Here you will find general information on parameters.

This chapter lists the parameters of the E84AYCEO communication module (EtherNet/IP) in numerically ascending order.

### C13000

Parameter   Name: <b>C13000   IP Address</b>		Data type: UNSIGNED_8 Index: 11575 = 0x2D37
Setting of the IP address ▶ <a href="#">Setting the IP configuration of the Inverter Drive 8400</a> (42)		
<b>Setting range</b> (min. value   unit   max. value)		
0		255
<b>Subcodes</b>	<b>Lenze setting</b>	<b>Info</b>
C13000/1	192	IP address (most significant byte)
C13000/2	168	IP address
C13000/3	124	IP address
C13000/4	16	IP address (least significant byte)
<input checked="" type="checkbox"/> Read access <input checked="" type="checkbox"/> Write access <input type="checkbox"/> CINH <input type="checkbox"/> PLC STOP <input type="checkbox"/> No transfer <input type="checkbox"/> PDO_MAP_RX <input type="checkbox"/> PDO_MAP_TX <input type="checkbox"/> COM <input type="checkbox"/> MOT		

### C13001

Parameter   Name: <b>C13001   Subnetwork Mask</b>		Data type: UNSIGNED_8 Index: 11574 = 0x2D36
Setting of the subnet mask ▶ <a href="#">Setting the IP configuration of the Inverter Drive 8400</a> (42)		
<b>Setting range</b> (min. value   unit   max. value)		
0		255
<b>Subcodes</b>	<b>Lenze setting</b>	<b>Info</b>
C13001/1	255	Subnet mask (most significant byte)
C13001/2	255	Subnet mask
C13001/3	255	Subnet mask
C13001/4	0	Subnet mask (least significant byte)
<input checked="" type="checkbox"/> Read access <input checked="" type="checkbox"/> Write access <input type="checkbox"/> CINH <input type="checkbox"/> PLC STOP <input type="checkbox"/> No transfer <input type="checkbox"/> PDO_MAP_RX <input type="checkbox"/> PDO_MAP_TX <input type="checkbox"/> COM <input type="checkbox"/> MOT		

# 13

## Parameter reference

### 13.1

#### Parameters of the communication module

#### C13002

Parameter   Name: <b>C13002   Gateway Address</b>		Data type: UNSIGNED_8 Index: 11573 = 0x2D35
Setting of the gateway address ▶ <a href="#">Setting the IP configuration of the Inverter Drive 8400 (📖 42)</a>		
<b>Setting range</b> (min. value   unit   max. value)		
0		255
<b>Subcodes</b>	<b>Lenze setting</b>	<b>Info</b>
C13002/1	0	Gateway address (most significant byte)
C13002/2	0	Gateway address
C13002/3	0	Gateway address
C13002/4	0	Gateway address (least significant byte)
<input checked="" type="checkbox"/> Read access <input checked="" type="checkbox"/> Write access <input type="checkbox"/> CINH <input type="checkbox"/> PLC STOP <input type="checkbox"/> No transfer <input type="checkbox"/> PDO_MAP_RX <input type="checkbox"/> PDO_MAP_TX <input type="checkbox"/> COM <input type="checkbox"/> MOT		

#### C13003

Parameter   Name: <b>C13003   MAC ID</b>		Data type: OCTET_STRING Index: 11572 = 0x2D34
Display of the MAC-ID		
<input checked="" type="checkbox"/> Read access <input type="checkbox"/> Write access <input type="checkbox"/> CINH <input type="checkbox"/> PLC STOP <input type="checkbox"/> No transfer <input type="checkbox"/> PDO_MAP_RX <input type="checkbox"/> PDO_MAP_TX <input type="checkbox"/> COM <input type="checkbox"/> MOT		

#### C13005

Parameter   Name: <b>C13005   IP Config Control</b>		Data type: UNSIGNED_8 Index: 11570 = 0x2D32
Selection how the IP configuration is to be effected. (Instance attribute 3 (Configuration Control) in the <a href="#">TCP/IP Interface Object (245 / 0xF5) (📖 141)</a> ) ▶ <a href="#">Setting the IP configuration of the Inverter Drive 8400 (📖 42)</a>		
<b>Selection list</b> (Lenze setting printed in bold)		<b>Info</b>
0	Use stored IP	The IP configuration currently saved in the communication module is used.
<b>1</b>	<b>Use BOOTP</b>	The IP configuration is assigned by the scanner using BOOTP.
2	Use DHCP	The IP configuration is assigned by the scanner using DHCP. The assignment of a gateway address which is not in the same subnetwork than the IP address, is rejected.
<input checked="" type="checkbox"/> Read access <input checked="" type="checkbox"/> Write access <input type="checkbox"/> CINH <input type="checkbox"/> PLC STOP <input type="checkbox"/> No transfer <input type="checkbox"/> PDO_MAP_RX <input type="checkbox"/> PDO_MAP_TX <input type="checkbox"/> COM <input type="checkbox"/> MOT		



## C13006

Parameter   Name: <b>C13006   Multicast IP Start Address</b>		Data type: UNSIGNED_8 Index: 11569 = 0x2D31
Setting of the multicast IP address ▶ <a href="#">Setting the IP configuration of the Inverter Drive 8400</a> (142)		
<b>Setting range</b> (min. value   unit   max. value)		
0		255
<b>Subcodes</b>	<b>Lenze setting</b>	<b>Info</b>
C13006/1	239	Multicast IP start address (most significant byte)
C13006/2	64	Multicast IP start address
C13006/3	2	Multicast IP start address
C13006/4	224	Multicast start address (least significant byte)
<input checked="" type="checkbox"/> Read access <input checked="" type="checkbox"/> Write access <input type="checkbox"/> CINH <input type="checkbox"/> PLC STOP <input type="checkbox"/> No transfer <input type="checkbox"/> PDO_MAP_RX <input type="checkbox"/> PDO_MAP_TX <input type="checkbox"/> COM <input type="checkbox"/> MOT		

## C13010

Parameter   Name: <b>C13010   Active IP Address</b>		Data type: UNSIGNED_8 Index: 11565 = 0x2D2D
Display of the active IP address (Instance attribute 5 (IP Address) in the <a href="#">TCP/IP Interface Object (245 / 0xF5)</a> (141))		
<b>Display range</b> (min. value   unit   max. value)		
0		255
<b>Subcodes</b>		<b>Info</b>
C13010/1		Active IP address (most significant byte)
C13010/2		Active IP Address
C13010/3		Active IP Address
C13010/4		Active IP address (least significant byte)
<input checked="" type="checkbox"/> Read access <input type="checkbox"/> Write access <input type="checkbox"/> CINH <input type="checkbox"/> PLC STOP <input type="checkbox"/> No transfer <input type="checkbox"/> PDO_MAP_RX <input type="checkbox"/> PDO_MAP_TX <input type="checkbox"/> COM <input type="checkbox"/> MOT		

## C13011

Parameter   Name: <b>C13011   Active Subnetwork Mask</b>		Data type: UNSIGNED_8 Index: 11564 = 0x2D2C
Display of the active subnetwork mask (Instance attribute 5 (IP Network Mask) in the <a href="#">TCP/IP Interface Object (245 / 0xF5)</a> (141))		
<b>Display range</b> (min. value   unit   max. value)		
0		255
<b>Subcodes</b>		<b>Info</b>
C13011/1		Active subnet mask (most significant byte)
C13011/2		Active Subnetwork Mask
C13011/3		Active Subnetwork Mask
C13011/4		Active subnet mask (least significant byte)
<input checked="" type="checkbox"/> Read access <input type="checkbox"/> Write access <input type="checkbox"/> CINH <input type="checkbox"/> PLC STOP <input type="checkbox"/> No transfer <input type="checkbox"/> PDO_MAP_RX <input type="checkbox"/> PDO_MAP_TX <input type="checkbox"/> COM <input type="checkbox"/> MOT		

# 13

## Parameter reference

### 13.1

#### Parameters of the communication module

---

#### C13012

Parameter   Name: <b>C13012   Active Gateway Address</b>		Data type: UNSIGNED_8 Index: 11563 = 0x2D2B
Display of the active gateway address (Instance attribute 5 (Gateway Address) in the <a href="#">TCP/IP Interface Object (245 / 0xF5)</a> ( <a href="#">□ 141</a> ))		
<b>Display range</b> (min. value   unit   max. value)		
0		255
<b>Subcodes</b>		<b>Info</b>
C13012/1		Active gateway address (most significant byte)
C13012/2		Active gateway address
C13012/3		Active gateway address
C13012/4		Active gateway address (least significant byte)
<input checked="" type="checkbox"/> Read access <input type="checkbox"/> Write access <input type="checkbox"/> CINH <input type="checkbox"/> PLC STOP <input type="checkbox"/> No transfer <input type="checkbox"/> PDO_MAP_RX <input type="checkbox"/> PDO_MAP_TX <input type="checkbox"/> COM <input type="checkbox"/> MOT		

#### C13016

Parameter   Name: <b>C13016   Active Multicast IP Address</b>		Data type: UNSIGNED_8 Index: 11559 = 0x2D27
Display of the active multicast IP address		
<b>Display range</b> (min. value   unit   max. value)		
0		255
<b>Subcodes</b>		<b>Info</b>
C13016/1		Multicast IP address (most significant byte)
C13016/2		Multicast IP address
C13016/3		Multicast IP address
C13016/4		Multicast IP address (least significant byte)
<input checked="" type="checkbox"/> Read access <input type="checkbox"/> Write access <input type="checkbox"/> CINH <input type="checkbox"/> PLC STOP <input type="checkbox"/> No transfer <input type="checkbox"/> PDO_MAP_RX <input type="checkbox"/> PDO_MAP_TX <input type="checkbox"/> COM <input type="checkbox"/> MOT		

## C13017

Parameter   Name: <b>C13017   Ethernet Config Control</b>		Data type: UNSIGNED_16 Index: 11558 = 0x2D26
Setting of the baud rate for the Ethernet connections Dependent on the configuration of the Ethernet port of the device to be connected, we recommend the use of a cross-over cable. <a href="#">▶ EtherNet/IP connection (□ 29)</a>		
Selection list		
0	Auto-Negotiation	
1	10 Mbps	
2	100 Mbps	
3	Reserved	
4	Reserved	
5	10 Mbps/Half Duplex	
6	10 Mbps/Full Duplex	
7	100 Mbps/Half Duplex	
8	100 Mbps/Full Duplex	
9	Reserved	
10	Reserved	
11	Reserved	
12	Reserved	
Subcodes	Lenze setting	Info
C13017/1	0: Auto-Negotiation	Ethernet setting port X259
C13017/2	0: Auto-Negotiation	Ethernet setting port X260
<input checked="" type="checkbox"/> Read access <input checked="" type="checkbox"/> Write access <input type="checkbox"/> CINH <input type="checkbox"/> PLC STOP <input type="checkbox"/> No transfer <input type="checkbox"/> PDO_MAP_RX <input type="checkbox"/> PDO_MAP_TX <input type="checkbox"/> COM <input type="checkbox"/> MOT		

## C13018

Parameter   Name: <b>C13018   Multicast Config Alloc Control</b>		Data type: UNSIGNED_8 Index: 11557 = 0x2D25
Selection for multicast IP addressing via instance attribute 9 (Mcast Config) in the <a href="#">TCP/IP Interface Object (245 / 0xF5) (□ 141)</a>		
Selection list (Lenze setting printed in bold)		
0	<b>Default Allocation Algorithm</b>	
1	Multicast IP Start Address	
<input checked="" type="checkbox"/> Read access <input checked="" type="checkbox"/> Write access <input type="checkbox"/> CINH <input type="checkbox"/> PLC STOP <input type="checkbox"/> No transfer <input type="checkbox"/> PDO_MAP_RX <input type="checkbox"/> PDO_MAP_TX <input type="checkbox"/> COM <input type="checkbox"/> MOT		

## C13019

Parameter   Name: <b>C13019   Multicast Config TTL Value</b>		Data type: UNSIGNED_8 Index: 11556 = 0x2D24
Setting of the multicast TTL value for the validity time of data packets in the EtherNet/IP network (Instance attribute 8 (TTL Value) in the <a href="#">TCP/IP Interface Object (245 / 0xF5) (□ 141)</a> )		
Setting range (min. value   unit   max. value)	Lenze setting	
1	255	<b>1</b>
<input checked="" type="checkbox"/> Read access <input checked="" type="checkbox"/> Write access <input type="checkbox"/> CINH <input type="checkbox"/> PLC STOP <input type="checkbox"/> No transfer <input type="checkbox"/> PDO_MAP_RX <input type="checkbox"/> PDO_MAP_TX <input type="checkbox"/> COM <input type="checkbox"/> MOT		

# 13

## Parameter reference

### 13.1

#### Parameters of the communication module

#### C13020

Parameter   Name: <b>C13020   Multicast Config Num Mcast</b>		Data type: UNSIGNED_8 Index: 11555 = 0x2D23
Used to set how many multicast IP addresses will be assigned. (Instance attribute 9 (Num Mcast) in the <a href="#">TCP/IP Interface Object (245 / 0xF5)</a> ( <a href="#">141</a> ))		
<b>Setting range</b> (min. value   unit   max. value)		<b>Lenze setting</b>
1		8 <b>1</b>
<input checked="" type="checkbox"/> Read access <input checked="" type="checkbox"/> Write access <input type="checkbox"/> CINH <input type="checkbox"/> PLC STOP <input type="checkbox"/> No transfer <input type="checkbox"/> PDO_MAP_RX <input type="checkbox"/> PDO_MAP_TX <input type="checkbox"/> COM <input type="checkbox"/> MOT		

#### C13021

Parameter   Name: <b>C13021   Quality of Service (VLAN-Tagging)</b>		Data type: UNSIGNED_8 Index: 11554 = 0x2D22
Used to set whether QoS tags will be used for the prioritisation of the data packets to be transferred. (Instance attribute 1 (802.1Q Tag Enable) in the <a href="#">Quality of Service (QoS) Object (72 / 0x48)</a> ( <a href="#">139</a> ))		
<b>Selection list</b> (Lenze setting printed in bold)		
<b>0</b>	<b>802.1Q Tag Disable</b>	
1	802.1Q Tag Enable	
<input checked="" type="checkbox"/> Read access <input checked="" type="checkbox"/> Write access <input type="checkbox"/> CINH <input type="checkbox"/> PLC STOP <input type="checkbox"/> No transfer <input type="checkbox"/> PDO_MAP_RX <input type="checkbox"/> PDO_MAP_TX <input type="checkbox"/> COM <input type="checkbox"/> MOT		

#### C13022

Parameter   Name: <b>C13022   Quality of Service (DSCP)</b>		Data type: UNSIGNED_8 Index: 11553 = 0x2D21
Setting for the prioritisation of the data packets to be transferred using Differentiated Services Codepoints (DSCP)		
<b>Setting range</b> (min. value   unit   max. value)		
0		63
<b>Subcodes</b>	<b>Lenze setting</b>	<b>Info</b>
C13022/1	59	Reserved
C13022/2	47	Reserved
C13022/3	55	Reserved
C13022/4	47	QoS DSCP Scheduled (Instance attribute 5 (DSCP Scheduled) in the <a href="#">Quality of Service (QoS) Object (72 / 0x48)</a> ( <a href="#">139</a> ))
C13022/5	43	QoS DSCP High Prio (Instance attribute 6 (DSCP High Prio) in the <a href="#">Quality of Service (QoS) Object (72 / 0x48)</a> ( <a href="#">139</a> ))
C13022/6	31	Reserved
C13022/7	27	QoS DSCP Explicit Msg (Instance attribute 8 (DSCP Explicit Msg.) in the <a href="#">Quality of Service (QoS) Object (72 / 0x48)</a> ( <a href="#">139</a> ))
<input checked="" type="checkbox"/> Read access <input checked="" type="checkbox"/> Write access <input type="checkbox"/> CINH <input type="checkbox"/> PLC STOP <input type="checkbox"/> No transfer <input type="checkbox"/> PDO_MAP_RX <input type="checkbox"/> PDO_MAP_TX <input type="checkbox"/> COM <input type="checkbox"/> MOT		

## C13840

Parameter   Name: <b>C13840   DLR Network Topology</b>		Data type: UNSIGNED_8 Index: 10735 = 0x29EF
Display of the used DLR network topology (Device Level Ring) (Instance attribute 1 (Network Topology) in the <a href="#">Device Level Ring (DLR) Object (71 / 0x47)</a> ( <a href="#">137</a> ))		
<b>Selection list</b> (read only)		
0	Linear	
1	Ring	
<input checked="" type="checkbox"/> Read access <input type="checkbox"/> Write access <input type="checkbox"/> CINH <input type="checkbox"/> PLC STOP <input type="checkbox"/> No transfer <input type="checkbox"/> PDO_MAP_RX <input type="checkbox"/> PDO_MAP_TX <input type="checkbox"/> COM <input type="checkbox"/> MOT		

## C13841

Parameter   Name: <b>C13841   DLR Network Status</b>		Data type: UNSIGNED_8 Index: 10734 = 0x29EE
Display of the DLR network status (Device Level Ring) (Instance attribute 2 (Network Status) in the <a href="#">Device Level Ring (DLR) Object (71 / 0x47)</a> ( <a href="#">137</a> ))		
<b>Selection list</b> (read only)		
0	Normal	
1	Ring Fault	
2	Unexpected Loop detected	
<input checked="" type="checkbox"/> Read access <input type="checkbox"/> Write access <input type="checkbox"/> CINH <input type="checkbox"/> PLC STOP <input type="checkbox"/> No transfer <input type="checkbox"/> PDO_MAP_RX <input type="checkbox"/> PDO_MAP_TX <input type="checkbox"/> COM <input type="checkbox"/> MOT		

## C13842

Parameter   Name: <b>C13842   Supervisor IP Address</b>		Data type: UNSIGNED_8 Index: 10733 = 0x29ED
Display of the supervisor IP address (Instance attribute 10 (Supervisor IP Address) in the <a href="#">Device Level Ring (DLR) Object (71 / 0x47)</a> ( <a href="#">137</a> ))		
<b>Display range</b> (min. value   unit   max. value)		
0		255
<b>Subcodes</b>		<b>Info</b>
C13842/1		Supervisor IP address (most significant byte)
C13842/2		Supervisor IP Address
C13842/3		Supervisor IP Address
C13842/4		Supervisor IP address (least significant byte)
<input checked="" type="checkbox"/> Read access <input type="checkbox"/> Write access <input type="checkbox"/> CINH <input type="checkbox"/> PLC STOP <input type="checkbox"/> No transfer <input type="checkbox"/> PDO_MAP_RX <input type="checkbox"/> PDO_MAP_TX <input type="checkbox"/> COM <input type="checkbox"/> MOT		

## C13843

Parameter   Name: <b>C13843   Supervisor MAC ID</b>		Data type: OCTET_STRING Index: 10732 = 0x29EC
Display of the supervisor MAC ID (Instance attribute 10 (Supervisor MAC Address) in the <a href="#">Device Level Ring (DLR) Object (71 / 0x47)</a> ( <a href="#">137</a> ))		
<input checked="" type="checkbox"/> Read access <input type="checkbox"/> Write access <input type="checkbox"/> CINH <input type="checkbox"/> PLC STOP <input type="checkbox"/> No transfer <input type="checkbox"/> PDO_MAP_RX <input type="checkbox"/> PDO_MAP_TX <input type="checkbox"/> COM <input type="checkbox"/> MOT		

# 13

## Parameter reference

### 13.1

#### Parameters of the communication module

#### C13844

Parameter   Name: <b>C13844   Beacon Times</b>		Data type: UNSIGNED_32 Index: 10731 = 0x29EB
Display of the beacon times (µs)		
Subcodes	Info	
C13844/1	Beacon interval	
C13844/2	Beacon timeout	
<input checked="" type="checkbox"/> Read access <input type="checkbox"/> Write access <input type="checkbox"/> CINH <input type="checkbox"/> PLC STOP <input type="checkbox"/> No transfer <input type="checkbox"/> PDO_MAP_RX <input type="checkbox"/> PDO_MAP_TX <input type="checkbox"/> COM <input type="checkbox"/> MOT		

#### C13845

Parameter   Name: <b>C13845   Beacon Frames</b>		Data type: UNSIGNED_32 Index: 10730 = 0x29EA
Display of beacon frame information		
Subcodes	Info	
C13845/1	Beacon frames - port X259	
C13845/2	Beacon frame error - port X259	
C13845/3	Beacon frames - port X260	
C13845/4	Beacon frame error - port X260	
<input checked="" type="checkbox"/> Read access <input type="checkbox"/> Write access <input type="checkbox"/> CINH <input type="checkbox"/> PLC STOP <input type="checkbox"/> No transfer <input type="checkbox"/> PDO_MAP_RX <input type="checkbox"/> PDO_MAP_TX <input type="checkbox"/> COM <input type="checkbox"/> MOT		

#### C13846

Parameter   Name: <b>C13846   Address Conflict Detection</b>		Data type: UNSIGNED_8 Index: 10729 = 0x29E9
Activation of the address conflict detection (ACD) (Instance attribute 10 (SelectAcd) in the <a href="#">TCP/IP Interface Object (245 / 0xF5)</a> ( <a href="#">□ 141</a> )) Changing this value requires a reset of the device ("power off/on" or "type 0 reset").		
Selection list (Lenze setting printed in bold)		
0	Deactivated	
<b>1</b>	<b>Enable</b>	
<input checked="" type="checkbox"/> Read access <input checked="" type="checkbox"/> Write access <input type="checkbox"/> CINH <input type="checkbox"/> PLC STOP <input type="checkbox"/> No transfer <input type="checkbox"/> PDO_MAP_RX <input type="checkbox"/> PDO_MAP_TX <input type="checkbox"/> COM <input type="checkbox"/> MOT		

#### C13847

Parameter   Name: <b>C13847   Active Conflict Detection State</b>		Data type: UNSIGNED_8 Index: 10728 = 0x29E8
Display of the status of address conflict detection (ACD)		
Selection list (read only)		
0	Not conflicted	
1	Conflicted	
<input checked="" type="checkbox"/> Read access <input type="checkbox"/> Write access <input type="checkbox"/> CINH <input type="checkbox"/> PLC STOP <input type="checkbox"/> No transfer <input type="checkbox"/> PDO_MAP_RX <input type="checkbox"/> PDO_MAP_TX <input type="checkbox"/> COM <input type="checkbox"/> MOT		

## C13848

Parameter   Name: <b>C13848   Last Conflicted MAC ID</b>	Data type: OCTET_STRING Index: 10727 = 0x29E7
<p>Display of the MAC address of the EtherNet/IP node with the last address conflict (ACD). The data of the last conflict will only be saved in this code if ACD is active at the moment when the conflict occurs (<a href="#">C13846</a> = 1). (Instance attribute 11 (RemoteMAC) in the <a href="#">TCP/IP Interface Object (245 / 0xF5)</a> (<a href="#">141</a>))</p>	
<input checked="" type="checkbox"/> Read access <input type="checkbox"/> Write access <input type="checkbox"/> CINH <input type="checkbox"/> PLC STOP <input type="checkbox"/> No transfer <input type="checkbox"/> PDO_MAP_RX <input type="checkbox"/> PDO_MAP_TX <input type="checkbox"/> COM <input type="checkbox"/> MOT	

## C13849

Parameter   Name: <b>C13849   Last Conflicted IP Address</b>	Data type: UNSIGNED_8 Index: 10726 = 0x29E6
<p>Display of the MAC address of the EtherNet/IP node with the last address conflict (ACD). The data of the last conflict will only be saved in this code if ACD is active at the moment when the conflict occurs (<a href="#">C13846</a> = 1).</p>	
<b>Display range (min. value   unit   max. value)</b>	
0	255
<b>Subcodes</b>	<b>Info</b>
C13849/1	Last conflicted IP address (most significant byte)
C13849/2	Last conflicted IP address
C13849/3	Last conflicted IP address
C13849/4	Last conflicted IP address (least significant byte)
<input checked="" type="checkbox"/> Read access <input type="checkbox"/> Write access <input type="checkbox"/> CINH <input type="checkbox"/> PLC STOP <input type="checkbox"/> No transfer <input type="checkbox"/> PDO_MAP_RX <input type="checkbox"/> PDO_MAP_TX <input type="checkbox"/> COM <input type="checkbox"/> MOT	

## C13850

Parameter   Name: <b>C13850   All words to scanner</b>	Data type: INTEGER_16 Index: 10725 = 0x29E5
<p>Display of the I/O data words transferred from the communication module (adapter) to the scanner. In the subcodes, all I/O data words transferred to the scanner are displayed. However, only the configured I/O data words are valid.</p>	
<b>Display range (min. value   unit   max. value)</b>	
-32768	32767
<b>Subcodes</b>	<b>Info</b>
C13850/1	
...	
C13850/16	
<input checked="" type="checkbox"/> Read access <input type="checkbox"/> Write access <input type="checkbox"/> CINH <input type="checkbox"/> PLC STOP <input type="checkbox"/> No transfer <input type="checkbox"/> PDO_MAP_RX <input type="checkbox"/> PDO_MAP_TX <input type="checkbox"/> COM <input type="checkbox"/> MOT	

# 13

## Parameter reference

### 13.1

#### Parameters of the communication module

#### C13851

Parameter   Name: <b>C13851   All words from scanner</b>		Data type: INTEGER_16 Index: 10724 = 0x29E4
Display of the I/O data words transferred from the scanner to the communication module (adapter). In the subcodes, all I/O data words transferred from the scanner are displayed. However, only the configured I/O data words are valid.		
<b>Display range (min. value   unit   max. value)</b>		
-32768		32767
<b>Subcodes</b>		<b>Info</b>
C13851/1		
...		
C13851/16		
<input checked="" type="checkbox"/> Read access <input type="checkbox"/> Write access <input type="checkbox"/> CINH <input type="checkbox"/> PLC STOP <input type="checkbox"/> No transfer <input type="checkbox"/> PDO_MAP_RX <input type="checkbox"/> PDO_MAP_TX <input type="checkbox"/> COM <input type="checkbox"/> MOT		

#### C13852

Parameter   Name: <b>C13852   All words to the basic device</b>		Data type: INTEGER_16 Index: 10723 = 0x29E3
Display of the I/O data words transferred from the scanner to the communication module (adapter). In the subcodes, all I/O data words transferred from the scanner are displayed. However, only the configured I/O data words are valid.		
<b>Display range (min. value   unit   max. value)</b>		
-32768		32767
<b>Subcodes</b>		<b>Info</b>
C13852/1		
...		
C13852/16		
<input checked="" type="checkbox"/> Read access <input type="checkbox"/> Write access <input type="checkbox"/> CINH <input type="checkbox"/> PLC STOP <input type="checkbox"/> No transfer <input type="checkbox"/> PDO_MAP_RX <input type="checkbox"/> PDO_MAP_TX <input type="checkbox"/> COM <input type="checkbox"/> MOT		

#### C13853

Parameter   Name: <b>C13853   All words to the basic device</b>		Data type: INTEGER_16 Index: 10722 = 0x29E2
Display of the I/O data words transferred from the communication module (adapter) to the scanner. In the subcodes, all I/O data words transferred to the scanner are displayed. However, only the configured I/O data words are valid.		
<b>Display range (min. value   unit   max. value)</b>		
-32768		32767
<b>Subcodes</b>		<b>Info</b>
C13853/1		
...		
C13853/16		
<input checked="" type="checkbox"/> Read access <input type="checkbox"/> Write access <input type="checkbox"/> CINH <input type="checkbox"/> PLC STOP <input type="checkbox"/> No transfer <input type="checkbox"/> PDO_MAP_RX <input type="checkbox"/> PDO_MAP_TX <input type="checkbox"/> COM <input type="checkbox"/> MOT		



## C13858

Parameter   Name: <b>C13858   Ethernet Port Statistics</b>		Data type: UNSIGNED_32 Index: 10717 = 0x29DD
Display of statistical values for the data transfer via the Ethernet connections		
Subcodes	Info	
C13858/1	Ethernet port X259: RX	
C13858/2	Ethernet port X259: RX CRC error	
C13858/3	Ethernet port X259: RX discarded	
C13858/4	Ethernet port X259: TX	
C13858/5	Ethernet port X259: TX discarded	
C13858/6	Ethernet port X260: RX	
C13858/7	Ethernet port X260: RX CRC error	
C13858/8	Ethernet port X260: RX discarded	
C13858/9	Ethernet port X260: TX	
C13858/10	Ethernet port X260: TX discarded	
<input checked="" type="checkbox"/> Read access <input type="checkbox"/> Write access <input type="checkbox"/> CINH <input type="checkbox"/> PLC STOP <input type="checkbox"/> No transfer <input type="checkbox"/> PDO_MAP_RX <input type="checkbox"/> PDO_MAP_TX <input type="checkbox"/> COM <input type="checkbox"/> MOT		

## C13861

Parameter   Name: <b>C13861   CIP Module Status</b>		Data type: UNSIGNED_16 Index: 10714 = 0x29DA
Display of the current CIP module status (Instance attribute 8 (State) in the <a href="#">Identity Object (1 / 0x01)</a> ( <a href="#">□ 126</a> )) <ul style="list-style-type: none"> <li>• The status is also indicated via the MS LED.</li> </ul> ▶ <a href="#">LED status displays</a> ( <a href="#">□ 89</a> )		
Selection list (read only)		
0	Nonexistent	
1	Device Self Testing	
2	Standby	
3	Operational	
4	Major Recoverable Fault	
5	Major Unrecoverable Fault	
<input checked="" type="checkbox"/> Read access <input type="checkbox"/> Write access <input type="checkbox"/> CINH <input type="checkbox"/> PLC STOP <input type="checkbox"/> No transfer <input type="checkbox"/> PDO_MAP_RX <input type="checkbox"/> PDO_MAP_TX <input type="checkbox"/> COM <input type="checkbox"/> MOT		

## C13862

Parameter   Name: <b>C13862   CIP Network Status</b>		Data type: UNSIGNED_16 Index: 10713 = 0x29D9
Display of the current CIP network status <ul style="list-style-type: none"> <li>The status is also indicated via the NS LED.</li> </ul> <a href="#">▶ LED status displays (89)</a>		
<b>Selection list (read only)</b>		
0	No IP Address	
1	Nonexistent	
2	Established	
3	Timed Out	
4	Duplicate IP	
5	Self-Test	
<input checked="" type="checkbox"/> Read access <input type="checkbox"/> Write access <input type="checkbox"/> CINH <input type="checkbox"/> PLC STOP <input type="checkbox"/> No transfer <input type="checkbox"/> PDO_MAP_RX <input type="checkbox"/> PDO_MAP_TX <input type="checkbox"/> COM <input type="checkbox"/> MOT		

## C13863

Parameter   Name: <b>C13863   Ethernet Port</b>		Data type: UNSIGNED_16 Index: 10712 = 0x29D8
Display of the baud rate currently used on the Ethernet connections		
<b>Selection list (read only)</b>		
0	Nonexistent	
1	10 Mbps/Half Duplex	
2	10 Mbps/Full Duplex	
3	100 Mbps/Half Duplex	
4	100 Mbps/Full Duplex	
5	Reserved	
6	Reserved	
<b>Subcodes</b>		<b>Info</b>
C13863/1		Ethernet port X259 link state
C13863/2		Ethernet port X260 link state
<input checked="" type="checkbox"/> Read access <input type="checkbox"/> Write access <input type="checkbox"/> CINH <input type="checkbox"/> PLC STOP <input type="checkbox"/> No transfer <input type="checkbox"/> PDO_MAP_RX <input type="checkbox"/> PDO_MAP_TX <input type="checkbox"/> COM <input type="checkbox"/> MOT		

## C13870

Parameter   Name: <b>C13870   CIP Connections State</b>		Data type: UNSIGNED_16 Index: 10705 = 0x29D1
Display of the current CIP connection status		
<b>Selection list (read only)</b>		
0	Nonexistent	
3	Established	
4	Timed Out	
<b>Subcodes</b>		<b>Info</b>
C13870/1		Status of CIP connection 1
...		...
C13870/8		Status of CIP connection 8
<input checked="" type="checkbox"/> Read access <input type="checkbox"/> Write access <input type="checkbox"/> CINH <input type="checkbox"/> PLC STOP <input type="checkbox"/> No transfer <input type="checkbox"/> PDO_MAP_RX <input type="checkbox"/> PDO_MAP_TX <input type="checkbox"/> COM <input type="checkbox"/> MOT		

## C13871

Parameter   Name: <b>C13871   CIP Connections Type</b>		Data type: UNSIGNED_16 Index: 10704 = 0x29D0
Display of the current CIP connection types • "Listen Only" connections are not displayed.		
<b>Selection list (read only)</b>		
0	Nonexistent	
1	Exclusive Owner	
2	Input Only	
3	Listen Only	
4	Explicit Connection	
<b>Subcodes</b>		<b>Info</b>
C13871/1		Type of CIP connection 1
...		...
C13871/8		Type of CIP connection 8
<input checked="" type="checkbox"/> Read access <input type="checkbox"/> Write access <input type="checkbox"/> CINH <input type="checkbox"/> PLC STOP <input type="checkbox"/> No transfer <input type="checkbox"/> PDO_MAP_RX <input type="checkbox"/> PDO_MAP_TX <input type="checkbox"/> COM <input type="checkbox"/> MOT		

## C13872

Parameter   Name: <b>C13872   CIP Connection Triggers</b>		Data type: UNSIGNED_16 Index: 10703 = 0x29CF
Display of the current CIP connection class		
<b>Selection list (read only)</b>		
0	Nonexistent	
1	Class 1, Cyclic, Client	
163	Class 3, App. Obj., Server	
<b>Subcodes</b>		<b>Info</b>
C13872/1		Trigger of CIP connection 1
...		...
C13872/8		Trigger of CIP connection 8
<input checked="" type="checkbox"/> Read access <input type="checkbox"/> Write access <input type="checkbox"/> CINH <input type="checkbox"/> PLC STOP <input type="checkbox"/> No transfer <input type="checkbox"/> PDO_MAP_RX <input type="checkbox"/> PDO_MAP_TX <input type="checkbox"/> COM <input type="checkbox"/> MOT		

## C13873

Parameter   Name: <b>C13873   CIP Connections RPI</b>		Data type: UNSIGNED_32 Index: 10702 = 0x29CE
Display of the RPI times (Requested Package Interval) currently used for the CIP connections ("Originator to Target" time)		
<b>Display range (min. value   unit   max. value)</b>		
0	ms	4294967295
<b>Subcodes</b>		<b>Info</b>
C13873/1		RPI of CIP connection 1
...		...
C13873/8		RPI of CIP connection 8
<input checked="" type="checkbox"/> Read access <input type="checkbox"/> Write access <input type="checkbox"/> CINH <input type="checkbox"/> PLC STOP <input type="checkbox"/> No transfer <input type="checkbox"/> PDO_MAP_RX <input type="checkbox"/> PDO_MAP_TX <input type="checkbox"/> COM <input type="checkbox"/> MOT		

## C13874

Parameter   Name: <b>C13874   CIP Connections Timeout Time</b>		Data type: UNSIGNED_32 Index: 10701 = 0x29CD
Display of the timeouts (ms) of the CIP connections		
<b>Display range (min. value   unit   max. value)</b>		
0	ms	4294967295
<b>Subcodes</b>		<b>Info</b>
C13874/1		Timeout time of CIP connection 1
...		...
C13874/8		Timeout time of CIP connection 8
<input checked="" type="checkbox"/> Read access <input type="checkbox"/> Write access <input type="checkbox"/> CINH <input type="checkbox"/> PLC STOP <input type="checkbox"/> No transfer <input type="checkbox"/> PDO_MAP_RX <input type="checkbox"/> PDO_MAP_TX <input type="checkbox"/> COM <input type="checkbox"/> MOT		

## C13875

Parameter   Name: <b>C13875   CIP Connections RUN/IDLE Flag</b>		Data type: UNSIGNED_16 Index: 10700 = 0x29CC
Display of the run and idle flags of the CIP connections		
<b>Selection list (read only)</b>		
0	Nonexistent	
1	IDLE	
2	RUN	
<b>Subcodes</b>		<b>Info</b>
C13875/1		RUN/IDLE flag - CIP connection 1
...		...
C13875/8		RUN/IDLE flag - CIP connection 8
<input checked="" type="checkbox"/> Read access <input type="checkbox"/> Write access <input type="checkbox"/> CINH <input type="checkbox"/> PLC STOP <input type="checkbox"/> No transfer <input type="checkbox"/> PDO_MAP_RX <input type="checkbox"/> PDO_MAP_TX <input type="checkbox"/> COM <input type="checkbox"/> MOT		

## C13880

Parameter   Name: <b>C13880   Monitoring Reaction</b>		Data type: UNSIGNED_8 Index: 10695 = 0x29C7
Setting of the monitoring response in the event of a <a href="#">Fault with regard to EtherNet/IP communication (88)</a> (Mapping of the Lenze object <a href="#">Lenze Class (101 / 0x65) (155)</a> ) A change in the monitoring response becomes immediately effective.		
<b>Selection list</b>		
0	No response	
1	Fault	
3	Quick stop by trouble	
4	Warning Locked	
6	Information	
<b>Subcodes</b>	<b>Lenze setting</b>	<b>Info</b>
C13880/1	0: No Response	Idle Mode
C13880/2	3: Quick stop by trouble	Fault Mode (only for "exclusive owner" connections)
C13880/3	0: No Response	Expl. message timeout
C13880/4	0: No Response	Overall Ethernet communication timeout
<input checked="" type="checkbox"/> Read access <input checked="" type="checkbox"/> Write access <input type="checkbox"/> CINH <input type="checkbox"/> PLC STOP <input type="checkbox"/> No transfer <input type="checkbox"/> PDO_MAP_RX <input type="checkbox"/> PDO_MAP_TX <input type="checkbox"/> COM <input type="checkbox"/> MOT		

## C13881

Parameter   Name: <b>C13881   Overall Ethernet Timeout Time</b>		Data type: UNSIGNED_16 Index: 10694 = 0x29C6
Setting of the overall monitoring time (see <a href="#">Fault with regard to EtherNet/IP communication (□ 88)</a> ) A change in the monitoring response becomes immediately effective.		
<b>Setting range</b> (min. value   unit   max. value)		<b>Lenze setting</b>
500	ms	65535 <b>10000 ms</b>
<input checked="" type="checkbox"/> Read access <input checked="" type="checkbox"/> Write access <input type="checkbox"/> CINH <input type="checkbox"/> PLC STOP <input type="checkbox"/> No transfer <input type="checkbox"/> PDO_MAP_RX <input type="checkbox"/> PDO_MAP_TX <input type="checkbox"/> COM <input type="checkbox"/> MOT		

## C13885

Parameter   Name: <b>C13885   Clear I/O Data</b>		Data type: UNSIGNED_8 Index: 10690 = 0x29C2
Setting which I/O data are to be processed by the adapter to maintain internal communication if ... <ul style="list-style-type: none"> <li>the network status of the controlling I/O connection is "Not connected" (see <a href="#">C13862</a>) or</li> <li>an idle event has occurred.</li> </ul> Changes in the setting becomes effective immediately. (See <a href="#">Fault with regard to EtherNet/IP communication (□ 88)</a> .)		
<b>Selection list</b> (Lenze setting printed in bold)		
0	Use of last Scanner Output Data	
1	<b>Clear Scanner Output Data</b>	
<input checked="" type="checkbox"/> Read access <input checked="" type="checkbox"/> Write access <input type="checkbox"/> CINH <input type="checkbox"/> PLC STOP <input type="checkbox"/> No transfer <input type="checkbox"/> PDO_MAP_RX <input type="checkbox"/> PDO_MAP_TX <input type="checkbox"/> COM <input type="checkbox"/> MOT		

## C13899

Parameter   Name: <b>C13899   Hostname</b>		Data type: VISIBLE_STRING Index: 10676 = 0x29B4
Each subcode contains a string with a length of 32 bytes indicating the designation of the EtherNet/IP node. (Instance attribute 6 (Host Name) in the <a href="#">TCP/IP Interface Object (245 / 0xF5) (□ 141)</a> )		
<b>Subcodes</b>	<b>Lenze setting</b>	<b>Info</b>
C13899/1		Host name
C13899/2		Host name
<input checked="" type="checkbox"/> Read access <input checked="" type="checkbox"/> Write access <input type="checkbox"/> CINH <input type="checkbox"/> PLC STOP <input type="checkbox"/> No transfer <input type="checkbox"/> PDO_MAP_RX <input type="checkbox"/> PDO_MAP_TX <input type="checkbox"/> COM <input type="checkbox"/> MOT		

## C13900

Parameter   Name: <b>C13900   Firmware Product Type</b>		Data type: VISIBLE_STRING Index: 10675 = 0x29B3
The code contains a string with a length of 8 bytes. The identification code "E84AYCEO" is output.		
<input checked="" type="checkbox"/> Read access <input type="checkbox"/> Write access <input type="checkbox"/> CINH <input type="checkbox"/> PLC STOP <input type="checkbox"/> No transfer <input type="checkbox"/> PDO_MAP_RX <input type="checkbox"/> PDO_MAP_TX <input type="checkbox"/> COM <input type="checkbox"/> MOT		

## C13901

Parameter   Name: <b>C13901   Firmware Compilation Date</b>		Data type: VISIBLE_STRING Index: 10674 = 0x29B2
The code contains a string with a length of 20 bytes. The software creation date ("MMM DD YYYY") and time ("hh:mm:ss") are displayed (e.g. "Mar 21 2005 12:31:21").		
<input checked="" type="checkbox"/> Read access <input type="checkbox"/> Write access <input type="checkbox"/> CINH <input type="checkbox"/> PLC STOP <input type="checkbox"/> No transfer <input type="checkbox"/> PDO_MAP_RX <input type="checkbox"/> PDO_MAP_TX <input type="checkbox"/> COM <input type="checkbox"/> MOT		

# 13

## Parameter reference

### 13.1

#### Parameters of the communication module

---

#### C13902

Parameter   Name: <b>C13902   Firmware Version</b>	Data type: VISIBLE_STRING Index: 10673 = 0x29B1
The code contains a string with a length of 11 bytes. The firmware version is displayed (e.g. "01.00.01.00").	
<input checked="" type="checkbox"/> Read access <input type="checkbox"/> Write access <input type="checkbox"/> CINH <input type="checkbox"/> PLC STOP <input type="checkbox"/> No transfer <input type="checkbox"/> PDO_MAP_RX <input type="checkbox"/> PDO_MAP_TX <input type="checkbox"/> COM <input type="checkbox"/> MOT	

#### C13920

Parameter   Name: <b>C13920   Rotary coding switches: xxx.yyy.zzz.DDD</b>	Data type: UNSIGNED_8 Index: 10655 = 0x299F
Indication of the current value set by means of the rotary coding switches. ▶ <a href="#">Setting node addresses by means of rotary coding switches (40)</a>	
<b>Display range (min. value   unit   max. value)</b>	
0	255
<input checked="" type="checkbox"/> Read access <input type="checkbox"/> Write access <input type="checkbox"/> CINH <input type="checkbox"/> PLC STOP <input type="checkbox"/> No transfer <input type="checkbox"/> PDO_MAP_RX <input type="checkbox"/> PDO_MAP_TX <input type="checkbox"/> COM <input type="checkbox"/> MOT	

# 13 Parameter reference

## 13.2 Table of attributes

### 13.2 Table of attributes

The table of attributes contains information required for communication with the inverter via parameters.

#### How to read the table of attributes:

Column		Meaning	Entry	
Code		Parameter name	Cxxxxx	
Name		Parameter short text (display text)	Text	
Index	dec	Index under which the parameter is addressed. The subindex for array variables corresponds to the Lenze subcode number.	24575 - Lenze code number	Is only required for access via a bus system.
	hex		0x5FFF - Lenze code number	
Data	DS	Data structure	E	Single variable (only one parameter element)
			A	Array variable (several parameter elements)
	DA	Number of array elements (subcodes)	Number	
	DT	Data type	BITFIELD_8	1 byte, bit-coded
			BITFIELD_16	2 bytes, bit-coded
			BITFIELD_32	4 bytes, bit-coded
			INTEGER_8	1 byte, with sign
			INTEGER_16	2 bytes with sign
			INTEGER_32	4 bytes, with sign
			UNSIGNED_8	1 byte without sign
			UNSIGNED_16	2 bytes without sign
			VISIBLE_STRING	ASCII string
			OCTET_STRING	
Factor	Factor for data transmission via a bus system, depending on the number of decimal positions	Factor	1 = No decimal positions 10 = 1 decimal position 100 = 2 decimal positions 1000 = 3 decimal positions	
Access	R	Read access	<input checked="" type="checkbox"/> Reading permitted	
	W	Write access	<input checked="" type="checkbox"/> Writing permitted	
	CINH	Controller inhibit (CINH) required	<input checked="" type="checkbox"/> Writing is only possible when the controller is inhibited	

Table of attributes

Code	Name	Index		Data				Access		
		dec	hex	DS	DA	DT	Factor	R	W	CINH
<a href="#">C13000</a>	IP address	11575	0x2D37	A	4	UNSIGNED_8		<input checked="" type="checkbox"/>	<input checked="" type="checkbox"/>	
<a href="#">C13001</a>	Subnet mask	11574	0x2D36	A	4	UNSIGNED_8		<input checked="" type="checkbox"/>	<input checked="" type="checkbox"/>	
<a href="#">C13002</a>	Gateway address	11573	0x2D35	A	4	UNSIGNED_8		<input checked="" type="checkbox"/>	<input checked="" type="checkbox"/>	
<a href="#">C13003</a>	MAC-ID	11572	0x2D34	E	1	OCTET_STRING		<input checked="" type="checkbox"/>		
<a href="#">C13005</a>	IP Config Control	11570	0x2D32	E	1	UNSIGNED_8	1	<input checked="" type="checkbox"/>	<input checked="" type="checkbox"/>	
<a href="#">C13006</a>	Multicast IP Start Address	11569	0x2D31	A	4	UNSIGNED_8		<input checked="" type="checkbox"/>	<input checked="" type="checkbox"/>	
<a href="#">C13010</a>	Active IP Address	11565	0x2D2D	A	4	UNSIGNED_8	1	<input checked="" type="checkbox"/>		
<a href="#">C13011</a>	Active Subnetwork Mask	11564	0x2D2C	A	4	UNSIGNED_8	1	<input checked="" type="checkbox"/>		
<a href="#">C13012</a>	Active gateway address	11563	0x2D2B	A	4	UNSIGNED_8	1	<input checked="" type="checkbox"/>		
<a href="#">C13016</a>	Active Multicast IP Address	11559	0x2D27	A	4	UNSIGNED_8	1	<input checked="" type="checkbox"/>		
<a href="#">C13017</a>	Ethernet Config Control	11558	0x2D26	A	2	UNSIGNED_16	1	<input checked="" type="checkbox"/>	<input checked="" type="checkbox"/>	
<a href="#">C13018</a>	Multicast Config Alloc Control	11557	0x2D25	E	1	UNSIGNED_8	1	<input checked="" type="checkbox"/>	<input checked="" type="checkbox"/>	
<a href="#">C13019</a>	Multicast Config TTL Value	11556	0x2D24	E	1	UNSIGNED_8	1	<input checked="" type="checkbox"/>	<input checked="" type="checkbox"/>	
<a href="#">C13020</a>	Multicast Config Num Mcast	11555	0x2D23	E	1	UNSIGNED_8	1	<input checked="" type="checkbox"/>	<input checked="" type="checkbox"/>	
<a href="#">C13021</a>	Quality of Service (VLAN-Tagging)	11554	0x2D22	E	1	UNSIGNED_8	1	<input checked="" type="checkbox"/>	<input checked="" type="checkbox"/>	
<a href="#">C13022</a>	Quality of Service (DSCP)	11553	0x2D21	A	7	UNSIGNED_8		<input checked="" type="checkbox"/>	<input checked="" type="checkbox"/>	
<a href="#">C13840</a>	DLR Network Topology	10735	0x29EF	E	1	UNSIGNED_8	1	<input checked="" type="checkbox"/>		
<a href="#">C13841</a>	DLR Network Status	10734	0x29EE	E	1	UNSIGNED_8	1	<input checked="" type="checkbox"/>		
<a href="#">C13842</a>	Supervisor IP Address	10733	0x29ED	A	4	UNSIGNED_8	1	<input checked="" type="checkbox"/>		
<a href="#">C13843</a>	Supervisor MAC ID	10732	0x29EC	E	1	OCTET_STRING		<input checked="" type="checkbox"/>		
<a href="#">C13844</a>	Beacon Times	10731	0x29EB	A	2	UNSIGNED_32	1	<input checked="" type="checkbox"/>		
<a href="#">C13845</a>	Beacon Frames	10730	0x29EA	A	4	UNSIGNED_32	1	<input checked="" type="checkbox"/>		
<a href="#">C13846</a>	Address Conflict Detection	10729	0x29E9	E	1	UNSIGNED_8	1	<input checked="" type="checkbox"/>	<input checked="" type="checkbox"/>	
<a href="#">C13847</a>	Active Conflict Detection State	10728	0x29E8	E	1	UNSIGNED_8	1	<input checked="" type="checkbox"/>		
<a href="#">C13848</a>	Last Conflicted MAC ID	10727	0x29E7	E	1	OCTET_STRING		<input checked="" type="checkbox"/>		
<a href="#">C13849</a>	Last Conflicted IP Address	10726	0x29E6	A	4	UNSIGNED_8	1	<input checked="" type="checkbox"/>		
<a href="#">C13850</a>	All words to scanner	10725	0x29E5	A	16	INTEGER_16	1	<input checked="" type="checkbox"/>		
<a href="#">C13851</a>	All words from scanner	10724	0x29E4	A	16	INTEGER_16	1	<input checked="" type="checkbox"/>		
<a href="#">C13852</a>	All words to the basic device	10723	0x29E3	A	16	INTEGER_16	1	<input checked="" type="checkbox"/>		
<a href="#">C13853</a>	All words to the basic device	10722	0x29E2	A	16	INTEGER_16	1	<input checked="" type="checkbox"/>		
<a href="#">C13858</a>	Ethernet Port Statistics	10717	0x29DD	A	10	UNSIGNED_32	1	<input checked="" type="checkbox"/>		
<a href="#">C13861</a>	CIP Module Status	10714	0x29DA	E	1	UNSIGNED_16	1	<input checked="" type="checkbox"/>		
<a href="#">C13862</a>	CIP Network Status	10713	0x29D9	E	1	UNSIGNED_16	1	<input checked="" type="checkbox"/>		
<a href="#">C13863</a>	Ethernet Port	10712	0x29D8	A	2	UNSIGNED_16	1	<input checked="" type="checkbox"/>		
<a href="#">C13870</a>	CIP Connections State	10705	0x29D1	A	8	UNSIGNED_16	1	<input checked="" type="checkbox"/>		
<a href="#">C13871</a>	CIP Connections Type	10704	0x29D0	A	8	UNSIGNED_16	1	<input checked="" type="checkbox"/>		
<a href="#">C13872</a>	CIP Connection Triggers	10703	0x29CF	A	8	UNSIGNED_16	1	<input checked="" type="checkbox"/>		
<a href="#">C13873</a>	CIP Connections RPI	10702	0x29CE	A	8	UNSIGNED_32	1	<input checked="" type="checkbox"/>		
<a href="#">C13874</a>	CIP Connections Timeout Time	10701	0x29CD	A	8	UNSIGNED_32	1	<input checked="" type="checkbox"/>		
<a href="#">C13875</a>	CIP Connections RUN/IDLE Flag	10700	0x29CC	A	8	UNSIGNED_16	1	<input checked="" type="checkbox"/>		
<a href="#">C13880</a>	Monitoring Reaction	10695	0x29C7	A	4	UNSIGNED_8	1	<input checked="" type="checkbox"/>	<input checked="" type="checkbox"/>	
<a href="#">C13881</a>	Overall Ethernet Timeout Time	10694	0x29C6	E	1	UNSIGNED_16	1	<input checked="" type="checkbox"/>	<input checked="" type="checkbox"/>	
<a href="#">C13885</a>	Clear I/O Data	10690	0x29C2	E	1	UNSIGNED_8	1	<input checked="" type="checkbox"/>	<input checked="" type="checkbox"/>	
<a href="#">C13899</a>	Hostname	10676	0x29B4	A	2	VISIBLE_STRING		<input checked="" type="checkbox"/>	<input checked="" type="checkbox"/>	
<a href="#">C13900</a>	Firmware Product Type	10675	0x29B3	E	1	VISIBLE_STRING		<input checked="" type="checkbox"/>		
<a href="#">C13901</a>	Firmware Compilation Date	10674	0x29B2	E	1	VISIBLE_STRING		<input checked="" type="checkbox"/>		
<a href="#">C13902</a>	Firmware Version	10673	0x29B1	E	1	VISIBLE_STRING		<input checked="" type="checkbox"/>		
<a href="#">C13920</a>	Rotary coding switch: xxx.yyy.zzz.DDD	10655	0x299F	E	1	UNSIGNED_8	1	<input checked="" type="checkbox"/>		



## 14 Implemented CIP™ objects

An EtherNet/IP node can be seen as an accumulation of objects. An individual object is characterised by its class, its instances and attributes. Several services such as read and write services can be applied to these objects.



### Note!

This chapter only describes the CIP objects implemented by Lenze and the properties supported by them (attributes, service codes etc.).

Not all object properties described in the "Common Industrial Protocol Specification" of the ODVA are supported.



### "Common Industrial Protocol Specification" of the ODVA

Here you will find detailed information about the CIP objects.

### Overview of the implemented CIP objects

CIP objects	Description
<b>General objects</b>	
<a href="#">Identity Object (1 / 0x01)</a> (📖 126)	Identification and general information about the device
<a href="#">Message Router Object (2 / 0x02)</a> (📖 128)	Addressing of a service for the transfer of data to any object class or instance
<a href="#">Assembly Object (4 / 0x04)</a> (📖 129)	Input/output data of the scanner
<a href="#">Connection Manager Object (6 / 0x06)</a> (📖 135)	Management of the internal resources for the transfer of data (implicit/explicit messaging)
<b>EtherNet/IP objects</b>	
<a href="#">Device Level Ring (DLR) Object (71 / 0x47)</a> (📖 137)	Status information for the DLR protocol
<a href="#">Quality of Service (QoS) Object (72 / 0x48)</a> (📖 139)	Classification and prioritisation of the data packets for EtherNet/IP communication
<a href="#">TCP/IP Interface Object (245 / 0xF5)</a> (📖 141)	Configuration of the TCP/IP network interface of the device
<a href="#">Ethernet Link Object (246 / 0xF6)</a> (📖 145)	General information and status information about the Ethernet interfaces of the device
<b>AC drive profile objects</b>	
<a href="#">Motor Data Object (40 / 0x28)</a> (📖 149)	Data basis for motor parameters
<a href="#">Control Supervisor Object (41 / 0x29)</a> (📖 150)	Management functions of the motor control devices.
<a href="#">AC Drive Object (42 / 0x2A)</a> (📖 152)	Device-specific functions of the drive, e.g. speed ramps, torque control etc.
<b>Lenze objects</b>	
<a href="#">Lenze Class (101 / 0x65)</a> (📖 155)	Lenze error responses to EtherNet/IP errors
<a href="#">Lenze Class (103 / 0x67)</a> (📖 157)	Image of the scanner input data
<a href="#">Lenze Class (104 / 0x68)</a> (📖 158)	Image of the scanner output data
<a href="#">Lenze Class (110 / 0x6E)</a> (📖 159)	Access to Lenze codes

## General class attributes

Attribute ID	Service	Name	Data type	Description
1	Get	Revision	UINT	Revision no. of the object
2	Get	Max. Instance	UINT	Max. number of instances of the object
3	Get	Number of Instances	UINT	Number of instances of the object
4	Get	Optional Attribute List:	STRUCT of:	List of the optional instance attributes:
		Number Attributes	UINT	Number of optional attributes
		Optional Attributes	ARRAY of UINT	Listing of the optional attributes
5	Get	Optional Service List:	STRUCT of:	List of the optional services:
		Number Services	UINT	Number of optional services
		Optional Services	ARRAY of UINT	Listing of the optional services
6	Get	Max. ID Number Class Attributes	UINT	The attribute ID of the last class attribute of the class description implemented in the device
7	Get	Max. ID Number Instance Attributes	UINT	The attribute ID of the last instance attribute of the class description implemented in the device

# 14 Implemented CIP™ objects

## 14.1 General CIP objects

---

### 14.1 General CIP objects

#### 14.1.1 Identity Object (1 / 0x01)

The "Identity Object" provides the identification and general information about the device.

##### Class attributes

Attribute ID	Service	Name	Data type	Value
1	Get	Revision	UINT	1 (0x0001)
2	Get	Max. Instance	UINT	1 (0x0001)
3	Get	Number of Instances	UINT	1 (0x0001)
6	Get	Max. ID Number Class Attributes	UINT	7 (0x0007)
7	Get	Max. ID Number Instance Attributes	UINT	8 (0x0008)

##### Instance attributes

Attribute ID	Service	Name	Data type	Value
1	Get	Vendor ID	UINT	587 (0x024B)
2	Get	Device Type	UINT	2 (0x0002): AC Drive
3	Get	Product Code	UINT	8400 (0x20D0)
4	Get	Revision:	STRUCT of:	Firmware revision of the device
		Major Revision	USINT	
		Minor Revision	USINT	
5	Get	Status	WORD	Current device status (status bits) <ul style="list-style-type: none"><li>• <a href="#">Instance attribute "Status" (attribute 5)</a> (<a href="#">☞ 127</a>)</li><li>• <a href="#">EtherNet/IP state diagram</a> (<a href="#">☞ 55</a>)</li></ul>
6	Get	Serial Number	UDINT	Serial number of the device
7	Get	Product Name	SHORT_STRING	E84AYCEO
8	Get	State	USINT	Current device state: <ul style="list-style-type: none"><li>• 0: Nonexistent</li><li>• 1: Device self-testing</li><li>• 2: Standby</li><li>• 3: Operational</li><li>• 4: Major recoverable fault</li><li>• 5: Major unrecoverable fault</li><li>• 6 ... 254: Reserved</li><li>• 255: Standard for "Get_Attributes_All" service</li></ul> (See also <a href="#">C13861</a> , <a href="#">LED status displays</a> ( <a href="#">☞ 89</a> ))

**Instance attribute "Status" (attribute 5)**

Bits	Name	Description
0	Owned	The state '1' indicates that the device (or an object within the device) has an owner. Within a master/slave model, the state '1' indicates that the "predefined master/slave connection set" is assigned to a master. Outside the master/slave model, it means "TBD".
1	-	Reserved (0)
2	Configured	The state '1' indicates that the activities the device application carries out differ from the "out of box" standard configuration. This should not comprise the configuration of communication.
3	-	Reserved (0)
4 ... 7	Extended Device Status	<ul style="list-style-type: none"> <li>• 0000: Status is "self-testing" or unknown</li> <li>• 0001: Firmware update is being carried out</li> <li>• 0010: At least one faulty I/O connection</li> <li>• 0011: No I/O connections available</li> <li>• 0100: Non-volatile configuration is faulty</li> <li>• 0101: "Major fault" (bit 10 or 11 is '1')</li> <li>• 0110: At least one I/O connection is in the "run mode"</li> <li>• 0111: At least one I/O connection is available, all are in the "idle mode"</li> <li>• 1000: Reserved</li> <li>• 1001: Reserved</li> <li>• 1010 ... 1111: Reserved / manufacturer-specific</li> </ul>
8	Minor Recoverable Fault	The state '1' indicates that a "Minor Recoverable Fault" has occurred.
9	Minor Unrecoverable Fault	The state '1' indicates that a "Minor Unrecoverable Fault" has occurred.
10	Major Recoverable Fault	The state '1' indicates that a "Major Recoverable Fault" has occurred.
11	Major Unrecoverable Fault	The state '1' indicates that a "Major Unrecoverable Fault" has occurred.
12 ... 15	Extended Device Status 2	Reserved (0) / manufacturer-specific

**Supported service codes**

Service code [hex]	Name	Description
0x01	Get_Attributes_All	Outputs a list of the attributes and the attribute's values for a certain object.
0x05	Reset	These reset service types are supported: <ul style="list-style-type: none"> <li>• 0: Mains switching (power off/on) is simulated.</li> <li>• 1: The parameters of the device are reset to the Lenze setting and mains switching (power off/on) is simulated.</li> </ul>
0x0E	Get_Attribute_Single	Outputs the value of a certain attribute.

### 14.1.2 Message Router Object (2 / 0x02)

With the "Message Router Object", a client can address a service for the transfer of data to any object class or instance.

#### Class attributes

Attribute ID	Service	Name	Data type	Value
1	Get	Revision	UINT	1 (0x0001)
2	Get	Max. Instance	UINT	1 (0x0001)
3	Get	Number of Instances	UINT	1 (0x0001)
4	Get	Optional Attribute List:	STRUCT of:	
		Number Attributes	UINT	2 (0x0002)
		Optional Attributes	ARRAY of UINT	1, 2 (0x0001.0002)
5	Get	Optional Service List:	STRUCT of:	
		Number Services	UINT	1 (0x0001)
		Optional Services	ARRAY of UINT	10 (0x000A)
6	Get	Max. ID Number Class Attributes	UINT	7 (0x0007)
7	Get	Max. ID Number Instance Attributes	UINT	6 (0x0006)

#### Instance attributes

Attribute ID	Service	Name	Data type	Value
1	Get	Object list:	STRUCT of:	Object list:
		Number	UINT	Number of supported object class codes
		Classes	ARRAY of UINT	Listing of the supported object class codes
2	Get	Number Available	UINT	Max. number of supported connections

#### Supported service codes

Service code [hex]	Name	Description
0x01	Get_Attributes_All	Outputs a list of the attributes and the attribute's values for a certain object.
0x0E	Get_Attribute_Single	Outputs the value of a certain attribute.

### 14.1.3 Assembly Object (4 / 0x04)

For data exchange, the communication module supports the following assembly object instances:

Application	Instance ID		Assembly object instance
	[dec]	[hex]	
Lenze technology applications / user-definable parameter sets	110	0x6E	Custom Output
	111	0x6F	Custom Input
"AC Drive Profile" application	20	0x14	Basic Speed Control Output
	21	0x15	Extended Speed Control Output
	22	0x16	Speed and Torque Control Output
	23	0x17	Extended Speed and Torque Control Output
	70	0x46	Basic Speed Control Input
	71	0x47	Extended Speed Control Input
	72	0x48	Speed and Torque Control Input
	73	0x49	Extended Speed and Torque Control Input

The contents of the input and output data depends on the I/O data arrangement in the drive ([I/O data mapping](#) (57)).



#### Application note

An example of parameter data transfer (read/write parameters) in a "AC Drive Profile" application can be found in the download area (Application Knowledge Base) at [www.Lenze.com](http://www.Lenze.com).

#### Class attributes

Attribute ID	Service	Name	Data type	Value
1	Get	Revision	UINT	2 (0x0002)
2	Get	Max. Instance	UINT	130 (0x0082)
3	Get	Number of Instances	UINT	11 (0x000B)
4	Get	Optional Attribute List:	STRUCT of:	
		Number Attributes	UINT	1 (0x0001)
		Optional Attributes	ARRAY of UINT	4 (0x0004)
6	Get	Max. ID Number Class Attributes	UINT	7 (0x0007)
7	Get	Max. ID Number Instance Attributes	UINT	4 (0x0004)

---

**Instance attributes for output data of the scanner**

Attribute ID	Service	Name	Data type	Value
3	Get / Set	Data	ARRAY of SINT / INT / DINT	Max. 16 bytes from the scanner to the adapter: <ul style="list-style-type: none"> <li>• 20 (0x14): Basic Speed Control Output</li> <li>• 21 (0x15): Extended Speed Control Output</li> <li>• 22 (0x16): Speed and Torque Control Output</li> <li>• 23 (0x17): Extended Speed and Torque Control Output</li> <li>• 110 (0x6E): Custom Output</li> </ul> <a href="#">▶ Instance attribute "Data" (attribute 3) (131)</a>
4	Get	Size	UINT	Number of bytes in attribute 3 (Data)

Assembly output objects (scanner to adapter) are assumed to have a 4-byte header (32-bit "run/idle header"). When mapping the assemblies, this header will automatically be added to the data stream by most Allen-Bradley PLC/SLC equipment.

If your PLC does not support this header (like the Rockwell PLCs do), add a preceding 32-bit header to the output image.

You can then define the **bit 0** of this header in the process image of your PLC:

- State '0': idle mode
- State '1': run mode

For the operation with Rockwell PLCs, adaptations are not required.

The [Lenze Class \(104 / 0x68\)](#) (158) provides the image of the output data of the scanner.

## Instance attributes for input data of the scanner

Attribute ID	Service	Name	Data type	Value
3	Get / Set	Data	ARRAY of SINT / INT / DINT	Max. 16 bytes from the adapter to the scanner: <ul style="list-style-type: none"> <li>• 70 (0x46): Basic Speed Control Input</li> <li>• 71 (0x47): Extended Speed Control Input</li> <li>• 72 (0x48): Speed and Torque Control Input</li> <li>• 73 (0x49): Extended Speed and Torque Control Input</li> <li>• 111 (0x6F): Custom Input</li> </ul> <a href="#">▶ Instance attribute "Data" (attribute 3) (📖 131)</a>
4	Get	Size	UINT	Number of bytes in attribute 3 (Data)

The assembly input objects (adapter to scanner) are mapped in the adapter memory starting with byte 0.

The input objects are transmitted in a "modeless" manner, i.e. a 4-byte header is not included in the transfer.

So the start address in the assembly memory map is the actual start of the first assembly data element.

Please observe the actual assembly lengths when mapping the input objects to the controller memory.

The [Lenze Class \(103 / 0x67\)](#) (📖 157) provides the image of the input data of the scanner.

## Instance attribute "Data" (attribute 3)

Instance	Byte	Bit 7	Bit 6	Bit 5	Bit 4	Bit 3	Bit 2	Bit 1	Bit 0
20 (0x14)	0						Fault Reset		Run Fwd
	1								
	2	Speed Reference (Low Byte)							
	3	Speed Reference (High Byte)							
21 (0x15)	0		Net Ref	NetCtrl			Fault Reset	Run Rev	Run Fwd
	1								
	2	Speed Reference (Low Byte)							
	3	Speed Reference (High Byte)							
22 (0x16)	0						Fault Reset		Run Fwd
	1								
	2	Speed Reference (Low Byte)							
	3	Speed Reference (High Byte)							
	4	Torque Reference (Low Byte)							
	5	Torque Reference (High Byte)							



Instance	Byte	Bit 7	Bit 6	Bit 5	Bit 4	Bit 3	Bit 2	Bit 1	Bit 0
23 (0x17)	0		Net Ref	NetCtrl			Fault Reset	Run Rev	Run Fwd
	1								
	2	Speed Reference (Low Byte)							
	3	Speed Reference (High Byte)							
	4	Torque Reference (Low Byte)							
	5	Torque Reference (High Byte)							
110 (0x6E)	0	Custom Output							
	...	...							
	31	Custom Output							
70 (0x46)	0						Running1 (Fwd)		Faulted
	1								
	2	Speed Actual (Low Byte)							
	3	Speed Actual (High Byte)							
71 (0x47)	0	At Reference	RefFrom Net	CtrlFrom Net	Ready	Running2 (Rev)	Running1 (Fwd)	Warning	Faulted
	1	Drive State							
	2	Speed Actual (Low Byte)							
	3	Speed Actual (High Byte)							
72 (0x48)	0						Running1 (Fwd)		Faulted
	1								
	2	Speed Actual (Low Byte)							
	3	Speed Actual (High Byte)							
	4	Torque Actual (Low Byte)							
	5	Torque Actual (High Byte)							
73 (0x49)	0	At Reference	RefFrom Net	CtrlFrom Net	Ready	Running2 (Rev)	Running1 (Fwd)	Warning	Faulted
	1	Drive State							
	2	Speed Actual (Low Byte)							
	3	Speed Actual (High Byte)							
	4	Torque Actual (Low Byte)							
	5	Torque Actual (High Byte)							
111 (0x6F)	0	Custom Input							
	...	...							
	31	Custom Input							



### Note!

In order to be able to use the torque control for the **assembly object instances 22 (0x16), 23 (0x17), 72 (0x48), 73 (0x49)**, the "DriveMode" attribute has to be written by means of explicit message transfer.

► [Write "DriveMode" attribute](#) (□ 154)

### Data mapping of the output assemblies

Data component [Bits 0 ... 7]	Class		Instance Number	Attribute	
	Name	Number		Name	Number
RunFwd [Bit 0]	Control Supervisor	0x29	1	Run1	3
RunRev [Bit 1]	Control Supervisor	0x29	1	Run2	4
FaultReset [Bit 2]	Control Supervisor	0x29	1	FaultRst	12
NetCtrl [Bit 5]	Control Supervisor	0x29	1	NetCtrl	5
NetRef [Bit 6]	AC Drive	0x2A	1	NetRef	4
Drive Mode [Bits 0 ... 7]	AC Drive	0x2A	1	DriveMode	6
Speed Reference [Bits 0 ... 7]	AC Drive	0x2A	1	SpeedRef	8
Torque Reference [Bits 0 ... 7]	AC Drive	0x2A	1	TorqueRef	12
Custom Output [Bits 0 ... 7]					



#### Note!

In case of the assembly object instances **21 (0x15)** and **23 (0x17)**, **NetCtrl (Bit 5)** and **NetRef (Bit 6)** have to be set in order that the drive can receive start/stop commands and speed/torque commands via the network.

### Data mapping of the input assemblies

Data component [Bits 0 ... 7]	Class		Instance Number	Attribute	
	Name	Number		Name	Number
Faulted [Bit 0]	Control Supervisor	0x29	1	Faulted	10
Warning [Bit 1]	Control Supervisor	0x29	1	Warning	11
Running1 (Fwd) [Bit 2]	Control Supervisor	0x29	1	Running1	7
Running2 (Rev) [Bit 3]	Control Supervisor	0x29	1	Running2	8
Ready [Bit 4]	Control Supervisor	0x29	1	Ready	9
CtrlFromNet [Bit 5]	Control Supervisor	0x29	1	CtrlFromNet	15
RefFromNet [Bit 6]	AC Drive	0x2A	1	RefFromNet	29
At Reference [Bit 7]	AC Drive	0x2A	1	AtReference	3
Drive State [Bits 0 ... 7]	Control Supervisor	0x29	1	State	6
Speed Actual [Bits 0 ... 7]	AC Drive	0x2A	1	SpeedActual	7
Torque Actual [Bits 0 ... 7]	AC Drive	0x2A	1	TorqueActual	11
Custom Input [Bits 0 ... 7]					

---

**Supported service codes**

Service code [hex]	Name	Description
0x0E	Get_Attribute_Single	Outputs the value of a certain attribute.
0x10	Set_Attribute_Single	Changes the value of a certain attribute.

#### 14.1.4 Connection Manager Object (6 / 0x06)

The "Connection Manager Object" manages the internal resources for the I/O data transfer (implicit messaging) and the parameter data transfer (explicit messaging). The instance specified by the "connection manager" class refers to a "connection instance" or a "connection object".

##### Class attributes

Attribute ID	Service	Name	Data type	Value
1	Get	Revision	UINT	1 (0x0001)
2	Get	Max. Instance	UINT	1 (0x0001)
3	Get	Number of Instances	UINT	1 (0x0001)
4	Get	Optional Attribute List:	STRUCT of:	
		Number Attributes	UINT	8 (0x0008)
		Optional Attributes	ARRAY of UINT	1 ... 8 0x0001.0002.0003.0004.0005.0006.0007. 0008
6	Get	Max. ID Number Class Attributes	UINT	7 (0x0007)
7	Get	Max. ID Number Instance Attributes	UINT	8 (0x0008)

##### Instance attributes

Attribute ID	Service	Name	Data type	Value
1	Set <sup>1)</sup>	Open Requests	UINT	Number of "Forward Open Service Requests" received
2	Set <sup>1)</sup>	Open Format Rejects	UINT	Number of "Forward Open Service Requests" rejected due to faulty format.
3	Set <sup>1)</sup>	Open Resource Rejects	UINT	Number of "Forward Open Service Requests" rejected due to a lack of resources.
4	Set <sup>1)</sup>	Open Other Rejects	UINT	Number of "Forward Open Service Requests" rejected due to other reasons than faulty format or lack of resources.
5	Set <sup>1)</sup>	Close Requests	UINT	Number of "Forward Close Service Requests" received
6	Set <sup>1)</sup>	Close Format Requests	UINT	Number of "Forward Close Service Requests" rejected due to faulty format.
7	Set <sup>1)</sup>	Close Other Requests	UINT	Number of "Forward Close Service Requests" rejected due to other reasons than faulty format.
8	Set <sup>1)</sup>	Connection Timeouts	UINT	Total number of "Connection Timeouts" that have occurred within the connections monitored by this object.

- 1) A device can reject a "Request" of the attribute with the general status code "0x09" (invalid attribute value) if the attribute value sent is unequal to zero.

## Instance error messages

Error code [hex]	Extended code [hex]	Error designation	Description
0x000	-	SUCCESS	No error
0x001	0x106	OWNERSHIP_CONFLICT	The connection could not be established because another connection has already occupied the required resources. It is only possible to establish an "exclusive owner" connection to the adapter.
0x001	0x119	NON-LISTEN ONLY CONNECTION NOT OPENED	The connection could not be established because there is no "non-listen only" connection (input only, exclusive owner). The "non-listen only" connection must be of the "multicast" connection type.
0x001	0x127	INVALID_ORIGINATOR_TO_TARGET_SIZE	The resulting length of the ports mapped in the receive object PDO_RX0 does not correspond to the number of data bytes of the assembly object instance 110 (0x6E, Custom Output) defined in the scanner.
0x001	0x128	INVALID_TARGET_TO_ORIGINATOR_SIZE	The resulting length of the ports mapped in the transmit object PDO_TX0 does not correspond to the number of data bytes of the assembly object instance 111 (0x6F, Custom Input) defined in the scanner.
0x001	0x204	UNCONNECTED_REQUEST_TIMED_OUT	The adapter does not respond to the establishment of the connection. <ul style="list-style-type: none"> <li>• There might be no physical connection.</li> <li>• The adapter is switched off.</li> <li>• The adapter has an invalid IP configuration.</li> </ul>
0x001	0x320	ACCESS_CONTENTION	Manufacturer-specific error: <ul style="list-style-type: none"> <li>• The configurations of the assembly input and output objects are mixed up.</li> <li>• The connection could not be established because another connection has already occupied the required resources. It is only possible to establish an "exclusive owner" connection to the adapter.</li> </ul>
0x001	0x111	ROUTER_EXT_ERR_RPI_NOT_SUPPORTED	The RPI set for a connection is not supported. <ul style="list-style-type: none"> <li>• Min. class 1 RPI = 4 ms</li> <li>• Min. class-3-RPI = 10 ms</li> </ul>
0x001	0x112	RROUTER_EXT_ERR_RPI_VALUE_NOT_ACCEPTABLE	The RPI set for a connection is not supported. <ul style="list-style-type: none"> <li>• Min. class 1 RPI = 4 ms</li> <li>• Min. class-3-RPI = 10 ms</li> </ul>
0x001	0x123	ROUTER_EXT_ERR_INVALID_TO_CONNECTION_TYPE	The output image connection type is invalid or not supported.
0x001	0x124	ROUTER_EXT_ERR_INVALID_TO_CONNECTION_TYPE	The input image connection type is invalid or not supported.
0x001	0x12A	ROUTER_EXT_ERR_INVALID_CONSUMING_PATH	The path specification for the output data from the scanner is invalid.
0x001	0x12B	ROUTER_EXT_ERR_INVALID_PRODUCING_PATH	The path specification for the input data to the scanner is invalid.

## Supported service codes

Service code [hex]	Name	Description
0x54	Forward_Open	Opens a CIP connection from the PLC to the target drive.
0x4E	Forward_Close	Closes a CIP connection from the PLC to the target drive.
0x0E	Get_Attribute_Single	Outputs the value of a certain attribute.

## 14.2 EtherNet/IP objects

### 14.2.1 Device Level Ring (DLR) Object (71 / 0x47)

The "Device Level Ring (DLR) Object" provides status information for the DLR protocol. The DLR protocol is a "layer 2" protocol enabling the use of an Ethernet ring topology.



#### Note!

Only the "beacon-based ring node" mode is supported.

#### Class attributes

Attribute ID	Service	Name	Data type	Value
1	Get	Revision	UINT	2 (0x0002)
2	Get	Max. Instance	UINT	1 (0x0001)
3	Get	Number of Instances	UINT	1 (0x0001)
6	Get	Max. ID Number Class Attributes	UINT	7 (0x0007)
7	Get	Max. ID Number Instance Attributes	UINT	2 (0x0002)

#### Instance attributes

Attribute ID	Service	Name	Data type	Value
1	Get	Network Topology	USINT	Current network topology <ul style="list-style-type: none"> <li>• 0: Line topology</li> <li>• 1: Ring topology</li> </ul> (Display via <a href="#">C13840</a> )
2	Get	Network Status	USINT	Current network status <ul style="list-style-type: none"> <li>• 0: Normal</li> <li>• 1: Ring Fault (only for ring topology)</li> <li>• 2: Unexpected Loop Detected (only for line topology)</li> </ul> (Display via <a href="#">C13841</a> )
10	Get	Active Supervisor Address	STRUCT of:	IP and MAC address of the active ring supervisor
		Supervisor IP Address	UDINT	Ethernet MAC address The value '0' indicates that no IP address has been configured for the device. (Display via <a href="#">C13842</a> )
		Supervisor MAC Address	ARRAY of USINT[6]	Ethernet MAC address (Display via <a href="#">C13843</a> )
12	Get	Capability Flags	DWORD	Telegram processing method for the ring node implementation <ul style="list-style-type: none"> <li>• 2: Beacon-based ring node</li> </ul> ▶ <a href="#">Instance attribute "Capability Flags" (attribute 12)</a> (□ 138)

**Instance attribute "Capability Flags" (attribute 12)**

Bits	Name	Description
0	Announce-based Ring Node	Is not supported (state '0').
1	Beacon-based Ring Node	The state '1' is set if the ring node implementation is based on the processing of "beacon frames". See also: <ul style="list-style-type: none"> <li>• <a href="#">C13844</a> (Beacon Times)</li> <li>• <a href="#">C13845</a> (Beacon Frames)</li> </ul>
2 ... 31	-	Reserved (0)

**Supported service codes**

Service code [hex]	Name	Description
0x01	Get_Attributes_All	Outputs a list of the attributes and the attribute's values for a certain object.
0x0E	Get_Attribute_Single	Outputs the value of a certain attribute.
0x10	Set_Attribute_Single	Changes the value of a certain attribute.
0x18	Get_Member	Outputs the members of a certain attribute.

### 14.2.2 Quality of Service (QoS) Object (72 / 0x48)

The "Quality of Service (QoS) Object" enables different classifications and prioritisations of the data packets for EtherNet/IP communication. For this purpose, the EtherNet/IP messages are marked with "802.1Q tags" and "Differentiated Services Codepoints" (DSCP).

#### Class attributes

Attribute ID	Service	Name	Data type	Value
1	Get	Revision	UINT	1 (0x0001)
2	Get	Max. Instance	UINT	1 (0x0001)
3	Get	Number of Instances	UINT	1 (0x0001)
6	Get	Max. ID Number Class Attributes	UINT	7 (0x0007)
7	Get	Max. ID Number Instance Attributes	UINT	8 (0x0008)

#### Instance attributes

The instance attributes act independently of each other.

The DSCP values are used for the IP headers.

Irrespective of this, VLAN tagging can be activated in addition ([C13021](#) = 1).

The VLAN ID of Lenze devices is '0'.

The VLAN priority results from the DSCP values configured.

Changes in the attribute values will only take effect after a reset of the device ("power off/on" or "type 0 reset").



#### Note!

Before activating VLAN tagging, please ensure that all involved components support VLAN tagging. It may occur that the devices not supporting VLAN tagging cannot be accessed anymore.

Attribute ID	Service	Name	Data type	Value
1	Set	802.1Q Tag Enable	USINT	Enables the sending of data packets with 802.1Q tags ( <a href="#">C13021</a> ) <ul style="list-style-type: none"> <li>• 0: No use of 802.1Q tags (Lenze setting)</li> <li>• 1: Use of 802.1Q tags</li> </ul>
4	Set	DSCP Urgent	USINT	55: Urgent/imperative messages <b>Is not supported at the moment.</b>
5	Set	DSCP Scheduled	USINT	47: Scheduled messages (Can only be used for "exclusive owner" connections.) ( <a href="#">C13022/4</a> )
6	Set	DSCP High	USINT	43: Messages with high priority (Can only be used for "input only" and "listen only" connections.) ( <a href="#">C13022/5</a> )



---

Attribute ID	Service	Name	Data type	Value
7	Set	DSCP Low	USINT	31: Messages with low priority <b>Is not supported at the moment.</b>
8	Set	DSCP Explicit	USINT	27: "Explicit messages" (parameter data) <a href="#">(C13022/7)</a>

#### Supported service codes

Service code [hex]	Name	Description
0x0E	Get_Attribute_Single	Outputs the value of a certain attribute.
0x10	Set_Attribute_Single	Changes the value of a certain attribute.

### 14.2.3 TCP/IP Interface Object (245 / 0xF5)

The "TCP/IP Interface Object" serves to configure the TCP/IP network interface of the device.

#### Class attributes

Attribute ID	Service	Name	Data type	Value
1	Get	Revision	UINT	2 (0x0002)
2	Get	Max. Instance	UINT	1 (0x0001)
3	Get	Number of Instances	UINT	1 (0x0001)
4	Get	Optional Attribute List:	STRUCT of:	
		Number Attributes	UINT	4 (0x0004)
		Optional Attributes	ARRAY of UINT	8 ... 11 (0x0008.0009.000A.000B)
6	Get	Max. ID Number Class Attributes	UINT	0x0007
7	Get	Max. ID Number Instance Attributes	UINT	0x000B

#### Instance attributes



#### Note!

Write access to attribute 3 (Configuration Control) permanently saves the TCP/IP configuration defined in attribute 5.

If the TCP/IP configuration defined in attribute 5 is to be used as a "static IP" during the start-up, "0 = use static TCP/IP configuration" must be set in attribute 3.

Attribute ID	Service	Name	Data type	Value
1	Get	Status	DWORD	Current status of the TCP/IP network interface ▶ <a href="#">Instance attribute "Status" (attribute 1)</a> (📖 143)
2	Get	Configuration Capability	DWORD	Possible options for TCP/IP configuration ▶ <a href="#">Instance attribute "Configuration Capability" (attribute 2)</a> (📖 143)
3	Get / Set	Configuration Control	DWORD	Selection of how the TCP/IP configuration is to be made ( <a href="#">C13005</a> ): Possible values for bits 0 ... 3: <ul style="list-style-type: none"> <li>• 0000: Use static TCP/IP config.</li> <li>• 0001: TCP/IP config. via BOOTP</li> <li>• 0010: TCP/IP config. via DHCP</li> </ul> Bits 4 ... 31 are reserved (0).
4	Get	Physical Link Object:	STRUCT of:	Path to "Physical Link Object"
		Path Size	UINT	2 (0x0002)
		Path	padded EPATH	<ul style="list-style-type: none"> <li>• 32 (0x0020)</li> <li>• 246 (0x00F6)</li> <li>• 36 (0x0024)</li> <li>• 1 (0x0001)</li> </ul>

Attribute ID	Service	Name	Data type	Value
5	Get	Interface Configuration:	STRUCT of:	Current TCP/IP configuration
		IP Address	UDINT	<a href="#">C13010</a> (active IP address)
		Network Mask	UDINT	<a href="#">C13011</a> (active subnet mask)
		Gateway Address	UDINT	<a href="#">C13012</a> (active gateway address)
		Name Server	UDINT	
		Name Server 2	UDINT	
		Domain Name 1	STRING	
6	Get / Set	Host Name	STRING	Host name of the device ( <a href="#">C13899</a> , max. 64 ASCII characters)
8	Get / Set	TTL Value	USINT	TTL value ( <a href="#">C13019</a> ) for EtherNet/IP multicast data packets (value range: 1 ... 255)
9	Get / Set	Mcast Config:	STRUCT of:	Configuration of the multicast IP addressing
		Alloc Control	USINT	Control word ( <a href="#">C13018</a> ) for addressing: <ul style="list-style-type: none"> <li>• 0: The multicast IP addresses are generated with the standard assignment algorithm.</li> <li>• 1: The multicast IP addresses are assigned via the values in "Num Mcast" and "Mcast Start Addr" (<a href="#">C13006</a>)</li> <li>• 2: Reserved</li> </ul>
		Reserved	USINT	0 (0x0000)
		Num Mcast	UINT	Total number of multicast IP addresses assigned ( <a href="#">C13020</a> )
		Mcast Start Addr	UDINT	Active multicast IP start address ( <a href="#">C13016</a> )
10	Set	SelectAcd	BOOL	Activation of address conflict detection (ACD, <a href="#">C13846</a> ) <ul style="list-style-type: none"> <li>• 0: Disable ACD</li> <li>• 1: Enable ACD</li> </ul> Changing this value requires a reset of the device ("power off/on" or "type 0 reset").
11	Get / Set	LastConflictDetected:	STRUCT of:	ACD diagnostics information about the last occurred address conflict
		AcdActivity	USINT	Status of the ACD algorithm when the last address conflict occurred: <ul style="list-style-type: none"> <li>• 0: NoConflictDetected (default)</li> <li>• 1: Probelpv4Address</li> <li>• 2: OngoingDetection</li> <li>• 3: SemiActiveProbe</li> </ul>
		RemoteMAC	ARRAY of USINT[6]	MAC address of the device with the last address conflict
		ArpPdu	ARRAY of USINT[28]	Reproduction of the ARP message with information about the address conflict <ul style="list-style-type: none"> <li>▶ <a href="#">Structure of the ARP message (attribute 11, "ArpPdu")</a> (□ 144)</li> </ul>

**Instance attribute "Status" (attribute 1)**

Bits	Name	Description
0 ... 3	Interface Configuration Status	<ul style="list-style-type: none"> <li>• 0000: No TCP/IP configuration available (attribute 5)</li> <li>• 0001: Valid TCP/IP configuration (attribute 5) via BOOTP, DHCP or static/permanent storage</li> <li>• 0010 ... 1111: Reserved</li> </ul>
4	Mcast Pending	This bit indicates a pending change of the multicast configuration in attribute 9 (Mcast Config) and/or the TTL value ( <a href="#">C13019</a> ). It is set to '1' if either a multicast attribute or the TTL value is set. The pending change will only take effect after a reset of the device ("power off/on" or "type 0 reset"). This bit is then reset to '0'.
5	Interface Configuration Pending	This bit indicates a pending change of the TCP/IP configuration in attribute 5 (Interface Configuration). It is set to '1' if an attribute is set. The pending change will only take effect after a reset of the device ("power off/on" or "type 0 reset").
6	AcdStatus	Display of the status of address conflict detection (ACD, <a href="#">C13847</a> ): <ul style="list-style-type: none"> <li>• 0: No address conflict detected</li> <li>• 1: Address conflict detected</li> </ul>
7 ... 31	-	Reserved (0)

**Instance attribute "Configuration Capability" (attribute 2)**

Bits	Name	Description
0	BOOTP Client	The state '1' indicates that BOOTP is used for the TCP/IP configuration of the device.
1	DNS Client	Is not supported (state '0').
2	DHCP Client	The state '1' indicates that DHCP is used for the TCP/IP configuration of the device.
3	DHCP-DNS Update	Is not supported (state '0').
4	Configuration Settable	The state '1' indicates that the TCP/IP configuration can be set in attribute 5 (Interface Configuration).
5	Hardware Configurable	Is not supported (state '0').
6	Interface Configuration Change Requires Reset	The state '1' indicates that changes of the TCP/IP configuration in attribute 5 (Interface Configuration) will only take effect after a reset of the device ("power off/on" or "type 0 reset"). The state '0' is not supported (changes becoming effective immediately).
7	AcdCapable	The state '1' indicates that the device is provided with address conflict detection (ACD).
8 ... 31	-	Reserved (0)

**Structure of the ARP message (attribute 11, "ArpPdu")**

Field size [Bytes]	Field name	Value
2	Hardware Address Type	1: Ethernet H/W
2	Protocol Address Type	0x0800: IP
1	HADDR LEN	6: Ethernet H/W
1	PADDR LEN	4: IP
2	OPERATION	1: Request 2: Response
6	SENDER HADDR	H/W address of the sender
4	SENDER PADDR	Protocol address of the sender
6	TARGET HADDR	H/W address of the target
4	TARGET PADDR	Protocol address of the target

**Supported service codes**

Service code [hex]	Name	Description
0x01	Get_Attributes_All	Outputs a list of the attributes and the attribute's values for a certain object.
0x0E	Get_Attribute_Single	Outputs the value of a certain attribute.
0x10	Set_Attribute_Single	Changes the value of a certain attribute.

### 14.2.4 Ethernet Link Object (246 / 0xF6)

The "Ethernet Link Object" provides general information and status information about the Ethernet interfaces (IEEE 802.3).



#### Note!

Write accesses to writable attributes become effective immediately.

#### Class attributes

Attribute ID	Service	Name	Data type	Value
1	Get	Revision	UINT	3 (0x0003)
2	Get	Max. Instance	UINT	2 (0x0002)
3	Get	Number of Instances	UINT	2 (0x0002)
4	Get	Optional Attribute List:	STRUCT of:	
		Number Attributes	UINT	4 (0x0004)
		Optional Attributes	ARRAY of UINT	7 ... 10 (0x0007.0008.0009.000A)
6	Get	Max. ID Number Class Attributes	UINT	0x0007
7	Get	Max. ID Number Instance Attributes	UINT	0x000A

#### Instance attributes

Attribute ID	Service	Name	Data type	Value
1	Get	Interface Speed	UDINT	Current baud rate <ul style="list-style-type: none"> <li>• 10 Mbps</li> <li>• 100 Mbps</li> </ul>
2	Get	Interface Flags	DWORD	Status bits of the Ethernet interface <a href="#">▶ Instance attribute "Interface Flags" (attribute 2)</a> (📖 146)
3	Get	Physical Address	ARRAY of USINT[6]	MAC address of the Ethernet interface
6	Set	Interface Control	STRUCT of:	
		Control Bits	WORD	Control bits for the Ethernet interface <a href="#">▶ Instance attribute "Control Bits" (attribute 6, Interface Control)</a> (📖 147)
		Forced Interface Speed	UINT	Baud rate [in Mbps] at which the Ethernet interface is to be operated ( <a href="#">C13017</a> ). Example values: <ul style="list-style-type: none"> <li>• 10 = 10 Mbps</li> <li>• 100 = 100 Mbps</li> </ul>
7	Get	Interface Type	USINT	Interface type (transmission medium) <ul style="list-style-type: none"> <li>• 0: Unknown interface type</li> <li>• 1: Device-internal interface (e.g. embedded switch)</li> <li>• 2: Twisted pair (e.g. 100Base-TX), Lenze setting</li> <li>• 3: Optical fibre (e.g. 100Base-FX)</li> <li>• 4 ... 255: Reserved</li> </ul>

Attribute ID	Service	Name	Data type	Value
8	Get	Interface State	USINT	Current operating status of the Ethernet interface <ul style="list-style-type: none"> <li>• 0: Unknown status</li> <li>• 1: Enable (The interface can send and receive data.)</li> <li>• 2: Disable</li> <li>• 3: Testing</li> <li>• 4 ... 255: Reserved</li> </ul>
9	Set	Admin State	USINT	Administrative status <ul style="list-style-type: none"> <li>• 0: Reserved</li> <li>• 1: Enable</li> <li>• 2: Disable</li> <li>• 3 ... 255: Reserved</li> </ul>
10	Get	Interface Label	SHORT_STRING	Text for the identification/designation of the Ethernet interface

#### Instance attribute "Interface Flags" (attribute 2)

Bits	Name	Description
0	Link Status	This bit indicates whether the Ethernet interface is connected to an active network. <ul style="list-style-type: none"> <li>• 0: No Ethernet connection available</li> <li>• 1: Ethernet connection available</li> </ul>
1	Half/Full Duplex	This bit indicates the current transmission mode of the Ethernet interface. <ul style="list-style-type: none"> <li>• 0: Half duplex</li> <li>• 1: Full duplex</li> </ul> <b>Note:</b> If "Link Status" bit = 0, it is not possible to determine the value of the "Half/Full Duplex" bit.
2 ... 4	Negotiation Status	These bits indicate the status of "Link Auto-Negotiation". <ul style="list-style-type: none"> <li>• 000: "Link Auto-Negotiation" is being processed.</li> <li>• 001: "Link Auto-Negotiation" and speed detection have failed. <ul style="list-style-type: none"> <li>• Use the standard baud rate and transmission mode values.</li> <li>• The standard values depend on the product; recommended values are '10 Mbps' and 'Half Duplex'.</li> </ul> </li> <li>• 010: "Link Auto-Negotiation" has failed, but a baud rate has been detected. <ul style="list-style-type: none"> <li>• Use the recommended value ('Half Duplex') for the transmission mode .</li> </ul> </li> <li>• 011: "Link Auto-Negotiation" and speed detection have been successful.</li> <li>• 100: No "Link Auto-Negotiation" active.</li> </ul>
5	Manual Setting Requires Reset	Reset after changes in the link parameters <ul style="list-style-type: none"> <li>• 0: The Ethernet interface can activate changes in the link parameters (auto-negotiation, transmission mode, baud rate) automatically.</li> <li>• 1: If the link parameters (auto-negotiation, transmission mode, baud rate) are changed, the device must be reset ("power off/on" or "type 0 reset").</li> </ul>
6	Local Hardware Fault	Hardware fault detection <ul style="list-style-type: none"> <li>• 0: No hardware fault has been detected on the Ethernet interface.</li> <li>• 1: A hardware fault has been detected on the Ethernet interface.</li> </ul>
7 ... 31	-	Reserved (0)

**Instance attribute "Control Bits" (attribute 6, Interface Control)**

Bits	Name	Description
0	Auto-negotiate	Activation of "Link Auto-Negotiation" <ul style="list-style-type: none"> <li>• 0: "Link Auto-Negotiation" is not active. The device uses the settings of the bits "Forced Duplex Mode" (bit 1) and "Forced Interface Speed" (see attribute 6, Interface Control).</li> <li>• 1: "Link Auto-Negotiation" is active.</li> </ul>
1	Forced Duplex Mode	If "Auto-negotiate" bit = 0, this bit indicates the transmission mode to be used. <ul style="list-style-type: none"> <li>• 0: Half duplex</li> <li>• 1: Full duplex</li> </ul>
2 ... 15	-	Reserved (0)

**Supported service codes**

Service code [hex]	Name	Description
0x01	Get_Attributes_All	Outputs a list of the attributes and the attribute's values for a certain object.
0x0E	Get_Attribute_Single	Outputs the value of a certain attribute.
0x10	Set_Attribute_Single	Changes the value of a certain attribute.



### 14.3 "AC Drive Profile" objects

From inverter drive version V13.00 and communication module version V01.02, the EtherNet/IP specified "AC Drive Profile" is supported.

The standard device code **C00005** = "**1100: AC Drive Profile**" serves to select the "AC Drive Profile" application.

The "AC Drive Profile" contains ...

- the data basis for motor parameters,
- management functions of the motor control devices,
- Device-specific functions of the drive, e.g. speed ramps, torque control etc.

For using the "AC Drive Profile", the following assembly object instances in the host (scanner) have to be used:

Instance ID		Assembly object instance	
[dec]	[hex]		
20	0x14	Basic Speed Control Output	Outputs: From the scanner to the adapter
21	0x15	Extended Speed Control Output	
22	0x16	Speed and Torque Control Output	
23	0x17	Extended Speed and Torque Control Output	
70	0x46	Basic Speed Control Input	Inputs: From the adapter to the scanner
71	0x47	Extended Speed Control Input	
72	0x48	Speed and Torque Control Input	
73	0x49	Extended Speed and Torque Control Input	

See also [Assembly Object \(4 / 0x04\)](#) (📖 129)



**Software manual / »Engineer« online help for the Inverter Drive 8400**

Here you can find detailed information on how to use the "AC Drive Profile".

### 14.3.1 Motor Data Object (40 / 0x28)

The "Motor Data Object" provides a data basis for motor parameters.

#### Class attributes

Attribute ID	Service	Name	Data type	Value
1	Get	Revision	UINT	1 (0x0001)
2	Get	Max. Instance	UINT	1 (0x0001)
3	Get	Number of Instances	UINT	1 (0x0001)

#### Instance attributes

Attribute ID	Service	Name	Data type	Value
1	Get	NumAttr	USINT	Number of supported attributes
2	Get	Attributes	ARRAY of USINT	Listing of the supported attributes
3	Get / Set	MotorType	USINT	AC motor type <ul style="list-style-type: none"> <li>• 6: Wound-rotor induction motor</li> <li>• 7: Squirrel-cage induction motor</li> </ul>

#### Instance attributes for AC motor types

Attribute ID	Service	Name	Data type	Value
6	Get / Set	RatedCurrent	UINT	Rated stator current [100mA]
7	Get / Set	RatedVoltage	UINT	Rated base voltage [V]

For a write access to the attributes *RatedCurrent* and *RatedVoltage*, the controller enable (RFR = 0) has to be deactivated.

#### Supported service codes

Service code [hex]	Name	Description
0x01	Get_Attributes_All	Outputs a list of the attributes and the attribute's values for a certain object.
0x0E	Get_Attribute_Single	Outputs the value of a certain attribute.
0x10	Set_Attribute_Single	Changes the value of a certain attribute.

### 14.3.2 Control Supervisor Object (41 / 0x29)

The "Control Supervisor Object" describes all management functions of the devices used to control the motor.

#### Class attributes

Attribute ID	Service	Name	Data type	Value
1	Get	Revision	UINT	1 (0x0001)
2	Get	Max. Instance	UINT	1 (0x0001)
3	Get	Number of Instances	UINT	1 (0x0001)

#### Instance attributes

Attribute ID	Service	Name	Data type	Value
1	Get	NumAttr	USINT	Number of supported attributes
2	Get	Attributes	ARRAY of USINT	Listing of the supported attributes
3	Set	Run1	BOOL	Run/stop can be controlled via a local setting on the device or terminal, or via the network (see attribute "NetCtrl"). The relationship between Run1, Run2 and the trigger events is described in the <a href="#">Run/stop event (151)</a> section.
4	Set	Run2	BOOL	
5	Set	NetCtrl	BOOL	Run/Stop control <ul style="list-style-type: none"> <li>• 0: Run/stop control via local setting on the device or terminal</li> <li>• 1: Run/stop control via network (e.g. from the scanner)</li> </ul>
6	Get	State	USINT	<ul style="list-style-type: none"> <li>• 0: Manufacturer-specific</li> <li>• 1: Startup</li> <li>• 2: Not_Ready</li> <li>• 3: Ready</li> <li>• 4: Enabled</li> <li>• 5: Stopping</li> <li>• 6: Fault_Stop</li> <li>• 7: Faulted</li> </ul>
7	Get	Running1	BOOL	<ul style="list-style-type: none"> <li>• 0: Other status than listed under '1'</li> <li>• 1: [Enabled and Run1] or [Stopping and Running1] or [Fault_Stop and Running1]</li> </ul>
8	Get	Running2	BOOL	<ul style="list-style-type: none"> <li>• 0: Other status than listed under '1'</li> <li>• 1: [Enabled and Run2] or [Stopping and Running2] or [Fault_Stop and Running2]</li> </ul>
9	Get	Ready	BOOL	<ul style="list-style-type: none"> <li>• 0: Other status than listed under '1'</li> <li>• 1: Ready or Enabled or Stopping</li> </ul>
10	Get	Faulted	BOOL	<ul style="list-style-type: none"> <li>• 0: No errors</li> <li>• 1: Errors have occurred</li> </ul>
11	Get	Warning	BOOL	<ul style="list-style-type: none"> <li>• 0: No warnings</li> <li>• 1: Warnings have occurred</li> </ul>
12	Set	FaultRst	BOOL	<ul style="list-style-type: none"> <li>• 0 → 1: Reset error</li> <li>• 0: No Response</li> </ul>

Attribute ID	Service	Name	Data type	Value
13	Get	FaultCode	UINT	DRIVECOM error code of the error causing the Faulted status. <a href="#">▶ Mapping of Lenze device errors to DRIVECOM errors (102)</a>
15	Get	CtrlFromNet	BOOL	Status of run/stop control <ul style="list-style-type: none"> <li>• 0: Run/stop control via local setting on the device or terminal</li> <li>• 1: Run/stop control via network (e.g. from the scanner)</li> </ul>

### Run/stop event

Relationships between Run1 and Run2:

Run1 / Run2	Starter					Drive
	Contactora	Starter	Reverser	Speed	Soft start	
Run1	Close	Run	RunFwd	RunLow	RunRamp1	RunFwd
Run2	No Action	No Action	RunRev	RunHigh	RunRamp2	RunRev

Run1 and Run2 trigger:

Run1	Run2	Trigger event	Run type
0	0	Stop	No Action
0 → 1	0	Run	Run1
0	0 → 1	Run	Run2
0 → 1	0 → 1	No Action	No Action
1	1	No Action	No Action
1 → 0	1	Run	Run2
1	1 → 0	Run	Run1

### Supported service codes

Service code [hex]	Name	Description
0x01	Get_Attributes_All	Outputs a list of the attributes and the attribute's values for a certain object.
0x0E	Get_Attribute_Single	Outputs the value of a certain attribute.
0x10	Set_Attribute_Single	Changes the value of a certain attribute.

### 14.3.3 AC Drive Object (42 / 0x2A)

The "AC Drive Object" describes the device-specific functions of the drive, e.g. speed ramps, torque control etc.

#### Class attributes

Attribute ID	Service	Name	Data type	Value
1	Get	Revision	UINT	1 (0x0001)
2	Get	Max. Instance	UINT	1 (0x0001)
3	Get	Number of Instances	UINT	1 (0x0001)

#### Instance attributes

Attribute ID	Service	Name	Data type	Value
1	Get	NumAttr	USINT	Number of supported attributes
2	Get	Attributes	ARRAY of USINT	Listing of the supported attributes
3	Get	AtReference	BOOL	1: The drive currently runs at reference speed or reference torque (depending on attribute 6, DriveMode).
4	Get / Set	NetRef	BOOL	<ul style="list-style-type: none"> <li>• 0: Reference via local setting on the device or terminal</li> <li>• 1: Reference via network (e.g. from the scanner)</li> </ul>
6	Get / Set	DriveMode	USINT	Drive mode: <ul style="list-style-type: none"> <li>• 1: Idle speed (frequency)</li> <li>• 3: Torque control</li> </ul> In order to be able to use the torque control for the assembly object instances <b>22 (0x16)</b> , <b>23 (0x17)</b> , <b>72 (0x48)</b> , <b>73 (0x49)</b> , this attribute has to be written. <a href="#">▶ Write "DriveMode" attribute (154)</a>
7	Get	SpeedActual	INT	Current speed [rpm/2 <sup>SpeedScale</sup> ]
8	Get / Set	SpeedRef	INT	Reference speed [rpm/2 <sup>SpeedScale</sup> ]
11	Get	TorqueActual	INT	Current torque [Nm/2 <sup>TorqueScale</sup> ]
12	Get / Set	TorqueRef	INT	Reference torque [Nm/2 <sup>TorqueScale</sup> ]
22	Get / Set	SpeedScale	SINT	From inverter drive version V13.00 and communication module version V01.02! Speed scaling factor [Nm/2 <sup>SpeedScale</sup> ] Value range: -128 ... 127

Attribute ID	Service	Name	Data type	Value
24	Get / Set	TorqueScale	SINT	Torque scaling factor [Nm/2 <sup>TorqueScale</sup> ] Value range: -128 ... 127
29	Get / Set	RefFromNet	BOOL	Status of reference speed / reference torque <ul style="list-style-type: none"> <li>• 0: Reference via local setting on the device or terminal</li> <li>• 1: Reference via network (e.g. from the scanner)</li> </ul>

#### Supported service codes

Service code [hex]	Name	Description
0x01	Get_Attributes_All	Outputs a list of the attributes and the attribute's values for a certain object.
0x0E	Get_Attribute_Single	Outputs the value of a certain attribute.
0x10	Set_Attribute_Single	Changes the value of a certain attribute.

#### 14.3.4 Write "DriveMode" attribute

In order to be able to use the torque control for the **Assembly-Objektinstanzen 22 (0x16), 23 (0x17), 72 (0x48), 73 (0x49)**, the "DriveMode" attribute has to be written by means of explicit message transfer.

In order to write the "DriveMode" attribute by means of explicit message transmission, the following settings are required:

Settings	Value / description
1 Message Type	"CIP Generic"
2 Service Type	"Set Attribute Single" (service code "0x10")
3 Class	"2A" (AC Drive Object)
4 Instance	"1"
5 Attribute	"6" ("DriveMode" attribute )
6 Source Element	"Drive_Mode" (variable in the PLC program used as data source for writing.)
7 Source Length	"1 byte" (The variable data type is SINT.)

# 14 Implemented CIP™ objects

## 14.4 Lenze objects

---

### 14.4 Lenze objects

#### 14.4.1 Lenze Class (101 / 0x65)

The "Lenze Class (101 / 0x65)" enables the access to the adjustable error responses to EtherNet/IP errors which can be set in code [C13880](#).



#### Note

The attributes of this class are described in the EDS file. Using the »RSNetWorx« Rockwell software, the attributes can thus be directly set under "Parameters" in the properties dialog of the EtherNet/IP node.

#### Class attributes

Attribute ID	Service	Name	Data type	Value
1	Get	Revision	UINT	2 (0x0002)
2	Get	Max. Instance	UINT	1 (0x0001)

#### Instance attributes

Attribute ID	Service	Name	Data type	Value
1	Get	No. of supported Attributes	USINT	6 (0x0006)
2	Get	Attribute List	USINT	1 (0x0001) ... 6 (0x0006)
3	Get / Set	Reaction on Idle Mode	USINT	Corresponds to the value in <a href="#">C13880/1</a> : <ul style="list-style-type: none"><li>• 0 = no response</li><li>• 1 = error</li><li>• 4 = warning locked</li></ul>
4	Get / Set	Reaction on Fault Mode	USINT	Corresponds to the value in <a href="#">C13880/2</a> : <ul style="list-style-type: none"><li>• 0 = no response</li><li>• 1 = error</li><li>• 4 = warning locked</li></ul>
5	Get / Set	Reaction on Expl. Msg. TO	USINT	Corresponds to the value in <a href="#">C13880/3</a> : <ul style="list-style-type: none"><li>• 0 = no response</li><li>• 1 = error</li><li>• 4 = warning locked</li></ul>
6	Get / Set	Reaction on I/O Timeout	USINT	Corresponds to the value in <a href="#">C13880/4</a> : <ul style="list-style-type: none"><li>• 0 = no response</li><li>• 1 = error</li><li>• 4 = warning locked</li></ul>



---

**Supported service codes**

Service code [hex]	Name	Description
0x01	Get_Attributes_All	Outputs a list of the attributes and the attribute's values for a certain object.
0x0E	Get_Attribute_Single	Outputs the value of a certain attribute.
0x10	Set_Attribute_Single	Changes the value of a certain attribute.

### 14.4.2 Lenze Class (103 / 0x67)

The "Lenze Class (103 / 0x67)" provides the image of the scanner input data.

The input data for the scanner are provided at the **MCI\_OUT** interface of the communication module and are sent to the scanner by means of the assembly object instance **111 (0xE6)**.

#### Class attributes

Attribute ID	Service	Name	Data type	Value
1	Get	Revision	UINT	2 (0x0002)
2	Get	Max. Instance	UINT	1 (0x0001)

#### Instance attributes

Attribute ID	Service	Name	Data type	Value
1	Get	No. of supported Attributes	USINT	3 (0x0003)
2	Get	Attribute List	USINT	1 (0x0001) ... 3 (0x0003)
3	Get	I/O image of produced data	USINT	Image of the scanner input data

#### Supported service codes

Service code [hex]	Name	Description
0x01	Get_Attributes_All	Outputs a list of the attributes and the attribute's values for a certain object.
0x0E	Get_Attribute_Single	Outputs the value of a certain attribute.

### 14.4.3 Lenze Class (104 / 0x68)

The "Lenze Class (104 / 0x68)" provides the image of the scanner output data.

The output data of the scanner are sent by means of the assembly object instance **110 (0xE5, Custom Output)** and are provided at the **MCI\_IN** interface of the communication module.

#### Class attributes

Attribute ID	Service	Name	Data type	Value
1	Get	Revision	UINT	2 (0x0002)
2	Get	Max. Instance	UINT	1 (0x0001)

#### Instance attributes

Attribute ID	Service	Name	Data type	Value
1	Get	No. of supported Attributes	USINT	3 (0x0003)
2	Get	Attribute List	USINT	1 (0x0001) ... 3 (0x0003)
3	Get	I/O image of consumed data	USINT	Image of the scanner output data

#### Supported service codes

Service code [hex]	Name	Description
0x01	Get_Attributes_All	Outputs a list of the attributes and the attribute's values for a certain object.
0x0E	Get_Attribute_Single	Outputs the value of a certain attribute.

#### 14.4.4 Lenze Class (110 / 0x6E)

The "Lenze Class (110 / 0x6E)" enables read or write access to Lenze codes.

The Lenze code must be specified as an "instance" (corresponding code no. 1 ... 65535) and its subcodes must be specified as "attributes".



#### Note!

- If the corresponding Lenze code does not have a subcode, the value '0' must be entered in the attribute. If '0' is not supported as attribute value by the engineering tool used, the value '1' must be entered.
- A display code cannot be configured using "Set\_Attribute\_Single".

#### Class attributes

Attribute ID	Service	Name	Data type	Value
1	Get	Revision	UINT	2 (0x0002)
2	Get	Max. Instance	UINT	1 (0x0001)

#### Instance attributes

Attribute ID	Service	Name	Data type	Value
0 ... 255	Get / Set	Lenze Subcode number	Data type of the subcode	Value of the subcode

#### Supported service codes

Service code	Name	Description
0x0E	Get_Attribute_Single	Outputs the value of a certain attribute.
0x10	Set_Attribute_Single	Changes the value of a certain attribute.

# Index

---

## A

AC Drive Object (42 / 0x2A) [152](#)  
AC drive profile objects [148](#)  
AC Drive Profile technology application [59](#)  
Activating changed setting [51](#)  
Active Conflict Detection State (C13847) [113](#)  
Active gateway address (C13012) [109](#)  
Active IP address (C13010) [108](#)  
Active Multicast IP Address (C13016) [109](#)  
Active subnetwork mask (C13011) [108](#)  
Address Conflict Detection (C13846) [113](#)  
All words from scanner (C13851) [115](#)  
All words to scanner (C13850) [114](#)  
All words to the basic device (C13852) [115](#)  
All words to the basic device (C13853) [115](#)  
Application as directed [13](#)  
Application notes [10](#)  
Approvals [16](#)  
ARP message [144](#)  
Assemblies [60](#)  
Assembly input objects (adapter to scanner) [61](#)  
Assembly Object (4 / 0x04) [129](#)  
Assembly output objects (scanner to adapter) [61](#)

## B

Baud rate [16](#)  
Beacon Frames (C13845) [113](#)  
Beacon Times (C13844) [113](#)  
Before initial switch-on [35](#)  
BOOTP server [47](#)

## C

C13000 | IP Address [106](#)  
C13001 | Subnetwork mask [106](#)  
C13002 | Gateway Address [107](#)  
C13003 | MAC ID [107](#)  
C13005 | IP Config Control [107](#)  
C13006 | Multicast IP Start Address [108](#)  
C13010 | Active IP address [108](#)  
C13011 | Active Subnetwork Mask [108](#)  
C13012 | Active gateway address [109](#)  
C13016 | Active Multicast IP Address [109](#)  
C13017 | Ethernet Config Control [110](#)  
C13018 | Multicast Config Alloc Control [110](#)  
C13019 | Multicast Config TTL Value [110](#)  
C13020 | Multicast Config Num Mcast [111](#)  
C13021 | Quality of Service (VLAN-Tagging) [111](#)  
C13022 | Quality of Service (DSCP) [111](#)  
C13840 | DLR Network Topology [112](#)  
C13841 | DLR Network Status [112](#)  
C13842 | Supervisor IP Address [112](#)  
C13843 | Supervisor MAC ID [112](#)  
C13844 | Beacon Times [113](#)

C13845 | Beacon Frames [113](#)  
C13846 | Address Conflict Detection [113](#)  
C13847 | Active Conflict Detection State [113](#)  
C13848 | Last Conflicted MAC ID [114](#)  
C13849 | Last Conflicted IP Address [114](#)  
C13850 | All words to scanner [114](#)  
C13851 | All words from scanner [115](#)  
C13852 | All words to the basic device [115](#)  
C13853 | All words to the basic device [115](#)  
C13858 | Ethernet Port Statistics [116](#)  
C13861 | CIP Module Status [116](#)  
C13862 | CIP Network Status [117](#)  
C13863 | Ethernet Port [117](#)  
C13870 | CIP Connections State [117](#)  
C13871 | CIP Connections Type [118](#)  
C13872 | CIP Connection Triggers [118](#)  
C13873 | CIP Connections RPI [118](#)  
C13874 | CIP Connections Timeout Time [119](#)  
C13875 | CIP Connections RUN/IDLE Flag [119](#)  
C13880 | Monitoring Reaction [119](#)  
C13881 | Overall Ethernet Timeout Time [120](#)  
C13885 | Clear I/O Data [120](#)  
C13899 | Hostname [120](#)  
C13900 | Firmware product type [120](#)  
C13901 | Firmware compilation date [120](#)  
C13902 | Firmware version [121](#)  
C13920 | Rotary coding switch: xxx.yyy.zzz.DDD [121](#)  
Cable length [16](#)  
CIP Connection Triggers (C13872) [118](#)  
CIP Connections RPI (C13873) [118](#)  
CIP Connections RUN/IDLE Flag (C13875) [119](#)  
CIP Connections State (C13870) [117](#)  
CIP Connections Timeout Time (C13874) [119](#)  
CIP Connections Type (C13871) [118](#)  
CIP error messages [101](#)  
CIP Module Status (C13861) [116](#)  
CIP Network Status (C13862) [117](#)  
CIP objects [124](#)  
CIP status indicators [91](#)  
Class attributes [125](#)  
Clear I/O Data (C13885) [120](#)  
Codes [106](#)  
Colour code of the Ethernet cable [32](#)  
Commissioning [35](#)  
Communication channels [53](#)  
Communication medium [16](#)  
Communication profile [16](#)  
Communication time [20](#)  
Configuring "AC Drive Profile" technology application [67](#)  
Configuring AC Drive Profile application [67](#)  
Configuring Lenze technology applications [62](#)  
Configuring the host system (scanner) [36](#)  
Configuring the scanner [36](#)

Configuring user-definable parameter sets [62](#)  
Conformities [16](#)  
Connection Manager Object (6 / 0x06) [135](#)  
Connections [15](#)  
Control Supervisor Object (41 / 0x29) [150](#)  
Conventions [8](#)  
Conventions used [8](#)  
Cyclic I/O data [54](#)

## D

Data mapping of the input assemblies [133](#)  
Data mapping of the output assemblies [133](#)  
Data transfer [52](#)  
Device and application-specific safety instructions [12](#)  
Device Level Ring (DLR) Object (71 / 0x47) [137](#)  
Device protection [12](#)  
Device type [16](#)  
DHCP server [47](#)  
Diagnostics [89](#)  
Diagnostics with the »Engineer« [95](#)  
Dimensions [22](#)  
DLR Network Status (C13841) [112](#)  
DLR Network Topology (C13840) [112](#)  
Document history [7](#)  
Drive profiles [58](#)  
DRIVECOM error [102](#)

## E

EDS files [37](#)  
Electrical installation [27](#)  
E-mail to Lenze [164](#)  
Error messages [96](#)  
    Causes and remedies [97](#)  
    Short overview [96](#)  
Error messages of the "Connection Manager Object" (0x06) [136](#)  
Error number  
    0x01bc3100 [97](#)  
    0x01bc5531 [97](#)  
    0x01bc5532 [97](#)  
    0x01bc5533 [97](#)  
    0x01bc6010 [97](#)  
    0x01bc6011 [98](#)  
    0x01bc6100 [98](#)  
    0x01bc6101 [98](#)  
    0x01bc641f [98](#)  
    0x01bc6420 [98](#)  
    0x01bc6430 [98](#)  
    0x01bc6533 [99](#)  
    0x01bc8111 [99](#)  
    0x01bc8112 [99](#)  
    0x01bc8114 [99](#)  
    0x01bc8121 [99](#)  
    0x01bc8132 [100](#)  
    0x01bc8273 [100](#)

Establishing an online connection via EtherNet/IP using the Lenze »Engineer« [49](#)  
Establishing communication [51](#)  
Ethernet cable [31](#)  
Ethernet cable specification [31](#)  
Ethernet cable, colour code [32](#)  
Ethernet cable, structure [31](#)  
Ethernet Config Control (C13017) [110](#)  
Ethernet Link Object (246 / 0xF6) [145](#)  
Ethernet Port (C13863) [117](#)  
Ethernet Port Statistics (C13858) [116](#)  
EtherNet/IP  
    Duplicate IP Address (error message) [100](#)  
    Error: Lenze Setting Loaded (error message) [98](#)  
    Ethernet cable pulled out (error message) [99](#)  
    Exist. connect. to 8400 lost (error message) [97](#)  
    Explicit Message Timeout (error message) [99](#)  
    Fault Mode (error message) [99](#)  
    Idle Mode (error message) [100](#)  
    Internal error (error message) [98](#)  
    Invalid Configuration (error message) [98](#)  
    Invalid IP Parameter (error message) [99](#)  
    Invalid Parameter Set (error message) [98](#)  
    Memory  
        No Access (error message) [97](#)  
        Read Error (error message) [97](#)  
        Write Error (error message) [97](#)  
    Overall Ethernet Timeout (error message) [99](#)  
    Restart by Watchdogreset (error message) [97](#)  
EtherNet/IP connection [29](#)  
EtherNet/IP error messages: Causes and remedies [97](#)  
EtherNet/IP objects [137](#)  
EtherNet/IP state diagram [55](#)  
Explicit messages [84](#)  
Explicit messages (parameter data transfer) [54](#)  
External voltage supply [33](#)

## F

Fault with regard to EtherNet/IP communication [88](#)  
Feedback to Lenze [164](#)  
Firmware Compilation Date (C13901) [120](#)  
Firmware Product Type (C13900) [120](#)  
Firmware Version (C13902) [121](#)

## G

Gateway address [46](#)  
Gateway Address (C13002) [107](#)  
General data [16](#)  
General safety and application notes [11](#)

# Index

---

## H

Hostname (C13899) [120](#)

## I

I/O assemblies [60](#)

I/O configuration in the »Engineer« [62](#)

I/O configuration with »RSLogix 5000« version 19 or lower [68](#)

I/O configuration with »RSLogix 5000« version 20 or higher [73](#)

I/O data mapping [57](#)

I/O data transfer (implicit messages) [56](#)

Identification [13](#)

Identity Object (1 / 0x01) [126](#)

Implicit messages [56](#)

Implicit messages (I/O data transfer) [54](#)

Information regarding the validity [6](#)

Initial switch-on [51](#)

Input assemblies [60](#)

Input assemblies data mapping [133](#)

Installation [23](#)

Interface for communication [16](#)

Interfaces [15](#)

Internal switch latency [21](#)

IP address [46](#)

IP address (C13000) [106](#)

IP Config Control (C13005) [107](#)

## L

Last Conflicted IP Address (C13849) [114](#)

Last Conflicted MAC ID (C13848) [114](#)

Layout of the safety instructions [10](#)

LED status displays [89](#)

Lenze Class (101 / 0x65) [155](#)

Lenze Class (103 / 0x67) [157](#)

Lenze Class (104 / 0x68) [158](#)

Lenze Class (110 / 0x6E) [159](#)

Lenze objects [155](#)

Lenze technology application [58](#)

## M

MAC-ID (C13003) [107](#)

Mapping of Lenze device errors to DRIVECOM errors [102](#)

Mechanical installation [24](#)

Message Router Object (2 / 0x02) [128](#)

Module status displays [90](#)

Monitoring [88](#)

Monitoring Reaction (C13880) [119](#)

Motor Data Object (40 / 0x28) [149](#)

Mounting for standard devices of 0.25 kW and 0.37 kW [24](#)

Mounting for standard devices of 0.55 kW or more [25](#)

Multicast Config Alloc Control (C13018) [110](#)

Multicast Config Num Mcast (C13020) [111](#)

Multicast Config TTL Value (C13019) [110](#)

Multicast configuration [48](#)

Multicast IP Start Address [48](#)

Multicast IP Start Address (C13006) [108](#)

## N

Nameplate [13](#)

Network topology [16](#), [27](#)

Number of nodes [16](#)

## O

Operating conditions [16](#)

Output assemblies [60](#)

Output assemblies data mapping [133](#)

Overall Ethernet Timeout Time (C13881) [120](#)

## P

Parameter data transfer (explicit messages) [84](#)

Parameter reference [106](#)

Parameters of the communication module [106](#)

Pin assignment of the RJ45 sockets [30](#)

Processing time [20](#)

Product code [16](#)

Product description [13](#)

Product features [14](#)

Protection against uncontrolled restart [51](#)

Protection of persons [12](#)

Protective insulation [17](#)

Protocol data [20](#)

## Q

Quality of Service (DSCP, C13022) [111](#)

Quality of Service (QoS) Object (72 / 0x48) [139](#)

Quality of Service (VLAN Tagging, C13021) [111](#)

## R

Read parameters [86](#)

Replacing the communication module [26](#)

Residual hazards [12](#)

Rotary coding switch: xxx.yyy.zzz.DDD (C13920) [121](#)

Rotary coding switches [40](#)

Runtime delays [21](#)

# Index

---

## S

Safety instructions [10](#), [11](#)  
Saving the I/O configuration in »RSLogix 5000« [83](#)  
Screenshots/application examples [6](#)  
Setting the IP configuration [42](#)  
Setting via the EtherNet/IP configurator of the »Engineer« [43](#)  
Short overview of EtherNet/IP error messages [96](#)  
State diagram [55](#)  
Status displays (LEDs) [89](#)  
Status indicators at the RJ45 sockets (X259, X260) [94](#)  
Structure of the Ethernet cable [31](#)  
Subnet mask [46](#)  
Subnetwork mask (C13001) [106](#)  
Supervisor IP Address (C13842) [112](#)  
Supervisor MAC ID (C13843) [112](#)  
Switch latency [16](#), [21](#)  
Switching method [16](#)  
System error messages [96](#)

## T

Table of attributes [122](#)  
Target group [6](#)  
TCP/IP Interface Object [47](#)  
TCP/IP Interface Object (245 / 0xF5) [141](#)  
Technical data [16](#)  
Technology applications (TA) [58](#)  
Telegram types [54](#)  
Terminals [34](#)  
Terminology used [9](#)  
Terms [9](#)  
Transmission mode [16](#)  
Type of node [16](#)

## U

User-definable parameter sets [58](#)  
Using the communication module [13](#)

## V

Vendor ID [16](#)  
VLAN tagging [139](#)  
Voltage supply [16](#), [33](#)

## W

Wiring according to EMC guidelines [27](#)  
Write "DriveMode" attribute [154](#)  
Write DriveMode (attribute ID 6) [154](#)  
Write parameters [85](#)



# FEEDBACK



## Your opinion is important to us

These instructions were created to the best of our knowledge and belief to give you the best possible support for handling our product.

If you have suggestions for improvement, please e-mail us to:

[feedback-docu@Lenze.de](mailto:feedback-docu@Lenze.de)

Thank you for your support.

*Your Lenze documentation team*



Lenze Drives GmbH

Postfach 10 13 52

D-31763 Hameln

Germany

☎ +49 (0)51 54 / 82-0

📠 +49 (0)51 54 / 82-28 00

✉ [Lenze@Lenze.de](mailto:Lenze@Lenze.de)

🌐 [www.Lenze.com](http://www.Lenze.com)

#### Service

Lenze Service GmbH

Breslauer Straße 3

D-32699 Extertal

Germany

☎ 00 80 00 / 24 4 68 77 (24 h helpline)

📠 +49 (0)51 54 / 82-11 12

✉ [Service@Lenze.de](mailto:Service@Lenze.de)



# PROFINET

E84AYCER

Inverter Drives 8400 -----

Communication manual EN



13564915

# Contents

---

## Contents

<b>1</b>	<b>About this documentation</b> .....	<b>5</b>
1.1	Document history .....	7
1.2	Conventions used .....	8
1.3	Terminology used .....	9
1.4	Notes used .....	10
<b>2</b>	<b>Safety instructions</b> .....	<b>11</b>
2.1	General safety and application notes .....	11
2.2	Device and application-specific safety instructions .....	12
2.3	Residual hazards .....	12
<b>3</b>	<b>Product description</b> .....	<b>13</b>
3.1	Application as directed .....	13
3.2	Identification .....	13
3.3	Product features .....	14
3.4	Connections and interfaces .....	15
<b>4</b>	<b>Technical data</b> .....	<b>16</b>
4.1	General data and operating conditions .....	16
4.2	Protective insulation .....	17
4.3	Protocol data .....	20
4.4	Communication time .....	20
4.5	Internal switch latency .....	21
4.6	Dimensions .....	22
<b>5</b>	<b>Installation</b> .....	<b>23</b>
5.1	Mechanical installation .....	24
5.1.1	Mounting for standard devices of 0.25 kW and 0.37 kW .....	24
5.1.2	Mounting for standard devices of 0.55 kW or more .....	25
5.1.3	Exchanging the communication module .....	26
5.2	Electrical installation .....	27
5.2.1	Wiring according to EMC guidelines .....	27
5.2.2	Network topology .....	27
5.2.3	PROFINET connection .....	29
5.2.4	Ethernet cable specification .....	31
5.2.5	External voltage supply .....	33

# Contents

---

<b>6</b>	<b>Commissioning</b> .....	<b>35</b>
6.1	Before initial switch-on .....	35
6.2	Configuring the PROFINET IO controller .....	36
6.3	Setting the station name .....	37
6.4	Setting the IP configuration .....	39
6.4.1	Settings via the PROFINET configurator of the »Engineer« .....	40
6.4.2	Setting via codes in the »Engineer« .....	42
6.5	Establishing an online connection via PROFINET with the Lenze »Engineer« .....	44
6.6	Initial switch-on .....	46
<b>7</b>	<b>Data transfer</b> .....	<b>47</b>
<b>8</b>	<b>Process data transfer</b> .....	<b>48</b>
8.1	Access to process data / PDO mapping .....	48
8.2	Preconfigured port interconnection of the process data objects (PDO) .....	49
8.3	Freely configuring the port interconnection of the process data objects (PDO) .....	50
<b>9</b>	<b>Parameter data transfer</b> .....	<b>54</b>
9.1	The acyclic channel (PROFIdrive profile) .....	54
9.1.1	Connection establishment of an I/O controller to an I/O device .....	54
9.1.2	Acyclic data transmission process .....	55
9.1.3	Structure of the PROFINET data frame .....	56
9.2	Reading parameters from the inverter .....	57
9.2.1	Response to a correctly executed read request .....	58
9.2.2	Response to a read error .....	59
9.2.3	Frame example: Read request .....	60
9.3	Writing parameters to the inverter .....	62
9.3.1	Response to a correctly executed write request .....	64
9.3.2	Response to a write error .....	64
9.3.3	Frame example: Write request .....	66
9.4	Error information (error) .....	68
9.5	Consistent parameter data .....	70
<b>10</b>	<b>Monitoring</b> .....	<b>71</b>
10.1	Interruption of PROFINET communication .....	71
10.2	Interruption of internal communication .....	72

# Contents

---

<b>11</b>	<b>Diagnostics</b> .....	<b>73</b>
11.1	LED status displays .....	73
11.1.1	Module status displays .....	74
11.1.2	Fieldbus status displays .....	75
11.1.3	Status displays at X256 and X257 .....	76
11.2	Diagnostics with the »Engineer« .....	77
11.3	Diagnostic data .....	78
<b>12</b>	<b>Error messages</b> .....	<b>80</b>
12.1	Short overview of the PROFINET error messages .....	80
12.2	Possible causes and remedies .....	81
<b>13</b>	<b>Parameter reference</b> .....	<b>85</b>
13.1	Parameters of the communication module .....	85
13.2	Table of attributes .....	96
<b>14</b>	<b>Index</b> .....	<b>98</b>

## 1 About this documentation

### Contents

This documentation exclusively describes the E84AYCER communication module (PROFINET).



### Note!

This documentation supplements the **mounting instructions** supplied with the communication module and the **hardware manual "Inverter Drives 8400"**.

The features and functions of the communication module are described in detail.

Examples illustrate typical applications.

This documentation also contains...

- Safety instructions that must be observed
- The most important technical data of the communication module
- Information about the versions of the Lenze standard devices to be used
- Notes on troubleshooting and fault elimination

The theoretical context is only explained as far as it is required for understanding the function of the communication module.

Depending on the software version of the inverter and the »Engineer« software installed, the screenshots in this documentation may deviate from the »Engineer« representation.

This documentation does not describe the software of other manufacturers. No responsibility is taken for corresponding information given in this documentation. Information on how to use the software can be obtained from the documents of the host system (master).

All brand names mentioned in this documentation are trademarks of their corresponding owners.



### Tip!

Detailed information on PROFINET can be found on the homepage of the PROFIBUS user organisation which also develops the PROFINET communication technology:

[www.profibus.com](http://www.profibus.com)

# About this documentation

---

## Target group

This documentation addresses to persons who configure, install, commission, and maintain the networking and remote maintenance of a machine.



### Tip!

Information and software updates for Lenze products can be found in the download area at:

[www.Lenze.com](http://www.Lenze.com)

## Information regarding the validity

The information given in this documentation is valid for the following devices:

Extension module	Type designation	From hardware version	From software version
PROFINET communication module	E84AYCER	VA	02.00



# About this documentation

## Document history

---

### 1.1 Document history

Version			Description
3.0	02/2019	TD23	General revision
2.0	11/2010	TD17	<ul style="list-style-type: none"><li>• General revision</li><li>• Update for SW version 02.00</li></ul>
1.0	04/2010	TD17	First edition



# About this documentation

## Conventions used

---

### 1.2 Conventions used

This documentation uses the following conventions to distinguish between different types of information:

Type of information	Highlighting	Examples/notes
Spelling of numbers		
Decimal	Normal spelling	Example: 1234
Hexadecimal	0x[0 ... 9, A ... F]	Example: 0x60F4
Binary • Nibble	In inverted commas Point	Example: '100' Example: '0110.0100'
Decimal separator	Point	The decimal point is always used. For example: 1234.56
Text		
Program name	» «	PC software Example: Lenze »Engineer«
Control element	<b>Bold</b>	The <b>OK</b> button... / The <b>Copy</b> command... / The <b>Properties</b> tab... / The <b>Name</b> input field...
Hyperlink	<u>Underlined</u>	Optically highlighted reference to another topic. Can be activated with a mouse-click in this documentation.
Icons		
Page reference	 8	Optically highlighted reference to another page. Can be activated with a mouse-click in this documentation.
Step-by-step instructions		Step-by-step instructions are indicated by a pictograph.

# About this documentation

## Terminology used

---

### 1.3 Terminology used

Term	Meaning
Inverter	Lenze inverters of the "Inverter Drives 8400" product series for which the communication module can be used. ▶ <a href="#">Application as directed</a> (□ 12)
Standard device	
»Engineer«	Lenze PC software which supports you during the "Engineering" process (parameterisation, diagnostics, and configuration) throughout the whole life cycle, i. e. from planning to maintenance of the machine commissioned.
Code	Parameter which serves to parameterise and monitor the inverter. In normal usage, the term is usually referred to as "Index".
Subcode	If a code contains several parameters, they are stored in "subcodes". This manual uses a slash "/" as a separator between code and subcode (e.g. "C00118/3"). This term is also referred to as "subindex" in common parlance.
Lenze setting	This setting is the default factory setting of the device.
Basic setting	
HW	Hardware
SW	Software
I/O controller	PROFINET master The I/O controller takes over the master function for data communication of the decentralised field devices. The I/O controller usually is the communication interface of a PLC.
I/O device	PROFINET slave
IO supervisor	Engineering and diagnostics tools The IO supervisor can access process data, diagnostic data, and alarm data.

# About this documentation

## Notes used

---

### 1.4 Notes used

The following signal words and symbols are used in this documentation to indicate dangers and important information:

#### Safety instructions

Layout of the safety instructions:



#### Pictograph and signal word!

(characterise the type and severity of danger)

#### Note

(describes the danger and gives information about how to prevent dangerous situations)

Pictograph	Signal word	Meaning
	Danger!	<b>Danger of personal injury through dangerous electrical voltage</b> Reference to an imminent danger that may result in death or serious personal injury if the corresponding measures are not taken.
	Danger!	<b>Danger of personal injury through a general source of danger</b> Reference to an imminent danger that may result in death or serious personal injury if the corresponding measures are not taken.
	Stop!	<b>Danger of property damage</b> Reference to a possible danger that may result in property damage if the corresponding measures are not taken.

#### Application notes

Pictograph	Signal word	Meaning
	Note!	Important note to ensure trouble-free operation
	Tip!	Useful tip for easy handling
		Reference to another document

## 2 Safety instructions



### Note!

It is absolutely vital that the stated safety measures are implemented in order to prevent serious injury to persons and damage to material assets.

Always keep this documentation to hand in the vicinity of the product during operation.

### 2.1 General safety and application notes



### Danger!

If the following basic safety measures are disregarded, severe injuries to persons and damage to material assets may result.

- Lenze drive and automation components ...
  - must only be used as directed.
    - ▶ [Application as directed](#) (□ 12)
  - must never be commissioned if they display signs of damage.
  - must never be technically modified.
  - must never be commissioned if they are not fully mounted.
  - must never be operated without required covers.
  - during and after operation can have live, moving and rotating parts, depending on their degree of protection. Surfaces can be hot.
- The following applies to Lenze drive components ...
  - only use the accessories approved.
  - Only use original manufacturer spare parts.
- Observe all specifications contained in the enclosed documentation and related documentation.
  - This is the precondition for safe and trouble-free operation and for obtaining the product features specified.
    - ▶ [Product features](#) (□ 13)
  - The specifications, processes, and circuitry described in this document are for guidance only and must be adapted to your own specific application. Lenze does not take responsibility for the suitability of the process and circuit proposals.
- All works on and with Lenze drive and automation components must only be carried out by qualified personnel. According to IEC 60364 or CENELEC HD 384 these are persons who ...
  - are familiar with installing, mounting, commissioning, and operating the product.
  - who have the corresponding qualifications for their work.
  - who know and can apply all regulations for the prevention of accidents, directives, and laws applicable at the place of use.

# Safety instructions

Device and application-specific safety instructions

---

## 2.2 Device and application-specific safety instructions

- During operation, the communication module must be securely connected to the standard device.
- Always use a separate power supply unit safely separated according to EN 61800-5-1 ("SELV/PELV") in every control cabinet for external voltage supply.
- Only use cables corresponding to the given specifications.
  - ▶ [Ethernet cable specification](#) (📖 30)



### Documentation for the standard device, control system, system/machine

All the other measures prescribed in this documentation must also be implemented. Observe the safety instructions and application notes contained in this manual.

## 2.3 Residual hazards

### Protection of persons

- If the Inverter Drives 8400 are operated on a phase-earthed mains with a rated mains voltage of  $\geq 400$  V, external measures need to be implemented in order to ensure protection against accidental contact.
  - ▶ [Protective insulation](#) (📖 16)

### Device protection

- The communication module contains electronic components which may be damaged or destroyed by electrostatic discharge.
  - ▶ [Installation](#) (📖 22)

# Product description

Application as directed

## 3 Product description

### 3.1 Application as directed

The communication module ...

- is an accessory module that can be used in conjunction with the following standard devices:

Product series	Type designation	From software version
Inverter Drives 8400 StateLine	E84AVSCxxxxx	05.00
Inverter Drives 8400 HighLine	E84AVHCxxxxx	05.00
Inverter Drives 8400 TopLine	E84AVTCxxxxx	01.00

- is a device intended for use in industrial power systems.
- should only be used under the operating conditions prescribed in this documentation.
- should only be used in PROFINET networks.

**Any other use shall be deemed inappropriate!**

### 3.2 Identification

Type designation and hardware and software version of the communication module are indicated on the nameplate:

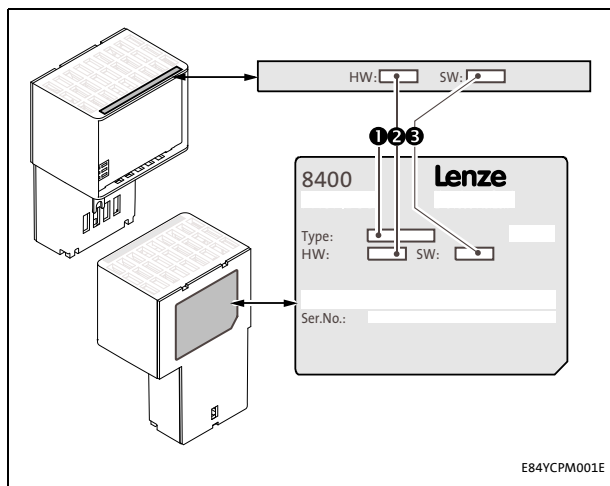

**1 Type designation (type)**  
E84 Product series  
A Version  
Y Module identification: Extension module  
C Module type: Communication module  
ER PROFINET  
V/S V: Coated version  
S: Standard version

**2 Hardware version (HW)**

**3 Software version (SW)**

E84YCPM001E

[3-1] Identification data

# Product description

## Product features

---

### 3.3 Product features

- Interface module for the PROFINET IO communication system to the expansion slots of the Inverter Drives 8400
- The communication module can either be supplied internally by the standard device or externally by a separate voltage source.
- Support of the I&M0...4 functionality for the identification of the standard device
- Automatic detection of the baud rate 100 Mbps
- A line topology is enabled by the integrated 2-port switch.
- Support of the LLDP protocol for the topology recognition
- Support of the SNMP protocol for diagnostic purposes
- Support of the MRP (Media Redundancy Protocol)  
The Inverter Drive 8400 can be integrated into a ring topology as a client node.
- Access to all Lenze parameters
- An online connection via PROFINET can be established using the Lenze »Engineer«.



### 3.4 Connections and interfaces

- 2 RJ45 sockets for the PROFINET connection
- 2-pole plug connector for the external voltage supply of the communication module.
- Front LEDs for diagnosing the ...
  - voltage supply of the communication module;
  - connection to the standard device;
  - PROFINET connection;
  - PROFINET activity.

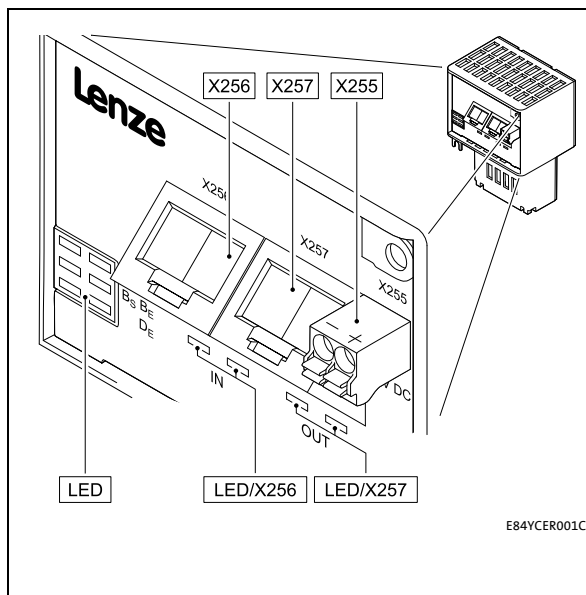

**X255** External voltage supply of the communication module

- 2-pin plug connector with spring connection
- ▶ [External voltage supply](#) (□ 32)

**X256** PROFINET input (IN)

**X257** PROFINET output (OUT)

- RJ45-sockets
- each with 2 LED status displays for diagnostics

- ▶ [Network topology](#) (□ 26)
- ▶ [PROFINET connection](#) (□ 28)
- ▶ [Status displays at X256 and X257](#) (□ 76)

**MS** 5 LED status displays for diagnostics

**ME** ▶ [Module status displays](#) (□ 74)

**BS** ▶ [Fieldbus status displays](#) (□ 75)

**BE**

**EN**

[3-2] E84AYCER communication module (PROFINET)

# Technical data

## General data and operating conditions

### 4 Technical data

#### 4.1 General data and operating conditions

Range	Values	
Order designation	E84AYCER	
Communication profile	PROFINET	
Communication medium	S/FTP (Screened Foiled Twisted Pair, ISO/IEC 11801 or EN 50173), CAT 5e	
Interface for communication	RJ45: Standard Ethernet (in accordance with IEEE 802.3), 100Base-TX (Fast Ethernet)	
Network topology	Tree, star, and line	
Type of node	I/O device with real time (RT) communication properties	
Number of device nodes	Max. 255 in the subnetwork	
Max. cable length	100 m	
PNO identification number	0x0106	
Device identification (Device ID)	0x8400	
TCP port	8410	
Baud rate	100 Mbps	
Switching method	"Store and forward"	
Switch latency	Approx. 125 µs at max. frame length	
Voltage supply	External supply via separate power supply unit <ul style="list-style-type: none"><li>• "+": U = 24 V DC (20.4 V - 0 % ... 28.8 V + 0 %), I = 140 mA</li><li>• "-": Reference potential for external voltage supply</li></ul>	
Conformities, approvals	CE	2004/108/EC, EMC Directive 2006/95/EC, Low-Voltage Directive
	EAC	Eurasian conformity TR CU: Technical Regulations of Customs Union
		TP TC 004/2011 (TR CU 004/2011) About the safety of low voltage equipment
		TP TC 020/2011 (TR CU 020/2011) Electromagnetic compatibility of technical means
UL	UL 508C / C22.2 No. 14, Power Conversion Equipment (File-No. E132659)	



#### Hardware manual "Inverter Drives 8400"

Here you can find the **ambient conditions** and data on the **electromagnetic compatibility (EMC)**, which also apply to the communication module.

### 4.2 Protective insulation



#### **Danger!**

##### **Dangerous voltage**

If the Inverter Drives 8400 are operated on a phase-earthed mains with a rated mains voltage of  $\geq 400$  V, external measures need to be implemented in order to ensure protection against accidental contact.

##### **Possible consequences:**

- Death or severe injuries

##### **Protective measures:**

- If protection against accidental contact is required for the control terminals of the inverter and the connections of the device modules plugged, ...
  - a double isolating distance must exist.
  - the components to be connected must be provided with the second isolating distance.



#### **Note!**

The existing protective insulation in the Inverter Drives 8400 is implemented according to EN 61800-5-1.

# Technical data

## Protective insulation

The following illustration ...

- shows the arrangement of the terminal strips and the separate potential areas of the Inverter Drive 8400.
- serves to determine the decisive protective insulation between two terminals located in differently insulated separate potential areas.

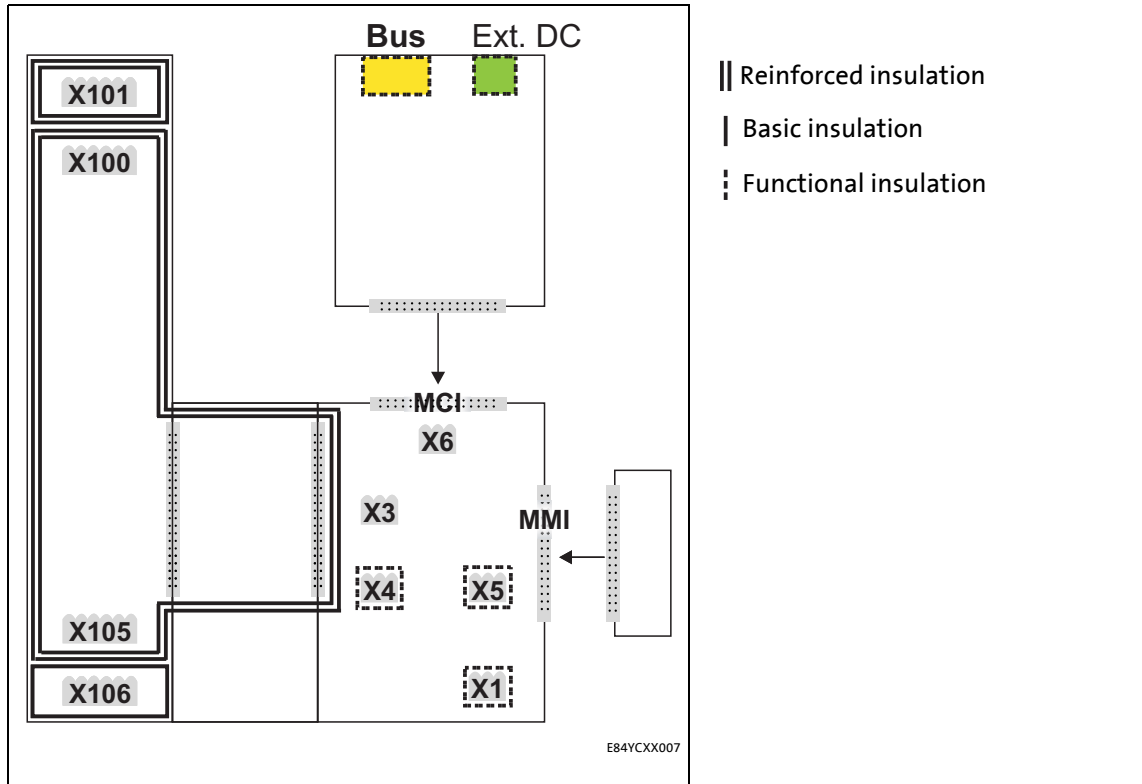

[4-1] Protective insulation in accordance with EN61800-5-1

Terminal strip	Connection
X100	Mains/DC-bus connection
X101	Relay contact
X105	Motor/brake resistor
X106	Motor PTC
X1	System bus (CANopen)
X3	Analog inputs/outputs
X4	Digital outputs
X5	Digital inputs
X6	Diagnostics
MCI	Slot for the communication module
MMI	Slot for the memory module

### Example

Which type of protective insulation is used between the bus terminal of the device module in slot MCI and the X100 mains terminal?

- The separate potential area with the better protective insulation is decisive.
  - The separate potential area of the bus terminal of the device module has a "functional insulation".
  - The separate potential area of the mains terminal has a "reinforced insulation".
- Result: The insulation between mains terminal X100 and the bus terminal is of the "reinforced insulation" type.

# Technical data

## Protocol data

---

### 4.3 Protocol data

Range	Values
Process data words (PCD)	Max. 16 process data words (max. 32 bytes)
Acyclic parameter data channel	Limited by the PROFINET frame size

### 4.4 Communication time

The communication time is the time between the start of a request and the arrival of the corresponding response.

The communication times in the PROFINET network depend on the ...

- processing time in the inverter;
- frame runtime (baud rate / frame length);
- nesting depth of the network.

#### Processing time inside the inverter

Data	Processing time
Process data	Approx. 2 ms + 0 ... 1 ms + 1 ... x ms Update cycle Processing time in the module Runtime of the application task of the technology application used (tolerance)
Parameter data	Approx. 30 ms + a tolerance of 20 ms (typically) • For some codes, the processing time may be longer (see software manual/»Engineer« online help for the Inverter Drive 8400).

There are no interdependencies between parameter data and process data.

### 4.5 Internal switch latency

The integrated 2-port switch causes runtime delays which can be calculated as follows:

$$\text{Runtime delay} = ((36 \text{ permanent bytes} + \text{process data in bytes}) \times 8 \times 10 \text{ nsec}) + 4 \mu\text{sec}$$

#### Example :

20 process data words + 4 PROFIsafe words => 48 bytes

- $((36 \text{ permanent bytes} + 48 \text{ bytes}) \times 8 \times 10 \text{ nsec}) + 4 \mu\text{sec}$
- $(84 \text{ bytes} \times 8 \times 10 \text{ nsec}) + 4 \mu\text{sec}$
- $6.72 \mu\text{sec} + 4 \mu\text{sec} = \mathbf{10.72 \mu\text{sec}}$

In accordance with the PROFINET specification, the shortest PROFINET I/O frame must have a data length of 72 bytes. If the 36 permanent bytes are subtracted from the 72 bytes, 36 bytes are available for process data. If now less than 36 bytes of process data are used, the PROFINET I/O frame is filled with "zero bytes" until it can be transmitted. As a consequence for the calculation formula, the shortest PROFINET I/O frame with 18 process data words (36 bytes) has always the same length and thus the runtime delay is the same, too.



#### Note!

The use of external switches can also lead to runtime delays. Depending on the system constellation, it may be useful to create a star topology or a line/mix topology.

▶ [Network topology](#) (📖 26)

# Technical data

## Dimensions

### 4.6 Dimensions

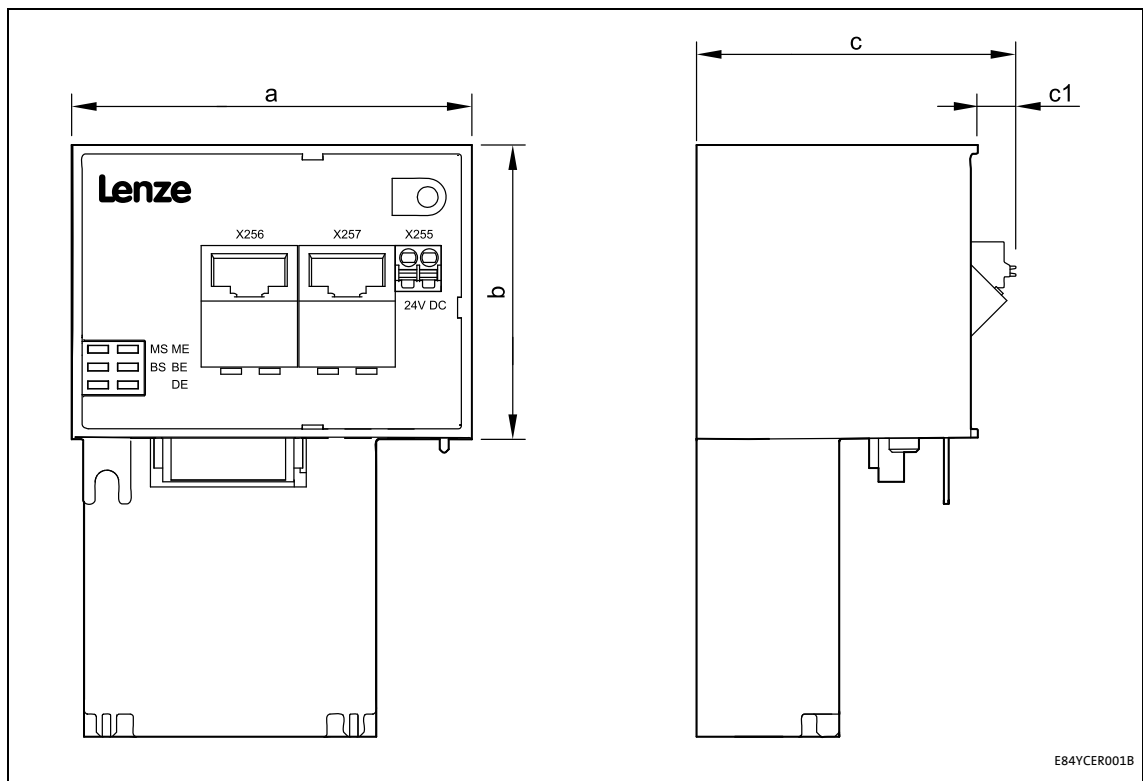

[4-2] Dimensions

Type	Dimensions [mm]			
	a	b	c	c1
E84AYCER	67	50	57	8



## 5 Installation



### **Stop!**

#### **Electrostatic discharge**

Electronic components within the communication module can be damaged or destroyed by electrostatic discharge.

#### **Possible consequences:**

- The communication module is defective.
- Fieldbus communication is not possible or faulty.

#### **Protective measures**

- Before touching the module, be sure that you are free of electrostatic charge.

# Installation

## Mechanical installation

---

### 5.1 Mechanical installation

The communication module can be plugged in or unplugged from the MCI slot when the inverter is switched on. When the module is plugged in, it is detected automatically, and a function and version plausibility check is executed.

#### 5.1.1 Mounting for standard devices of 0.25 kW and 0.37 kW

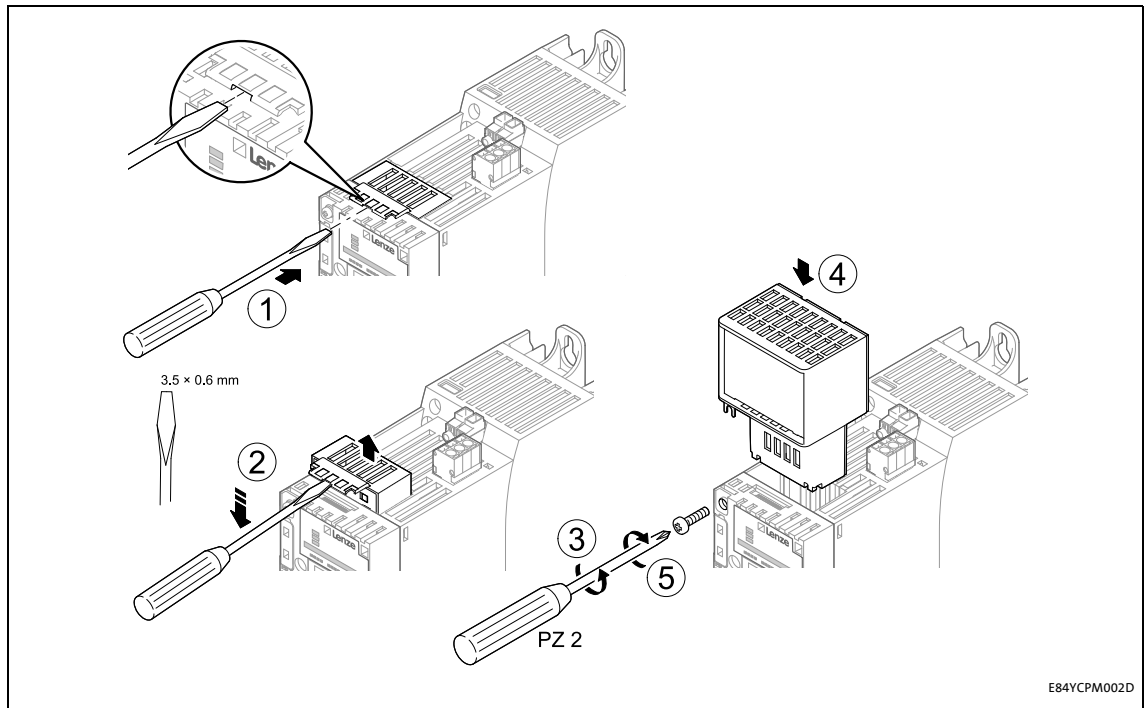

[5-1] Mounting for standard devices of 0.25 kW and 0.37 kW

#### Mounting steps

1. Use a screwdriver to lever out the cover of the MCI slot of the standard device and remove it (1, 2).
2. Loosen the securing screw for the communication module at the standard device (3).
3. Insert the communication module into the MCI slot of the standard device (4).
4. Tighten the securing screw again (5).

# Installation

## Mechanical installation

### 5.1.2 Mounting for standard devices of 0.55 kW or more

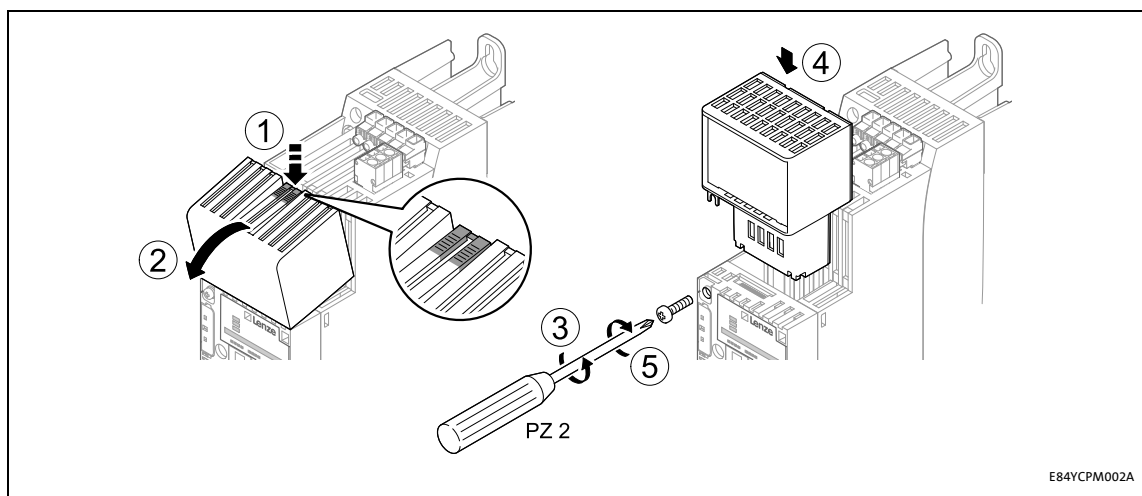

[5-2] Mounting for standard devices of 0.55 kW or more

#### Mounting steps

1. Slightly press on the marked spot on the top of the MCI slot cover of the standard device (1).
2. Tilt the cover forward and remove it from the standard device (2).
3. Loosen the securing screw for the communication module at the standard device (3).
4. Insert the communication module into the MCI slot of the standard device (4).
5. Tighten the securing screw again (5).

# Installation

## Mechanical installation

### 5.1.3 Exchanging the communication module

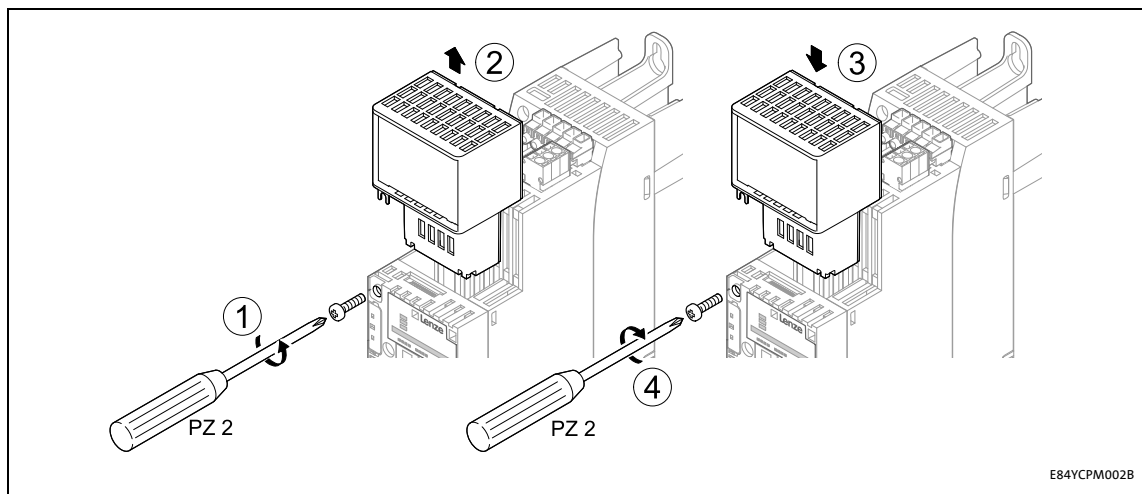

[5-3] Exchanging the communication module

#### Mounting steps

1. Loosen the securing screw for the communication module at the standard device (1).
2. Pull the communication module out of the MCI slot of the standard device (2).
3. Insert the new communication module into the MCI slot of the standard device (3).
4. Tighten the securing screw again (4).

# Installation

## Electrical installation

---

### 5.2 Electrical installation



**Documentation for the standard device, control system, system/machine**  
Observe the notes and wiring instructions contained in this documentation.

#### 5.2.1 Wiring according to EMC guidelines

In typical systems, standard shielding is sufficient for Ethernet cables.

However, in environments with a very high level of interference, EMC resistance can be improved by additionally earthing the cable shield on both sides.

For this observe the following notes:

1. Remove the plastic sheath of the cable at a length of 2 cm.
2. Fasten the cable shield to the shield support of the standard device.

#### 5.2.2 Network topology

It is typical of PROFINET to have a rather free topology the limiting factor of which is large message latencies due to e.g. switches connected in series.

▶ [Internal switch latency](#) (20)

The combination of a line and a stub is useful for system wiring.

PROFINET supports the following topologies:

- Switch / star

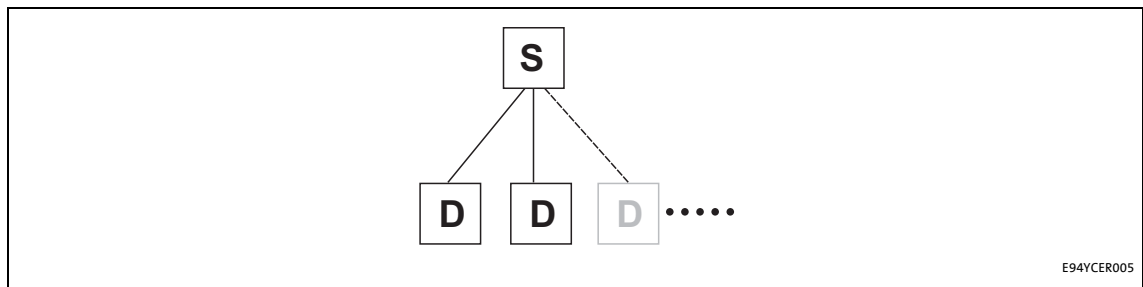

[5-4] Switch / star topology (S = switch, D = I/O device)

# Installation

## Electrical installation

---

- Tree via switches

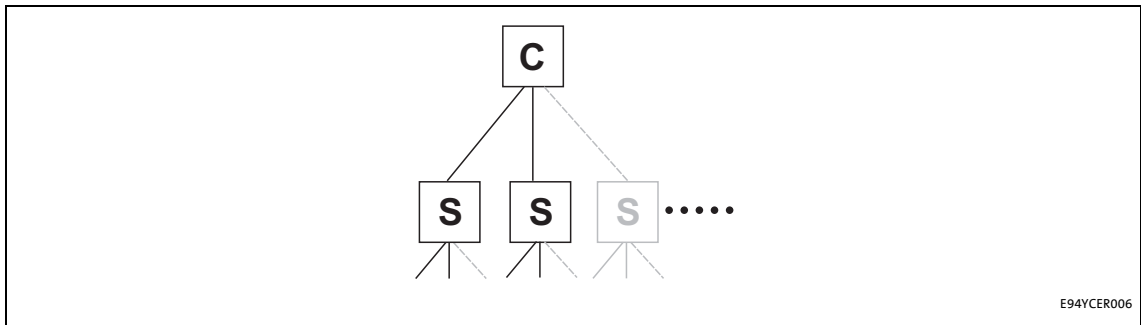

[5-5] Tree topology (C = I/O controller, S = switch)

- Switch / switch

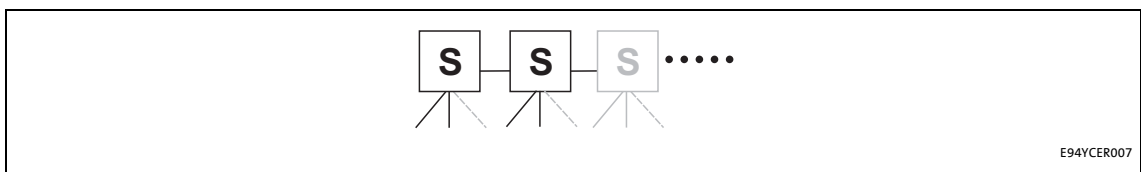

[5-6] Switch/switch topology (S = switch)

- I/O controller / I/O device

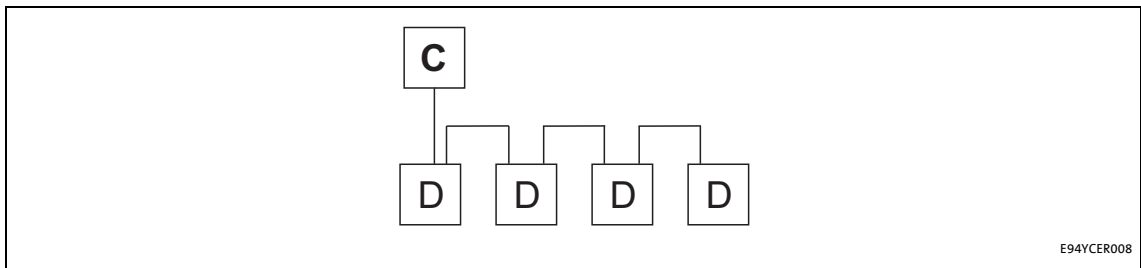

[5-7] Line topology (C = I/O controller, D = I/O device)

# Installation

## Electrical installation

### 5.2.3 PROFINET connection

PROFINET is connected via the RJ45 sockets X256 (IN) and X257 (OUT).

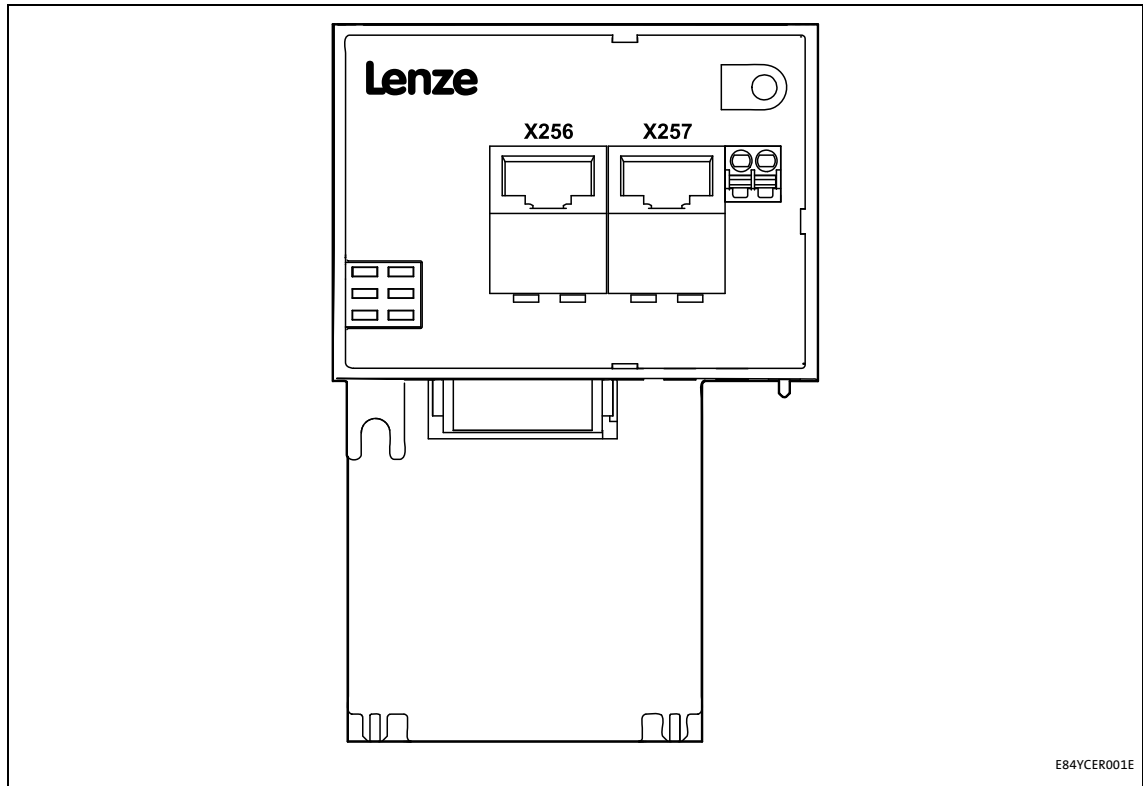

[5-8] PROFINET connections X256 (IN) and X257 (OUT)

For connection of the communication module to the PROFINET fieldbus, a standard Ethernet patch cable is suitable.

▶ [Ethernet cable specification](#) (30)

The installation and removal of the Ethernet cables is optimised for the use of connectors in accordance with the "Automation Initiative of German Domestic Automobile Manufacturers" (AIDA).



#### Note!

To prevent the RJ45 socket from being damaged, insert or remove the Ethernet cable connector straight (at a right angle) into or from the socket.

# Installation

## Electrical installation

---

### Pin assignment of the RJ45 sockets

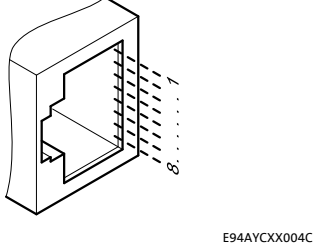
RJ45 socket	Pin	Signal
 E94AYCXX004C	1	Tx +
	2	Tx -
	3	Rx +
	4	-
	5	-
	6	Rx -
	7	-
	8	-



#### Tip!

The PROFINET interfaces feature an auto-MDIX function. This function adjusts the polarity of the RJ45 interfaces so that a connection can be established irrespective of the polarity of the opposite PROFINET interface and irrespective of the type of cable used (standard patch cable or crossover cable).



# Installation

## Electrical installation

### 5.2.4 Ethernet cable specification



#### Note!

Only use cables that meet the listed specifications.

Ethernet cable specification	
Ethernet standard	Standard Ethernet (in accordance with IEEE 802.3), 100Base-TX (Fast Ethernet)
Cable type	S/FTP (Screened Foiled Twisted Pair), ISO/IEC 11801 or EN 50173, CAT 5e
Damping	23.2 dB (for 100 MHz and 100 m each)
Crosstalk damping	24 dB (at 100 MHz and per 100 m)
Return loss	10 dB (per 100 m)
Surge impedance	100 $\Omega$

#### Structure of the Ethernet cable

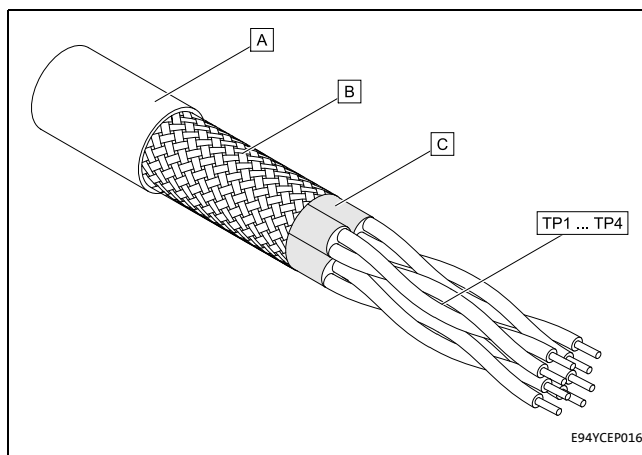

**A** Cable insulation

**B** Braid

**C** Foil shielding

**TP1** Twisted core pairs 1 ... 4

... [▶ Colour code of the Ethernet cable](#)

**TP4** [\(31\)](#)

[5-9] Structure of the Ethernet cable (S/FTP, CAT 5e)

# Installation

## Electrical installation

### Colour code of the Ethernet cable



#### Note!

Wiring and colour code are standardised in EIA/TIA 568A/568B.

In accordance with the industrial standard, the use of 4-pin Ethernet cables is permissible. The cable type only connects the assigned pins 1, 2, 3 and 6 to one another.

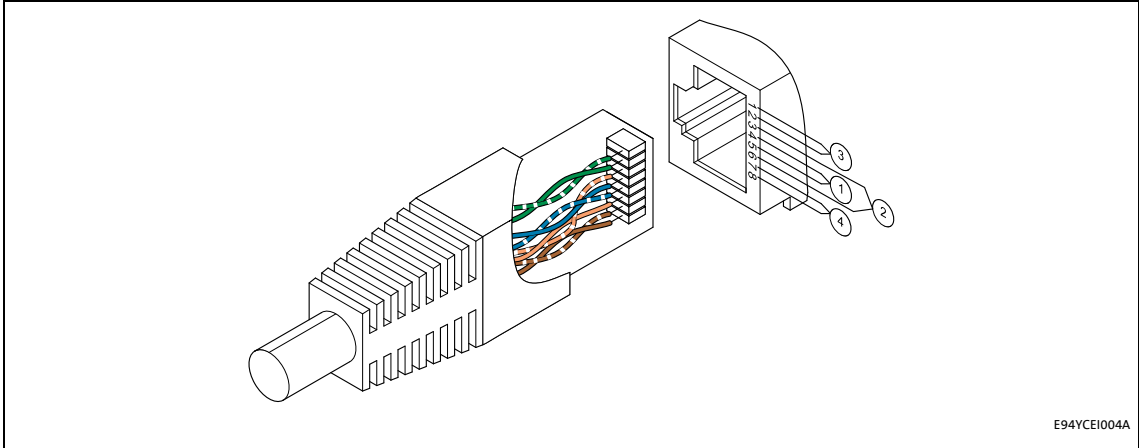

E94YCEI004A

[5-10] Ethernet plug in accordance with EIA/TIA 568A/568B

Pair	Pin	Signal	EIA/TIA 568A	EIA/TIA 568B
3	1	Tx +	White / Green	White / Orange
	2	Tx -	green	orange
2	3	Rx +	White / Orange	White / Green
1	4		blue	blue
	5		White / Blue	Blue / White
2	6	Rx -	orange	green
4	7		White / Brown	White / Brown
	8		brown	brown

# Installation

## Electrical installation

### 5.2.5 External voltage supply

The communication module can be externally supplied with voltage via separate supply cables at the 2-pin plug connector X255.



#### Note!

Always use a separate power supply unit safely separated according to EN 61800-5-1 ("SELV/PELV") in every control cabinet for external voltage supply.

- External voltage supply of the communication module is required if the communication via the bus should be maintained when the supply of the standard device fails.
- Access to parameters of a standard device disconnected from the mains is not possible.

#### Wiring of the X255 plug connector



#### Stop!

Only wire the plug connector if the standard device is disconnected from the mains.

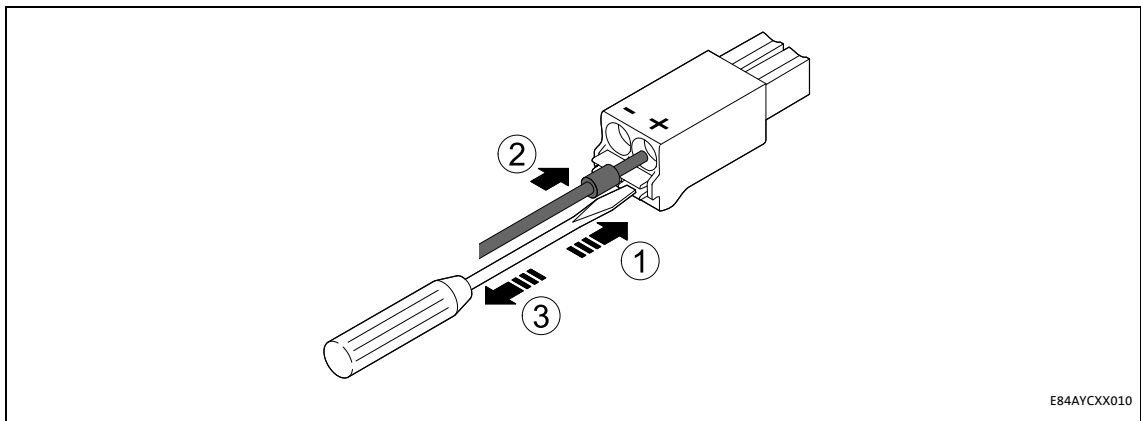

[5-11] Wiring of the 2-pin plug connector with spring connection

How to wire the plug connector with spring connection:

1. Press a screwdriver into the notch below the terminal and keep it pressed.
2. Place the supply cable in the terminal.
3. Remove the screwdriver from the notch.



# Installation

## Electrical installation

### Assignment of the X255 plug connector

Name	Description
+	U = 24 V DC (20.4 V - 0 % ... 28.8 V + 0 %) I = 140 mA
-	Reference potential for the external voltage supply

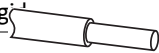
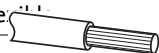
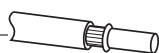
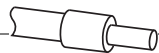
### Terminal data

Range	Values		
Electrical connection	2-pin plug connector with spring connection		
Possible connections	Rigid  0.2 ... 1.5 mm <sup>2</sup> (AWG 24 ... 16)		
	Flexible  <ul style="list-style-type: none"> <li> Without wire end ferrule 0.2 ... 1.5 mm<sup>2</sup> (AWG 24 ... 16)</li> <li> With wire end ferrule, without plastic sleeve 0.2 ... 1.5 mm<sup>2</sup> (AWG 24 ... 16)</li> <li> With wire end ferrule, with plastic sleeve 0.2 ... 1.5 mm<sup>2</sup> (AWG 24 ... 16)</li> </ul>		
		Stripping length	10 mm

# Commissioning

Before initial switch-on

---

## 6 Commissioning

During commissioning, system-related data such as motor parameters, operating parameters, responses, and parameters for fieldbus communication are defined for the inverter. For Lenze devices, this is done via the codes.

The codes of the inverter and communication are saved non-volatilely as a data set in the memory module.

In addition, there are codes for diagnosing and monitoring the stations.

▶ [Parameter reference](#) (□ 85)

### 6.1 Before initial switch-on



#### Stop!

Before switching on the standard device together with the communication module, check the entire wiring for completeness, short-circuit, and earth fault.

### 6.2 Configuring the PROFINET IO controller

To enable communication with the inverter, you have to configure the IO controller first.

#### Configuration for device control

For the configuration of PROFINET, the current PROFINET device description file (XML) of the E84AYCER communication module (PROFINET) has to be imported in the IO controller.

You can find the **GSDML-Vx.z-Lenze-8400PNabb-yyyymmdd.xml** device description file in the Download area at:

[www.Lenze.com](http://www.Lenze.com)

Wildcards in the "GSDML-Vx.z-Lenze-8400PN100-yyyymmdd.xml" file name	
x	Main version of the GSDML scheme used
z	Subversion of the GSDML scheme used
a	Major version of the software version
bb	Minor version of the software version
yyyy	Year
mm	Month
dd	Day

#### Defining the user data length

The user data length is defined during the initialisation phase of the I/O controller.

The Inverter Drives 8400 support the configuration of max. 16 process data words (max. 32 bytes).

#### Description of the device data base file

Selection text	Parameter data (with consistency)	Process data (with consistency)	Assigned I/O memory
PCD (nW) AR cons.	-	n words	n words
n = 1 ... 16 process data words			

#### Example of selecting the device data base file

- "PCD (8W) AR cons." = 8 process data words (only in slot 1 of the PROFINET telegram)



#### Tip!

A detailed description of consistency is given in the chapter "[Consistent parameter data](#)" (70).

### 6.3 Setting the station name



#### Note!

- The "Node blinking test" PROFINET function by means of which an accessible device can be identified is supported. During execution of the function, the red LED **ME** ([Module status displays \( 74\)](#)) blinks.
- Operation on the PROFINET requires a valid station name.
- In the case of impermissible settings, the red **BE** ([Fieldbus status displays \( 75\)](#)) blinks and the error message [PROFINET: Station name error \[0x01bc6532\] \( 83\)](#) is output. The communication module then continues to work internally with the name deleted.
- If the station name is assigned by the IO controller via PROFINET or the PROFINET configurator of the »Engineer«, changes will be effective immediately.

The station name currently used is shown in code [C13864](#).

The station name ...

- is required for unambiguous addressing of the Inverter Drive 8400 by the I/O controller.
- can either be assigned by the I/O controller via PROFINET or set manually in the »Engineer«.
- has to be allocated in accordance with the PROFINET specification:
  - 1 or several labels separated by ".".
  - Max. length per label: 63 characters
  - Max. total length: 240 characters
  - Permissible characters: [a ... z], [0 ... 9], [.] , [-]
  - Labels must not begin or end with [-].
- Prohibited syntax:
  - "n.n.n.n" (n = 0 ... 999)
  - "port-xyz" (x, y, z = 0 ... 9)
  - "port-xyz-abcde" (a, b, c, d, e, x, y, z = 0 ... 9)

# Commissioning

## Setting the station name

In the »Engineer« the station name is set under the **Settings** tab.

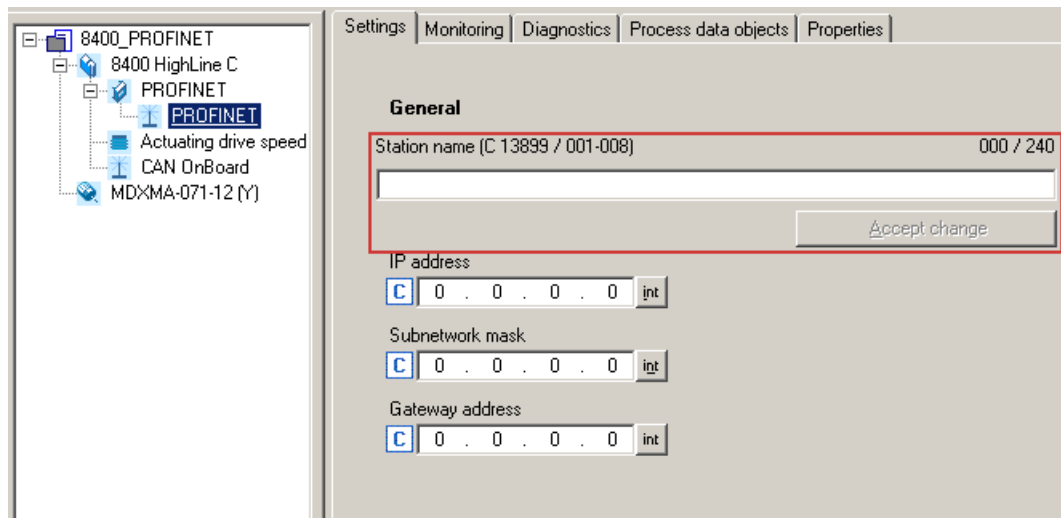

- Then click **Accept change**. The station name is saved and written to code [C13899](#).
- In the Lenze setting a deleted name is displayed. The name is also deleted if the "Reset to factory defaults" command is executed by an IO supervisor or an I/O controller.



### How to activate changed settings in the »Engineer«:

1. Execute device command **C00002 = "11: Save all parameter sets"**.
2. Carry out a "reset node" of the node, or switch the voltage supply of the communication module off and on again



### 6.4 Setting the IP configuration

The IP configuration is required for addressing the Inverter Drive 8400 if communication between the PC/»Engineer« or the IO controller and the inverter is to be established via PROFINET. This requires the allocation of an IP address, subnet mask, and gateway address.

If no PROFINET network or IO controller is available yet, you can allocate the IP address, subnet mask, and gateway address for the communication module by using the following options:

- [Settings via the PROFINET configurator of the »Engineer«](#) (📖 40)
- [Setting via codes in the »Engineer«](#) (📖 42)



#### Note!

- If the IP parameters are assigned by the IO controller via PROFINET or the PROFINET configurator of the »Engineer«, changes become effective immediately and are saved with mains failure protection.
- The assignment of invalid combinations of IP address, subnet mask, and gateway address can have the consequence that no connection to the PROFINET can be established.
- In the case of impermissible settings, the red LED **BE** ([Fieldbus status displays](#) (📖 75)) blinks and the error message [PROFINET: IP address error \[0x01bc6533\]](#) (📖 84) is output.

# Commissioning

## Setting the IP configuration

### 6.4.1 Settings via the PROFINET configurator of the »Engineer«



#### Note!

- The IP address must only be allocated manually in the »Engineer« if the PROFINET network is not actuated on the IO controller yet (IP address was not allocated by the IO controller yet).
- During the IP parameters are set in the »Engineer«, PROFINET communication with the IO controller must not take place at the same time.
- Changes will be effective immediately and are saved with mains failure protection.
- The parameter values currently used are shown in codes [C13010](#) (IP address), [C13011](#) (subnet mask), and [C13012](#) (gateway address).



#### How to set the IP parameters via the PROFINET configurator:

1. Execute the menu command **Online** → **Profinet configurator addresses...**

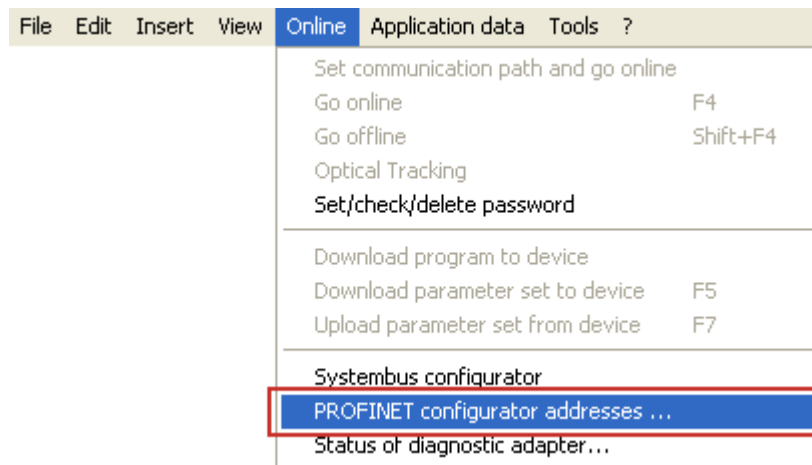

The **Assign IP addresses** dialog window is opened, and all Lenze PROFINET devices connected are listed.

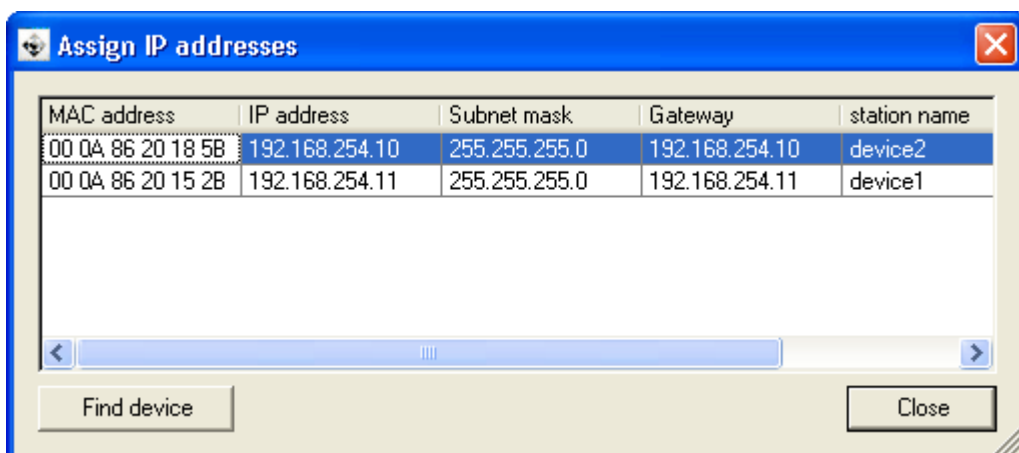

# Commissioning

## Setting the IP configuration

---

2. By double-clicking on the individual IP parameters, you can set the IP configuration for each PROFINET node in the **Configure nodes** dialog window.

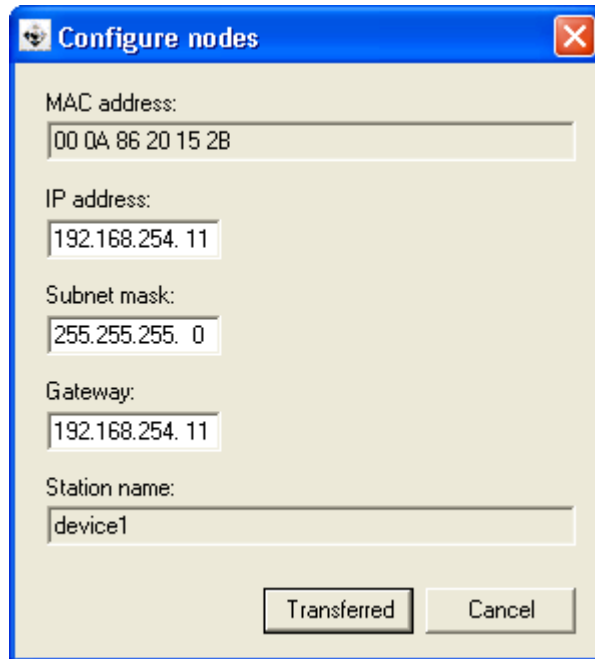

The screenshot shows a dialog box titled "Configure nodes" with a blue header and a close button. The dialog contains the following fields and values:

- MAC address: 00 0A 86 20 15 2B
- IP address: 192.168.254. 11
- Subnet mask: 255.255.255. 0
- Gateway: 192.168.254. 11
- Station name: device1

At the bottom of the dialog, there are two buttons: "Transferred" and "Cancel".

3. Click **Transferred**.
  - The IP configuration is transferred to the corresponding PROFINET node.
  - Changes in the IP parameters will become effective immediately.
  - The IP parameters are written to codes [C13000](#) (IP address), [C13001](#) (subnet mask) and [C13002](#) (gateway address) of the communication module.



### Tip!

By clicking the **Find device** button in the **Assign IP addresses** dialog window (see step 1), you can check whether the configuration was transferred successfully.

With device command **C00002 = "11: Save all parameter sets"**, the current IP configuration is saved non-volatilely in the memory module.

# Commissioning

## Setting the IP configuration

### 6.4.2 Setting via codes in the »Engineer«



#### Note!

- The IP address must only be allocated manually in the »Engineer« if the PROFINET network is not operated on the IO controller yet (IP address has not been allocated by the IO controller yet).
- While setting the IP parameters in the »Engineer«, PROFINET communication with the IO controller must not take place at the same time.
- The parameter values currently used are shown in codes [C13010](#) (IP address), [C13011](#) (subnet mask), and [C13012](#) (gateway address).

In the »Engineer« under the **Settings** tab you can set the IP parameters manually via code.

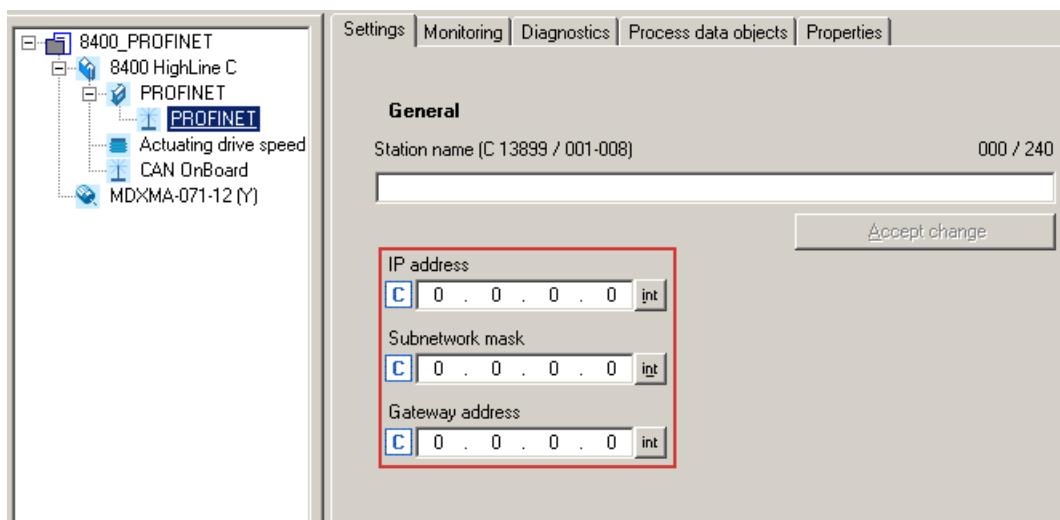

The IP parameters are written to codes [C13000](#) (IP address), [C13001](#) (subnet mask), and [C13002](#) (gateway address).



#### How to activate changed settings in the »Engineer«:

1. Execute the device command **C00002 = "11: Save start parameters"**.
2. Carry out a "reset node" of the node, or switch the voltage supply of the communication module off and on again

# Commissioning

## Setting the IP configuration

### Decimal representation of the IP parameters

By clicking the [ int ] buttons on the right next to the input fields, the IP parameters are represented as decimal values.

In the case of the decimal representation, the byte sequence is inverted.

**Example:** IP address 192.168.0.1

- [C13000](#) = 16820416 [00000001.00000000.10101000.11000000<sub>bin</sub>]

Byte 3	Byte 2	Byte 1	Byte 0
1	0	168	192
0 0 0 0 0 0 0 1	0 0 0 0 0 0 0 0	1 0 1 0 1 0 0 0	1 1 0 0 0 0 0 0
<a href="#">C13010/4</a>	<a href="#">C13010/3</a>	<a href="#">C13010/2</a>	<a href="#">C13010/1</a>

### IP address

- Valid IP addresses are defined in accordance with RFC 3330.
- The IP address is set/changed in [C13000](#).
- In [C13010/1...4](#) the IP address currently used is shown.

Example: Display of the IP address 192.168.0.1				
Code	<a href="#">C13010/1</a>	<a href="#">C13010/2</a>	<a href="#">C13010/3</a>	<a href="#">C13010/4</a>
Value	192	168	0	1

### Subnet Mask

- The subnet mask indicates which part of the IP address is evaluated as net ID or host ID.
- Valid subnet masks are defined in accordance with RFC 1878
- The subnet mask is set/changed in [C13001](#).
- In [C13011/1...4](#) the subnet mask currently used is shown.

Example: Display of the subnet mask 255.255.255.0				
Code	<a href="#">C13011/1</a>	<a href="#">C13011/2</a>	<a href="#">C13011/3</a>	<a href="#">C13011/4</a>
Value	255	255	255	0

### Gateway address

- The gateway address is valid if the network address of the IP address and the gateway address are identical.
- If the gateway address and the IP address are identical, gateway functionality is not used.
- DHCP is not supported.
- The gateway address is set/changed in [C13002](#).
- In [C13012/1...4](#) the gateway address currently used is shown.

Example: Display of the gateway address 192.168.0.1				
Code	<a href="#">C13012/1</a>	<a href="#">C13012/2</a>	<a href="#">C13012/3</a>	<a href="#">C13012/4</a>
Value	192	168	0	1

# Commissioning

Establishing an online connection via PROFINET with the Lenze »Engineer«

---

## 6.5 Establishing an online connection via PROFINET with the Lenze »Engineer«

This functionality is only supported **from software version V01.30.05**.



### Note!

To ensure perfect operation of cyclic PROFINET communication, online access with the »Engineer« must be effected via a PROFINET switch.

The PROFINET switch integrated in the communication module can execute cyclic PROFINET communication prior to normal TCP/IP communication. In the case of PROFINET this is effected via the VLAN identification in the Ethernet frame.

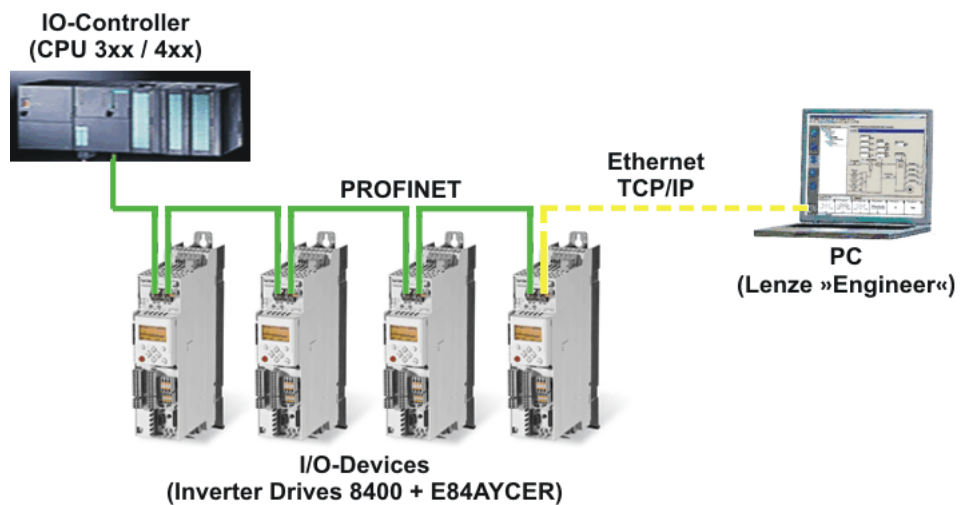

For an online connection between the »Engineer« and the inverter, the inverter must have an IP address (see [Setting the IP configuration](#) (39)).

# Commissioning

Establishing an online connection via PROFINET with the Lenze »Engineer«

In the »Engineer« via the menu command **Online → Set communication path and go online**, you can select the PROFINET communication path. The PROFINET nodes previously configured are shown in the *Communication path* dialog window:

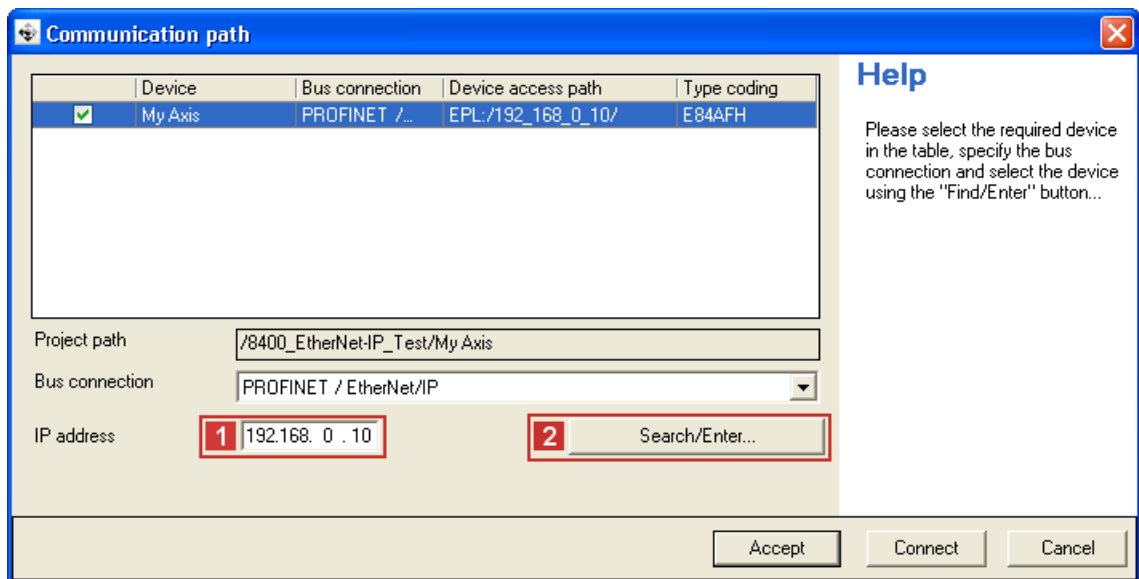

If the device access path is not configured correctly, the **1** IP address of the inverter selected in the display field can be entered manually here.

Via **2** **Search/Enter** you can establish a connection to devices which have not appeared in the display field. Corresponding settings for this can be made in the dialog window *Enter IP address*, which is shown:

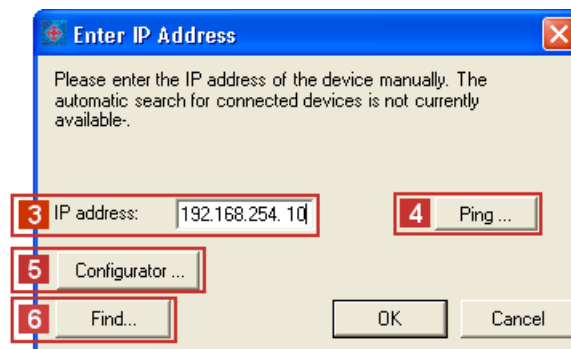

Here you can enter an **3** **IP address** manually or execute the following actions using the buttons:

- Execute the console command **4** **Ping**.
- Assign the IP address via the **5** **Configurator**.
  - ▶ [Settings via the PROFINET configurator of the »Engineer«](#) (40)
- Select the device access path to the desired inverter by clicking **6** **Find**.

After having established the online connection, you can continue work with the »Engineer« as usual.

### 6.6 Initial switch-on



#### Documentation for the standard device

Observe the safety instructions and information on residual hazards.



#### Note!

##### Establishing communication

In order to establish communication via an externally supplied communication module, the standard device must be switched on as well.

For further communication of the externally supplied module it is not relevant whether the standard device is switched on or not.

##### Protection against uncontrolled restart

After a fault (e.g. short-term mains failure), it is sometimes undesirable or even impermissible for the drive to restart.

The restart protection is activated in the Lenze setting of the Inverter Drives 8400.

The restart behaviour of the inverter can be set via **C00142** ("auto-start option"):

- **C00142 = 9** (Lenze setting)
  - The inverter remains inhibited (even if the fault is no longer active).
  - Bit 0 (inhibit at power-on) and bit 3 (inhibit in the case of undervoltage) are set.
  - The drive restarts in a controlled mode through explicit controller enable: LOW-HIGH edge at digital input X4/RFR.
- **C00142 = 8** (Enabled)
  - In order to enable the device directly when switching it on, set bit 0 to zero (FALSE).
  - An uncontrolled restart of the drive is possible.



## 7 Data transfer

PROFINET transmits parameter data, configuration data, diagnostic data, alarm messages, and process data between the host system (IO controller) and the inverters that are part of the fieldbus (I/O devices). As a function of their time-critical behaviour, the data are transmitted via corresponding communication channels.

### Communication channels

- The process data channel transmits process data.
  - The process data serve to control the inverter.
  - The transmission of process data is time-critical.
  - Process data are transmitted cyclically between the I/O controller and the I/O devices that are part of the fieldbus according to the Provider/Consumer model (continuous exchange of current input and output data).
  - The I/O controller can directly access the process data. In the PLC, for instance, the data are directly assigned to the I/O area.
  - Inverter Drives 8400 allow for a maximum of 16 process data words (16 bits/word) to be exchanged for each direction.
  - Process data are not saved in the inverter.
  - Process data are e.g. setpoints, actual values, control words, and status words.



### Note!

Please observe the direction of the flow of information!

- Process input data (Rx data):
  - Process data from the inverter (IO device) to the IO controller
- Process output data (Tx data):
  - Process data from the IO controller to the inverter (IO device)

- Parameter data are transmitted via the acyclic channel.
  - The transmission of parameter data is usually not time-critical.
  - The access to the parameter data depends on the PROFIdrive profile.
  - Examples of parameter data are operating parameters, motor data, and diagnostic information.
  - The acyclic channel provides access to all Lenze codes.
  - Parameter data changes must be saved via code **C00002** of the Inverter Drives 8400.

# Process data transfer

Access to process data / PDO mapping

## 8 Process data transfer

### 8.1 Access to process data / PDO mapping

Process data (MCI-PDOs) are transferred via the MCI interface.

- A maximum of 16 words are exchanged per direction.
- The process data are accessed via the port blocks **LP\_MciIn** and **LP\_MciOut**. The port blocks are also called process data channels.
- The port block **LP\_MciIn** maps the received MCI-PDOs.
- The port block **LP\_MciOut** maps the MCI-PDOs to be sent.
- The port/function block interconnection of the process data objects (PDO) takes place via the Lenze »Engineer«.

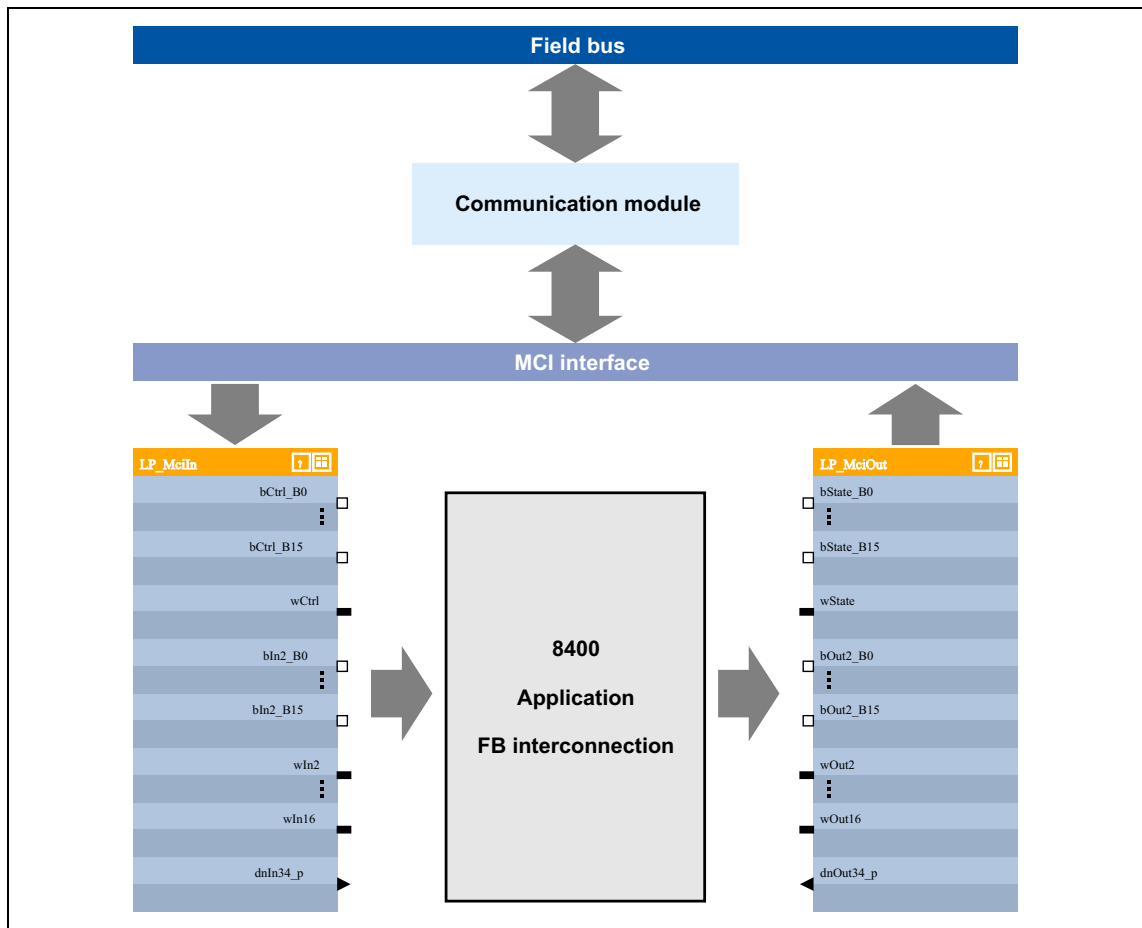

[8-1] External and internal data transfer between the bus system, inverter, and application



#### Software manual / »Engineer« online help for the Inverter Drive 8400

Here you will find detailed information on the port/function block interconnection in the »Engineer« and the port blocks.

# Process data transfer

Preconfigured port interconnection of the process data objects (PDO)



## Note!

The »Engineer« screenshots shown on the following pages are only examples of the setting sequence and the resulting screens.

The data in the display fields may differ from the ones of your project.

## 8.2 Preconfigured port interconnection of the process data objects (PDO)

The preconfigured port interconnection of the process data objects can be activated by setting standard device code **C00007** = "40: MCI".

The function block editor (FB Editor) serves to display the port blocks "LP\_MciIn" and "LP\_MciOut" with the preconfigured interconnections:

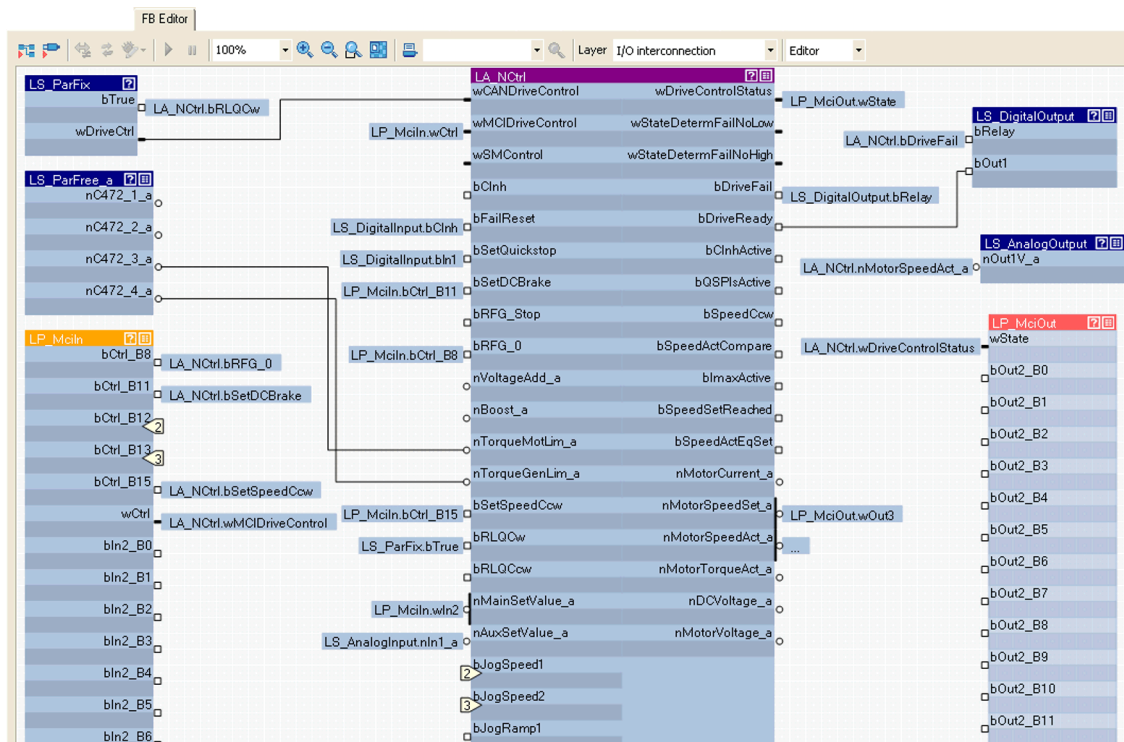

# Process data transfer

Freely configuring the port interconnection of the process data objects (PDO)

## 8.3 Freely configuring the port interconnection of the process data objects (PDO)



How to freely configure the port interconnection in the »Engineer«:

1. Go to the **Process data objects** tab and click **Go to application**.

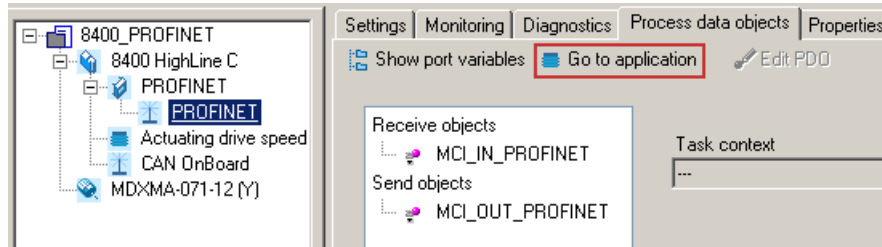

2. Go to the **Ports** tab, select the port blocks "MCI\_IN" or "MCI\_OUT" and click **Activate** to activate them.

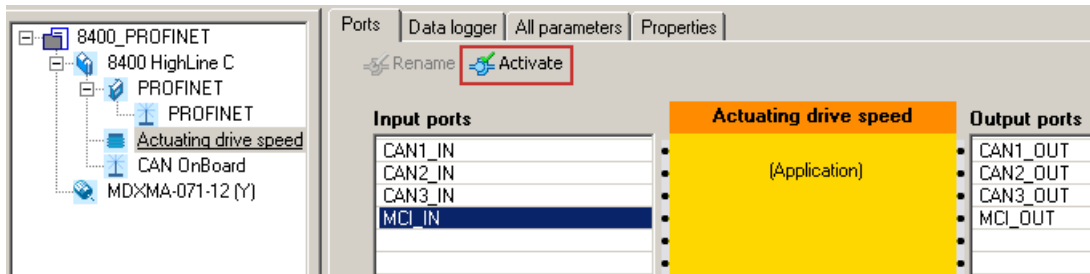

3. Click the **Change Variable ...** button.

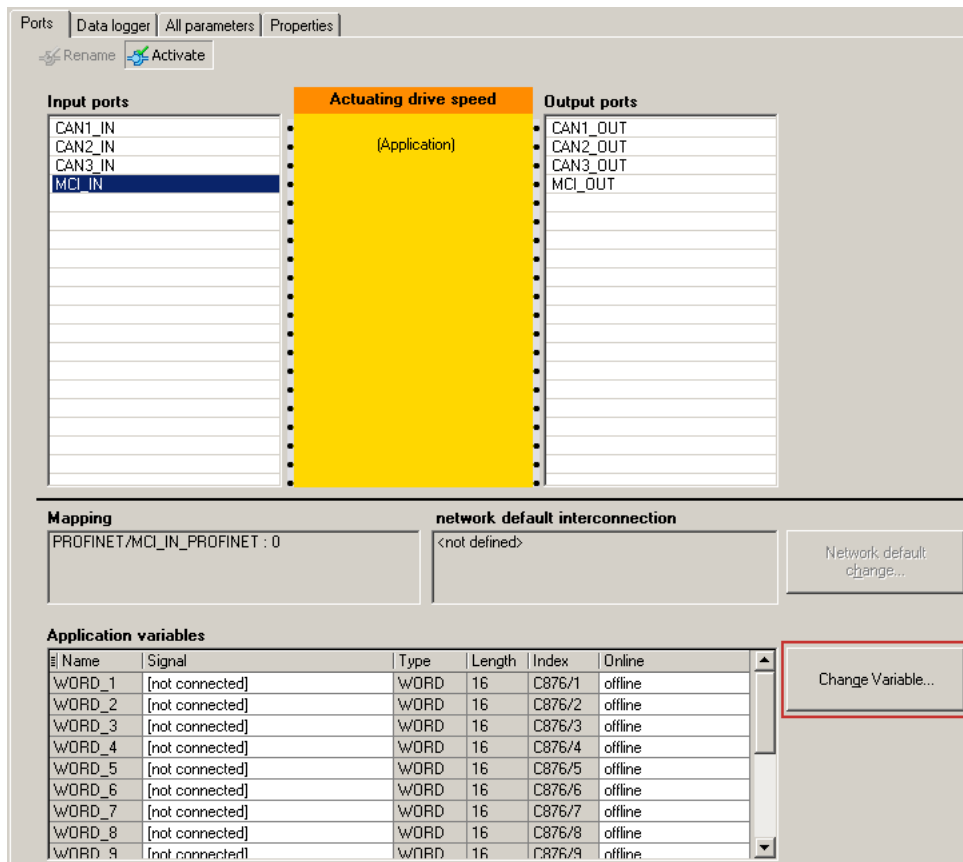

# Process data transfer

Freely configuring the port interconnection of the process data objects (PDO)

4. Via the  button, you can assign signals to the process data words in the *Assignment Signal --> Function Block* dialog window.  
→ Select the signals and then confirm the selection with **OK**.

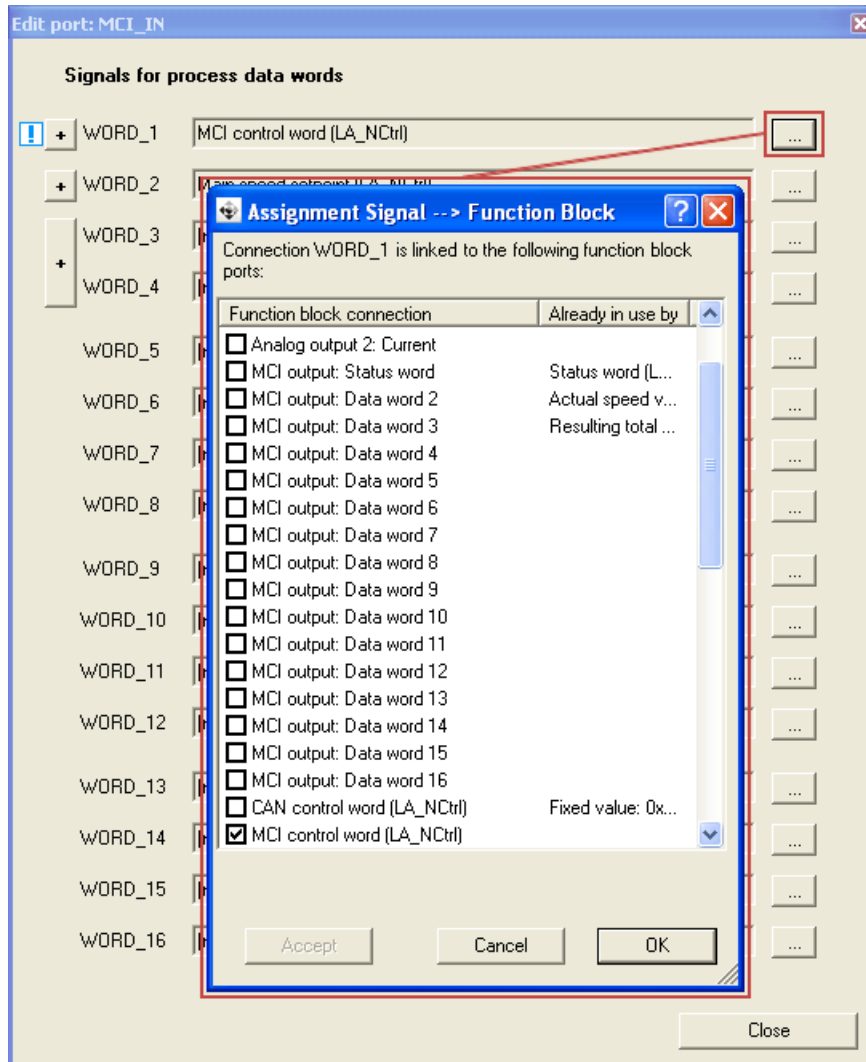

# Process data transfer

Freely configuring the port interconnection of the process data objects (PDO)

Moreover you can assign signals to the individual control and status bits at the WORD\_1 and WORD\_2 process data words via the **+** and **...** buttons.  
→ Select the signals and then click **OK**.

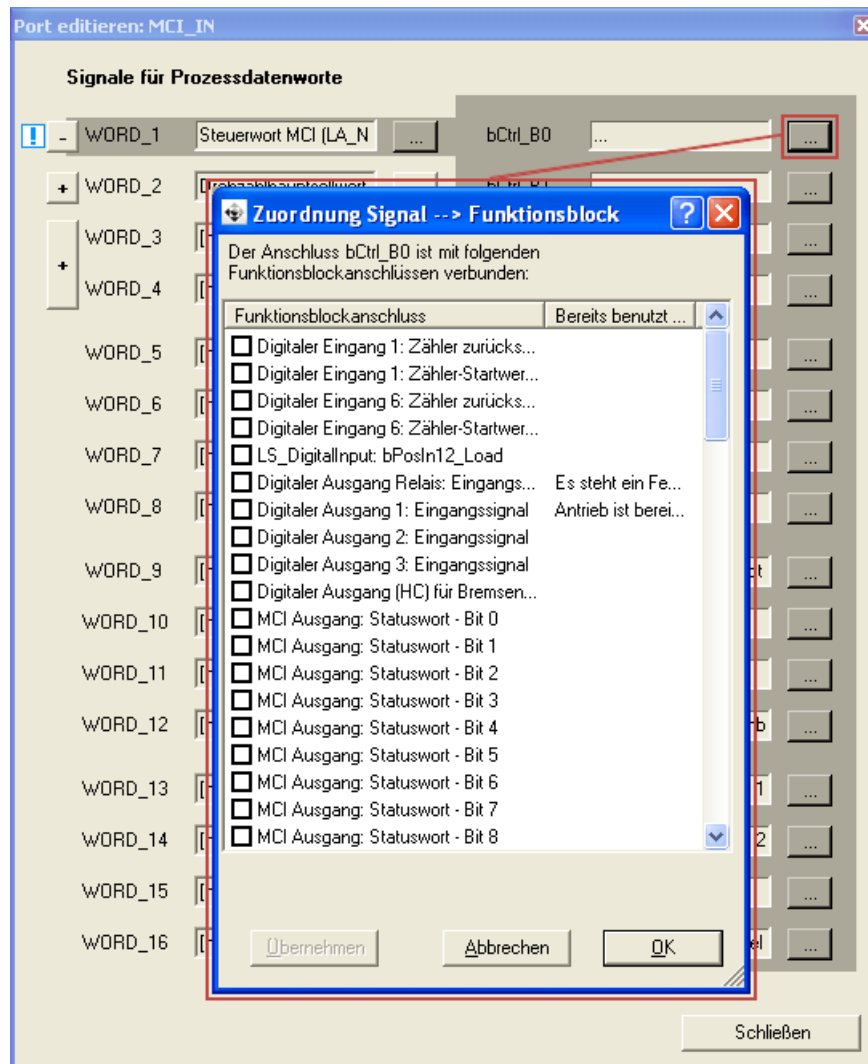

# Process data transfer

Freely configuring the port interconnection of the process data objects (PDO)



Tip!

When the port blocks "LP\_MciIn" and "LP\_MciOut" are activated (see 1.), they will be visible in the FB Editor. Here you can also assign signals to the process data words.

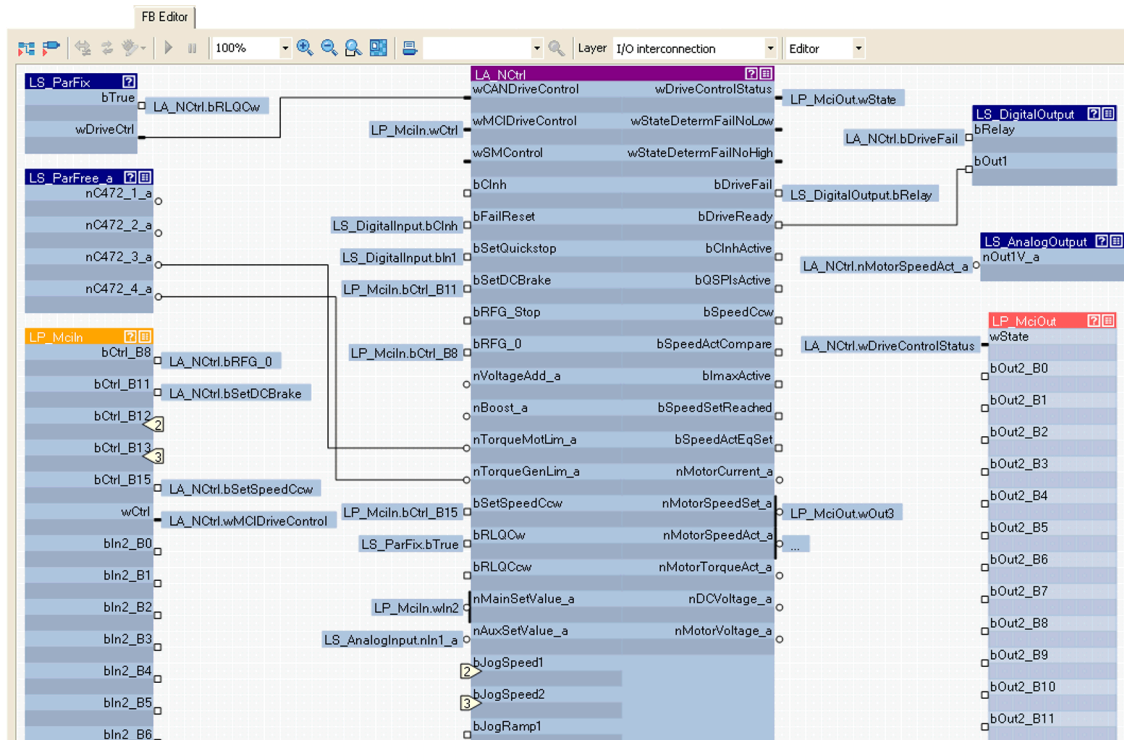

# Parameter data transfer

The acyclic channel (PROFdrive profile)

---

## 9 Parameter data transfer

### 9.1 The acyclic channel (PROFdrive profile)

An optional service extension is the acyclic parameter data transfer.

Cyclic and acyclic PROFINET services can be operated simultaneously in the network.

#### Product features

- There is always only one parameter request in process (no pipelining).
- No spontaneous messages are transferred.
- There are only acyclic parameter requests.
- Profile-specific parameters can be read independently of the I/O device state.

#### 9.1.1 Connection establishment of an I/O controller to an I/O device

An I/O controller can always be used to request parameters from an I/O device if the I/O device is in the "DATA\_EXCHANGE" state.

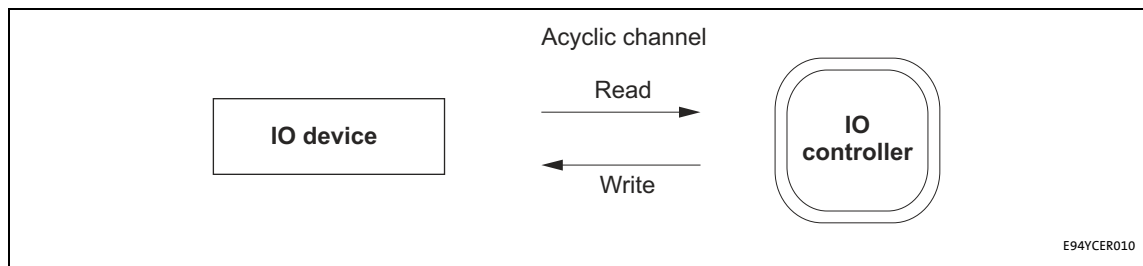

[9-1] Data communication via the acyclic channel



# Parameter data transfer

The acyclic channel (PROFdrive profile)

## 9.1.2 Acyclic data transmission process

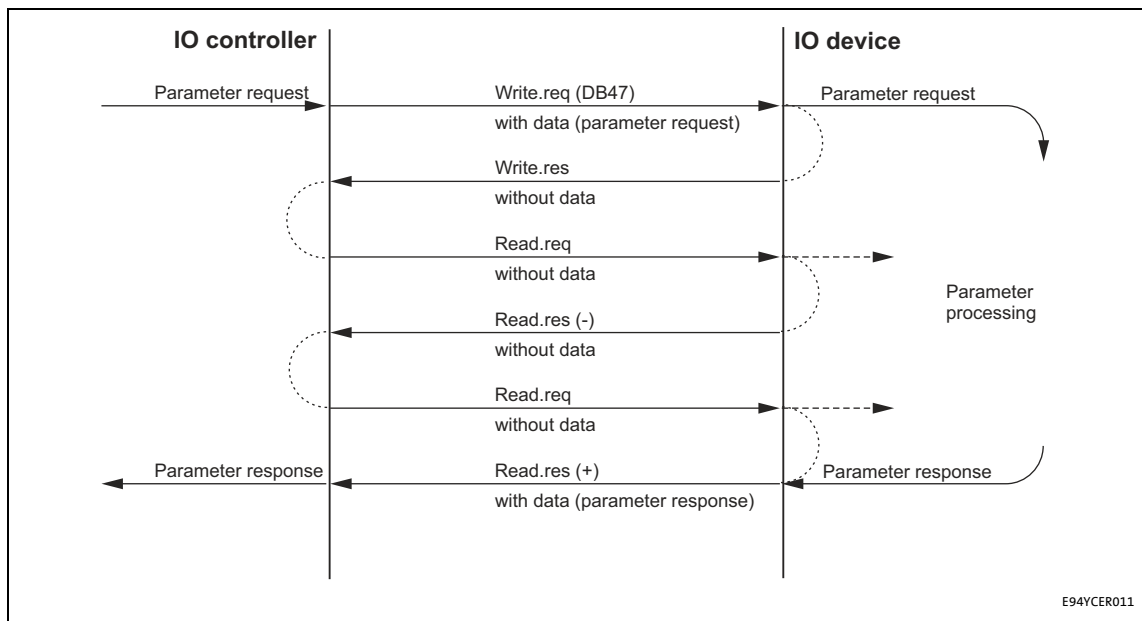

[9-2] Data communication via the acyclic channel

- A "Write.req" is used to transmit the data set (DB47) in the form of a parameter request to the I/O device.
- "Write.res" confirms the receipt of the message by the I/O controller.
- The I/O controller requests the response of the I/O device with "Read.req".
- The I/O device responds with a "Read.res (-)" if processing is not yet completed.
- After parameter processing, the parameter request is completed by transmitting the parameter response in the form of a "Read.res (+)" to the I/O controller.

# Parameter data transfer

The acyclic channel (PROFIdrive profile)

## 9.1.3 Structure of the PROFINET data frame

Dest Addr	Scr Addr	VLAN Day	Type 0800H	RPC	NDR	Read/Write Block	Data	FSC
6 bytes	6 bytes	4 bytes	4 bytes	80 bytes	64 bytes	64 bytes	0 ... 240 bytes	4 bytes

[9-3] PROFINET data telegram

In the "Read/Write Block", the initiator specifies the access to data set "DB47". The data which are written to this index or read by it contain a header and the parameter request or the parameter response. The read data or the data to be written are contained in the "Data" field.

The following subchapters describe the parameter request and the parameter response in detail.



### PROFINET specification

Here you will find detailed information on the PROFINET data telegram.

### Assignment of the user data depending on the data type

Depending on the data type used, the user data are assigned as follows:

Data type	Length	User data assignment				
		Byte 1	Byte 2	Byte 3	Byte 4	Byte ...
String	x bytes					
U8	1 byte		00			
U16	2 bytes	High byte	Low byte			
U32	4 bytes	High word		Low word		
		High byte	Low byte	High byte	Low byte	

# Parameter data transfer

Reading parameters from the inverter

## 9.2 Reading parameters from the inverter



### Note!

- When a read request is processed, no parameter value is written to the I/O device.
- In the case of a multi-parameter read request, parameter attribute, index, and subindex are repeated "n" times, "n" being the number of parameters requested.

### Request header

Byte 1	Byte 2	Byte 3	Byte 4
Request reference	Request identification	Axis	Number of indices

Field	Data type	Values
Request reference	U8	This value is specified by the I/O controller.
Request identification	U8	0x01: Request parameters for reading
Axis	U8	0x00 or 0x01
Number of indices	U8	0x"n" (n = number of parameters requested)

### Parameter attribute

Byte 5	Byte 6
Attribute	Number of subindices

Field	Data type	Values
Attribute	U8	0x10: Value
Number of subindices	U8	0x00 or 0x01

### Index and subindex

Byte 7	Byte 8	Byte 9	Byte 10
Index		Subindex	
High byte	Low byte	High byte	Low byte

Field	Data type	Values
Index	U16	0x0001 ... 0xFFFF (1 ... 65535)
Subindex	U16	0x0001 ... 0xFFFF (1 ... 65535)

# Parameter data transfer

Reading parameters from the inverter

## 9.2.1 Response to a correctly executed read request



### Note!

- Responses to read requests do not contain parameter attributes and indices/subindices.
- When a multi-parameter read request is transmitted, the parameter format and the parameter value are repeated "n" times, "n" being the number of parameters requested.

### Response header

Byte 1	Byte 2	Byte 3	Byte 4
Request reference (mirrored)	Response identification	Axis (mirrored)	Number of indices

Field	Data type	Values
Request reference	U8	Mirrored value of the parameter request
Response identification	U8	0x01: Parameter has been read
Axis	U8	0x00 or 0x01
Number of indices	U8	0x"n" (n = number of parameters requested)

### Parameter format

Byte 5	Byte 6
Format	Number of values

Field	Data type	Values
Format	U8	0x02: Integer8 0x03: Integer16 0x04: Integer32 0x05: Unsigned8 0x06: Unsigned16 0x07: Unsigned32 0x09: Visible string 0x0A: Octet string 0x40: Zero 0x41: Byte 0x42: Word 0x43: Double word
Number of values	U8	<ul style="list-style-type: none"> <li>• 0x01</li> <li>• Number of requested subindices. (If there is more than one subindex, only the parameter value is repeated.)</li> <li>• In the case of string codes, the number of characters is entered here.</li> </ul>

# Parameter data transfer

Reading parameters from the inverter

## Parameter value

Byte 7	Byte 8	Byte 9	Byte 10
Value			

Field	Data type	Values
Value	String	Any
	U8	0x00 .... 0xFF
	U16	0x0000 .... 0xFFFF
	U32	0x0000 0000 .... 0xFFFF FFFF

## 9.2.2 Response to a read error

### Response header

Byte 1	Byte 2	Byte 3	Byte 4
Request reference (mirrored)	Response identification	Axis (mirrored)	Number of indices

Field	Data type	Values
Request reference	U8	Mirrored value of the parameter request
Response identification	U8	0x81: Parameter has not been read • The data in the bytes 7 + 8 must be interpreted as an error code.
Axis	U8	0x00 or 0x01
Number of indices	U8	0x"n" (n = number of parameters requested)

### Parameter format

Byte 5	Byte 6
Format	Number of values

Field	Data type	Values
Format	U8	0x44: Error
Number of values	U8	0x01: Error code without additional information 0x02: Error code with additional information

# Parameter data transfer

## Reading parameters from the inverter

### Error code

Byte 7	Byte 8	Byte 9	Byte 10
Error code		Additional information (if available)	
High byte	Low byte	High byte	Low byte

Field	Data type	Values
Error code	U16	0x0000 .... 0xFFFF ▶ <a href="#">Error information (error)</a> (68)
Additional information (if available)	U16	

### 9.2.3 Frame example: Read request

The heatsink temperature of the inverter is to be read.

- Code to be read: C00061
- Heatsink temperature: 43 °C

#### Parameter request

Byte 1	Byte 2	Byte 3	Byte 4
Request reference	Request identification	Axis	Number of indices
0xXX	0x01	0x00	0x01
	Request parameters for reading		

Byte 5	Byte 6
Attribute	Number of subindices
0x10	0x00
Value	No subindex

Byte 7	Byte 8	Byte 9	Byte 10
Index		Subindex	
High byte	Low byte	High byte	Low byte
0x5F	0xC2	0x00	0x00
Index = 24575 - code no. = 24575 - 61 = 24514 = 0x5F C2		No subindex	

# Parameter data transfer

## Reading parameters from the inverter

### Parameter response to a correctly executed read request

Byte 1	Byte 2	Byte 3	Byte 4
Request reference	Response identification	Axis	Number of indices
0xXX	0x01	0x00	0x01
(mirrored)	Parameter has been read	(mirrored)	

Byte 5	Byte 6
Format	Number of values
0x43	0x01
Double word	1 value

Byte 7	Byte 8	Byte 9	Byte 10
Value			
High word: high byte	High word: low byte	Low- word: high byte	Low word: low byte
0x00	0x00	0x00	0x2B
Read value = 0x00 00 00 2B = 43 x 1 (internal factor) = 43 [°C]			

### Parameter response to a read error

Byte 1	Byte 2	Byte 3	Byte 4
Request reference	Response identification	Axis	Number of indices
0xXX	0x81	0x00	0x01
(mirrored)	Parameters not read	(mirrored)	

Byte 5	Byte 6
Format	Number of values
0x44	0x01
Error	Error code without additional information

Byte 7	Byte 8
Error code	
High byte	Low byte
For the meaning see the chapter " <a href="#">Error information (error)</a> " (□ 68)	

# Parameter data transfer

## Writing parameters to the inverter

### 9.3 Writing parameters to the inverter



#### Note!

- When a multi-parameter write request is processed, the parameter attribute, index, subindex, and then the parameter format and parameter value are repeated "n" times, "n" being the number of parameters requested.
- A parameter request must not exceed the maximum data length of 240 bytes.

#### Request header

Byte 1	Byte 2	Byte 3	Byte 4
Request reference	Request identification	Axis	Number of indices

Field	Data type	Values
Request reference	U8	This value is specified by the I/O controller.
Request identification	U8	0x02: Write parameter
Axis	U8	0x00 or 0x01
Number of indices	U8	0x"n" (n = number of parameters requested)

#### Parameter attribute

Byte 5	Byte 6
Attribute	Number of subindices

Field	Data type	Values
Attribute	U8	0x10: Value
Number of subindices	U8	0x00 or 0x01

#### Index and subindex

Byte 7	Byte 8	Byte 9	Byte 10
Index		Subindex	
High byte	Low byte	High byte	Low byte

Field	Data type	Values
Index	U16	0x0001 ... 0xFFFF (1 ... 65535)
Subindex	U16	0x0001 ... 0xFFFF (1 ... 65535)



# Parameter data transfer

Writing parameters to the inverter

## Parameter format

Byte 11	Byte 12
Format	Number of values

Field	Data type	Values
Format	U8	0x02: Integer8 0x03: Integer16 0x04: Integer32 0x05: Unsigned8 0x06: Unsigned16 0x07: Unsigned32 0x09: Visible string 0x0A: Octet string 0x40: Zero 0x41: Byte 0x42: Word 0x43: Double word
Number of values	U8	<ul style="list-style-type: none"> <li>• 0x01</li> <li>• Number of requested subindices. (If there is more than one subindex, only the parameter value is repeated.)</li> <li>• In the case of string codes, the number of characters is entered here.</li> </ul>

## Parameter value

Byte 13	Byte 14	Byte 15	Byte 16
Value			

Field	Data type	Values
Value	String	Any
	U8	0x00 .... 0xFF
	U16	0x0000 .... 0xFFFF
	U32	0x0000 0000 .... 0xFFFF FFFF

# Parameter data transfer

Writing parameters to the inverter

---

## 9.3.1 Response to a correctly executed write request

### Response header

Byte 1	Byte 2	Byte 3	Byte 4
Request reference (mirrored)	Response identification	Axis (mirrored)	Number of indices

Field	Data type	Values
Request reference	U8	Mirrored value of the parameter request
Response identification	U8	0x01: Parameter written
Axis	U8	0x00 or 0x01
Number of indices	U8	0x"n" (n = number of parameters requested)

## 9.3.2 Response to a write error



### Note!

In the case of a multi-parameter request, correct and possible faulty messages are summarised in one frame. They have the following data contents:

- Correct message
  - Format: 0x40
  - Number of values: 0x00
- Faulty message
  - Format: 0x44
  - Number of values: 0x01 or 0x02
  - Error code without additional information (number of values = 0x01) *or*
  - Error code with additional information (number of values = 0x02)

A faulty access to a parameter "n" is indicated at the nth position in the response frame of a multi-parameter request.

# Parameter data transfer

## Writing parameters to the inverter

### Response header

Byte 1	Byte 2	Byte 3	Byte 4
Request reference (mirrored)	Response identification	Axis (mirrored)	Number of indices

Field	Data type	Values
Request reference	U8	Mirrored value of the parameter request
Response identification	U8	0x82: Parameter has not been written • The data in the bytes 7 + 8 must be interpreted as an error code.
Axis	U8	0x00 or 0x01
Number of indices	U8	0x"n" (n = number of parameters requested)

### Parameter format

Byte 5	Byte 6
Format	Number of values

Field	Data type	Values
Format	U8	0x44: Error
Number of values	U8	0x01: Error code without additional information 0x02: Error code with additional information

### Error code

Byte 7	Byte 8	Byte 9	Byte 10
Error code		Additional information (if available)	
High byte	Low byte	High byte	Low byte

Field	Data type	Values
Error code	U16	0x0000 .... 0xFFFF ▶ <a href="#">Error information (error)</a> (□ 68)
Additional information (if available)	U16	

# Parameter data transfer

## Writing parameters to the inverter

### 9.3.3 Frame example: Write request

In the inverter, the deceleration time for quick stop is to be set to 50 ms.

- Code to be written: C00105

#### Parameter request

Byte 1	Byte 2	Byte 3	Byte 4
Request reference	Request identification	Axis	Number of indices
0xXX	0x02	0x00	0x01
	Write parameters	Axis 0	1 index

Byte 5	Byte 6
Attribute	Number of subindices
0x10	0x00
Value	No subindex

Byte 7	Byte 8	Byte 9	Byte 10
Index		Subindex	
High byte	Low byte	High byte	Low byte
0x5F	0x96	0x00	0x00
Index = 24575 - code no. = 24575 - 105 = 24470 = 0x5F 96		No subindex	

Byte 11	Byte 12
Format	Number of values
0x43	0x01
Double word	1 value

Byte 13	Byte 14	Byte 15	Byte 16
Value			
High word: high byte	High word: low byte	Low- word: high byte	Low word: low byte
0x00	0x00	0x00	0x32
Value to be written = 0.05 [s] x 1000 (internal factor) = 50 = 0x00 00 00 32			

# Parameter data transfer

## Writing parameters to the inverter

---

### Parameter response to a correctly executed write request

Byte 1	Byte 2	Byte 3	Byte 4
Request reference	Response identification	Axis	Number of indices
0xXX	0x02	0x00	0x01
(mirrored)	Parameter has been written	(mirrored)	1 index

### Parameter response after write error

Byte 1	Byte 2	Byte 3	Byte 4
Request reference	Response identification	Axis	Number of indices
0xXX	0x82	0x00	0x01
(mirrored)	Parameter has not been written	(mirrored)	1 index

Byte 5	Byte 6
Format	Number of values
0x44	0x01
Error	Error code without additional information

Byte 7	Byte 8
Error code	
High byte	Low byte
For the meaning see the chapter " <a href="#">Error information (error)</a> " ( <a href="#">68</a> )	

# Parameter data transfer

Error information (error)

## 9.4 Error information (error)

Error code	Meaning	Description	Additional information
0x0000	Impermissible parameter number	Access to unavailable parameter	-
0x0001	Parameter value cannot be changed	Change access to a parameter value that cannot be changed	Subindex
0x0002	Lower or upper value limit exceeded	Change access with value beyond the value limits	Subindex
0x0003	Faulty subindex	Access to unavailable subindex	Subindex
0x0004	No array	Access with subindex to non-indicated parameter	-
0x0005	Wrong data type	Change access with value that does not match the data type of the parameter	-
0x0006	No setting permitted (only resettable)	Change access with value unequal to 0 where this is not permitted	Subindex
0x0007	Description element cannot be changed	Change access to a description element that cannot be changed	Subindex
0x0008	Reserved	(PROFIdrive profile V2: PPO-Write requested in the IR is not available)	-
0x0009	Description data not available	Access to unavailable description (parameter value is available)	-
0x000A	Reserved	(PROFIdrive profile V2: Wrong access group)	-
0x000B	No parameter change rights	Change access without parameter change rights	-
0x000C	Reserved	(PROFIdrive profile V2: Wrong password)	-
0x000D	Reserved	(PROFIdrive profile V2: Text in the cyclic traffic cannot be read)	-
0x000E	Reserved	(PROFIdrive profile V2: Name in the cyclic traffic cannot be read)	-
0x000F	No text array available	Access to unavailable text array (parameter value is available)	-
0x0010	Reserved	(PROFIdrive profile V2: Missing PPO-Write)	-
0x0011	Request cannot be executed due to the operating state	Access is not possible due to temporary reasons not specified here	-
0x0012	Reserved	(PROFIdrive profile V2: Other error)	-
0x0013	Reserved	(PROFIdrive profile V2: date in the cyclic traffic cannot be read)	-
0x0014	Value impermissible	Change access with the value that is inside the value limits but not permissible for other permanent reasons (parameters with defined individual values)	Subindex
0x0015	Response too long	The length of the current response exceeds the maximum transmittable length	-
0x0016	Parameter address impermissible	Impermissible or non-supported value for attribute, number of subindices, parameter number, or subindex, or a combination	-
0x0017	Format impermissible	Write request: Impermissible or non-supported format of parameter data	-
0x0018	Number of values not consistent	Write request: Number of values of the parameter data do not match the number of subindices in the parameter address	-
0x0019	Reserved	-	-
...			
0x0064			

# Parameter data transfer

Error information (error)

---

Error code	Meaning	Description	Additional information
0x0065	Manufacturer-specific	-	-
...			
0x00FF			

# Parameter data transfer

## Consistent parameter data

### 9.5 Consistent parameter data

In the PROFINET communication system, data are permanently exchanged between the host (CPU + I/O controller) and the standard device via the plugged-on I/O device interface module. The I/O controller and the CPU (central processing unit) of the host access a joint memory: the dual port memory (DPM).

- The DPM permits a data exchange in both directions (write/read):



It could happen that a slower I/O controller writing would be overtaken by a faster CPU reading within a cycle time without any further data organisation.

In order to avoid such an impermissible state, the parameter data to be transmitted must be marked as "consistent".

#### Data communication with consistent data

With consistency, either "reading" or "writing" is possible when the I/O controller and the CPU simultaneously access the memory:

- The I/O controller transfers data only as a complete data set.
- The CPU can only access completely updated data sets.
- The I/O controller cannot read or write data as long as the CPU accesses consistent data.

The result becomes clear from the example below:

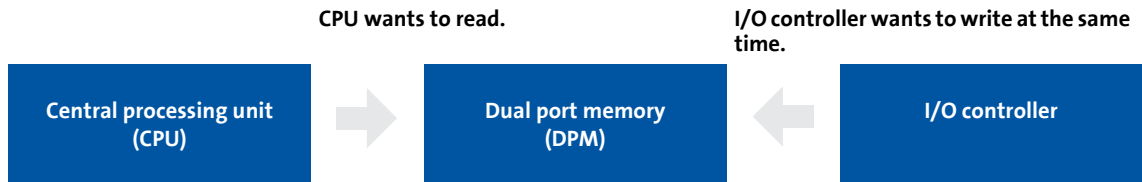

1. As the I/O controller can only write when the CPU does not read, the I/O controller has to wait until the data are completely read by the CPU.
2. The I/O controller only writes a complete data set into the DPM.

#### Configuring consistent data



#### Note!

Consistency is achieved by an appropriate I/O controller configuration (see documentation for the configuring software).



# Monitoring

## Interruption of PROFINET communication

## 10 Monitoring

### 10.1 Interruption of PROFINET communication

An interruption of PROFINET communication in the "Data\_Exchange" state, e.g. by cable break or failure of the I/O controller is recognised by the I/O device.



The response to the interruption of communication is controlled via the following settings:

1. During the initialisation of PROFINET communication the watchdog monitoring time specified in the I/O controller ([C13882](#)) is transferred to the I/O device.

If the I/O device does not receive any valid process data in the "Data\_Exchange" state, the process data are treated according to the setting in **2** [C13885](#). (Like this the data that were sent last by the I/O controller can be used or set to zero.)

After the watchdog monitoring time has elapsed, the I/O device changes to the "No\_Data\_Exchange" status (see [C13861](#)), and the red LED **BE** is activated ([Fieldbus status displays](#) (875)).

There is no response in the I/O device.

2. To trigger a response in the IO device, you additionally have to set a **Response of the Inverter Drive 8400** **1** ([C13880](#)) under the **Monitoring** tab in the »Engineer«.

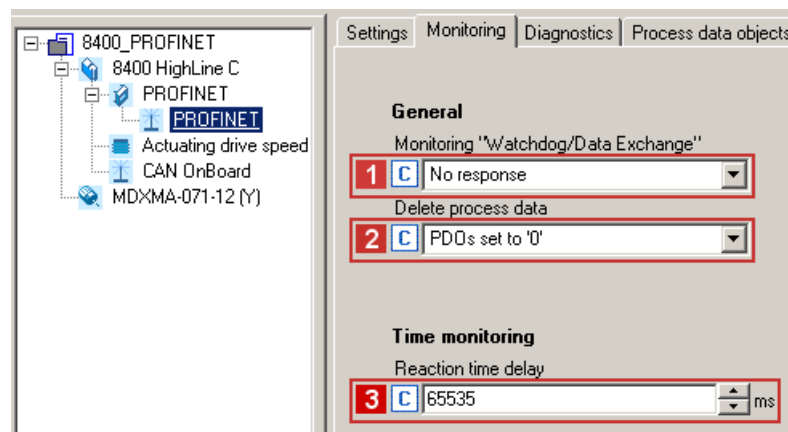

By setting a **Reaction time delay** **3** ([C13881](#)) you can decelerate this response.

- In the Lenze setting "0 ms", this monitoring is activated.
- With the setting "65535 ms", this monitoring is deactivated.
- A change of monitoring will be effective immediately.
- The monitoring time elapses when the "Data\_Exchange" status is exited.

After this response delay has elapsed, the response set is executed with the error message "[PROFINET: Data Exchange status quit \[0x01bc6531\]](#)" (83).

### 10.2 Interruption of internal communication

- The response in the event of a communication error between the communication module and the Inverter Drive 8400 can be set via code **C01501**.
- The communication module reports a connection interruption to the IO controller and changes to the "No\_Data\_Exchange" state.

# Monitoring

Interruption of internal communication

---

- The error message "[PROFINET: Exist. conn. to 8400 lost \[0x01bc3100\]](#)" (📄 81) is output.

## 11 Diagnostics

For purposes of fault diagnostics, the communication module is provided with the LEDs on the front. Furthermore you can carry out the [Diagnostics with the »Engineer«](#) (77).

### 11.1 LED status displays



#### Note!

During normal operation ...

- only the LEDs **MS** (74) and **BS** (75) should be lit permanently.
- the green LEDs on the RJ45 sockets X256/X257 must be lit or blinking (76).

The following status displays are distinguished:



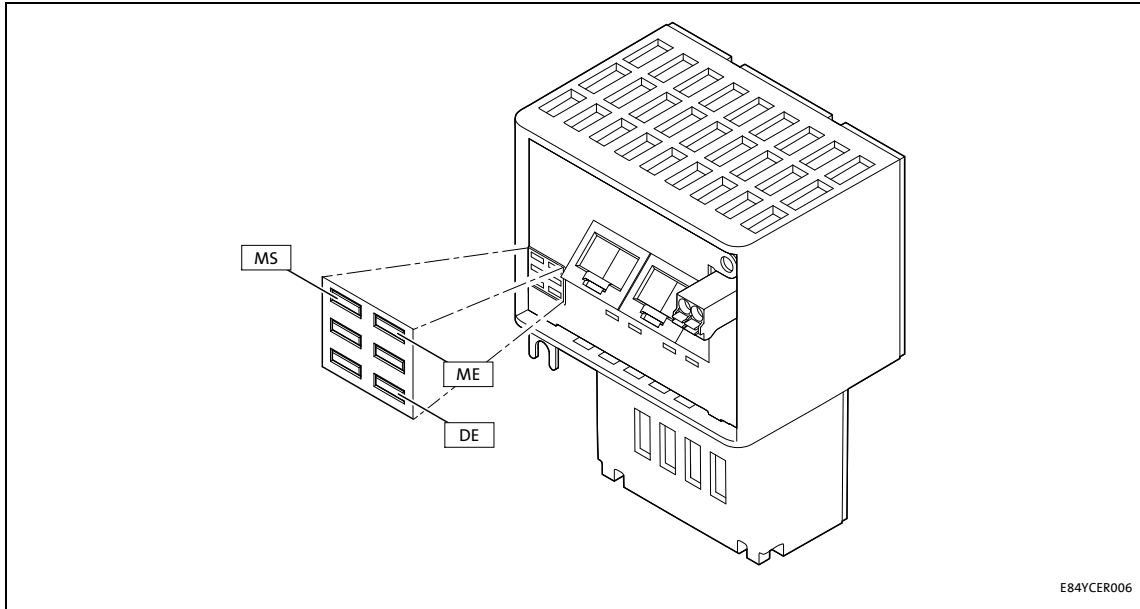

- [Module status displays](#) (74)
- [Fieldbus status displays](#) (75)
- [Status displays at X256 and X257](#) (76)

### 11.1.1 Module status displays

The LEDs **MS**, **ME** and **DE** indicate the module status.



E84YCER006



LED	Colour	Status	Description
MS	green	On	 The communication module is supplied with voltage and is connected to the standard device.
		blinking	 The communication module is supplied with voltage, but is not connected to the standard device. (Standard device is switched off, in the initialisation phase, or not available.)
ME	red	On	 An error has occurred in the communication module.
		blinking	 The "Node blinking test" PROFINET function is activated by the I/O controller. The blinking LED serves to identify/localise accessible I/O devices.
EN	red	On	 The communication module is not accepted by the basic device or the basic device is not active (see notes in the documentation relating to the basic device.)

### 11.1.2 Fieldbus status displays

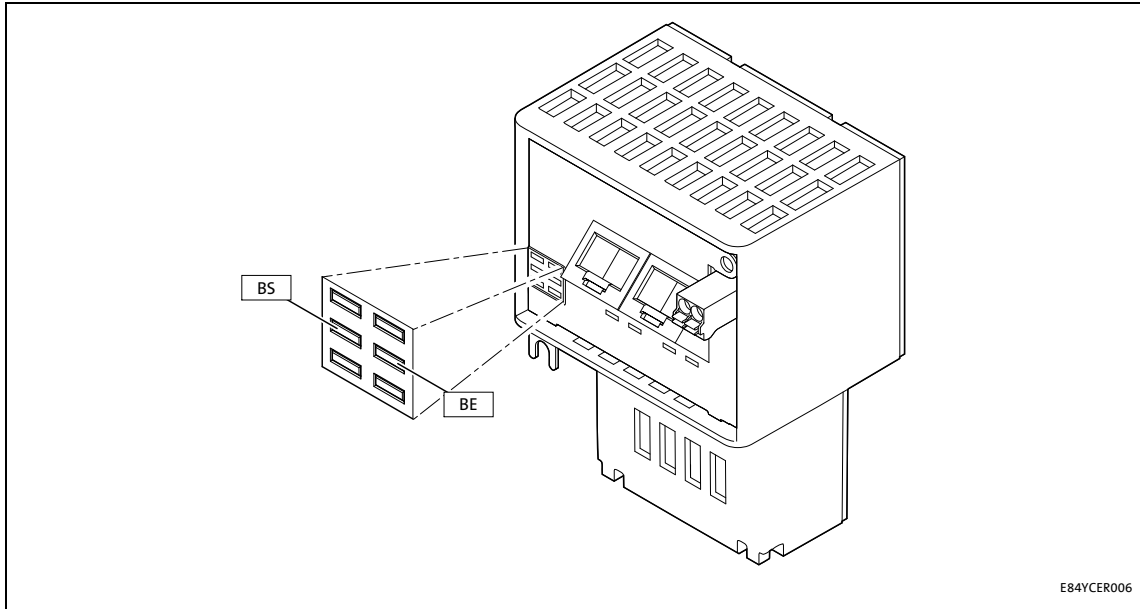
The LEDs **BS** and **BE** indicate the fieldbus status.







E84YCER006

LED	Colour	Status	Description
BS	green	Off	The communication module is not active on the fieldbus or is in the INIT state.
		blinking	 200 ms The communication module is in the DATA_EXCHANGE status.
BE	red	On	 Bus error/fault is active (e.g. Ethernet cable not connected). The communication module is in the NO_DATA_EXCHANGE status.
		blinking	 200 ms Impermissible settings: <ul style="list-style-type: none"> <li>• Invalid station name</li> <li>• Invalid IP parameters</li> </ul> The communication module has been initialised and continues to work internally with the respective standard values.

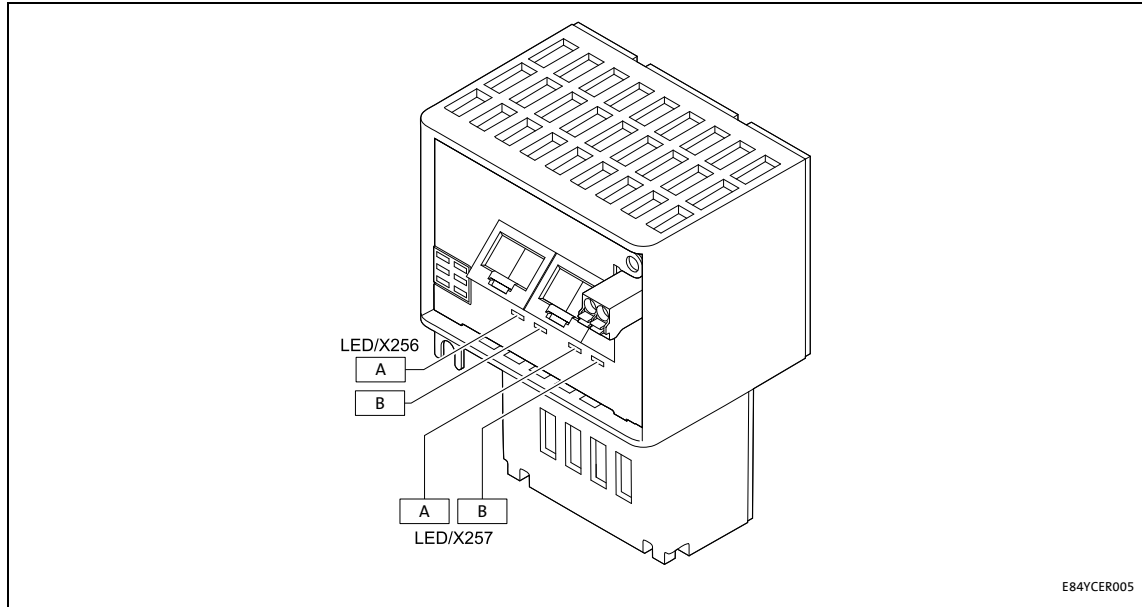
### 11.1.3 Status displays at X256 and X257

The LEDs below the RJ45 sockets X256 and X257 indicate the PROFINET connection status.



LED	Colour	Status	Description
A	green	Off	No connection to PROFINET
		On	 Connection to PROFINET has been established.
B	Yellow	Off	No communication
		On or Flickers	  Communication active

# Diagnostics

Diagnostics with the »Engineer«

## 11.2 Diagnostics with the »Engineer«

In the »Engineer« under the **Diagnostics** tab, you will find PROFINET diagnostics information.

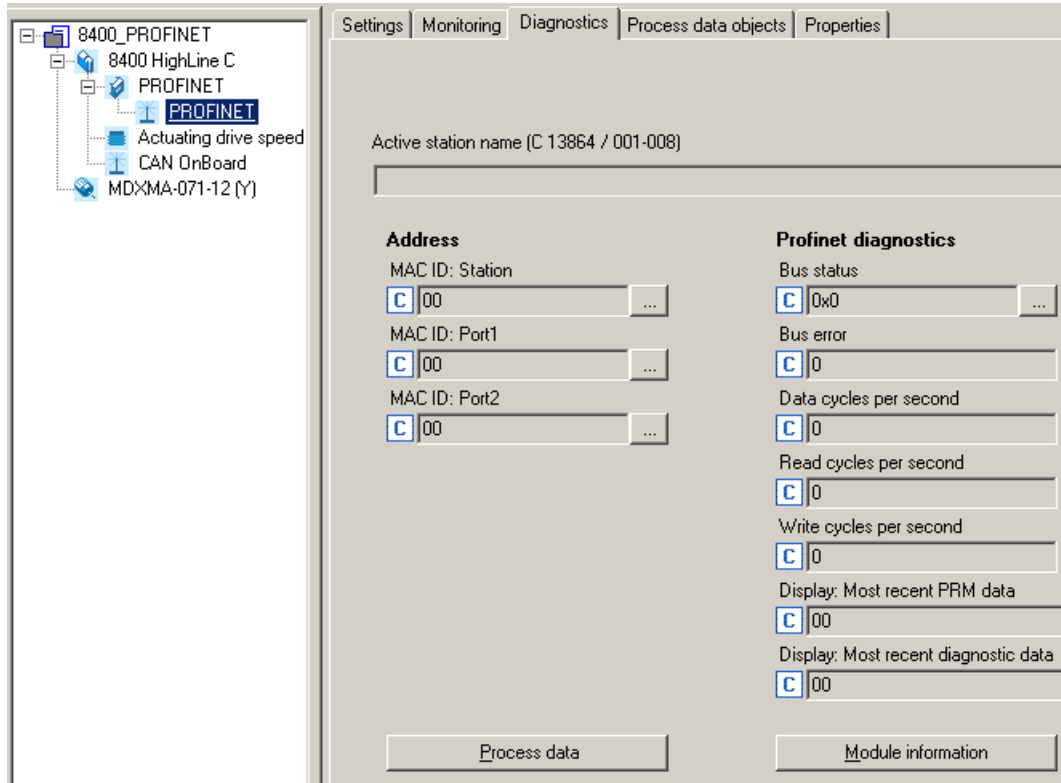

# Diagnostics

## Diagnostic data

---

### 11.3 Diagnostic data

- The I/O device sends an alarm message to the I/O controller to signalise the diagnostic data below.
- Errors and warnings of the Inverter Drive 8400 and the module connected to it are sent to the IO controller as extended diagnostic messages.
- With code [C13887](#), the transmission of an alarm message can be suppressed for specific error messages.
- The diagnostic data can be displayed using the hexadecimal representation of the Siemens S7 engineering tool.

Bytes	Meaning	Value [hex]
1 ... 6	Diag. block header	0x0010 001C 0100
7 ... 8	Alarm type	0x0001 (diagnosis)
9 ... 12	API	0x0000 0000
13, 14	Slot number	0x0001 / 0x0002
15, 16	Subslot number	0x0001
17 ... 20	Module ID	ID according to module
21 ... 24	Submodule ID	ID according to module
25, 26	Alarm specifier	0xB000
27, 28	User structure identifier	0x0001
29 ... 32	Error code of the Inverter Drive 8400 / E84AYCER	



# Diagnostics

Diagnostic data

## Error code of Inverter Drive 8400

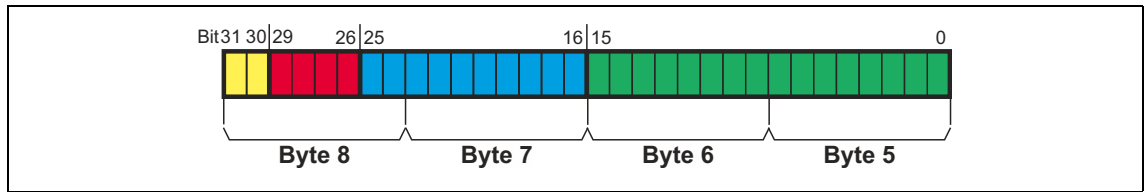

- The error code can be found in bytes 29 ... 32 of the diagnostic message.
- In the logbook and in code **C00165**, the error number is shown in the following syntax in order to facilitate the readability:

**[error type].[error subject area no.].[error ID]**

**Example:** error message "[PROFINET: Data Exchange status quit \[0x01bc6531\]](#)"

Byte 32		Byte 31								Byte 30								Byte 29													
0x01		0xbc								0x65								0x31													
0	0	0	0	0	0	0	1	1	0	1	1	1	1	0	0	0	1	1	0	0	1	0	1	0	0	1	1	0	0	0	1
Response	Instance ID	Module ID								Error ID																					



**Software manual/»Engineer« online help for Inverter Drive 8400**

Detailed information on the error codes is provided here.

# Error messages

Short overview of the PROFINET error messages

## 12 Error messages

[ALinkKeywords]  
Error messages

This chapter supplements the error list in the software manual and the »Engineer« online help for the Inverter Drive 8400 by the error messages of the communication module.



### Software manual/»Engineer« online help for Inverter Drive 8400

Here you will find general information on diagnostics & fault analysis and on error messages.

[Search-Keywords]  
Error messages

### 12.1 Short overview of the PROFINET error messages

The following table contains all PROFINET error messages in numerical order of the error number. Furthermore the preset error response and - if applicable – the parameter for setting the error response is specified.



#### Tip!

If you click on the cross-reference in the first column, you will get a detailed description (causes and remedies) of the corresponding error message.

Error no. [hex]	Subject area no. [dec]	Error no. [dec]	Error text	Error type (Error response)	Adjustable in
<a href="#">0x01bc3100</a>	444	12544	PROFINET: Exist. connect. to 8400 lost	1: No Response	-
<a href="#">0x01bc5531</a>	444	21809	PROFINET: Memory: No access	1: No Response	-
<a href="#">0x01bc5532</a>	444	21810	PROFINET: Memory: Read error	1: No Response	-
<a href="#">0x01bc5533</a>	444	21811	PROFINET: Memory: Write error	1: No Response	-
<a href="#">0x01bc6010</a>	444	24592	PROFINET: Restart by watchdog reset	1: No Response	-
<a href="#">0x01bc6011</a>	444	24593	PROFINET: Internal error	1: No Response	-
<a href="#">0x01bc6100</a>	444	24832	PROFINET: Internal error	1: No Response	-
<a href="#">0x01bc6101</a>	444	24833	PROFINET: Internal error	1: No Response	-
<a href="#">0x01bc641f</a>	444	25631	PROFINET: Invalid parameter set	1: No Response	-
<a href="#">0x01bc6420</a>	444	25632	PROFINET: Error: Lenze setting loaded	1: No Response	-
<a href="#">0x01bc6430</a>	444	25648	PROFINET: Invalid module configuration	1: No Response	-
<a href="#">0x01bc6501</a>	444	25857	PROFINET: Record parameter: Invalid read	4: Warning locked	-
<a href="#">0x01bc6502</a>	444	25858	PROFINET: Record parameter: Invalid write	4: Warning locked	-
<a href="#">0x01bc6503</a>	444	25859	PROFINET: Data output status bad	4: Warning locked	-
<a href="#">0x01bc6531</a>	444	25905	PROFINET: Data_Exchange status quit	0: None	<a href="#">C13880/1</a>
<a href="#">0x01bc6532</a>	444	25906	PROFINET: Station name error	1: No Response	-
<a href="#">0x01bc6533</a>	444	25907	PROFINET: IIP address error	1: No Response	-
<a href="#">0x01bc6534</a>	444	25908	PROFINET: Stack init error	1: No Response	-
<a href="#">0x01bc6650</a>	444	26192	PROFINET: Internal error	1: No Response	-

# Error messages

## Possible causes and remedies

### 12.2 Possible causes and remedies

In this chapter, all error messages of the communication module are listed in numerical order of the error numbers. Possible causes and remedies and responses to the error messages are described in detail.



**Tip!**

You will find a list of all error messages of the communication module in alphabetical order in the previous chapter "[Short overview of the PROFINET error messages](#)" (80).

#### PROFINET: Exist. conn. to 8400 lost [0x01bc3100]

<b>Response</b> (Lenze setting printed in bold)		<b>Setting:</b> not possible
<input type="checkbox"/> No reaction <input type="checkbox"/> System fault <input checked="" type="checkbox"/> <b>Fault</b> <input type="checkbox"/> Trouble <input type="checkbox"/> Quick stop by trouble <input type="checkbox"/> WarningLocked <input type="checkbox"/> Warning <input type="checkbox"/> Information		
Cause	Remedy	
MCI communication to Inverter Drive 8400 is interrupted. <ul style="list-style-type: none"><li>• Inverter Drive 8400 is switched off.</li><li>• The communication module is not connected correctly at the MCI slot of the Inverter Drive 8400.</li></ul>	<ul style="list-style-type: none"><li>• Switch on Inverter Drive 8400.</li><li>• Check screwed connection of the communication module at the MCI slot of the Inverter Drive 8400.</li><li>• Send the communication module and Inverter Drive 8400 together with a description of the fault to Lenze.</li></ul>	

#### PROFINET: Memory: No access [0x01bc5531]

<b>Response</b> (Lenze setting printed in bold)		<b>Setting:</b> not possible
<input type="checkbox"/> No reaction <input type="checkbox"/> System fault <input checked="" type="checkbox"/> <b>Fault</b> <input type="checkbox"/> Trouble <input type="checkbox"/> Quick stop by trouble <input type="checkbox"/> WarningLocked <input type="checkbox"/> Warning <input type="checkbox"/> Information		
Cause	Remedy	
Access to memory was not possible.	Send communication module together with a description of the fault to Lenze.	

#### PROFINET: Memory: Read error [0x01bc5532]

<b>Response</b> (Lenze setting printed in bold)		<b>Setting:</b> not possible
<input type="checkbox"/> No reaction <input type="checkbox"/> System fault <input checked="" type="checkbox"/> <b>Fault</b> <input type="checkbox"/> Trouble <input type="checkbox"/> Quick stop by trouble <input type="checkbox"/> WarningLocked <input type="checkbox"/> Warning <input type="checkbox"/> Information		
Cause	Remedy	
Parameter could not be read.	Send communication module together with a description of the fault to Lenze.	

#### PROFINET: Memory: Write error [0x01bc5533]

<b>Response</b> (Lenze setting printed in bold)		<b>Setting:</b> not possible
<input type="checkbox"/> No reaction <input type="checkbox"/> System fault <input checked="" type="checkbox"/> <b>Fault</b> <input type="checkbox"/> Trouble <input type="checkbox"/> Quick stop by trouble <input type="checkbox"/> WarningLocked <input type="checkbox"/> Warning <input type="checkbox"/> Information		
Cause	Remedy	
Parameter could not be written.	Send communication module together with a description of the fault to Lenze.	

# Error messages

## Possible causes and remedies

### PROFINET: Restart by watchdog reset [0x01bc6010]

<b>Response</b> (Lenze setting printed in bold)		<b>Setting:</b> not possible
<input type="checkbox"/> No reaction <input type="checkbox"/> System fault <input checked="" type="checkbox"/> <b>Fault</b> <input type="checkbox"/> Trouble <input type="checkbox"/> Quick stop by trouble <input type="checkbox"/> WarningLocked <input type="checkbox"/> Warning <input type="checkbox"/> Information		
<b>Cause</b>		<b>Remedy</b>
Communication module is defective.		Send communication module together with a description of the fault to Lenze.

### PROFINET: Internal error [0x01bc6011]

<b>Response</b> (Lenze setting printed in bold)		<b>Setting:</b> not possible
<input type="checkbox"/> No reaction <input type="checkbox"/> System fault <input checked="" type="checkbox"/> <b>Fault</b> <input type="checkbox"/> Trouble <input type="checkbox"/> Quick stop by trouble <input type="checkbox"/> WarningLocked <input type="checkbox"/> Warning <input type="checkbox"/> Information		
<b>Cause</b>		<b>Remedy</b>
Communication module is defective.		Send communication module together with a description of the fault to Lenze.

### PROFINET: Internal error [0x01bc6100]

<b>Response</b> (Lenze setting printed in bold)		<b>Setting:</b> not possible
<input type="checkbox"/> No reaction <input type="checkbox"/> System fault <input checked="" type="checkbox"/> <b>Fault</b> <input type="checkbox"/> Trouble <input type="checkbox"/> Quick stop by trouble <input type="checkbox"/> WarningLocked <input type="checkbox"/> Warning <input type="checkbox"/> Information		
<b>Cause</b>		<b>Remedy</b>
Internal error		Send communication module together with a description of the fault to Lenze.

### PROFINET: Internal error [0x01bc6101]

<b>Response</b> (Lenze setting printed in bold)		<b>Setting:</b> not possible
<input type="checkbox"/> No reaction <input type="checkbox"/> System fault <input checked="" type="checkbox"/> <b>Fault</b> <input type="checkbox"/> Trouble <input type="checkbox"/> Quick stop by trouble <input type="checkbox"/> WarningLocked <input type="checkbox"/> Warning <input type="checkbox"/> Information		
<b>Cause</b>		<b>Remedy</b>
Internal error		Send communication module together with a description of the fault to Lenze.

### PROFINET: Invalid parameter set [0x01bc641f]

<b>Response</b> (Lenze setting printed in bold)		<b>Setting:</b> not possible
<input type="checkbox"/> No reaction <input type="checkbox"/> System fault <input checked="" type="checkbox"/> <b>Fault</b> <input type="checkbox"/> Trouble <input type="checkbox"/> Quick stop by trouble <input type="checkbox"/> WarningLocked <input type="checkbox"/> Warning <input type="checkbox"/> Information		
<b>Cause</b>		<b>Remedy</b>
No active parameter set could be loaded.		<ul style="list-style-type: none"> <li>• Download application again (including module).</li> <li>• Send communication module together with a description of the fault to Lenze.</li> </ul>

### PROFINET: Error: Lenze setting loaded [0x01bc6420]

<b>Response</b> (Lenze setting printed in bold)		<b>Setting:</b> not possible
<input type="checkbox"/> No reaction <input type="checkbox"/> System fault <input checked="" type="checkbox"/> <b>Fault</b> <input type="checkbox"/> Trouble <input type="checkbox"/> Quick stop by trouble <input type="checkbox"/> WarningLocked <input type="checkbox"/> Warning <input type="checkbox"/> Information		
<b>Cause</b>		<b>Remedy</b>
Access to parameter set in the memory module was not possible.		<ul style="list-style-type: none"> <li>• Download application again (including module).</li> <li>• Send device with error description to Lenze.</li> </ul>

# Error messages

## Possible causes and remedies

### PROFINET: Invalid module configuration [0x01bc6430]

<b>Response</b> (Lenze setting printed in bold)	<b>Setting:</b> not possible
<input type="checkbox"/> No reaction <input type="checkbox"/> System fault <input checked="" type="checkbox"/> <b>Fault</b> <input type="checkbox"/> Trouble <input type="checkbox"/> Quick stop by trouble <input type="checkbox"/> WarningLocked <input type="checkbox"/> Warning <input type="checkbox"/> Information	
<b>Cause</b>	<b>Remedy</b>
A module or submodule does not comply with the configuration of the Siemens S7 engineering tool.	Check configuration.

### PROFINET: Record Parameter: Invalid read [0x01bc6501]

<b>Response</b> (Lenze setting printed in bold)	<b>Setting:</b> not possible
<input type="checkbox"/> None <input type="checkbox"/> System fault <input type="checkbox"/> Fault <input type="checkbox"/> Trouble <input type="checkbox"/> Quick stop by trouble <input checked="" type="checkbox"/> <b>Warning locked</b> <input type="checkbox"/> Warning <input type="checkbox"/> Information	
<b>Cause</b>	<b>Remedy</b>
Invalid parameter read access	Check configuration.

### PROFINET: Record Parameter: Invalid write [0x01bc6502]

<b>Response</b> (Lenze setting printed in bold)	<b>Setting:</b> not possible
<input type="checkbox"/> None <input type="checkbox"/> System fault <input type="checkbox"/> Fault <input type="checkbox"/> Trouble <input type="checkbox"/> Quick stop by trouble <input checked="" type="checkbox"/> <b>Warning locked</b> <input type="checkbox"/> Warning <input type="checkbox"/> Information	
<b>Cause</b>	<b>Remedy</b>
Invalid parameter write access When reading back the data, the IO Controller has requested a data length (number of data bytes) that is too small.	Check configuration.

### PROFINET: Data output status bad [0x01bc6503]

<b>Response</b> (Lenze setting printed in bold)	<b>Setting:</b> not possible
<input type="checkbox"/> None <input type="checkbox"/> System fault <input type="checkbox"/> Fault <input type="checkbox"/> Trouble <input type="checkbox"/> Quick stop by trouble <input checked="" type="checkbox"/> <b>Warning locked</b> <input type="checkbox"/> Warning <input type="checkbox"/> Information	
<b>Cause</b>	<b>Remedy</b>
<ul style="list-style-type: none"> <li>• Output data invalid.</li> <li>• Connection to Siemens S7 has been interrupted.</li> </ul>	<ul style="list-style-type: none"> <li>• Check cables and terminals.</li> <li>• Connect network cable to PROFINET connections.</li> </ul>

### PROFINET: Data\_Exchange status quit [0x01bc6531]

<b>Response</b> (Lenze setting printed in bold)	<b>Setting:</b> <a href="#">C13880/1</a> ( <input checked="" type="checkbox"/> Adjustable response)
<input checked="" type="checkbox"/> <b>None</b> <input type="checkbox"/> System fault <input checked="" type="checkbox"/> <b>Fault</b> <input type="checkbox"/> Trouble <input checked="" type="checkbox"/> Quick stop by trouble <input checked="" type="checkbox"/> Warning locked <input type="checkbox"/> Warning <input checked="" type="checkbox"/> Information	
<b>Cause</b>	<b>Remedy</b>
The data exchange via PROFINET has been terminated. • Also see the chapter " <a href="#">Interruption of PROFINET communication</a> " ( <a href="#">□ 71</a> ).	<ul style="list-style-type: none"> <li>• Check cables and terminals.</li> <li>• Connect network cable to PROFINET connections.</li> </ul>

### PROFINET: Station name error [0x01bc6532]

<b>Response</b> (Lenze setting printed in bold)	<b>Setting:</b> not possible
<input type="checkbox"/> No reaction <input type="checkbox"/> System fault <input checked="" type="checkbox"/> <b>Fault</b> <input type="checkbox"/> Trouble <input type="checkbox"/> Quick stop by trouble <input type="checkbox"/> WarningLocked <input type="checkbox"/> Warning <input type="checkbox"/> Information	
<b>Cause</b>	<b>Remedy</b>
Station name is not DNS-conform.	Use a DNS-compliant station name. ▶ <a href="#">Setting the station name</a> ( <a href="#">□ 36</a> )

# Error messages

Possible causes and remedies

---

## PROFINET: IP address error [0x01bc6533]

<b>Response</b> (Lenze setting printed in bold)	<b>Setting:</b> not possible
<input type="checkbox"/> No reaction <input type="checkbox"/> System fault <input checked="" type="checkbox"/> <b>Fault</b> <input type="checkbox"/> Trouble <input type="checkbox"/> Quick stop by trouble <input type="checkbox"/> WarningLocked <input type="checkbox"/> Warning <input type="checkbox"/> Information	
<b>Cause</b>	<b>Remedy</b>
An invalid IP address has been assigned by the I/O controller via PROFINET or has been set in code <a href="#">C13000</a> .	<ul style="list-style-type: none"><li>• Make sure that the I/O controller has assigned a valid IP address via PROFINET.</li><li>• Set a valid IP address.</li></ul> <a href="#">▶ Setting the IP configuration (📖 38)</a>

## PROFINET: Stack init error [0x01bc6534]

<b>Response</b> (Lenze setting printed in bold)	<b>Setting:</b> not possible
<input type="checkbox"/> No reaction <input type="checkbox"/> System fault <input checked="" type="checkbox"/> <b>Fault</b> <input type="checkbox"/> Trouble <input type="checkbox"/> Quick stop by trouble <input type="checkbox"/> WarningLocked <input type="checkbox"/> Warning <input type="checkbox"/> Information	
<b>Cause</b>	<b>Remedy</b>
The stack cannot be initialised with the parameters selected by the user. This may be due to a station name which does not comply with the PROFINET specification.	Check and, if necessary, adapt PROFINET parameters: <a href="#">▶ Setting the IP configuration (📖 38)</a> <a href="#">▶ Setting the station name (📖 36)</a>

## PROFINET: Internal error [0x01bc6650]

<b>Response</b> (Lenze setting printed in bold)	<b>Setting:</b> not possible
<input type="checkbox"/> No reaction <input type="checkbox"/> System fault <input checked="" type="checkbox"/> <b>Fault</b> <input type="checkbox"/> Trouble <input type="checkbox"/> Quick stop by trouble <input type="checkbox"/> WarningLocked <input type="checkbox"/> Warning <input type="checkbox"/> Information	
<b>Cause</b>	<b>Remedy</b>
Internal error	Send communication module together with a description of the fault to Lenze.

# Parameter reference

Parameters of the communication module

## 13 Parameter reference

[ALinkKeywords]  
Parameters

This chapter supplements the parameter list and the table of attributes for the Inverter Drive 8400 contained in the software manual and in the »Engineer« online help by the parameters of the communication module E84AYCER (PROFINET).



### Software manual/»Engineer« online help for the Inverter Drive 8400

Here you will find general information on parameters.

[Search-Keywords]  
Hlp\_Para

### 13.1 Parameters of the communication module

This chapter lists the parameters of the E84AYCER communication module (PROFINET) in numerically ascending order.



#### Note!

##### PROFINET command "Reset to Factory Defaults"

If the "Reset to factory defaults" PROFINET command is executed by an IO supervisor or an I/O controller, the PROFINET-specific parameters will be reset to their standard values:

- [C13000](#) | IP address
- [C13001](#) | Subnetwork mask
- [C13002](#) | Gateway address
- [C13010](#) | Active IP address
- [C13011](#) | Active subnetwork mask
- [C13012](#) | Active gateway address
- [C13864](#) | Active station name
- [C13887](#) | Suppress signalling diag. mess. upon
- [C13899](#) | Station name
- [C13910](#) | I&M1 system designation
- [C13911](#) | I&M1 installation site
- [C13912](#) | I&M2 installation date
- [C13913](#) | I&M3 additional information
- [C13914](#) | I&M4 signature code

### C13000

Parameter   Name: <b>C13000</b>   IP address		Data type: UNSIGNED_32 Index: 11575 <sub>d</sub> = 2D37 <sub>h</sub>
Setting of the IP address ▶ <a href="#">Setting the IP configuration (38)</a>		
<b>Setting range</b> (min. value   unit   max. value)		<b>Lenze setting</b>
0		4294967295 0
<input checked="" type="checkbox"/> Read access <input checked="" type="checkbox"/> Write access <input type="checkbox"/> CINH <input type="checkbox"/> PLC-STOP <input type="checkbox"/> No transfer <input type="checkbox"/> PDO_MAP_RX <input type="checkbox"/> PDO_MAP_TX <input type="checkbox"/> COM <input type="checkbox"/> MOT		

# Parameter reference

## Parameters of the communication module

### C13001

Parameter   Name: <b>C13001   Subnetwork mask</b>		Data type: UNSIGNED_32 Index: 11574 <sub>d</sub> = 2D36 <sub>h</sub>	
Setting of the subnet mask <a href="#">▶ Setting the IP configuration (38)</a>			
<b>Setting range (min. value   unit   max. value)</b>		<b>Lenze setting</b>	
0		4294967295	0
<input checked="" type="checkbox"/> Read access <input checked="" type="checkbox"/> Write access <input type="checkbox"/> CINH <input type="checkbox"/> PLC-STOP <input type="checkbox"/> No transfer <input type="checkbox"/> PDO_MAP_RX <input type="checkbox"/> PDO_MAP_TX <input type="checkbox"/> COM <input type="checkbox"/> MOT			

### C13002

Parameter   Name: <b>C13002   Gateway address</b>		Data type: UNSIGNED_32 Index: 11573 <sub>d</sub> = 2D35 <sub>h</sub>	
Setting of the gateway address <a href="#">▶ Setting the IP configuration (38)</a>			
<b>Setting range (min. value   unit   max. value)</b>		<b>Lenze setting</b>	
0		4294967295	0
<input checked="" type="checkbox"/> Read access <input checked="" type="checkbox"/> Write access <input type="checkbox"/> CINH <input type="checkbox"/> PLC-STOP <input type="checkbox"/> No transfer <input type="checkbox"/> PDO_MAP_RX <input type="checkbox"/> PDO_MAP_TX <input type="checkbox"/> COM <input type="checkbox"/> MOT			

### C13003

Parameter   Name: <b>C13003   Physical address</b>		Data type: OCTET_STRING Index: 11572 <sub>d</sub> = 2D34 <sub>h</sub>	
Display of the MAC-ID			
<b>Subcodes</b>		<b>Info</b>	
C13003/1		MAC ID: Station	
C13003/2		MAC ID: Port1	
C13003/3		MAC ID: Port2	
<input checked="" type="checkbox"/> Read access <input type="checkbox"/> Write access <input type="checkbox"/> CINH <input type="checkbox"/> PLC-STOP <input type="checkbox"/> No transfer <input type="checkbox"/> PDO_MAP_RX <input type="checkbox"/> PDO_MAP_TX <input type="checkbox"/> COM <input type="checkbox"/> MOT			



# Parameter reference

## Parameters of the communication module

### C13010

Parameter   Name: <b>C13010   Active IP address</b>		Data type: UNSIGNED_8 Index: 11565 <sub>d</sub> = 2D2D <sub>h</sub>
Display of the active IP address <ul style="list-style-type: none"> <li>The active IP address may differ from the contents of code <a href="#">C13000</a>, depending on whether the station name was changed via the fieldbus or the parameter.</li> </ul>		
Subcodes	Info	
C13010/1	Active IP address.1	
C13010/2	Active IP address.2	
C13010/3	Active IP address.3	
C13010/4	Active IP address.4	
<input checked="" type="checkbox"/> Read access <input type="checkbox"/> Write access <input type="checkbox"/> CINH <input type="checkbox"/> PLC-STOP <input type="checkbox"/> No transfer <input type="checkbox"/> PDO_MAP_RX <input type="checkbox"/> PDO_MAP_TX <input type="checkbox"/> COM <input type="checkbox"/> MOT		

### C13011

Parameter   Name: <b>C13011   Active subnetwork mask</b>		Data type: UNSIGNED_8 Index: 11564 <sub>d</sub> = 2D2C <sub>h</sub>
Display of the active subnetwork mask <ul style="list-style-type: none"> <li>The active subnetwork mask may differ from the contents of code <a href="#">C13001</a>, depending on whether the station name was changed via the fieldbus or the parameter.</li> </ul>		
Display range (min. value   unit   max. value)		
0		255
Subcodes	Info	
C13011/1	Active subnetwork mask.1	
C13011/2	Active subnetwork mask.2	
C13011/3	Active subnetwork mask.3	
C13011/4	Active subnetwork mask.4	
<input checked="" type="checkbox"/> Read access <input type="checkbox"/> Write access <input type="checkbox"/> CINH <input type="checkbox"/> PLC-STOP <input type="checkbox"/> No transfer <input type="checkbox"/> PDO_MAP_RX <input type="checkbox"/> PDO_MAP_TX <input type="checkbox"/> COM <input type="checkbox"/> MOT		

### C13012

Parameter   Name: <b>C13012   Active gateway address</b>		Data type: UNSIGNED_8 Index: 11563 <sub>d</sub> = 2D2B <sub>h</sub>
Display of the active gateway address <ul style="list-style-type: none"> <li>The active gateway address may differ from the contents of code <a href="#">C13002</a>, depending on whether the station name was changed via the fieldbus or the parameter.</li> </ul>		
Display range (min. value   unit   max. value)		
0		255
Subcodes	Info	
C13012/1	Active gateway address.1	
C13012/2	Active gateway address.2	
C13012/3	Active gateway address.3	
C13012/4	Active gateway address.4	
<input checked="" type="checkbox"/> Read access <input type="checkbox"/> Write access <input type="checkbox"/> CINH <input type="checkbox"/> PLC-STOP <input type="checkbox"/> No transfer <input type="checkbox"/> PDO_MAP_RX <input type="checkbox"/> PDO_MAP_TX <input type="checkbox"/> COM <input type="checkbox"/> MOT		

# Parameter reference

## Parameters of the communication module

### C13850

Parameter   Name: <b>C13850   All words to master</b>		Data type: UNSIGNED_16 Index: 10725 <sub>d</sub> = 29E5 <sub>h</sub>
Display of the process data words which are transmitted from the inverter to the IO controller. In the subcodes 1 to 16, all process data words to the I/O controller are displayed. However, only the configured process data words are valid.		
<b>Display range (min. value   unit   max. value)</b>		
0		65535
<b>Subcodes</b>		<b>Info</b>
C13850/1		
...		
C13850/16		
<input checked="" type="checkbox"/> Read access <input type="checkbox"/> Write access <input type="checkbox"/> CINH <input type="checkbox"/> PLC-STOP <input type="checkbox"/> No transfer <input type="checkbox"/> PDO_MAP_RX <input type="checkbox"/> PDO_MAP_TX <input type="checkbox"/> COM <input type="checkbox"/> MOT		

### C13851

Parameter   Name: <b>C13851   All words from master</b>		Data type: UNSIGNED_16 Index: 10724 <sub>d</sub> = 29E4 <sub>h</sub>
Display of the process data words which are transmitted from the IO controller to the inverter. In the subcodes 1 to 16, all process data words from the I/O controller are displayed. However, only the configured process data words are valid.		
<b>Display range (min. value   unit   max. value)</b>		
0		65535
<b>Subcodes</b>		<b>Info</b>
C13851/1		
...		
C13851/16		
<input checked="" type="checkbox"/> Read access <input type="checkbox"/> Write access <input type="checkbox"/> CINH <input type="checkbox"/> PLC-STOP <input type="checkbox"/> No transfer <input type="checkbox"/> PDO_MAP_RX <input type="checkbox"/> PDO_MAP_TX <input type="checkbox"/> COM <input type="checkbox"/> MOT		

### C13852

Parameter   Name: <b>C13852   All words to standard device</b>		Data type: UNSIGNED_16 Index: 10723 <sub>d</sub> = 29E3 <sub>h</sub>
Display of the process data words 1 ... 16, which are transmitted from the IO controller to the inverter.		
<b>Display range (min. value   unit   max. value)</b>		
0		65535
<b>Subcodes</b>		<b>Info</b>
C13852/1		
...		
C13852/16		
<input checked="" type="checkbox"/> Read access <input type="checkbox"/> Write access <input type="checkbox"/> CINH <input type="checkbox"/> PLC-STOP <input type="checkbox"/> No transfer <input type="checkbox"/> PDO_MAP_RX <input type="checkbox"/> PDO_MAP_TX <input type="checkbox"/> COM <input type="checkbox"/> MOT		

# Parameter reference

## Parameters of the communication module

### C13853

Parameter   Name: <b>C13853   All words from standard device</b>		Data type: UNSIGNED_16 Index: 10722 <sub>d</sub> = 29E2 <sub>h</sub>
Display of the process data words 1 ... 16, which are transmitted from the inverter to the IO controller.		
<b>Display range (min. value   unit   max. value)</b>		
0		65535
<b>Subcodes</b>		<b>Info</b>
C13853/1		
...		
C13853/16		
<input checked="" type="checkbox"/> Read access <input type="checkbox"/> Write access <input type="checkbox"/> CINH <input type="checkbox"/> PLC-STOP <input type="checkbox"/> No transfer <input type="checkbox"/> PDO_MAP_RX <input type="checkbox"/> PDO_MAP_TX <input type="checkbox"/> COM <input type="checkbox"/> MOT		

### C13860

Parameter   Name: <b>C13860   Settings</b>		Data type: UNSIGNED_8 Index: 10715 <sub>d</sub> = 29DB <sub>h</sub>
<b>Display range (min. value   unit   max. value)</b>		
0		255
<b>Subcodes</b>		<b>Info</b>
C13860/1		Reserved
C13860/2		Number of process data words
C13860/3		Reserved
C13860/4		Reserved
<input checked="" type="checkbox"/> Read access <input type="checkbox"/> Write access <input type="checkbox"/> CINH <input type="checkbox"/> PLC-STOP <input type="checkbox"/> No transfer <input type="checkbox"/> PDO_MAP_RX <input type="checkbox"/> PDO_MAP_TX <input type="checkbox"/> COM <input type="checkbox"/> MOT		

### C13861

Parameter   Name: <b>C13861   Bus status</b>		Data type: BITFIELD_16 Index: 10714 <sub>d</sub> = 29DA <sub>h</sub>
Bit-coded display of current bus status		
<b>Value is bit-coded:</b>		
Bit 0	Initialised	
Bit 1	Online	
Bit 2	Connected	
Bit 3	Address conflict	
Bit 4	Hardware error	
Bit 5	EEPROM error	
Bit 6	Watchdog error	
Bit 7	Protocol error	
Bit 8	Profinet stack ok	
Bit 9	Profinet stack not configured	
Bit 10	Ethernet controller error	
Bit 11	UDP stack error	
Bit 12	Reserved	
Bit 13	Reserved	
Bit 14	Reserved	
Bit 15	Reserved	
<input checked="" type="checkbox"/> Read access <input type="checkbox"/> Write access <input type="checkbox"/> CINH <input type="checkbox"/> PLC-STOP <input type="checkbox"/> No transfer <input type="checkbox"/> PDO_MAP_RX <input type="checkbox"/> PDO_MAP_TX <input type="checkbox"/> COM <input type="checkbox"/> MOT		

# Parameter reference

## Parameters of the communication module

### C13862

Parameter   Name: <b>C13862   Bus counter</b>		Data type: UNSIGNED_32 Index: 10713 <sub>d</sub> = 29D9 <sub>h</sub>
Display of the data cycles per second (independent of data changes)		
<b>Display range</b> (min. value   unit   max. value)		
0		4294967295
<b>Subcodes</b>		<b>Info</b>
C13862/1		Data cycles per second
C13862/2		Read cycles per second
C13862/3		Write cycles per second
<input checked="" type="checkbox"/> Read access <input type="checkbox"/> Write access <input type="checkbox"/> CINH <input type="checkbox"/> PLC-STOP <input type="checkbox"/> No transfer <input type="checkbox"/> PDO_MAP_RX <input type="checkbox"/> PDO_MAP_TX <input type="checkbox"/> COM <input type="checkbox"/> MOT		

### C13864

Parameter   Name: <b>C13864   Active station name</b>		Data type: VISIBLE_STRING Index: 10711 <sub>d</sub> = 29D7 <sub>h</sub>
Displays the active station name used by the inverter. It may differ from the contents of code <a href="#">C13899</a> , depending on whether the station name has been changed via the fieldbus or via <a href="#">C13899</a> . <a href="#">▶ Setting the station name (□ 36)</a>		
<b>Subcodes</b>		<b>Info</b>
C13864/1		1st ... 30th character
C13864/2		31th ... 60th character
C13864/3		61th ... 90th character
C13864/4		91th ... 120th character
C13864/5		121th ... 150th character
C13864/6		151th ... 180th character
C13864/7		181th ... 210th character
C13864/8		211th ... 240th character
<input checked="" type="checkbox"/> Read access <input type="checkbox"/> Write access <input type="checkbox"/> CINH <input type="checkbox"/> PLC-STOP <input type="checkbox"/> No transfer <input type="checkbox"/> PDO_MAP_RX <input type="checkbox"/> PDO_MAP_TX <input type="checkbox"/> COM <input type="checkbox"/> MOT		

# Parameter reference

## Parameters of the communication module

### C13867

Parameter   Name: <b>C13867   Display: Most recent diagnostic data</b>		Data type: OCTET_STRING Index: 10708 <sub>d</sub> = 29D4 <sub>h</sub>
Display of the diagnostic data sent by the inverter most recently.		
<input checked="" type="checkbox"/> Read access <input type="checkbox"/> Write access <input type="checkbox"/> CINH <input type="checkbox"/> PLC-STOP <input type="checkbox"/> No transfer <input type="checkbox"/> PDO_MAP_RX <input type="checkbox"/> PDO_MAP_TX <input type="checkbox"/> COM <input type="checkbox"/> MOT		
Bytes	Information	
0	Slot	
1		
2	Subslot	
3		
4	Error code	
...		
7		
8	Slot	
9		
10	Subslot	
11		
12	Error code	
...		
15		

### C13877

Parameter   Name: <b>C13877   Bus error(1)</b>		Data type: UNSIGNED_16 Index: 10698 <sub>d</sub> = 29CA <sub>h</sub>
The code contains the error currently detected on the fieldbus.		
<ul style="list-style-type: none"> <li>The error values can occur in combination with the error values from code <a href="#">C13878</a>.</li> </ul>		
Selection list (read only)	Info	
0	No error	
1	Internal error	
2	Unit ID unknown	
3	Max. units exceeded	
4	Invalid size	
5	Unit type unknown	
6	Runtime plug	
7	Invalid argument	
8	Service pending	
9	Stack not ready	
10	Command unknown	
11	Invalid address descriptor	
12	Watchdog expired	
13	Protocol not supported	
<input checked="" type="checkbox"/> Read access <input type="checkbox"/> Write access <input type="checkbox"/> CINH <input type="checkbox"/> PLC-STOP <input type="checkbox"/> No transfer <input type="checkbox"/> PDO_MAP_RX <input type="checkbox"/> PDO_MAP_TX <input type="checkbox"/> COM <input type="checkbox"/> MOT		

# Parameter reference

## Parameters of the communication module

### C13878

Parameter   Name: <b>C13878   Bus error(2)</b>		Data type: BITFIELD_16 Index: 10697 <sub>d</sub> = 29C9 <sub>h</sub>
<p>The code contains the error currently detected on the fieldbus.</p> <ul style="list-style-type: none"> <li>The error values can occur in combination with the error values from code <a href="#">C13877</a>.</li> </ul>		
<b>Value is bit-coded:</b>		<b>Info</b>
Bit 0	Reserved	
...	...	
Bit 6	Reserved	
Bit 7	IP address error	
Bit 8	Station name error	
Bit 9	DataExch left	
Bit 10	Stack boot error	
Bit 11	Stack online error	
Bit 12	Stack state error	
Bit 13	Stack revision error	
Bit 14	Stack init error	
Bit 15	Stack CPU boot error	
<input checked="" type="checkbox"/> Read access <input type="checkbox"/> Write access <input type="checkbox"/> CINH <input type="checkbox"/> PLC-STOP <input type="checkbox"/> No transfer <input type="checkbox"/> PDO_MAP_RX <input type="checkbox"/> PDO_MAP_TX <input type="checkbox"/> COM <input type="checkbox"/> MOT		

### C13880

Parameter   Name: <b>C13880   Monitoring Reaction</b>		Data type: UNSIGNED_8 Index: 10695 <sub>d</sub> = 29C7 <sub>h</sub>
<p>The action set in subcode 1 of the code is carried out when the node recognises that it is no longer in the DATA_EXCHANGE status.</p> <ul style="list-style-type: none"> <li>Please also observe the notes provided in code <a href="#">C13881</a>.</li> <li>A change in the monitoring response becomes immediately effective.</li> </ul>		
<b>Selection list</b>		
0	No response	
1	Error	
3	Quick stop by trouble	
4	Warning Locked	
6	Information	
<b>Subcodes</b>	<b>Lenze setting</b>	<b>Info</b>
C13880/1	0: No Response	"Watchdog/Data Exchange" monitoring
<input checked="" type="checkbox"/> Read access <input checked="" type="checkbox"/> Write access <input type="checkbox"/> CINH <input type="checkbox"/> PLC-STOP <input type="checkbox"/> No transfer <input type="checkbox"/> PDO_MAP_RX <input type="checkbox"/> PDO_MAP_TX <input type="checkbox"/> COM <input type="checkbox"/> MOT		

### C13881

Parameter   Name: <b>C13881   Reaction time delay</b>		Data type: UNSIGNED_16 Index: 10694 <sub>d</sub> = 29C6 <sub>h</sub>
<p>If the DATA_EXCHANGE status is exited, the response parameterised in <a href="#">C13880</a> is activated after the time set here has elapsed.</p> <ul style="list-style-type: none"> <li>A value of "65535" in this code deactivates the monitoring function.</li> <li>A change of monitoring will be effective immediately.</li> </ul>		
<b>Setting range (min. value   unit   max. value)</b>		<b>Lenze setting</b>
0	ms	65535 <b>0 ms</b>
<input checked="" type="checkbox"/> Read access <input checked="" type="checkbox"/> Write access <input type="checkbox"/> CINH <input type="checkbox"/> PLC-STOP <input type="checkbox"/> No transfer <input type="checkbox"/> PDO_MAP_RX <input type="checkbox"/> PDO_MAP_TX <input type="checkbox"/> COM <input type="checkbox"/> MOT		

# Parameter reference

## Parameters of the communication module

### C13885

Parameter   Name: <b>C13885   Clear process data</b>		Data type: UNSIGNED_8 Index: 10690 <sub>d</sub> = 29C2 <sub>h</sub>
This code is used to set the process data that are to be processed by the I/O device in order to maintain the internal communication when the PROFINET has left the DATA_EXCHANGE status.		
Selection list (Lenze setting printed in bold)		Info
0	Use of most recent master PDOs	The last data sent by the I/O controller are used.
<b>1</b>	<b>PDOs are set to the value 0'</b>	The contents of the process data are set to the value "0".
<input checked="" type="checkbox"/> Read access <input checked="" type="checkbox"/> Write access <input type="checkbox"/> CINH <input type="checkbox"/> PLC-STOP <input type="checkbox"/> No transfer <input type="checkbox"/> PDO_MAP_RX <input type="checkbox"/> PDO_MAP_TX <input type="checkbox"/> COM <input type="checkbox"/> MOT		

### C13887

Parameter   Name: <b>C13887   Suppress signalling diag. mess. upon</b>		Data type: BITFIELD_8 Index: 10688 <sub>d</sub> = 29C0 <sub>h</sub>
This code serves to inhibit the transmission of alarm messages to the IO controller. By this, errors of a specific type can be systematically suppressed. All errors are furthermore entered in the logbook.		
<ul style="list-style-type: none"> <li>• A change will only be effective immediately if no error number with the error type selected here is active in standard device code <b>C00165</b>.</li> </ul>		
Value is bit-coded:		Info
Bit 0	Error	
Bit 1	Fault	
Bit 2	Quick stop by trouble	
Bit 3	Warning Locked	
Bit 4	Warning	
Bit 5	Information	
Bit 6	Reserved	
Bit 7	Connection to 8400 lost	
<input checked="" type="checkbox"/> Read access <input checked="" type="checkbox"/> Write access <input type="checkbox"/> CINH <input type="checkbox"/> PLC-STOP <input type="checkbox"/> No transfer <input type="checkbox"/> PDO_MAP_RX <input type="checkbox"/> PDO_MAP_TX <input type="checkbox"/> COM <input type="checkbox"/> MOT		

### C13899

Parameter   Name: <b>C13899   Station name</b>		Data type: VISIBLE_STRING Index: 10676 <sub>d</sub> = 29B4 <sub>h</sub>
The name with a max. length of 240 characters is distributed to the subindices. The name can be entered starting with subindex 1. The following unused subindices are not relevant.		
<ul style="list-style-type: none"> <li>• The station name must be assigned in accordance with the PROFINET specification. In the standard setting a deleted name is displayed. The name is also deleted if the "Reset to factory defaults" command is executed by an IO supervisor or an I/O controller.</li> <li>• A change of the station name will only become effective by switching the mains of the inverter.</li> </ul>		
▶ <a href="#">Setting the station name</a> (□ 36)		
Subcodes	Lenze setting	Info
C13899/1		1st ... 30th character
C13899/2		31th ... 60th character
C13899/3		61th ... 90th character
C13899/4		91th ... 120th character
C13899/5		121th ... 150th character
C13899/6		151th ... 180th character
C13899/7		181th ... 210th character
C13899/8		211th ... 240th character
<input checked="" type="checkbox"/> Read access <input checked="" type="checkbox"/> Write access <input type="checkbox"/> CINH <input type="checkbox"/> PLC-STOP <input type="checkbox"/> No transfer <input type="checkbox"/> PDO_MAP_RX <input type="checkbox"/> PDO_MAP_TX <input type="checkbox"/> COM <input type="checkbox"/> MOT		

# Parameter reference

## Parameters of the communication module

### C13900

Parameter   Name: <b>C13900   Firmware product type</b>	Data type: VISIBLE_STRING Index: 10675 <sub>d</sub> = 29B3 <sub>h</sub>
The code contains a string with a length of 8 characters. The "E84DFYER" identification code is output.	
<input checked="" type="checkbox"/> Read access <input type="checkbox"/> Write access <input type="checkbox"/> CINH <input type="checkbox"/> PLC-STOP <input type="checkbox"/> No transfer <input type="checkbox"/> PDO_MAP_RX <input type="checkbox"/> PDO_MAP_TX <input type="checkbox"/> COM <input type="checkbox"/> MOT	

### C13901

Parameter   Name: <b>C13901   Firmware compilation date</b>	Data type: VISIBLE_STRING Index: 10674 <sub>d</sub> = 29B2 <sub>h</sub>
The code contains a string with a length of 20 characters. The creation date ("MMM DD YYYY") and time ("hh:mm:ss") of the software are displayed, e.g. "Mar 21 2005 12:31:21".	
<input checked="" type="checkbox"/> Read access <input type="checkbox"/> Write access <input type="checkbox"/> CINH <input type="checkbox"/> PLC-STOP <input type="checkbox"/> No transfer <input type="checkbox"/> PDO_MAP_RX <input type="checkbox"/> PDO_MAP_TX <input type="checkbox"/> COM <input type="checkbox"/> MOT	

### C13902

Parameter   Name: <b>C13902   Firmware version</b>	Data type: VISIBLE_STRING Index: 10673 <sub>d</sub> = 29B1 <sub>h</sub>
The code contains a string with a length of 11 characters. The identification code is displayed (e.g. "01.00.00.00").	
<input checked="" type="checkbox"/> Read access <input type="checkbox"/> Write access <input type="checkbox"/> CINH <input type="checkbox"/> PLC-STOP <input type="checkbox"/> No transfer <input type="checkbox"/> PDO_MAP_RX <input type="checkbox"/> PDO_MAP_TX <input type="checkbox"/> COM <input type="checkbox"/> MOT	

### C13910

Parameter   Name: <b>C13910   I&amp;M1 System designation</b>	Data type: VISIBLE_STRING Index: 10665 <sub>d</sub> = 29A9 <sub>h</sub>
Input/output of the I&M1 plant identification code • The Lenze setting shows an empty string.	
<input checked="" type="checkbox"/> Read access <input checked="" type="checkbox"/> Write access <input type="checkbox"/> CINH <input type="checkbox"/> PLC-STOP <input type="checkbox"/> No transfer <input type="checkbox"/> PDO_MAP_RX <input type="checkbox"/> PDO_MAP_TX <input type="checkbox"/> COM <input type="checkbox"/> MOT	

### C13911

Parameter   Name: <b>C13911   I&amp;M1 Installation site</b>	Data type: VISIBLE_STRING Index: 10664 <sub>d</sub> = 29A8 <sub>h</sub>
Input/output of the I&M1 location identification code • The Lenze setting shows an empty string.	
<input checked="" type="checkbox"/> Read access <input checked="" type="checkbox"/> Write access <input type="checkbox"/> CINH <input type="checkbox"/> PLC-STOP <input type="checkbox"/> No transfer <input type="checkbox"/> PDO_MAP_RX <input type="checkbox"/> PDO_MAP_TX <input type="checkbox"/> COM <input type="checkbox"/> MOT	

### C13912

Parameter   Name: <b>C13912   I&amp;M2 Installation date</b>	Data type: VISIBLE_STRING Index: 10663 <sub>d</sub> = 29A7 <sub>h</sub>
Input/output of the I&M2 date of installation • The Lenze setting shows an empty string.	
<input checked="" type="checkbox"/> Read access <input checked="" type="checkbox"/> Write access <input type="checkbox"/> CINH <input type="checkbox"/> PLC-STOP <input type="checkbox"/> No transfer <input type="checkbox"/> PDO_MAP_RX <input type="checkbox"/> PDO_MAP_TX <input type="checkbox"/> COM <input type="checkbox"/> MOT	



# Parameter reference

## Parameters of the communication module

### C13913

Parameter   Name: <b>C13913   I&amp;M3 additional information</b>		Data type: VISIBLE_STRING Index: 10662 <sub>d</sub> = 29A6 <sub>h</sub>
Input/output if the I&M3 additional information <ul style="list-style-type: none"> <li>The Lenze setting shows an empty string.</li> </ul>		
Subcodes	Lenze setting	Info
C13913/1		I&M3 additional information
C13913/2		I&M3 additional information
<input checked="" type="checkbox"/> Read access <input checked="" type="checkbox"/> Write access <input type="checkbox"/> CINH <input type="checkbox"/> PLC-STOP <input type="checkbox"/> No transfer <input type="checkbox"/> PDO_MAP_RX <input type="checkbox"/> PDO_MAP_TX <input type="checkbox"/> COM <input type="checkbox"/> MOT		

### C13914

Parameter   Name: <b>C13914   I&amp;M4 signature code</b>		Data type: OCTET_STRING Index: 10661 <sub>d</sub> = 29A5 <sub>h</sub>
Input/output of the I&M4 signature		
Subcodes	Lenze setting	Info
C13914/1	00000000000000000000000000000000 00000000000000000000000000000000	I&M4 signature code
C13914/2	00000000000000000000000000000000 00000000000000000000000000000000	I&M4 signature code
<input checked="" type="checkbox"/> Read access <input checked="" type="checkbox"/> Write access <input type="checkbox"/> CINH <input type="checkbox"/> PLC-STOP <input type="checkbox"/> No transfer <input type="checkbox"/> PDO_MAP_RX <input type="checkbox"/> PDO_MAP_TX <input type="checkbox"/> COM <input type="checkbox"/> MOT		

# Parameter reference

## Table of attributes

### 13.2 Table of attributes

The table of attributes contains information that is required for communication with the inverter via parameters.

#### How to read the table of attributes:

Column		Meaning	Entry	
Code		Parameter name	Cxxxxx	
Name		Parameter short text (display text)	Text	
Index	dec	Index under which the parameter is addressed. The subindex for array variables corresponds to the Lenze subcode number.	24575 - Lenze code number	Is only required for access via a bus system.
	hex		5FFF <sub>n</sub> - Lenze code number	
Data	DS	Data structure	E	Single variable (only one parameter element)
			A	Array variable (several parameter elements)
	DA	Number of array elements (subcodes)	Number	
	DT	Data type	BITFIELD_8	1 byte, bit-coded
			BITFIELD_16	2 bytes, bit-coded
			BITFIELD_32	4 bytes, bit-coded
			INTEGER_8	1 byte, with sign
			INTEGER_16	2 bytes with sign
			INTEGER_32	4 bytes, with sign
			UNSIGNED_8	1 byte without sign
UNSIGNED_16			2 bytes without sign	
Factor	Factor for data transmission via a bus system, depending on the number of decimal positions	VISIBLE_STRING	ASCII string	
		OCTET_STRING		
Access	R	Read access	<input checked="" type="checkbox"/> Reading permitted	
	W	Write access	<input checked="" type="checkbox"/> Writing permitted	
	CINH	Controller inhibit required	<input checked="" type="checkbox"/> Writing is only possible if controller inhibit is set	

# Parameter reference

## Table of attributes

Table of attributes

Code	Name	Index		DS	DA	Data		Access		
		dec	hex			Data type	Factor	R	W	CINH
<a href="#">C13000</a>	IP address	11575	2D37	E	1	UNSIGNED_32	1	<input checked="" type="checkbox"/>	<input checked="" type="checkbox"/>	
<a href="#">C13001</a>	Subnet Mask	11574	2D36	E	1	UNSIGNED_32	1	<input checked="" type="checkbox"/>	<input checked="" type="checkbox"/>	
<a href="#">C13002</a>	Gateway address	11573	2D35	E	1	UNSIGNED_32	1	<input checked="" type="checkbox"/>	<input checked="" type="checkbox"/>	
<a href="#">C13003</a>	Physical address	11572	2D34	A	3	OCTET_STRING		<input checked="" type="checkbox"/>		
<a href="#">C13010</a>	Active IP Address	11565	2D2D	A	4	UNSIGNED_8	1	<input checked="" type="checkbox"/>		
<a href="#">C13011</a>	Active Subnetwork Mask	11564	2D2C	A	4	UNSIGNED_8	1	<input checked="" type="checkbox"/>		
<a href="#">C13012</a>	Active IP Address	11563	2D2B	A	4	UNSIGNED_8	1	<input checked="" type="checkbox"/>		
<a href="#">C13850</a>	All words from drive to master	10725	29E5	A	16	UNSIGNED_16	1	<input checked="" type="checkbox"/>		
<a href="#">C13851</a>	All words from master to drive	10724	29E4	A	16	UNSIGNED_16	1	<input checked="" type="checkbox"/>		
<a href="#">C13852</a>	All words to the basic device	10723	29E3	A	16	UNSIGNED_16	1	<input checked="" type="checkbox"/>		
<a href="#">C13853</a>	All words to the basic device	10722	29E2	A	16	UNSIGNED_16	1	<input checked="" type="checkbox"/>		
<a href="#">C13860</a>	Settings	10715	29DB	A	4	UNSIGNED_8	1	<input checked="" type="checkbox"/>		
<a href="#">C13861</a>	Bus status	10714	29DA	E	1	BITFIELD_16		<input checked="" type="checkbox"/>		
<a href="#">C13862</a>	Bus counter	10713	29D9	A	3	UNSIGNED_32	1	<input checked="" type="checkbox"/>		
<a href="#">C13864</a>	Active station name	10711	29D7	A	8	VISIBLE_STRING		<input checked="" type="checkbox"/>		
<a href="#">C13867</a>	Display: Most recent diagnostic data	10708	29D4	E	1	OCTET_STRING		<input checked="" type="checkbox"/>		
<a href="#">C13877</a>	Bus error(1)	10698	29CA	E	1	UNSIGNED_16	1	<input checked="" type="checkbox"/>		
<a href="#">C13878</a>	- Bus error(2)	10697	29C9	E	1	BITFIELD_16		<input checked="" type="checkbox"/>		
<a href="#">C13880</a>	Monitoring Reaction	10695	29C7	A	1	UNSIGNED_8	1	<input checked="" type="checkbox"/>	<input checked="" type="checkbox"/>	
<a href="#">C13881</a>	Reaction time delay	10694	29C6	E	1	UNSIGNED_16	1	<input checked="" type="checkbox"/>	<input checked="" type="checkbox"/>	
<a href="#">C13885</a>	Delete process data	10690	29C2	E	1	UNSIGNED_8	1	<input checked="" type="checkbox"/>	<input checked="" type="checkbox"/>	
<a href="#">C13887</a>	Suppress signalling diag. mess. upon	10688	29C0	E	1	BITFIELD_8		<input checked="" type="checkbox"/>	<input checked="" type="checkbox"/>	
<a href="#">C13899</a>	Station name	10676	29B4	A	8	VISIBLE_STRING		<input checked="" type="checkbox"/>	<input checked="" type="checkbox"/>	
<a href="#">C13900</a>	Firmware Product Type	10675	29B3	E	1	VISIBLE_STRING		<input checked="" type="checkbox"/>		
<a href="#">C13901</a>	Firmware Compilation Date	10674	29B2	E	1	VISIBLE_STRING		<input checked="" type="checkbox"/>		
<a href="#">C13902</a>	Firmware Version	10673	29B1	E	1	VISIBLE_STRING		<input checked="" type="checkbox"/>		
<a href="#">C13910</a>	I&M1 system designation	10665	29A9	E	1	VISIBLE_STRING		<input checked="" type="checkbox"/>	<input checked="" type="checkbox"/>	
<a href="#">C13911</a>	I&M1 installation site	10664	29A8	E	1	VISIBLE_STRING		<input checked="" type="checkbox"/>	<input checked="" type="checkbox"/>	
<a href="#">C13912</a>	I&M2 installation date	10663	29A7	E	1	VISIBLE_STRING		<input checked="" type="checkbox"/>	<input checked="" type="checkbox"/>	
<a href="#">C13913</a>	I&M3 additional information	10662	29A6	A	2	VISIBLE_STRING		<input checked="" type="checkbox"/>	<input checked="" type="checkbox"/>	
<a href="#">C13914</a>	I&M4 signature code	10661	29A5	A	2	OCTET_STRING		<input checked="" type="checkbox"/>	<input checked="" type="checkbox"/>	

## 14 Index

### A

Accessing process data [48](#)  
Active gateway address (C13012) [87](#)  
Active IP address (C13010) [87](#)  
Active station name (C13864) [90](#)  
Active subnetwork mask (C13011) [87](#)  
Acyclic channel (PROFIdrive profile) [54](#)  
Acyclic data transfer [55](#)  
Acyclic data transmission process [55](#)  
All words from drive to master (C13850) [88](#)  
All words from master to drive (C13851) [88](#)  
All words to the basic device (C13852) [88](#)  
All words to the basic device (C13853) [89](#)  
Application as directed [13](#)  
Application notes (representation) [10](#)  
Approvals [16](#)

### B

Baud rate [16](#)  
Before initial switch-on [35](#)  
Bus counter (C13862) [90](#)  
Bus error(1) (C13877) [91](#)  
Bus error(2) (C13878) [92](#)  
Bus state (C13861) [89](#)

### C

C13000 | IP Address [86](#)  
C13001 | Subnetwork mask [86](#)  
C13002 | Gateway Address [86](#)  
C13003 | Physical address [86](#)  
C13010 | Active IP address [87](#)  
C13011 | Active Subnetwork Mask [87](#)  
C13012 | Active gateway address [87](#)  
C13850 | All words from drive to master [88](#)  
C13851 | All words from master to drive [88](#)  
C13852 | All words to the basic device [88](#)  
C13853 | All words to the basic device [89](#)  
C13860 | Settings [89](#)  
C13861 | Bus state [89](#)  
C13862 | Bus counter [90](#)  
C13864 | Active station name [90](#)  
C13867 | Display  
    Most recent diagnostic data [91](#)  
C13877 | Bus error(1) [91](#)  
C13878 | Bus error(2) [92](#)  
C13880 | Monitoring Reaction [92](#)  
C13881 | Reaction time delay [92](#)  
C13885 | Delete process data [93](#)  
C13887 | Suppress signalling diag. mess. upon [93](#)  
C13899 | Station name [93](#)  
C13900 | Firmware product type [94](#)

C13901 | Firmware compilation date [94](#)  
C13902 | Firmware version [94](#)  
C13910 | I&M1 system designation [94](#)  
C13911 | I&M1 installation site [94](#)  
C13912 | I&M2 installation date [94](#)  
C13913 | I&M3 additional information [95](#)  
C13914 | I&M4 signature code [95](#)  
Cable length [16](#)  
Carry out the port interconnection in the »Engineer« [50](#)  
Codes [85](#)  
Colour code of the Ethernet cable [32](#)  
Commissioning [35](#)  
Communication channels [47](#)  
Communication medium [16](#)  
Communication profile [16](#)  
Communication time [20](#)  
Configuration for device control [36](#)  
Configuring consistent data [70](#)  
Configuring the IO controller [36](#)  
Conformities [16](#)  
Connection establishment of an I/O controller to an I/O device [54](#)  
Connections [15](#)  
Consistent parameter data [70](#)  
Conventions [8](#)  
Conventions used [8](#)

### D

Data communication with consistent data [70](#)  
Data transfer [47](#)  
Data transmission (process) [55](#)  
Decimal representation of the IP parameters [43](#)  
Delete process data (C13885) [93](#)  
Device and application-specific safety instructions [12](#)  
Device data base file [36](#)  
Device description file [36](#)  
Device ID [16](#)  
Device identification [16](#)  
Device protection [12](#)  
Diagnostic data [78](#)  
Diagnostic messages [78](#)  
Diagnostics [73](#)  
Diagnostics with the »Engineer« [77](#)  
Dimensions [22](#)  
Display  
    Most recent diagnostic data (C13867) [91](#)  
Document history [7](#)

### E

Electrical installation [27](#)  
Error code of Inverter Drive 8400 [79](#)

- Error information (error) [68](#)
- Error messages [80](#)
  - Causes and remedies [81](#)
- Error messages (short overview) [80](#)
- Error number
  - 0x01bc3100 [81](#)
  - 0x01bc5531 [81](#)
  - 0x01bc5532 [81](#)
  - 0x01bc5533 [81](#)
  - 0x01bc6010 [82](#)
  - 0x01bc6011 [82](#)
  - 0x01bc6100 [82](#)
  - 0x01bc6101 [82](#)
  - 0x01bc641f [82](#)
  - 0x01bc6420 [82](#)
  - 0x01bc6430 [83](#)
  - 0x01bc6501 [83](#)
  - 0x01bc6502 [83](#)
  - 0x01bc6503 [83](#)
  - 0x01bc6531 [83](#)
  - 0x01bc6532 [83](#)
  - 0x01bc6533 [84](#)
  - 0x01bc6534 [84](#)
  - 0x01bc6650 [84](#)
- Establishing an online connection via PROFINET with the Lenze »Engineer« [44](#)
- Establishing communication [46](#)
- EtherCAT error messages
  - Causes and remedies [81](#)
- Ethernet cable [31](#)
- Ethernet cable colour code [32](#)
- Ethernet cable specification [31](#)
- Ethernet cable, structure [31](#)
- Exchanging the communication module [26](#)
- External voltage supply [33](#)
- F**
- Fieldbus status displays [75](#)
- Firmware Compilation Date (C13901) [94](#)
- Firmware Product Type (C13900) [94](#)
- Firmware Version (C13902) [94](#)
- Frame example
  - Read request [60](#)
  - Write request [66](#)
- G**
- Gateway address [43](#)
- Gateway Address (C13002) [86](#)
- General data [16](#)
- General safety and application notes [11](#)
- I**
- I&M1 installation site (C13911) [94](#)
- I&M1 system designation (C13910) [94](#)
- I&M2 installation date (C13912) [94](#)
- I&M3 additional information (C13913) [95](#)
- I&M4 signature code (C13914) [95](#)
- Identification [13](#)
- Initial switch-on [46](#)
- Installation [23](#)
- Interface [16](#)
- Interfaces [15](#)
- Internal switch latency [21](#)
- Interruption of internal communication [72](#)
- Interruption of PROFINET communication [71](#)
- IP address [43](#)
- IP address (C13000) [86](#)
- L**
- LED status displays [73](#)
- M**
- Mechanical installation [24](#)
- Module status displays [74](#)
- Monitoring [71](#)
- Monitoring Reaction (C13880) [92](#)
- Mounting for standard devices of 0.25 kW and 0.37 kW [24](#)
- Mounting for standard devices of 0.55 kW or more [25](#)
- N**
- Nameplate [13](#)
- Network topology [16](#), [27](#)
- Notes used [10](#)
- Number of nodes [16](#)
- O**
- Operating conditions [16](#)
- P**
- Parameter data [47](#)
- Parameter data transfer [54](#)
- Parameter reference [85](#)
- Parameters of the communication module [85](#)
- PDO mapping [48](#)
- Physical address (C13003) [86](#)
- Pin assignment of the RJ45 sockets [30](#)
- PNO identification number [16](#)
- Process data transfer [48](#)
- Processing time [20](#)
- Product description [13](#)
- Product features [14](#)
- PROFINET
  - Data output status bad (error message) [83](#)
  - Data\_Exchange status quit (error message) [83](#)
  - Error
    - Lenze Setting Loaded (error message) [82](#)
    - Exist. conn. to 8400 lost (error message) [81](#)

- Internal error (error message) [82](#), [84](#)
- Invalid module configuration (error message) [83](#)
- Invalid Parameter Set (error message) [82](#)
- IP address error (error message) [84](#)
- Memory
  - No access (error message) [81](#)
  - Read error (error message) [81](#)
  - Write error (error message) [81](#)
- Record parameter
  - Invalid read (error message) [83](#)
  - Invalid write (error message) [83](#)
- Restart by watchdog reset (error message) [82](#)
- Stack init error (error message) [84](#)
- Station name error (error message) [83](#)
- PROFINET configurator of the »Engineer« [40](#)
- PROFINET connection [29](#)
- PROFINET error messages (short overview) [80](#)
- Protection against uncontrolled restart [46](#)
- Protection of persons [12](#)
- Protective insulation [17](#)
- Protocol data [20](#)

## R

- Reaction time delay (C13881) [92](#)
- Reading parameters from the inverter [57](#)
- Residual hazards [12](#)
- Runtime delays [21](#)

## S

- Safety instructions [11](#)
- Safety instructions (representation) [10](#)
- Setting the IP configuration [39](#)
- Setting the station name [37](#)
- Settings (C13860) [89](#)
- Station name (C13899) [93](#)
- Status displays (LEDs) [73](#)
- Status displays at X256 and X257 [76](#)
- Structure of the Ethernet cable [31](#)
- Structure of the PROFINET data frame [56](#)
- Subnet Mask [43](#)
- Subnetwork mask (C13001) [86](#)
- Suppress signalling diag. mess. upon (C13887) [93](#)
- Switch latency [16](#), [21](#)
- Switching method [16](#)
- System error messages [80](#)

## T

- Table of attributes [96](#)
- Target group [6](#)
- TCP port [16](#)
- Technical data [16](#)
- Terminals [34](#)
- Terminology used [9](#)
- Terms [9](#)
- Type of node [16](#)

## U

- Use of repeaters [28](#)
- User data assignment [56](#)
- User data length [36](#)
- Using the communication module [13](#)

## V

- Validity of the documentation [6](#)
- Voltage supply [16](#), [33](#)

## W

- Wiring according to EMC guidelines [27](#)
- Writing parameters to the inverter [62](#)

## X

- XML file for configuration [36](#)

Lenze Drives GmbH

Postfach 10 13 52, D-31763 Hameln  
Breslauer Straße 3, D-32699 Extertal  
Germany

HR Lemgo B 6478

☎ +49 5154 82-0

📠 +49 5154 82-2800

@ [sales.de@lenze.com](mailto:sales.de@lenze.com)

🌐 [www.lenze.com](http://www.lenze.com)

Lenze Service GmbH

Breslauer Straße 3, D-32699 Extertal  
Germany

☎ 008000 24 46877 (24 h helpline)

📠 +49 5154 82-1112

@ [service.de@lenze.com](mailto:service.de@lenze.com)



E84AYCET

# EtherCAT®

Inverter Drives 8400 -----

Communication Manual EN

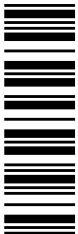

13429553



# Contents

---

<b>1</b>	<b>About this documentation</b>	<b>4</b>
1.1	Document history	6
1.2	Conventions used	7
1.3	Terminology used	8
1.4	Notes used	9
<b>2</b>	<b>Safety instructions</b>	<b>10</b>
2.1	General safety and application notes	10
2.2	Device- and application-specific safety instructions	11
2.3	Residual hazards	11
<b>3</b>	<b>Product description</b>	<b>12</b>
3.1	Application as directed	12
3.2	Identification	12
3.3	Product features	13
3.4	Terminals and interfaces	14
<b>4</b>	<b>Technical data</b>	<b>15</b>
4.1	General data and operating conditions	15
4.2	Protective insulation	16
4.3	Protocol data	19
4.4	Communication time	19
4.5	Dimensions	20
<b>5</b>	<b>Installation</b>	<b>21</b>
5.1	Mechanical installation	22
5.1.1	Mounting for standard devices 0.25 kW and 0.37 kW	22
5.1.2	Mounting for standard devices from 0.55 kW onwards	23
5.1.3	Replacing the communication module	24
5.2	Electrical installation	25
5.2.1	EMC-compliant wiring	25
5.2.2	Network topology	26
5.2.3	EtherCAT connection	27
5.2.4	Specification of the Ethernet cable	29
5.2.5	External voltage supply	31
<b>6</b>	<b>Commissioning</b>	<b>33</b>
6.1	Before initial switch-on	33
6.2	Configuring the Controller (EtherCAT master)	34
6.2.1	Installing device description files	34
6.2.2	Automatic device identification	35
6.2.3	Configuring process data	35
6.2.4	Determining the cycle time	35
6.3	Address allocation	36
6.4	Synchronisation with "Distributed Clocks" (DC)	37
6.4.1	DC configuration in the master	38
6.4.2	DC configuration in the Inverter Drive 8400 (slave)	38
6.4.3	Response of the Lenze EtherCAT nodes during start-up	39
6.5	Establishing an online connection with the »Engineer«	40
6.5.1	Gateway Controller -> configure EtherCAT	41
6.5.2	Gateway Controller -> configure EtherCAT ADS (Beckhoff)	43
6.6	EtherCAT ADS communication parameters in »TwinCAT« and »Engineer«	45
6.6.1	Example: Structure without a Beckhoff Controller	45
6.6.2	Example: Structure with a Beckhoff DIN rail IPC CX1020	49
6.7	Initial switch-on	53

# Contents

---

<b>7</b>	<b>Data transfer</b>	54
7.1	EtherCAT-Frames	55
7.2	EtherCAT datagrams	56
7.3	EtherCAT state machine	57
<b>8</b>	<b>Process data transfer</b>	59
8.1	Accessing process data / PDO mapping	60
8.2	Preconfigured port interconnection of the process data objects (PDO)	61
8.3	Free configuration of the port interconnection of the process data objects (PDO)	62
8.4	CiA402 PDO mapping in case of Inverter Drive 8400 TopLine P	66
<b>9</b>	<b>Parameter data transfer</b>	68
9.1	Establishing a connection between master and slave	68
9.2	Reading and writing parameters	69
9.2.1	Reading parameters (SDO upload)	70
9.2.2	Writing parameters (SDO download)	74
9.3	Implemented CoE objects	79
9.4	EtherCAT objects of the communication module	80
9.5	SDO abort codes (Abort codes)	81
<b>10</b>	<b>Monitoring</b>	82
10.1	Interruption of EtherCAT communication	82
10.2	Sync frame failure detection	83
10.3	Interruption of internal communication	83
<b>11</b>	<b>Diagnostics</b>	84
11.1	LED status displays	84
11.1.1	Module status displays	85
11.1.2	Fieldbus status displays	86
11.1.3	Status displays at X246 and X247	88
11.2	Diagnostics with the »Engineer«	89
11.3	Emergency requests / Emergency messages	90
11.3.1	Structure of the Emergency message	90
11.3.2	Emergency messages (overview)	91
<b>12</b>	<b>Error messages</b>	92
12.1	Short overview of the EtherCAT error messages	92
12.2	Possible causes and remedies	93
<b>13</b>	<b>Parameter reference</b>	96
13.1	Communication-relevant parameters of the standard device	96
13.2	Parameters of the communication module	97
13.3	Table of attributes	103
	<b>Index</b>	105
	Your opinion is important to us	108

# 1 About this documentation

---

## 1 About this documentation

### Contents

This documentation only contains descriptions for the E84AYCET communication module (EtherCAT®).



### Note!

This documentation supplements the **Mounting Instructions** supplied with the communication module and the **"Inverter Drives 8400" Hardware Manual**.

The features and functions of the communication module are described in detail.

Examples illustrate typical applications.

The theoretical concepts are only explained to the level of detail required to understand the function of the communication module.

This documentation does not describe any software provided by other manufacturers. No warranty can be given for corresponding data provided in this documentation. For information on how to use the software, please refer to the control system documents (Controller, EtherCAT master).

All product names mentioned in this documentation are trademarks of their corresponding owners.



### Tip!

Detailed information about EtherCAT can be found on the website of the EtherCAT Technology Group:

[www.EtherCAT.org](http://www.EtherCAT.org)

# 1 About this documentation

---

## Target group

This documentation is intended for all persons who plan, install, commission and maintain the networking and remote servicing of a machine.



### Tip!

Current documentation and software updates with regard to Lenze products can be found in the download area at:

[www.Lenze.com](http://www.Lenze.com)

## Validity information

The information in this documentation applies to the following devices:

Extension module	Type designation	From hardware version	From software version
EtherCAT communication module	E84AYCET	VC	01.00...03
		1A	01.04/05 02.00

## Screenshots/application examples

All screenshots in this documentation are application examples. Depending on the firmware version of the communication module and the software version of the engineering tools installed (e.g. »Engineer«), the screenshots in this documentation may differ from the actual screen representation.

# 1 About this documentation

## 1.1 Document history

---

### 1.1 Document history



Version			Description
1.0	08/2009	TD17	First edition
2.0	10/2009	TD17	Amendment of the information on the synchronisation via the fieldbus and general revision
3.0	04/2010	TD17	General revision
4.0	11/2010	TD17	Information about the EtherCAT register " <a href="#">AL Status Code</a> " (📖 58) supplemented.
4.1	11/2012	TD17	EtherCAT® is a registered trademark by Beckhoff Automation GmbH, Germany.
5.0	05/2013	TD17	<ul style="list-style-type: none"><li>• Revision of firmware version V02.00</li><li>• New layout</li></ul>

# 1 About this documentation

## 1.2 Conventions used

### 1.2 Conventions used

This documentation uses the following conventions to distinguish different types of information:

Type of information	Identification	Examples/notes
Numbers		
Decimal separator	Point	In general, the decimal point is used. Example: 1234.56
Hexadecimal	0x[0 ... 9, A ... F]	Example: 0x60F4
Binary • Nibble	In inverted commas Point	Example: '100' Example: '0110.0100'
Text		
Version information	<b>Text colour blue</b>	All pieces of information that only apply to or from a specific software version of the inverter are highlighted accordingly in this documentation. Example: <b>This function extension is available from software version V3.0!</b>
Program name	» «	The Lenze PC software »Engineer«...
Window	<i>italics</i>	The <i>message window</i> ... / The <i>Options</i> dialog box ...
Variable name		Setting <i>bEnable</i> to TRUE...
Control element	<b>Bold</b>	The <b>OK</b> button ... / The <b>Copy</b> command ... / The Properties tab ... / The <b>Name</b> input field ...
Sequence of menu commands		If several successive commands are required for executing a function, the individual commands are separated from each other by an arrow: Select the command <b>File → Open</b> to...
Hyperlink	<u>Underlined</u>	Optically highlighted reference to another topic. Can be activated with a mouse-click in this online documentation.
Icons		
Page reference	 5	Optically highlighted reference to another page. Can be activated with a mouse-click in this online documentation.
Step-by-step instructions		Step-by-step instructions are marked by a pictograph.

# 1 About this documentation

## 1.3 Terminology used

---

### 1.3 Terminology used

Term	Meaning
Inverter	Lenze inverters of the "Inverter Drives 8400" series
Standard device	
Code	Parameter which serves to parameterise and monitor the drive. In normal usage, the term is usually referred to as "Index".
Subcode	If a code contains several parameters, they are stored in so-called "subcodes". This manual uses a slash "/" as a separator between code and subcode (e.g. "C00118/3"). In normal usage, the term is also referred to as "Subindex".
CoE	CANopen over EtherCAT
DC	"Distributed clocks" for EtherCAT synchronisation
»Engineer«	PC software from Lenze which supports you during engineering (parameterisation, diagnostics, and configuration) throughout the entire life cycle, i.e. from planning to maintenance of the commissioned machine.
»PLC Designer«	
ESI	EtherCAT slave information (device description file in XML format)
	EtherCAT® is a real-time capable Ethernet system with the highest performance. EtherCAT® is a registered trademark and patented technology, licensed by Beckhoff Automation GmbH, Germany.
EtherCAT master	Control system (Controller)
HW	Hardware
I-1600.8	CoE index (hexadecimal representation) In the example: index 0x1600, subindex 8
Lenze setting	Settings with which the device is preconfigured ex works.
Standard setting	
PDO	Process data object
SDO	Service data object
SW	Software
»TwinCAT«	Beckhoff PC software for EtherCAT configuration

# 1 About this documentation

## 1.4 Notes used

### 1.4 Notes used

The following signal words and symbols are used in this documentation to indicate dangers and important information:

#### Safety instructions

Layout of the safety instructions:



#### **Pictograph and signal word!**

(characterise the type and severity of danger)

#### **Note**

(describes the danger and suggests how to prevent dangerous situations)

Pictograph	Signal word	Meaning
	<b>Danger!</b>	<b>Danger of personal injury through dangerous electrical voltage</b> Reference to an imminent danger that may result in death or serious personal injury if the corresponding measures are not taken.
	<b>Danger!</b>	<b>Danger of personal injury through a general source of danger</b> Reference to an imminent danger that may result in death or serious personal injury if the corresponding measures are not taken.
	<b>Stop!</b>	<b>Danger of damage to material assets</b> Reference to a possible danger that may result in damage to material assets if the corresponding measures are not taken.

#### Application notes

Pictograph	Signal word	Meaning
	<b>Note!</b>	Important note to ensure trouble-free operation
	<b>Tip!</b>	Useful tip for easy handling
		Reference to other documentation



## 2 Safety instructions



### Note!

Always observe the specified safety measures to avoid severe injury to persons and damage to property!

Always keep this documentation to hand in the vicinity of the product during operation.

### 2.1 General safety and application notes



### Danger!

If you ignore the following basic safety measures, severe injury to persons and damage to material assets may result.

Lenze drive and automation components ...

- shall only be used as directed.
  - ▶ [Application as directed](#) (12)
- must never be commissioned if they display any signs of damage.
- must never be technically modified.
- must never be commissioned if they are not fully mounted.
- must never be operated without the covers required.
- during and after operation can have live, moving and rotating parts, depending on their degree of protection. Surfaces can be hot.

For Lenze drive components ...

- only use the accessories approved.
- only use genuine spare parts supplied by the manufacturer of the product.

Observe all specifications contained in the enclosed documentation and related documentation.

- This is the precondition for a safe and trouble-free operation and for obtaining the product features specified.
  - ▶ [Product features](#) (13)
- The specifications, processes, and circuitry described in this document are for guidance only and must be adapted to your own specific application. Lenze does not take responsibility for the suitability of the process and circuit proposals.

All works on and with Lenze drive and automation components must only be carried out by qualified personnel. According to IEC 60364 or CENELEC HD 384 these are persons who ...

- who are familiar with the installation, assembly, commissioning and operation of the product.
- who have the corresponding qualifications for their work.
- who know all regulations for the prevention of accidents, directives and laws applicable on site and are able to apply them.

## 2 Safety instructions

### 2.2 Device- and application-specific safety instructions

---

#### 2.2 Device- and application-specific safety instructions

- During operation, the communication module must be firmly connected to the standard device.
- With external voltage supply, always use a separate power supply unit, safely separated to EN 61800-5-1 in every control cabinet (SELV/PELV).
- Only use cables that correspond to the given specifications.
  - ▶ [Specification of the Ethernet cable](#) (☞ 29)



#### **Documentation for the standard device, control system, plant/machine**

All the other measures prescribed in this documentation must also be implemented. Observe the safety instructions and application notes stated in this manual.

#### 2.3 Residual hazards

##### **Protection of persons**

If Inverter Drives 8400 are used on a phase earthed mains with a rated mains voltage of  $\geq 400$  V, external measures need to be implemented in order to provide reliable protection against accidental contact.

- ▶ [Protective insulation](#) (☞ 16)

##### **Device protection**

The communication module contains electronic components that can be damaged or destroyed by electrostatic discharge.

- ▶ [Installation](#) (☞ 21)

# 3 Product description

## 3.1 Application as directed

# 3 Product description

## 3.1 Application as directed

The communication module ...

- is an accessory module which can be used with the following standard devices:

Product series	Type designation	From software version
Inverter Drives 8400 StateLine	E84AVSCxxxxx	03.00
Inverter Drives 8400 HighLine	E84AVHCxxxxx	02.00
Inverter Drives 8400 TopLine	E84AVTCxxxxx	01.00
Inverter Drives 8400 TopLine P (with CiA402)	E84AVPCxxxxx	01.00

- is an item of equipment intended for use in industrial power systems.
- may only be operated under the operating conditions specified in this documentation.
- may only be used in EtherCAT networks.

**Any other use shall be deemed inappropriate!**

## 3.2 Identification

The type designation as well as the hardware and software version of the communication module are specified on the nameplate:

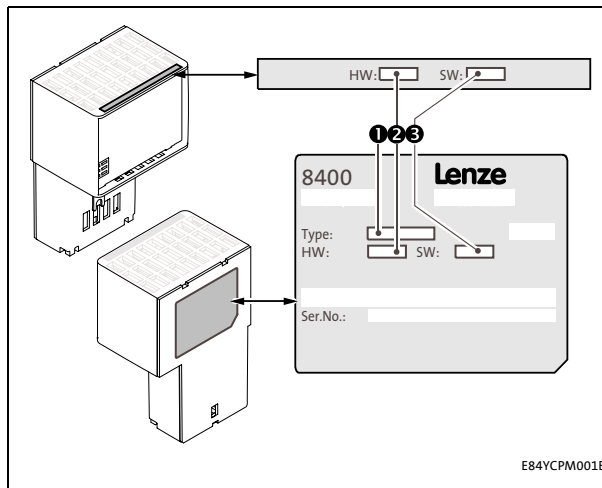

### 1 Type designation (type)

E84 Product series

A Version

Y Module identification: Extension module

C Module type: Communication module

ET EtherCAT

V/S V: Coated version

S: Standard version

### 2 Hardware version (HW)

### 3 Software version (SW)

[3-1] Identification data

# 3 Product description

## 3.3 Product features

---

### 3.3 Product features

- Interface module for the EtherCAT communication system to the expansion slots of the Inverter Drives 8400
- The communication module can be supplied internally by the standard device and externally via a separate voltage source.
- Supports the "Distributed Clocks" (DC) functionality for synchronisation via the fieldbus
- Cycle times:
  - 1 ms or an integer multiple of 1 ms
  - max. 15 ms if "Distributed Clocks" (DC) are used
- PDO transfer with CoE (CANopen over EtherCAT)
- Up to 16 process data words (16 bits/word) per direction can be exchanged.
- Access to all Lenze parameters with CoE (CANopen over EtherCAT)

# 3 Product description

## 3.4 Terminals and interfaces

### 3.4 Terminals and interfaces

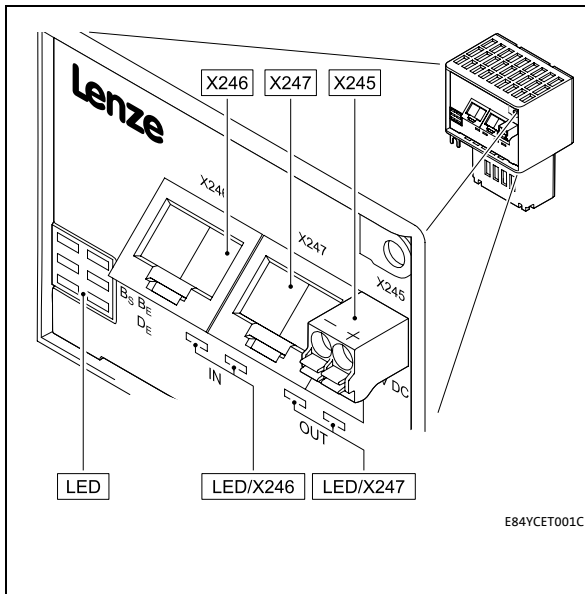

[3-2] E84AYCET communication module (EtherCAT)

**X245** External voltage supply of the communication module

2-pole plug connector with spring connection

▶ [External voltage supply](#) (📖 31)

**X246** EtherCAT input (IN)

**X247** EtherCAT output (OUT)

- RJ45 sockets according to IEC/EN 60603-7
- with 2 LED status displays each for diagnostics

▶ [Network topology](#) (📖 26)

▶ [EtherCAT connection](#) (📖 27)

▶ [Status displays at X246 and X247](#) (📖 88)

**MS** 5 LED status displays for diagnostics

**ME** ▶ [Module status displays](#) (📖 85)

**BS** ▶ [Fieldbus status displays](#) (📖 86)

**BE**

**DE**

# 4

## Technical data

### 4.1

#### General data and operating conditions

---

# 4

## Technical data

### 4.1

#### General data and operating conditions

Area	Values
Order designation	E84AYCET
Communication profile	EtherCAT
Supported device profile and mailbox protocol	CANopen over EtherCAT (CoE)
Communication medium	S/FTP (Screened Foiled Twisted Pair, ISO/IEC 11801 or EN 50173), CAT 5e
Interface for communication	RJ45: Standard Ethernet (in accordance with IEEE 802.3), 100Base-TX (Fast Ethernet)
Network topology	Line, switch
Bus device type	EtherCAT slave
Number of nodes	Max. 65535 ( in the entire network )
Max. cable length between two EtherCAT nodes	100 m (typically)
Vendor ID [hex]	0x3B
Product ID	Depending on the standard device used (see chapter <a href="#">Automatic device identification</a> (□ 35)).
Revision ID	Depending on the software version of the communication module (see chapter <a href="#">Identification</a> (□ 12)).
Baud rate	100 Mbps, full duplex
Cycle times	1 ms or an integer multiple of 1 ms, max. 15 ms if "Distributed clocks" (DC) are used
Voltage supply	External supply via a separate power supply unit • "+": V = 24 V DC (20.4 V - 0 % ... 28.8 V + 0 %), I = 140 mA • "-": Reference potential for external voltage supply
Conformity, approvals	CE UL (see hardware manual "Inverter Drives 8400")



#### "Inverter Drives 8400" Hardware Manual

Here you can find the **ambient conditions** and information on the **electromagnetic compatibility (EMC)** which also apply to the communication module.

**Danger!****Dangerous voltage**

If Inverter Drives 8400 are used on a phase earthed mains with a rated mains voltage  $\geq 400$  V, external measures need to be implemented in order to provide reliable protection against accidental contact.

**Possible consequences:**

Death or severe injury

**Protective measures:**

If protection against accidental contact is required for the control terminals of the inverter and the connections of the plugged device modules, ...

- a double isolating distance must be available.
- the components to be connected must be provided with a second isolating distance.

**Note!**

The protective insulation provided in Inverter Drives 8400 is realised in accordance with EN 61800-5-1.

The following illustration ...

- shows the arrangement of the terminal strips and the separate potential areas of the inverter.
- serves to determine the decisive protective insulation between two terminals located in differently insulated separate potential areas.

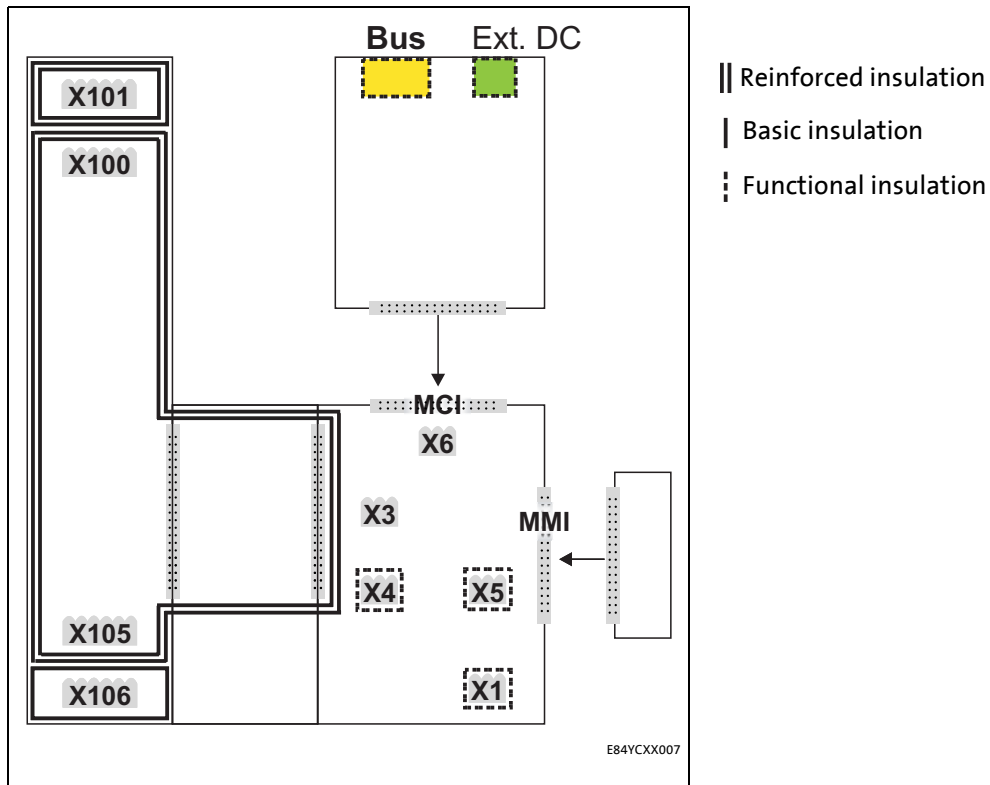

[4-1] Protective insulation in accordance with EN61800-5-1

Terminal strip	Connection
X100	Mains / DC bus connection
X101	Relay contact
X105	Motor/brake resistor
X106	Motor PTC
X1	System bus (CAN)
X3	Analog inputs/outputs
X4	Digital outputs
X5	Digital inputs
X6	Diagnostics
MCI	Slot for communication module
MMI	Slot for memory module



**Example**

Which type of protective insulation is used between the bus terminal of the device module in slot MCI and the mains terminal X100?

The separate potential area with the better protective insulation is decisive.

- The separate potential area of the bus terminal of the device module has a "basic insulation".
- The separate potential area of the mains terminal has a "reinforced insulation".

Result: The insulation between the X100 mains terminal and the bus terminal is of the "reinforced insulation" type.

# 4 Technical data

## 4.3 Protocol data

### 4.3 Protocol data

Area	Values
Process data words	1 ... 16 process data words per direction (max. 32 bytes, 16 bits/word)
Parameter data (mailbox size for CoE transfer)	Max. 128 bytes

### 4.4 Communication time

The communication time is the time between the start of a request and the arrival of the corresponding response.

The communication times in the EtherCAT network depend on the ...

- processing time in the inverter;
- telegram runtime (baud rate / telegram length).

#### processing time within the inverter

Data	Processing time	
Process data for synchronised operation	0.2 ms	Processing time in the module
	+ 1 ... x ms	Runtime of the application task of the technology application used (tolerance)
Process data for non-synchronised operation	2 ms	Processing time in the module
	+ 1 ... x ms	Runtime of the application task of the technology application used (tolerance)
Parameter data	approx. 30 ms	Processing time
	+ 20 ms	Tolerance (typical) Some codes may require a longer processing time (see software manual/online help for the Inverter Drive 8400).

# 4 Technical data

## 4.5 Dimensions

### 4.5 Dimensions

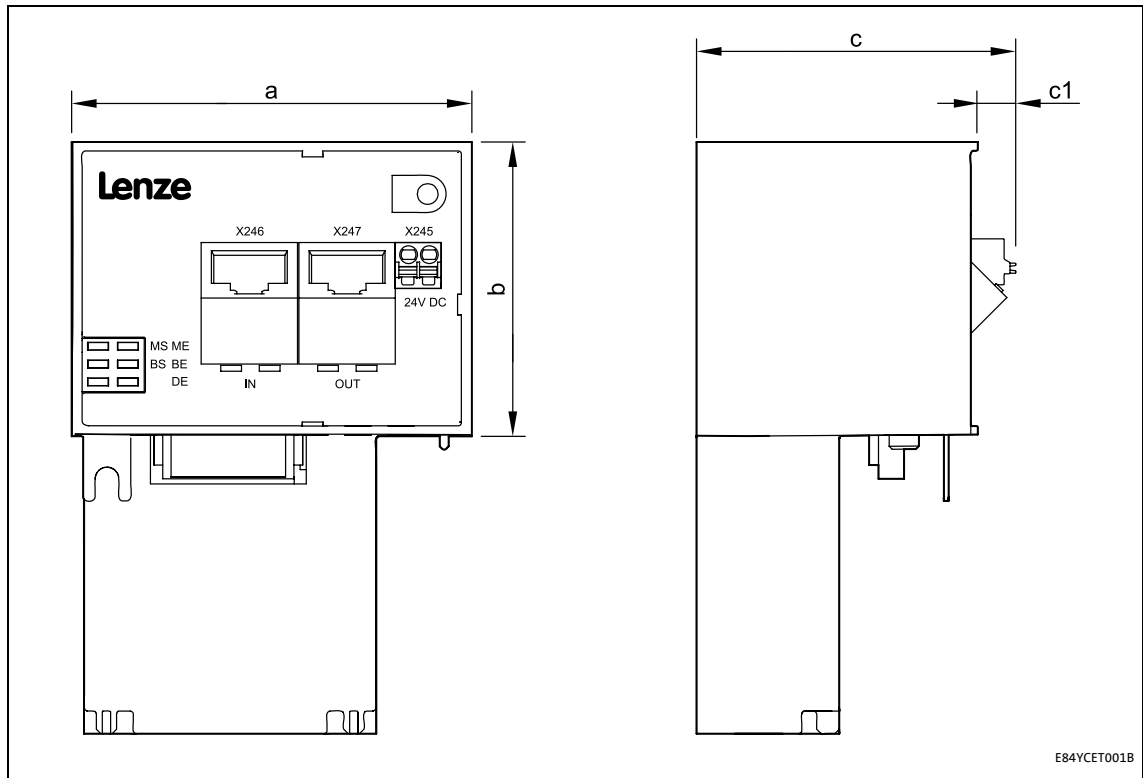

[4-2] Dimensions

Type	Dimensions [mm]			
	a	b	c	c1
E84AYCET	67	50	57	8

### 5 Installation



#### **Stop!**

##### **Electrostatic discharge**

Electronic components in the communication module can be damaged or destroyed by electrostatic discharge.

##### **Possible consequences:**

- The communication module is defective.
- Fieldbus communication is faulty or not possible.

##### **Protective measures:**

Before touching the module, make sure that you are free of electrostatic charge.

## 5.1 Mechanical installation

The communication module can be plugged into the MCI slot or removed while the frequency inverter is switched on. When the module is plugged in, it is recognised automatically and checked for plausibility regarding its function and version.

### 5.1.1 Mounting for standard devices 0.25 kW and 0.37 kW

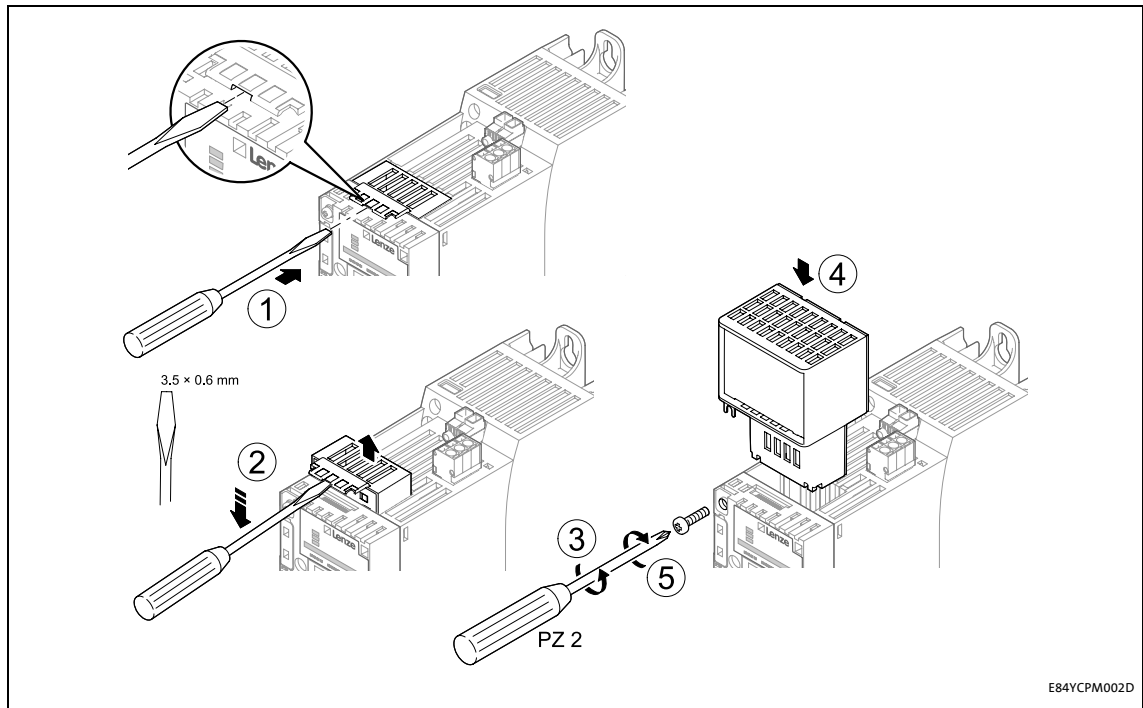

[5-1] Mounting for standard devices 0.25 kW and 0.37 kW

#### Mounting steps

1. Use a screwdriver to lever out the cover of the MCI slot of the standard device and remove it (1, 2).
2. Loosen the securing screw for the communication module at the standard device (3).
3. Insert the communication module into the MCI slot of the standard device (4).
4. Tighten the securing screw again (5).

### 5.1.2 Mounting for standard devices from 0.55 kW onwards

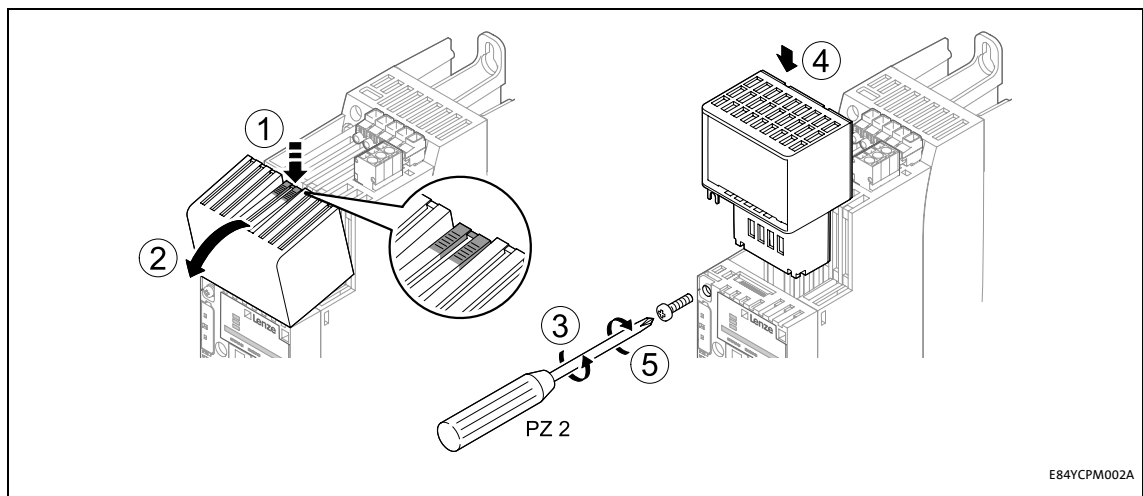

[5-2] Mounting for standard devices from 0.55 kW onwards

#### Mounting steps

1. Slightly impress the pressure surface of the top side of the MCI slot cover of the standard device (1).
2. Bend the cover forward and remove it from the standard device (2).
3. Loosen the securing screw for the communication module at the standard device (3).
4. Insert the communication module into the MCI slot of the standard device (4).
5. Tighten the securing screw again (5).

### 5.1.3 Replacing the communication module

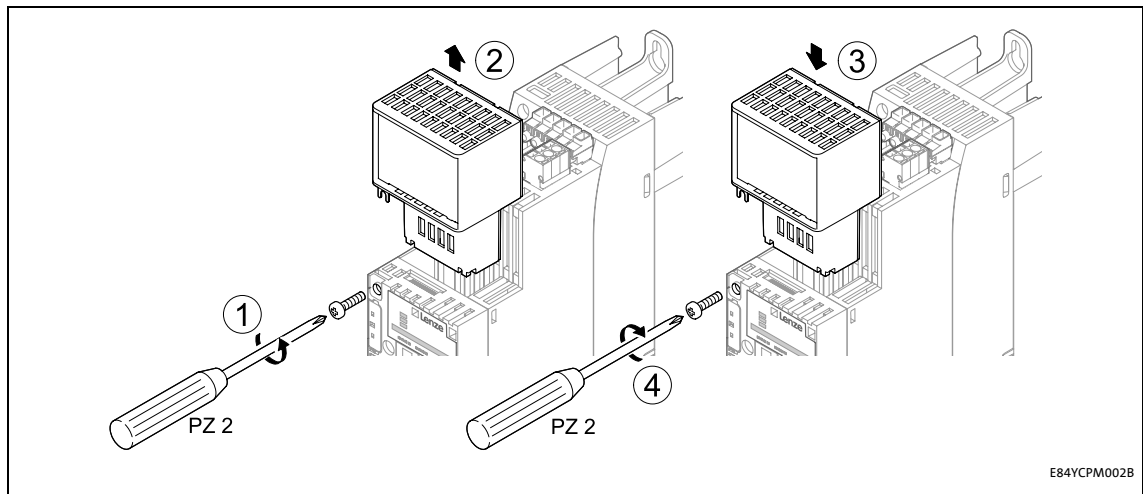

[5-3] Replacing the communication module

#### Mounting steps

1. Loosen the securing screw for the communication module at the standard device (1).
2. Remove the communication module from the MCI slot of the standard device (2).
3. Insert the new communication module into the MCI slot of the standard device (3).
4. Tighten the securing screw again (4).

## 5.2

**Electrical installation**

**Documentation for the standard device, control system, plant/machine**

Observe the notes and wiring instructions stated.

## 5.2.1

**EMC-compliant wiring**

In typical systems, standard shielding is sufficient for Ethernet cables.

However, in environments with a very high level of interference, EMC resistance can be improved by earthing both sides of the cable shield as well.

For this purpose, observe the following notes:

1. Remove the plastic sheath of the cable on a length of 2 cm.
2. Fasten the cable shield to the shield support of the basic device.



### 5.2.2 Network topology

An EtherCAT frame is sent through a pair of wires from the master to the slaves. The frame is forwarded from slave to slave until it has passed through all the devices. Finally, the last slave returns the frame to the master through a second pair of wires. In this way, EtherCAT always forms a logic ring topology, irrespective of the topology used.

#### Line topology

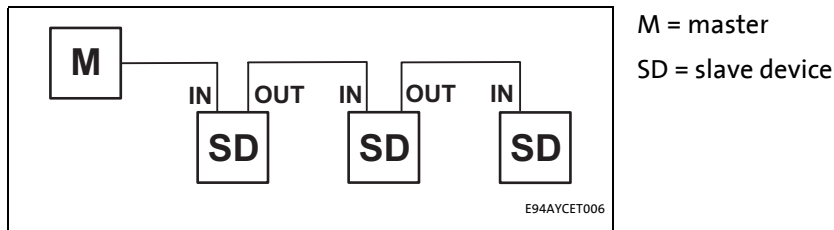

[5-4] Line topology

The devices are interconnected successively.

In order to ensure trouble-free operation, it is required to assign and wire the EtherCAT inputs (IN) and EtherCAT outputs (OUT) correctly.

The receiving line is plugged into socket X246 (IN), the forwarding line into socket X247 (OUT).

The direction of data transmission is from the master to the slaves.



**Tip!**

The termination of the last EtherCAT node is effected automatically by the slave.

#### Switch topology

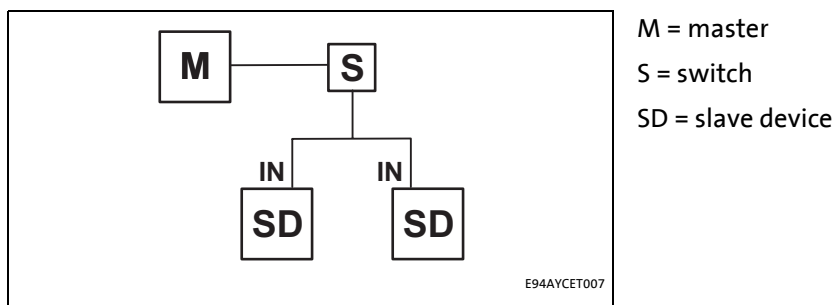

[5-5] Switch topology

The wiring can also be carried out in a star structure via an appropriate switch. For this, observe the additional runtimes.

### 5.2.3 EtherCAT connection

EtherCAT is connected via the RJ45 sockets **X246 (IN)** and **X247 (OUT)**.

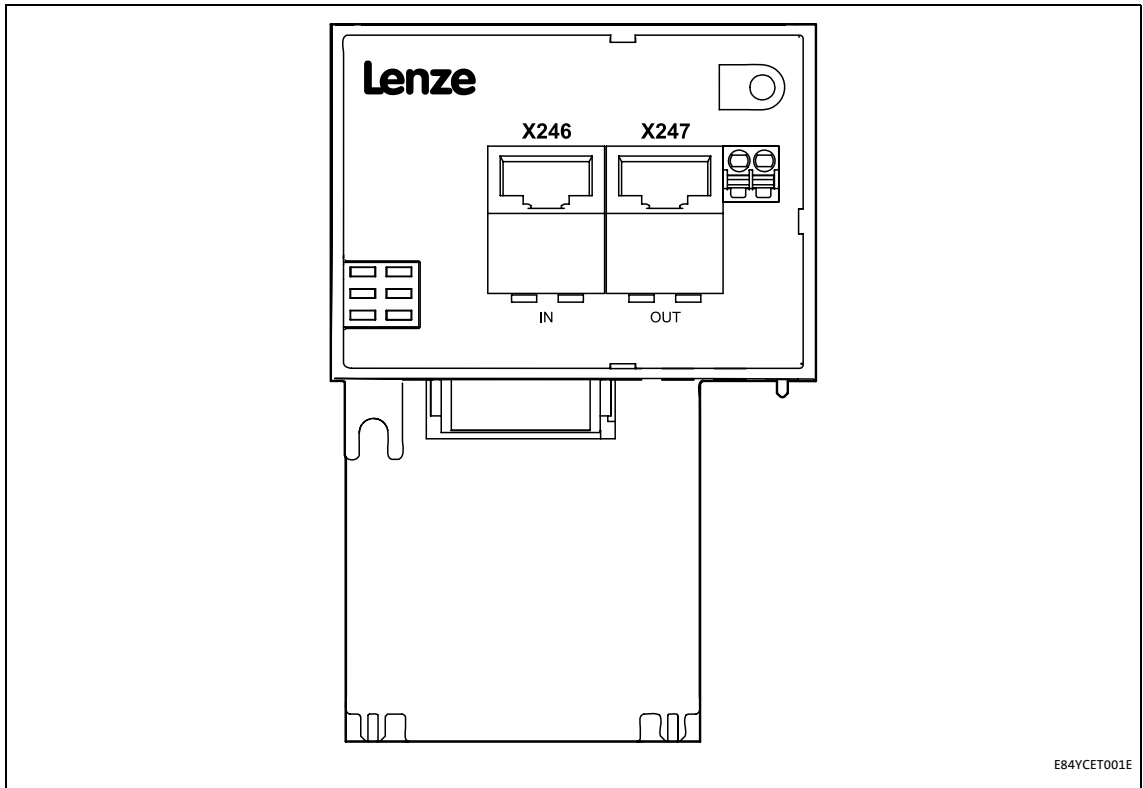

[5-6] EtherCAT connection

A standard Ethernet patch cable is suitable for connecting the communication module to the EtherCAT fieldbus.

▶ [Specification of the Ethernet cable](#) (29)



#### Note!

In order to prevent damage to the RJ45 socket, plug or remove the Ethernet cable connector straight (at a right angle) into/from the socket.

### Pin assignment of the RJ45 sockets

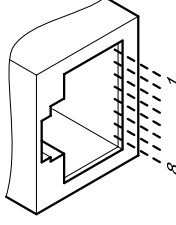
RJ45 socket	Pin	Signal
 <p>E94AYCXX004C</p>	1	Tx +
	2	Tx -
	3	Rx +
	4	-
	5	-
	6	Rx -
	7	-
	8	-



#### Tip!

The EtherCAT interfaces are provided with an auto MDIX function. This function adjusts the polarity of the RJ45 interfaces so that a connection can be established irrespective of the polarity of the opposite EtherCAT interface and irrespective of the type of cable used (standard patch cable or crossover cable).

### 5.2.4 Specification of the Ethernet cable



#### Note!

Only use cables that correspond to the given specifications.

Specification of the Ethernet cable	
Ethernet standard	Standard Ethernet (acc. to IEEE 802.3), 100Base-TX (Fast Ethernet)
Cable type	S/FTP (Screened Foiled Twisted Pair, ISO/IEC 11801 or EN 50173), CAT 5e
Damping	23.2 dB (for 100 MHz and 100 m each)
Crosstalk damping	24 dB (for 100 MHz and 100 m each)
Return loss	10 dB (100 m each)
Surge impedance	100 $\Omega$

#### Structure of the Ethernet cable

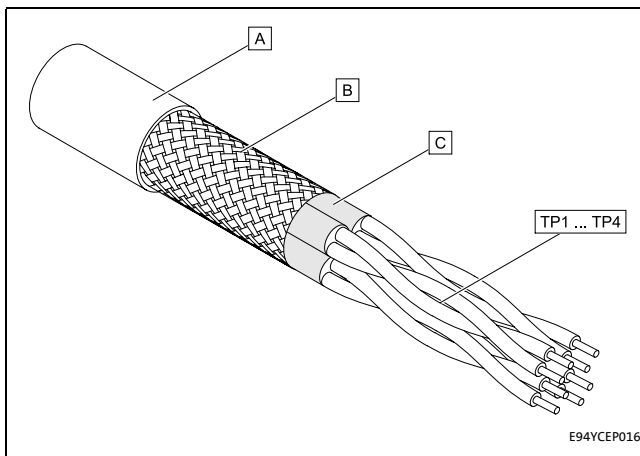

**A** Cable insulation

**B** Braid

**C** Foil shielding

**TP1** Twisted core pairs 1 ... 4

...

**TP4**

[5-7] Structure of the Ethernet cable (S/FTP, CAT 5e)

### Colour code of the Ethernet cable



#### Note!

Wiring and colour code are standardised in EIA/TIA 568A/568B.

The use of 4-pole Ethernet cables according to industrial standard is permissible. The cable type only connects the assigned pins 1, 2, 3 and 6.

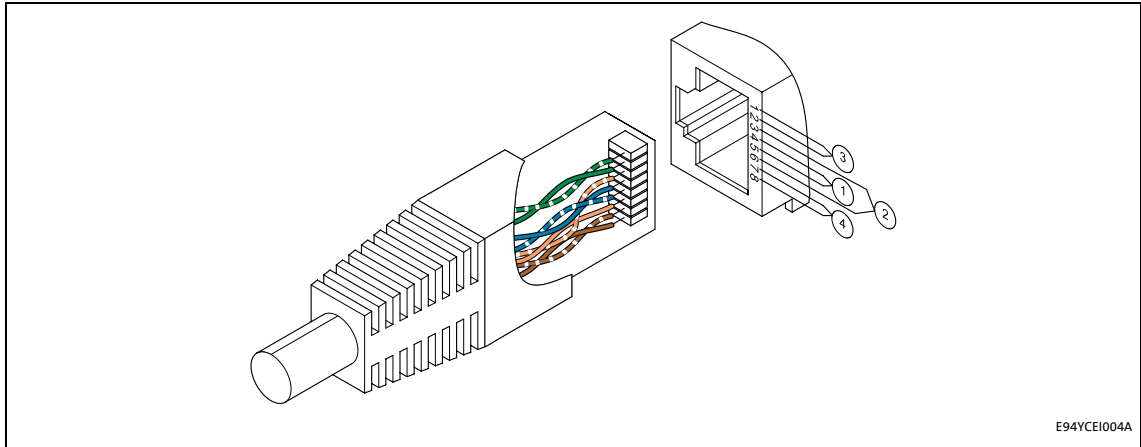

[5-8] Ethernet plugs in accordance with EIA/TIA 568A/568B

Pair	Pin	Signal	EIA/TIA 568A	EIA/TIA 568B
3	1	Tx +	white / green	white / orange
	2	Tx -	green	orange
2	3	Rx +	white / orange	white / green
1	4		blue	blue
	5		white / blue	blue / white
2	6	Rx -	orange	green
4	7		white / brown	white / brown
	8		brown	brown

### 5.2.5 External voltage supply

The communication module can be supplied externally with voltage via separate supply cables at the 2-pole plug connector **X245**.



#### Note!

With external voltage supply, always use a separate power supply unit, safely separated to EN 61800-5-1 in every control cabinet (SELV/PELV).

External voltage supply of the communication module is necessary if the bus communication is to be continued in the event of a failure of the supply of the standard device.

Access to parameters of a standard device disconnected from the mains is not possible.

#### Wiring plug connector X245



#### Stop!

Only wire the plug connector if the standard device is disconnected from the mains.

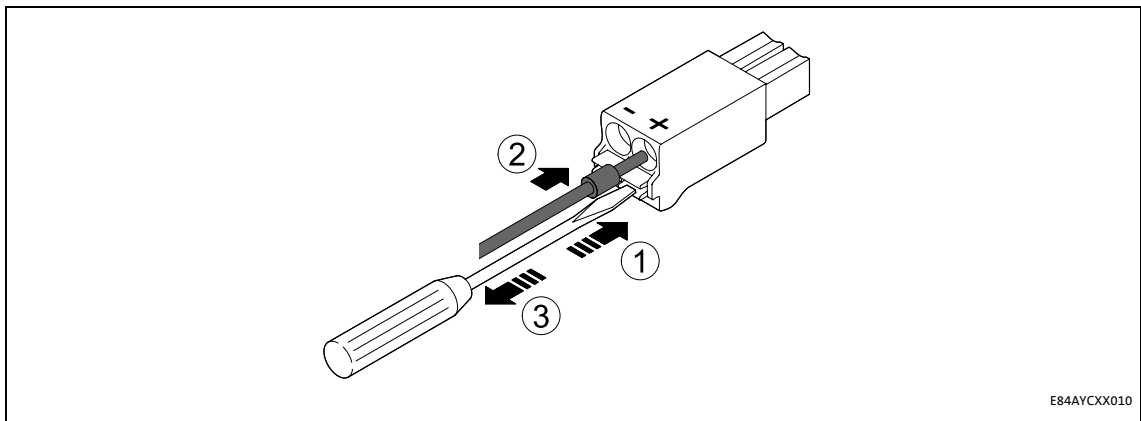

[5-9] Wiring of the 2-pole plug connector with spring connection



How to wire the plug connector with spring connection:

1. Place a screwdriver in the notch beneath the contact slot and keep it pressed.
2. Insert the supply cable in the contact slot.
3. Remove the screwdriver from the notch.

### Assignment of the X245 plug connector

Designation	Description
+	U = 24 V DC (20.4 V - 0 % ... 28.8 V + 0 %) I = 140 mA
-	Reference potential for the external voltage supply

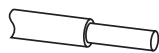
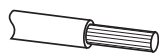
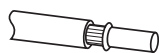
### Terminal data

Area	Values
Electrical connection	2-pole plug connector with spring connection
Possible connections	Fixed:
	 0.2 ... 1.5 mm <sup>2</sup> (AWG 24 ... 16)
	Flexible:
	 Without wire end ferrule 0.2 ... 1.5 mm <sup>2</sup> (AWG 24 ... 16)
	 With wire end ferrule, without plastic sleeve 0.2 ... 1.5 mm <sup>2</sup> (AWG 24 ... 16)
 With wire end ferrule, with plastic sleeve 0.2 ... 1.5 mm <sup>2</sup> (AWG 24 ... 16)	
Stripping length	10 mm

# 6 Commissioning

## 6.1 Before initial switch-on

---

# 6 Commissioning

During commissioning, plant-specific data such as motor parameters, operating parameters, responses, and parameters for fieldbus communication are defined for the inverter. Lenze devices use codes for this purpose.

The codes of the inverter and for communication are saved to the memory module in a non-volatile data set.

In addition, there are codes for diagnosing and monitoring the stations.

▶ [Parameters of the communication module](#) (📖 97)

## 6.1 Before initial switch-on



### Stop!

Before you switch on the Inverter Drive 8400 and the communication module for the first time, check the entire wiring for completeness, short circuit and earth fault.



## 6.2 Configuring the Controller (EtherCAT master)

The Controller (EtherCAT master) must be configured before communication with the communication module is possible.

In order to configure EtherCAT networks, you always need a configuration software for the Controller, e.g.:

- Lenze »PLC Designer«
- Beckhoff »TwinCAT«

These are software systems for the programming of control programs, EtherCAT configuration, real-time execution, and diagnostics.

The basic parameters of the communication module are stored in the internal configuration memory and can be used by the master for the node identification.

For the node search (fieldbus scan), the corresponding device descriptions of the Lenze device family are used.

### 6.2.1 Installing device description files

The current XML device description file required for configuring the EtherCAT node can be found in the download area at:

[www.Lenze.com](http://www.Lenze.com)

The **Lenze\_Inverter\_8400\_IO\_yyyymmdd.xml** device description file has to be installed via the EtherCAT configuration software.

Wildcards in the file name	
yyyy	Year
mm	Month
dd	Day

The description file includes all EtherCAT capable devices of the Inverter Drives 8400 series (Inverter Drives 8400 with EtherCAT V01.xx and V02.xx, 8400 motec with EtherCAT V01.xx).

### 6.2.2 Automatic device identification

For a faultless integration of the EtherCAT slaves into a master configuration it is necessary to select the correct Lenze device in the EtherCAT configuration software.

Each EtherCAT node is identified unambiguously by the configuration software by means of the product code (equal to the CoE object I-1018.2), the manufacturer's identification mark (0x3B), and the main software version of the communication module.

▶ [Identification](#) (□ 12)

▶ [Implemented CoE objects](#) (□ 79)

In order that the configuration software select the configuration from the device description file specific for the EtherCAT node, the product code is automatically set in the identity object. An update is made after switching off/on the voltage supply.

During initialisation, the product code is transferred to the EtherCAT master. On the basis of this identification, the master can accept the corresponding settings from the device description.

#### Product codes for Inverter Drives 8400

The product code defines the following Inverter Drives 8400 in the device description files:

Product code [dec]						Meaning
8	4	0	0	2	2	Inverter Drive 8400 StateLine
8	4	0	0	2	3	Inverter Drive 8400 HighLine
8	4	0	0	2	4	Inverter Drive 8400 TopLine
8	4	0	0	2	5	Inverter Drive 8400 TopLine P (with CiA402)

### 6.2.3 Configuring process data

Inverter Drives 8400 support the configuration of max. 16 process data words (max. 32 bytes) per direction.

The process data configuration is determined during the initialisation phase of the master (PDO mapping).

The process data configuration is predefined in the device description file for each application.

The process data length can be adjusted by the user if required.

### 6.2.4 Determining the cycle time

The process data objects (PDO) are transferred cyclically between the EtherCAT master and the slaves (inverters).

The cycle time is set with the EtherCAT configuration software.

### 6.3 Address allocation

The EtherCAT nodes are normally addressed via a fixed 16-bit address defined by the EtherCAT master. During start-up, the master assigns this address to each node, depending on the physical order in the EtherCAT network. The address is not saved and is lost when the device is switched off.

Via the **Station alias address** input field you can assign a fixed address to the EtherCAT slave.

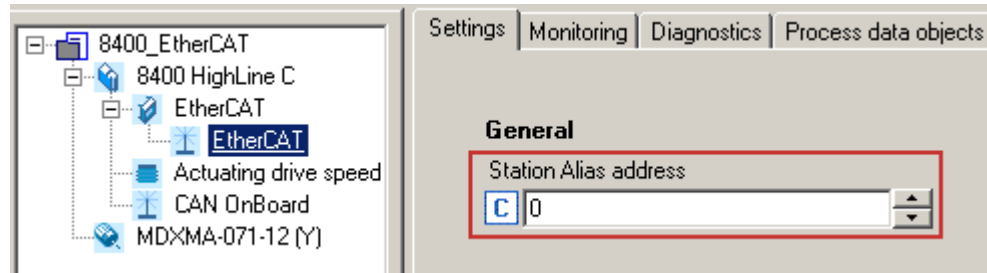

#### Note!

- The station alias address must be unambiguous and may only be assigned once within the EtherCAT network.
- Use the same station alias address in the EtherCAT master and in the slave.

Valid address range: 0 ... 32767

- Address 0 means that no station alias address is assigned.
- Impermissible addresses are marked in red in the input field.
- The address is written to code [C13899](#).

In addition, specify the use of the fixed addressing on the master.

The address assigned by the master is displayed under code [C13864](#).

## 6.4 Synchronisation with "Distributed Clocks" (DC)

The "Distributed clocks" (DC) functionality enables exact time synchronisation for applications in which several axes perform a coordinated movement simultaneously. Data are incorporated synchronously with the PLC program. During DC synchronisation, all slaves are synchronised with a reference clock, the so-called "DC master".



### Note!

- DC synchronisation is absolutely required for Motion applications.
- DC synchronisation can also be used for Logic applications.
- Not all slaves support the DC functionality.
- On order to be able to use the DC functionality, the first slave connected to the EtherCAT master (e.g. Lenze Controller) must have **DC master capability**. When further slaves are connected, DC-capable and non-DC-capable devices can be mixed.
- The first EtherCAT slave after the Lenze Controller must be the **DC master** that supplies the other EtherCAT nodes (incl. Controller) with the exact time.

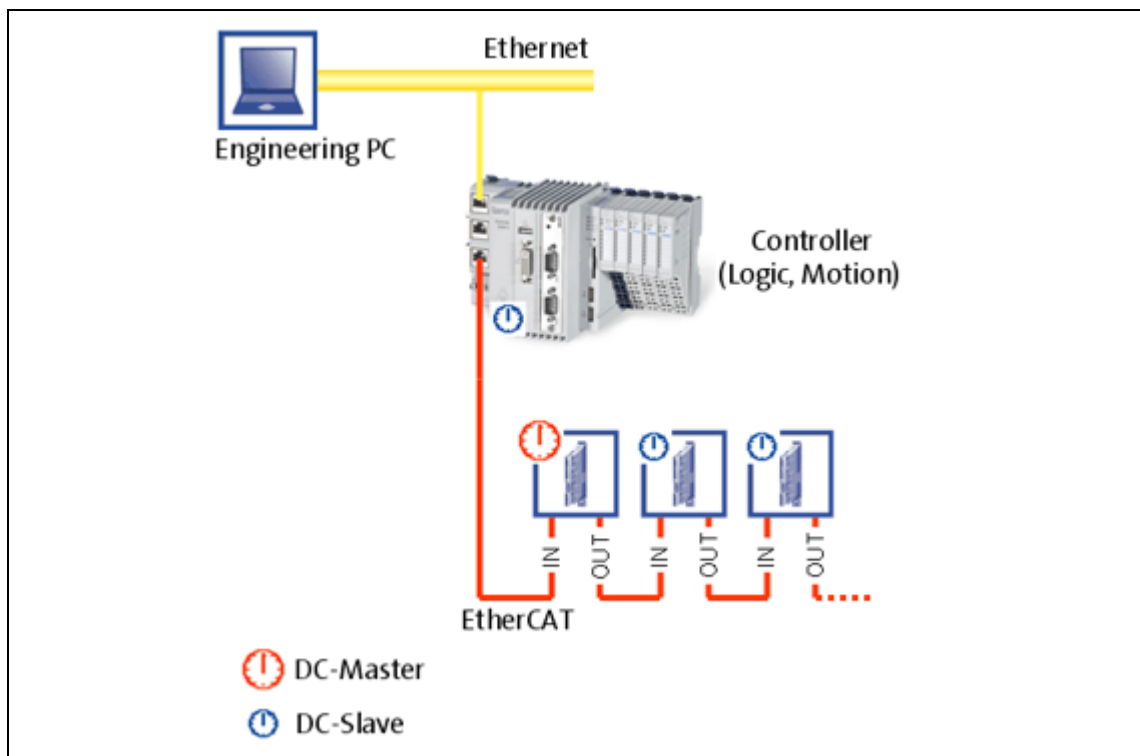

[6-1] Example: "Distributed clocks" in the EtherCAT bus system with Lenze Controller 3231 C

The DC synchronisation is set with the EtherCAT configuration software.



### "Control technology EtherCAT" communication manual

Here you can find some detailed information about the EtherCAT configuration and the commissioning of Lenze devices in the EtherCAT network.

### 6.4.1 DC configuration in the master

By default, the application of the DC synchronisation is deactivated in the device description ([34](#)). Parameterise the DC synchronisation in the EtherCAT configuration software («PLC Designer«, »TwinCAT«).

Set the synchronisation cycle time in the master. It is mainly defined by the processing time of the master and the slaves.



#### Note!

The synchronisation cycle time ...

- must be an integer multiple of 1 ms;
- may be maximally 15 ms.

### 6.4.2 DC configuration in the Inverter Drive 8400 (slave)



#### Note!

The settings of the parameter sync cycle time (C01121), sync phase position (C01122), sync tolerance (C01123) and sync PLL increment (C01124) common for the Lenze system bus (CAN) cannot be made for EtherCAT. These values are automatically calculated by the EtherCAT communication module and set internally in the inverter.

In order to use the DC synchronisation in the Inverter Drive 8400, select the sync source by means of the standard device code [C01120](#):

Selection 4: MCI (synchronisation via MCI (communication module))

### 6.4.3 Response of the Lenze EtherCAT nodes during start-up

Code [C13883](#) indicates whether the DC synchronisation for the communication module has been activated.

If the DC synchronisation is used, the communication module only changes to the "Operational" state when the standard device has adapted its phase position to the DC signal. This process may take several seconds.



#### Note!

- If the communication module does not change to the "Operational" state, there might be an error in the configuration or in the EtherCAT wiring.
- The communication module compares the cycle time defined by the EtherCAT master to the internal processing time (1 ms) of the standard device. The synchronisation cycle time in the master must be identical with or an integer multiple of 1 ms.
- Furthermore it is checked whether the sync source selection in standard device code [C01120](#) is correct.
- Further information can be found in the status information or emergency messages of the master.

The state of the standard device synchronicity is displayed under code [C13884](#).

## 6.5 Establishing an online connection with the »Engineer«

With the »Engineer« you can establish an online connection to the individual field devices.

When an online connection has been established, you can for instance carry out parameter settings directly in the field device or diagnose the field device.



### Stop!

If parameters in the »Engineer« are changed while the Engineer is connected online to the field device, the changes are directly accepted to the device!



### Note!

To go online, the EtherCAT bus at least has to be in the "Pre-Operational" state.

The functions for establishing/cancelling an online connection in the »Engineer« can be executed via the **Online** menu:

Menu command	Shortcut
Online → Go online	<F4>
Online → Set communication path and go online	
Configuring a bus connection: <ul style="list-style-type: none"> <li>• <a href="#">Gateway Controller -&gt; configure EtherCAT</a> (41)</li> <li>• <a href="#">Gateway Controller -&gt; configure EtherCAT ADS (Beckhoff)</a> (43)</li> </ul>	
Online → Go offline	<Shift>+<F4>



### Documentation for the Lenze »Engineer«

Here you'll find further detailed information about how to establish an online connection.

# 6 Commissioning

## 6.5 Establishing an online connection with the »Engineer«

---

### 6.5.1 Gateway Controller -> configure EtherCAT

The Lenze Controller provides a gateway function to establish an online connection to a field device via EtherCAT.

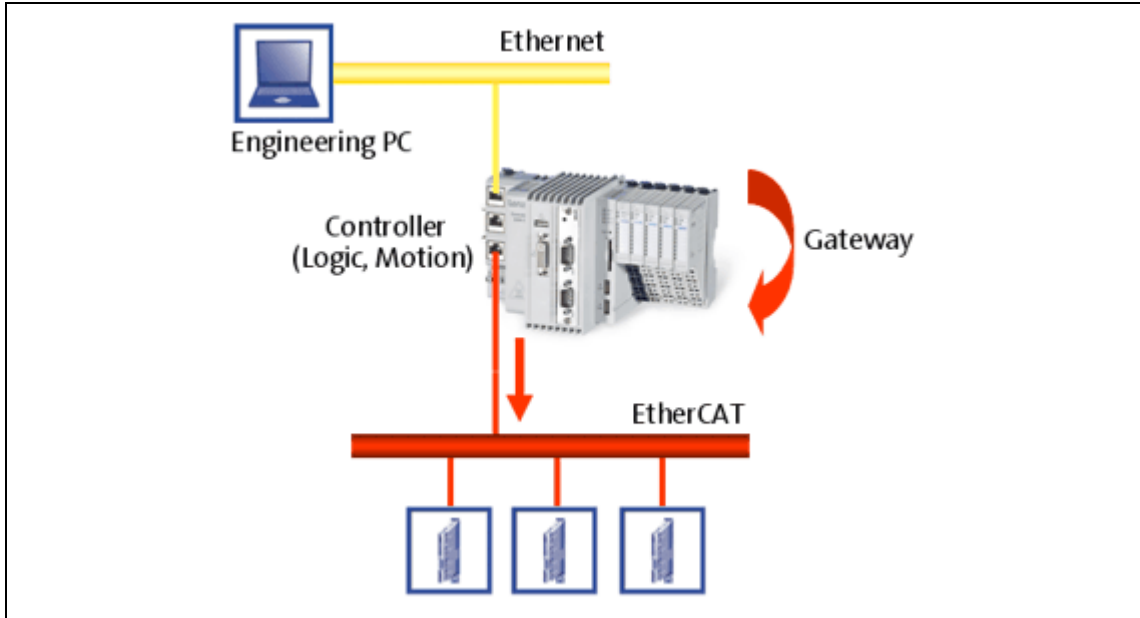

[6-2] Example: EtherCAT bus system with a Lenze Controller 3231 C as gateway





### How to configure an online connection to a field device which is connected to the Lenze Controller via EtherCAT:

1. Go to the *Communication path* dialog box and the *Bus connection* list field, and select the entry "Gateway Controller -> EtherCAT" there.
2. Click **Search/Enter...**

The *Gateway Controller -> Set up EtherCAT bus* dialog box is shown:

IPC name	IP address	IPC interface
EL 870	172.31.207.20	ECAT1

IPC (Gateway)

Name:

IP address:  .  .  .

Interface:

Field device

Name:

Ethercat address:

Diagram: Ethernet --- Gateway device --- EtherCAT --- Field device

3. Enter the **IP address** of the Controller.

By clicking the **Ping** button, you can carry out a simple test which verifies whether a device can actually be reached via the IP address set

4. Click **OK**.
  - The *Enter IP address* dialog box is closed.
  - In the *Communication path* dialog box in the **Device access path** column, the corresponding device access path is shown (e.g. "IPC:172\_31\_207\_254.ECAT.ecat1.dev1001.").

### 6.5.2 Gateway Controller -> configure EtherCAT ADS (Beckhoff)

The **Gateway EtherCAT ADS** bus connection makes it possible to establish an online connection to a Lenze inverter that is connected to a Beckhoff Controller via EtherCAT (gateway function).

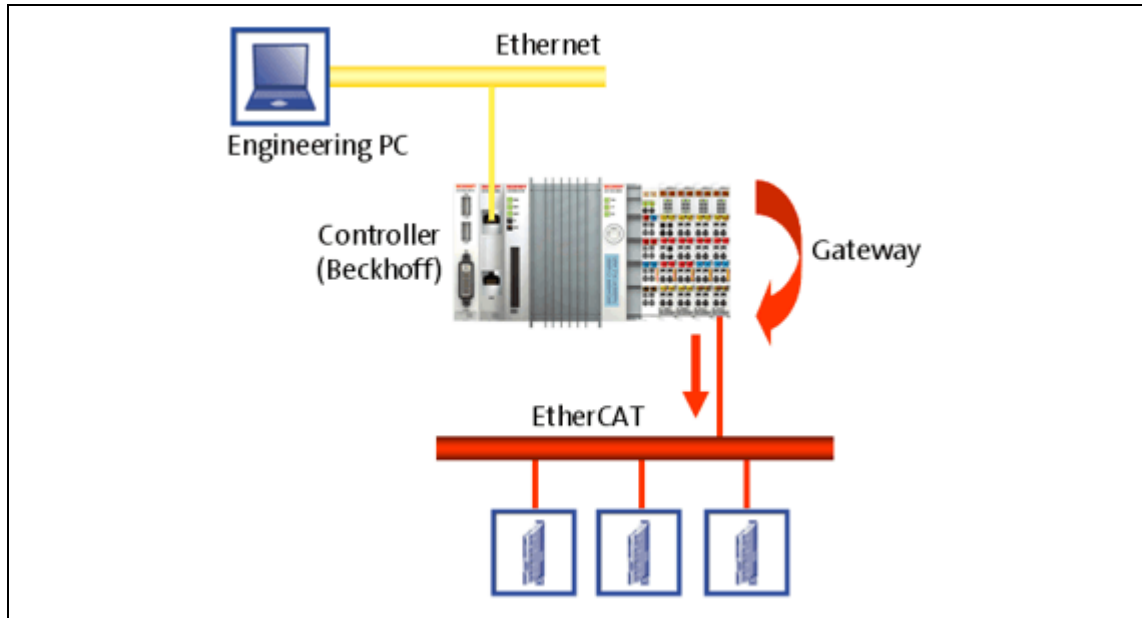

[6-3] Example: EtherCAT bus system with a Beckhoff Controller as Gateway



**How to configure an online connection to a field device which is connected to a Beckhoff Controller via EtherCAT:**

1. Highlight the project root  in the project.  
Alternatively: Create a new project or carry out a fieldbus scan.
2. Execute the menu command **Insert → Insert device detected online**.
3. Select **Gateway Controller -> EtherCAT ADS** as bus connection.
4. Configure access data:
  - Configure the access data applicable to the Controller via the **Insert address** button.
  - The **Search** button initiates the Controller to display the fieldbus nodes connected to the EtherCAT segment.



### How to use the EtherCAT ADS communication path:

1. Highlight the desired inverter, to which a gateway connection via EtherCAT ADS is to be established, in the project tree.
2. Call the menu command **Online → Set communication path and go online**.

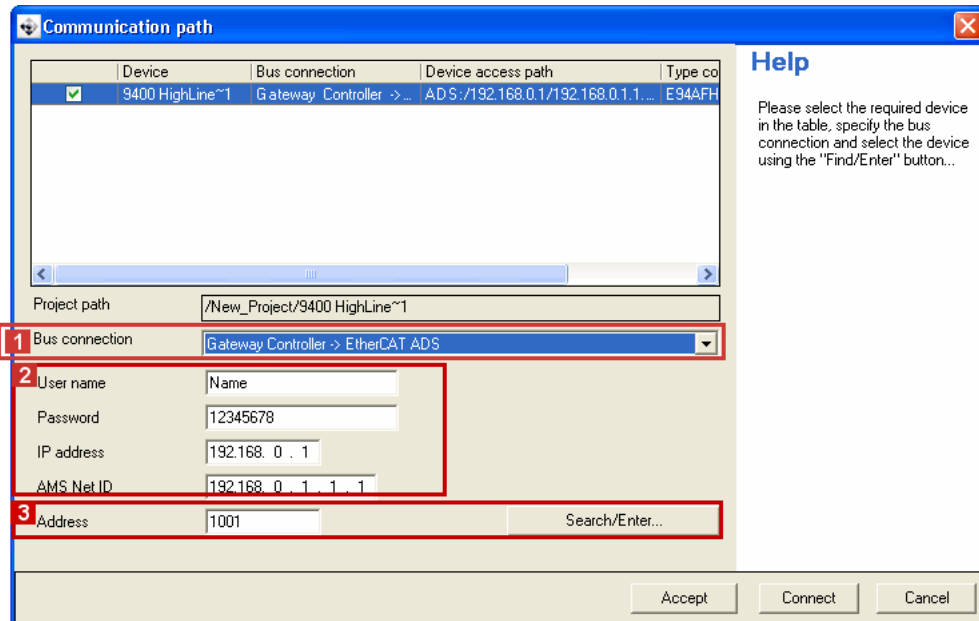

3. Select **1 Gateway Controller -> EtherCAT ADS** as bus connection.
4. Enter the access data applicable to the Controller in area **2**.  
Enter the user name, password, and the IP address and the AMS Net ID of the EtherCAT interface of the Controller.
5. In area **3**, specify the EtherCAT address of the field device to which the online connection is to be established.

Alternatively you can click the **Search/Enter** button which calls the *Select Device Access Path* dialog window. By this, the »Engineer« initiates the Controller to display the devices detected on the EtherCAT segment.

## 6.6 EtherCAT ADS communication parameters in »TwinCAT« and »Engineer«

In the following, two example structures are used to describe where you can find the EtherCAT ADS communication parameters in the Beckhoff »TwinCAT« and in the Lenze »Engineer« EtherCAT.

### 6.6.1 Example: Structure without a Beckhoff Controller

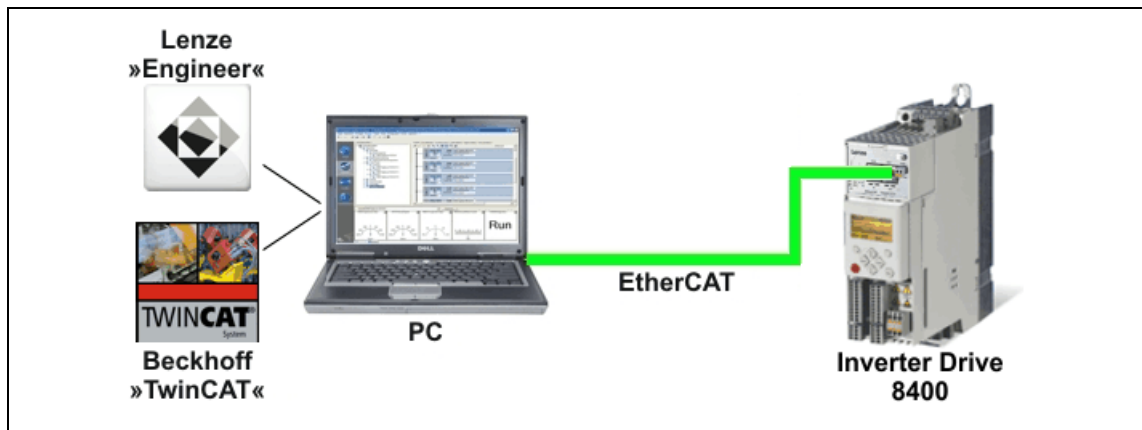

[6-4] Example: EtherCAT bus system without Beckhoff Controller

The Beckhoff Soft-PLC runs on the Microsoft Windows XP PC on which the Beckhoff »TwinCAT« and the Lenze »Engineer« are installed as well.

### Display of the communication parameters in »TwinCAT«

The communication parameters **1** IP address (here '172.31.200.200') and **2** EtherCAT Master Net ID (here '172.31.200.200.2.1') can be found under the target system selection:

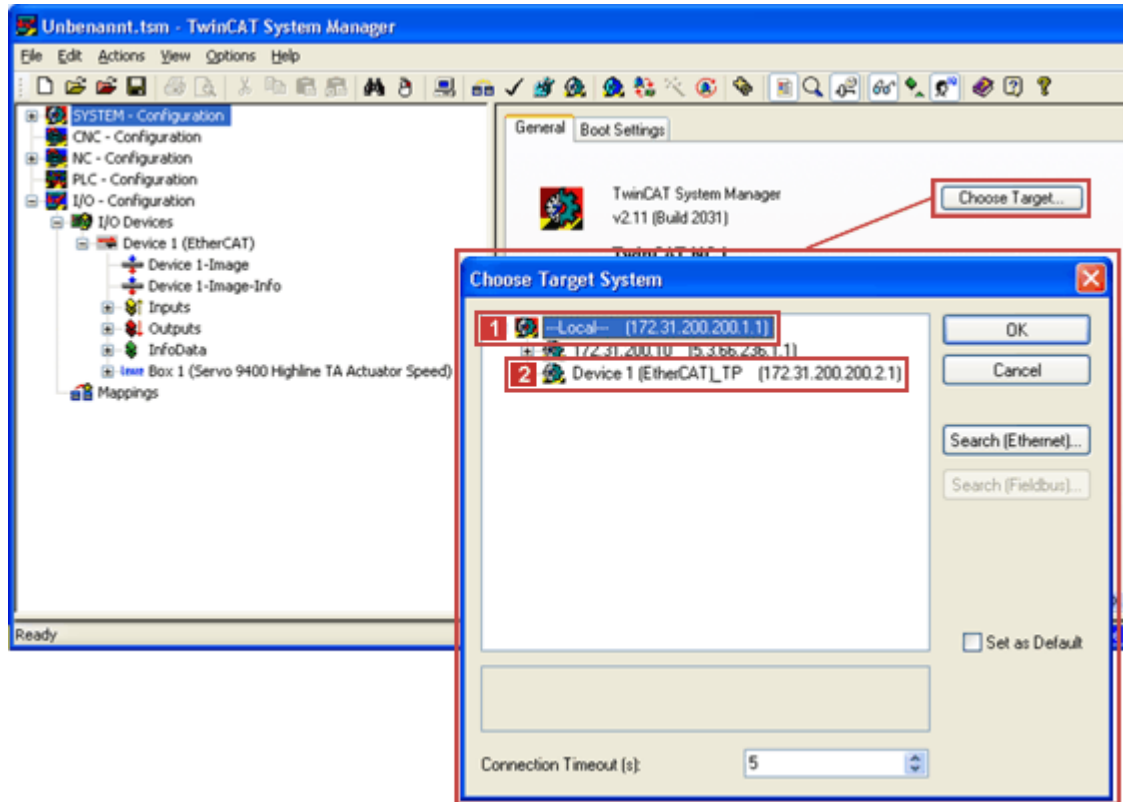

The EtherCAT **1** Slave address (here '1001') can be found under the **EtherCAT** tab of the **2** EtherCAT slave:

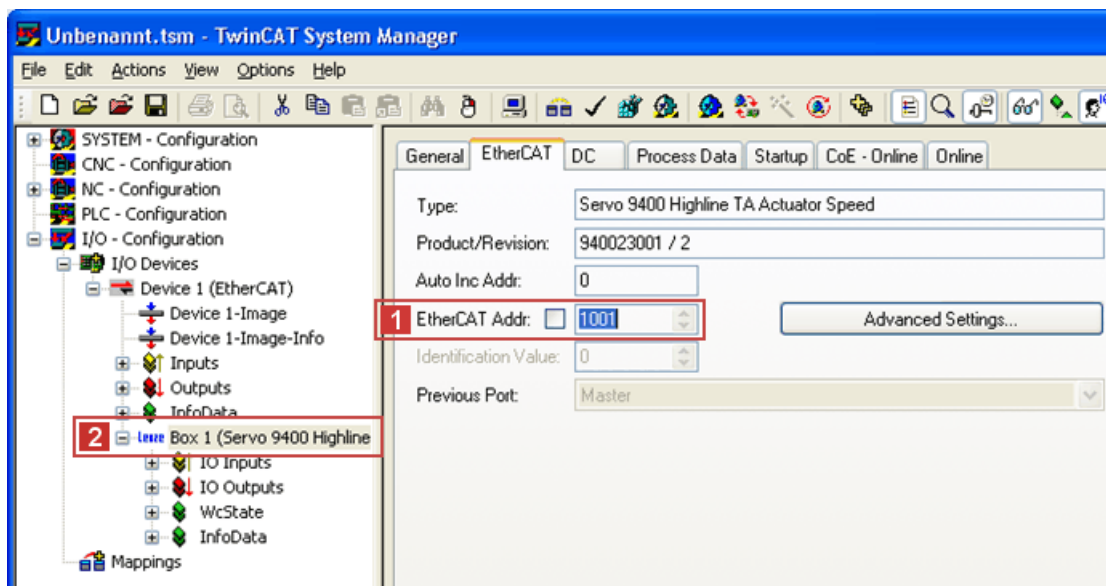

### Online device identification in the »Engineer« start-up wizard

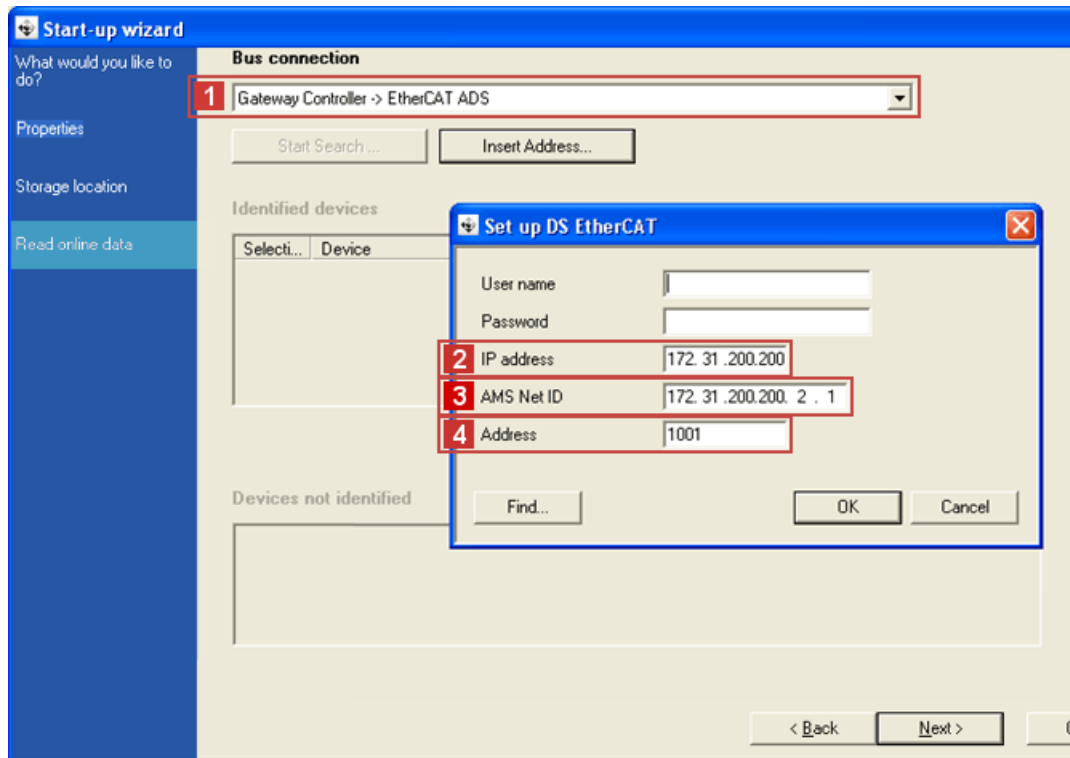

In the »Engineer« start-up wizard under the **1 Gateway Controller -> EtherCAT ADS** bus connection, a field device was detected online:

- 2 IP address:** 172.31.200.200
- 3 EtherCAT Net ID:** 172.31.200.200.2.1
- 4 EtherCAT slave address:** 1001

Display of the identification of the field device detected in the »Engineer« start-up wizard:

- 1** IP address: 172.31.200.200
- 2** EtherCAT Net ID: 172.31.200.200.2.1
- 3** EtherCAT slave address: 1001

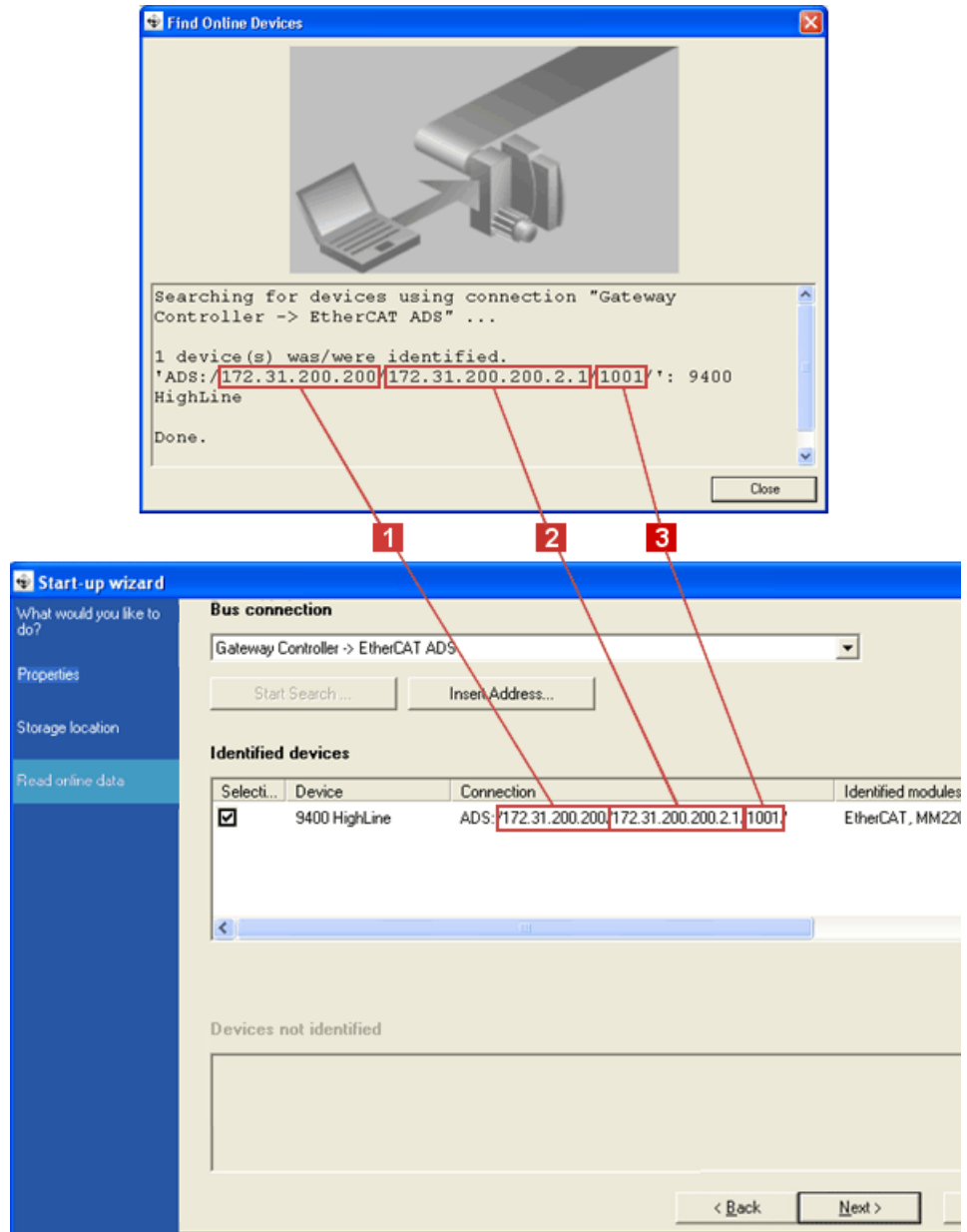

## 6.6.2 Example: Structure with a Beckhoff DIN rail IPC CX1020

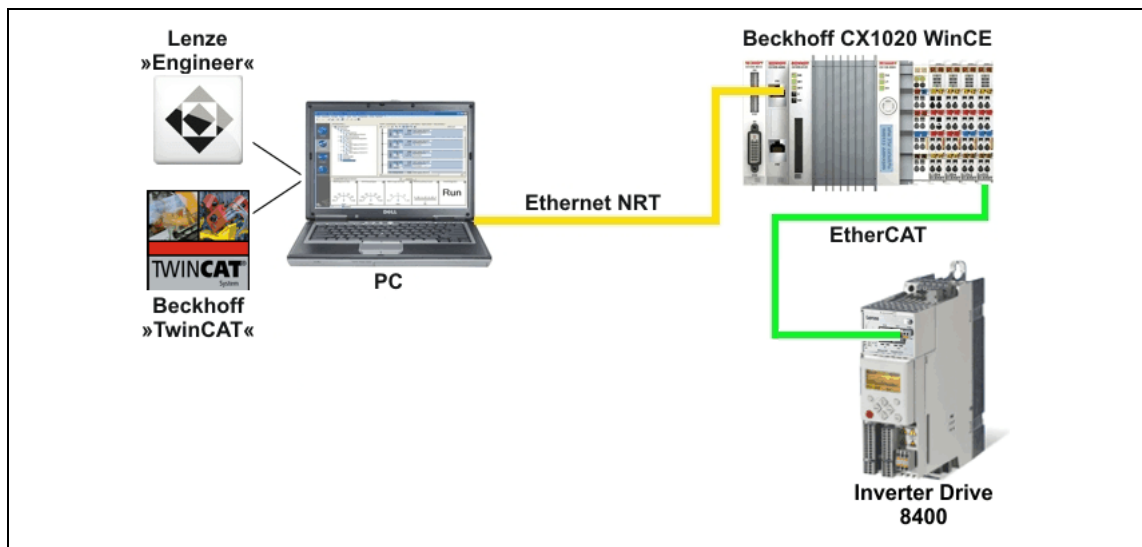

[6-5] Example: EtherCAT bus system with Beckhoff Controller

A Beckhoff DIN rail IPC with the Microsoft Windows CE operating system is used. The Beckhoff »TwinCAT« and the Lenz »Engineer« are installed on a Windows XP PC.

## Display of the communication parameters in »TwinCAT«

The communication parameters **1** IP address (here '172.31.200.10') and **2** EtherCAT Master Net ID (here '5.3.66.236.4.1') can be found under the target system selection:

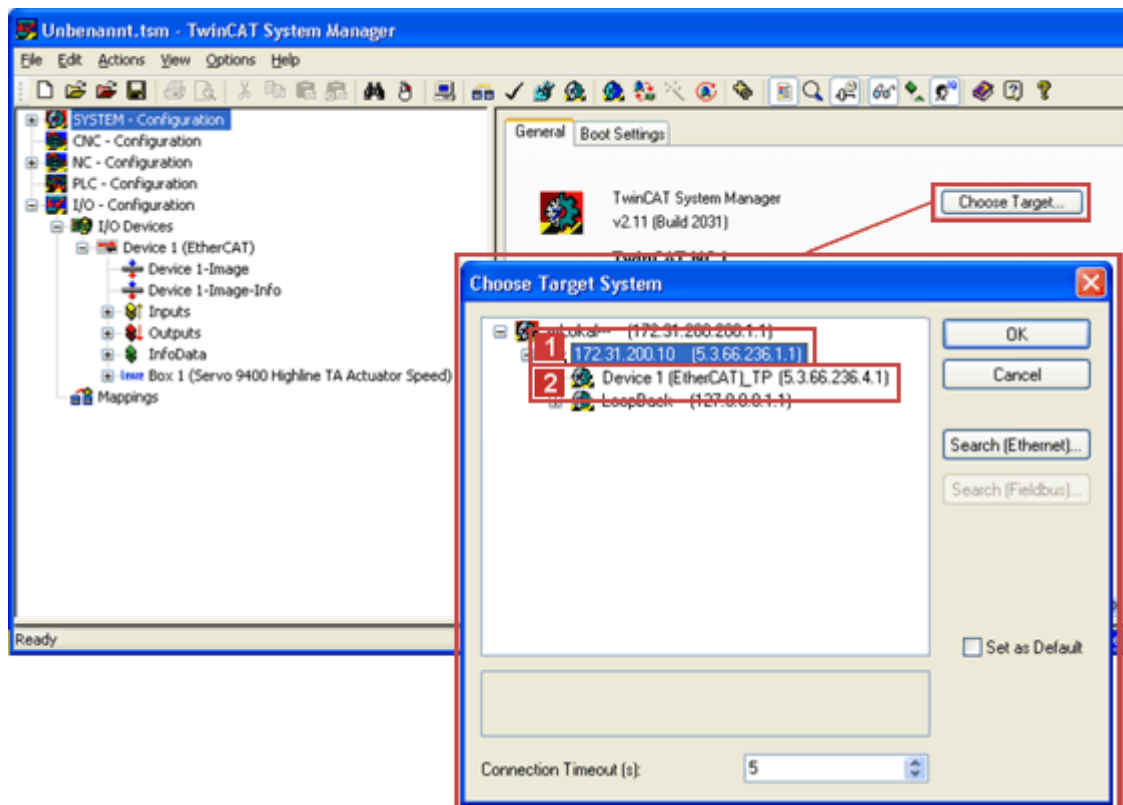



The **1** EtherCAT Master Net ID (here '5.3.66.236.4.1') can also be found under the EtherCAT tab of the **2** EtherCAT master:

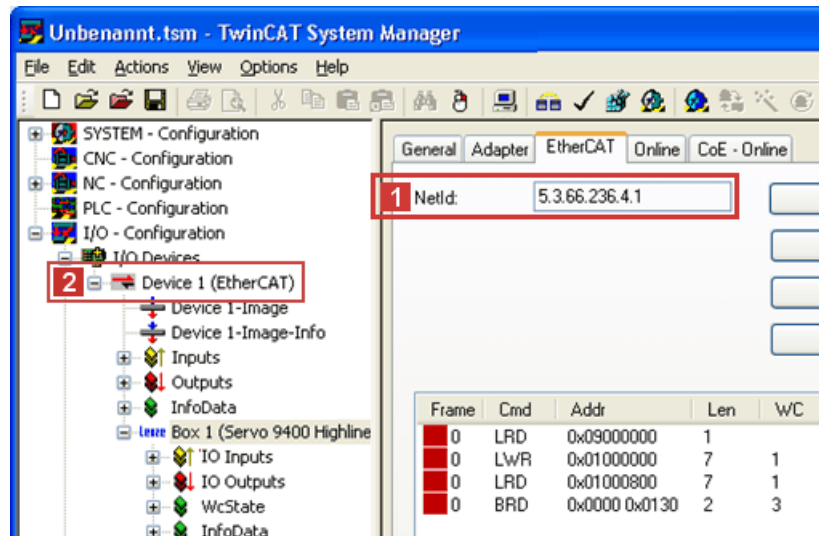

The EtherCAT **1** slave address (here '1003') can be found under the EtherCAT tab of the **2** EtherCAT slave:

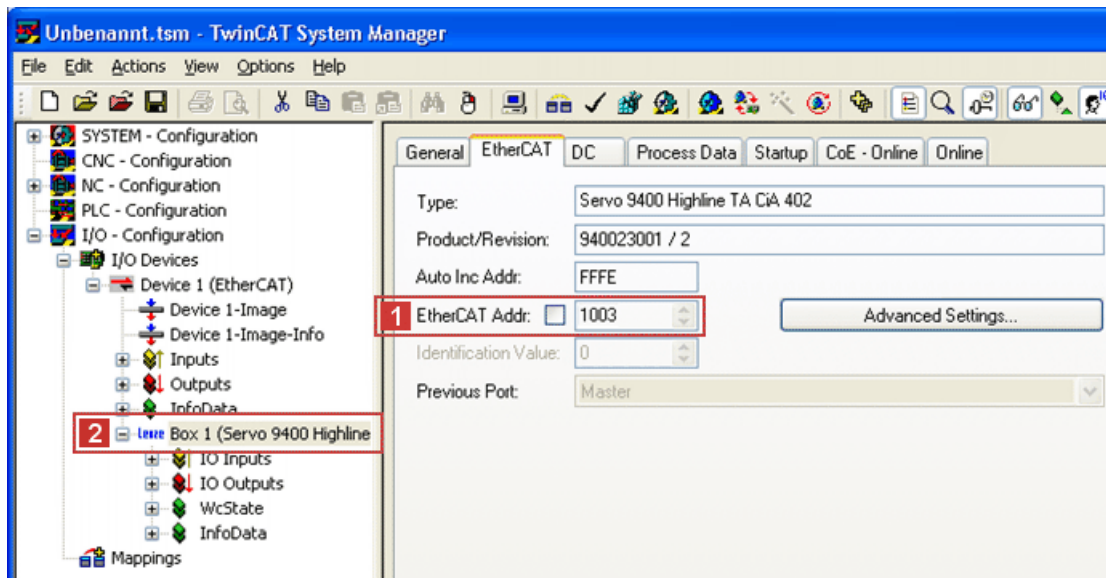

## Online device identification in the »Engineer« start-up wizard

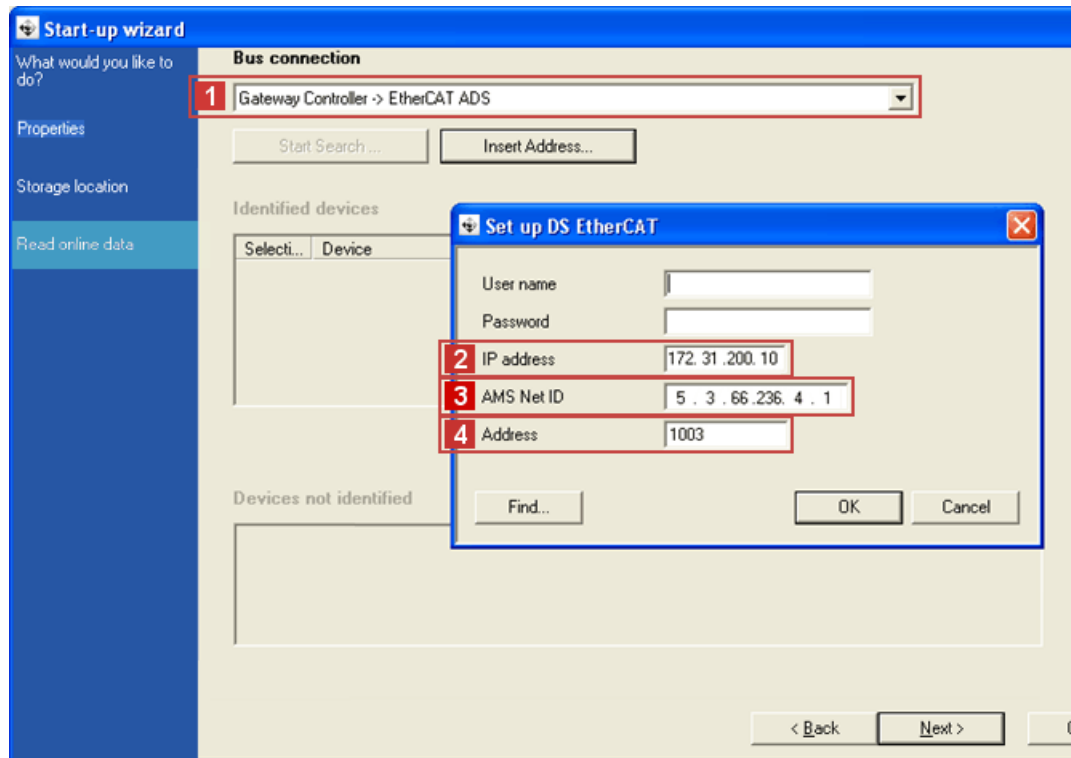

In the »Engineer« start-up wizard under the **1 Gateway Controller -> EtherCAT ADS** bus connection, a field device was detected online:

- 2 IP address:** 172.31.200.10
- 3 EtherCAT Net ID:** 5.3.66.236.4.1
- 4 EtherCAT slave address:** 1003

Display of the identification of the field device detected in the »Engineer« start-up wizard:

- 1** IP address: 172.31.200.10
- 2** EtherCAT Net ID: 5.3.66.236.4.1
- 3** EtherCAT slave address: 1003

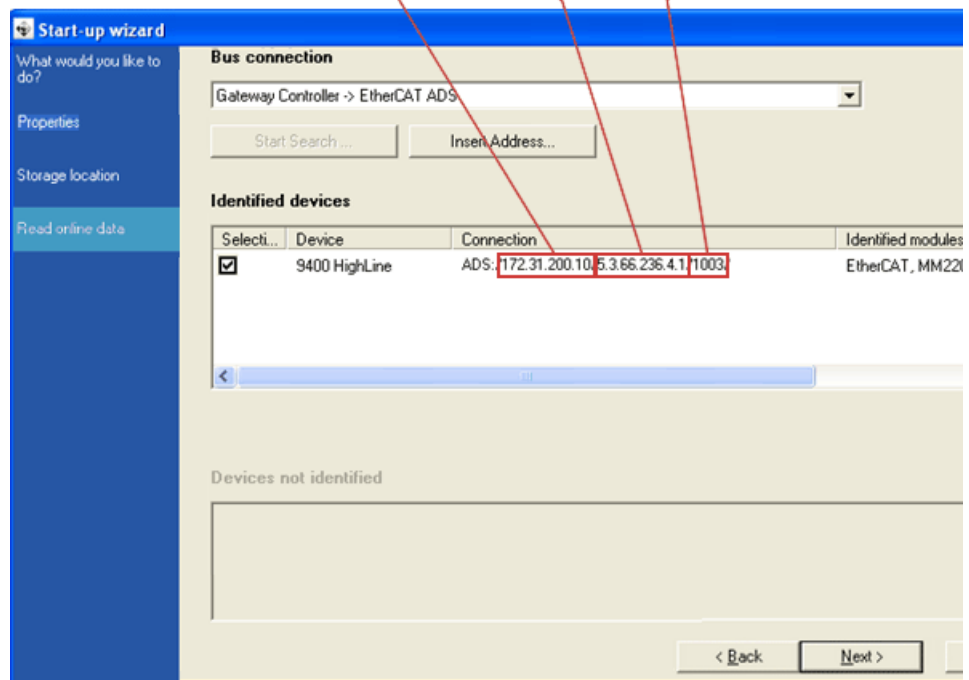
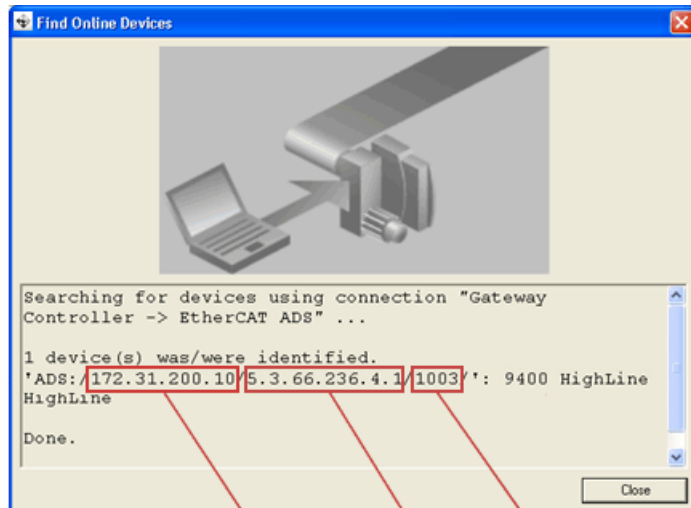

## 6.7

## Initial switch-on

**Documentation for the standard device**

Observe the safety instructions and residual hazards stated.

**Note!****Establishing communication**

In order to establish communication via an externally supplied communication module, the standard device must be switched on as well.

After communication has been established, the externally supplied module operates independently of the power on/off state of the standard device.

**Activating changed settings**

In order to activate changed settings ...

- execute the device command "11: Save all parameter sets" via the standard device code **C00002** and ...
- then execute a "reset node" of the node or switch off the voltage supply of the communication module and switch it on again.

**Protection against uncontrolled restart**

After a fault (e.g. short-time mains failure), the restart of a drive is not always wanted and - in some cases - even not allowed.

In the Lenze setting for Inverter Drives 8400, the restart protection is active.

Via the standard device code **C00142** ("Autostart option") you can set the restart behaviour of the inverter:

**C00142 = 9** (Lenze setting)

- The inverter remains inhibited (even if the fault is no longer active).
- Bit 0 (inhibit if device is ON) and bit 3 (inhibit in case of undervoltage) are set.
- An explicit inverter enable causes the drive to start up in a controlled manner: LOW-HIGH edge at digital input X4/RFR.

**C00142 = 8** (enabled)

- In order to directly enable the device at switch-on, bit 0 must be set to zero (FALSE).
- An uncontrolled restart of the drive is possible.

### 7 Data transfer

Compared with conventional Ethernet, the collision-free transfer of frames on the fieldbus makes EtherCAT a real-time capable bus system.

Communication is always initiated by the EtherCAT master, e.g. a Lenze Controller. A frame sent by the master passes through all EtherCAT slaves. The last slave of the communication chain sends the frame back to the EtherCAT master. On the way back, the frame is directly sent to the master, without being processed in the slaves.

EtherCAT transmits data in so-called "EtherCAT frames". The EtherCAT nodes only extract the data intended for them while the EtherCAT frame passes through the device. At the same time output data are inserted into the frame while it passes through the device. Read and write accesses are only executed on a small section of the entire EtherCAT frame – the datagrams. Therefore it is not necessary to receive the complete frame before it can be processed. Processing starts as soon as possible.

EtherCAT transmits process data, parameter data, configuration data, and diagnostic data between the EtherCAT master and the inverters (slaves) that are part of the fieldbus. The data are transmitted via corresponding communication channels depending on their time-critical behaviour (see [Process data transfer](#) (□ 59) / [Parameter data transfer](#) (□ 68)).

# 7 Data transfer

## 7.1 EtherCAT-Frames

### 7.1 EtherCAT-Frames

EtherCAT frames have the following structure:

Ethernet header			Ethernet data				FCS
48 bits	48 bits	16 bits	11 bits	1 bit	4 bits	48 ... 1498 bytes	32 bits
Destination	Source	EtherType	Frame header			Datagrams	
			Length	Reserved	Type		

#### Ethernet header

The Ethernet header contains the following information:

- Target address of the EtherCAT frame (destination)
- Source address of the EtherCAT frame (source)
- Type of the EtherCAT frame (EtherType = 0x88A4)

#### Ethernet data

The Ethernet data contain the following information:

- Length of the datagrams within the EtherCAT frame (Length)
- One reserved bit (Reserved)
- Type of the datagrams within the EtherCAT frame (Type)
- EtherCAT datagrams (Datagrams)

#### FCS

Checksum of the EtherCAT frame

# 7 Data transfer

## 7.2 EtherCAT datagrams

---

### 7.2 EtherCAT datagrams

Read and write accesses are always only executed in one small section of the complete EtherCAT frame – the datagrams.

EtherCAT datagrams have the following structure:

EtherCAT Command header	Data	WKC
10 bytes	Max. 1486 bytes	2 bytes

#### EtherCAT Command header

The EtherCAT command header contains the following information:

- Command to be executed
- Addressing information
- Length of the data area (Data)
- Interrupt field

#### Data

The data area contains the data of the command to be executed.

#### WKC (Working Counter)

The working counter is evaluated by the master for monitoring the execution of the command.

### 7.3 EtherCAT state machine

Before communication is possible via EtherCAT, the fieldbus passes through the EtherCAT state machine during start-up. The following illustration depicts the possible state changes from the point of view of an EtherCAT slave:

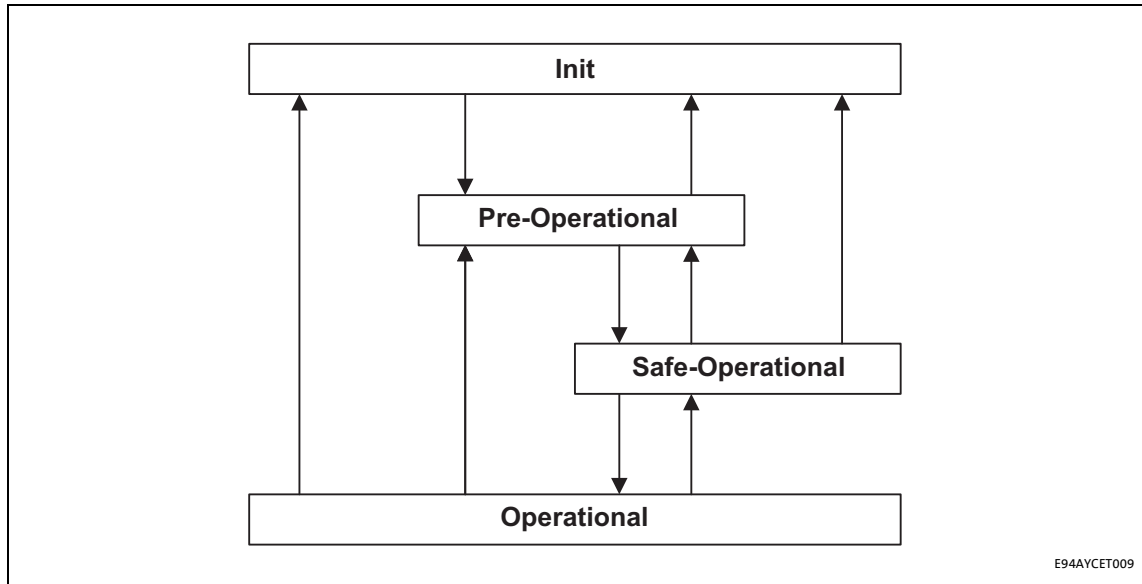

[7-1] EtherCAT state machine

State	Description
Init	<ul style="list-style-type: none"> <li>Initialisation phase</li> <li>No SDO/PDO communication with the slaves</li> <li>Device detection possible by means of a fieldbus scan</li> </ul>
Pre-operational	<ul style="list-style-type: none"> <li>The fieldbus is active.</li> <li>SDO communication (mailbox communication) is possible.</li> <li>No PDO communication</li> </ul>
Safe-operational	<ul style="list-style-type: none"> <li>SDO communication (mailbox communication) is possible.</li> <li>PDO communication:               <ul style="list-style-type: none"> <li>The input data in the process image are updated.</li> <li>The output data from the process image are not transferred to the slaves.</li> </ul> </li> </ul>
Operational	Normal operation: <ul style="list-style-type: none"> <li>SDO communication</li> <li>PDO communication</li> <li>Fieldbus synchronisation successful (if used)</li> </ul>



#### Note!

- A fieldbus scan can be carried out during any EtherCAT status.
- SDO communication via the EtherCAT bus is only possible if at least the "Pre-Operational" state has been reached.
- Only in the transitional phases between states can bus nodes be in different states.

The current status of the EtherCAT state machine is shown in [C13861](#) and indicated via the **BS** LED.

Possible errors at the state transitions are shown in [C13879](#). Additionally, an error message is entered in the "AL status code" EtherCAT register" ([☞ 58](#)).



▶ [Diagnostics with the »Engineer«](#) (📖 89)

▶ [Fieldbus status displays](#) (📖 86)

### AL Status Code

Information about how the "AL Status Code" EtherCAT register (address 0x0134:0x0135) can be accessed can be found in the documentation of the EtherCAT master.

These error messages can be entered in the "AL Status Code" register:

AL Status Code [hex]	Description
0x0000	No fault
0x0011	Invalid status change requested
0x0012	Unknown status requested
0x0013	"Bootstrap" status is not supported
0x0016	Invalid mailbox configuration "Pre-operational"
0x001A	Synchronisation error
0x001B	Sync manager watchdog
0x001D	Invalid output data configuration
0x001E	Invalid input data configuration
0x002B	Invalid input and output data
0x0030	Invalid configuration of DC synchronisation
0x9001	Firmware watchdog error
0x9002	Mapping error

### 8 Process data transfer

Process data are transmitted by means of [EtherCAT datagrams](#) (□ 56) via the process data channel.

The Inverter Drive 8400 is controlled by means of the process data.

The transmission of process data is time-critical.

Process data are transferred cyclically between the Controller (EtherCAT master) and the inverters (slaves) (continuous exchange of current input and output data).

The master can directly access the process data. In the PLC for instance, the data are directly stored in the I/O area.

Up to 16 process data words (16 bits/word) per direction can be exchanged.

Process data are not saved in the Inverter Drive 8400.

Process data are for instance setpoints, actual values, control words, and status words.

8.1 Accessing process data / PDO mapping

Process data (MCI PDO) are transmitted via the MCI interface.

- Max. 16 words are exchanged per direction.
- The process data are accessed via the port blocks **LP\_MciIn** and **LP\_MciOut**. These port blocks are also referred to as process data channels.
- The port/function block interconnection of the process data objects (PDO) is made via the Lenze »Engineer«.

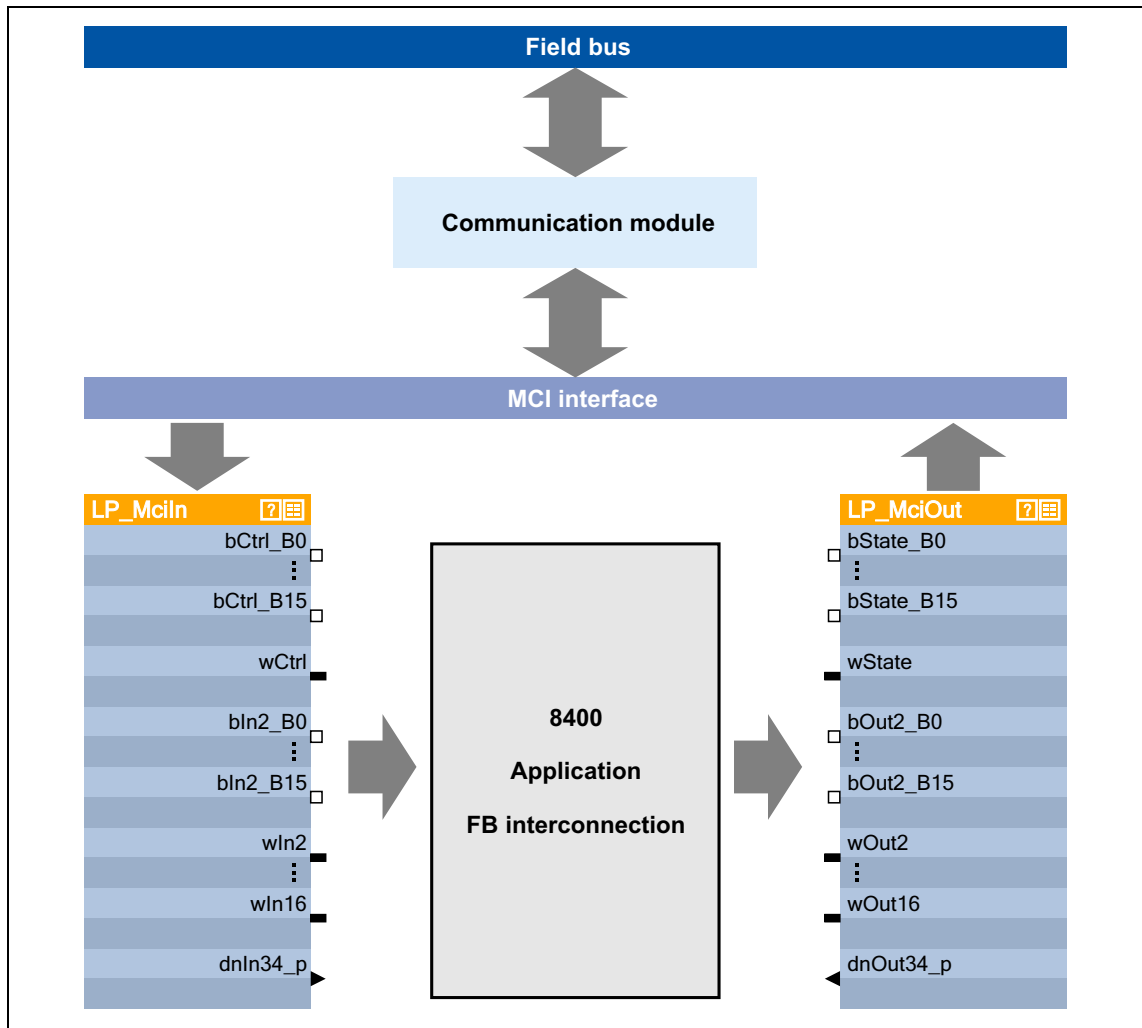

[8-1] Outer and inner data transfer between bus system, inverter, and application



**Software manual / online help for the Inverter Drive 8400**

Here you can find detailed information on the port/function block interconnection in the »Engineer« and on port blocks.

# 8 Process data transfer

## 8.2 Preconfigured port interconnection of the process data objects (PDO)

### 8.2 Preconfigured port interconnection of the process data objects (PDO)

The preconfigured port interconnection of the process data objects can be activated by setting the standard device code **C00007 = 40: MCI**.

The »FB Editor« serves to display the port blocks "LP\_MciIn" and "LP\_MciOut" with the preconfigured interconnections:

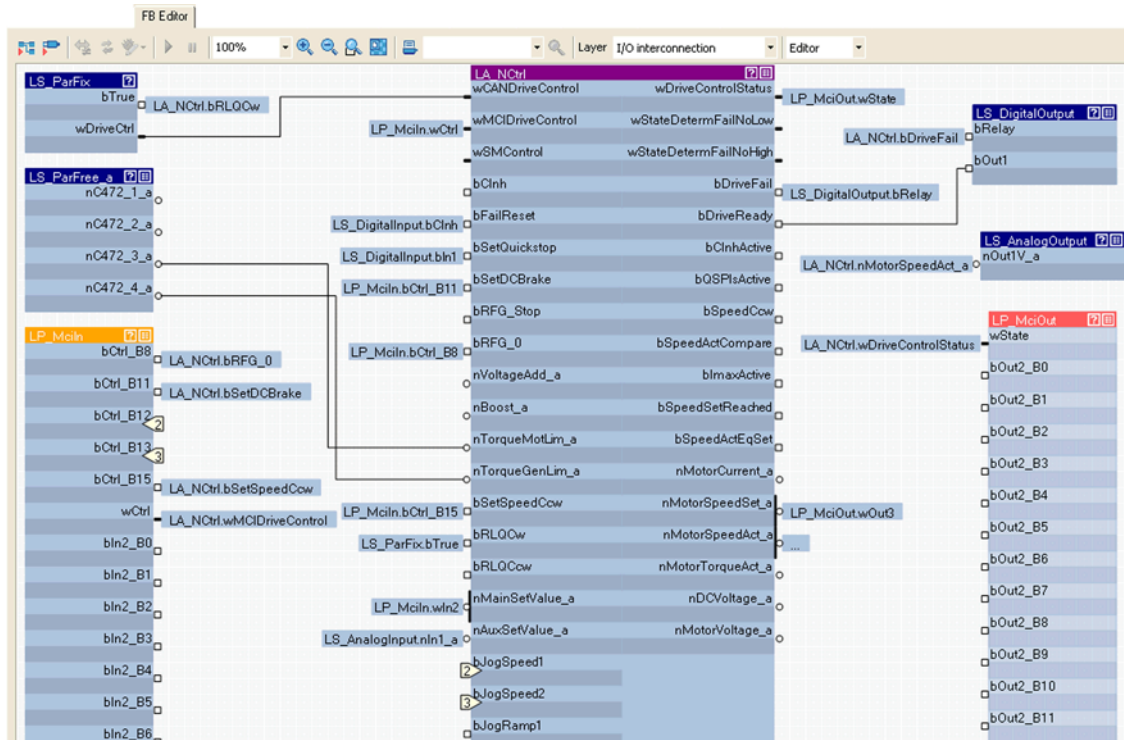

# 8 Process data transfer

## 8.3 Free configuration of the port interconnection of the process data objects (PDO)

### 8.3 Free configuration of the port interconnection of the process data objects (PDO)



How to configure the port interconnection in the »Engineer«:

1. Under the **Process data objects** tab, click on the **Go to application** button.

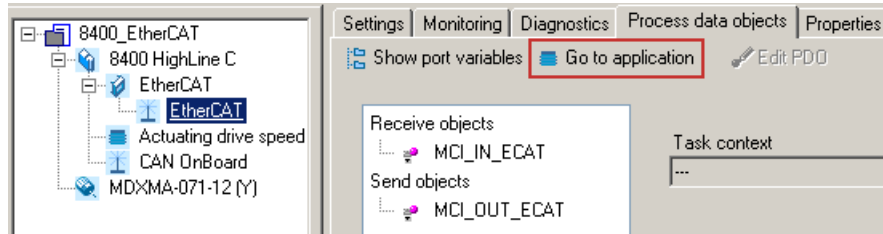

2. Under the **Ports** tab, select port block "MCI\_IN" or "MCI\_OUT" by mouse-click and activate it via the **Activate** button.

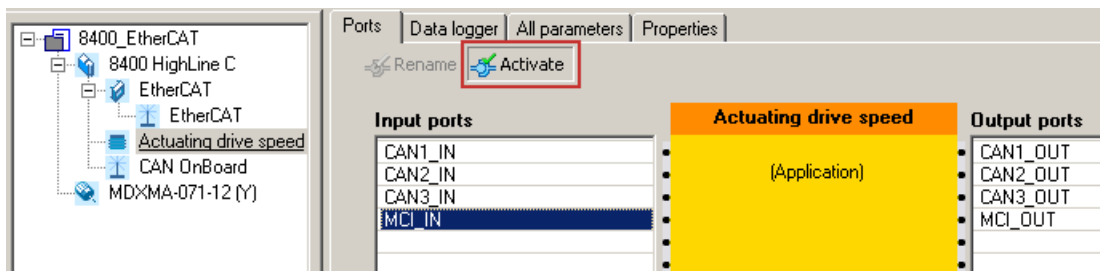

3. Click the **Change Variable...** button.

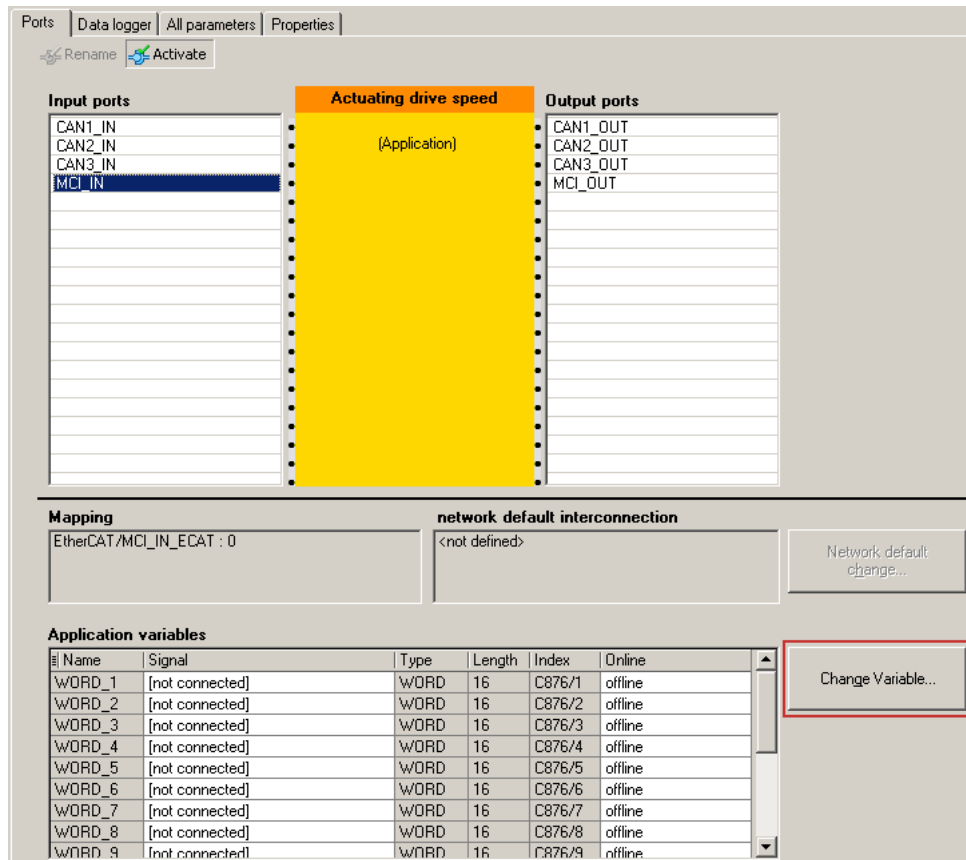

# 8 Process data transfer

## 8.3 Free configuration of the port interconnection of the process data objects (PDO)

4. The  button serves to assign signals to the process data words in the *Assignment Signal* --> *Function Block* dialog box.  
→ Select signals and then click the **OK** button.

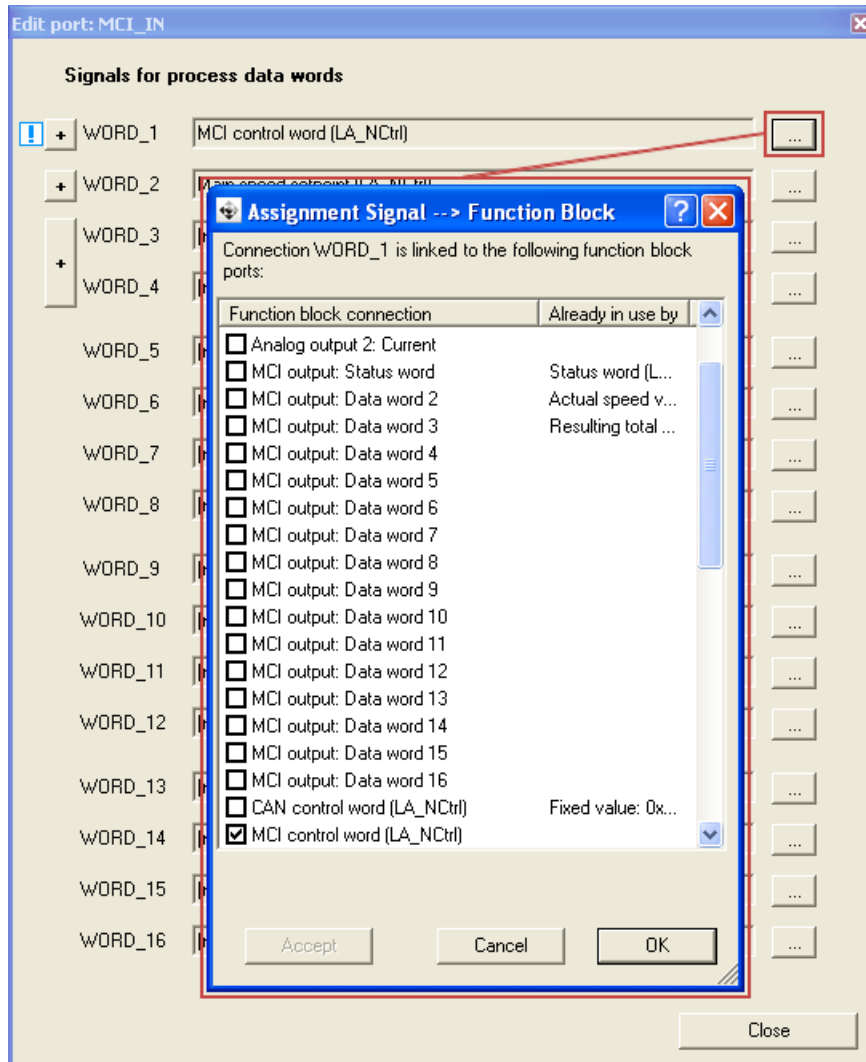

# 8 Process data transfer

## 8.3 Free configuration of the port interconnection of the process data objects (PDO)

Moreover you can assign signals to the individual control and status bits at the WORD\_1 and WORD\_2 process data words via the **+** and **...** buttons.  
→ Select the signals and then click **OK**.

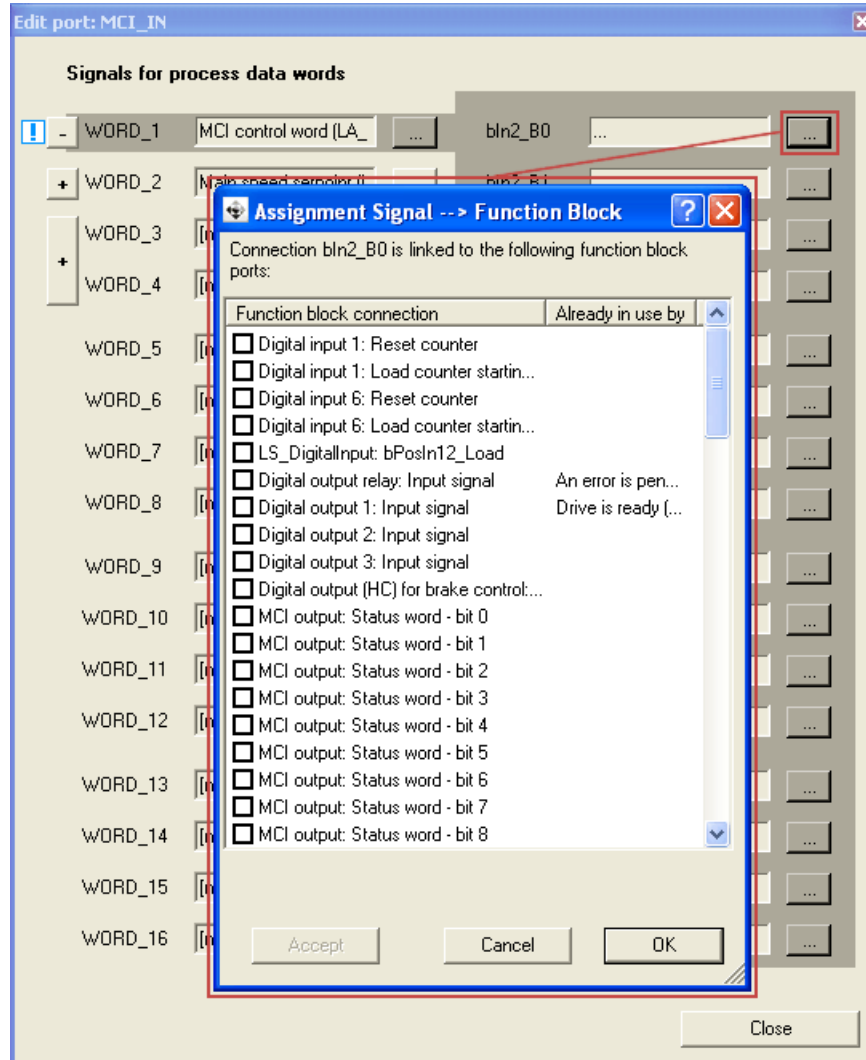

**Tip!**

When the port blocks "LP\_MciIn" and "LP\_MciOut" are activated (see 1.), they will be visible in the »FB-Editor«. Here you can also assign signals to the process data words.

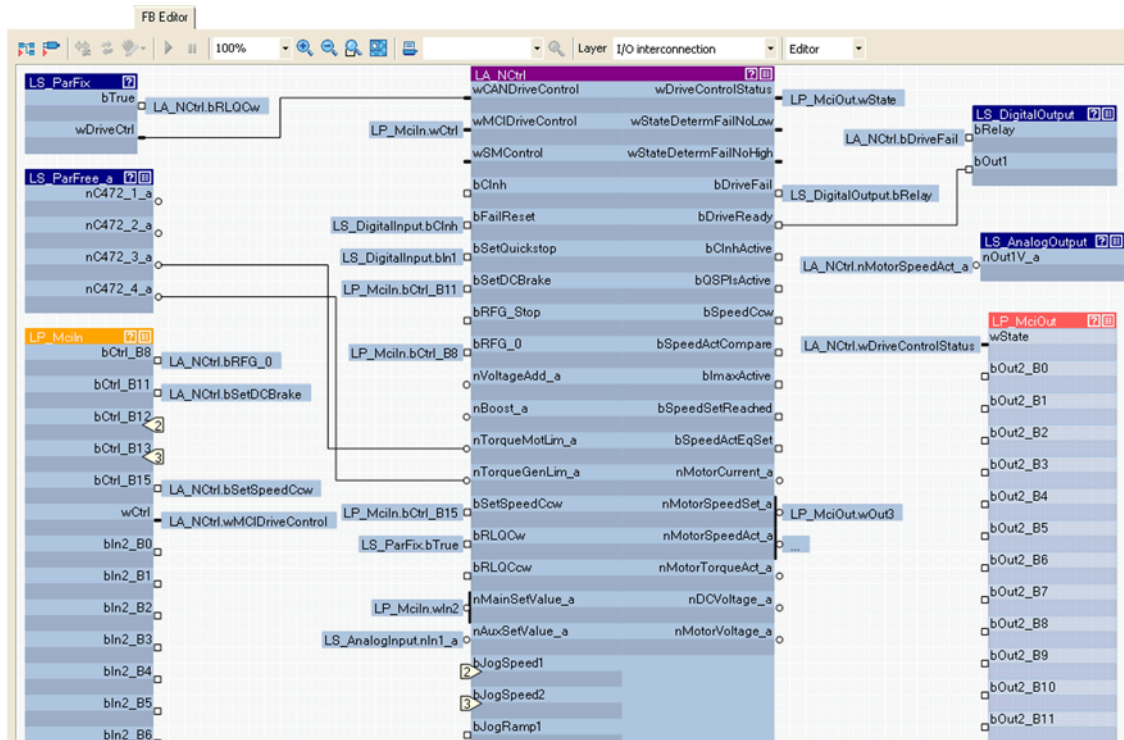



#### 8.4 CiA402 PDO mapping in case of Inverter Drive 8400 TopLine P

The Inverter Drive 8400 TopLine P supports the CiA402 profile.

The following tables show an overview of the CiA402 objects used in the receipt PDO (Rx-PDO) and transmit PDO (Tx-PDO).



#### Software manual/online help for the Inverter Drive 8400 TopLine P

Here you will find detailed information on the functions of the CiA402 objects.

#### Receipt PDO (Rx-PDO)

Word	Index [hex]	Description
1	0x6040	Control word
2	0x6060	Operating mode
	0x60FE.1	Physical outputs
3	0x6042	Target velocity for "Velocity Mode" (is not supported yet)
4	0x607A	Target position
5		
6	0x60B1	Offset for velocity
7		
8	0x60B2	Offset for torque
9	0x60B8	Touch probe function
10	0x60E0	Positive torque limit
11	0x60E1	Negative torque limit
12	0XXXX	Upper speed limit for "CST Mode" (is not supported yet)
13		
14	0XXXX	Lower speed limit for "CST Mode" (is not supported yet)
15		
16	0xA580.1	Freely interconnectable

**Transmit PDO (Tx-PDO)**

Word	Index [hex]	Description
1	0x6041	Status word
2	0x6061	Display of the operating mode
	0x60FD	Physical inputs
3	0x6044	Current velocity for "Velocity Mode" (is not supported yet)
4	0x6064	Current position
5		
6	0x606C	Current velocity
7		
8	0x6077	Current torque
9	0x60B9	Touch probe status
10	0x60BA	Touch probe 1 positive edge
11		
12	0x60BB	Touch probe 1 negative edge
13		
14	0x603F	Error code
15	0x6074	Following error
16		

# 9 Parameter data transfer

## 9.1 Establishing a connection between master and slave

---

## 9 Parameter data transfer

Parameter data are transmitted via the fieldbus as so-called SDOs (Service Data Objects). The SDO services provide for the write and read access to the object directory.

The SDO channel provides for access to [Implemented CoE objects](#) (□ 79) and Lenze codes by means of the CoE protocol.

In general, the parameter data transfer is not time-critical.

Parameter data are, for instance, operating parameters, motor data, diagnostic information.

### 9.1 Establishing a connection between master and slave

Basically a master can always request parameter jobs from a slave if the slave is at least in the "Pre-operational" state.

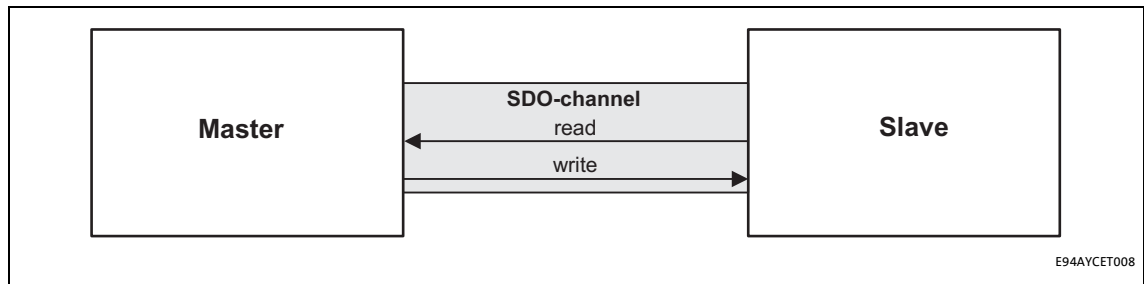

[9-1] Data communication via the SDO channel

# 9 Parameter data transfer

## 9.2 Reading and writing parameters

### 9.2 Reading and writing parameters

Parameters ...

- for instance are set for one-time system settings or if materials are changed within a machine;
- are transmitted with a low priority.

In the case of Lenze inverters, the parameters to be changed are contained in codes.

#### Indexing of the Lenze codes

If they are accessed via a communication module, the codes of the inverter are addressed by the index.

The index of Lenze code numbers within the manufacturer-specific area of the object directory is between 8192 (0x2000) and 24575 (0x5FFF).

Conversion formula	
Index [dec]	Index [hex]
24575 - Lenze code	0x5FFF - Lenze code <sub>hex</sub>

Example of C00002 (device commands)	
Index [dec]	Index [hex]
24575 - 2 = 24573	0x5FFF - 2 = 0x5FFD

#### Structure of a mailbox datagram

Mailbox data are transmitted in a datagram within an EtherCAT frame. The data area of the mailbox datagram has the following structure:

Mailbox Header	CoE Header	SDO control byte	Index	Subindex	Data	Data
6 bytes	2 bytes	1 byte	2 bytes	1 byte	4 bytes	1 ... n bytes

### 9.2.1 Reading parameters (SDO upload)

1. The master sends "Initiate Domain Upload Request".
2. The slave acknowledges the request with a positive response ("Initiate Domain Upload Response").

In the event of an error the slave responds with "Abort Domain Transfer".



#### Note!

In the case of jobs for the inverter, please make sure that you convert the code into an index.

▶ [Indexing of the Lenze codes](#) (69)

#### SDO upload request

Detailed breakdown of the data for an "SDO upload request":

SDO frame area	Data field	Data type / length	Value / description	
<b>Mailbox header</b>	Length	WORD	2 bytes	0x0A: Length of the mailbox service data
	Address	WORD	2 bytes	Station address of the source if an EtherCAT master is the instructing party. Station address of the target if an EtherCAT slave is the instructing party.
	Channel	WORD	6 bits (0 ... 5)	0x00: Reserved
	Priority		2 bits (6, 7)	0x00: Lowest priority ... 0x03: Highest priority
	Type		4 bits (8 ... 11)	0x03: CANopen over EtherCAT (CoE)
	Reserved		4 bits (12 ... 15)	0x00
<b>CANopen header</b>	Number		WORD	9 Bits (0 ... 8)
Reserved	3 bits (9 ... 11)	0x00		
Service	4 bits (12 ... 15)	0x02: SDO request		
<b>SDO</b>	Reserved	BYTE	4 bits (0 ... 3)	0x00
	Complete access		1 bit (4)	0x00: The entry addressed with an index and subindex is read. 0x01: The complete object is read. (Is currently not supported.)
	Command specifier		3 bits (5 ... 7)	0x02: Upload request
	Index	WORD	2 bytes	Index of the object
	Subindex	BYTE	1 byte	Subindex of the object 0x00 or 0x01 if "Complete access" = 0x01.
	Reserved	DWORD	4 bytes	0x00

**SDO Upload Expedited Response**

An "SDO Upload Expedited Response" is effected if the data length of the parameter data to be read is up to 4 bytes.

Detailed breakdown of the data for an "SDO Upload Expedited Response":

SDO frame area	Data field	Data type / length		Value / description
<b>Mailbox header</b>	Length	WORD	2 bytes	0x0A: Length of the mailbox service data
	Address	WORD	2 bytes	Station address of the source if an EtherCAT master is the instructing party. Station address of the target if an EtherCAT slave is the instructing party.
	Channel	WORD	6 bits (0 ... 5)	0x00: Reserved
	Priority		2 bits (6, 7)	0x00: Lowest priority ... 0x03: Highest priority
	Type		4 bits (8 ... 11)	0x03: CANopen over EtherCAT (CoE)
Reserved	4 bits (12 ... 15)		0x00	
<b>CANopen header</b>	Number	WORD	9 Bits (0 ... 8)	0x00
	Reserved		3 bits (9 ... 11)	0x00
	Service		4 bits (12 ... 15)	0x03: SDO response
<b>SDO</b>	Size indicator	BYTE	1 bit (0)	0x01: Size of the data in the "Data set size"
	Transfer type		1 bit (1)	0x01: Expedited transfer
	Data set size		2 bits (2, 3)	0x00: 4 bytes of data 0x01: 3 bytes of data 0x02: 2 bytes of data 0x03: 1 byte of data
	Complete access		1 bit (4)	0x00: The entry addressed with an index and subindex is read. 0x01: The complete object is read. (Is currently not supported.)
	Command specifier		3 bits (5 ... 7)	0x02: Upload response
	Index		WORD	2 bytes
	Subindex	BYTE	1 byte	Subindex of the object 0x00 or 0x01 if "Complete access" = 0x01.
	Data	DWORD	4 bytes	Data of the object

**SDO Upload Normal Response**

An "SDO Upload Normal Response" is effected if the data length of the parameter data to be read  $\geq$  is 4 bytes.

Detailed breakdown of the data for an "SDO Upload Normal Response":

SDO frame area	Data field	Data type / length	Value / description	
<b>Mailbox header</b>	Length	WORD	2 bytes	$n \geq 0x0A$ : Length of the mailbox service data
	Address	WORD	2 bytes	Station address of the source if an EtherCAT master is the instructing party. Station address of the target if an EtherCAT slave is the instructing party.
	Channel	WORD	6 bits (0 ... 5)	0x00: Reserved
	Priority		2 bits (6, 7)	0x00: Lowest priority ... 0x03: Highest priority
	Type		4 bits (8 ... 11)	0x03: CANopen over EtherCAT (CoE)
Reserved	4 bits (12 ... 15)		0x00	
<b>CANopen header</b>	Number	WORD	9 Bits (0 ... 8)	0x00
	Reserved		3 bits (9 ... 11)	0x00
	Service		4 bits (12 ... 15)	0x03: SDO response
<b>SDO</b>	Size indicator	BYTE	1 bit (0)	0x01
	Transfer type		1 bit (1)	0x00: Normal transfer
	Data set size		2 bits (2, 3)	0x00
	Complete access		1 bit (4)	0x00: The entry addressed with an index and subindex is read. 0x01: The complete object is read. (Is currently not supported.)
	Command specifier		3 bits (5 ... 7)	0x02: Upload response
	Index		WORD	2 bytes
	Subindex	BYTE	1 byte	Subindex of the object 0x00 or 0x01 if "Complete access" = 0x01.
	Complete size	DWORD	4 bytes	Total data length of the object
	Data	BYTE	n - 10 bytes	Data of the object

**Example**

In case of an **Upload** to index 0x5FD8 (Standard setting of C00039/1 (fixed setpoint\_1) = 0x0FA0<sub>hex</sub> (4000<sub>dec</sub>)), the transmitted response structure contains the following data:

SDO frame area	Data field	Data type / length		Value / description
<b>Mailbox header</b>	Length	WORD	2 bytes	0x0A: Length of the mailbox service data
	Address	WORD	2 bytes	0x00
	Channel	WORD	6 bits (0 ... 5)	0x00: Reserved
	Priority		2 bits (6, 7)	0x00: Lowest priority
	Type		4 bits (8 ... 11)	0x03: CANopen over EtherCAT (CoE)
	Reserved		4 bits (12 ... 15)	0x00
<b>CANopen header</b>	Number	WORD	9 Bits (0 ... 8)	0x00
	Reserved		3 bits (9 ... 11)	0x00
	Service		4 bits (12 ... 15)	0x03: SDO response
<b>SDO</b>	Size indicator	BYTE	1 bit (0)	0x01: Length of the data in the "Data set size"
	Transfer type		1 bit (1)	0x01: Expedited transfer
	Data set size		2 bits (2, 3)	0x02: 2 bytes of data
	Complete access		1 bit (4)	0x00: The entry addressed with an index and subindex is read.
	Command specifier		3 bits (5 ... 7)	0x02: Upload response
	Index	WORD	2 bytes	0xD8: Index low byte of the object 0x5F: Index high byte of the object
	Subindex	BYTE	1 byte	0x01
	Data	DWORD	2 bytes	0x0FA0



# 9 Parameter data transfer

## 9.2 Reading and writing parameters

---

### 9.2.2 Writing parameters (SDO download)

1. The master sends "Initiate Domain Download Request".
2. The slave acknowledges the request with a positive response ("Initiate Domain Download Response").

In the event of an error the slave responds with "Abort Domain Transfer".



#### Note!

In the case of jobs for the inverter, please make sure that you convert the code into an index.

▶ [Indexing of the Lenze codes](#) (📖 69)

**SDO Download Expedited Request**

An "SDO Download Expedited Request" is effected if the data length of the parameter data to be written is up to 4 bytes.

Detailed breakdown of the data for an "SDO Download Expedited Request":

SDO frame area	Data field	Data type / length	Value / description	
<b>Mailbox header</b>	Length	WORD	2 bytes	0x0A: Length of the mailbox service data
	Address	WORD	2 bytes	Station address of the source if an EtherCAT master is the instructing party. Station address of the target if an EtherCAT slave is the instructing party.
	Channel	WORD	6 bits (0 ... 5)	0x00: Reserved
	Priority		2 bits (6, 7)	0x00: Lowest priority ... 0x03: Highest priority
	Type		4 bits (8 ... 11)	0x03: CANopen over EtherCAT (CoE)
Reserved	4 bits (12 ... 15)		0x00	
<b>CANopen header</b>	Number	WORD	9 Bits (0 ... 8)	0x00
	Reserved		3 bits (9 ... 11)	0x00
	Service		4 bits (12 ... 15)	0x02: SDO request
<b>SDO</b>	Size indicator	BYTE	1 bit (0)	0x01: Size of the data in the "Data set size"
	Transfer type		1 bit (1)	0x01: Expedited transfer
	Data set size		2 bits (2, 3)	0x00: 4 bytes of data 0x01: 3 bytes of data 0x02: 2 bytes of data 0x03: 1 byte of data
	Complete access		1 bit (4)	0x00: The entry addressed with an index and subindex is written. 0x01: The complete object is written. (Is currently not supported.)
	Command specifier		3 bits (5 ... 7)	0x01: Download request
	Index		WORD	2 bytes
	Subindex	BYTE	1 byte	Subindex of the object 0x00 or 0x01 if "Complete access" = 0x01.
	Data	DWORD	4 bytes	Data of the object

**SDO Download Normal Request**

An "SDO Download Normal Request" is effected if the data length of the parameter data to be written  $\geq$  is 4 bytes.

Detailed breakdown of the data for an "SDO Download Normal Request":

SDO frame area	Data field	Data type / length	Value / description	
<b>Mailbox header</b>	Length	WORD	2 bytes	$n \geq 0x0A$ : Length of the mailbox service data
	Address	WORD	2 bytes	Station address of the source if an EtherCAT master is the instructing party. Station address of the target if an EtherCAT slave is the instructing party.
	Channel	WORD	6 bits (0 ... 5)	0x00: Reserved
	Priority		2 bits (6, 7)	0x00: Lowest priority ... 0x03: Highest priority
	Type		4 bits (8 ... 11)	0x03: CANopen over EtherCAT (CoE)
Reserved	4 bits (12 ... 15)		0x00	
<b>CANopen header</b>	Number	WORD	9 Bits (0 ... 8)	0x00
	Reserved		3 bits (9 ... 11)	0x00
	Service		4 bits (12 ... 15)	0x02: SDO request
<b>SDO</b>	Size indicator	BYTE	1 bit (0)	0x01
	Transfer type		1 bit (1)	0x00: Normal transfer
	Data set size		2 bits (2, 3)	0x00
	Complete access		1 bit (4)	0x00: The entry addressed with an index and subindex is written. 0x01: The complete object is written. (Is currently not supported.)
	Command specifier		3 bits (5 ... 7)	0x01: Download request
	Index		WORD	2 bytes
	Subindex	BYTE	1 byte	Subindex of the object 0x00 or 0x01 if "Complete access" = 0x01.
	Complete size	DWORD	4 bytes	Total data length of the object
	Data	BYTE	n - 10 bytes	Data of the object

**SDO Download Response**

Detailed breakdown of the data for a "SDO download response":

SDO frame area	Data field	Data type / length		Value / description
<b>Mailbox header</b>	Length	WORD	2 bytes	0x0A: Length of the mailbox service data
	Address	WORD	2 bytes	Station address of the source if an EtherCAT master is the instructing party. Station address of the target if an EtherCAT slave is the instructing party.
	Channel	WORD	6 bits (0 ... 5)	0x00: Reserved
	Priority		2 bits (6, 7)	0x00: Lowest priority ... 0x03: Highest priority
	Type		4 bits (8 ... 11)	0x03: CANopen over EtherCAT (CoE)
	Reserved		4 bits (12 ... 15)	0x00
<b>CANopen header</b>	Number	WORD	9 Bits (0 ... 8)	0x00
	Reserved		3 bits (9 ... 11)	0x00
	Service		4 bits (12 ... 15)	0x03: SDO response
<b>SDO</b>	Size indicator	BYTE	1 bit (0)	0x0
	Transfer type		1 bit (1)	0x0
	Data set size		2 bits (2, 3)	0x0
	Complete access		1 bit (4)	0x00: The entry addressed with an index and subindex is written. 0x01: The complete object is written. (Is currently not supported.)
	Command specifier		3 bits (5 ... 7)	0x3: Download response
	Index		WORD	2 bytes
	Subindex	BYTE	1 byte	Subindex of the object 0x00 or 0x01 if "Complete access" = 0x01.
	Reserved	DWORD	4 bytes	0x00

**Example**

In the case of a **Download** to the index 0x1600, the transmitted request structure contains the following data:

SDO frame area	Data field	Data type / length		Value / description
<b>Mailbox header</b>	Length	WORD	2 bytes	0x0A: Length of the mailbox service data
	Address	WORD	2 bytes	0x00
	Channel	WORD	6 bits (0 ... 5)	0x00: Reserved
	Priority		2 bits (6, 7)	0x00: Lowest priority
	Type		4 bits (8 ... 11)	0x03: CANopen over EtherCAT (CoE)
	Reserved		4 bits (12 ... 15)	0x00
<b>CANopen header</b>	Number	WORD	9 Bits (0 ... 8)	0x00
	Reserved		3 bits (9 ... 11)	0x00
	Service		4 bits (12 ... 15)	0x02: SDO request
<b>SDO</b>	Size indicator	BYTE	1 bit (0)	0x01: Size of the data in the "Data set size"
	Transfer type		1 bit (1)	0x01: Expedited transfer
	Data set size		2 bits (2, 3)	0x00: 4 bytes of data
	Complete access		1 bit (4)	0x00: The entry addressed with an index and subindex is written.
	Command specifier		3 bits (5 ... 7)	0x01: Download request
	Index	WORD	2 bytes	0x00: Index low byte of the object 0x16: Index high byte of the object
	Subindex	BYTE	1 byte	0x01: Subindex of the object
	Data	DWORD	4 bytes	0x5C930110

# 9 Parameter data transfer

## 9.3 Implemented CoE objects

### 9.3 Implemented CoE objects

Lenze devices can be parameterised with both Lenze codes and the manufacturer-independent "CoE objects". In order to fully comply with EtherCAT communication, you must only use the CoE objects for parameterisation. The CoE objects described in this manual are defined in the "EtherCAT Specification, Part 6 – Application Layer Protocol Specification".

Index	Designation	Subindex	Subindex name	Type	Bits	Access
0x1000	Device type	-	-	UDINT	32	R
0x1008	Device name	-	-	STRING(8)	64	R
0x1009	Hardware version	-	-	STRING(8)	64	R
0x100A	Software version	-	-	STRING(7)	56	R
0x1018	Identity	0	Subindex 000	USINT	8	R
		1	Vendor ID	UDINT	32	R
		2	Product code	UDINT	32	R
		3	Revision number	UDINT	32	R
		4	Serial number	UDINT	32	R
0x10F1	Error Settings Object	0	Subindex 000	USINT	8	R
		1	Local Error Reaction	USINT	8	R
		2	Sync Error Counter Limit	USINT	8	RW
0x1600	RxPDO 1	0	Subindex 000	USINT	8	RW
		1 ... 16	Output Object 1 ... 16	UDINT	32	RW
0x1A00	TxPDO 1	0	Subindex 000	USINT	8	RW
		1 ... 16	Input Object 1 ... 16	UDINT	32	RW
0x1C00	Sync Man Communication type	0	Subindex 000	USINT	8	R
		1	Elements	UDINT	32	R
0x1C12	Sync Man 2 Assignment	0	Subindex 000	USINT	8	R
		1	PDO Mapping object index of assigned RxPDO	UDINT	32	R
0x1C13	Sync Man 3 Assignment	0	Subindex 000	USINT	8	R
		1	PDO Mapping object index of assigned TxPDO	UDINT	32	R
0x1C32	Sync Man 2 Synchronization	0	Subindex 000	USINT	8	R
		1	Synchronization type	UINT	16	R
		2	Cycle time / ns	UDINT	32	R
		3	Shift time / ns	UDINT	32	R
		4	Sync types supported	UINT	16	R
		5	Minimum cycle time / ns	UDINT	32	R
		6	Minimum shift time / ns	UDINT	32	R
0x1C33	Sync Man 3 Synchronization	0	Subindex 000	USINT	8	R
		1	Synchronization type	UINT	16	R
		2	Cycle time / ns	UDINT	32	R
		3	Shift time / ns	UDINT	32	R
		4	Sync types supported	UINT	16	R
		5	Minimum cycle time / ns	UDINT	32	R
		6	Minimum shift time / ns	UDINT	32	R

R: Read access only  
RW: Read and write access

## 9.4 EtherCAT objects of the communication module

The object directory displays the [Parameters of the communication module](#) (□ 97) as objects:

Index	Code	Index name	Subindex	Subindex name	Type	Bits	Access
0x29E5	<a href="#">C13850</a>	All words to master	1 ... 16	All words to master	UNSIGNED	16	R
0x29E4	<a href="#">C13851</a>	All words from master	1 ... 16	All words from master	UNSIGNED	16	R
0x29E3	<a href="#">C13852</a>	All words to standard device	1 ... 16	All words to standard device	UNSIGNED	16	R
0x29E2	<a href="#">C13853</a>	All words from standard device	1 ... 16	All words from standard device	UNSIGNED	16	R
0x29DC	<a href="#">C13859</a>	Number of Tx PDOs	-	-	UNSIGNED	16	R
0x29DB	<a href="#">C13860</a>	Number of Rx PDOs	-	-	UNSIGNED	16	R
0x29DA	<a href="#">C13861</a>	Bus state	-	-	UNSIGNED	16	R
0x29D7	<a href="#">C13864</a>	Active station address	-	-	UNSIGNED	16	R
0x29D4	<a href="#">C13867</a>	Display of emergency data	-	-	STRING(8)	64	R
0x29C8	<a href="#">C13879</a>	Bus error	-	-	UNSIGNED	16	R
0x29C7	<a href="#">C13880</a>	Reaction on communication failure	2	1: Response to communication interruption 2: Response to sync telegram failure	UNSIGNED	8	RW
0x29C6	<a href="#">C13881</a>	Response time when exiting "Operational"	-	-	UNSIGNED	16	RW
0x29C4	<a href="#">C13883</a>	DC active	-	-	UNSIGNED	8	R
0x29C3	<a href="#">C13884</a>	Synchronisation is active	-	-	UNSIGNED	8	R
0x29C2	<a href="#">C13885</a>	Clear process data	-	-	UNSIGNED	8	RW
0x29C0	<a href="#">C13887</a>	Suppress emergency message in case of	-	-	BITFIELD	8	RW
0x29B4	<a href="#">C13899</a>	Station alias address	-	-	UNSIGNED	16	RW
0x29B3	<a href="#">C13900</a>	Firmware product type	-	-	STRING(8)	64	R
0x29B2	<a href="#">C13901</a>	Firmware compilation date	-	-	STRING(20)	160	R
0x29B1	<a href="#">C13902</a>	Firmware version	-	-	STRING(11)	88	R

R: Read access only

RW: Read and write access

# 9 Parameter data transfer

## 9.5 SDO abort codes (Abort codes)

### 9.5 SDO abort codes (Abort codes)

If an SDO request is evaluated negatively, a corresponding error code is output.

Index [hex]	Description
0x00000000	No fault
0x05030000	The status of the toggle bit has not changed
0x05040000	SDO protocol time-out
0x05040001	Invalid or unknown specification symbol for the client/server command
0x05040005	Not enough space in the main memory
0x06010000	Access to object not supported
0x06010001	Read access to a write-protected object
0x06010002	Write access to a write-protected object
0x06020000	An object does not exist in the object directory
0x06040041	An object cannot be mapped into the PDO
0x06040042	The number and/or length of the objects mapped would exceed the PDO length
0x06040043	General parameter incompatibility
0x06040047	General internal device incompatibility
0x06060000	Access has failed due to a fault in the hardware
0x06070010	The data type or the parameter length does not correspond
0x06070012	Incorrect data type (The parameter length is too large)
0x06070013	Incorrect data type (The parameter length is too small)
0x06090011	A subindex is not available
0x06090030	The value range for parameters is too great (only for write access)
0x06090031	The parameter value is too high
0x06090032	The parameter value is too low
0x06090036	The maximum value is lower than the minimum value
0x08000000	General error
0x08000020	Data cannot be transferred to the application or stored in the application
0x08000021	Due to local control, data cannot be transferred to the application or stored in the application
0x08000022	Due to the current device state, data cannot be transferred to the application or stored in the application
0x08000023	The dynamic object directory generation has failed, or no object directory is available



## 10 Monitoring

### 10.1 Interruption of EtherCAT communication

An interruption of the EtherCAT communication in the "Operational" state, e.g. due to cable break or failure of the EtherCAT master, is detected by the slave.

The response to an interrupted communication is triggered by settings in the **Monitoring** tab:

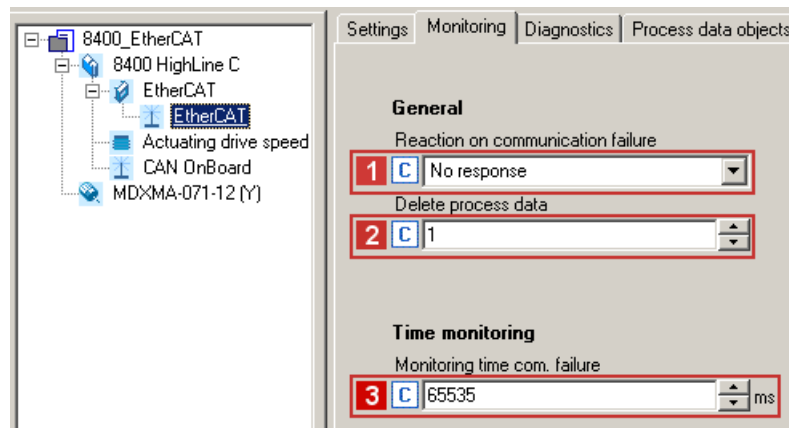

- During the initialisation of the EtherCAT communication, the sync manager watchdog monitoring time determined in the master is transferred to the slave. If the slave does not receive any valid process data in the "Operational" status, the setting in **2** [C13885](#) is taken as a basis for the process data:
  - Value '0': The data sent last by the master are used.
  - Value '1': PDOs are set to the value '0'.
 After the watchdog monitoring time has elapsed, the slave changes to the "Safe operational" state (see [C13861](#)) and the green LED **BS** is activated (see [Fieldbus status displays \(□ 86\)](#)). There is no response in the slave.
- In order that a response is triggered in the slave, you have to set a **1** **Reaction on communication failure** ([C13880/1](#)).
- The response is delayed if you set an internal **3** **monitoring time** ([C13881](#)) in addition. In the Lenze setting ([C13881](#) = 0), no delay is set. The monitoring time elapses as soon as the "Operational" state is exited. (See 1.). After the monitoring time has elapsed, the response set is executed with the error message "[Operational status quit \[0x01bc8131\]](#)" ([□ 95](#)).

---

## 10.2 Sync frame failure detection

During the [Synchronisation with "Distributed Clocks" \(DC\)](#) (☞ 37), this monitoring checks whether an EtherCAT PDO telegram (Sync Manager 2 Event) has arrived between two signals.

For this purpose, the communication module comes with an internal EtherCAT telegram failure error counter. The telegram failure error counter is incremented by the value '3' in case of a telegram failure. For each PDO received correctly, the counter is decremented by '1'. If the internal telegram failure error counter reaches a threshold adjustable in CoE object 0x10F1.2, a change to "Safe-Operational" takes place and the "[Sync telegram failure \[0x01bc8700\]](#)" error message is output.

In the standard setting, monitoring is deactivated (0x10F1.2 = 0). A sensible setting is a value > '5' in order that an error will only be triggered in the inverter when a second telegram fails.

An error response can be set via code [C13880/2](#) ("0: No response" is preset here).

## 10.3 Interruption of internal communication

The response to a communication error between the communication module and the standard device can be set in the standard device code [C01501](#) (module in the MCI slot).

An externally supplied communication module reports a connection abort to the standard device via an emergency telegram to the master and changes to the "Safe-operational" state.

The error message "[Lost connection to 8400 \[0x01bc3100\]](#)" (☞ 93) is output.

# 11 Diagnostics

## 11.1 LED status displays

---

# 11 Diagnostics

For fault diagnostics, the communication module is provided with LEDs on the front. Furthermore, you can carry out the [Diagnostics with the »Engineer«](#) (89).

## 11.1 LED status displays



### Note!

During normal operation ...

- only the LEDs **MS** (85) and **BS** (86) should be lit constantly.
- the green LED at the RJ45 sockets X246/X247 must be lit (88).

The following status displays can be differentiated:



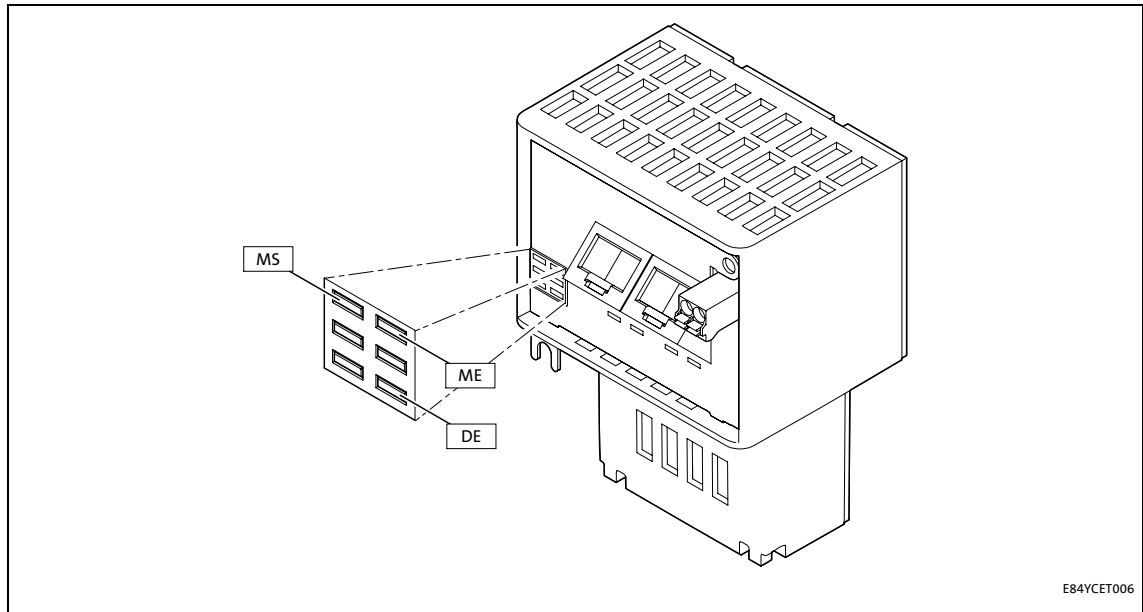

- [Module status displays](#) (85)
- [Fieldbus status displays](#) (86)
- [Status displays at X246 and X247](#) (88)

**11.1.1 Module status displays**

The LEDs **MS**, **ME** and **DE** show the module status.



[11-1] LEDs MS, ME, DE

LED	Colour	State	Description
MS	green	on	 The communication module is supplied with voltage and is connected to the standard device.
		blinking	 The communication module is supplied with voltage, but has no connection to the standard device (the standard device is switched off, in the initialisation phase, or not available).
ME	red	on	 An error has occurred in the communication module.
DE	red	on	 The communication module is not accepted by the standard device, or the standard device is not active. (See notes in the documentation for the standard device).

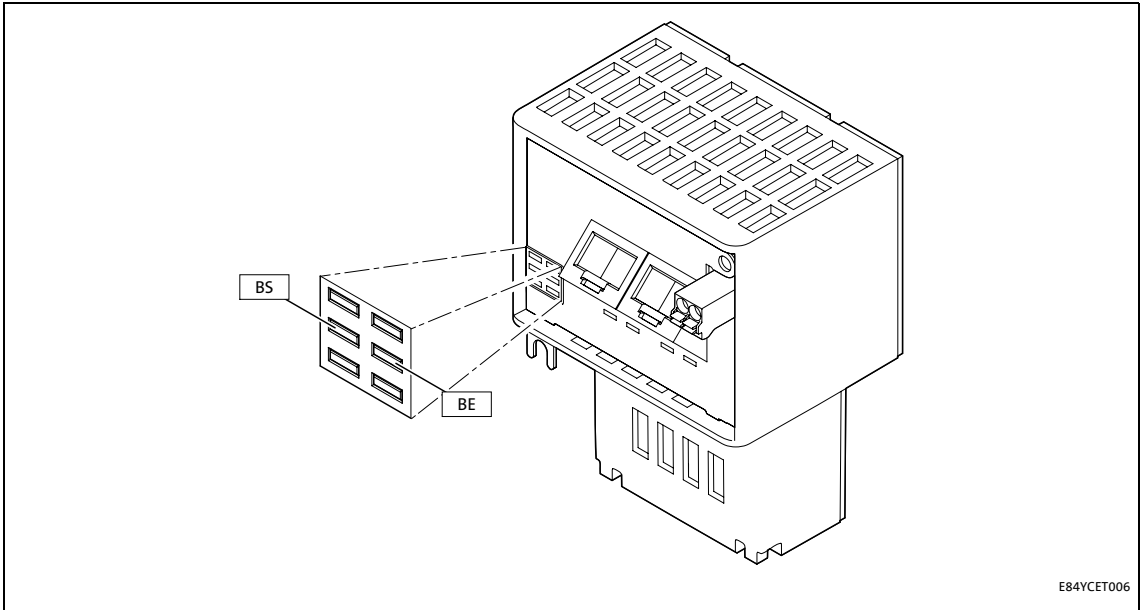

**11.1.2 Fieldbus status displays**

The LEDs **BS** and **BE** show the fieldbus status.

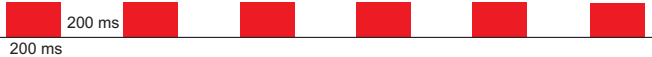
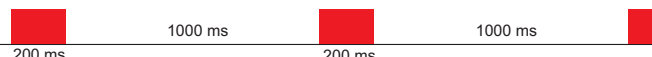

[11-2] LEDs BS, BE

LED	Colour	State	Description
BS	green	off	The communication module is not active on the fieldbus or is in the "Init" state.
		blinking	<p>200 ms</p> <p>200 ms</p> <p>"Pre-operational" status is active:</p> <ul style="list-style-type: none"> <li>• Access to parameters and objects is possible.</li> <li>• No process data exchange.</li> </ul>
		blinking once (single flash)	<p>200 ms</p> <p>1000 ms</p> <p>200 ms</p> <p>1000 ms</p> <p>"Safe-operational" status is active:</p> <ul style="list-style-type: none"> <li>• The data are not yet active in the standard device.</li> </ul>
		on	<p>The communication module is in the "Operational" state.</p>



LED	Colour	State	Description
BE	red	off	No fault
		blinking	 <p>The configuration is invalid/faulty.</p>
		blinking once (single flash)	 <ul style="list-style-type: none"> <li>• A non requested state change has occurred. (The slave application has autonomously changed the EtherCAT status.)</li> <li>• Synchronisation error (The EtherCAT node automatically changes to the "Safe-operational" state.)</li> </ul>
		blinking twice (double flash)	 <p>An "Application Watchdog Timeout" or a "Sync Manager Watchdog Timeout" has occurred.</p>

**11.1.3 Status displays at X246 and X247**

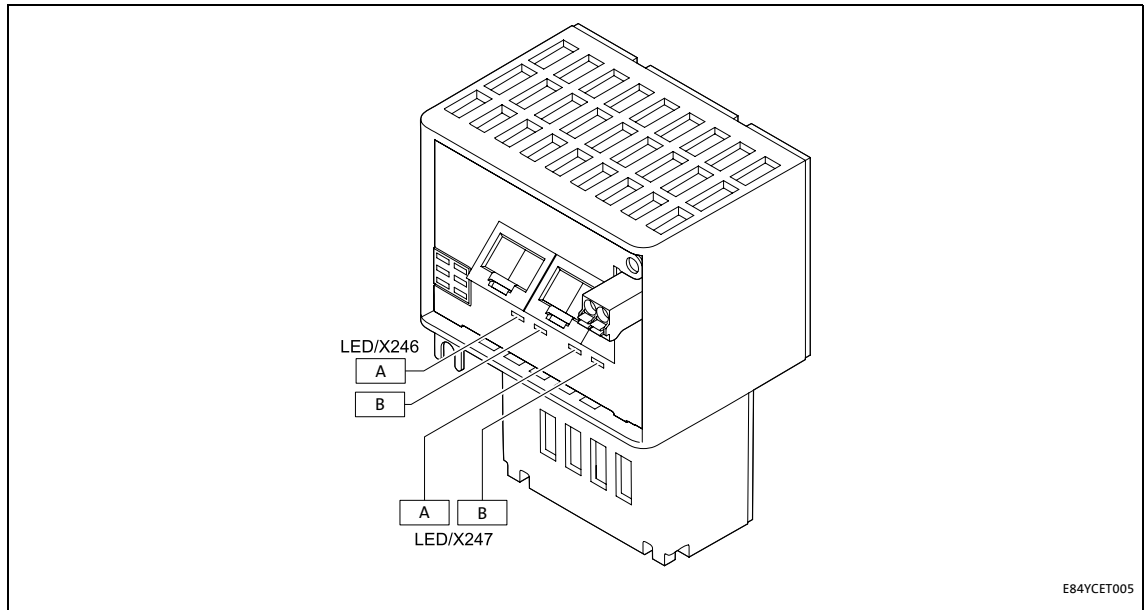
The LEDs beneath the RJ45 sockets X246 and X247 show the EtherCAT connection status.



[11-3] LEDs at the RJ45 sockets X246 and X247

LED	Colour	State	Description
A	green	on	 A physical EtherCAT connection is available.
		flickering	 50 ms Data are being exchanged via EtherCAT.
B	red	off	This LED is not used.

# 11 Diagnostics

## 11.2 Diagnostics with the »Engineer«

### 11.2 Diagnostics with the »Engineer«

In the »Engineer«, the **Diagnostics** tab displays various pieces of EtherCAT diagnostic information.

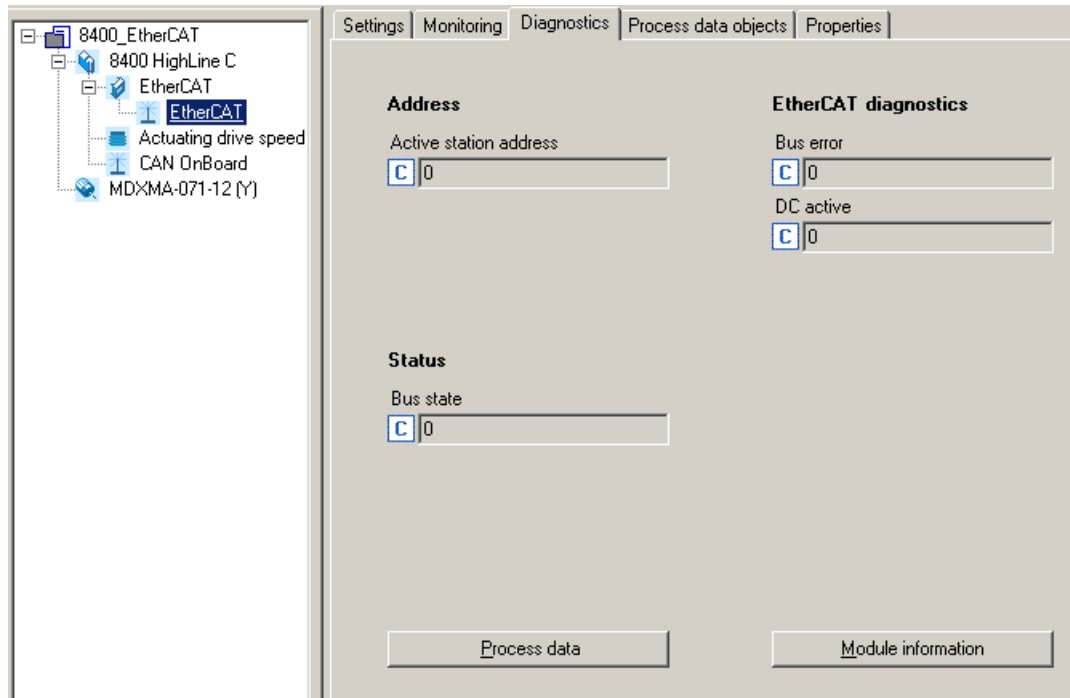



### 11.3 Emergency requests / Emergency messages

Emergency messages are sent to the EtherCAT master once when the error status of the inverter changes, i.e. ...

- when an error in the inverter or in the communication module occurs;
- when an internal error of the communication module is eliminated.

An "Emergency Request" on the fieldbus consists of the components "Mailbox Header", "CANopen Header" and the actual "Emergency Message":

Mailbox header	CANopen header	Emergency Message
6 bytes	2 bytes	8 bytes

The emergency message last sent by the Inverter Drive 8400 is displayed in code [C13867](#).

Code [C13887](#) serves to select the error responses where no emergency messages are to be sent to the EtherCAT master.

#### 11.3.1 Structure of the Emergency message

**Example:** Emergency message of the error "[Operational status quit \[0x01bc8131\]](#)"

Byte 1	Byte 2	Byte 3	Byte 4	Byte 5	Byte 6	Byte 7	Byte 8
Emergency Error code		Error Register (I-1001)	Reserved	Error code Inverter Drive 8400 / E84AYCET			
Low byte	High byte	Low byte	High byte	Low word		High word	
				Low byte	High byte	Low byte	High byte
<b>0x00</b>	<b>0x10</b>	<b>0x01</b>	<b>0x00</b>	<b>0x31</b>	<b>0x81</b>	<b>0xbc</b>	<b>0x01</b>

- Bytes 1 and 2 display that an error is pending.
- Byte 3 display the contents of the error register (I-1001).
- Bytes 5 ... 8 contain the error code.



**Software manual/online help for the Inverter Drive 8400**

Here you will find detailed information on the error codes.

### 11.3.2 Emergency messages (overview)

The following emergency messages can occur:

Emergency no. [hex]	Designation	Extended error code [hex]	Description
0x1000	General error	0x01bc3100	<a href="#">Lost connection to 8400 [0x01bc3100]</a> (📖 93)
0x1000	General error	0x01bc6430	<a href="#">Invalid module configuration [0x01bc6430]</a> (📖 94)
0x1000	General error	0x01bc8131	<a href="#">Operational status quit [0x01bc8131]</a> (📖 95)
0xA000	Synchronisation error	0x01bc8265	<a href="#">Sync telegram failure [0x01bc8700]</a> (📖 95)
0x0000	Error reset	-	-

# 12 Error messages

## 12.1 Short overview of the EtherCAT error messages

---

# 12 Error messages

This chapter provides the error messages of the communication module E84AYCET EtherCAT as a supplement to the error list in the software manual and the »Engineer« online help for the Inverter Drives 8400.

## 12.1 Short overview of the EtherCAT error messages



### Software manual/online help for the Inverter Drive 8400

Here you can find general information on diagnostics & fault analysis and on error messages.

The following table lists all EtherCAT error messages in numerical order of the error number. Furthermore the preset error response and – if available – the parameters for setting the error response are specified.



### Tip!

When you click the cross-reference in the first column, you will see a detailed description (causes and remedies) of this error message.

Error no. [hex]	Subject area no. [dec]	Error no. [dec]	Error text	Error type (Error response)	Adjustable in
<a href="#">0x01bc3100</a>	444	12544	Lost connection to 8400 base device	1: Fault	-
<a href="#">0x01bc5531</a>	444	21809	Memory: No access	1: Fault	-
<a href="#">0x01bc5532</a>	444	21810	Memory: Read error	1: Fault	-
<a href="#">0x01bc5533</a>	444	21811	Memory: Write error	1: Fault	-
<a href="#">0x01bc6010</a>	444	24592	Restart by watchdog reset	1: Fault	-
<a href="#">0x01bc6011</a>	444	24593	Internal error	1: Fault	-
<a href="#">0x01bc6100</a>	444	24832	Internal error	1: Fault	-
<a href="#">0x01bc6101</a>	444	24833	Internal error	1: Fault	-
<a href="#">0x01bc641f</a>	444	25631	Invalid parameter record	1: Fault	-
<a href="#">0x01bc6420</a>	444	25632	Error: Lenze setting loaded	1: Fault	-
<a href="#">0x01bc6430</a>	444	25648	Invalid module configuration	1: Fault	-
<a href="#">0x01bc8131</a>	444	33073	"Operational" status quit	0: No response	<a href="#">C13880/1</a>
<a href="#">0x01bc8700</a>	444	34560	Sync telegram failure	0: No response	<a href="#">C13880/2</a>

## 12.2 Possible causes and remedies

This chapter lists all EtherCAT error messages in the numerical order of the error numbers. Possible causes and remedies as well as responses to the error messages are described in detail.

### Lost connection to 8400 [0x01bc3100]

<b>Response</b> (Lenze setting printed in bold)		<b>Setting:</b> not possible
<input type="checkbox"/> None <input type="checkbox"/> System fault <input type="checkbox"/> Fault <input type="checkbox"/> Trouble <input type="checkbox"/> Quick stop by trouble <input type="checkbox"/> Warning locked <input type="checkbox"/> Warning <input checked="" type="checkbox"/> <b>Information</b>		
<b>Cause</b>	<b>Remedy</b>	
MCI communication for the Inverter Drives 8400 is interrupted. <ul style="list-style-type: none"> <li>• Inverter Drive 8400 is switched off.</li> <li>• The communication module has not been inserted properly into the slot of the Inverter Drives 8400.</li> </ul>	<ul style="list-style-type: none"> <li>• Switch on Inverter Drive 8400.</li> <li>• Check screwed connection of the communication module to the MC slot of the Inverter Drive 8400.</li> <li>• Send communication module and Inverter Drive 8400 with error description to Lenze.</li> </ul>	

### Memory: No access [0x01bc5531]

<b>Response</b> (Lenze setting printed in bold)		<b>Setting:</b> not possible
<input type="checkbox"/> None <input type="checkbox"/> System fault <input checked="" type="checkbox"/> <b>Fault</b> <input type="checkbox"/> Trouble <input type="checkbox"/> Quick stop by trouble <input type="checkbox"/> Warning locked <input type="checkbox"/> Warning <input type="checkbox"/> Information		
<b>Cause</b>	<b>Remedy</b>	
Access via standard device to parameter set within the memory module was not successful.	Repeat download of the application (including module).	

### Memory: Read error [0x01bc5532]

<b>Response</b> (Lenze setting printed in bold)		<b>Setting:</b> not possible
<input type="checkbox"/> None <input type="checkbox"/> System fault <input checked="" type="checkbox"/> <b>Fault</b> <input type="checkbox"/> Trouble <input type="checkbox"/> Quick stop by trouble <input type="checkbox"/> Warning locked <input type="checkbox"/> Warning <input type="checkbox"/> Information		
<b>Cause</b>	<b>Remedy</b>	
Parameters of the memory module could not be read.	Repeat download of the application (including module).	

### Memory: Write error [0x01bc5533]

<b>Response</b> (Lenze setting printed in bold)		<b>Setting:</b> not possible
<input type="checkbox"/> None <input type="checkbox"/> System fault <input checked="" type="checkbox"/> <b>Fault</b> <input type="checkbox"/> Trouble <input type="checkbox"/> Quick stop by trouble <input type="checkbox"/> Warning locked <input type="checkbox"/> Warning <input type="checkbox"/> Information		
<b>Cause</b>	<b>Remedy</b>	
Parameters of the memory module could not be written.	Repeat download of the application (including module).	

### Restart by watchdog reset [0x01bc6010]

<b>Response</b> (Lenze setting printed in bold)		<b>Setting:</b> not possible
<input type="checkbox"/> None <input type="checkbox"/> System fault <input checked="" type="checkbox"/> <b>Fault</b> <input type="checkbox"/> Trouble <input type="checkbox"/> Quick stop by trouble <input type="checkbox"/> Warning locked <input type="checkbox"/> Warning <input type="checkbox"/> Information		
<b>Cause</b>	<b>Remedy</b>	
Communication module is defective.	Send communication module with error description to Lenze.	

**Internal error [0x01bc6011]**

<b>Response</b> (Lenze setting printed in bold)	<b>Setting:</b> not possible
<input type="checkbox"/> None <input type="checkbox"/> System fault <input checked="" type="checkbox"/> <b>Fault</b> <input type="checkbox"/> Trouble <input type="checkbox"/> Quick stop by trouble <input type="checkbox"/> Warning locked <input type="checkbox"/> Warning <input type="checkbox"/> Information	
<b>Cause</b>	<b>Remedy</b>
Communication module is defective.	Send communication module with error description to Lenze.

**Internal error [0x01bc6100]**

<b>Response</b> (Lenze setting printed in bold)	<b>Setting:</b> not possible
<input type="checkbox"/> None <input type="checkbox"/> System fault <input checked="" type="checkbox"/> <b>Fault</b> <input type="checkbox"/> Trouble <input type="checkbox"/> Quick stop by trouble <input type="checkbox"/> Warning locked <input type="checkbox"/> Warning <input type="checkbox"/> Information	
<b>Cause</b>	<b>Remedy</b>
Communication module is defective.	Send communication module with error description to Lenze.

**Internal error [0x01bc6101]**

<b>Response</b> (Lenze setting printed in bold)	<b>Setting:</b> not possible
<input type="checkbox"/> None <input type="checkbox"/> System fault <input checked="" type="checkbox"/> <b>Fault</b> <input type="checkbox"/> Trouble <input type="checkbox"/> Quick stop by trouble <input type="checkbox"/> Warning locked <input type="checkbox"/> Warning <input type="checkbox"/> Information	
<b>Cause</b>	<b>Remedy</b>
Communication module is defective.	Send communication module with error description to Lenze.

**Invalid parameter set [0x01bc641f]**

<b>Response</b> (Lenze setting printed in bold)	<b>Setting:</b> not possible
<input type="checkbox"/> None <input type="checkbox"/> System fault <input checked="" type="checkbox"/> <b>Fault</b> <input type="checkbox"/> Trouble <input type="checkbox"/> Quick stop by trouble <input type="checkbox"/> Warning locked <input type="checkbox"/> Warning <input type="checkbox"/> Information	
<b>Cause</b>	<b>Remedy</b>
No active parameter set could be loaded.	Repeat download of the application (including module).

**Error: Lenze setting loaded [0x01bc6420]**

<b>Response</b> (Lenze setting printed in bold)	<b>Setting:</b> not possible
<input type="checkbox"/> None <input type="checkbox"/> System fault <input checked="" type="checkbox"/> <b>Fault</b> <input type="checkbox"/> Trouble <input type="checkbox"/> Quick stop by trouble <input type="checkbox"/> Warning locked <input type="checkbox"/> Warning <input type="checkbox"/> Information	
<b>Cause</b>	<b>Remedy</b>
Access via standard device to parameter set within the memory module was not successful.	Repeat download of the application (including module).

**Invalid module configuration [0x01bc6430]**

<b>Response</b> (Lenze setting printed in bold)	<b>Setting:</b> not possible
<input checked="" type="checkbox"/> <b>None</b> <input type="checkbox"/> System fault <input type="checkbox"/> Fault <input type="checkbox"/> Trouble <input type="checkbox"/> Quick stop by trouble <input type="checkbox"/> Warning locked <input type="checkbox"/> Warning <input type="checkbox"/> Information	
<b>Cause</b>	<b>Remedy</b>
<ul style="list-style-type: none"> <li>• Faulty module configuration.</li> <li>• Incorrect sync settings.</li> </ul>	Check and correct module configuration/sync settings.

## Operational status quit [0x01bc8131]

<b>Response</b> (Lenze setting printed in bold)	<b>Setting:</b> <a href="#">C13880/1</a> ( <input checked="" type="checkbox"/> Adjustable response)
<input checked="" type="checkbox"/> <b>None</b> <input type="checkbox"/> System fault <input checked="" type="checkbox"/> Fault <input type="checkbox"/> Trouble <input checked="" type="checkbox"/> Quick stop by trouble <input checked="" type="checkbox"/> Warning locked <input type="checkbox"/> Warning <input checked="" type="checkbox"/> Information	
<b>Cause</b>	<b>Remedy</b>
The EtherCAT data exchange was stopped in the "Operational" state. See also chapter " <a href="#">Interruption of EtherCAT communication</a> " ( <a href="#">82</a> ).	<ul style="list-style-type: none"> <li>• Check cables and terminals.</li> <li>• The master has to reset the node to the "Operational" status. (If required, check a pending emergency message first).</li> </ul>

## Sync telegram failure [0x01bc8700]

<b>Response</b> (Lenze setting printed in bold)	<b>Setting:</b> <a href="#">C13880/2</a> ( <input checked="" type="checkbox"/> Adjustable response)
<input checked="" type="checkbox"/> <b>None</b> <input type="checkbox"/> System fault <input checked="" type="checkbox"/> Fault <input type="checkbox"/> Trouble <input checked="" type="checkbox"/> Quick stop by trouble <input checked="" type="checkbox"/> Warning locked <input type="checkbox"/> Warning <input checked="" type="checkbox"/> Information	
<b>Cause</b>	<b>Remedy</b>
<ul style="list-style-type: none"> <li>• The cycle time settings are faulty.</li> <li>• The task time setting of a linked PLC program is faulty.</li> <li>• EtherCAT master / DC master settings are incorrect.</li> <li>• The sync source setting is faulty.</li> </ul>	<ul style="list-style-type: none"> <li>• Check the cycle times.</li> <li>• Check the task time of a linked PLC program.</li> <li>• Check the EtherCAT master / DC master settings.</li> <li>• Check the settings in <a href="#">C01120</a> of the standard device (selection of the sync source).</li> </ul>

# 13 Parameter reference

## 13.1 Communication-relevant parameters of the standard device

# 13 Parameter reference

This chapter supplements the parameter list and the table of attributes in the software manual and in the »Engineer« online help for the Inverter Drive 8400 by the parameters of the E84AYCET communication module (EtherCAT).



### Software manual/online help for the Inverter Drive 8400

Here you will find general information about parameters.

## 13.1 Communication-relevant parameters of the standard device

This chapter lists the communication-relevant parameters of the Inverter Drive 8400 in numerically ascending order.

### C01120

Parameter   Name: <b>C01120   Sync signal source</b>		Data type: UNSIGNED_8 Index: 23455 <sub>d</sub> = 5B9F <sub>h</sub>
Selection of the source for DC synchronisation signals. <ul style="list-style-type: none"> <li>• Select "4: MCI" for the communication module.</li> <li>• In general, only one source can synchronise the drive.</li> </ul> <a href="#">▶ Synchronisation with "Distributed Clocks" (DC) (□ 37)</a>		
Selection list (Lenze setting printed in bold)		Info
<b>0</b>	Off	Synchronisation off
1	CAN on board	Synchronisation via the system bus "CAN on board"
4	MCI	Synchronisation via MCI (communication module)
<input checked="" type="checkbox"/> Read access <input checked="" type="checkbox"/> Write access <input type="checkbox"/> CINH <input type="checkbox"/> PLC-STOP <input type="checkbox"/> No transfer <input type="checkbox"/> COM <input type="checkbox"/> MOT                   Scaling factor: 1		

### C01501

Parameter   Name: <b>C01501   Reaction on communication error with MCI</b>		Data type: UNSIGNED_8 Index: 23074 <sub>d</sub> = 5A22 <sub>h</sub>
Configuration of monitoring functions for the communication module		
Selection list		
0	No response	
1	Error	
2	Trouble	
3	Quick stop by trouble	
4	Warning locked	
5	Warning	
6	Information	
Subcodes	Lenze setting	Info
C01501/1	0: No response	Reaction on MCI communication failure <ul style="list-style-type: none"> <li>• Response to a communication error (module in slot)</li> </ul>
C01501/2	0: No response	Reaction on MCI module invalid <ul style="list-style-type: none"> <li>• Response to an incompatible communication module or module not in slot</li> </ul>
<input checked="" type="checkbox"/> Read access <input checked="" type="checkbox"/> Write access <input type="checkbox"/> CINH <input type="checkbox"/> PLC-STOP <input type="checkbox"/> No transfer <input type="checkbox"/> COM <input type="checkbox"/> MOT                   Scaling factor: 1		

# 13 Parameter reference

## 13.2 Parameters of the communication module

### 13.2 Parameters of the communication module

This chapter lists the parameters of the E84AYCET communication module (EtherCAT) in ascending numerical order.

#### C13850

Parameter   Name: <b>C13850   All words to master</b>		Data type: UNSIGNED_16 Index: 10725 <sub>d</sub> = 29E5 <sub>h</sub>
Display of the process data words (subcodes 1 ... 16) which are transferred from the communication module to the master. Only those which are configured are valid.		
<b>Display area (min. value   unit   max. value)</b>		
0		65535
<b>Subcodes</b>		<b>Info</b>
C13850/1		
...		
C13850/16		
<input checked="" type="checkbox"/> Read access <input type="checkbox"/> Write access <input type="checkbox"/> CINH <input type="checkbox"/> PLC-STOP <input type="checkbox"/> No transfer <input type="checkbox"/> PDO_MAP_RX <input type="checkbox"/> PDO_MAP_TX <input type="checkbox"/> COM <input type="checkbox"/> MOT		

#### C13851

Parameter   Name: <b>C13851   All words from master</b>		Data type: UNSIGNED_16 Index: 10724 <sub>d</sub> = 29E4 <sub>h</sub>
Display of the process data words (subcodes 1 ... 16) which are transferred from the master to the communication module. Only those which are configured are valid.		
<b>Display area (min. value   unit   max. value)</b>		
0		65535
<b>Subcodes</b>		<b>Info</b>
C13851/1		
...		
C13851/16		
<input checked="" type="checkbox"/> Read access <input type="checkbox"/> Write access <input type="checkbox"/> CINH <input type="checkbox"/> PLC-STOP <input type="checkbox"/> No transfer <input type="checkbox"/> PDO_MAP_RX <input type="checkbox"/> PDO_MAP_TX <input type="checkbox"/> COM <input type="checkbox"/> MOT		

#### C13852

Parameter   Name: <b>C13852   All words to standard device</b>		Data type: UNSIGNED_16 Index: 10723 <sub>d</sub> = 29E3 <sub>h</sub>
Display of the process data words (subcodes 1 ... 16) which are transferred from the communication module to the standard device.		
<b>Display area (min. value   unit   max. value)</b>		
0		65535
<b>Subcodes</b>		<b>Info</b>
C13852/1		
...		
C13852/16		
<input checked="" type="checkbox"/> Read access <input type="checkbox"/> Write access <input type="checkbox"/> CINH <input type="checkbox"/> PLC-STOP <input type="checkbox"/> No transfer <input type="checkbox"/> PDO_MAP_RX <input type="checkbox"/> PDO_MAP_TX <input type="checkbox"/> COM <input type="checkbox"/> MOT		



## C13853

Parameter   Name: <b>C13853   All words from standard device</b>		Data type: UNSIGNED_16 Index: 10722 <sub>d</sub> = 29E2 <sub>h</sub>
Display of the process data words (subcodes 1 ... 16) which are transferred from the standard device to the communication module.		
<b>Display area (min. value   unit   max. value)</b>		
0		65535
<b>Subcodes</b>		<b>Info</b>
C13853/1		
...		
C13853/16		
<input checked="" type="checkbox"/> Read access <input type="checkbox"/> Write access <input type="checkbox"/> CINH <input type="checkbox"/> PLC-STOP <input type="checkbox"/> No transfer <input type="checkbox"/> PDO_MAP_RX <input type="checkbox"/> PDO_MAP_TX <input type="checkbox"/> COM <input type="checkbox"/> MOT		

## C13859

Parameter   Name: <b>C13859   Number of Tx PDOs</b>		Data type: UNSIGNED_16 Index: 10716 <sub>d</sub> = 29DC <sub>h</sub>
Number of process data words sent		
<b>Display area (min. value   unit   max. value)</b>		
0		16
<input checked="" type="checkbox"/> Read access <input type="checkbox"/> Write access <input type="checkbox"/> CINH <input type="checkbox"/> PLC-STOP <input type="checkbox"/> No transfer <input type="checkbox"/> PDO_MAP_RX <input type="checkbox"/> PDO_MAP_TX <input type="checkbox"/> COM <input type="checkbox"/> MOT		

## C13860

Parameter   Name: <b>C13860   Number of Rx PDOs</b>		Data type: UNSIGNED_16 Index: 10715 <sub>d</sub> = 29DB <sub>h</sub>
Number of process data words received		
<b>Display area (min. value   unit   max. value)</b>		
0		16
<input checked="" type="checkbox"/> Read access <input type="checkbox"/> Write access <input type="checkbox"/> CINH <input type="checkbox"/> PLC-STOP <input type="checkbox"/> No transfer <input type="checkbox"/> PDO_MAP_RX <input type="checkbox"/> PDO_MAP_TX <input type="checkbox"/> COM <input type="checkbox"/> MOT		

## C13861

Parameter   Name: <b>C13861   Bus state</b>		Data type: UNSIGNED_16 Index: 10714 <sub>d</sub> = 29DA <sub>h</sub>
Display of the current bus status <a href="#">▶ EtherCAT state machine (57)</a>		
<b>Selection list (read only)</b>		<b>Info</b>
0	Nonexistent	No online value available (communication module is offline).
1	Init	
2	Pre-operational	
3	Bootstrap	Is not supported.
4	Safe-operational	
8	Operational	
<input checked="" type="checkbox"/> Read access <input type="checkbox"/> Write access <input type="checkbox"/> CINH <input type="checkbox"/> PLC-STOP <input type="checkbox"/> No transfer <input type="checkbox"/> PDO_MAP_RX <input type="checkbox"/> PDO_MAP_TX <input type="checkbox"/> COM <input type="checkbox"/> MOT		

## C13864

Parameter   Name: <b>C13864   Active station address</b>		Data type: UNSIGNED_16 Index: 10711 <sub>d</sub> = 29D7 <sub>h</sub>
Display of the station address allocated by the master		
<b>Display area (min. value   unit   max. value)</b>		
0		32767
<input checked="" type="checkbox"/> Read access <input type="checkbox"/> Write access <input type="checkbox"/> CINH <input type="checkbox"/> PLC-STOP <input type="checkbox"/> No transfer <input type="checkbox"/> PDO_MAP_RX <input type="checkbox"/> PDO_MAP_TX <input type="checkbox"/> COM <input type="checkbox"/> MOT		

## C13867

Parameter   Name: <b>C13867   Display of emergency data</b>		Data type: OCTET_STRING Index: 10708 <sub>d</sub> = 29D4 <sub>h</sub>
Display of the emergency data last sent by the inverter (string with a length of 8 bytes). ▶ <a href="#">Emergency requests / Emergency messages</a> (📖 90)		
<input checked="" type="checkbox"/> Read access <input type="checkbox"/> Write access <input type="checkbox"/> CINH <input type="checkbox"/> PLC-STOP <input type="checkbox"/> No transfer <input type="checkbox"/> PDO_MAP_RX <input type="checkbox"/> PDO_MAP_TX <input type="checkbox"/> COM <input type="checkbox"/> MOT		

## C13879

Parameter   Name: <b>C13879   Bus error</b>		Data type: UNSIGNED_16 Index: 10696 <sub>d</sub> = 29C8 <sub>h</sub>
Bit coded display of the bus error Additionally, an error message is entered in the EtherCAT register " <a href="#">AL Status Code</a> " (📖 58).		
<b>Value is bit-coded:</b>		<b>Info</b>
Bit 0	General bus error	
Bit 1	Reserved	
...	...	
Bit 31	Reserved	
<input checked="" type="checkbox"/> Read access <input type="checkbox"/> Write access <input type="checkbox"/> CINH <input type="checkbox"/> PLC-STOP <input type="checkbox"/> No transfer <input type="checkbox"/> PDO_MAP_RX <input type="checkbox"/> PDO_MAP_TX <input type="checkbox"/> COM <input type="checkbox"/> MOT		

## C13880

Parameter   Name: <b>C13880   Reaction on communication failure</b>		Data type: UNSIGNED_8 Index: 10695 <sub>d</sub> = 29C7 <sub>h</sub>
The set response will be executed if ... <ul style="list-style-type: none"> <li>• the node detects that is no longer in the "Operational" state and the monitoring time (<a href="#">C13881</a>) has elapsed or</li> <li>• a sync telegram failure has been detected.</li> </ul>		
<b>Selection list</b>		
0	No response	
1	Error	
3	Quick stop by trouble	
4	Warning locked	
6	Information	
<b>Subcodes</b>		<b>Info</b>
C13880/1	0: No response	Response to communication interruption ▶ <a href="#">Interruption of EtherCAT communication</a> (📖 82)
C13880/2	0: No response	Response to sync telegram failure ▶ <a href="#">Sync frame failure detection</a> (📖 83)
<input checked="" type="checkbox"/> Read access <input checked="" type="checkbox"/> Write access <input type="checkbox"/> CINH <input type="checkbox"/> PLC-STOP <input type="checkbox"/> No transfer <input type="checkbox"/> PDO_MAP_RX <input type="checkbox"/> PDO_MAP_TX <input type="checkbox"/> COM <input type="checkbox"/> MOT		

## C13881

Parameter   Name: <b>C13881   Response time when exiting "Operational"</b>		Data type: UNSIGNED_16 Index: 10694 <sub>d</sub> = 29C6 <sub>h</sub>
If the "Operational" state is exited, the response parameterised with <a href="#">C13880</a> occurs after the time set here has elapsed. A change in monitoring is effective immediately.		
<b>Setting range (min. value   unit   max. value)</b>		<b>Lenze setting</b>
0	ms	65535 <b>0 ms</b>
<input checked="" type="checkbox"/> Read access <input checked="" type="checkbox"/> Write access <input type="checkbox"/> CINH <input type="checkbox"/> PLC-STOP <input type="checkbox"/> No transfer <input type="checkbox"/> PDO_MAP_RX <input type="checkbox"/> PDO_MAP_TX <input type="checkbox"/> COM <input type="checkbox"/> MOT		

## C13883

Parameter   Name: <b>C13883   DC active</b>		Data type: UNSIGNED_8 Index: 10692 <sub>d</sub> = 29C4 <sub>h</sub>
The code displays if the DC synchronisation has been activated for the communication module. ▶ <a href="#">Synchronisation with "Distributed Clocks" (DC) (□ 37)</a>		
<b>Selection list (read only)</b>		<b>Info</b>
0	DC unused	
1	DC for synchronisation	
<input checked="" type="checkbox"/> Read access <input type="checkbox"/> Write access <input type="checkbox"/> CINH <input type="checkbox"/> PLC-STOP <input type="checkbox"/> No transfer <input type="checkbox"/> PDO_MAP_RX <input type="checkbox"/> PDO_MAP_TX <input type="checkbox"/> COM <input type="checkbox"/> MOT		

## C13884

Parameter   Name: <b>C13884   Base device synchronisation status</b>		Data type: UNSIGNED_8 Index: 10691 <sub>d</sub> = 29C3 <sub>h</sub>
The code displays whether the inverter is DC-synchronised. ▶ <a href="#">Synchronisation with "Distributed Clocks" (DC) (□ 37)</a>		
<b>Selection list (read only)</b>		<b>Info</b>
0	Not synchronised	
1	Synchronised	
<input checked="" type="checkbox"/> Read access <input type="checkbox"/> Write access <input type="checkbox"/> CINH <input type="checkbox"/> PLC-STOP <input type="checkbox"/> No transfer <input type="checkbox"/> PDO_MAP_RX <input type="checkbox"/> PDO_MAP_TX <input type="checkbox"/> COM <input type="checkbox"/> MOT		

## C13885

Parameter   Name: <b>C13885   Clear process data</b>		Data type: UNSIGNED_8 Index: 10690 <sub>d</sub> = 29C2 <sub>h</sub>
This code serves to set which process data the slave is to process for maintaining internal communication when the EtherCAT has exited the "Operational" state.		
<b>Selection list (Lenze setting printed in bold)</b>		<b>Info</b>
0	Use of most recent master PDOs	The data last sent by the master are used.
1	<b>PDOs are set to the value '0'</b>	The process data contents is set to the value '0'.
<input checked="" type="checkbox"/> Read access <input checked="" type="checkbox"/> Write access <input type="checkbox"/> CINH <input type="checkbox"/> PLC-STOP <input type="checkbox"/> No transfer <input type="checkbox"/> PDO_MAP_RX <input type="checkbox"/> PDO_MAP_TX <input type="checkbox"/> COM <input type="checkbox"/> MOT		

## C13887

Parameter   Name: <b>C13887   Suppress emergency message in case of</b>		Data type: BITFIELD_8 Index: 10688 <sub>d</sub> = 29C0 <sub>h</sub>
This code serves to prevent the emergency messages from being transmitted to the EtherCAT master. Here, errors of a certain type can be suppressed deliberately. Furthermore, all errors are entered in the logbook. A change will only be effective if no error number with the error type selected here is available in the standard device code <b>C00165</b> .		
<b>Value is bit-coded:</b>		<b>Info</b>
Bit 0	Error	
Bit 1	Trouble	
Bit 2	Quick stop by trouble	
Bit 3	Warning locked	
Bit 4	Warning	
Bit 5	Information	
Bit 6	Reserved	
Bit 7	Reserved	
<input checked="" type="checkbox"/> Read access <input checked="" type="checkbox"/> Write access <input type="checkbox"/> CINH <input type="checkbox"/> PLC-STOP <input type="checkbox"/> No transfer <input type="checkbox"/> PDO_MAP_RX <input type="checkbox"/> PDO_MAP_TX <input type="checkbox"/> COM <input type="checkbox"/> MOT		

## C13899

Parameter   Name: <b>C13899   Station alias</b>		Data type: UNSIGNED_16 Index: 10676 <sub>d</sub> = 29B4 <sub>h</sub>
This code serves to set a station alias address. In order to use a station alias address, you must select a value > '0'. <ul style="list-style-type: none"> <li>The station alias address must only be set if the node is part of a "hot connect" group.</li> <li>The station alias address must be unambiguous and may only be assigned once within the EtherCAT network.</li> <li>Use the same station alias address in the EtherCAT master and in the slave.</li> </ul> <a href="#">▶ Address allocation (□ 36)</a>		
<b>Setting range (min. value   unit   max. value)</b>		<b>Lenze setting</b>
0		32767 0
<input checked="" type="checkbox"/> Read access <input checked="" type="checkbox"/> Write access <input type="checkbox"/> CINH <input type="checkbox"/> PLC-STOP <input type="checkbox"/> No transfer <input type="checkbox"/> PDO_MAP_RX <input type="checkbox"/> PDO_MAP_TX <input checked="" type="checkbox"/> COM <input type="checkbox"/> MOT		

## C13900

Parameter   Name: <b>C13900   Firmware: Product type</b>		Data type: VISIBLE_STRING Index: 10675 <sub>d</sub> = 29B3 <sub>h</sub>
The code contains a string with a length of 8 bytes. The following identification code is output: <ul style="list-style-type: none"> <li>"E84AFCET" (up to V01.05)</li> <li>"E84AFYET" (from V02.00)</li> </ul>		
<input checked="" type="checkbox"/> Read access <input type="checkbox"/> Write access <input type="checkbox"/> CINH <input type="checkbox"/> PLC-STOP <input type="checkbox"/> No transfer <input type="checkbox"/> PDO_MAP_RX <input type="checkbox"/> PDO_MAP_TX <input type="checkbox"/> COM <input type="checkbox"/> MOT		

## C13901

Parameter   Name: <b>C13901   Firmware compilation date</b>		Data type: VISIBLE_STRING Index: 10674 <sub>d</sub> = 29B2 <sub>h</sub>
The code contains a string with a length of 20 bytes. The creation date ("MM DD YYYY") and the time ("hh:mm:ss") of the software are output here. Example: "Mar 21 2005 12:31:21"		
<input checked="" type="checkbox"/> Read access <input type="checkbox"/> Write access <input type="checkbox"/> CINH <input type="checkbox"/> PLC-STOP <input type="checkbox"/> No transfer <input type="checkbox"/> PDO_MAP_RX <input type="checkbox"/> PDO_MAP_TX <input type="checkbox"/> COM <input type="checkbox"/> MOT		

## C13902

Parameter   Name: <b>C13902   Firmware version</b>	Data type: VISIBLE_STRING Index: 10673 <sub>d</sub> = 29B1 <sub>h</sub>
The code contains a string with a length of 5 bytes. The firmware version is output here. Example: "01.00"	
<input checked="" type="checkbox"/> Read access <input type="checkbox"/> Write access <input type="checkbox"/> CINH <input type="checkbox"/> PLC-STOP <input type="checkbox"/> No transfer <input type="checkbox"/> PDO_MAP_RX <input type="checkbox"/> PDO_MAP_TX <input type="checkbox"/> COM <input type="checkbox"/> MOT	

# 13 Parameter reference

## 13.3 Table of attributes

### 13.3 Table of attributes

The table of attributes contains information required for communicating with the Inverter Drive 8400 via parameters.

#### How to read the table of attributes:

Column		Meaning	Entry		
Code		Parameter designation	Cxxxxx		
Name		Parameter short text (display text)	Text		
Index	dec	Index by which the parameter is addressed. The subindex for array variables corresponds to the Lenze subcode number.	24575 - Lenze- code	Only required for access via a bus system	
	hex		5FFF <sub>n</sub> - Lenze code number		
Data	DS	Data structure	E	Single variable (only one parameter element)	
			A	Array variable (several parameter elements)	
	DA	Number of the array elements (subcodes)	Number		
	DT	Data type	BITFIELD_8	1 byte, bit-coded	
			BITFIELD_16	2 bytes, bit-coded	
			BITFIELD_32	4 bytes, bit-coded	
			INTEGER_8	1 byte, with sign	
			INTEGER_16	2 bytes, with sign	
			INTEGER_32	4 bytes, with sign	
			UNSIGNED_8	1 byte, without sign	
			UNSIGNED_16	2 bytes, without sign	
			UNSIGNED_32	4 bytes, without sign	
			VISIBLE_STRING	ASCII string	
OCTET_STRING					
Factor	Factor for data transmission via a bus system, depending on the number of decimal positions	Factor	1 = no decimal positions 10 = 1 decimal position 100 = 2 decimal positions 1000 = 3 decimal positions		
Access	R	Read access	<input checked="" type="checkbox"/> Reading permitted		
	W	Write access	<input checked="" type="checkbox"/> Writing permitted		
	CINH	Controller inhibit (CINH) required	<input checked="" type="checkbox"/> Writing only possible if the controller is inhibited (CINH)		

Table of attributes

Code	Name	Index		Data				Access		
		dec	hex	DS	DA	DT	Factor	R	W	CINH
<a href="#">C13850</a>	All words to master	10725	29E5	A	16	UNSIGNED_16	1	<input checked="" type="checkbox"/>		
<a href="#">C13851</a>	All words from master	10724	29E4	A	16	UNSIGNED_16	1	<input checked="" type="checkbox"/>		
<a href="#">C13852</a>	All words to standard device	10723	29E3	A	16	UNSIGNED_16	1	<input checked="" type="checkbox"/>		
<a href="#">C13853</a>	All words from standard device	10722	29E2	A	16	UNSIGNED_16	1	<input checked="" type="checkbox"/>		
<a href="#">C13859</a>	Number of Tx PDOs	10716	29DC	E	1	UNSIGNED_16	1	<input checked="" type="checkbox"/>		
<a href="#">C13860</a>	Number of Rx PDOs	10715	29DB	E	1	UNSIGNED_16	1	<input checked="" type="checkbox"/>		
<a href="#">C13861</a>	Bus state	10714	29DA	E	1	UNSIGNED_16	1	<input checked="" type="checkbox"/>		
<a href="#">C13864</a>	Active station address	10711	29D7	E	1	UNSIGNED_16	1	<input checked="" type="checkbox"/>		
<a href="#">C13867</a>	Display of emergency data	10708	29D4	E	1	OCTET_STRING		<input checked="" type="checkbox"/>		
<a href="#">C13879</a>	Bus error	10696	29C8	E	1	UNSIGNED_16	1	<input checked="" type="checkbox"/>		
<a href="#">C13880</a>	Reaction on communication failure	10695	29C7	A	2	UNSIGNED_8	1	<input checked="" type="checkbox"/>	<input checked="" type="checkbox"/>	
<a href="#">C13881</a>	Response time when exiting "Operational"	10694	29C6	E	1	UNSIGNED_16	1	<input checked="" type="checkbox"/>	<input checked="" type="checkbox"/>	
<a href="#">C13883</a>	DC active	10692	29C4	E	1	UNSIGNED_8	1	<input checked="" type="checkbox"/>		
<a href="#">C13884</a>	Synchronisation is active	10691	29C3	E	1	UNSIGNED_8	1	<input checked="" type="checkbox"/>		
<a href="#">C13885</a>	Clear process data	10690	29C2	E	1	UNSIGNED_8	1	<input checked="" type="checkbox"/>	<input checked="" type="checkbox"/>	
<a href="#">C13887</a>	Suppress emergency message in case of	10688	29C0	E	1	BITFIELD_8		<input checked="" type="checkbox"/>	<input checked="" type="checkbox"/>	
<a href="#">C13899</a>	Station alias address	10676	29B4	E	1	UNSIGNED_16	1	<input checked="" type="checkbox"/>	<input checked="" type="checkbox"/>	
<a href="#">C13900</a>	Firmware product type	10675	29B3	E	1	VISIBLE_STRING		<input checked="" type="checkbox"/>		
<a href="#">C13901</a>	Firmware compilation date	10674	29B2	E	1	VISIBLE_STRING		<input checked="" type="checkbox"/>		
<a href="#">C13902</a>	Firmware version	10673	29B1	E	1	VISIBLE_STRING		<input checked="" type="checkbox"/>		

# Index

---

## A

Abort codes [81](#)  
Accessing process data [60](#)  
Activating changed settings [53](#)  
Active station address (C13864) [99](#)  
Address allocation [36](#)  
ADS communication parameters in »TwinCAT« and »Engineer« [45](#)  
AL Status Code [58](#)  
All words from master (C13851) [97](#)  
All words from standard device (C13853) [98](#)  
All words to master (C13850) [97](#)  
All words to standard device (C13852) [97](#)  
Application as directed [12](#)  
Application notes (representation) [9](#)  
Approvals [15](#)  
Automatic device identification [35](#)

## B

Base device synchronisation status (C13884) [100](#)  
Baud rate [15](#)  
Before initial switch-on [33](#)  
Bus device type [15](#)  
Bus error (C13879) [99](#)  
Bus state (C13861) [98](#)

## C

C01120 | Sync signal source [96](#)  
C01501 | Reaction on MCI communication failure [96](#)  
C13850 | All words to master [97](#)  
C13851 | All words from master [97](#)  
C13852 | All words to standard device [97](#)  
C13853 | All words from standard device [98](#)  
C13859 | Number of Tx PDOs [98](#)  
C13860 | Number of mapped words PDO Rx [98](#)  
C13861 | Bus state [98](#)  
C13864 | Active station address [99](#)  
C13867 | Display of emergency data [99](#)  
C13879 | Bus error [99](#)  
C13880 | Reaction on communication failure [99](#)  
C13881 | Response time when exiting "Operational" [100](#)  
C13883 | DC active [100](#)  
C13884 | Base device synchronisation status [100](#)  
C13885 | Clear process data [100](#)  
C13887 | Suppress emergency message in case of [101](#)  
C13899 | Station alias [101](#)  
C13900 | Firmware product type [101](#)  
C13901 | Firmware compilation date [101](#)  
C13902 | Firmware version [102](#)

Carrying out the port interconnection in the »Engineer« [62](#)  
CiA402 PDO mapping - Inverter Drive 8400 TopLine P [66](#)  
CiA402 receipt PDO (Rx-PDO) [66](#)  
CiA402 transmit PDO (Tx-PDO) [67](#)  
Clear process data (C13885) [100](#)  
Codes [96](#)  
CoE objects [79](#)  
Colour code of the Ethernet cable [30](#)  
Commissioning [33](#)  
Communication medium [15](#)  
Communication parameters in »TwinCAT« and »Engineer« [45](#)  
Communication profile [15](#)  
Communication time [19](#)  
Communication-relevant parameters of the standard device [96](#)  
Configuration of the master [34](#)  
Configuring process data [35](#)  
Configuring the Controller (EtherCAT master) [34](#)  
Configuring the EtherCAT master [34](#)  
Conformities [15](#)  
Conventions [7](#)  
Conventions used [7](#)  
Cycle times [15](#)

## D

Data transfer [54](#)  
Datagrams [56](#)  
DC active (C13883) [100](#)  
DC configuration in the Inverter Drive 8400 (slave) [38](#)  
DC configuration in the master [38](#)  
DC master [37](#)  
Determining the cycle time [35](#)  
Device- and application-specific safety instructions [11](#)  
Device identification [35](#)  
Device profile [15](#)  
Device protection [11](#)  
Diagnostics [84](#)  
Diagnostics with the »Engineer« [89](#)  
Dimensions [20](#)  
Display of emergency data (C13867) [99](#)  
Distributed Clocks (DC) [37](#)  
Document history [6](#)  
Download [74](#)



## E

- Electrical installation [25](#)
- E-mail to Lenze [108](#)
- EMC-compliant wiring [25](#)
- Emergency messages [90](#)
- Emergency requests [90](#)
- Error: Lenze setting loaded (error message) [94](#)
- Error code [90](#)
- Error messages [92](#)
  - Causes and remedies [93](#)
  - Short overview [92](#)
- Error number
  - 0x01bc3100 [93](#)
  - 0x01bc5531 [93](#)
  - 0x01bc5532 [93](#)
  - 0x01bc5533 [93](#)
  - 0x01bc6010 [93](#)
  - 0x01bc6011 [94](#)
  - 0x01bc6100 [94](#)
  - 0x01bc6101 [94](#)
  - 0x01bc641f [94](#)
  - 0x01bc6420 [94](#)
  - 0x01bc6430 [94](#)
  - 0x01bc8131 [95](#)
  - 0x01bc8700 [95](#)
- Establishing a master - slave connection [68](#)
- Establishing an online connection to the »Engineer« [40](#)
- Establishing communication [53](#)
- EtherCAT ADS communication parameters in »TwinCAT« and »Engineer« [45](#)
- EtherCAT connection [27](#)
- EtherCAT datagrams [56](#)
- EtherCAT error messages
  - Causes and remedies [93](#)
  - Short overview [92](#)
- EtherCAT frames [55](#)
- EtherCAT objects of the communication module [80](#)
- EtherCAT state machine [57](#)
- Ethernet cable [29](#)
- Ethernet cable colour code [30](#)
- Ethernet cable, structure [29](#)
- External voltage supply [31](#)

## F

- Feedback to Lenze [108](#)
- Fieldbus status displays [86](#)
- Firmware compilation date (C13901) [101](#)
- Firmware product type (C13900) [101](#)
- Firmware version (C13902) [102](#)
- Frame structure [55](#)

## G

- Gateway Controller -> configure EtherCAT [41](#)
- Gateway Controller -> configure EtherCAT ADS (Beckhoff) [43](#)
- General data [15](#)
- General safety and application notes [10](#)

## I

- Identification [12](#)
- Indexing of the Lenze codes [69](#)
- Initial switch-on [53](#)
- Installation [21](#)
- Installing device description files [34](#)
- Interface for communication [15](#)
- Interfaces [14](#)
- Internal error (error message) [94](#)
- Interruption of EtherCAT communication [82](#)
- Interruption of internal communication [83](#)
- Invalid module configuration (error message) [94](#)

## L

- LED status displays [84](#)
- Line topology [26](#)
- Lost connection to 8400 base device (error message) [93](#)

## M

- Mailbox datagram [69](#)
- Mailbox protocol [15](#)
- Max. cable length [15](#)
- Mechanical installation [22](#)
- Memory
  - No access (error message) [93](#)
  - Read error (error message) [93](#)
  - Write error (error message) [93](#)
- Module status displays [85](#)
- Monitoring [82](#)
- Mounting for standard devices 0.25 kW and 0.37 kW [22](#)
- Mounting for standard devices from 0.55 kW onwards [23](#)

## N

- Nameplate [12](#)
- Network topology [15](#), [26](#)
- Notes used [9](#)
- Number of nodes [15](#)
- Number of Rx PDOs (C13860) [98](#)
- Number of Tx PDOs (C13859) [98](#)

## O

- Operating conditions [15](#)
- Operational status quit (error message) [95](#)

# Index

---

## P

Parameter data transfer [68](#)  
Parameter reference [96](#)  
Parameter set invalid (error message) [94](#)  
Parameters of the communication module [97](#)  
PDO mapping [60](#)  
Pin assignment of the RJ45 sockets [28](#)  
Process data [59](#)  
Process data transfer [59](#)  
Processing time [19](#)  
Product codes for Inverter Drives 8400 [35](#)  
Product description [12](#)  
Product features [13](#)  
Product ID [15](#)  
Protection against uncontrolled restart [53](#)  
Protection of persons [11](#)  
Protective insulation [16](#)  
Protocol data [19](#)

## R

Reaction on communication failure (C13880) [99](#)  
Reaction on MCI communication failure (C01501) [96](#)  
Reading parameters (SDO upload) [70](#)  
Replacing the communication module [24](#)  
Residual hazards [11](#)  
Response of the Lenze EtherCAT nodes during start-up [39](#)  
Response time when exiting "Operational" (C13881) [100](#)  
Restart by watchdog reset (error message) [93](#)  
Revision ID [15](#)

## S

Safety instructions [10](#)  
Safety instructions (representation) [9](#)  
Screenshots/application examples [5](#)  
SDO abort codes (Abort codes) [81](#)  
SDO download [74](#)  
SDO upload [70](#)  
Specification of the Ethernet cable [29](#)  
State machine [57](#)  
Station alias (C13899) [101](#)  
Status displays (LEDs) [84](#)  
Status displays at X246 and X247 [88](#)  
Structure of the Emergency message [90](#)  
Structure of the Ethernet cable [29](#)  
Suppress emergency message in case of (C13887) [101](#)  
Switch topology [26](#)  
Sync frame failure detection [83](#)  
Sync signal source (C01120) [96](#)  
Sync telegram failure (error message) [95](#)  
Synchronisation with "Distributed Clocks" (DC) [37](#)  
System error messages [92](#)

## T

Table of attributes [103](#)  
Target group [5](#)  
Technical data [15](#)  
Terminals [14](#), [32](#)  
Terminology used [8](#)  
Terms [8](#)

## U

Upload [70](#)  
Using the communication module [12](#)

## V

Validity of the documentation [5](#)  
Vendor ID [15](#)  
Voltage supply [15](#), [31](#)

## W

Writing parameters (SDO download) [74](#)



## Your opinion is important to us

These instructions were created to the best of our knowledge and belief to give you the best possible support for handling our product.

Perhaps we have not succeeded in achieving this objective in every respect. If you notice this, please send your suggestions and points of criticism in a short e-mail to:

[feedback-docu@Lenze.de](mailto:feedback-docu@Lenze.de)

Thank you for your support.

*Your Lenze documentation team*



Lenze Automation GmbH  
Hans-Lenze-Str. 1  
D-31855 Aerzen  
Germany  
☎ +49 (0)51 54 / 82-0  
📠 +49 (0)51 54 / 82-28 00  
✉ [Lenze@Lenze.de](mailto:Lenze@Lenze.de)  
🌐 [www.Lenze.com](http://www.Lenze.com)

#### Service

Lenze Service GmbH  
Breslauer Straße 3  
D-32699 Extertal  
Germany  
☎ 00 80 00 / 24 4 68 77 (24 h helpline)  
📠 +49 (0)51 54 / 82-11 12  
✉ [Service@Lenze.de](mailto:Service@Lenze.de)

EDS84AYCIB  
13362260

# L-force *Communication*



Communication Manual

## 8400



**E84AYCIB**

**INTERBUS communication module**

# Lenze



## Contents

<b>1</b>	<b><u>About this documentation</u></b> .....	<b>6</b>
1.1	<u>Document history</u> .....	8
1.2	<u>Conventions used</u> .....	9
1.3	<u>Terminology used</u> .....	10
1.4	<u>Notes used</u> .....	11
<b>2</b>	<b><u>Safety instructions</u></b> .....	<b>12</b>
2.1	<u>General safety instructions and application notes</u> .....	12
2.2	<u>Device- and application-specific safety instructions</u> .....	13
2.3	<u>Residual hazards</u> .....	13
<b>3</b>	<b><u>Product description</u></b> .....	<b>14</b>
3.1	<u>Application as directed</u> .....	14
3.2	<u>Identification</u> .....	14
3.3	<u>Product features</u> .....	15
3.4	<u>Terminals and interfaces</u> .....	16
<b>4</b>	<b><u>Technical data</u></b> .....	<b>17</b>
4.1	<u>General data and operating conditions</u> .....	17
4.2	<u>Protective insulation</u> .....	18
4.3	<u>Protocol data</u> .....	21
4.4	<u>Communication time</u> .....	21
4.5	<u>Dimensions</u> .....	22
<b>5</b>	<b><u>Installation</u></b> .....	<b>23</b>
5.1	<u>Mechanical installation</u> .....	24
5.1.1	<u>Mounting for standard devices 0.25 kW and 0.37 kW</u> .....	24
5.1.2	<u>Mounting for standard devices from 0.55 kW onwards</u> .....	25
5.1.3	<u>Replacing the communication module</u> .....	26
5.2	<u>Electrical installation</u> .....	27
5.2.1	<u>EMC-compliant wiring</u> .....	27
5.2.2	<u>Network topology</u> .....	27
5.2.3	<u>INTERBUS connection</u> .....	28
5.2.4	<u>Specification of the bus cable</u> .....	30
5.2.5	<u>Bus cable length</u> .....	30
5.2.6	<u>External voltage supply</u> .....	31

<b>6</b>	<b><u>Commissioning</u></b> .....	<b>33</b>
6.1	<u>Before initial switch-on</u> .....	33
6.2	<u>Possible settings through DIP switch</u> .....	34
6.2.1	<u>Setting the number of process data words (PD)</u> .....	35
6.2.2	<u>Setting the number of parameter data words (PCP)</u> .....	36
6.2.3	<u>Setting the baud rate</u> .....	37
6.3	<u>Settings in the »Engineer«</u> .....	38
6.4	<u>Initial switch-on</u> .....	39
<b>7</b>	<b><u>Data transfer</u></b> .....	<b>40</b>
<b>8</b>	<b><u>Process data transfer</u></b> .....	<b>41</b>
8.1	<u>Access to process data / PDO mapping</u> .....	41
8.2	<u>Preconfigured port interconnection of the process data objects (PDO)</u> .....	42
8.3	<u>Freely configuring the port interconnection of the process data objects (PDO)</u> .....	43
<b>9</b>	<b><u>Parameter data transfer</u></b> .....	<b>48</b>
9.1	<u>Addressing of the parameter data</u> .....	48
9.2	<u>Initialising PCP communication</u> .....	48
9.3	<u>Supported PMS services</u> .....	49
9.3.1	<u>Initiate</u> .....	49
9.3.2	<u>Abort</u> .....	49
9.3.3	<u>Reject</u> .....	49
9.3.4	<u>Read / Write</u> .....	50
9.3.5	<u>Get-OD</u> .....	50
9.3.6	<u>Identify</u> .....	51
9.3.7	<u>Status</u> .....	52
<b>10</b>	<b><u>Monitoring</u></b> .....	<b>53</b>
<b>11</b>	<b><u>Diagnostics</u></b> .....	<b>54</b>
11.1	<u>LED status displays</u> .....	54
11.1.1	<u>Module status displays</u> .....	55
11.1.2	<u>Fieldbus status displays</u> .....	56
11.2	<u>Querying the current bus status</u> .....	57
11.3	<u>Diagnostic data</u> .....	58
<b>12</b>	<b><u>Error messages</u></b> .....	<b>59</b>
12.1	<u>Short overview (A-Z) of the INTERBUS error messages</u> .....	59
12.2	<u>Possible causes and remedies</u> .....	60



<b>13</b>	<b><a href="#">Parameter reference</a></b> .....	<b>63</b>
13.1	<a href="#">Parameters of the communication module</a> .....	63
13.2	<a href="#">Table of attributes</a> .....	70
<b>14</b>	<b><a href="#">Index</a></b> .....	<b>72</b>

## 1 About this documentation

### Contents

The descriptions contained in this documentation refer only to the E84AYCIB communication module (INTERBUS).



#### Note!

This documentation supplements the **mounting instructions** supplied with the communication module and the **"Inverter Drives 8400" hardware manual**.

The features and functions of the communication module are described in detail.

Typical applications are illustrated by means of examples.

This documentation also contains:

- ▶ Safety instructions that must be observed
- ▶ Key technical data relating to the communication module
- ▶ Information about the versions of the Lenze standard devices to be used
- ▶ Notes on troubleshooting and fault elimination

The theoretical concepts are only explained to the level of detail required to understand the function of the communication module.

Depending on the software version of the controller used and the version of the »Engineer« software installed, the screenshots provided in this documentation may not match up with those displayed by your »Engineer«.

This documentation does not describe any software provided by other manufacturers. No liability can be accepted for corresponding data provided in this documentation. For information on how to use the software, please refer to the host system (master) documents.

All product names mentioned in this documentation are trademarks of their respective owners.



#### Tip!

Detailed information on the INTERBUS can be found on the internet page of the INTERBUS user organisation:

[www.interbusclub.com](http://www.interbusclub.com)

## Target group

This documentation addresses to people involved in configuring, installing, commissioning and maintaining a machine's networking and remote maintenance features.



### Tip!

You will find documentation and software updates relating to Lenze products on the Internet, in the "Services & Downloads" area at:

[www.Lenze.com](http://www.Lenze.com)

## Validity information

The information in this documentation applies to the following devices:

Extension module	Type designation	From hardware version	From software version
INTERBUS communication module	E84AYCIB	VA	01.00

## 1.1 Document history

Material number	Version			Description
13295951	1.0	06/2009	TD17	First edition
13320780	2.0	11/2009	TD17	Parameter descriptions updated.
13329723	3.0	02/2010	TD17	Chapters "Diagnostics" and "Installation" updated.
13362260	4.0	11/2010	TD17	General revision

### Your opinion is important to us!

These instructions were created to the best of our knowledge and belief to give you the best possible support for handling our product.

Perhaps we have not succeeded in achieving this objective in every respect. If you notice this, please send your suggestions and points of criticism in a short e-mail to:



[feedback-docu@Lenze.de](mailto:feedback-docu@Lenze.de)

Thank you very much for your support.

Your Lenze documentation team

## 1.2 Conventions used

This documentation uses the following conventions to distinguish between different types of information:

Type of information	Identification	Examples/notes
Spelling of numbers		
Decimal	Standard notation	Example:1234
Hexadecimal	0x[0 ... 9, A ... F]	Example: 0x60F4
Binary • Nibble	In quotation marks Point	Example: '100' Example: '0110.0100'
Decimal separator	Point	The decimal point is always used. For example: 1234.56
Text		
Program name	» «	PC software Example: Lenze »Engineer«
Control element	<b>Bold</b>	The <b>OK</b> button ... / The <b>Copy</b> command ... / The <b>Properties</b> tab ... / The <b>Name</b> input field ...
Hyperlink	<u>Underlined</u>	Optically highlighted reference to another subject which is activated with a mouse-click.
Symbols		
Page reference	 9	Optically highlighted reference to another page which is activated with a mouse-click.
Step-by-step instructions		Step-by-step instructions are indicated by a pictograph.

## 1.3 Terminology used

Term	Meaning
Standard device Controller	Lenze frequency inverter from the "Inverter Drives 8400" product series, with which the communication module can be used. ▶ <a href="#">Application as directed</a> (□ 14)
»Engineer«	Lenze software, supporting you during the entire life cycle of a machine - from the planning phase to maintenance.
Code	"Container" for one or more parameters which you can use to parameterise or monitor the communication module.
Subcode	If a code contains several parameters, the individual parameters are stored under "subcodes". This manual uses a slash "/" as a separator between the code and subcode (e.g. "C00118/3").
PCP	Peripherals Communication Protocol (parameter data transmission)
PD	Process data / process data words
PDO	Process data object
PDU	Process Data Unit
PMS	Peripheral Message Specification
HW	Hardware
SW	Software

## 1.4 Notes used

The following signal words and symbols are used in this documentation to indicate dangers and important information:

### Safety instructions

Layout of the safety instructions:



#### Pictograph and signal word!

(characterise the type and severity of danger)

#### Note

(describes the danger and gives information about how to prevent dangerous situations)

Pictograph	Signal word	Meaning
	Danger!	<b>Danger of personal injury through dangerous electrical voltage</b> Reference to an imminent danger that may result in death or serious personal injury if the corresponding measures are not taken.
	Danger!	<b>Danger of personal injury through a general source of danger</b> Reference to an imminent danger that may result in death or serious personal injury if the corresponding measures are not taken.
	Stop!	<b>Danger of property damage</b> Reference to a possible danger that may result in property damage if the corresponding measures are not taken.

### Application notes

Pictograph	Signal word	Meaning
	Note!	Important note to ensure trouble-free operation
	Tip!	Useful tip for simple handling
		Reference to another documentation

## 2 Safety instructions



### Note!

It is absolutely vital that the stated safety measures are implemented in order to prevent serious injury to persons and damage to material assets.

Always keep this documentation to hand in the vicinity of the product during operation.

### 2.1 General safety instructions and application notes

- ▶ Lenze drive components ...
  - may only be used as directed.
    - ▶ [Application as directed](#) (14)
  - must never be commissioned if they display any signs of damage.
  - must never be modified technically.
  - must never be commissioned if they are not fully mounted.
  - must never be operated without the required covers.
  - can have live, moving and rotating parts during operation, depending on their degree of protection. Surfaces can be hot.
- ▶ The following applies to Lenze drive components ...
  - Only use accessories that have been approved for the product.
  - Only use genuine spare parts supplied by the manufacturer of the product.
- ▶ Observe all regulations for the prevention of accidents, directives and laws that apply to the location of use.
- ▶ Observe all the specifications contained in the enclosed documentation.
  - This is a precondition for ensuring safe, trouble-free operation and for making use of the stated product features.
    - ▶ [Product features](#) (15)
  - The specifications, processes, and circuitry described in this documentation are for guidance only and must be adapted to your own specific application. Lenze does not take responsibility for the suitability of the process and circuit proposals.
- ▶ All works on and with Lenze drive components may only be carried out by qualified personnel. According to IEC 364 and CENELEC HD 384 these are persons who ...
  - are familiar with installing, mounting, commissioning and operating the product.
  - have the qualifications necessary for their occupation.
  - know and are able to apply all regulations for the prevention of accidents, directives and laws that apply to the location of use.



## 2.2 Device- and application-specific safety instructions

- ▶ During operation, the communication module must be securely connected to the standard device.
- ▶ Use a safely separated power supply unit in accordance with EN 61800-5-1 ("SELV"/ "PELV").
- ▶ Only use cables that meet the listed specifications.
  - ▶ [Specification of the bus cable](#) (📖 30)



### Documentation for the standard device, control system, plant/machine

All the other measures prescribed in this documentation must also be implemented. Observe the safety instructions and application notes contained in this manual.

## 2.3 Residual hazards

### Protection of persons

- ▶ If Inverter Drives 8400 are used on a phase earthed mains with a rated mains voltage  $\geq 400$  V, external measures need to be implemented in order to provide reliable protection against accidental contact.
  - ▶ [Protective insulation](#) (📖 18)

### Device protection

- ▶ The communication module contains electronic components that can be damaged or destroyed by electrostatic discharge.
  - ▶ [Installation](#) (📖 23)

## 3 Product description

### 3.1 Application as directed

The communication module ...

- ▶ Is an accessory module that can be used in conjunction with the following standard devices:

Product series	Type designation	From software version
Inverter Drives 8400 Stateline	E84AVSCxxxxx	04.00
Inverter Drives 8400 HighLine	E84AVHCxxxxx	04.00
Inverter Drives 8400 TopLine	E84AVTCxxxxx	01.00

- ▶ Is an item of equipment intended for use in industrial power systems
- ▶ Should only be used under the operating conditions prescribed in this documentation
- ▶ Should only be used in INTERBUS networks

**Any other use shall be deemed inappropriate!**

### 3.2 Identification

The type designation, hardware version, and software version of a communication module are indicated on its nameplate:

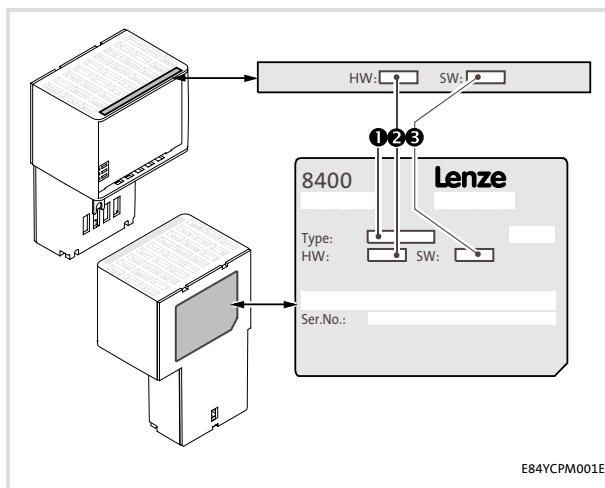

#### 1 Type designation (type)

- E84 Product series
- A Version
- Y Module identification: extension module
- C Module type: communication module
- IB INTERBUS
- V/S V: Coated version  
S: Standard version

#### 2 Hardware version (HW)

#### 3 Software version (SW)

[3-1] Identification data

## 3.3 Product features

- ▶ Interface module for the INTERBUS communication system for attachment to the expansion slots of Inverter Drives 8400
- ▶ The communication module can either be supplied internally by the 8400 standard device or externally by a separate voltage source.
- ▶ Slave functionality
- ▶ Access to all Lenze parameters
- ▶ DIP switch settings:
  - Number of process data words and parameter data words
  - Baud rate (500 kbps or 2 Mbps)
- ▶ Bus coupling via remote bus in accordance with the RS485 standard
- ▶ Up to 10 process data words are possible
- ▶ Support of the PMS services:
  - Initiate
  - Abort
  - Reject
  - Read
  - Write
  - Get-OD
  - Identify
  - Status

#### 3.4 Terminals and interfaces

- ▶ 2 connections for the INTERBUS
  - 1 input (9-pole Sub-D plug)
  - 1 output (9-pole Sub-D socket)
- ▶ 2-pole plug connector with spring connection for the external voltage supply of the communication module
- ▶ DIP switch for setting the ...
  - Number of process data words and parameter data words
  - Baud rate
- ▶ Front LEDs for diagnostics ...
  - of the communication module voltage supply;
  - of the module status;
  - of the INTERBUS status.

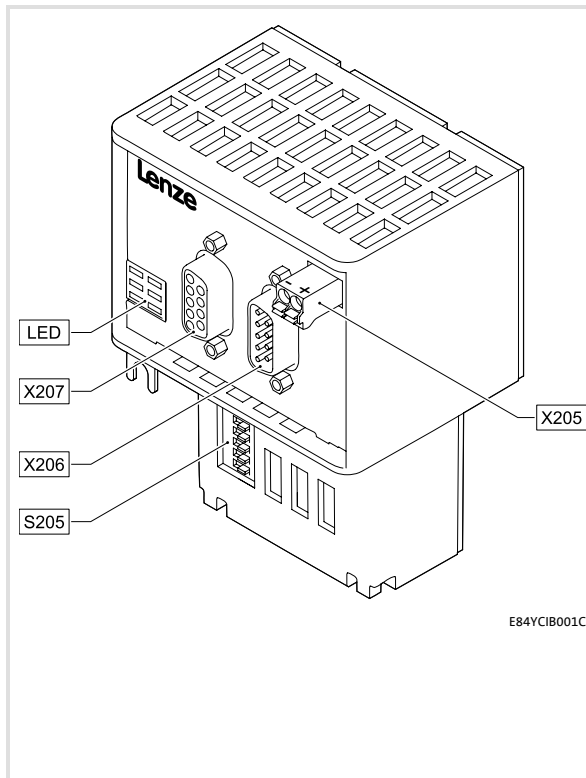

**S205** DIP switch for setting the ...

- Number of process data words and parameter data words
- Baud rate

[▶ Possible settings through DIP switch \(□ 34\)](#)

**X205** External voltage supply of the communication module

- 2-pole plug connector with spring connection

[▶ External voltage supply \(□ 31\)](#)

**X206** INTERBUS input (IN)

- 9-pole Sub-D plug

**X207** INTERBUS output (OUT)

- 9-pole Sub-D socket

[▶ Network topology \(□ 27\)](#)  
[▶ INTERBUS connection \(□ 28\)](#)

**MS** 5 LED status displays for diagnostics

**ME** [▶ Module status displays \(□ 55\)](#)

**BS** [▶ Fieldbus status displays \(□ 56\)](#)

**BE**

**DE**

[3-2] E84AYCIB communication module (INTERBUS)

## 4 Technical data



### "Inverter Drives 8400" hardware manual

This manual contains data on the **ambient conditions** and the **electromagnetic compatibility (EMC)** that also apply to the communication module.

### 4.1 General data and operating conditions

Field	Values
Order designation	<ul style="list-style-type: none"> <li>E84AYCIBV (coated version)</li> <li>E84AYCIBS: (standard version)</li> </ul>
Communication profile	INTERBUS
Interfaces	<ul style="list-style-type: none"> <li>Input (IN): 9-pole Sub-D plug</li> <li>Output (OUT): 9-pole Sub-D socket</li> </ul>
Communication medium	RS485
Network topology	Ring
Type of node	INTERBUS slave
Number of nodes	<ul style="list-style-type: none"> <li>1 master</li> <li>512 slaves</li> </ul>
Baud rate	500 kbps or 2 Mbps (can be set via DIP switch or code)
Max. cable length	<ul style="list-style-type: none"> <li>400 m at 500 kbps</li> <li>150 m at 2 Mbps</li> </ul> (between the individual INTERBUS nodes)
Process data words (PD) to be used	0 ... 10: 16 bits/word (can be set via DIP switch or code)
Parameter data words (PCP)	0, 1, 2, 4: 16 bits/word (can be set via DIP switch or code)
Max. number of data words	10 (PD + PCP): 16 bits/word
Max. PDU length	64 bytes
INTERBUS identification (module ID)	<ul style="list-style-type: none"> <li>3 = 0x3 (PCP 0 words)</li> <li>227 = 0xE3 (PCP 1 word)</li> <li>224 = 0xE0 (PCP 2 words)</li> <li>225 = 0xE1 (PCP 4 words)</li> </ul>
Voltage supply	External supply via the 2-pole plug connector <ul style="list-style-type: none"> <li>"+": U = 24 V DC (21.6 V - 0 % ... 26.4 V + 0 %), I<sub>max</sub> = 180 mA</li> <li>"-": Reference potential for external voltage supply</li> </ul>
Conformities, approvals	CE

## 4.2 Protective insulation



### **Danger!**

#### **Dangerous electrical voltage**

If Inverter Drives 8400 are used on a phase earthed mains with a rated mains voltage  $\geq 400$  V, external measures need to be implemented in order to provide reliable protection against accidental contact.

#### **Possible consequences:**

- Death or serious injury

#### **Protective measures:**

- If protection against accidental contact needs to be provided for the control terminals of the controller and for the connections of the plugged-in device modules, ...
  - a double isolating distance must exist.
  - the components to be connected must be provided with the second isolating distance.



### **Note!**

The protective insulation provided in Inverter Drives 8400 is realised in accordance with EN 61800-5-1.

The illustration below ...

- ▶ shows the arrangement of the terminal strips and the separate potential areas of the controller.
- ▶ serves to determine the decisive protective insulation between two terminals located in differently insulated separate potential areas.



## Note!

The INTERBUS input (X206) is isolated from the voltage supply (X205) and the INTERBUS output (X207).

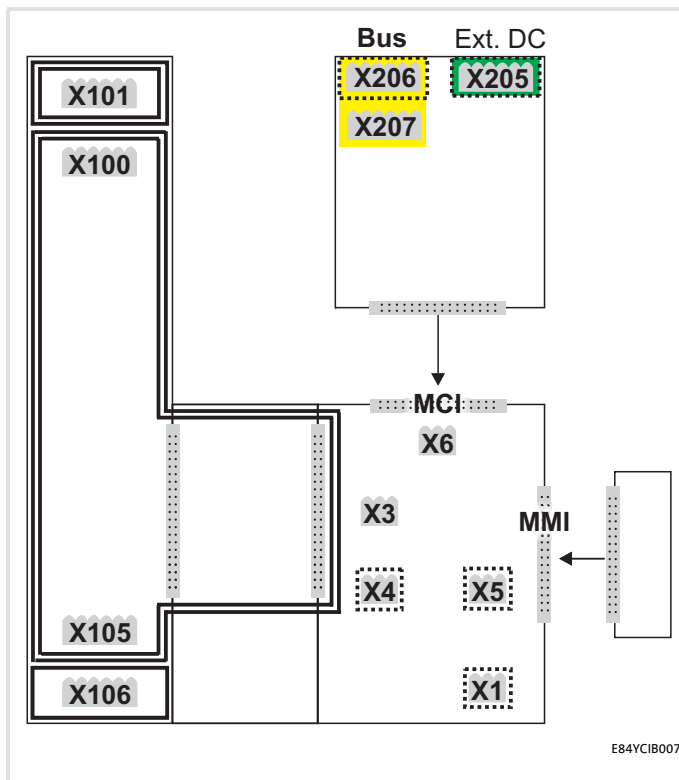

[4-1] Protective insulation in accordance with EN61800-5-1

Terminal strip	Connection
X100	Mains/DC-bus connection
X101	Relay contact
X105	Motor/brake resistor
X106	Motor PTC
X1	System bus (CANopen)
X3	Analog inputs/outputs
X4	Digital outputs
X5	Digital inputs
X6	Diagnostics
MCI	Slot for communication module
MMI	Slot for memory module

## Example

Which type of protective insulation is used between the bus terminal of the device module in slot MCI and the mains terminal X100?

- ▶ The separate potential area with the better protective insulation is decisive.
  - The separate potential area of the device module bus terminal is "functionally insulated".
  - The separate potential area of the mains terminal has a "reinforced insulation".
- ▶ Result: The insulation between the mains terminal X100 and the bus terminal is of the "reinforced insulation" type.



### 4.3 Protocol data

Field	Values
Process data words	0 ... 10 words (16 bits/word)
Supported PMS services	<ul style="list-style-type: none"> <li>• Initiate</li> <li>• Abort</li> <li>• Reject</li> <li>• Read</li> <li>• Write</li> <li>• Get-OD</li> <li>• Identify</li> <li>• Status</li> </ul>

### 4.4 Communication time

The communication time is the time between the start of a request and the arrival of the corresponding response.

The communication times in the INTERBUS network depend on the...

- ▶ Processing time in the controller;
- ▶ Telegram runtime (baud rate / telegram length).

#### Processing time in the controller

The parameter data and process data are independent of each other.

Data	Processing time
Process data	Approx. 2 ms + 1 ms tolerance + runtime of the technology application used
Parameter data	Approx. 30 ms + 20 ms tolerance (typical) <ul style="list-style-type: none"> <li>• Some codes may require a longer processing time (see software manual/ »Engineer« online help for Inverter Drives 8400).</li> </ul>

## 4.5 Dimensions

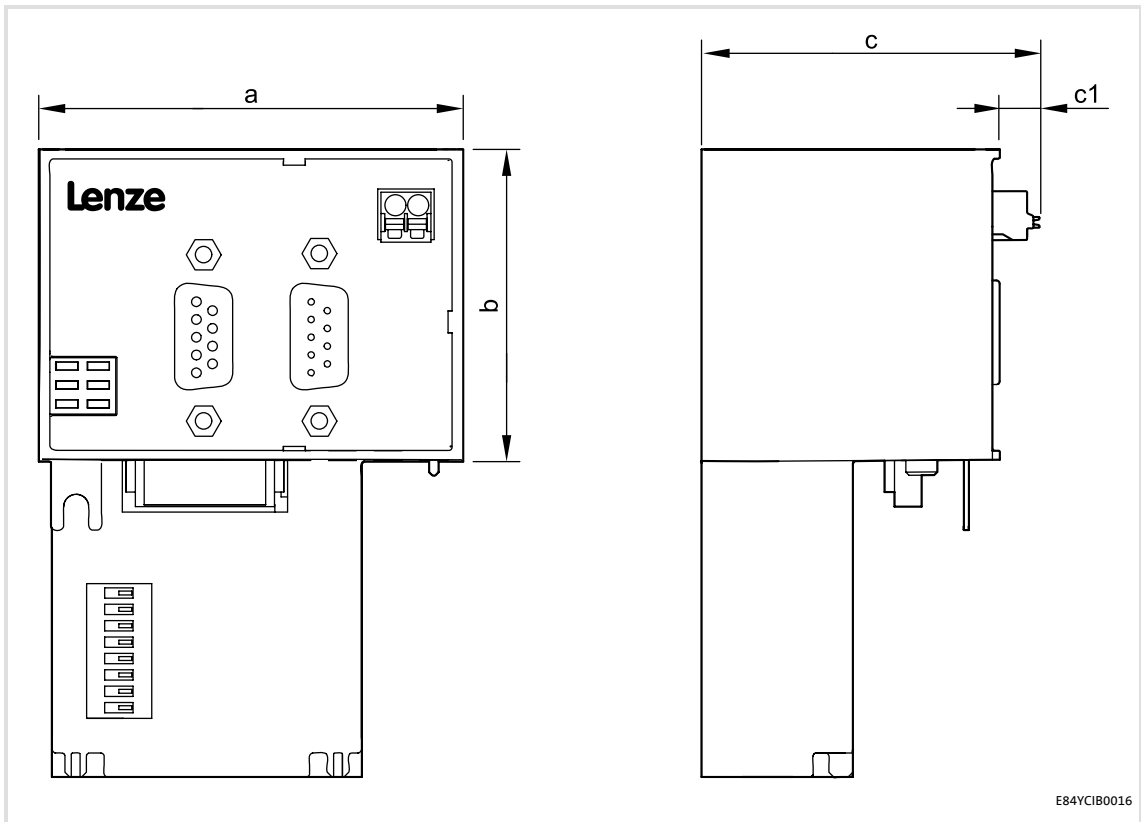

E84YCIB0016

[4-2] Dimensions

Type	Dimensions [mm]			
	a	b	c	c1
E84AYCIB	67	50	57	8

## 5 Installation



### Stop!

#### Electrostatic discharge

Electronic components within the communication module can be damaged or destroyed by electrostatic discharge.

#### Possible consequences:

- The communication module is damaged.
- Fieldbus communication is not possible or is faulty.

#### Protective measures:

- Ensure that you are free of electrostatic charge before you touch the module.

#### 5.1 Mechanical installation

The communication module can be plugged into the MCI slot or removed from there while the controller is switched on. When the module is plugged in, it is recognised automatically and checked for plausibility regarding its function and version.

##### 5.1.1 Mounting for standard devices 0.25 kW and 0.37 kW

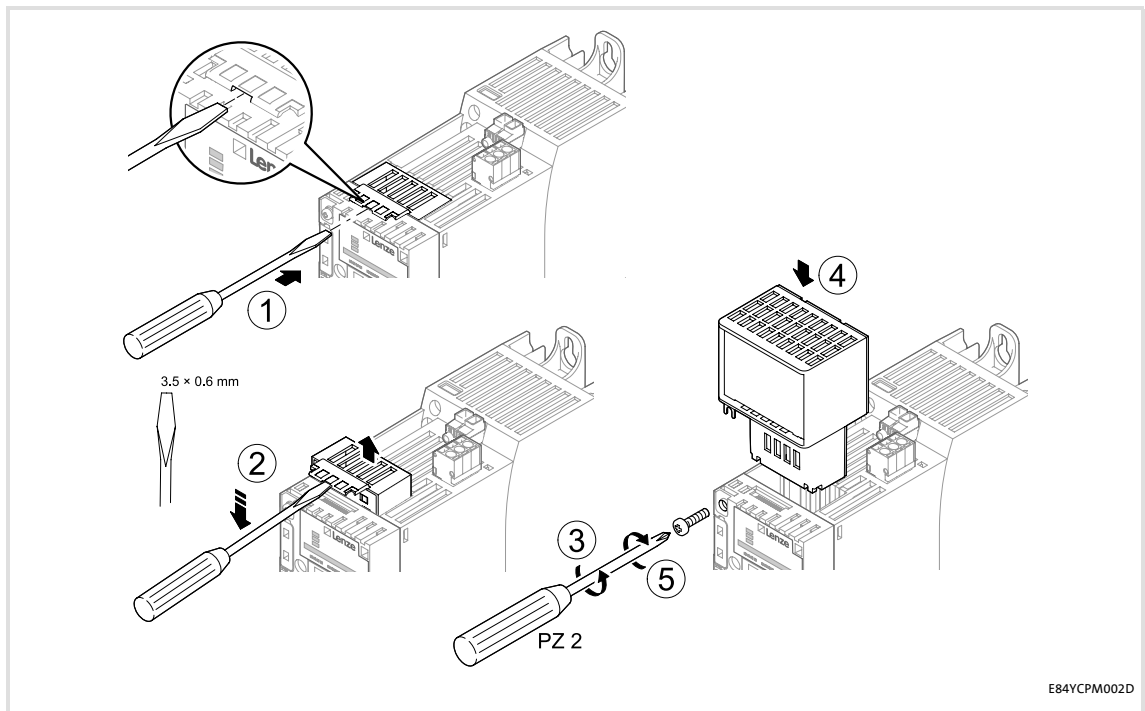

[5-1] Mounting for standard devices 0.25 kW and 0.37 kW

#### Mounting steps

1. Use a screwdriver to lever out the cover of the MCI slot of the standard device and remove it (1, 2).
2. Loosen the securing screw for the communication module at the standard device (3).
3. Insert the communication module into the MCI slot of the standard device (4).
4. Tighten the securing screw again (5).

### 5.1.2 Mounting for standard devices from 0.55 kW onwards

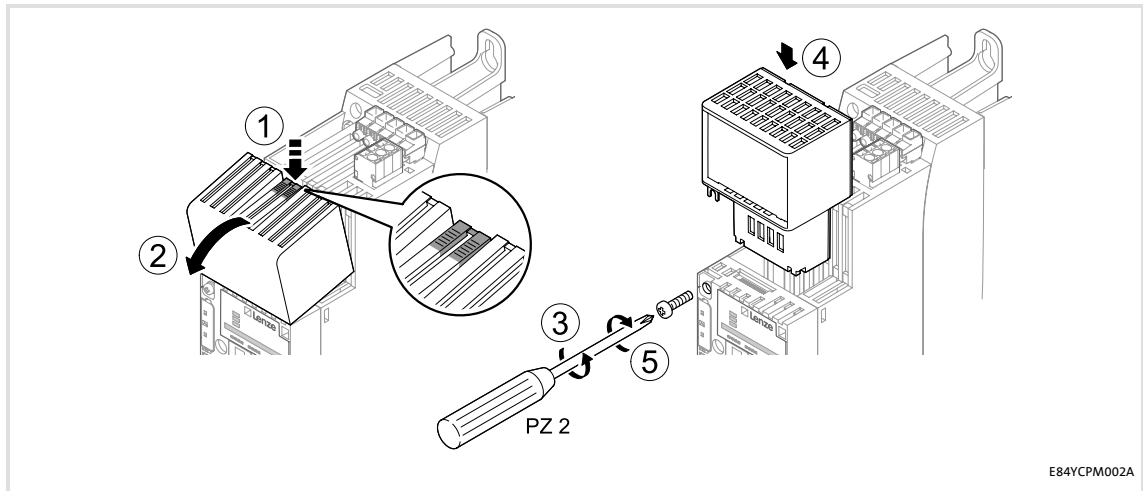

[5-2] Mounting for standard devices from 0.55 kW onwards

#### Mounting steps

1. Slightly impress the pressure surface on the top side of the standard device MCI slot cover (1).
2. Bend the cover forward and remove it from the standard device (2).
3. Loosen the securing screw for the communication module at the standard device (3).
4. Insert the communication module into the MCI slot of the standard device (4).
5. Tighten the securing screw again (5).

#### 5.1.3 Replacing the communication module

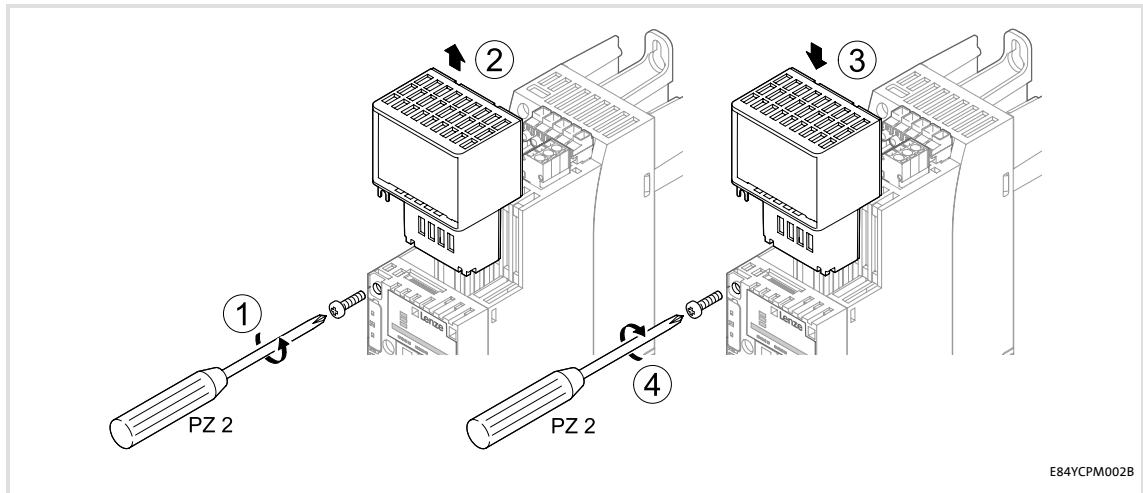

[5-3] Replacing the communication module

#### Mounting steps

1. Loosen the securing screw for the communication module at the standard device (1).
2. Remove the communication module from the MCI slot of the standard device (2).
3. Insert the new communication module into the MCI slot of the standard device (3).
4. Tighten the securing screw again (4).

## 5.2 Electrical installation



### Documentation for the standard device, control system, plant/machine

Observe the notes and wiring instructions contained in this documentation.

### 5.2.1 EMC-compliant wiring

In typical systems, standard shielding of the Ethernet cables is sufficient.

However, in environments with a very high level of interference, EMC resistance can be improved by additionally earthing the cable shield on both sides.

For this observe the following notes:

1. Remove the plastic sheath of the cable on a length of 2 cm.
2. Fasten the cable shield onto the shield contact of the standard device.

### 5.2.2 Network topology

The bus system must be designed as a ring. Feed and return lines must be integrated in the same bus cable. The ring goes from the INTERBUS master via all other nodes and back again to the master.

An INTERBUS ring can consist of maximally 513 nodes (1 master + standard devices connected).

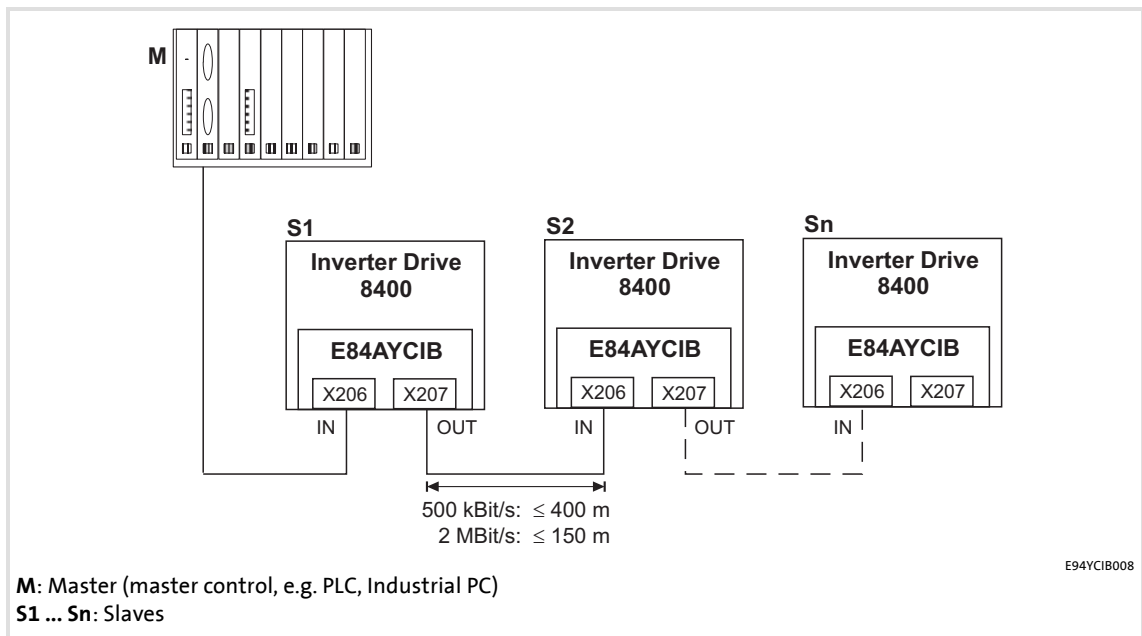

[5-4] INTERBUS ring

#### 5.2.3 INTERBUS connection

The INTERBUS connection of the communication module is effected via **X206** (input, 9-pole Sub-D plug) and **X207** (output, 9-pole Sub-D socket).

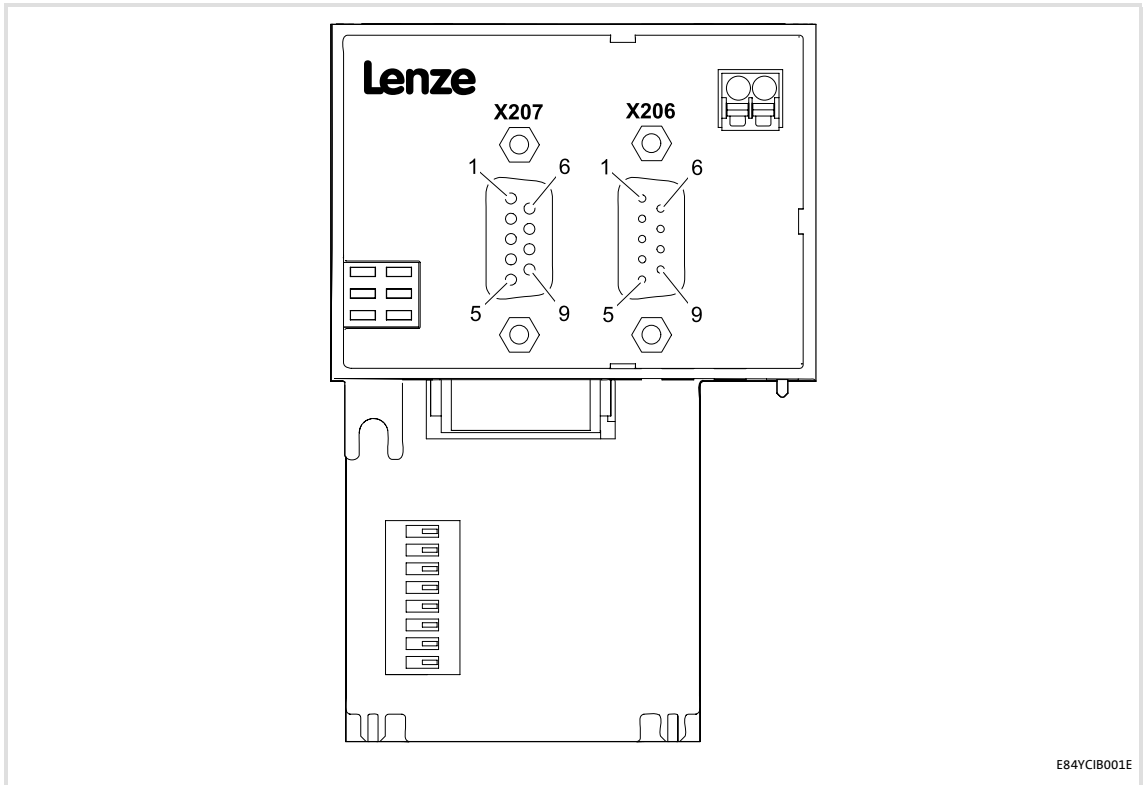

[5-5] INTERBUS terminals X206 (input) and X207 (output)

The nodes on the bus system have to be connected to each other by means of a fieldbus cable in accordance with the INTERBUS specification. INTERBUS cables are for instance produced by PHOENIX CONTACT (Germany).

▶ [Specification of the bus cable](#) (30)



**Assignment of the 9-pole Sub-D plug X206 (IN)**

Pin	Designation	Input/output	Description
1	DO1	Input	RS485: DO1 not inverted
2	DI1	Output	RS485: DI1 not inverted
3	GND		Reference potential
4	Free		Not assigned
5	Vcc5	Output	5 V DC
6	/DO1	Input	RS485: DO1 inverted
7	/DI1	Output	RS485: DI1 inverted
8	Vcc5	Output	5 V DC
9	Free		Not assigned

**Assignment of the 9-pole Sub-D socket X207 (OUT)**

Pin	Designation	Input/output	Description
1	DO2	Output	RS485: DO2 not inverted
2	DI2	Input	RS485: DI2 not inverted
3	GND		Reference potential
4	GND		
5	Vcc5	Output	5 V DC
6	/DO2	Output	RS485: DO2 inverted
7	/DI2	Input	RS485: DI2 inverted
8	Vcc5	Output	5 V DC
9	RBST	Signalling input	Connection to the outgoing INTERBUS is plugged.

#### 5.2.4 Specification of the bus cable



#### Note!

Only use cables that meet the listed specifications.

Specification of the INTERBUS cable	
Cable type	Sold by the meter (e.g. PHOENIX CONTACT: IBS RBC meter-T, order no. 28 06 28 6)
No. of conductors	3 x 2, twisted in pairs, with joint shielding
Conductor cross-section	> 0.2 mm <sup>2</sup>
DC-cable resistance	< 96 Ω/km
Impedance (characteristic)	<ul style="list-style-type: none"><li>• 120 Ω ± 20 % (f = 64 kHz)</li><li>• 100 Ω ± 15 Ω (f &gt; 1 MHz)</li></ul>
Capacitance per unit length	< 60 nF/km (f = 800 Hz)

#### 5.2.5 Bus cable length

Adapt the baud rate according to the bus cable length:

Baud rate	Cable length between the individual INTERBUS nodes
500 kbps	Max. 400 m
2 Mbps	Max. 150 m



#### Note!

Select the baud rate which depends on the data volume, cycle time, and number of nodes only as high as required for the application.

## 5.2.6 External voltage supply

The communication module can be supplied externally with voltage via separate supply cables at the 2-pole plug connector (X205).



### Note!

With external voltage supply, always use a separate power supply unit, safely separated in accordance with EN 61800-5-1 in every control cabinet ("SELV" / "PELV").

- ▶ External voltage supply of the communication module is necessary if the bus communication is to continue when the supply of the standard device fails.
- ▶ It is not possible to access the parameters of a standard device that is disconnected from the mains.

### Wiring the X205 plug connector



### Stop!

Only wire the plug connector if the standard device is disconnected from the mains.

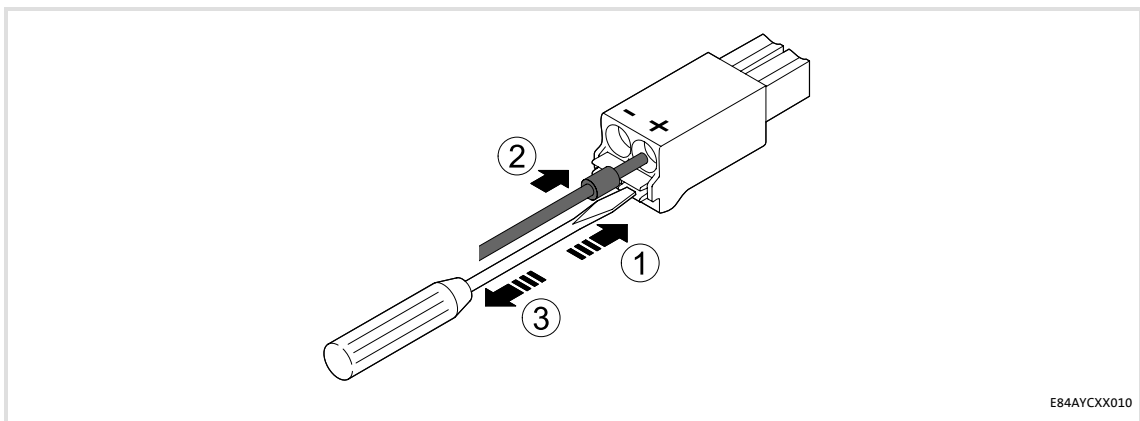

[5-6] Wiring of the 2-pole plug connector with spring connection

How to wire the plug connector with spring connection:

1. Place a screwdriver into the notch below the terminal and keep it pressed.
2. Place the supply cable in the terminal.
3. Remove the screwdriver from the notch.

#### Assignment of the X205 plug connector

Designation	Explanation
+	U = 24 V DC (21.6 V - 0 % ... 26.4 V + 0 %) I = 180 mA
-	Reference potential for external voltage supply

#### Terminal data

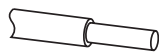
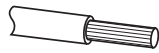
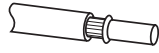
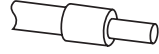
Field	Values
Electrical connection	2-pole plug connector with spring connection
Possible connections	Rigid:
	 0.2 ... 1.5 mm <sup>2</sup> (AWG 24 ... 16)
	Flexible:
	 Without wire end ferrule 0.2 ... 1.5 mm <sup>2</sup> (AWG 24 ... 16)
	 With wire end ferrule, without plastic sleeve 0.2 ... 1.5 mm <sup>2</sup> (AWG 24 ... 16)
 With wire end ferrule, with plastic sleeve 0.2 ... 1.5 mm <sup>2</sup> (AWG 24 ... 16)	
Stripping length	10 mm

## 6 Commissioning

During commissioning, system-specific data such as motor parameters, operating parameters, responses, and parameters for fieldbus communication are defined for the controller. For Lenze devices this is effected via the so-called codes.

The codes of the controller and for communication are saved non-volatilely as a data set in the memory module.

Additionally there are codes for diagnostics and monitoring of the nodes.

▶ [Parameters of the communication module](#) (📖 63)

### 6.1 Before initial switch-on



#### Stop!

Before switching on the standard device with the communication module for the first time, check the entire wiring for completeness, short circuit, and earth fault.

#### 6.2 Possible settings through DIP switch

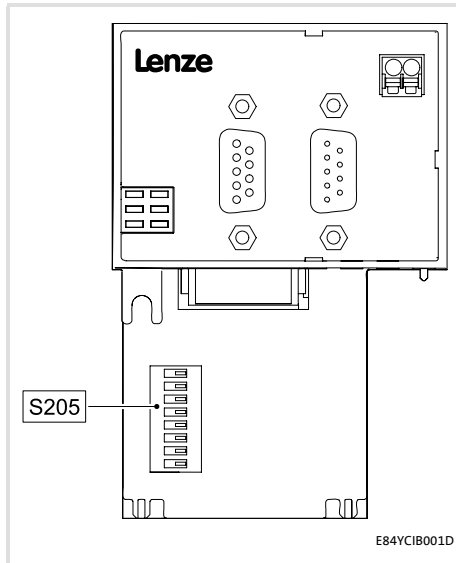

[6-1] DIP switch

The following can be set through the DIP switch (S205):

- ▶ Number of process data words (PD)  
Switches: 1 ... 4 ([35](#))
- ▶ Number of parameter data words (PCP)  
Switches: 5 and 6 ([36](#))
- ▶ Baud rate  
Switch: 8 ([37](#))

Lenze setting: All switches "OFF"

Switch 7 has no function.



#### Note!

To make any modified settings take effect, switch the voltage supply of the communication module off and then on again.

▶ [Initial switch-on](#) ([39](#))

The settings can also be made via codes:

- All DIP switches = "OFF" (Lenze setting):  
At switch-on, the configuration from codes [C13892](#), [C13893](#), and [C13894](#) becomes active.
- At least one DIP switch = "ON":  
At switch-on, the values are accepted from the switch positions.

The data word sum (PD + PCP) may maximally amount to 10 words.

## 6.2.1 Setting the number of process data words (PD)

- ▶ The number of process data words (PD) can be set via switches 1 ... 4 or code [C13893](#) (for this, see [Settings in the »Engineer«](#) (p. 38)).
- ▶ 0 ... 10 process data words can be used.
- ▶ The current setting is displayed in [C13860/2](#).



### Note!

The data word sum (PD + PCP) must amount to 1 ... 10 words. Impermissible settings are reported by the LED "BE" (red blinking).

▶ [LED status displays](#) (p. 54)

The communication module then continues to operate internally with the following values:

- PD = 2 (words)
- PCP = 1 (word)

DIP switch	Number of PD	Switch				Max. number of PCP
		1	2	3	4	
OFF ON	0	OFF	OFF	OFF	OFF	4
	1	OFF	OFF	OFF	ON	
	2	OFF	OFF	ON	OFF	
	3	OFF	OFF	ON	ON	
	4	OFF	ON	OFF	OFF	
	5	OFF	ON	OFF	ON	
	6	OFF	ON	ON	OFF	
	7	OFF	ON	ON	ON	2
	8	ON	OFF	OFF	OFF	
	9	ON	OFF	OFF	ON	1
	10	ON	OFF	ON	OFF	0

#### 6.2.2 Setting the number of parameter data words (PCP)

- ▶ The number of parameter data words (PCP) can be set via switches 5 and 6 or code [C13892](#) (for this, see [Settings in the »Engineer«](#) (p 38)).
- ▶ 0, 1, 2 or 4 parameter data words can be used.
- ▶ The current setting is displayed in [C13860/1](#).



#### Note!

The data word sum (PD + PCP) must amount to 1 ... 10 words. Impermissible settings are reported by the LED "BE" (red blinking).

▶ [LED status displays](#) (p 54)

The communication module then continues to operate internally with the following values:

- PD = 2 (words)
- PCP = 1 (word)

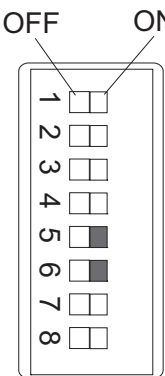
DIP switch	Number of PCP	Switch		Max. number of PD	ID code [hex]
		5	6		
	0	OFF	OFF	10	0x03
	1	OFF	ON	9	0xE3
	2	ON	OFF	8	0xE0
	4	ON	ON	6	0xE1



## 6.2.3 Setting the baud rate

- ▶ The baud rate can be set via switch 8 or code [C13894](#) (for this, see [Settings in the »Engineer«](#) (☰ 38)).
- ▶ The current setting of the baud rate is displayed in [C13863/](#).

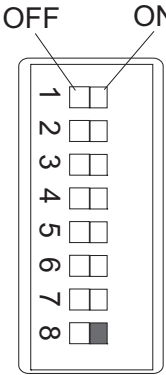
DIP switch	Switch 8	Baud rate	Max. cable length between adjacent nodes
	OFF	500 kbps	400 m
	ON	2 Mbps	150 m

#### 6.3 Settings in the »Engineer«

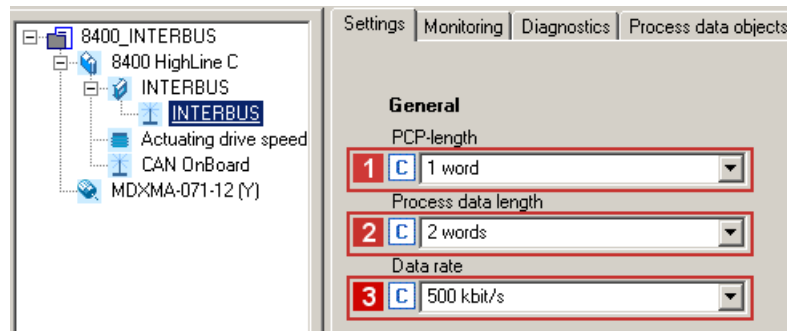

Under the **Settings** tab in the »Engineer« you can set the following parameters:

- ▶ **1** Number of parameter data words (PCP, [C13892](#))
- ▶ **2** Number of process data words (PD, [C13893](#))
- ▶ **3** Baud rate ([C13894](#))

## 6.4 Initial switch-on

**Documentation for the standard device**

Observe the safety instructions and information on residual hazards contained in this documentation.

**Note!****Establishing communication**

In order to establish communication via an externally supplied communication module, the standard device must be switched on as well.

After communication has been established, the power on/off state of the standard device is irrelevant.

**Activating altered settings**

To activate altered settings, ...

- use standard device code **C00002** to execute the device command "11: save all parameter sets", and ...
- then switch the voltage supply of the communication module off and on again.

**Protection against uncontrolled restart**

Following a fault (e.g. short-term mains failure), it is sometimes undesirable or even impermissible for the drive to restart.

In the Lenze setting for Inverter Drives 8400, restart protection is active.

The restart behaviour of the controller can be set using **C00142** ("autostart option"):

- **C00142 = 9** (Lenze setting)
  - The controller remains inhibited (even when the fault is no longer active).
  - Bit 0 (inhibit at power-on) and bit 3 (inhibit in the case of undervoltage) are set.
  - An explicit controller enable causes the drive to start up in a controlled manner: LOW-HIGH edge at digital input X4/RFR.
- **C00142 = 8** (enabled)
  - In order to directly enable the device at switch-on, bit 0 must be set to zero (FALSE).
  - An uncontrolled restart of the drive is possible.

### 7 Data transfer

The INTERBUS master and controller communicate with each other by exchanging data telegrams via INTERBUS. The user data area of the data telegram contains parameter data or process data. In the controller, the parameter data and process data are assigned to different communication channels.

#### Communication channels

- ▶ The process data channel transmits process data.
  - The process data are used to actuate the controller.
  - The host (master) can directly access the process data. In the PLC, for instance, the data are directly assigned to the I/O area.
  - Process data are not saved in the controller.
  - Process data are transmitted cyclically between the host and the controllers (permanent exchange of current input and output data).
  - Process data for instance are setpoints, actual values, control words, and status words.
  - In the case of Inverter Drives 8400 a maximum of 16 process data words (16 bits/word) can be exchanged for each direction.



#### Note!

Observe the direction of the flow of information!

- Process input data (Rx data):
  - Process data from the controller (slave) to the master
- Process output data (Tx data):
  - Process data from the master to the controller (slave)

- ▶ The parameter data channel transmits parameter data.
  - The parameter data channel provides access to all Lenze codes.
  - The transmission of parameter data usually is not time-critical.
  - Parameter data for instance are operating parameters, motor data, and diagnostics information.
  - The parameter changes must be stored via code **C00002** of the Inverter Drive 8400.
  - The parameter data channel assigns up to 4 words of the input and output data words in the master and is structured identically for both transmission directions.

## 8 Process data transfer

### 8.1 Access to process data / PDO mapping

The process data (MCI-PDOs) are transferred via the MCI interface.

- ▶ A maximum of 16 words is exchanged for each direction.
- ▶ The process data are accessed via the port blocks **LP\_MciIn** and **LP\_MciOut**. These port blocks are also referred to as process data channels.
- ▶ The port block **LP\_MciIn** maps the MCI-PDOs received.
- ▶ The port block **LP\_MciOut** maps the MCI-PDOs to be transmitted.
- ▶ The port/function block interconnection of the process data objects (PDO) is made via the Lenze »Engineer«.

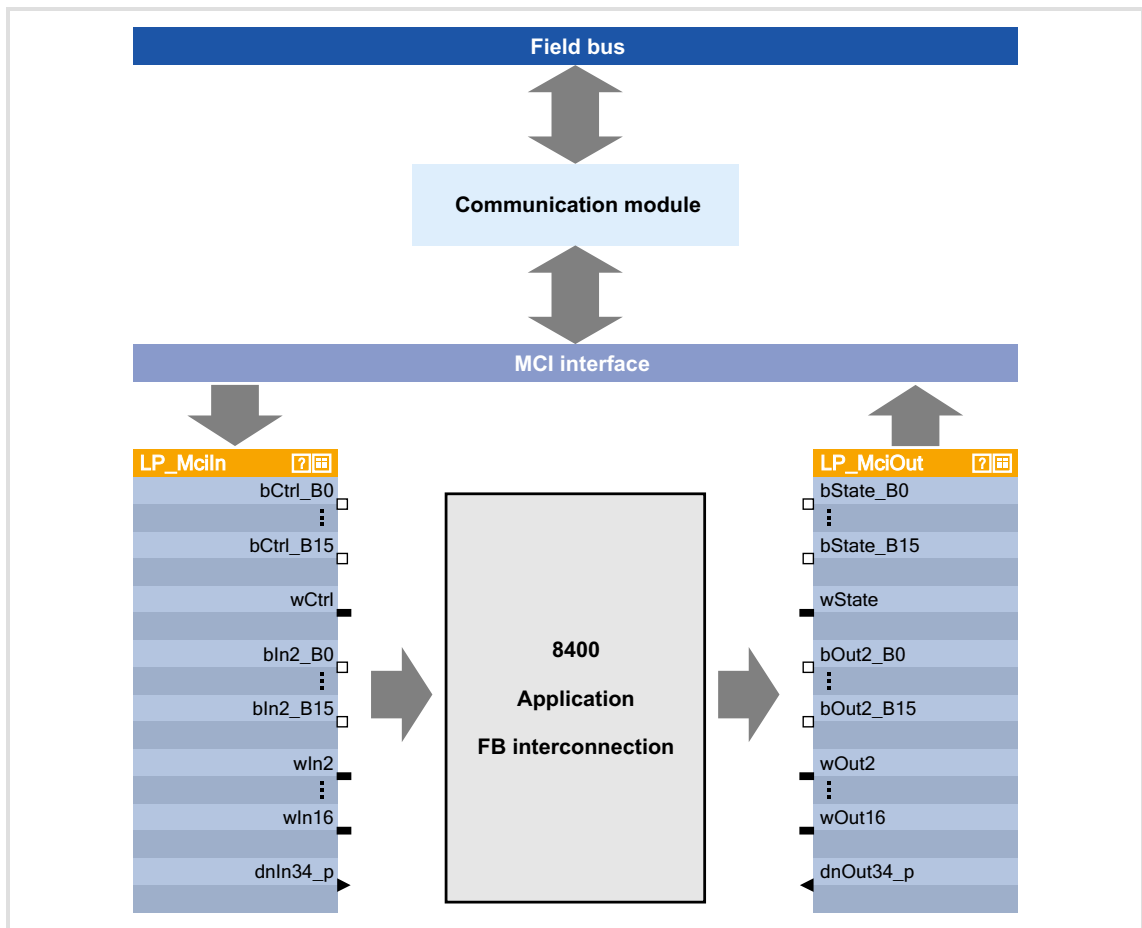

[8-1] External and internal data transfer between the bus system, controller, and application



#### Software manual / »Engineer« online help for the Inverter Drive 8400

Here you'll find detailed information on the port /function block interconnection in the »Engineer« and on port blocks.



#### Note!

The »Engineer« screenshots shown in the following are only examples for the setting sequence and the resulting displays.

The data in the display fields highlighted in white may differ from the ones of your project.

## 8.2 Preconfigured port interconnection of the process data objects (PDO)

The preconfigured port interconnection of the process data objects can be activated by setting standard device code **C00007 = "40: MCI"**.

The »FB Editor« serves to display the port blocks "LP\_MciIn" and "LP\_MciOut" with the preconfigured interconnections:

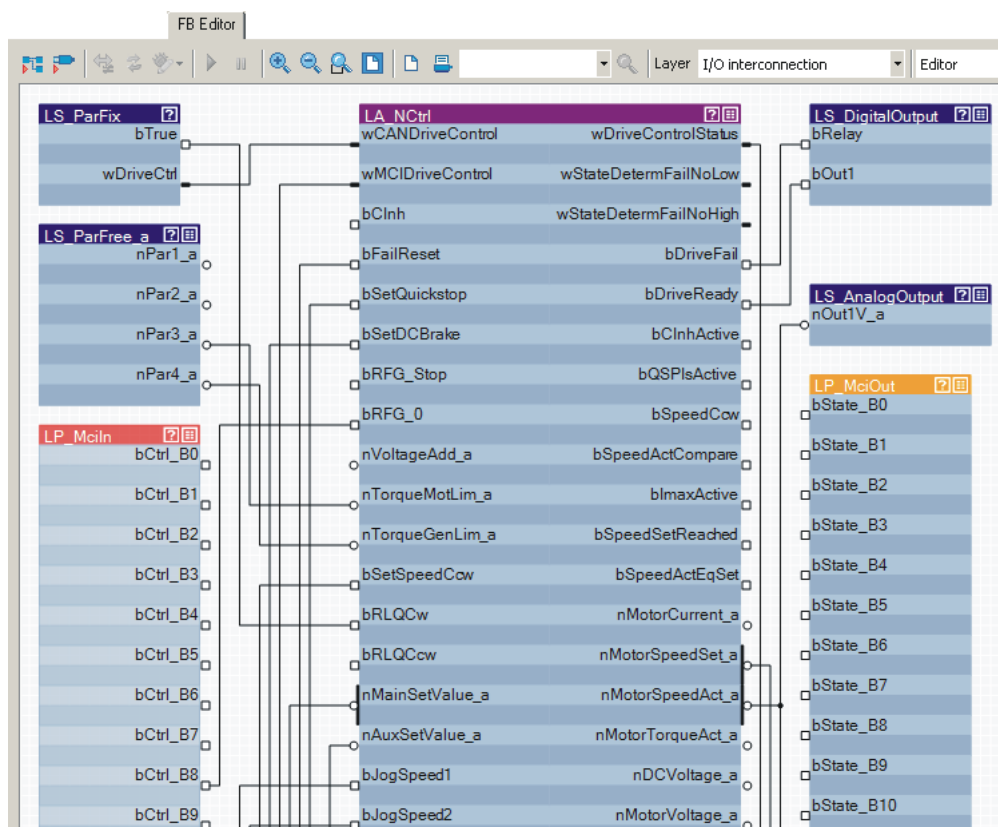

#### 8.3 Freely configuring the port interconnection of the process data objects (PDO)



**How to freely configurate the port interconnection in the »Engineer«:**

1. Go to the **Process data objects** tab to click the **Go to application** button.

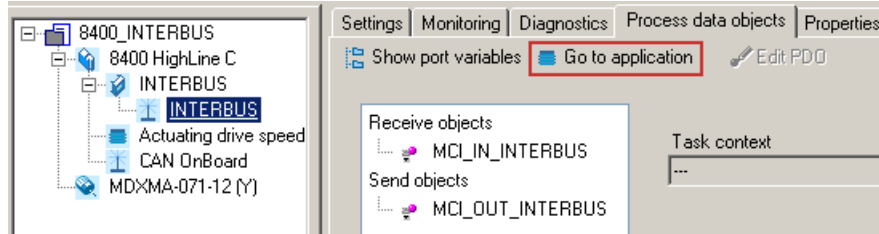

2. Select the "MCI\_IN" or "MCI\_OUT" port blocks in the **Ports** tab via mouse-click and activate them with the **Activate** button.

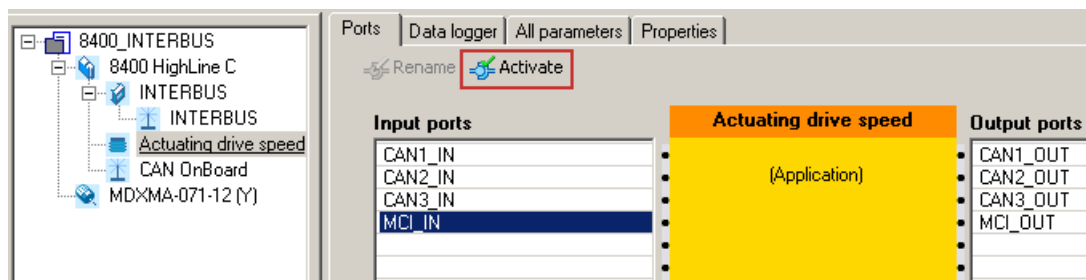

# E84AYCIB communication manual (INTERBUS)

Process data transfer

Freely configuring the port interconnection of the process data objects (PDO)

3. Click the **Change variable...** button.

The screenshot shows the configuration software interface with the following sections:

- Ports:** Includes tabs for 'Data logger', 'All parameters', and 'Properties'. Below are 'Rename' and 'Activate' buttons.
- Input ports:** A list containing CAN1\_IN, CAN2\_IN, CAN3\_IN, and MCI\_IN (highlighted).
- Actuating drive speed:** A yellow vertical bar with the text '(Application)' in the center.
- Output ports:** A list containing CAN1\_OUT, CAN2\_OUT, CAN3\_OUT, and MCI\_OUT.
- Mapping:** Shows 'INTERBUS/MCI\_IN\_INTERBUS : 0'.
- network default interconnection:** Shows '<not defined>'. A 'Network default change...' button is located to the right.
- Application variables:** A table with columns: Name, Signal, Type, Length, Index, and Online. A 'Change Variable...' button is highlighted with a red box to the right of the table.

Name	Signal	Type	Length	Index	Online
WORD_1	[not connected]	WORD	16	C876/1	offline
WORD_2	[not connected]	WORD	16	C876/2	offline
WORD_3	[not connected]	WORD	16	C876/3	offline
WORD_4	[not connected]	WORD	16	C876/4	offline
WORD_5	[not connected]	WORD	16	C876/5	offline
WORD_6	[not connected]	WORD	16	C876/6	offline
WORD_7	[not connected]	WORD	16	C876/7	offline
WORD_8	[not connected]	WORD	16	C876/8	offline
WORD_9	[not connected]	WORD	16	C876/9	offline



4. The  button serves to assign signals to the process data words in the *Assignment signal --> function block* dialog box.  
→ Select signals and then click the **OK** button.

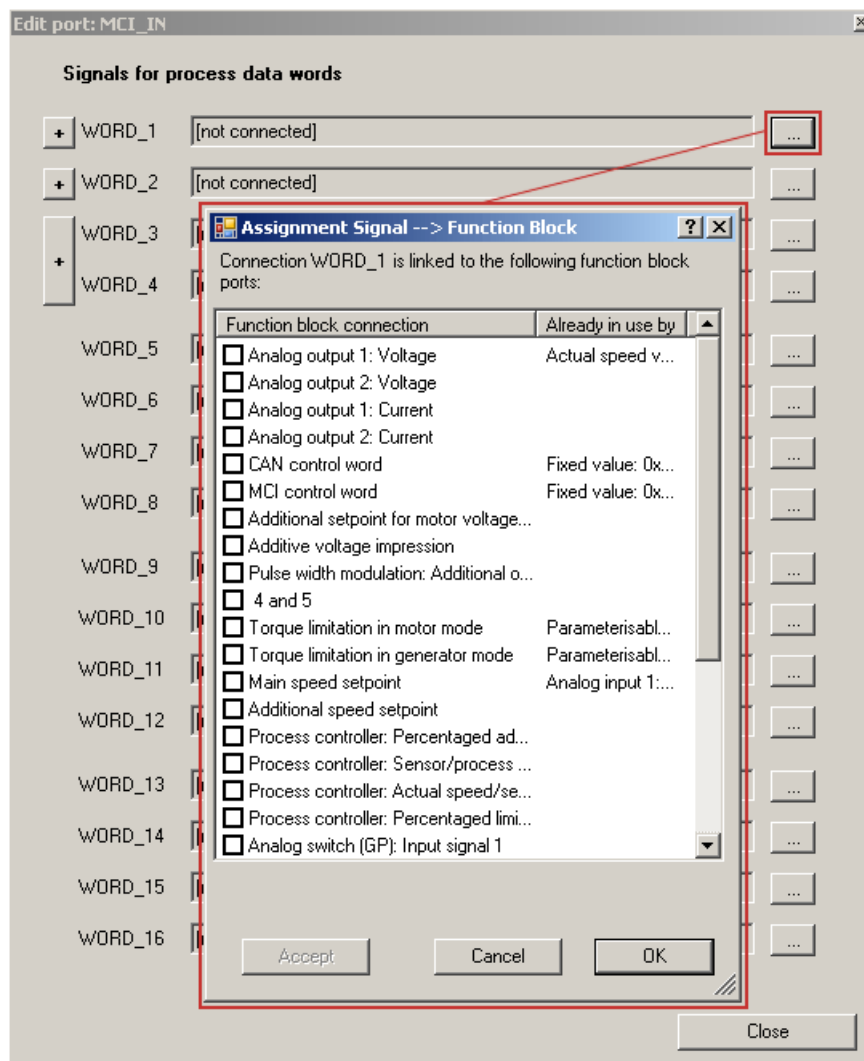

# E84AYCIB communication manual (INTERBUS)

Process data transfer

Freely configuring the port interconnection of the process data objects (PDO)

Moreover you can assign signals to the individual control and status bits at the WORD\_1... WORD\_4 process data words via the **+** and **...** buttons.  
→ Select the signals and then click **OK**.

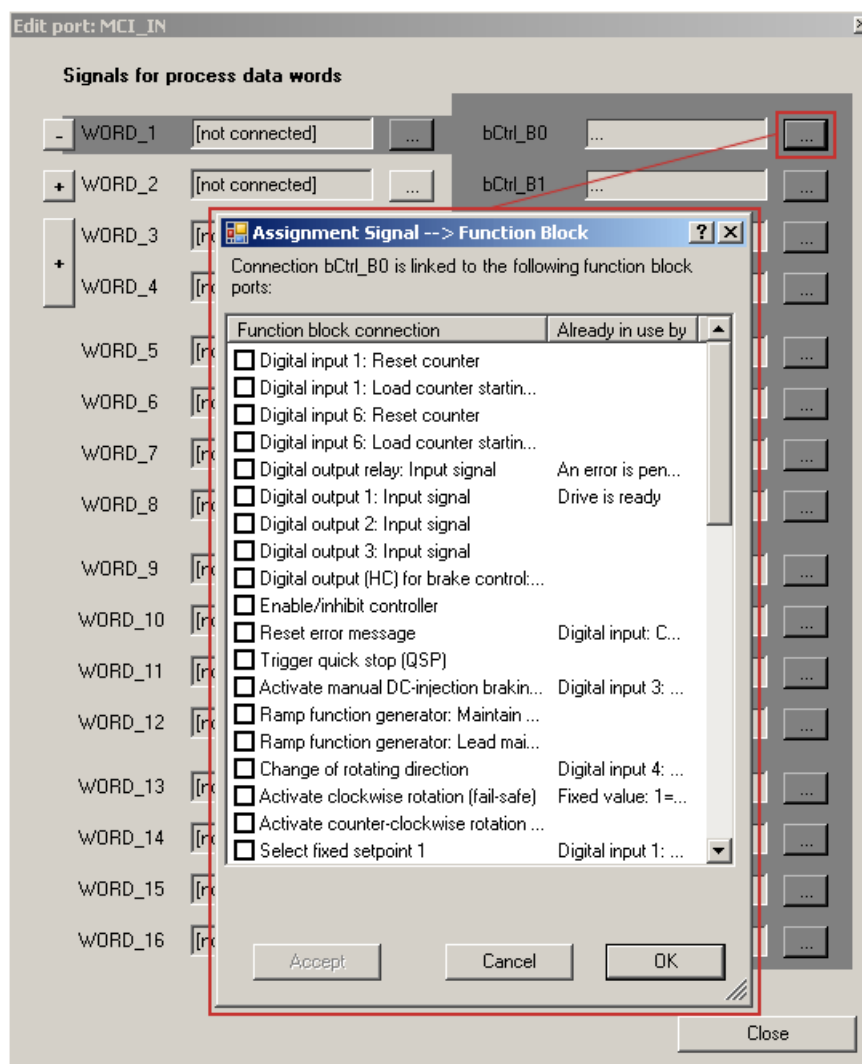



#### Tip!

When the port blocks "LP\_MciIn" and "LP\_MciOut" are activated (see 1.), they will be visible in the »FB Editor«. Here you can also assign signals to the process data words.

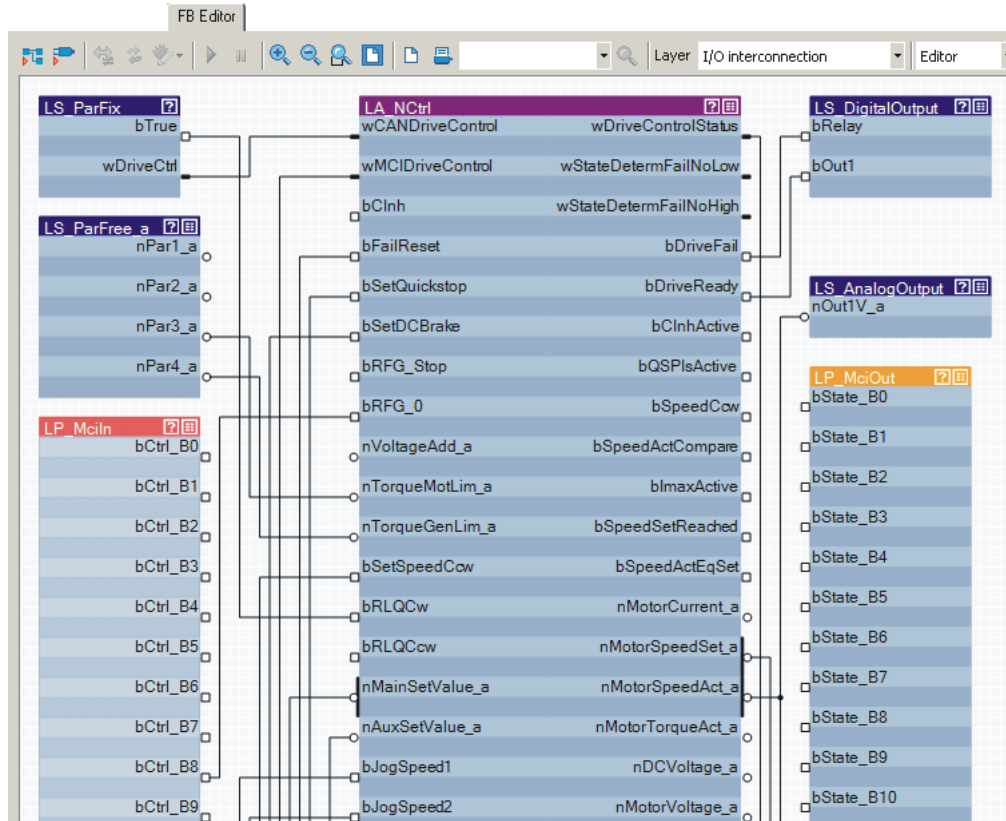

## 9 Parameter data transfer

### 9.1 Addressing of the parameter data

The parameter data are addressed via codes which are listed in the form of a code table in this communication manual and in the corresponding documentation for your controller.

▶ [Parameter reference](#) (63)

#### Addressing of the Lenze parameters

With the INTERBUS parameter data channel, the parameters of a device are not directly addressed via the Lenze codes but via an index and subindex.

The conversion is made via an offset (24575 or 0x5FFF):

- ▶ INTERBUS index (dec) = 24575 - Lenze code number (dec)
- ▶ INTERBUS index (hex) = 0x5FFF - Lenze code number (hex)

#### Example of C00105 (deceleration time quick stop (QSP))

- ▶ INTERBUS index (dec) = 24575 - 105 = 24470
- ▶ INTERBUS index (hex) = 0x5FFF - 0x69 = 0x5F96

### 9.2 Initialising PCP communication

Make entries into the CRL (communication relation list) so that communication between the INTERBUS master and the communication module can take place.

Make the following entries in the CRL of the INTERBUS master:

Field name	Entry
Communication reference	2
Connection type	Master slave acyclic
Connection attribute	Defined
Max-PDU Sending-High-Prio	0
Max-PDU Sending-Low-Prio	64
Max-PDU Receiving-High-Prio	0
Max-PDU Receiving-Low-Prio	64
Supported Services Request	0x803000
Supported Services Response	0x000000
Maximum SCC	1
Maximum RCC	1
Maximum SAC	1
Maximum RAC	1

### 9.3 Supported PMS services

Parameters are transferred via the PCP channel (PCP = Peripherals Communication Protocol). This is executed via PMS services.

In the following, only parameters and their contents are given that are returned by the Lenze controllers. All other transfer parameters of the given PMS services can be obtained from the corresponding descriptions of the INTERBUS master.

The following PMS services are supported by Lenze controllers:

- ▶ Initiate: Establish a connection from the INTERBUS master to the controller
- ▶ Abort: Abort connection
- ▶ Reject: Reject impermissible PMS service
- ▶ Read: Read parameters
- ▶ Write: Write parameters
- ▶ Get-OD: Read out the object directory
- ▶ Identify: Identification of the controller
- ▶ Status: Read the status of the controller

#### 9.3.1 Initiate

The "Initiate" PMS service establishes a logic connection between the INTERBUS master and the communication module.

The controller provides the following parameters:

Designation	Value	Description
Profile number	0	No profile is supported.
Password	0	The password function of INTERBUS is not supported.
Access groups	0	There are no access groups.
Access-Protection Supported	TRUE	Access protection is supported.
Version OD	0	Version of the object directory

#### 9.3.2 Abort

The "Abort" PMS service aborts a logic connection between the INTERBUS master and the communication module.

#### 9.3.3 Reject

The "Reject" PMS service rejects a non-supported PMS service.

## 9.3.4 Read / Write

The "Read" PMS service reads parameters from the controller. The controller outputs the requested parameter or an error message.

The "Write" PMS service writes to parameters of the controller. The controller outputs a positive feedback or an error message.

The following error messages can occur:

Error Class	Error Code	Additional Code [hex]	Description
6	3	0x00	No access authorisation
6	5	0x10	Impermissible job parameter
6	5	0x11	Invalid subindex
6	5	0x12	Data length too big
6	5	0x13	Data length too small
6	6	0x00	Object is not a parameter
6	7	0x00	Object does not exist
6	8	0x00	Data types do not comply with each other
8	0	0x00	Job cannot be executed
8	0	0x20	Job currently cannot be executed
8	0	0x21	Cannot be executed because of local control
8	0	0x22	Cannot be executed because of device state
8	0	0x30	Quit value range / parameter can only be changed when the controller is inhibited.
8	0	0x31	Value of the parameter is too high
8	0	0x32	Value of the parameter is too low
8	0	0x33	Subparameter outside the value range
8	0	0x34	Value of the subparameter is too high
8	0	0x35	Value of the subparameter is too low
8	0	0x36	Maximum value is lower than minimum value
8	0	0x41	Communication object cannot be displayed on process data
8	0	0x42	Length of the process data exceeded
8	0	0x43	General collision with other values

## 9.3.5 Get-OD

The "Get-OD" PMS service reads out the object description for every parameter and data type.

## 9.3.6 Identify

The "Identify" PMS service provides information on how to identify the controller.

The controller with the plugged-on communication module provides the following parameters for this:

Parameter	Type	Description
Device manufacturer	Visible string	Company name "Lenze"
Device type	Visible-string (15 characters)	Device name for the controller and the communication module
Device version	Visible-string (15 characters)	Firmware version of the controller and the communication module

### Example: Visible string "device type" (15 characters)

1	2	3	4	5	6	7	8	9	10	11	12	13	14	15
E	8	4		A	F	G	H	C		A	F	Y	I	B

Character	Description
1 ... 3	Product range of the controller and the communication module (E84 = 8400 series)
4	Blank
5 ... 6	A: Version of the controller F: Firmware of the controller
7 ... 9	G: Device / controller SC: StateLine C HC: HighLine C
10	Blank
11 ... 12	A: Version of the communication module F: Firmware of the communication module
13 ... 15	Y: Communication module IB: INTERBUS

### Structure of the visible string "device version" (15 characters)

1	2	3	4	5	6	7	8	9	10	11	12	13	14	15
0	4	.	0	0		0	1	.	0	0				

Character	Description
1 ... 5	Firmware version of the controller (from C00099/0, e.g. "04.00.xx.yy", without internal revision status ["xx"] and build status ["yy"])
6	Blank
7 ... 11	Firmware version of the communication module (from <a href="#">C13902</a> , e.g. "01.00.xx.yy", without internal revision status ["xx"] and build status ["yy"])
12 ... 15	Blank

## 9.3.7 Status

The "Status" PMS service provides status information about the controller.

The controller provides the following values:

Status	Value	Description
Logical status	0 = ready for communication	Information about the current operating mode of the controller with regard to communication
Physical status	<ul style="list-style-type: none"><li>• 0 = ready for operation (device state "OPERATION ENABLED")</li><li>• 1 = ready for operation to a limited extent (all other device states)</li></ul>	Information about the current operating status of the controller.
Local Detail	0	Is not supported.



## 10 Monitoring

### Communication fault

- ▶ If INTERBUS communication is interrupted, e.g. due to cable break or INTERBUS master failure, no process data are transmitted to the slave in the "IBS-ACTIVE" (57) status.
- ▶ After the time to be parameterised by the user in [C13881](#) has elapsed, the response parameterised in [C13880/1](#) is executed in the controller.

### Settings in the »Engineer«

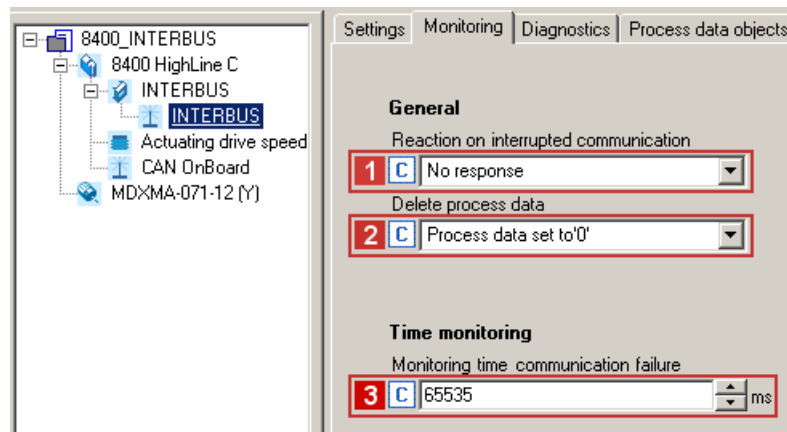

Under the **Settings** tab in the »Engineer« you can set the following parameters:

- ▶ **1** Reaction on interrupted INTERBUS communication ([C13880/1](#))
- ▶ **2** Delete process data ([C13885](#))
  - Setting of the process data which the controller is to process further for maintaining internal communication when the INTERBUS has failed.
- ▶ **3** Monitoring time for INTERBUS communication failure ([C13881](#))

## 11 Diagnostics

For fault diagnostics, the INTERBUS module is provided with the LEDs on the front. Furthermore code [C13861](#) can be used to query the current bus status (for this, see [Diagnostics with the »Engineer«](#) (57)).

### 11.1 LED status displays



#### Note!

In normal operation only the LEDs **MS** (55) and **BS** (56) should be lit constantly.

The following status displays are distinguished:



- ▶ [Module status displays](#) (55)
- ▶ [Fieldbus status displays](#) (56)

## 11.1.1 Module status displays

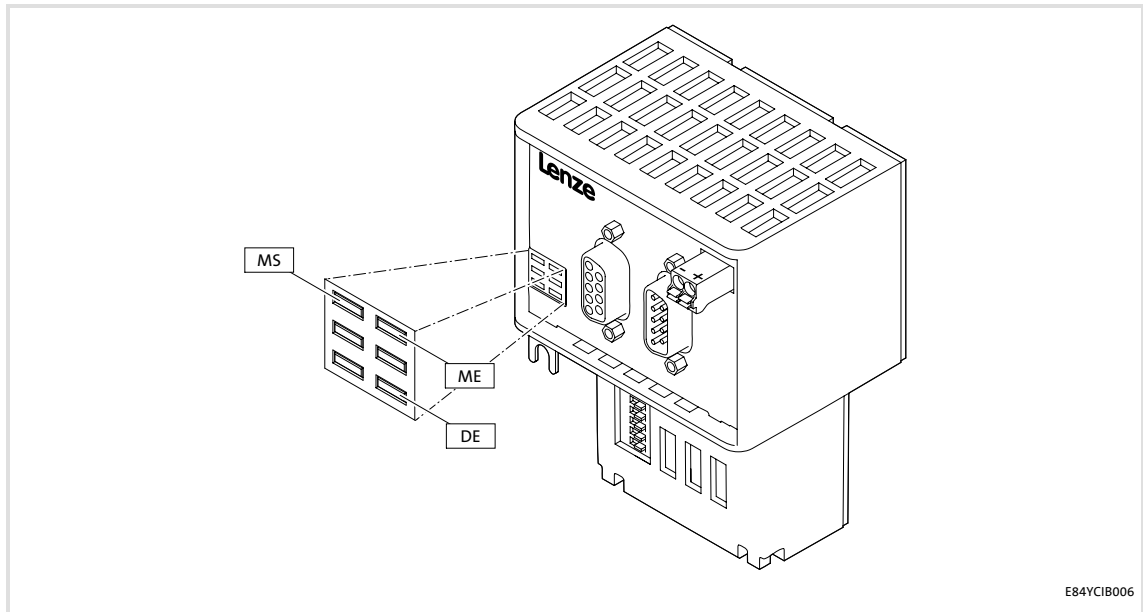
The LEDs **MS**, **ME** and **DE** display the module status.

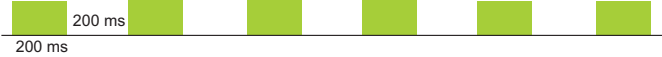
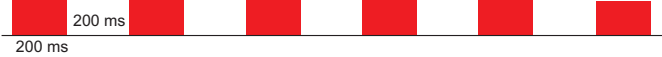

E84YCIB006



LED	Colour	Status	Description
MS	Green	On	 <p>The communication module is supplied with voltage and has established a connection to the standard device.</p>
		Blinking	 <p>The communication module is supplied with voltage, but has not established a connection to the standard device. (Standard device is switched off, initialising or not present.)</p>
ME	Red	Blinking	 <p>An error in the communication module has occurred.</p>
DE	Red	On	 <p>The communication module is not accepted by the standard device (see notes in the documentation for the standard device), or the standard device is not active.</p>

## 11.1.2 Fieldbus status displays

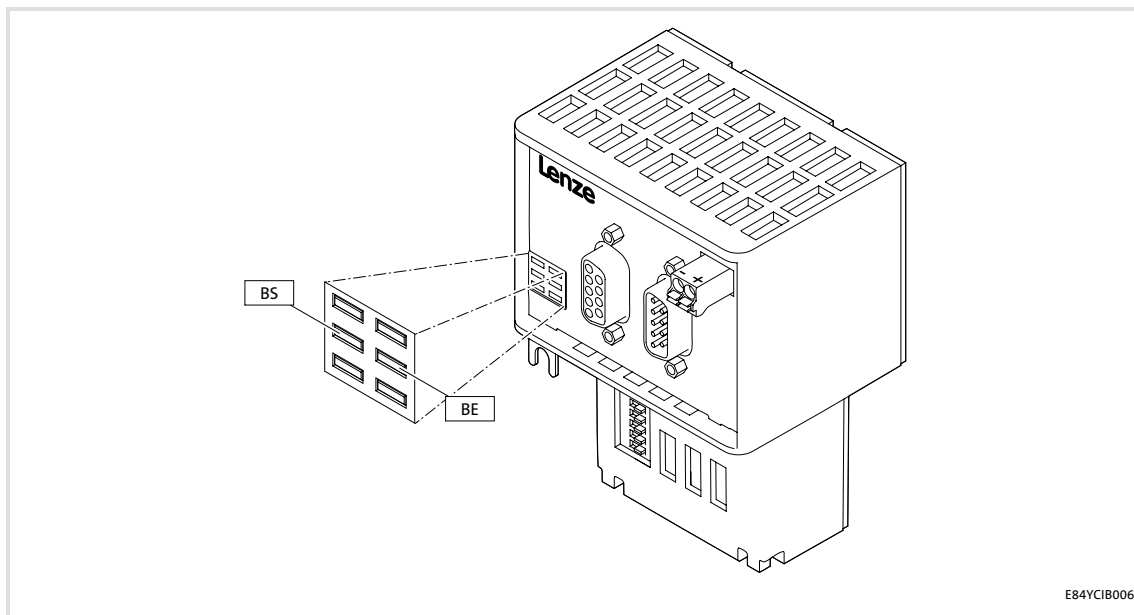
The LEDs **BS** and **BE** display the fieldbus status.



E84YCIB006

LED	Colour	Status	Description
BS	Green	Off	The communication module is not active on the fieldbus. Data cycles are not executed.
		Blinking	 <p>Communication has been established via the communication module. The INTERBUS is active. Data cycles are executed.</p>
BE	Red	On	 <p>INTERBUS communication is interrupted. Data cycles are not executed.</p>
		Blinking	 <p>Impermissible setting:</p> <ul style="list-style-type: none"> <li>• Data word sum (PD + PCP) &gt; 10</li> <li>• Data word sum (PD + PCP) = 0</li> </ul> <p>The communication module has been initialised and continues to operate internally with the following values:</p> <ul style="list-style-type: none"> <li>• PD = 2 (words)</li> <li>• PCP = 1 (word)</li> </ul>

## 11.2 Querying the current bus status

Code [C13861](#) displays the current bus status of the INTERBUS node:

Value of C13861 [hex]	Bus status	Description
0xyyy0	IBS-INIT	Initialisation
0xyyy1	IBS-ACTIVE	The bus is active. Data cycles are executed.
0xyyy2	IBS-READY	The bus is ready for operation. No data cycles are executed.

yyy = device-internal use

### Diagnostics with the »Engineer«

In the »Engineer« the **Diagnostics** tab serves to display various pieces of diagnostic INTERBUS information.

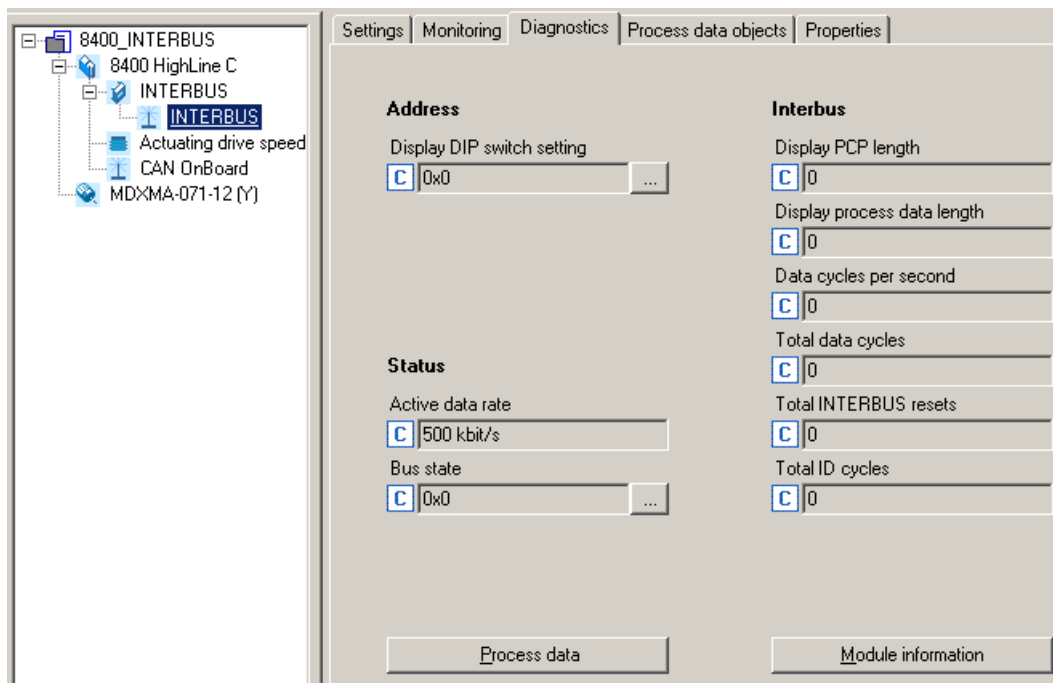

## 11.3 Diagnostic data

- ▶ Pending diagnostic data are signalised by the master via an alarm message to the slave.
- ▶ Errors and warnings in the standard device and the plugged-in module are transmitted to the master as extended diagnostic messages.
- ▶ The diagnostic data can be viewed via the hexadecimal representation of the Engineering tool.

Bytes	Meaning	Value [hex]
1 ... 6	Diagnostics block header	0x0010 001C 0100
7 ... 8	Alarm type	0x0001 (Diagnosis)
9 ... 12	API	0x0000 0000
13, 14	Slot number	0x0001 / 0x0002
15, 16	Subslot number	0x0001
17 ... 20	Module ID number	ID according to module
21 ... 24	Submodule number	ID according to module
25, 26	Alarm specifier	0xB000
27, 28	User structure identifier	0x0001
29 ... 32	Error code of the Inverter Drive 8400	

### Error code of the Inverter Drive 8400

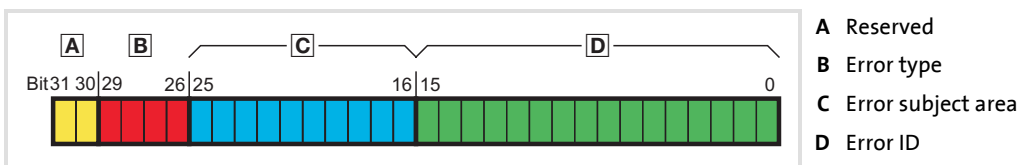

[11-1] Structure of the error number

- ▶ Bytes 29 ... 32 of the diagnostic message contain the error code of the Inverter Drive 8400.
- ▶ The logbook and standard device code **C00165** show the error number in the following syntax to improve the legibility:  
**[error type].[error subject area no.].[error ID]**



#### Software manual/»Engineer« online help for the Inverter Drive 8400

Here you'll find detailed information on the structure and the contents of the error codes.

## 12 Error messages

This chapter provides the error messages of the communication module as a supplement to the error list in the software manual and the »Engineer« online help for the Inverter Drive 8400.



### Software manual/»Engineer« online help for the Inverter Drive 8400

Here you'll find general information on diagnostics & fault analysis and error messages.

### 12.1 Short overview (A-Z) of the INTERBUS error messages

The following table contains all error messages of the communication module in alphabetical order with the preset error response and, if available, the parameter for setting the error response.



#### Tip!

When you click the cross-reference in the last column, you will get to the detailed description (causes and remedies) of the corresponding error message.

Error text	Error type	Subject area no.	Error no.	Adjustable in	Detailed information
Communication stack reset	Error	444	33062	-	<a href="#">0x01bc8126</a>
Data exchange stopped	No response	444	33073	<a href="#">C13880/1</a>	<a href="#">0x01bc8131</a>
Internal error	Error	444	24592	-	<a href="#">0x01bc6010</a>
Internal error	Error	444	24593	-	<a href="#">0x01bc6011</a>
Internal error	Error	444	24832	-	<a href="#">0x01bc6100</a>
Internal error	Error	444	24833	-	<a href="#">0x01bc6101</a>
Invalid configuration	Warning	444	33061	-	<a href="#">0x01bc8125</a>
Invalid initialisation	Warning	444	33063	-	<a href="#">0x01bc8127</a>
Invalid module configuration	Error	444	25648	-	<a href="#">0x01bc6430</a>
Invalid parameter set	Error	444	25631	-	<a href="#">0x01bc641f</a>
Lenze setting loaded	Error	444	25632	-	<a href="#">0x01bc6420</a>
Lost connection to 8400 base device	Error	444	12544	-	<a href="#">0x01bc3100</a>
Memory not accessible	Error	444	21809	-	<a href="#">0x01bc5531</a>
Memory read error	Error	444	21810	-	<a href="#">0x01bc5532</a>
Memory write error	Error	444	21811	-	<a href="#">0x01bc5533</a>

## 12.2 Possible causes and remedies

This chapter includes a list of all error messages of the communication module in numerically ascending order of the error number. Possible causes and remedies as well as responses to error messages are described in detail.



### Tip!

A list of all error messages of the communication module in alphabetical order is provided in the previous chapter "[Short overview \(A-Z\) of the INTERBUS error messages](#)" (□ 59).

### Lost connection to 8400 base device [0x01bc3100]

<b>Response</b> (Lenze setting in bold)		<b>Setting:</b> not possible
<input type="checkbox"/> None <input type="checkbox"/> System fault <input checked="" type="checkbox"/> <b>Fault</b> <input type="checkbox"/> Trouble <input type="checkbox"/> Quick stop by trouble <input type="checkbox"/> Warning locked <input type="checkbox"/> Warning <input type="checkbox"/> Information		
<b>Cause</b>	<b>Remedy</b>	
Network cable (plug) is defective. Network cable at INTERBUS terminal X206 (IN) or X207 (OUT) is disconnected.	Check network cable (plug) and replace it, if required. Plug in network cable at INTERBUS terminal X206 (IN) or X207 (OUT).	

### Memory not accessible [0x01bc5531]

<b>Response</b> (Lenze setting in bold)		<b>Setting:</b> not possible
<input type="checkbox"/> None <input type="checkbox"/> System fault <input checked="" type="checkbox"/> <b>Fault</b> <input type="checkbox"/> Trouble <input type="checkbox"/> Quick stop by trouble <input type="checkbox"/> Warning locked <input type="checkbox"/> Warning <input type="checkbox"/> Information		
<b>Cause</b>	<b>Remedy</b>	
Memory could not be accessed.	Send module with error description to Lenze.	

### Memory read error [0x01bc5532]

<b>Response</b> (Lenze setting in bold)		<b>Setting:</b> not possible
<input type="checkbox"/> None <input type="checkbox"/> System fault <input checked="" type="checkbox"/> <b>Fault</b> <input type="checkbox"/> Trouble <input type="checkbox"/> Quick stop by trouble <input type="checkbox"/> Warning locked <input type="checkbox"/> Warning <input type="checkbox"/> Information		
<b>Cause</b>	<b>Remedy</b>	
Parameter in the memory module could not be read.	Repeat download of the application (including module).	

### Memory write error [0x01bc5533]

<b>Response</b> (Lenze setting in bold)		<b>Setting:</b> not possible
<input type="checkbox"/> None <input type="checkbox"/> System fault <input checked="" type="checkbox"/> <b>Fault</b> <input type="checkbox"/> Trouble <input type="checkbox"/> Quick stop by trouble <input type="checkbox"/> Warning locked <input type="checkbox"/> Warning <input type="checkbox"/> Information		
<b>Cause</b>	<b>Remedy</b>	
Parameter in the memory module could not be written.	Repeat download of the application (including module).	



## Internal error [0x01bc6010]

<b>Response</b> (Lenze setting in bold)		<b>Setting:</b> not possible	
<input type="checkbox"/> None <input type="checkbox"/> System fault <input checked="" type="checkbox"/> <b>Fault</b> <input type="checkbox"/> Trouble <input type="checkbox"/> Quick stop by trouble <input type="checkbox"/> Warning locked <input type="checkbox"/> Warning <input type="checkbox"/> Information			
<b>Cause</b>		<b>Remedy</b>	
Communication module is defective.		Send communication module with error description to Lenze.	

## Internal error [0x01bc6011]

<b>Response</b> (Lenze setting in bold)		<b>Setting:</b> not possible	
<input type="checkbox"/> None <input type="checkbox"/> System fault <input checked="" type="checkbox"/> <b>Fault</b> <input type="checkbox"/> Trouble <input type="checkbox"/> Quick stop by trouble <input type="checkbox"/> Warning locked <input type="checkbox"/> Warning <input type="checkbox"/> Information			
<b>Cause</b>		<b>Remedy</b>	
Communication module is defective.		Send communication module with error description to Lenze.	

## Internal error [0x01bc6100]

<b>Response</b> (Lenze setting in bold)		<b>Setting:</b> not possible	
<input type="checkbox"/> None <input type="checkbox"/> System fault <input checked="" type="checkbox"/> <b>Fault</b> <input type="checkbox"/> Trouble <input type="checkbox"/> Quick stop by trouble <input type="checkbox"/> Warning locked <input type="checkbox"/> Warning <input type="checkbox"/> Information			
<b>Cause</b>		<b>Remedy</b>	
Communication module is defective.		Send communication module with error description to Lenze.	

## Internal error [0x01bc6101]

<b>Response</b> (Lenze setting in bold)		<b>Setting:</b> not possible	
<input type="checkbox"/> None <input type="checkbox"/> System fault <input checked="" type="checkbox"/> <b>Fault</b> <input type="checkbox"/> Trouble <input type="checkbox"/> Quick stop by trouble <input type="checkbox"/> Warning locked <input type="checkbox"/> Warning <input type="checkbox"/> Information			
<b>Cause</b>		<b>Remedy</b>	
Communication module is defective.		Send communication module with error description to Lenze.	

## Invalid parameter set [0x01bc641f]

<b>Response</b> (Lenze setting in bold)		<b>Setting:</b> not possible	
<input type="checkbox"/> None <input type="checkbox"/> System fault <input checked="" type="checkbox"/> <b>Fault</b> <input type="checkbox"/> Trouble <input type="checkbox"/> Quick stop by trouble <input type="checkbox"/> Warning locked <input type="checkbox"/> Warning <input type="checkbox"/> Information			
<b>Cause</b>		<b>Remedy</b>	
Loading of an active parameter set was not possible.		Repeat download of the application (including module).	

## Lenze setting loaded [0x01bc6420]

<b>Response</b> (Lenze setting in bold)		<b>Setting:</b> not possible	
<input type="checkbox"/> None <input type="checkbox"/> System fault <input checked="" type="checkbox"/> <b>Fault</b> <input type="checkbox"/> Trouble <input type="checkbox"/> Quick stop by trouble <input type="checkbox"/> Warning locked <input type="checkbox"/> Warning <input type="checkbox"/> Information			
<b>Cause</b>		<b>Remedy</b>	
Access via standard device to the parameter set in the memory module failed.		Repeat download of the application (including module).	

# E84AYCIB communication manual (INTERBUS)

## Error messages

### Possible causes and remedies

#### Invalid module configuration [0x01bc6430]

<b>Response</b> (Lenze setting in bold)		<b>Setting:</b> not possible
<input type="checkbox"/> None <input type="checkbox"/> System fault <input checked="" type="checkbox"/> <b>Fault</b> <input type="checkbox"/> Trouble <input type="checkbox"/> Quick stop by trouble <input type="checkbox"/> Warning locked <input type="checkbox"/> Warning <input type="checkbox"/> Information		
<b>Cause</b>	<b>Remedy</b>	
Module configuration is faulty.	Check and correct module configuration.	

#### Invalid configuration [0x01bc8125]

<b>Response</b> (Lenze setting in bold)		<b>Setting:</b> not possible
<input type="checkbox"/> None <input type="checkbox"/> System fault <input type="checkbox"/> Fault <input type="checkbox"/> Trouble <input type="checkbox"/> Quick stop by trouble <input type="checkbox"/> Warning locked <input checked="" type="checkbox"/> <b>Warning</b> <input type="checkbox"/> Information		
<b>Cause</b>	<b>Remedy</b>	
The active configuration is invalid: <ul style="list-style-type: none"><li>• Data word sum (PD + PCP) &gt; 10 words</li><li>• Data word sum (PD + PCP) = 0</li></ul>	Adapt the number of PD and PCP: <ul style="list-style-type: none"><li>• Data word sum (PD + PCP) = 1 ... 10 words</li></ul>	

#### Communication stack reset [0x01bc8126]

<b>Response</b> (Lenze setting in bold)		<b>Setting:</b> not possible
<input type="checkbox"/> None <input type="checkbox"/> System fault <input checked="" type="checkbox"/> <b>Fault</b> <input type="checkbox"/> Trouble <input type="checkbox"/> Quick stop by trouble <input type="checkbox"/> Warning locked <input type="checkbox"/> Warning <input type="checkbox"/> Information		
<b>Cause</b>	<b>Remedy</b>	
Error during processing the INTERBUS services	Execute reinitialisation by the master.	

#### Invalid initialisation [0x01bc8127]

<b>Response</b> (Lenze setting in bold)		<b>Setting:</b> not possible
<input type="checkbox"/> None <input type="checkbox"/> System fault <input type="checkbox"/> Fault <input type="checkbox"/> Trouble <input type="checkbox"/> Quick stop by trouble <input type="checkbox"/> Warning locked <input checked="" type="checkbox"/> <b>Warning</b> <input type="checkbox"/> Information		
<b>Cause</b>	<b>Remedy</b>	
The INTERBUS initialisation has failed.	Execute reinitialisation by the master.	

#### Data exchange stopped [0x01bc8131]

<b>Response</b> (Lenze setting in bold)		<b>Setting:</b> <a href="#">C13880/1</a>
<input checked="" type="checkbox"/> <b>None</b> <input type="checkbox"/> System fault <input checked="" type="checkbox"/> <b>Fault</b> <input type="checkbox"/> Trouble <input checked="" type="checkbox"/> Quick stop by trouble <input checked="" type="checkbox"/> Warning locked <input type="checkbox"/> Warning <input checked="" type="checkbox"/> Information		
<b>Cause</b>	<b>Remedy</b>	
The data exchange at the INTERBUS has been terminated.	<ul style="list-style-type: none"><li>• Check cables and connections.</li><li>• Execute reinitialisation by the master.</li></ul>	

## 13 Parameter reference

This chapter supplements the parameter list and the table of attributes in the software manual and the »Engineer« online help for the Inverter Drive 8400 by parameters of the E84AYCIB communication module (INTERBUS).



### Software manual/»Engineer« online help for the Inverter Drive 8400

Here you'll find general information about parameters.

### 13.1 Parameters of the communication module

This chapter lists the parameters of the E84AYCIB communication module (INTERBUS) in numerically ascending order.

#### C13850

Parameter   Name:	Data type: UNSIGNED_16 Index: 10725 <sub>d</sub> = 29E5 <sub>h</sub>
<b>C13850   All words to master</b>	
Display of the process data words which are transmitted from the communication module to the master.	
<ul style="list-style-type: none"> <li>Subcodes 1 ... 16 display all process data words to the master. Only those which are configured are valid. Maximally the first 10 words are relevant to the E84AYCIB INTERBUS module.</li> </ul>	
<b>Display area (min. value   unit   max. value)</b>	
0	65535
<b>Subcodes</b>	<b>Information</b>
C13850/1	
...	
C13850/16	
<input checked="" type="checkbox"/> Read access <input type="checkbox"/> Write access <input type="checkbox"/> CINH <input type="checkbox"/> PLC-STOP <input type="checkbox"/> No transfer <input type="checkbox"/> PDO_MAP_RX <input type="checkbox"/> PDO_MAP_TX <input type="checkbox"/> COM <input type="checkbox"/> MOT	

#### C13851

Parameter   Name:	Data type: UNSIGNED_16 Index: 10724 <sub>d</sub> = 29E4 <sub>h</sub>
<b>C13851   All words from master</b>	
Display of the process data words which are transmitted from the master to the communication module.	
<ul style="list-style-type: none"> <li>Subcodes 1 ... 16 display all process data words from the master. Only those which are configured are valid. Maximally the first 10 words are relevant to the E84AYCIB INTERBUS module.</li> </ul>	
<b>Display area (min. value   unit   max. value)</b>	
0	65535
<b>Subcodes</b>	<b>Information</b>
C13851/1	
...	
C13851/16	
<input checked="" type="checkbox"/> Read access <input type="checkbox"/> Write access <input type="checkbox"/> CINH <input type="checkbox"/> PLC-STOP <input type="checkbox"/> No transfer <input type="checkbox"/> PDO_MAP_RX <input type="checkbox"/> PDO_MAP_TX <input type="checkbox"/> COM <input type="checkbox"/> MOT	

# E84AYCIB communication manual (INTERBUS)

## Parameter reference

### Parameters of the communication module

#### C13852

Parameter   Name:		Data type: UNSIGNED_16
<b>C13852   All words to standard device</b>		Index: 10723 <sub>d</sub> = 29E3 <sub>h</sub>
Display of the process data words which are transmitted from the communication module to the standard device.		
• Subcodes 1 ... 16 display all process data words to the standard device. Maximally the first 10 words are relevant to the E84AYCIB INTERBUS module.		
<b>Display area (min. value   unit   max. value)</b>		
0		65535
<b>Subcodes</b>		<b>Information</b>
C13852/1		
...		
C13852/16		
<input checked="" type="checkbox"/> Read access <input type="checkbox"/> Write access <input type="checkbox"/> CINH <input type="checkbox"/> PLC-STOP <input type="checkbox"/> No transfer <input type="checkbox"/> PDO_MAP_RX <input type="checkbox"/> PDO_MAP_TX <input type="checkbox"/> COM <input type="checkbox"/> MOT		

#### C13853

Parameter   Name:		Data type: UNSIGNED_16
<b>C13853   All words from standard device</b>		Index: 10722 <sub>d</sub> = 29E2 <sub>h</sub>
Display of the process data words which are transmitted from the standard device to the communication module.		
• Subcodes 1 ... 16 display all process data words from the standard device. Maximally the first 10 words are relevant to the E84AYCIB INTERBUS module.		
<b>Display area (min. value   unit   max. value)</b>		
0		65535
<b>Subcodes</b>		<b>Information</b>
C13853/1		
...		
C13853/16		
<input checked="" type="checkbox"/> Read access <input type="checkbox"/> Write access <input type="checkbox"/> CINH <input type="checkbox"/> PLC-STOP <input type="checkbox"/> No transfer <input type="checkbox"/> PDO_MAP_RX <input type="checkbox"/> PDO_MAP_TX <input type="checkbox"/> COM <input type="checkbox"/> MOT		

#### C13860

Parameter   Name:		Data type: UNSIGNED_8
<b>C13860   Active settings</b>		Index: 10715 <sub>d</sub> = 29DB <sub>h</sub>
Display of the set number for		
• Parameter data words (PCP)		
• Process data words (PD) to be used		
(16 bits/word)		
<b>Display area (min. value   unit   max. value)</b>		
0		255
<b>Subcodes</b>		<b>Information</b>
C13860/1		Display of PCP data length
C13860/2		Display of process data length
<input checked="" type="checkbox"/> Read access <input type="checkbox"/> Write access <input type="checkbox"/> CINH <input type="checkbox"/> PLC-STOP <input type="checkbox"/> No transfer <input type="checkbox"/> PDO_MAP_RX <input type="checkbox"/> PDO_MAP_TX <input type="checkbox"/> COM <input type="checkbox"/> MOT		

#### C13861

Parameter   Name: <b>C13861   Bus status</b>	Data type: BITFIELD_16 Index: 10714 <sub>d</sub> = 29DA <sub>h</sub>
Display of the current bus status <a href="#">▶ Querying the current bus status (□ 57)</a>	
Meaning of the resulting hexadecimal values:	
<ul style="list-style-type: none"> <li>• 0xyyy0 = IBS-INIT</li> <li>• 0xyyy1 = IBS-ACTIVE</li> <li>• 0xyyy2 = IBS-READY</li> </ul>	
Value is bit coded:	Information
Bit 0 Bit 0	
... ..	
Bit 15 Bit 15	
<input checked="" type="checkbox"/> Read access <input type="checkbox"/> Write access <input type="checkbox"/> CINH <input type="checkbox"/> PLC-STOP <input type="checkbox"/> No transfer <input type="checkbox"/> PDO_MAP_RX <input type="checkbox"/> PDO_MAP_TX <input type="checkbox"/> COM <input type="checkbox"/> MOT	

#### C13862

Parameter   Name: <b>C13862   Counter</b>	Data type: UNSIGNED_16 Index: 10713 <sub>d</sub> = 29D9 <sub>h</sub>
Counter for cycles and INTERBUS resets	
Display area (min. value   unit   max. value)	
0     65535	
Subcodes	Information
C13862/1	Data cycles per second
C13862/2	Total data cycles
C13862/3	Number of INTERBUS resets
C13862/4	Number of ID cycles
<input checked="" type="checkbox"/> Read access <input type="checkbox"/> Write access <input type="checkbox"/> CINH <input type="checkbox"/> PLC-STOP <input type="checkbox"/> No transfer <input type="checkbox"/> PDO_MAP_RX <input type="checkbox"/> PDO_MAP_TX <input type="checkbox"/> COM <input type="checkbox"/> MOT	

#### C13863

Parameter   Name: <b>C13863   Active baud rate</b>	Data type: UNSIGNED_8 Index: 10712 <sub>d</sub> = 29D8 <sub>h</sub>
Display of the set baud rate	
Selection list (read only)	
0 500 kbps	
1 2.00 Mbps	
<input checked="" type="checkbox"/> Read access <input type="checkbox"/> Write access <input type="checkbox"/> CINH <input type="checkbox"/> PLC-STOP <input type="checkbox"/> No transfer <input type="checkbox"/> PDO_MAP_RX <input type="checkbox"/> PDO_MAP_TX <input type="checkbox"/> COM <input type="checkbox"/> MOT	

# E84AYCIB communication manual (INTERBUS)

## Parameter reference

### Parameters of the communication module

#### C13880

Parameter   Name: <b>C13880   Reaction on communication failure</b>		Data type: UNSIGNED_8 Index: 10695 <sub>d</sub> = 29C7 <sub>h</sub>
Monitoring response in case of a communication fault A change in the monitoring response becomes effective immediately. ▶ <a href="#">Communication fault (53)</a>		
Selection list		
0	No response	
1	Error	
3	Quick stop by trouble	
4	Warning locked	
6	Information	
Subcodes	Lenze setting	Information
C13880/1	0: No response	Response to interrupted INTERBUS communication
<input checked="" type="checkbox"/> Read access <input checked="" type="checkbox"/> Write access <input type="checkbox"/> CINH <input type="checkbox"/> PLC-STOP <input type="checkbox"/> No transfer <input type="checkbox"/> PDO_MAP_RX <input type="checkbox"/> PDO_MAP_TX <input type="checkbox"/> COM <input type="checkbox"/> MOT		

#### C13881

Parameter   Name: <b>C13881   Monitoring time for Interbus communication failure</b>		Data type: UNSIGNED_16 Index: 10694 <sub>d</sub> = 29C6 <sub>h</sub>
If the "IBS-ACTIVE" status (INTERBUS is active and data are cyclically exchanged) is quit, the response parameterised in <a href="#">C13880/1</a> is executed after the monitoring time set for the data exchange has elapsed.		
<ul style="list-style-type: none"> <li>The value "65535" in this code deactivates monitoring.</li> <li>A change in monitoring is effective immediately.</li> </ul> ▶ <a href="#">Communication fault (53)</a>		
Setting range (min. value   unit   max. value)		Lenze setting
0	ms	65535
		<b>65535 ms</b>
<input checked="" type="checkbox"/> Read access <input checked="" type="checkbox"/> Write access <input type="checkbox"/> CINH <input type="checkbox"/> PLC-STOP <input type="checkbox"/> No transfer <input type="checkbox"/> PDO_MAP_RX <input type="checkbox"/> PDO_MAP_TX <input type="checkbox"/> COM <input type="checkbox"/> MOT		

#### C13885

Parameter   Name: <b>C13885   Delete process data</b>		Data type: UNSIGNED_8 Index: 10690 <sub>d</sub> = 29C2 <sub>h</sub>
Setting of the process data which the controller is to process further for maintaining internal communication when the INTERBUS has failed.		
Selection list (Lenze setting printed in bold)		
0	Use of the last master process data	
1	<b>Process data are set to the value '0'</b>	
<input checked="" type="checkbox"/> Read access <input checked="" type="checkbox"/> Write access <input type="checkbox"/> CINH <input type="checkbox"/> PLC-STOP <input type="checkbox"/> No transfer <input type="checkbox"/> PDO_MAP_RX <input type="checkbox"/> PDO_MAP_TX <input type="checkbox"/> COM <input type="checkbox"/> MOT		

## C13892

Parameter | Name: **C13892 | PCP - length** Data type: UNSIGNED\_8  
Index: 10683<sub>d</sub> = 29BB<sub>h</sub>

Setting of the number of the parameter data words to be used (PCP)

The setting is activated ...

- if all DIP switches (S205) are in the "OFF" position;
- after executing the "11: Save start parameters" device command via standard device code C00002 and performing another mains switching of the communication module/drive afterwards.

▶ [Setting the number of parameter data words \(PCP\)](#) (📖 36)

Selection list (Lenze setting printed in bold)	
0	No PCB data
<b>1</b>	<b>1 word</b>
2	2 words
4	4 words

Read access  Write access  CINH  PLC-STOP  No transfer  PDO\_MAP\_RX  PDO\_MAP\_TX  COM  MOT

## C13893

Parameter | Name: **C13893 | Process data length** Data type: UNSIGNED\_8  
Index: 10682<sub>d</sub> = 29BA<sub>h</sub>

Setting of the number of the process data words to be used (PD)

The setting is activated ...

- if all DIP switches (S205) are in the "OFF" position;
- after executing the "11: Save start parameters" device command via standard device code C00002 and performing another mains switching of the communication module/drive afterwards.

▶ [Setting the number of process data words \(PD\)](#) (📖 35)

Selection list (Lenze setting printed in bold)	
0	No process data
1	1 word
<b>2</b>	<b>2 words</b>
3	3 words
4	4 words
5	5 words
6	6 words
7	7 words
8	8 words
9	9 words
10	10 words

Read access  Write access  CINH  PLC-STOP  No transfer  PDO\_MAP\_RX  PDO\_MAP\_TX  COM  MOT

# E84AYCIB communication manual (INTERBUS)

## Parameter reference

### Parameters of the communication module

#### C13894

Parameter | Name: **C13894 | Baud rate** Data type: UNSIGNED\_8  
Index: 10681<sub>d</sub> = 29B9<sub>h</sub>

Setting of the baud rate

The setting is activated ...

- if all DIP switches (S205) are in the "OFF" position;
- after executing the "11: Save start parameters" device command via standard device code C0002 and performing another mains switching of the communication module/drive afterwards.

▶ [Setting the baud rate](#) (📖 37)

Selection list (Lenze setting printed in bold)

0	<b>500 kbps</b>
1	2.00 Mbps

Read access  Write access  CINH  PLC-STOP  No transfer  PDO\_MAP\_RX  PDO\_MAP\_TX  COM  MOT

#### C13900

Parameter | Name: **C13900 | Firmware product type** Data type: VISIBLE\_STRING  
Index: 10675<sub>d</sub> = 29B3<sub>h</sub>

Display of the product type (string with a length of 8 bytes)

The following identification code is output: "E94AFYIB".

Read access  Write access  CINH  PLC-STOP  No transfer  PDO\_MAP\_RX  PDO\_MAP\_TX  COM  MOT

#### C13901

Parameter | Name: **C13901 | Firmware compilation date** Data type: VISIBLE\_STRING  
Index: 10674<sub>d</sub> = 29B2<sub>h</sub>

Display of the compilation date of the firmware (string with a length of 20 bytes)

The date ("MMM TT JJJ") and time ("hh:mm:ss") are output, e.g. "Mar 21 2005 12:31:21".

Read access  Write access  CINH  PLC-STOP  No transfer  PDO\_MAP\_RX  PDO\_MAP\_TX  COM  MOT

#### C13902

Parameter | Name: **C13902 | Firmware version** Data type: VISIBLE\_STRING  
Index: 10673<sub>d</sub> = 29B1<sub>h</sub>

Display of the firmware version (string with a length of 11 bytes)

The identification code is output, e.g. "01.00.00.00".

Read access  Write access  CINH  PLC-STOP  No transfer  PDO\_MAP\_RX  PDO\_MAP\_TX  COM  MOT



#### C13920

Parameter | Name: **C13920 | Display DIP switch setting** Data type: BITFIELD\_8  
Index: 10655<sub>d</sub> = 299F<sub>h</sub>

Display of the current DIP switch position

- The set PCP data length is displayed in [C13860/1](#).
- The set process data length is displayed in [C13860/2](#).
- The set baud rate is displayed in [C13863](#).

▶ [Possible settings through DIP switch \(□ 34\)](#)

Value is bit coded:	Information
Bit 0 DIP 8	Baud rate
Bit 1 DIP 7	No function
Bit 2 DIP 6	Number of parameter data words (PCP)
Bit 3 DIP 5	
Bit 4 DIP 4	Number of process data words (PD)
Bit 5 DIP 3	
Bit 6 DIP 2	
Bit 7 DIP 1	

Read access  Write access  CINH  PLC-STOP  No transfer  PDO\_MAP\_RX  PDO\_MAP\_TX  COM  MOT

## 13.2 Table of attributes

The table of attributes contains information required for communicating with the controller via parameters.

### How to read the table of attributes:

Column	Meaning	Entry		
Code	Parameter name	Cxxxxx		
Name	Parameter short text (display text)	<i>Text</i>		
Index	dec	Index by which the parameter is addressed. The subindex for array variables corresponds to the Lenze subcode number.	24575 - Lenze code number	Is only required for access via a bus system.
	hex		5FFF <sub>h</sub> - Lenze code number	
Data	DS	Data structure	E	Single variable (one parameter element only)
			A	Array variable (multiple parameter elements)
	DA	Number of array elements (subcodes)	<i>Number</i>	
	DT	Data type	BITFIELD_8	1 byte, bit-coded
			BITFIELD_16	2 bytes, bit-coded
			BITFIELD_32	4 bytes, bit-coded
			INTEGER_8	1 byte with sign
			INTEGER_16	2 bytes, with sign
			INTEGER_32	4 bytes with sign
			UNSIGNED_8	1 byte without sign
			UNSIGNED_16	2 bytes, without sign
			UNSIGNED_32	4 bytes, without sign
			VISIBLE_STRING	ASCII string
OCTET_STRING				
Factor	Factor for data transmission via a bus system, depending on the number of decimal positions	<i>Factor</i>	1 = no decimal positions 10 = 1 decimal position 100 = 2 decimal positions 1000 = 3 decimal positions	
Access	R	Read access	<input checked="" type="checkbox"/> Reading permitted	
	W	Write access	<input checked="" type="checkbox"/> Writing permitted	
	CINH	Controller inhibit required	<input checked="" type="checkbox"/> Writing is only possible when the controller is inhibited	

Table of attributes

Code	Name	Index		Data				Access		
		dec	hex	DS	DA	DT	Factor	R	W	CINH
<a href="#">C13850</a>	All words to master	10725	29E5	A	16	UNSIGNED_16	1	<input checked="" type="checkbox"/>		
<a href="#">C13851</a>	All words from master	10724	29E4	A	16	UNSIGNED_16	1	<input checked="" type="checkbox"/>		
<a href="#">C13852</a>	All words to standard device	10723	29E3	A	16	UNSIGNED_16	1	<input checked="" type="checkbox"/>		
<a href="#">C13853</a>	All words from standard device	10722	29E2	A	16	UNSIGNED_16	1	<input checked="" type="checkbox"/>		
<a href="#">C13860</a>	Active settings	10715	29DB	A	2	UNSIGNED_8	1	<input checked="" type="checkbox"/>		
<a href="#">C13861</a>	Bus status	10714	29DA	E	1	BITFIELD_16		<input checked="" type="checkbox"/>		
<a href="#">C13862</a>	Counter	10713	29D9	A	4	UNSIGNED_16	1	<input checked="" type="checkbox"/>		
<a href="#">C13863</a>	Active baud rate	10712	29D8	E	1	UNSIGNED_8	1	<input checked="" type="checkbox"/>		
<a href="#">C13880</a>	Reaction on communication failure	10695	29C7	A	1	UNSIGNED_8	1	<input checked="" type="checkbox"/>	<input checked="" type="checkbox"/>	
<a href="#">C13881</a>	Monitoring time for Interbus communication failure	10694	29C6	E	1	UNSIGNED_16	1	<input checked="" type="checkbox"/>	<input checked="" type="checkbox"/>	
<a href="#">C13885</a>	Delete process data	10690	29C2	E	1	UNSIGNED_8	1	<input checked="" type="checkbox"/>	<input checked="" type="checkbox"/>	
<a href="#">C13892</a>	PCP - length	10683	29BB	E	1	UNSIGNED_8	1	<input checked="" type="checkbox"/>	<input checked="" type="checkbox"/>	
<a href="#">C13893</a>	Process data length	10682	29BA	E	1	UNSIGNED_8	1	<input checked="" type="checkbox"/>	<input checked="" type="checkbox"/>	
<a href="#">C13894</a>	Baud rate	10681	29B9	E	1	UNSIGNED_8	1	<input checked="" type="checkbox"/>	<input checked="" type="checkbox"/>	
<a href="#">C13900</a>	Firmware product type	10675	29B3	E	1	VISIBLE_STRING		<input checked="" type="checkbox"/>		
<a href="#">C13901</a>	Firmware compilation date	10674	29B2	E	1	VISIBLE_STRING		<input checked="" type="checkbox"/>		
<a href="#">C13902</a>	Firmware version	10673	29B1	E	1	VISIBLE_STRING		<input checked="" type="checkbox"/>		
<a href="#">C13920</a>	Display DIP switch setting	10655	299F	E	1	BITFIELD_8		<input checked="" type="checkbox"/>		

## 14 Index

### Zahlen

- 9-pole Sub-D plug [29](#)
- 9-pole Sub-D socket [29](#)

### A

- Abort (PMS service) [49](#)
- Access to process data [41](#)
- Activating altered settings [39](#)
- Active baud rate (C13863) [65](#)
- Active settings (C13860) [64](#)
- Addressing of the Lenze parameters [48](#)
- Addressing of the parameter data [48](#)
- All words from master (C13851) [63](#)
- All words from standard device (C13853) [64](#)
- All words to master (C13850) [63](#)
- All words to standard device (C13852) [64](#)
- Application as directed [14](#)
- Application notes (representation) [11](#)
- Approvals [17](#)
- Assignment of the 9-pole Sub-D plug [29](#)
- Assignment of the 9-pole Sub-D socket [29](#)

### B

- Baud rate [17](#)
- Baud rate (C13894) [68](#)
- Before initial switch-on [33](#)
- Bus cable length [30](#)
- Bus status (C13861) [65](#)

### C

- C13850 | All words to master [63](#)
- C13851 | All words from master [63](#)
- C13852 | All words to standard device [64](#)
- C13853 | All words from standard device [64](#)
- C13860 | Active settings [64](#)
- C13861 | Bus status [65](#)
- C13862 | Counter [65](#)
- C13863 | Active baud rate [65](#)
- C13880 | Reaction on communication failure [66](#)
- C13881 | Monitoring time for Interbus communication failure [66](#)
- C13885 | Delete process data [66](#)
- C13892 | PCP - length [67](#)
- C13893 | Process data length [67](#)
- C13894 | Baud rate [68](#)
- C13900 | Firmware product type [68](#)
- C13901 | Firmware compilation date [68](#)
- C13902 | Firmware version [68](#)
- C13920 | Display DIP switch setting [69](#)
- Cable length [17](#)
- Carrying out the port interconnection in the

- »Engineer« [43](#)
- Codes [63](#)
- Commissioning [33](#)
- Communication channels [40](#)
- Communication fault [53](#)
- Communication medium [17](#)
- Communication profile [17](#)
- Communication stack reset (error message) [62](#)
- Communication time [21](#)
- Conformities [17](#)
- Conventions [9](#)
- Conventions used [9](#)
- Copyright [2](#)
- Counter (C13862) [65](#)
- CRL (communication relation list) [48](#)

### D

- Data exchange stopped (error message) [62](#)
- Data transfer [40](#)
- Delete process data (C13885) [66](#)
- Device- and application-specific safety instructions [13](#)
- Device protection [13](#)
- Diagnostic data [58](#)
- Diagnostic messages [58](#)
- Diagnostics [54](#)
- Diagnostics with the »Engineer« [57](#)
- Dimensions [22](#)
- DIP switch settings [34](#)
- Display DIP switch setting (C13920) [69](#)
- Document history [8](#)

### E

- Electrical installation [27](#)
- EMC-compliant wiring [27](#)
- Error code of the Inverter Drive 8400 [58](#)
- Error messages [59](#)
  - Causes and remedies [60](#)
- Error messages (PCP services Read / Write) [50](#)
- Error messages (short overview) [59](#)
- Error number
  - 0x01bc3100 [60](#)
  - 0x01bc5531 [60](#)
  - 0x01bc5532 [60](#)
  - 0x01bc5533 [60](#)
  - 0x01bc6010 [61](#)
  - 0x01bc6011 [61](#)
  - 0x01bc6100 [61](#)
  - 0x01bc6101 [61](#)
  - 0x01bc641f [61](#)
  - 0x01bc6420 [61](#)
  - 0x01bc6430 [62](#)
  - 0x01bc8125 [62](#)

- 0x01bc8126 [62](#)
  - 0x01bc8127 [62](#)
  - 0x01bc8131 [62](#)
  - Establishing communication [39](#)
  - EtherCAT error messages
    - Causes and remedies [60](#)
  - External voltage supply [31](#)
- F**
- Fieldbus status displays [56](#)
  - Firmware compilation date (C13901) [68](#)
  - Firmware product type (C13900) [68](#)
  - Firmware version (C13902) [68](#)
- G**
- General data [17](#)
  - General safety instructions and application notes [12](#)
  - Get-OD (PMS service) [50](#)
- I**
- IBS-ACTIVE [57](#)
  - IBS-INIT [57](#)
  - IBS-READY [57](#)
  - Identification [14](#)
  - Identify (PMS service) [51](#)
  - Initial switch-on [39](#)
  - Initialising PCP communication [48](#)
  - Initiate (PMS service) [49](#)
  - Installation [23](#)
  - INTERBUS connection [28](#)
  - INTERBUS identification [17](#)
  - INTERBUS ring [27](#)
  - Interfaces [16](#), [17](#)
  - Internal error (error message) [61](#)
  - Invalid configuration (error message) [62](#)
  - Invalid initialisation (error message) [62](#)
  - Invalid module configuration (error message) [62](#)
  - Invalid parameter set (error message) [61](#)
- L**
- LED status displays [54](#)
  - Lenze setting loaded (error message) [61](#)
  - Lost connection to 8400 base device (error message) [60](#)
- M**
- Max. number of data words [17](#)
  - Max. PDU length [17](#)
  - Mechanical installation [24](#)
  - Memory not accessible (error message) [60](#)
  - Memory read error (error message) [60](#)
  - Memory write error (error message) [60](#)
  - Module ID [17](#)
  - Module status displays [55](#)
- Monitoring [53](#)
  - Monitoring time for Interbus communication failure (C13881) [66](#)
  - Mounting for standard devices 0.25 kW and 0.37 kW [24](#)
  - Mounting for standard devices from 0.55 kW onwards [25](#)
- N**
- Nameplate [14](#)
  - Network topology [17](#), [27](#)
  - Notes used [11](#)
  - Number of nodes [17](#)
- O**
- Operating conditions [17](#)
- P**
- Parameter data transfer [48](#)
  - Parameter data words (PCP) [17](#)
  - Parameter reference [63](#)
  - Parameters of the communication module [63](#)
  - PCP - length (C13892) [67](#)
  - PDO mapping [41](#)
  - PMS services [49](#)
  - Process data length (C13893) [67](#)
  - Process data transfer [41](#)
  - Process data words (PD) [17](#)
  - Processing time [21](#)
  - Product description [14](#)
  - Product features [15](#)
  - PROFINET error messages (short overview) [59](#)
  - Protection against uncontrolled restart [39](#)
  - Protection of persons [13](#)
  - Protective insulation [18](#)
  - Protocol data [21](#)
- Q**
- Querying the bus status [57](#)
  - Querying the current bus status [57](#)
- R**
- Reaction on communication failure (C13880) [66](#)
  - Read (PMS service) [50](#)
  - Reject (PMS service) [49](#)
  - Replacing the communication module [26](#)
  - Residual hazards [13](#)
- S**
- Safety instructions [12](#)
  - Safety instructions (representation) [11](#)
  - Setting the baud rate [37](#)
  - Setting the number of parameter data words (PCP) [36](#)
  - Setting the number of process data words (PD) [35](#)

Settings in the »Engineer« [38](#)  
Specification of the bus cable [30](#)  
Status (PMS service) [52](#)  
Status displays (LEDs) [54](#)  
Supported PMS services [49](#)  
System error messages [59](#)

### T

Table of attributes [70](#)  
Target group [7](#)  
Technical data [17](#)  
Terminals [16](#), [32](#)  
Terminology used [10](#)  
Terms [10](#)  
Type of node [17](#)

### U

Using the communication module [14](#)

### V

Validity of the documentation [7](#)  
Voltage supply [17](#), [31](#)

### W

Write (PCP service) [50](#)



© 11/2010



Lenze Drives GmbH  
Postfach 10 13 52  
D-31763 Hameln  
Germany



+49 (0)51 54 / 82-0



+49 (0)51 54 / 82-28 00



[Lenze@Lenze.de](mailto:Lenze@Lenze.de)



[www.Lenze.com](http://www.Lenze.com)

Service Lenze Service GmbH  
Breslauer Straße 3  
32699 Extertal  
Germany



00 80 00 24 4 68 77 (24 h helpline)



+49 (0)51 54 / 82-11 12



[Service@Lenze.de](mailto:Service@Lenze.de)

EDS84AYCIB ■ 13362260 ■ EN 4.0 ■ TD17

10 9 8 7 6 5 4 3 2 1



E84AYCPM

# PROFIBUS®

Inverter Drives 8400 \_\_\_\_\_

Communication Manual

EN



13422193



# Contents

---

<b>1</b>	<b>About this documentation</b>	<b>5</b>
1.1	Document history	7
1.2	Conventions used	8
1.3	Terminology used	9
1.4	Notes used	10
<b>2</b>	<b>Safety instructions</b>	<b>11</b>
2.1	General safety and application instructions	11
2.2	Device- and application-specific safety instructions	12
2.3	Residual hazards	12
<b>3</b>	<b>Product description</b>	<b>13</b>
3.1	Application as directed	13
3.2	Identification	13
3.3	Features	14
3.4	Terminals and interfaces	14
<b>4</b>	<b>Technical data</b>	<b>15</b>
4.1	General data and operating conditions	15
4.2	Protective insulation	16
4.3	Protocol data	19
4.4	Communication time	19
4.5	Dimensions	20
<b>5</b>	<b>Installation</b>	<b>21</b>
5.1	Mechanical installation	22
5.1.1	Mounting for 0.25 kW and 0.37 kW standard devices	22
5.1.2	Mounting for standard devices of 0.55 kW and more	23
5.1.3	Replacing the communication module	24
5.2	Electrical installation	25
5.2.1	Network topology	25
5.3	Activating the bus terminating resistor	27
5.3.1	Bus cable specification	28
5.3.2	PROFIBUS connection	29
<b>6</b>	<b>Commissioning</b>	<b>30</b>
6.1	Before initial switch-on	30
6.2	Configuration of the controller (master)	31
6.3	Setting the station address	32
6.4	Initial switch-on	34
6.5	Going online with »Engineer« via TCI	35
<b>7</b>	<b>Data transfer</b>	<b>44</b>
<b>8</b>	<b>Process data transfer</b>	<b>45</b>
8.1	Access to process data / PDO mapping	45
8.2	Preconfigured port interconnection of the process data objects (PDO)	46
8.3	Free configuration of the port interconnection of process data objects (PDO)	47

# Contents

---

<b>9</b>	<b>Parameter data transfer</b>	<b>51</b>
9.1	Addressing of the parameter data	51
9.2	DRIVECOM parameter data channel (DP-V0)	52
9.2.1	Telegram structure (overview)	52
9.2.2	Byte 1: Service	53
9.2.2.1	Reading parameter data from the inverter	54
9.2.2.2	Writing parameter data to the inverter	54
9.2.2.3	Abort of data transfer by the inverter	55
9.2.2.4	Data transfer abort by the master	55
9.2.3	Byte 2: Subindex	56
9.2.4	Bytes 3 + 4: Index	56
9.2.5	Bytes 5 ... 8: Parameter value / error information	57
9.2.6	Error codes	58
9.2.7	Telegram examples	59
9.2.7.1	Read request: Querying the heatsink temperature	59
9.2.7.2	Write request: Setting the deceleration time for quick stop (QSP)	60
9.3	PROFIdrive parameter data channel (DP-V1)	61
9.3.1	Connection establishment between master and slave	62
9.3.2	Acyclic data transfer	63
9.3.3	Telegram structure	64
9.3.3.1	Reading parameter data from the inverter	65
9.3.3.2	Response to a correctly executed read request	66
9.3.3.3	Response to a read error	68
9.3.3.4	Writing parameter data to the inverter	70
9.3.3.5	Response to a correctly executed write request	72
9.3.3.6	Response to a write error	73
9.3.4	Error codes	74
9.3.5	Telegram examples	76
9.3.5.1	Read request: Querying the heatsink temperature	76
9.3.5.2	Write request: Setting the deceleration time for quick stop (QSP)	78
9.4	Consistent parameter data	80
<b>10</b>	<b>Monitoring</b>	<b>81</b>
10.1	Permanent interruption of PROFIBUS communication	81
10.2	Short-time interruption of PROFIBUS communication	82
10.3	Settings and displays in the »Engineer«	83
<b>11</b>	<b>Diagnostics</b>	<b>84</b>
11.1	LED status displays	84
11.1.1	Module status displays	85
11.1.2	Fieldbus status displays	86
11.2	Diagnosing with the »Engineer«	87
11.3	Advanced diagnostic message	89
<b>12</b>	<b>Error messages</b>	<b>91</b>
12.1	Short overview of the PROFIBUS error messages	91
12.2	Possible causes and remedies	92

# Contents

---

<b>13</b>	<b>Parameter reference</b>	95
13.1	Parameters of the communication module	95
13.2	Table of attributes	103
13.3	Implemented PROFIdrive objects (DP-V1)	105
<b>14</b>	<b>DIP switch positions for setting the station address</b>	107
	Your opinion is important to us	114

# 1 About this documentation

---

## 1 About this documentation

This documentation exclusively describes the E84AYCPM communication module (PROFIBUS).



### Note!

This documentation supplements the **mounting instructions** supplied with the communication module and the "**Inverter Drives 8400**" hardware manual.

**The hardware manual contains safety instructions which must be observed!**

The features and functions of the communication module are described in detail.

Typical applications are explained with the help of examples.

The theoretical connections are only explained in so far as they are necessary for comprehending the function of the communication module.

This documentation does not describe the software of other manufacturers. No responsibility is taken for corresponding information given in this documentation. Information on how to use the software can be obtained from the documents of the control system (master).

All brand names used in this documentation are trademarks of their respective owners.



### Tip!

Detailed information about PROFIBUS can be found on the website of the PROFIBUS & PROFINET user organisation:

[www.profibus.com](http://www.profibus.com)

# 1 About this documentation

---

## Target group

This documentation is intended for all persons who plan, install, commission and maintain the networking and remote servicing of a machine.



### Tip!

Current documentation and software updates with regard to Lenze products can be found in the download area at:

[www.Lenze.com](http://www.Lenze.com)

## Validity information

The information given in this documentation is valid for the following devices:

Extension module	Type designation	From hardware version	From software version
PROFIBUS communication module	E84AYCPM	VA	01.00

## Screenshots/application examples

All screenshots in this documentation are application examples. Depending on the firmware version of the communication module and the software version of the Engineering tools installed («Engineer«, »STEP7«), the screenshots in this documentation may differ from the actual screen display.

# 1 About this documentation

## 1.1 Document history

---

### 1.1 Document history



Version			Description
1.0	11/2007	TD17	First edition
2.0	11/2008	TD17	General revision
3.0	02/2010	TD17	<ul style="list-style-type: none"><li>• Update of chapter structure</li><li>• General revision</li></ul>
4.0	11/2010	TD17	General revision
5.0	11/2011	TD17	<ul style="list-style-type: none"><li>• New layout</li><li>• New: <a href="#">Going online with »Engineer« via TCI (📖 35)</a></li><li>• General corrections</li></ul>

# 1 About this documentation

## 1.2 Conventions used

### 1.2 Conventions used

This manual uses the following conventions to distinguish between different types of information:

Type of information	Writing	Examples/notes
Numbers		
Decimal separator	Point	The decimal point is always used. Example: 1234.56
Hexadecimal	0x[0 ... 9, A ... F]	Example: 0x60F4
Binary • Nibble	In inverted commas Point	Example: '100' Example: '0110.0100'
Text		
Version information	Text colour blue	All pieces of information that only apply to or from a specific software version of the inverter are highlighted accordingly in this documentation. Example: <a href="#">This function extension is available from software version V3.0!</a>
Program name	» «	The Lenze PC software »Engineer«...
Window	<i>italics</i>	The <i>message window</i> ... / The <i>Options</i> dialog box ...
Variable name		Setting <i>bEnable</i> to TRUE...
Control element	<b>Bold</b>	The <b>OK</b> button ... / The <b>Copy</b> command ... / The Properties tab ... / The <b>Name</b> input field ...
Sequence of menu commands		If several successive commands are required for executing a function, the individual commands are separated from each other by an arrow: Select the command <b>File → Open</b> to...
Hyperlink	<u>underlined</u>	Optically highlighted reference to another topic. Can be activated with a mouse-click in this online documentation.
Symbols		
Page reference	 6	Optically highlighted reference to another page. Can be activated with a mouse-click in this online documentation.
Step-by-step instructions		Step-by-step instructions are indicated by a pictograph.

# 1 About this documentation

## 1.3 Terminology used

### 1.3 Terminology used

Term	Meaning
Inverter	Lenze inverter of the "Inverter Drives 8400" product series
Standard device	
Code	Parameters which serve to parameterise or monitor the inverter. This term is usually called "index".
Subcode	If a code contains several parameters, these are stored in subcodes. This manual uses a slash "/" as a separator between code and subcode (e.g. "C118/3"). This term is usually called "subindex".
GSD / GSE	Device data base file (device description for PROFIBUS stations)
HW	Hardware
Lenze setting	Settings with which the device is preconfigured ex works.
Basic setting	
	PROFIBUS® (Process Field Bus) is a widely-used fieldbus system for the automation of machines and production plants. PROFIBUS® is a registered trademark and patented technology licensed by the PROFIBUS & PROFINET International (PI) user organisation.
PDO	Process data object
PLC	Programmable Logic Controller (German designation: SPS - Speicherprogrammierbare Steuerung)
»STEP7«	Siemens software for programming and configuring PROFIBUS Siemens control systems
SW	Software
TCI	Tool Calling Interface



# 1 About this documentation

## 1.4 Notes used

### 1.4 Notes used

The following signal words and symbols are used in this documentation to indicate dangers and important information:

#### Safety instructions

Structure of the safety instructions:



#### **Danger!**

(characterises the type and severity of danger)

#### **Note**

(describes the danger and informs how to prevent dangerous situations)

Pictograph	Signal word	Meaning
	<b>Danger!</b>	<b>Danger of personal injury through dangerous electrical voltage</b> Reference to an imminent danger that may result in death or serious personal injury if the corresponding measures are not taken.
	<b>Danger!</b>	<b>Danger of personal injury through a general source of danger</b> Reference to an imminent danger that may result in death or serious personal injury if the corresponding measures are not taken.
	<b>Stop!</b>	<b>Danger of property damage</b> Reference to a possible danger that may result in property damage if the corresponding measures are not taken.

#### Application notes

Pictograph	Signal word	Meaning
	<b>Note!</b>	Important note to ensure trouble-free operation
	<b>Tip!</b>	Useful tip for easy handling
		Reference to other documents

## 2 Safety instructions



### Note!

Always observe the specified safety measures to avoid severe injury to persons and damage to property!

Always keep this documentation to hand in the vicinity of the product during operation.

### 2.1 General safety and application instructions



### Danger!

If you disregard the following basic safety measures, this can cause severe injury to persons and damage to material assets.

Lenze drive and automation components ...

- must only be used as directed.
  - ▶ [Application as directed](#) (13)
- must never be commissioned in the event of visible damage.
- must never be technically modified.
- must never be commissioned before they have been completely mounted.
- must never be operated without the covers required.
- can - depending on their degree of protection - have live, moving or rotating parts during and after operation. Surfaces can be hot.

For Lenze drive components ...

- use only the accessories approved.
- use only original spare parts from the manufacturer.

Observe all specifications given in the attached and associated documentation.

- This is the precondition for safe and trouble-free operation and for obtaining the product features specified.
  - ▶ [Features](#) (14)
- The procedural notes and circuit details described in this document are only proposals. It is up to the user to check whether they can be adapted to the particular applications. Lenze does not take any responsibility for the suitability of the procedures and circuit proposals described.

Only qualified personnel may work with and on Lenze drive and automation components. According to IEC 60364 and CENELEC HD 384, these are persons ...

- who are familiar with the installation, assembly, commissioning and operation of the product.
- who have the corresponding qualifications for their work.
- who know all regulations for the prevention of accidents, directives and laws applicable on site and are able to apply them.

## 2 Safety instructions

### 2.2 Device- and application-specific safety instructions

---

#### 2.2 Device- and application-specific safety instructions

- During operation, the communication module must be firmly connected to the standard device.
- Only use cables corresponding to the given specifications.
  - ▶ [Bus cable specification](#) (📖 28)



#### **Documentation for the standard device, control system, plant/machine**

All other measures prescribed in this documentation must also be implemented.  
Observe the safety instructions and application notes specified in the documentation.

#### 2.3 Residual hazards

##### **Protection of persons**

If the Inverter Drives 8400 are used on a phase earthed mains with a rated mains voltage  $\geq 400$  V, protection against accidental contact is not ensured without implementing external measures.

- ▶ [Protective insulation](#) (📖 16)

##### **Device protection**

The communication module contains electronic components which may be damaged or destroyed by electrostatic discharge.

- ▶ [Installation](#) (📖 21)

# 3 Product description

## 3.1 Application as directed

# 3 Product description

## 3.1 Application as directed

The communication module ...

- is an accessory module for use in conjunction with the following Lenze standard devices:

Product series	Type designation	From software version
Inverter Drives 8400 StateLine	E84AVSCxxxxx	01.00
Inverter Drives 8400 HighLine	E84AVHCxxxxx	01.00
Inverter Drives 8400 TopLine	E84AVTCxxxxx	01.00

- is a device intended for use in industrial power systems.
- is only to be operated under the operating conditions specified in this documentation.
- may only be used in PROFIBUS networks.

**Any other use shall be deemed inappropriate!**

## 3.2 Identification

The type designation as well as the hardware and software version of the communication module are indicated on the nameplate:

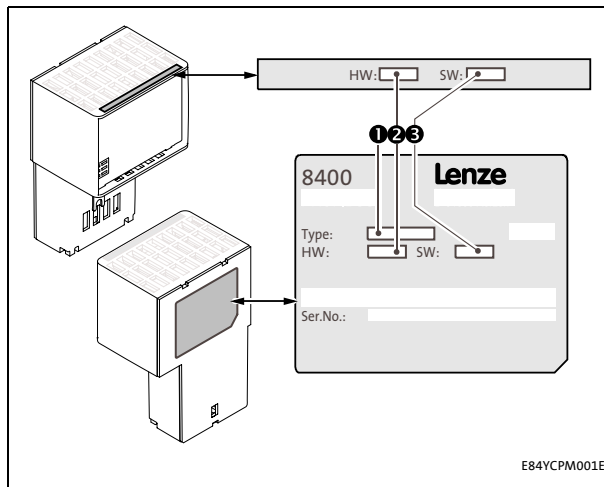

### 1 Type designation (type)

E84 Product series

A Version

Y Module identification: extension module

C Module type: communication module

PM PROFIBUS

V/S V: coated version

S: standard version

### 2 Hardware version (HW)

### 3 Software version (SW)

[3-1] Identification data

# 3 Product description

## 3.3 Features

### 3.3 Features

- Interface module for the PROFIBUS communication system for connection to the expansion slots of the Inverter Drives 8400
- Support of parameter data channels DRIVECOM (DP-V0) and PROFIDrive (DP-V1)
- A maximum of 16 process data words per direction can be exchanged.
- The communication module is supplied with voltage via the standard device.
- Bus coupling via remote bus according to the RS485 standard
- Automatic detection of the baud rate (9.6 kbps to 12 Mbps)
- Setting of the station address is possible via DIP switch or code.
- Access to all Lenze parameters

### 3.4 Terminals and interfaces

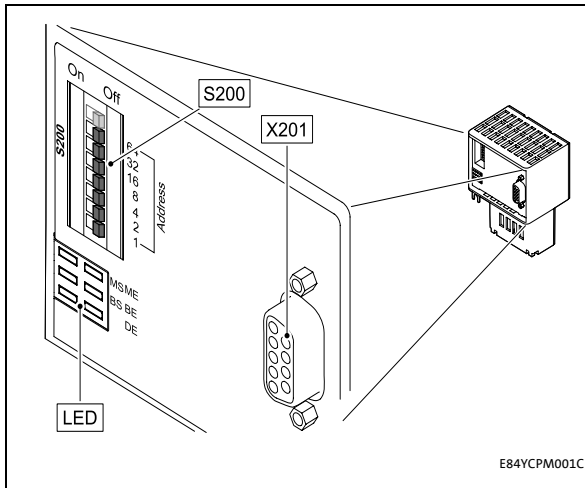

**S200** DIP switches for setting the station address  
▶ [Setting the station address](#) (📖 32)

**X201** PROFIBUS connection  
• 9-pin Sub-D socket  
▶ [Network topology](#) (📖 25)  
▶ [PROFIBUS connection](#) (📖 29)

**MS** 5 LED status displays for diagnostics  
**ME** ▶ [Module status displays](#) (📖 85)  
**BS** ▶ [Fieldbus status displays](#) (📖 86)  
**BE**  
**DE**

[3-2] E84AYCPM communication module (PROFIBUS)

## 4 Technical data



### "Inverter Drives 8400" hardware manual

Here you can find the **ambient conditions** and information on the **electromagnetic compatibility (EMC)** which also apply to the communication module.

### 4.1 General data and operating conditions

Area	Values
Order designation	<ul style="list-style-type: none"> <li>• E84AYCPMV (coated version)</li> <li>• E84AYCPMS (standard version)</li> </ul>
Communication profile	<ul style="list-style-type: none"> <li>• PROFIBUS DP-V0 (DRIVECOM)</li> <li>• PROFIBUS DP-V1 (PROFIdrive)</li> </ul>
Communication medium	RS485
Interface	9-pin Sub-D socket
Network topology	<ul style="list-style-type: none"> <li>• Line (without repeater)</li> <li>• Tree/line (with repeater)</li> </ul>
Bus device type	PROFIBUS slave
Number of slaves	<ul style="list-style-type: none"> <li>• Max. 31 (without repeater)</li> <li>• Max. 125 (with repeater)</li> </ul>
Max. cable length	1200 m (depending on the selected baud rate and the cable type used)
PNO identification number	0x0A89
Baud rate for cable type A (EN 50170)	9.6 kbps ... 12 Mbps (automatic detection)
Conformities, approvals	<ul style="list-style-type: none"> <li>• CE</li> <li>• UL</li> </ul>

### 4.2 Protective insulation



#### **Danger!**

##### **Dangerous voltage**

If the Inverter Drives 8400 are used on a phase earthed mains with a rated mains voltage  $\geq 400$  V, protection against accidental contact is not ensured without implementing external measures.

##### **Possible consequences:**

Death or severe injury

##### **Protective measures:**

If protection against accidental contact is required for the control terminals of the inverter and the terminals of the plugged-in device modules, ...

- a double isolating distance must be provided.
- the components to be connected must be provided with a second isolating distance.



#### **Note!**

The existing protective insulation in the Inverter Drives 8400 is implemented according to EN 61800-5-1.

The following illustration ...

- shows the arrangement of the terminal strips and the separate potential areas of the Inverter Drives 8400.
- serves to determine the decisive protective insulation between two terminals located in differently insulated separate potential areas.

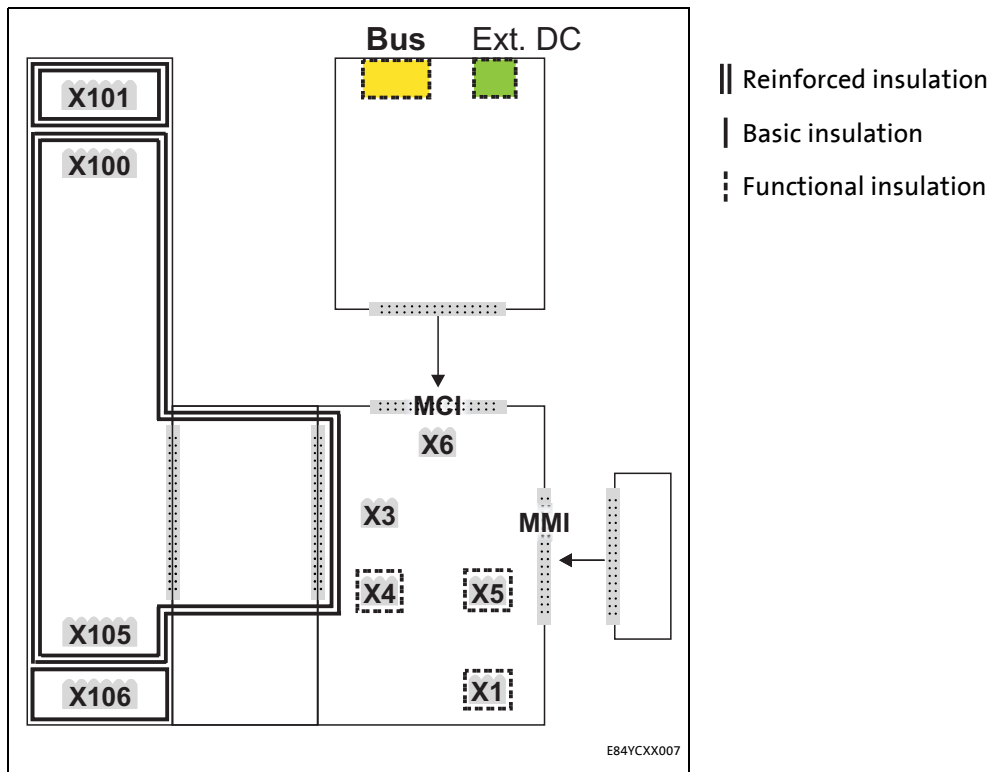

[4-1] Protective insulation in accordance with EN61800-5-1

Terminal strip	Connection
X100	Mains / DC bus connection
X101	Relay contact
X105	Motor/brake resistor
X106	Motor PTC
X1	System bus (CANopen)
X3	Analog inputs/outputs
X4	Digital outputs
X5	Digital inputs
X6	Diagnostics
MCI	Slot for communication module
MMI	Slot for memory module



**Example**

Which type of protective insulation is used between the bus terminal of the device module in the MCI slot and the mains terminal X100?

The separate potential area with the better protective insulation is decisive.

- The separate potential area of the device module's bus terminal is "functionally insulated".
- The separate potential area of the mains terminal has a "reinforced insulation".

Result: The insulation between the mains terminal X100 and the bus terminal is of the "reinforced insulation" type.

# 4 Technical data

## 4.3 Protocol data

### 4.3 Protocol data

Area	Values
Process data words (PCD)	1 ... 16 words (16 bits/word)
Cyclic parameter data channel (DP-V0)	4 words
Acyclic parameter data channel (DP-V1)	Max. 240 bytes
PROFIBUS user data length	1 ... 16 words process data channel + 4 words parameter data channel

### 4.4 Communication time

The communication time is the time between the start of a request and the arrival of the corresponding response.

The communication times in a PROFIBUS network depend on ...

- the processing time in the inverter;
- the transmission delay time (baud rate / telegram length);
- the nesting depth of the network.

#### Processing time in the inverter

Data	Processing time
Process data	Approx. 2 ms + 0 ... 1 ms + 1 ... x ms update cycle processing time in the module application task runtime of the technology application used (tolerance)
Parameter data	Approx. 30 ms + 20 ms tolerance (typical) For some codes, the processing time may be longer (see software manual// »Engineer« online help for Inverter Drives 8400).

There are no interdependencies between parameter data and process data.

# 4 Technical data

## 4.5 Dimensions

### 4.5 Dimensions

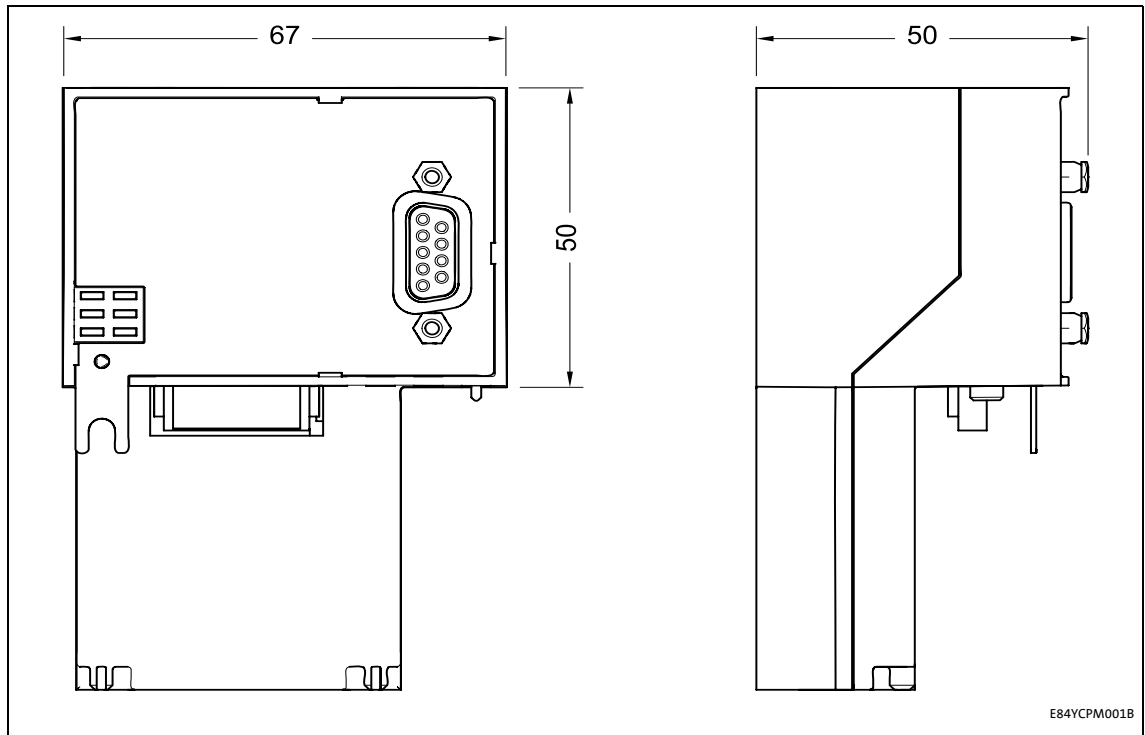

[4-2] Dimensions

Dimensions in mm

### 5 Installation



#### **Stop!**

##### **Electrostatic discharge**

Electronic components within the communication module can be damaged or destroyed by electrostatic discharge.

##### **Possible consequences:**

- The communication module is defective.
- Communication via the fieldbus is not possible or faulty.

##### **Protective measures**

Discharge electrostatic charges before touching the module.

# 5 Installation

## 5.1 Mechanical installation

### 5.1 Mechanical installation

The communication module can be plugged into the MCI slot or unplugged while the inverter is switched on. When the module is plugged in, it is detected automatically, and a plausibility check regarding the function and version is carried out.

#### 5.1.1 Mounting for 0.25 kW and 0.37 kW standard devices

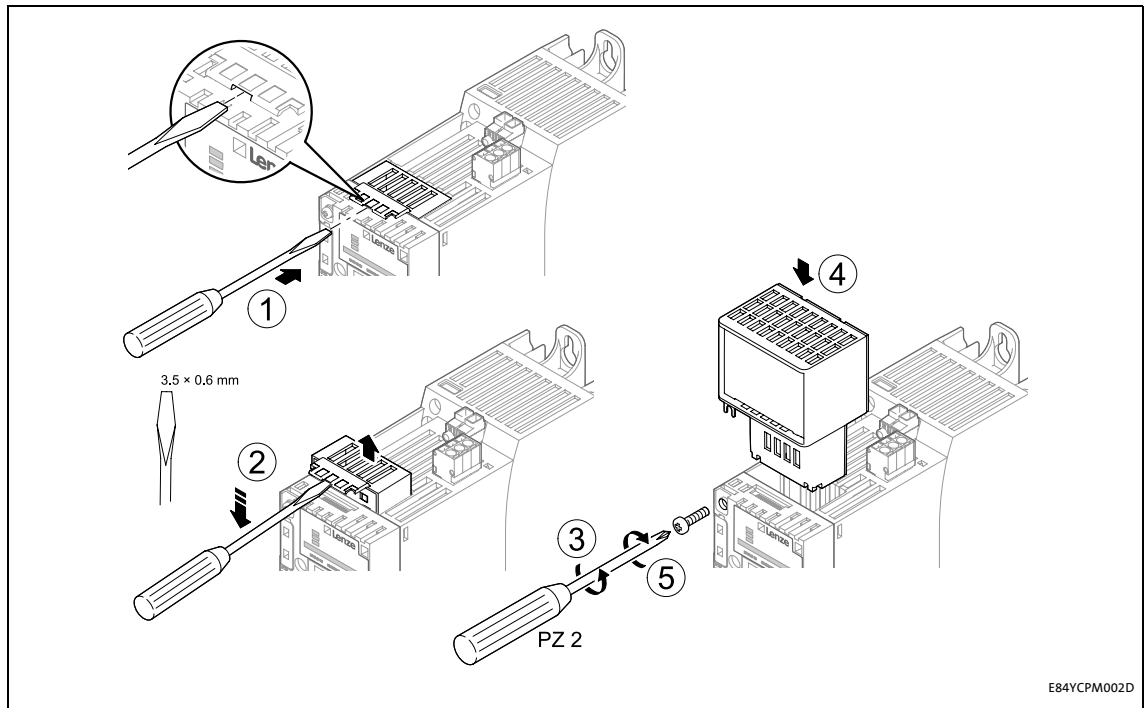

[5-1] Mounting for 0.25 kW and 0.37 kW standard devices

#### Mounting steps

1. Pry the cover out of the MCI slot using a screwdriver and remove it (1, 2).
2. Loosen the securing screw for the communication module on the standard device (3).
3. Insert the communication module into the MCI slot of the standard device (4).
4. Fasten the securing screw (5).

### 5.1.2 Mounting for standard devices of 0.55 kW and more

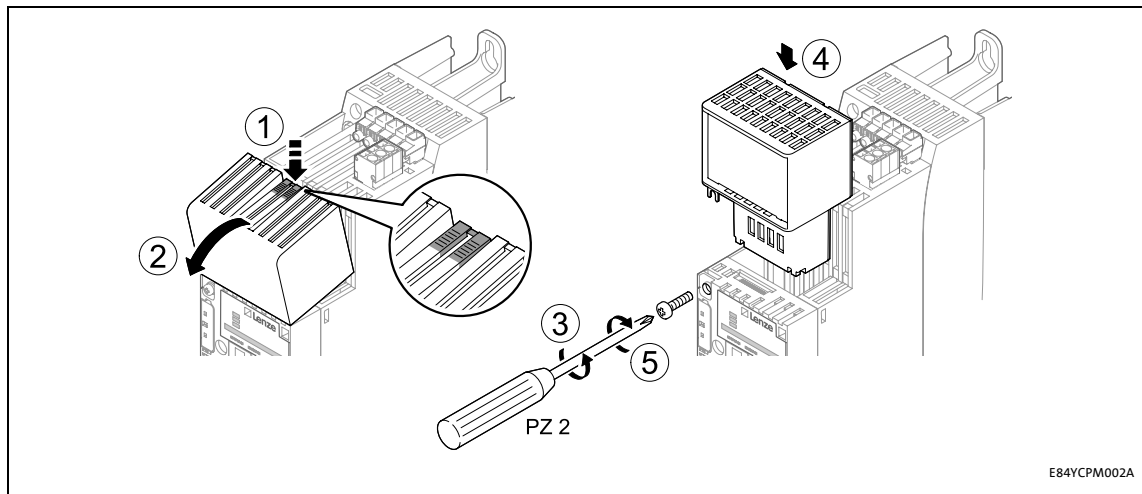

[5-2] Mounting for standard devices of 0.55 kW and more

#### Mounting steps

1. Slightly press on the area indicated in the illustration at the top of the cover for the standard device's MCI slot (1).
2. Tilt the cover forward and remove it from the standard device (2).
3. Loosen the securing screw for the communication module on the standard device (3).
4. Insert the communication module into the MCI slot of the standard device (4).
5. Fasten the securing screw (5).

### 5.1.3 Replacing the communication module

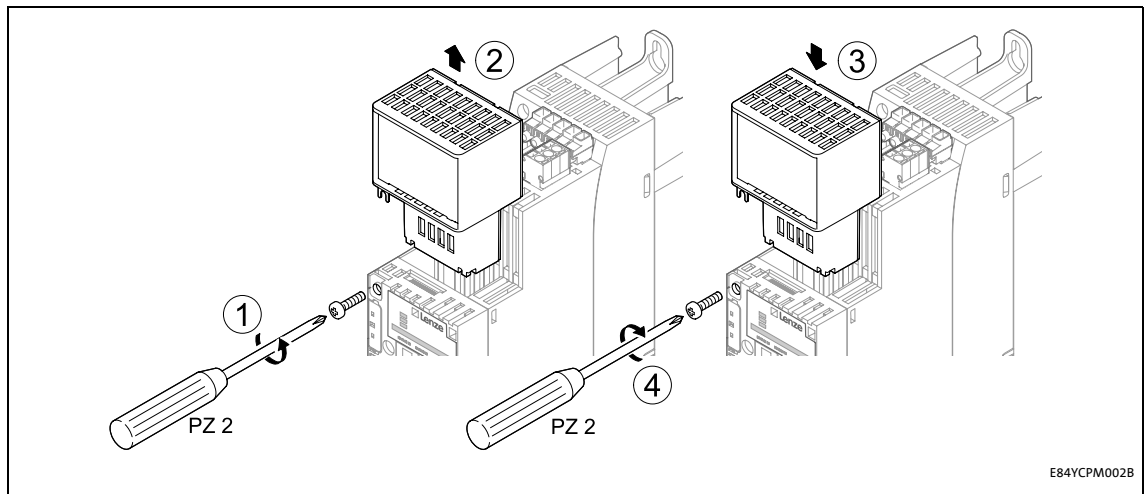

[5-3] Replacing the communication module

#### Mounting steps

1. Loosen the securing screw for the communication module on the standard device (1).
2. Remove the communication module from the MCI slot of the standard device (2).
3. Insert the new communication module into the MCI slot of the standard device (3).
4. Fasten the securing screw (4).

## 5.2

## Electrical installation

**Documentation for the standard device, control system, plant/machine**

Observe the notes and wiring instructions given in the documentation.

## 5.2.1

## Network topology

The following examples show two simple RS485 networks.

Every segment of the network must be terminated at both ends. The bus terminators of the PROFIBUS are marked with a "Z" in the below examples.

In the case of an RS485 network of only one segment, the PROFIBUS master (M) with the integrated bus terminator starts the segment while the bus terminating resistor in the connector of the last PROFIBUS station (S) must be activated.

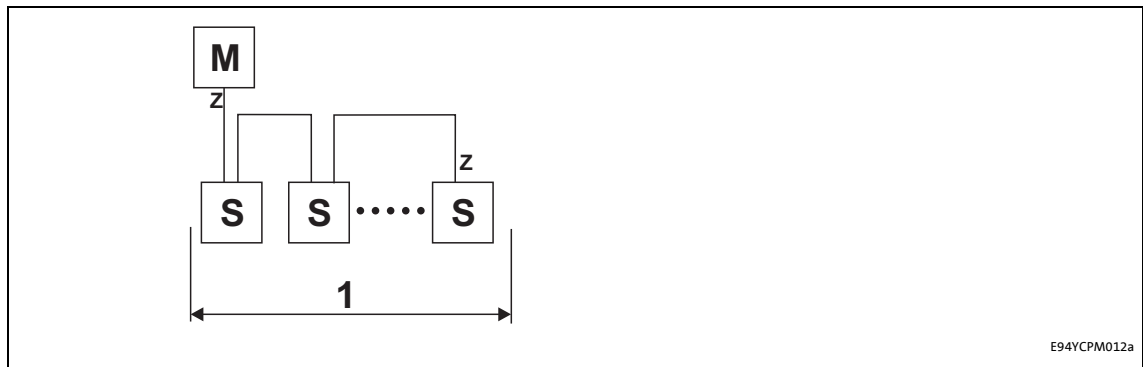

[5-4] RS485 network with one segment

An RS485 network consisting of several segments contains repeaters (R) for coupling the segments. The repeaters are provided with integrated bus terminating resistors.

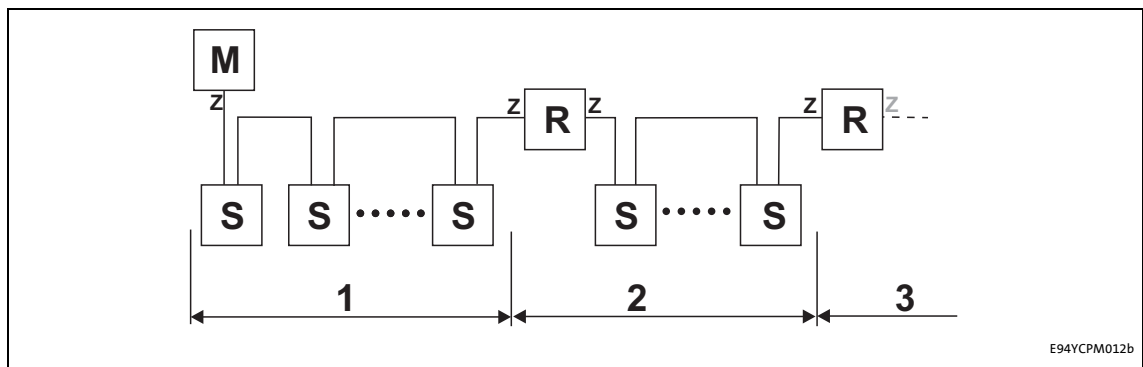

[5-5] RS485 network with a repeater

If no repeater is to be used at the end of the segment, the bus terminating resistor must be activated in the connector of the last device. The bus termination is supplied by the station itself.



**Stop!**

The bus terminator must always be supplied. Otherwise, the bus can get unstable.

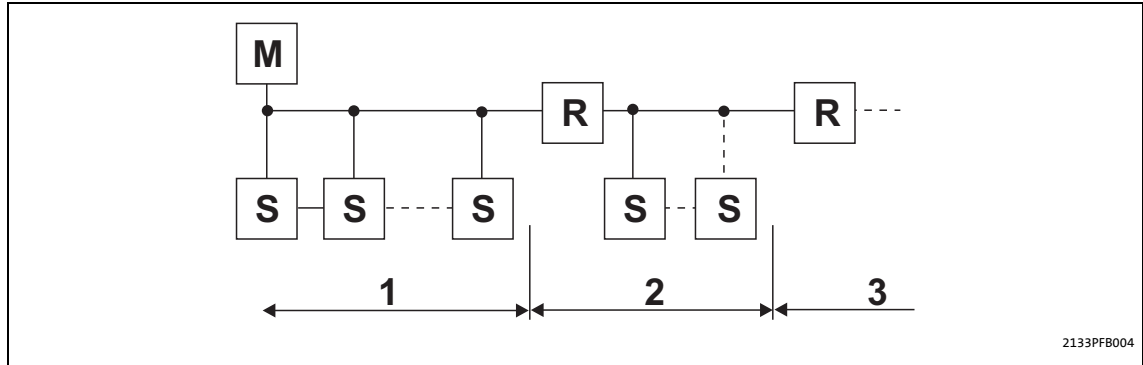

▶ [Activating the bus terminating resistor](#) (📖 27)

**Number of stations**



[5-6] Number of stations

Segment	Master (M)	Slave (S)	Repeater (R)
1	1	31	-
	2	30	-
2	-	30	1
3	-	30	1

 **Tip!**

Repeaters do not have a station address. When calculating the maximum number of stations, they reduce the number of stations by 1 on each side of the segment.

Repeaters can be used to build up line and tree topologies. The maximum total bus system expansion depends on ...

- the baud rate used;
- the number of repeaters used.

---

### 5.3 Activating the bus terminating resistor

The PROFIBUS must be terminated by a bus terminating resistor at the first and last physical bus station.

The bus terminating resistor in the bus connector of the bus cable is activated by means of a switch. PROFIBUS cables with integrated bus terminating resistor are offered by several cable manufacturers.



#### Note!

If you want to disconnect individual bus stations, ensure that the bus terminators at the cable ends remain active.

Please observe that the bus termination is not active any longer if ...

- the bus connector has been disconnected;
- the voltage supply of the Inverter Drive 8400 has been switched off.

### 5.3.1 Bus cable specification



#### Note!

Only use cables which meet the listed specifications of the PROFIBUS user organisation.

Area	Values
Cable resistance	135 ... 165 $\Omega$ /km, (f = 3 ... 20 MHz)
Capacitance per unit length	$\leq$ 30 nF/km
Loop resistance	< 110 $\Omega$ /km
Core diameter	> 0.64 mm
Core cross-section	> 0.34 mm <sup>2</sup>
Cores	Twisted in pairs, insulated and shielded

#### Bus cable length

The length of the bus cable depends on the baud rate and cable type used. The data in the following table applies to PROFIBUS cables of "FC-Standard Cable" cable type .

Baud rate	Length
9.6 ... 93.75 kbps	1200 m
187.5 kbps	1000 m
500 kbps	400 m
1500 kbps	200 m
3000 ... 12000 kbps	100 m



#### Note!

The baud rate depending of the data volume, cycle time and number of stations should only be selected as high as required for the application.



#### Tip!

We recommend taking the use of optical fibres into consideration for high baud rates.

Advantages of optical fibres:

- External electromagnetic interferences have no effect on the transmission path.
- Bus lengths of several kilometres are also possible with higher baud rates.
- The bus length is ...
  - independent of the baud rate;
  - dependent on the optical fibre used.

### 5.3.2 PROFIBUS connection

The 9-pole Sub-D socket **X201** serves to connect the communication module to the bus system.

#### Assignment of the 9-pin Sub-D socket X201

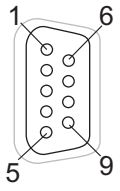
View	Pin	Assignment	Description
	1	Not assigned	-
	2	Not assigned	-
	3	RxD/TxD-P	Data line B (received data/transmitted data, plus)
	4	RTS	Request To Send (received data/transmitted data, no differential signal)
	5	M5V2	Data ground (ground to 5 V)
	6	P5V2	5 V DC / 30 mA (bus termination)
	7	Not assigned	-
	8	RxD/TxD-N	Data line A (received data/transmitted data, minus)
	9	Not assigned	-

# 6 Commissioning

## 6.1 Before initial switch-on

---

# 6 Commissioning

During commissioning, plant-specific data such as motor parameters, operating parameters, responses, and parameters for fieldbus communication are defined for the inverter. Lenze devices use codes for this purpose.

The codes of the inverter and for communication are saved to the memory module in a non-volatile data set.

In addition, there are codes for diagnosing and monitoring the stations.

▶ [Parameter reference](#) (📖 95)

## 6.1 Before initial switch-on



### Stop!

Before switching on the inverter for the first time, check ...

- the entire wiring for completeness, short circuit and earth fault.
- whether the bus system is terminated by means of a bus terminating resistor at the first and last physical bus station.

▶ [Activating the bus terminating resistor](#) (📖 27)

## 6.2 Configuration of the controller (master)

The controller (master) must be configured before communication with the communication module is possible.

### Configuration for the controller (master) and the DP-V0 parameter data channel

For configuring the PROFIBUS you must read the device description file of the communication module into the master.

The device description file for the E84AYCPM communication module (PROFIBUS) can be found in the Download area at:

[www.Lenze.com](http://www.Lenze.com)

The following language variants of the device description file can be used:

- LENZ0A89.GSD (source file, English)
- LENZ0A89.GSG (German)
- LENZ0A89.GSE (English)

### Defining the user data length

The user data length is defined during the initialisation phase of the master.

The Inverter Drives 8400 support the configuration of a maximum of 16 process data words (max. 32 bytes). The optional activation of the cyclic parameter data channel additionally occupies 4 process data word (8 bytes).

The user data lengths for process input data and process output data are the same.

### Description of the device data base file

Selection text	Parameter data with consistency	Process data		Assigned IO memory
		with consistency	without consistency	
DRIVECOM-PAR (cons) + PCD (nW cons)	Yes	n words	-	4 + n words
PCD (nW cons)	-	n words	-	n words
PCD (nW)	-	-	4 words	4 words
n = 1 ... 16 process data words				

### Example of selecting the device data base file

DRIVECOM-PAR (cons) + PCD (8W cons)

- "Drivecom-PAR (cons)" = DP-V0 parameter data channel (4 words)
- "PCD (8W cons)" = 8 process data words



#### Tip!

A detailed description of consistency is given in the chapter "[Consistent parameter data](#)" (80).

6.3 Setting the station address

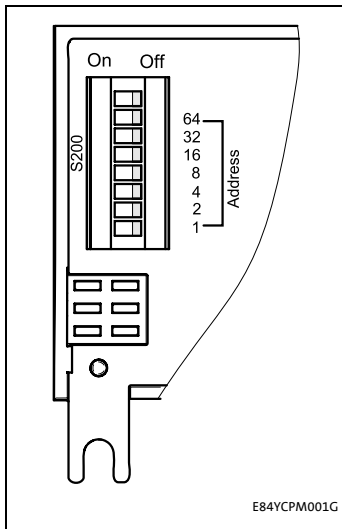

The station address can be set via DIP switches 1 ... 64 or via the »Engineer« (code [C13899](#)).

The unlabelled DIP switch (topmost position) does not have any function.

Lenze setting: all switches in OFF position

[6-1] DIP switch

The station addresses must differ from each other if several networked PROFIBUS stations are used. The station address can be set via DIP switches 1 ... 64 or via the »Engineer« (code [C13899](#)).

	Setting the station address via ...	
	DIP switch	C13899
Condition	At least one switch 1 ... 64 = ON	<ul style="list-style-type: none"> <li>Switches 1 ... 64 = OFF</li> <li>All switches 1 ... 64 = ON (invalid value "127")</li> </ul>

The housing labelling indicates the valencies of the individual DIP switches for setting the station address.

DIP switch	64	32	16	8	4	2	1
Switch position	OFF	OFF	ON	OFF	ON	ON	ON
Value	0	0	16	0	4	2	1
Station address	= sum of the valencies = 16 + 4 + 2 + 1 = 23 ▶ <a href="#">DIP switch positions for setting the station address</a> (📖 107)						

- Valid address range: 1 ... 126 (max. 126 slave stations)
- [C13920](#): Display of the current address setting of the switches
- [C13864](#): Display of the station address active on the PROFIBUS



**Note!**

Switch off the voltage supply of the communication module and then on again in order to activate changed settings.

### Setting the station address via the »Engineer«

In the »Engineer«, the station address can be set via the **Settings** tab.

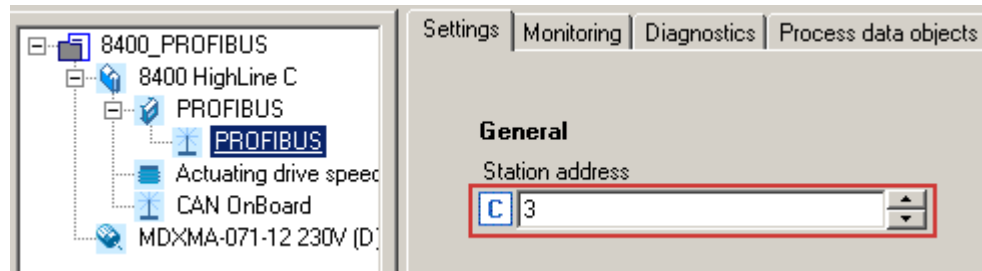

Impermissible addresses are displayed in red in the **Station address** (code [C13899](#)).

Save the changed settings with device command **C0002/11** (save all parameter sets).



## 6.4

## Initial switch-on

**Documentation for the standard device**

Observe the safety instructions and residual hazards stated.

**Note!****Establishing communication**

In order to establish communication via an externally supplied communication module, the standard device must be switched on as well.

After communication has been established, the externally supplied module operates independently of the power on/off state of the standard device.

**Protection against uncontrolled restart**

After a fault (e.g. short-time mains failure), the restart of a drive is not always wanted and - in some cases - even not allowed.

In the Lenze setting of the Inverter Drives 8400, the restart protection is activated.

The restart behaviour of the inverter can be set via **C00142** ("Autostart Option"):

**C00142 = 9** (Lenze setting)

- The inverter remains inhibited (even if the fault is no longer active).
- Bit 0 (inhibited at power-on) and bit 3 (inhibited at undervoltage) are set.
- The drive starts in a controlled mode by explicitly enabling the inverter: LOW-HIGH edge at digital input X4/RFR.

**C00142 = 8** (enabled)

- To enable the device directly at power-on, bit 0 must be set to zero (FALSE).
- An uncontrolled restart of the drive is possible.

## 6.5 Going online with »Engineer« via TCI

Via Tool Calling Interfaces (TCI) you can connect to a TCI-capable integrated development environment and parameterise and diagnose your field devices without having to exit the integrated development environment.

You cannot set the TCI communication path directly in the »Engineer«. The selection is carried out by the »STEP7« Siemens software.

The TCI function requires a PN/DP-CPU. Information on the Siemens PLC types that are equipped with the TCI function is provided via the Siemens Support at:

<http://support.automation.siemens.com>



### How to configure TCI communication:

1. Allocate names for the individual axes in the »Engineer« project.

In our case, "9400" was allocated for 9400 HighLine, and "8400" for 8400 StateLine:

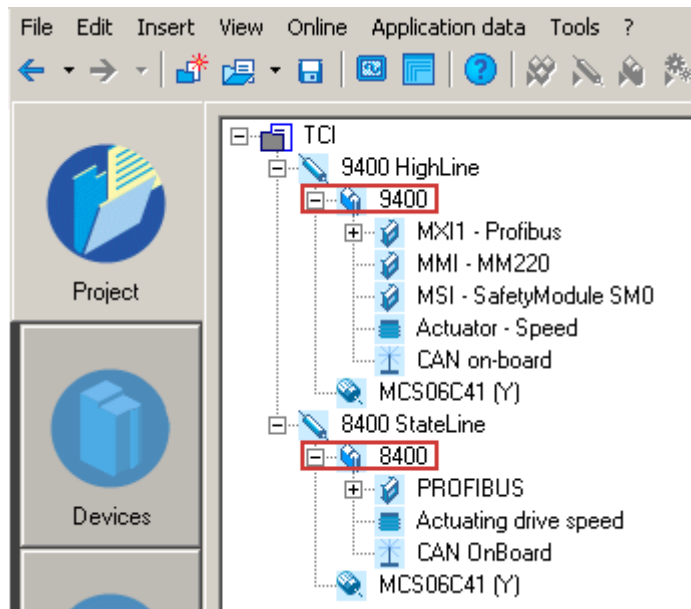

2. In »STEP7« in the »HW Konfig« ...
  - create the Lenze PROFIBUS stations with the corresponding station addresses and
  - create a PROFIBUS network.

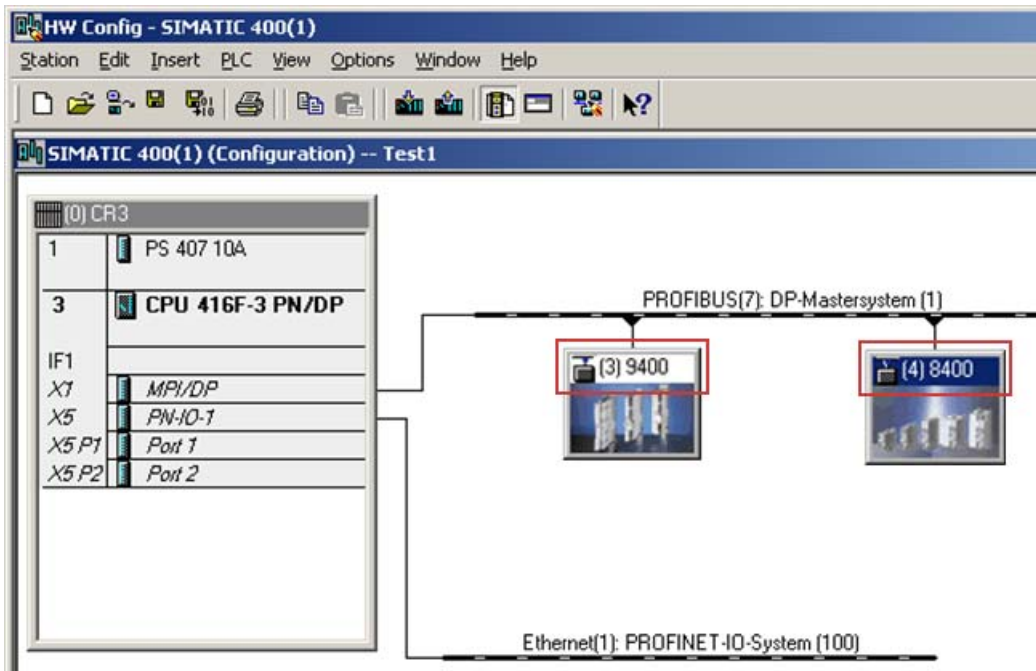

Here a Servo Drive 9400 (address 3) and an Inverter Drive 8400 (address 4) are operated on the PROFIBUS.

- The names of the PROFIBUS slaves in the »HW Konfig« must be identical to those of the corresponding Lenze axes in the »Engineer« (here "9400" and "8400").
  - The selection of the process data configuration has no impact on TCI communication.
3. Establish an Ethernet connection to the PROFIBUS CPU.

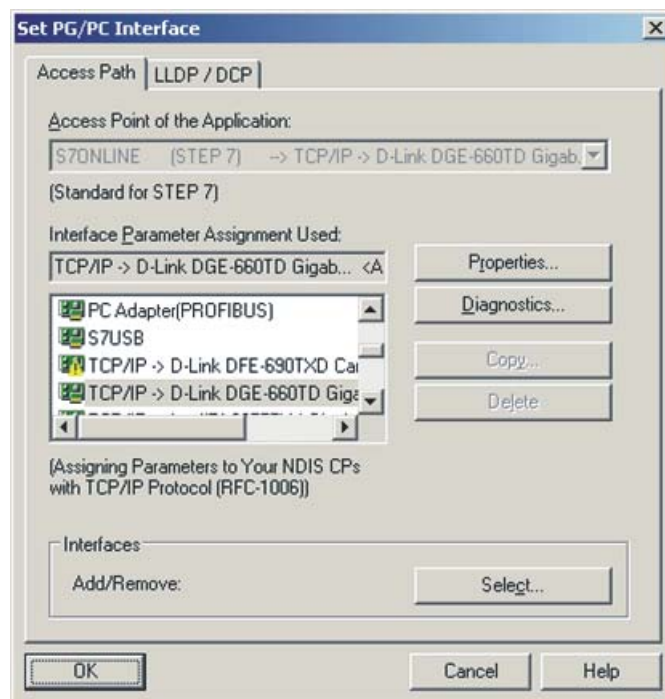

4. Load the »STEP7« project to the CPU.
5. Use the menu command **Insert** → **Station** → **7 PG/PC** to integrate a PG/PC station into the »STEP7« project.

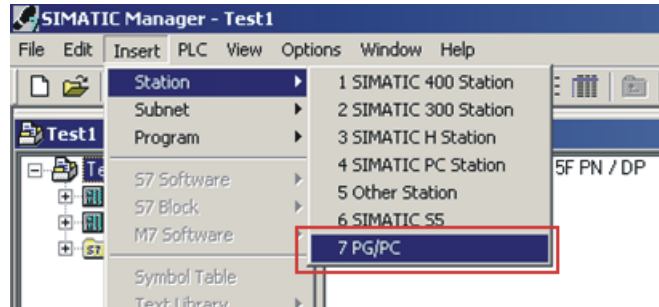

6. By double-clicking the PG/PC station inserted, open its "Properties" dialog.
7. Under the **Interfaces** tab, select a new Ethernet interface and confirm the selection with **OK**.

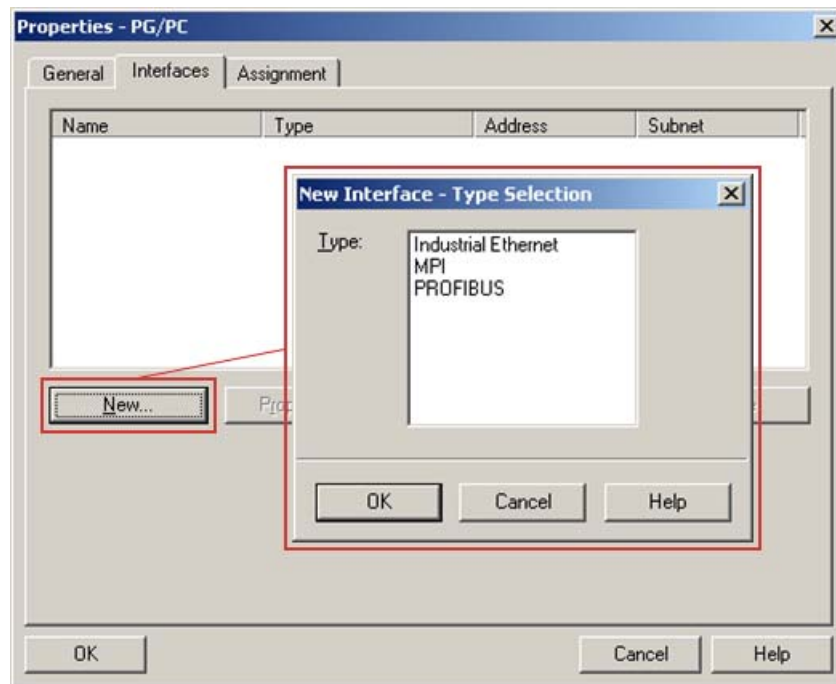

8. Select the Ethernet connection which you are using to go online with »STEP7« (the same Ethernet connection that has been configured in the »HW Konfig«).

In our case this is the Ethernet(1) connection:

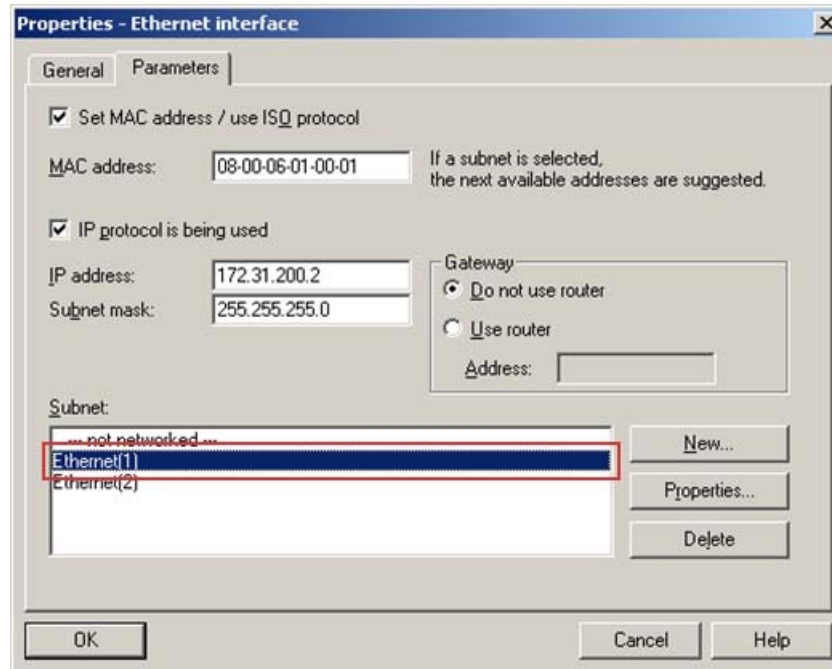

9. Confirm the selection with OK.

The connection has been accepted.

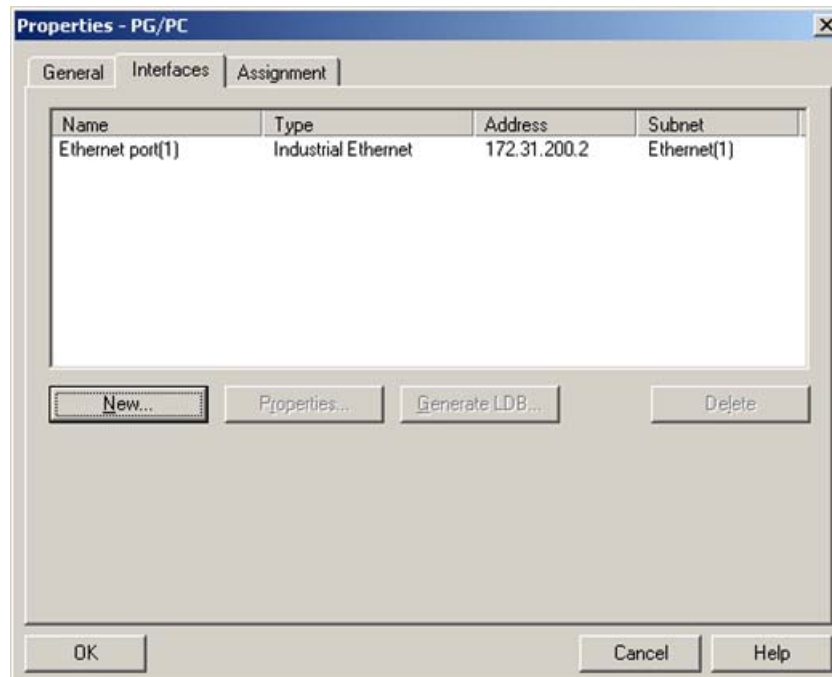

10. Select the actual PG/PC connection under the **Assignment** tab.

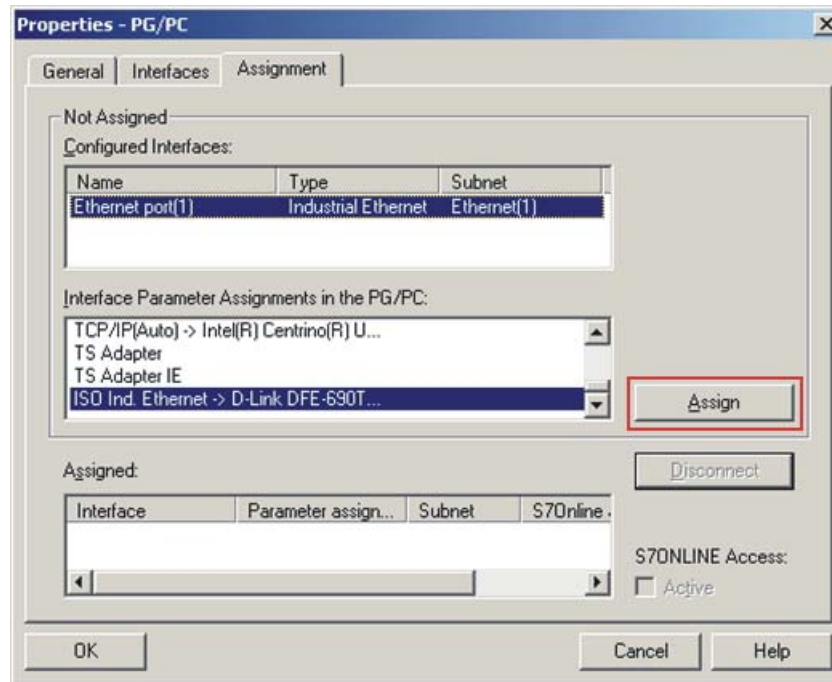

The connection highlighted is assigned by means of the **Assign** button.

11. Confirm the following message with **OK**.

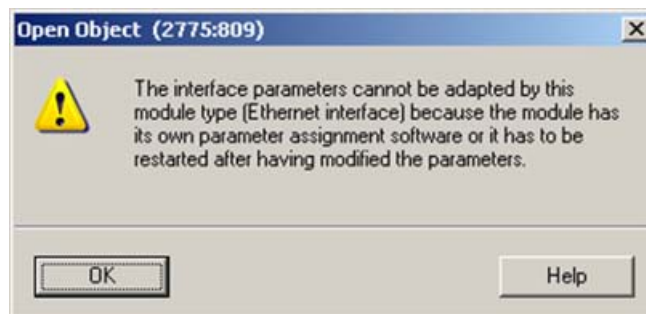

12. After the assignment, the connection appears in the "Assigned" display area. Close the dialog with OK.

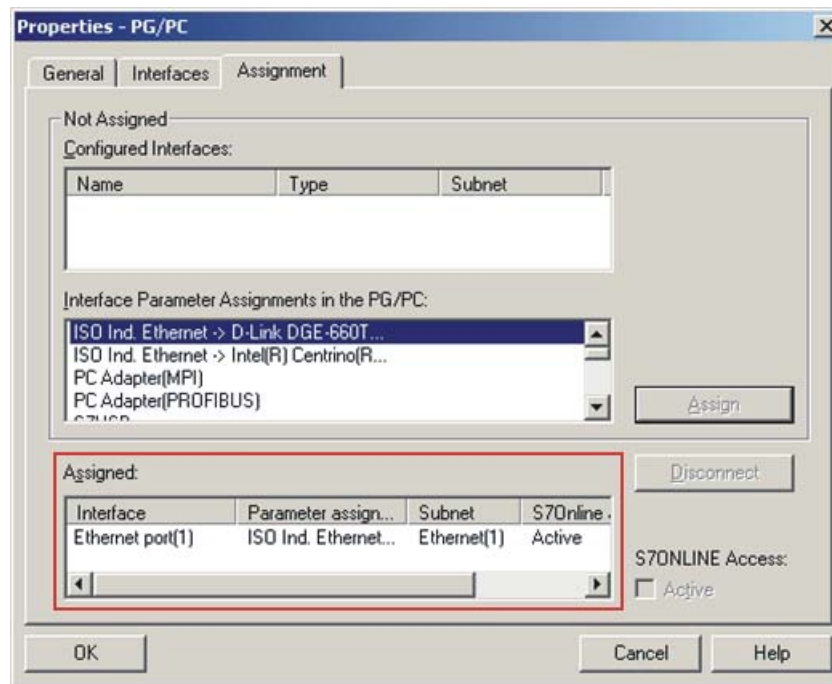

13. In the »STEP7« project, the PG/PC station is marked with a yellow arrow. (The connection selected is active.)

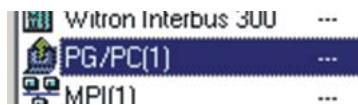

14. Start the transfer of the TCI communication parameters in the »HW Konfig« using the right mouse button and the menu command **Start Device Tool**→ **L-force Engineer**.

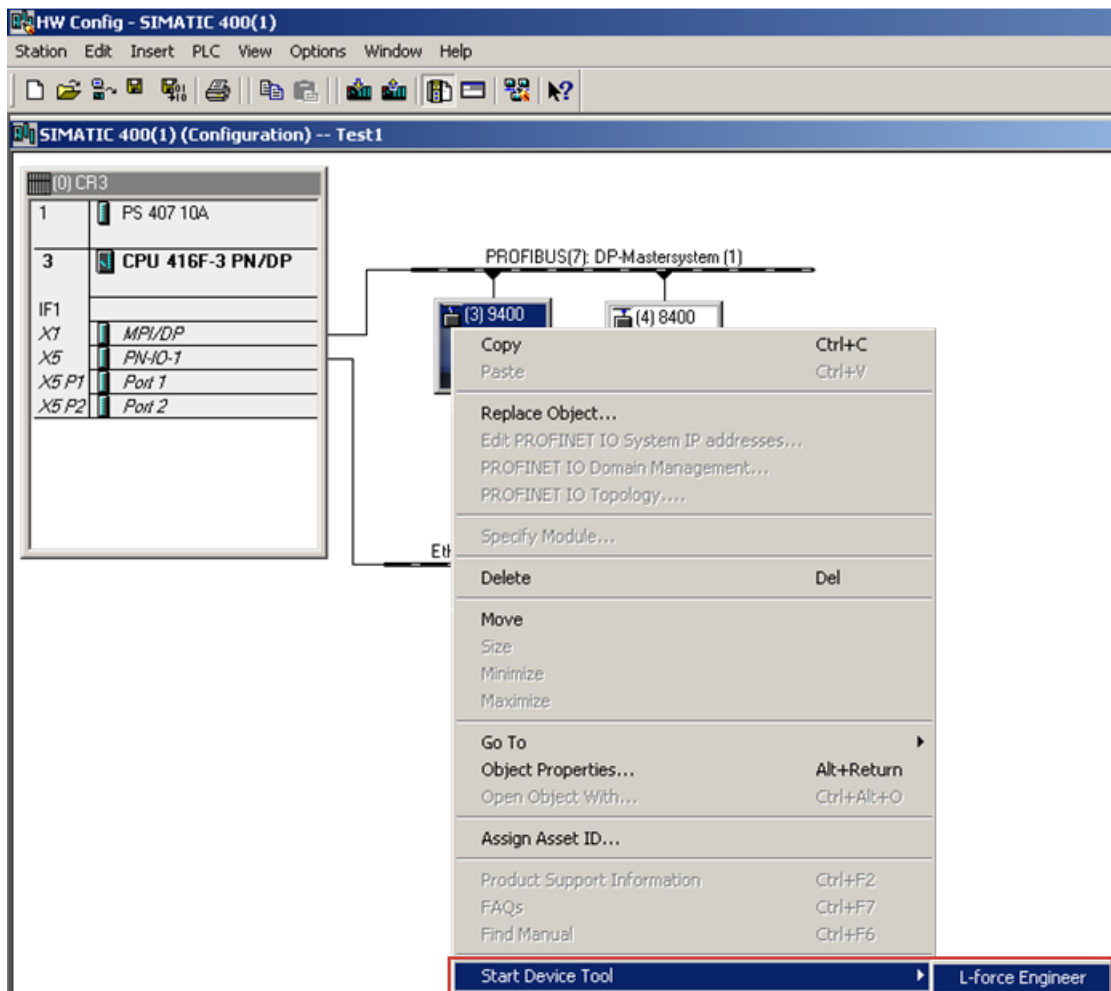

15. If the »Engineer« has already been started with the applicable project, the following message will appear:

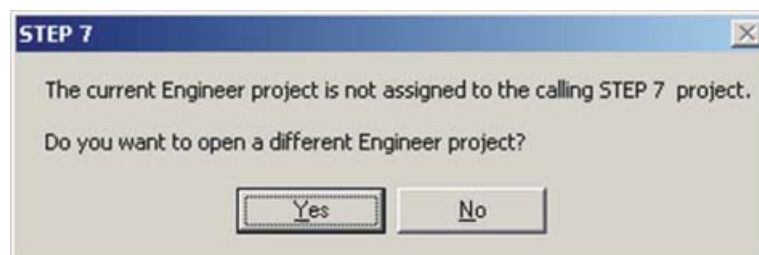

- The message says that the »Engineer« project is not set to a TCI communication path and provides information about whether this action is to be executed now.
- If you confirm the message with **Yes**, the applicable TCI communication parameter settings of the »STEP7« project are transferred to the »Engineer«.



If the »Engineer« has not already been started, it is started automatically now and you have to open the applicable project.

If the project selected has not been set to a TCI communication path yet, this can now be executed by clicking **Yes**:

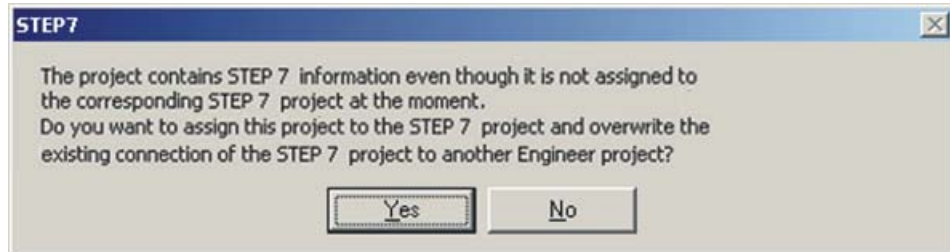

16. The transfer of the TCI communication parameters is documented in the »Engineer« message window.

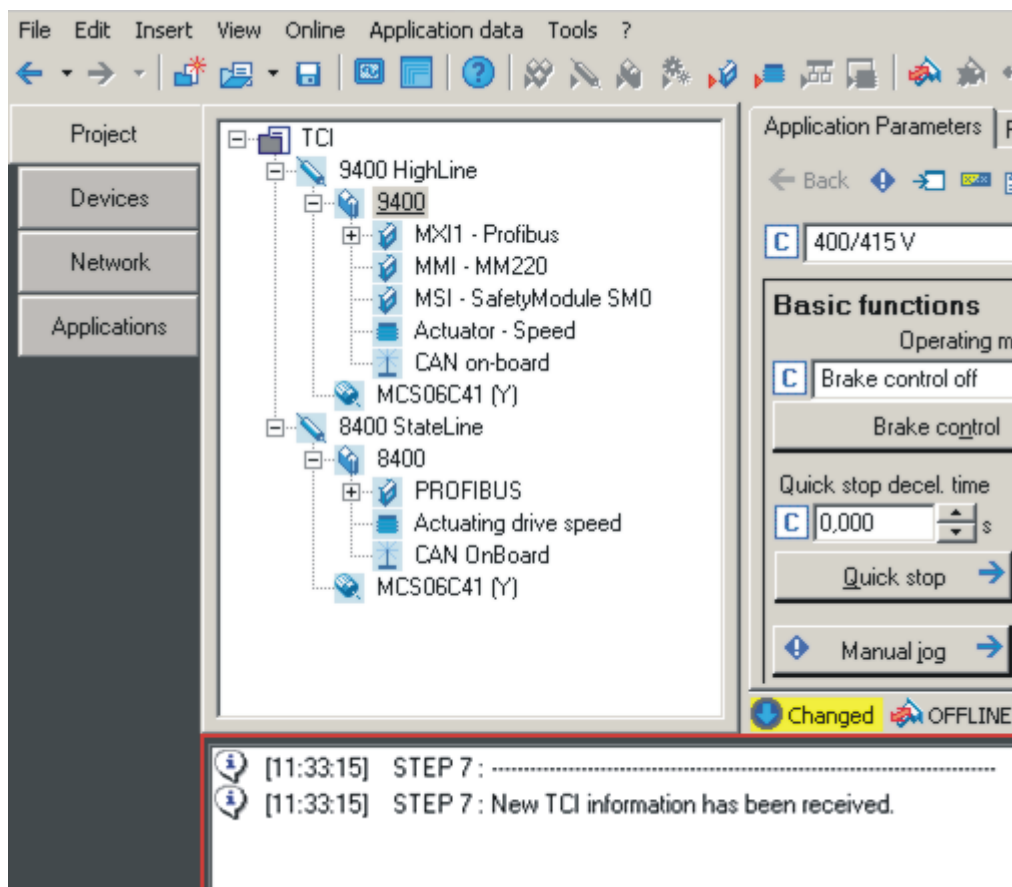

Here the communication settings have been carried out successfully. The individual PROFIBUS addresses in the respective codes have been adapted to the »STEP7« project.

17. If you now call the "Go online" function of the »Engineer«, the TCI communication settings are displayed as follows:

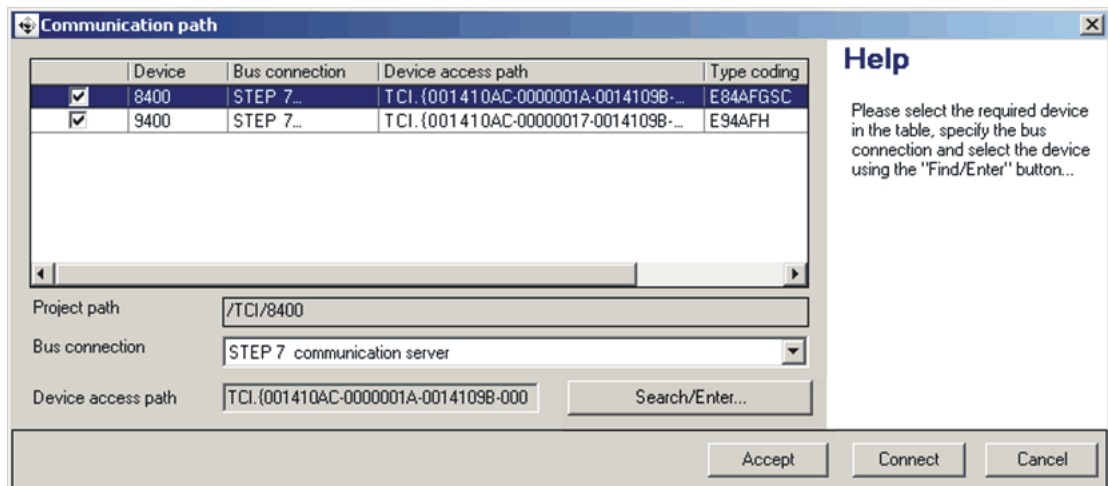

- "STEP7 Communication Server" appears as bus connection.
- The device access path contains a very long string.
- Use the **Connect** button to establish an online connection.
- By means of the **Search/Enter** button, you can update the TCI communication parameters.

## 7 Data transfer

The PROFIBUS master and inverter communicate through the exchange of data telegrams via PROFIBUS. The user data area of the data telegram contains parameter data or process data. In the inverter, different communication channels are assigned to the parameter data and process data.

### Communication channels

The process data channel serves to transfer process data.

- The process data serve to control the inverter.
- The controller (master) can directly access the process data. In the PLC, for instance, the data are directly saved to the I/O area.
- Process data are not saved in the inverter.
- Process data are transferred cyclically between the controller and the inverters (permanent exchange of current input / output data).
- Process data are, for instance, setpoints, actual values, control words and status words.
- The Inverter Drives 8400 can exchange a maximum of 16 process data word (16 bits/word) per direction.



### Note!

Observe the direction of the information flow!

- Process input data (Rx data):
  - Process data from the inverter (slave) to the master
- Process output data (Tx data):
  - Process data from the master to the inverter (slave)

The parameter data channel serves to transfer parameter data.

- The parameter data channel provides access to all Lenze codes.
- In general, the parameter data transfer is not time-critical.
- Parameter data are, for instance, operating parameters, diagnostic information, and motor data.
- Parameter changes must be saved by means of code **C00002** of the Inverter Drive 8400.

## 8 Process data transfer

### 8.1 Access to process data / PDO mapping



**Note!**

PDO mapping and the objects required for this purpose are not supported in the software version 01.00 of the E84AYCPM communication module.

The process data (MCI-PDOs) are transferred via the MCI interface.

- A maximum of 16 words for each direction is exchanged.
- The process data are accessed via the **LP\_MciIn** and **LP\_MciOut** port blocks. These port blocks are also referred to as process data channels.
- The port/function block interconnection of the process data objects (PDO) takes place via the Lenze »Engineer«.

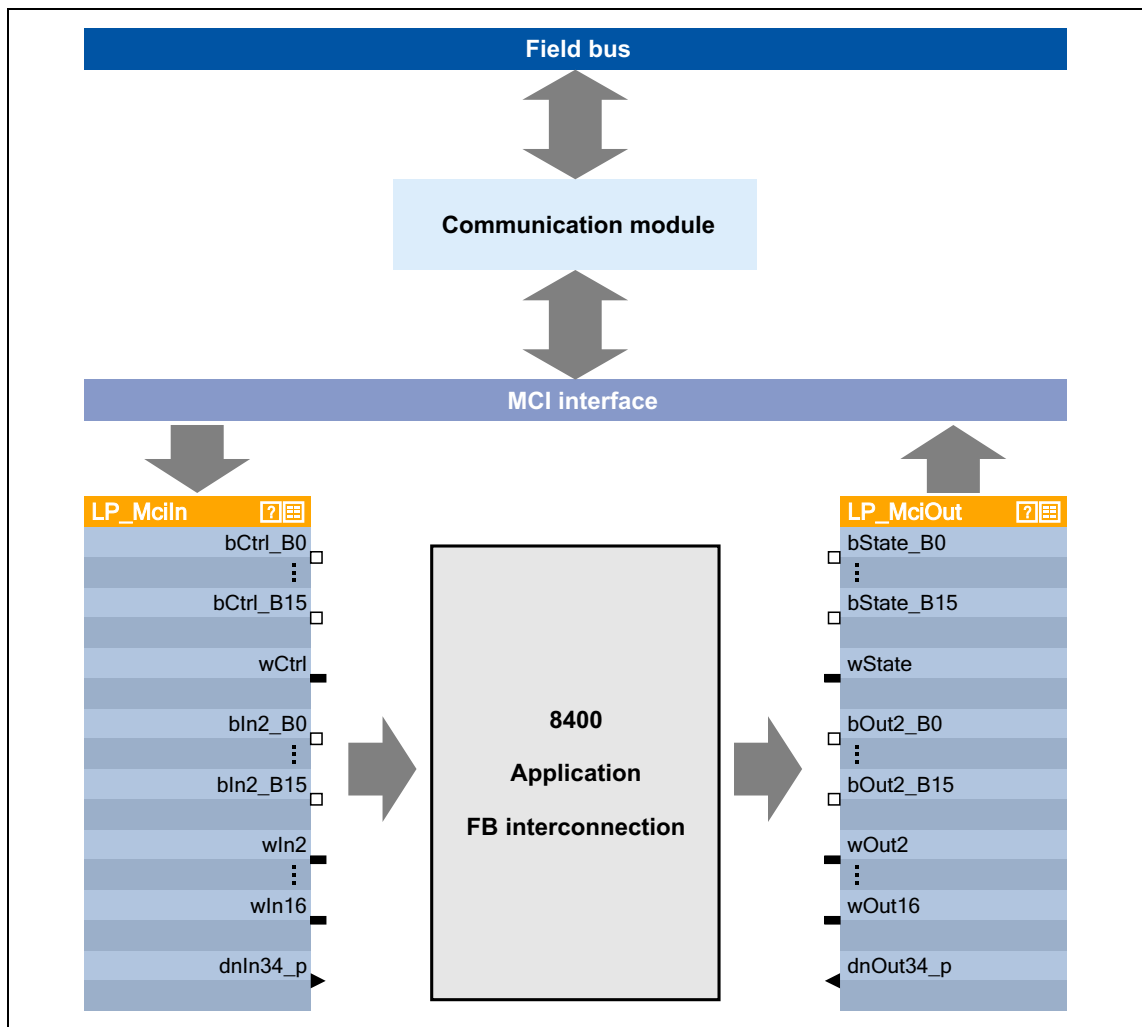

[8-1] External and internal data transfer between the bus system, inverter, and function block interconnection

# 8 Process data transfer

## 8.2 Preconfigured port interconnection of the process data objects (PDO)



### Software manual/ »Engineer« online help for Inverter Drives 8400

Here you'll find some detailed information about the port/function block interconnection in the »Engineer« and about port blocks.

## 8.2 Preconfigured port interconnection of the process data objects (PDO)

The preconfigured port interconnection of the process data objects is activated by setting standard device code **C00007 = "40: MCI"**.

It is possible to display the port blocks "LP\_MciIn" and "LP\_MciOut" as well as the preconfigured interconnections in the »FB Editor« :

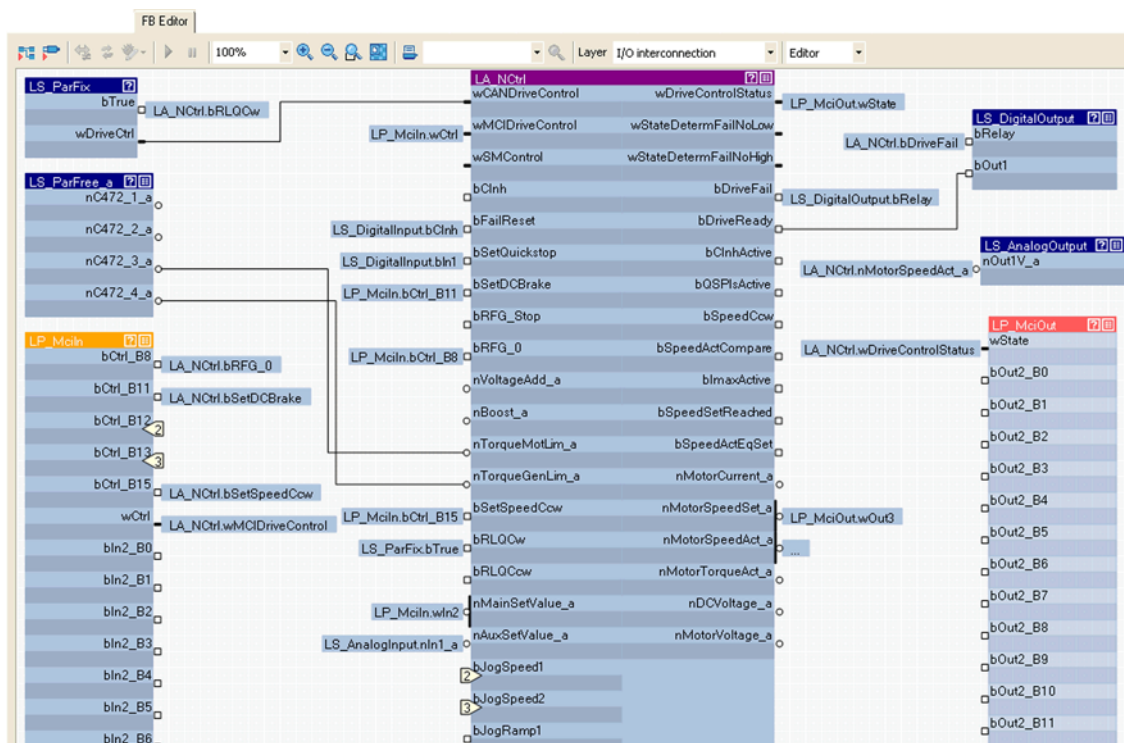

# 8 Process data transfer

## 8.3 Free configuration of the port interconnection of process data objects (PDO)

### 8.3 Free configuration of the port interconnection of process data objects (PDO)



How to freely configure the port interconnection in the »Engineer«:

1. Go to the **Process data objects** tab and click **Go to application**.

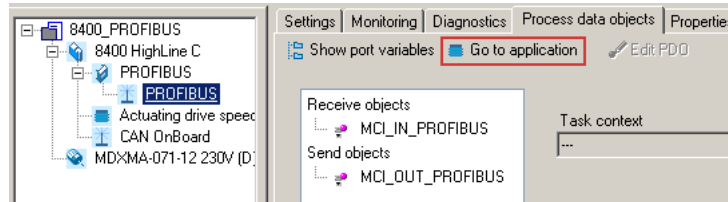

2. Go to the **Ports** tab and select the port block "MCI\_IN" or "MCI\_OUT" via mouse-click. Activate it by clicking **Activate**.

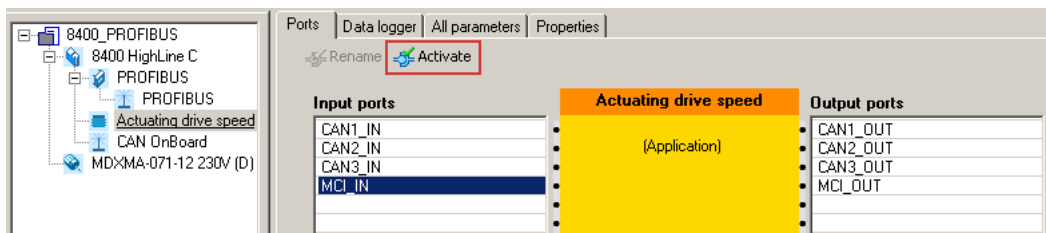

3. Click the **Edit port ...** button.

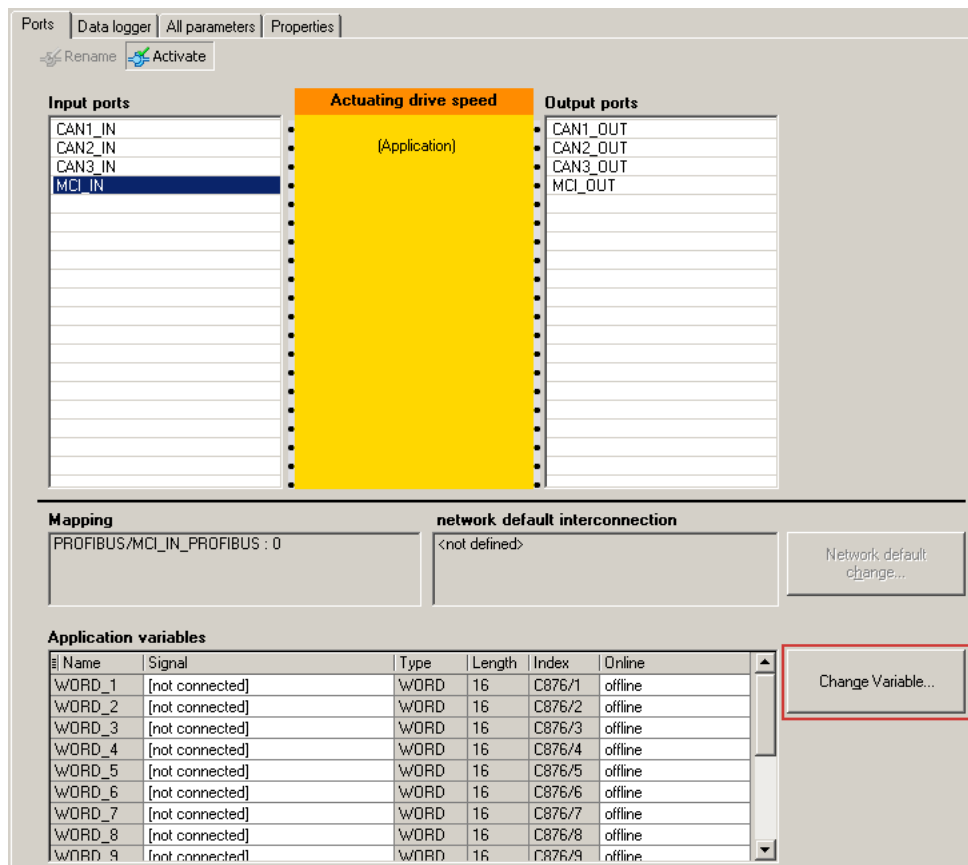

# 8 Process data transfer

## 8.3 Free configuration of the port interconnection of process data objects (PDO)

4. Via the  button, you can assign signals to the process data words in the *Assignment Signal --> Function Block* dialog box.  
→ Select the signals and then confirm the selection with **OK**.

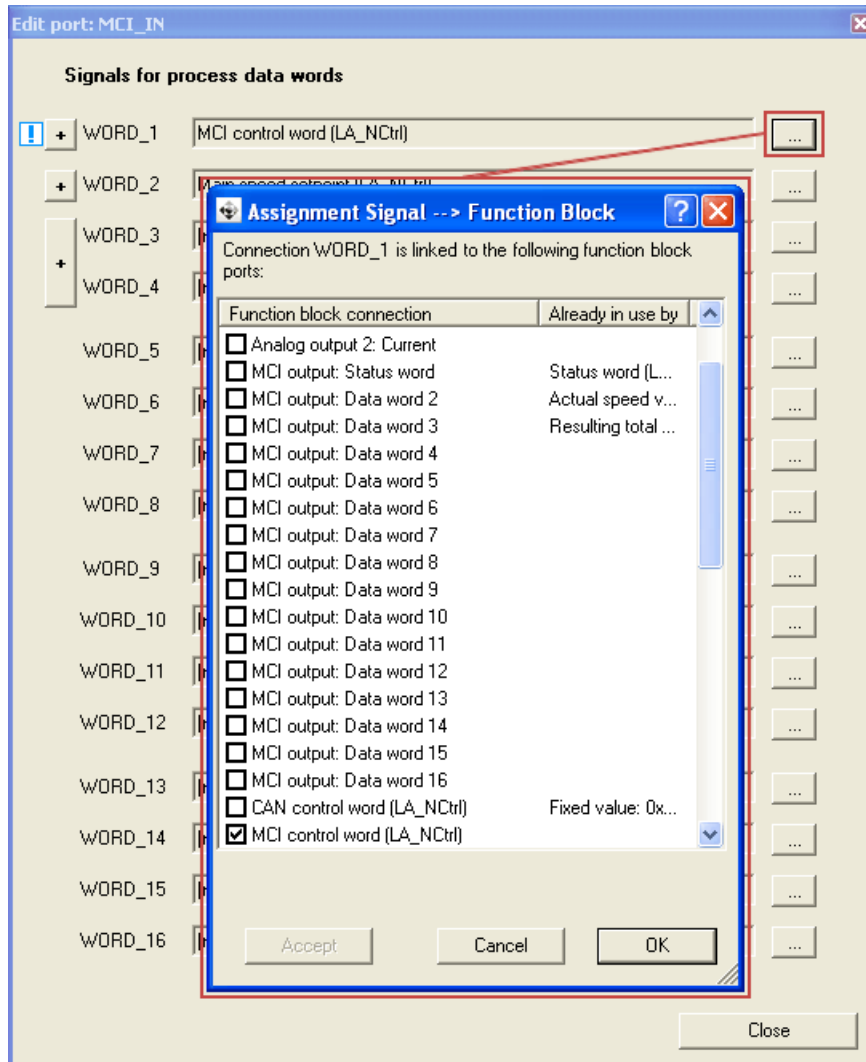

For the process data words WORD\_1 and WORD\_2, you can also assign signals to the individual control bits and status bits via the **+** and **...** buttons.

→ Select the signals and then confirm the selection with **OK**.

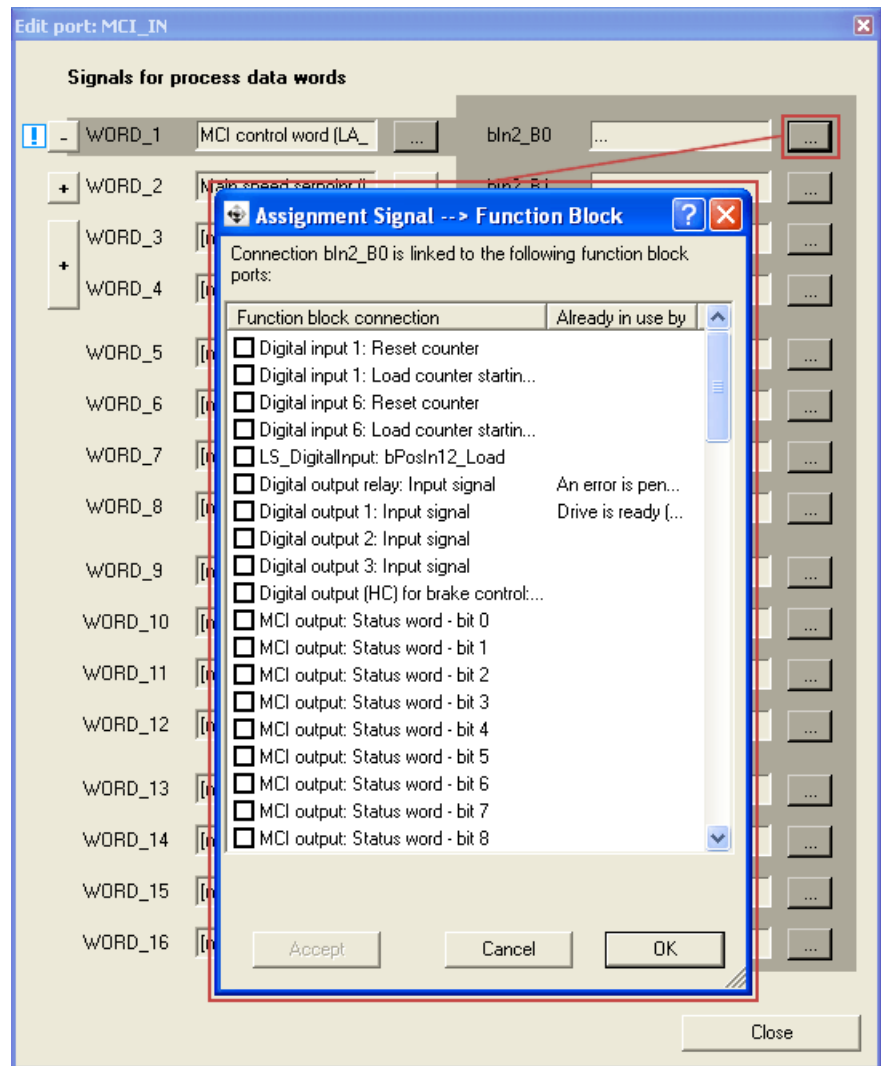



# 8 Process data transfer

## 8.3 Free configuration of the port interconnection of process data objects (PDO)



**Tip!**

If the port blocks "LP\_MciIn" and "LP\_MciOut" are activated (see step 1), they are displayed in the »FB Editor«. Here you can also assign signals to the process data words.

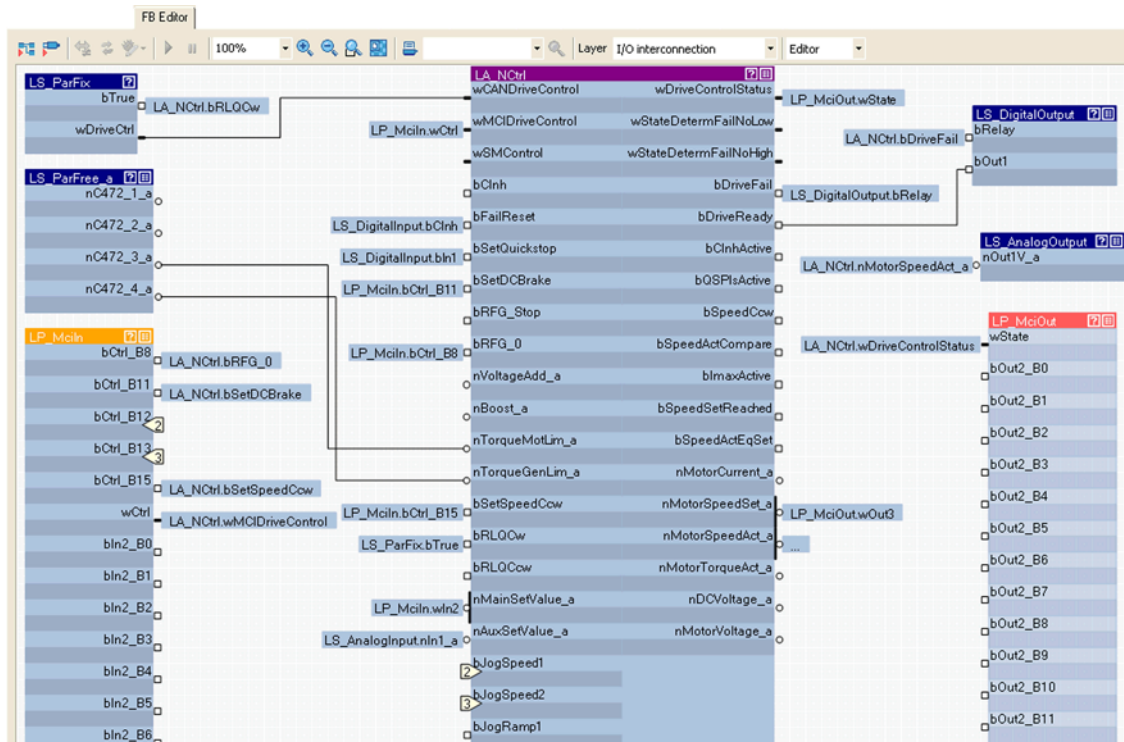

## 9 Parameter data transfer

### 9.1 Addressing of the parameter data

---

## 9 Parameter data transfer

The E84AYCPM communication module supports the cyclic and acyclic transmission of parameter data:

- Cyclic DP-V0 parameter data are based on the DRIVECOM profile.  
If the DP-V0 parameter data channel is active, it additionally occupies 4 words of the input data and the output data.
- Acyclic DP-V1 parameter data are based on the PROFIdrive profile.

### 9.1 Addressing of the parameter data

The parameter data are addressed via codes which can be found in this documentation and in the corresponding documentation of your inverter.

▶ [Parameter reference](#) (□ 95)

#### Addressing of Lenze parameters

In the case of the DP-V0 parameter data channel, the parameters of a device are not addressed directly via Lenze code numbers, but via indices (bytes 3 + 4) and subindices (byte 2).

The conversion is made via an offset (24575 / 0x5FFF):

- PROFIBUS-DP  $\text{index}_{\text{dec}} = 24575 - \text{Lenze code number}$
- PROFIBUS-DP  $\text{index}_{\text{hex}} = 0x5FFF - \text{Lenze code number}_{\text{hex}}$

Example of C00105 (quick stop deceleration time):

- PROFIBUS-DP  $\text{index}_{\text{dec}} = 24575 - 105 = 24470$
- PROFIBUS-DP  $\text{index}_{\text{hex}} = 0x5FFF - 0x69 = 0x5F96$

The parameter values are entered into the user data (bytes 5 to 8) of the telegram.

# 9 Parameter data transfer

## 9.2 DRIVECOM parameter data channel (DP-V0)

---

### 9.2 DRIVECOM parameter data channel (DP-V0)

The DRIVECOM parameter data channel (DP-V0) ...

- enables parameter setting and diagnosing of the inverter.
- provides access to all Lenze parameters (codes).
- additionally occupies 4 words (16 bits/word) of the input and output data words in the master.
- is identical for both transmission directions.

#### 9.2.1 Telegram structure (overview)

The telegram of the parameter data channel consists of a total of 8 bytes:

Byte 1	Byte 2	Byte 3	Byte 4	Byte 5	Byte 6	Byte 7	Byte 8
Service	Subindex	Index High byte	Index Low byte	Data 4 / Error 4	Data 3 / Error 3	Data 2 / Error 2	Data 1 / Error 1

The individual bytes are described in detail in the following subchapters.

### 9.2.2 Byte 1: Service

Byte 1	Byte 2	Byte 3	Byte 4	Byte 5	Byte 6	Byte 7	Byte 8
Service	Subindex	Index High byte	Index Low byte	Data 4 / Error 4	Data 3 / Error 3	Data 2 / Error 2	Data 1 / Error 1

#### Request and response control for the parameter data channel

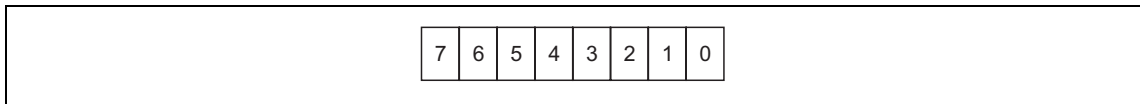

[9-1] Method of counting for bits 0 ... 7

Bit 0 ... 2: Request	
Read/write request from the master to the inverter	
000	No request
001	Read request ▶ <a href="#">Reading parameter data from the inverter</a> (□ 54)
010	Write request (write data to the inverter) ▶ <a href="#">Writing parameter data to the inverter</a> (□ 54)
100	Data transfer abort by the master ▶ <a href="#">Data transfer abort by the master</a> (□ 55)

Bit 3
Reserved

Bit 4/5: Data length	
Data length ≤ 4 bytes in the telegram bytes 5 ... 8 (data 1 ... 4 / error 1 ... 4)	
00	1 byte
01	2 bytes
10	3 bytes
11	4 bytes

Bit 6: Handshake
Indicates a new request. <ul style="list-style-type: none"> <li>• The state of this (toggle) bit is changed by the master for every new request.</li> <li>• The inverter copies the bit into its response telegram.</li> </ul>

Bit 7: Status	
Status information from the inverter to the master when sending the request confirmation. This status bit informs the master whether the request has been carried out without errors.	
0	Request completed without errors.
1	Request not completed because of an error. <ul style="list-style-type: none"> <li>• The set status bit indicates that the telegram is an "error telegram". The data of bytes 5 ... 8 (data/error) must be interpreted as an error message.</li> </ul> ▶ <a href="#">Error codes</a> (□ 58)

# 9 Parameter data transfer

## 9.2 DRIVECOM parameter data channel (DP-V0)

---

### 9.2.2.1 Reading parameter data from the inverter

#### General procedure:

1. Define the user data area of the inverter, i.e. define the location of the DP user data in the controller (observe manufacturer-specific information).
2. Enter the address of the required parameter in the "Index" and "Subindex" fields (DP output data).
3. Request in the service byte = read request.  
The handshake bit in the service byte must be changed (DP output data).
4. Check whether the handshake bit in the service byte is the same for the DP input data and the DP output data.
  - If the handshake bit is the same, the response has been received.
  - It is useful to implement a time monitoring tool.
5. Check whether the status bit in the service byte is set:
  - Status bit is not set: The "Data/Error" field contains the required [Parameter value \(data\)](#) (☐ 57).
  - Status bit is set: The read request has not been executed correctly. The "Data/Error" field contains the [Error codes](#) (☐ 58).

### 9.2.2.2 Writing parameter data to the inverter

#### General procedure:

1. Define the user data area of the inverter, i.e. define the location of the DP user data in the controller (observe manufacturer-specific information).
2. Enter the address of the required parameter in the "Index" and "Subindex" fields (DP output data).
3. Enter the parameter value in the "Data/Error" field.
4. Request in the service byte = write request.  
The handshake bit in the service byte must be changed (DP output data).
5. Check whether the handshake bit in the service byte is the same for the DP input data and the DP output data.
  - If the handshake bit is the same, the response has been received.
  - It is useful to implement a time monitoring tool.
6. Check whether the status bit in the service byte is set:
  - Status bit is not set: The write request has been executed correctly.
  - Status bit is set: The write request has not been executed correctly. The "Data/Error" field contains the [Error codes](#) (☐ 58).

### 9.2.2.3 Abort of data transfer by the inverter

The error telegram is used to abort the transfer.

- The error telegram is marked by a set status bit in the service byte.
- The telegram can either be the response to an "Initiate Read/Write Service" or to a "Read/Write Segment Service".

**Inverter response in the event of an error:**

Byte 1	Byte 2	Byte 3	Byte 4	Byte 5	Byte 6	Byte 7	Byte 8
Service	Subindex	Index High byte	Index Low byte	Data 4 / Error 4	Data 3 / Error 3	Data 2 / Error 2	Data 1 / Error 1
1t110000	SIDX	IDXH	IDXL	Error Class	Error code	Additional Code High	Additional Code Low

### 9.2.2.4 Data transfer abort by the master

The master can use this error telegram to abort a running segment transmission.

- The error telegram is marked by a set status bit in the service byte.
- The service byte also contains the request code "4" ( $100_{bin}$ ).
- Bit 4 and bit 5 in the service byte (data length) are without meaning.
- Additional information (subindex, index, error information) is not transmitted.

Byte 1	Byte 2	Byte 3	Byte 4	Byte 5	Byte 6	Byte 7	Byte 8
Service	Reserved	Reserved	Reserved	Reserved	Reserved	Reserved	Reserved
1txx0100	0	0	0	0	0	0	0

**Inverter response in the case of correct execution:**

The inverter confirms the error telegram of the master by also sending an error telegram.

- The error telegram is marked by a set status bit in the service byte.
- In the case of correct execution, the telegram contains the error information "0x00000000" in bytes 5 ... 8.
- Additional information (subindex, index) is not transmitted.

Byte 1	Byte 2	Byte 3	Byte 4	Byte 5	Byte 6	Byte 7	Byte 8
Service	SIDX	IDXH	IDXL	Error Class	Error code	Additional Code High	Additional Code Low
1t110000	0	0	0	0	0	0	0

### 9.2.3 Byte 2: Subindex

Byte 1	Byte 2	Byte 3	Byte 4	Byte 5	Byte 6	Byte 7	Byte 8
Service	<b>Subindex</b>	Index High byte	Index Low byte	Data 4 / Error 4	Data 3 / Error 3	Data 2 / Error 2	Data 1 / Error 1

Additional addressing via the subindex is required for those codes of the Inverter Drives 8400 that contain a subcode (see code table).

### 9.2.4 Bytes 3 + 4: Index

Byte 1	Byte 2	Byte 3	Byte 4	Byte 5	Byte 6	Byte 7	Byte 8
Service	Subindex	<b>Index High byte</b>	<b>Index Low byte</b>	Data 4 / Error 4	Data 3 / Error 3	Data 2 / Error 2	Data 1 / Error 1

The parameter (Lenze code) is selected via these two bytes according to the formula:

- $\text{Index} = 24575 - \text{Lenze code number}$

(Also see "[Addressing of Lenze parameters](#)" (51))

#### Example:

The parameter C00105 (quick stop (QSP) deceleration time) is to be addressed:

- $\text{Index} = 24575 - 105 = 24470 = 0x5F96$
- The entries in bytes 3 + 4 for this example would be:

Byte 1	Byte 2	Byte 3	Byte 4	Byte 5	Byte 6	Byte 7	Byte 8
Service	Subindex	<b>0x5F</b>	<b>0x96</b>	Data 4 / Error 4	Data 3 / Error 3	Data 2 / Error 2	Data 1 / Error 1

### 9.2.5 Bytes 5 ... 8: Parameter value / error information

Byte 1	Byte 2	Byte 3	Byte 4	Byte 5	Byte 6	Byte 7	Byte 8
Service	Subindex	Index High byte	Index Low byte	Data 4 / Error 4	Data 3 / Error 3	Data 2 / Error 2	Data 1 / Error 1

The state of status bit 7 in the service byte determines the meaning of this data field:

Status bit	Meaning of bytes 5 ... 8
0	Bytes 5 ... 8 contain the parameter value (data 1 ... 4).
1	Bytes 5 ... 8 contain an error message (error 1 ... 4) due to an invalid access. ▶ <a href="#">Error codes</a> (📖 58)

#### Parameter value (data)



#### Note!

Strings or data blocks cannot be transmitted.

Depending on the data format, the length of the parameter value is between 1 and 4 bytes.

Data are saved in the Motorola format, i.e. first the high byte (high word), then the low byte (low word):

Byte 5	Byte 6	Byte 7	Byte 8
High byte	Low byte	High byte	Low byte
High word		Low word	
Double word			

Principle for the assignment of bytes 5 ... 8 with parameter values of different lengths:

Byte 5	Byte 6	Byte 7	Byte 8
Parameter value (length 1)	0x00	0x00	0x00
Parameter value (length 2)		0x00	0x00
Parameter value (length 4)			



### 9.2.6 Error codes

The following error messages may appear:

Byte 8	Byte 7	Byte 6	Byte 5	Meaning
Error 1	Error 2	Error 3	Error 4	
0x06	0x03	0x00	0x00	No right to access
0x06	0x05		0x11	Invalid subindex
0x06	0x05		0x12	Data length too large
0x06	0x05		0x13	Data length too small
0x06	0x07		0x00	Object does not exist
0x06	0x08		0x00	Data types do not comply with each other
0x08	0x00		0x00	Request cannot be executed
0x08	0x00		0x20	Request cannot be executed at the moment
0x08	0x00		0x22	Request cannot be executed due to the device status / The parameter can only be changed in the case of a controller inhibit
0x08	0x00		0x30	Value ranged exited
0x08	0x00		0x31	Parameter value too high
0x08	0x00		0x32	Parameter value too low
0x08	0x00		0x80	Hardware error

### 9.2.7 Telegram examples

#### 9.2.7.1 Read request: Querying the heatsink temperature

The heatsink temperature of the inverter is to be read.

- Code to be read: C00061
- Heatsink temperature: 43 °C

##### Byte 1: Service (request)

Request =  $0t110001_{bin}$

- Bit 0 ... 2 =  $001_{bin}$  for read request
- Bit 3 = 0 (reserved)
- Bit 4/5 =  $01_{bin}$  for 2-byte data length (only relevant for the response telegram)
- Bit 6 = handshake bit (t ≡ status is changed in the response telegram)
- Bit 7 = status bit (only relevant for the response telegram)

##### Byte 2: Subindex

Subindex = 0 because code C00061 does not contain any subindices.

##### Bytes 3 + 4: Index

Index = 24575 - code number = 24575 - 61 = 24514 =  $0x5FC2$

- Byte 3 (high byte) =  $0x5F$
- Byte 4 (low byte) =  $0xC2$

##### Bytes 5 ... 8: Data

The response telegram contains the value of code C00061:

Data 3 + 4 = 43 [°C] x 1 (internal factor) = 43 =  $0x002B$

##### Result:

Request telegram from master to drive:

Byte 1	Byte 2	Byte 3	Byte 4	Byte 5	Byte 6	Byte 7	Byte 8
Service	Subindex	Index High byte	Index Low byte	Data 4	Data 3	Data 2	Data 1
0x01	0x00	0x5F	0xC2	0x00	0x00	0x00	0x00
$0t000001_{bin}$	$00000000_{bin}$	$01011111_{bin}$	$11000010_{bin}$	$00000000_{bin}$	$00000000_{bin}$	$00000000_{bin}$	$00000000_{bin}$
Waiting for change of handshake bit 6 in service byte 1 of the response.							

Response telegram from drive to master (for correct execution):

Byte 1	Byte 2	Byte 3	Byte 4	Byte 5	Byte 6	Byte 7	Byte 8
Service	Subindex	Index High byte	Index Low byte	Data 4	Data 3	Data 2	Data 1
0x11	0x00	0x5F	0xC2	0x00	0x2B	0x00	0x00
$0t010001_{bin}$	$00000000_{bin}$	$01011111_{bin}$	$11000010_{bin}$	$00000000_{bin}$	$00101011_{bin}$	$00000000_{bin}$	$00000000_{bin}$

### 9.2.7.2 Write request: Setting the deceleration time for quick stop (QSP)

In the inverter, the deceleration time for quick stop (QSP) is to be set to 50 ms.

- Code to be written: C00105

#### Byte 1: Service (request)

Request =  $0t110010_{bin}$

- Bit 0 ... 2 =  $010_{bin}$  for write request
- Bit 3 = 0 (reserved)
- Bit 4/5 =  $11_{bin}$  for 4-byte data length
- Bit 6 = handshake bit (t = status is changed in the response telegram)
- Bit 7 = status bit (only relevant for the response telegram)

#### Byte 2: Subindex

Subindex = 0 because code C00105 does not contain any subindices.

#### Bytes 3 + 4: Index

Index = 24575 - code number = 24575 - 105 = 24470 =  $0x5F96$

- Byte 3 (high byte) =  $0x5F$
- Byte 4 (low byte) =  $0x96$

#### Bytes 5 ... 8: Data

The parameter value of 0.05 s to be set is multiplied by the code-specific factor of "1000" and entered in the user data:

Data 1 ... 4 =  $0.05 [s] \times 1000$  (internal factor) = 50 =  $0x00000032$

#### Result:

Request telegram from master to drive:

Byte 1	Byte 2	Byte 3	Byte 4	Byte 5	Byte 6	Byte 7	Byte 8
Service	Subindex	Index High byte	Index Low byte	Data 4	Data 3	Data 2	Data 1
0x72	0x00	0x5F	0x96	0x00	0x00	0x00	0x32
$0t110010_{bin}$	$00000000_{bin}$	$01011111_{bin}$	$10010110_{bin}$	$00000000_{bin}$	$00000000_{bin}$	$00000000_{bin}$	$00110010_{bin}$
Waiting for change of handshake bit 6 in service byte 1 of the response							

Response telegram from drive to master (for correct execution):

Byte 1	Byte 2	Byte 3	Byte 4	Byte 5	Byte 6	Byte 7	Byte 8
Service	Subindex	Index High byte	Index Low byte	Data 4	Data 3	Data 2	Data 1
0x40	0x00	0x5F	0x96	0x00	0x00	0x00	0x32
$0t000000_{bin}$	$00000000_{bin}$	$01011111_{bin}$	$10010110_{bin}$	$00000000_{bin}$	$00000000_{bin}$	$00000000_{bin}$	$00110010_{bin}$

# 9 Parameter data transfer

## 9.3 PROFIdrive parameter data channel (DP-V1)

---

### 9.3 PROFIdrive parameter data channel (DP-V1)

Data communication with PROFIBUS-DP-V0 is characterised by cyclic diagnostics and cyclic process data and parameter data transfer.

An optional service expansion is the acyclic parameter data transfer of PROFIBUS-DP-V1. This service does not impair the functionality of the standard services under PROFIBUS-DP-V0.

PROFIBUS-DP-V0 and PROFIBUS-DP-V1 can be operated simultaneously in the same network. This enables the step-by-step expansion or retrofitting of a system.

The services of PROFIBUS-DP-V1 can be used by the class 1 master (PLC) and the class 2 master (diagnostics master, etc.).

The integration of the acyclic service into the fixed bus cycle depends on the corresponding configuration of the class 1 master:

- With configuration, a time slot is reserved.
- Without configuration the acyclic service is *appended* when a class 2 master acyclically accesses a DP-V1 slave.

#### Features

- Parameter number and subindex addresses with a width of 16 bits each.
- Several parameter requests can be combined to one request (multi-parameter request).
- There is always only one parameter request in process (no pipelining).
- A parameter request/response must fit into a data block (max. 240 bytes). Requests/responses cannot be split into several data blocks.
- No spontaneous messages are transferred.
- There are only acyclic parameter requests.
- Profile-specific parameters can be read independently of the slave state.

### 9.3.1 Connection establishment between master and slave

A class 1 master can always request parameters from a slave if the slave is in the "Data\_Exchange" state.

In addition to the class 1 master, a class 2 master can establish a communication connection to the slave:

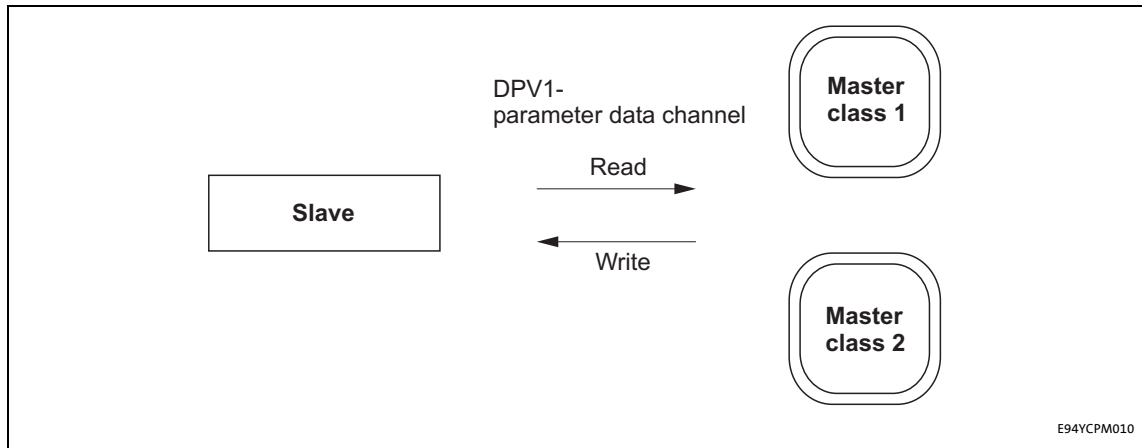

[9-2] Data communication via the DP-V1 parameter data channel

## 9.3.2 Acyclic data transfer

**Note!**

A parameter request refers to one or several parameter(s) (multi-parameter request).

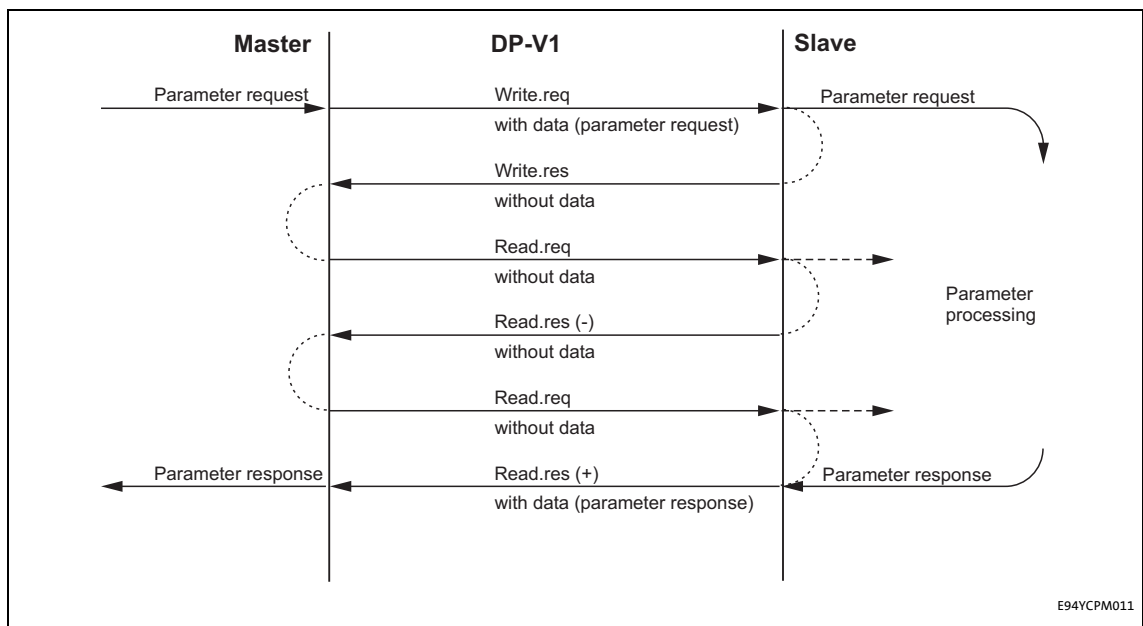

[9-3] Transmission directions

## Explanation

- A "Write.req" is used to pass the data set (DB47) to the slave in the form of a parameter request.
- With "Write.res" the master receives the confirmation for the receipt of the message.
- The master requests the response of the slave with "Read.req".
- The slave responds with "Read.res (-)" if processing has not yet been completed.
- After parameter processing, the parameter request is completed by transmitting the parameter response to the master with "Read.res (+)".

**9.3.3 Telegram structure**

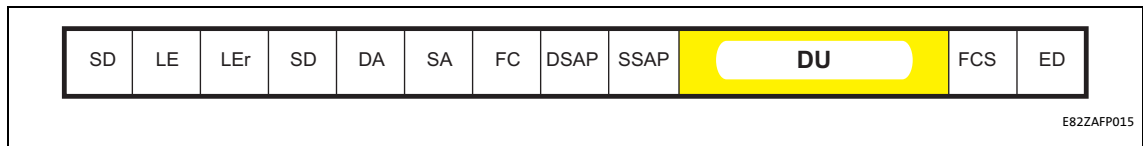

[9-4] PROFIBUS data telegram

The data unit (DU) contains the DP-V1 header and the parameter request or the parameter response.

The following subchapters describe the parameter request and the parameter response in detail.



**Note!**

The DP-V1 header consists of:

- Function identification
- Slot number
- Data set
- Length of the user data

Please refer to the corresponding PROFIBUS specification for further information on the DP-V1 header.

**Assignment of the user data depending on the data type**

Depending on the data type used, the user data are assigned as follows:

Data type	Length	User data assignment				
		Byte 1	Byte 2	Byte 3	Byte 4	Byte ...
String	x bytes					
U8	1 byte		0x00			
U16	2 bytes	High byte	Low byte			
U32	4 bytes	High word		Low word		
		High byte	Low byte	High byte	Low byte	

### 9.3.3.1 Reading parameter data from the inverter



#### Note!

- When a read request is processed, no parameter value is written to the slave.
- In the case of a multi-parameter read request, the parameter attribute, index, and subindex are repeated with the number "n" of the requested parameters.
- A read request must not exceed the maximum data length of 240 bytes.

#### Request header

Byte 1	Byte 2	Byte 3	Byte 4
Request reference	Request identification	Axis	Number of indices

Field	Data type	Values
Request reference	U8	This value is specified by the master
Request identification	U8	0x01: Request parameters for reading
Axis	U8	0x00 or 0x01
Number of indices	U8	0x"n" (n = number of parameters requested)

#### Parameter attribute

Byte 5	Byte 6
Attribute	Number of subindices

Field	Data type	Values
Attribute	U8	0x10: Value
Number of subindices	U8	0x00 (For array elements: Enter the number of array elements required.)

#### Index and subindex

Byte 7	Byte 8	Byte 9	Byte 10
Index		Subindex	
High byte	Low byte	High byte	Low byte

Field	Data type	Values
Index	U16	0x0001 ... 0xFFFF (1 ... 65535)
Subindex	U16	0x0001 ... 0xFFFF (1 ... 65535)



### 9.3.3.2 Response to a correctly executed read request



#### Note!

Responses to a read request do not contain parameter attributes, indices and subindices.

#### Response header

Byte 1	Byte 2	Byte 3	Byte 4
Request reference (mirrored)	Response identification	Axis (mirrored)	Number of indices

Field	Data type	Values
Request reference	U8	Mirrored value of the parameter request
Response identification	U8	0x01: Parameter has been read
Axis	U8	0x00 or 0x01
Number of indices	U8	0x"n" (n = number of parameters requested)

#### Parameter format

Byte 5	Byte 6
Format	Number of values

Field	Data type	Values
Format	U8	0x02: Integer8 0x03: Integer16 0x04: Integer32 0x05: Unsigned8 0x06: Unsigned16 0x07: Unsigned32 0x09: Visible string 0x0A: Octet string 0x40: Zero 0x41: Byte 0x42: Word 0x43: Double word
Number of values	U8	0x01 or number of requested subindices/parameters (with several subindices/parameters only the parameter value is repeated). In the case of string codes, the number of characters is entered here.

**Parameter value**

Byte 7	Byte 8	Byte 9	Byte 10
Value			

Field	Data type	Values
Value	String	Any (length > 4 bytes possible)
	U8	0x00 .... 0xFF
	U16	0x0000 .... 0xFFFF
	U32	0x0000 0000 .... 0xFFFF FFFF

### 9.3.3.3 Response to a read error



#### Note!

In the case of a multi-parameter request, correct and possible faulty messages are summarised in one telegram. They have the following data contents:

#### Correct message

- Format: data type of the value requested
- Number of values: as described in the chapter "[Reading parameter data from the inverter](#)" (□ 65).
- Parameter value: value requested

#### Faulty message

- Format: 0x44
- Number of values: 0x01 or 0x02
- Error code without additional information (for number of values = 0x01) or
- Error code with additional information (for number of values = 0x02)

A faulty access to a parameter "n" is indicated at the nth position in the response telegram of a multi-parameter request.

#### Response header

Byte 1	Byte 2	Byte 3	Byte 4
Request reference (mirrored)	Response identification	Axis (mirrored)	Number of indices

Field	Data type	Values
Request reference	U8	Mirrored value of the parameter request
Response identification	U8	0x81: Parameter has not been read • The data in the bytes 7 + 8 must be interpreted as an error code.
Axis	U8	0x00 or 0x01
Number of indices	U8	0x"n" (n = number of parameters requested)

#### Parameter format

Byte 5	Byte 6
Format	Number of values

Field	Data type	Values
Format	U8	0x44: Error
Number of values	U8	0x01: Error code without additional information 0x02: Error code with additional information

**Error code**

Byte 7	Byte 8	Byte 9	Byte 10
Error code		Additional information (if available)	
High byte	Low byte	High byte	Low byte

Field	Data type	Values
Error code	U16	0x0000 .... 0xFFFF
Additional information (if available)	U16	▶ <a href="#">Error codes (□ 74)</a>

### 9.3.3.4 Writing parameter data to the inverter



#### Note!

When a multi-parameter write request is transferred, the ...

- Parameter attribute
- Index and subindex

and then the ...

- Parameter format
- Parameter value

... are repeated with the number "n" of the parameters addressed.

A write request must not exceed the maximum data length of 240 bytes.

#### Request header

Byte 1	Byte 2	Byte 3	Byte 4
Request reference	Request identification	Axis	Number of indices

Field	Data type	Values
Request reference	U8	This value is defined by the master.
Request identification	U8	0x02: Write parameter
Axis	U8	0x00 or 0x01
Number of indices	U8	0x"n" (n = number of parameters addressed)

#### Parameter attribute

Byte 5	Byte 6
Attribute	Number of subindices

Field	Data type	Values
Attribute	U8	0x10: Value
Number of subindices	U8	0x00 (For array elements: Enter the number of array elements required.)

#### Index and subindex

Byte 7	Byte 8	Byte 9	Byte 10
Index		Subindex	
High byte	Low byte	High byte	Low byte

Field	Data type	Values
Index	U16	0x0001 ... 0xFFFF (1 ... 65535)
Subindex	U16	0x0001 ... 0xFFFF (1 ... 65535)

**Parameter format**

Byte 11	Byte 12
Format	Number of values

Field	Data type	Values
Format	U8	0x02: Integer8 0x03: Integer16 0x04: Integer32 0x05: Unsigned8 0x06: Unsigned16 0x07: Unsigned32 0x09: Visible string 0x0A: Octet string 0x40: Zero 0x41: Byte 0x42: Word 0x43: Double word
Number of values	U8	0x01 or number of written subindices/parameters (with several subindices/parameters only the parameter value is repeated). In the case of string codes, the number of characters is entered here.

**Parameter value**

Byte 13	Byte 14	Byte 15	Byte 16
Value			

Field	Data type	Values
Value	String	Any (length > 4 bytes possible)
	U8	0x00 .... 0xFF
	U16	0x0000 .... 0xFFFF
	U32	0x0000 0000 .... 0xFFFF FFFF

### 9.3.3.5 Response to a correctly executed write request



#### Note!

In the case of a multi-parameter request, correct and possible faulty messages are summarised in one telegram. They have the following data contents:

#### Correct message

- Format: 0x40
- Number of values: 0x00

#### Faulty message

- Format: 0x44
- Number of values: 0x01 or 0x02
- Error code without additional information (for number of values = 0x01) or with additional information (for number of values = 0x02)

A faulty access to a parameter "n" is indicated at the nth position in the response telegram of a multi-parameter request.

#### Response header

Byte 1	Byte 2	Byte 3	Byte 4
Request reference (mirrored)	Response identification	Axis (mirrored)	Number of indices

Field	Data type	Values
Request reference	U8	Mirrored value of the parameter request
Response identification	U8	0x02: Parameter has been written
Axis	U8	0x00 or 0x01
Number of indices	U8	0xn (n = number of parameter addressed)

### 9.3.3.6 Response to a write error

#### Response header

Byte 1	Byte 2	Byte 3	Byte 4
Request reference (mirrored)	Response identification	Axis (mirrored)	Number of indices

Field	Data type	Values
Request reference	U8	Mirrored value of the parameter request
Response identification	U8	0x82: Parameter has not been written • The data in the bytes 7 + 8 must be interpreted as an error code.
Axis	U8	0x00 or 0x01
Number of indices	U8	0x"n" (n = number of parameters addressed)

#### Parameter format

Byte 5	Byte 6
Format	Number of values

Field	Data type	Values
Format	U8	0x44: Error
Number of values	U8	0x01: Error code without additional information 0x02: Error code with additional information

#### Error code

Byte 7	Byte 8	Byte 9	Byte 10
Error code		Additional information (if available)	
High byte	Low byte	High byte	Low byte

Field	Data type	Values
Error code	U16	0x0000 .... 0xFFFF
Additional information (if available)	U16	▶ <a href="#">Error codes (□ 74)</a>



### 9.3.4 Error codes

Error code	Description	Explanation	Additional information
0x0000	Impermissible parameter number	Access to unavailable parameter	-
0x0001	Parameter value cannot be changed	Change access to a parameter value that cannot be changed	Subindex
0x0002	Lower or upper value limit exceeded	Change access with value beyond the value limits	Subindex
0x0003	Faulty subindex	Access to unavailable subindex	Subindex
0x0004	No array	Access with subindex to non-indicated parameter	-
0x0005	Wrong data type	Change access with value that does not match the data type of the parameter	-
0x0006	No setting permitted (only resettable)	Change access with value unequal to 0 where this is not permitted	Subindex
0x0007	Description element cannot be changed	Change access to a description element that cannot be changed	Subindex
0x0008	Reserved	(PROFIdrive profile V2: PPO-Write requested in the IR is not available)	-
0x0009	Description data not available	Access to unavailable description (parameter value is available)	-
0x000A	Reserved	(PROFIdrive profile V2: Wrong access group)	-
0x000B	No parameter change rights	Change access without parameter change rights	-
0x000C	Reserved	(PROFIdrive profile V2: Wrong password)	-
0x000D	Reserved	(PROFIdrive profile V2: Text in the cyclic traffic cannot be read)	-
0x000E	Reserved	(PROFIdrive profile V2: Name in the cyclic traffic cannot be read)	-
0x000F	No text array available	Access to unavailable text array (parameter value is available)	-
0x0010	Reserved	(PROFIdrive profile V2: Missing PPO-Write)	-
0x0011	Request cannot be executed due to the operating state	Access is not possible due to temporary reasons not specified here	-
0x0012	Reserved	(PROFIdrive profile V2: Other error)	-
0x0013	Reserved	(PROFIdrive profile V2: date in the cyclic traffic cannot be read)	-
0x0014	Value impermissible	Change access with the value that is inside the value limits but not permissible for other permanent reasons (parameters with defined individual values)	Subindex
0x0015	Response too long	The length of the current response exceeds the maximum transmittable length	-
0x0016	Parameter address impermissible	Impermissible or non-supported value for attribute, number of subindices, parameter number, or subindex, or a combination	-
0x0017	Format impermissible	Write request: Impermissible or non-supported format of parameter data	-
0x0018	Number of values not consistent	Write request: Number of values of the parameter data do not match the number of subindices in the parameter address	-
0x0019	Reserved	-	-
...			
0x0064			

---

Error code	Description	Explanation	Additional information
0x0065	Manufacturer-specific	-	-
...			
0x00FF			

### 9.3.5 Telegram examples

#### 9.3.5.1 Read request: Querying the heatsink temperature

The heatsink temperature of the inverter is to be read.

- Code to be read: C00061
- Heatsink temperature: 43 °C

##### Parameter request

Byte 1	Byte 2	Byte 3	Byte 4
Request reference	Request identification	Axis	Number of indices
0xXX	0x01	0x00	0x01
	Request parameters for reading		

Byte 5	Byte 6
Attribute	Number of subindices
0x10	0x00
Value	No subindex

Byte 7	Byte 8	Byte 9	Byte 10
Index		Subindex	
High byte	Low byte	High byte	Low byte
0x5F	0xC2	0x00	0x00
Index = 24575 - code no. = 24575 - 61 = 24514 = 0x5F C2		No subindex	

##### Parameter response to a correctly executed read request

Byte 1	Byte 2	Byte 3	Byte 4
Request reference (mirrored)	Response identification	Axis (mirrored)	Number of indices
0xXX	0x01	0x00	0x01
	Parameter has been read		

Byte 5	Byte 6
Format	Number of values
0x03	0x01
Integer16	1 value

Byte 7	Byte 8
Value	
High byte	Low byte
0x00	0x2B
Value read = 0x 00 2B = 43 x 1 (internal factor) = 43 [°C]	

**Parameter response to a read error**

Byte 1	Byte 2	Byte 3	Byte 4
Request reference (mirrored)	Response identification	Axis (mirrored)	Number of indices
0xXX	0x81	0x00	0x01
	Parameter has not been read		

Byte 5	Byte 6
Format	Number of values
0x44	0x01
Error	Error code without additional information

Byte 7	Byte 8
Error code	
High byte	Low byte
For the meaning, see the " <a href="#">Error codes</a> " ( <a href="#">74</a> ) chapter	

### 9.3.5.2 Write request: Setting the deceleration time for quick stop (QSP)

In the inverter, the deceleration time for quick stop (QSP) is to be set to 50 ms.

Code to be written: C00105

#### Parameter request

Byte 1	Byte 2	Byte 3	Byte 4
Request reference	Request identification	Axis	Number of indices
0xXX	0x02	0x00	0x01
	Write parameter	Axis 0	1 index

Byte 5	Byte 6
Attribute	Number of subindices
0x10	0x00
Value	No subindex

Byte 7	Byte 8	Byte 9	Byte 10
Index		Subindex	
High byte	Low byte	High byte	Low byte
0x5F	0x96	0x00	0x00
Index = 24575 - code no. = 24575 - 105 = 24470 = 0x5F 96		No subindex	

Byte 11	Byte 12
Format	Number of values
0x43	0x01
Double word	1 value

Byte 13	Byte 14	Byte 15	Byte 16
Value			
High word: high byte	High word: low byte	Low- word: high byte	Low word: low byte
0x00	0x00	0x00	0x32
Value to be written = 0.05 [s] x 1000 (internal factor) = 50 = 0x00 00 00 32			

#### Parameter response to a correctly executed write request

Byte 1	Byte 2	Byte 3	Byte 4
Request reference (mirrored)	Response identification	Axis (mirrored)	Number of indices
0xXX	0x02	0x00	0x01
	Parameter has been written		1 index

**Parameter response to a read error**

Byte 1	Byte 2	Byte 3	Byte 4
Request reference (mirrored)	Response identification	Axis (mirrored)	Number of indices
0xXX	0x82	0x00	0x01
	Parameter has not been written		1 index

Byte 5	Byte 6
Format	Number of values
0x44	0x01
Error	Error code without additional information

Byte 7	Byte 8
Error code	
High byte	Low byte
For the meaning, see the <a href="#">Error codes</a> (74)	

### 9.4 Consistent parameter data

In the PROFIBUS communication system, data are permanently exchanged between the control system (CPU + PROFIBUS master) and the inverter via the plugged-on slave interface module. Both the PROFIBUS master and the CPU (central processing unit) of the control system access a joint memory: the dual port memory (DPM).

The DPM permits a data exchange in both directions (write/read):



It could happen that a slower PROFIBUS master writing would be overtaken by a faster CPU reading within a cycle time without any further data organisation.

In order to avoid such an impermissible state, the parameter data to be transmitted must be marked as "consistent".

#### Data communication with consistent data

With consistency, either "reading" or "writing" is possible when the master and the CPU simultaneously access the memory:

- The PROFIBUS master transfers data only as a complete data set.
- The CPU can only access completely updated data sets.
- The PROFIBUS master cannot read or write data as long as the CPU accesses consistent data.

The result becomes clear from the example below:



1. As the master can only write if the CPU does not read, the master waits until the data are read completely by the CPU.
2. The master only writes a complete data set into DPM.

#### Configuring consistent data



#### Note!

Consistency is achieved by an appropriate PROFIBUS master configuration. For this purpose, refer to the documentation for your configuring software.

---

**10****Monitoring****10.1****Permanent interruption of PROFIBUS communication**

If PROFIBUS communication is interrupted permanently, e.g. by cable breakage or failure of the PROFIBUS master, no process data are transmitted to the slave being in the "Data Exchange" state.

After the watchdog monitoring time determined by the master has expired, the response parameterised in [C13880/1](#) is executed in the inverter (slave).

The process data are treated according to the setting in [C13885](#). (The data sent last by the master can be used or can be set to zero.)

**Preconditions for a inverter (slave) response**

- A monitoring time of 1 ... 65534 ms for the "Data\_Exchange" status ([C13881](#)) is set.  
A value of "65535 ms" (Lenze setting) deactivates the monitoring.
- A response for the slave is set in [C13880/1](#) (Lenze setting "No response").
- The slave is in the "Data\_Exchange" state.
- The watchdog monitoring time is configured correctly in the master.

If one of these preconditions is not met, the response to the absence of cyclic process data telegrams from the master is not executed.

▶ [Settings and displays in the »Engineer«](#) (📖 83)



## 10.2

## Short-time interruption of PROFIBUS communication

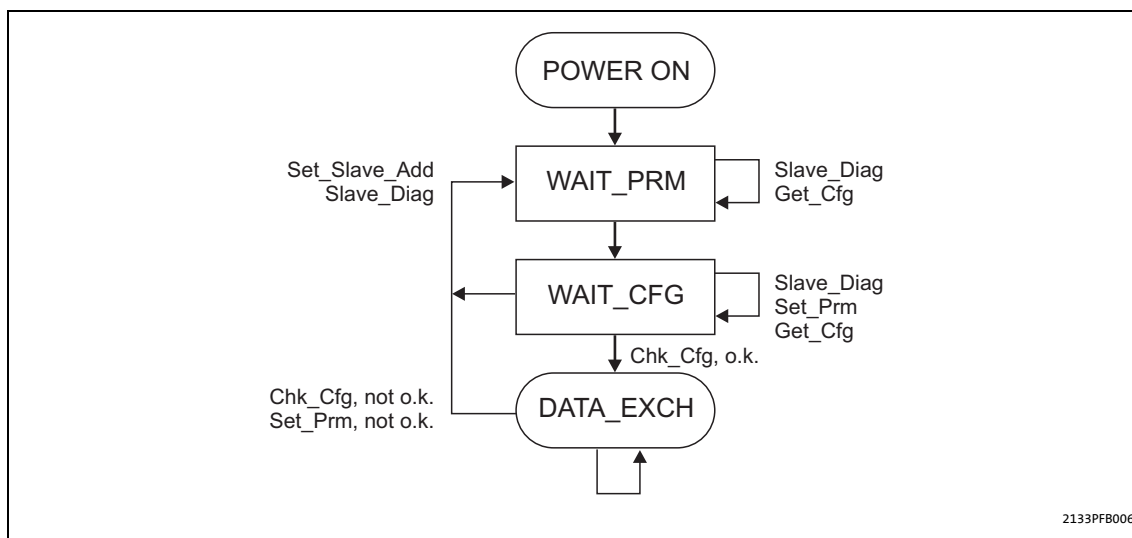

[10-1] DP states (Decentralized Peripherals) for short-time interruption of communication

The master detects the communication fault and, only after a few microseconds, transfers the slave to the "WAIT\_PRM" status of the DP state machine (see fig. [\[10-1\]](#)).

Only after the state chain of the DP state machine ending in the "Data\_Exchange" state (DATA\_EXCH) has been passed through, the watchdog monitoring time calculated for the slave (in milliseconds) continues to run.

**Note!**

The watchdog monitoring time does not continue running if the slave does not reach the "Data\_Exchange" state due to repeated communication errors (e.g. caused by loose contact).

**Additional monitoring for the data exchange**

For this reason an additional monitoring function for the data exchange is available with [C13881](#), which is activated when "Data\_Exchange" is exited and the parameterised time (0 ... 65535 ms) has expired. The active monitoring triggers the response parameterised in [C13880/1](#).

**Note!**

Observe the following condition for the time setting:

Monitoring time for the data exchange ([C13881](#))  $\leq$  watchdog monitoring time of the PROFIBUS ([C13882/1](#)).

## 10.3

## Settings and displays in the »Engineer«

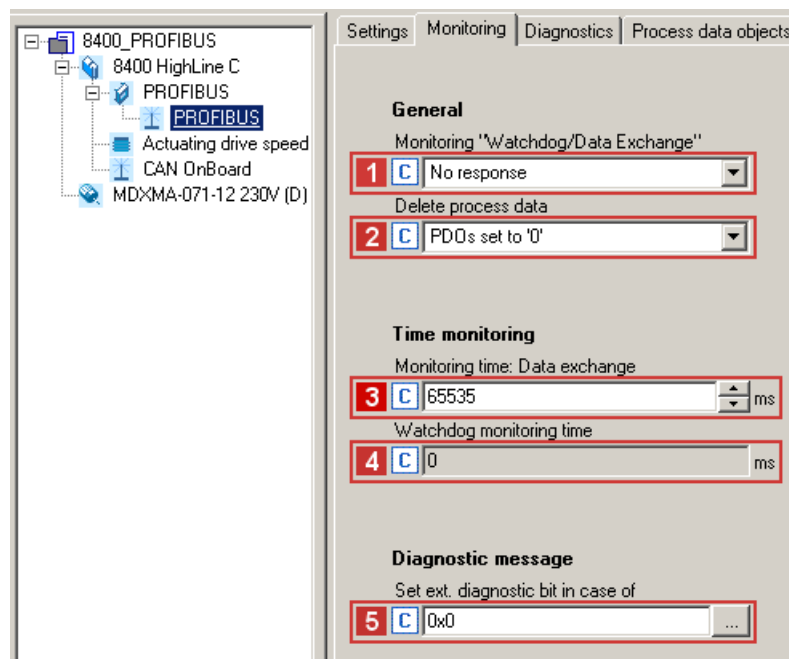

On the **Monitoring** tab of the »Engineer«, you can set or display the following parameters:

Parameter	Description
<b>1</b> <b>Reaction on communication fault</b> ( <a href="#">C13880/1</a> )	The response set here takes place if the PROFIBUS station ... <ul style="list-style-type: none"> <li>• does not receive a message from the master within the watchdog monitoring time (displayed in <a href="#">C13882/1</a>) if there is an active connection;</li> <li>• recognises that it is not in the "Data_Exchange" status anymore.</li> </ul> Please see also the information on <b>3</b> .
<b>2</b> <b>Clear process data</b> ( <a href="#">C13885</a> )	Selection of the process data which the inverter will process in the event of a PROFIBUS failure in order to maintain internal communication. The process data sent last by the master can be used or the process data can be set to zero.
<b>3</b> <b>Monitoring time: Data exchange</b> ( <a href="#">C13881</a> )	After the monitoring time set here has elapsed, the response set in <b>1</b> takes place for the data exchange. <ul style="list-style-type: none"> <li>• The value "65535" deactivates the monitoring function.</li> <li>• The monitoring time set here must be smaller than the watchdog monitoring time <b>4</b>.</li> <li>• A change in monitoring is effective immediately.</li> </ul> ▶ <a href="#">Permanent interruption of PROFIBUS communication</a> (☞ 81)
<b>4</b> <b>Monitoring time: Watchdog</b> ( <a href="#">C13882/1</a> )	Display of the watchdog monitoring time determined by the PROFIBUS master <ul style="list-style-type: none"> <li>• Monitoring starts with the receipt of the first telegram.</li> <li>• When a value of "0" is displayed, the monitoring function is deactivated.</li> <li>• A change in the watchdog monitoring time in the master is immediately effective.</li> </ul> ▶ <a href="#">Permanent interruption of PROFIBUS communication</a> (☞ 81)
<b>5</b> <b>Set ext. diagnostic bit upon</b> ( <a href="#">C13886</a> )	Bit-coded selection of the error responses in the standard device causing the external diagnostic bit ("diag bit") to be set (see PROFIBUS specification; bit 3 of byte 1 of the DP diagnostic messages). <ul style="list-style-type: none"> <li>• The diagnostic bit is sent to the PROFIBUS master where it is evaluated separately.</li> <li>• The diagnostic bit is always set when a system error occurs.</li> <li>• The Lenze setting "0" means that the diagnostic bit is not set for the following error responses.</li> <li>• An advanced diagnostic message is always sent.</li> </ul>

# 11 Diagnostics

## 11.1 LED status displays

---

# 11 Diagnostics

For diagnosing faults of the PROFIBUS module, the LEDs on the front panel are provided. Furthermore you can query the current bus status via code [C13861](#).

## 11.1 LED status displays



### Note!

During normal operation, the LED **BS** ([86](#)) blinks and the LED **MS** ([86](#)) is lit permanently.

The following status displays are distinguished:

- [Module status displays](#) ([85](#))
- [Fieldbus status displays](#) ([86](#))



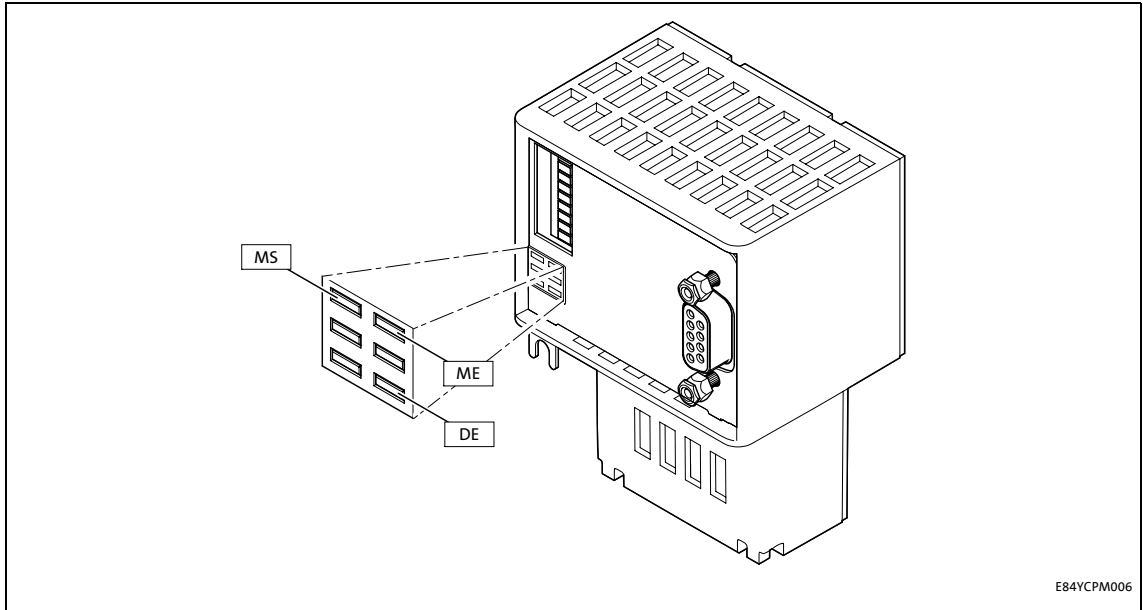

**11.1.1 Module status displays**

The LEDs **MS**, **ME** and **DE** indicate the module status.



E84YCPM006

[11-1] LED status displays MS, ME, and DE

LED	Colour	State	Description
MS	Green	On	 The communication module is supplied with voltage and has established a connection to the standard device.
		Blinking	 The communication module is supplied with voltage, but has not yet established a connection to the standard device. (Standard device is switched off, initialising or not present.)
ME	Red	On	 An error concerning the communication module has occurred.
DE	Red	On	 The communication module is not accepted by the standard device or the standard device is not active. (See notes in the documentation for the standard device.)

**11.1.2 Fieldbus status displays**

The LEDs **BS** and **BE** indicate the fieldbus status.

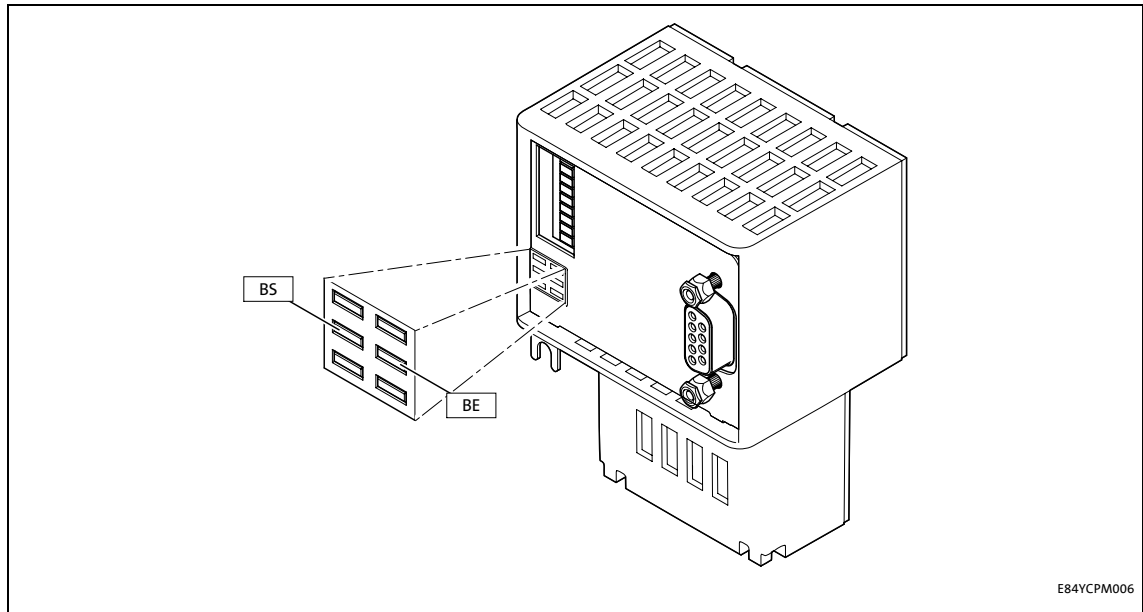

E84YCPM006

[11-2] LED status displays BS and BE

LED	Colour	State	Description
BS	Green	Off	The communication module is not active on the fieldbus or is being initialised.
		Blinking	<p>The communication module is in the DATA_EXCH state ("Data_Exchange"). Data are exchanged via PROFIBUS.</p>
BE	Red	Blinking	<p>Incorrect setting for the station address. The communication module is initialised and internally operates with the respective default values.</p>
		On	<p>Bus error/fault is active (e.g. bus cable unplugged).</p>

**11.2 Diagnosing with the »Engineer«**

In the »Engineer«, the **Diagnostics** tab displays various pieces of PROFIBUS diagnostic information.

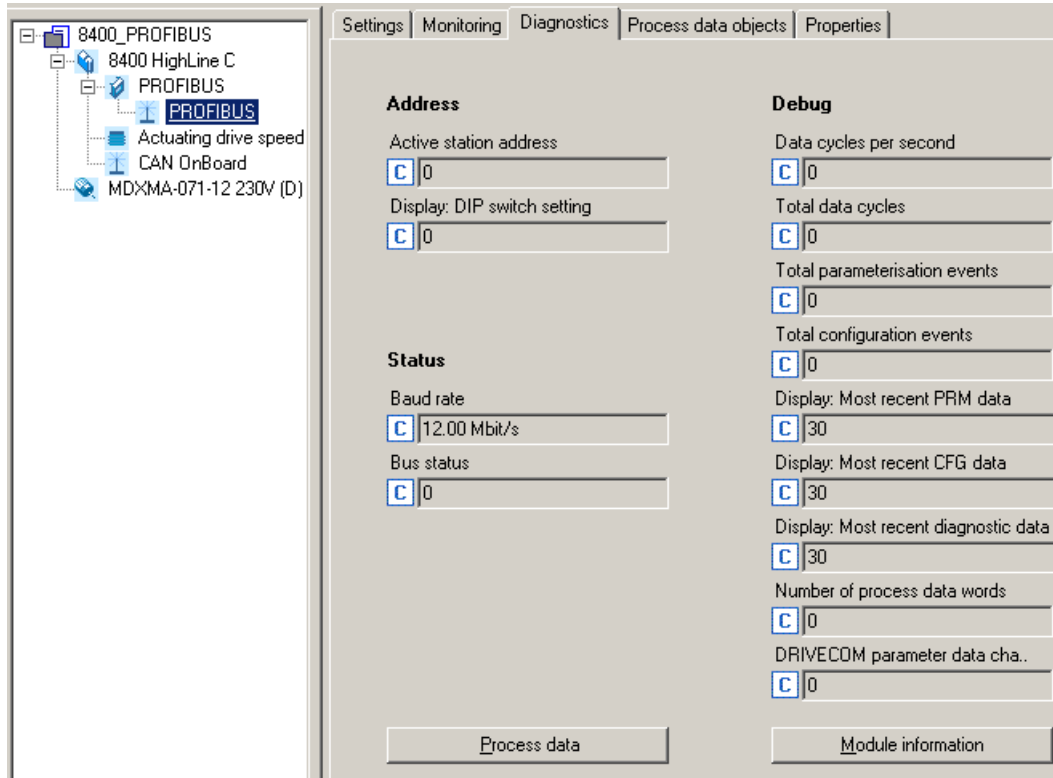

### Querying the current bus status

Code [C13861](#) displays the current PROFIBUS status in a bit-coded form:

Bit assignment				Description
Bit 3	Bit 2	Bit 1	Bit 0	Reserved
<b>Status of the DP state machine (DP-STATE)</b>				
	Bit 5	Bit 4		
	0	0	WAIT_PRM	The slave waits for a parameter data telegram after acceleration. Other types of telegrams will not be processed. Data exchange is not yet possible.
	0	1	WAIT_CFG	The slave waits for the configuration telegram that specifies the number of input and output bytes. The master informs the slave about the number of I/O bytes that will be transferred.
	1	0	DATA_EXCH	If the parameter settings as well as the configuration have been accepted by the firmware and by the application, the slave state changes to DATA_EXCH ("Data Exchange", exchange of user data with the master).
	1	1	Not possible	
<b>Status of the watchdog state machine (WD-STATE)</b>				
	Bit 7	Bit 6		
	0	0	BAUD_SEARCH	The PROFIBUS slave is able to automatically detect the baud rate.
	0	1	BAUD_CONTROL	After recognising the correct baud rate, the slave status changes to BAUD_CONTROL and the baud rate is monitored.
	1	0	DP_CONTROL	The DP_CONTROL status serves for response monitoring of the master.
	1	1	Not possible	
<b>PROFIBUS baud rate detected</b>				
Bit 11	Bit 10	Bit 9	Bit 8	
0	0	0	0	12 Mbps
0	0	0	1	6 Mbps
0	0	1	0	3 Mbps
0	0	1	1	1.5 Mbps
0	1	0	0	500 kbps
0	1	0	1	187.5 kbps
0	1	1	0	93.75 kbps
0	1	1	1	45.45 kbps
1	0	0	0	19.2 kbps
1	0	0	1	9.6 kbps
Bit 15	Bit 14	Bit 13	Bit 12	Reserved

### 11.3 Advanced diagnostic message

Errors in the inverter and its plugged-in modules are transmitted to the PROFIBUS master in the form of advanced diagnostic messages.

#### Structure of the diagnostic message

Byte	Description
1	Bit 0: Station does not exist (set by the master). Bit 1: Slave is not ready for data exchange. Bit 2: Configuration data do not correspond. Bit 3: Slave has extended diagnostic data. Bit 4: Requested function is not supported by the slave. Bit 5: Slave response is invalid (set by the master) Bit 6: Incorrect parameter setting Bit 7: Slave has been parameterised by another master (set by the master).
2	Bit 0: Slave must be parameterised again. Bit 1: Static diagnostics Bit 2: Permanently set to "1". Bit 3: Watchdog active Bit 4: Freeze command received. Bit 5: Sync command received. Bit 6: Reserved Bit 7: Slave is deactivated (set by the master).
3	Bit 7: Diagnostics overflow - amount of diagnostic information present in the slave is too large to fit into one telegram.
4	Bits 0 ... 7: Master address after parameterisation ("0xFF" without parameterisation)
5	Bits 0 ... 7: ID number (high byte)
6	Bits 0 ... 7: ID number (low byte)
7	Header <ul style="list-style-type: none"> <li>The header contains the block length of the advanced diagnostics including the header byte.</li> <li>In this case, the value of the entry is "0x0A" (bytes 7 ... 16 = 10 bytes).</li> </ul>
8	Status_Type The value of this entry is fixed. For the following bit assignment it is "0x81": <ul style="list-style-type: none"> <li>Bit 7 = 1: "status"</li> <li>Bit 0 = 1: "status message"</li> <li>Value of all other bits = 0</li> </ul>
9	Slot_Number The value of the slot number is "0x00".
10	Specifier <ul style="list-style-type: none"> <li>An indicated error is entered in the specifier with the identification "0x1" (status coming).</li> <li>An eliminated error is entered in the specifier with the identification "0x02" (status going).</li> <li>If no errors are indicated, the entry in the specifier has the value "0x00" (no further differentiation).</li> </ul>
11	Reserved
12	
13 ... 16	Error code of the Inverter Drive 8400 <ul style="list-style-type: none"> <li>Code <b>C00165</b> can be used to read out the contents of the fault memory.</li> <li>Detailed information regarding the error codes of the Inverter Drive 8400 can be found in the documentation of the inverter.</li> </ul>



-----

**Example: "Short circuit (OC1)" error in the Inverter Drive 8400**

Byte	Value [hex]	Description
1	x	Standard data (PRM_Fault)
...		
6		
7	0A	Block length of the advanced diagnostics = 10 bytes
8	81	Status message
9	00	Slot 0
10	01	Status coming
11	00	Error message 0x11C4000B "Short circuit (OC1)" <ul style="list-style-type: none"> <li>• Error type: "Warning locked"</li> <li>• Subject area: 0x11C4 (current)</li> <li>• Error ID: 0x000B</li> </ul>
12	00	
13	0B	
14	00	
15	C4	
16	11	The error number "0x11C4000B" indicates the following: In the "Current" subject area, an overcurrent has been detected. The error response to this is a "Warning locked", which must be unlocked separately after the error has been eliminated.

## 12 Error messages

This chapter supplements the error list contained in the software manual and in the »Engineer« online help for Inverter Drives 8400 by the error messages of the communication module.



### Software manual/online help for Inverter Drives 8400

Here you can find general information on diagnostics & fault analysis and on error messages.

### 12.1 Short overview of the PROFIBUS error messages

The following table lists all PROFIBUS error messages in numerical order of the error number. Furthermore the preset error response and – if available – the parameters for setting the error response are specified.



#### Tip!

When you click the cross-reference in the first column, you will see a detailed description (causes and remedies) of this error message.

Error number			Error text	Error type	Adjustable in
hex	dec (subject area no.)	dec (error no.)			
<a href="#">0x01bc3100</a>	444	12544	Connection to 8400 standard device lost	Error	-
<a href="#">0x01bc5531</a>	444	21809	Memory: No access	Error	-
<a href="#">0x01bc5532</a>	444	21810	Memory: Read error	Error	-
<a href="#">0x01bc5533</a>	444	21811	Memory: Write error	Error	-
<a href="#">0x01bc6010</a>	444	24592	Restart after watchdog reset	Error	-
<a href="#">0x01bc6011</a>	444	24593	Internal error	Error	-
<a href="#">0x01bc6100</a>	444	24832	Internal error	Error	-
<a href="#">0x01bc6101</a>	444	24833	Internal error	Error	-
<a href="#">0x01bc6110</a>	444	24848	Internal error	Error	-
<a href="#">0x01bc641f</a>	444	25631	Invalid parameter set	Error	-
<a href="#">0x01bc6420</a>	444	25632	Error: Lenze settings loaded	Error	-
<a href="#">0x01bc8130</a>	444	33072	Profibus watchdog: Monitoring time elapsed	No response	<a href="#">C13880/1</a>
<a href="#">0x01bc8131</a>	444	33073	Profibus: Data_Exchange state exited	No response	<a href="#">C13880/1</a>
<a href="#">0x01bc8132</a>	444	33074	Profibus Watchdog: DP-V1 MSC2 monitoring time exceeded	No response	<a href="#">C13880/2</a>

## 12.2 Possible causes and remedies

This chapter lists all PROFIBUS error messages in the numerical order of the error numbers. Possible causes and remedies as well as responses to the error messages are described in detail.

### Connection to 8400 standard device lost [0x01bc3100]

<b>Response</b> (Lenze setting printed in bold)		<b>Setting:</b> not possible
<input type="checkbox"/> None <input type="checkbox"/> System fault <input checked="" type="checkbox"/> <b>Fault</b> <input type="checkbox"/> Trouble <input type="checkbox"/> Quick stop by trouble <input type="checkbox"/> Warning locked <input type="checkbox"/> Warning <input type="checkbox"/> Information		
<b>Cause</b>		<b>Remedy</b>
<ul style="list-style-type: none"> <li>• Network cable (plug) is defective.</li> <li>• Network cable is not connected to the PROFIBUS terminal X201.</li> <li>• Voltage supply is interrupted.</li> </ul>		<p>Check cables and terminals. Connect network cable to the PROFIBUS terminal X201.</p>

### Memory: No access [0x01bc5531]

<b>Response</b> (Lenze setting printed in bold)		<b>Setting:</b> not possible
<input type="checkbox"/> None <input type="checkbox"/> System fault <input checked="" type="checkbox"/> <b>Fault</b> <input type="checkbox"/> Trouble <input type="checkbox"/> Quick stop by trouble <input type="checkbox"/> Warning locked <input type="checkbox"/> Warning <input type="checkbox"/> Information		
<b>Cause</b>		<b>Remedy</b>
Access to memory was not possible.		Repeat the download of the application (including module)

### Memory: Read error [0x01bc5532]

<b>Response</b> (Lenze setting printed in bold)		<b>Setting:</b> not possible
<input type="checkbox"/> None <input type="checkbox"/> System fault <input checked="" type="checkbox"/> <b>Fault</b> <input type="checkbox"/> Trouble <input type="checkbox"/> Quick stop by trouble <input type="checkbox"/> Warning locked <input type="checkbox"/> Warning <input type="checkbox"/> Information		
<b>Cause</b>		<b>Remedy</b>
Parameter could not be read.		Repeat the download of the application (including module)

### Memory: Write error [0x01bc5533]

<b>Response</b> (Lenze setting printed in bold)		<b>Setting:</b> not possible
<input type="checkbox"/> None <input type="checkbox"/> System fault <input checked="" type="checkbox"/> <b>Fault</b> <input type="checkbox"/> Trouble <input type="checkbox"/> Quick stop by trouble <input type="checkbox"/> Warning locked <input type="checkbox"/> Warning <input type="checkbox"/> Information		
<b>Cause</b>		<b>Remedy</b>
Parameter could not be written.		Repeat the download of the application (including module)

### Restart after watchdog reset [0x01bc6010]

<b>Response</b> (Lenze setting printed in bold)		<b>Setting:</b> not possible
<input type="checkbox"/> None <input type="checkbox"/> System fault <input checked="" type="checkbox"/> <b>Fault</b> <input type="checkbox"/> Trouble <input type="checkbox"/> Quick stop by trouble <input type="checkbox"/> Warning locked <input type="checkbox"/> Warning <input type="checkbox"/> Information		
<b>Cause</b>		<b>Remedy</b>
Module defective.		If this occurs repeatedly, contact the Lenze service.

**Internal error [0x01bc6011]**

<b>Response</b> (Lenze setting printed in bold)	<b>Setting:</b> not possible
<input type="checkbox"/> None <input type="checkbox"/> System fault <input checked="" type="checkbox"/> <b>Fault</b> <input type="checkbox"/> Trouble <input type="checkbox"/> Quick stop by trouble <input type="checkbox"/> Warning locked <input type="checkbox"/> Warning <input type="checkbox"/> Information	
<b>Cause</b>	<b>Remedy</b>
Module defective.	If this occurs repeatedly, contact the Lenze service.

**Internal error [0x01bc6100]**

<b>Response</b> (Lenze setting printed in bold)	<b>Setting:</b> not possible
<input type="checkbox"/> None <input type="checkbox"/> System fault <input checked="" type="checkbox"/> <b>Fault</b> <input type="checkbox"/> Trouble <input type="checkbox"/> Quick stop by trouble <input type="checkbox"/> Warning locked <input type="checkbox"/> Warning <input type="checkbox"/> Information	
<b>Cause</b>	<b>Remedy</b>
Internal error.	If this occurs repeatedly, contact the Lenze service.

**Internal error [0x01bc6101]**

<b>Response</b> (Lenze setting printed in bold)	<b>Setting:</b> not possible
<input type="checkbox"/> None <input type="checkbox"/> System fault <input checked="" type="checkbox"/> <b>Fault</b> <input type="checkbox"/> Trouble <input type="checkbox"/> Quick stop by trouble <input type="checkbox"/> Warning locked <input type="checkbox"/> Warning <input type="checkbox"/> Information	
<b>Cause</b>	<b>Remedy</b>
The communication module carries out an automatic software reset and reinitialises itself.	If this occurs repeatedly, contact the Lenze service.

**Internal error [0x01bc6110]**

<b>Response</b> (Lenze setting printed in bold)	<b>Setting:</b> not possible
<input type="checkbox"/> None <input type="checkbox"/> System fault <input checked="" type="checkbox"/> <b>Fault</b> <input type="checkbox"/> Trouble <input type="checkbox"/> Quick stop by trouble <input type="checkbox"/> Warning locked <input type="checkbox"/> Warning <input type="checkbox"/> Information	
<b>Cause</b>	<b>Remedy</b>
Module defective.	If this occurs repeatedly, contact the Lenze service.

**Invalid parameter set [0x01bc641f]**

<b>Response</b> (Lenze setting printed in bold)	<b>Setting:</b> not possible
<input type="checkbox"/> None <input type="checkbox"/> System fault <input checked="" type="checkbox"/> <b>Fault</b> <input type="checkbox"/> Trouble <input type="checkbox"/> Quick stop by trouble <input type="checkbox"/> Warning locked <input type="checkbox"/> Warning <input type="checkbox"/> Information	
<b>Cause</b>	<b>Remedy</b>
No active parameter set could be loaded.	Repeat the download of the application (including module)

**Error: Lenze settings loaded [0x01bc6420]**

<b>Response</b> (Lenze setting printed in bold)	<b>Setting:</b> not possible
<input type="checkbox"/> None <input type="checkbox"/> System fault <input checked="" type="checkbox"/> <b>Fault</b> <input type="checkbox"/> Trouble <input type="checkbox"/> Quick stop by trouble <input type="checkbox"/> Warning locked <input type="checkbox"/> Warning <input type="checkbox"/> Information	
<b>Cause</b>	<b>Remedy</b>
Access to parameter set was not successful.	Repeat the download of the application (including module).

## Profibus watchdog: Monitoring time elapsed [0x01bc8130]

<b>Response</b> (Lenze setting printed in bold)	<b>Setting:</b> <a href="#">C13880/1</a> (☑ Adjustable response)
☑ <b>None</b> <input type="checkbox"/> System fault <input checked="" type="checkbox"/> Fault <input type="checkbox"/> Trouble <input checked="" type="checkbox"/> Quick stop by trouble <input checked="" type="checkbox"/> Warning locked <input type="checkbox"/> Warning <input checked="" type="checkbox"/> Information	
<b>Cause</b>	<b>Remedy</b>
Permanent interruption of communication to the PROFIBUS master. Also see the chapter " <a href="#">Permanent interruption of PROFIBUS communication</a> " (☞ 81).	Check cables and terminals.

## Profibus: Data\_Exchange state exited [0x01bc8131]

<b>Response</b> (Lenze setting printed in bold)	<b>Setting:</b> <a href="#">C13880/1</a> (☑ Adjustable response)
☑ <b>None</b> <input type="checkbox"/> System fault <input checked="" type="checkbox"/> Fault <input type="checkbox"/> Trouble <input checked="" type="checkbox"/> Quick stop by trouble <input checked="" type="checkbox"/> Warning locked <input type="checkbox"/> Warning <input checked="" type="checkbox"/> Information	
<b>Cause</b>	<b>Remedy</b>
Data exchange via PROFIBUS has been stopped. Also see the chapter " <a href="#">Permanent interruption of PROFIBUS communication</a> " (☞ 81).	Check cables and terminals. The slave must receive new parameterisation and configuration files from the master in order to be able to exchange data again.

## Profibus watchdog: DP-V1 MSC2 monitoring time exceeded [0x01bc8132]

<b>Response</b> (Lenze setting printed in bold)	<b>Setting:</b> <a href="#">C13880/2</a> (☑ Adjustable response)
☑ <b>None</b> <input type="checkbox"/> System fault <input checked="" type="checkbox"/> Fault <input type="checkbox"/> Trouble <input checked="" type="checkbox"/> Quick stop by trouble <input checked="" type="checkbox"/> Warning locked <input type="checkbox"/> Warning <input checked="" type="checkbox"/> Information	
<b>Cause</b>	<b>Remedy</b>
Permanent interruption of communication to C2-PROFIBUS master. Also see the chapter " <a href="#">Permanent interruption of PROFIBUS communication</a> " (☞ 81).	Check cables and terminals.

# 13 Parameter reference

## 13.1 Parameters of the communication module

# 13 Parameter reference

This chapter supplements the parameter list and the table of attributes contained in the software manual and in the »Engineer« online help for Inverter Drives 8400 by the parameters of the E84AYCPM communication module (PROFIBUS).



**Software manual/»Engineer« online help for Inverter Drives 8400**

Here you can find general information on parameters.

## 13.1 Parameters of the communication module

This chapter lists the parameters of the E84AYCPM communication module (PROFIBUS) in numerically ascending order.

### C13850

Parameter   Name: <b>C13850   All words to master</b>		Data type: UNSIGNED_16 Index: 10725 <sub>d</sub> = 29E5 <sub>h</sub>
Display of the process data words transferred from the communication module to the PROFIBUS master. In subcodes 1 ... 16, all process data words to the master are displayed. Only the process data words configured are valid.		
<b>Display area (min. value   unit   max. value)</b>		
0		65535
<b>Subcodes</b>		<b>Info</b>
C13850/1		
...		
C13850/16		
<input checked="" type="checkbox"/> Read access <input type="checkbox"/> Write access <input type="checkbox"/> CINH <input type="checkbox"/> PLC-STOP <input type="checkbox"/> No transfer <input type="checkbox"/> PDO_MAP_RX <input type="checkbox"/> PDO_MAP_TX <input type="checkbox"/> COM <input type="checkbox"/> MOT		

### C13851

Parameter   Name: <b>C13851   All words from master</b>		Data type: UNSIGNED_16 Index: 10724 <sub>d</sub> = 29E4 <sub>h</sub>
Display of the process data words transferred from the PROFIBUS master to the communication module. In subcodes 1 ... 16, all process data words to the master are displayed. Only the process data words configured are valid.		
<b>Display area (min. value   unit   max. value)</b>		
0		65535
<b>Subcodes</b>		<b>Info</b>
C13851/1		
...		
C13851/16		
<input checked="" type="checkbox"/> Read access <input type="checkbox"/> Write access <input type="checkbox"/> CINH <input type="checkbox"/> PLC-STOP <input type="checkbox"/> No transfer <input type="checkbox"/> PDO_MAP_RX <input type="checkbox"/> PDO_MAP_TX <input type="checkbox"/> COM <input type="checkbox"/> MOT		

# 13

## Parameter reference

### 13.1

### Parameters of the communication module

#### C13852

Parameter   Name: <b>C13852   All words to standard device</b>		Data type: UNSIGNED_16 Index: 10723 <sub>d</sub> = 29E3 <sub>h</sub>
Display of process data words 1 ... 16 which are transferred from the communication module to the standard device. In subcodes 1 ... 16, all process data words from the communication module are displayed.		
<b>Display area (min. value   unit   max. value)</b>		
0		65535
<b>Subcodes</b>		<b>Info</b>
C13852/1		
...		
C13852/16		
<input checked="" type="checkbox"/> Read access <input type="checkbox"/> Write access <input type="checkbox"/> CINH <input type="checkbox"/> PLC-STOP <input type="checkbox"/> No transfer <input type="checkbox"/> PDO_MAP_RX <input type="checkbox"/> PDO_MAP_TX <input type="checkbox"/> COM <input type="checkbox"/> MOT		

#### C13853

Parameter   Name: <b>C13853   All words from standard device</b>		Data type: UNSIGNED_16 Index: 10723 <sub>d</sub> = 29E3 <sub>h</sub>
Display of process data words 1 ... 16 which are transferred from the standard device to the communication module. In subcodes 1 ... 16, all process data words from the standard device are displayed.		
<b>Display area (min. value   unit   max. value)</b>		
0		65535
<b>Subcodes</b>		<b>Info</b>
C13853/1		
...		
C13853/16		
<input checked="" type="checkbox"/> Read access <input type="checkbox"/> Write access <input type="checkbox"/> CINH <input type="checkbox"/> PLC-STOP <input type="checkbox"/> No transfer <input type="checkbox"/> PDO_MAP_RX <input type="checkbox"/> PDO_MAP_TX <input type="checkbox"/> COM <input type="checkbox"/> MOT		

#### C13860

Parameter   Name: <b>C13860   Settings</b>		Data type: UNSIGNED_8 Index: 10715 <sub>d</sub> = 29DB <sub>h</sub>
Display of the current configuration data.		
<b>Display area (min. value   unit   max. value)</b>		
0		255
<b>Subcodes</b>		<b>Info</b>
C13860/1		Reserved
C13860/2		Number of process data words (1 ... 16 words)
C13860/3		DRIVECOM parameter data channel • 0: Not active • 1: Active
C13860/4		Reserved
<input checked="" type="checkbox"/> Read access <input type="checkbox"/> Write access <input type="checkbox"/> CINH <input type="checkbox"/> PLC-STOP <input type="checkbox"/> No transfer <input type="checkbox"/> PDO_MAP_RX <input type="checkbox"/> PDO_MAP_TX <input type="checkbox"/> COM <input type="checkbox"/> MOT		

## C13861

Parameter   Name: <b>C13861   Bus status</b>		Data type: UNSIGNED_16 Index: 10714 <sub>d</sub> = 29DA <sub>h</sub>
Bit-coded display of the current bus state. ▶ <a href="#">Querying the current bus status</a> (□ 88)		
<b>Display area (min. value   unit   max. value)</b>		
0		65535
<input checked="" type="checkbox"/> Read access <input type="checkbox"/> Write access <input type="checkbox"/> CINH <input type="checkbox"/> PLC-STOP <input type="checkbox"/> No transfer <input type="checkbox"/> PDO_MAP_RX <input type="checkbox"/> PDO_MAP_TX <input type="checkbox"/> COM <input type="checkbox"/> MOT		

## C13862

Parameter   Name: <b>C13862   Bus counter</b>		Data type: UNSIGNED_16 Index: 10713 <sub>d</sub> = 29D9 <sub>h</sub>
When the maximum count value of 65535 is reached, the counter starts again with 0.		
<b>Display area (min. value   unit   max. value)</b>		
0		65535
<b>Subcodes</b>		<b>Info</b>
C13862/1		Data cycles per second
C13862/2		Total data cycles
C13862/3		Total parameterisation events
C13862/4		Total configuration events
<input checked="" type="checkbox"/> Read access <input type="checkbox"/> Write access <input type="checkbox"/> CINH <input type="checkbox"/> PLC-STOP <input type="checkbox"/> No transfer <input type="checkbox"/> PDO_MAP_RX <input type="checkbox"/> PDO_MAP_TX <input type="checkbox"/> COM <input type="checkbox"/> MOT		

## C13863

Parameter   Name: <b>C13863   Baud rate</b>		Data type: UNSIGNED_8 Index: 10712 <sub>d</sub> = 29D8 <sub>h</sub>
Display of the baud rate		
<b>Selection list (read only)</b>		
0	12.00 Mbps	
1	6.00 Mbps	
2	3.00 Mbps	
3	1.50 Mbps	
4	500.00 kbps	
5	187.50 kbps	
6	93.75 kbps	
7	45.45 kbps	
8	19.20 kbps	
9	9.60 kbps	
<input checked="" type="checkbox"/> Read access <input type="checkbox"/> Write access <input type="checkbox"/> CINH <input type="checkbox"/> PLC-STOP <input type="checkbox"/> No transfer <input type="checkbox"/> PDO_MAP_RX <input type="checkbox"/> PDO_MAP_TX <input type="checkbox"/> COM <input type="checkbox"/> MOT		



## C13864

Parameter   Name: <b>C13864   Active station address</b>	Data type: UNSIGNED_8 Index: 10711 <sub>d</sub> = 29D7 <sub>h</sub>
Display of the active station address If all DIP switches 1 ... 64 are in the "OFF" position (Lenze setting), the station address set in <a href="#">C13899</a> becomes active and is displayed here after switching on. <a href="#">▶ Setting the station address (□ 32)</a>	
<b>Display area (min. value   unit   max. value)</b>	
0	255
<input checked="" type="checkbox"/> Read access <input type="checkbox"/> Write access <input type="checkbox"/> CINH <input type="checkbox"/> PLC-STOP <input type="checkbox"/> No transfer <input type="checkbox"/> PDO_MAP_RX <input type="checkbox"/> PDO_MAP_TX <input type="checkbox"/> COM <input type="checkbox"/> MOT	

## C13865

Parameter   Name: <b>C13865   Display: Most recent PRM data</b>	Data type: OCTET_STRING Index: 10710 <sub>d</sub> = 29D6 <sub>h</sub>
Display of the last parameter data sent by the PROFIBUS master with the "Set-Prm" telegram (ASCII string with 24 characters)	
<input checked="" type="checkbox"/> Read access <input type="checkbox"/> Write access <input type="checkbox"/> CINH <input type="checkbox"/> PLC-STOP <input type="checkbox"/> No transfer <input type="checkbox"/> PDO_MAP_RX <input type="checkbox"/> PDO_MAP_TX <input type="checkbox"/> COM <input type="checkbox"/> MOT	

## C13866

Parameter   Name: <b>C13866   Display: Most recent CFG data</b>	Data type: OCTET_STRING Index: 10709 <sub>d</sub> = 29D5 <sub>h</sub>
Display of the last configuration data sent by the PROFIBUS master with the "Chk-Cfg" telegram (ASCII string with 22 characters)	
<input checked="" type="checkbox"/> Read access <input type="checkbox"/> Write access <input type="checkbox"/> CINH <input type="checkbox"/> PLC-STOP <input type="checkbox"/> No transfer <input type="checkbox"/> PDO_MAP_RX <input type="checkbox"/> PDO_MAP_TX <input type="checkbox"/> COM <input type="checkbox"/> MOT	

## C13867

Parameter   Name: <b>C13867   Display: Most recent diagnostic data</b>	Data type: OCTET_STRING Index: 10708 <sub>d</sub> = 29D4 <sub>h</sub>
Display of the last diagnostic data sent to the PROFIBUS master (ASCII string with 16 characters) <a href="#">▶ Advanced diagnostic message (□ 89)</a>	
<input checked="" type="checkbox"/> Read access <input type="checkbox"/> Write access <input type="checkbox"/> CINH <input type="checkbox"/> PLC-STOP <input type="checkbox"/> No transfer <input type="checkbox"/> PDO_MAP_RX <input type="checkbox"/> PDO_MAP_TX <input type="checkbox"/> COM <input type="checkbox"/> MOT	

## C13880

Parameter   Name: <b>C13880   Reaction on communication fault</b>		Data type: UNSIGNED_8 Index: 10695 <sub>d</sub> = 29C7 <sub>h</sub>
Monitoring response to a communication fault on the PROFIBUS A change in the monitoring response is effective immediately. ▶ <a href="#">Permanent interruption of PROFIBUS communication</a> (📖 81)		
Selection list		
0	No response	
1	Error	
3	Quick stop by trouble	
4	Warning locked	
6	Information	
Subcodes	Lenze setting	Info
C13880/1	0: No response	The response set here for the "Watchdog/Data Exchange" monitoring function is executed if the bus station ... <ul style="list-style-type: none"> <li>• does not receive a message from the master within the watchdog monitoring time (displayed in <a href="#">C13882/1</a>) if there is an active connection.</li> <li>• detects that it is no longer in the "Data_Exchange" status. Please see also the notes given under <a href="#">C13881</a>.</li> </ul>
C13880/2	0: No response	The response set here for the "DPV1 MSAC2" monitoring is executed if the bus station does not receive any "DPV1 MSAC2" message from the master within the monitoring time (displayed in <a href="#">C13882/2</a> if there is an active connection) and the MSAC2 connection is stopped by the slave. <b>Note:</b> We recommend only setting "information" as response so that no drive-relevant response is executed.
<input checked="" type="checkbox"/> Read access <input checked="" type="checkbox"/> Write access <input type="checkbox"/> CINH <input type="checkbox"/> PLC-STOP <input type="checkbox"/> No transfer <input type="checkbox"/> PDO_MAP_RX <input type="checkbox"/> PDO_MAP_TX <input type="checkbox"/> COM <input type="checkbox"/> MOT		

## C13881

Parameter   Name: <b>C13881   Monitoring time: Data exchange</b>		Data type: UNSIGNED_16 Index: 10694 <sub>d</sub> = 29C6 <sub>h</sub>
If the "Data Exchange" state is exited, the response parameterised under <a href="#">C13880/1</a> is carried out when the monitoring time for data exchange set here has expired. <ul style="list-style-type: none"> <li>• A value of "65535" in this code deactivates the monitoring function.</li> <li>• A change in monitoring is effective immediately.</li> <li>• The value set here for the monitoring time must be smaller than the watchdog monitoring time (<a href="#">C13882/1</a>).</li> </ul> ▶ <a href="#">Permanent interruption of PROFIBUS communication</a> (📖 81)		
Setting range (min. value   unit   max. value)		Lenze setting
0	ms	65535
		<b>65535 ms</b>
<input checked="" type="checkbox"/> Read access <input checked="" type="checkbox"/> Write access <input type="checkbox"/> CINH <input type="checkbox"/> PLC-STOP <input type="checkbox"/> No transfer <input type="checkbox"/> PDO_MAP_RX <input type="checkbox"/> PDO_MAP_TX <input type="checkbox"/> COM <input type="checkbox"/> MOT		

## C13882

Parameter   Name: <b>C13882   Monitoring time: Watchdog</b>		Data type: UNSIGNED_32 Index: 10693 <sub>d</sub> = 29C5 <sub>h</sub>
Display of the watchdog monitoring time determined by the PROFIBUS master <ul style="list-style-type: none"> <li>• A change in the watchdog monitoring time is immediately effective.</li> <li>• Monitoring starts with the receipt of the first telegram.</li> <li>• When a value of "0" is displayed, the monitoring function is deactivated.</li> </ul> <a href="#">▶ Permanent interruption of PROFIBUS communication (□ 81)</a>		
<b>Display area (min. value   unit   max. value)</b>		
0	ms	4294967295
<b>Subcodes</b>		<b>Info</b>
C13882/1		Watchdog monitoring time
C13882/2		DP-V1 MSC2
<input checked="" type="checkbox"/> Read access <input type="checkbox"/> Write access <input type="checkbox"/> CINH <input type="checkbox"/> PLC-STOP <input type="checkbox"/> No transfer <input type="checkbox"/> PDO_MAP_RX <input type="checkbox"/> PDO_MAP_TX <input type="checkbox"/> COM <input type="checkbox"/> MOT		

## C13885

Parameter   Name: <b>C13885   Clear process data</b>		Data type: UNSIGNED_8 Index: 10690 <sub>d</sub> = 29C2 <sub>h</sub>
Selection of the process data which the inverter will process in the event of a PROFIBUS failure in order to maintain internal communication.		
<b>Selection list (Lenze setting printed in bold)</b>		
0	Use of most recent master PDOs	
<b>1</b>	<b>PDOs are set to the value '0'</b>	
<input checked="" type="checkbox"/> Read access <input checked="" type="checkbox"/> Write access <input type="checkbox"/> CINH <input type="checkbox"/> PLC-STOP <input type="checkbox"/> No transfer <input type="checkbox"/> PDO_MAP_RX <input type="checkbox"/> PDO_MAP_TX <input type="checkbox"/> COM <input type="checkbox"/> MOT		

## C13886

Parameter   Name: <b>C13886   Set ext. diagnostic bit by</b>		Data type: BITFIELD_8 Index: 10689 <sub>d</sub> = 29C1 <sub>h</sub>
Bit-coded selection of the error responses in the standard device causing the external diagnostic bit ("diag bit") to be set (see PROFIBUS specification; bit 3 of byte 1 of the DP diagnostic messages). <ul style="list-style-type: none"> <li>• The diagnostic bit is sent to the PROFIBUS master where it is evaluated separately.</li> <li>• The diagnostic bit is always set when a system error occurs.</li> <li>• The Lenze setting "0" means that the diagnostic bit is not set for the following error responses.</li> <li>• An advanced diagnostic message is always sent.</li> </ul>		
<b>Value is bit-coded:</b>		
Bit 0	Error	
Bit 1	Trouble	
Bit 2	Quick stop by trouble	
Bit 3	Warning locked	
Bit 4	Warning	
Bit 5	Reserved	
Bit 6	Reserved	
Bit 7	Reserved	
<input checked="" type="checkbox"/> Read access <input checked="" type="checkbox"/> Write access <input type="checkbox"/> CINH <input type="checkbox"/> PLC-STOP <input type="checkbox"/> No transfer <input type="checkbox"/> PDO_MAP_RX <input type="checkbox"/> PDO_MAP_TX <input type="checkbox"/> COM <input type="checkbox"/> MOT		

## C13887

Parameter   Name: <b>C13887   Suppress signalling diag. mess. upon</b>		Data type: BITFIELD_8 Index: 10688 <sub>d</sub> = 29C0 <sub>h</sub>
Selection of the error responses not causing a diagnostic request to the PROFIBUS master. The Lenze setting "0" means that for each of the following error responses a diagnostic request is signalled.		
<b>Value is bit-coded:</b>		
Bit 0	Error	
Bit 1	Trouble	
Bit 2	Quick stop by trouble	
Bit 3	Warning locked	
Bit 4	Warning	
Bit 5	Reserved	
Bit 6	Reserved	
Bit 7	Reserved	
<input checked="" type="checkbox"/> Read access <input checked="" type="checkbox"/> Write access <input type="checkbox"/> CINH <input type="checkbox"/> PLC-STOP <input type="checkbox"/> No transfer <input type="checkbox"/> PDO_MAP_RX <input type="checkbox"/> PDO_MAP_TX <input type="checkbox"/> COM <input type="checkbox"/> MOT		

## C13899

Parameter   Name: <b>C13899   Station address</b>		Data type: UNSIGNED_8 Index: 10676 <sub>d</sub> = 29B4 <sub>h</sub>
Optional setting of the station address (instead of setting via DIP switches 1 ... 64)		
<ul style="list-style-type: none"> <li>The station address set here only becomes effective if the DIP switches 1 ... 64 have been set to OFF prior to mains switching.</li> <li>The active station address is displayed under <a href="#">C13864</a>.</li> </ul>		
<b>Note:</b> A change of the station address will not be effective until the "Save parameter set" device command has been executed and another mains switching for the communication module/inverter has been performed. <a href="#">▶ Setting the station address (□ 32)</a>		
<b>Setting range (min. value   unit   max. value)</b>		<b>Lenze setting</b>
3		126 3
<input checked="" type="checkbox"/> Read access <input checked="" type="checkbox"/> Write access <input type="checkbox"/> CINH <input type="checkbox"/> PLC-STOP <input type="checkbox"/> No transfer <input type="checkbox"/> PDO_MAP_RX <input type="checkbox"/> PDO_MAP_TX <input checked="" type="checkbox"/> COM <input type="checkbox"/> MOT		

## C13900

Parameter   Name: <b>C13900   Firmware product type</b>		Data type: VISIBLE_STRING Index: 10675 <sub>d</sub> = 29B3 <sub>h</sub>
Display of the product type (string with a length of 8 bytes) The following identification code is displayed: "E84AFYPM".		
<input checked="" type="checkbox"/> Read access <input type="checkbox"/> Write access <input type="checkbox"/> CINH <input type="checkbox"/> PLC-STOP <input type="checkbox"/> No transfer <input type="checkbox"/> PDO_MAP_RX <input type="checkbox"/> PDO_MAP_TX <input type="checkbox"/> COM <input type="checkbox"/> MOT		

## C13901

Parameter   Name: <b>C13901   Firmware compilation date</b>		Data type: VISIBLE_STRING Index: 10674 <sub>d</sub> = 29B2 <sub>h</sub>
Display of the compilation date of the firmware (string with a length of 20 bytes) The date ("MMM DD YYYY") and time ("hh:mm:ss") are displayed, e.g. "Mar 21 2005 12:31:21".		
<input checked="" type="checkbox"/> Read access <input type="checkbox"/> Write access <input type="checkbox"/> CINH <input type="checkbox"/> PLC-STOP <input type="checkbox"/> No transfer <input type="checkbox"/> PDO_MAP_RX <input type="checkbox"/> PDO_MAP_TX <input type="checkbox"/> COM <input type="checkbox"/> MOT		

# 13

## Parameter reference

### 13.1

#### Parameters of the communication module

---

#### C13902

Parameter   Name: <b>C13902   Firmware version</b>	Data type: VISIBLE_STRING Index: 10673 <sub>d</sub> = 29B1 <sub>h</sub>
Display of the firmware version (string with a length of 5 bytes) Example: "01.00"	
<input checked="" type="checkbox"/> Read access <input type="checkbox"/> Write access <input type="checkbox"/> CINH <input type="checkbox"/> PLC-STOP <input type="checkbox"/> No transfer <input type="checkbox"/> PDO_MAP_RX <input type="checkbox"/> PDO_MAP_TX <input type="checkbox"/> COM <input type="checkbox"/> MOT	

#### C13920

Parameter   Name: <b>C13920   Display: DIP switch setting</b>	Data type: UNSIGNED_8 Index: 10655 <sub>d</sub> = 299F <sub>h</sub>
Display of the current DIP switch setting <ul style="list-style-type: none"><li>• The displayed value corresponds to the sum of the individual DIP switch values 1 ... 64.</li><li>• The active station address is displayed under <a href="#">C13864</a>.</li></ul> <a href="#">▶ Setting the station address (□ 32)</a>	
<b>Display area (min. value   unit   max. value)</b>	
0	255
<input checked="" type="checkbox"/> Read access <input type="checkbox"/> Write access <input type="checkbox"/> CINH <input type="checkbox"/> PLC-STOP <input type="checkbox"/> No transfer <input type="checkbox"/> PDO_MAP_RX <input type="checkbox"/> PDO_MAP_TX <input type="checkbox"/> COM <input type="checkbox"/> MOT	

# 13 Parameter reference

## 13.2 Table of attributes

### 13.2 Table of attributes

The table of attributes contains information required for communication with the inverter via parameters.

#### How to read the table of attributes:

Column		Meaning	Entry		
Code		Parameter designation	Cxxxxx		
Name		Parameter short text (display text)	Text		
Index	dec	Index by which the parameter is addressed. The subindex for array variables corresponds to the Lenze subcode number.	24575 - Lenze code number	Is only required for access via a bus system.	
	hex		5FFF <sub>h</sub> - Lenze code number		
Data	DS	Data structure	E	Single variable #(only one parameter element)	
			A		Array variable (several parameter elements)
	DA	Number of array elements (subcodes)	Number		
	DT	Data type	BITFIELD_8	1 byte, bit-coded	
			BITFIELD_16	2 bytes, bit-coded	
			BITFIELD_32	4 bytes, bit-coded	
			INTEGER_8	1 byte with sign	
			INTEGER_16	2 bytes with sign	
			INTEGER_32	4 bytes with sign	
			UNSIGNED_8	1 byte without sign	
			UNSIGNED_16	2 bytes without sign	
			UNSIGNED_32	4 bytes, without sign	
			VISIBLE_STRING	ASCII string	
OCTET_STRING					
Factor	Factor for data transmission via a bus system, depending on the number of decimal positions	Factor	1 = no decimal positions 10 = 1 decimal position 100 = 2 decimal positions 1000 = 3 decimal positions		
Access	R	Read access	<input checked="" type="checkbox"/> Reading permitted		
	W	Write access	<input checked="" type="checkbox"/> Writing permitted		
	CINH	Controller inhibit required	<input checked="" type="checkbox"/> Writing is only possible if controller inhibit is set		

Table of attributes

Code	Name	Index		Data				Access		
		dec	hex	DS	DA	DT	Factor	R	W	CINH
<a href="#">C13850</a>	All words to master	10725	29E5	A	16	UNSIGNED_16	1	<input checked="" type="checkbox"/>		
<a href="#">C13851</a>	All words from master	10724	29E4	A	16	UNSIGNED_16	1	<input checked="" type="checkbox"/>		
<a href="#">C13852</a>	All words to standard device	10723	29E3	A	16	UNSIGNED_16	1	<input checked="" type="checkbox"/>		
<a href="#">C13853</a>	All words from standard device	10722	29E2	A	16	UNSIGNED_16	1	<input checked="" type="checkbox"/>		
<a href="#">C13860</a>	Settings	10715	29DB	A	4	UNSIGNED_8	1	<input checked="" type="checkbox"/>		
<a href="#">C13861</a>	Bus status	10714	29DA	E	1	UNSIGNED_16	1	<input checked="" type="checkbox"/>		
<a href="#">C13862</a>	Bus counter	10713	29D9	A	4	UNSIGNED_16	1	<input checked="" type="checkbox"/>		
<a href="#">C13863</a>	Baud rate	10712	29D8	E	1	UNSIGNED_8	1	<input checked="" type="checkbox"/>		
<a href="#">C13864</a>	Active station address	10711	29D7	E	1	UNSIGNED_8	1	<input checked="" type="checkbox"/>		
<a href="#">C13865</a>	Display: Most recent PRM data	10710	29D6	E	1	OCTET_STRING		<input checked="" type="checkbox"/>		
<a href="#">C13866</a>	Display: Most recent CFG data	10709	29D5	E	1	OCTET_STRING		<input checked="" type="checkbox"/>		
<a href="#">C13867</a>	Display: Most recent diagnostic data	10708	29D4	E	1	OCTET_STRING		<input checked="" type="checkbox"/>		
<a href="#">C13880</a>	Reaction on communication fault	10695	29C7	A	2	UNSIGNED_8	1	<input checked="" type="checkbox"/>	<input checked="" type="checkbox"/>	
<a href="#">C13881</a>	Monitoring time: Data exchange	10694	29C6	E	1	UNSIGNED_16	1	<input checked="" type="checkbox"/>	<input checked="" type="checkbox"/>	
<a href="#">C13882</a>	Monitoring time: Watchdog	10693	29C5	A	2	UNSIGNED_32	1	<input checked="" type="checkbox"/>		
<a href="#">C13885</a>	Clear process data	10690	29C2	E	1	UNSIGNED_8	1	<input checked="" type="checkbox"/>	<input checked="" type="checkbox"/>	
<a href="#">C13886</a>	Set ext. diagnostic bit upon	10689	29C1	E	1	BITFIELD_8		<input checked="" type="checkbox"/>	<input checked="" type="checkbox"/>	
<a href="#">C13887</a>	Suppress signalling diag. mess. upon	10688	29C0	E	1	BITFIELD_8		<input checked="" type="checkbox"/>	<input checked="" type="checkbox"/>	
<a href="#">C13899</a>	Station address	10676	29B4	E	1	UNSIGNED_8	1	<input checked="" type="checkbox"/>	<input checked="" type="checkbox"/>	
<a href="#">C13900</a>	Firmware product type	10675	29B3	E	1	VISIBLE_STRING		<input checked="" type="checkbox"/>		
<a href="#">C13901</a>	Firmware compilation date	10674	29B2	E	1	VISIBLE_STRING		<input checked="" type="checkbox"/>		
<a href="#">C13902</a>	Firmware version	10673	29B1	E	1	VISIBLE_STRING		<input checked="" type="checkbox"/>		
<a href="#">C13920</a>	Display: DIP switch setting	10655	299F	E	1	UNSIGNED_8	1	<input checked="" type="checkbox"/>		

### 13.3 Implemented PROFIdrive objects (DP-V1)

#### I-918

Index   Name: <b>0x918   Display of station address</b>		Data type: U16
Display of the station address set		
<b>Display area</b> (min. value   unit   max. value)		
1		126
<input checked="" type="checkbox"/> Read access <input type="checkbox"/> Write access		

#### I-963

Index   Name: <b>0x963   Baud rate</b>		Data type: U16
Display of the PROFIBUS baud rate		
<b>Selection list</b> (read only)		
0	9.6 kbps	
1	19.2 kbps	
2	93.75 kbps	
3	187.5 kbps	
4	500 kbps	
6	1.5 Mbps	
7	3 Mbps	
8	6 Mbps	
9	12 Mbps	
10	31.25 kbps	
11	45.45 kbps	
<input checked="" type="checkbox"/> Read access <input type="checkbox"/> Write access		

#### I-964

Index   Name: <b>0x964   Device identification</b>		Data type: U16
Display of identification data		
Subindex	Display	Info
0x964/0	262	Manufacturer: Lenze
0x964/1	8400	Device type
0x964/2	xxyy	Software version, e.g. 0100 (V 01.00)
0x964/3	yyyy	Firmware date (year), e.g. 2007
0x964/4	ddmm	Firmware date (day/month), e.g. 0506 (5th June)
<input checked="" type="checkbox"/> Read access <input type="checkbox"/> Write access		



## I-974

Index   Name: <b>0x974   Maximum time per DPV1 parameter access</b>		Data type: U16
Display of access statistics		
Subindex	Display	Info
0x974/0	240 bytes	Maximum block length
0x974/1	40	Maximum number of parameter accesses
0x974/2	0	Maximum time per access
<input checked="" type="checkbox"/> Read access <input type="checkbox"/> Write access		

## 14 DIP switch positions for setting the station address

The station address results from the sum of the binary valencies of switches 1 ... 64.

The following table shows the switch positions for the valid address range 1 ... 126.

▶ [Setting the station address](#) (□ 32)

Station address	DIP switch						
	64	32	16	8	4	2	1
1	OFF	OFF	OFF	OFF	OFF	OFF	ON
2	OFF	OFF	OFF	OFF	OFF	ON	OFF
3	OFF	OFF	OFF	OFF	OFF	ON	ON
4	OFF	OFF	OFF	OFF	ON	OFF	OFF
5	OFF	OFF	OFF	OFF	ON	OFF	ON
6	OFF	OFF	OFF	OFF	ON	ON	OFF
7	OFF	OFF	OFF	OFF	ON	ON	ON
8	OFF	OFF	OFF	ON	OFF	OFF	OFF
9	OFF	OFF	OFF	ON	OFF	OFF	ON
10	OFF	OFF	OFF	ON	OFF	ON	OFF
11	OFF	OFF	OFF	ON	OFF	ON	ON
12	OFF	OFF	OFF	ON	ON	OFF	OFF
13	OFF	OFF	OFF	ON	ON	OFF	ON
14	OFF	OFF	OFF	ON	ON	ON	OFF
15	OFF	OFF	OFF	ON	ON	ON	ON
16	OFF	OFF	ON	OFF	OFF	OFF	OFF
17	OFF	OFF	ON	OFF	OFF	OFF	ON
18	OFF	OFF	ON	OFF	OFF	ON	OFF
19	OFF	OFF	ON	OFF	OFF	ON	ON
20	OFF	OFF	ON	OFF	ON	OFF	OFF
21	OFF	OFF	ON	OFF	ON	OFF	ON
22	OFF	OFF	ON	OFF	ON	ON	OFF
23	OFF	OFF	ON	OFF	ON	ON	ON
24	OFF	OFF	ON	ON	OFF	OFF	OFF
25	OFF	OFF	ON	ON	OFF	OFF	ON
26	OFF	OFF	ON	ON	OFF	ON	OFF
27	OFF	OFF	ON	ON	OFF	ON	ON
28	OFF	OFF	ON	ON	ON	OFF	OFF
29	OFF	OFF	ON	ON	ON	OFF	ON
30	OFF	OFF	ON	ON	ON	ON	OFF
31	OFF	OFF	ON	ON	ON	ON	ON
32	OFF	ON	OFF	OFF	OFF	OFF	OFF
33	OFF	ON	OFF	OFF	OFF	OFF	ON
34	OFF	ON	OFF	OFF	OFF	ON	OFF
35	OFF	ON	OFF	OFF	OFF	ON	ON
36	OFF	ON	OFF	OFF	ON	OFF	OFF
37	OFF	ON	OFF	OFF	ON	OFF	ON

Station address	DIP switch						
	64	32	16	8	4	2	1
38	OFF	ON	OFF	OFF	ON	ON	OFF
39	OFF	ON	OFF	OFF	ON	ON	ON
40	OFF	ON	OFF	ON	OFF	OFF	OFF
41	OFF	ON	OFF	ON	OFF	OFF	ON
42	OFF	ON	OFF	ON	OFF	ON	OFF
43	OFF	ON	OFF	ON	OFF	ON	ON
44	OFF	ON	OFF	ON	ON	OFF	OFF
45	OFF	ON	OFF	ON	ON	OFF	ON
46	OFF	ON	OFF	ON	ON	ON	OFF
47	OFF	ON	OFF	ON	ON	ON	ON
48	OFF	ON	ON	OFF	OFF	OFF	OFF
49	OFF	ON	ON	OFF	OFF	OFF	ON
50	OFF	ON	ON	OFF	OFF	ON	OFF
51	OFF	ON	ON	OFF	OFF	ON	ON
52	OFF	ON	ON	OFF	ON	OFF	OFF
53	OFF	ON	ON	OFF	ON	OFF	ON
54	OFF	ON	ON	OFF	ON	ON	OFF
55	OFF	ON	ON	OFF	ON	ON	ON
56	OFF	ON	ON	ON	OFF	OFF	OFF
57	OFF	ON	ON	ON	OFF	OFF	ON
58	OFF	ON	ON	ON	OFF	ON	OFF
59	OFF	ON	ON	ON	OFF	ON	ON
60	OFF	ON	ON	ON	ON	OFF	OFF
61	OFF	ON	ON	ON	ON	OFF	ON
62	OFF	ON	ON	ON	ON	ON	OFF
63	OFF	ON	ON	ON	ON	ON	ON
64	ON	OFF	OFF	OFF	OFF	OFF	OFF
65	ON	OFF	OFF	OFF	OFF	OFF	ON
66	ON	OFF	OFF	OFF	OFF	ON	OFF
67	ON	OFF	OFF	OFF	OFF	ON	ON
68	ON	OFF	OFF	OFF	ON	OFF	OFF
69	ON	OFF	OFF	OFF	ON	OFF	ON
70	ON	OFF	OFF	OFF	ON	ON	OFF
71	ON	OFF	OFF	OFF	ON	ON	ON
72	ON	OFF	OFF	ON	OFF	OFF	OFF
73	ON	OFF	OFF	ON	OFF	OFF	ON
74	ON	OFF	OFF	ON	OFF	ON	OFF
75	ON	OFF	OFF	ON	OFF	ON	ON
76	ON	OFF	OFF	ON	ON	OFF	OFF
77	ON	OFF	OFF	ON	ON	OFF	ON
78	ON	OFF	OFF	ON	ON	ON	OFF
79	ON	OFF	OFF	ON	ON	ON	ON
80	ON	OFF	ON	OFF	OFF	OFF	OFF

Station address	DIP switch						
	64	32	16	8	4	2	1
81	ON	OFF	ON	OFF	OFF	OFF	ON
82	ON	OFF	ON	OFF	OFF	ON	OFF
83	ON	OFF	ON	OFF	OFF	ON	ON
84	ON	OFF	ON	OFF	ON	OFF	OFF
85	ON	OFF	ON	OFF	ON	OFF	ON
86	ON	OFF	ON	OFF	ON	ON	OFF
87	ON	OFF	ON	OFF	ON	ON	ON
88	ON	OFF	ON	ON	OFF	OFF	OFF
89	ON	OFF	ON	ON	OFF	OFF	ON
90	ON	OFF	ON	ON	OFF	ON	OFF
91	ON	OFF	ON	ON	OFF	ON	ON
92	ON	OFF	ON	ON	ON	OFF	OFF
93	ON	OFF	ON	ON	ON	OFF	ON
94	ON	OFF	ON	ON	ON	ON	OFF
95	ON	OFF	ON	ON	ON	ON	ON
96	ON	ON	OFF	OFF	OFF	OFF	OFF
97	ON	ON	OFF	OFF	OFF	OFF	ON
98	ON	ON	OFF	OFF	OFF	ON	OFF
99	ON	ON	OFF	OFF	OFF	ON	ON
100	ON	ON	OFF	OFF	ON	OFF	OFF
101	ON	ON	OFF	OFF	ON	OFF	ON
102	ON	ON	OFF	OFF	ON	ON	OFF
103	ON	ON	OFF	OFF	ON	ON	ON
104	ON	ON	OFF	ON	OFF	OFF	OFF
105	ON	ON	OFF	ON	OFF	OFF	ON
106	ON	ON	OFF	ON	OFF	ON	OFF
107	ON	ON	OFF	ON	OFF	ON	ON
108	ON	ON	OFF	ON	ON	OFF	OFF
109	ON	ON	OFF	ON	ON	OFF	ON
110	ON	ON	OFF	ON	ON	ON	OFF
111	ON	ON	OFF	ON	ON	ON	ON
112	ON	ON	ON	OFF	OFF	OFF	OFF
113	ON	ON	ON	OFF	OFF	OFF	ON
114	ON	ON	ON	OFF	OFF	ON	OFF
115	ON	ON	ON	OFF	OFF	ON	ON
116	ON	ON	ON	OFF	ON	OFF	OFF
117	ON	ON	ON	OFF	ON	OFF	ON
118	ON	ON	ON	OFF	ON	ON	OFF
119	ON	ON	ON	OFF	ON	ON	ON
120	ON	ON	ON	ON	OFF	OFF	OFF
121	ON	ON	ON	ON	OFF	OFF	ON
122	ON	ON	ON	ON	OFF	ON	OFF
123	ON	ON	ON	ON	OFF	ON	ON

## 14 DIP switch positions for setting the station address

---

Station address	DIP switch						
	64	32	16	8	4	2	1
124	ON	ON	ON	ON	ON	OFF	OFF
125	ON	ON	ON	ON	ON	OFF	ON
126	ON	ON	ON	ON	ON	ON	OFF

## A

Abort of data transfer by the inverter (DP-V0) [55](#)  
Access to process data [45](#)  
Activating the bus terminating resistor [27](#)  
Active station address (C13864) [98](#)  
Acyclic data transfer (DP-V1) [63](#)  
Addressing of Lenze parameters/parameter data [51](#)  
All words from master (C13851) [95](#)  
All words from standard device (C13853) [96](#)  
All words to master (C13850) [95](#)  
All words to standard device (C13852) [96](#)  
Application as directed [13](#)  
Application notes [10](#)  
Application of the communication module [13](#)  
Approvals [15](#)

## B

Baud rate [15](#)  
Baud rate (C13863) [97](#)  
Before initial switch-on [30](#)  
Bus cable length [28](#)  
Bus counter (C13862) [97](#)  
Bus device type [15](#)  
Bus status (C13861) [97](#)

## C

C13850 | All words to master [95](#)  
C13851 | All words from master [95](#)  
C13852 | All words to standard device [96](#)  
C13853 | All words from standard device [96](#)  
C13860 | Settings [96](#)  
C13861 | Bus status [97](#)  
C13862 | Bus counter [97](#)  
C13863 | Baud rate [97](#)  
C13864 | Active station address [98](#)  
C13865 | Display: Most recent PRM data [98](#)  
C13866 | Display: Most recent CFG data [98](#)  
C13867 | Display: Most recent diagnostic data [98](#)  
C13880 | Reaction on communication fault [99](#)  
C13881 | Monitoring time: Data exchange [99](#)  
C13882 | Monitoring time: Watchdog [100](#)  
C13885 | Clear process data [100](#)  
C13886 | Set ext. diagnostic bit upon [100](#)  
C13887 | Suppress signalling diag. mess. upon [101](#)  
C13899 | Station address [101](#)

C13900 | Firmware product type [101](#)  
C13901 | Firmware compilation date [101](#)  
C13902 | Firmware version [102](#)  
C13920 | Display: DIP switch setting [102](#)  
Cable length [15](#)  
Clear process data (C13885) [100](#)  
Codes [95](#)  
Commissioning [30](#)  
Communication channels [44](#)  
Communication medium [15](#)  
Communication profile [15](#)  
Communication time [19](#)  
Configuration of the controller (master) [31](#)  
Configuration of the master [31](#)  
Configuration of the PROFIBUS master [31](#)  
Configuring the port interconnection in the »Engineer« [47](#)  
Conformities [15](#)  
Connection establishment between master and slave (DP-V1) [62](#)  
Connection to 8400 standard device lost (error message) [92](#)  
Consistent parameter data [80](#)  
Conventions [8](#)  
Conventions used [8](#)

## D

Data transfer [44](#)  
Data transfer abort by the master (DP-V0) [55](#)  
Defining the user data length [31](#)  
Device- and application-specific safety instructions [12](#)  
Device data base file [31](#)  
Device protection [12](#)  
Diagnostic message [89](#)  
Diagnostics [84](#)  
Diagnostics with the »Engineer« [87](#)  
Dimensions [20](#)  
DIP switch positions for setting the station address [107](#)  
Display  
    DIP switch setting (C13920) [102](#)  
    Most recent CFG data (C13866) [98](#)  
    Most recent diagnostic data (C13867) [98](#)  
    Most recent PRM data (C13865) [98](#)  
Document history [7](#)  
DP states for short-time interruption of communication [82](#)  
DP-V0 [52](#)  
DP-V1 [61](#)  
DRIVECOM [52](#)  
DRIVECOM parameter data channel (DP-V0) [52](#)

## E

- Electrical installation [25](#)
- E-mail to Lenze [114](#)
- Error: Lenze settings loaded (error message) [93](#)
- Error codes (DP-V0) [58](#)
- Error codes (DP-V1) [74](#)
- Error messages [91](#)
  - Causes and remedies [92](#)
  - Short overview [91](#)
- Error number
  - 0x01bc3100 [92](#)
  - 0x01bc5531 [92](#)
  - 0x01bc5532 [92](#)
  - 0x01bc5533 [92](#)
  - 0x01bc6010 [92](#)
  - 0x01bc6011 [93](#)
  - 0x01bc6100 [93](#)
  - 0x01bc6101 [93](#)
  - 0x01bc6110 [93](#)
  - 0x01bc641f [93](#)
  - 0x01bc6420 [93](#)
  - 0x01bc8130 [94](#)
  - 0x01bc8131 [94](#)
  - 0x01bc8132 [94](#)
- Establishing communication [34](#)

## F

- Features [14](#)
- Feedback to Lenze [114](#)
- Fieldbus status displays [86](#)
- Firmware compilation date (C13901) [101](#)
- Firmware product type (C13900) [101](#)
- Firmware version (C13902) [102](#)

## G

- General data [15](#)
- General safety and application instructions [11](#)
- Going online with »Engineer« via TCI [35](#)

## I

- Identification [13](#)
- Initial switch-on [34](#)
- Installation [21](#)
- Interface [15](#)
- Interfaces [14](#)
- Internal error (error message) [93](#)
- Invalid parameter record (error message) [93](#)

## L

- LED status displays [84](#)

## M

- Mechanical installation [22](#)
- Memory
  - No access (error message) [92](#)
  - Read error (error message) [92](#)
  - Write error (error message) [92](#)
- Module status displays [85](#)
- Monitoring [81](#)
  - Permanent interruption of PROFIBUS communication [81](#)
  - Settings and displays in the »Engineer« [83](#)
  - Short-time interruption of PROFIBUS communication [82](#)
- Monitoring time
  - Data exchange (C13881) [99](#)
  - Watchdog (C13882) [100](#)
- Mounting for 0.25 kW and 0.37 kW standard devices [22](#)
- Mounting for standard devices of 0.55 kW and more [23](#)

## N

- Nameplate [13](#)
- Network topology [15](#), [25](#)
- Notes used [10](#)
- Number of stations [15](#), [26](#)

## O

- Operating conditions [15](#)

## P

- Parameter addressing [51](#)
- Parameter data transfer [51](#)
- Parameter reference [95](#)
- Parameters of the communication module [95](#)
- PDO mapping [45](#)
- PNO identification number [15](#)
- Process data transfer [45](#)
- Processing time [19](#)
- Product description [13](#)
- Profibus: Data\_Exchange state exited (error message) [94](#)
- PROFIBUS connection [29](#)
- PROFIBUS error messages
  - Causes and remedies [92](#)
  - Short overview [91](#)
- Profibus watchdog
  - DP-V1 MSC2 monitoring time exceeded (error message) [94](#)
  - Monitoring time elapsed (error message) [94](#)
- PROFIdrive [61](#)
- PROFIdrive objects (DP-V1) [105](#)
- PROFIdrive parameter data channel (DP-V1) [61](#)
- Protection against uncontrolled restart [34](#)
- Protection of persons [12](#)
- Protective insulation [16](#)
- Protocol data [19](#)

# Index

---

## Q

Querying the bus status [88](#)

Querying the current bus status [88](#)

## R

Reaction on communication fault (C13880) [99](#)

Reading parameter data from the inverter (DP-V0) [54](#)

Reading parameter data from the inverter (DP-V1) [65](#)

Replacing the communication module [24](#)

Residual hazards [12](#)

Restart after watchdog reset (error message) [92](#)

## S

Safety instructions [10](#), [11](#)

Screenshots/application examples [6](#)

Set ext. diagnostic bit upon (C13886) [100](#)

Setting the station address [32](#)

Settings (C13860) [96](#)

Station address (C13899) [101](#)

Status displays (LEDs) [84](#)

Structure of the safety instructions [10](#)

Suppress signalling diag. mess. upon (C13887) [101](#)

System error messages [91](#)

## T

Table of attributes [103](#)

Target group [6](#)

TCI (Tool Calling Interfaces) [35](#)

Technical data [15](#)

Telegram examples (DP-V0) [59](#)

Telegram examples (DP-V1) [76](#)

Telegram structure (DP-V0) [52](#)

Telegram structure (DP-V1) [64](#)

Terminals [14](#)

Terminology used [9](#)

Terms [9](#)

## U

Use of repeaters [25](#)

## V

Validity of the documentation [6](#)

## W

Writing parameter data to the inverter (DP-V0) [54](#)

Writing parameter data to the inverter (DP-V1) [70](#)

## X

XML file for configuration [31](#)



# FEEDBACK



## Your opinion is important to us

These instructions were created to the best of our knowledge and belief to give you the best possible support for handling our product.

If you have suggestions for improvement, please e-mail us to:

[feedback-docu@Lenze.de](mailto:feedback-docu@Lenze.de)

Thank you for your support.

*Your Lenze documentation team*



Lenze Drives GmbH  
Postfach 10 13 52  
D-31763 Hameln  
Germany  
☎ +49 (0)51 54 / 82-0  
📠 +49 (0)51 54 / 82-28 00  
✉ [Lenze@Lenze.de](mailto:Lenze@Lenze.de)  
🌐 [www.Lenze.com](http://www.Lenze.com)

#### Service

Lenze Service GmbH  
Breslauer Straße 3  
D-32699 Extertal  
Germany  
☎ 00 80 00 / 24 4 68 77 (24 h helpline)  
📠 +49 (0)51 54 / 82-11 12  
✉ [Service@Lenze.de](mailto:Service@Lenze.de)